

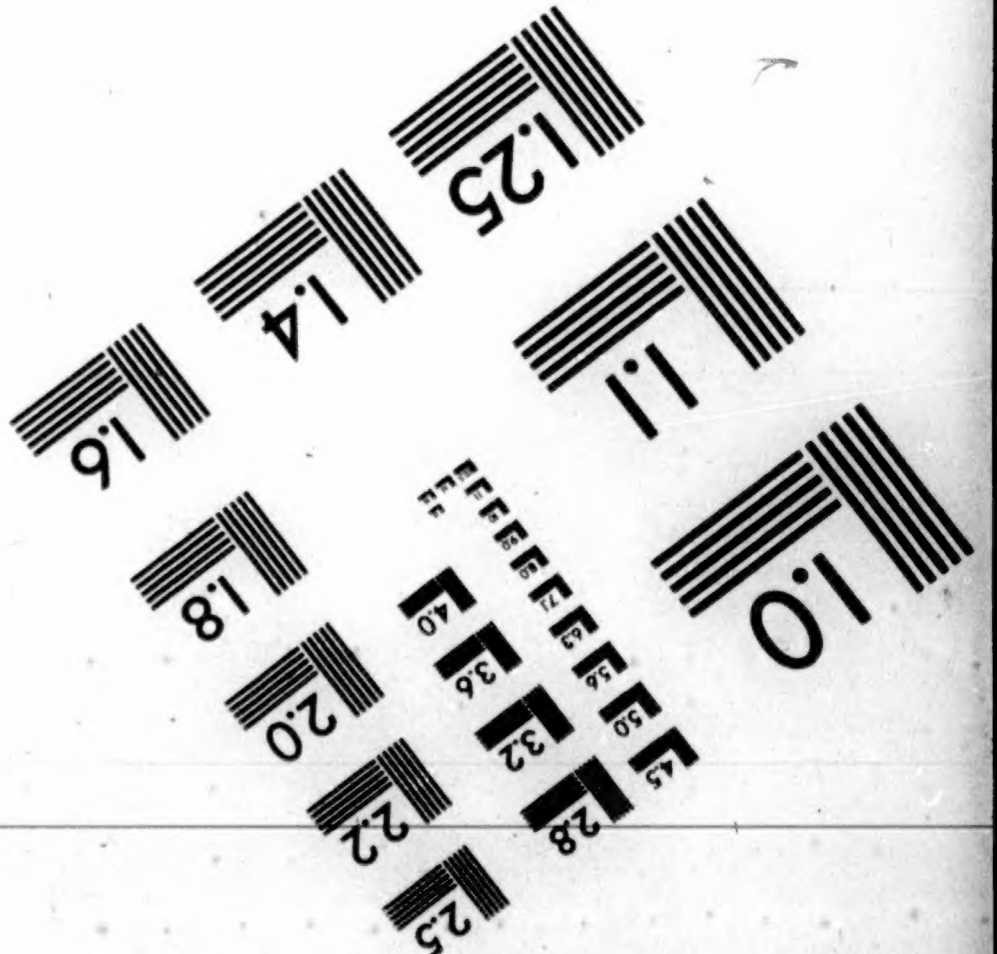

NATIONAL  
ARCHIVES  
MICROFILM  
PUBLICATIONS

# IMAGE EVALUATION TEST TARGET (QA-3)

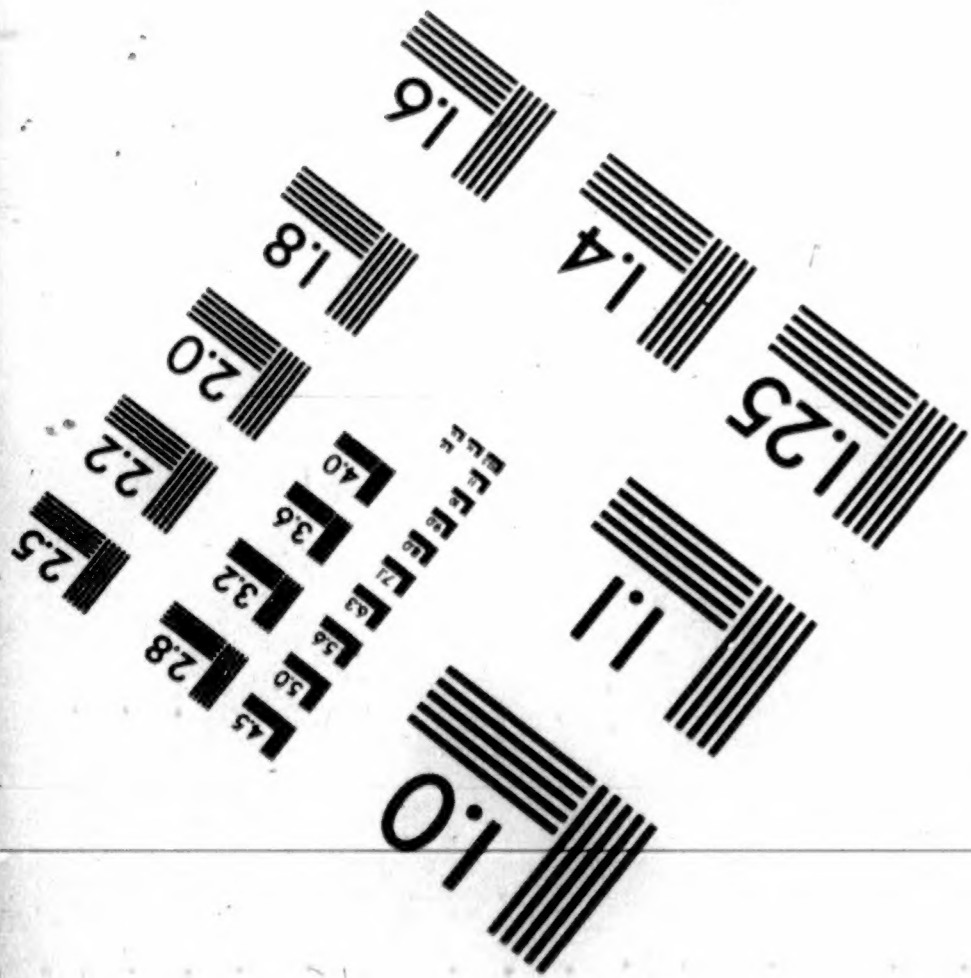
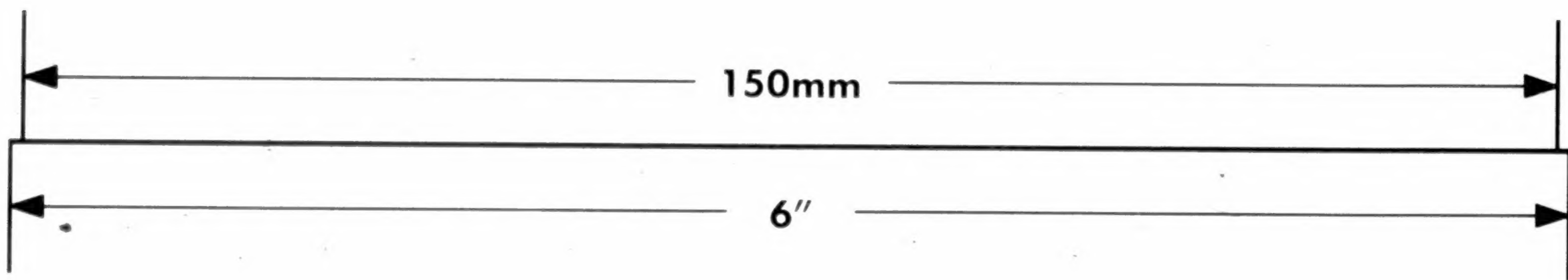
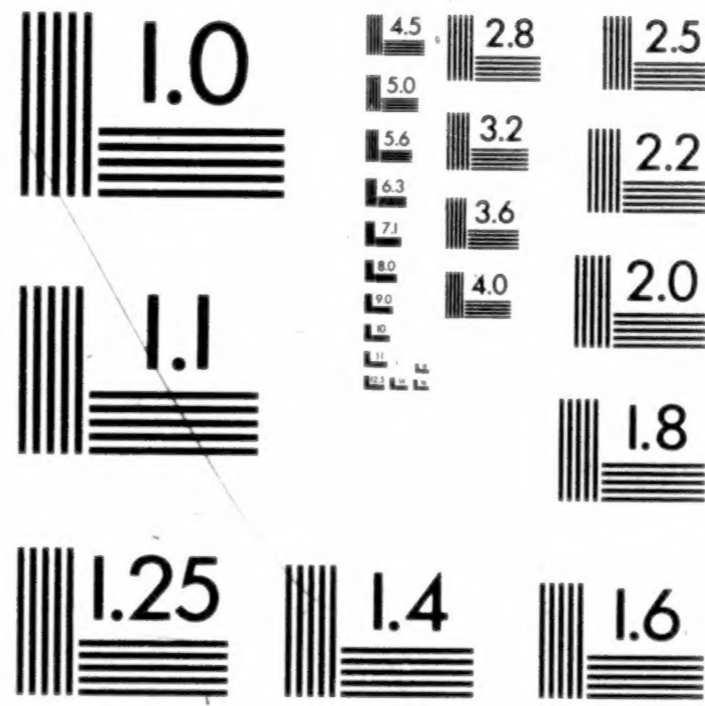
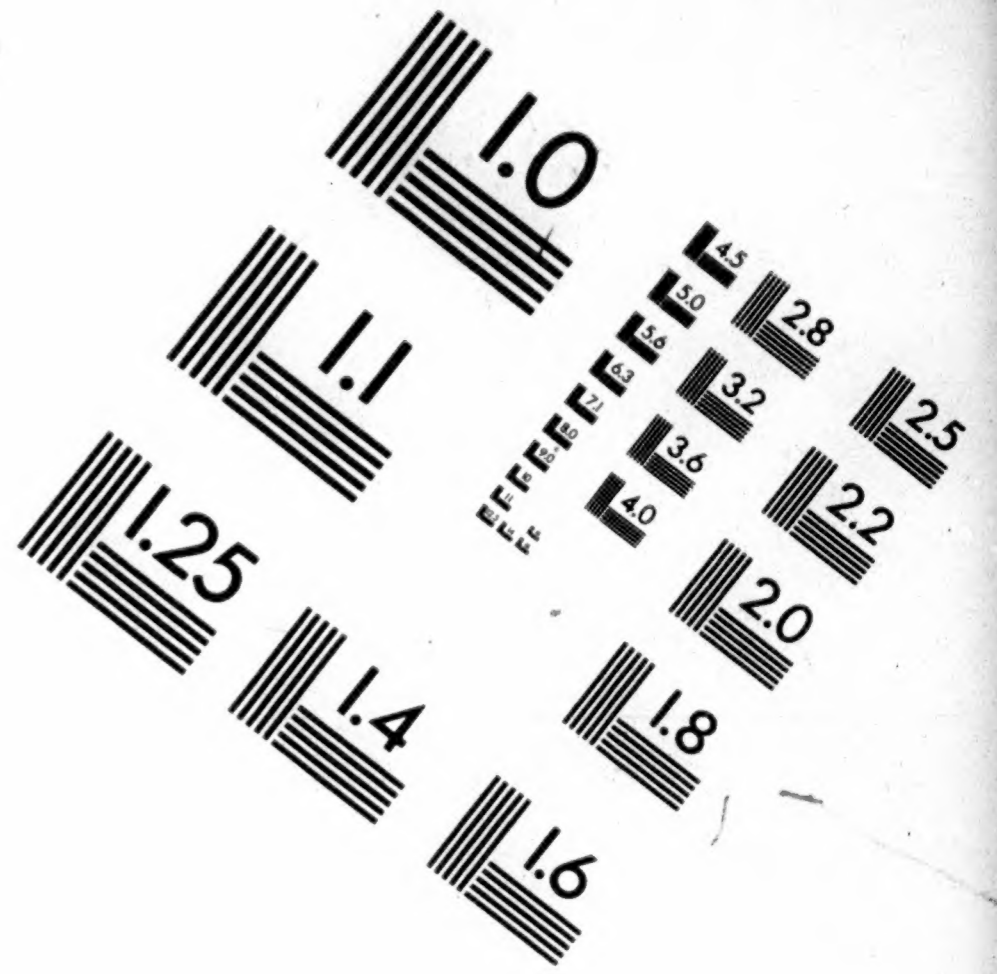
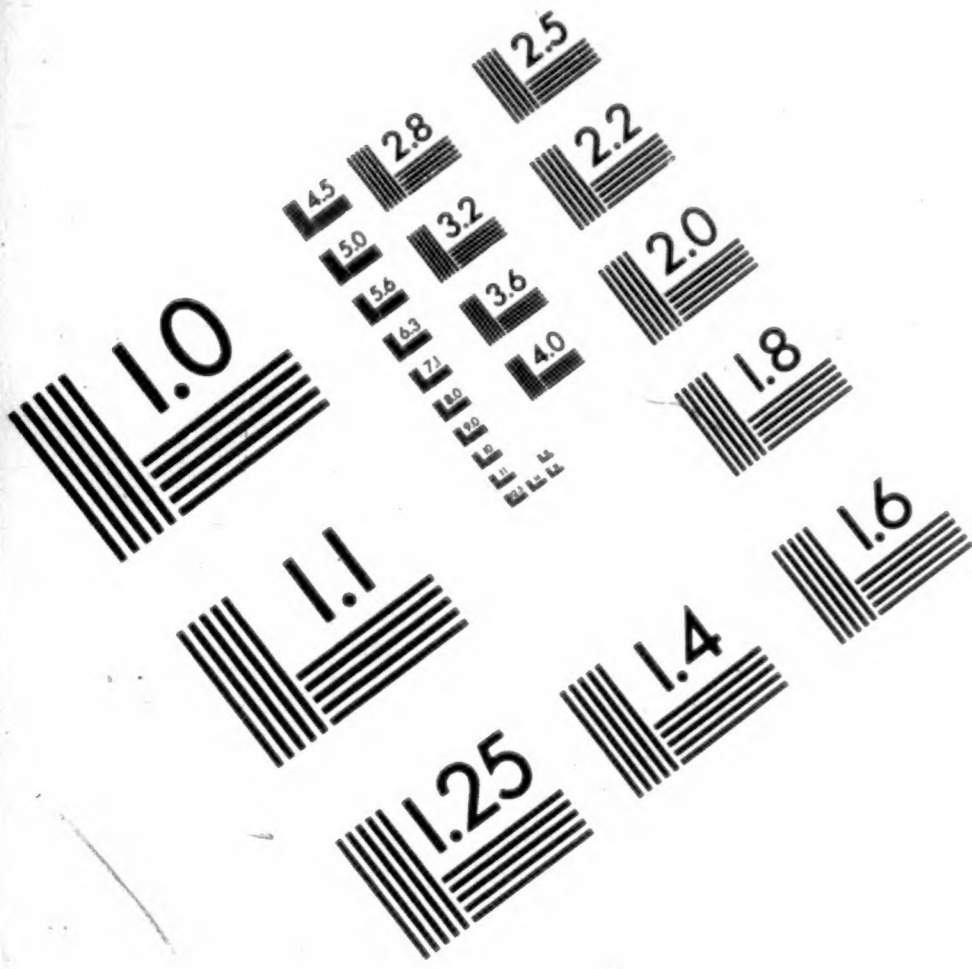

**APPLIED IMAGE, Inc**  
1653 East Main Street  
Rochester, NY 14609 USA  
Phone: 716/482-0300  
Fax: 716/288-5989

© 1993, Applied Image, Inc., All Rights Reserved

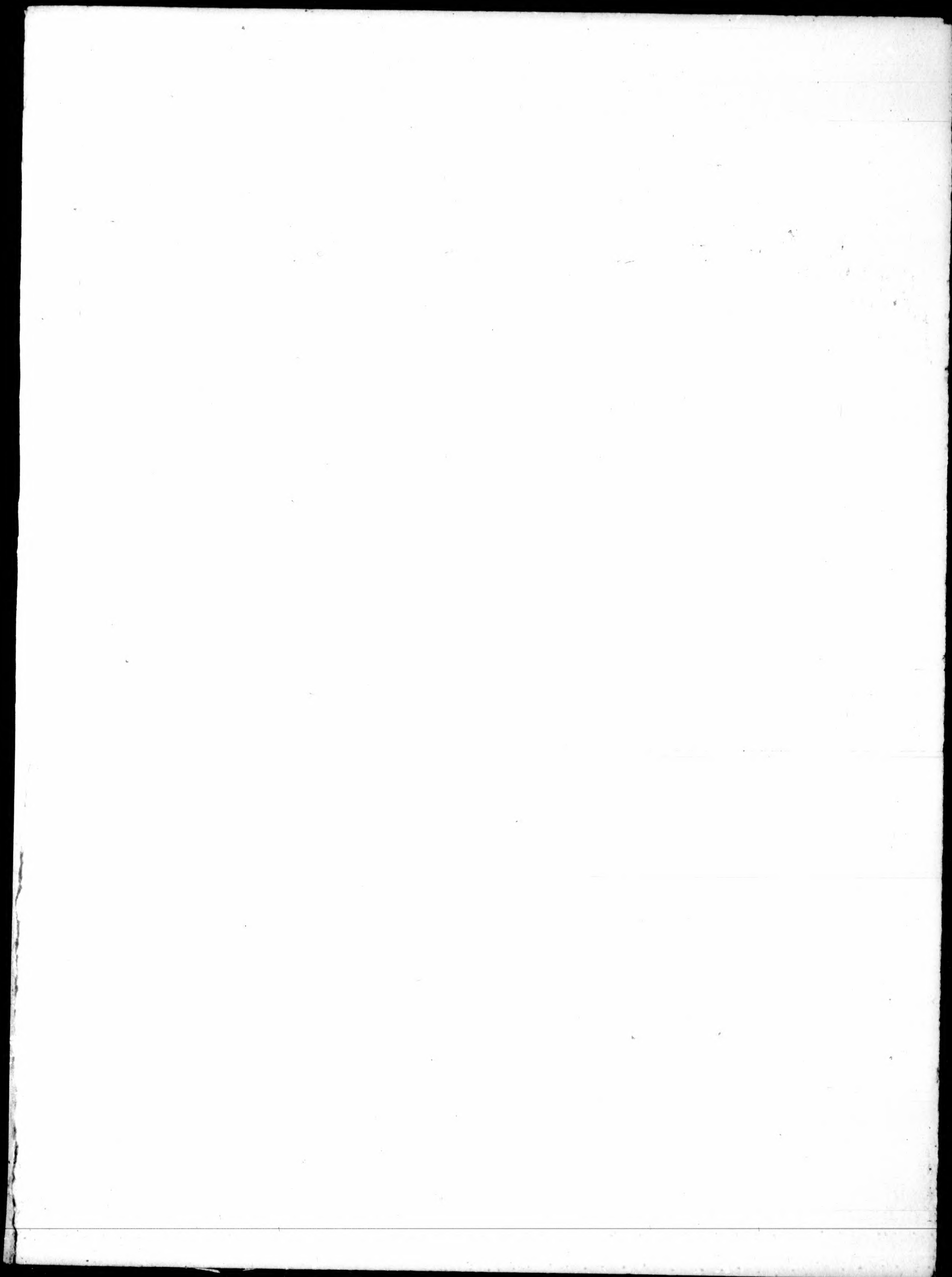

National Archives at College Park



8601 Adelphi Road College Park MD 20740-6001

Rebecca Sullivan 23

OPERATOR

CAMERA

August 22, 1997 10

DATE FILMED

REDUCTION RATIO

3510107

FILM EMULSION NUMBER

M-1817 58

PROJECT NUMBER

ROLL NUMBER

MICROCOPY

1947

ROLL 58

M1817

COMPILED MILITARY SERVICE RECORDS OF  
VOLUNTEER UNION SOLDIERS WHO SERVED WITH THE  
UNITED STATES COLORED TROOPS:  
1st Through 5th United States Colored Cavalry  
5th Massachusetts Cavalry (Colored)  
6th United States Colored Cavalry

Introduction by Michael E. Pilgrim

Records prepared for microfilming by members of  
the Civil War Conservation Corps

Budge Weidman, Project Director

Pat Alfredson	Naomi Glass	Dave Murray
Phyllis Altrogge	Sue Goward*	Ray Puzio
Kenneth Ashton	Bert Greenstein	Bill Schneider
Sue Barnard*	Anne Greenwood	Sylvia Scott
Dee Benson	Jim Harris	Lynn Shearouse
Ann N. Brown	Walter Hayden	Mary Stack-Dunne
Robert Budway	Mary Hayden	Ben Stearns
MaryAnn Castellana*	Pat Ikonen	Bill Stormer*
Mary Lou Cole	Dick Ives	Pat Sullivan
Marjory Cooper	Sarah Jaffe	Gorman Tidball*
Giovanni Croce	Barbara Kemp	Cathy Tinston
B. H. Custer	Bev Manypenny	John Toole
Bob Denney	Frank Masterson	Maryellen Toole
Richard Dow	Joe Mazur	Milt Weatherhead
Yvette Fallin	Sarah McDougall	C. Lois Young
	Ben Miles	

Team leaders are indicated by the asterisk.

National Archives and Records Administration  
1997

## INTRODUCTION

On the 107 rolls of this microfilm publication, M1817, are reproduced the compiled military service records of volunteer Union soldiers belonging to the 1st through 5th United States Colored Cavalry, the 5th Massachusetts Cavalry (Colored), and the 6th United States Colored Cavalry. While the 5th Massachusetts did retain its state designation, these units were all part of the United States Colored Troops (USCT). The USCT included 7 numbered cavalry regiments; 14 numbered artillery regiments; 144 numbered infantry regiments; plus Brigade Bands Nos. 1 & 2 (Corps d'Afrique and US Colored Troops); Powell's Regiment Colored Infantry; Southard's Company Colored Infantry; Quartermaster Detachment; Pioneer Corps, 1st Division, 16th Army Corps; Unassigned Company A Colored Infantry and Unassigned USCT. The records reproduced are part of the Records of the Adjutant General's Office, 1780's-1917, Record Group (RG) 94.

## Background

### United States Colored Troops

Since the time of the American Revolution, African Americans have volunteered to serve their country in time of war. The Civil War was no exception. Official sanction was the difficulty. In the fall of 1862 there were four Union regiments of African Americans raised in New Orleans, LA: the 1st, 2d, and 3d Louisiana Native Guard, and the 1st Louisiana Heavy Artillery (African Descent). The 1st South Carolina Infantry (African Descent) was not officially organized until January 1863; however, three companies of the regiment were on coastal expeditions as early as November 1862. Similarly, the 1st Kansas Colored Infantry was not mustered into Federal service until January 1863, even though the regiment had already participated in the action at Island Mound, MO, on October 27, 1862. These early unofficial regiments received little Federal support, but they showed the strength of the African American soldier's desire to fight for freedom.

The first official authorization to employ African Americans in Federal service was the Second Confiscation and Militia Act of July 17, 1862. This act allowed President Abraham Lincoln to receive into the military or naval service persons of African descent and gave him permission to use them for any purpose "he may judge best for the public welfare." However, the President did not authorize use of African Americans until issuance of the Emancipation Proclamation on January 1, 1863.

In late January 1863, Gov. John Andrew of Massachusetts received permission to raise a regiment of African American soldiers. The pace of organizing additional regiments was very slow. In March Secretary of War Edwin M. Stanton sent Gen. Lorenzo Thomas to the lower Mississippi Valley to recruit



free and contraband African Americans. Thomas was given broad authority. He was to explain the administration's policy regarding African American soldiers and recruit volunteers to raise and command them. Stanton wanted all officers of such units to be white, but that policy was softened to allow African American surgeons and chaplains. By the end of the war, in addition to the chaplains and surgeons, there were some 87 African-American officers. Thomas's endeavor was very successful, and on May 22, 1863, the Bureau of Colored Troops was established to coordinate and organize regiments from all parts of the country. Created under War Department General Order No. 143, the bureau was responsible for handling "all matters relating to the organization of Colored Troops." The bureau was directly under the Adjutant General's Office and its procedures and rules were specific and strict. All African American regiments were now to be designated United States Colored Troops (USCT). At this time there were some African American regiments with state names and a few regiments in the Department of the Gulf designated as Corps d'Afrique. All these were ultimately assimilated into the USCT, even though some of the regiments, such as the 5th Massachusetts, retained their state designations.

To facilitate recruiting in the states of Maryland, Missouri, Tennessee, and eventually Kentucky, the War Department issued General Order No. 329 on October 3, 1863. Section 6 of the order stated that if any citizen should offer his or her slave for enlistment into the military service, that person would, "if such slave be accepted, receive from the recruiting officer a certificate thereof, and become entitled to compensation for the service or labor of said slave, not exceeding the sum of three hundred dollars, upon filing a valid deed of manumission and of release, and making satisfactory proof of title." For this reason, some records of manumission are contained in the compiled service records reproduced in this publication.

The USCT fought in 39 major engagements and over 400 lesser ones. Sixteen African American soldiers received Medals of Honor. As it was in other units, the death toll from disease was very high in the USCT. Deaths from disease and battle totaled 37,000. The last regiment of the USCT was mustered out of Federal service in December 1867.

Important sources for information about African American units in the Civil War are the War Department's *The War of the Rebellion: A Compilation of the Official Records of the Union and Confederate Armies* (Washington, DC: 1880-1901; reprinted Harrisburg, 1971 and 1985) and the Navy Department's *The War of the Rebellion: A Compilation of the Official Records of the Union and Confederate Navies* (Washington, DC: 1874-1922; reprinted Harrisburg, 1971 and 1985). These multivolume works contains reports of operations and other official correspondence.

**1st United States Colored Cavalry**

This regiment was organized at Camp Hamilton, VA, on December 22, 1863, and assigned to duty in the Department of Virginia and North Carolina. The 1st participated in Gen. Benjamin F. Butler's operations on the south side of the James River and against Petersburg and Richmond, May 4-28, 1864. These included the capture of Bermuda Hundred and City Point, VA, on May 5, and events leading up to and including the siege of Petersburg. In August 1864 it was transferred to the defenses of Portsmouth, District of Eastern Virginia. On June 10, 1865, the 1st sailed from City Point, VA, to Texas where it was assigned duty on the Rio Grande and various other areas of the state. The unit was mustered out on February 4, 1866. Compiled casualty figures are not available.

**2d United States Colored Cavalry**

This regiment was organized at Fort Monroe, VA, on December 22, 1863, and assigned to duty in the Department of Virginia and North Carolina. The 2d participated in Gen. Benjamin F. Butler's operations on the south side of the James River and against Petersburg and Richmond, May 4-28, 1864. These included the capture of Bermuda Hundred and City Point, VA, on May 5, and events leading up to and including the siege of Petersburg. In February 1865 it was transferred to Norfolk, District of Eastern Virginia. On June 10, 1865, the 2d sailed from City Point, VA, to Texas where it was assigned duty on the Rio Grande and various other areas of the state. The unit was mustered out on February 12, 1866. Losses included 19 killed in action and 161 dead from disease and other causes.

**3d United States Colored Cavalry**

Organized at Vicksburg, MS, on October 9, 1863, as the 1st Mississippi Cavalry (African Descent), this regiment was redesignated the 3d U.S. Colored Cavalry on March 11, 1864. From its organization until March 1864, the unit was attached to the District of Northeast Louisiana and from January to March 1864 participated in operations up the Yazoo River and the occupation of Yazoo City. The regiment was then transferred to the District of Vicksburg, Department of Tennessee, where it remained until December 1864. That month the unit moved to Memphis, TN, and from December 21, 1864, to January 5, 1865, participated in Gen. Benjamin Grierson's raid to destroy the Mobile & Ohio Railroad. The 3d remained on duty in Memphis and the District of West Tennessee and took part in the expedition from Memphis to Brownsville, MS, April 23-26, 1865. On April 29 the regiment returned to Vicksburg and operated around Natchez in search of fugitive Confederate President Jefferson Davis. The unit remained in the District of West Tennessee and Department of Mississippi until January 26, 1866, when it was mustered out. Losses included 37 killed in action and 367 dead from disease and other causes.

**4th United States Colored Cavalry**

Organized on September 12, 1863, as the 1st Corps d'Afrique Cavalry, this regiment was redesignated the 4th United States Colored Cavalry on April 4, 1864. From its organization until August 1864, it was attached to the Defenses of New Orleans, Department of the Gulf. On August 8, 1864, the 4th was ordered to Baton Rouge, LA, District of Port Hudson, and remained on duty at that post until July 1865 when it was transferred to the Department of Mississippi. It performed duties at various points in that department until it was mustered out on March 20, 1866. Compiled casualty figures are not available.

**5th United States Colored Cavalry**

This regiment was organized at Camp Nelson, KY, on October 24, 1864, and attached to the 1st Division, District of Kentucky, Department of Ohio. December 10-29, 1864, it participated in Stoneman's Raid into southwestern Virginia, including the capture of Saltville and the destruction of saltworks on December 20-21. In February 1865 the regiment was transferred to the Military District and Department of Kentucky until December of that year when it was ordered to the Department of Arkansas. During the latter period the unit performed mostly garrison duty. The regiment was mustered out March 20, 1866. Losses included 35 killed in action and 152 dead from disease and other causes.

**5th Massachusetts Cavalry (Colored)**

This regiment was organized at Camp Meigs, Reedville, MA, in the spring of 1864, and sent to Washington, DC, in May of that year. On May 13 the regiment moved to City Point, VA, where it was attached to the 18th Army Corps. Until June 16 it functioned as an infantry unit and participated in the siege of Petersburg. On June 30 it was moved to Point Lookout, MD, to guard prisoners of war. In July 1864 the regiment, still at Point Lookout, became part of the 22d Army Corps. It was transferred to the 25th Army Corps in March 1865 and ordered to the field near Richmond and Petersburg. In June the regiment was ordered to the Department of Texas where it was assigned duty at Clarksville until October 31, 1865, when it was mustered out. Losses included 7 men killed in action and 116 dead from disease and other causes.

**6th United States Colored Cavalry**

This regiment was organized at Camp Nelson, KY, on October 24, 1864, and attached to the 1st Division, District of Kentucky, Department of Ohio. December 10-29, 1864, it participated in Stoneman's Raid, including the destruction of the lead mines in southwestern Virginia. At the end of December the regiment returned to Camp Nelson and in February 1865 was transferred to the Military District and Department of Kentucky. It remained there until December

1865 when it was ordered to the Department of Arkansas. The unit was mustered out on April 15, 1866. Compiled casualty figures are not available.

#### Records Description

Compiled service records consist of a jacket-envelope for each soldier, labeled with his name, rank, unit, and card numbers. The compilation of service records of Union soldiers began in 1890 under the direction of Col. Fred C. Ainsworth, head of the Record and Pension Office of the Adjutant General's Office, Department of War. Information from muster rolls, regimental returns, descriptive books, and other records was copied verbatim onto cards. A separate card was prepared each time an individual name appeared on a document. These cards were numbered on the back, and these numbers were entered onto the outside jacket containing the cards. The carded information was verified by a separated operation of comparison; great care was taken to ensure that the cards were accurate.

A typical jacket contains card abstracts of entries found in original records relating to the soldier and original documents relating solely to that soldier. Examples of the latter include enlistment papers, substitute certificates, casualty sheets, death reports, prisoner-of-war memorandums, and correspondence. Unique to the records of the USCT are deeds of manumission, oaths of allegiance, proof of ownership, certificates of monetary award, and bills of sale. These items appear most frequently in units recruited in the border states of Kentucky, Missouri, and Maryland. These states remained in the Union but were slave states. Jackets and cards include a section labeled "bookmark" which was reserved for cross-references to other records relating to the individual or his unit. The service records are arranged by arm of service, thereunder numerically by regiment or independent battalion or company and thereunder alphabetically by name of the soldier. Records for officers are interfiled alphabetically by name with the records of enlisted men. If an individual served in more than one unit, which was typical for USCT officers, there will be a separate service record for each unit in which he served.

#### Related Records

Among the records of the Adjutant General's Office in the National Archives are many of the original records that were abstracted or "carded" by the Record and Pension Office. These include the individual unit's muster rolls, returns and descriptive books. Other series in RG 94 that contain information relating to volunteer Union soldiers who served with the USCT include carded records relating to Union staff officers, carded medical records of volunteer Union soldiers, unbound and bound regimental records and "record of events" cards. The regimental records of the 54th Massachusetts Infantry (Colored) have been

reproduced as Microfilm Publication M1659, *Records of the Fifty-fourth Massachusetts Infantry Regiment (Colored), 1863-1865*.

The "record of events" cards include information copied from the unit's muster rolls and returns. They show the stations of the field and staff and those of the various companies of the regiment at the time the muster roll or return was prepared and sometimes mention battles, skirmishes, or other activities in which the regiment participated. The cards have been reproduced as Microfilm Publication M594 *Compiled Records Showing Service of Military Units in Volunteer Union Organizations*.

Record Group 94 also includes a card index for the USCT, reproduced as Microfilm Publication M589, *Index to Compiled Military Service Records of Volunteer Union Soldiers Who Served with U.S. Colored Troops*, which may be used to locate the regiment of USCT personnel. An index card gives the name of the soldier and his rank, as well as the unit in which he served; sometimes there is a cross-reference to his service in other units or organizations. The National Archives is continually producing microfilm publications of volunteer Union compiled military service records. A complete listing of finished publications can be found in the National Archives' *Microfilm Resources for Research: A Comprehensive Catalog* which is available online at <http://www.nara.gov>.

The Records of the Colored Troops Division, within RG 94, include division correspondence and records relating to recruiting, the appointment of officers, and the slave or free status of individuals; and a compilation of historical extracts and official papers concerning the military service of African Americans from the colonial period through the Civil War entitled *The Negro in the Military Service of the United States 1639-1886*. This compilation is reproduced as Microfilm Publication M858. The Records of the Bounty and Claims Division, also in RG 94, include correspondence of the division and records relating to bounties and claims paid to loyal owners of slaves by the Slave Claims Commissions of Delaware, Kentucky, Maryland, Missouri, Tennessee and West Virginia.

If an application for a pension was made, the pension application case file may be among the Records of the Veterans Administration (RG 15). Indexes to the pension applications have been reproduced as Microfilm Publication T288, *General Index to Pension Files, 1861-1934*, and T289, *Organizational Index to Pension Files of Veterans Who Served Between 1861 and 1900*.

If a soldier or officer was tried before a general court-martial or if an individual or his unit was the subject of a court of inquiry or military commission, transcripts of the proceedings may be among the Records of the Office of the Judge Advocate General (Army) (RG 153). The registers to the proceedings have been reproduced as Microfilm Publication M1105, *Registers of the Records of the Proceedings of the U.S. Army General Courts-Martial, 1809-1890*.

Other record groups having information pertaining to the USCT include Records of the Bureau of Refugees, Freedmen, and Abandoned Lands (RG 105); Records of the Provost Marshal General's Bureau (Civil War) (RG 110); Records of the Accounting Officers of the Department of the Treasury (RG 217); and Records of U.S. Army Continental Commands, 1821-1920 (RG 393).

ROLL LIST

Roll    Description

**1st United States Colored Cavalry**

- 1    Akess, Alexander - Bom, John H.
- 2    Bomer, James - Cartwright, John
- 3    Casey, Thomas - Davenport, John J.
- 4    Davis, Augustus - Floyd, George
- 5    Fly, Benjamin - Griffin, Oliver
- 6    Griffin, Quinton - Holstead, Peter
- 7    Holt, George - Jones, Herbert
- 8    Jones, Howell - Macoy, Peter
- 9    Madry, Andrew - Mosley, Jacob
- 10   Moss, James - Polk, James
- 11   Pollard, Sipio - Sales, William
- 12   Sample, Abram (Abraham) - Smith, Ives
- 13   Smith, James - Times, Nelson
- 14   Tines, Archer - Wheldon, Charles M.
- 15   Whitby, Joseph - Wilson, Isaac
- 16   Wilson, James - Zoe (no first name)

**2d United States Colored Cavalry**

- 17   Abbot, John - Bell, Charles
- 18   Bell, Henry - Burns, Richard
- 19   Burroughs, George L. - Cotton, Samuel
- 20   Coues, Alexander - Duncan, Levi
- 21   Dunkins, Ezekiah James - Gardner, Richard
- 22   Garris, Henry - Harrison, Thomas
- 23   Harrison, William - Humphries, David
- 24   Hunter, Francis - Jones, Robert
- 25   Jones, Robert F. - Martin, Robert (Martin)
- 26   Martin, Thaddeus or Martin, Thaddeus W. - Osborne, Henry S.
- 27   Oulden, Jacob - Prior, Edward or Edmund
- 28   Proctor, David - Sawyer, Wilson
- 29   Scabber, Charles - Stanley, William
- 30   Stanley, Wright or Right - Upshear, Neverson
- 31   Upshear, Samuel - Whites, Joe
- 32   Whites, Silas - Zodrick, Isaiah A. or Isaiah

**3d United States Colored Cavalry**

- 33   Aaron, John - Black, David
- 34   Black, Richard - Cameron, Wyatt

<u>Roll</u>	<u>Description</u>
35	Cammel, Austin - Cooper, Stephen
36	Coran, Joseph - Erving, Tilson
37	Erwin, Anderson - Gool, George
38	Gordon, Alfred - Haskins, Jasper
39	Hawkins, Frank - Jackson, Harvey
40	Jackson, Henry - Kembro, Abraham
41	Kenedy, Lemuel - Lott, Judge
42	Lott, Matton - Mitchell, Berry
43	Mitchell, George - Pettis, Edmond
44	Pettis, George - Roberson, Jefferson
45	Roberson, Wallace - Simpson, Levi
46	Sims, Anderson - Taylor, Phillip
47	Taylor, Richard - Washington, Isaac
48	Washington, Oscar - Williams, Mitchel
49	Williams, Moses - Young, Mathew

**4th United States Colored Cavalry**

50	Abraham, Randall - Blanchan, William
51	Blanchard, Moses - Clark, Moses
52	Clark, Theodore - Ellars, James
53	Ellars, John - Heath, Culbert
54	Henderson, George - Johnson, Henderson
55	Johnson, Henry - Mayberry, Nelson
56	Macomory, John - Oliver, Celestine
57	Olsten, Alexander - Robinson, William
58	Robinson, William E. - Thomas, Stephen
59	Thomas, William - Williams, Horace
60	Williams, Isaac - Zulia, Francois

**5th United States Colored Cavalry**

61	Abel, Fletcher - Biggs, Randall
62	Birch, Benjamin - Burly, Frank
63	Burly, James - Coffman, James D.
64	Coke, Samuel - Dudley, John
65	Duke, John - Givens, Peter
66	Glen, John - Harriden, Edmund
67	Harrigan, Harden - Hughes, Thomas
68	Hulse, James - Keller, Ephraim
69	Kelley, Franklin - Matthews, Benjamin
70	Maupin, Preston - Murry, Ned
71	Murtney, Morton - Ray, John
72	Ray, Thomas - Sherrod, William



**Roll      Description**

- 73      Shrewsbury, Joseph - Stone, John
- 74      Stone, Lewis - Trye, Benjamin
- 75      Trueheart, Samuel - Williams, James
- 76      Williams, Jerry - Yowell, Joseph

**5th Massachusetts Cavalry (Colored)**

- 77      Abbey, David - Biers, William
- 78      Billings, Jeremiah - Burgess, Williams
- 79      Burnett, Lewis - Cook, Joseph T.
- 80      Cooper, Isaac - Dunmore, William
- 81      Durbin, Stephen - Furman, Seneca A.
- 82      Gadson, James - Gurley, Joseph L.
- 83      Guy, James - Hill, John W.
- 84      Hill, Richard - Johns, Thomas H.
- 85      Johnson, Aaron - Lambert, William
- 86      Lancaster, James - Mason, John
- 87      Mason, John H. - Nelson, Philip
- 88      Nelson, Preston - Preston, Thomas
- 89      Price, Adam - Sampson, George P.
- 90      Sanborn, Madison - Stringer, William
- 91      Strother, Frank - Vance, William H.
- 92      Van Hoesen, Charles - Wilkinson, Simon
- 93      Williams, Abram H. - Young, Thomas

**6th United States Colored Cavalry**

- 94      Abbot, John - Birch, James
- 95      Bivins, Gabriel - Buckner, George
- 96      Buckner, Henderson - Compton, James
- 97      Cook, Benjamin - Ellis, William
- 98      Ellis, Wyatt - Godley, Isaac
- 99      Gooch, Alexander - Herston, Abraham
- 100      Heywood, John R. - Johnson, Jackson
- 101      Johnson, James M. - Marshall, Lyman
- 102      Marshall, William - Neihardt, Isaac D.
- 103      Nelson, Joseph - Redd, Tiney
- 104      Redway, Hamilton K. - Sebree, Bob Woodcock
- 105      Sebree, Crittenden - Sumpter, John
- 106      Sutherland, Williams - Washington, Charles
- 107      Washington, George - Wren (no first name)

NATIONAL ARCHIVES MICROFILM PUBLICATIONS

Microfilm Publication M1817

COMPILED MILITARY SERVICE RECORDS OF VOLUNTEER UNION  
SOLDIERS WHO SERVED WITH THE UNITED STATES COLORED  
TROOPS: 1st Through 5th United States Colored Cavalry, 5th Massachusetts  
Cavalry (Colored), 6th United States Colored Cavalry

Roll 58

4th United States Colored Cavalry

Robinson, William E. - Thomas, Stephen

Robinson William E.

Co. A, 4 U. S. Col'd Cav.

Private

Private

CARD NUMBERS.

1	5348480	26
2	5348582	27
3	5348687	28
4	5348784	29
5	5348875	30
6	5348965	31
7	5349049	32
8	5349139	33
9	5349213	34
10	5349304	35
11	6349388	36
12	5349478	37
13	5349559	38
14	5349768	39
15	40729172	40
16		41
17		42
18		43
19		44
20		45
21		46
22		47
23		48
24		49
25		50

Book Mark:

See also

C | **4 Cav.** | **U.S.C.T.**

William E. Robinson

Private, Co. A, 1 Reg't La. Cav., Corps d'Afrique.\*

Appears on

**Company Muster-in Roll**

of the organization named above. Roll dated

New Orleans La, Sept 12, 1863.

Muster-in to date

Sept 12, 1863.

Joined for duty and enrolled:

When Aug. 28, 1863.

Where New Orleans

Period 3 years.

Valuation of horse, \$.....100

Valuation of horse equipments, \$.....100

Remarks:

Age 18

\*This organization subsequently became Co. A 4 Reg't U. S. Colored Cavalry.

Book mark:

M. A. Michaels

(356)

Copyist.

R

4 Cav. | U.S.C.T.

William E Robinson

Priv, Co. A, 1 Reg't La. Cav., Corps d'Afrique.\*

Appears on

Company Muster Roll

for Sept 12 to Dec 31, 1863

Present or absent Present

Stoppage, \$ 100 for

Due Gov't, \$ 100 for

Valuation of horse, \$ 100

Valuation of horse equipments, \$ 100

Remarks:

\*This organization subsequently became Co. A, Reg't U. S. Colored Cavalry.

Book mark:

R. S. Richardson

(358)

Copyist.

R

4 Cav. U.S C.T.

William E Robinson

Priv, Co. A, 1 Reg't Cav., Corps d'Afrique.\*

Appears on

Company Muster Roll

for Jan & Feb, 1864

Present or absent Present

Stoppage, \$ 100 for

Due Gov't, \$ 100 for

Valuation of horse, \$ 100

Valuation of horse equipments, \$ 100

Remarks:

\* This organization subsequently became Co. A, 4 Reg't U. S. Colored Cavalry.

Book mark:

R. Richardson

(358)

Copyist.

R | 4 Cav. | U.S.C.T.

William E Robinson

Pmi, Co. A, 4 Reg't U. S. Col'd Cavalry.

Appears on

**Company Muster Roll**

for *March & April*, 1864

Present or absent *Present*

Stoppage, \$ *100* for

Due Gov't, \$ *100* for

Valuation of horse, \$ *100*

Valuation of horse equipments, \$ *100*

Remarks:

Book mark:

*R S Richardson*

R | 4 Cav. | U.S.C.T.

William E Robinson  
Pow, Co. A, 4 Reg't U. S. Col'd Cavalry.

Appears on

**Company Muster Roll**

for May + June, 186 4

Present or absent Present

Stoppage, \$ 100 for

Due Gov't, \$ 100 for

Valuation of horse, \$ 100

Valuation of horse equipments, \$ 100

Remarks: In debt to Govt  
for 1 Sabra Knot

Book mark: \_\_\_\_\_

R. S. Richardson

(358)

Copyist.



R | 4 Cav. | U.S.C.T.

William E Robinson

Sm, Co. A, 4 Reg't U. S. Col'd Cavalry.

Appears on

**Company Muster Roll**

for July & Aug, 1864

Present or absent Present

Stoppage, \$ 100 for

Due Gov't, \$ 100 for

Valuation of horse, \$ 100

Valuation of horse equipments, \$ 100

Remarks: Is in debt to Govt for one (1) Sabre Knot

Book mark:

W. Richardson

R | 4 Cav. | U.S.C.T.

William E. Robinson

Pri, Co. A, 4 Reg't U. S. Col'd Cavalry.

Appears on

Company Muster Roll

for Sept & Oct, 1864.

Present or absent Present

Stoppage, \$ 100 for

Due Gov't, \$ 100 for

Valuation of horse, \$ 100

Valuation of horse equipments, \$ 100

Remarks: Stop for me Sabre  
Rust

Book mark:

Donnelly

R | 4 Cav. | U.S.C.T.

William E. Robinson

Pi

Co. A, 4 Reg't U. S. Col'd Cavalry.

Appears on

Company Muster Roll

for

Nov & Dec

1864

Present or absent

Present

Stoppage, \$

100 for

Due Gov't, \$

100 for

Valuation of horse, \$

100

Valuation of horse equipments, \$

100

Remarks:

Stop for 1 sabre  
Rush

Book mark:

Donnelly

(358)

Copyist.

*R* | 4 Cav. | U.S.C.T.

William E. Robinson

*Pri*, Co. A, 4 Reg't U. S. Col'd Cavalry.

Appears on

Company Muster Roll  
for *Jan & Feb*, 186 *5*  
Present or absent *Present*

Stoppage, \$ *100* for

Due Gov't, \$ *100* for

Valuation of horse, \$ *100*

Valuation of horse equipments, \$ *100*

Remarks: *Stop for 1 pair spurs  
1 straps, 1 carbine socket,  
1 tom-pion*

Book mark:

*Donnelly*

(358)

Copyist.

R | 4 Cav. | U.S.C.T.

William E. Robinson

Pri, Co. A, 4 Reg't U. S. Col'd Cavalry.

Appears on

Company Muster Roll

for Mar & Apr, 1865.

Present or absent Present

Stoppage, \$ 100 for

Due Gov't, \$ 100 for

Valuation of horse, \$ 100

Valuation of horse equipments, \$ 100

Remarks: Stop for 1 Haversack  
1 brush thing & wiper

Book mark:

Drumelly

(358)

Copyist.

*R* | 4 Cav. | U.S.C.T.

William E. Robinson

*Pri*

Co. A, 4 Reg't U. S. Col'd Cavalry.

Appears on

Company Muster Roll

for

*May & June*

186 *5*

Present or absent

*Present*

Stoppage, \$ *100* for

Due Gov't, \$ *100* for

Valuation of horse, \$ *100*

Valuation of horse equipments, \$ *100*

Remarks:

*Stop for 1 haversack  
& 1 brush & wiper*

Book mark:

*Donnelly*

*R* | 4 Cav. | U.S.C.T.

*William E. Robinson*

*Pi*

....., Co. A, 4 Reg't U. S. Col'd Cavalry.

Appears on

**Company Muster Roll**

for *July & Aug* ....., 186 *5*

Present or absent *Present*

Stoppage, \$ *95* / *100* for *C. Co. Capt.*

*lost & overdrawn*

Due Gov't, \$ *100* for .....

Valuation of horse, \$ *100*

Valuation of horse equipments, \$ *100*

Remarks: .....

Book mark: .....

*Donnelly*

(358)

Copyist.

R | **4 Cav.** | **U.S.C.T.**

William E. Robinson  
Pvt, Co. A, 4 Reg't U. S. Col'd Cavalry.

Appears on

**Company Muster Roll**

for Sept & Oct, 1865.

Present or absent Absent

Stoppage, \$ 100 for

Due Gov't, \$ 100 for

Valuation of horse, \$ 100

Valuation of horse equipments, \$ 100

Remarks: Absent without leave  
since Oct. 25, 1865.

NEXT ROLL ON FILE FEB 1866

Book mark:

(358)

Prewitt  
Copyist.



Q | 4 Cav. | U.S.C.T.

William E. Robinson

Pvt., Co. H, 4 Reg't U. S. Colored Cav.

Appears on Returns as follows:

Jan. to March 1864 - (1 Reg't Cav.,  
Corps d'Afrique) - On  
duty Co. Cook

Apr. to June 1864 - (4 Reg't U.S. Col. Cav.)  
On duty Co. Cook.

Jan. 1865 - On duty Co. Cook

July to Sept. 1865 - On duty  
Co. Cook.

Oct. 1865 - Absent without  
leave since Oct. 25/65

Dec. 1865 - Rec'd Dec. 6/65  
Pt. Hudson La. De-  
serted.

Book mark:

E. Thomson

(546)

Copyist.

Q | **4 Cav. | U.S.C.T.**

William E. Robinson  
Pvt., Co. A, 4 Reg't U. S. Col'd Cavalry.

Appears on **Co. Muster-out Roll**, dated  
New Orleans La., Feb 20, 1866.

Muster-out to date \_\_\_\_\_, 186 .

Last paid to Feb 28, 1865.

**Clothing account:**

Last settled \_\_\_\_\_, 186 ; drawn since \$ \_\_\_\_\_ 100

Due soldier \$ \_\_\_\_\_ 100; due U. S. \$ 26 60 100

Am't for cloth'g in kind or money adv'd \$ \_\_\_\_\_ 100

Due U. S. for arms, equipments, &c., \$ 69 57 100

Bounty paid \$ \_\_\_\_\_ 100; due \$ \_\_\_\_\_ 100

Remarks: Joined at orig org. Deserted  
Oct 24, 65 at Payson, Ara La Stop  
Burnside carb., 1 Lt. carb. Sabre / carb.  
Sling, 1 swivel, 1 cart. box, 1 cap. pouch,  
1 Sabre belt & plate, 1 Sabre knot  
1 leath. bridle, 1 leath. comb, 1 Girth  
(over)

Book mark: \_\_\_\_\_

(361)

Prewitt  
Copyist.

JAN-8

5349768

★ 1891 ★

1 halter, 1 horse brush, 1 cart-  
socket 1 Saddle 1 pr Stirrup  
Straps 2 sweat leathers 1 Surcin-  
gle. 1 Saddle blanket. 1 pr spurs  
& straps

Rochter Adolph

Co F L, 4 U. S. Col'd Cav.

Sergeant | Private

CARD NUMBERS.

1	5358623	26
2	5358677	27
3	5358754	28
4	5358772	29
5	5348032	30
6	5356604	31
7	5355690	32
8	5355830	33
9	5355910	34
10	5355991	35
11	5356069	36
12	5347626	37
13	5356146	38
14		39
15		40
16		41
17		42
18		43
19		44
20		45
21		46
22		47
23		48
24		49
25		50

Book Mark:

See also

S610234. P.O.:96  
 S-960866-P.C.-M+M  
 S1034659-2 Paul p. d. re  
 S. 1065633 Lead  
 S. 1066938 2 and sold  
 S. 1432098 G.A.R.  
 M. S. 1068898

D. Jordan  
 Ex

A | **4 Cav. | U.S.C.T.**

*Adolph Roehner*

Appears with rank of *Priv.* on

**Muster and Descriptive Roll of a Detachment of U. S. Vols. forwarded**

for the 4 Reg't U. S. Col'd Cavalry. Roll dated *New Orleans, La., June 1, 1864.*

Where born *La.*

Age *22* y'rs; occupation *Laborer*

When enlisted *Mich., 28*, 1864.

Where enlisted *New Orleans*

For what period enlisted *3* years.

Eyes *Black*; hair *Black*

Complexion *Black*; height *5 ft. 6 in.*

When mustered in *June 1*, 1864.

Where mustered in *New Orleans*

*Premium paid 2*  
Bounty paid \$ *100*; due \$ *100*

Where credited

Company to which assigned *L*

Remarks:

Book mark:

*Feaster*

R | 4 Car. | U.S.C.T.

Adolph Rocton  
Sgt, Co. F, 4 Reg't U. S. Col'd Car.  
Appears on

**M. and D. Roll of Men Transferred**

to the organization named above, by Consol.  
from Co. R

Roll dated Port Hudson, La Apr 29, 1865.

When enlisted May 28, 1864.

Period for which enlisted 3 years.

When mustered in June 1, 1864.

Present or absent Not stated

Company to which assigned F

Remarks:

Book mark :

W. Leonard

R | 4 Cav. | U.S.C.T.

Adolphe Rochter

2<sup>nd</sup> Sgt, Co. G, 4 Reg't U. S. Col'd Cavalry.

Age ..... years.

Appears on

Company Muster Roll\*

for Enlistment to Aug. 31, 1864.

Joined for duty and enrolled:

When March 28, 1864.

Where New Orleans

Period 3 years.

Mustered in:

When June 1, 1864.

Where New Orleans La.

Present or absent Present

Stoppage, \$ 100 for .....

Due Gov't, \$ 100 for .....

Valuation of horse, \$ 100

Valuation of horse equipments, \$ 100

Remarks: Promoted from private July 9<sup>th</sup> 1864

\*First current roll. No muster-in roll of this battery on file.

Book mark : .....

Lerring



R | **4 Cav.** | **U.S.C.T.**

Adolphe Roehner  
4<sup>th</sup> Sgt., Co. L, 4 Reg't U.S. Col'd Cavalry.

Appears on

**Company Muster Roll**

for Sept. + Oct., 1864.

Present or absent Present

Stoppage, \$ 100 for

Due Gov't, \$ 100 for

Valuation of horse, \$ 100

Valuation of horse equipments, \$ 100

Remarks:

Book mark:

(358)

Lerrin

Copyist.

R | 4 Cav. | U.S.C.T.

Adolph Doctor  
Pvt., Co. L, 4 Reg't U. S. Col'd Cavalry.

Appears on

Company Muster Roll  
for Nov. & Dec., 1864.

Present or absent Present

Stoppage, \$ 100 for

Due Gov't, \$ 100 for

Valuation of horse, \$ 100

Valuation of horse equipments, \$ 100

Remarks: Reduced to the rank  
per S.O. No. 118 Head Qu. Dec.  
14, 1864, from Sergt.

Book mark:

(358)

Lurrying

Copyist.

R | 4 Cav. | U.S.C.T.

Adolph Roctor

1st Lt., Co. L, 4 Reg't U. S. Col'd Cavalry.

Appears on

Company Muster Roll

for Jan. & Feb., 1865.

Present or absent Present

Stoppage, \$ 100 for

Due Gov't, \$ 100 for

Valuation of horse, \$ 100

Valuation of horse equipments, \$ 100

Remarks: Promoted from private to 1st Lt. to rank as such from Jan. 1st, 1865 by S.O. No. 3 Head Qu. 4th U.S. Cav. dated Jan. 3rd 1865

Book mark:

Lerrin

R | **4 Cav.** | **U.S.C.T.**

Adolph Ractor

4<sup>th</sup> C.S., Co. F, 4 Reg't U.S. Col'd Cavalry.

Appears on

**Company Muster Roll**

for Mich & Apr, 186 5

Present or absent Present

Stoppage, \$ 100 for

Due Gov't, \$ 100 for

Valuation of horse, \$ 100

Valuation of horse equipments, \$ 100

Remarks: Joined by Transfer from  
"L. Co. R. S. C. No. 28" dated  
Ad. Drs. Dept of the Gulf  
Jan. 28/65

Book mark: \_\_\_\_\_

L. A. Harris

*R* | 4 Cav. | U.S.C.T.

*Aldolpho Rochter*

*4<sup>th</sup> Sergt*, Co. F, 4 Reg't U. S. Col'd Cavalry.

Appears on

**Company Muster Roll**

for *May & June*, 186 *5*.

Present or absent *Present*

Stoppage, \$ \_\_\_\_\_  $\overline{100}$  for \_\_\_\_\_

Due Gov't, \$ \_\_\_\_\_  $\overline{100}$  for \_\_\_\_\_

Valuation of horse, \$ \_\_\_\_\_  $\overline{100}$

Valuation of horse equipments, \$ \_\_\_\_\_  $\overline{100}$

Remarks: \_\_\_\_\_  
\_\_\_\_\_  
\_\_\_\_\_  
\_\_\_\_\_  
\_\_\_\_\_  
\_\_\_\_\_  
\_\_\_\_\_  
\_\_\_\_\_

Book mark: \_\_\_\_\_

*J. A. Harris*

(358)

Copyist.

R | 4 Cav. | U.S.C.T.

Adolphe Rochter  
Prh, Co. F, 4 Reg't U. S. Col'd Cavalry.

Appears on

**Company Muster Roll**

for July & Aug, 1865.

Present or absent Present

Stoppage, \$ 100 for

Due Gov't, \$ 100 for

Valuation of horse, \$ 100

Valuation of horse equipments, \$ 100

Remarks: Reduced for neglect  
of duty July 15/865.

Book mark:

A. Harris

(358)

Copyist.

R | 4 Cav. | U.S.C.T.

Adolph Roctor  
Priv, Co. F, 4 Reg't U. S. Col'd Cavalry.

Appears on

**Company Muster Roll**

for Sept & Oct, 1865

Present or absent Present

Stoppage, \$ 100 for

Due Gov't, \$ 100 for

Valuation of horse, \$ 100

Valuation of horse equipments, \$ 100

Remarks: Stop for one Sabre Knob

Book mark: \_\_\_\_\_

J. H. Harris

(358)

Copyist.

R | 4 Cav. | U.S.C.T.

Adolph Roctor

P, Co. F, 4 Reg't U. S. Col'd Cavalry.

Appears on

Company Muster Roll

for Nov. 9 Dec. 1865.

Present or absent Present

Stoppage, \$ —  $\frac{32}{100}$  for order lost

Due Gov't, \$  $\frac{100}{100}$  for

Valuation of horse, \$  $\frac{100}{100}$

Valuation of horse equipments, \$  $\frac{100}{100}$

Remarks:

Book mark:

(358)

Hibbard  
Copyist.



R | 4 Cav. | U.S.C.T.

Adolph Roctor

P., Co. F, 4 Reg't U. S. Col'd Cavalry.

Appears on

Company Muster Roll

for Jan. 1<sup>st</sup> Feb., 1866.

Present or absent Present

Stoppage, \$ —  $\frac{32}{100}$  for ordn. lost;

Due Gov't, \$  $\frac{100}{100}$  for

Valuation of horse, \$  $\frac{100}{100}$

Valuation of horse equipments, \$  $\frac{100}{100}$

Remarks:

Book mark:

(358)

Hibbard

Copyist.

R | 4 Cav. | U.S.C.T.

Adolph Rector

P, Co. F, 4 Reg't U. S. Col'd Cavalry.

Appears on Co. Muster-out Roll, dated  
New Orleans, La., Mch. 20, 1866.

Muster-out to date Mch. 20, 1866.

Last paid to June 30, 1865.

Clothing account:

Last settled....., 186 ; drawn since \$..... 100

Due soldier \$ 4. <sup>06</sup>/<sub>100</sub>; due U. S. \$..... 100

Am't for cloth'g in kind or money adv'd \$..... 100

Due U. S. for arms, equipments, &c., \$..... <sup>32</sup>/<sub>100</sub>

Bounty paid \$..... 100; due \$..... 100

Remarks: Joined by transfer from  
L Co. per S.O. 28 Hdqrs. D. C. Jan  
28, 65. Seryt. from Mch. 25, 65  
to July 15, 65.

Stop 1 square knot.

Book mark: V35 - P46 - 68.

(861)

Hibbard

Copyist.

1938  
Rockley Gilbert

Co B, 4 U. S. Col'd Cav.

Private

Private

CARD NUMBERS.

1	26
2	27
3	28
4	29
5	30
6	31
7	32
8	33
9	34
10	35
11	36
12	37
13	38
14	39
15	40
16	41
17	42
18	43
19	44
20	45
21	46
22	47
23	48
24	49
25	50

See Rockley Gilbert

Book Mark:

See also:

Rodriguez Joseph

Co G, 4 U. S. Col'd Cav.

Private

Private

CARD NUMBERS.

1	5356241	26
2	5356294	27
3	5356399	28
4	5356445	29
5	5356505	30
6	5356565	31
7	5356626	32
8	5356709	33
9	5356792	34
10	5356884	35
11	5356971	36
12	5357054	37
13	5357139	38
14	40729175	39
15		40
16		41
17		42
18		43
19		44
20		45
21		46
22		47
23		48
24		49
25		50

Book Mark:

See also

S. 154 5657 Aud. W.D.  
P 1591451 P O m + m

19

H. Jordan  
Ex

R | **4 Cav.** | **U.S.C.T.**

Joseph Rodregus  
Priv., Co. G, 1 Reg't, Corps d'Afrique Cavalry.\*  
\*Age 19 yrs.  
Appears on

**Company Muster-in Roll**

of the organization named above. Roll dated  
New Orleans, La, Feb 5, 1864.  
Muster-in to date Feb 5, 1864.

Joined for duty and enrolled:

When Jan 16, 1864.

Where New Orleans, La.

Period 2 years.

Valuation of horse, \$ 100

Valuation of horse equipments, \$ 100

Remarks: Ed # 2 Perm.

\* Inserted by Jordan Ex

\*This organization subsequently became Co. G, 4 Reg't U. S. Colored Cavalry.

Book mark: \_\_\_\_\_

(356)

Loumy

Copyist.

*R* | **4 Cav. U.S C.T.**

*Joseph Rodrigues*  
*Pvt*, Co. *G*, 1 Reg't Cav., Corps d'Afrique.\*

Appears on

**Company Muster Roll**  
for *Enrollment to Feb 27, 1864.*

Present or absent.....

Stoppage, \$..... 100 for.....

Due Gov't, \$..... 100 for.....

Valuation of horse, \$..... 100

Valuation of horse equipments, \$..... 100

Remarks: *Deserted Feb 13/64*

\* This organization subsequently became Co. *G*, 4 Reg't U. S. Colored Cavalry.

Book mark:.....

(358)

*Lowry*

Copyist.

R | 4 Cav. | U. S. C. T.

Joseph Rodregus  
Plvt, Co. G, 4 Reg't U. S. Col'd Cavalry.

Appears on

**Company Muster Roll**

for *May & June*, 1864.

Present or absent *Present*

Stoppage, \$ *100* for

Due Gov't, \$ *100* for

Valuation of horse, \$ *100*

Valuation of horse equipments, \$ *100*

Remarks: *Deserted Feb. 1<sup>st</sup> / 64  
Returned to Company  
and assigned to duty  
May 3 / 64.*

Book mark:

(355)

*Lewy*

Copyist.



R | **4 Cav. | U. S. C. T.**

*Joseph Rodregus*  
*Pl't*, Co. G, 4 Reg't U. S. Col'd Cavalry.

Appears on

**Company Muster Roll**

for *July & Aug*, 1864.

Present or absent *Present*

Stoppage, \$ 100 for

Due Gov't, \$ 100 for

Valuation of horse, \$ 100

Valuation of horse equipments, \$ 100

Remarks: *Absent without  
leave from Feb 13/64  
to May 3/64.*

Book mark:

*Lowry*

(358)

Copyist.

R | **4 Cav.** | **U. S. C. T.**

Joseph Rodregus  
Plvt, Co. G, 4 Reg't U. S. Col'd Cavalry.

Appears on

**Company Muster Roll**

for Sept & Oct, 1864.

Present or absent Present

Stoppage, \$ 100 for

Due Gov't, \$ 100 for

Valuation of horse, \$ 100

Valuation of horse equipments, \$ 100

Remarks: Absent without  
leave from Feb 13/64  
to May 3/64.

Book mark: \_\_\_\_\_

(355)

Lowny

Copyist.

R | **4 Cav. | U. S. C. T.**

*Joseph Rodriguez*  
*Pr*, Co. G, 4 Reg't U. S. Col'd Cavalry.

Appears on

**Company Muster Roll**

for *Pr & Dec*, 1864

Present or absent *Present*

Stoppage, \$ 100 for

Due Gov't, \$ 100 for

Valuation of horse, \$ 100

Valuation of horse equipments, \$ 100

Remarks: *Absent without leave from Feb 13, 64 to May 3, 64 (on Muster Roll of Oct 3, read may for March free on or before Apr 19, 61*

Book mark:

(358)

*Atwood*  
Copyist.

R | 4 Cav. | U.S.C.T.

Joseph Rodriguez  
Sgt., Co. G, 4 Reg't U. S. Col'd Cavalry.

Appears on

Company Muster Roll

for Jan & Feb, 1865:

Present or absent Present

Stoppage, \$ 100 for

Due Gov't, \$ 100 for

Valuation of horse, \$ 100

Valuation of horse equipments, \$ 100

Remarks Absent without leave  
from Feb 13, 64 to May 3, 64  
Restored to duty per S.O. No. 79  
dated 19 Dec 1865  
Post paid on La Feb 4, 65.

Book mark:

(358)

*[Signature]*  
Copyist.

R | 4 Cav. | U.S.C.T.

*Joseph Rodriguez*  
*Pvt.*, Co. G, 4 Reg't U. S. Col'd Cavalry.

Appears on

**Company Muster Roll**

for *Men & Am*, 1863.

Present or absent *Present*

Stoppage, \$ 100 for

Due Gov't, \$ 100 for

Valuation of horse, \$ 100

Valuation of horse equipments, \$ 100

Remarks:

Book mark:

(358)

*Antonio L*  
Copyist.

R

4 Cav. | U. S. C. T.

Joseph Rodriguez  
Pr, Co. G, 4 Reg't U. S. Col'd Cavalry.

Appears on

Company Muster Roll

for May & June, 1865.

Present or absent Present

Stoppage, \$ 100 for

Due Gov't, \$ 100 for

Valuation of horse, \$ 100

Valuation of horse equipments, \$ 100

Remarks: Stopped saddle  
blanket & spurs

Book mark:

Pr  
Copyist.

R

4 Cav. | U.S.C.T.

Joseph Rodriguez

Pr, Co. G, 4 Reg't U. S. Col'd Cavalry.

Appears on

Company Muster Roll

for July & Aug, 1864

Present or absent Present

Stoppage, \$ 100 for

Due Gov't, \$ 100 for

Valuation of horse, \$ 100

Valuation of horse equipments, \$ 100

Remarks:

Book mark:

(355)

Quinn

Copyright

*R* | **4 Cav.** | **U. S. C. T.**

*Joseph Rodragus*

*Priv*, Co. G, 4 Reg't U. S. Col'd Cavalry.

Appears on

**Company Muster Roll**

for *Sept & Oct*, 186 *5*

Present or absent *Present*

Stoppage, \$ *100* for

Due Gov't, \$ *100* for

Valuation of horse, \$ *100*

Valuation of horse equipments, \$ *100*

Remarks:

NOT ROLL ON FILE FEB 1866

Book mark:

*Fletcher*

(359)

Copyist.



R | **4 Cav.** | **U. S. C. T.**

*Joseph Rodregus*

*Pri*, Co. G, 4 Reg't U. S. Col'd Cavalry.

Appears on

**Company Muster Roll**

for *Jan & Feb*, 1866.

Present or absent *Present*

Stoppage, \$ *5 <sup>10</sup>/<sub>100</sub>* for *lost ordnance*

Due Gov't, \$ *100* for

Valuation of horse, \$ *100*

Valuation of horse equipments, \$ *100*

Remarks:

Book mark:

*Fletcher*

(35S)

Copyist.

Q

4 Cav. U.S.C.T.

Joseph Rodrigue  
Pvt, Co. G, 4 Reg't U. S. Colored Cav.

Appears on Returns as follows:

May 1864. - Gained May 3/64  
N. Orleans La. from  
desertion.

Book mark:

E. Thomson

(546)

Copyist.

*R* | **4 Cav. U.S.C.T.**

*Joseph Rodregas*  
*Co. G*, 4 Reg't U. S. Col'd Cavalry.

Appears on **Co. Muster-out Roll**, dated  
*New Orleans, La, Mch 20*, 1866.

Muster-out to date *Mch 20*, 1866.

Last paid to *June 30*, 1865.

**Clothing account:**

Last settled....., 186 ; drawn since \$..... 100

Due soldier \$..... 100; due U. S. \$ *63* <sup>*72*</sup>/<sub>100</sub>

Am't for cloth'g in kind or money adv'd \$..... 100

Due U. S. for arms, equipments, &c., \$ *5* <sup>*00*</sup>/<sub>100</sub>

Bounty paid \$..... 100; due \$..... 100

Remarks: *Joined at orig. org*

*Step 1 curb bridle,*

Book mark: *V209 P296. 74*

(361)

*Fletcher*  
Copyist.

*440*  
*Rolling Burrell*

Co. *B*, **4** U. S. Col'd Cav.

*Private*

*Saddler*

CARD NUMBERS.

1	5349849	26
2	5349896	27
3	5349996	28
4	5350100	29
5	5350202	30
6	5350298	31
7	5350378	32
8	5350450	33
9	5350526	34
10	5350605	35
11	5350689	36
12	5350787	37
13	5350876	38
14	5350961	39
15	5351040	40
16	5351121	41
17	40729186	42
18		43
19		44
20		45
21		46
22		47
23		48
24		49
25		50

Book Mark:

See also

NR 02

S893040 Rant,

29

H Jordan  
EJ

R | **4 Cav.** | **U.S.C.T.**

Burrill Roffing

Co. B, 1 Reg't La. Cav., Corps d'Afrique.\*

Age 29 yrs.

Appears on

**Company Muster-in Roll**

of the organization named above. Roll dated

New Orleans La Oct 27, 1863.

Muster-in to date

Oct 27, 1863.

Joined for duty and enrolled:

When Oct 1, 1863.

Where New Orleans

Period 3 years.

Valuation of horse, \$.....100

Valuation of horse equipments, \$.....100

Remarks:.....

\*Inserted by Jordan Ex

\*This organization subsequently became Co. B, 4 Reg't U. S. Colored Cavalry.

Book mark:.....

(356)

Spring

Copyist.

*JP*

**4 Cav. | U.S.C.T.**

*Burrill Peffing*

*Artificer*, Co. *B*, 1 Reg't La. Cav., Corps d'Afrique.\*

Appears on

**Company Muster Roll**

for *Oct 27 to Dec 31*, 186 *3*.

Present or absent *Present*

Stoppage, \$ *100* for

Due Gov't, \$ *100* for

Valuation of horse, \$ *100*

Valuation of horse equipments, \$ *100*

Remarks:

*Filed with Peffing Burrill*

\*This organization subsequently became Co. *B*, 4 Reg't U. S. Colored Cavalry.

Book mark:

*Peffing*

Copyist.

*R.*

**4 Cav. U.S.C.T.**

*Burrill Giffing*  
Artificer *B.*, 1 Reg't Cav., Corps d'Afrique.\*

Appears on

**Company Muster Roll**

for *Jan + Feb*, 186*4*.

Present or absent *Present*

Stoppage, \$ *100* for

Due Gov't, \$ *100* for

Valuation of horse, \$ *100*

Valuation of horse equipments, \$ *100*

Remarks:  
-----  
-----  
-----  
-----  
-----  
-----  
-----  
-----

\* This organization subsequently became Co. *B.* 4 Reg't U. S. Colored Cavalry.

Book mark : -----

(358)

*Giffing*

Copyist.



*C* | **4 Cav.** | **U.S.C.T.**

*Burrill Coffey*  
Artificer, Co. B. 4 Reg't U. S. Col'd Cavalry.

Appears on

**Company Muster Roll**

for *March & April*, 1864.

Present or absent *Present*

Stoppage, \$ 100 for

Due Gov't, \$ 100 for

Valuation of horse, \$ 100

Valuation of horse equipments, \$ 100

Remarks :  
-----  
-----  
-----  
-----  
-----  
-----  
-----  
-----  
-----  
-----

Book mark :  
-----

(358)

*Coffey*  
Copyist.

*B-* | **4 Cav.** | **U.S.C.T.**

*Burrill Coffey*  
*Artificer*, Co. B. 4 Reg't U. S. Col'd Cavalry.

Appears on

**Company Muster Roll**

for *May & June*, 186*4*.

Present or absent *Present*

Stoppage, \$ *100* for

Due Gov't, \$ *100* for

Valuation of horse, \$ *100*

Valuation of horse equipments, \$ *100*

Remarks :

Book mark :

(358)

*King*  
Copyist.

*P*

**4 Cav. | U.S.C.T.**

*Burrill Goffney*  
Saddler, Co. B. 4 Reg't U. S. Col'd Cavalry.

Appears on

**Company Muster Roll**

for *July & Aug*, 186*6*.

Present or absent *Present*

Stoppage, \$ 100 for

Due Gov't, \$ 100 for

Valuation of horse, \$ 100

Valuation of horse equipments, \$ 100

Remarks :

Book mark :

(358)

*Burrill Goffney*  
Copyist.

*R* | **4 Cav.** | **U.S.C.T.**

*Burrill Poffing*  
-----  
*Sadler*, Co. B. 4 Reg't U. S. Col'd Cavalry.

Appears on

**Company Muster Roll**

for *Sept. & Oct.*, 186*4*.

Present or absent *Present*

Stoppage, \$ *100* for -----

Due Gov't, \$ *100* for -----

Valuation of horse, \$ *100*

Valuation of horse equipments, \$ *100*

Remarks : -----  
-----  
-----  
-----  
-----  
-----  
-----  
-----  
-----  
-----

Book mark : -----

(358)

*Tracy*  
-----  
Copyist.

R | **4 Cav.** | **U.S.C.T.**

Burrill Rolfeing  
Saddler, Co. B. 4 Reg't U. S. Col'd Cavalry.

Appears on

**Company Muster Roll**

for Nov & Dec, 1864.

Present or absent present

Stoppage, \$ 100 for

Due Gov't, \$ 100 for

Valuation of horse, \$ 100

Valuation of horse equipments, \$ 100

Remarks :

Book mark :

Somer

R | **4 Cav.** | **U.S.C.T.**

Burrill Roffing  
Saddler, Co. B. 4 Reg't U. S. Col'd Cavalry.

Appears on  
**Company Muster Roll**  
for Jan & Feb., 1867.

Present or absent present

Stoppage, \$ 100 for

Due Gov't, \$ 100 for

Valuation of horse, \$ 100

Valuation of horse equipments, \$ 100

Remarks: Received only \$7 per  
month to include Apr 30/64

Book mark : \_\_\_\_\_

Somers  
\_\_\_\_\_  
(358) Copyist.

R | **4 Cav.** | **U.S.C.T.**

*Burrill Roffing*

*Saddler*, Co. B. 4 Reg't U. S. Col'd Cavalry.

Appears on

**Company Muster Roll**

for *Mich & Apr*, 186*5*.

Present or absent *present*

Stoppage, \$ 100 for

Due Gov't, \$ 100 for

Valuation of horse, \$ 100

Valuation of horse equipments, \$ 100

Remarks :

-----  
-----  
-----  
-----  
-----  
-----  
-----  
-----

Book mark :

-----  
-----

*Somer*

R | **4 Cav.** | **U.S.C.T.**

*Burrill Ruffling*

*Saddler*, Co. B. 4 Reg't U. S. Col'd Cavalry.

Appears on

**Company Muster Roll**

for *May & June*, 186*9*.

Present or absent *Absent*

Stoppage, \$ 100 for

Due Gov't, \$ 100 for

Valuation of horse, \$ 100

Valuation of horse equipments, \$ 100

Remarks: *On furloughs of  
sick (7) days*

Book mark :

*Lomer*



R | **4 Cav.** | **U.S.C.T.**

Burrill Ruffing

Saddler, Co. B. 4 Reg't U. S. Col'd Cavalry.

Appears on

**Company Muster Roll**

for July & Aug, 1865.

Present or absent present

Stoppage, \$ 100 for

Due Gov't, \$ 100 for

Valuation of horse, \$ 100

Valuation of horse equipments, \$ 100

Remarks :

Book mark :

(358)

Forner Copyist.

R | 4 Cav. | U.S.C.T.

*Burrell Ruffing*  
Saddler, Co. B. 4 Reg't U. S. Col'd Cavalry.

Appears on

**Company Muster Roll**

for *Sept & Oct*, 186*5*.

Present or absent *present*

Stoppage, \$ 100 for

Due Gov't, \$ 100 for

Valuation of horse, \$ 100

Valuation of horse equipments, \$ 100

Remarks :

Book mark :

*Somers*

(858)

Copyist.

*B* | **4 Cav.** | **U.S.C.T.**

*Burrell Ruffing*  
Saddler Co. B. 4 Reg't U. S. Col'd Cavalry.

Appears on

**Company Muster Roll**

for *Nov. & Dec.*, 186*6*

Present or absent *Present*

Stoppage, \$ 100 for

Due Gov't, \$ 100 for

Valuation of horse, \$ 100

Valuation of horse equipments, \$ 100

Remarks :  
-----  
-----  
-----  
-----  
-----  
-----  
-----  
-----

Book mark :  
-----

*Chandler*  
Copyist.

*AB* | **4 Cav.** | **U.S.C.T.**

*Burrell Puffing*  
Saddler Co. B. 4 Reg't U. S. Col'd Cavalry.

Appears on

**Company Muster Roll**

for *Jan. & Feb.*, 186*6*

Present or absent *Present*

Stoppage, \$ 100 for

Due Gov't, \$ 100 for

Valuation of horse, \$ 100

Valuation of horse equipments, \$ 100

Remarks :  
-----  
-----  
-----  
-----  
-----  
-----  
-----  
-----  
-----

Book mark :  
-----

*Chandler*  
-----  
(358) Copyist.

Q | **4 Cav.** | **U.S.C.T.**

*Burrill Ruffin*

*Prs*, Co. *Q*, 4 Reg't U. S. Colored Cav.

Appears on Returns as follows:

*June 1865. - Absent on  
furlough since  
June 27/65*

Book mark : \_\_\_\_\_

*E. Hemmon*

(546)

Copyist.

*P* | **4 Cav.** | **U.S.C.T.**

*Burrell Ruffin*  
Saddler, Co. *B*, 4 Reg't U. S. Col'd Cavalry.

Appears on **Co. Muster-out Roll**, dated  
*New Orleans, La., Mch. 20*, 1866.

Muster-out to date *Mch. 24*, 1866.

Last paid to *June 30*, 1865.

**Clothing account:**

Last settled....., 186 ; drawn since \$.....100

Due soldier \$ *56* <sup>*21*</sup>/<sub>100</sub>; due U. S. \$.....100

Am't for cloth'g in kind or money adv'd \$.....100

Due U. S. for arms, equipments, &c., \$.....100

Bounty paid \$.....100; due \$.....100

Remarks: *Joined at Orgl. Org.*

Book mark: *V. 207. P. 113, 74.*

(361)

*Chandler*  
Copyist.

Romain Philip

Co D, 4 U. S. Col'd Cav.

Private

Private

CARD NUMBERS.

1	5349850	26
2	5349952	27
3	5350046	28
4	5350152	29
5	5350248	30
6	5350339	31
7	5350418	32
8	5350493	33
9	5350568	34
10	5350653	35
11	5350739	36
12	5350834	37
13	5350920	38
14	5351005	39
15	5351086	40
16	5351167	41
17	40729176	42
18		43
19		44
20		45
21		46
22		47
23		48
24		49
25		50

Book Mark: .....

See also .....

*P* | **4 Cav. | U.S.C.T.**

*Phillip Romain*

*Co. B*, 1 Reg't La. Cav., Corps d'Afrique.\*  
\*Age 20 yrs.  
Appears on

**Company Muster-in Roll**

of the organization named above. Roll dated  
*New Orleans La, Oct 27*, 1863.

Muster-in to date *Oct 27*, 1863.

**Joined for duty and enrolled:**

When *Sept 26*, 186 .

Where *New Orleans*

Period *3* years.

Valuation of horse, \$.....100

Valuation of horse equipments, \$.....100

Remarks :  
.....  
.....

\*Insured by *Jordan & Co*

\*This organization subsequently became Co. *B*, 4 Reg't U. S. Colored Cavalry.

Book mark :  
.....

(356)

*J. R. [Signature]*

Copyist.



*P*

**4 Cav. | U.S.C.T.**

*Phillip Romain*

*Co. B*, 1 Reg't La. Cav., Corps d'Afrique.\*

Appears on

**Company Muster Roll**

for *Oct 27 to Dec 31*, 186*3*.

Present or absent *Present*

Stoppage, \$ *100* for

Due Gov't, \$ *100* for

Valuation of horse, \$ *100*

Valuation of horse equipments, \$ *100*

Remarks:  
-----  
-----  
-----  
-----  
-----  
-----  
-----  
-----

\*This organization subsequently became Co. *B*, 4 Reg't U. S. Colored Cavalry.

Book mark: -----

(358)

*[Signature]*

Copyist.

*R*

**4 Cav. U.S C.T.**

*Phillip Romain*

*Co. B*, 1 Reg't Cav., Corps d'Afrique.\*

Appears on

**Company Muster Roll**

for *Jan. & Feb*, 186*4*.

Present or absent *Present*

Stoppage, \$ *100* for

Due Gov't, \$ *100* for

Valuation of horse, \$ *100*

Valuation of horse equipments, \$ *100*

Remarks: \_\_\_\_\_  
\_\_\_\_\_  
\_\_\_\_\_  
\_\_\_\_\_  
\_\_\_\_\_

\* This organization subsequently became Co. *B*, 4 Reg't U. S. Colored Cavalry.

Book mark: \_\_\_\_\_

(358)

*Boyer*  
Copyist.

P | **4 Cav.** | **U.S.C.T.**

Philip Romaine

Co., Co. B. 4 Reg't U. S. Col'd Cavalry.

Appears on

**Company Muster Roll**

for March & April, 1864.

Present or absent Present

Stoppage, \$ 100 for

Due Gov't, \$ 100 for

Valuation of horse, \$ 100

Valuation of horse equipments, \$ 100

Remarks :

Book mark :

(358)

[Signature]  
Copyist.

*P*

**4 Cav. | U.S.C.T.**

*Philip Roman*  
-----  
*Ortr*, Co. B. 4 Reg't U. S. Col'd Cavalry.

Appears on

**Company Muster Roll**

for *May & June*, 186*4*.

Present or absent *Present*

Stoppage, \$ *100* for -----

Due Gov't, \$ *100* for -----

Valuation of horse, \$ *100*

Valuation of horse equipments, \$ *100*

Remarks : -----  
-----  
-----  
-----  
-----  
-----  
-----  
-----  
-----  
-----

Book mark : -----

*Spiny*

*P* | **4 Cav. | U.S.C.T.**

*Phillip Gorman*  
*Cop*, Co. B. 4 Reg't U. S. Col'd Cavalry.

Appears on

**Company Muster Roll**

for *July + Aug*, 186*4*.

Present or absent *Present*

Stoppage, \$ 100 for

Due Gov't, \$ 100 for

Valuation of horse, \$ 100

Valuation of horse equipments, \$ 100

Remarks :  
.....  
.....  
.....  
.....  
.....  
.....  
.....  
.....  
.....  
.....

Book mark :  
.....

(358)

*J. M. P.* Copyist.

*P* | **4 Cav. | U.S.C.T.**

*Phillip Fomaine*  
*Co. B.*, Co. B. 4 Reg't U. S. Col'd Cavalry.

Appears on

**Company Muster Roll**

for *Sept & Oct*, 186*4*.

Present or absent *Present*

Stoppage, \$ 100 for

Due Gov't, \$ 100 for

Valuation of horse, \$ 100

Valuation of horse equipments, \$ 100

Remarks :

Book mark :

(358)

*S. F.*  
Copyist.

R | **4 Cav.** | **U.S.C.T.**

*Phillip Romain*

*priv*, Co. B. 4 Reg't U. S. Col'd Cavalry.

Appears on

**Company Muster Roll**

for *Nov & Dec*, 1864.

Present or absent *Present*

Stoppage, \$ 100 for

Due Gov't, \$ 100 for

Valuation of horse, \$ 100

Valuation of horse equipments, \$ 100

Remarks: *Stop for one spur  
strap*

Book mark:

*Somner*

R | **4 Cav.** | **U.S.C.T.**

Phillip Romain  
priv., Co. B. 4 Reg't U. S. Col'd Cavalry.

Appears on

**Company Muster Roll**

for Jan & Feb., 1867.

Present or absent present

Stoppage, \$ 100 for

Due Gov't, \$ 100 for

Valuation of horse, \$ 100

Valuation of horse equipments, \$ 100

Remarks: Received only \$7 a  
month to include Apr 30/64  
Stop for 1 spur & strap, one  
horse brush

Book mark:

Romain



R | **4 Cav.** | **U.S.C.T.**

*Phillip Romaine*

*priv.*, Co. B. 4 Reg't U. S. Col'd Cavalry.

Appears on

**Company Muster Roll**

for *March & April*, 1865.

Present or absent *present*

Stoppage, \$ 100 for

Due Gov't, \$ 100 for

Valuation of horse, \$ 100

Valuation of horse equipments, \$ 100

Remarks: *Stop for one horse  
blanket one curb Bridle*

Book mark:

*Louise*

R | **4 Cav.** | **U.S.C.T.**

Philip Romain

priv, Co. B. 4 Reg't U. S. Col'd Cavalry.

Appears on

**Company Muster Roll**

for May + June, 1863.

Present or absent present

Stoppage, \$ 100 for

Due Gov't, \$ 100 for

Valuation of horse, \$ 100

Valuation of horse equipments, \$ 100

Remarks : Stop for 1 Sabre  
knob 2 Spurs & Straps  
and 1 Saddle blanket

Book mark :

Romain

(358)

Copyist.

R | **4 Cav.** | **U.S.C.T.**

Phillip Romaine

prvt., Co. B. 4 Reg't U. S. Col'd Cavalry.

Appears on

**Company Muster Roll**

for July & Aug, 1865.

Present or absent present

Stoppage, \$ 100 for

Due Gov't, \$ 100 for

Valuation of horse, \$ 100

Valuation of horse equipments, \$ 100

Remarks :

Book mark :

(358)

Romaine

Copyist.

R | **4 Cav.** | **U.S.C.T.**

Philip Romaine

priv., Co. B. 4 Reg't U. S. Col'd Cavalry.

Appears on

**Company Muster Roll**

for Sept & Oct., 1865.

Present or absent present

Stoppage, \$ 100 for

Due Gov't, \$ 100 for

Valuation of horse, \$ 100

Valuation of horse equipments, \$ 100

Remarks :

Book mark :

Somer

*R* | **4 Cav.** | **U.S.C.T.**

*Phillip Roman*

*Priv.*, Co. B. 4 Reg't U. S. Col'd Cavalry.

Appears on

**Company Muster Roll**

for *Nov. 1865*, 1865.

Present or absent *Present*

Stoppage, \$ 100 for

Due Gov't, \$ 100 for

Valuation of horse, \$ 100

Valuation of horse equipments, \$ 100

Remarks :

Book mark :

(358)

*Chandler*  
Copyist.

*SR* | **4 Cav.** | **U.S.C.T.**

*Phillip Roman*  
*Priv*, Co. B. 4 Reg't U. S. Col'd Cavalry.

Appears on

**Company Muster Roll**

for *Jan. & Feb.*, 1866.

Present or absent *Present*

Stoppage, \$ *100* for

Due Gov't, \$ *100* for

Valuation of horse, \$ *100*

Valuation of horse equipments, \$ *100*

Remarks :

Book mark :

*L Chandler*  
Copyist.

R | 4 Cav. | U.S.C.T.

Phillip Romain  
Pvt., Co. B, 4 Reg't U. S. Colored Cav.

Appears on Returns as follows:

Feb'y & Mch, 1864 (1 Reg't Cav.  
Corps d'Affaire) On duty  
as cook.  
Apr 1864 (4 Reg't U.S. Col. Cav.) On  
duty as cook

\* Name appears also as  
Phillip Corvain

Book mark :

Stottrell

(546)

Copyist.

*B* | **4 Cav.** | **U.S.C.T.**

*Phillip Roman*

*For*, Co. *B*, 4 Reg't U. S. Col'd Cavalry.

Appears on **Co. Muster-out Roll**, dated  
*New Orleans La*, *Mch. 20*, 1866.

Muster-out to date *Mch. 20*, 1866.

Last paid to *June 30*, 1866.

**Clothing account:**

Last settled....., 186 ; drawn since \$.....100

Due soldier \$ *18 09*/<sub>100</sub>; due U. S. \$.....100

Am't for cloth'g in kind or money adv'd \$.....100

Due U. S. for arms, equipments, &c., \$.....100

Bounty paid \$.....100; due \$.....100

Remarks: *Joined at Org'l org.*

Book mark: *V. 237 P. 101, 68*

(361)

*Chandler*

Copyist.



44205 Alphonse  
Romar Alfred

Co. A, 4 U. S. Col'd Cav.

Private | Private

CARD NUMBERS.

1	5348478	26
2	5348516	27
3	5348616	28
4	5348714	29
5	5348807	30
6	5348974	31
7	5349050	32
8	5349140	33
9	5349214	34
10	5349305	35
11	5349389	36
12	5349479	37
13	5349560	38
14	5349635	39
15	5349705	40
16	40729177	41
17		42
18		43
19		44
20		45
21		46
22		47
23		48
24		49
25		50

Book Mark:

See also

S-724089. P. 6:90  
S-1131865 - P.O. MOW

L Jordan  
Ex

R | 4 Cav. | U.S.C.T.

Alfred Romar  
Private, Co. A, 1 Reg't La. Cav., Corps d'Afrique.\*

Appears on

**Company Muster-in Roll**

of the organization named above. Roll dated  
New Orleans La Sept 12, 1863.

Muster-in to date Sept 12, 1863.

Joined for duty and enrolled:

When Aug 30, 1863.

Where New Orleans

Period 3 years.

Valuation of horse, \$ 100

Valuation of horse equipments, \$ 100

Remarks: Age 24

\*This organization subsequently became Co. A, 4 Reg't U. S. Colored Cavalry.

Book mark: \_\_\_\_\_

M. A. Michaels

(358)

Copyist.

R | 4 Cav. | U.S.C.T.

Alphonzo Roman

4 Sg't, Co. A, 1 Reg't La. Cav., Corps d'Afrique.\*

Appears on

Company Muster Roll

for Sept 12 to Dec 31, 1863

Present or absent Present

Stoppage, \$ 100 for

Due Gov't, \$ 100 for

Valuation of horse, \$ 100

Valuation of horse equipments, \$ 100

Remarks:

\*This organization subsequently became Co. A 4 Reg't U. S. Colored Cavalry.

Book mark:

R Richardson

*R* | **4 Cav. | U.S.C.T.**

*Alphonse Romar*  
*6<sup>th</sup> Sgts. Co. A*, 1 Reg't Cav., Corps d'Afrique.\*

Appears on

**Company Muster Roll**

for *Jan & Feb*, 186 *4*

Present or absent *Present*

Stoppage, \$ *100* for

Due Gov't, \$ *100* for

Valuation of horse, \$ *100*

Valuation of horse equipments, \$ *100*

Remarks: \_\_\_\_\_  
\_\_\_\_\_  
\_\_\_\_\_  
\_\_\_\_\_  
\_\_\_\_\_

\* This organization subsequently became Co. *A*, 4 Reg't U. S. Colored Cavalry.

Book mark: \_\_\_\_\_

*R. Richardson*

R | **4 Cav.** | **U.S.C.T.**

Alphones Romar

Serjt, Co. A, 4 Reg't U. S. Col'd Cavalry.

Appears on

**Company Muster Roll**

for Feb + apl, 1864

Present or absent Present

Stoppage, \$ 100 for

Due Gov't, \$ 100 for

Valuation of horse, \$ 100

Valuation of horse equipments, \$ 100

Remarks:

Book mark:

R. Richardson

R | 4 Cav. | U.S.C.T.

Alphouse Romar  
Sergt, Co. A, 4 Reg't U. S. Col'd Cavalry.

Appears on

**Company Muster Roll**

for May & June, 1864.

Present or absent Absent

Stoppage, \$ 100 for

Due Gov't, \$ 100 for

Valuation of horse, \$ 100

Valuation of horse equipments, \$ 100

Remarks: Absent without leave

Book mark:

R. H. Richardson

R | 4 Cav. | U.S.C.T.

Alphonse Romar

Pari, Co. A, 4 Reg't U. S. Col'd Cavalry.

Appears on

Company Muster Roll

for July + Aug, 1864

Present or absent Absent

Stoppage, \$ 100 for

Due Gov't, \$ 100 for

Valuation of horse, \$ 100

Valuation of horse equipments, \$ 100

Remarks: Absent without leave June 26/64

Book mark:

R Richardson



*R* | 4 Cav. | U.S.C.T.

*Alphonse Roman*

*Pri*, Co. A, 4 Reg't U. S. Col'd Cavalry.

Appears on

Company Muster Roll

for *Sept 1864*, 186 *4*.

Present or absent *Present*

Stoppage, \$ *100* for

Due Gov't, \$ *100* for

Valuation of horse, \$ *100*

Valuation of horse equipments, \$ *100*

Remarks: *Absent without  
leave from June 24 to Sept  
8/64*

Book mark:

*Donnelly*

R | 4 Cav. | U.S.C.T.

Alphonse Romar  
Pri

Co. A, 4 Reg't U. S. Col'd Cavalry.

Appears on

Company Muster Roll

for Nov & Dec, 1864.

Present or absent Present

Stoppage, \$ 100 for

Due Gov't, \$ 100 for

Valuation of horse, \$ 100

Valuation of horse equipments, \$ 100

Remarks: Absent without  
leave from June 24 to  
Sept 8. 64. Stop for 1  
halter & strap & 1 pr  
spurs & straps

Book mark:

Donnelly

(358)

Copyist.

R | 4 Cav. | U.S.C.T.

Alphonse Romar

Pri

, Co. A, 4 Reg't U. S. Col'd Cavalry.

Appears on

Company Muster Roll

for Jan & Feb, 1865

Present or absent Present

Stoppage, \$ 100 for

Due Gov't, \$ 100 for

Valuation of horse, \$ 100

Valuation of horse equipments, \$ 100

Remarks: Absent without leave

from June 24 to Sept 8. 64.

Stop for 1 halter & strap,

2 pairs spurs & straps,

Ret'd to Co. per S. O. No. 40 dated

Feb 24 65 Forces Port Hudson

La Feb 17. 65. App'd Reg't

Sept 12. 63. Reduced to the ranks

July 1. 64

Book mark:

Donnelly

*R* | 4 Cav. | U.S.C.T.

*Alphonse Romar*

*Pri*, Co. A, 4 Reg't U. S. Col'd Cavalry.

Appears on

**Company Muster Roll**

for *Mar & Apr*, 1865.

Present or absent *Present*

Stoppage, \$ *100* for

Due Gov't, \$ *100* for

Valuation of horse, \$ *100*

Valuation of horse equipments, \$ *100*

Remarks:

Book mark:

*Donnelly*

*R* | 4 Cav. | U.S.C.T.

*Alphouse Roman*

*Pn*, Co. A, 4 Reg't U. S. Col'd Cavalry.

Appears on

Company Muster Roll

for *May & June*, 186*5*.

Present or absent *Present*

Stoppage, \$ 100 for

Due Gov't, \$ 100 for

Valuation of horse, \$ 100

Valuation of horse equipments, \$ 100

Remarks: *Orderly at Post Hd Qrs*

Book mark: \_\_\_\_\_

*Donnelly*

R | 4 Cav. | U.S.C.T.

Alphonse Romar

Pi, Co. A, 4 Reg't U. S. Col'd Cavalry.

Appears on

Company Muster Roll  
for July & Aug, 1865.

Present or absent Present

Stoppage, \$  $\frac{87}{100}$  for lost ordnance

Due Gov't, \$  $\frac{100}{100}$  for

Valuation of horse, \$  $\frac{100}{100}$

Valuation of horse equipments, \$  $\frac{100}{100}$

Remarks:

Book mark:

Donnelly

*R* | **4 Cav.** | **U.S.C.T.**

*Alphonse Roman*  
*Pr*....., Co. A, 4 Reg't U. S. Col'd Cavalry.

Appears on

**Company Muster Roll**

for *Sept & Oct*....., 1865.

Present or absent *Present*.....

Stoppage, \$..... 100 for.....

Due Gov't, \$..... 100 for.....

Valuation of horse, \$..... 100

Valuation of horse equipments, \$..... 100

Remarks:.....

**NEXT ROLL ON FILE FEB 1865**

Book mark:.....

*Prewitt*

(358)

Copyist.

R | **4 Cav.** | **U.S.C.T.**

Alphonse Roman  
Priv, Co. A, 4 Reg't U. S. Col'd Cavalry.

Appears on

**Company Muster Roll**

for Jan & Feb, 1866.

Present or absent Present

Stoppage, \$ 100 for

Due Gov't, \$ 100 for

Valuation of horse, \$ 100

Valuation of horse equipments, \$ 100

Remarks:

Book mark:

(358)

Prewitt  
Copyist.



R | **4 Cav.** | **U.S.C.T.**

Alphonse Roman  
Priv., Co. A, 4 Reg't U. S. Colored Cav.

Appears on Returns as follows:

June & Aug. 1864. - Absent  
without leave since  
June 26, 64

Feb. to Sept. 1865. - On duty  
detailed as Orderly  
at Post Ho. D.C.

Book mark :

*E. Thomas*

R | 4 Cav. | U.S.C.T.

Alphonse Romer  
Pvt., Co. A, 4 Reg't U. S. Col'd Cavalry.

Appears on Co. Muster-out Roll, dated  
New Orleans La, Mch 20, 1866.

Muster-out to date Mch 20, 1866.

Last paid to June 30, 1865.

Clothing account:

Last settled....., 186 ; drawn since \$..... 100

Due soldier \$..... 100; due U. S. \$ 29 <sup>95</sup>/<sub>100</sub>

Am't for cloth'g in kind or money adv'd \$..... 100

Due U. S. for arms, equipments, &c., \$..... 100

Bounty paid \$..... 100; due \$..... 100

Remarks: Joined at orig reg.  
Sergt to July, 1864.

Book mark: { V 36 P 141, 69  
Y 25 P 145, 68

443

*Book Austin*  
Co *C*, 4 U. S. Col'd Cav.

*Private* | *Private*

CARD NUMBERS.

1	5351411	26
2	5351491	27
3	5352541	28
4	40729179	29
5		30
6		31
7		32
8		33
9		34
10		35
11		36
12		37
13		38
14		39
15		40
16		41
17		42
18		43
19		44
20		45
21		46
22		47
23		48
24		49
25		50

Book Mark: .....

See also .....

R | 4 Cav. | U.S.C.T.

Austin Rooks  
Sgt., Co. C, 1 Reg't La. Cav., Corps d'Afrique.\*

Appears on

Company Muster Roll

for Jan Feb, 1864.

Present or absent Present

Stoppage, \$ 100 for

Due Gov't, \$ 100 for

Valuation of horse, \$ 100

Valuation of horse equipments, \$ 100

Remarks: Not mustered on account of being transferred to Recruiting Depot & afterwards returned to Company. Enrolled Nov. 15/63 at New Orleans for 3 yrs. Muster in not shown.

\*This organization subsequently became Co. 4 Reg't U. S. Colored Cavalry.

Book mark:

Proctor

(358)

Copyist.

R | **4 Cav.** | **U.S.C.T.**

Austin Rooks  
Rt., Co. C, 4 Reg't U. S. Colored Cavalry.

Appears on

**Company Muster Roll**

for March & April, 1864.

Present or absent .....

Stoppage, \$ 100 for .....

Due Gov't, \$ 100 for .....

Valuation of horse, \$ 100

Valuation of horse equipments, \$ 100

Remarks : Absent March 27/64

Book mark : .....

(358)

Rooks

Copyist.

R | 4 Cav. | U.S.C.T.

Austin Rooks

Priv., Co. B, 4 Reg't U. S. Colored Cav.

Appears on Returns as follows:

Feb. 1864. (1 Regt. Cav., Corps  
d'Afrique) Absent with  
leave since Feb. 28/64  
to Bayou La Fourche on  
account of sickness  
in his family.

Feb. 1864 - Lost: Deserted  
Feb. 27/64

Book mark :

R. Thomsen

D | 4 Cav. | U.S.C.T.

Austin Books

Co. C, 4 Reg't U. S. Col'd Cavalry

Appears on Co. Muster-out Roll, dated

New Orleans La, Mar 20, 1866.

Muster-out to date ..... 186 .

Last paid to ..... 186 .

Clothing account:

Last settled ..... 186 ; drawn since \$ ..... 100

Due soldier \$ ..... 100; due U. S. \$ ..... 100

Am't for cloth'g in kind or money adv'd \$ ..... 100

Due U. S. for arms, equipments, &c., \$ ..... 100

Bounty paid \$ ..... 100; due \$ ..... 100

Remarks: See Rolls for March

& April 1864. Mustered out in  
accordance with Special Orders No 44  
Head Qrs Dept of La. C.S. to take  
effect March 20-1866. Their ser-  
vice being no longer required

Book mark:

Filed with Austin Books.

(361)

M. A. Michaels

Copyist.

144  
Rooks Peter

Co C, 4 U. S. Col'd Cav.

Private

Private

CARD NUMBERS.

1	5351272	26
2	5351327	27
3	5351382	28
4	5351467	29
5	5351558	30
6	5351620	31
7	5351805	32
8	5351895	33
9	5351997	34
10	5352097	35
11	5352195	36
12	5352288	37
13	5352376	38
14	5352465	39
15	40729180	40
16		41
17		42
18		43
19		44
20		45
21		46
22		47
23		48
24		49
25		50

Book Mark: 2404 C. S. 83.

See also



REP 346244.

6738998 - Rugo

9938045 Gaud

S-940965 - 2 And. Pils.

S-969449

S-1081860 Jordan

REP 405447-

J. 1355367 P. O. R. L.

2901178. and and

3174606 P. O. R. L.

D. Jordan  
Ex

*P* | 4 Cav. | U.S.C.T.

*Peter Rooks*  
Pot, Co. *C* 1 Reg't La. Cav., Corps d'Afrique.\*

Appears on

**Company Muster-in Roll**

of the organization named above, Roll dated

*New Orleans La*, 186*3*.

Muster-in to date *Nov 7*, 186*3*.

Joined for duty and enrolled:

When *Oct 27*, 186*3*.

Where *New Orleans city*

Period *3* years.

Valuation of horse, \$ 100

Valuation of horse equipments, \$ 100

Remarks:

*Apr 20*

\*This organization subsequently became Co. *C* 4 Reg't U. S. Colored Cavalry.

Book mark: *...*

*Rocheater*

*P* | 4 Cav. | U.S.C.T.

*Peter Cook*  
Co. C, 1 Reg't La. Cav., Corps d'Afrique.\*

Appears on

**Company Muster Roll**

for *Nov 31*, 186*3*

Present or absent *Present*

Stoppage, \$ *100* for

Due Gov't, \$ *100* for

Valuation of horse, \$ *100*

Valuation of horse equipments, \$ *100*

Remarks:

FROM SECOND AUDITOR'S ROLL.

\*This organization subsequently became Co. *C* 4 Reg't U. S. Colored Cavalry.

Book mark:

*Robert*

R | 4 Cav. | U.S.C.T.

Peter Cooke  
Pvt., Co. C, 1 Reg't La. Cav., Corps d'Afrique.\*

Appears on

**Company Muster Roll**

for Jan & Feb, 1867.

Present or absent Present

Stoppage, \$ 100 for

Due Gov't, \$ 100 for

Valuation of horse, \$ 100

Valuation of horse equipments, \$ 100

Remarks:  
\_\_\_\_\_  
\_\_\_\_\_  
\_\_\_\_\_  
\_\_\_\_\_  
\_\_\_\_\_  
\_\_\_\_\_

\*This organization subsequently became Co. C 4 Reg't U. S. Colored Cavalry.

Book mark: \_\_\_\_\_

Rochester

Copyist.

*R* | **4 Cav.** | **U.S.C.T.**

*Peter Rooks*  
*Pvt*, Co. C, 4 Reg't U. S. Colored Cavalry.

Appears on

**Company Muster Roll**  
for *March 25th*, 1864.

Present or absent *Present*

Stoppage, \$ 100 for

Due Gov't, \$ 100 for

Valuation of horse, \$ 100

Valuation of horse equipments, \$ 100

Remarks :

Book mark :

(358)

*Robert*

Copyist.

*R* | **4 Cav. | U.S.C.T.**

*Peter Cook*  
*Pvt*, Co. C, 4 Reg't U. S. Colored Cavalry.

Appears on

**Company Muster Roll**

for *May & June*, 1864.

Present or absent

Stoppage, \$ 100 for

Due Gov't, \$ 100 for

Valuation of horse, \$ 100

Valuation of horse equipments, \$ 100

Remarks:

*Absented June 25, 1864*

Book mark:

*Peter Cook*

C | 4 Cav. | U.S.C.T.

Peter Cook  
Sgt, Co. C, 4 Reg't U. S. Colored Cavalry.

Appears on

**Company Muster Roll**

for July & Aug, 1864.

Present or absent

Stoppage, \$ 100 for

Due Gov't, \$ 100 for

Valuation of horse, \$ 100

Valuation of horse equipments, \$ 100

Remarks: Wanted from camp  
knapsack, cartridges, carried  
haversack and pair  
scales June 25, 1864

Book mark:

Rocketer

(358)

Copyist.

R | 4 Cav. | U.S.C.T.

Peter Rooks  
Priv, Co. C, 4 Reg't U. S. Colored Cavalry.

Appears on

**Company Muster Roll**

for Jan & Feb, 1865.

Present or absent absent

Stoppage, \$ 100 for

Due Gov't, \$ 100 for

Valuation of horse, \$ 100

Valuation of horse equipments, \$ 100

Remarks: Received 7.00 per  
month to include Apr.  
30, 1864. In Post Guard  
House since Feb 5, 65  
for desertion.

Book mark: \_\_\_\_\_

(358)

Moy

Copyist.



*R* | 4 Cav. | U.S.C.T.

*Peter Rooks*  
*Priv*, Co. C, 4 Reg't U. S. Colored Cavalry.

Appears on

Company Muster Roll  
for *Meh 2 Apr*, 1865.

Present or absent *absent*

Stoppage, \$ *100* for

Due Gov't, \$ *100* for

Valuation of horse, \$ *100*

Valuation of horse equipments, \$ *100*

Remarks: *In Post Guard House since Feb 5th/65, for desertion.*

Book mark:

(358)

*May*  
Copyist.

*R* | **4 Cav.** | **U.S.C.T.**

*Peter Rooks*

*Priv*, Co. C, 4 Reg't U. S. Colored Cavalry.

Appears on

**Company Muster Roll**

for *May & June*, 186*5*.

Present or absent *absent*

Stoppage, \$ *100* for

Due Gov't, \$ *100* for

Valuation of horse, \$ *100*

Valuation of horse equipments, \$ *100*

Remarks: *In post guard house since Feb 5, 1865 for desertion.*

Book mark:

(358)

*May*

Copyist.

R | **4 Cav.** | **U.S.C.T.**

Peter Rooks  
Priv, Co. C, 4 Reg't U. S. Colored Cavalry.

Appears on

**Company Muster Roll**

for July & Aug, 1865.

Present or absent present

Stoppage, \$ 100 for

Due Gov't, \$ 100 for

Valuation of horse, \$ 100

Valuation of horse equipments, \$ 100

Remarks: Ret'd to duty by pardon  
per S.O. 186, Hd Qrs Dept of  
Gulf, dated MO La July 12/65.

Book mark: \_\_\_\_\_

(358)

May

Copyist.

*P* | **4 Cav.** | **U.S.C.T.**

*Peter Rooks*  
Priv., Co. C, 4 Reg't U. S. Colored Cavalry.

Appears on

**Company Muster Roll**

for *Sept & Oct*, 1865.

Present or absent *present*

Stoppage, \$ 100 for

Due Gov't, \$ 100 for

Valuation of horse, \$ 100

Valuation of horse equipments, \$ 100

Remarks: *Deserted from Co at  
Camp Parapet La July 25/64.  
Arrested by a party sent  
for the purpose Feb 5/65,  
and confined in P.H. House  
Port Henderson, from whence  
he was returned to the Co  
& to duty without trial*

Book mark :

*(over)*

*May*

JAN. - 8

5352195

☆ 1891 ☆

by pardon per 80186,  
Adjts Dept. of Gulf  
N.O., La. July 12/65, Reported  
for duty July 17/65,

*R* | **4 Cav.** | **U.S.C.T.**

*Peter Rooks*

*Private*, Co. C, 4 Reg't U. S. Colored Cavalry.

Appears on

**Company Muster Roll**

for *Nov & Dec*, 186*5*.

Present or absent *present*

Stoppage, \$ *100* for

Due Gov't, \$ *100* for

Valuation of horse, \$ *100*

Valuation of horse equipments, \$ *100*

Remarks: *Returned to duty  
from confinement in Post  
Gd 26. Post Hudson La per  
S.O 186 dated Hd Qrs Dept  
of Gulf New Orleans La  
July 12 - 1865*

Book mark: \_\_\_\_\_

*M. A. Michaels*

(358)

Copyist.

*R* | **4 Cav.** | **U.S.C.T.**

*Peter Rooks*

*Private*, Co. C, 4 Reg't U. S. Colored Cavalry.

Appears on

**Company Muster Roll**

for *Jan'y & Febr.*, 186*6*.

Present or absent *present*

Stoppage, \$ *100* for

Due Gov't, \$ *100* for

Valuation of horse, \$ *100*

Valuation of horse equipments, \$ *100*

Remarks: *Ret'd to duty from confinement in Port Gd House, Port Hudson La per S.O 186 dated Hd Qtrs Dept of Gulf New Orleans La July 12/65.*

Book mark:

*M. A. Michaels*

(358)

Copyist.

R | 4 Cav. | U.S.C.T.

Peter Rooks

Priv., Co. C, 4 Reg't U. S. Colored Cav.

Appears on Returns as follows:

June 1864. - Absent without leave.

July 1864. - Des. July 1  
Camp Parapet. Dropped  
from Co. Rolls Deserted.

Feb. 1865. - Guin Feb. 5/65  
Port Hudson La. Returned  
from desertion.

Absent in confinement  
at Port Hudson.

March to June 1865. - Absent in  
confinement at Port  
Hudson La.

Book mark:

E. Thomson

(546)

Copyist.



R | 4 Cav. | U.S.C.T.

Peter Rocks

Private, Co. B, 4 Reg't U. S. Col'd Cavalry.

Appears on **Co. Muster-out Roll**, dated  
New Orleans La Mar. 20, 1866.

Muster-out to date Mar. 20, 1866.

Last paid to Apr 30, 1864.

Clothing account:

Last settled....., 186 ; drawn since \$..... 100

Due soldier \$..... 100; due U. S. \$ 59 <sup>92</sup>/<sub>100</sub>

Am't for cloth'g in kind or money adv'd \$..... 100

Due U. S. for arms, equipments, &c., \$..... 100

Bounty paid \$..... 100; due \$..... 100

Remarks: Joined orig. org deserted  
June 25/64 returned to Co Febr  
5/65 restored to duty without  
trial for S.O. 186 Hd Qrs. D.C.  
July 17/65

Book mark: 2404-C. 7/83. V 25 P 106-68.  
21. 1883 - S.O. 186 D.C. July 17/65 on file "Mis orders" 67

M. A. Michaels

(361)

Copyist.

945  
Rosamond Paul

Co E, 4 U. S. Col'd Cav.

Sergeant | Sergeant

CARD NUMBERS.

1	5353800	26
2	5353803	27
3	5353909	28
4	5353965	29
5	5354026	30
6	5354094	31
7	5354163	32
8	5354229	33
9	5354290	34
10	5354354	35
11	5354439	36
12	5354524	37
13	5354599	38
14	5354670	39
15	5354803	40
16	5357949	41
17	5354876	42
18	5358023	43
19	40729181	44
20		45
21		46
22		47
23		48
24		49
25		50

Book Mark: .....

See also .....

S.1082759 P.O. m m

20

H Jordan  
J. E.

*R* | **4 Cav.** | **U.S.C.T.**

*Paul Rosamond*

*2d Sgt., Co. E, 1 Reg't, Corps d'Afrique Cavalry.\**  
*Age 20 yrs.*  
Appears on

**Company Muster-in Roll**

of the organization named above. Roll dated

*New Orleans, La, Dec. 31, 1863*

Muster-in to date *Dec. 31, 1863.*

Joined for duty and enrolled:

When *Oct. 1*, 186 .

Where *New Orleans*

Period *3* years.

Valuation of horse, \$ *100*

Valuation of horse equipments, \$ *100*

Remarks:

*\*Inserted by Jordan Cox*

\*This organization subsequently became Co. E, 4 Reg't U. S. Colored Cavalry.

Book mark:

*Wendel*

*R* **4 Cav. U.S C.T.**

*Paul Rosamond*  
*2<sup>d</sup> Sgt, Co. E, 1 Reg't Cav., Corps d'Afrique.\**

Appears on

**Company Muster Roll**

for *Enlistment to Dec. 31, 186*

Present or absent *Present*

Stoppage, \$ *100* for

Due Gov't, \$ *100* for

Valuation of horse, \$ *100*

Valuation of horse equipments, \$ *100*

Remarks:  
.....  
.....  
.....  
.....  
.....  
.....

\* This organization subsequently became Co. *E*, 4 Reg't U. S. Colored Cavalry.

Book mark: .....

*Wendell*  
(358) Copyist.

*R* | **4 Cav. | U.S C.T.**

*Paul Rosamond*

, Co. *E*, 1 Reg't Cav., Corps d'Afrique.\*

Appears on

**Company Muster Roll**

for *Jan & Feb*, 1864

Present or absent *Present*

Stoppage, \$ *100* for

Due Gov't, \$ *100* for

Valuation of horse, \$ *100*

Valuation of horse equipments, \$ *100*

Remarks:

\* This organization subsequently became Co. *E*, 4 Reg't U. S. Colored Cavalry.

Book mark:

*L. L. L.*

(358)

Copyist.

R | **4 Cav.** | **U.S.C.T.**

Paul Rosemond

Sgt., Co. E, 4 Reg't U. S. Col'd Cav.

Appears on

**Company Muster Roll**

for Mar + Apr, 1864.

Present or absent Present

Stoppage, \$ 100 for \_\_\_\_\_

Due Gov't, \$ 100 for \_\_\_\_\_

Valuation of horse, \$ 100

Valuation of horse equipments, \$ 100

Remarks: \_\_\_\_\_

Book mark: \_\_\_\_\_

Lewman

(358)

Copyist.

R | **4 Cav.** | **U.S.C.T.**

Paul Rosamond

Sgt., Co. E, 4 Reg't U. S. Col'd Cav.

Appears on

**Company Muster Roll**

for May & June, 186 4

Present or absent Present

Stoppage, \$ 100 for \_\_\_\_\_

Due Gov't, \$ 100 for \_\_\_\_\_

Valuation of horse, \$ 100

Valuation of horse equipments, \$ 100

Remarks: \_\_\_\_\_

Book mark: \_\_\_\_\_

Lammie



R | **4 Cav.** | **U.S.C.T.**

Paul Roseman

Q 1, Co. E, 4 Reg't U. S. Col'd Cav.

Appears on

**Company Muster Roll**

for July & Aug, 1864.

Present or absent Present

Stoppage, \$ 100 for \_\_\_\_\_

Due Gov't, \$ 100 for \_\_\_\_\_

Valuation of horse, \$ 100

Valuation of horse equipments, \$ 100

Remarks: \_\_\_\_\_  
\_\_\_\_\_  
\_\_\_\_\_  
\_\_\_\_\_  
\_\_\_\_\_  
\_\_\_\_\_  
\_\_\_\_\_  
\_\_\_\_\_  
\_\_\_\_\_

Book mark: \_\_\_\_\_

L. L. L.

(358)

Copyist.

R | **4 Cav.** | **U.S.C.T.**

*Paul Rowman*

*Sgt.*, Co. E, 4 Reg't U. S. Col'd Cav.

Appears on

**Company Muster Roll**

for *Sept - Oct*, 186 *4*

Present or absent *Present*

Stoppage, \$ 100 for

Due Gov't, \$ 100 for

Valuation of horse, \$ 100

Valuation of horse equipments, \$ 100

Remarks:

Book mark:

*Lawrence*

(358)

Copyist.

*R* | **4 Cav.** | **U.S.C.T.**

*Paul Rosamond*  
*Sgt*, Co. E, 4 Reg't U. S. Col'd Cav.

Appears on

**Company Muster Roll**

for *Nov & Dec*, 1864.

Present or absent *Present*

Stoppage, \$ *100* for

Due Gov't, \$ *100* for

Valuation of horse, \$ *100*

Valuation of horse equipments, \$ *100*

Remarks:

Book mark:

(358)

*Wenus*

Copyist.

R | 4 Cav. | U.S.C.T.

Paul Rosamond  
Ct Sgt, Co. E, 4 Reg't U. S. Col'd Cav.

Appears on

**Company Muster Roll**

for Jan. & Feb., 1865.

Present or absent Present

Stoppage, \$ 100 for

Due Gov't, \$ 100 for

Valuation of horse, \$ 100

Valuation of horse equipments, \$ 100

Remarks: Recd only \$7.00 per month  
to include Apr 30/65 app'd  
Supt Oct 3/63 from Private

Book mark:

(358) Wines Copyist.

*R* | **4 Cav.** | **U.S.C.T.**

*Paul Rosamond*

*Sgt*, Co. E, 4 Reg't U. S. Col'd Cav.

Appears on

**Company Muster Roll**

for *Mar & Apr*, 186*5*.

Present or absent *Present*

Stoppage, \$ *100* for

Due Gov't, \$ *100* for

Valuation of horse, \$ *100*

Valuation of horse equipments, \$ *100*

Remarks:

Book mark:

*Wines*

(358)

Copyist.

*R* | **4 Cav.** | **U.S.C.T.**

*Paul Rosemond*  
*Sgt*, Co. E, 4 Reg't U. S. Col'd Cav.

Appears on

**Company Muster Roll**

for *May & June*, 186*5*.

Present or absent *Present*

Stoppage, \$ *100* for

Due Gov't, \$ *100* for

Valuation of horse, \$ *100*

Valuation of horse equipments, \$ *100*

Remarks:

Book mark:

(358)

*Wines*  
Copyist.

*R* | **4 Cav.** | **U.S.C.T.**

*Paul Rosamond*

*Sgt*, Co. E, 4 Reg't U. S. Col'd Cav.

Appears on

**Company Muster Roll**

for *July & Aug*, 186*5*.

Present or absent *Present*

Stoppage, \$ *100* for

Due Gov't, \$ *100* for

Valuation of horse, \$ *100*

Valuation of horse equipments, \$ *100*

Remarks:

Book mark:

(358)

*Wines*

Copyist.

*R* | **4 Cav.** | **U.S.C.T.**

*Paul Rosamond*

*Sgt*, Co. E, 4 Reg't U. S. Col'd Cav.

Appears on

**Company Muster Roll**

for *Sept + Oct*, 186*5*.

Present or absent *Present*

Stoppage, \$ *100* for

Due Gov't, \$ *100* for

Valuation of horse, \$ *100*

Valuation of horse equipments, \$ *100*

Remarks:

Book mark:

(358)

*Wines*

Copyist.



*R* | **4 Cav.** | **U.S.C.T.**

*Paul Rosamond*

*Serjt*, Co. E, 4 Reg't U. S. Col'd Cav.

Appears on

**Company Muster Roll**

for *Nov. & Dec.*, 186 *5*.

Present or absent. *Present*

Stoppage, \$ *100* for

Due Gov't, \$ *100* for

Valuation of horse, \$ *100*

Valuation of horse equipments, \$ *100*

Remarks:

Book mark:

(358)

*Floyd*

Copyist.

R | 4 Cav. | U.S.C.T.

Paul Rosamond

Serjt, Co. E, 4 Reg't U. S. Col'd Cav.

Appears on

Company Muster Roll

for Jan'y + Feby, 1866.

Present or absent

Stoppage, \$ 100 for

Due Gov't, \$ 100 for

Valuation of horse, \$ 100

Valuation of horse equipments, \$ 100

Remarks: Transferred to Co. H,  
per S.O. No 13 dated Hd qrs  
Port Hudson Feby 3, 1866.

Book mark:

Floyd

(358)

Copyist.

*Y* | **4 Cav.** | **U.S.C.T.**

*Paul Rosamond*

*1<sup>st</sup> Sgt*, Co. H, 4 Reg't U. S. Col'd Cavalry.

Appears on

**Company Muster Roll**

for *Jan & Feb.*, 186*6*.

Present or absent *Present*

Stoppage, \$ *100* for

Due Gov't, \$ *100* for

Valuation of horse, \$ *100*

Valuation of horse equipments, \$ *100*

Remarks: *Transferred from Co "E" same Regt as Sergt. per S. O. 13 dated Hd. Qrs. 4 U. S. C. C. Feb 3/66 for promotion & promoted 1<sup>st</sup> Sergt. Co. H. Feb 3/66*

Book mark:

*A. C. Stuart*

(358)

Copyist.

Q | 4 Cav. | U.S.C.T.

Paul Rosamer

Sgt., Co. ~~E~~<sup>E</sup><sub>26</sub>, 4 Reg't U. S. Colored Cav.

Appears on Returns as follows:

Feb. 1866. - Lost Feb. 3, 66  
Pt. Hudson, Transferred  
from Co. E to Co. 26  
4 U.S. C. C.

(Co. 26) - Gained Feb. 3/66  
Pt. Hudson, Gained  
by transfer from Co. E  
4 U.S. C. C.

Book mark:

E. Thenton

(546)

Copyist.

R | 4 Cav. | U.S.C.T.

Paul Rosamond

1st Sgt, Co. A., 4 Reg't U. S. Col'd Cavalry.

Appears on Co. Muster-out Roll, dated

New Orleans La, Mar 25, 1866.

Muster-out to date Mar 25, 1866.

Last paid to June 30, 1865.

Clothing account:

Last settled \_\_\_\_\_, 186 ; drawn since \$ \_\_\_\_\_ 100

Due soldier \$ 10 <sup>24</sup>/<sub>100</sub>; due U. S. \$ \_\_\_\_\_ 100

Am't for cloth'g in kind or money adv'd \$ \_\_\_\_\_ 100

Due U. S. for arms, equipments, &c., \$ \_\_\_\_\_ 100

Bounty paid \$ \_\_\_\_\_ 100; due \$ \_\_\_\_\_ 100

Remarks: Joined by transfer

from Co. E to accept

promotion as 1st Sgt.

Feb 3/66 Per S.O. 43

Ad. Ins. 4th U.S.C. Co.

Book mark:

A. C. Howard

(861)

Copyist.

R | **4 Cav.** | **U.S.C.T.**

Paul Rosamond

Seyt, Co. E, 4 Reg't U. S. Col'd Cavalry.

Appears on **Co. Muster-out Roll**, dated  
New Orleans La, Mch 20, 1866.

Muster-out to date \_\_\_\_\_, 186 .

Last paid to \_\_\_\_\_, 186 .

**Clothing account:**

Last settled \_\_\_\_\_, 186 ; drawn since \$ \_\_\_\_\_ 100

Due soldier \$ \_\_\_\_\_ 100; due U. S. \$ \_\_\_\_\_ 100

Am't for cloth'g in kind or money adv'd \$ \_\_\_\_\_ 100

Due U. S. for arms, equipments, &c., \$ \_\_\_\_\_ 100

Bounty paid \$ \_\_\_\_\_ 100; due \$ \_\_\_\_\_ 100

Remarks: Joined at org. org.

Transferred to Col's per S.O. 19  
Hodges 4 U. S. C. Cav. Feb 3/66

Book mark : \_\_\_\_\_

(861)

Lloyd

Copyist.

490  
Rose John

Co., 4 U. S. Col'd Cav.

Private Private

CARD NUMBERS.

1. 5347766.	26
2	27
3	28
4	29
5	30
6	31
7	32
8	33
9	34
10	35
11	36
12	37
12	38
14	39
15	40
16	41
17	42
18	43
19	44
20	45
21	46
22	47
23	48
24	49
25	50

Book Mark: 552, 1882,

See also

1864

Q | **4 Cav. U.S.C.T.**

*Colm. Coe*

Appears with rank of *Capt.* on

**Muster and Descriptive Roll of a Detachment of U. S. Vols. forwarded**

for the 4 Reg't U. S. Col'd Cavalry. Roll dated

*New Orleans, La., Aug. 10, 1864.*

Where born *Puyon, La.*

Age *44* y'rs; occupation *Planter*

When enlisted *Aug. 6*, 186 .

Where enlisted *New Orleans*

For what period enlisted *3* years.

Eyes *Black*; hair *Black*

Complexion *Dark*; height *6* ft. *1* in.

When mustered in *August*, 186 .

Where mustered in *New Orleans, La.*

Bounty paid \$ *100* <sup>100</sup>; due \$ *200* <sup>100</sup>

Where credited *New Orleans*

Company to which assigned *D*

Remarks: *Recruit entitled to*

*Bounty*

Book mark: *552, 1864,*

*over*

*J. H. Tyler*

(339)

Copyist.



JAN. - 8

5347766

☆ 1891 ☆

*Name not taken up on  
Bills of any Co.*

Ross Philip

Co B, 4 U.S. Col'd Cav.

Private | Private

CARD NUMBERS.

1 5349853  
2 5349954  
3 5350048  
4 5350153  
5 5350249  
6 5350340  
7 5350419  
8 5350510  
9 5351209  
10 40729182

26  
27  
28  
29  
30  
31  
32  
33  
34  
35  
36  
37  
38  
39  
40  
41  
42  
43  
44  
45  
46  
47  
48  
49  
50

Book Mark:

EB. Vol 10. 543.

See also

*P* | 4 Cav. | U.S.C.T.

*Phillip Ross*

*Priv*, Co. *B*, 1 Reg't La. Cav., Corps d'Afrique.\*

\* *Age 20 yrs.*

Appears on

**Company Muster-in Roll**

of the organization named above. Roll dated

*New Orleans La, Oct 27*, 186*3*

Muster-in to date *Oct 27*, 186*3*

Joined for duty and enrolled:

When *Oct 8*, 186 .

Where *New Orleans*

Period *3* years.

Valuation of horse, \$ *100*

Valuation of horse equipments, \$ *100*

Remarks:

\* *Inserted by Jordan C. J.*

\* This organization subsequently became Co. *B*, 4 Reg't U. S. Colored Cavalry.

Book mark:

(356)

*Jordan C. J.*  
Coyt.

*7*

**4 Cav. | U.S.C.T.**

*Phillip Ross*

*Det. Co. B*, 1 Reg't La. Cav., Corps d'Afrique.\*

Appears on

**Company Muster Roll**

for *Oct 27 to Dec 31*, 1863.

Present or absent *Present*

Stoppage, \$ *100* for

Due Gov't, \$ *100* for

Valuation of horse, \$ *100*

Valuation of horse equipments, \$ *100*

Remarks:

\*This organization subsequently became Co. *B*, 4 Reg't U. S. Colored Cavalry.

Book mark:

(358)

*Tracy*

Copyist.

*P* **4 Cav. U.S.C.T.**

*Phillip Ross*

*Co. B*, 1 Reg't Cav., Corps d'Afrique.\*

Appears on

**Company Muster Roll**

for *Jan & Feb*, 1864.

Present or absent *Present*

Stoppage, \$ *100* for

Due Gov't, \$ *100* for

Valuation of horse, \$ *100*

Valuation of horse equipments, \$ *100*

Remarks:

-----  
-----  
-----  
-----  
-----

\* This organization subsequently became Co. *B*, 4 Reg't U. S. Colored Cavalry.

Book mark: -----

(358)

*[Signature]*  
Copyist.

*R*

**4 Cav. U.S.C.T.**

*Philip Ross*

*Co.*, Co. B. 4 Reg't U. S. Col'd Cavalry.

Appears on

**Company Muster Roll**

for *March*, 186*4*.

Present or absent *Present*

Stoppage, \$ *100* for

Due Gov't, \$ *100* for

Valuation of horse, \$ *100*

Valuation of horse equipments, \$ *100*

Remarks: *Due U.S. for Bond  
warrant \$12.00*

Book mark :

(358)

*F. J. [unclear]*  
Copyist.

*F* | **4 Cav. | U.S.C.T.**

*Philip Ross*  
*Cor.*, Co. B. 4 Reg't U. S. Col'd Cavalry.

Appears on

**Company Muster Roll**

for *May + June*, 186*4*

Present or absent *Present*

Stoppage, \$ *100* for

Due Gov't, \$ *100* for

Valuation of horse, \$ *100*

Valuation of horse equipments, \$ *100*

Remarks :

Book mark :

(358)

*[Signature]*  
Copyist.

*J* | **4 Cav.** | **U.S.C.T.**

*Phillip Ross*

*Co.*, Co. B. 4 Reg't U. S. Col'd Cavalry.

Appears on

**Company Muster Roll**

for *July + Aug*, 186*4*.

Present or absent *Present*

Stoppage, \$ *100* for

Due Gov't, \$ *100* for

Valuation of horse, \$ *100*

Valuation of horse equipments, \$ *100*

Remarks :  
.....  
.....  
.....  
.....  
.....  
.....  
.....  
.....  
.....  
.....

Book mark :  
.....

(358)

*Spring*  
Copyist.



*P* | **4 Cav.** | **U.S.C.T.**

*Phillip Ross*

*P*, Co. B. 4 Reg't U. S. Col'd Cavalry.

Appears on

**Company Muster Roll**

for *Sept & Oct*, 1864.

Present or absent *Present*

Stoppage, \$ *100* for

Due Gov't, \$ *100* for

Valuation of horse, \$ *100*

Valuation of horse equipments, \$ *100*

Remarks :

Book mark :

(358)

*[Signature]*  
Copyist.

R | **4 Cav.** | **U.S.C.T.**

*Phillip Ross.*

*priv.*, Co. B. 4 Reg't U. S. Col'd Cavalry.

Appears on

**Company Muster Roll**

for *Nov & Dec*, 1864.

Present or absent

Stoppage, \$ 100 for

Due Gov't, \$ 100 for

Valuation of horse, \$ 100

Valuation of horse equipments, \$ 100

Remarks: *died in Post Hospital at Fort Hudson Tex. Nov. 5/64. See Serial #1200*

Book mark:

*Lomera*

(358)

Copyist.

Q | **4 Cav.** | **U.S.C.T.**

*Phillip Ross*  
*Priv. Co. Q, 4 Reg't U. S. Colored Cav.*

Appears on **Returns** as follows:

*Nov. 1864. - Lost Nov. 5/64  
Port Hudson. Died.*

Book mark : \_\_\_\_\_

(546)

*E. Therman*

Copyist.

*I* | **4 Cav.** | **U.S.C.T.**

*Phillip Ross*

....., Co. *B*, 4 Reg't U. S. Col'd Cavalry.

Appears on **Co. Muster-out Roll**, dated  
*New Orleans, La. Feb. 20, 1866.*

Muster-out to date ..... 186 .

Last paid to ..... 186 .

**Clothing account:**

Last settled ..... 186 ; drawn since \$ ..... 100

Due soldier \$ ..... 100 ; due U. S. \$ ..... 100

Am't for cloth'g in kind or money adv'd \$ ..... 100

Due U. S. for arms, equipments, &c., \$ ..... 100

Bounty paid \$ ..... 100 ; due \$ ..... 100

Remarks: *Joined at Org'l Org.*  
*died at Port Hudson La.*  
*Nov. 3./65*

Book mark: *died Nov. 5./65 - E. B. Vol. 10*  
*543*

(861)

*Chandler*

Copyist.

Ross, Phillip

P, Co. B, 4 Reg't 150 Cav.

2 Enclosures.

Bed Cards	Descriptive Lists
Burial Records	Final Statements (
Certs. of Dis. for Discharge	Furloughs
C. M. Charges	Med. Des. Lists
Med. Certificates	Orders

Other papers relating to—

Admission to Hosp'l	Furlough
Casualty Sheet (Officer's)	Med. Examination
Confinement	Misc. Information
Contracts	Pay or Clothing
Death or Effects /	Personal Reports
Desertions	Rank
Discharge from Hosp'l	Transfer to Hosp'l
Discharge from Service	Transfer to V. R. C.
Duty	Transportation

*A.D.O.*  
*See list sent 2d Auditor*  
*B.*

**FINAL STATEMENT**

OF

*Private Phillip Ross, Co. B.*  
*4<sup>th</sup> Reg't of U. S. Colored Cavalry*

**VOLUNTEERS.**

*Phillip Ross*  
*Nov 5 1864*

NOTE 1.—Two of these certificates (or duplicates) are to be given to each volunteer soldier who may be discharged previously to the discharge of his company, that he may at once receive from the Paymaster the pay, &c., due him, and the captain or other officer commanding the company will certify to the act of the delivery of the duplicate certificates; on these certificates the Soldier is "entitled to" his discharge, and should also present his discharge to the Paymaster to have the payment endorsed on it. The discharge is to be given back to the Soldier by the Paymaster; the latter only retaining as his voucher the duplicate certificates.

NOTE 2.—If the Soldier is entitled to pay for the use of his horse, the Company Commander will certify to that fact, and also to the time he has pay due for having been so mounted on his own horse.

NOTE 3.—Amounts due the Sutler and Laundress must be entered on the Muster Roll on which the death, desertion, &c., is reported, as well as on the final statement, otherwise the amount cannot be collected from the United States.

NOTE 4.—This blank will be used for deceased volunteers as well as others.

[OFFICE INDORSEMENT.]

**War Department,**

ADJUTANT GENERAL'S OFFICE,

*Dec 12*, 1873

The death of *Phillip Ross*  
 Private, Co. B, 4<sup>th</sup> Reg't U. S.  
 Colored Cavalry, is reported as follows:—

On Company Muster Roll.  
 For ~~Nov 4~~ *Dec*, 1864, ~~Nov 5~~ *Nov 5*, 1864  
 Company Muster-out Roll.  
 Died *November 3<sup>d</sup>*, 1865  
 Company Descriptive Book.

....., 186  
 Company Morning Reports.  
 ..... , 186  
 Soldier's Final Statement.

....., 186  
 Soldier's Record of Death and Interment.  
 ..... , 186  
 Soldier's Inventory of Effects.

....., 186  
 Soldier's Certificate of Disability for Discharge.  
 ..... , 186  
 Soldier's Individual Muster-out Roll.

....., 186  
 Regimental Return.  
 For *November*, 1864, *November 5<sup>th</sup>*, 1864  
 Regimental Quarterly Returns.

....., 186  
 Regimental Descriptive Book.  
 ..... , 186  
 By Surgeon General.

....., 186  
*Nov 5*, 1864 is held to be  
 the correct date, and the Company Muster ~~out~~  
 Roll will be amended accordingly.

*Thoma M. Lawrence*  
 C.B. 10  
 543 *Asst. Adj. Gen.*  
*see letter to 2d Auditor*  
*dated Jan'y 10. 1874.*



*Lawrence*

ADJUTANT GENERAL'S OFFICE.

*DEC 5 1864*

Duplicate with Inventory sent 2d Auditor.

I certify, on honor, that Phillip Ross a Private of  
 Captain S. McCormack's Company (B) of the Fourth Regiment of U.S. Colored Cavalry,  
**VOLUNTEERS**, of the State of \_\_\_\_\_, born in St. John Baptiste, State  
 of Louisiana, aged 20 years; 5 feet 6 inches high; Black complexion,  
Black eyes, Black hair, and by occupation a Labourer, having joined the company on  
 its original organization at New Orleans, Louisiana, and enrolled in it at the muster into  
 the service of the United States at New Orleans, Louisiana, on the Twenty seventh day  
 of October, 1863, (or was mustered in service as a recruit, by \_\_\_\_\_  
 \_\_\_\_\_, at \_\_\_\_\_, on the \_\_\_\_\_ day of \_\_\_\_\_,  
 186 , to serve in the Regiment,) for the term of Three years  
 and having served **HONESTLY** and **FAITHFULLY** with his Company in The Field  
 to the present date, is now entitled to a **DISCHARGE** by reason of Death.

(Copy)  
 Dec 20<sup>th</sup> 1864 Seal number 13  
 The said Private Phillip Ross was last paid by Paymaster  
Majr. Soffland to include the Thirtieth day of April, 1864, and has  
 pay due him from that time to the present date; he is entitled to pay and subsistence for  
~~TRAVELING~~ to place of enrollment and whatever other allowances are authorized to volunteer  
 soldiers, or militia, so discharged. He has received (55.94) Fifty five  $\frac{94}{100}$  dollars, value in  
 advanced by the United States on account of **CLOTHING**. Kind.

There is to be stopped from him, on account of the State of \_\_\_\_\_, or other  
 authorities for **CLOTHING**, &c., received on entering service, \_\_\_\_\_ dollars; also,  
 for expenses of **SUBSISTENCE** for **TRAVELING** from place of enrollment to the place of rendezvous,  
 amounting to \_\_\_\_\_ dollars: and on account of the United States for **EXTRA**  
**CLOTHING** received in kind from \_\_\_\_\_ and for other  
 stoppages, viz:

\_\_\_\_\_ amounting to \_\_\_\_\_ dollars;  
 and he has been **SUBSISTED** for **TRAVELING** to his place of enrollment, up to the \_\_\_\_\_  
 \_\_\_\_\_, 186 .

He is indebted to John Wild, **SUTLER**, (12.11) Twelve  $\frac{11}{100}$  dollars.  
 He is indebted to \_\_\_\_\_, **LAUNDRESS**, \_\_\_\_\_ dollars.

Given in Duplicate, at Port Hudson, La, this 12<sup>th</sup> day of November, 1864.

Sidoro McCormack  
Captain 4<sup>th</sup> U.S.C. Cavalry  
 Commanding Company.

ARTICLES OF WAR.

ART. 95. When any non-commissioned officer or soldier shall die, or be killed in the service of the United States, the then commanding officer of the troop or company shall, in the presence of two other commissioned officers, take an account of what effects he died possessed of, above his arms and accoutrements, and transmit the same to the office of the Department of War, which said effects are to be accounted for, and paid to the representatives of such deceased non-commissioned officer or soldier. And in case any of the officers, so authorized to take care of the effects of deceased officers and soldiers, should, before they have accounted to their representatives for the same, have occasion to leave the regiment or post, by preferment or otherwise, they shall, before they be permitted to quit the same, deposit in the hands of the commanding officer, or of the assistant military agent, all the effects of such deceased non-commissioned officers and soldiers, in order that the same may be secured for, and paid to, their respective representatives.

ARMY REGULATIONS—EDITION OF 1861.

DECEASED SOLDIERS.

Par. 152. Inventories of the effects of deceased non-commissioned officers and soldiers, required by the 95th Article of War, will be forwarded to the Adjutant General, by the commander of the company to which the deceased belonged, and a duplicate of the same to the colonel of the regiment. Final statements of pay, clothing, &c., will be sent with the inventories. When a soldier dies at a post or station absent from his company, it will be the duty of his immediate commander to furnish the required inventory, and, at the same time, to forward to the commanding officer of the company to which the soldier belonged, a report of his death, specifying the date, place, and cause; to what time he was last paid, and the money or other effects in his possession at the time of his decease; which report will be noted on the next muster-roll of the company to which the man belonged. Each inventory will be endorsed, "Inventory of the effects of \_\_\_\_\_, late of company (—) \_\_\_\_\_ regiment of \_\_\_\_\_, who died at \_\_\_\_\_, the \_\_\_\_\_ day of \_\_\_\_\_, 186—." If a legal representative receive the effects, it will be stated in the report. If the soldier leave no effects, the fact will be reported.

Par. 153. Should the effects of a deceased non-commissioned officer or soldier not be administered upon within a short period after his decease, they shall be disposed of by a Council of Administration, under the authority of the commanding officer of the post, and the proceeds deposited with the Paymaster, to the credit of the United States, until they shall be claimed by the legal representatives of the deceased.

Par. 154. In all such cases of sales by the Council of Administration, a statement in detail, or account of the proceeds, duly certified by the Council and commanding officer, accompanied by the Paymaster's receipt for the proceeds, will be forwarded by the commanding officer to the Adjutant General. The statement will be endorsed, "Report of the proceeds of the effects of \_\_\_\_\_, late of company (—) \_\_\_\_\_ regiment of \_\_\_\_\_, who died at \_\_\_\_\_, the \_\_\_\_\_ day of \_\_\_\_\_, 186—."

NOTE 1.—The effects in all cases, when called for, should be turned over to the legal representative, without further authority from the Adjutant General. When the effects are turned over to the relatives of the deceased before these inventories are sent to the Adjutant General, their receipts therefor should be attached to the inventories. In all other cases, one copy will be sent with a letter of transmittal direct to the Adjutant General, and a duplicate retained by the officer.

NOTE 2.—Particular care should be taken to take receipts in duplicate from the Paymaster for any funds turned over to him; one copy should be sent direct to the Adjutant General and one retained by the officer.

INVENTORY OF THE EFFECTS

OF

*Private Phillip Ross*

Late of Company *B*

*4<sup>th</sup>* Reg't of *U. S. Col. Early*

Volunteers, who died at *Fort Hayes Fort Wm*

on the *5<sup>th</sup>* day of *March* 186*4*.



Inventory of the effects of Phillip Ross late  
 a Private of Captain \_\_\_\_\_ Company B of  
 the 4<sup>th</sup> Regiment of U. S. Cos. Cav. Volunteers, who was enrolled as  
 a \_\_\_\_\_ at \_\_\_\_\_ in the State of \_\_\_\_\_ on  
 the \_\_\_\_\_ day of \_\_\_\_\_ 186 \_\_\_\_\_, and mustered into the service of the United  
 States as a \_\_\_\_\_ on the \_\_\_\_\_ day of \_\_\_\_\_ 186 \_\_\_\_\_, at \_\_\_\_\_  
 in Company \_\_\_\_\_, Regiment of \_\_\_\_\_ Volunteers, to serve \_\_\_\_\_  
 years or during the war; he was born in \_\_\_\_\_ in the State  
 of \_\_\_\_\_; he was \_\_\_\_\_ years of age, \_\_\_\_\_ feet \_\_\_\_\_ inches  
 high, \_\_\_\_\_ complexion, \_\_\_\_\_ eyes, \_\_\_\_\_ hair, and by occupation, when enrolled,  
 a \_\_\_\_\_; he died in San Antonio at  
San Antonio, Tex. on the 5<sup>th</sup> day of November 1864, by  
 reason of Scarlet fever.

INVENTORY.								
ARTICLES.	No.	ARTICLES.	No.	ARTICLES.	No.			
Hats .....	}	Pairs trousers .....	}	Knapsacks .....	}			
Caps .....		Pairs flannel drawers .....						
Forage caps .....		Pairs cotton drawers .....						
Great coats .....		Flannel shirts .....						
Uniform coats .....		Cotton shirts .....						
Uniform jackets .....		Pairs boots .....						
Flannel sack coats .....		Pairs shoes .....						
Blouses .....		Pairs socks .....						
Stable frocks .....		Blankets .....						
Fatigue overalls .....		Haversacks .....						
				MONEY.		Specie .....	\$	{
						Notes .....	\$	}

I CERTIFY, ON HONOR, that the above inventory comprises all the effects of Phillip Ross  
Phillip Ross deceased, and that the effects are in the hands  
 of Surg. A. G. David at San Antonio, Tex.  
San Antonio, Tex. to be disposed of by a Council of Administration.

( DUPLICATES. )

STATION : San Antonio, Tex.

DATE : November 5<sup>th</sup> 1864

A. G. David  
 Surgeon in Charge of San Antonio  
 Commanding the Company.

948 H. Aug.  
Rowley Ralph A.  
Co H, 4 U. S. Col'd Cav.

1st Lieut | 1st Lieut.

CARD NUMBERS.

1	5347388	26
2	5357229	27
3	5357284	28
4	5357343	29
5	5357397	30
6	5357448	31
7	5357497	32
8	5357543	33
9	5357629	34
10	5357716	35
11	5357795	36
12	5357873	37
13	5357948	38
14	5358022	39
15	M-297-07-1865	40
16	40729184	41
17		42
18		43
19		44
20		45
21		46
22		47
23		48
24		49
25		50

Book Mark: M-297-07-1865

See also 3 Mass Cav.

S1579481 auto.

RX P601338.

D. 2432930 PONTM

D. Jordan  
Ex

R | 4. Cav | U.S.C.T.

Ralph A. Rowley  
1<sup>st</sup> Lt. H. 4 (Regt. Cav 6<sup>th</sup> A.)  
Co. H., 4 Regt U. S. Col'd Cav

Age 21 years.

Appears on an

**Individual Muster-in Roll**

of the organization named above. Roll dated

New Orleans, April 8, 1864.

Muster-in to date April 8, 1864.

Joined for duty and enrolled:

When April 8, 1864.

Where New Orleans

Period 3 years.

Valuation of horse, \$ 100

Valuation of horse equipments, \$ 100

Remarks: Honorably dis-  
charged to accept  
promotion Feb. 1864  
as sergeant 3<sup>rd</sup> Mass.

Book mark: M-297-07-1865

(336)

Pennington  
over Copyist.

JAN. - 8

5347388

★ 1891 ★

Remarks:  
Cavalry in Par. 3,  
Special Orders No.  
29, Dated Hd. Qrs.  
Dept. of the Gulf.  
Feby 3<sup>rd</sup> 1864.  
Original Vacancy.

*R* | **4 Cav.** | **U.S.C.T.**

*R. Aug. Rowley*  
*1st Lieut.*, Co. H, 4 Reg't U. S. Col'd Cavalry.

Appears on

**Company Muster Roll**

for *Apr. 8 to 30*, 1864.

Present or absent *Present*

Stoppage, \$ *100* for

Due Gov't, \$ *100* for

Valuation of horse, \$ *100*

Valuation of horse equipments, \$ *100*

Remarks:

Book mark:

*L. Williams*

(358)

Copyist.

*R* | **4 Cav.** | **U.S.C.T.**

*R. Aug. Rowley*  
*1st Lt.* Co. H, 4 Reg't U. S. Cold Cavalry.

Appears on

**Company Muster Roll**

for *May & June*, 186*4*.

Present or absent *Present*

Stoppage, \$ *100* for

Due Gov't, \$ *100* for

Valuation of horse, \$ *100*

Valuation of horse equipments, \$ *100*

Remarks: *Allowance claimed for being in charge of company property since Apr. 8*

Book mark:

(358)

*C. Williams*

Copyist.

*R* | **4 Cav.** | **U.S.C.T.**

*R. Aug. Rowley*  
*1st Lieut*, Co. H, 4 Reg't U. S. Corp'd Cavalry.

Appears on

**Company Muster Roll**  
for *July & Aug*, 1864  
Present or absent *Present*

Stoppage, \$ *100* for

Due Gov't, \$ *100* for

Valuation of horse, \$ *100*

Valuation of horse equipments, \$ *100*

Remarks: *allowance*  
*claimed for being re-*  
*sponsible for Company*  
*property since*  
*June 30.*

Book mark: *i*

(358)

*L. Williams,*  
Copyist.



*R* | **4 Cav.** | **U.S.C.T.**

*R. Aug Rowley*

*1* ~~Lieut.~~, Co. H, 4 Reg't U. S. Col'd Cavalry.

Appears on

**Company Muster Roll**

for *Sept. & Oct.*, 1864.

Present or absent *Present*

Stoppage, \$ *100* for

Due Gov't, \$ *100* for

Valuation of horse, \$ *100*

Valuation of horse equipments, \$ *100*

Remarks: *Allowance claimed for being responsible for Co. property since Aug. 31<sup>st</sup>*

Book mark:

(358)

*G. Williams*  
Copyist.

R | 4 Cav. | U.S.C.T.

Ralph A Rowley  
1st Lieut, Co. H, 4 Reg't U. S. Col'd Cavalry.

Appears on

**Company Muster Roll**

for Nov, & Dec, 1864.

Present or absent Present

Stoppage, \$ 100 for

Due Gov't, \$ 100 for

Valuation of horse, \$ 100

Valuation of horse equipments, \$ 100

Remarks: Allowance claimed  
for property responsibility  
since Apr, 8, 1864.

Book mark:

C. Williams,

R

4 Cav. U.S.C.T.

Ralph A. Rowley

1<sup>st</sup> Lt., Co. H, 4 Reg't U. S. Col'd Cavalry.

Appears on

Company Muster Roll

for Jan'y & Feb, 1865.

Present or absent Present.

Stoppage, \$ 100 for

Due Gov't, \$ 100 for

Valuation of horse, \$ 100

Valuation of horse equipments, \$ 100

Remarks: Allowance claimed for Property Responsibility since Aug 3<sup>rd</sup> /64

Book mark:

Harlan

Copyist.

R | 4 Cav. | U.S.C.T.

Ralph A. Cowley  
1st Lt., Co. H, 4 Reg't U. S. Col'd Cavalry.

Appears on

Company Muster Roll

for March and April, 1865.

Present or absent Present

Stoppage, \$ 100 for

Due Gov't, \$ 100 for

Valuation of horse, \$ 100

Valuation of horse equipments, \$ 100

Remarks: Assigned to duty in  
Co. "A" 4 Inf. Co. by S. O.  
no. 15. Adprs. 4 Inf. Co. Co.  
March 24/65. Allowed for  
responsibility of U.S. Prop-  
erty to March 24/65.  
Dues to S. for advance  
46 cents.

Book mark:

M  
Master

*R* | **4 Cav. | U.S.C.T.**

*Ralph A. Rowley*  
*1st Lt.*, Co. H, 4 Reg't U. S. Col'd Cavalry.

Appears on

**Company Muster Roll**

for *May J. June*, 186*5*.

Present or absent

Stoppage, \$ 100 for

Due Gov't, \$ 100 for

Valuation of horse, \$ 100

Valuation of horse equipments, \$ 100

Remarks: *Absent. Sick in*  
*Marine Hospital New*  
*Orleans, La. Stop. for*  
*2 mosquito bars \$4.00.*  
*Stop. 2 hrs. Srgt's Chev-*  
*rons \$54, 30 cross*  
*sabres \$60.*

*Due U.S. for ordnance \$46*

Book mark:

*Feaster*

*R* | **4 Cav.** | **U.S.C.T.**

*Ralph A. Rowley*  
*1st Lt.*, Co. H, 4 Reg't U. S. Col'd Cavalry.

Appears on

**Company Muster Roll**  
for *July & Aug*, 186*5*.

Present or absent

Stoppage, \$ 100 for

Due Gov't, \$ 100 for

Valuation of horse, \$ 100

Valuation of horse equipments, \$ 100

Remarks: *Detailed as act adjt.,*  
*per S. O. No. 43. Ex't. 2<sup>nd</sup>.*  
*dated Hd Qrs. 4<sup>th</sup> U.S. C. C.,*  
*Port Hudson, La., Aug. 10<sup>th</sup> /65.*  
*Stop for 2 mosquito bars*  
*\$4.00. 2 Srgts chevrons*  
*\$5.40. 30 Cross sabres*  
*\$60. Due U.S. for advance*  
*\$46.*

Book mark:

*Feaster*

R | **4 Cav.** | **U.S.C.T.**

*Ralph A. Rowley*

*1st Lt.*, Co. H, 4 Reg't U. S. Col'd Cavalry.

Appears on

**Company Muster Roll**

for *Sept. 9. Oct.*, 186*5*.

Present or absent *Absent*

Stoppage, \$ 100 for

Due Gov't, \$ 100 for

Valuation of horse, \$ 100

Valuation of horse equipments, \$ 100

Remarks: *Detained as Act.*

*Reg't. Adj't., Aug. 10, 1865, per  
S.O. No. 43, Ex. 2d, dated 24<sup>th</sup> Dec. 4<sup>th</sup>.  
U.S. C. Co., Port Henderson, La.,  
Aug. 10, 1865. Claims allowed for  
commanding company from  
Aug. 31, 1864 to March 24, 1865.  
Also for commanding "A" com-*

Book mark: \_\_\_\_\_

*(over)*

*Scaster*

JAN. - 8

5357795

1891

Army from March  
24<sup>th</sup> 1860 to May 21<sup>st</sup> 1865.  
Stop for 2 mosquito  
bars \$4. 2 Srgt. chev-  
rons \$34. 30 cross-  
sabres \$60.

Due U.S. for ord-  
nance \$46.



R | 4 Cav. | U.S.C.T.

*Culpeper M. Rowley*  
1st Lt., Co. H, 4 Reg't U. S. Col'd Cavalry.

Appears on

**Company Muster Roll**

for *dated Dec 31*, 1865.

Present or absent *Present*

Stoppage, \$ *100* for

Due Gov't, \$ *100* for

Valuation of horse, \$ *100*

Valuation of horse equipments, \$ *100*

Remarks: *Ordered as acting Adjutant Aug 10/65 per S.O. 43 dated H. Ins. H. U.S.C. Aug 10/65. One for Comdg. Co. from Aug 3/64 to Mar 24/65. One for Comdg. Co. "A" from Mar 24/65 to May 2/65. Slip for two mosquito bars, 2 Serjeants Chevrons, 30 cross sabres, total \$5.14*

Book mark: \_\_\_\_\_

(358)

*A. E. Arnold*

Copyist.

1865

*R.* | **4 Cav.** | **U.S.C.T.**

*Ralph A. Rowley*

*1st Lieut* Co. H, 4 Reg't U. S. Col'd Cavalry.

Appears on

**Company Muster Roll**

for *Jan + Feb.*, 186*6*.

Present or absent *Present*

Stoppage, \$ *100* for

Due Gov't, \$ *100* for

Valuation of horse, \$ *100*

Valuation of horse equipments, \$ *100*

Remarks: *Detained as Act. Adj. Aug. 10/65 per S.O. 43, dated Ad. Drs. 4" U.S.C.C. Aug 10/65. Due for Comd. Co. "H" from Aug 31/64 to Mar. 24/65. Due for Comd. Co. "A" from Mar 24 to May 21, 65. Stop for 2 (over)*

Book mark:

*H. E. Harold*

(358)

Copyist.

JAN. - 8

5357948

1891 \*

Mosquito Bars \$4.00.  
2 Sgt. Chevrons, 30 cts.  
30, Cross Sabre, Total \$5.14

R | 4 Cav. | U.S.C.T.

+ Ralph W. Rowley

1st Lt., Co. D, 4 Reg't U. S. Colored Cav.  
H

Appears on Returns as follows:

Feb. 1864. - (1 Regt. Cav., Corps  
d'Afrique) Present, comm'd.  
but not mustered. Assigned  
to duty temporarily with  
Co. B

March 1864. - Present, assigned  
to duty temporarily.

Apr. 1864. - (Co. H, 4 Regt. U.S. Col. Cav.)  
Present. Transf'd from Co. B  
& mustered in Co. H.

May to Sept. 1864. - Present

Oct. 1864. - Present

Nov. 1864 to Feb. 1865. - Present

March 1865. - Present. Relieved from  
duty with Co. H and as-  
signed to command of  
Co. H, in S.O. No. 15 Geo.

Iss. 4" U.S. Col. Cav. March 24/65

April 1865. - Present. Assigned to  
duty in Co. H, by S.O. No. 15 (over)

Book mark:

E. Thornton

JAN. 18

40729184

1899.

Head. Ser. 4 U.S. C. Navy, March 24  
'65.

May 1865. - Present. Relieved  
from duty with Co. A,  
S.O. No. 22 Head. Ser. 4 U.S.  
C. Navy. Series 1865

June 1865. - Absent sick in  
Marine Hosp. at New  
Orleans La. since June 14/65

July 1865. - Present

Aug. & Sept. 1865. Present actg.  
adjt. of Regt. per S.O. 43 Head.  
Ser. 4 U.S.C. Aug. 8/65

Oct. to Dec. 1865. Present actg.  
adjt. per S.O. No. 295  
Head. Ser. C. Dept. of A.  
Oct. 16/65

Jan. & Feb. 1866. - Present

\* name appears also as Ralph  
Rowley, R. Aug. Rowley, R. S.  
Rowley.

R. | H. Cary. : | Wfe R

Ralph A. Rowley.

1st Lieut, Co. . . . ., 4<sup>th</sup> Reg't Wfe Cary.

**NOTATION.**

Book mark: M. 297. C. D. 1865.

**War Department,**

Adjutant General's Office,

Washington, October 8<sup>th</sup>, 1879.

See also Co. L. 3 Mass. Cav.

A. M. Muzzey  
Copyist.

*R* | **4 Cav. | U.S.C.T.**

*Ralph A Rowley*

*1<sup>st</sup>* Lieut, Co. *H*, 4 Reg't U. S. Col'd Cavalry.

Appears on **Co. Muster-out Roll**, dated  
*New Orleans La, Mar 20, 1866*.

Muster-out to date *Mar 20, 1866*.

Last paid to *May 31, 1865*.

**Clothing account:**

Last settled....., 186 ; drawn since \$.....100

Due soldier \$.....100; due U. S. \$.....100

Am't for cloth'g in kind or money adv'd \$.....100

Due U. S. for arms, equipments, &c., \$.....100

Bounty paid \$.....100; due \$.....100

Remarks: *Entered service at  
Boston Mass. as privt.  
2<sup>nd</sup> Mass. Cav. Nov 15/61  
App'd. 1<sup>st</sup> Lieut. 4<sup>th</sup> U.S.C. 4<sup>th</sup>  
Apr. 8/64. Entitled to  
3 months extra pay paper*

Book mark: *over*

*N. E. Arnold*

JAN.-8

5358022

1891

as provided in G. O.  
45 of 1865, War Dept.  
A. G. O. Service has  
been continuous



Rowley R. A.

Lieut. Co. 4 Reg't U.S.C.C.

Enclosures.

Bed Cards	Final Statements
Burial Records	Furloughs or L. of A.
Certs. of Dis. for Discharge	Med. Certificates
C. M. Charges	Med. Des. Lists
Descriptive Lists	Orders
Discharge Certificates	Pris. of War Record
Enlistment Papers	Resignations

Other papers relating to—

Admission to Hosp'l	Furlough or L. of A.
Casualty Sheet	Med. Examination
Confinement	Misc. Information 2
Contracts	Pay or Clothing
Death or Effects	Personal Reports
Desertion	Rank
Discharge from Hosp'l	Transfer to Hosp'l
Discharge from Service	Transfer to V. R. C.
Duty /	Transportation

MICROFILM PUBLICATION M 1820

COMPILED MILITARY SERVICE RECORDS  
OF VOLUNTEER UNION SOLDIERS WHO  
SERVED WITH THE USCT (US COLORED TROOPS)  
4TH REGIMENT OF CAVALRY

PERSONAL PAPERS' TARGET SHEET

PLEASE NOTE THE CHECKED INFORMATION ABOUT THE PERSONAL PAPERS IN  
THIS FILE:



NO PERSONAL PAPERS WERE FOUND IN THIS FILE WHEN THE  
RECORDS WERE ARRANGED FOR MICROFILMING.



3 PERSONAL PAPER(S) FOUND IN THIS FILE WHEN THE RECORDS  
WERE ARRANGED FOR MICROFILMING.

3647

Grand Auditor U.S. C. Co.  
Port Hudson, La.

White Paper 1,  
Grand Auditor U.S. C. Co.

Receipts on Order of the  
1st Lt. G. S. Co. "H"

U.S. C. Co. on Submarine  
and other Accounts  
of the Grand Auditor

24 1865

Finley  
P

Recd P.M. Oct 11<sup>th</sup> 1865

Head-Quarters, United States Forces,

Port Hudson, La., Oct 11<sup>th</sup> 1865.

Q. R. 278

Respectfully forwarded:

Approved

H. N. Frisbie

Col. 92d U. S. Col'd Inf'ty Commanding Post.



St. Kew, 1<sup>st</sup> Dec 1864  
A King for our children  
of the day / in the old  
Garden

Mar 11, 64

Delivered to  
John Morris  
1st Co. 63

Wm C. B. M. Co. D. A.  
New Orleans La.  
March 11<sup>th</sup> 64.

Captain

Please deliver to  
bearer the belts and sabre belonging to  
private Harrison Gray of this command.  
Said Harrison Gray was before the  
Court yesterday as a witness and was  
afterward sent back to camp under  
guard his belts being retained.

Very Respectfully

Your Obedt. Servant

Ralph Aug. Rowley  
M. Hunt - Conroy Company

To Capt. J. Pickens  
Asst. Post Marshall  
Defences of New Orleans

Head Quarters, Dist. of Morganza.  
Morganza, La. April 10<sup>th</sup> 1865.

---

Thomas J. M. Kean  
Brig. Genl. Comdg. Dist.

---

Tender report of the arrival  
and return of Lieut. Rowley  
4<sup>th</sup> U. S. C. Cav.

---

File

Vol. 47 SR. Dist. R.H. Co. 1865

Recd Dist PH April 10 1865

No 175

Headquarters District of Morganza,

Morganza, La., April 6<sup>th</sup> 1865.

Sir

Sicut Nowley 11<sup>th</sup> U.S.C. has arrived at this Post last night with a small escort to telegraph repairer and as I did not deem it safe for him to return by land, I have sent him by Government Boat.

Very respectfully

Your Obedt. Servant

Wm. J. McKeen

15<sup>th</sup> Regt. U.S.C.

Company Post.

Company Officer

Dist. Post Hudson

Post Hudson

La.



*Ruffin Burrell*

**Co B, 4 U. S. Col'd Cav.**

*Private*

*Saddler*

**CARD NUMBERS.**

1	26
2	27
3	28
4	29
5	30
6	31
7	32
8	33
9	34
10	35
11	36
12	37
13	38
14	39
15	40
16	41
17	42
18	43
19	44
20	45
21	46
22	47
23	48
24	49
25	50

*See Ruffing, Burrell.*

**Book Mark:** \_\_\_\_\_

**See also:** \_\_\_\_\_

950

Rushton Lloyd

Co. A, 4 U. S. Col'd Cav.

Private

Private

CARD NUMBERS.

1	5347574	26
2	5358428	27
3	5358477	28
4	5358528	29
5	5358572	30
6	5358614	31
7	5348051	32
8	5355659	33
9	5355743	34
10	5355825	35
11	5355905	36
12	5355986	37
13	5356064	38
14	5356141	39
15	40729187	40
16		41
17		42
18		43
19		44
20		45
21		46
22		47
23		48
24		49
25		50

Book Mark:

See also

*R* | **4 Cav.** | **U.S.C.T.**

*Floyd Rushton*

Appears with rank of *Priv.* on

**Muster and Descriptive Roll of a Detachment of U. S. Vols. forwarded**

for the 4 Reg't U. S. Col'd Cavalry. Roll dated *New Orleans La., May 9, 1864.*

Where born *Annapolis, Md.*

Age *41* y'rs; occupation *Waiter*

When enlisted *Apr. 27*, 1864.

Where enlisted *Alexandria*

For what period enlisted *3* years.

Eyes *Black*; hair *Black*

Complexion *Black*; height *5-3/4* in.

When mustered in *May 9*, 1864.

Where mustered in *New Orleans*

*Premium paid*  
Bounty paid \$ *100*; due \$ *100*

Where credited

Company to which assigned *R*

Remarks:

Book mark:

*Wm. A. Steer*

R | 4 Cav. | U.S.C.T.

Lloyd Rushton  
Co. K, 4 Reg't U. S. Col'd Cavalry.

Age ..... years.

Appears on

Company Muster Roll\*

for May 9 to June 30, 1864.

Joined for duty and enrolled:

When Apr. 27, 1864.

Where Alexandria, La.

Period 3 years.

Mustered in:

When May 9, 1864.

Where New Orleans, La.

Present or absent Present

Stoppage, \$ 100 for

Due Gov't, \$ 100 for

Valuation of horse, \$ 100

Valuation of horse equipments, \$ 100

Remarks :

\* First current roll. - No muster-in roll of this battery on file.

Book mark :

(3586)

W. S. Thompson

Copyist.

19 | 4 Cav. | U.S.C.T.

Lloyd Washburn

Private, Co. K, 4 Reg't U. S. Col'd Cav.

Appears on

Company Muster Roll

for July & Aug., 1864.

Present or absent Present

Stoppage, \$ 100 for

Due Gov't, \$ 100 for

Valuation of horse, \$ 100

Valuation of horse equipments, \$ 100

Remarks: Captain's servant

Book mark:

W. S. Sampson

(358)

Copyist.

R | **4 Cav.** | **U.S.C.T.**

Lloyd Rushton  
Priv., Co. K, 4 Reg't U. S. Col'd Cav.

Appears on

**Company Muster Roll**

for Sept & Oct., 1864.

Present or absent Present

Stoppage, \$ 100 for

Due Gov't, \$ 100 for

Valuation of horse, \$ 100

Valuation of horse equipments, \$ 100

Remarks: Company Cook  
since Sept 30, 64

Book mark: \_\_\_\_\_

(358)

M. S. Thompson  
Copyist.

R | 4 Cav. | U.S.C.T.

Lloyd Rushton  
Cvt., Co. K, 4 Reg't U. S. Col'd Cav.

Appears on

Company Muster Roll

for Nov. & Dec., 1864.

Present or absent Present

Stoppage, \$ 100 for

Due Gov't, \$ 100 for

Valuation of horse, \$ 100

Valuation of horse equipments, \$ 100

Remarks: Company Cook  
since Sept. 20

Book mark:

(358)

W.S. Thompson  
Copyist.

R | **4 Cav.** | **U.S.C.T.**

Lloyd Rishston  
Priv., Co. K, 4 Reg't U. S. Col'd Cav.

Appears on

**Company Muster Roll**

for Jan. & Feb., 1865.

Present or absent Present

Stoppage, \$ 100 for

Due Gov't, \$ 100 for

Valuation of horse, \$ 100

Valuation of horse equipments, \$ 100

Remarks: Company Cook since  
Sept. 30, 1864.

Book mark: \_\_\_\_\_

(358)

W. S. Thompson  
Copyist.



4 Cav. | **U.S.C.T.**

Lloyd Ruskton  
Bvt. Co. G, 4 Reg't U. S. Col'd Cav.

Appears on

**M. and D. Roll of Men Transferred**

to the organization named above, by Consul.  
from Co. K

Roll dated Port Hudson, La. Apr 29, 1865.

When enlisted Apr 27, 1864.

Period for which enlisted 3 years.

When mustered in May 9, 1864.

Present or absent Not Stated

Company to which assigned A

Remarks:

Book mark:

(342) *M. J. ...* Copyist.

*P* | **4 Cav. | U.S.C.T.**

*Lloyd Pushtori*  
*Pvt*, Co. F, 4 Reg't U. S. Col'd Cavalry.

Appears on

**Company Muster Roll**  
for *Mch & Apr*, 186*5*  
Present or absent *Present*

Stoppage, \$ *100* for

Due Gov't, \$ *100* for

Valuation of horse, \$ *100*

Valuation of horse equipments, \$ *100*

Remarks: *Joined by Transfer*  
*from K<sup>o</sup> Co. Pr S.O No. 28"*  
*dated Hd Qrs. Dept of the*  
*Gulf Jan. 28/865*

Book mark :

*L. H. Harris*

(358)

Copyist.

*R* | **4 Cav.** | **U.S.C.T.**

*Lloyd Rushton*

*Pr*, Co. F, 4 Reg't U. S. Col'd Cavalry.

Appears on

**Company Muster Roll**

for *May & June*, 186*5*

Present or absent *Present*

Stoppage, \$.....100 for .....

Due Gov't, \$.....100 for .....

Valuation of horse, \$.....100

Valuation of horse equipments, \$.....100

Remarks: .....

Book mark: .....

*J. A. Harris*

(358)

Copyist.

*R* | **4 Cav.** | **U.S.C.T.**

*Lloyd Rushton*

*Pvt.*, Co. F, 4 Reg't U. S. Col'd Cavalry.

Appears on

**Company Muster Roll**

for *July & Aug*, 186 *5*

Present or absent *Present*

Stoppage, \$ *100* for

Due Gov't, \$ *100* for

Valuation of horse, \$ *100*

Valuation of horse equipments, \$ *100*

Remarks:

Book mark:

*M Harris*

*R* | 4 Cav. | U.S.C.T.

*Lloyd Rushton*

*Pr*, Co. F, 4 Reg't U. S. Col'd Cavalry.

Appears on

**Company Muster Roll**

for *Sept & Oct*, 186 *5*.

Present or absent *Present*

Stoppage, \$ *100* for

Due Gov't, \$ *100* for

Valuation of horse, \$ *100*

Valuation of horse equipments, \$ *100*

Remarks:

Book mark:

*A Harris*

R | 4 Cav. | U.S.C.T.

Lloyd Rushton

P, Co. F, 4 Reg't U. S. Col'd Cavalry.

Appears on

**Company Muster Roll**

for Nov. & Dec., 1865.

Present or absent Present

Stoppage, \$ 100 for

Due Gov't, \$ 100 for

Valuation of horse, \$ 100

Valuation of horse equipments, \$ 100

Remarks:

Book mark:

(358)

Hibbard  
Copyist.

R | 4 Cav. | U.S.C.T.

Lloyd Rushton

P, Co. F, 4 Reg't U. S. Col'd Cavalry.

Appears on

**Company Muster Roll**

for Jan. Feb., 1866.

Present or absent Present

Stoppage, \$ 100 for

Due Gov't, \$ 100 for

Valuation of horse, \$ 100

Valuation of horse equipments, \$ 100

Remarks:

Book mark:

(358)

Hibbard

Copyist.

9 | 4 Cav. | U.S.C.T.

Lloyd Rushton  
Priv. Co. K. 4 Reg't U. S. Colored Cav.

Appears on Returns as follows:

May & June 1864 - On duty  
Co. Cook

Aug. & Sept. 1864 - On duty  
servant for Capt.  
Goodrich

Oct. 1864 - On duty Co. Cook.

Nov. 1864 to Feb. 1865 - On  
duty Co. Cook.

\* name appears also as George  
Rushton

Book mark:

E. Hernton

(546)

Copyist.



R | 4 Cav. | U.S.C.T.

*Lloyd Rushton*

P, Co. F, 4 Reg't U. S. Col'd Cavalry.

Appears on Co. Muster-out Roll, dated  
*New Orleans, La., Mch. 20* 1866.

Muster-out to date *Mch. 20*, 1866.

Last paid to *June 30*, 1865.

Clothing account:

Last settled....., 186 ; drawn since \$..... 100

Due soldier \$ *26.71* 100; due U. S. \$..... 100

Am't for cloth'g in kind or money adv'd \$..... 100

Due U. S. for arms, equipments, &c., \$..... 100

Bounty paid \$..... 100; due \$..... 100

Remarks: *Joined by transfer from  
K Co. per S.O. 28, Hdqrs. D. G.  
Jan. 28, 65.*

Book mark: *V62 - P123 - 69.*

(861)

*Wibbard*  
Copyist.

957

Russell Victor

Co D, 4 U. S. Col'd Cav.

Private

Private

CARD NUMBERS.

1	5349855	26
2	5349955	27
3	5350071	28
4	5350177	29
5	5351232	30
6	40729188	31
7		32
8		33
9		34
10		35
11		36
12		37
13		38
14		39
15		40
16		41
17		42
18		43
19		44
20		45
21		46
22		47
23		48
24		49
25		50

Book Mark:

See also

*R* | **4 Cav. | U.S.C.T.**

*Victor Russell*

*Co. B*, 1 Reg't La. Cav., Corps d'Afrique.\*

\*Age 20 yrs.

Appears on

**Company Muster-in Roll**

of the organization named above. Roll dated

*New Orleans La Oct 27*, 186<sup>3</sup>.

Muster-in to date

*Oct 27*, 186<sup>3</sup>.

Joined for duty and enrolled:

When

*Oct 19*

186

Where

*New Orleans*

Period

*3*

years.

Valuation of horse, \$.....100

Valuation of horse equipments, \$.....100

Remarks:

\* Inserted by *Jordan Ex*

\*This organization subsequently became Co. *B*, 4 Reg't U. S. Colored Cavalry.

Book mark:

(356)

*Miss*  
Coyist.

*P* | **4 Cav. | U.S.C.T.**

*Victor Russell*  
*Co. B*, 1 Reg't La. Cav., Corps d'Afrique.\*

Appears on

**Company Muster Roll**

for *Oct 27 to Nov 31*, 186 *3*

Present or absent *Present*

Stoppage, \$ *100* for

Due Gov't, \$ *100* for

Valuation of horse, \$ *100*

Valuation of horse equipments, \$ *100*

Remarks:  
\_\_\_\_\_  
\_\_\_\_\_  
\_\_\_\_\_  
\_\_\_\_\_  
\_\_\_\_\_

\*This organization subsequently became Co. *B*, 4 Reg't U. S. Colored Cavalry.

Book mark: \_\_\_\_\_

*Spring*  
Copyist.

*P.*

**4 Cav. U.S C.T.**

*Victor Russell*

*Plt*, Co. *B*, 1 Reg't Cav., Corps d'Afrique.\*

Appears on

**Company Muster Roll**

for *Jan & Feb*, 1864.

Present or absent

Stoppage, \$ *100* for

Due Gov't, \$ *100* for

Valuation of horse, \$ *100*

Valuation of horse equipments, \$ *100*

Remarks: *Deserted, New Orleans*  
*Jan 12" 1864. Due U.S. for Ord-*  
*nance \$10.65*

\* This organization subsequently became Co. *B*, 4 Reg't U. S. Colored Cavalry.

Book mark:

*Spiny*  
Copyist.

*P* | **4 Cav.** | **U.S.C.T.**

*Victor Russell*

*Co. B.*, Co. B. 4 Reg't U. S. Col'd Cavalry.

Appears on

**Company Muster Roll**

for *Mch + Apr*, 186*4*

Present or absent

Stoppage, \$ *100* for

Due Gov't, \$ *100* for

Valuation of horse, \$ *100*

Valuation of horse equipments, \$ *100*

Remarks: *Deserted New Orleans  
Feb 1<sup>st</sup>. Arrested and sent to  
Cay Tortugas by Judge Atacha  
for 3 years*

Book mark:

(358)

*J. D.* Copyist.

R | 4 Cav. | U.S.C.T.

Victor Russell

Priv. Co. D, 4 Reg't U. S. Colored Cav.

Appears on Returns as follows:

Feb. & March 1864. - (1 Regt. Cav.,  
corps d'Afrique) Loss:  
Departed Jan. 12/64  
at Bayou St. John.

Book mark:

(546)

E. H. Therman

Copyist.

*RB* | **4 Cav.** | **U.S.C.T.**

*Victor Russell*

....., Co *B*, 4 Reg't U. S. Col'd Cavalry.

Appears on **Co. Muster-out Roll**, dated  
*New Orleans, La. Mch. 20*, 1866.

Muster-out to date ....., 186 .

Last paid to ....., 186 .

Clothing account:

Last settled *never*, 186 ; drawn since \$ *44* <sup>69</sup>/<sub>100</sub>

Due soldier \$ ..... 100; due U. S. \$ ..... 100

Am't for cloth'g in kind or money adv'd \$ ..... 100

Due U. S. for arms, equipments, &c., \$ ..... 100

Bounty paid \$ ..... 100; due \$ ..... 100

Remarks: *Joined at Org'l Regt.*

*Deserted at Bayou St. John La.*  
*Jan. 12. /64*

Book mark : .....

(361)

*Chandler*

Copyist.



Sabine Amiel

Co G, 4 U. S. Col'd Cav.

Sergeant Private

CARD NUMBERS.

1	5356196	26
2	5356249	27
3	5356303	28
4	5356359	29
5	5356411	30
6	5356460	31
7	5356521	32
8	5356585	33
9	5356710	34
10	5356795	35
11	5356887	36
12	5356973	37
13	5357068	38
14	5357154	39
15		40
16		41
17		42
18		43
19		44
20		45
21		46
22		47
23		48
24		49
25		50

Book Mark:

See also

01409426 aud. recd.  
01649648 aud. recd.

*W. H. Miller*

S | **4 Cav.** | **U.S.C.T.**

Amiel Sabine  
Sgt., Co. G, 1 Reg't, Corps d'Afrique Cavalry.\*  
Appears on

**Company Muster-in Roll**

of the organization named above. Roll dated  
New Orleans, La, Feb 8, 1864.  
Muster-in to date Feb 8, 1864.

Joined for duty and enrolled:

When Dec 25, 1863.  
Where New Iberia, La.  
Period 3 years.

Valuation of horse, \$.....100

Valuation of horse equipments, \$.....100

Remarks: Pd. \$2 Premium

\*This organization subsequently became Co. G, 4 Reg't U. S. Colored Cavalry.

Book mark: .....

(356)

Louvy

Copyist.

*S* 4 Cav. | U.S C.T.

*Amiel Sabine*

*Sgt*, Co. *G*, 1 Reg't Cav., Corps d'Afrique.\*  
Appears on

**Company Muster Roll**

for *Enrollment to Feb 29, 1864.*

Present or absent *Present*

Stoppage, \$ *100* for

Due Gov't, \$ *100* for

Valuation of horse, \$ *100*

Valuation of horse equipments, \$ *100*

Remarks:  
-----  
-----  
-----  
-----  
-----  
-----  
-----  
-----

\* This organization subsequently became Co. *G*, 4 Reg't U. S. Colored Cavalry.

Book mark: -----

*Lowry*

*S* | **4 Cav. | U. S. C. T.**

*Amiel Sabine*  
*Sgt*, Co. G, 4 Reg't U. S. Col'd Cavalry.  
Appears on

**Company Muster Roll**

for *Mich & Apr*, 1864.

Present or absent *Present*

Stoppage, \$ *100* for

Due Gov't, \$ *100* for

Valuation of horse, \$ *100*

Valuation of horse equipments, \$ *100*

Remarks:

Book mark:

(358) *Lowry* Copyist.

*S* | **4 Cav. | U.S.C.T.**

*Amiel Sabine*  
*198*, Co. G, 4 Reg't U. S. Col'd Cavalry.  
Appears on

**Company Muster Roll**

for *May & June*, 1864.

Present or absent *Present*

Stoppage, \$ *100* for

Due Gov't, \$ *100* for

Valuation of horse, \$ *100*

Valuation of horse equipments, \$ *100*

Remarks:

Book mark:

(355)

*Lowry*  
Copyist.

*S* | **4 Cav.** | **U. S. C. T.**

*Amiel Sabine*  
*Sgt*, Co. G, 4 Reg't U. S. Col'd Cavalry.

Appears on

**Company Muster Roll**

for *July & Aug*, 186*4*.

Present or absent *Present*

Stoppage, \$ *100* for

Due Gov't, \$ *100* for

Valuation of horse, \$ *100*

Valuation of horse equipments, \$ *100*

Remarks:

Book mark:

(358)

*Lowry*

Copyist.

*D* | **4 Cav. | U. S. C. T.**

*Amiel Subine*  
*197*, Co. G, 4 Reg't U. S. Col'd Cavalry.  
Appears on

**Company Muster Roll**

for *Sep & Oct*, 186*4*.

Present or absent *Present*

Stoppage, \$ *100* for

Due Gov't, \$ *100* for

Valuation of horse, \$ *100*

Valuation of horse equipments, \$ *100*

Remarks:  
.....  
.....  
.....  
.....  
.....  
.....  
.....  
.....  
.....  
.....

Book mark: .....

*Lowry*  
(358) *Lowry* Copyist.



*ES* | **4 Cav. | U.S.C.T.**

*Amiel Sabine*

*Sgt*, Co. G, 4 Reg't U. S. Col'd Cavalry.

Appears on

**Company Muster Roll**

for *Fort Vie*, 186*4*

Present or absent *Present*

Stoppage, \$ *100* for

Due Gov't, \$ *100* for

Valuation of horse, \$ *100*

Valuation of horse equipments, \$ *100*

Remarks: *Stop for Curry Comb  
Brush, more tag, for  
Spurs here on or  
before April 1961*

Book mark: \_\_\_\_\_

(358)

*Amiel Sabine*  
Copyist.

*AS* | 4 Cav. | U. S. C. T.

*Amiel Sabine*

*Capt.*, Co. G, 4 Reg't U. S. Col'd Cavalry.

Appears on

**Company Muster Roll**

for *Jan & Feb*, 1865.

Present or absent *Present*

Stoppage, \$ *100* for

Due Gov't, \$ *100* for

Valuation of horse, \$ *100*

Valuation of horse equipments, \$ *100*

Remarks: *Received only \$7 per month in Apr 30, 64 & Surg from Feb 86 & in Jan, 65 - from on or before Apr 1, 64. Stop for Curry comb, brush, Mord bag, & pair spurs*

Book mark:

*Amiel Sabine*

*S* | **4 Cav. | U. S. C. T.**

*Amie Sabius*

*On*, Co. G, 4 Reg't U. S. Col'd Cavalry.

Appears on

**Company Muster Roll**

for *Men & am*, 186*5*.

Present or absent *Present*

Stoppage, \$ *100* for

Due Gov't, \$ *100* for

Valuation of horse, \$ *100*

Valuation of horse equipments, \$ *100*

Remarks:

Book mark:

(353)

*Amie Sabius*  
Copyist.

*S* | **4 Cav. | U. S. C. T.**

*Amir Sabir*  
*Am'*, Co. G, 4 Reg't U. S. Col'd Cavalry.

Appears on

**Company Muster Roll**

for *May & June*, 186*5*.

Present or absent *Present*

Stoppage, \$ *100* for

Due Gov't, \$ *100* for

Valuation of horse, \$ *100*

Valuation of horse equipments, \$ *100*

Remarks: *Stop for 2 weeks*  
*2 saddle blankets 3 horse*  
*brushes*

Book mark:

(358)

*Amir Sabir*  
Copyist.

*S* | **4 Cav. | U. S. C. T.**

*Amie Sabier*  
*Amie*, Co. G, 4 Reg't U. S. Col'd Cavalry.

Appears on

**Company Muster Roll**

for *July & Aug*, 1865?

Present or absent *Present*

Stoppage, \$ 100 for

Due Gov't, \$ 100 for

Valuation of horse, \$ 100

Valuation of horse equipments, \$ 100

Remarks:

Book mark:

(358)

*Amie Sabier*  
Copyist.

*S*

**4 Cav. | U. S. C. T.**

*Amiel Sabine*  
....., Co. G, 4 Reg't U. S. Col'd Cavalry.

Appears on

**Company Muster Roll**

for *Sept & Oct*, 186*5*.

Present or absent *Present*

Stoppage, \$.....*100* for .....

Due Gov't, \$.....*100* for .....

Valuation of horse, \$.....*100*

Valuation of horse equipments, \$.....*100*

Remarks: .....

.....  
.....  
.....  
.....  
.....  
.....

ROLL ON FILE FEB 1886

Book mark: .....

*Fletcher*

(358)

Copyist.

*S* | **4 Cav.** | **U.S.C.T.**

*Amiel Sabine*  
*Priv*, Co. G, 4 Reg't U. S. Col'd Cavalry.

Appears on

**Company Muster Roll**

for *Jan & Feb*, 1866.

Present or absent

Stoppage, \$ *5 <sup>25</sup>/<sub>100</sub>* for *lost ransance*

Due Gov't, \$ *100* for

Valuation of horse, \$ *100*

Valuation of horse equipments, \$ *100*

Remarks: *Discharged on*  
*Surgeons Certificate of Dis-*  
*ability Feb 15<sup>th</sup> 1866,*

Book mark: *2000*

(358)

*Fletcher*  
Copyist.

*S* | **4 Cav.** | **U.S.C.T.**

*Amiel Sabine*

*Priv*, Co. *G*, 4 Reg't U. S. Col'd Cavalry.

Appears on **Co. Muster-out Roll**, dated  
*New Orleans, La, Nov 20*, 1866.

Muster-out to date \_\_\_\_\_, 186 .

Last paid to \_\_\_\_\_, 186 .

Clothing account:

Last settled \_\_\_\_\_, 186 ; drawn since \$ \_\_\_\_\_ 100

Due soldier \$ \_\_\_\_\_ 100; due U. S. \$ \_\_\_\_\_ 100

Am't for cloth'g in kind or money adv'd \$ \_\_\_\_\_ 100

Due U. S. for arms, equipments, &c., \$ \_\_\_\_\_ 100

Bounty paid \$ \_\_\_\_\_ 100; due \$ \_\_\_\_\_ 100

Remarks: *Joined at orig. org.*  
*Discharged Feb 15 '66 for*  
*disability*

Book mark: *V 227 P 26. 76*

(861)

*Hletcher*  
Copyist.



Satine, Amiel

P, Co. G, 4 Regt. U. S. C. Cav.

1 Enclosures.

Bed Cards	Descriptive Lists
Burial Records	Final Statements
Certs. of Dis. for Discharge 1	Furloughs
C. M. Charges	Med. Des. Lists
Med. Certificates	Orders

Other papers relating to—

Admission to Hosp'l	Furlough
Casualty Sheet (Officer's)	Med. Examination
Confinement	Misc. Information
Contracts	Pay or Clothing
Death or Effects	Personal Reports
Desertions	Rank
Discharge from Hosp'l	Transfer to Hosp'l
Discharge from Service	Transfer to V. R. C.
Duty	Transportation

Headquarters, Department of Louisiana,  
New Orleans, La. February 13th 1866.  
To be discharged.

By order of Major-General E. R. S. CANBY:

*D. I. Casiare*

1st Lieut., Brevet Captain and A. A. A. G.

duty, or service, or injury was received or disease contracted, stating particularly whether the injury was received or the disease contracted in the line of his duty; and whatever other facts may aid a judgment as to the cause, immediate or remote, of the disability, and the circumstances attending it.

When the facts are not known to the company commander, the certificate of any officer, or affidavit of other person having such knowledge, will be appended—as the surgeon in charge of a hospital, the officer commanding a detachment of recruits, &c., &c.

NOTE 2.

When a probable case for pension, special care must be taken to state the degree of disability—as *1, 2, &c.*, &c.; to describe particularly the disability, wound, or disease; the extent of which it deprives him of the use of any limb or faculty, or affects his health, strength, activity, constitution, or capacity to labor or earn his subsistence. The surgeon will add, from his knowledge of the facts and circumstances, and from the evidence in the case, his professional opinion of the cause or origin of the disability. In the case of discharges by Medical Inspectors, the last paragraph will state that the "discharge was given by consent of the soldier, after a personal examination, and for disability, the nature, degree, and origin of which are correctly described in the within certificate."

Par. 1260 Regulations, Edit. 1861.

Medical officers, in giving certificates of disability, are to take particular care in all cases that have not been under their charge; and especially in epilepsy, convulsions, chronic rheumatism, derangement of the urinary organs, ophthalmia, ulcers, or any obscure disease liable to be feigned or purposely produced; and in no case shall such certificate be given until after sufficient time and examination to detect any attempt at deception.

DIRECTIONS.

This certificate will be made out in *duplicate* by the soldier's company commander, or other officer commanding the separate detachment to which he belongs, and sent by him to the surgeon who has charge of the hospital where the soldier is sick. The surgeon will then fill out and sign the surgeon's certificate, and forward these papers to the regimental, detachment, or post commander, who will forward them, with his action endorsed thereon, through the proper channel, to his division commander; or, if the troops are not attached to a division, to his corps, department, or other commander or officer to whom the authority to discharge enlisted men may be specially delegated.

These certificates, after having received the action of the highest authority to which they are required to be sent, will be returned through the same channel to the regimental, post, or detachment commander, who will, if the discharge is authorized by the endorsement of the proper authority, sign the soldier's discharge, and the last certificate on this paper; see that the soldier is furnished with the proper final statements in duplicate, and furnish BOTH of these certificates direct to the Adjutant General, United States Army, at Washington, D. C.; they will not, under any circumstances, be given into the hands of the soldier.

ADJUTANT GENERAL'S OFFICE  
March 5<sup>th</sup> 1866  
Duplicate sent the Pension Office.

1866 5  
CERTIFICATE OF DISABILITY FOR DISCHARGE

IN THE CASE OF

*Amiel Sabine*  
*Private 1<sup>st</sup> Co. 4<sup>th</sup> Reg't of U.S. Col. Cavalry*

Corps d'Afrique U. S. General Hospital.

New Orleans, La. Feb'y 10<sup>th</sup> 1866

Respectfully forwarded

Discharge approved by  
Board of Examination  
*F. E. Pyette*  
Surgeon 8<sup>th</sup> Reg't U.S. Col. Cavalry  
President of Board



Received (A. G. Office) 1866  
*Enton R. Cas*  
*A. B.*

Louisiana  
New Orleans, Feb'y 12 1866  
Respectfully forwarded to the  
Adjutant General  
Department of Louisiana  
*J. D. Martin*  
Adj. Gen'l  
Medical Director

**ARMY OF THE UNITED STATES.**  
**CERTIFICATE**  
**OF DISABILITY FOR DISCHARGE.**



*Amiel Sabino* a private, of Captain *J. W. Loomis*  
of Company, (*G*) of the *Fourth* Regiment of the United States  
*Cavalry* was enlisted by *Lieut. Everts* of  
the *Fourth* Regiment of *United States Cavalry* at *New Iberia La*  
on the *Twenty fifth* day of *December*, 186*3*, to serve *three* years; he was born  
in *Wachonias* in the State of *Louisiana*, is *Twenty four*  
years of age, *Five* feet *Nine* inches high, *Brown* complexion, *Black* eyes,  
~~Black~~ hair, and by occupation when enlisted a *Farmer* During the last two  
months said soldier has been unfit for duty *60* days.\*

STATION: *Corps de Afrique, Genl Hospital*  
DATE: *New Orleans La Feb 11<sup>th</sup> 1866*

*F. E. Piquette*  
*Surgeon in Charge*  
~~Commanding Company~~

I CERTIFY, that I have carefully examined the said *Amiel Sabino*, Private  
of Captain *J. W. Loomis's* Company, and find him incapable of performing the duties of a  
soldier because of † *Phtisis Pulmonalis*

*This disease seems to have commenced since enlistment  
while in the line of duty His present degree  
of disability one third*

*Chas Lodge*  
*C. A. A. Surgeon U. S. A.*

DISCHARGED, this *Fifteenth* day of *February*, 186*6*, at *Corps de Afrique*  
*U. S. General Hospital New Orleans La*

*F. E. Piquette*  
*Surgeon in Charge*  
~~Commanding the Regt.~~

The Soldier desires to be addressed at

Town \_\_\_\_\_ County \_\_\_\_\_ State \_\_\_\_\_

\* See Note 1 on the back of this. † See Note 2 on the back of this.

935  
Dallas Alfred

Co H, 4 U. S. Col'd Cav.

Private | Private

CARD NUMBERS.

1	5347759	26
2	5358228	27
3	5358282	28
4	5358332	29
5	5358375	30
6	5348027	31
7	5357616	32
8	5357698	33
9	5357780	34
10	5357858	35
11	5357933	36
12	5358008	37
12	5358080	38
14	40729203	39
15	30832744	40
16		41
17		42
18		43
19		44
20		45
21		46
22		47
23		48
24		49
25		50

Book Mark:

See also

S | **4 Cav.** | **U.S.C.T.**

Alfred Sallas

Appears with rank of Priv. on

**Muster and Descriptive Roll of a Detachment of U. S. Vols. forwarded**

for the 4 Reg't U. S. Col'd Cavalry. Roll dated New Orleans, La., Aug. 6, 1864.

Where born New Orleans, La.

Age 19 y'rs; occupation Steam B'nd

When enlisted Aug. 1, 1864.

Where enlisted Carrollton, La.

For what period enlisted 3 years.

Eyes Black; hair Brown

Complexion Light; height 5 ft. 3 in.

When mustered in Aug. 6, 1864.

Where mustered in Carrollton, La.

Bounty paid \$ 150 100; due \$ 200 100

Where credited Carrollton, La.

Company to which assigned D

Remarks: recruit entitled to  
Bounty.

Book mark: \_\_\_\_\_

W. C. Taylor

*S* | **4 Cav.** | **U.S.C.T.**

*Alfred Sallas*

*Plt*, Co. I, 4 Reg't U. S. Col'd Cavalry.

Appears on

**Company Muster Roll**

for *July & Aug*, 1864.

Present or absent *Present*

Stoppage, \$ 100 for

Due Gov't, \$ 100 for

Valuation of horse, \$ 100

Valuation of horse equipments, \$ 100

Remarks:

Book mark:

(358)

*Hynes*

Copyist.

*S* | 4 Cav. | U.S.C.T.

*Alfred Sallas*

*Priv*, Co. I, 4 Reg't U. S. Col'd Cavalry.

Appears on

**Company Muster Roll**

for *Sept - Oct*, 186 *4*

Present or absent *Present*

Stoppage, \$ *100* for

Due Gov't, \$ *100* for

Valuation of horse, \$ *100*

Valuation of horse equipments, \$ *100*

Remarks: *Bounty paid \$100. Bounty due \$200.*

Book mark:

*Styus*

*S* | 4 Cav. | U.S.C.T.

*Alfred Sallas*

*Plt*, Co. I, 4 Reg't U. S. Col'd Cavalry.

Appears on

**Company Muster Roll**

for *Nov & Dec*, 186*4*

Present or absent *Present*

Stoppage, \$ *100* for

Due Gov't, \$ *100* for

Valuation of horse, \$ *100*

Valuation of horse equipments, \$ *100*

Remarks: *Bounty paid \$100. Bounty due \$200. Slip for one Screw driver, one Ripper, one Sabre Knif, one Carbine slug & Surel.*

Book mark:

*Styus*

(358)

Copyist.



S | 4 Cav. | U.S.C.T.

Alfred Dallas

Plt, Co. I, 4 Reg't U. S. Col'd Cavalry.

Appears on

**Company Muster Roll**

for Jan + Feb, 1865.

Present or absent Present

Stoppage, \$ 100 for

Due Gov't, \$ 100 for

Valuation of horse, \$ 100

Valuation of horse equipments, \$ 100

Remarks: Bounty paid \$100. Bounty  
due \$200. Bounty allowed by Circular No. 27  
Pro Mar 20. July 15, 65. Stop for one  
Screw driver, one niper, one Sabre Knif  
One Carbine Shing + Survival

Book mark:

Styus

(358)

Copyist.

S | 4 Cav. | U.S.C.T.

*Alfred Sallas*

*Govt.*, Co: H, 4 Reg't U. S. Col'd Cavalry.

Appears on

**Company Muster Roll**

for *March & April*, 186*5*.

Present or absent *Present*

Stoppage, \$ *100* for

Due Gov't, \$ *100* for

Valuation of horse, \$ *100*

Valuation of horse equipments, \$ *100*

Remarks: *Transferred from  
Co. I in consolidation  
by S. O. 28. Hdqrs. Dept.  
of Jan. 28/65. Bounty  
paid 100 ds. Bounty due  
200. allowed by circular  
27. Prov. Mar. Genl. Off.  
July 19/64*

Book mark:

*Feaster*

*S* *4 Cav* | **U.S.C.T.**

*Alfred Dallas*  
*Pvt*, Co. *A*, *4* Reg't U. S. Col'd *Cav.*

Appears on

**M. and D. Roll of Men Transferred**

to the organization named above, *by consol.*  
from *C. D.*

Roll dated *Port Hudson La Apr 29*, 1865.

When enlisted *Aug 1*, 1864.

Period for which enlisted *3* years.

When mustered in *Aug 6*, 1864.

Present or absent *Not stated*

Company to which assigned *A*

Remarks:

Book mark:

(342)

*W. Leonard*

Copyist.

*S* | **4 Cav.** | **U.S.C.T.**

*Alfred Sallas*  
Pot., Co. H, 4 Reg't U. S. Col'd Cavalry.

Appears on

**Company Muster Roll**

for *May & June*, 186*5*.

Present or absent *Present*

Stoppage, \$ 100 for

Due Gov't, \$ 100 for

Valuation of horse, \$ 100

Valuation of horse equipments, \$ 100

Remarks: *Bounty paid \$100.  
Bounty due \$200, allowed  
by circular no. 27 Pro  
M. Genl. Office July 1964.  
Stop. for 1 Sabre Knott  
\$ 30.*

Book mark: \_\_\_\_\_

*Feaster*

*S* | **4 Cav. | U.S.C.T.**

*Alfred Sallas*

*Pvt.*, Co. H, 4 Reg't U. S. Col'd Cavalry.

Appears on

**Company Muster Roll**

for *July & Aug.*, 186*2*.

Present or absent *Present*

Stoppage, \$ *100* for

Due Gov't, \$ *100* for

Valuation of horse, \$ *100*

Valuation of horse equipments, \$ *100*

Remarks: *Bounty pd \$100.  
Bounty due \$200  
allowed per cir. No. 27,  
P. M. Genl. office July  
19, 1864*

Book mark: \_\_\_\_\_

*Feaster*

*S* | 4 Cav. | U.S.C.T.

*Alfred Sallas*  
*Pvt.*, Co. H, 4 Reg't U. S. Col'd Cavalry.

Appears on

**Company Muster Roll**  
for *Sept. & Oct.*, 186*2*.

Present or absent.....

Stoppage, \$.....100 for.....

Due Gov't, \$.....100 for.....

Valuation of horse, \$.....100

Valuation of horse equipments, \$.....100

Remarks: *Absent sick*  
*in Post Hospital Baton*  
*Rouge, La. Bounty*  
*paid \$100. Bounty due*  
*\$200, allowed by circu-*  
*lar No. 27, Pro. Mar.*  
*Genl. office, July 19<sup>th</sup> 1864.*

Book mark:.....

*Feaster*

(358)

Copyist.

*S* | *4 bar usca*

*Alfred Scillius*  
*Cpt*, Co. *H*, *4* Reg't *usca*

Appears on

**Hospital Muster Roll**

of U. S. A. Post Hospital,

at Baton Rouge, La.,

for *Sept & Oct*, 186<sup>*5*</sup>.

Attached to hospital:

When *Oct 1*, 186<sup>*5*</sup>.

How employed \_\_\_\_\_

Last paid by Maj. \_\_\_\_\_

to \_\_\_\_\_, 186 .

Bounty paid \$ 100; due \$ 100

Present or absent *Present*

Remarks : \_\_\_\_\_

\_\_\_\_\_

\_\_\_\_\_

\_\_\_\_\_

\_\_\_\_\_

\_\_\_\_\_

\_\_\_\_\_

\_\_\_\_\_

Book mark : \_\_\_\_\_

\_\_\_\_\_

\_\_\_\_\_

\_\_\_\_\_

\_\_\_\_\_

\_\_\_\_\_

\_\_\_\_\_

\_\_\_\_\_

\_\_\_\_\_

\_\_\_\_\_

\_\_\_\_\_

\_\_\_\_\_

\_\_\_\_\_

\_\_\_\_\_

*A. H. King*

*S* | **4 Cav.** | **U.S.C.T.**

*Alfred Sullas*  
*Sullas*, Co. H, 4 Reg't U. S. Col'd Cavalry.

Appears on

**Company Muster Roll**

for *dated Dec 31*, 186 *1*

Present or absent *Present*

Stoppage, \$ *100* for

Due Gov't, \$ *100* for

Valuation of horse, \$ *100*

Valuation of horse equipments, \$ *100*

Remarks: *County paid \$100*  
*Due \$200, allowed by*  
*circular No. 27, M.G.*  
*office July 19/64*

Book mark:

*A. B. Arnold*

(358)

Copyist.



*S* | **4 Cav. | U.S.C.T.**

*Alfred Sallas*

*Pri.*, Co. H, 4 Reg't U. S. Col'd Cavalry.

Appears on

**Company Muster Roll**

for *Jan + Feb*, 186*6*.

Present or absent *Present*

Stoppage, \$ *100* for

Due Gov't, \$ *100* for

Valuation of horse, \$ *100*

Valuation of horse equipments, \$ *100*

Remarks: *Bounty paid \$100.00*  
*Bounty due \$200.00*  
*allowed by circular*  
*No. 27. Gen. M. Gen. office*  
*July 19/64*

Book mark:

*A. C. Stoddard*

4 Cav. U.S.C.T.

Alfred Dallas  
Co. D, 4 Reg't U. S. Colored Cav.

Appears on Returns as follows:

Aug 1864 - Gain: Aug 6 Can  
Abelton Recruit mustered  
in Co.

Book mark:

(546)

W. R. Lee

Copyist.

A | **4 Cav.** | **U.S.C.T.**

Alfred Sallar  
Prvt., Co. H., 4 Reg't U. S. Col'd Cavalry.

Appears on **Co. Muster-out Roll**, dated  
New Orleans La., Mar 29 1866.

Muster-out to date Mar 20, 1866.

Last paid to June 30, 1865.

Clothing account:

Last settled....., 186 ; drawn since \$..... 100

Due soldier \$..... 100; due U. S. \$ 59 64/100

Am't for cloth'g in kind or money adv'd \$..... 100

Due U. S. for arms, equipments, &c., \$..... 32/100

Bounty paid \$ 100/100; due \$..... 100

Remarks: joined by transfer  
from Co "D" Mar 24/65  
per S. O. 28 Hd. Qrs. Dept  
Gulf series 1865  
Stop for Sabre knot  
lost.

Book mark : .....

(361)

H. E. M. M. M.  
Copyist.

Sallas, Alfred

, Co. , 4 Reg't U. S. C.

Enclosures.

Bed Cards	Final Statements
Burial Records	Furloughs or L. of A.
Certs. of Dis. for Discharge	Med. Certificates
C. M. Charges	Med. Des. Lists
Descriptive Lists	Orders
Discharge Certificates	Pris. of War Record
Enlistment Papers	Resignations

Other papers relating to—

Admission to Hosp'l	Furlough or L. of A.
Casualty Sheet	Med. Examination
Confinement	Misc. Information
Contracts	Pay or Clothing
Death or Effects	Personal Reports
Desertion	Rank
Discharge from Hosp'l	Transfer to Hosp'l
Discharge from Service	Transfer to V. R. C.
Duty	Transportation

NOTE 1.—This blank will be used for both enlistments and re-enlistments—enlistment of veterans, &c., &c., in the volunteer service. They will be made out in duplicate in all cases—one to accompany the recruiting return of the superintendent (not the recruiting officer) to the Adjutant General, and one to accompany the accounts of the officer who pays bounty, &c. The Regiment and Company in which the soldier last served should be given on the back.

NOTE 2.—An enlistment holds to service. A muster-in must, in all cases, precede payment of pay, bounty, pension, &c. A muster-in roll must, in all cases, be filed in the Adjutant General's Office as evidence of muster-in. The mustering officer, commissary, or assistant commissary of musters, as the case may be, will countersign both enlistments as having mustered the soldier into the service of the United States before either of them is given to the disbursing officer.

DECLARATION OF RECRUIT.

I, Alfred Sceller, desiring to VOLUNTEER as a Soldier in the Army of the United States, for the term of THREE YEARS, Do Declare, That I am fifteen years and \_\_\_\_\_ months of age; that I have never been discharged from the United States service on account of disability or by sentence of a court martial, or by order before the expiration of a term of enlistment; and I know of no impediment to my serving honestly and faithfully as a soldier for three years.

GIVEN at Camp Parapet La the first day of August 1864

Witness:

Charles Wemy  
Lt-4 Regt. U. S. C.

Alfred Sceller  
recruit

No. \_\_\_\_\_

Alfred Sceller

Volunteered at Camp Parapet La

August 1st, 1864

By \_\_\_\_\_

4th Regiment of U. S. Cavalry

Company

enlistment; last served in Company ( )

Regt of \_\_\_\_\_

Discharged \_\_\_\_\_, 18 \_\_\_\_\_

Received from Second Auditor

August 26th, 1892.

CONSENT IN CASE OF MINOR.

I, \_\_\_\_\_, Do CERTIFY, That I am the \_\_\_\_\_ of \_\_\_\_\_; that the said \_\_\_\_\_ is \_\_\_\_\_ years of age; and I do hereby freely give my CONSENT to his volunteering as a SOLDIER in the ARMY OF THE UNITED STATES for the period of THREE YEARS.

GIVEN at \_\_\_\_\_ the \_\_\_\_\_ day of \_\_\_\_\_

Witness: \_\_\_\_\_

VOLUNTEER ENLISTMENT.

STATE OF



TOWN OF

*Louisiana*

*Carrollton*

I, *Alfred Sellar*, born in *New Orleans* in the State of *Louisiana*, aged *seventeen* years, and by occupation a *Steam Boat Hand*, Do HEREBY ACKNOWLEDGE to have volunteered this *first* day of *August*, 1864, to serve as a **Soldier** in the **Army of the United States of America**, for the period of **THREE YEARS**, unless sooner discharged by proper authority: Do also agree to accept such bounty, pay, rations, and clothing, as are, or may be, established by law for volunteers. And I, *Alfred Sellar*, do solemnly swear, that I will bear true faith and allegiance to the **United States of America**, and that I will serve them honestly and faithfully against all their enemies or opposers whomsoever; and that I will observe and obey the orders of the President of the United States, and the orders of the officers appointed over me, according to the Rules and Articles of War.

Sworn and subscribed to, at *Camp Parapel Lee* this *1st* day of *August*, 1864.

BEFORE *Charles Wenz* Sr 4th Vol. Co'd. Cav

*Alfred Sellar* *sig* *mark*

I CERTIFY, ON HONOR, That I have carefully examined the above-named Volunteer, agreeably to the General Regulations of the Army, and that, in my opinion, he is free from all bodily defects and mental infirmity, which would in any way disqualify him from performing the duties of a soldier.

*D. D. Hanson*

EXAMINING SURGEON.

I CERTIFY, ON HONOR, That I have minutely inspected the Volunteer *Alfred Sellar* previously to his enlistment, and that he was entirely sober when enlisted; that, to the best of my judgment and belief, he is of lawful age; and that, in accepting him as duly qualified to perform the duties of an able-bodied soldier, I have strictly observed the Regulations which govern the recruiting service. This soldier has *Black* eyes, *Brown* hair, *Light* complexion, is *Five* feet *Three* inches high.

*Charles Wenz*  
Sr 4th Regiment of *Vol. Co'd. Cav* Volunteers,

RECRUITING OFFICER.

Mustered into the service of the United States, for three years or during the war from date of enlistment, in Company *D*, *4th* Regiment of *W. S. C. C.* Volunteers, on the *1st* day of *August*, 1864, at *Carrollton La.*  
*Rescript entitled to Company*  
*Under Circular No. 29, P. M. Gen. Office*  
*Date July 19th 1864*  
*J. B. Chamberlain*  
*1st Lt. Co. S. C. Regt. 26*  
*H. E. Powell*

754

*Sam Louis*

Co. C, 4 U. S. Col'd Cav.

*Private* | *Private*

CARD NUMBERS.

1		26
2		27
3	<i>see Louis Samuel</i>	
4		29
5		30
6		31
7		32
8		33
9		34
10		35
11		36
12		37
13		38
14		39
15		40
16		41
17		42
18		43
19		44
20		45
21		46
22		47
23		48
24		49
25		50

Book Mark:

See also

953  
Sampson Mearns

Co., 4 U. S. Col'd Cav.

Private

CARD NUMBERS.

1	5347750	26
2		27
3		28
4		29
5		30
6		31
7		32
8		33
9		34
10		35
11		36
12		37
12		38
14		39
15		40
16		41
17		42
18		43
19		44
20		45
21		46
22		47
23		48
24		49
25		50

Book Mark:

See also:



S | 4 Cav. | U.S.C.T.

Mrs Jackson

Appears with rank of *Pl* on

**Muster and Descriptive Roll of a Detachment of U. S. Vols. forwarded**

for the 4 Reg't U. S. Col'd Cavalry. Roll dated

*New Orleans La Aug 6*, 186*4*.

Where born *Terry Co, Miss*

Aged *22* y'rs; occupation *Labour*

When enlisted *July 26*, 186*4*.

Where enlisted *New Orleans La*

For what period enlisted *3* years.

Eyes *Brown*; hair *Black*

Complexion *DK*; height *6 ft. 1 in.*

When mustered in *Aug 6*, 186*4*.

Where mustered in *Carrollton*

Bounty paid \$ *100*<sup>*100*</sup>; due \$ *200*<sup>*100*</sup>

Where credited *to New Orleans La*

Company to which assigned *B*

Remarks: *Recruit, entitled*

*to Bounty.*

*not found in Roll of Regt.*

Book mark : .....

*Jackson*

496  
Sanders Samuel

Co *YG*, 4 U. S. Col'd Cav.

*Private* | *Private*

CARD NUMBERS.

1	5349860	26
2	5349960	27
3	5350052	28
4	5350158	29
5	5350252	30
6	5350341	31
7	5350421	32
8	5350495	33
9	5350570	34
10	5350656	35
11	5350759	36
12	5350836	37
13	5350922	38
14	5351006	39
15	5351088	40
16	5351169	41
17		42
18		43
19		44
20		45
21		46
22		47
23		48
24		49
25		50

Book Mark:

See also

S-754116-2 aud.

*R. Miller*  
20

*S* | **4 Cav.** | **U.S.C.T.**

*Samuel Saunders*

*Gov*, Co. *B*, 1 Reg't La. Cav., Corps d'Afrique.\*

Appears on

**Company Muster-in Roll**

of the organization named above. Roll dated

*New Orleans La Oct 27*, 1863.

Muster-in to date

*Oct 27*, 1863.

Joined for duty and enrolled:

When *Oct 18*, 1863.

Where *New Orleans*

Period *3* years.

Valuation of horse, \$.....100

Valuation of horse equipments, \$.....100

Remarks:.....

\*This organization subsequently became Co. *B*, 4 Reg't U. S. Colored Cavalry.

Book mark:.....

(356)

*Tracy*  
*P* Copyist.

*S* | **4 Cav. | U.S.C.T.**

*Samuel Sanders*  
*Priv*, Co. *B*, 1 Reg't La. Cav., Corps d'Afrique.\*

Appears on

**Company Muster Roll**

for *Oct 27 to Dec 31*, 186 *B*

Present or absent *Present*

Stoppage, \$ *100* for

Due Gov't, \$ *100* for

Valuation of horse, \$ *100*

Valuation of horse equipments, \$ *100*

Remarks:

\*This organization subsequently became Co. *B*, 4 Reg't U. S. Colored Cavalry.

Book mark:

(358)

*[Signature]*  
Copyist.

*S*

**4 Cav. U.S.C.T.**

*Samuel Saunders*

*Co. B*, 1 Reg't Cav., Corps d'Afrique.\*

Appears on

**Company Muster Roll**

for

*Jan & Feb*, 186*4*.

Present or absent

*Present*

Stoppage, \$

100 for

Due Gov't, \$

100 for

Valuation of horse, \$

100

Valuation of horse equipments, \$

100

Remarks:

\* This organization subsequently became Co. *B*, 4 Reg't U. S. Colored Cavalry.

Book mark:

*King*

Copyist.

(358)

*S* | **4 Cav.** | **U.S.C.T.**

*Samuel Saunders*  
*Prvt*, Co. B. 4 Reg't U. S. Col'd Cavalry.

Appears on

**Company Muster Roll**

for *March & Apr*, 186*4*.

Present or absent *Present*

Stoppage, \$ *100* for

Due Gov't, \$ *100* for

Valuation of horse, \$ *100*

Valuation of horse equipments, \$ *100*

Remarks :

Book mark :

(358)

*Privy*  
Copyist.

*S* | **4 Cav.** | **U.S.C.T.**

*Samuel Saunders*

*Orly*, Co. B. 4 Reg't U. S. Col'd Cavalry.

Appears on

**Company Muster Roll**

for *May & June*, 186*4*.

Present or absent *Present*

Stoppage, \$ 100 for

Due Gov't, \$ 100 for

Valuation of horse, \$ 100

Valuation of horse equipments, \$ 100

Remarks :

-----  
-----  
-----  
-----  
-----  
-----  
-----  
-----  
-----  
-----

Book mark :

-----

(358)

*J. J. [Signature]*  
Copyist.



*S* | **4 Cav.** | **U.S.C.T.**

*Samuel Summers*  
*Potter*, Co. B. 4 Reg't U. S. Col'd Cavalry.

Appears on

**Company Muster Roll**

for *July & Aug*, 186*4*.

Present or absent *Present*

Stoppage, \$ 100 for

Due Gov't, \$ 100 for

Valuation of horse, \$ 100

Valuation of horse equipments, \$ 100

Remarks :

Book mark :

(358)

*Copyist*

*S.* | **4 Cav.** | **U.S.C.T.**

*Samuel Saunders*

*Priv.*, Co. B. 4 Reg't U. S. Col'd Cavalry.

Appears on

**Company Muster Roll**

for *Sept & Oct*, 1864.

Present or absent *Present*

Stoppage, \$ 100 for

Due Gov't, \$ 100 for

Valuation of horse, \$ 100

Valuation of horse equipments, \$ 100

Remarks :

Book mark :

(358)

*J. J. J.*  
Copyist.

S | **4 Cav.** | **U.S.C.T.**

Samuel Saunders

priv., Co. B. 4 Reg't U. S. Col'd Cavalry.

Appears on

**Company Muster Roll**

for Nov & Dec., 1864.

Present or absent present

Stoppage, \$ 100 for

Due Gov't, \$ 100 for

Valuation of horse, \$ 100

Valuation of horse equipments, \$ 100

Remarks :

Book mark :

(358)

Somer

Copyist.

S | **4 Cav.** | **U.S.C.T.**

Samuel Saunders

prvt., Co. B. 4 Reg't U. S. Col'd Cavalry.

Appears on

**Company Muster Roll**

for Jan & Feb., 1865.

Present or absent present

Stoppage, \$ 100 for

Due Gov't, \$ 100 for

Valuation of horse, \$ 100

Valuation of horse equipments, \$ 100

Remarks: Received only \$7 a  
month to include Apr 30/64  
Stop for 10 Burnside Car-  
bine cartridges

Book mark: \_\_\_\_\_

Somers

S | **4 Cav.** | **U.S.C.T.**

Samuel Saunders

priv., Co. B. 4 Reg't U. S. Col'd Cavalry.

Appears on

**Company Muster Roll**

for March & April, 1860.

Present or absent present

Stoppage, \$ 100 for

Due Gov't, \$ 100 for

Valuation of horse, \$ 100

Valuation of horse equipments, \$ 100

Remarks :

Book mark :

(358)

Samuel

Copyist.

P | **4 Cav.** | **U.S.C.T.**

Samuel Saunders  
spt., Co. B. 4 Reg't U. S. Col'd Cavalry.

Appears on

**Company Muster Roll**

for May & June, 1867.

Present or absent present

Stoppage, \$ 100 for

Due Gov't, \$ 100 for

Valuation of horse, \$ 100

Valuation of horse equipments, \$ 100

Remarks: Stop for 1 Sabre  
knob.

Book mark:

Lomer  
(358) Copyist.

1177 210  
S<sup>r</sup> | **4 Cav.** | **U.S.C.T.**

*Samuel Sanders*

*Sgt.*, Co. B. 4 Reg't U. S. Col'd Cavalry.

Appears on

**Company Muster Roll**

for *July & Aug*, 1865.

Present or absent *present*

Stoppage, \$ 100 for

Due Gov't, \$ 100 for

Valuation of horse, \$ 100

Valuation of horse equipments, \$ 100

Remarks :

Book mark :

*Somer*

(358)

Copyist.

S. | **4 Cav.** | **U.S.C.T.**

Samuel Sanders

pot, Co. B. 4 Reg't U. S. Col'd Cavalry.

Appears on

**Company Muster Roll**

for Sept & Oct., 1867.

Present or absent present

Stoppage, \$ 100 for

Due Gov't, \$ 100 for

Valuation of horse, \$ 100

Valuation of horse equipments, \$ 100

Remarks :

Book mark :

Sanders  
(358) Copyist.



*S* | **4 Cav. | U.S.C.T.**

*Samuel Sanders*  
*Sgt*, Co. B. 4 Reg't U. S. Col'd Cavalry.

Appears on

**Company Muster Roll**

for *Nov. 20<sup>th</sup>*, 1865.

Present or absent *Present*

Stoppage, \$ 100 for

Due Gov't, \$ 100 for

Valuation of horse, \$ 100

Valuation of horse equipments, \$ 100

Remarks :  
.....  
.....  
.....  
.....  
.....  
.....  
.....  
.....

Book mark :  
.....

*Sanders*  
Copyist.

*S* | **4 Cav.** | **U.S.C.T.**

*Samuel Sanders*

*Pvt.*, Co. B. 4 Reg't U. S. Col'd Cavalry.

Appears on

**Company Muster Roll**

for *Jan. & Feb.*, 186 *6*

Present or absent *Present*

Stoppage, \$ *100* for

Due Gov't, \$ *100* for

Valuation of horse, \$ *100*

Valuation of horse equipments, \$ *100*

Remarks :

Book mark :

*Chandler*

(358)

Copyist.

*S* | **4 Cav.** | **U.S.C.T.**

*Samuel Sanders*  
-----  
*Pvt.*, Co. *B*, 4 Reg't U. S. Col'd Cavalry.

Appears on **Co. Muster-out Roll**, dated  
*New Orleans, La. Feb. 20*, 1866.

Muster-out to date *Feb. 20*, 1866.

Last paid to *June 30*, 1865.

**Clothing account:**

Last settled \_\_\_\_\_, 186 ; drawn since \$ \_\_\_\_\_ 100

Due soldier \$ *19 26* / 100; due U. S. \$ \_\_\_\_\_ 100

Am't for cloth'g in kind or money adv'd \$ \_\_\_\_\_ 100

Due U. S. for arms, equipments, &c., \$ \_\_\_\_\_ 100

Bounty paid \$ \_\_\_\_\_ 100; due \$ \_\_\_\_\_ 100

Remarks: *Joined an Org'l org.*

Book mark: *V. 128. P. 153. 71*

(361)

*Chandler*  
-----  
Copyist.

*Sargent Claiborne*

Co *C*, 4 U. S. Col'd Cav.

*Private Private*

CARD NUMBERS.

1	5351413	26
2	5351493	27
3	5352542	28
4	40729196	29
5		30
6		31
7		32
8		33
9		34
10		35
11		36
12		37
13		38
14		39
15		40
16		41
17		42
18		43
19		44
20		45
21		46
22		47
23		48
24		49
25		50

Book Mark:

See also

*S* | **4 Cav. | U.S.C.T.**

*Clairborne Sargent*  
*Plt, Co. C, 1 Reg't La. Cav., Corps d'Afrique.\**

Appears on

**Company Muster Roll**

for *Jan Feb* 1864

Present or absent *Present*

Stoppage, \$ *100* for

Due Gov't, \$ *100* for

Valuation of horse, \$ *100*

Valuation of horse equipments, \$ *100*

Remarks: *Not mustered on account  
of being transferred to  
Recruiting Depot & after-  
wards returned to  
Columbus  
school at New Orleans  
(3 years)*

\*This organization subsequently became Co *C*, 4 Reg't U. S. Colored Cavalry.

Book mark: \_\_\_\_\_

*Recharacter*

(358)

Copyist.

S. | **4 Cav.** | **U.S.C.T.**

*Edai Jones Sergeant*  
*Pr*, Co. C, 4 Reg't U. S. Colored Cavalry.

Appears on

**Company Muster Roll**  
for *Month of*, 1864.

Present or absent

Stoppage, \$ 100 for

Due Gov't, \$ 100 for

Valuation of horse, \$ 100

Valuation of horse equipments, \$ 100

Remarks: *Deserted March 5/64*  
*(never in line)*

Book mark :

(358)

*Recher*

Copyist.

8

4 Cav. U.S.C.T.

Wrayborne Dargent  
Port Co. 4 Reg't U. S. Colored Cav.

Appears on Returns as follows:

Feb 1864 - (1 Regt Cav., Corps d'Afrique)  
Absent with leave since Feb  
28/64 to Bayou La Fourche  
on account of sickness in his  
family.

Mich 1864 - Lost: Deserted Mar  
5/64

Book mark:

W. R. Lee

(546)

Copyist.

S 4 Cav U.S.C.T.

Claiborne Sargent

Co. C, 4 Reg't U. S. Col'd Louisiana

Appears on Co. Muster-out Roll, dated

New Orleans La, Mar 20, 1866.

Muster-out to date \_\_\_\_\_, 186 .

Last paid to \_\_\_\_\_, 186 .

Clothing account:

Last settled \_\_\_\_\_, 186 ; drawn since \$ \_\_\_\_\_ 100

Due soldier \$ \_\_\_\_\_ 100; due U. S. \$ \_\_\_\_\_ 100

Am't for cloth'g in kind or money adv'd \$ \_\_\_\_\_ 100

Due U. S. for arms, equipments, &c., \$ \_\_\_\_\_ 100

Bounty paid \$ \_\_\_\_\_ 100; due \$ \_\_\_\_\_ 100

Remarks: See Rolls for March & April 1864. Mustered out in accordance with Special Order No 44. Head Qrs Dept of La' Co. S. to take effect March 20 1866. Their services being no longer required.

Book mark: \_\_\_\_\_

M. A. Michaels

(361)

Copyist.



150  
Sargent Isaac

Co B, 4 U. S. Col'd Cav.

Private | Private

CARD NUMBERS.

1	5351278	26
2	5351334	27
3	5351388	28
4	5351492	29
5	5352532	30
6	8114-05-1874	31
7	40729194	32
8		33
9		34
10		35
11		36
12		37
13		38
14		39
15		40
16		41
17		42
18		43
19		44
20		45
21		46
22		47
23		48
24		49
25		50

Book Mark: 8114-05-1874

See also

*S* | **4 Cav. | U.S.C.T.**

*Isaac Sargent*  
Pvt. Co. C, 1 Reg't La. Cav., Corps d'Afrique.\*

Appears on

**Company Muster-in Roll**

of the organization named above. Roll dated

*New Orleans* *Nov 7*, 1863.

Muster-in to date

*Nov 7*, 1863

Joined for duty and enrolled:

When *Oct 29*, 1863.

Where *New Orleans city*

Period *3* years.

Valuation of horse, \$ 100

Valuation of horse equipments, \$ 100

Remarks:

*Age: 24*

\*This organization subsequently became Co. *C*, 4 Reg't U. S. Colored Cavalry.

Book mark: *S 114-05-1874*

(356)

*Reuter*

Copyist.

*S* | **4 Cav. | U.S.C.T.**

*Isaac Sargent*  
*Co. C*, 1 Reg't La. Cav., Corps d'Afrique.\*

Appears on

**Company Muster Roll**

for *Nov 7 to Dec 31*, 186*3*

Present or absent *Present*

Stoppage, \$.....100 for.....

Due Gov't, \$.....100 for.....

Valuation of horse, \$.....100

Valuation of horse equipments, \$.....100

Remarks:.....

**FROM SECOND AUDITOR'S ROLL.**

\*This organization subsequently became *Co. C*, 4 Reg't U. S. Colored Cavalry.

Book mark:.....

*R. Sargent*

*S* | **4 Cav. | U.S.C.T.**

*Isaac Sargent*  
Pt. Co. *C*, 1 Reg't La. Cav., Corps d'Afrique.\*

Appears on

**Company Muster Roll**

for *Jan Feb*, 1864.

Present or absent *Present*

Stoppage, \$ *100* for

Due Gov't, \$ *100* for

Valuation of horse, \$ *100*

Valuation of horse equipments, \$ *100*

Remarks:  
-----  
-----  
-----  
-----  
-----  
-----  
-----  
-----

\*This organization subsequently became Co. *C*, 4 Reg't U. S. Colored Cavalry.

Book mark: -----

(358)

*Rochester*

Copyist.

*I* | **4 Cav.** | **U.S.C.T.**

*Isaac Sargent*  
*Pvt.*, Co. C, 4 Reg't U. S. Colored Cavalry.

Appears on

**Company Muster Roll**

for *March & April*, 1864.

Present or absent

Stoppage, \$ 100 for

Due Gov't, \$ 100 for

Valuation of horse, \$ 100

Valuation of horse equipments, \$ 100

Remarks: *Discharged March 2/64*

Book mark:

*Reed*

A | 4 Cav. | U.S.C.T.

Isaac Dargent

Port Co. B, 4 Reg't U. S. Colored Cav.

Appears on Returns as follows:

Mich 1864 - 11 Regt. Cav., Corps d'Afrique  
2000: Deserted Mar 21/64

Book mark:

(546)

W. R. Lee

Copyist.

S | 4 Cav. | U.S.C.T.

Isaac Sargent

Private, Co. C, 4 Reg't U. S. Col'd Cavalry

Appears on Co. Muster-out Roll, dated  
New Orleans La, Mar 20, 1866.

Muster-out to date \_\_\_\_\_, 186 .

Last paid to *never paid* \_\_\_\_\_, 186 .

Clothing account:

Last settled \_\_\_\_\_, 186 ; drawn since \$ \_\_\_\_\_ 100

Due soldier \$ \_\_\_\_\_ 100; due U. S. \$ \_\_\_\_\_ / <sup>53</sup>/<sub>100</sub>

Am't for cloth'g in kind or money adv'd \$ \_\_\_\_\_ 100

Due U. S. for arms, equipments, &c., \$ \_\_\_\_\_ 100

Bounty paid \$ \_\_\_\_\_ 100; due \$ \_\_\_\_\_ 100

Remarks: *Joined orig. org.  
deserted Mch 5/65<sup>4</sup> at  
New Orleans La*

Book mark: *E.B. 146*

(361)

*M. A. Michaels*

Copyist.

S. 1 4<sup>th</sup> Cav. 1 U.S. b. J

Isaac Sargent

, Co. B, 4<sup>th</sup> Reg't U.S. b. Cav.

E.B. 1496 with **NOTATION.**

Book mark: S. 114. b. J. 1874.

**War Department,**

**Adjutant General's Office,**

Washington, June 15<sup>th</sup>, 1874.

Deserter'd Mch. 2<sup>nd</sup>, 1864.

E. P. Conner.



Saml Spencer

Co K & H, 4 U. S. Col'd Cav.

Private | Private

CARD NUMBERS.

1	5347576	26
2	5358430	27
3	5358479	28
4	5358530	29
5	5358574	30
6	5358616	31
7	5348040	32
8	5357617	33
9	5357699	34
10	5357781	35
11	5357859	36
12	5357934	37
13	5358009	38
14	5358081	39
15	5796-C-1889.	40
16	40729193	41
17		42
18		43
19		44
20		45
21		46
22		47
23		48
24		49
25		50

Book Mark:

5796-C-89

See also

1348208 - P.O. Miami  
D. 2493965 Ant. W.D.

*W. H. Miller*

*S* | **4 Cav.** | **U.S.C.T.**

*Spencer Sank*

Appears with rank of *Pvt.* on

**Muster and Descriptive Roll of a Detachment of U. S. Vols. forwarded**

for the 4 Reg't U. S. Col'd Cavalry. Roll dated  
*New Orleans La., May 9, 1864.*

Where born *La.*

Age *22* y'rs; occupation *Peaster*

When enlisted *Apr. 30*, 1864.

Where enlisted *Alexandria*

For what period enlisted *3* years.

Eyes *Black*; hair *Black*

Complexion *Black*; height *5* ft. *7* in.

When mustered in *May 9*, 1864.

Where mustered in *New Orleans*

*Premium paid 2*  
Bounty paid \$ *100*; due \$ *100*

Where credited

Company to which assigned *K*

Remarks:

Book mark: *5796-C-1889*

*Peaster*

*S* | **4 Cav.** | **U.S.C.T.**

*Spencer Sank*  
-----  
*Priv.*, Co. *A*, 4 Reg't U. S. Col'd Cavalry.

Age ----- years.

Appears on

**Company Muster Roll\***

for *May 9 to June 30*, 186 *4*.

Joined for duty and enrolled:

When *Apr. 30*, 1864.

Where *Alexandria, La.*

Period *3* years.

Mustered in:

When *May 9*, 1864.

Where *New Orleans, La.*

Present or absent *Present.*

Stoppage, \$ *100* for -----

Due Gov't, \$ *100* for -----

Valuation of horse, \$ *100*

Valuation of horse equipments, \$ *100*

Remarks : -----  
-----

\* First current roll. No muster-in roll of this battery on file.

Book mark : -----

(3586)

*W. S. Thompson*  
-----  
Copyist.

*S* | **4 Cav.** | **U.S.C.T.**

*Spencer Lamb*  
-----  
*Priv.*, Co. K, 4 Reg't U. S. Col'd Cav.

Appears on

**Company Muster Roll**

for *July & Aug.*, 1864.

Present or absent *Present*

Stoppage, \$ *100* for

Due Gov't, \$ *100* for

Valuation of horse, \$ *100*

Valuation of horse equipments, \$ *100*

Remarks: -----  
-----  
-----  
-----  
-----  
-----  
-----  
-----  
-----

Book mark: -----

*W. S. Thompson*  
-----  
(358) Copyist.

*S* | **4 Cav.** | **U.S.C.T.**

*Spencer Bank*  
*177*, Co. K, 4 Reg't U. S. Col'd Cav.

Appears on

**Company Muster Roll**

for *Sept. 2 Oct.*, 1864.

Present or absent *Present*

Stoppage, \$ *100* for

Due Gov't, \$ *100* for

Valuation of horse, \$ *100*

Valuation of horse equipments, \$ *100*

Remarks:  
\_\_\_\_\_  
\_\_\_\_\_  
\_\_\_\_\_  
\_\_\_\_\_  
\_\_\_\_\_  
\_\_\_\_\_  
\_\_\_\_\_  
\_\_\_\_\_

Book mark: *1864*

(358)

*W. S. Thompson*  
Copyist.

*S* | **4 Cav.** | **U.S.C.T.**

*Spencer Sank*  
.....  
*Priv.*, Co. K, 4 Reg't U. S. Col'd Cav.

Appears on

**Company Muster Roll**

for *Nov. & Dec.*, 1864.

Present or absent *Present*

Stoppage, \$ 100 for .....

Due Gov't, \$ 100 for .....

Valuation of horse, \$ 100

Valuation of horse equipments, \$ 100

Remarks: .....

Book mark: .....

(358)

*W. S. Thompson*  
.....  
Copyist.

28 | **4 Cav.** | **U.S.C.T.**

Spencer Sank  
Pvt., Co. K, 4 Reg't U. S. Col'd Cav.

Appears on

**Company Muster Roll**

for Jan. & Feb., 1865.

Present or absent Present

Stoppage, \$ 100 for

Due Gov't, \$ 100 for

Valuation of horse, \$ 100

Valuation of horse equipments, \$ 100

Remarks:  
\_\_\_\_\_  
\_\_\_\_\_  
\_\_\_\_\_  
\_\_\_\_\_  
\_\_\_\_\_  
\_\_\_\_\_  
\_\_\_\_\_  
\_\_\_\_\_

Book mark: \_\_\_\_\_

W. S. Thompson  
(358) Copyist.



S | 4 Cav. | U.S.C.T.

Spencer Sank  
Pot., Co. H, 4 Reg't U. S. Col'd Cavalry.

Appears on

**Company Muster Roll**

for *Mch. 8. Apl.*, 186 *5-*

Present or absent *Present*

Stoppage, \$ *100* for

Due Gov't, \$ *100* for

Valuation of horse, \$ *100*

Valuation of horse equipments, \$ *100*

Remarks: *Transferred from  
Co. K in consolidation  
by S. O. 28. Hdqrs. Dept.  
July. Jan. 28/65-*

Book mark:

*Master*

S | 4 Cav. | U.S.C.T.

Spencer Sank

Pr, Co. N, 4 Reg't U. S. Col'd Cav.

Appears on

**M. and D. Roll of Men Transferred**

to the organization named above, by Consol,  
from Co. A

Roll dated Port Hudson, La. Apr 29, 1863.

When enlisted Apr 30, 1864.

Period for which enlisted 3 years.

When mustered in May 9, 1864.

Present or absent Not stated

Company to which assigned D

Remarks:

Book mark: See 5796-6-87

(342)

J. Leonard

Copyist.

S | 4 Cav. | U.S.C.T.

Spencer Sank  
Capt., Co. H, 4 Reg't U. S. Col'd Cavalry.

Appears on

Company Muster Roll

for May & June, 1865.

Present or absent Present

Stoppage, \$ 100 for

Due Gov't, \$ 100 for

Valuation of horse, \$ 100

Valuation of horse equipments, \$ 100

Remarks:

Book mark:

Feaster

(358)

Copyist.

*S* | **4 Cav. | U.S.C.T.**

*Spencer Sank*  
-----  
*Priv.*, Co. H, 4 Reg't U. S. Col'd Cavalry.

Appears on

**Company Muster Roll**

for *July 1. Aug.*, 186*2*.

Present or absent *Present*

Stoppage, \$ *100* for

Due Gov't, \$ *100* for

Valuation of horse, \$ *100*

Valuation of horse equipments, \$ *100*

Remarks: -----  
-----  
-----  
-----  
-----  
-----  
-----  
-----  
-----  
-----

Book mark: -----

*Feaster*

*S* | **4 Cav.** | **U.S.C.T.**

*Spencer Sank*  
*Pvt.*, Co. H, 4 Reg't U. S. Col'd Cavalry.

Appears on

**Company Muster Roll**

for *Sept. 8. Oct.*, 186*5*:-

Present or absent *Present*

Stoppage, \$ *100* for

Due Gov't, \$ *100* for

Valuation of horse, \$ *100*

Valuation of horse equipments, \$ *100*

Remarks:

Book mark: *Feaster*

*S* | **4 Cav.** | **U.S.C.T.**

*Spencer Tanks*  
*Li.*, Co. H, 4 Reg't U. S. Col'd Cavalry.

Appears on

**Company Muster Roll**

for *dated Dec 31*, 186 *1*.

Present or absent *Present*

Stoppage, \$ *100* for

Due Gov't, \$ *100* for

Valuation of horse, \$ *100*

Valuation of horse equipments, \$ *100*

Remarks:

Book mark:

*A. C. Howard*

(358)

Copyist.

*S* | **4 Cav. | U.S.C.T.**

*Samuel Danks*  
*Chi*, Co. H, 4 Reg't U. S. Col'd Cavalry.

Appears on

**Company Muster Roll**

for *Jan & Feb*, 186*6*.

Present or absent *Present*

Stoppage, \$ *100* for

Due Gov't, \$ *100* for

Valuation of horse, \$ *100*

Valuation of horse equipments, \$ *100*

Remarks:  
\_\_\_\_\_  
\_\_\_\_\_  
\_\_\_\_\_  
\_\_\_\_\_  
\_\_\_\_\_  
\_\_\_\_\_  
\_\_\_\_\_  
\_\_\_\_\_  
\_\_\_\_\_

Book mark: \_\_\_\_\_

(358)

*A. C. Shurt*  
Copyist.

S

4 Cav. U.S.C.T.

Spencer Rank  
Priv., Co. H, 4 Reg't U. S. Colored Cav.

Appears on Returns as follows:

May 1864 -  
June & July 1865 } On duty  
Nov 1865 - to Feb 1866 } detailed as  
Co. Cook.

Book mark:

W. R. Zell  
Copyist.

(546)



*S* | **4 Cav. | U.S.C.T.**

*Spencer Sank*  
*Pri., Co. H*, 4 Reg't U. S. Col'd Cavalry.

Appears on **Co. Muster-out Roll**, dated  
*New Orleans La, Mar 20*, 1866.

Muster-out to date *Mar 20*, 1866.

Last paid to *June 30*, 1865.

**Clothing account:**

Last settled....., 186 ; drawn since \$.....100

Due soldier \$ *31*<sup>*7*</sup>/<sub>*100*</sub>; due U. S. \$.....100

Am't for cloth'g in kind or money adv'd \$.....100

Due U. S. for arms, equipments, &c., \$.....100

Bounty paid \$.....100; due \$.....100

Remarks: *joined by transfer*  
*from Co. K. Me. 24/65*  
*per S. O. 28, Hd. Quarters*  
*Gulf series 1865*

Book mark: *See 5796 C-89*

(361)

*H. E. Arnold*  
Copyist.

D. | 4<sup>th</sup> Can | M<sup>d</sup> @

James Davis

, Co. 20, 4<sup>th</sup> Reg't M<sup>d</sup> @ Can

**NOTATION.**

Book mark: 5296 - @ - 1889

**War Department,**

*R. B. D. M.*  
**Adjutant-General's Office,**

Washington, July 24<sup>th</sup>, 1889.

Application for certificate in lieu of lost discharge.

One Certificate \_\_\_\_\_ furnished.

A. W. Johnson

*900*  
Scanland Francis M

Co *F*, 4 U. S. Col'd Cav.

*2nd Lt*  
Lieutenant Lieutenant

CARD NUMBERS.

1	5-354909	26
2	0-347389	27
3	5-355000	28
4	5-355187	29
5	5-356163	30
6	159-05-1879	31
7	40729197	32
8		33
9		34
10		35
11		36
12		37
13		38
14		39
15		40
16		41
17		42
18		43
19		44
20		45
21		46
22		47
23		48
24		49
25		50

Book Mark: *159-05-1879*  
*14-CV-79*

See also 2 Ill Cav

S | 4. Cav. | U.S.C.T.

Francis M. Sealand

2<sup>d</sup> Co. A, 4 Reg't U. S. Col'd Cav.

Age 30 years.

Appears on an

**Individual Muster-in Roll**

of the organization named above. Roll dated

A. W. Veria La. Dec 28, 1863.

Muster-in to date

Dec 19, 1863.

Joined for duty and enrolled:

When Nov 2, 1863.

Where Permillion La.

Period \_\_\_\_\_ years.

Valuation of horse, \$ \_\_\_\_\_ 100

Valuation of horse equipments, \$ \_\_\_\_\_ 100

Remarks: Promoted from  
Sergt - Co. K, 2<sup>d</sup> Ill  
Cavalry discharged as  
such in S.O. No 98. Hd Qrs  
19 Army Corps.

Book mark: \_\_\_\_\_

(336)

Permillion  
Copyist.

*S* | 4 Cav. | U.S.C.T.

*Francis M. Scanlan*

*2<sup>d</sup> St.*, Co. A, Mounted Rangers, Corps d'Afrique. †

Age ..... years.

Appears on

**Company Muster Roll\***

for *Nov & Dec*, 186*3*.

Joined for duty and enrolled:

When *Nov. 2*, 186*3*.

Where *Vermillion, La*

Period ..... years.

Mustered in:

When *Dec. 19*, 186*3*.

Where *Alberia, La*

Present or absent *Present*

Stoppage, \$ ..... 100 for .....

Due Gov't \$ ..... 100 for .....

Valuation of horse, \$ ..... 100

Valuation of horse equipments, \$ ..... 100

Remarks: .....

† This organization subsequently became Co. F, 4 U. S. Col'd Cav.  
\* First current roll. No muster-in roll of this ~~company~~ *battery* on file.

Book mark: *159-05-1879*

*Wanning*  
(3586) Copyright.

*S* | **4 Cav. | U.S C.T.**

*Francis M. Scanland*  
*2<sup>d</sup> Lt., Co. F*, 1 Reg't Cav., Corps d'Afrique.\*

Appears on

**Company Muster Roll**

for *James P. Feby*, 1864.

Present or absent *Present*

Stoppage, \$ *100* for

Due Gov't, \$ *100* for

Valuation of horse, \$ *100*

Valuation of horse equipments, \$ *100*

Remarks:

\* This organization subsequently became Co. *F*, 4 Reg't U. S. Colored Cavalry.

Book mark:

(358)

*Manning*  
Copyist.

S | 4 Cav. | U.S.C.T.

Francis M. Scanland  
2<sup>d</sup> Lt., Co. F, 4 Reg't U. S. Col'd Cavalry.

Appears on

**Company Muster Roll**

for March & April, 1864

Present or absent.....

Stoppage, \$.....100 for.....

Due Gov't, \$.....100 for.....

Valuation of horse, \$.....100

Valuation of horse equipments, \$.....100

Remarks: Discharged  
by Special order  
No 64, by Command  
of Maj Gen. N. P.  
Banks Comdg Dept  
of Gulf

Book mark: LP <sup>12</sup> 409 & 159 V 17 C 279

Discharged March 13/64

W. M. M. M. M.  
Copyist.

①

4 Cav. U.S.C.T.

Francis M. Deaun  
2 Lt, Co. G, 4 Reg't U. S. Colored Cav.

Appears on Returns as follows:

Feb'y 1864 - (1 Reg't Cav, Corps d'Afrique)  
Present

March 1864 - Loss; Dismissed by  
D.O. No 64 dated Med. Dep.  
West Gulf Mar 13 64

Book mark:

W. R. Lee

(546)

Copyist.



S | 4 Cav. | U.S.C.T.

Francis M. Scanland  
2 Lt., Co. F, 4 Reg't U. S. Col'd Cavalry.

Appears on Co. Muster-out Roll, dated  
New Orleans, La., Mch. 20 1866.

Muster-out to date \_\_\_\_\_, 186 .

Last paid to \_\_\_\_\_, 186 .

Clothing account:

Last settled \_\_\_\_\_, 186 ; drawn since \$ \_\_\_\_\_ 100

Due soldier \$ \_\_\_\_\_ 100 ; due U. S. \$ \_\_\_\_\_ 100

Am't for cloth'g in kind or money adv'd \$ \_\_\_\_\_ 100

Due U. S. for arms, equipments, &c., \$ \_\_\_\_\_ 100

Bounty paid \$ \_\_\_\_\_ 100 ; due \$ \_\_\_\_\_ 100

Remarks: Discharged per S.O. 64

D. G. Rerico 1864.

Book mark: Disch'd. Mch. 13, 64. L. B. <sup>12</sup>/<sub>409</sub>  
159. v. 14C. J. 79.

(361)

Hibbard

Copyist.

S | 4" Cav | U. S. C. I.

Francis M. Scanlon  
2<sup>d</sup> Lieut Co. F, 4<sup>th</sup> Reg't U. S. C. Cav.

**NOTATION.**

Book mark: L. B-12-407  
159-C-J-1879

**War Department,**

Adjutant General's Office,

Washington, Jan'y 21, 1879.

Discharged March 13, 1864.

See also Co. H. 2<sup>d</sup> Ill. Cav.

M. Allen

Scanland, F. M.

St. Co. F, 4 Reg't U.S.C. Bay

2 Enclosures.

Bed Cards .....	Final Statements .....
Burial Records .....	Furloughs or L. of A .....
Certs. of Dis. for Discharge .....	Med. Certificates .....
C. M. Charges .....	Med. Des. Lists .....
Descriptive Lists .....	Orders .....
Discharge Certificates .....	Pris. of War Record .....
Enlistment Papers .....	Resignations .....

Other papers relating to—

Admission to Hosp'l .....	Furlough or L. of A .....
Casualty Sheet .....	Med. Examination .....
Confinement .....	Misc. Information 2 .....
Contracts .....	Pay or Clothing .....
Death or Effects .....	Personal Reports .....
Desertion .....	Rank .....
Discharge from Hosp'l .....	Transfer to Hosp'l .....
Discharge from Service .....	Transfer to V. R. C. .....
Duty .....	Transportation .....

C. D. J. 232 1864

New Orleans La  
March 3<sup>o</sup> 1864

Francis W Scanlan  
2<sup>o</sup> St. 1<sup>st</sup> C. A. Cav

Certificate of Examination

4<sup>o</sup> U. S. C. Cav

Discharge  
for Union  
S. O. Mch 13/64.  
64

New-Orleans, La., March 3<sup>rd</sup> 1864

This Certifies that 2<sup>nd</sup> Lieut. Francis M. Scanlan, 1<sup>st</sup> Cav. C.S.A. having been duly examined before the authorized Board of Examiners according to instructions from proper authority, has <sup>not</sup> been found qualified for <sup>any</sup> position of \_\_\_\_\_ in any \_\_\_\_\_

Regiment of the Corps d'Afrique, and we respectfully recommend that he <sup>vacate</sup> ~~receive~~ his commission accordingly.

Ed. Currie

Col. 133<sup>rd</sup> N.Y. Vols. and President

N. J. Stealy

Col. 2<sup>nd</sup> Louisiana Cavalry

Samuel Kershner

Captain 8<sup>th</sup> Inftry C.S.A.

Members of the Board.

Approved,

Brig. Gen'l Vol.,

Commanding Corps d'Afrique.

Ellerbrooks. —

2<sup>d</sup>. Lieut. Francis W. Scanland C. F. 4<sup>th</sup> C. Cav.

Completed. —

Adjutant General's Office,

COLORED TROOPS BRANCH,

March 31<sup>st</sup>, 1874

Vol. C. T., 187

Wanted in case of 2<sup>d</sup> Lieut Francis M. Scanland, Co. 'F',  
4<sup>th</sup> Reg't U. S. Colored Cav. - Copy of P. O. - nos 4 - Dated  
H<sup>d</sup> Q<sup>r</sup> Dept Gulf series of 1864 - Discharging him from service

Respectfully,

W. A. Woodward  
Chief Clerk.

P. J. Hanson

Adjutant General's Office,

Div of Record, and Blanks.

April 3<sup>rd</sup>, 1874.

Vol. C. T., 187

Reply in case of Lieut F. M. Scanland, Co. "F",  
4<sup>th</sup> Reg't U. S. Col. Cavalry.

Head Quarters Department of the Gulf,  
New Orleans. March 13. 1864.

Special Orders }  
no 64

Extract -

2<sup>d</sup> Lieutenant Francis M. Scanland 1<sup>st</sup> Cavalry Corps  
d'Apigue having been examined by a duly authorized board  
of Examiners, and found unqualified for his position is  
hereby discharged the military service of the United States with  
condition that he shall receive no final payments until he  
has satisfied the Pay Department that he is not indebted to  
the Government.

By Command of Major Genl Banks.  
Signed Rich<sup>d</sup> B. Dornier  
A. A. G.

Mr. Ellbrook.  
Z. R.

R. B. D.

Scates Henry

Co *F*, 4 U. S. Col'd Cav.

Private Saddler

CARD NUMBERS.

1	5354983	26
2	5355072	27
3	5355164	28
4	5355252	29
5	5355341	30
6	5355377	31
7	5355458	32
8	5355534	33
9	5355613	34
10	5355699	35
11	5355781	36
12	5355861	37
13	5355948	38
14	5356028	39
15	5356105	40
16	40729198	41
17		42
18		43
19		44
20		45
21		46
22		47
23		48
24		49
25		50

Book Mark:

See also



P1314001 and 912

D. 13165-12. P.O. memo

51329975 and W.D

Form letter to P. Seaton 3/1/55  
re copy sent

*W. M. M.*

P1314001 and 91-D

D. 13165-12. P.O. memo

51329975 and N.D.

John letter to R. Seater 3/1/54  
re copy sent

*W. M. ...*

*S* | **4 Cav.** | **U.S.C.T.**

*Henry Seates*  
*Pvt*, Co. A, Mounted Rangers, Corps d'Afrique. †

Age ..... years.

Appears on

**Company Muster Roll\***

for *Nov P Dec*, 186*3*.

Joined for duty and enrolled:

When *Nov 1*, 186*3*.

Where *Iberia, La*

Period ..... years.

Mustered in:

When *Nov 30*, 186*3*.

Where *Iberia, La*

Present or absent *Present*

Stoppage, \$.....<sup>100</sup> for.....

Due Gov't \$.....<sup>100</sup> for.....

Valuation of horse, \$.....<sup>100</sup>

Valuation of horse equipments, \$.....<sup>100</sup>

Remarks:.....

†This organization subsequently became Co. F, 4 U. S. Col'd Cav.

\*First current roll. No muster-in roll of this ~~entry~~ *entry* on file.

Book mark:.....

*Manning*  
(3586) Copyist.

*S* | **4 Cav.** | **U.S C.T.**

*Henry Seates*  
*Pvt.*, Co. *F*, 1 Reg't Cav., Corps d'Afrique.\*

Appears on

**Company Muster Roll**

for *June 2 Feb*, 1864.

Present or absent *Present*

Stoppage, \$ *100* for

Due Gov't, \$ *100* for

Valuation of horse, \$ *100*

Valuation of horse equipments, \$ *100*

Remarks:

\* This organization subsequently became Co. *F*, 4 Reg't U. S. Colored Cavalry.

Book mark:

(358)

*Manning*

Copyist.

*S* | **4 Cav.** | **U.S.C.T.**

*Henry Scats*

*Pr*, Co. F, 4 Reg't U. S. Col'd Cavalry.

Appears on

**Company Muster Roll**

for *March & April*, 1864.

Present or absent *Present*

Stoppage, \$ *100* for

Due Gov't, \$ *100* for

Valuation of horse, \$ *100*

Valuation of horse equipments, \$ *100*

Remarks:

Book mark:

*Manning*  
Copyist.

*S* | **4 Cav.** | **U.S.C.T.**

*Henry Seates*  
*Priv*, Co. F, 4 Reg't U. S. Col'd Cavalry.

Appears on

**Company Muster Roll**

for *May & June*, 1864.

Present or absent *Present*

Stoppage, \$ *100* for

Due Gov't, \$ *100* for

Valuation of horse, \$ *100*

Valuation of horse equipments, \$ *100*

Remarks:

Book mark:

(358)

*Wam*  
Copyist.

*S* | **4 Cav.** | **U.S.C.T.**

*Henry Seates*

*Pr*, Co. F, 4 Reg't U. S. Col'd Cavalry.

Appears on

**Company Muster Roll**

for *July & Aug*, 186*4*.

Present or absent *Present*

Stoppage, \$ *100* for

Due Gov't, \$ *100* for

Valuation of horse, \$ *100*

Valuation of horse equipments, \$ *100*

Remarks: *Stop for one  
Spent 30c*

Book mark:

*W. M. Munn*  
Copyist.

*S* | **4 Cav.** | **U.S.C.T.**

*Henry Scates*  
Saddler, Co. F, 4 Reg't U. S. Col'd Cavalry.

Appears on

**Company Muster Roll**

for *Sept & Oct*, 186*4*.

Present or absent *Present*

Stoppage, \$ *100* for

Due Gov't, \$ *100* for

Valuation of horse, \$ *100*

Valuation of horse equipments, \$ *100*

Remarks: *Stop for one*  
*year 30 &*

Book mark:

(358)

*W. J. ...*  
Copyist.



*S* | **4 Cav.** | **U.S.C.T.**

*Henry Scates*  
Saddler, Co. F, 4 Reg't U. S. Col'd Cavalry.

Appears on

**Company Muster Roll**

for *Nov & Dec*, 186*4*

Present or absent *Present*

Stoppage, \$ *100* for

Due Gov't, \$ *100* for

Valuation of horse, \$ *100*

Valuation of horse equipments, \$ *100*

Remarks: *Stop for one Halter, one  
Spur & Strap.*

Book mark :

*L. H. Harris*

*S* | **4 Cav.** | **U.S.C.T.**

*Henry Scater*  
*Saddler*, Co. F, 4 Reg't U. S. Col'd Cavalry.

Appears on

**Company Muster Roll**

for *Jan & Feby*, 186 *5*

Present or absent *Present*

Stoppage, \$ *100* for

Due Gov't, \$ *100* for

Valuation of horse, \$ *100*

Valuation of horse equipments, \$ *100*

Remarks: *Stop for one Halter.*

Book mark: \_\_\_\_\_

*J. A. Harris*

*S* | **4 Cav.** | **U.S.C.T.**

*Henry Scates*

*Saddler*, Co. F, 4 Reg't U. S. Col'd Cavalry.

Appears on

**Company Muster Roll**

for *Mch & Apr*, 186*5*.

Present or absent *Present*

Stoppage, \$.....<sup>100</sup> for .....

Due Gov't, \$.....<sup>100</sup> for .....

Valuation of horse, \$.....<sup>100</sup>

Valuation of horse equipments, \$.....<sup>100</sup>

Remarks: .....

Book mark: .....

*J. A. Harris*

*S* | **4 Cav.** | **U.S.C.T.**

*Henry Scates*  
Saddler, Co. F, 4 Reg't U. S. Col'd Cavalry.

Appears on

**Company Muster Roll**  
for *May + June*, 186 *5*  
Present or absent *Present*

Stoppage, \$.....100 for .....

Due Gov't, \$.....100 for .....

Valuation of horse, \$.....100

Valuation of horse equipments, \$.....100

Remarks: .....

Book mark: .....

*S. H. Harris*

*B* | **4 Cav.** | **U.S.C.T.**

*Henry Scates*

*Saddler*, Co. F, 4 Reg't U. S. Col'd Cavalry.

Appears on

**Company Muster Roll**

for *July & Aug*, 186*5*

Present or absent *Present*

Stoppage, \$ 100 for

Due Gov't, \$ 100 for

Valuation of horse, \$ 100

Valuation of horse equipments, \$ 100

Remarks:

Book mark:

*J. H. Harris*

S | **4 Cav.** | **U.S.C.T.**

*Henry Scates*  
Saddler, Co. F, 4 Reg't U. S. Col'd Cavalry.

Appears on

**Company Muster Roll**

for *Sept & Oct*, 186 *5*

Present or absent *Present*

Stoppage, \$ *100* for

Due Gov't, \$ *100* for

Valuation of horse, \$ *100*

Valuation of horse equipments, \$ *100*

Remarks:

Book mark:

*H. Harris*

S | 4 Cav. | U.S.C.T.

Henry Scates

Saddler, Co. F, 4 Reg't U. S. Col'd Cavalry.

Appears on

**Company Muster Roll**

for Nov. 1 Dec., 1865.

Present or absent

Stoppage, \$ 100 for

Due Gov't, \$ 100 for

Valuation of horse, \$ 100

Valuation of horse equipments, \$ 100

Remarks: Absent on furlough of (7) days commencing Dec. 25, 65 and ending Jan. 1, 66.

\* Name in column of "Present", cancelled by lines through.

Book mark:

(358)

Hibbard  
Copyist.

S | 4 Cav. | U.S.C.T.

Henry Scates

Saddler, Co. F, 4 Reg't U. S. Col'd Cavalry.

Appears on

Company Muster Roll

for Jan. Feb., 1866.

Present or absent Present

Stoppage, \$ 100 for

Due Gov't, \$ 100 for

Valuation of horse, \$ 100

Valuation of horse equipments, \$ 100

Remarks:

Book mark:

(358)

Hibbard Copyist.



2 | 4 Cav. | U.S.C.T.

Henry Scates  
Dadler, Co. F, 4 Reg't U. S. Colored Cav.

Appears on Returns as follows:

Dec 1865 - Absent with leave  
for seven days.

Book mark:

(546)

W. R. Lee

Copyist.

3 | 4 Cav. | U.S.C.T.

Henry Scates  
Saddler Co. F., 4 Reg't U. S. Col'd Cavalry.

Appears on **Co. Muster-out Roll**, dated  
New Orleans, La., Mch. 20 1866.

Muster-out to date Mch. 20 1866.

Last paid to June 30 1865.

Clothing account:

Last settled....., 186 ; drawn since \$.....100

Due soldier \$ 21<sup>27</sup>/100; due U. S. \$.....100

Am't for cloth'g in kind or money adv'd \$.....100

Due U. S. for arms, equipments, &c., \$.....100

Bounty paid \$.....100; due \$.....100

Remarks: Joined at orig. org.

Book mark: V26-P62-68.

(361)

Hibbard  
Copyist.

Scatter <sup>9050</sup> Eben

Co *D*, 4 U. S. Col'd Cav.

Private | Private

CARD NUMBERS.

1	5347838	26
2	5853211	27
3	5353304	28
4	5353398	29
5	5353502	30
6	5353764	31
7	30852800	32
8	30854422	33
9	40729202	34
10		35
11		36
12		37
13		38
14		39
15		40
16		41
17		42
18		43
19		44
20		45
21		46
22		47
23		48
24		49
25		50

Book Mark:

See also

8802128- P090

5925039 P.O. mom.

W. H. H. H.

I | **4 Cav. | U.S.C.T.**

Eben Scarter

Appears with rank of Priv. on

**Muster and Descriptive Roll of a Detachment of U. S. Vols. forwarded**

for the 4 Reg't U. S. Col'd Cavalry. Roll dated

New Orleans, La., Feb. 8, 1865.

Where born Woodville, Miss.

Age 24 y'rs; occupation Laborer

When enlisted Feb. 20, 1865.

Where enlisted New Orleans,

For what period enlisted 3 years.

Eyes Black; hair Black

Complexion Dark; height 5 ft. 7 in.

When mustered in Feb. 8, 1865.

Where mustered in New Orleans

Bounty paid \$ 100 100; due \$ 200 100

Where credited Co. East Feliciana,  
Port Hudson, La.  
Company to which assigned C

Remarks:

Book mark:

(339)

G. C. Tyler

Copyist.

*S* | **4 Cav.** | **U.S.C.T.**

*Ellen Seaton*

*D*, Co. D, 4 Reg't U. S. Col'd Cavalry.

Appears on

**Company Muster Roll**

for *Dec & Apr*, 1865.

Present or absent *Present*

Stoppage, \$ *100* for

Due Gov't, \$ *100* for

Valuation of horse, \$ *100*

Valuation of horse equipments, \$ *100*

Remarks: *# 107 Garrison by paid  
# 207 blue*

Book mark:

(358)

*W. Wright*  
Copyist.

*S* | **4 Cav. | U.S.C.T.**

*Abner Searles*

*P*, Co. D, 4 Reg't U. S. Col'd Cavalry.

Appears on

**Company Muster Roll**

for *May & June*, 186*5*.

Present or absent *Present*

Stoppage, \$ *100* for

Due Gov't, \$ *100* for

Valuation of horse, \$ *100*

Valuation of horse equipments, \$ *100*

Remarks: *#1 in Company - Paid  
#2 in Co*

Book mark:

(358)

*A. Searles*  
Copyist.

*S* | **4 Cav. | U.S.C.T.**

*Eben Carter*

*P*, Co. D, 4 Reg't U. S. Col'd Cavalry.

Appears on

**Company Muster Roll**

for *July & Aug*, 1865.

Present or absent *Absent*

Stoppage, \$ *100* for

Due Gov't, \$ *100* for

Valuation of horse, \$ *100*

Valuation of horse equipments, \$ *100*

Remarks: *#100 Brown by pair  
Horse  
Absent - sick at camp  
Sept per Col. Thompson  
New Orleans La*

Book mark:

*A. M. Wright*  
Copyist.



S | 4 Cav. | U. S. A.

Even Dearter

4th, Co. D, 4 Reg't U. S. A. Cav.

Appears on

**Hospital Muster Roll**

of Corps d'Afrique U. S. A. General Hospital,

at New Orleans, La.,

for July & Aug, 1865.

Attached to hospital:

When, 186 .

How employed

Last paid by Maj.

to, 186 .

Bounty paid \$ 100; due \$ 100

Present or absent present

Remarks:

Book mark:

(848)

James

Copist.

| **4 Cav.** | **U.S.C.T.**

John Jester

P, Co. D, 4 Reg't U. S. Col'd Cavalry.

Appears on

**Company Muster Roll**

for Sept - Oct, 1865.

Present or absent         

Stoppage, \$ 100 for         

Due Gov't, \$ 100 for         

Valuation of horse, \$ 100

Valuation of horse equipments, \$ 100

Remarks: Discharged for Dis-  
ability Oct-18, 65.

Book mark: Disch'd Oct-18, 65.

SB 104548

(358)

A. J. Wright

Copyist.

*S 4 Cav USCF*

*Eben J Carter*  
*Priv, 4 Reg US Cavalry*

Appears on

**Hospital Muster Roll**

of Corps d'Afrique U. S. A. General Hospital,

at New Orleans, La.,

for *Sept & Oct*, 1865.

Attached to hospital:

When \_\_\_\_\_, 186 .

How employed \_\_\_\_\_

Last paid by Maj. \_\_\_\_\_

to \_\_\_\_\_, 186 .

Bounty paid \$ 100; due \$ 100

Present or absent \_\_\_\_\_

Remarks: *Discharged*  
*Oct 5, 1865.*

Book mark: \_\_\_\_\_

*Steward*

(845)

Copyist.

S

4 Cav. | U.S.C.T.

+ Eben Dearter

Port, Co. D, 4 Reg't U. S. Colored Cav.

Appears on Returns as follows:

Mich 1865 - Gain: Mar 26/65 Port  
Hudson La. Recruit from  
depot.

Oct 1865 - Loss: Oct 17/65 N.  
Orleans killed in receipt.

+ Name appears also as  
Ephraim Dearter

Book mark:

W. B. Lee

S | **4 Cav.** | **U.S.C.T.**

Eben Scooter

Priv, Co. H, 4 Reg't U. S. Col'd Cavalry.

Appears on **Co. Muster-out Roll**, dated  
New Orleans, La, Feb 20, 1866.

Muster-out to date \_\_\_\_\_, 186 .

Last paid to \_\_\_\_\_, 186 .

**Clothing account:**

Last settled \_\_\_\_\_, 186 ; drawn since \$ \_\_\_\_\_ <sup>100</sup>

Due soldier \$ \_\_\_\_\_ <sup>100</sup>; due U. S. \$ \_\_\_\_\_ <sup>100</sup>

Am't for cloth'g in kind or money adv'd \$ \_\_\_\_\_ <sup>100</sup>

Due U. S. for arms, equipments, &c., \$ \_\_\_\_\_ <sup>100</sup>

Bounty paid \$ \_\_\_\_\_ <sup>100</sup>; due \$ \_\_\_\_\_ <sup>100</sup>

Remarks: Joined as recruit.  
Discharged Oct. 5/65.  
for disability.

Book mark : \_\_\_\_\_

M. Andrews

(861)

Copyist.

Scarter, Eben

P. Co. D, 4 U.S.C. Cav.

7 Enclosures.

Bed Cards	Descriptive Lists
Burial Records	Final Statements
Certs. of Dis. for Discharge 1	Furloughs
C. M. Charges	Med. Des. Lists
Med. Certificates	Orders

E. P. \_\_\_\_\_ /

Other papers relating to—

Admission to Hosp'l	Furlough
Casualty Sheet (Officer's)	Med. Examination
Confinement	Misc. Information
Contracts	Pay or Clothing
Death or Effects	Personal Reports
Desertions	Rank
Discharge from Hosp'l	Transfer to Hosp'l
Discharge from Service	Transfer to V. R. C.
Duty	Transportation

[OFFICE INDORSEMENT.]

War Department,

ADJUTANT GENERAL'S OFFICE,

February 4<sup>th</sup>, 1874

The discharge of Iben Carter

Private, Co. D, 4<sup>th</sup> Reg't U. S. Colored Cavalry, is reported as follows:—

On Company Muster Roll.

For Sep. & Oct. 1865, October 18<sup>th</sup>, 1865

Company Muster-out Roll.

October 5<sup>th</sup>, 1865

Company Descriptive Book.

, 186

Company Morning Reports.

, 186

Soldier's Final Statement.

, 186

Soldier's Record of Death and Interment.

, 186

Soldier's Inventory of Effects.

, 186

Soldier's Certificate of Disability for Discharge.

October 5<sup>th</sup>, 1865.

Soldier's Individual Muster-out Roll.

, 186

Regimental Return.

For October, 1865, Died Oct. 17<sup>th</sup>, 1865

Regimental Quarterly Returns.

, 186

Regimental Descriptive Book.

, 186

By Surgeon General.

, 186

Oct 5<sup>th</sup>, 1865, is held to be

the correct date, and the Company Muster

Roll will be amended accordingly.

Thomas M. Seward

EP. 10

Asst. Adj. Gen.

Valid 598, see letter to [unclear]

H. M. April 2<sup>d</sup> 1874

Hutchinson, R.

Headquarters, Dept. of Louisiana  
Medical Director's Office  
New Orleans, La., Aug. 29, 1865

Respectfully returned to the  
Assistant Adjutant General of  
the [unclear] [unclear]

*R. D. Alexander*

Subj. U. S. Army  
Medical Director

Respectfully forwarded  
Approved  
Samuel W. [unclear]  
Capt. Comdr. Regt.

Adj. Gen. Eastern District of Louisiana

New Orleans, August 1865

SR 4395

Respectfully forwarded, recommending  
that General Order No. 9, 1<sup>st</sup> Gulf Cavalry  
Series be first returned to.

*[Handwritten signatures and stamps]*  
RECEIVED  
ADJUTANT GENERAL'S OFFICE  
1865

Approved

*M. Decey*  
Surgeon 118<sup>th</sup> Ill. Infy. Vols.  
Surgeon in chg. Sub-District  
Post Hudson 4<sup>th</sup> Baton Rouge

Headquarters, Department of Louisiana,  
New Orleans, La., [unclear] 1865.

Respectfully [unclear]  
[unclear]  
[unclear]  
[unclear]

By order of Major-General E. R. S. Canby:  
*[Signature]*  
Major, Assistant Adjutant-General.

Corps [unclear] [unclear]  
New Orleans [unclear] 1865

Approved by Board  
of examination  
*Hubert Smith*  
Asst. Surgeon-Gen.  
Recorder of Board

NOTE 1.

The company commander will here add a statement of all the facts known to him concerning the disease or wound, or cause of disability of the soldier; the time, place, manner, and all the circumstances under which the injury occurred, or disease originated or appeared; the duty, or service, or situation of the soldier at the time the injury was received or disease contracted, stating particularly whether the injury was received or the disease contracted in the line of his duty; and whatever other facts may aid a judgment as to the cause, immediate or remote, of the disability, and the circumstances attending it.

When the facts are not known to the company commander, the certificate of any officer, or affidavit of other person having such knowledge, will be appended—as the surgeon in charge of a hospital, the officer commanding a detachment of recruits, &c., &c.

NOTE 2.

When a probable case for pension, special care must be taken to state the degree of disability—as *h, h, &c.*, &c.; to describe particularly the disability, wound, or disease; the extent to which it deprives him of the use of any limb or faculty, or affects his health, strength, activity, constitution, or capacity to labor or earn his subsistence. The surgeon will add, from his knowledge of the facts and circumstances, and from the evidence in the case, his professional opinion of the cause or origin of the disability. In the case of discharges by Medical Inspectors, the last paragraph will state that the "discharge was given by consent of the soldier, after a personal examination, and for disability, the nature, degree, and origin of which are correctly described in the within certificate."

Par. 1260 Regulations, Edit. 1861.

Medical officers, in giving certificates of disability, are to take particular care in all cases that have not been under their charge; and especially in epilepsy, convulsions, chronic rheumatism, derangement of the urinary organs, ophthalmia, ulcers, or any obscure disease liable to be feigned or purposely produced; and in no case shall such certificate be given until after sufficient time and examination to detect any attempt at deception.

DIRECTIONS.

This certificate will be made out in duplicate by the soldier's company commander, or other officer commanding the separate detachment.

Headquarters, Department of Louisiana

New Orleans, La., August 2<sup>d</sup> 1865

To be discharged.

By order of Major-General E. R. S. Canby:

ADJUTANT GENERAL

Oct 16 1865

Duplicate sent the Pension Office.

CERTIFICATE OF DISABILITY FOR DISCHARGE

IN THE CASE OF

1859 R of 54  
 Eben Scatter  
 a Private of Co. D  
 4<sup>th</sup> Regt of US C

A. D. Ins 4<sup>th</sup> Regt. C  
 of Hudsonsburg 1863  
 Respectfully forwarded  
 approved  
 Samuel White  
 Capt Comdr. Regt.

Robert Eastern District of Louisiana  
 New Orleans, August 1865  
 344395  
 Respectfully forwarded, recommending  
 that General Order No. 9, 11th July Current  
 Series, be first confirmed to

Approved  
 E. R. S. Canby  
 Adjutant General

approved

M. Decey  
 Surgeon 118<sup>th</sup> Ills. Infy Regt.  
 Surgeon in chg Sub-District  
 Post Hudson 4<sup>th</sup> Bn on Range

Headquarters, Department of Louisiana,  
 New Orleans, La., August 17 1865.

Respectfully forwarded to the  
 Adjutant General's Office  
 for the purpose of  
 being forwarded to the  
 Adjutant General's Office

By order of Major-General E. R. S. Canby:

Major, Assistant Adjutant-General.

Approved by Board  
 of examination

John Smith  
 A. A. Surgeon U.S.A.  
 Recorder of Board



ARMY OF THE UNITED STATES  
 CERTIFICATE  
 OF DISABILITY FOR DISCHARGE.



Private Eben Scarter, of Captain Oscar C. Jackson's Company, (.....) of the Fourth Regiment of United States Cold Cavalry was enlisted by Capt M. Allister of the 10th Regiment of U.S. Cold Cavalry at New Orleans La on the 20th day of February, 1865, to serve 3 years; he was born in Woodville in the State of Mississippi, is twenty-four years of age, 5 feet 7 inches high, dark complexion, blue eyes black hair, and by occupation when enlisted a laborer. During the last two months said soldier has been unfit for duty 60 days.\* The said soldier was sick when he came from the depot and has been unfit for duty nine tenths of his time of enlistment, in consequence of loss of his lungs.

STATION: Camp Hudson  
 DATE: See Aug 3<sup>rd</sup> 1865 O. C. Jackson  
Capt  
 Commanding Company.

I CERTIFY, that I have carefully examined the said Eben Scarter of Captain Jackson's Company, and find him incapable of performing the duties of a soldier because of Pulmonary Consumption. This man has had during the past year 8 or 10 different attacks of Pneumonia and for the last two or three months his lungs have remained in a state of subacute inflammation. I think the lung affection existed in a latent state prior to enlistment. Degree of disability ~~Not fit for Veteran~~ None Not fit for Veteran uservs Corps.

D. D. Hanson Surgeon.  
4<sup>th</sup> Med. C. Candy

DISCHARGED, this 14<sup>th</sup> day of October 1865, at Camp d'Afrique  
Gen Hospital New Orleans La  
F. E. Pyrite  
 Surgeon in Charge  
 Commanding the Reg't

The Soldier desires to be addressed at  
 Town ..... County ..... State .....

\* See Note 1 on the back of this. † See Note 2 on the back of this.

NOTE 1.—This blank will be used for both enlistments and re-enlistments—enlistment of veterans, &c., &c., in the volunteer service. They will be made out in duplicate in all cases—one to accompany the recruiting return of the superintendent (not the recruiting officer) to the Adjutant General, and one to accompany the accounts of the officer who pays bounty, &c. The Regiment and Company in which the soldier last served should be given on the back.

NOTE 2.—An enlistment holds to service. A muster-in must, in all cases, precede payment of pay, bounty, pension, &c. A muster-in roll must, in all cases, be filed in the Adjutant General's Office as evidence of muster-in. The mustering officer, commissary, or assistant commissary of musters, as the case may be, will countersign both enlistments as having mustered the soldier into the service of the United States before either of them is given to the disbursing officer.

DECLARATION OF RECRUIT.

I, Eben Scatter, desiring to VOLUNTEER as a Soldier in the Army of the United States, for the term of THREE YEARS. Do Declare, That I am 24 years and \_\_\_\_\_ months of age; that I have never been discharged from the United States service on account of disability or by sentence of a court martial, or by order before the expiration of a term of enlistment; and I know of no impediment to my serving honestly and faithfully as a soldier for three years.

GIVEN at New Orleans La the 20<sup>th</sup> day of February 1865

Witness:

John C. ...  
1<sup>st</sup> Lieut. 10<sup>th</sup> U.S.C. Art. 14

Eben Scatter  
mark B

Received from Second Auditor  
October 7th. 1892.

Discharged 18  
Recruit entitled to the Bounty  
provided by Circular No 27  
Office. Pa. Gran. Serv.  
July 19<sup>th</sup> 1864

enlistment; last served in Company ( )  
Reg't of

No. \_\_\_\_\_  
Eben Scatter  
Volunteered at New Orleans  
February 20<sup>th</sup> 1865  
By Capl. A. H. ...  
of the 4<sup>th</sup> Regiment of U.S. Col. ...

CONSENT IN CASE OF MINOR.

I, \_\_\_\_\_, Do CERTIFY, That I am the \_\_\_\_\_ of \_\_\_\_\_; that the said \_\_\_\_\_ is \_\_\_\_\_ years of age; and I do hereby freely give my CONSENT to his volunteering as a SOLDIER in the ARMY OF THE UNITED STATES for the period of THREE YEARS.

GIVEN at \_\_\_\_\_ the \_\_\_\_\_ day of \_\_\_\_\_

Witness:

VOLUNTEER ENLISTMENT.

STATE OF

TOWN OF

*Louisiana*



*New Orleans La*

I, *Eben Scatter*, born in *Woodville* in the State of *Mississippi*, aged *24* years, and by occupation a *Laborer*, Do HEREBY ACKNOWLEDGE to have volunteered this *Twentieth* day of *February*, 1865, to serve as a **Soldier** in the **Army of the United States of America**, for the period of **THREE YEARS**, unless sooner discharged by proper authority: Do also agree to accept such bounty, pay, rations, and clothing, as are, or may be, established by law for volunteers. And I, *Eben Scatter*, do solemnly swear, that I will bear true faith and allegiance to the **United States of America**, and that I will serve them honestly and faithfully against all their enemies or opposers whomsoever; and that I will observe and obey the orders of the President of the United States, and the orders of the officers appointed over me, according to the Rules and Articles of War.

Sworn and subscribed to, at *New Orleans La* his *Eben Scatter*  
this *20<sup>th</sup>* day of *February* 1865, *Mark.*  
BEFORE *James W. Zinsman*  
*1<sup>st</sup> Lieut. 10<sup>th</sup> U. S. Col. 116*

I CERTIFY, ON HONOR, That I have carefully examined the above-named Volunteer, agreeably to the General Regulations of the Army, and that, in my opinion, he is free from all bodily defects and mental infirmity, which would in any way disqualify him from performing the duties of a soldier.

*W. H. Woods*  
EXAMINING SURGEON.

I CERTIFY, ON HONOR, That I have minutely inspected the Volunteer previously to his enlistment, and that he was entirely sober when enlisted; that, to the best of my judgment and belief, he is of lawful age; and that, in accepting him as duly qualified to perform the duties of an able-bodied soldier, I have strictly observed the Regulations which govern the recruiting service. This soldier has *Black* eyes, *Black* hair, *Dark* complexion, is *five* feet *seven* inches high.

*W. M. Allison* Capt-  
*10<sup>th</sup>* Regiment of *W. S. G. H. V.* Volunteers,  
RECRUITING OFFICER.

(A. G. O. No. 74 & 76.)

Mustered into the service of the United States, for three years or during the war, from date of enlistment, in Company *D* of the *10<sup>th</sup>* Regiment of *W. S. G. H. V.* Volunteers, on the *20<sup>th</sup>* day of *February*, 1865, at *New Orleans La*

*John H. ...*  
*2<sup>nd</sup> Lieut. 10<sup>th</sup> U. S. Col. 116*  
*W. M. Allison*

700

Schillman Frank

Co E, 4 U. S. Col'd Cav.

4<sup>th</sup> Sergeant | Private

CARD NUMBERS.

1	5353802	26
2	5353856	27
3	5353911	28
4	5353967	29
5	5354095	30
6	5354164	31
7	5354230	32
8	5354291	33
9	5354355	34
10	5354440	35
11	5354525	36
12	5354600	37
12	5354724	38
14	5354794	39
15	5354863	40
16	40729214	41
17		42
18		43
19		44
20		45
21		46
22		47
23		48
24		49
25		50

Book Mark:

See also

D. 1580161 PTMOM  
D 1579856 PO app

*James*  
50

*S* | **4 Cav.** | **U.S.C.T.**

*Frank S. Hillman*

*4* Sgt, Co. *E*, 1 Reg't, Corps d'Afrique Cavalry.\*

Appears on

**Company Muster-in Roll**

of the organization named above. Roll dated

*New Orleans, La., Dec. 31,* 186*3.*

Muster-in to date

*Dec. 31,* 186*3.*

Joined for duty and enrolled:

When *Nov. 18,* 186*3.*

Where *New Orleans*

Period *3* years.

Valuation of horse, \$ *100*

Valuation of horse equipments, \$ *100*

Remarks:  
\_\_\_\_\_  
\_\_\_\_\_  
\_\_\_\_\_

\*This organization subsequently became Co. *E*, 4 Reg't U. S. Colored Cavalry.

Book mark: \_\_\_\_\_  
\_\_\_\_\_

*Wendell*

*S*

**4 Cav. U.S C.T.**

*Frank Schillman*

*4<sup>th</sup> Sgt*, Co. *E*, 1 Reg't Cav., Corps d'Afrique.\*

Appears on

**Company Muster Roll**

for *Enlistment to Dec. 31*, 1863.

Present or absent *Present*

Stoppage, \$ *100* for

Due Gov't, \$ *100* for

Valuation of horse, \$ *100*

Valuation of horse equipments, \$ *100*

Remarks:

\* This organization subsequently became Co. *E* 4 Reg't U. S. Colored Cavalry.

Book mark:

(358)

*W. Davis*  
*Comptroller* *Copyist*

*S* | **4 Cav. | U.S C.T.**

*Frank Schellman*

*P*, Co. *E*, 1 Reg't Cav., Corps d'Afrique.\*

Appears on

**Company Muster Roll**

for *Jan + Feb*, 186*4*

Present or absent *\* Present*

Stoppage, \$ *100* for

Due Gov't, \$ *100* for

Valuation of horse, \$ *100*

Valuation of horse equipments, \$ *100*

Remarks:

*\* Added by N.A.J. Apr 2, 98*

\* This organization subsequently became Co. *E*, 4 Reg't U. S. Colored Cavalry.

Book mark:

*Lawrence*



*S* | **4 Cav.** | **U.S.C.T.**

*Frank Schillman*

*Sgt.*, Co. E, 4 Reg't U. S. Col'd Cav.

Appears on

**Company Muster Roll**

for *Mar + Apr*, 1864.

Present or absent *Present*

Stoppage, \$ *100* for

Due Gov't, \$ *100* for

Valuation of horse, \$ *100*

Valuation of horse equipments, \$ *100*

Remarks:

Book mark:

*Lewis*

*S* | **4 Cav.** | **U.S.C.T.**

*Frank Schillman*

*Sgt*, Co. E, 4 Reg't U. S. Col'd Cav.

Appears on

**Company Muster Roll**

for *July + Aug*, 1864.

Present or absent *Present*

Stoppage, \$ *100* for

Due Gov't, \$ *100* for

Valuation of horse, \$ *100*

Valuation of horse equipments, \$ *100*

Remarks:

Book mark:

*Lummer*

*S* | **4 Cav.** | **U.S.C.T.**

*Frank Schilman*

*Sgt.*, Co. E, 4 Reg't U. S. Col'd Cav.

Appears on

**Company Muster Roll**

for *Sept + Oct.*, 186 *4*

Present or absent *Present*

Stoppage, \$ *100* for

Due Gov't, \$ *100* for

Valuation of horse, \$ *100*

Valuation of horse equipments, \$ *100*

Remarks:

Book mark:

*Sumner*

*D* | **4 Cav.** | **U.S.C.T.**

*Frank Schilman*

*Sgt.*, Co. E, 4 Reg't U. S. Col'd Cav.

Appears on

**Company Muster Roll**

for *Sept - Oct*, 186 *4*

Present or absent *Present*

Stoppage, \$ *100* for

Due Gov't, \$ *100* for

Valuation of horse, \$ *100*

Valuation of horse equipments, \$ *100*

Remarks:

Book mark:

*Sumner*

S | **4 Cav.** | **U.S.C.T.**

*Francis Schillman*

*Sgt*, Co. E, 4 Reg't U. S. Col'd Cav.

Appears on

**Company Muster Roll**

for *Nov & Dec*, 186 *4*

Present or absent *Present*

Stoppage, \$ *100* for

Due Gov't, \$ *100* for

Valuation of horse, \$ *100*

Valuation of horse equipments, \$ *100*

Remarks: *Stopped for 1 cap  
Souch Duffty 1 Sabre Belt*

Book mark: \_\_\_\_\_

(358)

*Mines*

Copyist.

*S* | **4 Cav.** | **U.S.C.T.**

*Frank Schillman*

*Sgt*, Co. E, 4 Reg't U. S. Col'd Cav.

Appears on

**Company Muster Roll**

for *Jan & Feb*, 186*5*.

Present or absent *Present*

Stoppage, \$ *100* for

Due Gov't, \$ *100* for

Valuation of horse, \$ *100*

Valuation of horse equipments, \$ *100*

Remarks: *Stop for 1 pr spurs & straps  
1 curry comb & 1 nose bag. Rec'd  
only \$7.00 per month to include  
Apr. 30/64 app't Srgt Nov. 18/63  
from private stop for 1 sabb  
belt & 1 cappauch*

Book mark:

*Wines*

S | **4 Cav.** | **U.S.C.T.**

Frank Schillman

Sgt, Co. E, 4 Reg't U. S. Col'd Cav.

Appears on

**Company Muster Roll.**

for Must Apr, 1865.

Present or absent Present

Stoppage, \$.....100 for .....

Due Gov't, \$.....100 for .....

Valuation of horse, \$.....100

Valuation of horse equipments, \$.....100

Remarks: .....

Book mark: .....

Wines

S | **4 Cav.** | **U.S.C.T.**

*Frank Schillman*

*Sgt*, Co. E, 4 Reg't U. S. Col'd Cav.

Appears on

**Company Muster Roll**

for *May & June*, 186*5*.

Present or absent *Present*

Stoppage, \$ *100* for

Due Gov't, \$ *100* for

Valuation of horse, \$ *100*

Valuation of horse equipments, \$ *100*

Remarks:

Book mark:

(358)

*Wines*

Copyist.



*S* | **4 Cav. | U.S.C.T.**

*Frank Stillman*

*Sgt*, Co. E, 4 Reg't U. S. Col'd Cav.

Appears on

**Company Muster Roll**

for *July, & Aug*, 186*5*.

Present or absent *Present*

Stoppage, \$ *100* for

Due Gov't, \$ *100* for

Valuation of horse, \$ *100*

Valuation of horse equipments, \$ *100*

Remarks:

Book mark:

(358)

*Wines*

Copyist.

*S* | **4 Cav.** | **U.S.C.T.**

*Frank Schillman*

*Sgt*, Co. E, 4 Reg't U. S. Col'd Cav.

Appears on

**Company Muster Roll**

for *Sept & Oct*, 186*5*.

Present or absent *Present*

Stoppage, \$ *100* for

Due Gov't, \$ *100* for

Valuation of horse, \$ *100*

Valuation of horse equipments, \$ *100*

Remarks:

Book mark:

(358)

*Miss*

Copyist.

*S* | **4 Cav.** | **U.S.C.T.**

*Frank Schillman*

*Put*, Co. E, 4 Reg't U. S. Col'd Cav.

Appears on

**Company Muster Roll**

for *Nov. + Dec.*, 1865.

Present or absent *Present.*

Stoppage, \$ *100* for

Due Gov't, \$ *100* for

Valuation of horse, \$ *100*

Valuation of horse equipments, \$ *100*

Remarks: *Reduced to the ranks  
Dec. 8, 1865 from Sgt.*

Book mark:

(358)

*Floyd*

Copyist.

*S* | **4 Cav.** | **U.S.C.T.**

*Frank Schillman*

*Put*, Co. E, 4 Reg't U. S. Col'd Cav.

Appears on

**Company Muster Roll**

for *Jany & Seby*, 186*6*.

Present or absent *Present.*

Stoppage, \$ *100* for

Due Gov't, \$ *100* for

Valuation of horse, \$ *100*

Valuation of horse equipments, \$ *100*

Remarks: *Reduced to the ranks  
from Sergt. Dec. 8. 1865.*

Book mark:

(358)

*Floyd*

Copyist.

S | **4 Cav. | U.S.C.T.**

Frank Skillman

Serjt., Co. C, 4 Reg't U. S. Colored Cav.

Appears on Returns as follows:

Jan 1865 - Absent furloughed  
for seven days Jan 24/65  
Port Hudson La.

Book mark:

W. R. Lee

*S* | **4 Cav.** | **U.S.C.T.**

*Frank Schillman*

*Put*, Co. *E*, 4 Reg't U. S. Col'd Cavalry.

Appears on **Co. Muster-out Roll**, dated  
*New Orleans La, Mch 20, 1866.*

Muster-out to date *Mch 20, 1866.*

Last paid to *June 30 1865.*

**Clothing account:**

Last settled....., 186 ; drawn since \$.....  $\overline{100}$

Due soldier \$.....  $\overline{100}$ ; due U. S. \$ *52*  $\frac{87}{100}$

Am't for cloth'g in kind or money adv'd \$.....  $\overline{100}$

Due U. S. for arms, equipments, &c., \$.....  $\overline{100}$

Bounty paid \$.....  $\overline{100}$ ; due \$.....  $\overline{100}$

Remarks: *Joined at orig. org. Sergeant  
to Dec. 8, 1865*

Book mark: *N 26. P 131. 68*

(861)

*Floyd*

Copyist.

167

*Schyleaux Richard*

Co *D*, 4 U. S. Col'd Cav.

*Private* | *Private*

CARD NUMBERS.

1	5347874	26
2	5352744	27
3	5352809	28
4	5352870	29
5	5352944	30
6	5353026	31
7	5353131	32
8	5353762	33
9	40729194	34
10		35
11		36
12		37
13		38
14		39
15		40
16		41
17		42
18		43
19		44
20		45
21		46
22		47
23		48
24		49
25		50

Book Mark: \_\_\_\_\_

See also \_\_\_\_\_

*S* | **4 Cav. | U.S.C.T.**

*Richard Schybeaux*

Appears with rank of *Private* on

**Muster and Descriptive Roll of a Detachment of U. S. Vols. forwarded**

for the 4 Reg't U. S. Col'd Cavalry. Roll dated

*New Orleans La. Apr 17, 1864.*

Where born -----

Age *44* y'rs; occupation *Laborer*

When enlisted *Mar 22*, 1864.

Where enlisted *Alexandria*

For what period enlisted *3* years.

Eyes *Black*; hair *Black*

Complexion *Black*; height *5* ft. *5* in.

When mustered in *Apr 17*, 1864

Where mustered in *New Orleans, La*

Bounty paid \$ *100*; due \$ *100*

Where credited -----

Company to which assigned -----

Remarks: -----

-----

-----

-----

Book mark: -----

-----

*Sallade*



0777 304  
S | **4 Cav.** | **U.S.C.T.**

Richard Schyleaux

Pat, Co. D. 4 Reg't U. S. Col'd Cavalry.

Appears on

**Company Muster Roll**

for March & April, 1864.

Present or absent Present

Stoppage, \$ 100 for

Due Gov't, \$ 100 for

Valuation of horse, \$ 100

Valuation of horse equipments, \$ 100

Remarks:

Book mark:

(358)

Rosenbaum  
Copyist.

S | **4 Cav.** | **U.S.C.T.**

*Richard Schyleaux*

*Plt.*, Co. D. 4 Reg't U. S. Col'd Cavalry.

Appears on

**Company Muster Roll**

for *May & June*, 1864.

Present or absent *Present*

Stoppage, \$ 100 for

Due Gov't, \$ 100 for

Valuation of horse, \$ 100

Valuation of horse equipments, \$ 100

Remarks:

Book mark:

(358)

*Rosenblum*

Copyist.

J | 4 Cav. | U.S.C.T.

*Richard Schyleaux*

*Pvt.*, Co. D. 4 Reg't U. S. Col'd Cavalry.

Appears on

**Company Muster Roll**

for *July & Aug*, 1864.

Present or absent *Present*

Stoppage, \$ 100 for

Due Gov't, \$ 100 for

Valuation of horse, \$ 100

Valuation of horse equipments, \$ 100

Remarks:

Book mark:

(358)

*Rosenbaum*  
Copyist.

S | **4 Cav.** | **U.S.C.T.**

*Richard Schyleaux*

*Plt*, Co. D, 4 Reg't U. S. Col'd Cavalry.

Appears on

**Company Muster Roll**

for *Sept & Oct*, 1864.

Present or absent *Present*

Stoppage, \$ 100 for

Due Gov't, \$ 100 for

Valuation of horse, \$ 100

Valuation of horse equipments, \$ 100

Remarks:

Book mark:

(358)

*Rosenbaum*  
Copyist.

D | **4 Cav.** | **U.S.C.T.**

Richard Schuler

P, Co. D, 4 Reg't U. S. Col'd Cavalry.

Appears on

**Company Muster Roll**

for Nov Dec, 1864.

Present or absent Present

Stoppage, \$ 100 for

Due Gov't, \$ 100 for

Valuation of horse, \$ 100

Valuation of horse equipments, \$ 100

Remarks: On duty as  
Co Cook  
Due 25 for and 01 ch

Book mark:

(358)

L. T. Wright

Copyist.

*D* | **4 Cav.** | **U.S.C.T.**

*Richard Schycaun*

*D*, Co. D, 4 Reg't U. S. Col'd Cavalry.

Appears on

**Company Muster Roll**

for *Jan & Feb*, 1865.

Present or absent.....

Stoppage, \$.....100 for.....

Due Gov't, \$.....100 for.....

Valuation of horse, \$.....100

Valuation of horse equipments, \$.....100

Remarks: *Discharged Feb*  
*1865.*

Book mark:.....

(358) *A. M. Wright* Copyist.

D | 4 Cav. | U.S.C.T.

Richard Schyleaux  
Port Co. H, 4 Reg't U. S. Colored Cav.

Appears on Returns as follows:

Apr 1864 - Gain: Apr 17/64  
N. Orleans Recruit from  
depot.

Aug 1864 - On duty Carpenter for  
R. G. M.

Dec 1864 & Jan 1865 - On duty detailed  
as Co. Cook.

Feb 1865 - Loss: Feb 11/65  
Port Hudson, La. Disch'd.  
for disability

Name appears also as  
Rich'd. Schyleaux

Book mark:

W. R. Lu

(546)

Copyist.

S | **4 Cav. | U.S.C.T.**

Richard Schyleaux

Put, Co. H, 4 Reg't U. S. Col'd Cavalry.

Appears on **Co. Muster-out Roll**, dated  
New Orleans, La, March 20, 1866.

Muster-out to date \_\_\_\_\_, 186 .

Last paid to \_\_\_\_\_, 186 .

**Clothing account:**

Last settled \_\_\_\_\_, 186 ; drawn since \$ \_\_\_\_\_ 100

Due soldier \$ \_\_\_\_\_ 100; due U. S. \$ \_\_\_\_\_ 100

Am't for cloth'g in kind or money adv'd \$ \_\_\_\_\_ 100

Due U. S. for arms, equipments, &c., \$ \_\_\_\_\_ 100

Bounty paid \$ \_\_\_\_\_ 100; due \$ \_\_\_\_\_ 100

Remarks: Joined as recruit,  
Discharged Feb. 11/65.

Book mark: V 71, P 11, 69

J. D. Andrews



Schuyler, Richard  
 P. Co. 10, 4 U.S.C. Cav.

Enclosures.

Bed Cards	Descriptive Lists
Burial Records	Final Statements
Certs. of Dis. for Discharge /	Furloughs
C. M. Charges	Med. Des. Lists
Med. Certificates	Orders

Other papers relating to—

Admission to Hosp'l	Furlough
Casualty Sheet (Officer's)	Med. Examination
Confinement	Misc. Information
Contracts	Pay or Clothing
Death or Effects	Personal Reports
Desertions	Rank
Discharge from Hosp'l	Transfer to Hosp'l
Discharge from Service	Transfer to V. R. C.
Duty	Transportation

NOTE 1.

The company commander will here add a statement of all the facts known to him concerning the disease or wound, or cause of disability of the soldier; the time, place, manner, and all the circumstances under which the injury occurred, or disease originated or appeared; the duty, or service, or situation of the soldier at the time the injury was received or disease contracted, stating particularly whether the injury was received or the disease contracted in the line of his duty; and whatever other facts may aid a judgment as to the cause, immediate or remote, of the disability, and the circumstances attending it.

When the facts are not known to the company commander, the certificate of any officer, or affidavit of other person having such knowledge, will be appended—as the surgeon in charge of a hospital, the officer commanding a detachment of recruits, &c., &c.

NOTE 2.

When a probable case for pension, special care must be taken to state the degree of disability—as *1, 1/2, &c., &c.*; to describe particularly the disability, wound, or disease; the extent of which it deprives him of the use of any limb or faculty, or affects his health, strength, activity, constitution, or capacity to labor or earn his subsistence. The surgeon will add, from his knowledge of the facts and circumstances, and from the evidence in the case, his professional opinion of the cause or origin of the disability. In the case of discharges by Medical Inspectors, the last paragraph will state that the "discharge was given by consent of the soldier, after a personal examination, and for disability, the nature, degree, and origin of which are correctly described in the within certificate."

Par. 1260 Regulations, Edit. 1861.

Medical officers, in giving certificates of disability, are to take particular care in all cases that have not been under their charge; and especially in epilepsy, convulsions, chronic rheumatism, derangement of the urinary organs, ophthalmia, ulcers, or any obscure disease liable to be feigned or purposely produced; and in no case shall such certificate be given until after sufficient time and examination to detect any attempt at deception.

DIRECTIONS.

This certificate will be made out in duplicate by the soldier's company commander, or other officer commanding the separate detachment to which he belongs, and sent by him to the surgeon who has charge of the hospital where the soldier is sick. The surgeon will then fill out and sign the surgeon's certificate, and forward these papers to the regimental, detachment, or post commander, who will forward them, with his action endorsed thereon, through the proper channel, to his division commander; or, if the troops are not attached to a division, to his corps, department, or other commander or officer to whom the authority to discharge enlisted men may be specially delegated.

These certificates, after having received the action of the highest authority to which they are required to be sent, will be returned through the same channel to the regimental, post, or detachment commander, who will, if the discharge is authorized by the endorsement of the proper authority, sign the soldier's discharge, and the last certificate on this paper; see that the soldier is furnished with the proper final statements in duplicate, and forward BOTH of these certificates direct to the Adjutant General, United States Army, at Washington, D. C.; they will not, under any circumstances, be given into the hands of the soldier.

Duplicate sent the Pension Office.  
McL 11 1865

53  
1865  
CERTIFICATE OF DISABILITY FOR DISCHARGE  
IN THE CASE OF

Richard Schuyler  
a Private Co. D  
Hawth Regt of U.S.A.

Approved Jan 30 5

Head Quarters Dept of the Gulf  
New Orleans Feb 1 1865  
To be discharged  
By command of  
Maj Gen. Hurlbut  
Capt & A. A. General

Received A. G. Office  
Circular stamp: RECEIVED FEB 1 1865 GENL'S OFFICE

Office Surgeon in Chief  
District of Baton Rouge & Port Hudson  
January 24<sup>th</sup> 1865

Respectfully Approved  
Chas. A. Dever  
Surgeon 2<sup>nd</sup> La Vol Infy  
In Charge District of Baton Rouge & Port Hudson

Head Quarters Dist. Dist. of  
Baton Rouge, La. Jan 27 1865  
District of Baton Rouge & Port Hudson  
Approved

Geo. L. Andrews  
Surgeon in Chief  
District of Baton Rouge & Port Hudson

Memo:  
Dec 11. P. 11. 69  
A. G.

# ARMY OF THE UNITED STATES.

## CERTIFICATE.

OF DISABILITY FOR DISCHARGE.



Private Richard Schuyler of Captain Oscar C. Jackson's Company, (10th) of the Fourth Regiment of the United States Infantry was enlisted by T. S. Sicker of the Fourth Regiment of Alexandria at Alexandria on the twenty-second day of March, 1864 to serve three years; he was born in France in the State of France, is forty-four years of age, five feet three inches high, Black complexion, Black eyes, Black hair, and by occupation when enlisted a Labourer. During the last two months said soldier has been unfit for duty sixty days.\* This Soldier has never done duty except as company cook and think him not capable for that.

STATION: Port Hudson La  
 DATE: Feb 11<sup>th</sup> 1865

Oscar C. Jackson  
Captain  
 Commanding Company.

No. 101  
 I CERTIFY, that I have carefully examined the said Richard Schuyler of Captain Jackson's Company, and find him incapable of performing the duties of a soldier because of Old age (at least 60 years) and Distortion of right and joints of foot. He was unfit for the service on entering it. Unfit for service in Invalid Corps. Henry B. Moore Surgeon of the U.S. Army

W. Coak Surgeon  
Surgeon S

DISCHARGED, this Eleventh day of February, 1865, at Port Hudson Louisiana

Wm. C. Mitchell  
Major  
 Commanding the Reg't.

The Soldier desires to be addressed at  
 Town New Orleans County Orleans State Louisiana

\* See Note 1 on the back of this. † See Note 2 on the back of this.

Offer Post & pay over  
 Port Hudson La  
 Jan 21 1865  
 Approved  
 W. G. Wood  
 Post Surg Con  
 Respectfully

960

Scotter Eben

Co D, 4 U. S. Col'd Cav.

Private | Private

CARD NUMBERS.

1		26
2		
3	all Scotter Eben	27
4		29
5		30
6		31
7		32
8		33
9		34
10		35
11		36
12		37
13		38
14		39
15		40
16		41
17		42
18		43
19		44
20		45
21		46
22		47
23		48
24		49
25		50

Book Mark:

See also

Scott John E.

Co A, 4 U. S. Col'd Cav.

Private Sergeant

CARD NUMBERS.

1	5348484	26
2	5348517	27
3	5348615	28
4	5348715	29
5	5348808	30
6	5348976	31
7	5349059	32
8	5349719	33
9	30848450	34
10	30849009	35
11	30849877	36
12	40729200	37
13		38
14		39
15		40
16		41
17		42
18		43
19		44
20		45
21		46
22		47
23		48
24		49
25		50

Book Mark:

See also

*S* | 4 Cav. | U.S.C.T.

*John E. Scott*  
Private, Co. *A*, 1 Reg't La. Cav., Corps d'Afrique.\*

Appears on

**Company Muster-in Roll**

of the organization named above. Roll dated

*New Orleans Sept 12*, 1863.

Muster-in to date *Sept 12*, 1863.

Joined for duty and enrolled:

When *Sept 3*, 1863.

Where *New Orleans*

Period *3* years.

Valuation of horse, \$ *100*

Valuation of horse equipments, \$ *100*

Remarks:

*Age 28*

\*This organization subsequently became Co *A*, 4 Reg't U. S. Colored Cavalry.

Book mark:

*M. A. Michaels*

(356)

Copyist.

J

4 Cav. U.S.C.T.

John E. Scott  
Sergeant, Co. A, 1 Reg't La. Cav., Corps d'Afrique.\*

Appears on

Company Muster Roll

for Sept 12 to Dec 31, 1863.

Present or absent Present

Stoppage, \$ 100 for

Due Gov't, \$ 100 for

Valuation of horse, \$ 100

Valuation of horse equipments, \$ 100

Remarks:

\*This organization subsequently became Co. A, 4 Reg't U. S. Colored Cavalry.

Book mark:

R. Richardson

*S* | **4 Cav. U.S.C.T.**

*John E. Scott*  
*Sgt*, Co. *A*, 1 Reg't Cav., Corps d'Afrique.\*

Appears on

**Company Muster Roll**

for *Jan & Feb*, 186*4*

Present or absent *Present*

Stoppage, \$ *100* for

Due Gov't, \$ *100* for

Valuation of horse, \$ *100*

Valuation of horse equipments, \$ *100*

Remarks:  
.....  
.....  
.....  
.....  
.....

\* This organization subsequently became Co. *A* 4 Reg't U. S. Colored Cavalry.

Book mark: .....

*R. Richardson*  
Copyist.



*S* | **4 Cav. | U.S.C.T.**

*John E. Scott*  
-----  
*Serg't*, Co. A, 4 Reg't U. S. Col'd Cavalry.

Appears on

**Company Muster Roll**

for *March + April*, 1864.

Present or absent *absent*

Stoppage, \$ *100* for

Due Gov't, \$ *100* for

Valuation of horse, \$ *100*

Valuation of horse equipments, \$ *100*

Remarks: *Detained on recruiting service with Maj Payne since March 15 1864*

Book mark: \_\_\_\_\_

*R. Richardson*

S | 4 Cav. | U.S.C.A.

John E. Scott  
Sgt, Co. A, 4 Reg't Cav.

Appears on

**Hospital Muster Roll**

of Corps d'Afrique U. S. A. General Hospital,

at New Orleans, La.,

for mis & cape, 1864.

Attached to hospital:

When \_\_\_\_\_, 186 .

How employed \_\_\_\_\_

Last paid by Maj. \_\_\_\_\_

to \_\_\_\_\_, 186 .

Bounty paid \$ 100; due \$ 100

Present or absent Present

Remarks: \_\_\_\_\_  
\_\_\_\_\_  
\_\_\_\_\_  
\_\_\_\_\_  
\_\_\_\_\_  
\_\_\_\_\_  
\_\_\_\_\_  
\_\_\_\_\_

Book mark: \_\_\_\_\_

(843)

Morgan  
Coppist.

I | **4 Cav.** | **U.S.C.T.**

John E Scott  
Sergeant, Co. A, 4 Reg't U. S. Col'd Cavalry.

Appears on

**Company Muster Roll**

for May & June, 186 4

Present or absent Absent

Stoppage, \$ 100 for

Due Gov't, \$ 100 for

Valuation of horse, \$ 100

Valuation of horse equipments, \$ 100

Remarks: Absent on recruiting  
Service by Spec ord 22  
Head Qrs Recty, Dept U.S.C.T.  
March 8/64

Book mark:

R. Richardson

*S* | *4 car* | *USCY*

*John E. Scott*  
*Sgt., Co. A, 4 Reg't US car*

Appears on

**Hospital Muster Roll**

of **Corps d'Afrique U. S. A. General Hospital,**

at **New Orleans, La.,**

for *May & June*, 186*4*.

Attached to hospital:

When....., 186 .

How employed.....

Last paid by Maj. ....

to ....., 186 .

Bounty paid \$ 100; due \$ 100

Present or absent *Present*

Remarks: .....

Book mark: .....

*S* | **4 Cav.** | **U.S.C.T.**

*John E Scott*  
*Sergt*, Co. A, 4 Reg't U. S. Col'd Cavalry.

Appears on

**Company Muster Roll**

for *July + Aug*, 186 *4*

Present or absent.....

Stoppage, \$.....100 for.....

Due Gov't, \$.....100 for.....

Valuation of horse, \$.....100

Valuation of horse equipments, \$.....100

Remarks: *Discharged from*  
*Co. 5 D Afrigue Genl*  
*Hospital New Orleans*  
*Aug 15/64 Disability*

Book mark:.....

*R. H. Richardson*

S | 4 Cav | U.S.A.

John E. Scott  
Pvt, Co. A, 4 Reg't U.S. Cav

Appears on

**Hospital Muster Roll**

of Corps d'Afrique U. S. A. General Hospital,

at New Orleans, La.,

for July & Aug, 1864

Attached to hospital:

When, 186 .

How employed

Last paid by Maj.

to, 186 .

Bounty paid \$ 100; due \$ 100

Present or absent

Remarks: Discharged from U.S. Service Aug 13-64

Book mark:

Wark

(848)

Copyist.

S | 4 Cav. | U.S.C.T.

John E. Scott

Regt., Co. A, 4 Reg't U. S. Col'd Cavalry.

Appears on

Company Muster Roll

for Sept & Oct, 1864.

Present or absent

Stoppage, \$ 100 for

Due Gov't, \$ 100 for

Valuation of horse, \$ 100

Valuation of horse equipments, \$ 100

Remarks: Discharged from Corps  
at Afrigue Lt New Orleans  
Aug 13/64 for disability

Book mark: Discharged Aug 13. 64. E. B.  
V. 10, p 488

Donnelly

4 Cav. U.S.C.T.

John E. Scott  
Sergt. Co. A, 4 Reg't U. S. Colored Cav.

Appears on Returns as follows:

Jan 1864 - (1 Reg't Cav., Corps d'Afrique)  
Absent on furlough 7 days.

Apr to June 1864 - (4 Reg't. U.S. Col'd. Cav.)  
Absent detailed on Recruiting  
service Mar 15/64

Aug 1864 - Loss: Aug 15 N.  
Orleans Wschgd for disability

Book mark:

W. R. Lee

(546)

Copyist.



*S* | **4 Cav.** | **U.S.C.T.**

*John E. Scott*  
-----  
*Serjt.*, Co. *A*, 4 Reg't U. S. Col'd Cavalry.

Appears on **Co. Muster-out Roll**, dated  
*New Orleans La, Mch 20*, 1866 .

Muster-out to date -----, 186 .

Last paid to -----, 186 .

**Clothing account:**

Last settled -----, 186 ; drawn since \$ ----- 100

Due soldier \$ ----- 100 ; due U. S. \$ ----- 100

Am't for cloth'g in kind or money adv'd \$ ----- 100

Due U. S. for arms, equipments, &c., \$ ----- 100

Bounty paid \$ ----- 100 ; due \$ ----- 100

Remarks: *Joined at orig. org. discharged*  
*Aug 25 64. at New Orleans La.*

-----  
-----  
-----  
-----  
-----  
Book mark: *Discharged Aug 13 64*  
*E. R. V. 10. P. 488.*  
*V. 36 P. 99. 69*  
*V. 25, P. 61. 68 CD*

(361)

*Prewitt*  
-----  
Copyist.

Scott, John, C  
Sgt, Co. A, 4 U.S.C. Cav.

2 Enclosures.

Bed Cards	Descriptive Lists
Burial Records	Final Statements
Certs. of Dis. for Discharge 1	Furloughs
C. M. Charges	Med. Des. Lists
Med. Certificates	Orders

Other papers relating to—

Admission to Hosp'l	Furlough
Casualty Sheet (Officer's)	Med. Examination
Confinement	Misc. Information 1
Contracts	Pay or Clothing
Death or Effects	Personal Reports
Desertions	Rank
Discharge from Hosp'l	Transfer to Hosp'l
Discharge from Service	Transfer to V. R. C.
Duty	Transportation

MICROFILM PUBLICATION M 1820

COMPILED MILITARY SERVICE RECORDS  
OF VOLUNTEER UNION SOLDIERS WHO  
SERVED WITH THE USCT (US COLORED TROOPS)  
4TH REGIMENT OF CAVALRY

PERSONAL PAPERS' TARGET SHEET

PLEASE NOTE THE CHECKED INFORMATION ABOUT THE PERSONAL PAPERS IN  
THIS FILE:

- NO PERSONAL PAPERS WERE FOUND IN THIS FILE WHEN THE  
RECORDS WERE ARRANGED FOR MICROFILMING.
  
- 3 PERSONAL PAPER(S) FOUND IN THIS FILE WHEN THE RECORDS  
WERE ARRANGED FOR MICROFILMING.

NOTE 1.

The company commander will here add a statement of all the facts known to him concerning the disease or wound, or cause of disability of the soldier; the time, place, manner, and all the circumstances under which the injury occurred, or disease originated or appeared; the duty, or service, or situation of the soldier at the time the injury was received or disease contracted, stating particularly whether the injury was received or the disease contracted in the line of his duty; and whatever other facts may aid a judgment as to the cause, immediate or remote, of the disability, and the circumstances attending it.

When the facts are not known to the company commander, the certificate of any officer, or affidavit of other person having such knowledge, will be appended—as the surgeon in charge of a hospital, the officer commanding a detachment of recruits, &c., &c.

NOTE 2.

When a probable case for pension, special care must be taken to state the degree of disability—as 1/2, 3/4, &c., &c.; to describe particularly the disability, wound, or disease; the extent to which it deprives him of the use of any limb or faculty, or affects his health, strength, activity, constitution, or capacity to labor or earn his subsistence. The surgeon will add, from his knowledge of the facts and circumstances, and from the evidence in the case, his professional opinion of the cause or origin of the disability. In the case of discharges by Medical Inspectors, the last paragraph will state that the "discharge was given by consent of the soldier, after a personal examination, and for disability, the nature, degree, and origin of which are correctly described in the within certificate."

Par. 1260 Regulations, Edit. 1861.

Medical officers, in giving certificates of disability, are to take particular care in all cases that have not been under their charge; and especially in epilepsy, convulsions, chronic rheumatism, derangement of the urinary organs, ophthalmia, ulcers, or any obscure disease liable to be feigned or purposely produced; and in no case shall such certificate be given until after sufficient time and examination to detect any attempt at deception.

DIRECTIONS.

This certificate will be made out in duplicate by the soldier's company commander, or other officer commanding the separate detachment to which he belongs, and sent by him to the surgeon who has charge of the hospital where the soldier is sick. The surgeon will then fill out and sign the surgeon's certificate, and forward these papers to the regimental, detachment, or post commander, who will forward them, with his action endorsed thereon, through the proper channel, to his division commander; or, if the troops are not attached to a division, to his corps, department, or other commander or officer to whom the authority to discharge enlisted men may be specially delegated.

These certificates, after having received the action of the highest authority to which they are required to be sent, will be returned through the same channel to the regimental, post, or detachment commander, who will, if the discharge is authorized by the endorsement of the proper authority, sign the soldier's discharge, and the last certificate on this paper; see that the soldier is furnished with the proper final statements in duplicate, and forward BOTH of these certificates direct to the Adjutant General United States Army, at Washington, D. C.; they will not, under any circumstances, be given into the hands of the soldier.

ADJUTANT GENERAL'S OFFICE.  
Aug 25<sup>th</sup> 1864  
Duplicate for Pension Office.

1864  
CERTIFICATE OF DISABILITY FOR DISCHARGE

IN THE CASE OF

John C. Scott  
a Sgt. Co. A  
4<sup>th</sup> Reg't of M.S.C. Cav.

Approved by Board of Examination  
at Camp d'Iniquite Gen Hospital  
New Orleans La.

F. E. Pryor  
Surgeon in Charge

Approved Aug 9<sup>th</sup>  
R. A. Mearns

Received (A. G. Office) \_\_\_\_\_, 186 .

Carson of Office

Head Quarters Dept. of the Gulf,  
New Orleans, August 12, 1864.

To be discharged.

By command of Maj. Genl. Banks:  
J. S. Sargent  
A. A. General

War Department,  
Adjutant General's Office  
Washington, D.C., Oct. 18, 1864

The Muster Out Roll of Co.  
4<sup>th</sup> U.S. S. Cav. reports Sg't  
John C. Scott discharged Aug.  
9<sup>th</sup>, 1864.

The Co. Muster Roll for July and  
August 1864, indicates that he was  
discharged at New Orleans, Aug.  
13, 1864, for Disability.

The Surgeon's Certificate of Dis-  
ability for discharge gives Aug. 13, 1864  
as the date of discharge, which  
date is held to be correct and the  
Co. Muster and Muster Out Roll  
will be amended accordingly.

Thoma M. Present  
E. B. 11 Assist Adj't General  
Solid 30.11.

ARMY OF THE UNITED STATES  
 CERTIFICATE  
 OF DISABILITY FOR DISCHARGE.



Sergt John E Scott, of Captain \_\_\_\_\_  
 Company, (A) of the 4<sup>th</sup> Regiment of United States  
C. Cavalry was enlisted by Capt. Fittet of  
 the 4<sup>th</sup> Regiment of U.S.C. Cav. at New Orleans  
 on the third day of Sept., 1863, to serve 3 years; he was born  
 in Madison in the State of Missouri, is 28  
 years of age, 5 feet 2 inches high, Brown complexion, Brown eyes  
black hair, and by occupation when enlisted a Moulder. During the last two  
 months said soldier has been unfit for duty 61 days.\*

STATION: New Orleans  
 DATE: Aug. 2<sup>o</sup> 1864

\_\_\_\_\_  
 Commanding Company.

I CERTIFY, that I have carefully examined the said Sergt. John E. Scott of  
 Captain \_\_\_\_\_ Company, and find him incapable of performing the duties of a soldier  
 because of Gunshot wound of superior maxillary. Also of right thigh.  
Also fracture of hand. He was wounded in skirmish 4 or 5 miles  
from Alexandria. Degree of Disability 1/2. Wounded in  
U.S. Service. Not fit for Invalid Corps.

James H. Angel  
Actg. Surg. Surgeon, U.S.A.

DISCHARGED, this Thirteenth day of August, 1864, at New Orleans La.

J. E. Pynette  
Surgeon in Charge  
 Commanding the Reg't  
C. Cavalry Hosp

The Soldier desires to be addressed at

Town \_\_\_\_\_ County \_\_\_\_\_ State \_\_\_\_\_

\* See Note 1 on the back of this.

† See Note 2 on the back of this.

PLB 938 P.M.C. 1866

Had you ever of the  
and Orleans Dec 5 1866

Hood & A. S.

V. W. W. W. S.

Direct and amount

Prot. pro. E. Scott + W. H.

Int. our Capt. Billie

No. 100 - 1861 4<sup>th</sup> U.S. Army  
Greenfield Mass 3<sup>rd</sup> 1866

Headquarters, Eastern District of Louisiana,

196.

New Orleans, La., March 3<sup>rd</sup>, 1866.

Comdg. Officer  
Co. A. S. C. Cavalry.  
At Greenville.

Sir:

You will arrest and send under  
guard to the Provost Marshal, Parish  
of Orleans, John E. Scott, servant for  
Captain M. Williams, Co. A. S. C. Cavalry,  
to be held as a deserter.

By order of  
Col. Maj. Gen. J. M. Thurman  
J. H. Wood,  
Lieut. & A. S. C.  
Cavalry

Balance of discharges reported

Muster-Roll for July & August - 64 -	Discharged New Orleans,	Aug 15. 64 -	Disability
Muster-out-Roll -	"	Aug 25. 64 -	"
Surgeon's Certificate of Disability	"	Aug 13. 64 -	"

*Aug 13/64*  
*W. H. [unclear]*

2. R. -



Scott Joseph

Co —, 4 U. S. Col'd Cav.

Private

CARD NUMBERS.

1	5347781	26
2		27
3		28
4		29
5		30
6		31
7		32
8		33
9		34
10		35
11		36
12		37
13		38
14		39
15		40
16		41
17		42
18		43
19		44
20		45
21		46
22		47
23		48
24		49
25		50

Book Mark:

See also

S | **4 Cav.** | **U.S.C.T.**

Joseph Scott

Appears with rank of Priv. on

**Muster and Descriptive Roll of a Detachment of U. S. Vols. forwarded**

for the 4 Reg't U. S. Col'd Cavalry. Roll dated New Orleans, La., Aug. 26, 1864.

Where born New Orleans, La.

Age 18 y'rs; occupation Waiter

When enlisted Aug. 26, 1864.

Where enlisted New Orleans

For what period enlisted 3 years.

Eyes Black; hair Black

Complexion Whip; height 5 ft. in.

When mustered in Aug. 26, 1864.

Where mustered in New Orleans

Bounty paid \$ 100 100; due \$ 200 100

Where credited New Orleans

Company to which assigned B

Remarks: Recruits entitled to

bounty. Rejected by muster

ing officer. Entry excepted

not borne on Rolls of Regt

Book mark:

(339)

G. H. Tyler

Copyist.

JAN-18  
5347781  
REMARKS (Cont.)

1891

marks" Rejected by "Mustering  
officer" cancelled by line.

8

W. J.

5347781

1891

Remarks (cont.)

marks" Rejected by Mustering  
officer" cancelled by line.

900  
Scott Rowla

Co *A*, 4 U. S. Col'd Cav.

Private Private

CARD NUMBERS.

1	5354980	26
2	5355069	27
3	5355160	28
4	5355270	29
5	5355343	30
6	5355426	31
7	5355507	32
8	5355582	33
9	5355666	34
10	5355750	35
11	5355833	36
12	5355913	37
13	5355994	38
14	5356072	39
15	5356149	40
16		41
17		42
18		43
19		44
20		45
21		46
22		47
23		48
24		49
25		50

Book Mark:

See also

8-939989-PO MAM  
1583644 Pass.

*[Faint handwritten signature]*

*S* | **4 Cav.** | **U.S.C.T.**

*Rawls Scott*

*Pvt*, Co. A, Mounted Rangers, Corps d'Afrique.†

Age ..... years.

Appears on

**Company Muster Roll\***

for *Nov. & Dec*, 186*3*.

Joined for duty and enrolled:

When *Nov 1*, 186*3*.

Where *Iberia, La*

Period ..... years.

Mustered in:

When *Nov 30*, 186*3*.

Where *Iberia, La*

Present or absent *Present*

Stoppage, \$ ..... 100 for

Due Gov't \$ ..... 100 for

Valuation of horse, \$ ..... 100

Valuation of horse equipments, \$ ..... 100

Remarks: .....

†This organization subsequently became Co. F, 4th U.S. Col'd Cav.

\*First current roll. No muster-in roll of this ~~battery~~ on file.

Book mark: .....

(3586)

*Manning*  
Copyist.

*S* | **4 Cav. | U.S C.T.**

*Rawla Scott*  
*Pl.*, Co. *F*, 1 Reg't Cav., Corps d'Afrique.\*

Appears on

**Company Muster Roll**

for *Jan'y P. Feb'y*, 186*4*.

Present or absent *Present*

Stoppage, \$ 100 for

Due Gov't, \$ 100 for

Valuation of horse, \$ 100

Valuation of horse equipments, \$ 100

Remarks:

\* This organization subsequently became Co. *F*, 4 Reg't U. S. Colored Cavalry.

Book mark:

(358)

*Manning*

Copyist.



*S* | **4 Cav. U.S.C.T.**

*Rawla Scott*

*Pr*, Co. F, 4 Reg't U. S. Col'd Cavalry.

Appears on

**Company Muster Roll**

for *March & April*, 1864.

Present or absent *Present*

Stoppage, \$ 100 for

Due Gov't, \$ 100 for

Valuation of horse, \$ 100

Valuation of horse equipments, \$ 100

Remarks:

Book mark:

*Hanning*  
Copyist.

*S* | **4 Cav.** | **U.S.C.T.**

*Rawla Scott*

*Pvt*, Co. F, 4 Reg't U. S. Col'd Cavalry.

Appears on

**Company Muster Roll**

for *May & June*, 1864.

Present or absent

Stoppage, \$ 100 for

Due Gov't, \$ 100 for

Valuation of horse, \$ 100

Valuation of horse equipments, \$ 100

Remarks: *Deserted Returned  
Voluntarily June 28  
1864*

Book mark:

*Hamm*

(358)

Copyist.

*S* | 4 Cav. | U.S.C.T.

*Rawla Scott*

*Pvt*, Co. F, 4 Reg't U. S. Col'd Cavalry.

Appears on

**Company Muster Roll**

for *May & June*, 1864.

Present or absent.....

Stoppage, \$..... 100 for.....

Due Gov't, \$..... 100 for.....

Valuation of horse, \$..... 100

Valuation of horse equipments, \$..... 100

Remarks: *Deserted Returned  
Voluntarily June 28  
1864*

Book mark : .....

*Hammy*

*S* | **4 Cav. | U.S.C.T.**

*Rawley Scott*

*Cvt*, Co. F, 4 Reg't U. S. Col'd Cavalry.

Appears on

**Company Muster Roll**

for *July & Aug*, 1864.

Present or absent *Present*

Stoppage, \$ *100* for

Due Gov't, \$ *100* for

Valuation of horse, \$ *100*

Valuation of horse equipments, \$ *100*

Remarks:

Book mark:

(358)

*Warrin*  
Copyist.

*S* | **4 Cav.** | **U.S.C.T.**

*Rowley Scott*

*Pr*, Co. F, 4 Reg't U. S. Col'd Cavalry.

Appears on

**Company Muster Roll**

for *Sept & Oct*, 1864.

Present or absent *Present*

Stoppage, \$ *100* for

Due Gov't, \$ *100* for

Valuation of horse, \$ *100*

Valuation of horse equipments, \$ *100*

Remarks:

Book mark:

(358)

*Manning*  
Copyist.

*S* | **4 Cav. | U.S.C.T.**

*Rawla Scott*

*Priv*, Co. F, 4 Reg't U. S. Col'd Cavalry.

Appears on

**Company Muster Roll**  
for *Nov. & Dec*, 186 *4*

Present or absent *Present*

Stoppage, \$ *100* for

Due Gov't, \$ *100* for

Valuation of horse, \$ *100*

Valuation of horse equipments, \$ *100*

Remarks:  
.....  
.....  
.....  
.....  
.....  
.....  
.....  
.....  
.....  
.....

Book mark : .....

*J. A. Harris*  
Copyist.

*S* | **4 Cav.** | **U.S.C.T.**

*Rawla Scott*

*Pvt*, Co. F, 4 Reg't U. S. Col'd Cavalry.

Appears on

**Company Muster Roll**

for *Jan & Feby*, 186*5*.

Present or absent *Present*

Stoppage, \$ *100* for

Due Gov't, \$ *100* for

Valuation of horse, \$ *100*

Valuation of horse equipments, \$ *100*

Remarks:

Book mark:

*J. H. Harris*

S | 4 Cav. | U.S.C.T.

Rawla Scott

Priv, Co. F, 4 Reg't U. S. Col'd Cavalry.

Appears on

**Company Muster Roll**

for Mich & Apr, 186 5

Present or absent Present

Stoppage, \$ 100 for

Due Gov't, \$ 100 for

Valuation of horse, \$ 100

Valuation of horse equipments, \$ 100

Remarks:  
\_\_\_\_\_  
\_\_\_\_\_  
\_\_\_\_\_  
\_\_\_\_\_  
\_\_\_\_\_  
\_\_\_\_\_  
\_\_\_\_\_  
\_\_\_\_\_

Book mark: \_\_\_\_\_

J. D. Harris



S | **4 Cav.** | **U.S.C.T.**

Kawla Scott

Pvt, Co. F, 4 Reg't U. S. Col'd Cavalry.

Appears on

**Company Muster Roll**

for May + June, 1865

Present or absent Present

Stoppage, \$.....100 for .....

Due Gov't, \$.....100 for .....

Valuation of horse, \$.....100

Valuation of horse equipments, \$.....100

Remarks: .....

Book mark: .....

H. Harris

*S* | **4 Cav.** | **U.S.C.T.**

*Rawley Scott*

*Prk*, Co. F, 4 Reg't U. S. Col'd Cavalry.

Appears on

**Company Muster Roll**

for *July & Aug*, 186 *5*.

Present or absent *Present*

Stoppage, \$ *100* for

Due Gov't, \$ *100* for

Valuation of horse, \$ *100*

Valuation of horse equipments, \$ *100*

Remarks:

Book mark:

*A. Harris*

(358)

Copyist.

*S* | **4 Cav. | U.S.C.T.**

*Rawla Scott*

*Prh*, Co. F, 4 Reg't U. S. Col'd Cavalry.

Appears on

**Company Muster Roll**

for *Sept & Oct*, 186 *5*

Present or absent *Present*

Stoppage, \$ *100* for

Due Gov't, \$ *100* for

Valuation of horse, \$ *100*

Valuation of horse equipments, \$ *100*

Remarks:

Book mark:

*J. Harris*

S | 4 Cav. | U.S.C.T.

Ranla Scott

P, Co. F, 4 Reg't U. S. Col'd Cavalry.

Appears on

Company Muster Roll

for Nov. & Dec., 1865.

Present or absent Present

Stoppage, \$ 6.  $\frac{05}{100}$  for ordn. lost.

Due Gov't, \$ 100 for

Valuation of horse, \$ 100

Valuation of horse equipments, \$ 100

Remarks:

Book mark:

(358)

Hibbard  
Copyist.

S | 4 Cav. | U.S.C.T.

Rawla Scott

P., Co. F, 4 Reg't U. S. Col'd Cavalry.

Appears on

Company Muster Roll

for Jan. Feb., 1866.

Present or absent Present

Stoppage, \$ 6. 05/100 for ordn. lost;

Due Gov't, \$ 100 for

Valuation of horse, \$ 100

Valuation of horse equipments, \$ 100

Remarks:

Book mark:

Hibbard

S | 4 Cav. | U.S.C.T.

Ranla Scott

P, Co. F, 4 Reg't U. S. Col'd Cavalry.

Appears on **Co. Muster-out Roll**, dated  
New Orleans, La., March 20, 1866.

Muster-out to date March 20, 1866.

Last paid to June 30, 1865.

Clothing account:

Last settled....., 186 ; drawn since \$..... 100

Due soldier \$..... 100; due U. S. \$..... <sup>14</sup>100

Am't for cloth'g in kind or money adv'd \$..... 100

Due U. S. for arms, equipments, &c., \$ 7. <sup>07</sup>100

Bounty paid \$..... 100; due \$..... 100

Remarks: Joined at orig. org.

Stop 1 bridle, 2 carbine sockets,  
1 girth.

Book mark: V26 - P68 - 68.

(361)

Hibbard

Copyist.

Seal <sup>1964</sup> Hampton

Co E., 4 U. S. Col'd Cav.

Private

CARD NUMBERS.

1	5-3 5-4 497	26
2	5-3 5-4 579	27
3	5-3 5-4 657	28
4	5-3 5-4 726	29
5	5-3 5-4 796	30
6	5-3 5-4 865	31
7	40729201	32
8		33
9		34
10		35
11		36
12		37
13		38
14		39
15		40
16		41
17		42
18		43
19		44
20		45
21		46
22		47
23		48
24		49
25		50

Book Mark:

See also

S.611063 P.O. Rite,

7897620 Power

Power Ct 772938 9/1/34  
S.S. To Rosaly 3/14/34

2m44stone 4/12/34

*W. H. Stone*



*S* | **4 Cav.** | **U.S.C.T.**

*Hampton Seals*

*Rot*, Co. E, 4 Reg't U. S. Col'd Cav.

Appears on

**Company Muster Roll**

for *May & June*, 186*J.*

Present or absent *Present*

Stoppage, \$ *100* for

Due Gov't, \$ *100* for

Valuation of horse, \$ *100*

Valuation of horse equipments, \$ *100*

Remarks: *Bounty Paid \$100. Bounty  
due \$200,  
enrolled Apr 3. 65 & M. J. in  
Apr 25. 65 at Orleans, 3  
years)*

Book mark: \_\_\_\_\_

(358)

*Wines*

Copyist.

*S* | **4 Cav.** | **U.S.C.T.**

*Hampton Seals*

*Boy*, Co. E, 4 Reg't U. S. Col'd Cav.

Appears on

**Company Muster Roll**

for *July & Aug*, 186*S.*

Present or absent *Present*

Stoppage, \$ *100* for

Due Gov't, \$ *100* for

Valuation of horse, \$ *100*

Valuation of horse equipments, \$ *100*

Remarks: *Stop for one carbine sling. Recd #100, County #200, one*

Book mark:

(358)

*Wines*

Copyist.

*S* | **4 Cav.** | **U.S.C.T.**

*Hampton Seals*

*Pat*, Co. E, 4 Reg't U. S. Col'd Cav.

Appears on

**Company Muster Roll**

for *Sept & Oct*, 186*5*.

Present or absent. *Present*

Stoppage, \$ *100* for

Due Gov't, \$ *100* for

Valuation of horse, \$ *100*

Valuation of horse equipments, \$ *100*

Remarks: *County paid <sup>B</sup> 100.*  
*County due \$200.*

Book mark: *50000*

(358)

*Wines*

Copyist.

S | 4 Cav. | U.S.C.T.

Hampton Seals

Put, Co. E, 4 Reg't U. S. Col'd Cav.

Appears on

Company Muster Roll

for Nov. & Dec., 1865.

Present or absent Present.

Stoppage, \$ 2  $\frac{43}{100}$  for lost ordnance

Due Gov't, \$ 100 for

Valuation of horse, \$ 100

Valuation of horse equipments, \$ 100

Remarks: \$100. Bounty paid  
\$200. due.

Book mark:

(358)

Floyd

Copyist.

*S* | **4 Cav.** | **U.S.C.T.**

*Hampton Seals*

*Put*, Co. E, 4 Reg't U. S. Col'd Cav.

Appears on

**Company Muster Roll**

for *Jany & Peby*, 1866.

Present or absent *Present*

Stoppage, \$ *2 <sup>43</sup>/<sub>100</sub>* for *lost ordnance*

Due Gov't, \$ *100* for

Valuation of horse, \$ *100*

Valuation of horse equipments, \$ *100*

Remarks: *\$100 Bounty Paid*  
*\$200. Due.*

Book mark:

(358)

*Floyd*

Copyist.

S | **4 Cav.** | **U.S.C.T.**

Hampton Deales  
Priv. Co. E, 4 Reg't U. S. Colored Cav.

Appears on Returns as follows:

May 1865 - Gain: May 14/65  
New Orleans Recruit from  
depot.

Book mark:

W. R. Lee

(546)

Copyist.

S | 4 Cav. | U.S.C.T.

Hampton Seal

Put, Co. E, 4 Reg't U. S. Col'd Cavalry.

Appears on **Co. Muster-out Roll**, dated  
New Orleans La, Mich 20, 1866.

Muster-out to date Mich 20, 1866.

Last paid to June 30, 1865.

Clothing account:

Last settled....., 186 ; drawn since \$.....100

Due soldier \$ 3 62/100; due U. S. \$.....100

Am't for cloth'g in kind or money adv'd \$.....100

Due U. S. for arms, equipments, &c., \$.....100

Bounty paid \$ 100 100; due \$ none 100

Remarks: joined as Recruit Staff  
for 1 Horsebrush 1 Curry comb  
1 girth 1 per Spurs & straps 1 Sabre  
Rest.

Book mark: 1/26 P. 142.

(861)

Floyd

Copyist.

Seals, Hamilton

Co. \_\_\_\_\_, 4 Reg't U S Cavalry.

1 Enclosures.

Bed Cards	Final Statements
Burial Records	Furloughs or L. of A
Certs. of Dis. for Discharge	Med. Certificates
C. M. Charges	Med. Des. Lists
Descriptive Lists	Orders
Discharge Certificates	Pris. of War Record
Enlistment Papers	Resignations

Other papers relating to—

Admission to Hosp'l	Furlough or L. of A
Casualty Sheet	Med. Examination
Confinement	Misc. Information
Contracts	Pay or Clothing
Death or Effects	Personal Reports
Desertion	Rank
Discharge from Hosp'l	Transfer to Hosp'l
Discharge from Service	Transfer to V. R. C.
Duty	Transportation



MICROFILM PUBLICATION M 1820

COMPILED MILITARY SERVICE RECORDS  
OF VOLUNTEER UNION SOLDIERS WHO  
SERVED WITH THE USCT (US COLORED TROOPS)  
4TH REGIMENT OF CAVALRY

PERSONAL PAPERS' TARGET SHEET

PLEASE NOTE THE CHECKED INFORMATION ABOUT THE PERSONAL PAPERS IN  
THIS FILE:

- NO PERSONAL PAPERS WERE FOUND IN THIS FILE WHEN THE  
RECORDS WERE ARRANGED FOR MICROFILMING.
- 2 PERSONAL PAPER(S) FOUND IN THIS FILE WHEN THE RECORDS  
WERE ARRANGED FOR MICROFILMING.

NOTE 1.—This blank will be used for both enlistments and re-enlistments—enlistment of veterans, &c., &c., in the volunteer service. They will be made out in duplicate in all cases—one to accompany the recruiting return of the superintendent (not the recruiting officer) to the Adjutant General, and one to accompany the accounts of the officer who pays bounty, &c. The Regiment and Company in which the soldier last served should be given on the back.

NOTE 2.—An enlistment holds to service. A muster-in must, in all cases, precede payment of pay, bounty, pension, &c. A muster-in roll must, in all cases, be filed in the Adjutant General's Office as evidence of muster-in. The mustering officer, commissary, or assistant commissary of musters, as the case may be, will countersign both enlistments as having mustered the soldier into the service of the United States before either of them is given to the disbursing officer.

DECLARATION OF RECRUIT.

I, Hamilton Grals, desiring to VOLUNTEER as a Soldier in the Army of the United States, for the term of THREE YEARS, Do Declare, That I am 19 years and \_\_\_\_\_ months of age; that I have never been discharged from the United States service on account of disability or by sentence of a court martial, or by order before the expiration of a term of enlistment; and I know of no impediment to my serving honestly and faithfully as a soldier for three years.

GIVEN at New Orleans La the 3 day of April 1865

Witness: J. B. Birdman Hamilton Grals  
*1st Lieut. 10th U.S. Cavalry* *Recruit*

No. \_\_\_\_\_

Hamilton Grals  
 Volunteered at New Orleans La

April 3, 1865

By Capt. W. M. Williams

1st Regiment of Mo. Vols. Co.

\_\_\_\_\_ enlistment; last served in Company ( )

\_\_\_\_\_ Reg't of \_\_\_\_\_

Discharged \_\_\_\_\_, 18 \_\_\_\_\_

*Approved for the Adjutant General's Office  
 Gen. Mark Geo. Hardy 19th March*

Received from Second Auditor  
 October 7th, 1892.

CONSENT IN CASE OF MINOR.

I, \_\_\_\_\_ Do CERTIFY, That I am the \_\_\_\_\_ of \_\_\_\_\_; that the said \_\_\_\_\_ is \_\_\_\_\_ years of age; and I do hereby freely give my CONSENT to his volunteering as a SOLDIER in the ARMY OF THE UNITED STATES for the period of THREE YEARS.

GIVEN at \_\_\_\_\_ the \_\_\_\_\_ day of \_\_\_\_\_

Witness: \_\_\_\_\_

VOLUNTEER ENLISTMENT.

STATE OF

Louisiana



TOWN OF

New Orleans

I, Hamilton Seals, born in Clinton in the State of Louisiana, aged Eighteen years, and by occupation a Laborer, Do HEREBY ACKNOWLEDGE to have volunteered this Third day of April, 1865, to serve as a **Soldier** in the **Army of the United States of America**, for the period of **THREE YEARS**, unless sooner discharged by proper authority: Do also agree to accept such bounty, pay, rations, and clothing, as are, or may be, established by law for volunteers. And I, Hamilton Seals, do solemnly swear, that I will bear true faith and allegiance to the **United States of America**, and that I will serve them honestly and faithfully against all their enemies or opposers whomsoever; and that I will observe and obey the orders of the President of the United States, and the orders of the officers appointed over me, according to the Rules and Articles of War.

Sworn and subscribed to, at New Orleans La this 3<sup>d</sup> day of April, 1865, BEFORE John Geo. Birdman Hamilton Seals 1<sup>st</sup> Lieut. 10<sup>th</sup> U. S. C. A. Regt

I CERTIFY, ON HONOR, That I have carefully examined the above-named Volunteer, agreeably to the General Regulations of the Army, and that, in my opinion, he is free from all bodily defects and mental infirmity, which would in any way disqualify him from performing the duties of a soldier.

W. B. Curtis  
Examining Surgeon  
EXAMINING SURGEON.

I CERTIFY, ON HONOR, That I have minutely inspected the Volunteer Hamilton Seals previously to his enlistment, and that he was entirely sober when enlisted; that, to the best of my judgment and belief, he is of lawful age; and that, in accepting him as duly qualified to perform the duties of an able-bodied soldier, I have strictly observed the Regulations which govern the recruiting service. This soldier has Black eyes, Black hair, White complexion, is 5'0" feet seven inches high.

Wm. C. Allister  
Capt 10<sup>th</sup> Regiment of U. S. C. A. Regt Volunteers.  
RECRUITING OFFICER.

( A. G. O. No. 74 & 75. )

Mustered into the service of the United States, for three years or during the war, from date of enlistment, in Company C, 4<sup>th</sup> Regiment of U. S. C. A. Volunteers, on the 25<sup>th</sup> day of April, 1865, at New Orleans La.

John H. ...  
2<sup>nd</sup> Lieut. 10<sup>th</sup> U. S. C. A. Regt

Statement of Service Reference Slip.

Office C. of P.

Claim No. Ch 772938

Hampton Seal  
(Name.)

, Co. E, 4 Reg't USC Cav

To Med Div. 9-7-, 1916

For Statement

normal p.p.

Johnson  
Fa. P.D.

No medical record found.

Statement furnished 9-8-, 1916

D.G.J.

770  
James Archibald

Co B, 4 U. S. Col'd Cav.

Private Private

CARD NUMBERS.

1	5-349857	26
2	5-349957	27
3	5-350050	28
4	5-350155	29
5	5-350275	30
6		31
7		32
8		33
9		34
10		35
11		36
12		37
13		38
14		39
15		40
16		41
17		42
18		43
19		44
20		45
21		46
22		47
23		48
24		49
25		50

Book Mark:

See also

*S* | **4 Cav. | U.S.C.T.**

*Aurelius Semmes*

*Priv*, Co. *B*, 1 Reg't La. Cav., Corps d'Afrique.\*

Appears on

**Company Muster-in Roll**

of the organization named above. Roll dated

*New Orleans La, Oct 27*, 186 *2*.

Muster-in to date *Oct 27*, 186 *3*.

Joined for duty and enrolled:

When *Oct 1*, 186 .

Where *New Orleans*

Period *3* years.

Valuation of horse, \$.....*100*

Valuation of horse equipments, \$.....*100*

Remarks: .....

\*This organization subsequently became Co. *B*, 4 Reg't U. S. Colored Cavalry.

Book mark: .....

(356)

*Copyist*  
Copyist.

*S* | **4 Cav. | U.S.C.T.**

*Aurelius Sumner*

*Potr*, Co. ...., 1 Reg't La. Cav., Corps d'Afrique.\*

Appears on

**Company Muster Roll**

for *Oct 27 to Dec 31*, 186*3*.

Present or absent *Absent*

Stoppage, \$ ..... *100* for

Due Gov't, \$ ..... *100* for

Valuation of horse, \$ ..... *100*

Valuation of horse equipments, \$ ..... *100*

Remarks: *Sick in Genl Hospital*

\*This organization subsequently became Co *B*, 4 Reg't U. S. Colored Cavalry.

Book mark: .....

(358)

*King*  
Copyist.

*J* 4 Cav. U.S.C.T.

*Aurelius Lemmes*  
*Co. B*, Co. *B*, 1 Reg't Cav., Corps d'Afrique.\*

Appears on

**Company Muster Roll**

for *Jan + Feb*, 186*7*.

Present or absent *Present*

Stoppage, \$ *100* for

Due Gov't, \$ *100* for

Valuation of horse, \$ *100*

Valuation of horse equipments, \$ *100*

Remarks:

\* This organization subsequently became Co *B*, 4 Reg't U. S. Colored Cavalry.

Book mark:

(358)

*King*  
Copyist.



*S* | **4 Cav.** | **U.S.C.T.**

*Aurelius Semmes*

*20th*, Co. B. 4 Reg't U. S. Col'd Cavalry.

Appears on

**Company Muster Roll**

for *March + April*, 186*4*.

Present or absent *Present*

Stoppage, \$ *100* for

Due Gov't, \$ *100* for

Valuation of horse, \$ *100*

Valuation of horse equipments, \$ *100*

Remarks :

Book mark :

(358)

*Henry D* Copyist.

*S* | **4 Cav. | U.S.C.T.**

*Aurelius Semmes*  
*Co. B.*, Co. B. 4 Reg't U. S. Col'd Cavalry.

Appears on

**Company Muster Roll**

for *May & June*, 186*4*.

Present or absent

Stoppage, \$ 100 for

Due Gov't, \$ 100 for

Valuation of horse, \$ 100

Valuation of horse equipments, \$ 100

Remarks: *Deserted May 25/64*  
*from Camp Parapet, La.*

Book mark:

(358)

*Emy*  
Copyist.

*S* | **4 Cav.** | **U.S.C.T.**

*Aurelius Semmes*

....., Co. *B*, 4 Reg't U. S. Col'd Cavalry.

Appears on **Co. Muster-out Roll**, dated  
*New Orleans, La, Feb. 20* 1866.

Muster-out to date ..... 186 .

Last paid to ..... 186 .

**Clothing account:**

Last settled *never*, 186 ; drawn since \$ *65-69* <sup>100</sup>

Due soldier \$ ..... <sup>100</sup>; due U. S. \$ ..... <sup>100</sup>

Am't for cloth'g in kind or money adv'd \$ ..... <sup>100</sup>

Due U. S. for arms, equipments, &c., \$ ..... <sup>100</sup>

Bounty paid \$ ..... <sup>100</sup>; due \$ ..... <sup>100</sup>

Remarks: *Joined at Orge, Ariz.*  
*Disced at Camp Poper, La.*  
*May 25/64.*

Book mark : .....

(361)

*Chandler*  
Copyist.

4 U.S.C. Cav.

Sims, Arrelia

P, Co. B

1 Reg't

La Cas

Enclosures.

Bed Cards

Descriptive Lists

Burial Records

Final Statements

Certs. of Dis. for Discharge

Furloughs

C. M. Charges

Med. Des. Lists /

Med. Certificates

Orders

Other papers relating to—

Admission to Hosp'l

Furlough

Casualty Sheet (Officer's)

Med. Examination

Confinement

Misc. Information

Contracts

Pay or Clothing

Death or Effects

Personal Reports

Descriptions

Rank

Discharge from Hosp'l

Transfer to Hosp'l

Discharge from Service

Transfer to V. R. C.

Duty

Transportation

No. 0

Name of Hospital, *Capt. W. Ayague*  
 Name of Patient, *Anthon Lund*  
 Disease or Injury, *Diarrhoea*  
 Result, *Cured*  
 Date of Transmission, *Sept 18, 1864*

REMARKS AS TO CONDITION OF PATIENT, &c.	DIET.	TREATMENT.	DATE.
<p><i>4 U.S. Cav</i> <i>1 La Cav</i></p>			

## MEDICAL DESCRIPTIVE LIST.

Ward *A*, Bed ..... General Hospital at *New Orleans La*  
 Name *Arrelia Sims*, Age ....., Rank *Private*, Co. *B*, Regiment *1<sup>st</sup> La Cav.*  
 Disease or Injury, *Diarrhea*  
 Result, *Recovery*  
 [Name of attending Medical Officer.]  
*Geo. C. Dalton, M.D., Surg. U.S.A.*

Admission, *December 29<sup>th</sup> 1863*  
 Return to duty, cured, *February 2<sup>nd</sup>*  
 Furlough, .....  
 Discharge from service, .....  
 Transfer to another Hospital, .....  
 Death, .....

NOTE.—When a patient is first received into a General Hospital, the entries on this Descriptive List will be commenced. All important changes in his condition will be noted on it, (in ink,) from time to time, by the Surgeon in charge of the Ward. When the patient has been wounded, the date and character of the wound will be stated, the nature of the operation, (if any,) and, above all, the result. In case of transfer, this list will be sent, through the Officer in charge of the transportation, or failing one, by mail, to the Surgeon in charge of the Hospital receiving the patient. When this Medical History shall have been completed, by the cure, discharge, furlough, or death of the patient, it will, with the treatment and result carefully noted, be transmitted directly to the Surgeon General.

DATE.	TREATMENT.	DIET.	REMARKS AS TO CONDITION OF PATIENT, &c.
<i>Dec 30.</i>	<i>R. Pl. Ricini ℥ʒ after it acts R. Pulv. Oprij Acid Tannic ℥ʒij 3 t. d.</i>	<i>L. D.</i>	
<i>31<sup>st</sup> Jan 1<sup>st</sup></i>	<i>Opium &amp; Tannin 3 t. d.</i>	<i>L. D.</i>	
<i>2<sup>nd</sup> 3<sup>d</sup></i>		<i>L. D.</i>	
<i>4<sup>th</sup></i>		<i>H. D.</i>	
<i>6<sup>th</sup></i>		<i>F. D.</i>	<i>F. it for duty</i>

411  
Semmes Salmar

Co B, 4 U. S. Col'd Cav.

Private Corporal

CARD NUMBERS.

1	5349858	26
2	5349958	27
3	5350051	28
4	5350156	29
5	5350250	30
6	5350293	31
7	5350371	32
8	5350446	33
9	5350522	34
10	5350655	35
11	5350741	36
12	5350783	37
13	5350872	38
14	5350956	39
15	5351037	40
16	5351117	41
17		42
18		43
19		44
20		45
21		46
22		47
23		48
24		49
25		50

Book Mark:

See also

J. 2069 394 P.O. M.M.  
M.S. 1114158  
USUB 7/29/31 020

*James  
H*



*S* | **4 Cav.** | **U.S.C.T.**

*Walter Sumner*

*Co. B*, 1 Reg't La. Cav., Corps d'Afrique.\*

Appears on

**Company Muster-in Roll**

of the organization named above. Roll dated

*New Orleans La Oct 27*, 186*3*.

Muster-in to date *Oct 27*, 186*3*.

Joined for duty and enrolled:

When *Oct 12*, 186 .

Where *New Orleans*

Period *3* years.

Valuation of horse, \$.....100

Valuation of horse equipments, \$.....100

Remarks :  
.....  
.....  
.....

\*This organization subsequently became Co. *B*, 4 Reg't U. S. Colored Cavalry.

Book mark :  
.....

(356)

*W. J. King*  
Cognist.

*S* | **4 Cav. | U.S.C.T.**

*Vahna Lemmes*  
*Co. B*, Co. *B*, 1 Reg't La. Cav., Corps d'Afrique.\*

Appears on

**Company Muster Roll**

for *Oct 27 to Dec 31*, 186 *3*.

Present or absent *Present*

Stoppage, \$ *100* for

Due Gov't, \$ *100* for

Valuation of horse, \$ *100*

Valuation of horse equipments, \$ *100*

Remarks:

\*This organization subsequently became Co. *B* 4 Reg't U. S. Colored Cavalry.

Book mark:

(358)

*Kimm*

Copyist.

*S* 4 Cav. U.S.C.T.

*Valmar Semmes*  
*Co. B*, 1 Reg't Cav., Corps d'Afrique.\*

Appears on

**Company Muster Roll**

for *Jan & Feb*, 1864.

Present or absent *Present*

Stoppage, \$ *100* for

Due Gov't, \$ *100* for

Valuation of horse, \$ *100*

Valuation of horse equipments, \$ *100*

Remarks: \_\_\_\_\_  
\_\_\_\_\_  
\_\_\_\_\_  
\_\_\_\_\_  
\_\_\_\_\_  
\_\_\_\_\_

\* This organization subsequently became Co. *B*, 4 Reg't U. S. Colored Cavalry.

Book mark: \_\_\_\_\_

(358)

*Spring*  
Copyist.

*S* | **4 Cav.** | **U.S.C.T.**

*Valmar Lemmer*

*Wt*; Co. B. 4 Reg't U. S. Col'd Cavalry.

Appears on

**Company Muster Roll**

for *March & Apr*, 186*4*.

Present or absent *Present*

Stoppage, \$ *100* for

Due Gov't, \$ *100* for

Valuation of horse, \$ *100*

Valuation of horse equipments, \$ *100*

Remarks :

Book mark :

(358)

*King*  
Copyist.

7 | 4 Cav. | U.S.C.T.

*Valmas Semmes*

*Capt.*, Co. B. 4 Reg't U. S. Col'd Cavalry.

Appears on

**Company Muster Roll**

for *May & June*, 1864.

Present or absent *Present*

Stoppage, \$ 100 for

Due Gov't, \$ 100 for

Valuation of horse, \$ 100

Valuation of horse equipments, \$ 100

Remarks :

-----  
-----  
-----  
-----  
-----  
-----  
-----  
-----  
-----

Book mark :

-----

-----  
*[Signature]*  
Copyist.

*S* | **4 Cav. | U.S.C.T.**

*Vulman Lemmas*  
*6<sup>th</sup> Corp.*, Co. B. 4 Reg't U. S. Col'd Cavalry.

Appears on

**Company Muster Roll**

for *July & Aug.*, 186*4*.

Present or absent *Present*

Stoppage, \$ *100* for

Due Gov't, \$ *100* for

Valuation of horse, \$ *100*

Valuation of horse equipments, \$ *100*

Remarks: *Promoted Corp'l July*  
*16/64 Vice George Brad*  
*ley deserted*

Book mark:

(358)

*[Signature]*  
Copyist.

*S* | **4 Cav.** | **U.S.C.T.**

*Walter Sumner*

*4 Corp*, Co. B. 4 Reg't U. S. Col'd Cavalry.

Appears on

**Company Muster Roll**

for *Sept & Oct*, 1864.

Present or absent *Present*

Stoppage, \$ 100 for

Due Gov't, \$ 100 for

Valuation of horse, \$ 100

Valuation of horse equipments, \$ 100

Remarks :

Book mark :

(358)

*Wm J*

Copyist.

S | **4 Cav.** | **U.S.C.T.**

Valuer Semmes

4-Corp., Co. B. 4 Reg't U. S. Col'd Cavalry.

Appears on

**Company Muster Roll**

for Nov & Dec, 1864.

Present or absent present

Stoppage, \$ 100 for

Due Gov't, \$ 100 for

Valuation of horse, \$ 100

Valuation of horse equipments, \$ 100

Remarks :

Book mark :

(358)

Semmes

Copyist.



S | **4 Cav.** | **U.S.C.T.**

Valmar Sumner  
Corp., Co. B. 4 Reg't U. S. Col'd Cavalry.

Appears on

**Company Muster Roll**

for Jan & Feb., 1865.

Present or absent present

Stoppage, \$ 100 for

Due Gov't, \$ 100 for

Valuation of horse, \$ 100

Valuation of horse equipments, \$ 100

Remarks: Received only \$7 per  
month to include Apr 30/64.

Book mark: \_\_\_\_\_

Sumner

S | **4 Cav.** | **U.S.C.T.**

Valmar Sumner  
priv, Co. B. 4 Reg't U. S. Col'd Cavalry.

Appears on

**Company Muster Roll**

for Mich & Apr, 1865.

Present or absent present

Stoppage, \$ 100 for

Due Gov't, \$ 100 for

Valuation of horse, \$ 100

Valuation of horse equipments, \$ 100

Remarks :

Book mark :

(358)

Sumner

Copyist.

S | **4 Cav.** | **U.S.C.T.**

Valuo Serenus

Svt., Co. B. 4 Reg't U. S. Col'd Cavalry.

Appears on

**Company Muster Roll**

for May & June, 1865.

Present or absent present

Stoppage, \$ 100 for

Due Gov't, \$ 100 for

Valuation of horse, \$ 100

Valuation of horse equipments, \$ 100

Remarks :

Book mark :

(358)

Senus

Copyist.

S | 4 Cav. | U.S.C.T.

Valmo Summer  
Corp., Co. B. 4 Reg't U. S. Col'd Cavalry.

Appears on

**Company Muster Roll**

for July & Aug, 1864.

Present or absent present

Stoppage, \$ 100 for

Due Gov't, \$ 100 for

Valuation of horse, \$ 100

Valuation of horse equipments, \$ 100

Remarks :

Book mark :

(358)

Summer

Copyist.

S | **4 Cav.** | **U.S.C.T.**

Valuo Sumner  
Corp., Co. B. 4 Reg't U. S. Col'd Cavalry.

Appears on

**Company Muster Roll**

for Sept & Oct, 1865.

Present or absent Present

Stoppage, \$ 100 for

Due Gov't, \$ 100 for

Valuation of horse, \$ 100

Valuation of horse equipments, \$ 100

Remarks: Promoted to Corporal  
July 1/65

Book mark:

(358)

Sumner

Copyist.

*S* | **4 Cav.** | **U.S.C.T.**

*Valmo Lemmes*  
Corpl. Co. B. 4 Reg't U. S. Col'd Cavalry.

Appears on

**Company Muster Roll**

for *Nov. & Dec.*, 1865.

Present or absent *Present*

Stoppage, \$ 100 for

Due Gov't, \$ 100 for

Valuation of horse, \$ 100

Valuation of horse equipments, \$ 100

Remarks: *Appointed corporal  
July 1, 65.*

Book mark : \_\_\_\_\_

*Chandler*  
Coryist.

*S* | **4 Cav.** | **U.S.C.T.**

*Valmo Lemmes*  
Corpl., Co. B. 4 Reg't U. S. Col'd Cavalry.

Appears on

**Company Muster Roll**

for *Jan. & Feb.*, 1866.

Present or absent *Present*

Stoppage, \$ 100 for

Due Gov't, \$ 100 for

Valuation of horse, \$ 100

Valuation of horse equipments, \$ 100

Remarks: *Appointed Corporal  
July 1, 1865.*

Book mark :

(358)

*Chandler*  
Copyist.

*S* | **4 Cav.** | **U.S.C.T.**

*Palmo Semmes*  
-----  
*Corpl*, Co. *B*, 4 Reg't U. S. Col'd Cavalry.

Appears on **Co. Muster-out Roll**, dated  
*New Orleans, La.,* *Feb. 2,* 1866.

Muster-out to date *Feb. 24* 1866.

Last paid to *June 30* 1865.

**Clothing account:**

Last settled....., 186 ; drawn since \$..... 100

Due soldier \$ *36* <sup>*24*</sup> / 100; due U. S. \$..... 100

Am't for cloth'g in kind or money adv'd \$..... 100

Due U. S. for arms, equipments, &c., \$..... 100

Bounty paid \$..... 100; due \$..... 100

Remarks: *Joined at Orgl. Org. for*  
*to July 16, 64.*

Book mark: *6384 Pl. 9, June 24/66*  
*v. 25. P. 81. 68.*

(361)

*Chandler*  
-----  
Coryist.



*Seward Gabb*

Co *D*, 4 U. S. Col'd Cav.

*Private* | *Private*

CARD NUMBERS.

1 5352582  
2 5352632  
3 5352683  
4 5352741  
5 5352807  
6 5352868  
7 5352945  
8 5353027  
9 5353130  
10 5353761  
11 40729206

26  
27  
28  
29  
30  
31  
32  
33  
34  
35  
36  
37  
38  
39  
40  
41  
42  
43  
44  
45  
46  
47  
48  
49  
50

Book Mark:

See also

*S* | **4 Cav.** | **U.S.C.T.**

*Gabb Seward*

*Priv.*, Co. *D*, 1 Reg't, Corps d'Afrique Cavalry.\*

Appears on

**Company Muster-in Roll**

of the organization named above. Roll dated

*New Orleans La.*, *Nov 26*, 1863.

Muster-in to date *Nov 26*, 1863.

Joined for duty and enrolled:

When *Nov 10*, 186 .

Where *New Orleans*

Period *3* years.

Valuation of horse, \$ *100*

Valuation of horse equipments, \$ *100*

Remarks: .....

\*This organization subsequently became Co. *D*, 4 Reg't U. S. Colored Cavalry.

Book mark: .....

*Rosenbaum*

(356)

Copyist.

J 4 Cav. U.S.C.T.

Gabe Seward

Pvt., Co. D, 1 Reg't Cav., Corps d'Afrique.\*

Appears on

Company Muster Roll

for *From Enlistment to Dec 31, 1863.*

Present or absent *Present*

Stoppage, \$ *100* for

Due Gov't, \$ *100* for

Valuation of horse, \$ *100*

Valuation of horse equipments, \$ *100*

Remarks:

\* This organization subsequently became Co. D, 4 Reg't U. S. Colored Cavalry.

Book mark:

*Rosenbaum*

*D* 4 Cav. U.S C.T.

*Gabe Servard*

*Priv*, Co. *D*, 1 Reg't Cav., Corps d'Afrique.\*

Appears on

**Company Muster Roll**

for *Jerry V. Kelly*, 1864.

Present or absent *Present*

Stoppage, \$ *100* for

Due Gov't, \$ *100* for

Valuation of horse, \$ *100*

Valuation of horse equipments, \$ *100*

Remarks:

\* This organization subsequently became Co. *D*, 4 Reg't U. S. Colored Cavalry.

Book mark:

*Rosenbaum*  
Copyist.

MAY 4 1864

*S* | **4 Cav.** | **U.S.C.T.**

---

*Gabe Seward*

*Pvt*, Co. D. 4 Reg't U. S. Col'd Cavalry.

Appears on

**Company Muster Roll**

for *March & April*, 1864.

Present or absent *Present*

Stoppage, \$.....100 for .....

Due Gov't, \$.....100 for .....

Valuation of horse, \$.....100

Valuation of horse equipments, \$.....100

Remarks: .....

.....

.....

.....

.....

.....

.....

.....

.....

Book mark: .....

---

---

(358)

*Rosenbaum*

Copyist.

*S* | **4 Cav.** | **U.S.C.T.**

*Gabe Seward*

*Pvt.*, Co. D. 4 Reg't U. S. Col'd Cavalry.

Appears on

**Company Muster Roll**

for *May & June*, 1864.

Present or absent *Present*

Stoppage, \$ *100* for

Due Gov't, \$ *100* for

Valuation of horse, \$ *100*

Valuation of horse equipments, \$ *100*

Remarks: *due U.S. for last  
Ordinance \$ 20.00*

Book mark:

*Rosenbom*

(358)

Copyist.

S | **4 Cav.** | **U.S.C.T.**

Gabe Seward

Pvt., Co. D. 4 Reg't U. S. Col'd Cavalry.

Appears on

**Company Muster Roll**

for July & Aug, 1864.

Present or absent Present

Stoppage, \$ 100 for

Due Gov't, \$ 100 for

Valuation of horse, \$ 100

Valuation of horse equipments, \$ 100

Remarks: Due U.S. for lost  
ordnance \$25.00

Book mark:

(358)

Rosenbaum  
Copyist.

S | **4 Cav.** | **U.S.C.T.**

Gabe Seward

Pot, Co. D. 4 Reg't U. S. Col'd Cavalry.

Appears on

**Company Muster Roll**

for Sept & Oct, 1864.

Present or absent Present

Stoppage, \$ 100 for

Due Gov't, \$ 100 for

Valuation of horse, \$ 100

Valuation of horse equipments, \$ 100

Remarks: Due U.S. for lost  
Ordinance \$ 20.00

Book mark:

(358)

Rosenbaum

Copyist.



*W* | **4 Cav. | U.S.C.T.**

*John Seward*

*P*, Co. D, 4 Reg't U. S. Col'd Cavalry.

Appears on

**Company Muster Roll**

for *Nov - Dec*, 186*4*.

Present or absent *Present*

Stoppage, \$ 100 for

Due Gov't, \$ 100 for

Valuation of horse, \$ 100

Valuation of horse equipments, \$ 100

Remarks: *Due 24. for Col # 2000*

Book mark:

(358)

*H. H. Wright*

Copyist.

4 Cav. U.S.C.T.

*John Howard*

*P*, Co. D, 4 Reg't U. S. Col'd Cavalry.

Appears on

**Company Muster Roll**

for *Jan & Feb*, 1865.

Present or absent

Stoppage, \$ 100 for

Due Gov't, \$ 100 for

Valuation of horse, \$ 100

Valuation of horse equipments, \$ 100

Remarks: *Discharge Feb 11 1865*

Book mark: *Vol. P 120, 69*

(358)

*John Howard*

Copyist.

A | 4 Cav. | U.S.C.T.

Gabe Deeward  
Port C, Co. D, 4 Reg't U. S. Colored Cav.

Appears on Returns as follows:

July 1864 - On duty Pr. servant  
to Capt. H. J. Crickmore.

Sept 1864 - On duty at Co. Stable

Feb 1865 - Loro: Feb 11/65  
Port Hudson La. Dischd.  
for disability.

Name appears also as:  
Gabe Deeward

Book mark:

(546) W. R. Lee Copyist.

S | **4 Cav.** | **U.S.C.T.**

Gable Seaward  
-----  
Put Co. 10, 4 Reg't U. S. Col'd Cavalry.

Appears on **Co. Muster-out Roll**, dated  
New Orleans, La, March, 1866.

Muster-out to date -----, 186 .

Last paid to -----, 186 .

**Clothing account:**

Last settled -----, 186 ; drawn since \$ ----- 100

Due soldier \$ ----- 100; due U. S. \$ ----- 100

Am't for cloth'g in kind or money adv'd \$ ----- 100

Due U. S. for arms, equipments, &c., \$ ----- 100

Bounty paid \$ ----- 100; due \$ ----- 100

Remarks: Joined Reg. Reg.  
Discharged Feb 11/65 for  
disability

Book mark: 262, P. 120, 69, U.S.  
10. 19. 69

W. J. Anderson  
-----  
(361) Copyist.

Seward, Gabe  
P, Co. H, 4 U.S.C. Cav.

( Enclosures.

Bed Cards	Descriptive Lists
Burial Records	Final Statements
Certs. of Dis. for Discharge /	Furloughs
C. M. Charges	Med. Des. Lists
Med. Certificates	Orders

Other papers relating to—

Admission to Hosp'l	Furlough
Casualty Sheet (Officer's)	Med. Examination
Confinement	Misc. Information
Contracts	Pay or Clothing
Death or Effects	Personal Reports
Desertions	Rank
Discharge from Hosp'l	Transfer to Hosp'l
Discharge from Service	Transfer to V. R. C.
Duty	Transportation

NOTE 1.

The company commander will here add a statement of all the facts known to him concerning the disease or wound, or cause of disability of the soldier; the time, place, manner, and all the circumstances under which the injury occurred, or disease originated or appeared; the duty, or service, or situation of the soldier at the time the injury was received or disease contracted, stating particularly whether the injury was received or the disease contracted in the line of his duty; and whatever other facts may aid a judgment as to the cause, immediate or remote, of the disability, and the circumstances attending it.

When the facts are not known to the company commander, the certificate of any officer, or affidavit of other person having such knowledge, will be appended—as the surgeon in charge of a hospital, the officer commanding a detachment of recruits, &c., &c.

NOTE 2.

When a probable case for pension, special care must be taken to state the degree of disability—as  $\frac{1}{2}$ ,  $\frac{1}{3}$ , &c., &c.; to describe particularly the disability, wound, or disease; the extent to which it deprives him of the use of any limb or faculty, or affects his health, strength, activity, constitution, or capacity to labor or earn his subsistence. The surgeon will add, from his knowledge of the facts and circumstances, and from the evidence in the case, his professional opinion of the cause or origin of the disability. In the case of discharges by Medical Inspectors, the last paragraph will state that the "discharge was given by consent of the soldier, after a personal examination, and for disability, the nature, degree, and origin of which are correctly described in the within certificate."

Par. 1260 Regulations, Edit. 1861.

Medical officers, in giving certificates of disability, are to take particular care in all cases that have not been under their charge; and especially in epilepsy, convulsions, chronic rheumatism, derangement of the urinary organs, ophthalmia, ulcers, or any obscure disease liable to be feigned or purposely produced; and in no case shall such certificate be given until after sufficient time and examination to detect any attempt at deception.

DIRECTIONS.

This certificate will be made out in duplicate by the soldier's company commander, or other officer commanding the separate detachment to which he belongs, and sent by him to the surgeon who has charge of the hospital where the soldier is sick. The surgeon will then fill out and sign the surgeon's certificate, and forward these papers to the regimental, detachment, or post commander, who will forward them, with his action endorsed thereon, through the proper channel, to his division commander; or, if the troops are not attached to a division, to his corps, department, or other commander or officer to whom the authority to discharge enlisted men may be specially delegated.

These certificates, after having received the action of the highest authority to which they are required to be sent, will be returned through the same channel to the regimental, post, or detachment commander, who will, if the discharge is authorized by the endorsement of the proper authority, sign the soldier's discharge, and the last certificate on this paper; see that the soldier is furnished with the proper final statements in duplicate, and forward BOTH of these certificates direct to the Adjutant General United States Army, at Washington, D. C.; they will not, under any circumstances, be given into the hands of the soldier.

ADJUTANT GENERAL'S OFFICE

Jan 11 1865

Duplicate sent the Pension Office.

CERTIFICATE OF DISABILITY FOR DISCHARGE

IN THE CASE OF

1775  
Gabe Seward  
a Private Co. D  
Hawth Regt of U.S.C.

Approved Jan 30 5

[Signature]

Head Quarters Dept of the Gulf  
New Orleans Feb 1 1865  
To be discharged  
By command of  
Maj. Genl. Hurlbut,

[Signature]  
Capt. A. J. General

Received (A. G. Office) 186

Curson [Signature]  
[Stamp]

Office Surgeon in Chief  
District of Baton Rouge & Port Hudson  
January 24<sup>th</sup> 1865  
Respectfully Approved  
Chas. A. Owen  
Surgeon 2<sup>nd</sup> La. Vol. Infy  
In Charge District of Baton Rouge & Port Hudson

# ARMY OF THE UNITED STATES

## CERTIFICATE OF DISABILITY FOR DISCHARGE.



Private Gabe Seward of Captain Oscar C. Jackson Company, (20<sup>th</sup>) of the Fourth Regiment of United States Infantry was enlisted by J. D. Rhodes of the Fourth Regiment of W. C. Cavalry at New Orleans La on the Tenth day of November 1864, to serve Three years; he was born in New Orleans in the State of Louisiana is Seventy years of age, five feet five inches high, Dark complexion, Hazel eyes, Dark hair, and by occupation when enlisted a Mason. During the last two months said soldier has been unfit for duty Sixty days. This soldier has been off duty about four months and much him incompetent of being a soldier.

STATION: Port Hudson La  
 DATE: Feb 11<sup>th</sup> 1865

Oscar C. Jackson  
Captain  
 Commanding Company.

We we I CERTIFY, that I have carefully examined the said Gabe Seward of Captain Jackson's Company, and find him incapable of performing the duties of a soldier because of † Epilepsy resulting in mental imbecility which probably existed prior to enlistment. He is sometimes insane for several days at a time.

Invalid Corps Disability by Henry M. Brown Surgeon 4th US (Inf)  
D. J. Hanson Surg 4th US (Inf) C. Bradley  
M. Good Asst Surg 10th US (Inf) Surgeon.

DISCHARGED, this Eleventh day of February 1865, at Port Hudson Louisiana

Wm. Mitchell  
Major  
 Commanding the Reg't.

The soldier desires to be addressed at  
 Town New Orleans County \_\_\_\_\_ State Louisiana.

\* See Note 1 on the back of this. † See Note 2 on the back of this.

Office Post Surgeon  
 Port Hudson La  
 Jan 19 1865  
 Respectfully Approved  
 Wm. Mitchell  
 Post Surgeon

915

*Sewen William*

Co *C*, 4 U. S. Col'd Cav.

*Private* | *Private*

CARD NUMBERS.

1	5347850	26
2	5354005	27
3	5354074	28
4	5354210	29
5	5354145	30
6	5354276	31
7	5354337	32
8	5354422	33
9	5354496	34
10	5354578	35
11	5354655	36
12	5354725	37
12	5354795	38
14	5354864	39
15	<i>R. &amp; P. 523,015</i>	40
16	40729239	41
17		42
18		43
19		44
20		45
21		46
22		47
23		48
24		49
25		50

Book Mark: *R. & P. 523,015.*

See also



A-149 2264, Aud. W.D.  
Q 1539488 P.O. m. 74  
R. + P. 523015

2 1625071 Aud. W.D.  
E 1673750 - P.O. aff  
S 1810248 P.O. aff  
L 2100127 P.O. aff  
S 2161365 P.O. aff

*W. H. Miller*  
*W*

*S* | **4 Cav.** | **U.S.C.T.**

*William Berwen*

Appears with rank of *Private* on

**Muster and Descriptive Roll of a Detachment of U. S. Vols. forwarded**

for the 4 Reg't U. S. Col'd Cavalry. Roll dated

*New Orleans La, Mch 11, 1864.*

Where born *La*

Age *19* y'rs; occupation *laborer*

When enlisted *Feb 8*, 1864

Where enlisted *New Orleans*

For what period enlisted *3* years.

Eyes *Blk*; hair *Blk*

Complexion *Blk*; height *5* ft. *7* in.

When mustered in *Mch 11*, 1864.

Where mustered in *New Orleans*

Bounty paid \$ *100*; due \$ *100*

Where credited

Company to which assigned *E*

Remarks:

Book mark: *R.R. 523,015.*

*Dallade*  
(339) Copyist.

*S* | **4 Cav.** | **U.S.C.T.**

*William Berwen*

Appears with rank of *Private* on

**Muster and Descriptive Roll of a Detachment of U. S. Vols. forwarded**

for the 4 Reg't U. S. Col'd Cavalry. Roll dated

*New Orleans La, Mch 11, 1864.*

Where born *La*

Age *19* y'rs; occupation *laborer*

When enlisted *Feb 8*, 1864

Where enlisted *New Orleans*

For what period enlisted *3* years.

Eyes *Blk*; hair *Blk*

Complexion *Blk*; height *5 ft. 7 in.*

When mustered in *Mch 11*, 1864

Where mustered in *New Orleans*

Bounty paid \$ *100*; due \$ *100*

Where credited

Company to which assigned *E*

Remarks:

Book mark: *Reg. 523,015.*

*Dallade*  
(339) Copyist.

*S* | **4 Cav.** | **U.S.C.T.**

*William Sewen*

*Plt.*, Co. E, 4 Reg't U. S. Col'd Cav.

Appears on

**Company Muster Roll**

for *Month April*, 186*4*

Present or absent *Present*

Stoppage, \$ *100* for

Due Gov't, \$ *100* for

Valuation of horse, \$ *100*

Valuation of horse equipments, \$ *100*

Remarks:

Book mark:

*Lamm*

(358)

Copyist.

S | **4 Cav.** | **U.S.C.T.**

William Sewer

Priv, Co. E, 4 Reg't U. S. Col'd Cav.

Appears on

**Company Muster Roll**

for May & June, 1864.

Present or absent Present

Stoppage, \$ 100 for

Due Gov't, \$ 100 for

Valuation of horse, \$ 100

Valuation of horse equipments, \$ 100

Remarks:

Book mark:

L. L. L.

S | 4 Cav. | U.S.C.T.

William Swen

Priv., Co. E, 4 Reg't U. S. Col'd Cav.

Appears on

**Company Muster Roll**

for July & Aug, 1864

Present or absent Present

Stoppage, \$ 100 for

Due Gov't, \$ 100 for

Valuation of horse, \$ 100

Valuation of horse equipments, \$ 100

Remarks:

Book mark:

Approved

*S* | **4 Cav.** | **U.S.C.T.**

*William Seiver*

*Priv*, Co. E, 4 Reg't U. S. Col'd Cav.

Appears on

**Company Muster Roll**

for *Sept + Oct*, 186 *4*

Present or absent *Present*

Stoppage, \$ *100* for

Due Gov't, \$ *100* for

Valuation of horse, \$ *100*

Valuation of horse equipments, \$ *100*

Remarks:

Book mark:

*L. L. L.*

(358)

Copyist.

S | **4 Cav.** | **U.S.C.T.**

*William Seven*

*Priv*, Co. E, 4 Reg't U. S. Col'd Cav.

Appears on

**Company Muster Roll**

for *Nov 1864*, 186 *4*

Present or absent *Present*

Stoppage, \$ *100* for

Due Gov't, \$ *100* for

Valuation of horse, \$ *100*

Valuation of horse equipments, \$ *100*

Remarks:

Book mark:

(358)

*Wines*

Copyist.



*S* | **4 Cav.** | **U.S.C.T.**

*William Servern*

*Private*, Co. E, 4 Reg't U. S. Col'd Cav.

Appears on

**Company Muster Roll**

for *Jan & Feb*, 186*5*.

Present or absent *Present*

Stoppage, \$ *100* for

Due Gov't, \$ *100* for

Valuation of horse, \$ *100*

Valuation of horse equipments, \$ *100*

Remarks: *Rec'd only 7 dol.  
per month to include  
Apr 30/64*

Book mark:

*Wines*

S | **4 Cav.** | **U.S.C.T.**

William Berwen

Private, Co. E, 4 Reg't U. S. Col'd Cav.

Appears on

**Company Muster Roll**

for Mar & Apr, 186S.

Present or absent Present

Stoppage, \$ 100 for

Due Gov't, \$ 100 for

Valuation of horse, \$ 100

Valuation of horse equipments, \$ 100

Remarks:

Book mark:

*S* | **4 Cav.** | **U.S.C.T.**

*William Severn*  
*Pvt*, Co. E, 4 Reg't U. S. Col'd Cav.

Appears on

**Company Muster Roll**

for *May & June*, 186*5*.

Present or absent *Present*

Stoppage, \$ *100* for

Due Gov't, \$ *100* for

Valuation of horse, \$ *100*

Valuation of horse equipments, \$ *100*

Remarks:  
\_\_\_\_\_  
\_\_\_\_\_  
\_\_\_\_\_  
\_\_\_\_\_  
\_\_\_\_\_  
\_\_\_\_\_  
\_\_\_\_\_  
\_\_\_\_\_

Book mark: \_\_\_\_\_  
\_\_\_\_\_

(358)

*Wines*  
Copyist.

*S* | **4 Cav.** | **U.S.C.T.**

*William Sewin*  
*Pvt*, Co. E, 4 Reg't U. S. Col'd Cav.

Appears on

**Company Muster Roll**

for *July & Aug*, 186*5*.

Present or absent *Present*

Stoppage, \$ *100* for

Due Gov't, \$ *100* for

Valuation of horse, \$ *100*

Valuation of horse equipments, \$ *100*

Remarks:

Book mark:

(358)

*Wines*

Copyist.

S | **4 Cav.** | **U.S.C.T.**

William Servern  
Pvt, Co. E, 4 Reg't U. S. Col'd Cav.

Appears on

**Company Muster Roll**

for Sept & Oct, 1865.

Present or absent Present

Stoppage, \$ 100 for

Due Gov't, \$ 100 for

Valuation of horse, \$ 100

Valuation of horse equipments, \$ 100

Remarks:

Book mark:

(358)

Wines

Copyist.

S | **4 Cav.** | **U.S.C.T.**

*William Sewer*

*Put*, Co. E, 4 Reg't U. S. Col'd Cav.

Appears on

**Company Muster Roll**

for *Nov. & Dec.*, 186 *5*.

Present or absent. *Present*

Stoppage, \$ *1* <sup>*77*</sup>/<sub>*100*</sub> for *lost ordnance*

Due Gov't, \$ *100* for

Valuation of horse, \$ *100*

Valuation of horse equipments, \$ *100*

Remarks:

Book mark:

(358)

*Floyd*

Copyist.

S | **4 Cav.** | **U.S.C.T.**

William Sewen  
Put, Co. E, 4 Reg't U. S. Col'd Cav.

Appears on

**Company Muster Roll**

for Jany & Peby, 1866.

Present or absent Present.

Stoppage, \$ 1 <sup>77</sup>/<sub>100</sub> for lost ordnance

Due Gov't, \$ 100 for \_\_\_\_\_

Valuation of horse, \$ 100

Valuation of horse equipments, \$ 100

Remarks: \_\_\_\_\_  
\_\_\_\_\_  
\_\_\_\_\_  
\_\_\_\_\_  
\_\_\_\_\_  
\_\_\_\_\_  
\_\_\_\_\_  
\_\_\_\_\_

Book mark: \_\_\_\_\_

(358) Floyd Copyist.

2 | 4 Cav. | U.S.C.T.

William Dewen

Priv., Co. E, 4 Reg't U. S. Colored Cav.

Appears on Returns as follows:

Mich 1864 - (1 Regt Cav., Corps d'Afrique)  
Paris: Mar 11 / 64 N. Orleans  
Rec'd. from depot.

Book mark:

W. R. Lee



*S* | **4 Cav.** | **U.S.C.T.**

*William Sever*

*Put*, Co. *E*, 4 Reg't U. S. Col'd Cavalry.

Appears on **Co. Muster-out Roll**, dated  
*New Orleans La*, *Mch 20*, 1866.

Muster-out to date *Mch 20*, 1866.

Last paid to *June 30*, 1865.

**Clothing account:**

Last settled....., 186 ; drawn since \$..... $\overline{100}$

Due soldier \$..... $\overline{100}$ ; due U. S. \$ *22*  $\frac{27}{100}$

Am't for cloth'g in kind or money adv'd \$..... $\overline{100}$

Due U. S. for arms, equipments, &c., \$ *2*  $\frac{17}{100}$

Bounty paid \$..... $\overline{100}$ ; due \$..... $\overline{100}$

Remarks: *Joined as recruit. Slop*  
*1 Horsebrush, 1 curry comb 1 pr*  
*Spurs & straps 1 Sabre knot*

Book mark : .....

(861)

*Floyd*

Copyist.

D. | 4 Cav. U.S.C.

William Severn  
Priv., Co. E, 4 Reg't U.S.C.

**NOTATION.**

Book mark: R. & P. 523015

**Record and Pension Office,**

WAR DEPARTMENT,

Washington, June 25, 1898.

It has this day ( June 25, 1898 )

been determined by this Department from the records and from information furnished by the Auditor for the War Dept. that this man was enrolled Nov. 8, 1863.

A. G. N.

914

Seymour George E.

Co D & H, 4 U. S. Col'd Cav.

Captain | Captain

CARD NUMBERS.

1	5347390	26
2	5358127	27
3	5358182	28
4	5358239	29
5	5358291	30
6	5358339	31
7	5347993	32
8	5357542	33
9	5357628	34
10	5357714	35
11	5357794	36
12	5357872	37
13	5357947	38
14	5358021	39
15	40729204	40
16	42557203	41
17	42557217	42
18	42557238	43
19		44
20		45
21		46
22		47
23		48
24		49
25		50

Book Mark: 772. CIA 82

See also

8607440 - 3<sup>d</sup> Aud -

*W. M. ...*

S 4, Cav. U.S.C.T.

Geo. E. Seymour  
Capt, Co. I, 4 Reg't U. S. Col'd Cav  
Age 38 years.

Appears on an

**Individual Muster-in Roll**

of the organization named above. Roll dated  
New Orleans La, April 27, 1864.

Muster-in to date April 27, 1864.

Joined for duty and enrolled:

When April 27, 1864.

Where New Orleans

Period 3 years.

Valuation of horse, \$ 100

Valuation of horse equipments, \$ 100

Remarks: Appointed from  
Civil life by Adjt.  
Gen. Thomas Original  
Vacancy

Book mark:

(336)

P. M. Smith  
Copyist.

*S* | 4 Cav. | U.S.C.T.

*George E Seymour*  
*Capt*, Co. *I*, 4 Reg't U. S. Col'd Cavalry.

Age ..... years.

Appears on

**Company Muster Roll\***

for *April 27 to June 30*, 1864.

Joined for duty and enrolled:

When *Feb 29*, 1864.

Where *Williamsburg, N.Y.*

Period *3* years.

Mustered in:

When *Apr. 27*, 1864.

Where *New Orleans*

Present or absent *Present*

Stoppage, \$ *100* for .....

Due Gov't, \$ *100* for .....

Valuation of horse, \$ *100*

Valuation of horse equipments, \$ *100*

Remarks : .....

\* First current roll. No muster-in roll of this battery on file.

Book mark : .....

(3586)

*Steyns*  
Copyist.

S | **4 Cav.** | **U.S.C.T.**

Geo E Seymour  
Capt, Co. I, 4 Reg't U. S. Col'd Cavalry.

Appears on

**Company Muster Roll**

for

July & Aug, 1864.

Present or absent

Present

Stoppage, \$ 100 for

Due Gov't, \$ 100 for

Valuation of horse, \$ 100

Valuation of horse equipments, \$ 100

Remarks:

Book mark:

(358)

V. H. [Signature]

Copyist.

*S* | **4 Cav.** | **U.S.C.T.**

*Geo E Seymour*

*Capt*, Co. I, 4 Reg't U. S. Col'd Cavalry.

Appears on

**Company Muster Roll**

for *Sept & Oct*, 186*4*.

Present or absent *Present*

Stoppage, \$ *100* for

Due Gov't, \$ *100* for

Valuation of horse, \$ *100*

Valuation of horse equipments, \$ *100*

Remarks:

Book mark:

*Styus*  
Copyist.



S | 4 Cav. | U.S.C.T.

Geo. E. Seymour  
Capt., Co. I, 4<sup>th</sup> Reg't U. S. Col'd Cavalry.

Appears on

**Company Muster Roll**

for Nov. & Dec, 1864.

Present or absent Present

Stoppage, \$ 100 for

Due Gov't, \$ 100 for

Valuation of horse, \$ 100

Valuation of horse equipments, \$ 100

Remarks: Reported in accordance  
with instructions from War Dept  
July 29. at New Orleans

Book mark: \_\_\_\_\_

Hynes  
Copyist.

S | **4 Cav.** | **U.S.C.T.**

Geo E Seymour

Captain, Co. I, 4 Reg't U. S. Col'd Cavalry.

Appears on

**Company Muster Roll**

for Jan + Feb, 1865.

Present or absent Present

Stoppage, \$ 100 for

Due Gov't, \$ 100 for

Valuation of horse, \$ 100

Valuation of horse equipments, \$ 100

Remarks:

Book mark:

Styves

*D* | **4 Cav.** | **U.S.C.T.**

*Geo. E. Seymour*

*Capt.*, Co. H, 4 Reg't U. S. Col'd Cavalry.

Appears on

**Company Muster Roll**

for *Mch. & Apl.*, 186 *5*-

Present or absent *Present*

Stoppage, \$ *100* for

Due Gov't, \$ *100* for

Valuation of horse, \$ *100*

Valuation of horse equipments, \$ *100*

Remarks; *Transferred from  
Co. I via Consolidation  
by S. O. 28. Hdqrs. Dep't  
Wash Jan. 28/65-*

Book mark: \_\_\_\_\_

*Paster*

*S* | 4 Cav | **U.S.C.T.**

*George E. Seymour*  
Capt, Co. *N*, 4 Reg't U. S. Col'd *Cav*

Appears on

**M. and D. Roll of Men Transferred**

to the organization named above, by *transfer*  
from *Co. I*

Roll dated *Fort Hudson La. Apr 29, 1865.*

When enlisted *Feb 4 29, 1864.*

Period for which enlisted *3* years.

When mustered in *Apr 27, 1864.*

Present or absent *not stated*

Company to which assigned *H.*

Remarks:

Book mark:

*W. Leonard*

*S* | **4 Cav. | U.S.C.T.**

*George E. Seymour*  
Capt., Co. H, 4 Reg't U. S. Col'd Cavalry.

Appears on

**Company Muster Roll**

for *May 9, June*, 186*2*.

Present or absent *Present*

Stoppage, \$ *100* for

Due Gov't, \$ *100* for

Valuation of horse, \$ *100*

Valuation of horse equipments, \$ *100*

Remarks: *Stop for 4 pr's.  
Sewed Boots \$18.60*

Book mark:

*Foster*

*D* | **4 Cav. | U.S.C.T.**

*George E. Seymour*  
Capt., Co. H, 4 Reg't U. S. Col'd Cavalry.

Appears on

**Company Muster Roll**

for *July & Aug.*, 186*2*.

Present or absent

Stoppage, \$ 100 for

Due Gov't, \$ 100 for

Valuation of horse, \$ 100

Valuation of horse equipments, \$ 100

Remarks: *Was sent with leave since Aug. 1st 1862. Stop for four pr. of sewed boots \$18.00.*

Book mark:

*D*  
*Master.*

8 1 4 1865  
Geo. E. Seymour  
Capt Detach 4th U.S. Col'd Cavalry

**Return**

of the Post of Baton Rouge, La.,  
for the month of Sept, 1865,  
dated Sept 30 1865,  
shows the following with regard to the person  
named above:

Post or station Baton Rouge La  
Remarks:

Book mark:

Austin Clark

*S* | **4 Cav.** | **U.S.C.T.**

*George E. Seymour*  
*Capt.*, Co. H, 4 Reg't U. S. Col'd Cavalry.

Appears on

**Company Muster Roll**

for *Sept & Oct.*, 186*5*.

Present or absent *Present*

Stoppage, \$ *100* for

Due Gov't, \$ *100* for

Valuation of horse, \$ *100*

Valuation of horse equipments, \$ *100*

Remarks: *Due for commanding company (\$10 per month) Feb. 28, 1865 to July 31st, 1865 (\$50).*

Book mark: *1*

*Feaster*

(358)

Copyist.



S 1 4 Car. 1908.6.7  
Geo E. Seymour  
Capt Detchd 4908 60th Army

**Return**

of the Post of Baton Rouge, La.,  
for the month of October, 1865,  
dated October 31, 1865,  
shows the following with regard to the person  
named above:

Post or station Baton Rouge La

Remarks:

Book mark:

Curtis Clark

(516)

Copyist.

8 14 Car W.S. G. J.

Geo. E. Seymour  
Capt Detached & W.S. G. J. Cavalry

**Return**

of the Post of Baton Rouge, La.,

for the month of November, 1865,

dated November 30 1865,

shows the following with regard to the person  
named above:

Post or station Baton Rouge La

Remarks:

Book mark:

Curtis Clark.

*J* | **4 Cav.** | **U.S.C.T.**

*George C. Seymour*  
Capt, Co. H, 4 Reg't U. S. Col'd Cavalry.

Appears on

**Company Muster Roll**

for *dated Dec 31*, 186*5*.

Present or absent *Absent*

Stoppage, \$ *100* for

Due Gov't, \$ *100* for

Valuation of horse, \$ *100*

Valuation of horse equipments, \$ *100*

Remarks: *On for Comd'g Co. # 10 Newmarket from Feb'y 28/65 to Nov. 30/65 except month of August. Detached on G.C.M. for S.O. 314 Head Qrs. Eastern Dist. of La. Nov. 9/65*

Book mark:

*H. C. Knolls*

*D* | **4 Cav. | U.S.C.T.**

*George E. Seymour*  
Capt., Co. H, 4 Reg't U.S. Col'd Cavalry.

Appears on

**Company Muster Roll**

for *Jan & Feb*, 1866.

Present or absent *Present*

Stoppage, \$ *100* for

Due Gov't, \$ *100* for

Valuation of horse, \$ *100*

Valuation of horse equipments, \$ *100*

Remarks: *Due for board co. \$10.00 per month from Feb. 28/65 to Nov. 30/65 except for the month of August/65*

Book mark: *1*

(358)

*A. E. Smith*  
Copyist.

D | 4 Cav. | U.S.C.T.

<sup>+</sup> George C. Seymour  
Capt, Co. H., 4 Reg't U. S. Colored Cav.

Appears on Returns as follows:

May 1864 to Feb 1865 - Present.  
Mch to June 1865 - (Co. H.) Present - Transferred  
from Company J. to Company H. in  
accordance with D.O. No 28 Hd Qrs.  
Department of the Gulf, New Orleans  
Jan 28, 1865.  
July & Aug 1865. Absent on leave per S.O.  
No. 4 Hd. Qrs. Dept of S. & Texas  
July 21/65  
Sept to Nov 1865 - Absent detached with  
Company on duty since Aug 6/65  
in Baton Rouge La. per D.O. No  
54. Hd. Qrs. Sub Dist. Port Hudson  
and Baton Rouge Aug 5/65.  
Dec 1865. Absent on g. l. M. Baton Rouge La.  
per S.O. 314 E. Dist of S. Nov 9/65  
Jan 1866 - Absent ordered to N. O. La. from Hd Qrs.  
Dept of S. no D.O. in the case.  
Feb 1866. Present

\* Name appears also as Geo. C. Seymour

Book mark :

W. R. See

(646)

Copyist.

*D* | **4 Cav.** | **U.S.C.T.**

*George C. Seymour*  
Capt, Co. *H*, 4 Reg't U. S. Col'd Cavalry.

Appears on **Co. Muster-out Roll**, dated  
*New Orleans La, March, 1860*.

Muster-out to date *March, 1860*.

Last paid to *Nov. 30, 1860*.

**Clothing account:**

Last settled \_\_\_\_\_, 186 ; drawn since \$ \_\_\_\_\_ 100

Due soldier \$ \_\_\_\_\_ 100; due U. S. \$ \_\_\_\_\_ 100

Am't for cloth'g in kind or money adv'd \$ \_\_\_\_\_ 100

Due U. S. for arms, equipments, &c., \$ *43* <sup>*75*</sup> 100

Bounty paid \$ \_\_\_\_\_ 100; due \$ \_\_\_\_\_ 100

Remarks: *Recd. appl. at New York N.Y. Service has been continuous. Entitled to three months extra pay per An. as provided in A.O. 45, War*

Book mark: *772. C. T. 82* <sup>*(over)*</sup>

(861)

*H. E. Stuart*  
Coyt.

JAN. - 8

5358021

1891

Dept. A. G. O. Series 1865.  
Entitled to \$10. per  
month from Feb 28/65  
to July 31/65, and  
from Aug 31/65 to  
Nov 30/65, now respon-  
sibility of Company  
Property.

Seymour George E.  
Capt., Co. D, 4 Reg't U.S.C.C.

4 Enclosures.

Bed Cards	Final Statements
Burial Records	Furloughs or L. of A
Certs. of Dis. for Discharge	Med. Certificates
C. M. Charges	Med. Des. Lists
Descriptive Lists	Orders 4
Discharge Certificates	Pris. of War Record
Enlistment Papers	Resignations

Other papers relating to—

Admission to Hosp'l	Furlough or L. of A /
Casualty Sheet	Med. Examination
Confinement	Misc. Information /
Contracts	Pay or Clothing
Death or Effects	Personal Reports
Desertion	Rank
Discharge from Hosp'l	Transfer to Hosp'l
Discharge from Service	Transfer to V. R. C.
Duty /	Transportation



MICROFILM PUBLICATION M 1820

COMPILED MILITARY SERVICE RECORDS  
OF VOLUNTEER UNION SOLDIERS WHO  
SERVED WITH THE USCT (US COLORED TROOPS)  
4TH REGIMENT OF CAVALRY

PERSONAL PAPERS' TARGET SHEET

PLEASE NOTE THE CHECKED INFORMATION ABOUT THE PERSONAL PAPERS IN  
THIS FILE:

NO PERSONAL PAPERS WERE FOUND IN THIS FILE WHEN THE  
RECORDS WERE ARRANGED FOR MICROFILMING.

8 PERSONAL PAPER(S) FOUND IN THIS FILE WHEN THE RECORDS  
WERE ARRANGED FOR MICROFILMING.

29-a-42

Head-Quarters U.S. Cavalry, 2d,

Camp Colfax La. May 8th.

~~A. (S. G.) 442 1864~~

Alexander. Lt Col A. B.

Requests that Capt George E. Seymour be relieved from Recruiting Service and ordered to his Rest for duty.

Respectfully forwarded  
Robt Hillier Col  
commanding District  
Carrollton

U.S. Department of War

May 9, 1864

Respectfully forwarded.

Appd. J. J. Reynolds  
Major General

Do do  
1864

S. O. 122

May 11/64.

Head Quarters 4<sup>th</sup> U.S. Cavalry, (C.S.),  
Camp Colfax May 8<sup>th</sup> 1864.

To Asst Adjt Gen<sup>l</sup>

Dept of the Gulf

I have the honor to request  
that Captain George E. Seymour, be  
relieved from Recruiting Service and ordered  
to report to his regiment for duty.

I have a Squadron  
mustered in and no officer to command  
it, without assigning from other squadrons  
which are short of officers by various detach-  
ments.

I am Sir

Very Respectfully

Your Obedt Servt  
Alexander L. Col  
Commanding

Head Quarters 4<sup>th</sup> U.S. Cavalry, (Ct.),  
Camp Colfax May 8<sup>th</sup> 1864.

To Asst Adjt Gen<sup>l</sup>

Dept of the Gulf

I have the honor to request  
that Captain George E. Seymour, be  
relieved from Recruiting service and ordered  
to report to his regiment for duty—

I have a Squadron  
mustered in and no officer to command  
it, without assigning from other squadrons  
which are short of officers by various detach-  
ments.

I am Sir

Very Respectfully

Your Obedt Servt  
William L. Col  
Commanding

348  
B. M. Hatfield

Major W. Hoffmann  
a. a. General  
Head Quarters Dept. of Ind.

Department of Ind.  
4th S. C. Co.

Monthly report of the  
Board of Examiners  
for U. S. Army Troops.

file

Recd 52 Mar 1, 1866

Head Quarters Dept of the Gulf.  
New Orleans, La. May 29<sup>th</sup> 1865.

Special Orders }  
No 140 } Extract

1. A Board of examiners for u. s. colored Troops, to consist of the following named officers is hereby appointed to meet in this city as soon after the receipt of this order as practicable, for the examination of such applicants for commissions in the u. s. colored Troops, as may from time to time be ordered before it.

Detail for the Board.

Lieut Col Chas B. Gaskill. 81<sup>st</sup> u. s. Col<sup>d</sup> Inf. President of Board.  
Major George Baily. 65<sup>th</sup> u. s. Colored Inf.  
2<sup>d</sup> Lieut John of St. Clair. 1<sup>st</sup> u. s. Col<sup>d</sup> Inf. (Recorder),  
The Board will transmit a weekly report of its proceedings to these Head Quarters.

By command of Major General Banks.

J. C. Stone.  
Capt & a. a. Genl.

Official.

Nathaniel Banks.  
1<sup>st</sup> Lieut & a. a. a. Genl.

Headquarters Dept. of the Gulf.  
New Orleans, La. June 9<sup>th</sup> 1865.

Special Order }  
No 153 } Extract.

4. Colonel S. M. Quincy, 73<sup>rd</sup> U. S. Colored Infantry,  
is relieved from duty with his regiment and will  
resume his duties as President of the Board of Examiners  
for candidates for commissions and promotions in  
the U. S. Colored Troops.

By order of Major Genl L. R. S. Leiby.

C. H. Dyer.  
Capt + a. a. Genl.

Official

George T. Wilbur.  
Lieut a. a. a Genl.

1866 543

Board of Examining Board for U.S. Col. Troops.

Department of Louisiana

New Orleans Louisiana, February 24<sup>th</sup> 1866.

All the members being present the Board proceeded to  
examine the following named applicants.

*Seymour George F.* Captain George L. Seymour, 4<sup>th</sup> U.S. Colored Cavalry.

Examined and report forwarded.

Respectfully submitted.

S. M. Quincy  
Colonel 81<sup>st</sup> U.S. I. C. S.  
President Board

*[Signature]*  
Edw. J. Blair  
1<sup>st</sup> Lt. 5<sup>th</sup> U.S. Col. Inf.  
Recorder Board of Examiners.



S 45 A Sept 1865

Quarters 10th U.S. Col. Cav.  
Fort Hudson La. July 15th 1865

Dear Sir

- H. M. S. C. Carley -

Account of some ...  
... ..  
... ..  
... ..

Headquarters Dist. of East Louisiana,  
Baton Rouge, La. July 17th 1865  
Respectfully forwarded to H. B.  
Quarters Dept. of the  
Gulf. Approved:  
M. K. Lawler  
Brevet Major General Commanding.

Very Truly Yours  
H. M. S. C. Carley

S. J. S. H. 1865  
Head and U.S. Forces  
Park: Hudson La July 15/65  
Respectfully forwarded  
Approved  
Genl. Hamilton  
Brig General  
Cavalry

Headq's Dis't of East Louisiana,

BATON ROUGE, LA. July 17th 1865

Respectfully forwarded to H. B.  
Quarters Dept. of the  
Gulf. Approved:  
M. K. Lawler  
Brevet Major General Commanding.

S. J. S. H. P. 221 1865

Received  
C. 115. 1865  
1865

Camp 4<sup>th</sup> U.S. Cold Cavalry  
Port Hudson La, July 10<sup>th</sup> 1865.

Bvt. Lt. Col.

J. Schuyler Crosby A. A. G. Dept. of Gulf  
Sir;

I have the honor to request a leave of absence for (20) twenty days, for the purpose of visiting my family at Williamsburgh T. M. with permission to apply for an extension of (20) twenty days.

I entered the Army in March 1862, and have never had a leave of absence - my family is now sick and needs my presence for a short time.

2<sup>d</sup> Lieutenant Henry C. Coverts is serving with the Company to which I am attached and my services can readily be spared for the period desired.

Very Respectfully  
Your Obedt. Servt.

Geo. C. Seymour

Capt. 4<sup>th</sup> U.S. C. C.

Company 2<sup>d</sup> Company

S. 68. ADJ. GEN., 1865

New York.

Aug. 6. 1865.

Capt. Geo. E. Seymour

4th U. S. A. C.

Applies for extension  
of leave of absence.

Recd Aug 8. 1865

Headquarters  
Department of Louisiana and Texas  
New Orleans, La., July 21, 1865  
Special Orders }  
No. 4. } Extract

Leave of absence for twenty (20) days, with recommendation to the Adjutant General of the Army for an extension of twenty (20) days, is hereby granted to Captain George E. Seymour, Company "H," 4<sup>th</sup> U.S. Colored Cavalry.

By order of Major-General C. B. S. Canby  
J. Schuyler Crosby  
B. Lt. Col. A. S. C. Acting Asst. Adj. Genl.

Official:

Copy

Nathaniel Burbank  
1<sup>st</sup> Lieut. Acting Asst. Adj. General

New York August 6<sup>th</sup> 1865.  
Adjutant General U. S. A.

Sir;

I have the honor to apply for an extension of twenty (20) days as recommended in the above order.

Very Respectfully  
Your Obedt Servt.

Geo. E. Seymour

Capt. "H" Company

4<sup>th</sup> U. S. Colored Cavalry

Address

Care of American Bank, Note Co

New York

271 1866

New Orleans La  
February 24<sup>th</sup> 1866

Board of Examiners  
Col S. M. Quincy  
President.

Forwarded pro-  
ceedings of the  
Board in the case  
of Capt George  
E. Seymour  
4<sup>th</sup> Regt colored  
Cavalry

pic

March 22<sup>nd</sup> 1866

Rooms of Examining Board, for U. S. Colored Troops,

DEPARTMENT OF LOUISIANA.

NO. 195 ST. JOSEPH STREET

New Orleans,

186

( )

( )

( )

( )

( )

( )

( )

( )

( )

( )

( )

( )

( )

( )

( )

( )

( )

( )

( )

( )

Official

(Signed) Nathaniel Barbours

1st Lieut. Col. 11th U.S. Col. Troop

Major H. Morrison  
et al, et,  
Department of Justice.

Sir:

The Commission on the  
Organization of the Court has  
and Col. [Name] & [Name],  
U.S. Army, [Name] and [Name] to  
assist to [Name] as follows:

[Name] [Name] [Name]  
[Name] [Name] [Name] [Name]  
[Name] [Name] [Name] [Name] [Name]  
[Name] [Name] [Name] [Name] [Name]  
[Name] [Name] [Name] [Name] [Name]  
[Name] [Name] [Name] [Name] [Name]  
[Name] [Name] [Name] [Name] [Name]  
[Name] [Name] [Name] [Name] [Name]  
[Name] [Name] [Name] [Name] [Name]  
[Name] [Name] [Name] [Name] [Name]  
[Name] [Name] [Name] [Name] [Name]  
[Name] [Name] [Name] [Name] [Name]

The said [Name] [Name] report

that it does not appear from Captain  
Dugan's report, either that he is dis-  
cussing to return his private property  
in the service.

Very respectfully,  
Yours

S. M. Quincy

Major U.S. Army

Fort Snelling

James M. Smith

Major U.S. Army

Fort Snelling

1st Regt. U.S. Inf.

Becker Road



Lo 813 Q 50 1865

Hd Qrs. 4<sup>th</sup> Regt. Col & Coas<sup>y</sup>

Port Hudson La Dec 5<sup>th</sup> 1865

~~Lo 813 Q 50 1865~~

Mitchell Aache C  
Lt. Col. Comdg Regiment

Requests that Captain  
Geo E. Seymour C<sup>o</sup> H<sup>o</sup>  
his regiment be ordered  
before a board of examiners  
to test his fitness for the  
position he holds &c

29226 — M — 1268  
Headquarters U. S. Forces

Port Hudson La. Dec 6 1865

Respectfully forwarded.

Approved  
Wm S Dickey  
Col Comdg Port

Rec<sup>d</sup> at Dec 13<sup>th</sup> 1865

Headquarters East Dist of Va  
Rich<sup>mond</sup> Dec 11<sup>th</sup> 1865

~~Lo 813 Q 50~~

Respectfully forwarded to  
Dep<sup>t</sup> Headquarters  
Wm S Dickey  
Lt. Col. Comdg Regt

*[Signature]*

S. D. 13<sup>th</sup> 1865

Headquarters 4<sup>th</sup> U.S. Colored Cavalry  
Post Hudson La December 6<sup>th</sup> 1865

Major William Hoffman

Asst. Adjt General  
Dept of La.

Sir,

I consider it my duty, from personal observation, as well as that of many other officers, to recommend that Captain George E. Deymore Co<sup>st</sup> "H" 4<sup>th</sup> U.S. Colored Cavalry commanding Co<sup>st</sup> "H & C" same regiment at Baton Rouge, be ordered before a board of examiners to test his fitness for the position he holds, or if that be impracticable that he be at once discharged the better for the good thereof. He has to my entire dissatisfaction proven himself the most incompetent company commander in the regiment & the conduct of his company & management of that detachment is calculated to bring the regiment into disrepute.

I have the honor to be

Very respectfully

Your obt. servt.

Nathl. Mitchell

2<sup>d</sup> Colonel's Regiment

Seymour, Gen. &  
Capt. 4<sup>th</sup> & 5<sup>th</sup> Regs.

5

SPECIAL ORDERS }  
No. 502.

HEADQUARTERS OF THE ARMY,  
ADJUTANT GENERAL'S OFFICE,  
Washington, November 22d, 1867.

(Extract.)

\* \* \* \* \*

10. Under the provisions of Joint Resolution of Congress, approved July 26th, 1866, the muster into service of Captain *George E. Seymour*, 4th U. S. Colored Cavalry, of date April 27th, 1864, is, by direction of the Secretary of War, hereby amended to date February 22d, 1864, and he is mustered for pay from February 22d, 1864, to April 26th, 1864, both dates inclusive.

\* \* \* \* \*

BY COMMAND OF GENERAL GRANT:

E. D. TOWNSEND,

*Assistant Adjutant General.*

OFFICIAL:

*E. D. Townsend*  
*Assistant Adjutant General.*

*General Pelouze.*

Rec'd Motor Nov. 23rd 67, P.M. S.A.S.

SPECIAL ORDERS }  
No. 502. }

HEADQUARTERS OF THE ARMY,  
ADJUTANT GENERAL'S OFFICE,  
Washington, November 22d, 1867.

(Extract.)

\* \* \* \* \*

10. Under the provisions of Joint Resolution of Congress, approved July 26th, 1866, the muster into service of Captain *George E. Seymour*, 4th U. S. Colored Cavalry, of date April 27th, 1864, is, by direction of the Secretary of War, hereby amended to date February 22d, 1864, and he is mustered for pay from February 22d, 1864, to April 26th, 1864, both dates inclusive.

\* \* \* \* \*

BY COMMAND OF GENERAL GRANT:

E. D. TOWNSEND.

*Assistant Adjutant General.*

OFFICIAL:

*E. D. Townsend*  
*Assistant Adjutant General.*

*General Pelouze*

*[Signature]*

*Symour Henry*

Co E, 4 U. S. Col'd Cav.

*Private* | *Private*

CARD NUMBERS.

1		28
2		29
3	<i>see Symore Henry</i>	30
4		31
5		32
6		33
7		34
8		35
9		36
10		37
11		38
12		39
13		40
14		41
15		42
16		43
17		44
18		45
19		46
20		47
21		48
22		49
23		50

Book Mark:

See also

976

Shepley Andrew

Co D, 4 U. S. Col'd Cav.

Private | Private

CARD NUMBERS.

1	5352583	26
2	5352633	27
3	5352685	28
4	5352742	29
5	5352823	30
6	5352884	31
7	5352965	32
8	5353796	33
9	40729208	34
10		35
11		36
12		37
13		38
14		39
15		40
16		41
17		42
18		43
19		44
20		45
21		46
22		47
23		48
24		49
25		50

Book Mark:

See also



A. 26649630

*Mull*  
90

S | **4 Cav.** | **U.S.C.T.**

Andrew Shepley  
Priv., Co. D, 1 Reg't, Corps d'Afrique Cavalry.\*

Appears on

**Company Muster-in Roll**

of the organization named above. Roll dated

New Orleans La., Nov 26, 1863.

Muster-in to date Nov 26, 1863.

Joined for duty and enrolled:

When Nov 4, 186 .

Where New Orleans

Period 3 years.

Valuation of horse, \$.....100

Valuation of horse equipments, \$.....100

Remarks:.....  
.....  
.....  
.....

\*This organization subsequently became Co. D, 4 Reg't U. S. Colored Cavalry.

Book mark:.....  
.....

(356)

Rosenbaum

Copyist.

S

4 Cav. U.S.C.T.

Andrew Shepley

Pvt., Co. D, 1 Reg't Cav., Corps d'Afrique.\*

Appears on

Company Muster Roll

for From Enlistment to Dec 31, 1863.

Present or absent Present

Stoppage, \$ 100 for

Due Gov't, \$ 100 for

Valuation of horse, \$ 100

Valuation of horse equipments, \$ 100

Remarks:

\* This organization subsequently became Co. D, 4 Reg't U. S. Colored Cavalry.

Book mark:

Rosenbaum

*S* | **4 Cav. | U.S C.T.**

*Andrew Shepley*  
*Pvt.*, Co. *D*, 1 Reg't Cav., Corps d'Afrique.\*

Appears on

**Company Muster Roll**

for *Lamy & Gely*, 1864.

Present or absent *Present*

Stoppage, \$ *100* for

Due Gov't, \$ *100* for

Valuation of horse, \$ *100*

Valuation of horse equipments, \$ *100*

Remarks:

\* This organization subsequently became Co. *D*, 4 Reg't U. S. Colored Cavalry.

Book mark:

(358) *Rosenbaum* Copyist.

S | **4 Cav.** | **U.S.C.T.**

Andrew Shepley

Pvt, Co. D. 4 Reg't U. S. Col'd Cavalry.

Appears on

**Company Muster Roll**

for March & April, 1864.

Present or absent Present

Stoppage, \$ 100 for

Due Gov't, \$ 100 for

Valuation of horse, \$ 100

Valuation of horse equipments, \$ 100

Remarks:

Book mark:

(358)

Rosenbaum  
Copyist.

S | **4 Cav.** | **U.S.C.T.**

Andrew Shepley

Pvt, Co. D. 4 Reg't U. S. Col'd Cavalry.

Appears on

**Company Muster Roll**

for May & June, 1864.

Present or absent

Stoppage, \$ 100 for

Due Gov't, \$ 100 for

Valuation of horse, \$ 100

Valuation of horse equipments, \$ 100

Remarks: Deserted from Camp  
Parafret-Carrotton La  
June 19-1864

Book mark:

(358)

Rosenbaum

Copyist.

S | **4 Cav.** | **U.S.C.T.**

Andrew Shepley  
Priv., Co. D. 4 Reg't U. S. Col'd Cavalry.

Appears on

**Company Muster Roll**

for July & Aug, 186 <sup>4</sup>/<sub>4</sub>.

Present or absent \_\_\_\_\_

Stoppage, \$ \_\_\_\_\_ 100 for \_\_\_\_\_

Due Gov't, \$ \_\_\_\_\_ 100 for \_\_\_\_\_

Valuation of horse, \$ \_\_\_\_\_ 100

Valuation of horse equipments, \$ \_\_\_\_\_ 100

Remarks: Deserted from Camp  
Parafet - June 19 - 1864

Book mark: \_\_\_\_\_

(358)

Rosenbaum  
Copyist.

S | 4 Cav. | U.S.C.T.

Andrew Shepley

Pvt., Co. D, 4 Reg't U. S. Col'd Cavalry.

Appears on

**Company Muster Roll**

for Sept & Oct, 1864.

Present or absent.....

Stoppage, \$.....100 for.....

Due Gov't, \$.....100 for.....

Valuation of horse, \$.....100

Valuation of horse equipments, \$.....100

Remarks: Deserted from Camp  
Parapet June 19-1864

Book mark:.....

(358)

Rosenbaum

Copyist.



5 | 4 Cav. | U.S.C.T.

Andrew Shepley  
Priv., Co. D, 4 Reg't U. S. Colored Cav.

Appears on Returns as follows:

June + July 1864 - Absent without  
leave since June 22 from  
Camp Parapet La.

Aug 1864 - Loss: June 22 Camp  
Parapet deserted.

Name appears also as  
Andrew Shepley

Book mark:

W. R. Lee

(546)

Copyist.

5 | **4 Cav. | U.S.C.T.**

*Andrew Shepley*

*Put*, Co. *10*, 4 Reg't U. S. Col'd Cavalry.

Appears on **Co. Muster-out Roll**, dated  
*New Orleans, La*, *May 20*, 186*6*.

Muster-out to date \_\_\_\_\_, 186 .

Last paid to *Apr 30*, 186*4*.

**Clothing account:**

Last settled \_\_\_\_\_, 186 ; drawn since \$ \_\_\_\_\_  $\overline{100}$

Due soldier \$ \_\_\_\_\_  $\overline{100}$ ; due U. S. \$ *32*  $\overline{100}$  <sup>*33*</sup>

Am't for cloth'g in kind or money adv'd \$ \_\_\_\_\_  $\overline{100}$

Due U. S. for arms, equipments, &c., \$ \_\_\_\_\_  $\overline{100}$

Bounty paid \$ \_\_\_\_\_  $\overline{100}$ ; due \$ \_\_\_\_\_  $\overline{100}$

Remarks: *Joined at Org. Org.*  
*Deserted June 22/64 at*  
*Camp Parapet, La.*

Book mark: \_\_\_\_\_

*M. Andrews*

(861)

Copyist.

Swift Edward

Co E, 4 U. S. Col'd Cav.

Private Blacksmith

CARD NUMBERS.

1	5 3 5 3 8 4 1	26
2	5 3 5 3 8 9 4	27
3	5 3 5 3 9 4 9	28
4	5 3 5 4 0 1 6	29
5	5 3 5 4 0 7 5	30
6	5 3 5 4 1 4 6	31
7	5 3 5 4 2 1 1	32
8	5 3 5 4 2 4 1	33
9	5 3 5 4 3 3 4	34
10	5 3 5 4 3 6 8	35
11	5 3 5 4 4 5 2	36
12	5 3 5 4 5 3 5	37
13	5 3 5 4 6 1 2	38
14	5 3 5 4 6 8 5	39
15	5 3 5 4 7 5 3	40
16	5 3 5 4 8 2 3	41
17	4 0 7 2 9 2 3 8	42
18		43
19		44
20		45
21		46
22		47
23		48
24		49
25		50

Book Mark:

See also

5904 596 P.O. man  
A. 1585 254 P.O. aff.  
Ormsby Holmes 5537 NTZ

*Ormsby Holmes*

*S* | **4 Cav. | U.S.C.T.**

*Edward Sheriff*  
....., Co. *E*, 1 Reg't, Corps d'Afrique Cavalry.\*

Appears on

**Company Muster-in Roll**

of the organization named above. Roll dated  
*New Orleans, La., Dec. 31,* 186*3.*

Muster-in to date *Dec. 31,* 186*3.*

Joined for duty and enrolled:

When *Nov. 12*, 186*3.*

Where *New Orleans*

Period *3* years.

Valuation of horse, \$.....*100*

Valuation of horse equipments, \$.....*100*

Remarks: .....

\*This organization subsequently became Co. *E*, 4 Reg't U. S. Colored Cavalry.

Book mark: .....

*Wendell*

*S* | **4 Cav. U.S C.T.**

*Edward Shwiff*  
*Pvt*, Co. *E*, 1 Reg't Cav., Corps d'Afrique.\*

Appears on

**Company Muster Roll**

for *Enlistment to Dec. 31*, 186*3*.

Present or absent *Present*

Stoppage, \$ *100* for

Due Gov't, \$ *100* for

Valuation of horse, \$ *100*

Valuation of horse equipments, \$ *100*

Remarks:  
.....  
.....  
.....  
.....  
.....  
.....

\* This organization subsequently became Co. *E*, 4 Reg't U. S. Colored Cavalry.

Book mark: *see page 5*

*W. W. W.*

*S* | **4 Cav. | U.S C.T.**

*Edward Shwift*

, Co. *E*, 1 Reg't Cav., Corps d'Afrique.\*

Appears on

**Company Muster Roll**

for *Jan & Feb*, 186 *4*.

Present or absent *Present*

Stoppage, \$ *100* for

Due Gov't, \$ *100* for

Valuation of horse, \$ *100*

Valuation of horse equipments, \$ *100*

Remarks:

\* This organization subsequently became Co. *E*, 4 Reg't U. S. Colored Cavalry.

Book mark:

*Lawrence*

*S* | **4 Cav.** | **U.S.C.T.**

*Edward Swift*

*Priv.*, Co. E, 4 Reg't U. S. Col'd Cav.

Appears on

**Company Muster Roll**

for *Mar + Apr*, 186 *4*

Present or absent *Absent*

Stoppage, \$ 100 for

Due Gov't, \$ 100 for

Valuation of horse, \$ 100

Valuation of horse equipments, \$ 100

Remarks: *Absent on recruiting service*

Book mark: \_\_\_\_\_

*Learned*



*S* | **4 Cav.** | **U.S.C.T.**

*Edward Schwift*

*Priv.*, Co. E, 4 Reg't U. S. Col'd Cav.

Appears on

**Company Muster Roll**

for *May & June*, 186*4*

Present or absent *Present*

Stoppage, \$ *100* for

Due Gov't, \$ *100* for

Valuation of horse, \$ *100*

Valuation of horse equipments, \$ *100*

Remarks:

Book mark:

*Lammie*

S | **4 Cav.** | **U.S.C.T.**

*Edward Schwoft*

*Priv.*, Co. E, 4 Reg't U. S. Col'd Cav.

Appears on

**Company Muster Roll**

for *July + Aug*, 186*4*

Present or absent *Present*

Stoppage, \$ 100 for

Due Gov't, \$ 100 for

Valuation of horse, \$ 100

Valuation of horse equipments, \$ 100

Remarks:

Book mark:

*Sumner*

*S* | **4 Cav.** | **U.S.C.T.**

*Edward Schwift*

*Put*, Co. E, 4 Reg't U. S. Col'd Cav.

Appears on

**Company Muster Roll**

for *Sept & Oct*, 186*4*

Present or absent *Present*

Stoppage, \$ *100* for

Due Gov't, \$ *100* for

Valuation of horse, \$ *100*

Valuation of horse equipments, \$ *100*

Remarks: *Due U S for Lost  
Ordnance 43 cts*

Book mark:

*Lamm*

(358)

Copyist.

*S* | **4 Cav.** | **U.S.C.T.**

*Edward Schwift*

*Blissmith*, Co. E, 4 Reg't U. S. Col'd Cav.

Appears on

**Company Muster Roll**

for *Nov & Dec*, 1864.

Present or absent *Present*

Stoppage, \$ *100* for

Due Gov't, \$ *100* for

Valuation of horse, \$ *100*

Valuation of horse equipments, \$ *100*

Remarks: *Stopped for 1 Horse  
Blanket 1 Horse Bag*

Book mark:

(358)

*Wines*

Copyist.

*S* | **4 Cav.** | **U.S.C.T.**

*Edward Schwift*

*Pr*

, Co. E, 4 Reg't U. S. Col'd Cav.

Appears on

**Company Muster Roll**

for *Jan & Feb*, 186*S.*

Present or absent *Present*

Stoppage, \$ *100* for

Due Gov't, \$ *100* for

Valuation of horse, \$ *100*

Valuation of horse equipments, \$ *100*

Remarks: *Stop for 1 horse blanket  
& one nose bag*

Book mark:

*Wines*

S | **4 Cav.** | **U.S.C.T.**

Edward Schrift

Blk Smith, Co. E, 4 Reg't U. S. Col'd Cav.

Appears on

**Company Muster Roll**

for Mar & Apr, 1865.

Present or absent Present

Stoppage, \$ 100 for

Due Gov't, \$ 100 for

Valuation of horse, \$ 100

Valuation of horse equipments, \$ 100

Remarks:

Book mark:

(358)

Wines  
Copyist.

*S*

**4 Cav.**

**U.S.C.T.**

*Edward Schrift*

*Bloomst*, Co. E, 4 Reg't U. S. Col'd Cav.

Appears on

**Company Muster Roll**

for *May & June*, 186*S.*

Present or absent *Present*

Stoppage, \$ *100* for

Due Gov't, \$ *100* for

Valuation of horse, \$ *100*

Valuation of horse equipments, \$ *100*

Remarks:

Book mark:

(358)

*Wines*

Copyist.

*S* | **4 Cav.** | **U.S.C.T.**

*Edward Schwift*

*Blenworth*, Co. E, 4 Reg't U. S. Col'd Cav.

Appears on

**Company Muster Roll**

for *July & Aug*, 186 *5*.

Present or absent *Present*

Stoppage, \$ 100 for

Due Gov't, \$ 100 for

Valuation of horse, \$ 100

Valuation of horse equipments, \$ 100

Remarks:

Book mark:

(358)

*Mines*

Copyist.



*S* | **4 Cav.** | **U.S.C.T.**

*Edward Schwift*

*Blk Smith*, Co. E, 4 Reg't U. S. Col'd Cav.

Appears on

**Company Muster Roll**

for *Sept & Oct*, 186 *5-*

Present or absent *Present*

Stoppage, \$ *100* for

Due Gov't, \$ *100* for

Valuation of horse, \$ *100*

Valuation of horse equipments, \$ *100*

Remarks:

Book mark: *358*

(358)

*Wills*

Copyist.

*S* | **4 Cav.** | **U.S.C.T.**

*Edward Schwipt*

*Blk. Smith* Co. E, 4 Reg't U. S. Col'd Cav.

Appears on

**Company Muster Roll**

for *Nov. & Dec.*, 186 *5*.

Present or absent *Present*

Stoppage, \$ *100* for

Due Gov't, \$ *100* for

Valuation of horse, \$ *100*

Valuation of horse equipments, \$ *100*

Remarks:

-----  
-----  
-----  
-----  
-----  
-----  
-----  
-----

Book mark: -----

-----

(358)

*Floyd*

Copyist.

*S* | **4 Cav.** | **U.S.C.T.**

*Edward Schwift*

*Bk Sm.*, Co. E, 4 Reg't U. S. Col'd Cav.

Appears on

**Company Muster Roll**

for *Jany & Lehy*, 186*6*.

Present or absent *Present*

Stoppage, \$ *100* for

Due Gov't, \$ *100* for

Valuation of horse, \$ *100*

Valuation of horse equipments, \$ *100*

Remarks:

Book mark:

(358)

*Floyd*

Copyist.

D

4 Cav. | U.S.C.T.

Edward Swift

Port , Co. W , 4 Reg't U. S. Colored Cav.

Appears on Returns as follows:

March 1864 - (1 Regt Cav., Corps d'Afrique)  
Absent detached. Mar 9/64 on  
recruitg. service.

April & May 1864 - (1 Regt. U. S. Col'd Cav)  
Absent detached on Recruitg.  
service since Mar 10. 64.

Sept 1864 - On duty Blacksmith  
for R. G. M.

Nov 1865 & Jan 1866 - On duty as  
Blacksmith.

Name appears also as  
Edward Schwift  
Edward Schroft  
Edward Schriфт

Book mark:

W. R. Lee

*S* | **4 Cav.** | **U.S.C.T.**

*Edward Schwift*

*Bksm*, Co. *E*, 4 Reg't U. S. Col'd Cavalry.

Appears on **Co. Muster-out Roll**, dated

*New Orleans La*, *Mch 20*, 1866.

Muster-out to date *Mch 20*, 1866.

Last paid to *June 30*, 1865.

Clothing account:

Last settled....., 186 ; drawn since \$..... $\overline{100}$

Due soldier \$..... $\overline{100}$ ; due U. S. \$ *16*  $\overline{19}$

Am't for cloth'g in kind or money adv'd \$..... $\overline{100}$

Due U. S. for arms, equipments, &c., \$..... $\overline{100}$

Bounty paid \$..... $\overline{100}$ ; due \$..... $\overline{100}$

Remarks: *Joined orig org.*

Book mark: *V. 26 P. 156. 68*

(861)

*Floyd*

Copyist.

970

Simmons Benjamin

Co H, 4 U. S. Col'd Cav.

Private Private

CARD NUMBERS.

1	5347920	26
2	5357217	27
3	5357273	28
4	5357327	29
5	5357384	30
6	5357438	31
7	5357495	32
8	5358117	33
9	40729210	34
10		35
11		36
12		37
12		38
14		39
15		40
16		41
17		42
18		43
19		44
20		45
21		46
22		47
23		48
24		49
25		50

Book Mark:

See also

S | **4 Cav.** | **U.S.C.T.**

Benjamin Simmons

Appears with rank of Private on

**Muster and Descriptive Roll of a Detachment of U. S. Vols. forwarded**

for the 4 Reg't U. S. Col'd Cavalry. Roll dated

New Orleans La, Apr 8, 1864.

Where born Charleston S.C.

Age 30 y'rs; occupation laborer

When enlisted March 22, 1864

Where enlisted Alexandria

For what period enlisted 3 years.

Eyes Black; hair Black

Complexion Black; height 5 ft. 1/2 in.

When mustered in Apr 8, 1864

Where mustered in New Orleans

Bounty paid \$ 100; due \$ 100

Where credited \_\_\_\_\_

Company to which assigned H

Remarks: \_\_\_\_\_

\_\_\_\_\_

\_\_\_\_\_

Book mark: \_\_\_\_\_

(339)

Dallade

Copyist.

*S* | **4 Cav.** | **U.S.C.T.**

*Benjamin Simmons*  
*Pvt.*, Co. H, 4 Reg't U. S. Col'd Cavalry.

Appears on

**Company Muster-in and Descriptive Roll**  
of the organization named above. Roll dated

*New Orleans La, Apr, 8, 1864.*

Where born *Charleston, S.C.*

Age *20* y'rs; occupation *Laborer*

When enlisted *Mar, 22*, 186*4.*

Where enlisted *Alexandria, La*

For what period enlisted *3* years.

Eyes *black*; hair *black*

Complexion *black*; height *5 ft. 1 1/2 in.*

When mustered in *Apr, 8*, 186*4.*

Where mustered in *New Orleans, La*

Bounty paid \$ *2* 100; due \$ *100*

Where credited .....

Company to which assigned .....

Remarks: .....

.....

.....

.....

.....

.....

.....

.....

.....

.....

.....

.....

.....

.....

.....

.....

.....

.....

.....

.....

(356d)

*C. Williams,*

Copyist.



*S* | **4 Cav.** | **U.S.C.T.**

*Benj. Simmons*  
*Pvt.*, Co. H, 4 Reg't U. S. Col'd Cavalry.

Appears on

**Company Muster Roll**

for *Apr. 8 to 30*, 186 *4*

Present or absent *Present.*

Stoppage, \$.....100 for .....

Due Gov't, \$.....100 for .....

Valuation of horse, \$.....100

Valuation of horse equipments, \$.....100

Remarks: .....

.....

.....

.....

.....

.....

.....

.....

.....

Book mark: .....

*C. Williams*  
(358) Copyist.

*S* | **4 Cav.** | **U.S.C.T.**

*Ber. Simmons*  
*Plt*, Co. H, 4 Reg't U. S. Col'd Cavalry.

Appears on

**Company Muster Roll**

for *May & June*, 186 *4*

Present or absent *Present*

Stoppage, \$ *100* for

Due Gov't, \$ *100* for

Valuation of horse, \$ *100*

Valuation of horse equipments, \$ *100*

Remarks:

-----  
-----  
-----  
-----  
-----  
-----  
-----  
-----  
-----  
-----

Book mark:

-----

*L. Williams*

*S* | **4 Cav.** | **U.S.C.T.**

*Benjamin Simmons*  
*Pitt*, Co. H, 4 Reg't U. S. Col'd Cavalry.

Appears on

**Company Muster Roll**  
for *July + Aug*, 1864.  
Present or absent *Present*

Stoppage, \$ 100 for

Due Gov't, \$ 100 for

Valuation of horse, \$ 100

Valuation of horse equipments, \$ 100

Remarks:  
\_\_\_\_\_  
\_\_\_\_\_  
\_\_\_\_\_  
\_\_\_\_\_  
\_\_\_\_\_  
\_\_\_\_\_  
\_\_\_\_\_  
\_\_\_\_\_

Book mark: \_\_\_\_\_

(358)

*S. Williams*  
Copyist.

*S* | **4 Cav.** | **U.S.C.T.**

*Benjamin Simmons,*  
*Pvt.*, Co. H, 4 Reg't U. S. Col'd Cavalry.

Appears on

**Company Muster Roll**

for *Sept. & Oct.*, 186 *4*

Present or absent *Present*

Stoppage, \$ 100 for

Due Gov't, \$ 20/100 for *ordnance*

*(wiper)*

Valuation of horse, \$ 100

Valuation of horse equipments, \$ 100

Remarks:

-----  
-----  
-----  
-----  
-----  
-----  
-----  
-----  
-----

Book mark:

-----

*G. Williams*

*S* | **4 Cav.** | **U.S.C.T.**

*Benjamin Simmons*  
*Pvt.*, Co. H, 4 Reg't U. S. Col'd Cavalry.

Appears on

**Company Muster Roll**

for *Nov, + Dec*, 186 *4*

Present or absent.....

Stoppage, \$.....100 for.....

Due Gov't, \$.....100 for.....

Valuation of horse, \$.....100

Valuation of horse equipments, \$.....100

Remarks: *Died in Post Hoop*  
*Nov, 23<sup>rd</sup>, 1864* *Sebelity*  
*Due John Wild, Sebel*  
*7.00*  
*Due for ordnance lost. 33*

Book mark: *A.G.O. Died Nov, 23*

*S. Williams*

(358)

Copyist.

JAN.-E

5357495

1891\*

'64 E.B.  $\frac{11}{98}$  8304 2<sup>d</sup>  
@ Mch. 27 '68.

8 | 4 Cav. | U.S.C.T.

Benj. Dimmone  
Port, Co. H, 4 Reg't U. S. Colored Cav.

Appears on Returns as follows:

Nov 1861 - 2000: Nov 23/61  
Port Hudson - Wied.

Book mark:

(546) W. R. Lee Copyist.

1864

*H* | **4 Cav. | U.S.C.T.**

*Benjamin Simmons*  
Pri., Co. *H*, 4 Reg't U. S. Col'd Cavalry.

Appears on **Co. Muster-out Roll**, dated  
*New Orleans La, Feb 20*, 1866.

Muster-out to date \_\_\_\_\_, 186 .  
Last paid to \_\_\_\_\_, 186 .

**Clothing account:**

Last settled \_\_\_\_\_, 186 ; drawn since \$ \_\_\_\_\_ 100  
Due soldier \$ \_\_\_\_\_ 100; due U. S. \$ \_\_\_\_\_ 100  
Am't for cloth'g in kind or money adv'd \$ \_\_\_\_\_ 100

Due U. S. for arms, equipments, &c., \$ \_\_\_\_\_ 100  
Bounty paid \$ \_\_\_\_\_ 100; due \$ \_\_\_\_\_ 100

Remarks: *Joined as Capt. Aug. Died*  
*in Post Hosp't, Port Hud-*  
*son La. Nov. 22/64. Final*  
*statements forwarded. Rec'd*  
*\$7.00 per mth. from enlist-*  
*ment to Apr. 30/64*

Book mark : \_\_\_\_\_

*H. E. Arnold*  
(861) Copyist.



Summers, Benf'

P, Co. H., 4 Regt. U.S.C. Cav

2 Enclosures.

Bed Cards	Descriptive Lists
Burial Records	Final Statements /
Certs. of Dis. for Discharge	Furloughs
C. M. Charges	Med. Des. Lists
Med. Certificates	Orders

Other papers relating to—

Admission to Hosp'l	Furlough
Casualty Sheet (Officer's)	Med. Examination
Confinement	Misc. Information
Contracts	Pay or Clothing
Death or Effects /	Personal Reports
Desertions	Rank
Discharge from Hosp'l	Transfer to Hosp'l
Discharge from Service	Transfer to V. R. C.
Duty	Transportation

See letter to <sup>me</sup> and July 2, 1864

[OFFICE INDORSEMENT.]

# War Department,

ADJUTANT GENERAL'S OFFICE,

June 15, 1864,

The death of Ben Simmons  
Private, Co. H, 4<sup>th</sup> Reg't U. S.

Colored Cav, is reported as follows:

On Company Muster Roll.

For Nov. 1<sup>st</sup>, 1864, Nov. 22<sup>d</sup>, 1864

Company Muster-out Roll.

November 22<sup>d</sup>, 1864

Company Descriptive Book.

, 186

Company Morning Reports.

, 186

Soldier's Final Statement.

November 22<sup>d</sup>, 1864

Soldier's Record of Death and Interment.

, 186

Soldier's Inventory of Effects.

, 186

Soldier's Certificate of Disability for Discharge.

, 186

Soldier's Individual Muster-out Roll.

, 186

Regimental Return.

For November, 1864, Nov. 23<sup>d</sup>, 1864

Regimental Quarterly Returns.

, 186

Regimental Descriptive Book.

, 186

By Surgeon General.

Nov 22, 1864

Nov 22, 1864 is held to be

the correct date, and the Company Muster Roll will be amended accordingly.

*Thoma M. Lucent*  
Assistant Adjutant General.

Notat

Soldiers Register -  
S.R.

## FINAL STATEMENT

OF

Private Ben Simmons

4<sup>th</sup> Reg't of U.S. Col. Cav.

### VOLUNTEERS.

NOTE 1.—Two of these certificates (or duplicates) are to be given to each Volunteer Soldier or drafted man who may be discharged previously to the discharge of his company, that he may at once receive from the Paymaster the pay, &c., due him, and the captain or other COMMISSIONED officer commanding the company will certify to the act of the delivery of the duplicate certificates; on these certificates the Soldier is "entitled to" his discharge, and should also present his discharge to the Paymaster to have the payment endorsed on it. The discharge is to be given back to the Soldier by the Paymaster; the latter only retaining as his voucher the duplicate certificates.

NOTE 2.—If the Soldier is entitled to pay for the use of his horse, the Company Commander will certify to that fact on the back of both these final statements, and also to the time he has pay due for having been so mounted on his own horse.

NOTE 3.—When a Soldier is furnished with final statements, his descriptive list, if he has one, should be taken up by the officer who gives the Soldier these statements, and endorsed with a statement to this effect by the officer. This endorsement should exhibit a full statement of the time for which the Soldier was allowed pay on his final statements, the clothing account, and all other charges against him or in his favor, so as to comprise a complete exhibit of his account. It will then be transmitted to the company commander of the Soldier, who will enter all the data necessary to a full understanding of the Soldier's account on the muster roll upon which the Soldier's discharge is reported. The descriptive list will then be destroyed. The object of this is, that the remaining portion of the Soldier's account may be settled upon the receipt of these muster rolls, and the Soldier receive any pay or allowances that may be due him at the time of his discharge, and which may not appear on his final statements from the fact that his descriptive list is incomplete. These accounts for back pay, &c., are settled by the 2d Auditor of the Treasury Department.

NOTE 4.—Charges for loss or injury to ordnance, horse equipments, and other miscellaneous charges, should appear under the heading of "Other Stoppages."

NOTE 5.—Bounty paid by State authorities, and not by the United States, will not be entered on this statement.

NOTE 6.—Amounts due the Sutler and Laundress must be entered on the muster roll on which the discharge, death, desertion, &c., is reported, as well as on the final statement, otherwise the amount cannot be collected from the United States.

NOTE 7.—This blank will be used for deceased volunteers and drafted men, as well as for others.

NOTE 8.—Where a Soldier dies in Hospital or on detached service, his descriptive list, if he has one, should be sent with his final statements, in duplicate, to the Adjutant General, Washington, D. C.

*J. M. [Signature]*

FINAL STATEMENT

OF

*Private Ben Simmons*

*2d* Reg't of *U.S. Col'd Caval*

**VOLUNTEERS.**

*March 22 1865*

NOTE 1.—Two of these certificates (or duplicates) are to be given to each Volunteer Soldier or drafted man who may be discharged previously to the discharge of his company, that he may at once receive from the Paymaster the pay, &c., due him, and the captain or other COMMISSIONED officer commanding the company will certify to the act of the delivery of the duplicate certificates; on these certificates the Soldier is "entitled to" his discharge, and should also present his discharge to the Paymaster to have the payment endorsed on it. The discharge is to be given back to the Soldier by the Paymaster; the latter only retaining as his voucher the duplicate certificates.

NOTE 2.—If the Soldier is entitled to pay for the use of his horse, the Company Commander will certify to that fact on the back of both these final statements, and also to the time he has pay due for having been so mounted on his own horse.

NOTE 3.—When a Soldier is furnished with final statements, his descriptive list, if he has one, should be taken up by the officer who gives the Soldier these statements, and endorsed with a statement to this effect by the officer. This endorsement should exhibit a full statement of the time for which the Soldier was allowed pay on his final statements, the clothing account, and all other charges against him or in his favor, so as to comprise a complete exhibit of his account. It will then be transmitted to the company commander of the Soldier, who will enter all the data necessary to a full understanding of the Soldier's account on the muster roll upon which the Soldier's discharge is reported. The descriptive list will then be destroyed. The object of this is, that the remaining portion of the Soldier's account may be settled upon the receipt of these muster rolls, and the Soldier receive any pay or allowances that may be due him at the time of his discharge, and which may not appear on his final statements from the fact that his descriptive list is incomplete. These accounts for back pay, &c., are settled by the 2d Auditor of the Treasury Department.

NOTE 4.—Charges for loss or injury to ordnance, horse equipments, and other miscellaneous charges, should appear under the heading of "Other Stoppages."

NOTE 5.—Bounty paid by State authorities, and not by the United States, will not be entered on this statement.

NOTE 6.—Amounts due the Sutler and Laundress must be entered on the muster roll on which the discharge, death, desertion, &c., is reported, as well as on the final statement, otherwise the amount cannot be collected from the United States.

NOTE 7.—This blank will be used for deceased volunteers and drafted men, as well as for others.

NOTE 8.—Where a Soldier dies in Hospital or on detached service, his descriptive list, if he has one, should be sent with his final statements, in duplicate, to the Adjutant General, Washington, D. C.

*[Signature]*

ADJUTANT GENERAL'S OFFICE.

*April 11 1865*

Duplicate with Inventory sent 2d Auditor.

I certify, on honor, that Benj. Simmons a Private of  
 Captain Ralph A. Rowley, Company (H) of the 4<sup>th</sup> Regiment of U.S. Col'd Cavalry  
**VOLUNTEERS**, of the State of \_\_\_\_\_, born in Charleston, State  
 of South Carolina, aged 20 years; 5 feet 5 1/2 inches high; Blk complexion,  
Blk eyes, Blk hair, and by occupation a Laborer, having joined the company on  
 its original organization at Alexandria March 22<sup>nd</sup>, and enrolled in it at the muster into  
 the service of the United States at New Orleans, on the Eighth day  
 of April, 1864, (or was mustered in service as a recruit, by \_\_\_\_\_  
 \_\_\_\_\_, at \_\_\_\_\_, on the \_\_\_\_\_ day of \_\_\_\_\_,  
 1864, or was drafted and mustered into the service of the United States from the \_\_\_\_\_  
 Enrollment District of the State of \_\_\_\_\_, at \_\_\_\_\_,  
 on the \_\_\_\_\_ day of \_\_\_\_\_, 1864) to serve in the Regiment, for  
 the term of Three Years: and having served **HONESTLY** and  
**FAITHFULLY** with his Company in the field to the present date, is now  
 entitled to a **DISCHARGE** by reason of Death

Died in 1st Hosp. 1st Hudson Fa. No. 22<sup>nd</sup> 1st Regt. 2<sup>nd</sup> Div.

The said Private Benj. Simmons was last paid by Paymaster  
Prof. Gofland to include the 30<sup>th</sup> day of April, 1864, at the rate of \$7.00 per month  
 pay due him from that time to the present date; he is entitled to pay and subsistence for  
**TRAVELING** to place of enrollment, and whatever other allowances are authorized to volunteer  
 soldiers, drafted men, or militia, so discharged. He has received from the United States **CLOTHING**  
 amounting to \$49.00 <sup>of</sup> 100 dollars, since the 22<sup>nd</sup> day of March,  
 1864, when his clothing account was last settled. He has received from the United States  
 \_\_\_\_\_ 100 dollars advanced **BOUNTY**.

There is to be stopped from him, on account of the State of \_\_\_\_\_, or other  
 authorities, for **CLOTHING**, &c., received on entering service, \_\_\_\_\_ 100 dollars; and  
 for other stoppages, viz: 1st Ordnance

\_\_\_\_\_ 23 100 dollars.  
 He has been furnished with **TRANSPORTATION** in kind from the place of his discharge to  
 \_\_\_\_\_; and he has been **SUBSISTED** for **TRAVELING** to his  
 place of enrollment, up to the \_\_\_\_\_, 1864

He is indebted to John Wild, **SUTLER**, \$7.00 100 dollars.  
 He is indebted to \_\_\_\_\_, **LAUNDRESS**, \_\_\_\_\_ 100 dollars.

Given in Duplicate, at 1st Hudson Fa, this 25<sup>th</sup> day  
 of March, 1865.

Ralph A. Rowley  
1st Lt. Co H 4<sup>th</sup> U.S. Col'd Cavalry  
 Commanding Company

ARTICLES OF WAR.

ART. 95. When any non-commissioned officer or soldier shall die, or be killed in the service of the United States, the then commanding officer of the troop or company shall, in the presence of two other commissioned officers, take an account of what effects he died possessed of, above his arms and accoutrements, and transmit the same to the office of the Department of War, which said effects are to be accounted for, and paid to the representatives of such deceased non-commissioned officer or soldier. And in case any of the officers, so authorized to take care of the effects of deceased officers and soldiers, should, before they have accounted to their representatives for the same, have occasion to leave the regiment or post, by preferment or otherwise, they shall, before they be permitted to quit the same, deposit in the hands of the commanding officer, or of the assistant military agent, all the effects of such deceased non-commissioned officers and soldiers, in order that the same may be secured for, and paid to, their respective representatives.

ARMY REGULATIONS—EDITION OF 1861.

DECEASED SOLDIERS.

Par. 152. Inventories of the effects of deceased non-commissioned officers and soldiers, required by the 95th Article of War, will be forwarded to the Adjutant General, by the commander of the company to which the deceased belonged, and a duplicate of the same to the colonel of the regiment. Final statements of pay, clothing, &c., will be sent with the inventories. When a soldier dies at a post or station absent from his company, it will be the duty of his immediate commander to furnish the required inventory, and, at the same time, to forward to the commanding officer of the company to which the soldier belonged, a report of his death, specifying the date, place, and cause; to what time he was last paid, and the money or other effects in his possession at the time of his decease; which report will be noted on the next muster-roll of the company to which the man belonged. Each inventory will be endorsed, "Inventory of the effects of \_\_\_\_\_, late of company (—) \_\_\_\_\_ regiment of \_\_\_\_\_, who died at \_\_\_\_\_, the \_\_\_\_\_ day of \_\_\_\_\_, 186—." If a legal representative receive the effects, it will be stated in the report. If the soldier leave no effects, the fact will be reported.

Par. 153. Should the effects of a deceased non-commissioned officer or soldier not be administered upon within a short period after his decease, they shall be disposed of by a Council of Administration, under the authority of the commanding officer of the post, and the proceeds deposited with the Paymaster, to the credit of the United States, until they shall be claimed by the legal representatives of the deceased.

Par. 154. In all such cases of sales by the Council of Administration, a statement in detail, or account of the proceeds, duly certified by the Council and commanding officer, accompanied by the Paymaster's receipt for the proceeds, will be forwarded by the commanding officer to the Adjutant General. The statement will be endorsed, "Report of the proceeds of the effects of \_\_\_\_\_, late of company (—) \_\_\_\_\_ regiment of \_\_\_\_\_, who died at \_\_\_\_\_, the \_\_\_\_\_ day of \_\_\_\_\_, 186—."

NOTE 1.—The effects in all cases, when called for, should be turned over to the legal representative, without further authority from the Adjutant General. When the effects are turned over to the relatives of the deceased before these inventories are sent to the Adjutant General, their receipts therefor should be attached to the inventories. In all other cases, one copy will be sent with a letter of transmittal direct to the Adjutant General, and a duplicate retained by the officer.

NOTE 2.—Particular care should be taken to take receipts in duplicate from the Paymaster for any funds turned over to him; one copy should be sent direct to the Adjutant General and one retained by the officer.

INVENTORY OF THE EFFECTS

OF

*West* *Benj. Simmons*

Late of Company *H*

*A*<sup>5</sup> Reg't of *U. S. C. Cavalry*

Volunteers, who died at *P. H. Hays*

on the *22* day of *November* 186*4*.

Inventory of the effects of *Benj. Simmons* late  
 a *Private* of Captain \_\_\_\_\_ Company *H* of  
 the *4<sup>th</sup>* Regiment of *U. S. Army* Volunteers, who was enrolled as  
 a \_\_\_\_\_ at \_\_\_\_\_ in the State of \_\_\_\_\_ on  
 the \_\_\_\_\_ day of \_\_\_\_\_ 186\_\_\_\_, and mustered into the service of the United  
 States as a \_\_\_\_\_ on the \_\_\_\_\_ day of \_\_\_\_\_ 186\_\_\_\_, at \_\_\_\_\_  
 in Company \_\_\_\_\_, \_\_\_\_\_ Regiment of \_\_\_\_\_ Volunteers, to serve \_\_\_\_\_  
 years or during the war; he was born in \_\_\_\_\_ in the State  
 of \_\_\_\_\_; he was \_\_\_\_\_ years of age, \_\_\_\_\_ feet \_\_\_\_\_ inches  
 high, \_\_\_\_\_ complexion, \_\_\_\_\_ eyes, \_\_\_\_\_ hair, and by occupation, when enrolled,  
 a \_\_\_\_\_; he died in *Post Hospital*, at  
*Post Hudson, Ga.* on the *22* day of *November* 186*4* by  
 reason of *General Debility*

INVENTORY.								
ARTICLES.	No.	ARTICLES.	No.	ARTICLES.	No.			
Hats .....	}	Pairs trousers .....	}	Knapsacks .....	}			
Caps .....		Pairs flannel drawers .....						
Forage caps .....		Pairs cotton drawers .....						
Great coats .....		Flannel shirts .....						
Uniform coats .....		Cotton shirts .....						
Uniform jackets .....		Pairs boots .....						
Flannel sack coats .....		Pairs shoes .....						
Blouses .....		Pairs socks .....						
Stable frocks .....		Blankets .....						
Fatigue overalls .....		Haversacks .....						
							MONEY.	
							Specie .....	\$ (
				Notes .....	\$ (			

I CERTIFY, ON HONOR, that the above inventory comprises all the effects of \_\_\_\_\_  
 \_\_\_\_\_, deceased, and that the effects are in the hands  
 of \_\_\_\_\_ at \_\_\_\_\_  
 \_\_\_\_\_ to be disposed of by a Council of Administration.

( DUPLICATES. )

STATION: *Post Hudson, Ga.*

DATE: *November 22<sup>nd</sup> 1864.*

*W. G. Davis 78 U.S.A.*  
*Surgeon in charge of Post Hospital*  
*Commanding the Company.*

9110  
Simmons Edward

Co E, 4 U. S. Col'd Cav.

Private | Corporal

CARD NUMBERS.

1	28
2	29
3	30
4	31
5	32
6	33
7	34
8	35
9	36
10	37
11	38
12	39
13	40
14	41
15	42
16	43
17	44
18	45
19	46
20	47
21	48
22	49
23	50
24	
25	

Book Mark: .....

See also .....

980

*Simmons Robert*

Co *D*, **4** U. S. Col'd Cav.

*Private* | *Sejsant*

CARD NUMBERS.

1	5352585	26
2	5352635	27
3	5352686	28
4	5352743	29
5	5352808	30
6	5352869	31
7	5352942	32
8	5353024	33
9	5353109	34
10	5353138	35
11	5353234	36
12	5353334	37
13	5353426	38
14	5353511	39
15	5353593	40
16	5353675	41
17	40729211	42
18		43
19		44
20		45
21		46
22		47
23		48
24		49
25		50

Book Mark: \_\_\_\_\_

See also \_\_\_\_\_



A1057741 P.O. mail  
S. 2729542 P.O. mail  
S. 2775465 P.O. mail

*[Handwritten signature]*

S | **4 Cav.** | **U.S.C.T.**

Robert Simmons

Plt., Co. S, 1 Reg't, Corps d'Afrique Cavalry.\*

Appears on

**Company Muster-in Roll**

of the organization named above. Roll dated

New Orleans La, Nov 26, 1863.

Muster-in to date Nov 26, 1863.

Joined for duty and enrolled:

When Nov 5, 186 .

Where New Orleans

Period 3 years.

Valuation of horse, \$ 100

Valuation of horse equipments, \$ 100

Remarks :  
-----  
-----  
-----

\*This organization subsequently became Co. S, 4 Reg't U. S. Colored Cavalry.

Book mark :  
-----

(356)

Rosenbaum  
Copyist.

*S* | **4 Cav. U.S C.T.**

*Robert Simmons*

*Priv.*, Co. *D*, 1 Reg't Cav., Corps d'Afrique.\*

Appears on

**Company Muster Roll**

for *From Enlistment to Dec 31, 1863.*

Present or absent *Present*

Stoppage, \$ 100 for

Due Gov't, \$ 100 for

Valuation of horse, \$ 100

Valuation of horse equipments, \$ 100

Remarks:

\* This organization subsequently became Co. *D*, 4 Reg't U. S. Colored Cavalry.

Book mark:

(358)

*Roumlan*  
Copyist.

*S* 4 Cav. U.S.C.T.

*Robert Simmons*

*Plt*, Co. *D*, 1 Reg't Cav., Corps d'Afrique.\*

Appears on

**Company Muster Roll**

for *Lamy & Fely*, 1864.

Present or absent *Present*

Stoppage, \$ *100* for

Due Gov't, \$ *100* for

Valuation of horse, \$ *100*

Valuation of horse equipments, \$ *100*

Remarks:

\* This organization subsequently became Co. *D*, 4 Reg't U. S. Colored Cavalry.

Book mark:

(358)

*Rosenbaum*

Copyist.

*S* | **4 Cav.** | **U.S.C.T.**

*Robert Simmons*

*Priv.*, Co. D. 4 Reg't U. S. Col'd Cavalry.

Appears on

**Company Muster Roll**

for *March & April*, 1864.

Present or absent *Present*

Stoppage, \$ 100 for

Due Gov't, \$ 100 for

Valuation of horse, \$ 100

Valuation of horse equipments, \$ 100

Remarks:

Book mark:

(358)

*Rosenbaum*  
Copyist.

S | **4 Cav.** | **U.S.C.T.**

Robert Simmons

Pvt, Co. D. 4 Reg't U. S. Col'd Cavalry.

Appears on

**Company Muster Roll**

for May & June, 1864.

Present or absent Present

Stoppage, \$.....100 for .....

Due Gov't, \$.....100 for .....

Valuation of horse, \$.....100

Valuation of horse equipments, \$.....100

Remarks:.....  
.....  
.....  
.....  
.....  
.....  
.....  
.....  
.....  
.....  
.....

Book mark:.....

(358)

Rosenbaum  
Copyist.

*S* | **4 Cav.** | **U.S.C.T.**

*Robert Simmons*

*Pvt.*, Co. D. 4 Reg't U. S. Col'd Cavalry.

Appears on

**Company Muster Roll**

for *July & Aug*, 186*4*.

Present or absent *Present*

Stoppage, \$ *100* for

Due Gov't, \$ *100* for

Valuation of horse, \$ *100*

Valuation of horse equipments, \$ *100*

Remarks:

Book mark:

(358) ,

*Rosenbom*

Copyist.

S | **4 Cav.** | **U.S.C.T.**

Robert Simmon  
Pvt., Co. D, 4 Reg't U. S. Col'd Cavalry.

Appears on

**Company Muster Roll**

for Sept & Oct, 1864.

Present or absent Present

Stoppage, \$ 100 for

Due Gov't, \$ 100 for

Valuation of horse, \$ 100

Valuation of horse equipments, \$ 100

Remarks:

Book mark:

(358)

Rosenblau  
Copyist.



J | 4 Cav. | U.S.C.T.

Robert Simmons

P, Co. D, 4 Reg't U. S. Col'd Cavalry.

Appears on

Company Muster Roll

for Nov 1 Dec, 1864.

Present or absent Present

Stoppage, \$ 100 for

Due Gov't, \$ 100 for

Valuation of horse, \$ 100

Valuation of horse equipments, \$ 100

Remarks: Due U.S. for Ord # 507

Book mark:

(358)

A. H. Wright Copyist

*S* | **4 Cav.** | **U.S.C.T.**

*Robert Simmons*

*P*, Co. D, 4 Reg't U. S. Col'd Cavalry.

Appears on

**Company Muster Roll**

for *Jan & Feb*, 1865.

Present or absent *Present*

Stoppage, \$ *100* for

Due Gov't, \$ *5* <sup>*07*</sup>/<sub>*100*</sub> for *Ordnance*

Valuation of horse, \$ *100*

Valuation of horse equipments, \$ *100*

Remarks: *hired mule #7 for  
Month to include Apr 30, 1865*

Book mark:

(358)

*L. T. Knight*

Copyist.

*J* | **4 Cav.** | **U.S.C.T.**

*Robert Simmons*

*Sgt.*, Co. D, 4 Reg't U. S. Col'd Cavalry.

Appears on

**Company Muster Roll**

for *March & April*, 186*5*.

Present or absent *Present*

Stoppage, \$ *100* for

Due Gov't, \$ *100* for

Valuation of horse, \$ *100*

Valuation of horse equipments, \$ *100*

Remarks: *From General*

*100*

*Stoppage 100 - 200*

Book mark: *...*

(358)

*...*

Copyist.

*S* | **4 Cav. | U.S.C.T.**

*Robert S. [unclear]*

*Sgt.*, Co. D, 4 Reg't U. S. Col'd Cavalry.

Appears on

**Company Muster Roll**

for *May & June*, 1865.

Present or absent *Absent*

Stoppage, \$ *100* for

Due Gov't, \$ *100* for

Valuation of horse, \$ *100*

Valuation of horse equipments, \$ *100*

Remarks: *Dis from Pri Apr 1, 65*  
*Absent with leave*

Book mark: \_\_\_\_\_

*[Signature]*  
Copyist.

*J* | **4 Cav. | U.S.C.T.**

*Robert Simmons*

*Sgt.*, Co. D, 4 Reg't U. S. Col'd Cavalry.

Appears on

**Company Muster Roll**

for *July & Aug.*, 186*5*.

Present or absent *Present*

Stoppage, \$ *100* for

Due Gov't, \$ *100* for

Valuation of horse, \$ *100*

Valuation of horse equipments, \$ *100*

Remarks: *Pr from Pri Aug*  
*1865*

Book mark:

(358)

*R. H. Wright*  
Copyist.

*J* | **4 Cav.** | **U.S.C.T.**

*Robert Simmons*

*Sgt.*, Co. D, 4 Reg't U. S. Col'd Cavalry.

Appears on

**Company Muster Roll**

for *Sept - Oct*, 1865.

Present or absent *Present*

Stoppage, \$ *100* for

Due Gov't, \$ *100* for

Valuation of horse, \$ *100*

Valuation of horse equipments, \$ *100*

Remarks:

Book mark:

*W. H. Wright*

8 | 4 Cav. | U.S.C.T.

Robert Simmons

Serjt. Co. D, 4 Reg't U. S. Col'd Cavalry.

Appears on

Company Muster Roll

for Nov & Dec, 1865.

Present or absent Present

Stoppage, \$ 100 for

Due Gov't, \$ 100 for

Valuation of horse, \$ 100

Valuation of horse equipments, \$ 100

Remarks:

Book mark:

W. J. Goodrich

(358)

Copyist.

S | **4 Cav.** | **U.S.C.T.**

Robert Simmons

Sgt, Co. D, 4 Reg't U. S. Col'd Cavalry.

Appears on

**Company Muster Roll**

for Jan & Feb, 1866.

Present or absent Present

Stoppage, \$ 100 for

Due Gov't, \$ 100 for

Valuation of horse, \$ 100

Valuation of horse equipments, \$ 100

Remarks:

Book mark:

(358)

J. M. Simmons

Copyist.



1865  
S | 4 Cav. | U.S.C.T.

Robert Simmons

Prk, Co. D, 4 Reg't U. S. Colored Cav.

Appears on Returns as follows:

June 1865 - Absent on furlough  
since June 27/65

Book mark:

W R Lu

(546)

Copyist.

8 | **4 Cav. | U.S.C.T.**

Robert Simmons  
Sgt, Co. H, 4 Reg't U. S. Col'd Cavalry.

Appears on **Co. Muster-out Roll**, dated  
New Orleans, La, April 20, 1866.  
Muster-out to date May 20, 1866.  
Last paid to June 30, 1866.

**Clothing account:**

Last settled....., 186 ; drawn since \$..... 100  
Due soldier \$..... 100; due U. S. \$ 11 22/100  
Am't for cloth'g in kind or money adv'd \$..... 100  
Due U. S. for arms, equipments, &c., \$..... 30/100  
Bounty paid \$..... 100; due \$..... 100

Remarks: Joined Orig Regt  
Sergt since April 1/65  
Stop 1 Labors Recd.

Book mark: V25, P175. 68

Wm. Andrews

9017  
Simore Henry

Co 2, 4 U. S. Col'd Cav.

Private Private

CARD NUMBERS.

1	5353840	26
2	5353893	27
3	5353948	28
4	5354003	29
5	5354072	30
6	5354143	31
7	5354208	32
8	5354274	33
9	5354335	34
10	5354421	35
11	5354513	36
12	5354887	37
13	40729205	38
14		39
15		40
16		41
17		42
18		43
19		44
20		45
21		46
22		47
23		48
24		49
25		50

Book Mark:

See also

*S* | **4 Cav.** | **U.S.C.T.**

*Henry Simons*  
.....  
*P.W.*, Co. *E* 1 Reg't, Corps d'Afrique Cavalry.\*

Appears on

**Company Muster-in Roll**

of the organization named above. Roll dated  
*New Orleans La. Dec. 31*, 186*2*.

Muster-in to date *Dec. 31*, 186*2*.

Joined for duty and enrolled:

When *Nov. 12*, 186*2*.

Where *New Orleans*

Period *3* years.

Valuation of horse, \$ 100

Valuation of horse equipments, \$ 100

Remarks: .....

\*This organization subsequently became Co. *E*, 4 Reg't U. S. Colored Cavalry.

Book mark: .....

*Wendel*

*S* | **4 Cav. U.S C.T.**

*Henry Simons*  
*Co. G, 1 Reg't Cav., Corps d'Afrique.\**

Appears on

**Company Muster Roll**

for *Subsistence to Dec. 31, 1862*

Present or absent *Present*

Stoppage, \$ *100* for

Due Gov't, \$ *100* for

Valuation of horse, \$ *100*

Valuation of horse equipments, \$ *100*

Remarks:  
.....  
.....  
.....  
.....  
.....  
.....

\* This organization subsequently became Co. *G*, 4 Reg't U. S. Colored Cavalry.

Book mark: .....

*Wendel*

(358)

Copyist.

*S* 4 Cav. | U.S C.T.

*Henry Semore*

....., Co. *E* ....., 1 Reg't Cav., Corps d'Afrique.\*

Appears on

**Company Muster Roll**

for ..... *Jan & Feb* ....., 1864.

Present or absent ..... *Present* .....

Stoppage, \$ ..... *100* for .....

Due Gov't, \$ ..... *100* for .....

Valuation of horse, \$ ..... *100*

Valuation of horse equipments, \$ ..... *100*

Remarks: .....

\* This organization subsequently became Co. *E* ....., 4 Reg't U.S. Colored Cavalry.

Book mark: .....

*Lawrence*

S | **4 Cav.** | **U.S.C.T.**

Henry Semore

Plt., Co. E, 4 Reg't U. S. Col'd Cav.

Appears on

**Company Muster Roll**

for Mar + Apr, 1864.

Present or absent Present

Stoppage, \$ 100 for

Due Gov't, \$ 100 for

Valuation of horse, \$ 100

Valuation of horse equipments, \$ 100

Remarks:

Book mark:

Lawrence

S | **4 Cav.** | **U.S.C.T.**

*Henry Semore*

*Priv.*, Co. E, 4 Reg't U. S. Col'd Cav.

Appears on

**Company Muster Roll**

for *May & June, 1864*

Present or absent *Present*

Stoppage, \$ 100 for

Due Gov't, \$ 100 for

Valuation of horse, \$ 100

Valuation of horse equipments, \$ 100

Remarks:

Book mark:

*L. A. ...*



S | **4 Cav.** | **U.S.C.T.**

Henry Simon

Priv., Co. E, 4 Reg't U. S. Col'd Cav.

Appears on

**Company Muster Roll**

for July & Aug., 1864.

Present or absent Present

Stoppage, \$ 100 for

Due Gov't, \$ 100 for

Valuation of horse, \$ 100

Valuation of horse equipments, \$ 100

Remarks:

Book mark:

Simon

S | **4 Cav.** | **U.S.C.T.**

Henry Semore

Plt., Co. E, 4 Reg't U. S. Col'd Cav.

Appears on

**Company Muster Roll**

for Sept + Oct, 1864

Present or absent Present

Stoppage, \$ 100 for

Due Gov't, \$ 100 for

Valuation of horse, \$ 100

Valuation of horse equipments, \$ 100

Remarks: Due U S for Ordnance  
5345

Book mark: \_\_\_\_\_

Lawrence

*S* | **4 Cav.** | **U.S.C.T.**

*Henry Semore*

*Priv*, Co. E, 4 Reg't U. S. Col'd Cav.

Appears on

**Company Muster Roll**

for *Nov & Dec*, 1864.

Present or absent *Present*

Stoppage, \$ 100 for

Due Gov't, \$ 100 for

Valuation of horse, \$ 100

Valuation of horse equipments, \$ 100

Remarks: *Stop for 1 nose bag*

Book mark: \_\_\_\_\_

(358)

*Wines*

Copyist.

S | **4 Cav.** | **U.S.C.T.**

Henry Simore

Pvt, Co. E, 4 Reg't U. S. Col'd Cav.

Appears on

**Company Muster Roll**

for Jan & Feb, 1865.

Present or absent Present

Stoppage, \$ 100 for

Due Gov't, \$ 100 for

Valuation of horse, \$ 100

Valuation of horse equipments, \$ 100

Remarks: Stop for 1 blanket  
1 halter 1 pr spurs & straps  
1 curry comb 1 horse brush  
1 surcingle and 1 carbine  
socret Recd only 7 doll per  
month to include Apr  
3/les stop for 1 nose bag

Book mark:

(358)

Wines

Copyist.

*S* | **4 Cav.** | **U.S.C.T.**

*Henry Semore*  
*Plt*, Co. E, 4 Reg't U. S. Col'd Cav.

Appears on

**Company Muster Roll**

for *Mar & Apr*, 186*5*.

Present or absent *Present*

Stoppage, \$ *100* for

Due Gov't, \$ *100* for

Valuation of horse, \$ *100*

Valuation of horse equipments, \$ *100*

Remarks:

Book mark:

(358)

*Mines*

Copyist.

S | 4 Cav. | U.S.C.T.

Henry Semore  
Pot, Co. E, 4 Reg't U. S. Col'd Cav.

Appears on

**Company Muster Roll**

for *May & June*, 1865.

Present or absent

Stoppage, \$ 100 for

Due Gov't, \$ 100 for

Valuation of horse, \$ 100

Valuation of horse equipments, \$ 100

Remarks: *Discharged by order  
of Maj. Gen. E. R. S. Canby  
June 26<sup>th</sup> as discharge  
and final statements  
given*

Book mark:

(358)

*Mines*

Copyist.

1777 030  
A | 4 Cav. | U.S.C.T.

Henry Seymour  
Port Co. E, 4 Reg't U. S. Colored Cav.

Appears on Returns as follows:

June 1865 2022: June 26/65  
Port Hudson La. Discharged  
for disability

Book mark:

(546)

W. R. Lee

Copyist.

*S* | **4 Cav.** | **U.S.C.T.**

*Henry Seymour*

*Put*, Co. *E*, 4 Reg't U. S. Col'd Cavalry.

Appears on **Co. Muster-out Roll**, dated  
*New Orleans La*, *March 20*, 1866.

Muster-out to date \_\_\_\_\_, 186 .

Last paid to \_\_\_\_\_, 186 .

Clothing account:

Last settled \_\_\_\_\_, 186 ; drawn since \$ \_\_\_\_\_ 100

Due soldier \$ \_\_\_\_\_ 100; due U. S. \$ \_\_\_\_\_ 100

Am't for cloth'g in kind or money adv'd \$ \_\_\_\_\_ 100

Due U. S. for arms, equipments, &c., \$ \_\_\_\_\_ 100

Bounty paid \$ \_\_\_\_\_ 100; due \$ \_\_\_\_\_ 100

Remarks: *joined at orig org. Discharged*  
*June 26/65. for disability.*

Book mark : \_\_\_\_\_

(861)

*Floyd*

Copyist.



Seymour, Henry  
P. Co. B, 4 U. S. C. Cav.

1 Enclosures.

Bed Cards	Descriptive Lists
Burial Records	Final Statements
Certs. of Dis. for Discharge /	Furloughs
C. M. Charges	Med. Des. Lists
Med. Certificates	Orders

Other papers relating to—

Admission to Hosp'l	Furlough
Casualty Sheet (Officer's)	Med. Examination
Confinement	Misc. Information
Contracts	Pay or Clothing
Death or Effects	Personal Reports
Desertions	Rank
Discharge from Hosp'l	Transfer to Hosp'l
Discharge from Service	Transfer to V. R. C.
Duty	Transportation

NOTE 1.

The company commander will here add a statement of all the facts known to him concerning the disease or wound, or cause of disability of the soldier; the time, place, manner, and all the circumstances under which the injury occurred, or disease originated or appeared; the duty, or service, or situation of the soldier at the time the injury was received or disease contracted, stating particularly whether the injury was received or the disease contracted in the line of his duty; and whatever other facts may aid a judgment as to the cause, immediate or remote, of the disability, and the circumstances attending it.

When the facts are not known to the company commander, the certificate of any officer, or affidavit of other person having such knowledge, will be appended—as the surgeon in charge of a hospital, the officer commanding a detachment of recruits, &c., &c.

NOTE 2.

When a probable case for pension, special care must be taken to state the degree of disability—as 1/2, 3/4, &c., &c.; to describe particularly the disability, wound, or disease; the extent of which it deprives him of the use of any limb or faculty, or affects his health, strength, activity, constitution, or capacity to labor or earn his subsistence. The surgeon will add, from his knowledge of the facts and circumstances, and from the evidence in the case, his professional opinion of the cause or origin of the disability. In the case of discharges by Medical Inspectors, the last paragraph will state that the "discharge was given by consent of the soldier, after a personal examination, and for disability, the nature, degree, and origin of which are correctly described in the within certificate."

Par. 1260 Regulations, Edit. 1861.

Medical officers, in giving certificates of disability, are to take particular care in all cases that have not been under their charge; and especially in epilepsy, convulsions, chronic rheumatism, derangement of the urinary organs, ophthalmia, ulcers, or any obscure disease liable to be feigned or purposely produced; and in no case shall such certificate be given until after sufficient time and examination to detect any attempt at deception.

DIRECTIONS.

This certificate will be made out in duplicate by the soldier's company commander, or other officer commanding the separate detachment to which he belongs, and sent by him to the surgeon who has charge of the hospital where the soldier is sick. The surgeon will then fill out and sign the surgeon's certificate, and forward these papers to the regimental, detachment, or post commander, who will forward them, with his action endorsed thereon, through the proper channel, to his division commander; or, if the troops are not attached to a division, to his corps, department, or other commander or officer to whom the authority to discharge enlisted men may be specially delegated.

These certificates, after having received the action of the highest authority to which they are required to be sent, will be returned through the same channel to the regimental, post, or detachment commander, who will, if the discharge is authorized by the endorsement of the proper authority, sign the soldier's discharge, and the

last certificate on this paper, see that the soldier is furnished with the proper final statements in duplicate, and forward both of these certificates to the Adjutant General United States Army, at Washington, D. C., they will not, under any circumstances, be given to the hands of the soldier.

Duplicate sent the Pension Office.

86270 of Dis  
1865

CERTIFICATE OF DISABILITY FOR DISCHARGE

IN THE CASE OF.

Henry Seymour  
a Private Co. "E"

Fourth Regt of Life D.

Office Chief Med. Officer,

Dep't of the Gulf,

N. P. June 18 1865.

Approved:

E. H. Hodge  
Surgeon U. S. A.  
Chf. Med. Off.

M. Reese

Headquarters, Department of the Gulf,

New Orleans, La., June 18 1865.

To be discharged.

By order of Major General E. R. S. Canby:

E. J. Barred  
Capt. and A. D. C.

Received (A. G. Office) 1865  
Out on O. P. of Cas.  
affd

# ARMY OF THE UNITED STATES.

## CERTIFICATE

### OF DISABILITY FOR DISCHARGE.



*Henry Seymour Private*, of Captain *E. W. Bangs*  
 Company, (*10<sup>th</sup>*) of the *Fourth* Regiment of the United States  
*Colonel Par* was enlisted by *Capt. Brewster* of  
 the *Fourth* Regiment of *U.S.C.* at *Franklin La*  
 on the *12<sup>th</sup>* day of *November* 186*3* to serve *3* years; he was born  
 in *Indian Bend* in the State of *Louisiana*, is *white*  
 years of age, *5* feet *5* inches high, *Black* complexion, *Black* eyes,  
*Black* hair, and by occupation when enlisted a *Laborer*. During the last two  
 months said soldier has been unfit for duty *60* days.\* *The said soldier has*  
*been unfit for duty ever since enlistment*  
*on account of mental debility and*  
*physical infirmity.*

STATION: *Post Hudson La*  
 DATE: *June 2<sup>nd</sup> 1865*  
*[Signature]*  
Commanding Company.

I CERTIFY, that I have carefully examined the said *Henry Seymour*  
 of Captain *Bangs* Company, and find him incapable of performing the duties of a  
 soldier because of † *Lack of Intelligence sufficient for the*  
*duties of a Cavalry soldier*  
*Disability existed prior to enlistment and in*  
*degree is 1/4 one fourth*

*D. D. Hanson*  
 Surgeon.

DISCHARGED, this *26<sup>th</sup>* day of *June*, 186*5*, at *Post*  
*Hudson La*  
*[Signature]*  
Commanding the Reg't.

The Soldier desires to be addressed at  
 Town \_\_\_\_\_ County \_\_\_\_\_ State \_\_\_\_\_

\* See Note 1 on the back of this. † See Note 2 on the back of this.

Office, Post Surgeon  
 Port Hudson, La. June 5/65  
 Approved, on basis of oral examination  
*Wesley H. Montgomery*  
 Surgeon 53<sup>rd</sup> U.S. C. Inf.

+

987  
Simpson James

Co *G*, 4 U. S. Col'd Cav.

Private Private

CARD NUMBERS.

1	5354981	28
2	5355070	27
3	5355161	28
4	5355271	29
5	5356192	30
6	40729212	31
7		32
8		33
9		34
10		35
11		36
12		37
13		38
14		39
15		40
16		41
17		42
18		43
19		44
20		45
21		46
22		47
23		48
24		49
25		50

Book Mark:

See also

S | 4 Cav. | U.S.C.T.

James Simpson

Opt, Co. A, Mounted Rangers, Corps d'Afrique. †

Age ..... years.

Appears on

Company Muster Roll\*

for Nov - Dec, 1863.

Joined for duty and enrolled:

When Nov 1, 1863.

Where Iberia, La

Period ..... years.

Mustered in:

When Nov 30, 1863.

Where Iberia, La

Present or absent Present

Stoppage, \$ 100 for

Due Gov't \$ 100 for

Valuation of horse, \$ 100

Valuation of horse equipments, \$ 100

Remarks:

† This organization subsequently became Co. F, 4 U. S. Col'd Cav.  
\* First current roll. No muster-in roll of this ~~battery~~ <sup>company</sup> on file.

Book mark:

(3586)

Mumming Copyist.

*S* | **4 Cav. | U.S C.T.**

*James Simpson*  
*Pt*, Co. *F*, 1 Reg't Cav., Corps d'Afrique.\*

Appears on

**Company Muster Roll**

for *Jan'y P Feby*, 186 *4*

Present or absent *Present*

Stoppage, \$ *100* for

Due Gov't, \$ *100* for

Valuation of horse, \$ *100*

Valuation of horse equipments, \$ *100*

Remarks:

\* This organization subsequently became Co. *F*, 4 Reg't U. S. Colored Cavalry.

Book mark:

*Manning*  
Copyist.

*S* | 4 Cav. | U.S.C.T.

*James Simpson*  
*Pvt*, Co. F, 4 Reg't U.S. Col'd Cavalry.

Appears on

**Company Muster Roll**

for *March & April*, 1864.

Present or absent *Present*

Stoppage, \$ 100 for

Due Gov't, \$ 100 for

Valuation of horse, \$ 100

Valuation of horse equipments, \$ 100

Remarks:

Book mark:

*Manning*  
Copyist.

*S* | 4 Cav. | U.S.C.T.

*James Simpson*  
*Pr*, Co. F, 4 Reg't U. S. Col'd Cavalry.

Appears on

**Company Muster Roll**

for *May & June*, 1864

Present or absent

Stoppage, \$ 100 for

Due Gov't, \$ 100 for

Valuation of horse, \$ 100

Valuation of horse equipments, \$ 100

Remarks: *Deserted June*  
*22, 1864*

Book mark:

(358)

*Manning*  
Copyist.



S

4 Cav. U.S.C.T.

James Simpson  
Pvt, Co. F, 4 Reg't U. S. Colored Cav.

Appears on Returns as follows:

July 1864 - Absent without leave  
since June 25/64 from Camp  
Paragnet La.

Aug 1864 - Loro: Aug 13 Green-  
ville, deserted.

Book mark:

W. R. Lee

(546)

Copyist.

S | 4 Cav. | U.S.C.T.

James Simpson

P., Co. F, 4 Reg't U. S. Col'd Cavalry.

Appears on Co. Muster-out Roll, dated  
New Orleans, La., Mch. 20, 1866.

Muster-out to date \_\_\_\_\_, 186 .

Last paid to \_\_\_\_\_, 186 .

Clothing account:

Last settled \_\_\_\_\_, 186 ; drawn since \$ \_\_\_\_\_ 100

Due soldier \$ \_\_\_\_\_ 100; due U. S. \$ 28.  $\frac{71}{100}$

Am't for cloth'g in kind or money adv'd \$ \_\_\_\_\_ 100

Due U. S. for arms, equipments, &c., \$ \_\_\_\_\_ 100

Bounty paid \$ \_\_\_\_\_ 100; due \$ \_\_\_\_\_ 100

Remarks: Joined at orig. org.  
Deserted June 22, 64, at  
Greenville, La.

Book mark: \_\_\_\_\_

(861)

Hisbary  
Copyist.

185  
Singelton Robert

Co A, 4 U. S. Col'd Cav.

Private | Private

CARD NUMBERS.

1	26
2	27
3	28
4	see Singelton Robt.
5	30
6	31
7	32
8	33
9	34
10	35
11	36
12	37
13	38
14	39
15	40
16	41
17	42
18	43
19	44
20	45
21	46
22	47
23	48
24	49
25	50

Book Mark:

See also

984

Singleton Robert

Co A, 4 U.S. Col'd Cav.

Private | Private

CARD NUMBERS.

1	5348482	26
2	5348583	27
3	5348704	28
4	5349748	29
5	\$155-05-1873	30
6	40729213	31
7		32
8		33
9		34
10		35
11		36
12		37
13		38
14		39
15		40
16		41
17		42
18		43
19		44
20		45
21		46
22		47
23		48
24		49
25		50

Book Mark: \$155-05-1873

See also

*S* | **4 Cav.** | **U.S.C.T.**

*Robert Singleton*  
*Private, Co. A, 1 Reg't La. Cav., Corps d'Afrique.\**

Appears on

**Company Muster-in Roll**

of the organization named above. Roll dated

*New Orleans La, Sept 12, 1863.*

Muster-in to date *Sept 12, 1863.*

Joined for duty and enrolled:

When *Aug 30, 1863.*

Where *New Orleans*

Period *3* years.

Valuation of horse, \$ *100*

Valuation of horse equipments, \$ *100*

Remarks:

*Age 22*

\*This organization subsequently became Co. *A*, 4 Reg't U. S. Colored Cavalry.

Book mark: *S 155-05-1873*

*M. A. Michaels*

(356)

Copyist.

*S* | **4 Cav. | U.S.C.T.**

*Robert Singleton*  
....., Co. *A*, 1 Reg't La. Cav., Corps d'Afrique.\*

Appears on

**Company Muster Roll**

for *Sept 12 to Dec 31*, 186*3*.

Present or absent *Present*

Stoppage, \$..... *100* for .....

Due Gov't, \$..... *100* for .....

Valuation of horse, \$..... *100*

Valuation of horse equipments, \$..... *100*

Remarks: .....

\*This organization subsequently became Co. *A*, 4. Reg't U. S. Colored Cavalry.

Book mark: .....

*R Richardson*

S

4 Cav. U.S C.T.

Robert Singleton

Pr, Co. A, 1 Reg't Cav., Corps d'Afrique.\*

Appears on

Company Muster Roll

for Jan + Feb, 1864

Present or absent

Stoppage, \$ 100 for

Due Gov't, \$ 100 for

Valuation of horse, \$ 100

Valuation of horse equipments, \$ 100

Remarks: Accidentally shot himself at Boute Station Feb 8<sup>th</sup> 1864

\* This organization subsequently became Co. A, 4 Reg't U. S. Colored Cavalry.

Book mark:

R. Richardson

(358)

Copyist.

D | **4 Cav. | U.S.C.T.**

Robert Singleton  
Priv., Co. A, 4 Reg't U. S. Colored Cav.

Appears on Returns as follows:

Feb 1864 - (1 Regt Cav., Corps d'Afrique)  
Loss: Accidentally shot  
himself at Bosta Station  
Feb 8/64

Book mark:

W. R. Lee

(546)

Copyist.



*S* | **4 Cav.** | **U.S.C.T.**

*Robert Singleton*  
*Priv.*, Co. *D*, 4 Reg't U. S. Col'd Cavalry.

Appears on **Co. Muster-out Roll**, dated  
*New Orleans La, Feb 20*, 1866.

Muster-out to date \_\_\_\_\_, 186 .

Last paid to \_\_\_\_\_, 186 .

**Clothing account:**

Last settled \_\_\_\_\_, 186 ; drawn since \$ \_\_\_\_\_ 100

Due soldier \$ \_\_\_\_\_ 100; due U. S. \$ \_\_\_\_\_ 100

Am't for cloth'g in kind or money adv'd \$ \_\_\_\_\_ 100

Due U. S. for arms, equipments, &c., \$ \_\_\_\_\_ 100

Bounty paid \$ \_\_\_\_\_ 100; due \$ \_\_\_\_\_ 100

Remarks: *Joined at orig reg. Dec*  
*11-28-63 at New Orleans La*

*(Died Feb 8/64. E.D. V. 10. P 543*  
Book mark: *S. 155 V. 10 C. 7. 73*

S. 1 4<sup>th</sup> Cav. U.S.C.

Robert Singleton  
, Co. A, 4<sup>th</sup> Reg't U.S.C.

**NOTATION.**

Book mark: S. 155.6.7. 1873.

**Record and Pension Office,**

WAR DEPARTMENT.

This book mark refers only to a report from the medical records, made by the Surgeon General to the Adjutant General, relative to the above-named man. As the medical records have since been carded, no transcript of this report is made hereon.

(491)

E. P. Conroyer.

Copyist.

Singleton, Robert  
P, Co. A, 4 U.S.C. Cav.

/ Enclosures.

Bed Cards	Descriptive Lists
Burial Records	Final Statements
Certs. of Dis. for Discharge	Furloughs
C. M. Charges	Med. Des. Lists
Med. Certificates	Orders

Other papers relating to—

Admission to Hosp'l	Furlough
Casualty Sheet ( <del>Officer's</del> ) /	Med. Examination
Confinement	Misc. Information
Contracts	Pay or Clothing
Death or Effects	Personal Reports
Desertions	Rank
Discharge from Hosp'l	Transfer to Hosp'l
Discharge from Service	Transfer to V. R. C.
Duty	Transportation

ENDORSEMENT.]

Department,

GENERAL'S OFFICE,

Account No. 125, 1873,

of Private Robert

Co. C 4<sup>th</sup>, 4<sup>th</sup> Reg't U. S.

is reported as follows:—

Company Muster Roll.

1864, Feb'y 8, 1864,

Muster-out Roll.

28, 1863,

Descriptive Book.

, 186

Morning Reports.

, 186

Final Statement.

, 186

of Death and Interment.

, 186

Inventory of Effects.

, 186

of Disability for Discharge.

, 186

Final Muster-out Roll.

, 186

Final Return.

186, 186

Quarterly Returns.

, 186

Descriptive Book.

, 186

Report General.

, 186

, 1864, is held to be

Company Muster Out

accordingly.

*M. S. Francis*

Asst. Adj. Gen.  
Jan'y 10. 1874.

CASUALTY STATEMENT

No. ....

*Robt. Singleton*

*Private* of *C*

*4<sup>th</sup>* Regiment of *U. S.*

*State Volunteers.*

NATURE OF CASUALTY

[OFFICE INDORSEMENT.]

War Department,

ADJUTANT GENERAL'S OFFICE,

December 12, 1873

The death of Robt. Singleton, Co. C, 4<sup>th</sup> Regt U. S. Colored Cavalry, is reported as follows:—

On Company Muster Roll.	
For <u>July 5<sup>th</sup> 1864</u> , <u>July 5</u> , 1864,	
Company Muster-out Roll.	
<u>Nov. 28</u> , 1863,	
Company Descriptive Book.	, 186
Company Morning Reports.	, 186
Soldier's Final Statement.	, 186
Soldier's Record of Death and Interment.	, 186
Soldier's Inventory of Effects.	, 186
Soldier's Certificate of Disability for Discharge.	, 186
Soldier's Individual Muster-out Roll.	, 186
Regimental Return.	, 186
For <u>1864</u> , 186 ,	, 186
Regimental Quarterly Returns.	, 186
Regimental Descriptive Book.	, 186
By Surgeon General.	, 186

July 5, 1864, 1864, is held to be the correct date, and the Company Muster Out Roll will be amended accordingly.

*Thomas M. Lucent*

noted - E.B. 10/31/73. noted see letter to 2d and 3d Asst. Adj. Gen. dated July 18, 1874.

1864

CASUALTY SHEET

No. ....

Robt. Singleton  
Private of Company A  
4<sup>th</sup> Regiment of U. S. Col. Cav  
State Volunteers.

NATURE OF CASUALTY.

Dates of death reported

M. Roll ~~for~~ from Organization to Dec. 31<sup>st</sup> 63. reports him --- Present for duty

M. R. 20<sup>th</sup> Jan & Feb. 64 died Feb. 8<sup>th</sup> 64 - accidentally shot himself ---

M. B. Roll --- died --- Nov. 28<sup>th</sup> 63.

No Final State sent on file

CR Records give no information. ---

*July 8. 1864  
Lied correct  
Roll*

*No record*

CAUSE OF CASUALTY—(NAME OF DISEASE, &C.)  
 "accidentally shot himself"  
 DEGREE OF DISABILITY.  
 BY WHOM CERTIFIED.  
 Captain Charles H. arcourt  
 DATE OF ~~DISCHARGE~~, DEATH, &C.  
 February 8<sup>th</sup> 1864  
 PLACE OF DISCHARGE, DEATH, &C.  
 Boutee Station La.

BY WHOM DISCHARGED.  
 FROM WHAT SOURCE THIS INFORMATION WAS OBTAINED.  
 CR muster - Roll for January & Feb. 64.  
 REMARKS.

*Edward Renaud*  
Clerk.

CASUALTY SHEET.

Name: Robert Lingleton

Rank: Private Company: A Regiment: 4<sup>th</sup>

Arm: U. S. Cavalry State: \_\_\_\_\_

Nature of Casualty: Death

CAUSE OF CASUALTY—(NAME OF DISEASE, &c.)

"accidentally shot himself"

DEGREE OF DISABILITY.

BY WHOM CERTIFIED.

Captain Charles H. Arcourt

DATE OF ~~DISCHARGE~~, DEATH, &c.

February 8<sup>th</sup> 1864

PLACE OF DISCHARGE, DEATH, &c.

Boutee Station La.

BY WHOM DISCHARGED.

FROM WHAT SOURCE THIS INFORMATION WAS OBTAINED.

C. Muster - Roll for January & Feb. 64.

REMARKS.

Edward Renaud

Clerk.

10  
Lawson Daniel D.

~~Co~~ ~~4th~~ ~~S.~~ **4** U. S. Col'd Cav.

*Surgeon* | *Surgeon*

CARD NUMBERS.

1 5-347391  
2 5-348265-  
3 5-348282  
4 5-348294  
5 5-348309  
6 5-348320  
7 5-348335-  
8 5-348345-  
9 5-348353  
10 5-348363  
11 5-348373  
12 5-348381  
13 5-348389  
14 5-348396  
15 40729245  
16  
17  
18  
19  
20  
21  
22  
23  
24  
25

26  
27  
28  
29  
30  
31  
32  
33  
34  
35  
36  
37  
38  
39  
40  
41  
42  
43  
44  
45  
46  
47  
48  
49  
50

Book Mark:

See also

60 Ind. Vols.



RR 635301  
AL 2354604

*St. Louis*

*S* | *4. Cav.* | **U.S.C.T.**

*Daniel J. Lawson*

*Supr.*, Co. ...., *4* <sup>(Regt-Cav b'd'a)</sup> Reg't U. S. Col'd. *Cav.*

Age *43* years.

Appears on an

**Individual Muster-in Roll**

of the organization named above. Roll dated  
*New Orleans La, Mch 29, 1864.*

Muster-in to date *Mch 29, 1864.*

Joined for duty and enrolled :

When *Mch. 29.*, 1864.

Where *New Orleans*

Period *3* years.

Valuation of horse, \$ *100*

Valuation of horse equipments, \$ *100*

Remarks : *Honorably discharged  
as Hospital Steward of  
the 60<sup>th</sup> Indiana Vols. in  
Per. C. Special orders*

Book mark : .....

*Perminator*

(336)

Copyist.

*Jover*

JAN.-8

5347391

1891

Remarks:

No. 74. dated, Ad. grs.  
Dept. of the Gulf March  
23<sup>rd</sup> 1864. Original  
Vacancy -

S | 4 Cav. | U.S.C.T.

D. D. Slauson

Rank *Surgeon*, 4 Reg't U. S. Col'd Cav.

Appears on

**Field and Staff Muster Roll**

for *Mar & Apr*, 1864.

Present or absent *Present*

Stoppage, \$ *100* for

Due Gov't, \$ *100* for

Valuation of horse, \$ *100*

Valuation of horse equipments, \$ *100*

Remarks:

Book mark:

*Bowman*

(357)

Copyist.

S | 4 Cav. | U.S.C.T.

D. D. Slanson

Rank *Surgn*, 4 Reg't U. S. Col'd Cav.

Appears on

**Field and Staff Muster Roll**

for *May & June*, 1864.

Present or absent *Present*

Stoppage, \$ *100* for

Due Gov't, \$ *100* for

Valuation of horse, \$ *100*

Valuation of horse equipments, \$ *100*

Remarks:

Book mark:

*Bowman*

(357)

*Copied.*

S | 4 Cav. | **U.S.C.T.**

D. D. Slanson

Rank Surgeon, 4 Reg't U. S. Col'd Cav.

Appears on

**Field and Staff Muster Roll**

for Jul & Aug, 1864.

Present or absent Present

Stoppage, \$ 100 for

Due Gov't, \$ 100 for

Valuation of horse, \$ 100

Valuation of horse equipments, \$ 100

Remarks:

Book mark:

Boroman

*S. 14 Cav.* | **U.S.C.T.**

*D. D. Slanson*

Rank *Surgeon, H* Reg't U. S. Col'd *Cav.*

Appears on

**Field and Staff Muster Roll**

for *Sept & Oct*, 1864.

Present or absent *Present*

Stoppage, \$ *100* for

Due Gov't, \$ *100* for

Valuation of horse, \$ *100*

Valuation of horse equipments, \$ *100*

Remarks:

Book mark:

*Bowman*

(357)

*Copied.*

*S* 14 Cav. | **U.S.C.T.**

*D. D. Slawson*

Rank *Surgeon, 4* Reg't U. S. Col'd *Cav.*

Appears on

**Field and Staff Muster Roll**

for *Nov & Dec*, 1864.

Present or absent *Present*

Stoppage, \$ *100* for

Due Gov't, \$ *100* for

Valuation of horse, \$ *100*

Valuation of horse equipments, \$ *100*

Remarks: *Stop for 138 Rations  
in kind*

Book mark:

*Bowman*



*S* | *4 Cav.* | **U.S.C.T.**

*D. D. Slauson*

Rank *Surgeon*, *4* Reg't U. S. Col'd *Cav.*

Appears on

**Field and Staff Muster Roll**

for *Jan & Feb*, 1865.

Present or absent *Present*

Stoppage, \$ *100* for

Due Gov't, \$ *100* for

Valuation of horse, \$ *100*

Valuation of horse equipments, \$ *100*

Remarks: *Stop for (45) Forty Five  
Rations in Kind*

Book mark:

*Bowman*

*S* | *4 Cav.* | **U.S.C.T.**

*Daniel D. Slawson*

Rank *Surgeon, 4* Reg't U. S. Col'd *Cav.*

Appears on

**Field and Staff Muster Roll**

for *Mar & Apr*, 186 *5*.

Present or absent *Present*

Stoppage, \$ *100* for

Due Gov't, \$ *100* for

Valuation of horse, \$ *100*

Valuation of horse equipments, \$ *100*

Remarks:

Book mark:

*Bowman*

S | 4 Cav. | **U.S.C.T.**

Daniel D. Slanson

Rank Surgeon, 4 Reg't U. S. Col'd Cav.

Appears on

**Field and Staff Muster Roll**

for May & June 1865.

Present or absent Present

Stoppage, \$ 100 for

Due Gov't, \$ 100 for

Valuation of horse, \$ 100

Valuation of horse equipments, \$ 100

Remarks:

Book mark:

Bowman

(357)

Copyist.

*S* | *4 Cav* | **U.S.C.T.**

*D. D. Lawson*

Rank *Surgeon* *4* Reg't U. S. Col'd *leav*

Appears on

**Field and Staff Muster Roll**

for *Jul + Aug* 186*5*.

Present or absent *Present*

Stoppage, \$ *100* for

Due Gov't, \$ *100* for

Valuation of horse, \$ *100*

Valuation of horse equipments, \$ *100*

Remarks:

Book mark:

*Bowman*

S | 4 Cav. | U.S.C.T.

D. D. Lawson

Rank Surgeon 4 Reg't U. S. Col'd Cav.

Appears on

**Field and Staff Muster Roll**

for Sept & Oct 1865.

Present or absent Absent

Stoppage, \$ 100 for

Due Gov't, \$ 100 for

Valuation of horse, \$ 100

Valuation of horse equipments, \$ 100

Remarks: Absent with leave per  
S.O. 80 Hd Qrs. Dept of La. Oct-6, 1865

Book mark:

Bowman

S | 4 Cav | U.S.C.T.

D. D. Clauson

Rank Surgeon 4 Reg't U. S. Col'd Cav.

Appears on

**Field and Staff Muster Roll**

for Nov + Dec 1865.

Present or absent Present

Stoppage, \$ 100 for

Due Gov't, \$ 100 for

Valuation of horse, \$ 100

Valuation of horse equipments, \$ 100

Remarks:

Book mark:

Bowman

S | 4 Cav. | U.S.C.T.

D. D. Slauson

Rank Surgeon, 4 Reg't U. S. Col'd Cav

Appears on

**Field and Staff Muster Roll**

for Jan & Feb 1866.

Present or absent Present

Stoppage, \$ 100 for

Due Gov't, \$ 100 for

Valuation of horse, \$ 100

Valuation of horse equipments, \$ 100

Remarks:

Book mark:

Bowman

D | **4 Cav.** | **U.S.C.T.**

+ Daniel D. Lawson

Surgeon, Co. ...., 4 Reg't U. S. Colored Cav.

Appears on **Returns** as follows:

Mich 1864 (Regt Cav., Corps d'Afrique) Present  
reported for duty Mar 31/64

Apr 1864 to Sept 1865 (Regt U.S. Colored Cav)  
Present

Oct & Nov 1865 - Absent with leave per  
O.O. 80 Hd. Qrs. Dept of La  
Oct 6/65

Dec 1865 to Feb 1866 - Present

+ Name appears also as

D. D. Lawson

Book mark :

W. R. See

(546)

Copyist.



S | 4 Cav. | U.S.C.T.

Daniel D. Slanson

Rank Surgeon, 4 Reg't U. S. Col'd Cav

Appears on a

Field and Staff Muster-out Roll

of the organization named above. Roll dated  
New Orleans La. Mar 20, 1866 .

Muster-out to date Mar 20, 1866 .

Last paid to June 30, 1865 .

Clothing account:

Last settled....., 186 ; drawn since \$..... 100

Due soldier \$..... 100; due U. S. \$..... 100

Am't for cloth'g in kind or money adv'd \$..... 100

Due U. S. for arms, equipments, &c., \$..... 100

Bounty paid \$..... 100; due \$..... 100

Remarks: Entered Service at  
Washington Ind. Sept 23/62  
as Hospital Steward 60<sup>th</sup> Ind.  
Inf. Discharged to accept  
promotion as Surgeon 16<sup>th</sup> Ill.  
(4 U.S.C.) per S.O. 28 Hd Qrs. Dept  
Over

Book mark: .....

Bowman

JAN. - 8

5348396

1891

*of the Gulf, Series of 1864.  
Service has been continuous  
entitled to three months  
Extra pay as provided in  
Genl Order 45 War Dept  
A. G. O. Series 1865*

Stanson D. D.

Inf. Co., 4<sup>th</sup> Reg't U.S.C.C.

4 Enclosures.

Bed Cards	Final Statements
Burial Records	Furloughs or L. of A.
Certs. of Dis. for Discharge	Med. Certificates
C. M. Charges	Med. Des. Lists
Descriptive Lists	Orders /
Discharge Certificates	Pris. of War Record
Enlistment Papers	Resignations

Other papers relating to—

Admission to Hosp'l	Furlough or L. of A. /
Casualty Sheet	Med. Examination
Confinement	Misc. Information 2
Contracts	Pay or Clothing
Death or Effects	Personal Reports
Desertion	Rank
Discharge from Hosp'l	Transfer to Hosp'l
Discharge from Service	Transfer to V. R. C.
Duty	Transportation

Office Post Surgeon  
Sept. 27. 1864

David D. G. Post Surgeon

Request that Surg. Lawson  
of the 4<sup>th</sup> Cav. in addition to his  
present be ordered to attend  
upon the Sick of the 12<sup>th</sup> Mass  
Battery. & the Prov. Marshal's  
Dep't. and that Surg. M. Coan  
76<sup>th</sup> U.S.I. in addition to his  
present duty take charge of the  
Sick of the 78<sup>th</sup> U.S.I. —

+ + + +  
Hiler

L. 51 (Orders) 1864

See J. O. 265 & 283

72 182 — 1864 —

D. D. Slawson

4 U.S.C. Cav.

Office Post Surgeon  
Post Hutchins Dept 27<sup>th</sup> 1864  
Genl C B Rohan  
A. A. General

I have the honor to  
request of the General commanding that Surgeon  
J S Lawson 4<sup>th</sup> U S C Cavalry in addition to his  
present be ordered to attend upon the sick of the  
12 Mass. Battery and the Provost Marshals Department  
and that Asst. Surgeon M Good 76 U S C Infantry  
in addition to his present duties take charge of the sick  
of the 78 U S C Infantry. Both relieving Asst Surgeon  
J H Baird ordered by S. O 255. Hd Qrs Dept Gulf  
to report to Barrancas Florida.

Very Respectfully  
Jawm Perot  
W G David  
Post Surgeon

Camp 4<sup>th</sup> U.S. Cavalry  
Port Hudson, La., July 20<sup>th</sup> 1865

Staufon, D. D.  
Surgeon

Requests a leave of absence  
of seven (7) days to enable  
him to visit New Orleans, La.  
on business.

Head Quarters U.S. Army  
Port Hudson, La. July 20<sup>th</sup> 1865

Respectfully forwarded  
Approved,

Capt Samuel White  
Comdg Regt

Recd P.H., July 20<sup>th</sup> 1865

S - 33 - P.H. - 1865

Head-Quarters, United States Forces,

Port Hudson., La., July 21<sup>st</sup> 1865.

Respectfully forwarded:

Approved

Logus Hamlin  
Brig. Gen. Commanding.

Recd  
S. O. No. 44 P.H.  
Dist East La. July 24/65

MARK 553  
Camp 4<sup>th</sup> U.S. Cold. Cavalry  
Fort Hudson, La., July 20<sup>th</sup>, 1865.

Capt. Edward Hemenway  
A. A. Genl. District East La.

Sir: - I have the honor  
to request a leave of absence of seven (7) days to  
enable me to visit the city of New Orleans, La., on  
business.

The Asst. Surgeon is detailed to take charge  
of the regiment during my absence.

I am, Sir, Very Respectfully  
Your Obedt. Servant.

L. D. Hanson  
Surgeon 4<sup>th</sup> U.S. Cav.

L. R. "S" 36

Camp #4<sup>th</sup> U. S. Cavalry  
Port Hudson, Louisiana

September 30<sup>th</sup> 1865.  
Col. H. N. Frisbie

Stanton, D. D.

Surgeon

Requests a leave of absence  
from the Department.

Head Quarters  
Port Hudson La Sept 30 1865

Respectfully forwarded

Approved

Samuel White,  
Capt Comdg Regt

Recd H. Q. P. H. La, Sept 30/65

Head-Quarters, United States Forces,

Port Hudson, La., Sept 30<sup>th</sup> 1865.

Respectfully: Referred to  
Surgeon John Murphy  
Surg. in Chief for his opinion.

By Order of Col. H. N. FRISBIE,

John W. Coats

1st Lieut. and A. A. A. Gen.

Port Hudson La

October 1<sup>st</sup> 1865

Offic Senior Surgeon

Respectfully  
of whom is

A. A. A. General.

Approved. The services  
of said Officer cannot  
be spared without distur-  
bance to the service

John Murphy  
Surgeon in Chief  
Port Hudson

Approved  
J. W. Coats

Recd Port Hudson La

Head-Quarters, United States Forces,

Port Hudson, La., Oct 1<sup>st</sup> 1865.

Respectfully forwarded:

Approved

H. N. Frisbie

Col. 92d U. S. Cold Infy Commanding Post.

Head Qrs Eastern Dist of La,  
New Orleans, Oct 3<sup>rd</sup> 1865

J. S. D. 15.

Respectfully forwarded  
Approved

W. W. Wilman

Brig Adj Genl Commdy

Headquarters Department of Louisiana,  
New Orleans, La., Oct. 3, 1865.

Respectfully referred to the  
Medical Director of  
the Department.

By order of Major-General E. R. S. Canby

William Hoffman

E 121549 Major, Assistant Adjutant-General.



Camp 4<sup>th</sup> U. S. C. Cav'y.  
Port Hudson, Louisiana.  
September 30<sup>th</sup>, 1865.

Major Wickham Hoffman  
A. A. Genl. Dept. of La.

Sir:

I have the honor to request a leave of absence from the Department of twenty (20) days with permission to apply for an extension of thirty (30) days to enable me to transact business in the States of New York and Indiana.

I have never had a leave from the Department.

The Asst. Surg. is at the Post; his present duties are light and he can at any time when necessary assume charge of the regiment.

Truly, Sir, Very Respectfully  
Your obedient servant

D. D. Hanson  
Surgeon 4<sup>th</sup> U. S. C. Cav'y.

Louisiana

New Orleans, Oct 5 5

Respectfully returned to the  
Adjut. Genl. of the Dept  
Approved

J. H. Baird  
C. B. 90 Fort. Colonel <sup>and</sup> Surgeon U.S.A.  
Medical Director

Hd. Qrs. Dept. of Louisiana  
New Orleans, Oct. 6, 1865.

Respectfully forwarded to  
Hd. Qrs. Div. of the Army, en-  
closing copy of Par. 2, of S. O. No.  
80, granting twenty days leave  
of absence, and recommending  
an extension of thirty days.

E. B. 134  
Edw. Canby  
Maj. Gen. Commanding

SPECIAL ORDERS, } HEADQUARTERS,  
No. 80. } DEPARTMENT OF LOUISIANA,  
New Orleans, La., October 6, 1865.

[Extract.]

2. Leave of absence for twenty (20) days, with recommendation to the Major-General Commanding Military Division of the Gulf, for an extension of thirty (30) days, is hereby granted to Surgeon D. D. S'auson, 4th U. S. Colored Cavalry.

By order of Major-General E. R. S. Canby :

WICKHAM HOFFMAN,  
Assistant Adjutant General.

OFFICIAL :

*Sathaniel W. Bank*

1st Lieut., Acting Ass't Adj't General.

*Small John*

Co *A*, **4** U. S. Col'd Cav.

*Private* | *Private*

CARD NUMBERS.

1	5-3 4 8 4 8 1	26
2	5-3 4 8 5 2 4	27
3	5-3 4 8 6 8 8	28
4	5-3 4 8 7 8 5	29
5	5-3 4 8 8 7 6	30
6	5-3 4 8 9 6 4	31
7	5-3 4 9 0 5 1	32
8	5-3 4 9 1 4 1	33
9	5-3 4 9 2 1 6	34
10	5-3 4 9 3 0 7	35
11	5-3 4 9 3 9 1	36
12	5-3 4 9 4 8 2	37
13	5-3 4 9 5 6 2	38
14	5-3 4 9 6 3 7	39
15	5-3 4 9 7 0 7	40
16		41
17		42
18		43
19		44
20		45
21		46
22		47
23		48
24		49
25		50

Book Mark:

See also

S. 1065034 P. Dimm

AMO 520157 <sup>57</sup> RMB

ALY 2136234 /13

*Handwritten signature*

S. | 4 Cav. | U.S.C.T.

John Small  
Private, Co. A, 1 Reg't La. Cav., Corps d'Afrique.\*

Appears on

**Company Muster-in Roll**

of the organization named above. Roll dated  
New Orleans La, Sept 12, 1863.

Muster-in to date Sept 12, 1863.

Joined for duty and enrolled:

When Aug 22, 1863.

Where New Orleans

Period 3 years.

Valuation of horse, \$ 100

Valuation of horse equipments, \$ 100

Remarks:  
Age 26

\*This organization subsequently became Co A 4 Reg't U. S. Colored Cavalry.

Book mark: \_\_\_\_\_

(356) M. A. Michaels  
Copyist.

*S* | **4 Cav. | U.S.C.T.**

*John Small*  
-----  
*Prin*, Co. *A*, 1 Reg't La. Cav., Corps d'Afrique.\*

Appears on

**Company Muster Roll**

for *Sept 12 to Dec 31*, 186*3*.

Present or absent *Present*

Stoppage, \$ *100* for

Due Gov't, \$ *100* for

Valuation of horse, \$ *100*

Valuation of horse equipments, \$ *100*

Remarks:-----  
-----  
-----  
-----  
-----  
-----

\*This organization subsequently became Co. *A*, 4 Reg't U. S. Colored Cavalry.

Book mark:-----

*R. S. Richardson*

(358)

Copyist.

*S* | **4 Cav. | U.S.C.T.**

*John Small*  
-----  
*Com*, Co. *A*, 1 Reg't La. Cav., Corps d'Afrique.\*

Appears on

**Company Muster Roll**

for *Sept 12 to Dec 31*, 186*3*.

Present or absent *Present*

Stoppage, \$ *100* for

Due Gov't, \$ *100* for

Valuation of horse, \$ *100*

Valuation of horse equipments, \$ *100*

Remarks: -----  
-----  
-----  
-----  
-----  
-----  
-----

\*This organization subsequently became Co. *A*, 4 Reg't U. S. Colored Cavalry.

Book mark: -----

-----  
*R. S. Richardson*  
-----  
(358) Copyist.



*S* 4 Cav. U.S C.T.

*John Small*  
*Pr.*, Co. *A*, 1 Reg't Cav., Corps d'Afrique.\*

Appears on

**Company Muster Roll**

for *June & Feb*, 186 *4*.

Present or absent *Present*

Stoppage, \$ *100* for

Due Gov't, \$ *100* for

Valuation of horse, \$ *100*

Valuation of horse equipments, \$ *100*

Remarks:  
.....  
.....  
.....  
.....  
.....  
.....

\* This organization subsequently became Co. *A*, 4 Reg't U. S. Colored Cavalry.

Book mark: .....

*R. Richardson*

S | 4 Cav. | U.S.C.T.

John Small  
Priv., Co. A, 4 Reg't U. S. Col'd Cavalry.

Appears on

Company Muster Roll

for *mech + ap*, 186 4

Present or absent *Present*

Stoppage, \$ 100 for

Due Gov't, \$ 100 for

Valuation of horse, \$ 100

Valuation of horse equipments, \$ 100

Remarks:

Book mark:

*R. Richardson*

S | 4 Cav. | U.S.C.T.

John Small  
Priv, Co. A, 4 Reg't U. S. Col'd Cavalry.

Appears on

**Company Muster Roll**

for May & June, 1864

Present or absent Present

Stoppage, \$ 100 for

Due Gov't, \$ 100 for

Valuation of horse, \$ 100

Valuation of horse equipments, \$ 100

Remarks: In debt to Govt  
for one Remington  
Revolver

Book mark:

R. Richardson

S | 4 Cav. | U.S.C.T.

John Small

Priv., Co. A, 4 Reg't U. S. Col'd Cavalry.

Appears on

**Company Muster Roll**

for July & Aug, 1864

Present or absent Present

Stoppage, \$ 100 for

Due Gov't, \$ 100 for

Valuation of horse, \$ 100

Valuation of horse equipments, \$ 100

Remarks: Is in debt to Govt for one (1) Remington Revolver

Book mark:

R. Richardson

S | 4 Cav. | U.S.C.T.

John Small

Pri, Co. A, 4 Reg't U. S. Col'd Cavalry.

Appears on

Company Muster Roll

for Sept & Oct, 1864

Present or absent Present

Stoppage, \$ 100 for

Due Gov't, \$ 100 for

Valuation of horse, \$ 100

Valuation of horse equipments, \$ 100

Remarks: Stop for 1 Remington Revolver

Book mark:

Dunnally

(358)

Copyist.

S | 4 Cav. | U.S.C.T.

John Small  
Pr.

Co. A, 4 Reg't U. S. Col'd Cavalry.

Appears on

Company Muster Roll

for Nov & Dec, 1864

Present or absent Present

Stoppage, \$ 100 for

Due Gov't, \$ 100 for

Valuation of horse, \$ 100

Valuation of horse equipments, \$ 100

Remarks: Stops for 1 Rem  
Revolver, 1 surcingle

Book mark:

3

1864

Donnelly

S | 4 Cav. | U.S.C.T.

John Small

Pri., Co. A, 4 Reg't U. S. Col'd Cavalry.

Appears on

Company Muster Roll  
for Jan & Feb, 1865  
Present

Present or absent

Stoppage, \$ 100 for

Due Gov't, \$ 100 for

Valuation of horse, \$ 100

Valuation of horse equipments, \$ 100

Remarks: Stop for 1 surcingle  
& 1 tom-pion

Book mark:

Donnelly

S | 4 Cav. | U.S.C.T.

John Small

Pi., Co. A, 4 Reg't U. S. Col'd Cavalry.

Appears on

Company Muster Roll

for *Mar & Apr*, 186 *5*

Present or absent *Present*

Stoppage, \$ *100* for

Due Gov't, \$ *100* for

Valuation of horse, \$ *100*

Valuation of horse equipments, \$ *100*

Remarks:

Book mark:

*Dunnally*

(358)

Copyist.



S | 4 Cav. | U.S.C.T.

John Smal  
Pri

Co. A, 4 Reg't U. S. Col'd Cavalry.

Appears on

Company Muster Roll

for May - June, 1865.

Present or absent Present

Stoppage, \$ 100 for

Due Gov't, \$ 100 for

Valuation of horse, \$ 100

Valuation of horse equipments, \$ 100

Remarks:

Book mark:

Samuelly

(358)

Copyist.

S | 4 Cav. | U.S.C.T.

John Small

Pi, Co. A, 4 Reg't U. S. Col'd Cavalry.

Appears on

Company Muster Roll

for July & Aug, 1865.

Present or absent Present

Stoppage, \$ 2 <sup>25</sup>/<sub>100</sub> for lost ordnance

Due Gov't, \$ 100 for

Valuation of horse, \$ 100

Valuation of horse equipments, \$ 100

Remarks:

Book mark:

(358)

Donnelly

Copyist.

*S* | **4 Cav.** | **U.S.C.T.**

*John Small*

*Col.*, Co. A, 4 Reg't U. S. Col'd Cavalry.

Appears on

**Company Muster Roll**

for *Sept & Oct*, 1865.

Present or absent. *Present*

Stoppage, \$ *100* for

Due Gov't, \$ *100* for

Valuation of horse, \$ *100*

Valuation of horse equipments, \$ *100*

Remarks:

NEXT ROLL ON FILE FEB 1866

Book mark:

*Prewitt*

(358)

Copyist.

*S* | **4 Cav.** | **U.S.C.T.**

*John Small*  
*Privt*, Co. A, 4 Reg't U. S. Col'd Cavalry.

Appears on

**Company Muster Roll**

for *Jan & Feb*, 186*6*.

Present or absent *Present*

Stoppage, \$ *100* for

Due Gov't, \$ *100* for

Valuation of horse, \$ *100*

Valuation of horse equipments, \$ *100*

Remarks:  
-----  
-----  
-----  
-----  
-----  
-----  
-----  
-----  
-----  
-----

Book mark: -----

*Prewitt*  
Copyist.

*S* | **4 Cav.** | **U.S.C.T.**

*John Small*  
*Privt*, Co. *D*, 4 Reg't U. S. Col'd Cavalry.

Appears on **Co. Muster-out Roll**, dated  
*New Orleans La*, *Mich 20*, 1866.

Muster-out to date *Mich 20*, 1866.

Last paid to *June 30*, 1865.

**Clothing account:**

Last settled....., 186 ; drawn since \$..... $\frac{100}{100}$

Due soldier \$..... $\frac{100}{100}$ ; due U. S. \$ *32*  $\frac{100}{100}$

Am't for cloth'g in kind or money adv'd \$..... $\frac{100}{100}$

Due U. S. for arms, equipments, &c., \$..... $\frac{55}{100}$

Bounty paid \$..... $\frac{100}{100}$ ; due \$..... $\frac{100}{100}$

Remarks: *Joined at orig org.*  
*Stop 1 pr spurs & straps*

Book mark : .....

(361)

*Prewitt*

Copyist.

Smith Augustus

Co 49, 4 U. S. Col'd Cav.

Private | Private

CARD NUMBERS.

1	5349859	26
2	5349959	27
3	5350053	28
4	5350157	29
5	5350251	30
6	5350295	31
7	5350420	32
8	5350494	33
9	5350569	34
10	5350654	35
11	5350740	36
12	5350835	37
13	5350921	38
14	5351007	39
15	5351087	40
16	5351168	41
17	40729240	42
18		43
19		44
20		45
21		46
22		47
23		48
24		49
25		50

Book Mark:

See also

*S* | **4 Cav. | U.S.C.T.**

*Augustus Smith*  
*Prk*, Co. *B*, 1 Reg't La. Cav., Corps d'Afrique.\*

Appears on

**Company Muster-in Roll**

of the organization named above. Roll dated

*New Orleans La Oct 27*, 186<sup>3</sup>.

Muster-in to date *Oct 27*, 186<sup>3</sup>.

Joined for duty and enrolled:

When *Oct 24*, 186 .

Where *New Orleans*

Period *3* years.

Valuation of horse, \$.....100

Valuation of horse equipments, \$.....100

Remarks:.....  
.....  
.....  
.....

\*This organization subsequently became Co. *D*, 4 Reg't U. S. Colored Cavalry.

Book mark:.....

(356)

*[Signature]*  
Copyist.

*S* | **4 Cav. | U.S.C.T.**

*Augustus Smith*  
*Co. B*, 1 Reg't La. Cav., Corps d'Afrique.\*

Appears on

**Company Muster Roll**

for *Oct 27 to Dec 31*, 1863.

Present or absent *Present*

Stoppage, \$ *100* for

Due Gov't, \$ *100* for

Valuation of horse, \$ *100*

Valuation of horse equipments, \$ *100*

Remarks:  
-----  
-----  
-----  
-----  
-----  
-----  
-----

\*This organization subsequently became *Co. B*, 4 Reg't U. S. Colored Cavalry.

Book mark: -----

(358)

*King*  
Copyist.



*J* 4 Cav. U.S.C.T.

*Augustus Smith*  
*C Co. B*, 1 Reg't Cav., Corps d'Afrique.\*

Appears on

**Company Muster Roll**

for *Jan + Feb*, 186*4*.

Present or absent *Present*

Stoppage, \$ *100* for

Due Gov't, \$ *100* for

Valuation of horse, \$ *100*

Valuation of horse equipments, \$ *100*

Remarks:  
-----  
-----  
-----  
-----  
-----  
-----  
-----

\* This organization subsequently became Co. *B*, 4 Reg't U. S. Colored Cavalry.

Book mark : -----

(358)

*Henry*  
Copyist.

*S* | **4 Cav.** | **U.S.C.T.**

*Augustus Smith*  
*Prvt*, Co. B. 4 Reg't U. S. Col'd Cavalry.

Appears on

**Company Muster Roll**

for *March April*, 1864.

Present or absent *Present*

Stoppage, \$ *100* for

Due Gov't, \$ *100* for

Valuation of horse, \$ *100*

Valuation of horse equipments, \$ *100*

Remarks :  
-----  
-----  
-----  
-----  
-----  
-----  
-----  
-----  
-----

Book mark :  
-----

(358)

*[Signature]*  
Copyist.

*S* | **4 Cav.** | **U.S.C.T.**

*Augustus Smith*  
*Co. B.*, Co. B. 4 Reg't U. S. Col'd Cavalry.

Appears on

**Company Muster Roll**

for *May & June*, 186*4*.

Present or absent *Present*

Stoppage, \$ *100* for

Due Gov't, \$ *100* for

Valuation of horse, \$ *100*

Valuation of horse equipments, \$ *100*

Remarks :

Book mark :

(358)

*J. J. J.*  
Copyist.

*S* | **4 Cav.** | **U.S.C.T.**

*Augustus Smith*  
*S. Sharp*, Co. B. 4 Reg't U. S. Col'd Cavalry.

Appears on

**Company Muster Roll**

for *July & Aug*, 186*4*.

Present or absent *Present*

Stoppage, \$ *100* for

Due Gov't, \$ *100* for

Valuation of horse, \$ *100*

Valuation of horse equipments, \$ *100*

Remarks: *Promoted Capt. July*  
*6/64. Lieut. Washington Brown*  
*reduced*

Book mark :

(358)

*[Signature]*  
Copyist.

*S* | **4 Cav.** | **U.S.C.T.**

*Augustus Smith*  
*Co. B.*, Co. B. 4 Reg't U. S. Col'd Cavalry.

Appears on

**Company Muster Roll**

for *Sept + Oct*, 186*C.*

Present or absent *Present*

Stoppage, \$ *100* for

Due Gov't, \$ *100* for

Valuation of horse, \$ *100*

Valuation of horse equipments, \$ *100*

Remarks: *Reduced from the rank of Capt. to that of Pvt. Sept 13/64*

Book mark :

*Amey*  
Copyist.

19 | **4 Cav. | U.S.C.T.**

*Augustus Smith*

*priv.*, Co. B. 4 Reg't U. S. Col'd Cavalry.

Appears on

**Company Muster Roll**

for *Nov & Dec*, 186*7*.

Present or absent *present*

Stoppage, \$ 100 for

Due Gov't, \$ 100 for

Valuation of horse, \$ 100

Valuation of horse equipments, \$ 100

Remarks: *Extra pay due as  
corporal from July 16/64 to  
Sept. 13/64. Attached with  
Right Quartermaster. Stop for  
one curb chain, one curry comb*

Book mark:

*Lorne*

S | 4 Cav. | U.S.C.T.

Augustus Smith

priv., Co. B. 4 Reg't U. S. Col'd Cavalry.

Appears on

**Company Muster Roll**

for Jan & Feb., 1864.

Present or absent present

Stoppage, \$ 100 for

Due Gov't, \$ 100 for

Valuation of horse, \$ 100

Valuation of horse equipments, \$ 100

Remarks: Received only \$7 a month to include Apr 30/64. Detached with Regt. Quarter-master. Stop for one curry comb.

Book mark:

Lomer

S | **4 Cav.** | **U.S.C.T.**

*Augustus Smith*

*priv.*, Co. B. 4 Reg't U. S. Col'd Cavalry.

Appears on

**Company Muster Roll**

for *March & April*, 186*3*.

Present or absent *present*

Stoppage, \$ 100 for

Due Gov't, \$ 100 for

Valuation of horse, \$ 100

Valuation of horse equipments, \$ 100

Remarks: *On daily duty with  
Regimental Quarter master*

Book mark :

*Somer*



4 Cav. U.S.C.T.

*Augustus Smith*

*priv.*, Co. B. 4 Reg't U. S. Col'd Cavalry.

Appears on

**Company Muster Roll**

for *May & June*, 186*5*.

Present or absent *present*

Stoppage, \$ *100* for

Due Gov't, \$ *100* for

Valuation of horse, \$ *100*

Valuation of horse equipments, \$ *100*

Remarks: *Stop for 2 spurs & strap. On duty in R. I. M. Capt.*

Book mark:

*Smith*

(358)

Copyist.

S | **4 Cav.** | **U.S.C.T.**

Augustus Smith  
priv., Co. B. 4 Reg't U. S. Col'd Cavalry.

Appears on

**Company Muster Roll**

for July & Aug, 1867.

Present or absent present

Stoppage, \$ 100 for

Due Gov't, \$ 100 for

Valuation of horse, \$ 100

Valuation of horse equipments, \$ 100

Remarks :  
-----  
-----  
-----  
-----  
-----  
-----  
-----  
-----  
-----  
-----

Book mark :  
-----  
-----

(358)

Forner

Copyist.

S | **4 Cav.** | **U.S.C.T.**

*Augustus Smith*

*priv*, Co. B. 4 Reg't U. S. Col'd Cavalry.

Appears on

**Company Muster Roll**

for *Sept & Oct.*, 186*9*.

Present or absent *present*

Stoppage, \$ 100 for

Due Gov't, \$ 100 for

Valuation of horse, \$ 100

Valuation of horse equipments, \$ 100

Remarks :

Book mark :

*Done*

(358)

*Copist.*

*S* | **4 Cav. | U.S.C.T.**

*Augustus Smith*  
*Priv.*, Co. B. 4 Reg't U. S. Col'd Cavalry.

Appears on

**Company Muster Roll**

for *Nov. 1862*, 186 *2-*

Present or absent *Present*

Stoppage, \$ *100* for

Due Gov't, \$ *100* for

Valuation of horse, \$ *100*

Valuation of horse equipments, \$ *100*

Remarks :  
.....  
.....  
.....  
.....  
.....  
.....  
.....  
.....

Book mark :  
.....

*Chandler*  
Copyist.

*S* | **4 Cav.** | **U.S.C.T.**

*Augustus Smith*  
*For*, Co. B. 4 Reg't U. S. Col'd Cavalry.

Appears on

**Company Muster Roll**

for *Jan. & Feb.*, 186*6*.

Present or absent *Present*

Stoppage, \$ 100 for

Due Gov't, \$ 100 for

Valuation of horse, \$ 100

Valuation of horse equipments, \$ 100

Remarks :

Book mark :

*Chandler*

(358)

Copyist.

A | 4 Cav. | U.S.C.T.

Augustus Smith  
Priv., Co. B, 4 Reg't U. S. Colored Cav.

Appears on Returns as follows:

Sept 1864 - On duty Blacksmith  
for G. M.

Nov 1864 - On duty in Regt G. M. Dept.

Nov 1864 - About sent in arrest

March 6/64 to P. M. New Orleans

Dec 1864 - On duty detailed as Regt  
teamster.

Feb & March 1865 - On duty detailed  
in Regt G. M. Dept.

Apr 1865 - On duty detailed as  
teamster.

May to Aug 1865 - On duty detailed  
in Regt G. M. Dept.

Book mark :

W. R. Lee

(546)

Copyist.

*S* | **4 Cav.** | **U.S.C.T.**

*Augustus Smith*

*Priv*, Co. *B*, 4 Reg't U. S. Col'd Cavalry.

Appears on **Co. Muster-out Roll**, dated *New Orleans, La, Mch 20, 1866.*

Muster-out to date *Mch 20, 1866.*

Last paid to *June 30, 1866.*

**Clothing account:**

Last settled....., 186 ; drawn since \$..... 100

Due soldier \$ *5-4*<sup>*32*</sup> 100; due U. S. \$..... 100

Am't for cloth'g in kind or money adv'd \$..... 100

Due U. S. for arms, equipments, &c., \$..... 100

Bounty paid \$..... 100; due \$..... 100

Remarks: *Joined as Regt. Priv. to July 16. 64. Corp'l to Sept. 13. 64.*

Book mark: *V. 146. P. 60. 72*

(361) *9924* *C. Chandler*  
Copyist.

Smith Benjamin

Co A, 4 U.S. Col'd Cav.

Private Private

CARD NUMBERS.

1	5354984	26
2	5355073	27
3	5355165	28
4	5355253	29
5	5355342	30
6	5355425	31
7	5355506	32
8	5355581	33
9	5355664	34
10	5355748	35
11	5355831	36
12	5355911	37
12	5355992	38
14	5356070	39
15	5356147	40
16		41
17		42
18		43
19		44
20		45
21		46
22		47
23		48
24		49
25		50

Book Mark:

See also



0751554 0090  
51134346 00. m m  
P. 13973358. 0. aff

*Handwritten signature*

*S* | **4 Cav.** | **U.S.C.T.**

*Benjamin Smith*

*Pvt*, Co. A, Mounted Rangers, Corps d'Afrique. †

Age ..... years.

Appears on

**Company Muster Roll\***

for *Nov, 2 Dec*, 186*3*.

Joined for duty and enrolled:

When *Nov 1*, 186*3*.

Where *Iberia, La*

Period ..... years.

Mustered in:

When *Nov, 30*, 186*3*.

Where *Iberia, La*

Present or absent *Present*

Stoppage, \$ ..... 100 for .....

Due Gov't \$ ..... 100 for .....

Valuation of horse, \$ ..... 100

Valuation of horse equipments, \$ ..... 100

Remarks: .....

† This organization subsequently became Co. F, 4 U. S. Col'd Cav.

\* First current roll. No muster-in roll of this ~~book~~ on file.

Book mark: .....

(3586)

*Hamming*  
Copyist.

*S* | **4 Cav. | U.S C.T.**

*Benjamin Smith*  
*Pvt.*, Co. *F*, 1 Reg't Cav., Corps d'Afrique.\*

Appears on

**Company Muster Roll**

for *Jerry D. Feby*, 1864

Present or absent *Present*

Stoppage, \$ *100* for

Due Gov't, \$ *100* for

Valuation of horse, \$ *100*

Valuation of horse equipments, \$ *100*

Remarks:  
.....  
.....  
.....  
.....  
.....  
.....

\* This organization subsequently became Co. *F*, 4 Reg't U. S. Colored Cavalry.

Book mark: .....

(358) *Meanning* Copyist.

*S* | **4 Cav.** | **U.S.C.T.**

*Benjamin Smith*  
*Pvt*, Co. F, 4 Reg't U. S. Col'd Cavalry.

Appears on

**Company Muster Roll**

for *March & April*, 1864.

Present or absent *Present*

Stoppage, \$ 100 for

Due Gov't, \$ 100 for

Valuation of horse, \$ 100

Valuation of horse equipments, \$ 100

Remarks:

Book mark:

(358)

*Manning*  
Copyist

*S* | **4 Cav. U.S.C.T.**

*Benjamin Smith*  
*Pr*, Co. F, 4 Reg't U. S. Col'd Cavalry.

Appears on

**Company Muster Roll**

for *May & June*, 186*4*

Present or absent *Present*

Stoppage, \$ *100* for

Due Gov't, \$ *100* for

Valuation of horse, \$ *100*

Valuation of horse equipments, \$ *100*

Remarks:

Book mark:

*Manning*  
Copyist.

*S* | **4 Cav.** | **U.S.C.T.**

*Benjamin Smith*  
*Pr*, Co. F, 4 Reg't U. S. Col'd Cavalry.

Appears on

**Company Muster Roll**

for *July & Aug*, 1864.

Present or absent *Present*

Stoppage, \$ 100 for

Due Gov't, \$ 100 for

Valuation of horse, \$ 100

Valuation of horse equipments, \$ 100

Remarks:

Book mark:

(358)

*W. H. ...*  
Copyist.

*S* | 4 Cav. | U.S.C.T.

*Benjamin Smith*  
*Pr*, Co. F, 4 Reg't U. S. Col'd Cavalry.

Appears on

**Company Muster Roll**

for *Sept & Oct*, 1864.

Present or absent *Present*

Stoppage, \$ 100 for

Due Gov't, \$ 100 for

Valuation of horse, \$ 100

Valuation of horse equipments, \$ 100

Remarks:

Book mark:

(358)

*Manning*  
Copyist.

*S* | **4 Cav.** | **U.S.C.T.**

*Benjamin Smith*  
*Priv*, Co. F, 4 Reg't U. S. Col'd Cavalry.

Appears on

**Company Muster Roll**  
for *Nov. & Dec*, 186 *4*

Present or absent *Present*

Stoppage, \$.....100 for .....

Due Gov't, \$.....100 for .....

Valuation of horse, \$.....100

Valuation of horse equipments, \$.....100

Remarks: .....

Book mark: .....

*J. W. Harris*

(358)

Copyist.



*S* | **4 Cav.** | **U.S.C.T.**

*Benjamin Smith*  
*Prk*, Co. F, 4 Reg't U. S. Col'd Cavalry.

Appears on

**Company Muster Roll**

for *Jan & Feby*, 186 *5*

Present or absent *Present*

Stoppage, \$ 100 for

Due Gov't, \$ 100 for

Valuation of horse, \$ 100

Valuation of horse equipments, \$ 100

Remarks:

Book mark:

*J. A. Harris*

S | 4 Cav. | U.S.C.T.

Benjamin Smith  
Priv, Co. F, 4 Reg't U. S. Col'd Cavalry.

Appears on

**Company Muster Roll**  
for Mch & Apr, 186 5

Present or absent Present

Stoppage, \$ 100 for

Due Gov't, \$ 100 for

Valuation of horse, \$ 100

Valuation of horse equipments, \$ 100

Remarks:

Book mark:

J. H. Harris

(358)

Copyist.

*S* | **4 Cav.** | **U.S.C.T.**

*Benjamin Smith*  
*Pr*, Co. F, 4 Reg't U. S. Col'd Cavalry.

Appears on

**Company Muster Roll**

for *May & June*, 186*5*

Present or absent *Present*

Stoppage, \$ *100* for

Due Gov't, \$ *100* for

Valuation of horse, \$ *100*

Valuation of horse equipments, \$ *100*

Remarks:

Book mark:

*S. H. Harris*

*S* | **4 Cav.** | **U.S.C.T.**

*Benjamin Smith*

*Pr*, Co. F, 4 Reg't U. S. Col'd Cavalry.

Appears on

**Company Muster Roll**

for *July & Aug*, 186*5*.

Present or absent *Present*

Stoppage, \$ *100* for

Due Gov't, \$ *100* for

Valuation of horse, \$ *100*

Valuation of horse equipments, \$ *100*

Remarks:

Book mark:

*H Harris*

S | 4 Cav. | U.S.C.T.

Benjamin Smith  
Pvt

....., Co. F, 4 Reg't U. S. Col'd Cavalry.

Appears on

Company Muster Roll

for Sept & Oct, 1865

Present or absent Present

Stoppage, \$ 100 for

Due Gov't, \$ 100 for

Valuation of horse, \$ 100

Valuation of horse equipments, \$ 100

Remarks: Stop for one Halter & Strap one Nose Bag.

Book mark :

J. A. Harris

S | 4 Cav. | U.S.C.T.

Benjamin Smith

P, Co. F, 4 Reg't U. S. Col'd Cavalry.

Appears on

**Company Muster Roll**

for Nov. & Dec., 1865

Present or absent Present

Stoppage, \$ 4.  $\frac{40}{100}$  for ordn. lost

Due Gov't, \$ 100 for

Valuation of horse, \$ 100

Valuation of horse equipments, \$ 100

Remarks:

Book mark:

(358)

Hibbard

Copyist.

S | 4 Cav. | U.S.C.T.

Benjamin Smith

P, Co. F, 4 Reg't U. S. Col'd Cavalry.

Appears on

Company Muster Roll

for Jan. 1<sup>st</sup> Feb., 1866.

Present or absent Present

Stoppage, \$ 4. <sup>40</sup>/<sub>100</sub> for ordn. lost

Due Gov't, \$ \_\_\_\_\_ <sup>100</sup> for \_\_\_\_\_

Valuation of horse, \$ \_\_\_\_\_ <sup>100</sup>

Valuation of horse equipments, \$ \_\_\_\_\_ <sup>100</sup>

Remarks: \_\_\_\_\_  
\_\_\_\_\_  
\_\_\_\_\_  
\_\_\_\_\_  
\_\_\_\_\_  
\_\_\_\_\_  
\_\_\_\_\_  
\_\_\_\_\_

Book mark: \_\_\_\_\_

(358)

Hibbard

Copyist.

S | 4 Cav. | U.S.C.T.

Benjamin Smith  
P, Co. T, 4 Reg't U. S. Col'd Cavalry.

Appears on **Co. Muster-out Roll**, dated  
New Orleans, La., Mch. 20 1866.

Muster-out to date Mch. 20 1866.

Last paid to June 30, 1865.

Clothing account:

Last settled....., 186 ; drawn since \$..... 100

Due soldier \$ 19.98 100; due U. S. \$..... 100

Am't for cloth'g in kind or money adv'd \$..... 100

Due U. S. for arms, equipments, &c., \$ 4.40 100

Bounty paid \$..... 100; due \$..... 100

Remarks: Joined at orig. org.  
Stop 1 halter & strap, 1 nose bag.

Book mark: V160 - P58 - 73

(861) Hibbard Copyist.



Smith Charles

Co G, 4 U. S. Col'd Cav.

Private Private

CARD NUMBERS.

1	5-3475-23	26
2	5-35-6797	27
3	5-35-6888	28
4	5-35-6975-	29
5	5-35-7057	30
6	5-35-7141	31
7	40729215	32
8		33
9		34
10		35
11		36
12		37
13		38
14		39
15		40
16		41
17		42
18		43
19		44
20		45
21		46
22		47
23		48
24		49
25		50

Book Mark:

See also

REP 395852.

D 1078957. P.O. in m

51186077 P.O. ret

~~P. 1641860 and W. J.~~

*[Handwritten signature]*

*S* | **4 Cav. | U.S.C.T.**

*Charles Smith*

Appears with rank of *Private* on

**Muster and Descriptive Roll of a Detachment of U. S. Vols. forwarded**

for the 4 Reg't U. S. Col'd Cavalry. Roll dated

*New Orleans La, Apr. 25, 1865.*

Where born *Opolusas, La.*

Age *37* y'rs; occupation *Laborer*

When enlisted *Apr. 9*, 1865.

Where enlisted *New Orleans, La.*

For what period enlisted *3* years.

Eyes *Black*; hair *Black*

Complexion *Black*; height *5 ft. 5 in.*

When mustered in *Apr. 25*, 1865.

Where mustered in *New Orleans.*

Bounty paid \$ *100* <sub>100</sub>; due \$ *200* <sub>100</sub>

Where credited *1<sup>st</sup> Dist. 2<sup>nd</sup> Ward Orleans }  
New Orleans, La.*

Company to which assigned

Remarks:

Book mark:

*O. T. Taylor*

(339)

Copyist.

*S* | **4 Cav. | U. S. C. T.**

*Charles Smith*

*Pr*, Co. G, 4 Reg't U. S. Col'd Cavalry.

Appears on

**Company Muster Roll**

for *May & June*, 1865.

Present or absent *Present*

Stoppage, \$ *100* for

Due Gov't, \$ *100* for

Valuation of horse, \$ *100*

Valuation of horse equipments, \$ *100*

Remarks *\$100 Bounty paid  
\$200 due stop for  
Haber not paid  
A recruit from depot  
May 4, 65.*

Book mark :

(358)

*Amund*  
Copyist.

*S* | **4 Cav. | U.S.C.T.**

*Charles Smith*

*Pr.*, Co. G, 4 Reg't U. S. Col'd Cavalry.

Appears on

**Company Muster Roll**

for *July & Aug*, 1865.

Present or absent *Present*

Stoppage, \$ 100 for

Due Gov't, \$ 100 for

Valuation of horse, \$ 100

Valuation of horse equipments, \$ 100

Remarks *\$ 20 Bounty paid*  
*\$ 200 due*

Book mark: \_\_\_\_\_

*Atwood* Copyist.

*S* | **4 Cav. | U.S.C.T.**

*Charles Smith*  
*Pvt*, Co. G, 4 Reg't U. S. Col'd Cavalry.

Appears on

**Company Muster Roll**

for *Sept & Oct*, 186*5*.

Present or absent *Present*

Stoppage, \$ *100* for

Due Gov't, \$ *100* for

Valuation of horse, \$ *100*

Valuation of horse equipments, \$ *100*

Remarks: *\$100. Bounty paid*  
*\$200 due.*

NEXT ROLL ON FILE FEB 1866

Book mark:

*Fletcher*

(355)

Copyist.

*S* | **4 Cav. | U.S.C.T.**

*Charles Smith*

*Priv*, Co. G, 4 Reg't U. S. Col'd Cavalry.

Appears on

**Company Muster Roll**

for *Jan & Feb*, 186 *6*.

Present or absent *Present*

Stoppage, \$ *100* for

Due Gov't, \$ *100* for

Valuation of horse, \$ *100*

Valuation of horse equipments, \$ *100*

Remarks:

Book mark:

*Fletcher*

D | **4 Cav. | U.S.C.T.**

Charles Smith

Port, Co. G, 4 Reg't U. S. Colored Cav.

Appears on **Returns** as follows:

May 1865 - Gain: May 14/65  
New Orleans Recredit from  
depot.

Book mark: \_\_\_\_\_

W. R. Lee

(546)

Copyist.



*S* | **4 Cav.** | **U.S.C.T.**

*Charles Smith*

*Priv*, Co. *G*, 4 Reg't U. S. Col'd Cavalry.

Appears on **Co. Muster-out Roll**, dated  
*New Orleans, La.,* *March 20*, 1866.

Muster-out to date *March 20*, 1866.

Last paid to *June 30*, 1865.

**Clothing account:**

Last settled....., 186 ; drawn since \$.....  $\overline{100}$

Due soldier \$.....  $\overline{100}$ ; due U. S. \$ *10*  $\frac{06}{100}$

Am't for cloth'g in kind or money adv'd \$.....  $\overline{100}$

Due U. S. for arms, equipments, &c., \$.....  $\overline{100}$

Bounty paid \$ *100*  $\overline{100}$ ; due \$ *None*  $\overline{100}$

Remarks: *Joined as recruit*

Book mark: *V246 B16.77*

(861)

*Fletcher*  
Copyist.

Smith, Charles

Co. 4 Reg't U.S.C.

Enclosures.

Bed Cards	Final Statements
Burial Records	Furloughs or L. of A.
Certs. of Dis. for Discharge	Med. Certificates
C. M. Charges	Med. Des. Lists
Descriptive Lists	Orders
Discharge Certificates	Pris. of War Record
Enlistment Papers	Resignations

Other papers relating to—

Admission to Hosp'l	Furlough or L. of A.
Casualty Sheet	Med. Examination
Confinement	Misc. Information
Contracts	Pay of Clothing
Death or Effects	Personal Reports
Desertion	Rank
Discharge from Hosp'l	Transfer to Hosp'l
Discharge from Service	Transfer to V. R. C.
Duty	Transportation

**NOTE 1.**—This blank will be used for both enlistments and re-enlistments—must be made out in duplicate in all cases—one to accompany the recruiting return of the superintendent (not the recruiting officer) to the Adjutant General, and one to accompany the accounts of the officer who pays bounty, &c. The Regiment and Company in which the soldier last served should be given on the back.

**NOTE 2.**—An enlistment holds to service. A muster-in must, in all cases, precede payment of pay, bounty, pension, &c. A muster-in roll must, in all cases, be filed in the Adjutant General's Office as evidence of muster-in. The mustering officer, commissary, or assistant commissary of musters, as the case may be, will countersign both enlistments as having mustered the soldier into the service of the United States, before either of them is given to the disbursing officer.

DECLARATION OF RECRUIT.

I, *Charles Smith*, desiring to VOLUNTEER as a Soldier in the Army of the United States, for the term of THREE YEARS, Do Declare, That I am *34* years and \_\_\_\_\_ months of age; that I have never been discharged from the United States service on account of disability or by sentence of a court martial, or by order before the expiration of a term of enlistment; and I know of no impediment to my serving honestly and faithfully as a soldier for three years.

GIVEN at *New Orleans La.* the *9* day of *April 1865*

Witness: *Genl Geo. B. Friedman*  
*1st Lieut. 10th U. S. C. A. Reg.*

*Charles Smith*  
*mark*

No \_\_\_\_\_  
*Charles Smith*  
Volunteered at *New Orleans La.*  
*April 9 1865*  
By *Capt. C. M. Wilkins*  
for the *4th* Regiment of *U. S. C. A.*

Discharged \_\_\_\_\_ 18\_\_\_\_  
Regt of \_\_\_\_\_  
enlistment: last served in Company ( ) \_\_\_\_\_  
*Permit nullified by the Adjutant General's Office, New Orleans, La. July 19th 1864*

Received from Second Auditor  
October 7th. 1892.

CONSENT IN CASE OF MINOR.

I, \_\_\_\_\_, Do CERTIFY, That I am \_\_\_\_\_ the \_\_\_\_\_ of \_\_\_\_\_; that the said \_\_\_\_\_ is \_\_\_\_\_ years of age; and I do hereby freely give my CONSENT to his volunteering as a SOLDIER in the ARMY OF THE UNITED STATES for the period of THREE YEARS.

GIVEN at \_\_\_\_\_ the \_\_\_\_\_ day of \_\_\_\_\_

Witness: \_\_\_\_\_

VOLUNTEER ENLISTMENT.

STATE OF

TOWN OF

*Louisiana*



*New Orleans*

I, *Charles Smith*, born in *Copulas* in the State of *Louisiana*, aged *thirty seven* years, and by occupation a *Labourer*, Do HEREBY ACKNOWLEDGE to have volunteered this *ninth* day of *April*, 1865, to serve as a **Soldier** in the **Army of the United States of America**, for the period of **THREE YEARS**, unless sooner discharged by proper authority: Do also agree to accept such bounty, pay, rations, and clothing, as are, or may be, established by law for volunteers. And I, *Charles Smith*, do solemnly swear, that I will bear true faith and allegiance to the **United States of America**, and that I will serve them honestly and faithfully against all their enemies or opposers whomsoever; and that I will observe and obey the orders of the President of the United States, and the orders of the officers appointed over me, according to the Rules and Articles of War.

Sworn and subscribed to, at *New Orleans La* } *Charles Smith*  
this *9<sup>th</sup>* day of *April*, 1865, } *mark*  
BEFORE *Saml Geo. Friedman*  
*1<sup>st</sup> Lieut. 10<sup>th</sup> U. S. C. O. N.Y.*

I CERTIFY, ON HONOR, That I have carefully examined the above-named Volunteer, agreeably to the General Regulations of the Army, and that, in my opinion, he is free from all bodily defects and mental infirmity, which would in any way disqualify him from performing the duties of a soldier.

*Wm H. Conroy*  
*Surgeon Sr. U.S. Army*  
EXAMINING SURGEON.

I CERTIFY, ON HONOR, That I have minutely inspected the Volunteer *Charles Smith* previously to his enlistment, and that he was entirely sober when enlisted; that, to the best of my judgment and belief, he is of lawful age; and that, in accepting him as duly qualified to perform the duties of an able-bodied soldier, I have strictly observed the Regulations which govern the recruiting service. This soldier has *Black* eyes, *Black* hair, *Black* complexion, is *five* feet *five* inches high.

*Wm C. Allister*  
Capt. 10<sup>th</sup> Regiment of U.S.C.A. Reg. Volunteers,  
RECRUITING OFFICER.

(A. G. O. No. 71 & 76.)

Mustered into the service of the United States, for three years or during the war from date of enlistment, in Company *B* of *4<sup>th</sup>* Regiment of *W. B. B.* Volunteers, on the *23* day of *April* 1865, at *New Orleans La.*

*John H. Campbell*  
*1<sup>st</sup> Lieut. 10<sup>th</sup> Regt U.S.A.*  
*11.9.76*

*B*

Smith <sup>990</sup> Clay

Co D, 4 U. S. Col'd Cav.

Private Sergeant

CARD NUMBERS.

1	5349944	26
2	5352947	27
3	5353029	28
4	5353112	29
5	5353139	30
6	5353235	31
7	5353335	32
8	5353425	33
9	5353510	34
10	5353592	35
11	5353674	36
12	40729216	37
13		38
14		39
15		40
16		41
17		42
18		43
19		44
20		45
21		46
22		47
23		48
24		49
25		50

Book Mark:

See also

Smith <sup>990</sup> Clay

Co D, 4 U. S. Col'd Cav.

Private Sergeant

CARD NUMBERS.

1	5347944	26
2	5352947	27
3	5353029	28
4	5353112	29
5	5353139	30
6	5353235	31
7	5353335	32
8	5353425	33
9	5353510	34
10	5353592	35
11	5353674	36
12	40729216	37
13		38
14		39
15		40
16		41
17		42
18		43
19		44
20		45
21		46
22		47
23		48
24		49
25		50

Book Mark:

See also

8-937762-PO. M+M

21792836 Enc. 1

*W. M. M.*

*L* | *4 cav* | **U.S.C.T**

*Clay Smith*

Appears with rank of *Priv* on

**Muster and Descriptive Roll of a Detachment of Drafted Men and Substitutes forwarded**

for the *4* Reg't U.S. Col'd *Cav* Roll dated  
*New Orleans La Sept 1, 1864*

Where born *Richmond Va*

Age *25* years; occupation *Laborer*

**Drafted and mustered in:**

When *Sept 1*, 1864.

Where *New Orleans*

Period *3* years.

Eyes *Blk*; hair *Blk*

Complexion *Fallow*; height *5 ft. 7 in.*

Paid bounty and advance pay, \$ *100*

Bounty due \$ *100* *none*

Where credited

Company to which assigned *D*

Remarks:

Book mark:

(340)

*J. Woodward*

Copyist.



*S* | **4 Cav.** | **U.S.C.T.**

*Clay Smith*

*Priv*, Co. D. 4 Reg't U. S. Col'd Cavalry.

Appears on

**Company Muster Roll**

for *Sept & Oct*, 1864.

Present or absent *Present*

Stoppage, \$ *100* for

Due Gov't, \$ *100* for

Valuation of horse, \$ *100*

Valuation of horse equipments, \$ *100*

Remarks:

Book mark:

(358)

*Rosenbaum*

Copyist.

*S* | **4 Cav.** | **U.S.C.T.**

*Clay Smith*

*Pvt*, Co. D. 4 Reg't U. S. Col'd Cavalry.

Appears on

**Company Muster Roll**

for *Sept & Oct*, 1864.

Present or absent *Present*

Stoppage, \$ *100* for

Due Gov't, \$ *100* for

Valuation of horse, \$ *100*

Valuation of horse equipments, \$ *100*

Remarks:

Book mark:

(358)

*Rosenbaum*

Copyist.



J | 4 Cav. | U.S.C.T.

Wm Smith

Co. D, 4 Reg't U. S. Col'd Cavalry.

Appears on

Company Muster Roll

for Jan 7 Feb, 1865.

Present or absent Present

Stoppage, \$ 100 for

Due Gov't, \$ 2 00 for Ordnance

Valuation of horse, \$ 100

Valuation of horse equipments, \$ 100

Remarks:

Book mark:

W. H. Wright

*e* | **4 Cav. | U.S.C.T.**

*Wm Smith*

*Sgt*, Co. D, 4 Reg't U. S. Col'd Cavalry.

Appears on

**Company Muster Roll**

for *Mar & Apr*, 186*5*.

Present or absent *Present*

Stoppage, \$ *100* for

Due Gov't, \$ *100* for

Valuation of horse, \$ *100*

Valuation of horse equipments, \$ *100*

Remarks: *See from Muster*  
*105-*

Book mark:

(358)

*Wm Smith*

Copyist.

D | **4 Cav. | U.S.C.T.**

*Sam Smith*

*Sgt*, Co. D, 4 Reg't U. S. Col'd Cavalry.

Appears on

**Company Muster Roll**

for *May & June*, 1865.

Present or absent *Present*

Stoppage, \$ 100 for

Due Gov't, \$ 100 for

Valuation of horse, \$ 100

Valuation of horse equipments, \$ 100

Remarks: *Present & paid for 100*

Book mark: \_\_\_\_\_

(358)

*W. Wright*

Copyist.

*J* | **4 Cav.** | **U.S.C.T.**

*Henry Smith*

*Sgt*, Co. D, 4 Reg't U. S. Col'd Cavalry.

Appears on

**Company Muster Roll**

for *John H. King*, 186 *7*.

Present or absent *Present*

Stoppage, \$ *100* for

Due Gov't, \$ *100* for

Valuation of horse, \$ *100*

Valuation of horse equipments, \$ *100*

Remarks: *Per from Philip*  
*103-*

Book mark:

(358)

*W. H. King*  
Copyist.

21 | 4 Cav. | U.S.C.T.

*Wm. Smith*

*Sgt.*, Co. D, 4 Reg't U. S. Col'd Cavalry.

Appears on

**Company Muster Roll**

for *Sept - Oct*, 186*5*.

Present or absent *Present*

Stoppage, \$ 100 for

Due Gov't, \$ 100 for

Valuation of horse, \$ 100

Valuation of horse equipments, \$ 100

Remarks:  
-----  
-----  
-----  
-----  
-----  
-----  
-----  
-----  
-----  
-----

Book mark: -----

*W. Smith*  
-----  
(358) Copyist.



4 Cav. U.S.C.T.

Clay Smith

Sgt., Co. D, 4 Reg't U. S. Col'd Cavalry.

Appears on

Company Muster Roll

for Nov 4 Dec, 1865

Present or absent Present

Stoppage, \$ 100 for

Due Gov't, \$ 100 for

Valuation of horse, \$ 100

Valuation of horse equipments, \$ 100

Remarks:

Book mark:

W. A. Audinore

(358)

Copyist.

*S* | **4 Cav. | U.S.C.T.**

*Clay Smith*

*Sergt*, Co. D, 4 Reg't U. S. Col'd Cavalry.

Appears on

**Company Muster Roll**

for *Jan + Feb*, 186*4*.

Present or absent *Present*

Stoppage, \$ *100* for

Due Gov't, \$ *100* for

Valuation of horse, \$ *100*

Valuation of horse equipments, \$ *100*

Remarks:

Book mark:

*J. D. Anderson*

(358)

Copyist.

*S*

**4 Cav. U.S.C.T.**

*Clay Smith*

*Port*, Co. *H*, 4 Reg't U. S. Colored Cav.

Appears on Returns as follows:

*Sept 1864 - Gain: Sept 2/64  
Port H Adson Enlisted.*

Book mark:

*W. R. Lee*

(546)

Copyist.

S | **4 Cav.** | **U.S.C.T.**

Clay Smith  
Supt, Co. D, 4 Reg't U. S. Col'd Cavalry.

Appears on **Co. Muster-out Roll**, dated  
New Orleans La, Nov 20, 1866.

Muster-out to date Nov 20, 1866.

Last paid to Jan 30, 1865.

Clothing account:

Last settled....., 186 ; drawn since \$..... 100

Due soldier \$..... 100; due U. S. \$ 13 <sup>64</sup>/<sub>100</sub>

Am't for cloth'g in kind or money adv'd \$..... 100

Due U. S. for arms, equipments, &c., \$..... 100

Bounty paid \$..... 100; due \$..... 100

Remarks: Joined as recruit.

Supt since Apr. 1/65

Book mark: V 25, P. 227. 68

(361)

W. S. Andrews

Copyist.

991

Smith Henry

Co D, 4 U. S. Col'd Cav.

Private | Private

CARD NUMBERS.

1	5347945	26
2	5352948	27
3	5353030	28
4	5353113	29
5	5353209	30
6	5353302	31
7	5353396	32
8	5353485	33
9	5353571	34
10	5353654	35
11	5353734	36
12	40729217	37
13		38
14		39
15		40
16		41
17		42
18		43
19		44
20		45
21		46
22		47
23		48
24		49
25		50

Book Mark:

See also

Rep 356822.

8797434. R090

S-911674 - Pleasent 7/11/60

S. 1325073. P.O. number

D. 1685171 P. O. no.

*Amuse*

*S* | *4 Cav* | **U.S.C.T**

*Henry Smith*

Appears with rank of *Priv* on

**Muster and Descriptive Roll of a Detachment of Drafted Men and Substitutes forwarded**

for the *4* Reg't U.S. Col'd *Cav* Roll dated *New Orleans La, Sept 1, 1864*

Where born *Richmond Va*

Age *38* years; occupation *Laborer*

**Drafted and mustered in:**

When *Sept 1*, 1864.

Where *New Orleans*

Period *3* years.

Eyes *Blk*; hair *Blk*

Complexion *Dark*; height *5 ft. 7 in.*

Paid bounty and advance pay, \$ *100*

Bounty due \$ *100* *none*

Where credited

Company to which assigned *D*

Remarks:

Book mark:

(340)

*J. Henderson*

*Wp. 660.*

*S* | **4 Cav.** | **U.S.C.T.**

*Henry Smith*

*Pat*, Co. D, 4 Reg't U. S. Col'd Cavalry.

Appears on

**Company Muster Roll**

for *Sept & Oct*, 1864.

Present or absent *Present*

Stoppage, \$ *100* for

Due Gov't, \$ *100* for

Valuation of horse, \$ *100*

Valuation of horse equipments, \$ *100*

Remarks:

Book mark:

(358)

*Rosenblum*

Copyist.



*J* | **4 Cav. | U.S.C.T.**

*Henry Smith*  
....., Co. D, 4 Reg't U. S. Col'd Cavalry.

Appears on

**Company Muster Roll**

for *15- Dec*, 186 *1*.

Present or absent *Present*

Stoppage, \$ *100* for .....

Due Gov't, \$ *100* for .....

Valuation of horse, \$ *100*

Valuation of horse equipments, \$ *100*

Remarks: .....

Book mark: .....

(358)

*A. H. [unclear]*

Copyist.

J | 4 Cav. | U.S.C.T.

*Henry Smith*

....., Co. D, 4 Reg't U. S. Col'd Cavalry.

Appears on

**Company Muster Roll**

for *Jan & Feb*, 1865.

Present or absent *Present*

Stoppage, \$.....100 for.....

Due Gov't, \$.....100 for.....

Valuation of horse, \$.....100

Valuation of horse equipments, \$.....100

Remarks:.....

Book mark :.....

(358)

*W. H. Wright*

Copyist.

*e* | **4 Cav. | U.S.C.T.**

*Henry Smith*  
P  
....., Co. D, 4 Reg't U. S. Col'd Cavalry.

Appears on

**Company Muster Roll**

for *March & April*, 1865

Present or absent *Present*

Stoppage, \$ 100 for

Due Gov't, \$ 100 for

Valuation of horse, \$ 100

Valuation of horse equipments, \$ 100

Remarks:

Book mark:

(358)

*W. B. Knight*  
Copyist.

*J* | **4 Cav.** | **U.S.C.T.**

*Henry Smith*

*P*, Co. D, 4 Reg't U. S. Col'd Cavalry.

Appears on

**Company Muster Roll**

for *May & June*, 186*5*.

Present or absent *Present*

Stoppage, \$ *100* for

Due Gov't, \$ *100* for

Valuation of horse, \$ *100*

Valuation of horse equipments, \$ *100*

Remarks: *Cc Cook*

Book mark:

(358)

*A. H. Wright*  
Copyist.

*S* | **4 Cav. | U.S.C.T.**

*Henry Smith*

*A*, Co. D, 4 Reg't U. S. Col'd Cavalry.

Appears on

**Company Muster Roll**

for *July & Aug*, 186*5*.

Present or absent *Present*

Stoppage, \$ 100 for

Due Gov't, \$ 100 for

Valuation of horse, \$ 100

Valuation of horse equipments, \$ 100

Remarks:

Book mark:

(358)

*A. H. Wright*

Copyist.

c' | 4 Cav. | U.S.C.T.

Henry Smith

P, Co. D, 4 Reg't U. S. Col'd Cavalry.

Appears on

Company Muster Roll

for Sept - Oct, 1864.

Present or absent Present

Stoppage, \$ 100 for

Due Gov't, \$ 100 for

Valuation of horse, \$ 100

Valuation of horse equipments, \$ 100

Remarks: Sick

Book mark:

(358)

W. H. Wright

Copyist.

*S* | **4 Cav. | U.S.C.T.**

*Henry Smith*

*Priv*, Co. D, 4 Reg't U. S. Col'd Cavalry.

Appears on

**Company Muster Roll**

for *Month of Dec*, 186*5*

Present or absent *Present*

Stoppage, \$ *100* for

Due Gov't, \$ *100* for

Valuation of horse, \$ *100*

Valuation of horse equipments, \$ *100*

Remarks:

Book mark:

*W. J. Goodwin*

*at* | **4 Cav. U.S.C.T.**

*Henry Smith*

*Plt*, Co. D, 4 Reg't U. S. Col'd Cavalry.

Appears on

**Company Muster Roll**

for *Jan 9 Feb*, 186*6*.

Present or absent *Present*

Stoppage, \$ *100* for

Due Gov't, \$ *100* for

Valuation of horse, \$ *100*

Valuation of horse equipments, \$ *100*

Remarks:

Book mark:

*W. D. Goodwin*



A | 4 Cav. | U.S.C.T.

Henry Smith

Port, Co. B, 4 Reg't U. S. Colored Cav.

Appears on Returns as follows:

Sept 1864 - (year): Sept 3/64  
Port Hudson Enlisted

Apr to July 1865)  
Apr 1865 } On duty detailed  
as Co. Cook.

Book mark:

W. R. Lee

(546)

Copyist.

S | **4 Cav. | U.S.C.T.**

Henry Smith

Priv, Co. 10, 4 Reg't U. S. Col'd Cavalry.

Appears on **Co. Muster-out Roll**, dated  
New Orleans, La., Feb 20, 1866.

Muster-out to date Feb 20, 1866.

Last paid to June 30, 1865.

Clothing account:

Last settled....., 186 ; drawn since \$.....100

Due soldier \$.....100; due U. S. \$ 24<sup>81</sup>/100

Am't for cloth'g in kind or money adv'd \$.....100

Due U. S. for arms, equipments, &c., \$.....100

Bounty paid \$.....100; due \$.....100

Remarks: Joined as recruit,

Book mark: V169, P2 31, 13.

W. S. Andrews

(361)

Copyist.

992

Smith Isaac

Co. 6, 4 U. S. Col'd Cav.

Private Private

CARD NUMBERS.

1	5347522	26
2	5352003	27
3	5352100	28
4	5352200	29
5	5352293	30
6	5352381	31
7	5352470	32
8	40729218	33
9		34
10		35
11		36
12		37
13		38
14		39
15		40
16		41
17		42
18		43
19		44
20		45
21		46
22		47
23		48
24		49
25		50

Book Mark:

See also:

Q 634715 Q. D. aff  
S. 689893. 20. Am. (P. 8)  
5 10 1-8 9-13 20 22 23 24 25 26 27 28 29 30 31 32 33 34 35 36 37 38 39 40 41 42 43 44 45 46 47 48 49 50 51 52 53 54 55 56 57 58 59 60 61 62 63 64 65 66 67 68 69 70 71 72 73 74 75 76 77 78 79 80 81 82 83 84 85 86 87 88 89 90 91 92 93 94 95 96 97 98 99 100

*A. Kraus*  
*W*

*S* | **4 Cav. U.S.C.T.**

*Isaac Smith*

Appears with rank of *Private* on

**Muster and Descriptive Roll of a Detachment of U. S. Vols. forwarded**

for the 4 Reg't U. S. Col'd Cavalry. Roll dated

*New Orleans, La, Apr. 25, 1865.*

Where born *Port Hudson, La*

Age *23* y'rs; occupation *Laborer*

When enlisted *Apr. 9*, 1865.

Where enlisted *New Orleans, La*

For what period enlisted *3* years.

Eyes *Dark*; hair *Black*

Complexion *Black*; height *5* ft. *5* in.

When mustered in *Apr. 25*, 1865.

Where mustered in *New Orleans*

Bounty paid \$ *100* <sup>100</sup>; due \$ *200* <sup>100</sup>

Where credited *McIntosh's 2nd Regt Cavalry*

Company to which assigned *C.*

Remarks :

-----

-----

Book mark :

-----

*O. J. Taylor*

S | 4 Cav. | U.S.C.T.

Isaac Smith

Priv, Co. C, 4 Reg't U. S. Colored Cavalry.

Appears on

**Company Muster Roll**

for May & June, 1865.

Present or absent present

Stoppage, \$ 100 for

Due Gov't, \$ 100 for

Valuation of horse, \$ 100

Valuation of horse equipments, \$ 100

Remarks: Recruit from depot,  
joined May 15, 65,  
stop for one haversack  
and canteen.

Book mark: \_\_\_\_\_

(358)

Moy  
Copyist.

S | 4 Cav. | U.S.C.T.

Isaac Smith

Priv., Co. C, 4 Reg't U. S. Colored Cavalry.

Appears on

**Company Muster Roll**

for July & Aug, 1865.

Present or absent present

Stoppage, \$ 100 for

Due Gov't, \$ 100 for

Valuation of horse, \$ 100

Valuation of horse equipments, \$ 100

Remarks: Recruit from depot,  
joined May 13/65. Stop  
for canteen and havers-  
sack. Total \$ 1.60.

Book mark:

(358)

May

Copyist.

S | 4 Cav. | U.S.C.T.

Isaac Smith

Priv., Co. C, 4 Reg't U. S. Colored Cavalry.

Appears on

**Company Muster Roll**

for Sept & Oct, 1865.

Present or absent present

Stoppage, \$ 100 for \_\_\_\_\_

Due Gov't, \$ 100 for \_\_\_\_\_

Valuation of horse, \$ 100

Valuation of horse equipments, \$ 100

Remarks : \_\_\_\_\_  
\_\_\_\_\_  
\_\_\_\_\_  
\_\_\_\_\_  
\_\_\_\_\_  
\_\_\_\_\_  
\_\_\_\_\_  
\_\_\_\_\_

Book mark : \_\_\_\_\_

May

(358)

Copyist.



S | **4 Cav.** | **U.S.C.T.**

*Isaac Smith*

*Private*, Co. C, 4 Reg't U. S. Colored Cavalry.

Appears on

**Company Muster Roll**

for *Nov & Dec*, 1865.

Present or absent *present*

Stoppage, \$ 100 for

Due Gov't, \$ 100 for

Valuation of horse, \$ 100

Valuation of horse equipments, \$ 100

Remarks:

Book mark:

*M. A. Michaels*

(358)

Copyist.

S | **4 Cav.** | **U.S.C.T.**

Isaac Smith

Private, Co. C, 4 Reg't U. S. Colored Cavalry.

Appears on

**Company Muster Roll**

for Jan'y & Febr, 1866.

Present or absent present

Stoppage, \$ 100 for

Due Gov't, \$ 100 for

Valuation of horse, \$ 100

Valuation of horse equipments, \$ 100

Remarks:  
.....  
.....  
.....  
.....  
.....  
.....  
.....  
.....  
.....

Book mark: .....

(358) M. A. Michaels  
Copyist.

A | 4 Cav. | U.S.C.T.

Isaac Smith

Port. Co. B, 4 Reg't U. S. Colored Cav.

Appears on Returns as follows:

May 1865 - Fair: May  
14 65 - New Orleans Recruit  
from Depot.

Book mark:

W. R. Lee

(546)

Copyist.



Smith, Isaac

Co. 4 Reg't U.S.C.C.

Enclosures.

Bed Cards	Final Statements
Burial Records	Furloughs or L. of A.
Certs. of Dis. for Discharge	Med. Certificates
C. M. Charges	Med. Des. Lists
Descriptive Lists	Orders
Discharge Certificates	Pris. of War Record
Enlistment Papers	Resignations

Other papers relating to—

Admission to Hosp'l	Furlough or L. of A.
Casualty Sheet	Med. Examination
Confinement	Misc. Information
Contracts	Pay of Clothing
Death or Effects	Personal Reports
Desertion	Rank
Discharge from Hosp'l	Transfer to Hosp'l
Discharge from Service	Transfer to V. R. C.
Duty	Transportation

NOTE 1.—This blank will be used for both enlistments and re-enlistments—enlistment of veterans, &c., &c., in the volunteer service. They will be made out in duplicate in all cases—one to accompany the recruiting return of the superintendent (not the recruiting officer) to the Adjutant General, and one to accompany the accounts of the officer who pays bounty, &c. The Regiment and Company in which the soldier last served should be given on the back.

NOTE 2.—An enlistment holds to service. A muster-in must, in all cases, precede payment of pay, bounty, pension, &c. A muster-in roll must, in all cases, be filed in the Adjutant General's Office as evidence of muster-in. The mustering officer, commissary, or assistant commissary of musters, as the case may be, will countersign both enlistments as having mustered the soldier into the service of the United States before either of them is given to the disbursing officer.

DECLARATION OF RECRUIT.

I, *Isaac Smith*, desiring to VOLUNTEER as a Soldier in the Army of the United States, for the term of THREE YEARS. Do Declare, That I am *23* years and \_\_\_\_\_ months of age; that I have never been discharged from the United States service on account of disability or by sentence of a court martial, or by order before the expiration of a term of enlistment; and I know of no impediment to my serving honestly and faithfully as a soldier for three years.

GIVEN at *New Orleans La* the *9* day of *April* 1865

Witness: *Isaac Smith*  
*1st Lieut. 10th U.S. Army*

Received from Second Auditor  
October 7th, 1892.

No. \_\_\_\_\_  
*Isaac Smith*  
Volunteered at *New Orleans La*  
*April 9*, 1865  
By *Isaac Smith*  
*1st Lieut. 10th U.S. Army*

CONSENT IN CASE OF MINOR.

I, \_\_\_\_\_, Do CERTIFY, That I am the \_\_\_\_\_ of \_\_\_\_\_; that the said \_\_\_\_\_ is \_\_\_\_\_ years of age; and I do hereby freely give my CONSENT to his volunteering as a SOLDIER in the ARMY OF THE UNITED STATES for the period of THREE YEARS.

GIVEN at \_\_\_\_\_ the \_\_\_\_\_ day of \_\_\_\_\_

Witness: \_\_\_\_\_

VOLUNTEER ENLISTMENT.

STATE OF

TOWN OF

Louisiana

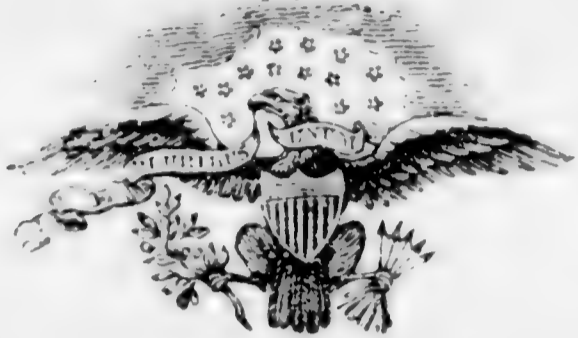

New Orleans

I, Isaac Smith, born in Port Hudson in the State of Louisiana, aged twenty three years, and by occupation a Laborer. Do HEREBY ACKNOWLEDGE to have volunteered this Ninth day of April, 1865, to serve as a Soldier in the Army of the United States of America, for the period of THREE YEARS, unless sooner discharged by proper authority: Do also agree to accept such bounty, pay, rations, and clothing, as are, or may be, established by law for volunteers. And I, do solemnly swear, that I will bear true faith and allegiance to the United States of America, and that I will serve them honestly and faithfully against all their enemies or opposers whomsoever; and that I will observe and obey the orders of the President of the United States, and the orders of the officers appointed over me, according to the Rules and Articles of War.

Sworn and subscribed to, at New Orleans, La. this 9th day of April, 1865, BEFORE me, Geo. Bird, 1st Lieut 10th U.S.C.A.

Isaac Smith

I CERTIFY, ON HONOR, That I have carefully examined the above-named Volunteer, agreeably to the General Regulations of the Army, and that, in my opinion, he is free from all bodily defects and mental infirmity, which would in any way disqualify him from performing the duties of a soldier.

Examining Surgeon

I CERTIFY, ON HONOR, That I have minutely inspected the Volunteer Isaac Smith previously to his enlistment, and that he was entirely sober when enlisted; that, to the best of my judgment and belief, he is of lawful age; and that, in accepting him as duly qualified to perform the duties of an able-bodied soldier, I have strictly observed the Regulations which govern the recruiting service. This soldier has Dark eyes, Black hair, Black complexion, is five feet five inches high.

Recruiting Officer

(A. G. O. No. 74 & 76.)

Mustered into the service of the United States, for three years or during the war, from date of enlistment, in Company 1st B. Regiment of U.S.C.A. Volunteers, on the 23 day of April, 1865, at New Orleans, La.

Arthur Starnes

Smith Isaac <sup>993</sup>

Co F, 4 U. S. Col'd Cav.

Corporal Sergeant

CARD NUMBERS.

1	5354917	26
2	5355007	27
3	5355098	28
4	5355192	29
5	5355284	30
6	5355369	31
7	5355449	32
8	5355526	33
9	5355605	34
10	5355692	35
11	5355773	36
12	5355854	37
13	5355934	38
14	5356013	39
15	5356090	40
16	40729241	41
17		42
18		43
19		44
20		45
21		46
22		47
23		48
24		49
25		50

Book Mark:

See also:



8 195 27 24 P.C. 64

*Handwritten signature*

*S* | 4 Cav. | U.S.C.T.

*Isaac Smith*  
Coop, Co. A, Mounted Rangers, Corps d'Afrique.†

Age ..... years.

Appears on

**Company Muster Roll\***

for *Nov & Dec*, 1863.

Joined for duty and enrolled:

When *Nov. 1*, 1863.

Where *Aberia, La*

Period ..... years.

Mustered in:

When *Nov. 30*, 1863.

Where *Aberia, La*

Present or absent *Present*

Stoppage, \$ ..... 100 for .....

Due Gov't \$ ..... 100 for .....

Valuation of horse, \$ ..... 100

Valuation of horse equipments, \$ ..... 100

Remarks: .....

† This organization subsequently became Co. F, 4 U. S. Col'd Cav.  
\* First current roll. No muster-in roll of this ~~battery~~ on file.

Book mark: .....

*W. H. Manning*  
(3586) Copyist.

*S* | 4 Cav. U.S C.T.

*Isaac Smith*  
Corp, Co. *F*, 1 Reg't Cav., Corps d'Afrique.\*

Appears on

**Company Muster Roll**

for *Jan'y P. Feb'y*, 1864

Present or absent *Present*

Stoppage, \$ *100* for

Due Gov't, \$ *100* for

Valuation of horse, \$ *100*

Valuation of horse equipments, \$ *100*

Remarks:

\* This organization subsequently became Co. *F*, 4 Reg't U. S. Colored Cavalry.

Book mark:

(358)

*Manning*  
Copyist.

*S* | 4 Cav. | U.S.C.T.

*Isaac Smith*  
*Capt.*, Co. F, 4 Reg't U. S. Col'd Cavalry.

Appears on

**Company Muster Roll**

for *March & April*, 1864.

Present or absent *Absent*

Stoppage, \$ *100* for

Due Gov't, \$ *100* for

Valuation of horse, \$ *100*

Valuation of horse equipments, \$ *100*

Remarks: *On Recruiting  
Service since Nov  
9, 1864*

Book mark: \_\_\_\_\_

(358)

*Manning*  
Copyist.

*A* | 4 Cav. | U.S.C.T.

*Leaac Smith*  
*Corp.*, Co. F, 4 Reg't U. S. Col'd Cavalry.

Appears on

**Company Muster Roll**

for *May & June*, 1864.

Present or absent *Present*

Stoppage, \$ *100* for

Due Gov't, \$ *100* for

Valuation of horse, \$ *100*

Valuation of horse equipments, \$ *100*

Remarks: *Returned to  
Company from  
Recruiting service  
June 3, 1864*

Book mark: \_\_\_\_\_

*Manning*  
Copyist.

*S* | **4 Cav.** | **U.S.C.T.**

*Edward Smith*

*Corp*, Co. F, 4 Reg't U.S. Col'd Cavalry.

Appears on

**Company Muster Roll**

for *July & Aug*, 186*4*.

Present or absent *Present*

Stoppage, \$ *100* for

Due Gov't, \$ *100* for

Valuation of horse, \$ *100*

Valuation of horse equipments, \$ *100*

Remarks:

Book mark:

*Manning*  
Copyist.

*S* | **4 Cav.** | **U.S.C.T.**

*Isaac Smith*

*Capt*, Co. F, 4 Reg't U.S. Col'd Cavalry.

Appears on

**Company Muster Roll**

for *Sept & Oct*, 186*4*.

Present or absent *Present*

Stoppage, \$ *100* for

Due Gov't, \$ *100* for

Valuation of horse, \$ *100*

Valuation of horse equipments, \$ *100*

Remarks:

Book mark:

(358)

*W. M. M. M. M.*  
Copyist.

*S* | **4 Cav. | U.S.C.T.**

*Isaac Smith*

*Corpl*, Co. F, 4 Reg't U. S. Col'd Cavalry.

Appears on

**Company Muster Roll**

for *Nov & Dec*, 186 *4*

Present or absent *Present*

Stoppage, \$..... *100* for .....

Due Gov't, \$..... *100* for .....

Valuation of horse, \$..... *100*

Valuation of horse equipments, \$..... *100*

Remarks: .....

.....  
.....  
.....  
.....  
.....  
.....  
.....  
.....  
.....  
.....

Book mark: .....

*W. Harris*



*S* | 4 Cav. | U.S.C.T.

*Isaac Smith*

*Corpl*, Co. F, 4 Reg't U. S. Col'd Cavalry.

Appears on

**Company Muster Roll**

for *Jan & Feby*, 186 *5*

Present or absent *Present*

Stoppage, \$ *100* for

Due Gov't, \$ *100* for

Valuation of horse, \$ *100*

Valuation of horse equipments, \$ *100*

Remarks: *App'd Corpl. Nov 30/863*

Book mark: \_\_\_\_\_

*J. A. Harris*

*S* | **4 Cav. U.S.C.T.**

*Isaac Smith*

*56.S.*, Co. F, 4 Reg't U. S. Col'd Cavalry.

Appears on

**Company Muster Roll**

for *Mc'h & Apr*, 186 *5*.

Present or absent *Present*

Stoppage, \$ *100* for

Due Gov't, \$ *100* for

Valuation of horse, \$ *100*

Valuation of horse equipments, \$ *100*

Remarks:

Book mark:

*A Harris*

*S* | **4 Cav.** | **U.S.C.T.**

*Isaac Smith*

*5* Sergt., Co. F, 4 Reg't U. S. Col'd Cavalry.

Appears on

**Company Muster Roll**

for *May & June*, 186 *5*

Present or absent *Present*

Stoppage, \$.....100 for .....

Due Gov't, \$.....100 for .....

Valuation of horse, \$.....100

Valuation of horse equipments, \$.....100

Remarks: .....

Book mark: .....

*A. W. Harris*

S | **4 Cav.** | **U.S.C.T.**

*Isaac Smith*

*C. Sergh*, Co. F, 4 Reg't U. S. Col'd Cavalry.

Appears on

**Company Muster Roll**

for *July & Aug.*, 186 *5*.

Present or absent *Present*

Stoppage, \$ 100 for

Due Gov't, \$ 100 for

Valuation of horse, \$ 100

Valuation of horse equipments, \$ 100

Remarks:

Book mark:

*M. Davis*

*S* | **4 Cav.** | **U.S.C.T.**

*Isaac Smith*

*4<sup>th</sup> S.*, Co. F, 4 Reg't U. S. Col'd Cavalry.

Appears on

**Company Muster Roll**

for *Sept & Oct*, 186 *5*

Present or absent *Present*

Stoppage, \$ *100* for

Due Gov't, \$ *100* for

Valuation of horse, \$ *100*

Valuation of horse equipments, \$ *100*

Remarks: *Stop for one Pr. Spur & Strap.*

Book mark: \_\_\_\_\_

*W. Harris*

(358)

Copyist.

S | 4 Cav. | U.S.C.T.

Isaac Smith

Sgt., Co. F, 4 Reg't U. S. Col'd Cavalry.

Appears on

**Company Muster Roll**

for Nov. Dec., 1865.

Present or absent Present

Stoppage, \$ —  $\frac{.55}{100}$  for ordnance lost.

Due Gov't, \$  $\frac{100}{100}$  for

Valuation of horse, \$  $\frac{100}{100}$

Valuation of horse equipments, \$  $\frac{100}{100}$

Remarks: Promoted to Sgt. from  
Corpl. Feb. 1, 65. Recd. only  
Corpl's. pay to June 30, 65.

Book mark:

(358)

Hibbard  
Copyist.

S | 4 Cav. | U.S.C.T.

Isaac Smith

Serg't., Co. F, 4 Reg't U. S. Col'd Cavalry.

Appears on

Company Muster Roll

for Jan. Feb., 1866.

Present or absent Present

Stoppage, \$ - 55 for ordn. lost.

Due Gov't, \$ 100 for

Valuation of horse, \$ 100

Valuation of horse equipments, \$ 100

Remarks: Promoted to Sgt. from  
Corpl. Mch. 1, 65.

Book mark:

Hibbard

(358)

Copyist.

D | **4 Cav. | U.S.C.T.**

Isaac Smith

Part Corp<sup>l</sup>, Co. <sup>11</sup>F, 4 Reg't U. S. Colored Cav.

Appears on Returns as follows:

Apr 1864 - Absent detached Recruitg  
Mar 9/64

May 1864 (Corp<sup>l</sup>) Absent Mar 9/64  
In Recruitg. Service

Book mark :

W. R. Lee



S | 4 Cav. | U.S.C.T.

Isaac Smith

Sgt., Co. F, 4 Reg't U. S. Col'd Cavalry.

Appears on Co. Muster-out Roll, dated  
New Orleans La. Mch. 20 1866.

Muster-out to date Mch. 20, 1866.

Last paid to June 30 1865.

Clothing account:

Last settled....., 186 ; drawn since \$..... 100

Due soldier \$..... 100; due U. S. \$ 23. <sup>95</sup>/<sub>100</sub>

Am't for cloth'g in kind or money adv'd \$..... 100

Due U. S. for arms, equipments, &c., \$..... <sup>55</sup>/<sub>100</sub>

Bounty paid \$..... 100; due \$..... 100

Remarks: joined at-orig. org.  
Corpl. to Mch. 1, 65. Stop 1 pr.  
spurs & straps.

Book mark: V 138 - P 110 - 72

Hibbard

(361)

Copyist.

Smith Jackson

Co L & G, 4 U. S. Col'd Cav.

Private B. H. Smith

CARD NUMBERS.

1	5347627	26
2	5347867	27
3	5347966	28
4	5358656	29
5	5358701	30
6	5358734	31
7	5358774	32
8	5356711	33
9	5356796	34
10	5356836	35
11	5356994	36
12	5357009	37
12	5357093	38
14	40729219	39
15		40
16		41
17		42
18		43
19		44
20		45
21		46
22		47
23		48
24		49
25		50

Book Mark:

See also

*S* | **4 Cav. | U.S.C.T.**

*Jack Smith*  
Appears with rank of *Priv.* on

**Muster and Descriptive Roll of a Detachment of U. S. Vols. forwarded**

for the 4 Reg't U. S. Col'd Cavalry. Roll dated *New Orleans La., June 1, 1864.*

Where born *Oglethorpe Co., Ga.*

Age *37* y'rs; occupation *Laborer*

When enlisted *May 31, 1864.*

Where enlisted *New Orleans*

For what period enlisted *3* years.

Eyes *Black*; hair *Black*

Complexion *Black*; height *5-6* in.

When mustered in *June 1, 1864.*

Where mustered in *New Orleans*

~~Premium paid~~ *2*  
~~Bounty paid \$~~ *100*; due \$ *100*

Where credited

Company to which assigned *L*

Remarks:

Book mark:

*Feaster*

28 | **4 Cav. | U.S.C.T.**

Quaker Smith

Appears with rank of Capt. on

**Muster and Descriptive Roll of a Detachment of U. S. Vols. forwarded**

for the 4 Reg't U. S. Col'd Cavalry. Roll dated Fort Henderson, April 29, 1864.

Where born Waltham, Georgia

Age 7 y'rs; occupation Farmer

When enlisted May 31, 1864.

Where enlisted New Orleans

For what period enlisted 3 years.

Eyes Black; hair Black

Complexion Black; height 5 ft. 6 in.

When mustered in June 1, 1864.

Where mustered in New Orleans

Bounty paid \$ 100; due \$ 100

Where credited

Company to which assigned

Remarks: Transferred from 1st  
Company in consolidation

Book mark:

J. H. Tyler

*S* 4 car. **U.S.C.T.**

*Jackson Smith*  
Co. 4, 4 Reg't U. S. Col'd Car.

Appears on

**M. and D. Roll of Men Transferred**

to the organization named above, *by consol.*  
from *Co. L*

Roll dated *Port Hudson, La. Apr 29, 1865.*

When enlisted *May 31*, 1864.

Period for which enlisted *3* years.

When mustered in *June 1*, 1864.

Present or absent *not stated.*

Company to which assigned *I 1*

Remarks: \_\_\_\_\_

Book mark : \_\_\_\_\_

(342)

*J. H. Leonard*

Copyist.

4 Cav. U.S.C.T.

Jackson Smith  
Pvt., Co. L, 4 Reg't U. S. Col'd Cavalry.

Age.....years.

Appears on

Company Muster Roll\*

for Enlistment to Aug. 31, 1864.

Joined for duty and enrolled:

When Mar 31, 1864.

Where New Orleans La.

Period 3 years.

Mustered in:

When June 1, 1864.

Where New Orleans La.

Present or absent Present

Stoppage, \$ 100 for

Due Gov't, \$ 100 for

Valuation of horse, \$ 100

Valuation of horse equipments, \$ 100

Remarks :

\* First current roll. No muster-in roll of this battery on file.

Book mark :

Jerring

1862

4 Cav. U.S.C.T.

Jackson Smith

Pvt., Co. L, 4 Reg't U. S. Col'd Cavalry.

Appears on

**Company Muster Roll**

for Sept. & Oct., 1862.

Present or absent Present

Stoppage, \$ 100 for

Due Gov't, \$ 100 for

Valuation of horse, \$ 100

Valuation of horse equipments, \$ 100

Remarks:

Book mark:

(358)

Curry

Copyist.

4 Cav. | U.S.C.T.

*Jack Smith*

*Black Smith* Co. L, 4 Reg't U. S. Col'd Cavalry.

Appears on

Company Muster Roll

for *Nov. & Dec.*, 1864.

Present or absent *Present*

Stoppage, \$ 100 for

Due Gov't, \$ 100 for

Valuation of horse, \$ 100

Valuation of horse equipments, \$ 100

Remarks:

Book mark:

(358)

*J. Smith*

Copyist.



WAR 623

4 Cav. | U.S.C.T.

*Jackson Smith*

*Black Smith*, Co. L, 4 Reg't U.S. Col'd Cavalry.

Appears on

**Company Muster Roll**

for *Jan & Feb*, 1865.

Present or absent *Present*

Stoppage, \$ *100* for

Due Gov't, \$ *100* for

Valuation of horse, \$ *100*

Valuation of horse equipments, \$ *100*

Remarks:

Book mark:

*Levin*

(358)

Copyist.

*S* | **4 Cav. | U. S. C. T.**

*James W. Smith*  
*Pr*, Co. G, 4 Reg't U. S. Col'd Cavalry.

Appears on

**Company Muster Roll**

for *Men & Op*, 1865.

Present or absent *Present*

Stoppage, \$ 100 for

Due Gov't, \$ 100 for

Valuation of horse, \$ 100

Valuation of horse equipments, \$ 100

Remarks: *formed by transfer*

*in consolidation*

*from Co L Mar 24<sup>th</sup> 1865*

*So. M 28 dated & d 2<sup>nd</sup>*

*Sept July Jan 28, 65.*

Book mark: \_\_\_\_\_

(358)

*James W. Smith*  
Copyist.

*2*

**4 Cav. | U.S.C.T.**

*Jackson Smith*

*On*, Co. G, 4 Reg't U. S. Col'd Cavalry.

Appears on

**Company Muster Roll**

for *May & June*, 186*5*.

Present or absent *Present*

Stoppage, \$ *100* for

Due Gov't, \$ *100* for

Valuation of horse, \$ *100*

Valuation of horse equipments, \$ *100*

Remarks: \_\_\_\_\_  
\_\_\_\_\_  
\_\_\_\_\_  
\_\_\_\_\_  
\_\_\_\_\_  
\_\_\_\_\_  
\_\_\_\_\_  
\_\_\_\_\_

Book mark: \_\_\_\_\_

*David*

*ES* | 4 Cav. | U.S.C.T.

*Jackson Smith*  
*Bvt. Smith* G, 4 Reg't U. S. Col'd Cavalry.

Appears on

**Company Muster Roll**

for *July & Aug*, 1865.

Present or absent *Present*

Stoppage, \$ *100* for

Due Gov't, \$ *100* for

Valuation of horse, \$ *100*

Valuation of horse equipments, \$ *100*

Remarks:  
.....  
.....  
.....  
.....  
.....  
.....  
.....  
.....  
.....  
.....

Book mark: .....

(358)

*[Signature]*  
Copyist.

*S* | 4 Cav. | U. S. C. T.

*Jackson Smith*  
*Blissville*, Co. G, 4 Reg't U. S. Col'd Cavalry.

Appears on

**Company Muster Roll**

for *Sept & Oct*, 186*5*

Present or absent *Present*

Stoppage, \$ *100* for

Due Gov't, \$ *100* for

Valuation of horse, \$ *100*

Valuation of horse equipments, \$ *100*

Remarks:

ROLL ON FILE FEB 1966

Book mark:

*Fletcher*

(358)

Copyist.



1777 023  
D | 4 Cav. | U.S.C.T.

Jackson Smith  
Pvt., Co. G, 4 Reg't U. S. Colored Cav.

Appears on Returns as follows:

July & Aug 1864 - On duty Co. Cook  
Sept & Oct 1864 - On duty Blacksmith  
for Regtl. G. M.

Nov 1864 - On duty in R. G. M. Dept.  
Dec 1864 to Feb 1865

Mar & Apr 1865 (Co G) (On duty detailed  
as Regtl. Blacksmith.

May & June 1865 - On duty detailed  
in R. G. M. Dept.

July 1865 - On duty R. Bk. Smith.

\* Name appears also as

John Smith  
Jack Smith

Book mark :

W. R. See

(546)

Copyist.

*S* | **4 Cav.** | **U.S.C.T.**

*Jackson Smith*  
*Blksmith, Co. G*, 4 Reg't U. S. Col'd Cavalry.

Appears on **Co. Muster-out Roll**, dated  
*New Orleans, La. Mch 20*, 1866.

Muster-out to date *Mch 20*, 1866.

Last paid to *June 30*, 1865.

Clothing account:

Last settled....., 186 ; drawn since \$..... 100

Due soldier \$..... 100; due U. S. \$ *38* <sup>*98*</sup>/<sub>100</sub>

Am't for cloth'g in kind or money adv'd \$..... 100

Due U. S. for arms, equipments, &c., \$..... 100

Bounty paid \$..... 100; due \$..... 100

Remarks: *Joined by transfer from*  
*Co L for S.C. 28 Hd. Qrs*  
*Dept Gulf Jan'y 28, 65*

Book mark: *P.M. 8. 7657 July 17/66*  
*(over)*

(361)

*Fletcher*

Copyist.



JAN. - 8

5357093

1891\*

*N. 40 P 128, 69*

945  
Smith James

Co D, 4 U. S. Col'd Cav.

Private | Private

CARD NUMBERS.

1	5347839	26
2	5353210	27
3	5353303	28
4	5353397	29
5	5353486	30
6	5353572	31
7	5353655	32
8	5353735	33
9	40729220	34
10		35
11		36
12		37
13		38
14		39
15		40
16		41
17		42
18		43
19		44
20		45
21		46
22		47
23		48
24		49
25		50

Book Mark:

See also

Rep 346913.

\$ 765270 P. O. m. m.

*W. H. ...*

*J* | **4 Cav. | U.S.C.T.**

*James Smith*

Appears with rank of *Priv.* on

**Muster and Descriptive Roll of a Detachment of U. S. Vols. forwarded**

for the 4 Reg't U. S. Col'd Cavalry. Roll dated

*New Orleans, La.,* *Feb. 8,* 186*2.*

Where born *Jackson, Miss.*

Age *21* y'rs; occupation *Seaman*

When enlisted *Feb. 20*, 186*2.*

Where enlisted *New Orleans*

For what period enlisted *3* years.

Eyes *Black*; hair *Black*

Complexion *Dark*; height *5* ft. *4* in.

When mustered in *Feb. 8*, 186*2.*

Where mustered in *New Orleans*

Bounty paid \$ *100* *100*; due \$ *200* *100*

Where credited *Par. East Detachment,*  
*Port Hudson, La.*

Company to which assigned *C.*

Remarks:

-----

Book mark:

-----

(339)

*G. C. Tyler*

Copyist.

*S* | **4 Cav. | U.S.C.T.**

*James Smith*

*v p*, Co. D, 4 Reg't U. S. Col'd Cavalry.

Appears on

**Company Muster Roll**

for *March & April*, 1865.

Present or absent *Present*

Stoppage, \$ 100 for

Due Gov't, \$ 100 for

Valuation of horse, \$ 100

Valuation of horse equipments, \$ 100

Remarks: *# 1st Bounty paid*  
*# 2nd due*

Book mark:

*L. H. Wright*

25 | 4 Cav. | U.S.C.T.

James Smith

Co. D, 4 Reg't U. S. Col'd Cavalry.

Appears on

Company Muster Roll

for ... 1865.

Present or absent ... Present

Stoppage, \$ 100 for

Due Gov't, \$ 100 for

Valuation of horse, \$ 100

Valuation of horse equipments, \$ 100

Remarks: ... paid ... done

Book mark:

W. H. ...

*S* | **4 Cav.** | **U.S.C.T.**

*James Smith*  
....., Co. D, 4 Reg't U. S. Col'd Cavalry.

Appears on

**Company Muster Roll**

for *July & Aug*, 186*3*.

Present or absent *Present*

Stoppage, \$ *100* for .....

Due Gov't, \$ *100* for .....

Valuation of horse, \$ *100*

Valuation of horse equipments, \$ *100*

Remarks: *#1 on 12/20/63 - Paid  
for horse  
present in 1863*

Book mark: .....

(358)

*A. J. Wright*  
Copyist.

1865

*C* | **4 Cav.** | **U.S.C.T.**

*James Smith*  
....., Co. D, 4 Reg't U. S. Col'd Cavalry.

Appears on

**Company Muster Roll**

for *Sept - Oct*, 1865.

Present or absent *absent*

Stoppage, \$ *100* for

Due Gov't, \$ *100* for

Valuation of horse, \$ *100*

Valuation of horse equipments, \$ *100*

Remarks: *absent - no repair made -  
no money paid #100 due*

Book mark: .....

*A. Wright*  
(358) Copyist.



4 Cav. U.S.C.T.

James Smith  
Sgt

Co. D, 4 Reg't U. S. Col'd Cavalry.

Appears on

Company Muster Roll

for Nov 1 Nov 1863.

Present or absent Present

Stoppage, \$ 100 for

Due Gov't, \$ 100 for

Valuation of horse, \$ 100

Valuation of horse equipments, \$ 100

Remarks: 13 months paid \$157.00  
13 months due \$217.00

Book mark:

W. A. [unclear]

**4 Cav. U.S.C.T.**

*James Smith*  
*Plt*, Co. D, 4 Reg't U. S. Col'd Cavalry.

Appears on

**Company Muster Roll**

for *Jan 7 20th*, 1861.

Present or absent *Present*

Stoppage, \$ 100 for

Due Gov't, \$ 100 for

Valuation of horse, \$ 100

Valuation of horse equipments, \$ 100

Remarks:

Book mark:

A

4 Cav. U.S.C.T.

James Smith  
Priv., Co. H, 4 Reg't U. S. Colored Cav.

Appears on Returns as follows:

Mich 1865 - Gain: Mar 26/65  
Port Hudson La. Recruit  
from depot.  
Apr 1865 - On duty Co. Cook.

Book mark:

W. R. Lee

8 | **4 Cav.** | **U.S.C.T.**

James Smith

Put, Co. D, 4 Reg't U. S. Col'd Cavalry.

Appears on **Co. Muster-out Roll**, dated  
New Orleans, La, Me 20, 1866.

Muster-out to date Nov 20, 1866.

Last paid to None paid, 1866.

**Clothing account:**

Last settled....., 1866 ; drawn since \$.....100

Due soldier \$ 15<sup>89</sup>/100; due U. S. \$.....100

Am't for cloth'g in kind or money adv'd \$.....100

Due U. S. for arms, equipments, &c., \$.....100

Bounty paid \$ 100/100; due \$ None 100

Remarks: Joined as recruit

Book mark : .....

W. S. Andrews

(361)

Copyist.

Smith, James

Co. 4 Reg't U. S. Cav.

Enclosures.

Bed Cards	Final Statements
Burial Records	Furloughs or L. of A.
Certs. of Dis. for Discharge	Med. Certificates
C. M. Charges	Med. Des. Lists
Descriptive Lists	Orders
Discharge Certificates	Pris. of War Record
Enlistment Papers	Resignations

Other papers relating to—

Admission to Hosp'l	Furlough or L. of A.
Casualty Sheet	Med. Examination
Confinement	Misc. Information
Contracts	Pay of Clothing
Death or Effects	Personal Reports
Desertion	Rank
Discharge from Hosp'l	Transfer to Hosp'l
Discharge from Service	Transfer to V. R. C.
Duty	Transportation

NOTE 1.—This blank will be used for both enlistments and re-enlistments—enlistment of veterans, &c., &c., in the volunteer service. They will be made out in duplicate in all cases—one to accompany the recruiting return of the superintendent (not the recruiting officer) to the Adjutant General, and one to accompany the accounts of the officer who pays bounty, &c. The Regiment and Company in which the soldier last served should be given on the back.

NOTE 2.—An enlistment holds to service. A muster-in must, in all cases, precede payment of pay, bounty, pension, &c. A muster-in roll must, in all cases, be filed in the Adjutant General's Office as evidence of muster-in. The mustering officer, commissary, or assistant commissary of musters, as the case may be, will countersign both enlistments as having mustered the soldier into the service of the United States before either of them is given to the disbursing officer.

Received from Second Auditor  
October 7th. 1892.

Discharged ..... 18  
Recruit returned to the Board  
of Review by Secretary No 27  
Office for Prov. Secul  
July 19th 1864

DECLARATION OF RECRUIT.

I, James Smith, desiring to VOLUNTEER as a Soldier in the Army of the United States, for the term of THREE YEARS. Do Declare, That I am 21 years and \_\_\_\_\_ months of age; that I have never been discharged from the United States service on account of disability or by sentence of a court martial, or by order before the expiration of a term of enlistment; and I know of no impediment to my serving honestly and faithfully as a soldier for three years.

GIVEN at New Orleans La the 20<sup>th</sup> day of February 1865

Witness: James C. Friedman James Smith  
1st Lieut. 10<sup>th</sup> U. S. Cav. Regt.

No. \_\_\_\_\_  
James Smith  
Volunteered at New Orleans La  
February 20<sup>th</sup> 1865  
By Capt R. M. Miller  
for the 4<sup>th</sup> Regiment of Vol. I. C. Cav

enlistment; last served in Company ( )

Reg't of \_\_\_\_\_

CONSENT IN CASE OF MINOR.

I, \_\_\_\_\_, Do CERTIFY, That I am \_\_\_\_\_; that the said \_\_\_\_\_ is \_\_\_\_\_ years of age; and I do hereby freely give my CONSENT to his volunteering as a SOLDIER in the ARMY OF THE UNITED STATES for the period of THREE YEARS.

GIVEN at \_\_\_\_\_ the \_\_\_\_\_ day of \_\_\_\_\_

Witness:

VOLUNTEER ENLISTMENT.

STATE OF

TOWN OF

Louisiana

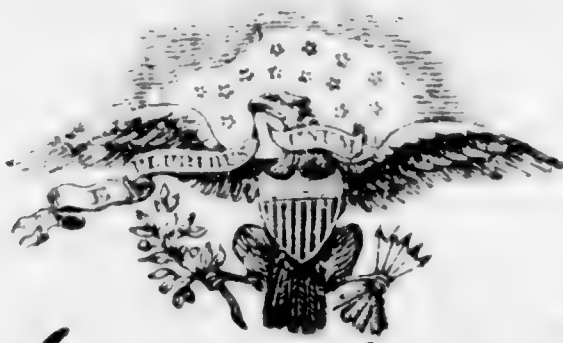

New Orleans

I, James Smith, born in Jackson in the State of Mississippi, aged 21 years, and by occupation a Laborer. Do HEREBY ACKNOWLEDGE to have volunteered this nineteenth day of February, 1865, to serve as a Soldier in the Army of the United States of America, for the period of THREE YEARS, unless sooner discharged by proper authority: Do also agree to accept such bounty, pay, rations, and clothing, as are, or may be, established by law for volunteers. And I, James Smith, do solemnly swear, that I will bear true faith and allegiance to the United States of America, and that I will serve them honestly and faithfully against all their enemies or opposers whomsoever; and that I will observe and obey the orders of the President of the United States, and the orders of the officers appointed over me, according to the Rules and Articles of War.

Sworn and subscribed to, at New Orleans, Louisiana, his James Smith mark  
this 20th day of February 1865  
BEFORE John Geo. Friedman  
1st Lieut. 10th Regt. U.S. Cavalry

I CERTIFY, ON HONOR, That I have carefully examined the above-named Volunteer, agreeably to the General Regulations of the Army, and that, in my opinion, he is free from all bodily defects and mental infirmity, which would in any way disqualify him from performing the duties of a soldier.

Abner W. Wood  
EXAMINING SURGEON.

I CERTIFY, ON HONOR, That I have minutely inspected the Volunteer James Smith previously to his enlistment, and that he was entirely sober when enlisted; that, to the best of my judgment and belief, he is of lawful age; and that, in accepting him as duly qualified to perform the duties of an able-bodied soldier, I have strictly observed the Regulations which govern the recruiting service. This soldier has Black eyes, Black hair, Dark complexion, is five feet four inches high.

Wm. Allison - Capt.  
10th Regt of U.S. Cavalry/Volunteers,  
RECRUITING OFFICER.

(A. G. O. No. 71 & 76.)

Mustered into the service of the United States, for three years or during the war, from date of enlistment, in Company "D" 1st Regiment of New Orleans Volunteers, on the 20th day of February, 1865, at New Orleans, La.

James Smith  
20th Feb 1865  
ASPTM  
Wm. Allison  
10th Regt U.S. Cavalry

Smith John

Co B, 4 U. S. Col'd Cav.

Private | Corporal

CARD NUMBERS.

1	5347433	26
2	5351412	27
3	5351472	28
4	5351556	29
5	5351598	30
6	5351676	31
7	5351741	32
8	5351768	33
9	5351841	34
10	5351930	35
11	5352127	36
12	5348223	37
12	5352516	38
14	40729222	39
15		40
16		41
17		42
18		43
19		44
20		45
21		46
22		47
23		48
24		49
25		50

Book Mark:

See also



S-831968-P.G.M. & M. Rev.

D 938034 - 2nd

S. 1872454 2nd. (P. 15)

D 1063327 - Pomme

D 1084461 - Pomme

*Miller*

*S* | **4 Cav. | U.S.C.T.**

*John Smith*

Appears with rank of *Seriate* on

**Muster and Descriptive Roll of a Detachment of U. S. Vols. forwarded**

for the 4 Reg't U. S. Col'd Cavalry. Roll dated

*New Orleans La April 29, 1864.*

Where born *Knoxville, Tenn*

Age *21* y'rs; occupation *Laborer*

When enlisted *Jan 10, 1864*

Where enlisted *New Orleans*

For what period enlisted *3* years.

Eyes *Black*; hair *Black*

Complexion *Dark*; height *5 ft. 10 in.*

When mustered in *April 29, 1864.*

Where mustered in

Bounty paid \$ *100*; due \$ *100*

Where credited

Company to which assigned

Remarks:

Book mark:

*O. F. Taylor*

*S* | **4 Cav. | U.S.C.T.**

*John Smith*  
Co. *C*, 1 Reg't La. Cav., Corps d'Afrique.\*

Appears on

**Company Muster Roll**

for *Jan + Feb*, 186*4*.

Present or absent *Present*

Stoppage, \$ *100* for

Due Gov't, \$ *100* for

Valuation of horse, \$ *100*

Valuation of horse equipments, \$ *100*

Remarks: *Not mustered on account  
of being transferred to  
Recruiting Depot + afterwards  
returned to Company*

\*This organization subsequently became Co *C*, 4 Reg't U. S. Colored Cavalry.

Book mark: \_\_\_\_\_

*Becker*

*S* | **4 Cav. | U.S.C.T.**

*John Smith*  
*Capt.*, Co. C, 4 Reg't U. S. Colored Cavalry.

Appears on

**Company Muster Roll**

for *March 1864*, 186*4*.

Present or absent *Present*

Stoppage, \$ *100* for

Due Gov't, \$ *100* for

Valuation of horse, \$ *100*

Valuation of horse equipments, \$ *100*

Remarks: *Promoted to Corp.*  
*March 13, 64 vice*  
*Corran promoted*

Book mark:

*Rochester*

*S* | **4 Cav.** | **U.S.C.T.**

*John Smith*  
*Cap*, Co. C, 4 Reg't U. S. Colored Cavalry.

Appears on

**Company Muster Roll**

for *May + June*, 1864.

Present or absent

Stoppage, \$ 100 for

Due Gov't, \$ 100 for

Valuation of horse, \$ 100

Valuation of horse equipments, \$ 100

Remarks :

*absent June 25, 1864*

Book mark :

(358)

*Rochester*

Copyist.

S | **4 Cav.** | **U.S.C.T.**

John Smith  
Cpt., Co. C, 4 Reg't U. S. Colored Cavalry.

Appears on

**Company Muster Roll**

for July & Aug, 1864.

Present or absent Present

Stoppage, \$ 100 for

Due Gov't, \$ 100 for

Valuation of horse, \$ 100

Valuation of horse equipments, \$ 100

Remarks: corporal, deserted  
June 25, 1864,  
Returned, reduced  
to the rank of Aug  
24, 1864 Lost a  
pair scales

Book mark: .....

W. Hester  
(358) Copyist.

*S* | **4 Cav. | U.S.C.T.**

*John Smith*  
Co. C, 4 Reg't U. S. Colored Cavalry.

Appears on

**Company Muster Roll**

for *Sept & Oct*, 186*4*.

Present or absent *Present*

Stoppage, \$ 100 for

Due Gov't, \$ 100 for

Valuation of horse, \$ 100

Valuation of horse equipments, \$ 100

Remarks: *Lost - caning injuries*  
*\$1.88*

Book mark :

*S* | 4 Cav. | U.S.C.T.

*John Smith*  
*Priv*, Co. C, 4 Reg't U. S. Colored Cavalry.

Appears on

**Company Muster Roll**

for *Nov 9 1864*, 186 *U*

Present or absent *present*

Stoppage, \$ *2*<sup>*13*</sup>/<sub>*100*</sub> for *ordnance*

Due Gov't, \$ *100* for

Valuation of horse, \$ *100*

Valuation of horse equipments, \$ *100*

Remarks: *Lost ordnance*

Book mark: \_\_\_\_\_

(358)

*Moy*  
Copyist.



S | **4 Cav. U.S.C.T.**

*John Smith*  
Corpl, Co. C, 4 Reg't U. S. Colored Cavalry.

Appears on

**Company Muster Roll**

for *Jan & Feb*, 1865.

Present or absent *present*

Stoppage, \$ 100 for

Due Gov't, \$ 100 for

Valuation of horse, \$ 100

Valuation of horse equipments, \$ 100

Remarks: *Promoted to Corporal  
Jan 1, 65. Received \$7.00  
per month to include  
April 30, 1864. Stop for  
one halter and strap, and  
one plate screw. Absent with-  
out leave and returned to  
duty per SO No 46 Hd Qrs Port  
Hendson Feb 20, 65*

Book mark: \_\_\_\_\_

*Moy*

*S* | **4 Cav.** | **U.S.C.T.**

*John Smith*  
*Capt.*, Co. C, 4 Reg't U. S. Colored Cavalry.

Appears on

**Company Muster Roll**

for *March & Apr*, 186*5*.

Present or absent *present*

Stoppage, \$ *100* for

Due Gov't, \$ *100* for

Valuation of horse, \$ *100*

Valuation of horse equipments, \$ *100*

Remarks:

Book mark:

(358)

*May*

Copyist.

S | **4 Cav.** | **U.S.C.T.**

John Smith  
Corpl, Co. C, 4 Reg't U. S. Colored Cavalry.

Appears on

**Company Muster Roll**

for May & June, 1865.

Present or absent present

Stoppage, \$ 100 for

Due Gov't, \$ 100 for

Valuation of horse, \$ 100

Valuation of horse equipments, \$ 100

Remarks: Absent without  
leave and returned to duty  
per Special Order No 46  
dated Head Quarters US Forces  
Port Henderson La Feb 20, 1865,  
Promoted to Corporal  
Jan 1, 1865, Stop for  
one hoursack

Book mark: \_\_\_\_\_

(358)

May

Copyist.

S. | 4<sup>th</sup> Cav. | U.S.C.T.

John Smith,  
Capt, Co. C, 4<sup>th</sup> Reg't U. S. Col'd Cav.

Appears on

**Descriptive List of Deserters**

dated Pt. Hudson Sea, July 31, 1865.

Deserted:

When July 6, 1865.

Where Port Hudson La.

Arrested:

When \_\_\_\_\_, 186 .

Where \_\_\_\_\_

Remarks: \_\_\_\_\_

Book mark: \_\_\_\_\_

*[Signature]*

*S* | **4 Cav.** | **U.S.C.T.**

*John Smith*  
Priv, Co. C, 4 Reg't U. S. Colored Cavalry.

Appears on

**Company Muster Roll**

for *July & Aug*, 1865.

Present or absent

Stoppage, \$ 100 for

Due Gov't, \$ 100 for

Valuation of horse, \$ 100

Valuation of horse equipments, \$ 100

Remarks: *Deserted from Port  
Henderson La. July 6/65,  
Stop 2 Haversacks, 1 Canteen,  
1 pr metallic seals,  
Total \$ 3.25,*

Book mark:

(358)

*May*  
Copyist.

N | 4 Cav. | U.S.C.T.

John Smith  
book  
Part, Co. B, 4 Reg't U. S. Colored Cav.

Appears on Returns as follows:

June 1864 - Absent without leave

July 1864 - 2020: July 1 Camp  
Paragnet, dropped from Co  
Rolls, deserted

Aug 1864 - Gain: Aug 24  
Port Hudson Ret'd from  
desertion

July 1865 (Part) 2020: July  
6 P. Hudson deserted

Book mark:

W. R. Lu

S | 4 Cav. U.S.C.T.

John Smith  
Corp., Co. C, 4 Reg't U. S. Col'd Cavalry

Appears on Co. Muster-out Roll, dated  
New Orleans La, Mar 20, 1866.

Muster-out to date \_\_\_\_\_, 186 .

Last paid to Apr 30, 1864.

Clothing account:

Last settled \_\_\_\_\_, 186 ; drawn since \$ \_\_\_\_\_ 100

Due soldier \$ \_\_\_\_\_ 100; due U. S. \$ 87 <sup>20</sup>/<sub>100</sub>

Am't for cloth'g in kind or money adv'd \$ \_\_\_\_\_ 100

Due U. S. for arms, equipments, &c., \$ \_\_\_\_\_ 100

Bounty paid \$ \_\_\_\_\_ 100; due \$ \_\_\_\_\_ 100

Remarks: Joined as recruit  
deserted June 25/64 returned  
to Co Aug 24 64 deserted  
July 6 65 Port Hudson La  
Corp. from Jan 1/63 to July 8/65

Book mark: V191 P289-74

(361)

M. A. Michaels  
Copyist.

Smith, John  
Co. C, 4 Reg't U.S.C. Bay

3 Enclosures.

Bed Cards	Final Statements
Burial Records	Furloughs or L. of A.
Certs. of Dis. for Discharge	Med. Certificates
C. M. Charges	Med. Des. Lists
Descriptive Lists	Orders
Discharge Certificates	Pris. of War Record
Enlistment Papers	Resignations

Other papers relating to—

Admission to Hosp'l	Furlough or L. of A.
Casualty Sheet	Med. Examination
Confinement	Misc. Information 3
Contracts	Pay or Clothing
Death or Effects	Personal Reports
Desertion	Rank
Discharge from Hosp'l	Transfer to Hosp'l
Discharge from Service	Transfer to V. R. C.
Duty	Transportation



NARR 050  
MICROFILM PUBLICATION M 1820

COMPILED MILITARY SERVICE RECORDS  
OF VOLUNTEER UNION SOLDIERS WHO  
SERVED WITH THE USCT (US COLORED TROOPS)  
4TH REGIMENT OF CAVALRY

PERSONAL PAPERS' TARGET SHEET

PLEASE NOTE THE CHECKED INFORMATION ABOUT THE PERSONAL PAPERS IN  
THIS FILE:

- NO PERSONAL PAPERS WERE FOUND IN THIS FILE WHEN THE  
RECORDS WERE ARRANGED FOR MICROFILMING.
- 4 PERSONAL PAPER(S) FOUND IN THIS FILE WHEN THE RECORDS  
WERE ARRANGED FOR MICROFILMING.

672.R.B. 174-1865  
Quarters Co C 4<sup>th</sup> Md<sup>th</sup> Col<sup>th</sup> Can  
Port Hudson La Feb 24<sup>th</sup> 1865

Blasdel Capt J W  
Makes application to  
have John Smith Co  
Returned to duty

Head Quarters 4<sup>th</sup> U.S. Cav.  
Port Hudson La. Feby 24. 1865

Respectfully forwarded  
Approved

Nashel. Mitchell  
Major Comdg.

~~J. H. D. U.S. Forces~~  
Port Hudson La  
Feb 25 1865

Request granted  
S. O. N. 46 E 6 [1111]  
Filed

A. G. H. 16 25.

Head Q. 4<sup>th</sup> U.S. Cav. Feby 24/65

Quarters Company C 4<sup>th</sup> U.S. Colored Cavalry  
Port Hudson La February 24<sup>th</sup> 1865

I have the honor to represent that  
John Smith of Company C 4<sup>th</sup> U.S. Colored Cavalry was  
absent without leave from the 25<sup>th</sup> day of June 1864 until  
the 24<sup>th</sup> day August 1864 in consequence of which he is  
<sup>not</sup> able to draw his pay. He has since his return to his  
company served honestly and faithfully. I therefore  
ask that he be returned to duty without trial as char-  
ges have not been preferred against him

Capt. Geo C. Fitchell  
A. A. A. G.  
U.S. Forces Port Hudson

Very Respectfully  
Your Obedt Servant  
J. W. Blizard  
Capt Comd Co C 4<sup>th</sup> U.S. C. C.

Ellerbrook — ✓

Cop: Johns Smith - C<sup>d</sup> C<sup>d</sup> - W. S. Col. Cav  
complete

War Department

Adjutant General's Office,

COLORED TROOPS BRANCH,

December 13<sup>th</sup>, 1873

Vol. C. T., 187

Wanted in case of Corporal John Smith, Co. "C",  
4<sup>th</sup> Reg't W. S. Col'd Cav. - Copy of P. O. no. 46 - Dated  
Head Quarters Fort Hudson La: Feb: 20<sup>th</sup> 1865 - returning him  
to duty after absence without leave.

Respectfully,

W. A. Woodward

Chief Clerk.

P. J. Falcon

Adjutant General's Office,

Mr. Ellersbrook

Z. R.

, 187

Vol. C. T., 187

Reply in case of \_\_\_\_\_, Co. \_\_\_\_\_,  
Reg't \_\_\_\_\_

Specimen Order  
no. 6. ) Letters

The Private John Smith Co. C 4<sup>th</sup> W. S. Col'd Cav. is hereby returned to duty at the request of his Company, and Regiments.

By Command of Brig Gen. Cyrus Hamilton  
Deputy Geo. C. Gilbert  
Adj. Gen.

Ellerbrook ✓

Corp: pro: Smith Co. 4<sup>th</sup> W. I. Col. Cav.

File -

Adjutant General's Office,

COLORED TROOPS BRANCH,

December 17<sup>th</sup>, 1873

Vol. C. T., 187 Corporal

Wanted in case of ~~Private~~ John Smith, Co. "C",  
4<sup>th</sup> Reg't W. S. Colored Cavalry - Copy of S. O. No. 46 - dated  
Headquarters W. S. Forces Port Hudson La. Feb. 25<sup>th</sup> 1865 - returning  
him to duty from absence without leave.

Respectfully,

J. A. Woodward

Chief Clerk.

J. A. Dalton

Mr. Ellbrook.

E. R.

Adjutant General's Office,

, 187

Vol. C. T., 187

Reply in case of \_\_\_\_\_, Co. \_\_\_\_\_,

Reg't \_\_\_\_\_

S. O. No. 46, Hd Qrs W. S. Forces  
Port Hudson, La., dated Feb. 25<sup>th</sup> 1865.  
Returns Smith to duty at the request  
of his Co. and Reg't Commanders.  
Was guilty of absence without  
leave.

J. A. Dalton  
12.23.73 J. A. Dalton

Ellerbrook. —

Corp: Johns. Smith C<sup>o</sup> "C" — 4<sup>th</sup> W. S. C. Cav. —

complete —



Adjutant General's Office,

COLORED TROOPS BRANCH,

March 3<sup>rd</sup>, 1874

Vol. C. T., 187

Wanted in case of Corporal John Smith, Co. D,  
4<sup>th</sup> Reg't W. S. Colored Cav - Particulars of trial for first  
desertion - He is reported present for duty - Deserted June  
25<sup>th</sup> 64 - Returned reduced to the ranks Aug. 24, 64 \* \* \*  
(Vide M. R. for July & Aug 64).

Mr. Allbrook.

Respectfully,

E. A. Woodward

Chief Clerk.

J. J. Patton

Adjutant General's Office,

March 9<sup>th</sup>, 1874

Vol. C. T., 187

Reply in case of \_\_\_\_\_, Co. \_\_\_\_\_,

Reg't \_\_\_\_\_

S. O. 46. U. S. Forces, Fort Hudson La. Feb 25<sup>th</sup> 1865.  
Par. II "Private John Smith Co. C. 4<sup>th</sup> U. S. Colored Cav.  
guilty of absence without leave, is hereby returned  
to duty, at the request of his company and regimental  
Commander."

Attest Regimental records not on file

Smith Joseph

Co A, 4 U. S. Col'd Cav.

Private Private

CARD NUMBERS.

1	5348486	26
2	5348520	27
3	5348620	28
4	5348718	29
5	5348811	30
6	5348900	31
7	5348995	32
8	5349142	33
9	5349217	34
10	5349308	35
11	5349392	36
12	5349483	37
13	5349563	38
14	5349638	39
15	5349708	40
16		41
17		42
18		43
19		44
20		45
21		46
22		47
23		48
24		49
25		50

Book Mark:

See also

S-1014291-P.O. mem

*[Handwritten signature]*

*S* | **4 Cav. | U.S.C.T.**

*Joseph Smith*  
Private, Co. *A*, 1 Reg't La. Cav., Corps d'Afrique.\*

Appears on

**Company Muster-in Roll**

of the organization named above. Roll dated  
*New Orleans La, Sept 12, 1863.*

Muster-in to date *Sept 12, 1863.*

Joined for duty and enrolled:

When *Aug. 30, 1863.*

Where *New Orleans*

Period *3* years.

Valuation of horse, \$ *100*

Valuation of horse equipments, \$ *100*

Remarks:  
*Age 20*

\*This organization subsequently became Co. *A*, 4 Reg't U. S. Colored Cavalry.

Book mark:

*M. A. Michaels*

(356)

Copyist.

*S* | **4 Cav. | U.S.C.T.**

*Joseph Smith*  
2<sup>d</sup> *Co. A*, 1 Reg't La. Cav., Corps d'Afrique.\*

Appears on

**Company Muster Roll**  
for *Sept 12 to Dec 31*, 1863.

Present or absent *Present*

Stoppage, \$..... *100* for .....

Due Gov't, \$..... *100* for .....

Valuation of horse, \$..... *100*

Valuation of horse equipments, \$..... *100*

Remarks: .....

\*This organization subsequently became Co. *A*, 4 Reg't U. S. Colored Cavalry.

Book mark: .....

(358)

*R. Richardson*  
Copyist.

*S* | **4 Cav. U.S.C.T.**

*Joseph Smith*  
3 *Cop* Co. *A*, 1 Reg't Cav., Corps d'Afrique.\*

Appears on

**Company Muster Roll**

for *June & Feb*, 1864

Present or absent *Present*

Stoppage, \$ *100* for

Due Gov't, \$ *100* for

Valuation of horse, \$ *100*

Valuation of horse equipments, \$ *100*

Remarks:

\* This organization subsequently became Co. *A*, 4 Reg't U. S. Colored Cavalry.

Book mark:

*R Richardson*

(358)

Copyist.

*S* | **4 Cav. | U.S.C.T.**

*Joseph Smith*  
*Corpl*, Co. A, 4 Reg't U. S. Col'd Cavalry.

Appears on

**Company Muster Roll**

for *March + April*, 186 *4*

Present or absent *Present*

Stoppage, \$ *100* for

Due Gov't, \$ *100* for

Valuation of horse, \$ *100*

Valuation of horse equipments, \$ *100*

Remarks:

Book mark:

*R. Richardson*

(358)

Copyist.

S | 4 Cav. | U.S.C.T.

Joseph Smith  
Copt, Co. A, 4 Reg't U. S. Col'd Cavalry.

Appears on

**Company Muster Roll**

for *May & June*, 1867.

Present or absent *Present*

Stoppage, \$ *100* for

Due Gov't, \$ *100* for

Valuation of horse, \$ *100*

Valuation of horse equipments, \$ *100*

Remarks:

Book mark:

*R. A. Richardson*

(358)

Copyist.



*S* | **4 Cav.** | **U.S.C.T.**

*Joseph Smith*  
-----  
*Coppl*, Co. A, 4 Reg't U. S. Col'd Cavalry.

Appears on

**Company Muster Roll**

for *July & Aug*, 186*4*.

Present or absent.. *Present*

Stoppage, \$.....*100* for

Due Gov't, \$.....*100* for

Valuation of horse, \$.....*100*

Valuation of horse equipments, \$.....*100*

Remarks:.....  
.....  
.....  
.....  
.....  
.....  
.....  
.....  
.....  
.....

Book mark:.....

*R. Richardson*  
-----  
Copyist.

S | 4 Cav. | U.S.C.T.

Joseph Smith  
Sergeant, Co. A, 4 Reg't U. S. Col'd Cavalry.

Appears on

Company Muster Roll  
for Sept & Oct, 1864.  
Present or absent Present

Stoppage, \$ 100 for

Due Gov't, \$ 100 for

Valuation of horse, \$ 100

Valuation of horse equipments, \$ 100

Remarks: Promoted from Corp to  
Sergeant Oct 11 / 64

Book mark:

Donnelly

(358)

Copyist.

S | 4 Cav. | U.S.C.T.

Joseph Smith

Pr, Co. A, 4 Reg't U. S. Col'd Cavalry.

Appears on

Company Muster Roll

for Nov Dec, 1864

Present or absent Present

Stoppage, \$ 100 for

Due Gov't, \$ 100 for

Valuation of horse, \$ 100

Valuation of horse equipments, \$ 100

Remarks: Promoted from Corp to Sergt Oct 11. Reduced to the ranks 164 Nov 20/04. Free, La, St. Charles Parish

Book mark:

Donnelly

(358)

Copyist.

S | 4 Cav. | U.S.C.T.

Joseph Smith

Pri, Co. A, 4 Reg't U. S. Col'd Cavalry.

Appears on

Company Muster Roll  
for Jan & Feb, 1865  
Present

Present or absent

Stoppage, \$ 100 for

Due Gov't, \$ 100 for

Valuation of horse, \$ 100

Valuation of horse equipments, \$ 100

Remarks: Promoted from Priv to  
Corp Sept 12. 63. to Sergt Oct  
1. 64. Reduced to ranks Nov  
20. 64. Born free St. Charles  
Parish La. Slop for 1 pair spurs  
& straps & 1 tom-pion

Book mark:

Donnelly

(358)

Copyist.

S | 4 Cav. | U.S.C.T.

Joseph Smith

Pri., Co. A, 4 Reg't U. S. Col'd Cavalry.

Appears on

Company Muster Roll

for *Man & apl*, 186 *5*

Present or absent *Present*

Stoppage, \$ *100* for

Due Gov't, \$ *100* for

Valuation of horse, \$ *100*

Valuation of horse equipments, \$ *100*

Remarks:

Book mark:

*Donnelly*

(358)

Copyist.

S | 4 Cav. | U.S.C.T.

Joseph Smith  
Pri

, Co. A, 4 Reg't U. S. Col'd Cavalry.

Appears on

Company Muster Roll

for *May + June*, 186*5*.

Present or absent *Present*

Stoppage, \$ 100 for

Due Gov't, \$ 100 for

Valuation of horse, \$ 100

Valuation of horse equipments, \$ 100

Remarks:

Book mark:

*Dornely*

(358)

Copyist.

S | 4 Cav. | U.S.C.T.

Joseph Smith

Pri, Co. A, 4 Reg't U. S. Col'd Cavalry.

Appears on

**Company Muster Roll**

for July & Aug, 1865.

Present or absent Present

Stoppage, \$ 100 for

Due Gov't, \$ 100 for

Valuation of horse, \$ 100

Valuation of horse equipments, \$ 100

Remarks:

Book mark:

Dunnally

(358)

Copyist.

4777 855

*J* | **4 Cav. | U.S.C.T.**

*Joseph Smith*  
*Priv*, Co. A, 4 Reg't U. S. Col'd Cavalry.

Appears on

**Company Muster Roll**

for *Sept & Oct*, 186*5*.

Present or absent. *Present*

Stoppage, \$ *100* for

Due Gov't, \$ *100* for

Valuation of horse, \$ *100*

Valuation of horse equipments, \$ *100*

Remarks:

NEXT ROLL ON FILE FEB 1866

Book mark:

*Prewitt*

(358)

Copyist.



*S* | **4 Cav. | U.S.C.T.**

*Joseph Smith*  
*Priv*, Co. A, 4 Reg't U. S. Col'd Cavalry.

Appears on

**Company Muster Roll**

for *Jan & Feb*, 1866.

Present or absent *Present*

Stoppage, \$ *100* for

Due Gov't, \$ *100* for

Valuation of horse, \$ *100*

Valuation of horse equipments, \$ *100*

Remarks:  
.....  
.....  
.....  
.....  
.....  
.....  
.....  
.....

Book mark: .....

*Prewitt*  
(358) Copyist.

*J* | **4 Cav.** | **U.S.C.T.**

*Joseph Smith*  
-----  
*Capt*, Co. *A*, 4 Reg't U. S. Col'd Cavalry.

Appears on **Co. Muster-out Roll**, dated  
*New Orleans La*, *March 20*, 1866.

Muster-out to date *March 20*, 1866.

Last paid to *June 30*, 1865.

**Clothing account:**

Last settled \_\_\_\_\_, 186 ; drawn since \$ \_\_\_\_\_ 100

Due soldier \$ *16* <sup>*72*</sup> / 100; due U. S. \$ \_\_\_\_\_ 100

Am't for cloth'g in kind or money adv'd \$ \_\_\_\_\_ 100

Due U. S. for arms, equipments, &c., \$ \_\_\_\_\_ <sup>*52*</sup> / 100

Bounty paid \$ \_\_\_\_\_ 100; due \$ \_\_\_\_\_ 100

Remarks *Joined at orig. org.*

*Stop 1 sabre knot 1 curry comb  
1 horse brush.*

*5 1/2 m*  
*6051 P.M. to June 19. 66*

Book mark } *V 25. P. 57. 68*

*Prewitt*

(361)

Copyist.

Smith <sup>990</sup> Levi

Co H, 4 U. S. Col'd Cav.

Private | Private

CARD NUMBERS.

1	5347922	26
2	5357219	27
3	5357275	28
4	5357328	29
5	5357385	30
6	5357439	31
7	5357488	32
8	5357535	33
9	5357614	34
10	5357696	35
11	5357782	36
12	5357861	37
12	5357935	38
14	5358010	39
15	5358082	40
16		41
17		42
18		43
19		44
20		45
21		46
22		47
23		48
24		49
25		50

Book Mark:

See also

SW 6 56 26 Poucey

*Amuse*  
90

1 | **4 Cav. | U.S.C.T.**

Levi Smith

Appears with rank of Private on

**Muster and Descriptive Roll of a Detachment of U. S. Vols. forwarded**

for the 4 Reg't U. S. Col'd Cavalry. Roll dated

New Orleans La, Feb 8, 1864.

Where born Springfield Ky

Age 18 y'rs; occupation Waiter

When enlisted Feb 24, 1864.

Where enlisted Indiana

For what period enlisted 3 years.

Eyes Black; hair Black

Complexion Rk; height 5 ft. 3 in.

When mustered in Feb 8, 1864.

Where mustered in New Orleans

Bounty paid \$ 100; due \$ 100

Where credited

Company to which assigned H

Remarks:

Book mark:

W. Allade  
(339) Copyist.

1864

*L* **4 Cav. U.S.C.T.**  
*Levi Smith*  
*Priv.*, Co. H, 4 Reg't U. S. Col'd Cavalry.

Appears on  
**Company Muster-in and Descriptive Roll**  
of the organization named above. Roll dated  
*New Orleans La Apr. 8, 1864.*  
Where born *Springfield Ky.*  
Age *18* y'rs; occupation *Waiter*  
When enlisted *Feb. 24, 1864.*  
Where enlisted *Indianola, La.*  
For what period enlisted *3* years.  
Eyes *black*; hair *black*  
Complexion *dark*; height *5 ft. 3 in.*  
When mustered in *Apr. 8, 1864.*  
Where mustered in *New Orleans, La.*  
Bounty paid \$ *2* 100; due \$ 100  
Where credited  
Company to which assigned  
Remarks:  
Book mark:

*L. Williams*  
(356d) Copyist.

*S* | **4 Cav. | U.S.C.T.**

*Levi Smith*  
*Pvt*, Co. H, 4 Reg't U. S. Col'd Cavalry.

Appears on

**Company Muster Roll**

for *Apr. 8 to 30*, 186 *4*.

Present or absent *Present*

Stoppage, \$ *100* for

Due Gov't, \$ *100* for

Valuation of horse, \$ *100*

Valuation of horse equipments, \$ *100*

Remarks:

Book mark:

*S. Williams*

(358)

Copyist.

*S.* | **4 Cav.** | **U.S.C.T.**  
*Levi Smith*  
*Priv.*, Co. H, 4 Reg't U. S. Col'd Cavalry.

Appears on

**Company Muster Roll**

for *May & June*, 1864.

Present or absent *Present*

Stoppage, \$ 100 for

Due Gov't, \$ 100 for

Valuation of horse, \$ 100

Valuation of horse equipments, \$ 100

Remarks:

Book mark:

(358)

*C. Williams*  
Copyist.



*A* | **4 Cav.** | **U.S.C.T.**  
*Levi Smith*  
*Plt.*, Co. H, 4 Reg't U. S. Col'd Cavalry.

Appears on

**Company Muster Roll**  
for *July & Aug.*, 186*4*.  
Present or absent *Present*

Stoppage, \$.....100 for .....

Due Gov't, \$.....100 for .....

Valuation of horse, \$.....100

Valuation of horse equipments, \$.....100

Remarks: .....

Book mark: .....

*C. Williams*  
Copyist.

*S* | **4 Cav. | U.S.C.T.**

*Levi Smith*

*Priv.*, Co. H, 4 Reg't U. S. Col'd Cavalry.

Appears on

**Company Muster Roll**

for *Sept. & Oct.*, 186*4*

Present or absent *Present*

Stoppage, \$.....*100* for.....

Due Gov't, \$.....*20*/*100* for *ordnance*

*(expensed)*

Valuation of horse, \$.....*100*

Valuation of horse equipments, \$.....*100*

Remarks:.....

Book mark:.....

*C. Williams*  
Copyist.

*S.* **4 Cav. U.S.C.T.**  
*Levi Smith*  
*Priv.*, Co. H, 4 Reg't U. S. Col'd Cavalry.

Appears on

**Company Muster Roll**

for *Nov, & Dec*, 186*4*

Present or absent *Present*

Stoppage, \$ *20*  
*100* for *one wiped*

Due Gov't, \$ *100* for

Valuation of horse, \$ *100*

Valuation of horse equipments, \$ *100*

Remarks:

Book mark:

(358)

*C. Williams*

Copyist.

*S* | **4 Cav.** | **U.S.C.T.**

*Levi Smith*

*Priv.*, Co. H, 4 Reg't U. S. Col'd Cavalry.

Appears on

**Company Muster Roll**

for *Jan. 9. 64*, 186*3*.

Present or absent *Present*

Stoppage, \$ *100* for

Due Gov't, \$ *100* for

Valuation of horse, \$ *100*

Valuation of horse equipments, \$ *100*

Remarks: *Due M.D. (wiper) 20  
Received but 7.00 per  
month up to Apr. 30/64.*

Book mark:

*Master*

*S* | **4 Cav. | U.S.C.T.**

*George Smith*  
-----  
*Priv.*, Co. H, 4 Reg't U. S. Col'd Cavalry.

Appears on

**Company Muster Roll**

for *Meck. F. A. H.*, 186*2*.

Present or absent *Present*

Stoppage, \$ *100* for

Due Gov't, \$ *100* for

Valuation of horse, \$ *100*

Valuation of horse equipments, \$ *100*

Remarks: -----  
-----  
-----  
-----  
-----  
-----  
-----  
-----  
-----  
-----

Book mark: -----

(358)

*Geo. Smith*

Copyist.

J | 4 Cav. | U.S.C.T.

Levi Smith

Pvt., Co. H, 4 Reg't U. S. Col'd Cavalry.

Appears on

Company Muster Roll

for May & June, 1862.

Present or absent Present

Stoppage, \$ 100 for

Due Gov't, \$ 100 for

Valuation of horse, \$ 100

Valuation of horse equipments, \$ 100

Remarks:

Book mark:

Heaster

*S* | **4 Cav.** | **U.S.C.T.**

*Levi Smith*  
*Plt*, Co. H, 4 Reg't U. S. Col'd Cavalry.

Appears on

**Company Muster Roll**

for *July & Aug.*, 186*2*.

Present or absent *Present*

Stoppage, \$ *100* for

Due Gov't, \$ *100* for

Valuation of horse, \$ *100*

Valuation of horse equipments, \$ *100*

Remarks:  
\_\_\_\_\_  
\_\_\_\_\_  
\_\_\_\_\_  
\_\_\_\_\_  
\_\_\_\_\_  
\_\_\_\_\_  
\_\_\_\_\_  
\_\_\_\_\_

Book mark: \_\_\_\_\_

*M*  
*Beaster*

*S* | **4 Cav.** | **U.S.C.T.**

*Levi Smith*

*Pvt.*, Co. H, 4 Reg't U. S. Col'd Cavalry.

Appears on

**Company Muster Roll**

for *Sept. & Oct.*, 186 *7*

Present or absent *Present*

Stoppage, \$ *100* for

Due Gov't, \$ *100* for

Valuation of horse, \$ *100*

Valuation of horse equipments, \$ *100*

Remarks:

Book mark:

*Feaster*

(358)

Copyist.



*S* | **4 Cav. | U.S.C.T.**

*Levi Smith*

*Private*, Co. H, 4 Reg't U. S. Col'd Cavalry.

Appears on

**Company Muster Roll**

for *dated Dec 31*, 186 *4*.

Present or absent *Present*

Stoppage, \$ *100* for

Due Gov't, \$ *100* for

Valuation of horse, \$ *100*

Valuation of horse equipments, \$ *100*

Remarks:

Book mark:

*H. E. Smith*

(358)

Copyist.

*A* | **4 Cav.** | **U.S.C.T.**

*Lewie Smith*

*Co.*, Co. H, 4 Reg't U. S. Col'd Cavalry.

Appears on

**Company Muster Roll**

for *Jan & Feb*, 186*6*.

Present or absent *Present*

Stoppage, \$ *100* for

Due Gov't, \$ *100* for

Valuation of horse, \$ *100*

Valuation of horse equipments, \$ *100*

Remarks:

Book mark:

*A. E. M...*

*S* | **4 Cav.** | **U.S.C.T.**

*Lewis Smith*  
*Pr.*, Co. *A*, 4 Reg't U. S. Col'd Cavalry.

Appears on **Co. Muster-out Roll**, dated  
*New Orleans La, Mar 20*, 1866.

Muster-out to date *Mar 20*, 1866.

Last paid to *June 30*, 1865.

Clothing account:

Last settled....., 186 ; drawn since \$..... 100

Due soldier \$..... 100; due U. S. \$ *16*<sup>*87*</sup>/<sub>*100*</sub>

Am't for cloth'g in kind or money adv'd \$..... 100

Due U. S. for arms, equipments, &c., \$..... 100

Bounty paid \$..... 100; due \$..... 100

Remarks: *Joined as Capt. Org.*

Book mark: *No. 9, P. 139, 70*

(861)

*A. E. M. W. D.*  
Copyist.

999  
Smoot Thomas

Co., 4 U. S. Col'd Cav.

Private 2<sup>d</sup> Lt. Sergeant

CARD NUMBERS.

1	5-35-25-84	26
2	5-35-2634	27
3	5-35-2644	28
4	5-35-2746	29
5	5-35-2773	30
6	5-35-2837	31
7	5-35-2895	32
8	5-35-2972	33
9	5-35-3052	34
10	5-35-3134	35
11	5-35-3230	36
12	5-35-3330	37
13	5-35-3421	38
14	5-35-3507	39
15	5-35-3589	40
16	5-35-3672	41
17	40729224	42
18		43
19		44
20		45
21		46
22		47
23		48
24		49
25		50

Book Mark:

See also

S. 672889, P. 6-9 d...  
S-928913 - P.O. M.L.M.  
P1314409, P. 07/2

S 1857123 J. J. H.  
A2286024 and W. J.

S. 2708 616 P. O. B. K.

*R. M. Hill*

S | 4 Cav. | U.S.C.T.

Thomas Smoot

Pat, Co. S, 1 Reg't, Corps d'Afrique Cavalry.\*

Appears on

**Company Muster-in Roll**

of the organization named above. Roll dated

New Orleans La, Nov 26, 1863.

Muster-in to date Nov 26, 1863.

Joined for duty and enrolled:

When Oct 12, 186  .

Where New Orleans

Period 3 years.

Valuation of horse, \$ 100

Valuation of horse equipments, \$ 100

Remarks: ..

\*This organization subsequently became Co. S, 4 Reg't U. S. Colored Cavalry.

Book mark: ..

(356)

Rosenbaum  
Copyist.

*S* | **4 Cav. U.S C.T.**

*Thomas Smoot*

*Pvt*, Co. *D*, 1 Reg't Cav., Corps d'Afrique.\*

Appears on

**Company Muster Roll**

for *From Enlistment to Dec 31*, 1863.

Present or absent *Present*

Stoppage, \$ ..... *100* for .....

Due Gov't, \$ ..... *100* for .....

Valuation of horse, \$ ..... *100*

Valuation of horse equipments, \$ ..... *100*

Remarks: .....

\* This organization subsequently became Co. *D*, 4 Reg't U. S. Colored Cavalry.

Book mark: .....

*Rosenbaum*

*S* 4 Cav. U.S C.T.

*Thomas Smoot*

*Pvt*, Co. *D*, 1 Reg't Cav., Corps d'Afrique.\*

Appears on

**Company Muster Roll**

for *Jan'y & Feby*....., 1864.

Present or absent *Present*

Stoppage, \$ ..... 100 for .....

Due Gov't, \$ ..... 100 for .....

Valuation of horse, \$ ..... 100

Valuation of horse equipments, \$ ..... 100

Remarks: .....

\* This organization subsequently became Co. *D*, 4 Reg't U. S. Colored Cavalry.

Book mark: .....

*Rosenbaw*  
Copyist.



S | **4 Cav.** | **U.S.C.T.**

Thomas Sweet

Pat, Co. D. 4 Reg't U. S. Col'd Cavalry.

Appears on

**Company Muster Roll**

for March & April, 1864.

Present or absent Absent

Stoppage, \$ 100 for

Due Gov't, \$ 100 for

Valuation of horse, \$ 100

Valuation of horse equipments, \$ 100

Remarks: Detached on Recruiting Service by special order March 9.

Book mark: \_\_\_\_\_

Rosenbaum  
Copyist.

of | **4 Cav.** | **U.S.C.T.**

Thomas Smoot

4 Corp'l, Co. D. 4 Reg't U. S. Col'd Cavalry.

Appears on

**Company Muster Roll**

for May & June, 1864.

Present or absent Absent

Stoppage, \$ 100 for

Due Gov't, \$ 100 for

Valuation of horse, \$ 100

Valuation of horse equipments, \$ 100

Remarks: Detached on Recruiting  
by special order since  
March 9-1864

Book mark:

(358)

Rosenblum

Copyist.

S | **4 Cav.** | **U.S.C.T.**

Thomas Smoot

4 Copt., Co. D. 4 Reg't U. S. Col'd Cavalry.

Appears on

**Company Muster Roll**

for July & Aug, 1864.

Present or absent Present

Stoppage, \$ 100 for

Due Gov't, \$ 100 for

Valuation of horse, \$ 100

Valuation of horse equipments, \$ 100

Remarks:

Book mark:

(358)

Rosenbaum  
Copyist.

4 Cav. U.S.C.T.

Thomas Smoots

Sergt, Co. D. 4 Reg't U. S. Col'd Cavalry.

Appears on

Company Muster Roll

for Sept & Oct, 1864.

Present or absent Present

Stoppage, \$ 100 for

Due Gov't, \$ 100 for

Valuation of horse, \$ 100

Valuation of horse equipments, \$ 100

Remarks: Promoted to the Rank of Sergt Sept-1-1864

Book mark:

Rosenbaum

(358)

Copyist.

21 | **4 Cav. | U.S.C.T.**

*William J. Smith*

*Smith*, Co. D, 4 Reg't U. S. Col'd Cavalry.

Appears on

**Company Muster Roll**

for *Jan 1864*, 1864

Present or absent *Present*

Stoppage, \$ *100* for

Due Gov't, \$ *100* for

Valuation of horse, \$ *100*

Valuation of horse equipments, \$ *100*

Remarks: *Transferred to the  
muster at Fort-Sept-1864*

Book mark:

*W. J. Smith*

J | 4 Cav. | U.S.C.T.

Thomas J. Smith

Sgt., Co. D, 4 Reg't U. S. Col'd Cavalry.

Appears on

Company Muster Roll

for Jan & Feb, 1865

Present or absent Present

Stoppage, \$ 100 for

Due Gov't, \$ 100 for

Valuation of horse, \$ 100

Valuation of horse equipments, \$ 100

Remarks: Dismissed Sgt  
Sept - 1864  
Rec'd pay \$ 7 per  
month to 30 Oct 64  
30, 00

Book mark:

(358) [Signature] Copyist.

c' | **4 Cav. | U.S.C.T.**

*Thomas Stewart*

*Wm. Stewart*, Co. D, 4 Reg't U. S. Col'd Cavalry.

Appears on

**Company Muster Roll**

for *March 1867*, 1867.

Present or absent *Present*

Stoppage, \$ 100 for

Due Gov't, \$ 100 for

Valuation of horse, \$ 100

Valuation of horse equipments, \$ 100

Remarks:

Book mark:

(358)

*Wm Stewart*

Copyist.

*S* | **4 Cav. | U.S.C.T.**

*Thomas L. ...*

*W. Sgt.* Co. D, 4 Reg't U. S. Col'd Cavalry.

Appears on

**Company Muster Roll**

for *May 7 June*, 186*5*.

Present or absent *Present*

Stoppage, \$ *100* for

Due Gov't, \$ *100* for

Valuation of horse, \$ *100*

Valuation of horse equipments, \$ *100*

Remarks:

Book mark:

(358)

*W. L. ...*

Copyist.



*D* | **4 Cav.** | **U.S.C.T.**

*Company Muster*

*Q. M. Sgt.* Co. D, 4 Reg't U. S. Col'd Cavalry.

Appears on

**Company Muster Roll**

for *July & Aug*, 186*5*.

Present or absent *Present*

Stoppage, \$ 100 for

Due Gov't, \$ 100 for

Valuation of horse, \$ 100

Valuation of horse equipments, \$ 100

Remarks:

Book mark:

*W. H. [unclear]*  
(358) *W. H. [unclear]* Copyist.

*21* | **4 Cav. | U.S.C.T.**

*Thomas Smith*

*Sgt.*, Co. D, 4 Reg't U. S. Col'd Cavalry.

Appears on

**Company Muster Roll**

for *Sept - Oct*, 186*5*.

Present or absent *Present*

Stoppage, \$ 100 for

Due Gov't, \$ 100 for

Valuation of horse, \$ 100

Valuation of horse equipments, \$ 100

Remarks:

Book mark:

*W. H. Wright*  
Copyist.

*S.* | **4 Cav.** | **U.S.C.T.**

*Thomas Amonts*

*De la Haye*, Co. D, 4 Reg't U. S. Col'd Cavalry.

Appears on

**Company Muster Roll**

for *Four of June*, 186*1*.

Present or absent *Present*

Stoppage, \$ *100* for

Due Gov't, \$ *100* for

Valuation of horse, \$ *100*

Valuation of horse equipments, \$ *100*

Remarks:

Book mark:

(358) -

*J. W. Anderson*

Copyist.

*S* | **4 Cav.** | **U.S.C.T.**

*Thomas Smeets*

*E. M. Supt.* Co. D, 4 Reg't U. S. Col'd Cavalry.

Appears on

**Company Muster Roll**

for *Jan + Feb*, 186*6*.

Present or absent *Present*

Stoppage, \$ 100 for

Due Gov't, \$ 100 for

Valuation of horse, \$ 100

Valuation of horse equipments, \$ 100

Remarks:

Book mark:

*J. M. Anderson*

(358) ✓

Copyist.

1877 525  
D | 4 Cav. | U.S.C.T.

Thomas Smoot

Priv., Co. H, 4 Reg't U. S. Colored Cav.

Appears on Returns as follows:

Nov 1864 (1 Regt Cav., Corps d'Afrique)  
Absent detached Mar 9/64 on  
recruiting service.

Apr to June 1864 - (4 Regt U.S. Col'd Cav.)  
Absent detached on Recruiting  
service Mar 9/64

Book mark:

W. R. Lee

S | **4 Cav.** | **U.S.C.T.**

Thomas Smoots

2. Med. Sgt., Co. H., 4 Reg't U. S. Col'd Cavalry.

Appears on **Co. Muster-out Roll**, dated  
New Orleans, La., Feb 20, 1866.

Muster-out to date Feb 20, 1866.

Last paid to June 30, 1865.

**Clothing account:**

Last settled....., 186 ; drawn since \$..... 100

Due soldier \$ 50 <sup>09</sup> / 100; due U. S. \$..... 100

Am't for cloth'g in kind or money adv'd \$..... 100

Due U. S. for arms, equipments, &c., \$..... 100

Bounty paid \$..... 100; due \$..... 100

Remarks: joined at Arq.  
a Sgt since Sept 6/64.

Book mark: .....

W. G. Anderson

(361)

Copyist.

100  
Snow Thomas

Co D, 4 U. S. Col'd Cav.

Saddles Saddles

CARD NUMBERS.

1	5-3 4 7 8 7 5-	26
2	5-3 5-2 7 4 5-	27
3	5-3 5-2 6 1 0	28
4	5-3 5-2 6 7 1	29
5	5-3 5-2 9 4 3	30
6	5-3 5-3 0 2 5-	31
7	5-3 5-3 1 1 0	32
8	5-3 3-3 1 5-1	33
9	5-3 5-3 2 4 7	34
10	5-3 5-3 3 4 6	35
11	5-3 5-3 4 3 6	36
12	5-3 5-3 5-2 3	37
13	5-3 5-3 6 0 5-	38
14	5-3 5-3 6 6 7	39
15	40729225	40
16		41
17		42
18		43
19		44
20		45
21		46
22		47
23		48
24		49
25		50

Book Mark:

See also

S-1583961 P8 on the

W. H. Miller



*S* | **4 Cav. U.S.C.T.**

*Thomas Snow*

Appears with rank of *Private* on

**Muster and Descriptive Roll of a Detachment of U. S. Vols. forwarded**

for the 4 Reg't U. S. Col'd Cavalry. Roll dated

*New Orleans, La, April 17, 1864.*

Where born *Franklin, Louisiana*

Age *29* y'rs; occupation *Labourer*

When enlisted *June 22*, 186*4*

Where enlisted *Alexandria*

For what period enlisted *3* years.

Eyes *Dark*; hair *Black*

Complexion *Black*; height *5 ft. 1 1/2 in.*

When mustered in *April 17*, 186*4*

Where mustered in *New Orleans, La*

Bounty paid \$ *100*; due \$ *100*

Where credited

Company to which assigned

Remarks:

Book mark:

*Ballade*  
(339) Copyist.

*S* | **4 Cav.** | **U.S.C.T.**

*Thomas Snow*

*Pvt*, Co. D. 4 Reg't U. S. Col'd Cavalry.

Appears on

**Company Muster Roll**

for *March & April*, 1864.

Present or absent *Absent*

Stoppage, \$ 100 for

Due Gov't, \$ 100 for

Valuation of horse, \$ 100

Valuation of horse equipments, \$ 100

Remarks: *Detached as Quartermaster  
for Depot Quartermaster  
by special order April  
27.*

Book mark:

(358)

*Rosenbaum*  
Copyist.

S | **4 Cav.** | **U.S.C.T.**

Thomas Snow

Priv, Co. D. 4 Reg't U. S. Col'd Cavalry.

Appears on

**Company Muster Roll**

for May & June, 1864.

Present or absent Absent

Stoppage, \$ 100 for

Due Gov't, \$ 100 for

Valuation of horse, \$ 100

Valuation of horse equipments, \$ 100

Remarks: Detached as Teamster  
by Special Order dated  
March 27 for L. M. Rec't Depot

Book mark:

(358)

Rosenbaum  
Copyist.

J | 4 Cav. | U.S.C.T.

Thomas Snow

Pvt., Co. D. 4 Reg't U. S. Col'd Cavalry.

Appears on

**Company Muster Roll**

for July & Aug, 1864.

Present or absent absent

Stoppage, \$ 100 for

Due Gov't, \$ 100 for

Valuation of horse, \$ 100

Valuation of horse equipments, \$ 100

Remarks: Detached as Gunner  
at Recty Depot N.C. by  
S.A. dated Mar 27-64

Book mark:

(358)

Rosenbaum  
Copyist.

S | **4 Cav.** | **U.S.C.T.**

Thomas Snow

Priv, Co. D. 4 Reg't U. S. Col'd Cavalry.

Appears on

**Company Muster Roll**

for Sept & Oct, 1864.

Present or absent Present

Stoppage, \$ 100 for

Due Gov't, \$ 100 for

Valuation of horse, \$ 100

Valuation of horse equipments, \$ 100

Remarks:

Book mark:

Rosenbarn

(358)

Copyist.

*S* | **4 Cav.** | **U.S.C.T.**

*Thomas Simon*

*P*, Co. D, 4 Reg't U. S. Col'd Cavalry.

Appears on

**Company Muster Roll**

for *Jan & Dec*, 1864.

Present or absent *Present*

Stoppage, \$ 100 for

Due Gov't, \$ 100 for

Valuation of horse, \$ 100

Valuation of horse equipments, \$ 100

Remarks:

Book mark:

(358)

*A. H. Wright*  
Copyist.

21 | 4 Cav. | U.S.C.T.

Thomas Sims

Co. D, 4 Reg't U. S. Col'd Cavalry.

Appears on

Company Muster Roll

for Dec 22 & Feb, 1865.

Present or absent Present

Stoppage, \$ 100 for

Due Gov't, \$ 100 for

Valuation of horse, \$ 100

Valuation of horse equipments, \$ 100

Remarks: Head only #7 for  
worth to include up to 3/1/64

Book mark:

(358) L. G. Wright Copyist.

1 | **4 Cav.** | **U.S.C.T.**

*Thomas Stone*

*Co. D, 4 Reg't U. S. Col'd Cavalry.*

Appears on

**Company Muster Roll**

for *March 1864*, 1864

Present or absent *Present*

Stoppage, \$ 100 for

Due Gov't, \$ 100 for

Valuation of horse, \$ 100

Valuation of horse equipments, \$ 100

Remarks: *Appointed Supt*  
*Apr 1864*

Book mark:

*W. H. Bright*



*21* | **4 Cav. | U.S.C.T.**

*Thomas Jones*

*Saddle Co.* Co. D, 4 Reg't U. S. Col'd Cavalry.

Appears on

**Company Muster Roll**

for *March to June*, 186*5*.

Present or absent *Present*

Stoppage, \$ 100 for

Due Gov't, \$ 100 for

Valuation of horse, \$ 100

Valuation of horse equipments, \$ 100

Remarks: *see Saddle Co. No. 105*

Book mark: \_\_\_\_\_

*W. H. Knight*  
(358) Copyist.

*J* | **4 Cav.** | **U.S.C.T.**

*William Smith*

*Saddler* Co. D, 4 Reg't U. S. Col'd Cavalry.

Appears on

**Company Muster Roll**

for *July & Aug*, 186*4*

Present or absent *Present*

Stoppage, \$ *100* for

Due Gov't, \$ *100* for

Valuation of horse, \$ *100*

Valuation of horse equipments, \$ *100*

Remarks: *appointed Saddler  
Apr 1865*

Book mark:

(358)

*W. H. Smith*

Copyist.

*C* | **4 Cav. | U.S.C.T.**

*Thomas Hunt*

*Saddler* Co. D, 4 Reg't U. S. Col'd Cavalry.

Appears on

**Company Muster Roll**

for *Capt - & Co*, 1865.

Present or absent *Present*

Stoppage, \$ 100 for

Due Gov't, \$ 100 for

Valuation of horse, \$ 100

Valuation of horse equipments, \$ 100

Remarks:

Book mark:

(358)

*W. H. Wright*

Copyist.

1877 530  
D | 4 Cav. | U.S.C.T.

Thomas A. ...

... Co. D, 4 Reg't U. S. Col'd Cavalry.

Appears on

**Company Muster Roll**

for ... 1865.

Present or absent ...

Stoppage, \$ 100 for

Due Gov't, \$ 100 for

Valuation of horse, \$ 100

Valuation of horse equipments, \$ 100

Remarks:

Book mark:

ms. Audens

(358)

Copyist.

4 Cav. U.S.C.T.

Thomas Sumner

Saddly, Co. D, 4 Reg't U. S. Col'd Cavalry.

Appears on

Company Muster Roll

for Jan & Feb, 1864.

Present or absent Present

Stoppage, \$ 100 for

Due Gov't, \$ 100 for

Valuation of horse, \$ 100

Valuation of horse equipments, \$ 100

Remarks:

Book mark:

Jos. Buckner

| **4 Cav.** | **U.S.C.T.**

Thomas Snow

Port, Co. D, 4 Reg't U. S. Colored Cav.

Appears on **Returns** as follows:

Apr 1864 - Jan: Apr 17/64  
N. Orleans Recruit from  
depot.

Absent depot teamster Apr  
29/64

May 1864 - Absent teamster  
for depot G.M. Apr 29/64

June 1864 Absent sick in depot  
N. Orleans.

July 1864 - Absent det. as teamster  
at Recruiting depot N. O. S. O.  
36 Hd. Quarters U. S. C. Army  
Apr 29/64

Aug 1864 - Absent teamster at  
Recruiting depot C. P. at  
New Orleans.

Does not appear elsewhere  
Thomas Snow

Book mark: \_\_\_\_\_

S- | **4 Cav. | U.S.C.T.**

*Thomas Snow*

*Saddler*, Co. *D*, 4 Reg't U. S. Col'd Cavalry.

Appears on **Co. Muster-out Roll**, dated  
*New Orleans, La.*, *April 21*, 1864.

Muster-out to date *April 21*, 1864.

Last paid to *June 30*, 1865.

**Clothing account:**

Last settled....., 186 ; drawn since \$..... 100

Due soldier \$..... 100; due U. S. \$ *2 1/2* <sup>*64*</sup>/<sub>100</sub>

Am't for cloth'g in kind or money adv'd \$..... 100

Due U. S. for arms, equipments, &c., \$..... 100

Bounty paid \$..... 100; due \$..... 100

Remarks: *found as account*

Book mark: *V 26, P 244, 68*

*W. C. ...*

(361)

Copyist.

Snow Thomas

Pvt. Co. D, 4 Reg't U.S.C.

1 Enclosures.

Red Cards .....	Final Statements .....
Burial Records .....	Furloughs or L. of A. ....
Certs. of Dis. for Discharge .....	Med. Certificates .....
C. M. Charges .....	Med. Des. Lists .....
Descriptive Lists .....	Orders .....
Discharge Certificates .....	Pris. of War Record .....
Enlistment Papers .....	Resignations .....

Other papers relating to—

Admission to Hosp'l .....	Furlough or L. of A. ....
Casualty Sheet .....	Med. Examination .....
Confinement .....	Misc. Information / .....
Contracts .....	Pay or Clothing .....
Death or Effects .....	Personal Reports .....
Desertion .....	Rank .....
Discharge from Hosp'l .....	Transfer to Hosp'l .....
Discharge from Service .....	Transfer to V. R. C. ....
Duty .....	Transportation .....



New Orleans, May 10, 1864

Chas. H. Roberts, 1<sup>st</sup> Lt. & a. q. m.  
Recruiting Depot U.S. (C. & A.) Troops.

Requests that Private Thomas Sarr  
Co. D. 4<sup>th</sup> U.S. Cav (C. & A.) be detached  
at Recruiting Depot in the Department.  
11-38

Office Rec'tg Depot  
U.S. Troops, fold.

A.O. May 13<sup>th</sup> 1864

Respectfully for-  
warded & recommended

It would seem  
that officers or en-  
listed officers men  
could be spared from  
this Reg't for necessary  
special duty in its  
present unorganized con-  
dition

J. D. Hanger  
St Col & g. p. of Reg't  
U.S. Cav

Rec'd May 13<sup>th</sup> 1864

Ued Ins Defenses Orleans.  
May 13, 1864

Respectfully referred to Com-  
manding officer 4<sup>th</sup> U.S.  
Cavalry (C. & A.) for answer.  
Respectfully  
Maj. H. H. General

U.S. in 42<sup>nd</sup> was com-  
Camp about May 15<sup>th</sup> 64

Subject to this man  
being detailed out  
of the Regiment  
and would request  
that he be ordered to  
his Reg't at once

Very Respectfully  
J. H. Hanger  
Comdr Reg't

4<sup>th</sup> U.S. Cav  
Head Qrs. Dist. of Carrollton  
May 16/64

Respectfully returned  
with reply of Col. Alexander  
Enclosed

Robt Wilson  
Col Comdg District

file

Recruiting Depot U. S. C. I.  
New Orleans, La. May 13 1864.

Maj. John Levering  
A. A. G.

Majors

I have the honor  
to request that Private Thomas Snow of  
Co. D, 4<sup>th</sup> U. S. Cav. Bde. be detailed as  
this Depot in the 2<sup>nd</sup> U. S. Dept.

Very Respectfully

Yours Obedt Serv<sup>t</sup>

Chas H Roberts 1<sup>st</sup> Lt  
A. A. G. Recruiting Dept  
U. S. Colored Troops

100  
Solomon Washington

Co *A*, 4 U. S. Col'd Cav.

Private | Private

CARD NUMBERS.

1	5354982	26
2	5355071	27
3	5355163	28
4	5355257	29
5	5355340	30
6	5355424	31
7	5355505	32
8	5355592	33
9	5356168	34
10	40729228	35
11		36
12		37
13		38
14		39
15		40
16		41
17		42
18		43
19		44
20		45
21		46
22		47
23		48
24		49
25		50

Book Mark:

See also

*S* | **4 Cav.** | **U.S.C.T.**

*Washington Solomon*

*Pvt*, Co. A, Mounted Rangers, Corps d'Afrique. †

Age ..... years.

Appears on

**Company Muster Roll\***

for *Nov & Dec*, 186 *3*.

Joined for duty and enrolled:

When *Nov 1*, 186 *3*.

Where *Iberia, La*

Period ..... years.

Mustered in:

When *Nov 30*, 186 *3*.

Where *Iberia, La*

Present or absent *Present*

Stoppage, \$ ..... 100 for .....

Due Gov't \$ ..... 100 for .....

Valuation of horse, \$ ..... 100

Valuation of horse equipments, \$ ..... 100

Remarks: .....

† This organization subsequently became Co. F, 4 U. S. Col'd Cav.  
\* First current roll. No muster-in roll of this ~~battery~~ on file.

Book mark: .....

*M. M. M. M. M.*  
(3586) Copyist.

*S* | **4 Cav. | U.S C.T.**

*Washington Solomon*  
*Pr*, Co. *F*, 1 Reg't Cav., Corps d'Afrique.\*

Appears on

**Company Muster Roll**

for *July 10 Feb*, 1864.

Present or absent *Present*

Stoppage, \$ 100 for

Due Gov't, \$ 100 for

Valuation of horse, \$ 100

Valuation of horse equipments, \$ 100

Remarks:

\*This organization subsequently became Co. *F*, 4 Reg't U.S. Colored Cavalry.

Book mark:

(358)

*Manning* Copyist.

*S* | **4 Cav. U.S.C.T.**

*Washington Solomon,*  
*Pvt*, Co. F, 4 Reg't U. S. Col'd Cavalry.

Appears on

**Company Muster Roll**

for *March & April*, 1864.

Present or absent *Present*

Stoppage, \$ *100* for

Due Gov't, \$ *100* for

Valuation of horse, \$ *100*

Valuation of horse equipments, \$ *100*

Remarks:

Book mark:

(358)

*Hamming*  
Copyist.

*S* 4 Cav. U.S.C.T.

*Washington Solomon*  
*Pop*, Co. F, 4 Reg't U. S. Col'd Cavalry.

Appears on

**Company Muster Roll**

for *May & June*, 1864.

Present or absent *Present*

Stoppage, \$ *100* for

Due Gov't, \$ *100* for

Valuation of horse, \$ *100*

Valuation of horse equipments, \$ *100*

Remarks:

Book mark:

(358)

*Manning*  
Copyist.

*S* | **4 Cav. U.S.C.T.**

*Washington Solomon*

*Plt*, Co. F, 4 Reg't U. S. Col'd Cavalry.

Appears on

**Company Muster Roll**

for *July & Aug*, 1864.

Present or absent *Present*

Stoppage, \$ *100* for

Due Gov't, \$ *100* for

Valuation of horse, \$ *100*

Valuation of horse equipments, \$ *100*

Remarks:

Book mark:

(358)

*Manning*  
Copyist.



1864  
S | 4 Cav. | U.S.C.T.

Washington Solomon,  
Pvt., Co. F, 4 Reg't U. S. Col'd Cavalry.

Appears on

**Company Muster Roll**

for Sept & Oct, 1864.

Present or absent Present

Stoppage, \$ 100 for

Due Gov't, \$ 100 for

Valuation of horse, \$ 100

Valuation of horse equipments, \$ 100

Remarks:

Book mark:

(358)

Hanning  
Copyist.

*S* | **4 Cav.** | **U.S.C.T.**

*Washington Solomon*  
*Pot*, Co. F, 4 Reg't U.S. Col'd Cavalry.

Appears on

**Company Muster Roll**

for *Nov. & Dec*, 186*4*

Present or absent *Present*

Stoppage, \$ *100* for

Due Gov't, \$ *100* for

Valuation of horse, \$ *100*

Valuation of horse equipments, \$ *100*

Remarks:  
.....  
.....  
.....  
.....  
.....  
.....  
.....  
.....

Book mark: .....

*J. H. Harris*

(358)

Copyist.

S | 4 Cav. | U.S.C.T.

Washington Solomon  
Prt, Co. F, 4 Reg't U. S. Col'd Cavalry.

Appears on

**Company Muster Roll**

for Jan & Feby, 186 5

Present or absent \_\_\_\_\_

Stoppage, \$ \_\_\_\_\_ 100 for \_\_\_\_\_

Due Gov't, \$ \_\_\_\_\_ 100 for \_\_\_\_\_

Valuation of horse, \$ \_\_\_\_\_ 100

Valuation of horse equipments, \$ \_\_\_\_\_ 100

Remarks: Discharged and Final  
Statement given.

Book mark: \_\_\_\_\_

J. A. Harris

(358)

Copyist.

A. | 4 Cav. | U.S.C.T.

Washington Solomon  
Port \_\_\_\_\_, Co. F, 4 Reg't U. S. Colored Cav.

Appears on Returns as follows:

Feb & March 1864 (1 Regt Cav. Corps d'Afrique)

On duty Co. Cook

April 1864 to June 1865 - (4 Regt U.S. Col'd Cav)

On duty Detailed as Co. Cook

Feb 1865 - Dis: Feb 13/65 Port

Hudson La. Disch'd for  
disability.

Book mark :

W. R. See

(540)

Copist.

S | 4 Cav. | U.S.C.T.

Washington Solomon

P, Co. P, 4 Reg't U. S. Col'd Cavalry.

Appears on **Co. Muster-out Roll**, dated New Orleans, La., Mch. 20 1866.

Muster-out to date \_\_\_\_\_, 186 .

Last paid to \_\_\_\_\_, 186 .

**Clothing account:**

Last settled \_\_\_\_\_, 186 ; drawn since \$ \_\_\_\_\_ 100

Due soldier \$ \_\_\_\_\_ 100; due U. S. \$ \_\_\_\_\_ 100

Am't for cloth'g in kind or money adv'd \$ \_\_\_\_\_ 100

Due U. S. for arms, equipments, &c., \$ \_\_\_\_\_ 100

Bounty paid \$ \_\_\_\_\_ 100; due \$ \_\_\_\_\_ 100

Remarks: Joined at orig. org.  
Discharged Feb. 13, 65, for disability

Book mark: V26-P113-68  
3236-1878.

(361)

Hibbard  
Copyist.

Solomon, Washington

P, Co. A, 4 Regt U.S.C. Cav.

Enclosures.

- |                                |                   |
|--------------------------------|-------------------|
| Bed Cards                      | Descriptive Lists |
| Burial Records                 | Final Statements  |
| Certs. of Dis. for Discharge / | Furloughs         |
| C. M. Charges                  | Med. Des. Lists   |
| Med. Certificates              | Orders            |

Other papers relating to—

- |                            |                      |
|----------------------------|----------------------|
| Admission to Hosp'l        | Furlough             |
| Casualty Sheet (Officer's) | Med. Examination     |
| Confinement                | Misc. Information    |
| Contracts                  | Pay or Clothing      |
| Death or Effects           | Personal Reports     |
| Desertions                 | Rank                 |
| Discharge from Hosp'l      | Transfer to Hosp'l   |
| Discharge from Service     | Transfer to V. R. C. |
| Duty                       | Transportation       |

NOTE 1.

The company commander will here add a statement of all the facts known to him concerning the disease or wound, or cause of disability of the soldier; the time, place, manner, and all the circumstances under which the injury occurred, or disease originated or appeared; the duty, or service, or situation of the soldier at the time the injury was received or disease contracted, stating particularly whether the injury was received or the disease contracted in the line of his duty; and whatever other facts may aid a judgment as to the cause, immediate or remote, of the disability, and the circumstances attending it.

When the facts are not known to the company commander, the certificate of any officer, or affidavit of other person having such knowledge, will be appended—as the surgeon in charge of a hospital, the officer commanding a detachment of recruits, &c., &c.

NOTE 2.

When a probable case for pension, special care must be taken to state the degree of disability—as 1/2, 3/4, &c., &c.; to describe particularly the disability, wound, or disease, the extent of which it deprives him of the use of any limb or faculty, or affects his health, strength, activity, constitution, or capacity to labor or earn his subsistence. The surgeon will add, from his knowledge of the facts and circumstances, and from the evidence in the case, his professional opinion of the cause or origin of the disability. In the case of discharges by Medical Inspectors, the last paragraph will state that the "discharge was given by consent of the soldier, after a personal examination, and for disability, the nature, degree, and origin of which are correctly described in the within certificate."

Par. 1260 Regulations, Edit. 1861.

Medical officers, in giving certificates of disability, are to take particular care in all cases that have not been under their charge; and especially in epilepsy, convulsions, chronic rheumatism, derangement of the urinary organs, ophthalmia, ulcers, or any obscure disease liable to be feigned or purposely produced; and in no case shall such certificate be given until after sufficient time and examination to detect any attempt at deception.

DIRECTIONS.

This certificate will be made out in duplicate by the soldier's company commander, or other officer commanding the separate detachment to which he belongs, and sent by him to the surgeon who has charge of the hospital where the soldier is sick. The surgeon will then fill out and sign the surgeon's certificate, and forward these papers to the regimental, detachment, or post commander, who will forward them, with his action endorsed thereon, through the proper channel, to his division commander; or, if the troops are not attached to a division, to his corps, department, or other commander or officer to whom the authority to discharge enlisted men may be specially delegated.

These certificates, after having received the action of the highest authority to which they are required to be sent, will be returned through the same channel to the regimental, post, or detachment commander, who will, if the discharge is authorized by the endorsement of the proper authority, sign the soldier's discharge, and the last certificate on this paper; see that the soldier is furnished with the proper final statements in duplicate, and forward BOTH of these certificates direct to the Adjutant General United States Army, at Washington, D. C.; they will not, under any circumstances, be given into the hands of the soldier.

McL 11 1865

Duplicate sent the Pension Office.

CERTIFICATE OF DISABILITY FOR DISCHARGE  
IN THE CASE OF

Washington Salamanca  
a Private Co. 7th  
Leventh Reg't of U.S. A.

Approved Jan 30 5

Head Quarters, Dept of the Gulf  
New Orleans, February 2 1865  
To be discharged  
By command of Maj. Genl. Hurlbut  
J. A. Stone  
Captain U.S. Army

Received (A. G. Office)

Carroll Coffey  
1865

Office Surgeon in Chief  
District of Baton Rouge & Port Hudson  
January 24<sup>th</sup> 1865  
Respectfully Approved  
Chas. A. DeCuir  
Surgeon 2<sup>nd</sup> La. Vol. Infy  
In Charge District of Baton Rouge & Port Hudson

# ARMY OF THE UNITED STATES.

## CERTIFICATE

### OF DISABILITY FOR DISCHARGE.



Washington Solomon, of Captain White's Company, ( 4th ) of the 4th Regiment of the United States Infantry was enlisted by Capt. [unclear] of the 4th Regiment of Infantry at Fort [unclear] on the 1st day of August, 1863, to serve 3 years; he was born in Richmond in the State of Virginia, is 24 years of age, 5 feet 10 inches high, Blk complexion, Blk eyes, Blk hair, and by occupation when enlisted a Labourer. During the last two months said soldier has been unfit for duty 60 days.\*

STATION: Fort Hudson, La.  
 DATE: Jan 10 1865  
[Signature]  
 Capt.  
 Commanding Company.

I CERTIFY, that I have carefully examined the said Washington Solomon of Captain White's Company, and find him incapable of performing the duties of a soldier because of old age and family jam fracture of tibia he also has lumbago and stiffness of joints this disability existed prior to enlistment. He is unfit for service in Invalid Corps.  
Henry W. Brown Surgeon U.S.A.

D. D. Hanson Surgeon U.S.A.  
H. Good Asst. Surg. U.S.A. Surgeon.

DISCHARGED, this 10th day of February, 1865, at Fort  
Hudson Louisiana  
Nathel Mitchell  
 Major  
 Commanding the Reg't.

The Soldier desires to be addressed at  
 Town Franklin County [unclear] State Louisiana

\* See Note 1 on the back of this. † See Note 2 on the back of this.

Office Fort Hudson  
 Post 4th Regt Inf  
 Jan 9 1865  
 Reported approved  
 W. D. [unclear] 18 used  
 Post Surg [unclear]



1007

Solomon Joseph

Co L, 4 U. S. Col'd Cav.

Private | Private

CARD NUMBERS.

1	5-347682	26
2	5-347682	27
3	5-358655	28
4	5-358715	29
5	5-348129	30
6	40729227	31
7		32
8		33
9		34
10		35
11		36
12		37
13		38
14		39
15		40
16		41
17		42
18		43
19		44
20		45
21		46
22		47
23		48
24		49
25		50

Book Mark:

See also

*J* | 4 Cav. | U.S.C.T.

*Joseph Solomon*

Appears with rank of *Pr* on

**Muster and Descriptive Roll of a Detachment of U. S. Vols. forwarded**

for the 4 Reg't U. S. Col'd Cavalry. Roll dated *New Orleans La July 18*, 1864.

Where born *La*

Age *24* y'rs; occupation *Laborer*

When enlisted *Apr 9*, 1864.

Where enlisted *Alexandria*

For what period enlisted *3* years.

Eyes *DK*; hair *DK*

Complexion *DK*; height *5 ft. 3 in.*

When mustered in *June 22*, 1864.

Where mustered in *New Orleans*

Bounty paid \$ *100*; due \$ *100*

Where credited *To Alexandria La*

Company to which assigned *L*

Remarks:

Book mark:

*Van Hook*

*S* | **4 Cav. U.S.C.T.**

*Joseph Solomon*

Appears with rank of *Pl* on

**Muster and Descriptive Roll of a Detachment of U. S. Vols. forwarded**

for the 4 Reg't U. S. Col'd Cavalry. Roll dated

*New Orleans La June 22, 1864*

Where born *La*

Age *24* y'rs; occupation *Laborer*

When enlisted *Apr 9*, 186*4*

Where enlisted *Alexandria*

For what period enlisted *3* years.

Eyes *DK*; hair *DK*

Complexion *DK*; height *5* ft. *3* in.

When mustered in \_\_\_\_\_, 186*4*

Where mustered in *New Orleans*

Bounty paid \$ *2* <sup>100</sup>; due \$ <sup>100</sup>

Where credited *to Alexandria La*

Company to which assigned *S*

Remarks: \_\_\_\_\_

\_\_\_\_\_

\_\_\_\_\_

Book mark: \_\_\_\_\_

\_\_\_\_\_

*Jau Hunter*  
(339) Copyist.

*L* | **4 Cav. | U.S.C.T.**

*Joseph Solomon*  
Pvt., Co. *L*, 4 Reg't U. S. Col'd Cavalry.

Age.....years.

Appears on

**Company Muster Roll\***  
for *Enlistment to Aug. 31*, 1864.

Joined for duty and enrolled:

When *Apr. 9*, 1864.

Where *Alexandria La*

Period *3* years.

Mustered in:

When *June 22*, 1864.

Where *New Orleans La*

Present or absent *Present*

Stoppage, \$ *100* for.....

Due Gov't, \$ *100* for.....

Valuation of horse, \$ *100*

Valuation of horse equipments, \$ *100*

Remarks : .....

\* First current roll. No muster-in roll of this battery on file.

Book mark : .....

*Lorring*  
(3586) Copyist.

S | 4 Cav. | U.S.C.T.

Joseph Solomon

Pvt.

Co. L, 4 Reg't U. S. Col'd Cavalry.

Appears on

Company Muster Roll

for Sept. & Oct., 1867.

Present or absent

Stoppage, \$ 100 for

Due Gov't, \$ 100 for

Valuation of horse, \$ 100

Valuation of horse equipments, \$ 100

Remarks: Died Sept. 25th 1867  
in Company Quarters Fort  
Gadsden La. Due U.S. Gov't  
Advance  $\frac{20}{100}$  wages

Book mark:

Curry

(358)

Copyist.

1 | **4 Cav. | U.S.C.T.**

Joseph R. Solomon  
Port, Co. 2, 4 Reg't U. S. Colored Cav.

Appears on Returns as follows:

Sept 1861 - 2022: Sept 25/61  
Port Hudson Resisted.

Book mark: \_\_\_\_\_

W. R. Zee

21 - Copy | **U.S.C.T.**

Henry Johnson  
1st Co., 7 Reg't U. S. Col'd Copy  
Appears on a

**Detachment Muster-out Roll**

of the organization named above. Roll dated  
New Orleans La., Mar 20, 1866 .

Muster-out to date \_\_\_\_\_, 186 .

Last paid to \_\_\_\_\_, 186 .

**Clothing account:**

Last settled \_\_\_\_\_, 186 ; drawn since \$ \_\_\_\_\_ 100

Due soldier \$ \_\_\_\_\_ 100 ; due U. S. \$ \_\_\_\_\_ 100

Am't for cloth'g in kind or money adv'd \$ \_\_\_\_\_ 100

Due U. S. for arms, equipments, &c., \$ \_\_\_\_\_ 100

Bounty paid \$ \_\_\_\_\_ 100 ; due \$ \_\_\_\_\_ 100

Remarks: listed at original  
organization listed at Port  
London La. Sept 20, 1864  
of General Utility.

Book mark: \_\_\_\_\_

(349)

F. J. [Signature]

Copyist.

Solomon, Joseph

P, Co. L, 4 U.S.C. Cav.

2 Enclosures.

Bed Cards	Descriptive Lists
Burial Records	Final Statements 2
Certs. of Dis. for Discharge	Furloughs
C. M. Charges	Med. Des. Lists
Med. Certificates	Orders

Other papers relating to—

Admission to Hosp'l	Furlough
Casualty Sheet (Officer's)	Med. Examination
Confinement	Misc. Information
Contracts	Pay or Clothing
Death or Effects	Personal Reports
Desertions	Rank
Discharge from Hosp'l	Transfer to Hosp'l
Discharge from Service	Transfer to V. R. C.
Duty	Transportation



FINAL STATEMENT

OF  
*Private Joseph Solomon*  
*Co. 4<sup>th</sup> Reg't of U.S. Cavalry Colonel*

VOLUNTEERS.

*[Signature]*

NOTE 1.—Two of these certificates (or duplicates) are to be given to each volunteer soldier who may be discharged previously to the discharge of his company, that he may at once receive from the Paymaster the pay, &c., due him, and the captain or other officer commanding the company will certify to the act of the delivery of the duplicate certificates, on these certificates the Soldier is "entitled to" his discharge, and should also present his discharge to the Paymaster to have the payment endorsed on it. The discharge is to be given back to the Soldier by the Paymaster; the latter only retaining as his voucher the duplicate certificates.

NOTE 2.—If the Soldier is entitled to pay for the use of his horse, the Company Commander will certify to that fact, and also to the time he has pay due for having been so mounted on his own horse.

NOTE 3.—Amounts due the Sutler and Laundress must be entered on the Muster Roll on which the death, desertion, &c., is reported, as well as on the final statement, otherwise the amount cannot be collected from the United States.

NOTE 4.—This blank will be used for deceased volunteers as well as others.

ADJUTANT GENERAL'S OFFICE.  
*Co. 19<sup>th</sup> 1864.*  
Duplicate with Inventory sent 2d Auditor.

RECEIVED  
OCT  
18  
1864  
ADJUTANT GEN'L'S OFFICE

*[Signature]*

I certify, on honor, that Joseph Solomon a Private of Captain Lieut. A. J. Whittier Company (A) of the 4<sup>th</sup> Regiment of Cavalry Colored U.S. VOLUNTEERS, of the State of Louisiana, born in \_\_\_\_\_, State of Louisiana, aged 24 years; 5 feet 3 inches high; Dart complexion, Dark eyes, Dark hair, and by occupation a Laborer, having joined the company on its original organization at New Orleans La. April 2<sup>nd</sup> 1864 and enrolled in it at the muster into the service of the United States at New Orleans La., on the 22<sup>nd</sup> day of June, 1864, (or was mustered in service as a recruit, by Lieut. Chamberlain, at New Orleans La on the 22<sup>nd</sup> day of June, 1864, to serve in the Regiment,) for the term of Three Years; and having served HONESTLY and FAITHFULLY with his Company in the Field to the present date, is now entitled to a **DISCHARGE** by reason of Death

The said Private Joseph Solomon was last paid by Paymaster Pay to include the Tenth day of April, 1864, and has pay due him from that time to the present date; he is entitled to pay and subsistence for TRAVELING to place of enrollment and whatever other allowances are authorized to volunteer soldiers, or militia, so discharged. He has received Twenty Three Dollars <sup>23</sup>/<sub>100</sub> dollars, advanced by the United States on account of **CLOTHING**.

There is to be stopped from him, on account of the State of \_\_\_\_\_, or other authorities for **CLOTHING**, &c., received on entering service, \_\_\_\_\_ dollars; also, for expenses of SUBSISTENCE for TRAVELING from place of enrollment to the place of rendezvous, amounting to \_\_\_\_\_ dollars: and on account of the United States for **EXTRA CLOTHING** received in kind from \_\_\_\_\_ and for other stoppages, viz:

due U.S. for last advances on paper amounting to \_\_\_\_\_ 20/<sub>100</sub> dollars;

and he has been SUBSISTED for TRAVELING to his place of enrollment, up to the \_\_\_\_\_, 186 .

He is indebted to John Wild, SUTLER, 12 5/<sub>100</sub> dollars.

He is indebted to \_\_\_\_\_, LAUNDRESS, \_\_\_\_\_ dollars.

Given in Duplicate, at Port Hudson, this 26<sup>th</sup> day of September 1864.

A. J. Whittier  
1<sup>st</sup> Lieut.  
 Commanding Company.  
4<sup>th</sup> U.S. Cav Regt

200  
FINAL STATEMENT

OF

*Joseph H. Suter*  
Reg't of *Col. 1st Cavalry*  
*(112)*

**VOLUNTEERS.**

*Joseph H. Suter*

NOTE 1.—Two of these certificates (or duplicates) are to be given to each Volunteer Soldier or drafted man who may be discharged previously to the discharge of his company, that he may at once receive from the Paymaster the pay, &c., due him, and the captain or other COMMISSIONED officer commanding the company will certify to the act of the delivery of the duplicate certificates; on these certificates the Soldier is "entitled to" his discharge, and should also present his discharge to the Paymaster to have the payment endorsed on it. The discharge is to be given back to the Soldier by the Paymaster; the latter only retaining as his voucher the duplicate certificates.

NOTE 2.—If the Soldier is entitled to pay for the use of his horse, the Company Commander will certify to that fact on the back of both these final statements, and also to the time he has pay due for having been so mounted on his own horse.

NOTE 3.—When a Soldier is furnished with final statements, his descriptive list, if he has one, should be taken up by the officer who gives the Soldier these statements, and endorsed with a statement to this effect by the officer. This endorsement should exhibit a full statement of the time for which the Soldier was allowed pay on his final statements, the clothing account, and all other charges against him or in his favor, so as to comprise a complete exhibit of his account. It will then be transmitted to the company commander of the Soldier, who will enter all the data necessary to a full understanding of the Soldier's account on the muster roll upon which the Soldier's discharge is reported. The descriptive list will then be destroyed. The object of this is, that the remaining portion of the Soldier's account may be settled upon the receipt of these muster rolls, and the Soldier receive any pay or allowances that may be due him at the time of his discharge, and which may not appear on his final statements from the fact that his descriptive list is incomplete. These accounts for back pay, &c., are settled by the 2d Auditor of the Treasury Department.

NOTE 4.—Charges for loss or injury to ordnance, horse equipments, and other miscellaneous charges, should appear under the heading of "Other Stoppages."

NOTE 5.—Bounty paid by State authorities, and not by the United States, will not be entered on this statement.

NOTE 6.—Amounts due the Sutler and Laundress must be entered on the muster roll on which the discharge, death, desertion, &c., is reported, as well as on the final statement, otherwise the amount cannot be collected from the United States.

NOTE 7.—This blank will be used for deceased volunteers and drafted men, as well as for others.

NOTE 8.—Where a Soldier dies in Hospital or on detached service, his descriptive list, if he has one, should be sent with his final statements, in duplicate, to the Second Auditor, Washington, D. C.



ADJUTANT GENERAL'S OFFICE

*1864*  
Duplicate with Inventory sent 2d Auditor.

I certify, on honor, that Joseph M. Johnson a Sergeant of Captain Company (B) of the 4th Regiment of Colored Cavalry VOLUNTEERS, of the State of Louisiana, born in ..., State of Louisiana, aged 27 years; 5 feet ... inches high; ... complexion, ... eyes, ... hair, and by occupation a Barber, having joined the company on its original organization at ..., and enrolled in it at the muster into the service of the United States at ..., on the 12th day of ..., 1864, (~~or~~ was mustered in service as a recruit, by ... at ..., on the 12th day of ..., 1864, or was drafted and mustered into the service of the United States from the Enrollment District of the State of ..., at ..., on the ... day of ..., 1864,) to serve in the Regiment, for the term of Three years: and having served HONESTLY and FAITHFULLY with his Company in The Field to the present date, is now entitled to a **DISCHARGE** by reason of Death.

The said Joseph M. Johnson was last paid by Paymaster ... to include the 1st day of April, 1864, and has pay due him from that time to the present date; he is entitled to pay and subsistence for TRAVELING to place of enrollment, and whatever other allowances are authorized to volunteer soldiers, drafted men, or militia, so discharged. He has received from the United States **CLOTHING** amounting to 8.23 100 dollars, since the 1st day of April, 1864, when his clothing account was last settled. He has received from the United States ... 100 dollars advanced **BOUNTY**.

There is to be stopped from him, on account of the State of ..., or other authorities, for **CLOTHING**, &c., received on entering service ... 100 dollars; and for other stoppages, viz: Due \$60 for lost subsistence ... 100 dollars.

He has been furnished with TRANSPORTATION in kind from the place of his discharge to ...; and he has been SUBSISTED for TRAVELING to his place of enrollment, up to the ..., 1864.

He is indebted to John Will, **SUTLER**, ... 100 dollars.

He is indebted to ..., **LAUNDRESS**, ... 100 dollars.

Given in Duplicate, at Paul M. Custouner, this 25th day of September, 1864.

Asst. Surg. J. H. ...  
...

Commanding Company

*(Handwritten notes on the left margin)*

1003

Somers Edward

Co B, 4 U. S. Col'd Cav.

Private Corporal

CARD NUMBERS.

1	5353842	26
2	5353895	27
3	5353950	28
4	5354004	29
5	5354073	30
6	5354144	31
7	5354209	32
8	5354275	33
9	5354336	34
10	5354364	35
11	5354449	36
12	5354534	37
13	5354609	38
14	5354677	39
15	5354746	40
16	5354815	41
17	40729244	42
18		43
19		44
20		45
21		46
22		47
23		48
24		49
25		50

Book Mark:

See also

S1096421-POmm  
 P-1547202-AsWB  
 2-1625039-AsWB  
 P-1845089P O.aff  
 S1879849 P.aff

*Handwritten signature*

*S* | **4 Cav. U.S.C.T.**

*Edward Somers*

*Pvt.*, Co. *G*, 1 Reg't, Corps d'Afrique Cavalry.\*

Appears on

**Company Muster-in Roll**

of the organization named above. Roll dated  
*New Orleans, La. Dec. 31*, 186*2*.

Muster-in to date *Dec. 31*, 186*2*

Joined for duty and enrolled:

When *Nov. 10*, 186 .

Where *New Orleans*

Period *3* years.

Valuation of horse, \$ 100

Valuation of horse equipments, \$ 100

Remarks: \_\_\_\_\_  
\_\_\_\_\_  
\_\_\_\_\_

\*This organization subsequently became Co. *G*, 4 Reg't U. S. Colored Cavalry.

Book mark: \_\_\_\_\_

*Wendell*

*S* 4 Cav. U.S.C.T.

*Edward Somers*  
Co. *E*, 1 Reg't Cav., Corps d'Afrique.\*

Appears on

**Company Muster Roll**

for *Enlistment to Dec. 31, 1863*

Present or absent *Present*

Stoppage, \$ *100* for

Due Gov't, \$ *100* for

Valuation of horse, \$ *100*

Valuation of horse equipments, \$ *100*

Remarks:  
-----  
-----  
-----  
-----  
-----  
-----

\* This organization subsequently became Co. *E*, 4 Reg't U.S. Colored Cavalry.

Book mark: -----

*Wendell*



*S* 4 Cav. | U.S C.T.

*Edward Somers*

, Co. *E*, 1 Reg't Cav., Corps d'Afrique.\*

Appears on

**Company Muster Roll**

for *Jan & Feb*, 1864.

Present or absent *Present*

Stoppage, \$ *100* for

Due Gov't, \$ *100* for

Valuation of horse, \$ *100*

Valuation of horse equipments, \$ *100*

Remarks:

\* This organization subsequently became Co. *F*, 4 Reg't U. S. Colored Cavalry.

Book mark:

*Lamm*

(358)

Copyist.

S | 4 Cav. | U.S.C.T.

Edward Semore

Priv., Co. E, 4 Reg't U. S. Col'd Cav.

Appears on

**Company Muster Roll**

for Mar + Apr, 1864

Present or absent Present

Stoppage, \$ 100 for

Due Gov't, \$ 100 for

Valuation of horse, \$ 100

Valuation of horse equipments, \$ 100

Remarks:

Book mark:

Laurens

*S* | **4 Cav. | U.S.C.T.**

*Edward Somers*

*Plt*, Co. E, 4 Reg't U. S. Col'd Cav.

Appears on

**Company Muster Roll**

for *May & June*, 186*4*

Present or absent *Present*

Stoppage, \$ *100* for

Due Gov't, \$ *100* for

Valuation of horse, \$ *100*

Valuation of horse equipments, \$ *100*

Remarks:

Book mark:

*Lummer*

*S* | **4 Cav.** | **U.S.C.T.**

*Edward Somers*

*Out.*, Co. E, 4 Reg't U. S. Col'd Cav.

Appears on

**Company Muster Roll**

for *July + Aug*, 186*4*

Present or absent *Present*

Stoppage, \$ *100* for

Due Gov't, \$ *100* for

Valuation of horse, \$ *100*

Valuation of horse equipments, \$ *100*

Remarks:

Book mark:

(358)

*Lawrence*

Copyist.

*S* | **4 Cav.** | **U.S.C.T.**

*Edward Somers*

*Plt*, Co. E, 4 Reg't U. S. Col'd Cav.

Appears on

**Company Muster Roll**

for *Sept & Oct*, 1864.

Present or absent *Present*

Stoppage, \$ *100* for

Due Gov't, \$ *100* for

Valuation of horse, \$ *100*

Valuation of horse equipments, \$ *100*

Remarks: *Due 11 d for cont.*  
*Ordnance 43 d*

Book mark:

*Lawrence*

*S* | **4 Cav.** | **U.S.C.T.**

*Edward Somers*

*Rot*, Co. E, 4 Reg't U. S. Col'd Cav.

Appears on

**Company Muster Roll**

for *Nov & Dec*, 1864.

Present or absent *Present*

Stoppage, \$ *100* for

Due Gov't, \$ *100* for

Valuation of horse, \$ *100*

Valuation of horse equipments, \$ *100*

Remarks:

Book mark:

*Wines*

(358)

Copyist.

S | **4 Cav.** | **U.S.C.T.**

Edward Somers

Pvt, Co. E, 4 Reg't U. S. Col'd Cav.

Appears on

**Company Muster Roll**

for Jan & Feb, 186 5.

Present or absent Present

Stoppage, \$ 100 for

Due Gov't, \$ 100 for

Valuation of horse, \$ 100

Valuation of horse equipments, \$ 100

Remarks: Stop for 1 bridle 1  
halter and 1 surcingle  
Rec'd only 7 doll. per month  
to include Apr. 30/64

Book mark: \_\_\_\_\_

(358)

Wines

Copyist.

*S* | **4 Cav.** | **U.S.C.T.**

*Edward Somers*  
*Cpl*, Co. E, 4 Reg't U. S. Col'd Cav.

Appears on

**Company Muster Roll**

for *Mar + Apr*, 186*S.*

Present or absent *Present*

Stoppage, \$ *100* for

Due Gov't, \$ *100* for

Valuation of horse, \$ *100*

Valuation of horse equipments, \$ *100*

Remarks: *Appointed corp Apr*  
*1/6 S-*

Book mark:

(358)

*Wines*  
Copyist.



S | **4 Cav.** | **U.S.C.T.**

Edward Somers

Cpl, Co. E, 4 Reg't U. S. Col'd Cav.

Appears on

**Company Muster Roll**

for May & June, 1865.

Present or absent Present

Stoppage, \$ 100 for

Due Gov't, \$ 100 for

Valuation of horse, \$ 100

Valuation of horse equipments, \$ 100

Remarks: Stop for 1 pr spurs  
and strap / curry comb &  
1 brush

Book mark: \_\_\_\_\_

(358)

Wines

Copyist.

*S* | **4 Cav.** | **U.S.C.T.**

*Edward Summers*

*cpl*, Co. E, 4 Reg't U. S. Col'd Cav.

Appears on

**Company Muster Roll**

for *July & Aug*, 186*5*.

Present or absent *Present*

Stoppage, \$ *100* for

Due Gov't, \$ *100* for

Valuation of horse, \$ *100*

Valuation of horse equipments, \$ *100*

Remarks: *stop for 1) one pair  
spurs & straps, one curry  
comb, one horse brush*

Book mark:

(358)

*Wines*

Copyist.

*S* | **4 Cav.** | **U.S.C.T.**

*Edward Somers*

*Cpl*, Co. E, 4 Reg't U. S. Col'd Cav.

Appears on

**Company Muster Roll**

for *Sept & Oct*, 186*5*.

Present or absent *Present*

Stoppage, \$ *100* for

Due Gov't, \$ *100* for

Valuation of horse, \$ *100*

Valuation of horse equipments, \$ *100*

Remarks:

Book mark: *30925*

(358)

*Wines*

Copyist.

S | **4 Cav.** | **U.S.C.T.**

Edward Simmons

Co. E, Co. E, 4 Reg't U. S. Col'd Cav.

Appears on

**Company Muster Roll**

for Nov. & Dec., 1865.

Present or absent Present.

Stoppage, \$ 7 <sup>57</sup>/<sub>100</sub> for lost allowance

Due Gov't, \$ 100 for \_\_\_\_\_

Valuation of horse, \$ 100

Valuation of horse equipments, \$ 100

Remarks: \_\_\_\_\_

Book mark: \_\_\_\_\_

(358)

Floyd

Copyist.

*S* | **4 Cav.** | **U.S.C.T.**

*Edward Summers*

*Corp*, Co. E, 4 Reg't U. S. Col'd Cav.

Appears on

**Company Muster Roll**

for *Jan'y & Feb'y*, 186*6*.

Present or absent *Present*

Stoppage, \$ *7*  $\frac{57}{100}$  for *lost ordnance*

Due Gov't, \$  $\frac{100}{100}$  for

Valuation of horse, \$  $\frac{100}{100}$

Valuation of horse equipments, \$  $\frac{100}{100}$

Remarks:

Book mark:

(358)

*Floyd*

Copyist.

7777 700  
D | 4 Cav. | U.S.C.T.

(Edward Somers)  
Priv., Co. C, 4 Reg't U. S. Colored Cav.

Appears on Returns as follows:

June 1864. On duty detailed  
in Reg't. G. M. Dept.

Book mark : \_\_\_\_\_

(546) W. R. Lee Copyist.

J | 4 Cav. | U.S.C.T.

Edward Summers

Cos. E, Co. E, 4 Reg't U. S. Col'd Cavalry.

Appears on Co. Muster-out Roll, dated  
New Orleans La., Mch 20, 1866.

Muster-out to date Mch 20, 1866.

Last paid to June 30, 1865.

Clothing account:

Last settled, 186 ; drawn since \$ 100

Due soldier \$ 100; due U. S. \$ 41 <sup>47</sup>/<sub>100</sub>

Am't for cloth'g in kind or money adv'd \$ 100

Due U. S. for arms, equipments, &c., \$ 10 <sup>77</sup>/<sub>100</sub>

Bounty paid \$ 100; due \$ 100

Remarks: joined at orig. org. Priv to  
Apr 1/65. Stop, 1 halter & strap  
1 suscingle, 1 horsebrush, 1 curry  
comb, 1 girth, 1 pr spurs & straps  
1 Saddle Blanket.

Book mark: V. 26 P. 148. 68

(861)

Lloyd

Copied.

1004  
Sommers Martin

Co *a*, 4 U. S. Col'd Cav.

Private | Private

CARD NUMBERS.

1	5-348483	26
2	5-348585	27
3	5-348689	28
4	5-348725	29
5	5-348777	30
6	5-348966	31
7	5-349052	32
8	5-349183	33
9	5-349218	34
10	5-349309	35
11	5-349404	36
12	5-349730	37
12	40729237	38
14		39
15		40
16		41
17		42
18		43
19		44
20		45
21		46
22		47
23		48
24		49
25		50

Book Mark:

See also



*S* | **4 Cav.** | **U.S.C.T.**

*Martin Sommers*  
Private, Co. *A* 1 Reg't La. Cav., Corps d'Afrique.\*

Appears on

**Company Muster-in Roll**

of the organization named above. Roll dated  
*New Orleans La, Sept 12, 1863.*

Muster-in to date *Sept 12, 1863.*

Joined for duty and enrolled:

When *Aug 28*, 1863.

Where *New Orleans*

Period *3* years.

Valuation of horse, \$ *100*

Valuation of horse equipments, \$ *100*

Remarks:

*Age 48.*

\*This organization subsequently became Co. *A*, 4 Reg't U. S. Colored Cavalry.

Book mark:

(356)

*M. A. Michaels*  
Copyist.

*S* | **4 Cav. | U.S.C.T.**

*Martin Summers*  
*Priv*, Co. *a*, 1 Reg't La. Cav., Corps d'Afrique.\*

Appears on

**Company Muster Roll**

for *Sept 12 to Dec 31*, 186 *3*.

Present or absent *Present*

Stoppage, \$ *100* for

Due Gov't, \$ *100* for

Valuation of horse, \$ *100*

Valuation of horse equipments, \$ *100*

Remarks:

\*This organization subsequently became Co. *a* 4 Reg't U. S. Colored Cavalry.

Book mark:

*R. Richardson*

S

4 Cav. U.S C.T.

Martin Summers  
Troop, Co. A, 1 Reg't Cav., Corps d'Afrique.\*

Appears on

Company Muster Roll

for Jan & Feb, 1864

Present or absent Present

Stoppage, \$ 100 for

Due Gov't, \$ 100 for

Valuation of horse, \$ 100

Valuation of horse equipments, \$ 100

Remarks:

\* This organization subsequently became Co. A, 4 Reg't U. S. Colored Cavalry.

Book mark:

R. Richardson

S | 4 Cav. | U.S.C.T.

Martin Summers

Teamster, Co. A, 4 Reg't U. S. Col'd Cavalry.

Appears on

**Company Muster Roll**

for March + April, 1864.

Present or absent Present

Stoppage, \$ 100 for

Due Gov't, \$ 100 for

Valuation of horse, \$ 100

Valuation of horse equipments, \$ 100

Remarks: Detailed as  
Regimental Teamster

Book mark: \_\_\_\_\_

R. Richardson

(358)

Copyist.

S | 4 Cav. | U.S.C.T.

Martin Summers  
Priv, Co. A, 4 Reg't U. S. Col'd Cavalry.

Appears on

**Company Muster Roll**

for May & June, 1864

Present or absent Present

Stoppage, \$ 100 for

Due Gov't, \$ 100 for

Valuation of horse, \$ 100

Valuation of horse equipments, \$ 100

Remarks:

Book mark:

R. Richardson

4777 530  
S | 4 Cav. | U.S.C.T.

Martin Sommers

Pow, Co. A, 4 Reg't U. S. Col'd Cavalry.

Appears on

**Company Muster Roll**

for July + Aug, 1864

Present or absent Present

Stoppage, \$ 100 for

Due Gov't, \$ 100 for

Valuation of horse, \$ 100

Valuation of horse equipments, \$ 100

Remarks:

Book mark:

A. B. Richardson

S | 4 Cav. | U.S.C.T.

Martin Sommers

Pri, Co. A, 4 Reg't U. S. Col'd Cavalry.

Appears on

Company Muster Roll

for Sept & Oct, 1864

Present or absent Present

Stoppage, \$ 100 for

Due Gov't, \$ 100 for

Valuation of horse, \$ 100

Valuation of horse equipments, \$ 100

Remarks: Teamster

Book mark:

Donnelly

(358)

Copyist.

S | 4 Cav. | U.S.C.T.

Martin Sommers

Pri., Co. A, 4 Reg't U. S. Col'd Cavalry.

Appears on

Company Muster Roll

for Nov & Dec, 1864

Present or absent Present

Stoppage, \$ 100 for

Due Gov't, \$ 100 for

Valuation of horse, \$ 100

Valuation of horse equipments, \$ 100

Remarks: Stop for 1 halter & strap, 1 nose bag,

Book mark:

Donnelly



S | 4 Cav. | U.S.C.T.

Martin Sommers

Pi, Co. A, 4 Reg't U. S. Col'd Cavalry.

Appears on

Company Muster Roll  
for Jan & Feb, 1865.

Present or absent Present

Stoppage, \$ 100 for

Due Gov't, \$ 100 for

Valuation of horse, \$ 100

Valuation of horse equipments, \$ 100

Remarks: Strap for one halter & strap, 2 nose bags, 1 curry comb & brush

Book mark:

Donnelly

S | 4 Cav. | U.S.C.T.

Martin Summers

Pr

....., Co. A, 4 Reg't U. S. Col'd Cavalry.

Appears on

for ..... **Company Muster Roll** ..... 186 <sup>x</sup> <sub>or</sub> <sup>✓</sup>

Present or absent ..... *Present* .....

Stoppage, \$ ..... 100 for .....

Due Gov't, \$ ..... 100 for .....

Valuation of horse, \$ ..... 100

Valuation of horse equipments, \$ ..... 100

Remarks: .....

.....  
.....  
.....  
.....  
.....

*\* corrected by Thomas Pr*

Book mark: .....

.....  
*Donnelly*  
.....

(358)

Copyist.

S | 4 Cav. | U.S.C.T.

Martin Somers

Pri, Co. A, 4 Reg't U. S. Col'd Cavalry.

Appears on

Company Muster Roll

for May + June, 1865.

Present or absent

Stoppage, \$ 100 for

Due Gov't, \$ 100 for

Valuation of horse, \$ 100

Valuation of horse equipments, \$ 100

Remarks: Discharged by reason  
of disability. Final state-  
ments given June 25/65

Book mark:

Donnelly

4 Cav. | U.S.C.T.

Martin Summers

Priv., Co. A, 4 Reg't U. S. Colored Cav.

Appears on Returns as follows:

Apl 1864 - On duty Regtl teamster  
May 1864 - Absent sick sent to Genl Hosp.  
June 1864 - On duty teamster for Regtl. G. M.  
Dept.  
Sept & Oct 1864 - On duty teamster  
Nov 1864 - On duty in R. G. M. Dept.  
Mch 1865 - On duty detailed in Regtl.  
G. M. Dept.  
May 1865 - On duty detailed as nurse  
in Post Hosp.  
June 1865 - 2000; June 25/65 - Post  
Hudson La. Discharged for  
disability.

\* Name appears also as  
Martin Somers

Book mark :

W. R. Lee

*S* | **4 Cav.** | **U.S.C.T.**

*Martin Summers*  
*Prvt*, Co. *A*, 4 Reg't U. S. Col'd Cavalry.

Appears on **Co. Muster-out Roll**, dated  
*New Orleans La, Mech 20*, 1866.

Muster-out to date \_\_\_\_\_, 186 .

Last paid to \_\_\_\_\_, 186 .

**Clothing account:**

Last settled \_\_\_\_\_, 186 ; drawn since \$ \_\_\_\_\_ 100

Due soldier \$ \_\_\_\_\_ 100; due U. S. \$ \_\_\_\_\_ 100

Am't for cloth'g in kind or money adv'd \$ \_\_\_\_\_ 100

Due U. S. for arms, equipments, &c., \$ \_\_\_\_\_ 100

Bounty paid \$ \_\_\_\_\_ 100; due \$ \_\_\_\_\_ 100

Remarks *Joined at orig reg. Discharged*  
*June 26, 65, at New Orleans La.*

*Discharged June 25, 65*  
*E. B. O. 10 P 488*

Book mark: *V. 171 P. 252, 73* *A. D.*

(361)

*Prewitt*  
Copyist.

Summers, Martin

P, Co. A, 4 Regt U.S.C. Cav.

1 Enclosures.

Bed Cards	Descriptive Lists
Burial Records	Final Statements
Certs. of Dis. for Discharge /	Furloughs
C. M. Charges	Med. Des. Lists
Med. Certificates	Orders

Other papers relating to—

Admission to Hosp'l	Furlough
Casualty Sheet (Officer's)	Med. Examination
Confinement	Misc. Information
Contracts	Pay or Clothing
Death or Effects	Personal Reports
Desertions	Rank
Discharge from Hosp'l	Transfer to Hosp'l
Discharge from Service	Transfer to V. R. C.
Duty	Transportation

NOTE 1.

The company commander will here add a statement of all the facts known to him concerning the disease or wound, or cause of disability of the soldier; the time, place, manner, and all the circumstances under which the injury occurred, or disease originated or appeared; the duty, or service, or situation of the soldier at the time the injury was received or disease contracted, stating particularly whether the injury was received or the disease contracted in the line of his duty; and whatever other facts may aid a judgment as to the cause, immediate or remote, of the disability, and the circumstances attending it.

When the facts are not known to the company commander, the certificate of any officer, or affidavit of other person having such knowledge, will be appended—as the surgeon in charge of a hospital, the officer commanding a detachment of recruits, &c., &c.

NOTE 2.

When a probable case for pension, special care must be taken to state the degree of disability—as  $\frac{1}{2}$ ,  $\frac{3}{4}$ , &c., &c.; to describe particularly the disability, wound, or disease; the extent to which it deprives him of the use of any limb or faculty, or affects his health, strength, activity, constitution, or capacity to labor or earn his subsistence. The surgeon will add, from his knowledge of the facts and circumstances, and from the evidence in the case, his professional opinion of the cause or origin of the disability. In the case of discharges by Medical Inspectors, the last paragraph will state that the discharge was given by consent of the soldier, after a personal examination, and for disability, the nature, degree, and origin of which are correctly described in the within certificate.

Par. 1260 Regulations, Edit. 1861.

Medical officers, in giving certificates of disability, are to take particular care in all cases that have not been under their charge; and especially in epilepsy, convulsions, chronic rheumatism, derangement of the urinary organs, ophthalmia, ulcers, or any obscure disease liable to be feigned or purposely produced; and in no case shall such certificate be given until after sufficient time and examination to detect any attempt at deception.

DIRECTIONS.

This certificate will be made out in duplicate by the soldier's company commander, or other officer commanding the separate detachment to which he belongs, and sent by him to the surgeon who has charge of the hospital where the soldier is sick. The surgeon will then fill out and sign the surgeon's certificate, and forward these papers to the regimental, detachment, or post commander, who will forward them, with his action endorsed thereon, through the proper channel, to his division commander; or, if the troops are not attached to a division, to his corps, department, or other commander or officer to whom the authority to discharge enlisted men may be specially delegated.

These certificates, after having received the action of the highest authority to which they are required to be sent, will be returned through the same channel to the regimental, post, or detachment commander, who will, if the discharge is authorized by the endorsement of the proper authority, sign the soldier's discharge, and the last certificate on this paper; see that the soldier is furnished with the proper final statements in duplicate, and forward BOTH of these certificates direct to the Adjutant General United States Army, at Washington, D. C.; they will not, under any circumstances, be given into the hands of the soldier.

CERTIFICATE OF DISABILITY FOR DISCHARGE

IN THE CASE OF

*M. S. Rice*  
*Asst. Surg. Gen.*  
*Martin Summers*

a Private Co. C.

4<sup>th</sup> Reg't of U.S. Cav.

Office Chief Med. Officer

Dep't of the Gulf,

N. D. June 15<sup>th</sup> 1865.

Approved.

*J. H. Abadie*  
Surgeon & I. S.  
Chf. Med. Off.

*M. Rice*  
Surgeon U.S. Army, Med. Dept.  
Surgeon in Chg. D. C. S.

Headquarters, Department of the Gulf,

New Orleans, La., June 18<sup>th</sup> 1865.

To be discharged.

By order of Major General E. R. S. Canby:

*E. P. Jarrett*  
Capt. and A. D. C.

War Department,

Adjutant General's Office,

Washington, D. C., Oct. 29, 1873.

The Co. Muster Roll of Co. C, 4<sup>th</sup> U. S. C. Cav. reports Private Martin Summers, discharged June 26, 1865.

The Co. Muster Roll for May and June 1865, and Surgeon's Certificate of Disability for Discharge indicate that he was discharged June 25, 1865, - which date is held to be correct and the Co. Muster Roll will be amended accordingly.

*Thomas M. Freeman*  
Asst. to Adj. General  
Noted 26/73

Received (A. G. Office) \_\_\_\_\_, 186

*J. H. Abadie*

*Co. Muster Roll*  
*26/73*

ADJUTANT GENERAL'S OFFICE

*July 22, 1865*

Duplicate sent the Pension Office.

# ARMY OF THE UNITED STATES

## CERTIFICATE

### OF DISABILITY FOR DISCHARGE.



Private Martin Sumner of Captain Robert  
Robert Company, (A) of the Fourth Regiment of United States  
Colored Cavalry was enlisted by Captain Abells of  
the Fourth Regiment of United States at New Orleans  
on the twenty fifth day of August 1865, to serve 3 years; he was born  
in Nelson in the State of Kentucky is Twenty Eight  
years of age, 5 feet 7 inches high, Brown complexion, Brown eyes,  
Black hair, and by occupation when enlisted a carriage. During the last two  
months said soldier has been unfit for duty more than half of his time during the last  
fifteen in the hospital with pain in

STATION: Fort Hudson La  
DATE: June 2 1865

R. J. Roberts  
Commanding Company.

I CERTIFY, that I have carefully examined the said Private Martin Sumner of  
Captain Robert Company, and find him incapable of performing the duties of a soldier  
because of Old Age and feeble Constitution  
Disability existed prior to enlistment and in  
degree is (1/2) one half

D. D. Hanson  
Surgeon.

DISCHARGED, this twenty fifth day of June 1865, at Fort Hudson La

Walter Mitchell  
Lieut Colonel  
Commanding the Reg't.

The soldier desires to be addressed at  
Town \_\_\_\_\_ County Nelson State Kentucky

\* See Note 1 on the back of this. † See Note 2 on the back of this.

Office, Post Surgeon  
 Port Hudson, La. June 5/65  
 Approved on personal examination  
Mosley H. Hanson  
 Surgeon U.S. Army  
 Port Hudson, La.



1005 or Augustin

*Stangstar August*

---

**Co C, 4 U. S. Col'd Cav.**

---

*Private* | *Private*

**CARD NUMBERS.**

1	5-35-1277	26
2	5-35-1333	27
3	5-35-1387	28
4	5-35-1471	29
5	5-35-1540	30
6	5-35-1622	31
7	5-35-2533	32
8	40729229	33
9		34
10		35
11		36
12		37
13		38
14		39
15		40
16		41
17		42
18		43
19		44
20		45
21		46
22		47
23		48
24		49
25		50

Book Mark: /

See also

S | **4 Cav.** | **U.S.C.T.**

August Stangor  
(Pt. C), Co. C, 1 Reg't La. Cav., Corps d'Afrique.\*

Appears on

**Company Muster-in Roll**

of the organization named above. Roll dated

New Orleans, La., Nov 7, 1863.

Muster-in to date Nov 7, 1863.

Joined for duty and enrolled:

When Oct 15, 1863.

Where New Orleans city

Period 3 years.

Valuation of horse, \$.....100

Valuation of horse equipments, \$.....100

Remarks: Age: 18

\*This organization subsequently became Co. B, 4 Reg't U. S. Colored Cavalry.

Book mark: .....

Stangor

C | 4 Cav. | U.S.C.T.

*August Stangorstan*  
*(Pt. C)*, 1 Reg't La. Cav., Corps d'Afrique.\*

Appears on

**Company Muster Roll**

for *Nov 7 to Dec 31*, 186*3*.

Present or absent *Absent*

Stoppage, \$ 100 for

Due Gov't, \$ 100 for

Valuation of horse, \$ 100

Valuation of horse equipments, \$ 100

Remarks: *Absent sick*

FROM SECOND AUDITOR'S ROLL.

\*This organization subsequently became Co. *C* 4 Reg't U. S. Colored Cavalry.

Book mark:

*Robert*

*S* | **4 Cav. | U.S.C.T.**

*August Staqueta*  
*Co. C, 1 Reg't La. Cav., Corps d'Afrique.\**

Appears on

**Company Muster Roll**

for *Jan Feb*, 186*4*.

Present or absent *Absent*

Stoppage, \$ *100* for

Due Gov't, \$ *100* for

Valuation of horse, \$ *100*

Valuation of horse, equipments, \$ *100*

Remarks: *Absent sick and  
recommended for  
discharge;*

\*This organization subsequently became Co. *C* 4 Reg't U. S. Colored Cavalry.

Book mark: \_\_\_\_\_

*Rochester*

S | **4 Cav.** | **U.S.C.T.**

*Augustus Stangusta*  
*Pvt.*, Co. C, 4 Reg't U. S. Colored Cavalry.

Appears on

**Company Muster Roll**

for *March & April*, 1864.

Present or absent *Absent*

Stoppage, \$ 100 for

Due Gov't, \$ 100 for

Valuation of horse, \$ 100

Valuation of horse equipments, \$ 100

Remarks: *Absent sick*

*and recommended for  
discharge*

Book mark:

*Bochster*

S | **4 Cav.** | **U.S.C.T.**

*Augustus Stangusta*  
*Co.*, Co. C, 4 Reg't U. S. Colored Cavalry.

Appears on

**Company Muster Roll**

for *May & June*, 1864.

Present or absent *Absent*

Stoppage, \$ 100 for

Due Gov't, \$ 100 for

Valuation of horse, \$ 100

Valuation of horse equipments, \$ 100

Remarks: *Absent sick*

Book mark:

*Co. C*

*S* | **4 Cav.** | **U.S.C.T.**

*Augustus Stungustu*  
*St*, Co. C, 4 Reg't U. S. Colored Cavalry.

Appears on

**Company Muster Roll**

for *July & Aug*, 1864.

Present or absent *Absent*

Stoppage, \$ 100 for

Due Gov't, \$ 100 for

Valuation of horse, \$ 100

Valuation of horse equipments, \$ 100

Remarks: *Absent Sick.*  
*Not recommended for*  
*discharge*

Book mark :

*Bochner*

4 Cav. U.S.C.T.

Augustus Stangust  
Port, Co. W, 4 Reg't U. S. Colored Cav.

Appears on Returns as follows:

Jan to Mch 1864 - (1 Regt. Cav., Corps d'Afrique)

Absent sick in Gen Hosp. at

New Orleans since Jan 3/64

Apr 1864 - (4 Regt U.S. Col'd Cav) Absent

sick at home "Blind" recom-

mended for discharge Jan 1/64

May 1864 - Absent sick since Feb 14/64

14/64

June 1864 - Absent sick N.O.

Name appears also as

Augustus Stangustaw

Book mark:

W. R. Lee

546

Copyist.



S | 4 Cav. | U.S.C.T.

August Stanguster  
Private, Co. C, 4 Reg't U. S. Col'd Cavalry

Appears on Co. Muster-out Roll, dated  
New Orleans La Mar 20, 1866.

Muster-out to date \_\_\_\_\_, 186 .  
Last paid to *Never paid* \_\_\_\_\_, 186 .

Clothing account:

Last settled \_\_\_\_\_, 186 ; drawn since \$ \_\_\_\_\_ 100

Due soldier \$ *6* <sup>*08*</sup> / 100; due U. S. \$ \_\_\_\_\_ 100

Am't for cloth'g in kind or money adv'd \$ \_\_\_\_\_ 100

Due U. S. for arms, equipments, &c., \$ \_\_\_\_\_ 100

Bounty paid \$ \_\_\_\_\_ 100; due \$ \_\_\_\_\_ 100

Remarks: *Joined orig. org.  
Mustered. Absent sick,  
originally, never was with  
Co since muster in, dropped  
as deserted Oct 3/65*

Book mark: \_\_\_\_\_

*M. A. Michaels*

(361)

Copyist.

1006

Stanton William

Co G, 4 U. S. Col'd Cav.

Sergeant Sergeant

CARD NUMBERS.

1	5-35-6199	26
2	5-35-6252	27
3	5-35-6306	28
4	5-35-6360	29
5	5-35-6412	30
6	5-35-6459	31
7	5-35-6520	32
8	5-35-6632	33
9	5-35-7155	34
10	40729243	35
11		36
12		37
13		38
14		39
15		40
16		41
17		42
18		43
19		44
20		45
21		46
22		47
23		48
24		49
25		50

Book Mark

See also

*S* | **4 Cav. | U.S.C.T.**

*William Stanton*

*Sgt*, Co. *G*, 1 Reg't, Corps d'Afrique Cavalry.\*

Appears on

**Company Muster-in Roll**

of the organization named above. Roll dated

*New Orleans, La., Feb 8*, 1864.

Muster-in to date *Feb 8*, 1864.

Joined for duty and enrolled:

When *Jan 14*, 1864.

Where *New Orleans, La.*

Period *2* years.

Valuation of horse, \$ 100

Valuation of horse equipments, \$ 100

Remarks: *Pd \$2 Premium*

\*This organization subsequently became Co. *G*, 4 Reg't U. S. Colored Cavalry.

Book mark: \_\_\_\_\_

*Lowry*

(356)

Copyist.

*S* 4 Cav. | U.S C.T.

*William Stanton*

*Sgt*, Co. *G*, 1 Reg't Cav., Corps d'Afrique.\*

Appears on

**Company Muster Roll**

for *Enrollment to Feb 29*, 186*4*.

Present or absent *Present*

Stoppage, \$ *100* for

Due Gov't, \$ *100* for

Valuation of horse, \$ *100*

Valuation of horse equipments, \$ *100*

Remarks:

\* This organization subsequently became Co. *G*, 4 Reg't U. S. Colored Cavalry.

Book mark:

(358)

*Lowry*

Copyist.

S | **4 Cav. | U.S.C.T.**

William Stanton

Sgt, Co. G, 4 Reg't U. S. Col'd Cavalry.  
Appears on

**Company Muster Roll**

for March & April, 1867.

Present or absent Present

Stoppage, \$ 100 for

Due Gov't, \$ 100 for

Valuation of horse, \$ 100

Valuation of horse equipments, \$ 100

Remarks:  
.....  
.....  
.....  
.....  
.....  
.....  
.....  
.....  
.....  
.....  
.....

Book mark: .....

(358)

Lowry

Copyist.

*S* | **4 Cav. | U. S. C. T.**

*William Stanton*  
*Sgt*, Co. G, 4 Reg't U. S. Col'd Cavalry.  
Appears on

**Company Muster Roll**

for *May & June*, 1864.

Present or absent *Present*

Stoppage, \$ *100* for

Due Gov't, \$ *100* for

Valuation of horse, \$ *100*

Valuation of horse equipments, \$ *100*

Remarks:

Book mark:

*Louy* Copyist.

*S* | **4 Cav. | U. S. C. T.**

*William Stanton*

*Sgt*, Co. G, 4 Reg't U. S. Col'd Cavalry.

Appears on

**Company Muster Roll**

for *July & Aug*, 1864.

Present or absent *Present*

Stoppage, \$ *100* for

Due Gov't, \$ *100* for

Valuation of horse, \$ *100*

Valuation of horse equipments, \$ *100*

Remarks:  
.....  
.....  
.....  
.....  
.....  
.....  
.....  
.....

Book mark: .....

(358)

*Lowny*

Copyist.

4771322

*S* | **4 Cav. | U. S. C. T.**

*William Stanton*  
*Sgt*, Co. G, 4 Reg't U. S. Col'd Cavalry.

Appears on

**Company Muster Roll**

for *Sept & Oct*, 186*4*.

Present or absent *Present*

Stoppage, \$ *100* for

Due Gov't, \$ *100* for

Valuation of horse, \$ *100*

Valuation of horse equipments, \$ *100*

Remarks:  
.....  
.....  
.....  
.....  
.....  
.....  
.....  
.....  
.....  
.....

Book mark: .....

(355)

*Louvy*

Copyist.



*28* | **4 Cav. | U. S. C. T.**

*William Stanton*

*Sgt.*, Co. G, 4 Reg't U. S. Col'd Cavalry.

Appears on

**Company Muster Roll**

for *Nov & Dec*, 186*4*.

Present or absent *Present*

Stoppage, \$ *100* for

Due Gov't, \$ *100* for

Valuation of horse, \$ *100*

Valuation of horse equipments, \$ *100*

Remarks:

Book mark:

*Almond*  
Copyist.

*S* | **4 Cav.** | **U. S. C. T.**

*William Stanton*

*Sgt*, Co. G, 4 Reg't U. S. Col'd Cavalry.

Appears on

**Company Muster Roll**

for *Jan & Feb*, 1865-

Present or absent

Stoppage, \$ 100 for

Due Gov't, \$ 100 for

Valuation of horse, \$ 100

Valuation of horse equipments, \$ 100

Remarks: *Wounded at Post  
Hudson LaFayette.  
Rec'd only \$7 per month  
in apr 30, 4 Sgt from  
8, 64*

Book mark:

(358)

*Antoni*  
Copyist.

S | **4 Cav.** | **U.S.C.T.**

William Stanton

Sgt, Co. F, 4 Reg't U. S. Colored Cav.

Appears on **Returns** as follows:

Jan 1865 - Loss: Jan 9/65  
Port Hudson La. drowned  
accidentally

Book mark : \_\_\_\_\_

(548)

W. R. Lee

Copyist.

*S* | **4 Cav. U.S.C.T.**

*William Stanton*  
-----  
*Sgt*, Co. *G*, 4 Reg't U. S. Col'd Cavalry.

Appears on **Co. Muster-out Roll**, dated  
*New Orleans, La. Nov 20*, 186*6*.

Muster-out to date -----, 186 .  
Last paid to -----, 186 .

**Clothing account:**

Last settled -----, 186 ; drawn since \$ ----- 100  
Due soldier \$ ----- 100; due U. S. \$ ----- 100  
Am't for cloth'g in kind or money adv'd \$ ----- 100

Due U. S. for arms, equipments, &c., \$ ----- 100

Bounty paid \$ ----- 100; due \$ ----- 100

Remarks: *Joined at orig org.*  
*Died Jan'y 9' 65 at Port*  
*Hudson, La*

Book mark : -----

(361)

*J. Fletcher*  
-----  
Copyist.

Stanton, William

Sep, Co. G, 4 U.S.C. Cav.

Enclosures.

Bed Cards	Descriptive Lists
Burial Records	Final Statements
Certs. of Dis. for Discharge	Furloughs
C. M. Charges	Med. Des. Lists
Med. Certificates	Orders

Other papers relating to—

Admission to Hosp'l	Furlough
Casualty Sheet (Officer's)	Med. Examination
Confinement	Misc. Information
Contracts	Pay or Clothing
Death or Effects	Personal Reports
Desertions	Rank
Discharge from Hosp'l	Transfer to Hosp'l
Discharge from Service	Transfer to V. R. C.
Duty	Transportation

1865

*C. G. L. ... 13. 1865  
He's not for effects.  
2d Auditor B,*

**FINAL STATEMENT**

OF

*Sergeant William Stanton*  
2<sup>d</sup> Reg't of *U.S. Cavalry*

**VOLUNTEERS.**

*Company G 1865*

NOTE 1.—Two of these certificates (or duplicates) are to be given to each Volunteer Soldier or drafted man who may be discharged previously to the discharge of his company, that he may at once receive from the Paymaster the pay, &c., due him, and the captain or other COMMISSIONED officer commanding the company will certify to the act of the delivery of the duplicate certificates; on these certificates the Soldier is "entitled to" his discharge, and should also present his discharge to the Paymaster to have the payment endorsed on it. The discharge is to be given back to the Soldier by the Paymaster; the latter only retaining as his voucher the duplicate certificates.

NOTE 2.—If the Soldier is entitled to pay for the use of his horse, the Company Commander will certify to that fact on the back of both these final statements, and also to the time he has pay due for having been so mounted on his own horse.

NOTE 3.—When a Soldier is furnished with final statements, his descriptive list, if he has one, should be taken up by the officer who gives the Soldier these statements, and endorsed with a statement to this effect by the officer. This endorsement should exhibit a full statement of the time for which the Soldier was allowed pay on his final statements, the clothing account, and all other charges against him or in his favor, so as to comprise a complete exhibit of his account. It will then be transmitted to the company commander of the Soldier, who will enter all the data necessary to a full understanding of the Soldier's account on the muster roll upon which the Soldier's discharge is reported. The descriptive list will then be destroyed. The object of this is, that the remaining portion of the Soldier's account may be settled upon the receipt of these muster rolls, and the Soldier receive any pay or allowances that may be due him at the time of his discharge, and which may not appear on his final statements from the fact that his descriptive list is incomplete. These accounts for back pay, &c., are settled by the 2d Auditor of the Treasury Department.

NOTE 4.—Charges for loss or injury to ordnance, horse equipments, and other miscellaneous charges, should appear under the heading of "Other Stoppages."

NOTE 5.—Bounty paid by State authorities, and not by the United States, will not be entered on this statement.

NOTE 6.—Amounts due the Sutler and Laundress must be entered on the muster roll on which the discharge, dea h. desertion, &c., is reported, as well as on the final statement, otherwise the amount cannot be collected from the United States.

NOTE 7.—This blank will be used for deceased volunteers and drafted men, as well as for others.

NOTE 8.—Where a Soldier dies in Hospital or on detached service, his descriptive list, if he has one, should be sent with his final statements, in duplicate, to the Adjutant General, Washington, D. C.

**ADJUTANT GENERAL'S OFFICE**  
*Jan 31 1865*  
Duplicate with Inventory sent 2d Auditor.



*Done*

NARRATIVE

I certify, on honor, that William Stanton a Sergt of  
Captain J. R. Loomis Company (G) of the 4<sup>th</sup> Regiment of M. S. Cavalry  
**VOLUNTEERS**, of the State of \_\_\_\_\_, born in Baltimore, State  
of Maryland, aged 22 years; 5 feet 5 inches high; Dark complexion,  
Black eyes, Black hair, and by occupation a Laborer, having joined the company on  
its original organization at New Orleans La Jan 14<sup>th</sup> 1864 and enrolled in it at the muster into  
the service of the United States at New Orleans La, on the 8<sup>th</sup> day  
of February, 1864, (or was mustered in service as a recruit, by \_\_\_\_\_  
\_\_\_\_\_, at \_\_\_\_\_, on the \_\_\_\_\_ day of \_\_\_\_\_,  
186\_\_\_\_, or was drafted and mustered into the service of the United States from the \_\_\_\_\_  
Enrollment District of the State of \_\_\_\_\_, at \_\_\_\_\_,  
on the \_\_\_\_\_ day of \_\_\_\_\_, 186\_\_\_\_) to serve in the Regiment, for  
the term of Three Years: and having served **HONESTLY** and  
**FAITHFULLY** with his Company in the Regt to the present date, is now  
entitled to a **DISCHARGE** by reason of Death Died at Fort Hudson

La Jan 9<sup>th</sup> 1865 by reason of Contracting  
The said Sergt William Stanton was last paid by Paymaster  
J. A. Holland to include the 30<sup>th</sup> day of April, 1864, and has  
pay due him from that time to the present date; he is entitled to pay and subsistence for  
**TRAVELING** to place of enrollment, and whatever other allowances are authorized to volunteer  
soldiers, drafted men, or militia, so discharged. He has received from the United States **CLOTHING**  
amounting to 106 <sup>64</sup>/<sub>100</sub> dollars, since the Enlistment Jan 14<sup>th</sup> 1864  
186\_\_\_\_, when his clothing account was last settled. He has received from the United States  
100 dollars advanced **BOUNTY**.

There is to be stopped from him, on account of the State of \_\_\_\_\_, or other  
authorities, for **CLOTHING**, &c., received on entering service, \_\_\_\_\_ dollars; and  
for other stoppages, viz: \_\_\_\_\_

\_\_\_\_\_ dollars.

He has been furnished with **TRANSPORTATION** in kind from the place of his discharge to  
\_\_\_\_\_; and he has been **SUBSISTED** for **TRAVELING** to his  
place of enrollment, up to the \_\_\_\_\_, 186\_\_\_\_.

He is indebted to John Child, **SUTLER**, 16 <sup>00</sup>/<sub>100</sub> dollars.

He is indebted to \_\_\_\_\_, **LAUNDRESS**, \_\_\_\_\_ dollars.

Given in Duplicate, at Fort Hudson La, this 14<sup>th</sup> day  
of Jan 14<sup>th</sup>, 1865.

J. R. Loomis  
Capt Commanding Company.

1871  
Steele Thatcher A.

Co. G, 4 U. S. Col'd Cav.

2<sup>nd</sup> Lieutenant Captain

CARD NUMBERS.

1	26
2	
3	see tickets Thatcher A.
4	29
5	30
6	31
7	32
8	33
9	34
10	35
11	36
12	37
13	38
14	39
15	40
16	41
17	42
18	43
19	44
20	45
21	46
22	47
23	48
24	49
25	50

Book Mark: .....

See also .....



1088

Stevenson Samuel

Co H, 4 U. S. Col'd Cav.

Private | G. D. Gyles

CARD NUMBERS.

1	5-347921	26
2	5-35-7214	27
3	5-35-7274	28
4	5-35-7297	29
5	5-35-7355	30
6	5-35-7411	31
7	5-35-7454	32
8	5-35-7506	33
9	5-35-7560	34
10	5-35-7647	35
11	5-35-7732	36
12	5-35-7811	37
12	5-35-7888	38
14	5-35-7964	39
15	5-35-8036	40
16		41
17		42
18		43
19		44
20		45
21		46
22		47
23		48
24		49
25		50

Book Mark:

See also

R + P 360 479  
S 819 011 - P 090  
S-951136 - PO mem

*Handwritten signature*

4 Cav. U.S.C.T.

Daniel Stevenson

Appears with rank of Private on

Muster and Descriptive Roll of a Detachment of U. S. Vols. forwarded

for the 4 Reg't U. S. Col'd Cavalry. Roll dated New Orleans La, Apr 8, 1864.

Where born Franklin, La

Age 18 y'rs; occupation Shoemaker

When enlisted Nov 16, 1863

Where enlisted New Orleans

For what period enlisted 3 years.

Eyes Black; hair Black

Complexion Light; height 5 ft. 2 1/2 in.

When mustered in Apr 8, 1864

Where mustered in New Orleans

Bounty paid \$ 100; due \$ 100

Where credited

Company to which assigned A

Remarks:

Book mark:

(339)

Sallade

Copyist.

4 Cav. U.S.C.T.

*Samuel Stephenson*  
Pvt., Co. H, 4 Reg't U. S. Col'd Cavalry.

Appears on

**Company Muster-in and Descriptive Roll**

of the organization named above. Roll dated

*New Orleans, La. Apr. 8, 1864.*

Where born *Franklin, La.*

Age *18* y'rs; occupation *Shoemaker*

When enlisted *Nov. 16*, 1863.

Where enlisted *New Orleans, La.*

For what period enlisted *3* years.

Eyes *black*; hair *black*

Complexion *light*; height *5 ft. 2 1/2 in.*

When mustered in *Apr. 8*, 1864.

Where mustered in *New Orleans, La.*

Bounty paid \$ *2* 100; due \$ 100

Where credited

Company to which assigned

Remarks:

Book mark:

*C. Williams*

(356d) Copyist.

*S* | **4 Cav.** | **U.S.C.T.**

*Samuel Stephenson*

*Priv.*, Co. H, 4 Reg't U. S. Col'd Cavalry.

Appears on

**Company Muster Roll**

for *April 8 to 30*, 186*4*

Present or absent *Present*

Stoppage, \$ *100* for

Due Gov't, \$ *100* for

Valuation of horse, \$ *100*

Valuation of horse equipments, \$ *100*

Remarks:

Book mark:

*L. Williams*

1877 1300

*S* | **4 Cav.** | **U.S.C.T.**

*Sam'l Stephenson*  
*Bugler*, Co. H, 4 Reg't U. S. Col'd Cavalry.

Appears on

**Company Muster Roll**

for *May & June*, 186*4*.

Present or absent *Present*

Stoppage, \$ 100 for

Due Gov't, \$ 100 for

Valuation of horse, \$ 100

Valuation of horse equipments, \$ 100

Remarks:  
-----  
-----  
-----  
-----  
-----  
-----  
-----  
-----  
-----  
-----

Book mark: -----

(358)

*C. Williams*  
Copyist.

*S* | **4 Cav. U.S.C.T.**

*Samuel Stephenson*

*Bugler*, Co. H, 4 Reg't U. S. Col'd Cavalry.

Appears on

**Company Muster Roll**

for *July & Aug.*, 1864.

Present or absent *Present.*

Stoppage, \$ *100* for

Due Gov't, \$ *100* for

Valuation of horse, \$ *100*

Valuation of horse equipments, \$ *100*

Remarks:  
-----  
-----  
-----  
-----  
-----  
-----  
-----  
-----  
-----  
-----

Book mark: -----

*C. Williams,*  
Copyist.

*S* | **4 Cav.** | **U.S.C.T.**

*Samuel Stephenson*

*Rugler*, Co. H, 4 Reg't U. S. Col'd Cavalry.

Appears on

**Company Muster Roll**

for *Sept. & Oct.*, 1864.

Present or absent *Present*

Stoppage, \$ 100 for

Due Gov't, \$ 100 for

Valuation of horse, \$ 100

Valuation of horse equipments, \$ 100

Remarks:

Book mark:

*G. Williams*

(358)

Copyist.



*S* | **4 Cav. | U.S.C.T.**

*Samuel Stephenson*  
*Bugler*, Co. H, 4 Reg't U. S. Col'd Cavalry.

Appears on

**Company Muster Roll**

for *Nov, & Dec*, 186 *4*

Present or absent *Present*

Stoppage, \$ *100* for

Due Gov't, \$ *100* for

Valuation of horse, \$ *100*

Valuation of horse equipments, \$ *100*

Remarks:  
-----  
-----  
-----  
-----  
-----  
-----  
-----  
-----  
-----

Book mark: -----

(358)

*G. Williams*  
Copyist.

*S* | **4 Cav.** | **U.S.C.T.**

*Samuel Stephenson*  
*Bugler*, Co. H, 4 Reg't U. S. Col'd Cavalry.

Appears on

**Company Muster Roll**

for *Jan & Feb*, 1865.

Present or absent *Present*

Stoppage, \$ *100* for

Due Gov't, \$ *100* for

Valuation of horse, \$ *100*

Valuation of horse equipments, \$ *100*

Remarks: *Received but 700 for month*  
*up to Apr 30/65*

Book mark:

(358)

*Harlan*  
Copyist.

1877 1841  
J | 4 Cav. | U.S.C.T.

*Nammal Stephenson*  
*Bugler*, Co. H, 4 Reg't U. S. Col'd Cavalry.

Appears on

**Company Muster Roll**

for *March and April*, 1865.

Present or absent *Present*

Stoppage, \$ *100* for

Due Gov't, \$ *100* for

Valuation of horse, \$ *100*

Valuation of horse equipments, \$ *100*

Remarks:  
\_\_\_\_\_  
\_\_\_\_\_  
\_\_\_\_\_  
\_\_\_\_\_  
\_\_\_\_\_  
\_\_\_\_\_  
\_\_\_\_\_  
\_\_\_\_\_

Book mark: \_\_\_\_\_

*Master*

1862

S | 4 Cav. | U.S.C.T.

*Samuel Stephenson*  
Bugler, Co. H, 4 Reg't U. S. Col'd Cavalry.

Appears on

**Company Muster Roll**

for *May & June*, 1862

Present or absent *Present*

Stoppage, \$ 100 for

Due Gov't, \$ 100 for

Valuation of horse, \$ 100

Valuation of horse equipments, \$ 100

Remarks:

Book mark:

*Feaster*

(358)

Copyist.

4 Cav. U.S.C.T.

Samuel Stephenson

Reuler, Co. H, 4 Reg't U. S. Col'd Cavalry.

Appears on

Company Muster Roll

for July & Aug. 1865

Present or absent Present

Stoppage, \$ 100 for

Due Gov't, \$ 100 for

Valuation of horse, \$ 100

Valuation of horse equipments, \$ 100

Remarks:

Book mark:

Treaster

*S* | **4 Cav. U.S.C.T.**

*Samuel Stephenson*  
Bugler, Co. H, 4 Reg't U. S. Col'd Cavalry.

Appears on

**Company Muster Roll**

for *Sept & Oct*, 186 *5*.

Present or absent *Present*

Stoppage, \$ *100* for *1*

Due Gov't, \$ *100* for

Valuation of horse, \$ *100*

Valuation of horse equipments, \$ *100*

Remarks:  
\_\_\_\_\_  
\_\_\_\_\_  
\_\_\_\_\_  
\_\_\_\_\_  
\_\_\_\_\_  
\_\_\_\_\_  
\_\_\_\_\_  
\_\_\_\_\_

Book mark: \_\_\_\_\_

*Peaster*

*of* | **4 Cav. | U.S.C.T.**

*Sumner H. Hefner*  
*Buyler*, Co. H, 4 Reg't U. S. Col'd Cavalry.

Appears on

**Company Muster Roll**

for *dated* *Dec 31*, 186*5*.

Present or absent *Present*

Stoppage, \$ *100* for

Due Gov't, \$ *100* for

Valuation of horse, \$ *100*

Valuation of horse equipments, \$ *100*

Remarks:  
-----  
-----  
-----  
-----  
-----  
-----  
-----  
-----  
-----

Book mark: -----

(358)

*A. E. Shurt*  
Copyist.

*S* | **4 Cav. | U.S.C.T.**

*Samuel Stevenson*

*Bugler*, Co. H, 4 Reg't U. S. Col'd Cavalry.

Appears on

**Company Muster Roll**

for *Jan & Feb*, 1866.

Present or absent *Present*

Stoppage, \$ *100* for

Due Gov't, \$ *100* for

Valuation of horse, \$ *100*

Valuation of horse equipments, \$ *100*

Remarks:

Book mark:

*A. E. Smith*  
Copyist.



*S* | **4 Cav. | U.S.C.T.**

*Samuel Stephenson*  
*Bugler, Co. H., 4 Reg't U. S. Col'd Cavalry.*

Appears on **Co. Muster-out Roll**, dated  
*New Orleans La., Mar 20, 1860.*

Muster-out to date *Mar 20, 1860.*

Last paid to *June 20, 1865.*

Clothing account:

Last settled....., 186 ; drawn since \$..... 100

Due soldier \$ *11*<sup>66</sup> 100; due U. S. \$..... 100

Am't for cloth'g in kind or money adv'd \$..... 100

Due U. S. for arms, equipments, &c., \$..... 100

Bounty paid \$..... 100; due \$..... 100

Remarks: *Joined at Orgl Orgi.*

Book mark: *V. 24. P. 24. 68- 882. 1878*

(361)

*A. E. M...*  
Copyist.

Steward. Weston

Co D & H, 4 U. S. Col'd Cav.

Private | Private

CARD NUMBERS.

1	5-3-4-7-4-8-0	26
2	5-3-5-8-0-8-3	27
3	5-3-5-8-1-6-5	28
4	5-3-5-8-2-2-7	29
5	5-3-5-8-2-8-1	30
6	5-3-5-8-3-3-1	31
7	5-3-5-8-3-7-4	32
8	5-3-4-8-0-2-6	33
9	5-3-5-7-6-1-5	34
10	5-3-5-7-6-9-7	35
11	5-3-5-7-7-8-3	36
12	5-3-5-7-8-6-0	37
13	5-3-5-7-9-3-6	38
14	5-3-5-8-0-1-1	39
15		40
16		41
17		42
18		43
19		44
20		45
21		46
22		47
23		48
24		49
25		50

Book Mark:

See also

S 151420 (and IV D)

1720772 P.O. 24724

2820213 Pass

55-28. 9/6/30, u.

*[Handwritten signature]*

*J* | **4 Cav.** | **U.S.C.T.**

*Walter Stewart*

Appears with rank of *Private* on

**Muster and Descriptive Roll of a Detachment of U. S. Vols. forwarded**

for the 4 Reg't U. S. Col'd Cavalry. Roll dated

*New Orleans La April 27, 1864.*

Where born *Miss*

Age *18* y'rs; occupation *Farmer*

When enlisted *April 15*, 186 .

Where enlisted *Grand Ecore, La.*

For what period enlisted *3* years.

Eyes *Brown*; hair *Black*

Complexion *Black*; height *5 ft. 4 1/2 in.*

When mustered in *April 27*, 1864.

Where mustered in *New Orleans*

Bounty paid \$ *2* <sup>100</sup>; due \$ <sup>100</sup>

Where credited

Company to which assigned *D*

Remarks:

Book mark:

*A. J. Taylor*

*S* | 4 Cav. | U.S.C.T.

*Wiston Stewart*

*Pl*, Co. *D*, 4 Reg't U. S. Col'd Cavalry.

Age \_\_\_\_\_ years.

Appears on

Company Muster Roll\*

for *Cpl. 27 to June 30*, 1864.

Joined for duty and enrolled:

When *Apr. 15*, 1864.

Where *Grand Ecore, La.*

Period *3* years.

Mustered in:

When *Cpl. 27*, 1864.

Where *New Orleans, La.*

Present or absent *Present*

Stoppage, \$ 100 for \_\_\_\_\_

Due Gov't, \$ 100 for \_\_\_\_\_

Valuation of horse, \$ 100

Valuation of horse equipments, \$ 100

Remarks : \_\_\_\_\_

\* First current roll. No muster-in roll of this battery on file.

Book mark : \_\_\_\_\_

(3586)

*Hym*

Copist.

*S* | **4 Cav.** | **U.S.C.T.**

*Wiston Stewart*

*Plt*, Co. I, 4 Reg't U. S. Col'd Cavalry.

Appears on

**Company Muster Roll**

for *July + Aug*, 1864.

Present or absent *Present*

Stoppage, \$ 100 for

Due Gov't, \$ 100 for

Valuation of horse, \$ 100

Valuation of horse equipments, \$ 100

Remarks: \_\_\_\_\_  
\_\_\_\_\_  
\_\_\_\_\_  
\_\_\_\_\_  
\_\_\_\_\_  
\_\_\_\_\_  
\_\_\_\_\_  
\_\_\_\_\_

Book mark: \_\_\_\_\_

*Hines*

*S* | **4 Cav.** | **U.S.C.T.**

*Weston Stewart*

*Pl*, Co. I, 4 Reg't U. S. Col'd Cavalry.

Appears on

**Company Muster Roll**

for *Sept + Oct*, 1864.

Present or absent *Present*

Stoppage, \$ 100 for

Due Gov't, \$ 100 for

Valuation of horse, \$ 100

Valuation of horse equipments, \$ 100

Remarks:

Book mark:

S | 4 Cav. | U.S.C.T.

Wiston Stewart

Plt, Co. I, 4 Reg't U. S. Col'd Cavalry.

Appears on

Company Muster Roll

for Nov + Dec, 1864.

Present or absent Present

Stoppage, \$ 100 for

Due Gov't, \$ 100 for

Valuation of horse, \$ 100

Valuation of horse equipments, \$ 100

Remarks:

Book mark:

Styger

(358)

Copyist.



S | 4 Cav. | U.S.C.T.

Wiston Stewart

Plt, Co. I, 4 Reg't U. S. Col'd Cavalry.

Appears on

Company Muster Roll

for Jan & Feb, 1865.

Present or absent Present

Stoppage, \$ 100 for

Due Gov't, \$ 100 for

Valuation of horse, \$ 100

Valuation of horse equipments, \$ 100

Remarks:

Book mark:

Hyman

Copyist.

4 Cav. U.S.C.T.

Winston Stevash  
Pvt., Co. A, 4 Reg't U. S. Col'd Cav.

Appears on

**M. and D. Roll of Men Transferred**

to the organization named above, by transfer,  
from Co. D.

Roll dated Putnam, Apr 24, 1865.

When enlisted Apr 16, 1864.

Period for which enlisted 3 years.

When mustered in Apr 27, 1864.

Present or absent Not stated

Company to which assigned A

Remarks:

Book mark:

(342)

W. H. Conant

Copyist.

S | 4 Cav. | U.S.C.T.

*Wesley Stewart*

....., Co. H, 4 Reg't U. S. Col'd Cavalry.

Appears on

**Company Muster Roll**

for *Mch. 9, 1862*, 1862.

Present or absent *Present*

Stoppage, \$ *100* for

Due Gov't, \$ *100* for

Valuation of horse, \$ *100*

Valuation of horse equipments, \$ *100*

Remarks: *Transferred from  
Co. I. in consolidation  
by S. O. 28, Hdqrs.  
Dept. Gulf, Jan. 28, 63*

Book mark: .....

*Heaster*

*S* | **4 Cav. | U.S.C.T.**

*Wilson Stewart*  
-----  
*Pvt.*, Co. H, 4 Reg't U. S. Col'd Cavalry.

Appears on

**Company Muster Roll**

for *May 9 June*, 186*5*.

Present or absent *Present*

Stoppage, \$ \_\_\_\_\_ *100* for \_\_\_\_\_

Due Gov't, \$ \_\_\_\_\_ *100* for \_\_\_\_\_

Valuation of horse, \$ \_\_\_\_\_ *100*

Valuation of horse equipments, \$ \_\_\_\_\_ *100*

Remarks: \_\_\_\_\_  
\_\_\_\_\_  
\_\_\_\_\_  
\_\_\_\_\_  
\_\_\_\_\_  
\_\_\_\_\_  
\_\_\_\_\_  
\_\_\_\_\_  
\_\_\_\_\_

Book mark: \_\_\_\_\_

(358)

*Feaster*

Copyist.

*S* | **4 Cav.** | **U.S.C.T.**

*Weston Stewart*  
Pot., Co. H, 4 Reg't U. S. Col'd Cavalry.

Appears on

**Company Muster Roll**

for *July & Aug.*, 186*2*.

Present or absent *Present*

Stoppage, \$ *100* for

Due Gov't, \$ *100* for

Valuation of horse, \$ *100*

Valuation of horse equipments, \$ *100*

Remarks:

Book mark:

(358)

*Feaster*

Copyist.

*S* | **4 Cav. | U.S.C.T.**

*Wiston Stewart*  
*Pvt.*, Co. H, 4 Reg't U. S. Col'd Cavalry.

Appears on

**Company Muster Roll**

for *Sept. & Oct.*, 186*2*.

Present or absent *Present*

Stoppage, \$ *100* for

Due Gov't, \$ *100* for

Valuation of horse, \$ *100*

Valuation of horse equipments, \$ *100*

Remarks:

Book mark:

*Feaster*

*S* | **4 Cav.** | **U.S.C.T.**

*Michael Stewart*  
.....  
*Co.*, Co. H, 4 Reg't U. S. Col'd Cavalry.

Appears on

**Company Muster Roll**

for *dated Dec 31*, 186*5*.

Present or absent *Present*

Stoppage, \$..... *100* for .....

Due Gov't, \$..... *100* for .....

Valuation of horse, \$..... *100*

Valuation of horse equipments, \$..... *100*

Remarks: *Stop for service*  
*Dec 31*

Book mark: .....

(358)

*A. E. Stewart*  
.....  
Copyist.

1 | **4 Cav.** | **U.S.C.T.**

Wiston Stewart

Pr., Co. H, 4 Reg't U. S. Col'd Cavalry.

Appears on

**Company Muster Roll**

for Jan & Feb, 1866.

Present or absent Present

Stoppage, \$ 5 100 for 100

Due Gov't, \$ 100 for

Valuation of horse, \$ 100

Valuation of horse equipments, \$ 100

Remarks:

Book mark:

(358)

A. E. Howard

Copyist.



*S* | **4 Cav.** | **U.S.C.T.**

*Wiston Steward*  
*Pr*, Co. *H*, 4 Reg't U. S. Col'd Cavalry.

Appears on **Co. Muster-out Roll**, dated  
*New Orleans, Mar 20, 1866*.

Muster-out to date *Mar 20, 1866*.

Last paid to *June 30, 1865*.

**Clothing account:**

Last settled \_\_\_\_\_, 186 ; drawn since \$ \_\_\_\_\_ 100

Due soldier \$ \_\_\_\_\_ 100; due U. S. \$ *12*  $\frac{42}{100}$

Am't for cloth'g in kind or money adv'd \$ \_\_\_\_\_ 100

Due U. S. for arms, equipments, &c., \$ *5* 100

Bounty paid \$ \_\_\_\_\_ 100; due \$ \_\_\_\_\_ 100

Remarks: *Joined by trans-*  
*fer from Co. "I" Mar 24/65*  
*per S.O. 28, Hd. Qrs.*  
*Dep't. Gulf series 1865*  
*Stop for Bridle lost*

Book mark: *V19.P189.68. Vol. P133.69*

(361)

*A. E. Arnold*

Copyist.

Stewart Sandy

Co H, 4 U. S. Col'd Cav.

Buyler Private

CARD NUMBERS.

1 3-3475-90

26

2 5-357329

27

3 5-357386

28

4 5-357445

29

5 5-358118

30

6 40729230

31

7

32

8

33

9

34

10

35

11

36

12

37

12

38

14

39

15

40

16

41

17

42

18

43

19

44

20

45

21

46

22

47

23

48

24

49

25

50

Book Mark

See also

*S* | **4 Cav. | U.S.C.T.**

*Sandy Stewart*

Appears with rank of *Bugler* on

**Muster and Descriptive Roll of a Detachment of U. S. Vols. forwarded**

for the 4 Reg't U. S. Col'd Cavalry. Roll dated

*New Orleans La, May 10, 1864.*

Where born *New York Va.*

Age *23* y'rs; occupation *Colored*

When enlisted *April 23, 1864.*

Where enlisted *New Orleans*

For what period enlisted *3* years.

Eyes *Black*; hair *Black*

Complexion \_\_\_\_\_; height *5 ft. 7/2* in.

When mustered in *May*, 1864.

Where mustered in *New Orleans*

~~Premium paid~~ *2* ~~Bounty paid~~ \$ *100*; due \$ *100*

Where credited \_\_\_\_\_

Company to which assigned *He*

Remarks: *credited to the City of New Orleans, La.*

Book mark: \_\_\_\_\_

*Master*

*S* | **4 Cav. U.S.C.T.**

*Sandy Stuart*  
*Pvt.*, Co. H, 4 Reg't U. S. Col'd Cavalry.

Appears on

**Company Muster Roll**

for *May & June*, 186 *4*

Present or absent *Present*

Stoppage, \$ 100 for

Due Gov't, \$ 100 for

Valuation of horse, \$ 100

Valuation of horse equipments, \$ 100

Remarks:

Book mark:

*C. Williams,*  
Copyist.

*S* | **4 Cav. | U.S.C.T.**

*Sandy Stuart*  
*Priv.*, Co. H, 4 Reg't U. S. Col'd Cavalry.

Appears on

**Company Muster Roll**  
for *July & Aug.*, 1864.  
Present or absent *Present.*

Stoppage, \$.....100 for .....

Due Gov't, \$.....100 for .....

Valuation of horse, \$.....100

Valuation of horse equipments, \$.....100

Remarks: .....

Book mark: .....

(358) *C. Williams,*  
Copyist.

1877 1860

*S* | **4 Cav.** | **U.S.C.T.**

*Sandy Stewart*

*Priv.*, Co. H, 4 Reg't U. S. Col'd Cavalry.

Appears on

**Company Muster Roll**  
for *Sept. & Oct.*, 1864.

Present or absent.....

Stoppage, \$.....<sup>100</sup> for.....

Due Gov't, \$.....<sup>100</sup> for.....

Valuation of horse, \$.....<sup>100</sup>

Valuation of horse equipments, \$.....<sup>100</sup>

Remarks: *Died in Reg't'l Hosp.  
Port Hudson, La., Oct. 6, '64.*

Book mark:.....

*L. Williams,*

Copyist.

4 Cav. | U.S.C.T.

\* Andy Stewart  
Port, Co. H, 4 Reg't U. S. Colored Cav.

Appears on Returns as follows:

May 1864 - Join: May 12/64  
New Orleans La. Recruit  
from Depot.

Oct 1864 - Dis: Oct 6/64 Port  
Hudson N.Y.

\* Name appears also as  
Dancy Stewart

Book mark:

W. R. Lee

21 | **4 Cav.** | **U.S.C.T.**

Samuel Stewart  
Co. H., 4 Reg't U. S. Col'd Cavalry.

Appears on **Co. Muster-out Roll**, dated  
New Orleans La. Micho., 1866.

Muster-out to date \_\_\_\_\_, 186 .

Last paid to \_\_\_\_\_, 186 .

**Clothing account:**

Last settled \_\_\_\_\_, 186 ; drawn since \$ \_\_\_\_\_ 100

Due soldier \$ \_\_\_\_\_ 100; due U. S. \$ \_\_\_\_\_ 100

Am't for cloth'g in kind or money adv'd \$ \_\_\_\_\_ 100

Due U. S. for arms, equipments, &c., \$ \_\_\_\_\_ 100

Bounty paid \$ \_\_\_\_\_ 100; due \$ \_\_\_\_\_ 100

Remarks: joined in recruit  
sent into the Hospital  
at New Orleans La. Camp  
stated statements for  
warded

Book mark: \_\_\_\_\_

(861)

H. E. Stewart  
Coppist.



Stuart, Sandy

P, Co H, 4 U.S.C. Cav.

1 Enclosures.

Bed Cards	Descriptive Lists
Burial Records	Final Statements 1
Certs. of Dis. for Discharge	Furloughs
C. M. Charges	Med. Des. Lists
Med. Certificates	Orders

Other papers relating to—

Admission to Hosp'l	Furlough
Casualty Sheet (Officer's)	Med. Examination
Confinement	Misc. Information
Contracts	Pay or Clothing
Death or Effects	Personal Reports
Desertions	Rank
Discharge from Hosp'l	Transfer to Hosp'l
Discharge from Service	Transfer to V. R. C.
Duty	Transportation

*Extract from Act of Congress.*

SEC. 12. *And be it further enacted,* That the fees of agents and attorneys for making out and causing to be executed the papers necessary to establish a claim for a pension, bounty, and other allowance before the Pension Office, under this act, shall not exceed the following rates: For making out and causing to be duly executed a declaration by the applicant, with the necessary affidavits, and forwarding the same to the Pension Office, with the requisite correspondence, ten dollars; which sum shall be received by such agent or attorney in full for all services in obtaining such pension, and shall not be demanded or received, in whole or in part, until such pension shall be obtained; and the sixth and seventh sections of an act entitled "An act to grant pensions," approved July [fourteenth,] eighteen hundred and sixty-two, are hereby repealed.

SEC. 13. *And be it further enacted,* That any agent or attorney who shall, directly or indirectly, demand or receive any greater compensation for his services under this act than is prescribed in the preceding section of this act, or who shall contract or agree to prosecute any claim for a pension, bounty, or other allowance under this act, on the condition that he shall receive a per centum upon any portion of the amount of such claim, or who shall wrongfully withhold from a pensioner or other claimant the whole or any part of the pension or claim allowed and due to such pensioner or claimant, shall be deemed guilty of a high misdemeanor, and, upon conviction thereof, shall, for every such offense, be fined not exceeding three hundred dollars, or imprisoned at hard labor not exceeding two years, or both, according to the circumstances and aggravations of the offense.

Approved July 4, 1864.

NOTE 10.—If any soldier is charged a higher fee than that allowed by the above act, he should report the fact and the name of the agent to the Adjutant General, in order that steps may be taken to have the same refunded.

*See 112. 3. 6. 10*

ADJUTANT GENERAL'S OFFICE  
*Recd 8/1/64*  
 Duplicate with Inventory sent 2d Auditor.

FINAL STATEMENT

OF

*Sandy Stuart*  
 4<sup>th</sup> Reg't of *U.S. Cavalry*

VOLUNTEERS.

*Must roll 1044*

NOTE 1.—Two of these certificates (or duplicates) are to be given to each Volunteer Soldier or drafted man who may be discharged without being mustered out (Final Statements are never given to men mustered out of service) that he may at once receive from the Paymaster the pay, &c., due him, and the captain or other COMMISSIONED officer commanding the company will certify to the act of the delivery of the duplicate certificates; with these certificates the Soldier is "entitled to" his discharge, and should also present his discharge to the Paymaster to have the payment endorsed on it. The discharge is to be given back to the Soldier by the Paymaster; the latter only retaining as his vouchers the duplicate certificates.

NOTE 2.—If the Soldier is entitled to pay for the use of his horse, the Company Commander will certify to that fact on the back of both these final statements, and also to the time he has pay due for having been so mounted on his own horse.

NOTE 3.—When a Soldier is furnished with final statements, his descriptive list, if he has one, should be taken up by the officer who gives the Soldier these statements, and endorsed with a statement to this effect by the officer. The endorsement should exhibit a full statement of the time for which the Soldier was allowed pay on his final statements, the clothing account, and all other charges against him or in his favor, so as to comprise a complete exhibit of his account. It will then be transmitted to the Company Commander of the soldier, who will enter all the data necessary to a full understanding of the Soldier's account on the muster roll upon which the Soldier's discharge is reported. The descriptive list will then be destroyed. The object of this is, that the remaining portion of the Soldier's account may be retained upon the receipt of these muster rolls, and the Soldier receive any pay or allowances that may be due him at the time of his discharge, and which may not appear on his last final statements from the fact that his descriptive list is incomplete. These accounts for back pay, &c., are settled by the 2d Auditor of the Treasury Department.

NOTE 4.—Charges for loss or injury to ordnance, horse equipments, and other miscellaneous charges, should appear under the heading of "Other Stoppages."

NOTE 5.—Bounty paid by State authorities, and not by the United States, will not be entered on this statement.

NOTE 6.—Amounts due the Sutler and Laundress must be entered on the muster roll on which the discharge, death, desertion, &c., is reported, as well as on the final statement, otherwise the amount cannot be collected from the United States.

NOTE 7.—This blank will be used for deceased volunteers and drafted men, as well as for officers.

NOTE 8.—Where a Soldier dies in Hospital or on detached service, his descriptive list, if he has one, should be sent with his final statements, in duplicate, to the Adjutant General, Washington, D. C.

NOTE 9.—If the soldier is a drafted man or substitute, the space for time, &c., of enrolled, should contain only the word *drafted* or *substitute*, as the case may be. If the Soldier is a "VETERAN," (or RECRUIT,) the words as a *veteran*, (or *recruit*,) as the case may be, should be interlined after the words *mustered into the service of the U. S.* A statement of all the installments of *Veteran* or *Recruit* Bounty RECEIVED by the Soldier must be made on the back of each final statement.

MAY 1875

I certify, on honor, that Sandy Stuart, a Private of  
Captain Frank Butler Company (H) of the 4<sup>th</sup> Regiment of U.S. Cavalry  
**VOLUNTEERS**, of the State of Louisiana, born in \_\_\_\_\_, State  
of \_\_\_\_\_, aged \_\_\_\_\_ years; \_\_\_\_\_ feet \_\_\_\_\_ inches high; \_\_\_\_\_ complexion,  
\_\_\_\_\_ eyes, \_\_\_\_\_ hair, and by occupation a \_\_\_\_\_, who joined for service  
and was enrolled (see Note 9) on the 23<sup>rd</sup> day of April, 1864, at New Orleans  
by H. Butler, for the period of Three years, and mustered into  
the service of the United States on the 24<sup>th</sup> day of April 1864, at  
this man except by his death; and having served  
HONESTLY and FAITHFULLY with his Company to the present date, is now entitled to a  
**DISCHARGE** by reason of Death, having died in Reg't Hospital  
at Fort Hudson La. Oct 6<sup>th</sup> 1864

The said Sandy Stuart has pay <sup>enrollment</sup> in arrears was last paid by Paymaster  
\_\_\_\_\_, to include the \_\_\_\_\_ day of \_\_\_\_\_, 1864, and  
has pay due him from that time to the present date; he is entitled to pay and subsistence for  
**TRAVELING** to place of enrollment, and whatever other allowances are authorized to volunteer  
soldiers, drafted men, or militia, so discharged. He has received from the United States **CLOTHING**  
amounting to 18 <sup>25</sup>/<sub>100</sub> dollars, since the 23<sup>rd</sup> day of April,  
1864, when his clothing account was last settled. He has received from the United States  
\_\_\_\_\_ <sup>100</sup>/<sub>100</sub> dollars advanced **BOUNTY**.

There is to be stopped from him, on account of the State of \_\_\_\_\_, or other  
authorities, for **CLOTHING, &c.**, received on entering service, \_\_\_\_\_ <sup>100</sup>/<sub>100</sub> dollars; and  
for other stoppages, viz: \_\_\_\_\_

\_\_\_\_\_ <sup>100</sup>/<sub>100</sub> dollars.  
He has been furnished with **TRANSPORTATION** in kind from the place of his discharge to  
\_\_\_\_\_; and he has been **SUBSISTED** for **TRAVELING** to his  
place of enrollment, up to the \_\_\_\_\_, 1864.

He is indebted to \_\_\_\_\_, **SUTLER**, \_\_\_\_\_ <sup>100</sup>/<sub>100</sub> dollars.

He is indebted to \_\_\_\_\_, **LAUNDRESS**, \_\_\_\_\_ <sup>100</sup>/<sub>100</sub> dollars.

Given in Duplicate, at Fort Hudson La., this 26<sup>th</sup> day  
of July, 1864.

W. C. Lyman  
\_\_\_\_\_  
Captain

Commanding Company.

1011

Stewart Stephen

Co G, 4 U. S. Col'd Cav.

Private Corporal

CARD NUMBERS.

1	5-347521	26
2	5-356794	27
3	5-356489	28
4	5-354920	29
5	5-357003	30
6	5-357047	31
7	40729231	32
8		33
9		34
10		35
11		36
12		37
13		38
14		39
15		40
16		41
17		42
18		43
19		44
20		45
21		46
22		47
23		48
24		49
25		50

Book Mark:

See also

APR 1960

J. 558185 R.C. 9d,  
S-1006138 - PD. MEM  
S 1236916 P.O. aff  
J. 2135611 P.O. Ret.

*[Handwritten signature]*

*S* | **4 Cav.** | **U.S.C.T.**

*Stephen Stewart*

Appears with rank of *Private* on

**Muster and Descriptive Roll of a Detachment of U. S. Vols. forwarded**

for the 4 Reg't U. S. Col'd Cavalry. Roll dated

*New Orleans, La. Apr. 25, 1865.*

Where born *Opolusas, La.*

Age *27* y'rs; occupation *Laborer*

When enlisted *Apr. 9*, 1865.

Where enlisted *New Orleans, La.*

For what period enlisted *3* years.

Eyes *Black*; hair *Black*

Complexion *Black*; height *6 ft. 0 in.*

When mustered in *Apr. 25*, 1865.

Where mustered in *New Orleans*

Bounty paid \$ *100* <sup>100</sup>; due \$ *200* <sup>100</sup>

Where credited *1st Dist 3rd Ward, Orleans, New Orleans, La.*

Company to which assigned *G.*

Remarks :

Book mark :

(339)

*O. T. Taylor*

Copyist.

*S* | **4 Cav. | U. S. C. T.**

*Stephen Stuart*

*Pr*, Co. G, 4 Reg't U. S. Col'd Cavalry.

Appears on

**Company Muster Roll**

for *May 1865*, 1865.

Present or absent *Present*

Stoppage, \$ *100* for

Due Gov't, \$ *100* for

Valuation of horse, \$ *100*

Valuation of horse equipments, \$ *100*

Remarks: *Pr. 3 months paid  
& 2 months for  
fabric. not in  
rec'd. under Dept  
files -*

Book mark: \_\_\_\_\_

(358)

*Amund*  
Copyist.

*S* | **4 Cav.** | **U.S.C.T.**

*Stephen Stewart*

....., Co. G, 4 Reg't U. S. Col'd Cavalry.

Appears on

**Company Muster Roll**

for *July & Aug* ....., 1865.

Present or absent *Present*

Stoppage, \$ ..... 100 for .....

Due Gov't, \$ ..... 100 for .....

Valuation of horse, \$ ..... 100

Valuation of horse equipments, \$ ..... 100

Remarks *S. & Brantley paid*

*\$ 200.00*

Book mark : .....

*Amund*  
Copyist.



S | 4 Cav. | U.S.C.T.

Stephen Stewart  
Corp., Co. G, 4 Reg't U. S. Col'd Cavalry.  
Appears on

**Company Muster Roll**

for Sept & Oct, 1865.

Present or absent Present

Stoppage, \$ 100 for

Due Gov't, \$ 100 for

Valuation of horse, \$ 100

Valuation of horse equipments, \$ 100

Remarks: Promoted to rank  
of Corporal by S.C. No 55  
dated Hdqrs 4th U.S.C. Co.  
Oct 7/65

\$100. Bounly Paid \$200 due

NEED ROLL ON FILE FEB 1866

Book mark:

Fletcher

S. | **4 Cav.** | **U.S.C.T.**

Stephen Stewart  
Corp., Co. G, 4 Reg't U. S. Col'd Cavalry.

Appears on

**Company Muster Roll**

for Jan & Feb, 1866.

Present or absent Present

Stoppage, \$ 100 for

Due Gov't, \$ 100 for

Valuation of horse, \$ 100

Valuation of horse equipments, \$ 100

Remarks: \$100.00 Bounty paid  
\$200.00 Promoted to Capt.  
Oct 7. 1865

Book mark: \_\_\_\_\_

Fletcher

(358)

Copyist.

| **4 Cav. | U.S.C.T.**

Stephen Stewart  
Port, Co. G, 4 Reg't U. S. Colored Cav.

Appears on **Returns** as follows:

May 1865 - Gain: May 14/65  
New Orleans Recruit  
from depot.

Book mark: \_\_\_\_\_

546,

W. R. Lee

Copyist.

*S* | **4 Cav.** | **U.S.C.T.**

*Stephen Stewart*  
Corporal, Co. *E*, 4 Reg't U. S. Col'd Cavalry.

Appears on **Co. Muster-out Roll**, dated  
*New Orleans, La. Mch 20*, 1866.

Muster-out to date *Mch 20*, 1866.

Last paid to *June 30*, 1865.

Clothing account:

Last settled \_\_\_\_\_, 186 ; drawn since \$ \_\_\_\_\_ 100

Due soldier \$ \_\_\_\_\_ 100; due U. S. \$ *22* <sup>80</sup>/<sub>100</sub>

Am't for cloth'g in kind or money adv'd \$ \_\_\_\_\_ 100

Due U. S. for arms, equipments, &c., \$ \_\_\_\_\_ 100

Bounty paid \$ *100.* 100; due \$ *none* 100

Remarks: *Joined as recruit*  
*Priv. to Oct 7, 65*

Book mark: *V. 172 P. 287, 73*

*J. Fletcher*

Stewart, Stephen

Co. \_\_\_\_\_, Reg't U. S. Cav.

Enclosures.

- |                              |                       |
|------------------------------|-----------------------|
| Bed Cards                    | Final Statements      |
| Burial Records               | Furloughs or L. of A. |
| Certs. of Dis. for Discharge | Med. Certificates     |
| C. M. Charges                | Med. Des. Lists       |
| Descriptive Lists            | Orders                |
| Discharge Certificates       | Pris. of War Record   |
| Enlistment Papers            | Resignations          |

Other papers relating to—

- |                        |                      |
|------------------------|----------------------|
| Admission to Hosp'l    | Furlough or L. of A. |
| Casualty Sheet         | Med. Examination     |
| Confinement            | Misc. Information    |
| Contracts              | Pay or Clothing      |
| Death or Effects       | Personal Reports     |
| Desertion              | Rank                 |
| Discharge from Hosp'l  | Transfer to Hosp'l   |
| Discharge from Service | Transfer to V. R. C. |
| Duty                   | Transportation       |

1865

NOTE 1.—This blank will be used for both enlistments and re-enlistments—enlistment of veterans, &c., &c., in the volunteer service. They will be made out in duplicate in all cases—one to accompany the recruiting return of the superintendent (not the recruiting officer) to the Adjutant General, and one to accompany the accounts of the officer who pays bounty, &c. The Regiment and Company in which the soldier last served should be given on the back.

NOTE 2.—An enlistment holds to service. A muster-in must, in all cases, precede payment of pay, bounty, pen. m. &c. A muster-in roll must, in all cases, be filed in the Adjutant General's Office as evidence of muster-in. The mustering officer, commissary, or assistant commissary of musters, as the case may be, will countersign both enlistments as having mustered the soldier into the service of the United States before either of them is given to the disbursing officer.

DECLARATION OF RECRUIT.

I, *Stephen Herrard*, desiring to VOLUNTEER as a Soldier in the Army of the United States, for the term of THREE YEARS. Do Declare, That I am *27* years and \_\_\_\_\_ months of age; that I have never been discharged from the United States service on account of disability or by sentence of a court martial, or by order before the expiration of a term of enlistment; and I know of no impediment to my serving honestly and faithfully as a soldier for three years.

GIVEN at *New Orleans La.* the *9* day of *April* 18*65*

Witness: *John Leo Birdman* *Stephen Herrard*  
*1<sup>st</sup> Lieut. 10<sup>th</sup> U. S. C. A.* *mark*

Received from Second Auditor  
October 7th, 1892.

*Account enlisted to the Company provided by number 107 of the 1<sup>st</sup> Div. 10<sup>th</sup> U. S. C. A. of the 1865*

Discharged ..... 18  
enlistment: last served in (Company) ( )  
Reg't of .....

*Stephen Herrard*  
Volunteered at *New Orleans La.*  
*April* 18*65*  
By *Charles T. McMillister*  
*1<sup>st</sup> Regiment of W. V. R. C.*

CONSENT IN CASE OF MINOR.

I, \_\_\_\_\_, Do CERTIFY, That I am the \_\_\_\_\_ of \_\_\_\_\_; that the said \_\_\_\_\_ is \_\_\_\_\_ years of age; and I do hereby freely give my CONSENT to his volunteering as a SOLDIER in the ARMY OF THE UNITED STATES for the period of THREE YEARS.

GIVEN at \_\_\_\_\_ the \_\_\_\_\_ day of \_\_\_\_\_

Witness:

APR 1865

VOLUNTEER ENLISTMENT.

STATE OF

TOWN OF

*Louisiana*



*New Orleans*

I, *Stephen Stewart*, born in *Opalusa* in the State of *Louisiana*, aged *twenty seven* years, and by occupation a *Laborer*, Do HEREBY ACKNOWLEDGE to have volunteered this *ninth* day of *April*, 1865, to serve as a **Soldier** in the **Army of the United States of America**, for the period of **THREE YEARS**, unless sooner discharged by proper authority: Do also agree to accept such bounty, pay, rations, and clothing, as are, or may be, established by law for volunteers. And I, *Stephen Stewart*, do solemnly swear, that I will bear true faith and allegiance to the **United States of America**, and that I will serve them honestly and faithfully against all their enemies or opposers whomsoever; and that I will observe and obey the orders of the President of the United States, and the orders of the officers appointed over me, according to the Rules and Articles of War.

Sworn and subscribed to, at *New Orleans*, this *9<sup>th</sup>* day of *April*, 1865, BEFORE *Gen Geo Henderson* *1<sup>st</sup> Lieut. 10<sup>th</sup> U. S. C. A.* *Stephen Stewart* his mark

I CERTIFY, ON HONOR, That I have carefully examined the above-named Volunteer, agreeably to the General Regulations of the Army, and that, in my opinion, he is free from all bodily defects and mental infirmity, which would in any way disqualify him from performing the duties of a soldier.

*J. H. Brown*  
*Surgeon 8<sup>th</sup> U. S. C. A.*  
EXAMINING SURGEON.

I CERTIFY, ON HONOR, That I have minutely inspected the Volunteer *Stephen Stewart* previously to his enlistment, and that he was entirely sober when enlisted; that, to the best of my judgment and belief, he is of lawful age; and that, in accepting him as duly qualified to perform the duties of an able-bodied soldier, I have strictly observed the Regulations which govern the recruiting service. This soldier has *black* eyes, *black* hair, *black* complexion, is *six* feet *—* inches high.

*W. C. Allison*  
*Capt 10<sup>th</sup> Regiment of U. S. C. A. Reg. Volunteers,*  
RECRUITING OFFICER.

(A. G. O. No. 74 & 76.)

Mustered into the service of the United States, for three years or during the war, from date of enlistment, in Company "E" 4<sup>th</sup> Regiment of *W. S. C. A.* Volunteers, on the *25* day of *April*, 1865, at *New Orleans La.*

*John Harrison*  
*10<sup>th</sup> U. S. C. A.*  
*11/1/77*

*James M. Hanna*  
Co *M E A*, 4 U. S. Col'd Cav.

*2<sup>nd</sup>* Lieutenant Captain

CARD NUMBERS.

1	5-347969	26
2	5-347392	27
3	5-35-8807	28
4	5-35-8860	29
5	5-35-8912	30
6	5-35-8961	31
7	5-35-4350	32
8	5-35-4435	33
9	5-35-4593	34
10	5-348119	35
11	5-347393	36
12	5-35-0766	37
13	5-35-0855	38
14	5-35-0940	39
15	5-35-1022	40
16	5-35-1103	41
17	5-35-7875	42
18	40729232	43
19		44
20		45
21		46
22		47
23		48
24		49
25		50

Book Mark:

See also *J. J. Harvey*



MAR 1957

J. G. 119.051.2. Aud.

Rep 407502

D. 3123018 Pointm

*W. Miller*  
2

S 4, Cav, U.S.C.T.

Pletcher A. Steffel

2<sup>d</sup> Lt., Co. M, 4 Reg't U. S. Col'd Cav.

Age 21 years.

Appears on an

**Individual Muster-in Roll**

of the organization named above. Roll dated

New Orleans La, Aug 2, 1864.

Muster-in to date

July 23, 1864.

Joined for duty and enrolled:

When July 23, 1864.

Where New Orleans

Period 3 years.

Valuation of horse, \$ 100

Valuation of horse equipments, \$ 100

Remarks: Discharged as private  
of Co. F, 2<sup>d</sup> Ill. Vet. Cav  
July 16, 1864 in Special  
orders No. 202, Hd Qrs.

Book mark: \_\_\_\_\_

Perrington  
over Copyist.

JAN.-8

5347392

1891

Remarks:  
Dept of the Gulf.  
July 30<sup>th</sup> 1864, to accept  
promotion. To fill  
Original vacancy  
in Co. "M"

JAN. - 8

5347392

1891

Remarks:  
Dept of the Gulf.  
July 30<sup>th</sup> 1864, to accept  
promotion. To fill  
Original vacancy  
in Co. "M"

S | 4, Cav | U.S.C.T.

Fletcher A. Stearns

Capt, Co. B, 4 Reg't U. S. Col'd Cav

Age 22 years.

Appears on an

**Individual Muster-in Roll**

of the organization named above. Roll dated

Baton Rouge La, Aug 10, 1865.

Muster-in to date Aug 10, 1865.

Joined for duty and enrolled:

When Aug 10, 1865.

Where Baton Rouge La.

Period 3 years.

Valuation of horse, \$ 100

Valuation of horse equipments, \$ 100

Remarks: Mustered out as  
2nd Lieut, 4th U.S. Col'd  
Cav, to date Aug 9, 1865  
to enable him to be

Book mark:

(336)

Summington  
over Copyist.

JAN. - 8.

5347393

★ TEST ★

Remarks:  
Mustered as Captain  
in same Regt - as per  
Commission from  
Secy of War. Mustered  
in as Captain C. B.  
4<sup>th</sup> U. S. Colored Cavalry,  
by virtue of his Com-  
mission as Capt.  
Vice J. M. Cormier  
resigned -

S 14000 | U.S.C.T.

Fletcher A. Strokel  
2<sup>d</sup> Lieut, Co M, 4 Reg't U.S. Col'd Cavalry

Age ..... years.

Appears on

**Company Muster Roll\***

for *Enlistment to Aug 3/1864.*

Joined for duty and enrolled:

When ....., 186 .

Where .....

Period ..... years.

Mustered in:

When *July 23*, 186<sup>4</sup>.

Where *New Orleans, La*

Present or absent *Present*

Stoppage, \$ ..... 100 for .....

Due Gov't, \$ ..... 100 for .....

Valuation of horse, \$ ..... 100

Valuation of horse equipments, \$ ..... 100

Remarks : .....

\* First current roll. No muster-in roll of this company on file.

Book mark : .....

(3586)

*JW Davis*

Copyist.

S | **4 Cav. | U.S.C.T.**

Fletcher A. Stoppel  
2<sup>d</sup> Lieut, Co. M, 4 Reg't U. S. Col'd Cavalry.

Appears on

**Company Muster Roll**  
for Sept 7 001, 1864.

Present or absent Present

Stoppage, \$ 100 for

Due Gov't, \$ 100 for

Valuation of horse, \$ 100

Valuation of horse equipments, \$ 100

Remarks: \_\_\_\_\_  
\_\_\_\_\_  
\_\_\_\_\_  
\_\_\_\_\_  
\_\_\_\_\_  
\_\_\_\_\_  
\_\_\_\_\_  
\_\_\_\_\_  
\_\_\_\_\_

Book mark: \_\_\_\_\_

(358)

J. W. S. Am  
Copyist.



S | 4 Cav. | U.S.C.T.

Fletcher A. Stichel  
2<sup>d</sup> Lieut., Co. M, 4 Reg't U. S. Col'd Cavalry.

Appears on

**Company Muster Roll**

for *Nov & Dec*, 186*4*.

Present or absent *Present*

Stoppage, \$ *100* for

Due Gov't, \$ *100* for

Valuation of horse, \$ *100*

Valuation of horse equipments, \$ *100*

Remarks: *Placed in command of  
Company per S.O. 121. Hd Qrs  
4<sup>th</sup> U.S. Cav. December 22, 1864  
Waco Cleveland discharged  
Narrations drawn (62) Fifty  
two.*

Book mark: *300*

(358)

*G. W. Davis*  
Copyist.

S | 4 Cav. | U.S.C.T.

Fletcher A Stickel  
2<sup>d</sup> Lt, Co. M, 4 Reg't U. S. Col'd Cavalry.

Appears on  
Company Muster Roll  
for Jan & Feb, 1865

Present or absent Present

Stoppage, \$ 100 for

Due Gov't, \$ 100 for

Valuation of horse, \$ 100

Valuation of horse equipments, \$ 100

Remarks: In command of Co.  
since Dec 22<sup>d</sup>, 1864  
Stop for 32 rations

Book mark:

(358) J. W. Davis Copyist.

4 Cav. U.S.C.T.

Netcher A. Strickel  
2<sup>nd</sup> Lt, Co. E, 4 Reg't U. S. Col'd Cav.

Appears on

**M. and D. Roll of Men Transferred**

to the organization named above, by consoli-  
from Co M.

Roll dated Fort Anderson La Apr 29, 1865.

When enlisted \_\_\_\_\_, 186 \_\_\_\_\_.

Period for which enlisted 3 years.

When mustered in July 23, 1864.

Present or absent Not stated

Company to which assigned E

Remarks:

Book mark:

(342)

*[Signature]*  
Copyist.

S | **4 Cav.** | **U.S.C.T.**

Blitcher, Slickel  
2<sup>d</sup> Lieut, Co. E, 4 Reg't U. S. Col'd Cav.

Appears on

**Company Muster Roll**

for Mar & Apr, 1865.

Present or absent Present

Stoppage, \$.....100 for .....

Due Gov't, \$.....100 for .....

Valuation of horse, \$.....100

Valuation of horse equipments, \$.....100

Remarks: Transferred from Co  
M. by consolidation in  
compliance with special  
order no 28, dated 1865  
Dept of the Gulf Jan. 28. 1865  
(Copy attached)

Book mark: .....

(358)

Wines

Copyist.

*S* | **4 Cav.** | **U.S.C.T.**

*F. A. Sticker*

*2<sup>d</sup> Lieut.*, Co. E, 4 Reg't U. S. Col'd Cav.

Appears on

**Company Muster Roll**

for *May & June*, 186*5*.

Present or absent *Present*

Stoppage, \$ *100* for

Due Gov't, \$ *100* for

Valuation of horse, \$ *100*

Valuation of horse equipments, \$ *100*

Remarks: *Stop for 1 Cap Pruck*

Book mark:

(358)

*Wines*

Copyist.

*S* | **4 Cav.** | **U.S.C.T.**

*J. M. Stickel*

*2<sup>d</sup> Lieut*, Co. E, 4 Reg't U. S. Col'd Cav.

Appears on

**Company Muster Roll**

for *July & Aug*, 186 *5*.

Present or absent

Stoppage, \$ 100 for

Due Gov't, \$ 100 for

Valuation of horse, \$ 100

Valuation of horse equipments, \$ 100

Remarks: *Promoted to Capt*  
*Co. B.*

Book mark:

(358)

*Wines*

Copyist.

S | **4 Cav.** | **U.S.C.T.**

F. A. Stickel

Capt., Co. B. 4 Reg't U. S. Col'd Cavalry.

Appears on

**Company Muster Roll**

for July & Aug, 1867.

Present or absent present

Stoppage, \$ 100 for

Due Gov't, \$ 100 for

Valuation of horse, \$ 100

Valuation of horse equipments, \$ 100

Remarks: Success in command  
of Co Aug 20/65. U.S.  
Reg't from July 8/65  
to Aug 8/65

Book mark:

Somer  
(358) Copyist.

S | **4 Cav.** | **U.S.C.T.**

F. A. Stichel

Capt., Co. B. 4 Reg't U. S. Col'd Cavalry.

Appears on

**Company Muster Roll**

for Sept & Oct, 1865.

Present or absent present

Stoppage, \$ 100 for

Due Gov't, \$ 100 for

Valuation of horse, \$ 100

Valuation of horse equipments, \$ 100

Remarks: Took command of  
Company Aug 20/65 -  
acted adjutant from  
July 8/65 to Aug 8/65

Book mark: \_\_\_\_\_

(358)

Somers

Copyist.



*S* | **4 Cav. | U.S.C.T.**

*F. A. Steikel*  
-----  
*Capt.*, Co. B. 4 Reg't U. S. Col'd Cavalry.

Appears on

**Company Muster Roll**

for *Nov. 1865*, 1865.

Present or absent *Present*

Stoppage, \$ 100 for

Due Gov't, \$ 100 for

Valuation of horse, \$ 100

Valuation of horse equipments, \$ 100

Remarks: *Promoted from 2nd*  
*Ser. Co. E. vice McCormick*  
*resigned. Placed in com.*  
*of Co. Aug. 20, 65.*

Book mark : \_\_\_\_\_

(358)

*Chandler*  
-----  
Copyist.

*S* | **4 Cav.** | **U.S.C.T.**

*F. A. Stichel*  
Capt., Co. B. 4 Reg't U. S. Col'd Cavalry.

Appears on

**Company Muster Roll**

for *Jan. & Feb.*, 1866.

Present or absent *Present*

Stoppage, \$ 100 for

Due Gov't, \$ 100 for

Valuation of horse, \$ 100

Valuation of horse equipments, \$ 100

Remarks: *Had command of  
Company since Aug.  
30, 1865+*

Book mark :

(358)

*Chandler*  
Copyist.

*S* | *4 leav.* | **U.S.C.T.**

*Fletcher A. Stickel*  
*2<sup>d</sup> Lt, Co M, 4 Reg't U. S. Col'd Cav.*

Appears on an

**Individual Muster-out Roll**

of the organization named above. Roll dated

*Baton Rouge La., Aug. 9, 1865.*

Muster-out to date *Aug. 9, 1865.*

Last paid to *Feb. 28, 1865.*

**Clothing account:**

Last settled ..... 186 ; drawn since \$ ..... 100

Due soldier \$ ..... 100 ; due U. S. \$ ..... 100

Am't for cloth'g in kind or money adv'd \$ ..... 100

Due U. S. for arms, equipments, &c., \$ ..... 100

Bounty paid \$ ..... 100 due \$ ..... 100

Remarks: *Joined at original organization of company. Was promoted from Private in 2<sup>d</sup> Ills. Cavalry Regt. Mustered out to enable him to be mustered as Captain 1st B 4<sup>th</sup> US Cav.*

Book mark: ..... (over)

(348)

*Murray*

Copyist.

JAN. - 8

5348119

1891

Cavalry, he having received  
a commission from the Secretary  
of War.

S | **4 Cav.** | **U.S.C.T.**

<sup>+</sup> Fletcher A. Stickle  
2<sup>nd</sup> Lt                      m  
Capt                      Co. E, 4 Reg't U. S. Colored Cav.

Appears on Returns as follows:

Aug 1864 - Present reported for duty  
Aug 6/64

Sept 1864 to Feb 1865 - Present

March to June 1865. (2<sup>nd</sup> Lt Co. E) Present  
Transferred from Company M.  
to Company E. in accordance  
with O. O. No 28 Hd. Qrs. Report  
- ment of the Gulf, New Orleans  
Jan'y 28, 1865.

July 1865 - Present Act'g Adjt. Pr. S. O.  
34 Hd. Qrs. H. Q. S. O. E. July 8/65

Aug to Nov 1865 - (Capt Co. E) Present  
assumed command of Co. Aug  
20/65 -

Dec 1865 - Presence or absence not stated

Jan & Feb 1866 - Present

<sup>+</sup> Name appears also as

Fletcher A Stickle

Book mark :

W. R. See

*S* | **4 Cav. | U.S.C.T.**

*Fletcher A. Stickels*

*2 Lt*, Co. *E*, 4 Reg't U. S. Col'd Cavalry.

Appears on **Co. Muster-out Roll**, dated  
*New Orleans La, Mch 20*, 1866.

Muster-out to date \_\_\_\_\_, 186 .

Last paid to \_\_\_\_\_, 186 .

**Clothing account:**

Last settled \_\_\_\_\_, 186 ; drawn since \$ \_\_\_\_\_ 100

Due soldier \$ \_\_\_\_\_ 100 ; due U. S. \$ \_\_\_\_\_ 100

Am't for cloth'g in kind or money adv'd \$ \_\_\_\_\_ 100

Due U. S. for arms, equipments, &c., \$ \_\_\_\_\_ 100

Bounty paid \$ \_\_\_\_\_ 100 ; due \$ \_\_\_\_\_ 100

Remarks: *Discharged to accept  
promotion as Capt Co B.  
Aug 10/65;*

Book mark : \_\_\_\_\_

(861)

*Floyd*

Copyist.

*S* | **4 Cav.** | **U.S.C.T.**

*Fletcher A. Steckle*  
*Capt*, Co. *B*, 4 Reg't U. S. Col'd Cavalry.

Appears on **Co. Muster-out Roll**, dated  
*New Orleans La. Mch. 20, 1866.*

Muster-out to date *Mch. 20, 1866.*

Last paid to \_\_\_\_\_, 186 .

**Clothing account:**

Last settled \_\_\_\_\_, 186 ; drawn since \$ \_\_\_\_\_ 100

Due soldier \$ \_\_\_\_\_ 100; due U. S. \$ \_\_\_\_\_ 100

Am't for cloth'g in kind or money adv'd \$ \_\_\_\_\_ 100

Due U. S. for arms, equipments, &c., \$ \_\_\_\_\_ 100

Bounty paid \$ \_\_\_\_\_ 100; due \$ \_\_\_\_\_ 100

Remarks: *Entered service at*  
*Monticello Ills. Aug. 20/62*  
*as Pvt in 2. Ills. Cav. Dischar-*  
*ged per S. O. 202 Hd. Qrs. Dept*  
*of the Gulf July 16/64. to accept*  
*promotion as 2<sup>nd</sup> Lieut. 4<sup>th</sup> U. S. C.*

Book mark: \_\_\_\_\_ (*over*)

(361)

*C. Chandler*  
Copyist.

JAN. - 8

5351103

1891

Appointed Capt. July 25, 65.  
Due \$10. per month for responsi-  
bility of co. property since  
Aug. 29/65. Services have  
been continuous. Entitled  
to 3 months extra pay proper  
as provided in G.O. 45 War  
Dept. A.G.O. Series 1865.



Stickels, Fletcher A.

Co. 4 Reg't U.S. Cav.

Enclosures.

Bed Cards .....	Final Statements .....
Burial Records .....	Furloughs or L. of A .....
Certs. of Dis. for Discharge .....	Med. Certificates .....
C. M. Charges .....	Med. Des. Lists .....
Descriptive Lists .....	Orders .....
Discharge Certificates .....	Pris. of War Record .....
Enlistment Papers .....	Resignations .....

Other papers relating to—

Admission to Hosp'l .....	Furlough or L. of A .....
Casualty Sheet .....	Med. Examination .....
Confinement .....	Misc. Information .....
Contracts .....	Pay or Clothing .....
Death or Effects .....	Personal Reports .....
Desertion .....	Rank .....
Discharge from Hosp'l .....	Transfer to Hosp'l .....
Discharge from Service .....	Transfer to V. R. C. .....
Duty .....	Transportation .....

Bataw Range La.  
Aug 11<sup>th</sup> 1853

Stichel F. W.  
Capt 4<sup>th</sup> Reg. C. C.

Applies for a leave  
of absence for seven  
days for the purpose  
of visiting the City of  
New Orleans La.

File  
Ser. P. O. No. 60. 4. 1

Mustering Office  
Colonel Roger La

Aug 11<sup>th</sup> 1865

Capt Edward H. Hays

A. A. General

Capt.

Having been  
mustered out as 2<sup>d</sup> Lt. (who mustered  
in as Capt.) I have the honor  
to request that a leave of  
absence of (1) seven days be  
given me with permission  
to visit the City of New Orleans  
La for the purpose of getting  
my final pay as 2<sup>d</sup> Lt.

I have the honor to be  
Very Respectfully  
Yours Obedt Servant.  
F. A. Stichel  
Capt Co. B 4<sup>th</sup> U.S.C.

St. John Alexander

Co *A*, 4 U. S. Col'd Cav.

Private | Private

CARD NUMBERS.

1	5-347849	26
2	5-35-5-162	27
3	5-35-5-250	28
4	5-35-5-339	29
5	5-35-5-423	30
6	5-35-5-504	31
7	5-35-5-5-50	32
8	5-35-5-665	33
9	5-35-5-749	34
10	5-35-5-832	35
11	5-35-5-912	36
12	5-35-5-993	37
13	5-35-6071	38
14	5-35-6148	39
15	40729233	40
16		41
17		42
18		43
19		44
20		45
21		46
22		47
23		48
24		49
25		50

Book Mark: .....

See also .....

D. 1379020. P.O. Mexico

MS 920476

*Amuse*  
H

*S* | **4 Cav. | U.S.C.T.**

*Alexander St. John*

Appears with rank of *Private* on

**Muster and Descriptive Roll of a Detachment of U. S. Vols. forwarded**

for the 4 Reg't U. S. Col'd Cavalry. Roll dated

*New Orleans, La. Mch 11, 1864*

Where born *St. Martin's, La*

Age *20* y'rs; occupation *Labourer*

When enlisted *Feb 29*, 1864.

Where enlisted *New Orleans*

For what period enlisted *3* years.

Eyes *Blk*; hair *Blk*

Complexion *Blk*; height *5* ft. *3* in.

When mustered in *Mch 11*, 1864.

Where mustered in *New Orleans*

Bounty paid \$ *100*; due \$ *100*

Where credited

Company to which assigned *F*

Remarks:

Book mark:

*Ballade*

*S* | **4 Cav. U.S.C.T.**

*Alexander St. John*  
*Pvt*, Co. F, 4 Reg't U. S. Col'd Cavalry.

Appears on

**Company Muster Roll**

for *March & April*, 1864.

Present or absent *Present*

Stoppage, \$ *100* for

Due Gov't, \$ *100* for

Valuation of horse, \$ *100*

Valuation of horse equipments, \$ *100*

Remarks:

Book mark:

(358)

*Manning*  
Copyist.

*S* | 4 Cav. | U.S.C.T.

*Alexander St. John*  
*Pr*, Co. F, 4 Reg't U. S. Col'd Cavalry.

Appears on

**Company Muster Roll**

for *May & June*, 1864.

Present or absent *Present*

Stoppage, \$ 100 for

Due Gov't, \$ 100 for

Valuation of horse, \$ 100

Valuation of horse equipments, \$ 100

Remarks:

Book mark:

(358)

*Manning*  
Copyist.



*S* | **4 Cav. U.S.C.T.**

*Alexander St John*  
*Pr*, Co. F, 4 Reg't U. S. Col'd Cavalry.

Appears on

**Company Muster Roll**

for *July & Aug*, 1864.

Present or absent *Present*

Stoppage, \$ *100* for

Due Gov't, \$ *100* for

Valuation of horse, \$ *100*

Valuation of horse equipments, \$ *100*

Remarks: *Stop for one*  
*Cartridge Box, plate*  
*and one gun sling*  
*26¢*

Book mark:

(358)

*Murray*  
Copyist.

*S* | **4 Cav.** | **U.S.C.T.**

*Alexander St. John*

*Pr*, Co. F, 4 Reg't U. S. Col'd Cavalry.

Appears on

**Company Muster Roll**

for *Sept & Oct*, 1864.

Present or absent *Present*

Stoppage, \$ *100* for

Due Gov't, \$ *100* for

Valuation of horse, \$ *100*

Valuation of horse equipments, \$ *100*

Remarks:

Book mark:

*Meaning*  
Copyist

S | **4 Cav.** | **U.S.C.T.**

Alexander St. John  
Pvt, Co. F, 4 Reg't U.S. Col'd Cavalry.

Appears on

**Company Muster Roll**  
for Nov. & Dec, 1864

Present or absent Present

Stoppage, \$ 100 for

Due Gov't, \$ 100 for

Valuation of horse, \$ 100

Valuation of horse equipments, \$ 100

Remarks: Stop for one Nose Bag.

Book mark: \_\_\_\_\_

J. W. Harris

(358)

Copyist.

*S* | **4 Cav.** | **U.S.C.T.**

*Alexander St. John*

*Pvt*, Co. F, 4 Reg't U. S. Col'd Cavalry.

Appears on

**Company Muster Roll**

for *Jan & Feby*, 186 *5*

Present or absent *Present*

Stoppage, \$ *100* for

Due Gov't, \$ *100* for

Valuation of horse, \$ *100*

Valuation of horse equipments, \$ *100*

Remarks: *Stop for one Nose Bag.*

Book mark: \_\_\_\_\_

(358)

*J. W. Harris*

Copyist.

S | **4 Cav.** | **U.S.C.T.**

Alexander St. John  
Pvt, Co. F, 4 Reg't U.S. Col'd Cavalry.

Appears on

**Company Muster Roll**

for Mc'h & Apr, 1865

Present or absent Present

Stoppage, \$ 100 for

Due Gov't, \$ 100 for

Valuation of horse, \$ 100

Valuation of horse equipments, \$ 100

Remarks:

Book mark:

J. W. Harris

S | **4 Cav.** | **U.S.C.T.**

Alexander St. John  
Pvt., Co. F, 4 Reg't U. S. Col'd Cavalry.

Appears on

**Company Muster Roll**

for May & June, 1865

Present or absent Present

Stoppage, \$.....100 for .....

Due Gov't, \$.....100 for .....

Valuation of horse, \$.....100

Valuation of horse equipments, \$.....100

Remarks: Due U.S. lost Ordnance  
\$2 <sup>63</sup>/<sub>100</sub> Halter, Spurs,

Book mark: .....

J H Harris

S | **4 Cav.** | **U.S.C.T.**

*Alexander St. John*  
*Pvt*, Co. F, 4 Reg't U. S. Col'd Cavalry.

Appears on

**Company Muster Roll**

for *July & Aug*, 186 *5*.

Present or absent: *Present*

Stoppage, \$ 100 for

Due Gov't, \$ *2* <sup>*67*</sup>/<sub>*100*</sub> for *Ordinance & Horse Equipments.*

Valuation of horse, \$ 100

Valuation of horse equipments, \$ 100

Remarks:

-----  
-----  
-----  
-----  
-----  
-----  
-----  
-----  
-----

Book mark:

*J. W. Harris*

*S* | **4 Cav. | U.S.C.T.**

*Alexander St. John*  
*Priv*, Co. F, 4 Reg't U. S. Col'd Cavalry.

Appears on

**Company Muster Roll**

for *Sept & Oct*, 186 *5*

Present or absent *Present*

Stoppage, \$ *100* for

Due Gov't, \$ *100* for

Valuation of horse, \$ *100*

Valuation of horse equipments, \$ *100*

Remarks: *Stop for one Currycomb,*  
*One Horse Brush one Surcingle,*

Book mark :

*J. Harris*



S | 4 Cav. | U.S.C.T.

Alexander St. John

P., Co. F, 4 Reg't U. S. Col'd Cavalry.

Appears on

Company Muster Roll

for Nov. & Dec., 1865

Present or absent Present

Stoppage, \$ 3. <sup>62</sup>/<sub>100</sub> for *order lost*

Due Gov't, \$ 100 for

Valuation of horse, \$ 100

Valuation of horse equipments, \$ 100

Remarks:

Book mark:

(358)

Hibbard

Copyist.

S | 4 Cav. | U.S.C.T.

Alexander St. John  
P

, Co. F, 4 Reg't U. S. Col'd Cavalry.

Appears on

Company Muster Roll

for Jan. Feb., 1866.

Present or absent Present

Stoppage, \$ 3.  $\frac{62}{100}$  for ordn. lost.

Due Gov't, \$ 100 for

Valuation of horse, \$ 100

Valuation of horse equipments, \$ 100

Remarks:

Book mark:

(358)

Hibbard

Copyist.

A | **4 Cav. | U.S.C.T.**

Alex. St. John  
Priv., Co. F, 4 Reg't U. S. Colored Cav.

Appears on Returns as follows:

Mich 1864 - (1 Regt Cav., Corps d'Afrique)  
Garr: Mar 11 / 64 N. Orleans  
Rec'd. from Depot.

Book mark: \_\_\_\_\_

W. R. Lee

S | 4 Cav. | U.S.C.T.

Alexander St. John

P, Co. F, 4 Reg't U. S. Col'd Cavalry.

Appears on Co. Muster-out Roll, dated New Orleans, La., Mch. 20 1866.

Muster-out to date Mch. 20, 1866.

Last paid to June 30, 1865.

Clothing account:

Last settled, 186 ; drawn since \$ 100

Due soldier \$ 100; due U. S. \$ 29. 04/100

Am't for cloth'g in kind or money adv'd \$ 100

Due U. S. for arms, equipments, &c., \$ 3. 62/100

Bounty paid \$ 100; due \$ 100

Remarks: Joined as recruit. Stop 1 curry comb, 1 horse brush, 1 muscingle, 1 sabre knot, 1 carbine socket.

Book mark: U224-P151-76.

Wibbard

(861)

Copyist.

*Strander Lewis*

Co *A*, 4 U. S. Col'd Cav.

*Private*

*Private*

CARD NUMBERS.

1	5-348485	26
2	5-348586	27
3	5-348690	28
4	5-348711	29
5	5-348805	30
6	5-348897	31
7	5-348989	32
8	5-349082	33
9	5-349156	34
10	5-349234	35
11	5-349322	36
12	5-349481	37
13	5-349573	38
14	5-348235	39
15	5-349769	40
16	R.P.386477	41
17	40729242	42
18		43
19		44
20		45
21		46
22		47
23		48
24		49
25		50

Book Mark: *R.P.386477*

See also

Q.683874 2ant.

S 758790 P.O. 90

REP386477

REP399252

O.1310026 P.O. m gm

S.1013535 - ant. n. h. c.

O1767400 Ant. n. h. c.

REP 616556

*Handwritten signature*

*S* | 4 Cav. | U.S.C.T.

*Lewis Strawder*

*Private*, Co. *A*, 1 Reg't La. Cav., Corps d'Afrique.\*

Appears on

**Company Muster-in Roll**

of the organization named above. Roll dated

*New Orleans* *Sept 12*, 1863.

Muster-in to date *Sept 12*, 1863.

Joined for duty and enrolled:

When *Aug 30*, 1863

Where *New Orleans*

Period *3* years.

Valuation of horse, \$.....100

Valuation of horse equipments, \$.....100

Remarks:

*Age 35*

\*This organization subsequently became Co. *A*, 4 Reg't U. S. Colored Cavalry.

Book mark: *R. P. 386 477*

*M. A. Michaels*

(356)

Copyist.

*S* | **4 Cav. | U.S.C.T.**

*Lewis Strander*

*Priv*, Co. *A*, 1 Reg't La. Cav., Corps d'Afrique.\*

Appears on

**Company Muster Roll**

for *Sept 12 to Dec 31*, 186 *3*

Present or absent *Present*

Stoppage, \$.....*100* for .....

Due Gov't, \$.....*100* for .....

Valuation of horse, \$.....*100*

Valuation of horse equipments, \$.....*100*

Remarks:.....  
.....  
.....  
.....  
.....  
.....  
.....  
.....

\*This organization subsequently became Co. *A*, 4 Reg't U. S. Colored Cavalry.

Book mark: .....

*R. Richardson*

(358)

Copyist.



1864

*S* | **4 Cav. U.S C.T.**

*Lewis Strawder*  
*Priv*, Co. *A*, 1 Reg't Cav., Corps d'Afrique.\*

Appears on

**Company Muster Roll**

for *Jan 7 Feb*, 186 *4*

Present or absent *Present*

Stoppage, \$ *100* for

Due Gov't, \$ *100* for

Valuation of horse, \$ *100*

Valuation of horse equipments, \$ *100*

Remarks:  
.....  
.....  
.....  
.....  
.....  
.....  
.....

\* This organization subsequently became Co. *A* Reg't U. S. Colored Cavalry.

Book mark: .....

*R. Richardson*  
Copyist.

*S* | **4 Cav.** | **U.S.C.T.**

*Lewis Strander*  
-----  
*Sergt*, Co. A, 4 Reg't U. S. Col'd Cavalry.

Appears on

**Company Muster Roll**

for *mech + apl*, 1864

Present or absent *Present*

Stoppage, \$ *100* for

Due Gov't, \$ *100* for

Valuation of horse, \$ *100*

Valuation of horse equipments, \$ *100*

Remarks: -----  
-----  
-----  
-----  
-----  
-----  
-----  
-----  
-----  
-----

Book mark: -----

*R. Richardson*

S | **4 Cav.** | **U.S.C.T.**

Lewis Strander

Sgt, Co. A, 4 Reg't U. S. Col'd Cavalry.

Appears on

**Company Muster Roll**

for May & June, 1864.

Present or absent Present

Stoppage, \$ 100 for

Due Gov't, \$ 100 for

Valuation of horse, \$ 100

Valuation of horse equipments, \$ 100

Remarks:

Book mark:

A. Richardson

*S* | **4 Cav.** | **U.S.C.T.**

*Lewis Strander*  
*Comy Sgt*, Co. A, 4 Reg't U. S. Col'd Cavalry.

Appears on

**Company Muster Roll**

for *July & Aug*, 186 *4*

Present or absent... *Present*

Stoppage, \$..... *100* for .....

Due Gov't, \$..... *100* for .....

Valuation of horse, \$..... *100*

Valuation of horse equipments, \$..... *100*

Remarks: .....

Book mark: .....

*R. Richardson*

(358)

Copyist.

S | 4 Cav. | U.S.C.T.

Louis Strander

Comp Regt Co. A, 4 Reg't U, S. Col'd Cavalry.

Appears on

Company Muster Roll

for Sept & Oct, 1864

Present or absent Present

Stoppage, \$ 100 for

Due Gov't, \$ 100 for

Valuation of horse, \$ 100

Valuation of horse equipments, \$ 100

Remarks:

Book mark:

Donnelly

(358)

Copyist.

S | 4 Cav. | U.S.C.T.

Lewis Strander

Com G. Co. A, 4 Reg't U. S. Col'd Cavalry.

Appears on

Company Muster Roll

for Nov & Dec, 1864

Present or absent Present

Stoppage, \$ 100 for

Due Gov't, \$ 100 for

Valuation of horse, \$ 100

Valuation of horse equipments, \$ 100

Remarks:

Book mark:

J. J. J. Copyist

S | 4 Cav. | U.S.C.T.

Lewis Strander

Com. Sgt, Co. A, 4 Reg't U. S. Col'd Cavalry.

Appears on

Company Muster Roll

for Jan & Feb, 1865

Present or absent Present

Stoppage, \$ 100 for

Due Gov't, \$ 100 for

Valuation of horse, \$ 100

Valuation of horse equipments, \$ 100

Remarks: Appointed Com. Sgt  
from Priv Mar 15 1864

x corrected by H. A. J. June 11, 1902

Book mark:

Donnelly

S | 4 Cav. | U.S.C.T.

Louis Strander

Com Sgt, Co. A, 4 Reg't U. S. Col'd Cavalry.

Appears on

Company Muster Roll

for Mar & Apr, 1865.

Present or absent Present

Stoppage, \$ 100 for

Due Gov't, \$ 100 for

Valuation of horse, \$ 100

Valuation of horse equipments, \$ 100

Remarks:

Book mark:

Wormly



S | 4 Cav. | U.S.C.T.

Louis Strander

Com Sgt, Co. A, 4 Reg't U. S. Col'd Cavalry.

Appears on

Company Muster Roll

for May & June, 1865

Present or absent Present

Stoppage, \$ 100 for

Due Gov't, \$ 100 for

Valuation of horse, \$ 100

Valuation of horse equipments, \$ 100

Remarks:

Book mark:

Donnelly

*S* | **4 Cav.** | **U.S.C.T.**

*Louis Stranden*

*Pri*, Co. A, 4 Reg't U. S. Col'd Cavalry.

Appears on

**Company Muster Roll**

for *July & Aug*, 186 *5*

Present or absent *Absent*

Stoppage, \$ 100 for

Due Gov't, \$ 100 for

Valuation of horse, \$ 100

Valuation of horse equipments, \$ 100

Remarks: *Absent without leave  
since July 9. 65, Reduced to  
ranks from Sergeant Aug 15/65*

Book mark: \_\_\_\_\_

*Donnelly*

*S.* | *4<sup>th</sup> Cav.* | **U. S. C. T.**

*Louis Steuder*

*Priv.*, Co. *A*, *4<sup>th</sup>* Reg't U. S. Col'd *Cav.*

Appears on

**Descriptive List of Deserters**

dated *Pt. Hudson La. Aug. 21*, 186*5*.

Deserted:

When *July 9*, 186*5*.

Where *Port Hudson La.*

Arrested:

When \_\_\_\_\_, 186 .

Where \_\_\_\_\_

Remarks: \_\_\_\_\_

Book mark: \_\_\_\_\_

(351)

*[Signature]*

Copyist.

*S* | **4 Cav.** | **U.S.C.T.**

*Lewis Strander*  
*Port*, Co. A, 4 Reg't U. S. Col'd Cavalry.

Appears on

**Company Muster Roll**

for *Sept & Oct*, 1865.

Present or absent..

Stoppage, \$.....100 for

Due Gov't, \$.....100 for

Valuation of horse, \$.....100

Valuation of horse equipments, \$.....100

Remarks: *Deserted July 9, 1865 at  
Port Hudson, La.*

NEXT ROLL ON FILE FEB 1866

Book mark:

*Prewitt*

(358)

Copyist.

A | 4 Cav. | U.S.C.T.

<sup>+</sup>  
Louis Strander  
Sgt  
Pvt, Co. A, 4 Reg't U. S. Colored Cav.

Appears on **Returns** as follows:

Aug 1864 - On duty Co. b. A.  
June 1865 - (Pvt) Absent on furlough  
since June 27/65  
July 1865 - Absent without leave  
since July 8. (Sgt)  
Aug 1865 - Absent without leave  
since July 9/65  
Sept 1865 - Loss: July 9/65  
Port Hudson Resisted -

Name appears also as

Louis Strander

Book mark :

W. R. Lee

(548)

Copyist.

*S* | **4 Cav.** | **U.S.C.T.**

*Lewis Strander*

*Privt*, Co. *A*, 4 Reg't U. S. Col'd Cavalry.

Appears on **Co. Muster-out Roll**, dated  
*New Orleans La, Mich 20*, 1866.

Muster-out to date \_\_\_\_\_, 186 .

Last paid to *Feb 28*, 1865 .

**Clothing account:**

Last settled \_\_\_\_\_, 186 ; drawn since \$ \_\_\_\_\_ 100

Due soldier \$ *10* <sup>*04*</sup> / 100; due U. S. \$ \_\_\_\_\_ 100

Am't for cloth'g in kind or money adv'd \$ \_\_\_\_\_ 100

Due U. S. for arms, equipments, &c., \$ \_\_\_\_\_ 100

Bounty paid \$ \_\_\_\_\_ 100; due \$ \_\_\_\_\_ 100

Remarks: *Joined at orig org. Deserted*  
*Sept. 30. 65. at Port. Hudson La.*

Book mark : \_\_\_\_\_

(361)

*Prewitt*  
Copyist.

S. | 4 Cav. | U.S.C.V.

Lewis Strander

, Co A, 4 Reg't U.S.C. Cav.

**NOTATION.**

Book mark: R + P. 386477

**Record and Pension Office,**

WAR DEPARTMENT,

Washington, May 19, 1898

The charges of desertion of  
July 9 and Sept. 15,  
1865,

against this man are removed and he is discharged  
to date July 9, 1865, under the pro-  
visions of the act of Congress, approved March 2, 1889.

Discharge certificate furnished by War Department  
May 19, 1898.

(443)



Copyist.

*Stricklin Edmond*

Co —, 4 U. S. Col'd Cav.

*Private* —

CARD NUMBERS.

1	5347822	26
2		27
3		28
4		29
5		30
6		31
7		32
8		33
9		34
10		35
11		36
12		37
13		38
14		39
15		40
16		41
17		42
18		43
19		44
20		45
21		46
22		47
23		48
24		49
25		50

Book Mark: .....

See also .....



Omiso Adstone 12/20/06 WFe

Omiso  
H

S | **4 Cav. | U.S.C.T.**

Edmond Stricklin

Appears with rank of Capt. on

**Muster and Descriptive Roll of a Detachment of U. S. Vols. forwarded**

for the 4 Reg't U. S. Col'd Cavalry. Roll dated New Orleans, La., Jan. 3, 1865.

Where born Port Hudson, La.

Age 20 y'rs; occupation Seaman

When enlisted Dec. 26, 1864.

Where enlisted New Orleans

For what period enlisted 3 years.

Eyes Black; hair Black

Complexion Black; height 5 ft. 11 in.

When mustered in Jan. 3, 1865.

Where mustered in New Orleans

Bounty paid \$ 100.00; due \$ 200.00

Where credited 2<sup>d</sup> Dist. 3<sup>d</sup> Ward Parish of Orleans, New Orleans, La.  
Company to which assigned

Remarks: Absent from Muster

Entry except "Remarks" cancelled

by line

not borne in Roll of Reg't.

Book mark:

G. E. Dyer

(339)

Copyist.

Strickland, Edmund  
Regt. Co. 4, Regt. Webbaw

5 Enclosures.

Bed Cards	Descriptive Lists
Burial Records 1	Final Statements 1
Certs. of Dis. for Discharge	Furloughs
C. M. Charges	Med. Des. Lists
Med. Certificates	Orders

Other papers relating to—

Admission to Hosp'l	Furlough
Casualty Sheet (Officer's) 1	Med. Examination
Confinement	Misc. Information 1
Contracts	Pay or Clothing
Death or Effects 2	Personal Reports
Desertions	Rank
Discharge from Hosp'l	Transfer to Hosp'l
Discharge from Service	Transfer to V. R. C.
Duty	Transportation

MICROFILM PUBLICATION M 1820

COMPILED MILITARY SERVICE RECORDS  
OF VOLUNTEER UNION SOLDIERS WHO  
SERVED WITH THE USCT (US COLORED TROOPS)  
4TH REGIMENT OF CAVALRY

PERSONAL PAPERS' TARGET SHEET

PLEASE NOTE THE CHECKED INFORMATION ABOUT THE PERSONAL PAPERS IN  
THIS FILE:

- NO PERSONAL PAPERS WERE FOUND IN THIS FILE WHEN THE  
RECORDS WERE ARRANGED FOR MICROFILMING.
- 6 PERSONAL PAPER(S) FOUND IN THIS FILE WHEN THE RECORDS  
WERE ARRANGED FOR MICROFILMING.

2 ft 2 in sent for Co Surg Gen Nov 13/65 per

*Complete*  
CASUALTY SHEET

No. \_\_\_\_\_

*Edwin Strickles*

*Priv* of Company *A*

*4<sup>th</sup>* Regiment of *U.S.C.I.*

State Volunteers.

NATURE OF CASUALTY.

*Died Jan. 5, 1865.*

*See 4<sup>th</sup> reg. b. bar,*  
*W.D.*

*Entouch & Co.*

CASUALTY SHEET.

Name: *Edwin Strickles*

Rank: *Priv* Company: *A* Regiment: *40*

Arm: *U.S. C.I.* State: \_\_\_\_\_

Nature of Casualty: *Death*

CAUSE OF CASUALTY—(NAME OF DISEASE, &c.)

BY WHOM DISCHARGED.

DEGREE OF DISABILITY.

FROM WHAT SOURCE THIS INFORMATION WAS OBTAINED.

*Act of Honor Louisiana Pg 134*

BY WHOM CERTIFIED.

*Jas M. Moore*  
*Alm*

REMARKS.

DATE OF DISCHARGE, DEATH, &c.

*Jan 5, 1865*

PLACE OF DISCHARGE, DEATH, &c.

*Buried N Orleans, La*

*J.D.*

Clerk.

ARTICLES OF WAR.

ART. 95. When any non-commissioned officer or soldier shall die, or be killed in the service of the United States, the then commanding officer of the troop or company shall, in the presence of two other commissioned officers, take an account of what effects he died possessed of, above his arms and accoutrements, and transmit the same to the office of the Department of War, which said effects are to be accounted for, and paid to the representatives of such deceased non-commissioned officer or soldier. And in case any of the officers, so authorized to take care of the effects of deceased officers and soldiers, should, before they have accounted to their representatives for the same, have occasion to leave the regiment or post, by preferment or otherwise, they shall, before they be permitted to quit the same, deposit in the hands of the commanding officer, or of the assistant military agent, all the effects of such deceased non-commissioned officers and soldiers, in order that the same may be secured for, and paid to, their respective representatives.

ARMY REGULATIONS—EDITION OF 1861.

DECEASED SOLDIERS.

Par. 152. Inventories of the effects of deceased non-commissioned officers and soldiers, required by the 95th Article of War, will be forwarded to the Adjutant General, by the commander of the company to which the deceased belonged, and a duplicate of the same to the colonel of the regiment. Final statements of pay, clothing, &c., will be sent with the inventories. When a soldier dies at a post or station absent from his company, it will be the duty of his immediate commander to furnish the required inventory, and, at the same time, to forward to the commanding officer of the company to which the soldier belonged, a report of his death, specifying the date, place, and cause; to what time he was last paid, and the money or other effects in his possession at the time of his decease; which report will be noted on the next muster roll of the company to which the man belonged. Each inventory will be endorsed, "Inventory of the effects of \_\_\_\_\_, late of company (—) \_\_\_\_\_ regiment of \_\_\_\_\_, who died at \_\_\_\_\_, the \_\_\_\_\_ day of \_\_\_\_\_, 186—." If a legal representative receive the effects, it will be stated in the report. If the soldier leave no effects, the fact will be reported.

Par. 153. Should the effects of a deceased non-commissioned officer or soldier not be administered upon within a short period after his decease, they shall be disposed of by a Council of Administration, under the authority of the commanding officer of the post, and the proceeds deposited with the Paymaster, to the credit of the United States, until the same shall be claimed by the legal representatives of the deceased.

Par. 154. In all such cases of sales by the Council of Administration, a statement in detail, or account of the proceeds, duly certified by the Council and commanding officer, accompanied by the Paymaster's receipt for the proceeds, will be forwarded by the commanding officer to the Adjutant General. The statement will be endorsed, "Report of the proceeds of the effects of \_\_\_\_\_, late of company (—) \_\_\_\_\_ regiment of \_\_\_\_\_, who died at \_\_\_\_\_, the \_\_\_\_\_ day of \_\_\_\_\_, 186—."

NOTE 1.—The effects in all cases, when called for, should be turned over to the legal representative, without further authority from the Adjutant General. When the effects are turned over to the relatives of the deceased before these inventories are sent to the Adjutant General, the receipts therefor should be attached to the inventories. In all other cases, one copy will be sent with a letter of transmittal direct to the Adjutant General, and a duplicate retained by the officer.

NOTE 2.—Particular care should be taken to take receipts in duplicate from the Paymaster for any funds turned over to him; one copy should be sent direct to the Adjutant General and one retained by the officer.

INVENTORY OF THE EFFECTS

OF

Emma Strickland

Late of Company Reerin

4<sup>th</sup> Reg't of U. S. Col. Em.

Volunteers, who died at New Orleans, La.

on the 5 day of January 1865.

Judges General's Office  
Record and Pension Division  
Washington D.C. Jan 24<sup>th</sup> 1867

This Inventory is  
the copy retained with the  
records of the Camp de l'Unique  
General Hospital New Orleans  
La; filed in this Office, and  
contains all information in  
the case that can be found.  
By order of the Judges General

J. J. [Signature]  
Bot. Prof. [Signature]  
OFFICE. STAN. GA.

INVENTORY

Inventory of the effects of Edmund Strickland late  
 a Recruit of Captain \_\_\_\_\_ Company \_\_\_\_\_ of  
 the 4<sup>th</sup> Regiment of U.S. Col. Co. Volunteers, who was enrolled as  
 a Private at New Orleans in the State of Louisiana on  
 the 26<sup>th</sup> day of December 1864, and <sup>never</sup> mustered into the service of the United  
 States as a \_\_\_\_\_ on the \_\_\_\_\_ day of \_\_\_\_\_ 186 , at \_\_\_\_\_  
 in Company \_\_\_\_\_, \_\_\_\_\_ Regiment of \_\_\_\_\_ Volunteers, to serve \_\_\_\_\_  
 years or during the war; he was born in Port Madison in the State  
 of Louisiana; he was 20 years of age, 5 feet 11 inches  
 high, Blk. complexion, Blk. eyes, Blk. hair, and by occupation, when enrolled,  
 a Laborer; he died in Genl. U.S. Gen. Wash. at  
New Orleans La. on the 5<sup>th</sup> day of January 1865, by  
 reason of Pleritis.

INVENTORY.					
ARTICLES.	No.	ARTICLES.	No.	ARTICLES.	No.
Hats.....		Pairs trousers.....		Knapsacks.....	
Caps.....		Pairs flannel drawers.....			
Forage caps.....		Pairs cotton drawers.....			
Great coats.....		Flannel shirts.....			
Uniform coats.....		Cotton shirts.....			
Uniform jackets.....		Pairs boots.....			
Flannel sack coats.....		Pairs shoes.....			
Blouses.....		Pairs socks.....			
Stable frocks.....		Blankets.....			
Fatigue overalls.....		Haversacks.....			
			I have had no effects	MONEY.	
				Specie.....	\$
				Notes.....	\$

I CERTIFY, ON HONOR, that the above inventory comprises all the effects of \_\_\_\_\_  
 \_\_\_\_\_, deceased, and that the effects are in the hands  
 of \_\_\_\_\_ at \_\_\_\_\_  
 \_\_\_\_\_ to be disposed of by a Council of Administration.

( DUPLICATES. )

STATION: New Orleans La.

DATE: January 5<sup>th</sup> 1865

\_\_\_\_\_  
 Commanding the Company.



ARTICLES OF WAR.

ART. 95. When any non-commissioned officer or soldier shall die, or be killed in the service of the United States, the then commanding officer of the troop or company shall, in the presence of two other commissioned officers, take an account of what effects he died possessed of, above his arms and accoutrements, and transmit the same to the office of the Department of War, which said effects are to be accounted for, and paid to the representatives of such deceased non-commissioned officer or soldier. And in case any of the officers, so authorized to take care of the effects of deceased officers and soldiers, should, before they have accounted to their representatives for the same, have occasion to leave the regiment or post, by preferment or otherwise, they shall, before they be permitted to quit the same, deposit in the hands of the commanding officer, or of the assistant military agent, all the effects of such deceased non-commissioned officers and soldiers, in order that the same may be secured for, and paid to, their respective representatives.

DIRECTIONS.

NOTE 1.—One copy of the inventories of the effects of deceased non-commissioned officers and soldiers, required by the 95th Article of War, will be forwarded to the Adjutant General, by the commander of the company to which the deceased belonged, and a duplicate of the same to the colonel of the regiment. Final statements of pay, clothing, &c., in duplicate, will be sent to the Adjutant General with one copy of the inventory. Both inventory and final statements should be forwarded, as a general rule, through Regimental Headquarters. When a soldier dies at a post or station absent from his company, it will be the duty of his immediate commander to furnish, direct to the Adjutant General, the required inventory and final statements, and, at the same time, to forward to the commanding officer of the company to which the soldier belonged, a report of his death, specifying the date, place, and cause; to what time he was last paid, and the money or other effects in his possession at the time of his decease; which report will be noted on the next muster roll of the company to which the man belonged. Each inventory will be endorsed, "Inventory of the effects of ———, late of company (—) ——— regiment of ———, who died at ———, the ——— day of ———, 186—." If a legal representative receive the effects, it will be stated in the report. If the soldier leave no effects, the fact will be reported on the blank for inventory.

NOTE 2.—Should the effects of a deceased non-commissioned officer or soldier not be administered upon within a short period after his decease, they shall be disposed of by a Council of Administration, under the authority of the commanding officer of the post, and the proceeds deposited with the Paymaster, to the credit of the United States, until they shall be claimed by the legal representatives of the deceased.

NOTE 3.—In all such cases of sales by the Council of Administration, a statement in detail, or account of the proceeds duly certified by the Council and commanding officer, (Form 5) accompanied by the Paymaster's receipt for the proceeds, will be forwarded by the commanding officer to the Adjutant General. The statement will be endorsed, "Report of the proceeds of the effects of ———, late of company (—) ——— regiment of ———, who died at ———, the ——— day of ———, 186—."

NOTE 4.—The effects in all cases, when called for, should be turned over to the legal representative, without further authority from the Adjutant General. When the effects are turned over to the relatives of the deceased before these inventories are sent to the Adjutant General, their receipts therefor should be attached to the inventories. In all other cases, one copy will be sent with a letter of transmittal direct to the Adjutant General, and a duplicate retained by the officer.

NOTE 5.—Particular care should be taken to take receipts in duplicate from the Paymaster for any funds turned over to him; one copy should be sent direct to the Adjutant General and one retained by the officer.

INVENTORY OF THE EFFECTS

OF

*Edmund Strickland*

*Late of Company Recruit*

*4<sup>th</sup> Reg't of U.S. Cold. Cav.*

*Volunteers, who died at New Orleans La.*

*on the 5<sup>th</sup> day of January 1865.*

Surgeon General's Office,

RECORD & PENSION BUREAU,

Washington, 186

*The within Inventory is a true copy from the records*

*of the Hospital*

*and is on file in*

*this Office, and contains all the information in the case that*

*can be found.*

BY ORDER OF THE SURGEON GENERAL.

*Bvt. Major, Assistant Surgeon, U. S. A.*

*Copy*

Inventory of the effects of Edmund Strickland late  
 a Recruit of Captain \_\_\_\_\_ Company \_\_\_\_\_ of  
 the 4<sup>th</sup> Regiment of U.S. Gold Guard Volunteers, who was enrolled as  
 a Private at New Orleans in the State of Louisiana on  
 the 26<sup>th</sup> day of December 1864, and <sup>never</sup> mustered into the service of the United  
 States as \_\_\_\_\_ on the \_\_\_\_\_ day of \_\_\_\_\_ 186  , at \_\_\_\_\_  
 in Company \_\_\_\_\_, \_\_\_\_\_ Regiment of \_\_\_\_\_ Volunteers, to serve \_\_\_\_\_  
 years or during the war; he was born in Port Hudson in the State  
 of Louisiana; he was 20 years of age, 5 feet 11 inches  
 high, Black complexion, Black eyes, Black hair, and by occupation, when enrolled,  
 a Laborer; he died in Camp d'Albique U.S. Hosp. at  
New Orleans, La. on the 5<sup>th</sup> day of January 1865, by  
 reason of Pleuritis.

INVENTORY.					
ARTICLES.	No.	ARTICLES.	No.	ARTICLES.	No.
Hats.....		Pairs trousers.....		Knapsacks.....	
Caps.....		Pairs flannel drawers.....			
Forage caps.....		Pairs cotton drawers.....			
Great coats.....		Flannel shirts.....			
Uniform coats.....		Cotton shirts.....			
Uniform jackets.....		Pairs boots.....			
Flannel sack coats.....		Pairs shoes.....			
Blouses.....		Pairs socks.....			
Stable frocks.....		Blankets.....			
Fatigue overalls.....		Haversacks.....			
				MONEY.	
				Specie.....	\$
				Notes.....	\$

I CERTIFY, ON HONOR, that the above inventory comprises all the effects of \_\_\_\_\_  
 \_\_\_\_\_, deceased, and that the effects are in the hands  
 of \_\_\_\_\_ at \_\_\_\_\_  
 \_\_\_\_\_ to be disposed of by a Council of Administration.

(DUPLICATES.)

STATION: New Orleans, La.

\_\_\_\_\_  
Commanding the Company.

DATE: January 5<sup>th</sup> 1865.

7. v. best copy of the 1865

**FINAL STATEMENT**

Receipt <sup>OF</sup>  
Edmund Strickland

4<sup>th</sup> Reg't of U. S. Col. Cav.

**VOLUNTEERS.**

Rec'd Jan 5<sup>th</sup> 1865

NOTE 1.—Two of these certificates (or duplicates) are to be given to each Volunteer Soldier or drafted man who may be discharged previously to the discharge of his company, that he may at once receive from the Paymaster the pay, &c., due him, and the captain or other COMMISSIONED officer commanding the company will certify to the act of the delivery of the duplicate certificates; on these certificates the Soldier is "entitled to" his discharge, and should also present his discharge to the Paymaster to have the payment endorsed on it. The discharge is to be given back to the Soldier by the Paymaster; the latter only retaining as his voucher the duplicate certificates.

NOTE 2.—If the Soldier is entitled to pay for the use of his horse, the Company Commander will certify to that fact on the back of both these final statements, and also to the time he has pay due for having been so mounted on his own horse.

NOTE 3.—When a Soldier is furnished with final statements, his descriptive list, if he has one, should be taken up by the officer who gives the Soldier these statements, and endorsed with a statement to this effect by the officer. This endorsement should exhibit a full statement of the time for which the Soldier was allowed pay on his final statements, the clothing account, and all other charges against him or in his favor, so as to comprise a complete exhibit of his account. It will then be transmitted to the company commander of the Soldier, who will enter all the data necessary to a full understanding of the Soldier's account on the muster roll upon which the Soldier's discharge is reported. The descriptive list will then be destroyed. The object of this is, that the remaining portion of the Soldier's account may be settled upon the receipt of these muster rolls, and the Soldier receive any pay or allowances that may be due him at the time of his discharge, and which may not appear on his final statements from the fact that his descriptive list is incomplete. These accounts for back pay, &c., are settled by the 2d Auditor of the Treasury Department.

NOTE 4.—Charges for loss or injury to ordnance, horse equipments, and other miscellaneous charges, should appear under the heading of "Other Stoppages."

NOTE 5.—Bounty paid by State authorities, and not by the United States, will not be entered on this statement.

NOTE 6.—Amounts due the Sutler and Laundress must be entered on the muster roll on which the discharge, death, desertion, &c., is reported, as well as on the final statement, otherwise the amount cannot be collected from the United States.

NOTE 7.—This blank will be used for deceased volunteers and drafted men, as well as for others.

NOTE 8.—Where a Soldier dies in Hospital or on detached service, his descriptive list, if he has one, should be sent with his final statements, in duplicate, to the Second Auditor, Washington, D. C.

U. S. A.  
President sent 2<sup>d</sup> Aud.  
745

ADJUTANT GENERAL'S OFFICE.  
July 21<sup>st</sup> 1865  
Duplicate with Inventory sent 2d Auditor.



I certify, on honor, that Edmund Strickland a Recruit of  
Captain \_\_\_\_\_ Company (\_\_\_\_) of the 4<sup>th</sup> Regiment of U.S. Col. Gen.  
**VOLUNTEERS**, of the State of Louisiana, born in Port-Nordson, State  
of Louisiana, aged 20 years; 5 feet 11 inches high; Blk. complexion,  
Blk. eyes, Blk. hair, and by occupation a Laborer, having joined the company on  
its original organization at \_\_\_\_\_, and enrolled in it at the muster into  
the service of the United States at \_\_\_\_\_, on the \_\_\_\_\_ day  
of \_\_\_\_\_, 1864, (or was ~~mustered~~ <sup>enrolled</sup> in service as a recruit, by \_\_\_\_\_  
\_\_\_\_\_, at New Orleans, on the Twenty-sixth day of December,  
1864, or was drafted and mustered into the service of the United States from the \_\_\_\_\_  
Enrollment District of the State of \_\_\_\_\_, at \_\_\_\_\_,  
on the \_\_\_\_\_ day of \_\_\_\_\_, 1864), to serve in the Regiment, for  
the term of Three years: and having served **HONESTLY** and  
**FAITHFULLY** with his Company in U.S. Service to the present date, is now  
entitled to a **DISCHARGE** by reason of Death from Pleuritis at  
New Orleans La. January 5 - 1865.

The said Edmund Strickland was <sup>never</sup> last paid by Paymaster  
\_\_\_\_\_ to include the \_\_\_\_\_ day of \_\_\_\_\_, 1864, and has  
pay due him from that time to the present date; he is entitled to pay and subsistence for  
**TRAVELING** to place of enrollment, and whatever other allowances are authorized to volunteer  
soldiers, drafted men, or militia, so discharged. He has received from the United States **CLOTHING**  
amounting to no  $\frac{1}{100}$  dollars, since the \_\_\_\_\_ day of enrollment,  
1864, when his clothing account was last settled. He has received from the United States  
 $\frac{1}{100}$  dollars advanced **BOUNTY**.

There is to be stopped from him, on account of the State of \_\_\_\_\_, or other  
authorities, for **CLOTHING**, &c., received on entering service, \_\_\_\_\_  $\frac{1}{100}$  dollars; and  
for other stoppages, viz: \_\_\_\_\_

\_\_\_\_\_  $\frac{1}{100}$  dollars.  
He has been furnished with **TRANSPORTATION** in kind from the place of his discharge to  
\_\_\_\_\_; and he has been **SUBSISTED** for **TRAVELING** to his  
place of enrollment, up to the \_\_\_\_\_, 1864.

He is indebted to \_\_\_\_\_, **SUTLER**, \_\_\_\_\_  $\frac{1}{100}$  dollars.

He is indebted to \_\_\_\_\_, **LAUNDRESS**, \_\_\_\_\_  $\frac{1}{100}$  dollars.

Given in Duplicate, at New Orleans La., this 5<sup>th</sup> day  
of January, 1865.

F. E. Piquette

Sarg. 86<sup>th</sup> U.S. Col. Inf. in charge  
Commanding Company  
Gen. d'Arigue U.S. Gen. Hosp.

COPY OF RECORD

FOR THE

ADJUTANT GENERAL U. S. ARMY.



No. 2.

RECORD OF DEATH AND INTERMENT.

Name and number of person interred, *Edmund Strickland*

Number and locality of the grave, -

Hospital number of the deceased, - *4346*

Regiment, Rank, and Company, - - *4<sup>th</sup> U. S. Col. Cav. - Recruit*

Residence before enlistment, - - -

Conjugal condition (and if married, )  
the residence of the widow, )

Cause of death, ) *Pleuritis*

Age of the deceased, - - - - -

Nativity, - - - - -

References and Remarks, - - - }

Date of death and burial, - - - *January 5<sup>th</sup> /65* 186

[A duplicate of this Record has been forwarded to the Sexton, and the other remains at this Hospital.]

To *Adj. Genl. U. S. Army*  
SIR:

It becomes my duty to inform you that the person above described died at this Hospital as herein stated: and that it is desired his remains should be interred with the usual military honors.

Respectfully,

*J. E. Fiquette*  
86<sup>th</sup> *Col. Inf.*  
Surgeon U. S. Army  
*in charge*

MILITARY HOSPITAL, *Corps d'Afrique N. Orleans La.*

This copy of Record is to be transmitted to the Adjutant General at Washington immediately after the place of burial and the number of the grave have been ascertained and registered. The above notification is to remain attached.

E. B., S. G. O.

Surgeon General's Office,

Record and Pension Bureau,

*4<sup>th</sup> Can*

*January 24<sup>th</sup>, 1866.*

Respectfully returned. The records of

*this office and Corps of Surgeons  
General Hospital, San Carlos*

on file in this Office, furnish no evidence con-  
cerning the within named man.

*Serial 10000  
First Division Cavalry  
1st Cavalry Division*

*but it will be given to you  
that the man is supposed to be  
the soldier referred to within*

By Order of the Surgeon General:



*Edward*

Major and Assistant Surgeon, U. S. A.

*1369*

*1867*

*Stroud Philip*

Co *D*, 4 U. S. Col'd Cav.

*Private* | *Private*

CARD NUMBERS.

1	28
2	29
3	<i>see Stroud Philip</i>
4	29
5	30
6	31
7	32
8	33
9	34
10	35
11	36
12	37
13	38
14	39
15	40
16	41
17	42
18	43
19	44
20	45
21	46
22	47
23	48
24	49
5	50

Book Mark: .....

See also .....



*Strowde Philip*

*Co D*, 4 U. S. Col'd Cav.

*Private* | *Private*

CARD NUMBERS.

1	5-347943	26
2	5-35-2946	27
3	5-35-3028	28
4	5-35-3111	29
5	5-35-3202	30
6	5-35-3320	31
7	5-35-3763	32
8	40729234	33
9		34
10		35
11		36
12		37
13		38
14		39
15		40
16		41
17		42
18		43
19		44
20		45
21		46
22		47
23		48
24		49
25		50

Book Mark:

See also

1 | 4 Cav | **U.S.C.T**

Philip Strowde

Appears with rank of Priv on

**Muster and Descriptive Roll of a Detachment of Drafted Men and Substitutes forwarded**

for the 4 Reg't U.S. Col'd Cav Roll dated New Orleans La, Sept 1, 1864

Where born Jackson Miss

Age 19 years; occupation Laborer

Drafted and mustered in:

When Sept 1, 1864.

Where New Orleans

Period 3 years.

Eyes Blk; hair Blk

Complexion Dark; height 5 ft. 0 in.

Paid bounty and advance pay, \$ 100

Bounty due \$ 100 none

Where credited \_\_\_\_\_

Company to which assigned D

Remarks: \_\_\_\_\_

Book mark: \_\_\_\_\_

J. Mendenhall  
Cty. Col.

S | **4 Cav.** | **U.S.C.T.**

*Philip Stroud*

*Priv.*, Co. D, 4 Reg't U. S. Col'd Cavalry.

Appears on

**Company Muster Roll**

for *Sept & Oct*, 1864.

Present or absent *Present*

Stoppage, \$ 100 for

Due Gov't, \$ 100 for

Valuation of horse, \$ 100

Valuation of horse equipments, \$ 100

Remarks: *Due U.S. for lost  
Ordinance \$1.83*

*\* Name appears in column of  
names Present as Philip Stroud*

Book mark:

*Rosenbaum*

*S* | **4 Cav.** | **U.S.C.T.**

*Philip Howard*

*D*, Co. D, 4 Reg't U. S. Col'd Cavalry.

Appears on

**Company Muster Roll**

for *Jan-Dec*, 186*t*.

Present or absent *Present*

Stoppage, \$ *100* for

Due Gov't, \$ *100* for

Valuation of horse, \$ *100*

Valuation of horse equipments, \$ *100*

Remarks: *Rec'd U.S. for Ord # 1053*

Book mark:

(358)

*R. Albright*

Copyist.

*S* | **4 Cav.** | **U.S.C.T.**

*Philip Starnel*

*P*, Co. D, 4 Reg't U. S. Col'd Cavalry.

Appears on

**Company Muster Roll**

for *Jan 7th*, 1865.

Present or absent *Present*

Stoppage, \$ 100 for

Due Gov't, \$ *10* <sup>*25*</sup>/<sub>100</sub> for *Balance*

Valuation of horse, \$ 100

Valuation of horse equipments, \$ 100

Remarks:

Book mark:

*Philip Starnel*

*e* | **4 Cav. | U.S.C.T.**

*William Wood*  
.....  
*D*....., Co. D, 4 Reg't U. S. Col'd Cavalry.

Appears on

**Company Muster Roll**

for *Mich V copy*....., 186*5*.

Present or absent *Present*.....

Stoppage, \$.....100 for.....

Due Gov't, \$.....100 for.....

Valuation of horse, \$.....100

Valuation of horse equipments, \$.....100

Remarks:.....  
.....  
.....  
.....  
.....  
.....  
.....  
.....  
.....  
.....

Book mark:.....

*W. H. Wright*  
.....  
(358) *W. H. Wright* Copyist.

*J* | **4 Cav.** | **U.S.C.T.**

*Philip Stone*

*P*, Co. D, 4 Reg't U. S. Col'd Cavalry.

Appears on

**Company Muster Roll**

for *May & June*, 186*5*.

Present or absent.....

Stoppage, \$.....*100* for.....

Due Gov't, \$.....*100* for.....

Valuation of horse, \$.....*100*

Valuation of horse equipments, \$.....*100*

Remarks: *Dischd June 25, 65.  
on Certificate of disability.*

Book mark: *Dischd June 24, 65. E.B.  
V 11 P 2*

*W. A. Wright*

S | **4 Cav. | U.S.C.T.**

Philip Stroud

Co. H, 4 Reg't U. S. Colored Cav.

Appears on Returns as follows:

Sept 1864 - Jan: Sept 3/64  
Port Hudson Enlisted

June 1865 - 200: June 25/65  
Port Hudson La. Discharged  
for disability

Name appears also as  
Philip Stroud.

Book mark:

W. R. Lee



*S* | **4 Cav. | U.S.C.T.**

*Philip Stroud*

*priv*, Co. *D*, 4 Reg't U. S. Col'd Cavalry.

Appears on **Co. Muster-out Roll**, dated  
*New Orleans, La. Mch 20*, 1866.

Muster-out to date \_\_\_\_\_, 186 .

Last paid to \_\_\_\_\_, 186 .

**Clothing account:**

Last settled \_\_\_\_\_, 186 ; drawn since \$ \_\_\_\_\_ 100

Due soldier \$ \_\_\_\_\_ 100; due U. S. \$ \_\_\_\_\_ 100

Am't for cloth'g in kind or money adv'd \$ \_\_\_\_\_ 100

Due U. S. for arms, equipments, &c., \$ \_\_\_\_\_ 100

Bounty paid \$ \_\_\_\_\_ 100; due \$ \_\_\_\_\_ 100

Remarks: *Joined as recruit*  
*Discharged June 24, '65.*  
*for disability*

Book mark : \_\_\_\_\_

(861)

*Est. McKinnis*

*Comp* <sup>Copyright.</sup>

Stroud, Philip  
P, Co. D, 4 U.S.C. Cav.

1 Enclosures.

Bed Cards	Descriptive Lists
Burial Records	Final Statements
Certs. of Dis. for Discharge /	Furloughs
C. M. Charges	Med. Des. Lists
Med. Certificates	Orders

Other papers relating to—

Admission to Hosp'l	Furlough
Casualty Sheet (Officer's)	Med. Examination
Confinement	Misc. Information
Contracts	Pay or Clothing
Death or Effects	Personal Reports
Desertions	Rank
Discharge from Hosp'l	Transfer to Hosp'l
Discharge from Service	Transfer to V. R. C.
Duty	Transportation

[OFFICE INDORSEMENT.]

War Department,

ADJUTANT GENERAL'S OFFICE,

July 5, 1874

The discharge of Philip Stroud  
Private, Co. D, 4th Reg't U. S.  
Colored Cavalry, is reported as follows:—

On Company Muster Roll.

For ~~May~~ June, 1865, ~~June 25th~~ 1865

Company Muster-out Roll.

June 24th, 1865

Company Descriptive Book.

, 186

Company Morning Reports.

, 186

Soldier's Final Statement.

, 1865

Soldier's Record of Death and Interment.

, 186

Soldier's Inventory of Effects.

, 186

Soldier's Certificate of Disability for Discharge.

June 24th, 1865

Soldier's Individual Muster-out Roll.

, 186

Regimental Return.

For June, 1865, June 25th, 1865.

Regimental Quarterly Returns.

, 186

Regimental Descriptive Book.

, 186

By Surgeon General.

, 186

June 24, 1865, is held to be  
the correct date, and the Company Muster-out

Roll will be amended accordingly.

Thomas M. Sargent  
Adj. Gen.  
E. B. 2 Noted April 2d 1874

Noted on R.

CERTIFICATE OF DISABILITY FOR DISCHARGE

IN THE CASE OF

Philip Stroud  
a Private Co. D

4th Reg't of U. S. C.

Office Presl Medl Officer,  
Dep't of the Gulf,  
N. O. June 15<sup>th</sup> 1865.

Approved

E. H. Bodge  
Surgeon, U. S. A.  
Chf. Medl Off

Received (A. G. Office) , 186 .

Cut out of Prof Car  
E. B.

Approved M. Rice  
Surgeon, U. S. A.  
Chf. Medl Off

Headquarters, Department of the Gulf,  
New Orleans, La., June 18<sup>th</sup> 1865.

To be discharged.

By order of Major General E. R. S. Cady:

E. R. S. Cady  
Capt and A. D. C.

NOTE 1.

The company commander will here add a statement of all the facts known to him concerning the disease or wound, or cause of disability of the soldier; the time, place, manner, and all the circumstances under which the injury occurred, or disease originated or appeared; the duty, or service, or situation of the soldier at the time the injury was received or disease contracted, stating particularly whether the injury was received or the disease contracted in the line of his duty; and whatever other facts may aid a judgment as to the cause, immediate or remote, of the disability, and the circumstances attending it.

When the facts are not known to the company commander, the certificate of any officer, or affidavit of other person having such knowledge, will be appended—as the surgeon in charge of a hospital, the officer commanding a detachment of recruits, &c., &c.

NOTE 2.

When a probable case for pension, special care must be taken to state the degree of disability—as *t. t.*, &c., &c.; to describe particularly the disability, wound, or disease; the extent to which it deprives him of the use of any limb or faculty, or affects his health, strength, activity, constitution, or capacity to labor or earn his subsistence. The surgeon will add, from his knowledge of the facts and circumstances, and from the evidence in the case, his professional opinion of the cause or origin of the disability. In the case of discharges by Medical Inspectors, the last paragraph will state that the "discharge was given by consent of the soldier, after a personal examination, and for disability, the nature, degree, and origin of which are correctly described in the within certificate."

Par. 1260 Regulations, Edit. 1861.

Medical officers, in giving certificates of disability, are to take particular care in all cases that have not been under their charge; and especially in epilepsy, convulsions, chronic rheumatism, derangement of the urinary organs, ophthalmia, ulcers, or any obscure disease liable to be feigned or purposely produced; and in no case shall such certificate be given until after sufficient time and examination to detect any attempt at deception.

DIRECTIONS.

This certificate will be made out in duplicate by the soldier's company commander, or other officer commanding the separate detachment to which he belongs, and sent by him to the surgeon who has charge of the hospital where the soldier is sick. The surgeon will then fill out and sign the surgeon's certificate, and forward these papers to the regimental, detachment, or post commander, who will forward them, with his action endorsed thereon, through the proper channel, to his division commander; or, if the troops are not attached to a division, to his corps, department, or other commander or officer to whom the authority to discharge enlisted men may be specially delegated.

These certificates, after having received the action of the highest authority to which they are required to be sent, will be returned through the same channel to the regimental, post, or detachment commander, who will, if the discharge is authorized by the endorsement of the proper authority, sign the soldier's discharge, and the last certificate on this paper; see that the soldier is furnished with the proper final statements in duplicate, and forward BOTH of these certificates direct to the Adjutant General United States Army, at Washington, D. C.; they will not, under any circumstances, be given into the hands of the soldier.

ADJUTANT GENERAL'S OFFICE  
July 29, 1865  
Duplicate sent the Pension Office.

CERTIFICATE OF DISABILITY FOR DISCHARGE

1864  
IN THE CASE OF  
Philip Storey  
a Private Co. D  
7th Reg't of W. C. C.

Office Chief Med. Officer,  
Dep't of the Gulf,  
N. O. June 15<sup>th</sup> 1865.

Approved

E. H. Hodge  
Surgeon, U. S. A.  
Chf. Med. Off.

Approved M. Ruce  
Surgeon  
Surg. Gen. Bty. Dist. E. Sa

Headquarters, Department of the Gulf,  
New Orleans, La., June 18<sup>th</sup> 1865.

To be discharged.

By order of Major General E. R. S. Gandy:

C. J. Jarrett  
Capt. and A. D. C.

Received (A. G. Office) , 186 .

Out on O. R. of Car  
A. B.

# ARMY OF THE UNITED STATES.

## CERTIFICATE OF DISABILITY FOR DISCHARGE.



Private Philip Strand of Captain Oscar C Jackson's Company, (D) of the 4<sup>th</sup> Regiment of United States Artillery was enlisted by Drafted of the 1<sup>st</sup> Regiment of New Orleans on the 1<sup>st</sup> day of September 1864 to serve 3 years; he was born in Jackson in the State of Mississippi is 19 years of age, 5 feet — inches high, Light complexion, Blk eyes, Blk hair, and by occupation when enlisted a Laborer. During the last two months said soldier has been unfit for duty 60 days.\*

Inadequate Age and Mental Incapacity. He has been incompetent to learn the duties of a soldier. Since he has been in the Company he has been discharged as he was found to be incompetent to take care of himself.

STATION: Port Hudson La  
DATE: June 1<sup>st</sup> 1865

Oscar C. Jackson  
Capt  
Commanding Company.

I CERTIFY, that I have carefully examined the said Philip Strand of Captain O. C. Jackson Company, and find him incapable of performing the duties of a soldier because of Mental Incapacity or lack of Intelligence rendering him incapable of learning his duties or properly using or preserving his arms. Disability existed prior to enlistment and in degree is one-half.

D. P. Lindsey

Surgeon.

DISCHARGED, this 24<sup>th</sup> day of June 1865, at 4<sup>th</sup> U.S. Cavalry Port Hudson La

Wash. C. Mitchell  
1<sup>st</sup> Col

Commanding the Reg't.

The soldier desires to be addressed at

Town New Orleans County — State Louisiana.

\* See Note 1 on the back of this.

† See Note 2 on the back of this.

Office, Post Surgeon  
 Port Hudson, La, June 5/65  
 Approved, on personal examination  
 of Philip Strand  
 Surgeon D. P. Lindsey

Summer Benedict

Co B, 4 U.S. Col'd Cav.

Private G. M. Seymour

CARD NUMBERS.

1	5-35-1279	26
2	5-35-1335-	27
3	5-35-1351	28
4	5-35-1426	29
5	5-35-1494	30
6	5-35-1563	31
7	5-35-1630	32
8	5-35-1694	33
9	5-35-1758	34
10	5-35-1832	35
11	5-35-1921	36
12	5-35-2029	37
13	5-35-2132	38
14	5-35-2227	39
15	5-35-2315	40
16	5-35-2403	41
17	40729235	42
18		43
19		44
20		45
21		46
22		47
23		48
24		49
25		50

Book Mark:

See also

*S* | **4 Cav. | U.S.C.T.**

*Benedict Summer*  
Pvt., Co. *C*, 1 Reg't La. Cav., Corps d'Afrique.\*

Appears on

**Company Muster-in Roll**

of the organization named above. Roll dated

*New Orleans La, Nov 7*, 186*3*.

Muster-in to date *Nov 7*, 186*3*.

Joined for duty and enrolled:

When *Oct 6*, 186*3*.

Where *New Orleans city*

Period *3* years.

Valuation of horse, \$.....*100*

Valuation of horse equipments, \$.....*100*

Remarks:

*Age: 24*

\*This organization subsequently became Co. *C*, 4 Reg't U. S. Colored Cavalry.

Book mark:

*Receptor*

*I* | 4 Cav. | U.S.C.T.

*Benedict Summer*  
Pt. Co. *C*, 1 Reg't La. Cav., Corps d'Afrique.\*

Appears on

**Company Muster Roll**

for *Jul 7 to Dec 31*, 186*9*

Present or absent *Present*

Stoppage, \$ \_\_\_\_\_ *100* for \_\_\_\_\_

Due Gov't, \$ \_\_\_\_\_ *100* for \_\_\_\_\_

Valuation of horse, \$ \_\_\_\_\_ *100*

Valuation of horse equipments, \$ \_\_\_\_\_ *100*

Remarks: \_\_\_\_\_  
\_\_\_\_\_  
\_\_\_\_\_

**FROM SECOND AUDITOR'S ROLL.**

\*This organization subsequently became Co. *C*, 4 Reg't U. S. Colored Cavalry.

Book mark: \_\_\_\_\_

*Roemer*



*S* | **4 Cav. | U.S.C.T.**

*Benedict Summer*  
Serg't, Co. *C*, 1 Reg't La. Cav., Corps d'Afrique.\*

Appears on

**Company Muster Roll**

for *July & Feb*, 1864.

Present or absent *Present*

Stoppage, \$ *100* for

Due Gov't, \$ *100* for

Valuation of horse, \$ *100*

Valuation of horse equipments, \$ *100*

Remarks: *Promoted to S.M.  
Serg't. January 1st  
1864*

\*This organization subsequently became Co. *C*, 4 Reg't U. S. Colored Cavalry.

Book mark: \_\_\_\_\_

*Recherter*

S | **4 Cav. | U.S.C.T.**

*Benedict Summer*  
*L.M. Sgt* Co. C, 4 Reg't U. S. Colored Cavalry.

Appears on

**Company Muster Roll**

for *March 1st*, 1864.

Present or absent *Present*

Stoppage, \$ 100 for

Due Gov't, \$ 100 for

Valuation of horse, \$ 100

Valuation of horse equipments, \$ 100

Remarks: *Promoted to Co. L. M. Sergt. Jan 1/64*

Book mark:

*Bocher*

Copyist.

*S* | **4 Cav.** | **U.S.C.T.**

*Benedict Sumner*  
*L. M. St.* Co. C, 4 Reg't U. S. Colored Cavalry.

Appears on

**Company Muster Roll**

for *May & June*, 186*4*.

Present or absent *Present*

Stoppage, \$ 100 for

Due Gov't, \$ 100 for

Valuation of horse, \$ 100

Valuation of horse equipments, \$ 100

Remarks :  
-----  
-----  
-----  
-----  
-----  
-----  
-----  
-----  
-----  
-----

Book mark :  
-----

*Rehder*  
-----  
(358) Copyist.

I | **4 Cav.** | **U.S.C.T.**

*Benedict Summer*  
2nd Lt. Co. C, 4 Reg't U. S. Colored Cavalry.

Appears on

**Company Muster Roll**

for *July & Aug, 1864.*

Present or absent *Absent*

Stoppage, \$ 100 for

Due Gov't, \$ 100 for

Valuation of horse, \$ 100

Valuation of horse equipments, \$ 100

Remarks :

Book mark :

*Robert*

S | **4 Cav.** | **U.S.C.T.**

*Benedict Sumner*  
C. Supt, Co. C, 4 Reg't U. S. Colored Cavalry.

Appears on

**Company Muster Roll**

for *Sept & Oct*, 1864.

Present or absent *Present*

Stoppage, \$ 100 for

Due Gov't, \$ 100 for

Valuation of horse, \$ 100

Valuation of horse equipments, \$ 100

Remarks *Lost Horse Bag \$1.25*

Book mark :

*Boerner*

S | 4 Cav. | U.S.C.T.

Benedict Sumner

LMS, Co. C, 4 Reg't U. S. Colored Cavalry.

Appears on

**Company Muster Roll**

for Nov & Dec, 1864.

Present or absent present

Stoppage, \$ 1<sup>25</sup>/100 for ordnance

Due Gov't, \$ 100 for

Valuation of horse, \$ 100

Valuation of horse equipments, \$ 100

Remarks: Stopped last ordnance

Book mark: \_\_\_\_\_

(358)

May

Copyist.

S | **4 Cav.** | **U.S.C.T.**

*Benedict Sumner*  
*LMS*, Co. C, 4 Reg't U. S. Colored Cavalry.

Appears on

**Company Muster Roll**

for *Jan & Feb*, 18*63*,

Present or absent *present*

Stoppage, \$ 100 for

Due Gov't, \$ 100 for

Valuation of horse, \$ 100

Valuation of horse equipments, \$ 100

Remarks: *Stop for one*  
*nose bag. Sergt since*  
*Jan 1, 64. Received \$7.00*  
*per month to include*  
*Apr 30, 1864.*

Book mark:

*Moy*

*S* | **4 Cav.** | **U.S.C.T.**

*Benedict Sumner*  
*LMS*, Co. C, 4 Reg't U. S. Colored Cavalry.

Appears on

**Company Muster Roll**

for *Jan & Feb*, 186*3*

Present or absent *present*

Stoppage, \$ *100* for

Due Gov't, \$ *100* for

Valuation of horse, \$ *100*

Valuation of horse equipments, \$ *100*

Remarks: *Stop for one*  
*nose bag. Srgt since*  
*Jan 1, 64. Received \$7.00*  
*per month to include*  
*Apr 30, 1864.*

Book mark:

(358)

*Moy*

Copyist.



S | **4 Cav.** | **U.S.C.T.**

*Benedict Sumner*  
*LMS*, Co. C, 4 Reg't U. S. Colored Cavalry.

Appears on

**Company Muster Roll**

for *March & Apr*, 1865.

Present or absent *present*

Stoppage, \$ 100 for

Due Gov't, \$ 100 for

Valuation of horse, \$ 100

Valuation of horse equipments, \$ 100

Remarks:

Book mark:

*Moy*  
Copyist.

*S* | **4 Cav.** | **U.S.C.T.**

*Benedict Sumner*  
*2m 8*, Co. C, 4 Reg't U. S. Colored Cavalry.

Appears on

**Company Muster Roll**

for *May & June*, 1865.

Present or absent *present*

Stoppage, \$ *100* for

Due Gov't, \$ *100* for

Valuation of horse, \$ *100*

Valuation of horse equipments, \$ *100*

Remarks: *Stop for one  
pair spurs & straps.*

Book mark: \_\_\_\_\_

(358)

*Moyle*  
Copyist.

*S* | **4 Cav.** | **U.S.C.T.**

*Benedict Sumner*  
*LMS*, Co. C, 4 Reg't U. S. Colored Cavalry.

Appears on

**Company Muster Roll**

for *July & Aug*, 186*5*.

Present or absent *present*

Stoppage, \$ *100* for

Due Gov't, \$ *100* for

Valuation of horse, \$ *100*

Valuation of horse equipments, \$ *100*

Remarks: *Stop for 1 pr. Spurs  
and straps, Total 60 cts*

Book mark: \_\_\_\_\_

(358)

*Moy*  
Copyist.

8 | 4 Cav. | U.S.C.T.

*Benedict Summer*

*2MS*, Co. C, 4 Reg't U. S. Colored Cavalry.

Appears on

**Company Muster Roll**

for *Sept & Oct*, 186*5*.

Present or absent *present*

Stoppage, \$ 100 for

Due Gov't, \$ 100 for

Valuation of horse, \$ 100

Valuation of horse equipments, \$ 100

Remarks:

Book mark:

(358)

*Moz*

Copyist.

*S* | **4 Cav.** | **U.S.C.T.**

*Benedict Sumner*  
*Sergt*, Co. C, 4 Reg't U. S. Colored Cavalry.

Appears on

**Company Muster Roll**  
for *Nov & Dec*, 186*5*.

Present or absent *present*

Stoppage, \$ *100* for

Due Gov't, \$ *100* for

Valuation of horse, \$ *100*

Valuation of horse equipments, \$ *100*

Remarks:  
\_\_\_\_\_  
\_\_\_\_\_  
\_\_\_\_\_  
\_\_\_\_\_  
\_\_\_\_\_  
\_\_\_\_\_  
\_\_\_\_\_  
\_\_\_\_\_

Book mark: \_\_\_\_\_

(358) *M. A. Michaels*  
Copyist.

S | **4 Cav.** | **U.S.C.T.**

*Benedict Sumner*

*Q. M. Sergt.*, Co. C, 4 Reg't U. S. Colored Cavalry.

Appears on

**Company Muster Roll**

for *Jan & Febr*, 186 *6*

Present or absent *present*

Stoppage, \$ *100* for

Due Gov't, \$ *100* for

Valuation of horse, \$ *100*

Valuation of horse equipments, \$ *100*

Remarks:

Book mark:

*M. A. Michaels*

(358)

Copyist.

*S.* | **4 Cav.** | **U.S.C.T.**

*Benedict Summer*  
*Am Sert, Co. C.*, 4 Reg't U. S. Col'd Cavalry.

Appears on **Co. Muster-out Roll**, dated  
*New Orleans La, Mar 20*, 1866.

Muster-out to date *Mar 20*, 1866.

Last paid to *June 30*, 1865.

Clothing account:

Last settled....., 186 ; drawn since \$..... 100

Due soldier \$ *42 77* 100; due U. S. \$..... 100

Am't for cloth'g in kind or money adv'd \$..... 100

Due U. S. for arms, equipments, &c., \$..... 100

Bounty paid \$..... 100; due \$..... 100

Remarks: *Joined Orig. Org Prior*  
*to Jan'y 1/64 as Am Sert*  
*to Sept 30/64 Com'g Sert*  
*to Dec 14/64*

Book mark: *V. 25. P. 112 - 68*

(361)

*M. A. Michaels*

Copyist.

A | **4 Cav. | U.S.C.T.**

Ben Sumner

Sergt., Co. l, 4 Reg't U. S. Colored Cav.

Appears on **Returns** as follows:

Jan 1864 - On duty Comis. Sergt.  
(1 Regt Cav., Corps d'Afrique)

Book mark: \_\_\_\_\_

W. R. See

546

Copyist.



1017  
Sydney James

Co B, 4 U. S. Col'd Cav.

Private Private

CARD NUMBERS.

1	5-349856	26
2	5-349956	27
3	5-35-0049	28
4	5-35-0154	29
5	5-35-0270	30
6	5-35-1212	31
7	30847603	32
8	30847830	33
9	30848662	34
10	40729209	35
11		36
12		37
13		38
14		39
15		40
16		41
17		42
18		43
19		44
20		45
21		46
22		47
23		48
24		49
25		50

Book Mark:

See also:

1017  
Sydney James

Co. B, 4 U. S. Col'd Cav.

Private Private

CARD NUMBERS.

1	5-349856	26
2	5-349956	27
3	5-35-0049	28
4	5-35-0154	29
5	5-35-0270	30
6	5-35-1212	31
7	30847603	32
8	30847830	33
9	30848662	34
10	40729209	35
11		36
12		37
13		38
14		39
15		40
16		41
17		42
18		43
19		44
20		45
21		46
22		47
23		48
24		49
25		50

Book Mark:

See also:

*S* | **4 Cav. | U.S.C.T.**

*James Sydney*  
Cot. Co. *B*, 1 Reg't La. Cav., Corps d'Afrique.\*

Appears on

**Company Muster-in Roll**

of the organization named above. Roll dated

*New Orleans La, Oct 27*, 1863.

Muster-in to date *Oct 27*, 1863.

Joined for duty and enrolled:

When *Oct 4*, 186 .

Where *New Orleans*

Period *3* years.

Valuation of horse, \$ *100*

Valuation of horse equipments, \$ *100*

Remarks: \_\_\_\_\_

\*This organization subsequently became Co. *B*, 4 Reg't U. S. Colored Cavalry.

Book mark: \_\_\_\_\_

(356)

*Henry*  
Copyist.

*J* | **4 Cav. | U.S.C.T.**

*James Sydney*  
-----  
*Co. B*, Co. *B*, 1 Reg't La. Cav., Corps d'Afrique.\*

Appears on

**Company Muster Roll**

for *Oct 27 to Dec 31*, 186*3*.

Present or absent *Absent*

Stoppage, \$ *100* for

Due Gov't, \$ *100* for

Valuation of horse, \$ *100*

Valuation of horse equipments, \$ *100*

Remarks: *Sick in Genl  
Hospital.*

\*This organization subsequently became Co. *B*, 4 Reg't U. S. Colored Cavalry.

Book mark: -----

(358)

*King*  
-----  
Copyist.

1871 12 30

S 1 / La. Cav. U.S.C.P.

James Sidney  
Prig, Co. B, 1 Reg't La. Cav.

Appears on

**Hospital Muster Roll**

of **Corps d'Afrique U. S. A. General Hospital,**

at **New Orleans, La.,**

for Nov & Dec, 1863

Attached to hospital:

When \_\_\_\_\_, 186 .

How employed \_\_\_\_\_

Last paid by Maj. \_\_\_\_\_

to \_\_\_\_\_, 186 .

Bounty paid \$ 100; due \$ 100

Present or absent Present

Remarks: \_\_\_\_\_

Book mark: \_\_\_\_\_

(848)

Morgan  
Copyist.

*S* 4 Cav. U.S.C.T.

*James Sydney*  
*Co. B*, 1 Reg't Cav., Corps d'Afrique.\*

Appears on

**Company Muster Roll**

for *Jan & Feb*, 1864.

Present or absent *Absent*

Stoppage, \$ *100* for

Due Gov't, \$ *100* for

Valuation of horse, \$ *100*

Valuation of horse equipments, \$ *100*

Remarks: *Sick in C. & A. Genl Hospital*

\* This organization subsequently became Co. *B*, 4 Reg't U. S. Colored Cavalry.

Book mark: \_\_\_\_\_

(358)

*Amey*  
Copyist.

S 1 / La. Cav. U.S.C.T.

James Sidney  
Pri., Co. B, 1 Reg't La Cav.

Appears on

**Hospital Muster Roll**

of Corps d'Afrique U. S. A. General Hospital,

at New Orleans, La.,

for Jan & Feb, 1864.

Attached to hospital:

When \_\_\_\_\_, 186 .

How employed \_\_\_\_\_

Last paid by Maj. \_\_\_\_\_

to \_\_\_\_\_, 186 .

Bounty paid \$ 100; due \$ 100

Present or absent Present

Remarks: \_\_\_\_\_

\_\_\_\_\_

\_\_\_\_\_

\_\_\_\_\_

\_\_\_\_\_

\_\_\_\_\_

\_\_\_\_\_

\_\_\_\_\_

\_\_\_\_\_

Book mark: \_\_\_\_\_

\_\_\_\_\_

Morgan  
Copyist.

S 1 / La. Cav. U.S.C.T.

James Sidney  
Pri, Co. B, 1 Reg't La Cav.

Appears on

**Hospital Muster Roll**

of **Corps d'Afrique U. S. A. General Hospital,**

at **New Orleans, La.,**

for Jan & Feb, 1864.

Attached to hospital:

When \_\_\_\_\_, 186 .

How employed \_\_\_\_\_

Last paid by Maj. \_\_\_\_\_

to \_\_\_\_\_, 186 .

Bounty paid \$ 100; due \$ 100

Present or absent Present

Remarks: \_\_\_\_\_

\_\_\_\_\_  
\_\_\_\_\_  
\_\_\_\_\_  
\_\_\_\_\_  
\_\_\_\_\_  
\_\_\_\_\_

Book mark: \_\_\_\_\_

\_\_\_\_\_

\_\_\_\_\_

\_\_\_\_\_

\_\_\_\_\_

\_\_\_\_\_

\_\_\_\_\_

\_\_\_\_\_

\_\_\_\_\_

\_\_\_\_\_

\_\_\_\_\_

\_\_\_\_\_

*Morgan*



*S* | **4 Cav.** | **U.S.C.T.**

*James Sydney*  
*Porter*, Co. B. 4 Reg't U. S. Col'd Cavalry.

Appears on

**Company Muster Roll**

for *March & April*, 186*4*.

Present or absent *Absent*

Stoppage, \$ *100* for

Due Gov't, \$ *100* for

Valuation of horse, \$ *100*

Valuation of horse equipments, \$ *100*

Remarks: *Sick in hospital*  
*Genl. Hospital*

Book mark :

(358)

*Henry*  
Copyist.

*S* | **4 Cav.** | **U.S.C.T.**

*James Sydney*  
*Cott*, Co. B. 4 Reg't U. S. Col'd Cavalry.

Appears on

**Company Muster Roll**

for *March & April*, 1864.

Present or absent *Absent*

Stoppage, \$ *100* for

Due Gov't, \$ *100* for

Valuation of horse, \$ *100*

Valuation of horse equipments, \$ *100*

Remarks: *Sick in H.Q.*  
*sent. Hospital*

Book mark :

(358)

*Henry*  
Coryist.

S | 1 Cav. |

James Sidney  
Tri, Co. B, 1 Reg't Cav.

Appears on

**Hospital Muster Roll**

of Corps d'Afrique U. S. A. General Hospital,

at New Orleans, La.,

for Mch & Apr, 1864.

Attached to hospital:

When ....., 186 .

How employed .....

Last paid by Maj. ....

to ....., 186 .

Bounty paid \$ 100; due \$ 100

Present or absent .....

Remarks: Died Mch 29/64.

Book mark: .....

Morgan  
Copyst.

*S* | **4 Cav.** | **U.S.C.T.**

*James Sydney*  
*Post*, Co. B. 4 Reg't U. S. Col'd Cavalry.

Appears on

**Company Muster Roll**

for *May & June*, 1864.

Present or absent

Stoppage, \$ 100 for

Due Gov't, \$ 100 for

Valuation of horse, \$ 100

Valuation of horse equipments, \$ 100

Remarks: *Aid Mch. 29, 1864*

*But rec'd no information  
until May 2" '64*

Book mark:

(358)

*Ames*  
Copyist.

D

4 Cav. U.S.C.T.

James Sidney  
Priv., Co. B, 4 Reg't U. S. Colored Cav.

Appears on Returns as follows:

Feb'y 1864 - Absent sick Dec 5/63  
at N. Orleans La. (1 Regt.  
Cav. Corps d'Afrique)

Mich 1864 - Dors: Mar 29/64  
N. Orleans died in Govl.  
Hosp.

Name appears also as  
James Sidney

Book mark:

W. R. Lu

*S* | **4 Cav.** | **U.S.C.T.**

*James Sidney*

....., Co. *B*, 4 Reg't U. S. Col'd Cavalry.

Appears on **Co. Muster-out Roll**, dated  
*New Orleans, La. Feb. 20*, 1866.

Muster-out to date' ....., 186 .

Last paid to ....., 186 .

**Clothing account:**

Last settled ....., 186 ; drawn since \$ ..... 100

Due soldier \$ ..... 100; due U. S. \$ ..... 100

Am't for cloth'g in kind or money adv'd \$ ..... 100

Due U. S. for arms, equipments, &c., \$ ..... 100

Bounty paid \$ ..... 100; due \$ ..... 100

Remarks: *Joined at Orpl. org.  
died at New Orleans, La.  
March 29, 64.*

Book mark : .....

*Chandler*

(361)

Copyist.

Sidney, James

P, Co. B, 4 U.S.C. Cav.

1 Enclosures.

Bed Cards	Descriptive Lists
Burial Records	Final Statements /
Certs. of Dis. for Discharge	Furloughs
C. M. Charges	Med. Des. Lists
Med. Certificates	Orders

Other papers relating to—

Admission to Hosp'l	Furlough
Casualty Sheet (Officer's)	Med. Examination
Confinement	Misc. Information
Contracts	Pay or Clothing
Death or Effects	Personal Reports
Desertions	Rank
Discharge from Hosp'l	Transfer to Hosp'l
Discharge from Service	Transfer to V. R. C.
Duty	Transportation

*Extract from Act of Congress.*

SEC. 12. *And be it further enacted,* That the fees of agents and attorneys for making out and causing to be executed the papers necessary to establish a claim for a pension, bounty, and other allowance before the Pension Office, under this act, shall not exceed the following rates: For making out and causing to be duly executed a declaration by the applicant, with the necessary affidavits, and forwarding the same to the Pension Office, with the requisite correspondence, ten dollars; which sum shall be received by such agent or attorney in full for all services in obtaining such pension, and shall not be demanded or received, in whole or in part, until such pension shall be obtained; and the sixth and seventh sections of an act entitled "An act to grant pensions," approved July [fourteenth.] eighteen hundred and sixty-two, are hereby repealed.

SEC. 13. *And be it further enacted,* That any agent or attorney who shall, directly or indirectly, demand or receive any greater compensation for his services under this act than is prescribed in the preceding section of this act, or who shall contract or agree to prosecute any claim for a pension, bounty, or other allowance under this act, on the condition that he shall receive a per centum upon any portion of the amount of such claim, or who shall wrongfully withhold from a pensioner or other claimant the whole or any part of the pension or claim allowed and due to such pensioner or claimant, shall be deemed guilty of a high misdemeanor, and, upon conviction thereof, shall, for every such offense, be fined not exceeding three hundred dollars, or imprisoned at hard labor not exceeding two years, or both, according to the circumstances and aggravations of the offense.

Approved July 4, 1864.

NOTE 10.—If any soldier is charged a higher fee than that allowed by the above act, he should report the fact and the name of the agent to the Adjutant General, in order that steps may be taken to have the same refunded.

ADJUTANT GENERAL'S OFFICE

*Sept 12. 1865*

Duplicate with Inventory sent 2d Auditor.

FINAL STATEMENT

OR

*James Sidney Post*  
*4 Reg't of U.S. Cavalry*

VOLUNTEERS.

*and March 29, 1864*

NOTE 1.—Two of these certificates (or duplicates) are to be given to each Volunteer Soldier or drafted man who may be discharged without being mustered out. (Final statements are never given to men mustered out of service.) That he is to get from the Paymaster the pay, &c., due him, and the commanding officer commanding the company will certify to the act of the delivery of the duplicate certificates; with these certificates the Soldier is "entitled to" his discharge, and should also present his discharge to the Paymaster to have the payment endorsed on it. The discharge is to be given back to the Soldier by the Paymaster; the latter only retaining as his vouchers the duplicate certificates.

NOTE 2.—If the Soldier is entitled to pay for the use of his horse, the Company Commander will certify to that fact on the back of both these final statements, and also to the time he has pay due for having been so mounted on his own horse.

NOTE 3.—When a Soldier is furnished with final statements, his descriptive list, if he has one, should be taken up by the officer who gives the Soldier these statements, and endorsed with a statement to this effect by the officer. The endorsement should exhibit a full statement of the time for which the Soldier was allowed pay on his final statements, the clothing account, and all other charges against him or in his favor, so as to comprise a complete exhibit of his account. It will then be transmitted to the Company Commander of the Soldier, who will enter all the data necessary to a full understanding of the Soldier's account on the muster roll upon which the Soldier's discharge is reported. The descriptive list will then be destroyed. The object of this is, that the remaining portion of the Soldier's account may be settled upon the receipt of these muster rolls, and the Soldier receive any pay or allowances that may be due him at the time of his discharge, and which may not appear on his last final statements from the fact that his descriptive list is incomplete. These accounts for back pay, &c., are settled by the 2d Auditor of the Treasury Department.

NOTE 4.—Charges for loss or injury to ordnance, horse equipments, and other miscellaneous charges, should appear under the heading of "Other Stoppages."

NOTE 5.—Bounty paid by State authorities, and not by the United States, will not be entered on this statement.

NOTE 6.—Amounts due the Sutler and Laundress must be entered on the muster roll on which the discharge, death, desertion, &c., is reported, as well as on the final statement, otherwise the amount cannot be collected from the United States.

NOTE 7.—This blank will be used for deceased volunteers and drafted men, as well as for others.

NOTE 8.—Where a Soldier dies in Hospital or on detached service, his descriptive list, if he has one, should be sent with his final statements, in duplicate, to the Adjutant General, Washington, D. C.

NOTE 9.—If the Soldier is a drafted man or substitute, the space for time, &c., of enrolled, should contain only the word *drafted* or *substitute*, as the case may be. If the Soldier is a "VETERAN," (or RECRUIT,) the words *as a veteran*, (or *recruit*,) as the case may be, should be interlined after the words *mustered into the service of the U. S.* A statement of all the installments of *Veteran or Recruit Bounty RECEIVED* by the Soldier must be made on the back of each final statement.



I certify, on honor, that James Sidney, a Private of  
 Captain Andrew McCannock Company (B) of the 4th Regiment of U.S. Colored  
**VOLUNTEERS**, of the State of \_\_\_\_\_, born in Licksburg, State  
 of Mississippi, aged 24 years; 5 feet 7 inches high; Black complexion,  
Black eyes, Curly hair, and by occupation a \_\_\_\_\_, who joined for service  
 and was enrolled (see Note 9) on the 14th day of October, 1863, at New Orleans  
 by Sgt. Miller, for the period of Three years, and mustered into  
 the service of the United States on the 27th day of October, 1863, at  
New Orleans La., by Sgt. McAlistair; and having served  
 HONESTLY and FAITHFULLY with his Company to the present date, is now entitled to a  
**DISCHARGE** by reason of Death, having died in C.D.A. Gen Hospital  
New Orleans La on the 29th day of March 1865 of Diphtheria & Typhoid

The said James Sidney was last paid by Paymaster  
Major Boyd, to include the 31st day of December, 1863, and  
 has pay due him from that time to the present date; he is entitled to pay and subsistence for  
**TRAVELING** to place of enrollment, and whatever other allowances are authorized to volunteer  
 soldiers, drafted men, or militia, so discharged. He has received from the United States **CLOTHING**  
 amounting to 411 <sup>68</sup>/<sub>100</sub> dollars, since the 14th day of October,  
 1863, when his clothing account was last settled. He has received from the United States  
 \_\_\_\_\_ <sup>100</sup>/<sub>100</sub> dollars advanced **BOUNTY**.

There is to be stopped from him, on account of the State of \_\_\_\_\_, or other  
 authorities, for **CLOTHING**, &c., received on entering service, \_\_\_\_\_ <sup>100</sup>/<sub>100</sub> dollars; and  
 for other stoppages, viz: \_\_\_\_\_  
 \_\_\_\_\_ <sup>100</sup>/<sub>100</sub> dollars.

He has been furnished with **TRANSPORTATION** in kind from the place of his discharge to  
 \_\_\_\_\_; and he has been **SUBSISTED** for **TRAVELING** to his  
 place of enrollment, up to the \_\_\_\_\_, 186 .

He is indebted to \_\_\_\_\_, **SUTLER**, \_\_\_\_\_ <sup>100</sup>/<sub>100</sub> dollars.  
 He is indebted to \_\_\_\_\_, **LAUNDRESS**, \_\_\_\_\_ <sup>100</sup>/<sub>100</sub> dollars.

Given in Duplicate, at Port Hudson La, this 20th day  
 of August, 1865.

Harrison Hubert  
1st Lieut

Commanding Company.

This is the original of James Sidney's discharge & bounty & clothing account.

*Ho. Office*

Tallbird, Jacob

Co C, 4 U. S. Col'd Cav.

Private | Saddler

CARD NUMBERS.

1	5351282	26
2	5351338	27
3	5351355	28
4	5351431	29
5	5351545	30
6	5351600	31
7	5351643	32
8	5351707	33
9	5351772	34
10	5351850	35
11	5351939	36
12	5352047	37
12	5352150	38
14	5352244	39
15	5352332	40
16	5352420	41
17	40729246	42
18		43
19		44
20		45
21		46
22		47
23		48
24		49
25		50

Book Mark:

See also

0705353 (2-2)  
1937790 - Roman

H Jordan  
E

7 | **4 Cav.** | **U.S.C.T.**

*Jacob Tallabird*  
Sgt., Co. C, 1 Reg't La. Cav., Corps d'Afrique.\*

Appears on

**Company Muster-in Roll**

of the organization named above. Roll dated

*New Orleans La Nov 7*, 1863.

Muster-in to date

*Nov 7*, 1863.

Joined for duty and enrolled:

When *Oct 7*, 1863.

Where *New Orleans city*

Period 3 years.

Valuation of horse, \$.....100

Valuation of horse equipments, \$.....100

Remarks:

*Apr 31*

\*This organization subsequently became Co. C, 4 Reg't U. S. Colored Cavalry.

Book mark:

*Admirer*

J | **4 Cav. | U.S.C.T.**

*Jacob Tallard*  
Pvt., Co. C, 1 Reg't La. Cav., Corps d'Afrique.\*

Appears on

**Company Muster Roll**

for *Nov 7 to Dec 31*, 1863.

Present or absent *Present*

Stoppage, \$ 100 for

Due Gov't, \$ 100 for

Valuation of horse, \$ 100

Valuation of horse equipments, \$ 100

Remarks:

FROM SECOND AUDITOR'S ROLL.

\*This organization subsequently became Co. C, 4 Reg't U. S. Colored Cavalry.

Book mark:

*Proctor*

*J* | 4 Cav. | U.S.C.T.

*Jacob Tallabird*  
*Sgt. Co. C*, 1 Reg't La. Cav., Corps d'Afrique.\*

Appears on

**Company Muster Roll**

for *Jan + Feb*, 1864.

Present or absent *Present*

Stoppage, \$ *100* for

Due Gov't, \$ *100* for

Valuation of horse, \$ *100*

Valuation of horse equipments, \$ *100*

Remarks: *Promoted to Outer Sgt.  
January 1st 1864  
to be stopped forty  
dollars for one  
pair of lost*

\*This organization subsequently became Co. *C*, 4 Reg't U. S. Colored Cavalry.

Book mark: \_\_\_\_\_

*Rocheater*

7 | **4 Cav.** | **U.S.C.T.**

*Jacob Tallabrid*  
*Sgt*, Co. C, 4 Reg't U. S. Colored Cavalry.

Appears on

**Company Muster Roll**

for *Mex & Ind*, 1864.

Present or absent *Present*

Stoppage, \$ 100 for

Due Gov't, \$ 100 for

Valuation of horse, \$ 100

Valuation of horse equipments, \$ 100

Remarks: *Promoted to Capt.*  
*Jan 1/64, reduced to the*  
*ranks as private,*  
*March 14/64 Lost*  
*my remaining revolver*

Book mark :

(358)

*Provester*

Copyist.

7 | **4 Cav.** | **U.S.C.T.**

*Jacob Tallbird*

*JT*, Co. C, 4 Reg't U. S. Colored Cavalry.

Appears on

**Company Muster Roll**

for *May + June*, 186*4*.

Present or absent *Present*

Stoppage, \$ 100 for

Due Gov't, \$ 100 for

Valuation of horse, \$ 100

Valuation of horse equipments, \$ 100

Remarks :

Book mark :



7 | 4 Cav. | U.S.C.T.

*Jacob Tallabrig*  
Sgt., Co. C, 4 Reg't U. S. Colored Cavalry.

Appears on

**Company Muster Roll**

for *July & Aug*, 1864.

Present or absent *Present*

Stoppage, \$ 100 for

Due Gov't, \$ 100 for

Valuation of horse, \$ 100

Valuation of horse equipments, \$ 100

Remarks :

Book mark :

*Bohater*

1864

J | **4 Cav.** | **U.S.C.T.**

*Jacob Tollard*  
*Saddler*, Co. C, 4 Reg't U. S. Colored Cavalry.

Appears on

**Company Muster Roll**

for *Sept & Oct*, 1864.

Present or absent *Present*

Stoppage, \$ 100 for

Due Gov't, \$ 100 for

Valuation of horse, \$ 100

Valuation of horse equipments, \$ 100

Remarks :

Book mark :

*Recorder*

(858)

Copyist.

J | 4 Cav. | U.S.C.T.

Jacob Tallabire

Saddler, Co. C, 4 Reg't U. S. Colored Cavalry.

Appears on

**Company Muster Roll**

for Nov 20<sup>th</sup>, 1864

Present or absent present

Stoppage, \$ 88 / 100 for ordnance

Due Gov't, \$ 100 for

Valuation of horse, \$ 100

Valuation of horse equipments, \$ 100

Remarks: Lost ordnance

Book mark: \_\_\_\_\_

(358)

Moy  
Copyist.

J | 4 Cav. | U.S.C.T.

Jacob Tallabird  
Saddler Co. C, 4 Reg't U. S. Colored Cavalry.

Appears on

**Company Muster Roll**

for Jan & Feb, 1865.

Present or absent present

Stoppage, \$ 100 for

Due Gov't, \$ 100 for

Valuation of horse, \$ 100

Valuation of horse equipments, \$ 100

Remarks: Stop for one Carbine  
swivel, one curry comb  
and brush, Received  
\$100 per month to  
include April 30, 1865.

Book mark: \_\_\_\_\_

(358)

May  
Copyist.

7 | 4 Cav. | U.S.C.T.

*Jacob Tallabird*  
Saddler, Co. C, 4 Reg't U. S. Colored Cavalry.

Appears on

**Company Muster Roll**

for *March & Apr.*, 1865.

Present or absent *present*

Stoppage, \$ 100 for

Due Gov't, \$ 100 for

Valuation of horse, \$ 100

Valuation of horse equipments, \$ 100

Remarks:

Book mark:

(358)

*May* Copyist.

J | **4 Cav. U.S.C.T.**

Jacob Tallabird  
Saddler Co. C, 4 Reg't U. S. Colored Cavalry.

Appears on

**Company Muster Roll**

for May & June, 1865.

Present or absent present

Stoppage, \$ 100 for

Due Gov't, \$ 100 for

Valuation of horse, \$ 100

Valuation of horse equipments, \$ 100

Remarks: Stop for one Contem  
thaversack,

Book mark: \_\_\_\_\_

(358)

May  
Copyist.

*J* | **4 Cav.** | **U.S.C.T.**

*Jacob Tallabird*  
Saddler Co. C, 4 Reg't U. S. Colored Cavalry.

Appears on

**Company Muster Roll**

for *July & Aug*, 186*5*.

Present or absent *present*

Stoppage, \$ *100* for

Due Gov't, \$ *100* for

Valuation of horse, \$ *100*

Valuation of horse equipments, \$ *100*

Remarks: *Stop for 1 Canteen  
and 1 Haversack, Total \$1.60.*

Book mark: \_\_\_\_\_

(358)

*Moy*  
Copyist.

J | 4 Cav. | U.S.C.T.

*Jacob Tallabird*  
In Adler, Co. C, 4 Reg't U. S. Colored Cavalry.

Appears on

**Company Muster Roll**

for *Sept & Oct*, 186*3*

Present or absent *present*

Stoppage, \$ 100 for

Due Gov't, \$ 100 for

Valuation of horse, \$ 100

Valuation of horse equipments, \$ 100

Remarks: *Stop for 1 horse  
brush 67 cts, 1 brush wiper  
33 cts, 1 sabre knot 30 cts  
Total \$1.30.*

Book mark:

(358)

*Moy*  
Copyist.



J | 4 Cav. | U.S.C.T.

Jacob Tallabird  
Saddler, Co. C, 4 Reg't U. S. Colored Cavalry.

Appears on

**Company Muster Roll**

for Nov + Dec . . . . ., 1865.

Present or absent *present*

Stoppage, \$ *52* / *100* for *Lost*

*ordnance*

Due Gov't, \$ *100* for

Valuation of horse, \$ *100*

Valuation of horse equipments, \$ *100*

Remarks:

.....  
.....  
.....  
.....  
.....  
.....  
.....  
.....

Book mark:

(358) *M.A. Michaels* Copyist.

*J* | **4 Cav.** | **U.S.C.T.**

*Jacob Tallabird*  
*Saddler*, Co. C, 4 Reg't U. S. Colored Cavalry.

Appears on

**Company Muster Roll**

for *Jan'y & Feb'y*, 186*6*.

Present or absent *present*

Stoppage, \$ *1* <sup>*52*</sup>/<sub>*100*</sub> for *Lost*

*Ordnance*

Due Gov't, \$ *100* for

Valuation of horse, \$ *100*

Valuation of horse equipments, \$ *100*

Remarks:

Book mark:

(358)

*M. A. Michaels*  
Copyist.

5

4 Cav. | U.S.C.T.

Jacob Tallbird

, Co. b, 4 Reg't U. S. Colored Cav.

Appears on Returns as follows:

Jan 1865 - Absent in search  
of deserters

Book mark:

W. R. Lee

(546)

Copyist.

*J* | 4 Cav. | U.S.C.T.

*Jacob Tallabird*  
Saddler, Co. C., 4 Reg't U. S. Col'd Cavalry.

Appears on Co. Muster-out Roll, dated  
*New Orleans La Mar 20*, 1866.  
Muster-out to date *Mar 20*, 1866.  
Last paid to *June 30*, 1865.

Clothing account:

Last settled....., 186 ; drawn since \$..... 100  
Due soldier \$..... 100; due U. S. \$..... *4* <sup>08</sup>/<sub>100</sub>  
Am't for cloth'g in kind or money adv'd \$..... 100

Due U. S. for arms, equipments, &c., \$..... *1* <sup>32</sup>/<sub>100</sub>

Bounty paid \$..... 100; due \$..... 100

Remarks: *Joined orig. org. Priv.*  
*to Jan 1/64 Serg't to*  
*Feb 11/64 reduced to ranks*  
*App'td Saddler Sept 5/64*  
*Corpl July 8/65 reduced to Saddler*  
*July 23/65 Stop 1 horse brush*  
Book mark: *V. 25. P. 120. 68*

*M. A. Michaels*

(361)

Copyist.

JAN. - 8

5352420

☆ 1891 ☆

1 Sabreknout 1 brush-  
wiper

102

*Tanner, Joseph*  
Co B, 4 U. S. Col'd Cav.

*Private* | *Private*

CARD NUMBERS.

1	26
2	27
3	<i>Sr Toney, Joseph</i>
4	29
5	30
6	31
7	32
8	33
9	34
10	35
11	36
12	37
13	38
14	39
15	40
16	41
17	42
18	43
19	44
20	45
21	46
22	47
23	48
24	49
25	50

Book Mark: .....

See also .....

1022  
Toppin George

Co B, 4 U. S. Col'd Cav.

Private

Private

CARD NUMBERS.

1	28
2	27
3	26
4	29
5	30
6	31
7	32
8	33
9	34
10	35
11	36
12	37
13	38
14	39
15	40
16	41
17	42
18	43
19	44
20	45
21	46
22	47
23	48
24	49
25	50

Book Mark:

See also

1025

*Taylor, Alexander*  
Co *B*, **4** U. S. Col'd Cav.

*Private* | *Private*

CARD NUMBERS.

1	5347832	26
2	5351902	27
3	5352004	28
4	5352102	29
5	5352201	30
6	5352294	31
7	5352382	32
8	5352471	33
9	40729248	34
10		35
11		36
12		37
13		38
14		39
15		40
16		41
17		42
18		43
19		44
20		45
21		46
22		47
23		48
24		49
25		50

Book Mark: .....

See also .....



81106829 - power  
8116116 - aud.

H Jordan  
E

9 | 4 Cav. | U.S.C.T.

Alexander Taylor

Appears with rank of Priv. on

**Muster and Descriptive Roll of a Detachment of U. S. Vols. forwarded**

for the 4 Reg't U. S. Col'd Cavalry. Roll dated New Orleans, La., Feb. 18, 1862.

Where born New Orleans, La.

Age 28 y'rs; occupation laborer

When enlisted Feb. 4, 1862.

Where enlisted New Orleans

For what period enlisted 3 years.

Eyes Brown; hair Black

Complexion Dark; height 5 ft. 0 in.

When mustered in Feb. 18, 1862.

Where mustered in New Orleans

Bounty paid \$ 100 100; due \$ 200 100

Where credited 1 Dist. 3 Ward Parish of Orleans New Orleans, La.  
Company to which assigned C

Remarks:

Book mark:

(339)

A. C. Taylor

Copyist.

T | 4 Cav. | U.S.C.T.

Alexander Taylor  
Priv, Co. C, 4 Reg't U. S. Colored Cavalry.

Appears on

**Company Muster Roll**

for March & Apr, 1865.

Present or absent present

Stoppage, \$ 100 for

Due Gov't, \$ 100 for

Valuation of horse, \$ 100

Valuation of horse equipments, \$ 100

Remarks:

Book mark:

(358)

May

Copyist.

*J* | **4 Cav.** | **U.S.C.T.**

*Alexander Taylor*  
*Priv*, Co. C, 4 Reg't U. S. Colored Cavalry.

Appears on

**Company Muster Roll**

for *May & June*, 1865.

Present or absent *present*

Stoppage, \$ *100* for

Due Gov't, \$ *100* for

Valuation of horse, \$ *100*

Valuation of horse equipments, \$ *100*

Remarks: *Stop for one canteen,  
one haversack, one  
pair metallic seals.*

Book mark: \_\_\_\_\_

(358)

*May*

Copyist.

*J* | **4 Cav.** | **U.S.C.T.**

*Alexander Taylor*  
*Priv.*, Co. C, 4 Reg't U. S. Colored Cavalry.

Appears on

**Company Muster Roll**

for *July & Aug*, 1865.

Present or absent *present*

Stoppage, \$ *100* for

Due Gov't, \$ *100* for

Valuation of horse, \$ *100*

Valuation of horse equipments, \$ *100*

Remarks: *Stop for 1 canteen,  
1 haversack, 1 pr metallic  
scalis, Total \$ 2.30.*

Book mark: \_\_\_\_\_

(358)

*Moy*

Copyist.

*J* | **4 Cav.** | **U.S.C.T.**

*Alexander Taylor*  
*Priv*, Co. C, 4 Reg't U. S. Colored Cavalry.

Appears on

**Company Muster Roll**

for *Sept & Oct*, 186*5*.

Present or absent *present*

Stoppage, \$ *100* for

Due Gov't, \$ *100* for

Valuation of horse, \$ *100*

Valuation of horse equipments, \$ *100*

Remarks :  
.....  
.....  
.....  
.....  
.....  
.....  
.....  
.....  
.....

Book mark : .....

(358)

*May*  
Copyist.

J | **4 Cav.** | **U.S.C.T.**

*Alexander Taylor*  
Private, Co. C, 4 Reg't U. S. Colored Cavalry.

Appears on

**Company Muster Roll**

for *Nov - & Dec*, 186*5*.

Present or absent *present*

Stoppage, \$ *100* for

Due Gov't, \$ *100* for

Valuation of horse, \$ *100*

Valuation of horse equipments, \$ *100*

Remarks:  
.....  
.....  
.....  
.....  
.....  
.....  
.....  
.....  
.....

Book mark: .....

*M. A. Michaels*  
Copyist.

*T* | **4 Cav.** | **U.S.C.T.**

*Alexander Taylor*  
Private, Co. C, 4 Reg't U. S. Colored Cavalry.

Appears on

**Company Muster Roll**

for *Jan'y & Febr*, 186*6*.

Present or absent *present*

Stoppage, \$ *100* for

Due Gov't, \$ *100* for

Valuation of horse, \$ *100*

Valuation of horse equipments, \$ *100*

Remarks:

Book mark:

*M. A. Michaels*

(358)

Copyist.



5 | 4 Cav. | U.S.C.T.

Alexander Taylor  
Pvt, Co. C, 4 Reg't U. S. Colored Cav.

Appears on Returns as follows:

Mich 1865. Gain: Mich 26/65  
Port Hudson Recruit  
from Depot.

Book mark: \_\_\_\_\_

(546)

W. R. Lee

Copyist.

*A* 4 Cav. U.S.C.T.

*Alexander Taylor*  
Private, Co. C., 4 Reg't U. S. Col'd Cavalry.

Appears on Co. Muster-out Roll, dated  
*New Orleans La, Mar 20, 1866.*

Muster-out to date *Mar. 20, 1866.*

Last paid to *June 30, 1866.*

Clothing account:

Last settled....., 186 ; drawn since \$..... 100

Due soldier \$ *44 81* / 100; due U. S. \$..... 100

Am't for cloth'g in kind or money adv'd \$..... 100

Due U. S. for arms, equipments, &c., \$..... 100

Bounty paid \$ *100* / 100; due \$..... 100

Remarks: *Joined as recruit*

Book mark: .....

*M. A. Nichols*  
Copyist.

Taylor, Alexander

Co. 4 Reg't U.S.C. Navy

Enclosures.

Bed Cards	Final Statements
Burial Records	Furloughs or L. of A.
Certs. of Dis. for Discharge	Med. Certificates
C. M. Charges	Med. Des. Lists
Descriptive Lists	Orders
Discharge Certificates	Pris. of War Record
Enlistment Papers	Resignations

Other papers relating to—

Admission to Hosp'l	Furlough or L. of A.
Casualty Sheet	Med. Examination
Confinement	Misc. Information
Contracts	Pay of Clothing
Death or Effects	Personal Reports
Desertion	Rank
Discharge from Hosp'l	Transfer to Hosp'l
Discharge from Service	Transfer to V. R. C.
Duty	Transportation

1259

NOTE 1.—This blank will be used for both enlistments and re-enlistments—enlistment of veterans, &c., &c., in the volunteer service. They will be made out in duplicate in all cases—one to accompany the recruiting return of the superintendent (not the recruiting officer) to the Adjutant General, and one to accompany the accounts of the officer who pays bounty, &c. The Regiment and Company in which the soldier last served should be given on the back.

NOTE 2.—An enlistment holds to service. A muster-in must, in all cases, precede payment of pay, bounty, pension, &c. A muster-in roll must, in all cases, be filed in the Adjutant General's Office as evidence of muster-in. The mustering officer, commissary, or assistant commissary of musters, as the case may be, will countersign both enlistments as having mustered the soldier into the service of the United States before either of them is given to the disbursing officer.

DECLARATION OF RECRUIT.

I, Alexander Taylor, desiring to VOLUNTEER as a Soldier in the Army of the United States, for the term of THREE YEARS, Do Declare, That I am twenty eight years and \_\_\_\_\_ months of age; that I have never been discharged from the United States service on account of disability or by sentence of a court martial, or by order before the expiration of a term of enlistment; and I know of no impediment to my serving honestly and faithfully as a soldier for three years.

GIVEN at New Orleans, La the 4<sup>th</sup> day of February 1865

Witness: John Geo. Friedman Alexander Taylor  
1st Lieut. 10<sup>th</sup> U.S. C. Art. 144. must.

No. Alexander Taylor  
Volunteered at New Orleans, La  
February 4<sup>th</sup> 1865  
By Capt. Wm. M. Miller  
10<sup>th</sup> Regt. of U.S. Cavalry  
Enlistment: last served in Company ( )  
Regt of \_\_\_\_\_  
Discharged \_\_\_\_\_ 18\_\_\_\_  
Received from Second Auditor  
October 7th. 1892.  
Received by Alexander Taylor  
19<sup>th</sup> 1861

CONSENT IN CASE OF MINOR.

I, \_\_\_\_\_, Do CERTIFY, That I am the \_\_\_\_\_ of \_\_\_\_\_; that the said \_\_\_\_\_ is \_\_\_\_\_ years of age; and I do hereby freely give my CONSENT to his volunteering as a SOLDIER in the ARMY OF THE UNITED STATES for the period of THREE YEARS.

GIVEN at \_\_\_\_\_ the \_\_\_\_\_ day of \_\_\_\_\_

Witness: \_\_\_\_\_

VOLUNTEER ENLISTMENT.

STATE OF

TOWN OF

*Louisiana*



*New Orleans*

I, *Alexander Paulsen*, born in *New Orleans* in the State of *Louisiana*, aged *twenty eight* years, and by occupation a *Labourer*. Do HEREBY ACKNOWLEDGE to have volunteered this *fourth* day of *February*, 1865, to serve as a **Soldier** in the **Army of the United States of America**, for the period of **THREE YEARS**, unless sooner discharged by proper authority: Do also agree to accept such bounty, pay, rations, and clothing, as are, or may be, established by law for volunteers. And I, \_\_\_\_\_, do solemnly swear, that I will bear true faith and allegiance to the **United States of America**, and that I will serve them honestly and faithfully against all their enemies or opposers whomsoever; and that I will observe and obey the orders of the President of the United States, and the orders of the officers appointed over me, according to the Rules and Articles of War.

Sworn and subscribed to, at *New Orleans, La.* this *4th* day of *February*, 1865, BEFORE *John Geo. Friedman* *Alexander Taylor* *Notary Public*

I CERTIFY, ON HONOR, That I have carefully examined the above-named Volunteer, agreeably to the General Regulations of the Army, and that, in my opinion, he is free from all bodily defects and mental infirmity, which would in any way disqualify him from performing the duties of a soldier.

*J. Blunt*  
*Asst Surg U.S.A.*  
EXAMINING SURGEON.

I CERTIFY, ON HONOR, That I have minutely inspected the Volunteer *Alexander Taylor* previously to his enlistment, and that he was entirely sober when enlisted; that, to the best of my judgment and belief, he is of lawful age; and that, in accepting him as duly qualified to perform the duties of an able-bodied soldier, I have strictly observed the Regulations which govern the recruiting service. This soldier has *Brown* eyes, *Black* hair, *Dark* complexion, is *five* feet *five* inches high.

*W. M. Allison*  
Capt. U.S.A. Volunteers,  
RECRUITING OFFICER.

(A. G. O. No. 74 & 76.)

Mustered into the service of the United States, for three years or during the war, from date of enlistment, in Company *C.* *H.* Regiment of *U.S.C.V.* Volunteers, on the *18th* day of *February*, 1865, at *New Orleans, La.*

*John Geo. Friedman*  
*Notary Public*  
*Asst Surg U.S.A.*

1024  
Taylor, Andrew

Co. H, 4 U. S. Col'd Cav.

Private

Private

CARD NUMBERS.

1	5357220	26
2	5347923	27
3	5357276	28
4	5357330	29
5	5357387	30
6	5357440	31
7	5357489	32
8	5357536	33
9	5357618	34
10	5357700	35
11	5357784	36
12	5357863	37
12	5357937	38
14	5358012	39
15	5358084	40
16	7160372	41
17	30832741	42
18	40729249	43
19		44
20		45
21		46
22		47
23		48
24		49
25		50

Book Mark:

See also

*T* | **4 Cav.** | **U.S.C.T.**

*Andrew Taylor*  
*Priv.*, Co. H, 4 Reg't U. S. Col'd Cavalry.

Appears on

**Company Muster-in and Descriptive Roll**  
of the organization named above. Roll dated

*New Orleans La, Apr, 8, 1864.*

Where born *Richmond, Va*

Age *30* y'rs; occupation *servant*

When enlisted *Feb, 26, 1864.*

Where enlisted *Indianola, Tex*

For what period enlisted *3* years.

Eyes *black*; hair *dark*

Complexion *dark*; height *5* ft. *5* in.

When mustered in *Apr, 8, 1864.*

Where mustered in *New Orleans, La,*

Bounty paid \$ *2* 100; due \$ 100

Where credited

Company to which assigned

Remarks:

Book mark:

*C. Williams,*  
Copyist.

(356d)

1

4 Cav. | U.S.C.T.

Andrew Taylor

Appears with rank of *Private* on

**Muster and Descriptive Roll of a Detachment of U. S. Vols. forwarded**

for the 4 Reg't U. S. Col'd Cavalry. Roll dated

*New Orleans La*, *Apr 8*, 1864.

Where born *Richmond, Va*

Age *30* y'rs; occupation *Servant*

When enlisted *Feb 24*, 1864.

Where enlisted *Indiana*

For what period enlisted *3* years.

Eyes *Black*; hair *Black*

Complexion *dk*; height *5* ft. *5* in.

When mustered in *Apr 8*, 1864.

Where mustered in *New Orleans*

Bounty paid \$ *100*; due \$ *100*

Where credited

Company to which assigned *H*

Remarks:

Book mark:

*Sallade*



4 Cav. U.S.C.T.

Andrew Taylor  
Priv., Co. H, 4 Reg't U. S. Col'd Cavalry.

Appears on

Company Muster Roll

for Apr 8 to 30, 1864

Present or absent Present

Stoppage, \$ 100 for

Due Gov't, \$ 100 for

Valuation of horse, \$ 100

Valuation of horse equipments, \$ 100

Remarks:

Book mark:

C. Williams

7 | 4 Cav. | U.S.C.T.

Andrew Taylor  
Sgt., Co. H, 4 Reg't U. S. Col'd Cavalry.

Appears on

**Company Muster Roll**

for *May & June, 1864*

Present or absent *Present*

Stoppage, \$ *100* for

Due Gov't, \$ *100* for

Valuation of horse, \$ *100*

Valuation of horse equipments, \$ *100*

Remarks:

Book mark:

*C. Williams*

(358)

Copyist.

9 | **4 Cav. | U.S.C.T.**

Andrew Taylor  
Pvt., Co. H, 4 Reg't U. S. Col'd Cavalry.

Appears on

**Company Muster Roll**  
for July & Aug., 1864  
Present or absent Present

Stoppage, \$.....100 for .....

Due Gov't, \$.....100 for .....

Valuation of horse, \$.....100

Valuation of horse equipments, \$.....100

Remarks: .....

Book mark: .....

(358)

G. Williams,  
Copyist.

9 | **4 Cav.** | **U.S.C.T.**

Andrew Taylor  
Pvt., Co. H, 4 Reg't U.S. Col'd Cavalry.

Appears on

**Company Muster Roll**  
for Sept. & Oct., 1864

Present or absent Present

Stoppage, \$ 100 for

Due Gov't, \$ 16 for ordnance

(quitting)  
Valuation of horse, \$ 100

Valuation of horse equipments, \$ 100

Remarks: \_\_\_\_\_  
\_\_\_\_\_  
\_\_\_\_\_  
\_\_\_\_\_  
\_\_\_\_\_  
\_\_\_\_\_  
\_\_\_\_\_  
\_\_\_\_\_

Book mark: \_\_\_\_\_

C. Williams  
(358) Copyist.

*A* | **4 Cav.** | **U.S.C.T.**

*Andrew Taylor*  
*Priv.*, Co. H, 4 Reg't U. S. Col'd Cavalry.

Appears on

**Company Muster Roll**

for *Nov<sup>4</sup> + Dec<sup>4</sup>*, 186 ~~4~~

Present or absent *Present.*

Stoppage, \$ <sup>*16*</sup> 100 for *one must-  
ket sling.*

Due Gov't, \$ 100 for

Valuation of horse, \$ 100

Valuation of horse equipments, \$ 100

Remarks:

Book mark:

*C. Williams*

**4 Cav. U.S.C.T.**

*Andrew Taylor*  
*Priv.*, Co. H, 4 Reg't U. S. Col'd Cavalry.

Appears on

**Company Muster Roll**

for *Jan. 9. File.*, 186 *5.*

Present or absent *Present*

Stoppage, \$ *100* for

Due Gov't, \$ *100* for

Valuation of horse, \$ *100*

Valuation of horse equipments, \$ *100*

Remarks: *Due M. S. (must be  
shipped 16.  
He received but 7.00 per  
month in to Apr. 30/61*

Book mark:

*Feaster*

*P* | **4 Cav. U.S.C.T.**

*Andrew Taylor*

*Tot*, Co. H, 4 Reg't U. S. Col'd Cavalry.

Appears on

**Company Muster Roll**

for *Mch. 1. Apl.*, 186*5*.

Present or absent *Present*

Stoppage, \$ *100* for

Due Gov't, \$ *100* for

Valuation of horse, \$ *100*

Valuation of horse equipments, \$ *100*

Remarks:

Book mark:

*Treaster*

*J* | **4 Cav.** | **U.S.C.T.**

*Andrew Taylor*  
-----  
*Pvt.*, Co. H, 4 Reg't U. S. Col'd Cavalry.

Appears on

**Company Muster Roll**

for *May 4. June*, 186*5*.

Present or absent *Present*

Stoppage, \$ *100* for -----

Due Gov't, \$ *100* for -----

Valuation of horse, \$ *100*

Valuation of horse equipments, \$ *100*

Remarks: -----  
-----  
-----  
-----  
-----  
-----  
-----  
-----  
-----  
-----

Book mark: -----

*Feaster*



*J* | **4 Cav.** | **U.S.C.T.**

*Andrew Taylor*  
Pot., Co. H, 4 Reg't U. S. Col'd Cavalry.

Appears on

**Company Muster Roll**

for *July & Aug.*, 186 *2*.

Present or absent *Present*

Stoppage, \$ *100* for

Due Gov't, \$ *100* for

Valuation of horse, \$ *100*

Valuation of horse equipments, \$ *100*

Remarks:  
-----  
-----  
-----  
-----  
-----  
-----  
-----  
-----  
-----  
-----

Book mark: -----

*Leaster*

*S* | **4 Cav.** | **U.S.C.T.**

*Andrew Taylor*

*Pvt.*, Co. H, 4 Reg't U. S. Col'd Cavalry.

Appears on

**Company Muster Roll**

for *Sept. 8, Oct.*, 186*2*.

Present or absent *Present*

Stoppage, \$ *100* for

Due Gov't, \$ *100* for

Valuation of horse, \$ *100*

Valuation of horse equipments, \$ *100*

Remarks:

Book mark:

*Feaster*

D | Hbar uscp

Andy Taylor  
Pos., Co. H, 4th Reg't USCCav

Appears on

**Hospital Muster Roll**

of U. S. A. Post Hospital,

at Baton Rouge, La.,

for Sept & Oct, 1865

Attached to hospital:

When Oct 19, 1865

How employed

Last paid by Maj.

to \_\_\_\_\_, 1865

Bounty paid \$ 100; due \$ 100

Present or absent Present

Remarks:

Book mark:

(848)

A. King  
Copyist.

*27* | **4 Cav.** | **U.S.C.T.**

*Andrew Taylor*  
*Pri*, Co. H, 4 Reg't U. S. Col'd Cavalry.

Appears on

**Company Muster Roll**

for *dated Dec 31*, 186*5*.

Present or absent *Present*

Stoppage, \$ *100* for

Due Gov't, \$ *100* for

Valuation of horse, \$ *100*

Valuation of horse equipments, \$ *100*

Remarks:

Book mark:

(358)

*A. B. Howard*  
Copyist.

*J* | **4 Cav.** | **U.S.C.T.**

*Andrew Taylor*  
*Pri.*, Co. H, 4 Reg't U. S. Col'd Cavalry.

Appears on

**Company Muster Roll**

for *Jan & Feb*, 1866.

Present or absent *Present*

Stoppage, \$ *100* for

Due Gov't, \$ *100* for

Valuation of horse, \$ *100*

Valuation of horse equipments, \$ *100*

Remarks:

Book mark:

(358)

*H. C. Arnold*  
Copyist.

*N* | **4 Cav.** | **U.S.C.T.**

*Andrew Taylor*  
*Tri*, Co. *H*, 4 Reg't U. S. Col'd Cavalry.

Appears on **Co. Muster-out Roll**, dated  
*New Orleans La, Mar 29* 1866.

Muster-out to date \_\_\_\_\_, 186\_\_ .

Last paid to *June 30*, 1865 .

**Clothing account:**

Last settled \_\_\_\_\_, 186\_\_ ; drawn since \$ \_\_\_\_\_  $\overline{100}$

Due soldier \$ \_\_\_\_\_  $\overline{100}$ ; due U. S. \$ *10*  $\frac{91}{100}$

Am't for cloth'g in kind or money adv'd \$ \_\_\_\_\_  $\overline{100}$

Due U. S. for arms, equipments, &c., \$ \_\_\_\_\_  $\overline{100}$

Bounty paid \$ \_\_\_\_\_  $\overline{100}$ ; due \$ \_\_\_\_\_  $\overline{100}$

Remarks: *Joined at Orgl. Orgi.*  
*Absent sick in Ctl*  
*u. Genl Hospital, New*  
*Orleans La. No discharge*  
*furnished. None will be*

Book mark: *Discharged. See Acc.*  
*(over)*

(361)

*A. C. Munn*  
Copyist.

JAN. - 8

5358084

★ 1891 ★

List on file in Mis.  
Box V219, P168. 75.  
4744 P.M.G. May 25/66

9 | 4 Cav. | U.S.C.T.

Andrew Taylor

Priv., Co. H, 4 Reg't U. S. Colored Cav.

Appears on Returns as follows:

Apr 1864 }  
July & Aug 1864 } On duty  
Nov 1864 to Feb 1865 } detailed as  
Co. Cook.

Feb 1866 - On duty at Post  
of M. Beckwith Shop

Thus appears as  
Andrew Taylor

Book mark: \_\_\_\_\_

W. R. Lu



*P* | *4 (Cav.)* | **U.S.C.T.**

*Andrew Taylor*

*Pvt.*, Co. *H*, *4* Reg't U. S. Col'd <sup>*Cav.*</sup> ~~Inf.~~

Appears on a *(in the 84<sup>th</sup> U.S. C.T.)*  
List of Discharges furnished by C. M. O. of State,  
under the provisions of circular dated A. G. O.,  
June 29, 1865.

Discharge furnished *April 28<sup>th</sup>*, 186*6*.

to date from \_\_\_\_\_, 186*6*.

Remarks : \_\_\_\_\_  
\_\_\_\_\_  
\_\_\_\_\_  
\_\_\_\_\_  
\_\_\_\_\_  
\_\_\_\_\_  
\_\_\_\_\_  
\_\_\_\_\_  
\_\_\_\_\_  
\_\_\_\_\_

Book Mark : \_\_\_\_\_

*W. Pagan*

1025  
Taylor, Ball

Co. H, 4 U. S. Col'd Cav.

Private | Private

CARD NUMBERS.

1	5357222	26
2	5347925	27
3	5357278	28
4	5357331	29
5	5357394	30
6	5358120	31
7	40729250	32
8		33
9		34
10		35
11		36
12		37
12		38
14		39
15		40
16		41
17		42
18		43
19		44
20		45
21		46
22		47
23		48
24		49
25		50

Book Mark:

See also

9 | **4 Cav.** | **U.S.C.T.**

Ball Taylor  
Priv., Co. H, 4 Reg't U. S. Col'd Cavalry.

Appears on

**Company Muster-in and Descriptive Roll**  
of the organization named above. Roll dated

New Orleans, La, Apr. 8, 1864.

Where born Louisiana Bay, La.

Age 42 y'rs; occupation Laborer

When enlisted Mar. 22, 1864.

Where enlisted Alexandria La

For what period enlisted 3 years.

Eyes black; hair black

Complexion black; height 5 ft. 8 1/2 in.

When mustered in Apr. 8, 1864.

Where mustered in New Orleans, La

Bounty paid \$ 2 100; due \$ 100

Where credited \_\_\_\_\_

Company to which assigned \_\_\_\_\_

Remarks: \_\_\_\_\_  
\_\_\_\_\_  
\_\_\_\_\_  
\_\_\_\_\_

Book mark: \_\_\_\_\_

C. Williams

(356d)

Copyist.

5 | 4 Cav. | U.S.C.T.

Ball Taylor

Appears with rank of Private on

Muster and Descriptive Roll of a Detachment of U. S. Vols. forwarded

for the 4 Reg't U. S. Col'd Cavalry. Roll dated

New Orleans La, April 8, 1864.

Where born La Parish La.

Age 22 y'rs; occupation laborer

When enlisted Feb 22, 1864

Where enlisted Alexandria

For what period enlisted 3 years.

Eyes Black; hair Black

Complexion Black; height 5 ft. 8 1/2 in.

When mustered in April 8, 1864.

Where mustered in New Orleans

Bounty paid \$ 100; due \$ 100

Where credited

Company to which assigned H

Remarks:

Book mark:

Ballade Copyist.

*T* | **4 Cav.** | **U.S.C.T.**

*Ball Taylor*  
*Priv.*, Co. H, 4 Reg't U. S. Col'd Cavalry.

Appears on

**Company Muster Roll**

for *Apr. 8 to 30*, 1864.

Present or absent *Present*

Stoppage, \$ 100 for

Due Gov't, \$ 100 for

Valuation of horse, \$ 100

Valuation of horse equipments, \$ 100

Remarks:

Book mark:

*G. Williams*

9 | **4 Cav.** | **U.S.C.T.**

Ball Taylor  
Priv., Co. H, 4 Reg't U. S. Col'd Cavalry.

Appears on

**Company Muster Roll**

for May & June, 1864

Present or absent Absent

Stoppage, \$ 100 for

Due Gov't, \$ 100 for

Valuation of horse, \$ 100

Valuation of horse equipments, \$ 100

Remarks:

Book mark:

(358)

C. Williams

Copyist.

9 | **4 Cav.** | **U.S.C.T.**

Ball Taylor  
Priv., Co. H, 4 Reg't U. S. Col'd Cavalry.

Appears on

**Company Muster Roll**  
for July & Aug., 1864  
Present or absent

Stoppage, \$ 100 for

Due Gov't, \$ 100 for

Valuation of horse, \$ 100

Valuation of horse equipments, \$ 100

Remarks: Died in G.I.  
Apique Gen. Hosp.  
New Orleans, Aug. 13  
'64.

Book mark: \_\_\_\_\_

(358)

G. Williams  
Copyist.

5 | 4 Cav. | U.S.C.T.

Ball Taylor

Port, Co. H, 4 Reg't U. S. Colored Cav.

Appears on Returns as follows:

May 1864. On duty as Cook

July 1864. absent sick sent  
to G. H. July 13/64

Aug 1864. 2000: Aug 13 N.  
Orleans Died in Genl  
Hospital.

Book mark:

W. R. Lee



*J* | **4 Cav. | U.S.C.T.**

*Bull Taylor*  
*Co. H., 4 Reg't U. S. Col'd Cavalry.*

Appears on **Co. Muster-out Roll**, dated  
*New Orleans La, Feb 20, 1866.*

Muster-out to date \_\_\_\_\_, 186 .

Last paid to \_\_\_\_\_, 186 .

**Clothing account:**

Last settled \_\_\_\_\_, 186 ; drawn since \$ \_\_\_\_\_  $\overline{100}$

Due soldier \$ \_\_\_\_\_  $\overline{100}$ ; due U. S. \$ \_\_\_\_\_  $\overline{100}$

Am't for cloth'g in kind or money adv'd \$ \_\_\_\_\_  $\overline{100}$

Due U. S. for arms, equipments, &c., \$ \_\_\_\_\_  $\overline{100}$

Bounty paid \$ \_\_\_\_\_  $\overline{100}$ ; due \$ \_\_\_\_\_  $\overline{100}$

Remarks: *Joined at Camp Co. in*  
*Oct. in Co. H. 4th*  
*Reg't. New Orleans La.*  
*Aug. 13/64. Final state*  
*papers forwarded*

Book mark : \_\_\_\_\_

(861)

*N. E. Howard*  
Copied.

Taylor Ball

P. Co. A, 4 Reg't U.S.C. Cal.

5 Enclosures.

Bed Cards	Descriptive Lists
Burial Records 1	Final Statements 1
Certs. of Dis. for Discharge	Furloughs
C. M. Charges	Med. Des. Lists
Med. Certificates	Orders

Other papers relating to—

Admission to Hosp'l	Furlough
Casualty Sheet (Officer's) 1	Med. Examination
Confinement	Misc. Information
Contracts	Pay or Clothing
Death or Effects 2	Personal Reports
Desertions	Rank
Discharge from Hosp'l	Transfer to Hosp'l
Discharge from Service	Transfer to V. R. C.
Duty	Transportation

3 yrs in duty for the Surg Gen Am 13. 1863

Complete CASUALTY SHEET

No.

Ball Taylor

Priv of Company H

41<sup>st</sup> Regiment of U.S.C.V.

State Volunteers.

NATURE OF CASUALTY.

Died Aug. 13, 1864

Belongs to  
41<sup>st</sup> U.S. Col. Co.

OK

My

Entom C. P. of C.

CASUALTY SHEET.

Name: *Ball Taylor*  
Rank: *Priv.* Company: *H* Regiment: *4<sup>th</sup>*  
Arm: *U.S.C. I.* State: \_\_\_\_\_  
Nature of Casualty: *Death*

CAUSE OF CASUALTY—(NAME OF DISEASE, &c.)

BY WHOM DISCHARGED.

FROM WHAT SOURCE THIS INFORMATION WAS OBTAINED.

DEGREE OF DISABILITY.

*Rock-H-Louisiana*  
*Pg. 131*

BY WHOM CERTIFIED.

REMARKS.

*Just M. Moore*  
*A. G. H.*

DATE OF DISCHARGE, DEATH, &c.

*Aug. 13. 1864*

PLACE OF DISCHARGE, DEATH, &c.

*Bureau N. Orleans, La*

*J. B.*

Clerk.

*Duplicate*

ARTICLES OF WAR.

ART. 95. When any non-commissioned officer or soldier shall die, or be killed in the service of the United States, the then commanding officer of the troop or company shall, in the presence of two other commissioned officers, take an account of what effects he died possessed of, above his arms and accoutrements, and transmit the same to the office of the Department of War, which said effects are to be accounted for, and paid to the representatives of such deceased non-commissioned officer or soldier. And in case any of the officers, so authorized to take care of the effects of deceased officers and soldiers, should, before they have accounted to their representatives for the same, have occasion to leave the regiment or post, by preferment or otherwise, they shall, before they be permitted to quit the same, deposit in the hands of the commanding officer, or of the assistant military agent, all the effects of such deceased non-commissioned officers and soldiers, in order that the same may be secured for, and paid to, their respective representatives.

ARMY REGULATIONS—EDITION OF 1861.

DECEASED SOLDIERS.

Par. 152. Inventories of the effects of deceased non-commissioned officers and soldiers, required by the 95th Article of War, will be forwarded to the Adjutant General, by the commander of the company to which the deceased belonged, and a duplicate of the same to the colonel of the regiment. Final statements of pay, clothing, &c., will be sent with the inventories. When a soldier dies at a post or station absent from his company, it will be the duty of his immediate commander to furnish the required inventory, and, at the same time, to forward to the commanding officer of the company to which the soldier belonged, a report of his death, specifying the date, place, and cause; to what time he was last paid, and the money or other effects in his possession at the time of his decease; which report will be noted on the next muster roll of the company to which the man belonged. Each inventory will be endorsed, "Inventory of the effects of \_\_\_\_\_, late of company (—) \_\_\_\_\_ regiment of \_\_\_\_\_, who died at \_\_\_\_\_, the \_\_\_\_\_ day of \_\_\_\_\_, 186—." If a legal representative receive the effects, it will be stated in the report. If the soldier leave no effects, the fact will be reported.

Par. 153. Should the effects of a deceased non-commissioned officer or soldier not be administered upon within a short period after his decease, they shall be disposed of by a Council of Administration, under the authority of the commanding officer of the post, and the proceeds deposited with the Paymaster, to the credit of the United States, until they shall be claimed by the legal representatives of the deceased.

Par. 154. In all such cases of sales by the Council of Administration, a statement in detail, or account of the proceeds, duly certified by the Council and commanding officer, accompanied by the Paymaster's receipt for the proceeds, will be forwarded by the commanding officer to the Adjutant General. The statement will be endorsed, "Report of the proceeds of the effects of \_\_\_\_\_, late of company (—) \_\_\_\_\_ regiment of \_\_\_\_\_, who died at \_\_\_\_\_, the \_\_\_\_\_ day of \_\_\_\_\_, 186—."

NOTE 1.—The effects in all cases, when called for, should be turned over to the legal representative, without further authority from the Adjutant General. When the effects are turned over to the relatives of the deceased before these inventories are sent to the Adjutant General, their receipts therefor should be attached to the inventories. In all other cases, one copy will be sent with a letter of transmittal direct to the Adjutant General, and a duplicate retained by the officer.

NOTE 2.—Particular care should be taken to take receipts in duplicate from the Paymaster for any funds turned over to him; one copy should be sent direct to the Adjutant General and one retained by the officer.

INVENTORY OF THE EFFECTS

OF *Private*

*Ball Taylor*

Late of Company *F. H.*

*4* Reg't of *W. S. G. Co.*

Volunteers, who died at *Camp D. H. G. Wash.*

on the *13* day of *August* 186*4*



*1357*

Inventory of the effects of Ball Taylor late  
 a Private of Captain R. A. Borden Company A. C. of  
 the 4<sup>th</sup> Regiment of U. S. Col<sup>d</sup> Party Volunteers, who was enrolled as  
 a Private at Alexandria in the State of Louisiana on  
 the 22 day of March 1864, and mustered into the service of the United  
 States as a Private on the 8 day of April 1864 at New Orleans La  
 in Company K, 4 Regiment of U. S. Col<sup>d</sup> Party Volunteers, to serve 3  
 years or during the war; he was born in La Parish in the State  
 of Louisiana; he was 42 years of age, 5 feet 8 1/2 inches  
 high, Blk complexion, Blk eyes, Blk hair, and by occupation, when enrolled,  
 a Laborer; he died in Camp D'Arque du Dept., at  
New Orleans La on the 13<sup>th</sup> day of August 1864 by  
 reason of (Dysentery Chronic)

INVENTORY.					
ARTICLES.	No.	ARTICLES.	No.	ARTICLES.	No.
Hats.....		Pairs trousers.....		Knapsacks.....	
Caps.....		Pairs flannel drawers.....			
Forage caps.....		Pairs cotton drawers.....			
Great coats.....		Flannel shirts.....			
Uniform coats.....		Cotton shirts.....			
Uniform jackets.....		Pairs boots.....			
Flannel sack coats.....		Pairs shoes.....			
Blouses.....		Pairs socks.....			
Stable frocks.....		Blankets.....		MONEY.	
Fatigue overalls.....		Haversacks.....		Specie.....	\$
				Notes.....	\$

I CERTIFY, ON HONOR, that the above inventory comprises all the effects of \_\_\_\_\_  
 \_\_\_\_\_, deceased, and that the effects are in the hands  
 of \_\_\_\_\_ at \_\_\_\_\_  
 \_\_\_\_\_ to be disposed of by a Council of Administration.

(DUPLICATES.)

STATION: New Orleans La  
 DATE: Aug 13 ' 1864

F. E. Piquette  
Surgeon in Charge (D. S. A.)  
 Commanding the Company.

INVENTORY

Inventory of the effects of Ball Taylor late  
 a Private of Captain R. A. Borden Company A. C. of  
 the 4<sup>th</sup> Regiment of U. S. Col. Brady Volunteers, who was enrolled as  
 a Private at Alexandria in the State of Louisiana on  
 the 22 day of March 1864, and mustered into the service of the United  
 States as a Private on the 8 day of April 1864 at New Orleans La  
 in Company H, 4 Regiment of U. S. Col. Brady Volunteers, to serve 3  
 years or during the war; he was born in La Parrotte in the State  
 of Louisiana; he was 42 years of age, 5 feet 8 1/2 inches  
 high, Blk complexion, Blk eyes, Blk hair, and by occupation, when enrolled,  
 a Laborer; he died in Camp D'Arque du Dept., at  
New Orleans La on the 13<sup>th</sup> day of August 1864, by  
 reason of (Dysentery Chronic)

INVENTORY.					
ARTICLES.	No.	ARTICLES.	No.	ARTICLES.	No.
Hats.....		Pairs trowsers.....		Knapsacks.....	
Caps.....		Pairs flannel drawers.....			
Forage caps.....		Pairs cotton drawers.....			
Great coats.....		Flannel shirts.....			
Uniform coats.....		Cotton shirts.....			
Uniform jackets.....		Pairs boots.....			
Flannel sack coats.....		Pairs shoes.....			
Blouses.....		Pairs socks.....			
Stable frocks.....		Blankets.....			
Fatigue overalls.....		Haversacks.....			
				MONEY.	
				Specie.....	\$
				Notes.....	\$

I CERTIFY, ON HONOR, that the above inventory comprises all the effects of \_\_\_\_\_  
 \_\_\_\_\_, deceased, and that the effects are in the hands  
 of \_\_\_\_\_ at \_\_\_\_\_  
 \_\_\_\_\_ to be disposed of by a Council of Administration.

( DUPLICATES. )

STATION: New Orleans La  
 DATE: Aug 13 ' 1864

F. E. Piquette  
Surgeon in Charge (D. S. G. H.)  
 Commanding the Company.

ARTICLES OF WAR.

ART. 95. When any non-commissioned officer or soldier shall die, or be killed in the service of the United States, the then commanding officer of the troop or company shall, in the presence of two other commissioned officers, take an account of what effects he died possessed of, above his arms and accoutrements, and transmit the same to the office of the Department of War, which said effects are to be accounted for, and paid to the representatives of such deceased non-commissioned officer or soldier. And in case any of the officers, so authorized to take care of the effects of deceased officers and soldiers, should, before they have accounted to their representatives for the same, have occasion to leave the regiment or post, by preferment or otherwise, they shall, before they be permitted to quit the same, deposit in the hands of the commanding officer, or of the assistant military agent, all the effects of such deceased non-commissioned officers and soldiers, in order that the same may be secured for, and paid to, their respective representatives.

DIRECTIONS.

NOTE 1.—One copy of the inventories of the effects of deceased non-commissioned officers and soldiers, required by the 95th Article of War, will be forwarded to the Adjutant General, by the commander of the company to which the deceased belonged, and a duplicate of the same to the colonel of the regiment. Final statements of pay, clothing, &c., in duplicate, will be sent to the Adjutant General with one copy of the inventory. Both inventory and final statements should be forwarded, as a general rule, through Regimental Headquarters. When a soldier dies at a post or station absent from his company, it will be the duty of his immediate commander to furnish, direct to the Adjutant General, the required inventory and final statements, and, at the same time, to forward to the commanding officer of the company to which the soldier belonged, a report of his death, specifying the date, place, and cause; to what time he was last paid, and the money or other effects in his possession at the time of his decease; which report will be noted on the next muster roll of the company to which the man belonged. Each inventory will be endorsed, "Inventory of the effects of ———, late of company (—) ——— regiment of ———, who died at ———, the ——— day of ———, 186—." If a legal representative receive the effects, it will be stated in the report. If the soldier leave no effects, the fact will be reported on the blank for inventory.

NOTE 2.—Should the effects of a deceased non-commissioned officer or soldier not be administered upon within a short period after his decease, they shall be disposed of by a Council of Administration, under the authority of the commanding officer of the post, and the proceeds deposited with the Paymaster, to the credit of the United States, until they shall be claimed by the legal representatives of the deceased.

NOTE 3.—In all such cases of sales by the Council of Administration, a statement in detail, or account of the proceeds duly certified by the Council and commanding officer, (Form 5.) accompanied by the Paymaster's receipt for the proceeds, will be forwarded by the commanding officer to the Adjutant General. The statement will be endorsed, "Report of the proceeds of the effects of ———, late of company (—) ——— regiment of ———, who died at ———, the ——— day of ———, 186—."

NOTE 4.—The effects in all cases, when called for, should be turned over to the legal representative, without further authority from the Adjutant General. When the effects are turned over to the relatives of the deceased before these inventories are sent to the Adjutant General, their receipts therefor should be attached to the inventories. In all other cases, one copy will be sent with a letter of transmittal direct to the Adjutant General, and a duplicate retained by the officer.

NOTE 5.—Particular care should be taken to take receipts in duplicate from the Paymaster for any funds turned over to him; one copy should be sent direct to the Adjutant General and one retained by the officer.

INVENTORY OF THE EFFECTS

OF

*Private*  
*Prvt. Bull, 1st Regt*

Late of Company *14*

*1<sup>st</sup>* Reg't of *U. S. Col. Cav.*

Volunteers, who died at *Papua, P. I. Hosp.*  
 on the *13<sup>th</sup>* day of *August* 186*4*.

Surgeon General's Office,

RECORD & PENSION BUREAU,

Washington, ----- 186

*The within inventory is a true copy from the records of ----- Hospital -----, on file in this Office, and contains all the information in the case that can be found.*

BY ORDER OF THE SURGEON GENERAL:

*Bvt. Major, Assistant Surgeon, U. S. A.*



Inventory of the effects of Bull Taylor late  
 a Private of Captain R. A. Bowley Company A of  
 the 11<sup>th</sup> Regiment of U. S. Colored Troop Volunteers, who was enrolled as  
 a Private at Alexandria in the State of Louisiana on  
 the 22 day of March 1864, and mustered into the service of the United  
 States as a Private on the 8 day of April 1864, at New Orleans La.  
 in Company N, 11 Regiment of U. S. Colored Troop Volunteers, to serve 3  
 years or during the war; he was born in La Parish in the State  
 of Louisiana; he was 42 years of age, 5 feet 3 1/2 inches  
 high, Blk complexion, Blk eyes, Blk hair, and by occupation, when enrolled,  
 a Laborer; he died in Co. A. 1st Regt. U. S. Col. Troop, at  
New Orleans La. on the 13<sup>th</sup> day of August 1864, by  
 reason of Diarrhoea Chronic.

INVENTORY.					
ARTICLES.	No.	ARTICLES.	No.	ARTICLES.	
Hats.....		Pairs trousers.....		Knapsacks.....	
Caps.....		Pairs flannel drawers.....			
Forage caps.....		Pairs cotton drawers.....			
Great coats.....		Flannel shirts.....			
Uniform coats.....		Cotton shirts.....			
Uniform jackets.....		Pairs boots.....			
Flannel sack coats.....		Pairs shoes.....			
Blouses.....		Pairs socks.....			
Stable frocks.....		Blankets.....		MONEY.	Specie..... \$
Fatigue overalls.....		Haversacks.....			Notes..... \$

I CERTIFY, ON HONOR, that the above inventory comprises all the effects of \_\_\_\_\_  
 \_\_\_\_\_, deceased, and that the effects are in the hands  
 of \_\_\_\_\_ at \_\_\_\_\_  
 \_\_\_\_\_ to be disposed of by a Council of Administration.

( DUPLICATES. )

STATION: New Orleans, La.  
 DATE: August 13<sup>th</sup> 1864

J. C. Piquette  
 Surgeon in Charge Co. A. 1st Regt. U. S. Col. Troop  
 Commanding the Company.

MAR 12 1864

*Pall Taylor*  
*A. A. G. O.*

COPY OF RECORD

FOR THE

ADJUTANT GENERAL U. S. ARMY.



RECORD OF DEATH AND INTERMENT.

Name and number of person interred,	<i>Ball Gayton</i>	
Number and locality of the grave, -		
Hospital number of the deceased, -	<i>(1540)</i>	
Regiment, Rank, and Company, - -	<i>Private Co H, 4<sup>th</sup> U. S. Col<sup>d</sup> Cavalry</i>	
Residence before enlistment, - - -		
Conjugal condition (and if married, ) the residence of the widow, )		
Cause of death, )	<i>Dysentery chronic</i>	
Age of the deceased, - - - - -		
Nativity, - - - - -		
References and Remarks, - - )		
Date of death and burial, - - -	<i>August 13<sup>th</sup> 1</i>	<i>1864</i>

[A duplicate of this Record has been forwarded to the Sexton, and the other remains at this Hospital.]

To *Adj<sup>t</sup> General U. S. A.*

SIR :

It becomes my duty to inform you that the person above described died at this Hospital as herein stated: and that it is desired his remains should be interred with the usual military honors.

Respectfully,

*J. E. Piquette*  
Surgeon U. S. Army.

MILITARY HOSPITAL, *Capt D'Angue*

*86 in a col sup<sup>y</sup>*  
*in charge.*

This copy of Record is to be transmitted to the Adjutant General at Washington immediately after the place of burial and the number of the grave have been ascertained and registered. The above notification is to remain attached.

A.G.C.  
See list sent 2d Auditor,  
&

A.G.C.

**FINAL STATEMENT**

OF Private

*Ball Taylor*

4<sup>th</sup> Reg't of *W. S. Wood*

**VOLUNTEERS.**

*See page 13 etc.*

NOTE 1.—Two of these certificates (or duplicates) are to be given to each volunteer soldier who may be discharged previously to the discharge of his company, that he may at once receive from the Paymaster the pay, &c., due him, and the captain or other officer commanding the company will certify to the act of the delivery of the duplicate certificates; on these certificates the Soldier is "entitled to" his discharge, and should also present his discharge to the Paymaster to have the payment endorsed on it. The discharge is to be given back to the Soldier by the Paymaster; the latter only retaining as his voucher the duplicate certificates.

NOTE 2.—If the Soldier is entitled to pay for the use of his horse, the Company Commander will certify to that fact, and also to the time he has pay due for having been so mounted on his own horse.

NOTE 3.—Amounts due the Sutler and Laundress must be entered on the Muster Roll on which the death, desertion, &c., is reported, as well as on the final statement, otherwise the amount cannot be collected from the United States.

NOTE 4.—This blank will be used for deceased volunteers as well as others.

ADJUTANT GENERAL'S OFFICE.  
*Oct 11<sup>th</sup> 1861*  
Duplicate with Inventory sent 2d Auditor.



*Sub 3*

I certify, on honor, that Ball Taylor a Private of  
Captain R. A. Bowley Company (A) of the 4 Regiment of W. S. Col's ready  
**VOLUNTEERS**, of the State of Louisiana, born in La Parish, State  
of Louisiana, aged 42 years; 5 feet 8 1/2 inches high; Blk complexion,  
Blk eyes, Blk hair, and by occupation a Laborer, having joined the company on  
its original organization at Alexandria La, and enrolled in it at the muster into  
the service of the United States at New Orleans La, on the 9 day  
of April, 1864, (or was mustered in service as a recruit, by  
....., at ....., on the ..... day of .....,  
1864, to serve in the Regiment,) for the term of 3 Years

and having served **HONESTLY** and **FAITHFULLY** with his Company in Dept of the Gulf  
to the present date, is now entitled to a **DISCHARGE** by reason of Death from  
Dysentery at New Orleans La  
August 13<sup>th</sup> 1864

The said Ball Taylor was last paid by Paymaster  
May Loftano to include the 30<sup>th</sup> day of April, 1864 and has  
pay due him from that time to the present date; he is entitled to pay and subsistence for  
**TRAVELING** to place of enrollment and whatever other allowances are authorized to volunteer  
soldiers, or militia, so discharged. He has received ..... 100 dollars,  
advanced by the United States on account of **CLOTHING**.

There is to be stopped from him, on account of the State of ....., or other  
authorities for **CLOTHING**, &c., received on entering service, Thirty One 1/10 dollars; also,  
for expenses of **SUBSISTENCE** for **TRAVELING** from place of enrollment to the place of rendezvous,  
amounting to ..... 100 dollars: and on account of the United States for **EXTRA**  
**CLOTHING** received in kind from ..... and for other  
stoppages, viz:

..... amounting to ..... 100 dollars;  
and he has been **SUBSISTED** for **TRAVELING** to his place of enrollment, up to the .....,  
....., 1864.

He is indebted to ....., **SUTLER**, ..... 100 dollars.

He is indebted to ....., **LAUNDRESS**, ..... 100 dollars.

Given in Duplicate, at New Orleans La, this 13 day of August, 1864

J. E. Pyrette  
Sergeon in Charge Corps de Artillery  
Commanding Company.

1020  
Taylor, Ben Townsena

Co H, 4 U. S. Col'd Cav.

Private | Private

CARD NUMBERS.

1	5357221	26
2	5347924	27
3	5357277	28
4	5357337	29
5	5358119	30
6	30848496	31
7	30849159	32
8	40729251	33
9		34
10		35
11		36
12		37
13		38
14		39
15		40
16		41
17		42
18		43
19		44
20		45
21		46
22		47
23		48
24		49
25		50

Book Mark:

See also

*T* | **4 Cav.** | **U.S.C.T.**

*New Townsend Taylor*  
*Priv*, Co. H, 4 Reg't U. S. Cold Cavalry.

Appears on

**Company Muster-in and Descriptive Roll**

of the organization named above. Roll dated

*New Orleans La Apr 8*, 1864.

Where born *Port Gibson, Miss*

Age *18* y'rs; occupation *Waiter*

When enlisted *Feb. 14*, 1864.

Where enlisted *Indianola, Tex*

For what period enlisted *3* years.

Eyes *black*; hair *black*

Complexion *dark*; height *5* ft. *5* in.

When mustered in *Apr. 8*, 1864.

Where mustered in *New Orleans, La*

Bounty paid \$ *2* 100; due \$ 100

Where credited

Company to which assigned

Remarks:

Book mark:

*C. Williams,*

(356d)

Copyist.

5

4 Cav. U.S.C.T.

New Townsend Taylor

Appears with rank of Private on

Muster and Descriptive Roll of a Detachment of U. S. Vols. forwarded

for the 4 Reg't U. S. Col'd Cavalry. Roll dated

New Orleans La, Apr 8, 1864.

Where born Port Gibson Miss

Age 14 y'rs; occupation Waiter

When enlisted Feb 14, 1864.

Where enlisted Indiana

For what period enlisted 3 years.

Eyes Black; hair Black

Complexion Dark; height 5 ft. 5 in.

When mustered in Apr 8, 1864.

Where mustered in New Orleans

Bounty paid \$ 100; due \$ 100

Where credited

Company to which assigned H

Remarks:

Book mark:

Gallade



*9* | **4 Cav.** | **U.S.C.T.**

*Ben Townsend Taylor*  
*Priv.*, Co. H, 4 Reg't U. S. Col'd Cavalry.

Appears on

**Company Muster Roll**

for *Apr. 8 to 30*, 186*4*.

Present or absent *Absent*

Stoppage, \$ *100* for

Due Gov't, \$ *100* for

Valuation of horse, \$ *100*

Valuation of horse equipments, \$ *100*

Remarks: *Sick in U.S. Col'd*  
*Gen. Hosp.*

Book mark:

*C. Williams*  
Copyist.

I | 4 Cav. | U.S.

Ben T. Taylor  
Priv, Co A, 4 Reg't U.S. Cav.

Appears on

**Hospital Muster Roll**

of **Corps d'Afrique U. S. A. General Hospital,**

at **New Orleans, La.,**

for March 9<sup>th</sup>, 1864.

Attached to hospital:

When \_\_\_\_\_, 186 .

How employed \_\_\_\_\_

Last paid by Maj. Never paid

to \_\_\_\_\_, 186 .

Bounty paid \$ 100; due \$ 100

Present or absent Present

Remarks: \_\_\_\_\_

\_\_\_\_\_

\_\_\_\_\_

\_\_\_\_\_

\_\_\_\_\_

\_\_\_\_\_

\_\_\_\_\_

\_\_\_\_\_

\_\_\_\_\_

\_\_\_\_\_

\_\_\_\_\_

\_\_\_\_\_

\_\_\_\_\_

\_\_\_\_\_

\_\_\_\_\_

\_\_\_\_\_

\_\_\_\_\_

\_\_\_\_\_

\_\_\_\_\_

\_\_\_\_\_

Morgan  
Coy. 1st.

9 | **4 Cav.** | **U.S.C.T.**

Ben. T. Taylor  
Priv., Co. H, 4 Reg't U. S. Col'd Cavalry.

Appears on

**Company Muster Roll**

for May & June, 1864.

Present or absent \_\_\_\_\_

Stoppage, \$ \_\_\_\_\_ 100 for \_\_\_\_\_

Due Gov't, \$ \_\_\_\_\_ 100 for \_\_\_\_\_

Valuation of horse, \$ \_\_\_\_\_ 100

Valuation of horse equipments, \$ \_\_\_\_\_ 100

Remarks: Dead.

Book mark: \_\_\_\_\_

(358)

S. Williams  
Copyist.

*T* | *41000* | *USCG*

*Ben L Taylor*

*Priv*, *Co. K*, *4* Reg't *USCA*

Appears on

**Hospital Muster Roll**

of **Corps d'Afrique U. S. A. General Hospital,**

at **New Orleans, La.,**

for *May & June*, 186 *4*.

Attached to hospital:

When \_\_\_\_\_, 186 .

How employed \_\_\_\_\_

Last paid by Maj. \_\_\_\_\_

to \_\_\_\_\_, 186 .

Bounty paid \$ 100; due \$ 100

Present or absent \_\_\_\_\_

Remarks: *Released to duty*  
*May 23/64*

Book mark: \_\_\_\_\_

*Atwood*

5 | 4 Cav. | U.S.C.T.

Benj. M. Taylor  
Co. H, 4 Reg't U. S. Colored Cav.

Appears on Returns as follows:

June 1864 Loss: June 1864  
Camp Colfax Died of  
disease.

Book mark:

W. R. Lee

*J* | **4 Cav. | U.S.C.T.**

*Benjamin Taylor*  
-----  
*Co. H*, 4 Reg't U. S. Col'd Cavalry.

Appears on **Co. Muster-out Roll**, dated  
*New Orleans La, March 20*, 186*k*.

Muster-out to date -----, 186 .

Last paid to -----, 186 .

**Clothing account:**

Last settled -----, 186 ; drawn since \$ ----- 100

Due soldier \$ ----- 100; due U. S. \$ ----- 100

Am't for cloth'g in kind or money adv'd \$ ----- 100

Due U. S. for arms, equipments, &c., \$ ----- 100

Bounty paid \$ ----- 100; due \$ ----- 100

Remarks: *Joined at Capt. Orgi.*  
*Co. Greenville La.*  
*June 15/64. Final*  
*Statements forwarded*

Book mark: -----

(861)

*A. E. Moore*  
-----  
Copyist.

Taylor, Ben, Townsend  
B, Co. H, 4 U.S.C. Cav.

Enclosures.

Bed Cards	Descriptive Lists
Burial Records	Final Statements /
Certs. of Dis. for Discharge	Furloughs
C. M. Charges	Med. Des. Lists
Med. Certificates	Orders

Other papers relating to—

Admission to Hosp'l	Furlough
Casualty Sheet (Officer's)	Med. Examination
Confinement	Misc. Information
Contracts	Pay or Clothing
Death or Effects	Personal Reports
Desertions	Rank
Discharge from Hosp'l	Transfer to Hosp'l
Discharge from Service	Transfer to V. R. C.
Duty	Transportation

FINAL STATEMENT

OF

*Ben Lannard Taylor*  
Co H  
4<sup>th</sup> Reg't of U. S. Colored Cav

VOLUNTEERS.

*Wm. J. ...*

NOTE 1.—Two of these certificates (or duplicates) are to be given to each Volunteer Soldier or drafted man who may be discharged previously to the discharge of his company, that he may at once receive from the Paymaster the pay, &c., due him, and the captain or other COMMISSIONED officer commanding the company will certify to the act of the delivery of the duplicate certificates; on these certificates the Soldier is "entitled to" his discharge, and should also present his discharge to the Paymaster to have the payment endorsed on it. The discharge is to be given back to the Soldier by the Paymaster; the latter only retaining as his voucher the duplicate certificates.

NOTE 2.—If the Soldier is entitled to pay for the use of his horse, the Company Commander will certify to that fact on the back of both these final statements, and also to the time he has pay due for having been so mounted on his own horse.

NOTE 3.—When a Soldier is furnished with final statements, his descriptive list, if he has one, should be taken up by the officer who gives the Soldier these statements, and endorsed with a statement to this effect by the officer. This endorsement should exhibit a full statement of the time for which the Soldier was allowed pay on his final statements, the clothing account, and all other charges against him or in his favor, so as to comprise a complete exhibit of his account. It will then be transmitted to the company commander of the Soldier, who will enter all the data necessary to a full understanding of the Soldier's account on the muster roll upon which the Soldier's discharge is reported. The descriptive list will then be destroyed. The object of this is, that the remaining portion of the Soldier's account may be settled upon the receipt of these muster rolls, and the Soldier receive any pay or allowances that may be due him at the time of his discharge, and which may not appear on his final statements from the fact that his descriptive list is incomplete. These accounts for back pay, &c., are settled by the 2d Auditor of the Treasury Department.

NOTE 4.—Charges for loss or injury to ordnance, horse equipments, and other miscellaneous charges, should appear under the heading of "Other Charges."

NOTE 5.—Bounty paid by State authorities, and not by the United States, will not be entered on this statement.

NOTE 6.—Amounts due the Sutler and Laundress must be entered on the muster roll on which the discharge, death, desertion, &c., is reported, as well as on the final statement, otherwise the amount cannot be collected from the United States.

NOTE 7.—This blank will be used for deceased volunteers and drafted men, as well as for others.

NOTE 8.—Where a Soldier dies in Hospital or on detached service, his descriptive list, if he has one, should be sent with his final statements, in duplicate, to the Second Auditor, Washington, D. C.

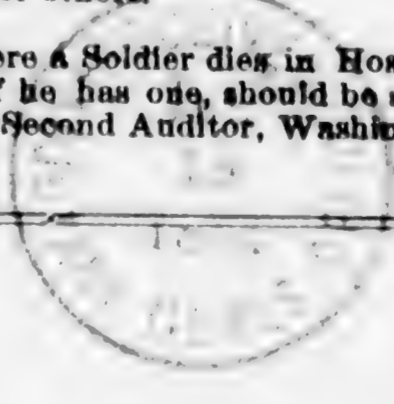

*July 19*

ADJUTANT GENERAL'S OFFICE.  
*July 19 1861*  
Duplicate with Inventory sent 2d Auditor.



MAY 1864

I certify, on honor, that Ben Townsend Taylor a Private of  
Captain Baters Company (76) of the 4<sup>th</sup> Regiment of U.S. Colored Cav-  
**VOLUNTEERS**, of the State of \_\_\_\_\_, born in Port Gibson, State  
of Miss, aged 18 years; 5 feet 3 inches high; Dark complexion,  
Blk eyes, Blk hair, and by occupation a Writer, having joined the company on  
its original organization at New Orleans La, and enrolled in it at the muster into  
the service of the United States at New Orleans La, on the Eighth day  
of April, 1864, (or was mustered in service as a recruit, by \_\_\_\_\_  
at \_\_\_\_\_, on the \_\_\_\_\_ day of \_\_\_\_\_,  
186 , or was drafted and mustered into the service of the United States from the \_\_\_\_\_  
Enrollment District of the State of \_\_\_\_\_, at \_\_\_\_\_,  
on the \_\_\_\_\_ day of \_\_\_\_\_, 186 ) to serve in the Regiment, for  
the term of three years: and having served HONESTLY and  
FAITHFULLY with his Company in New Orleans La to the present date, is now  
entitled to a **DISCHARGE** by reason of Death Died in Co Quarters  
Camp Halifax Greenville La June 15<sup>th</sup> 1864 of Dysentery

The said Ben Townsend Taylor was last paid by Paymaster  
Mag' Noormanis to include the 30<sup>th</sup> day of April, 1864, and has  
pay due him from that time to the present date; he is entitled to pay and subsistence for  
TRAVELING to place of enrollment, and whatever other allowances are authorized to volunteer  
soldiers, drafted men, or militia, so discharged. He has received from the United States **CLOTHING**  
amounting to 31 <sup>58</sup>/<sub>100</sub> dollars, since the 14<sup>th</sup> day of February,  
1864, when his clothing account was last settled. He has received from the United States  
\_\_\_\_\_/<sub>100</sub> dollars advanced **BOUNTY**.

There is to be stopped from him, on account of the State of \_\_\_\_\_, or other  
authorities, for **CLOTHING, &c.**, received on entering service, \_\_\_\_\_/<sub>100</sub> dollars; and  
for other stoppages, viz: \_\_\_\_\_

\_\_\_\_\_ dollars.  
He has been furnished with **TRANSPORTATION** in kind from the place of his discharge to  
\_\_\_\_\_ ; and he has been **SUBSISTED** for **TRAVELING** to his  
place of enrollment, up to the \_\_\_\_\_, 186 .

He is indebted to \_\_\_\_\_, **BUTLER**, \_\_\_\_\_ dollars.

He is indebted to \_\_\_\_\_, **LAUNDRESS**, \_\_\_\_\_ dollars.

Given in Duplicate, at Camp Parapet La, this 20<sup>th</sup> day  
of June, 1864.

Jas W Ellers

20<sup>th</sup> Lieut

Commanding Company.

Taylor, Essey

Co H, 4 U. S. Col'd Cav.

Private

Private

CARD NUMBERS.

1	5 3 4 7 9 2 6	26
2	5 3 5 7 2 2 3	27
3	5 3 5 7 2 7 9	28
4	5 3 5 7 3 3 2	29
5	5 3 5 7 3 8 8	30
6	5 3 5 7 4 4 6	31
7	5 3 5 8 1 2 1	32
8	4 0 7 2 9 2 5 2	33
9		34
10		35
11		36
12		37
13		38
14		39
15		40
16		41
17		42
18		43
19		44
20		45
21		46
22		47
23		48
24		49
25		50

Book Mark:

See also

NOV 1950

Ref 471701

D. Jordan  
EJ

4 Cav. U.S.C.T.

Essey Taylor

Appears with rank of Private on

**Muster and Descriptive Roll of a Detachment of U. S. Vols. forwarded**

for the 4 Reg't U. S. Col'd Cavalry. Roll dated  
New Orleans La, Apr 8, 1864.

Where born Bayou Bourf

Age 18 y'rs; occupation laborer

When enlisted March 22, 1864

Where enlisted Alexandria

For what period enlisted 3 years.

Eyes Black; hair Black

Complexion Black; height 5 ft. 4 in.

When mustered in Apr 8, 1864.

Where mustered in New Orleans

Bounty paid \$ 100; due \$ 100

Where credited

Company to which assigned A

Remarks:

Book mark:

(339)

Ballade

Copyist.

*G* | **4 Cav.** | **U.S.C.T.**

*Essex Taylor*  
*Priv.*, Co. H, 4 Regt U. S. Col'd Cavalry.

Appears on

**Company Muster-in and Descriptive Roll**  
of the organization named above. Roll dated

*New Orleans, La, Apr 8*, 186*4*

Where born *Bayou Boeuf, La*

Age *18* y'rs; occupation *Laborer*

When enlisted *Mar, 22*, 186*4*

Where enlisted *Alexandria, La*

For what period enlisted *3* years.

Eyes *black*; hair *black*

Complexion *black*; height *5* ft. *4* in.

When mustered in *Apr, 8*, 186*4*.

Where mustered in *New Orleans, La*

Bounty paid \$ *2* <sup>100</sup>; due \$ <sup>100</sup>

Where credited

Company to which assigned

Remarks:

Book mark:

(356d)

*C. Williams,*  
Copyist.

9 | **4 Cav.** | **U.S.C.T.**

*Ossey Taylor*  
-----  
*Priv.*, Co. H, 4 Reg't U. S. Col'd Cavalry.

Appears on

**Company Muster Roll**

for *Apr. 8 to 30*, 186 *4*

Present or absent *Present.*

Stoppage, \$ 100 for -----

Due Gov't, \$ 100 for -----

Valuation of horse, \$ 100

Valuation of horse equipments, \$ 100

Remarks: -----  
-----  
-----  
-----  
-----  
-----  
-----  
-----  
-----

Book mark: -----

(358)

*C. Williams*  
-----  
Copyist.

*T* | **4 Cav.** | **U.S.C.T.**

*Essex Taylor*  
*Priv.*, Co. H, 4 Reg't U. S. Col'd Cavalry.

Appears on

**Company Muster Roll**

for *May & June*, 186*4*

Present or absent *Present*

Stoppage, \$ *100* for

Due Gov't, \$ *100* for

Valuation of horse, \$ *100*

Valuation of horse equipments, \$ *100*

Remarks:

Book mark:

*L. Williams*  
Copyist.

*T* | **4 Cav.** | **U.S.C.T.**

*Casser Taylor*

*Pl't*, Co. H, 4 Reg't U. S. Col'd Cavalry.

Appears on

**Company Muster Roll**  
for *July & Aug.*, 1864.

Present or absent *Absent*

Stoppage, \$ *100* for

Due Gov't, \$ *100* for

Valuation of horse, \$ *100*

Valuation of horse equipments, \$ *100*

Remarks: *Sick in S.A. Afrique  
New Hosp. at New Or-  
leans since July 13 '64.*

Book mark:



9 | **4 Cav.** | **U.S.C.T.**

*Essex Taylor*

*Pvt.*, Co. H, 4 Reg't U. S. Col'd Cavalry.

Appears on

**Company Muster Roll**

for *Sept. + Oct.*, 1864

Present or absent

Stoppage, \$ 100 for

Due Gov't, \$ 100 for

Valuation of horse, \$ 100

Valuation of horse equipments, \$ 100

Remarks: *Died in bed of-  
rigue Gen'l Hosp. New  
Orleans, La. Aug. 31, 1864*

Book mark:

*C. Williams,*

(358)

Copyist.

31 | 4 Cav. | U.S.C.T.

Ossex Taylor

Port, Co. H, 4 Reg't U. S. Colored Cav.

Appears on Returns as follows:

July 1864 - Absent sick sent to  
G. H. July 13/64

Aug 1864 - Absent sick in Hosp  
at N. Orleans since July  
13/64

Sept 1864 - Loss: Aug 31/64  
Port Hudson died in  
Regt Hospital.

Oct 1864 - Loss: Aug 31/64 New  
Orleans died in Genl. Hospital

Book mark: \_\_\_\_\_

W. R. Lee

*S* | **4 Cav.** | **U.S.C.T.**

*Essex Taylor*  
-----  
*Pri*, Co. *A*, 4 Reg't U. S. Col'd Cavalry.

Appears on **Co. Muster-out Roll**, dated  
*New Orleans La, Mich 20*, 186*6*.

Muster-out to date -----, 186 .

Last paid to -----, 186 .

**Clothing account:**

Last settled -----, 186 ; drawn since \$ ----- 100

Due soldier \$ ----- 100; due U. S. \$ ----- 100

Am't for cloth'g in kind or money adv'd \$ ----- 100

Due U. S. for arms, equipments, &c., \$ ----- 100

Bounty paid \$ ----- 100; due \$ ----- 100

Remarks: *Joined at Orgl. Orgi.*  
*Died in G'd. A. Genl.*  
*Hosptl. New Orleans La.*  
*Aug. 31/64. Final state-*  
*ments forwarded.*

Book mark: -----

(861)

*H. C. Stewart*  
-----  
Copyist.

Taylor, Essex

P. A. 4 Reg't U.S.C. Cav.  
Co.

4 Enclosures.

Bed Cards	Descriptive Lists
Burial Records 1	Final Statements 2
Certs. of Dis. for Discharge	Furloughs
C. M. Charges	Med. Des. Lists
Med. Certificates	Orders

Other papers relating to—

Admission to Hosp'l	Furlough
Casualty Sheet (Officer's)	Med. Examination
Confinement	Misc. Information
Contracts	Pay or Clothing
Death or Effects 1	Personal Reports
Desertions	Rank
Discharge from Hosp'l	Transfer to Hosp'l
Discharge from Service	Transfer to V. R. C.
Duty	Transportation

ARTICLES OF WAR.

ART. 95. When any non-commissioned officer or soldier shall die, or be killed in the service of the United States, the then commanding officer of the troop or company shall, in the presence of two other commissioned officers, take an account of what effects he died possessed of, above his arms and accoutrements, and transmit the same to the office of the Department of War, which said effects are to be accounted for, and paid to the representatives of such deceased non-commissioned officer or soldier. And in case any of the officers, so authorized to take care of the effects of deceased officers and soldiers, should, before they have accounted to their representatives for the same, have occasion to leave the regiment or post, by preferment or otherwise, they shall, before they be permitted to quit the same, deposit in the hands of the commanding officer, or of the assistant military agent, all the effects of such deceased non-commissioned officers and soldiers, in order that the same may be secured for, and paid to, their respective representatives.

ARMY REGULATIONS—EDITION OF 1861.

DECEASED SOLDIERS.

Par. 152. Inventories of the effects of deceased non-commissioned officers and soldiers, required by the 95th Article of War, will be forwarded to the Adjutant General, by the commander of the company to which the deceased belonged, and a duplicate of the same to the colonel of the regiment. Final statements of pay, clothing, &c., will be sent with the inventories. When a soldier dies at a post or station absent from his company, it will be the duty of his immediate commander to furnish the required inventory, and, at the same time, to forward to the commanding officer of the company to which the soldier belonged, a report of his death, specifying the date, place, and cause; to what time he was last paid, and the money or other effects in his possession at the time of his decease; which report will be noted on the next muster roll of the company to which the man belonged. Each inventory will be endorsed, "Inventory of the effects of \_\_\_\_\_, late of company (—) \_\_\_\_\_ regiment of \_\_\_\_\_, who died at \_\_\_\_\_, the \_\_\_\_\_ day of \_\_\_\_\_, 186—." If a legal representative receive the effects, it will be stated in the report. If the soldier leave no effects, the fact will be reported.

Par. 153. Should the effects of a deceased non-commissioned officer or soldier not be administered upon within a short period after his decease, they shall be disposed of by a Council of Administration, under the authority of the commanding officer of the post, and the proceeds deposited with the Paymaster, to the credit of the United States, until they shall be claimed by the legal representatives of the deceased.

Par. 154. In all such cases of sales by the Council of Administration, a statement in detail, or account of the proceeds, duly certified by the Council and commanding officer, accompanied by the Paymaster's receipt for the proceeds, will be forwarded by the commanding officer to the Adjutant General. The statement will be endorsed, "Report of the proceeds of the effects of \_\_\_\_\_, late of company (—) \_\_\_\_\_ regiment of \_\_\_\_\_, who died at \_\_\_\_\_, the \_\_\_\_\_ day of \_\_\_\_\_, 186—."

NOTE 1.—The effects in all cases, when called for, should be turned over to the legal representative, without further authority from the Adjutant General. When the effects are turned over to the relatives of the deceased before these inventories are sent to the Adjutant General, their receipts therefor should be attached to the inventories. In all other cases, one copy will be sent with a letter of transmittal direct to the Adjutant General, and a duplicate retained by the officer.

NOTE 2.—Particular care should be taken to take receipts in duplicate from the Paymaster for any funds turned over to him; one copy should be sent direct to the Adjutant General and one retained by the officer.

*Duplicate*

INVENTORY OF THE EFFECTS

OF *Private*  
*Ernest Taylor*

Late of Company *H.*  
*4<sup>th</sup>* Reg't of *2<sup>d</sup> H<sup>o</sup> Car*

Volunteers, who died at *Cadwell Hospital*  
on the *31* day of *August* 1864.

Inventory of the effects of Essex Taylor late  
 a Private of <sup>1<sup>st</sup> Lieut</sup> Captain Rauy Rowles Company H of  
 the 4<sup>th</sup> Regiment of U S C Cav Volunteers, who was enrolled as  
 a Private at Alexandria in the State of Louisiana on  
 the 22<sup>nd</sup> day of March 1864, and mustered into the service of the United  
 States as a Private on the 8<sup>th</sup> day of April 1864, at New Orleans  
 in Company H, 4<sup>th</sup> Regiment of U S C Cav Volunteers, to serve Three  
 years or during the war; he was born in Bayou Boeuf in the State  
 of Louisiana; he was 18 years of age, 5 feet 4 inches  
 high, Blk complexion, Blk eyes, Blk hair, and by occupation, when enrolled,  
 a Sawyer; he died in Cadizque Gen Hospital, at  
New Orleans La on the 31<sup>st</sup> day of August 1864, by  
 reason of Typhoid Fever

INVENTORY.					
ARTICLES.	No.	ARTICLES.	No.	ARTICLES.	No.
Hats.....		Pairs trousers.....		Knapsacks.....	
Caps.....		Pairs flannel drawers.....			
Forage caps.....		Pairs cotton drawers.....			
Great coats.....		Flannel shirts.....			
Uniform coats.....		Cotton shirts.....			
Uniform jackets.....		Pairs boots.....			
Flannel sack coats.....		Pairs shoes.....			
Blouses.....		Pairs socks.....			
Stable frocks.....		Blankets.....		MONEY.	
Fatigue overalls.....		Haversacks.....		Specie.....	\$
				Notes.....	\$

I CERTIFY, ON HONOR, that the above inventory comprises all the effects of \_\_\_\_\_  
 \_\_\_\_\_, deceased, and that the effects are in the hands  
 of \_\_\_\_\_ at \_\_\_\_\_  
 \_\_\_\_\_ to be disposed of by a Council of Administration.

( DUPLICATES. )

STATION: New Orleans La

DATE: August 31 1864

Surgeon Charge Cadizque Gen Hospital  
 Commanding the Company.

1864



*Essay Taylor*  
*G. H. Taylor & Co.*

COPY OF RECORD

FOR THE

ADJUTANT GENERAL U. S. ARMY.

RECORD OF DEATH AND INTERMENT.

Name and number of person interred,	<i>Essex Taylor</i>
Number and locality of the grave, -	
Hospital number of the deceased, -	<i>1541.</i>
Regiment, Rank, and Company, - -	<i>4<sup>th</sup> U.S. Col. Cav'y. Private - H.</i>
Residence before enlistment, - - -	
Conjugal condition (and if married, ) the residence of the widow, )	
Cause of death, )	<i>Typhoid Fever</i>
Age of the deceased, - - - - -	
Nativity, - - - - -	
References and Remarks, - - )	
Date of death and burial, - - -	<i>August 31<sup>st</sup> / 64</i>

186

[A duplicate of this Record has been forwarded to the Sexton, and the other remains at this Hospital.]

To *Adj. General U. S. A.*

SIR :

It becomes my duty to inform you that the person above described died at this Hospital as herein stated: and that it is desired his remains should be interred with the usual military honors.

Respectfully,

*F. E. Pyquette*  
Surgeon U. S. Army.

MILITARY HOSPITAL, *Corps d'Afrique N. Orleans La*

*86 U.S. Col. Inf.*

This copy of Record is to be transmitted to the Adjutant General at Washington immediately after the place of burial and the number of the grave have been ascertained and registered. The above notification is to remain attached.



RECEIVED

110

FINAL STATEMENT

OF

*Private*  
*Emose Taylor*

*4th* Reg't of *2d S.C. Cav*

VOLUNTEERS.

*Nov 1, 1864*

NOTE 1.—Two of these certificates (or duplicates) are to be given to each Volunteer Soldier or drafted man who may be discharged previously to the discharge of his company, that he may at once receive from the Paymaster the pay, &c., due him, and the captain or other COMMISSIONED officer commanding the company will certify to the act of the delivery of the duplicate certificates; on these certificates the Soldier is "entitled to" his discharge, and should also present his discharge to the Paymaster to have the payment endorsed on it. The discharge is to be given back to the Soldier by the Paymaster; the latter only retaining as his voucher the duplicate certificates.

NOTE 2.—If the Soldier is entitled to pay for the use of his horse, the Company Commander will certify to that fact on the back of both these final statements, and also to the time he has pay due for having been so mounted on his own horse.

NOTE 3.—When a Soldier is furnished with final statements, his descriptive list, if he has one, should be taken up by the officer who gives the Soldier these statements, and endorsed with a statement to this effect by the officer. This endorsement should exhibit a full statement of the time for which the Soldier was allowed pay on his final statements, the clothing account, and all other charges against him or in his favor, so as to comprise a complete exhibit of his account. It will then be transmitted to the company commander of the Soldier, who will enter all the data necessary to a full understanding of the Soldier's account on the muster roll upon which the Soldier's discharge is reported. The descriptive list will then be destroyed. The object of this is, that the remaining portion of the Soldier's account may be settled upon the receipt of these muster rolls, and the Soldier receive any pay or allowances that may be due him at the time of his discharge, and which may not appear on his final statements from the fact that his descriptive list is incomplete. These accounts for back pay, &c., are settled by the 2d Auditor of the Treasury Department.

NOTE 4.—Charges for loss or injury to ordnance, horse equipments, and other miscellaneous charges, should appear under the heading of "Other Stoppages."

NOTE 5.—Bounty paid by State authorities, and not by the United States, will not be entered on this statement.

NOTE 6.—Amounts due the Sutler and Laundress must be entered on the muster roll on which the discharge, death, desertion, &c., is reported, as well as on the final statement, otherwise the amount cannot be collected from the United States.

NOTE 7.—This blank will be used for deceased volunteers and drafted men, as well as for others.

NOTE 8.—Where a Soldier dies in Hospital or on detached service, his descriptive list, if he has one, should be sent with his final statements, in duplicate, to the Adjutant General, Washington, D. C.

ADJUTANT GENERAL'S OFFICE.

*Oct 11 1864*

Duplicate with Inventory sent 2d Auditor.



I certify, on honor, that *Essex Taylor* a *Private* of  
*Lieut* *Captain R. A. Parks* Company (*B*) of the *4th* Regiment of *U S C Cav*  
**VOLUNTEERS**, of the State of *Louisiana*, born in *Bayou Boeuf*, State  
of *Louisiana*, aged *18* years; *5* feet *4* inches high; *Blk* complexion,  
*Blk* eyes, *Blk* hair, and by occupation a *Sabrer*, having joined the company on  
its original organization at \_\_\_\_\_, and enrolled in it at the muster into  
the service of the United States at *Alexandria La*, on the *22nd* day  
of *March*, 1864, (or was mustered in service as a recruit, by \_\_\_\_\_  
\_\_\_\_\_, at \_\_\_\_\_, on the \_\_\_\_\_ day of \_\_\_\_\_,  
1864, or was drafted and mustered into the service of the United States from the \_\_\_\_\_  
Enrollment District of the State of \_\_\_\_\_, at \_\_\_\_\_,  
on the \_\_\_\_\_ day of \_\_\_\_\_, 1864,) to serve in the Regiment, for  
the term of *Three years*: and having served **HONESTLY** and  
**FAITHFULLY** with his Company in *Dept of the Gulf* to the present date, is now  
entitled to a **DISCHARGE** by reason of *Death*

*by Typhoid Fever New Orleans La Aug 31st 1864*  
The said *Essex Taylor* was last paid by Paymaster  
*May Loftund* to include the *30th* day of *April*, 1864, and has  
pay due him from that time to the present date; he is entitled to pay and subsistence for  
**TRAVELING** to place of enrollment, and whatever other allowances are authorized to volunteer  
soldiers, drafted men, or militia, so discharged. He has received from the United States **CLOTHING**  
amounting to *Thirty two*  $\frac{81}{100}$  dollars, since the \_\_\_\_\_ day of *Enrollment*,  
1864, when his clothing account was last settled. He has received from the United States  
\_\_\_\_\_  $\frac{100}{100}$  dollars advanced **BOUNTY**.

There is to be stopped from him, on account of the State of \_\_\_\_\_, or other  
authorities, for **CLOTHING**, &c., received on entering service, \_\_\_\_\_  $\frac{100}{100}$  dollars; and  
for other stoppages, viz: \_\_\_\_\_

\_\_\_\_\_  $\frac{100}{100}$  dollars.  
He has been furnished with **TRANSPORTATION** in kind from the place of his discharge to  
\_\_\_\_\_; and he has been **SUBSISTED** for **TRAVELING** to his  
place of enrollment, up to the \_\_\_\_\_, 1864.

He is indebted to \_\_\_\_\_, **SUTLER**, \_\_\_\_\_  $\frac{100}{100}$  dollars.  
He is indebted to \_\_\_\_\_, **LAUNDRESS**, \_\_\_\_\_  $\frac{100}{100}$  dollars.

Given in Duplicate, at *New Orleans La*, this *31st* day  
of *August*, 1864.

*F. E. Piquette*  
*Surgeon in charge C. A. Mays Gen Hospital*  
*Commanding Company*

*Triplicates* *Aug 31 1864*

FINAL STATEMENT

OF

*Private*  
*Ezra Taylor*

*4<sup>th</sup>* Reg't of *U S C Cavalry*

VOLUNTEERS.

*C. A. Hoop*

NOTE 1.—Two of these certificates (or duplicates) are to be given to each Volunteer Soldier or drafted man who may be discharged previously to the discharge of his company, that he may at once receive from the Paymaster the pay, &c., due him, and the captain or other COMMISSIONED officer commanding the company will certify to the act of the delivery of the duplicate certificates; on these certificates the Soldier is "entitled to" his *discharge*, and should also present his discharge to the Paymaster to have the payment endorsed on it. The discharge is to be given back to the Soldier by the Paymaster; the latter only retaining as his voucher the duplicate certificates.

NOTE 2.—If the Soldier is entitled to pay for the use of his horse, the Company Commander will certify to that fact on the back of both these final statements, and also to the time he has pay due for having been so mounted on his own horse.

NOTE 3.—When a Soldier is furnished with final statements, his descriptive list, if he has one, should be taken up by the officer who gives the Soldier these statements, and endorsed with a statement to this effect by the officer. This endorsement should exhibit a full statement of the time for which the Soldier was allowed pay on his final statements, the clothing account, and all other charges against him or in his favor, so as to comprise a complete exhibit of his account. It will then be transmitted to the company commander of the Soldier, who will enter all the data necessary to a full understanding of the Soldier's account on the muster roll upon which the Soldier's discharge is reported. The descriptive list will then be destroyed. The object of this is, that the remaining portion of the Soldier's account may be settled upon the receipt of these muster rolls, and the Soldier receive any pay or allowances that may be due him at the time of his discharge, and which may not appear on his final statements from the fact that his descriptive list is incomplete. These accounts for back pay, &c., are settled by the 2d Auditor of the Treasury Department.

NOTE 4.—Charges for loss or injury to ordnance, horse equipments, and other miscellaneous charges, should appear under the heading of "Other Stoppages."

NOTE 5.—Bounty paid by State authorities, and not by the United States, will not be entered on this statement.

NOTE 6.—Amounts due the Sutler and Laundress must be entered on the muster roll on which the discharge, death, desertion, &c., is reported, as well as on the final statement, otherwise the amount cannot be collected from the United States.

NOTE 7.—This blank will be used for deceased volunteers and drafted men, as well as for others.

NOTE 8.—Where a Soldier dies in Hospital or on detached service, his descriptive list, if he has one, should be sent with his final statements, in duplicate, to the Adjutant General, Washington, D. C.

I certify, on honor, that *Essex Taylor* a *Private* of  
*1st Lieut* *Raymond* Company (*H*) of the *4th* Regiment of *U.S.C. Cav*  
**VOLUNTEERS**, of the State of *Louisiana*, born in *Bayou Boeuf*, State  
of *Louisiana*, aged *18* years; *5* feet *4* inches high; *Blk* complexion,  
*Blk* eyes, *Blk* hair, and by occupation a *Sailor*, having joined the company on  
its original organization at \_\_\_\_\_, and enrolled in it at the muster into  
the service of the United States at *Alexandria La*, on the *22<sup>nd</sup>* day  
of *March*, 1864, (or was mustered in service as a recruit, by \_\_\_\_\_  
at \_\_\_\_\_, on the \_\_\_\_\_ day of \_\_\_\_\_,  
1864, or was drafted and mustered into the service of the United States from the \_\_\_\_\_  
Enrollment District of the State of \_\_\_\_\_, at \_\_\_\_\_,  
on the \_\_\_\_\_ day of \_\_\_\_\_, 1864,) to serve in the Regiment, for  
the term of *Three years*; and having served **HONESTLY** and  
**FAITHFULLY** with his Company in *Dept of the Gulf* to the present date, is now  
entitled to a **DISCHARGE** by reason of *Death*

*of Typhoid Fever*  
The said *Essex Taylor* was last paid by Paymaster  
*Maj Liffano* to include the *30<sup>th</sup>* day of *April*, 1864, and has  
pay due him from that time to the present date; he is entitled to pay and subsistence for  
**TRAVELING** to place of enrollment, and whatever other allowances are authorized to volunteer  
soldiers, drafted men, or militia, so discharged. He has received from the United States **CLOTHING**  
amounting to *Thirty two*  $\frac{51}{100}$  dollars, since the \_\_\_\_\_ day of *Enrollment*  
1864, when his clothing account was last settled. He has received from the United States  
\_\_\_\_\_ dollars advanced **BOUNTY**.

There is to be stopped from him, on account of the State of \_\_\_\_\_, or other  
authorities, for **CLOTHING**, &c., received on entering service, \_\_\_\_\_ dollars; and  
for other stoppages, viz: \_\_\_\_\_

\_\_\_\_\_ dollars.  
He has been furnished with **TRANSPORTATION** in kind from the place of his discharge to  
\_\_\_\_\_ ; and he has been **SUBSISTED** for **TRAVELING** to his  
place of enrollment, up to the \_\_\_\_\_, 1864.

He is indebted to \_\_\_\_\_, **SUTLER**, \_\_\_\_\_ dollars.

He is indebted to \_\_\_\_\_, **LAUNDRESS**, \_\_\_\_\_ dollars.

Given in Duplicate, at *New Orleans La*, this *31<sup>st</sup>* day  
of *August*, 1864.

*Surgeon Charge* \_\_\_\_\_ *Co Hospital*  
Commanding Company

Taylor, George

Co B, 4 U. S. Col'd Cav.

Private | Corporal

CARD NUMBERS.

1	5351281	26
2	5351337	27
3	5351390	28
4	5351475	29
5	5351543	30
6	5351599	31
7	5351677	32
8	5351742	33
9	5351810	34
10	5351844	35
11	5351931	36
12	5352042	37
13	5352145	38
14	5352239	39
15	5352327	40
16	5352415	41
17		42
18		43
19		44
20		45
21		46
22		47
23		48
24		49
25		50

Book Mark: EB Vol. 9, P 134

See also

7 | 4 Cav. | U.S.C.T.

George Taylor  
Sgt., Co. C, 1 Reg't La. Cav., Corps d'Afrique.\*

Appears on

**Company Muster-in Roll**

of the organization named above. Roll dated  
New Orleans La, Nov 7, 1863.

Muster-in to date Nov 7, 1863.

Joined for duty and enrolled:

When Oct 12, 1863.

Where New Orleans city

Period 3 years.

Valuation of horse, \$ 100

Valuation of horse equipments, \$ 100

Remarks:  
Ag: 24

\*This organization subsequently became Co. C, 4 Reg't U. S. Colored Cavalry.

Book mark:

(356)

*[Signature]*

Copyist.

*C* | 4 Cav. | U.S.C.T.

*George Taylor*  
Pvt, Co. *C*, 1 Reg't La. Cav., Corps d'Afrique.\*

Appears on

**Company Muster Roll**

for *Nov 7 to Dec 31*, 186*3*

Present or absent *Present*

Stoppage, \$ *100* for

Due Gov't, \$ *100* for

Valuation of horse, \$ *100*

Valuation of horse equipments, \$ *100*

Remarks:

FROM SECOND AUDITOR'S HOLL

\*This organization subsequently became Co. *C*, 4 Reg't U. S. Colored Cavalry.

Book mark:

*Bevnter*

7 | 4 Cav. | U.S.C.T.

George Taylor  
Co. C, 1 Reg't La. Cav., Corps d'Afrique.\*

Appears on

Company Muster Roll

for July - Feb, 1864.

Present or absent Present

Stoppage, \$ 100 for

Due Gov't, \$ 100 for

Valuation of horse, \$ 100

Valuation of horse equipments, \$ 100

Remarks:  
\_\_\_\_\_  
\_\_\_\_\_  
\_\_\_\_\_  
\_\_\_\_\_  
\_\_\_\_\_  
\_\_\_\_\_

\*This organization subsequently became Co. C, 4 Reg't U. S. Colored Cavalry.

Book mark: \_\_\_\_\_

Boehmer



7 | 4 Cav. | U.S.C.T.

*George Taylor*  
*PT*, Co. C, 4 Reg't U. S. Colored Cavalry.

Appears on

**Company Muster Roll**

for *March 1864*, 1864.

Present or absent *Present*

Stoppage, \$ 100 for

Due Gov't, \$ 100 for

Valuation of horse, \$ 100

Valuation of horse equipments, \$ 100

Remarks :

Book mark :

*Robert*

7 | **4 Cav.** | **U.S.C.T.**

George Taylor  
Co. C, Co. C, 4 Reg't U. S. Colored Cavalry.

Appears on

**Company Muster Roll**

for May & June, 1864.

Present or absent Present

Stoppage, \$ 100 for

Due Gov't, \$ 100 for

Valuation of horse, \$ 100

Valuation of horse equipments, \$ 100

Remarks :

Book mark :

(358)

Rockwell

Copyist.

7 | **4 Cav.** | **U.S.C.T.**

George Taylor  
Co. C, Co. C, 4 Reg't U. S. Colored Cavalry.

Appears on

**Company Muster Roll**

for July to Aug, 1864.

Present or absent Present

Stoppage, \$ 100 for

Due Gov't, \$ 100 for

Valuation of horse, \$ 100

Valuation of horse equipments, \$ 100

Remarks :

Book mark :

Proctor

7 | 4 Cav. | U.S.C.T.

George Taylor  
7th, Co. C, 4 Reg't U. S. Colored Cavalry.

Appears on

Company Muster Roll

for Sept 1864, 1864

Present or absent Present

Stoppage, \$ 100 for

Due Gov't, \$ 100 for

Valuation of horse, \$ 100

Valuation of horse equipments, \$ 100

Remarks: No surcharge  
\$1.10

Book mark :

Robert  
(358) Copyist.

7 | 4 Cav. | U.S.C.T.

*George Taylor*  
*Priv*, Co. C, 4 Reg't U. S. Colored Cavalry.

Appears on

**Company Muster Roll**

for *Nov 9 & Dec*, 1864

Present or absent *present*

Stoppage, \$ *1* <sup>*24*</sup>/<sub>100</sub> for *ordnance*

Due Gov't, \$ \_\_\_\_\_ <sup>100</sup> for \_\_\_\_\_

Valuation of horse, \$ \_\_\_\_\_ <sup>100</sup>

Valuation of horse equipments, \$ \_\_\_\_\_ <sup>100</sup>

Remarks: *Lost ordnance*

Book mark: \_\_\_\_\_

(358)

*Moy*  
Copyist.

*J* | 4 Cav. | U.S.C.T.

*George Taylor*  
*Priv*, Co. C, 4 Reg't U. S. Colored Cavalry.

Appears on

**Company Muster Roll**

for *Jan & Feb*, 186*3*.

Present or absent *present*

Stoppage, \$ *100* for

Due Gov't, \$ *100* for

Valuation of horse, \$ *100*

Valuation of horse equipments, \$ *100*

Remarks: *Stop for one curb chain, one surcingle. Received \$7.00 per month to include April 30, 1864.*

Book mark: \_\_\_\_\_

(358)

*Moy*  
Copyist.

*J* | 4 Cav. | U.S.C.T.

*George Taylor*  
*Corpl*, Co. C, 4 Reg't U. S. Colored Cavalry.

Appears on

**Company Muster Roll**

for *March*, 1863.

Present or absent *present*

Stoppage, \$ *100* for

Due Gov't, \$ *100* for

Valuation of horse, \$ *100*

Valuation of horse equipments, \$ *100*

Remarks: *Promoted to Corpl*  
*April 1<sup>st</sup> 1863,*

Book mark: \_\_\_\_\_

(358)

*May*  
Copyist.

*J* | 4 Cav. | U.S.C.T.

*George Taylor*  
Corpl, Co. C, 4 Reg't U. S. Colored Cavalry.

Appears on

**Company Muster Roll**

for *May & June*, 186*6*.

Present or absent *present*

Stoppage, \$ *100* for

Due Gov't, \$ *100* for

Valuation of horse, \$ *100*

Valuation of horse equipments, \$ *100*

Remarks: *Appointed Corporal  
Apr 1, 65, Stop for one  
Canteen & haversack.*

Book mark: \_\_\_\_\_

(358)

*May* Copyist.



J | **4 Cav.** | **U.S.C.T.**

George Taylor  
Corpl, Co. C, 4 Reg't U. S. Colored Cavalry.

Appears on

**Company Muster Roll**

for July & Aug, 1865.

Present or absent present

Stoppage, \$ 100 for

Due Gov't, \$ 100 for

Valuation of horse, \$ 100

Valuation of horse equipments, \$ 100

Remarks: Apptd Corpl Apr 1/65  
Stop for canteen and  
knapsack, Total \$1.60

Book mark: \_\_\_\_\_

(358)

Moy  
Copyist.

7 | **4 Cav.** | **U.S.C.T.**

George Taylor  
Corpl., Co. C, 4 Reg't U. S. Colored Cavalry.

Appears on

**Company Muster Roll**

for Sept & Oct, 1865.

Present or absent present

Stoppage, \$ 100 for

Due Gov't, \$ 100 for

Valuation of horse, \$ 100

Valuation of horse equipments, \$ 100

Remarks: Stop for 1 brush  
wiper 33cts.

Book mark:

(358)

Moy  
Copyist.

*T* | **4 Cav.** | **U.S.C.T.**

*George Taylor*  
-----  
*Privt.*, Co. C, 4 Reg't U. S. Colored Cavalry.

Appears on

**Company Muster Roll**

for *Nov & Dec*, 186*5*.

Present or absent *present*

Stoppage, \$ *20* / *100* for *Lost*  
*ordnance*

Due Gov't, \$ *100* for

Valuation of horse, \$ *100*

Valuation of horse equipments, \$ *100*

Remarks: -----  
-----  
-----  
-----  
-----  
-----  
-----  
-----  
-----  
-----

Book mark: -----

(358)

*M. A. Michaels*  
-----  
Copyist.

*J* | **4 Cav.** | **U.S.C.T.**

*George Taylor*  
*Corpl*, Co. C, 4 Reg't U. S. Colored Cavalry.

Appears on

**Company Muster Roll**

for *Jan'y & Feb'y*, 186*6*.

Present or absent *Present*

Stoppage, \$ *20* / *100* for *Last*  
*Ordnance*

Due Gov't, \$ *100* for

Valuation of horse, \$ *100*

Valuation of horse equipments, \$ *100*

Remarks:  
.....  
.....  
.....  
.....  
.....  
.....  
.....  
.....

Book mark: .....

*M. A. Michaels*  
(358) *Copyist.*

*J* | **4 Cav.** | **U.S.C.T.**

*George Taylor*  
Copt. *C*, Co. *C*, 4 Reg't U. S. Col'd Cavalry.

Appears on **Co. Muster-out Roll**, dated  
*New Orleans La Mar 20*, 1866.

Muster-out to date *Mar. 20*, 1866.

Last paid to *June 30*, 1865.

Clothing account:

Last settled....., 186 ; drawn since \$..... 100

Due soldier \$..... 100; due U. S. \$ *50* <sup>*34*</sup>/<sub>100</sub>

Am't for cloth'g in kind or money adv'd \$..... 100

Due U. S. for arms, equipments, &c., \$..... *20*/<sub>100</sub>

Bounty paid \$..... 100; due \$..... 100

Remarks: *Joined Orig. Org.*

*Private to Apr 1/65. Copt. to*  
*July 1/65. Private to July 23/65*  
*Step 1. Brush wiper*

Book mark: *E. B. Vol. 9 P. 134*

*M. A. Michaels*

(361)

Copyist.

*Weyler, James*

Co *B*, *4* U. S. Col'd Cav.

*Private*

*Private*

CARD NUMBERS.

1	<i>5347848</i>	26
2	<i>5350160</i>	27
3	<i>5350255</i>	28
4	<i>5350356</i>	29
5	<i>5351234</i>	30
6	<i>40729254</i>	31
7		32
8		33
9		34
10		35
11		36
12		37
13		38
14		39
15		40
16		41
17		42
18		43
19		44
20		45
21		46
22		47
23		48
24		49
25		50

Book Mark:

See also

*D* | **4 Cav. | U.S.C.T.**

*James Taylor*  
Appears with rank of *Private* on

**Muster and Descriptive Roll of a Detachment of U. S. Vols. forwarded**

for the 4 Reg't U. S. Col'd Cavalry. Roll dated  
*New Orleans La. Mch 11, 1864*

Where born *Jefferson La.*

Age *26* y'rs; occupation *Cooper*

When enlisted *Mch 2*, 1864

Where enlisted *New Orleans*

For what period enlisted *3* years.

Eyes *DK*; hair *DK*

Complexion *Yellow*; height *5* ft. in.

When mustered in *Mch 11*, 1864

Where mustered in *New Orleans*

Bounty paid \$ *100*; due \$ *100*

Where credited

Company to which assigned *B*

Remarks:

Book mark:

*Dallade*

*J* | **4 Cav.** | **U.S.C.T.**

*James Taylor*

*Co. B.*, Co. B. 4 Reg't U. S. Col'd Cavalry.

Appears on

**Company Muster Roll**

for *March & Apr*, 186*4*.

Present or absent *Present*

Stoppage, \$ *100* for

Due Gov't, \$ *100* for

Valuation of horse, \$ *100*

Valuation of horse equipments, \$ *100*

Remarks :

Book mark :

*J. W. W.*  
(358) *J. W. W.* Copyist.



*J* | **4 Cav.** | **U.S.C.T.**

*James Taylor*  
-----  
*Co.*, Co. B. 4 Reg't U. S. Col'd Cavalry.

Appears on

**Company Muster Roll**

for *May & June*, 186*4*.

Present or absent *Absent*

Stoppage, \$ 100 for -----

Due Gov't, \$ 100 for -----

Valuation of horse, \$ 100

Valuation of horse equipments, \$ 100

Remarks: *Absent without*  
*leave since June 29, 1864*

Book mark: -----

(358)

*[Signature]*  
-----  
Copyst.

1877 1044

*T* | **4 Cav.** | **U.S.C.T.**

*James Taylor*  
*Co.*, Co. B. 4 Reg't U. S. Col'd Cavalry.

Appears on  
**Company Muster Roll**  
for *July & Aug.*, 186*6*.

Present or absent \_\_\_\_\_  
Stoppage, \$ 100 for \_\_\_\_\_

Due Gov't, \$ 100 for \_\_\_\_\_

Valuation of horse, \$ 100  
Valuation of horse equipments, \$ 100

Remarks: *Deserted at Camp*  
*Parapet. Ga. July 3, 1866*  
*Due U.S. for Ordnance \$12.00*

Book mark: \_\_\_\_\_

(358)

*Wm*  
Copyist.

5 | 4 Cav. | U.S.C.T.

James Taylor  
Priv., Co. B, 4 Reg't U. S. Colored Cav.

Appears on Returns as follows:

Mich 1864 - (1 Regt Cav., Corps d'Afrique)  
Gain: Mar 30/64 N. Orleans  
Rec'd from Recruitg. Depot.

June to Aug 1864 - absent without  
leave since June 28/64  
(4 Regt U. S. Col'd. Cav.)

Sept 1864 - Loss: June 25/64  
Camp Parapet, deserted.

Book mark:

W. R. Lee

*J* | **4 Cav.** | **U.S.C.T.**

*James Taylor*

, Co. *B*, 4 Reg't U. S. Col'd Cavalry.

Appears on **Co. Muster-out Roll**, dated  
*New Orleans, La, Feb. 20*, 1866.

Muster-out to date \_\_\_\_\_, 186 .

Last paid to \_\_\_\_\_, 186 .

Clothing account:

Last settled *Never*, 186 ; drawn since \$ *24* <sup>*61*</sup>/<sub>100</sub>

Due soldier \$ \_\_\_\_\_100; due U. S. \$ \_\_\_\_\_100

Am't for cloth'g in kind or money adv'd \$ \_\_\_\_\_100

Due U. S. for arms, equipments, &c., \$ \_\_\_\_\_100

Bounty paid \$ \_\_\_\_\_100; due \$ \_\_\_\_\_100

Remarks: *Joined as Recruit*  
*Presented at Camp Parapet, La.*  
*June 28, 64.*

Book mark : \_\_\_\_\_

(361)

*Chandler*  
Copyist.

1030

Taylor, James  
Co B, 4 U. S. Col'd Cav.

Private | Private

CARD NUMBERS.

1	535/283	26
2	535/339	27
3	535/391	28
4	535/476	29
5	535/559	30
6	535/623	31
7	535/2534	32
8	40729253	33
9		34
10		35
11		36
12		37
13		38
14		39
15		40
16		41
17		42
18		43
19		44
20		45
21		46
22		47
23		48
24		49
25		50

Book Mark:

See also

7 | **4 Cav.** | **U.S.C.T.**

*James Taylor*  
Sgt., Co. *C* 1 Reg't La. Cav., Corps d'Afrique.\*

Appears on

**Company Muster-in Roll**

of the organization named above. Roll dated

*New Orleans, La. Nov 7*, 186*3*.

Muster-in to date

*Nov 7*, 186*3*.

Joined for duty and enrolled:

When

*Oct 13*, 186*3*.

Where

*New Orleans city*

Period

*3* years.

Valuation of horse, \$.....100

Valuation of horse equipments, \$.....100

Remarks:

*Apr: 25*

\*This organization subsequently became Co. *C*, 4 Reg't U. S. Colored Cavalry.

Book mark:

*Recher*

*C* | **4 Cav. | U.S.C.T.**

*James Taylor*  
*Pvt.*, Co. *C*, 1 Reg't La. Cav., Corps d'Afrique.\*

Appears on

**Company Muster Roll**

for *Nov 31*, 1863.

Present or absent *Present*

Stoppage, \$ 100 for

Due Gov't, \$ 100 for

Valuation of horse, \$ 100

Valuation of horse equipments, \$ 100

Remarks:

**FROM SECOND AUDITOR'S ROLL.**

\*This organization subsequently became Co. *C*, 4 Reg't U. S. Colored Cavalry.

Book mark:

*Rochester*

7 | **4 Cav. | U.S.C.T.**

James Taylor  
Pl. Co. C, 1 Reg't La. Cav., Corps d'Afrique.\*

Appears on

**Company Muster Roll**

for Aut Feb, 1864.

Present or absent Present

Stoppage, \$ 100 for

Due Gov't, \$ 100 for

Valuation of horse, \$ 100

Valuation of horse equipments, \$ 100

Remarks: Teamster

\*This organization subsequently became Co. C, 4 Reg't U. S. Colored Cavalry.

Book mark: \_\_\_\_\_

Beater  
Copyist,



7 | **4 Cav.** | **U.S.C.T.**

*James Taylor*  
-----  
*Pvt.*, Co. C, 4 Reg't U. S. Colored Cavalry.

Appears on

**Company Muster Roll**

for *March to April*, 1864.

Present or absent *Present*

Stoppage, \$ 100 for -----

Due Gov't, \$ 100 for -----

Valuation of horse, \$ 100

Valuation of horse equipments, \$ 100

Remarks : -----  
-----  
-----  
-----  
-----  
-----  
-----  
-----  
-----  
-----

Book mark : -----

*Reedester*

7 | 4 Cav. | U.S.C.T.

James Taylor  
Sgt., Co. C, 4 Reg't U. S. Colored Cavalry.

Appears on

**Company Muster Roll**

for *May & June*, 1864.

Present or absent

Stoppage, \$ 100 for

Due Gov't, \$ 100 for

Valuation of horse, \$ 100

Valuation of horse equipments, \$ 100

Remarks:

*Deserted June 25. 1864*

Book mark:

*Rochester*

T | **4 Cav.** | **U.S.C.T.**

James Taylor  
Pvt., Co. C, 4 Reg't U. S. Colored Cavalry.

Appears on

**Company Muster Roll**

for July & Aug, 1864.

Present or absent

Stoppage, \$ 100 for

Due Gov't, \$ 100 for

Valuation of horse, \$ 100

Valuation of horse equipments, \$ 100

Remarks: Absent June 25,  
left from Camp Parapet,  
Carrollton, La. carrying  
away one haversack  
and one pair scales

Book mark:

Boester

(358)

Copyist.

5 | 4 Cav. | U.S.C.T.

James Taylor  
Pvt., Co. D, 4 Reg't U. S. Colored Cav.

Appears on Returns as follows:

Feb 1864 - (1 Regt. Cav., Corps d'Afrique)  
On duty teamster.  
Mch 1864 - On duty Co. teamster  
Apr 1864 - On duty Regtl. teamster  
(H Regt U.S. Col'd Cav)

June 1864 - Absent without leave  
July 1864 - Loss: July 1 camp  
Parapet dropped from Co.  
Rolls - deserted.

Book mark:

W. R. Lee

J | 4 Cav. | U.S.C.T.

James Taylor  
Private, Co. C, 4 Reg't U. S. Col'd Cavalry

Appears on Co. Muster-out Roll, dated

New Orleans La, Mar 20, 1866.

Muster-out to date \_\_\_\_\_, 186 .

Last paid to Apl 30, 1864.

Clothing account:

Last settled \_\_\_\_\_, 186 ; drawn since \$ 100

Due soldier \$ 100; due U. S. \$ 62 <sup>45</sup>/<sub>100</sub>

Am't for cloth'g in kind or money adv'd \$ 100

Due U. S. for arms, equipments, &c., \$ 100

Bounty paid \$ 100; due \$ 100

Remarks: Joined orig. org.

deserted June 25/64 at  
Carrollton La

Book mark : \_\_\_\_\_

(361)

M. A. Michael

Copyist.

1051  
Taylor, James

Co F, 4 U. S. Col'd Cav.

Private Private

CARD NUMBERS.

1	3354986	26
2	3355075	27
3	3355167	28
4	3355205	29
5	3355340	30
6	3355428	31
7	3355509	32
8	3355584	33
9	3355670	34
10	3355754	35
11	3355837	36
12	3355917	37
12	3355998	38
14	3356075	39
15	3356151	40
16	40729256	41
17		42
18		43
19		44
20		45
21		46
22		47
23		48
24		49
25		50

Book Mark:

See also

A.629800 P.O. 90  
0,1309180 P.O. mmm  
S-2218461 Ann W.D

De Jordan  
Ex

*J* | **4 Cav.** | **U.S.C.T.**

*James Taylor*

*Priv*, Co. A, Mounted Rangers, Corps d'Afrique.†

Age ..... years.

Appears on

**Company Muster Roll\***

for *Nov. & Dec*, 186*3*.

Joined for duty and enrolled:

When *Nov. 1*, 186*3*.

Where *Iberia, La*

Period ..... years.

Mustered in:

When *Nov. 20*, 186*3*.

Where *Iberia, La*

Present or absent *Present*

Stoppage, \$ ..... 100 for .....

Due Gov't \$ ..... 100 for .....

Valuation of horse, \$ ..... 100

Valuation of horse equipments, \$ ..... 100

Remarks: .....

† This organization subsequently became Co. F, 4 U. S. Col'd Cav.  
\* First current roll. No muster-in roll of this ~~battery~~ <sup>Company</sup> on file.

Book mark: .....

(3586)

*Manning*  
Copyist.



*J* | **4 Cav. | U.S C.T.**

*James Taylor*  
*Pvt*, Co. *F*, 1 Reg't Cav., Corps d'Afrique.\*

Appears on

**Company Muster Roll**

for *Jan'y 2 Feb'y*, 1864.

Present or absent *Present*

Stoppage, \$ *100* for

Due Gov't, \$ *100* for

Valuation of horse, \$ *100*

Valuation of horse equipments, \$ *100*

Remarks:

\* This organization subsequently became Co. *F*, 4 Reg't U. S. Colored Cavalry.

Book mark:

*Manning*  
Copyist.

*J* | **4 Cav. | U.S.C.T.**

*James Taylor*  
*Pr*, Co. F, 4 Reg't U. S. Col'd Cavalry.

Appears on

**Company Muster Roll**

for *March & April*, 1864.

Present or absent *Present*

Stoppage, \$ *100* for

Due Gov't, \$ *100* for

Valuation of horse, \$ *100*

Valuation of horse equipments, \$ *100*

Remarks:

Book mark:

(358)

*Manning*  
Copyist.

*J* | **4 Cav.** | **U.S.C.T.**

*James Taylor*  
*Pr*, Co. F, 4 Reg't U. S. Col'd Cavalry.

Appears on

**Company Muster Roll**

for *May & June*, 1864.

Present or absent *Present*

Stoppage, \$ 100 for

Due Gov't, \$ 100 for

Valuation of horse, \$ 100

Valuation of horse equipments, \$ 100

Remarks:

Book mark:

*Manning*  
Copyist.

*J* | **4 Cav. | U.S.C.T.**

*James Taylor*  
*Pr*, Co. F, 4 Reg't U. S. Col'd Cavalry.

Appears on

**Company Muster Roll**

for *July & Aug*, 1864.

Present or absent *Present*

Stoppage, \$ 100 for

Due Gov't, \$ 100 for

Valuation of horse, \$ 100

Valuation of horse equipments, \$ 100

Remarks: *Stop for one*  
*Cartridge Box, plate*  
*one gun sling*  
*and one spur*

Book mark: \_\_\_\_\_

(358)

*W. W. J.*  
Copyist.

*J* | 4 Cav. | U.S.C.T.

*James Taylor*  
*Priv*, Co. F, 4 Reg't U. S. Col'd Cavalry.

Appears on

**Company Muster Roll**

for *Sept & Oct*, 1864.

Present or absent *Present*

Stoppage, \$ *100* for

Due Gov't, \$ *100* for

Valuation of horse, \$ *100*

Valuation of horse equipments, \$ *100*

Remarks: *Stop for one  
gun sling one  
Cartridge Box plate  
and one spur 56¢*

Book mark:

(358)

*W. H. Hanning*  
Copyist.

*T* | 4 Cav. | U.S.C.T.

*James Taylor*

*Pvt*, Co. F, 4 Reg't U. S. Col'd Cavalry.

Appears on

Company Muster Roll

for *Nov. & Dec*, 186 *4*

Present or absent *Absent*

Stoppage, \$ *100* for

Due Gov't, \$ *100* for

Valuation of horse, \$ *100*

Valuation of horse equipments, \$ *100*

Remarks: *Stop for one Gun Sling,  
one Cartridge Box Plate, one  
Strap, Absent since Nov,  
19" in Post Guard House,  
Awaiting trial for theft.*

Book mark: \_\_\_\_\_

*L. A. Harris*

(358)

Copyist.

*T* | **4 Cav.** | **U.S.C.T.**

*James Taylor*  
*Prvt*, Co. F, 4 Reg't U. S. Col'd Cavalry.

Appears on

**Company Muster Roll**

for *Jan & Feby*, 186*5*

Present or absent *Present*

Stoppage, \$ *100* for

Due Gov't, \$ *100* for

Valuation of horse, \$ *100*

Valuation of horse equipments, \$ *100*

Remarks:

Book mark:

*J. W. Harris*

*T* | **4 Cav.** | **U.S.C.T.**

*James Taylor*  
.....  
*Plt*, Co. F, 4 Reg't U. S. Col'd Cavalry.

Appears on

**Company Muster Roll**  
for *Mch & Apr* ....., 186*5*.

Present or absent *Present*

Stoppage, \$ ..... 100 for .....

Due Gov't, \$ ..... 100 for .....

Valuation of horse, \$ ..... 100

Valuation of horse equipments, \$ ..... 100

Remarks: .....

.....

.....

.....

.....

.....

.....

.....

.....

Book mark: .....

*J. A. Harris*  
.....  
Copyist.



*T* 4 Cav. U.S.C.T.

*James Taylor*  
*Pvt*, Co. F, 4 Reg't U. S. Col'd Cavalry.

Appears on

**Company Muster Roll**

for *May + June*, 186*5*

Present or absent *Present*

Stoppage, \$ *100* for

Due Gov't, \$ *100* for

Valuation of horse, \$ *100*

Valuation of horse equipments, \$ *100*

Remarks: *Due U. S. lost Ordnance*  
*\$5.53. Halter, Blanket,*  
*1 Nose Bag.*

Book mark :

*J. H. Harris*

(358)

Copyist.

*T* | **4 Cav.** | **U.S.C.T.**

*James Taylor*

*Pr*, Co. F, 4 Reg't U. S. Col'd Cavalry.

Appears on

**Company Muster Roll**

for *July & Aug*, 186 *5*

Present or absent *Present*

Stoppage, \$ *100* for

Due Gov't, \$ *5* <sup>*53*</sup>/<sub>*100*</sub> for *Ordinance & Horse Equipments.*

Valuation of horse, \$ *100*

Valuation of horse equipments, \$ *100*

Remarks:

Book mark:

*A. Harris*

(358)

Copyist.

*J* | 4 Cav. | U.S.C.T.

*James Taylor*  
*Pvt*, Co. F, 4 Reg't U.S. Col'd Cavalry.

Appears on

**Company Muster Roll**  
for *Sept & Oct*, 186 *5*

Present or absent *Present*

Stoppage, \$.....100 for .....

Due Gov't, \$.....100 for .....

Valuation of horse, \$.....100

Valuation of horse equipments, \$.....100

Remarks: *Stop for one Curry Comb,  
one Horse Brush one Surcingle*

Book mark: .....

*J. H. Harris*

(358)

Copyist.

T | 4 Cav. | U.S.C.T.

James Taylor

P., Co. F, 4 Reg't U. S. Col'd Cavalry.

Appears on

**Company Muster Roll**

for Nov. & Dec., 186 5

Present or absent Present

Stoppage, \$ 3. 30 for ordn. lost  
100

Due Gov't, \$ 100 for

Valuation of horse, \$ 100

Valuation of horse equipments, \$ 100

Remarks:

Book mark:

(358)

Hibbard

Copyist.

T | 4 Cav. | U.S.C.T.

James Taylor

, Co. F, 4 Reg't U. S. Col'd Cavalry.

Appears on

Company Muster Roll

for Jan. Feb., 1866

Present or absent Present

Stoppage, \$ 3.  $\frac{30}{100}$  for ordn. lost.

Due Gov't, \$ 100 for

Valuation of horse, \$ 100

Valuation of horse equipments, \$ 100

Remarks:

Book mark:

Hibbard

(358)

Copyist.

ST | 4 Cav. | U.S.C.T.

James Spaylor  
Priv., Co. G, 4 Reg't U. S. Colored Cav.

Appears on Returns as follows:

Nov 1864 - absent sent Nov 19 1864  
to Post guard house to  
await trial.

Dec 1864 }  
Jan 1865 } absent in confine  
ment at Fort Hudson La.  
since Nov 9/64

Book mark:

W. R. La

J | 4 Cav. | U.S.C.T.

James Taylor

P, Co. F, 4 Reg't U. S. Col'd Cavalry.

Appears on Co. Muster-out Roll, dated  
New Orleans, La. Mch. 20, 1866.

Muster-out to date Mch. 20, 1866.

Last paid to June 30, 1865.

Clothing account:

Last settled \_\_\_\_\_, 186 ; drawn since \$ \_\_\_\_\_ 100

Due soldier \$ \_\_\_\_\_ 100; due U. S. \$ 39. <sup>23</sup>/<sub>100</sub>

Am't for cloth'g in kind or money adv'd \$ \_\_\_\_\_ 100

Due U. S. for arms, equipments, &c., \$ 4. <sup>37</sup>/<sub>100</sub>

Bounty paid \$ ' \_\_\_\_\_ 100; due \$ \_\_\_\_\_ 100

Remarks: Joined at Orig. Reg.  
Stop 1 Curry comb, 1 horse  
brush, 1 Kuncingle, 1 Carbine  
rocket, 1 girth.

Book mark: \_\_\_\_\_

(361)

Hibbard

Copyist.

1054  
Taylor, James R  
Co L, 4 U. S. Col'd Cav.

Private | Private

CARD NUMBERS.

1	5358660	26
2	5358717	27
3	5358704	28
4	5347629	29
5	5348126	30
6	40729255	31
7		32
8		33
9		34
10		35
11		36
12		37
13		38
14		39
15		40
16		41
17		42
18		43
19		44
20		45
21		46
22		47
23		48
24		49
25		50

Book Mark:

See also



1944

01438124. POMM

De Jordan  
Ex

T | **4 Cav.** | **U.S.C.T.**

James R. Taylor  
Appears with rank of Bugler on

**Muster and Descriptive Roll of a Detachment of U. S. Vols. forwarded**

for the 4 Reg't U. S. Col'd Cavalry. Roll dated  
New Orleans, La., June 1<sup>st</sup>, 1864.

Where born La.

Age 18 y'rs; occupation Laborer

When enlisted May 18, 1864.

Where enlisted New Orleans

For what period enlisted 3 years.

Eyes Black; hair Black

Complexion Black; height 5 ft. 2 in.

When mustered in June 1, 1864.

Where mustered in New Orleans  
Premium paid 2

Bounty paid \$ 100; due \$ 100

Where credited \_\_\_\_\_

Company to which assigned D

Remarks: \_\_\_\_\_

Book mark: \_\_\_\_\_

Feaster

4 Cav. U.S.C.T.

James Taylor  
Pvt., Co. L, 4 Reg't U. S. Col'd Cavalry.

Age.....years.

Appears on

**Company Muster Roll\***

for Enlistment out to Aug. 31, 1864.

Joined for duty and enrolled:

When May 15, 1864.

Where New Orleans La.

Period 3 years.

Mustered in:

When June 1, 1864.

Where New Orleans La.

Present or absent Present

Stoppage, \$ 100 for.....

Due Gov't, \$ 100 for.....

Valuation of horse, \$ 100

Valuation of horse equipments, \$ 100

Remarks : .....

\* First current roll. No muster-in roll of this battery on file.

Book mark : .....

(3586)

Lovring

Copyist.

5 | **4 Cav.** | **U.S.C.T.**

James Taylor  
Capt., Co. L, 4 Reg't U.S. Col'd Cavalry.

Appears on

**Company Muster Roll**

for Dec. 1864, 1864.

Present or absent

Stoppage, \$ 100 for

Due Gov't, \$ 100 for

Valuation of horse, \$ 100

Valuation of horse equipments, \$ 100

Remarks: Discharged Oct. 30/64  
per surgeon's certificate of  
disability & final statement  
given

Book mark: Discharged Oct. 28/64 R.O.N. 10.P. 512

Terrill

(358)

Copyist.

4 Cav. | U.S.C.T.

James Taylor  
Pvt., Co. L, 4 Reg't U. S. Col'd Cavalry.

Appears on

Company Muster Roll

for Sept. & Oct., 1864.

Present or absent Present

Stoppage, \$ 100 for

Due Gov't, \$ 100 for

Valuation of horse, \$ 100

Valuation of horse equipments, \$ 100

Remarks: Discharged per Surgeon's certificate Oct. 29<sup>th</sup> '64. Final statement given

Entire entry cancelled by line.

Book mark:

T | 4 Cav. | U.S.C.T.

James Taylor  
Priv., Co. E, 4 Reg't U. S. Colored Cav.

Appears on Returns as follows:

Sept 1864. On duty with Regt  
gr. mstr.

Oct 1864 - Loss: Oct 29/64 Priv  
Hudson discharged

Book mark:

W. R. Fu

546,

Copyist.

2 | 4 | U.S.C.T.

James Taylor

Priv, Co. L, 4 Reg't U. S. Col'd Early

Appears on a

**Detachment Muster-out Roll**

of the organization named above. Roll dated  
New Orleans La, Mar 20, 1866

Muster-out to date \_\_\_\_\_, 186 .

Last paid to \_\_\_\_\_, 186 .

Clothing account:

Last settled \_\_\_\_\_, 186 ; drawn since \$ \_\_\_\_\_ 100

Due soldier \$ \_\_\_\_\_ 100; due U. S. \$ \_\_\_\_\_ 100

Am't for cloth'g in kind or money adv'd \$ \_\_\_\_\_ 100

Due U. S. for arms, equipments, &c., \$ \_\_\_\_\_ 100

Bounty paid \$ \_\_\_\_\_ 100; due \$ \_\_\_\_\_ 100

Remarks: Wounded in regular  
organization. Discharged on  
Surgeons Certificate of Disability  
Oct 29, 64.

Book mark: 1. 172. Co. L. 73. C. D.

G. Gossett

(349)

Copyist.

over.

JAN. - 8

5348126

1891

Discharged Oct 28/64 C.S.  
10. P. 9-12.



Taylor, James  
P, Co. L, 4 U.S.C. Cav.

1 Enclosures.

Bed Cards	Descriptive Lists
Burial Records	Final Statements
Certs. of Dis. for Discharge /	Furloughs
C. M. Charges	Med. Des. Lists
Med. Certificates	Orders

Other papers relating to—

Admission to Hosp'l	Furlough
Casualty Sheet (Officer's)	Med. Examination
Confinement	Misc. Information
Contracts	Pay or Clothing
Death or Effects	Personal Reports
Desertions	Rank
Discharge from Hosp'l	Transfer to Hosp'l
Discharge from Service	Transfer to V. R. C.
Duty	Transportation

[OFFICE INDORSEMENT.]

War Department,

ADJUTANT GENERAL'S OFFICE,

November 24, 1873,

The discharge of Private James R. Taylor, Co. L, 4<sup>th</sup> Reg't U. S. Colored Infantry, is reported as follows:—

On Company Muster Roll.

For Sept<sup>ua</sup> Oct., 1864, Oct. 30, 1864,

Company Muster-out Roll.

October 29, 1864.

Company Descriptive Book.

, 186

Company Morning Reports.

, 186

~~Soldier's~~ Final Statement.

, 186

Soldier's Record of Death and Interment.

, 186

Soldier's Inventory of Effects.

, 186

Soldier's Certificate of Disability for Discharge.

October 25, 1864

Soldier's Individual Muster-out Roll.

, 186

Regimental Return.

For 186, 186

Regimental Quarterly Returns.

, 186

Regimental Descriptive Book.

, 186

By Surgeon General.

, 186

October 25<sup>th</sup>, 1864, is held to be the correct date, and the Company ~~Muster~~ Roll will be amended accordingly.

Thomas M. Sweet

Adj. Gen.

Dec. 10, 1873

1864.

42812 of 1864

CERTIFICATE OF DISABILITY FOR DISCHARGE

IN THE CASE OF

James Taylor  
a Private Co. L

4<sup>th</sup> Reg't of U.S. Colored Infantry

Head Qrs. Dist. of R.R. and P.H.  
Baton Rouge La. Oct 26/64.

To be Discharged.

By command of  
Brig. Genl. Benton

L. H. Mowry  
Capt. and A. A. A. G.

Received (A. G. O.) 186

Carson



Carson

**NOTE 1.**

The company commander will here add a statement of all the facts known to him concerning the disease or wound, or cause of disability of the soldier; the time, place, manner, and all the circumstances under which the injury occurred, or disease originated or appeared; the duty, or service, or situation of the soldier at the time the injury was received or disease contracted, stating particularly whether the injury was received or the disease contracted in the line of his duty; and whatever other facts may aid a judgment as to the cause, immediate or remote, of the disability, and the circumstances attending it.

When the facts are not known to the company commander, the certificate of any officer, or affidavit of other person having such knowledge, will be appended—as the surgeon in charge of a hospital, the officer commanding a detachment of recruits, &c., &c.

**NOTE 2.**

When a *probable* case for *pension*, *special care* must be taken to state the *degree* of disability—as  $\frac{1}{2}$ ,  $\frac{3}{4}$ , &c., &c.; to describe particularly the disability, wound, or disease, the extent of which it deprives him of the use of any limb or faculty, or affects his health, strength, activity, constitution, or capacity to labor or earn his subsistence. The surgeon will add, from his knowledge of the facts and circumstances, and from the evidence in the case, his professional opinion of the cause or origin of the disability. In the case of discharges by Medical Inspectors, the last paragraph will state that the "discharge was given by consent of the soldier, after a personal examination, and for disability, the nature, degree, and origin of which are correctly described in the within certificate."

Par. 1260 Regulations, Edit. 1861.

Medical officers, in giving certificates of disability, are to take particular care in all cases that have not been under their charge; and especially in epilepsy, convulsions, chronic rheumatism, derangement of the urinary organs, ophthalmia, ulcers, or any obscure disease liable to be feigned or purposely produced; and in no case shall such certificate be given until after sufficient time and examination to detect any attempt at deception.

**DIRECTIONS.**

This certificate will be made out in *duplicate* by the soldier's company commander, or other officer commanding the separate detachment to which he belongs, and sent by him to the surgeon who has charge of the hospital where the soldier is sick. The surgeon will then fill out and sign the surgeon's certificate, and forward these papers to the regimental, detachment, or post commander, who will forward them, with his action endorsed thereon, through the proper channel, to his division commander; or, if the troops are not attached to a division, to his corps, department, or other commander or officer to whom the authority to discharge enlisted men may be specially delegated.

These certificates, after having received the action of the highest authority to which they are required to be sent, will be returned through the same channel to the regimental, post, or detachment commander, who will, if the discharge is authorized by the endorsement of the proper authority, sign the soldier's discharge, and the last certificate on this paper; see that the soldier is furnished with the proper final statements in duplicate, and forward BOTH of these certificates *direct* to the Adjutant General of the United States Army, at Washington, D. C. They will not be given in any other instances, be given into the hands of the soldier.

ADJUTANT GENERAL'S OFFICE

Nov 23<sup>rd</sup> 1864

Duplicate sent the Pension Office.

1864.

42814 of file

**CERTIFICATE OF DISABILITY FOR DISCHARGE**

IN THE CASE OF

*James Taylor*  
a *Private* Co. *L*

*4<sup>th</sup>* Reg't of *U.S. Cavalry*

Head Qrs. Dist. of R.R. and P.H.  
Baton Rouge La. Oct 26/64.

To be Discharged.

By command of  
Brig. Genl. Benton

*L. H. Mowry*  
Capt. and A. A. A. S.

Received (A. G. Office) 186

*Curran*



*Curran*

# ARMY OF THE UNITED STATES.

## CERTIFICATE

### OF DISABILITY FOR DISCHARGE.



James Taylor a Private, of <sup>Lieut</sup> Captain A. J. Whittier Company, (D.) of the Fourth Regiment of the United States Col<sup>d</sup> Cavalry was enlisted by Major J. W. Paine of the 4th Regiment of U.S.C. Cavalry at New Orleans La on the 18th day of May, 1864, to serve Three years; he was born in Louisiana, is Fifteen years of age, 5 feet 2 inches high, Black complexion, Black eyes, Black hair, and by occupation when enlisted a Laborer. During the last two months said soldier has been unfit for duty 60 days\* by reason of debility and being under age, is totally unfit for the duty of a Soldier.

STATION: Port Hudson La  
DATE: October 18th 1864.

John W. Equels  
1st Lt. Co. G 4th U.S.C.  
Commanding Company "L"

I CERTIFY, that I have carefully examined the said James Taylor of Captain Lt. A. J. Whittier Company, and find him incapable of performing the duties of a soldier because of Insufficient age and development and also a Strumous Deuthties and present debility. Said Taylor is unfit for Invalid Corps, He never possessed any capacity for labor.

Respectfully approved  
M. J. Druehl  
Post Surgeon  
Post Hudson

D. D. Hanson Surgeon.  
4th U.S.C. Cavalry

DISCHARGED, this 28th day of October, 1864, at Port Hudson Louisiana.

A. G. Wickmore  
Major  
Commanding the Reg't.

The Soldier desires to be addressed at  
Town Alexandria County Louisiana State Louisiana

\* See Note 1 on the back of this. † See Note 2 on the back of this.

Approved  
W. R. Sadler  
Lieut. Col.  
19th Regt. Col.  
Batteries Range & Post Hudson

Taylor, John  
Co E, 4 U. S. Col'd Cav.

Private | Private

CARD NUMBERS.

1	5353844	26
2	5353897	27
3	5353953	28
4	5355152	29
5	5354079	30
6	5354150	31
7	5354221	32
8	5358674	33
9	5358730	34
10	5358792	35
11	5348212	36
12	5354878	37
13	5348141	38
14	40729257	39
15		40
16		41
17		42
18		43
19		44
20		45
21		46
22		47
23		48
24		49
25		50

Book Mark:

See also

*J* | **4 Cav. | U.S.C.T.**

*John Taylor*  
-----  
*Pvt*, Co. *E*, 1 Reg't, Corps d'Afrique Cavalry.\*  
+ *Age 23 yrs.*  
Appears on

**Company Muster-in Roll**

of the organization named above. Roll dated  
*New Orleans, La, Dec. 31*, 186*7*.  
Muster-in to date *Dec. 31*, 186*7*.

Joined for duty and enrolled:

When *Nov. 10*, 186 .

Where *New Orleans*

Period *3* years.

Valuation of horse, \$ 100

Valuation of horse equipments, \$ 100

Remarks: -----  
-----

*\* Inserted by Jordan Ex*

\*This organization subsequently became Co. *E*, 4 Reg't U. S. Colored Cavalry.

Book mark: -----

*Wendell*

*J*

**4 Cav. U.S.C.T.**

*John Taylor*  
*Co. E*, 1 Reg't Cav., Corps d'Afrique.\*

Appears on

**Company Muster Roll**

for *enlistment to Dec. 31*, 186*3*

Present or absent *Present*

Stoppage, \$ *100* for

Due Gov't, \$ *100* for

Valuation of horse, \$ *100*

Valuation of horse equipments, \$ *100*

Remarks:  
.....  
.....  
.....  
.....  
.....  
.....  
.....

\* This organization subsequently became Co. *E*, 4 Reg't U.S. Colored Cavalry.

Book mark: .....

*Wendel*

*J* | **4 Cav. | U.S C.T.**

*John Taylor*

, Co. *E*, 1 Reg't Cav., Corps d'Afrique.\*

Appears on

**Company Muster Roll**

for *Jan + Feb*, 186*4*

Present or absent *absent*

Stoppage, \$ *100* for

Due Gov't, \$ *100* for

Valuation of horse, \$ *100*

Valuation of horse equipments, \$ *100*

Remarks: *Deserted Feb 7/64*

\* This organization subsequently became Co. *E*, 4 Reg't U. S. Colored Cavalry.

Book mark: \_\_\_\_\_

*Lawrence*



*J* | **4 Cav. | U.S.C.T.**

*John Taylor*  
*Plt*, Co. F, 4 Reg't U. S. Col'd Cavalry.

Appears on

**Company Muster Roll**

for *March & April*, 1864.

Present or absent *Present*

Stoppage, \$ 100 for

Due Gov't, \$ 100 for

Valuation of horse, \$ 100

Valuation of horse equipments, \$ 100

Remarks:

Book mark:

(358)

*Manning*  
Copyist.

J | **4 Cav.** | **U.S.C.T.**

John Taylor

Priv, Co. E, 4 Reg't U. S. Col'd Cav.

Appears on

**Company Muster Roll**

for May & June, 1864.

Present or absent Present

Stoppage, \$ 100 for

Due Gov't, \$ 100 for

Valuation of horse, \$ 100

Valuation of horse equipments, \$ 100

Remarks:

Book mark:

(358)

Lamm

Copyist.

J | **4 Cav.** | **U.S.C.T.**

*G. M. Taylor*

*Priv.*, Co. E, 4 Reg't U. S. Col'd Cav.

Appears on

**Company Muster Roll**

for *July & Aug*, 186 *4*

Present or absent *Present*

Stoppage, \$ *100* for

Due Gov't, \$ *100* for

Valuation of horse, \$ *100*

Valuation of horse equipments, \$ *100*

Remarks:

Book mark:

(358)

*L. M. M. M.*

Copyist.

7 | 4 Cav. | U.S.C.T.

*John Taylor*

*Priv.*, Co. E, 4 Reg't U. S. Col'd Cav.

Appears on

**Company Muster Roll**

for *Sept + Oct*, 186*4*

Present or absent

Stoppage, \$ *100* for

Due Gov't, \$ *100* for

Valuation of horse, \$ *100*

Valuation of horse equipments, \$ *100*

Remarks *Transfd. to Co (2)*

*Sept 13/64*

Book mark:

*Lawrence*

(358)

Copyist.

4 Cav. U.S.C.T.

John Taylor

1st Sgt., Co. L, 4 Reg't U. S. Col'd Cavalry.

Appears on

Company Muster Roll

for Sept & Oct, 1862.

Present or absent Present

Stoppage, \$ 100 for

Due Gov't, \$ 100 for

Valuation of horse, \$ 100

Valuation of horse equipments, \$ 100

Remarks: Transferred from Co. E to Co. L 1st U.S. Col'd Cav. Sept 13 1862 with the rank of 1st Sgt.

Book mark:

Lanning

4 Cav. U.S.C.T.

John Taylor  
1<sup>st</sup> Sgt., Co. L, 4 Reg't U.S. Col'd Cavalry.

Appears on

Company Muster Roll

for Nov. & Dec., 1864.

Present or absent Present

Stoppage, \$ 100 for

Due Gov't, \$ 100 for

Valuation of horse, \$ 100

Valuation of horse equipments, \$ 100

Remarks: Transferred as a private from Co. C to Co. L and promoted to 1<sup>st</sup> Sgt. Sept. 3<sup>rd</sup> 1864. Force prior to April 1/61

Book mark:

Lerrin

5 | **4 Cav.** | **U.S.C.T.**

John Taylor  
Pvt., Co. L, 4 Reg't U. S. Col'd Cavalry.

Appears on

**Company Muster Roll**

for Jan & Feb, 1865.

Present or absent Absent

Stoppage, \$ 100 for

Due Gov't, \$ 100 for

Valuation of horse, \$ 100

Valuation of horse equipments, \$ 100

Remarks: Reduced to the ranks  
from 1st Lieut. Feb. 24<sup>th</sup>  
1865 by order of Maj. Mitchell.  
Absent without leave since  
Feb. 25<sup>th</sup> 1865. Lost 3 troups &  
brush wipers. 99

Book mark: \_\_\_\_\_

(358)

Swain

Copyist.

T. H. Car. U.S.C.T.

John Taylor.

Pvt., Co. L., Reg't U. S. Col'd.

Appears on

**Descriptive List of Deserters**

dated Pt. Hudson Sea, Feb. 31, 1865.

Deserted:

When March 4, 1865.

Where Port Hudson Sea.

Arrested:

When \_\_\_\_\_, 186 .

Where \_\_\_\_\_

Remarks:

Book mark:

(351)

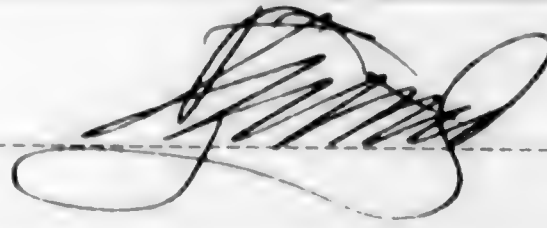

Copyist.



2 | 4 Co. | **U.S.C.T.**

John Taylor

Co., 4 Reg't U. S. Col'd

Appears on a

**Detachment Muster-out Roll**

of the organization named above. Roll dated  
New Orleans, March 20, 1866 .

Muster-out to date ..... 186 .

Last paid to ..... 186 .

**Clothing account:**

Last settled....., 186 ; drawn since \$..... 100

Due soldier \$..... 100; due U. S. \$..... 100

Am't for cloth'g in kind or money adv'd \$..... 100

Due U. S. for arms, equipments, &c., \$..... 100

Bounty paid \$..... 100; due \$..... 100

Remarks: Transferred from Co. C  
and promoted to 1st Sgt.  
Sept 13, 1864. Reduced to the  
rank Nov 24, 1865. Deserted  
same day at Port Hudson La.

Book mark: .....

Grossett

D | 4 Cav. | U.S.C.T.

John Taylor  
Port Co. E, 4 Reg't U. S. Colored Cav.

Appears on Returns as follows:

June 1864 - Gain: June 2/64 Greenville Ret'd from desertion  
June & July 1864 On duty nurse in Reg't 16 sept.

Sept 1864 - Loss: June 13/64 Port Hudson Transferred for promotion in Co. E.  
(Co. E) Gain Sept 13/64 Port Hudson Transferred from Co. E.

Feb 1865 - absent without leave  
Mch 1865 - Loss: Mar 27/65 Port Hudson La. deserted.

Book mark:

W. R. Lee

*J* | **4 Cav.** | **U.S.C.T.**

*John Taylor*  
-----  
*Pub*, Co. *E*, 4 Reg't U. S. Col'd Cavalry.

Appears on **Co. Muster-out Roll**, dated  
*New Orleans La, Mch 20*, 1866.

Muster-out to date -----, 186 .

Last paid to -----, 186 .

**Clothing account:**

Last settled -----, 186 ; drawn since \$ ----- <sup>100</sup>

Due soldier \$ ----- <sup>100</sup>; due U. S. \$ ----- <sup>100</sup>

Am't for cloth'g in kind or money adv'd \$ ----- <sup>100</sup>

Due U. S. for arms, equipments, &c., \$ ----- <sup>100</sup>

Bounty paid \$ ----- <sup>100</sup>; due \$ ----- <sup>100</sup>

Remarks: *Joined at org. org.*  
*transferred to Co. H. per S.O. 93*  
*Hd qrs 4 U. S. C. Cav. Sept 13/64.*

Book mark: -----

(861)

*Floyd*

Copyist.

1034  
Taylor, Stephen

Co *L. F.*, 4 U. S. Col'd Cav.

Private

Private

CARD NUMBERS.

1	5347654	26
2	5347684	27
3	5358658	28
4	5358702	29
5	5358756	30
6	5358793	31
7	5348035	32
8	5355669	33
9	5355753	34
10	5355836	35
11	5355916	36
12	5355997	37
13	5356074	38
14	5356152	39
15	40729258	40
16		41
17		42
18		43
19		44
20		45
21		46
22		47
23		48
24		49
25		50

Book Mark:

See also

*J* | 4 Cav. | U.S.C.T.

*Stephen Taylor*

Appears with rank of *Pt* on

**Muster and Descriptive Roll of a Detachment of U. S. Vols. forwarded**

for the 4 Reg't U. S. Col'd Cavalry. Roll dated

*New Orleans La June 22*, 186*4*.

Where born *Pa.*

Aged *22* y'rs; occupation *Laborer*

When enlisted *Apr 9*, 186*4*.

Where enlisted *Alexandria*

For what period enlisted *3* years.

Eyes *DK*; hair *DK*

Complexion *DK*; height *5* ft. *6* in.

When mustered in \_\_\_\_\_, 186 .

Where mustered in *New Orleans*

Bounty paid \$ *2* <sup>100</sup>; due \$ <sup>100</sup>

Where credited *to Alexandria La*

Company to which assigned *D*

Remarks : \_\_\_\_\_

Book mark : \_\_\_\_\_

*Jan H. H. H.*

*S* | **4 Cav. | U.S.C.T.**

*Stephen Taylor*

Appears with rank of *Pl* on

**Muster and Descriptive Roll of a Detachment of U. S. Vols. forwarded**

for the 4 Reg't U. S. Col'd Cavalry. Roll dated

*New Orleans La July 18, 1864.*

Where born *Va*

Age *22* y'rs; occupation *Laborer*

When enlisted *Apr 9*, 186*4*

Where enlisted *Alexandria*

For what period enlisted *3* years.

Eyes *DK*; hair *DK*

Complexion *DK*; height *5 ft. 6* in.

When mustered in *June 22, 1864*

Where mustered in *New Orleans*

Bounty paid \$ *100*; due \$ *100*

Where credited *to Alexandria La*

Company to which assigned *L*

Remarks:

Book mark:

*Mustered in*

5 | **4 Cav. | U.S.C.T.**

*Stephen Taylor*  
Pvt., Co. *L*, 4 Reg't U. S. Col'd Cavalry.

Age.....years.

Appears on

**Company Muster Roll\***

for *Enlistment to Aug 31*, 1864.

Joined for duty and enrolled:

When *Apr. 9*, 1864.

Where *Alexandria La.*

Period *3* years.

Mustered in:

When *June 22*, 1864.

Where *New Orleans La.*

Present or absent *Present*

Stoppage, \$.....100 for.....

Due Gov't, \$.....100 for.....

Valuation of horse, \$.....100

Valuation of horse equipments, \$.....100

Remarks : .....

\* First current roll. No muster-in roll of this battery on file.

Book mark : .....

*Lanning*

| **4 Cav.** | **U.S.C.T.**

Stephen Taylor  
Pvt., Co. L, 4 Reg't U.S. Col'd Cavalry.

Appears on

**Company Muster Roll**

for Sept. & Oct., 1864.

Present or absent Present

Stoppage, \$ 100 for \_\_\_\_\_

Due Gov't, \$ 100 for \_\_\_\_\_

Valuation of horse, \$ 100

Valuation of horse equipments, \$ 100

Remarks: \_\_\_\_\_

Book mark: \_\_\_\_\_

(358)

Loring  
Copyist.



| **4 Cav.** | **U.S.C.T.**

Stephen Taylor  
Pvt., Co. L, 4 Reg't U. S. Col'd Cavalry.

Appears on

**Company Muster Roll**  
for Nov. & Dec, 1864.

Present or absent Present

Stoppage, \$ 100 for \_\_\_\_\_

Due Gov't, \$ 100 for \_\_\_\_\_

Valuation of horse, \$ 100

Valuation of horse equipments, \$ 100

Remarks: \_\_\_\_\_  
\_\_\_\_\_  
\_\_\_\_\_  
\_\_\_\_\_  
\_\_\_\_\_  
\_\_\_\_\_  
\_\_\_\_\_  
\_\_\_\_\_

Book mark: \_\_\_\_\_

Lorrie  
(358)          Copyist.

4 Cav. U.S.C.T.

Stephen Taylor

Pvt., Co. L, 4 Reg't U.S. Col'd Cavalry.

Appears on

Company Muster Roll

for Jan. + Feb., 1865.

Present or absent Present

Stoppage, \$ 100 for

Due Gov't, \$ 100 for

Valuation of horse, \$ 100

Valuation of horse equipments, \$ 100

Remarks: Promoted from private to Corp. to rank as such from Jan. 1st per S.L. No. 3. Hd. Qrs. 4th U.S. Cav. dated Jan. 13/65. Reduced to the ranks per S.L. No 12. Hd. Qrs. 4th U.S. Cav. Feb. 15th 1865

Book mark:

Lerrin

1877 1403

T | **4 Cav. | U.S.C.T.**

Stephen Taylor  
Priv, Co. F, 4 Reg't U. S. Col'd Cavalry.

Appears on

**Company Muster Roll**  
for Mch & Apr, 1865

Present or absent Present

Stoppage, \$ 100 for

Due Gov't, \$ 100 for

Valuation of horse, \$ 100

Valuation of horse equipments, \$ 100

Remarks: Joined by Transfer from  
"L. Co. 28 S. C. No. 28" dated 4<sup>th</sup>  
Qrs. Dept of the Gulf Jan 28  
1865

Book mark: \_\_\_\_\_

A. H. Harris

(358)

Copyist.

5 | 4 Cav. | **U.S.C.T.**

Stephen Taylor  
Pr, Co. F, 4 Reg't U. S. Col'd Cav

Appears on

**M. and D. Roll of Men Transferred**

to the organization named above, by *amcol.*  
from *Co. I*

Roll dated *Port Hudson La. Apr 29, 1865.*

When enlisted *Apr 9*, 186*4*.

Period for which enlisted *3* years.

When mustered in *June 22*, 1864.

Present or absent *Not stated*

Company to which assigned *F*

Remarks:

Book mark:

(342)

*J. W. Leonard*  
Copyist.

*T.* | **4 Cav.** | **U.S.C.T.**

*Stephen Taylor*

*Pvt.*, Co. F, 4 Reg't U. S. Col'd Cavalry.

Appears on

**Company Muster Roll**

for *May & June*, 186 *5*

Present or absent *Present*

Stoppage, \$ *100* for

Due Gov't, \$ *100* for

Valuation of horse, \$ *100*

Valuation of horse equipments, \$ *100*

Remarks:

Book mark:

*J. A. Harris*

*I* | **4 Cav.** | **U.S.C.T.**

*Stephen Taylor*  
*Pvt*, Co. F, 4 Reg't U. S. Col'd Cavalry.

Appears on

**Company Muster Roll**

for *July & Aug*, 186 *5*.

Present or absent *Present*

Stoppage, \$ \_\_\_\_\_ *100* for \_\_\_\_\_

Due Gov't, \$ \_\_\_\_\_ *100* for \_\_\_\_\_

Valuation of horse, \$ \_\_\_\_\_ *100*

Valuation of horse equipments, \$ \_\_\_\_\_ *100*

Remarks: \_\_\_\_\_  
\_\_\_\_\_  
\_\_\_\_\_  
\_\_\_\_\_  
\_\_\_\_\_  
\_\_\_\_\_  
\_\_\_\_\_  
\_\_\_\_\_

Book mark: \_\_\_\_\_

*A Harris*

*T* | 4 Cav. | U.S.C.T.

*Stephen Taylor*  
*Pvt*, Co. F, 4 Reg't U. S. Col'd Cavalry.

Appears on

**Company Muster Roll**

for *Sept & Oct*, 186 *3*

Present or absent *Present*

Stoppage, \$ *100* for

Due Gov't, \$ *100* for

Valuation of horse, \$ *100*

Valuation of horse equipments, \$ *100*

Remarks:

Book mark:

*J. W. Harris*

7 | **4 Cav. U.S.C.T.**

Stephen Taylor

P., Co. F, 4 Reg't U. S. Col'd Cavalry.

Appears on

**Company Muster Roll**

for Nov. & Dec., 1865.

Present or absent Present

Stoppage, \$ 100 for

Due Gov't, \$ 100 for

Valuation of horse, \$ 100

Valuation of horse equipments, \$ 100

Remarks: \_\_\_\_\_

Book mark: \_\_\_\_\_

Hibbard



T | **4 Cav.** | **U.S.C.T.**

*Stephen Taylor*

P, Co. F, 4 Reg't U. S. Col'd Cavalry.

Appears on

**Company Muster Roll**

for *Jan. & Feb.*, 186*6*.

Present or absent *Present*

Stoppage, \$ 100 for

Due Gov't, \$ 100 for

Valuation of horse, \$ 100

Valuation of horse equipments, \$ 100

Remarks:

Book mark:

*Hibbard*

S | **4 Cav. | U.S.C.T.**

Stephen Taylor

Priv., Co. <sup>S</sup> F, 4 Reg't U. S. Colored Cav.

Appears on Returns as follows:

Nov 1864 - On duty in R. G. M.  
Dept.

Aug 1865 to Jan 1866 - On duty  
Wagoner (Co F)

Feb 1866 - On duty Teamster

Book mark: \_\_\_\_\_

W. R. Lee

**T** | **4 Cav.** | **U.S.C.T.**

*Stephen Taylor*

*P*, Co. *P*, 4 Reg't U. S. Col'd Cavalry.

Appears on **Co. Muster-out Roll**, dated  
*New Orleans, La., Mch. 20*, 1866.

Muster-out to date *Mch. 20*, 1866.

Last paid to *June 30*, 1865.

**Clothing account:**

Last settled \_\_\_\_\_, 186 ; drawn since \$ \_\_\_\_\_ 100

Due soldier \$ *29*<sup>*35*</sup> / 100; due U. S. \$ \_\_\_\_\_ 100

Am't for cloth'g in kind or money adv'd \$ \_\_\_\_\_ 100

Due U. S. for arms, equipments, &c., \$ \_\_\_\_\_ 100

Bounty paid \$ \_\_\_\_\_ 100; due \$ \_\_\_\_\_ 100

Remarks: *Joined by transfer  
from Co. L per S.O. 28, Hdqrs.  
D. S. Jan'y. 28, 65.*

Book mark: *V62-P125-69.*

(361)

*Hibbard*  
Copyist.

<sup>1863</sup>  
Taylor, William

Co *K.B.* 4 U. S. Col'd Cav.

Private | Corporal

CARD NUMBERS.

1	5347577	26
2	5358391	27
3	5358446	28
4	5358497	29
5	5358541	30
6	5358586	31
7	5348078	32
8	5350601	33
9	5350685	34
10	5350781	35
11	5350870	36
12	5350955	37
13	5351035	38
14	5351115	39
15		40
16		41
17		42
18		43
19		44
20		45
21		46
22		47
23		48
24		49
25		50

Book Mark:

See also

NARR 419  
A. 65-0094 P. 90  
S 843239 - Portd med  
S 1066845 PO aff  
S 1066849 PO aff  
S 1113263 PO mon ref

DeJorden  
ex

7 | **4 Cav.** | **U.S.C.T.**

*William Taylor*

Appears with rank of *Pvt.* on

**Muster and Descriptive Roll of a Detachment of U. S. Vols. forwarded**

for the 4 Reg't U. S. Col'd Cavalry. Roll dated

*New Orleans La., May 9, 1864.*

Where born *Alexandria La.*

Age *18* y'rs; occupation *Labourer*

When enlisted *Apr. 25*, 1864.

Where enlisted *Alexandria*

For what period enlisted *3* years.

Eyes *Black*; hair *Black*

Complexion *Black*; height *5* ft. *7* in.

When mustered in *May 9*, 1864.

Where mustered in *New Orleans*

*Premium paid 2*

Bounty paid \$ *100*; due \$ *100*

Where credited

Company to which assigned *K*

Remarks:

Book mark:

*Feaster*

*T* | **4 Cav. | U.S.C.T.**

*William Taylor*  
-----  
*Capt*, Co. *K*, 4 Reg't U. S. Col'd Cavalry.

Age ----- years.

Appears on

**Company Muster Roll\***

for *May 9 to June 30*, 1864.

Joined for duty and enrolled:

When *Apr. 25*, 1864.

Where *Alexandria, La.*

Period *3* years.

Mustered in:

When *May 9*, 1864.

Where *New Orleans, La.*

Present or absent *Present*

Stoppage, \$ *100* for -----

Due Gov't, \$ *100* for -----

Valuation of horse, \$ *100*

Valuation of horse equipments, \$ *100*

Remarks: *Promoted Capt*  
*May 20 1864*

\* First current roll. No muster-in roll of this battery on file.

Book mark : -----

(3586)

*W. S. Thompson*  
-----  
Copyist.

*D.* | **4 Cav.** | **U.S.C.T.**

*William Taylor*  
-----  
*corp'l*, Co. K, 4 Reg't U. S. Col'd Cav.

Appears on

**Company Muster Roll**

for *July & Aug.* -----, 1864.

Present or absent *Present* -----

Stoppage, \$ ----- *100* for -----

Due Gov't, \$ ----- *100* for -----

Valuation of horse, \$ ----- *100*

Valuation of horse equipments, \$ ----- *100*

Remarks: -----  
-----  
-----  
-----  
-----  
-----  
-----  
-----  
-----  
-----

Book mark: -----

*W.S. Thompson*  
-----  
(358) Copyist.



*4* | **4 Cav.** | **U.S.C.T.**

*William Taylor*  
-----  
*Capt.*, Co. K, 4 Reg't U. S. Col'd Cav.

Appears on

**Company Muster Roll**  
for *Sept. & Oct.* -----, 1864.  
Present or absent *Present* -----

Stoppage, \$ ----- 100 for -----

Due Gov't, \$ ----- 100 for -----

Valuation of horse, \$ ----- 100

Valuation of horse equipments, \$ ----- 100

Remarks: -----  
-----  
-----  
-----  
-----  
-----  
-----  
-----  
-----  
-----

Book mark: -----

*W. S. Thompson*  
-----  
(358) Copyist.

4 Cav. U.S.C.T.

William Taylor

Corpl, Co. K, 4 Reg't U. S. Col'd Cav.

Appears on

**Company Muster Roll**

for Nov. & Dec., 1864.

Present or absent Present

Stoppage, \$ 100 for

Due Gov't, \$ 100 for

Valuation of horse, \$ 100

Valuation of horse equipments, \$ 100

Remarks:  
.....  
.....  
.....  
.....  
.....  
.....  
.....  
.....  
.....

Book mark: .....

W. S. Thompson  
(358) Copyist.

**4 Cav. U.S.C.T.**

*William Taylor*  
Corpl., Co. K, 4 Reg't U. S. Col'd Cav.

Appears on

**Company Muster Roll**

for *Jan. 8 Feb.*, 1865.

Present or absent *Present*

Stoppage, \$ *100* for

Due Gov't, \$ *100* for

Valuation of horse, \$ *100*

Valuation of horse equipments, \$ *100*

Remarks: *Reappointed Corp'l  
from Co. K, May 20/64*

Book mark:

(358)

*W. S. Thompson*  
Copyist.

7 | **4 Cav. | U.S.C.T.**

William Taylor  
Corp., Co. B. 4 Reg't U. S. Col'd Cavalry.

Appears on

**Company Muster Roll**

for March & April, 1861.

Present or absent present

Stoppage, \$ 100 for

Due Gov't, \$ 100 for

Valuation of horse, \$ 100

Valuation of horse equipments, \$ 100

Remarks: Transferred to Company  
by consolidation, in accord-  
ance with G.O. "123. dated  
Ad 22d. Dept. of Gulf Jan 28/61

Book mark: \_\_\_\_\_

(358)

James

Copyist.

4 Cav | U.S.C.T.

William Taylor

Capt, Co. G, 4 Reg't U. S. Col'd Cav.

Appears on

**M. and D. Roll of Men Transferred**

to the organization named above, by *comd*  
from *Co. K*

Roll dated *Port Hudson La. Apr 29*, 1865.

When enlisted *Apr 25*, 1864.

Period for which enlisted *3* years.

When mustered in *May 9*, 1864.

Present or absent *not stated*

Company to which assigned *B*

Remarks:

Book mark :

*E. L. Leonard*

7 | **4 Cav. | U.S.C.T.**

William Taylor  
Corp., Co. B. 4 Reg't U. S. Col'd Cavalry.

Appears on

**Company Muster Roll**

for May & June, 1864.

Present or absent present

Stoppage, \$ 100 for

Due Gov't, \$ 100 for

Valuation of horse, \$ 100

Valuation of horse equipments, \$ 100

Remarks: Stop for 2 days &  
wraps

Book mark :

Sumner  
Copyist.

7 | 4 Cav. | U.S.C.T.

*William Taylor*  
Corp., Co. B. 4 Reg't U. S. Col'd Cavalry.

Appears on

**Company Muster Roll**

for *July & Aug*, 186*5*.

Present or absent *present*

Stoppage, \$ 100 for

Due Gov't, \$ 100 for

Valuation of horse, \$ 100

Valuation of horse equipments, \$ 100

Remarks :  
-----  
-----  
-----  
-----  
-----  
-----  
-----  
-----  
-----

Book mark :  
-----  
-----

(358) *J. J. [unclear]* Copyist.

7 | **4 Cav.** | **U.S.C.T.**

*William Taylor*

*Corp.*, Co. B. 4 Reg't U. S. Col'd Cavalry.

Appears on

**Company Muster Roll**

for *Sept & Oct*, 186*1*.

Present or absent *present*

Stoppage, \$ 100 for

Due Gov't, \$ 100 for

Valuation of horse, \$ 100

Valuation of horse equipments, \$ 100

Remarks :

Book mark :

*Lomax*



*T* | **4 Cav.** | **U.S.C.T.**

*William Taylor*  
*Corpl.*, Co. B. 4 Reg't U. S. Col'd Cavalry.

Appears on

**Company Muster Roll**

for *Nov. & Dec.*, 186*5*.

Present or absent *Present*

Stoppage, \$ 100 for

Due Gov't, \$ 100 for

Valuation of horse, \$ 100

Valuation of horse equipments, \$ 100

Remarks :

Book mark :

*Chandler*  
Copyist.

2 | 4 Cav. | U.S.C.T.

*William Taylor*  
Corpl., Co. B. 4 Reg't U. S. Col'd Cavalry.

Appears on

**Company Muster Roll**

for *Jan. & Feb.*, 1866.

Present or absent *Present*

Stoppage, \$ 100 for

Due Gov't, \$ 100 for

Valuation of horse, \$ 100

Valuation of horse equipments, \$ 100

Remarks :

Book mark :

(358)

*Chandler*  
Copist.

*J* | **4 Cav.** | **U.S.C.T.**

*William Taylor*

*Corpl*, Co. *B*, 4 Reg't U. S. Col'd Cavalry.

Appears on **Co. Muster-out Roll**, dated  
*New Orleans, La., Mch. 20*, 1866.

Muster-out to date *Mch. 20*, 1866.

Last paid to *June 30*, 1865.

**Clothing account:**

Last settled....., 186 ; drawn since \$..... 100

Due soldier \$ *45 92* / 100; due U. S. \$..... 100

Am't for cloth'g in kind or money adv'd \$..... 100

Due U. S. for arms, equipments, &c., \$..... 100

Bounty paid \$..... 100; due \$..... 100

Remarks: *Joined by transfer from  
Co. K. per L.O. 29. Had. Rec. Dept  
Gulf July 28/65.*

Book mark: *v. 211. P. 246. 74.*

(361)

*Chandler*

Copyist.

1036

Terril, John

Co G, 4 U. S. Col'd Cav.

Private | Corporal

CARD NUMBERS.

1	5356243	26
2	5356296	27
3	5356310	28
4	5356364	29
5	5356415	30
6	5356463	31
7	5356524	32
8	5356583	33
9	5356646	34
10	5356704	35
11	5356826	36
12	5356913	37
12	5356998	38
14	5357082	39
15	40729259	40
16		41
17		42
18		43
19		44
20		45
21		46
22		47
23		48
24		49
25		50

Book Mark:

See also

MAR 1955

D. 1055409. 2071 1711.

L. Jordan  
E.

T | **4 Cav.** | **U.S.C.T.**

John Terril

Priv., Co. G, 1 Reg't, Corps d'Afrique Cavalry.\*  
+ Age 30 yrs.  
Appears on

**Company Muster-in Roll**

of the organization named above. Roll dated  
New Orleans, La, Feb 8, 1864.  
Muster-in to date Feb 8, 1864.

Joined for duty and enrolled:

When Nov. 17, 1863.

Where New Orleans, La.

Period 3 years.

Valuation of horse, \$ 100

Valuation of horse equipments, \$ 100

Remarks: Pd<sup>2</sup> Prem.

\* Inserted by Jordan Ex

\* This organization subsequently became Co. G, 4 Reg't U. S. Colored Cavalry.

Book mark: \_\_\_\_\_

(356)

Lowry

Copyist.

4 Cav. U.S C.T.

*John Terril*  
*Co. G*, 1 Reg't Cav., Corps d'Afrique.\*

Appears on

**Company Muster Roll**

for *Enrollment to Feb. 29*, 1864.

Present or absent *Present*

Stoppage, \$ *100* for

Due Gov't, \$ *100* for

Valuation of horse, \$ *100*

Valuation of horse equipments, \$ *100*

Remarks:

\* This organization subsequently became Co. *G*, 4 Reg't U. S. Colored Cavalry.

Book mark:

*Lavery*

*J* | **4 Cav. | U.S.C.T.**

*John Tirrel*  
*Capt*, Co. G, 4 Reg't U. S. Col'd Cavalry.

Appears on

**Company Muster Roll**

for *March & April*, 1864.

Present or absent *Present*

Stoppage, \$ *100* for

Due Gov't, \$ *100* for

Valuation of horse, \$ *100*

Valuation of horse equipments, \$ *100*

Remarks:

*Filed with Serial John*

Book mark:

*Lowry*



*J* | **4 Cav. | U. S. C. T.**

*John Ferril*  
*Capt*, Co. G, 4 Reg't U. S. Col'd Cavalry.

Appears on

**Company Muster Roll**

for *May & June*, 186*4*.

Present or absent *Present*

Stoppage, \$ *100* for

Due Gov't, \$ *100* for

Valuation of horse, \$ *100*

Valuation of horse equipments, \$ *100*

Remarks:

Book mark:

(355)

*Lowry*

Copyist.

7 | **6 Cav. | U. S. C. T.**

John Tirrel

Capt, Co. G, 6 Reg't U. S. Col'd Cavalry.

Appears on

**Company Muster Roll**

for July & Aug, 1864.

Present or absent Present

Stoppage, \$ 100 for

Due Gov't, \$ 100 for

Valuation of horse, \$ 100

Valuation of horse equipments, \$ 100

Remarks:

Book mark:

(358)

Lowry

Copyist.

27 | **4 Cav. | U. S. C. T.**

*John Turrel*  
*Cople*, Co. G, 4 Reg't U. S. Col'd Cavalry.

Appears on

**Company Muster Roll**

for *Sep & Oct*, 1864.

Present or absent

*Present*

Stoppage, \$ *100* for

Due Gov't, \$ *100* for

Valuation of horse, \$ *100*

Valuation of horse equipments, \$ *100*

Remarks:

Book mark:

*L. W. M.*

*F* | **4 Cav. | U. S. C. T.**

*John Tisse*  
-----  
*Capt*, Co. G, 4 Reg't U. S. Col'd Cavalry.

Appears on

**Company Muster Roll**

for *Nov & Dec*, 186*4*.

Present or absent *Present*

Stoppage, \$ *100* for

Due Gov't, \$ *100* for

Valuation of horse, \$ *100*

Valuation of horse equipments, \$ *100*

Remarks: -----  
-----  
-----  
-----  
-----  
-----  
-----  
-----  
-----  
-----  
-----

Book mark : -----

*[Signature]*  
-----  
Copyright

| **4 Cav. | U. S. C. T.**

John Tinsel  
Capt., Co. G, 4 Reg't U. S. Col'd Cavalry.

Appears on

**Company Muster Roll**

for Nov & Dec, 1864.

Present or absent Present

Stoppage, \$ 100 for

Due Gov't, \$ 100 for

Valuation of horse, \$ 100

Valuation of horse equipments, \$ 100

Remarks: \_\_\_\_\_  
\_\_\_\_\_  
\_\_\_\_\_  
\_\_\_\_\_  
\_\_\_\_\_  
\_\_\_\_\_  
\_\_\_\_\_  
\_\_\_\_\_  
\_\_\_\_\_

Book mark: \_\_\_\_\_

          
Copyist

*[Handwritten mark]* | **4 Cav. | U. S. C. T.**

*John Pissel*

*[Handwritten mark]*, Co. G, 4 Reg't U. S. Col'd Cavalry.

Appears on

**Company Muster Roll**

for *Jan & Feb*, 1865.

Present or absent *Present*

Stoppage, \$ *100* for

Due Gov't, \$ *100* for

Valuation of horse, \$ *100*

Valuation of horse equipments, \$ *100*

Remarks: *Rec'd only \$7 per month in Apr 30 & 4 Corporal from Dec 28 & 4 in Jan 1, 65-*

Book mark:

*[Handwritten signature]*

(358)

Copyist.

*7*

**4 Cav. | U.S.C.T.**

*John Tittel*

*Capt*, Co. G, 4 Reg't U. S. Col'd Cavalry.

Appears on

**Company Muster Roll**

for *Men & arms*, 1865:

Present or absent *Present*

Stoppage, \$ *100* for

Due Gov't, \$ *100* for

Valuation of horse, \$ *100*

Valuation of horse equipments, \$ *100*

Remarks:

Book mark:

*Amund*



**4 Cav. | U.S.C.T.**

*John Pirel*  
*Carp*, Co. G, 4 Reg't U. S. Col'd Cavalry.

Appears on

**Company Muster Roll**

for *May & June*, 1865.

Present or absent *Present*

Stoppage, \$ *100* for

Due Gov't, \$ *100* for

Valuation of horse, \$ *100*

Valuation of horse equipments, \$ *100*

Remarks:  
.....  
.....  
.....  
.....  
.....  
.....  
.....  
.....  
.....  
.....

Book mark : .....

(355)

*[Signature]*  
Copyist.



*[Handwritten mark]*

**4 Cav. | U. S. C. T.**

*John T. [unclear]*  
*Capt.*, Co. G, 4 Reg't U. S. Col'd Cavalry.

Appears on

**Company Muster Roll**

for *July & Aug*, 1867.

Present or absent *Present*

Stoppage, \$ *100* for

Due Gov't, \$ *100* for

Valuation of horse, \$ *100*

Valuation of horse equipments, \$ *100*

Remarks:

Book mark:

*[Handwritten signature]*

*J* | **4 Cav. | U.S.C.T.**

*John Ferrel*  
.....  
*Capt.* , Co. G, 4 Reg't U. S. Col'd Cavalry.

Appears on

**Company Muster Roll**

for *Sept & Oct* , 186*5*.

Present or absent *Present*

Stoppage, \$ *100* for .....

Due Gov't, \$ *100* for .....

Valuation of horse, \$ *100*

Valuation of horse equipments, \$ *100*

Remarks: .....

RECEIVED ON FILE FEB 1865

Book mark: .....

*Fletcher*  
.....  
Copyist.

*J* | **4 Cav.** | **U.S.C.T.**

*John Tinsel*  
*capt.*, Co. G, 4 Reg't U. S. Col'd Cavalry.

Appears on

**Company Muster Roll**

for *Jan + Feb*, 186*6*.

Present or absent *Present*

Stoppage, \$ *100* for

Due Gov't, \$ *100* for

Valuation of horse, \$ *100*

Valuation of horse equipments, \$ *100*

Remarks:

Book mark:

*Fletcher*

G | 4 Cav. | U.S.C.T.

John Merrill

Art, Co, G, 4 Reg't U. S. Colored Cav.

Appears on Returns as follows:

July 1865 - On duty at Post  
Hd. Qrs.

Aug 1865 - On duty Carpenter  
at Post Hd. Qrs.

Book mark:

W. R. Lee

*T* | **4 Cav.** | **U.S.C.T.**

*John Turel*  
-----  
*Capt.*; Co. *G*, 4 Reg't U. S. Col'd Cavalry.

Appears on **Co. Muster-out Roll**, dated  
*New Orleans, La.,* *March 20*, 1866.

Muster-out to date *March 20*, 1866.

Last paid to *June 30*, 1865.

Clothing account:

Last settled....., 186 ; drawn since \$..... 100

Due soldier \$..... 100; due U. S. \$..... *9.55*/<sub>100</sub>

Am't for cloth'g in kind or money adv'd \$..... 100

Due U. S. for arms, equipments, &c., \$..... 100

Bounty paid \$..... 100; due \$..... 100

Remarks: *Joined at orig. org.*  
*Capt since March 24 '65*

Book mark: *V. 186 P 196, 74*

Thomas Albert

Co G, 4 U. S. Col'd Cav.

Corporal | Private

CARD NUMBERS.

1	356203	26
2	356256	27
3	356347	28
4	356396	29
5	356446	30
6	356506	31
7	356566	32
8	356627	33
9	356712	34
10	356799	35
11	356890	36
12	356985	37
13	357058	38
14	357166	39
15	30848497	40
16	30849190	41
17	30865625	42
18	30865653	43
19	40729260	44
20		45
21		46
22		47
23		48
24		49
25		50

Book Mark: 1564. 1880.

See also

*T* | **4 Cav.** | **U.S.C.T.**

*Albert Thomas*

*Capt.*, Co. *G*, 1 Reg't, Corps d'Afrique Cavalry.\*  
\* *Age 22 yrs.*  
Appears on

**Company Muster-in Roll**

of the organization named above. Roll dated

*New Orleans, La., Feb. 8,* 1864.

Muster-in to date *Feb. 5,* 1864.

Joined for duty and enrolled:

When *Dec 23*, 1863.

Where *New Iberia, La.*

Period *2* years.

Valuation of horse, \$ 100

Valuation of horse equipments, \$ 100

Remarks: *Pd. #2 Prem*

*\* Inserted by Jordan Ex*

\*This organization subsequently became Co. *G*, 4 Reg't U. S. Colored Cavalry.

Book mark: \_\_\_\_\_

(356)

*Lowry*

Copyist.

*T* 4 Cav. U.S C.T.

*Albert Thomas*  
Corpl, Co. *G*, 1 Reg't Cav., Corps d'Afrique.\*

Appears on

**Company Muster Roll**

for *Enrollment to Feb 27*, 186*4*.

Present or absent *Present*

Stoppage, \$ *100* for

Due Gov't, \$ *100* for

Valuation of horse, \$ *100*

Valuation of horse equipments, \$ *100*

Remarks:

\* This organization subsequently became Co. *G*, 4 Reg't U. S. Colored Cavalry.

Book mark:

(358)

*Lown*

Copyist.



T | 4 Cav. | U. S.

Albert Thomas  
Art, Co. G, 4 Reg't U. S. Cav.

Appears on

**Hospital Muster Roll**

of Corps d'Afrique U. S. A. General Hospital,

at New Orleans, La.,

for March, 1864.

Attached to hospital:

When \_\_\_\_\_, 186 .

How employed \_\_\_\_\_

Last paid by Maj. Never paid  
to \_\_\_\_\_, 186 .

Bounty paid \$ 100; due \$ 100

Present or absent Present

Remarks: \_\_\_\_\_

Book mark: \_\_\_\_\_

Morgan  
Coppist.

27

4 Cav. | U. S. C. T.

Albert Thomas

Priv., Co. G, 4 Reg't U. S. Col'd Cavalry.

Appears on

Company Muster Roll

for *March & April*, 1867.

Present or absent *Absent*

Stoppage, \$ *100* for

Due Gov't, \$ *100* for

Valuation of horse, \$ *100*

Valuation of horse equipments, \$ *100*

Remarks: *Sick in General Hospital*

Book mark:

*Lowny*

(353)

Copyist.

4 | 4<sup>em</sup> | MSC 9

Albert Thomas

Pvt, Co. 9, 4 Reg't MSC

Appears on

**Hospital Muster Roll**

of Corps d'Afrique U. S. A. General Hospital,

at New Orleans, La.,

for May & June, 1864.

Attached to hospital:

When....., 186 .

How employed.....

Last paid by Maj. ....

to ....., 186 .

Bounty paid \$ 100; due \$ 100

Present or absent

Remarks: Returned to duty May 19/64

Book mark: .....



*J* | **4 Cav.** | **U. S. C. T.**

*Albert Thomas*  
*Patrick*, Co. G, 4 Reg't U. S. Col'd Cavalry.

Appears on

**Company Muster Roll**

for *May & June*, 1864.

Present or absent *Present*

Stoppage, \$ *100* for

Due Gov't, \$ *100* for

Valuation of horse, \$ *100*

Valuation of horse equipments, \$ *100*

Remarks:

Book mark:

*Lowry*

*T* | **4 Cav. | U. S. C. T.**

*Albert Thomas*  
*Priv*, Co. G, 4 Reg't U. S. Col'd Cavalry.

Appears on

**Company Muster Roll**

for *July & Aug*, 1864.

Present or absent *Present*

Stoppage, \$ *100* for

Due Gov't, \$ *100* for

Valuation of horse, \$ *100*

Valuation of horse equipments, \$ *100*

Remarks:

Book mark:

*Lowry*

*T* | **4 Cav.** | **U.S.C.T.**

*Albert Thomas*  
*Priv*, Co. G, 4 Reg't U. S. Col'd Cavalry.

Appears on

**Company Muster Roll**

for *Sep & Oct*, 186 *4*.

Present or absent *Present*

Stoppage, \$ *100* for

Due Gov't, \$ *100* for

Valuation of horse, \$ *100*

Valuation of horse equipments, \$ *100*

Remarks:

Book mark:

*Loren*

(355)

Copyist.

*J* | *4 bar* | *US67*

*Albert Thomas*

*Pr*, Co. *G*, *4* Reg't *US6 bar*

Appears on

**Hospital Muster Roll**

of **U. S. A. Post Hospital,**

at **Port Hudson, La.,**

for *Nov + Dec*, 186*5*.

Attached to hospital:

When \_\_\_\_\_, 186*5*.

How employed *Patient*

Last paid by Maj. *Snider*

to *June 30*, 186*5*.

Bounty paid \$ *100*; due \$ *100*

Present or absent *Present*

Remarks: \_\_\_\_\_

Book mark: \_\_\_\_\_

*Mason*

*D* | **4 Cav.** | **U.S.C.T.**

*Albert Thomas*

*Pr*, Co. G, 4 Reg't U. S. Col'd Cavalry.

Appears on

**Company Muster Roll**

for *Nov 9 Dec*, 186*4*

Present or absent *Present*

Stoppage, \$ *100* for

Due Gov't, \$ *100* for

Valuation of horse, \$ *100*

Valuation of horse equipments, \$ *100*

Remarks:

Book mark:

*Amund*



*T* | **4 Cav.** | **U. S. C. T.**

*Albert Thomas*

*On*....., Co. G, 4 Reg't U. S. Col'd Cavalry.

Appears on

**Company Muster Roll**

for *Jan & Feb*....., 186*5*.

Present or absent *Present*

Stoppage, \$..... *100* for.....

Due Gov't, \$..... *100* for.....

Valuation of horse, \$..... *100*

Valuation of horse equipments, \$..... *100*

Remarks *Rec'd only \$7 per month in Apr 30, 64*  
*Corporal from Feb 8, 64*  
*in Mar 28, 64*

Book mark : .....

*[Signature]* Copyist.

*J* | **4 Cav. | U.S.C.T.**

*Albert Thomas*

*Pr*, Co. G, 4 Reg't U. S. Col'd Cavalry.

Appears on

**Company Muster Roll**

for *Men & App*, 1865.

Present or absent *Present*

Stoppage, \$ 100 for

Due Gov't, \$ 100 for

Valuation of horse, \$ 100

Valuation of horse equipments, \$ 100

Remarks:

Book mark:

*Pr*

*A* | **4 Cav. | U. S. C. T.**

*Albert Thomas*  
*Ma*, Co. G, 4 Reg't U. S. Col'd Cavalry.

Appears on  
**Company Muster Roll**  
for *May & June*, 186*5*

Present or absent *Present*

Stoppage, \$ *100* for

Due Gov't, \$ *100* for

Valuation of horse, \$ *100*

Valuation of horse equipments, \$ *100*

Remarks:  
.....  
.....  
.....  
.....  
.....  
.....  
.....  
.....  
.....  
.....

Book mark: .....

*Amiel*  
Copyist.

*[Handwritten mark]* | **4 Cav. | U. S. C. T.**

*Albert Thomas*

*A*, Co. G, 4 Reg't U. S. Col'd Cavalry.

Appears on

**Company Muster Roll**

for *July & Aug*, 186*5*.

Present or absent *Present*

Stoppage, \$ *100* for

Due Gov't, \$ *100* for

Valuation of horse, \$ *100*

Valuation of horse equipments, \$ *100*

Remarks:

Book mark:

*[Handwritten signature]*

Copyist

*T* | **4 Cav.** | **U.S.C.T.**

*Albert Thomas*  
*Pvt*, Co. G, 4 Reg't U. S. Col'd Cavalry.

Appears on

**Company Muster Roll**

for *Sept & Oct*, 186*5*.

Present or absent *Present*

Stoppage, \$ *100* for

Due Gov't, \$ *100* for

Valuation of horse, \$ *100*

Valuation of horse equipments, \$ *100*

Remarks:

NEXT ROLL ON FILE FEB 1866

Book mark:

*H. Fletcher*  
Copyist.

*T* | **4 Cav.** | **U.S.C.T.**

*Albert Thomas*

*Priv*, Co. G, 4 Reg't U. S. Col'd Cavalry.

Appears on

**Company Muster Roll**

for *Jan & Feb*, 1866.

Present or absent *Absent*

Stoppage, \$ *100* for

Due Gov't, \$ *100* for

Valuation of horse, \$ *100*

Valuation of horse equipments, \$ *100*

Remarks: *Absent since*

Book mark:

*Fletcher*

7 | 460 | 1867

Albert Thomas  
Pr, Co. G, 4 Reg't 11660

Appears on

**Hospital Muster Roll**

of **U. S. A. Post Hospital,**

at **Port Hudson, La.,**

for Jan + Feb, 1866.

Attached to hospital:

When \_\_\_\_\_, 1866.

How employed Patient

Last paid by Maj. Inider

to June 30, 1866.

Bounty paid \$ 100; due \$ 100

Present or absent \_\_\_\_\_

Remarks: Died Jan 7/66

Book mark: \_\_\_\_\_

D. Brown

51 | 4 Cav. | U.S.C.T.

Albert Thomas

Port, Co. G, 4 Reg't U. S. Colored Cav.

Appears on Returns as follows:

Apr 1864 - Absent sick sent  
to Genl Hosp. Apr 28/64

Book mark:

W. R. Lee



*T* | **4 Cav. | U.S.C.T.**

*Albert Thomas*  
*Priv*, Co. *G*, 4 Reg't U. S. Col'd Cavalry.

Appears on **Co. Muster-out Roll**, dated  
*New Orleans, La. Nov 20*, 1866.

Muster-out to date \_\_\_\_\_, 186 .

Last paid to \_\_\_\_\_, 186 .

**Clothing account:**

Last settled \_\_\_\_\_, 186 ; drawn since \$ \_\_\_\_\_ 100

Due soldier \$ \_\_\_\_\_ 100; due U. S. \$ \_\_\_\_\_ 100

Am't for cloth'g in kind or money adv'd \$ \_\_\_\_\_ 100

Due U. S. for arms, equipments, &c., \$ \_\_\_\_\_ 100

Bounty paid \$ \_\_\_\_\_ 100; due \$ \_\_\_\_\_ 100

Remarks: *Joined at orig. org.*  
*Said Jan'y 7<sup>th</sup> 66 Port*  
*Hudson, La.*

Book mark: *1564/1880*

(861)

*Fletcher*

Copyist.

Thomas, Albert

, Co. *G*, *4* Reg't *USCav.*

*3* Enclosures.

Bed Cards	Descriptive Lists
Burial Records	Final Statements <i>2</i>
Certs. of Dis. for Discharge	Furloughs
C. M. Charges	Med. Des. Lists
Med. Certificates	Orders

Other papers relating to—

Admission to Hosp'l	Furlough
Casualty Sheet (Officer's)	Med. Examination
Confinement	Misc. Information
Contracts	Pay or Clothing
Death or Effects	Personal Reports
Desertions	Rank
Discharge from Hosp'l	Transfer to Hosp'l
Discharge from Service	Transfer to V. R. C.
Duty	Transportation

U.C. 5th Regt 8th 1866  
Advt Genl List sent 2nd

1866

FINAL STATEMENT

OF

Albert Thomas

4th Reg't of U.S.C. Cav.

VOLUNTEERS.

Advt Genl 7th 1866

NOTE 1.—Two of these certificates (or duplicates) are to be given to each volunteer soldier who may be discharged previously to the discharge of his company, that he may at once receive from the Paymaster the pay, &c., due him, and the captain or other officer commanding the company will certify to the act of the delivery of the duplicate certificates; on these certificates the Soldier is "entitled to" his discharge, and should also present his discharge to the Paymaster to have the payment endorsed on it. The discharge is to be given back to the Soldier by the Paymaster; the latter only retaining as his voucher the duplicate certificates.

NOTE 2.—If the Soldier is entitled to pay for the use of his horse, the Company Commander will certify to that fact, and also to the time he has pay due for having been so mounted on his own horse.

NOTE 3.—Amounts due the Sutler and Laundress must be entered on the Muster Roll on which the death, desertion, &c., is reported, as well as on the final statement, otherwise the amount cannot be collected from the United States.

NOTE 4.—This blank will be used for deceased volunteers as well as others.

ADJUTANT GENERAL'S OFFICE

July 8th 1866

Duplicate with inventory sent to Adj. Genl.

*[Faint signature and stamp]*

I certify, on honor, that Albert Thomas a Private of  
Captain J. R. Loomis Company (E) of the 4<sup>th</sup> Regiment of Mississippi  
**VOLUNTEERS**, of the State of \_\_\_\_\_, born in Grand Gulf, State  
of Mississippi, aged 22 years; 5 feet 3 inches high; Brown complexion,  
Blue eyes, Black hair, and by occupation a Labourer, having joined the company on  
its original organization at \_\_\_\_\_, and enrolled in it at the muster into  
the service of the United States at New Iberia, on the 23<sup>d</sup> day  
of December, 1863, (or was mustered in service as a recruit, by Captain  
McAlister, at New Orleans, on the 8<sup>th</sup> day of February  
1864, to serve in the Regiment,) for the term of Three years  
and having served **HONESTLY** and **FAITHFULLY** with his Company in \_\_\_\_\_

to the present date, ~~is now entitled to a DISCHARGE~~ by reason of did in  
Post-Hospital Port Hudson La. Jan. 7<sup>th</sup> 1866. by  
reason of Debility from malarial disease

The said Private Albert Thomas was last paid by Paymaster  
Maj. Snider to include the 30<sup>th</sup> day of June, 1865, and has  
pay due him from that time to the present date; he is entitled to pay and subsistence for  
**TRAVELING** to place of enrollment and whatever other allowances are authorized to volunteer  
soldiers, or militia, so discharged. He has received (Eighty) 80. <sup>70</sup>/<sub>100</sub> dollars,  
advanced by the United States on account of **CLOTHING**. since Dec. 31<sup>st</sup> 1864

There is to be stopped from him, on account of the State of \_\_\_\_\_, or other  
authorities for **CLOTHING**, &c., received on entering service, \_\_\_\_\_ <sup>100</sup>/<sub>100</sub> dollars; also,  
for expenses of **SUBSISTENCE** for **TRAVELING** from place of enrollment to the place of rendezvous,  
amounting to \_\_\_\_\_ <sup>100</sup>/<sub>100</sub> dollars: and on account of the United States for **EXTRA**  
**CLOTHING** received in kind from \_\_\_\_\_ and for other  
stoppages, viz:

\_\_\_\_\_ amounting to \_\_\_\_\_ <sup>100</sup>/<sub>100</sub> dollars;  
and he has been **SUBSISTED** for **TRAVELING** to his place of enrollment, up to the \_\_\_\_\_  
\_\_\_\_\_, 186 .

He is indebted to \_\_\_\_\_ SUTLER, \_\_\_\_\_ <sup>100</sup>/<sub>100</sub> dollars.

He is indebted to \_\_\_\_\_ LAUNDRESS, \_\_\_\_\_ <sup>100</sup>/<sub>100</sub> dollars.

Given in Duplicate, at Port Hudson this 7<sup>th</sup> day of Jan, 1866.

J. M. Jenkins Capt.  
Asst. Surg. In charge  
Commanding Company  
Post Hospital

Jan 4<sup>th</sup> 1866

FINAL STATEMENT

OF

Albert Thomas

5<sup>th</sup> Reg't of U. S. Cav.

VOLUNTEERS.

G.H.

NOTE 1.—Two of these certificates (or duplicates) are to be given to each volunteer soldier who may be discharged previously to the discharge of his company, that he may at once receive from the Paymaster the pay, &c., due him, and the captain or other officer commanding the company will certify to the act of the delivery of the duplicate certificates; on these certificates the Soldier is "entitled to" his discharge, and should also present his discharge to the Paymaster to have the payment endorsed on it. The discharge is to be given back to the Soldier by the Paymaster; the latter only retaining as his voucher the duplicate certificates.

NOTE 2.—If the Soldier is entitled to pay for the use of his horse, the Company Commander will certify to that fact, and also to the time he has pay due for having been so mounted on his own horse.

NOTE 3.—Amounts due the Sutler and Laundress must be entered on the Muster Roll on which the death, desertion, &c., is reported, as well as on the final statement, otherwise the amount cannot be collected from the United States.

NOTE 4.—This blank will be used for deceased volunteers as well as others.

I certify, on honor, that Albert Thomas a Private of  
Captain J. R. Loomis's Company (E) of the 4<sup>th</sup> Regiment of U.S.C. Vol.  
**VOLUNTEERS**, of the State of Mississippi, born in Grand Gulf, State  
of Mississippi, aged 22 years; 5 feet 3 inches high; Brown complexion,  
Blue eyes, Black hair, and by occupation a Labourer, having joined the company on  
its original organization at \_\_\_\_\_, and enrolled in it at the muster into  
the service of the United States at New Iberia, on the 23<sup>d</sup> day  
of December, 1863, (or was mustered in service as a recruit, by Captain  
McAlister, at New Orleans, on the 8<sup>th</sup> day of February  
1864, to serve in the Regiment,) for the term of Three years  
and having served **HONESTLY** and **FAITHFULLY** with his Company in

to the present date, ~~is now entitled to a DISCHARGE by reason of~~ did in  
Post Hospital Post Hudson La. Jan. 7<sup>th</sup> 1866  
by reason of Debility from Miasmatic disease

The said Private Albert Thomas was last paid by Paymaster  
Maj. Snider to include the 30<sup>th</sup> day of June, 1865, and has  
pay due him from that time to the present date; he is entitled to pay and subsistence for  
**TRAVELING** to place of enrollment and whatever other allowances are authorized to volunteer  
soldiers, or militia, so discharged. He has received (Eighty) 80 <sup>70</sup>/<sub>100</sub> dollars,  
advanced by the United States on account of **CLOTHING**. since Dec. 31<sup>st</sup> 1864.

There is to be stopped from him, on account of the State of \_\_\_\_\_, or other  
authorities for **CLOTHING**, &c., received on entering service, \_\_\_\_\_<sub>100</sub> dollars; also,  
for expenses of **SUBSISTENCE** for **TRAVELING** from place of enrollment to the place of rendezvous,  
amounting to \_\_\_\_\_<sub>100</sub> dollars: and on account of the United States for **EXTRA**  
**CLOTHING** received in kind from \_\_\_\_\_ and for other  
stoppages, viz:

\_\_\_\_\_ amounting to \_\_\_\_\_<sub>100</sub> dollars;  
and he has been **SUBSISTED** for **TRAVELING** to his place of enrollment, up to the \_\_\_\_\_  
\_\_\_\_\_, 186 .

He is indebted to \_\_\_\_\_ SUTLER \_\_\_\_\_<sub>50</sub> dollars.

He is indebted to \_\_\_\_\_ LAUNDRESS \_\_\_\_\_<sub>100</sub> dollars.

Given in Duplicate, at Post Hudson La., this 7<sup>th</sup> day of Jan., 1866.

J. M. Jenkins Capt.  
Asst. Surg. in charge  
Post Hospital

Inventory of the effects of Albert Thomas Priv.  
 Company G, 1<sup>st</sup> Regiment Infantry,  
 who died in the Post Hudson Post General Hospital Post Hudson  
Jan. 7<sup>th</sup>, 1866.

CAPS .....	<i>No effects</i>	BLANKETS .....	<i>No effects</i>
DRESS COATS .....		KNAPSACKS .....	
OVERCOATS .....		CANTEENS .....	
JACKETS .....		HIVERSACKS .....	
TROUSERS .....		MUSKETS .....	
SHIRTS .....		BAYONETS .....	
DRAWERS .....		CARTRIDGE BOX .....	
BOOTS, pairs .....		BELT .....	
SHOES, pairs .....		MONEY .....	
STOCKINGS .....			

INVENTORY

OF THE EFFECTS OF

Albert Thomas

Late of Company G, 1<sup>st</sup> Regiment

Infantry, who died

at Post Hudson Post General

Hospital Jan 7<sup>th</sup>,

1866.

Regular Inventory  
(No. 104.) sent to G. S. O.  
with Final Statement

MARK 1475

U. S. Army General Hospital,

186

Commanding Officer, Company,

Regiment

I have to inform you

that of your Company died in this

Hospital on of

I enclose his Descriptive List, with Pay and Clothing Account, and Inventory of his effects.

Very respectfully, yours, &c.,

J. M. Jenkins

Asst. Surgeon U. S.

In charge of General Hospital



100  
Thomas Alexander

Co A, 4 U. S. Col'd Cav.

Private Private

CARD NUMBERS.

1	5348879	26
2	5348967	27
3	5349069	28
4	5349752	29
5	40729262	30
6		31
7		32
8		33
9		34
10		35
11		36
12		37
13		38
14		39
15		40
16		41
17		42
18		43
19		44
20		45
21		46
22		47
23		48
24		49
25		50

Book Mark:

See also

D. 1569645 pom m

D. Jordan  
E

Y | 4 Cav. | U.S.C.T.

Alex Thomas

Priv, Co. A, 4 Reg't U. S. Col'd Cavalry.

Appears on

Company Muster Roll

for May + June, 1864

Present or absent not stated

Stoppage, \$ 100 for

Due Gov't, \$ 100 for

Valuation of horse, \$ 100

Valuation of horse equipments, \$ 100

Remarks: not mustered

For enrollment see Card for July & Aug. 64.

Book mark:

R. Richardson

*y* | 4 Cav. | U.S.C.T.

Alexander Thomas  
Pmi, Co. A, 4 Reg't U. S. Col'd Cavalry.

Appears on

**Company Muster Roll**

for *July & Aug*, 186 *4*

Present or absent *Present*

Stoppage, \$ *100* for

Due Gov't, \$ *100* for

Valuation of horse, \$ *100*

Valuation of horse equipments, \$ *100*

Remarks: *Not mustered*

*Enrolled June 3/64 at New Orleans for 3 yrs - Muster in not shown*

Book mark:

*R. Richardson*

J | 4 Cav. | U.S.C.T.

Alexander Thomas

Pi, Co. A, 4 Reg't U. S. Col'd Cavalry.

Appears on

Company Muster Roll

for Sept & Oct, 1864.

Present or absent

Stoppage, \$ 100 for

Due Gov't, \$ 100 for

Valuation of horse, \$ 100

Valuation of horse equipments, \$ 100

Remarks: Died in Reg't Hospital  
Oct 24. 64

Book mark: 4749, 2<sup>d</sup> and. Sept 21/67

Donnelly

(358)

Copyist.

SP | 4 Cav. | U.S.C.T.

Alex. Thomas

Sgt., Co. A, 4 Reg't U. S. Colored Cav.

Appears on Returns as follows:

June 1864. Gain: June 3/64  
Camp Bolivar Enlisted  
in the Regt.

Absent Recruit to be mustered

Book mark:

W. R. Lee

*J* | **4 Cav. | U.S.C.T.**

*Alexander Thomas*

....., Co. *A*, 4 Reg't U. S. Col'd Cavalry.

Appears on **Co. Muster-out Roll**, dated

*New Orleans La, Mch 20*, 186*6*.

Muster-out to date ..... 186 .

Last paid to ..... 186 .

**Clothing account:**

Last settled....., 186 ; drawn since \$..... 100

Due soldier \$..... 100; due U. S. \$..... 100

Am't for cloth'g in kind or money adv'd \$..... 100

Due U. S. for arms, equipments, &c., \$..... 100

Bounty paid \$..... 100; due \$..... 100

Remarks:.....

Book mark *{ See Sept & Oct. 64. Roll*  
*V 25 P 52, 68*

(361)

*Prewitt*

Copyist.

Thomas, Alexander

Co. A, 4 Reg't U.S.C. Co

1 Enclosures.

Bed Cards	Final Statements
Burial Records	Furloughs or L. of A.
Certs. of Dis. for Discharge	Med. Certificates
C. M. Charges	Med. Des. Lists
Descriptive Lists	Orders
Discharge Certificates	Pris. of War Record
Enlistment Papers	Resignations

Other papers relating to—

Admission to Hosp'l	Furlough or L. of A.
Casualty Sheet	Med. Examination
Confinement	Misc. Information
Contracts	Pay or Clothing
Death or Effects	Personal Reports
Desertion	Rank
Discharge from Hosp'l	Transfer to Hosp'l
Discharge from Service	Transfer to V. R. C.
Duty	Transportation



CASUALTY SHEET

No. ....

Alexander Thomas 1864

Private of Company A

4<sup>th</sup> Regiment of W. S. Col<sup>d</sup> Cav.

State Volunteers.

Dec 24, 1864

NATURE OF CASUALTY.

### CASUALTY SHEET.

Name: Alexander Thomas

Rank: Private Company: A Regiment: 4<sup>th</sup>

Arm: U. S. Col. Cav. State: \_\_\_\_\_

Nature of Casualty: death

CAUSE OF CASUALTY—(NAME OF DISEASE, &C.)

BY WHOM DISCHARGED.

DEGREE OF DISABILITY.

FROM WHAT SOURCE THIS INFORMATION WAS OBTAINED.

Master Roll for Sept. & Oct. 64

BY WHOM CERTIFIED.

Capt. John Kirk

REMARKS.

DATE OF DISCHARGE, DEATH, &C.

October 24<sup>th</sup> 1864

PLACE OF DISCHARGE, DEATH, &C.

Port Hudson La.

Edward Renaud  
Clerk.

Thomas, Alexander

Co E, 4 U.S. Col'd Cav.

Private | Private

CARD NUMBERS.

1	5353846	26
2	5353898	27
3	5353954	28
4	5354007	29
5	5354089	30
6	5354158	31
7	5354898	32
8	40729261	33
9		34
10		35
11		36
12		37
13		38
14		39
15		40
16		41
17		42
18		43
19		44
20		45
21		46
22		47
23		48
24		49
25		50

Book Mark:

EB VII P 12.

See also

D. 1569645 PONTA

D. Jordan  
Ed

*T* | **4 Cav. | U.S.C.T.**

*Alexander Thomas*

*Pvt*, Co. *E*, 1 Reg't, Corps d'Afrique Cavalry.\*  
\* Age 24 yrs.  
Appears on

**Company Muster-in Roll**

of the organization named above. Roll dated  
*New Orleans La. Dec. 31*, 186*3*.

Muster-in to date *Dec. 31*, 186*3*.

Joined for duty and enrolled:

When *Nov. 8*, 186 .

Where *New Orleans*

Period *3* years.

Valuation of horse, \$ 100

Valuation of horse equipments, \$ 100

Remarks:

*\* Inserted by Jordan Exp*

\* This organization subsequently became Co. *E*, 4 Reg't U. S. Colored Cavalry.

Book mark:

*Wendell*

*J* **4 Cav. | U.S C.T.**

*Alexander Thomas*  
*Pvt.*, Co. *E*, 1 Reg't Cav., Corps d'Afrique.\*

Appears on

**Company Muster Roll**

for *Enlistment to Dec. 31, 1883*

Present or absent *Present*

Stoppage, \$ *100* for

Due Gov't, \$ *100* for

Valuation of horse, \$ *100*

Valuation of horse equipments, \$ *100*

Remarks:  
.....  
.....  
.....  
.....  
.....  
.....  
.....

\* This organization subsequently became Co. *E*, 4 Reg't U.S. Colored Cavalry.

Book mark: .....

*Wendel*

J 4 Cav. | U.S C.T.

Alexander Thomas

, Co. E, 1 Reg't Cav., Corps d'Afrique.\*

Appears on

Company Muster Roll

for Jan & Feb, 1864

Present or absent Present

Stoppage, \$ 100 for

Due Gov't, \$ 100 for

Valuation of horse, \$ 100

Valuation of horse equipments, \$ 100

Remarks:

\* This organization subsequently became Co. E, 4 Reg't U. S. Colored Cavalry.

Book mark:

Larwood

I | **4 Cav.** | **U.S.C.T.**

Alexander Thomas

Priv., Co. E, 4 Reg't U. S. Col'd Cav.

Appears on

**Company Muster Roll**

for Mar + Apr, 186 4

Present or absent Present

Stoppage, \$ 100 for

Due Gov't, \$ 100 for

Valuation of horse, \$ 100

Valuation of horse equipments, \$ 100

Remarks:

Book mark:

Lawrence

(358)

Copyist.



A | **4 Cav.** | **U.S.C.T.**

Thomas Alexander

Priv., Co. E, 4 Reg't U. S. Col'd Cav.

Appears on

**Company Muster Roll**

for May & June, 1864.

Present or absent.....

Stoppage, \$.....100 for .....

Due Gov't, \$.....100 for .....

Valuation of horse, \$.....100

Valuation of horse equipments, \$.....100

Remarks: Died May 19/64

Filed with Thomas Alexander

Book mark: Died May 22/64

EB 911 P. 12

L. J. J. J.

(358)

Copyist.

J | **4 Cav.** | **U.S.C.T.**

Alexander Thomas

Priv, Co. E, 4 Reg't U. S. Col'd Cav.

Appears on

**Company Muster Roll**

for July + Aug, 1864.

Present or absent.....

Stoppage, \$.....100 for.....

Due Gov't, \$.....100 for.....

Valuation of horse, \$.....100

Valuation of horse equipments, \$.....100

Remarks: Dis d May 19/64

Book mark: .....

(358)

Lawrence

Copyist.

91 | 4 Cav. | U.S.C.T.

Alex Thomas

Port, Co. C, 4 Reg't U. S. Colored Cav.

Appears on Returns as follows:

May 1861 - Loss; May 19/61  
Greenville La. died of  
disease.

Book mark:

W. R. Lee

546,

Copyist.

A | 4 Cav. | U.S.C.T.

Thomas Alexander

Put, Co. E, 4 Reg't U. S. Col'd Cavalry.

Appears on **Co. Muster-out Roll**, dated  
New Orleans La, Mch 20, 1866.

Muster-out to date \_\_\_\_\_, 186\_\_.

Last paid to \_\_\_\_\_, 186\_\_.

Clothing account:

Last settled \_\_\_\_\_, 186\_\_ ; drawn since \$ \_\_\_\_\_ 100

Due soldier \$ \_\_\_\_\_ 100; due U. S. \$ \_\_\_\_\_ 100

Am't for cloth'g in kind or money adv'd \$ \_\_\_\_\_ 100

Due U. S. for arms, equipments, &c., \$ \_\_\_\_\_ 100

Bounty paid \$ \_\_\_\_\_ 100; due \$ \_\_\_\_\_ 100

Remarks: joined at orig. org.  
died July 12/64 at New  
Orleans La.

Book mark: died May 22/64 E B V. P. 12

(861)

Lloyd

Copyist.

Thomas, Alexander

P. Co B, 4 U. S. C. Cav.

/ Enclosures.

Bed Cards	Descriptive Lists
Burial Records	Final Statements /
Certs. of Dis. for Discharge	Furloughs
C. M. Charges	Med. Des. Lists
Med. Certificates	Orders

Other papers relating to—

Admission to Hosp'l	Furlough
Casualty Sheet ( <del>Officer's</del> )	Med. Examination
Confinement	Misc. Information
Contracts	Pay or Clothing
Death or Effects	Personal Reports
Desertions	Rank
Discharge from Hosp'l	Transfer to Hosp'l
Discharge from Service	Transfer to V. R. C.
Duty	Transportation

FINAL STATEMENT

OF

Alexander Thomas

4<sup>th</sup> Reg't of W.C. Cavalry

VOLUNTEERS.

And 1<sup>st</sup> Reg't 25<sup>th</sup> Inf.

NOTE 1.—Two of these certificates (or duplicates) are to be given to each volunteer soldier who may be discharged previously to the discharge of his company, that he may at once receive from the Paymaster the pay, &c., due him, and the captain or other officer commanding the company will certify to the act of the delivery of the duplicate certificates; on these certificates the Soldier is "entitled to" his discharge, and should also present his discharge to the Paymaster to have the payment endorsed on it. The discharge is to be given back to the Soldier by the Paymaster; the latter only retaining as his voucher the duplicate certificates.

NOTE 2.—If the Soldier is entitled to pay for the use of his horse, the Company Commander will certify to that fact, and also to the time he has pay due for having been so mounted on his own horse.

NOTE 3.—Amounts due the Sutler and Laundress must be entered on the Muster Roll on which the death, desertion, &c., is reported, as well as on the final statement, otherwise the amount cannot be collected from the United States.

NOTE 4.—This blank will be used for deceased volunteers as well as others.

[OFFICE INDORSEMENT.]

War Department,

ADJUTANT GENERAL'S OFFICE,

March 7, 1874.

The death of Alexander Thomas  
Private, Co. E; 4<sup>th</sup> Reg't U. S.  
Colored Cavalry, is reported as follows:

On Company Muster Roll.  
For May 1<sup>st</sup> June, 1864, May 19<sup>th</sup>, 1864  
Company Muster-out Roll.

July 12<sup>th</sup> 1864  
Company Descriptive Book.

....., 186  
Company Morning Reports.

....., 186  
Soldier's Final Statement.

May 22<sup>d</sup> 1864  
Soldier's Record of Death and Interment.

....., 186  
Soldier's Inventory of Effects.

....., 186  
Soldier's Certificate of Disability for Discharge.

....., 186  
Soldier's Individual Muster-out Roll.

....., 186  
Regimental Return.

For May, 1864, May 19<sup>th</sup>, 1864  
Regimental Quarterly Returns.

....., 186  
Regimental Descriptive Book.

....., 186  
By Surgeon General.

(.....) 186  
May 22, 1864, is held to be  
the correct date, and the Company Muster  
Roll will be amended accordingly.

Thomas M. Stewart  
Assistant Adjutant General.

E.O. 11<sup>1/2</sup> See letter to 2<sup>d</sup> Adjt.  
dated April 2<sup>d</sup> 1874.

noted on R -

ADJUTANT GENERAL'S OFFICE

Aug 21<sup>st</sup> 1874

2 Duplicates with [unclear] [unclear]



24173

I certify, on honor, that Alexander Thomas Brinot of  
 Captain C. W. Briggs Company (E) of the 44 Regiment of 109 Col'd Cal  
**VOLUNTEERS**, of the State of Louisiana, born in New Orleans, State  
 of Louisiana, aged 24 years; 5 feet 6 inches high; Blk complexion,  
Blk eyes, Blk hair, and by occupation a Farmer, having joined the company on  
 its original organization at New Orleans, and enrolled in it at the muster into  
 the service of the United States at New Orleans, on the Eight day  
 of November, 1863, (or was mustered in service as a recruit, by W. D. Miller  
at New Orleans, on the thirtyfirst day of December,  
 1863, to serve in the Regiment,) for the term of three years  
 and having served **HONESTLY** and **FAITHFULLY** with his Company in  
 to the present date, is now entitled to a **DISCHARGE** by reason of Death  
died at Regt Hospital of Pneumonia  
the 22<sup>nd</sup> day of May 1864

The said Alexander Thomas was last paid by Paymaster  
W. J. Loflan to include the 30<sup>th</sup> day of April, 1864 and has  
 pay due him from that time to the present date; he is entitled to pay and subsistence for  
**TRAVELING** to place of enrollment and whatever other allowances are authorized to volunteer  
 soldiers, or militia, so discharged. He has received seventeen 30/100 dollars,  
 advanced by the United States on account of **CLOTHING**.

There is to be stopped from him, on account of the State of \_\_\_\_\_, or other  
 authorities for **CLOTHING**, &c., received on entering service, \_\_\_\_\_/100 dollars; also,  
 for expenses of **SUBSISTENCE** for **TRAVELING** from place of enrollment to the place of rendezvous,  
 amounting to \_\_\_\_\_/100 dollars: and on account of the United States for **EXTRA**  
**CLOTHING** received in kind from \_\_\_\_\_ and for other  
 stoppages, viz:

\_\_\_\_\_ amounting to \_\_\_\_\_/100 dollars;  
 and he has been **SUBSISTED** for **TRAVELING** to his place of enrollment, up to the \_\_\_\_\_  
 \_\_\_\_\_, 1864.

He is indebted to \_\_\_\_\_, **SUTLER**, \_\_\_\_\_/100 dollars.

He is indebted to \_\_\_\_\_, **LAUNDRESS**, \_\_\_\_\_/100 dollars.

Given in Duplicate, at Camp Colfax this 23<sup>d</sup> day of May, 1864,

W. B. Casdel

W. B. Casdel

Commanding Company.

1040  
Thomas Rosen

Co B, 4 U. S. Col'd Cav.

Private | Corporal

CARD NUMBERS.

1	5349861	26
2	5349961	27
3	5350054	28
4	5350159	29
5	5350253	30
6	5350342	31
7	5350422	32
8	5350496	33
9	5350571	34
10	5350657	35
11	5350742	36
12	5350837	37
13	5350923	38
14	5350957	39
15	5351036	40
16	5351116	41
17		42
18		43
19		44
20		45
21		46
22		47
23		48
24		49
25		50

Book Mark:

See also



1040  
Thomas Rosen

Co B, 4 U. S. Col'd Cav.

Private | Corporal

CARD NUMBERS.

1	5349861	26
2	5349961	27
3	5350054	28
4	5350159	29
5	5350253	30
6	5350342	31
7	5350422	32
8	5350496	33
9	5350571	34
10	5350657	35
11	5350742	36
12	5350837	37
12	5350923	38
14	5350957	39
15	5351036	40
16	5351116	41
17		42
18		43
19		44
20		45
21		46
22		47
23		48
24		49
25		50

Book Mark:

See also

J | **4 Cav.** | **U.S.C.T.**

Bosen Thomas

Co. B, Co. B, 1 Reg't La. Cav., Corps d'Afrique.\*

Age 20 yrs.  
Appears on

**Company Muster-in Roll**

of the organization named above. Roll dated

New Orleans, La, Oct 27, 1863.

Muster-in to date Oct 27, 1863.

Joined for duty and enrolled:

When Oct 12, 1863.

Where New Orleans

Period 3 years.

Valuation of horse, \$ 100

Valuation of horse equipments, \$ 100

Remarks: \_\_\_\_\_

+ Inserted by Jordan Ex

\*This organization subsequently became Co. \_\_\_\_\_, 4 Reg't U. S. Colored Cavalry.

Book mark: \_\_\_\_\_

(356)

Tracy  
Copyist.

*J* | **4 Cav. | U.S.C.T.**

*Joseph Thomas*  
-----  
*Co. B*, Co. *B*, 1 Reg't La. Cav., Corps d'Afrique.\*

Appears on

**Company Muster Roll**

for *Oct 27 to Dec 31*, 186*3*.

Present or absent *Present*

Stoppage, \$ \_\_\_\_\_ *100* for \_\_\_\_\_

Due Gov't, \$ \_\_\_\_\_ *100* for \_\_\_\_\_

Valuation of horse, \$ \_\_\_\_\_ *100*

Valuation of horse equipments, \$ \_\_\_\_\_ *100*

Remarks: \_\_\_\_\_  
\_\_\_\_\_  
\_\_\_\_\_  
\_\_\_\_\_  
\_\_\_\_\_  
\_\_\_\_\_

\*This organization subsequently became Co. *B*. 4 Reg't U. S. Colored Cavalry.

Book mark: \_\_\_\_\_

*King*

*J*

**4 Cav. | U.S C.T.**

*Bosen Thompson*  
*Cob*, Co. *B*, 1 Reg't Cav., Corps d'Afrique.\*

Appears on

**Company Muster Roll**

for *Jan & Feb*, 186*4*.

Present or absent *Present*

Stoppage, \$ *100* for

Due Gov't, \$ *100* for

Valuation of horse, \$ *100*

Valuation of horse equipments, \$ *100*

Remarks:

\* This organization subsequently became Co. *B*, 4 Reg't U. S. Colored Cavalry.

Book mark:

(358)

*[Signature]*

Copyist.

*J* | **4 Cav.** | **U.S.C.T.**

*Wesen Thomas*

*W*, Co. B. 4 Reg't U. S. Col'd Cavalry.

Appears on

**Company Muster Roll**

for *1st & 2d*, 1864.

Present or absent *Present*

Stoppage, \$ 100 for

Due Gov't, \$ 100 for

Valuation of horse, \$ 100

Valuation of horse equipments, \$ 100

Remarks :

Book mark :

(358)

*[Signature]*  
Coygist.

*T* | **4 Cav.** | **U.S.C.T.**

*Boseu Thomas*  
*Bob*, Co. B. 4 Reg't U. S. Col'd Cavalry.

Appears on

**Company Muster Roll**

for *May & June*, 1864.

Present or absent *Present*

Stoppage, \$ 100 for

Due Gov't, \$ 100 for

Valuation of horse, \$ 100

Valuation of horse equipments, \$ 100

Remarks :  
\_\_\_\_\_  
\_\_\_\_\_  
\_\_\_\_\_  
\_\_\_\_\_  
\_\_\_\_\_  
\_\_\_\_\_  
\_\_\_\_\_  
\_\_\_\_\_

Book mark : \_\_\_\_\_

(358) \_\_\_\_\_ *Copyist.*

*T* | **4 Cav.** | **U.S.C.T.**

*Bosen Thomas*  
*Capt*, Co. B. 4 Reg't U. S. Col'd Cavalry.

Appears on

**Company Muster Roll**

for *July + Aug*, 186*C*.

Present or absent *Present*

Stoppage, \$ *100* for

Due Gov't, \$ *100* for

Valuation of horse, \$ *100*

Valuation of horse equipments, \$ *100*

Remarks :  
\_\_\_\_\_  
\_\_\_\_\_  
\_\_\_\_\_  
\_\_\_\_\_  
\_\_\_\_\_  
\_\_\_\_\_  
\_\_\_\_\_  
\_\_\_\_\_

Book mark : \_\_\_\_\_

*[Signature]*  
Copyist.

*T* | 4 Cav. | U.S.C.T.

*Robert Thomas*

*Bob*, Co. B. 4 Reg't U. S. Col'd Cavalry.

Appears on

**Company Muster Roll**

for *Sept + Oct*, 1864.

Present or absent *Present*

Stoppage, \$ 100 for

Due Gov't, \$ 100 for

Valuation of horse, \$ 100

Valuation of horse equipments, \$ 100

Remarks :

Book mark :

(358)

*Tracy*  
Copyist.



T | **4 Cav.** | **U.S.C.T.**

Rose Thomas

priv., Co. B. 4 Reg't U. S. Col'd Cavalry.

Appears on

**Company Muster Roll**

for Nov + Dec, 1864.

Present or absent present

Stoppage, \$ 100 for

Due Gov't, \$ 100 for

Valuation of horse, \$ 100

Valuation of horse equipments, \$ 100

Remarks :

Book mark :

Somere

7 | **4 Cav.** | **U.S.C.T.**

Bosw Thomas

priv., Co. B. 4 Reg't U. S. Col'd Cavalry.

Appears on

**Company Muster Roll**

for Jan & Feb., 1865.

Present or absent present

Stoppage, \$ 100 for

Due Gov't, \$ 100 for

Valuation of horse, \$ 100

Valuation of horse equipments, \$ 100

Remarks: Received only \$7 a  
month to include Apr 30/64  
Stop for 2 Spurs & Strap, One  
nose bag.

Book mark:

7 | **4 Cav.** | **U.S.C.T.**

Bosew Thomas

priv., Co. B. 4 Reg't U. S. Col'd Cavalry.

Appears on

**Company Muster Roll**

for March & April, 1865.

Present or absent present

Stoppage, \$ 100 for

Due Gov't, \$ 100 for

Valuation of horse, \$ 100

Valuation of horse equipments, \$ 100

Remarks :

Book mark :

Thomas

5 | **4 Cav. | U.S.C.T.**

*Bosun Thomas*

*prk*, Co. B. 4 Reg't U. S. Col'd Cavalry.

Appears on

**Company Muster Roll**

for *May & June*, 1865.

Present or absent *Present*

Stoppage, \$ 100 for

Due Gov't, \$ 100 for

Valuation of horse, \$ 100

Valuation of horse equipments, \$ 100

Remarks: *Stop page, Balance  
due 2 Spurs & stirrups*

Book mark:

*Comer*

7 | **4 Cav. | U.S.C.T.**

Robert Thomas

Priv., Co. B. 4 Reg't U. S. Col'd Cavalry.

Appears on

**Company Muster Roll**

for July & Aug, 1867.

Present or absent present

Stoppage, \$ 100 for

Due Gov't, \$ 100 for

Valuation of horse, \$ 100

Valuation of horse equipments, \$ 100

Remarks :

-----  
-----  
-----  
-----  
-----  
-----  
-----  
-----  
-----  
-----

Book mark :

-----  
-----

Robert Thomas  
(358) Copyist.

4 Cav. U.S.C.T.

Bosaw Thomas

priv. Co. B. 4 Reg't U. S. Col'd Cavalry.

Appears on

Company Muster Roll

for Sept & Oct, 1861.

Present or absent present

Stoppage, \$ 100 for

Due Gov't, \$ 100 for

Valuation of horse, \$ 100

Valuation of horse equipments, \$ 100

Remarks:

Book mark:

Spencer

*F* | **4 Cav.** | **U.S.C.T.**

*Basen Thomas*  
-----  
*Capt.* Co. B. 4 Reg't U. S. Col'd Cavalry.

Appears on

**Company Muster Roll**

for *Nov. 1865*, 1865.

Present or absent *Present*

Stoppage, \$ *100* for

Due Gov't, \$ *100* for

Valuation of horse, \$ *100*

Valuation of horse equipments, \$ *100*

Remarks: *Appointed Corporal*  
*Dec. 1/65*

Book mark : \_\_\_\_\_

(358)

*Chandler*  
-----  
Copyist.

T. | 4 Cav. | U.S.C.T.

*Bosen Thomas,*  
*Corpl*, Co. B. 4 Reg't U. S. Col'd Cavalry.

Appears on

**Company Muster Roll**

for *Jan & Feb*, 186*6*.

Present or absent *present*.

Stoppage, \$ *100* for

Due Gov't, \$ *100* for

Valuation of horse, \$ *100*

Valuation of horse equipments, \$ *100*

Remarks: *Appointed Corpl*  
*Dec. 11 1865*

Book mark :

*M. J. French,*  
*Comptroller, Copyright*



*J* | **4 Cav.** | **U.S.C.T.**

*Basin Thomas*  
-----  
*Capt. Co. D*, 4 Reg't U. S. Col'd Cavalry.

Appears on **Co. Muster-out Roll**, dated  
*New Orleans, La., Mch. 29* 1866.

Muster-out to date *Mch. 29* 1866.

Last paid to \_\_\_\_\_, 186 .

**Clothing account:**

Last settled \_\_\_\_\_, 186 ; drawn since \$ \_\_\_\_\_ 100

Due soldier \$ *27*<sup>*30*</sup> 100; due U. S. \$ \_\_\_\_\_ 100

Am't for cloth'g in kind or money adv'd \$ \_\_\_\_\_ 100

Due U. S. for arms, equipments, &c., \$ \_\_\_\_\_ 100

Bounty paid \$ \_\_\_\_\_ 100; due \$ \_\_\_\_\_ 100

Remarks: *joined at Org'l Org.*  
*Dec. 1/65:*

Book mark: *V. 25, P. 85-68*

(361)

*Chandler*  
-----  
Copyist.

1871  
Thomas. Evans.

Co E, 4 U. S. Col'd Cav.

Private | Bugler.

CARD NUMBERS.

1		26
2		27
3	See Thomas	28 Evans
4		29
5		30
6		31
7		32
8		33
9		34
10		35
11		36
12		37
13		38
14		39
15		40
16		41
17		42
18		43
19		44
20		45
21		46
22		47
23		48
24		49
25		50

Book Mark:

See also

Thomas, George  
Co A, 4 U.S. Col'd Cav.

Private | Private

CARD NUMBERS.

1	5347418	26
2	5348623	27
3	5348721	28
4	5348813	29
5	5348901	30
6	5348997	31
7	5349145	32
8	5349227	33
9	5349732	34
10	40729263	35
11		36
12		37
13		38
14		39
15		40
16		41
17		42
18		43
19		44
20		45
21		46
22		47
23		48
24		49
25		50

Book Mark:

See also

S712032 PO 7th + 7th  
S 1052223 and  
D1297332 P.O. 6/16

D. Jordan  
Jr

*4 Cav.* | **U.S.C.T.**

*George Thomas*  
Pt. Co. *4* Reg't U. S. Col'd *4 Cav.*

Age *23* years.

Appears on a

**Detachment Muster-in Roll**

of the organization named above. Roll dated  
*New Orleans Feb 1, 1864*

Muster-in to date *Feb 1, 1864*

Joined for duty and enrolled:

When *Oct 20*, 186*3*.

Where *New Orleans La*

Period *3* years.

Valuation of horse, \$ *100*

Valuation of horse equipments, \$ *100*

Remarks:  
.....  
.....  
.....  
.....

Book mark :  
.....

*Reed*  
(337) Copyist.

*P*

**4 Cav. | U.S.C.T.**

*George Thomas*  
*6<sup>th</sup> Co. A*, 1 Reg't Cav., Corps d'Afrique.\*

Appears on

**Company Muster Roll**

for *Jan & Feb*, 186*4*.

Present or absent *Present*

Stoppage, \$ *100* for

Due Gov't, \$ *100* for

Valuation of horse, \$ *100*

Valuation of horse equipments, \$ *100*

Remarks:

\* This organization subsequently became Co. *A* 4 Reg't U. S. Colored Cavalry.

Book mark:

*R. S. Richardson*

T | **4 Cav.** | **U.S.C.T.**

George Thomas  
Corpl, Co. A, 4 Reg't U. S. Col'd Cavalry.

Appears on

**Company Muster Roll**

for March + April, 1864

Present or absent Present

Stoppage, \$ 100 for

Due Gov't, \$ 100 for

Valuation of horse, \$ 100

Valuation of horse equipments, \$ 100

Remarks:

Book mark:

R. S. Richardson

(358)

Copyist.

*P* | **4 Cav. | U.S.C.T.**

*George Thomas*  
*Coupl*, Co. A, 4 Reg't U. S. Col'd Cavalry.

Appears on

**Company Muster Roll**

for *May & June*, 186*4*.

Present or absent *Absent*

Stoppage, \$ *100* for

Due Gov't, \$ *100* for

Valuation of horse, \$ *100*

Valuation of horse equipments, \$ *100*

Remarks: *Absent Sick*  
*Since June 16<sup>th</sup> 1864.*  
*Is in debt to Government*  
*for one Sabra Knot*

Book mark: \_\_\_\_\_

*A. Richardson*

(358)

Copyist.



*G* | **4 Cav. | U.S.C.T.**

*George Thomas*  
*Capt*, Co. A, 4 Reg't U. S. Col'd Cavalry.

Appears on

**Company Muster Roll**

for *July & Aug*, 186*4*

Present or absent *Present*

Stoppage, \$ *100* for

Due Gov't, \$ *100* for

Valuation of horse, \$ *100*

Valuation of horse equipments, \$ *100*

Remarks: *Is in debt to Gov't for one (1) Sabre Knot*

Book mark: \_\_\_\_\_

*R. Richardson*

J | 4 Cav. | U.S.C.T.

George Thomas

Cmp, Co. A, 4 Reg't U. S. Col'd Cavalry.

Appears on

Company Muster Roll

for Sept & Oct, 1864.

Present or absent Absent

Stoppage, \$ 100 for

Due Gov't, \$ 100 for

Valuation of horse, \$ 100

Valuation of horse equipments, \$ 100

Remarks: Stop for one sabre  
knob. Absent sick in  
Post Hospital

Book mark:

Donnelly

J

4 Cav. U.S.C.T.

George Thomas

Pri, Co. A, 4 Reg't U. S. Col'd Cavalry.

Appears on

Company Muster Roll

for Nov & Dec, 1864

Present or absent Present

Stoppage, \$ 100 for

Due Gov't, \$ 100 for

Valuation of horse, \$ 100

Valuation of horse equipments, \$ 100

Remarks: Appointed Corp'l Oct 20 63. Reduced to the ranks Dec 18 64. Stop for 1 Sabre Rusk

Book mark:

Dannelly

J | 4 Cav. | U.S.C.T.

George Thomas

Pri, Co. A, 4 Reg't U. S. Col'd Cavalry.

Appears on

Company Muster Roll

for Jan & Feb, 1865

Present or absent

Stoppage, \$ 100 for

Due Gov't, \$ 100 for

Valuation of horse, \$ 100

Valuation of horse equipments, \$ 100

Remarks: Discharged at Port  
Hudson upon Surgeons Cer-  
tificate of disability. Final  
statements given Feb 13/65

Book mark:

Donnelly

(358)

Copyist.

G | 4 Cav. | U.S.C.T.

George Thomas  
Sgt, Co. A, 4 Reg't U. S. Colored Cav.

Appears on Returns as follows:

June 1864 - Absent sick

Nov 1864 - Absent sick Nov 1/64  
sent to Post. Hospital.

Feb 1865 - 2000; Feb 13/65  
Post Hudson Co. Dischgd  
for disability

Book mark:

W. R. Lee

*S* | **4 Cav.** | **U.S.C.T.**

*George Thomas*  
*Priv.*, Co. *A*, 4 Reg't U. S. Col'd Cavalry.

Appears on **Co. Muster-out Roll**, dated  
*New Orleans La, Mch 24*, 1866.

Muster-out to date ..... 186 .  
Last paid to ..... 186 .

Clothing account:

Last settled ..... 186 ; drawn since \$ ..... 100

Due soldier \$ ..... 100; due U. S. \$ ..... 100

Am't for cloth'g in kind or money adv'd \$ ..... 100

Due U. S. for arms, equipments, &c., \$ ..... 100

Bounty paid \$ ..... 100; due \$ ..... 100

Remarks: *Joined as priv't. Discharged*  
*Feb. 13, 66, at New Orleans La*

*V. 18, P. 117, 68*  
Book mark: *V. 64, P. 88, 69*      *Q. P.*

(361)

*Prewitt*  
Copyist.

Thomas, George  
P, Co. A, 4 U.S.C. Cav.

/ Enclosures.

Bed Cards	Descriptive Lists
Burial Records	Final Statements
Certs. of Dis. for Discharge /	Furloughs
C. M. Charges	Med. Des. Lists
Med. Certificates	Orders

Other papers relating to—

Admission to Hosp'l	Furlough
Casualty Sheet (Officer's)	Med. Examination
Confinement	Misc. Information
Contracts	Pay or Clothing
Death or Effects	Personal Reports
Desertions	Rank
Discharge from Hosp'l	Transfer to Hosp'l
Discharge from Service	Transfer to V. R. C.
Duty	Transportation

NOTE 1.

The company commander will here add a statement of all the facts known to him concerning the disease or wound, or cause of disability of the soldier; the time, place, manner, and all the circumstances under which the injury occurred, or disease originated or appeared; the duty, or service, or situation of the soldier at the time the injury was received or disease contracted, stating particularly whether the injury was received or the disease contracted in the line of his duty; and whatever other facts may aid a judgment as to the cause, immediate or remote, of the disability, and the circumstances attending it.

When the facts are not known to the company commander, the certificate of any officer, or affidavit of other person having such knowledge, will be appended—as the surgeon in charge of a hospital, the officer commanding a detachment of recruits, &c., &c.

NOTE 2.

When a probable case for pension, special care must be taken to state the degree of disability—as 1/2, 3/4, &c., &c.; to describe particularly the disability, wound, or disease, the extent of which it deprives him of the use of any limb or faculty, or affects his health, strength, activity, constitution, or capacity to labor or earn his subsistence. The surgeon will add, from his knowledge of the facts and circumstances, and from the evidence in the case, his professional opinion of the cause or origin of the disability. In the case of discharges by Medical Inspectors, the last paragraph will state that the "discharge was given by consent of the soldier, after a personal examination, and for disability, the nature, degree, and origin of which are correctly described in the within certificate."

Par. 1260 Regulations, Edit. 1861.

Medical officers, in giving certificates of disability, are to take particular care in all cases that have not been under their charge; and especially in epilepsy, convulsions, chronic rheumatism, derangement of the urinary organs, ophthalmia, ulcers, or any obscure disease liable to be feigned or purposely produced; and in no case shall such certificate be given until after sufficient time and examination to detect any attempt at deception.

DIRECTIONS.

This certificate will be made out in duplicate by the soldier's company commander, or other officer commanding the separate detachment to which he belongs, and sent by him to the surgeon who has charge of the hospital where the soldier is sick. The surgeon will then fill out and sign the surgeon's certificate, and forward these papers to the regimental, detachment, or company commander, who will forward them, with his action endorsed thereon, through the proper channel, to his division commander; or, if the troops are not attached to a division, to his corps, department, or other commander or officer to whom the authority to discharge enlisted men may be specially delegated.

These certificates, after having received the action of the highest authority to which they are required to be sent, will be returned through the same channel to the regimental, post, or detachment commander, who will, if the discharge is authorized by the endorsement of the proper authority, sign the soldier's discharge, and the last certificate on this paper; see that the soldier is furnished with the proper final statements in duplicate, and forward ~~copy~~ of these certificates direct to the Adjutant General United States Army, at Washington, D. C.; they will not, under any circumstances, be given into the hands of the soldier.

ADJ

Med 11 1865

Duplicate sent the Pension Office.

T 430 1865

CERTIFICATE OF DISABILITY FOR DISCHARGE

IN THE CASE OF

George Thomas  
a private Co. "A"  
Fourth Reg't of W. V. Cav.

Approved Jan 30 5

[Signature]

Head Quarters Dept of the Gulf  
New Orleans Feb 11 1865

To be discharged  
By command of  
Maj. Genl. Hurlbut

[Signature]  
Capt & A. A. General

Received (A. G. Office) 1865

Out on R. of Gen. [Signature]

Office Surgeon in Chief  
District of Baton Rouge Port Hudson  
January 24 1865

Respectfully Approved  
Chas. A. Deam  
Surgeon 2nd La. Vol. Infy  
in Charge District of Baton Rouge Port Hudson



# ARMY OF THE UNITED STATES.

## CERTIFICATE

### OF DISABILITY FOR DISCHARGE.



Private George Thomas, of Captain 1st Lieut B.F. Robert's Company, (A) of the Fourth Regiment of the United States Colored band, was enlisted by Capt. Tibbitts, lat. of the Fourth Regiment of U.S. Soldiers at New Orleans, La. on the twentieth day of October, 1863, to serve three years; he was born in New Orleans, in the State of Louisiana, is twenty-three years of age, five feet six inches high, Dark complexion, dark eyes, black hair, and by occupation when enlisted a Drayman. During the last two months said soldier has been unfit for duty 60 days. Said soldier has been utterly worthless, as to any capability of doing duty for a long time.

STATION: Port Hudson, La.  
 DATE: Jan 6th, 1865.

John W. Day  
1st Lieut Co "C"  
 Commanding Company. A

<sup>we</sup> I CERTIFY, that I have carefully examined the said George Thomas of Captain Lieut Robert's Company, and find him incapable of performing the duties of a soldier because of Pulmonary consumption. This soldier had a tubercular or scrophulous constitution, on entering the service had been sick most of the time with Pneumonia, Fever, Dropsy and finally Consumptive.

His medical certificate was given by  
D. D. Hanson Surgeon 4th U.S. Col. Cadiz  
U.S. Coast Art. Surg. 6/21/63. Surgeon.

DISCHARGED, this Thirteenth day of February, 1865, at Port Hudson La.

Wm. B. Mitchell  
Major  
 Commanding the Reg't.

The Soldier desires to be addressed at  
 Town \_\_\_\_\_ County \_\_\_\_\_ State \_\_\_\_\_

\* See Note 1 on the back of this. † See Note 2 on the back of this.

Official Post Surgeon  
 Port Hudson La.  
 Jan 19 1865  
 Respectfully Approved  
W. G. H. 78 used  
Post Surg com

Thomas, John

Co'd A, B4 U. S. Col'd Cav.

Private | Private

CARD NUMBERS.

1	5348488	26
2	5348587	27
3	5348691	28
4	5348786	29
5	5348878	30
6	5348906	31
7	5349062	32
8	5358675	33
9	5358731	34
10	5358770	35
11	5347951	36
12	5350590	37
13	5350675	38
14	5350770	39
15	5350859	40
16	5350944	41
17	5351089	42
18	5349718	43
19	5351170	44
20	40729265	45
21		46
22		47
23		48
24		49
25		50

Book Mark:

See also

*J* | 4 Cav. | U.S.C.T.

*John Thomas*

*Private*, Co. *A*, 1 Reg't La. Cav., Corps d'Afrique.\*

Appears on

**Company Muster-in Roll**

of the organization named above. Roll dated

*New Orleans La, Sept 12*, 1863.

Muster-in to date

*Sept 12*, 1863.

Joined for duty and enrolled:

When

*Sept 3*, 1863.

Where

*New Orleans*

Period *3* years.

Valuation of horse, \$.....100

Valuation of horse equipments, \$.....100

Remarks:

*Age 27*

\*This organization subsequently became Co. *A* 4 Reg't U. S. Colored Cavalry.

Book mark:

(356)

*M. A. Michaels*

Copyist.

T | **4 Cav. | U.S.C.T.**

John Thomas  
Priv, Co. A, 1 Reg't La. Cav., Corps d'Afrique.\*

Appears on

**Company Muster Roll**

for Sept 12 to Dec 31, 1863.

Present or absent Present

Stoppage, \$ 100 for

Due Gov't, \$ 100 for

Valuation of horse, \$ 100

Valuation of horse equipments, \$ 100

Remarks: \_\_\_\_\_  
\_\_\_\_\_  
\_\_\_\_\_  
\_\_\_\_\_  
\_\_\_\_\_  
\_\_\_\_\_  
\_\_\_\_\_

\*This organization subsequently became Co. A, 4 Reg't U. S. Colored Cavalry.

Book mark: \_\_\_\_\_

R. Richardson

*J* 4 Cav. U.S.C.T.

*John Thomas*  
*Priv*, Co. *A*, 1 Reg't Cav., Corps d'Afrique.\*

Appears on

**Company Muster Roll**

for *Jan & Feb*, 186 *4*

Present or absent *Present*

Stoppage, \$ *100* for

Due Gov't, \$ *100* for

Valuation of horse, \$ *100*

Valuation of horse equipments, \$ *100*

Remarks:

\* This organization subsequently became Co. *A*, 4 Reg't U. S. Colored Cavalry.

Book mark:

*R. Richardson*

J | 4 Cav. | U.S.C.T.

John Thomas

Priv, Co. A, 4 Reg't U. S. Col'd Cavalry.

Appears on

**Company Muster Roll**

for *March + April*, 1864

Present or absent *Present*

Stoppage, \$ 100 for

Due Gov't, \$ 100 for

Valuation of horse, \$ 100

Valuation of horse equipments, \$ 100

Remarks:

Book mark:

*R. Richardson*

T | 4 Cav. | U.S.C.T.

John Thomas  
Pmi, Co. A, 4 Reg't U. S. Col'd Cavalry.

Appears on

**Company Muster Roll**

for May + June, 1864

Present or absent Present

Stoppage, \$ 100 for

Due Gov't, \$ 100 for

Valuation of horse, \$ 100

Valuation of horse equipments, \$ 100

Remarks: In debt to Gov't  
for one Remington  
Revolver + one Sabre Knit

Book mark:

R. S. Richardson

*G* | 4 Cav. | U.S.C.T.

*John Thomas*  
*Coppl*, Co. A, 4 Reg't U. S. Col'd Cavalry.

Appears on

**Company Muster Roll**

for *July + Aug*, 186*4*

Present or absent *Presents*

Stoppage, \$ *100* for

Due Gov't, \$ *100* for

Valuation of horse, \$ *100*

Valuation of horse equipments, \$ *100*

Remarks: *In debt to Gov't  
for one (1) Sabre Knot  
and one (1) Remington  
Revolver Promotion  
from Private July 1/64*

Book mark: \_\_\_\_\_

*R. Richardson*

(358)

Copyist.



J | 4 Cav. | U.S.C.T.

John Thomas

Corp, Co. A, 4 Reg't U. S. Col'd Cavalry.

Appears on

Company Muster Roll

for Sept & Oct, 1864

Present or absent

Stoppage, \$ 100 for

Due Gov't, \$ 100 for

Valuation of horse, \$ 100

Valuation of horse equipments, \$ 100

Remarks: Transferred to Co L  
for promotion. S.O. 93  
7th 2nd 4th US Col'd Cav Rept 12/64

Book mark:

Donnelly

4 Cav. U.S.C.T.

John Thomas

2nd Lt., Co. L, 4 Reg't U.S. Col'd Cavalry.

Appears on

Company Muster Roll

for Sept. & Oct., 1864.

Present or absent Present

Stoppage, \$ 100 for

Due Gov't, \$ 100 for

Valuation of horse, \$ 100

Valuation of horse equipments, \$ 100

Remarks: Transferred from Co. F to Co. L 4th U.S. Col'd Cavalry. 13th rank of Sergeant. Due U.S. for lost ordnance Remington pistol value Recd \$16.30

Book mark:

Lerring

5 | 4 Cav. | U.S.C.T.

John Thomas

Lt., Co. L, 4 Reg't U.S. Col'd Cavalry.

Appears on

Company Muster Roll

for Nov. & Dec., 1864.

Present or absent Present

Stoppage, \$ 6 <sup>30</sup>/<sub>100</sub> for Advance  
lost.

Due Gov't, \$ 100 for

Valuation of horse, \$ 100

Valuation of horse equipments, \$ 100

Remarks: Transferred as a Corp'l.  
from Co. A to Co. L Sept. 13<sup>th</sup>  
1864 and promoted to Sgt.  
Lost one Remington Revolver  
prior to April 1861

Book mark:

L. J. Loring

4 Cav. | U.S.C.T.

John Thomas

Sgt., Co. L, 4 Reg't U. S. Col'd Cavalry.

Appears on

Company Muster Roll

for Jan. & Feb., 1865.

Present or absent Present

Stoppage, \$ 100 for

Due Gov't, \$ 100 for

Valuation of horse, \$ 100

Valuation of horse equipments, \$ 100

Remarks: Stopped for one Remington Revolver. There is due the soldier \$14.36 for clothing not drawn. Recd. per month to include Apl. 30 & Dec prior to Apl. 1st.

Book mark:

Lerrins

J | 4 Cav. | **U.S.C.T.**

John Thomas

Sgt, Co. D, 4 Reg't U. S. Col'd Cav.

Appears on

**M. and D. Roll of Men Transferred**

to the organization named above, by consol.  
from Co. A

Roll dated Port Hudson, La. Apr 29, 1865.

When enlisted Sept 3, 1863.

Period for which enlisted 3 years.

When mustered in Sept 12, 1863.

Present or absent not stated

Company to which assigned D

Remarks: \_\_\_\_\_

\_\_\_\_\_

\_\_\_\_\_

\_\_\_\_\_

\_\_\_\_\_

\_\_\_\_\_

\_\_\_\_\_

\_\_\_\_\_

\_\_\_\_\_

\_\_\_\_\_

\_\_\_\_\_

\_\_\_\_\_

\_\_\_\_\_

\_\_\_\_\_

\_\_\_\_\_

\_\_\_\_\_

\_\_\_\_\_

\_\_\_\_\_

\_\_\_\_\_

Book mark : \_\_\_\_\_

(342)

E. L. Lewis

Copyist.

4 Cav. U.S.C.T.

*James Thomas*

*Sgt.*, Co. B. 4 Reg't U. S. Col'd Cavalry.

Appears on

**Company Muster Roll**

for *March & April*, 1863.

Present or absent *present*

Stoppage, \$ 100 for

Due Gov't, \$ 100 for

Valuation of horse, \$ 100

Valuation of horse equipments, \$ 100

Remarks: *Transferred to Company  
by consolidation, in accord-  
ance with S. O. 4125, dated  
1st. Dec. 1862. Stop for one  
Carbide string.*

Book mark:

*Thomas*

(358)

Copyist.

1867

7 | **4 Cav.** | **U.S.C.T.**

John Thomas

Sgt., Co. B. 4 Reg't U. S. Col'd Cavalry.

Appears on

**Company Muster Roll**

for May & June, 1867.

Present or absent present

Stoppage, \$ 100 for

Due Gov't, \$ 100 for

Valuation of horse, \$ 100

Valuation of horse equipments, \$ 100

Remarks :

Book mark :

(358)

James  
Copyist.

**4 Cav. | U.S.C.T.**

*John Thomas*

*Sgt.*, Co. B. 4 Reg't U. S. Col'd Cavalry.

Appears on

**Company Muster Roll**

for *July & Aug*, 186*1*.

Present or absent *present*

Stoppage, \$ 100 for

Due Gov't, \$ 100 for

Valuation of horse, \$ 100

Valuation of horse equipments, \$ 100

Remarks: *due the soldier for  
one (1) Remington Re  
volver which was  
stopped twice against  
his pay.*

Book mark:

*Forner*



7 | **4 Cav. | U.S.C.T.**

*John Thomas*

*Sgt.*, Co. B. 4 Reg't U. S. Col'd Cavalry.

Appears on

**Company Muster Roll**

for *Sept 7 Oct*, 186*5*.

Present or absent *present*

Stoppage, \$ *100* for

Due Gov't, \$ *100* for

Valuation of horse, \$ *100*

Valuation of horse equipments, \$ *100*

Remarks :

Book mark :

*Thomas*

*F* | **4 Cav.** | **U.S.C.T.**

*John Thomas*  
-----  
*Sergt*, Co. B. 4 Reg't U. S. Col'd Cavalry.

Appears on

**Company Muster Roll**

for *Nov. 1865*, 186 *5-*

Present or absent *Present*

Stoppage, \$ 100 for

Due Gov't, \$ 100 for

Valuation of horse, \$ 100

Valuation of horse equipments, \$ 100

Remarks :  
-----  
-----  
-----  
-----  
-----  
-----  
-----  
-----  
-----  
-----

Book mark :  
-----  
-----

(358)

*Chandler*  
-----  
Copyist.

*J* | **4 Cav. U.S.C.T.**

*John Thomas*  
*Prvt*, Co. B. 4 Reg't U. S. Col'd Cavalry.

Appears on

**Company Muster Roll**

for *Jan. & Feb.*, 1866.

Present or absent *Present*

Stoppage, \$ *100* for

Due Gov't, \$ *100* for

Valuation of horse, \$ *100*

Valuation of horse equipments, \$ *100*

Remarks: *Reduced to the Ranks  
from Serjt Jan. 30, 1866.*

Book mark:

(358)

*Chandler*  
Copyist.

J | **4 Cav. | U.S.C.T.**

John Thomas

Port  
Co. <sup>A</sup><sub>2</sub>, 4 Reg't U. S. Colored Cav.  
Copt

Appears on Returns as follows:

June 1864 (Port Co. A) }  
July 1864 (Copt Co. A) } On duty  
Regtl Hsepl. Nurse

Sept 1864. 2025; Sept 13/64 Port  
Hudson Transferred for  
prom +

(Port Co. B) Gain: Sept 13/64  
Port Hudson Transferred  
from Co. A.

Oct 1865. (Port Co. B) Gain: Sept 16/65  
Pt. Hudson Sa. deserted  
from Co. and voluntarily  
returned 16 Sept. Not account  
ed for on Rolls until Oct  
Return.

Book mark:

W. R. Lee

*J* | 4 Cav. | U.S.C.T.

*John Thomas*  
-----  
*Priv*, Co. *B*, 4 Reg't U. S. Col'd Cavalry.

Appears on **Co. Muster-out Roll**, dated  
*New Orleans, La, Feb. 20, 1866.*

Muster-out to date *Feb. 20, 1866.*

Last paid to *June 30, 1866.*

Clothing account:

Last settled \_\_\_\_\_, 186 ; drawn since \$ \_\_\_\_\_ 100

Due soldier \$ *45-42* 100; due U. S. \$ \_\_\_\_\_ 100

Am't for cloth'g in kind or money adv'd \$ \_\_\_\_\_ 100

Due U. S. for arms, equipments, &c., \$ \_\_\_\_\_ 100

Bounty paid \$ \_\_\_\_\_ 100; due \$ *100* 100

Remarks: *Joined by transfer*  
*from Co. G. per R. O. 28. Ad.*  
*1st. Dept. Gulf Jan. 29. 65-*  
*Priv. to Sept. 13. 64, Sergt. to*  
*Jan. 30, 65. Free on or before*  
*April 19. 61*

Book mark: *V. 25. P. 87. 68. V. 36. P. 404.*  
*69.*

(361)

*Chandler*  
-----  
Copyist.

J | **4 Cav. | U.S.C.T.**

John Thomas  
Capt., Co. A, 4 Reg't U. S. Col'd Cavalry.

Appears on **Co. Muster-out Roll**, dated  
New Orleans La, March 20, 1866.

Muster-out to date \_\_\_\_\_, 186 .

Last paid to \_\_\_\_\_, 186 .

**Clothing account:**

Last settled \_\_\_\_\_, 186 ; drawn since \$ \_\_\_\_\_ 100

Due soldier \$ \_\_\_\_\_ 100; due U. S. \$ \_\_\_\_\_ 100

Am't for cloth'g in kind or money adv'd \$ \_\_\_\_\_ 100

Due U. S. for arms, equipments, &c., \$ \_\_\_\_\_ 100

Bounty paid \$ \_\_\_\_\_ 100; due \$ \_\_\_\_\_ 100

Remarks: Joined at orig org.  
transferred to Co L. Sept. 13, 64

Book mark : \_\_\_\_\_

(361)

Prewitt

Copyist.

Thomas, John

Co D, 4 U. S. Col'd Cav.

Private | Private

CARD NUMBERS.

1	352587	26
2	352637	27
3	352688	28
4	352714	29
5	352772	30
6	352836	31
7	352898	32
8	352976	33
9	353057	34
10	353214	35
11	353306	36
12	353400	37
13	353488	38
14	353574	39
15	353657	40
16	353737	41
17	40729264	42
18		43
19		44
20		45
21		46
22		47
23		48
24		49
25		50

Book Mark:

See also

S-762440 P090  
S 1094571 No. 7m 7m  
D 2393692 (1002)

L. Jordan  
L. J.



Y | 4 Cav. | U.S.C.T.

John Thomas

Pvt., Co. D., 1 Reg't, Corps d'Afrique Cavalry.\*

\* Age 19.  
Appears on

**Company Muster-in Roll**

of the organization named above. Roll dated

New Orleans La., Nov 26, 1863.

Muster-in to date Nov 26, 1863.

Joined for duty and enrolled:

When Nov 5-, 186 .

Where New Orleans

Period 3 years.

Valuation of horse, \$ 100

Valuation of horse equipments, \$ 100

Remarks:

\* Inserted by Jordan Ex

\*This organization subsequently became Co. D, 4 Reg't U. S. Colored Cavalry.

Book mark:

Rosenbaum

(356)

Copyist.

*J*

**4 Cav. U.S C.T.**

*John Thomas*

*Rot*, Co. *D*, 1 Reg't Cav., Corps d'Afrique.\*

Appears on

**Company Muster Roll**

for *From Enlistment to Dec 31*, 1863.

Present or absent *Present*

Stoppage, \$ *100* for

Due Gov't, \$ *100* for

Valuation of horse, \$ *100*

Valuation of horse equipments, \$ *100*

Remarks:

\* This organization subsequently became Co. *D*, 4 Reg't U. S. Colored Cavalry.

Book mark:

*Rosenbaum*

*J* 4 Cav. | U.S C.T.

*John Thomas*  
Pvt, Co. *D*, 1 Reg't Cav., Corps d'Afrique.\*

Appears on

**Company Muster Roll**

for *Lamy & Fely*, 1864.

Present or absent *Present*

Stoppage, \$ *100* for

Due Gov't, \$ *100* for

Valuation of horse, \$ *100*

Valuation of horse equipments, \$ *100*

Remarks:

\* This organization subsequently became Co. *D*, 4 Reg't U. S. Colored Cavalry.

Book mark:

(358)

*Rosenbaum*

Copyist.

J | 4 Cav. | U.S.C.T.

John Thomas

4 Corp'l, Co. D. 4 Reg't U. S. Col'd Cavalry.

Appears on

**Company Muster Roll**

for March & April, 1864.

Present or absent Present

Stoppage, \$ 100 for

Due Gov't, \$ 100 for

Valuation of horse, \$ 100

Valuation of horse equipments, \$ 100

Remarks: Appointed Corporal  
by special order dated  
April 1 Vice Butler reduced

Book mark:

Rosenbaum

(358)

Copyist.

J | **4 Cav.** | **U.S.C.T.**

John Thomas

3 Corp'l., Co. D. 4 Reg't U. S. Col'd Cavalry.

Appears on

**Company Muster Roll**

for May & June, 1864.

Present or absent Present

Stoppage, \$ 100 for

Due Gov't, \$ 100 for

Valuation of horse, \$ 100

Valuation of horse equipments, \$ 100

Remarks:

Book mark:

(358)

Rosenblum

Copyist.

3 | 4 Cav. | U.S.C.T.

*John Thomas*

*3 Capt.*, Co. D. 4 Reg't U. S. Col'd Cavalry.

Appears on

**Company Muster Roll**

for *July & Aug*, 1864.

Present or absent. *Present*

Stoppage, \$ *100* for

Due Gov't, \$ *100* for

Valuation of horse, \$ *100*

Valuation of horse equipments, \$ *100*

Remarks:

Book mark:

(358)

*Rosenbaum*

Copyist.

*J* | 4 Cav. | U.S.C.T.

*John Thomas*

*Corpl.*, Co. D, 4 Reg't U. S. Col'd Cavalry.

Appears on

**Company Muster Roll**

for *Sept & Oct*, 1864.

Present or absent *Present*

Stoppage, \$ *100* for

Due Gov't, \$ *100* for

Valuation of horse, \$ *100*

Valuation of horse equipments, \$ *100*

Remarks:

Book mark:

*Rosenbaum*  
Copyist.

*J* | **4 Cav.** | **U.S.C.T.**

*John Thomas*  
*Co*, Co. D, 4 Reg't U. S. Col'd Cavalry.

Appears on

**Company Muster Roll**

for *Jan Dec*, 1867.

Present or absent *Absent*

Stoppage, \$ 100 for

Due Gov't, \$ 100 for

Valuation of horse, \$ 100

Valuation of horse equipments, \$ 100

Remarks: *Due U.S. for Gen-  
man's U.S. Co.*

Book mark:

*A. H. Wright*  
Copyist.



7 | **4 Cav.** | **U.S.C.T.**

John Thomas  
Co., Co. D, 4 Reg't U. S. Col'd Cavalry.

Appears on  
**Company Muster Roll**  
for Jan & Feb, 1865.

Present or absent Present

Stoppage, \$ 100 for

Due Gov't, \$ 100 for Ordinance

Valuation of horse, \$ 100

Valuation of horse equipments, \$ 100

Remarks: up, limited Corp Apr  
1864.  
Recd only \$ 2 per month  
to include Apr 30, 64

Book mark: \_\_\_\_\_

J. H. Wright  
(358) Copyist.

J | **4 Cav.** | **U.S.C.T.**

John Thomas

VP, Co. D, 4 Reg't U. S. Col'd Cavalry.

Appears on

**Company Muster Roll**

for March & April, 1865.

Present or absent Present

Stoppage, \$ 100 for

Due Gov't, \$ 100 for

Valuation of horse, \$ 100

Valuation of horse equipments, \$ 100

Remarks: Rede to rank from  
Co. March 30, 65

Book mark:

J. H. Smith

J | 4 Cav. | U.S.C.T.

John Thomas

V.D., Co. D, 4 Reg't U. S. Col'd Cavalry.

Appears on

**Company Muster Roll**

for May & June, 1865.

Present or absent Present

Stoppage, \$ 100 for

Due Gov't, \$ 100 for

Valuation of horse, \$ 100

Valuation of horse equipments, \$ 100

Remarks: Added to rank,  
muster was 31.05.

Book mark:

e. Wright

J | 4 Cav. | U.S.C.T.

John Thomas  
P, Co. D, 4 Reg't U. S. Col'd Cavalry.

Appears on

**Company Muster Roll**

for July & Aug, 1865.

Present or absent Present

Stoppage, \$ 100 for

Due Gov't, \$ 100 for

Valuation of horse, \$ 100

Valuation of horse equipments, \$ 100

Remarks: Reduced from Co  
to Rank, Feb 20, 65

Book mark:

(358)

H. W. Wright  
Copyist.

*T* | **4 Cav. | U.S.C.T.**

*John Thomas*

*62*, Co. D, 4 Reg't U. S. Col'd Cavalry.

Appears on

**Company Muster Roll**

for *Sept - Dec -*, 186*5*.

Present or absent *Present*

Stoppage, \$ 100 for

Due Gov't, \$ 100 for

Valuation of horse, \$ 100

Valuation of horse equipments, \$ 100

Remarks:

Book mark:

*W. H. Bright*

7 | 4 Cav. | U.S.C.T.

John Thomas

Priv., Co. D, 4 Reg't U. S. Col'd Cavalry.

Appears on

Company Muster Roll

for Nov & Dec, 1865.

Present or absent Present

Stoppage, \$ 100 for

Due Gov't, \$ 100 for

Valuation of horse, \$ 100

Valuation of horse equipments, \$ 100

Remarks:

Book mark:

W. J. C. C. C. C. C. C.

9 | 4 Cav. | U.S.C.T.

John Thomas

Priv., Co. D, 4 Reg't U. S. Col'd Cavalry.

Appears on

**Company Muster Roll**

for Jan 1 Feb, 1866.

Present or absent Present

Stoppage, \$ 100 for

Due Gov't, \$ 100 for

Valuation of horse, \$ 100

Valuation of horse equipments, \$ 100

Remarks:

Book mark:

J. D. Anderson

T | **4 Cav.** | **U.S.C.T.**

John Thomas  
Pt, Co. H, 4 Reg't U. S. Colored Cav.

Appears on **Returns** as follows:

Jan 1865 - About furloughed  
for several days Jan 24/65  
Port Henderson, La.

Book mark: \_\_\_\_\_

W. A. Lee



7 | 4 Cav. | U.S.C.T.

John Thomas

Priv., Co. D, 4 Reg't U. S. Col'd Cavalry.

Appears on **Co. Muster-out Roll**, dated  
New Orleans La, March 20, 1866.

Muster-out to date March 20, 1866.

Last paid to June 30, 1865.

Clothing account:

Last settled....., 186 ; drawn since \$..... 100

Due soldier \$ 9 <sup>27</sup>/<sub>100</sub>; due U. S. \$..... 100

Am't for cloth'g in kind or money adv'd \$..... 100

Due U. S. for arms, equipments, &c., \$..... <sup>30</sup>/<sub>100</sub>

Bounty paid \$..... 100; due \$..... 100

Remarks: joined Reg. Org.  
Stop 1 Latr Knot.

Book mark: V. 26, P 243, 68,  
6053, P. H. G. June 19/66.

Wm. Anderson

Thomas, John.

Co. 4 Reg't U.S.C. Cav.

Enclosures.

Bed Cards	Final Statements
Burial Records	Furloughs or L. of A.
Certs. of Dis. for Discharge	Med. Certificates
C. M. Charges	Med. Des. Lists
Descriptive Lists	Orders
Discharge Certificates	Pris. of War Record
Enlistment Papers	Resignations

Other papers relating to—

Admission to Hosp'l	Furlough or L. of A.
Casualty Sheet	Med. Examination
Confinement	Misc. Information /
Contracts	Pay or Clothing
Death or Effects	Personal Reports
Desertion	Rank
Discharge from Hosp'l	Transfer to Hosp'l
Discharge from Service	Transfer to V. R. C.
Duty	Transportation

Col. N. B. Portman  
ordering release of  
prisoner

Sept 2<sup>o</sup> 1864

7-1180

Headquarters Carrollton District.

Carrollton, La., Sept 2<sup>d</sup> 1864.

Capt Wagg

Prov Mar - will  
deliver the prisoner,  
John Thomas 4<sup>th</sup> U.S.  
C. Car to Lt Hoyt.  
Taking receipt therefor.

N. D. Parham  
Cpl Canby

1845  
Thomas, Mary F.

Co., 4 U. S. Col'd Cav.

Matron

Matron

CARD NUMBERS.

1	5348104	26
2	5348105	27
3		28
4		29
5		30
6		31
7		32
8		33
9		34
10		35
11		36
12		37
13		38
14		39
15		40
16		41
17		42
18		43
19		44
20		45
21		46
22		47
23		48
24		49
25		50

Book Mark:

See also

*D* 14 Cav. | **U.S.C.T.**

*Mary F. Thomas*  
....., Co....., *4* Reg't U. S. Col'd *Cav.*,

Appears on **Hospital Muster Roll**

of *4* Reg't U. S. Col'd *Cav.*,

for *June 11 to Aug. 31*, 1864

When attached to Hosp. *June 11*, 1864.

How employed *Nurse*

Present or absent *Present*

Remarks: *Employed by Surgeon in Charge June 11" 1864.*

Book mark : .....

*Casterling*  
(343) Copyist.

J | 4 Cav. | **U.S.C.T.**

Mary F. Thomas

....., Co....., 4 Reg't U. S. Col'd Cav.,

Appears on **Hospital Muster Roll**

of 4 Reg't U. S. Col'd Cav.,

for Sept. & Oct., 1864

When attached to Hosp. June 11, 1864.

How employed Matron,

Present or absent Present,

Remarks: Employed by  
Surgeon in Charge  
June 11" 1864.

Book mark : .....

(343)

Castling

Copyist.

Thomas, Nicodemus

Co C, 4 U. S. Col'd Cav.

Private | Private

CARD NUMBERS.

1	5351284	26
2	5351341	27
3	5351392	28
4	5351474	29
5	5351542	30
6	5351601	31
7	5351678	32
8	5351743	33
9	5351811	34
10	5351904	35
11	5352006	36
12	5352105	37
13	5352204	38
14	5352296	39
15	5352384	40
16	5352473	41
17		42
18		43
19		44
20		45
21		46
22		47
23		48
24		49
25		50

Book Mark: 1857. 6. 1879

See also



7 | 4 Cav. | U.S.C.T.

*Godemus Thomas*  
Ct., Co. C, 1 Reg't La. Cav., Corps d'Afrique.\*

Appears on

**Company Muster-in Roll**

of the organization named above. Roll dated

*New Orleans, Nov 7*, 1863.

Muster-in to date

*Nov 7*, 1863.

Joined for duty and enrolled:

When *Oct 13*, 1863.

Where *New Orleans city*

Period 3 years.

Valuation of horse, \$.....100

Valuation of horse equipments, \$.....100

Remarks:

*Age: 18*

\*This organization subsequently became Co. C, 4 Reg't U. S. Colored Cavalry.

Book mark:

*Rochester*

(356)

Copyist.

C | 4 Cav. | U.S.C.T.

*Nicolaus Thomas*  
Pvt. Co. C, 1 Reg't La. Cav., Corps d'Afrique.\*

Appears on

**Company Muster Roll**

for *Jan 7 to Dec 31*, 1863.

Present or absent *Present*

Stoppage, \$ 100 for

Due Gov't, \$ 100 for

Valuation of horse, \$ 100

Valuation of horse equipments, \$ 100

Remarks:

FROM SECOND AUDITOR'S ROLL.

\*This organization subsequently became Co. C 4 Reg't U. S. Colored Cavalry.

Book mark:

*Asst. Copyist*

J | 4 Cav. | U.S.C.T.

Nicodemus Thomas  
Co. C, 1 Reg't La. Cav., Corps d'Afrique.\*

Appears on

Company Muster Roll

for Jan & Feb, 1864.

Present or absent Present

Stoppage, \$ 100 for

Due Gov't, \$ 100 for

Valuation of horse, \$ 100

Valuation of horse equipments, \$ 100

Remarks:

\*This organization subsequently became Co. C, 4 Reg't U. S. Colored Cavalry.

Book mark:

Rooster

7 | **4 Cav.** | **U.S.C.T.**

*Nicodemus Thomas*  
*Pr*, Co. C, 4 Reg't U. S. Colored Cavalry.

Appears on

**Company Muster Roll**

for *March 1864*, 1864.

Present or absent *Present*

Stoppage, \$ 100 for

Due Gov't, \$ 100 for

Valuation of horse, \$ 100

Valuation of horse equipments, \$ 100

Remarks :

Book mark :

(358)

*Robert*

Copyist.

7 | 4 Cav. | U.S.C.T.

*Nicodemus Thomas*  
*Pvt*, Co. C, 4 Reg't U. S. Colored Cavalry.

Appears on

**Company Muster Roll**

for *May & June*, 1864.

Present or absent *Present*

Stoppage, \$ 100 for

Due Gov't, \$ 100 for

Valuation of horse, \$ 100

Valuation of horse equipments, \$ 100

Remarks :

Book mark :

(358)

*Robert*

Copyist.

7 | **4 Cav.** | **U.S.C.T.**

*Nicodemus Thomas*  
*Prvt*, Co. C, 4 Reg't U. S. Colored Cavalry.

Appears on

**Company Muster Roll**

for *July & Aug*, 186*4*.

Present or absent *Present*

Stoppage, \$ 100 for

Due Gov't, \$ 100 for

Valuation of horse, \$ 100

Valuation of horse equipments, \$ 100

Remarks :

Book mark :

(358)

*Recherter*

Copyist.

T | **4 Cav.** | **U.S.C.T.**

*Nicodemus Thomas*  
*2d*, Co. C, 4 Reg't U. S. Colored Cavalry.

Appears on

**Company Muster Roll**

for *Sept 1864*, 1864.

Present or absent *Present*

Stoppage, \$ 100 for

Due Gov't, \$ 100 for

Valuation of horse, \$ 100

Valuation of horse equipments, \$ 100

Remarks :

Book mark :

*Royster*

J | 4 Cav. | U.S.C.T.

Nicodemus Thomas  
Priv, Co. C, 4 Reg't U. S. Colored Cavalry.

Appears on

**Company Muster Roll**

for Nov & Dec, 1864

Present or absent present

Stoppage, \$ 3<sup>68</sup> 100 for ordnance

Due Gov't, \$ 100 for

Valuation of horse, \$ 100

Valuation of horse equipments, \$ 100

Remarks: Lost ordnance

Book mark:

(358)

Moy Copyist.



T | 4 Cav. | U.S.C.T.

Nichodemus Thomas  
Priv, Co. C, 4 Reg't U. S. Colored Cavalry.

Appears on

**Company Muster Roll**

for Jan & Feb, 1865

Present or absent present

Stoppage, \$ 100 for

Due Gov't, \$ 100 for

Valuation of horse, \$ 100

Valuation of horse equipments, \$ 100

Remarks: Stop for one curry  
comb and brush, plate  
screw, nose bag, surcingle,  
spurs & straps. Receives  
\$7.00 per month to include  
April 30, 1864.

Book mark: \_\_\_\_\_

(358)

Moy

Copyist.

7 | 4 Cav. | U.S.C.T.

*Nichodemus Thomas*  
*Priv*, Co. C, 4 Reg't U. S. Colored Cavalry.

Appears on

**Company Muster Roll**

for *Mch & Apr*, 1865.

Present or absent *present*

Stoppage, \$ *100* for

Due Gov't, \$ *100* for

Valuation of horse, \$ *100*

Valuation of horse equipments, \$ *100*

Remarks:

Book mark:

(358)

*May*  
Copyist.

*J* | 4 Cav. | U.S.C.T.

*Nicodemus Thomas*  
*Priv*, Co. C, 4 Reg't U. S. Colored Cavalry.

Appears on

**Company Muster Roll**

for *May + June*, 186*5*.

Present or absent *present*

Stoppage, \$ *100* for

Due Gov't, \$ *100* for

Valuation of horse, \$ *100*

Valuation of horse equipments, \$ *100*

Remarks: *Stop for one horse brush, one canteen, one haversack, one pair metallic scales.*

Book mark: \_\_\_\_\_

(358)

*M. Moy* Copyist.

T | **4 Cav.** | **U.S.C.T.**

Neodesmus Thomas  
Pvt, Co. C, 4 Reg't U. S. Colored Cavalry.

Appears on

**Company Muster Roll**

for July & Augt., 1865.

Present or absent absent

Stoppage, \$ 100 for

Due Gov't, \$ 100 for

Valuation of horse, \$ 100

Valuation of horse equipments, \$ 100

Remarks: Absent in arrest at Provost  
Guard House, Baton Rouge, La, since  
Aug. 15, '65 - Stop for horse brush, 1  
canteen, 1 harness, 1 pr. metallica  
scales - Total \$3.17

Book mark : \_\_\_\_\_

(358)

Parkinson, Camp

Copyists

J | 4 Cav. | U.S.C.T.

Nicodemus Thomas  
Priv, Co. C, 4 Reg't U. S. Colored Cavalry.

Appears on

**Company Muster Roll**

for Sept & Oct, 1865.

Present or absent absent

Stoppage, \$ 100 for

Due Gov't, \$ 100 for

Valuation of horse, \$ 100

Valuation of horse equipments, \$ 100

Remarks: Absent in arrest  
in PG House Baton  
Rouge, since Aug 29/65.

Book mark :

(358)

Mey

Copyist.

*J* | **4 Cav. U.S.C.T.**

*Nicodemus Thomas*  
Private, Co. C, 4 Reg't U. S. Colored Cavalry.

Appears on

**Company Muster Roll**

for *Nov. & Dec.*, 186*5*.

Present or absent *present*

Stoppage, \$ *100* for

Due Gov't, \$ *100* for

Valuation of horse, \$ *100*

Valuation of horse equipments, \$ *100*

Remarks: *Sentenced by Gen. C.M. to confinement & loss of all pay for three months from Sept 11<sup>th</sup> 1865 to Dec. 11. 65. Sentence carried out at Baton Rouge La. Returned to duty Dec 11-1865.*

Book mark: \_\_\_\_\_

(358)

*M. A. Michaels*  
Copyist.

*T* | **4 Cav.** | **U.S.C.T.**

*Nicodemus Thomas*  
Private, Co. C, 4 Reg't U. S. Colored Cavalry.

Appears on

**Company Muster Roll**

for *Jan'y & Febr*, 1866.

Present or absent *Present*

Stoppage, \$ *100* for

Due Gov't, \$ *100* for

Valuation of horse, \$ *100*

Valuation of horse equipments, \$ *100*

Remarks: *Sentenced by G.C.M. to 3 months confinement and loss of all pay during said confinement from Sept 16/65 to Dec 16/65. Sentence carried out at Baton Rouge La. ret'd to duty Dec 11/65*

Book mark: \_\_\_\_\_

*M.A. Michaels*

*A* | **4 Cav. | U.S.C.T.**

*Nicodemus Thomas*

*Private*, Co. *C*, 4 Reg't U. S. Col'd Cavalry.

Appears on **Co. Muster-out Roll**, dated  
*New Orleans La.*, *Mar 20*, 186*6*.

Muster-out to date *Mar 20*, 186*6*.

Last paid to *June 30*, 186*5*.

**Clothing account:**

Last settled....., 186 ; drawn since \$.....  $\overline{100}$

Due soldier \$ *20*  $\frac{97}{100}$ ; due U. S. \$.....  $\overline{100}$

Am't for cloth'g in kind or money adv'd \$.....  $\overline{100}$

Due U. S. for arms, equipments, &c., \$ *3*  $\frac{30}{100}$

Bounty paid \$.....  $\overline{100}$ ; due \$.....  $\overline{100}$

Remarks: *Joined orig. org. Sentenced*  
*by G. C. M. to confinement for 3 months*  
*Sept 16/65 with loss of all pay during*  
*confinement returned to Co Dec 16/65*  
*The 3 months pay has not been deducted.*  
*Stop 1 horsebrush, 1 Haversack, 1 Quilt*  
*over*

Book mark: *2<sup>d</sup> And. 9845 May 7/68. 1857 C. 9. 1879*  
*V 26 P 182-69. V 216 P 4-75*

*M. A. Michaels*



JAN. - 8

5352473

1891

*Chair Scales*

1047  
Thomas, Philip

Co. C, 4 U. S. Col'd Cav.

Private | Private

CARD NUMBERS.

1	5351280	26
2	5351336	27
3	5351389	28
4	5351473	29
5	5351541	30
6	5351602	31
7	5351679	32
8	5351744	33
9	5351812	34
10	5351905	35
11	5352007	36
12	5352104	37
13	5352203	38
14	5352297	39
15	5352385	40
16	5352474	41
17	40729266	42
18		43
19		44
20		45
21		46
22		47
23		48
24		49
25		50

Book Mark: .....

See also .....

7 | 4 Cav. | U.S.C.T.

Philip Thomas  
Sgt, Co. C, 1 Reg't La. Cav., Corps d'Afrique.\*

Appears on

Company Muster-in Roll

of the organization named above. Roll dated  
New Orleans, La. Nov 7, 1863.

Muster-in to date Nov 7, 1863.

Joined for duty and enrolled:

When Oct 14, 1863.

Where New Orleans City

Period 3 years.

Valuation of horse, \$ 100

Valuation of horse equipments, \$ 100

Remarks:  
Age 28

\*This organization subsequently became Co. C, 4 Reg't U. S. Colored Cavalry.

Book mark:

Robert

4 Cav. | U.S.C.T.

*Philip Thomas*  
Co. C, 1 Reg't La. Cav., Corps d'Afrique.\*

Appears on

Company Muster Roll

for *Sept to Dec 31*, 186*5*.

Present or absent *Present*

Stoppage, \$ 100 for

Due Gov't, \$ 100 for

Valuation of horse, \$ 100

Valuation of horse equipments, \$ 100

Remarks:

.....  
.....  
.....  
.....  
.....

\*This organization subsequently became Co. C, 4 Reg't U. S. Colored Cavalry.

Book mark:

*W. H. Smith*

1864

7 | **4 Cav. | U.S.C.T.**

Phillip Thomas  
Pvt. Co. C, 1 Reg't La. Cav., Corps d'Afrique.\*

Appears on

**Company Muster Roll**

for Jan Feb, 1864

Present or absent Present

Stoppage, \$ 100 for

Due Gov't, \$ 100 for

Valuation of horse, \$ 100

Valuation of horse equipments, \$ 100

Remarks:  
.....  
.....  
.....  
.....  
.....  
.....

\*This organization subsequently became Co. C 4 Reg't U. S. Colored Cavalry.

Book mark: .....

(358)

Reister

Copyist.

J | **4 Cav. | U.S.C.T.**

*Phillip Thomas*  
*Pvt.*, Co. C, 4 Reg't U. S. Colored Cavalry.

Appears on

**Company Muster Roll**

for *March 1864*, 186*4*.

Present or absent *Present*

Stoppage, \$ 100 for

Due Gov't, \$ 100 for

Valuation of horse, \$ 100

Valuation of horse equipments, \$ 100

Remarks :

Book mark :

(358)

*Redacted*

Copyist.

J | **4 Cav.** | **U.S.C.T.**

*Philip Thomas*

*Pvt.*, Co. C, 4 Reg't U. S. Colored Cavalry.

Appears on

**Company Muster Roll**

for *May & June*, 186*4*.

Present or absent *Present*

Stoppage, \$ 100 for

Due Gov't, \$ 100 for

Valuation of horse, \$ 100

Valuation of horse equipments, \$ 100

Remarks :

Book mark :

*Rochester*

*T* | **4 Cav.** | **U.S.C.T.**

*Philip Thomas*

*Pvt.*, Co. C, 4 Reg't U. S. Colored Cavalry.

Appears on

**Company Muster Roll**

for *July to Aug.* 1864.

Present or absent *Present*

Stoppage, \$ 100 for

Due Gov't, \$ 100 for

Valuation of horse, \$ 100

Valuation of horse equipments, \$ 100

Remarks :

Book mark :

(358)

*Roberts*

Copyist.



7 | 4 Cav. | U.S.C.T.

Phillip Thomas  
Pvt., Co. C, 4 Reg't U. S. Colored Cavalry.

Appears on

Company Muster Roll

for Sept, 1864.

Present or absent Present

Stoppage, \$ 100 for

Due Gov't, \$ 100 for

Valuation of horse, \$ 100

Valuation of horse equipments, \$ 100

Remarks :

Book mark :

Rochester

(358)

Copyist.

4771090  
J | 4 Cav. | U.S.C.T.

Phillip Thomas  
Priv, Co. C, 4 Reg't U. S. Colored Cavalry.

Appears on

Company Muster Roll

for Nov 20<sup>th</sup>, 1864

Present or absent present

Stoppage, \$ 100 for

Due Gov't, \$ 100 for

Valuation of horse, \$ 100

Valuation of horse equipments, \$ 100

Remarks:

Book mark:

(358)

Moy  
Copyist.

*J* | 4 Cav. | U.S.C.T.

*Philip Thomas*

*Priv*, Co. C, 4 Reg't U. S. Colored Cavalry.

Appears on

**Company Muster Roll**

for *Jan & Feb*, 186*3*.

Present or absent *present*

Stoppage, \$ *100* for

Due Gov't, \$ *100* for

Valuation of horse, \$ *100*

Valuation of horse equipments, \$ *100*

Remarks: *Received \$7.00  
per month to include  
Apr 30, 1864.*

Book mark: \_\_\_\_\_

(358)

*May*

Copyist.

J | 4 Cav. | U.S.C.T.

Philip Thomas

Priv, Co. C, 4 Reg't U. S. Colored Cavalry.

Appears on

Company Muster Roll

for *March*, 1865.

Present or absent *present*

Stoppage, \$ 100 for

Due Gov't, \$ 100 for

Valuation of horse, \$ 100

Valuation of horse equipments, \$ 100

Remarks:

Book mark:

*W. J. May*

(358)

Copyist.

*T* | 4 Cav. | U.S.C.T.

*Philip Thomas*  
*Priv*, Co. C, 4 Reg't U. S. Colored Cavalry.

Appears on

**Company Muster Roll**

for *May & June*, 186*5*.

Present or absent *present*

Stoppage, \$ *100* for

Due Gov't, \$ *100* for

Valuation of horse, \$ *100*

Valuation of horse equipments, \$ *100*

Remarks: *Detailed in Reg't's*  
*Q M Dept.*

Book mark: \_\_\_\_\_

(358)

*Woy*  
Copyist.

I | **4 Cav.** | **U.S.C.T.**

Philip Thomas

Priv, Co. C, 4 Reg't U. S. Colored Cavalry.

Appears on

**Company Muster Roll**

for July & Aug, 1863.

Present or absent present

Stoppage, \$ 100 for

Due Gov't, \$ 100 for

Valuation of horse, \$ 100

Valuation of horse equipments, \$ 100

Remarks: Company Transfer

Book mark: \_\_\_\_\_

(358)

Moy

Copyist.

J | 4 Cav. | U.S.C.T.

Philip Thomas  
Priv., Co. C, 4 Reg't U. S. Colored Cavalry.

Appears on

**Company Muster Roll**  
for Sept & Oct, 1865.

Present or absent present

Stoppage, \$ 100 for

Due Gov't, \$ 100 for

Valuation of horse, \$ 100

Valuation of horse equipments, \$ 100

Remarks: Company Muster,  
Stop for 1 wagon saddle  
complete \$ 4.60, 1 bridle complete  
4.60, 1 saddle blanket 2.75,  
1 pr spurs & straps boots, 1  
curry comb & brush 87cts, 1  
Carbine socket & strap 47cts, Total  
of ordnance \$8.74, Total of charges \$

Book mark: \_\_\_\_\_

(358)

Moy

Copyist.

*J* | **4 Cav. U.S.C.T.**

*Phillip Thomas*  
Private, Co. C, 4 Reg't U. S. Colored Cavalry.

Appears on

**Company Muster Roll**

for *Nov + Dec*, 186*2*

Present or absent *present*

Stoppage, \$ *11* <sup>*60*</sup>/<sub>*100*</sub> for *lost*  
*ordnance*

Due Gov't, \$ <sup>*100*</sup>/<sub>*100*</sub> for

Valuation of horse, \$ <sup>*100*</sup>/<sub>*100*</sub>

Valuation of horse equipments, \$ <sup>*100*</sup>/<sub>*100*</sub>

Remarks:  
.....  
.....  
.....  
.....  
.....  
.....  
.....  
.....

Book mark: .....

(358) *M. A. Michaels*  
Copyist.



*J* | **4 Cav.** | **U.S.C.T.**

*Philip Thomas*

*Private*, Co. C, 4 Reg't U. S. Colored Cavalry.

Appears on

**Company Muster Roll**

for *Jan'y & Febr*, 1866.

Present or absent *present*

Stoppage, \$ *11* <sup>*60*</sup>/<sub>*100*</sub> for *Lost*  
*Ordinance*

Due Gov't, \$ *100* for

Valuation of horse, \$ *100*

Valuation of horse equipments, \$ *100*

Remarks: *Transfer Stop for*  
*1 wagon saddle complete*  
*on acct of I.M. Stores*

Book mark:

*M. A. Michaels*

(358)

Copyist.

1867 10 10  
D | 4 Cav. | U.S.C.T.

Philip Thomas

Port, Co. W, 4 Reg't U. S. Colored Cav.

Appears on Returns as follows:

Jan 1865 - On duty detailed as  
Regtl Blacksmith

Mch 1865 - On duty detailed  
as teamster

Apr to July 1865 - On duty detailed  
in Regtl. G. M. Dept.

Book mark:

W. R. Lee

(546)

Copyist.

*J* | **4 Cav. U.S.C.T.**

*Phillip Thomas*  
*Private*, Co. *C*, 4 Reg't U. S. Col'd Cavalry.

Appears on **Co. Muster-out Roll**, dated  
*New Orleans La Mar 20*, 1866.

Muster-out to date *Mar 20*, 1866.

Last paid to *June 30*, 1865.

**Clothing account:**

Last settled....., 186 ; drawn since \$..... 100

Due soldier \$ *26*<sup>*22*</sup>/<sub>100</sub>; due U. S. \$..... 100

Am't for cloth'g in kind or money adv'd \$..... 100

Due U. S. for arms, equipments, &c., \$ *11*<sup>*60*</sup>/<sub>100</sub>

Bounty paid \$..... 100; due \$..... 100

Remarks: *Joined at orig. org. Stop*  
*1 Carbine Socket & Straps, 1 Curb*  
*bridle, 1 Saddle blanket, 1 pair Spurs*  
*& Straps, 1 horsebrush, 1 Curry*  
*comb.*

Book mark: *P.M. 96790 July 27/66.*

*V. 112 - P 120 - 70*

*M. A. Michaels*

1046

Thomas Samuel

Co A, 4 U. S. Col'd Cav.

Private

Private

CARD NUMBERS.

1	5348487	26
2	5348606	27
3	5348705	28
4	5348797	29
5	5348975	30
6	5349073	31
7	5349771	32
8	D113-CJ-1874	33
9	40729267	34
10		35
11		36
12		37
13		38
14		39
15		40
16		41
17		42
18		43
19		44
20		45
21		46
22		47
23		48
24		49
25		50

Book Mark: *Robert 74*  
D113-CJ-1874

See also

*T* | 4 Cav. | U.S.C.T.

*Samuel Thomas*

*Private*, Co. *A*, 1 Reg't La. Cav., Corps d'Afrique.\*

Appears on

**Company Muster-in Roll**

of the organization named above, Roll dated

*New Orleans La, Sept 12*, 1863.

Muster-in to date

*Sept 12*, 1863.

Joined for duty and enrolled:

When *Aug 30*, 1863.

Where *New Orleans*

Period *3* years.

Valuation of horse, \$ *100*

Valuation of horse equipments, \$ *100*

Remarks:

*Age 35*

\*This organization subsequently became Co. *A*, 4 Reg't U. S. Colored Cavalry.

Book mark *D 113 - C J - 1874*

(356)

*M. A. Michaels*

Copyist.

Y | 4 Cav. | U.S.C.T.

Samuel Thomas

Priv., Co. A, 1 Reg't La. Cav., Corps d'Afrique.\*

Appears on

Company Muster Roll

for Sept 17 to Dec 31, 1863

Present or absent

Stoppage, \$ 100 for

Due Gov't, \$ 100 for

Valuation of horse, \$ 100

Valuation of horse equipments, \$ 100

Remarks: Deserted at Camp  
Companys Canal  
Oct 20<sup>th</sup> 1863

\*This organization subsequently became Co. A, 4 Reg't U. S. Colored Cavalry.

Book mark:

R. S. Richardson

(358)

Copyist.

1864

*Y* 4 Cav. U.S C.T.

*Samuel Thomas*  
Co. *A*, 1 Reg't Cav., Corps d'Afrique.\*

Appears on

**Company Muster Roll**

for *Jan & Feb*, 1864

Present or absent

Stoppage, \$ 100 for

Due Gov't, \$ 100 for

Valuation of horse, \$ 100

Valuation of horse equipments, \$ 100

Remarks: *Deserted at*  
*New Orleans Feb*  
*2<sup>nd</sup> 1864*

\* This organization subsequently became Co. *A*, 4 Reg't U. S. Colored Cavalry.

Book mark:

*R. M. Nicholson*  
Copyist.

T | 4 Cav. | U.S.C.T.

Samuel Thomas

Prin, Co. A, 4 Reg't U. S. Col'd Cavalry,

Appears on

Company Muster Roll

for *March 1864*, 1864

Present or absent

Stoppage, \$ 100 for

Due Gov't, \$ 100 for

Valuation of horse, \$ 100

Valuation of horse equipments, \$ 100

Remarks: *Deserted from  
Company's Cavalry  
Feb 2<sup>nd</sup> 1864*

*Roll July & Aug '64 must  
on which name appears*

Book mark:

*R. Richardson*



*D* | **4 Cav. | U.S.C.T.**

*Samuel Thomas*  
*Priv*, Co. A, 4 Reg't U. S. Col'd Cavalry.

Appears on

**Company Muster Roll**

for *July & Aug*, 186*4*

Present or absent *Absent*

Stoppage, \$ *100* for

Due Gov't, \$ *100* for

Valuation of horse, \$ *100*

Valuation of horse equipments, \$ *100*

Remarks: *In charge of Provost*  
*Marshal District of*  
*Carrollton \$30 to be*  
*stopped from his pay*  
*by off Jas Callaghan*  
*for apprehension as*  
*adverser*

Book mark:

*R Richardson*

7 | 4 Cav. | U.S.C.T.

Samuel Thomas

Pri, Co. A, 4 Reg't U. S. Col'd Cavalry.

Appears on

Company Muster Roll

for Sept Oct, 1864

Present or absent

Stoppage, \$ 100 for

Due Gov't, \$ 100 for

Valuation of horse, \$ 100

Valuation of horse equipments, \$ 100

Remarks: Deserted Sept 8/64. To be stopped \$30 for apprehension as a deserter July 27/64

Book mark:

Donnelly

(358)

Copyist.

T | 4 Cav. | U.S.C.T.

\* Samuel Thomas

Priv., Co. A, 4 Reg't U. S. Colored Cav.

Appears on Returns as follows:

Jan 1864 - (1 Regt. Cav., Corps d'Afrique)  
Absent in arrest, in Regt.  
Guard House New Orleans

Feb 1864 -

Apr 1864 - (4 Regt U.S. Col'd Cav.) } Loss:  
New Orleans Feb 2/64  
Deserted.

July 1864 - Jan: July 25 Camp  
Parapet Ret'd. from desertion

Aug 1864 - Absent in hands of Pro-  
vost Marshal Dist. of  
Carrollton since July 26/64

Sept 1864 - Loss: Sept 8/64 New  
Orleans, Deserted.

\* Name appears also as

Samuel Thomas alias Jenkins

Book mark:

W. R. Lee

S | **4 Cav.** | **U.S.C.T.**

Samuel Thomas  
Priv., Co. A, 4 Reg't U. S. Col'd Cavalry.

Appears on **Co. Muster-out Roll**, dated  
New Orleans La, Feb 20, 1866.

Muster-out to date \_\_\_\_\_, 186 .

Last paid to \_\_\_\_\_, 186 .  
Never Paid

**Clothing account:**

Last settled \_\_\_\_\_, 186 ; drawn since \$ \_\_\_\_\_ 100

Due soldier \$ \_\_\_\_\_ 100; due U. S. \$ \_\_\_\_\_ 100

Am't for cloth'g in kind or money adv'd \$ \_\_\_\_\_ 100

Due U. S. for arms, equipments, &c., \$ \_\_\_\_\_ 100

Bounty paid \$ \_\_\_\_\_ 100; due \$ \_\_\_\_\_ 100

Remarks: Joined at orig. org. Deserted  
Oct. 20. 63, at New Orleans La.

Book mark } Deserted Sept. 8. 64  
J. 113 V. 10 C. J. 74

(361)

Prewitt

Copyist.

J. 1 4<sup>th</sup> Cav. 1 U.S. b. J.

Samuel Thomas

, Co. A, 4<sup>th</sup> Reg't U.S. b. Cav.

E.B. 11/196 with **NOTATION.**

Book mark:

J. 113. b. J. 1874.

War Department,

Adjutant General's Office,

Washington, Oct. 19<sup>th</sup>, 1874.

Deserter Sept. 8<sup>th</sup>, 1864.

E. P. Conroy,

(438)

Copyist.

Thomas Samuel

Co. 4 Reg't U.S.C.C.

1 Enclosures.

Bed Cards	Final Statements
Burial Records	Furloughs or L. of A.
Certs. of Dis. for Discharge	Med. Certificates
C. M. Charges	Med. Des. Lists
Descriptive Lists	Orders
Discharge Certificates	Pris. of War Record
Enlistment Papers	Resignations

Other papers relating to—

Admission to Hosp'l	Furlough or L. of A.
Casualty Sheet	Med. Examination
Confinement	Misc. Information
Contracts	Pay or Clothing
Death or Effects	Personal Reports
Desertion	Rank
Discharge from Hosp'l	Transfer to Hosp'l
Discharge from Service	Transfer to V. R. C.
Duty	Transportation

MICROFILM PUBLICATION M 1820

COMPILED MILITARY SERVICE RECORDS  
OF VOLUNTEER UNION SOLDIERS WHO  
SERVED WITH THE USCT (US COLORED TROOPS)  
4TH REGIMENT OF CAVALRY

PERSONAL PAPERS' TARGET SHEET

PLEASE NOTE THE CHECKED INFORMATION ABOUT THE PERSONAL PAPERS IN  
THIS FILE:

- NO PERSONAL PAPERS WERE FOUND IN THIS FILE WHEN THE  
RECORDS WERE ARRANGED FOR MICROFILMING.
- 2 PERSONAL PAPER(S) FOUND IN THIS FILE WHEN THE RECORDS  
WERE ARRANGED FOR MICROFILMING.

Communication from  
Col Bartram in regard  
to confinement of prisoner  
Samuel Thomas 4<sup>th</sup> U.S.  
Cavalry Regiment  
July 27. 1864



Headquarters, District of Carrollton,

Carrollton, La., July 26<sup>th</sup> 1864

Capt E. L. Page

Provost Marshal, Carrollton District

Captain:

You will receive this  
prisoner private Samuel Thomas Co A 4<sup>th</sup> U.S. Col<sup>d</sup>  
Cavalry, and place him in confinement to await for  
trial, as charges are being preferred against him.

In Command

Capt Wm. G. Bartram

J. N. Evans

1<sup>st</sup> Lieut Robert A. A. Gent

Dept of the Gulf U. S. Mail. Del.  
New Orleans Aug 28<sup>th</sup> 1864

Genl A. A. Smit  
Judge Advocate

States that Smit Billsteris  
will not be required to charge  
against Samuel Thomas of the  
U. S. C. will be sent to Port Head,  
son for trial

DEPARTMENT OF THE GULF,

United States Military Telegraph Office,

New Orleans, Aug 28 1864

By Telegraph from

Carrolton.

To

J Lovell Capt  
A. A. A. A.

Dr. Billsteins presence  
will not be required.  
Charges against Samuel  
Thomas & N. S. Caraly  
will be sent to Port Hudson  
for trial.

G. A. Price

D. Judge Advocate

1044  
Thomas, Stephen

Co., 4 U. S. Col'd Cav.

Private | Private

CARD NUMBERS.

1	5347524	26	
2		27	
3		28	
4		29	
5		30	
6		31	
7		32	
8		33	
9		34	
10		35	
11		36	
12		37	
13		38	
14		39	
15		40	
16		41	
17		42	
18		43	
19		44	
20		45	
21		46	
22		47	
23		48	
24		49	
25		50	

Book Mark: \_\_\_\_\_

See also \_\_\_\_\_

4 Cav. U.S.C.T.

+ Stephen Thomas

Appears with rank of *Private* on

**Muster and Descriptive Roll of a Detachment of U. S. Vols. forwarded**

for the 4 Reg't U. S. Col'd Cavalry. Roll dated

*New Orleans, La. Apr. 25, 1865.*

Where born *Wilkinson Co. Mississippi*

Age *25* y'rs; occupation *Laborer*

When enlisted *Apr. 3*, 1865.

Where enlisted *New Orleans, La.*

For what period enlisted *3* years.

Eyes *Black*; hair *Black*

Complexion *Black*; height *5 ft. 3 in.*

When mustered in *Apr. 25*, 1865.

Where mustered in *New Orleans*

Bounty paid \$ *100* <sup>100</sup>; due \$ *200* <sup>100</sup>

Where credited *Quar. 2<sup>nd</sup> Ward, Orleans, La.*

Company to which assigned *B.*

Remarks: *Absent from Muster.*

+ Entry cancelled on Roll by line.

Book mark: *Name not taken up on Rolls of any Co.*

*O. T. Taylor*

1850  
Thomas, William

Co B, 4 U. S. Col'd Cav.

Private | Private

CARD NUMBERS.

1	5 3 4 9 8 6 2	26
2	5 3 4 9 8 9 5	27
3	5 3 5 0 0 5 5	28
4	5 3 5 0 1 6 1	29
5	5 3 5 0 2 5 4	30
6	5 3 5 0 3 4 3	31
7	5 3 5 0 4 2 3	32
8	5 3 5 0 4 9 7	33
9	5 3 5 0 5 7 2	34
10	5 3 5 0 6 5 8	35
11	5 3 5 0 7 4 3	36
12	5 3 5 0 8 3 8	37
13	5 3 5 0 9 2 4	38
14	5 3 5 1 0 0 8	39
15	5 3 5 1 0 9 0	40
16	5 3 5 1 1 7 1	41
17	4 0 7 2 9 2 6 8	42
18		43
19		44
20		45
21		46
22		47
23		48
24		49
25		50

Book Mark:

See also

A. 2531572 Pomeroy  
SSV. 6/28/29

D. Jordan  
Cf

*J* | **4 Cav. U.S.C.T.**

*William Thomas*

*Co. B*, Co. *B*, 1 Reg't La. Cav., Corps d'Afrique.\*

*Age 31 yrs -*  
Appears on

**Company Muster-in Roll**

of the organization named above. Roll dated

*New Orleans La Oct 27*, 186 *3*.

Muster-in to date *Oct 27*, 186 *3*.

Joined for duty and enrolled:

When *Oct 19*, 186 .

Where *New Orleans*

Period *3* years.

Valuation of horse, \$.....*100*

Valuation of horse equipments, \$.....*100*

Remarks:.....

*\* Inserted by Jordan Ex*

\*This organization subsequently became Co. *B* 4 Reg't U. S. Colored Cavalry.

Book mark:.....

(356)

*Army*  
Copyst.



*T*

**4 Cav. | U.S.C.T.**

*William Thomas*

*Company B*, 1 Reg't La. Cav., Corps d'Afrique.\*

Appears on

**Company Muster Roll**

for *Sept 1 to Dec 31*, 186*3*.

Present or absent *Present*

Stoppage, \$ *100* for

Due Gov't, \$ *100* for

Valuation of horse, \$ *100*

Valuation of horse equipments, \$ *100*

Remarks:

\*This organization subsequently became Co. *B*, 4 Reg't U. S. Colored Cavalry.

Book mark:

(358)

*Copyist.*

*T*

**4 Cav. U.S.C.T.**

*William Thomas*  
*Co. B*, Co. *B*, 1 Reg't Cav., Corps d'Afrique.\*

Appears on

**Company Muster Roll**

for *Jan & Feb*, 1864.

Present or absent *Present*

Stoppage, \$ *100* for

Due Gov't, \$ *100* for

Valuation of horse, \$ *100*

Valuation of horse equipments, \$ *100*

Remarks:  
-----  
-----  
-----  
-----  
-----  
-----  
-----  
-----

\* This organization subsequently became Co. *B*, 4 Reg't U. S. Colored Cavalry.

Book mark: -----

(358)

*King*  
Copyist.

ARRIVED

*J* | **4 Cav. | U.S.C.T.**

*Williams Thomas*  
*Co. B.*, Co. B. 4 Reg't U. S. Col'd Cavalry.

Appears on

**Company Muster Roll**

for *March + April*, 1864.

Present or absent *Present*

Stoppage, \$ 100 for

Due Gov't, \$ 100 for

Valuation of horse, \$ 100

Valuation of horse equipments, \$ 100

Remarks :  
.....  
.....  
.....  
.....  
.....  
.....  
.....  
.....  
.....

Book mark :  
.....

(358)

*A. M. G.*  
Copyist.

*T* | **4 Cav.** | **U.S.C.T.**

*William Thomas*

*Co.*, Co. B. 4 Reg't U. S. Col'd Cavalry.

Appears on

**Company Muster Roll**

for *May 1866*, 186*6*.

Present or absent *Present*

Stoppage, \$ *100* for

Due Gov't, \$ *100* for

Valuation of horse, \$ *100*

Valuation of horse equipments, \$ *100*

Remarks :  
.....  
.....  
.....  
.....  
.....  
.....  
.....  
.....  
.....  
.....

Book mark :  
.....

(358)

*[Signature]*  
Copyist.

*T* | **4 Cav.** | **U.S.C.T.**

*William Thomas*  
*Co.*, Co. B. 4 Reg't U. S. Col'd Cavalry.

Appears on

**Company Muster Roll**

for *July & Aug*, 186*4*.

Present or absent *Present*

Stoppage, \$ *100* for

Due Gov't, \$ *100* for

Valuation of horse, \$ *100*

Valuation of horse equipments, \$ *100*

Remarks :

Book mark :

(358)

*[Signature]*  
Copyist.

*T* | **4 Cav.** | **U.S.C.T.**

*William Thomas*  
*Co. B.*, Co. B. 4 Reg't U. S. Col'd Cavalry.

Appears on

**Company Muster Roll**

for *Sept & Oct*, 1864.

Present or absent *Present*

Stoppage, \$ 100 for

Due Gov't, \$ 100 for

Valuation of horse, \$ 100

Valuation of horse equipments, \$ 100

Remarks :  
.....  
.....  
.....  
.....  
.....  
.....  
.....  
.....  
.....  
.....

Book mark : .....

(358)

*J. King*  
Copyist.

5 | **4 Cav.** | **U.S.C.T.**

William Thomas  
ser., Co. B. 4 Reg't U. S. Col'd Cavalry.

Appears on  
**Company Muster Roll**  
for Nov & Dec, 1864.  
Present or absent present  
Stoppage, \$ 100 for

Due Gov't, \$ 100 for

Valuation of horse, \$ 100

Valuation of horse equipments, \$ 100

Remarks: Detached with  
Reg'tt. Quartermaster,  
Stop for one horse Bag.

Book mark:

Somer  
(358) Copyist.

T | **4 Cav.** | **U.S.C.T.**

William Thomas

priv., Co. B. 4 Reg't U. S. Col'd Cavalry.

Appears on

**Company Muster Roll**

for Jan & Feb., 1865.

Present or absent Present

Stoppage, \$ 100 for

Due Gov't, \$ 100 for

Valuation of horse, \$ 100

Valuation of horse equipments, \$ 100

Remarks: Received only \$7 a  
month to include Apr 30/64  
detained with Regimental  
quartermaster Stop for our  
mess bag.

Book mark:

Sumner



777104

**4 Cav. U.S.C.T.**

*William Hoover*

*priv.*, Co. B. 4 Reg't U. S. Col'd Cavalry.

Appears on

**Company Muster Roll**

for *March + April*, 186*5*.

Present or absent *present*

Stoppage, \$ 100 for

Due Gov't, \$ 100 for

Valuation of horse, \$ 100

Valuation of horse equipments, \$ 100

Remarks: *Stop for one horse blanket. One daily duty with Regimental Quartermaster*

Book mark:

(358)

*Hoover*

Copyist.

7 | 4 Cav. | U.S.C.T.

William Thomas

sergeant, Co. B. 4 Reg't U. S. Col'd Cavalry.

Appears on

**Company Muster Roll**

for May & June, 1861.

Present or absent present

Stoppage, \$ 100 for

Due Gov't, \$ 100 for

Valuation of horse, \$ 100

Valuation of horse equipments, \$ 100

Remarks: On extra duty in  
W. D. M. Dept. Stop for  
saddle blanket.

Book mark:

James

MAR 15 1869

7 | **4 Cav.** | **U.S.C.T.**

William Thomas

ser., Co. B. 4 Reg't U. S. Col'd Cavalry.

Appears on

**Company Muster Roll**

for July & Aug, 1869.

Present or absent Present

Stoppage, \$ 100 for

Due Gov't, \$ 100 for

Valuation of horse, \$ 100

Valuation of horse equipments, \$ 100

Remarks :  
\_\_\_\_\_  
\_\_\_\_\_  
\_\_\_\_\_  
\_\_\_\_\_  
\_\_\_\_\_  
\_\_\_\_\_  
\_\_\_\_\_  
\_\_\_\_\_

Book mark :  
\_\_\_\_\_  
\_\_\_\_\_

Thomas

*T* | **4 Cav. | U.S.C.T.**

*William Thomas*

*priv.*, Co. B. 4 Reg't U. S. Col'd Cavalry.

Appears on

**Company Muster Roll**

for *Sept & Oct*, 186*4*.

Present or absent *present*

Stoppage, \$ *100* for

Due Gov't, \$ *100* for

Valuation of horse, \$ *100*

Valuation of horse equipments, \$ *100*

Remarks :

Book mark :

*James*

*T* | **4 Cav. U.S.C.T.**

*William Thomas*  
*Priv*, Co. B. 4 Reg't U. S. Col'd Cavalry.

Appears on

**Company Muster Roll**

for *Nov. 1865*, 1865

Present or absent *Present*

Stoppage, \$ *100* for

Due Gov't, \$ *100* for

Valuation of horse, \$ *100*

Valuation of horse equipments, \$ *100*

Remarks :

Book mark :

(358)

*Chandler*  
Copyist.

*T* | **4 Cav.** | **U.S.C.T.**

*William Thomas*  
*Priv*, Co. B. 4 Reg't U. S. Col'd Cavalry.

Appears on

**Company Muster Roll**

for *Jan. & Feb.*, 1866.

Present or absent *Present*

Stoppage, \$ 100 for

Due Gov't, \$ 100 for

Valuation of horse, \$ 100

Valuation of horse equipments, \$ 100

Remarks :

Book mark :

(358)

*Chandler*  
Copyist.

D | 4 Cav. | U.S.C.T.

William Thomas

Priv., Co. B, 4 Reg't U. S. Colored Cav.

Appears on Returns as follows:

Feb'y & March 1864 - (1 Regt. Caval. Corps d'elite)

On duty - teamster for Regtl. G. M.

Apr. to June 1864 - (4 Regt U. S. Col'd Cav.)

On duty Regtl. teamster in

G. M. Dept.

Oct 1864 On duty in Regtl. G. M. Dept.

Nov 1864 On duty in R. G. M. Dept.

Dec 1864 - On duty detailed as Regtl

teamster

Feb & March 1865 On duty detailed  
in Regtl. G. M. Dept.

Apr 1865. On duty detailed as  
teamster

May & June 1865 - On duty detailed  
in Regtl. G. M. Dept.

Book mark:

W. R. Lee

*J* | **4 Cav.** | **U.S.C.T.**

*William Thomas*

*Pvt*, Co. *B*, 4 Reg't U. S. Col'd Cavalry.

Appears on **Co. Muster-out Roll**, dated  
*New Orleans, La, Mch. 20* 1866.

Muster-out to date *Mch. 20* 1866.

Last paid to *June 30*, 1865.

**Clothing account:**

Last settled....., 186 ; drawn since \$..... 100

Due soldier \$ *41*<sup>*17*</sup> / 100; due U. S. \$..... 100

Am't for cloth'g in kind or money adv'd \$..... 100

Due U. S. for arms, equipments, &c., \$..... <sup>*64*</sup> / 100

Bounty paid \$..... 100; due \$..... 100

Remarks: *Joined Orgil org.*

*Stop for 2 Sabre Knives*

Book mark: *V. 115, P. 138, 70.*

(361)

*Chandler*

Copyist.



Thomas William

Co H, 4 U. S. Col'd Cav.

Private

Private

CARD NUMBERS.

1	5347481	26
2	5358166	27
3	5358230	28
4	5358284	29
5	5358334	30
6	5358377	31
7	5348028	32
8	5357620	33
9	5357702	34
10	5357785	35
11	5357864	36
12	5357939	37
13	5358012	38
14	5358087	39
15	40729272	40
16	40729271	41
17		42
18		43
19		44
20		45
21		46
22		47
23		48
24		49
25		50

Book Mark:

See also

A 1806447 P.O. mazy  
A 2502367 and 1000  
D. of P. ~~RD~~, 1722540.

F-17-32  
Sh.

H. Jordan  
ex

7 | **4 Cav.** | **U.S.C.T.**

William Thomas

Appears with rank of Private on

**Muster and Descriptive Roll of a Detachment of U. S. Vols. forwarded**

for the 4 Reg't U. S. Col'd Cavalry. Roll dated

New Orleans La., April 27, 1864.

Where born New Orleans, La

Age 40 y'rs; occupation Laborer

When enlisted April 16, 186 .

Where enlisted Grand Ecure La

For what period enlisted 3 years.

Eyes Brown; hair Black

Complexion Black; height 5 ft. 8 in.

When mustered in April 27, 1864.

Where mustered in New Orleans

Bounty paid \$ 2 <sup>100</sup>; due \$ 100

Where credited \_\_\_\_\_

Company to which assigned D

Remarks: \_\_\_\_\_

\_\_\_\_\_

\_\_\_\_\_

Book mark: \_\_\_\_\_

O. J. Taylor

*A* | 4 Cav. | U.S.C.T.

*William Thomas*

*Pvt*, Co. *D*, 4 Reg't U. S. Col'd Cavalry.

Age.....years.

Appears on

Company Muster Roll\*

for *April 27 to June 30*, 1864.

Joined for duty and enrolled:

When *Apr. 16*, 1864.

Where *Grand Ecore La,*

Period *3* years.

Mustered in:

When *Apr. 27*, 1864.

Where *New Orleans, La,*

Present or absent *Present*

Stoppage, \$.....100 for.....

Due Gov't, \$.....100 for.....

Valuation of horse, \$.....100

Valuation of horse equipments, \$.....100

Remarks: *Detached as Teamster for 2<sup>nd</sup> M.,  
May 4, 1864*

\* First current roll. No muster-in roll of this battery on file.

Book mark :.....

(358b)

*Styus*

Copyist.

*A* | 4 Cav. | U.S.C.T.

*William Thomas*

*Pl*, Co. I, 4 Reg't U. S. Col'd Cavalry.

Appears on

**Company Muster Roll**

for *July & Aug*, 1864.

Present or absent *Present*

Stoppage, \$ *100* for

Due Gov't, \$ *100* for

Valuation of horse, \$ *100*

Valuation of horse equipments, \$ *100*

Remarks: *Detached as Reg't Drums for  
May 4 '1864*

Book mark:

*Styus*

9 | 4 Cav. | U.S.C.T.

*Williams Thomas*

*Plt*, Co. I, 4 Reg't U. S. Col'd Cavalry.

Appears on

**Company Muster Roll**

for *Sept & Oct*, 1864.

Present or absent *Present*

Stoppage, \$ 100 for

Due Gov't, \$ 100 for

Valuation of horse, \$ 100

Valuation of horse equipments, \$ 100

Remarks: *Detained as Reg't Muster  
by S.O. 37. May 4. 1864*

Book mark:

(358)

*H. J. ...*  
Copyist.

*A* | 4 Cav. | U.S.C.T.

*William Thomas*

*Pl*, Co. I, 4 Reg't U. S. Col'd Cavalry.

Appears on

**Company Muster Roll**

for *Nov & Dec*, 186*4*.

Present or absent *Present*

Stoppage, \$ 100 for

Due Gov't, \$ 100 for

Valuation of horse, \$ 100

Valuation of horse equipments, \$ 100

Remarks: *Retained as Reg'tt Quartermaster  
May 4. by S.O. 37*

Book mark:

(358)

*Thyns*  
Copyist.

*A* | 4 Cav. | U.S.C.T.

*William Thomas*

*Pl*, Co. I, 4 Reg't U. S. Col'd Cavalry.

Appears on

Company Muster Roll

for *Jan & Feb*, 1865.

Present or absent *Present*

Stoppage, \$ 100 for

Due Gov't, \$ 100 for

Valuation of horse, \$ 100

Valuation of horse equipments, \$ 100

Remarks: *Detailed Reg'l Muster  
May 4, 1864 per S.O. 37.*

Book mark:

(358)

*Styer*

Copyist.



*P* | **4 Cav.** | **U.S.C.T.**

*William Thomas*

*Priv.*, Co. H, 4 Reg't U. S. Col'd Cavalry.

Appears on

**Company Muster Roll**

for *Feb. 9. April*, 186*2*.

Present or absent *Present*

Stoppage, \$ *100* for

Due Gov't, \$ *100* for

Valuation of horse, \$ *100*

Valuation of horse equipments, \$ *100*

Remarks: *Transferred from Co. I in consolidation by S. O. 28. Adprs. Dept. July, Jan. 28/63-*

Book mark:

*Master*

*I 4 Cav* | **U.S.C.T.**

*William Thomas*  
*Prs, Co. A, 4 Reg't U. S. Col'd Cav.*

Appears on

**M. and D. Roll of Men Transferred**

to the organization named above, *by answer*  
from *Co. I*

Roll dated *Port Hudson La Apr 29, 1865.*

When enlisted *Apr 16, 1864.*

Period for which enlisted *3* years.

When mustered in *Apr 27, 1864.*

Present or absent *not stated*

Company to which assigned *A*

Remarks:

Book mark:

*J. L. Leman*

4 Cav. U.S.C.T.

William Thomas  
Cvt., Co. H, 4 Reg't U. S. Col'd Cavalry.

Appears on

Company Muster Roll

for May & June, 1862.

Present or absent

Stoppage, \$ 100 for

Due Gov't, \$ 100 for

Valuation of horse, \$ 100

Valuation of horse equipments, \$ 100

Remarks: Absent on fur  
rough since June 20/62  
at New Orleans

Book mark:

Feaster

*P* | **4 Cav.** | **U.S.C.T.**

*William Thomas*  
*Pvt.*, Co. H, 4 Reg't U. S. Col'd Cavalry.

Appears on

**Company Muster Roll**  
for *July & Aug.*, 186 *3.*  
Present or absent

Stoppage, \$ 100 for

Due Gov't, \$ 100 for

Valuation of horse, \$ 100

Valuation of horse equipments, \$ 100

Remarks:  
\_\_\_\_\_  
\_\_\_\_\_  
\_\_\_\_\_  
\_\_\_\_\_  
\_\_\_\_\_  
\_\_\_\_\_  
\_\_\_\_\_  
\_\_\_\_\_

Book mark: \_\_\_\_\_

*Coast*  
\_\_\_\_\_  
(358) Copyist.

*F* | **4 Cav.** | **U.S.C.T.**

*William Thomas*

*Pvt.*, Co. H, 4 Reg't U. S. Col'd Cavalry.

Appears on

**Company Muster Roll**

for *Sept. & Oct.*, 186*5*.

Present or absent *Present*

Stoppage, \$ 100 for

Due Gov't, \$ 100 for

Valuation of horse, \$ 100

Valuation of horse equipments, \$ 100

Remarks:

Book mark:

*Feaster*

1863  
D | 4 Cav. | U.S.C.T.

William Thomas  
Pi, Co. H, 4 Reg't U. S. Col'd Cavalry.

Appears on

**Company Muster Roll**

for dated Dec 31, 1863.

Present or absent Present

Stoppage, \$ 100 for

Due Gov't, \$ 100 for

Valuation of horse, \$ 100

Valuation of horse equipments, \$ 100

Remarks:

Book mark:

(358)

A. C. Thomas

Copyist.

*S* | **4 Cav.** | **U.S.C.T.**

*William Thomas*  
*Pr.*, Co. H, 4 Reg't U. S. Col'd Cavalry.

Appears on

**Company Muster Roll**

for *Jan & Feb*, 186*6*.

Present or absent *Present*

Stoppage, \$ *100* for

Due Gov't, \$ *100* for

Valuation of horse, \$ *100*

Valuation of horse equipments, \$ *100*

Remarks:

Book mark:

(358)

*A. C. Howard*  
Copyist.

1865  
D | 4 Cav. | U.S.C.T.

William Thomas

Port, Co. H, 4 Reg't U. S. Colored Cav.

Appears on Returns as follows:

March to May 1865 - On duty detailed  
in Reg't G. M. Dept.

June 1865 - Absent on furlough  
since June 20/65

July 1865 - On duty teamster

Dec 1865 to Feb 1866 - On duty  
teamster

Book mark:

W. R. Lee



S | 4 Cav. | U.S.C.T.

+ William Thomas

Port, Co. D, 4 Reg't U. S. Colored Cav.

Appears on Returns as follows:

May to Aug 1864 - On duty Teamster  
for Reg't G. M.

Sept 1864 - On duty teamster.

Oct 1864 - On duty teamster.

Nov 1864 - On duty in R. G. M.  
Sept.

Jan & Feb 1865 - On duty detailed  
as Reg't teamster

\* Name appears also as  
William Thomas

Book mark:

W. R. Lee

*J* | **4 Cav.** | **U.S.C.T.**

*William Thomas*  
*Pri*, Co. *H*, 4 Reg't U. S. Col'd Cavalry.

Appears on **Co. Muster-out Roll**, dated  
*New Orleans La, Mar 24* 1866.

Muster-out to date *Mar 24* 1866.

Last paid to *June 30*, 1865.

Clothing account:

Last settled....., 186 ; drawn since \$.....  $\overline{100}$

Due soldier \$.....  $\overline{100}$ ; due U. S. \$.....  $\frac{15}{100}$

Am't for cloth'g in kind or money adv'd \$.....  $\overline{100}$

Due U. S. for arms, equipments, &c., \$.....  $\overline{100}$

Bounty paid \$.....  $\overline{100}$ ; due \$.....  $\overline{100}$

Remarks: *Joined by transfer*  
*from Co. I Mar 24/65*  
*per S.O. 28. Hd. Qrs.*  
*Dept. Gulf series 1865*

Book mark: *V35. P12. 68*

(361)

*H. E. Andrews*  
Copyist.

Thomas, William

Co E, 4 U. S. Col'd Cav.

Private Private

CARD NUMBERS.

1	5353843	26
2	5353896	27
3	5353952	28
4	5354006	29
5	5354076	30
6	5354147	31
7	5354212	32
8	5354277	33
9	5354338	34
10	5354423	35
11	5354498	36
12	5354592	37
13	53548243	38
14	5354663	39
15	5354732	40
16	5354799	41
17	5354867	42
18	40729269	43
19		44
20		45
21		46
22		47
23		48
24		49
25		50

Book Mark:

See also

*J* | **4 Cav. | U.S.C.T.**

*William Thomas*

*Pvt. E*, Co. *E*, 1 Reg't, Corps d'Afrique Cavalry.\*  
+ *Aguz 22 yrs.*  
Appears on

**Company Muster-in Roll**

of the organization named above. Roll dated  
*New Orleans, La., Dec. 21,* 186*2*

Muster-in to date *Dec. 21,* 186*2*

Joined for duty and enrolled:

When *Oct. 22*, 186*2*

Where *New Orleans*

Period *2* years.

Valuation of horse, \$ *100*

Valuation of horse equipments, \$ *100*

Remarks:

*Inserted by Jordan Ex*

\*This organization subsequently became Co. *E*, 4 Reg't U. S. Colored Cavalry.

Book mark:

*Wendell*

*T* **4 Cav. U.S C.T.**

*William Thomas*  
*Pvt*, Co. *E*, 1 Reg't Cav., Corps d'Afrique.\*

Appears on

**Company Muster Roll**

for *Enlistment to Dec. 31, 186* *9*

Present or absent *Present*

Stoppage, \$ *100* for

Due Gov't, \$ *100* for

Valuation of horse, \$ *100*

Valuation of horse equipments, \$ *100*

Remarks:  
.....  
.....  
.....  
.....  
.....  
.....

\* This organization subsequently became Co. *E*, 4 Reg't U. S. Colored Cavalry.

Book mark: .....

*Wessel*  
(358) *Wessel* Copyist.

J 4 Cav. U.S.C.T.

William Thomas

, Co. E, 1 Reg't Cav., Corps d'Afrique.\*

Appears on

Company Muster Roll

for Jan & Feb, 1864

Present or absent Present

Stoppage, \$ 100 for

Due Gov't, \$ 100 for

Valuation of horse, \$ 100

Valuation of horse equipments, \$ 100

Remarks:

\* This organization subsequently became Co. S, 4 Reg't U.S. Colored Cavalry.

Book mark:

Lawrence

J | 4 Cav. | U.S.C.T.

*William Thomas*  
-----  
*Pvt.*, Co. E, 4 Reg't U. S. Col'd Cav.

Appears on

**Company Muster Roll**

for *Nov & Apr*, 1864.

Present or absent *Present*

Stoppage, \$ *100* for

Due Gov't, \$ *100* for

Valuation of horse, \$ *100*

Valuation of horse equipments, \$ *100*

Remarks: -----  
-----  
-----  
-----  
-----  
-----  
-----  
-----  
-----

Book mark: -----  
-----

(358)

*Lawrence*  
-----  
Copyist.

J | **4 Cav.** | **U.S.C.T.**

William Thomas

Plt, Co. E, 4 Reg't U. S. Col'd Cav.

Appears on

**Company Muster Roll**

for May & June, 1864

Present or absent Present

Stoppage, \$ 100 for

Due Gov't, \$ 100 for

Valuation of horse, \$ 100

Valuation of horse equipments, \$ 100

Remarks:

Book mark:

Laurence



J | 4 Cav. | U.S.C.T.

William Thomas

Priv., Co. E, 4 Reg't U. S. Col'd Cav.

Appears on

**Company Muster Roll**

for July & Aug, 1864

Present or absent Present

Stoppage, \$ 100 for

Due Gov't, \$ 100 for

Valuation of horse, \$ 100

Valuation of horse equipments, \$ 100

Remarks:

Book mark:

Lawrence

7 | 4 Cav. | U.S.C.T.

William Thomas

Put, Co. E, 4 Reg't U. S. Col'd Cav.

Appears on

Company Muster Roll

for Sept + Oct, 1864

Present or absent Present

Stoppage, \$ 100 for

Due Gov't, \$ 100 for

Valuation of horse, \$ 100

Valuation of horse equipments, \$ 100

Remarks: Due US for lost  
Ordnance 43 ct

Book mark:

Lamm

G | **4 Cav.** | **U.S.C.T.**

*William Thomas*

*Priv*, Co. E, 4 Reg't U. S. Col'd Cav.

Appears on

**Company Muster Roll**

for *Nov & Dec*, 1864.

Present or absent *Present*

Stoppage, \$ 100 for

Due Gov't, \$ 100 for

Valuation of horse, \$ 100

Valuation of horse equipments, \$ 100

Remarks:

Book mark:

(358)

*Wines*

Copyist.

*D* | **4 Cav.** | **U.S.C.T.**

*William Thomas*

*Pvt*, Co. E, 4 Reg't U. S. Col'd Cav.

Appears on

**Company Muster Roll**

for *Jan & Feb*, 186*5*.

Present or absent *Present*

Stoppage, \$ *100* for

Due Gov't, \$ *100* for

Valuation of horse, \$ *100*

Valuation of horse equipments, \$ *100*

Remarks: *Rec'd only 7 doll  
per month to include  
Apr 30/65*

Book mark: \_\_\_\_\_

(358)

*Wines*

Copyist.

APR 1863

*J* | **4 Cav.** | **U.S.C.T.**

---

*William Thomas*

*Priv*, Co. E, 4 Reg't U. S. Col'd Cav.

Appears on

**Company Muster Roll**

for *Mar 1 Apr*, 186*5*.

Present or absent *Present*

Stoppage, \$ 100 for

Due Gov't, \$ 100 for

Valuation of horse, \$ 100

Valuation of horse equipments, \$ 100

Remarks:

Book mark:

(358)

*Wines*

Copyist.

MAY 1864

*J* | **4 Cav.** | **U.S.C.T.**

*William Thomas*

*Pvt*, Co. E, 4 Reg't U. S. Col'd Cav.

Appears on

**Company Muster Roll**

for *May & June*, 186 *5*.

Present or absent. *Present*

Stoppage, \$ *100* for

Due Gov't, \$ *100* for

Valuation of horse, \$ *100*

Valuation of horse equipments, \$ *100*

Remarks:

Book mark:

(358)

*Wines*

Copyist.

1865

*N* | **4 Cav.** | **U.S.C.T.**

*William Thomas*

*Private*, Co. E, 4 Reg't U. S. Col'd Cav.

Appears on

**Company Muster Roll**

for *July & Aug*, 186*5*.

Present or absent *Present*

Stoppage, \$ *100* for

Due Gov't, \$ *100* for

Valuation of horse, \$ *100*

Valuation of horse equipments, \$ *100*

Remarks: *Absent from Post  
Hudson, La, Aug. 18, 1865*

\* *As shown on roll*

Book mark *2*

*Wines*

J | 4<sup>th</sup> Cav. | U.S.C.T.

Wm Thomas,

Prst., Co. E, H Reg't U. S. Col'd Cav.

Appears on

**Descriptive List of Deserters**

dated Pt. Hudson Sa., Aug. 31, 1865.

Deserted:

When Aug. 18, 1865.

Where Port Hudson Sa.

Arrested:

When \_\_\_\_\_, 186 .

Where \_\_\_\_\_

Remarks:

Returned Voluntarily  
Sept. 21/64.

Book mark: \_\_\_\_\_

(351)

*[Signature]*

Copyist.



*J* | **4 Cav.** | **U.S.C.T.**

*William Thomas*  
*Pvt*, Co. E, 4 Reg't U. S. Col'd Cav.

Appears on

**Company Muster Roll**

for *Sept & Oct*, 186*5*

Present or absent *Present*

Stoppage, \$ *100* for

Due Gov't, \$ *100* for

Valuation of horse, \$ *100*

Valuation of horse equipments, \$ *100*

Remarks: *In confinement having voluntarily returned from desertion application has been made to restore him to duty without trial*

Book mark:

(358)

*Wines*

Copyist.

7 | **4 Cav.** | **U.S.C.T.**

*William Thomas*

*Put*, Co. E, 4 Reg't U. S. Col'd Cav.

Appears on

**Company Muster Roll**

for *Nov. & Dec.*, 186 *5*.

Present or absent *Present*

Stoppage, \$ *1* <sup>*53*</sup>/<sub>*100*</sub> for *lost ownership*

Due Gov't, \$ *100* for

Valuation of horse, \$ *100*

Valuation of horse equipments, \$ *100*

Remarks:

Book mark:

*Floyd*

*J* | 4 Cav. | U.S.C.T.

*William Thomas*

*Put*, Co. E, 4 Reg't U. S. Col'd Cav.

Appears on

**Company Muster Roll**

for *Jan'y + Feb'y*, 1866.

Present or absent *Present.*

Stoppage, \$ *3  $\frac{78}{100}$*  for *lost ordnance*.

Due Gov't, \$ *100* for \_\_\_\_\_

Valuation of horse, \$ *100*

Valuation of horse equipments, \$ *100*

Remarks: \_\_\_\_\_  
\_\_\_\_\_  
\_\_\_\_\_  
\_\_\_\_\_  
\_\_\_\_\_  
\_\_\_\_\_  
\_\_\_\_\_  
\_\_\_\_\_

Book mark: \_\_\_\_\_

*Floyd*

ST | 4 Cav. | U.S.C.T.

William Thomas

Port, Co. B, 4 Reg't U. S. Colored Cav.

Appears on Returns as follows:

Feb 1865 - On duty detailed  
in Reg't G. M. Dept.

Feb 1866 - On duty as talker with  
at Post G. M. Shop.

Book mark: \_\_\_\_\_

W. R. Lee

J | **4 Cav.** | **U.S.C.T.**

William Thomas

Put, Co. E, 4 Reg't U. S. Col'd Cavalry.

Appears on **Co. Muster-out Roll**, dated  
New Orleans La, Mch 20, 1866.

Muster-out to date Mch 20, 1866.

Last paid to June 30, 1865.

**Clothing account:**

Last settled....., 186 ; drawn since \$.....  $\frac{100}{100}$

Due soldier \$.....  $\frac{100}{100}$ ; due U. S. \$ 41  $\frac{46}{100}$

Am't for cloth'g in kind or money adv'd \$.....  $\frac{100}{100}$

Due U. S. for arms, equipments, &c., \$ 2  $\frac{57}{100}$

Bounty paid \$.....  $\frac{100}{100}$ ; due \$.....  $\frac{100}{100}$

Remarks: Joined orig org. Deserted  
Aug. 18/65 Restored to duty without  
trial per S.O. 127 Hd qrs D of Cav.  
Nov. 28/65 to make good time lost  
by desertion. Sup. 1 horsebrush 1 curry  
comb 1 girth.

Book mark: V 116 P 324.70

Floyd

Thomas, Wm

P, Co. E, 4 Reg't U.S.C. Cav.

2 Enclosures.

Bed Cards .....	Final Statements .....
Burial Records .....	Furloughs or L. of A. ....
Certs. of Dis. for Discharge .....	Med. Certificates .....
C. M. Charges .....	Med. Des. Lists .....
Descriptive Lists .....	Orders .....
Discharge Certificates .....	Pris. of War Record .....
Enlistment Papers .....	Resignations .....

Other papers relating to—

Admission to Hosp'l .....	Furlough or L. of A .....
Casualty Sheet .....	Med. Examination .....
Confinement .....	Misc. Information ..... 2
Contracts .....	Pay or Clothing .....
Death or Effects .....	Personal Reports .....
Desertion .....	Rank .....
Discharge from Hosp'l .....	Transfer to Hosp'l .....
Discharge from Service .....	Transfer to V. R. C. ....
Duty .....	Transportation .....

NARR 1670  
MICROFILM PUBLICATION M 1820

COMPILED MILITARY SERVICE RECORDS  
OF VOLUNTEER UNION SOLDIERS WHO  
SERVED WITH THE USCT (US COLORED TROOPS)  
4TH REGIMENT OF CAVALRY

PERSONAL PAPERS' TARGET SHEET

PLEASE NOTE THE CHECKED INFORMATION ABOUT THE PERSONAL PAPERS IN  
THIS FILE:

- NO PERSONAL PAPERS WERE FOUND IN THIS FILE WHEN THE  
RECORDS WERE ARRANGED FOR MICROFILMING.
- 3 PERSONAL PAPER(S) FOUND IN THIS FILE WHEN THE RECORDS  
WERE ARRANGED FOR MICROFILMING.

Ex M 61 P 110 - 1865  
Camp Detachment H. of Caval  
Vidalia La 12/65

Deming E. W. Caplain  
Co E H. of Cavalry

Requests that Private  
William Thomas Co E  
of Cavalry be returned  
to duty without trial -  
Recd O. L. Nov 25/65

Head Quarters of Vidalia  
Vidalia La Nov 12/65  
Respectfully forwarded  
Approved -  
Nathl. Mitchell  
Lt Col. H. of Cavalry  
Comdg. Post.

Recd H. of Cavalry Vidalia La 12/65

E. B. 78. P. 126. U.S. of La, 1865.  
Head Quarters of Cavalry  
Memorandum Nov 17/65

Ref'd forwarded  
+ ppd  
(W. C. Doolittle)  
By you (over)

Es. O. Nov 28, 65



Camp Detachment H<sup>th</sup> N<sup>y</sup> Cal<sup>d</sup> Cavalry  
Vidalia La November 12 1865  
Capt B. B. Campbell  
A. A. General U. S. Dist of La  
Captain

I have the honor to request that Private William Thomas of Co G 5<sup>th</sup> South N<sup>y</sup> Cal<sup>d</sup> Cavalry be returned to duty without trial he having voluntarily returned from desertion. He was captured on the 18<sup>th</sup> day of August 1865 and returned on the 21<sup>st</sup> day of September 1865

Very Respectfully  
Your Obedt<sup>t</sup> Servant  
E. W. Dango  
Capt Co G H<sup>th</sup> N<sup>y</sup> Cal<sup>d</sup> Cavalry

L 433. Vol. 1865.

Memorandum, Nov 17. 1865

Louisiana N.E. Dist.

Genl. John H. Berlittis Company  
Wrappers

Forwarded request of Capt  
E. W. Banas, to have fait.

William Thomas Co  
of U.S.A. returned to  
duty without delay

1 Enclosure

SO Nov 28. 1865

Recd L. L. Nov 28/65

Headquarters, Department of the Gulf,

New Orleans, 1864.

To

The Commanding Officer

of

Through

Sir;

The commanding General directs  
that descriptive list be made out for the following named men of your  
command who in the Hospital in  
, and forwarded to Surgeon  
in charge of Hospital, at once.

Co.

Co.

Co.

Co.

Co.

Co.

Very respectfully,

Your obedient servant,

Assistant Adjutant General.

Ellebrooks—

Private Wm Thomas C.E. & C. Case

complete

Ellerbrook -

Private Mr Thomas C. E. & C. Case

complete

Adjutant General's Office,

COLORED TROOPS BRANCH,

February 27<sup>th</sup>, 1874

Vol. C. T., 187

Wanted in case of Private Wm Thomas, Co. E.,  
4<sup>th</sup> Reg't U.S. Col'd Cav. Copy of S. O. No. 127 H<sup>d</sup> Quarters Dept  
La. Nov. 28<sup>th</sup> 65 - returning him to duty, without trial, from  
desertion.

Mr. Ellbrook -

R. B. -

Respectfully,

J. A. Woodward

P. J. Hallow <sup>Chief Clerk.</sup>

Adjutant General's Office,

Record Room

March 6<sup>th</sup>, 1874

Vol. C. T., 187

Reply in case of Private Wm Thomas, Co. E,  
4<sup>th</sup> Reg't U.S. Col'd Cav.

Headquarters Department of Louisiana,  
New Orleans, La., November 28<sup>th</sup> 1865.

Special Orders }  
No. 127

(Extract)

Private William Thomas Co. "C" 4<sup>th</sup> U.S. Colored Cavalry  
Having voluntarily returned from desertion, is restored to duty  
without trial. He will make good the time lost by  
desertion.

By order of Major General E. A. S. Canby.  
Signed William Hoffman.  
Major, act. asst. adj. Genl.

MICRO

PH

ROOL

ENI

# IMAGE EVALUATION TEST TARGET (QA-3)

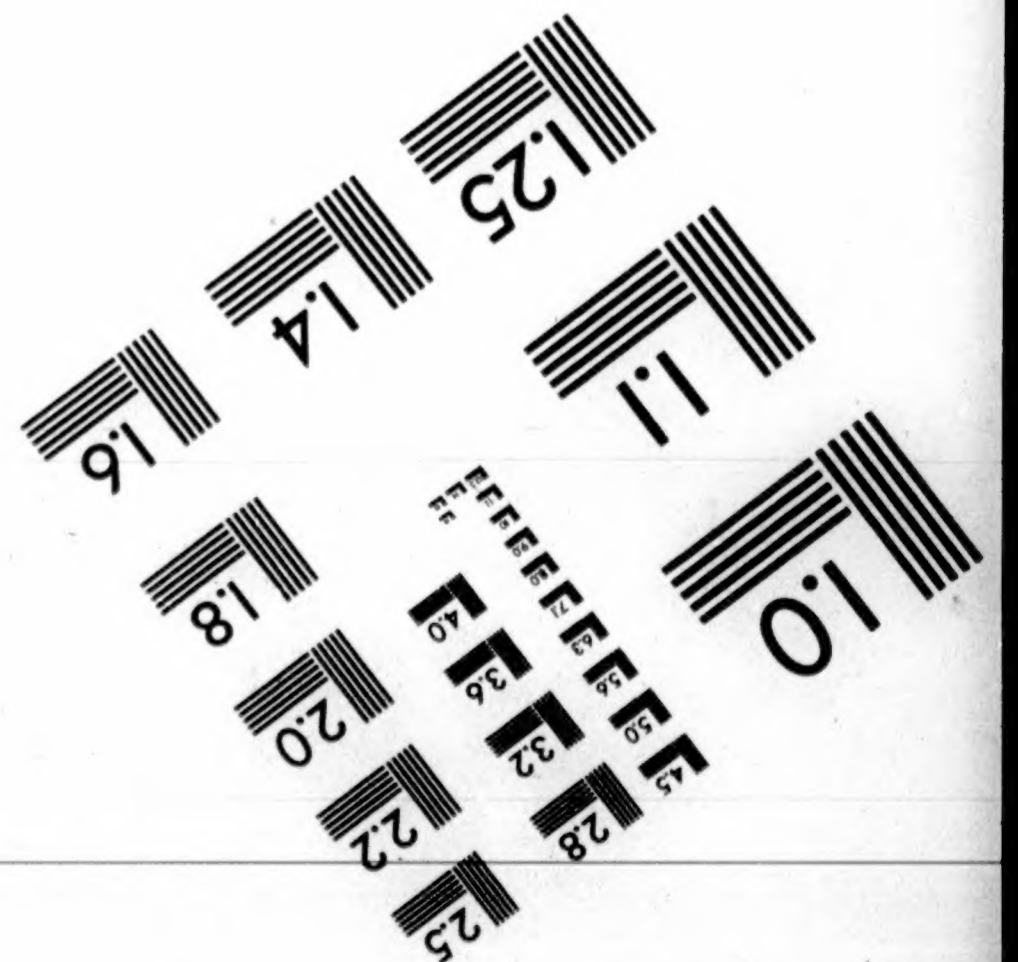
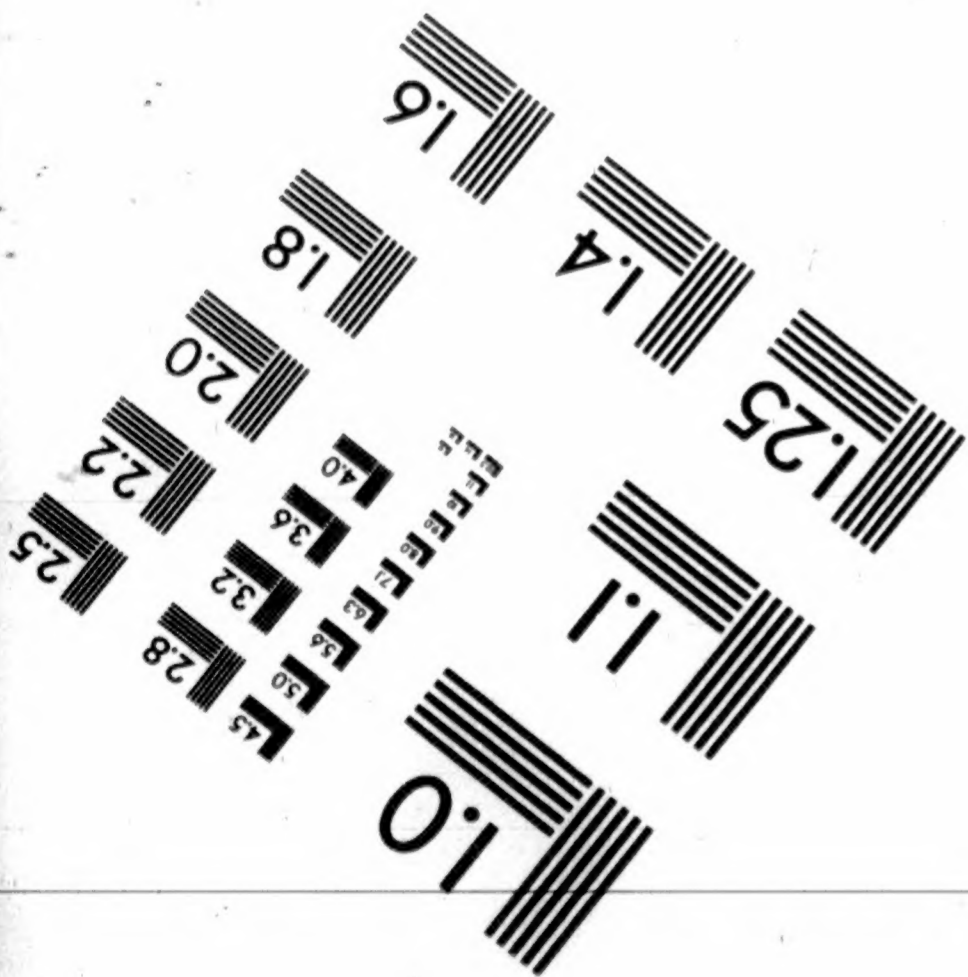
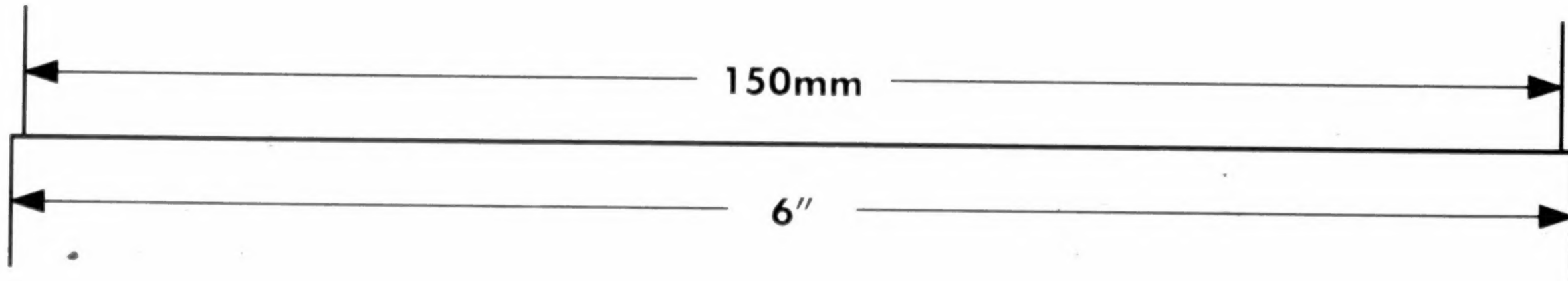
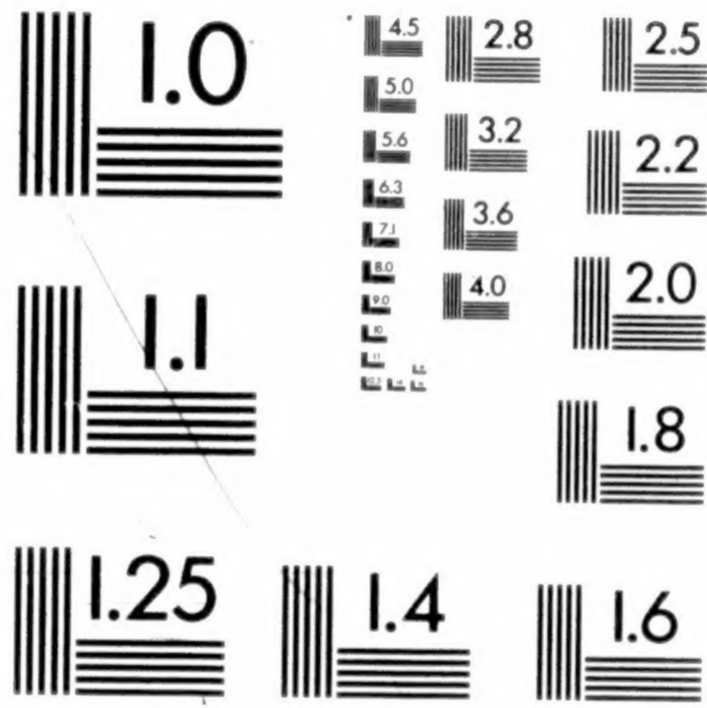
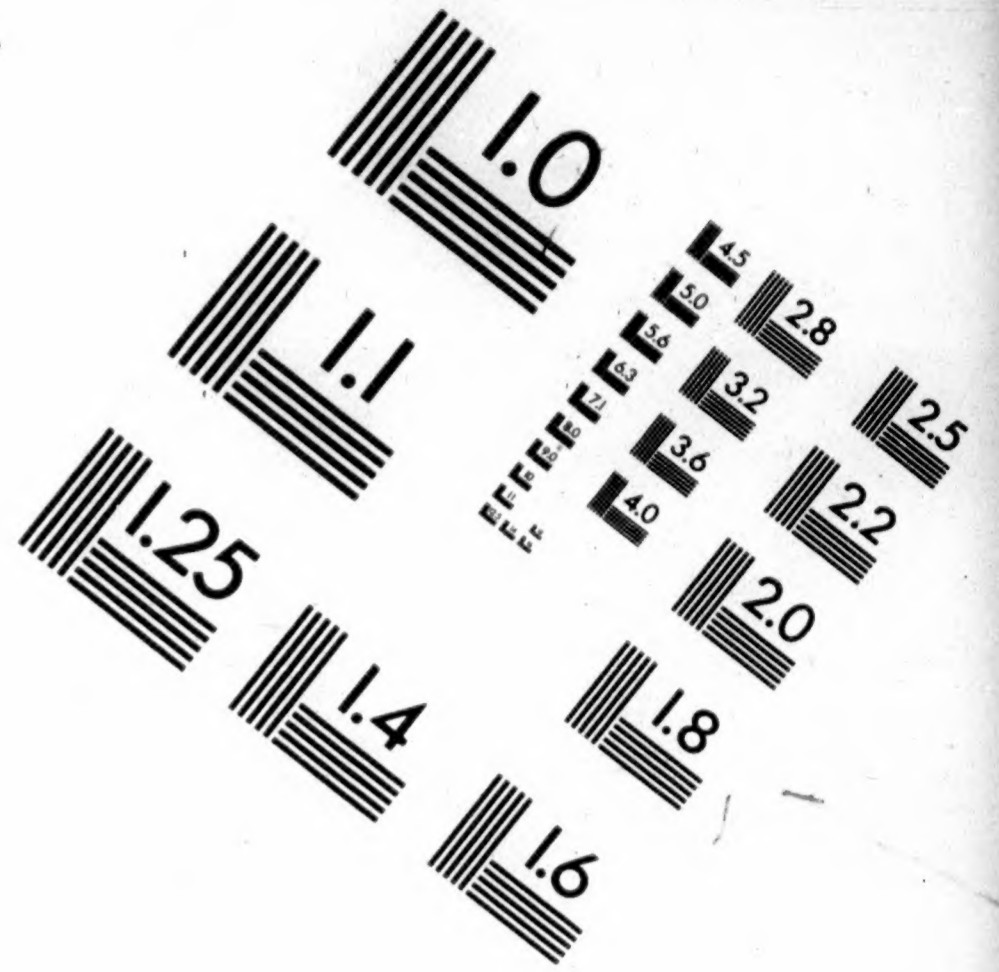
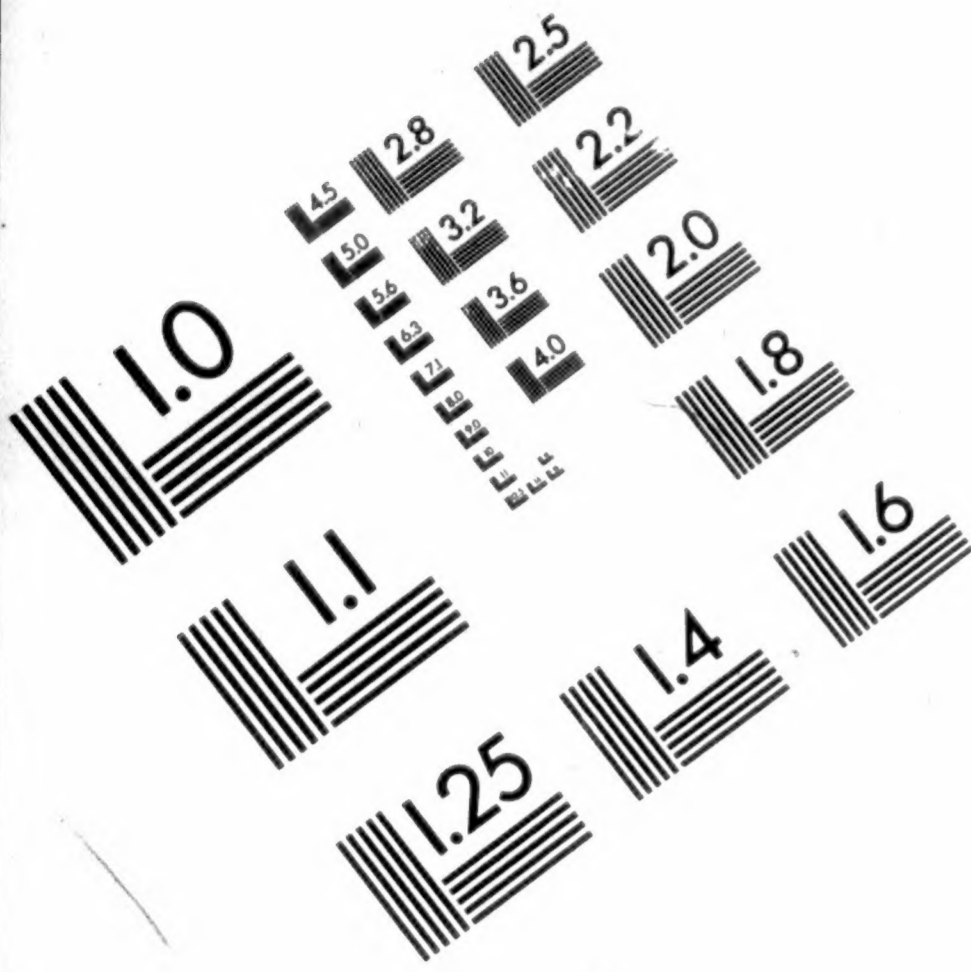

**APPLIED IMAGE, Inc**  
 1653 East Main Street  
 Rochester, NY 14609 USA  
 Phone: 716/482-0300  
 Fax: 716/288-5989

© 1993, Applied Image, Inc., All Rights Reserved



**THE END**

**PLEASE**

**REWIND**

