

**NATIONAL
ARCHIVES
MICROFILM
PUBLICATIONS**

IMAGE EVALUATION TEST TARGET (QA-3)

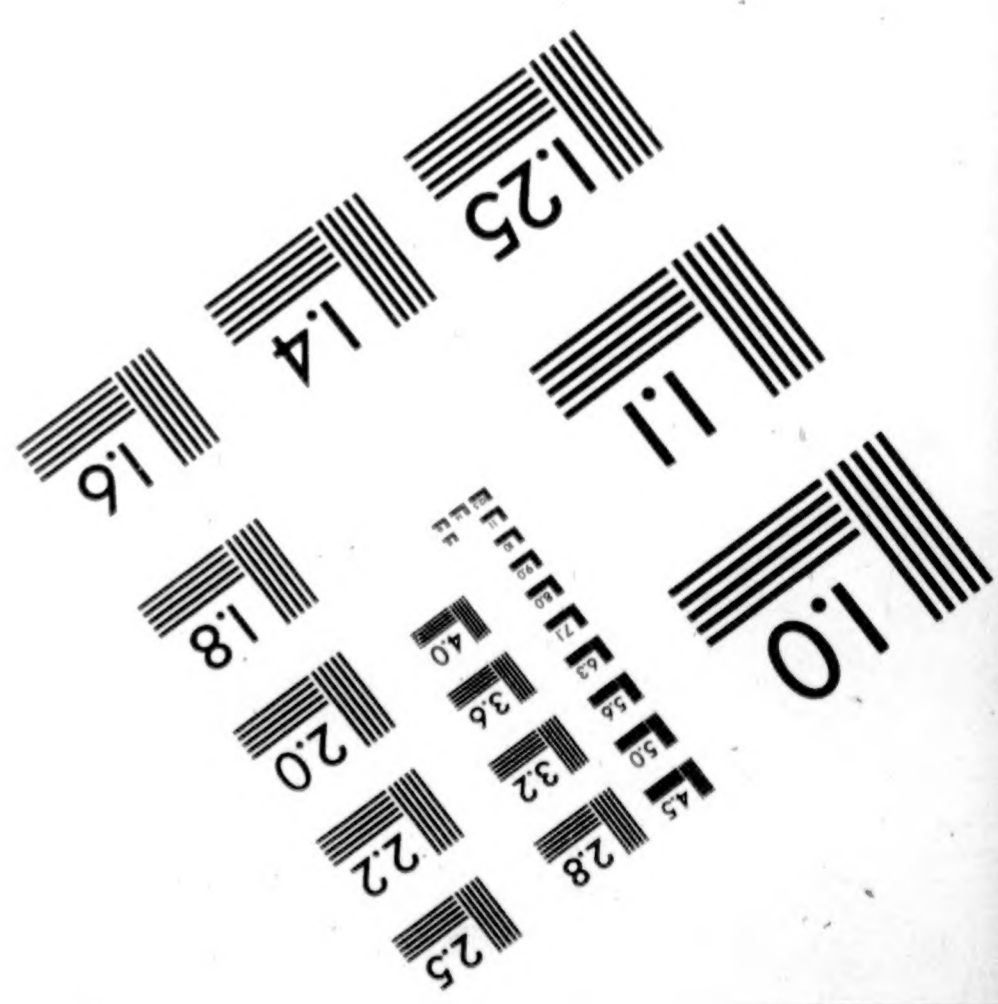
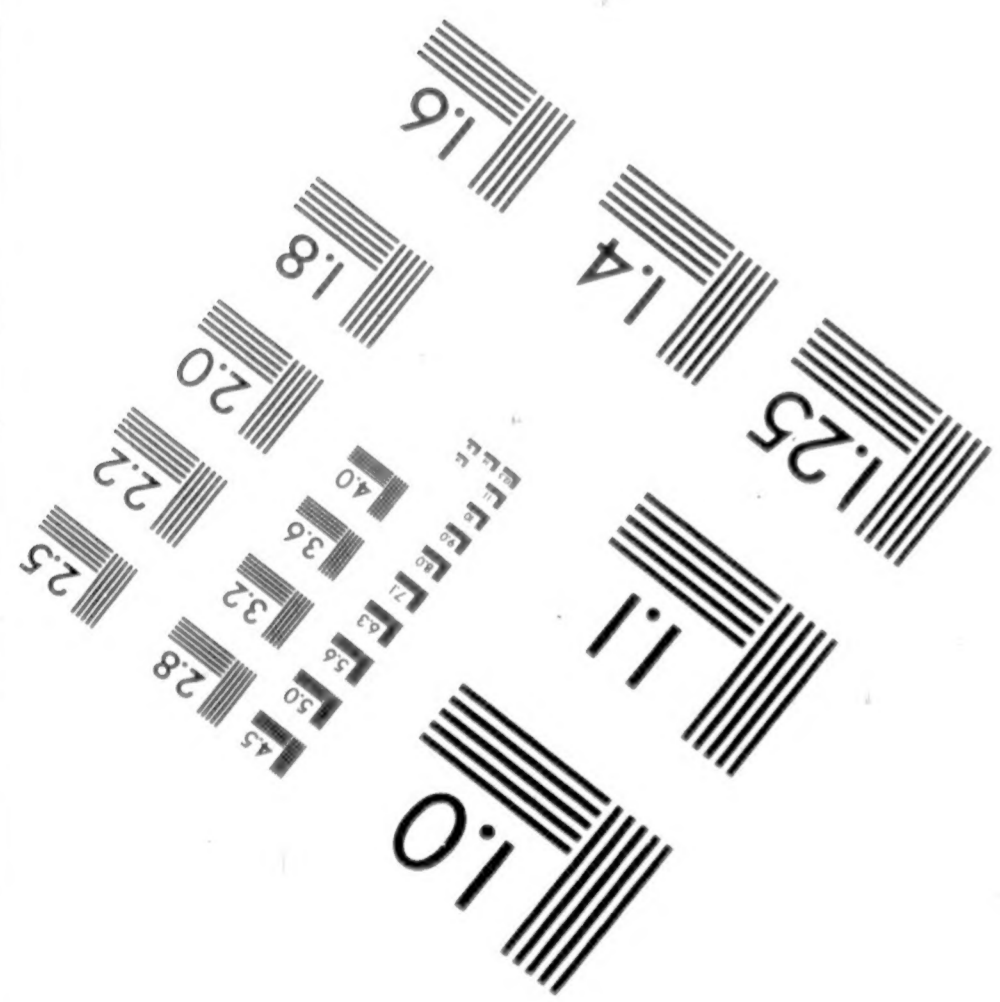
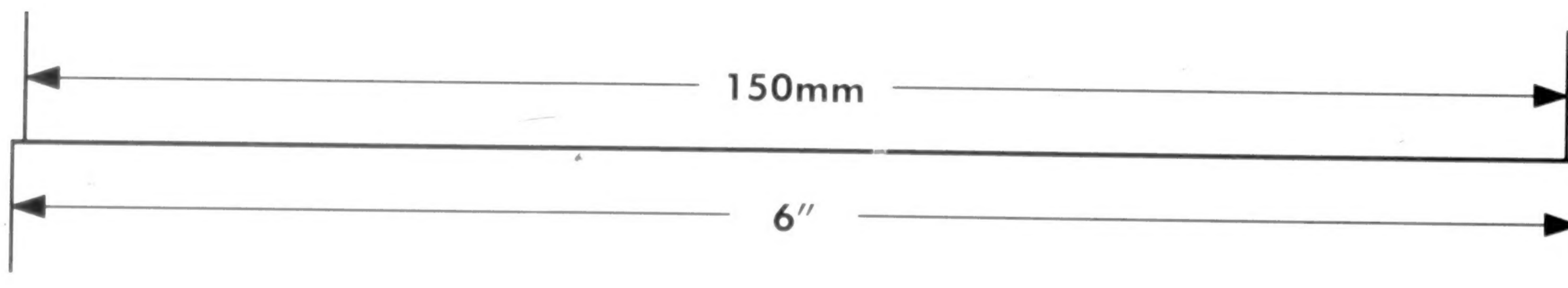
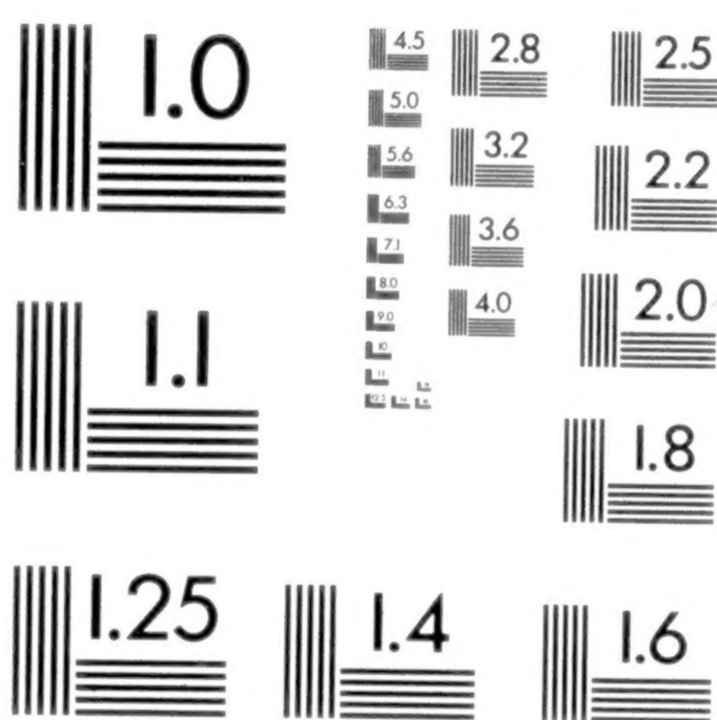
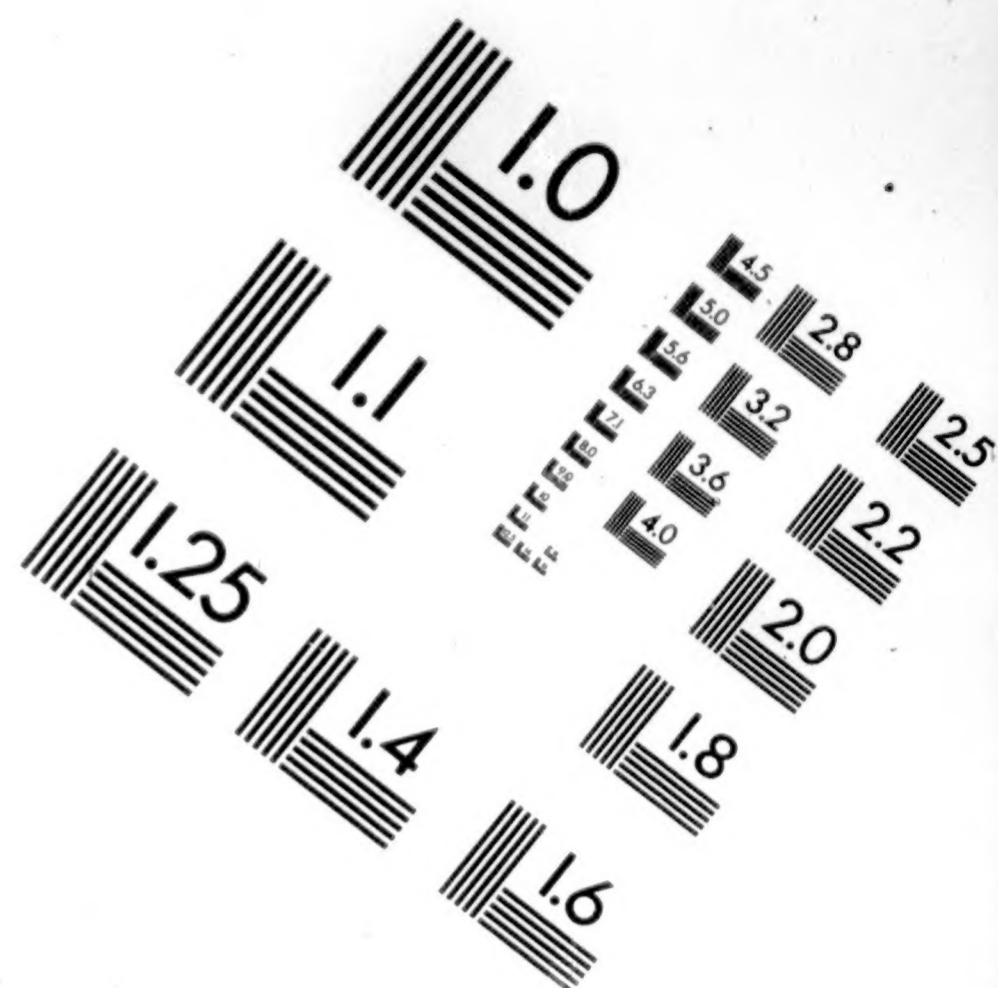
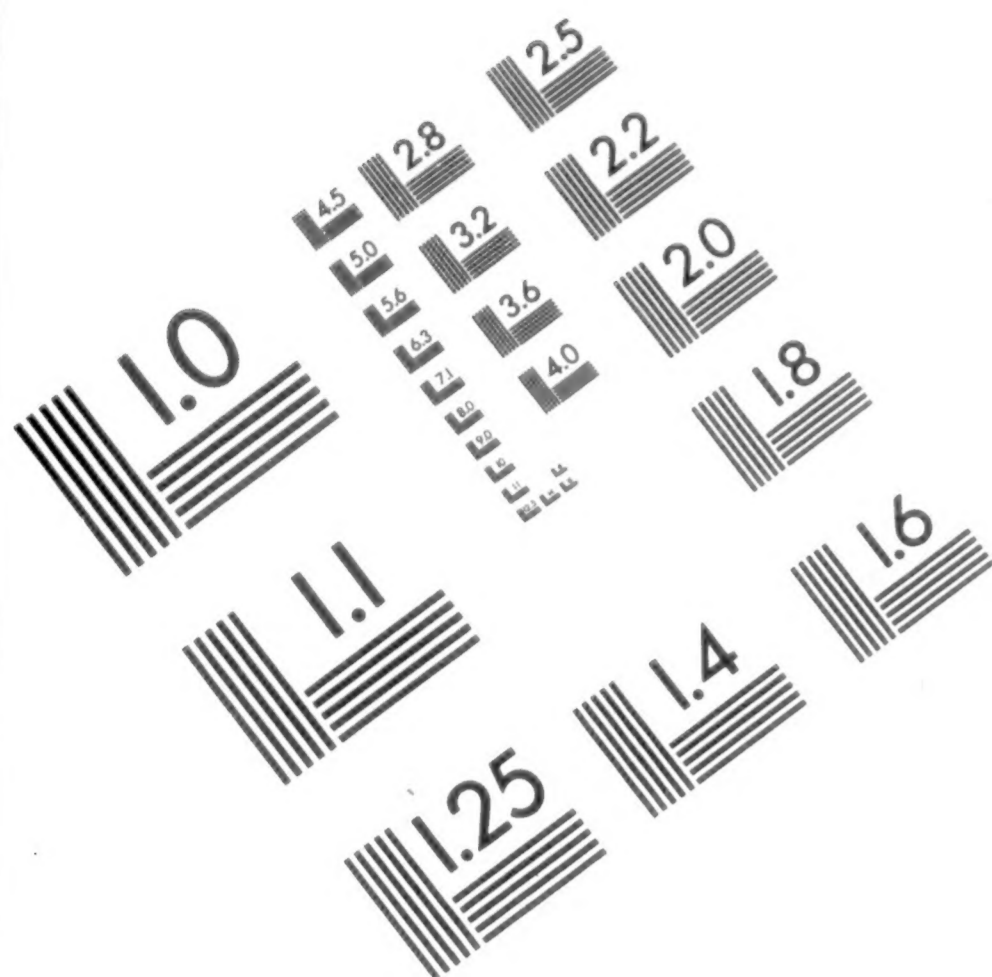

APPLIED IMAGE, Inc
 1653 East Main Street
 Rochester, NY 14609 USA
 Phone: 716/482-0300
 Fax: 716/288-5989

© 1993, Applied Image, Inc., All Rights Reserved

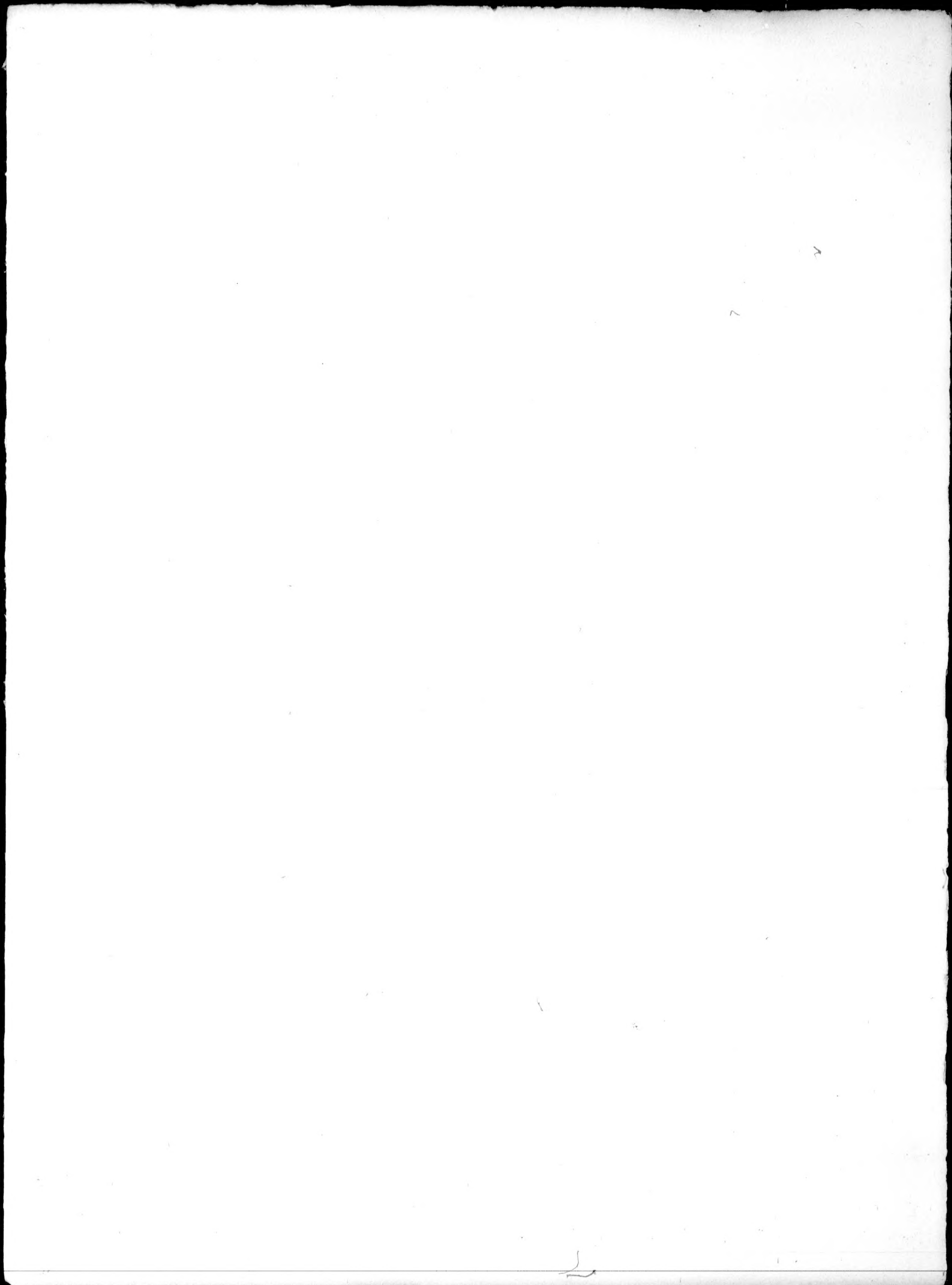

National Archives at College Park



8601 Adelphi Road College Park MD 20740-6001

Sièh Loreta Z-1

OPERATOR

CAMERA

9 Sept. 1997 10

DATE FILMED

REDUCTION RATIO

03510107 AGFA

FILM EMULSION NUMBER

M1817 59

PROJECT NUMBER

ROLL NUMBER

ROLL

5

9

MICROCOPY

1

8

1

7

M1817

**COMPILED MILITARY SERVICE RECORDS OF
VOLUNTEER UNION SOLDIERS WHO SERVED WITH THE
UNITED STATES COLORED TROOPS:
1st Through 5th United States Colored Cavalry
5th Massachusetts Cavalry (Colored)
6th United States Colored Cavalry**

Introduction by Michael E. Pilgrim

Records prepared for microfilming by members of
the Civil War Conservation Corps

Budge Weidman, Project Director

Pat Alfredson	Naomi Glass	Dave Murray
Phyllis Altrogge	Sue Goward*	Ray Puzio
Kenneth Ashton	Bert Greenstein	Bill Schneider
Sue Barnard*	Anne Greenwood	Sylvia Scott
Dee Benson	Jim Harris	Lynn Shearouse
Ann N. Brown	Walter Hayden	Mary Stack-Dunne
Robert Budway	Mary Hayden	Ben Stearns
MaryAnn Castellana*	Pat Ikonen	Bill Stormer*
Mary Lou Cole	Dick Ives	Pat Sullivan
Marjory Cooper	Sarah Jaffe	Gorman Tidball*
Giovanni Croce	Barbara Kemp	Cathy Tinston
B. H. Custer	Bev Manypenny	John Toole
Bob Denney	Frank Masterson	Maryellen Toole
Richard Dow	Joe Mazur	Milt Weatherhead
Yvette Fallin	Sarah McDougall	C. Lois Young
	Ben Miles	

Team leaders are indicated by the asterisk.

National Archives and Records Administration
1997

INTRODUCTION

On the 107 rolls of this microfilm publication, M1817, are reproduced the compiled military service records of volunteer Union soldiers belonging to the 1st through 5th United States Colored Cavalry, the 5th Massachusetts Cavalry (Colored), and the 6th United States Colored Cavalry. While the 5th Massachusetts did retain its state designation, these units were all part of the United States Colored Troops (USCT). The USCT included 7 numbered cavalry regiments; 14 numbered artillery regiments; 144 numbered infantry regiments; plus Brigade Bands Nos. 1 & 2 (Corps d'Afrique and US Colored Troops); Powell's Regiment Colored Infantry; Southard's Company Colored Infantry; Quartermaster Detachment; Pioneer Corps, 1st Division, 16th Army Corps; Unassigned Company A Colored Infantry and Unassigned USCT. The records reproduced are part of the Records of the Adjutant General's Office, 1780's-1917, Record Group (RG) 94.

Background

United States Colored Troops

Since the time of the American Revolution, African Americans have volunteered to serve their country in time of war. The Civil War was no exception. Official sanction was the difficulty. In the fall of 1862 there were four Union regiments of African Americans raised in New Orleans, LA: the 1st, 2d, and 3d Louisiana Native Guard, and the 1st Louisiana Heavy Artillery (African Descent). The 1st South Carolina Infantry (African Descent) was not officially organized until January 1863; however, three companies of the regiment were on coastal expeditions as early as November 1862. Similarly, the 1st Kansas Colored Infantry was not mustered into Federal service until January 1863, even though the regiment had already participated in the action at Island Mound, MO, on October 27, 1862. These early unofficial regiments received little Federal support, but they showed the strength of the African American soldier's desire to fight for freedom.

The first official authorization to employ African Americans in Federal service was the Second Confiscation and Militia Act of July 17, 1862. This act allowed President Abraham Lincoln to receive into the military or naval service persons of African descent and gave him permission to use them for any purpose "he may judge best for the public welfare." However, the President did not authorize use of African Americans until issuance of the Emancipation Proclamation on January 1, 1863.

In late January 1863, Gov. John Andrew of Massachusetts received permission to raise a regiment of African American soldiers. The pace of organizing additional regiments was very slow. In March Secretary of War Edwin M. Stanton sent Gen. Lorenzo Thomas to the lower Mississippi Valley to recruit

free and contraband African Americans. Thomas was given broad authority. He was to explain the administration's policy regarding African American soldiers and recruit volunteers to raise and command them. Stanton wanted all officers of such units to be white, but that policy was softened to allow African American surgeons and chaplains. By the end of the war, in addition to the chaplains and surgeons, there were some 87 African-American officers. Thomas's endeavor was very successful, and on May 22, 1863, the Bureau of Colored Troops was established to coordinate and organize regiments from all parts of the country. Created under War Department General Order No. 143, the bureau was responsible for handling "all matters relating to the organization of Colored Troops." The bureau was directly under the Adjutant General's Office and its procedures and rules were specific and strict. All African American regiments were now to be designated United States Colored Troops (USCT). At this time there were some African American regiments with state names and a few regiments in the Department of the Gulf designated as Corps d'Afrique. All these were ultimately assimilated into the USCT, even though some of the regiments, such as the 5th Massachusetts, retained their state designations.

To facilitate recruiting in the states of Maryland, Missouri, Tennessee, and eventually Kentucky, the War Department issued General Order No. 329 on October 3, 1863. Section 6 of the order stated that if any citizen should offer his or her slave for enlistment into the military service, that person would, "if such slave be accepted, receive from the recruiting officer a certificate thereof, and become entitled to compensation for the service or labor of said slave, not exceeding the sum of three hundred dollars, upon filing a valid deed of manumission and of release, and making satisfactory proof of title." For this reason, some records of manumission are contained in the compiled service records reproduced in this publication.

The USCT fought in 39 major engagements and over 400 lesser ones. Sixteen African American soldiers received Medals of Honor. As it was in other units, the death toll from disease was very high in the USCT. Deaths from disease and battle totaled 37,000. The last regiment of the USCT was mustered out of Federal service in December 1867.

Important sources for information about African American units in the Civil War are the War Department's *The War of the Rebellion: A Compilation of the Official Records of the Union and Confederate Armies* (Washington, DC: 1880-1901; reprinted Harrisburg, 1971 and 1985) and the Navy Department's *The War of the Rebellion; A Compilation of the Official Records of the Union and Confederate Navies* (Washington, DC: 1874-1922; reprinted Harrisburg, 1971 and 1985). These multivolume works contains reports of operations and other official correspondence.

1st United States Colored Cavalry

This regiment was organized at Camp Hamilton, VA, on December 22, 1863, and assigned to duty in the Department of Virginia and North Carolina. The 1st participated in Gen. Benjamin F. Butler's operations on the south side of the James River and against Petersburg and Richmond, May 4-28, 1864. These included the capture of Bermuda Hundred and City Point, VA, on May 5, and events leading up to and including the siege of Petersburg. In August 1864 it was transferred to the defenses of Portsmouth, District of Eastern Virginia. On June 10, 1865, the 1st sailed from City Point, VA, to Texas where it was assigned duty on the Rio Grande and various other areas of the state. The unit was mustered out on February 4, 1866. Compiled casualty figures are not available.

2d United States Colored Cavalry

This regiment was organized at Fort Monroe, VA, on December 22, 1863, and assigned to duty in the Department of Virginia and North Carolina. The 2d participated in Gen. Benjamin F. Butler's operations on the south side of the James River and against Petersburg and Richmond, May 4-28, 1864. These included the capture of Bermuda Hundred and City Point, VA, on May 5, and events leading up to and including the siege of Petersburg. In February 1865 it was transferred to Norfolk, District of Eastern Virginia. On June 10, 1865, the 2d sailed from City Point, VA, to Texas where it was assigned duty on the Rio Grande and various other areas of the state. The unit was mustered out on February 12, 1866. Losses included 19 killed in action and 161 dead from disease and other causes.

3d United States Colored Cavalry

Organized at Vicksburg, MS, on October 9, 1863, as the 1st Mississippi Cavalry (African Descent), this regiment was redesignated the 3d U.S. Colored Cavalry on March 11, 1864. From its organization until March 1864, the unit was attached to the District of Northeast Louisiana and from January to March 1864 participated in operations up the Yazoo River and the occupation of Yazoo City. The regiment was then transferred to the District of Vicksburg, Department of Tennessee, where it remained until December 1864. That month the unit moved to Memphis, TN, and from December 21, 1864, to January 5, 1865, participated in Gen. Benjamin Grierson's raid to destroy the Mobile & Ohio Railroad. The 3d remained on duty in Memphis and the District of West Tennessee and took part in the expedition from Memphis to Brownsville, MS, April 23-26, 1865. On April 29 the regiment returned to Vicksburg and operated around Natchez in search of fugitive Confederate President Jefferson Davis. The unit remained in the District of West Tennessee and Department of Mississippi until January 26, 1866, when it was mustered out. Losses included 37 killed in action and 367 dead from disease and other causes.

4th United States Colored Cavalry

Organized on September 12, 1863, as the 1st Corps d'Afrique Cavalry, this regiment was redesignated the 4th United States Colored Cavalry on April 4, 1864. From its organization until August 1864, it was attached to the Defenses of New Orleans, Department of the Gulf. On August 8, 1864, the 4th was ordered to Baton Rouge, LA, District of Port Hudson, and remained on duty at that post until July 1865 when it was transferred to the Department of Mississippi. It performed duties at various points in that department until it was mustered out on March 20, 1866. Compiled casualty figures are not available.

5th United States Colored Cavalry

This regiment was organized at Camp Nelson, KY, on October 24, 1864, and attached to the 1st Division, District of Kentucky, Department of Ohio. December 10-29, 1864, it participated in Stoneman's Raid into southwestern Virginia, including the capture of Saltville and the destruction of saltworks on December 20-21. In February 1865 the regiment was transferred to the Military District and Department of Kentucky until December of that year when it was ordered to the Department of Arkansas. During the latter period the unit performed mostly garrison duty. The regiment was mustered out March 20, 1866. Losses included 35 killed in action and 152 dead from disease and other causes.

5th Massachusetts Cavalry (Colored)

This regiment was organized at Camp Meigs, Reedville, MA, in the spring of 1864, and sent to Washington, DC, in May of that year. On May 13 the regiment moved to City Point, VA, where it was attached to the 18th Army Corps. Until June 16 it functioned as an infantry unit and participated in the siege of Petersburg. On June 30 it was moved to Point Lookout, MD, to guard prisoners of war. In July 1864 the regiment, still at Point Lookout, became part of the 22d Army Corps. It was transferred to the 25th Army Corps in March 1865 and ordered to the field near Richmond and Petersburg. In June the regiment was ordered to the Department of Texas where it was assigned duty at Clarksville until October 31, 1865, when it was mustered out. Losses included 7 men killed in action and 116 dead from disease and other causes.

6th United States Colored Cavalry

This regiment was organized at Camp Nelson, KY, on October 24, 1864, and attached to the 1st Division, District of Kentucky, Department of Ohio. December 10-29, 1864, it participated in Stoneman's Raid, including the destruction of the lead mines in southwestern Virginia. At the end of December the regiment returned to Camp Nelson and in February 1865 was transferred to the Military District and Department of Kentucky. It remained there until December

1865 when it was ordered to the Department of Arkansas. The unit was mustered out on April 15, 1866. Compiled casualty figures are not available.

Records Description

Compiled service records consist of a jacket-envelope for each soldier, labeled with his name, rank, unit, and card numbers. The compilation of service records of Union soldiers began in 1890 under the direction of Col. Fred C. Ainsworth, head of the Record and Pension Office of the Adjutant General's Office, Department of War. Information from muster rolls, regimental returns, descriptive books, and other records was copied verbatim onto cards. A separate card was prepared each time an individual name appeared on a document. These cards were numbered on the back, and these numbers were entered onto the outside jacket containing the cards. The carded information was verified by a separated operation of comparison; great care was taken to ensure that the cards were accurate.

A typical jacket contains card abstracts of entries found in original records relating to the soldier and original documents relating solely to that soldier. Examples of the latter include enlistment papers, substitute certificates, casualty sheets, death reports, prisoner-of-war memorandums, and correspondence. Unique to the records of the USCT are deeds of manumission, oaths of allegiance, proof of ownership, certificates of monetary award, and bills of sale. These items appear most frequently in units recruited in the border states of Kentucky, Missouri, and Maryland. These states remained in the Union but were slave states. Jackets and cards include a section labeled "bookmark" which was reserved for cross-references to other records relating to the individual or his unit. The service records are arranged by arm of service, thereunder numerically by regiment or independent battalion or company and thereunder alphabetically by name of the soldier. Records for officers are interfiled alphabetically by name with the records of enlisted men. If an individual served in more than one unit, which was typical for USCT officers, there will be a separate service record for each unit in which he served.

Related Records

Among the records of the Adjutant General's Office in the National Archives are many of the original records that were abstracted or "carded" by the Record and Pension Office. These include the individual unit's muster rolls, returns and descriptive books. Other series in RG 94 that contain information relating to volunteer Union soldiers who served with the USCT include carded records relating to Union staff officers, carded medical records of volunteer Union soldiers, unbound and bound regimental records and "record of events" cards. The regimental records of the 54th Massachusetts Infantry (Colored) have been

reproduced as Microfilm Publication M1659, *Records of the Fifty-fourth Massachusetts Infantry Regiment (Colored), 1863-1865*.

The "record of events" cards include information copied from the unit's muster rolls and returns. They show the stations of the field and staff and those of the various companies of the regiment at the time the muster roll or return was prepared and sometimes mention battles, skirmishes, or other activities in which the regiment participated. The cards have been reproduced as Microfilm Publication M594 *Compiled Records Showing Service of Military Units in Volunteer Union Organizations*.

Record Group 94 also includes a card index for the USCT, reproduced as Microfilm Publication M589, *Index to Compiled Military Service Records of Volunteer Union Soldiers Who Served with U.S. Colored Troops*, which may be used to locate the regiment of USCT personnel. An index card gives the name of the soldier and his rank, as well as the unit in which he served; sometimes there is a cross-reference to his service in other units or organizations. The National Archives is continually producing microfilm publications of volunteer Union compiled military service records. A complete listing of finished publications can be found in the National Archives' *Microfilm Resources for Research: A Comprehensive Catalog* which is available online at <http://www.nara.gov>.

The Records of the Colored Troops Division, within RG 94, include division correspondence and records relating to recruiting, the appointment of officers, and the slave or free status of individuals; and a compilation of historical extracts and official papers concerning the military service of African Americans from the colonial period through the Civil War entitled *The Negro in the Military Service of the United States 1639-1886*. This compilation is reproduced as Microfilm Publication M858. The Records of the Bounty and Claims Division, also in RG 94, include correspondence of the division and records relating to bounties and claims paid to loyal owners of slaves by the Slave Claims Commissions of Delaware, Kentucky, Maryland, Missouri, Tennessee and West Virginia.

If an application for a pension was made, the pension application case file may be among the Records of the Veterans Administration (RG 15). Indexes to the pension applications have been reproduced as Microfilm Publication T288, *General Index to Pension Files, 1861-1934*, and T289, *Organizational Index to Pension Files of Veterans Who Served Between 1861 and 1900*.

If a soldier or officer was tried before a general court-martial or if an individual or his unit was the subject of a court of inquiry or military commission, transcripts of the proceedings may be among the Records of the Office of the Judge Advocate General (Army) (RG 153). The registers to the proceedings have been reproduced as Microfilm Publication M1105, *Registers of the Records of the Proceedings of the U.S. Army General Courts-Martial, 1809-1890*.

NATIONAL ARCHIVES MICROFILM PUBLICATIONS

Other record groups having information pertaining to the USCT include Records of the Bureau of Refugees, Freedmen, and Abandoned Lands (RG 105); Records of the Provost Marshal General's Bureau (Civil War) (RG 110); Records of the Accounting Officers of the Department of the Treasury (RG 217); and Records of U.S. Army Continental Commands, 1821-1920 (RG 393).

ROLL LIST

Roll Description

1st United States Colored Cavalry

- 1 Akess, Alexander - Bom, John H.
- 2 Bomer, James - Cartwright, John
- 3 Casey, Thomas - Davenport, John J.
- 4 Davis, Augustus - Floyd, George
- 5 Fly, Benjamin - Griffin, Oliver
- 6 Griffin, Quinton - Holstead, Peter
- 7 Holt, George - Jones, Herbert
- 8 Jones, Howell - Macoy, Peter
- 9 Madry, Andrew - Mosley, Jacob
- 10 Moss, James - Polk, James
- 11 Pollard, Sipio - Sales, William
- 12 Sample, Abram (Abraham) - Smith, Ives
- 13 Smith, James - Times, Nelson
- 14 Tines, Archer - Wheldon, Charles M.
- 15 Whitby, Joseph - Wilson, Isaac
- 16 Wilson, James - Zoe (no first name)

2d United States Colored Cavalry

- 17 Abbot, John - Bell, Charles
- 18 Bell, Henry - Burns, Richard
- 19 Burroughs, George L. - Cotton, Samuel
- 20 Coues, Alexander - Duncan, Levi
- 21 Dunkins, Ezekiah James - Gardner, Richard
- 22 Garris, Henry - Harrison, Thomas
- 23 Harrison, William - Humphries, David
- 24 Hunter, Francis - Jones, Robert
- 25 Jones, Robert F. - Martin, Robert (Martin)
- 26 Martin, Thaddeus or Martin, Thaddeus W. - Osborne, Henry S.
- 27 Oulden, Jacob - Prior, Edward or Edmund
- 28 Proctor, David - Sawyer, Wilson
- 29 Scabber, Charles - Stanley, William
- 30 Stanley, Wright or Right - Upshear, Neverson
- 31 Upshear, Samuel - Whites, Joe
- 32 Whites, Silas - Zodrick, Isaiah A. or Isaiah

3d United States Colored Cavalry

- 33 Aaron, John - Black, David
- 34 Black, Richard - Cameron, Wyatt

NATIONAL ARCHIVES MICROFILM PUBLICATIONS

<u>Roll</u>	<u>Description</u>
35	Cammel, Austin - Cooper, Stephen
36	Coran, Joseph - Erving, Tilson
37	Erwin, Anderson - Gool, George
38	Gordon, Alfred - Haskins, Jasper
39	Hawkins, Frank - Jackson, Harvey
40	Jackson, Henry - Kembro, Abraham
41	Kenedy, Lemuel - Lott, Judge
42	Lott, Matton - Mitchell, Berry
43	Mitchell, George - Pettis, Edmond
44	Pettis, George - Roberson, Jefferson
45	Roberson, Wallace - Simpson, Levi
46	Sims, Anderson - Taylor, Phillip
47	Taylor, Richard - Washington, Isaac
48	Washington, Oscar - Williams, Mitchel
49	Williams, Moses - Young, Mathew

4th United States Colored Cavalry

50	Abraham, Randall - Blanchan, William
51	Blanchard, Moses - Clark, Moses
52	Clark, Theodore - Ellars, James
53	Ellars, John - Heath, Culbert
54	Henderson, George - Johnson, Henderson
55	Johnson, Henry - Mayberry, Nelson
56	Macomory, John - Oliver, Celestine
57	Olsten, Alexander - Robinson, William
58	Robinson, William E. - Thomas, Stephen
59	Thomas, William - Williams, Horace
60	Williams, Isaac - Zulia, Francois

5th United States Colored Cavalry

61	Abel, Fletcher - Biggs, Randall
62	Birch, Benjamin - Burly, Frank
63	Burly, James - Coffman, James D.
64	Coke, Samuel - Dudley, John
65	Duke, John - Givens, Peter
66	Glen, John - Harriden, Edmund
67	Harrigan, Harden - Hughes, Thomas
68	Hulse, James - Keller, Ephraim
69	Kelley, Franklin - Matthews, Benjamin
70	Maupin, Preston - Murry, Ned
71	Murtney, Morton - Ray, John
72	Ray, Thomas - Sherrod, William

Roll Description

- 73 Shrewsbury, Joseph - Stone, John
- 74 Stone, Lewis - Trye, Benjamin
- 75 Trueheart, Samuel - Williams, James
- 76 Williams, Jerry - Yowell, Joseph

5th Massachusetts Cavalry (Colored)

- 77 Abbey, David - Biers, William
- 78 Billings, Jeremiah - Burgess, Williams
- 79 Burnett, Lewis - Cook, Joseph T.
- 80 Cooper, Isaac - Dunmore, William
- 81 Durbin, Stephen - Furman, Seneca A.
- 82 Gadson, James - Gurley, Joseph L.
- 83 Guy, James - Hill, John W.
- 84 Hill, Richard - Johns, Thomas H.
- 85 Johnson, Aaron - Lambert, William
- 86 Lancaster, James - Mason, John
- 87 Mason, John H. - Nelson, Philip
- 88 Nelson, Preston - Preston, Thomas
- 89 Price, Adam - Sampson, George P.
- 90 Sanborn, Madison - Stringer, William
- 91 Strother, Frank - Vance, William H.
- 92 Van Hoesen, Charles - Wilkinson, Simon
- 93 Williams, Abram H. - Young, Thomas

6th United States Colored Cavalry

- 94 Abbot, John - Birch, James
- 95 Bivins, Gabriel - Buckner, George
- 96 Buckner, Henderson - Compton, James
- 97 Cook, Benjamin - Ellis, William
- 98 Ellis, Wyatt - Godley, Isaac
- 99 Gooch, Alexander - Herston, Abraham
- 100 Heywood, John R. - Johnson, Jackson
- 101 Johnson, James M. - Marshall, Lyman
- 102 Marshall, William - Neihardt, Isaac D.
- 103 Nelson, Joseph - Redd, Tiney
- 104 Redway, Hamilton K. - Sebree, Bob Woodcock
- 105 Sebree, Crittenden - Sumpter, John
- 106 Sutherland, Williams - Washington, Charles
- 107 Washington, George - Wren (no first name)

NATIONAL ARCHIVES MICROFILM PUBLICATIONS

Microfilm Publication M1817

COMPILED MILITARY SERVICE RECORDS OF VOLUNTEER UNION
SOLDIERS WHO SERVED WITH THE UNITED STATES COLORED
TROOPS: 1st Through 5th United States Colored Cavalry, 5th Massachusetts
Cavalry (Colored), 6th United States Colored Cavalry

Roll 59

4th United States Colored Cavalry

Thomas, William - Williams, Horace

NATIONAL ARCHIVES AND RECORDS ADMINISTRATION

1053

Thomas William

Co *F*, 4 U. S. Col'd Cav.

Private

Sergeant

CARD NUMBERS.

1	5347745	26
2	5358808	27
3	5358861	28
4	5358913	29
5	5358962	30
6	5347968	31
7	5355599	32
8	5355685	33
9	5355768	34
10	5355849	35
11	5355995	36
12	5356017	37
13	5356093	38
14	D105-05-1874	39
15		40
16		41
17		42
18		43
19		44
20		45
21		46
22		47
23		48
24		49
25		50

Book Mark: D105-05-1874

See also

J | **4 Cav. | U.S.C.T.**

William Thomas

Appears with rank of *Pl* on

Muster and Descriptive Roll of a Detachment of U. S. Vols. forwarded

for the 4 Reg't U. S. Col'd Cavalry. Roll dated

New Orleans La July 23, 1864

Where born *Philadelphia Pa*

Age *21* y'rs; occupation *Waiter*

When enlisted *July 7, 1864*

Where enlisted *New Orleans*

For what period enlisted *3* years.

Eyes *Blk*; hair *Blk*

Complexion *Blk*; height *5* ft. *6* in.

When mustered in *July 13, 1864*

Where mustered in *New Orleans*

Bounty paid \$ *100*; due \$ *100*

Where credited *to New Orleans La.*

Company to which assigned *M*

Remarks:

Book mark:

Van Hook

(339) Copyist.

T | *4 Cav.* | **U.S.C.T.**

Wm Thomas

Serg't, Co. M, 4 Reg't U.S. Col'd Cavalry

Age years.

Appears on

Company Muster Roll*

for *Enlistment to Aug 31, 1864.*

Joined for duty and enrolled:

When *July 7*, 1864.

Where *New Orleans La*

Period *3* years.

Mustered in:

When *July 19*, 1864.

Where *New Orleans La*

Present or absent *Present*

Stoppage, \$ *100* for

Due Gov't, \$ *100* for

Valuation of horse, \$ *100*

Valuation of horse equipments, \$ *100*

Remarks: *Promoted from Pvt to 1st Serg't to rank as such from July 23, 1864*

* First current roll. No muster-in roll of this company on file.

Book mark :

J. W. Davis

T | 4 Cav. | U.S.C.T.

William Thomas

1 Serjt, Co. M, 4 Reg't U. S. Col'd Cavalry.

Appears on

Company Muster Roll

for *Sept & Oct*, 186*4*

Present or absent *Present*

Stoppage, \$ *100* for

Due Gov't, \$ *100* for

Valuation of horse, \$ *100*

Valuation of horse equipments, \$ *100*

Remarks:

Book mark:

J. W. Davis

T | **4 Cav. | U.S.C.T.**

William Thomas

1st Sergt, Co. M, 4 Reg't U. S. Col'd Cavalry.

Appears on

Company Muster Roll

for *Nov & Dec*, 186 *4*

Present or absent *Present*

Stoppage, \$ *100* for

Due Gov't, \$ *100* for

Valuation of horse, \$ *100*

Valuation of horse equipments, \$ *100*

Remarks: *Promoted to 1st Sergt*
July 23^d 1864

Book mark:

G. W. Davis

J

4 Cav. | U. S. C. T.

William Thomas

1 Seryt, Co. M, 4 Reg't U. S. Col'd Cavalry.

Appears on

Company Muster Roll

for *Jan & Feb*, 186 *5*.

Present or absent *Present*

Stoppage, \$ *100* for

Due Gov't, \$ *100* for

Valuation of horse, \$ *100*

Valuation of horse equipments, \$ *100*

Remarks:

Book mark: *Transferred to Co "F." EB*
(over)

JW Sav

JAN. - 9

5358962

☆ 1891 ☆

U.11. P.180. & 7.105, U.10. C.J.74

I 4 Cav. U.S.C.T.

William Thomas

1st Sgt, Co. F, 4 Reg't U. S. Col'd Cav.

Appears on

M. and D. Roll of Men Transferred

to the organization named above, by const.

from C M

Roll dated Port Hudson La. Apr 29, 1865.

When enlisted July 7, 1864.

Period for which enlisted 3 years.

When mustered in July 13, 1864.

Present or absent Not stated

Company to which assigned F

Remarks:

Book mark:

J. M. Thomas

J | **4 Cav.** | **U.S.C.T.**

William Thomas
1st Sergt, Co. F, 4 Reg't U. S. Col'd Cavalry.

Appears on

Company Muster Roll

for *Mch & Apr*, 1865.

Present or absent *Present*

Stoppage, \$ *100* for

Due Gov't, \$ *100* for

Valuation of horse, \$ *100*

Valuation of horse equipments, \$ *100*

Remarks: *Joined by transfer from*
"M" (A. J. S. C. No. 28) dated
Hd Qrs. Dept of the Gulf
Jan. 25/865

Book mark:

A. J. Harris

T | 4 Cav. | U.S.C.T.

William Thomas

1st Sergt, Co. F, 4 Reg't U. S. Col'd Cavalry.

Appears on

Company Muster Roll

for *May & June*, 186 *5*

Present or absent *Present*

Stoppage, \$..... *100* for

Due Gov't, \$..... *100* for

Valuation of horse, \$..... *100*

Valuation of horse equipments, \$..... *100*

Remarks:

Book mark:

J. H. Harris

J | **4 Cav.** | **U.S.C.T.**

William Thomas

1st Sergh, Co. F, 4 Reg't U. S. Col'd Cavalry.

Appears on

Company Muster Roll

for *July & Aug*, 186*5*

Present or absent *Present*

Stoppage, \$ *100* for

Due Gov't, \$ *100* for

Valuation of horse, \$ *100*

Valuation of horse equipments, \$ *100*

Remarks:

Book mark:

A. Harris

T | 4 Cav. | U.S.C.T.

William Thomas

1st Supt, Co. F, 4 Reg't U. S. Col'd Cavalry.

Appears on

Company Muster Roll

for *Sept & Oct*, 186*5*

Present or absent *Present*

Stoppage, \$ *100* for

Due Gov't, \$ *100* for

Valuation of horse, \$ *100*

Valuation of horse equipments, \$ *100*

Remarks:

Book mark:

M Harris

T | 4 Cav. | U.S.C.T.

William Thomas

P

, Co. F, 4 Reg't U. S. Col'd Cavalry.

Appears on

Company Muster Roll

for Nov, Dec, 1865.

Present or absent Present

Stoppage, \$ 100 for

Due Gov't, \$ 100 for

Valuation of horse, \$ 100

Valuation of horse equipments, \$ 100

Remarks: Reduced to ranks from
1 Sgt. Dec. 5, 65, by command
of Lt. Col. N. C. Mitchell.

Book mark:

(358)

Hibbard
Copyist.

J | 4 Cav. | U.S.C.T.

William Thomas

Serpt., Co. F, 4 Reg't U. S. Col'd Cavalry.

Appears on

Company Muster Roll

for Jan. Feb., 1866.

Present or absent Present

Stoppage, \$ 100 for

Due Gov't, \$ 100 for

Valuation of horse, \$ 100

Valuation of horse equipments, \$ 100

Remarks: Promoted to Serpt. from ranks Jan. 19, 66. Reduced to ranks from 1st Serpt. Dec. 5, 65.

Book mark:

(358)

Wibbard Copyist.

J. 1 4" bar. 1 U.S. b. J.

William Thomas,
Co. Mth 4th Reg't U.S. b. bar.

E. B. 11/180 with **NOTATION.**

Book mark: J. 105. b. J. 1874.

War Department,

Adjutant General's Office,

Washington, Sept. 25th, 1874.

Transferred to Co. G.

E. P. Conroyer,

J | 4 Cav. | U.S.C.T.

William Thomas

Sgt., Co. F, 4 Reg't U. S. Col'd Cavalry.

Appears on Co. Muster-out Roll, dated
New Orleans, La., March 20 1866.

Muster-out to date March 20, 1866.

Last paid to June 30 1865.

Clothing account:

Last settled....., 186 ; drawn since \$..... 100

Due soldier \$ 19.67 / 100; due U. S. \$..... 100

Am't for cloth'g in kind or money adv'd \$..... 100

Due U. S. for arms, equipments, &c., \$..... 100

Bounty paid \$..... 100; due \$..... 100

Remarks: Joined by transfer from
Co. M per S.O. 28 Hdqrs. D.C.
Jan. 28, 65. 1 Sgt. to Dec. 1, 65.
Reduced to ranks. Promoted
Serjeant. Jan. 19, 66.

Book mark: V123 P212 71

(361)

Hibbard
Copyist.

1054 1 or William
Thomas, William H

Co C, 4 U. S. Col'd Cav.

Private | Private

CARD NUMBERS.

1	5347525	26
2	5352008	27
3	5352106	28
4	5352205	29
5	5352298	30
6	5352386	31
7	5352475	32
8	40729270	33
9		34
10		35
11		36
12		37
13		38
14		39
15		40
16		41
17		42
18		43
19		44
20		45
21		46
22		47
23		48
24		49
25		50

Book Mark:

See also

4 Cav. U.S.C.T.

William H. Thomas

Appears with rank of *Private* on

Muster and Descriptive Roll of a Detachment of U. S. Vols. forwarded

for the 4 Reg't U. S. Col'd Cavalry. Roll dated

New Orleans, La., Apr. 25, 1865.

Where born *Lumberton, Mississippi*

Age *38* y'rs; occupation *Labourer*

When enlisted *Apr. 9*, 1865.

Where enlisted *New Orleans, La.*

For what period enlisted *3* years.

Eyes *Dark*; hair *Black*

Complexion *Black*; height *5* ft. *8* in.

When mustered in *Apr. 25*, 1865.

Where mustered in *New Orleans*

Bounty paid \$ *100* ¹⁰⁰; due \$ *200* ¹⁰⁰

Where credited *1st Dist 2nd Ward, New Orleans, La.*

Company to which assigned *A.*

Remarks:

Book mark:

C. P. Taylor

J | **4 Cav. U.S.C.T.**

William H. Thomas

Priv, Co. C, 4 Reg't U. S. Colored Cavalry.

Appears on

Company Muster Roll

for *May & June*, 1865.

Present or absent *present*

Stoppage, \$ *100* for

Due Gov't, \$ *100* for

Valuation of horse, \$ *100*

Valuation of horse equipments, \$ *100*

Remarks: *Recruit from depot,
joined May 15, 1865,*

Book mark:

(358)

Moyle
Copyist.

I | **4 Cav.** | **U.S.C.T.**

William A Thomas

Priv, Co. C, 4 Reg't U. S. Colored Cavalry.

Appears on

Company Muster Roll

for *July & Aug*, 1865.

Present or absent *present*

Stoppage, \$ 100 for

Due Gov't, \$ 100 for

Valuation of horse, \$ 100

Valuation of horse equipments, \$ 100

Remarks: *Recruit from depot
Joined May 15 1865.*

Book mark: _____

Moy

(358)

Copyist.

J | 4 Cav. | U.S.C.T.

William K. Thomas
Private, Co. C, 4 Reg't U. S. Colored Cavalry.

Appears on

Company Muster Roll

for *Sept & Oct*, 186*5*.

Present or absent *present*

Stoppage, \$ 100 for

Due Gov't, \$ 100 for

Valuation of horse, \$ 100

Valuation of horse equipments, \$ 100

Remarks :

Book mark :

(358)

Moy
Copyist.

J | **4 Cav.** | **U.S.C.T.**

William H. Thomas

Private, Co. C, 4 Reg't U. S. Colored Cavalry.

Appears on

Company Muster Roll

for *Nov & Dec*, 186*5*.

Present or absent *Present*

Stoppage, \$ *100* for

Due Gov't, \$ *100* for

Valuation of horse, \$ *100*

Valuation of horse equipments, \$ *100*

Remarks:

Book mark:

M. A. Michaels

(358)

Copyist.

J | **4 Cav.** | **U.S.C.T.**

William H Thomas
Private, Co. C, 4 Reg't U. S. Colored Cavalry.

Appears on

Company Muster Roll

for *Jan'y & Febr*, 186*6*.

Present or absent *present*.

Stoppage, \$ 100 for

Due Gov't, \$ 100 for

Valuation of horse, \$ 100

Valuation of horse equipments, \$ 100

Remarks:

Book mark:

M. A. Michaels

(358)

Copyist.

G | **4 Cav. | U.S.C.T.**

William H. Thomas
Priv, Co. *10*, 4 Reg't U. S. Colored Cav.

Appears on **Returns** as follows:

May 1865 - Gain: May 14/65
New Orleans Recruit
from Depot.

Book mark:

W. R. Lee
.546. Copyist.

J | **4 Cav. U.S.C.T.**

William Thomas

Private, Co. *C*, 4 Reg't U. S. Col'd Cavalry.

Appears on **Co. Muster-out Roll**, dated *New Orleans La Mar 20*, 186*6*.

Muster-out to date *Mar 20*, 186*6*.

Last paid to *June 30*, 186*5*.

Clothing account:

Last settled....., 186 ; drawn since \$.....100

Due soldier \$.....100; due U. S. \$ *30* ^{*53*}/_{*100*}

Am't for cloth'g in kind or money adv'd \$.....100

Due U. S. for arms, equipments, &c., \$.....100

Bounty paid \$.....100; due \$.....100

Remarks: *Joined as recruit*

Book mark: *V. 25 P. 122 - 69*

M. A. Michaels

(361)

Copyist.

Thomas William H.

....., Co., 4 Reg't N. S. C. Cav.

Enclosures.

Bed Cards	Final Statements
Burial Records	Furloughs or L. of A.
Certs. of Dis. for Discharge	Med. Certificates
C. M. Charges	Med. Des. Lists
Descriptive Lists	Orders
Discharge Certificates	Pris. of War Record
Enlistment Papers	Resignations

Other papers relating to—

Admission to Hosp'l	Furlough or L. of A.
Casualty Sheet	Med. Examination
Confinement	Misc. Information
Contracts	Pay of Clothing
Death or Effects	Personal Reports
Desertion	Rank
Discharge from Hosp'l	Transfer to Hosp'l
Discharge from Service	Transfer to V. R. C.
Duty	Transportation
.....

DECLARATION OF RECRUIT.

I, William H. Thomas, desiring to VOLUNTEER as a Soldier in the Army of the United States, for the term of THREE YEARS, Do Declare, That I am 38 years and _____ months of age; that I have never been discharged from the United States service on account of disability or by sentence of a court martial, or by order before the expiration of a term of enlistment; and I know of no impediment to my serving honestly and faithfully as a soldier for three years.

GIVEN at New Orleans La the 9 day of April 1865

Witness: John Geo. Hurd William H. Thomas
1st Lieut. 10th U. S. C. O. Regt. mark

No. _____

William H. Thomas
Volunteered at New Orleans La

April 9 1865

By Saml. W. McWhorter

for the 4th Regiment of W. V. C.

Enlistment: last served in Company ()

Reg't of _____

Discharged _____ 1865

Account entered to the Company provided by master of the ship "The M. Wade" from party by July 1865.

Received from Second Auditor
October 7th, 1892.

CONSENT IN CASE OF MINOR.

I, _____, DO CERTIFY, That I am the _____ of _____; that the said _____ is _____ years of age; and I do hereby freely give my CONSENT to his volunteering as a SOLDIER in the ARMY OF THE UNITED STATES for the period of THREE YEARS.

GIVEN at _____ the _____ day of _____

Witness: _____

NOTE 1.—This blank will be used for both enlistments and re-enlistments—enlistment of veterans, &c., &c., in the volunteer service. They will be made out in duplicate in all cases—one to accompany the recruiting return of the superintendent (not the recruiting officer) to the Adjutant General, and one to accompany the accounts of the officer who pays bounty, &c. The Regiment and Company in which the soldier last served should be given on the back
NOTE 2.—An enlistment holds to service. A muster-in must, in all cases, precede payment of pay, bounty, pension, &c. A muster-in roll must, in all cases, be filed in the Adjutant General's Office as evidence of muster-in. The mustering officer, commissary, or assistant commissary of musters, as the case may be, will countersign both enlistments as having mustered the soldier into the service of the United States before either of them is given to the disbursing officer.

VOLUNTEER ENLISTMENT.

STATE OF

TOWN OF

Louisiana



New Orleans

I, *William H. Thomas*, born in *Harrison* in the State of *Kentucky*, aged *thirty eight* years, and by occupation a *Laborer*, Do HEREBY ACKNOWLEDGE to have volunteered this *North* day of *April*, 1865, to serve as a **Soldier** in the **Army of the United States of America**, for the period of **THREE YEARS**, unless sooner discharged by proper authority: Do also agree to accept such bounty, pay, rations, and clothing, as are, or may be, established by law for volunteers. And I, *William H. Thomas*, do solemnly swear, that I will bear true faith and allegiance to the **United States of America**, and that I will serve them honestly and faithfully against all their enemies or opposers whomsoever; and that I will observe and obey the orders of the President of the United States, and the orders of the officers appointed over me, according to the Rules and Articles of War.

Sworn and subscribed to, at *New Orleans La* this *9th* day of *April*, 1865, *William H. Thomas* his mark
 BEFORE *John Lee Stindeman* 1st Lieut. 10th U. S. C. A. 1847

I CERTIFY, ON HONOR, That I have carefully examined the above-named Volunteer, agreeably to the General Regulations of the Army, and that, in my opinion, he is free from all bodily defects and mental infirmity, which would in any way disqualify him from performing the duties of a soldier.

John H. Crow
Surgeon St. U.S. Army
 EXAMINING SURGEON.

I CERTIFY, ON HONOR, That I have minutely inspected the Volunteer *William H. Thomas* previously to his enlistment, and that he was entirely sober when enlisted; that, to the best of my judgment and belief, he is of lawful age; and that, in accepting him as duly qualified to perform the duties of an able-bodied soldier, I have strictly observed the Regulations which govern the recruiting service. This soldier has *Dark* eyes, *Black* hair, *Black* complexion, is *five* feet *eight* inches high.

W. Altitude
 Capt. 10 Regiment of U.S.C.A. Reg. Volunteers,
 RECRUITING OFFICER.

(A. G. O. No. 74 & 76.)

Mustered into the service of the United States, for three years or during the war, from date of enlistment, in Company "C" 1st Regiment of U.S.C.A. Volunteers, on the 25 day of April 1865, at New Orleans La.

John H. Crow
 Surgeon St. U.S. Army

1053

Thompson Gilbert
Co *A*, **4** U. S. Col'd Cav.

Private | *Private*

CARD NUMBERS.

1	5354985	26
2	5355074	27
3	5355166	28
4	5355254	29
5	5355344	30
6	5355427	31
7	5355508	32
8	5355583	33
9	5355671	34
10	5355755	35
11	5355838	36
12	5355918	37
12	5355999	38
14	5356076	39
15	5356153	40
16		41
17		42
18		43
19		44
20		45
21		46
22		47
23		48
24		49
25		50

Book Mark: *2451, 1880,*

See also

Rep 354807-
S-1011925-PO MAM
D1364577 And W.D.
S. 2189460 P.C. MAM

H Jordan
Ex

J | 4 Cav. | U.S.C.T.

Gilbert Thompson

Cpt, Co. A, Mounted Rangers, Corps d'Afrique. †

Age years.

Appears on

Company Muster Roll*

for *Nov Dec*, 186*3*.

Joined for duty and enrolled:

When *Nov 1*, 186*3*.

Where *Iberia, La*

Period years.

Mustered in:

When *Nov 30*, 186*3*.

Where *Iberia, La*

Present or absent *Present*

Stoppage, \$ 100 for

Due Gov't \$ 100 for

Valuation of horse, \$ 100

Valuation of horse equipments, \$ 100

Remarks:

† This organization subsequently became Co. F, 4 U. S. Col'd Cav.
* First current roll. No muster-in roll of this ~~battery~~ ^{Company} on file.

Book mark:

Hammond
(3586) Copyist.

F | **4 Cav. | U.S C.T.**

Gilbert Thompson
Pvt., Co. *F*, 1 Reg't Cav., Corps d'Afrique.*

Appears on

Company Muster Roll

for *Jan'y & Feb'y*, 186*4*

Present or absent *Present*

Stoppage, \$ *100* for

Due Gov't, \$ *100* for

Valuation of horse, \$ *100*

Valuation of horse equipments, \$ *100*

Remarks:

* This organization subsequently became Co. *F*, 4 Reg't U. S. Colored Cavalry.

Book mark:

Manning
Copyist.

J | 4 Cav. | U.S.C.T.

Gilbert Thompson
Pr, Co. F, 4 Reg't U. S. Col'd Cavalry.

Appears on

Company Muster Roll

for *March & April*, 1864.

Present or absent *Present*

Stoppage, \$ 100 for

Due Gov't, \$ 100 for

Valuation of horse, \$ 100

Valuation of horse equipments, \$ 100

Remarks:

.....
.....
.....
.....
.....
.....
.....

Book mark:

.....

Mummg
Copyist.

J | 4 Cav. | U.S.C.T.

Gilbert Thompson
Co, Co. F, 4 Reg't U. S. Col'd Cavalry.

Appears on

Company Muster Roll

for *May & June*, 1864.

Present or absent *Present*

Stoppage, \$ 100 for

Due Gov't, \$ 100 for

Valuation of horse, \$ 100

Valuation of horse equipments, \$ 100

Remarks:

Book mark:

(358)

Manning
Copyist.

J | 4 Cav. | U.S.C.T.

Gilbert Thompson
Pvt., Co. F, 4 Reg't U. S. Col'd Cavalry.

Appears on

Company Muster Roll

for *July & Aug*, 1864.

Present or absent. *Present*

Stoppage, \$ 100 for

Due Gov't, \$ 100 for

Valuation of horse, \$ 100

Valuation of horse equipments, \$ 100

Remarks: *Stop for one month*
16c

Inserted by Camp

Book mark: *J*

Manning

F | **4 Cav.** | **U.S.C.T.**

Gilbert Thompson
Pvt., Co. F, 4 Reg't U. S. Col'd Cavalry.

Appears on

Company Muster Roll

for *Sept & Oct*, 1864.

Present or absent *Present*

Stoppage, \$ *100* for

Due Gov't, \$ *100* for

Valuation of horse, \$ *100*

Valuation of horse equipments, \$ *100*

Remarks: *Stop for one*
gun sling

Book mark:

T | 4 Cav. | U.S.C.T.

Gilbert Thompson

Pvt, Co. F, 4 Reg't U. S. Col'd Cavalry.

Appears on

Company Muster Roll

for *Nov. & Dec*, 186*4*

Present or absent *Present*

Stoppage, \$ 100 for

Due Gov't, \$ 100 for

Valuation of horse, \$ 100

Valuation of horse equipments, \$ 100

Remarks:

Book mark:

A. Harris

J | 4 Cav. | U.S.C.T.

Gilbert Thompson

Pvt, Co. F, 4 Reg't U. S. Col'd Cavalry.

Appears on

Company Muster Roll

for *Jan & Feb*, 186 *5*.

Present or absent *Present*

Stoppage, \$ *100* for

Due Gov't, \$ *100* for

Valuation of horse, \$ *100*

Valuation of horse equipments, \$ *100*

Remarks:

Book mark:

W. H. ...

(358)

Copyist.

J | 4 Cav. | U.S.C.T.

Gilbert Thompson

Pvt, Co. F, 4 Reg't U. S. Col'd Cavalry.

Appears on

Company Muster Roll

for *Mch & Apr*, 1865.

Present or absent *Present*

Stoppage, \$ 100 for

Due Gov't, \$ 100 for

Valuation of horse, \$ 100

Valuation of horse equipments, \$ 100

Remarks:

Book mark:

J. H. Harris

J | **4 Cav.** | **U.S.C.T.**

Gilbert Thompson

Plt, Co. F, 4 Reg't U. S. Col'd Cavalry.

Appears on

Company Muster Roll

for *May & June*, 186 *5*

Present or absent *Present*

Stoppage, \$ *100* for

Due Gov't, \$ *100* for

Valuation of horse, \$ *100*

Valuation of horse equipments, \$ *100*

Remarks: *Quell. A. lost Ordnance
\$2.00 Halter, Curry Comb
Horse Brush.*

Book mark:

L H Harris

(358)

Copyist.

T | 4 Cav. | U.S.C.T.

Gilbert Thompson

Priv, Co. F, 4 Reg't U. S. Col'd Cavalry.

Appears on

Company Muster Roll

for *July & Aug*, 186 *5*.

Present or absent *Present*

Stoppage, \$ *100* for

Due Gov't, \$ *2* ^{*19*}/_{*100*} for *Indmanee & Horse Equipmts.*

Valuation of horse, \$ *100*

Valuation of horse equipments, \$ *100*

Remarks:

Book mark:

H. A. Harris

(358)

Copyist.

T | **4 Cav. | U.S.C.T.**

Gilbert Thompson

Pvt, Co. F, 4 Reg't U. S. Col'd Cavalry.

Appears on

Company Muster Roll

for *Sept & Oct*, 186*5*

Present or absent *Present*

Stoppage, \$ *100* for

Due Gov't, \$ *100* for

Valuation of horse, \$ *100*

Valuation of horse equipments, \$ *100*

Remarks: *Stop for one Halter Pr. Spurs & Strap Surcingle,*

Book mark: _____

M Harris

(358)

Copyist.

J | 4 Cav. | U.S.C.T.

Gilbert Thompson

P, Co. F, 4 Reg't U. S. Col'd Cavalry.

Appears on

Company Muster Roll

for Nov. 1st Dec., 1865.

Present or absent Present

Stoppage, \$ 4. 95/100 for ordn. lost.

Due Gov't, \$ 100 for

Valuation of horse, \$ 100

Valuation of horse equipments, \$ 100

Remarks:

Book mark:

Hibbard

(358)

Copyist.

T | 4 Cav. | U.S.C.T.

Gilbert Thompson

P, Co. F, 4 Reg't U. S. Col'd Cavalry.

Appears on

Company Muster Roll

for Jan. Feb., 1866.

Present or absent Present

Stoppage, \$ 4. 95 for ordn. lost.

Due Gov't, \$ 100 for

Valuation of horse, \$ 100

Valuation of horse equipments, \$ 100

Remarks:

Book mark:

Hibbard

(358)

Copyist.

NARA 46

T | 4 Cav. | U.S.C.T.

Gilbert Thompson

P, Co. P, 4 Reg't U. S. Col'd Cavalry.

Appears on Co. Muster-out Roll, dated
New Orleans, La., March 20, 1866.

Muster-out to date March 20, 1866.

Last paid to June 30, 1865.

Clothing account:

Last settled....., 186 ; drawn since \$.....¹⁰⁰

Due soldier \$.....¹⁰⁰; due U. S. \$ 43.⁶³/₁₀₀

Am't for cloth'g in kind or money adv'd \$.....¹⁰⁰

Due U. S. for arms, equipments, &c., \$ 16.¹⁹/₁₀₀

Bounty paid \$.....¹⁰⁰; due \$.....¹⁰⁰

Remarks: joined at orig. org.

Stop 1 halter, 1 pr. spurs & straps
1 surcingle, 2 carbine pockets,
1 sabre, 1 girth, 1 carbine sling,
1 cap pouch.

Book mark: V26 - P49 - 68.

2451 - 1880.

(361)

Hibbard
Copyist.

1036

Thompson Henry
Co A, 4 U. S. Col'd Cav.

Private | Private

CARD NUMBERS.

1	5348489	26
2	5348607	27
3	5349770	28
4	40729273	29
5		30
6		31
7		32
8		33
9		34
10		35
11		36
12		37
13		38
14		39
15		40
16		41
17		42
18		43
19		44
20		45
21		46
22		47
23		48
24		49
25		50

Book Mark:

See also

J | **4 Cav.** | **U.S.C.T.**

Henry Thompson
Private, Co. *A*, 1 Reg't La. Cav., Corps d'Afrique.*

Appears on

Company Muster-in Roll

of the organization named above. Roll dated

New Orleans La, Sept 12, 1863.

Muster-in to date *Sept 12*, 1863.

Joined for duty and enrolled:

When *Sept 3*, 1863.

Where *New Orleans*

Period *3* years.

Valuation of horse, \$ *100*

Valuation of horse equipments, \$ *100*

Remarks:

Age 22.

*This organization subsequently became Co. *A* 4 Reg't U. S. Colored Cavalry.

Book mark:

(356)

M. A. Michaels
Coryist.

T

4 Cav. | U.S.C.T.

Henry Thompson

(Priv), Co. *A*, 1 Reg't La. Cav., Corps d'Afrique.*

Appears on

Company Muster Roll

for *Sept 12 to Dec 31*, 186 *3*

Present or absent

Stoppage, \$ 100 for

Due Gov't, \$ 100 for

Valuation of horse, \$ 100

Valuation of horse equipments, \$ 100

Remarks: *Deserted at New Orleans Oct 28/63*

*This organization subsequently became Co. *A*, 4 Reg't U. S. Colored Cavalry.

Book mark:

R. S. Richardson

(358)

Copyist.

G | **4 Cav.** | **U.S.C.T.**

Henry Thompson
Sgt., Co. A, 4 Reg't U. S. Colored Cav.

Appears on Returns as follows:

Jan 1861 - 2000: Oct 28/62
New Orleans, deserted.
(1 Regt. Cav., Corps d'Afrique)

Book mark:

W. R. Lee

I | **4 Cav. | U.S.C.T.**

Henry Thompson
Priv, Co. *A*, 4 Reg't U. S. Col'd Cavalry.

Appears on **Co. Muster-out Roll**, dated
New Orleans La, Feb 20, 1866.

Muster-out to date _____, 186 .

Last paid to _____, 186 .
Never Paid.

Clothing account:

Last settled _____, 186 ; drawn since \$ _____ 100

Due soldier \$ _____ 100 ; due U. S. \$ _____ 100

Am't for cloth'g in kind or money adv'd \$ _____ 100

Due U. S. for arms, equipments, &c., \$ _____ 100

Bounty paid \$ _____ 100 ; due \$ _____ 100

Remarks: *Joined at orig. org. Deserted*
Oct. 14, 63, at New Orleans La

Book mark : _____

(361)

Orewitt

Copyist.

1057

Thompson John

Co E, 4 U. S. Col'd Cav.

Private

Private

CARD NUMBERS.

1	5353846	26
2	5353899	27
3	5353955	28
4	5354008	29
5	5354077	30
6	5354148	31
7	5354214	32
8	5354279	33
9	5354339	34
10	5354426	35
11	5354500	36
12	5354581	37
12	5354656	38
14	5354727	39
15	5354797	40
16	5354866	41
17	40729274	42
18		43
19		44
20		45
21		46
22		47
23		48
24		49
25		50

Book Mark:

See also

T | **4 Cav. | U.S.C.T.**

John Thompson
Pvt, Co. *E*, 1 Reg't, Corps d'Afrique Cavalry.*
Age *21 yrs.*
Appears on

Company Muster-in Roll

of the organization named above. Roll dated

New Orleans, La. Dec. 31, 186*3*.

Muster-in to date *Dec. 31*, 186*3*.

Joined for duty and enrolled:

When *Nov. 6*, 186 .

Where *New Orleans*

Period *3* years.

Valuation of horse, \$ *100*

Valuation of horse equipments, \$ *100*

Remarks:

** Inserted by Jordan Ex*

*This organization subsequently became Co. *E*, 4 Reg't U. S. Colored Cavalry.

Book mark:

Wendell

J

4 Cav. U.S C.T.

John Thompson
Pvt., Co. *E*, 1 Reg't Cav., Corps d'Afrique.*

Appears on

Company Muster Roll

for *Enlistment to Dec. 31*, 186*3*

Present or absent *Present*

Stoppage, \$ *100* for

Due Gov't, \$ *100* for

Valuation of horse, \$ *100*

Valuation of horse equipments, \$ *100*

Remarks:

* This organization subsequently became Co. *E*, 4 Reg't U. S. Colored Cavalry.

Book mark: -----

Wendel

NARA 55

J **4 Cav. | U.S C.T.**

John Thompson

, Co. *E*, 1 Reg't Cav., Corps d'Afrique.*

Appears on

Company Muster Roll

for *Jan + Feb*, 186*4*.

Present or absent *Present*

Stoppage, \$ *100* for

Due Gov't, \$ *100* for

Valuation of horse, \$ *100*

Valuation of horse equipments, \$ *100*

Remarks:

*This organization subsequently became Co. *E*, 4 Reg't U. S. Colored Cavalry.

Book mark:

Lawrence

(358)

Copyist.

J | **4 Cav.** | **U.S.C.T.**

John Thompson

Priv, Co. E, 4 Reg't U. S. Col'd Cav.

Appears on

Company Muster Roll

for Mar + Apr, 1864.

Present or absent Present

Stoppage, \$ 100 for

Due Gov't, \$ 100 for

Valuation of horse, \$ 100

Valuation of horse equipments, \$ 100

Remarks:

Book mark:

Lamm

9 | 4 Cav. | U.S.C.T.

John Thompson

Priv., Co. E, 4 Reg't U. S. Col'd Cav.

Appears on

Company Muster Roll

for *May & June*, 186*x*

Present or absent *Present*

Stoppage, \$ 100 for

Due Gov't, \$ 100 for

Valuation of horse, \$ 100

Valuation of horse equipments, \$ 100

Remarks:

Book mark:

L. Lawrence

J | 4 Cav. | U.S.C.T.

John Thompson

Out, Co. E, 4 Reg't U. S. Col'd Cav.

Appears on

Company Muster Roll

for *July & Aug*, 1864

Present or absent *Present*

Stoppage, \$ 100 for

Due Gov't, \$ 100 for

Valuation of horse, \$ 100

Valuation of horse equipments, \$ 100

Remarks: -----

Book mark: -----

Lawrence

Copyist.

7 | 4 Cav. | U.S.C.T.

John Thompson

Put, Co. E, 4 Reg't U. S. Col'd Cav.

Appears on

Company Muster Roll

for *Sept + Oct*, 186*4*

Present or absent *Present*

Stoppage, \$ *100* for

Due Gov't, \$ *100* for

Valuation of horse, \$ *100*

Valuation of horse equipments, \$ *100*

Remarks: *Due 48 per cont -
Ordnance 4800*

Book mark:

Laurie

(358)

Copyist.

J | **4 Cav.** | **U.S.C.T.**

John Thompson

PT, Co. E, 4 Reg't U. S. Col'd Cav.

Appears on

Company Muster Roll

for *Nov & Dec*, 1864.

Present or absent *Present*

Stoppage, \$ 100 for

Due Gov't, \$ 100 for

Valuation of horse, \$ 100

Valuation of horse equipments, \$ 100

Remarks:

Book mark:

(358)

Wines

Copyist.

J | **4 Cav.** | **U.S.C.T.**

John Thompson

Priv, Co. E, 4 Reg't U. S. Col'd Cav.

Appears on

Company Muster Roll

for *Jan & Feb*, 186*5*.

Present or absent *Present*

Stoppage, \$ *100* for

Due Gov't, \$ *100* for

Valuation of horse, \$ *100*

Valuation of horse equipments, \$ *100*

Remarks: *Rec'd only 7 doil
per month to include
Apr 30/64*

Book mark:

(358)

Wines

Copyist.

J | **4 Cav.** | **U.S.C.T.**

John Thompson

Pvt, Co. E, 4 Reg't U. S. Col'd Cav.

Appears on

Company Muster Roll

for *Mar & Apr*, 186*4*.

Present or absent. *Present*

Stoppage, \$ *100* for

Due Gov't, \$ *100* for

Valuation of horse, \$ *100*

Valuation of horse equipments, \$ *100*

Remarks:

Book mark:

(358)

Wines

Copyist.

J | **4 Cav.** | **U.S.C.T.**

John Thompson
PT, Co. E, 4 Reg't U. S. Col'd Cav.

Appears on

Company Muster Roll

for *May & June*, 186*5*

Present or absent *Present*

Stoppage, \$ *100* for

Due Gov't, \$ *100* for

Valuation of horse, \$ *100*

Valuation of horse equipments, \$ *100*

Remarks:

Book mark:

Wines

J | **4 Cav.** | **U.S.C.T.**

John Thompson

Priv, Co. E, 4 Reg't U. S. Col'd Cav.

Appears on

Company Muster Roll

for *July & Aug*, 186*5*.

Present or absent *Present*

Stoppage, \$ *100* for

Due Gov't, \$ *100* for

Valuation of horse, \$ *100*

Valuation of horse equipments, \$ *100*

Remarks:

Book mark:

Wines

✓ | 4 Cav. | U.S.C.T.

John Thompson

Pvt, Co. E, 4 Reg't U. S. Col'd Cav.

Appears on

Company Muster Roll

for *Sept & Oct*, 186*5*.

Present or absent *Present*

Stoppage, \$.....100 for

Due Gov't, \$.....100 for

Valuation of horse, \$.....100

Valuation of horse equipments, \$.....100

Remarks:.....

Book mark:.....

(358)

W. J. [unclear]

Copyist.

J | 4 Cav. | U.S.C.T.

John Thompson
Pvt, Co. E, 4 Reg't U. S. Col'd Cav.

Appears on

Company Muster Roll

for *Nov. & Dec*, 1865.

Present or absent *Present*

Stoppage, \$ *5 ¹⁸/₁₀₀* for *lost ordnance*

Due Gov't, \$ *100* for

Valuation of horse, \$ *100*

Valuation of horse equipments, \$ *100*

Remarks:

Book mark:

(358) *Lloyd* Copyist.

J | **4 Cav.** | **U.S.C.T.**

John Thompson

Pvt, Co. E, 4 Reg't U. S. Col'd Cav.

Appears on

Company Muster Roll

for *Jan'y & Feby*, 186 *6*.

Present or absent *Present*

Stoppage, \$ *5 ¹⁸/₁₀₀* for *lost ordnance*

Due Gov't, \$ *100* for

Valuation of horse, \$ *100*

Valuation of horse equipments, \$ *100*

Remarks:

Book mark:

(358)

Floyd

Copyist.

D | **4 Cav.** | **U.S.C.T.**

John Thompson
Prvt, Co. E, 4 Reg't U. S. Colored Cav.

Appears on **Returns** as follows:

June 1864 - On duty priv.
servant to Lt. B. Asdel

Book mark : _____

W. R. Lee

S | 4 Cav. | U.S.C.T.

John Thompson
Put, Co. *E*, 4 Reg't U. S. Col'd Cavalry.

Appears on **Co. Muster-out Roll**, dated
New Orleans La, *Mch 20*, 1866.

Muster-out to date *Mch 20*, 1866.

Last paid to *June 30*, 1865.

Clothing account:

Last settled....., 186 ; drawn since \$..... $\overline{100}$

Due soldier \$..... $\overline{100}$; due U. S. \$..... $\overline{100}$

Am't for cloth'g in kind or money adv'd \$..... $\overline{100}$

Due U. S. for arms, equipments, &c., \$ *14* $\frac{3}{100}$

Bounty paid \$..... $\overline{100}$; due \$..... $\overline{100}$

Remarks: *Joined orig. org. Stop for*
1 Surcingle 1 horsebrush 1 curry
comb 1 pr spurs + straps 1
Saddle Blanket 1 Sabre Knot

Book mark: *G. F. M. 6983 P. M. G. July 5/66*
L V 26 P 153. 68

(861) *Floyd* Copyist.

1038

Thompson Joseph
 Co. H, 4 U. S. Col'd Cav.

Private | Private

CARD NUMBERS.

1 5347760
 2 5358229
 3 5358283
 4 5358333
 5 5358376
 6 5348029
 7 5357619
 8 5357701
 9 5357786
 10 5357862
 11 5357938
 12 5358013
 13 5358085
 14 40729275
 15
 16
 17
 18
 19
 20
 21
 22
 23
 24
 25

26
 27
 28
 29
 30
 31
 32
 33
 34
 35
 36
 37
 38
 39
 40
 41
 42
 43
 44
 45
 46
 47
 48
 49
 50

Book Mark:

See also

9 | 4 Cav. | U.S.C.T.

Joseph E. Thompson

Appears with rank of Priv. on

Muster and Descriptive Roll of a Detachment of U. S. Vols. forwarded

for the 4 Reg't U. S. Col'd Cavalry. Roll dated

New Orleans, La., Aug. 6, 1864.

Where born New Orleans, La.

Age 20 y'rs; occupation Waiter

When enlisted Aug. 11, 1864.

Where enlisted New Orleans, La.

For what period enlisted 3 years.

Eyes Black; hair black

Complexion black; height 5 ft. 4 in.

When mustered in Aug. 6, 1864.

Where mustered in Barretton, La.

Bounty paid \$ 100 100; due \$ 200 100

Where credited New Orleans, La.

Company to which assigned D

Remarks: Account entitled to

Bounty

Book mark:

J. H. Taylor

7

4 Cav. U.S.C.T.

Joseph Thompson
Pvt, Co. I, 4 Reg't U. S. Col'd Cavalry.

Appears on

Company Muster Roll

for July & Aug, 1864.

Present or absent Present

Stoppage, \$ 100 for

Due Gov't, \$ 100 for

Valuation of horse, \$ 100

Valuation of horse equipments, \$ 100

Remarks:

Book mark:

Copyist.

J | 4 Cav. | U.S.C.T.

Joseph Thompson

Pr, Co. I, 4 Reg't U. S. Col'd Cavalry.

Appears on

Company Muster Roll

for *Sept & Oct*, 186*4*.

Present or absent *Present*

Stoppage, \$ *100* for

Due Gov't, \$ *100* for

Valuation of horse, \$ *100*

Valuation of horse equipments, \$ *100*

Remarks: *Bounty paid \$100. Bounty due \$200.*

Book mark:

Atys

A | 4 Cav. | U.S.C.T.

Joseph Thompson

Thompson, Co. I, 4 Reg't U. S. Col'd Cavalry.

Appears on

Company Muster Roll

for *Nov + Dec*, 1864.

Present or absent *Present*

Stoppage, \$ 100 for

Due Gov't, \$ 100 for

Valuation of horse, \$ 100

Valuation of horse equipments, \$ 100

Remarks: *Bounty paid \$100. Bounty due \$200. Stop fee on screw driver*

Book mark:

Hyne

A | 4 Cav. | U.S.C.T.

Joseph Thompson

PT, Co. I, 4 Reg't U. S. Col'd Cavalry.

Appears on

Company Muster Roll

for *Jan & Feb*, 1865.

Present or absent *Present*

Stoppage, \$ 100 for

Due Gov't, \$ 100 for

Valuation of horse, \$ 100

Valuation of horse equipments, \$ 100

Remarks: *Bounty paid \$100. Bounty due \$200. Bounty allowed by Circular No. 27 Pro Mar G.O. July 29. 1864*

Book mark:

Styer

7 | 4 Cav. | U.S.C.T.

Joseph Thompson

Priv., Co. H, 4 Reg't U. S. Col'd Cavalry.

Appears on

Company Muster Roll

for *Mich. & April*, 186*2*.

Present or absent *Present*

Stoppage, \$ *100* for

Due Gov't, \$ *100* for

Valuation of horse, \$ *100*

Valuation of horse equipments, \$ *100*

Remarks: *Transferred from Co. I in consolidation by S. O. 28. Adgrs. Dept. Genl Jan. 28/63. Bounty paid 100 doll. Bounty due 200 doll.; allowed by circum-
-stances. Priv. Mar. Genl off. July 19/64*

Book mark: *Filed with Thompson, Joseph
Feaster*

4 Cav. | U.S.C.T.

Joseph Thompson

Am, Co. A, 4 Reg't U. S. Col'd Cav.

Appears on

M. and D. Roll of Men Transferred

to the organization named above, by consol.
from Cav.

Roll dated Port Hudson La Apr 29, 1865.

When enlisted Aug 4, 1864.

Period for which enlisted 3 years.

When mustered in Aug 6, 1864.

Present or absent Not stated.

Company to which assigned A

Remarks:

Book mark :

(342)

[Handwritten Signature]

Copyist.

J | **4 Cav.** | **U.S.C.T.**

Joseph Thompson
Pvt., Co. H, 4 Reg't U. S. Col'd Cavalry.

Appears on

Company Muster Roll

for *May & June*, 186*5*.

Present or absent *Present*.

Stoppage, \$.....*100* for

Due Gov't, \$.....*100* for

Valuation of horse, \$.....*100*

Valuation of horse equipments, \$.....*100*

Remarks: *Bounty paid \$100.*
Bounty due \$200, allowed
by circular no. 2-7.
Pro. M. Genl. Office
July 19/64

Book mark:

H
Heaster

J 4 Cav. U.S.C.T.

Joseph Thompson
Pvt., Co. H, 4 Reg't U. S. Col'd Cavalry.

Appears on

Company Muster Roll

for *July 8. Aug.*, 186*2*.

Present or absent *Present*

Stoppage, \$ *100* for

Due Gov't, \$ *100* for

Valuation of horse, \$ *100*

Valuation of horse equipments, \$ *100*

Remarks: *Bounty pd \$100.
Bounty due \$200,
allowed per cir. No. 27,
P. M. Genl. office, July
19, 1864*

Book mark:

Feaster

J | **4 Cav. | U.S.C.T.**

Joseph Thompson

Pvt., Co. H, 4 Reg't U. S. Col'd Cavalry.

Appears on

Company Muster Roll

for *Sept. 4. Oct.*, 186*5*.

Present or absent *Present*

Stoppage, \$ *100* for -----

Due Gov't, \$ *100* for -----

Valuation of horse, \$ *100*

Valuation of horse equipments, \$ *100*

Remarks: *Bounty paid \$100.*
Bounty due \$200, al-
lowed by circular No.
27. Pro. War. Genl. office,
July 19th 1864.

Book mark: -----

Feaster

27 | 4 Cav. | U.S.C.T.

Joseph Thompson
Pri., Co. H, 4 Reg't U. S. Col'd Cavalry.

Appears on

Company Muster Roll

for *dated Dec 31*, 186 *5*.

Present or absent *Present*

Stoppage, \$ *100* for

Due Gov't, \$ *100* for

Valuation of horse, \$ *100*

Valuation of horse equipments, \$ *100*

Remarks: *Bounty paid \$100
Due \$200 allowed by
circular No. 27, P. M. G.
office July 19, 64*

Book mark:

A. E. Howard

W | 4 Cav. | U.S.C.T.

Joseph Thompson
Pri., Co. H, 4 Reg't U. S. Col'd Cavalry.

Appears on

Company Muster Roll

for Jan & Feb, 1866.

Present or absent Present

Stoppage, \$ 32/100 for Sabre knot

Due Gov't, \$ 100 for

Valuation of horse, \$ 100

Valuation of horse equipments, \$ 100

Remarks: Bounty paid \$100.00
Bounty paid \$200.00, al-
lowed by circular No 27
P. M. G. Office July 19/64

Book mark:

(358) H. E. Howard Copyist.

NARA 83
D | 4 Cav. | U.S.C.T.

Joseph S. Thompson
Port, Co. D, 4 Reg't U. S. Colored Cav.

Appears on Returns as follows:

Aug 1864 (Co D) Jan's Army Co.
N. Orleans Recruit Mustered
in Co.

May to July 1865. On duty orderly
at Post Hd-qs. (Co D)

Book mark:

W. R. Lee

D | **4 Cav.** | **U.S.C.T.**

Joseph Thompson
Co. H., 4 Reg't U. S. Col'd Cavalry.

Appears on **Co. Muster-out Roll**, dated
New Orleans La, Mar 20, 1866.

Muster-out to date *Mar 20, 1866.*

Last paid to *June 30, 1865.*

Clothing account:

Last settled....., 186 ; drawn since \$..... $\overline{100}$

Due soldier \$..... $\overline{100}$; due U. S. \$ *7* $\frac{14}{100}$

Am't for cloth'g in kind or money adv'd \$..... $\overline{100}$

Due U. S. for arms, equipments, &c., \$ *3* $\frac{22}{100}$

Bounty paid \$ *100* $\overline{100}$; due \$..... $\overline{100}$

Remarks: *Joined by transfer*
from Co Ith Mich 24/65
per S. O. 28, Hd. Qu. Capt.
Quit service 1865. Stop for
1 Halter & Strap, 1 Knit
1 Carbine Pocket lost.

Book mark:

N. E. Howard

(361)

Copyist.

Thompson, Joseph

....., Co., *4* Reg't *U. S. Cavalry*

Enclosures.

Bed Cards	Final Statements
Burial Records	Furloughs or L. of A.
Certs. of Dis. for Discharge	Med. Certificates
C. M. Charges	Med. Des. Lists
Descriptive Lists	Orders
Discharge Certificates	Pris. of War Record
Enlistment Papers	Resignations

Other papers relating to—

Admission to Hosp'l	Furlough or L. of A.
Casualty Sheet	Med. Examination
Confinement	Misc. Information
Contracts	Pay of Clothing
Death or Effects	Personal Reports
Desertion	Rank
Discharge from Hosp'l	Transfer to Hosp'l
Discharge from Service	Transfer to V. R. C.
Duty	Transportation
.....

1864

NOTE 1.—This blank will be used for both enlistments and re-enlistments—enlistment of veterans, &c., &c., in the volunteer service. They will be made out in duplicate in all cases—one to accompany the recruiting return of the superintendent (not the recruiting officer) to the Adjutant General, and one to accompany the accounts of the officer who pays bounty, &c. The Regiment and Company in which the soldier last served should be given on the back.

NOTE 2.—An enlistment holds to service. A muster-in must, in all cases, precede payment of pay, bounty, pension, &c. A muster-in roll must, in all cases, be filed in the Adjutant General's Office as evidence of muster-in. The mustering officer, commissary, or assistant commissary of musters, as the case may be, will countersign both enlistments as having mustered the soldier into the service of the United States before either of them is given to the disbursing officer.

DECLARATION OF RECRUIT.

I, Joseph Thompson, desiring to VOLUNTEER as a Soldier in the Army of the United States, for the term of THREE YEARS, Do Declare, That I am Twenty years and _____ months of age; that I have never been discharged from the United States service on account of disability or by sentence of a court martial, or by order before the expiration of a term of enlistment; and I know of no impediment to my serving honestly and faithfully as a soldier for three years.

GIVEN at New Orleans La. the 4th day of August 1864

Witness:

J. Butler

Joseph Thompson

No. _____

Joseph Thompson

Volunteered at New Orleans La.

August 4th, 1864

By Joseph F. Butler

4th Regiment of U. S. C. Cavalry

enlistment; last served in Company ()

Reg't of _____

Discharged _____, 18 _____

Received from Second Auditor

August 26th, 1892.

CONSENT IN CASE OF MINOR.

I, _____, Do CERTIFY, That I am _____ the _____ of _____; that the said _____ is _____ years of age; and I do hereby freely give my CONSENT to his volunteering as a SOLDIER in the ARMY OF THE UNITED STATES for the period of THREE YEARS.

GIVEN at _____ the _____ day of _____

Witness:

VOLUNTEER ENLISTMENT.

STATE OF

TOWN OF

Louisiana



New Orleans

I, *Joseph Thompson*, born in *New Orleans* in the State of *Louisiana*, aged *Twenty* years, and by occupation a *Writer*, Do HEREBY ACKNOWLEDGE to have volunteered this *fourth* day of *August*, 1864, to serve as a **Soldier** in the **Army of the United States of America**, for the period of **THREE YEARS**, unless sooner discharged by proper authority: Do also agree to accept such bounty, pay, rations, and clothing, as are, or may be, established by law for volunteers. And I, *Joseph Thompson*, do solemnly swear, that I will bear true faith and allegiance to the **United States of America**, and that I will serve them honestly and faithfully against all their enemies or opposers whomsoever; and that I will observe and obey the orders of the President of the United States, and the orders of the officers appointed over me, according to the Rules and Articles of War.

Sworn and subscribed to, at *New Orleans*

this *4th* day of *August*, 1864.

BEFORE *Capt. F. Bunter*

4th U.S. col. Cavalry

Joseph Thompson
mark

I CERTIFY, ON HONOR, That I have carefully examined the above-named Volunteer, agreeably to the General Regulations of the Army, and that, in my opinion, he is free from all bodily defects and mental infirmity, which would in any way disqualify him from performing the duties of a soldier.

D. D. Hanson

EXAMINING SURGEON.

I CERTIFY, ON HONOR, That I have minutely inspected the Volunteer *Joseph Thompson* previously to his enlistment, and that he was entirely sober when enlisted; that, to the best of my judgment and belief, he is of lawful age; and that, in accepting him as duly qualified to perform the duties of an able-bodied soldier, I have strictly observed the Regulations which govern the recruiting service. This soldier has *Black* eyes, *Black* hair, *Black* complexion, is *five* feet *four* inches high.

Frank Bunter Capt.

4th Regiment of U.S. col. Volunteers, Cavalry

RECRUITING OFFICER.

(A. G. O. No. 74 & 76.)

Mastered into the service of the United States, for three years or during the war, from date of enlistment, in Company *D* of the *4th* Regiment of *U. S. Col. V.* Volunteers, on the *4th* day of *August*, 1864, at *Parrotton La.*
Reservist entitled to Bounty
Under Circular No. 27 P. M. Gen. Order
Date July 19th 1864
J. M. Chaurantain
1st Lt. U. S. A. July 26
A. E. Muelers

NAME

1059

Thompson Lewis

Co A, 4 U. S. Col'd Cav.

Private

Private

CARD NUMBERS.

1	5 3 5 2 5 8 8	26
2	5 3 5 2 6 3 8	27
3	5 3 5 2 6 8 9	28
4	5 3 5 2 7 4 8	29
5	5 3 5 2 8 1 2	30
6	5 3 5 2 8 7 3	31
7	5 3 5 2 9 0 2	32
8	5 3 5 2 9 8 0	33
9	5 3 5 3 0 6 0	34
10	5 3 5 3 2 1 3	35
11	5 3 5 3 3 0 7	36
12	5 3 5 3 4 0 1	37
12	5 3 5 3 4 8 9	38
14	5 3 5 3 5 7 5	39
15	5 3 5 3 6 5 8	40
16	5 3 5 3 7 3 8	41
17		42
18		43
19		44
20		45
21		46
22		47
23		48
24		49
25		50

Book Mark:

See also

NOV 19 1900

1626555 and 1626555

Jordan
ex

J | 4 Cav. | U.S.C.T.

Lewis Thompson

Pat., Co. *D*, 1 Reg't, Corps d'Afrique Cavalry.*

+ Age 30
Appears on

Company Muster-in Roll

of the organization named above. Roll dated

New Orleans La., *Nov 26*, 1863.

Muster-in to date *Nov 26*, 1863.

Joined for duty and enrolled:

When *Nov 15*, 186 .

Where *New Orleans*

Period *3* years.

Valuation of horse, \$ 100

Valuation of horse equipments, \$ 100

Remarks:

+ Inserted by Jordan Ex

*This organization subsequently became Co. *D*, 4 Reg't U. S. Colored Cavalry.

Book mark:

Rosenbaum

J 4 Cav. | U.S C.T.

Lewis Thompson

Pat, Co. *D*, 1 Reg't Cav., Corps d'Afrique.*

Appears on

Company Muster Roll

for *From Enlistment to Dec 31, 1863.*

Present or absent *Present*

Stoppage, \$ *100* for

Due Gov't, \$ *100* for

Valuation of horse, \$ *100*

Valuation of horse equipments, \$ *100*

Remarks:

* This organization subsequently became Co. *D*, 4 Reg't U. S. Colored Cavalry.

Book mark:

Rosenbaum

(358)

Copyist.

J | 4 Cav. | U.S C.T.

Lewis Thompson

Priv, Co. *D*, 1 Reg't Cav., Corps d'Afrique.*

Appears on

Company Muster Roll

for *Janry & Febry*, 1864.

Present or absent *Present*

Stoppage, \$ 100 for

Due Gov't, \$ 100 for

Valuation of horse, \$ 100

Valuation of horse equipments, \$ 100

Remarks:

* This organization subsequently became Co. *J*, 4 Reg't U. S. Colored Cavalry.

Book mark:

Rosenblum

J | **4 Cav.** | **U.S.C.T.**

Lewis Thompson

Plt., Co. D. 4 Reg't U. S. Col'd Cavalry.

Appears on

Company Muster Roll

for March & April, 1864.

Present or absent Present

Stoppage, \$ 100 for

Due Gov't, \$ 100 for

Valuation of horse, \$ 100

Valuation of horse equipments, \$ 100

Remarks:

Book mark:

Rosenbaum

(358)

Copyist.

J | 4 Cav. | U.S.C.T.

Lewis Thompson

Pat., Co. D. 4 Reg't U. S. Col'd Cavalry.

Appears on

Company Muster Roll

for May & June, 1864.

Present or absent Present

Stoppage, \$ 100 for

Due Gov't, \$ 100 for

Valuation of horse, \$ 100

Valuation of horse equipments, \$ 100

Remarks:

Book mark:

Rosenbaum

(358)

Copyist.

J | **4 Cav.** | **U.S.C.T.**

Lewis Thompson

Plt, Co. D. 4 Reg't U. S. Col'd Cavalry.

Appears on

Company Muster Roll

for *July & Aug*, 1864.

Present or absent *Present*

Stoppage, \$ 100 for

Due Gov't, \$ 100 for

Valuation of horse, \$ 100

Valuation of horse equipments, \$ 100

Remarks:

Book mark:

Rosenbaum

(358)

Copyist.

J | 4 Cav. | U.S.C.T.

Lewis Thompson

Corpl., Co. D, 4 Reg't U. S. Col'd Cavalry.

Appears on

Company Muster Roll

for *Sept & Oct*, 1864.

Present or absent *Present*

Stoppage, \$ *100* for

Due Gov't, \$ *100* for

Valuation of horse, \$ *100*

Valuation of horse equipments, \$ *100*

Remarks: *Promoted to the Rank of Corpl Oct 1-1864*

Book mark:

Rosenbaum

(358)

Copyist.

C | 4 Cav. | U.S.C.T.

Lewis Thompson
Cox, Co. D, 4 Reg't U. S. Col'd Cavalry.

Appears on

Company Muster Roll

for *1st Dec*, 186*7*.

Present or absent *Present*

Stoppage, \$ *100* for

Due Gov't, \$ *100* for

Valuation of horse, \$ *100*

Valuation of horse equipments, \$ *100*

Remarks: *Present in the*
Rank of Cox Oct-1-1867

Book mark:

J | **4 Cav.** | **U.S.C.T.**

Louis Thompson

Corp, Co. D, 4 Reg't U. S. Col'd Cavalry.

Appears on

Company Muster Roll

for *Jan & Feb*, 186*5*.

Present or absent *Present*

Stoppage, \$ 100 for

Due Gov't, \$ 100 for

Valuation of horse, \$ 100

Valuation of horse equipments, \$ 100

Remarks: *Appointed Corp Oct 11/64
rec'd only \$7 pr Month
to include Apr 30, 64*

Book mark:

(358)

L. H. Wright

Copyist.

37 | 4 Cav. | U.S.C.T.

Louis Thompson

P, Co. D, 4 Reg't U. S. Col'd Cavalry.

Appears on

Company Muster Roll

for *March & April*, 1865.

Present or absent *Present*

Stoppage, \$ 100 for

Due Gov't, \$ 100 for

Valuation of horse, \$ 100

Valuation of horse equipments, \$ 100

Remarks: *Reduced to rank
from Capt. Mar 20, 65*

Book mark:

W. H. Wright

T | 4 Cav. | U.S.C.T.

Louis Thompson

D, Co. D; 4 Reg't U. S. Col'd Cavalry.

Appears on

Company Muster Roll

for *Nov & Dec*, 1865.

Present or absent *Present*

Stoppage, \$ *100* for

Due Gov't, \$ *100* for

Valuation of horse, \$ *100*

Valuation of horse equipments, \$ *100*

Remarks: *Redeem'd to bank
from Gov't Dec 2, 1865*

Book mark:

W. H. Wright
Copyist.

J | **4 Cav.** | **U.S.C.T.**

Lewis Thompson

P, Co. D, 4 Reg't U. S. Col'd Cavalry.

Appears on

Company Muster Roll

for *July & Aug*, 186*5*.

Present or absent *Present*

Stoppage, \$ *100* for

Due Gov't, \$ *100* for

Valuation of horse, \$ *100*

Valuation of horse equipments, \$ *100*

Remarks: *Reduced from Ensl
to Rank of Mch 31/65*

Book mark:

A. B. Wright

T | 4 Cav. | U.S.C.T.

Lewis Thompson

P, Co. D, 4 Reg't U. S. Col'd Cavalry.

Appears on

Company Muster Roll

for *Sept - & Oct -*, 186*5*.

Present or absent *Present*

Stoppage, \$ 100 for

Due Gov't, \$ 100 for

Valuation of horse, \$ 100

Valuation of horse equipments, \$ 100

Remarks:

Book mark:

W. Wright

J | **4 Cav.** | **U.S.C.T.**

Lewis Thompson

Plt

, Co. D, 4 Reg't U. S. Col'd Cavalry.

Appears on

Company Muster Roll

for *Nov 1 Dec*, 186*5*.

Present or absent *Present*

Stoppage, \$ *100* for

Due Gov't, \$ *100* for

Valuation of horse, \$ *100*

Valuation of horse equipments, \$ *100*

Remarks:

Book mark:

J. J. (Cavalry)

7 | 4 Cav. | U.S.C.T.

Lewis Thompson

Plt, Co. D, 4 Reg't U. S. Col'd Cavalry.

Appears on

Company Muster Roll

for Jan & Feb, 1864.

Present or absent Present

Stoppage, \$ 100 for

Due Gov't, \$ 100 for

Valuation of horse, \$ 100

Valuation of horse equipments, \$ 100

Remarks:

Book mark:

W. J. Becher

4 | 4 Cav. | U.S.C.T.

Lewis Thompson

Put, Co. D, 4 Reg't U. S. Col'd Cavalry.

Appears on Co. Muster-out Roll, dated

New Orleans, La, Feb 20, 1866.

Muster-out to date Feb 20, 1866.

Last paid to June 30, 1865.

Clothing account:

Last settled....., 186 ; drawn since \$.....100

Due soldier \$ 38 ⁹⁷ / 100; due U. S. \$.....100

Am't for cloth'g in kind or money adv'd \$.....100

Due U. S. for arms, equipments, &c., \$.....100

Bounty paid \$.....100; due \$.....100

Remarks: Joined Disg. Org.

Book mark: V. 25, P. 73. 68.

(861)

Wm. C. Anderson

Copyist.

1060

Thompson Richard

Co G, 4 U. S. Col'd Cav.

Private

Private

CARD NUMBERS.

1	5356242	26
2	5356295	27
3	5356346	28
4	5356400	29
5	5357165	30
6	30847610	31
7	30847876	32
8	40729276	33
9		34
10		35
11		36
12		37
13		38
14		39
15		40
16		41
17		42
18		43
19		44
20		45
21		46
22		47
23		48
24		49
25		50

Book Mark:

See also

F | La. Cav. | U. S. C. T.

Richard Thompson
Priv, Co. E, 1 Reg't La. Cav.

Appears on

Hospital Muster Roll

of **Corps d'Afrique U. S. A. General Hospital,**

at **New Orleans, La.,**

for Nov & Dec, 1863

Attached to hospital:

When....., 186 .

How employed.....

Last paid by Maj.

to, 186 .

Bounty paid \$ 100; due \$ 100

Present or absent Present

Remarks:

.....
.....
.....
.....
.....
.....
.....
.....

Book mark:

(343)

Morgan
Copyist.

T | **4 Cav. | U.S.C.T.**

Richard Thompson

*Priv. Co. G, 1 Reg't, Corps d'Afrique Cavalry.**
 * *Age 18 yrs.*
 Appears on

Company Muster-in Roll

of the organization named above. Roll dated

New Orleans, La, Feb 8, 1864.

Muster-in to date *Feb 8, 1864.*

Joined for duty and enrolled:

When *Nov. 14*, 186*3*.

Where *New Orleans, La.*

Period *3* years.

Valuation of horse, \$ 100

Valuation of horse equipments, \$ 100

Remarks: *Pd # 2 Prem.*

** Inserted by Jordan Ex*

*This organization subsequently became Co. *G*, 4 Reg't U. S. Colored Cavalry.

Book mark: _____

(356)

Lowry

Copyist.

T 1 / La. Cav. / U. S. C. T.

Richard Thomson

Co. E, / Reg't La. Cav.

Appears on

Hospital Muster Roll

of Corps d'Afrique U. S. A. General Hospital,

at New Orleans, La.,

for Jan & Feb, 1864.

Attached to hospital :

When....., 186 .

How employed.....

Last paid by Maj.

to....., 186 .

Bounty paid \$ 100 ; due \$ 100

Present or absent

Remarks : Retd. to duty Feb 2/4.

Book mark :

Morgan
Copyist.

4 Cav. U.S C.T.

Richard Thompson
Priv., Co. *G*, 1 Reg't Cav., Corps d'Afrique.*

Appears on

Company Muster Roll

for *Enrollment to Feb 29, 1864.*

Present or absent *Present*

Stoppage, \$ *100* for

Due Gov't, \$ *100* for

Valuation of horse, \$ *100*

Valuation of horse equipments, \$ *100*

Remarks:

* This organization subsequently became Co. *G*, 4 Reg't U. S. Colored Cavalry.

Book mark: -----

Louvy
Copyist.

NARA 111

T | **4 Cav. | U. S. C. T.**

Richard Thompson
Govt, Co. G, 4 Reg't U. S. Col'd Cavalry.

Appears on

Company Muster Roll

for *Mich & Apl*, 186*4*.

Present or absent *Present*

Stoppage, \$ *100* for

Due Gov't, \$ *100* for

Valuation of horse, \$ *100*

Valuation of horse equipments, \$ *100*

Remarks:

Book mark:

L. W. J.

(358)

Copyist.

T

4 Cav. | U. S. C. T.

Richard Thompson
Priv, Co. G, 4 Reg't U. S. Col'd Cavalry.

Appears on

Company Muster Roll

for *May & June*, 1864.

Present or absent

Stoppage, \$ *100* for

Due Gov't, \$ *100* for

Valuation of horse, \$ *100*

Valuation of horse equipments, \$ *100*

Remarks: *Died in Regt
Hospital June 7/64.*

Book mark:

Lowny

T | 4 Cav. | U.S.C.T.

Richd Thompson

Pvt, Co. G, 4 Reg't U. S. Colored Cav.

Appears on Returns as follows:

June 1861 - 200: June 7/61
Camp Colfax died of
disease.

Book mark :

W. R. Lee

T | 4 Cav. | U.S.C.T.

Richard Thompson

Pvt, Co. *G*, 4 Reg't U. S. Col'd Cavalry.

Appears on Co. Muster-out Roll, dated *New Orleans, La, Nov 20*, 1866.

Muster-out to date _____, 186 .

Last paid to _____, 186 .

Clothing account:

Last settled _____, 186 ; drawn since \$ _____ 100

Due soldier \$ _____ 100; due U. S. \$ _____ 100

Am't for cloth'g in kind or money adv'd \$ _____ 100

Due U. S. for arms, equipments, &c., \$ _____ 100

Bounty paid \$ _____ 100; due \$ _____ 100

Remarks: *Joined at orig. org.*
Died June 7th 64 Greenville
La.

Book mark : _____

Blitcher

(361)

Copyist.

Thompson, Richard
P, Co. *G*, **4** **U.S.C. Cav.**
 Reg't

1 Enclosures.

Bed Cards	Descriptive Lists
Burial Records	Final Statements <i>/</i>
Certs. of Dis. for Discharge	Furloughs
C. M. Charges	Med. Des. Lists
Med. Certificates	Orders

Other papers relating to—

Admission to Hosp'l	Furlough
Casualty Sheet (Officer's)	Med. Examination
Confinement	Misc. Information
Contracts	Pay or Clothing
Death or Effects	Personal Reports
Desertions	Rank
Discharge from Hosp'l	Transfer to Hosp'l
Discharge from Service	Transfer to V. R. C.
Duty	Transportation

1864

FINAL STATEMENT

OF

Richard [unclear]
C. 44 Reg't of *U.S. Colored Cavalry*

VOLUNTEERS.

[Signature]

NOTE 1.—Two of these certificates (or duplicates) are to be given to each volunteer soldier who may be discharged previously to the discharge of his company, that he may at once receive from the Paymaster the pay, &c., due him, and the captain or other officer commanding the company will certify to the act of the delivery of the duplicate certificates, on these certificates the Soldier is "entitled to" his discharge, and should also present his discharge to the Paymaster to have the payment endorsed on it. The discharge is to be given back to the Soldier by the Paymaster; the latter only retaining as his voucher the duplicate certificates.

NOTE 2.—If the Soldier is entitled to pay for the use of his horse, the Company Commander will certify to that fact, and also to the time he has pay due for having been so mounted on his own horse.

NOTE 3.—Amounts due the Sutler and Laundress must be entered on the Muster Roll on which the death, desertion, &c., is reported, as well as on the final statement, otherwise the amount cannot be collected from the United States.

NOTE 4.—This blank will be used for deceased volunteers as well as others.

ADJUTANT GENERAL'S OFFICE.

June 27th 1864.

Duplicate with Inventory sent 2d Auditor.



I certify, on honor, that Richard Thompson a Private of
 Captain J. K. Fournier Company (4) of the 5th Regiment of U.S. Colored Cavalry
VOLUNTEERS, of the State of _____, born in Franklin La., State
 of Louisiana, aged 18 years; 5 feet 5 inches high; Black complexion,
Black eyes, Black hair, and by occupation a Laborer, having joined the company on
 its original organization at New Orleans Nov 12 / 63 and enrolled in it at the muster into
 the service of the United States at New Orleans La on the 10th day
 of February, 1864, (or was mustered in service as a recruit, by _____
 _____, at _____, on the _____ day of _____,
 186 , to serve in the Regiment,) for the term of one year;
 and having served **HONESTLY** and **FAITHFULLY** with his Company in _____
 to the present date, is now entitled to a **DISCHARGE** by reason of death. Died
in Regt. Hospital June 9 1864 of B. at
New Orleans La

The said Richard Thompson was last paid by Paymaster
J. K. Fournier to include the thirtieth day of April, 1864, and has
 pay due him from that time to the present date; he is entitled to pay and subsistence for
TRAVELING to place of enrollment and whatever other allowances are authorized to volunteer
 soldiers, or militia, so discharged. He has received Twenty five $\frac{75}{100}$ dollars,
 advanced by the United States on account of **CLOTHING**.

There is to be stopped from him, on account of the State of _____, or other
 authorities for **CLOTHING**, &c., received on entering service, _____ dollars; also,
 for expenses of **SUBSISTENCE** for **TRAVELING** from place of enrollment to the place of rendezvous,
 amounting to _____ dollars: and on account of the United States for **EXTRA**
CLOTHING received in kind from _____ and for other
 stoppages, viz:

_____ amounting to _____ dollars;
 and he has been **SUBSISTED** for **TRAVELING** to his place of enrollment, up to the _____
 _____, 186 .

He is indebted to _____, **SUTLER**, _____ dollars.
 He is indebted to _____, **LAUNDRESS**, _____ dollars.

Given in Duplicate, at New Orleans La, this 9 day of June, 1864.

J. K. Fournier
Capt. Co. 4, U.S. Col. Cav.
 Commanding Company.

1061

Tibbitts, Charles

Co A, 4 U. S. Col'd Cav.

Captain Captain

CARD NUMBERS.

1	5347394	26
2		27
3		28
4		29
5		30
6		31
7		32
8		33
9		34
10		35
11		36
12		37
13		38
14		39
15		40
16		41
17		42
18		43
19		44
20		45
21		46
22		47
23		48
24		49
25		50

Book Mark:

See also 3 Mass. Cav.

F | 4, Cav, | U.S.C.T.

Charles Tibbitts
Capt, Co. A, 4 ^(10 Regt Cav C'd A) Reg't U. S. Col'd Cav

Age 23 years.

Appears on an

Individual Muster-in Roll

of the organization named above. Roll dated

New Orleans La, Sept 17, 1863.

Muster-in to date Sept 15, 1863.

Joined for duty and enrolled:

When Sept 15, 186 .

Where New Orleans

Period 3 years.

Valuation of horse, \$ 100

Valuation of horse equipments, \$ 100

Remarks: Honorably discharged
as Private in the
3rd Mass Cavalry in
par 4. of Special Orders

~~Book mark:~~
Name not taken up on Rolls Co. A.

Perrington
over Copyist.

JAN. - 8

5347394

1891

Remarks:
No. 230. Ad Qrs, Dept.
of the Gulf. Original
Vacancy -

Tilbotts Charles

Capt, co. A, 4 Reg't U. S. C. C.

Enclosures.

- | | |
|------------------------------|-----------------------|
| Bed Cards | Final Statements |
| Burial Records | Furloughs or L. of A. |
| Certs. of Dis. for Discharge | Med. Certificates |
| C. M. Charges | Med. Des. Lists |
| Descriptive Lists | Orders |
| Discharge Certificates | Pris. of War Record |
| Enlistment Papers | Resignations |

Other papers relating to—

- | | |
|------------------------|----------------------|
| Admission to Hosp'l | Furlough or L. of A. |
| Casualty Sheet | Med. Examination |
| Confinement | Misc. Information |
| Contracts | Pay or Clothing |
| Death or Effects | Personal Reports |
| Desertion | Rank |
| Discharge from Hosp'l | Transfer to Hosp'l |
| Discharge from Service | Transfer to V. R. C. |
| Duty | Transportation |

J. 214 1863

New Orleans
Dec 22/63

Fibbitts - Charles
Capt Co. A. 1st Regt

Finders his origi-
nator.

H. W. C. C.

J. J. R. P. 1864

50 Dec 22

Recd. S. A. G. Jan 20 1864

Ms. A. 9. 2. 3
New Orleans, Dec 22nd 1863.

Major G. Norman Lieber
A. A. Generaly
Sir;

I hereby tender
my resignation as Captain of Co
"A" 1st Cavalry Corps d. Afrique,
in compliance with orders received
from the President of the Board
of Examiners.

I have the honor, to be, Sir,
Very Respectfully
Yours most Obedt. Servt.
Charles. Silbitts
Captain Co "A" 1st Cd. A. Calif.

1862
Pizzol, John

Co G, 4 U. S. Col'd Cav.

Private | Corporal

CARD NUMBERS.

1	28
2	29
3	30
4	31
5	32
6	33
7	34
8	35
9	36
10	37
11	38
12	39
13	40
14	41
15	42
16	43
17	44
18	45
19	46
20	47
21	48
22	49
23	50
24	
25	

Book Mark:

See also

1063

Toles William

Co *D*, 4 U. S. Col'd Cav.

Sergeant | *Private*

CARD NUMBERS.

1	5353803	26
2	5353855	27
3	5353951	28
4	5354010	29
5	5354078	30
6	5354149	31
7	5354215	32
8	5354280	33
9	5354342	34
10	5354425	35
11	5354514	36
12	5354888	37
13	40729277	38
14		39
15		40
16		41
17		42
18		43
19		44
20		45
21		46
22		47
23		48
24		49
25		50

Book Mark:

See also

J | **4 Cav. | U.S.C.T.**

William Totes

5th Sergt Co. *E*, 1 Reg't, Corps d'Afrique Cavalry.*
Age 22 yrs -
Appears on

Company Muster-in Roll

of the organization named above. Roll dated

New Orleans, La., Dec. 31, 186*3.*

Muster-in to date *Dec. 31,* 186*3.*

Joined for duty and enrolled:

When *Nov. 8*, 186 .

Where *New Orleans*

Period *3* years.

Valuation of horse, \$ 100

Valuation of horse equipments, \$ 100

Remarks:

** Inserted by Jordan Ex*

*This organization subsequently became Co. *E*, 4 Reg't U. S. Colored Cavalry.

Book mark:

Wense

T

4 Cav. | U.S C.T.

William Foles

5th Lt, Co. *E*, 1 Reg't Cav., Corps d'Afrique.*

Appears on

Company Muster Roll

for *enlistment to Dec. 31, 1863*

Present or absent *Present*

Stoppage, \$ *100* for

Due Gov't, \$ *100* for

Valuation of horse, \$ *100*

Valuation of horse equipments, \$ *100*

Remarks:

.....
.....
.....
.....
.....

* This organization subsequently became Co. *E*, 4 Reg't U.S. Colored Cavalry.

Book mark:

Wensel

J 4 Cav. | U.S C.T.

William Joler

, Co. *E*, 1 Reg't Cav., Corps d'Afrique.*

Appears on

Company Muster Roll

for *Jan + Feb*, 186*4*.

Present or absent *Present*

Stoppage, \$ *100* for

Due Gov't, \$ *100* for

Valuation of horse, \$ *100*

Valuation of horse equipments, \$ *100*

Remarks:

* This organization subsequently became Co. *E*, 4 Reg't U. S. Colored Cavalry.

Book mark:

Lawrence

J | 4 Cav. | U.S.C.T.

William Jones

Put, Co. E, 4 Reg't U. S. Col'd Cav.

Appears on

Company Muster Roll

for Mar & Apr, 1864.

Present or absent Present

Stoppage, \$ 100 for

Due Gov't, \$ 100 for

Valuation of horse, \$ 100

Valuation of horse equipments, \$ 100

Remarks:

Book mark:

Lawrence

J | **4 Cav.** | **U.S.C.T.**

William Tolls

Pl, Co. E, 4 Reg't U. S. Col'd Cav.

Appears on

Company Muster Roll

for *May & June*, 186 *4*

Present or absent *Present*

Stoppage, \$ *100* for

Due Gov't, \$ *100* for

Valuation of horse, \$ *100*

Valuation of horse equipments, \$ *100*

Remarks:

Book mark:

L. M. ...

J | **4 Cav.** | **U.S.C.T.**

William Jolly

Priv, Co. E, 4 Reg't U. S. Col'd Cav.

Appears on

Company Muster Roll

for July & Aug, 1864.

Present or absent Present

Stoppage, \$ 100 for

Due Gov't, \$ 100 for

Valuation of horse, \$ 100

Valuation of horse equipments, \$ 100

Remarks: Due U.S. for Ordnance
Lost at Fort Hudson Tex
#294

Book mark:

Laurence

J | 4 Cav. | U.S.C.T.

William Jolly

Sgt, Co. E, 4 Reg't U. S. Col'd Cav.

Appears on

Company Muster Roll

for *Sept + Oct*, 186*4*

Present or absent *Present*

Stoppage, \$ 100 for

Due Gov't, \$ 100 for

Valuation of horse, \$ 100

Valuation of horse equipments, \$ 100

Remarks:

Book mark:

Lawrence

J | **4 Cav.** | **U.S.C.T.**

William Tolls
Pvt, Co. E, 4 Reg't U. S. Col'd Cav.

Appears on

Company Muster Roll

for *Nov & Dec*, 186*4*

Present or absent *Present*

Stoppage, \$ *100* for

Due Gov't, \$ *100* for

Valuation of horse, \$ *100*

Valuation of horse equipments, \$ *100*

Remarks: *On detached service with Regt Q.M. Stop for 1 pr spurs & straps 1 Singl. 1 carbine socket. Free before Apr. 1, 1861*

Book mark:

(358)

Wines

Copyist.

J | **4 Cav.** | **U.S.C.T.**

William Tolls

Priv, Co. E, 4 Reg't U. S. Col'd Cav.

Appears on

Company Muster Roll

for *Jan & Feb*, 186*5*.

Present or absent *Present*

Stoppage, \$ *100* for

Due Gov't, \$ *100* for

Valuation of horse, \$ *100*

Valuation of horse equipments, \$ *100*

Remarks: *Recd only 7 doll per month to include Apr 30/65 stop for 1 pr spurs & straps 1 surcingh 1 carb socker. Free before Apr 1/65. Up'd Sergt. Nov 8/63 from private. Reduced to the ranks Jan. 3/65.*

Book mark: _____

Wines

G | **4 Cav.** | **U.S.C.T.**

William Tolls

Plt, Co. E, 4 Reg't U. S. Col'd Cav.

Appears on

Company Muster Roll

for *Mar. & Apr*, 186*5*.

Present or absent *Present*

Stoppage, \$ *100* for

Due Gov't, \$ *100* for

Valuation of horse, \$ *100*

Valuation of horse equipments, \$ *100*

Remarks:

Book mark:

(358) *Wines* Copyist.

J | **4 Cav.** | **U.S.C.T.**

William Jolls

J, Co. E, 4 Reg't U. S. Col'd Cav.

Appears on

Company Muster Roll

for *May & June*, 186*S.*

Present or absent

Stoppage, \$ 100 for

Due Gov't, \$ 100 for

Valuation of horse, \$ 100

Valuation of horse equipments, \$ 100

Remarks: *Discharged by order of Maj Gen, E. R. S. Canby June 26/65. Discharge and final statements given*

Book mark:

(358)

Wines

Copyist.

5 | 4 Cav. | U.S.C.T.

William Tolls

Port, Co. E, 4 Reg't U. S. Colored Cav.

Appears on Returns as follows:

July 1864 - On duty Priv. servant
to St. Jas. Ellars

Sept 1864 On duty Co. Cook

Dec 1864 to Feb 1865 - On duty detailed
in Regtl. of M. Hopt.

March 1865 - On duty detailed as
Teamster

Apr + May 1865 - On duty detailed
in Regtl. of M. Hopt.

June 1865 - Does: June 26/65
Port Hudson La, Discharged
for disability

Wm. Tolls
1865 Tolls

Book mark:

W. R. Lee

J | **4 Cav. U.S.C.T.**

William Tolls

Put, Co. *E*, 4 Reg't U. S. Col'd Cavalry.

Appears on **Co. Muster-out Roll**, dated *New Orleans La*, *Mch 20*, 1866.

Muster-out to date _____, 186 .

Last paid to _____, 186 .

Clothing account:

Last settled _____, 186 ; drawn since \$ _____ 100

Due soldier \$ _____ 100; due U. S. \$ _____ 100

Am't for cloth'g in kind or money adv'd \$ _____ 100

Due U. S. for arms, equipments, &c., \$ _____ 100

Bounty paid \$ _____ 100; due \$ _____ 100

Remarks: *Joined at orig. org. Discharged June 26/65. for disability*

Book mark: *V. 221 P 172.75-*

Tolls, William
P. Co. E, **4** Reg **U.S.C. Cav.**

/ Enclosures.

Bed Cards	Descriptive Lists
Burial Records	Final Statements
Certs. of Dis. for Discharge /	Furloughs
C. M. Charges	Med. Des. Lists
Med. Certificates	Orders

Other papers relating to—

Admission to Hosp'l	Furlough
Casualty Sheet (Officer's)	Med. Examination
Confinement	Misc. Information
Contracts	Pay or Clothing
Death or Effects	Personal Reports
Desertions	Rank
Discharge from Hosp'l	Transfer to Hosp'l
Discharge from Service	Transfer to V. R. C.
Duty	Transportation

NOTE 1.

The company commander will here add a statement of all the facts known to him concerning the disease or wound, or cause of disability of the soldier; the time, place, manner, and all the circumstances under which the injury occurred, or disease originated or appeared; the duty, or service, or situation of the soldier at the time the injury was received or disease contracted, stating particularly whether the injury was received or the disease contracted in the line of his duty; and whatever other facts may aid a judgment as to the cause, immediate or remote, of the disability, and the circumstances attending it.

When the facts are not known to the company commander, the certificate of any officer, or affidavit of other person having such knowledge, will be appended—as the surgeon in charge of a hospital, the officer commanding a detachment of recruits, &c., &c.

NOTE 2.

When a probable case for pension, special care must be taken to state the degree of disability—as 1/2, 3/4, &c., &c.; to describe particularly the disability, wound, or disease; the extent to which it deprives him of the use of any limb or faculty, or affects his health, strength, activity, constitution, or capacity to labor or earn his subsistence. The surgeon will add, from his knowledge of the facts and circumstances, and from the evidence in the case, his professional opinion of the cause or origin of the disability. In the case of discharges by Medical Inspectors, the last paragraph will state that the "discharge was given by consent of the soldier, after a personal examination, and for disability, the nature, degree, and origin of which are correctly described in the within certificate."

Par. 1260 Regulations, Edit. 1861.

Medical officers, in giving certificates of disability, are to take particular care in all cases that have not been under their charge; and especially in epilepsy, convulsions, chronic rheumatism, derangement of the urinary organs, ophthalmia, ulcers, or any obscure disease liable to be feigned or purposely produced; and in no case shall such certificate be given until after sufficient time and examination to detect any attempt at deception.

DIRECTIONS.

This certificate will be made out in duplicate by the soldier's company commander, or other officer commanding the separate detachment to which he belongs, and sent by him to the surgeon who has charge of the hospital where the soldier is sick. The surgeon will then fill out and sign the surgeon's certificate, and forward these papers to the regimental, detachment, or post commander, who will forward them, with his action endorsed thereon, through the proper channel, to his division commander; or, if the troops are not attached to a division, to his corps, department, or other commander or officer to whom the authority to discharge enlisted men may be specially delegated.

These certificates, after having received the action of the highest authority to which they are required to be sent, will be returned through the same channel to the regimental, post, or detachment commander, who will, if the discharge is authorized by the endorsement of the proper authority, sign the soldier's discharge, and the last certificate on this paper; see that the soldier is furnished with the proper final statements in duplicate, and forward BOTH of these certificates direct to the Adjutant General United States Army, at Washington, D. C.; they will not, under any circumstances, be given into the hands of the soldier.

ADJUTANT GENERAL'S OFFICE.
July 29. 1865.
Duplicate sent the Pension Office.

429 A.R. of Rec
1865

CERTIFICATE OF DISABILITY FOR DISCHARGE

IN THE CASE OF

William Tolls
a Private Co. E
Fourth Reg't of U.S.C.

Office Chief Med'l Officer,
Dept of the Gulf,
N. O. June 15th 1865

Approved.

E. H. Abadie
Surgeon, U.S.A.
Chf Med. Off.

M. Reece
Surgeon Major, U.S.A.
Adj. Gen. U.S.A.

Headquarters, Department of the Gulf,
New Orleans, La., June 18th 1865.
To be discharged.

By order of Major General E. R. S. Cooby:

C. J. Jarrett
Captain and A. D. C.

Received (A. G. Office) 1865
Out and Refused
A.R.

ARMY OF THE UNITED STATES
 CERTIFICATE
 OF DISABILITY FOR DISCHARGE.



William Eells Private, of Captain E W Baues
 Company, (E.) of the fourth Regiment of United States
Col'd Cav was enlisted by Leary Touch back of
 the second Regiment of Native Guards at New Orleans La
 on the eight day of November, 1863, to serve three years; he was born
 in Buffalo in the State of New York, is 25
 years of age, 3 feet 8 inches high, black complexion, black eyes
black hair, and by occupation when enlisted a barber. During the last two
 months said soldier has been unfit for duty 60 days. The said soldier
has been unfit for duty during the last
six months for account of constant
sickness. He was unfit for a soldier when
enlisted.

STATION: Post Hudson La
 DATE: June 2^d 1865

E W Baues
 Captain
 Commanding Company.

Office Post Hudson La June 5 1865
 Approved and personal by amateur
Major Keampsey
Major 50th & 60th
Post Engineer

I CERTIFY, that I have carefully examined the said William Eells of
 Captain Baues Company, and find him incapable of performing the duties of a soldier
 because of Feeble Constitution and habitual sickness
Disability existed prior to enlistment and in de-
gree is (1/2) one half

J. D. Hanson
 Surgeon.

DISCHARGED, this twenty sixth day of June, 1865, at Post Hudson La

Nathl G. Mitchell
 Lt Colonel
 Commanding the Reg't

The Soldier desires to be addressed at
 Town _____ County _____ State _____

* See Note 1 on the back of this. † See Note 2 on the back of this.

1064
Tollabine, Jacob.

Co B, 4 U.S. Col'd Cav.

Private Saddler.

CARD NUMBERS.

1	26
2	27
3	28
4	29
5	30
6	31
7	32
8	33
9	34
10	35
11	36
12	37
13	38
14	39
15	40
16	41
17	42
18	43
19	44
20	45
21	46
22	47
23	48
24	49
25	50

Book Mark:

See also

1065

Tom Peter

Co L, 4 U. S. Col'd Cav.

Private

Private

CARD NUMBERS.

1	5347683	26
2	5347653	27
3	5358657	28
4	5358703	29
5	5358755	30
6	5358794	31
7	5348034	32
8	5355668	33
9	5355752	34
10	5355835	35
11	5355915	36
12	5355996	37
13	5356073	38
14	5356150	39
15		40
16		41
17		42
18		43
19		44
20		45
21		46
22		47
23		48
24		49
25		50

Book Mark:

See also

S | **4 Cav. | U.S.C.T.**

Peter Tom

Appears with rank of *Pl* on

Muster and Descriptive Roll of a Detachment of U. S. Vols. forwarded

for the 4 Reg't U. S. Col'd Cavalry. Roll dated

New Orleans La July 18, 186 *4*.

Where born *La*

Age *20* y'rs; occupation *Laborer*

When enlisted *Apr 9*, 186 *4*.

Where enlisted *Alexandria*

For what period enlisted *3* years.

Eyes *DK*; hair *DK*

Complexion *DK*; height *5* ft. *3* in.

When mustered in *June 22*, 186 *4*.

Where mustered in *New Orleans*

Bounty paid \$ *100*; due \$ *100*

Where credited *to Alexandria La*

Company to which assigned *D*

Remarks:

Book mark:

W. A. H. T. J.

S | **4 Cav. U.S.C.T.**

Peter Tom

Appears with rank of *Pf* on

Muster and Descriptive Roll of a Detachment of U. S. Vols. forwarded

for the 4 Reg't U. S. Col'd Cavalry. Roll dated

New Orleans La June 22, 1864

Where born *La*

Age *20* y'rs; occupation *Laborer*

When enlisted *Apr 9*, 1864

Where enlisted *Alexandria*

For what period enlisted *3* years.

Eyes *DK*; hair *DK*

Complexion *DK*; height *5* ft. *3* in.

When mustered in _____, 1864

Where mustered in *New Orleans*

Bounty paid \$ *2* ¹⁰⁰; due \$ ¹⁰⁰

Where credited *to Alexandria La*

Company to which assigned *L*

Remarks: _____

Book mark: _____

Vaut Hubin

F | 4 Cav. | U.S.C.T.

Porter, Tom
Cvt., Co. *L*, 4 Reg't U. S. Col'd Cavalry.

Age _____ years.

Appears on

Company Muster Roll*

for *Enlistment to Aug. 31, 1864.*

Joined for duty and enrolled:

When *Apr. 9*, 1864.

Where *Alexandria La.*

Period *3* years.

Mustered in:

When *June 22nd*, 1864.

Where *New Orleans La.*

Present or absent *Present*

Stoppage, \$ 100 for _____

Due Gov't, \$ 100 for _____

Valuation of horse, \$ 100

Valuation of horse equipments, \$ 100

Remarks : _____

* First current roll. No muster-in roll of this battery on file.

Book mark : _____

Loring

5 | 4 Cav. | U.S.C.T.

Peter Tom

Pvt., Co. L, 4 Reg't U.S. Col'd Cavalry.

Appears on

Company Muster Roll

for Sept. & Oct., 1864.

Present or absent Present

Stoppage, \$ 100 for

Due Gov't, \$ 100 for

Valuation of horse, \$ 100

Valuation of horse equipments, \$ 100

Remarks:

Book mark:

Curry

4 Cav. U.S.C.T.

Peter Tom

Pvt., Co. L, 4 Reg't U. S. Col'd Cavalry.

Appears on

Company Muster Roll

for Nov. & Dec., 1864.

Present or absent Present

Stoppage, \$ 100 for

Due Gov't, \$ 100 for

Valuation of horse, \$ 100

Valuation of horse equipments, \$ 100

Remarks:

Book mark:

Loring

T | **4 Cav.** | **U.S.C.T.**

Peter Tom

Cvt., Co. L, 4 Reg't U. S. Col'd Cavalry.

Appears on

Company Muster Roll

for *Jan. + Feb.*, 1865.

Present or absent *Present*

Stoppage, \$ 100 for

Due Gov't, \$ 100 for

Valuation of horse, \$ 100

Valuation of horse equipments, \$ 100

Remarks:

Book mark:

Lerring

(358)

Copyist.

14 Cav | U.S.C.T.

Peter Tom

Prv, Co. F, 4 Reg't U. S. Col'd Cav.

Appears on

M. and D. Roll of Men Transferred

to the organization named above, by Comd.

from Co. L

Roll dated Port Hudson, La Apr 29, 1865.

When enlisted Apr 9, 1864.

Period for which enlisted 3 years.

When mustered in June 22, 1864.

Present or absent Not stated

Company to which assigned A

Remarks:

Book mark:

Ed Leonard

J | **4 Cav.** | **U.S.C.T.**

Peter James

Pvt, Co. F, 4 Reg't U. S. Col'd Cavalry.

Appears on

Company Muster Roll

for *Mch & Apr*, 186 *3*

Present or absent *Present*

Stoppage, \$ 100 for

Due Gov't, \$ 100 for

Valuation of horse, \$ 100

Valuation of horse equipments, \$ 100

Remarks: *Joined by transfer from "L. Co. P. S. Co. No. 28" dated 4th Drs. Dept of the Gulf Jan 28/865.*

Book mark: _____

J. H. Harris

J | 4 Cav. | U.S.C.T.

Peter Toms

Pvt, Co. F, 4 Reg't U. S. Col'd Cavalry.

Appears on

Company Muster Roll

for *May & June*, 186*5*.

Present or absent *Present*

Stoppage, \$.....*100* for

Due Gov't, \$.....*100* for

Valuation of horse, \$.....*100*

Valuation of horse equipments, \$.....*100*

Remarks:

Book mark:

J. Harris

I | **4 Cav.** | **U.S.C.T.**

Peter Tom

Prk, Co. F, 4 Reg't U. S. Col'd Cavalry.

Appears on

Company Muster Roll

for *July & Aug*, 186*3*.

Present or absent *Present*

Stoppage, \$ 100 for

Due Gov't, \$ 100 for

Valuation of horse, \$ 100

Valuation of horse equipments, \$ 100

Remarks:

Book mark:

M Harris

J | 4 Cav. | U.S.C.T.

Peter Town

Pvt, Co. F, 4 Reg't U. S. Col'd Cavalry.

Appears on

Company Muster Roll

for *Sept & Oct*, 186 *5*

Present or absent *Present*

Stoppage, \$ 100 for

Due Gov't, \$ 100 for

Valuation of horse, \$ 100

Valuation of horse equipments, \$ 100

Remarks:

Book mark: _____

A. W. Harn;

T | 4 Cav. | U.S.C.T.

Peter Toms

P., Co. F, 4 Reg't U. S. Col'd Cavalry.

Appears on

Company Muster Roll

for Nov. 1865

Present or absent Present

Stoppage, \$ 100 for

Due Gov't, \$ 100 for

Valuation of horse, \$ 100

Valuation of horse equipments, \$ 100

Remarks:

Book mark:

(358)

Hibbard

Copyist.

T | 4 Cav. | U.S.C.T.

Peter Toms

P, Co. F, 4 Reg't U. S. Col'd Cavalry.

Appears on

Company Muster Roll

for Jan. Feb., 1866

Present or absent Present

Stoppage, \$ 100 for

Due Gov't, \$ 100 for

Valuation of horse, \$ 100

Valuation of horse equipments, \$ 100

Remarks:

Book mark:

Hibbard Copyist.

T | 4 Cav. | U.S.C.T.

Peter Jones

P, Co. F, 4 Reg't U. S. Col'd Cavalry.

Appears on Co. Muster-out Roll, dated
New Orleans, La. Mch. 20, 1866.

Muster-out to date Mch. 20, 1866.

Last paid to June 30, 1865.

Clothing account:

Last settled, 186 ; drawn since \$ 100

Due soldier \$ 100; due U. S. \$ 13. 31/100

Am't for cloth'g in kind or money adv'd \$ 100

Due U. S. for arms, equipments, &c., \$ 50/100

Bounty paid \$ 100; due \$ 100

Remarks: Joined by transfer from
Co. L per S.O. 28, Hdqrs D.S.
Jan. 28, 65. Stop 1 Carbine
Pocket.

Book mark: V116-P283-70

Hibbard

1066

1066
Eram
Thomas, Oram, or,

Co. E, 4 U. S. Col'd Cav.

Private | Bugler

CARD NUMBERS

1	5353847	26
2	5353900	27
3	5353956	28
4	5354009	29
5	5354085	30
6	5354104	31
7	5354213	32
8	5354278	33
9	5354340	34
10	5354424	35
11	5354499	36
12	5354580	37
12	5354611	38
14	5354684	39
15	5354752	40
16	5354822	41
17		42
18		43
19		44
20		45
21		46
22		47
23		48
24		49
25		50

Book Mark:

See also

1893

S. 11515 82 and N. D.
D. 1329946 and N. D.

D. Jordan
C.

T | **4 Cav. U.S.C.T.**

Evam Thomas

Pvt., Co. *E*, 1 Reg't, Corps d'Afrique Cavalry.*
* *Age 22 yrs.*
Appears on

Company Muster-in Roll

of the organization named above. Roll dated

New Orleans La. Dec. 31, 186*3*.

Muster-in to date *Dec. 31*, 186*3*.

Joined for duty and enrolled:

When *Nov. 12*, 186 .

Where *New Orleans*

Period *3* years.

Valuation of horse, \$ 100

Valuation of horse equipments, \$ 100

Remarks:

+ Inserted by Jordan Ex.

*This organization subsequently became Co. *E*, 4 Reg't U. S. Colored Cavalry.

Book mark:

Wendell

T 4 Cav. U.S C.T.

Erasmus Thomas
PW, Co. *E*, 1 Reg't Cav., Corps d'Afrique.*

Appears on
Company Muster Roll

for *in list dated to Dec. 31, 1863*

Present or absent *Present*

Stoppage, \$ *100* for

Due Gov't, \$ *100* for

Valuation of horse, \$ *100*

Valuation of horse equipments, \$ *100*

Remarks:
.....
.....
.....
.....
.....

* This organization subsequently became Co. *E*, 4 Reg't U. S. Colored Cavalry.

Book mark:

Wendel

J 4 Cav. U.S. C.T.

Evan Thomas

, Co. *E*, 1 Reg't Cav., Corps d'Afrique.*

Appears on

Company Muster Roll

for *Jan + Feb*, 186*4*

Present or absent *Present*

Stoppage, \$ *100* for

Due Gov't, \$ *100* for

Valuation of horse, \$ *100*

Valuation of horse equipments, \$ *100*

Remarks:

* This organization subsequently became Co. *E*, 4 Reg't U. S. Colored Cavalry.

Book mark: *S*

L. W. ...

J | **4 Cav. U.S.C.T.**

Errom Thomas

Put., Co. E, 4 Reg't U. S. Col'd Cav.

Appears on

Company Muster Roll

for *Mar & Apr*, 1864

Present or absent *Present*

Stoppage, \$ 100 for

Due Gov't, \$ 100 for

Valuation of horse, \$ 100

Valuation of horse equipments, \$ 100

Remarks:

Book mark:

Laurel

J | **4 Cav.** | **U.S.C.T.**

Evam Thomas

Angler, Co. E, 4 Reg't U. S. Col'd Cav.

Appears on

Company Muster Roll

for *May & June*, 1864.

Present or absent *Present*

Stoppage, \$ 100 for

Due Gov't, \$ 100 for

Valuation of horse, \$ 100

Valuation of horse equipments, \$ 100

Remarks:

Book mark:

L. L. Linnard

J | 4 Cav. | U.S.C.T.

Evan Thomas

Bugler, Co. E, 4 Reg't U. S. Col'd Cav.

Appears on

Company Muster Roll

for July & Aug, 1864

Present or absent Present

Stoppage, \$ 100 for

Due Gov't, \$ 100 for

Valuation of horse, \$ 100

Valuation of horse equipments, \$ 100

Remarks:

Book mark:

J | 4 Cav. | U.S.C.T.

Evan Thomas

Plt., Co. E, 4 Reg't U. S. Col'd Cav.

Appears on

Company Muster Roll

for *Sept + Oct*, 1864

Present or absent *Present*

Stoppage, \$ 100 for

Due Gov't, \$ 100 for

Valuation of horse, \$ 100

Valuation of horse equipments, \$ 100

Remarks: *Reduced to ranks
from Bugler Sept 1/64*

Book mark: *100*

L. L. L.

J | **4 Cav. U.S.C.T.**

Eram Thomas

Pvt, Co. E, 4 Reg't U. S. Col'd Cav.

Appears on

Company Muster Roll

for *Nov. & Dec.*, 1864.

Present or absent *Present*

Stoppage, \$ *100* for

Due Gov't, \$ *100* for

Valuation of horse, \$ *100*

Valuation of horse equipments, \$ *100*

Remarks: *Stop for no Bag*

Book mark:

Wines
(358) Copyist.

J | 4 Cav. | U.S.C.T.

Erem Thomas

Pvt, Co. E, 4 Reg't U. S. Col'd Cav.

Appears on

Company Muster Roll

for *Jan & Feb*, 186 *J.*

Present or absent *Present*

Stoppage, \$ *100* for

Due Gov't, \$ *100* for

Valuation of horse, \$ *100*

Valuation of horse equipments, \$ *100*

Remarks: *Stop for 1 blanket 1
pr spurs & straps and 1
suncingle Pres only
7 doll per month to
include Apr 30/63
stop for 1 nose bag*

Book mark:

Wines

J | 4 Cav. | U.S.C.T.

Eram Thomas

Pl, Co. E, 4 Reg't U. S. Col'd Cav.

Appears on

Company Muster Roll

for *Mar & Apr*, 1865.

Present or absent *Present*

Stoppage, \$ 100 for

Due Gov't, \$ 100 for

Valuation of horse, \$ 100

Valuation of horse equipments, \$ 100

Remarks:

Book mark:

Wines

J | 4 Cav. | U.S.C.T.

Evan Thomas

Plt, Co. E, 4 Reg't U. S. Col'd Cav.

Appears on

Company Muster Roll

for *May & June*, 186*J*.

Present or absent *Present*

Stoppage, \$.....*100* for

Due Gov't, \$.....*100* for

Valuation of horse, \$.....*100*

Valuation of horse equipments, \$.....*100*

Remarks:

Book mark:

Wines

J | 4 Cav. | U.S.C.T.

Eram Thomas

Plt, Co. E, 4 Reg't U. S. Col'd Cav.

Appears on

Company Muster Roll

for *July & Aug*, 186*5*.

Present or absent *Present*

Stoppage, \$.....*100* for

Due Gov't, \$.....*100* for

Valuation of horse, \$.....*100*

Valuation of horse equipments, \$.....*100*

Remarks:

Book mark:

(358)

Wines

Copyist.

J | 4 Cav. | U.S.C.T.

Eron Thomas

Bugler, Co. E, 4 Reg't U. S. Col'd Cav.

Appears on

Company Muster Roll

for *Sept & Oct*, 186*J*.

Present or absent *Present*

Stoppage, \$ *100* for

Due Gov't, \$ *100* for

Valuation of horse, \$ *100*

Valuation of horse equipments, \$ *100*

Remarks:

Book mark:

Wines
Copyist.

J | 4 Cav. | U.S.C.T.

Eram Thomas

Bugler, Co. E, 4 Reg't U. S. Col'd Cav.

Appears on

Company Muster Roll

for *Nov. & Dec.*, 1865.

Present or absent *Present.*

Stoppage, \$ *100* for

Due Gov't, \$ *100* for

Valuation of horse, \$ *100*

Valuation of horse equipments, \$ *100*

Remarks:

Book mark:

Lloyd

J | 4 Cav. | U.S.C.T.

Eron Thomas

Bugler, Co. E, 4 Reg't U. S. Col'd Cav.

Appears on

Company Muster Roll

for *Jany & Kelly*, 1866.

Present or absent *Present*

Stoppage, \$ *100* for

Due Gov't, \$ *100* for

Valuation of horse, \$ *100*

Valuation of horse equipments, \$ *100*

Remarks:

Book mark:

Floyd

J | 4 Cav. | U.S.C.T.

Evan Thomas

Bugby, Co. E, 4 Reg't U. S. Col'd Cavalry.

Appears on **Co. Muster-out Roll**, dated

New Orleans La, Mich 20, 1866.

Muster-out to date *Mich 20*, 1866.

Last paid to *June 30*, 1865.

Clothing account:

Last settled....., 186 ; drawn since \$..... 100

Due soldier \$..... 100; due U. S. \$ *31* ^{*93*}/₁₀₀

Am't for cloth'g in kind or money adv'd \$..... 100

Due U. S. for arms, equipments, &c., \$..... 100

Bounty paid \$..... 100; due \$..... 100

Remarks: *joined orig org. Priv to*
Oct. 1/65.

Book mark: *V. 26 P. 157. 68*

(861)

Lloyd

Copyist.

1067

Thompson, Joseph
Co. A, 4 U.S. Col'd Cav.

Private *Private*

CARD NUMBERS.

1	26
2	27
3	28
4	29
5	30
6	31
7	32
8	33
9	34
10	35
11	36
12	37
13	38
14	39
15	40
16	41
17	42
18	43
19	44
20	45
21	46
22	47
23	48
24	49
25	50

Book Mark:

See also

1068

Toney Joseph

Co C, 4 U. S. Col'd Cav.

Private

Private

CARD NUMBERS.

1	5347782	26
2	5351680	27
3	5351745	28
4	5351813	29
5	5351903	30
6	5352005	31
7	5352103	32
8	5352202	33
9	5352295	34
10	5352383	35
11	5352472	36
12	40729279	37
13		38
14		39
15		40
16		41
17		42
18		43
19		44
20		45
21		46
22		47
23		48
24		49
25		50

Book Mark:

See also

4 | **4 Cav. | U.S.C.T.**

Joseph Bond

Appears with rank of *Sub.* on

Muster and Descriptive Roll of a Detachment of U. S. Vols. forwarded

for the 4 Reg't U. S. Col'd Cavalry. Roll dated *New Orleans, La., Aug. 26,* 1864.

Where born *Iberville Parish, La.*

Age *24* y'rs; occupation *Subs.*

When enlisted *Aug. 24,* 1864.

Where enlisted *New Orleans*

For what period enlisted *3* years.

Eyes *Black*; hair *Black*

Complexion *Dark*; height *5 ft. 2 in.*

When mustered in *Aug. 26,* 1864.

Where mustered in *New Orleans*

Bounty paid \$ *100* ¹⁰⁰; due \$ *5.00* ¹⁰⁰

Where credited *New Orleans*

Company to which assigned *C*

Remarks: *Recruits entitled to*

Bounty.

Book mark:

H. J. Tyler

7 | 4 Cav. | U.S.C.T.

Joseph Toney
Sgt., Co. C, 4 Reg't U. S. Colored Cavalry.

Appears on

Company Muster Roll

for Sept & Oct, 1864.

Present or absent Absent

Stoppage, \$ 100 for

Due Gov't, \$ 100 for

Valuation of horse, \$ 100

Valuation of horse equipments, \$ 100

Remarks: Lost blanket
\$2.25 In arrest
since Oct 20. 64

Book mark:

Reedester

(358)

Copyist.

7 | **4 Cav.** | **U.S.C.T.**

Joseph Toney
Priv, Co. C, 4 Reg't U. S. Colored Cavalry.

Appears on

Company Muster Roll
for *Nov & Dec*, 186 *4*

Present or absent *present*

Stoppage, \$ *2* ^{*25*}/_{*100*} for *ordnance*

Due Gov't, \$ *100* for

Valuation of horse, \$ *100*

Valuation of horse equipments, \$ *100*

Remarks: *Lost ordnance*

Book mark: _____

(358)

Moy
Copyist.

J | **4 Cav.** | **U.S.C.T.**

Joseph Tony
Priv, Co. C, 4 Reg't U. S. Colored Cavalry.

Appears on
Company Muster Roll
for *Jan & Feb*, 186*5*.

Present or absent *present*

Stoppage, \$ *100* for

Due Gov't, \$ *100* for

Valuation of horse, \$ *100*

Valuation of horse equipments, \$ *100*

Remarks: *Stop for saddle
blanket, one halter
strap.*

Book mark: _____

(358)

May
Copyist.

7 | 4 Cav. | U.S.C.T.

Joseph Tony
Priv, Co. C, 4 Reg't U. S. Colored Cavalry.

Appears on

Company Muster Roll

for *Mehrap*, 1865.

Present or absent *present*

Stoppage, \$ *100* for

Due Gov't, \$ *100* for

Valuation of horse, \$ *100*

Valuation of horse equipments, \$ *100*

Remarks:

Book mark:

(358)

Moy
Copyist.

J | 4 Cav. | U.S.C.T.

Joseph Tony
Priv, Co. C, 4 Reg't U. S. Colored Cavalry.

Appears on

Company Muster Roll

for *May & June*, 186*3*.

Present or absent *present*

Stoppage, \$ *100* for

Due Gov't, \$ *100* for

Valuation of horse, \$ *100*

Valuation of horse equipments, \$ *100*

Remarks: *Stop for one canteen,
one haversack.*

Book mark:

(358)

Moy Copyist.

J | 4 Cav. | U.S.C.T.

Joseph Toney
Priv, Co. C, 4 Reg't U. S. Colored Cavalry.

Appears on

Company Muster Roll

for *July & Aug*, 186*5*

Present or absent *present*

Stoppage, \$ *100* for

Due Gov't, \$ *100* for

Valuation of horse, \$ *100*

Valuation of horse equipments, \$ *100*

Remarks: *Stop for 1 canteen
1 haversack, Total \$1.60*

Book mark:

(358)

Moy Copyist.

J | **4 Cav.** | **U.S.C.T.**

Joseph Toney
Priv, Co. C, 4 Reg't U. S. Colored Cavalry.

Appears on

Company Muster Roll

for *Sept & Oct*, 1865.

Present or absent *present*

Stoppage, \$ 100 for

Due Gov't, \$ 100 for

Valuation of horse, \$ 100

Valuation of horse equipments, \$ 100

Remarks: *Stop for 1 saddle complete (viz: 1 saddle, 1 pr stirrups & straps, 1 pr sweat leathers, 1 girth, 1 ear, socket & strap) Total, without a surcingle \$17.02, 1 carbine sling & swivel 1.83, 1 sabre knot 30cts, Total \$19.15*

Book mark:

** As appears on roll.*

Moy

J | **4 Cav.** | **U.S.C.T.**

Joseph Toney
Choate, Co. C, 4 Reg't U. S. Colored Cavalry.

Appears on

Company Muster Roll

for *Nov & Dec.*, 186*5*.

Present or absent *present*

Stoppage, \$ *18* ^{*83*}/_{*100*} for *lost*
ordnance

Due Gov't, \$ *100* for

Valuation of horse, \$ *100*

Valuation of horse equipments, \$ *100*

Remarks:

Book mark:

M. A. Michaels

S | **4 Cav.** | **U.S.C.T.**

Joseph Toney
Private, Co. C, 4 Reg't U. S. Colored Cavalry.

Appears on

Company Muster Roll

for *Jan'y & Febr.*, 186*6*.

Present or absent *present*

Stoppage, \$ *18*^{*83*}/₁₀₀ for *Lost*
Ordinance

Due Gov't, \$ *100* for

Valuation of horse, \$ *100*

Valuation of horse equipments, \$ *100*

Remarks:

Book mark:

M. A. Michaels
(358) Copyist.

J | **4 Cav.** | **U.S.C.T.**

Joseph Toney
Priv, Co. C, 4 Reg't U. S. Colored Cav.

Appears on **Returns** as follows:

Sept 1864 - Gain: Sept 21/64
Post Hudson Enlisted

Oct 1864 - Absent sent Oct 20/64
to Post Guard House to
await trial

Book mark: _____

W. R. Lee
Copyist.

J | **4 Cav.** | **U.S.C.T.**

Joseph James
Private, Co. *C*, 4 Reg't U. S. Col'd Cavalry.

Appears on **Co. Muster-out Roll**, dated
New Orleans La Mar 20, 186 *6*.

Muster-out to date *Mar 20*, 186 *6*.

Last paid to *June 30*, 186 *5*.

Clothing account:

Last settled....., 186 ; drawn since \$..... $\frac{100}{100}$

Due soldier \$..... $\frac{100}{100}$; due U. S. \$ *37* $\frac{98}{100}$

Am't for cloth'g in kind or money adv'd \$..... $\frac{100}{100}$

Due U. S. for arms, equipments, &c., \$ *19* $\frac{36}{100}$

Bounty paid \$ *100* $\frac{100}{100}$; due \$..... $\frac{100}{100}$

Remarks: *Joined as recruit*
Stop 1 Saddle, 1 pair Stirrups 2
Sweat leathers 1 Girth, 1 Carbine
Socket & Straps, 1 Carbine Sling
& Swivel 1 Sabre knot

Book mark :

W. A. Michaels

Tony, Joseph

, Co. 4 Reg't U. S. Cavalry

Enclosures.

Bed Cards	Final Statements
Burial Records	Furloughs or L. of A.
Certs. of Dis. for Discharge	Med. Certificates
C. M. Charges	Med. Des. Lists
Descriptive Lists	Orders
Discharge Certificates	Pris. of War Record
Enlistment Papers	Resignations

Other papers relating to—

Admission to Hosp'l	Furlough or L. of A.
Casualty Sheet	Med. Examination
Confinement	Misc. Information
Contracts	Pay of Clothing
Death or Effects	Personal Reports
Desertion	Rank
Discharge from Hosp'l	Transfer to Hosp'l
Discharge from Service	Transfer to V. R. C.
Duty	Transportation

NOTE 1.—This blank will be used for both enlistments and re-enlistments—enlistment of veterans, &c., &c., in the volunteer service. They will be made out in duplicate in all cases—one to accompany the recruiting return of the superintendent (not the recruiting officer) to the Adjutant General, and one to accompany the accounts of the officer who pays bounty, &c. The Regiment and Company in which the soldier last served should be given on the back.

NOTE 2.—An enlistment holds to service. A muster-in must, in all cases, precede payment of pay, bounty, pension, &c. A muster-in roll must, in all cases, be filed in the Adjutant General's Office as evidence of muster-in. The mustering officer, commissary, or assistant commissary of musters, as the case may be, will countersign both enlistments as having mustered the soldier into the service of the United States before either of them is given to the disbursing officer.

DECLARATION OF RECRUIT.

I, Joseph Toney, desiring to VOLUNTEER as a Soldier in the Army of the United States, for the term of THREE YEARS, Do Declare, That I am Twenty four years and _____ months of age; that I have never been discharged from the United States service on account of disability or by sentence of a court martial, or by order before the expiration of a term of enlistment; and I know of no impediment to my serving honestly and faithfully as a soldier for three years.

GIVEN at New Orleans the 24 day of August 1864

Witness: J. Bunker Joseph Toney
mark

No.

Joseph Toney

Volunteered at New Orleans

the 24 day of August, 1864.

By Capt. S. B. Carter

4 Regiment of U. S. Col.

Cavalry

enlistment; last served in Company ()

Regt of _____

Discharged _____, 1864

Recruited from the 4th Company
of the 4th Cavalry
at New Orleans
August 11th 1864

Received from Second Auditor

August 26th, 1892.

CONSENT IN CASE OF MINOR.

I, _____, Do CERTIFY, That I am _____ the _____ of _____; that the said _____ is _____ years of age; and I do hereby freely give my CONSENT to his volunteering as a SOLDIER in the ARMY OF THE UNITED STATES for the period of THREE YEARS.

GIVEN at _____ the _____ day of _____

Witness: _____

1864

VOLUNTEER ENLISTMENT.

STATE OF

TOWN OF

Louisiana

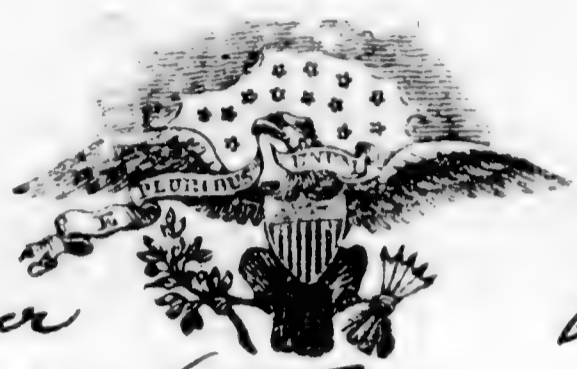

New Orleans,

I, *Joseph Tony*, born in *Parish Iberville*
in the State of *Louisiana*, aged *Twenty four* years,
and by occupation a *Laborer*, DO HEREBY ACKNOWLEDGE to have
volunteered this *Twenty fourth* day of *August*, 1864,
to serve as a **Soldier** in the **Army of the United States of America**, for
the period of **THREE YEARS**, unless sooner discharged by proper authority:
Do also agree to accept such bounty, pay, rations, and clothing, as are, or may be,
established by law for volunteers. And I, *Joseph Tony*, do
solemnly swear, that I will bear true faith and allegiance to the **United States
of America**, and that I will serve them honestly and faithfully against all
their enemies or opposers whomsoever; and that I will observe and obey the
orders of the President of the United States, and the orders of the officers
appointed over me, according to the Rules and Articles of War.

Sworn and subscribed to, at *New Orleans*
this *24* day of *August*, 1864, } *Joseph Tony*
BEFORE *Capt. F. Bruter* } *in part.*
4th Dr. S. vol. Cav.

I CERTIFY, ON HONOR, That I have carefully examined the above-named Volunteer, agreeably
to the General Regulations of the Army, and that, in my opinion, he is free from all bodily defects and
mental infirmity, which would in any way disqualify him from performing the duties of a soldier.

M. Matter
EXAMINING SURGEON.

I CERTIFY, ON HONOR, That I have minutely inspected the Volunteer *Joseph Tony*
previously to his enlistment, and that he was entirely sober when enlisted; that, to the best of my
judgment and belief, he is of lawful age; and that, in accepting him as duly qualified to perform the
duties of an able-bodied soldier, I have strictly observed the Regulations which govern the recruiting
service. This soldier has *blue* eyes, *black* hair, *dark* complexion, is *five*
feet *two* inches high.

Francis Bruter Capt.
4th Regiment of Dr. S. vol. Volunteers, Cav.
RECRUITING OFFICER.

(A. G. O. No. 74 & 76.)

Mastered into the service of the United States, for three years or during the war, from date of enlistment, in Company *C*
4th Regiment of M. S. Cav. Volunteers, on the 24th day of August, 1864 at New Orleans La.

John M. Chauvontayre
1st Lt. 10th U. S. V. (26)
A. E. M.

1069
Tonga, John

Co. D, 4 U. S. Col'd Cav.

Private Corporal

CARD NUMBERS.

1	26
2	27
3	28
4	29
5	30
6	31
7	32
8	33
9	34
10	35
11	36
12	37
13	38
14	39
15	40
16	41
17	42
18	43
19	44
20	45
21	46
22	47
23	48
24	49
25	50

See Tonga, John

Connected by O.M.H. May 19. 1912

Book Mark:

See also

1070

Ponsa John

Co *D.F.*, **4** U. S. Col'd Cav.

Private. | *Corporal*

CARD NUMBERS.

1	5347412	26
2	5354987	27
3	5355076	28
4	5355169	29
5	5355256	30
6	5355346	31
7	5355429	32
8	5355510	33
9	5355585	34
10	5355667	35
11	5355751	36
12	5355834	37
13	5355914	38
14	5355942	39
15	5356023	40
16	5356100	41
17	40729278	42
18		43
19		44
20		45
21		46
22		47
23		48
24		49
25		50

**Corrected by pmc. May 13. 1912*

Book Mark:

See also

Q 2901228 and no
D. 3072904 PONTM
A. G. 2098413 - Do 11/19/13

D. Jordan
Q

T. H. Law | U.S.C.T.

John Sousa

P. & M. Edwards
Co. *A*, *4* Reg't U. S. Col'd

Age years.

Appears on a

Detachment Muster-in Roll

of the organization named above. Roll dated

Siberia Dec 15, 1863.

Muster-in to date

Dec 15, 1863.

Joined for duty and enrolled:

When *Dec 5*, 1863.

Where *Siberia La*

Period years.

Valuation of horse, \$ 100

Valuation of horse equipments, \$ 100

Remarks :

Book mark :

x corrected by m. H. May 13 1912.

W. L. L.

4 Cav. U.S.C.T.

John Touse

Co. A, Mounted Rangers, Corps d'Afrique.†

Age _____ years.

Appears on

Company Muster Roll*

for Nov & Dec, 1863.

Joined for duty and enrolled:

When Dec 5, 1863.

Where Iberia, La

Period _____ years.

Mustered in:

When Dec 15, 1863.

Where Iberia, La

Present or absent Present

Stoppage, \$ 100 for _____

Due Gov't \$ 100 for _____

Valuation of horse, \$ 100

Valuation of horse equipments, \$ 100

Remarks: _____

†This organization subsequently became Co. F, 4 U.S. Col'd Cav.
*First current roll. No muster-in roll of this battery on file.

Book mark: _____

(3586) Hummery Copyist.

J | **4 Cav. | U.S C.T.**

John Tusa

Pt., Co. *F*, 1 Reg't Cav., Corps d'Afrique.*

Appears on

Company Muster Roll

for *Jan'y P Feb'y*, 186*4*.

Present or absent *Present*

Stoppage, \$ *100* for

Due Gov't, \$ *100* for

Valuation of horse, \$ *100*

Valuation of horse equipments, \$ *100*

Remarks:

* This organization subsequently became Co. *F*, 4 Reg't U. S. Colored Cavalry.

Book mark:

M. J. Copyist.

J | 4 Cav. | U.S.C.T.

John Touse
Priv, Co. F, 4 Reg't U. S. Col'd Cavalry.

Appears on

Company Muster Roll

for *March & April*, 1864.

Present or absent *Present*

Stoppage, \$ 100 for

Due Gov't, \$ 100 for

Valuation of horse, \$ 100

Valuation of horse equipments, \$ 100

Remarks:

Book mark:

Manning
Copyist.

J | 4 Cav. | U.S.C.T.

John Tausa

Cor, Co. F, 4 Reg't U. S. Col'd Cavalry.

Appears on

Company Muster Roll

for *May & June*, 186*4*.

Present or absent *Present*

Stoppage, \$ 100 for

Due Gov't, \$ 100 for

Valuation of horse, \$ 100

Valuation of horse equipments, \$ 100

Remarks:

Book mark:

W. H. ...
Cpyist.

J | **4 Cav.** | **U.S.C.T.**

John Tarrow

Pr, Co. F, 4 Reg't U. S. Col'd Cavalry.

Appears on

Company Muster Roll

for *July & Aug*, 1864.

Present or absent *Present*

Stoppage, \$ 100 for

Due Gov't, \$ 100 for

Valuation of horse, \$ 100

Valuation of horse equipments, \$ 100

Remarks:

Book mark:

W. M. ...
Copyist.

T | 4 Cav. | U.S.C.T.

John Touse
Prst, Co. F, 4 Reg't U. S. Col'd Cavalry.

Appears on

Company Muster Roll
for *Nov. & Dec*, 186*4*

Present or absent *Present*

Stoppage, \$ *100* for

Due Gov't, \$ *100* for

Valuation of horse, \$ *100*

Valuation of horse equipments, \$ *100*

Remarks: *Stop for one Halter.*

Book mark: _____

A. Harris

MAR 29 1865

J | 4 Cav. | U.S.C.T.

John Touse
Prvt, Co. F, 4 Reg't U. S. Col'd Cavalry.

Appears on

Company Muster Roll

for *Jan & Feby*, 1865

Present or absent *Present*

Stoppage, \$ *100* for

Due Gov't, \$ *100* for

Valuation of horse, \$ *100*

Valuation of horse equipments, \$ *100*

Remarks: *Stop for one halter,*

Book mark: _____

J. W. Harris

(358)

Copyist.

MAR 20 1865

J | 4 Cav. | U.S.C.T.

John Touse
Pvt, Co. F, 4 Reg't U. S. Col'd Cavalry.

Appears on

Company Muster Roll
for *Mich & Apr*, 186*5*

Present or absent *Present*

Stoppage, \$ 100 for

Due Gov't, \$ 100 for

Valuation of horse, \$ 100

Valuation of horse equipments, \$ 100

Remarks:

Book mark:

S. H. Harris

(358)

Copyist.

J | 4 Cav. | U.S.C.T.

John Touse
Pvt, Co. F, 4 Reg't U. S. Col'd Cavalry.

Appears on

Company Muster Roll

for *May + June*, 186 *5*

Present or absent *Present*

Stoppage, \$..... *100* for.....

Due Gov't, \$..... *100* for.....

Valuation of horse, \$..... *100*

Valuation of horse equipments, \$..... *100*

Remarks: *Quell U.S. lost Ordnance*
\$183
Surcingle, Horse Brush.

Book mark:

M. Harris

T | 4 Cav. | U.S.C.T.

John Sousa
Prk, Co. F, 4 Reg't U. S. Col'd Cavalry.

Appears on

Company Muster Roll

for *July & Aug*, 186 *5*

Present or absent *Present*

Stoppage, \$ 100 for

Due Gov't, \$ 1 ^{*83*}/₁₀₀ for *Ordinance & Horse Equipments.*

Valuation of horse, \$ 100

Valuation of horse equipments, \$ 100

Remarks:

Book mark:

S. A. Harris

(358)

Copyist.

J | 4 Cav. | U.S.C.T.

John Touse
Pvt., Co. F, 4 Reg't U. S. Col'd Cavalry.

Appears on

Company Muster Roll

for *Sept & Oct*, 186 *2*

Present or absent *Present*

Stoppage, \$.....100 for

Due Gov't, \$.....100 for

Valuation of horse, \$.....100

Valuation of horse equipments, \$.....100

Remarks:

Book mark:

A. Harris

T | 4 Cav. | U.S.C.T.

John Tausa
Corp., Co. F, 4 Reg't U. S. Col'd Cavalry.

Appears on

Company Muster Roll

for Nov. & Dec., 1865.

Present or absent Present

Stoppage, \$ 100 for

Due Gov't, \$ 100 for

Valuation of horse, \$ 100

Valuation of horse equipments, \$ 100

Remarks: Promoted Corp'l. from
Pvt. Dec. 1, 1865.

Book mark :

(358)

Hibbard
Copyist.

T | **4 Cav.** | **U.S.C.T.**

John Touse
Corp., Co. F, 4 Reg't U. S. Col'd Cavalry.

Appears on

Company Muster Roll

for *Jan. Feb.*, 186*6*.

Present or absent *Present*

Stoppage, \$ 100 for

Due Gov't, \$ 100 for

Valuation of horse, \$ 100

Valuation of horse equipments, \$ 100

Remarks: *Promoted Corp. Dec. 1, 65.*

Book mark:

(358)

Hibbard
Copyist.

D | 4 Cav. | U.S.C.T.

John Touse
Priv., Co. F, 4 Reg't U. S. Colored Cav.

Appears on Returns as follows:

July to Sept 1865 - On duty orderly
at Post Med. Dep.

John Touse

Book mark:

W. R. Lee

J | 4 Cav. | U.S.C.T.

John Tonga
Corp., Co. J, 4 Reg't U. S. Col'd Cavalry.

Appears on Co. Muster-out Roll, dated
New Orleans La., Mch. 20 1866.

Muster-out to date Mch. 20 1866.

Last paid to June 30 1865.

Clothing account:

Last settled....., 186 ; drawn since \$..... 100

Due soldier \$ 11³²..... 100; due U. S. \$..... 100

Am't for cloth'g in kind or money adv'd \$..... 100

Due U. S. for arms, equipments, &c., \$..... 100

Bounty paid \$..... 100; due \$..... 100

Remarks: Joined at orig. org.
Priv. to Dec 1, 65.

Book mark: V26, P63, 68.

(361)

Hibbard

Copyist.

1071

Poppin George

Co *C*, 4 U.S. Col'd Cav.

Private

Private

CARD NUMBERS.

1	5347434	26
2	5351414	27
3	5351477	28
4	5351544	29
5	5351624	30
6	5352535	31
7	40729286	32
8		33
9		34
10		35
11		36
12		37
13		38
14		39
15		40
16		41
17		42
18		43
19		44
20		45
21		46
22		47
23		48
24		49
25		50

Book Mark:

See also

T | **4 Cav. | U.S.C.T.**

George Tappin
 Appears with rank of *Private* on

Muster and Descriptive Roll of a Detachment of U. S. Vols. forwarded

for the 4 Reg't U. S. Col'd Cavalry. Roll dated
New Orleans La April 29, 1864.

Where born *Richmond, Va*

Age *36* y'rs; occupation *Laborer*

When enlisted *Jan. 15*, 1864.

Where enlisted *New Orleans*

For what period enlisted *3* years.

Eyes *Black*; hair *Black*

Complexion *Dark*; height *5 ft. 10 in.*

When mustered in *April 29*, 1864.

Where mustered in _____

Bounty paid \$ *100*; due \$ *100*

Where credited _____

Company to which assigned _____

Remarks : _____

Book mark : _____

O. J. Taylor

J | 4 Cav. | U.S.C.T.

George Toppin
Sgt., Co. C, 1 Reg't La. Cav., Corps d'Afrique.*

Appears on

Company Muster Roll

for Jan Feb, 1864.

Present or absent Present

Stoppage, \$ 100 for

Due Gov't, \$ 100 for

Valuation of horse, \$ 100

Valuation of horse equipments, \$ 100

Remarks: Not mustered on account of being transferred to Recruiting Depot & afterwards returned to Company

*This organization subsequently became Co. C 4 Reg't U. S. Colored Cavalry.

Book mark: _____

Bohmer

T | 4 Cav. | U.S.C.T.

George Toppin
Pot., Co. C, 4 Reg't U. S. Colored Cavalry.

Appears on

Company Muster Roll

for *March + April*, 186*4*.

Present or absent *Present*

Stoppage, \$ 100 for

Due Gov't, \$ 100 for

Valuation of horse, \$ 100

Valuation of horse equipments, \$ 100

Remarks :

Book mark :

Robert

J | **4 Cav.** | **U.S.C.T.**

George Tappin
Co. C, Co. C, 4 Reg't U. S. Colored Cavalry.

Appears on

Company Muster Roll

for *May & June*, 1864.

Present or absent *Present*

Stoppage, \$ 100 for

Due Gov't, \$ 100 for

Valuation of horse, \$ 100

Valuation of horse equipments, \$ 100

Remarks :

Filed with Tappin George

Book mark :

Robert

T | **4 Cav.** | **U.S.C.T.**

George Tappin
Pvt., Co. C, 4 Reg't U. S. Colored Cavalry.

Appears on

Company Muster Roll

for July & Aug, 1864.

Present or absent

Stoppage, \$ 100 for

Due Gov't, \$ 100 for

Valuation of horse, \$ 100

Valuation of horse equipments, \$ 100

Remarks: Absent August 11.
1864 from Camp Parapet,
Carrollton, Maryland, carrying away
one haversack and one
squir scales also lost
his infantry belts, bayonet
& scabbard.

Book mark:

Robert

51 | 4 Cav. | U.S.C.T.

George Hoppin

Priv., Co. C, 4 Reg't U. S. Colored Cav.

Appears on Returns as follows:

Aug 1862 - 2021; Aug 11
Camp Parapet Deserted

Book mark:

W. R. Lu

MAY 22

T | *4 Cav.* | **U.S.C.T.**

George Topin
Private, Co. C, 4 Reg't U. S. Col'd Cavalry

Appears on **Co. Muster-out Roll**, dated
New Orleans La Mar 20, 1866.

Muster-out to date _____, 186 .

Last paid to *Apr 30, 1864.*

Clothing account:

Last settled _____, 186 ; drawn since \$ _____ 100

Due soldier \$ _____ 100; due U. S. \$ *67* ^{*24*}/₁₀₀

Am't for cloth'g in kind or money adv'd \$ _____ 100

Due U. S. for arms, equipments, &c., \$ _____ 100

Bounty paid \$ _____ 100; due \$ _____ 100

Remarks: *Joined as recruit*
deserted Aug. 11/64 at
Carrollton La.

Book mark : _____

(361)

M. A. Michaels
Copyist.

1072
Tousa, John

Co D, 4 U. S. Col'd Cav.

Private | Corporal

CARD NUMBERS.

1		26
2		27
3	See Tousa, John	28
4		29
5		30
6		31
7		32
8		33
9		34
10		35
11		36
12		37
13		38
14		39
15		40
16		41
17		42
18		43
19		44
20		45
21		46
22		47
23		48
24		49
25		50

Book Mark:

See also

1073

Townsend William

Co M, E, 4 U. S. Col'd Cav.

Private

Private

CARD NUMBERS.

1	5347744	26
2	5358856	27
3	5358907	28
4	5358955	29
5	5359002	30
6	5347992	31
7	5354427	32
8	5354501	33
9	5354582	34
10	5354658	35
11	5354728	36
12	5354798	37
12	5354868	38
14	40729282	39
15	40729281	40
16		41
17		42
18		43
19		44
20		45
21		46
22		47
23		48
24		49
25		50

Book Mark:

See also

J | **4 Cav.** | **U.S.C.T.**

William Townsend

Appears with rank of *Pt* on

Muster and Descriptive Roll of a Detachment of U. S. Vols. forwarded

for the 4 Reg't U. S. Col'd Cavalry. Roll dated

New Orleans La July 23, 1864

Where born *La*

Age *25* y'rs; occupation *Laborer*

When enlisted *Apr 9*, 1864

Where enlisted *Alexandria*

For what period enlisted *3* years.

Eyes *DK*; hair *DK*

Complexion *DK*; height *5 ft. 5 in.*

When mustered in *July 13*, 1864

Where mustered in *New Orleans*

Bounty paid \$ *100*; due \$ *100*

Where credited *to Alexandria La*

Company to which assigned *M*

Remarks:

Book mark:

W. H. H. H.

T 4 Cav | **U.S.C.T.**

William Townsend
Priv, Co. *M*, *4* Reg't U.S. Col'd *Cavalry*

Age years.

Appears on

Company Muster Roll*

for *Enlistment to Aug 31*, 186*4*.

Joined for duty and enrolled:

When *Apr 9*, 186*4*.

Where *Alexandria*

Period *3* years.

Mustered in:

When *July 13*, 186*4*.

Where *New Orleans, La*

Present or absent *Present*

Stoppage, \$ *100* for

Due Gov't, \$ *100* for

Valuation of horse, \$ *100*

Valuation of horse equipments, \$ *100*

Remarks: *Detailed as nurse in Reg't*
Hosp 1 S.O. 90.4 W.S.C.C. Aug 29, 1864

* First current roll. No muster-in roll of this company on file.

Book mark :

J.W. Davis
 Copyist.

T | **4 Cav. | U.S.C.T.**

William Townsend

Pr, Co. M, 4 Reg't U. S. Col'd Cavalry.

Appears on

Company Muster Roll

for *Sept & Oct*, 186*4*

Present or absent *Present*

Stoppage, \$ *100* for

Due Gov't, \$ *100* for

Valuation of horse, \$ *100*

Valuation of horse equipments, \$ *100*

Remarks: *Detailed as nurse in Regimental Hoapl S.O. 9074d. Dis 14th U.S.C. Aug 29. 1864. Dis United States for ordnance 43cts*

Book mark:

J. W. Davis

(358)

Copyist.

J | 4 Cav. | U.S.C.T.

William Townsend

Priv, Co. M, 4 Reg't U. S. Col'd Cavalry.

Appears on

Company Muster Roll

for *Nov & Dec*, 186 *4*

Present or absent *Present*

Stoppage, \$ *100* for

Due Gov't, \$ *43*/₁₀₀ for *lost ordnance*

Valuation of horse, \$ *100*

Valuation of horse equipments, \$ *100*

Remarks:

Book mark:

J. W. Davis

J | 4 Cav. | U.S.C.T.

William Townsend

Pvt, Co. M, 4 Reg't U. S. Col'd Cavalry.

Appears on

Company Muster Roll

for *Jan & Feb*, 186 *5*

Present or absent *Present*

Stoppage, \$ *100* for

Due Gov't, \$ *100* for

Valuation of horse, \$ *100*

Valuation of horse equipments, \$ *100*

Remarks: *Lost 120 rsw driver, one wiper, money value of lost ordnance 43 ct*

Book mark:

(358)

J W S
Copyist.

J | 4 Cav. | U.S.C.T.

William Johnson

Pvt, Co. E, 4 Reg't U. S. Col'd Cav.

Appears on

Company Muster Roll

for *Mar & Apr*, 186*5*.

Present or absent *Present*

Stoppage, \$ *100* for

Due Gov't, \$ *100* for

Valuation of horse, \$ *100*

Valuation of horse equipments, \$ *100*

Remarks: *Transferred from Co M by consolidation in compliance with S.O. No. 28, dated, Hd, Qrs, Dept. of the Gulf, Jun, 28/65 (Copy Attached)*

Book mark:

Wires

J 4 Cav. | **U.S.C.T.**

William Townsend
Co. E, 4 Reg't U. S. Col'd *Cav.*

Appears on

M. and D. Roll of Men Transferred

to the organization named above, *by consol.*
from *C. M.*

Roll dated *Port Hudson, La. Apr 29,* 1865.

When enlisted *Apr 9,* 1864.

Period for which enlisted *3* years.

When mustered in *July 13,* 1864.

Present or absent *not placed*

Company to which assigned *E*

Remarks:

Book mark:

W. J. ...

J | **4 Cav.** | **U.S.C.T.**

William Townsend

Pvt, Co. E, 4 Reg't U. S. Col'd Cav.

Appears on

Company Muster Roll

for *May & June*, 186*5*.

Present or absent *Present*

Stoppage, \$ *100* for

Due Gov't, \$ *100* for

Valuation of horse, \$ *100*

Valuation of horse equipments, \$ *100*

Remarks:

Book mark:

(358) *Wines* Copyist.

J | 4 Cav. | U.S.C.T.

William Townsend
Pvt, Co. E, 4 Reg't U. S. Col'd Cav.

Appears on

Company Muster Roll

for July & Aug, 1865.

Present or absent Present

Stoppage, \$ 100 for

Due Gov't, \$ 100 for

Valuation of horse, \$ 100

Valuation of horse equipments, \$ 100

Remarks:

Book mark:

(358)

Wines
Copyist.

J | **4 Cav.** | **U.S.C.T.**

William Townsend
Pvt, Co. E, 4 Reg't U. S. Col'd Cav.

Appears on

Company Muster Roll

for *Sept & Oct*, 186 *5*.

Present or absent *Present*

Stoppage, \$ *100* for

Due Gov't, \$ *100* for

Valuation of horse, \$ *100*

Valuation of horse equipments, \$ *100*

Remarks:

Book mark:

(358) *Wines* Copyist.

J | 4 Cav. | U.S.C.T.

William Townsend

Put, Co. E, 4 Reg't U. S. Col'd Cav.

Appears on

Company Muster Roll

for *Nov. + Dec.*, 1865.

Present or absent *Present.*

Stoppage, \$ *2.99* for *lost ordnance*

Due Gov't, \$ *1.00* for

Valuation of horse, \$ *1.00*

Valuation of horse equipments, \$ *1.00*

Remarks:

Book mark:

Floyd

J | 4 Cav. | U.S.C.T.

William Townsend

Put....., Co. E, 4 Reg't U. S. Col'd Cav.

Appears on

Company Muster Roll

for *Jany & Reby*....., 1866.

Present or absent *Present.*

Stoppage, \$ *2*/₁₀₀ for *lost ordnance*

Due Gov't, \$ *1*/₁₀₀ for

Valuation of horse, \$ *1*/₁₀₀

Valuation of horse equipments, \$ *1*/₁₀₀

Remarks:

Book mark:

(358)

Floyd

Copyist.

D | **4 Cav.** | **U.S.C.T.**

W^m Townsend

Priv, Co. K, 4 Reg't U. S. Colored Cav.

Appears on **Returns** as follows:

Aug 1864 - On duty nurse in Regt
Hospital.

Book mark :

W. R. See

ST | 4 Cav. | U.S.C.T.

Wm Townsend

Priv, Co. M, 4 Reg't U. S. Colored Cav.

Appears on Returns as follows:

Sept 1864 - On duty at Post Hospital.

Oct 1864 - On duty Hospital Nurse

Book mark:

W. R. Lee

NARA 237

J | 4 Cav. | U.S.C.T.

William Townsend

Put, Co. *E*, 4 Reg't U. S. Col'd Cavalry.

Appears on **Co. Muster-out Roll**, dated
New Orleans La, *Mich 20*, 1866.

Muster-out to date *Mich 20*, 1866.

Last paid to *June 30*, 1865.

Clothing account:

Last settled....., 186 ; drawn since \$..... $\overline{100}$

Due soldier \$..... $\overline{100}$; due U. S. \$ *10* $\frac{54}{100}$

Am't for cloth'g in kind or money adv'd \$..... $\overline{100}$

Due U. S. for arms, equipments, &c., \$ *4* $\frac{19}{100}$

Bounty paid \$..... $\overline{100}$; due \$..... $\overline{100}$

Remarks: *Joined by transfer*
from Leo M. per S. O. Rodgers D. G.
Jan 28. 1865 - Stop 1 Surringle
1 Horsebrush 1 curry comb 1
Saber knot 1 Girth

Book mark: *V 26 P 176.68*

(861)

Floyd

Copyist.

1074

Lowsen Abram

Co *B.K.* 4 U.S. Col'd Cav.

Private | *Corporal*

CARD NUMBERS.

1	5347578	26
2	5358389	27
3	5358444	28
4	5358495	29
5	5358539	30
6	5358584	31
7	5348079	32
8	5350600	33
9	5350686	34
10	5350780	35
11	5350869	36
12	5350954	37
12	5351034	38
14	5351114	39
15		40
16		41
17		42
18		43
19		44
20		45
21		46
22		47
23		48
24		49
25		50

Book Mark:

See also

J | **4 Cav. | U.S.C.T.**

Abram Bowen

Appears with rank of *Pot.* on

Muster and Descriptive Roll of a Detachment of U. S. Vols. forwarded

for the 4 Reg't U. S. Col'd Cavalry. Roll dated *New Orleans, La., May 9, 1864.*

Where born *Baltimore Md.*

Age *44* y'rs; occupation *Laborer*

When enlisted *Apr. 26*, 1864.

Where enlisted *Alexandria*

For what period enlisted *3* years.

Eyes *Black*; hair *Black*

Complexion *Dark*; height *5-8* in.

When mustered in *May 9*, 1864.

Where mustered in *New Orleans*

Premium paid 2
Bounty paid \$ *2* ¹⁰⁰; due \$ *2* ¹⁰⁰

Where credited

Company to which assigned *K*

Remarks:

Book mark:

Feaster

1 | **4 Cav. | U.S.C.T.**

Abram Townson
Serjt, Co. K, 4 Reg't U. S. Col'd Cavalry.

Age _____ years.

Appears on

Company Muster Roll*

for May 9 to June 30, 1864.

Joined for duty and enrolled:

When Apr 26, 1864.

Where Alexandria La.

Period 3 years.

Mustered in:

When May 9, 1864.

Where New Orleans La.

Present or absent Present

Stoppage, \$ 100 for _____

Due Gov't, \$ 100 for _____

Valuation of horse, \$ 100

Valuation of horse equipments, \$ 100

Remarks: Promoted Serjt
May 20, 1864

* First current roll. No muster-in roll of this battery on file.

Book mark : _____

A. S. Thompson

(3586)

Copyist.

4 Cav. U.S.C.T.

Abraham P. Weller

Surge, Co. K, 4 Reg't U. S. Col'd Cav.

Appears on

Company Muster Roll

for *July Aug*, 1864.

Present or absent *Present*

Stoppage, \$ 100 for

Due Gov't, \$ 100 for

Valuation of horse, \$ 100

Valuation of horse equipments, \$ 100

Remarks: *Sick*

Book mark:

A. S. Thompson

4

4 Cav. U.S.C.T.

Abraham Busen

Sergeant, Co. K, 4 Reg't U. S. Col'd Cav.

Appears on

Company Muster Roll

for *Sept. & Oct.*, 1864.

Present or absent *Present.*

Stoppage, \$ *100* for

Due Gov't, \$ *100* for

Valuation of horse, \$ *100*

Valuation of horse equipments, \$ *100*

Remarks:

Book mark:

At Camp
Wm. H. ...

J

4 Cav.

U.S.C.T.

Abram Jansen

Corpl, Co. K, 4 Reg't U. S. Col'd Cav.

Appears on

Company Muster Roll

for *Nov. & Dec.*, 1864.

Present or absent *Present*

Stoppage, \$ *100* for

Due Gov't, \$ *100* for

Valuation of horse, \$ *100*

Valuation of horse equipments, \$ *100*

Remarks: *Reduced from Sergh
to corpl Per S.O. No. 118
14d Dec. 14th U.S.C. Co.
Dec 14*

Book mark:

H. S. Thompson

4 Cav. U.S.C.T.

Abram Tomson
Corpl., Co. K, 4 Reg't U. S. Col'd Cav.

Appears on

Company Muster Roll

for *June & July*, 1865.

Present or absent *Absent*

Stoppage, \$ 100 for

Due Gov't, \$ 100 for

Valuation of horse, \$ 100

Valuation of horse equipments, \$ 100

Remarks: *1000.00 paid
from Co. Muster roll
deduct a rank of Corp.
Dec. 11/64*

Book mark:

A. Tomson

5 | 4 Cav. | U.S.C.T.

Abraham Townsend

Corp., Co. B. 4 Reg't U. S. Col'd Cavalry.

Appears on

Company Muster Roll

for March & April, 1861.

Present or absent Present

Stoppage, \$ 100 for

Due Gov't, \$ 100 for

Valuation of horse, \$ 100

Valuation of horse equipments, \$ 100

Remarks: Transferred to Company
by consolidation in accord
with S.O. No. 28 dated
4th Dec. Jan 28 1861.

Book mark:

Lammers

5 | 4 Cav. | **U.S.C.T.**

Abram Townsen
Corp, Co. B, 4 Reg't U. S. Col'd Cav.

Appears on

M. and D. Roll of Men Transferred

to the organization named above, by ~~order~~
from Co K

Roll dated Port Hudson La, Apr 29, 1865.

When enlisted Apr 26, 1864.

Period for which enlisted 3 years.

When mustered in May 9, 1864.

Present or absent not stated

Company to which assigned B

Remarks:

Book mark:

(342)

J. M. Leonard

Copyist.

J | **4 Cav.** | **U.S.C.T.**

Abram Townsend

Corp., Co. B. 4 Reg't U. S. Col'd Cavalry.

Appears on

Company Muster Roll

for May 4 June, 186 5.

Present or absent present

Stoppage, \$ 100 for

Due Gov't, \$ 100 for

Valuation of horse, \$ 100

Valuation of horse equipments, \$ 100

Remarks :

Book mark : _____

(358) Townsend Copyist.

4 Cav. | U.S.C.T.

Abraam Townsend

Corp., Co. B. 4 Reg't U. S. Col'd Cavalry.

Appears on

Company Muster Roll

for *July & Aug*, 186*5*.

Present or absent *Present*

Stoppage, \$ 100 for

Due Gov't, \$ 100 for

Valuation of horse, \$ 100

Valuation of horse equipments, \$ 100

Remarks :

Book mark :

Comer

7 | **4 Cav.** | **U.S.C.T.**

Abraun Townsend
Corp., Co. B. 4 Reg't U. S. Col'd Cavalry.

Appears on

Company Muster Roll

for Sept & Oct, 1869.

Present or absent present

Stoppage, \$ 100 for

Due Gov't, \$ 100 for

Valuation of horse, \$ 100

Valuation of horse equipments, \$ 100

Remarks :

Book mark :

Forman

E | 4 Cav. | U.S.C.T.

Abram Townsen

Corpl. Co. B. 4 Reg't U. S. Col'd Cavalry.

Appears on

Company Muster Roll

for *Nov. 1861*, 1861-

Present or absent *Absent*

Stoppage, \$ 100 for

Due Gov't, \$ 100 for

Valuation of horse, \$ 100

Valuation of horse equipments, \$ 100

Remarks :

Book mark :

Chandler

F | **4 Cav.** | **U.S.C.T.**

Abram Townsen

Corpl., Co. B. 4 Reg't U. S. Col'd Cavalry.

Appears on

Company Muster Roll

for *Jan. & Feb.*, 186*2*.

Present or absent *Present*

Stoppage, \$ *100* for

Due Gov't, \$ *100* for

Valuation of horse, \$ *100*

Valuation of horse equipments, \$ *100*

Remarks :

Book mark :

Chandler
Copyist.

I | 4 Cav. | U.S.C.T.

Abram Towlers
Corpl, Co. B, 4 Reg't U. S. Col'd Cavalry.

Appears on **Co. Muster-out Roll**, dated *New Orleans La., Oct 20* 1866.

Muster-out to date *Oct 20*, 1866.

Last paid to *June 30*, 1865.

Clothing account:

Last settled....., 186 ; drawn since \$..... 100

Due soldier \$ *48 61* / 100; due U. S. \$..... 100

Am't for cloth'g in kind or money adv'd \$..... 100

Due U. S. for arms, equipments, &c., \$..... 100

Bounty paid \$..... 100; due \$..... 100

Remarks: *joined by transfer from
Co. K per A. O. 29 Hd. Qrs. Dept
Quet Jan 28/65 -*

Book mark: *V. 25, P 96, 68, 7, 87, U. 11. C
J. 75 -*

Chandler
Copyist.

1875

Preswell Louis

Co L, 4 U. S. Col'd Cav.

Private

Private

CARD NUMBERS.

1	5347628	26
2	5358659	27
3	5358726	28
4	5348142	29
5	30850348	30
6	30850999	31
7	40729283	32
8		33
9		34
10		35
11		36
12		37
13		38
14		39
15		40
16		41
17		42
18		43
19		44
20		45
21		46
22		47
23		48
24		49
25		50

Book Mark:

See also

5

4 Cav. U.S.C.T.

Louis Preswell

Appears with rank of Priv. on

Muster and Descriptive Roll of a Detachment of U. S. Vols. forwarded

for the 4 Reg't U. S. Col'd Cavalry. Roll dated

New Orleans La. June 1, 1864.

Where born Va.

Age 28 y'rs; occupation Laborer

When enlisted May 18, 1864.

Where enlisted New Orleans.

For what period enlisted 3 years.

Eyes Black; hair Black

Complexion Black; height 5 ft. 2 in.

When mustered in June 1, 1864.

Where mustered in New Orleans

Premium paid 2
Bounty paid \$ 100; due \$ 100

Where credited

Company to which assigned L

Remarks:

Book mark:

Feaster

4 Cav. U.S.C.T.

Louis Presnell
Pvt., Co. L, 4 Reg't U. S. Col'd Cavalry.

Age.....years.

Appears on

Company Muster Roll*

for Enlistment to Aug. 31, 1864.

Joined for duty and enrolled:

When May 15, 1864.

Where New Orleans La.

Period 3 years.

Mustered in:

When June 1, 1864.

Where New Orleans La.

Present or absent Absent

Stoppage, \$ 100 for

Due Gov't, \$ 100 for

Valuation of horse, \$ 100

Valuation of horse equipments, \$ 100

Remarks: Sick in Genl. Hospital
New Orleans since June
29/64

* First current roll. No muster-in roll of this battery on file.

Book mark :

Lanning

4 Cav. | U.S.C.T.

Samuel Maxwell

Pvt., Co. L, 4 Reg't U. S. Col'd Cavalry.

Appears on

Company Muster Roll

for *Sept. & Oct.*, 1864.

Present or absent

Stoppage, \$ 100 for

Due Gov't, \$ 100 for

Valuation of horse, \$ 100

Valuation of horse equipments, \$ 100

Remarks: *Inserted June 30th 1864 at New Orleans La.*

Book mark:

Jurins

1st Lieut. U.S.A.

Lewis Presnell
1st, Co., *L*, *4* Reg't *U.S.A.*

Appears on

Hospital Muster Roll

of Corps d'Afrique U. S. A. General Hospital,

at New Orleans, La.,

for *Sept 1 - Oct*, 186*4*.

Attached to hospital:

When....., 186 .

How employed.....

Last paid by Maj.

to, 186 .

Bounty paid \$ 100; due \$ 100

Present or absent *present*

Remarks:.....

Book mark:.....

Combs

9 | 4 Cav. | USA

Lewis Presnell
Pvt, Co. L, 4 Reg't USA

Appears on

Hospital Muster Roll

of Corps d'Afrique U. S. A. General Hospital,

at New Orleans, La.,

for Nov & Dec, 1864.

Attached to hospital:

When _____, 186 .

How employed _____

Last paid by Maj. _____

to _____, 186 .

Bounty paid \$ 100; due \$ 100

Present or absent _____

Remarks: Died Dec. 12, 1864

Book mark: _____

T | **4 Cav.** | **U.S.C.T.**

Lewis Presswell

Priv., Co. L, 4 Reg't U. S. Colored Cav.

Appears on **Returns** as follows:

July 1864. Absent sick in hospital
at Recruit's Depot.

Aug 1864. Absent sick in hospital
at New Orleans since
June 15/64

Sept 1864. Loss: June 15/64
New Orleans, deserted

Also appears also as

L. Presswell

Book mark: _____

W. R. Lee

I + Co. & Co. U.S.C.T.

James Maxwell

Priv., Co. 2, 4 Reg't U. S. Col'd Co. & Co.

Appears on a

Detachment Muster-out Roll

of the organization named above. Roll dated

New Orleans La, March, 1866

Muster-out to date _____, 186 .

Last paid to _____, 186 .

Clothing account:

Last settled _____, 186 ; drawn since \$ _____ 100

Due soldier \$ _____ 100; due U. S. \$ _____ 100

Am't for cloth'g in kind or money adv'd \$ _____ 100

Due U. S. for arms, equipments, &c., \$ _____ 100

Bounty paid \$ _____ 100; due \$ _____ 100

Remarks: inserted
with original
organization

W. H. C. Bell of Co.

Book mark: _____

Fossett

Jesswell, Lewis

P, Co. 4, 11 Reg't USCCan

4 Enclosures.

Bed Cards	Descriptive Lists
Burial Records 2	Final Statements 1
Certs. of Dis. for Discharge	Furloughs
C. M. Charges	Med. Des. Lists
Med. Certificates	Orders

Other papers relating to—

Admission to Hosp'l	Furlough
Casualty Sheet (Officer's)	Med. Examination
Confinement	Misc. Information
Contracts	Pay or Clothing
Death or Effects 1	Personal Reports
Desertions	Rank
Discharge from Hosp'l	Transfer to Hosp'l
Discharge from Service	Transfer to V. R. C.
Duty	Transportation

ARTICLES OF WAR.

ART. 95. When any non-commissioned officer or soldier shall die, or be killed in the service of the United States, the then commanding officer of the troop or company shall, in the presence of two other commissioned officers, take an account of what effects he died possessed of, above his arms and accoutrements, and transmit the same to the office of the Department of War, which said effects are to be accounted for, and paid to the representatives of such deceased non-commissioned officer or soldier. And in case any of the officers, so authorized to take care of the effects of deceased officers and soldiers, should, before they have accounted to their representatives for the same, have occasion to leave the regiment or post, by preferment or otherwise, they shall, before they be permitted to quit the same, deposit in the hands of the commanding officer, or of the assistant military agent, all the effects of such deceased non-commissioned officers and soldiers, in order that the same may be secured for, and paid to, their respective representatives.

ARMY REGULATIONS—EDITION OF 1861.

DECEASED SOLDIERS.

Par. 152. Inventories of the effects of deceased non-commissioned officers and soldiers, required by the 95th Article of War, will be forwarded to the Adjutant General, by the commander of the company to which the deceased belonged, and a duplicate of the same to the colonel of the regiment. Final statements of pay, clothing, &c., will be sent with the inventories. When a soldier dies at a post or station absent from his company, it will be the duty of his immediate commander to furnish the required inventory, and, at the same time, to forward to the commanding officer of the company to which the soldier belonged, a report of his death, specifying the date, place, and cause; to what time he was last paid, and the money or other effects in his possession at the time of his decease; which report will be noted on the next muster roll of the company to which the man belonged. Each inventory will be endorsed, "Inventory of the effects of _____, late of company (—) _____ regiment of _____, who died at _____, the _____ day of _____, 186—." If a legal representative receive the effects, it will be stated in the report. If the soldier leave no effects, the fact will be reported.

Par. 153. Should the effects of a deceased non-commissioned officer or soldier not be administered upon within a short period after his decease, they shall be disposed of by a Council of Administration, under the authority of the commanding officer of the post, and the proceeds deposited with the Paymaster, to the credit of the United States, until they shall be claimed by the legal representatives of the deceased.

Par. 154. In all such cases of sales by the Council of Administration, a statement in detail, or account of the proceeds, duly certified by the Council and commanding officer, accompanied by the Paymaster's receipt for the proceeds, will be forwarded by the commanding officer to the Adjutant General. The statement will be endorsed, "Report of the proceeds of the effects of _____, late of company (—) _____ regiment of _____, who died at _____, the _____ day of _____, 186—."

NOTE 1.—The effects in all cases, when called for, should be turned over to the legal representative, without further authority from the Adjutant General. When the effects are turned over to the relatives of the deceased before these inventories are sent to the Adjutant General, their receipts therefor should be attached to the inventories. In all other cases, one copy will be sent with a letter of transmittal direct to the Adjutant General, and a duplicate retained by the officer.

NOTE 2.—Particular care should be taken to take receipts in duplicate from the Paymaster for any funds turned over to him; one copy should be sent direct to the Adjutant General and one retained by the officer.

Duplicate

We had no Description *his*
INVENTORY OF THE EFFECTS

OF

Private Lewis Greswell

Late of Company "G"

4th Reg't of U. S. Col. Cav.

Volunteers, who died at New Orleans La.

on the 12th day of December 1864.

Inventory of the effects of Levin Freswell late
 a _____ of Captain _____ Company "G" of
 the 4th Regiment of U.S. Col. Gen. Volunteers, who was enrolled as
 a _____ at _____ in the State of _____ on
 the _____ day of _____ 186 , and mustered into the service of the United
 States as a _____ on the _____ day of _____ 186 , at _____
 in Company _____, _____ Regiment of _____ Volunteers, to serve _____
 years or during the war; he was born in _____ in the State
 of _____; he was _____ years of age, _____ feet _____ inches
 high, _____ complexion, _____ eyes, _____ hair, and by occupation, when enrolled,
 a _____; he died in Bayou d'Arbonne Gen. Hosp., at
New Orleans La. on the 12th day of December 1864, by
 reason of Typhoid.

INVENTORY.							
ARTICLES.	No.	ARTICLES.	No.	ARTICLES.	No.		
Hats.....		Pairs trousers.....	No. had no Effects.	Knapsacks.....			
Caps.....		Pairs flannel drawers.....					
Forage caps.....		Pairs cotton drawers.....					
Great coats.....		Flannel shirts.....					
Uniform coats.....		Cotton shirts.....					
Uniform jackets.....		Pairs boots.....					
Flannel sack coats.....		Pairs shoes.....					
Blouses.....		Pairs socks.....					
Stable frocks.....		Blankets.....					
Fatigue overalls.....		Haversacks.....					
					MONEY.	Specie.....	\$
						Notes.....	\$

I CERTIFY, ON HONOR, that the above inventory comprises all the effects of _____
 _____, deceased, and that the effects are in the hands
 of _____ at _____
 _____ to be disposed of by a Council of Administration.

(DUPLICATES.)

STATION: New Orleans La.

DATE: December 12th 1864

J. E. Pyrette
 Surg. in charge Bayou d'Arbonne U.S.
 Gen. Hospital Commanding the Company.

NOV 20 1864

Lewis Freswell
Priv. S. 4. U. S. C. Cav.
Dec. 11. 64.

Corps d'Afrique
New-Orleans.

HOSPITAL RECORD,

SUBJECT TO THE

ORDER OF THE SURGEON GENERAL,

UNITED STATES ARMY.

18

No. 1.

RECORD OF DEATH AND INTERMENT.

Name and number of person interred, *Lewis Treswell*

Number and locality of the Grave, -

Hospital number of the deceased, - *2091.*

Regiment, Rank, and Company, - *7 U.S. Col. Pavl. - Priv. - L.*

Residence before enlistment, - - -

Conjugal condition (and if married,)
the residence of the widow,)

Cause of death, - - - - - } *Pneumonia*

Age of the deceased, - - - - -

Nativity, - - - - -

References, and Remarks, - - - }

Date of death and burial, - - - *Decbr: 11th/64.* 186

Duplicates sent to the Adjutant General of the United States Army, and to the Sexton of the Cemetery.

Memoranda:

No. 2.

RECORD OF DEATH AND INTERMENT.

Name and number of person interred, *Lewis Freswell*

Number and locality of the grave, -

Hospital number of the deceased, - *2091*

Regiment, Rank, and Company, - *4th U.S. Col. Part. - Priv. - L.*

Residence before enlistment, - - -

Conjugal condition (and if married,)
the residence of the widow,)

Cause of death,) *Pneumonia*

Age of the deceased, - - - - -

Nativity, - - - - -

References and Remarks, - - }

Date of death and burial, - - - *Decr: 11/64* 186

[A duplicate of this Record has been forwarded to the Sexton, and the other remains at this Hospital.]

To *Adj. General U.S.A.*
SIR:

It becomes my duty to inform you that the person above described died at this Hospital as herein stated: and that it is desired his remains should be interred with the usual military honors.

Respectfully,

J. E. Lignette *Col. Inf.*
Surgeon U. S. Army.
in charge
Corps d'Afr. gen. Hosp.

MILITARY HOSPITAL, *Corps d'Afrique, N. Orleans*
L.A.

This copy of Record is to be transmitted to the Adjutant General at Washington immediately after the place of burial and the number of the grave have been ascertained and registered. The above notification is to remain attached.

I certify, on honor, that Sewin Presnell a private of
 Captain R. J. Whittier's Company (S) of the 4th Regiment of Inf. C. Cav.
VOLUNTEERS, of the State of _____, born in _____, State
 of Pennsylvania, aged 28 years; 5 feet 2 inches high; blk complexion,
blk eyes, blk hair, and by occupation a Sabotier, having joined the company on
 its original organization at New Orleans, and enrolled in it at the muster into
 the service of the United States at New Orleans, on the 18th day
 of May, 1864, (or was mustered in service as a recruit, by _____
 _____, at _____, on the _____ day of _____,
 186 _____, or was drafted and mustered into the service of the United States from the _____
 Enrollment District of the State of _____, at _____,
 on the _____ day of _____, 186 _____) to serve in the Regiment, for
 the term of three years: and having served **HONESTLY** and
FAITHFULLY with his Company in Hosp. to the present date, is now
 entitled to a **DISCHARGE** by reason of death - died in Great 7th Corps

d. Afrique Hosp. New Orleans Dec. 12th 1864
 The said Private - Sewin Presnell was ~~not~~ ^{never} paid by Paymaster
 _____ to include the _____ day of _____, 186 _____, and has
 pay due him from ~~that time~~ ^{enlistment} to the present date; he is entitled to pay and subsistence for
TRAVELING to place of enrollment, and whatever other allowances are authorized to volunteer
 soldiers, drafted men, or militia, so discharged. He has received from the United States **CLOTHING**
 amounting to 17 ⁸⁴/₁₀₀ dollars, since the 18th day of May 18,
 1864, when his clothing account was last settled. He has received from the United States
 _____ dollars advanced **BOUNTY**.

There is to be stopped from him, on account of the State of _____, or other
 authorities, for **CLOTHING**, &c., received on entering service, _____ dollars; and
 for other stoppages, viz: _____

_____ dollars.
 He has been furnished with **TRANSPORTATION** in kind from the place of his discharge to
 _____; and he has been **SUBSISTED** for **TRAVELING** to his
 place of enrollment, up to the _____, 186 _____.

He is indebted to _____, **SUTLER**, _____ dollars.
 He is indebted to _____, **LAUNDRESS**, _____ dollars.

Given in Duplicate, at Post Hudson La, this 14th day
 of December, 1864.

Leitcher A. Stickel
2^d Lt. Co "M" 4th Inf. C. Cav.
 Commanding Company. "S"

1076

Suant. Nora,

Co, **4** U. S. Col'd Cav.

Private | *Private*

CARD NUMBERS.

1		26	
2		27	
3	<i>See Turner,</i>	28	<i>Nora.</i>
4		29	
5		30	
6		31	
7		32	
8		33	
9		34	
10		35	
11		36	
12		37	
13		38	
14		39	
15		40	
16		41	
17		42	
18		43	
19		44	
20		45	
21		46	
22		47	
23		48	
24		49	
25		50	

Book Mark:

See also

1077

Tucker Daniel

Co D, 4 U. S. Col'd Cav.

Private

Private

CARD NUMBERS.

1	5352586	26
2	5352636	27
3	5352687	28
4	5352747	29
5	5352811	30
6	5352872	31
7	5352949	32
8	5353031	33
9	5353114	34
10	5353212	35
11	5353305	36
12	5353399	37
12	5353487	38
14	5353573	39
15	5353656	40
16	5353736	41
17	40729284	42
18		43
19		44
20		45
21		46
22		47
23		48
24		49
25		50

Book Mark: 282 0 85

See also

S-939990-P.O. Ret
S-942539-P.O. Ret
A 2452023 P.O. Ret.

L. Jordan
A

J | 4 Cav. | U.S.C.T.

Daniel Tucker

Pvt, Co. *D*, 1 Reg't, Corps d'Afrique Cavalry.*
+ *Age 37*
Appears on

Company Muster-in Roll

of the organization named above. Roll dated

New Orleans La, *Nov 26*, 186*3*.

Muster-in to date *Nov 26*, 186*3*.

Joined for duty and enrolled:

When *Oct 15*, 186 .

Where *New Orleans*

Period *3* years.

Valuation of horse, \$ 100

Valuation of horse equipments, \$ 100

Remarks:

+ *Inserted by Jordan, Ex*

*This organization subsequently became Co. *D*, 4 Reg't U. S. Colored Cavalry.

Book mark:

Rosenbaum

y 4 Cav. U.S. C.T.

Daniel Lucker

Pvt, Co. *D*, 1 Reg't Cav., Corps d'Afrique.*

Appears on

Company Muster Roll

for *From Enlistment to Dec 31, 1863*.

Present or absent *Present*

Stoppage, \$ *100* for

Due Gov't, \$ *100* for

Valuation of horse, \$ *100*

Valuation of horse equipments, \$ *100*

Remarks:

* This organization subsequently became Co. *D*, 4 Reg't U. S. Colored Cavalry.

Book mark:

Rosenbaum

J | 4 Cav. | U.S C.T.

Daniel Tucker

Pvt., Co. *D*, 1 Reg't Cav., Corps d'Afrique.*

Appears on

Company Muster Roll

for *Jan'y & Feby*, 186*4*.

Present or absent *Present*

Stoppage, \$ *100* for

Due Gov't, \$ *100* for

Valuation of horse, \$ *100*

Valuation of horse equipments, \$ *100*

Remarks:

* This organization subsequently became Co. *D*, 4 Reg't U. S. Colored Cavalry.

Book mark:

Rosenbaum
Copyist.

J | **4 Cav.** | **U.S.C.T.**

Daniel Tucker

Pvt, Co. D. 4 Reg't U. S. Col'd Cavalry.

Appears on

Company Muster Roll

for *March & April*, 1864.

Present or absent *Present*

Stoppage, \$ 100 for

Due Gov't, \$ 100 for

Valuation of horse, \$ 100

Valuation of horse equipments, \$ 100

Remarks:

Book mark:

Rosenbaum

(358)

Copyist.

Y | **4 Cav.** | **U.S.C.T.**

Daniel Lucker

Priv., Co. D. 4 Reg't U. S. Col'd Cavalry.

Appears on

Company Muster Roll

for *May & June*, 1864.

Present or absent *Present*

Stoppage, \$.....100 for

Due Gov't, \$.....100 for

Valuation of horse, \$.....100

Valuation of horse equipments, \$.....100

Remarks:.....

Book mark:.....

Rosenbarn

(358)

Copyist.

Y | **4 Cav.** | **U.S.C.T.**

Daniel Tucker

Pvt., Co. D. 4 Reg't U. S. Col'd Cavalry.

Appears on

Company Muster Roll

for July & Aug, 1864.

Present or absent Present

Stoppage, \$ 100 for

Due Gov't, \$ 100 for

Valuation of horse, \$ 100

Valuation of horse equipments, \$ 100

Remarks:

Book mark:

Rosenbaum

7 | **4 Cav.** | **U.S.C.T.**

Daniel Tucker

Pat, Co. D. 4 Reg't U. S. Col'd Cavalry.

Appears on

Company Muster Roll

for Sept & Oct, 1864.

Present or absent Present

Stoppage, \$ 100 for

Due Gov't, \$ 100 for

Valuation of horse, \$ 100

Valuation of horse equipments, \$ 100

Remarks:

Book mark:

Rosenbaum

(358)

Copyist.

J | 4 Cav. | U.S.C.T.

Daniel Tucker

D, Co. D, 4 Reg't U. S. Col'd Cavalry.

Appears on

Company Muster Roll

for Dec, 1864.

Present or absent Present

Stoppage, \$ 100 for

Due Gov't, \$ 100 for

Valuation of horse, \$ 100

Valuation of horse equipments, \$ 100

Remarks:

Book mark:

A. J. Bright

5 | **4 Cav. | U.S.C.T.**

Samuel Tucker

P, Co. D, 4 Reg't U. S. Col'd Cavalry.

Appears on

Company Muster Roll

for *Jan & Feb*, 186*5*.

Present or absent *Present*

Stoppage, \$ *100* for

Due Gov't, \$ *100* for

Valuation of horse, \$ *100*

Valuation of horse equipments, \$ *100*

Remarks: *heed only # 4 for months to include Apr 30 65*

Book mark:

a. T. Wright

27 | **4 Cav.** | **U.S.C.T.**

Samuel Tucker

D, Co. D, 4 Reg't U. S. Col'd Cavalry.

Appears on

Company Muster Roll

for *Week & 1/2*, 186*7*.

Present or absent *Present*

Stoppage, \$ 100 for

Due Gov't, \$ 100 for

Valuation of horse, \$ 100

Valuation of horse equipments, \$ 100

Remarks:

.....
.....
.....
.....
.....
.....
.....
.....
.....

Book mark:

.....

A. M. Wright

2 | **4 Cav. U.S.C.T.**

David Tucker

D, Co. D, 4 Reg't U. S. Col'd Cavalry.

Appears on

Company Muster Roll

for *May to June*, 186*5*.

Present or absent *Present*

Stoppage, \$ 100 for

Due Gov't, \$ 100 for

Valuation of horse, \$ 100

Valuation of horse equipments, \$ 100

Remarks: *Present with leave*

Book mark:

W. H. [Signature]
Copyist.

T | 4 Cav. | U.S.C.T.

Daniel Tucker

P, Co. D, 4 Reg't U. S. Col'd Cavalry.

Appears on

Company Muster Roll

for *July & Aug*, 1865:

Present or absent *Present*

Stoppage, \$ *100* for

Due Gov't, \$ *100* for

Valuation of horse, \$ *100*

Valuation of horse equipments, \$ *100*

Remarks:

Book mark:

(358)

A. H. B. ...

Copyist.

9 | 4 Cav. | U.S.C.T.

David Tucker

P, Co. D, 4 Reg't U. S. Col'd Cavalry.

Appears on

Company Muster Roll

for *Sept & Oct*, 186*6*.

Present or absent *Present*

Stoppage, \$ *100* for

Due Gov't, \$ *100* for

Valuation of horse, \$ *100*

Valuation of horse equipments, \$ *100*

Remarks:

Book mark:

W. H. [unclear]

11 | 4 Cav. | U.S.C.T.

Wm. L. Tucker

Pat

, Co. D, 4 Reg't U. S. Col'd Cavalry.

Appears on

Company Muster Roll

for Nov 7 1866, 1865.

Present or absent Present

Stoppage, \$ 100 for

Due Gov't, \$ 100 for

Valuation of horse, \$ 100

Valuation of horse equipments, \$ 100

Remarks:

Book mark:

Wm. L. Tucker

10 | **4 Cav.** | **U.S.C.T.**

Manuel Hoover

Put, Co. D, 4 Reg't U. S. Col'd Cavalry.

Appears on

Company Muster Roll

for *Jan + Feb*, 186*6*.

Present or absent *Present*

Stoppage, \$ *100* for

Due Gov't, \$ *100* for

Valuation of horse, \$ *100*

Valuation of horse equipments, \$ *100*

Remarks:
.....
.....
.....
.....
.....
.....
.....
.....

Book mark:

W. J. Hoover
(358) Copyist.

9 | 4 Cav. | U.S.C.T.

Daniel Tucker

Pvt., Co. D, 4 Reg't U. S. Colored Cav.

Appears on Returns as follows:

June 1864 - On duty detailed in
Ord. Dept.

July to Dec 1864 - On duty detailed
as Acting Regtl. Ordnance Sergt

Jan'y to May 1865 - On duty detailed
to take care of Regtl. Surplus
Ordnance.

June 1865 - Absent on furlough since
June 27/65.

July 1865 - On duty Actg. Ord. Sergt

Book mark :

W. R. Sel

J | 4 Cav. | U.S.C.T.

Daniel Tucker

Put, Co. D, 4 Reg't U. S. Col'd Cavalry.

Appears on Co. Muster-out Roll, dated New Orleans, La, Feb 20, 1865.

Muster-out to date March, 1866.

Last paid to June 30, 1865.

Clothing account:

Last settled, 186 ; drawn since \$ 100

Due soldier \$ 41 ⁰⁰/₁₀₀; due U. S. \$ 100

Am't for cloth'g in kind or money adv'd \$ 100

Due U. S. for arms, equipments, &c., \$ 100

Bounty paid \$ 100; due \$ 100

Remarks: Joined orig Reg

Book mark: V. 25, P 232, 68, 282 035

M. A. ...

(361)

Copyist.

1078

Turner James

Co A, 4 U. S. Col'd Cav.

Private

Private

CARD NUMBERS.

1	5347419	26
2	5348692	27
3	5348795	28
4	5349750	29
5	40729285	30
6		31
7		32
8		33
9		34
10		35
11		36
12		37
13		38
14		39
15		40
16		41
17		42
18		43
19		44
20		45
21		46
22		47
23		48
24		49
25		50

Book Mark: EB. V 10. P 495.

See also

J. H. Cow | U.S.C.T.

James Turner
Reg't U. S. Col'd *Cow*

Age *30* years.

Appears on a

Detachment Muster-in Roll

of the organization named above. Roll dated

New Orleans La Feb 1, 186*4*.

Muster-in to date *Feb 1*, 186*4*.

Joined for duty and enrolled:

When *Aug 24*, 186*7*.

Where *New Orleans La*

Period *3* years.

Valuation of horse, \$ *100*

Valuation of horse equipments, \$ *100*

Remarks:

Book mark:

reus
Copyist.

J

4 Cav. U.S C.T.

James Turner

Priv, Co. *A*, 1 Reg't Cav., Corps d'Afrique.*

Appears on

Company Muster Roll

for *Jan - 1 Feb*, 186 *4*

Present or absent *Present*

Stoppage, \$ *100* for

Due Gov't, \$ *100* for

Valuation of horse, \$ *100*

Valuation of horse equipments, \$ *100*

Remarks:

* This organization subsequently became Co. *A* 4 Reg't U. S. Colored Cavalry.

Book mark:

R S Richardson

J | 4 Cav. | U.S.C.T.

James Turner
Pri, Co. A, 4 Reg't U. S. Col'd Cavalry.

Appears on

Company Muster Roll

for *March + April*, 1864.

Present or absent

Stoppage, \$ 100 for

Due Gov't, \$ 100 for

Valuation of horse, \$ 100

Valuation of horse equipments, \$ 100

Remarks: *Died in Genl
Hospital, New Orleans
La April 10/63*

Book mark: *died April 7/64
(over)*

R S Richardson

PT | **4 Cav.** | **U.S.C.T.**

James Turner

Priv., Co. A, 4 Reg't U. S. Colored Cav.

Appears on **Returns** as follows:

Sept 1861 - 2022: Apr 10/64
N. Orleans - Killed

Book mark:

W. R. Sel

J | **4 Cav. | U.S.C.T.**

James Turner
Pvt., Co. *A*, 4 Reg't U. S. Col'd Cavalry.

Appears on **Co. Muster-out Roll**, dated
New Orleans La, Mch 20, 186*6*.

Muster-out to date _____, 186 .

Last paid to _____, 186 .

Clothing account:

Last settled _____, 186 ; drawn since \$ _____ 100

Due soldier \$ _____ 100; due U. S. \$ _____ 100

Am't for cloth'g in kind or money adv'd \$ _____ 100

Due U. S. for arms, equipments, &c., \$ _____ 100

Bounty paid \$ _____ 100; due \$ _____ 100

Remarks: *Joined at orig. org. Died*
Apr 7 1864. at New Orleans La.

Book mark *Died. Apr 7/64. E.B. V. 10 P. 495*

(361)

Prewitt
 Copyist.

Turner, James
 P, Co. A, 4 Regt. U. S. C. Cav.

2 Enclosures.

Bed Cards	Descriptive Lists
Burial Records	Final Statements
Certs. of Dis. for Discharge	Furloughs
C. M. Charges	Med. Des. Lists
Med. Certificates	Orders

Other papers relating to—

Admission to Hosp'l	Furlough
Casualty Sheet (Officer's)	Med. Examination
Confinement	Misc. Information
Contracts	Pay or Clothing
Death or Effects	Personal Reports
Desertions	Rank
Discharge from Hosp'l	Transfer to Hosp'l
Discharge from Service	Transfer to V. R. C.
Duty	Transportation

NOV 29 1864

COPY OF RECORD

K

FOR THE

C

ADJUTANT GENERAL, U. S. ARMY.

Recd. A. G. June 6th 1864.

NOV 29 1864

No. 2.

RECORD OF DEATH AND INTERMENT.

Name and number of person interred,	<i>James Turner</i>
Number and locality of the Grave, - -	
Hospital number of the deceased, - -	<i>516</i>
Regiment, rank, and company, - -	<i>1st La. Cav. - Priv. - A.</i>
Residence before enlistment, - - - -	
Conjugal condition, (and if married,) the residence of the widow,)	
Cause of death, - - - - -)	<i>Smallpox</i>
Age of the deceased, - - - - -	<i>26 years</i>
Nativity, - - - - -	
References and remarks, - - - -)	
Date of death and burial, - - - -	<i>April 7th '64.</i>

186 .

(A duplicate of this Record has been forwarded to the Sexton, and another remains at this Hospital.)

To _____

SIR :

It becomes my duty to inform you that the person above described died at this Hospital as herein stated ; and that it is desired his remains should be interred with the usual military honors.

Respectfully,

J. E. Pignette
Surgeon U. S. Army.

MILITARY HOSPITAL *New Orleans La.*

This copy of Record is to be transmitted to the Adjutant General at Washington immediately after the place of burial and the number of the grave have been ascertained and registered. The above notification is to remain attached.

A. G. O. Dec 13th 1864
P. M. Sect. for S. 21000
Sut 2 Auditor.

Adj. Gen. Office
Ins. of Adj. Gen. Office
Auditor

FINAL STATEMENT

OF

James Turner

4th Reg't of U. S. Col. Cav

VOLUNTEERS.

NOTE 1.—Two of these certificates (or duplicates) are to be given to each volunteer soldier who may be discharged previously to the discharge of his company, that he may at once receive from the Paymaster the pay, &c., due him, and the captain or other officer commanding the company will certify to the act of the delivery of the duplicate certificates; on these certificates the Soldier is "entitled to" his discharge, and should also present his discharge to the Paymaster to have the payment endorsed on it. The discharge is to be given back to the Soldier by the Paymaster; the latter only retaining as his voucher the duplicate certificates.

NOTE 2.—If the Soldier is entitled to pay for the use of his horse, the Company Commander will certify to that fact, and also to the time he has pay due for having been so mounted on his own horse.

NOTE 3.—Amounts due the Sutler and Laundress must be entered on the Muster Roll on which the death, desertion, &c., is reported, as well as on the final statement, otherwise the amount cannot be collected from the United States.

NOTE 4.—This blank will be used for deceased volunteers as well as others.

War Department,
Adjutant General's Office,
Washington, D.C., Oct. 25, 1863,
The Muster Roll of Co. A⁴ U.S. Cavalry reports Private James Turner died April 10, 1863. The Muster Roll of Co. gives April 10, 1864, as the date of death. The soldier's Final Statement indicates that he died April 7, 1864 which date is held to be correct and the Co Muster and Muster Out Rolls will be amended accordingly.

Thomas M. Sargent
Adj. Gen. Office
Sold
36.11

ADJUTANT GENERAL'S OFFICE
July 19 1864
Duplicate with Inventory sent 2d Auditor.



Link B

I certify, on honor, that James Turner a private of
 Captain W. Harcourt Company (A) of the 4th Regiment of U.S. Col^d Cal
VOLUNTEERS, of the State of La, born in Sherrille, State
 of South Carolina, aged 26 years; 4 feet 9 inches high; dark complexion,
black eyes, black hair, and by occupation a farmer, having joined the company on
 its original organization at New Orleans, and enrolled in it at the muster into
 the service of the United States at New Orleans, on the twelfth day
 of September, 1863, (or was mustered in service as a recruit, by _____
 _____, at _____, on the _____ day of _____,
 186 , to serve in the Regiment,) for the term of Three Years
 and having served HONESTLY and FAITHFULLY with his Company in _____
April 7th 1864

Dates of death reported

Muster-Roll for Mch: & April 64 - Died _____ April 10. 63 -
 M. O. R. _____ April 10. 64
 Final Statement _____ April 7th 64

*April 7th 1864
 (had correct equal)*

E. R.

CLOTHING received in kind from _____ and for other
 stoppages, viz:

_____ amounting to nothing $\frac{00}{100}$ dollars;
 and he has been SUBSISTED for TRAVELING to his place of enrollment, up to the _____
 _____, 186 . .

He is indebted to _____, SUTLER, nothing $\frac{00}{100}$ dollars.
 He is indebted to _____, LAUNDRESS, nothing $\frac{00}{100}$ dollars.

Given in Duplicate, at Carrollton La, this 2^d day of July, 1864.

John Stark
4th U.S. Col^d Cal.
 Commanding Company.

I certify, on honor, that James Turner a private of
 Captain W. Harcourt Company (A) of the 4th Regiment of U.S. Col. Cav
VOLUNTEERS, of the State of C, born in Beville, State
 of South Carolina, aged 26 years; 4 feet 9 inches high; dark complexion,
black eyes, black hair, and by occupation a farmer, having joined the company on
 its original organization at New Orleans, and enrolled in it at the muster into
 the service of the United States at New Orleans, on the twelfth day
 of September, 1863, (or was mustered in service as a recruit, by _____
 _____, at _____, on the _____ day of _____,
 186 , to serve in the Regiment,) for the term of Three Years

and having served **HONESTLY** and **FAITHFULLY** with his Company in _____
 to the present date, is now entitled to a **DISCHARGE** by reason of death
died in Camp de Afrique Hospital New Orleans of
Small pox April 7th 1864

The said James Turner was last paid by Paymaster
Major Hoyt to include the 31st day of December, 1863, and has
 pay due him from that time to the present date; he is entitled to pay and subsistence for
TRAVELING to place of enrollment and whatever other allowances are authorized to volunteer
 soldiers, or militia, so discharged. He has received Eighty four $\frac{18}{100}$ dollars,
 advanced by the United States on account of **CLOTHING**.

There is to be stopped from him, on account of the State of _____, or other
 authorities for **CLOTHING**, &c., received on entering service, Nothing $\frac{00}{100}$ dollars; also,
 for expenses of **SUBSISTENCE** for **TRAVELING** from place of enrollment to the place of rendezvous,
 amounting to Nothing $\frac{00}{100}$ dollars: and on account of the United States for **EXTRA**
CLOTHING received in kind from _____ and for other
 stoppages, viz:

_____ amounting to Nothing $\frac{00}{100}$ dollars;
 and he has been **SUBSISTED** for **TRAVELING** to his place of enrollment, up to the _____
 _____, 186 . .

He is indebted to _____, **SUTLER**, Nothing $\frac{00}{100}$ dollars.
 He is indebted to _____, **LAUNDRESS**, Nothing $\frac{00}{100}$ dollars.

Given in Duplicate, at Carrollton La this 2^d day of July, 1864.

John Stark
4th U.S. Col. Cav.
 Commanding Company.

1079

Turner Nora

Co D, 4 U. S. Col'd Cav.

Private | Private

CARD NUMBERS.

5347807	26
5353032	27
5353115	28
5353215	29
5353308	30
5353402	31
5353490	32
5353576	33
5353659	34
5353740	35

36
37
38
39
40
41
42
43
44
45
46
47
48
49
50

Mark:

also

§ 1523033 P.O. M. T. M.
§ 2074483 - P.O. M. T. M.
P.O. M. T. M. 352252-5-14-17 C D
Hester Appl 5/22/61-813

D. Jordan
Ex

4 Cav. U.S.C.T.

Wm. ...

Appears with rank of *Private* on

Muster and Descriptive Roll of a Detachment of U. S. Vols. forwarded

for the 4 Reg't U. S. Col'd Cavalry. Roll dated

New Orleans, La., Nov. 15, 1864.

Where born *St. Andrew, La.*

Age *23* y'rs; occupation *Farmer*

When enlisted *Nov. 15, 1864.*

Where enlisted *New Orleans*

For what period enlisted *2* years.

Eyes *Black*; hair *Black*

Complexion *Black*; height *5* ft. *10* in.

When mustered in *Nov. 15, 1864.*

Where mustered in *New Orleans, La.*

Bounty paid \$ *100* ¹⁰⁰; due \$ *200* ¹⁰⁰

Where credited *2nd Reg't Cavalry, New Orleans, La.*

Company to which assigned

Remarks:

Book mark:

J. C. ...

J | 4 Cav. | U.S.C.T.

John Turner

P, Co. D, 4 Reg't U. S. Col'd Cavalry.

Appears on

Company Muster Roll

for *Nov - Dec*, 1864.

Present or absent *Present*

Stoppage, \$ 100 for

Due Gov't, \$ 100 for

Valuation of horse, \$ 100

Valuation of horse equipments, \$ 100

Remarks:

Book mark:

(358)

A. T. Wright

Copyist,

D | **4 Cav.** | **U.S.C.T.**

Wm Turner

D, Co. D, 4 Reg't U. S. Col'd Cavalry.

Appears on

Company Muster Roll

for *Q 322 & Feb*, 186*5*.

Present or absent *Present*

Stoppage, \$ *100* for

Due Gov't, \$ *100* for

Valuation of horse, \$ *100*

Valuation of horse equipments, \$ *100*

Remarks: *# 05 Henry-pail*
2nd class

Book mark:

W. H. Wright
(358) Copyist.

51 | **4 Cav.** | **U.S.C.T.**

Anna Turner

P, Co. D, 4 Reg't U. S. Col'd Cavalry.

Appears on

Company Muster Roll

for March & Apr, 1865.

Present or absent Present

Stoppage, \$ 100 for

Due Gov't, \$ 100 for

Valuation of horse, \$ 100

Valuation of horse equipments, \$ 100

Remarks: Stop for lost - Ord
87015
1st B. Army - pencil
2nd B. Army

Book mark:

A. B. Wright

J | 4 Cav. | U.S.C.T.

Ara Turner

....., Co. D, 4 Reg't U. S. Col'd Cavalry.

Appears on

Company Muster Roll

for *May 1st* 186*5*.

Present or absent *Present*

Stoppage, \$ *100* for

Due Gov't, \$ *100* for

Valuation of horse, \$ *100*

Valuation of horse equipments, \$ *100*

Remarks: *Step for list - 2nd*
By ch -
on 2nd - Part # 2 of chue

Book mark:

A. J. [Signature]

T | 4 Cav. | U.S.C.T.

Ara Turner

P, Co. D, 4 Reg't U. S. Col'd Cavalry.

Appears on

Company Muster Roll

for *July & Aug*, 186*5*.

Present or absent *Present*

Stoppage, \$ *100* for

Due Gov't, \$ *100* for

Valuation of horse, \$ *100*

Valuation of horse equipments, \$ *100*

Remarks: *# for bounty paid*
2nd time

Book mark:

(358)

W. Wright

Copyist.

CT | **4 Cav.** | **U.S.C.T.**

Anna Turner

P, Co. D, 4 Reg't U. S. Col'd Cavalry.

Appears on

Company Muster Roll

for *Sept - Oct*, 186*5*.

Present or absent *Present*

Stoppage, \$ *100* for

Due Gov't, \$ *100* for

Valuation of horse, \$ *100*

Valuation of horse equipments, \$ *100*

Remarks: *# 13 entry paid # 200 due*

Book mark:

A. B. Knight

J | 4 Cav. | U.S.C.T.

Alva Turner

1st, Co. D, 4 Reg't U. S. Col'd Cavalry.

Appears on

Company Muster Roll

for Nov & Dec, 1865.

Present or absent Present

Stoppage, \$ 100 for

Due Gov't, \$ 100 for

Valuation of horse, \$ 100

Valuation of horse equipments, \$ 100

Remarks: Bounty paid \$100.00
Bounty due \$200.00

Book mark:

J. S. Anderson

7 | 4 Cav. | U.S.C.T.

Alora Turner

Put, Co. D, 4 Reg't U. S. Col'd Cavalry.

Appears on

Company Muster Roll

for *Jan 7 Feb*, 186*t.*

Present or absent *Present*

Stoppage, \$ *100* for

Due Gov't, \$ *100* for

Valuation of horse, \$ *100*

Valuation of horse equipments, \$ *100*

Remarks: *Bounty paid \$100.00*
Bounty due \$200.00

Book mark:

D. D. Woodhouse

J | 4 Cav. | U.S.C.T.

x Stora Juant

But, Co. hl, 4 Reg't U. S. Col'd Cavalry.

Appears on **Co. Muster-out Roll**, dated New Orleans, La, Feb 20, 1866.

Muster-out to date Feb 20, 1866.

Last paid to June 30, 1866.

Clothing account:

Last settled....., 186 ; drawn since \$.....100

Due soldier \$.....100; due U. S. \$ 7 ¹⁰/₁₀₀

Am't for cloth'g in kind or money adv'd \$.....100

Due U. S. for arms, equipments, &c., \$.....100

Bounty paid \$ 100 100; due \$ none 100

Remarks: joined as recruit,

x Stora appears on Muster Rolls
as Stora Turner.

Book mark: V 236, P 132, 26

J. C. Anderson

Turner Nora

, Co. , 4 Reg't U. S. C. C.

2 Enclosures.

Bed Cards	Final Statements
Burial Records	Furloughs or L. of A
Certs. of Dis. for Discharge	Med. Certificates
C. M. Charges	Med. Des. Lists
Descriptive Lists	Orders
Discharge Certificates	Pris. of War Record
Enlistment Papers 2	Resignations

Other papers relating to—

Admission to Hosp'l	Furlough or L. of A
Casualty Sheet	Med. Examination
Confinement	Misc. Information
Contracts	Pay or Clothing
Death or Effects	Personal Reports
Desertion	Rank
Discharge from Hosp'l	Transfer to Hosp'l
Discharge from Service	Transfer to V. R. C.
Duty	Transportation
5.5 Ref Slip 1	

NR 314

MICROFILM PUBLICATION M 1820

COMPILED MILITARY SERVICE RECORDS
OF VOLUNTEER UNION SOLDIERS WHO
SERVED WITH THE USCT (US COLORED TROOPS)
4TH REGIMENT OF CAVALRY

PERSONAL PAPERS' TARGET SHEET

PLEASE NOTE THE CHECKED INFORMATION ABOUT THE PERSONAL PAPERS IN
THIS FILE:

- NO PERSONAL PAPERS WERE FOUND IN THIS FILE WHEN THE
RECORDS WERE ARRANGED FOR MICROFILMING.
- 3 PERSONAL PAPER(S) FOUND IN THIS FILE WHEN THE RECORDS
WERE ARRANGED FOR MICROFILMING.

NOV 21 1867

DECLARATION OF RECRUIT.

I, Nora Turner desiring to VOLUNTEER as a Soldier in the Army of the United States, for the term of THREE YEARS, Do Declare, That I am 25 years and _____ months of age; that I have never been discharged from the United States service on account of disability or by sentence of a court martial, or by order before the expiration of a term of enlistment; and I know of no impediment to my serving honestly and faithfully as a soldier for three years.

GIVEN at New Orleans La the 5 day of November 1867

Witness:

A. P. Sullivan Nora Turner
1867

No. 1364

Nora Turner

Volunteered at New Orleans

November 5th 1867

By A. C. A. Sullivan

84 Regiment of Blacks

_____ enlistment; last served in Company ()

_____ Reg't of _____

Discharged _____ 18 _____

Reinstatement to Bounty
in September 1867
for 27 days
July 19 1867
and other No 58
1867

CONSENT IN CASE OF MINOR.

I, _____ Do CERTIFY, That I am the _____ of _____; that the said _____ is _____ years of age; and I do hereby freely give my CONSENT to his volunteering as a SOLDIER in the ARMY OF THE UNITED STATES for the period of THREE YEARS.

GIVEN at _____ the _____ day of _____

Witness:

(A. G. O. No. 74 & 76.)

NOTE 1.—This blank will be used for both enlistments and re-enlistments—enlistment of veterans, &c., &c., in the volunteer service. They will be made out in duplicate in all cases—one to accompany the recruiting return of the superintendent (not the recruiting officer) to the Adjutant General, and one to accompany the accounts of the officer who pays bounty, &c. The Regiment and Company in which the soldier last served should be given on the back.
NOTE 2.—An enlistment holds to service. A muster-in must, in all cases, precede payment of pay, bounty, pension, &c. A muster-in roll must, in all cases, be filed in the Adjutant General's Office as evidence of muster-in. The mustering officer, commissary, or assistant commissary of musters, as the case may be, will countersign both enlistments as having mustered the soldier into the service of the United States before either of them is given to the disbursing officer.

VOLUNTEER ENLISTMENT.

STATE OF

Louisiana



TOWN OF

New Orleans

I, Nora Turner

born in St Andrew

in the State of Louisiana aged 23 years,

and by occupation a Labourer Do HEREBY ACKNOWLEDGE to have

volunteered this 5th day of November 1864,

to serve as a **Soldier** in the **Army of the United States of America**, for the period of **THREE YEARS**, unless sooner discharged by proper authority:

Do also agree to accept such bounty, pay, rations, and clothing, as are, or may be, established by law for volunteers. And I, Nora Turner do

solemnly swear, that I will bear true faith and allegiance to the **United States of America**, and that I will serve them honestly and faithfully against all

their enemies or opposers whomsoever; and that I will observe and obey the orders of the President of the United States, and the orders of the officers

appointed over me, according to the Rules and Articles of War.

Sworn and subscribed to, at New Orleans

this 5th day of Nov 1864,

BEFORE H. Palmieri

1284th U.S.C.

Nora Turner
Exam

I CERTIFY, ON HONOR, That I have carefully examined the above-named Volunteer, agreeably to the General Regulations of the Army, and that, in my opinion, he is free from all bodily defects and mental infirmity, which would in any way disqualify him from performing the duties of a soldier.

Wm H. Humphrey

Exam

EXAMINING SURGEON.

I CERTIFY, ON HONOR, That I have minutely inspected the Volunteer, Nora Turner previously to his enlistment, and that he was entirely sober when enlisted; that, to the best of my judgment and belief, he is of lawful age; and that, in accepting him as duly qualified to perform the duties of an able-bodied soldier, I have strictly observed the Regulations which govern the recruiting service. This soldier has Blue eyes, Blue hair, Blue complexion, is 5

feet 7 inches high.

H. Palmieri

1284th U.S.C. Regiment of U.S.C. Volunteers,

RECRUITING OFFICER.

Mustered into the service of the United States, for three years or during the war, from date of enlistment, in Company 11th Regiment of Vol. B. Cav Volunteers, on the 5th day of November, 1864, at New Orleans

John Palmieri
Exam
1284th U.S.C.

NOV 17 1899

DECLARATION OF RECRUIT.

I, Nora Turner, desiring to VOLUNTEER as a Soldier in the Army of the United States, for the term of THREE YEARS, Do Declare, That I am 23 years and ~ months of age; that I have never been discharged from the United States service on account of disability or by sentence of a court martial, or by order before the expiration of a term of enlistment; and I know of no impediment to my serving honestly and faithfully as a soldier for three years.

GIVEN at New Orleans La the 5 day of November

Witness: P. Palmieri Nora Turner

NOTE 1.—This blank will be used for both enlistments and re-enlistments—enlistment of veterans, &c., &c., in the volunteer service. They will be made out in duplicate in all cases—one to accompany the recruiting return of the superintendent (not the recruiting officer) to the Adjutant General, and one to accompany the accounts of the officer who pays bounty, &c. The Regiment and Company in which the soldier mustered should be given on the back.
NOTE 2.—An enlistment holds to service. A muster-in must, in all cases precede payment of pay, bounty, pension, &c. A muster-in roll must, in all cases, be filed in the Adjutant General's Office as evidence of muster-in. The mustering officer, commissary, or assistant commissary of musters, as the case may be, will countersign both enlistments as having mustered the soldier into the service of the United States before either of them is given to the disbursing officer.

Received from Second Auditor Aug 20 1899

Discharged 18
Rec'd certificate to Bounty
Company with Certificate No
27 Co War Dept
July 19 1898
with bounty \$250.00
article 114th U.S.C.
1894

Volunteered at New Orleans
November 5 1898
By A. C. Palmieri
Sgt Regiment of 26th R. I.
enlistment; last served in Company ()
Reg't of

No. 4
Company

CONSENT IN CASE OF MINOR.

I, _____, Do CERTIFY, That I am the _____ of _____; that the said _____ is _____ years of age; and I do hereby freely give my CONSENT to his volunteering as a SOLDIER in the ARMY OF THE UNITED STATES for the period of THREE YEARS.

GIVEN at _____ the _____ day of _____

Witness: _____

VOLUNTEER ENLISTMENT.

STATE OF Louisiana



TOWN OF New Orleans

I, Nora Turner, born in St Andrews in the State of Louisiana, aged 23 years, and by occupation a Laborer, Do HEREBY ACKNOWLEDGE to have volunteered this 5 day of November, 1864 to serve as a **Soldier** in the **Army of the United States of America**, for the period of **THREE YEARS**, unless sooner discharged by proper authority: Do also agree to accept such bounty, pay, rations, and clothing, as are, or may be, established by law for volunteers. And I, Nora Turner, do solemnly swear, that I will bear true faith and allegiance to the **United States of America**, and that I will serve them honestly and faithfully against all their enemies or opposers whomsoever; and that I will observe and obey the orders of the President of the United States, and the orders of the officers appointed over me, according to the Rules and Articles of War.

Sworn and subscribed to, at New Orleans this 5 day of Nov, 1864 BEFORE H. Palmieri 1st Lt 84th U.S.C. Nora Turner mark

I CERTIFY, ON HONOR, That I have carefully examined the above-named Volunteer, agreeably to the General Regulations of the Army, and that, in my opinion, he is free from all bodily defects and mental infirmity, which would in any way disqualify him from performing the duties of a soldier.

Wm Mc Humphrey
Surgeon
EXAMINING SURGEON.

I CERTIFY, ON HONOR, That I have minutely inspected the Volunteer Nora Turner previously to his enlistment, and that he was entirely sober when enlisted; that, to the best of my judgment and belief, he is of lawful age; and that, in accepting him as duly qualified to perform the duties of an able-bodied soldier, I have strictly observed the Regulations which govern the recruiting service. This soldier has Dark eyes, Dark hair, Dark complexion, is 5 feet 7 inches high.

H. Palmieri
1st Lt 84th U.S.C. Volunteers,
RECRUITING OFFICER.

Mustered into the service of the United States, for three years or during the war, from date of enlistment, in Company 1st Regiment of 2nd Lt 84th U.S.C. Volunteers, on the 5 day of Nov, 1864 at New Orleans

John Palmieri
2d Lt 1st Artillery U.S.A.
Recr. Insp. Officer

Statement of Service Reference Slip.

Office Pension

Claim No. A. 35225-2

Noah Turner
(Name.)

P, Co. D, 4 Reg't U.S.C.

add.
No medical record found
^
✓ *6 cds. ret'd*

To Mr Div. 5-14, 1917

For State no m. r.
7-50
7-11

Statement furnished May 15, 1917.
D.J.M.

1080 or John B.
 Valcent John

Co A, 4 U. S. Col'd Cav.

Private Private

CARD NUMBERS.

1	5-347655	26
2	5-347685	27
3	5-358661	28
4	5-358705	29
5	5-358757	30
6	5-358795	31
7	5-348036	32
8	5-355643	33
9	5-355757	34
10	5-355840	35
11	5-355920	36
12	5-356001	37
13	5-356078	38
14	5-356156	39
15		40
16		41
17		42
18		43
19		44
20		45
21		46
22		47
23		48
24		49
25		50

Book Mark:

See also

MAR 21

\$1676614 P.O. money

J. B. Dowd
Exp

2 | 4 Cav. | U.S.C.T.

John P. Valser

Appears with rank of *Pl* on

Muster and Descriptive Roll of a Detachment of U. S. Vols. forwarded

for the 4 Reg't U. S. Col'd Cavalry. Roll dated

New Orleans La June 22, 186*4*.

Where born *Cane River La.*

Age *18* y'rs; occupation *Labourer*

When enlisted *June 16*, 186*4*.

Where enlisted *New Orleans*

For what period enlisted *3* years.

Eyes *Blk*; hair *Blk*

Complexion *Blk*; height *5 ft. 2 1/2 in.*

When mustered in _____, 186 .

Where mustered in *New Orleans*

Bounty paid \$ *2* ⁰⁰; due \$ ⁰⁰

Where credited *to New Orleans La*

Company to which assigned *F*

Remarks :

Book mark :

Jaupm...

4 Cav. U.S.C.T.

John P. Valsen
Pl

Appears with rank of on

Muster and Descriptive Roll of a Detachment of U. S. Vols. forwarded

for the 4 Reg't U. S. Col'd Cavalry. Roll dated

New Orleans La July 18, 1864.

Where born Core River La.

Age 18 y'rs; occupation Laborer

When enlisted June 16, 1864.

Where enlisted New Orleans

For what period enlisted 3 years.

Eyes Blue; hair Blue

Complexion Dark; height 5 ft. 2 1/2 in.

When mustered in June 22, 1864.

Where mustered in New Orleans

Bounty paid \$ 100; due \$ 100

Where credited to New Orleans La

Company to which assigned L

Remarks:

Book mark:

John Hunter

N | **4 Cav.** | **U.S.C.T.**

John Wilson
Pvt., Co. L, 4 Reg't U. S. Col'd Cavalry.

Age.....years.

Appears on

Company Muster Roll*

for Enlistment to Aug. 31, 1864.

Joined for duty and enrolled:

When June 16, 1864.

Where New Orleans La.

Period 3 years.

Mustered in:

When June 22, 1864.

Where New Orleans La.

Present or absent Present

Stoppage, \$.....100 for.....

Due Gov't, \$.....100 for.....

Valuation of horse, \$.....100

Valuation of horse equipments, \$.....100

Remarks :

* First current roll. No muster-in roll of this battery on file.

Book mark :

Lanning
(3586) Lanning Copyist.

17 | 4 Cav. | U.S.C.T.

John Wilson
Cvt., Co. L, 4 Reg't U.S. Col'd Cavalry.

Appears on

Company Muster Roll

for Sept & Oct, 1864

Present or absent Present

Stoppage, \$ 100 for

Due Gov't, \$ 100 for

Valuation of horse, \$ 100

Valuation of horse equipments, \$ 100

Remarks:

Book mark:

(358)

J. Wilson

Copyist.

17 | **4 Cav.** | **U.S.C.T.**

John Falcon
Pvt., Co. L, 4 Reg't U.S. Col'd Cavalry.

Appears on

Company Muster Roll

for *Nov. & Dec.*, 1864.

Present or absent *Present*

Stoppage, \$ *100* for

Due Gov't, \$ *100* for

Valuation of horse, \$ *100*

Valuation of horse equipments, \$ *100*

Remarks:

Book mark: _____

Loring

(358) *Loring* Copyist.

17 | 4 Cav. | U.S.C.T.

John Wilson
Pvt., Co. L, 4 Reg't U. S. Col'd Cavalry.

Appears on

Company Muster Roll

for Jan. & Feb., 1865.

Present or absent Present

Stoppage, \$ 100 for

Due Gov't, \$ 100 for

Valuation of horse, \$ 100

Valuation of horse equipments, \$ 100

Remarks:

Book mark:

Worring

2 | **4 Cav. | U.S.C.T.**

John Valcent
Prh, Co. F, 4 Reg't U. S. Col'd Cavalry.

Appears on

Company Muster Roll
for *Mch & Apr*, 1865.

Present or absent *Present*

Stoppage, \$ *100* for

Due Gov't, \$ *100* for

Valuation of horse, \$ *100*

Valuation of horse equipments, \$ *100*

Remarks: *Joined by Transfer*
from "L" Co. Pr. S. Co. No. 28 dated
Hd Qrs. Dept of the Gulf
Jan 28/865

Book mark: _____

H Harris

V | 4 Cav | **U.S.C.T.**
Cohn Valsen
Am, Co. H, 4 Reg't U. S. Col'd Cav

Appears on

M. and D. Roll of Men Transferred

to the organization named above, by Consol.
from Co R

Roll dated Port Hudson, La. Apr 19, 1865.

When enlisted June 16, 1864.

Period for which enlisted 3 years.

When mustered in June 22, 1864.

Present or absent Not stated

Company to which assigned H

Remarks:

Book mark :

[Signature]

V | **4 Cav.** | **U.S.C.T.**

John Valson
Pvt, Co. F, 4 Reg't U. S. Col'd Cavalry.

Appears on

Company Muster Roll

for *May & June*, 186*5*

Present or absent *Present*

Stoppage, \$.....*100* for

Due Gov't, \$.....*100* for

Valuation of horse, \$.....*100*

Valuation of horse equipments, \$.....*100*

Remarks:.....

Book mark:.....

J. Harris

W | 4 Cav. | U.S.C.T.

John Valson
Pvt, Co. F, 4 Reg't U. S. Col'd Cavalry.

Appears on

Company Muster Roll

for *July & Aug*, 1865.

Present or absent *Present*

Stoppage, \$ 100 for

Due Gov't, \$ 100 for

Valuation of horse, \$ 100

Valuation of horse equipments, \$ 100

Remarks:
.....
.....
.....
.....
.....
.....
.....
.....

Book mark:

J. W. Harris

MAR 33

V | 4 Cav. | U.S.C.T.

John Valcent
Pvt, Co. F, 4 Reg't U. S. Col'd Cavalry.

Appears on

Company Muster Roll

for *Sept & Oct*, 186 *5*

Present or absent *Present*

Stoppage, \$ 100 for

Due Gov't, \$ 100 for

Valuation of horse, \$ 100

Valuation of horse equipments, \$ 100

Remarks: *Stop for One Sabre Knot*

Book mark :

L. A. Harris

V | 4 Cav. | U.S.C.T.

John Valcent-
P., Co. F, 4 Reg't U. S. Col'd Cavalry.

Appears on

Company Muster Roll

for Nov. Dec., 1865

Present or absent Present-

Stoppage, \$ 32/100 for ordn. lost

Due Gov't, \$ 100 for

Valuation of horse, \$ 100

Valuation of horse equipments, \$ 100

Remarks:

Book mark:

(358)

Hibbard

Copyist,

V | 4 Cav. | U.S.C.T.

John Valent

Co. F, 4 Reg't U. S. Col'd Cavalry.

Appears on

Company Muster Roll

for Jan. Feb., 1866

Present or absent Present

Stoppage, \$ 32/100 for ordn. lost.

Due Gov't, \$ 100 for

Valuation of horse, \$ 100

Valuation of horse equipments, \$ 100

Remarks:

Book mark:

Hibbard

V | 4 Cav. | U.S.C.T.

John Valcent
 P Co. F., 4 Reg't U. S. Col'd Cavalry.

Appears on Co. Muster-out Roll, dated
 New Orleans, La., Mch. 20, 1866.

Muster-out to date Mch. 20, 1866.

Last paid to June 30, 1865.

Clothing account:

Last settled....., 186 ; drawn since \$..... 100

Due soldier \$ 15 ¹⁷/₁₀₀; due U. S. \$..... 100

Am't for cloth'g in kind or money adv'd \$..... 100

Due U. S. for arms, equipments, &c., \$..... ⁶⁴/₁₀₀

Bounty paid \$..... 100; due \$..... 100

Remarks: *Joined by transfer from
 Co. L per S.O. 28, Hdqrs. D. C.
 Jan. 28, 65.
 Stop 2 sabre knots.*

Book mark: V26 - P71 - 68.

(361)

Hibbard
 Copyist.

1081

Valsey Joseph

Co H, 4 U. S. Col'd Cav.

Private Private

CARD NUMBERS.

1	5-347482	26
2	5-358164	27
3	5-358231	28
4	5-358285	29
5	5-358335	30
6	5-358378	31
7	5-348030	32
8	5-357621	33
9	5-357703	34
10	5-357787	35
11	5-357865	36
12	5-357940	37
13	5-358015	38
14	5-358086	39
15	40729287	40
16		41
17		42
18		43
19		44
20		45
21		46
22		47
23		48
24		49
25		50

Book Mark:

See also

✓ 1116387 - P.O. 25710

J. 1993322 P.O. 25710

P.P. 640131

J. 2195674 P.O. 25710

J. 2224198 P.O. 25710

A-2733433 Aud. M. 20

J.B. Dowd
Ex

U | 4 Cav. | U.S.C.T.

Joseph Valse

Appears with rank of Private on

Muster and Descriptive Roll of a Detachment of U. S. Vols. forwarded

for the 4 Reg't U. S. Col'd Cavalry. Roll dated New Orleans, La April 27, 1864.

Where born Matchitoches, La.

Age 22 yrs; occupation Wagoner

When enlisted April 16, 186 .

Where enlisted Grand Ecore, La

For what period enlisted 3 years.

Eyes Brown; hair Black

Complexion Black; height 5 ft. 2 in.

When mustered in April 27, 1864.

Where mustered in New Orleans

Bounty paid \$ 2 ¹⁰⁰; due \$ 100

Where credited

Company to which assigned

Remarks:

Book mark:

A. J. Taylor

(339) Copyist.

V | 4 Cav. | U.S.C.T.

Joseph Valse
Pvt, Co. *D*, 4 Reg't U. S. Co'd Cavalry.

Age _____ years.

Appears on

Company Muster Roll*

for *April 27 to June 30*, 1864.

Joined for duty and enrolled:

When *April 16*, 1864.

Where *Grand Ecore, La.*

Period *3* years.

Mustered in:

When *April 27*, 1864.

Where *New Orleans, La.*

Present or absent *Present*

Stoppage, \$ _____ 100 for _____

Due Gov't, \$ _____ 100 for _____

Valuation of horse, \$ _____ 100

Valuation of horse equipments, \$ _____ 100

Remarks : _____

* First current roll. No muster-in roll of this battery on file.

Book mark : _____ *1*

Hys
Copyist.

25 4 Cav. U.S.C.T.

Joseph Valse

Rt, Co. I, 4 Reg't U. S. Col'd Cavalry.

Appears on

Company Muster Roll

for *July + Aug*, 186*4*.

Present or absent *Absent*

Stoppage, \$ *100* for

Due Gov't, \$ *100* for

Valuation of horse, \$ *100*

Valuation of horse equipments, \$ *100*

Remarks: *Absent on temporary detached service by S.O. 89 P. 3. Hd Qrs 4th U.S.C.*

Book mark:

J. H. ...
Copyist.

2 | 4 Cav. | U.S.C.T.

Joseph Valse
Priv

, Co. I, 4 Reg't U. S. Col'd Cavalry.

Appears on

Company Muster Roll

for *Sept - Oct*, 186*4*.

Present or absent *Present*

Stoppage, \$ *100* for

Due Gov't, \$ *100* for

Valuation of horse, \$ *100*

Valuation of horse equipments, \$ *100*

Remarks:

Book mark:

Hys

V | 4 Cav. | U.S.C.T.

Joseph Valsee

Pr, Co. I, 4 Reg't U. S. Col'd Cavalry.

Appears on

Company Muster Roll

for *Jan + Feb*, 1865.

Present or absent *Present*

Stoppage, \$ 100 for

Due Gov't, \$ 100 for

Valuation of horse, \$ 100

Valuation of horse equipments, \$ 100

Remarks:

Book mark:

(358)

Hyas

Copyist.

V | **4 Cav.** | **U.S.C.T.**

Joseph Valsey

Pvt., Co. II, 4 Reg't U. S. Col'd Cavalry.

Appears on

Company Muster Roll

for *Mch. 9. Apl.*, 186*5*.

Present or absent *Present*

Stoppage, \$ *100* for

Due Gov't, \$ *100* for

Valuation of horse, \$ *100*

Valuation of horse equipments, \$ *100*

Remarks: *Transferred from
Co. A in consolidation by
S. O. 28. Hdqrs. Dept
July Jan. 28/65.*

Book mark:

Peaster

N 14 Cav, U.S.C.T.

Joseph Valsey
Pvt, Co. H, Reg't U. S. Cav

Appears on

M. and D. Roll of Men Transferred

to the organization named above, by consol.
from Co. D.

Roll dated Fort Huachuca Apr 29, 1865.

When enlisted Apr. 16, 1864.

Period for which enlisted 3 years.

When mustered in Apr 29, 1864.

Present or absent Not stated

Company to which assigned N

Remarks:

Book mark :

(342)

A. W. Leonard

Copyist.

4799 346

N | **4 Cav.** | **U.S.C.T.**

Joseph Valsey

Pvt, Co. H, 4 Reg't U. S. Col'd Cavalry.

Appears on

Company Muster Roll

for *May & June*, 186*5*.

Present or absent *Present*

Stoppage, \$ *100* for

Due Gov't, \$ *100* for

Valuation of horse, \$ *100*

Valuation of horse equipments, \$ *100*

Remarks:

Book mark:

Heaster

W | **4 Cav.** | **U.S.C.T.**

Joseph Valse
W. H., Co. H, 4 Reg't U. S. Col'd Cavalry.

Appears on

Company Muster Roll

for July & Aug., 1865.

Present or absent Present

Stoppage, \$ 100 for

Due Gov't, \$ 100 for

Valuation of horse, \$ 100

Valuation of horse equipments, \$ 100

Remarks:

Book mark :

W. H. Valse

1863

V | **4 Cav. | U.S.C.T.**

Joseph Valsey

Pvt., Co. H, 4 Reg't U. S. Col'd Cavalry.

Appears on

Company Muster Roll

for *Sept. 8. Oct.*, 186*3*.

Present or absent *Present*

Stoppage, \$ 100 for _____

Due Gov't, \$ 100 for _____

Valuation of horse, \$ 100

Valuation of horse equipments, \$ 100

Remarks: _____

Book mark: _____

Feaster

V | **4 Cav.** | **U.S.C.T.**

Joseph Valsey
.....
Pvt., Co. H, 4 Reg't U. S. Col'd Cavalry.

Appears on

Company Muster Roll

for *dated Dec 31*, 186 *4*.

Present or absent *Present*

Stoppage, \$ 100 for

Due Gov't, \$ 100 for

Valuation of horse, \$ 100

Valuation of horse equipments, \$ 100

Remarks:

.....

.....

.....

.....

.....

.....

Book mark:

.....

A. E. Arnold

V | **4 Cav.** | **U.S.C.T.**

Joseph Valsey
Co. H, 4 Reg't U. S. Col'd Cavalry.

Appears on

Company Muster Roll

for *Jan & Feb*, 186*6*.

Present or absent *Present*

Stoppage, \$ *100* for

Due Gov't, \$ *100* for

Valuation of horse, \$ *100*

Valuation of horse equipments, \$ *100*

Remarks:

Book mark:

H. E. Howard

V | 4 Cav. | U.S.C.T.

Joseph Valsey

, Co. D, 4 Reg't U. S. Colored Cav.

Appears on Returns as follows:

Aug 1864 - Absent on duty with
R. G. M.

Book mark:

W. R. Lee

V | **4 Cav. | U.S.C.T.**

Joseph Valsey
Pri., Co. *H*, 4 Reg't U. S. Col'd Cavalry.

Appears on **Co. Muster-out Roll**, dated
New Orleans La, Mar 24, 1866.

Muster-out to date *Mar 20*, 1866.

Last paid to *June 30*, 1865.

Clothing account:

Last settled....., 186 ; drawn since \$..... 100

Due soldier \$ *19 94* / 100; due U. S. \$..... 100

Am't for cloth'g in kind or money adv'd \$..... 100

Due U. S. for arms, equipments, &c., \$..... 100

Bounty paid \$..... 100; due \$..... 100

Remarks: *Joined by transfer*
from Co. I Mar. 24 1865
for S. O. 28 Hd. Dep.
Dept. Gulf series 1865

Book mark: *V. 35, P. 17, 48*

A. E. Strode

(361)

Copyist.

1082

Laughlin Jacob

Co *A*, 4 U. S. Col'd Cav.

Private Corporal

CARD NUMBERS.

1	5-347791	26
2	5-352950	27
3	5-353033	28
4	5-353116	29
5	5-353144	30
6	5-353240	31
7	5-353340	32
8	5-353431	33
9	5-353516	34
10	5-353598	35
11	5-353680	36
12	40729288	37
13		38
14		39
15		40
16		41
17		42
18		43
19		44
20		45
21		46
22		47
23		48
24		49
25		50

Book Mark:

See also

J. 2029290 Pomona

J. 2913306 - PO off

AY. 1636415

S. 2987163 Aud. W.L.

W. Dowd
Ex

4 Cav. U.S.C.T.

Saco Vougne

Appears with rank of Sub on

Muster and Descriptive Roll of a Detachment of U. S. Vols. forwarded

for the 4 Reg't U. S. Col'd Cavalry. Roll dated New Orleans La., Aug. 30, 1864.

Where born Ascogoula, Miss.

Age 21 y'rs; occupation Laborer

When enlisted Aug. 26, 1864.

Where enlisted New Orleans

For what period enlisted 3 years.

Eyes Blk; hair Blk

Complexion Dark; height 5 ft. 8 in.

When mustered in Aug. 30, 1864.

Where mustered in New Orleans

Bounty paid \$ 100.00; due \$ 200.00

Where credited New Orleans

Company to which assigned D

Remarks: Recruit entitled to Bounty

Book mark:

J E Tyler Copyist.

77 | 4 Cav. | U.S.C.T.

Jacob Varney

Pl't, Co. D, 4 Reg't U. S. Col'd Cavalry.

Appears on

Company Muster Roll

for *Sept & Oct*, 1864.

Present or absent *Present*

Stoppage, \$ *100* for

Due Gov't, \$ *100* for

Valuation of horse, \$ *100*

Valuation of horse equipments, \$ *100*

Remarks:

First roll on which borne.

Book mark:

Rosenbaum

(358)

Copyist.

17 | 4 Cav. | U.S.C.T.

Isaac Vinyer
VP, Co. D, 4 Reg't U. S. Col'd Cavalry.

Appears on

Company Muster Roll

for *Nov Dec*, 1864.

Present or absent *Present*

Stoppage, \$ 100 for

Due Gov't, \$ 100 for

Valuation of horse, \$ 100

Valuation of horse equipments, \$ 100

Remarks: *Due U.S. for Ord. U.S. Ar.*

Book mark:

L. J. Wright
(358) Copyist.

27 | 4 Cav. | U.S.C.T.

Robert Young
Co. D, 4 Reg't U. S. Col'd Cavalry.

Appears on

Company Muster Roll

for *Jan & Feb*, 1865.

Present or absent *Present*

Stoppage, \$ *100* for

Due Gov't, \$ *100* for *Armed*

Valuation of horse, \$ *100*

Valuation of horse equipments, \$ *100*

Remarks: *# 100 Bounty Paid*
200 due

Book mark :

(358) *100/1212* Copyist.

70 | 4 Cav. | U.S.C.T.

Albert L. ...
Cor, Co. D, 4 Reg't U. S. Col'd Cavalry.

Appears on

Company Muster Roll

for ... 1864

Present or absent ...

Stoppage, \$ 100 for

Due Gov't, \$ 100 for

Valuation of horse, \$ 100

Valuation of horse equipments, \$ 100

Remarks: ...
...

Book mark:

4 Cav. U.S.C.T.

Livermore
Col, Co. D, 4 Reg't U. S. Col'd Cavalry.

Appears on

Company Muster Roll

for *May & June*, 186*5*.

Present or absent *Present*

Stoppage, \$ *100* for

Due Gov't, \$ *100* for

Valuation of horse, \$ *100*

Valuation of horse equipments, \$ *100*

Remarks: *See from Pickers list #100 bounty paid #100 due*

Book mark:

W. H. Wright

4 Cav. | U.S.C.T.

Albert V. ...
Co. D, 4 Reg't U. S. Col'd Cavalry.

Appears on

Company Muster Roll

for *July 1st 1865*, 1865.

Present or absent *Present*

Stoppage, \$ *100* for

Due Gov't, \$ *100* for

Valuation of horse, \$ *100*

Valuation of horse equipments, \$ *100*

Remarks: *Exp from ...*
...
...

Book mark:

4 1/2 ...

W | 4 Cav. | U.S.C.T.

George Vining
Cor, Co. D, 4 Reg't U. S. Col'd Cavalry.

Appears on

Company Muster Roll

for *Sept & Oct*, 1865.

Present or absent *Present*

Stoppage, \$ 100 for

Due Gov't, \$ 100 for

Valuation of horse, \$ 100

Valuation of horse equipments, \$ 100

Remarks: *Wm. Vining's unit*
2nd line

Book mark:

W. H. Wright

V | **4 Cav.** | **U.S.C.T.**

Wm. H. Houghton

Corp., Co. D, 4 Reg't U. S. Col'd Cavalry.

Appears on

Company Muster Roll

for *Nov 1866*, 186*6*

Present or absent *Present*

Stoppage, \$ *100* for

Due Gov't, \$ *100* for

Valuation of horse, \$ *100*

Valuation of horse equipments, \$ *100*

Remarks: *Balance paid 100.00*
Balance due \$200.00

Book mark:

W. H. Houghton

7 | 4 Cav. | U.S.C.T.

Jacob Hough
Co., Co. D, 4 Reg't U. S. Col'd Cavalry.

Appears on

Company Muster Roll

for *Jan 1st*, 186*6*.

Present or absent *Present*

Stoppage, \$ *100* for

Due Gov't, \$ *100* for

Valuation of horse, \$ *100*

Valuation of horse equipments, \$ *100*

Remarks: *Penalty paid \$100.00*
Penalty due \$200.00

Book mark:

J. H. Hough

U | 4 Cav. | U.S.C.T.

Jacob Vaughn

Prvt, Co. D, 4 Reg't U. S. Colored Cav.

Appears on Returns as follows:

Sept 1864 - Gain; Sept 3/61
Port Hudson Enlisted

Book mark :

W. R. Lee

U | **4 Cav. | U.S.C.T.**

Jacob Daughan

Coop, Co. *U*, 4 Reg't U. S. Col'd Cavalry.

Appears on **Co. Muster-out Roll**, dated

New Orleans, La, Feb 20, 186*6*.

Muster-out to date

Feb 20, 186*6*.

Last paid to

June 31, 186*5*.

Clothing account:

Last settled....., 186 ; drawn since \$.....100

Due soldier \$.....100; due U. S. \$ *27* $\frac{23}{100}$

Am't for cloth'g in kind or money adv'd \$.....100

Due U. S. for arms, equipments, &c., \$.....100

Bounty paid \$ *100* 100; due \$ *100* 100

Remarks: *Joined as recruit.*

Enl. since Apr 1/65.

Book mark:

M. J. ...

Vouagne, Jacob

....., Co., *4* Reg't *U. S. Cav.*

Enclosures.

Bed Cards.....	Final Statements.....
Burial Records.....	Furloughs or L. of A.....
Certs. of Dis. for Discharge.....	Med. Certificates.....
C. M. Charges.....	Med. Des. Lists.....
Descriptive Lists.....	Orders.....
Discharge Certificates.....	Pris. of War Record.....
Enlistment Papers.....	Resignations.....

Other papers relating to—

Admission to Hosp'l.....	Furlough or L. of A.....
Casualty Sheet.....	Med. Examination.....
Confinement.....	Misc. Information.....
Contracts.....	Pay of Clothing.....
Death or Effects.....	Personal Reports.....
Desertion.....	Rank.....
Discharge from Hosp'l.....	Transfer to Hosp'l.....
Discharge from Service.....	Transfer to V. R. C.....
Duty.....	Transportation.....
.....

NOTE 1.—This blank will be used for both enlistments and re-enlistments—enlistment of veterans, &c., &c. in the career service. They will be made out in duplicate in all cases—one to accompany the recruiting return of the superintendent (not the recruiting officer) to the Adjutant General, and one to accompany the account of the officer who pays bounty, &c. The Regiment and Company in which the soldier last served should be given on the back.

NOTE 2.—An enlistment holds to service. A muster-in mast, in all cases, precede payment of pay, bounty, pension, &c. A muster-in roll must, in all cases, be filed in the Adjutant General's Office as evidence of muster-in. The mustering officer, commissary, or assistant commissary of musters, as the case may be, will countersign both enlistments as having mustered the soldier into the service of the United States before either of them is given to the discharging officer.

DECLARATION OF RECRUIT.

I, *Jacob Vouyne*, desiring to VOLUNTEER as a Soldier in the Army of the United States, for the term of THREE YEARS, Do Declare, That I am *Twenty one* years and _____ months of age; that I have never been discharged from the United States service on account of disability or by sentence of a court martial, or by order before the expiration of a term of enlistment; and I know of no impediment to my serving honestly and faithfully as a soldier for three years.

GIVEN at *New Orleans La.* the *26th* day of *August 1864*

Witness: *H. Butler* *Jacob Vouyne* mark.

No. *Jacob Vouyne*
Volunteered at *New Orleans*
August 26th 1864
By *Capt. G. Butler*
4th Regiment of U. S. Col.
Company
Discharged _____ 18____
Hermit's tent to 18 months by General on 10/27/1864
Office July 1864
Received from Second Auditor
August 26th, 1892.

CONSENT IN CASE OF MINOR.

I, _____ Do CERTIFY, That I am _____ of _____; that the said _____ is _____ years of age; and I do hereby freely give my CONSENT to his volunteering as a SOLDIER in the ARMY OF THE UNITED STATES for the period of THREE YEARS.

GIVEN at _____ the _____ day of _____

Witness: _____

NOV 26 1864

VOLUNTEER ENLISTMENT.

STATE OF

TOWN OF

Louisiana



New Orleans

I, *Jacob Vouyne*, born in *Passagoula* in the State of *Mississippi*, aged *Twenty five* years, and by occupation a *Laborer*, DO HEREBY ACKNOWLEDGE to have volunteered this *Twenty sixth* day of *August*, 1864 to serve as a **Soldier** in the **Army of the United States of America**, for the period of **THREE YEARS**, unless sooner discharged by proper authority: Do also agree to accept such bounty, pay, rations, and clothing, as are, or may be, established by law for volunteers. And I, *Jacob Vouyne*, do solemnly swear, that I will bear true faith and allegiance to the **United States of America**, and that I will serve them honestly and faithfully against all their enemies or opposers whomsoever; and that I will observe and obey the orders of the President of the United States, and the orders of the officers appointed over me, according to the Rules and Articles of War.

Sworn and subscribed to, at

this *26th* day of *August*, 1864

BEFORE

Capt. H. Butler
4th U. S. Col. Cav.

Jacob Vouyne
mark.

I CERTIFY, ON HONOR, That I have carefully examined the above-named Volunteer, agreeably to the General Regulations of the Army, and that, in my opinion, he is free from all bodily defects and mental infirmity, which would in any way disqualify him from performing the duties of a soldier.

U. S. Leffingwell

Surgeon U. S. A.

EXAMINING SURGEON.

I CERTIFY, ON HONOR, That I have minutely inspected the Volunteer *Jacob Vouyne* previously to his enlistment, and that he was entirely sober when enlisted; that, to the best of my judgment and belief, he is of lawful age; and that, in accepting him as duly qualified to perform the duties of an able-bodied soldier, I have strictly observed the Regulations which govern the recruiting service. This soldier has *Dark* eyes, *Blond* hair, *Dark* complexion, is *five* feet *eight* inches high.

Francis Butler Capt.

4th Regiment of U. S. Col. Volunteers, Cav.

RECRUITING OFFICER.

(A. G. O. No. 74 & 76.)

Mustered into the service of the United States, for three years or during the war, from date of enlistment, in Company *D* Regiment of *W. H. C. Cav.* Volunteers, on the *26th* day of *August*, 1864, at *New Orleans*

John M. Chamberlain
1st U. S. Col. S. O. Art. (26)
H. G. W.

MAR 27 1883

1883

Verdine Robert

Co A, 4 U. S. Col'd Cav.

Private Private

CARD NUMBERS.

1	5-3 4 7 8 6 0	26
2	5-3 5-3 2 1 6	27
3	5-3 5-3 3 0 9	28
4	5-3 5-3 4 0 3	29
5	5-3 5-3 4 9 1	30
6	5-3 5-3 5 7 7	31
7	5-3 5-3 6 6 0	32
8	5-3 5-3 7 3 9	33
9	40729289	34
10		35
11		36
12		37
13		38
14		39
15		40
16		41
17		42
18		43
19		44
20		45
21		46
22		47
23		48
24		49
25		50

Book Mark:

See also

S1402212 - P.O. 7 Mon
S-2865952 - aud W D

J B Dowd
Ex

2 | 4 Cav. | U.S.C.T.

Robert Verdunier

Appears with rank of *Priv* on

Muster and Descriptive Roll of a Detachment of U. S. Vols. forwarded

for the *4* Reg't U. S. Col'd *Cav.* Roll dated

New Orleans La, Mch 25 186*5*.

Where born *St Marys Co La.*

Age *19* y'rs; occupation *Labour*

When enlisted *Mch 8*, 186*5*.

Where enlisted *New Orleans*

For what period enlisted *1* years.

Eyes *Brown*; hair *Blk*

Complexion *Mulatto*; height *5* ft. *7* in.

When mustered in *Mch 25*, 186*5*.

Where mustered in *New Orleans*

Bounty paid \$ *33* ^{*33*}/_{*100*}; due \$ *66* ^{*66*}/_{*100*}

Where credited *Dist / Ward No 2 La*

Company to which assigned *D*

Remarks:

Book mark:

McCormack

comp.

Copyist

27 | 4 Cav. | U.S.C.T.

Robert-Verdine
P, Co. D, 4 Reg't U. S. Col'd Cavalry.

Appears on

Company Muster Roll

for March & April, 1865.

Present or absent Absent

Stoppage, \$ 100 for

Due Gov't, \$ 100 for

Valuation of horse, \$ 100

Valuation of horse equipments, \$ 100

Remarks: Sick in C & D Co
at Camp near Mex 25, 65
333 Bounty paid
60.00 due

Book mark:

E. V. Murphy

(358)

Copyist.

Comp

4 Cav. U.S.C.T.

Robert Verdine

Co. D, 4 Reg't U. S. Col'd Cavalry.

Appears on

Company Muster Roll

for May 1st June, 1865.

Present or absent Present

Stoppage, \$ 100 for

Due Gov't, \$ 100 for

Valuation of horse, \$ 100

Valuation of horse equipments, \$ 100

Remarks: # 2233 1/2 Comby paid # 00.00 due

Book mark:

A. H. Bryant

4 Cav. U.S.C.T.

Robert L. Ordine

P, Co. D, 4 Reg't U. S. Col'd Cavalry.

Appears on

Company Muster Roll

for *July & Aug*, 186*5*.

Present or absent *Present*

Stoppage, \$ 100 for

Due Gov't, \$ 100 for

Valuation of horse, \$ 100

Valuation of horse equipments, \$ 100

Remarks: *# 1000 - 1000 - paid
1000 - 1000*

Book mark:

at night

4 Cav. U.S.C.T.

Robert Verdene

D, Co. D, 4 Reg't U. S. Col'd Cavalry.

Appears on

Company Muster Roll

for Sept-Oct, 1865.

Present or absent absent

Stoppage, \$ 100 for

Due Gov't, \$ 100 for

Valuation of horse, \$ 100

Valuation of horse equipments, \$ 100

Remarks: absent with leave # 333 Bounty paid 67.09

Book mark:

W. Wright

916 | 4 Cav. | U.S.C.T.

Robert Harding

Sgt, Co. D, 4 Reg't U. S. Col'd Cavalry.

Appears on

Company Muster Roll

for Nov & Dec, 1865.

Present or absent Present

Stoppage, \$ 100 for

Due Gov't, \$ 100 for

Valuation of horse, \$ 100

Valuation of horse equipments, \$ 100

Remarks: Bounty paid \$33.33
Bounty due \$6.67

Book mark:

103, 100, 100

W | 4 Cav. | U.S.C.T.

Robert Woodruff

Put, Co. D, 4 Reg't U. S. Col'd Cavalry.

Appears on

Company Muster Roll

for Jan 1 Feb, 1866.

Present or absent Present

Stoppage, \$ 100 for

Due Gov't, \$ 100 for

Valuation of horse, \$ 100

Valuation of horse equipments, \$ 100

Remarks: Bounty paid \$33.33
Bounty due Feb. 67

Book mark:

R. W. Woodruff

V | 4 Cav. | U.S.C.T.

Robert Verdine

Port, Co. D, 4 Reg't U. S. Colored Cav.

Appears on Returns as follows:

Apl 1865 - Gain; Mar 8/65
New Orleans La. Recruit
from depot.
Absent sick in Genl Hosp.
at New Orleans, La.

Book mark: _____

W. R. Lee

V | **4 Cav.** | **U.S.C.T.**

Robert Verdine

Put, Co. *H*, 4 Reg't U. S. Col'd Cavalry.

Appears on **Co. Muster-out Roll**, dated *New Orleans, La*, *March 20*, 186*6*.

Muster-out to date *March 20*, 186*6*.

Last paid to *June 30*, 186*5*.

Clothing account:

Last settled....., 186 ; drawn since \$..... $\frac{100}{100}$

Due soldier \$ *11* $\frac{72}{100}$; due U. S. \$..... $\frac{100}{100}$

Am't for cloth'g in kind or money adv'd \$..... $\frac{100}{100}$

Due U. S. for arms, equipments, &c., \$..... $\frac{30}{100}$

Bounty paid \$ *3* $\frac{3}{100}$; due \$ *66* $\frac{2}{100}$

Remarks: *Joined as recruit.*
Stop: 1 Salvo Knut.

Book mark:

J. S. Verdine

Nerdun, Robert

....., Co., *4* Reg't *U.S.C.*

Enclosures.

Bed Cards.....	Final Statements.....
Burial Records.....	Furloughs or L. of A.....
Certs. of Dis. for Discharge.....	Med. Certificates.....
C. M. Charges.....	Med. Des. Lists.....
Descriptive Lists.....	Orders.....
Discharge Certificates.....	Pris. of War Record.....
Enlistment Papers.....	Resignations.....

Other papers relating to—

Admission to Hosp'l.....	Furlough or L. of A.....
Casualty Sheet.....	Med. Examination.....
Confinement.....	Misc. Information.....
Contracts.....	Pay of Clothing.....
Death or Effects.....	Personal Reports.....
Desertion.....	Rank.....
Discharge from Hosp'l.....	Transfer to Hosp'l.....
Discharge from Service.....	Transfer to V. R. C.....
Duty.....	Transportation.....
.....

NOTE 1.—This blank will be used for both enlistments and re-enlistments—enlistment of veterans, &c., &c., in the volunteer service. They will be made out in duplicate in all cases—one to accompany the recruiting return of the superintendent (not the recruiting officer) to the Adjutant General, and one to accompany the accounts of the officer who pays bounty, &c. The Regiment and Company in which the soldier last served should be given on the back.

NOTE 2.—An enlistment holds to service. A muster-in must, in all cases, precede payment of pay, bounty, pension, &c. A muster-in roll must, in all cases, be filed in the Adjutant General's Office as evidence of muster-in. The mustering officer, commissary, or assistant commissary of musters, as the case may be, will countersign both enlistments as having mustered the soldier into the service of the United States before either of them is given to the disbursing officer.

(A. G. O. No. 74 & 76.)

DECLARATION OF RECRUIT.

I, Robert Ferdman, desiring to VOLUNTEER as a Soldier in the Army of the United States, for the term of ~~THREE~~ ^{one} YEARS, Do Declare, That I am 19 years and _____ months of age; that I have never been discharged from the United States service on account of disability or by sentence of a court martial, or by order before the expiration of a term of enlistment; and I know of no impediment to my serving honestly and faithfully as a soldier for ~~three~~ years.

GIVEN at New Orleans La the 8 day of March 1865

Witness:

John Leo Friedman
1st Lt. 10th U. S. C. A. Ky.

Robert Ferdman
made

Received from Second Auditor
October 7th. 1892.

Discharged _____, 18____
Re-enlistment to the Army
Recommended by Colonel to 2^d of June
New War. New July 19 - 1864.

enlistment; last served in Company ()

Reg't of _____

By Capt. A. McAlister
for the 4th Regiment of U. S. C. A.

Volunteered at New Orleans La.
March - 8 - 1865

No. _____
Robert Ferdman

CONSENT IN CASE OF MINOR.

I, _____, Do CERTIFY, That I am the _____ of _____; that the said _____ is _____ years of age; and I do hereby freely give my CONSENT to his volunteering as a SOLDIER in the ARMY OF THE UNITED STATES for the period of THREE YEARS.

GIVEN at _____ the _____ day of _____

Witness:

MAR 30 1865

VOLUNTEER ENLISTMENT.

STATE OF

Louisiana

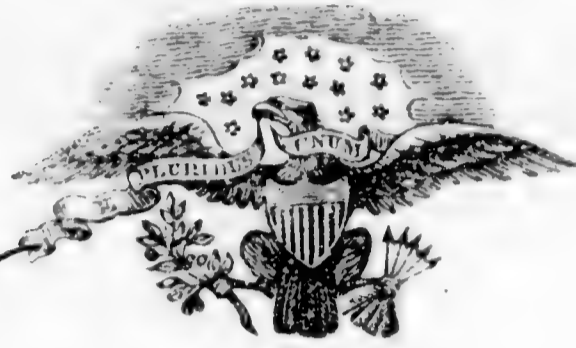

TOWN OF

New Orleans

I, Robert Ferdun, born in St. Mary's Pa. in the State of Louisiana, aged thirteen years, and by occupation a laborer, Do HEREBY ACKNOWLEDGE to have volunteered this eight day of March, 1865, to serve as a soldier in the Army of the United States of America, for the period of ~~three~~ one YEAR, unless sooner discharged by proper authority: Do also agree to accept such bounty, pay, rations, and clothing, as are, or may be, established by law for volunteers. And I, Robert Ferdun, do solemnly swear, that I will bear true faith and allegiance to the United States of America, and that I will serve them honestly and faithfully against all their enemies or opposers whomsoever; and that I will observe and obey the orders of the President of the United States, and the orders of the officers appointed over me, according to the Rules and Articles of War.

Sworn and subscribed to, at New Orleans La Robert Ferdun this 8 day of March, 1865, BEFORE John Geo. Friedman 1st Lt. 10th U. S. C. A. Reg.

I CERTIFY, ON HONOR, That I have carefully examined the above-named Volunteer, agreeably to the General Regulations of the Army, and that, in my opinion, he is free from all bodily defects and mental infirmity, which would in any way disqualify him from performing the duties of a soldier.

W. H. W. W. W.
EXAMINING SURGEON.

I CERTIFY, ON HONOR, That I have minutely inspected the Volunteer R. Ferdun previously to his enlistment, and that he was entirely sober when enlisted; that, to the best of my judgment and belief, he is of lawful age; and that, in accepting him as duly qualified to perform the duties of an able-bodied soldier, I have strictly observed the Regulations which govern the recruiting service. This soldier has Brown eyes, Black hair, Wolatto complexion, is five feet six inches high.

W. M. Allison
Capt. 10th Regiment of U. S. C. A. Reg. Volunteers,
RECRUITING OFFICER.

Mustered into the service of the United States, for three years or during the war, from date of enlistment, in Company G 4th Regiment of U. S. C. A. Volunteers, on the 25 day of March, 1865, at New Orleans La

John Geo. Friedman
1st Lt. 10th U. S. C. A. Reg.

NAVA 104

1004

Here John

Co G, 4 U.S. Col'd Cav.

Private Private

CARD NUMBERS.

1	5-3 4 7 8 6 3	26
2	5-3 4 4 6 6 6	27
3	5-3 4 4 6 8 6	28
4	5-3 5-8 6 6 2	29
5	5-3 5-8 7 0 6	30
6	5-3 5-8 7 5 8	31
7	5-3 5-8 7 9 6	32
8	5-3 4 7 9 6 2	33
9	5-3 5 6 7 1 3	34
10	5-3 5 6 8 0 0	35
11	5-3 5 6 8 9 1	36
12	5-3 5 6 9 7 6	37
13	5-3 5 7 0 5 4	38
14	5-3 5 7 1 4 2	39
15	4072 9290	40
16		41
17		42
18		43
19		44
20		45
21		46
22		47
23		48
24		49
25		50

x Added by Host. J. Aug. 9. 1902

Book Mark:

See also

S 1049361 Ro. un. un
S 1872479 Po aff

Rx P 625603

A 1954561 P. O. M. + 24

A. 2190345 Po. un. un

J. B. Doud
Exh

NA 399 396

S | **4 Cav. | U.S.C.T.**

John Vere

Appears with rank of *Pl* on

Muster and Descriptive Roll of a Detachment of U. S. Vols. forwarded

for the 4 Reg't U. S. Col'd Cavalry. Roll dated *New Orleans La June 22, 1864*

Where born *La*

Age *25* y'rs; occupation *Laborer*

When enlisted *Apr 9*, 186*4*

Where enlisted *Alexandria*

For what period enlisted *3* years.

Eyes *DK*; hair *DK*

Complexion *DK*; height *5* ft. *3* in.

When mustered in _____, 186 .

Where mustered in *New Orleans*

Bounty paid \$ *2* ¹⁰⁰; due \$ ¹⁰⁰

Where credited *to Alexandria La*

Company to which assigned *B*

Remarks :

Book mark : _____

Jan Ankin

2 | 4 Cav. | U.S.C.T.

John Tere

Appears with rank of *Pvt* on

Muster and Descriptive Roll of a Detachment of U. S. Vols. forwarded

for the 4 Reg't U. S. Col'd Cavalry. Roll dated *New Orleans La July 18*, 186*4*.

Where born *La*

Age *25* y'rs; occupation *Laborer*

When enlisted *Apr 9*, 186*4*.

Where enlisted *Alexandria*

For what period enlisted *3* years.

Eyes *DK*; hair *DK*

Complexion *DK*; height *5* ft. *3* in.

When mustered in *June 22*, 186*4*.

Where mustered in *New Orleans*

Bounty paid \$ *100*; due \$ *100*

Where credited *Alexandria La*

Company to which assigned *S*

Remarks:

Book mark:

Van Hook

N | **4 Cav. | U.S.C.T.**

John Vere

Pvt., Co. *E*, 4 Reg't U.S. Col'd Cavalry.

Age ----- years.

Appears on

Company Muster Roll*

for *Enlistment to Aug. 31*, 1864.

Joined for duty and enrolled:

When *Apr. 9*, 1864.

Where *Alexandria La.*

Period *3* years.

Mustered in:

When *June 22*, 1864.

Where *New Orleans La.*

Present or absent *Present*

Stoppage, \$ *100* for -----

Due Gov't, \$ *100* for -----

Valuation of horse, \$ *100*

Valuation of horse equipments, \$ *100*

Remarks : -----

* First current roll. No muster-in roll of this battery on file.

Book mark : -----

Receivable

(3586) *Copyist.*

13 | 4 Cav. | U.S.C.T.

John Ware
Pvt., Co. L, 4 Reg't U. S. Col'd Cavalry.

Appears on

Company Muster Roll

for Sept. & Oct., 1864.

Present or absent Present

Stoppage, \$ 100 for

Due Gov't, \$ 100 for

Valuation of horse, \$ 100

Valuation of horse equipments, \$ 100

Remarks: Due M.D. for lost
P.D. since 30th mizee and
ball screw

Book mark:

Loring

R | **4 Cav.** | **U.S.C.T.**

John Vere
Pvt., Co. L, 4 Reg't U. S. Col'd Cavalry.

Appears on

Company Muster Roll

for *Nov. & Dec.*, 1864.

Present or absent *Present*

Stoppage, \$ *33* for *Ordnance*
lost.

Due Gov't, \$ *100* for

Valuation of horse, \$ *100*

Valuation of horse equipments, \$ *100*

Remarks: *Ordnance lost*
one wiper & ball screw

Book mark:

(358)

Scoring

Copyist.

W | **4 Cav.** | **U.S.C.T.**

John Vere

Pvt., Co. L, 4 Reg't U. S. Col'd Cavalry.

Appears on

Company Muster Roll

for *Jan. & Feb.*, 186 *5*.

Present or absent *Present*

Stoppage, \$ *100* for

Due Gov't, \$ *100* for

Valuation of horse, \$ *100*

Valuation of horse equipments, \$ *100*

Remarks: *Stopped for one
gun wiper ball screw
33 etc.*

Book mark:

Loring

(358)

Copyist.

A | **4 Cav. | U. S. C. T.**

John A. ...

..., Co. G, 4 Reg't U. S. Col'd Cavalry.

Appears on

Company Muster Roll

for *March & April*, 186*5*.

Present or absent *Present*

Stoppage, \$ *100* for

Due Gov't, \$ *100* for

Valuation of horse, \$ *100*

Valuation of horse equipments, \$ *100*

Remarks: *formed by transfer
in consolidation
from Co. L Mar 24th per
L.O. No 28 dated 14th
L.O. Dept. Genl Jan 28th 65.*

Book mark: _____

...

11 | 4 Cav. | U.S.C.T.

John Taylor

Appears with rank of *Private* on

Muster and Descriptive Roll of a Detachment of U. S. Vols. forwarded

for the 4 Reg't U. S. Col'd Cavalry. Roll dated

at New Orleans, April 24, 1864.

Where born *Beaufort*

Age *26* y'rs; occupation *Palmer*

When enlisted *Apr 4*, 1864.

Where enlisted *Beaufort*

For what period enlisted *5* years.

Eyes *Dark*; hair *Dark*

Complexion *Dark*; height *5* ft. *5* in.

When mustered in *June 22*, 1864.

Where mustered in *New Orleans*

Bounty paid \$ *100*; due \$ *100*

Where credited

Company to which assigned *F*

Remarks: *Transferred from*

Company in consolidation

Book mark:

J. C. Taylor

14 Cav | U.S.C.T.

John Vere
Pr, Co. G, 4 Reg't U. S. Col'd Cav

Appears on

M. and D. Roll of Men Transferred

to the organization named above, by *transfer*,
from *Co D*

Roll dated *Port Hudson, La, Apr 9, 1865*.

When enlisted *Apr 9*, 1864.

Period for which enlisted *3* years.

When mustered in *June 22, 1864*.

Present or absent *not stated*

Company to which assigned *G*

Remarks:

Book mark:

(342)

W. L. ...

Copyist.

4 Cav. | U.S.C.T.

John Lane

John, Co. G, 4 Reg't U. S. Col'd Cavalry.

Appears on

Company Muster Roll

for *May 1st*, 1863.

Present or absent *Present*

Stoppage, \$ *100* for

Due Gov't, \$ *100* for

Valuation of horse, \$ *100*

Valuation of horse equipments, \$ *100*

Remarks:

Book mark:

Daniel

J | **4 Cav. | U.S.C.T.**

John Ous
Ous, Co. G, 4 Reg't U. S. Col'd Cavalry.

Appears on

Company Muster Roll

for *July & Aug*, 1867.

Present or absent *Present*

Stoppage, \$ *100* for

Due Gov't, \$ *100* for

Valuation of horse, \$ *100*

Valuation of horse equipments, \$ *100*

Remarks:

Book mark:

[Signature]
Copyist.

V | **4 Cav. | U. S. C. T.**

John Vere

One, Co. G, 4 Reg't U. S. Col'd Cavalry.

Appears on

Company Muster Roll

for *Sept & Oct*, 186 *5*

Present or absent *Present*

Stoppage, \$ *100* for

Due Gov't, \$ *100* for

Valuation of horse, \$ *100*

Valuation of horse equipments, \$ *100*

Remarks:

Book mark:

Fletcher

W

4 Cav. | U. S. C. T.

John Vere
Plu, Co. G, 4 Reg't U. S. Col'd Cavalry.

Appears on

Company Muster Roll

for *Jan & Feb*, 1866.

Present or absent *Present*

Stoppage, \$ 100 for

Due Gov't, \$ 100 for

Valuation of horse, \$ 100

Valuation of horse equipments, \$ 100

Remarks:

Book mark:

Fletcher

V | 4 Cav. | U.S.C.T.

John Vicar
Priv, Co. G, 4 Reg't U. S. Colored Cav.

Appears on Returns as follows:

Sept to Nov 1865 - On duty
Pa. Cook.

Also appears as
John Vicar
John Vere

Book mark:

W. R. Lee

W | **4 Cav. | U.S.C.T.**

John Vere

Priv, Co. *E*, 4 Reg't U. S. Col'd Cavalry.

Appears on **Co. Muster-out Roll**, dated
New Orleans, La, Mch 20, 1866.

Muster-out to date *Mch 20*, 1866.

Last paid to *June 30*, 1865.

Clothing account:

Last settled _____, 186 ; drawn since \$ _____ $\frac{100}{100}$

Due soldier \$ _____ $\frac{100}{100}$; due U. S. \$ *20* $\frac{47}{100}$

Am't for cloth'g in kind or money adv'd \$ _____ $\frac{100}{100}$

Due U. S. for arms, equipments, &c., \$ _____ $\frac{100}{100}$

Bounty paid \$ _____ $\frac{100}{100}$; due \$ _____ $\frac{100}{100}$

Remarks: *Joined by transfer from*
Co E 1st S.C. 28 Feb. 1865
Left Bn. Jan'y 28/65

Book mark: *195.1881* *314.1881*

J. Fletcher
Copyist.

1085

Victor Joseph

Co C, 4 U.S. Col'd Cav.

Private Corporal

CARD NUMBERS.

1	5347783	26
2	5351682	27
3	5351746	28
4	5351814	29
5	5351846	30
6	5351935	31
7	5352038	32
8	5352141	33
9	5352235	34
10	5352325	35
11	5352412	36
12	40729291	37
13		38
14		39
15		40
16		41
17		42
18		43
19		44
20		45
21		46
22		47
23		48
24		49
25		50

Book Mark:

See also

97 | 4 Cav. | U.S.C.T.

Joseph Victor

Appears with rank of *Sgt.* on

Muster and Descriptive Roll of a Detachment of U. S. Vols. forwarded

for the 4 Reg't U. S. Col'd Cavalry. Roll dated

New Orleans, La., Aug. 26, 1864.

Where born *New Orleans, La.*

Age *19* y'rs; occupation *Waiter*

When enlisted *Aug. 20*, 186*4*.

Where enlisted *New Orleans*

For what period enlisted *3* years.

Eyes *Black*; hair *Black*

Complexion *Grief*; height *3* ft. *6* in.

When mustered in *Aug. 26*, 186*4*.

Where mustered in *New Orleans*

Bounty paid \$ *100* *100*; due \$ *200* *100*

Where credited *New Orleans*

Company to which assigned *C*

Remarks: *Recruits entitled to*

bounty

Book mark:

E. E. Tyler

21 | 4 Cav. | U.S.C.T.

Joseph Victor
Sgt., Co. C, 4 Reg't U. S. Colored Cavalry.

Appears on

Company Muster Roll

for Sept 1864, 1864.

Present or absent Present

Stoppage, \$ 100 for

Due Gov't, \$ 100 for

Valuation of horse, \$ 100

Valuation of horse equipments, \$ 100

Remarks :

First roll of Co. on which borne,

Book mark :

Royster

N

4 Cav. U.S.C.T.

Joseph Victor

Priv, Co. C, 4 Reg't U. S. Colored Cavalry.

Appears on

Company Muster Roll

for *Nov & Dec*, 1864

Present or absent *present*

Stoppage, \$ *100* for

Due Gov't, \$ *100* for

Valuation of horse, \$ *100*

Valuation of horse equipments, \$ *100*

Remarks:

Book mark:

(358)

May Copyist.

N | 4 Cav. | U.S.C.T.

Joseph Victor
Priv, Co. C, 4 Reg't U. S. Colored Cavalry.

Appears on

Company Muster Roll

for *Jan & Feb*, 186*5*.

Present or absent *present*

Stoppage, \$ 100 for

Due Gov't, \$ 100 for

Valuation of horse, \$ 100

Valuation of horse equipments, \$ 100

Remarks:
.....
.....
.....
.....
.....
.....
.....
.....

Book mark:

(358) *Moy* Copyist.

N | 4 Cav. | U.S.C.T.

Joseph Victor
Corpl, Co. C, 4 Reg't U. S. Colored Cavalry.

Appears on

Company Muster Roll

for *Mch & Apr*, 1865.

Present or absent *present*

Stoppage, \$ *100* for

Due Gov't, \$ *100* for

Valuation of horse, \$ *100*

Valuation of horse equipments, \$ *100*

Remarks: *Promoted to Corp*
April 12th 1865

Book mark: _____

(358)

Moyn
Copyist.

N | 4 Cav. | U.S.C.T.

Joseph Victor
Corpl, Co. C, 4 Reg't U. S. Colored Cavalry.

Appears on

Company Muster Roll

for *May & June*, 1865.

Present or absent *present*

Stoppage, \$ *100* for

Due Gov't, \$ *100* for

Valuation of horse, \$ *100*

Valuation of horse equipments, \$ *100*

Remarks: *Appointed Corporal Apr 1, 1865. Stop for one bridle complete, one pair spurs and straps, one Canteen Thaversack*

Book mark: _____

(358)

May
Copyist.

N | **4 Cav. U.S.C.T.**

Joseph Victor
Corpl, Co. C, 4 Reg't U. S. Colored Cavalry.

Appears on

Company Muster Roll

for *July & Aug*, 186*5*.

Present or absent *present*

Stoppage, \$ *100* for

Due Gov't, \$ *100* for

Valuation of horse, \$ *100*

Valuation of horse equipments, \$ *100*

Remarks: *Apptd Corpl Apr 1/65.
Stop for 1 bridle complete,
1 pr spurs & straps and
haversack, Total \$ 6.15.*

Book mark:

(358) *May* Copyist.

N | **4 Cav.** | **U.S.C.T.**

Joseph Victor
Corpl, Co. C, 4 Reg't U. S. Colored Cavalry.

Appears on

Company Muster Roll

for *Sept Oct*, 1865.

Present or absent *present*

Stoppage, \$ 100 for

Due Gov't, \$ 100 for

Valuation of horse, \$ 100

Valuation of horse equipments, \$ 100

Remarks: *Stop for 1 horse brush
67 cts, 1 brush wiper 33 cts,
1 sabre knot 30 cts, 1 pair
spurs & straps 60 cts, 1
Saddle blanket 2.25,
Total \$4.15.*

Book mark:

(358)

Moy
Copyist.

7 | 4 Cav. | U.S.C.T.

Joseph Victor
Corpl, Co. C, 4 Reg't U. S. Colored Cavalry.

Appears on

Company Muster Roll
for *Nov. & Dec.*, 186*5*.

Present or absent *present*

Stoppage, \$ *6*/₁₀₀ for *Lost*
Ordinance

Due Gov't, \$ *100* for

Valuation of horse, \$ *100*

Valuation of horse equipments, \$ *100*

Remarks:

Book mark:

(358) *M. A. Michaels*
Copyist.

V | 4 Cav. | U.S.C.T.

Joseph Victor
Corpl, Co. C, 4 Reg't U. S. Colored Cavalry.

Appears on

Company Muster Roll

for *Jan'y & Febr*, 186*6*.

Present or absent *present*

Stoppage, \$ *6* ^{*67*}/₁₀₀ for *Last*
Ordnance

Due Gov't, \$ 100 for _____

Valuation of horse, \$ 100

Valuation of horse equipments, \$ 100

Remarks: _____

Book mark: _____

M. A. Michaels
(358) Copyist.

9 | 4 Cav. | U.S.C.T.

Joseph Victor

Priv, Co. B, 4 Reg't U. S. Colored Cav.

Appears on Returns as follows:

Sept 1864 - Paris; Sept 21st Port
Hudson - Enlisted

Book mark:

W. R. Lee

V | 4 Cav. | U.S.C.T.

Joseph Victor
 Corp, Co. C., 4 Reg't U. S. Col'd Cavalry.

Appears on Co. Muster-out Roll, dated
New Orleans La, Mar 20, 1866.

Muster-out to date *Mar 20*, 1866.

Last paid to *June 30*, 1865.

Clothing account:

Last settled....., 186 ; drawn since \$.....100

Due soldier \$.....100; due U. S. \$.....⁰²/₁₀₀

Am't for cloth'g in kind or money adv'd \$.....100

Due U. S. for arms, equipments, &c., \$ *6* ³²/₁₀₀

Bounty paid \$ *100* 100; due \$ *none* 100

Remarks: *Joined as recruit prior*
to Apl. 1/65. Stop 1 Saddle
blanket 1/2 Spurs & Straps
1 horse brush, 1 Sabie knot
1 brush wiper

Book mark: *7346 P.M.G. July 11/66*
V. 26 P. 183. 68

(361)

M.A. Michaels

Copyist.

Victor, Joseph

....., Co., *4* Reg't *U. S. Cavalry*

..... **Enclosures.**

Bed Cards.....	Final Statements.....
Burial Records.....	Furloughs or L. of A.....
Certs. of Dis. for Discharge.....	Med. Certificates.....
C. M. Charges.....	Med. Des. Lists.....
Descriptive Lists.....	Orders.....
Discharge Certificates.....	Pris. of War Record.....
Enlistment Papers.....	Resignations.....

Other papers relating to—

Admission to Hosp'l.....	Furlough or L. of A.....
Casualty Sheet.....	Med. Examination.....
Confinement.....	Misc. Information.....
Contracts.....	Pay of Clothing.....
Death or Effects.....	Personal Reports.....
Desertion.....	Rank.....
Discharge from Hosp'l.....	Transfer to Hosp'l.....
Discharge from Service.....	Transfer to V. R. C.....
Duty.....	Transportation.....
.....

NOV 18 1864

NOTE 1.—This blank will be used for both enlistments and re-enlistments—enlistment of veterans, &c., &c., in the volunteer service. They will be made out in duplicate in all cases—one to accompany the recruiting return of the superintendent (not the recruiting officer) to the Adjutant General, and one to accompany the accounts of the officer who pays bounty, &c. The Regiment and Company in which the soldier last served should be given on the back.

NOTE 2.—An enlistment binds to service. A muster-in must, in all cases, precede payment of pay, bounty, pension, &c. A muster-in roll must, in all cases, be filed in the Adjutant General's Office as evidence of muster-in. The mustering officer, commissary, or assistant commissary of musters, as the case may be, will countersign both enlistments as having mustered the soldier into the service of the United States before either of them is given to the disbursing officer.

DECLARATION OF RECRUIT.

I, Joseph Victor, desiring to VOLUNTEER as a Soldier in the Army of the United States, for the term of THREE YEARS, Do Declare, That I am thirteen years and _____ months of age; that I have never been discharged from the United States service on account of disability or by sentence of a court martial, or by order before the expiration of a term of enlistment; and I know of no impediment to my serving honestly and faithfully as a soldier for three years.

GIVEN at New Orleans the 20th day of August 1864

Witness:

J. Bunter

Joseph Victor

No. _____

Joseph Victor

Volunteered at New Orleans

The 20th August 1864

By Capt. J. Bunter

4th Regiment of U. S. Col.

Company

enlistment; last served in Company ()

Reg't of _____

Discharged _____, 18 _____

Term 4m. U.S. Army
by (re-enlistment) July 15 1864

Received from Second Auditor

August 26th, 1892.

CONSENT IN CASE OF MINOR.

I, _____, Do CERTIFY, That I am _____ of _____; that the said _____ is _____ years of age; and I do hereby freely give my CONSENT to his volunteering as a SOLDIER in the ARMY OF THE UNITED STATES for the period of THREE YEARS.

GIVEN at _____ the _____ day of _____

Witness:

NO 115

VOLUNTEER ENLISTMENT.

STATE OF

TOWN OF

Louisiana



New Orleans

I, *Joseph Victor*, born in *New Orleans* in the State of *Louisiana*, aged *Ninteen* years, and by occupation a *Waiter*, Do HEREBY ACKNOWLEDGE to have volunteered this *Twentieth* day of *August*, 1864, to serve as a **Soldier** in the **Army of the United States of America**, for the period of **THREE YEARS**, unless sooner discharged by proper authority: Do also agree to accept such bounty, pay, rations, and clothing, as are, or may be, established by law for volunteers. And I, *Joseph Victor*, do solemnly swear, that I will bear true faith and allegiance to the **United States of America**, and that I will serve them honestly and faithfully against all their enemies or opposers whomsoever; and that I will observe and obey the orders of the President of the United States, and the orders of the officers appointed over me, according to the Rules and Articles of War.

Sworn and subscribed to, at *New Orleans* } *Joseph Victor*
this *20th* day of *August*, 1864. }
BEFORE *Capt. B. Benter* }
4th U.S. Col. Cav. }

I CERTIFY, ON HONOR, That I have carefully examined the above-named Volunteer, agreeably to the General Regulations of the Army, and that, in my opinion, he is free from all bodily defects and mental infirmity, which would in any way disqualify him from performing the duties of a soldier.

B. C. Measter
EXAMINING SURGEON.

I CERTIFY, ON HONOR, That I have minutely inspected the Volunteer *Joseph Victor* previously to his enlistment, and that he was entirely sober when enlisted; that, to the best of my judgment and belief, he is of lawful age; and that, in accepting him as duly qualified to perform the duties of an able-bodied soldier, I have strictly observed the Regulations which govern the recruiting service. This soldier has *black* eyes, *black* hair, *griff* complexion, is *six* feet *six* inches high.

Frank Benter Capt.
4th Regiment of U.S. Col. Volunteers, Cav
RECRUITING OFFICER.

(A. G. O. No. 74 & 76.)

Mastered into the service of the United States, for three years or during the war, from date of enlistment, in Company *C* of *4th Regiment of U.S. Col. Volunteers*, on the *26th* day of *August*, 1864, at *New Orleans, La.*

J. M. Chantre
1st Lt. 10th U.S. C. Art. (26)

1086

Vier, John

Co *G*, **4** U. S. Col'd Cav.

Private

CARD NUMBERS.

1	<i>See Here, John</i>	26
2		27
3		28
4		29
5		30
6		31
7		32
8		33
9		34
10		35
11		36
12		37
13		38
14		39
15		40
16		41
17		42
18		43
19		44
20		45
21		46
22		47
23		48
24		49
25		50

Book Mark:

See also

1087

Vincent, John

Co A, 4 U. S. Col'd Cav.

Private Private

CARD NUMBERS.

1	5354988	26
2	5355078	27
3	5355170	28
4	5355258	29
5	5355348	30
6	5355431	31
7	5355512	32
8	5355586	33
9	5355672	34
10	5355756	35
11	5355839	36
12	5355919	37
13	5356000	38
14	5356077	39
15	5356154	40
16		41
17		42
18		43
19		44
20		45
21		46
22		47
23		48
24		49
25		50

Book Mark:

See also

NOV 4 19

0938038 Paul
S 1099672 P.O. in the

J.B. Powell
Ex

V | 4 Cav. | U.S.C.T.

John Vincent

Pr, Co. A, Mounted Rangers, Corps d'Afrique. †

Age years.

Appears on

Company Muster Roll*

for *Nov. & Dec*, 186*3*.

Joined for duty and enrolled:

When *Nov. 1*, 186*3*.

Where *Sherida, La*

Period years.

Mustered in:

When *Nov. 30*, 186*3*.

Where *Sherida, La*

Present or absent *Present*

Stoppage, \$ 100 for

Due Gov't \$ 100 for

Valuation of horse, \$ 100

Valuation of horse equipments, \$ 100

Remarks:

† This organization subsequently became Co. F, 4 U. S. Col'd Cav.
* First current roll. No muster-in roll of this ~~battery~~ *Company* on file.

Book mark:

(3586) *Manning* Copyist.

V

4 Cav. | U.S C.T.

John Vincent
Pr, Co. *F*, 1 Reg't Cav., Corps d'Afrique.*

Appears on

Company Muster Roll

for *Jan'y 10 Feby*, 1864.

Present or absent *Present*

Stoppage, \$ *100* for

Due Gov't, \$ *100* for

Valuation of horse, \$ *100*

Valuation of horse equipments, \$ *100*

Remarks:
.....
.....
.....
.....
.....
.....

* This organization subsequently became Co. *F*, 4 Reg't U. S. Colored Cavalry.

Book mark:

(358) *Manning* Copyist.

J

4 Cav. U.S.C.T.

John Vincent
Pvt

, Co. F, 4 Reg't U. S. Col'd Cavalry.

Appears on

Company Muster Roll

for *March & April*, 1864.

Present or absent *Present*

Stoppage, \$.....100 for

Due Gov't, \$.....100 for

Valuation of horse, \$.....100

Valuation of horse equipments, \$.....100

Remarks:

Book mark:

(358)

Manning
Copyist.

NO 423

V

4 Cav. U.S.C.T.

John Vincent

Priv, Co. F, 4 Reg't U. S. Col'd Cavalry.

Appears on

Company Muster Roll

for *May & June*, 1864.

Present or absent *Present*

Stoppage, \$ 100 for

Due Gov't, \$ 100 for

Valuation of horse, \$ 100

Valuation of horse equipments, \$ 100

Remarks:

Book mark:

(358)

Manning
Copyist.

NA 99 424

V | **4 Cav. | U.S.C.T.**

John Vincent

Pr, Co. F, 4 Reg't U. S. Col'd Cavalry.

Appears on

Company Muster Roll

for *July & Aug*, 1864.

Present or absent *Present*

Stoppage, \$ *100* for

Due Gov't, \$ *100* for

Valuation of horse, \$ *100*

Valuation of horse equipments, \$ *100*

Remarks:

Book mark:

(358)

Manning
Copyist.

NO 425

J 4 Cav. U.S.C.T.

John Vincent

Pr, Co. F, 4 Reg't U. S. Col'd Cavalry.

Appears on

Company Muster Roll

for *Sept & Oct*, 1864.

Present or absent *Present*

Stoppage, \$ 100 for

Due Gov't, \$ 100 for

Valuation of horse, \$ 100

Valuation of horse equipments, \$ 100

Remarks:

Book mark:

Warrington
(358) Copyist.

2 | **4 Cav. U.S.C.T.**

John Vincent
Prk, Co. F, 4 Reg't U. S. Col'd Cavalry.

Appears on

Company Muster Roll
for *Nov. & Dec*, 186*4*

Present or absent *Present*

Stoppage, \$ *100* for

Due Gov't, \$ *100* for

Valuation of horse, \$ *100*

Valuation of horse equipments, \$ *100*

Remarks:
.....
.....
.....
.....
.....
.....
.....
.....
.....

Book mark:

J. W. Harris

V | 4 Cav. | U.S.C.T.

John Vincent
Pvt, Co. F, 4 Reg't U. S. Col'd Cavalry.

Appears on

Company Muster Roll

for *Jan & Feby*, 186 *5*.

Present or absent *Present*

Stoppage, \$ *100* for

Due Gov't, \$ *100* for

Valuation of horse, \$ *100*

Valuation of horse equipments, \$ *100*

Remarks:

Book mark:

L Harris

V | **4 Cav.** | **U.S.C.T.**

John Vincent
Priv, Co. F, 4 Reg't U. S. Col'd Cavalry.

Appears on

Company Muster Roll

for *Mch & Apr*, 186 *5*.

Present or absent *Present*

Stoppage, \$ *100* for

Due Gov't, \$ *100* for

Valuation of horse, \$ *100*

Valuation of horse equipments, \$ *100*

Remarks:

Book mark:

J. H. Harris

V | **4 Cav.** | **U.S.C.T.**

John Vincent
Pvt, Co. F, 4 Reg't U. S. Col'd Cavalry.

Appears on

Company Muster Roll

for *May & June*, 186 *5*

Present or absent *Present*

Stoppage, \$ 100 for

Due Gov't, \$ 100 for

Valuation of horse, \$ 100

Valuation of horse equipments, \$ 100

Remarks:

Book mark:

L. H. Harris

V | **4 Cav. | U.S.C.T.**

John Vincent
Priv, Co. F, 4 Reg't U. S. Col'd Cavalry.

Appears on

Company Muster Roll

for *July & Aug*, 186 *5*

Present or absent *Present*

Stoppage, \$ *100* for

Due Gov't, \$ *100* for

Valuation of horse, \$ *100*

Valuation of horse equipments, \$ *100*

Remarks:

Book mark:

J. W. Harris

V | 4 Cav. | U.S.C.T.

John Vincent
Prk, Co. F, 4 Reg't U. S. Col'd Cavalry.

Appears on

Company Muster Roll

for *Sept & Oct*, 186 *5*

Present or absent *Present*

Stoppage, \$.....*100* for

Due Gov't, \$.....*100* for

Valuation of horse, \$.....*100*

Valuation of horse equipments, \$.....*100*

Remarks:

Book mark:

A. Harris

V | 4 Cav. | U.S.C.T.

John Vincent

P., Co. F, 4 Reg't U. S. Col'd Cavalry.

Appears on

Company Muster Roll

for Nov. Dec, 1865.

Present or absent Present

Stoppage, \$ 100 for

Due Gov't, \$ 100 for

Valuation of horse, \$ 100

Valuation of horse equipments, \$ 100

Remarks:

Book mark:

Hibbard Copyist

V | 4 Cav. | U.S.C.T.

John Vincent
P

, Co. F, 4 Reg't U. S. Col'd Cavalry.

Appears on

Company Muster Roll

for Jan. Feb., 1866.

Present or absent Present

Stoppage, \$ 100 for

Due Gov't, \$ 100 for

Valuation of horse, \$ 100

Valuation of horse equipments, \$ 100

Remarks:

Book mark:

(358)

Hibbard
Copyist.

V | 4 Cav. | U.S.C.T.

P John Vincent
P, Co. T, 4 Reg't U. S. Col'd Cavalry.

Appears on Co. Muster-out Roll, dated
New Orleans, La., Mch. 20 1866.

Muster-out to date Mch. 20 1866.

Last paid to June 30, 1865.

Clothing account:

Last settled....., 186 ; drawn since \$..... 100

Due soldier \$ 17. ²⁵ / 100; due U. S. \$..... 100

Am't for cloth'g in kind or money adv'd \$..... 100

Due U. S. for arms, equipments, &c., \$..... 100

Bounty paid \$..... 100; due \$..... 100

Remarks: *Joined at orig. org.*

Book mark: *6787-P.M.G.-June 29, 66.*

(361)

Hibbard

Copyist.

1088

Vinny Paul

Co A, 4 U. S. Col'd Cav.

Private Sergeant

CARD NUMBERS.

1	5348490	26
2	5348512	27
3	5348611	28
4	5348709	29
5	5348880	30
6	5348895	31
7	5348988	32
8	5349081	33
9	5349155	34
10	5349233	35
11	5349321	36
12	5349411	37
13	5349495	38
14	5349575	39
15	5349753	40
16	40729292	41
17		42
18		43
19		44
20		45
21		46
22		47
23		48
24		49
25		50

Book Mark:

See also

V | 4 Cav. | U.S.C.T.

Paul Vinya

Private, Co. *A*, 1 Reg't La. Cav., Corps d'Afrique.*

Appears on

Company Muster-in Roll

of the organization named above. Roll dated

New Orleans La, Sept 12, 1863.

Muster-in to date *Sept 12*, 1863.

Joined for duty and enrolled:

When *Sept 3*, 1863.

Where *New Orleans*

Period *3* years.

Valuation of horse, \$ 100

Valuation of horse equipments, \$ 100

Remarks:

Age 21.

*This organization subsequently became Co. *A*, 4 Reg't U. S. Colored Cavalry.

Book mark:

M. A. Michaels

7

4 Cav. | U.S.C.T.

Paul Vinyea

1st Sg't, Co. A, 1 Reg't La. Cav., Corps d'Afrique.*

Appears on

Company Muster Roll

for Sept 12 to Dec 31, 1863.

Present or absent Present

Stoppage, \$ 100 for

Due Gov't, \$ 100 for

Valuation of horse, \$ 100

Valuation of horse equipments, \$ 100

Remarks:

*This organization subsequently became Co. A, 4 Reg't U. S. Colored Cavalry.

Book mark:

R. S. Richardson

V | 4 Cav. | U.S.C.T.

Paul Vinjea

1st Supt, Co. A, 1 Reg't Cav., Corps d'Afrique.*

Appears on

Company Muster Roll

for Jan & Feb, 1864

Present or absent Present

Stoppage, \$ 100 for

Due Gov't, \$ 100 for

Valuation of horse, \$ 100

Valuation of horse equipments, \$ 100

Remarks:

* This organization subsequently became Co. A, 4 Reg't U. S. Colored Cavalry.

Book mark:

R. Richardson

N | 4 Cav. | U.S.C.T.

Carl Vinson

Sergt, Co. A, 4 Reg't U. S. Col'd Cavalry.

Appears on

Company Muster Roll

for *week + apr*, 186*4*

Present or absent *Present*

Stoppage, \$ *100* for

Due Gov't, \$ *100* for

Valuation of horse, \$ *100*

Valuation of horse equipments, \$ *100*

Remarks:

Book mark:

R. Richardson

NO 440

V | 4 Cav. | U.S.C.T.

Paul Vinyea
Priv., Co. A, 4 Reg't U. S. Col'd Cavalry.

Appears on

Company Muster Roll

for May & June, 1864

Present or absent Present

Stoppage, \$ 100 for

Due Gov't, \$ 100 for

Valuation of horse, \$ 100

Valuation of horse equipments, \$ 100

Remarks: Reduced to the rank,
from 1st Sergt by order of
Lieut Col J W Alexander
June 23/64 In debt to
Govt for one Remington
Revolver

Book mark: _____

R S Richardson

(358)

Copyist.

NO 441

7

4 Cav. U.S.C.T.

Paul Truysa

1st Seryt, Co. A, 4 Reg't U. S. Col'd Cavalry.

Appears on

Company Muster Roll

for July & Aug, 1864

Present or absent Present

Stoppage, \$ 100 for

Due Gov't, \$ 100 for

Valuation of horse, \$ 100

Valuation of horse equipments, \$ 100

Remarks: Reduced to the ranks from 1st Seryt June 28/64 Promoted to 1st Seryt Aug 1/64 Is in debt to Gov't for One Remington Revolver

Book mark:

R. Richardson

(358)

Copyist.

71 | 4 Cav. | U.S.C.T.

Paul Vinyea

1st Regt, Co. A, 4 Reg't U. S. Col'd Cavalry.

Appears on

Company Muster Roll

for Sept & Oct, 1864

Present or absent Present

Stoppage, \$ 100 for

Due Gov't, \$ 100 for

Valuation of horse, \$ 100

Valuation of horse equipments, \$ 100

Remarks: Reduced to the ranks from 1st Regt June 26. 64. Promoted to 1st Regt Aug 16. 64. Stop for one Remington Revolver

Book mark: 319

Donnelly

7 | 4 Cav. | U.S.C.T.

Paul Vinjea

1st Regt, Co. A, 4 Reg't U. S. Col'd Cavalry.

Appears on

Company Muster Roll

for Nov & Dec, 1864

Present or absent Present

Stoppage, \$ 100 for

Due Gov't, \$ 100 for

Valuation of horse, \$ 100

Valuation of horse equipments, \$ 100

Remarks: Reduced to the ranks from 1st Regt June 28. 64. Promoted to 1st Regt Aug 11/64 Stop for one Remington Revolver.

Book mark:

Donnelly

N | 4 Cav. | U.S.C.T.

Paul Myca

1st Sergt, Co. A, 4 Reg't U. S. Col'd Cavalry.

Appears on

Company Muster Roll

for *Jan & Feb*, 186*5*.

Present or absent *Present*

Stoppage, \$ *100* for

Due Gov't, \$ *100* for

Valuation of horse, \$ *100*

Valuation of horse equipments, \$ *100*

Remarks: *App'd 1st Sergt from
Priv Oct 11. 63, Reduced to
ranks June 24. 64. Promoted
to 1st Sergt Aug 1. 64. Clasp for
1 Sol. Blanket, bridle*

Book mark:

Donnelly

N | 4 Cav. | U.S.C.T.

Paul Vinjea

1st Supt, Co. A, 4 Reg't U. S. Col'd Cavalry.

Appears on

Company Muster Roll

for *Mar & Apr*, 186 *5*

Present or absent *Present*

Stoppage, \$ *100* for

Due Gov't, \$ *100* for

Valuation of horse, \$ *100*

Valuation of horse equipments, \$ *100*

Remarks:

Book mark:

Dannely

W | 4 Cav. | U.S.C.T.

Paul Vinyea

1st Regt, Co. A, 4 Reg't U. S. Col'd Cavalry.

Appears on

Company Muster Roll

for *May & June*, 186 *5*

Present or absent *Present*

Stoppage, \$ *100* for

Due Gov't, \$ *100* for

Valuation of horse, \$ *100*

Valuation of horse equipments, \$ *100*

Remarks:

Book mark:

Douneby

7i | 4 Cav. | U.S.C.T.

Paul Vineya

1st Regt., Co. A, 4 Reg't U. S. Col'd Cavalry.

Appears on

Company Muster Roll

for July & Aug, 1865

Present or absent Present

Stoppage, \$ 100 for

Due Gov't, \$ 100 for

Valuation of horse, \$ 100

Valuation of horse equipments, \$ 100

Remarks:

Book mark:

Donnelly

NARA 440

V | **4 Cav. | U.S.C.T.**

Paul Vinjea
1st Sergt, Co. A, 4 Reg't U. S. Col'd Cavalry.

Appears on

Company Muster Roll

for *Sept & Oct*, 1865.

Present or absent... *Present*

Stoppage, \$ *100* for

Due Gov't, \$ *100* for

Valuation of horse, \$ *100*

Valuation of horse equipments, \$ *100*

Remarks:

NEXT ROLL ON FILE FEB 1866

Book mark:

Prewitt

(358)

Copist.

V | **4 Cav.** | **U.S.C.T.**

Paul Vinyea

1st Sergt., Co. A, 4 Reg't U. S. Col'd Cavalry.

Appears on

Company Muster Roll

for *Jan & Feb*, 186*6*.

Present or absent. *Absent*

Stoppage, \$ *100* for

Due Gov't, \$ *100* for

Valuation of horse, \$ *100*

Valuation of horse equipments, \$ *100*

Remarks: *Absent without leave since Feb 25, 1866.*

Book mark:

Prewitt

W | 4 Cav. | U.S.C.T.

Paul Vinjea

1 Sgt, Co. A, 4 Reg't U. S. Colored Cav.

Appears on Returns as follows:

Jan 1865 - absent furloughed
Jan 24/65 Port Hudson
La. for seven days

July 1865 - absent in N.O.
in search of deserters
since July 26

Book mark:

W. R. Lee

P | **4 Cav. U.S.C.T.**

Paul Vinys
1st Sergt, Co. A, 4 Reg't U. S. Col'd Cavalry.

Appears on **Co. Muster-out Roll**, dated
New Orleans La, Mch 20, 1865.

Muster-out to date _____, 186 .

Last paid to *June 30, 1865.*

Clothing account:

Last settled _____, 186 ; drawn since \$ _____ 100

Due soldier \$ _____ 100; due U. S. \$ *2 2 16* / 100

Am't for cloth'g in kind or money adv'd \$ _____ 100

Due U. S. for arms, equipments, &c., \$ *25 34* / 100

Bounty paid \$ _____ 100; due \$ _____ 100

Remarks: *Joined at orig org. Deserted*
Feb. 26, 64, at Greenville La. Stop
1 Sabre belt & plate, 1 sabre knot
1 Girth, carbine socket, 1 Saddle
1 pr stirrups & straps

Book mark: *E. B. Vol. 8, Page 388, re*

(361)

Prewitt

Copyist.

1089
Voorhees John

Co *A*, 4 U. S. Col'd Cav.

Private Private

CARD NUMBERS.

1	5354989	26
2	5355077	27
3	5355168	28
4	5355257	29
5	5355347	30
6	5355438	31
7	5355528	32
8	5355618	33
9	5355708	34
10	30849045	35
11	30850100	36
12	40729293	37
13		38
14		39
15		40
16		41
17		42
18		43
19		44
20		45
21		46
22		47
23		48
24		49
25		50

Book Mark:

See also

V | 4 Cav. | U.S.C.T.

John Vorhes

Pvt, Co. A, Mounted Rangers, Corps d'Afrique. †

Age _____ years.

Appears on

Company Muster Roll*

for *Nov, P Dec*, 186*3*.

Joined for duty and enrolled:

When *Nov 1*, 186*3*.

Where *Aberia, La*

Period _____ years.

Mustered in:

When *Nov, 30*, 186*3*.

Where *Aberia, La*

Present or absent *Present*

Stoppage, \$ _____ 100 for _____

Due Gov't \$ _____ 100 for _____

Valuation of horse, \$ _____ 100 .

Valuation of horse equipments, \$ _____ 100

Remarks: _____

† This organization subsequently became Co. F, 4 U. S. Col'd Cav.

* First current roll. No muster-in roll of this ~~battery~~ *Company* on file.

Book mark: _____

(3586)

Hamm
Copyist.

V | **4 Cav. | U.S C.T.**

John Vorhes
Pvt., Co. *F*, 1 Reg't Cav., Corps d'Afrique.*

Appears on

Company Muster Roll

for *Jany D. Feby*, 1864.

Present or absent *Present*

Stoppage, \$ 100 for

Due Gov't, \$ 100 for

Valuation of horse, \$ 100

Valuation of horse equipments, \$ 100

Remarks:

*This organization subsequently became Co. *F*, 4 Reg't U.S. Colored Cavalry.

Book mark:

(358)

Manning
Copyist.

V

4 Cav. U.S.C.T.

John Vorhes

Plt, Co. F, 4 Reg't U. S. Col'd Cavalry.

Appears on

Company Muster Roll

for *March & April*, 1864.

Present or absent *Present*

Stoppage, \$ 100 for

Due Gov't, \$ 100 for

Valuation of horse, \$ 100

Valuation of horse equipments, \$ 100

Remarks:

Book mark:

Manning

V

4 Cav. U.S.C.T.

John Forbes

Priv, Co. F, 4 Reg't U. S. Col'd Cavalry.

Appears on

Company Muster Roll

for *May & June*, 1864.

Present or absent *Absent*

Stoppage, \$ 100 for

Due Gov't, \$ 100 for

Valuation of horse, \$ 100

Valuation of horse equipments, \$ 100

Remarks: *Sent to Gen. Hospital May 7, 1864.*

Book mark :

(358)

Manning Copyist.

J | *4th Co* | *USGI*

John Joshua
Pvt, *Co 4*, *4 Reg't* *USGI*

Appears on

Hospital Muster Roll

of **Corps d'Afrique U. S. A. General Hospital,**

at **New Orleans, La.,**

for *May & June*, 186*4*.

Attached to hospital:

When....., 186 .

How employed.....

Last paid by Maj.

to, 186 .

Bounty paid \$ 100; due \$ 100

Present or absent *Present*

Remarks:.....

Book mark:.....

Byrd

V | **4 Cav. | U.S.C.T.**

John Forbes
Pr, Co. F, 4 Reg't U. S. Col'd Cavalry.

Appears on

Company Muster Roll

for *July & Aug*, 186*4*.

Present or absent *Present*

Stoppage, \$ *100* for

Due Gov't, \$ *100* for

Valuation of horse, \$ *100*

Valuation of horse equipments, \$ *100*

Remarks: *Returned from
Genl Hospital at
New Orleans Aug
9, 1864*

Book mark:

Mumford
(358) Copyist.

U | 4 bar | USG

John Voorhies
Priv., Co. F, 4 Reg't US Cav

Appears on

Hospital Muster Roll

of Corps d'Afrique U. S. A. General Hospital,

at New Orleans, La.,

for July & Aug, 1864.

Attached to hospital:

When, 186 .

How employed

Last paid by Maj.

to, 186 .

Bounty paid \$ 100; due \$ 100

Present or absent

Remarks:

Returned to duty Aug 17, 64

Book mark:

Handwritten signature

V

4 Cav. U.S.C.T.

John Forbes
Pvt

Co. F, 4 Reg't U. S. Col'd Cavalry.

Appears on

Company Muster Roll

for *Sept & Oct*, 186*4*.

Present or absent *Present*

Stoppage, \$ 100 for

Due Gov't, \$ 100 for

Valuation of horse, \$ 100

Valuation of horse equipments, \$ 100

Remarks:

Book mark:

(358)

W. H. Murray
Copyist.

W | 4 Cav. | U.S.C.T.

John Vorhes
Pvt, Co. F, 4 Reg't U. S. Col'd Cavalry.

Appears on

Company Muster Roll
for *Nov. & Dec*, 186*4*

Present or absent *Present*

Stoppage, \$ *100* for

Due Gov't, \$ *100* for

Valuation of horse, \$ *100*

Valuation of horse equipments, \$ *100*

Remarks:

Book mark: _____

J. H. Martin

V | 4 Cav. | U.S.C.T.

John Vorhes
Prk, Co. F, 4 Reg't U. S. Col'd Cavalry.

Appears on

Company Muster Roll

for *Jan & Feby*, 1865.

Present or absent

Stoppage, \$ 100 for

Due Gov't, \$ 100 for

Valuation of horse, \$ 100

Valuation of horse equipments, \$ 100

Remarks: *Died in Post Hospital
at Port Hudson La. Feby 27.
1865,*

Book mark :

J. H. Harris

(358)

Copyist.

V | 4 Cav. | U.S.C.T.

+ John Vorhes
 Prof, Co. 5th, 4 Reg't U. S. Colored Cav.

Appears on Returns as follows:

May 1864 - absent sick sent
 May 7/64 to genl. Hosp.
 June 1864 - absent sick in genl.
 Hosp. N. Orleans, La.
 July 1864 - absent sick at g.
 Ho. since May 7

Jan 1865 - absent furloughed
 Jan 24/65 Port Hudson
 La, for seven days.

Feb 1865 - 200: Feb 27/65
 Port Hudson La. died of
 disease.

None appear: ~~as~~
 John Vorhes
 John Vorhes

Book mark: _____

W. R. Lee

V | 4 Cav. | U.S.C.T.

John Voohees

P, Co. T, 4 Reg't U. S. Col'd Cavalry.

Appears on Co. Muster-out Roll, dated New Orleans, La. Mch. 20, 1866.

Muster-out to date _____, 186 .

Last paid to _____, 186 .

Clothing account:

Last settled _____, 186 ; drawn since \$ _____ 100

Due soldier \$ _____ 100; due U. S. \$ _____ 100

Am't for cloth'g in kind or money adv'd \$ _____ 100

Due U. S. for arms, equipments, &c., \$ _____ 100

Bounty paid \$ _____ 100; due \$ _____ 100

Remarks: Joined at orig. org. Died Feb. 27, 65, at Port Hudson, La.

Book mark: V120, P211, 70

112, 512, H.B.V.

Hibbard

(361)

Copyist.

Worhes, Jno
P., Co. *F.*, **4** **U.S.C. Cav.**
 Reg't

2 Enclosures.

Bed Cards	Descriptive Lists
Burial Records	Final Statements <i>/</i>
Certs. of Dis. for Discharge	Furloughs
C. M. Charges	Med. Des. Lists
Med. Certificates	Orders

Other papers relating to—

Admission to Hosp'l	Furlough
Casualty Sheet (Officer's)	Med. Examination
Confinement	Misc. Information
Contracts	Pay or Clothing
Death or Effects <i>/</i>	Personal Reports
Desertions	Rank
Discharge from Hosp'l	Transfer to Hosp'l
Discharge from Service	Transfer to V. R. C.
Duty	Transportation

ARTICLES OF WAR.

ART. 95. When any non-commissioned officer or soldier shall die, or be killed in the service of the United States, the then commanding officer of the troop or company shall, in the presence of two other commissioned officers, take an account of what effects he died possessed of, above his arms and accoutrements, and transmit the same to the office of the Department of War, which said effects are to be accounted for, and paid to the representatives of such deceased non-commissioned officer or soldier. And in case any of the officers, so authorized to take care of the effects of deceased officers and soldiers, should, before they have accounted to their representatives for the same, have occasion to leave the regiment or post, by preferment or otherwise, they shall, before they be permitted to quit the same, deposit in the hands of the commanding officer, or of the assistant military agent, all the effects of such deceased non-commissioned officers and soldiers, in order that the same may be secured for, and paid to, their respective representatives.

ARMY REGULATIONS—EDITION OF 1861.

DECEASED SOLDIERS.

Par. 152. Inventories of the effects of deceased non-commissioned officers and soldiers, required by the 95th Article of War, will be forwarded to the Adjutant General, by the commander of the company to which the deceased belonged, and a duplicate of the same to the colonel of the regiment. Final statements of pay, clothing, &c., will be sent with the inventories. When a soldier dies at a post or station absent from his company, it will be the duty of his immediate commander to furnish the required inventory, and, at the same time, to forward to the commanding officer of the company to which the soldier belonged, a report of his death, specifying the date, place, and cause; to what time he was last paid, and the money or other effects in his possession at the time of his decease; which report will be noted on the next muster roll of the company to which the man belonged. Each inventory will be endorsed, "Inventory of the effects of _____, late of company (—) _____ regiment of _____, who died at _____, the _____ day of _____, 186—." If a legal representative receive the effects, it will be stated in the report. If the soldier leave no effects, the fact will be reported.

Par. 153. Should the effects of a deceased non-commissioned officer or soldier not be administered upon within a short period after his decease, they shall be disposed of by a Council of Administration, under the authority of the commanding officer of the post, and the proceeds deposited with the Paymaster, to the credit of the United States, until they shall be claimed by the legal representatives of the deceased.

Par. 154. In all such cases of sales by the Council of Administration, a statement in detail, or account of the proceeds, duly certified by the Council and commanding officer, accompanied by the Paymaster's receipt for the proceeds, will be forwarded by the commanding officer to the Adjutant General. The statement will be endorsed, "Report of the proceeds of the effects of _____, late of company (—) _____ regiment of _____, who died at _____, the _____ day of _____, 186—."

NOTE 1.—The effects in all cases, when called for, should be turned over to the legal representative, without further authority from the Adjutant General. When the effects are turned over to the relatives of the deceased before these inventories are sent to the Adjutant General, their receipts therefor should be attached to the inventories. In all other cases, one copy will be sent with a letter of transmittal direct to the Adjutant General, and a duplicate retained by the officer.

NOTE 2.—Particular care should be taken to take receipts in duplicate from the Paymaster for any funds turned over to him; one copy should be sent direct to the Adjutant General and one retained by the officer.

INVENTORY OF THE EFFECTS

OF

Private John Vorhes

Late of Company *A*

4th Reg't of *2nd Co*

Volunteers, who died at *Post Hospital*
Post Hudson
on the *27* day of *February* 1865.

Inventory of the effects of John Voshes. late
 a Private of Captain _____ Company 4 of
 the 4th Regiment of W.C.C. Volunteers, who was enrolled as
 a _____ at _____ in the State of _____ on
 the _____ day of _____ 186 , and mustered into the service of the United
 States as a _____ on the _____ day of _____ 186 , at _____
 in Company _____, _____ Regiment of _____ Volunteers, to serve _____
 years or during the war; he was born in _____ in the State
 of _____; he was _____ years of age, _____ feet _____ inches
 high, _____ complexion, _____ eyes, _____ hair, and by occupation, when enrolled,
 a _____; he died in Post Hospital, at
Post Hudson Ga on the 27 day of February 1865; by
 reason of Inflammation of Peritonium

INVENTORY.					
ARTICLES.	No.	ARTICLES.	No.	ARTICLES.	No.
Hats		Pairs trousers		Knapsacks	
Caps		Pairs flannel drawers			
Forage caps		Pairs cotton drawers			
Great coats	<u>No Effects</u>	Clare shirts			
Uniform coats		Cotton shirts			
Uniform jackets		Pairs boots			
Flannel sack coats		Pairs shoes			
Blouses		Pairs socks			
Stable frocks		Blankets			
Fatigue overalls		Haversacks			
				MONEY.	
				Specie	\$
				Notes	\$

I CERTIFY, ON HONOR, that the above inventory comprises all the effects of _____
 _____, deceased, and that the effects are in the hands
 of _____ at _____
 _____ to be disposed of by a Council of Administration.

(DUPLICATES.)

STATION: Post Hudson Ga

DATE: Feb 27 1865

W. Daniel Yancey
Jay Evans
 Commanding the Company.
Post Hospital

1865

Extract from Act of Congress.

SEC. 12. *And be it further enacted,* That the fees of agents and attorneys for making out and causing to be executed the papers necessary to establish a claim for a pension, bounty, and other allowance before the Pension Office, under this act, shall not exceed the following rates: For making out and causing to be duly executed a declaration by the applicant, with the necessary affidavits, and forwarding the same to the Pension Office, with the requisite correspondence, ten dollars; which sum shall be received by such agent or attorney in full for all services in obtaining such pension, and shall not be demanded or received, in whole or in part, until such pension shall be obtained; and the sixth and seventh sections of an act entitled "An act to grant pensions," approved July [fourteenth,] eighteen hundred and sixty-two, are hereby repealed.

SEC. 13. *And be it further enacted,* That any agent or attorney who shall, directly or indirectly, demand or receive any greater compensation for his services under this act than is prescribed in the preceding section of this act, or who shall contract or agree to prosecute any claim for a pension, bounty, or other allowance under this act, on the condition that he shall receive a per centum upon any portion of the amount of such claim, or who shall wrongfully withhold from a pensioner or other claimant the whole or any part of the pension or claim allowed and due to such pensioner or claimant, shall be deemed guilty of a high misdemeanor, and, upon conviction thereof, shall, for every such offense, be fined not exceeding three hundred dollars, or imprisoned at hard labor not exceeding two years, or both, according to the circumstances and aggravations of the offense.

Approved July 4, 1864.

NOTE 10.—If any soldier is charged a higher fee than that allowed by the above act, he should report the fact and the name of the agent to the Adjutant General, in order that steps may be taken to have the same refunded.

FINAL STATEMENT

OF

John Forbes, Private
4th Reg't of W. S. Wood's Cav'y

VOLUNTEERS.

NOTE 1.—Two of these certificates (or duplicates) are to be given to each Volunteer Soldier or drafted man who may be discharged without being mustered out, (Final Statements are never given to men mustered out of service,) that he may at once receive from the Paymaster the pay, &c., due him, and the captain or other COMMISSIONED officer commanding the company will certify to the act of the delivery of the duplicate certificates; with these certificates the Soldier is "entitled to" his discharge, and should also present his discharge to the Paymaster to have the payment endorsed on it. The discharge is to be given back to the Soldier by the Paymaster; the latter only retaining as his vouchers the duplicate certificates.

NOTE 2.—If the Soldier is entitled to pay for the use of his horse, the Company Commander will certify to that fact on the back of both these final statements, and also to the time he has pay due for having been so mounted on his own horse.

NOTE 3.—When a Soldier is furnished with final statements, his descriptive list, if he has one, should be taken up by the officer who gives the Soldier these statements, and endorsed with a statement to this effect by the officer. The endorsement should exhibit a full statement of the time for which the Soldier was allowed pay on his final statements, the clothing account, and all other charges against him or in his favor, so as to comprise a complete exhibit of his account. It will then be transmitted to the Company Commander of the Soldier, who will enter all the data necessary to a full understanding of the Soldier's account on the muster roll upon which the Soldier's discharge is reported. The descriptive list will then be destroyed. The object of this is, that the remaining portion of the Soldier's account may be settled upon the receipt of these muster rolls, and the Soldier receive any pay or allowances that may be due him at the time of his discharge, and which may not appear on his last final statements from the fact that his descriptive list is incomplete. These accounts for back pay, &c., are settled by the 2d Auditor of the Treasury Department.

NOTE 4.—Charges for loss or injury to ordnance, horse equipments, and other miscellaneous charges, should appear under the heading of "Other Stoppages."

NOTE 5.—Bounty paid by State authorities, and not by the United States, will not be entered on this statement.

NOTE 6.—Amounts due the Sutler and Laundress must be entered on the muster roll on which the discharge, death, desertion, &c., is reported, as well as on the final statement, otherwise the amount cannot be collected from the United States.

NOTE 7.—This blank will be used for deceased volunteers and drafted men, as well as for others.

NOTE 8.—Where a Soldier dies in Hospital or on detached service, his descriptive list, if he has one, should be sent with his final statements, in duplicate, to the Adjutant General, Washington, D. C.

NOTE 9.—If the soldier is a drafted man or substitute, the space for time, &c., of enrolled, should contain only the word *drafted* or *substitute*, as the case may be. If the Soldier is a "VETERAN," (or RECRUIT,) the words as a *veteran*, (or *recruit*,) as the case may be, should be interlined after the words *mustered into the service of the U. S.* A statement of all the installments of *Veteran* or *Recruit* Bounty RECEIVED by the Soldier must be made on the back of each final statement.

ADJUTANT GENERAL'S OFFICE

April 7th 1865

Duplicate with Inventory sent 2d Auditor.

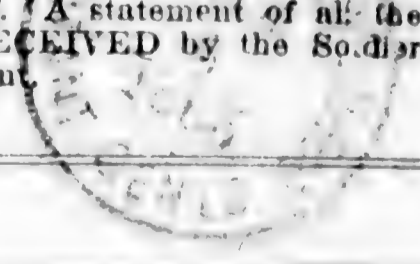

I certify, on honor, that John Forbes, a private of
 Captain Samuel White Company (F) of the 4th Regiment of Vol. Lev. Cav.
VOLUNTEERS, of the State of _____, born in Perry Brady, State
 of Virginia, aged 28 years; 5 feet 8 inches high; Dar complexion,
Blk eyes, Blk hair, and by occupation a Sutler, who joined for service
 and was enrolled (see Note 9) on the 1st day of Nov, 1863, at Orma La
 by S. White, for the period of three years, and mustered into
 the service of the United States on the 30th day of November, 1863, at
Orma La, by Capt Annable; and having served
 HONESTLY and FAITHFULLY with his Company to the present date, is now entitled to a
DISCHARGE by reason of Death

The said John Forbes was last paid by Paymaster
Cosby, to include the 31st day of August, 1864, and
Rec'd but \$7.25 a month from enlistment to include April 30 1864.
 has pay due him from that time to the present date; he is entitled to pay and subsistence for
TRAVELING to place of enrollment, and whatever other allowances are authorized to volunteer
 soldiers, drafted men, or militia, so discharged. He has received from the United States **CLOTHING**
 amounting to \$ 79. ⁵³/₁₀₀ dollars, since the 1st day of November
 1863, when his clothing account was last settled. He has received from the United States
_____ ¹⁰⁰/₁₀₀ dollars advanced **BOUNTY**.

There is to be stopped from him, on account of the State of _____, or other
 authorities, for **CLOTHING**, &c., received on entering service, _____ ¹⁰⁰/₁₀₀ dollars; and
 for other stoppages, viz: _____
 _____ ¹⁰⁰/₁₀₀ dollars.
 He has been furnished with **TRANSPORTATION** in kind from the place of his discharge to
 _____; and he has been **SUBSISTED** for **TRAVELING** to his
 place of enrollment, up to the _____, 186 .

He is indebted to _____, **SUTLER**, _____ ¹⁰⁰/₁₀₀ dollars.
 He is indebted to _____, **LAUNDRESS**, _____ ¹⁰⁰/₁₀₀ dollars.

Given in Duplicate, at Fort Hudson La, this 10th day
 of March, 1865.

Samuel White
Capt
 Commanding Company.

1090 W. Edmonds
 Wade Edward

Co. 4, 4 U. S. Col'd Cav.

Private Private

CARD NUMBERS.

1	5347806	26
2	5356507	27
3	5356567	28
4	5356628	29
5	5356714	30
6	5356801	31
7	5356892	32
8	5356977	33
9	5357066	34
10	5357143	35
11	40729295	36
12	40729294	37
13		38
14		39
15		40
16		41
17		42
18		43
19		44
20		45
21		46
22		47
23		48
24		49
25		50

Book Mark: _____

See also _____

J. 2014 323 P.O.M.M
S. 2077 257 P.O.M.M

S. A. Muhlman
43

21 | 4 Cav. | U.S.C.T.

Edward Wadel

Appears with rank of Pvt. on

Muster and Descriptive Roll of a Detachment of U. S. Vols. forwarded

for the 4 Reg't U. S. Col'd Cavalry. Roll dated New Orleans, La., Oct. 11, 1864.

Where born Woodville, Miss.

Age 19 y'rs; occupation Farmer

When enlisted Sept. 1, 1864.

Where enlisted Port Hudson, La.

For what period enlisted 3 years.

Eyes Black; hair Black

Complexion Dark; height 5 ft. 4 in.

When mustered in Oct. 11, 1864.

Where mustered in New Orleans

Bounty paid \$ 100 100; due \$ 200 100

Where credited Port Hudson, La.

Company to which assigned G

Remarks:

Book mark:

(339) G. E. Dyer Copyist.

H | **4 Cav.** | **U. S. C. T.**

Edward Wade
Priv, Co. G, 4 Reg't U. S. Col'd Cavalry.

Appears on

Company Muster Roll

for Sep & Oct, 1864.

Present or absent Present

Stoppage, \$ 100 for

Due Gov't, \$ 100 for

Valuation of horse, \$ 100

Valuation of horse equipments, \$ 100

Remarks: Joined a reserve
Sep 1/64.

Book mark:

Lowny

A

4 Cav. | U.S.C.T.

Edward Hade

Pr, Co. G, 4 Reg't U. S. Col'd Cavalry.

Appears on

Company Muster Roll

for *Nov & Dec*, 186 *4*

Present or absent *Present*

Stoppage, \$.....100 for.....

Due Gov't, \$.....100 for.....

Valuation of horse, \$.....100

Valuation of horse equipments, \$.....100

Remarks:.....

Book mark:.....

Pr

H | **4 Cav. | U.S.C.T.**

Edward Wade

Pr....., Co. G, 4 Reg't U. S. Col'd Cavalry.

Appears on

Company Muster Roll

for *Jan 9*....., 1865 :

Present or absent *Present*

Stoppage, \$.....100 for

Due Gov't, \$.....100 for

Valuation of horse, \$.....100

Valuation of horse equipments, \$.....100

Remarks *\$100 Bounty paid*
\$200 due

Book mark :

Quinn
Copyist

A | 4 Cav. | U.S.C.T.

Edward Wade

On....., Co. G, 4 Reg't U. S. Col'd Cavalry.

Appears on

Company Muster Roll

for *Men & apt*....., 186*5*.

Present or absent *Present*

Stoppage, \$.....*100* for.....

Due Gov't, \$.....*100* for.....

Valuation of horse, \$.....*100*

Valuation of horse equipments, \$.....*100*

Remarks: *\$100 Bounty paid*
\$200 due

Book mark :.....

Edward Copyist.

11 | 4 Cav. | U. S. C. T.

Edmonds, Adm

Adm, Co. G, 4 Reg't U. S. Col'd Cavalry.

Appears on

Company Muster Roll

for *May & June*, 1865.

Present or absent *Present*

Stoppage, \$ 100 for

Due Gov't, \$ 100 for

Valuation of horse, \$ 100

Valuation of horse equipments, \$ 100

Remarks: *\$100 monthly paid
\$ 200, due*

Book mark:

Adm
Copyist.

A | **4 Cav. | U. S. C. T.**

Edmond Wade

Pr, Co. G, 4 Reg't U. S. Col'd Cavalry.

Appears on

Company Muster Roll

for *July & Aug*, 186*7*.

Present or absent *Present*

Stoppage, \$ *100* for

Due Gov't, \$ *100* for

Valuation of horse, \$ *100*

Valuation of horse equipments, \$ *100*

Remarks: *\$ 20 Brandy paid*
\$ 200 due

Book mark:

Atwood
Copyist.

W | **4 Cav.** | **U.S.C.T.**

Edward Wade
Priv, Co. G, 4 Reg't U. S. Col'd Cavalry.

Appears on

Company Muster Roll

for *Sept + Oct*, 186*5*.

Present or absent *Present*

Stoppage, \$ *100* for

Due Gov't, \$ *100* for

Valuation of horse, \$ *100*

Valuation of horse equipments, \$ *100*

Remarks: *\$ Bounty paid*
\$ 200 due.

NO BILL ON FILE

Book mark:

F. Fletcher

(358)

Copyist.

W | **4 Cav.** | **U. S. C. T.**

Edward Wade

Priv, Co. G, 4 Reg't U. S. Col'd Cavalry.

Appears on

Company Muster Roll

for *Jan & Feb*, 186*6*.

Present or absent *Present*

Stoppage, \$ *100* for

Due Gov't, \$ *100* for

Valuation of horse, \$ *100*

Valuation of horse equipments, \$ *100*

Remarks: *\$100.00 Bounty paid
\$200.00 due.*

Book mark:

Fletcher

W. | 4 Cav. | U.S.C.T.

Edward Wade

Priv., Co. C, 4 Reg't U. S. Colored Cav.

Appears on Returns as follows:

Sept 1864 - Gain: Sept 11 64 Port
Hudson - Enlisted

Book mark :

W. R. Lee

(546)

Copyist.

W | 4 Cav. | U.S.C.T.

Edward Wade

Priv., Co. G, 4 Reg't U. S. Colored Cav.

Appears on Returns as follows:

Oct 1864 - Gain: Oct 16/64 Priv Hudson Recruit from Depot

Book mark :

W.R. See

W | **4 Cav.** | **U.S.C.T.**

Edward Wade

Priv, Co. *G*, 4 Reg't U. S. Col'd Cavalry.

Appears on **Co. Muster-out Roll**, dated *New Orleans, La, Mch 20*, 1866.

Muster-out to date *Mch 20*, 1866.

Last paid to *June 30*, 1865.

Clothing account:

Last settled....., 186 ; drawn since \$.....100

Due soldier \$.....100; due U. S. \$ *19*^{*39*}/₁₀₀

Am't for cloth'g in kind or money adv'd \$.....100

Due U. S. for arms, equipments, &c., \$ *32*/₁₀₀

Bounty paid \$ *100*/₁₀₀; due \$ ~~none~~ *none*/₁₀₀

Remarks: *Joined as recruit.*

Stop / false knot.

Book mark: *779.1881* *2261.1880*

Fletcher

Wade, Edward

, Co. , 4 Reg't U.S.C.

1 Enclosures.

Bed Cards	Final Statements
Burial Records	Furloughs or L. of A.
Certs. of Dis. for Discharge	Med. Certificates
C. M. Charges	Med. Des. Lists
Descriptive Lists	Orders
Discharge Certificates	Pris. of War Record
Enlistment Papers	Resignations

Other papers relating to—

Admission to Hosp'l	Furlough or L. of A.
Casualty Sheet	Med. Examination
Confinement	Misc. Information
Contracts	Pay of Clothing
Death or Effects	Personal Reports
Desertion	Rank
Discharge from Hosp'l	Transfer to Hosp'l
Discharge from Service	Transfer to V. R. C.
Duty	Transportation

DECLARATION OF RECRUIT.

I, Edward Wacker desiring to VOLUNTEER as a Soldier in the ARMY OF THE UNITED STATES, for the term of THREE YEARS, Do DECLARE, That I am Twenty years and _____ months of age; that I have never been discharged from the United States service on account of disability or by sentence of a court-martial, or by order before the expiration of a term of enlistment; and I know of no impediment to my serving honestly and faithfully as a soldier for three years.

GIVEN at Post Hudson La
The 1st day of September 1864

Witness:

Lieut James Collins
4th Mis. Cald, Co. Edward Wacker
his mark

Received

Received written
by Barron, under the
direction of Curran,
Major 3rd Mar. Signal Corps
July 19th 1864

No. _____
Edward Wacker
Volunteered at Post Hudson La
September 1st 1864
By Lieut James Collins
4th Mis. Cald, Co.
Regiment of Mis. Cald, Co.
La. S.
enlistment; last served in Company ()
Reg't of _____
Discharged _____ 18 _____

4 Barron

CONSENT IN CASE OF MINOR.

I, _____ Do CERTIFY, that I am _____ of _____; that the said _____ is _____ years of age; and I do hereby freely give my CONSENT to his volunteering as a SOLDIER in the ARMY OF THE UNITED STATES for the period of THREE YEARS.

GIVEN at _____
The _____ day of _____

Witness:

NOV 1864

VOLUNTEER ENLISTMENT.

STATE OF

TOWN OF

Louisiana

Port Hudson



I, *Edward Wade* born in *Goodwill*
in the State of *Miss* aged *Fifteen* years,
and by occupation a *Farmer* Do HEREBY ACKNOWLEDGE to have
volunteered this *First* day of *Sept* 18*64*,
to serve as a **Soldier** in the Army of the United States of America, for the
period of **THREE YEARS**, unless sooner discharged by proper authority: Do also
agree to accept such bounty, pay, rations, and clothing, as are, or may be, established
by law for volunteers. And I, *Edward Wade* do
solemnly swear, that I will bear true faith and allegiance to the **United States
of America**, and that I will serve them honestly and faithfully against all their
enemies or opposers whomsoever; and that I will observe and obey the orders of the
President of the United States, and the orders of the officers appointed over me,
according to the Rules and Articles of War.

Sworn and subscribed to, at *Port Hudson La*
this *1st* day of *Sept* 18*64* *Edward Wade*
BEFORE *J. James Ellers* *his*
4th U.S.C. Cav *mark*

I CERTIFY, ON HONOR, That I have carefully examined the above named Volunteer, agreeably to
the General Regulations of the Army, and that in my opinion he is free from all bodily defects and mental
infirmity, which would, in any way, disqualify him from performing the duties of a soldier.

D. D. Hanson

EXAMINING SURGEON.

4th U.S.C. C.

I CERTIFY, ON HONOR, That I have minutely inspected the Volunteer, *Edward Wade*
previously to his enlistment, and that he was entirely sober when enlisted; that, to the best of my
judgement and belief, he is of lawful age; and that, in accepting him as duly qualified to perform the duties
of an able-bodied soldier, I have strictly observed the Regulations which govern the recruiting service.
This soldier has *Blk* eyes, *Blk* hair, *Dark* complexion, is *5* feet, *4* inches
high.

1st Lieut James Ellers
Fourth Regiment of *U.S. Cavalry*

RECRUITING OFFICER.

*Mustered into the service of the United States for 3 years or during
the war from date of enlistment in 4th Regt U.S.C. Cavalry on the
11th day of October 1864 at New Orleans
J. M. Lechebert
Capt 10th U.S.C. A. 1861
A. Ernster*

1091

Wade James

Co B, 4 U. S. Col'd Cav.

Private Private

CARD NUMBERS.

1	5347526	26
2	5356756	27
3	5350850	28
4	5350936	29
5	5351020	30
6	5351101	31
7	5351182	32
8	40729296	33
9		34
10		35
11		36
12		37
13		38
14		39
15		40
16		41
17		42
18		43
19		44
20		45
21		46
22		47
23		48
24		49
25		50

Book Mark:

See also

NOV 4 1900

2691056 paid
S-1251703 - P.O. m m

11446420 P. O. aff
S. 1446410 P.O. aff.

S. A. Muhlman
S.H.

N | **4 Cav. | U.S.C.T.**

James Wade

Appears with rank of *Private* on

Muster and Descriptive Roll of a Detachment of U. S. Vols. forwarded

for the 4 Reg't U. S. Col'd Cavalry. Roll dated

New Orleans, La. Apr. 25, 1865

Where born *Milksom Co. Mississippi*

Age *22* y'rs; occupation *Laborer*

When enlisted *Apr. 3*, 1865

Where enlisted *New Orleans, La*

For what period enlisted *3* years.

Eyes *Black*; hair *Black*

Complexion *Black*; height *5* ft. *7* in.

When mustered in *Apr. 25*, 1865

Where mustered in *New Orleans*

Bounty paid \$ *100* ¹⁰⁰; due \$ *200* ¹⁰⁰

Where credited *1st Dist. 2nd Ward, Orleans }
New Orleans, La.*

Company to which assigned *B*,

Remarks :

Book mark : _____

O. T. Taylor

W | **4 Cav.** | **U.S.C.T.**

James Wade

priv., Co. B. 4 Reg't U. S. Col'd Cavalry.

Appears on

Company Muster Roll

for May & June, 1861.

Present or absent present

Stoppage, \$ 100 for

Due Gov't, \$ 100 for

Valuation of horse, \$ 100

Valuation of horse equipments, \$ 100

Remarks: Recruit, \$100 bounty
paid, \$200 bounty due

Book mark: _____

James

Or | **4 Cav.** | **U.S.C.T.**

James Wade,

priv., Co. B. 4 Reg't U. S. Col'd Cavalry.

Appears on

Company Muster Roll

for *July & Aug*, 1865.

Present or absent *present*

Stoppage, \$ 100 for

Due Gov't, \$ 100 for

Valuation of horse, \$ 100

Valuation of horse equipments, \$ 100

Remarks: *Rec'd \$100 bounty
\$2.00 due*

Book mark:

Somer

A | **4 Cav.** | **U.S.C.T.**

James Wade

priv., Co. B. 4 Reg't U. S. Col'd Cavalry.

Appears on

Company Muster Roll

for *Sept & Oct.*, 186*3*.

Present or absent *present*

Stoppage, \$ *100* for

Due Gov't, \$ *100* for

Valuation of horse, \$ *100*

Valuation of horse equipments, \$ *100*

Remarks :

Book mark :

Somer

W | **4 Cav.** | **U.S.C.T.**

James Wade

Por, Co. B. 4 Reg't U. S. Col'd Cavalry.

Appears on

Company Muster Roll

for *Nov. & Dec.*, 186*5*.

Present or absent *Present*

Stoppage, \$ 100 for

Due Gov't, \$ 100 for

Valuation of horse, \$ 100

Valuation of horse equipments, \$ 100

Remarks: *\$100. Bounty paid*
\$200. due.

Book mark :

Chandler

R | **4 Cav.** | **U.S.C.T.**

James Wade
J.W., Co. B. 4 Reg't U. S. Col'd Cavalry.

Appears on

Company Muster Roll

for *Jan. & Feb.*, 1866.

Present or absent *Present*

Stoppage, \$ 100 for

Due Gov't, \$ 100 for

Valuation of horse, \$ 100

Valuation of horse equipments, \$ 100

Remarks: *\$100. Bounty paid*
\$200. due

Book mark :

Chausse

W | 4 Cav. | U.S.C.T.

James Wade
Priv, Co. B, 4 Reg't U. S. Colored Cav.

Appears on Returns as follows:

May 1865 - Gain: May 14/65
New Orleans - Recruit
from Dept.

Book mark: _____

W. R. Lee

W | **4 Cav.** | **U.S.C.T.**

James Wade
Pvt., Co. *B*, 4 Reg't U. S. Col'd Cavalry.

Appears on **Co. Muster-out Roll**, dated *New Orleans, La, Feb. 2, 1866*.

Muster-out to date *Feb. 20, 1866*.

Last paid to *June 30, 1865*.

Clothing account:

Last settled....., 186 ; drawn since \$..... 100

Due soldier \$..... 100; due U. S. \$ *16* ^{*01*}/₁₀₀

Am't for cloth'g in kind or money adv'd \$..... 100

Due U. S. for arms, equipments, &c., \$..... 100

Bounty paid \$..... 100; due \$ *100* ^{*00*}/₁₀₀

Remarks: *Joined as Recruit*

Book mark :

(361)

Chandler

Copyist.

Wade James

Co. _____, *4th* Reg't *U.S.C.C.*

1 Enclosures.

Bed Cards	Final Statements
Burial Records	Furloughs or L. of A.
Certs. of Dis. for Discharge	Med. Certificates
C. M. Charges	Med. Des. Lists
Descriptive Lists	Orders
Discharge Certificates	Pris. of War Record
Enlistment Papers	Resignations

Other papers relating to—

Admission to Hosp'l	Furlough or L. of A.
Casualty Sheet	Med. Examination
Confinement	Misc. Information
Contracts	Pay or Clothing
Death or Effects	Personal Reports
Desertion	Rank
Discharge from Hosp'l	Transfer to Hosp'l
Discharge from Service	Transfer to V. R. C.
Duty	Transportation

DECLARATION OF RECRUIT.

I, James Wade, desiring to VOLUNTEER as a Soldier in the Army of the United States, for the term of THREE YEARS, Do Declare, That I am 22 years and months of age; that I have never been discharged from the United States service on account of disability or by sentence of a court martial, or by order before the expiration of a term of enlistment; and I know of no impediment to my serving honestly and faithfully as a soldier for three years.

GIVEN at New Orleans La the 3 day of April 1865

Witness: John G. Windham 1st Lieut. 10th U. S. C. A. N.Y.

James Wade mark

No.

James Wade Volunteered at New Orleans La

April 3, 1865

By Capt. W. McArthur

for the Regiment of the 5th U.S. C.

enlistment; last served in Company ()

Regt of

Discharged, 18

Re-enlistment with in the County provided by circular No 290 of the Prov. Mole. Gen. July 19th 1864

Received from Second Auditor October 7th 1892.

CONSENT IN CASE OF MINOR.

I, Do CERTIFY, That I am the of ; that the said is years of age; and I do hereby freely give my CONSENT to his volunteering as a SOLDIER in the ARMY OF THE UNITED STATES for the period of THREE YEARS.

GIVEN at the day of

Witness:

NOTE 1.—This blank will be used for both enlistments and re-enlistments—enlistment of veterans, &c., &c., in the volunteer service. They will be made out in duplicate in all cases—one to accompany the recruiting return of the superintendent (not the recruiting officer) to the Adjutant General, and one to accompany the accounts of the officer who pays bounty, &c. The Regiment and Company in which the soldier last served should be given on the back. NOTE 2.—An enlistment holds to service. A muster-in must, in all cases, precede payment of pay, bounty, pension, &c. A muster-in roll must, in all cases, be filed in the Adjutant General's Office as evidence of muster-in. The mustering officer, commissary, or assistant commissary of musters, as the case may be, will countersign both enlistments as having mustered the soldier into the service of the United States before either of them is given to the disbursing officer.

VOLUNTEER ENLISTMENT.

STATE OF

TOWN OF

Louisiana

New Orleans

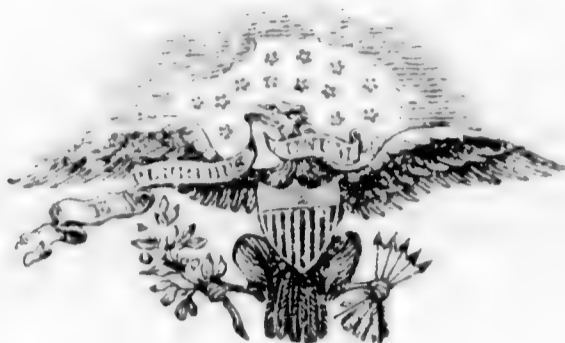

I, *James Wade*, born in *Witkov Co.* in the State of *Mississippi*, aged *twenty-two* years, and by occupation a *Labourer*, DO HEREBY ACKNOWLEDGE to have volunteered this *Third* day of *April*, 1865, to serve as a **Soldier** in the **Army of the United States of America**, for the period of **THREE YEARS**, unless sooner discharged by proper authority: Do also agree to accept such bounty, pay, rations, and clothing, as are, or may be, established by law for volunteers. And I, *James Wade*, do solemnly swear, that I will bear true faith and allegiance to the **United States of America**, and that I will serve them honestly and faithfully against all their enemies or opposers whomsoever; and that I will observe and obey the orders of the President of the United States, and the orders of the officers appointed over me, according to the Rules and Articles of War.

Sworn and subscribed to, at *New Orleans La* this *3^d* day of *April*, 1865, } *James Wade*
 BEFORE *Geo. W. Williams* }
1st Lieut. 10th U. S. C. A. H.

I CERTIFY, ON HONOR, That I have carefully examined the above-named Volunteer, agreeably to the General Regulations of the Army, and that, in my opinion, he is free from all bodily defects and mental infirmity, which would in any way disqualify him from performing the duties of a soldier.

J. B. Lewis
Surgeon
 EXAMINING SURGEON.

I CERTIFY, ON HONOR, That I have minutely inspected the Volunteer *James Wade* previously to his enlistment, and that he was entirely sober when enlisted; that, to the best of my judgment and belief, he is of lawful age; and that, in accepting him as duly qualified to perform the duties of an able-bodied soldier, I have strictly observed the Regulations which govern the recruiting service. This soldier has *Black* eyes, *Black* hair, *Black* complexion, is *5 ft 11 in* feet *11* inches high.

W. M. Altister
 Capt. 10th Regiment of U. S. C. A. H. Volunteers,
 RECRUITING OFFICER.

(A. G. O. No. 74 & 76.)

Mustered into the service of the United States, for three years or during the war, from date of enlistment, in Company *B*,
 4th Regiment of *U. S. C. A.* Volunteers, on the *25* day of *April*, 1865, at *New Orleans La.*

John Henry Green
2^d Lieut. 1st Regt. U. S. C. A. H.

1892

Wales Peter

Co E, 4 U. S. Col'd Cav.

Private Private

CARD NUMBERS.

1	5353850	26
2	5353903	27
3	5353959	28
4	5354013	29
5	5354084	30
6	5354154	31
7	5354223	32
8	5354899	33
9	40729300	34
10		35
11		36
12		37
13		38
14		39
15		40
16		41
17		42
18		43
19		44
20		45
21		46
22		47
23		48
24		49
25		50

Book Mark: { 982.1882
2B. VII. P12

See also

W | 4 Cav. | U.S.C.T.

Peter Wales

Co. E, 1 Reg't, Corps d'Afrique Cavalry.*
Appears on
Apr 19

Company Muster-in Roll

of the organization named above. Roll dated

New Orleans, La. Dec. 31, 1863.

Muster-in to date Dec. 31, 1863.

Joined for duty and enrolled:

When Nov. 18, 1863.

Where New Orleans

Period 3 years.

Valuation of horse, \$ 100

Valuation of horse equipments, \$ 100

Remarks:

*This organization subsequently became Co. E, 4 Reg't U. S. Colored Cavalry.

Book mark:

W. W. W.

W 4 Cav. U.S.C.T.

Peter, Wales
F.W., Co. E, 1 Reg't Cav., Corps d'Afrique.*

Appears on

Company Muster Roll

for *Enlistment to Dec 31, 1863*, 1863.

Present or absent *Present*

Stoppage, \$ *100* for

Due Gov't, \$ *100* for

Valuation of horse, \$ *100*

Valuation of horse equipments, \$ *100*

Remarks:

* This organization subsequently became Co. E, 4 Reg't U.S. Colored Cavalry.

Book mark:

W. Wales

NO 793

Vr 4 Cav. U.S C.T.

Peter Wallace

, Co. *E*, 1 Reg't Cav., Corps d'Afrique.*

Appears on

Company Muster Roll

for *Jan + Feb*, 1864.

Present or absent *Present*

Stoppage, \$ *100* for

Due Gov't, \$ *100* for

Valuation of horse, \$ *100*

Valuation of horse equipments, \$ *100*

Remarks:

* This organization subsequently became Co. *E*, 4 Reg't U. S. Colored Cavalry.

Book mark:

L. L. L.

MAR 30 4

N | **4 Cav.** | **U.S.C.T.**

Peter Wallace

Plt, Co. E, 4 Reg't U. S. Col'd Cav.

Appears on

Company Muster Roll

for *Mar & Apr*, 186*4*

Present or absent *Present*

Stoppage, \$ *100* for

Due Gov't, \$ *100* for

Valuation of horse, \$ *100*

Valuation of horse equipments, \$ *100*

Remarks:

Book mark:

L. Amner

11 | **4 Cav.** | **U.S.C.T.**

Peter Wallace

Plt., Co. E, 4 Reg't U. S. Col'd Cav.

Appears on

Company Muster Roll

for *May & June*, 186*4*

Present or absent *Present*

Stoppage, \$ *100* for

Due Gov't, \$ *100* for

Valuation of horse, \$ *100*

Valuation of horse equipments, \$ *100*

Remarks:

Book mark:

L. ...

A | **4 Cav.** | **U.S.C.T.**

Peter Wallis

Priv., Co. E, 4 Reg't U. S. Col'd Cav.

Appears on

Company Muster Roll

for *July & Aug*, 186*4*

Present or absent *Absent*

Stoppage, \$ *100* for

Due Gov't, \$ *100* for

Valuation of horse, \$ *100*

Valuation of horse equipments, \$ *100*

Remarks: *Sick in H. H. at N. O.*

Book mark: _____

Lawrence

W | **4 Cav.** | **U.S.C.T.**

Peter Wallis

Out, Co. E, 4 Reg't U. S. Col'd Cav.

Appears on

Company Muster Roll

for *Sept & Oct*, 1864.

Present or absent.....

Stoppage, \$.....100 for.....

Due Gov't, \$.....100 for.....

Valuation of horse, \$.....100

Valuation of horse equipments, \$.....100

Remarks: *died Aug 23/64*
one sister \$800

Book mark:.....

Lammie

W | 4 Cav. | U.S.C.T.

Peter Wallace

Port, Co. E, 4 Reg't U. S. Colored Cav.

Appears on Returns as follows:

July & Aug 1864 - absent sick since
July 30/64 in Genl Hosp
H.O.

Sept 1864 - Loss: June 27/64
New Orleans died in G.O.A.
G. Hospital.

Book mark:

W. R. Lee

W | **4 Cav.** | **U.S.C.T.**

Peter Wallace

Put, Co. E, 4 Reg't U. S. Col'd Cavalry.

Appears on **Co. Muster-out Roll**, dated New Orleans La Michro, 1866.

Muster-out to date _____, 186 .

Last paid to _____, 186 .

Clothing account:

Last settled _____, 186 ; drawn since \$ _____ 100

Due soldier \$ _____ 100; due U. S. \$ _____ 100

Am't for cloth'g in kind or money adv'd \$ _____ 100

Due U. S. for arms, equipments, &c., \$ _____ 100

Bounty paid \$ _____ 100; due \$ _____ 100

Remarks: joined at orig org.
died Aug. 20/64 at New
Orleans La.

Book mark 482. 1882. Died Aug 23/64
LEB VII P12

(861)

Lloyd

Copyist.

Wallace, Peter

P, Co. E, 4 Reg't U.S. Cavalry

4 Enclosures.

Bed Cards	Descriptive Lists
Burial Records 1	Final Statements 2
Certs. of Dis. for Discharge	Furloughs
C. M. Charges	Med. Des. Lists
Med. Certificates	Orders

Other papers relating to—

Admission to Hosp'l	Furlough
Casualty Sheet (Officer's)	Med. Examination
Confinement	Misc. Information
Contracts	Pay or Clothing
Death or Effects X	Personal Reports
Desertions	Rank
Discharge from Hosp'l	Transfer to Hosp'l
Discharge from Service	Transfer to V. R. C.
Duty	Transportation

duplicate a to Aug 23rd 1864

FINAL STATEMENT

OF

Private Peter Wallace
of *4th* Reg't of *U S Col's Cavry*

VOLUNTEERS.

C d'A Hoop

NOTE 1.—Two of these certificates (or duplicates) are to be given to each Volunteer Soldier or drafted man who may be discharged previously to the discharge of his company, that he may at once receive from the Paymaster the pay, &c., due him, and the cap'tain or other COMMISSIONED officer commanding the company will certify to the act of the delivery of the duplicate certificates; on these certificates the Soldier is "entitled to" his discharge, and should also present his discharge to the Paymaster to have the payment endorsed on it. The discharge is to be given back to the Soldier by the Paymaster; the latter only retaining as his voucher the duplicate certificates.

NOTE 2.—If the Soldier is entitled to pay for the use of his horse, the Company Commander will certify to that fact on the back of both these final statements, and also to the time he has pay due for having been so mounted on his own horse.

NOTE 3.—When a Soldier is furnished with final statements, his descriptive list, if he has one, should be taken up by the officer who gives the Soldier these statements, and endorsed with a statement to this effect by the officer. This endorsement should exhibit a full statement of the time for which the Soldier was allowed pay on his final statements, the clothing account, and all other charges against him or in his favor, so as to comprise a complete exhibit of his account. It will then be transmitted to the company commander of the Soldier, who will enter all the data necessary to a full understanding of the Soldier's account on the muster roll upon which the Soldier's discharge is reported. The descriptive list will then be destroyed. The object of this is, that the remaining portion of the Soldier's account may be settled upon the receipt of these muster rolls, and the Soldier receive any pay or allowances that may be due him at the time of his discharge, and which may not appear on his final statements from the fact that his descriptive list is incomplete. These accounts for back pay, &c., are settled by the 2d Auditor of the Treasury Department.

NOTE 4.—Charges for loss or injury to ordnance, horse equipments, and other miscellaneous charges, should appear under the heading of "Other Stoppages."

NOTE 5.—Bounty paid by State authorities, and not by the United States, will not be entered on this statement.

NOTE 6.—Amounts due the Sutler and Laundress must be entered on the muster roll on which the discharge, death, desertion, &c., is reported, as well as on the final statement, otherwise the amount cannot be collected from the United States.

NOTE 7.—This blank will be used for deceased volunteers and drafted men, as well as for others.

NOTE 8.—Where a Soldier dies in Hospital or on detached service, his descriptive list, if he has one, should be sent with his final statements, in duplicate, to the Adjutant General, Washington, D. C.

I certify, on honor, that Peter Wallace a Private of
 1st Lieut Captain J. W. Blasdel Company (C.) of the 4th Regiment of U S C Cav
VOLUNTEERS, of the State of Louisiana, born in _____, State
 of _____, aged 19 years; 5 feet 8 inches high; Blk complexion,
Blk eyes, Blk hair, and by occupation a _____, having joined the company on
 its original organization at _____, and enrolled in it at the muster into
 the service of the United States at New Orleans La, on the 18th day
 of November, 1863, (or was mustered in service as a recruit, by _____
 _____, at _____, on the _____ day of _____,
 186 , or was drafted and mustered into the service of the United States from the _____
 Enrollment District of the State of _____, at _____,
 on the _____ day of _____, 186 .) to serve in the Regiment, for
 the term of Three years; and having served **HONESTLY** and
FAITHFULLY with his Company in Dept of the Gulf to the present date, is now
 entitled to a **DISCHARGE** by reason of Death
by small Pox

The said Peter Wallace was last paid by Paymaster
Maj Loftland to include the 30th day of April, 1864, and has
 pay due him from that time to the present date; he is entitled to pay and subsistence for
TRAVELING to place of enrollment, and whatever other allowances are authorized to volunteer
 soldiers, drafted men, or militia, so discharged. He has received from the United States **CLOTHING**
 amounting to Seventeen $\frac{50}{100}$ dollars, since the _____ day of Enrollment,
 1863, when his clothing account was last settled. He has received from the United States
no $\frac{1}{100}$ dollars advanced **BOUNTY**.

There is to be stopped from him, on account of the State of _____, or other
 authorities, for **CLOTHING**, &c., received on entering service, _____ $\frac{100}{100}$ dollars; and
 for other stoppages, viz: _____

_____ $\frac{100}{100}$ dollars.
 He has been furnished with **TRANSPORTATION** in kind from the place of his discharge to
 _____; and he has been **SUBSISTED** for **TRAVELING** to his
 place of enrollment, up to the _____, 186 .

He is indebted to _____, **SUTLER**, _____ $\frac{100}{100}$ dollars.
 He is indebted to _____, **LAUNDRESS**, _____ $\frac{100}{100}$ dollars.

Given in Duplicate, at New Orleans La, this 23rd day
 of August, 1864.

F. E. Piquette
 Surgeon Charge Camp d'Espagne Gen Hospital
 Commanding Company

Duplicate

ARTICLES OF WAR.

ART. 95. When any non-commissioned officer or soldier shall die, or be killed in the service of the United States, the then commanding officer of the troop or company shall, in the presence of two other commissioned officers, take an account of what effects he died possessed of, above his arms and accoutrements, and transmit the same to the office of the Department of War, which said effects are to be accounted for, and paid to the representatives of such deceased non-commissioned officer or soldier. And in case any of the officers, so authorized to take care of the effects of deceased officers and soldiers, should, before they have accounted to their representatives for the same, have occasion to leave the regiment or post, by preferment or otherwise, they shall, before they be permitted to quit the same, deposit in the hands of the commanding officer, or of the assistant military agent, all the effects of such deceased non-commissioned officers and soldiers, in order that the same may be secured for, and paid to, their respective representatives.

ARMY REGULATIONS—EDITION OF 1861.

DECEASED SOLDIERS.

Par. 152. Inventories of the effects of deceased non-commissioned officers and soldiers, required by the 95th Article of War, will be forwarded to the Adjutant General, by the commander of the company to which the deceased belonged, and a duplicate of the same to the colonel of the regiment. Final statements of pay, clothing, &c., will be sent with the inventories. When a soldier dies at a post or station absent from his company, it will be the duty of his immediate commander to furnish the required inventory, and, at the same time, to forward to the commanding officer of the company to which the soldier belonged, a report of his death, specifying the date, place, and cause; to what time he was last paid, and the money or other effects in his possession at the time of his decease; which report will be noted on the next muster roll of the company to which the man belonged. Each inventory will be endorsed, "Inventory of the effects of _____, late of company (—) _____ regiment of _____, who died at _____, the _____ day of _____, 186—." If a legal representative receive the effects, it will be stated in the report. If the soldier leave no effects, the fact will be reported.

Par. 153. Should the effects of a deceased non-commissioned officer or soldier not be administered upon within a short period after his decease, they shall be disposed of by a Council of Administration, under the authority of the commanding officer of the post, and the proceeds deposited with the Paymaster, to the credit of the United States, until they shall be claimed by the legal representatives of the deceased.

Par. 154. In all such cases of sales by the Council of Administration, a statement in detail, or account of the proceeds, duly certified by the Council and commanding officer, accompanied by the Paymaster's receipt for the proceeds, will be forwarded by the commanding officer to the Adjutant General. The statement will be endorsed, "Report of the proceeds of the effects of _____, late of company (—) _____ regiment of _____, who died at _____, the _____ day of _____, 186—."

NOTE 1.—The effects in all cases, when called for, should be turned over to the legal representative, without further authority from the Adjutant General. When the effects are turned over to the relatives of the deceased before these inventories are sent to the Adjutant General, their receipts therefor should be attached to the inventories. In all other cases, one copy will be sent with a letter of transmittal direct to the Adjutant General, and a duplicate retained by the officer.

NOTE 2.—Particular care should be taken to take receipts in duplicate from the Paymaster for any funds turned over to him; one copy should be sent direct to the Adjutant General and one retained by the officer.

INVENTORY OF THE EFFECTS

OF

Private Peter Wallace

Late of Company *"E"*

4th Reg't of *U. S. C. Army*

Volunteers, who died at *6th U. S. Gen. Hospital*

on the *23rd* day of *August* 186*4*.

INVENTORY

Inventory of the effects of Peter Wallace late
 a Private of Captain J. W. Blasdel Company "E" of
 the 4th Regiment of U S C Cav Volunteers, who was enrolled as
 a Private at New Orleans in the State of Louisiana on
 the 18th day of November 1863, and mustered into the service of the United
 States as a Private on the 31st day of December 1863, at New Orleans
 in Company "E", 4th Regiment of U S C Cav Volunteers, to serve Three
 years or during the war; he was born in _____ in the State
 of _____; he was 19 years of age, 5 feet 8 inches
 high, Blk complexion, Blk eyes, Blk hair, and by occupation, when enrolled,
 a _____; he died in Camp St. Pierre Gen Hospital at
New Orleans La on the 23rd day of August 1864, by
 reason of Small Pox,

INVENTORY.					
ARTICLES.	No.	ARTICLES.	No.	ARTICLES.	No.
Hats.....		Pairs trousers.....		Knapsacks.....	
Caps.....		Pairs flannel drawers.....			
Forage caps.....		Pairs cotton drawers.....			
Great coats.....		Flannel shirts.....			
Uniform coats.....		Cotton shirts.....			
Uniform jackets.....		Pairs boots.....			
Flannel sack coats.....		Pairs shoes.....			
Blouses.....		Pairs socks.....			
Stable frocks.....		Blankets.....			
Fatigue overalls.....		Haversacks.....			
				Money.	
				\$.....	
				Notes.	
				\$.....	

I CERTIFY, ON HONOR, that the above inventory comprises all the effects of _____
 _____, deceased, and that the effects are in the hands
 of _____ at _____
 _____ to be disposed of by a Council of Administration.

(DUPLICATES.)

STATION: New Orleans La

DATE: August 23rd 1864.

[A. G. O. No. 104.]

J. E. Piquette
 Surgeon in Charge Camp St. Pierre Gen Hospital
 Commanding the Company

John Wallace
A. C. & Co.,
A. C.



COPY OF RECORD

FOR THE

ADJUTANT GENERAL U. S. ARMY.

NOV 1864

No. 2.

RECORD OF DEATH AND INTERMENT.

Name and number of person interred,	<i>Peter Wallace</i>
Number and locality of the grave, -	
Hospital number of the deceased, -	<i>1676</i>
Regiment, Rank, and Company, - -	<i>4th U. S. Col. Cav. - Priv. - E.</i>
Residence before enlistment, - - -	
Conjugal condition (and if married,) the residence of the widow,)	
Cause of death,)	<i>Smallpox</i>
Age of the deceased, - - - - -	
Nativity, - - - - -	
References and Remarks, - - }	
Date of death and burial, - - -	<i>August 23 / 64.</i>

186

[A duplicate of this Record has been forwarded to the Sexton, and the other remains at this Hospital.]

To *Adj. General M. S. W.*
SIR:

It becomes my duty to inform you that the person above described died at this Hospital as herein stated: and that it is desired his remains should be interred with the usual military honors.

Respectfully,

F. E. Piquette Jr.
Surgeon U. S. Army.
86th U. S. Col. Inf.

MILITARY HOSPITAL, *Corps d'Afrique N. Orleans*
La.

This copy of Record is to be transmitted to the Adjutant General at Washington immediately after the place of burial and the number of the grave have been ascertained and registered. The above notification is to remain attached.

MARR 517

*all
Desertion & credits
P*

ASC

FINAL STATEMENT

OF

Private Peter Wallace
4th Reg't of U S C Cavalry

VOLUNTEERS.

Went Aug 23rd 1864

NOTE 1.—Two of these certificates (or duplicates) are to be given to each Volunteer Soldier or drafted man who may be discharged previously to the discharge of his company, that he may at once receive from the Paymaster the pay, &c., due him, and the captain or other COMMISSIONED officer commanding the company will certify to the act of the delivery of the duplicate certificates; on these certificates the Soldier is "entitled to" his discharge, and should also present his discharge to the Paymaster to have the payment endorsed on it. The discharge is to be given back to the Soldier by the Paymaster; the latter only retaining as his voucher the duplicate certificates.

NOTE 2.—If the Soldier is entitled to pay for the use of his horse, the Company Commander will certify to that fact on the back of both these final statements, and also to the time he has pay due for having been so mounted on his own horse.

NOTE 3.—When a Soldier is furnished with final statements, his descriptive list, if he has one, should be taken up by the officer who gives the Soldier these statements, and endorsed with a statement to this effect by the officer. This endorsement should exhibit a full statement of the time for which the Soldier was allowed pay on his final statements, the clothing account, and all other charges against him or in his favor, so as to comprise a complete exhibit of his account. It will then be transmitted to the company commander of the Soldier, who will enter all the data necessary to a full understanding of the Soldier's account on the muster roll upon which the Soldier's discharge is reported. The descriptive list will then be destroyed. The object of this is, that the remaining portion of the Soldier's account may be settled upon the receipt of these muster rolls, and the Soldier receive any pay or allowances that may be due him at the time of his discharge, and which may not appear on his final statements from the fact that his descriptive list is incomplete. These accounts for back pay, &c., are settled by the 2d Auditor of the Treasury Department.

NOTE 4.—Charges for loss or injury to ordnance, horse equipments, and other miscellaneous charges, should appear under the heading of "Other Stoppages."

NOTE 5.—Bounty paid by State authorities, and not by the United States, will not be entered on this statement.

NOTE 6.—Amounts due the Sutler and Laundress must be entered on the muster roll on which the discharge, death, desertion, &c., is reported, as well as on the final statement, otherwise the amount cannot be collected from the United States.

NOTE 7.—This blank will be used for deceased volunteers and drafted men, as well as for others.

NOTE 8.—Where a Soldier dies in Hospital or on detached service, his descriptive list, if he has one, should be sent with his final statements, in duplicate, to the Adjutant General, Washington, D. C.

ADJUTANT GENERAL'S OFFICE.

Co 11th 1864

Duplicate with Inventory sent 2d Auditor.



Leuby

[OFFICE INDORSEMENT.]

War Department,

ADJUTANT GENERAL'S OFFICE,

March 7, 1874

The death of *Peter Wallace*
Private, Co. E., *4th Reg't U. S.*
Colored Cavalry, is reported as follows:

On Company Muster Roll.
For *July & Aug, 1864, Aug 23rd*, 1864
Company Muster-out Roll.
August 20th, 1864
Company Descriptive Book.

, 186
Company Morning Reports.
, 186
Soldier's Final Statement.

August 23rd, 1864
Soldier's Record of Death and Interment.
, 186

Soldier's Inventory of Effects.
, 186

Soldier's Certificate of Disability for Discharge.
, 186

Soldier's Individual Muster-out Roll.
, 186
Regimental Return.

For *Sept.*, 1864, *June 27th*, 1864
Regimental Quarterly Returns.
, 186

Regimental Descriptive Book.
, 186
By Surgeon General.

() , 186
Aug 23, 1864 is held to be
the correct date, and the Company Muster-out
Roll will be amended accordingly.

Thomas M. Furment
Assistant Adjutant General.

E.B. 11/2
Notes see letters to 2d Aud.
H.M. April 2^d 1874.
noted on R -
S.R.

NO 39 510

I certify, on honor, that Peter Wallace a Private of
 1st Lieut J. W. Blasdel Company (E.) of the 4th Regiment of U. S. Col
VOLUNTEERS, of the State of Louisiana, born in _____, State
 of _____, aged 19 years; 5 feet 8 inches high; Blk complexion,
Blk eyes, Blk hair, and by occupation a _____, having joined the company on
 its original organization at _____, and enrolled in it at the muster into
 the service of the United States at New Orleans La, on the 18th day
 of November, 1863, (or was mustered in service as a recruit, by _____
 _____, at _____, on the _____ day of _____,
 186 , or was drafted and mustered into the service of the United States from the _____
 Enrollment District of the State of _____, at _____,
 on the _____ day of _____, 186) to serve in the Regiment, for
 the term of Three years: and having served **HONESTLY** and
FAITHFULLY with his Company in Dept of the Gulf to the present date, is now
 entitled to a **DISCHARGE** by reason of Death

by a Small Pox, New Orleans La Aug 23rd 1864
 The said Peter Wallace was last paid by Paymaster
Maj Loftland to include the 30th day of April, 1864, and has
 pay due him from that time to the present date; he is entitled to pay and subsistence for
TRAVELING to place of enrollment, and whatever other allowances are authorized to volunteer
 soldiers, drafted men, or militia, so discharged. He has received from the United States **CLOTHING**
 amounting to Fourteen $\frac{50}{100}$ dollars, since the _____ day of Enrollment
 1863, when his clothing account was last settled. He has received from the United States
No $\frac{+}{100}$ dollars advanced **BOUNTY**.

There is to be stopped from him, on account of the State of _____, or other
 authorities, for **CLOTHING**, &c., received on entering service, _____ $\frac{100}{100}$ dollars; and
 for other stoppages, viz: _____

_____ $\frac{100}{100}$ dollars.
 He has been furnished with **TRANSPORTATION** in kind from the place of his discharge to
 _____; and he has been **SUBSISTED** for **TRAVELING** to his
 place of enrollment, up to the _____, 186 .

He is indebted to _____, **SUTLER**, _____ $\frac{100}{100}$ dollars.
 He is indebted to _____, **LAUNDRESS**, _____ $\frac{100}{100}$ dollars.

Given in Duplicate, at New Orleans La, this 23rd day
 of August, 1864.

F. O. Piquette
 Surgeon in Charge (Superintendent) Gen Hospital
 Commanding Company

1090

Walker, Daniel

Co C, 4 U. S. Col'd Cav.

Private Private

CARD NUMBERS.

1	5351286	26
2	5351342	27
3	5351394	28
4	5351480	29
5	5351547	30
6	5351603	31
7	5351681	32
8	5351747	33
9	5351818	34
10	5351906	35
11	5352009	36
12	5352107	37
13	5352206	38
14	5352299	39
15	5352387	40
16	5352476	41
17	40729298	42
18	30848553	43
19	30849253	44
20	40729297	45
21		46
22		47
23		48
24		49
25		50

Book Mark:

See also

11 | **4 Cav. U.S.C.T.**

James Walker
Pot, Co. *C*, 1 Reg't La. Cav., Corps d'Afrique.*

Appears on

Company Muster-in Roll

of the organization named above. Roll dated

New Orleans, La, Nov 7, 1863.

Muster-in to date

Nov 7, 1863.

Joined for duty and enrolled:

When *Oct 8*, 186*3*.

Where *New Orleans city*

Period *3* years.

Valuation of horse, \$ 100

Valuation of horse equipments, \$ 100

Remarks:

Sept 20

*This organization subsequently became Co. *C*, 1 Reg't U. S. Colored Cavalry.

Book mark:

Reister

NOV 21

W | 4 Cav. | U.S.C.T.

Daniel Walker
Priv. Co. C, 1 Reg't La. Cav., Corps d'Afrique.*

Appears on

Company Muster Roll

for *Nov 7 to Dec 31, 1863.*

Present or absent *Present*

Stoppage, \$ *100* for

Due Gov't, \$ *100* for

Valuation of horse, \$ *100*

Valuation of horse equipments, \$ *100*

Remarks:

FROM SECOND AUDITOR'S ROLL.

*This organization subsequently became Co. C, 4 Reg't U. S. Colored Cavalry.

Book mark:

Robert

NOV 1864

W | **4 Cav. | U.S.C.T.**

James Walker

A, Co. *C*, 1 Reg't La. Cav., Corps d'Afrique.*

Appears on

Company Muster Roll

for *Jan + Feb*, 1864.

Present or absent *Present*

Stoppage, \$ 100 for

Due Gov't, \$ 100 for

Valuation of horse, \$ 100

Valuation of horse equipments, \$ 100

Remarks:

*This organization subsequently became Co. *C*, 4 Reg't U. S. Colored Cavalry.

Book mark:

Rochester

W | 4 Cav. | U.S.C.T.

James Walker

Pvt, Co. C, 4 Reg't U. S. Colored Cavalry.

Appears on

Company Muster Roll

for *March 1864*, 1864.

Present or absent *Absent*

Stoppage, \$ 100 for

Due Gov't, \$ 100 for

Valuation of horse, \$ 100

Valuation of horse equipments, \$ 100

Remarks: *Lost one Remington revolver -
Acut sick in Gen Hospital New Orleans*

Book mark :

Rockster

W | *4 La. Cav.* | *M. S. C. T.*

Daniel Walker

Prs, Co. *C*, *4* Reg't *La. Cav.*

Appears on

Hospital Muster Roll

of **Corps d'Afrique U. S. A. General Hospital,**

at **New Orleans, La.,**

for *March & April*, 1864.

Attached to hospital:

When....., 186 .

How employed.....

Last paid by Maj.

to, 186 .

Bounty paid \$ 100; due \$ 100

Present or absent *Present*

Remarks:.....

Book mark :

D. Morgan
Coppist.

W | **4 Cav.** | **U.S.C.T.**

James Walker

Private, Co. C, 4 Reg't U. S. Colored Cavalry.

Appears on

Company Muster Roll

for May & June, 1864.

Present or absent Present

Stoppage, \$ 100 for

Due Gov't, \$ 100 for

Valuation of horse, \$ 100

Valuation of horse equipments, \$ 100

Remarks : Lost one Remington revolver

Book mark :

Receptor

W | 4 can VSCY

Daniel Walker

Priv, Co. C, 4 Reg't W can

Appears on

Hospital Muster Roll

of Corps d'Afrique U. S. A. General Hospital,

at New Orleans, La.,

for *May & June*, 186*4*

Attached to hospital:

When....., 186 .

How employed.....

Last paid by Maj.

to, 186 .

Bounty paid \$ 100; due \$ 100

Present or absent

Remarks: *Returned to duty
May 19/64*

Book mark :

[Signature]

W | **4 Cav.** | **U.S.C.T.**

James Walker
Private, Co. C, 4 Reg't U. S. Colored Cavalry.

Appears on

Company Muster Roll

for July & Aug, 1864.

Present or absent Present

Stoppage, \$ 100 for

Due Gov't, \$ 100 for

Valuation of horse, \$ 100

Valuation of horse equipments, \$ 100

Remarks: Took a fair
scales

Book mark:

Walker

W | 4 Cav. | U.S.C.T.

James Walker
Pvt, Co. C, 4 Reg't U. S. Colored Cavalry.

Appears on

Company Muster Roll

for *Sept*, 1864.

Present or absent *Present*

Stoppage, \$ 100 for

Due Gov't, \$ 100 for

Valuation of horse, \$ 100

Valuation of horse equipments, \$ 100

Remarks: *For Blanket \$2.25*

Book mark :

Bohater

H | 4 Cav. | U.S.C.T.

Daniel Walker

Priv, Co. C, 4 Reg't U. S. Colored Cavalry.

Appears on

Company Muster Roll

for *Nov 9 Dec*, 1864

Present or absent *present*

Stoppage, \$ *3*^{*88*}/₁₀₀ for *ordnance*

Due Gov't, \$ *100* for

Valuation of horse, \$ *100*

Valuation of horse equipments, \$ *100*

Remarks: *Lost ordnance*

Book mark:

Moy
Copyist.

H | **4 Cav.** | **U.S.C.T.**

Daniel Walker
Priv, Co. C, 4 Reg't U. S. Colored Cavalry.

Appears on

Company Muster Roll

for *Jan & Feb*, 1863.

Present or absent *present*

Stoppage, \$ 100 for

Due Gov't, \$ 100 for

Valuation of horse, \$ 100

Valuation of horse equipments, \$ 100

Remarks: *Stop for one saddle
blanket, Curry comb
and brush, curb chain,
nose bag, one pair spurs
and straps, and
another blanket.*

Book mark: _____

(358)

Moy

Copyist.

H | 4 Cav. | U.S.C.T.

Daniel Walker
Priv, Co. C, 4 Reg't U. S. Colored Cavalry.

Appears on

Company Muster Roll

for *Mch 9 Apr*, 186*5*.

Present or absent *present*

Stoppage, \$ 100 for

Due Gov't, \$ 100 for

Valuation of horse, \$ 100

Valuation of horse equipments, \$ 100

Remarks:

Book mark:

Moy

(358)

Copyist.

H | 4 Cav. | U.S.C.T.

Daniel Walker

Priv, Co. C, 4 Reg't U. S. Colored Cavalry.

Appears on

Company Muster Roll

for *May & June*, 186*5*.

Present or absent *present*

Stoppage, \$.....*100* for.....

Due Gov't, \$.....*100* for.....

Valuation of horse, \$.....*100*

Valuation of horse equipments, \$.....*100*

Remarks: *Stop for one Carbine sling & swivel, one canteen and haversack.*

Book mark:

May

H | **4 Cav.** | **U.S.C.T.**

Daniel Walker

Priv, Co. C, 4 Reg't U. S. Colored Cavalry.

Appears on

Company Muster Roll

for *July & Aug*, 186*5*.

Present or absent *present*

Stoppage, \$.....100 for

Due Gov't, \$.....100 for

Valuation of horse, \$.....100

Valuation of horse equipments, \$.....100

Remarks: *Stop for 1 carbine sling and swivel, 1 canteen and 1 haversack. Total \$3.43 -*

Book mark:

(358)

Moy
Copyist.

M | **4 Cav.** | **U.S.C.T.**

Daniel Walker

Priv, Co. C, 4 Reg't U. S. Colored Cavalry.

Appears on

Company Muster Roll

for *Sept 20th*, 1865.

Present or absent *present*

Stoppage, \$ 100 for

Due Gov't, \$ 100 for

Valuation of horse, \$ 100

Valuation of horse equipments, \$ 100

Remarks : *Stop for 1 bridle complete 4.60, 2 saddle blankets 4.50, 1 sabre knot 30 cts, 1 pair spurs & straps 60 cts, 1 Curry comb & brush 87 cts, 1 girth 60 cts, 2 Carbine sockets & straps 94 cts. Total \$17.47,*

Book mark :

Moy Copyist.

W | **4 Cav. | U.S.C.T.**

Daniel Walker

Private, Co. C, 4 Reg't U. S. Colored Cavalry.

Appears on

Company Muster Roll

for *Nov & Dec*, 186*5*.

Present or absent *present*

Stoppage, \$ *17*^{*74*}/₁₀₀ for *lost*
ordnance

Due Gov't, \$ *100* for

Valuation of horse, \$ *100*

Valuation of horse equipments, \$ *100*

Remarks:

Book mark:

M. A. Michaels

(358)

Copyist.

W | 4 Cav. | U.S.C.T.

Daniel Walker

Private, Co. C, 4 Reg't U. S. Colored Cavalry.

Appears on

Company Muster Roll

for *Jan'y & Febr*, 1866.

Present or absent *present*

Stoppage, \$ *18*/₁₀₀ for *Lost Ordnance*

Due Gov't, \$ *100* for

Valuation of horse, \$ *100*

Valuation of horse equipments, \$ *100*

Remarks:

Book mark:

M. A. Michaels

(358)

Copyist.

W | 4 Cav. | U.S.C.T.

Daniel Walker

Port, Co. C, 4 Reg't U. S. Colored Cav.

Appears on Returns as follows:

Apr 1864 - Absent sick in Genl

Hosp Apr 29/64

May 1864 - Absent sick at Genl.

Hosp since Apr 27/64

Book mark:

W. R. Lee

WAR 333
W | 4 Cav. | U.S.C.T.

David Walker
Co. A, 4 Reg't U. S. Colored Cav.

Appears on Returns as follows:

May 1864 - absent sick at Genl
Hosp. since Apr 27/64

Book mark: _____

W. R. Lee

W 4 Cav. U.S.C.T.

Daniel Walker

Private, Co. *C*, 4 Reg't U. S. Col'd Cavalry.

Appears on **Co. Muster-out Roll**, dated *New Orleans La*, *Mar 20*, 1866.

Muster-out to date *Mar 20*, 1866.

Last paid to *June 30*, 1865.

Clothing account:

Last settled....., 186 ; drawn since \$.....100

Due soldier \$.....100; due U. S. \$ *74* ^{*98*}/₁₀₀

Am't for cloth'g in kind or money adv'd \$.....100

Due U. S. for arms, equipments, &c., \$ *18* ^{*06*}/₁₀₀

Bounty paid \$.....100; due \$.....100

Remarks: *Joined at orig org. Step*
1 girth 2 Carbine sockets 1 Curb
bridle, 2 Saddle blankets, 1 pair
Spurs & Straps, 1 horsebrush
1 Curry comb, 2 Sabre knots.

Book mark: *V. 25 P 125 - 68.*

M. A. Michaels

(361)

Copyist.

1094

Walker George

Co A, 4 U.S. Col'd Cav.

Private Private

CARD NUMBERS.

1	5347948	26
2	5352957	27
3	5353640	28
4	5353123	29
5	5353222	30
6	5353313	31
7	5353408	32
8	5353496	33
9	5353582	34
10	5353665	35
11	5353745	36
12	40729299	37
13		38
14		39
15		40
16		41
17		42
18		43
19		44
20		45
21		46
22		47
23		48
24		49
25		50

Book Mark:

See also

W | 4 Cav | U.S.C.T

George Walker

Appears with rank of Pot on

Muster and Descriptive Roll of a Detachment of Drafted Men and Substitutes forwarded

for the 4 Reg't U.S. Col'd Cav Roll dated New Orleans La, Sept 1, 1864

Where born Lafourche La

Age 19 years; occupation Laborer

Drafted and mustered in:

When Sept 1, 1864

Where New Orleans

Period 3 years.

Eyes Brk; hair Brk

Complexion Dark; height 5 ft. 3 in.

Paid bounty and advance pay, \$ 100

Bounty due \$ 100 none

Where credited

Company to which assigned D

Remarks:

Book mark:

J. Anderson

H | **4 Cav.** | **U.S.C.T.**

George Walker

Pvt., Co. D. 4 Reg't U. S. Col'd Cavalry.

Appears on

Company Muster Roll

for *Sept & Oct*, 1864.

Present or absent *Present*

Stoppage, \$ *100* for

Due Gov't, \$ *100* for

Valuation of horse, \$ *100*

Valuation of horse equipments, \$ *100*

Remarks:

Book mark:

Rosenbaum

W | **4 Cav.** | **U.S.C.T.**

George Walker

D, Co. D, 4 Reg't U. S. Col'd Cavalry.

Appears on

Company Muster Roll

for *Mr & Dec*, 1864.

Present or absent *Present*

Stoppage, \$ 100 for

Due Gov't, \$ 100 for

Valuation of horse, \$ 100

Valuation of horse equipments, \$ 100

Remarks:

Book mark: -----

E. J. Smith

(358) Copyist.

11 | **4 Cav. | U.S.C.T.**

George Walker

D, Co. D, 4 Reg't U. S. Col'd Cavalry.

Appears on

Company Muster Roll

for Jan & Feb, 1865.

Present or absent Present

Stoppage, \$ 100 for

Due Gov't, \$ 100 for Advance

Valuation of horse, \$ 100

Valuation of horse equipments, \$ 100

Remarks:

Book mark:

E. J. Hight

11 | **4 Cav.** | **U.S.C.T.**

George Walker

....., Co. D, 4 Reg't U. S. Col'd Cavalry.

Appears on

Company Muster Roll

for Mar & Apr, 1865.

Present or absent Present

Stoppage, \$.....100 for

Due Gov't, \$.....100 for

Valuation of horse, \$.....100

Valuation of horse equipments, \$.....100

Remarks:

Book mark:

(358) W. H. Wright Copyist.

4 Cav. U.S.C.T.

George Walker
D

Co. D, 4 Reg't U. S. Col'd Cavalry.

Appears on

Company Muster Roll

for *May & June*, 186*5*.

Present or absent *Present*

Stoppage, \$ *100* for

Due Gov't, \$ *100* for

Valuation of horse, \$ *100*

Valuation of horse equipments, \$ *100*

Remarks: *Stip for int-Cred*
by ch

Book mark:

George Walker

A | **4 Cav. | U.S.C.T.**

George Hallier
.....
0, Co. D. 4 Reg't U. S. Col'd Cavalry.

Appears on

Company Muster Roll

for *July 1864*, 186*4*.

Present or absent *Present*

Stoppage, \$ *100* for

Due Gov't, \$ *100* for

Valuation of horse, \$ *100*

Valuation of horse equipments, \$ *100*

Remarks:

Book mark:

(358) *r. H. Wright* Copyist.

N | 4 Cav. | U.S.C.T.

George Walker

P, Co. D, 4 Reg't U. S. Col'd Cavalry.

Appears on

Company Muster Roll

for *Sept - Oct*, 186*5*.

Present or absent *Present*

Stoppage, \$ *100* for

Due Gov't, \$ *100* for

Valuation of horse, \$ *100*

Valuation of horse equipments, \$ *100*

Remarks:

Book mark:

1st Night

11 | 4 Cav. | U.S.C.T.

George Mulker

Put, Co. D, 4 Reg't U. S. Col'd Cavalry.

Appears on

Company Muster Roll

for *Nov 7 1864*, 186*4*.

Present or absent *Present*

Stoppage, \$ 100 for

Due Gov't, \$ 100 for

Valuation of horse, \$ 100

Valuation of horse equipments, \$ 100

Remarks:

Book mark:

J. S. Anderson

M | **4 Cav.** | **U.S.C.T.**

George Walker

Put, Co. D, 4 Reg't U. S. Col'd Cavalry.

Appears on

Company Muster Roll

for *Jan 1 1866*, 1866.

Present or absent *Present*

Stoppage, \$ *100* for

Due Gov't, \$ *100* for

Valuation of horse, \$ *100*

Valuation of horse equipments, \$ *100*

Remarks:

Book mark:

W | 4 Cav. | U.S.C.T.

George Walker
Port Co. D, 4 Reg't U. S. Colored Cav.

Appears on Returns as follows:

Sept 1864 - Gain: Sept 3/64
Port Hudson enlisted.

Book mark:

M. R. Lee

07 | 4 Cav. | U.S.C.T.

George Walker
Put, Co. 10, 4 Reg't U. S. Col'd Cavalry.

Appears on Co. Muster-out Roll, dated
New Orleans La, Dec 20, 1866.

Muster-out to date Dec 20, 1866.

Last paid to June 30, 1865.

Clothing account:

Last settled, 186 ; drawn since \$ 100

Due soldier \$ 100; due U. S. \$ 100
49

Am't for cloth'g in kind or money adv'd \$ 100

Due U. S. for arms, equipments, &c., \$ 100

Bounty paid \$ 100; due \$ 100

Remarks: Enlisted as recruit.

Book mark:

M. S. Andrews.

1095

Wallace Peter

Co E, 4 U.S. Col'd Cav.

Private

Private

CARD NUMBERS.

1		26
2	Su Wales, Peter	27
3		28
4		29
5		30
6		31
7		32
8		33
9		34
10		35
11		36
12		37
13		38
14		39
15		40
16		41
17		42
18		43
19		44
20		45
21		46
22		47
23		48
24		49
25		50

Book Mark:

See also

109
Walls, Wiley

Co A, 4 U. S. Col'd Cav.

Corporal | Corporal

CARD NUMBERS.

1	5354923	26
2	5355013	27
3	5355104	28
4	5355198	29
5	5355289	30
6	5355373	31
7	5355454	32
8	5355531	33
9	5355609	34
10	5355693	35
11	5355776	36
12	5355857	37
12	5355938	38
14	5356019	39
15	5356096	40
16	40729301	41
17		42
18		43
19		44
20		45
21		46
22		47
23		48
24		49
25		50

Book Mark:

See also

W | **4 Cav. U.S.C.T.**

Wiley Walls
Corp, Co. A, Mounted Rangers, Corps d'Afrique. †

Age years.

Appears on

Company Muster Roll*

for *Nov & Dec*, 1863.

Joined for duty and enrolled:

When *Nov 1*, 1863.

Where *Berida, La*

Period years.

Mustered in:

When *Nov 30*, 1863.

Where *Berida, La*

Present or absent *Present*

Stoppage, \$ 100 for

Due Gov't \$ 100 for

Valuation of horse, \$ 100

Valuation of horse equipments, \$ 100

Remarks:

For age see new roll

† This organization subsequently became Co. F, 4 U. S. Col'd Cav.
* First current roll. No muster-in roll of this ~~battery~~ on file.

Book mark:

Meamin
(3586) Copyist.

M

4 Cav. | U.S.C.T.

Wiley Wall
Corps, Co. *F*, 1 Reg't Cav., Corps d'Afrique.*

Appears on

Company Muster Roll

for *James P. Feby*, 1864.

Present or absent *Present*

Stoppage, \$ 100 for

Due Gov't, \$ 100 for

Valuation of horse, \$ 100

Valuation of horse equipments, \$ 100

Remarks:

*This organization subsequently became Co. *F*, 4 Reg't U. S. Colored Cavalry.

Book mark:

Manning

W | 4 Cav. | U.S.C.T.

Walls
Wiley ~~*Harris*~~

Capt, Co. F, 4 Reg't U. S. Col'd Cavalry.

Appears on

Company Muster Roll

for *March & April*, 1864.

Present or absent *Present*

Stoppage, \$ *100* for

Due Gov't, \$ *100* for

Valuation of horse, \$ *100*

Valuation of horse equipments, \$ *100*

Remarks:

x corrected by Hr

Book mark:

Hanning
Copyist.

A | 4 Cav. | U.S.C.T.

Wiley Walls

Corp, Co. F, 4 Reg't U. S. Col'd Cavalry.

Appears on

Company Muster Roll

for *May & June*, 186 *4*

Present or absent *Present*

Stoppage, \$ *100* for

Due Gov't, \$ *100* for

Valuation of horse, \$ *100*

Valuation of horse equipments, \$ *100*

Remarks: *Present in arrest*

Book mark:

Hanning
Copyist.

W | 4 Cav. | U.S.C.T.

Wiley Walls

Corpl, Co. F, 4 Reg't U. S. Col'd Cavalry.

Appears on

Company Muster Roll

for *July & Aug*, 186*4*.

Present or absent *Present*

Stoppage, \$ *100* for

Due Gov't, \$ *100* for

Valuation of horse, \$ *100*

Valuation of horse equipments, \$ *100*

Remarks: *Stop for one
Spur 30¢*

Book mark:

Manning

(358)

Copyist.

W | 4 Cav | U.S.C.T.

Walls
Wiley Walls

Capt., Co. F, 4 Reg't U. S. Col'd Cavalry.

Appears on

Company Muster Roll

for *Sept & Oct*, 186*4*.

Present or absent *Present*

Stoppage, \$ *100* for

Due Gov't, \$ *100* for

Valuation of horse, \$ *100*

Valuation of horse equipments, \$ *100*

Remarks: *Stop for
one spur, 20¢*

x Corrected by W

Book mark:

Winnery Copyist.

W | 4 Cav. | U.S.C.T.

Wiley Walls
Corpl, Co. F, 4 Reg't U. S. Col'd Cavalry.

Appears on

Company Muster Roll

for Nov & Dec, 1864

Present or absent Present

Stoppage, \$ 100 for

Due Gov't, \$ 100 for

Valuation of horse, \$ 100

Valuation of horse equipments, \$ 100

Remarks: Stop for one Spur & Strap!

Book mark:

J. H. Harris

W | 4 Cav. | U.S.C.T.

Wiley Walls
Corpl, Co. F, 4 Reg't U. S. Col'd Cavalry.

Appears on

Company Muster Roll

for *Janx Feby*, 186 *5*

Present or absent *Present*

Stoppage, \$ *100* for

Due Gov't, \$ *100* for

Valuation of horse, \$ *100*

Valuation of horse equipments, \$ *100*

Remarks: *Apr^d Corpl Nov. 30/863*

Book mark:

J. A. Harris

W | 4 Cav. | U.S.C.T.

Wiley Walls

Corpl, Co. F, 4 Reg't U. S. Col'd Cavalry.

Appears on

Company Muster Roll

for *Mch & Apr*, 186 *5*.

Present or absent *Present*

Stoppage, \$ *100* for

Due Gov't, \$ *100* for

Valuation of horse, \$ *100*

Valuation of horse equipments, \$ *100*

Remarks:

Book mark:

Walls

NOV 1864

W | 4 Cav. | U.S.C.T.

Wiley Walls

Capt, Co. F, 4 Reg't U. S. Col'd Cavalry.

Appears on

Company Muster Roll

for *May & June*, 186 *5*

Present or absent *Present*

Stoppage, \$.....100 for

Due Gov't, \$.....100 for

Valuation of horse, \$.....100

Valuation of horse equipments, \$.....100

Remarks:

Book mark:

A. Harris

W | **4 Cav. | U.S.C.T.**

Wiley Walls

Corpl, Co. F, 4 Reg't U. S. Col'd Cavalry.

Appears on

Company Muster Roll

for *July & Aug*, 186*5*

Present or absent *Present*

Stoppage, \$ *100* for

Due Gov't, \$ *100* for

Valuation of horse, \$ *100*

Valuation of horse equipments, \$ *100*

Remarks:

Book mark:

J. J. ...

W | 4 Cav. | U.S.C.T.

Wiley Walls
Corpl., Co. F, 4 Reg't U. S. Col'd Cavalry.

Appears on

Company Muster Roll

for *Sept & Oct*, 186 *5*

Present or absent *Present*

Stoppage, \$ *100* for

Due Gov't, \$ *100* for

Valuation of horse, \$ *100*

Valuation of horse equipments, \$ *100*

Remarks: *Stop for one Nose Bag.*

Book mark:

A. Harris

W | 4 Cav. | U.S.C.T.

Willy Walls

Corp., Co. F, 4 Reg't U. S. Col'd Cavalry.

Appears on

Company Muster Roll

for Nov. & Dec., 1865.

Present or absent Present

Stoppage, \$ 2.00 for ordnance lost

Due Gov't, \$ 1.00 for

Valuation of horse, \$ 1.00

Valuation of horse equipments, \$ 1.00

Remarks:

Book mark:

Hibbard

(358)

Copyist.

W | 4 Cav. | U.S.C.T.

Wiley Walls

Corp., Co. F, 4 Reg't U. S. Col'd Cavalry.

Appears on

Company Muster Roll

for Jan. & Feb., 1866.

Present or absent Present

Stoppage, \$ 2.00 for ordn. lost.

Due Gov't, \$ 1.00 for

Valuation of horse, \$ 1.00

Valuation of horse equipments, \$ 1.00

Remarks:

Book mark:

(358)

Hibbard Copyist.

W | 4 Cav. | U.S.C.T.

Wiley Wells

Port, Co. H, 4 Reg't U. S. Colored Cav.

Appears on Returns as follows:

Aug 1865 - absent with leave
since Aug 24/65 Port
Hudson.

Book mark:

W. R. Lee

W | 4 Cav. | U.S.C.T.

Wiley Walls

Corp., Co. F, 4 Reg't U. S. Col'd Cavalry.

Appears on Co. Muster-out Roll, dated
New Orleans, La. Mch. 20, 1866.

Muster-out to date Mch. 20 1866.

Last paid to June 30 1865.

Clothing account:

Last settled _____, 186 ; drawn since \$ _____ 100

Due soldier \$ 2. ³³/₁₀₀; due U. S. \$ _____ 100

Am't for cloth'g in kind or money adv'd \$ _____ 100

Due U. S. for arms, equipments, &c., \$ 4. ²²/₁₀₀

Bounty paid \$ _____ 100; due \$ _____ 100

Remarks: Joined at orig. org. as
Corpl. Strap 1 nose bag, 1 carbine
sling 1 swivel 1 brush thong.

Age 22

Book mark:	V	P	
	124	184	71
	218	129	75

Hibbard

(861)

Copyist.

1097

Walters Joseph

Co, 4 U. S. Col'd Cav.

Private

CARD NUMBERS.

1		26	
2	Su Waters	27	Joseph
3		28	
4		29	
5		30	
6		31	
7		32	
8		33	
9		34	
10		35	
11		36	
12		37	
13		38	
14		39	
15		40	
16		41	
17		42	
18		43	
19		44	
20		45	
21		46	
22		47	
23		48	
24		49	
25		50	

Book Mark:

See also

1898

Walton George

Co B, 4 U. S. Col'd Cav.

Private | Private

CARD NUMBERS.

1	5349866	26
2	5349964	27
3	5350058	28
4	5350164	29
5	5350258	30
6	5350346	31
7	5350426	32
8	5350500	33
9	5350576	34
10	5350661	35
11	5350746	36
12	5350841	37
13	5350927	38
14	5351011	39
15	5351093	40
16	5351174	41
17	40729302	42
18		43
19		44
20		45
21		46
22		47
23		48
24		49
25		50

Book Mark:

See also

N. | 4 Cav. | U.S.C.T.

George Walton

Co. B, 1 Reg't La. Cav., Corps d'Afrique.*

Apr 27

Appears on

Company Muster-in Roll

of the organization named above. Roll dated

New Orleans La, Oct 27, 1863.

Muster-in to date

Oct 27, 1863.

Joined for duty and enrolled:

When Oct 5, 1863.

Where New Orleans

Period 3 years.

Valuation of horse, \$ 100

Valuation of horse equipments, \$ 100

Remarks:

*This organization subsequently became Co. B, 4 Reg't U. S. Colored Cavalry.

Book mark:

(356)

King

Copyist.

N

4 Cav. | U.S.C.T.

George Walton

*Det. Co. B, 1 Reg't La. Cav., Corps d'Afrique.**

Appears on

Company Muster Roll

for *Oct 27 to Dec 31*, 186 *3*

Present or absent *Present*

Stoppage, \$ *100* for

Due Gov't, \$ *100* for

Valuation of horse, \$ *100*

Valuation of horse equipments, \$ *100*

Remarks:

*This organization subsequently became Co. *B*, 4 Reg't U. S. Colored Cavalry.

Book mark:

King
Copyist.

W

4 Cav. U.S C.T.

George Walton

Co. A, Co. , 1 Reg't Cav., Corps d'Afrique.*

Appears on

Company Muster Roll

for *Jan & Feb*, 1864.

Present or absent *Present*

Stoppage, \$ *100* for

Due Gov't, \$ *100* for

Valuation of horse, \$ *100*

Valuation of horse equipments, \$ *100*

Remarks:

* This organization subsequently became Co. *B*, 4 Reg't U. S. Colored Cavalry.

Book mark: -----

(358)

Keely
Copyist.

H | **4 Cav. | U.S.C.T.**

George Watson

John, Co. B. 4 Reg't U. S. Col'd Cavalry.

Appears on

Company Muster Roll

for *March & April*, 186*4*.

Present or absent *Present*

Stoppage, \$ 100 for

Due Gov't, \$ 100 for

Valuation of horse, \$ 100

Valuation of horse equipments, \$ 100

Remarks :

Book mark :

A. J. [Signature]
Copyist.

M | 4 Cav. | U.S.C.T.

George Walton
Sept, Co. B. 4 Reg't U. S. Col'd Cavalry.

Appears on

Company Muster Roll

for *May & June*, 186*4*.

Present or absent *Present*

Stoppage, \$ *100* for

Due Gov't, \$ *100* for

Valuation of horse, \$ *100*

Valuation of horse equipments, \$ *100*

Remarks :

.....
.....
.....
.....
.....
.....
.....
.....
.....
.....

Book mark :

.....

Spring
Copyist.

NO 370

H | **4 Cav.** | **U.S.C.T.**

George Walton
Co. B., Co. B. 4 Reg't U. S. Col'd Cavalry.

Appears on

Company Muster Roll

for *July & Aug.*, 186*4*.

Present or absent *Present*

Stoppage, \$ 100 for

Due Gov't, \$ 100 for

Valuation of horse, \$ 100

Valuation of horse equipments, \$ 100

Remarks :

Book mark : _____

(358)

[Signature]
Copyist.

N | **4 Cav.** | **U.S.C.T.**

George Walton
Pop, Co. B. 4 Reg't U. S. Col'd Cavalry.

Appears on
Company Muster Roll
for *Sept + Oct*, 186*4*.

Present or absent *Absent*

Stoppage, \$ *100* for

Due Gov't, \$ *100* for

Valuation of horse, \$ *100*

Valuation of horse equipments, \$ *100*

Remarks: *Absent in New-Orleans, as ordered with Lt. Col. Alexander*

Book mark:

(358) *James* Copyist.

NARA 500

W | **4 Cav.** | **U.S.C.T.**

George Walton

20th, Co. B. 4 Reg't U. S. Col'd Cavalry.

Appears on

Company Muster Roll

for *Nov & Dec*, 1864.

Present or absent *present*

Stoppage, \$ *100* for

Due Gov't, \$ *100* for

Valuation of horse, \$ *100*

Valuation of horse equipments, \$ *100*

Remarks: *Detached at Regi-
mental Head quarters as
orderly*

Book mark:

Somer
(358) Copyist.

W | **4 Cav.** | **U.S.C.T.**

George Wallow

priv; Co. B. 4 Reg't U. S. Col'd Cavalry.

Appears on

Company Muster Roll

for *Jan & Feb.*, 186*5*.

Present or absent *Present*

Stoppage, \$ *100* for

Due Gov't, \$ *100* for

Valuation of horse, \$ *100*

Valuation of horse equipments, \$ *100*

Remarks: *Received only \$7 a month to include upr 30/100 detailed as orderly at Regt. Hd. Qrs. Staff for one Sabre prot.*

Book mark:

Sumner

W | **4 Cav.** | **U.S.C.T.**

George Waller

priv., Co. B. 4 Reg't U. S. Col'd Cavalry.

Appears on

Company Muster Roll

for March & April, 1865.

Present or absent present

Stoppage, \$ 100 for

Due Gov't, \$ 100 for

Valuation of horse, \$ 100

Valuation of horse equipments, \$ 100

Remarks :

Book mark :

E. H. Waller

W | **4 Cav.** | **U.S.C.T.**

George Walton

priv., Co. B. 4 Reg't U. S. Col'd Cavalry.

Appears on

Company Muster Roll

for *May & June*, 186 *4*.

Present or absent *present*

Stoppage, \$ *100* for

Due Gov't, \$ *100* for

Valuation of horse, \$ *100*

Valuation of horse equipments, \$ *100*

Remarks: *Stop for 2 weeks +*
at camp.

Book mark:

James

W | **4 Cav.** | **U.S.C.T.**

George Walton

priv, Co. B. 4 Reg't U. S. Col'd Cavalry.

Appears on

Company Muster Roll

for July & Aug, 1867.

Present or absent present

Stoppage, \$ 100 for

Due Gov't, \$ 100 for

Valuation of horse, \$ 100

Valuation of horse equipments, \$ 100

Remarks :

Book mark :

George Walton

W | **4 Cav. | U.S.C.T.**

George Walton

priv., Co. B. 4 Reg't U. S. Col'd Cavalry.

Appears on

Company Muster Roll

for *Sept & Oct*, 186*9*.

Present or absent *present*

Stoppage, \$ 100 for

Due Gov't, \$ 100 for

Valuation of horse, \$ 100

Valuation of horse equipments, \$ 100

Remarks :

Book mark :

Simon

W | **4 Cav.** | **U.S.C.T.**

George Walton

Priv., Co. B. 4 Reg't U. S. Col'd Cavalry.

Appears on

Company Muster Roll

for *Nov. & Dec.*, 186*5*.

Present or absent *Present*

Stoppage, \$ 100 for

Due Gov't, \$ 100 for

Valuation of horse, \$ 100

Valuation of horse equipments, \$ 100

Remarks :

Book mark :

Chandler

W | **4 Cav.** | **U.S.C.T.**

George Walton

Por, Co. B. 4 Reg't U. S. Col'd Cavalry.

Appears on

Company Muster Roll

for *Jan. & Feb.*, 186*6*

Present or absent *Present*

Stoppage, \$ 100 for

Due Gov't, \$ 100 for

Valuation of horse, \$ 100

Valuation of horse equipments, \$ 100

Remarks :

Book mark :

Chandler

W | 4 Cav. | U.S.C.T.

George Walton
 Port, Co. B, 4 Reg't U. S. Colored Cav.

Appears on Returns as follows:

Feb & March 1864 - (1 Regt Cav., Comp'd Africa)
 On duty Orderly at Regtl. Hdqrs.

April to June 1864 - (4 Regt U.S. Col'd. Cav.)
 On duty Orderly at Regtl. Hdqrs.

Aug & Sept 1864 - On duty orderly
 for Lt. Col. J. H. Alexander.

Oct 1864. On duty servant for Lt. Col. Alexander at New Orleans La.

Nov & Dec 1864 - On duty detailed
 as orderly at Regtl. Hdqrs.

Sept 1865 - Absent on furlough from
 Sept 29/65 Port Hudson.

Name appears also as:
 Geo. Walter

Book mark:

W. F. Lee

7 | **4 Cav. | U.S.C.T.**

George Walton

Priv, Co. *B*, 4 Reg't U. S. Col'd Cavalry.

Appears on **Co. Muster-out Roll**, dated *New Orleans, La, Mich. 20, 1866.*

Muster-out to date *Mich. 20, 1866.*

Last paid to *June 30, 1865.*

Clothing account:

Last settled....., 186 ; drawn since \$..... 100

Due soldier \$ *39* ^{*83*} / 100; due U. S. \$..... 100

Am't for cloth'g in kind or money adv'd \$..... 100

Due U. S. for arms, equipments, &c., \$..... 100

Bounty paid \$..... 100; due \$ *100* / 100

Remarks: *Joined at Org'l Org.*
Free on or before April 19, 61

Book mark: *6987, P.M.G. July 5, 66*
V. 25, P. 76, 68

L. Chandler

1099

Ward Stephen

Co D, 4 U. S. Col'd Cav.

Private Private

CARD NUMBERS.

1	5349869	26
2	5349965	27
3	5350060	28
4	5350166	29
5	5350260	30
6	5350348	31
7	5350428	32
8	5350502	33
9	5350583	34
10	5351193	35
11	30848552	36
12	30849252	37
13	40729378	38
14		39
15		40
16		41
17		42
18		43
19		44
20		45
21		46
22		47
23		48
24		49
25		50

Book Mark:

See also

N | 4 Cav. | U.S.C.T.

Stephen Ward

Co. B, Co. *B*, 1 Reg't La. Cav., Corps d'Afrique.*

Age 22,
Appears on

Company Muster-in Roll

of the organization named above. Roll dated

New Orleans La Oct 27, 186³.

Muster-in to date *Oct 27*, 186³.

Joined for duty and enrolled:

When *Oct 12*, 186 .

Where *New Orleans*

Period *3* years.

Valuation of horse, \$ 100

Valuation of horse equipments, \$ 100

Remarks:

.....
.....
.....

*This organization subsequently became Co. *B*, 4 Reg't U. S. Colored Cavalry.

Book mark:

.....

Copyist.

W | **4 Cav. | U.S.C.T.**

Stephen Ward
Co. B, Co. *B*, 1 Reg't La. Cav., Corps d'Afrique.*

Appears on

Company Muster Roll

for *Oct. 27 to Dec 31*, 186 *3*.

Present or absent *Present*

Stoppage, \$ *100* for

Due Gov't, \$ *100* for

Valuation of horse, \$ *100*

Valuation of horse equipments, \$ *100*

Remarks:

*This organization subsequently became Co. *B*, 4 Reg't U. S. Colored Cavalry.

Book mark:

Wing

N 4 Cav. | U.S C.T.

Stephen Ward
Pos, Co. *T*, 1 Reg't Cav., Corps d'Afrique.*

Appears on

Company Muster Roll

for *Jan + Feb*, 186*4*.

Present or absent *Present*

Stoppage, \$ *100* for

Due Gov't, \$ *100* for

Valuation of horse, \$ *100*

Valuation of horse equipments, \$ *100*

Remarks:

* This organization subsequently became Co. *B*, 4 Reg't U. S. Colored Cavalry.

Book mark:

(358)

Copyist.

A | **4 Cav. | U.S.C.T.**

Stephen Ward

Cow, Co. B. 4 Reg't U. S. Col'd Cavalry.

Appears on

Company Muster Roll

for *March + Apr*, 186*4*.

Present or absent *Absent*

Stoppage, \$ *100* for

Due Gov't, \$ *100* for

Valuation of horse, \$ *100*

Valuation of horse equipments, \$ *100*

Remarks: *Sick in C.D.A.,
sent to Hospital.*

Book mark :

(358)

J. M. J.
Copyist.

W | **4 Cav.** | **U.S.C.T.**

Step ton Wardle

Pr, Co. B. 4 Reg't U. S. Col'd Cavalry.

Appears on

Company Muster Roll

for *May & June*, 186*4*.

Present or absent *Present*

Stoppage, \$ 100 for

Due Gov't, \$ 100 for

Valuation of horse, \$ 100

Valuation of horse equipments, \$ 100

Remarks :

Book mark :

(358)

Kerry
Copyist.

NOV 1906

N | **4 Cav.** | **U.S.C.T.**

Stephen Ward
Ward, Co. B. 4 Reg't U. S. Col'd Cavalry.

Appears on

Company Muster Roll

for *July & Aug*, 186*4*.

Present or absent *Present*

Stoppage, \$ *100* for

Due Gov't, \$ *100* for

Valuation of horse, \$ *100*

Valuation of horse equipments, \$ *100*

Remarks :

.....
.....
.....
.....
.....
.....
.....
.....

Book mark :

.....

(358)

Ward
Corynat.

24

4 Cav. | U.S.C.T.

Stephen Ward
Co. B. 4 Reg't U. S. Col'd Cavalry.

Appears on

Company Muster Roll

for *Sept + Oct*, 186*7*.

Present or absent *Present*

Stoppage, \$ 100 for

Due Gov't, \$ 100 for

Valuation of horse, \$ 100

Valuation of horse equipments, \$ 100

Remarks :

Book mark :

J. W. [unclear]

Copyist.

NOV 1900

N | **4 Cav.** | **U.S.C.T.**

Stephen Ward

priv., Co. B. 4 Reg't U. S. Col'd Cavalry.

Appears on

Company Muster Roll

for *Nov & Dec*, 186*4*

Present or absent *present*

Stoppage, \$ 100 for

Due Gov't, \$ 100 for

Valuation of horse, \$ 100

Valuation of horse equipments, \$ 100

Remarks :

Book mark :

Somer

W | **4 Cav.** | **U.S.C.T.**

Stephen Ward

priv., Co. B. 4 Reg't U. S. Col'd Cavalry.

Appears on

Company Muster Roll

for Jan & Feb., 1865.

Present or absent _____

Stoppage, \$ 100 for _____

Due Gov't, \$ 100 for _____

Valuation of horse, \$ 100

Valuation of horse equipments, \$ 100

Remarks: Discharged on certificate of disability by order of Maj Gen. Hurlbut Feb. 27/65. Received only \$7 a month to include Apr 30/64

Book mark: _____

Tanner

W | 1 La. Cav. | N. S. C. P.

Stephen Ward

Orin, Co. B, 1 Reg't La. Cav.

Appears on

Hospital Muster Roll

of **Corps d'Afrique U. S. A. General Hospital,**

at **New Orleans, La.,**

for March 7th 1864.

Attached to hospital:

When....., 186 .

How employed.....

Last paid by Maj. never paid

to....., 186 .

Bounty paid \$ 100; due \$ 100

Present or absent Present

Remarks:.....

.....
.....
.....
.....
.....
.....
.....
.....

Book mark:.....

.....

Morgan
Copyst.

H | *4 car* | *MSCY*

Stephens Ward

Priv, Co. *B*, *4* Reg't *MSC*

Appears on

Hospital Muster Roll

of **Corps d'Afrique U. S. A. General Hospital,**

at **New Orleans, La.,**

for *May & June*, 186*4*

Attached to hospital:

When....., 186 .

How employed.....

Last paid by Maj.

to, 186 .

Bounty paid \$ 100; due \$ 100

Present or absent

Remarks: *Returned to duty*
June 27 64

Book mark:

[Signature]

W | 4 Cav. | U.S.C.T.

Stephen Ward
Priv., Co. B, 4 Reg't U. S. Colored Cav.

Appears on Returns as follows:

Mch 1864 - (1 Regt. Cav., Camp d'Afrique)
Abs + sick, sent Mar 7/64
to Genl Heaph. G. O. Hill.
Apr 1864 - (1 Regt U.S. Col'd. Cav.) Absent
sick sent Mar 7 to Genl
Heaph. N. Orleans, La
Feb 1865 - 2000; Feb 27/65
Port Hudson La. Disch'd
for disability

Book mark :

W. R. Lu

(515)

Copyist.

W | **4 Cav. U.S.C.T.**

Stephen Gard

....., Co. *B*, 4 Reg't U. S. Col'd Cavalry.

Appears on **Co. Muster-out Roll**, dated *New Orleans La Feb. 20*, 1866.

Muster-out to date, 186 .

Last paid to, 186 .

Clothing account:

Last settled, 186 ; drawn since \$ 100

Due soldier \$ 100; due U. S. \$ 100

Am't for cloth'g in kind or money adv'd \$ 100

Due U. S. for arms, equipments, &c., \$ 100

Bounty paid \$ 100; due \$ 100

Remarks: *Joined at Orgl Org.
Discharged Feb. 26/66 - Fort
Hudson La. on Surg. Cer-
tificate of disability*

Book mark: *V. 19. P. 140, 68. V. 95. P. 34,
69. V. 64. P. 83. 69*

(361)

Chandler
Copyist.

WARD 694
Ward, Stephen

P, Co. B, 4 U.S.C. Cav.

Enclosures.

Bed Cards	Descriptive Lists
Burial Records	Final Statements
Certs. of Dis. for Discharge /	Furloughs
C. M. Charges	Med. Des. Lists
Med. Certificates	Orders

Other papers relating to—

Admission to Hosp'l	Furlough
Casualty Sheet (Officer's)	Med. Examination
Confinement	Misc. Information
Contracts	Pay or Clothing
Death or Effects	Personal Reports
Desertions	Rank
Discharge from Hosp'l	Transfer to Hosp'l
Discharge from Service	Transfer to V. R. C.
Duty	Transportation

NOTE 1.

The company commander will here add a statement of all the facts known to him concerning the disease or wound, or cause of disability of the soldier; the time, place, manner, and all the circumstances under which the injury occurred, or disease originated or appeared; the duty, or service, or situation of the soldier at the time the injury was received or disease contracted, stating particularly whether the injury was received or the disease contracted in the line of his duty; and whatever other facts may aid a judgment as to the cause, immediate or remote, of the disability, and the circumstances attending it.

When the facts are not known to the company commander, the certificate of any officer, or affidavit of other person having such knowledge, will be appended—as the surgeon in charge of a hospital, the officer commanding a detachment of recruits, &c., &c.

NOTE 2.

When a probable case for pension, special care must be taken to state the degree of disability—as $\frac{1}{2}$, $\frac{3}{4}$, &c., &c.; to describe particularly the disability, wound, or disease; the extent to which it deprives him of the use of any limb or faculty, or affects his health, strength, activity, constitution, or capacity to labor or earn his subsistence. The surgeon will add, from his knowledge of the facts and circumstances, and from the evidence in the case, his professional opinion of the cause or origin of the disability. In the case of discharges by Medical Inspectors, the last paragraph will state that the "discharge was given by consent of the soldier, after a personal examination, and for disability, the nature, degree, and origin of which are correctly described in the within certificate."

Par. 1260 Regulations, Edit. 1861.

Medical officers, in giving certificates of disability, are to take particular care in all cases that have not been under their charge; and especially in epilepsy, convulsions, chronic rheumatism, derangement of the urinary organs, ophthalmia, ulcers, or any obscure disease liable to be feigned or purposely produced; and in no case shall such certificate be given until after sufficient time and examination to detect any attempt at deception.

DIRECTIONS.

This certificate will be made out in duplicate by the soldier's company commander, or other officer commanding the separate detachment to which he belongs, and sent by him to the surgeon who has charge of the hospital where the soldier is sick. The surgeon will then fill out and sign the surgeon's certificate, and forward these papers to the regimental, detachment, or post commander, who will forward them, with his action endorsed thereon, through the proper channel, to his division commander; or, if the troops are not attached to a division, to his corps, department, or other commander or officer to whom the authority to discharge enlisted men may be specially delegated.

These certificates, after having received the action of the highest authority to which they are required to be sent, will be returned through the same channel to the regimental, post, or detachment commander, who will, if the discharge is authorized by the endorsement of the proper authority, sign the soldier's discharge, and the last certificate on this paper; see that the soldier is furnished with the proper final statements in duplicate, and forward BOTH of these certificates direct to the Adjutant General United States Army, at Washington, D. C.; they will not, under any circumstances, be given into the hands of the soldier.

ADJUTANT GENERAL'S OFFICE

March 30th 1865

Duplicate sent the Pension Office.

1865
CERTIFICATE OF DISABILITY FOR DISCHARGE

IN THE CASE OF
W. 948
Stephen Ward
a *Private* Co. *B*
Fourth Reg't of *U. S. C. Cavalry*

Office Surgeon in Chief
District of Baton Rouge & Port Hudson
January 24th 1865
Respectfully Approved
Chas. A. Deane
Surgeon 2nd La. Vol. Infy
In Charge District of Baton Rouge & Port Hudson

Approved Jan^{ry} 30th 5

R. A. Alexander

Head Quarters Dept of the Gulf
New Orleans Feb 2nd 1865;

To be discharged:
By command of
Maj Genl Humbert;

J. H. Stone
Capt & A. A. General

Received (A. G. Office) _____, 186 .

Dec V. 95. P 3409
D. M. A.
Edward O. Ruffin
Exp. P.

ARMY OF THE UNITED STATES
CERTIFICATE
OF DISABILITY FOR DISCHARGE.

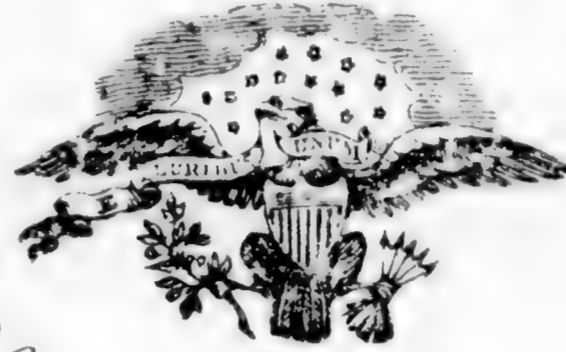

Private Stephen Ward of Captain Iodore
Mc Cormack's Company, (13) of the Fourth Regiment of United States
Colored Cavalry was enlisted by 2nd Lieutenant Selden of
the Fourth Regiment of U. S. C. Cavalry, at New Orleans, Louisiana
on the Twelfth day of October 1863, to serve Three years; he was born
in St. Louis in the State of Louisiana is Twenty two
years of age, Five feet Five inches high, Black complexion, Black eyes,
Black hair, and by occupation when enlisted a Labourer. During the last two
months said soldier has been unfit for duty 61 days.* On March 7th, 1864, he was
sent to Corps d'Asiique General Hospital having General
Debility, and Chills and fever, besides having had his feet
festered. On May 21st, 1864, he was returned to company for duty,
but has been unfit for any active duty since.

STATION: Port Hudson, Louisiana
DATE: January 8th 1865

Iodore Mc Cormack
Captain
Commanding Company.

I CERTIFY, that I have carefully examined the said Stephen Ward of
Captain Mc Cormack's Company, and find him incapable of performing the duties of a soldier
because of Anasarca from Heart Disease This soldier was
probably diseased on entering the service and has been on
sick list nearly all the time he is unfit for service in
Invalid Corps

Henry M. Brown, Surgeon 1st U.S.C.
of 4th U.S.C. Cavalry
Aboud Asst Surg. 1st U.S.C.
Surgeon

DISCHARGED, this Twenty seventh day of February 1865, at Port
Hudson, Louisiana.

Nathl. Mitchell
Major
Commanding the Reg't.

The soldier desires to be addressed at
Town New Orleans County _____ State Louisiana.

* See Note 1 on the back of this. † See Note 2 on the back of this.

Office Post Surgeon
Port Hudson La
Jan 19 1865
Respectfully appointed,
Mc Cormack 94 used
Post Surgeon

1100

Washington, Charles

Co. I, 4 U. S. Col'd Cav.

Private Private

CARD NUMBERS.

1	5347485	26
2	5358179	27
3	5348170	28
4	40729303	29
5		30
6		31
7		32
8		33
9		34
10		35
11		36
12		37
13		38
14		39
15		40
16		41
17		42
18		43
19		44
20		45
21		46
22		47
23		48
24		49
25		50

Book Mark:

See also

A | **4 Cav. U.S.C.T.**

Charles Washington

Appears with rank of *Private* on

Muster and Descriptive Roll of a Detachment of U. S. Vols. forwarded

for the 4 Reg't U. S. Col'd Cavalry. Roll dated *New Orleans, La April 27, 1864.*

Where born *La*

Age *31* y'rs; occupation *Laborer*

When enlisted *April 16*, 186 .

Where enlisted *Grand Ecore La*

For what period enlisted *3* years.

Eyes *Brown*; hair *Black*

Complexion *Black*; height *5* ft. *4* in.

When mustered in *April 27*, 1864.

Where mustered in *New Orleans*

Bounty paid \$ *2* ¹⁰⁰; due \$ ¹⁰⁰

Where credited

Company to which assigned *D*

Remarks :

Book mark :

O. P. Taylor

(339) Copyist.

W | 4 Cav. | U.S.C.T.

Charles Washington

Plt, Co. *D*, 4 Reg't U. S. Col'd Cavalry.

Age years.

Appears on

Company Muster Roll*

for *April 27 to June 30*, 1864.

Joined for duty and enrolled:

When *Apr. 16*, 1864.

Where *Grand Ecore, La.*

Period *3* years.

Mustered in:

When *Apr. 27*, 1864.

Where *New Orleans, La.*

Present or absent

Stoppage, \$ 100 for

Due Gov't, \$ 100 for

Valuation of horse, \$ 100

Valuation of horse equipments, \$ 100

Remarks: *hired in Regimental Greenville, La. June 19. 1864*

* First current roll. No muster-in roll of this ^{Co} battery on file.

Book mark :

Hym

W | 4 Cav. | U.S.C.T.

Charles Washington
Priv., Co. D, 4 Reg't U. S. Colored Cav.

Appears on Returns as follows:

June 1864 - 2000: June 19/64
Greenville Died of disease.

Book mark:

W. R. Lee

51
71. 4 Cavry | **U.S.C.T.**

Francis Washington
Sgt, Co. 1, 7 Reg't U. S. Col'd Cavry

Appears on a

Detachment Muster-out Roll

of the organization named above. Roll dated
New Orleans, Mar 20, 1866 .

Muster-out to date 186 .

Last paid to 186 .

Clothing account:

Last settled....., 186 ; drawn since \$..... 100

Due soldier \$..... 100; due U. S. \$..... 100

Am't for cloth'g in kind or money adv'd \$..... 100

Due U. S. for arms, equipments, &c., \$..... 100

Bounty paid \$..... 100; due \$..... 100

Remarks: Final at original
organization. Died
June 1964 at Greenville
La. Final statements
forwarded.

Book mark:

.....
Fosse H
.....

Washington, Charles

P, Co. I

4

U. S. C. Cav.

Enclosures.

Bed Cards	Descriptive Lists
Burial Records	Final Statements
Certs. of Dis. for Discharge	Furloughs
C. M. Charges	Med. Des. Lists
Med. Certificates	Orders

Other papers relating to—

Admission to Hosp'l	Furlough
Casualty Sheet (Officer's)	Med. Examination
Confinement	Misc. Information
Contracts	Pay or Clothing
Death or Effects	Personal Reports
Desertions	Rank
Discharge from Hosp'l	Transfer to Hosp'l
Discharge from Service	Transfer to V. R. C.
Duty	Transportation

NOV 9 1864

FINAL STATEMENT

OF

Priv Charles Washington

4th Reg't of Col'd Cav.

VOLUNTEERS.

Rec'd Jan 19 1864

NOTE 1.—Two of these certificates (or duplicates) are to be given to each volunteer soldier who may be discharged previously to the discharge of his company, that he may at once receive from the Paymaster the pay, &c., due him, and the captain or other officer commanding the company will certify to the act of the delivery of the duplicate certificates; on these certificates the Soldier is "entitled to" his discharge, and should also present his discharge to the Paymaster to have the payment endorsed on it. The discharge is to be given back to the Soldier by the Paymaster; the latter only retaining as his voucher the duplicate certificates.

NOTE 2.—If the Soldier is entitled to pay for the use of his horse, the Company Commander will certify to that fact, and also to the time he has pay due for having been so mounted on his own horse.

NOTE 3.—Amounts due the Sutler and Laundress must be entered on the Muster Roll on which the death, desertion, &c., is reported, as well as on the final statement, otherwise the amount cannot be collected from the United States.

NOTE 4.—This blank will be used for deceased volunteers as well as others.

ADJUTANT GENERAL'S OFFICE.
Aug 19 1864
Duplicate with Inventory sent 2d Auditor.



MAY 6 1864

I certify, on honor, that Charles Washington Private of
Captain Geo. E. Seymour Company ("2") of the 4" Regiment of U. S. Col'd Cav
VOLUNTEERS, of the State of United States, born in _____, State
of Virginia, aged 30 years; 5 feet 4 inches high; Black complexion,
Brown eyes, Black hair, and by occupation a Sabreur, having joined the company on
its original organization at New Orleans La and enrolled in it at the muster into
the service of the United States at New Orleans La, on the Sixteenth day
of April, 1864, (or was mustered in service as a recruit, by Major
J. W. Thine, at Grand Core, on the Sixteenth day of April,
1864 to serve in the Regiment,) for the term of Three Years:
and having served **HONESTLY** and **FAITHFULLY** with his Company in Louisiana
to the present date, is now entitled to a **DISCHARGE** by reason of Death
having died in Regt. Hospital at Greenville La on the
19th of June 1864.

The said Charles Washington has received was last paid by Paymaster
no pay since to include the Christmas day of _____, 1864, and has
pay due him from that time to the present date; he is entitled to pay and subsistence for
TRAVELING to place of enrollment and whatever other allowances are authorized to volunteer
soldiers, or militia, so discharged. He has received Thirty One $\frac{53}{100}$ dollars,
advanced by the United States on account of **CLOTHING**.

There is to be stopped from him, on account of the State of _____, or other
authorities for **CLOTHING**, &c., received on entering service, _____ $\frac{100}{100}$ dollars; also,
for expenses of **SUBSISTENCE** for **TRAVELING** from place of enrollment to the place of rendezvous,
amounting to _____ $\frac{100}{100}$ dollars: and on account of the United States for **EXTRA**
CLOTHING received in kind from _____ and for other
stoppages, viz:

_____ amounting to _____ $\frac{100}{100}$ dollars;
and he has been **SUBSISTED** for **TRAVELING** to his place of enrollment, up to the _____
_____, 1864.

He is indebted to John Wild, **SUTLER**, Five $\frac{100}{100}$ dollars.
He is indebted to _____, **LAUNDRESS**, _____ $\frac{100}{100}$ dollars.

Given in Duplicate, at Camp Propet La, this 2nd day of July, 1864.

Geo. E. Seymour
Captain
Commanding Company.

1101

Washington, Georgia

Co. A, 4 U. S. Col'd Cav.

Private Private

CARD NUMBERS.

1	5348492	26
2	5348590	27
3	5348696	28
4	5348790	29
5	5348884	30
6	5348970	31
7	5349152	32
8	5349146	33
9	5349220	34
10	5349311	35
11	5349393	36
12	5349484	37
13	5349564	38
14	5349639	39
15	5349709	40
16	40729305	41
17		42
18		43
19		44
20		45
21		46
22		47
23		48
24		49
25		50

Book Mark: 5928-a-89.

See also

NOV 19 1916

S-960 890 - P.O. - I.M. + m
S 13 72031 - P.O. M. 9 M
S. 1524040 Aud W.D.
S. 1635782. Aud W.D.

S. M. McKelvey
S.M.

W | 4 Cav. | U.S.C.T.

George Washington
Private, Co. A, 1 Reg't La. Cav., Corps d'Afrique.*

Appears on

Company Muster-in Roll

of the organization named above. Roll dated

New Orleans La Sept 12, 1863.

Muster-in to date *Sept 12*, 1863.

Joined for duty and enrolled:

When *Aug. 30*, 1863.

Where *New Orleans*

Period *3* years.

Valuation of horse, \$.....100

Valuation of horse equipments, \$.....100

Remarks:

Age 20

*This organization subsequently became Co. A, 4 Reg't U. S. Colored Cavalry.

Book mark:

M. A. Michaels

W | **4 Cav. | U.S.C.T.**

George Washington
Prin, Co. *A*, 1 Reg't La. Cav., Corps d'Afrique.*

Appears on

Company Muster Roll

for *Sept 12 to Dec 12*, 186 ³.

Present or absent *Present*

Stoppage, \$ *100* for

Due Gov't, \$ *100* for

Valuation of horse, \$ *100*

Valuation of horse equipments, \$ *100*

Remarks:

*This organization subsequently became Co. *A*, 4 Reg't U. S. Colored Cavalry.

Book mark: -----

A. Richardson

NOV 19

W

4 Cav. U.S C.T.

George Washington

Private, Co. *A*, 1 Reg't Cav., Corps d'Afrique.*

Appears on

Company Muster Roll

for *Jan 1 Feb*, 186 *4*

Present or absent *Present*

Stoppage, \$ *100* for

Due Gov't, \$ *100* for

Valuation of horse, \$ *100*

Valuation of horse equipments, \$ *100*

Remarks:

* This organization subsequently became Co. *A*, 4 Reg't U. S. Colored Cavalry.

Book mark:

P. Richardson

W | 4 Cav. | U.S.C.T.

George Washington
Poin

, Co. A, 4 Reg't U. S. Col'd Cavalry.

Appears on

Company Muster Roll

for *March + April*, 1867.

Present or absent *Present*

Stoppage, \$ 100 for

Due Gov't, \$ 100 for

Valuation of horse, \$ 100

Valuation of horse equipments, \$ 100

Remarks:

Book mark:

R. A. Richardson

72 | 4 Cav. | U.S.C.T.

George Washington
Priv., Co. A, 4 Reg't U. S. Col'd Cavalry.

Appears on

Company Muster Roll

for May + June, 1864

Present or absent Present

Stoppage, \$ 100 for

Due Gov't, \$ 100 for

Valuation of horse, \$ 100

Valuation of horse equipments, \$ 100

Remarks: In debt to Gov't
for one Revolver
Remington

Book mark:

R. Richardson

W | **4 Cav.** | **U.S.C.T.**

George Washington
Prin, Co. A, 4 Reg't U. S. Col'd Cavalry.

Appears on

Company Muster Roll

for *July & Aug*, 186*4*.

Present or absent *Present*

Stoppage, \$ *100* for

Due Gov't, \$ *100* for

Valuation of horse, \$ *100*

Valuation of horse equipments, \$ *100*

Remarks: *Is in debt to*
Gov't for one (1) Remington
Revolver

Book mark: _____

R. Richardson

W | **4 Cav.** | **U.S.C.T.**

George Washington

Pi, Co. A, 4 Reg't U. S. Col'd Cavalry.

Appears on

Company Muster Roll

for *Sept + Oct*, 186 *4*.

Present or absent *Present*

Stoppage, \$ *100* for

Due Gov't, \$ *100* for

Valuation of horse, \$ *100*

Valuation of horse equipments, \$ *100*

Remarks: *Stop for one Remington Revolver*

Book mark:

Donnelly

U | 4 Cav. | U.S.C.T.

George Washington

Pi

, Co. A, 4 Reg't U. S. Col'd Cavalry.

Appears on

Company Muster Roll

for Nov & Dec, 1864.

Present or absent

Present

Stoppage, \$ 100 for

Due Gov't, \$ 100 for

Valuation of horse, \$ 100

Valuation of horse equipments, \$ 100

Remarks:

Stop for 1 Rem
Revolver

Book mark:

Donnelly

W | 4 Cav. | U.S.C.T.

George Washington

Pri, Co. A, 4 Reg't U. S. Col'd Cavalry.

Appears on

Company Muster Roll

for Jan & Feb, 1865

Present or absent Present

Stoppage, \$ 100 for

Due Gov't, \$ 100 for

Valuation of horse, \$ 100

Valuation of horse equipments, \$ 100

Remarks: Stop for 1 month

Book mark:

Donnelly

W | 4 Cav. | U.S.C.T.

George Washington

Pri, Co. A, 4 Reg't U. S. Col'd Cavalry.

Appears on

Company Muster Roll

for *Mar & Apr*, 186 *5*

Present or absent *Present*

Stoppage, \$ *100* for

Due Gov't, \$ *100* for

Valuation of horse, \$ *100*

Valuation of horse equipments, \$ *100*

Remarks:

Book mark:

Donnelly

W | **4 Cav.** | **U.S.C.T.**

George Washington

Pri....., Co. A, 4 Reg't U. S. Col'd Cavalry.

Appears on

Company Muster Roll

for *May + June*....., 1865.

Present or absent *Present*

Stoppage, \$.....100 for

Due Gov't, \$.....100 for

Valuation of horse, \$.....100

Valuation of horse equipments, \$.....100

Remarks:.....

.....
.....
.....
.....
.....
.....
.....
.....

Book mark:.....

Donnelly

W | 4 Cav. | U.S.C.T.

George Washington

Pi, Co. A, 4 Reg't U. S. Col'd Cavalry.

Appears on

Company Muster Roll

for *July & Aug*, 186 *5*

Present or absent *Present*

Stoppage, \$ *100* for

Due Gov't, \$ *100* for

Valuation of horse, \$ *100*

Valuation of horse equipments, \$ *100*

Remarks:

Book mark:

Donnelly

W | **4 Cav. | U.S.C.T.**

George Washington
Pratt, Co. A, 4 Reg't U. S. Col'd Cavalry.

Appears on

Company Muster Roll

for *Sept & Oct*, 1865.

Present or absent.. *Present*

Stoppage, \$..... 100 for

Due Gov't, \$..... 100 for

Valuation of horse, \$..... 100

Valuation of horse equipments, \$..... 100

Remarks:

.....
.....
.....
.....

BOOK BOUND ON FILE FEB 1865

Book mark:

.....
.....
Crewitt

W | **4 Cav. | U.S.C.T.**

George Washington
Pvt, Co. A, 4 Reg't U. S. Col'd Cavalry.

Appears on

Company Muster Roll

for *Jan & Feb*, 1866.

Present or absent. *Present*

Stoppage, \$ *100* for

Due Gov't, \$ *100* for

Valuation of horse, \$ *100*

Valuation of horse equipments, \$ *100*

Remarks:

Book mark:

Prewitt
Copyist.

W | **4 Cav.** | **U.S.C.T.**

Geo. Washington

Port, Co. A, 4 Reg't U. S. Colored Cav.

Appears on **Returns** as follows:

June 1864 - On duty Regt. Sear
Nurse.

Book mark: _____

W. R. Lee

W | **4 Cav.** | **U.S.C.T.**

George Washington
Cpt., Co. *A*, 4 Reg't U. S. Col'd Cavalry.

Appears on **Co. Muster-out Roll**, dated
New Orleans La, *March 20*, 1866.

Muster-out to date *March 20*, 1866.

Last paid to *June 30*, 1865.

Clothing account:

Last settled _____, 186 ; drawn since \$ _____ 100

Due soldier \$ _____ 100; due U. S. \$ *6 25* / 100

Am't for cloth'g in kind or money adv'd \$ _____ 100

Due U. S. for arms, equipments, &c., \$ *58* / 100

Bounty paid \$ _____ 100; due \$ _____ 100

Remarks: *Joined at orig org.*
Stop / surcingle

17069 P.M.G. July 6/66
V 25. P 140. 68
Book mark: *5928, a. 89*

Prewitt

1102

Washington, Georgia

Co B, 4 U. S. Col'd Cav.

Private Private

CARD NUMBERS.

1	5-349865-	26
2	5-349963	27
3	5-35-50 5-6	28
4	5-3 5-8 16 2	29
5	5-3 5-8 25-6	30
6	5-3 5-1 344	31
7	5-3 5-1 424	32
8	5-3 5-8 498	33
9	5-3 5-8 573	34
10	5-3 5-8 659	35
11	5-3 5-8 744	36
12	5-3 5-8 839	37
12	5-3 5-8 925	38
14	5-3 5-10 09	39
15	5-3 5-10 91	40
16	5-3 5-11 72	41
17	40729306	42
18		43
19		44
20		45
21		
22		47
23		
24		
25		

Book Mark:

See also

NOV 24

Ø1475565. P.O. m m
Ø. 2143779 P.O. Rv
Ø. 3199214, P.O. Reto

23

St Muhleman
St

11 | **4 Cav. | U.S.C.T.**

George Washington
Co. B, Co. *B*, 1 Reg't La. Cav., Corps d'Afrique.*
Age 23
Appears on

Company Muster-in Roll

of the organization named above. Roll dated
New Orleans La, Oct 27, 186*3*.
Muster-in to date *Oct 27*, 186*3*.

Joined for duty and enrolled:

When *Oct 5*, 186 .
Where *New Orleans*
Period *5* years.

Valuation of horse, \$.....*100*

Valuation of horse equipments, \$.....*100*

Remarks :
.....
.....
.....

*This organization subsequently became Co. *B*, 4 Reg't U. S. Colored Cavalry.

Book mark :
.....

Tracy
Copyist.

A

4 Cav. | U.S.C.T.

George Washington

Co. B, Co. *B*, 1 Reg't La. Cav., Corps d'Afrique.*

Appears on

Company Muster Roll

for *Oct 27 to Dec 31*, 186 *3*

Present or absent *Present*

Stoppage, \$ *100* for

Due Gov't, \$ *100* for

Valuation of horse, \$ *100*

Valuation of horse equipments, \$ *100*

Remarks:

*This organization subsequently became Co. *B*, 4 Reg't U. S. Colored Cavalry.

Book mark: -----

Copyist
Copyist.

W

4 Cav. U.S.C.T.

George Washington
Potr, Co. B, 1 Reg't Cav., Corps d'Afrique.*

Appears on

Company Muster Roll

for *Jan + Feb*, 186*4*.

Present or absent *Present*

Stoppage, \$ *100* for

Due Gov't, \$ *100* for

Valuation of horse, \$ *100*

Valuation of horse equipments, \$ *100*

Remarks: *Due U.S. for Ord-*
nance \$12.00

* This organization subsequently became Co. *B*, 4 Reg't U. S. Colored Cavalry.

Book mark: _____

[Signature]
Copyist.

41 | **4 Cav. | U.S.C.T.**

George Washington
Post

Co. B. 4 Reg't U. S. Col'd Cavalry.

Appears on

Company Muster Roll

for March & April, 1864.

Present or absent Absent

Stoppage, \$ 100 for

Due Gov't, \$ 100 for

Valuation of horse, \$ 100

Valuation of horse equipments, \$ 100

Remarks: In confinement
See U.S. in Ordnance #120

Book mark:

(358)

K. M. A.
Copyist.

W | **4 Cav. | U.S.C.T.**

George Washington
Co, Co. B. 4 Reg't U. S. Col'd Cavalry.

Appears on

Company Muster Roll

for *May & June*, 1864.

Present or absent *Present*

Stoppage, \$ 100 for

Due Gov't, \$ 100 for

Valuation of horse, \$ 100

Valuation of horse equipments, \$ 100

Remarks: *See Hd. for*

Salmon \$12.00

Book mark:

W | **4 Cav.** | **U.S.C.T.**

George Washington
Porter, Co. B. 4 Reg't U. S. Col'd Cavalry.

Appears on

Company Muster Roll

for *July + Aug*, 186*4*.

Present or absent *Present*

Stoppage, \$ *100* for

Due Gov't, \$ *100* for

Valuation of horse, \$ *100*

Valuation of horse equipments, \$ *100*

Remarks: *Due Pd. for Red
manee \$12.00*

Book mark:

[Signature]
Copyist.

24 | **4 Cav. | U.S.C.T.**

George Washington
Co. B., Co. B. 4 Reg't U. S. Col'd Cavalry.

Appears on

Company Muster Roll

for *Sept & Oct*, 186*4*.

Present or absent *Present*

Stoppage, \$ *100* for

Due Gov't, \$ *100* for

Valuation of horse, \$ *100*

Valuation of horse equipments, \$ *100*

Remarks: *Due Mt. for Ord.*
nance \$12.00

Book mark:

(358)

[Signature]
Copyist.

NARR 642

OK | **4 Cav.** | **U.S.C.T.**

George Washington

ser., Co. B. 4 Reg't U. S. Col'd Cavalry.

Appears on

Company Muster Roll

for *Nov 4 Dec*, 186 *4*.

Present or absent *present*

Stoppage, \$ *100* for

Due Gov't, \$ *100* for

Valuation of horse, \$ *100*

Valuation of horse equipments, \$ *100*

Remarks: *Stop for Surcuign*

One Remington's patrol. Cal. 44.

Book mark:

Somers

W

4 Cav. U.S.C.T.

George Washington

priv, Co. B. 4 Reg't U. S. Col'd Cavalry.

Appears on

Company Muster Roll

for *Jan & Feb*, 186*1*.

Present or absent *present*

Stoppage, \$ *100* for

Due Gov't, \$ *100* for

Valuation of horse, \$ *100*

Valuation of horse equipments, \$ *100*

Remarks: *Map for one purchase
2 spurs & straps one horse bag.*

Book mark:

Somers

W | **4 Cav.** | **U.S.C.T.**

George Washington

pot., Co. B. 4 Reg't U. S. Col'd Cavalry.

Appears on

Company Muster Roll

for *Mch & Apr*, 186*5*.

Present or absent *present*

Stoppage, \$ *100* for

Due Gov't, \$ *100* for

Valuation of horse, \$ *100*

Valuation of horse equipments, \$ *100*

Remarks : *Stop for one Sabre knot.*

Book mark :

Sumner
(358) *Sumner* Copyist.

W | **4 Cav.** | **U.S.C.T.**

George Washington
prk, Co. B. 4 Reg't U. S. Col'd Cavalry.

Appears on

Company Muster Roll

for *May & June*, 186*7*.

Present or absent *present*

Stoppage, \$ *100* for

Due Gov't, \$ *100* for

Valuation of horse, \$ *100*

Valuation of horse equipments, \$ *100*

Remarks: *Stoppage 100 / Sabre knot*

Book mark :

W

W | **4 Cav.** | **U.S.C.T.**

George Washington

priv., Co. B. 4 Reg't U. S. Col'd Cavalry.

Appears on

Company Muster Roll

for July & Aug, 1864.

Present or absent present

Stoppage, \$ 100 for

Due Gov't, \$ 100 for

Valuation of horse, \$ 100

Valuation of horse equipments, \$ 100

Remarks :

Book mark :

(358) L. J. Jones Copyist.

W | **4 Cav.** | **U.S.C.T.**

George Washington

priv, Co. B. 4 Reg't U. S. Col'd Cavalry.

Appears on

Company Muster Roll

for *Sept & Oct*, 186*7*.

Present or absent *present*

Stoppage, \$ *100* for

Due Gov't, \$ *100* for

Valuation of horse, \$ *100*

Valuation of horse equipments, \$ *100*

Remarks :

Book mark :

Wm

W | **4 Cav. | U.S.C.T.**

George Washington
Priv, Co. B. 4 Reg't U. S. Col'd Cavalry.

Appears on

Company Muster Roll

for *Nov. & Dec.*, 1865.

Present or absent *Present*

Stoppage, \$ 100 for

Due Gov't, \$ 100 for

Valuation of horse, \$ 100

Valuation of horse equipments, \$ 100

Remarks :

Book mark :

Chandler
Copyist.

W | **4 Cav.** | **U.S.C.T.**

George Washington
Priv, Co. B. 4 Reg't U. S. Col'd Cavalry.

Appears on

Company Muster Roll

for *Jan. & Feb.*, 186*6*

Present or absent *Present*

Stoppage, \$ 100 for

Due Gov't, \$ 100 for

Valuation of horse, \$ 100

Valuation of horse equipments, \$ 100

Remarks :

Book mark : _____

Chaudin

W | 4 Cav. | U.S.C.T.

Geo. Washington
Priv., Co. B, 4 Reg't U. S. Colored Cav.

Appears on Returns as follows:

Mich 1864 (1 Regt. Cav., Corps d'Afrique)
Apr 1864 (4 Regt U. S. Col'd. Cav) (absent
in arrest since Mar 6/64 sent
to Parish Prison at N.
Orleans.

Book mark:

W. R. Lee

W | 4 Cav. | U.S.C.T.

George Washington
Sgt., Co. B, 4 Reg't U. S. Col'd Cavalry.

Appears on Co. Muster-out Roll, dated
New Orleans, La. Feb. 20, 1866.

Muster-out to date Feb. 20, 1866.

Last paid to June 30, 1865.

Clothing account:

Last settled....., 186 ; drawn since \$..... 100

Due soldier \$ 38 ⁸¹ / 100; due U. S. \$..... 100

Am't for cloth'g in kind or money adv'd \$..... 100

Due U. S. for arms, equipments, &c., \$..... 100

Bounty paid \$..... 100; due \$..... 100

Remarks: *Joined at org'l org.*

Book mark: *V. 83. P. 247. 69.*

(361) *Chandler*
Copyist.

Washington, George

P, Co. B, 4 Reg't U.S.C. Cav.

2 Enclosures.

Bed Cards	Descriptive Lists
Burial Records	Final Statements
Certs. of Dis. for Discharge	Furloughs
C. M. Charges /	Med. Des. Lists
Med. Certificates	Orders

Other papers relating to—

Admission to Hosp'l	Furlough
Casualty Sheet (Officer's)	Med. Examination
Confinement	Misc. Information /
Contracts	Pay or Clothing
Death or Effects	Personal Reports
Desertions	Rank
Discharge from Hosp'l	Transfer to Hosp'l
Discharge from Service	Transfer to V. R. C.
Duty	Transportation

Copy

Charges & Specifications
 against Private
 George Washington
 Co. B. 1st Regt.
 Cavalry

C. A. F.

Original sent to H. C. L.
 March 6th 1864

4th U. S. C. Cav-

NARA 654

Defences New Orleans,

Office Provost Marshal, No. 48 Baronne Street,

New Orleans,

1864.

Charges and Specifications against Private
George Washington, Co. B. 1st Regt. Cavalry,
Corps d'Arriere.

Charge 1st - Receiving Stolen U.S. Arms!

Specification - In this: that he, Private Geo.
Washington, Co. B. 1st Regt. Cavalry, ~~did~~
did receive from Private Augustus
Williams, Co. B. 1st Regt. Cav. C. d'A.
a revolver which he, the said George
Washington, knew to have been stolen,
by said Augustus Williams.

All this at New Orleans on or about
the 27th day of February, 1864.

Charge 2d - Selling or otherwise unlaw-
fully disposing of U.S. Arms.

Specification - In this: that he, Private
George Washington, Co. B. 1st Regt. Cav.
C. d'A. ~~did~~ did sell or otherwise dis-
pose of a revolver, which he, the said
Private George Washington received from
and knew to, have been stolen by

New Orleans,

1864.

Private Augustus Williams, Co. B.
1st Regt. Cavalry, C. d. A.

All this at New Orleans, on
or about the 27th day of February,
1864.

Sidore McCormack
Capt. Com. Co. B. 1st Regt.
Cavalry, C. d. A.

NOV 25 1896

Ellerbrook -

Priv: Geo: Washington, C.B. 4th Col. Cav.

wait for reply from A. B. -

Adjutant General's Office,

COLORED TROOPS BRANCH,

25th November, 1873

Vol. C. T., 187

Wanted in case of Private George Washington, Co. B,
4th Reg't U.S. Colored Cavalry, information as to the cause
of his confinement. He is reported "abst. in confinement" *
* (Vide Ms. R. for Mch: & April 64) "In arrest since Mch: 6th 64
at New Orleans (Vide Reg't Retⁿ for Mch: 64) "Present for duty"
(Vide Ms. R. for May & June 64).

Respectfully,

E. A. Woodward

Chief Clerk.

J. Fallon

Mr. Ellbrook.

Z.R.

Adjutant General's Office,

, 187

Vol. C. T., 187

Reply in case of _____, Co. _____,

Reg't _____

[Faint handwritten text, possibly a reply or note, mostly illegible due to fading.]

WARREN

1103

Washington, Georgia

Co C, 4 U. S. Col'd Cav.

Private Private

CARD NUMBERS.

1	5347528	26
2	5352010	27
3	5352108	28
4	5352207	29
5	53523010	30
6	5352388	31
7	5352477	32
8	40729304	33
9		34
10		35
11		36
12		37
12		38
14		39
15		40
16		41
17		42
18		43
19		44
20		45
21		46
22		47
23		48
24		49
25		50

Book Mark:

See also

NOV 20 1919

S 711471 - P090
RAP 381 000 -

S. 1241435 00 11/11

O. autum, W. 011056035, 10/27/19
S. to V. B. (Hay) 1/3/20 3me

S. M. M. M. M. M.
7/8

W | **4 Cav. | U.S.C.T.**

George Washington

Appears with rank of *Private* on

Muster and Descriptive Roll of a Detachment of U. S. Vols. forwarded

for the 4 Reg't U. S. Col'd Cavalry. Roll dated *New Orleans, La., Apr. 25, 1865.*

Where born *Clinton, Mississippi*

Age *20* y'rs; occupation *Labourer*

When enlisted *Apr. 9*, 1865.

Where enlisted *New Orleans, La.*

For what period enlisted *3* years.

Eyes *Brown*; hair *Black*

Complexion *Black*; height *5 ft. 6 in.*

When mustered in *Apr. 25*, 1865.

Where mustered in *New Orleans*

Bounty paid \$ *100* ¹⁰⁰; due \$ *200* ¹⁰⁰

Where credited *1st Dist 2nd Ward, Orleans, New Orleans, La.*

Company to which assigned *C.*

Remarks :

Book mark :

O. T. Taylor

A | 4 Cav. | U.S.C.T.

George Washington
Pria, Co. C, 4 Reg't U. S. Colored Cavalry.

Appears on

Company Muster Roll

for *May & June*, 1865.

Present or absent *present*

Stoppage, \$ *100* for

Due Gov't, \$ *100* for

Valuation of horse, \$ *100*

Valuation of horse equipments, \$ *100*

Remarks: *Recruit from depot,
joined May 15, 1865,*

Book mark:

Moy

W | **4 Cav. | U.S.C.T.**

George Washington
Pru, Co. C, 4 Reg't U. S. Colored Cavalry.

Appears on

Company Muster Roll

for *July & Aug*, 1865.

Present or absent *present*

Stoppage, \$ 100 for

Due Gov't, \$ 100 for

Valuation of horse, \$ 100

Valuation of horse equipments, \$ 100

Remarks: *Recruit from depot,
joined May 15/65,*

Book mark: _____

Moy Copyist.

W | **4 Cav.** | **U.S.C.T.**

George Washington
Priv, Co. C, 4 Reg't U. S. Colored Cavalry.

Appears on

Company Muster Roll

for Sept & Oct, 1865.

Present or absent present

Stoppage, \$.....100 for

Due Gov't, \$.....100 for

Valuation of horse, \$.....100

Valuation of horse equipments, \$.....100

Remarks: Stop for 1 saddle
Complete (viz: 1 saddle, 1 pr
stirrups & straps, 1 pr sweat
leathers, 1 car. socket & strap,
1 girth,) Total \$78.^x78 without
a surcharge \$17.02,

Book mark :

^x As appears on roll.

(358)

Moy Copyist.

NA 70 664

W | **4 Cav. U.S.C.T.**

George Washington
Private, Co. C, 4 Reg't U. S. Colored Cavalry.

Appears on

Company Muster Roll
for *Nov + Dec.*, 186*5*.

Present or absent *present*

Stoppage, \$ *16* ^{*65*}/_{*100*} for *lost*
ordnance

Due Gov't, \$ *100* for

Valuation of horse, \$ *100*

Valuation of horse equipments, \$ *100*

Remarks:
.....
.....
.....
.....
.....
.....
.....
.....

Book mark:

M. A. Michaels
(358) Copyist.

WAR 65

W | **4 Cav.** | **U.S.C.T.**

George Washington
Private, Co. C, 4 Reg't U. S. Colored Cavalry.

Appears on

Company Muster Roll

for *Jan'y & Febr*, 186*6*.

Present or absent *present*

Stoppage, \$ *17*/₁₀₀ for *Lost*
Ordnance

Due Gov't, \$ *100* for

Valuation of horse, \$ *100*

Valuation of horse equipments, \$ *100*

Remarks:
.....
.....
.....
.....
.....
.....
.....
.....

Book mark:

M. A. Michaels
Copyist.

(358)

W | 4 Cav. | U.S.C.T.

George Washington
Unassigned

Priv., Co. , 4 Reg't U. S. Colored Cav.

Appears on Returns as follows:

May 1865 - Gain: May 14/65
New Orleans Recruit
from depot.

Book mark:

W. R. Lee

W | **4 Cav. | U.S.C.T.**

George Washington
 Private, Co. C., 4 Reg't U. S. Col'd Cavalry.

Appears on **Co. Muster-out Roll**, dated
New Orleans La Mar 20, 1866.

Muster-out to date *Mar 20*, 1866.

Last paid to *June 30*, 1865.

Clothing account:

Last settled....., 186 ; drawn since \$.....100

Due soldier \$.....100; due U. S. \$ *12* ^{*38*}/₁₀₀

Am't for cloth'g in kind or money adv'd \$.....100

Due U. S. for arms, equipments, &c., \$ *17* ^{*02*}/₁₀₀

Bounty paid \$ *100* ₁₀₀; due \$.....100

Remarks: *Joined as recruit*
Stop 1 Saddle complete 1 pr Spurs
Straps, 2 Sweat leathers, 1 girth
1 carbine socket & Straps

Book mark: *V 25 P 109-68*

M. A. Michaels
 (361) Copyist.

Washington George

Co. C, 4 Reg't U.S.C.C.

1 Enclosures.

Bed Cards	Final Statements
Burial Records	Furloughs or L. of A.
Certs. of Dis. for Discharge	Med. Certificates
C. M. Charges	Med. Des. Lists
Descriptive Lists	Orders
Discharge Certificates	Pris. of War Record
Enlistment Papers /	Resignations

Other papers relating to—

Admission to Hosp'l	Furlough or L. of A.
Casualty Sheet	Med. Examination
Confinement	Misc. Information /
Contracts	Pay or Clothing
Death or Effects	Personal Reports
Desertion	Rank
Discharge from Hosp'l	Transfer to Hosp'l
Discharge from Service	Transfer to V. R. C.
Duty	Transportation

MICROFILM PUBLICATION M 1820

COMPILED MILITARY SERVICE RECORDS
OF VOLUNTEER UNION SOLDIERS WHO
SERVED WITH THE USCT (US COLORED TROOPS)
4TH REGIMENT OF CAVALRY

PERSONAL PAPERS' TARGET SHEET

PLEASE NOTE THE CHECKED INFORMATION ABOUT THE PERSONAL PAPERS IN
THIS FILE:

- NO PERSONAL PAPERS WERE FOUND IN THIS FILE WHEN THE
RECORDS WERE ARRANGED FOR MICROFILMING.
- 2 PERSONAL PAPER(S) FOUND IN THIS FILE WHEN THE RECORDS
WERE ARRANGED FOR MICROFILMING.

Adyrs Eastern Dist of La
New Orleans to Oct 25/65

Brevet Major Gen Sherman
Commanding
for E. Hemenway Act 9

Has reference to the case
of George Washington Prite
of Co C 4th U. S. C. Cav
and directs how to proceed
in the case &c

HEADQUARTERS
Headquarters, Eastern District of Louisiana,

New Orleans, La., April 5 1865.

Commanding Officer
Fort Hudson La.

Sir:

I am directed by B. Major General Sherman, to inform you that the provision of the sentence imposed by the Court Martial at Fort Hudson upon private Geo. Washington Co. C. 4th M. I. C. C. which sentences him to make good or certain parts the amount of \$118⁰⁰/₁₀₀, as a reparation for a private trespass, being illegal, has been disapproved. But at the same time it is your duty to see that justice is done in the case, under the 32nd Article of War. To do this, your answer would be to assemble a Board of Officers to inquire into and report upon the facts of the case,

and assess the proper damages upon the proper persons. The proceedings of this Board, after being acted upon by the first command, should be forwarded up for the final action of the Dept. Commander.

As two men were engaged in this robbery, one as principal, the other as accessory, both of whom have been convicted of the offenses charged, the question of apportioning the amount of trespass between these men, should receive my careful attention from the Board.

Very Respectfully

Yours Obedient Servant

Edward H. Mearns
Captain, A. A. G. S.

DECLARATION OF RECRUIT.

I, George Washington, desiring to VOLUNTEER as a Soldier in the Army of the United States, for the term of THREE YEARS. Do Declare, That I am 20 years and _____ months of age; that I have never been discharged from the United States service on account of disability or by sentence of a court martial, or by order before the expiration of a term of enlistment; and I know of no impediment to my serving honestly and faithfully as a soldier for three years.

GIVEN at New Orleans La the 9 day of April 1865

Witness:

John C. Friedman
14th Line 10: U. S. C. O. H.

George Washington
mark

No. _____

George Washington
Volunteered at New Orleans La

April 9, 1865

By Charles A. McWhorter

for the 4th Regiment of Ala. Inf.

enlistment; last served in Company ()

Reg't of _____

Discharged _____ 18 _____

*Permitted to the ...
forwarded by circular 1865; ...
1. No. 11. From. July 19 1865*

CONSENT IN CASE OF MINOR.

I, _____, Do CERTIFY, That I am _____ of _____; that the said _____ is _____ years of age; and I do hereby freely give my CONSENT to his volunteering as a SOLDIER in the ARMY OF THE UNITED STATES for the period of THREE YEARS.

GIVEN at _____ the _____ day of _____

Witness:

NOTE 1.—This blank will be used for both enlistments and re-enlistments—enlistment of veterans, &c., &c., in the volunteer service. They will be made out in duplicate in all cases—one to accompany the recruiting return of the superintendent (not the recruiting officer) to the Adjutant General, and one to accompany the accounts of the officer who pays bounty, &c. The Regiment and Company in which the soldier last served should be given on the back.

NOTE 2.—An enlistment holds to service. A muster-in must, in all cases, precede payment of pay, bounty, pension, &c. A muster-in roll must, in all cases, be filed in the Adjutant General's Office as evidence of muster-in. The mustering officer, commissary, or assistant commissary of musters, as the case may be, will countersign both enlistments as having mustered the soldier into the service of the United States before either of them is given to the disbursing officer.

VOLUNTEER ENLISTMENT.

STATE OF

Louisiana



TOWN OF

New Orleans.

I, George Washington, born in Clinton in the State of Mississippi, aged twenty years, and by occupation a Laborer. Do HEREBY ACKNOWLEDGE to have volunteered this Ninth day of April, 1865; to serve as a Soldier in the Army of the United States of America, for the period of THREE YEARS, unless sooner discharged by proper authority: Do also agree to accept such bounty, pay, rations, and clothing, as are, or may be, established by law for volunteers. And I, George Washington, do solemnly swear, that I will bear true faith and allegiance to the United States of America, and that I will serve them honestly and faithfully against all their enemies or opposers whomsoever; and that I will observe and obey the orders of the President of the United States, and the orders of the officers appointed over me, according to the Rules and Articles of War.

Sworn and subscribed to, at New Orleans, La. this 9th day of April, 1865, before John G. Sedgwick, 1st Lieut. 10th U. S. C. O. N.Y. George Washington mark

I CERTIFY, ON HONOR, That I have carefully examined the above-named Volunteer, agreeably to the General Regulations of the Army, and that, in my opinion, he is free from all bodily defects and mental infirmity, which would in any way disqualify him from performing the duties of a soldier.

James D. McAnulty EXAMINING SURGEON.

I CERTIFY, ON HONOR, That I have minutely inspected the Volunteer George Washington previously to his enlistment, and that he was entirely sober when enlisted; that, to the best of my judgment and belief, he is of lawful age; and that, in accepting him as duly qualified to perform the duties of an able-bodied soldier, I have strictly observed the Regulations which govern the recruiting service. This soldier has Brown eyes, Black hair, Black complexion, is five feet six inches high.

Wm. A. Allen Capt. 10th Regiment of U. S. C. O. N.Y. Volunteers, RECRUITING OFFICER.

(A. G. O. No. 74 & 76.)

Mustered into the service of the United States, for three years or during the war, from date of enlistment, in Company "D" 1st Regiment of U. S. C. O. N.Y. Volunteers, on the 25th day of April, 1865, at New Orleans, La.

John Francis Spear 2d Lieut. 1st Regt. N.Y. C.O.

1104

Washington, George
Coal, 4 U. S. Col'd Cav.
Private | Private

CARD NUMBERS.

1	5347876	26
2	5352753	27
3	5352816	28
4	5352877	29
5	5352955	30
6	5353037	31
7	5353120	32
8	5353219	33
9	5353325	34
10	5353782	35
11	40729307	36
12		37
13		38
14		39
15		40
16		41
17		42
18		43
19		44
20		45
21		46
22		47
23		48
24		49
25		50

Book Mark:

See also

NOV 19 1879

1940052. Land Comm.

S. A. Muhlmann
S.A.

NARA 677

M

4 Cav. U.S.C.T.

George Washington

Appears with rank of *Private* on

Muster and Descriptive Roll of a Detachment of U. S. Vols. forwarded

for the 4 Reg't U. S. Col'd Cavalry. Roll dated

New Orleans, La. Apr 17, 1864.

Where born *Opelousas, Louisiana*

Age *20* y'rs; occupation *laborer*

When enlisted *Mar 22, 1864*

Where enlisted *Alexandria*

For what period enlisted *3* years.

Eyes *Black*; hair *Black*

Complexion *Black*; height *5 ft. 4 1/2 in.*

When mustered in *Apr 17, 1864*

Where mustered in *New Orleans La*

Bounty paid \$ *100*; due \$ *100*

Where credited

Company to which assigned

Remarks:

Book mark:

Sallade

(339)

Copyist.

H | 4 Cav. | U.S.C.T.

George Washington

Plt, Co. D. 4 Reg't U. S. Col'd Cavalry.

Appears on

Company Muster Roll

for *March & April*, 1864.

Present or absent *Present*

Stoppage, \$ 100 for

Due Gov't, \$ 100 for

Valuation of horse, \$ 100

Valuation of horse equipments, \$ 100

Remarks:

Book mark:

Rosenbaum

4 | **4 Cav.** | **U.S.C.T.**

George Washington
Pvt., Co. D. 4 Reg't U. S. Col'd Cavalry.

Appears on

Company Muster Roll

for *May & June*, 1864.

Present or absent *Present*

Stoppage, \$ 100 for

Due Gov't, \$ 100 for

Valuation of horse, \$ 100

Valuation of horse equipments, \$ 100

Remarks:

Book mark:

Rosenbaum

H | **4 Cav.** | **U.S.C.T.**

George Washington
Pvt, Co. D. 4 Reg't U. S. Col'd Cavalry.

Appears on

Company Muster Roll

for *July & Aug*, 186*4*.

Present or absent *Present*

Stoppage, \$ 100 for

Due Gov't, \$ 100 for

Valuation of horse, \$ 100

Valuation of horse equipments, \$ 100

Remarks:

Book mark:

Rosenbom

H | 4 Cav. | U.S.C.T.

George Washington
Pvt, Co. D, 4 Reg't U. S. Col'd Cavalry.

Appears on

Company Muster Roll

for *Sept & Oct*, 1864.

Present or absent *Present*

Stoppage, \$ *100* for

Due Gov't, \$ *100* for

Valuation of horse, \$ *100*

Valuation of horse equipments, \$ *100*

Remarks:

Book mark:

Rosenbaum

117 | **4 Cav. | U.S.C.T.**

George Washington

P, Co. D, 4 Reg't U. S. Col'd Cavalry.

Appears on

Company Muster Roll

for *Jan Dec*, 186*1*

Present or absent *Present*

Stoppage, \$ *100* for

Due Gov't, \$ *100* for

Valuation of horse, \$ *100*

Valuation of horse equipments, \$ *100*

Remarks:

Book mark:

A. W. Wright

11 | **4 Cav. | U.S.C.T.**

George Washington

P, Co. D, 4 Reg't U. S. Col'd Cavalry.

Appears on

Company Muster Roll

for *Jan & Feb*, 1865:

Present or absent *Present*

Stoppage, \$ *100* for

Due Gov't, \$ *20* for *Ordinance*

Valuation of horse, \$ *100*

Valuation of horse equipments, \$ *100*

Remarks: *Feed only #7 for month
to include Apr 30th*

Book mark:

George Washington

117 | 4 Cav. | U.S.C.T.

George Washington

P, Co. D, 4 Reg't U. S. Col'd Cavalry.

Appears on

Company Muster Roll

for *March & Apr*, 1865.

Present or absent *Present*

Stoppage, \$ *100* for

Due Gov't, \$ *100* for

Valuation of horse, \$ *100*

Valuation of horse equipments, \$ *100*

Remarks: *Stk for lost - Col 30 ch -*

Book mark: _____

W. Hight

W | **4 Cav. | U.S.C.T.**

George Washington
P, Co. D, 4 Reg't U. S. Col'd Cavalry.

Appears on

Company Muster Roll

for *May & June*, 186*5*.

Present or absent _____

Stoppage, \$ _____ *100* for _____

Due Gov't, \$ _____ *100* for _____

Valuation of horse, \$ _____ *100*

Valuation of horse equipments, \$ _____ *100*

Remarks: *Died at Fort-Hugh*
Post Hudson La May 31, 65
Slap for lost Ord 30 cts

Book mark: _____

(358) *W. Wright* Copyist.

W. | 4 Cav. | U.S.C.T.

George Washington
Port, Co. H, 4 Reg't U. S. Colored Cav.

Appears on Returns as follows:

Apr 1864 Gain: Apr 17/64
N. Orleans Recruit from
Depot.

May 1865 Loss: May 31/65
Port Hudson died of disease

Book mark:

W. R. Lee

CV | **4 Cav.** | **U.S.C.T.**

George Washington

Put, Co. *H*, 4 Reg't U. S. Col'd Cavalry.

Appears on **Co. Muster-out Roll**, dated

New Orleans, La, *March 20*, 186*6*.

Muster-out to date _____, 186 .

Last paid to _____, 186 .

Clothing account:

Last settled _____, 186 ; drawn since \$ _____ 100

Due soldier \$ _____ 100; due U. S. \$ _____ 100

Am't for cloth'g in kind or money adv'd \$ _____ 100

Due U. S. for arms, equipments, &c., \$ _____ 100

Bounty paid \$ _____ 100; due \$ _____ 100

Remarks: *Joined as recruit.*

*Died May 31/65, at Port
Hudon, La.*

Book mark : _____

M. Andrews

Washington, Geo.
 P. S. 4 Reg't US Caval.

2 Enclosures.

Bed Cards	Descriptive Lists
Burial Records	Final Statements /
Certs. of Dis. for Discharge	Furloughs
C. M. Charges	Med. Des. Lists
Med. Certificates	Orders

Other papers relating to—

Admission to Hosp'l	Furlough
Casualty Sheet (Officer's)	Med. Examination
Confinement	Misc. Information
Contracts	Pay or Clothing
Death or Effects /	Personal Reports
Desertions	Rank
Discharge from Hosp'l	Transfer to Hosp'l
Discharge from Service	Transfer to V. R. C.
Duty	Transportation

ARTICLES OF WAR.

ART. 95. When any non-commissioned officer or soldier shall die, or be killed in the service of the United States, the then commanding officer of the troop or company shall, in the presence of two other commissioned officers, take an account of what effects he died possessed of, above his arms and accoutrements, and transmit the same to the office of the Department of War, which said effects are to be accounted for, and paid to the representatives of such deceased non-commissioned officer or soldier. And in case any of the officers, so authorized to take care of the effects of deceased officers and soldiers, should, before they have accounted to their representatives for the same, have occasion to leave the regiment or post, by preferment or otherwise, they shall, before they be permitted to quit the same, deposit in the hands of the commanding officer, or of the assistant military agent, all the effects of such deceased non-commissioned officers and soldiers, in order that the same may be secured for, and paid to, their respective representatives.

ARMY REGULATIONS—EDITION OF 1861.

DECEASED SOLDIERS.

Par. 152. Inventories of the effects of deceased non-commissioned officers and soldiers, required by the 95th Article of War, will be forwarded to the Adjutant General, by the commander of the company to which the deceased belonged, and a duplicate of the same to the colonel of the regiment. Final statements of pay, clothing, &c., will be sent with the inventories. When a soldier dies at a post or station absent from his company, it will be the duty of his immediate commander to furnish the required inventory, and, at the same time, to forward to the commanding officer of the company to which the soldier belonged, a report of his death, specifying the date, place, and cause; to what time he was last paid, and the money or other effects in his possession at the time of his decease; which report will be noted on the next muster roll of the company to which the man belonged. Each inventory will be endorsed, "Inventory of the effects of _____, late of company (—) _____ regiment of _____, who died at _____, the _____ day of _____, 186—." If a legal representative receive the effects, it will be stated in the report. If the soldier leave no effects, the fact will be reported.

Par. 153. Should the effects of a deceased non-commissioned officer or soldier not be administered upon within a short period after his decease, they shall be disposed of by a Council of Administration, under the authority of the commanding officer of the post, and the proceeds deposited with the Paymaster, to the credit of the United States, until they shall be claimed by the legal representatives of the deceased.

Par. 154. In all such cases of sales by the Council of Administration, a statement in detail, or account of the proceeds, duly certified by the Council and commanding officer, accompanied by the Paymaster's receipt for the proceeds, will be forwarded by the commanding officer to the Adjutant General. The statement will be endorsed, "Report of the proceeds of the effects of _____, late of company (—) _____ regiment of _____, who died at _____, the _____ day of _____, 186—."

NOTE 1.—The effects in all cases, when called for, should be turned over to the legal representative, without further authority from the Adjutant General. When the effects are turned over to the relatives of the deceased before these inventories are sent to the Adjutant General, their receipts therefor should be attached to the inventories. In all other cases, one copy will be sent with a letter of transmittal direct to the Adjutant General, and a duplicate retained by the officer.

NOTE 2.—Particular care should be taken to take receipts in duplicate from the Paymaster for any funds turned over to him; one copy should be sent direct to the Adjutant General and one retained by the officer.

INVENTORY OF THE EFFECTS

OF

Private George Washington

Late of Company D

4th Reg't of U. S. Cav.

Volunteers, who died at Port Hudson, La

on the 31st day of May 1865.

Inventory of the effects of George Washington late
a Private of Captain _____ Company D of
the 4th Regiment of U.S. C. Cav. Volunteers, who was enrolled as
a _____ at _____ in the State of _____ on
the _____ day of _____ 186 , and mustered into the service of the United
States as a _____ on the _____ day of _____ 186 , at _____
in Company _____, _____ Regiment of _____ Volunteers, to serve _____
years or during the war; he was born in _____ in the State
of _____; he was _____ years of age, _____ feet _____ inches
high, _____ complexion, _____ eyes, _____ hair, and by occupation, when enrolled,
a _____; he died in Port Hospital, at
Port Hudson, La on the 31st day of May 186 , by
reason of Pneumonia.

INVENTORY.					
ARTICLES.	No.	ARTICLES.	No.	ARTICLES.	No.
Hats.....		Pairs trousers.....		Knapsacks.....	
Caps.....		Pairs flannel drawers.....		<i>No effects</i>	
Forage caps.....		Pairs cotton drawers.....			
Great coats.....		Flannel shirts.....			
Uniform coats.....	<i>No effects</i>	Cotton shirts.....	<i>No effects</i>		
Uniform jackets.....	<i>No effects</i>	Pairs boots.....	<i>No effects</i>		
Flannel sack coats.....		Pairs shoes.....			
Blouses.....		Pairs socks.....			
Stable frocks.....		Blankets.....			
Fatigue overalls.....		Haversacks.....			
					MONEY.
				Specie.....	\$
				Notes.....	\$

I CERTIFY, ON HONOR, that the above inventory comprises all the effects of Private
George Washington, deceased, and that the effects are in the hands
of _____ at _____
_____ to be disposed of by a Council of Administration.

(DUPLICATES.)

STATION: Port Hudson, La

DATE: May 31st 1865

Wesley Combs
Surgeon U.S. C. Cav.
Commanding the Company.
in charge Hospital.

Extract from Act of Congress.

SEC. 12. *And be it further enacted,* That the fees of agents and attorneys for making out and causing to be executed the papers necessary to establish a claim for a pension, bounty, and other allowance before the Pension Office, under this act, shall not exceed the following rates: For making out and causing to be duly executed a declaration by the applicant, with the necessary affidavits, and forwarding the same to the Pension Office, with the requisite correspondence, ten dollars; which sum shall be received by such agent or attorney in full for all services in obtaining such pension, and shall not be demanded or received, in whole or in part, until such pension shall be obtained; and the sixth and seventh sections of an act entitled "An act to grant pensions," approved July [fourteenth,] eighteen hundred and sixty-two, are hereby repealed.

SEC. 13. *And be it further enacted,* That any agent or attorney who shall, directly or indirectly, demand or receive any greater compensation for his services under this act than is prescribed in the preceding section of this act, or who shall contract or agree to prosecute any claim for a pension, bounty, or other allowance under this act, on the condition that he shall receive a per centum upon any portion of the amount of such claim, or who shall wrongfully withhold from a pensioner or other claimant the whole or any part of the pension or claim allowed and due to such pensioner or claimant, shall be deemed guilty of a high misdemeanor, and, upon conviction thereof, shall, for every such offense, be fined not exceeding three hundred dollars, or imprisoned at hard labor not exceeding two years, or both, according to the circumstances and aggravations of the offense.

Approved July 4, 1864.

NOTE 10.—If any soldier is charged a higher fee than that allowed by the above act, he should report the fact and the name of the agent to the Adjutant General, in order that steps may be taken to have the same refunded.

ADJUTANT GENERAL'S OFFICE.

J. M. W. 15" 1865.
Duplicate with inventory sent 2d Auditor.

FINAL STATEMENT

OF

Private George Washington
7th
Reg't of U. S. C.

VOLUNTEERS.

Quil May 31 1865.

NOTE 1.—Two of these certificates (or duplicates) are to be given to each Volunteer Soldier or drafted man who may be discharged without being mustered out. (Final Statements are never given to men mustered out of service.) That he may at once receive from the Paymaster the pay, &c., due him, and the captain or other COMMISSIONED officer commanding the company will certify to the act of the delivery of the duplicate certificates; with these certificates the Soldier is "entitled to" his discharge, and should also present his discharge to the Paymaster to have the payment endorsed on it. The discharge is to be given back to the Soldier by the Paymaster; the latter only retaining as his vouchers the duplicate certificates.

NOTE 2.—If the Soldier is entitled to pay for the use of his horse, the Company Commander will certify to that fact on the back of both these final statements, and also to the time he has pay due for having been so mounted on his own horse.

NOTE 3.—When a Soldier is furnished with final statements, his descriptive list, if he has one, should be taken up by the officer who gives the Soldier these statements, and endorsed with a statement to this effect by the officer. The endorsement should exhibit a full statement of the time for which the Soldier was allowed pay on his final statements, the clothing account, and all other charges against him or in his favor, so as to comprise a complete exhibit of his account. It will then be transmitted to the Company Commander of the Soldier, who will enter all the data necessary to a full understanding of the Soldier's account on the muster roll upon which the Soldier's discharge is reported. The descriptive list will then be destroyed. The object of this is, that the remaining portion of the Soldier's account may be settled upon the receipt of these muster rolls, and the Soldier receive any pay or allowances that may be due him at the time of his discharge, and which may not appear on his last final statements from the fact that his descriptive list is incomplete. These accounts for back pay, &c., are settled by the 2d Auditor of the Treasury Department.

NOTE 4.—Charges for loss or injury to ordnance, horse equipments, and other miscellaneous charges, should appear under the heading of "Other Stoppages."

NOTE 5.—Bounty paid by State authorities, and not by the United States, will not be entered on this statement.

NOTE 6.—Amounts due the Sutler and Laundress must be entered on the muster roll on which the discharge, death, desertion, &c., is reported, as well as on the final statement, otherwise the amount cannot be collected from the United States.

NOTE 7.—This blank will be used for deceased volunteers and drafted men, as well as for others.

NOTE 8.—Where a Soldier dies in Hospital or on detached service, his descriptive list, if he has one, should be sent with his final statements, in duplicate, to the Adjutant General, Washington, D. C.

NOTE 9.—If the soldier is a drafted man or substitute, the space for time, &c., of enrolled, should contain only the word *drafted* or *substitute*, as the case may be. If the Soldier is a "VETERAN," (or RECRUIT,) the words *as a veteran*, (or *recruit*,) as the case may be, should be interlined after the words *mustered into the service of the U. S.* A statement of all the installments of *Veteran* or *Recruit Bounty RECEIVED* by the Soldier must be made on the back of each final statement.

NO 92

I certify, on honor, that George Washington, a Private of
Captain Crest Jackson Company (D) of the 11th Regiment of N.Y. Colored
VOLUNTEERS, of the State of _____, born in Apulonas, State
of La, aged 20 years; 5 feet 4 1/2 inches high; Black complexion,
Black eyes, Black hair, and by occupation a Laborer, who joined for service
and was enrolled (see Note 9) on the 22^d day of March, 1864, at Alexandria La
by J. S. Dickles, for the period of 3 years, and mustered into
the service of the United States on the 17th day of April, 1864, at
New Orleans, La., by Simon J. W. Chamberlain; and having served
HONESTLY and FAITHFULLY with his Company to the present date, is now entitled to a
DISCHARGE by reason of Death. Died at Post Hospital at
Port Hudson, La. May 31st 1865. of Pneumonia.

The said Private George Washington was last paid by Paymaster
Maj. Osborn, to include the thirty-first day of August, 1864, and
has pay due him from that time to the present date; he is entitled to pay and subsistence for
TRAVELING to place of enrollment, and whatever other allowances are authorized to volunteer
soldiers, drafted men, or militia, so discharged. He has received from the United States **CLOTHING**
amounting to 96 ⁷⁷/₁₀₀ dollars, since the 17th day of April,
1864, when his clothing account was last settled. He has received from the United States
_____ ^{_____}/₁₀₀ dollars advanced **BOUNTY**.

There is to be stopped from him, on account of the State of _____, or other
authorities, for **CLOTHING, &c.**, received on entering service, _____ ^{_____}/₁₀₀ dollars; and
for other stoppages, viz: Loose Ordnance 30 each.

_____ ^{_____}/₁₀₀ dollars.
He has been furnished with **TRANSPORTATION** in kind from the place of his discharge to
_____; and he has been **SUBSISTED** for **TRAVELING** to his
place of enrollment, up to the _____, 186 .

He is indebted to _____, **SUTLER**, _____ ^{_____}/₁₀₀ dollars.

He is indebted to _____, **LAUNDRESS**, _____ ^{_____}/₁₀₀ dollars.

Given in Duplicate, at Port Hudson, La, this 1st day
of June, 1865.

Crest Jackson
Capt. Comd. 11th Regt.

Commanding Company.

1100

Washington George

Co^Q, 4 U. S. Col'd Cav.

Private Private

CARD NUMBERS.

1	5353851	26
2	5353904	27
3	5353960	28
4	5354014	29
5	5354083	30
6	5354153	31
7	5354218	32
8	5354283	33
9	5354344	34
10	5354431	35
11	5354505	36
12	5354586	37
13	5354662	38
14	5354731	39
15	5354802	40
16	5354871	41
17		42
18		43
19		44
20		45
21		46
22		47
23		48
24		49
25		50

Book Mark:

See also:

NOV 29 1944

R2P335-278.
8723-276-R090
J. 735 568 7. cond. Relat.
S-978663 - P.S. mm
A. 2254 476. P. 126

S. A. Miller
etc.

W | 4 Cav. | U.S.C.T.

George Washington
PW, Co. E, 1 Reg't, Corps d'Afrique Cavalry.*

Appears on

Company Muster-in Roll

of the organization named above. Roll dated
New Orleans, La Dec. 31, 1863.

Muster-in to date Dec. 31, 1863.

Joined for duty and enrolled:

When Nov. 14, 1863.

Where New Orleans

Period 3 years.

Valuation of horse, \$ 100

Valuation of horse equipments, \$ 100

Remarks:
Age 25

*This organization subsequently became Co. E, 4 Reg't U. S. Colored Cavalry.

Book mark:

Wendell

W 4 Cav. | U.S. C.T.

George Washington
Pr, Co. *(B)*, 1 Reg't Cav., Corps d'Afrique.*

Appears on

Company Muster Roll

for *Enlistment to Dec. 31*, 186*3*

Present or absent *Present*

Stoppage, \$ *100* for

Due Gov't, \$ *100* for

Valuation of horse, \$ *100*

Valuation of horse equipments, \$ *100*

Remarks:

* This organization subsequently became Co. *E*, 4 Reg't U. S. Colored Cavalry.

Book mark: -----

Wenael

H 4 Cav. U.S C.T.

George Washington

, Co. *E*, 1 Reg't Cav., Corps d'Afrique.*

Appears on

Company Muster Roll

for *Jan & Feb*, 1864.

Present or absent *Present*

Stoppage, \$ *100* for

Due Gov't, \$ *100* for

Valuation of horse, \$ *100*

Valuation of horse equipments, \$ *100*

Remarks:

* This organization subsequently became Co. *E*, 4 Reg't U. S. Colored Cavalry.

Book mark:

George Washington

A | **4 Cav.** | **U.S.C.T.**

George Washington

Plt, Co. E, 4 Reg't U. S. Col'd Cav.

Appears on

Company Muster Roll

for *Mar + Apr*, 1864.

Present or absent *Present*

Stoppage, \$ *100* for

Due Gov't, \$ *100* for

Valuation of horse, \$ *100*

Valuation of horse equipments, \$ *100*

Remarks:

Book mark:

Lauren

W | **4 Cav.** | **U.S.C.T.**

George Washington
Priv., Co. E, 4 Reg't U. S. Col'd Cav.

Appears on

Company Muster Roll

for *May & June*, 186*4*

Present or absent *Present*

Stoppage, \$.....*100* for

Due Gov't, \$.....*100* for

Valuation of horse, \$.....*100*

Valuation of horse equipments, \$.....*100*

Remarks:

Book mark:

L. L. Linn

21 | 4 Cav. | U.S.C.T.

George Washington

Put. -----, Co. E, 4 Reg't U. S. Col'd Cav.

Appears on

Company Muster Roll

for ----- *July & Aug* -----, 1864.

Present or absent ----- *Present* -----

Stoppage, \$ ----- 100 for -----

Due Gov't, \$ ----- 100 for -----

Valuation of horse, \$ ----- 100

Valuation of horse equipments, \$ ----- 100

Remarks: -----

Book mark: -----

Lawrence

27

4 Cav.

U.S.C.T.

George Washington
Put., Co. E, 4 Reg't U. S. Col'd Cav.

Appears on

Company Muster Roll

for *Sept + Oct*, 186*4*

Present or absent *Present*

Stoppage, \$ *100* for

Due Gov't, \$ *100* for

Valuation of horse, \$ *100*

Valuation of horse equipments, \$ *100*

Remarks: *Due U S for Cont.*
Ordinance, 43 ct

Book mark:

Lawrence

A | **4 Cav.** | **U.S.C.T.**

George Washington
Pr, Co. E, 4 Reg't U. S. Col'd Cav.

Appears on

Company Muster Roll

for *Nov & Dec*, 1864.

Present or absent *Present*

Stoppage, \$ *100* for

Due Gov't, \$ *100* for

Valuation of horse, \$ *100*

Valuation of horse equipments, \$ *100*

Remarks: *Stop for 1 pr spurs & straps / cap pouch*

Book mark:

Wines

W | **4 Cav.** | **U.S.C.T.**

George Washington

Pvt, Co. E, 4 Reg't U. S. Col'd Cav.

Appears on

Company Muster Roll

for *Jan & Feb*, 186*J.*

Present or absent *Present*

Stoppage, \$ *100* for

Due Gov't, \$ *100* for

Valuation of horse, \$ *100*

Valuation of horse equipments, \$ *100*

Remarks: *Stop for 1 nose bag, 1
pr spurs & straps, 1 cap
pouch Rec'd only 7 doll
per month to include
Apr 30/64*

Book mark:

Wines

A | **4 Cav.** | **U.S.C.T.**

George Washington
Priv, Co. E, 4 Reg't U. S. Col'd Cav.

Appears on

Company Muster Roll

for *Mar & Apr*, 186*5*.

Present or absent *Present*

Stoppage, \$ *100* for

Due Gov't, \$ *100* for

Valuation of horse, \$ *100*

Valuation of horse equipments, \$ *100*

Remarks:

Book mark:

Wines
Copyist.

A | **4 Cav.** | **U.S.C.T.**

George Washington

Priv, Co. E, 4 Reg't U. S. Col'd Cav.

Appears on

Company Muster Roll

for *May & June*, 186 *5*.

Present or absent *Present*

Stoppage, \$ *100* for

Due Gov't, \$ *100* for

Valuation of horse, \$ *100*

Valuation of horse equipments, \$ *100*

Remarks: *Stop for 1 curry comb
and 1 horse brush*

Book mark:

(358)

Wines

Copyist.

W | **4 Cav.** | **U.S.C.T.**

George Washington
Pvt, Co. E, 4 Reg't U. S. Col'd Cav.

Appears on

Company Muster Roll

for *July & Aug*, 186*5*.

Present or absent *Present*

Stoppage, \$ *100* for

Due Gov't, \$ *100* for

Valuation of horse, \$ *100*

Valuation of horse equipments, \$ *100*

Remarks:

Book mark:

Wines

A | **4 Cav.** | **U.S.C.T.**

George Washington
A, Co. E, 4 Reg't U. S. Col'd Cav.

Appears on

Company Muster Roll

for *Sept & Oct*, 186*5*.

Present or absent *Present*

Stoppage, \$ 100 for

Due Gov't, \$ 100 for

Valuation of horse, \$ 100

Valuation of horse equipments, \$ 100

Remarks:

Book mark:

Wines

W | 4 Cav. | U.S.C.T.

George Washington
Put, Co. E, 4 Reg't U. S. Col'd Cav.

Appears on

Company Muster Roll

for Nov. & Dec., 1865.

Present or absent Present.

Stoppage, \$ 3 ⁵⁹/₁₀₀ for lost ordnance

Due Gov't, \$ 100 for

Valuation of horse, \$ 100

Valuation of horse equipments, \$ 100

Remarks:

Book mark:

(358) Floyd Copyist.

W | **4 Cav.** | **U.S.C.T.**

George Washington

Put, Co. E, 4 Reg't U. S. Col'd Cav.

Appears on

Company Muster Roll

for *Jany & Reby*, 186*6*.

Present or absent. *Present.*

Stoppage, \$ *1*^{*53*}/_{*100*} for *lost ordnance*

Due Gov't, \$ *100* for

Valuation of horse, \$ *100*

Valuation of horse equipments, \$ *100*

Remarks:

Book mark:

(358) *Hoyle* Copyist.

W | **4 Cav.** | **U.S.C.T.**

George Washington

Priv, Co. E, 4 Reg't U. S. Col'd Cavalry.

Appears on **Co. Muster-out Roll**, dated New Orleans La, Mch 20, 1866.

Muster-out to date Mch 20, 1866.

Last paid to June 30, 1865.

Clothing account:

Last settled....., 186 ; drawn since \$..... 100

Due soldier \$..... 100; due U. S. \$ 174 ¹⁷/₁₀₀

Am't for cloth'g in kind or money adv'd \$..... 100

Due U. S. for arms, equipments, &c., \$ 4 ⁷⁴/₁₀₀

Bounty paid \$..... 100; due \$..... 100

Remarks: Joined at orig. org. Stop
1 Surcingle 1 Horsebrush 1 Levery
comb 1 girth 1 pr spurs + straps.
1 Sabre Knot.

Book mark:

Floyd

Washington George

Pvt. Co. E, 4 Reg't USCC

10 Enclosures:

Bed Cards	Final Statements
Burial Records	Furloughs or L. of A.
Certs. of Dis. for Discharge	Med. Certificates
C. M. Charges	Med. Des. Lists
Descriptive Lists	Orders
Discharge Certificates	Pris. of War Record
Enlistment Papers	Resignations

Other papers relating to—

Admission to Hosp'l	Furlough or L. of A.
Casualty Sheet	Med. Examination
Confinement	Misc. Information 4
Contracts	Pay or Clothing
Death or Effects	Personal Reports
Desertion 6	Rank
Discharge from Hosp'l	Transfer to Hosp'l
Discharge from Service	Transfer to V. R. C.
Duty	Transportation

MICROFILM PUBLICATION M 1820

COMPILED MILITARY SERVICE RECORDS
OF VOLUNTEER UNION SOLDIERS WHO
SERVED WITH THE USCT (US COLORED TROOPS)
4TH REGIMENT OF CAVALRY

PERSONAL PAPERS' TARGET SHEET

PLEASE NOTE THE CHECKED INFORMATION ABOUT THE PERSONAL PAPERS IN
THIS FILE:

NO PERSONAL PAPERS WERE FOUND IN THIS FILE WHEN THE
RECORDS WERE ARRANGED FOR MICROFILMING.

11 PERSONAL PAPER(S) FOUND IN THIS FILE WHEN THE RECORDS
WERE ARRANGED FOR MICROFILMING.

Rewards for Deserters

HEADQUARTERS, DEPARTMENT OF THE GULF,

NEW ORLEANS, July 27, 1864.

GENERAL ORDERS }
No. 102. }

[For the more perfect protection of the interests and the officers of the Government, it is ordered that in the payment of rewards for the apprehension of deserters, the amount provided by law shall *in all cases* be charged against such deserter on his next Muster and Pay Rolls.

The Commanding Officer of the Company or Regiment in which such deserter is mustered will certify to the correctness of the arrest as a deserter, and be held responsible that the charge is made on the Muster Roll.

The Disbursing Officer will promptly report the payment as required by Regulations, and also to the Chief Paymaster of the Department.

BY COMMAND OF MAJOR GENERAL BANKS:

GEORGE B. DRAKE,

Assistant Adjutant General.

OFFICIAL:

Acting Assistant Adjutant General.

W. - 14864 (D. G.) 1864
Document (Sub.)

in
the case of
George Washington
Co. E. 4th W. S. C. Cavalry
Deserter.

Camp & Dist. Headquarters
Department of the Gulf

Sept 8th 1864

Capt Frederick S. Reid

U. S. Dept. of the Gulf
Cajon Viejo

I have in honor

to acknowledge receipt of your communication
in regard to a payment of thirty Dollars
as for arrears of pay since the termination
of the 1st of July. I think I should have
come to me with a certificate signed by
Major Pitcher stating that Detachment
of Cavalry had arrested and returned to
his Regt. Private George Washington Cook
& A. S. C. was. I knew that there was not
a man in my company but as I had
been detached from my Regt some time
and ~~did not~~ know that he had deserted
this man David Thomas was once a Lieut
in this same Co and when he stated

positively no record arrested his
 name and seeing no other signature
 attached to it I signed it certified
 and wrote the Commander of the Co to
 have the amount changed to him on
 the next Pay Rolls. I shall immediately
 take measures to have this man David
 -Weneseey brought to trial & made to
 refund the money. I should have
 answered your communication before
 as I got mistaken with my paper.

Very Respectfully
 W. D. Dwyer

Capt Dwyer Camp
 Detention W.C.

S 758 Dy 1864
Compend

ns
+ said low

Headquarters, Department of the Gulf,

ADJUTANT GENERAL'S OFFICE.

New Orleans, September 11. 1864.

OFFICE MARK.

COMPENDIUM.

Date, September 5. 1864

SUBJECT,

Captain Higby a g m

Pays \$30.7 for arrest of our
private George Washington Co. C 4. Col. Cav.
on Certificate of Major Pitcher Captain
Pang's same Regiment

Lieut. Col. Alexander Comg
4 16. S. Cold Cavalry says the man
has never been returned & the same can
not be charged against him

The Reward was paid to
Detetelus Hennessy on Certificate, as above
4 Capt. Pang's Report, that
he signed the Certificate presented by
Hennessy, because he saw May. Pitcher's
name on it. He was not on duty with
his Regiment & Co. at time. Should be looked
into. (Case Referred from Genl Sherman's)

HEADQUARTERS 719

Headquarters, Department of the Gulf,

New Orleans, Sept 21st 1864.

Capt. Brudick

Assistant Judge Advocate
Department of the Gulf

Sir

it was customary with the Juro marshals
of this department and of the defenses
to sign the Vouchers presented by special
officers on which they were to obtain
the \$50. Reward offered for the apprehension
of deserters. after the officer receiving
the prisoner had signed the certificate
on the Voucher. that the service had
been rendered &c. &c. the Voucher
upon which my signature appears
was so signed by Capt. Bangs
before I saw the Voucher at all, and
did appear on the said Voucher at the time
my signature was affixed. Officer
Honey was in my employ and may
have been unfaithful to his trust.
I do not aw. but always did his duty
while with me well and faithfully as far
as I had means of knowing. St. Granger.

was in the office when I first was ordered
to assume the duties of P.M. def. N.A.
And can attest to the truth of this
my statement if necessary. he is
a Member of Good Granges Staff

I would further state that I had
not as yet assumed the duties of the
office and had not fully learned the
system of Business of the office

I do
Certify ~~on~~ honor and will if called
upon on oath that the signature of
Leopold Bangs was affixed to the voucher
before my signature was attached to
it

Trusting Sir that the above
statement will be deemed satisfactory
I have the honor to be left
Yours Obedt. Servt

A. A. Pitches
Major 18th Cav
Leate P. M. def N.A.

NARA 729

Office Provost Marshal, Parish of Orleans,

No. 67 CARONDELET STREET,

New Orleans, September 27, 1864.

Private George Washington, Co E 4th U.S.C.

Arrested June 22, 1864 by Officer

W. H. Hennessey.

Sent to Tours Quartus June 23, 1864.

I Certify that the above is a correct copy
of the Record.

John W. Hester
Captain and Cust
Provost Marshal
Parish of Orleans.

MS. A. 9. 2. 11

Headquarters, Department of the Gulf,

New Orleans La. Oct-3rd 1864.

Capt Shipley
A. D. M.

Captain

Please

inform me whether \$30.00
should be paid U.S. for the
appropriation of "First Co."
Washington D.C. Co. Co. Co.
referred

Capt Shipley
is correct, but
this money should
be paid to the
bank of the
District of Columbia

Respectfully

W. D. Benedict
Adj. A.
D. C.

HEADQUARTERS, DEPARTMENT OF THE GULF,

New Orleans, Nov. 4th 1864.

(Capt. Alex. H. Stephens)
A. S. H.

Enclosed please find \$30. which is received and accepted for to Capt. J. W. Barks 14th U.S. Col. Cav. This money is repaid by Capt. Barks to the U.S. as an improper voucher signed by said Barks & then dated Aug. 20. 1864. for the pretended apprehension of the late Gen. Washington. Capt. Barks & Co. have had no criminal connection with the affair but refunds to the Govt. for his conduct in the matter as it was upon the credit of his name that the money was paid.

This payment is intended to annul such voucher and you will please send it to me cancelled with

a receipt for this payments
Receipt

C. D. Bonner
of
D.C.

Office Assistant Quartermaster,

No. 49 Union Street.

New Orleans, La., November 12th 1864.

I certify that Lieut. Col. E. D. Benedict, A. J. A.,
Dept. of the Gulf, has this day refunded ^{in behalf of E. W. Bangs} to me (\$30⁰⁰)
Thirty Dollars, which amount I had paid on the 30th
of July 1864. to David Hennekey for the apprehension
of George Washington, a Private of the 4th U. S. Col^d. Cav^y.

E. D. Benedict
Capt. & Asst. Q. M.

U. S. Army.

Respectfully
returned with
the Voucher -

Please return the
V^o as soon as
practicable

Wm. H. H. H.
Capt. A. D. H.

Sept 19 1864

NARA 726

Headquarters, Department of the Gulf,

New Orleans, Sept-17 1864.

Alex N Shipley
Capt- & A Lt in USM

Capt-

Please
send me the Certificate
Signed by H Murray
Pitcher & E W Banger
for the collection of \$30.
for the arrest- of
Private George Washington
Co & 4th U.S. Army
Cops d. ofry (Drafter)
& whatever vouchers
you took in the matter
I desire to see them
them with the view
of preferring Chap act- the
parties implicated & will
return them

E P Benedict
City Judge advoct

Head Quarters
Dept of the Gulf
New Orleans, Sept 13. 1864.

Respectfully referred to Maj. Gen. Litch, Judge Advocate of Dept whose attention is called to the enclosed copy of Genl Order No 102 C. S. from this Dept, and who will take the necessary action in the case.

By Command of
Maj. Genl Banks
S. C. Cosby
A. A. General

Head Quarters
Sept 4th 1864

Respectfully returned to Capt Bangs from Capt Stupley's endorsement - in view it appears that he was one of the parties who signed the certificate, having done so he cannot avoid the responsibility of accounting for the man or the money paid for his apprehension.

To be returned with report

By command of
Frederic Speed
A. A. Genl

Sept 7. 1864

Respy. returned to Dept. Hd. Qrs. Capt. Bangs having signed a certificate of the apprehension and delivery of a deserter from his company - and it having been shown that said deserter was never delivered, and Capt. Bangs not being able to account for him - is responsible for the \$30 paid on his certificate.

This forfeiture does not preclude punishment to all parties concerned in the affair.

W. H. Sherman
B. G. C.

Recd at Hd Qrs Dept A. O.
August 31st 1864.

Camp of Distribution,

U. S. COLORED TROOPS,

DEPARTMENT OF THE GULF.

New Orleans, August 30th 1864.

Capt Frederick Spauld

West Adj Gen Dep of U.S.
Army

I have the honor to acknowledge receipt of a communication from you dated Aug 29th in which you enquire if Private George Washington Lee E 4th U.S. Colored Co is at this camp. It is not and never has been there is such a man^{now} with his company at Port Hudson whether it is the same one mentioned in your letter I do not know

Very Respectfully
Yours Obedtly

E. W. Langer

Capt Comd'g Camp of Distribution
U. S. C.

Office Assistant Quartermaster, U. S. Army.

New Orleans, July 30th 1864

I have the honor to notify you, that I have
this day paid \$30 reward for the apprehension and delivery of
Private George Washington a deserter from Company E,
4th U. S. Cavalry & Corps of Artillery

Very respectfully,

Your obedient servant,

Alfred H. Ripley
Captain and Assistant Quartermaster, U. S. Army

Major George B. Drake
Acting Assist. Q. M.

1000. 10000

MAR 7 1900

1100
Washington, George

Co F, 4 U. S. Col'd Cav.

Private Private

CARD NUMBERS.

1	5354991	26
2	5355080	27
3	5355172	28
4	5355273	29
5	5355350	30
6	5355432	31
7	5355513	32
8	5355593	33
9	5356170	34
10	40729379	35
11		36
12		37
13		38
14		39
15		40
16		41
17		42
18		43
19		44
20		45
21		46
22		47
23		48
24		49
25		50

Book Mark:

See also

W | **4 Cav. U.S.C.T.**

George Washington

Ch., Co. A, Mounted Rangers, Corps d'Afrique. †

Age _____ years.

Appears on

Company Muster Roll*

for *Nov 1 Dec*, 186*3*.

Joined for duty and enrolled:

When *Nov 1*, 186*3*.

Where *Iberia, La*

Period _____ years.

Mustered in:

When *Nov 30*, 186*3*.

Where *Iberia, La*

Present or absent *Present*

Stoppage, \$ _____ 100 for _____

Due Gov't \$ _____ 100 for _____

Valuation of horse, \$ _____ 100

Valuation of horse equipments, \$ _____ 100

Remarks: _____

† This organization subsequently became Co. F, 4 U. S. Col'd Cav.

* First current roll. No muster-in roll of this ~~battery~~ ^{company} on file.

Book mark: _____

W. J. ...
(3586) Copyist.

M | **4 Cav. | U.S C.T.**

George Washington
Prvt, Co. *F*, 1 Reg't Cav., Corps d'Afrique.*

Appears on

Company Muster Roll

for *Jan'y 2 Feb'y*, 186*4*.

Present or absent *Present*

Stoppage, \$ *100* for

Due Gov't, \$ *100* for

Valuation of horse, \$ *100*

Valuation of horse equipments, \$ *100*

Remarks:
.....
.....
.....
.....
.....
.....

* This organization subsequently became Co. *F*, 4 Reg't U. S. Colored Cavalry.

Book mark:

Manning
Copyist.

M | **4 Cav. | U.S.C.T.**

George Washington
Pvt, Co. F, 4 Reg't U. S. Col'd Cavalry.

Appears on

Company Muster Roll

for *March & April*, 1864.

Present or absent *Present*

Stoppage, \$ *100* for

Due Gov't, \$ *100* for

Valuation of horse, \$ *100*

Valuation of horse equipments, \$ *100*

Remarks:

Book mark:

Manning
Copyist.

H | **4 Cav. U.S.C.T.**

George C. Washington
Pvt, Co. F, 4 Reg't U. S. Col'd Cavalry.

Appears on

Company Muster Roll

for *May & June*, 1864.

Present or absent.....

Stoppage, \$.....100 for.....

Due Gov't, \$.....100 for.....

Valuation of horse, \$.....100

Valuation of horse equipments, \$.....100

Remarks: *Deserted May*
30, 1864

Book mark:.....

(358)

Hanning
Copyist.

H | **4 Cav.** | **U.S.C.T.**

George Washington

Pr, Co. F, 4 Reg't U. S. Col'd Cavalry.

Appears on

Company Muster Roll

for *July & Aug*, 186*4*.

Present or absent *Present*

Stoppage, \$ 100 for

Due Gov't, \$ 100 for

Valuation of horse, \$ 100

Valuation of horse equipments, \$ 100

Remarks:

Book mark:

(358)

Manning Copyist.

W | **4 Cav.** | **U.S.C.T.**

George Washington
Pr, Co. F, 4 Reg't U. S. Col'd Cavalry.

Appears on

Company Muster Roll

for *Sept & Oct*, 1864.

Present or absent *Present*

Stoppage, \$ 100 for

Due Gov't, \$ 100 for

Valuation of horse, \$ 100

Valuation of horse equipments, \$ 100

Remarks:

Book mark:

(358)

W. W. ...
Copyist.

W

4 Cav. U.S.C.T.

George Washington

Priv, Co. F, 4 Reg't U. S. Col'd Cavalry.

Appears on

Company Muster Roll

for *Nov. & Dec*, 186*4*

Present or absent *Present*

Stoppage, \$ *100* for

Due Gov't, \$ *100* for

Valuation of horse, \$ *100*

Valuation of horse equipments, \$ *100*

Remarks:

Book mark:

J. Harris

W | **4 Cav.** | **U.S.C.T.**

George Washington

Pr, Co. F, 4 Reg't U. S. Col'd Cavalry.

Appears on

Company Muster Roll

for *Jan & Feby*, 186*5*

Present or absent

Stoppage, \$ 100 for

Due Gov't, \$ 100 for

Valuation of horse, \$ 100

Valuation of horse equipments, \$ 100

Remarks: *Discharged and Final Statement given Feby 13, 1865.*

Book mark: *69840 Mety, July 5/66*

W Harris

W | 4 Cav. | U.S.C.T.

George Washington
 Port, Co. G, 4 Reg't U. S. Colored Cav.

Appears on Returns as follows:

Feb & Mch 1864 - (1 Regt. Cav. Comp'd Africa)
 On duty Co. Cook.

Apr to Sept 1864 - (4 Regt U.S. Col'd. Cav)
 On duty Co. Cook.

Nov 1864 to Jan'y 1865 - On duty detailed
 as Co. Cook.

Feb 1865 - 2000: Feb 13/65
 Port Hudson La. Disch'd
 for disability.

Book mark :

W. R. Lee

W | 4 Cav. | U.S.C.T.

George Washington
P, Co. F, 4 Reg't U. S. Col'd Cavalry.

Appears on Co. Muster-out Roll, dated
New Orleans, La., Mch. 20, 1866.

Muster-out to date _____, 186 .

Last paid to _____, 186 .

Clothing account:

Last settled _____, 186 ; drawn since \$ _____ 100

Due soldier \$ _____ 100; due U. S. \$ _____ 100

Am't for cloth'g in kind or money adv'd \$ _____ 100

Due U. S. for arms, equipments, &c., \$ _____ 100

Bounty paid \$ _____ 100; due \$ _____ 100

Remarks: *joined at orig. org.*
Discharged Feb. 13, 65, for
disability.

Book mark: *V75-P4, 69*

(361)

Hibbard
Copyist.

Washington, George

P, Co. D, 4 U.S.C. Cav.

Enclosures.

Bed Cards	Descriptive Lists
Burial Records	Final Statements
Certs. of Dis. for Discharge /	Furloughs
C. M. Charges	Med. Des. Lists
Med. Certificates	Orders

Other papers relating to—

Admission to Hosp'l	Furlough
Casualty Sheet (Officer's)	Med. Examination
Confinement	Misc. Information
Contracts	Pay or Clothing
Death or Effects	Personal Reports
Desertions	Rank
Discharge from Hosp'l	Transfer to Hosp'l
Discharge from Service	Transfer to V. R. C.
Duty	Transportation

NOTE 1.

The company commander will here add a statement of all the facts known to him concerning the disease or wound, or cause of disability of the soldier; the time, place, manner, and all the circumstances under which the injury occurred, or disease originated or appeared; the duty, or service, or situation of the soldier at the time the injury was received or disease contracted, stating particularly whether the injury was received or the disease contracted in the line of his duty; and whatever other facts may aid a judgment as to the cause, immediate or remote, of the disability, and the circumstances attending it.

When the facts are not known to the company commander, the certificate of any officer, or affidavit of other person having such knowledge, will be appended—as the surgeon in charge of a hospital, the officer commanding a detachment of recruits, &c., &c.

NOTE 2.

When a probable cause for pension, special care must be taken to state the degree of disability—as $\frac{1}{2}$, $\frac{3}{4}$, &c., &c.; to describe particularly the disability, wound, or disease; the extent to which it deprives him of the use of any limb or faculty, or affects his health, strength, activity, constitution, or capacity to labor or earn his subsistence. The surgeon will add, from his knowledge of the facts and circumstances, and from the evidence in the case, his professional opinion of the cause or origin of the disability. In the case of discharges by Medical Inspectors, the last paragraph will state that the "discharge was given by consent of the soldier, after a personal examination, and for disability, the nature, degree, and origin of which are correctly described in the within certificate."

Par. 1260 Regulations, Edit. 1861.

Medical officers, in giving certificates of disability, are to take particular care in all cases that have not been under their charge; and especially in epilepsy, convulsions, chronic rheumatism, derangement of the urinary organs, ophthalmia, ulcers, or any obscure disease liable to be feigned or purposely produced; and in no case shall such certificate be given until after sufficient time and examination to detect any attempt at deception.

DIRECTIONS.

This certificate will be made out in duplicate by the soldier's company commander, or other officer commanding the separate detachment to which he belongs, and sent by him to the surgeon who has charge of the hospital where the soldier is sick. The surgeon will then fill out and sign the surgeon's certificate, and forward these papers to the regimental, detachment, or post commander, who will forward them, with his action endorsed thereon, through the proper channel, to his division commander; or, if the troops are not attached to a division, to his corps, department, or other commander or officer to whom the authority to discharge enlisted men may be specially delegated.

These certificates, after having received the action of the highest authority to which they are required to be sent, will be returned through the same channel to the regimental, post, or detachment commander, who will, if the discharge is authorized by the endorsement of the proper authority, sign the soldier's discharge, and the last certificate on this paper; see that the soldier is furnished with the proper final statements in duplicate, and forward BOTH of these certificates direct to the Adjutant General United States Army, at Washington, D. C.; they will not, under any circumstances, be given into the hands of the soldier.

ADJUTANT GENERAL'S OFFICE

Feb 11 1865

duplicate sent the Pension Office.

CERTIFICATE OF DISABILITY FOR DISCHARGE

1865
No 941 IN THE CASE OF
George Washington
a Private Co. F
Fourth Reg't of U.S.C.A.

Approved Jan 30 5

R. A. Alexander

Head Quarters, Dept of the Gulf
New Orleans February 2^d 1865

To be discharged

By command of Major Genl Spauld

J. A. Stone

Captain J. A. Stone

Received (A. G. Office) , 186 .

Current of Ross
A. B.

Office Surgeon in Chief
District of Baton Rouge & Port Hudson
January 24th 1865

Respectfully Approved
Chas. A. Dever
Surgeon 2nd La. Vol. Inf.
In charge District of Baton Rouge & Port Hudson

Wm. I. ... Dist. B. R. & P. H.
Baton Rouge, Jan. 27th 1865
Respectfully forwarded
Approved.

Geo. L. Andrews
Brig. Gen. Vol.
Comdy. Dist.

ARMY OF THE UNITED STATES
CERTIFICATE
OF DISABILITY FOR DISCHARGE.

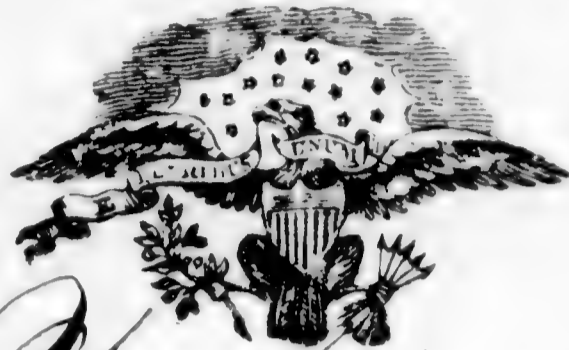

George Washington of Captain Samuel
White Company, (F) of the Fourth Regiment of United States
Infantry was enlisted by Capt Samuel White of
the 4th Regiment of U.S.C. at Texas
on the First day of December 1863, to serve Three years; he was born
in Richmond in the State of Virginia is fifty one
years of age, five feet Six inches high, Blk complexion, Blk eyes,
Blk hair, and by occupation when enlisted a Soldier. During the last two
months said soldier has been unfit for duty 60 days.* Employed only as
ambulance driver during all his service. He
was back, &c.

STATION: Post Hospital
DATE: January 6 1865

Samuel White
Capt
Commanding Company.

I CERTIFY, that I have carefully examined the said George Washington of
Captain White's Company, and find him incapable of performing the duties of a soldier
because of † Deformity & anchylosis of right knee which existed prior to
enlistment. Always complaining of Rheumatic pains
and stiffness in back and limbs. Not fit for service in Invalid
Corp. Henry M. Brown Surgeon 6th U.S. Inf.

D. D. Hanson Surgt. U.S. Cavalry
Surgeon.

DISCHARGED, this Thirteenth day of February 1865, at Post
Anderson Tennessee
Nathaniel Mitchell
Major
Commanding the Reg't.

The soldier desires to be addressed at
Town Memphis County _____ State Tenn.

* See Note 1 on the back of this. † See Note 2 on the back of this.

Office Post Surg Gen
Post Hospital
June 21, 1865
Properting Approved
Approved 48 based
Post Surg Gen

1101

Washington, George (1)

Co I, 4 U. S. Col'd Cav.

Private Private

CARD NUMBERS.

1	5347483	26
2	5358178	27
3	5348169	28
4	40729308	29
5		30
6		31
7		32
8		33
9		34
10		35
11		36
12		37
13		38
14		39
15		40
16		41
17		42
18		43
19		44
20		45
21		46
22		47
23		48
24		49
25		50

Book Mark:

See also

A | **4 Cav. | U.S.C.T.**

George Washington /
 Appears with rank of *Private* on

Muster and Descriptive Roll of a Detachment of U. S. Vols. forwarded

for the 4 Reg't U. S. Col'd Cavalry. Roll dated

New Orleans La, *April 27*, 1864.

Where born *Va*

Age *39* y'rs; occupation *Waiter*

When enlisted *April 16*, 186 .

Where enlisted *Grand Ecore, La*

For what period enlisted *3* years.

Eyes *Brown*; hair *Black*

Complexion *Black*; height *5* ft. *5* in.

When mustered in *April 27*, 1864.

Where mustered in *New Orleans*

Bounty paid \$ *2*¹⁰⁰; due \$ *100*

Where credited

Company to which assigned *I*

Remarks:

Book mark:

C. J. Taylor

W | 4 Cav. | U.S.C.T.

George Washington, Jr
Plt, Co. *D*, 4 Reg't U. S. Col'd Cavalry.

Age.....years.

Appears on

Company Muster Roll*

for *April 27 to June 30*, 1864.

Joined for duty and enrolled:

When *April 16*, 1864.

Where *Grand Ecore, La.*

Period *3* years.

Mustered in:

When *April 27*, 1864.

Where *New Orleans, La.*

Present or absent

Stoppage, \$.....100 for.....

Due Gov't, \$.....100 for.....

Valuation of horse, \$.....100

Valuation of horse equipments, \$.....100

Remarks: *Died in Genl Hospital New Orleans, La., May 13. 1864*

* First current roll. No muster-in roll of this battery on file.

Book mark :

Hynd

W | 4 Cav. | U.S.C.T.

George Washington
 Post, Co. D, 4 Reg't U. S. Colored Cav.

Appears on Returns as follows:

Apr 1864 - Absent sick sent Apr
 29/64 to Post Hospital. Town
 Building N. Orleans La.

May 1864 - Loss: May 13/64
 N. Orleans La. died of
 disease

Book mark:

W. R. Lee

U.S. Army | **U.S.C.T.**

George Washington
Co. I, 4 Reg't U. S. Col'd Army

Appears on a

Detachment Muster-out Roll

of the organization named above. Roll dated
New Orleans La, March, 1866

Muster-out to date 186 .

Last paid to 186 .

Clothing account:

Last settled....., 186 ; drawn since \$..... 100

Due soldier \$..... 100; due U. S. \$..... 100

Am't for cloth'g in kind or money adv'd \$..... 100

Due U. S. for arms, equipments, &c., \$..... 100

Bounty paid \$..... 100; due \$..... 100

Remarks: Am't of original
requirement. Died May 1864
San Antonio Hospital.
New Orleans La.

Book mark:

G. Fosse *

Washington, D.C.
P. Co. I, 4 Reg't USCB

4 Enclosures.

Bed Cards	Descriptive Lists
Burial Records	Final Statements
Certs. of Dis. for Discharge	Furloughs
C. M. Charges	Med. Des. Lists
Med. Certificates	Orders

Other papers relating to—

Admission to Hosp'l	Furlough
Casualty Sheet (Officer's)	Med. Examination
Confinement	Misc. Information
Contracts	Pay or Clothing
Death or Effects	Personal Reports
Desertions	Rank
Discharge from Hosp'l	Transfer to Hosp'l
Discharge from Service	Transfer to V. R. C.
Duty	Transportation

A. S. C.

ARTICLES OF WAR.

ART. 95. When any non-commissioned officer or soldier shall die, or be killed in the service of the United States, the then commanding officer of the troop or company shall, in the presence of two other commissioned officers, take an account of what effects he died possessed of, above his arms and accoutrements, and transmit the same to the office of the Department of War, which said effects are to be accounted for, and paid to the representatives of such deceased non-commissioned officer or soldier. And in case any of the officers, so authorized to take care of the effects of deceased officers and soldiers, should, before they have accounted to their representatives for the same, have occasion to leave the regiment or post, by preferment or otherwise, they shall, before they be permitted to quit the same, deposit in the hands of the commanding officer, or of the assistant military agent, all the effects of such deceased non-commissioned officers and soldiers, in order that the same may be secured for, and paid to, their respective representatives.

ARMY REGULATIONS—EDITION OF 1861.

DECEASED SOLDIERS.

Par. 152. Inventories of the effects of deceased non-commissioned officers and soldiers, required by the 95th Article of War, will be forwarded to the Adjutant General, by the commander of the company to which the deceased belonged, and a duplicate of the same to the colonel of the regiment. Final statements of pay, clothing, &c., will be sent with the inventories. When a soldier dies at a post or station absent from his company, it will be the duty of his immediate commander to furnish the required inventory, and, at the same time, to forward to the commanding officer of the company to which the soldier belonged, a report of his death, specifying the date, place, and cause; to what time he was last paid, and the money or other effects in his possession at the time of his decease; which report will be noted on the next muster roll of the company to which the man belonged. Each inventory will be endorsed, "Inventory of the effects of _____, late of company (—) _____ regiment of _____, who died at _____, the _____ day of _____, 186-." If a legal representative receive the effects, it will be stated in the report. If the soldier leave no effects, the fact will be reported.

Par. 153. Should the effects of a deceased non-commissioned officer or soldier not be administered upon within a short period after his decease, they shall be disposed of by a Council of Administration, under the authority of the commanding officer of the post, and the proceeds deposited with the Paymaster, to the credit of the United States, until they shall be claimed by the legal representatives of the deceased.

Par. 154. In all such cases of sales by the Council of Administration, a statement in detail, or account of the proceeds, duly certified by the Council and commanding officer, accompanied by the Paymaster's receipt for the proceeds, will be forwarded by the commanding officer to the Adjutant General. The statement will be endorsed, "Report of the proceeds of the effects of _____, late of company (—) _____ regiment of _____, who died at _____, the _____ day of _____, 186-."

NOTE 1.—The effects in all cases, when called for, should be turned over to the legal representative, without further authority from the Adjutant General. When the effects are turned over to the relatives of the deceased before these inventories are sent to the Adjutant General, their receipts therefor should be attached to the inventories. In all other cases, one copy will be sent with a letter of transmittal direct to the Adjutant General, and a duplicate retained by the officer.

NOTE 2.—Particular care should be taken to take receipts in duplicate from the Paymaster for any funds turned over to him; one copy should be sent direct to the Adjutant General and one retained by the officer.

INVENTORY OF THE EFFECTS

OF

Private George Washington

Late of Company *B*

4th Reg't of U.S. Cavalry Colored

Volunteers, who died at *Camp A. H. G. Wash*

on the *13th* day of *May* 186*4*



Inventory of the effects of George Washington late
a Private of Captain Leut John Eiland Company B of
the 4th Regiment of U.S. Country Colored Volunteers, who was enrolled as
a Private at Grand Esire in the State of Louisiana on
the 16th day of April 1864, and mustered into the service of the United
States as a Private on the 27th day of April 1864, at New Orleans La
in Company I, 4th Regiment of U.S. Country Colored Volunteers, to serve three
years or during the war; he was born in _____ in the State
of Virginia; he was 39 years of age, 5 feet 5 inches
high, Black complexion, Brown eyes, Black hair, and by occupation, when enrolled,
a Waiter; he died in Camps d' Afrique Genl Hospital, at
New Orleans Louisiana on the 13th day of May 1864, by
reason of Diarrhoea

INVENTORY.								
ARTICLES.	No.	ARTICLES.	No.	ARTICLES.	No.			
Hats.....	✓	Pairs trousers.....	✓	<div style="border: 1px solid black; width: 100%; height: 100%; position: relative;"> </div>				
Caps.....	✓	Pairs flannel drawers.....	✓					
Forage caps.....	✓	Pairs cotton drawers.....	✓					
Great coats.....	✓	Flannel shirts.....	✓					
Uniform coats.....	✓	Cotton shirts.....	✓					
Uniform jackets.....	✓	Pairs boots.....	✓					
Flannel sack coats.....	✓	Pairs shoes.....	✓					
Blouses.....	✓	Pairs socks.....	✓					
Stable frocks.....	✓	Blankets.....	✓					
Fatigue overalls.....	✓	Haversacks.....	✓					
						MONEY.	Specie.....	\$.....
							Notes.....	\$.....

I CERTIFY, ON HONOR, that the above inventory comprises all the effects of Private
George Washington, deceased, and that the effects are in the hands
of Surgeon in Charge at Camps d' Afrique Genl Hospital
New Orleans Louisiana to be disposed of by a Council of Administration.

(DUPLICATES.)

STATION: New Orleans La

DATE: 13th May 1864

[A. G. O. No. 104.]

J. E. Piquette
Surgeon & Capt U.S. Army Colored
Commanding the Company
In Charge of Camps d' Afrique Genl Hospital

COPY OF RECORD

FOR THE

ADJUTANT GENERAL, U. S. ARMY.

Handwritten initials or signature

No. 2.

RECORD OF DEATH AND INTERMENT.

Name and number of person interred,

George Washington

Number and locality of the Grave, - -

Hospital number of the deceased, - -

1164

Regiment, rank, and company, - -

4th U. S. Cav. - Priv. - B.

Residence before enlistment, - - - -

Conjugal condition, (and if married,)
the residence of the widow,)

Cause of death, - - - - - }

Dysentery acute

Age of the deceased, - - - - -

Nativity, - - - - -

References and remarks, - - - - - }

Date of death and burial, - - - -

May 13th 1864.

186 #

(A duplicate of this Record has been forwarded to the Sexton, and another remains at this Hospital.)

To

Adjutant General U.S.A.

SIR:

It becomes my duty to inform you that the person above described died at this Hospital as herein stated ; that it is desired his remains should be interred with the usual military honors.

Respectfully,

J. E. Piquette

Surgeon U. S. Army. *Albany*

Cops & Apique
MILITARY HOSPITAL, *New Mans Lee*

This copy of Record is to be transmitted to the Adjutant General at Washington immediately after the place of burial and the number of grave have been ascertained and registered. The above notification is to remain attached.

ARTICLES OF WAR.

ART. 95. When any non-commissioned officer or soldier shall die, or be killed in the service of the United States, the then commanding officer of the troop or company shall, in the presence of two other commissioned officers, take an account of what effects he died possessed of, above his arms and accoutrements, and transmit the same to the office of the Department of War, which said effects are to be accounted for, and paid to the representatives of such deceased non-commissioned officer or soldier. And in case any of the officers, so authorized to take care of the effects of deceased officers and soldiers, should, before they have accounted to their representatives for the same, have occasion to leave the regiment or post, by preferment or otherwise, they shall, before they be permitted to quit the same, deposit in the hands of the commanding officer, or of the assistant military agent, all the effects of such deceased non-commissioned officers and soldiers, in order that the same may be secured for, and paid to, their respective representatives.

ARMY REGULATIONS—EDITION OF 1861.

DECEASED SOLDIERS.

Par. 152. Inventories of the effects of deceased non-commissioned officers and soldiers, required by the 95th Article of War, will be forwarded to the Adjutant General, by the commander of the company to which the deceased belonged, and a duplicate of the same to the colonel of the regiment. Final statements of pay, clothing, &c., will be sent with the inventories. When a soldier dies at a post or station absent from his company, it will be the duty of his immediate commander to furnish the required inventory, and, at the same time, to forward to the commanding officer of the company to which the soldier belonged, a report of his death, specifying the date, place, and cause; to what time he was last paid, and the money or other effects in his possession at the time of his decease; which report will be noted on the next muster roll of the company to which the man belonged. Each inventory will be endorsed, "Inventory of the effects of _____, late of company (—) _____ regiment of _____, who died at _____, the _____ day of _____, 186—." If a legal representative receive the effects, it will be stated in the report. If the soldier leave no effects, the fact will be reported.

Par. 153. Should the effects of a deceased non-commissioned officer or soldier not be administered upon within a short period after his decease, they shall be disposed of by a Council of Administration, under the authority of the commanding officer of the post, and the proceeds deposited with the Paymaster, to the credit of the United States, until they shall be claimed by the legal representatives of the deceased.

Par. 154. In all such cases of sales by the Council of Administration, a statement in detail, or account of the proceeds, duly certified by the Council and commanding officer, accompanied by the Paymaster's receipt for the proceeds, will be forwarded by the commanding officer to the Adjutant General. The statement will be endorsed, "Report of the proceeds of the effects of _____, late of company (—) _____ regiment of _____, who died at _____, the _____ day of _____, 186—."

NOTE 1.—The effects in all cases, when called for, should be turned over to the legal representative, without further authority from the Adjutant General. When the effects are turned over to the relatives of the deceased before these inventories are sent to the Adjutant General, their receipts therefor should be attached to the inventories. In all other cases, one copy will be sent with a letter of transmittal direct to the Adjutant General, and a duplicate retained by the officer.

NOTE 2.—Particular care should be taken to take receipts in duplicate from the Paymaster for any funds turned over to him; one copy should be sent direct to the Adjutant General and one retained by the officer.

(Duplicate)

INVENTORY OF THE EFFECTS

OF

Private George Washington

Late of Company I

4th Reg't of West Virginia Colored

Volunteers, who died at Cape A. M. Supt

on the 10th day of May 1864

Inventory of the effects of George Washington late
a Private of Captain Lieut. John Ellard Company I of
the 4th Regiment of U.S. Cavalry Colored Volunteers, who was enrolled as
a Private at Grand Esore in the State of Louisiana on
the 16th day of April 1864, and mustered into the service of the United
States as a Private on the 27 day of April 1864, at New Orleans La
in Company I, 4th Regiment of U.S. Cavalry Colored Volunteers, to serve Three
years or during the war; he was born in _____ in the State
of Virginia; he was 39 years of age, 5 feet 5 inches
high, Black complexion, Black eyes, Black hair, and by occupation, when enrolled,
a Master; he died in Camp d. Affrique Genl Hospital, at
New Orleans Louisiana, on the 15th day of May 1864, by
reason of Dysentery

INVENTORY.					
ARTICLES.	No.	ARTICLES.	No.	ARTICLES.	No.
Hats.....	✓	Pairs trowsers.....	✓	<div style="border: 1px solid black; width: 100%; height: 100%; position: relative;"> </div>	
Caps.....	✓	Pairs flannel drawers.....	✓		
Forage caps.....	✓	Pairs cotton drawers.....	✓		
Great coats.....	✓	Flannel shirts.....	✓		
Uniform coats.....	✓	Cotton shirts.....	✓		
Uniform jackets.....	✓	Pairs boots.....	✓		
Flannel sack coats.....	✓	Pairs shoes.....	✓		
Blouses.....	✓	Pairs socks.....	✓		
Stable frocks.....	✓	Blankets.....	✓		
Fatigue overalls.....	✓	Haversacks.....	✓		
				MONEY.	
				Specie.....	\$.....
				Notes.....	\$.....

I CERTIFY, ON HONOR, that the above inventory comprises all the effects of Private
George Washington, deceased, and that the effects are in the hands
of Surgeon in Charge at Camp d. Affrique Genl Hospital
New Orleans Louisiana to be disposed of by a Council of Administration.

(DUPLICATES.)

STATION: New Orleans La

DATE: 13th May 1864

Surgeon &c Regt U.S. Infantry Colored
In Charge of Camp d. Affrique Genl Hospital
Commanding the Company.

FINAL STATEMENT

OF

George Washington 1st

4th Reg't of M.S. Colard Cavalry

VOLUNTEERS.

Died May 13th 1864

NOTE 1.—Two of these certificates (or duplicates) are to be given to each volunteer soldier who may be discharged previously to the discharge of his company, that he may at once receive from the Paymaster the pay, &c., due him, and the captain or other officer commanding the company will certify to the act of the delivery of the duplicate certificates; on these certificates the Soldier is "entitled to" his discharge, and should also present his discharge to the Paymaster to have the payment endorsed on it. The discharge is to be given back to the Soldier by the Paymaster; the latter only retaining as his voucher the duplicate certificates.

NOTE 2.—If the Soldier is entitled to pay for the use of his horse, the Company Commander will certify to that fact, and also to the time he has pay due for having been so mounted on his own horse.

NOTE 3.—Amounts due the Sutler and Laundress must be entered on the Muster Roll on which the death, desertion, &c., is reported, as well as on the final statement, otherwise the amount cannot be collected from the United States.

NOTE 4.—This blank will be used for deceased volunteers as well as others.

ADJUTANT GENERAL'S OFFICE.

June 7th 1864

3 copies of inventory sent 2d Auditor.

George Washington
1st
4th Reg't of M.S. Colard Cavalry

NO. 759

I certify, on honor, that George Washington a Private of
Captain Seymour Company (A) of the 4th Regiment of U.S. Colored Cavalry
VOLUNTEERS, of the State of _____, born in _____, State
of Virginia, aged 39 years; 5 feet 5 inches high; Black complexion,
Brown eyes, Black hair, and by occupation a Writer, having joined the company on
its original organization at Grand Bay La, and enrolled in it at the muster into
the service of the United States at New Orleans La, on the sixteenth day
of April, 1864, (or was mustered in service as a recruit, by _____
at _____, on the _____ day of _____,
186 , to serve in the Regiment,) for the term of Three years
and having served **HONESTLY** and **FAITHFULLY** with his Company in New Orleans La
to the present date, is now entitled to a **DISCHARGE** by reason of Death
General Hospital C.D. New Orleans La May 13 1864

The said George Washington was last paid by Paymaster
has never been paid to include the _____ day of _____, 186 , and has
pay due him from that time to the present date; he is entitled to pay and subsistence for
TRAVELING to place of enrollment and whatever other allowances are authorized to volunteer
soldiers, or militia, so discharged. He has received _____ $\frac{100}{100}$ dollars,
advanced by the United States on account of **CLOTHING**.

There is to be stopped from him, on account of the State of _____, or other
authorities for **CLOTHING**, &c., received on entering service, _____ $\frac{100}{100}$ dollars; also,
for expenses of **SUBSISTENCE** for **TRAVELING** from place of enrollment to the place of rendezvous,
amounting to _____ $\frac{100}{100}$ dollars: and on account of the United States for **EXTRA**
CLOTHING received in kind from has received clothing in kind and for other
stoppages, viz:

has received clothing in kind
amounting to 19 $\frac{73}{100}$ dollars;
and he has been **SUBSISTED** for **TRAVELING** to his place of enrollment, up to the _____
_____, 186 .

He is indebted to _____, **SUTLER**, _____ $\frac{100}{100}$ dollars.

He is indebted to _____, **LAUNDRESS**, _____ $\frac{100}{100}$ dollars.

Given in Duplicate, at Greenville La, this 16th day of May, 1864.

John Ellars

2d Lieut Co "H."
Commanding Company. J.

1108

Washington, George (1)

Co *R L*, 4 U. S. Col'd Cav.

Private Private

CARD NUMBERS.

1	5347633	26
2	5347865	27
3	5358669	28
4	5358713	29
5	5358764	30
6	5358797	31
7	5347964	32
8	5356716	33
9	5356803	34
10	5356894	35
11	5356979	36
12	5357062	37
13	5357145	38
14	B-163-RCY-168	39
15	40729309	40
16	42668842	41
17	40729313	42
18		43
19		44
20		45
21		46
22		47
23		48
24		49
25		50

Book Mark: B-163-RCY-1868

See also

W | **4 Cav. | U.S.C.T.**

George Washington

Appears with rank of *Pvt.* on

Muster and Descriptive Roll of a Detachment of U. S. Vols. forwarded

for the 4 Reg't U. S. Col'd Cavalry. Roll dated *New Orleans, La. June 1st*, 1864.

Where born *Ark.*

Age *22* y'rs; occupation *Laborer*

When enlisted *May 18*, 1864.

Where enlisted *New Orleans*

For what period enlisted *3* years.

Eyes *Black*; hair *Black*

Complexion *Black*; height *5 ft. 4 1/2 in.*

When mustered in *June 1*, 1864.

Where mustered in *New Orleans*

Premium paid 2
Bounty paid \$ *100*; due \$ *100*

Where credited

Company to which assigned *D*

Remarks:

Book mark:

Feaster

M | **4 Cav.** | **U.S.C.T.**

George Washington 1st

Appears with rank of *Capt.* on

Muster and Descriptive Roll of a Detachment of U. S. Vols. forwarded

for the 4 Reg't U. S. Col'd Cavalry. Roll dated

New Orleans La, April 9, 1864.

Where born *Arkansas*

Age *22* y'rs; occupation *Laborer*

When enlisted *May 18*, 1864.

Where enlisted *New Orleans*

For what period enlisted _____ years.

Eyes *Black*; hair *Black*

Complexion *Black*; height *5* ft. *4* in.

When mustered in *June 1*, 1864.

Where mustered in *New Orleans*

Bounty paid \$ *100*; due \$ *100*

Where credited _____

Company to which assigned *G*

Remarks: *Transferred from D Company in consolidation!*

Book mark: _____

H. E. Tyler
Copyist.

H | **4 Cav. | U.S.C.T.**

George Washington 1st
Cvt., Co. *L*, 4 Reg't U. S. Col'd Cavalry.

Age years.

Appears on

Company Muster Roll*

for *Existence to Aug. 31*, 1864.

Joined for duty and enrolled:

When *May 18*, 1864.

Where *New Orleans La.*

Period *3* years.

Mustered in:

When *June 1*, 1864.

Where *New Orleans La.*

Present or absent *Present*

Stoppage, \$ *100* for

Due Gov't, \$ *100* for

Valuation of horse, \$ *100*

Valuation of horse equipments, \$ *100*

Remarks :

* First current roll. No muster-in roll of this battery on file.

Book mark :

Lerrin
Copyist.

W | **4 Cav. | U.S.C.T.**

George Washington 1st
Pvt., Co. L, 4 Reg't U. S. Col'd Cavalry.

Appears on

Company Muster Roll

for *Sept. & Oct.*, 186*4*.

Present or absent *Present*

Stoppage, \$ *100* for

Due Gov't, \$ *100* for

Valuation of horse, \$ *100*

Valuation of horse equipments, \$ *100*

Remarks: *Due U.S. for lost*
Arduance 30 - 1 wizer,
waist belt plate U.S.

Book mark:

Levin

W | **4 Cav.** | **U.S.C.T.**

George Washington
Pvt., Co. L, 4 Reg't U. S. Col'd Cavalry.

Appears on

Company Muster Roll

for *Nov. 1864*, 186*4*.

Present or absent *Present*

Stoppage, \$ $\frac{30}{100}$ for *ordnance cost*

Due Gov't, \$ $\frac{100}{100}$ for

Valuation of horse, \$ $\frac{100}{100}$

Valuation of horse equipments, \$ $\frac{100}{100}$

Remarks: *ordnance cost
with plate U.S. and
wiper*

Book mark:

Scoring

(358)

Copyist.

H | **4 Cav.** | **U.S.C.T.**

George Washington ^{*1st*}
Co., Co. L, 4 Reg't U. S. Col'd Cavalry.

Appears on

Company Muster Roll

for *Jan. & Feb.*, 186*5*.

Present or absent *Present*

Stoppage, \$ *100* for

Due Gov't, \$ *100* for

Valuation of horse, \$ *100*

Valuation of horse equipments, \$ *100*

Remarks: *Spd. for one belt plate
(M^d & gun wiper*

Book mark: _____

(358)

Curry
Copyist.

W 4 Cav U.S.C.T.

George Washington 1st
Am, Co. G, 4 Reg't U. S. Col'd Cav.

Appears on

M. and D. Roll of Men Transferred

to the organization named above, by consol.
from Co. K

Roll dated Port Hudson, La, Apr 29, 1865.

When enlisted May 18, 1864.

Period for which enlisted 3 years.

When mustered in June 1, 1864.

Present or absent not stated

Company to which assigned G.

Remarks:

Book mark :

(342)

J. J. Leonard

Copyist.

A | **4 Cav. | U.S.C.T.**

George Washington

Pr, Co. G, 4 Reg't U. S. Col'd Cavalry.

Appears on

Company Muster Roll

for *Men & ap*, 1865.

Present or absent *Present*

Stoppage, \$ *100* for

Due Gov't, \$ *100* for

Valuation of horse, \$ *100*

Valuation of horse equipments, \$ *100*

Remarks: *joined by transfer
in consolidation from
Co L Mar 24th 1865
28 dated 2d 23rd Sept
1865*

Book mark:

Atwood

M | **4 Cav. | U. S. C. T.**

George Washington
Qu, Co. G, 4 Reg't U. S. Col'd Cavalry.

Appears on

Company Muster Roll

for *May 1 1863*, 1863.

Present or absent *Present*

Stoppage, \$ *100* for

Due Gov't, \$ *100* for

Valuation of horse, \$ *100*

Valuation of horse equipments, \$ *100*

Remarks:

Book mark:

Qu
Copyist.

H

4 Cav. | U.S.C.T.

George Washington

Pr, Co. G, 4 Reg't U. S. Col'd Cavalry.

Appears on

Company Muster Roll

for *July & Aug*, 1865.

Present or absent *Present*

Stoppage, \$ 100 for

Due Gov't, \$ 100 for

Valuation of horse, \$ 100

Valuation of horse equipments, \$ 100

Remarks:

Book mark:

Atwood

W | **4 Cav. | U. S. C. T.**

George Washington 1st
Pr, Co. G, 4 Reg't U. S. Col'd Cavalry.

Appears on

Company Muster Roll

for *Sept & Oct*, 1865.

Present or absent *Not stated*

Stoppage, \$ 100 for

Due Gov't, \$ 100 for

Valuation of horse, \$ 100

Valuation of horse equipments, \$ 100

Remarks:

Book mark:

Hitcher

W

4 Cav. U.S.C.T.

George Washington 1st

Prw, Co. G, 4 Reg't U. S. Col'd Cavalry.

Appears on

Company Muster Roll

for Jan & Feb, 1866

Present or absent Absent

Stoppage, \$ 100 for

Due Gov't, \$ 100 for

Valuation of horse, \$ 100

Valuation of horse equipments, \$ 100

Remarks: Absent in arrest

Stop per sent G. C. M. \$8.00 per month during confinement of one year. Stop per S. O. No 120 Hd. Qu. Dept. La. Nov 20 1865 \$53.00 for the benefit of Dick cold citizen

Book mark:

Fletcher

27

4 Cav. U.S.C.T.

George Washington 1st
Pvt., Co. G, 4 Reg't U. S. Col'd Cavalry.

Appears on Co. Muster-out Roll, dated
New Orleans, La. Mar 20, 1866.

Muster-out to date _____, 186 .

Last paid to Feb 28, 1865 .

Clothing account:

Last settled _____, 186 ; drawn since \$ _____ 100

Due soldier \$ 36 ⁴⁷ / 100; due U. S. \$ _____ 100

Am't for cloth'g in kind or money adv'd \$ _____ 100

Due U. S. for arms, equipments, &c., \$ _____ 100

Bounty paid \$ _____ 100; due \$ _____ 100

Remarks: Joined by transfer from
Co. E 1st S. C., 28 Mar. 1865 Dept
Quar. Jan'y 28 65 Absent
in confinement for sentence
of 8 m. for one year with
loss of \$8.00 pr month during

Book-mark: _____ (over)

Fletcher

(361)

Copyist.

JAN.-8

5357145

1891

confinement Stop pr S. C.
120 Hd. Dep. La. No
20-65 \$53.00 No discharge
furnished.

Book mark: See B163 Vol B.69
68. V35 P.35.68 See List
on file in Mo. Bch

H. H. Cary. Use P.

George Washington 1st
Co. G., H. Reg't Use Cary.

NOTATION.

Book mark: B. 163. R. I. 1868.

War Department,

Adjutant General's Office,

Washington, July 28th, 1868.

Call from

returned with report.

The above book mark was noted on rolls in order to preserve results of search in this case.

A. M. Muzzey Copyist.

W | 4 Cav. | U.S.C.T.

George Washington
Cook, Co. G, 4 Reg't U. S. Colored Cav.

Appears on Returns as follows:

Apr to Aug 1865 - On duty detailed
as Co. Cook

Nov 1865 - About undergoing
sentence by G. C. M. to be
confined one year with
bail & chain three months

Book mark:

W. R. Lee

W | 4 Cav | use

George Washington
Pot Co, G, 4 use

Return

of Fort Jefferson, Tortugas, Fla.,

for the month of October, 1866,

dated October 31, 1866,

shows the following with regard to the person
named above :

Post or station _____

Remarks: Lost Prisoner, by expiration
of sentence.

Book mark : _____

J. F. Maguire

W | 4 Cav. | U.S.C.T.

George Washington - 1
Port, Co. 2, 4 Reg't U. S. Colored Cav.

Appears on Returns as follows:

Jan 1865 - absent furloughed
for seven days - Jan 24/65
Port Hudson, La.

Feb 1865 On duty detailed as
- Co. Cook.

Book mark:

W. R. Lee

Washington, George
P, Co. G, 4 Reg't U.S.C. Cav.

4 Enclosures.

Bed Cards	Final Statements
Burial Records	Furloughs or L. of A
Certs. of Dis. for Discharge	Med. Certificates
C. M. Charges	Med. Des. Lists
Descriptive Lists	Orders
Discharge Certificates	Pris. of War Record
Enlistment Papers	Resignations

Other papers relating to—

Admission to Hosp'l	Furlough or L. of A
Casualty Sheet	Med. Examination
Confinement	Misc. Information 2
Contracts	Pay or Clothing
Death or Effects	Personal Reports
Desertion	Rank
Discharge from Hosp'l	Transfer to Hosp'l
Discharge from Service	Transfer to V. R. C.
Duty	Transportation

Case 100-100000
100-100000
100-100000

Office Provost Marshal, Parish of Orleans,

No. 67 Carondelet Street,

New Orleans, Nov 17 1865.

Sir,
 Please confine
 Geo Washington Co & wife
 charged with "Robbery"
 sentenced by G. O. S. E. & of La
 to Tortugas

Respectfully
 J. H. Casin

W. P. Combs

Ellerbrook—

Priv: Geo: Washington Co "E" - 4th W. S. C. Cav.

(complete) —

1890

Adjutant General's Office,

COLORED TROOPS BRANCH,

April 9th _____, 1874

Vol. _____ C. T., 187

Wanted in case of Private George Washington 1st, Co. 'G',
4th Reg't U. S. Col'd Cav. - Copy of P. O. No. 120 H^d Q^{rs}
Sept. Ser. Nov. 20th 1865 - promulgating sentence in his case.

Respectfully,

R. A. Woodward

Chief Clerk.

J. J. Patton

Adjutant General's Office,

Mr. Ellbrook.

S. R.

_____, 187

Vol. _____ C. T., 187

Reply in case of _____, Co. _____,

Reg't _____

Inventory of 3 files made on 20 Nov. 1874 by _____
accordance with preceding order, hereby offering as evidence
investigate and report on the same to _____

Ellerbrook-

Priv: Geo: Washington 1st Coth 4th Colth Cav^{ry}

complete

Adjutant General's Office,

COLORED TROOPS BRANCH,

April 16th, 1874 -

Vol. C. T., 187
Wanted in case of Geo. Washington 1st, Co. "G",
4th Reg't W. I. Colored Cavalry copy of G. O. No 58 - Dated
H^d Q^r Dist of Louisiana, N. O. La: October 25th 1865. - Promul-
-gating sentence in his case.

Respectfully,

R. W. Woodward
Chief Clerk.

P. A. Hackett

Mr. Ellersbrook -

2.12 -

Adjutant General's Office,

Head Quarters

April 23rd, 1874

Vol. C. T., 187
Reply in case of Geo. Washington 1st, Co. "G",
4th Reg't W. I. Colored Cavalry.

Records of St. Jefferson, La. show a fine of \$200 for G. O. No. 58.
To be confined 1st for G. O. No. 58. C. Dist. of La. Oct. 25th 65.

Said case filed with the court there. Charge "Robbery" Finding "Guilty".
Sentence: To be confined at hard labor for the period of 1 year, at such place
as the Circuit Court may direct; to wear a ball & chain of 12 pound weight
three months of the term. To have one hundred & eighty dollars, the
balance not refunded, stopped from his pay on his Co. Pay rolls, to be
paid to the parties from whom it was taken, and to forfeit \$3.00
per month of his monthly pay during the period of said confinement.

App'd except so much of sentence as requires that \$118.00 be stopped from his pay &
the portion is disapp'd. St. Jefferson La. designated as place of confinement.

By order of Brig Maj-Genl. J. W. Sherman, Adjt. Genl. New Orleans, La.

ms.

1109

Washington, George (2)

Co A, 4 U. S. Col'd Cav.

Private Private

CARD NUMBERS.

1	5347484	26
2	5358168	27
3	5358232	28
4	5358286	29
5	5358336	30
6	5358379	31
7	5348031	32
8	5357623	33
9	5357705	34
10	5357788	35
11	5357866	36
12	5357941	37
13	5358016	38
14	5358088	39
15		40
16		41
17		42
18		43
19		44
20		45
21		46
22		47
23		48
24		49
25		50

Book Mark:

See also

4 | **4 Cav. | U.S.C.T.**

George Washington 2

Appears with rank of *Private* on

Muster and Descriptive Roll of a Detachment of U. S. Vols. forwarded

for the 4 Reg't U. S. Col'd Cavalry. Roll dated

New Orleans La, April 27, 1864.

Where born *Miss*

Age *25* y'rs; occupation *Farmer*

When enlisted *April 15, 1864*

Where enlisted *Grand Ecore, La*

For what period enlisted *3* years.

Eyes *Brown*; hair *Black*

Complexion *Brown*; height *5 ft. 2 in.*

When mustered in *April 27, 1864.*

Where mustered in *New Orleans*

Bounty paid \$ *2* ¹⁰⁰; due \$ ¹⁰⁰

Where credited

Company to which assigned *D*

Remarks:

Book mark:

A. P. Taylor
Copyist.

W | 4 Cav. | U.S.C.T.

George Washington

Pvt, Co. *D*, 4 Reg't U. S. Col'd Cavalry.

Age.....years.

Appears on

Company Muster Roll*

for *Apr. 27 to June 30*, 1864.

Joined for duty and enrolled:

When *Apr. 15*, 1864.

Where *Grand Ecure, La.*

Period *3* years.

Mustered in:

When *Apr. 27*, 1864.

Where *New Orleans, La.*

Present or absent *Present*

Stoppage, \$.....100 for.....

Due Gov't, \$.....100 for.....

Valuation of horse, \$.....100

Valuation of horse equipments, \$.....100

Remarks :

* First current roll. No muster-in roll of this battery on file.

Book mark :

[Signature]
Copyist.

W | 4 Cav. | U.S.C.T.

George Washington
Pr, Co. I, 4 Reg't U. S. Col'd Cavalry.

Appears on

Company Muster Roll

for *July & Aug*, 1864.

Present or absent *Pr*

Stoppage, \$ 100 for

Due Gov't, \$ 100 for

Valuation of horse, \$ 100

Valuation of horse equipments, \$ 100

Remarks:

Book mark:

H. J. ...
Copyist.

WAR 791
W | 4 Cav. | U.S.C.T.

George Washington

PM, Co. I, 4 Reg't U. S. Col'd Cavalry.

Appears on

Company Muster Roll

for Nov r Dec, 1864

Present or absent Present

Stoppage, \$ 100 for

Due Gov't, \$ 100 for

Valuation of horse, \$ 100

Valuation of horse equipments, \$ 100

Remarks:

Book mark:

Hynes

W | 4 Cav. | U.S.C.T.

George Washington

Plt, Co. I, 4 Reg't U. S. Col'd Cavalry.

Appears on

Company Muster Roll

for *Jan + Feb*, 1865.

Present or absent *Present*

Stoppage, \$ *100* for

Due Gov't, \$ *100* for

Valuation of horse, \$ *100*

Valuation of horse equipments, \$ *100*

Remarks:

Book mark:

Hyman

W | 4 Cav. | U.S.C.T.

George Washington
Pot., Co. H, 4 Reg't U. S. Col'd Cavalry.

Appears on

Company Muster Roll

for *Feb. 2. April.*, 186*2*

Present or absent *Present*

Stoppage, \$ *100* for

Due Gov't, \$ *100* for

Valuation of horse, \$ *100*

Valuation of horse equipments, \$ *100*

Remarks: *Transferred from
Co. D in consolidation
by S. O. 28. Hdqrs. Dept.
Wash. Jan 28/63*

Book mark:

Feaster

W *100 Cav.* | **U.S.C.T.**

Geo. Washington
Co. H, 4 Reg't U. S. Col'd *Cav.*

Appears on

M. and D. Roll of Men Transferred

to the organization named above, *by consol.*
from *Co. I*

Roll dated *Port Hudson La April 9, 1865.*

When enlisted *Apr 15*, 186*4*.

Period for which enlisted *9* years.

When mustered in *Apr 27*, 186*4*.

Present or absent *not stated*

Company to which assigned *BY*

Remarks:

Book mark :

Wagoner

W | **4 Cav. | U.S.C.T.**

George Washington

Pvt., Co. H, 4 Reg't U. S. Col'd Cavalry.

Appears on

Company Muster Roll

for *May & June*, 186*2*-----

Present or absent *Present*-----

Stoppage, \$-----*100* for -----

Due Gov't, \$-----*100* for -----

Valuation of horse, \$-----*100*

Valuation of horse equipments, \$-----*100*

Remarks:-----

Book mark:-----

Feaster

W | **4 Cav. | U.S.C.T.**

George Washington
Pot., Co. H, 4 Reg't U. S. Col'd Cavalry.

Appears on

Company Muster Roll

for *July & Aug.*, 186*5*.

Present or absent *Present*

Stoppage, \$ 100 for

Due Gov't, \$ 100 for

Valuation of horse, \$ 100

Valuation of horse equipments, \$ 100

Remarks:

Book mark:

W. Caster

W | **4 Cav.** | **U.S.C.T.**

George Washington
Put., Co. H, 4 Reg't U. S. Col'd Cavalry.

Appears on

Company Muster Roll

for *Sept. 8. Oct.*, 186*5*.

Present or absent *Present*

Stoppage, \$ *100* for

Due Gov't, \$ *100* for

Valuation of horse, \$ *100*

Valuation of horse equipments, \$ *100*

Remarks: *Stop. for one
Saddle & Equipments
\$ 17.02.*

Book mark:

Master

A | **4 Cav. | U.S.C.T.**

George Washington
Co., Co. H, 4 Reg't U. S. Col'd Cavalry.

Appears on

Company Muster Roll

for *dated Dec 31*, 186*5*.

Present or absent *Present*

Stoppage, \$ *100* for

Due Gov't, \$ *100* for

Valuation of horse, \$ *100*

Valuation of horse equipments, \$ *100*

Remarks: *Stop for one*
saddle and equipments
\$17.02

Book mark: *5*

H. C. Howard

W | **4 Cav.** | **U.S.C.T.**

George Washington
Pr., Co. H, 4 Reg't U. S. Col'd Cavalry.

Appears on

Company Muster Roll

for *Jan + Feb.*, 1866.

Present or absent *Present*

Stoppage, \$ *18* ^{*5*}/₁₀₀ for *1 Saddle*
complete

Due Gov't, \$ *100* for

Valuation of horse, \$ *100*

Valuation of horse equipments, \$ *100*

Remarks:

Book mark:

A. E. Stewart

(358)

Copist.

W | **4 Cav.** | **U.S.C.T.**

George Washington
Pri, Co. *A.*, 4 Reg't U. S. Col'd Cavalry.

Appears on **Co. Muster-out Roll**, dated
New Orleans La, Mar 20, 1866 .

Muster-out to date *Mar 20*, 1866 .

Last paid to *June 30*, 1865 .

Clothing account:

Last settled....., 186 ; drawn since \$..... $\overline{100}$

Due soldier \$..... $\overline{100}$; due U. S. \$ *2* $\frac{5}{100}$

Am't for cloth'g in kind or money adv'd \$..... $\overline{100}$

Due U. S. for arms, equipments, &c., \$ *18* $\frac{15}{100}$

Bounty paid \$..... $\overline{100}$; due \$..... $\overline{100}$

Remarks: *Joined by transfer*
from Co. "I" Mar. 24/65
per S.O. 28, Ad. Dep. Dept.
Gulf series 1865.
Stop for 1 Saddle complete

Book mark: *W 116. P 326. 70*

H. E. Murot

1110

Washington, George, (2)

Co *LH*, 4 U. S. Col'd Cav.

Private | *Private*

CARD NUMBERS.

1	5347663	26
2	5347694	27
3	5347866	28
4	5358670	29
5	5358754	30
6	5358765	31
7	5358799	32
8	5347965	33
9	5356717	34
10	5356804	35
11	5356895	36
12	5356980	37
13	5357063	38
14	5357146	39
15	40729314	40
16		41
17		42
18		43
19		44
20		45
21		46
22		47
23		48
24		49
25		50

Book Mark:

See also

W | **4 Cav. U.S.C.T.**

George Washington 2nd

Appears with rank of *P* on

Muster and Descriptive Roll of a Detachment of U. S. Vols. forwarded

for the 4 Reg't U. S. Col'd Cavalry. Roll dated

New Orleans La June 20, 1864

Where born *La*

Age *22* y'rs; occupation *Laborer*

When enlisted *Apr 13*, 186*4*

Where enlisted *Alexandria*

For what period enlisted *3* years.

Eyes *DK*; hair *DK*

Complexion *Yellow*; height *5* ft. *5* in.

When mustered in *June 20, 1864*

Where mustered in *New Orleans*

Bounty paid \$ *100*; due \$ *100*

Where credited *to Alexandria La*

Company to which assigned *L*

Remarks:

Book mark:

Washington
(339) Copyist.

A | **4 Cav.** | **U.S.C.T.**

George Washington 2nd
Appears with rank of *Pl* on

Muster and Descriptive Roll of a Detachment of U. S. Vols. forwarded

for the 4 Reg't U. S. Col'd Cavalry. Roll dated
New Orleans La July 18, 186*4*.

Where born *La*

Age *27* y'rs; occupation *Labourer*

When enlisted *Apr 13*, 186*4*.

Where enlisted *Alexandria*

For what period enlisted *3* years.

Eyes *Br*; hair *Blk*

Complexion *Yellow*; height *5* ft. *5* in.

When mustered in *June 22*, 186*4*.

Where mustered in *New Orleans*

Bounty paid \$ *100*; due \$ *100*

Where credited *to Alexandria La*

Company to which assigned *D*

Remarks :

Book mark :

W. A. H. ...

170 | **4 Cav.** | **U.S.C.T.**

George Washington 3rd
Co., Co. 2, 4 Reg't U. S. Col'd Cavalry.

Age years.

Appears on

Company Muster Roll*

for Enlistment to Aug. 31, 1864.

Joined for duty and enrolled:

When Feb. 13, 1864.

Where Alexandria La.

Period 3 years.

Mustered in:

When June 22, 1864.

Where New Orleans La.

Present or absent Absent

Stoppage, \$ 100 for

Due Gov't, \$ 100 for

Valuation of horse, \$ 100

Valuation of horse equipments, \$ 100

Remarks: Detailed on extra duty
at New Orleans La. Aug. 28th 1864

* First current roll. No muster-in roll of this battery on file.

Book mark :

Loring
Copyist.

W | **4 Cav. | U.S.C.T.**

George Washington
Pvt., Co. L, 4 Reg't U. S. Col'd Cavalry.

Appears on

Company Muster Roll

for *Sept. & Oct.*, 1864.

Present or absent *Present*

Stoppage, \$ *100* for

Due Gov't, \$ *100* for

Valuation of horse, \$ *100*

Valuation of horse equipments, \$ *100*

Remarks:

Book mark:

Turris

117 | 4 Cav. | U.S.C.T.

George Washington ^{2nd}
Pvt., Co. L, 4 Reg't U.S. Col'd Cavalry.

Appears on

Company Muster Roll

for Nov. & Dec., 1864.

Present or absent Present

Stoppage, \$ 100 for

Due Gov't, \$ 100 for

Valuation of horse, \$ 100

Valuation of horse equipments, \$ 100

Remarks:

Book mark:

George Washington

175 | 4 Cav. | U.S.C.T.

George Washington ¹⁷⁵
Pvt., Co. L, 4 Reg't U. S. Col'd Cavalry.

Appears on

Company Muster Roll

for Jan. & Feb., 1865.

Present or absent Present

Stoppage, \$ 100 for

Due Gov't, \$ 100 for

Valuation of horse, \$ 100

Valuation of horse equipments, \$ 100

Remarks:

Book mark:

Lerring

4 Cav. | U. S. C. T.

George Washington 2d
Pr, Co. G, 4 Reg't U. S. Col'd Cavalry.

Appears on

Company Muster Roll

for *Men & Apr*, 186*5*.

Present or absent *Present*

Stoppage, \$ 100 for

Due Gov't, \$ 100 for

Valuation of horse, \$ 100

Valuation of horse equipments, \$ 100

Remarks: *found by trumpet*
in Co. L. dated
from Co L Mar 24
in Co L Apr 28 dated
rd 220 Dept. Geny
Jan 28, 65

Book mark:

[Signature]
Copyist.

A | **4 Cav. | U.S.C.T.**

George Washington "

Appears with rank of *Co. G.* on

Muster and Descriptive Roll of a Detachment of U. S. Vols. forwarded

for the 4 Reg't U. S. Col'd Cavalry. Roll dated

Fort Hudson, La., April 29, 1865.

Where born *Louisiana,*

Age *2* y'rs; occupation *Palmer*

When enlisted *May 13*, 1864.

Where enlisted *Madrid*

For what period enlisted *13* years.

Eyes *Dark*; hair *Dark*

Complexion *Dark*; height *5* ft. *1* in.

When mustered in *June 2*, 1864.

Where mustered in *New Orleans*

Bounty paid \$ *100*; due \$ *100*

Where credited

Company to which assigned *G*

Remarks: *Transferred from I*

Company by consolidation.

Book mark:

H.C. Tyles
Copyist.

W 4 Cav. | U.S.C.T.

George Washington 2d
Pvt, Co. G, 4 Reg't U. S. Col'd Cav.

Appears on

M. and D. Roll of Men Transferred

to the organization named above, by consol,
from Co. K

Roll dated Port Hudson La, Apr 29, 1865.

When enlisted May 13, 1864.

Period for which enlisted 3 years.

When mustered in June 22, 1864.

Present or absent Not stated

Company to which assigned G.

Remarks:

Book mark :

(342)

J. L. Leonard

Copyist.

11 | **4 Cav. | U.S.C.T.**

George Washington
Pr, Co. G, 4 Reg't U. S. Col'd Cavalry.

Appears on

Company Muster Roll

for *May & June*, 1865 :

Present or absent *Present*

Stoppage, \$ *100* for

Due Gov't, \$ *100* for

Valuation of horse, \$ *100*

Valuation of horse equipments, \$ *100*

Remarks:
.....
.....
.....
.....
.....
.....
.....
.....
.....
.....

Book mark :

[Signature]
Copyist.

H

4 Cav. | U. S. C. T.

George Washington 2d
Pr, Co. G, 4 Reg't U. S. Col'd Cavalry.

Appears on

Company Muster Roll

for *July & Aug*, 1867.

Present or absent *Present*

Stoppage, \$ *100* for

Due Gov't, \$ *100* for

Valuation of horse, \$ *100*

Valuation of horse equipments, \$ *100*

Remarks:

Book mark:

Quinn

W | **4 Cav.** | **U.S.C.T.**

George Washington 2^d
CW, Co. G, 4 Reg't U. S. Col'd Cavalry.

Appears on

Company Muster Roll

for *Sept & Oct*, 1865.

Present or absent *Present*

Stoppage, \$.....100 for

Due Gov't, \$.....100 for

Valuation of horse, \$.....100

Valuation of horse equipments, \$.....100

Remarks:

NEXT MILL ON FILE 1860-1865

Book mark:

Fletcher

W

4 Cav. | U.S.C.T.

George Washington 2^d
Priv, Co. G, 4 Reg't U. S. Col'd Cavalry.

Appears on

Company Muster Roll

for *Jan & Feb*, 186*6*.

Present or absent *Present*

Stoppage, \$ *100* for

Due Gov't, \$ *100* for

Valuation of horse, \$ *100*

Valuation of horse equipments, \$ *100*

Remarks:

Book mark: *George Washington*

Fletcher

W | **4 Cav.** | **U.S.C.T.**

George Washington 2^d
Port, Co. 2, 4 Reg't U. S. Colored Cav.

Appears on **Returns** as follows:

Aug 1864 - On duty gone with Regt.
 G. M. for horses
 Sept 1864 - On duty Co. Cook
 Oct 1864 - On duty Co. Cook
 Nov 1864 to Jan 1865 - On duty detailed
 as food book.

Book mark: _____

W. R. Lee

24 | 4 Cav. | U.S.C.T.

George Washington 2^d
Pi Co. G, 4 Reg't U. S. Col'd Cavalry.

Appears on Co. Muster-out Roll, dated
New Orleans La & Mich 20, 1866.

Muster-out to date Nov 20, 1866.

Last paid to June 30, 1865.

Clothing account:

Last settled....., 186 ; drawn since \$..... 100

Due soldier \$..... 100; due U. S. \$..... 6 50/100

Am't for cloth'g in kind or money adv'd \$..... 100

Due U. S. for arms, equipments, &c., \$..... 100

Bounty paid \$..... 100; due \$..... 100

Remarks: joined by transfer from
Co L in S. O. 28 Va. Inf.
Sept. 28. 65.

Book mark: V133 P 24, 71

J. Fletcher

MAR 17

1111

Washington George [3]

Co L, 4 U. S. Col'd Cav.

Private Private

CARD NUMBERS.

1	5347689	26
2	5347695	27
3	5358671	28
4	5358727	29
5	5348143	30
6	40729315	31
7		32
8		33
9		34
10		35
11		36
12		37
13		38
14		39
15		40
16		41
17		42
18		43
19		44
20		45
21		46
22		47
23		48
24		49
25		50

Book Mark:

See also

A | **4 Cav. | U.S.C.T.**

George Washington, 3^d

Appears with rank of *Pvt* on

Muster and Descriptive Roll of a Detachment of U. S. Vols. forwarded

for the 4 Reg't U. S. Col'd Cavalry. Roll dated

New Orleans La June 22, 186⁴

Where born *La*

Age *22* y'rs; occupation *Labourer*

When enlisted *June 15*, 186⁴

Where enlisted *New Orleans*

For what period enlisted *3* years.

Eyes *Blk*; hair *Blk*

Complexion *Sk*; height *5 ft. 10 in.*

When mustered in *June 22*, 186⁴

Where mustered in *New Orleans*

Bounty paid \$ *100*; due \$ *100*

Where credited *to New Orleans La*

Company to which assigned *F*

Remarks:

Book mark:

Jauffrot

W. | **4 Cav. | U.S.C.T.**

George Washington B

Appears with rank of *Pvt* on

Muster and Descriptive Roll of a Detachment of U. S. Vols. forwarded

for the 4 Reg't U. S. Col'd Cavalry. Roll dated

New Orleans La July 18, 186*4*.

Where born *Pa*

Age *22* y'rs; occupation *Laborer*

When enlisted *June 15*, 186*4*.

Where enlisted *New Orleans*

For what period enlisted *3* years.

Eyes *Blk*; hair *Blk*

Complexion *Dark*; height *5* ft. *10* in.

When mustered in *June 22*, 186*4*.

Where mustered in *New Orleans*

Bounty paid \$ *100*; due \$ *100*

Where credited *to New Orleans La*

Company to which assigned *I*

Remarks:

Book mark:

Washington

H | 4 Cav. | U.S.C.T.

George Washington 3rd
Pvt., Co. *L*, 4 Reg't U. S. Col'd Cavalry.

Age years.

Appears on

Company Muster Roll*

for *Enlistment to Aug. 31*, 1864.

Joined for duty and enrolled:

When *June 5*, 1864.

Where *New Orleans La.*

Period *3* years.

Mustered in:

When *June 22*, 1864.

Where *New Orleans La.*

Present or absent *Absent*

Stoppage, \$ *100* for

Due Gov't, \$ *100* for

Valuation of horse, \$ *100*

Valuation of horse equipments, \$ *100*

Remarks: *Absent without leave since June 15th 1864*

* First current roll. No muster-in roll of this battery on file.

Book mark :

Leering

H | 4 Cav. | U.S.C.T.

George Washington^{3rd}
U.S., Co. L, 4 Reg't U. S. Col'd Cavalry.

Appears on

Company Muster Roll

for *Sept. & Oct.*, 1864.

Present or absent

Stoppage, \$ 100 for

Due Gov't, \$ 100 for

Valuation of horse, \$ 100

Valuation of horse equipments, \$ 100

Remarks: *Discharged June 30th*
1864 at New Orleans La.

No work for Co.

Book mark:

Leering

(358)

Copyist.

10 | 4 Cav. | U.S.C.T.

George Washington 3d
Pvt., Co. 2, 4 Reg't U. S. Colored Cav.

Appears on Returns as follows:

July 1861. Absent without leave

Aug 1861 - Absent without leave
since June 15/61

Sept 1861 - 2000; June 15/61
New Orleans Deserted.

Book mark:

W. R. Lee

10. 17 Wady | **U.S.C.T.**

George Washington
1st, Co. A, 7 Reg't U. S. Col'd Wady

Appears on a

Detachment Muster-out Roll

of the organization named above. Roll dated
New Orleans La, Mar 20, 1866 .

Muster-out to date 186 .

Last paid to 186 .

Clothing account:

Last settled....., 186 ; drawn since \$..... 100

Due soldier \$..... 100; due U. S. \$..... 100

Am't for cloth'g in kind or money adv'd \$..... 100

Due U. S. for arms, equipments, &c., \$..... 100

Bounty paid \$..... 100; due \$..... 100

Remarks: Initial & original
organization. Discharged at
New Orleans La June 15, 1864.

Book mark:

(349) F. H. Hasset Copyist.

1112

Washington George C.

Co F, 4 U. S. Col'd Cav.

Private Private

CARD NUMBERS.

1	5354996	26
2	5355085	27
3	5355177	28
4	53552610	29
5	5356193	30
6	40729310	31
7		32
8		33
9		34
10		35
11		36
12		37
13		38
14		39
15		40
16		41
17		42
18		43
19		44
20		45
21		46
22		47
23		48
24		49
25		50

Book Mark:

See also

M | **4 Cav.** | **U.S.C.T.**

George C. Washington
Ct, Co. A, Mounted Rangers, Corps d'Afrique. †

Age ----- years.

Appears on

Company Muster Roll*

for *Nov & Dec*, 1863.

Joined for duty and enrolled:

When *Nov 1*, 1863.

Where *Iberia, La*

Period ----- years.

Mustered in:

When *Nov. 30*, 1863.

Where *Iberia, La*

Present or absent *Present*

Stoppage, \$ ----- 100 for -----

Due Gov't \$ ----- 100 for -----

Valuation of horse, \$ ----- 100

Valuation of horse equipments, \$ ----- 100

Remarks: -----

† This organization subsequently became Co. F, 4 U. S. Col'd Cav.
* First current roll. No muster-in roll of this ~~battery~~ on file.

Book mark: -----

Manning
(3586) Copyist.

M

4 Cav. | U.S C.T.

George C. Washington
Pvt, Co. *F*, 1 Reg't Cav., Corps d'Afrique.*

Appears on

Company Muster Roll

for *July 2*, 186*4*

Present or absent *Present*

Stoppage, \$ *100* for

Due Gov't, \$ *100* for

Valuation of horse, \$ *100*

Valuation of horse equipments, \$ *100*

Remarks:

* This organization subsequently became Co. *F*, 4 Reg't U. S. Colored Cavalry.

Book mark:

Manning
Copyist.

W | **4 Cav.** | **U.S.C.T.**

G. C. Washington

Pr, Co. F, 4 Reg't U. S. Col'd Cavalry.

Appears on

Company Muster Roll

for *March & April*, 1864.

Present or absent *Absent*

Stoppage, \$.....100 for.....

Due Gov't, \$.....100 for.....

Valuation of horse, \$.....100

Valuation of horse equipments, \$.....100

Remarks: *Sick in Regt Hospital since April 27, 1864*

Book mark:

(358)

W. J. ...
Copyist.

M | 4 Cav. | U.S.C.T.

George Washington
Pr, Co. F, 4 Reg't U. S. Col'd Cavalry.

Appears on

Company Muster Roll

for *May 9th June*, 186*4*

Present or absent *Present*

Stoppage, \$.....*100* for

Due Gov't, \$.....*100* for

Valuation of horse, \$.....*100*

Valuation of horse equipments, \$.....*100*

Remarks:

.....
.....
.....
.....
.....
.....
.....
.....

Book mark:

Manning
Copyist.

W | **4 Cav.** | **U.S.C.T.**

George L. Washington
Priv., Co. F, 4 Reg't U. S. Colored Cav.

Appears on **Returns** as follows:

Apr 1864 - Absent sent Apr 27/64
to Depot Dept Towns Build-
ing
May to July 1864 Absent without
leave from Camp Colfax
since May 30/64
Aug 1864 - 5022; June 22
Greenville Reserled.
Oct 1864 - On duty fo. Cook

Book mark:

W. R. Zee

W | **4 Cav.** | **U.S.C.T.**

Geo. C. Washington

P, Co. F, 4 Reg't U. S. Col'd Cavalry.

Appears on **Co. Muster-out Roll**, dated New Orleans, La., Feb. 20 1866.

Muster-out to date _____, 186 .

Last paid to _____, 186 .

Clothing account:

Last settled _____, 186 ; drawn since \$ _____ 100

Due soldier \$ _____ 100; due U. S. \$ 19. 60 / 100

Am't for cloth'g in kind or money adv'd \$ _____ 100

Due U. S. for arms, equipments, &c., \$ _____ 100

Bounty paid \$ _____ 100; due \$ _____ 100

Remarks: joined at orig. org.
Deserted May 30, 64, at
Greenville, La.

Book mark: _____

(361)

Hibbard
Copyist.

1113

Washington, Joseph

Co D, 4 U. S. Col'd Cav.

Private Private

CARD NUMBERS.

1	5349864	26
2	5349962	27
3	5350057	28
4	5350163	29
5	5350257	30
6	5350345	31
7	5350425	32
8	5350499	33
9	5350574	34
10	5350660	35
11	5350745	36
12	5350840	37
13	5350926	38
14	5351010	39
15	5351092	40
16	5351173	41
17		42
18		43
19		44
20		45
21		46
22		47
23		48
24		49
25		50

Book Mark:

See also

H | **4 Cav. U.S.C.T.**

Joseph Washington
Co. *B*, 1 Reg't La. Cav., Corps d'Afrique.*

Appears on

Company Muster-in Roll

of the organization named above. Roll dated
New Orleans, La., Oct 27, 186 *3*.
Muster-in to date *Oct 27,* 186 *3*.

Joined for duty and enrolled:

When *Oct 2*, 186 .
Where *New Orleans*
Period *3* years.

Valuation of horse, \$ *100*

Valuation of horse equipments, \$ *100*

Remarks: *Age 21*

*This organization subsequently became Co. *B* 4 Reg't U. S. Colored Cavalry.

Book mark: _____

Amey
DP

24

4 Cav. U.S.C.T.

Joseph Washington
Co. B, 1 Reg't La. Cav., Corps d'Afrique.*

Appears on

Company Muster Roll

for Oct 27 to Dec 31, 1863

Present or absent Present

Stoppage, \$ 100 for

Due Gov't, \$ 100 for

Valuation of horse, \$ 100

Valuation of horse equipments, \$ 100

Remarks:

*This organization subsequently became Co. B, 4 Reg't U. S. Colored Cavalry.

Book mark:

Copyist.

W | **4 Cav. U.S C.T.**

Joseph Washington
*Cpl., Co. B, 1 Reg't Cav., Corps d'Afrique.**

Appears on

Company Muster Roll

for *Jan & Feb*, 1864.

Present or absent *Present*

Stoppage, \$ *100* for

Due Gov't, \$ *100* for

Valuation of horse, \$ *100*

Valuation of horse equipments, \$ *100*

Remarks:

* This organization subsequently became Co. *B*, 4 Reg't U. S. Colored Cavalry.

Book mark: -----

Amey
Copyist.

W. | **4 Cav.** | **U.S.C.T.**

Joseph Washington
Scott, Co. B. 4 Reg't U. S. Col'd Cavalry.

Appears on

Company Muster Roll

for *March & Apr*, 1864.

Present or absent *Present*

Stoppage, \$ 100 for

Due Gov't, \$ 100 for

Valuation of horse, \$ 100

Valuation of horse equipments, \$ 100

Remarks :

Book mark :

W. Scott
Copyist.

W

4 Cav. U.S.C.T.

Joseph Washington

Private, Co. B. 4 Reg't U. S. Col'd Cavalry.

Appears on

Company Muster Roll

for *May & June*, 1864.

Present or absent *Present*

Stoppage, \$ 100 for

Due Gov't, \$ 100 for

Valuation of horse, \$ 100

Valuation of horse equipments, \$ 100

Remarks :

Book mark :

W

W | **4 Cav.** | **U.S.C.T.**

Joseph Washington
Pr, Co. B. 4 Reg't U. S. Col'd Cavalry.

Appears on

Company Muster Roll

for *July & Aug.*, 186*4*.

Present or absent *Present*

Stoppage, \$ *100* for

Due Gov't, \$ *100* for

Valuation of horse, \$ *100*

Valuation of horse equipments, \$ *100*

Remarks :

.....
.....
.....
.....
.....
.....
.....
.....

Book mark :

.....

Pr
Coptist

H | **4 Cav.** | **U.S.C.T.**

Joseph Washington
Co. B., Co. B. 4 Reg't U. S. Col'd Cavalry.

Appears on

Company Muster Roll

for *Sept & Oct*, 186*4*.

Present or absent *Present*

Stoppage, \$ *100* for

Due Gov't, \$ *100* for

Valuation of horse, \$ *100*

Valuation of horse equipments, \$ *100*

Remarks :

Book mark :

(358) *J. J. P.* Copyist.

W | **4 Cav. U.S.C.T.**

Joseph Washington

priv., Co. B. 4 Reg't U. S. Col'd Cavalry.

Appears on

Company Muster Roll

for *Nov & Dec*, 1864.

Present or absent *present*

Stoppage, \$ 100 for

Due Gov't, \$ 100 for

Valuation of horse, \$ 100

Valuation of horse equipments, \$ 100

Remarks: *Stop for one Sabre
knob one more bag. 2 spurs
& straps.*

Book mark:

Forner

W | **4 Cav.** | **U.S.C.T.**

Joseph Washington
pot, Co. B. 4 Reg't U. S. Col'd Cavalry.

Appears on

Company Muster Roll

for Jan & Feb, 1865.

Present or absent present

Stoppage, \$ 100 for

Due Gov't, \$ 100 for

Valuation of horse, \$ 100

Valuation of horse equipments, \$ 100

Remarks: Received only \$7 a
month to include Apr 30/64
Stop for 1 Sable Knot. Nose
bag. 2 spurs & Straps.

Book mark:

L. J. Jones

W | **4 Cav.** | **U.S.C.T.**

Joseph Washington
priv., Co. B. 4 Reg't U. S. Col'd Cavalry.

Appears on

Company Muster Roll

for *Mch + Apr*, 186*3*.

Present or absent *present*

Stoppage, \$ *100* for

Due Gov't, \$ *100* for

Valuation of horse, \$ *100*

Valuation of horse equipments, \$ *100*

Remarks :

Book mark :

Spencer

27 | 4 Cav. | U.S.C.T.

Joseph Washington
Svt., Co. B. 4 Reg't U. S. Col'd Cavalry.

Appears on

Company Muster Roll

for May June, 1863.

Present or absent present

Stoppage, \$ 100 for

Due Gov't, \$ 100 for

Valuation of horse, \$ 100

Valuation of horse equipments, \$ 100

Remarks: Stoppage 1 Sabre Knive
2 Spurs + 2 Tapes.

Book mark:

W | **4 Cav.** | **U.S.C.T.**

Joseph Washington

priv., Co. B. 4 Reg't U. S. Col'd Cavalry.

Appears on

Company Muster Roll

for *July & Aug*, 186*4*.

Present or absent *present*

Stoppage, \$ *100* for

Due Gov't, \$ *100* for

Valuation of horse, \$ *100*

Valuation of horse equipments, \$ *100*

Remarks :

Book mark :

L. J. ...

(358) Copyist.

W

4 Cav. U.S.C.T.

Joseph Washington
priv., Co. B. 4 Reg't U. S. Col'd Cavalry.

Appears on

Company Muster Roll

for *Sept & Oct.*, 186*9*.

Present or absent *present*

Stoppage, \$ *100* for

Due Gov't, \$ *100* for

Valuation of horse, \$ *100*

Valuation of horse equipments, \$ *100*

Remarks :

Book mark :

J. S. ...

W | **4 Cav. | U.S.C.T.**

Joseph Washington

Priv, Co. B. 4 Reg't U. S. Col'd Cavalry.

Appears on

Company Muster Roll

for *Nov. & Dec.*, 1865.

Present or absent *Present*

Stoppage, \$ *100* for

Due Gov't, \$ *100* for

Valuation of horse, \$ *100*

Valuation of horse equipments, \$ *100*

Remarks :

Book mark :

Chaudin

7 | **4 Cav. | U.S.C.T.**

Joseph Washington

Priv., Co. B. 4 Reg't U. S. Col'd Cavalry.

Appears on

Company Muster Roll

for *Jan. & Feb.*, 1866.

Present or absent *Present*

Stoppage, \$ 100 for

Due Gov't, \$ 100 for

Valuation of horse, \$ 100

Valuation of horse equipments, \$ 100

Remarks :

Book mark :

Chandler

W | **4 Cav.** | **U.S.C.T.**

Joseph Washington
For, Co. *B*, 4 Reg't U. S. Col'd Cavalry.

Appears on **Co. Muster-out Roll**, dated
New Orleans, La. Feb. 20 1866.

Muster-out to date *Feb. 20* 1866.

Last paid to *June 30*, 1865.

Clothing account:

Last settled....., 186 ; drawn since \$.....100

Due soldier \$ *34*^{*76*} 100; due U. S. \$.....100

Am't for cloth'g in kind or money adv'd \$.....100

Due U. S. for arms, equipments, &c., \$.....100

Bounty paid \$.....100; due \$.....100

Remarks: *Joined ar Orgl org.*

Book mark: *V. 25, P. 75, 68, V. 220, P.*
180, 75.

(361) *L. Chausse*
Copyist.

1114

Washington Peter

Co - , 4 U. S. Col'd Cav.

Private Private

CARD NUMBERS.

1	5347527	26
2		27
3		28
4		29
5		30
6		31
7		32
8		33
9		34
10		35
11		36
12		37
13		38
14		39
15		40
16		41
17		42
18		43
19		44
20		45
21		46
22		47
23		48
24		49
25		50

Book Mark:

See also

4 Cav. U.S.C.T.

+ Peter Washington

Appears with rank of Private on

Muster and Descriptive Roll of a Detachment of U. S. Vols. forwarded

for the 4 Reg't U. S. Col'd Cavalry. Roll dated New Orleans, La, Apr. 25, 1865.

Where born St. Andrews, La

Age 36 y'rs; occupation Laborer

When enlisted Apr. 9, 1865.

Where enlisted New Orleans, La

For what period enlisted 3 years.

Eyes Black; hair Black

Complexion Mulatto; height 5 ft 11 in.

When mustered in Apr. 25, 1865.

Where mustered in New Orleans.

Bounty paid \$ 100 100; due \$ 200 100

Where credited 1st Dist. 2nd Ward, Orleans, New Orleans, La

Company to which assigned Co.

Remarks: Absent from Muster.

+ Entry cancelled on Roll by line.

Book mark:

O. J. Taylor

Washington, Peter
Reed, Co. 41 Reg't U.S.Cav.

2 Enclosures.

Bed Cards	Descriptive Lists
Burial Records /	Final Statements
Certs. of Dis. for Discharge	Furloughs
C. M. Charges	Med. Des. Lists
Med. Certificates	Orders

Other papers relating to—

Admission to Hosp'l	Furlough
Casualty Sheet (Officer's)	Med. Examination
Confinement	Misc. Information
Contracts	Pay or Clothing
Death or Effects /	Personal Reports
Desertions	Rank
Discharge from Hosp'l	Transfer to Hosp'l
Discharge from Service	Transfer to V. R. C.
Duty	Transportation

1865

1865 -

Peter Washington

Recd.

4th of Oct

COPY OF RECORD

FOR THE

ADJUTANT GENERAL U. S. ARMY.

A. G.

Oct. 22 '66

Draw of effects sent
to Auditor

B. C.



No. 2.

RECORD OF DEATH AND INTERMENT.

Name and number of person interred,	<i>Peter Washington</i>	
Number and locality of the grave, -		
Hospital number of the deceased, -	<i>5237</i>	
Regiment, Rank, and Company, - -	<i>4th U. S. Col. Cav. - Recruit</i>	
Residence before enlistment, - - -		
Conjugal condition (and if married,) the residence of the widow,)		
Cause of death,)	<i>Smallpox</i>	
Age of the deceased, - - - - -		
Nativity, - - - - -		
References and Remarks, - -)		
Date of death and burial, - - -	<i>April 28/65</i>	186

[A duplicate of this Record has been forwarded to the Sexton, and the other remains at this Hospital.]

To *Adj. General U. S. A.*
SIR :

It becomes my duty to inform you that the person above described died at this Hospital as herein stated: and that it is desired his remains should be interred with the usual military honors.

Respectfully,

J. E. Piquette
Surgeon U. S. Army.
in charge

MILITARY HOSPITAL, *Corps d'Afrique, N Orleans*
La.

This copy of Record is to be transmitted to the Adjutant General at Washington immediately after the place of burial and the number of the grave have been ascertained and registered. The above notification is to remain attached.

No Description List e

ARTICLES OF WAR.

ART. 95. When any non-commissioned officer or soldier shall die, or be killed in the service of the United States, the then commanding officer of the troop or company shall, in the presence of two other commissioned officers, take an account of what effects he died possessed of, above his arms and accoutrements, and transmit the same to the office of the Department of War, which said effects are to be accounted for, and paid to the representatives of such deceased non-commissioned officer or soldier. And in case any of the officers, so authorized to take care of the effects of deceased officers and soldiers, should, before they have accounted to their representatives for the same, have occasion to leave the regiment or post, by preferment or otherwise, they shall, before they be permitted to quit the same, deposit in the hands of the commanding officer, or of the assistant military agent, all the effects of such deceased non-commissioned officers and soldiers, in order that the same may be secured for, and paid to, their respective representatives.

ARMY REGULATIONS—EDITION OF 1861.

DECEASED SOLDIERS.

Par. 152. Inventories of the effects of deceased non-commissioned officers and soldiers, required by the 95th Article of War, will be forwarded to the Adjutant General, by the commander of the company to which the deceased belonged, and a duplicate of the same to the colonel of the regiment. Final statements of pay, clothing, &c., will be sent with the inventories. When a soldier dies at a post or station absent from his company, it will be the duty of his immediate commander to furnish the required inventory, and, at the same time, to forward to the commanding officer of the company to which the soldier belonged, a report of his death, specifying the date, place, and cause; to what time he was last paid, and the money or other effects in his possession at the time of his decease; which report will be noted on the next muster roll of the company to which the man belonged. Each inventory will be endorsed, "Inventory of the effects of _____, late of company (—) _____ regiment of _____, who died at _____, the _____ day of _____, 186—." If a legal representative receive the effects, it will be stated in the report. If the soldier leave no effects, the fact will be reported.

Par. 153. Should the effects of a deceased non-commissioned officer or soldier not be administered upon within a short period after his decease, they shall be disposed of by a Council of Administration, under the authority of the commanding officer of the post, and the proceeds deposited with the Paymaster, to the credit of the United States, until they shall be claimed by the legal representatives of the deceased.

Par. 154. In all such cases of sales by the Council of Administration, a statement in detail, or account of the proceeds, duly certified by the Council and commanding officer, accompanied by the Paymaster's receipt for the proceeds, will be forwarded by the commanding officer to the Adjutant General. The statement will be endorsed, "Report of the proceeds of the effects of _____, late of company (—) _____ regiment of _____, who died at _____, the _____ day of _____, 186—."

NOTE 1.—The effects in all cases, when called for, should be turned over to the legal representative, without further authority from the Adjutant General. When the effects are turned over to the relatives of the deceased before these inventories are sent to the Adjutant General, their receipts therefor should be attached to the inventories. In all other cases, one copy will be sent with a letter of transmittal direct to the Adjutant General, and a duplicate retained by the officer.

NOTE 2.—Particular care should be taken to take receipts in duplicate from the Paymaster for any funds turned over to him; one copy should be sent direct to the Adjutant General and one retained by the officer.

INVENTORY OF THE EFFECTS

OF

Peter Washington (Recruit)

Late of Company

4th Reg't of U.S. Col. Cav

Volunteers, who died at New Orleans La

on the 28 day of April 1865.

Admitted from Recruiting Depot Tent Building New Orleans La

1115

Washington, Ralph

Co A, 4 U. S. Col'd Cav.

Private Private

CARD NUMBERS.

1	5347927	26
2	5357224	27
3	5357280	28
4	5357333	29
5	5357389	30
6	5357441	31
7	5357490	32
8	5357540	33
9	5358106	34
10	40729312	35
11		36
12		37
13		38
14		39
15		40
16		41
17		42
18		43
19		44
20		45
21		46
22		47
23		48
24		49
25		50

Book Mark:

See also

M | **4 Cav. | U.S.C.T.**

Ralph Washington

Appears with rank of *Private* on

Muster and Descriptive Roll of a Detachment of U. S. Vols. forwarded

for the 4 Reg't U. S. Col'd Cavalry. Roll dated

New Orleans, La, April 4, 1864.

Where born *New Orleans, La*

Age *22* y'rs; occupation *Barber*

When enlisted *Apr 1*, 1864

Where enlisted *New Orleans*

For what period enlisted *3* years.

Eyes *Black*; hair *Black*

Complexion *Yellow*; height *5* ft. *3* in.

When mustered in *Apr 8*, 1864

Where mustered in *New Orleans*

Bounty paid \$ *100*; due \$ *100*

Where credited

Company to which assigned *H*

Remarks :

Book mark :

Sallade
Copyist.

W | **4 Cav.** | **U.S.C.T.**

Ralph Washington
Priv., Co. H, 4 Reg't U. S. Col'd Cavalry.

Appears on

Company Muster-in and Descriptive Roll

of the organization named above. Roll dated

New Orleans, La, Apr., 8, 1864.

Where born *New Orleans, La*

Age *22* y'rs; occupation *Barber*

When enlisted *Apr., 1*, 1864.

Where enlisted *New Orleans, La*

For what period enlisted *3* years.

Eyes *black*; hair *black*

Complexion *yellow*; height *5* ft. *3* in.

When mustered in *Apr., 8, 1864*

Where mustered in *New Orleans, La.*

Bounty paid \$ *2* 100; due \$ 100

Where credited.....

Company to which assigned.....

Remarks:.....

.....

.....

.....

Book mark:.....

.....

.....

.....

(356d)

L. Williams
Copyist.

W | **4 Cav. | U.S.C.T.**

Ralph Washington

Priv., Co. H, 4 Reg't U. S. Col'd Cavalry.

Appears on

Company Muster Roll

for *Apr. 8 to 30*, 1864.

Present or absent.....

Stoppage, \$.....100 for.....

Due Gov't, \$.....100 for.....

Valuation of horse, \$.....100

Valuation of horse equipments, \$.....100

Remarks: *Deserted.*
Sue the United States
for ordnance 11.77

Book mark:.....

S. Williams
Copyist.

W | **4 Cav. | U.S.C.T.**

Ralph Washington

Plt, Co. H, 4 Reg't U. S. Col'd Cavalry.

Appears on

Company Muster Roll

for *May & June*, 186*4*

Present or absent *Present*

Stoppage, \$ *100* for

Due Gov't, \$ *11 ²² / 100* for *advance*

Valuation of horse, \$ *100*

Valuation of horse equipments, \$ *100*

Remarks:

Book mark:

L. Williams
Copyist.

W | **4 Cav.** | **U.S.C.T.**

Ralph Washington
Pvt., Co. H, 4 Reg't U. S. Col'd Cavalry.

Appears on

Company Muster Roll

for *July & Aug.*, 186*4*

Present or absent *Present*

Stoppage, \$ 100 for

Due Gov't, \$ 100 for

Valuation of horse, \$ 100

Valuation of horse equipments, \$ 100

Remarks:

Book mark:

L. Williams

(358)

Copyist.

W | **4 Cav.** | **U.S.C.T.**

Ralph Washington
Pvt., Co. H, 4 Reg't U. S. Col'd Cavalry.

Appears on

Company Muster Roll

for *Sept. & Oct.*, 186*4*

Present or absent *Present*

Stoppage, \$ *100* for

Due Gov't, \$ *66*/*100* for *advance*

(wipes, sponge & gunning)

Valuation of horse, \$ *100*

Valuation of horse equipments, \$ *100*

Remarks:

Book mark:

C. Williams

NOV 22 1864

W | **4 Cav.** | **U.S.C.T.**

Ralph Washington
Priv., Co. H, 4 Reg't U. S. Col'd Cavalry.

Appears on

Company Muster Roll

for *Nov. & Dec.*, 1864

Present or absent *Present.*

Stoppage, \$ $\frac{66}{100}$ for *one spring*
and musket sling & wiper.

Due Gov't, \$ $\frac{100}{100}$ for

Valuation of horse, \$ $\frac{100}{100}$

Valuation of horse equipments, \$ $\frac{100}{100}$

Remarks:

Book mark:

L. Williams

(358)

Copyist.

W | 4 Cav. | U.S.C.T.

Ralph Washington
Pot., Co. H, 4 Reg't U. S. Col'd Cavalry.

Appears on

Company Muster Roll

for Jan. 1, Feb., 1865.

Present or absent

Stoppage, \$ 100 for

Due Gov't, \$ 100 for

Valuation of horse, \$ 100

Valuation of horse equipments, \$ 100

Remarks: Discharged on Final
Statements given. Dis-
charged on Surgeon's
Certificate of Disability,
Feb 11/65:

Due U.S. (Spring vice
Musket shing & Wiper) 166 cts.

Book mark:

Peaster

115 | 4 Cav. | U.S.C.T.

Ralph Washington
Priv., Co. H, 4 Reg't U. S. Colored Cav.

Appears on Returns as follows:

Apr 1864 - Absent deserted Apr
15/64

Aug 1864 - On duty Carpenter
at Gen. Hosp. Port Hudson
La.

Sept 1864 - On duty Carpenter
on Port Hospital

Oct 1864 - On duty Carpenter on Port Hospital.

Feb 1865 - Loss: Feb 11/65
Port Hudson La. Dischgd.
for disability

Book mark:

W. R. Lee

9

4 Cav. U.S.C.T.

Ralph Washington
Pi, Co. H, 4 Reg't U. S. Col'd Cavalry.

Appears on Co. Muster-out Roll, dated
New Orleans La. Mar 20, 1864.

Muster-out to date _____, 186 .
Last paid to _____, 186 .

Clothing account:

Last settled _____, 186 ; drawn since \$ _____ 100
Due soldier \$ _____ 100; due U. S. \$ _____ 100
Am't for cloth'g in kind or money adv'd \$ _____ 100

Due U. S. for arms, equipments, &c., \$ _____ 100
Bounty paid \$ _____ 100; due \$ _____ 100

Remarks: Joined at Org'l
Org'n. Discharged on
Surgeon's Certificate of
Disability, Feb 11/65
at Port Hudson La.
Final statements forwarded

Book mark: _____

H. E. Howard

Washington, Ralph

P, Co A, 4 Reg't U.S.C. Cav.

Enclosures.

Bed Cards	Descriptive Lists
Burial Records	Final Statements
Certs. of Dis. for Discharge	Furloughs
C. M. Charges	Med. Des. Lists
Med. Certificates	Orders

Other papers relating to—

Admission to Hosp'l	Furlough
Casualty Sheet (Officer's)	Med. Examination
Confinement	Misc. Information
Contracts	Pay or Clothing
Death or Effects	Personal Reports
Desertions	Rank
Discharge from Hosp'l	Transfer to Hosp'l
Discharge from Service	Transfer to V. R. C.
Duty	Transportation

D. W. 42 R of 95
1511

CERTIFICATE OF DISABILITY FOR DISCHARGE

IN THE CASE OF

Ralph Washington
a *Private* Co. *H.*
Smith Reg't of *U.S.C.*

Office Surgeon in Chief
District of Baton Rouge & Fort Hudson
January 24th 1865
Respectfully Approved
Chas. A. Green
Surgeon 2nd La. Vol. Infy
In Charge District of Baton Rouge & Fort Hudson

NOTE 1.

The company commander will here add a statement of all the facts known to him concerning the disease or wound, or cause of disability of the soldier; the time, place, manner, and all the circumstances under which the injury occurred, or disease originated or appeared; the duty, or service, or situation of the soldier at the time the injury was received or disease contracted, stating particularly whether the injury was received or the disease contracted in the line of his duty; and whatever other facts may aid a judgment as to the cause, immediate or remote, of the disability, and the circumstances attending it.

When the facts are not known to the company commander, the certificate of any officer, or affidavit of other person having such knowledge, will be appended—as the surgeon in charge of a hospital, the officer commanding a detachment of recruits, &c., &c.

NOTE 2.

When a probable case for pension, special care must be taken to state the degree of disability—as *2*, *3*, &c., &c.; to describe particularly the disability, wound, or disease, the extent of which it deprives him of the use of any limb or faculty, or affects his health, strength, activity, constitution, or capacity to labor or earn his subsistence. The surgeon will add, from his knowledge of the facts and circumstances, and from the evidence in the case, his professional opinion of the cause or origin of the disability. In the case of discharges by Medical Inspectors, the last paragraph will state that the "discharge was given by consent of the soldier, after a personal examination, and for disability, the nature, degree, and origin of which are correctly described in the within certificate."

Par. 1260 Regulations, Edit. 1861.

Medical officers, in giving certificates of disability, are to take particular care in all cases that have not been under their charge; and especially in epilepsy, convulsions, chronic rheumatism, derangement of the urinary organs, ophthalmia, ulcers, or any obscure disease liable to be feigned or purposely produced; and in no case shall such certificate be given until after sufficient time and examination to detect any attempt at deception.

DIRECTIONS.

This certificate will be made out in duplicate by the soldier's company commander, or other officer commanding the separate detachment to which he belongs, and sent by him to the surgeon who has charge of the hospital where the soldier is sick. The surgeon will then fill out and sign the surgeon's certificate, and forward these papers to the regimental, detachment, or post commander, who will forward them, with his action endorsed thereon, through the proper channel, to his division commander; or, if the troops are not attached to a division, to his corps, department, or other commander or officer to whom the authority to discharge enlisted men may be specially delegated.

These certificates, after having received the action of the highest authority to which they are required to be sent, will be returned through the same channel to the regimental, post, or detachment commander, who will, if the discharge is authorized by the endorsement of the proper authority, sign the soldier's discharge, and the last certificate on this paper; see that the soldier is furnished with the proper final statements in duplicate, and forward BOTH of these certificates direct to the Adjutant General United States Army, at Washington, D. C.; they will not, under any circumstances, be given into the hands of the soldier.

ADJUTANT GENERAL'S OFFICE

Mar 11 1865

Duplicate sent the Pension Office.

Approved Jan 30 5.

[Signature]
Head Quarters Dept of the Gulf
New Orleans Feb 20 1865
To be discharged
By command of
Maj Gen Humboldt
[Signature]
Capt W. A. A. Gannon

Received (A. G. Office) 186

Curtis R. [Signature]
[Signature]

NOV 18 1865

ARMY OF THE UNITED STATES CERTIFICATE OF DISABILITY FOR DISCHARGE.



Sergeant *Ralph Washington*, of Captain *Ralph A. Rowley's* Company, ("36") of the *Fourth* Regiment of the United States *Cavalry* was enlisted by *Francis Beutler* Capt. of the *Fourth* Regiment of *U.S. Col'd Caval* at *New Orleans La* on the *1st* day of *April*, 1864, to serve *3* years; he was born in *New Orleans* in the State of *Louisiana*, is *Twenty two* years of age, *5* feet *3* inches high, *Yellow* complexion, *Blk* eyes, *Blk* hair, and by occupation when enlisted a *Barber*. During the last two months said soldier has been unfit for duty *60 days*.*

This soldier is at present and has been for several months subject to spells that rendered him totally unconscious of all his surroundings. He would wander about senseless being unable to give his name even.

STATION: *Fort Hudson La*
DATE: *Jan 6th 1865*

Ralph A. Rowley
M. J. 4th U.S. Col'd Cavalry,
Commanding Company.

I CERTIFY, that I have carefully examined the said *Ralph Washington* of Captain *Lieut Rowley's* Company, and find him incapable of performing the duties of a soldier because of *Mental derangement approaching Idiocy or Mental Imbecility. This condition existed prior to enlistment. He is unfit for service in Invalid Corps.*

Wm. B. Brown Surgeon 1st U.S. Inf
D. J. Hanson Surg 4th U.S. Cavalry
A. Couel Asst. Surg 1st U.S. Col'd Cavalry Surgeon, 3

DISCHARGED, this *Eleventh* day of *February*, 1865, at *Fort Hudson La*

Wm. Mitchell
Major
Commanding the Reg't.

The Soldier desires to be addressed at

Town *New Orleans* County _____ State *Louisiana*

* See Note 1 on the back of this. † See Note 2 on the back of this.

Office Post Surgeon
 Port Hudson La
 Jan 21 1865
 Respectfully Approved
 W. G. Brown 1st U.S. Inf
 Post Surgeon

1116

Washington Sidney

Co C, 4 U. S. Col'd Cav.

Private Private

CARD NUMBERS.

1	5347529	26
2	5348219	27
3	5352216	28
4	5352309	29
5	5352397	30
6	5352485	31
7	B-163-RCJ-1868	32
8	A-338-RCJ-1866	33
9	40729311	34
10		35
11		36
12		37
13		38
14		39
15		40
16		41
17		42
18		43
19		44
20		45
21		46
22		47
23		48
24		49
25		50

Book Mark: A. 338 R.C.J. 66
B-163 R.C.J-1868

See also

1959 079

S. 2423120 and W.D.
S. 2680728 and W.D.

S. A. Muhlenberg
S.H.

A | **4 Cav.** | **U.S.C.T.**

Sidney Washington

Appears with rank of *Private* on

Muster and Descriptive Roll of a Detachment of U. S. Vols. forwarded

for the 4 Reg't U. S. Col'd Cavalry. Roll dated

New Orleans La, Apr. 25, 1865.

Where born *S. Helena, La.*

Age *32* y'rs; occupation *Laborer*

When enlisted *Apr. 9*, 1865.

Where enlisted *New Orleans La.*

For what period enlisted *3* years.

Eyes *Black*; hair *Black*

Complexion *Black*; height *5 ft. 11* in.

When mustered in *Apr. 25*, 1865.

Where mustered in *New Orleans*

Bounty paid \$ *100* ¹⁰⁰; due \$ *200* ¹⁰⁰

Where credited *1st Div. 2nd Regt. Orleans & New Orleans La.*

Company to which assigned *C.*

Remarks :

Book mark :

O. J. Taylor

W | 4th Cav. | U.S.C.T.

Sidney Washington
 Pvt., Co., 4th Reg't U. S. Col'd Cav.

Appears on

Descriptive List of Deserters

dated Pt. Hudson La. May 21, 1865.

Deserted :

When May 25, 1864.

Where Post Hudson La.

Arrested :

When, 186 .

Where

Remarks :

Unassigned Recruit.

Book mark :

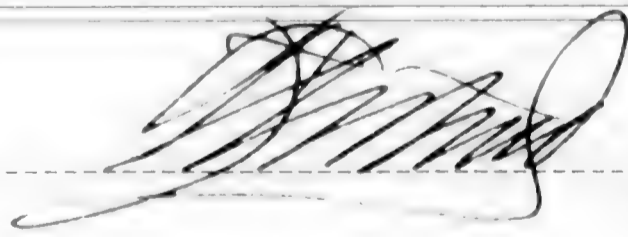

M | **4 Cav.** | **U.S.C.T.**

Sidney Washington
Priv., Co. C, 4 Reg't U. S. Colored Cavalry.

Appears on

Company Muster Roll
 for *Sept & Oct*, 1865.

Present or absent *absent*

Stoppage, \$ 100 for

Due Gov't, \$ 100 for

Valuation of horse, \$ 100

Valuation of horse equipments, \$ 100

Remarks *Absent without*
leave from May 28/65
to Oct 9/65, Now in
arrest in P.G. House
Baton Rouge La.

Just Co roll on which
name is borne,

Book mark:

Moy
 Copyist.

W | **4 Cav. U.S.C.T.**

Sidney Washington
Private, Co. C, 4 Reg't U. S. Colored Cavalry.

Appears on

Company Muster Roll

for *Nov & Dec.*, 186*5*.

Present or absent *absent*

Stoppage, \$ *100* for

Due Gov't, \$ *100* for

Valuation of horse, \$ *100*

Valuation of horse equipments, \$ *100*

Remarks: *Sentenced to loss of all pay & confinement for one year at Fort Jefferson Fla by J. C. M. Gen O. 66 dated Hd Qtrs E. Dist of La New Orleans La Oct 12 1865*

Book mark:

M. A. Michaels

W | **4 Cav. U.S.C.T.**

Sidney Washington
Private, Co. C, 4 Reg't U. S. Colored Cavalry.

Appears on

Company Muster Roll

for *Jan'y + Febr*, 186*6*.

Present or absent *Absent*

Stoppage, \$ *100* for

Due Gov't, \$ *100* for

Valuation of horse, \$ *100*

Valuation of horse equipments, \$ *100*

Remarks: *Sentenced by G.C.M. to confinement for 1 year, pay lost for time confined at Fort Jefferson Fla per G.O. No 66 Hed Acts C. Dist of La. N.O. La Oct 12/65*

Book mark:

M. A. Michaels

(358)

Copyist.

W | **4 Cav.** | **U.S.C.T.**

Sidney Washington
Unassigned
 Port, Co. G, 4 Reg't U. S. Colored Cav.

Appears on Returns as follows:

May 1865 - (Unassigned) Gain: May
 14/65 New Orleans Recruit
 from depot.
 Loss: May 28/65 Port
 Hudson deserted.

Dec 1865 to Feb 1866 - (Port Co. G) Absent
 serving out sentence of G. L. M.
 at Fort Jefferson Fla. since
 Dec 12/65.

Book mark:

W. R. Lee

2 | 4 Cav. | U.S.C.T.

Sidney Washington
Private, Co. *C*, 4 Reg't U. S. Col'd Cavalry.

Appears on Co. Muster-out Roll, dated
New Orleans La, Mar 20, 1866.

Muster-out to date _____, 186 .

Last paid to *Never paid*, 186 .

Clothing account:

Last settled _____, 186 ; drawn since \$ _____ 100

Due soldier \$ *52 47* 100; due U. S. \$ _____ 100

Am't for cloth'g in kind or money adv'd \$ _____ 100

Due U. S. for arms, equipments, &c., \$ _____ 100

Bounty paid \$ *100* 100; due \$ _____ 100

Remarks: *Joined as recruit,
Sentenced Oct 18/65 for desertion
to be confined at hard labor and
to lose all pay for 1 year per G.O.
66 East Dist Oct 12/65 - Absent
in confinement - no discharge furnished*

Book mark: *Dist list on file in Mis. Box - B -
163-2605 RCT/68 - A. 338 vol 4 RCT/66*

M. A. Michaels

W. 4th Cav. U.S.C.

Sidney Washington
Co. #6, 4th Reg't U.S.C. Cav.

NOTATION.

Book mark: A. 338. B. 6. J. 1866.

War Department,

Adjutant General's Office,

Washington, Dec. 6th, 1866.

Call from

returned with report.

The above book mark was noted on rolls in order to
preserve results of search in this case.

*Corrected 6/9/1903. Huston.

E. P. Conzizer,

(475)

Copyist.

M *H. Cavy* *Use*
Sidney Washington
C, *H* *Reg't* *Use Cavy*
, Co.

NOTATION.

Book mark: *B. 163 R. C. P. 1868.*

War Department,

Adjutant General's Office,

Washington, *July 28*, 1868.

Call from

returned with report.

The above book mark was noted on rolls in order to preserve results of search in this case.

A. M. Muzzey
Copyist.

Washington Sidney

Co.

4 Reg't *U.S.C.C.*

Enclosures.

Bed Cards	Final Statements
Burial Records	Furloughs or L. of A.
Certs. of Dis. for Discharge	Med. Certificates
C. M. Charges	Med. Des. Lists
Descriptive Lists	Orders
Discharge Certificates	Pris. of War Record
Enlistment Papers	Resignations

Other papers relating to—

Admission to Hosp'l	Furlough or L. of A.
Casualty Sheet	Med. Examination
Confinement	Misc. Information
Contracts	Pay or Clothing
Death or Effects	Personal Reports
Desertion	Rank
Discharge from Hosp'l	Transfer to Hosp'l
Discharge from Service	Transfer to V. R. C.
Duty	Transportation

RECEIVED

NOTE 1.—This blank will be used for both enlistments and re-enlistments—enlistment of veterans, &c., &c., in the volunteer service. They will be made out in duplicate in all cases—one to accompany the recruiting return of the superintendent (not the recruiting officer) to the Adjutant General, and one to accompany the accounts of the officer who pays bounty, &c. The Regiment and Company in which the soldier last served should be given on the back
NOTE 2.—An enlistment holds to service. A muster-in must, in all cases, precede payment of pay, bounty, pension, &c. A muster-in roll must, in all cases, be filed in the Adjutant General's Office as evidence of muster-in. The mustering officer, commissary, or assistant commissary of musters, as the case may be, will countersign both enlistments as having mustered the soldier into the service of the United States before either of them is given to the disbursing officer.

DECLARATION OF RECRUIT.

I, *Sidney Washington*, desiring to VOLUNTEER as a Soldier in the Army of the United States, for the term of THREE YEARS, Do Declare, That I am *32* years and _____ months of age; that I have never been discharged from the United States service on account of disability or by sentence of a court martial, or by order before the expiration of a term of enlistment; and I know of no impediment to my serving honestly and faithfully as a soldier for three years.

GIVEN at *New Orleans La* the *9* day of *April* 18*65*

Witness:

John Lee Friedman
1st Lieut. 10th U. S. C. & N.Y.

Sidney Washington
mark

Received from Second Auditor
October 7th. 1892.

Discharged 1865
Re-enlisted to the 1st Regt. 10th U.S.C. & N.Y. by order of the Adj. Gen. July 19th 1865

Discharged 18 ..

Reg't of ..

enlistment: last served in Company ()

No
Sidney Washington
Volunteered at *New Orleans La*
April 9 1865
By *Paul W. McArthur*
for the 1st Regiment of *W. S. C. & N.Y.*

CONSENT IN CASE OF MINOR.

I, _____, Do CERTIFY, That I am _____; that the _____ of _____; that the _____ is _____ years of age; and I do hereby freely give my CONSENT to his volunteering as a SOLDIER in the ARMY OF THE UNITED STATES for the period of THREE YEARS.

GIVEN at _____ the _____ day of _____

Witness:

NO 99 992

VOLUNTEER ENLISTMENT.

STATE OF

TOWN OF

Louisiana



New Orleans

I, *Sidney Washington*, born in *S. Helena* in the State of *Louisiana*, aged *thirty two* years, and by occupation a *Laborer*, DO HEREBY ACKNOWLEDGE to have volunteered this *Ninth* day of *April*, 1865, to serve as a **Soldier** in the **Army of the United States of America**, for the period of **THREE YEARS**, unless sooner discharged by proper authority: Do also agree to accept such bounty, pay, rations, and clothing, as are, or may be, established by law for volunteers. And I, *Sidney Washington*, do solemnly swear, that I will bear true faith and allegiance to the **United States of America**, and that I will serve them honestly and faithfully against all their enemies or opposers whomsoever; and that I will observe and obey the orders of the President of the United States, and the orders of the officers appointed over me, according to the Rules and Articles of War.

Sworn and subscribed to, at *New Orleans La.* this *9th* day of *April*, 1865, } *Sidney Washington*
BEFORE *John Lee Davidson* } *Must*
1st Lieut. 10th U. S. C. A. Regt.

I CERTIFY, ON HONOR, That I have carefully examined the above-named Volunteer, agreeably to the General Regulations of the Army, and that, in my opinion, he is free from all bodily defects and mental infirmity, which would in any way disqualify him from performing the duties of a soldier.

J. H. Brown
Surgeon &c. U.S. Army
EXAMINING SURGEON.

I CERTIFY, ON HONOR, That I have minutely inspected the Volunteer *Sidney Washington* previously to his enlistment, and that he was entirely sober when enlisted; that, to the best of my judgment and belief, he is of lawful age; and that, in accepting him as duly qualified to perform the duties of an able-bodied soldier, I have strictly observed the Regulations which govern the recruiting service. This soldier has *Black* eyes, *Black* hair, *Black* complexion, is *five* feet *eleven* inches high.

M. Altates
Capt. &c. Regiment of *U. S. C. A. Regt.* Volunteers,
RECRUITING OFFICER.

(A. G. O. No. 74 & 76.)

Mustered into the service of the United States, for three years or during the war, from date of enlistment, in Company *"B"* 1st Regiment of *U. S. C. A. Regt.* Volunteers, on the *25* day of *April*, 1865, at *New Orleans La.*

John Davidson
2^d Lieut. 10th U. S. C. A. Regt.

1117

Washington, William

Co G, 4 U. S. Col'd Cav.

Private Private

CARD NUMBERS.

1	5347804	26
2	5356508	27
3	5356568	28
4	5356629	29
5	5356718	30
6	5356805	31
7	5356896	32
8	5356981	33
9	5357064	34
10	5357147	35
11	40729390	36
12		37
13		38
14		39
15		40
16		41
17		42
18		43
19		44
20		45
21		46
22		47
23		48
24		49
25		50

Book Mark:

See also

NO 804

74 | 4 Cav. | U.S.C.T.

Hill and Washington

Appears with rank of Sub. on

Muster and Descriptive Roll of a Detachment of U. S. Vols. forwarded

for the 4 Reg't U. S. Col'd Cavalry. Roll dated

New Orleans La., Oct. 11, 1864.

Where born Vicksburg, Miss.

Age 17 y'rs; occupation Laborer

When enlisted Aug 26, 1864.

Where enlisted Port Hudson, La.

For what period enlisted 3 years.

Eyes Black; hair Black

Complexion Black; height 5 ft. 6 in.

When mustered in Oct 11, 1864.

Where mustered in New Orleans

Bounty paid \$ 100 100; due \$ 200 100

Where credited Port Hudson, La.

Company to which assigned G

Remarks:

Book mark:

G. E. Hyley

W | **4 Cav. | U. S. C. T.**

William Washington
Co., Co. G, 4 Reg't U. S. Col'd Cavalry.

Appears on

Company Muster Roll

for *Sep + Oct*, 1864.

Present or absent *Present*

Stoppage, \$ *100* for

Due Gov't, \$ *100* for

Valuation of horse, \$ *100*

Valuation of horse equipments, \$ *100*

Remarks: *Joined a regiment*
Aug 30/64.

Book mark:

Lowry

W | **4Cav. | U.S.C.T.**

William Washington
Pr, Co. G, 4 Reg't U. S. Col'd Cavalry.

Appears on

Company Muster Roll

for *Apr & Dec*, 1864

Present or absent *Present*

Stoppage, \$ 100 for

Due Gov't, \$ 100 for

Valuation of horse, \$ 100

Valuation of horse equipments, \$ 100

Remarks:

Book mark:

W. W. Washington

[Handwritten mark]

4 Cav. | U.S.C.T.

William Washington

Pr, Co. G, 4 Reg't U. S. Col'd Cavalry.

Appears on

Company Muster Roll

for *Jan & Feb*, 1865:

Present or absent *Present*

Stoppage, \$ *100* for

Due Gov't, \$ *100* for

Valuation of horse, \$ *100*

Valuation of horse equipments, \$ *100*

Remarks: *\$100 bounty paid*
\$200 due

Book mark:

[Handwritten signature]

NARA 800

M | **4 Cav. | U. S. C. T.**

William Washington

Pr 1, Co. G, 4 Reg't U. S. Col'd Cavalry.

Appears on

Company Muster Roll

for *Men & Apr*, 186*5*

Present or absent *Present*

Stoppage, \$ *100* for

Due Gov't, \$ *100* for

Valuation of horse, \$ *100*

Valuation of horse equipments, \$ *100*

Remarks: *Nov Buzanty paid \$200 due*

Book mark:

(355)

Quinn Copyist.

NA 99 999

A

4 Cav. | U. S. C. T.

William Washington

Pr, Co. G, 4 Reg't U. S. Col'd Cavalry.

Appears on

Company Muster Roll

for *May & June*, 186*7*.

Present or absent *Present*

Stoppage, \$ *100* for

Due Gov't, \$ *100* for

Valuation of horse, \$ *100*

Valuation of horse equipments, \$ *100*

Remarks *\$100 Bounty paid*
\$200 due stop for extra
knob & carbine sling
2 carb snipers

Book mark :

[Signature]

(358)

Copyist.

[Handwritten mark]

4 Cav. | U.S.C.T.

William Washington

Priv., Co. G, 4 Reg't U. S. Col'd Cavalry.

Appears on

Company Muster Roll

for *July & Aug*, 1865?

Present or absent *Present*

Stoppage, \$ *100* for

Due Gov't, \$ *100* for

Valuation of horse, \$ *100*

Valuation of horse equipments, \$ *100*

Remarks: *\$ 20.00 bounty paid
\$ 20.00 due*

Book mark:

[Handwritten signature]

21 | 4 Cav. | U.S.C.T.

William Washington
Finn, Co. G, 4 Reg't U. S. Col'd Cavalry.

Appears on

Company Muster Roll

for Sept & Oct, 1865.

Present or absent Present

Stoppage, \$ 100 for

Due Gov't, \$ 100 for

Valuation of horse, \$ 100

Valuation of horse equipments, \$ 100

Remarks: \$100 Bounty paid
\$200. due.

NEXT ROLL ON FILE PER 1122

Book mark:

J. Fletcher

W | **4 Cav.** | **U. S. C. T.**

William Washington

Priv, Co. G, 4 Reg't U. S. Col'd Cavalry.

Appears on

Company Muster Roll

for *Jan & Feb*, 186*6*.

Present or absent *Present*

Stoppage, \$ *100* for

Due Gov't, \$ *100* for

Valuation of horse, \$ *100*

Valuation of horse equipments, \$ *100*

Remarks: *\$100.00 Bounty paid*
\$200.00 due

Book mark: *Rec*

Fletcher

W | 4 Cav. | U.S.C.T.

William Washington
Priv., Co. ² G., 4 Reg't U. S. Colored Cav.

Appears on Returns as follows:

Aug 1864 (Co 2) Gain: Aug 28 - N-
Orleans Reert. not mustered.

Oct 1864 (Co G) Gain: Oct 16/64
Port Hudson Recruit from depot

Book mark :

(546) W.R. Lee Copyist.

W | **4 Cav.** | **U.S.C.T.**

William Washington
Tris, Co. *G*, 4 Reg't U. S. Col'd Cavalry.

Appears on **Co. Muster-out Roll**, dated *New Orleans La March 20*, 1866.

Muster-out to date *March 20*, 1866.

Last paid to *June 30*, 1865.

Clothing account:

Last settled....., 186 ; drawn since \$.....100

Due soldier \$.....100; due U. S. \$ *71* ^{*70*}/₁₀₀

Am't for cloth'g in kind or money adv'd \$.....100

Due U. S. for arms, equipments, &c., \$.....100

Bounty paid \$ *100* ^{*100*}/₁₀₀; due \$ *None* ^{*100*}/₁₀₀

Remarks: *Joined as recruit*

Book mark :

Fletcher

Washington, William

, Co. 4 Reg't U.S.C.

Enclosures.

Bed Cards	Final Statements
Burial Records	Furloughs or L. of A.
Certs. of Dis. for Discharge	Med. Certificates
C. M. Charges	Med. Des. Lists
Descriptive Lists	Orders
Discharge Certificates	Pris. of War Record
Enlistment Papers	Resignations

Other papers relating to—

Admission to Hosp'l	Furlough or L. of A.
Casualty Sheet	Med. Examination
Confinement	Misc. Information
Contracts	Pay of Clothing
Death or Effects	Personal Reports
Desertion	Rank
Discharge from Hosp'l	Transfer to Hosp'l
Discharge from Service	Transfer to V. R. C.
Duty	Transportation

DECLARATION OF RECRUIT.

I, *William Washington* desiring
 to VOLUNTEER as a Soldier in the ARMY OF THE UNITED STATES, for the term of THREE YEARS,
 Do DECLARE, That I am *Seventeen* years and _____ months
 of age; that I have never been discharged from the United States service on account of disability or
 by sentence of a court-martial, or by order before the expiration of a term of enlistment; and I know
 of no impediment to my serving honestly and faithfully as a soldier for three years.

GIVEN at *Port Hudson La*
 The *2nd* day of *August* 1864

Witness: *A. J. Whittier & William Washington*
4th U.S. Col. Cav. *Master*

No. *4*
Law

Wm Washington
 Volunteered at *Port Hudson La*
Twenty six August 1864.
 By *A. J. Whittier*
Master Regiment of *4th U.S. Col. Cav.*

enlistment; last served in Company ()
 Reg't of _____
 Discharged _____ 18 _____

*Recruit attested to be honest
 under provisions of Circular
 No. 27 Per War. Sec. Office
 July 19 1864*

Received from Second Auditor Aug. 26th. 1892

CONSENT IN CASE OF MINOR.

I, *George Washington* Do CERTIFY, That I am the
 said *Guardian* of *William Washington*; that the
 is *Seventeen* years of age; and I
 do hereby freely give my CONSENT to his volunteering as a SOLDIER in the ARMY OF THE UNITED STATES
 for the period of THREE YEARS.

GIVEN at *Wynona La.*
 The *26th* day of *August* 1864

Witness: *James Wright* *George Washington*
Master

VOLUNTEER ENLISTMENT.

STATE OF La



TOWN OF Port-Hudson

I, *Wm Washington* born in *Vicksburg*
 in the State of *Mississippi* aged *Seventeen* years
 and by occupation a *Laborer* Do HEREBY ACKNOWLEDGE to have
 volunteered this *Twenty six* day of *August* 1864
 to serve as a **Soldier** in the **Army of the United States of America**, for the
 period of **THREE YEARS**, unless sooner discharged by proper authority: Do also
 agree to accept such bounty, pay, rations, and Clothing, as are, or may be, established
 by law for volunteers. And I, do
 solemnly swear, that I will bear true faith and allegiance to the **United States**
of America, and that I will serve them honestly and faithfully against all
 their enemies or opposers whomsoever; and that I will observe and obey the
 orders of the President of the United States, and the orders of the officers
 appointed over me, according to the Rules and Articles of War.

Sworn and subscribed to, at *Port Hudson La*
 this *26th* day of *August* 1864 } *Wm Washington*
 BEFORE *F. J. Whittier* } *marks*
1st Lt & Co. of 1st La. Cav.

I CERTIFY, ON HONOR, That I have carefully examined the above named Volunteer, agreeably to
 the General Regulations of the Army, and that in my opinion he is free from all bodily defects and mental
 infirmity, which would, in any way, disqualify him from performing the duties of a soldier.

D. D. Hanson
 Examining Surgeon.
1st Lt. U.S.A.

I CERTIFY, ON HONOR, That I have minutely inspected the Volunteer, *Wm Washington*
 previously to his enlistment, and that he was entirely sober when enlisted; that, to the best of my
 judgement and belief, he is of lawful age; and that, in accepting him as duly qualified to perform the duties
 of an able-bodied soldier, I have strictly observed the Regulations which govern the recruiting service.
 This soldier has *Blk* eyes, *Blk* hair, *Blk* complexion: is *5* feet, *6* inches
 high.

Fourth Regiment of *Col'd U.S.* Volunteers,
1st Lt A. J. Whittier RECRUITING OFFICER.

*Washington will be service of the United States for three years or during the war
 from date of enlistment in Company G. 4th U.S. Cav. Co. on the 11th day of Oct. 1864
 from orders
 J. M. Chapman
 Capt. 10th U.S. I. & B. (1861)
 F. J. Whittier*

1118

Watch Pally

Co I, 4 U. S. Col'd Cav.

Private Private

CARD NUMBERS.

1	5347486	26
2	5358169	27
3	5358236	28
4	5348171	29
5	40729134	30
6	30849059	31
7	30850108	32
8		33
9		34
10		35
11		36
12		37
12		38
14		39
15		40
16		41
17		42
18		43
19		44
20		45
21		46
22		47
23		48
24		49
25		50

Book Mark:

See also

4 | **4 Cav. | U.S.C.T.**

Poley Hatch

Appears with rank of *Private* on

Muster and Descriptive Roll of a Detachment of U. S. Vols. forwarded

for the 4 Reg't U. S. Col'd Cavalry. Roll dated *New Orleans La April 27, 1864.*

Where born *Natchitoches, La*

Age *20* y'rs; occupation *Farmer*

When enlisted *April 25*, 186 .

Where enlisted *New Orleans La*

For what period enlisted *3* years.

Eyes *Black*; hair *Black*

Complexion *Black*; height *5 ft. 6 1/4 in.*

When mustered in *April 27*, 1864.

Where mustered in *New Orleans*

Bounty paid \$ *2*¹⁰⁰; due \$ *100*

Where credited _____

Company to which assigned _____

Remarks: _____

Book mark: _____

A. P. Taylor

W | 4 Cav. | U.S.C.T.

Poley Watch
Pat., Co. *D*, 4 Reg't U. S. Col'd Cavalry.

Age.....years.

Appears on

Company Muster Roll*
for *April 27 to June 30*, 1864.

Joined for duty and enrolled:

When *Apr. 23*, 1864.

Where *New Orleans, La.*

Period *3* years.

Mustered in:

When *Apr. 27*, 1864.

Where *New Orleans, La.*

Present or absent *Absent*

Stoppage, \$.....100 for.....

Due Gov't, \$.....100 for.....

Valuation of horse, \$.....100

Valuation of horse equipments, \$.....100

Remarks: *Absent sick in Genl Hospital since June 13. 1864.*

* First current roll. No muster-in roll of this battery on file.

Book mark :

N | *4 car* | *us cy*

Paley Hatch
Priv, Co. *D*, *4* Reg't *us car*

Appears on

Hospital Muster Roll

of **Corps d'Afrique U. S. A. General Hospital,**

at **New Orleans, La.,**

for *May & June*, 186*4*.

Attached to hospital:

When _____, 186 .

How employed _____

Last paid by Maj. *never paid*

to _____, 186 .

Bounty paid \$ 100; due \$ 100

Present or absent *Present*

Remarks: _____

Book mark: _____

Apson

W | **4 Cav.** | **U.S.C.T.**

Poley Watch

Pat, Co. I, 4 Reg't U. S. Col'd Cavalry.

Appears on

Company Muster Roll

for *July & Aug*, 1864.

Present or absent

Stoppage, \$ 100 for

Due Gov't, \$ 100 for

Valuation of horse, \$ 100

Valuation of horse equipments, \$ 100

Remarks: *Died in Reg'l Hqs. Port Hudson, La 30 Aug 1864*

Book mark:

Styus
Copyist.

W | 4 bar | U S 87

Poley Watch

Pvt, Co. I, 4 Reg't U. S. Cav

Appears on

Hospital Muster Roll

of Corps d'Afrique U. S. A. General Hospital,

at New Orleans, La.,

for July & Aug, 1864.

Attached to hospital:

When, 186 .

How employed

Last paid by Maj.

to, 186 .

Bounty paid \$ 100; due \$ 100

Present or absent

Remarks:

Returned to duty Aug 9, 1864

Book mark:

W. A. V.
Copyist.

9 | 4 Cav. | U.S.C.T.

Watch Policy
Cur, Co. I, 4 Reg't U. S. Colored Cav.

Appears on Returns as follows:

June 1864, Absent sick
in Gen. Hoop. N. Orleans
La.
July 1864, Absent sick
at G. Hoop. since June 13
Aug. 1864, - Nov Aug. 30
Port Hudson, Died
in Regt. Hoop.

Book mark :

(546) E. H. Norman Copyist.

76. 17 Army | **U.S.C.T.**

John Watson

Co. G., 4 Reg't U. S. Col'd Army

Appears on a

Detachment Muster-out Roll

of the organization named above. Roll dated

New Orleans La., March, 1866

Muster-out to date 186 .

Last paid to 186 .

Clothing account:

Last settled....., 186 ; drawn since \$..... 100

Due soldier \$..... 100; due U. S. \$..... 100

Am't for cloth'g in kind or money adv'd \$..... 100

Due U. S. for arms, equipments, &c., \$..... 100

Bounty paid \$..... 100; due \$..... 100

Remarks: killed at original
organization. Died
Aug 30/64. St. Tucker La.
Final statements forwarded.

Book mark:

Frassett

Watch, Poley

P, Co. I, 4 Reg't U. S. C. Cav.

Enclosures.

Bed Cards	Descriptive Lists
Burial Records	Final Statements /
Certs. of Dis. for Discharge	Furloughs
C. M. Charges	Med. Des. Lists
Med. Certificates	Orders

Other papers relating to—

Admission to Hosp'l	Furlough
Casualty Sheet (Officer's)	Med. Examination
Confinement	Misc. Information
Contracts	Pay or Clothing
Death or Effects	Personal Reports
Desertions	Rank
Discharge from Hosp'l	Transfer to Hosp'l
Discharge from Service	Transfer to V. R. C.
Duty	Transportation

FINAL STATEMENT

OF

Private Poley Match
4th Reg't of Cold Cav.

VOLUNTEERS.

Paid Aug 31st 1864

NOTE 1.—Two of these certificates (or duplicates) are to be given to each volunteer soldier who may be discharged previously to the discharge of his company, that he may at once receive from the Paymaster the pay, &c., due him, and the captain or other officer commanding the company will certify to the act of the delivery of the duplicate certificates; on these certificates the Soldier is "entitled to" his discharge, and should also present his discharge to the Paymaster to have the payment endorsed on it. The discharge is to be given back to the Soldier by the Paymaster; the latter only retaining as his voucher the duplicate certificates.

NOTE 2.—If the Soldier is entitled to pay for the use of his horse, the Company Commander will certify to that fact, and also to the time he has pay due for having been so mounted on his own horse.

NOTE 3.—Amounts due the Sutler and Laundress must be entered on the Muster Roll on which the death, desertion, &c., is reported, as well as on the final statement, otherwise the amount cannot be collected from the United States.

NOTE 4.—This blank will be used for deceased volunteers as well as others.

ASSISTANT GENERAL'S OFFICE.
Sept 20th 1864
Duplicate with Inventory sent 2d Auditor.



NO. 999

I certify, on honor, that Poley Watch a Private of
Captain Geo. B. Seymour Company (A) of the 4th Regiment of Col'd Cavalry
VOLUNTEERS, of the State of Louisiana, born in Natchitoches, State
of Louisiana, aged 20 years; 5 feet 6³/₄ inches high; Blk complexion,
Blk eyes, Blk hair, and by occupation a Farmer, having joined the company on
its original organization at New Orleans, and enrolled in it at the muster into
the service of the United States at New Orleans La, on the 23^d day
of April, 1864, (or was mustered in service as a recruit, by St. Jos. W. Cham
berlain at New Orleans La, on the 27th day of April,
1864 to serve in the Regiment,) for the term of Three Years
and having served HONESTLY and FAITHFULLY with his Company in the field
to the present date, is now entitled to a **DISCHARGE** by reason of Death
having died at in Reg't on at Port Hudson on
the 30th day of August of Epistaxis

The said Poley Watch has received no was last paid by Paymaster
Ray since to include the Enrollment day of April 23^d, 1864, and has
pay due him from that time to the present date; he is entitled to pay and subsistence for
TRAVELING to place of enrollment and whatever other allowances are authorized to volunteer
soldiers, or militia, so discharged. He has received Thirty four 43 dollars,
advanced by the United States on account of **CLOTHING**.

There is to be stopped from him, on account of the State of _____, or other
authorities for **CLOTHING**, &c., received on entering service, _____ dollars; also,
for expenses of SUBSISTENCE for TRAVELING from place of enrollment to the place of rendezvous,
amounting to _____ dollars: and on account of the United States for **EXTRA**
CLOTHING received in kind from _____ and for other
stoppages, viz:

_____ amounting to _____ dollars;
and he has been SUBSISTED for TRAVELING to his place of enrollment, up to the _____

_____ 186 .
He is indebted to John Wild, SUTLER, Five 50 dollars.
He is indebted to _____, LAUNDRESS, _____ dollars.

Given in Duplicate, at Port Hudson, this 30^d day of Sept., 1864.

Geo. B. Seymour
Captain
Commanding Company.

1119
 Waters, Joseph
 Co *A*, 4 U. S. Col'd Cav.

Private

CARD NUMBERS.

1	5347852	26
2	5355178	27
3	5355264	28
4	5355354	29
5	5355436	30
6	5355517	31
7	5355590	32
8	5355678	33
9	5355762	34
10	5355844	35
11	5355924	36
12	5356005	37
12	5356081	38
14	5356159	39
15	40729316	40
16		41
17		42
18		43
19		44
20		45
21		46
22		47
23		48
24		49
25		50

Book Mark:

See also

NO 9 19

D1334102. P.O. Rd
D1334267. No app.

S. T. Muller
S. T.

W | 4 Cav. | U.S.C.T.

Joseph Walters

Appears with rank of Private on

Muster and Descriptive Roll of a Detachment of U. S. Vols. forwarded

for the 4 Reg't U. S. Col'd Cavalry. Roll dated

New Orleans La, March 11, 1864.

Where born Maryland Co. Va.

Age 35 y'rs; occupation Labourer

When enlisted Jan 1, 1864

Where enlisted New Orleans

For what period enlisted 3 years.

Eyes blk; hair blk

Complexion dk; height 5 ft. 6 in.

When mustered in March 11, 1864.

Where mustered in New Orleans

Bounty paid \$ 100; due \$ 100

Where credited _____

Company to which assigned F

Remarks: _____

Book mark: _____

Ballard

A | 4 Cav. | U.S.C.T.

Joseph Waters
Pr, Co. F, 4 Reg't U. S. Col'd Cavalry.

Appears on

Company Muster Roll

for *March & April*, 1864.

Present or absent *Present*

Stoppage, \$ 100 for

Due Gov't, \$ 100 for

Valuation of horse, \$ 100

Valuation of horse equipments, \$ 100

Remarks:
.....
.....
.....
.....
.....
.....
.....
.....

Book mark:

(358) *W. Manning* Copyist.

A | 4 Cav. | U.S.C.T.

Joseph Waters

Pr, Co. F, 4 Reg't U. S. Col'd Cavalry.

Appears on

Company Muster Roll

for *May 1 June*, 186*4*

Present or absent *Present*

Stoppage, \$.....100 for

Due Gov't, \$.....100 for

Valuation of horse, \$.....100

Valuation of horse equipments, \$.....100

Remarks:

Book mark:

Manning
Copist.

J | **4 Cav. | U.S.C.T.**

Joseph Waters
Cor, Co. F, 4 Reg't U. S. Col'd Cavalry.

Appears on

Company Muster Roll

for *July & Aug*, 1864.

Present or absent *Present*

Stoppage, \$ 100 for

Due Gov't, \$ 100 for

Valuation of horse, \$ 100

Valuation of horse equipments, \$ 100

Remarks:

Book mark:

W. M. ...
Copyist.

M | 4 Cav. | U.S.C.T.

Joseph Staters
Pr

, Co. F, 4 Reg't U. S. Col'd Cavalry.

Appears on

Company Muster Roll

for *Sept & Oct*, 1864.

Present or absent *Present*

Stoppage, \$ 100 for

Due Gov't, \$ 100 for

Valuation of horse, \$ 100

Valuation of horse equipments, \$ 100

Remarks:

Book mark:

W. M. G.
Copyist.

W | 4 Cav. | U.S.C.T.

Joseph Waters

Pvt., Co. F, 4 Reg't U. S. Col'd Cavalry.

Appears on

Company Muster Roll

for *Nov. & Dec*, 186*4*

Present or absent *Present*

Stoppage, \$ *100* for

Due Gov't, \$ *100* for

Valuation of horse, \$ *100*

Valuation of horse equipments, \$ *100*

Remarks: *Stop for one Spur & Strap.*

Book mark: _____

J. A. Harris

W | **4 Cav. | U.S.C.T.**

Joseph Waters

Plt, Co. F, 4 Reg't U. S. Col'd Cavalry.

Appears on

Company Muster Roll

for *Jan & Feb*, 186 *5*

Present or absent *Present*

Stoppage, \$ *100* for

Due Gov't, \$ *100* for

Valuation of horse, \$ *100*

Valuation of horse equipments, \$ *100*

Remarks: *Stop for one Spur.*

Book mark:

M. A. ...

W | **4 Cav.** | **U.S.C.T.**

Joseph Waters
Pr, Co. F, 4 Reg't U. S. Col'd Cavalry.

Appears on

Company Muster Roll

for *McN & Apr*, 186 *5*

Present or absent *Present*

Stoppage, \$.....100 for

Due Gov't, \$.....100 for

Valuation of horse, \$.....100

Valuation of horse equipments, \$.....100

Remarks:.....

Book mark:.....

J. W. Harris

A | **4 Cav.** | **U.S.C.T.**

Joseph Water
Priv, Co. F, 4 Reg't U. S. Col'd Cavalry.

Appears on

Company Muster Roll

for *May + June*, 186 *5*

Present or absent *Present*

Stoppage, \$ *100* for

Due Gov't, \$ *100* for

Valuation of horse, \$ *100*

Valuation of horse equipments, \$ *100*

Remarks:

Book mark:

L Harris

W | 4 Cav. | U.S.C.T.

Joseph Waters
Plt, Co. F, 4 Reg't U. S. Col'd Cavalry.

Appears on

Company Muster Roll

for *July & Aug*, 186 *5*

Present or absent *Present*

Stoppage, \$ 100 for

Due Gov't, \$ ³⁰/₁₀₀ for *Advance & Horse Equip'mts.*

Valuation of horse, \$ 100

Valuation of horse equipments, \$ 100

Remarks:

Book mark:

J. A. Harris

W | 4 Cav. | U.S.C.T.

Joseph Waters
Prk, Co. F, 4 Reg't U. S. Col'd Cavalry.

Appears on

Company Muster Roll

for *Sept & Oct*, 186 *5*

Present or absent *Present*

Stoppage, \$ *100* for

Due Gov't, \$ *100* for

Valuation of horse, \$ *100*

Valuation of horse equipments, \$ *100*

Remarks:

Book mark:

A Harris

W | 4 Cav. | U.S.C.T.

Joseph Waters

....., Co. F, 4 Reg't U. S. Col'd Cavalry.

Appears on

Company Muster Roll

for Jan. & Feb., 1866.

Present or absent Present

Stoppage, \$.....100 for

Due Gov't, \$.....100 for

Valuation of horse, \$.....100

Valuation of horse equipments, \$.....100

Remarks:

Book mark:

(358)

Hibbard Copyist.

W | 4 Cav. | U.S.C.T.

Joseph Waters
Sgt., Co. F, 4 Reg't U. S. Colored Cav.

Appears on Returns as follows:

Mich 1864 - (1 Regt. Cav., Corps d'Afrique)
Gain: Mar 11/64 N. Orleans
rec'd. from depot.

Book mark:

W. R. Lee

W | 4 Cav. | U.S.C.T.

P Joseph Waters
Co. F., 4 Reg't U. S. Col'd Cavalry.

Appears on Co. Muster-out Roll, dated
New Orleans, La. Mch. 20, 1866.

Muster-out to date Mch. 20, 1866.

Last paid to June 30, 1865.

Clothing account:

Last settled....., 186 ; drawn since \$..... 100

Due soldier \$..... 100; due U. S. \$18. 96/100

Am't for cloth'g in kind or money adv'd \$..... 100

Due U. S. for arms, equipments, &c., \$1. 07/100

Bounty paid \$..... 100; due \$..... 100

Remarks: Joined as recruit:
Stop 1 Sad. Sixth.

Book mark: V109 - P140 - 70
474.634.

(861) Hibbard Copyist.

1.120

Watkins John

Co G, 4 U. S. Col'd Cav.

Private

CARD NUMBERS.

1	5-356245	26
2	5-356298	27
3	5-356349	28
4	5-356397	29
5	5-356447	30
6	5-356509	31
7	5-356569	32
8	5-356630	33
9	5-356715	34
10	5-356802	35
11	5-356893	36
12	5-356978	37
13	5-357061	38
14	5-357144	39
15	40729318	40
16		41
17		42
18		43
19		44
20		45
21		46
22		47
23		48
24		49
25		50

Book Mark:

See also

927

D-936390 - P.O. m + m

\$ 1733827 and w.o.
\$ 1837163 204/15
Riv. P. 637220.

J. 2040074 P.O. m + m
A3053317 P.O. m + m
St. Vit. Run. 8/16/25

21

S. A. Muhlman 9th.

M | **4 Cav.** | **U.S.C.T.**

John Watkins

Prov., Co., 1 Reg't, Corps d'Afrique Cavalry.*
Age 21
Appears on

Company Muster-in Roll

of the organization named above. Roll dated

New Orleans, La., Feb 8, 1864.

Muster-in to date *Feb 8,* 1864.

Joined for duty and enrolled:

When *Nov. 24* 1863.

Where *New Orleans, La.*

Period *?* years.

Valuation of horse, \$ 100

Valuation of horse equipments, \$ 100

Remarks: *Pl. & 2 Prev.*

*This organization subsequently became Co. *G*, 4 Reg't U. S. Colored Cavalry.

Book mark:

Lowry

H | **4 Cav. U.S C.T.**

John Watkins
Rob., Co. *G*, 1 Reg't Cav., Corps d'Afrique.*

Appears on

Company Muster Roll

for *Enrollment to Feb 29*, 1864.

Present or absent *Present*

Stoppage, \$ *100* for

Due Gov't, \$ *100* for

Valuation of horse, \$ *100*

Valuation of horse equipments, \$ *100*

Remarks:

* This organization subsequently became Co. *G*, 4 Reg't U. S. Colored Cavalry.

Book mark : -----

(358)

Louvy
Copyist.

4 | **4 Cav. | U. S. C. T.**

John Watkins
Priv

, Co. G, 4 Reg't U. S. Col'd Cavalry.

Appears on

Company Muster Roll

for *Mch. 1st*, 1864.

Present or absent *Present*

Stoppage, \$ *100* for

Due Gov't, \$ *100* for

Valuation of horse, \$ *100*

Valuation of horse equipments, \$ *100*

Remarks:

Book mark:

Louey

H | **4 Cav.** | **U. S. C. T.**

John Watkins
Plt, Co. G, 4 Reg't U. S. Col'd Cavalry.

Appears on

Company Muster Roll

for *May & June*, 1864.

Present or absent *Present*

Stoppage, \$ *100* for

Due Gov't, \$ *100* for

Valuation of horse, \$ *100*

Valuation of horse equipments, \$ *100*

Remarks:

Book mark : _____

(353)

Lowny
Copyist.

4 | **4 Cav. | U. S. C. T.**

John Watkins

Private, Co. G, 4 Reg't U. S. Col'd Cavalry.

Appears on

Company Muster Roll

for *July & Aug*, 1864.

Present or absent *Present*

Stoppage, \$ *100* for

Due Gov't, \$ *100* for

Valuation of horse, \$ *100*

Valuation of horse equipments, \$ *100*

Remarks:

Book mark:

Lowny

Y | **4 Cav. | U.S.C.T.**

John Hutchins
John....., Co. G, 4 Reg't U. S. Col'd Cavalry.

Appears on

Company Muster Roll

for *Sep 10th*....., 1864.

Present or absent *Present*

Stoppage, \$..... *100* for.....

Due Gov't, \$..... *100* for.....

Valuation of horse, \$..... *100*

Valuation of horse equipments, \$..... *100*

Remarks: *Delivered to the U.S.*
for one 11' Remside
Carbines, one Carbine
Sling and Link.

Book mark :

Lowry

H | **4 Cav. | U. S. C. T.**

John Mattins

Pr, Co. G, 4 Reg't U. S. Col'd Cavalry.

Appears on

Company Muster Roll

for *Nov & Dec*, 1864.

Present or absent *Present*

Stoppage, \$ 100 for

Due Gov't, \$ 100 for

Valuation of horse, \$ 100

Valuation of horse equipments, \$ 100

Remarks: *Wop for / Beside
Curtain / Car fling /
Car lines*

Book mark:

Quinn
Copyist.

1869 935

M | **4 Cav.** | **U. S. C. T.**

John Watkins
On, Co. G, 4 Reg't U. S. Col'd Cavalry.

Appears on

Company Muster Roll

for *Jan & Feb*, 1865.

Present or absent *Present*

Stoppage, \$ *100* for

Due Gov't, \$ *100* for

Valuation of horse, \$ *100*

Valuation of horse equipments, \$ *100*

Remarks: *Received only \$7 per month to apr 30, & stop for 1 Burnside Carbine 1 Carb sling 1 carb link*

Book mark:

(355)

Watkins
Copyist.

H

4 Cav. | U. S. C. T.

John Watkins

Pri, Co. G, 4 Reg't U. S. Col'd Cavalry.

Appears on

Company Muster Roll

for *Men & ap*, 1865.

Present or absent *Present*

Stoppage, \$.....100 for

Due Gov't, \$.....100 for

Valuation of horse, \$.....100

Valuation of horse equipments, \$.....100

Remarks:.....

Book mark:.....

Quinn

4 Cav. | U.S.C.T.

John A. ...

John A. ..., Co. G, 4 Reg't U. S. Col'd Cavalry.

Appears on

Company Muster Roll

for *March 1867*, 1867.

Present or absent *Present*

Stoppage, \$ 100 for

Due Gov't, \$ 100 for

Valuation of horse, \$ 100

Valuation of horse equipments, \$ 100

Remarks:

Book mark: *...*

...
Copyist.

H | **4 Cav. | U. S. C. T.**

John Hutton
Be, Co. G, 4 Reg't U. S. Col'd Cavalry.

Appears on

Company Muster Roll

for *July & Aug*, 186*5*

Present or absent *Present*

Stoppage, \$ *100* for

Due Gov't, \$ *100* for

Valuation of horse, \$ *100*

Valuation of horse equipments, \$ *100*

Remarks:

Book mark:

Atwood
Copyist.

W | **4Cav.** | **U.S.C.T.**

John Watkins
Priv

, Co. G, 4 Reg't U. S. Col'd Cavalry.

Appears on

Company Muster Roll

for *Sept & Oct*, 186*5*.

Present or absent *Present*

Stoppage, \$ *100* for

Due Gov't, \$ *100* for

Valuation of horse, \$ *100*

Valuation of horse equipments, \$ *100*

Remarks:

NOT IN FILE

Book mark:

Fletcher

W | **4Cav.** | **U.S.C.T.**

John Watkins

Priv, Co. G, 4 Reg't U. S. Col'd Cavalry.

Appears on

Company Muster Roll

for *Jan & Feb*, 186 *6*

Present or absent *Present*

Stoppage, \$ *100* for

Due Gov't, \$ *100* for

Valuation of horse, \$ *100*

Valuation of horse equipments, \$ *100*

Remarks:

Book mark:

Fletcher

Copyist.

W | 4 Cav. | U.S.C.T.

John Watkins

Port, Co. G, 4 Reg't U. S. Colored Cav.

Appears on Returns as follows:

March 1864 (1 Regt, Cav., Corps d' Afrique) Absent with leave from Mar 29 to Apr 1/64

March 1865 - Absent in confinement at Port Hudson La. (4 Regt. U.S. Col'd Cav.)

Book mark:

W. R. Su

W | **4 Cav. | U.S.C.T.**

John Watkins

Priv, Co. *G*, 4 Reg't U. S. Col'd Cavalry.

Appears on **Co. Muster-out Roll**, dated *New Orleans, La., May 20*, 186*6*.

Muster-out to date *May 20*, 186*6*.

Last paid to *June 30*, 186*5*.

Clothing account:

Last settled _____, 186 ; drawn since \$ _____ $\overline{100}$

Due soldier \$ *5 $\frac{42}{100}$* ; due U. S. \$ _____ $\overline{100}$

Am't for cloth'g in kind or money adv'd \$ _____ $\overline{100}$

Due U. S. for arms, equipments, &c., \$ _____ $\overline{100}$

Bounty paid \$ _____ $\overline{100}$; due \$ _____ $\overline{100}$

Remarks: *Joined at orig. org.*

Book mark: *V 88 P 8. 69*

Fletcher

1121

Watson, George

Co A & 4 U. S. Col'd Cav.

Private Private

CARD NUMBERS.

1	✓ 3 4 7 6 3 2	26
2	✓ 3 5 8 6 6 6	27
3	✓ 3 5 8 7 1 1	28
4	✓ 3 5 8 7 6 2	29
5	✓ 3 5 8 7 9 8	30
6	✓ 3 4 8 1 0 2	31
7	✓ 3 4 9 3 1 6	32
8	✓ 3 4 9 3 9 7	33
9	✓ 3 4 9 4 8 9	34
10	✓ 3 4 9 5 6 9	35
11	✓ 3 4 9 6 4 4	36
12	✓ 3 4 9 7 1 3	37
13	40729319	38
14		39
15		40
16		41
17		42
18		43
19		44
20		45
21		46
22		47
23		48
24		49
25		50

Book Mark:

See also

W | **4 Cav.** | **U.S.C.T.**

George Watson

Appears with rank of *Priv.* on

Muster and Descriptive Roll of a Detachment of U. S. Vols. forwarded

for the 4 Reg't U. S. Col'd Cavalry. Roll dated *New Orleans, La., June 1, 1864.*

Where born *La.*

Age *35* y'rs; occupation *Laborer*

When enlisted *May 18*, 1864.

Where enlisted *New Orleans*

For what period enlisted *3* years.

Eyes *Black*; hair *Black*

Complexion *Black*; height *5 ft. 10 in.*

When mustered in *June 1*, 1864.

Where mustered in *New Orleans*

Premium paid 2
Bounty paid \$ *100*; due \$ *100*

Where credited

Company to which assigned *L*

Remarks:

Book mark:

Master

W | **4 Cav. | U.S.C.T.**

George Watson
 Pvt., Co. *D*, 4 Reg't U. S. Col'd Cavalry.

Age.....years.

Appears on

Company Muster Roll*

for *Enlistment to Aug. 31*, 1864.

Joined for duty and enrolled:

When *May 15*, 1864.

Where *New Orleans La.*

Period *3* years.

Mustered in:

When *June 1*, 1864.

Where *New Orleans La.*

Present or absent *Present*

Stoppage, \$.....100 for.....

Due Gov't, \$.....100 for.....

Valuation of horse, \$.....100

Valuation of horse equipments, \$.....100

Remarks :

* First current roll. No muster-in roll of this battery on file.

Book mark :

Lerring
 (358b) Copyist.

W | **4 Cav. | U.S.C.T.**

George Watson
Pvt., Co. L, 4 Reg't U. S. Col'd Cavalry.

Appears on

Company Muster Roll

for *Sept. 1864*, 186*4*.

Present or absent *Present*

Stoppage, \$ *100* for

Due Gov't, \$ *100* for

Valuation of horse, \$ *100*

Valuation of horse equipments, \$ *100*

Remarks:

Book mark:

J. Currier
(358) *J. Currier* Copyist.

W | **4 Cav.** | **U.S.C.T.**

George Watson

Co. L, Co. L, 4 Reg't U. S. Col'd Cavalry.

Appears on

Company Muster Roll

for *Nov. & Dec.*, 186*4*.

Present or absent *Present*

Stoppage, \$ *100* for

Due Gov't, \$ *100* for

Valuation of horse, \$ *100*

Valuation of horse equipments, \$ *100*

Remarks:

Book mark:

(358)

Loring

Copyist.

17 | **4 Cav. | U.S.C.T.**

George Watson
Privt., Co. L, 4 Reg't U. S. Col'd Cavalry.

Appears on

Company Muster Roll

for *Jan. & Feb.*, 1865.

Present or absent *Present*

Stoppage, \$ *100* for

Due Gov't, \$ *100* for

Valuation of horse, \$ *100*

Valuation of horse equipments, \$ *100*

Remarks:

Book mark:

Lorin

W | 4 Cav. | U.S.C.T.

George Watson

Pri, Co. A, 4 Reg't U. S. Col'd Cavalry.

Appears on

Company Muster Roll

for Mar & Apr, 1865

Present or absent Present

Stoppage, \$ 100 for

Due Gov't, \$ 100 for

Valuation of horse, \$ 100

Valuation of horse equipments, \$ 100

Remarks: Transferred by consolidation in accordance with S.O. no 28 of 21st Dept of the Gulf Jan 28. 65. Copy attached

Book mark:

Donnelly

It | *4 Cav* | **U.S.C.T.**

George Watson

Pw, Co. *A*, *4* Reg't U. S. Col'd *Cav.*

Appears on

M. and D. Roll of Men Transferred

to the organization named above, *by Consul*
from *Co. L.*

Roll dated *Port Hudson La Apr 29*, 1865.

When enlisted *May 18*, 1864.

Period for which enlisted *3* years.

When mustered in *June 1*, 1864.

Present or absent *not stated*.

Company to which assigned *A*

Remarks: _____

Book mark : _____

Wm L. Lewis

W | 4 Cav. | U.S.C.T.

George Watson
Pri

....., Co. A, 4 Reg't U. S. Col'd Cavalry.

Appears on

Company Muster Roll

for May & June, 186 5

Present or absent Present

Stoppage, \$.....100 for

Due Gov't, \$.....100 for

Valuation of horse, \$.....100

Valuation of horse equipments, \$.....100

Remarks: Transferred by consoli-
dation in accordance with S.O.
no 28 Hd Qrs Dept of the Gulf
Jan 28/65

Book mark:

Donnelly

W | 4 Cav U.S.C.T

George Watson

Pri, Co. A, 4 Reg't U. S. Col'd Cav

Appears on

Company Muster Roll

for July - Aug, 1865

Present or absent Present

Stoppage, \$ 100 for

Due Gov't, \$ 100 for

Valuation of horse, \$ 100

Valuation of horse equipments, \$ 100

Remarks: Transferred in consol- idation as per S.O. no 28
Hd 2rs Sept - Gulf Jan 28.65

Book mark:

Donnelly

W | **4 Cav. | U.S.C.T.**

George Watson

Pol, Co. A, 4 Reg't U. S. Col'd Cavalry.

Appears on

Company Muster Roll

for *Sept & Oct*, 186*5*.

Present or absent... *Present*

Stoppage, \$ *100* for

Due Gov't, \$ *100* for

Valuation of horse, \$ *100*

Valuation of horse equipments, \$ *100*

Remarks:

NEXT ROLL ON FILE. FEB 1865

Book mark:

Prewitt

(358)

Copyist.

W | 4 Cav. | U.S.C.T.

George Watson
Plt, Co. A, 4 Reg't U. S. Col'd Cavalry.

Appears on

Company Muster Roll

for *Jan & Feb*, 1866.

Present or absent *Present*

Stoppage, \$ *100* for

Due Gov't, \$ *100* for

Valuation of horse, \$ *100*

Valuation of horse equipments, \$ *100*

Remarks:

Book mark:

Prewitt

W | 4 Cav. | U.S.C.T.

Geo. Watson

Port., Co. E, 4 Reg't U. S. Colored Cav.

Appears on Returns as follows:

July 1861. He went sick in G. H. Prince

Book mark:

W. R. Lee

W | **4 Cav.** | **U.S.C.T.**

George Watson
Priv., Co. *A*, 4 Reg't U. S. Col'd Cavalry.

Appears on **Co. Muster-out Roll**, dated
New Orleans La, Mch 20, 1866.

Muster-out to date *Mch 20*, 1866.

Last paid to *June 30*, 1865.

Clothing account:

Last settled....., 186 ; drawn since \$..... 100

Due soldier \$ *7*^{*74*}/₁₀₀; due U. S. \$..... 100

Am't for cloth'g in kind or money adv'd \$..... 100

Due U. S. for arms, equipments, &c., \$ *3*^{*70*}/₁₀₀

Bounty paid \$..... 100; due \$..... 100

Remarks: *Joined by transfer from*
Co. A. Q. 28. Ad. Dis. D. G.
June 28 65. Stop 1 curry comb
1 halter & strap 1 horse brush.

Book mark: *V 25 P 51, 68.*

Prewitt

1122

Watson Hamilton

Co *Q*, 4 U. S. Col'd Cav.

Private Private

CARD NUMBERS.

1	5351291	26
2	5351347	27
3	5351398	28
4	5351481	29
5	5351548	30
6	5351605	31
7	5351683	32
8	5351748	33
9	5351819	34
10	5351907	35
11	5352011	36
12	5352109	37
13	5352208	38
14	5352301	39
15	5352389	40
16	5352478	41
17		42
18		43
19		44
20		45
21		46
22		47
23		48
24		49
25		50

Book Mark:

See also

W | 4 Cav. | U.S.C.T.

Hamilton Watson

C, Co. *C*, 1 Reg't La. Cav., Corps d'Afrique.*

Appears on

Company Muster-in Roll

of the organization named above. Roll dated

New Orleans La, *July*, 186*3*.

Muster-in to date

July, 186*3*.

Joined for duty and enrolled:

When *Oct 6*, 186*3*.

Where *New Orleans city*

Period *3* years.

Valuation of horse, \$ *100*

Valuation of horse equipments, \$ *100*

Remarks:

Age: 18

*This organization subsequently became Co. *C*, 4 Reg't U. S. Colored Cavalry.

Book mark:

Proctor

W | 4 Cav. | U.S.C.T.

Hamilton Watson
Co. *C*, 1 Reg't La. Cav., Corps d'Afrique.*

Appears on

Company Muster Roll

for *Nov 7 to Dec 31*, 186*3*.

Present or absent *Present*

Stoppage, \$ *100* for

Due Gov't, \$ *100* for

Valuation of horse, \$ *100*

Valuation of horse equipments, \$ *100*

Remarks:

FROM SECOND AUDITOR'S ROLL.

*This organization subsequently became Co. *C*, 4 Reg't U. S. Colored Cavalry.

Book mark:

Rechner

W | 4 Cav. | U.S.C.T.

Hamilton Watson
Co. *C*, 1 Reg't La. Cav., Corps d'Afrique.*

Appears on

Company Muster Roll

for *July & Feb*, 186*4*.

Present or absent *Present*

Stoppage, \$ *100* for

Due Gov't, \$ *100* for

Valuation of horse, \$ *100*

Valuation of horse equipments, \$ *100*

Remarks:

*This organization subsequently became Co. *C*, 4 Reg't U. S. Colored Cavalry.

Book mark: _____

Cooper

W | **4 Cav.** | **U.S.C.T.**

Hamilton Watson

Pvt, Co. C, 4 Reg't U. S. Colored Cavalry.

Appears on

Company Muster Roll

for *Hutchins*, 186*4*.

Present or absent *Present*

Stoppage, \$ 100 for

Due Gov't, \$ 100 for

Valuation of horse, \$ 100

Valuation of horse equipments, \$ 100

Remarks :
.....
.....
.....
.....
.....
.....
.....
.....
.....
.....

Book mark :
.....

Robert

W | **4 Cav. | U.S.C.T.**

Hamilton Watson
Cpt, Co. C, 4 Reg't U. S. Colored Cavalry.

Appears on

Company Muster Roll

for *May June*, 1864.

Present or absent *Present*

Stoppage, \$ 100 for

Due Gov't, \$ 100 for

Valuation of horse, \$ 100

Valuation of horse equipments, \$ 100

Remarks :

Book mark :

Proctor

W | **4 Cav.** | **U.S.C.T.**

Hamilton Watson

Co. C, Co. C, 4 Reg't U. S. Colored Cavalry.

Appears on

Company Muster Roll

for *July & Aug*, 1864.

Present or absent *Present*

Stoppage, \$ 100 for

Due Gov't, \$ 100 for

Valuation of horse, \$ 100

Valuation of horse equipments, \$ 100

Remarks :

Book mark :

Co. C

N | **4 Cav.** | **U.S.C.T.**

Hamilton Watson
Priv, Co. C, 4 Reg't U. S. Colored Cavalry.

Appears on

Company Muster Roll

for *Sept Oct*, 1864.

Present or absent *Present*

Stoppage, \$ 100 for

Due Gov't, \$ 100 for

Valuation of horse, \$ 100

Valuation of horse equipments, \$ 100

Remarks :

Book mark :

Rochester

H | **4 Cav. U.S.C.T.**

Hamilton Watson

Priv, Co. C, 4 Reg't U. S. Colored Cavalry.

Appears on

Company Muster Roll

for *Nov 22*, 186*4*

Present or absent *present*

Stoppage, \$ 100 for

Due Gov't, \$ 100 for

Valuation of horse, \$ 100

Valuation of horse equipments, \$ 100

Remarks:

Book mark:

Moyn

H | 4 Cav. | U.S.C.T.

Hamilton Watson

Priv, Co. C, 4 Reg't U. S. Colored Cavalry.

Appears on

Company Muster Roll

for *Jan & Feb*, 186*5*

Present or absent *present*

Stoppage, \$ *100* for

Due Gov't, \$ *100* for

Valuation of horse, \$ *100*

Valuation of horse equipments, \$ *100*

Remarks: *Stop for two curry combs and two brushes, Received \$7.00 per month to include Apr. 30, 1864,*

Book mark: _____

(358)

May

Copyist.

H | 4 Cav. | U.S.C.T.

Hamilton Watson

Priv, Co. C, 4 Reg't U. S. Colored Cavalry.

Appears on

Company Muster Roll

for *March*, 1865.

Present or absent *present*

Stoppage, \$ *100* for

Due Gov't, \$ *100* for

Valuation of horse, \$ *100*

Valuation of horse equipments, \$ *100*

Remarks:

Book mark:

(358)

Moyle

Copyist.

H | 4 Cav. | U.S.C.T.

Hamilton Watson
Priv, Co. C, 4 Reg't U. S. Colored Cavalry.

Appears on

Company Muster Roll

for *May & June*, 1865.

Present or absent *present*

Stoppage, \$ *100* for

Due Gov't, \$ *100* for

Valuation of horse, \$ *100*

Valuation of horse equipments, \$ *100*

Remarks: *Stop for one carbine sling & swivel, 2 Canteens 2 Haversacks, one pair metal scales.*

Book mark:

(358)

May

Copyist.

W | **4 Cav.** | **U.S.C.T.**

Hamilton Watson

Priv, Co. C, 4 Reg't U. S. Colored Cavalry.

Appears on

Company Muster Roll

for *July & Aug*, 1865.

Present or absent *present*

Stoppage, \$ *100* for

Due Gov't, \$ *100* for

Valuation of horse, \$ *100*

Valuation of horse equipments, \$ *100*

Remarks: *Stop for 1 carbine sling & swivel, 2 canteens, 2 haversacks, 1 for metallic scales \$5.73.*

Book mark:

Moy

(358)

Copyist.

H | **4 Cav.** | **U.S.C.T.**

Hamilton Watson

Priv, Co. C, 4 Reg't U. S. Colored Cavalry.

Appears on

Company Muster Roll

for *Sept 20 et*, 186*3*.

Present or absent *present*

Stoppage, \$ 100 for

Due Gov't, \$ 100 for

Valuation of horse, \$ 100

Valuation of horse equipments, \$ 100

Remarks: *Stop for 1 bridle complete 4.60, 2 sabre knots 60cts, 1 pr spurs & straps 60cts, 1 curry comb & brush 87cts, Total \$6.67.*

Book mark:

(358)

May

Copyist.

W | **4 Cav.** | **U.S.C.T.**

Hamilton Watson

Private, Co. C, 4 Reg't U. S. Colored Cavalry.

Appears on

Company Muster Roll

for *Nov + Dec*, 186*8*.

Present or absent *present*

Stoppage, \$ *449* for *lost*
ordnance

Due Gov't, \$ *100* for

Valuation of horse, \$ *100*

Valuation of horse equipments, \$ *100*

Remarks:

Book mark:

M. A. Michaels

(358)

Copyist.

W | **4 Cav.** | **U.S.C.T.**

Hamilton Watson
Private, Co. C, 4 Reg't U. S. Colored Cavalry.

Appears on

Company Muster Roll

for *Jan'y & Febr*, 1866.

Present or absent *present*

Stoppage, \$ *4*/₁₀₀ for *Loose*

Ordnance

Due Gov't, \$ *1*/₁₀₀ for

Valuation of horse, \$ *1*/₁₀₀

Valuation of horse equipments, \$ *1*/₁₀₀

Remarks:

Book mark:

M. A. Michaels

(358)

Copyist.

W | **4 Cav. | U.S.C.T.**

Hamilton Watson

Private, Co. *C*, 4 Reg't U. S. Col'd Cavalry.

Appears on **Co. Muster-out Roll**, dated *New Orleans La, Mar 20*, 1866.

Muster-out to date *Mar 20*, 1866.

Last paid to *June 30*, 1866.

Clothing account:

Last settled....., 186 ; drawn since \$.....100

Due soldier \$.....100; due U. S. \$ *34* ^{*69*}/₁₀₀

Am't for cloth'g in kind or money adv'd \$.....100

Due U. S. for arms, equipments, &c., \$ *7* ^{*49*}/₁₀₀

Bounty paid \$.....100; due \$.....100

Remarks: *Joined at orig. org.*
Shop 1 Curbbridle, 1pc Spurs &
Straps, 1 horsebrush, 1 Curry
Comb 2 Sabreknives

Book mark :

M. A. Michaels

(361)

Copyist.

1123

Watton, George

Co D, 4 U. S. Col'd Cav.

Private Private

CARD NUMBERS.

1	26
2	27
3	28
4	29
5	30
6	31
7	32
8	33
9	34
10	35
11	36
12	37
13	38
14	39
15	40
16	41
17	42
18	43
19	44
20	45
21	46
22	47
23	48
24	49
25	50

Book Mark:

See also

1124

Watts, George

Co B, 4 U.S. Col'd Cav.

Private Corporal

CARD NUMBERS.

1	5349888	26
2	5349888	27
3	53500059	28
4	5350165	29
5	5350259	30
6	5350347	31
7	5350427	32
8	5350501	33
9	5350575	34
10	5350662	35
11	5350747	36
12	5350784	37
13	5350873	38
14	5350958	39
15	5351038	40
16	5351118	41
17	40729320	42
18		43
19		44
20		45
21		46
22		47
23		48
24		49
25		50

Book Mark:

See also

A 1947758 P.O. Post
A.Y. 1520673
A.Y. 2014172

St. Muhleisen
A.Y.

N | 4 Cav. | U.S.C.T.

George Watts

Co. B, 1 Reg't La. Cav., Corps d'Afrique.*

Apr 23
Appears on

Company Muster-in Roll

of the organization named above. Roll dated

New Orleans La Oct 27, 186*3*.

Muster-in to date *Oct 27*, 186*3*.

Joined for duty and enrolled:

When *Oct 12*, 186 .

Where *New Orleans*

Period *3* years.

Valuation of horse, \$ *100*

Valuation of horse equipments, \$ *100*

Remarks: _____

*This organization subsequently became Co. *B* 4 Reg't U. S. Colored Cavalry.

Book mark: _____

(356)

Spicy
Copyist.

M | 4 Cav. | U.S.C.T.

George Watts

Co. B, 1 Reg't La. Cav., Corps d'Afrique.*

Appears on

Company Muster Roll

for *Oct 27 to Dec 31*, 186 *3*

Present or absent *Present*

Stoppage, \$ *100* for

Due Gov't, \$ *100* for

Valuation of horse, \$ *100*

Valuation of horse equipments, \$ *100*

Remarks:

*This organization subsequently became Co. *B* 4 Reg't U. S. Colored Cavalry.

Book mark:

(358)

Tracy
Copyist.

W

4 Cav. U.S.C.T.

George Watts
Co. B, 1 Reg't Cav., Corps d'Afrique.*

Appears on

Company Muster Roll

for *Jan + Feb*, 1864.

Present or absent *Present*

Stoppage, \$ *100* for

Due Gov't, \$ *100* for

Valuation of horse, \$ *100*

Valuation of horse equipments, \$ *100*

Remarks:

* This organization subsequently became Co. *B*, 4 Reg't U. S. Colored Cavalry.

Book mark:

W
Copyist.

W | **4 Cav.** | **U.S.C.T.**

George Watts

Co. B., Co. B. 4 Reg't U. S. Col'd Cavalry.

Appears on

Company Muster Roll

for *Mch + Apr*, 1864.

Present or absent *Present*

Stoppage, \$ 100 for

Due Gov't, \$ 100 for

Valuation of horse, \$ 100

Valuation of horse equipments, \$ 100

Remarks :

Book mark :

(358)

Copyist.

N | **4 Cav.** | **U.S.C.T.**

George Watta
Cope, Co. B. 4 Reg't U. S. Col'd Cavalry.

Appears on

Company Muster Roll

for *May & June*, 186*1*.

Present or absent *Present*

Stoppage, \$ 100 for

Due Gov't, \$ 100 for

Valuation of horse, \$ 100

Valuation of horse equipments, \$ 100

Remarks :

Book mark :

(358)

[Signature]
Copyist.

N | **4 Cav.** | **U.S.C.T.**

George Watts

Watts, Co. B. 4 Reg't U. S. Col'd Cavalry.

Appears on

Company Muster Roll

for *July & Aug*, 186*C.*

Present or absent *Present*

Stoppage, \$ *100* for

Due Gov't, \$ *100* for

Valuation of horse, \$ *100*

Valuation of horse equipments, \$ *100*

Remarks :

Book mark :

Cherry
Copyist.

21 | **4 Cav.** | **U.S.C.T.**

George Watta

Co. B., Co. B. 4 Reg't U. S. Col'd Cavalry.

Appears on

Company Muster Roll

for *Sept + Oct*, 186*4*.

Present or absent *Present*

Stoppage, \$ *100* for

Due Gov't, \$ *100* for

Valuation of horse, \$ *100*

Valuation of horse equipments, \$ *100*

Remarks :

Book mark :

[Signature]
Copyist.

NOV 9 1864

OK | **4 Cav.** | **U.S.C.T.**

George Watts

priv., Co. B. 4 Reg't U. S. Col'd Cavalry.

Appears on

Company Muster Roll

for Nov & Dec, 1864.

Present or absent present

Stoppage, \$ 100 for

Due Gov't, \$ 100 for

Valuation of horse, \$ 100

Valuation of horse equipments, \$ 100

Remarks : Ex ha pay due as corporal
from Nov. 1/63 to Nov. 31/63.
Stop for one curb chain one
Bridle Reins. Free before
Apr. 1/61

Book mark :

(358) Lomer Copyist.

W | **4 Cav.** | **U.S.C.T.**

George Hutto

pr, Co. B. 4 Reg't U. S. Col'd Cavalry.

Appears on

Company Muster Roll

for *Jan & Feb.*, 186*9*.

Present or absent *present*

Stoppage, \$ 100 for

Due Gov't, \$ 100 for

Valuation of horse, \$ 100

Valuation of horse equipments, \$ 100

Remarks: *Received only \$7 a month to include Apr 30/64
Free before Apr 1/61. Stop
for 1 Bridle year, 20 B.C.
Ctga.*

Book mark: */*

Somers

W | **4 Cav.** | **U.S.C.T.**

George Wallis

priv., Co. B. 4 Reg't U. S. Col'd Cavalry.

Appears on

Company Muster Roll

for *March & April*, 186 *5*.

Present or absent *present*

Stoppage, \$ *100* for

Due Gov't, \$ *100* for

Valuation of horse, \$ *100*

Valuation of horse equipments, \$ *100*

Remarks :

Book mark :

L. J. ...

W | **4 Cav.** | **U.S.C.T.**

George Watts

Q.M., Co. B. 4 Reg't U. S. Col'd Cavalry.

Appears on

Company Muster Roll

for *May & June*, 186*5*.

Present or absent *Present*

Stoppage, \$ *100* for

Due Gov't, \$ *100* for

Valuation of horse, \$ *100*

Valuation of horse equipments, \$ *100*

Remarks :

Book mark :

(358)

F. J. ...

Copyist.

W | **4 Cav.** | **U.S.C.T.**

George Watts

Corp, Co. B. 4 Reg't U. S. Col'd Cavalry.

Appears on

Company Muster Roll

for *July & Aug*, 186*5*.

Present or absent *present*

Stoppage, \$ 100 for

Due Gov't, \$ 100 for

Valuation of horse, \$ 100

Valuation of horse equipments, \$ 100

Remarks :

Book mark :

(358)

L. M. ...

Copyist.

W | **4 Cav.** | **U.S.C.T.**

George Watts

Corp, Co. B. 4 Reg't U. S. Col'd Cavalry.

Appears on

Company Muster Roll

for *Sept & Oct*, 186*3*.

Present or absent *present*

Stoppage, \$ *100* for

Due Gov't, \$ *100* for

Valuation of horse, \$ *100*

Valuation of horse equipments, \$ *100*

Remarks: *Promoted to Corp.
oral July 1 / 65.*

Book mark :

Lomer

H | **4 Cav.** | **U.S.C.T.**

George Watts
Corpl., Co. B. 4 Reg't U. S. Col'd Cavalry.

Appears on

Company Muster Roll

for *Nov. & Dec.*, 186*5*.

Present or absent *Absent*

Stoppage, \$ 100 for

Due Gov't, \$ ³²100 for *Ordinance loss*

Valuation of horse, \$ 100

Valuation of horse equipments, \$ 100

Remarks: *Appointed Corpl July 1, 65. On seven days furlough since Dec. 25, 65.*

Book mark:

Chandler

(358)

Copyist.

W

4 Cav. | U.S.C.T.

George Watts
Corpl. Co. B. 4 Reg't U. S. Col'd Cavalry.

Appears on

Company Muster Roll

for *Jan. & Feb.*, 1866.

Present or absent *Present*

Stoppage, \$ 100 for

Due Gov't, \$ 32/100 for *Ordnance loss*

Valuation of horse, \$ 100

Valuation of horse equipments, \$ 100

Remarks: *Appointed Corporal
July 1, 1865.*

Book mark:

Chandler
Copyist.

W | 4 Cav. | U.S.C.T.

George Watts

Priv., Co. B., 4 Reg't U. S. Colored Cav.

Appears on Returns as follows:

Sept 1864 - On duty in charge
sick horses.

Dec 1865 - absent on furlough
seven days

Jan 1865 - absent furloughed
for seven days, Jan 24/65
Port Hudson, La.

Book mark:

W. R. Lee

W | **4 Cav.** | **U.S.C.T.**

George Watts
Corpl, Co. *B*, 4 Reg't U. S. Col'd Cavalry.

Appears on **Co. Muster-out Roll**, dated
New Orleans, La, *Feb. 24* 1866.

Muster-out to date *Feb. 20*, 1866.

Last paid to *June 30*, 1865.

Clothing account:

Last settled....., 186 ; drawn since \$..... 100

Due soldier \$ *39* ^{*29*} 100; due U. S. \$..... 100

Am't for cloth'g in kind or money adv'd \$..... 100

Due U. S. for arms, equipments, &c., \$..... ^{*82*} 100

Bounty paid \$..... 100; due \$ *100* 100

Remarks: *Joined at Orgl. Org. Pot. to*
Nov. 1, 63, Reduced Nov. 31, 63
Pot. to July 1, 65. Stop for 1 Barb
Knob. Free on or before April
19, 1861. Stop for one barbe
socket

Book mark: *v. 228. P. 126. 76*

(361)

Chandler
Copyist.

1123 or Janice

Weaver, John

Co E, 4 U. S. Col'd Cav.

Private Private

CARD NUMBERS.

1	5353849	26
2	5353912	27
3	5353958	28
4	5352012	29
5	5352082	30
6	5352152	31
7	5352220	32
8	5352285	33
9	5352347	34
10	5352905	35
11	30848575	36
12	30849049	37
12	30850102	38
14	40729321	39
15		40
16		41
17		42
18		43
19		44
20		45
21		46
22		47
23		48
24		49
25		50

Book Mark:

See also

D. 2547467 And wd
D. 2562871 Common
D. 2770863 And wd

J. A. Muhlenberg
etc.

W | 4 Cav. | U.S.C.T.

John Weaver

Co. E, 1 Reg't, Corps d'Afrique Cavalry.*

Appears on

Company Muster-in Roll

of the organization named above. Roll dated New Orleans La Dec. 31, 1863.

Muster-in to date Dec. 31, 1863.

Joined for duty and enrolled:

When Nov. 17, 1863

Where New Orleans

Period 3 years.

Valuation of horse, \$ 100

Valuation of horse equipments, \$ 100

Remarks: Age 21

*This organization subsequently became Co. E, 4 Reg't U. S. Colored Cavalry.

Book mark:

Weaver



W 4 Cav. | U.S C.T.

John Weaver
Pvt, Co. *E*, 1 Reg't Cav., Corps d'Afrique.*

Appears on

Company Muster Roll

for *Enlistment to Dec 31*, 186*2*

Present or absent *Present*

Stoppage, \$ *100* for

Due Gov't, \$ *100* for

Valuation of horse, \$ *100*

Valuation of horse equipments, \$ *100*

Remarks:

* This organization subsequently became Co. *E*, 4 Reg't U. S. Colored Cavalry.

Book mark:

Weaver

4 Cav. | U.S C.T.

Sam Weaver

, Co. *E*, 1 Reg't Cav., Corps d'Afrique.*

Appears on

Company Muster Roll

for *Jan & Feb*, 186*4*

Present or absent *Present*

Stoppage, \$ *100* for

Due Gov't, \$ *100* for

Valuation of horse, \$ *100*

Valuation of horse equipments, \$ *100*

Remarks:

* This organization subsequently became Co. *F*, 4 Reg't U. S. Colored Cavalry.

Book mark:

G. W. W. W.

W | **4 Cav.** | **U.S.C.T.**

John Weaver

Privt, Co. E, 4 Reg't U. S. Col'd Cav.

Appears on

Company Muster Roll

for *Mar + Apr*, 186*4*

Present or absent *Absent*

Stoppage, \$ *100* for

Due Gov't, \$ *100* for

Valuation of horse, \$ *100*

Valuation of horse equipments, \$ *100*

Remarks: *Absent sick in G.N.*

Book mark:

Lawrence

W | 4 La. Cav. | N. S. C. T.

John R. Weaver
P. W. Co. C, 4 Reg't La. Cav.

Appears on

Hospital Muster Roll

of **Corps d'Afrique U. S. A. General Hospital,**

at **New Orleans, La.,**

for Mch 24, 1864.

Attached to hospital:

When....., 186 .

How employed.....

Last paid by Maj. Sgt
to Dec 31, 1863.

Bounty paid \$ 100; due \$ 100

Present or absent Present

Remarks:
.....
.....
.....
.....
.....
.....
.....
.....
.....
.....

Book mark :

(343)

Morgan
Copyist.

N | **4 Cav.** | **U.S.C.T.**

John Weaver

Priv., Co. E, 4 Reg't U. S. Col'd Cav.

Appears on

Company Muster Roll

for *May & June*, 186*4*

Present or absent *Absent*

Stoppage, \$ *100* for

Due Gov't, \$ *100* for

Valuation of horse, \$ *100*

Valuation of horse equipments, \$ *100*

Remarks *In G N*

Book mark :

Linnard

N | *4000* | *USCY*
John Weaver
Pvt, Co. E, 4 Reg't USCA

Appears on

Hospital Muster Roll

of Corps d'Afrique U. S. A. General Hospital,

at New Orleans, La.,

for *May June*, 1864.

Attached to hospital:

When....., 186 .

How employed.....

Last paid by Maj. *Worshie*

to *Apr 30*, 1864

Bounty paid \$ 100; due \$ 100

Present or absent *Present*

Remarks:.....

Book mark:.....

Worshie

W | **4 Cav.** | **U.S.C.T.**

John Weaver

Priv., Co. E, 4 Reg't U. S. Col'd Cav.

Appears on

Company Muster Roll

for *July & Aug*, 1864.

Present or absent *Present*

Stoppage, \$ 100 for

Due Gov't, \$ 100 for

Valuation of horse, \$ 100

Valuation of horse equipments, \$ 100

Remarks:

Book mark:

L. Weaver

W | 4 bar | U.S.A.

John Weaver
Priv, Co. E, 4 Reg't U.S. Cav

Appears on

Hospital Muster Roll

of Corps d'Afrique U. S. A. General Hospital,

at New Orleans, La.,

for July & Aug, 1864.

Attached to hospital:

When, 186 .

How employed

Last paid by Maj.

to, 186 .

Bounty paid \$ 100; due \$ 100

Present or absent

Remarks:

Returned to duty July 30-64

Book mark:

Wear
Copyist.

W. | **4 Cav.** | **U.S.C.T.**

John Weaver

Plt., Co. E, 4 Reg't U. S. Col'd Cav.

Appears on

Company Muster Roll

for *Sept. - Oct.*, 186*4*.

Present or absent *Present*

Stoppage, \$ *100* for

Due Gov't, \$ *100* for

Valuation of horse, \$ *100*

Valuation of horse equipments, \$ *100*

Remarks:

Book mark:

Lawrence

H | 4 Cav. | U.S.C.T.

John Weaver

Priv, Co. E, 4 Reg't U. S. Col'd Cav.

Appears on

Company Muster Roll

for *Nov & Dec*, 1864.

Present or absent *Present*

Stoppage, \$ *100* for

Due Gov't, \$ *100* for

Valuation of horse, \$ *100*

Valuation of horse equipments, \$ *100*

Remarks: *Sick in Post Hospital*

Book mark:

(358)

Wines

Copyist.

A | **4 Cav.** | **U.S.C.T.**

John Weaver
Prvt, Co. E, 4 Reg't U. S. Col'd Cav.

Appears on

Company Muster Roll

for *Jan & Feb*, 186*5*.

Present or absent

Stoppage, \$ *100* for

Due Gov't, \$ *100* for

Valuation of horse, \$ *100*

Valuation of horse equipments, \$ *100*

Remarks: *Died in Post Hospital Port Hudson La. Jan. 26, 1865. Recd only 7 doll per month to include Apr. 30/65.*

Book mark: *Died Jan 26/65.*

Wines

W | 4 Cav. | U.S.C.T.

John Weaver

Pvt, Co. E, 4 Reg't U. S. Colored Cav.

Appears on Returns as follows:

Apr & May 1864 - Absent sick
in Genl Hospital, sent since
Apr 20/64

June 1864 Absent sick Genl
Hosp N. Orleans

Nov 1864 - Absent sick sent to
Post Hospital.

Dec 1864 Absent sick in Post
Hospital Port Hudson La.

Jan 1865 - 2000. Jan 24/65
Port Hudson, La. died of
disease.

Book mark:

W. R. Lee

W | 4 Cav. | U.S.C.T.

James Weaver
Priv, Co. E, 4 Reg't U. S. Col'd Cavalry.

Appears on **Co. Muster-out Roll**, dated
New Orleans La, March 20, 1866.

Muster-out to date _____, 186 .

Last paid to _____, 186 .

Clothing account:

Last settled _____, 186 ; drawn since \$ _____ 100

Due soldier \$ _____ 100; due U. S. \$ _____ 100

Am't for cloth'g in kind or money adv'd \$ _____ 100

Due U. S. for arms, equipments, &c., \$ _____ 100

Bounty paid \$ _____ 100; due \$ _____ 100

Remarks: Joined at orig. org.
died Jan'y 26/65 at Port
Hudson La.

Book mark : _____

(861)

Floyd

Copyst.

Weaver, Jms

I, Co. E, 4 Reg't USMC (B.V.)

3 Enclosures.

Bed Cards	Descriptive Lists
Burial Records	Final Statements <i>2</i>
Certs. of Dis. for Discharge	Furloughs
C. M. Charges	Med. Des. Lists
Med. Certificates	Orders

Other papers relating to—

Admission to Hosp'l	Furlough
Casualty Sheet (Officer's)	Med. Examination
Confinement	Misc. Information
Contracts	Pay or Clothing
Death or Effects <i>/</i>	Personal Reports
Desertions	Rank
Discharge from Hosp'l	Transfer to Hosp'l
Discharge from Service	Transfer to V. R. C.
Duty	Transportation <i>/</i>

ARTICLES OF WAR.

ART. 95. When any non-commissioned officer or soldier shall die, or be killed in the service of the United States, the then commanding officer of the troop or company shall, in the presence of two other commissioned officers, take an account of what effects he died possessed of, above his arms and accoutrements, and transmit the same to the office of the Department of War, which said effects are to be accounted for, and paid to the representatives of such deceased non-commissioned officer or soldier. And in case any of the officers, so authorized to take care of the effects of deceased officers and soldiers, should, before they have accounted to their representatives for the same, have occasion to leave the regiment or post, by preferment or otherwise, they shall, before they be permitted to quit the same, deposit in the hands of the commanding officer, or of the assistant military agent, all the effects of such deceased non-commissioned officers and soldiers, in order that the same may be secured for, and paid to, their respective representatives.

ARMY REGULATIONS—EDITION OF 1861.

DECEASED SOLDIERS.

Par. 152. Inventories of the effects of deceased non-commissioned officers and soldiers, required by the 95th Article of War, will be forwarded to the Adjutant General, by the commander of the company to which the deceased belonged, and a duplicate of the same to the colonel of the regiment. Final statements of pay, clothing, &c., will be sent with the inventories. When a soldier dies at a post or station absent from his company, it will be the duty of his immediate commander to furnish the required inventory, and, at the same time, to forward to the commanding officer of the company to which the soldier belonged, a report of his death, specifying the date, place, and cause; to what time he was last paid, and the money or other effects in his possession at the time of his decease; which report will be noted on the next muster roll of the company to which the man belonged. Each inventory will be endorsed, "Inventory of the effects of _____, late of company (—) _____ regiment of _____, who died at _____, the _____ day of _____, 186—." If a legal representative receive the effects, it will be stated in the report. If the soldier leave no effects, the fact will be reported.

Par. 153. Should the effects of a deceased non-commissioned officer or soldier not be administered upon within a short period after his decease, they shall be disposed of by a Council of Administration, under the authority of the commanding officer of the post, and the proceeds deposited with the Paymaster, to the credit of the United States, until they shall be claimed by the legal representatives of the deceased.

Par. 154. In all such cases of sales by the Council of Administration, a statement in detail, or account of the proceeds, duly certified by the Council and commanding officer, accompanied by the Paymaster's receipt for the proceeds, will be forwarded by the commanding officer to the Adjutant General. The statement will be endorsed, "Report of the proceeds of the effects of _____, late of company (—) _____ regiment of _____, who died at _____, the _____ day of _____, 186—."

NOTE 1.—The effects in all cases, when called for, should be turned over to the legal representative, without further authority from the Adjutant General. When the effects are turned over to the relatives of the deceased before these inventories are sent to the Adjutant General, their receipts therefor should be attached to the inventories. In all other cases, one copy will be sent with a letter of transmittal direct to the Adjutant General, and a duplicate retained by the officer.

NOTE 2.—Particular care should be taken to take receipts in duplicate from the Paymaster for any funds turned over to him; one copy should be sent direct to the Adjutant General and one retained by the officer.

INVENTORY OF THE EFFECTS

OF
Priv John Weaver

Late of Company *E*

4th Reg't of *U. S. Cavalry*

Volunteers, who died at *Fort Mifflin, Pa.*

on the *24* day of *January* 186*5*.

Reg't 279. Co. H. 54.

Inventory of the effects of John Weaver late
a Private of Captain _____ Company E of
the 4th Regiment of U. S. Army Volunteers, who was enrolled as
a _____ at _____ in the State of _____ on
the _____ day of _____ 186 , and mustered into the service of the United
States as a _____ on the _____ day of _____ 186 , at _____
in Company _____, _____ Regiment of _____ Volunteers, to serve _____
years or during the war; he was born in _____ in the State
of _____; he was _____ years of age, _____ feet _____ inches
high, _____ complexion, _____ eyes, _____ hair, and by occupation, when enrolled,
a _____; he died in Post Hospital, at
Post Hudson, N. Y. on the 24 day of January 1865, by
reason of Chronic Diarrhea.

INVENTORY.								
ARTICLES.	No.	ARTICLES.	No.	ARTICLES.	No.			
Hats.....	}	Pairs trousers.....	}	Knapsacks.....	}			
Caps.....		Pairs flannel drawers.....						
Forage caps.....		Pairs cotton drawers.....						
Great coats.....		Flannel shirts.....						
Uniform coats.....		Cotton shirts.....						
Uniform jackets.....		Pairs boots.....						
Flannel sack coats.....		Pairs shoes.....						
Blouses.....		Pairs socks.....						
Stable frocks.....		Blankets.....						
Fatigue overalls.....		Haversacks.....						
				MONEY.		Specie.....	\$	}
						Notes.....	\$	}

I CERTIFY, ON HONOR, that the above inventory comprises all the effects of _____
_____, deceased, and that the effects are in the hands
of _____ at _____
_____ to be disposed of by a Council of Administration.

(DUPLICATES.)

STATION: Post Hudson, N. Y.

DATE: January 24 '65

[A. G. O. No. 104.]

W. G. David 78 N. Y. S. 2
Surgeon in Charge, Post Hospital
Commanding the Company.

U. S. 4B. 54.

Extract from Act of Congress.

SEC. 12. *And be it further enacted,* That the fees of agents and attorneys for making out and causing to be executed the papers necessary to establish a claim for a pension, bounty, and other allowance before the Pension Office, under this act, shall not exceed the following rates: For making out and causing to be duly executed a declaration by the applicant, with the necessary affidavits, and forwarding the same to the Pension Office, with the requisite correspondence, ten dollars; which sum shall be received by such agent or attorney in full for all services in obtaining such pension, and shall not be demanded or received, in whole or in part, until such pension shall be obtained; and the sixth and seventh sections of an act entitled "An act to grant pensions," approved July [fourteenth,] eighteen hundred and sixty-two, are hereby repealed.

SEC. 13. *And be it further enacted,* That any agent or attorney who shall, directly or indirectly, demand or receive any greater compensation for his services under this act than is prescribed in the preceding section of this act, or who shall contract or agree to prosecute any claim for a pension, bounty, or other allowance under this act, on the condition that he shall receive a per centum upon any portion of the amount of such claim, or who shall wrongfully withhold from a pensioner or other claimant the whole or any part of the pension or claim allowed and due to such pensioner or claimant, shall be deemed guilty of a high misdemeanor, and, upon conviction thereof, shall, for every such offense, be fined not exceeding three hundred dollars, or imprisoned at hard labor not exceeding two years, or both, according to the circumstances and aggravations of the offense.

Approved July 4, 1864.

NOTE 10.—If any soldier is charged a higher fee than that allowed by the above act, he should report the fact and the name of the agent to the Adjutant General, in order that steps may be taken to have the same refunded.

ADJUTANT GENERAL'S OFFICE.

August 5th 1865

Duplicate with Inventory sent 21 Auditor.

FINAL STATEMENT

OF

John Weaver
H.V. Reg't of M.C. Co.

VOLUNTEERS.

Discharged January 24th 1865.

NOTE 1.—Two of these certificates (or duplicates) are to be given to each Volunteer Soldier or drafted man who may be discharged without being mustered out. (Final Statements are never given to men mustered out of service.) That he may at once receive from the Paymaster the pay, &c., due him, and the captain or other COMMISSIONED officer commanding the company will certify to the act of the delivery of the duplicate certificates; with these certificates the Soldier is "entitled to" his discharge, and should also present his discharge to the Paymaster to have the payment endorsed on it. The discharge is to be given back to the Soldier by the Paymaster; the latter only retaining as his vouchers the duplicate certificates.

NOTE 2.—If the Soldier is entitled to pay for the use of his horse, the Company Commander will certify to that fact on the back of both these final statements, and also to the time he has pay due for having been so mounted on his own horse.

NOTE 3.—When a Soldier is furnished with final statements, his descriptive list, if he has one, should be taken up by the officer who gives the Soldier these statements, and endorsed with a statement to this effect by the officer. The endorsement should exhibit a full statement of the time for which the Soldier was allowed pay on his final statements, the clothing account, and all other charges against him or in his favor, so as to comprise a complete exhibit of his account. It will then be transmitted to the Company Commander of the Soldier, who will enter all the data necessary to a full understanding of the Soldier's account on the muster roll upon which the Soldier's discharge is reported. The descriptive list will then be destroyed. The object of this is, that the remaining portion of the Soldier's account may be settled upon the receipt of these muster rolls, and the Soldier receive any pay or allowances that may be due him at the time of his discharge, and which may not appear on his last final statements from the fact that his descriptive list is incomplete. These accounts for back pay, &c., are settled by the 21 Auditor of the Treasury Department.

NOTE 4.—Charges for loss or injury to ordnance, horse equipments, and other miscellaneous charges, should appear under the heading of "Other Stoppages."

NOTE 5.—Bounty paid by State authorities, and not by the United States, will not be entered on this statement.

NOTE 6.—Amounts due the Sutler and Laundress must be entered on the muster roll on which the discharge, death, desertion, &c., is reported, as well as on the final statement, otherwise the amount cannot be collected from the United States.

NOTE 7.—This blank will be used for deceased volunteers and drafted men, as well as for others.

NOTE 8.—Where a Soldier dies in Hospital or on detached service, his descriptive list, if he has one, should be sent with his final statements, in duplicate, to the Adjutant General, Washington, D. C.

NOTE 9.—If the soldier is a drafted man or substitute, the space for time, &c., of enrolled, should contain only the word *drafted* or *substitute*, as the case may be. If the Soldier is a "VETERAN," (or RECRUIT,) the words *as a veteran*, (or *recruit*,) as the case may be, should be interlined after the words *mustered into the service of the U. S.* A statement of all the installments of *Veteran or Recruit Bounty* RECEIVED by the Soldier must be made on the back of each final statement.

OFFICE

MAR 19 1864

I certify, on honor, that John Weaver, a Private of
 Captain E. M. Jones Company (E) of the First Regiment of U. S. Cavalry
VOLUNTEERS, of the State of Severna, born in New Orleans, State
 of Severna, aged 25 years; 5 feet 9 inches high; Dark complexion,
Light eyes, Black hair, and by occupation a Laborer, who joined for service
 and was enrolled (see Note 9) on the 17 day of November, 1863, at New Orleans
 by Capt. Nichol, for the period of 3 years, and mustered into
 the service of the United States on the 31st day of December, 1863, at
New Orleans, by H. M. Allison; and having served
 HONESTLY and FAITHFULLY with his Company to the present date, is now entitled to a
DISCHARGE by reason of Death

The said John Weaver was last paid by Paymaster
May Booth, to include the 30 day of April, 1864, and
 has pay due him from that time to the present date; he is entitled to pay and subsistence for
TRAVELING to place of enrollment, and whatever other allowances are authorized to volunteer
 soldiers, drafted men, or militia, so discharged. He has received from the United States **CLOTHING**
 amounting to 144 ⁹⁴/₁₀₀ dollars, since the 1st day of February,
 1864, when his clothing account was last settled. He has received from the United States
100 dollars advanced **BOUNTY**.

There is to be stopped from him, on account of the State of _____, or other
 authorities, for **CLOTHING, &c.**, received on entering service, _____ ¹⁰⁰/₁₀₀ dollars; and
 for other stoppages, viz: _____
 _____ ¹⁰⁰/₁₀₀ dollars.
 He has been furnished with **TRANSPORTATION** in kind from the place of his discharge to
 _____; and he has been **SUBSISTED** for **TRAVELING** to his
 place of enrollment, up to the _____, 1864.

He is indebted to _____, **SUTLER**, _____ ¹⁰⁰/₁₀₀ dollars.

He is indebted to _____, **LAUNDRESS**, _____ ¹⁰⁰/₁₀₀ dollars.

Given in Duplicate, at Port Hudson La, this 20 day
 of July, 1865.

E. M. Jones
Captain

Commanding Company.

Recd. July 20 1865

[OFFICE INDORSEMENT.]

War Department,

ADJUTANT GENERAL'S OFFICE,

March 7, 1874.

The death of John Weaver
Private, Co. E, 4th Reg't U. S.
Colored Cavalry, is reported as follows:

On Company Muster Roll.

For Jan. 7th, 1865, Jan. 25th, 1865

Company Muster-out Roll.

January 24th (James Weaver) 1865

Company Descriptive Book.

, 186

Company Morning Reports.

, 186

Soldier's Final Statement.

January 24th, 1865. 186

Soldier's Record of Death and Interment.

, 186

Soldier's Inventory of Effects.

, 186

Soldier's Certificate of Disability for Discharge.

, 186

Soldier's Individual Muster-out Roll.

, 186

Regimental Return.

For January, 1865, Jan. 24th, 1865

Regimental Quarterly Returns.

, 186

Regimental Descriptive Book.

, 186

By Surgeon General.

, 186

Jan 24, 1865, is held to be
the correct date, and the Company Muster
Roll will be amended accordingly.

James M. Bennett
Assistant Adjutant General.

EB. 11/2. See letter to 2^d Aud.
April 2^d 1874.

Noted on R.
212.

FINAL STATEMENT

OF

Private John Weaver

4th Reg't of U.S. Cavalry

VOLUNTEERS.

Guid Jan 24th 1865.

NOTE 1.—Two of these certificates (or duplicates) are to be given to each Volunteer Soldier or drafted man who may be discharged previously to the discharge of his company, that he may at once receive from the Paymaster the pay, &c., due him, and the captain or other COMMISSIONED officer commanding the company will certify to the act of the delivery of the duplicate certificates; on these certificates the Soldier is "entitled to" his discharge, and should also present his discharge to the Paymaster to have the payment endorsed on it. The discharge is to be given back to the Soldier by the Paymaster; the latter only retaining as his voucher the duplicate certificates.

NOTE 2.—If the Soldier is entitled to pay for the use of his horse, the Company Commander will certify to that fact on the back of both these final statements, and also to the time he has pay due for having been so mounted on his own horse.

NOTE 3.—When a Soldier is furnished with final statements, his descriptive list, if he has one, should be taken up by the officer who gives the Soldier these statements, and endorsed with a statement to this effect by the officer. This endorsement should exhibit a full statement of the time for which the Soldier was allowed pay on his final statements, the clothing account, and all other charges against him or in his favor, so as to comprise a complete exhibit of his account. It will then be transmitted to the Company Commander of the Soldier, who will enter all the data necessary to a full understanding of the Soldier's account on the muster roll upon which the Soldier's discharge is reported. The descriptive list will then be destroyed. The object of this is, that the remaining portion of the Soldier's account may be settled upon the receipt of these muster rolls, and the Soldier receive any pay or allowances that may be due him at the time of his discharge, and which may not appear on his final statements from the fact that his descriptive list is incomplete. These accounts for back pay, &c., are settled by the 2d Auditor of the Treasury Department.

NOTE 4.—Charges for loss or injury to ordnance, horse equipments, and other miscellaneous charges, should appear under the heading of "Other Stoppages."

NOTE 5.—Bounty paid by State authorities, and not by the United States, will not be entered on this statement.

NOTE 6.—Amounts due the Sutler and Laundress must be entered on the muster roll on which the discharge, death, desertion, &c., is reported, as well as on the final statement, otherwise the amount cannot be collected from the United States.

NOTE 7.—This blank will be used for deceased volunteers and drafted men, as well as for others.

NOTE 8.—Where a Soldier dies in Hospital or on detached service, his descriptive list, if he has one, should be sent with his final statements, in duplicate, to the Adjutant General, Washington, D. C.

ADJUTANT GENERAL'S OFFICE.

July 13th 1865.

Duplicate with Inventory sent 2d Auditor.

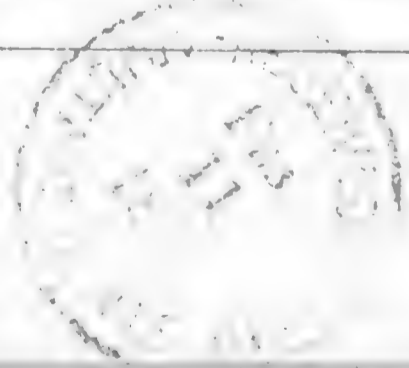

Handwritten signature or initials.

I certify, on honor, that John Weaver a Private of
 Captain W Bango Company (E) of the First Regiment of U S Cavalry
VOLUNTEERS, of the State of _____, born in Middleton Co., State
 of Tennessee, aged 25 years; 5 feet 9 inches high; fair complexion,
light eyes, black hair, and by occupation a laborer, having joined the company on
 its original organization at New Orleans La., and enrolled in it at the muster into
 the service of the United States at New Orleans La., on the 31st day
 of December, 1863, (or was mustered in service as a recruit, by _____
 _____, at _____, on the _____ day of _____,
 186 , or was drafted and mustered into the service of the United States from the _____
 Enrollment District of the State of _____, at _____,
 on the _____ day of _____, 186), to serve in the Regiment, for
 the term of Three years: and having served **HONESTLY** and
FAITHFULLY with his Company in The First to the present date, is now
 entitled to a **DISCHARGE** by reason of Death. Died in Parisian
Post Hudson La Jan 24th 1865 of Cholera Diarrhea

The said John Weaver was last paid by Paymaster
Voorhis to include the 30th day of April, 1864, and has
 pay due him from that time to the present date; he is entitled to pay and subsistence for
TRAVELING to place of enrollment, and whatever other allowances are authorized to volunteer
 soldiers, drafted men, or militia, so discharged. He has received from the United States **CLOTHING**
 amounting to Forty Four $\frac{99}{100}$ dollars, since the 1st day of February,
 1864, when his clothing account was last settled. He has received from the United States
 _____ $\frac{100}{100}$ dollars advanced **BOUNTY**.

There is to be stopped from him, on account of the State of _____, or other
 authorities, for **CLOTHING**, &c., received on entering service, _____ $\frac{100}{100}$ dollars; and
 for other stoppages, viz: _____
 _____ $\frac{100}{100}$ dollars.

He has been furnished with **TRANSPORTATION** in kind from the place of his discharge to
 _____; and he has been **SUBSISTED** for **TRAVELING** to his
 place of enrollment, up to the _____, 186 .

He is indebted to John Wild, **SUTLER**, _____ $\frac{100}{100}$ dollars.
 He is indebted to _____, **LAUNDRESS**, _____ $\frac{100}{100}$ dollars.

Given in Duplicate, at Post Hudson La, this 25th day
 of January, 1865.

W Bango

 Commanding Company.

ALCO or Albert

Webster Alfred

Co A, 4 U. S. Col'd Cav.

Private Private

CARD NUMBERS.

1	5-348509	26
2	5-3485-92	27
3	5-348698	28
4	5-348792	29
5	5-348886	30
6	5-348971	31
7	5-34905-6	32
8	5-349148	33
9	5-349222	34
10	5-349313	35
11	5-349394	36
12	5-349485	37
13	5-3495-65	38
14	5-349640	39
15	5-349710	40
16	30847519	41
17	30847720	42
18		43
19		44
20		45
21		46
22		47
23		48
24		49
25		50

Book Mark:

See also

NOV 19 1890

S. 2359100 and W.D

S. A. Muhlman
Sts.

W | **4 Cav. | U.S.C.T.**

Alfred Webster

Private, Co. *A*, 1 Reg't La. Cav., Corps d'Afrique.*

Appears on

Company Muster-in Roll

of the organization named above. Roll dated
New Orleans La Sept 12, 1863.

Muster-in to date *Sept 12*, 1863.

Joined for duty and enrolled:

When *Aug. 30*, 1863.

Where *New Orleans*

Period *3* years.

Valuation of horse, \$.....*100*

Valuation of horse equipments, \$.....*100*

Remarks:
Age 23

*This organization subsequently became Co. *A*, 4 Reg't U. S. Colored Cavalry.

Book mark:.....

M. A. Michael

W | **4 Cav. | U.S.C.T.**

Albert Webster

Priv, Co. *A*, 1 Reg't La. Cav., Corps d'Afrique.*

Appears on

Company Muster Roll

for *Sept 12 to Dec 31*, 186*3*.

Present or absent *Present*

Stoppage, \$.....*100* for

Due Gov't, \$.....*100* for

Valuation of horse, \$.....*100*

Valuation of horse equipments, \$.....*100*

Remarks:

*This organization subsequently became Co. *A*, 4 Reg't U. S. Colored Cavalry.

Book mark:

R. S. Richardson

W

4 Cav. U.S C.T.

Alfred Webster

Prin, Co. ..., 1 Reg't Cav., Corps d'Afrique.*

Appears on

Company Muster Roll

for *Jan & Feb*, 186 *6*

Present or absent *Present*

Stoppage, \$ *100* for

Due Gov't, \$ *100* for

Valuation of horse, \$ *100*

Valuation of horse equipments, \$ *100*

Remarks:

* This organization subsequently became Co. *A*, 4 Reg't U. S. Colored Cavalry.

Book mark:

A. K. Richardson

W | 4 Cav. | U.S.C.T.

Alfred Webster

Private, Co. A, 4 Reg't U. S. Col'd Cavalry.

Appears on

Company Muster Roll

for March April, 1864

Present or absent Present

Stoppage, \$ 100 for

Due Gov't, \$ 100 for

Valuation of horse, \$ 100

Valuation of horse equipments, \$ 100

Remarks:

Book mark:

R. W. Richardson

W | **4 Cav. | U.S.C.T.**

Alfred Webster

Paris, Co. A, 4 Reg't U. S. Col'd Cavalry.

Appears on

Company Muster Roll

for *May & June*, 186 *4*

Present or absent *Present*

Stoppage, \$ *100* for

Due Gov't, \$ *100* for

Valuation of horse, \$ *100*

Valuation of horse equipments, \$ *100*

Remarks:

Book mark:

R. Richardson

W | 4 Cav. | U.S.C.T.

Alfred Webster

Pmi, Co. A, 4 Reg't U. S. Co'd Cavalry.

Appears on

Company Muster Roll

for *July & Aug*, 186 *4*

Present or absent *Present*

Stoppage, \$ 100 for

Due Gov't, \$ 100 for

Valuation of horse, \$ 100

Valuation of horse equipments, \$ 100

Remarks:

Book mark: -----

R. Richardson

W | **4 Cav.** | **U.S.C.T.**

Alfred Webster
Ri

....., Co. A, 4 Reg't U. S. Col'd Cavalry.

Appears on

Company Muster Roll

for *Sept + Oct*, 186 *4*

Present or absent *Present*

Stoppage, \$..... *100* for

Due Gov't, \$..... *100* for

Valuation of horse, \$..... *100*

Valuation of horse equipments, \$..... *100*

Remarks:

Book mark:

Donnelly

U | 4 Cav. | U.S.C.T.

Alfred Webster

Pri, Co. A, 4 Reg't U. S. Col'd Cavalry.

Appears on

Company Muster Roll

for Nov & Dec, 1864.

Present or absent Present

Stoppage, \$ 100 for

Due Gov't, \$ 100 for

Valuation of horse, \$ 100

Valuation of horse equipments, \$ 100

Remarks:

Book mark:

Donnelly

W | 4 Cav. | U.S.C.T.

Alfred Webster

Pri, Co. A, 4 Reg't U. S. Col'd Cavalry.

Appears on

Company Muster Roll

for *Jan + Feb*, 1865.

Present or absent *Present*

Stoppage, \$ 100 for

Due Gov't, \$ 100 for

Valuation of horse, \$ 100

Valuation of horse equipments, \$ 100

Remarks:

Book mark:

Donnelly

W | 4 Cav. | U.S.C.T.

Alfred Webster
Pn

Co. A, 4 Reg't U. S. Col'd Cavalry.

Appears on

Company Muster Roll

for Mar & Apr, 1865.

Present or absent Present

Stoppage, \$ 100 for

Due Gov't, \$ 100 for

Valuation of horse, \$ 100

Valuation of horse equipments, \$ 100

Remarks: Stop for 1 Haversack

Book mark:

Donnelly

W | 4 Cav. | U.S.C.T.

Alfred Webster
Pri

....., Co. A, 4 Reg't U. S. Col'd Cavalry.

Appears on

Company Muster Roll

for May + June, 1865

Present or absent Present

Stoppage, \$ 100 for

Due Gov't, \$ 100 for

Valuation of horse, \$ 100

Valuation of horse equipments, \$ 100

Remarks: Stop for 1 hour -
back

Book mark:

Dunnally

W | 4 Cav. | U.S.C.T.

Alfred Webster

Pri, Co. A, 4 Reg't U. S. Col'd Cavalry.

Appears on

Company Muster Roll

for July & Aug, 1865

Present or absent Present

Stoppage, \$ 25/100 for Q. Col'd Cavalry look & overdraw

Due Gov't, \$ 100 for

Valuation of horse, \$ 100

Valuation of horse equipments, \$ 100

Remarks:

Book mark:

Donnelly

W | *1* *La. Cav. M.S.C.T.*

+ Alfred Webster

Qui, Co. *a*, *1* Reg't *La. Cav.*

Appears on

Hospital Muster Roll

of **Corps d'Afrique U. S. A. General Hospital,**

at **New Orleans, La.,**

for *Oct 1 to 31*, 186*3*

Attached to hospital:

When _____, 186 .

How employed _____

Last paid by Maj. _____

to _____, 186 .

Bounty paid \$ 100; due \$ 100

Present or absent *Present*

Remarks: _____

+ Cav. M.S.C.T.

Book mark: _____

Morgan
Copyist.

NOV 1863

W | 1 La. Cav. | U.S.C.A.

Alfred Webster

Q. i., Co. a, 1 Reg't La. Cav.

Appears on

Hospital Muster Roll

of **Corps d'Afrique U. S. A. General Hospital,**

at **New Orleans, La.,**

for Nov 7th Dec 3rd, 186 3.

Attached to hospital:

When....., 186 .

How employed.....

Last paid by Maj.

to, 186 .

Bounty paid \$ 100; due \$ 100

Present or absent

Remarks: Returned to duty Nov 21/63

Book mark :

(343)

Morgan
Copyist.

W | 4 Cav. | U.S.C.T.

Alfred Webster
Pvt, Co. A, 4 Reg't U. S. Col'd Cavalry.

Appears on

Company Muster Roll

for *Jan & Feb*, 1866.

Present or absent *Present*

Stoppage, \$ *100* for

Due Gov't, \$ *100* for

Valuation of horse, \$ *100*

Valuation of horse equipments, \$ *100*

Remarks:
.....
.....
.....
.....
.....
.....
.....
.....
.....
.....

Book mark:

Crewitt

APR 1865

W | **4 Cav.** | **U.S.C.T.**

Alfred Webster
Plt, Co. *D*, 4 Reg't U. S. Col'd Cavalry.

Appears on **Co. Muster-out Roll**, dated
New Orleans La, March 20, 1866.

Muster-out to date *March 20*, 1866.

Last paid to *June 30*, 1865.

Clothing account:

Last settled....., 186 ; drawn since \$..... 100

Due soldier \$ *15 ⁷⁰ / 100*; due U. S. \$..... 100

Am't for cloth'g in kind or money adv'd \$..... 100

Due U. S. for arms, equipments, &c., \$..... 100

Bounty paid \$..... 100; due \$..... 100

Remarks: *Joined at orig. org.*

Book mark: *16982 O.M.G. July 5/66*
V 25, P 150. 68

(361) *Prewitt* Copyist.

1141

Welcome Willis

Co A, 4 U. S. Col'd Cav.

Private Blacksmith

CARD NUMBERS.

1	5352593	26
2	5352643	27
3	5352694	28
4	5352754	29
5	5352815	30
6	5352875	31
7	5352952	32
8	5353035	33
9	5353119	34
10	5353152	35
11	5353248	36
12	5353347	37
13	5353439	38
14	5353524	39
15	5353606	40
16	5353688	41
17	40729322	42
18		43
19		44
20		45
21		46
22		47
23		48
24		49
25		50

Book Mark:

See also

S. 666 549 P.O. 90

S. A. Muhlen

549

4 | **4 Cav.** | **U.S.C.T.**

Willis Helcome

Part, Co. D, 1 Reg't, Corps d'Afrique Cavalry.*
Apr 40
Appears on

Company Muster-in Roll

of the organization named above. Roll dated

New Orleans La, Nov 26, 1863.

Muster-in to date Nov 26, 1863.

Joined for duty and enrolled:

When Nov 5, 186 .

Where New Orleans

Period 3 years.

Valuation of horse, \$.....100

Valuation of horse equipments, \$.....100

Remarks :
.....
.....
.....

*This organization subsequently became Co. D, 4 Reg't U. S. Colored Cavalry.

Book mark :
.....

Rosenbaum

H 4 Cav. | U.S C.T.

Hill's Welcome

Pvt., Co. *D*, 1 Reg't Cav., Corps d'Afrique.*

Appears on

Company Muster Roll

for *From Exhibit to sec 31*, 1863.

Present or absent *Present*

Stoppage, \$ *100* for

Due Gov't, \$ *100* for

Valuation of horse, \$ *100*

Valuation of horse equipments, \$ *100*

Remarks:

* This organization subsequently became Co. *D*, 4 Reg't U. S. Colored Cavalry.

Book mark:

Rosenbaum

H 4 Cav. | U.S C.T.

Hillis Helcolm
Pvt., Co. *D*, 1 Reg't Cav., Corps d'Afrique.*

Appears on

Company Muster Roll

for *Jan'y & Feby*, 1864.

Present or absent *Present*

Stoppage, \$ 100 for

Due Gov't, \$ 100 for

Valuation of horse, \$ 100

Valuation of horse equipments, \$ 100

Remarks:

* This organization subsequently became Co. *D*, 4 Reg't U. S. Colored Cavalry.

Book mark:

Rosenbaum
Copyist.

74 | 4 Cav. | U.S.C.T.

Willis Wilcoxon

Plt., Co. D. 4 Reg't U. S. Col'd Cavalry.

Appears on

Company Muster Roll

for March & April, 1864.

Present or absent Present

Stoppage, \$ 100 for

Due Gov't, \$ 100 for

Valuation of horse, \$ 100

Valuation of horse equipments, \$ 100

Remarks:

Book mark:

Rosenbaum

H | **4 Cav.** | **U.S.C.T.**

Willis Helcolm

Plt, Co. D. 4 Reg't U. S. Col'd Cavalry.

Appears on

Company Muster Roll

for *May & June*, 1864.

Present or absent *Present*

Stoppage, \$ *100* for

Due Gov't, \$ *100* for

Valuation of horse, \$ *100*

Valuation of horse equipments, \$ *100*

Remarks:

Book mark:

Rosenbaum

H | **4 Cav.** | **U.S.C.T.**

Willis Helcoline

Plt, Co. D. 4 Reg't U. S. Col'd Cavalry.

Appears on

Company Muster Roll

for *July & Aug*, 1864.

Present or absent *Present*

Stoppage, \$ 100 for

Due Gov't, \$ 100 for

Valuation of horse, \$ 100

Valuation of horse equipments, \$ 100

Remarks:

Book mark:

Rosenbaum

(358)

Copyist.

Yf | **4 Cav.** | **U.S.C.T.**

Willie Helcolme

Pat, Co. D, 4 Reg't U. S. Col'd Cavalry.

Appears on

Company Muster Roll

for *Sept & Oct*, 1864.

Present or absent. *Present*

Stoppage, \$ *100* for

Due Gov't, \$ *100* for

Valuation of horse, \$ *100*

Valuation of horse equipments, \$ *100*

Remarks: *Detailed as Company Cook*

Book mark:

Rosenbaum

H | **4 Cav.** | **U.S.C.T.**

Miss Helen

D, Co. D, 4 Reg't U. S. Col'd Cavalry.

Appears on

Company Muster Roll

for *Jan Dec*, 1864.

Present or absent *Present*

Stoppage, \$ *100* for

Due Gov't, \$ *100* for

Valuation of horse, \$ *100*

Valuation of horse equipments, \$ *100*

Remarks:

Book mark:

(358)

Miss Helen

Copyist.

W | **4 Cav.** | **U.S.C.T.**

J. J. McLenne

P, Co. D, 4 Reg't U. S. Col'd Cavalry.

Appears on

Company Muster Roll

for *Jan & Feb*, 186*5*.

Present or absent *Present*

Stoppage, \$ *100* for

Due Gov't, \$ *100* for

Valuation of horse, \$ *100*

Valuation of horse equipments, \$ *100*

Remarks: *Rec'd only #7, R. M. M. to include Apr 30, 64*

Book mark:

W. H. Wright
(358) Copyist.

4 Cav. | U.S.C.T.

David Williams

2nd Reg't Co. D, 4 Reg't U. S. Col'd Cavalry.

Appears on

Company Muster Roll

for Feb 1862, 1862.

Present or absent Present

Stoppage, \$ 100 for

Due Gov't, \$ 100 for

Valuation of horse, \$ 100

Valuation of horse equipments, \$ 100

Remarks: apt - Blacksmith
apt 1st
apt 1st - # 25

Book mark:

(358) David Williams Copyist.

117 | 4 Cav. | U.S.C.T.

William H. Brown

Company Co. D, 4 Reg't U. S. Col'd Cavalry.

Appears on

Company Muster Roll

for *March & June*, 1865.

Present or absent *Present*

Stoppage, \$ 100 for

Due Gov't, \$ 100 for

Valuation of horse, \$ 100

Valuation of horse equipments, \$ 100

Remarks: *up in black with 1/2*

lost for lost Ord #125

Book mark:

L. H. Knight

11 | **4 Cav.** | **U.S.C.T.**

William H. Herme

Farmer, Co. D, 4 Reg't U. S. Col'd Cavalry.

Appears on

Company Muster Roll

for *July & Aug*, 186*5*

Present or absent *Present*

Stoppage, \$ *100* for

Due Gov't, \$ *100* for

Valuation of horse, \$ *100*

Valuation of horse equipments, \$ *100*

Remarks: *Appointed Farmer*
11/65

Book mark:

L. T. H. Regt

4 Cav. U.S.C.T.

William H. ...

Blksmith, Co. D, 4 Reg't U. S. Col'd Cavalry.

Appears on

Company Muster Roll

for *Sep 4 Oct*, 1862.

Present or absent *Present*

Stoppage, \$ 100 for

Due Gov't, \$ 100 for

Valuation of horse, \$ 100

Valuation of horse equipments, \$ 100

Remarks:

Book mark:

W. H. ...

11 | 4 Cav. | U.S.C.T.

Wills' Manual

Blk Smith Co. D, 4 Reg't U. S. Col'd Cavalry.

Appears on

Company Muster Roll

for Nov 7 Dec, 1865.

Present or absent Present

Stoppage, \$ 100 for

Due Gov't, \$ 100 for

Valuation of horse, \$ 100

Valuation of horse equipments, \$ 100

Remarks:

Book mark:

Wills' Manual

MAR 1862

24 | 4 Cav. | U.S.C.T.

William Williams

Blount, Co. D, 4 Reg't U. S. Col'd Cavalry.

Appears on

Company Muster Roll

for Jan 7 - Feb, 1862.

Present or absent Present

Stoppage, \$ 100 for

Due Gov't, \$ 100 for

Valuation of horse, \$ 100

Valuation of horse equipments, \$ 100

Remarks:

Book mark:

Wm Williams

(358)

Copyist.

W | 4 Cav. | U.S.C.T.

Willie Welcome

Prk, Co. H, 4 Reg't U. S. Colored Cav.

Appears on Returns as follows:

Sept 1864 - On duty at Co. Stable

July 1865 - On duty R. G. M. D.

Book mark:

W. R. Lee

21 | 4 Cav. | U.S.C.T.

Walter McCormick

B. Smith, Co. ^N, 4 Reg't U. S. Col'd Cavalry.

Appears on Co. Muster-out Roll, dated

New Orleans, La., Nov 20, 1866.

Muster-out to date Nov 20, 1866.

Last paid to June 30, 1865.

Clothing account:

Last settled....., 186 ; drawn since \$.....100

Due soldier \$ ³ ⁸¹.....100; due U. S. \$.....100

Am't for cloth'g in kind or money adv'd \$.....100

Due U. S. for arms, equipments, &c., \$.....100

Bounty paid \$.....100; due \$.....100

Remarks: Am't of Exp. by

Book mark: V 116, P 245, 70

W. McCormick

Wellington Daniel

Co *A*, 4 U. S. Col'd Cav.

Private Private

CARD NUMBERS.

1	5354994	26
2	5355083	27
3	5355175	28
4	5355262	29
5	5355352	30
6	5355434	31
7	5355515	32
8	5355588	33
9	5355676	34
10	5355760	35
11	5355843	36
12	5355923	37
13	5356004	38
14	5356084	39
15	5356187	40
16		41
17		42
18		43
19		44
20		45
21		46
22		47
23		48
24		49
25		50

Book Mark:

See also

W | **4 Cav.** | **U.S.C.T.**

Daniel Wellington

Cpt, Co. A, Mounted Rangers, Corps d'Afrique. †

Age *—* years.

Appears on

Company Muster Roll*

for *Nov 9 Dec*, 1863.

Joined for duty and enrolled:

When *Nov 1*, 1863.

Where *Sberia, La*

Period *—* years.

Mustered in:

When *Nov 30*, 1863.

Where *Sberia, La*

Present or absent *Present*

Stoppage, \$ *—* 100 for *—*

Due Gov't \$ *—* 100 for *—*

Valuation of horse, \$ *—* 100

Valuation of horse equipments, \$ *—* 100

Remarks: *—*

†This organization subsequently became Co. F, 4 U. S. Col'd Cav.
 *First current roll. No muster-in roll of this ~~Company~~ ^{Battery} on file.

Book mark: *—*

Wanning
 (3586) Copyist.

M | 4 Cav. | U.S C.T.

Sam Wellington
Pr, Co. *F*, 1 Reg't Cav., Corps d'Afrique.*

Appears on

Company Muster Roll

for *Jan'y P Feb'y*, 1864.

Present or absent *Present*

Stoppage, \$ *100* for

Due Gov't, \$ *100* for

Valuation of horse, \$ *100*

Valuation of horse equipments, \$ *100*

Remarks:

* This organization subsequently became Co. *F*, 4 Reg't U. S. Colored Cavalry.

Book mark:

Samuel F
Copyist

MAR 1864

M | 4 Cav. | U.S.C.T.

Daniel Wellington

Pat, Co. F, 4 Reg't U. S. Col'd Cavalry.

Appears on

Company Muster Roll

for *March & April*, 1864.

Present or absent. *Present*

Stoppage, \$.....100 for

Due Gov't, \$.....100 for

Valuation of horse, \$.....100

Valuation of horse equipments, \$.....100

Remarks:

Book mark:

(358)

Hamm

Copyist.

APR 1864

M | 4 Cav. | U.S.C.T.

Daniel Wellington

Pr, Co. F, 4 Reg't U. S. Col'd Cavalry.

Appears on

Company Muster Roll

for *May & June*, 1864

Present or absent *Present*

Stoppage, \$ 100 for

Due Gov't, \$ 100 for

Valuation of horse, \$ 100

Valuation of horse equipments, \$ 100

Remarks:

Book mark:

(358)

Hamm
Copyist.

H | 4 Cav. | U.S.C.T.

Demetrius Wellington,
Priv, Co. F, 4 Reg't U. S. Col'd Cavalry.

Appears on

Company Muster Roll

for *July & Aug*, 1864.

Present or absent *Present*

Stoppage, \$ *100* for

Due Gov't, \$ *100* for

Valuation of horse, \$ *100*

Valuation of horse equipments, \$ *100*

Remarks: *Stop for one*
spur and one
brim angle

Book mark:

Manning
Copyist.

H | **4 Cav.** | **U.S.C.T.**

Daniel Wellington

Cor, Co. F, 4 Reg't U. S. Col'd Cavalry.

Appears on

Company Muster Roll

for *Sept & Oct*, 186*4*

Present or absent *Present*

Stoppage, \$ 100 for

Due Gov't, \$ 100 for

Valuation of horse, \$ 100

Valuation of horse equipments, \$ 100

Remarks: *Stop for one
spur and purchase
\$ 1.46*

Book mark: _____

Hammer Copyist.

W | **4 Cav. | U.S.C.T.**

Daniel Wellington

Pvt, Co. F, 4 Reg't U. S. Col'd Cavalry.

Appears on

Company Muster Roll

for *Nov. & Dec*, 186*4*

Present or absent *Present*

Stoppage, \$ *100* for

Due Gov't, \$ *100* for

Valuation of horse, \$ *100*

Valuation of horse equipments, \$ *100*

Remarks: *Stop for one Spur & Strap,
one Surcingle, one Nose Bag.*

Book mark:

A Harris

W | 4 Cav. | U.S.C.T.

Daniel Wellington
Pvt, Co. F, 4 Reg't U. S. Col'd Cavalry.

Appears on

Company Muster Roll

for *Jan & Feb*, 186 *5*

Present or absent *Present*

Stoppage, \$ *100* for

Due Gov't, \$ *100* for

Valuation of horse, \$ *100*

Valuation of horse equipments, \$ *100*

Remarks: *Stop for one Surcingle,*
one Nose Bag,

Book mark:

J. A. Harris

(358)

Copyist.

H | 4 Cav. | U.S.C.T.

Daniel Wellington
Pvt, Co. F, 4 Reg't U. S. Col'd Cavalry.

Appears on

Company Muster Roll

for *March & April*, 186 *5*

Present or absent *Present*

Stoppage, \$.....*100* for

Due Gov't, \$.....*100* for

Valuation of horse, \$.....*100*

Valuation of horse equipments, \$.....*100*

Remarks:

Book mark:

J. A. Harris

APR 1865

A 4 Cav. U.S.C.T.

Daniel Wellington
Post, Co. F, 4 Reg't U. S. Col'd Cavalry.

Appears on

Company Muster Roll

for *May & June*, 1865.

Present or absent *Present*

Stoppage, \$ *100* for

Due Gov't, \$ *100* for

Valuation of horse, \$ *100*

Valuation of horse equipments, \$ *100*

Remarks: *See MS for lost*
Ordinance \$100 Curry Comb
Horsebrush Sabre Knot

Book mark:

(358)

Revere
Empire

W | 4 Cav. | U.S.C.T.

Daniel Wellington

Prk, Co. F, 4 Reg't U.S. Col'd Cavalry.

Appears on

Company Muster Roll

for *July & Aug*, 186*9*.

Present or absent *Present*

Stoppage, \$ *100* for

Due Gov't, \$ *1 17/100* for *Ordinance &*

Horse Equipments.

Valuation of horse, \$ *100*

Valuation of horse equipments, \$ *100*

Remarks:

Book mark:

W Harris

W | **4 Cav. | U.S.C.T.**

Daniel Wellington

Prk, Co. F, 4 Reg't U. S. Col'd Cavalry.

Appears on

Company Muster Roll

for *Sept & Oct*, 186 *5*

Present or absent *Present*

Stoppage, \$ *100* for

Due Gov't, \$ *100* for

Valuation of horse, \$ *100*

Valuation of horse equipments, \$ *100*

Remarks: *Stop for one Surcingle*

Book mark:

J. Harris

WAR 1863
W | 4 Cav. | U.S.C.T.

Daniel Wellington

P, Co. F, 4 Reg't U. S. Col'd Cavalry.

Appears on

Company Muster Roll

for Nov. & Dec., 1865.

Present or absent Present

Stoppage, \$ 4, ⁴⁵/₁₀₀ for ordn. lost.

Due Gov't, \$ ¹⁰⁰/₁₀₀ for

Valuation of horse, \$ ¹⁰⁰/₁₀₀

Valuation of horse equipments, \$ ¹⁰⁰/₁₀₀

Remarks:

Book mark:

Wibbard

(358)

Copyist.

MAR 1869

W | 4 Cav. | U.S.C.T.

Daniel Wellington

P, Co. F, 4 Reg't U. S. Col'd Cavalry.

Appears on

Company Muster Roll

for Jan. Feb., 1866.

Present or absent

Stoppage, \$ 8. 70/100 for ordn. lost.

Due Gov't, \$ 100 for

Valuation of horse, \$ 100

Valuation of horse equipments, \$ 100

Remarks: Died at Port Hudson, La., in Post-Hosp., of Small Pox, Feb. 17, 66. Final statements forwarded Feb. 21, 66.

Book mark:

Hibbard

W | 4 Cav. | U.S.C.T.

Daniel Wellington

P, Co. *P*, 4 Reg't U. S. Col'd Cavalry.

Appears on **Co. Muster-out Roll**, dated
New Orleans, La., Mch. 20, 1866.

Muster-out to date _____, 186 .

Last paid to _____, 186 .

Clothing account:

Last settled _____, 186 ; drawn since \$ _____ 100

Due soldier \$ _____ 100; due U. S. \$ _____ 100

Am't for cloth'g in kind or money adv'd \$ _____ 100

Due U. S. for arms, equipments, &c., \$ _____ 100

Bounty paid \$ _____ 100; due \$ _____ 100

Remarks: *Joined at orig. org.*
Died Feb. 17, 66, at Fort
Hudson, La.

Book mark : _____

(861)

H. H. H.

Copyist.

Wellington, Daniel

P, Co. *A*, 4 U.S.C. Cav.
Reg't

1 Enclosures.

Bed Cards	Descriptive Lists
Burial Records	Final Statements
Certs. of Dis. for Discharge	Furloughs
C. M. Charges	Med. Des. Lists
Med. Certificates	Orders

Other papers relating to—

Admission to Hosp'l	Furlough
Casualty Sheet (Officer's)	Med. Examination
Confinement	Misc. Information
Contracts	Pay or Clothing
Death or Effects	Personal Reports
Desertions	Rank
Discharge from Hosp'l	Transfer to Hosp'l
Discharge from Service	Transfer to V. R. C.
Duty	Transportation

MAR 19 1872

Extract from Act of Congress.

SEC. 12. *And be it further enacted,* That the fees of agents and attorneys for making out and causing to be executed the papers necessary to establish a claim for a pension, bounty, and other allowance before the Pension Office, under this act, shall not exceed the following rates: For making out and causing to be duly executed a declaration by the applicant, with the necessary affidavits, and forwarding the same to the Pension Office, with the requisite correspondence, ten dollars; which sum shall be received by such agent or attorney in full for all services in obtaining such pension, and shall not be demanded or received, in whole or in part, until such pension shall be obtained; and the sixth and seventh sections of an act entitled "An act to grant pensions," approved July [fourteenth,] eighteen hundred and sixty-two, are hereby repealed.

SEC. 13. *And be it further enacted,* That any agent or attorney who shall, directly or indirectly, demand or receive any greater compensation for his services under this act than is prescribed in the preceding section of this act, or who shall contract or agree to prosecute any claim for a pension, bounty, or other allowance under this act, on the condition that he shall receive a per centum upon any portion of the amount of such claim, or who shall wrongfully withhold from a pensioner or other claimant the whole or any part of the pension or claim allowed and due to such pensioner or claimant, shall be deemed guilty of a high misdemeanor, and, upon conviction thereof, shall, for every such offense, be fined not exceeding three hundred dollars, or imprisoned at hard labor not exceeding two years, or both, according to the circumstances and aggravations of the offense.

Approved July 4, 1864.

NOTE 10.—If any soldier is charged a higher fee than that allowed by the above act, he should report the fact and the name of the agent to the Adjutant General, in order that steps may be taken to have the same refunded.

FINAL STATEMENT

OF

Levell Huntington
4th Reg't of U.S. Cav.

VOLUNTEERS.

Died Feb'y 17th 68

NOTE 1.—Two of these certificates (or duplicates) are to be given to each Volunteer Soldier or drafted man who may be discharged without being mustered out, (Final Statements are never given to men mustered out of service,) that he may at once receive from the Paymaster the pay, &c., due him, and the captain or other COMMISSIONED officer commanding the company will certify to the act of the delivery of the duplicate certificates; with these certificates the Soldier is "entitled to" his discharge, and should also present his discharge to the Paymaster to have the payment endorsed on it. The discharge is to be given back to the Soldier by the Paymaster; the latter only retaining as his vouchers the duplicate certificates.

NOTE 2.—If the Soldier is entitled to pay for the use of his horse, the Company Commander will certify to that fact on the back of both these final statements, and also to the time he has pay due for having been so mounted on his own horse.

NOTE 3.—When a Soldier is furnished with final statements, his descriptive list, if he has one, should be taken up by the officer who gives the Soldier these statements, and endorsed with a statement to this effect by the officer. The endorsement should exhibit a full statement of the time for which the Soldier was allowed pay on his final statements, the clothing account, and all other charges against him or in his favor, so as to comprise a complete exhibit of his account. It will then be transmitted to the Company Commander of the Soldier, who will enter all the data necessary to a full understanding of the Soldier's account on the muster roll upon which the Soldier's discharge is reported. The descriptive list will then be destroyed. The object of this is, that the remaining portion of the Soldier's account may be settled upon the receipt of these muster rolls, and the Soldier receive any pay or allowances that may be due him at the time of his discharge, and which may not appear on his last final statements from the fact that his descriptive list is incomplete. These accounts for back pay, &c., are settled by the 2d Auditor of the Treasury Department.

NOTE 4.—Charges for loss or injury to ordnance, horse equipments, and other miscellaneous charges, should appear under the heading of "Other Stoppages."

NOTE 5.—Bounty paid by State authorities, and not by the United States, will not be entered on this statement.

NOTE 6.—Amounts due the Sutler and Laundress must be entered on the muster roll on which the discharge, death, desertion, &c., is reported, as well as on the final statement, otherwise the amount cannot be collected from the United States.

NOTE 7.—This blank will be used for deceased volunteers and drafted men, as well as for others.

NOTE 8.—Where a Soldier dies in Hospital or on detached service, his descriptive list, if he has one, should be sent with his final statements, in duplicate, to the Adjutant General, Washington, D. C.

NOTE 9.—If the soldier is a drafted man or substitute, the space for time, &c., of enrolled, should contain only the word *drafted* or *substitute*, as the case may be. If the Soldier is a "VETERAN," (or RECRUIT,) the words *as a veteran*, (or *recruit*,) as the case may be, should be interlined after the words *mustered into the service of the U. S.* A statement of all the installments of *Veteran or Recruit Bounty RECEIVED* by the Soldier must be made on the back of each final statement.

200
[Signature]

ADJUTANT GENERAL'S OFFICE
March 5th 1868
Duplicate with Inventory sent 21 Auditor

NOV 1973

I certify, on honor, that Daniel Wellington, a Private of 1st Lt. H. C. Everts Company (B) of the 4th Regiment of U.S. C. C. **VOLUNTEERS**, of the State of _____, born in Petersburg, State of North Carolina aged 23 years; 5 feet, 4 1/2 inches high; Blk complexion, Blk eyes, Blk hair, and by occupation a Saturn, who joined for service and was enrolled (see Note 9) on the 1st day of November, 1865, at Stuvia by S. White, for the period of three years, and mustered into the service of the United States on the 30th day of November, 1865, at New Stuvia, by Capt. Annable; and having served

HONESTLY and FAITHFULLY with his Company to the present date, is now entitled to a **DISCHARGE** by reason of Death having died with the Small Pox at Fort Henderson La on the 17th day of Feb. 1866.

The said Daniel Wellington was last paid by Paymaster Maj. Snyder, to include the 30th day of June, 1865, and has pay due him from that time to the present date; he is entitled to pay and subsistence for **TRAVELING** to place of enrollment, and whatever other allowances are authorized to volunteer soldiers, drafted men, or militia, so discharged. He has received from the United States **CLOTHING** amounting to 98 ⁶³/₁₀₀ dollars, since the 21st day of December, 1864, when his clothing account was last settled. He has received from the United States _____ ^{_____}/₁₀₀ dollars advanced **BOUNTY**.

There is to be stopped from him, on account of the State of _____, or other authorities, for **CLOTHING**, &c., received on entering service, _____ ^{_____}/₁₀₀ dollars; and for other stoppages, viz: Ordinance Money.

_____ ⁸ ⁵⁰/₁₀₀ dollars.

He has been furnished with **TRANSPORTATION** in kind from the place of his discharge to _____; and he has been **SUBSISTED** for **TRAVELING** to his place of enrollment, up to the _____, 186 .

He is indebted to John Wild, **SUTLER**, _____ ⁹/₁₀₀ dollars.

He is indebted to _____, **LAUNDRESS**, _____ ^{_____}/₁₀₀ dollars.

Given in Duplicate, at Fort Henderson La, this 21st day of February, 1866.

Henry C Everts
1st Lt. Co. B, 4th U.S. C. C.
Commanding Company.

1124
Wenz Charles

Co D, 4 U. S. Col'd Cav.

2nd Lieutenant / Lieutenant

CARD NUMBERS.

1	5347397	26	34416653
2	5350084	27	34416700
3	5348120	28	42744479
4	5347395	29	
5	5350189	30	
6	5350279	31	
7	5350359	32	
8	5350437	33	
9	5350513	34	
10	5350585	35	
11	5350672	36	
12	5350767	37	
12	5350856	38	
14	5350941	39	
15	5351023	40	
16	5351185	41	
17	40729323	42	
18	34415843	43	
19	34415991	44	
20	34416119	45	
21	34416276	46	
22	34416405	47	
23	34416470	48	
24	34416526	49	
25	34416607	50	

Book Mark:

See also

MAR 1875

H | *4 Cav.* | **U.S.C.T.**

Charles Henry

(1 Regt Cav. C'd'd'a.)
2 Lt. B., 4 Reg't U. S. Col'd Cav

Age *19* years.

Appears on an

Individual Muster-in Roll

of the organization named above. Roll dated

New Orleans La., Mch 30, 1864.

Muster-in to date *Mch 15, 1864.*

Joined for duty and enrolled:

When *Mch 15, 1864.*

Where *New Orleans*

Period *3* years.

Valuation of horse, \$ *100*

Valuation of horse equipments, \$ *100*

Remarks: *Honorably dis-
charged as Private in
the 5th Iowa Cavalry
in Par. 1, Special orders*

Book mark:

Permittington
over Copyist.

JAN. - 8

5347397

1891

Remarks:
No. 67, dated Ad.
Pro, Dept. of the Gulf
March 16 1864, to
Sale, from March
14 1864 - Original
Vacancy -

MAR 1877

H | **4 Cav.** | **U.S.C.T.**

Charles Menz

2nd Lt, Co. B. 4 Reg't U. S. Col'd Cavalry.

Appears on

Company Muster Roll

for *March 1864*, 186*4*.

Present or absent *Present*

Stoppage, \$ 100 for

Due Gov't, \$ 100 for

Valuation of horse, \$ 100

Valuation of horse equipments, \$ 100

Remarks :

Book mark :

(358)

King

Copyist.

NOV 1878

21 | **4 Cav. | U.S.C.T.**

Charles Keuz

1st Lt., Co. B. 4 Reg't U. S. Col'd Cavalry.

Appears on

Company Muster Roll

for *May & June*, 186*4*.

Present or absent *Present*

Stoppage, \$ *100* for

Due Gov't, \$ *100* for

Valuation of horse, \$ *100*

Valuation of horse equipments, \$ *100*

Remarks: *Promoted to 1st Lt.
June 24th 1864. Vice killed
dismissed. I.B. 163, dated
Hd. Qrs. Dept. of the Gulf.
June 21, 1864*

Book mark:

Keuz
J.D. Copyist.

H | *4. Cav.* | **U.S.C.T.**

Charles Henry

1st Lt., Co. B, 4 Reg't U. S. Col'd Cav.

Age *19* years.

Appears on an

Individual Muster-in Roll

of the organization named above. Roll dated

New Orleans La, June 24, 1864.

Muster-in to date *June 24, 1864.*

Joined for duty and enrolled :

When *June 24*, 1864.

Where *New Orleans*

Period *3* years.

Valuation of horse, \$ 100

Valuation of horse equipments, \$ 100

Remarks: *Mustered out as
2nd Lt., Co. B, 4th U.S.
Colored Cavalry June 23rd 1864,
To fill vacancy caused*

Book mark :

Pennington
over Copyist.

NOV 10 1891

JAN. - 8

5347395

1891

Remarks:
by the dismissal
of 1st Lt. John G. Miller
Co. B 4th U.S. Cavalry,
Cavalry-

W | 4 lev. | U.S.C.T.

Charles Wenz

2d Lt, Co. B, 4 Reg't U. S. Col'd Lev.

Appears on an

Individual Muster-out Roll

of the organization named above. Roll dated

New Orleans La. June 23, 1864.

Muster-out to date June 23, 1864.

Last paid to Apl. 30, 1864.

Clothing account:

Last settled 186 ; drawn since \$ 100

Due soldier \$ 100; due U. S. \$ 100

Am't for cloth'g in kind or money adv'd \$ 100

Due U. S. for arms, equipments, &c., \$ 100

Bounty paid \$ 100 due \$ 100

Remarks: Mustered out to accept

Promotion. Has pay due as 2d Lieut from May 1st 1864 to June 23rd 1864 inclusive was in command of his co. from May 4th 1864 to June 23/64

Book mark:

Murray

(348)

Copyist.

W | **4 Cav. U.S.C.T.**

Charles Henry
1st Lt, Co. B. 4 Reg't U. S. Col'd Cavalry.

Appears on

Company Muster Roll

for *July & Aug*, 1864.

Present or absent *Present*

Stoppage, \$ 100 for

Due Gov't, \$ 100 for

Valuation of horse, \$ 100

Valuation of horse equipments, \$ 100

Remarks : *Promoted 1st Lieut
June 24/64 via Hiller dis-
missed SO #163 Hd. Qrs
Capt Gulf. June 21/64*

Book mark :

Henry
Copyist.

H | **4 Cav. | U.S.C.T.**

Charles Henry

1st Lt., Co. B. 4 Reg't U. S. Col'd Cavalry.

Appears on

Company Muster Roll

for *Sept + Oct*, 1864.

Present or absent *Present*

Stoppage, \$ 100 for

Due Gov't, \$ 100 for

Valuation of horse, \$ 100

Valuation of horse equipments, \$ 100

Remarks : *Pay due for corn
marching June 24/64
Aug 7/64*

Book mark :

H. Henry
Copyist.

W | **4 Cav.** | **U.S.C.T.**

Charles Wenz
1st Lt., Co. B. 4 Reg't U. S. Col'd Cavalry.

Appears on

Company Muster Roll

for *Nov + Dec*, 1864.

Present or absent *present*

Stoppage, \$ 100 for

Due Gov't, \$ 100 for

Valuation of horse, \$ 100

Valuation of horse equipments, \$ 100

Remarks: *Money due for commanding company from June 24/64 to Aug 7/64. Due M.D for Ordinance \$6¹⁵. Stop for one hundred & fifty three (153) rations drawn in kind.*

Book mark:

Somer

Ct | **4 Cav.** | **U.S.C.T.**

Charles Wenz.

1st Lt., Co. B. 4 Reg't U. S. Col'd Cavalry.

Appears on

Company Muster Roll

for *Jan + Feb.*, 186*3*.

Present or absent *present*

Stoppage, \$ *100* for

Due Gov't, \$ *100* for

Valuation of horse, \$ *100*

Valuation of horse equipments, \$ *100*

Remarks: *Stop for 20 Sabre -
knots. Stop for eighty-seven
(87) rations drawn in kind*

Book mark:

Somer

4 Cav. U.S.C.T.

Charles Henry

1st Lt., Co. B. 4 Reg't U. S. Col'd Cavalry.

Appears on

Company Muster Roll

for March & Apr, 1865.

Present or absent Not stated

Stoppage, \$ 100 for

Due Gov't, \$ 100 for

Valuation of horse, \$ 100

Valuation of horse equipments, \$ 100

Remarks: in error in quarters
Stop for 50 minutes brown
in hind

Book mark:

Tomura

A | **4 Cav.** | **U.S.C.T.**

Charlie Metz

Lt., Co. B. 4 Reg't U. S. Col'd Cavalry.

Appears on

Company Muster Roll

for May & June, 1865.

Present or absent Absent

Stoppage, \$ 100 for

Due Gov't, \$ 100 for

Valuation of horse, \$ 100

Valuation of horse equipments, \$ 100

Remarks : Absent in arrest
since May 13 1865

Book mark :

Somer

W | **4 Cav.** | **U.S.C.T.**

Charles Wenz

L Co. B. 4 Reg't U. S. Col'd Cavalry.

Appears on

Company Muster Roll

for *July & Aug*, 186*5*.

Present or absent *present*

Stoppage, \$ 100 for

Due Gov't, \$ 100 for

Valuation of horse, \$ 100

Valuation of horse equipments, \$ 100

Remarks: *Absent in arrest since May 13 '65. Stop for 50 ration*

Book mark:

Sumner

W | **4 Cav.** | **U.S.C.T.**

Charles Manz

1st Lt., Co. B. 4 Reg't U. S. Col'd Cavalry.

Appears on

Company Muster Roll

for Sept & Oct, 1869.

Present or absent Absent

Stoppage, \$ 100 for

Due Gov't, \$ 100 for

Valuation of horse, \$ 100

Valuation of horse equipments, \$ 100

Remarks : Absent in arrest
since May 13 / 69
Stop for fifty (50) ra-
lines

Book mark :

Forman

R

4 Cav. U.S.C.T.

Charles Wenz

1st Lieut., Co. B. 4 Reg't U. S. Col'd Cavalry.

Appears on

Company Muster Roll

for *Nov. & Dec.*, 1865.

Present or absent *Absent*

Stoppage, \$ 100 for

Due Gov't, \$ 100 for

Valuation of horse, \$ 100

Valuation of horse equipments, \$ 100

Remarks: *Absent in arrest since May 13, 65 - stop for fifty (50) Rations*

Book mark:

Chandler

W | 4 Cav. | USCT.

* Wm. W. W. W.
1st Co B.

Return

of the Post of Port Hudson, La.,

for the month of Jan, 1864,

dated Jan 3, 1864,

shows the following with regard to the person named above :

Post or station

Remarks: Dishonorably
Dismissed the Service
in G O 81 4th Div. Dep. of
La Dec 30-63

Remarks

Remarks

Book mark :

W. W. W.

W | **4 Cav.** | **U.S.C.T.**

Charles Kern

Kern, Co. B. 4 Reg't U. S. Col'd Cavalry.

Appears on

Company Muster Roll

for *Jan. & Feb.*, 1866.

Present or absent

Stoppage, \$ 100 for

Due Gov't, \$ 100 for

Valuation of horse, \$ 100

Valuation of horse equipments, \$ 100

Remarks: *Sentenced in G.O. #81 dated Hd. Qrs. Dept. La. Dec. 30/65 - to be dishonorably dismissed the service U.S.A. with forfeiture of all pay due or that may become due, and confined at hard labor at such Penitentiary as the Comdg. Genl may direct for the period of two years.*

Book mark:

Chandler

W

Chas. Wenz
Lieut

Appears on

Muster Roll

of Prisoners at Fort Jefferson, Fla.,

for Mar & Apr, 1866.

Station Fort Jefferson Fla

Clothing account:

Last settled _____, 186 ; drawn since \$ 100

Present or absent Present

Remarks: Sentence Two
years hard labor

Book mark :

J. Thomas

W

Chas. Wenz
Lieut.

Appears on

Muster Roll

of Prisoners at Fort Jefferson, Fla.,

for May & June, 1866.

Station Fort Jefferson Fla

Clothing account:

Last settled _____, 186 ; drawn since \$ 100

Present or absent Present

Remarks: Sentence 2 years
hard labor

Book mark : _____

J. K. Thomas

W

Chas. Menz
Lieut.

Appears on

Muster Roll

of Prisoners at Fort Jefferson, Fla.,

for *July & Aug, 1866.*

Station *Fort Jefferson Fla*

Clothing account:

Last settled _____, 186 ; drawn since \$ _____ 100

Present or absent *Present*

Remarks: *Sentence 2 years*
hard labor

Book mark : _____

(520)

J. Thomas

Copyist.

W
Chas. Wenz
Lieut.

Appears on

Muster Roll

of prisoners at Fort Jefferson, Florida,

for *Sept & Oct*, 1866

Station *Fort Jefferson Fla.*

Clothing account:

Last settled....., 186 ; drawn since \$.....100

Present or absent *Present.*

Remarks: *Sentence: two years
hard labor.*

Book mark:

J. S. Baker

W

Charles Wenz
Lieut.

Appears on
Muster Roll
of prisoners at Fort Jefferson, Florida,
for *Nov & Dec*, 186*6*
Station *Fort Jefferson Fla.*

Clothing account:
Last settled _____, 186*6* ; drawn since \$ _____ *100*

Present or absent *Present*
Remarks: *Sentence! Two*
years hard labor.

Book mark : _____

J. S. Baker

W
Charles Wenz
Lieut.

Appears on

Muster Roll

of prisoners at Fort Jefferson, Florida,

for Jan & Feb, 1867.

Station Fort Jefferson Fla.

Clothing account:

Last settled, 186 ; drawn since \$ 100

Present or absent Present

Remarks: Sentence! Two years
hard labor.

Book mark:

S. S. Baker

W
Charles Wenz
Lieut.

Appears on

Muster Roll

of prisoners at Fort Jefferson, Florida,

for Mar & Apr, 1867.

Station Fort Jefferson Fla.

Clothing account:

Last settled _____, 186 ; drawn since \$ _____ 100

Present or absent Present

Remarks: Charges, assault
with intent to commit rape,
date of sentence Dec, 30,
1865, Two years hard labor.

Book mark:

J. S. Baker

W | |

Charles Wenz
Lieut.

Appears on

Muster Roll

of prisoners at Fort Jefferson, Florida,

for May - June, 1867

Station F + Jefferson Fla.

Clothing account:

Last settled....., 186 ; drawn since \$.....100

Present or absent present

Remarks: Date of sentence Dec. 30/65.

Charge Assault with intent to commit Rape. Two years hard labor.

Book mark:

Long

W

Charles Wenz
Lieut

Appears on

Muster Roll

of prisoners at Fort Jefferson, Florida,

for July & Aug, 1867

Station Ft. Jefferson Fla.

Clothing account:

Last settled, 186 ; drawn since \$ 100

Present or absent present.

Remarks: Charge Assault with
intent to commit Rape.
Date of sentence Dec. 30/65.
Two years hard labor.

Book mark:

Long

W

Charles Wenz
late Lieut.

Appears on

Muster Roll

of prisoners at Fort Jefferson, Florida,

for Sept & Oct, 1867

Station Ft Jefferson Fla.

Clothing account:

Last settled _____, 186 ; drawn since \$ 100

Present or absent present

Remarks: Two years hard labor.
Date of Sentence Dec. 30 / 65.
Charge - Assault with intent
to Commit Rape.

Book mark :

Long

4 Car 4107

OCT 16.

34416700

1894.

W 1 4 U.S.C.T.

Charles Wenz
 2st
 1st , Co. B , 4 Reg't U. S. Col'd Inf.

Appears on Returns as follows:

Mch 1864 - (2 St Co B. 1 Regt Cav. Leans d'Almeida)
 Present reported and assigned to duty Mar 14/64
 Apl & May 1864 - (4 Regt U.S. Col'd Cav) Present
 June 1864 - Present appointed 1st. mustered June 24/64
 July 1864 to Mch 1865 - (1st) Present
 Apl 1865 - Present in arrest since Apr 23/65
 May to Dec 1865 - Present in arrest at Baton
 Rouge La. since May 11/65
 Jan 1866 - Dis: Dishonorably discharged
 the service per S.O. 81 Hd. Qrs. Dept of La.
 Dec 30/65
 A G.O. sentence of Court. Mar. set aside &
 annulled by G. C. M. O. H. 3 & new trial
 ordered, New Orleans, La. Sept 15/65
 (see G. O. 81 Hd of La Dec 31/65 for new
 trial)

Book mark:

W. R. Lee

N | **4 Cav.** | **U.S.C.T.**

Charles Menz

1st Lieut, Co. *B*, 4 Reg't U. S. Col'd Cavalry.

Appears on **Co. Muster-out Roll**, dated

New Orleans, La. Feb. 20, 186*6*.

Muster-out to date _____, 186 .

Last paid to _____, 186 .

Clothing account:

Last settled _____, 186 ; drawn since \$ _____ 100

Due soldier \$ _____ 100; due U. S. \$ _____ 100

Am't for cloth'g in kind or money adv'd \$ _____ 100

Due U. S. for arms, equipments, &c., \$ _____ 100

Bounty paid \$ _____ 100; due \$ _____ 100

Remarks: *Dishonorably discharged*
Dec. 20/65 per O. O. 81 dated Feb
20 Dept of La. Series 1865

Book mark : _____

Chandler

Wenz, Charles

1st St. Co., *4* Reg't *U. S. Caval.*

18 Enclosures.

Bed Cards	Final Statements
Burial Records	Furloughs or L. of A
Certs. of Dis. for Discharge	Med. Certificates
C. M. Charges <i>2</i>	Med. Des. Lists
Descriptive Lists	Orders <i>✓</i>
Discharge Certificates	Pris. of War Record
Enlistment Papers	Resignations

Other papers relating to—

Admission to Hosp'l	Furlough or L. of A
Casualty Sheet	Med. Examination
Confinement <i>2</i>	Misc. Information <i>10</i>
Contracts	Pay or Clothing
Death or Effects	Personal Reports
Desertion	Rank
Discharge from Hosp'l	Transfer to Hosp'l
Discharge from Service	Transfer to V. R. C.
Duty	Transportation

NOV 197

MICROFILM PUBLICATION M 1820

COMPILED MILITARY SERVICE RECORDS
OF VOLUNTEER UNION SOLDIERS WHO
SERVED WITH THE USCT (US COLORED TROOPS)
4TH REGIMENT OF CAVALRY

PERSONAL PAPERS' TARGET SHEET

PLEASE NOTE THE CHECKED INFORMATION ABOUT THE PERSONAL PAPERS IN
THIS FILE:

- NO PERSONAL PAPERS WERE FOUND IN THIS FILE WHEN THE
RECORDS WERE ARRANGED FOR MICROFILMING.

- 31 PERSONAL PAPER(S) FOUND IN THIS FILE WHEN THE RECORDS
WERE ARRANGED FOR MICROFILMING.

1899
No 99 N. York
Head Quarters Dist Port Hudson
Port Hudson La Apr 26th 65

Haulin Lyons
Brig Genl Comdg

Forwards enclosed affidavits in the
Case of 1st Lt Chas Wertz Co
8th W. S. Lt. Co, taken by
his Lieut. Recommends Lt
Wertz be dishonorably dismissed
the service.

file and S May 3

Recd W. S. Lt. Co May 3rd 65

NOV 19 1865

HEAD-QUARTERS, UNITED STATES FORCES,

Fort Hudson, La., April 26 - 1865.

Capt. W. H. Clegg.
U.S. Adj. Gen.
Div Northern Ca.)

Sir.

I have the honor to enclose some affidavits taken in my presence by my "Aid" St. Manning for this outrage committed by 1st Lieut Charles Wenz Co B. 4th W. S. C. Cavalry. I think some summary measure should be taken in his case. I would therefore earnestly recommend that he be at once dishonorably dismissed from the service.

I have the honor to be
Very respectfully

Yours Obedt. Servt.

Cyrus Kamein
Regt Line Vols
Comdly

Head Quarters Northern Div. La.
Baton Rouge La. May 5. 65

Clapp. Wm. H. Capt. 4th
acknowledges receipt of
letter and affidavit in the
case of 1st Lieut. Chas. Wenz
4th U.S. Cav. and directs
that Lieut. Wenz be sent
to these HdQrs. with copy
of charges against him.

31. P. 11, 1865
File

119,

Headquarters Northern Division of Louisiana,

Baton Rouge, La., May 5th 1865

General

I am directed by the Major
Genl Condy, to acknowledge the receipt
of your letter of the 26th ult, covering
affidavits in the case of 1st Lieut
Chas. Tracy & 4th Col. Cav. Maj Genl Harrow
directs that you cause charges to be
prepared against this officer, and send
him with the papers in the case, and a
list of the witnesses, to these Grand Ops
for trial by Genl Court Martial.
The prisoner will be sent under close
arrest.

I have the honor to be

Your most obt servant

Wm. B. Claiborne

Capt & Adj.

Brig Genl Hamilton

Condy Dist of

St Hudson

Head Quarters Dist of Baton Rouge
Baton Rouge La July 6th 1865

Respectfully referred to
Capt. Smith Pro. Mar. who
will give all the information
required in endorsement from
Head Quarters Dist of East Louisiana

By order of
Col. John G. Fonda
O. Robinson
Capt. U. S. A. A. Seal

Offici Pro. Marshal

Baton Rouge La July 6th 1865

I respectfully inform you
that Sec. of War was
capt in battle since he
was sent from Baton
Rouge, May 11, 1865.

He was tried & sentenced
by the Gen. Ct. Martial of
which Sec. of War was
1st Div (Hoy) army was president,
in the latter part of May.

on the early part of June
1865. The court was con-
-voked by Maj Gen. J. J.
Harris Comdr. No. 100
A. S. The findings of
the court in this case
have never been published.

Geo E Smith
Capt 30th Ala Vols
Pro means

Head Quarters Dist of Baton Rouge
Baton Rouge La July 6 1865
Respectfully forwarded to
Head Quarters Dist of East Louisiana
calling attention to Case of
Capt Smith Pro means

John G Fonda Col
Comdy Dist

file

W-15-(D. G.)-1865

New Orleans, La.
July 14. 1865

Wenz, Chas. Lieut.
Co "B," 4th 26th Co. Col.

Review of his case

The Sentence in this case is illegal. The act of Congress giving courts Martial jurisdiction in such cases declares that the punishment for the crimes mentioned shall never be less than those inflicted by the laws of the State, Territory or District on which they may have been committed, the Laws of the State of Louisiana declare that whoever shall commit a rape shall on conviction suffer death

See Sec 30 Act Congress approved March 3rd 1863 revised Stat. La. 1. 136.

The Statute of the State of La further provides, that in all cases where the punishment denounced by law is death it shall be lawful for the jury to qualify their Verdict by adding thereto

" Without Capital punishment "

and whenever the jury shall return a verdict qualified as aforesaid the person convicted shall be sentenced to hard labor for life in the State Penitentiary
See Rev. Stat. La. P. 163. "

This case should be forthwith returned for revision of finding and Sentence the place of confinement

MS. A. 1. 1. 15

should be designated by the Comdg. Gen'l.

W 732 P 1865

Received from Aug 27 1865

Mapper

Henry D. P.

Requests the release of his son, Charles Henry

E - No. 4 - M. S. C. Cavalry -

Headquarters
Left. of Louisiana
New Orleans.

August 27 1865

Respectfully referred to Col. F. A. Starnung, Provost Marshal General, in connection with previous papers in the case.

By order of
Major Genl. Canby
Lt. Col. Will Johnston
Major, Judge, Adm.

W 617/158 O. S. M. L. 1865

No. 4. Dept. of Louisiana
Office Prov. Marshal Genl.
N. O. Aug. 10 1865

Respectfully returned to the Judge Advocate of the Department. There are no records in the case of Stutz in this office, he having been tried by a military Commission.

F. A. Starnung,
Colonel 42^d sec. Infantry
Prov. Marshal Genl.

Nothing to
but: A copy of
W. full
File.

NARRATIVE

New Orleans August 2/65.

Major General Canby
Commander of the Dep^t of the Gulf.

General,

At the outbreak of the rebellion, 5 years ago, my son Charles, then at the College of ~~Buffalo~~ St Paul, a boy of 14 years, joined the Army, the 5th Iowa Cavalry, he has fought all the battles of the army of the Cumberland under General Rosecrans and distinguished himself several times, as the recommendations of his Superiors show. After three years hard service he got the Typhus Fever and his health being greatly impaired he got a furlough and came here to get cured. My family being here that winter from the North we received generally some officers, friends of my son at our house amongst others Major Mitchell, Col. Alexander, Capt M^o Cormick who prevailed on him to join their regiment the 1st U. S. C. Cavalry their station is this City, which he did, and as long as those gentlemen came to my house they professed to be great friends to my son.

Some time last year when the Regiment was at Camp Colfax, Capt. M^o Cormick being absent with a bad sickness, my son had charge of the Co^s, and found the books of the Co^s in very bad order, and a good many

articles which according to the books should have been there were not to be found, my son told M^o Cormick to settle this matter for he would not have the responsibility but M^o Cormick did not, when by accident Col Alexander learned the circumstance and ordered M^o Cormick under arrest and he was court martialed; since that time he was the declared enemy of my son and swore that he would be revenged on him believing that my son had been the cause of his shame, Mitchell then Major, now Lt Col, professing always to be a great friend to my family, courted a girl in this city with whom my son was also acquainted she being an acquaintance of my daughter, but as I understood since Mitchell & my son had some words on account of that girl, and since that time Mitchell turned my son's declared enemy; however things went on smoothly enough seemingly, until about 3 months ago, Col Mitchell being in this city for some weeks, his friend M^o Cormick having command of the regiment, my son was ordered to some expedition, and after coming back was put under arrest and most horrible charges preferred against him by M^o Cormick, who has since left the service, but my son was sent to Baton Rouge and had to appear before a Court Martial who could not make out any thing against him except perhaps having been drunk from some Whisky which M^o Cormick had furnished to the men of the expedition.

I never meddle with anything and when I first was told that my son was under arrest, I said, it is right, if he did anything wrong, he should be punished for it, but this morning, a gentleman from Baton Rouge came down to see me and told ^{me} that my son was sick, placed in the most miserable dungeon like a thief or murderer, that he had to eat the same food with the others, thieves and felons and inmates of the prison, that he is neither allowed to write nor receive any thing as any one and that nobody cared for him in his sickness, that all the officers up there said that young man was innocent of those vile charges, that there was a conspiracy against him, or jealousy the cause of it, that he was the best officer in that regiment and that it was shameful to have him treated in such a way, that I stuned see or write to your Excellency, who certainly did not know any thing of such a vile treatment to one of your officers who has perhaps risked his life a hundred times for this country, that gentleman told me further that the Court Martial or trial took place in his house and that the officers afterwards had a talk about it which he heard and wherein they concluded that there must be some conspiracy for they could not find any thing against him.

General, I do not want to interfere with your military laws, if the boy is guilty and your sentence would be to have him shot. If he deserved it, I would not murmur, but for God's sake if he is innocent let not put him in a dungeon for perhaps the offence of intoxication, for the other accusations are false, as every body says and impossible, as all who know him will say.

Be so kind, General and have the matter looked over, you are a Soldier and a Gentleman of justice and you will find it quite different to the accusations of M^r Cormie his worst enemy who did it in spite and out of revenge; have justice done to my son and release him, or send him here to get well again, or at least have him treated as a officer or soldier but not as a felon or thief.

I am convinced of your justice and hope that I shall soon hear of my sons release meanwhile I remain,

General

your most ob^t Serv^t
D^r. J. Henry
General Consul
213 Rampart St,

received
D^r. Henry

General

General

General Superdial 5/1865
Baylor & Co. La August 18th 65
D. P. L. S. - 1865
Harris

Smith
Capt Geo. E. Frowst, Mar

Asks for information in
regard to the case of Lieut
Charles ^{H. M. S. C. Carly} ~~Wing~~
found on charge of "Rape"

Head Quarters Post Baton Rouge
August 19th 1865

Respectfully forwarded
to the Eastern District
of La. for information
John G. Fonda
W. Brig. Genl. Comdg
S. R. P. P. 35. S. 7.

File

See 1st Letter Book
D. L. S. Aug 23rd 1865

Ad: Mr. J. Ant. de
A. Orleans Aug 21/
No 4519 - 15 65
Respe. forwarded
to Hd. Qu. etc.
no information
of this case is at
these Hd. Qu.

J. M. W. Mar
B. M. C.

W. M. L.

Provost Marshal's Office,

Baton Rouge, La., August 18th 1865.

Lieut.

I have the honor to invite the attention of the Commanding General to the following statement and would respectfully ask for instructions.

On the 11th day of May 1865 1st Lieut Charles Wenz of Co "B" 4th U. S. C. being was received here from Fort Hudson La under guard. He was charged with "rebel" and was confined in the Military Prison at this place by order of Major Gen. F. D. Herron to await trial. A General Court Martial was convened

by an order from Head Quarters So. Divⁿ of La Major Gen. Herron Comdg and the case was tried.

Soon after Head Qrs So. Division were removed to Shreveport - The result of the trial, has never been made known - It is possible that the proceedings were lost in transmission.

Lieut Wenz still remains here in Prison. The records of the So. Division were removed to Shreveport so that it is impossible

to arrive at the facts. The Officer has
been in Prison more than three months
and it would seem just to have his
case decided as soon as practicable.

I am very respectfully

Yours Obedt Servt

Geo. E. Smith

Capt 33rd Ills Vols, Prov Marshal

Lieut E. B. Hamilton

A. A. A General

Post of Baton Rouge

D. 18. D. 18. D. 18. 1865

Baton Rouge La
 August 20th 1865

Dillon J. S.

St 118th St. and A. A. J. Gent

On monthly Prison Report
 of Dist Baton Rouge and
 Port Hudson. for Aug 20th 1865

Wenz - Chap.

1 - 11 - 4 - 1 - 1 - 1

Recd D. 18. D. 18. 23rd 1865

Office of A. S. G. Sub-District of B. & B. R.
Bates Range Sa Aug 30th 1865

Genl Col John W. Nelson
Asst. Insp. Genl
Dept of Louisiana
Colonel

In obedience to Par 3^d

Act 1st of 1861 Office of Sub-District Genl Dept of Louisiana
New Orleans La July 15th 1865 I have the honor to
submit the following report of this Sub-District
Prison at Bates Range Sa, We regularly keep
Office of the "W. Guard" for each day receipts for
all the prisoners requiring on duty. Sanitary con-
dition of prison good, food quality of food well
prepared as furnished the prisoners. No prisoners
unreasonably detained except 1st St Charles Henry
Co "B" Lt. W. G. De... was here about the 16th of May 65, by G. H. M. Court
Commander by order from... Sa, dated
at Bates Range Sa about the 11th of May 65 (cannot
produce the original order or exact date) proceedings of
Court has never been promulgated.

Prison at Port Hudson Sa Official Conduct by
Lt. W. G. De... keeper good. Sanitary condition of Prison good.
Food good & well prepared. No prisoners unreasonably detained.

Prison at Bluffton Sa No prisoners con-
fined except vagrant Negroes, who are
employed in policing the Post. None
unreasonably detained

Good

Very Respectfully,
your Obedt Servant
J. S. Collins
1st St. N. W. & S. W. C. C.
Sub. Div. of P. O. & B. R.

Ad Qrs. Western Dist. of La
 Alexandria, La Aug. 31st 1865
 H. ~ 19 - (D. G.) - 1865
 Sup.

John P. Hawkins
 Brigadier Major General

Acknowledge the receipt of
 Court Martial proceedings in
 the case of Lieut. Newze
 4th N. S. C. Co. That
 certain officers composing
 the Court are not in his
 command & requests that
 they be ordered to report to
 him -

Headquarters Western District of Louisiana,

ALEXANDRIA LA. Aug. 30th 1865.

Maj. De Witt Clinton
Judge Advocate
Dept of La.

Major,

I have the honor
to acknowledge receipt of your
proceedings in the case of Lieut Wenz
4th U.S. Calend Cavalry, the trial was held
at Baton Rouge and of the Officers composing
the court the following are not in
my command viz

Capt. R. R. Griffith 13. Wis. Battery
1st Lieut. J. S. Dillon 118. Ill Mounted Inf.
Capt. Warren Olney 65. U.S.C.G. I. G.

The above officers are required to complete
a minimum court, and I would
respectfully request that they be ordered
to report to me, they had better assemble
in New Orleans and report together.

I am Major
Very Respectfully
Your Obedt. Servt.
John P. Hawthorn
Brig. Maj. Genl. Comdg.

Raton Range I. C.
Sept 23rd 1865

George J. C.
P. D. P. C. C. C.

Ask whether Louis Henry is
to be sent to New Orleans
To be tried or retained at
Raton Range.

H. U. S. C. C.

NOV 13 1866

U. S. MILITARY TELEGRAPH.

W.G. Sept 23^d 1866

By Telegraph from Palm Range 23^d 1866

To Capt P.B. Campbell A.S.

Serith Weary is ordered to be tried before a Court from Hd Qrs Eastern Dist La. Do you wish him sent down or retained here

Very Resp

J. J. Fonda
Bot Brig Genl Comdg

26 mil

NOV 19 1892

Chas. Henry
1892

Head-Quarters 1st Brigade, 2d Division, U. S. Colored Troops,

Department of the Gulf,

Port Hudson, La., February 14th 1865.

Special Orders } Extract
No 4 }

Pursuant to instruction
from Brig Genl G. L. Suddens Comdr
U. S. Col Troops Dept of the Gulf Lieut
Charles Henry 1st U. S. Col Troops
has appeared before the Board of Ex-
aminers to answer at this post his
questions as to his capacity, qualifications
property of conduct and efficiency as an
Officer

Chief of Board

By Command of
Colonel Chas. S. Jones
Lieut. C. M. Edwards
Capt. W. H. S. S. S.

Quarters Co "B" 4th U.S. Col. Cav.
Port Hudson, La. April 16th 1865

Henry Charles
1st Lieut 4th U.S. C. C.

Requests that a leave of absence be granted him
for seven days to visit the city of New Orleans

1st Lt 4th U.S. C. C.
Port Hudson La April 17 1865

Respectfully forwarded
Approved

The statement of
this officer is correct. He
has never had a leave of
absence since joining the
Regiment and a Captain
is in command of the Co

Acute b. Mitchell
Lt. Col Comdg.

Recd via R.F. ...

Headquarters Dist Port Hudson
Port Hudson La April 18 1865

Respectfully forwarded
Approved

Lynus Hamlin
Brig General

33. Ad Gen of La 1865
Granted see. Com. 2 of S. C. 71
Approved by Ad Gen of La.

Recd via ... of La April 21 1865

Quarters Company "B" 4th Reg. U.S. Col. & Cavalry.
Port Hudson. La. April 18th 1865.

Captain W. H. Clapp.
Asst Adjut Genl Mor. Div. of Sea.
Captain

I have the honor to respectfully request that
I be granted a leave of absence for seven days, to visit the City of New
Orleans, to see my family who have just arrived there from the North.
I am.

Very Respectfully

Your Obedient Servant
Charles Werry
1st Lieut Co "B" 4th U.S. C. & C.

Headquarters, Department of the Gulf,

New Orleans, La., Abstract 1865.

Charles Wenz 1st Lieut B Co 4th U.S.C. Cav.
was tried before a General Court Martial com-
menced by Major General Howson commanding
Southern Division of Louisiana, on the following
charges

Charge 1st Conduct unbecoming &c.

Charge 2nd Rape

Charge 3rd Assault and Battery with attempt
to commit Rape

The Specifications set forth the Allegations that
accused was under the influence of liquor, did
believe in a disorderly manner, in presence of un-
"listed men and did have connexion with an
aged colored woman in presence of an enlisted
man did revish and carnally know Ann Boyce
an aged colored woman, at Fort Hudson April
21st 1865.

Plow - to the 1st charge "Guilty"

to the 2nd & 3rd " " Not Guilty

Proof shows that accused went to the house of
a colored man by the name of Chanley

arrested the man and ~~sent~~^{sent} away from his house under Guard, went to the house ~~to~~ his orderly to bring him the wife of Charity (aged 60 years) Crew his pistol compelled the orderly to obey took the old woman in spite of her protestations stripped her, went to bed and had connexion with her; remained in bed half an hour the woman got up and fled to the woods, accused got up destroyed a portion of the furniture, took some shirts and shoes away.

No defence is made ~~accused by his~~
~~and~~ except a statement made by counsel and worse than nothing. The testimony fully supports the finding of the court of Guilty. accused is sentenced to be dishonorably dismissed with loss of all pay, to be stripped of his insignia of Rank and confined 5 years here to be such place as Comdg. Genl. may direct.

APR 21 1865

Ann Prooye - (Colored) being duly sworn Deposes and says - I am a colored woman, living with my husband in a small Cabin near the outer works of Fort Hudson - My husband is a gardner and our house is near the Camp of the 4th Regt. U.S. Cal. Cavry. The officers and men frequently came to my house and always treated me well, until yesterday (April 21st 1865) when Lieut Wentz of the 4th Cavalry - came with eight or nine men and one white man, up to my house and took my husband off - out of sight of the house. The Lieut & his Orderly remained - I then asked him what he wanted - he said he wanted to "do it to me" I refused and started to run away, when his Orderly came after me and carried me back by main force - and threw me on the bed. Lieut Wentz then stripped all my clothes off and left me naked as when first born. got on to me and ravished me lying on me for nearly two hours - from about an hour and a half by sun to after dark. He then called an Orderly and sent him out after an old grey headed woman who is a cripple and cant walk without a cane - and has no teeth, and made him lay her on another bed in the same room and ravish her - The Lieut and I were on one bed and his Orderly & this woman on a bed in the other corner of the room - The Old woman was crying out to the Orderly while he was ravishing her. "See no account

any more - I've no account. I'm too old"
 I am an old woman myself and have great
 grandchildren living. The Lieut had been
 drinking but was not so drunk but what
 he knew what he was doing to me. My
 Breast is sore where his buttons rubbed on my
 breast. I done all I could to stop him.

When he let me up - I ran away again
 into the woods. When I came back to my
 house I found my clothes scattered all
 over the floor - the bed turned up - my trunks
 broken open and my shirts and two pair
 of shoes carried away. Lieut Wentz has
 often been to my quarters before - never had
 any credit from him before - on one occa-
 sion I got some Tobacco from him - I
 met the Lieut when I was coming in this
 morning to report this. He was with his
 Company - he stopped - dismounted and came
 up to me - asked me not to ruin him by
 telling of this, offered me money - said
 he had sent my things back - and begged
 me not to tell what he had done - But
 I had promised God last night to come in
 and tell in the morning -

Ann ^{her} Dooze
 mark

Sworn and subscribed to
 before me this 22^d day of
 April 1845.

E. J. Manning -
 1st Lt. 8th U.S. Col. Inf'ty
 A.D.C.

NARRATIVE

Private Isaac Jackson "B" Co. 4th Cav. U. S. Colored.
being duly sworn deposes and says. I am a
Private in "B" Company, 4th Regt. U. S. Col. Cavalry and
I was ordered by Lieut Wintz, Comdg Company
yesterday - (April 21st 1865) went with him and
some other men outside the works yesterday. The
(Lieut Wintz) was drunk and so was I. partly
He treated us all to some liquor - a drink
apiece, a Drgt and eight men in all - We had
a white man - whose name I do not know. but
know him to be a Telegraph Repairer stationed
at Fort Hudson - We went to "Charlie" a colored
man - a gardner near the Fort. The Lieut ordered the
Drgt to carry old Charlie off a little ways and
keep him there - if he moved - "shoot him" - and
ordered the white man to stay with him. The
Lieut and I were left alone and in company
of old Charlie's wife. The Lieut asked her
to let him do it. (meaning thereby, improper
intercourse with her) she replied that she
"could not do such as that" and started to run.
The Lieut ordered me to catch her - and on my
refusal, threatened to shoot me - I went and
caught her, carrying her to the house. The
Lieut took her from me at the edge of the bed and
put his hand over her mouth to stop her cries for
"Charlie". threw her on the bed - stripped all her
clothing off from her and got onto her - he then
talked to her a moment and I thought she acted
as if she would let him do what he wanted to
but wanted me sent away - He sent me out
to look after the horses - but in a few moments

called me back - saying "go out of doors and bring that old woman in here and put her on the bed" I went out and got the old woman. she had grey hair, no teeth, and couldnt stand straight she was so old. The Lieut made me put her on the bed that stood in the other corner and ordered me to do to her what he was doing to his woman. I refused, saying, "I would as soon sleep with a dog as f- k her, she is so old." He drew his pistol and made me get onto her. I saw the Lieut have intercourse with her three or four times in one hour, and he laid on her the whole time. We then seemed satisfied and got up. she started up also and ran away into the woods. The Lieut sent me to bring her back I went but could not find her. The Lieut then broke open all the trunks and drawers - and took out two pairs of shoes and two shirts which he made me carry away. This woman the Lieut slept with was very old and said she had grand children. She struggled at first when I carried her to the tent. But the Lieut did not have any trouble with her and seemed very well satisfied when he was on her. We came back to camp and this morning the Lieut made me carry the things back to her. He was not drunk so bad, but what he knew what he was about - He seemed very hot however.

Geo. H. Jackson
 Ensign

Sworn and subscribed to
 before me this 22nd day
 of April 1865.

E. H. Manning

1st Lt. 8th U. S. Col. Inftry
 A. D. C.

Supt Patrick Green "B" Co. 4th Regt. U.S. Colored Cav.
 being duly sworn deposes and says. I am a
 Supt in Lieut Wentz's Company "B" 4th U.S. Col. Cav.
 and went with him outside the works at Port
Henderson yesterday. (April 21st 1865) with eight men
 and a white man whose name I do not know, but
 know him to be a Telegraph repairer who is
 stationed at Port Henderson. We went first to Nero
Louderie and from there to Mrs Montague's and
 thence to "Charlie's" an old colored man - a
 gardener living near the Fort. Before we got
 to the house Lieut Wentz ordered me to take three
 men and carry the man of the house (Charlie)
 away and keep him under arrest out of sight
 of the house. I done so, placing three of the
 men at the same time on picket to guard
 against a surprise by the rebels as we were
 outside the lines. I had taken Old Charlie
 but a little ways, when I heard a loud cry
 at the house, of a woman screaming. This
 screaming was kept up about fifteen (15)
 minutes, as near as I can tell. We
 got to the house about an hour by sun. The
 Lieut and his orderly were in the house a
 good hour. When they left they came out
 and called to me to come with my men and
 go with me. I done so - did not see anyone
 near the house then - Saw that the orderly had
 a small bag tied behind his saddle. Thought
 it looked as if a pair of shoes were in it. The
 white man - the repairer - went with me by the
 Lt's order when I had the man in the woods and

knew nothing of what was going on in the house - I suspected what was going on. but I did not dare leave my post to go and see. Shortly after I went into the woods with the old man. I saw a woman run out of the house and the Lieut's orderly, Don Jackson, run after her with a drawn sabre - saw him carrying her back to the house - as I was about three hundred yards off at the time, and the cane between us was very high I could not see more - But I saw the woman carried into the house - On our way back to camp were met by an Officer who arrested Lieut Wentz. Lieut Wentz was drunk - he had been drinking during the afternoon but was not so drunk but what he knew what he was about - I supposed until I saw Lieut Wentz arrested, that we were out on duty, by the Commanding Officer's order.

(Signed) Patrick Green -
 Engr. "B." Co. 4th U.S. Army

Sworn and subscribed to
 before me, this 22^d day of
 April 1865.

E. G. Manning
 1st Lieut. 8th U.S. Cal. Infy.
 A.D.C.

I certify the above to be true copies of the
 Original Depositions taken before me the 22^d
 day of April 1865.

E. G. Manning
 1st Lieut. 8th U.S. Cal. Infy.
 A.D.C.

Head Qtrs Dist East La
June 5, 1865.

Shanks Co. La.

Sicut v. A. C. C.

For Gen. Comdg directs
that report in case of
St. Heutz 4th U.S. C.
be furnished to H. Q. S.

Pos. Marshals Office
Baton Rouge La July 6, 1865.

Respectfully returned thro.
H. Q. S. Dist Baton Rouge.

Sicut Heutz is charged
with rape &c. He has
been in close confinement
since May 11, 1865.
I do not think a
person under such grave
charges should be allowed
mans privileges.

Geo. E. Smith
Capt 83 Ill. Vol
Pos Marshal

Head Qtrs Dist of Baton Rouge
Baton Rouge La July 6 1865
Respectfully forwarded calling
attention to enclosure of
Capt Smith.

John G. Fonda Col
County District

Head Qtrs Dist East La
July 6 1865

Respectfully returned to Capt
Smith Pos Marshal, thro
District of Baton Rouge, for
information as to whether
the officer within named
has been heretofore at any
time since his arrest - allow
ed the privilege asked - if
he has been tried - and
by what Court.

By Command of
Mort May Gen Lawd
G. Shanks
St. La. La

HEADQUARTERS DISTRICT
EAST LOUISIANA
July 5th 1863

Capt Smith
Provost Marshal.

The General Command-
ing directs that you furnish these
Head Quarters with a report in the case
of Lieut Wentz 4th U.S. Old Cav. now
in jail, as to whether it is unprejudicial
to the good of the Service to allow him
the limits of town during his arrest.

I am very respectfully
your Obedt Servant
Charles G. Shanks
Lieut 9th Co and A. A. G.

Dep't of War, 24 1865.
Headquarters
Dept. of Louisiana
New Orleans La
Nov 27 1865

Respectfully returned
with a copy of Genl Order
No. 113 U.S. from these
Headquarters, enclosed

The charges with
the proceedings in this
case have been forwarded
to the Judge-Advocate
General U.S. Army

By order of
Major Genl R. S. Johnson
William Hoffman
Major, U.S. Army
EX 175 426

Ms. A. 9. 2. 46
Louisiana Dept of
New Orleans Nov 27 1865

Major W. Hoffman
A. A. Genl

Transmits G. O. 113, Part-Dep't
in Formulating Proceedings of
G. M. C. P. G. (Hunt, Wash. C.)
The charges with proceedings hereon
sent to the Judge Advocate General
U.S. Army

Ms. A. 9. 2. 46
Filed in
"C"

Military Prison Baton Rouge Oct 1st 1865:

Dear Father

I have just received your letter dated September 29th 1865 and am very sorry to say it has only been the second one that I have received from you since I have been in confinement which is now nearly six months. In your letter you stated that I had pleaded guilty to all the charges that were against me I must beg leave to tell you that you have been wrongfully informed I pleaded guilty only to conduct unbecoming an officer and a gentleman because I was drunk and that is all I am guilty of as far as I know if I am guilty of the other charges I don't know as I said before I was drunk and don't know what I did at the time. I certainly would not plead guilty to the other charges when I don't know myself if I am or not. A man may do a great many things while under the influence of liquor that he won't know anything about when he becomes sober. And that is my sin. Now to give you a history of my military life. I enlisted in the year 1861 was among the first that left the state of Minnesota for the seat of war. Served honestly and faithfully as a private three years in the Army of the Cumberland and for the first time got a furlough for reenlisting as a veteran that was in the month of Feb 1864. when I came to New Orleans to see you the battles I was in and the hardships I suffered while I was in the Army of the Cumberland you have heard of before while I was in New Orleans as you well know I was ordered before a board of Examiners passed the board and received a commission as second lieutenant in the first Cavalry C. d. A. in May 1864. Adjutant General Thomas came to New Orleans and I received a commission as First Lieutenant in the 4th Regt of United States Colored Cavalry. I have been before two boards of Examiners since that time and passed them which makes three Military boards I have passed altogether. On the morning of the 27th of April 1865. after coming in with my company from drill I was in my tent and the first thing I saw was a guard

before my door and says to me you cant come out nor you cant
 talk to any one. I was kept there untill the tenth of may never received
 an order ordering me under arrest nor a copy of the charges against
 me untill the 9th of May on the 10th I was taken under guard to Baton
 Rouge there thrown into prison in close confinement with murderers
 and Robbers and others of that sort in about six days after that
 I had my trial. There was three charges against me the first was conduct
 unbecoming an officer and a gentleman. the second was Rape. the
 third was attempt to commit Rape. To the first charge I pleaded
 guilty for I was drunk. To the second and third charge I pleaded not
 guilty. The first thing I saw after that was a Colored Woman and
 two Colored Men who swore against me god knows what I cant
 remember half of it. If I did what they said I did I dont know
 it as God is my judge. I pleaded guilty to all I knew that I was
 guilty off like a man and that was being drunk. In a Military
 trial there is very little chance for the prisoner anyone may get some-
 one to swear that the prisoner done this or that and make the case
 three times as bad as it is. I may go to a court martial and swear
 you took a steamboat out of the river and carried it trough the
 streets of New Orleans which is an impossibility - but I suppose
 the court will have to go according to the evidence given them
 by the witnesses. After having my trial I was taken back to prison
 and kept there untill August 23rd when I was paroled within the
 limits of the city of Baton Rouge about two weeks after being
 allowed the limits of the city of Baton Rouge I was again put
 back in prison and in close confinement I was told that my
 papers had been found; after being in prison about a week I was
 told that my sentence was 5 years in prison loss of all pay and
 dishonorably dismissed from the service and that Maj. General Canby
 Commanding the Department of Louisiana had disapproved the

NOV 14 9

Sentence because it was not severe enough and had ordered another trial to punish me for more than five years. If that is so may God help me for I cant help myself. I might get out of prison and run away like a great many others have done but that is not my way of doing business. I will stay and take the consequences and may God help me. If I did what the colored Woman said I did I dont know it. I was drunk and in my own mind I dont think that I am guilty, others may think different. I would have written to Major General Canby myself about my case but the Army Regulations say an officer under arrest will not visit his Commanding or write to him officially unless he has permission to do so, first that is the reason that I did not write to him. Some men tell me that I may get shot if that is so let it come I have faced death more than once in this late war and I can do it again and do it like a man if I have got to go to a state prison for life or 25 years or so I would sooner be taken out and shot like a Soldier and a man then I will be out of all my trouble and misery. You state in your letter you got gray hairs by my Conduct I am very sorry and God help me if ever I get out of this you will never have to say that I am a disgrace to you or your family or anyone else. It was that damned infernal (excuse me for swearing) whiskey that got into my head and made me drunk. If I did what they say I did I dont know it this day for as I said before I was drunk and that is something that will never happen to me again as long as I live for I have sworn never to drink another drop and I will and mean to keep it. I have served this country Honestly and faithfully as a private and an Officer for more than four years and this has been my first bad Conduct and the first time that I ever was before a Court for bad Conduct in Civil life or Military life

MAR 11 1865

I am young yet am not 20 years old and if I dont get shot
or in prison I will soon wash out the stain that rests
on my name at present by future good conduct
I may have another trial or not I dont know nothing
about it here I am in a prison cell two feet
wide and four feet long hear nothing nor see
nothing and may God help I must now close
and will try to live and hope

Your Unfortunate Son
Chas. Henry

Write Soon

10-66
2
1865

General Court Martial.

GENERAL ORDERS, } HEADQUARTERS,
 No. 81. } DEPARTMENT OF LOUISIANA,
 New Orleans, La., December 30, 1865.

I. Before a General Court Martial, which convened at Baton Rouge, Louisiana, pursuant to Special Orders, No. 314, dated November 9, 1865, and Special Orders, No. 319, dated November 14, 1865, from Headquarters, Eastern District of Louisiana, of which Major *Francis Moore*, 65th U. S. Colored Infantry, is President, was arraigned and tried:
 1st Lieutenant *Charles Wenz*, Company "B," 4th U. S. Colored Cavalry.

CHARGE 1ST.—“*Conduct unbecoming an officer and a gentleman.*”
 CHARGE 2D.—“*Rape.*”
 CHARGE 3D.—“*Assault and battery with intent to commit rape.*”

PLEA.

To which charges, and their specifications, the accused pleaded—
 “*Not Guilty.*”

FINDING.

After mature deliberation on the evidence adduced, the Court finds the accused as follows:

Of the Specification of the 1st Charge, “*Guilty,*” except as to having sexual intercourse with a colored woman.

Of the 1st Charge—“*Guilty.*”

Of the Specification to the 2d Charge—“*Not Guilty.*”

Of the 2d Charge—“*Not Guilty.*”

Of the Specification to the 3d Charge—“*Guilty*”—except the words, “*did carry by force to a bed.*”

Of the 3d Charge—“*Guilty.*”

SENTENCE.

And does, therefore, sentence him, 1st Lieutenant *Charles Wenz*, Company "B," 4th U. S. Colored Cavalry, “*to be dishonorably dismissed the service of the United States, with forfeiture of all pay and allowances due, and to be confined at hard labor, at such State Penitentiary as the Commanding General may direct, for the period of two years.*”

II. The proceedings, finding and sentence in the foregoing case are approved. The accused, 1st Lieutenant *Charles Wenz*, Company "B," 4th U. S. Colored Cavalry, ceases to be an officer in the service of the United States from this date. He will be sent to the city of New Orleans, under a secure guard, and delivered into the custody of the Provost Marshal General of the Department, to await the designation of a place of confinement by the Secretary of War.

BY ORDER OF MAJOR-GENERAL E. R. S. CANBY:

WICKHAM HOFFMAN,

Assistant Adjutant General.

OFFICIAL;

Acting Assistant Adjutant General.

General Courts Martial.

GENERAL ORDERS, } HEADQUARTERS,
No. 43. } DEPARTMENT OF LOUISIANA,
New Orleans, La., September 15, 1865.

I. Before a General Court Martial which convened at Baton Rouge, La., pursuant to Special Orders No. 86, of May 11th, 1865, Headquarters, Northern Division of Louisiana, and of which Lieutenant-Colonel *William Ray*, 1st Indiana Heavy Artillery, is President, was arraigned and tried:

1st Lieutenant *Charles Wenz*, 4th U. S. Colored Cavalry.

CHARGE I.

"*Conduct unbecoming an officer and a gentleman.*"

CHARGE II.

"*Rape.*"

CHARGE III.

"*Assault and battery, with intent to commit rape.*"

To which Charges and their Specifications, the accused pleaded:

To the Specification of the 1st Charge; "*Guilty*," except the words "did behave in a very disorderly manner in the presence of several enlisted men," and the words "had sexual intercourse with an aged colored woman, one *Ann Booze*, in the presence of an enlisted man."

Of the 1st Charge—" *Guilty.*"

Of the 2d Charge and its Specification—" *Not Guilty.*"

Of the 3d Charge and its Specification—" *Not Guilty.*"

FINDING.

After mature deliberation, the Court finds the accused:

Of the Specification to 1st Charge—" *Guilty.*"

Of the 1st Charge—" *Guilty.*"

Of the Specification to 2d Charge—" *Guilty.*"

Of the 2d Charge—" *Guilty.*"

Of the Specification to 3d Charge—" *Guilty*," except the words "and did compel an enlisted man to seize and carry by force to a bed in her cabin the said *Ann Booze.*"

Of the 3d Charge—" *Guilty.*"

SENTENCE.

And does therefore sentence him, 1st Lieutenant *Charles Wenz*, 4th U. S. Colored Cavalry, "to be dishonorably dismissed the service of the United States, with loss of all pay and allowances now due, or that may become due him; to be stripped of the insignia of his rank and profession in the presence of his regiment, and be confined at hard labor for the period of five years at such place as the Commanding General may direct."

1154

II. The sentence in the foregoing case is annulled and set aside.

The Act of Congress giving Courts Martial jurisdiction over the crime of rape, in certain cases, provides, that in the event of a conviction, the punishment shall never be less than that prescribed by the laws of the State, Territory or District where the offence is committed.

The punishment awarded by the laws of Louisiana, for this offence, is death; but the jury may in their discretion, bring in a verdict of "guilty, without capital punishment," in which event imprisonment for life would be the punishment inflicted. The sentence therefore is illegal and void, and the proceedings are disapproved and rendered nugatory.

The accused will be brought to trial upon the same charges before a Court to be convened by the Commanding General of the Eastern District of Louisiana.

BY ORDER OF MAJOR-GENERAL E. R. S. CANBY:

WICKHAM HOFFMAN,

Assistant Adjutant General.

OFFICIAL:

Nathaniel Dubauk
Acting Asst. Adj. General.

General Courts Martial.

GENERAL ORDERS, } HEADQUARTERS,
No. 43. } DEPARTMENT OF LOUISIANA,
New Orleans, La., September 15, 1865.

I. Before a General Court Martial which convened at Baton Rouge, La., pursuant to Special Orders No. 86, of May 11th, 1865, Headquarters, Northern Division of Louisiana, and of which Lieutenant-Colonel William Ray, 1st Indiana Heavy Artillery, is President, was arraigned and tried:

1st Lieutenant Charles Wenz, 4th U. S. Colored Cavalry.

CHARGE I.

"Conduct unbecoming an officer and a gentleman."

CHARGE II.

"Rape."

CHARGE III.

"Assault and battery, with intent to commit rape."

To which Charges and their Specifications, the accused pleaded:

To the Specification of the 1st Charge; "Guilty," except the words did behave in a very disorderly manner in the presence of several enlisted men," and the words "had sexual intercourse with an aged colored woman, one Ann Booze, in the presence of an enlisted man,"

Of the 1st Charge—"Guilty."

Of the 2d Charge and its Specification—"Not Guilty."

Of the 3d Charge and its Specification—"Not Guilty."

FINDING.

After mature deliberation, the Court finds the accused:

Of the Specification to 1st Charge—"Guilty."

Of the 1st Charge—"Guilty."

Of the Specification to 2d Charge—"Guilty."

Of the 2d Charge—"Guilty."

Of the Specification to 3d Charge—"Guilty," except the words "and did compel an enlisted man to seize and carry by force to a bed in her cabin the said Ann Booze."

Of the 3d Charge—"Guilty."

SENTENCE.

And does therefore sentence him, 1st Lieutenant Charles Wenz, 4th U. S. Colored Cavalry, "to be dishonorably dismissed the service of the United States, with loss of all pay and allowances now due, or that may become due him; to be stripped of the insignia of his rank and profession in the presence of his regiment, and be confined at hard labor for the period of five years at such place as the Commanding General may direct."

Charles Henry
[illegible]

II. The sentence in the foregoing case is annulled and set aside.
The Act of Congress giving Courts Martial jurisdiction over the crime of rape, in certain cases, provides, that in the event of a conviction, the punishment shall never be less than that prescribed by the laws of the State, Territory or District where the offence is committed.

The punishment awarded by the laws of Louisiana, for this offence, is death; but the jury may in their discretion, bring in a verdict of "guilty, without capital punishment," in which event imprisonment for life would be the punishment inflicted. The sentence therefore is illegal and void, and the proceedings are disapproved and rendered nugatory.

The accused will be brought to trial upon the same charges before a Court to be convened by the Commanding General of the Eastern District of Louisiana.

BY ORDER OF MAJOR-GENERAL E. R. S. CANBY:
WICKHAM HOFFMAN,
Assistant Adjutant General.

OFFICIAL:

[illegible handwritten text]

Lead Cos. E. 1st. Sa
N. American, Nov. 25/65
S. R. 62, 72
Respectfully for-
warded to Det.
had given, requesting
a copy of the
showing, on which
this officer was
tried

Wm. W. Mc
M. W. G.

NOV 21 1867

U. S. MILITARY TELEGRAPH.

111 November 21 1867

By Telegraph from Baton Rouge 186

To Capt Edward Hemenway
a. a. s.

The original charges
against the men of fourth
regt of Cold Cavalry have
not been at their
head post since his
trial & it is not
known when they are -
will have new charges
made and forwarded
at once

N. B. Bartram
Col 53 regt
Cold Cavalry
Comdg Post

36 ml

Baton Rouge La.

Nov. 24th 1855

Bartholomew St. S.

Col. Comdr.

Report that the military
charges against Louis J. ...
are not at this time ...

3
44 ...

S 584
18

ORIGINAL 66

Prison Marshal's Office

Baton Rouge La, June 11th 1869

Sheridan M. J.

Capt & Prison Marshal

Sends under guard Charles Wenz
late 1st Lt. Co "B" 4th U. S. Col. Co
sentenced by G. C. A. to G. C. A. prison.

Received by J. P. C.
June 11

General Court Martial.

GENERAL ORDERS, } HEADQUARTERS,
DEPARTMENT OF LOUISIANA,
New Orleans, La., December 30, 1865.

No. 81.
I. Before a General Court Martial, which convened at Baton Rouge, Louisiana, pursuant to Special Orders, No. 314, dated November 9, 1865, and Special Orders, No. 319, dated November 14, 1865, from Headquarters, Eastern District of Louisiana, of which Major Francis Moore, 65th U. S. Colored Infantry, is President, was arraigned and tried:
1st Lieutenant Charles Wenz, Company "B," 4th U. S. Colored Cavalry.

CHARGE 1ST.—"Conduct unbecoming an officer and a gentleman."
CHARGE 2D.—"Rape."
CHARGE 3D.—"Assault and battery with intent to commit rape."

PLEA.
To which charges, and their specifications, the accused pleaded—"Not Guilty."

FINDING.
After mature deliberation on the evidence adduced, the Court finds the accused as follows:
Of the Specification of the 1st Charge, "Guilty," except as to having sexual intercourse with a colored woman.

Of the 1st Charge—"Guilty."
Of the Specification to the 2d Charge—"Not Guilty."
Of the 2d Charge—"Not Guilty."
Of the Specification to the 3d Charge—"Guilty"—except the words, "did carry by force to a bed."
Of the 3d Charge—"Guilty."

SENTENCE.
And does, therefore, sentence him, 1st Lieutenant Charles Wenz, Company "B," 4th U. S. Colored Cavalry, "to be dishonorably dismissed the service of the United States, with forfeiture of all pay and allowances due, and to be confined at hard labor, at such State Penitentiary as the Commanding General may direct, for the period of two years."

II. The proceedings, finding and sentence in the foregoing case are approved. The accused, 1st Lieutenant Charles Wenz, Company "B," 4th U. S. Colored Cavalry, ceases to be an officer in the service of the United States from this date. He will be sent to the city of New Orleans, under a secure guard, and delivered into the custody of the Provost Marshal General of the Department, to await the designation of a place of confinement by the Secretary of War.

BY ORDER OF MAJOR-GENERAL E. R. S. CANBY:
WICKHAM HOFFMAN,
Assistant Adjutant General.

OFFICIAL;

A. F. Hunt
Acting Assistant Adjutant General

1st Lieut & Capt. 65th U.S. Col. Inf.
Post Adjt.

Capt 68th U.S. Col. Inf. Pro Mar
Baton Rouge La.

Provost Marshal's Office,

La., January 11 1866

open

Orleans La

Drunk.

I send you
to Par. 2. S. O.
of Sa - Charles Wenz
of Co. Cavalry, sentenced
to confinement at hard
two years.

Respectfully

Servant

Sherriden

MAR 11 1862

Probost Marshal's Office,

Baton Rouge, La., January 11th 1862

Sreak Lucius Crooker

A. A. A. S.

New Orleans La

Sreak.

I send you
under guard, - in obedience to Par. 2. S. O.
No. 81. Series 1845, Dept of Sa - Charles Wray
late 1st Lieut Co "B" 4th U.S. C. Army, sentenced
by Genl Martial To confinement at hard
labor for the period of two years.

I am very Respectfully
Your Obedt Servant

W. J. Sheridan

Capt 60th U.S. C. Infy. Pro Mar
Baton Rouge La.

No. 29 B.B. & P. C. 1866

Date July 15th 1866

Order of Commitment in case of

Charles King said at
W. S. C. C.

1861

Head Quarters Department of Louisiana and Texas,

Office Provost Marshal General.

New Orleans, January 15th 1861

Commanding Officer:

Force Jail

You will receive and hold until further orders from these Head Quarters the body of

H. W. Carey

Charles Henry Cole 1st. Co. 13
Guard

herewith delivered: in custody of

..... arrested by order
of on the charge of

..... preferred by

and now on file at

Permitting the prisoner to hold no converse with any one, except on written permission from this office or superior authority.

under sentence pronounced
in Court Order No 51 4th ward
Sept 24, Dec 30, 1860

BY ORDER OF ~~Col. F. A. STARR~~ PROVOST MARSHAL GENERAL.

Lucius E. Mott
Act'g. Ass't. Adj't. General.

Thro. Pro. Marshal.

PARISH OF ORLEANS.

Chas. Wenz

4" U.S.C. Cert.

U.S.C. No. 1165

Not for deposit
New Orleans La

July 11 1866

Valley of the Mississippi
The American Canal Co. East of New Orleans
The canal will be built on the right side
of the river. The canal will be built
from New Orleans to the Gulf of Mexico.

Wm. H. Wenz
1165 U.S.C. Cert.
New Orleans La

The U.S. Canal Co. East of New Orleans
New Orleans La July 11 1866
The canal will be built on the right side
of the river. The canal will be built
from New Orleans to the Gulf of Mexico.

Wm. H. Wenz
1165 U.S.C. Cert.
New Orleans La

G. C. M. O. No. 25
M. D. A. G. O. Wash DC
Jan'y 29th 1866
St. Chas. Weitz 4th Regt

4th U. S. C. Cav.

25 AGO 66



GENERAL COURT MARTIAL } WAR DEPARTMENT.
ORDERS, No. 25. } ADJUTANT GENERAL'S OFFICE,
Washington, January 29, 1866.

In the case of *Charles Wenz*, late 1st Lieutenant, 4th U. S. Colored Cavalry, sentenced by a General Court Martial "*To be dishonorably dismissed the service of the United States, with forfeiture of all pay and allowances due, and to be confined at hard labor at such State Penitentiary as the Commanding General may direct for the period of two (2) years,*" and now in the custody of the Provost Marshal General of the Department of Louisiana, as promulgated in General Orders, No. 81, Headquarters, Department of Louisiana, New Orleans, Louisiana, December 30, 1865, Fort Jefferson, Dry Tortugas, Florida, is designated as the place of confinement, where the prisoner will be sent in charge of a suitable guard, under the orders of the Commanding General, Department of Louisiana, for the execution of his sentence.

BY ORDER OF THE SECRETARY OF WAR:

E. D. TOWNSEND,

Assistant Adjutant General.

OFFICIAL:

Assistant Adjutant General.

63 PLB H^o P^o MC 1166

And G. E. West do

New Orleans July 13th 1866

Mood 3K SP

F. W. W. G.

Direct that Chas. King
Sub 1st do to sent D. T. King
under a suitable guard

1 Lt. Chas. King
4 U. S. C. Cav.

Headquarters, Eastern District of Louisiana,

H.A.

New Orleans, La., July 13th, 1866.

Major A. M. Jackson.

Prison Marshal.

Parish of Orleans.

Sir:

You will send Charles King, (now in confinement at the Police Jail) under charge of a suitable guard accompanied with the enclosed orders, viz. Mil. Court Martial Order no. 25, War Dept. Adjutant General's Office, and General Order no. H. Hd. Qu. Dept. of So. Series of 1865, to Fort Jefferson Florida, and report your action to these Hd. Qu.

By order of
 Col. Maj. Gen. J. W. Sherman,
 J. H. Wood,
 Lieut. ^{in a. d. c.}
 a. d. c.

Ms. A. 1. 17

one line from you favorably endorsing the motion
request would lighten the burdens of a distressed father
I have the honor to be

Very respectfully,
your obt. servant
Wm. W.

W. B. De La Salle

New Orleans La.,
March 10th 1866.

Henry J.

Forwards petition for
the release from prison of Chas
Henry's Lieut. 4th U. S. Cav.

2 Enclosures

F. W.

Recd L. La. Mar. 10th 1866

New Orleans March 10/66.

Maj. Gen^l. C. N. S. Canby
Comd^g Dept. of Louisiana

General,

Pardon a bereaved and sorrowful father for intruding on your precious time, but I will endeavour to be as brief as possible in explaining to you my humble request.

My son 1st Lt. Charles Wenz, of the 4th U. S. C. Cav^y, was tried by G^l. Court Martial last December and sentenced to two years imprisonment.

My son was a mere boy when he joined the U. S. Army at the outbreak of the rebellion and was promoted to be a commissioned officer on account of his good soldierly conduct and qualities. A great misfortune it was that liquor should so overpower him, as at once to break down all his bright prospects for the future and ~~the~~ blighten the remaining days of his anxious father.

Dear General, assist me in saving my son from utter ruin for if he should remain in a prison state for two years, I can have no hope of seeing him again!

If you would act according to the dictates of your kind heart, listen to the prayer of a distressed father and have the kindness to endorse the within petition favorably, and have it forwarded to the Secretary of War, recommending the boys release, so that I may at once carry out my intention to

send him to College again in Germany or France
and make ^{him yet} a better man.

I can refer you to most respectable residents
of this City as to my standing amongst them. —
one line from you favorably endorsing the within
request would lighten the sorrows of a distressed father.

I have the honor to be

Very respectfully,
your obt. Servant
Wine,

SR 963 66

Henry Wang
1112 c

SR 963-66
Field "P"
Field "P"

27



Office Provost Marshal,
PARISH OF ASSUMPTION,

New Orleans, La., April 16th 1863

W. G. Hood
C. C. W. G.

Sir

On compliance with instructions, I have the honor to report that "Chas. May," Lt 4th U.S.C., was transferred to Fort Mifflin & was out the entrance April 13th 1863, under charge of Lt Foley 7th U.S.C.

Very Respectfully,
Your obedient servant
A. M. Jackson
Major 10th U.S.C.
Provost Marshal

NOV 17 1865

Dem La.
81 55

Henry Charles Lieut

Charles Henry
late 1st Lieut
4th U.S. Col. Cav.

U.S.C.T.

Head-Quarters Department of Louisiana
New Orleans, La. December 30th 1866.

General Orders)
No. 11 (

I. Before a General Court-Martial, which convened at "Baton Rouge" La. pursuant to Special Orders No. 214, dated November 9th 1865, and Special Orders No. 317, dated November 14th 1866, from Head-Quarters Eastern District of Louisiana, of which Major Francis H. Lee, 65th U.S. Col^d Infantry, is President, were assigned and tried

1st Lieutenant Charles King, Company B 4th U.S. Col^d Cavalry
Charge 1st - "Contumacious behavior toward a superior officer and a gentleman"
Charge 2nd - "Rape"
Charge 3rd - "Assault & battery with intent to commit rape"

Verdict

In which charges, and their specifications, the accused pleaded "Not Guilty"
Finding

After mature deliberation on the evidence adduced, the Court finds the accused as follows:

Of the Specification of the first charge "Guilty" except as to having sexual intercourse with a colored woman

Of the 1st Charge - "Guilty"

Of the Specification to the 2nd Charge - "Not Guilty"

Of the 2nd Charge - "Not Guilty"

Of the Specification to the 3rd Charge - "Guilty" except the words, "did carry by force to a bed."

Of the 3rd Charge - "Guilty"

Sentence

And does, therefore, sentence said 1st Lieutenant Charles King, Company B 4th U.S. Col^d Cavalry, to be dishonorably dismissed the service of the United States, with forfeiture of all pay and

General Court Martial.

GENERAL ORDERS, } HEADQUARTERS,
 No. 81. } DEPARTMENT OF LOUISIANA,
 New Orleans, La., December 30, 1865.

I. Before a General Court Martial, which convened at Baton Rouge, Louisiana, pursuant to Special Orders, No. 314, dated November 9, 1865, and Special Orders, No. 319, dated November 14, 1865, from Headquarters, Eastern District of Louisiana, of which Major Francis Moore, 65th U. S. Colored Infantry, is President, was arraigned and tried:

1st Lieutenant Charles Wenz, Company "B," 4th U. S. Colored Cavalry.

- CHARGE 1ST.—"Conduct unbecoming an officer and a gentleman."
- CHARGE 2D.—"Rape."
- CHARGE 3D.—"Assault and battery with intent to commit rape."

PLEA.

To which charges, and their specifications, the accused pleaded—"Not Guilty."

FINDING.

After mature deliberation on the evidence adduced, the Court finds the accused as follows:

Of the Specification of the 1st Charge, "Guilty," except as to having sexual intercourse with a colored woman.

Of the 1st Charge—"Guilty."

Of the Specification to the 2d Charge—"Not Guilty."

Of the 2d Charge—"Not Guilty."

Of the Specification to the 3d Charge—"Guilty"—except the words, "did carry by force to a bed."

Of the 3d Charge—"Guilty."

SENTENCE.

And does, therefore, sentence him, 1st Lieutenant Charles Wenz, Company "B," 4th U. S. Colored Cavalry, "to be dishonorably dismissed the service of the United States, with forfeiture of all pay and allowances due, and to be confined at hard labor, at such State Penitentiary as the Commanding General may direct, for the period of two years."

II. The proceedings, finding and sentence in the foregoing case are approved. The accused, 1st Lieutenant Charles Wenz, Company "B," 4th U. S. Colored Cavalry, ceases to be an officer in the service of the United States from this date. He will be sent to the city of New Orleans, under a secure guard, and delivered into the custody of the Provost Marshal General of the Department, to await the designation of a place of confinement by the Secretary of War.

BY ORDER OF MAJOR-GENERAL E. R. S. CANBY:

WICKHAM HOFFMAN,

Assistant Adjutant General.

OFFICIAL:

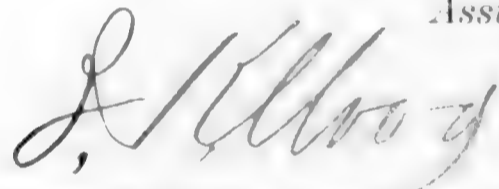

Acting Assistant Adjutant General.

*Moore, J. H.
 26th 1866.*

*most respectfully and
 petition in behalf of 1st Lt
 was tried by a General Court
 1st Lt. Cav. Regt. of La. Dec 30/65,
 for the period of two years,
 The Hon. Secretary of War.
 at yet 20 years old and
 year of age, then at the
 is Regiment he dutifully
 of recommendations
 recently a board of Exa-
 1st Lt. in the 1st Cav. Regt. of
 1st Lt. U. S. C. Cav.*

*in answer to the charges preferred against
 1st Lt. Wenz he had never been found fault with,
 but having been urged on by fellow officers to drink
 Whiskey to which he was unaccustomed, he soon
 became heavily drunk and unconscious of his acts.
 Considering the youth of the prisoner,
 his former good conduct and services in the field,
 his long confinement already (since Apr. 27/65), his
 loss of pay, amounting to \$1500⁰⁰., his very respectable
 and sorrowing relations who had set such great
 hopes on the promising young man and who
 over*

New Orleans, La.
 Febr. 26th 1866.

Hon. Secretary of War.
 Sir.

We, the Undersigned, most respectfully and earnestly request your attention to this our petition in behalf of 1st Lt. Charles Wenz, C: B. 4th U. S. C: Cav, who was tried by a General Court Martial, convened by General Order N: 81, Vol. Com. Sept. of La. Dec 30/65, and sentenced to be confined at hard labor for the period of two years, the place of confinement to be designated by the Hon. Secretary of War.

1st Lt. Charles Wenz is not yet 20 years old and joined the 5th Iowa Cav. when only 14 1/2 year of age, then at the College of St. Paul, Minnesota. In this Regiment he dutifully served his three years, receiving the best of recommendations from his superior; passed subsequently a board of Examiners, was commissioned as 2^d Lt. in the 1st Cav. C: d'af. and then commissioned 1st Lt. 4th Regt. U. S. C: Cav.

Prior to the Charges preferred against 1st Lt. Wenz he had never been found fault with, but having been urged on by fellow officers to drink Whiskey to which he was unaccustomed, he soon became heavily drunk and unconscious of his acts.

Considering the youth of the prisoner, his former good conduct and services in the field, his long confinement already (since Apr. 27/65), his loss of pay, amounting to \$1500⁰⁰., his very respectable and sorrowing relations who had set such great hopes on the promising young man and who

over

ALC

25

66

Charles Henry
4 U. S. Cold Carriage

A. S. D. Lo. 1866.

Ad. Gen. Dept. of Lo.

New Orleans, La.

July 12-1866.

Respectfully referred to Rob. Mj. Genl. Sherman, Comdg. Eastern Dist. of La. who will execute the within order of the War Dept. and report the execution to these Ad. Gen.

By order of
Maj. Genl. E. R. S. Canby.
Sgd. William Hoffman
Major, A. A. Genl.

Official Copy
J. H. Wood
Lt. Col.

Headquarters
Eastern Dist. of La.
New Orleans July 13/66

Respectfully referred to
Major C. M. Jackson
Sergeant Marshal, Parish
of Orleans, who will have
the within named
men with suitable guard, to
Fort Jefferson Florida.

By order of
Rob. Maj. Genl. J. W. Sherman

J. H. Wood
Lt. Col.

Chas. Henry

War Department.
 Adjutant General's Office.
 Washington, January 29 1866.

General Court Martial }
 Order, no. 25. }

In the case of Charles Herz, late 1st Lieutenant,
 4th United States Colored Cavalry, sentenced by a
 General Court Martial "to be dishonorably dismissed
 out of the service of the United States, with forfeiture
 of pay and allowances due, and to be
 confined at hard labor at such State Penitentiary
 as the commanding General may direct
 for the period of two (2) years," and now in
 the custody of the Provost Marshal General of
 the Department of Louisiana, as promulgated
 in General Order, no. 51, Headquarters, Depart-
 ment of Louisiana, New Orleans, Louisiana,
 December 20, 1865. Fort Jefferson, Dry Tortugas,
 Florida, is designated as the place of confine-
 ment, where the prisoner will be sent in
 charge of a suitable guard, under the orders
 of the commanding General, Department
 of Louisiana, for the execution of his sentence.

1130

West John

Co C, 4 U. S. Col'd Cav.

Private Private

CARD NUMBERS.

1	5-347787	26
2	5-35-1684	27
3	5-35-1749	28
4	5-35-1823	29
5	5-35-1914	30
6	5-35-2017	31
7	5-35-2114	32
8	5-35-2212	33
9	5-35-2305	34
10	5-35-2393	35
11	5-35-2482	36
12	40729324	37
13		38
14		39
15		40
16		41
17		42
18		43
19		44
20		45
21		46
22		47
23		48
24		49
25		50

Book Mark:

See also

4 Cav. U.S.C.T.

John West

Appears with rank of *Priv.* on

Muster and Descriptive Roll of a Detachment of U. S. Vols. forwarded

for the 4 Reg't U. S. Col'd Cavalry. Roll dated

New Orleans, La., Aug. 26, 1864.

Where born *Bayou Sara, Miss.*

Age *14* y'rs; occupation *Writer*

When enlisted *Aug. 22*, 1864.

Where enlisted *New Orleans*

For what period enlisted *3* years.

Eyes *Black*; hair *Black*

Complexion *Dark*; height *5* ft. *2* in.

When mustered in *Aug. 26*, 1864.

Where mustered in *New Orleans*

Bounty paid \$ *100* ¹⁰⁰; due \$ *200* ¹⁰⁰

Where credited *New Orleans*

Company to which assigned *C.*

Remarks: *Recruits entitled to bounty.*

Book mark:

J. E. Tyler
Copyist.

W | **4 Cav.** | **U.S.C.T.**

John West
Co. C, Co. C, 4 Reg't U. S. Colored Cavalry.

Appears on

Company Muster Roll

for *Sept*, 186*4*.

Present or absent *Present*

Stoppage, \$ 100 for

Due Gov't, \$ 100 for

Valuation of horse, \$ 100

Valuation of horse equipments, \$ 100

Remarks :

Book mark :

Rochester

A | 4 Cav. | U.S.C.T.

John West

Priv, Co. C, 4 Reg't U. S. Colored Cavalry.

Appears on

Company Muster Roll

for *Nov 9th Dec*, 1864.

Present or absent *present*

Stoppage, \$ *1*/₁₀₀ for *ordnance*

Due Gov't, \$ *1*/₁₀₀ for

Valuation of horse, \$ *1*/₁₀₀

Valuation of horse equipments, \$ *1*/₁₀₀

Remarks: *Lost ordnance*

Book mark:

Moy

M | 4 Cav. | U.S.C.T.

John West

Priv, Co. C, 4 Reg't U. S. Colored Cavalry.

Appears on

Company Muster Roll

for *Jan & Feb*, 186*5*

Present or absent *present*

Stoppage, \$ *100* for

Due Gov't, \$ *100* for

Valuation of horse, \$ *100*

Valuation of horse equipments, \$ *100*

Remarks: *Stop for one curry comb and brush and curb chain.*

Book mark: _____

(358)

Moy
Copyist.

A

4 Cav. U.S.C.T.

John West
Priv, Co. C, 4 Reg't U. S. Colored Cavalry.

Appears on

Company Muster Roll

for *March & Apr*, 186*5*

Present or absent *present*

Stoppage, \$ *100* for

Due Gov't, \$ *100* for

Valuation of horse, \$ *100*

Valuation of horse equipments, \$ *100*

Remarks:

Book mark:

(358)

May
Copyist.

H | 4 Cav. | U.S.C.T.

John West
Priv, Co. C, 4 Reg't U. S. Colored Cavalry.

Appears on

Company Muster Roll

for *May & June*, 1865.

Present or absent *present*

Stoppage, \$ *100* for

Due Gov't, \$ *100* for

Valuation of horse, \$ *100*

Valuation of horse equipments, \$ *100*

Remarks: *Stop for one saddle blanket, one canteen & haversack and one pair metallic scales.*

Book mark:

May

(358)

Copyist.

H | 4 Cav. | U.S.C.T.

John West
Priv, Co. C, 4 Reg't U. S. Colored Cavalry.

Appears on

Company Muster Roll

for *July & Aug*, 186*6*.

Present or absent *present*

Stoppage, \$ *100* for

Due Gov't, \$ *100* for

Valuation of horse, \$ *100*

Valuation of horse equipments, \$ *100*

Remarks: *Stop for saddle blanked, 1 canteen, 1 haversack, 1 for metallic seals. \$4.55.*

Book mark: _____

Moy

(358)

Copyist.

A | **4 Cav.** | **U.S.C.T.**

John West

Priv, Co. C, 4 Reg't U. S. Colored Cavalry.

Appears on

Company Muster Roll

for *Sept 20 01*, 186*5*.

Present or absent *present*

Stoppage, \$ *100* for

Due Gov't, \$ *100* for

Valuation of horse, \$ *100*

Valuation of horse equipments, \$ *100*

Remarks :

Book mark :

Moy

W | **4 Cav. | U.S.C.T.**

John West

Private, Co. C, 4 Reg't U. S. Colored Cavalry.

Appears on

Company Muster Roll

for *Nov & Dec*, 186*4*.

Present or absent *present*

Stoppage, \$ *100* for

Due Gov't, \$ *100* for

Valuation of horse, \$ *100*

Valuation of horse equipments, \$ *100*

Remarks:

Book mark:

M. A. Michaels

W | 4 Cav. | U.S.C.T.

John West
Private, Co. C, 4 Reg't U. S. Colored Cavalry.

Appears on

Company Muster Roll

for Jan'y + Febr, 1866

Present or absent present

Stoppage, \$ 100 for

Due Gov't, \$ 100 for

Valuation of horse, \$ 100

Valuation of horse equipments, \$ 100

Remarks:

Book mark:

M. A. Michaels
Copyist.

W | 4 Cav. | U.S.C.T.

John West

Prvt, Co. W, 4 Reg't U. S. Colored Cav.

Appears on Returns as follows:

Sept 1864 - Gaia; Sept 2/64
Port Hudson. Enlisted.

Feb 1866 - On duty detailed at
Post Hdq. Gns.

Book mark:

W. R. Lee

W | **4 Cav. | U.S.C.T.**

John West
Private, Co. *C*, 4 Reg't U. S. Col'd Cavalry.

Appears on **Co. Muster-out Roll**, dated
New Orleans La, Mar 20, 1866.

Muster-out to date *Mar 20*, 1866.

Last paid to *June 30*, 1866.

Clothing account:

Last settled....., 186 ; drawn since \$.....100

Due soldier \$.....100; due U. S. \$ *28* ^{*69*}/₁₀₀

Am't for cloth'g in kind or money adv'd \$.....100

Due U. S. for arms, equipments, &c., \$.....100

Bounty paid \$ *100* ^{*00*}/₁₀₀; due \$.....[—]/₁₀₀

Remarks: *Joined as recruit*

Book mark: *V116 P 303-70*

M. A. Michael

West, John

, Co. , 4 Reg't U.S.C.C.

Enclosures.

Bed Cards	Final Statements
Burial Records	Furloughs or L. of A.
Certs. of Dis. for Discharge	Med. Certificates
C. M. Charges	Med. Des. Lists
Descriptive Lists	Orders
Discharge Certificates	Pris. of War Record
Enlistment Papers	Resignations

Other papers relating to—

Admission to Hosp'l	Furlough or L. of A.
Casualty Sheet	Med. Examination
Confinement	Misc. Information
Contracts	Pay of Clothing
Death or Effects	Personal Reports
Desertion	Rank
Discharge from Hosp'l	Transfer to Hosp'l
Discharge from Service	Transfer to V. R. C.
Duty	Transportation

76 1010 New Orleans Aug 31st 1864

S.O. no 76. Sam Hambley
Maj Supt Regt Rifles

Details Private John West
Co C 4th U.S. Cav on recruiting
service

Head Quarters
Dept of the Gulf
New Orleans, Sept. 7th 1864

Respectfully referred to Col. J. S.
Hambley, Supt Rec't & Service
U.S. Col'd Troops, for explanation
of his authority to issue this
order.

By Command of
Col. Paul Banks
Adj. Gen'l
Asst. General

76 221 1864
Officer Supt Rec'tg Service U.S.C.T.
New Orleans, Sept. 4, 1864.

Respectfully returned to Head
Quarters Department of the Gulf
with answer that this man is
a recruit in the Depot, has never
yet been turned over to the
regiment and was detailed at
the request of the Recruiting
officer, Capt Bentz, who required
him for guard at his office
temporarily.

Samuel Hambley
Maj. Supt Rec'tg Service U.S.C.T.

NOV 12 1864

Office Superintendent Recruiting Service,
U. S. COLORED TROOPS,
DEPARTMENT OF THE GULF.

New Orleans, Aug³ 31st 1864.

Special Order }
No 76 } Extract

1 — Private John Nest
(bold)
Co to 4th U.S. Cav^y will report to
Cap^t Franz Benter 4th for duty on
Rec^tg. Service.

Private John Nest
11th U.S. Cav^y

Samuel Hamilton
Major and Sup^t Rec^tg.
U.S.C.

NOTES 1.—This blank will be used for both enlistments and re-enlistments—enlistment of veterans, &c., &c., in the volunteer service. They will be made out in duplicate in all cases—one to accompany the recruiting return of the superintendent (not the recruiting officer) to the Adjutant General, and one to accompany the accounts of the officer who pays bounty, &c. The Regiment and Company in which the soldier last served should be given on the back.

NOTE 2.—An enlistment holds to service. A muster-in must, in all cases, precede payment of pay, bounty, pension, &c. A muster-in roll must, in all cases, be filed in the Adjutant General's Office as evidence of muster-in. The mustering officer, commissary, or assistant commissary of musters, as the case may be, will countersign both enlistments as having mustered the soldier into the service of the United States before either of them is given to the disbursing officer.

DECLARATION OF RECRUIT.

I, John West, desiring to VOLUNTEER as a Soldier in the Army of the United States, for the term of THREE YEARS, Do Declare, That I am nineteen years and _____ months of age; that I have never been discharged from the United States service on account of disability or by sentence of a court martial, or by order before the expiration of a term of enlistment; and I know of no impediment to my serving honestly and faithfully as a soldier for three years.

GIVEN at New Orleans La. the 22nd day of August 1864.

Witness:

H. Bunker

J. J. M. W.

Received from Second Auditor
August 26th, 1892.

*Let me put this to bounty
for service until 1869
I appear in July 1864*

Discharged _____ 18__

Reg't of _____

enlistment; last served in Company ()

Caraboy.

By Capt. F. Brewster
Regiment of U. S. Col.

Volunteered at New Orleans
August 22nd, 1864

No. John West

CONSENT IN CASE OF MINOR.

I, _____, Do CERTIFY, That I am the _____ of _____; that the said _____ is _____ years of age; and I do hereby freely give my CONSENT to his volunteering as a SOLDIER in the ARMY OF THE UNITED STATES for the period of THREE YEARS.

GIVEN at _____ the _____ day of _____

Witness:

NOV 20 1864

VOLUNTEER ENLISTMENT.

STATE OF *Louisiana* TOWN OF *New Orleans*

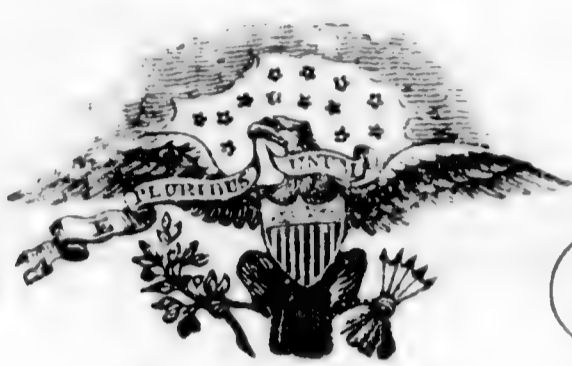

I, *John West*, born in *Bayou Sara* in the State of *Mississippi*, aged *nineteen* years, and by occupation a *Waiter*, Do HEREBY ACKNOWLEDGE to have volunteered this *twenty second* day of *August*, 1864 to serve as a **Soldier** in the **Army of the United States of America**, for the period of **THREE YEARS**, unless sooner discharged by proper authority: Do also agree to accept such bounty, pay, rations, and clothing, as are, or may be, established by law for volunteers. And I, *John West*, do solemnly swear, that I will bear true faith and allegiance to the **United States of America**, and that I will serve them honestly and faithfully against all their enemies or opposers whomsoever; and that I will observe and obey the orders of the President of the United States, and the orders of the officers appointed over me, according to the Rules and Articles of War.

Sworn and subscribed to, at *New Orleans* this *22nd* day of *August*, 1864 BEFORE *Capt. F. Beuter* 4th U. S. Col. Cav.

I CERTIFY, ON HONOR, That I have carefully examined the above-named Volunteer, agreeably to the General Regulations of the Army, and that, in my opinion, he is free from all bodily defects and mental infirmity, which would in any way disqualify him from performing the duties of a soldier.

James M. ... EXAMINING SURGEON.

I CERTIFY, ON HONOR, That I have minutely inspected the Volunteer *John West* previously to his enlistment, and that he was entirely sober when enlisted; that, to the best of my judgment and belief, he is of lawful age; and that, in accepting him as duly qualified to perform the duties of an able-bodied soldier, I have strictly observed the Regulations which govern the recruiting service. This soldier has *black* eyes, *black* hair, *dark* complexion, is *five* feet *two* inches high.

Francis Beuter Capt. 4th Regiment of *U. S. Col. Cav.* RECRUITING OFFICER.

(A. G. O. No. 74 & 76.)

Enlisted into the service of the United States, for three years or during the war, from date of enlistment, in Company *C* 4th Regiment of *U. S. Col. Cav.* Volunteers, on the *26th* day of *August*, 1864, at *New Orleans La.*

J. M. ...
151st St. N. O. S. & C. 1864
H. M. ...

1151

Wheeler Charles

Co L., 4 U. S. Col'd Cav.

Private Private

CARD NUMBERS.

1	5347661	26
2	5347692	27
3	5358668	28
4	5358712	29
5	5358766	30
6	5348131	31
7	40729325	32
8		33
9		34
10		35
11		36
12		37
13		38
14		39
15		40
16		41
17		42
18		43
19		44
20		45
21		46
22		47
23		48
24		49
25		50

Book Mark:

See also

A | **4 Cav. | U.S.C.T.**

Charles Wheeler

Appears with rank of *Pl* on

Muster and Descriptive Roll of a Detachment of U. S. Vols. forwarded

for the 4 Reg't U. S. Col'd Cavalry. Roll dated

New Orleans La June 22, 1864

Where born *Alexandria La*

Age *18* y'rs; occupation *Labourer*

When enlisted *Apr 9*, 186*4*.

Where enlisted *Alexandria*

For what period enlisted *3* years.

Eyes *BR*; hair *BR*

Complexion *Fair*; height *5* ft. *3* in.

When mustered in *June 22*, 186*4*.

Where mustered in *New Orleans*

Bounty paid \$ *100*; due \$ *100*

Where credited *to Alexandria La*

Company to which assigned *D*

Remarks:

Book mark:

Vault Hatcher

N | **4 Cav. U.S.C.T.**

Charles Wheeler

Appears with rank of *Pl* on

Muster and Descriptive Roll of a Detachment of U. S. Vols. forwarded

for the 4 Reg't U. S. Col'd Cavalry. Roll dated

New Orleans La July 18, 1864

Where born *Alexandria La*

Age *18* y'rs; occupation *Laborer*

When enlisted *Apr 9*, 1864

Where enlisted *Alexandria*

For what period enlisted *3* years.

Eyes *DK*; hair *DK*

Complexion *DK*; height *5* ft. *3* in.

When mustered in *June 22*, 1864

Where mustered in *New Orleans*

Bounty paid \$ *100*; due \$ *100*

Where credited *to Alexandria La*

Company to which assigned *D*

Remarks:

Book mark:

Van Hook

W | **4 Cav. | U.S.C.T.**

Charles Wheeler
Pvt., Co. *L*, 4 Reg't U.S. Col'd Cavalry.

Age _____ years.

Appears on

Company Muster Roll*

for *Enlistment to Aug. 31*, 1864.

Joined for duty and enrolled:

When *Apr. 9*, 1864.

Where *Alexandria La.*

Period *3* years.

Mustered in:

When *June 27*, 1864.

Where *New Orleans La.*

Present or absent *Present*

Stoppage, \$ 100 for _____

Due Gov't, \$ 100 for _____

Valuation of horse, \$ 100

Valuation of horse equipments, \$ 100

Remarks : _____

* First current roll. No muster-in roll of this battery on file.

Book mark : _____

Loring

H | **4 Cav.** | **U.S.C.T.**

Charles Wheeler

Capt., Co. L, 4 Reg't U. S. Col'd Cavalry.

Appears on

Company Muster Roll

for *Sept. & Oct.*, 1864.

Present or absent *Present*

Stoppage, \$ *100* for

Due Gov't, \$ *100* for

Valuation of horse, \$ *100*

Valuation of horse equipments, \$ *100*

Remarks: *Due U.S. for lost
ordnance \$ 9.59 End of
rifle. Shins, screw driver
& wiper*

Book mark:

Luzzini

H | **4 Cav.** | **U.S.C.T.**

Charles Wheeler

Cvt., Co. L, 4 Reg't U. S. Col'd Cavalry.

Appears on

Company Muster Roll

for *Nov. & Dec.*, 1864.

Present or absent

Stoppage, \$ *19* ^{*57*}/₁₀₀ for *ordnance*
lost

Due Gov't, \$ 100 for

Valuation of horse, \$ 100

Valuation of horse equipments, \$ 100

Remarks: *Disd Nov. 27/64*
Post Hosp. Ordnance lost
Musket, sling & wiper

Book mark:

Serrin

W | 4 Cav. | U.S.C.T.

Charles W. Heeler

Priv., Co. E, 4 Reg't U. S. Colored Cav.

Appears on Returns as follows:

Nov 1864 - Loss: Nov 27/64
Port Hudson Died.

Book mark:

W. R. Lee

70. 1 - Car'y | **U.S.C.T.**

Charles F. Fisher

Plat., Co. 2, 4 Reg't U. S. Col'd Car'y

Appears on a

Detachment Muster-out Roll

of the organization named above. Roll dated
New Orleans La, Mar 20, 1866 .

Muster-out to date 186 .

Last paid to 186 .

Clothing account:

Last settled....., 186 ; drawn since \$..... 100

Due soldier \$..... 100; due U. S. \$..... 100

Am't for cloth'g in kind or money adv'd \$..... 100

Due U. S. for arms, equipments, &c., \$..... 100

Bounty paid \$..... 100; due \$..... 100

Remarks: Final official organization
issued at Port Hudson La
Nov 27, 1864 of General Devilly

Book mark:

F. J. F. F.

MAR 21

Wheeler, Chas.

P., Co. 5, 4 Reg't US Cavalry

3 Enclosures.

Bed Cards	Descriptive Lists
Burial Records	Final Statements 2
Certs. of Dis. for Discharge	Furloughs
C. M. Charges	Med. Des. Lists
Med. Certificates	Orders

Other papers relating to—

Admission to Hosp'l	Furlough
Casualty Sheet (Officer's)	Med. Examination
Confinement	Misc. Information
Contracts	Pay or Clothing
Death or Effects /	Personal Reports
Desertions	Rank
Discharge from Hosp'l	Transfer to Hosp'l
Discharge from Service	Transfer to V. R. C.
Duty	Transportation

NA 1212

FINAL STATEMENT

OF

Private Charles Wheeler

H Reg't of *U.S. Cavalry*

VOLUNTEERS.

10th Cavalry 1865

NOTE 1.—Two of these certificates (or duplicates) are to be given to each Volunteer Soldier or drafted man who may be discharged previously to the discharge of his company, that he may at once receive from the Paymaster the pay, &c., due him, and the captain or other COMMISSIONED officer commanding the company will certify to the act of the delivery of the duplicate certificates; on these certificates the Soldier is "entitled to" his discharge, and should also present his discharge to the Paymaster to have the payment endorsed on it. The discharge is to be given back to the Soldier by the Paymaster; the latter only retaining as his voucher the duplicate certificates.

NOTE 2.—If the Soldier is entitled to pay for the use of his horse, the Company Commander will certify to that fact on the back of both these final statements, and also to the time he has pay due for having been so mounted on his own horse.

NOTE 3.—When a Soldier is furnished with final statements, his descriptive list, if he has one, should be taken up by the officer who gives the Soldier these statements, and endorsed with a statement to this effect by the officer. This endorsement should exhibit a full statement of the time for which the Soldier was allowed pay on his final statements, the clothing account, and all other charges against him or in his favor, so as to comprise a complete exhibit of his account. It will then be transmitted to the company commander of the Soldier, who will enter all the data necessary to a full understanding of the Soldier's account on the muster roll upon which the Soldier's discharge is reported. The descriptive list will then be destroyed. The object of this is, that the remaining portion of the Soldier's account may be settled upon the receipt of these muster rolls, and the Soldier receive any pay or allowances that may be due him at the time of his discharge, and which may not appear on his final statements from the fact that his descriptive list is incomplete. These accounts for back pay, &c., are settled by the 2d Auditor of the Treasury Department.

NOTE 4.—Charges for loss or injury to ordnance, horse equipments, and other miscellaneous charges, should appear under the heading of "Other Stoppages."

NOTE 5.—Bounty paid by State authorities, and not by the United States, will not be entered on this statement.

NOTE 6.—Amounts due the Sutler and Laundress must be entered on the muster roll on which the discharge, death, desertion, &c., is reported, as well as on the final statement, otherwise the amount cannot be collected from the United States.

NOTE 7.—This blank will be used for deceased volunteers and drafted men, as well as for others.

NOTE 8.—Where a Soldier dies in Hospital or on detached service, his descriptive list, if he has one, should be sent with his final statements, in duplicate, to the Adjutant General, Washington, D. C.

ADJUTANT GENERAL'S OFFICE

July 13th 1865

Duplicate with Inventory sent 2d Auditor.



Smith

I certify, on honor, that Charles Wheeler a Private of
~~Captain~~ Dr. A. Whittier Company (L) of the 4 Regiment of U.S. Cavalry
VOLUNTEERS, of the State of _____, born in Alexandria, State
of Louisiana, aged 18 years; 5 feet 3 inches high; Dark complexion,
Dark eyes, Dark hair, and by occupation a Laborer, having ^{enlisted in} joined the company on
its original organization at Alexandria La, and enrolled in it at the muster into
the service of the United States at New Orleans, on the 22 day
of June, 1864, (or was mustered in service as a recruit, by _____
at _____, on the _____ day of _____,
186 , or was drafted and mustered into the service of the United States from the _____
Enrollment District of the State of _____, at _____,
on the _____ day of _____, 186 .) to serve in the Regiment, for
the term of Three years: and having served **HONESTLY** and
FAITHFULLY with his Company in support of the Gulf to the present date, is now
entitled to a **DISCHARGE** by reason of Death due at Port Hudson La
Nov 24 1864 of debility

The said Private Charles Wheeler ^{never} was last paid by Paymaster
_____ to include the _____ day of _____, 186 , and has
pay due him from ^{date of enlistment} that time to the present date; he is entitled to pay and subsistence for
TRAVELING to place of enrollment, and whatever other allowances are authorized to volunteer
soldiers, drafted men, or militia, so discharged. He has received from the United States **CLOTHING**
amounting to 34 28 ¹⁰⁰ dollars, since the 9th day of April,
1864, when his clothing account was last settled. He has received from the United States
_____ ¹⁰⁰ dollars advanced **COUNTY**.

There is to be stopped from him, on account of the State of _____, or other
authorities, for **CLOTHING**, &c., received on entering service, _____ ¹⁰⁰ dollars; and
for other stoppages, viz: One Enfield Musket, sling, wipes
_____ ¹⁰⁰ dollars.

He has been furnished with **TRANSPORTATION** in kind from the place of his discharge to
_____ ; and he has been **SUBSISTED** for **TRAVELING** to his
place of enrollment, up to the _____, 186 .

He is indebted to John Miles, **SUTLER**, _____ ¹⁰⁰ dollars.
He is indebted to _____, **LAUNDRESS**, _____ ¹⁰⁰ dollars.

Given in Duplicate, at Port Hudson La, this 26 day
of January 1865.

Theodore Clarke Jones

Commanding Company

ARTICLES OF WAR,

ART. 95. When any non-commissioned officer or soldier shall die, or be killed in the service of the United States, the then commanding officer of the troop or company shall, in the presence of two other commissioned officers, take an account of what effects he died possessed of, above his arms and accoutrements, and transmit the same to the office of the Department of War, which said effects are to be accounted for, and paid to the representatives of such deceased non-commissioned officer or soldier. And in case any of the officers, so authorized to take care of the effects of deceased officers and soldiers, should, before they have accounted to their representatives for the same, have occasion to leave the regiment or post, by preferment or otherwise, they shall, before they be permitted to quit the same, deposit in the hands of the commanding officer, or of the assistant military agent, all the effects of such deceased non-commissioned officers and soldiers, in order that the same may be secured for, and paid to, their respective representatives.

ARMY REGULATIONS—EDITION OF 1861.

DECEASED SOLDIERS.

Par. 152. Inventories of the effects of deceased non-commissioned officers and soldiers, required by the 95th Article of War, will be forwarded to the Adjutant General, by the commander of the company to which the deceased belonged, and a duplicate of the same to the colonel of the regiment. Final statements of pay, clothing, &c., will be sent with the inventories. When a soldier dies at a post or station absent from his company, it will be the duty of his immediate commander to furnish the required inventory, and, at the same time, to forward to the commanding officer of the company to which the soldier belonged, a report of his death, specifying the date, place, and cause; to what time he was last paid, and the money or other effects in his possession at the time of his decease; which report will be noted on the next muster roll of the company to which the man belonged. Each inventory will be endorsed, "Inventory of the effects of _____, late of company (—) _____ regiment of _____, who died at _____, the _____ day of _____, 186—." If a legal representative receive the effects, it will be stated in the report. If the soldier leave no effects, the fact will be reported.

Par. 153. Should the effects of a deceased non-commissioned officer or soldier not be administered upon within a short period after his decease, they shall be disposed of by a Council of Administration, under the authority of the commanding officer of the post, and the proceeds deposited with the Paymaster, to the credit of the United States, until they shall be claimed by the legal representatives of the deceased.

Par. 154. In all such cases of sales by the Council of Administration, a statement in detail, or account of the proceeds, duly certified by the Council and commanding officer, accompanied by the Paymaster's receipt for the proceeds, will be forwarded by the commanding officer to the Adjutant General. The statement will be endorsed, "Report of the proceeds of the effects of _____, late of company (—) _____ regiment of _____, who died at _____, the _____ day of _____, 186—."

NOTE 1.—The effects in all cases, when called for, should be turned over to the legal representative, without further authority from the Adjutant General. When the effects are turned over to the relatives of the deceased before these inventories are sent to the Adjutant General, their receipts therefor should be attached to the inventories. In all other cases, one copy will be sent with a letter of transmittal direct to the Adjutant General, and a duplicate retained by the officer.

NOTE 2.—Particular care should be taken to take receipts in duplicate from the Paymaster for any funds turned over to him; one copy should be sent direct to the Adjutant General and one retained by the officer.

INVENTORY OF THE EFFECTS

OF

Privt Chas Wheeler

Late of Company L

4 Reg't of U. S. Cavalry

Volunteers, who died at Fort Hayes, Mo.

on the 27 day of November 1864.

Regt. 4th
11-275

NARRATIVE

Inventory of the effects of Charles Wheeler late
 a Private of Captain _____ Company G of
 the 4th Regiment of W. F. C. Guards Volunteers, who was enrolled as
 a _____ at _____ in the State of _____ on
 the _____ day of _____ 186 , and mustered into the service of the United
 States as a _____ on the _____ day of _____ 186 , at _____
 in Company _____, _____ Regiment of _____ Volunteers, to serve _____
 years or during the war; he was born in _____ in the State
 of _____; he was _____ years of age, _____ feet _____ inches
 high, _____ complexion, _____ eyes, _____ hair, and by occupation, when enrolled,
 a _____; he died in Port Hospital, at
Port Hudson, La. on the 27 day of November 1864, by
 reason of General Debility

INVENTORY.					
ARTICLES.	No.	ARTICLES.	No.	ARTICLES.	No.
Hats.....		Pairs trousers.....		Knapsacks.....	
Caps.....		Pairs flannel drawers.....			
Forage caps.....		Pairs cotton drawers.....			
Great coats.....		Flannel shirts.....			
Uniform coats.....		Cotton shirts.....			
Uniform jackets.....		Pairs boots.....			
Flannel sack coats.....		Pairs shoes.....			
Blouses.....		Pairs socks.....			
Stable frocks.....		Blankets.....	/	MONEY.	
Fatigue overalls.....		Haversacks.....		Specie.....	\$
				Notes.....	\$

I CERTIFY, ON HONOR, that the above inventory comprises all the effects of Private
Charles Wheeler, deceased, and that the effects are in the hands
 of Surgeon W. G. David at Port Hudson, La.
Port Hospital to be disposed of by a Council of Administration.

(DUPLICATES.)

STATION: Port Hudson, La.
 DATE: November 27, 1864.

W. G. David Surgeon in Charge
Port Hudson
 Commanding the Company.

D 168 116 2 R.L. 2/165

FINAL STATEMENT

OF

Private Charles Whelan
4th Reg't of U.S. Cav.

VOLUNTEERS.

Dec 27 1864

Adj. Aug 30/15
for Mr recd for effects
Sunt 2d Aud
H.

NOTE 1.—Two of these certificates (or duplicates) are to be given to each Volunteer Soldier or drafted man who may be discharged previously to the discharge of his company, that he may at once receive from the Paymaster the pay, &c., due him, and the captain or other COMMISSIONED officer commanding the company will certify to the act of the delivery of the duplicate certificates; on these certificates the Soldier is "entitled to" his discharge, and should also present his discharge to the Paymaster to have the payment endorsed on it. The discharge is to be given back to the Soldier by the Paymaster; the latter only retaining as his voucher the duplicate certificates.

NOTE 2.—If the Soldier is entitled to pay for the use of his horse, the Company Commander will certify to that fact on the back of both these final statements, and also to the time he has pay due for having been so mounted on his own horse.

NOTE 3.—When a Soldier is furnished with final statements, his descriptive list, if he has one, should be taken up by the officer who gives the Soldier these statements, and endorsed with a statement to this effect by the officer. This endorsement should exhibit a full statement of the time for which the Soldier was allowed pay on his final statements, the clothing account, and all other charges against him or in his favor, so as to comprise a complete exhibit of his account. It will then be transmitted to the company commander of the Soldier, who will enter all the data necessary to a full understanding of the Soldier's account on the muster roll upon which the Soldier's discharge is reported. The descriptive list will then be destroyed. The object of this is, that the remaining portion of the Soldier's account may be settled upon the receipt of these muster rolls, and the Soldier receive any pay or allowances that may be due him at the time of his discharge, and which may not appear on his final statements from the fact that his descriptive list is incomplete. These accounts for back pay, &c., are settled by the 2d Auditor of the Treasury Department.

NOTE 4.—Charges for loss or injury to ordnance, horse equipments, and other miscellaneous charges, should appear under the heading of "Other Stoppages."

NOTE 5.—Bounty paid by State authorities, and not by the United States, will not be entered on this statement.

NOTE 6.—Amounts due the Sutler and Laundress must be entered on the muster roll on which the discharge, death, desertion, &c., is reported, as well as on the final statement, otherwise the amount cannot be collected from the United States.

NOTE 7.—This blank will be used for deceased volunteers and drafted men, as well as for others.

NOTE 8.—Where a Soldier dies in Hospital, or on detached service, his descriptive list, if he has one, should be sent with his final statements, in duplicate, to the Adjutant General, Washington, D. C.

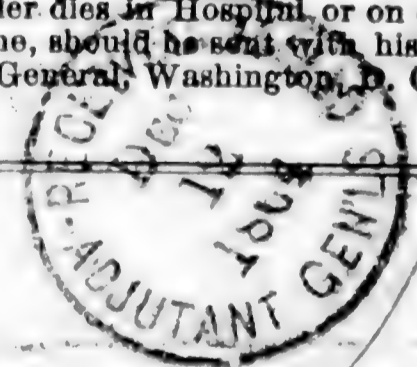

ADJUTANT GENERAL'S OFFICE

Dec 15 1864

Duplicate with Inventory sent 2d Auditor.

1132

Wheeler, Thomas

Co A, 4 U. S. Col'd Cav.

Perplant Perplant

CARD NUMBERS.

1	5352543	26
2	5352595	27
3	5352650	28
4	5352706	29
5	5352765	30
6	5352829	31
7	5352890	32
8	5352969	33
9	5353049	34
10	5353133	35
11	5353229	36
12	5353329	37
13	5353420	38
14	5353506	39
15	5353588	40
16	5353671	41
17	40729326	42
18		43
19		44
20		45
21		46
22		47
23		48
24		49
25		50

Book Mark:

See also

Yf | **4 Cav. | U.S.C.T.**

Thomas Wheeler

*1st Supt, Co. D., 1 Reg't, Corps d'Afrique Cavalry.**
Age 26,
 Appears on

Company Muster-in Roll

of the organization named above. Roll dated

New Orleans La., Nov 26, 1863.

Muster-in to date *Nov 26, 1863.*

Joined for duty and enrolled:

When *Oct 5*, 186 .

Where *New Orleans*

Period *3* years.

Valuation of horse, \$ *100*

Valuation of horse equipments, \$ *100*

Remarks:

*This organization subsequently became Co. D, 4 Reg't U. S. Colored Cavalry.

Book mark:

Rosenbaum

(356)

Copyist.

44

4 Cav. U.S.C.T.

Thomas Wheeler

1 Supt, Co. D, 1 Reg't Cav., Corps d'Afrique.*

Appears on

Company Muster Roll

for From August to Dec 31, 1863.

Present or absent Present

Stoppage, \$ 100 for

Due Gov't, \$ 100 for

Valuation of horse, \$ 100

Valuation of horse equipments, \$ 100

Remarks:

* This organization subsequently became Co. D, 4 Reg't U. S. Colored Cavalry.

Book mark:

Rosenbaum

H 4 Cav. U.S.C.T.

Thomas Wheeler
1st Sery Co. D, 1 Reg't Cav., Corps d'Afrique.*

Appears on

Company Muster Roll

for *Jas. T. Kelly*, 1864.

Present or absent *Present*

Stoppage, \$ *100* for

Due Gov't, \$ *100* for

Valuation of horse, \$ *100*

Valuation of horse equipments, \$ *100*

Remarks:

* This organization subsequently became Co. *D*, 4 Reg't U.S. Colored Cavalry.

Book mark: -----

(358) *Rosenbaum* Copyist.

H | **4 Cav.** | **U.S.C.T.**

Thomas Wheeler

Serjt, Co. D. 4 Reg't U. S. Col'd Cavalry.

Appears on

Company Muster Roll

for March & April, 1864.

Present or absent Present

Stoppage, \$ 100 for

Due Gov't, \$ 100 for

Valuation of horse, \$ 100

Valuation of horse equipments, \$ 100

Remarks:

Book mark:

Rosenbaum

H | **4 Cav.** | **U.S.C.T.**

Thomas Wheeler

1 Srgt., Co. D. 4 Reg't U. S. Col'd Cavalry.

Appears on

Company Muster Roll

for *May & June*, 186*4*.

Present or absent *Present*

Stoppage, \$ 100 for

Due Gov't, \$ 100 for

Valuation of horse, \$ 100

Valuation of horse equipments, \$ 100

Remarks:

Book mark:

Rosenbaum

4 | **4 Cav.** | **U.S.C.T.**

Thomas Wheeler

Sgt., Co. D. 4 Reg't U. S. Col'd Cavalry.

Appears on

Company Muster Roll

for July & Aug, 1864.

Present or absent Present

Stoppage, \$ 100 for

Due Gov't, \$ 100 for

Valuation of horse, \$ 100

Valuation of horse equipments, \$ 100

Remarks:

Book mark:

Rosenbauer
Copyist.

H | 4 Cav. | U.S.C.T.

Thomas Wheeler

1st sergt, Co. D, 4 Reg't U. S. Col'd Cavalry.

Appears on

Company Muster Roll

for *Sept & Oct*, 1864.

Present or absent *Present*

Stoppage, \$ *100* for

Due Gov't, \$ *100* for

Valuation of horse, \$ *100*

Valuation of horse equipments, \$ *100*

Remarks:

Book mark:

Roussell

11 | **4 Cav. | U.S.C.T.**

Thomas Wheeler

1297, Co. D, 4 Reg't U. S. Col'd Cavalry.

Appears on

Company Muster Roll

for *Apr Dec*, 186*7*.

Present or absent *Present*

Stoppage, \$ 100 for

Due Gov't, \$ 100 for

Valuation of horse, \$ 100

Valuation of horse equipments, \$ 100

Remarks:

Book mark:

W. J. ...
Copyist.

11 | **4 Cav.** | **U.S.C.T.**

Thomas Wheeler

Sgt., Co. D, 4 Reg't U. S. Col'd Cavalry.

Appears on

Company Muster Roll

for *Jan 1863*, 1863.

Present or absent *Present*

Stoppage, \$ *100* for

Due Gov't, \$ *100* for

Valuation of horse, \$ *100*

Valuation of horse equipments, \$ *100*

Remarks: *Appointed 1 Sgt
6-27-63
killed only 4 days
in service after 2/10/64*

Book mark:

W. H. [Signature]
Copyist.

11 | **4 Cav.** | **U.S.C.T.**

Thomas Johnson

Sgt., Co. D, 4 Reg't U. S. Col'd Cavalry.

Appears on

Company Muster Roll

for *Mich. 1862*, 186*2*.

Present or absent *Present*

Stoppage, \$ *100* for

Due Gov't, \$ *100* for

Valuation of horse, \$ *100*

Valuation of horse equipments, \$ *100*

Remarks: *Sick for last 30 days*

Book mark:

Thomas Johnson
Copyist.

11-1 | **4 Cav. | U.S.C.T.**

Thomas Hucker

1st, Co. D, 4 Reg't U. S. Col'd Cavalry.

Appears on

Company Muster Roll

for *Mar & June*, 1865.

Present or absent *Present*

Stoppage, \$ *100* for

Due Gov't, \$ *100* for

Valuation of horse, \$ *100*

Valuation of horse equipments, \$ *100*

Remarks *Stop for last 2 wks*
5th

Book mark: *11*

2 1/2 wks

21
11 | 4 Cav. | U.S.C.T.

Thomas Wheeler

Sgt., Co. D, 4 Reg't U. S. Col'd Cavalry.

Appears on

Company Muster Roll

for *July & Aug*, 186~~4~~⁵

Present or absent *Present*

Stoppage, \$ 100 for

Due Gov't, \$ 100 for

Valuation of horse, \$ 100

Valuation of horse equipments, \$ 100

Remarks:

Corrected by Ex.

Book mark:

W. H. ...

MAR 12 1861

M | **4 Cav.** | **U.S.C.T.**

Thomas Wheeler

Sgt., Co. D. 4 Reg't U. S. Col'd Cavalry.

Appears on

Company Muster Roll

for *Sept & Oct*, 186*5*.

Present or absent *Present*

Stoppage, \$ 100 for

Due Gov't, \$ 100 for

Valuation of horse, \$ 100

Valuation of horse equipments, \$ 100

Remarks:

Book mark:

(358)

W. H. Wright

Copyist.

14 | **4 Cav. | U.S.C.T.**

Thomas Wheeler

1 Sgt., Co. D, 4 Reg't U. S. Col'd Cavalry.

Appears on

Company Muster Roll

for Nov + Dec, 1865!

Present or absent Present

Stoppage, \$ 100 for

Due Gov't, \$ 100 for

Valuation of horse, \$ 100

Valuation of horse equipments, \$ 100

Remarks:

Book mark:

W. Andrew

N | **4 Cav.** | **U.S.C.T.**

Thomas Wheeler

1 Sgt, Co. D, 4 Reg't U. S. Col'd Cavalry.

Appears on

Company Muster Roll

for *Jan + Feb*, 186*6*.

Present or absent *Present*

Stoppage, \$ *100* for

Due Gov't, \$ *100* for

Valuation of horse, \$ *100*

Valuation of horse equipments, \$ *100*

Remarks:

Book mark:

M. Woodcock

W | **4 Cav.** | **U.S.C.T.**

Thos. Wheeler

, Co. D, 4 Reg't U. S. Colored Cav.

Appears on **Returns** as follows:

May 1864 - Absent sick sent
May 13/64 to G. H. N. D. La.

Book mark:

W. R. Lee

11 | 4 Cav. | U.S.C.T.

Thomas Wheeler

1 Sgt, Co. H, 4 Reg't U. S. Col'd Cavalry.

Appears on Co. Muster-out Roll, dated New Orleans, La, Mar 20, 1866.

Muster-out to date Mar 20, 1866.

Last paid to June 30, 1865.

Clothing account:

Last settled, 186 ; drawn since \$ 100

Due soldier \$ 32 ¹⁸/₁₀₀; due U. S. \$ 100

Am't for cloth'g in kind or money adv'd \$ 100

Due U. S. for arms, equipments, &c., \$ 100

Bounty paid \$ 100; due \$ 100

Remarks: Joined at Drigg, Or.
Sergt. since enlistment.

Book mark: 246090

M. S. Anderson

1133

White Albert

Co C, 4 U. S. Col'd Cav.

Private Private

CARD NUMBERS.

1	5347784	26
2	5351685	27
3	5351754	28
4	5351817	29
5	5351912	30
6	5352015	31
7	5352112	32
8	5352210	33
9	5352303	34
10	5352391	35
11	5352480	36
12	40729327	37
13		38
14		39
15		40
16		41
17		42
18		43
19		44
20		45
21		46
22		47
23		48
24		49
25		50

Book Mark:

See also

4 Cav. U.S.C.T.

Albert White

Appears with rank of Priv. on

Muster and Descriptive Roll of a Detachment of U. S. Vols. forwarded

for the 4 Reg't U. S. Col'd Cavalry. Roll dated New Orleans, La., Aug. 26, 1864.

Where born New Orleans, La.

Age 21 y'rs; occupation Waiter

When enlisted Aug. 23, 1864.

Where enlisted New Orleans

For what period enlisted 3 years.

Eyes Black; hair Black

Complexion Dark; height 5 ft. 6 in.

When mustered in Aug. 26, 1864.

Where mustered in New Orleans

Bounty paid \$ 100.00; due \$ 200.00

Where credited New Orleans

Company to which assigned C

Remarks: Recruits entitled to
Bounty.

Book mark:

G. E. Taylor
(339) Copyist.

W | 4 Cav. | U.S.C.T.

Albert Spitz
Sgt, Co. C, 4 Reg't U. S. Colored Cavalry.

Appears on

Company Muster Roll

for Sept, 1864.

Present or absent Present

Stoppage, \$ 100 for

Due Gov't, \$ 100 for

Valuation of horse, \$ 100

Valuation of horse equipments, \$ 100

Remarks: Foot Blanket,
Carriage Ring + wires \$4.08

Book mark :

Bochner

H | 4 Cav. | U.S.C.T.

Albert White

Priv, Co. C, 4 Reg't U. S. Colored Cavalry.

Appears on

Company Muster Roll

for *Nov & Dec*, 1864.

Present or absent *absent*

Stoppage, \$ *15* ^{*58*}/₁₀₀ for *ordnance*

Due Gov't, \$ *100* for

Valuation of horse, \$ *100*

Valuation of horse equipments, \$ *100*

Remarks: *Arrest for
desertion since Dec
14/64. Got ordnance*

Book mark:

Moy

A | 4 Cav. | U.S.C.T.

Albert White

Priv, Co. C, 4 Reg't U. S. Colored Cavalry.

Appears on

Company Muster Roll

for *Jan & Feb*, 186*5*.

Present or absent *Absent*

Stoppage, \$ *100* for

Due Gov't, \$ *100* for

Valuation of horse, \$ *100*

Valuation of horse equipments, \$ *100*

Remarks: *In Post Guard House for desertion waiting sentence of Court, Stop for two Carbine slings and two swivels, one sabre belt, sabre knot, one cap pouch, one saddle blanket, one halter and strap, one*

Book mark: *(over)*

M. J. Mury
Copyist.

Curry comb & brush,
one curb chain and
surcingle, and one
pair spurs and one
bridle complete.

JAN.-8

5351817

☆ 1891 ☆

H | 4 Cav. | U.S.C.T.

Albert White

Pvt, Co. C, 4 Reg't U. S. Colored Cavalry.

Appears on

Company Muster Roll
for *March & Apr*, 1863.

Present or absent *absent*

Stoppage, \$ 100 for

Due Gov't, \$ 100 for

Valuation of horse, \$ 100

Valuation of horse equipments, \$ 100

Remarks: *In Post Guard
House for desertion,
waiting sentence of C.M.,
Stop for 2 Car. Slings, 2
Swivels, 1 Sabe, belt, 1
Sabe, knot, 1 cap pouch,
2 saddle blankets, 1 halter
and strap, 1 Curry comb*

Book mark: *(over)*

May

7 brush, 1 curb chain,
1 surcingle, 1 for spurs
& straps, 1 bridle
complete,

☆ 1891 ☆

5351912

JAN.-8

W | 4 Cav. | U.S.C.T.

Albert White

Priv, Co. C, 4 Reg't U. S. Colored Cavalry.

Appears on

Company Muster Roll

for *May & June*, 186*5*.

Present or absent *absent*

Stoppage, \$ *100* for

Due Gov't, \$ *100* for

Valuation of horse, \$ *100*

Valuation of horse equipments, \$ *100*

Remarks: *In post guard house for desertion waiting sentence of C.M. Stop for 2 carbine slugs, 2 swords, 1 sabre belt, one sabre knot, one cap pouch, 2 saddle blankets, one halter & strap, one curry comb & brush, one curb chain, one surcingle, 1 pair spurs & straps, 1 bridle complete.*

Book mark: _____

May

(358)

Copyist.

A | **4 Cav.** | **U.S.C.T.**

Albert White

Priv, Co. C, 4 Reg't U. S. Colored Cavalry.

Appears on

Company Muster Roll

for *July & Aug*, 1865.

Present or absent *present*

Stoppage, \$ 100 for

Due Gov't, \$ 100 for

Valuation of horse, \$ 100

Valuation of horse equipments, \$ 100

Remarks: *Pardoned and ret'd to duty
per S.O. 186, Hdqtrs Dept. of
Gulf, dated N.O. La, July 12/65.
Stop for 2 carbine slings
and swivels, 1 sabre belt
and plate, 1 sabre knot,
1 cap pouch, 7 saddle
blankets, 1 halter and strap*

Book mark: _____
_____ *(over)*

(358)

Moy

Copyist.

PARA 1247

1 curry comb & brush,
1 curb chain, 1 snaffle,
1 pr spurs & straps, 1
Bridle complete, - Total
No. 21

JAN.-8

5352112

☆ 1891 ☆

A | **4 Cav.** | **U.S.C.T.**

Albert White

Priv, Co. C, 4 Reg't U. S. Colored Cavalry.

Appears on

Company Muster Roll

for *Sept 20*, 186*5*

Present or absent *present*

Stoppage, \$ *100* for

Due Gov't, \$ *100* for

Valuation of horse, \$ *100*

Valuation of horse equipments, \$ *100*

Remarks: *Deserted from Co at Port Henderson, La, Dec 9/64, Arrested by a scouting party Dec 14/64, & confined in P.G. House from whence he was released & ret'd. to Co. without trial by pardon per S.O. 186, Hdqtrs Dept of*

Book mark: _____

(over)

May

NARR 1249

JAN-8

5352210

1891

Issued, N.C. Co., July 17/65.
Reported for duty with Co
July 17/65. Stop for 2 car,
slings & swivels, 1 Sabra
belt and plate, 1 sabra
knob, 1 cap pouch, 2 saddle
blankets, 1 halter & strap,
1 curry comb & brush, 1
curb chain, 1 surcingler,
1 pr spurs & straps, 1 bridle
complete, Total of charges
\$20.21.

NARA 1250

W | 4 Cav. | U.S.C.T.

Albert White

Private, Co. C, 4 Reg't U. S. Colored Cavalry.

Appears on

Company Muster Roll

for *Nov & Dec.*, 1865!

Present or absent *absent*

Stoppage, \$ *26*^{*19*}/_{*100*} for *Lost Ordnance*

Due Gov't, \$ *100* for

Valuation of horse, \$ *100*

Valuation of horse equipments, \$ *100*

Remarks: *Returned to duty from confinement in Post G. H. Post Hudson La. per S.O. 186. dated Hd Qtrs Dept of Gulf New Orleans La July 12/65. Now confined in Post Gd. H. Baton Rouge La*

Book mark:

M. A. Michaels
(358) Copyist.

W | **4 Cav. | U.S.C.T.**

Albert White

Private, Co. C, 4 Reg't U. S. Colored Cavalry.

Appears on

Company Muster Roll

for *Jan'y + Febr*, 186*6*

Present or absent *present*

Stoppage, \$ *26*^{*19*}/_{*100*} for *Lost Ordnance*

Due Gov't, \$ *100* for

Valuation of horse, \$ *100*

Valuation of horse equipments, \$ *100*

Remarks: *Ret'd to duty from confinement in P.G. House Port Hudson La. per S.O. 186. Hd Qtrs Dept of Gulf New Orleans La July 17/65 - Arrested and sentenced to 1 month confinement to P.G. House Baton Rouge La from Dec 18/65 and loss of \$10 over*

Book mark: _____

M. A. Michaels

(358)

Copyist.

NOV 12 1891

JAN. 1 8
5352391
1891

*per month for the period
Confined, sentence carried
into effect at Baton Rouge.*

W | 4 Cav. | U.S.C.T.

Albert White

Port, Co. D, 4 Reg't U. S. Colored Cav.

Appears on Returns as follows:

Sept 1864 - Join: Sept 2/64
Port Hudson enlisted.

Dec 1864 - Absent confined in Port
Guard house since Dec 14/64
Jan to June 1865 - Absent in arrest,
in confinement at Port
Hudson, La.

Dec 1865 - Absent imprisoned at
Baton Rouge.

Jan 1866 - Absent serving out
sentence of J. L. M. at Baton
Rouge, La. since Dec 28/65

Book mark:

W. R. Lee

N | 4 Cav. | U.S.C.T.

Albert White

Private, Co. *C*, 4 Reg't U. S. Col'd Cavalry.

Appears on **Co. Muster-out Roll**, dated *New Orleans La Mar 20*, 1866.

Muster-out to date *Mar 20*, 1866.

Last paid to *Never paid*, 1866.

Clothing account:

Last settled....., 1866 ; drawn since \$ *1* ⁰⁰

Due soldier \$ ¹⁰⁰ ; due U. S. \$ *58* ⁸⁷ ₁₀₀

Am't for cloth'g in kind or money adv'd \$ ¹⁰⁰

Due U. S. for arms, equipments, &c., \$ *20* ²¹ ₁₀₀

Bounty paid \$ *100* ¹⁰⁰ ; due \$ ¹⁰⁰

Remarks: *Joined as recruit deserted Dec 9/64 restored to duty without trial per S.O. 186 Hd Qrs D.G. July 12/65. 1 Carbine Sling & Swivel, 1 Sabre belt & plate, 1 Sabre brush, 1 Cat's Pouch, 2 Saddle blankets, 1 Halter Strap, 1 Curry comb*

Book mark: *V. 62 P 116 - 69.*

S.O. 186 D.G. on file 'Misc Orders' 67

M. A. Michaels

NRRA 1255

JAN. 1 1955
5352480

1 horsebrush, 1 Surcingle, 1 pair
Spurs & Straps, 1 Curb Bridle

White, Albert

P, Co. *C*, *4* Reg't *U.S.C. Cav.*

3 Enclosures.

Bed Cards	Final Statements
Burial Records	Furloughs or L. of A.
Certs. of Dis. for Discharge	Med. Certificates
C. M. Charges	Med. Des. Lists
Descriptive Lists	Orders
Discharge Certificates	Pris. of War Record
Enlistment Papers	Resignations

Other papers relating to—

Admission to Hosp'l	Furlough or L. of A.
Casualty Sheet	Med. Examination
Confinement	Misc. Information <i>3</i>
Contracts	Pay or Clothing
Death or Effects	Personal Reports
Desertion	Rank
Discharge from Hosp'l	Transfer to Hosp'l
Discharge from Service	Transfer to V. R. C.
Duty	Transportation

MICROFILM PUBLICATION M 1820

COMPILED MILITARY SERVICE RECORDS
 OF VOLUNTEER UNION SOLDIERS WHO
 SERVED WITH THE USCT (US COLORED TROOPS)
 4TH REGIMENT OF CAVALRY

PERSONAL PAPERS' TARGET SHEET

PLEASE NOTE THE CHECKED INFORMATION ABOUT THE PERSONAL PAPERS IN
 THIS FILE:



NO PERSONAL PAPERS WERE FOUND IN THIS FILE WHEN THE
 RECORDS WERE ARRANGED FOR MICROFILMING.

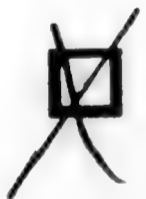

4 PERSONAL PAPER(S) FOUND IN THIS FILE WHEN THE RECORDS
 WERE ARRANGED FOR MICROFILMING.

NOTE 1.—This blank will be used for both enlistments and re-enlistments—enlistment of veterans, &c., &c., in the volunteer service. They will be made out in duplicate in all cases—one to accompany the recruiting return of the superintendent (not the recruiting officer) to the Adjutant General, and one to accompany the accounts of the officer who pays bounty, &c. The Regiment and Company in which the soldier last served should be given on the back.

NOTE 2.—An enlistment holds to service. A muster-in must, in all cases, precede payment of pay, bounty, pension, &c. A muster-in roll must, in all cases, be filed in the Adjutant General's Office as evidence of muster-in. The mustering officer, commissary, or assistant commissary of musters, as the case may be, will countersign both enlistments as having mustered the soldier into the service of the United States before either of them is given to the disbursing officer.

DECLARATION OF RECRUIT.

I, Albert White, desiring to VOLUNTEER as a Soldier in the Army of the United States, for the term of THREE YEARS, Do Declare, That I am Twenty one years and _____ months of age; that I have never been discharged from the United States service on account of disability or by sentence of a court martial, or by order before the expiration of a term of enlistment; and I know of no impediment to my serving honestly and faithfully as a soldier for three years.

GIVEN at New Orleans the 25 day of August 1864

Witness: F. Hunter Albert White

No. _____

Albert White

Volunteered at New Orleans

the 23 day of August, 1864

By Capt. F. Hunter

4 Regiment of M. S. Cavalry

Cavalry

enlistment; last served in Company ()

Regt of _____

Discharged _____, 18 _____

Recruitment taken to Company by
by (Sergeant) 11th March 1864
officer July 18 1864

Received from Second Auditor

August 24th 1892.

CONSENT IN CASE OF MINOR.

I, _____, Do CERTIFY, That I am the _____ of _____; that the said _____ is _____ years of age; and I do hereby freely give my CONSENT to his volunteering as a SOLDIER in the ARMY OF THE UNITED STATES for the period of THREE YEARS.

GIVEN at _____ the _____ day of _____

Witness: _____

NOV 12 1864

VOLUNTEER ENLISTMENT.

STATE OF

TOWN OF

Louisiana

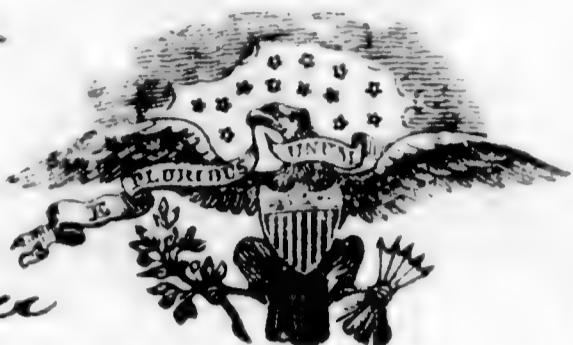

New Orleans

I, *Albert White*, born in *New Orleans* in the State of *Louisiana*, aged *Twenty one* years, and by occupation a *Waiter*, Do HEREBY ACKNOWLEDGE to have volunteered this *Twenty third* day of *August*, 1864, to serve as a **Soldier** in the **Army of the United States of America**, for the period of **THREE YEARS**, unless sooner discharged by proper authority: Do also agree to accept such bounty, pay, rations, and clothing, as are, or may be, established by law for volunteers. And I, *Albert White*, do solemnly swear, that I will bear true faith and allegiance to the **United States of America**, and that I will serve them honestly and faithfully against all their enemies or opposers whomsoever; and that I will observe and obey the orders of the President of the United States, and the orders of the officers appointed over me, according to the Rules and Articles of War.

Sworn and subscribed to, at *New Orleans* this *23rd* day of *August*, 1864, BEFORE *Capt. J. Bunter* } *Albert White* }
4th U. S. Col. Cav. } *wait.*

I CERTIFY, ON HONOR, That I have carefully examined the above-named Volunteer, agreeably to the General Regulations of the Army, and that, in my opinion, he is free from all bodily defects and mental infirmity, which would in any way disqualify him from performing the duties of a soldier.

A. H. Matter
EXAMINING SURGEON.

I CERTIFY, ON HONOR, That I have minutely inspected the Volunteer *Albert White* previously to his enlistment, and that he was entirely sober when enlisted; that, to the best of my judgment and belief, he is of lawful age; and that, in accepting him as duly qualified to perform the duties of an able-bodied soldier, I have strictly observed the Regulations which govern the recruiting service. This soldier has *blue* eyes, *black* hair, *swart* complexion, is *five* feet *five* inches high.

Frank Bunter, Capt.
4th Regiment of U. S. Col. Volunteers, Cav.
RECRUITING OFFICER.

(A. G. O. No. 74 & 76.)

Mastered into the service of the United States, for three years or during the war, from date of enlistment, in Company *B* of the *4th Regiment of U. S. Col. Cav. Volunteers*, on the *23rd* day of *August*, 1864, at *New Orleans*.

J. M. Shaw
1051 1/2 St. N. S. O. City - 26
J. E. M.

Ellerbrook

Private Albert White Co. "C" 4th U.S. Cav.

complete

Ellerbrook --

Prv: Albert White C. C. & W. S. C. Co.

✓ complete

Adjutant General's Office,

COLORED TROOPS BRANCH,

January 9th, 1874

Vol. C. T., 187

Wanted in case of Private Albert White, Co. "C", 4th Reg't W. S. Colored Cav. - information as to nature of offence trial and sentence - he is reported * * * "arrested and sentenced to one month's confinement in Post G. H. O. Baton Rouge La. from Dec 28th 65 and loss of \$10 for the period confined - sentence carried into effect at Baton Rouge" - (vide M. R. for Jan. & Feb. 1865) * second sentence and imprisonment of soldier -

Respectfully,

H. A. Woodward

Chief Clerk.

J. J. Dalton

Mr. Ellbrook-

E. R. -

Adjutant General's Office,

Record Room

Jan'y. 14, 1874

Vol. C. T., 187

Reply in case of Private Albert White, Co. "C", 4th Reg't W. S. Colored Cav.

From records of G. Dist. of La. (Name appears as Alfred White.)

Tried before a G. C. Martial at Baton Rouge La.

G. O. No. 70. N. G. Dist. of La. New Orleans La. Dec. 28th 65.

Charge 1st Absence without leave. - Charge 2nd Conduct inj. to good order & mil. discipline. - Finding. Guilty. - Sentence: To be confined at hard labor, at such place as the Comdg. Genl. may direct for the period of 4 months with loss of 10 dollars per month of his pay for same period.

Mitigated to confinement of 1 month ^{at Baton Rouge La.} & forfeiture of \$10. of his monthly pay for same period. App. 5

By order of Post Maj. Genl. G. W. Sherman

(Sgd) Z. W. Wood
A. D. C. & Adj. G.

M. J.

Lt. B. H. M. S. P. H. - 1865.

Dec 13 42 P. H. Jan 2 1865

Head Qrs U.S. P. H. Jan 2 1865
Drew Chas. H.
Col 76 U.S. I.

Head Qrs U.S. Forces. I. P. H.
July 20, 1865.

C. M. Drew
Col 60ndy Regt.

Reports that he is unable
to find record of Court
Martial Cases.

John

P. H.

Files

The Court of U.S.
C. M.

50 U.S. I.

Head Qrs P. H. Jan 22 1865

Head Quarters, U. S. Forces,

Fort Hudson, La., Jan'y 20th 1865.

Captain S Lovell

A. S. G.

Captain

I am unable to find any record of Court martial cases, to enable me to comply with Circular, from Hd Qrs Dept of the Gulf, dated Oct 26th 1864, requiring lists of cases, "tried, and to be tried" to be forwarded at the end of the month, to the Judge Advocate of the Department.

The only case on file at this office, for December 1864, to be tried, is that of Private Albert White, Co "C", 4th U. S. C. Cav, for desertion. I suppose it devolves upon me, to make the report

I am, very respectfully,

Yours obt servt

Chas W. Drew

Adj 7th U. S. C.

Comd'g Post

1134

White Edward

Co B, 4 U. S. Col'd Cav.

Private Private

CARD NUMBERS.

1	5-3475-85-	26
2	5-358434	27
3	5-35-8483	28
4	5-35-8533	29
5	5-35-85-77	30
6	5-35-8619	31
7	5-348084	32
8	5-35-0668	33
9	5-35-0753	34
10	5-35-7847	35
11	5-35-0933	36
12	5-35-1017	37
13	5-35-1098	38
14	5-35-1180	39
15	5777-a-1889	40
16		41
17		42
18		43
19		44
20		45
21		46
22		47
23		48
24		49
25		50

Book Mark: 5777-a-89

See also

S. 1364249, Po. wt m P. J.
D 265-1884 P. anie

S. A. Muhlman
St.

24 | **4 Cav.** | **U.S.C.T.**

Edward White

Appears with rank of *Priv.* on

Muster and Descriptive Roll of a Detachment of U. S. Vols. forwarded

for the 4 Reg't U. S. Col'd Cavalry. Roll dated

New Orleans La, May 9, 1864.

Where born *White Bluffs Fla*

Age *20* y'rs; occupation *Miller*

When enlisted *Apr. 30*, 1864.

Where enlisted *Alexandria*

For what period enlisted *3* years.

Eyes *Black*; hair *Black*

Complexion *Black*; height *5* ft. *10* in.

When mustered in *May 9*, 1864.

Where mustered in *New Orleans*

Bonus paid 2
Bounty paid \$ *100*; due \$ *100*

Where credited

Company to which assigned *A*

Remarks:

Book mark: *5797-2-1889*

Proster

NOV 12 1869

W | **4 Cav.** | **U.S.C.T.**

Edward White

W, Co. *K*, 4 Reg't U. S. Col'd Cavalry.

Age years.

Appears on

Company Muster Roll*

for *May 9 to June 30*, 186*4*.

Joined for duty and enrolled:

When *Apr. 30*, 186*4*.

Where *Alexandria, Va*

Period *3* years.

Mustered in:

When *May 9*, 186*4*.

Where *New Orleans, La*

Present or absent *Present*

Stoppage, \$ *100* for

Due Gov't, \$ *100* for

Valuation of horse, \$ *100*

Valuation of horse equipments, \$ *100*

Remarks: *Sick*

* First current roll. No muster-in roll of this battery on file.

Book mark :

W. S. Thompson

(3586)

Copyist.

of | **4 Cav. U.S.C.T.**

Edward White

Capt, Co. K, 4 Reg't U. S. Col'd Cav.

Appears on

Company Muster Roll

for *July & Aug.*, 186*4*.

Present or absent *Present*

Stoppage, \$ *100* for

Due Gov't, \$ *100* for

Valuation of horse, \$ *100*

Valuation of horse equipments, \$ *100*

Remarks: *Sick*

Book mark:

H. S. Champion

17

4 Cav. U.S.C.T.

Edward White

Pvt., Co. K, 4 Reg't U. S. Col'd Cav.

Appears on

Company Muster Roll

for Sept. & Oct., 1861.

Present or absent Present

Stoppage, \$ 100 for

Due Gov't, \$ 100 for

Valuation of horse, \$ 100

Valuation of horse equipments, \$ 100

Remarks:

Book mark:

M. S. Thompson

M | **4 Cav.** | **U.S.C.T.**

Edward White

Prvt., Co. K, 4 Reg't U. S. Col'd Cav.

Appears on

Company Muster Roll

for *Nov. & Dec.*, 1864.

Present or absent *Present*

Stoppage, \$ *100* for

Due Gov't, \$ *100* for

Valuation of horse, \$ *100*

Valuation of horse equipments, \$ *100*

Remarks:

Book mark:

H. S. Thompson

M

4 Cav. | U.S.C.T.

Edward White

S. A., Co. K, 4 Reg't U. S. Col'd Cav.

Appears on

Company Muster Roll

for *Jan. & Feb.*, 186*5*.

Present or absent *Present*

Stoppage, \$ *100* for

Due Gov't, \$ *100* for

Valuation of horse, \$ *100*

Valuation of horse equipments, \$ *100*

Remarks:

Book mark:

W. S. Thompson

W | **4 Cav. | U.S.C.T.**

Edward White

priv., Co. B. 4 Reg't U. S. Col'd Cavalry.

Appears on

Company Muster Roll

for *March & April*, 186*5*.

Present or absent *present*

Stoppage, \$ 100 for

Due Gov't, \$ 100 for

Valuation of horse, \$ 100

Valuation of horse equipments, \$ 100

Remarks: *Transferred to Company
by consolidation in accordance
with S.O. No 28. dated Hd. Qrs.
Sept of Gulf Jan. 28/65.*

Book mark: *5777-A-89.*

Forrester

N 4 Cav. | **U.S.C.T.**

Edward White

Co. B, 4 Reg't U. S. Col'd *Cav.*

Appears on

M. and D. Roll of Men Transferred

to the organization named above, by *Comd.*
from *Co. K*,

Roll dated *Port Hudson La. Apr 29*, 1865.

When enlisted *Apr 30*, 1864.

Period for which enlisted *3* years.

When mustered in *May 9*, 1864.

Present or absent *not stated*

Company to which assigned *B.*

Remarks: _____

Book mark: *See 5777 u 89*

J. U. Leonard

W | **4 Cav.** | **U.S.C.T.**

Edward White

407., Co. B. 4 Reg't U. S. Col'd Cavalry.

Appears on

Company Muster Roll

for *July & Aug*, 186*3*.

Present or absent *present*

Stoppage, \$ 100 for

Due Gov't, \$ 100 for

Valuation of horse, \$ 100

Valuation of horse equipments, \$ 100

Remarks :

Book mark :

Sumner

OR | **4 Cav. | U.S.C.T.**

Edward White

priv., Co. B. 4 Reg't U. S. Col'd Cavalry.

Appears on

Company Muster Roll

for *Sept & Oct*, 186*1*.

Present or absent *present*

Stoppage, \$ 100 for

Due Gov't, \$ 100 for

Valuation of horse, \$ 100

Valuation of horse equipments, \$ 100

Remarks :

Book mark :

Forner

W | **4 Cav.** | **U.S.C.T.**

Edward White

Priv, Co. B. 4 Reg't U. S. Col'd Cavalry.

Appears on

Company Muster Roll

for *Nov. 1865*, 1865.

Present or absent *Present*

Stoppage, \$ 100 for

Due Gov't, \$ 100 for

Valuation of horse, \$ 100

Valuation of horse equipments, \$ 100

Remarks :

Book mark :

Chandler

(358)

Copyist.

MAR 12 1866

W | **4 Cav. U.S.C.T.**

Edward White
Priv, Co. B. 4 Reg't U. S. Col'd Cavalry.

Appears on

Company Muster Roll

for *Jan. & Feb.*, 1866.

Present or absent *Present*

Stoppage, \$ 100 for

Due Gov't, \$ 100 for

Valuation of horse, \$ 100

Valuation of horse equipments, \$ 100

Remarks :

Book mark :

Chaudh

(358)

Copyist.

W | **4 Cav.** | **U.S.C.T.**

Edward White

Priv, Co. *B*, 4 Reg't U. S. Col'd Cavalry.

Appears on **Co. Muster-out Roll**, dated

New Orleans, La, *March 20*, 1866.

Muster-out to date *March 20*, 1866.

Last paid to *June 30*, 1865.

Clothing account:

Last settled....., 186 ; drawn since \$.....100

Due soldier \$ *42 84* 100; due U. S. \$.....100

Am't for cloth'g in kind or money adv'd \$.....100

Due U. S. for arms, equipments, &c., \$.....100

Bounty paid \$.....100; due \$.....100

Remarks: *Joined by transfer from*
Co. K. per A.O. 28. Hd. Qrs. Dept
Gulf. Jan'y 28/65.

Book mark: *v. 25-P. 98/68 5777-a-*
89.

(361)

Chandler

Copyist.

N | *4* | *Reg U.S.C.*

Edward White

Co K, 4th Reg U.S.C. Cav.

NOTATION.

Book mark: *5777 A. 1889.*

War Department,
A. G. O. Div.
Adjutant General's Office,

Washington *August 6, 1889.*

Application for certificate in lieu of lost discharge.

One Certificate furnished.

Warren

1135

White Samuel

Co. ^{A. & S.} ~~A. & S.~~, 4 U. S. Col'd Cav.

Captain Major

CARD NUMBERS.

1	5347399	26	40729077
2	5354907	27	
3	5354998	28	
4	5355089	29	
5	5355182	30	
6	5355274	31	
7	5355359	32	
8	5355441	33	
9	5355519	34	
10	5355596	35	
11	5355682	36	
12	5355766	37	
13	5348121	38	
14	5347400	39	
15	5355927	40	
16	5348371	41	
17	5348379	42	
18	5348387	43	
19	5356160	44	
20	5348395	45	
21	W938-67-1865	46	
22	42744380	47	
23	42744414	48	
24	42744426	49	
25	42744459	50	

Book Mark: W. 938-67-1865.

See also

WAP 1284

PAP 534 386

D. 2616734 Pomil

SS to Mr. Grank W. McGill, Jr., c/o LaFayette
Public Schools, LaFayette, Ills. 3/23/39-ef

S. A. Muller
41.

NOV 12 1863

W | **4 Cav.** | **U.S.C.T.**

Samuel White

Capt, Co. A, Mounted Rangers, Corps d'Afrique. †

Age years.

Appears on

Company Muster Roll*

for *Nov 9 Dec*, 1863.

Joined for duty and enrolled:

When *Nov 2*, 1863.

Where *Terrell, La*

Period years.

Mustered in:

When *Dec 19*, 1863.

Where *Iberia, La*

Present or absent *Present*

Stoppage, \$ 100 for

Due Gov't \$ 100 for

Valuation of horse, \$ 100

Valuation of horse equipments, \$ 100

Remarks:

†This organization subsequently became Co. F, 4 U. S. Col'd Cav.
*First current roll. No muster-in roll of this ~~Co.~~ battery on file.

Book mark:

Manning

(3586)

Copyist.

W | *U Cav,* | **U.S.C.T.**

Samuel White

Capt, Co. *A*, *4* Reg't U. S. Col'd *Cav.*

Age *23* years.

Appears on an

Individual Muster-in Roll

of the organization named above. Roll dated

New Orleans La, *Dec 26,* 1863.

Muster-in to date *Dec 19,* 1863.

Joined for duty and enrolled:

When *Nov 2*, 1863.

Where *Terrebonne La.*

Period _____ years.

Valuation of horse, \$ _____ 100

Valuation of horse equipments, \$ _____ 100

Remarks: *Promoted from*

Private Co. K, 2nd Ill.

Reg't, discharged as

such in S.O. No. 98.

H'd Qrs. 19th Army Corps.

Book mark: *W. 938 - C.T. - 1865.*

Perrington

W | **4 Cav. | U.S C.T.**

Samuel White

Capt, Co. *F*, 1 Reg't Cav., Corps d'Afrique.*

Appears on

Company Muster Roll

for *Jan'y & Feb'y*, 1864.

Present or absent *Present*

Stoppage, \$ *100* for

Due Gov't, \$ *100* for

Valuation of horse, \$ *100*

Valuation of horse equipments, \$ *100*

Remarks:
.....
.....
.....
.....
.....

* This organization subsequently became Co. *F*, 4 Reg't U. S. Colored Cavalry.

Book mark:

Manning
Copyist.

M | 4 Cav. | U.S.C.T.

Samuel White

Capt, Co. F, 4 Reg't U. S. Col'd Cavalry.

Appears on

Company Muster Roll

for *March & April*, 1864

Present or absent *Present*

Stoppage, \$ 100 for

Due Gov't, \$ 100 for

Valuation of horse, \$ 100

Valuation of horse equipments, \$ 100

Remarks:

Book mark:

Manning

(358)

Copyist.

M | 4 Cav. | U.S.C.T.

Samuel White

Capt, Co. F, 4 Reg't U. S. Col'd Cavalry.

Appears on

Company Muster Roll

for *May & June*, 1864

Present or absent *Present*

Stoppage, \$ 100 for

Due Gov't, \$ 100 for

Valuation of horse, \$ 100

Valuation of horse equipments, \$ 100

Remarks:

Book mark:

Manning

W

4 Cav. U.S.C.T.

Samuel White

Capt., Co. F, 4 Reg't U. S. Col'd Cavalry.

Appears on

Company Muster Roll

for *July & Aug*, 1864.

Present or absent *Present*

Stoppage, \$.....100 for.....

Due Gov't, \$.....100 for.....

Valuation of horse, \$.....100

Valuation of horse equipments, \$.....100

Remarks:.....

Book mark:.....

(358)

Manning
Copyist.

W 4 Cav. U.S.C.T.

Samuel White

Capt, Co. F, 4 Reg't U. S. Col'd Cavalry.

Appears on

Company Muster Roll

for *Sept & Oct*, 186*4*.

Present or absent *Present*

Stoppage, \$ *100* for

Due Gov't, \$ *100* for

Valuation of horse, \$ *100*

Valuation of horse equipments, \$ *100*

Remarks:

Book mark:

W. Manning Copyist.

W | 4 Cav. | U.S.C.T.

Samuel White

Capt, Co. F, 4 Reg't U. S. Col'd Cavalry.

Appears on

Company Muster Roll

for *Nov. & Dec.*, 186 *4*

Present or absent *Present*

Stoppage, \$ *100* for

Due Gov't, \$ *100* for

Valuation of horse, \$ *100*

Valuation of horse equipments, \$ *100*

Remarks:

Book mark:

J. A. Harris

W | 4 Cav. | U.S.C.T.

Samuel White

Capt, Co. F, 4 Reg't U. S. Col'd Cavalry.

Appears on

Company Muster Roll

for *Jan. & Feb*, 1865.

Present or absent *Present*

Stoppage, \$ *100* for

Due Gov't, \$ *100* for

Valuation of horse, \$ *100*

Valuation of horse equipments, \$ *100*

Remarks: *Stop for (12) Twelve
Infantry Cartridge Boxes.*

Book mark:

L. A. Harris

W | 4 Cav. | U.S.C.T.

Samuel White

Capt, Co. F, 4 Reg't U. S. Col'd Cavalry.

Appears on

Company Muster Roll

for *Mch. & Apr.*, 186 *5*

Present or absent *Present*

Stoppage, \$ *100* for

Due Gov't, \$ *100* for

Valuation of horse, \$ *100*

Valuation of horse equipments, \$ *100*

Remarks:
.....
.....
.....
.....
.....
.....
.....
.....

Book mark:

W Harris

W | 4 Cav. | U.S.C.T.

Samuel White

Capt., Co. F, 4 Reg't U. S. Col'd Cavalry.

Appears on

Company Muster Roll

for May & June, 1865

Present or absent

Stoppage, \$ 100 for

Due Gov't, \$ 100 for

Valuation of horse, \$ 100

Valuation of horse equipments, \$ 100

Remarks: Absent on a thirty day leave since June 11/865.

Book mark:

L. A. Harris

(358)

Copyist.

W 1 4 Gov U.S.P.

Samuel White
Govt U.S. Gold

Return

of the Post of Port Hudson, La.,

for the month of July, 1865,

dated Aug 1, 1865,

shows the following with regard to the person
named above :

Post or station Port Hudson La

Remarks: Govt U.S. Gold

Book mark:

C. H. ...

W | **4 Cav.** | **U.S.C.T.**

Samuel White

Capt....., Co. F, 4 Reg't U. S. Col'd Cavalry.

Appears on

Company Muster Roll

for *July & Aug*....., 186 *5*

Present or absent *Absent*.....

Stoppage, \$..... *100* for

Due Gov't, \$..... *100* for

Valuation of horse, \$..... *100*

Valuation of horse equipments, \$..... *100*

Remarks: *Absent on detached service at New Orleans La. since Aug 22 / 1865*

Book mark:

L. A. Harris

W | 4 Cav. | U.S.C.T.

Samuel White

Capt, Co. F, 4 Reg't U. S. Col'd Cavalry.

Appears on

Company Muster Roll

for *Sept & Oct*, 186*5*

Present or absent

Stoppage, \$ 100 for

Due Gov't, \$ 100 for

Valuation of horse, \$ 100

Valuation of horse equipments, \$ 100

Remarks: *Promoted to rank of Major and was mustered as such Oct 5/865 by Capt. McAlister 10 U. S. A. U. A. C. M.*

Book mark:

W Harris

W | *4 Cav.* | **U.S.C.T.**

Samuel White

Rank *Maj.*, *4* Reg't U. S. Col'd *Cav.*

Appears on

Field and Staff Muster Roll

for *Sept & Oct* 1865.

Present or absent *Present*

Stoppage, \$ *100* for

Due Gov't, \$ *100* for

Valuation of horse, \$ *100*

Valuation of horse equipments, \$ *100*

Remarks:

Book mark:

Bowman

W | 4 leav. | **U.S.C.T.**

Samuel White

Capt, Co. F, 4 Reg't U. S. Col'd leav.

Appears on an

Individual Muster-out Roll

of the organization named above. Roll dated

New Orleans La., Oct 4, 1865.

Muster-out to date Oct. 4, 1865.

Last paid to June 30, 1865.

Clothing account:

Last settled 186 ; drawn since \$ 100

Due soldier \$ 100; due U. S. \$ 100

Am't for cloth'g in kind or money adv'd \$ 100

Due U. S. for arms, equipments, &c., \$ 100

Bounty paid \$ 100 due \$ 100

Remarks: Mustered out to enable
him to accept promotion -
Entered Service as private
2d Ills leav. - at Spring-
field Ill. August 13. 1861

Book mark:

Murray

A | *4 Cav* | **U.S.C.T.**

Samuel White

Meyer Co., *4* Reg't U. S. Col'd *Cav*

Age years.

Appears on an

Individual Muster-in Roll

of the organization named above. Roll dated

New Orleans La., Oct 5, 186*5.*

Muster-in to date *Oct 5,* 186*5.*

Joined for duty and enrolled:

When *Oct 5,* 186*5.*

Where *New Orleans La.*

Period *3* years.

Valuation of horse, \$ 100

Valuation of horse equipments, \$ 100

Remarks: *Widowhood, out-as*
Captain Co. 4 U.S.
C.C. to enable him to
accept promotion

Book mark :

Perrington

JAN. - 8

5347400

1891

Remarks:

Mustered in as
Major on a Com-
mission from the
Sec. of War, Vice N.
Mitchell, promoted - Ag-
gregate entitled,
Strength of the
regiment, (Two Bat-
talions) 635.

NOV 13 1865

W 1 4 Cav U.S.A.

Samuel White
Maj, 4 U.S. C Cav

Return

of the Post of Port Hudson, La.,

for the month of Oct, 1865,

dated Nov 3, 1865,

shows the following with regard to the person named above:

Post or station Port Hudson La

Remarks: Comdg 4 U.S. C Cav
Gain Promoted from Capt
Sous. promoted to Maj

Book mark:

J. Moore

W | 4 Cav | U.S.C.T.

Samuel White

Rank Major, 4 Reg't U. S. Col'd Cav

Appears on

Field and Staff Muster Roll

for Nov & Dec 1865.

Present or absent Present

Stoppage, \$ 100 for

Due Gov't, \$ 100 for

Valuation of horse, \$ 100

Valuation of horse equipments, \$ 100

Remarks:

Book mark:

Bowman

NOV 13 1866

W 4 Cav U.S.C.
S. White
Maj. 4 U.S.C. Cav

Return

of the Post of Port Hudson, La.,

for the month of *Dec*, 186*5*,

dated *Dec 31*, 186*5*,

shows the following with regard to the person
named above :

Post or station *Port Hudson La*

Remarks: *Comdg 4 U.S.C. Cav*

Book mark:

A. J. J. J.

W | *4 Cav.* | **U.S.C.T.**

Samuel White

Rank *Major, 4* Reg't U. S. Col'd *Cav.*

Appears on

Field and Staff Muster Roll

for *Jan + Feb* 186 *6.*

Present or absent *Absent*

Stoppage, \$ *100* for

Due Gov't, \$ *100* for

Valuation of horse, \$ *100*

Valuation of horse equipments, \$ *100*

Remarks: *Detached on G. C. M.*

per S.O. 37 H^d 2^{as}. Dept of La.

Feb 14/66

Book mark:

Bowman

MAR 13 1866

W | *4 Cav.* | **U.S.C.T.**

Samuel White

Rank *Major, 4* Reg't U. S. Col'd *Cav*

Appears on a

Field and Staff Muster-out Roll

of the organization named above. Roll dated
New Orleans La., Mar 20, 1866

Muster-out to date *Mar 20, 1866*

Last paid to *Oct 4, 1866*

Clothing account:

Last settled....., 186 ; drawn since \$..... 100

Due soldier \$..... 100; due U. S. \$..... 100

Am't for cloth'g in kind or money adv'd \$..... 100

Due U. S. for arms, equipments, &c., \$..... 100

Bounty paid \$..... 100; due \$..... 100

Remarks: *Entered service at
Springfield, Ills, July 13/61 as
Private 2^d Illinois Cavalry.
Appointed Captain 1st Cavalry
C. d. A. (4 U. S. C. C.) Dec 19th 63.
Promoted major Oct 5/65.*

Over
Book mark:

Bowman

WAR 100

JAN. - 8

5348395

1891

Service has been continuous. Entitled to three months Extra pay proper as provided in G.O. 45 War Dept A.G.O. Series 1865

W | 4 Cav. | U.S.C.T.

Samuel White

Capt., Co. F., 4 Reg't U. S. Col'd Cavalry.

Appears on Co. Muster-out Roll, dated
New Orleans, La. Moh. 20, 1866.

Muster-out to date _____, 186 .

Last paid to _____, 186 .

Clothing account:

Last settled _____, 186 ; drawn since \$ _____ 100

Due soldier \$ _____ 100; due U. S. \$ _____ 100

Am't for cloth'g in kind or money adv'd \$ _____ 100

Due U. S. for arms, equipments, &c., \$ _____ 100

Bounty paid \$ _____ 100; due \$ _____ 100

Remarks: Disch'd. Oct. 5, 65 to
accept an appointment
as Major.

Book mark : _____

Hibbard
Copyist.

W | 4 Cav. | U.S.C.T.

Samuel White
Capt
Maj., Co. F, 4 Reg't U. S. Colored Cav.

Appears on Returns as follows:

Feb'y & Mch 1864 - (1 Reg't Cav. Corps d'Afrique)
Present

Apr 1864 to May 1865 - (1 Reg't U.S. Col'd Cav.) Present

June 1865 - Absent on leave by virtue of S.O.

No 144 Hed. G.O. Dept Gief May 31/65

July 1865 - Present Cond'g. Regt.

Aug 1865 - Present

Sept 1865 - Present Cond'g. Regt.

Oct 1865 - Loss: Promoted Major mustered

Oct 5/65 -

(Major) Present Cond'g. Regt.

Nov 1865 - Present

Dec 1865 - Present begins return as

Cond'g. Regt.

Jan 1866 - Present

Feb 1866 - Absent detached on G. O. M. at

H. O. S. per S. O. 37 Hed. G.O. Dept.

of S. Feb 14/66

Book mark :

(546)

W. P. See

Copyist.

44 14 Cav. U.S.C.

Samuel White
Major, Co., 4 Reg't U.S.C. Cav.

NOTATION.

Book mark: N. 938 O. I. 1865.

Record and Pension Office,

WAR DEPARTMENT,

Washington, Dec. 15, 1898.

Under the provisions of the act of Congress, approved February 24, 1897, this officer is held and considered by this Department to have been mustered into the service of the United States in the grade of

major
Co., 4 Reg't U. S. Colored
Cavalry

to take effect from Sept. 20, 1865

vice N. C. Mitchell, promoted

A. G. N.

White Samuel

Capt, Co. F, 4 Reg't H. S. C. Cav.

5 Enclosures.

Bed Cards	Final Statements
Burial Records	Furloughs or L. of A.
Certs. of Dis. for Discharge	Med. Certificates
C. M. Charges	Med. Des. Lists
Descriptive Lists	Orders 2
Discharge Certificates	Pris. of War Record
Enlistment Papers	Resignations

Other papers relating to—

Admission to Hosp'l	Furlough or L. of A. 1
Casualty Sheet	Med. Examination
Confinement	Misc. Information 2
Contracts	Pay or Clothing
Death or Effects	Personal Reports
Desertion	Rank
Discharge from Hosp'l	Transfer to Hosp'l
Discharge from Service	Transfer to V. R. C.
Duty	Transportation

Camp Parafet La
Aug 6th 1864

W. 21. W. O. 1864

Alexander, S.

A. Col. 4th U.S. C. I.

Report Capt
White to be unfit for
position as, minor of
piece, and request an
answer to an applica-
tion of Capt White
forwarded some time
previous.

4 USC I Car

Recd Head Qr. Adjutant
General, Aug. 27, 1864.
Recd. A. G. O. May 19th 1863

MAR 13 1864

Headqrs 4th U. S. col^d Cav'y
Camp Parapet, La, Aug 6th 64.

Brig. Genl. L. Thomas.

Adj't Genl. U. S. Army.

General.

Having a few days ago forwarded
an application from Capt. Sam. White
to you, in which he claims to be the senior
Captain of the regiment, I have endorsed
the same, omitting to state the unfitness
of this man. He is hardly fit to be junior
officer, no how senior Captain, therefore,
General, as he does not hold an appoint-
ment from you, and merely a provisional
commission from Genl. Banks, and ha-
ving heard the last decision at your
office in Washington, that your appoint-
ments outrank those of Genl. Banks, ^{and}
as I have other officers in my regiment,
holding appointments from you, and
proving themselves more efficient as officers
in every respect, that said Capt. White,

our

I hope, you do not comply with
the request in that application.

Hoping to hear from you as
soon as convenient and trusting you are
enjoying good health,

I have the honor, Genl, to be
resp^d Yours obedient Servant.

J. H. Alexander
Lt. Col. comd'g Regt



17
Sd. Brig 4th U.S. Cav.
Port Hudson April 2^d 1865

Mitchell A.C. Major
Comdg 4th U.S. Cav.

Requests that Capt Samuel
White of his Regt. be ordered to
proceed to New Orleans, with
thirty (30) recruits, for the pur-
pose of having them enlisted
and mustered into his Regt.

Request granted S.O. No. 75, 7th Div.

Col. S. H. Est. H. Atchafalaya - 1865

Recd Dis P.H. April 2^d 1865

HEADQUARTERS 41st U.S. COLORED CAVALRY

Port Hudson La. April 2^d 1865

Captain Geo. C. Felchell

Actg. Asst. Adjt. Genl.

Captain.

I have the honor to request that
Captain Samuel White, be ordered to proceed to New Orleans
in charge (30) Thirty Recruits for my command with
a view of having them mustered and returned
without delay.

I am, Captain

Very respectfully

Yours Obedt. Servt.

Nathl C. Mitchell

Major Commanding.

J.R. 302 66,
Headquarters, Eastern District of La.,
New Orleans, La., July 26 1866.

Respectfully referred to
Major Johnson per his
order will have proper
White brought before
the Court
James White

U.S. 266
BY ORDER OF BREVET MAJ. GEN. SHERMAN.
H. Williams
1st Lieutenant, A. D. C.,
A. A. A. General.

J.R. 302-66

Order for Johnson
in Orleans July 26

Respectfully returned.
Major Johnson's return upon
at this office, with a copy
Case from Lt. White, and
we had time before the
Court wanted. No further

action was taken in the
Case

U.S. Jackson
Major in Charge
140 March 1866

J.R. 302-66

Filed in "D"

1850 Orleans La

Nov 26th 1856J. H. Wood
A A A Gent

I have the honor to request that
 Officer Saml. White 4th U. S. Co. be arrested and
 brought before this Court as a witness, he having
 been duly subpoenaed, as such. He reported yesterday
 and was ordered to report again to day but has
 failed to do so. Thereby delaying the proceedings
 of the Court.

I have the honor to be very respectfully
 your (to J. H. Wood)

W. H. W.

P. S. Linn 1st U. S. Inf.
 Judge Advocate

New Orleans Feb. 16 - 1866

Comdy Major Genl by
Hoffman W. A. G.

States that Maj. White
of your Reg^t will relieve
you from detail on G. O. M.

H. H. A. L. L.

NOV 13 1866

DEPARTMENT OF THE GULF,

U. S. Military Telegraph Office,

July 16th 1866

By Telegraph from

New Orleans

To

St Col Mc Mitchell
4th usca

Major White of your regt
will relieve you from detail
on G. L. M. Order him to
This city immediately. Remain
yourself as at present

By order of Major Genl Canby
William Hoffman
A. G.

W. 210. 89. 1865
Quarters Co F 4th U. S. C. 6th Reg
Port Hudson La May 23rd 1865

White Samuel
Captain Commanding

Request that a leave of ab-
sence of thirty days be gran-
ted him to proceed to his
home in Illinois.

Hd Qrs. 4th U. S. C. 6th Reg
Port Hudson La May 23rd 1865

Respectfully forwarded
Approved

This officer has
been three years and eleven
months in the service has
been twice wounded & has
never had but seven days

furlough since enlist-
ment - the Lt on duty
with the Co is competent
in every respect to take
Command of it - in the
Captains absence -

Nathl C. Mitchell
Lt Col Commanding

W. 29. 9. 1. 26 1865
Hd Qrs. Dist. Port Hudson.

Port Hudson
May 23. 1865

Respectfully forwarded
Approved
Cyrus Hamlin
Bay Genl
Comdr

Hd Qrs 89. May 31. 1865 -

No 54. 1st Div of La Inf.
Hd. Qrs. Northern Division of Louisiana.

Baton Rouge, La., May 25. 1865

Respectfully forwarded to the Quarter

Dept of the Gulf (above)

Attn: Genl

Maj. Genl Commanding

W. 29. 9. 1. 26

S. O. May 31, 1865

1136

Whitman Alexander

Co C, 4 U. S. Col'd Cav.

Private Private

CARD NUMBERS.

1		26
2		27
3	Whitman Alexander	
4		29
5		30
6		31
7		32
8		33
9		34
10		35
11		36
12		37
13		38
14		39
15		40
16		41
17		42
18		43
19		44
20		45
21		46
22		47
23		48
24		49
25		50

Book Mark:

See also

1137 Next number.
1137-a

Whittier Andrew J.

Co. ~~A~~, 4 U. S. Col'd Cav.

2 Lieut

Lieutenant

CARD NUMBERS.

1	5-347401	26
2	5-35-2760	27
3	5-35-2764	28
4	5-35-2828	29
5	5-348122	30
6	5-347396	31
7	5-35-2889	32
8	5-35-8673	33
9	5-35-8729	34
10	5-35-8769	35
11	5-35-5597	36
12	5-35-5683	37
13	5-35-5767	38
14	5-35-5928	39
15	5-35-3751	40
16	5-35-6162	41
17	M 714 - C.T. - 1864	42
18	40729329	43
19		44
20		45
21		46
22		47
23		48
24		49
25		50

Book Mark: 3221-C.J./80 with
1.193-C.J./83
M 714 - C.T. - 1864.

See also

N. D. 716 804

S. 2261931 P. O. M. M.

S. A. Muhlmann
S.A.



Yf | **4 Cav.** | **U.S.C.T.**

Andrew J Whittier

Lieut., Co. D. 4 Reg't U. S. Col'd Cavalry.

Appears on

Company Muster Roll

for *March & April*, 1864.

Present or absent *Absent*

Stoppage, \$ *100* for

Due Gov't, \$ *100* for

Valuation of horse, \$ *100*

Valuation of horse equipments, \$ *100*

Remarks: *Detached on recruiting
service by special order
dated March 9,*

Book mark:

Rosenbaum

APR 1864

4 | **4 Cav.** | **U.S.C.T.**

Andrew J. Whittier

S. Lieut., Co. D. 4 Reg't U. S. Col'd Cavalry.

Appears on

Company Muster Roll

for *May & June*, 1864.

Present or absent *Present*

Stoppage, \$ 100 for

Due Gov't, \$ 100 for

Valuation of horse, \$ 100

Valuation of horse equipments, \$ 100

Remarks:

Book mark:

Rosenbaum

(358)

Copyist.

4 | **4 Cav.** | **U.S.C.T.**

Andrew J. Whittier

Lieut., Co. D. 4 Reg't U. S. Col'd Cavalry.

Appears on

Company Muster Roll

for *July & Aug*, 186*4*.

Present or absent *Present*

Stoppage, \$ 100 for

Due Gov't, \$ 100 for

Valuation of horse, \$ 100

Valuation of horse equipments, \$ 100

Remarks: *detailed as commander of Co "D" 4th U. S. C. C.*

Book mark:

Rosenbaum

W | 4 Cav. | **U.S.C.T.**

Andrew J. Whittier
2^d Lt, Co. D., 4 Reg't U. S. Col'd Cav.

Appears on an

Individual Muster-out Roll

of the organization named above. Roll dated

Port Hudson La., Aug. 22, 1864.

Muster-out to date Aug. 22, 1864.

Last paid to Apr. 30, 1864.

Clothing account:

Last settled _____, 186 ; drawn since \$ _____ 100

Due soldier \$ _____ 100; due U. S. \$ _____ 100

Am't for cloth'g in kind or money adv'd \$ _____ 100

Due U. S. for arms, equipments, &c., \$ _____ 100

Bounty paid \$ _____ 100 due \$ _____ 100

Remarks: Promoted from 2^d Lt.
Commission as First Lieut dated
Aug. 18. 1864 received on or
before Aug. 23rd 1864. Mustered
out Oct 4. 1864 to date August 22^d
to accept Promotion. Entitled to
(over)

Book mark: _____

Murray

MAR 1902

JAN. - 8

5348122

1891

pay as Second Lieut. from
May 1st 1864 to August
22^d 1864 inclusive.

A | *4* *CVV* | **U.S.C.T.**

Am. Geo. J. Whittier

1 *Lieut*, Co. *L*, *4* Reg't U. S. Col'd *Cur.*

Age *24* years.

Appears on an

Individual Muster-in Roll

of the organization named above. Roll dated

Port Hudson La, Oct 4, 1864.

Muster-in to date *Aug 23*, 1864.

Joined for duty and enrolled :

When *Aug 23*, 1864.

Where *Port Hudson La.*

Period *3* years.

Valuation of horse, \$ *100*

Valuation of horse equipments, \$ *100*

Remarks: *Promoted from*
2nd Lieut Co. A.
Mustered in, October 4
1864. from Aug 23 1864

Book mark : _____

(336)

Thompson
over Copyist.

JAN. - 8

5347396

☆ 1891 ☆

Remarks:
To fill an Original
Vacancy -

H | **4 Cav.** | **U.S.C.T.**

Andrew J Whittier
2nd Lt, Co. D. 4 Reg't U. S. Col'd Cavalry.

Appears on

Company Muster Roll

for *Sept & Oct*, 1864.

Present or absent

Stoppage, \$ 100 for

Due Gov't, \$ 100 for

Valuation of horse, \$ 100

Valuation of horse equipments, \$ 100

Remarks: *Promoted to the rank of 1st Lieut in Co "L" 4 U.S. Colored Cavalry Aug 23-1864 - Mustered Oct-4-64*

Book mark:

Rosenbaum
Copyist.

MAR 1865

W | 4 Cav. | U.S.C.T.

Andrew J. Martin
2nd Lt., Co. L, 4 Reg't U. S. Col'd Cavalry.

Appears on

Company Muster Roll

for Sept. & Oct., 1864.

Present or absent Present

Stoppage, \$ 100 for

Due Gov't, \$ 100 for

Valuation of horse, \$ 100

Valuation of horse equipments, \$ 100

Remarks: Entitled to pay from Apl. 3rd to Aug. 23rd inclusive as 2nd Lt. Co. I. Promoted from 2nd Lt. Co. I to 1st Lt. Co. L Aug. 23rd 1864. Placed in arrest per S.O. 104 near Dec. 4th U.S.C. Det. 15th 1864

Book mark:

Leaving

(358)

Copyist.

MAR 1907

H | 4 Cav. | U.S.C.T.

Andrew D. Winter
1st Lt., Co. L, 4 Reg't U.S. Col'd Cavalry.

Appears on

Company Muster Roll

for *Nov. & Dec.*, 1864.

Present or absent *Present*

Stoppage, \$ *100* for

Due Gov't, \$ *100* for

Valuation of horse, \$ *100*

Valuation of horse equipments, \$ *100*

Remarks: *entitled to pay from Apl. 30th to Aug. 23rd 64 as 2nd Lt. Co. I Promoted to 1st Lt Co. L, from 2nd Lt. Co. I. Responsible for Ordnance stores intell. Nov. 2nd Dec. Placed in arrest S.C. No. 57 Ad. Gen. 4th Div. Oct. 5/64*

Book mark:

Loring

11 | 4 Cav. | U.S.C.T.

Andrew J. Winter
1st Lt., Co. L, 4 Reg't U. S. Col'd Cavalry.

Appears on

Company Muster Roll

for Jan & Feb, 1865.

Present or absent Present

Stoppage, \$ 100 for

Due Gov't, \$ 100 for

Valuation of horse, \$ 100

Valuation of horse equipments, \$ 100

Remarks: In arrest since Oct. 5th per O.D. No. 104 & read Sub. No. 1st U.S.C.A. dated Oct. 5th per "Stopped for 20 rations."

Book mark:

L. Curry

W | 4 Cav. | U.S.C.T.

Andrew J. Whittier
1st Lt., Co. F, 4 Reg't U. S. Col'd Cavalry.

Appears on

Company Muster Roll

for *Mch & Apr*, 186 *5*

Present or absent *Present*

Stoppage, \$ *100* for

Due Gov't, \$ *100* for

Valuation of horse, \$ *100*

Valuation of horse equipments, \$ *100*

Remarks: *Due Ten dollars (\$10⁰⁰)*
per month for Comdy Co.
for the month of July & Aug,
1864. Present in arrest.
Transferred to Co. F. from Co. I
4th U.S.C. Pr. S. Co. No. 15 Hd
Des 4th U.S.C.

Book mark:

A Harris

MAR 10 49

A | 4 Cav. | U.S.C.T.

Andrew J. Whittier
1st Lieut., Co. F, 4 Reg't U. S. Col'd Cavalry.

Appears on

Company Muster Roll

for *May & June*, 1865.

Present or absent *Present*

Stoppage, \$ *100* for

Due Gov't, \$ *100* for

Valuation of horse, \$ *100*

Valuation of horse equipments, \$ *100*

Remarks: *Due \$10. per month for responsibility for the month of July, Aug., Sept. Oct. 1864. \$53 fine by G. C. M. Gen. Order No. 68, Hd. Qrs. Dept of Gulf dated May 22nd / 1865.*

Book mark: _____

L. A. Harris

(358)

Copyist.

NARR 1341

W | **4 Cav. | U.S.C.T.**

Andrew J. Whittier

1st Lt, Co. F, 4 Reg't U. S. Col'd Cavalry.

Appears on

Company Muster Roll

for *July & Aug*, 186 *5*

Present or absent *Present*

Stoppage, \$ *100* for

Due Gov't, \$ *100* for

Valuation of horse, \$ *100*

Valuation of horse equipments, \$ *100*

Remarks: *Due \$10 per month for
Comdg Co. July, Aug, Sept,
October 1864*

Book mark: _____

A Harris

(358)

Copyist.

M | **4 Cav. | U.S.C.T.**

Andrew J Whittier
1st Lieut, Co. *F*, 4 Reg't U. S. Col'd Cavalry.

Appears on

Company Muster Roll

for *Sept & Oct*, 186*5*

Present or absent

Stoppage, \$ *100* for

Due Gov't, \$ *100* for

Valuation of horse, \$ *100*

Valuation of horse equipments, \$ *100*

Remarks: *Discharged P.S.O.*
No. 465 dated War Dept
Aj's Genl Office
Washington D.C. Aug.
29" 1865,

Book mark:

S. A. Harris

(358)

Copyist.

W | *4, Cav,* | **U.S.C.T.**

Andrew J. Whittier
1st Regt (1 Regt Cav C'd'A.)
Co. D, *4* Reg't U. S. Col'd. *Cav*

Age *24* years.

Appears on an

Individual Muster-in Roll

of the organization named above. Roll dated

New Orleans La, Mch 7, 186*4.*

Muster-in to date *Mch 1,* 186*4.*

Joined for duty and enrolled:

When *Mch 1*, 186 .

Where *New Orleans*

Period *3* years.

Valuation of horse, \$ *100*

Valuation of horse equipments, \$ *100*

Remarks: *Discharged, as private from the 3rd Massachusetts Cavalry in Paragraph 2.*

Book mark: *W 714 - 8 - 1864.*

(336)

Perminington
over Copyist.

NOV 1944

JAN.-8

5347401

1891

Remarks,

Special orders no. 53.
Headquarters Dept.
of the Gulf. dated
"March 1" 1864.

Original Vacancy.

W | 4 | U.S.C.T.

Andrew J. Whittier
 2 St
 1 St
 Co. ¹⁰ St, 4 Reg't U. S. Col'd Cav.

Appears on Returns as follows:

Mch 1864 - (1 Regt Cav. Corps d'Afrique)
 Apl 1864 (4 Regt U. S. Col'd Cav) } Absent
 detached on recruiting service Mar 9/64
 A. O. No 11 Hed. Qrs - 1 Cav b'dd.
 May to July 1864 - Present
 Aug 1864 - (1 St) Present Promoted to 1 St. to
 fill original vacancy S. O. No 149 War Dept.
 New Orleans Aug 22/64
 Sept 1864 - (2 St) Present App'd. 1 St Co. 2.
 Oct 1864 - Saw Oct 4/64 Mustered in as 1 St
 Co. 2 -
 (1 St Co 2) Present
 Nov 1864 - Present
 Dec 1864 to Feb 1865 - Present in arrest await-
 ing result of a General Court Martial
 Mch 1865 (1 St Co 2) Present, Transferred
 from company 2 to company F in
 accordance with S. O. No 28 Hed. Qrs
 Department of the Gulf Jan 28 1865.
 In arrest awaiting result of a General
 (over)

Book mark :

W. R. See

NOV 1946

JAN. 18

40729329

1899

Court Marshal

Apl 1865- Present in arrest awaiting
 sentence of a general court Marshal
 May 1865- Present returned to duty
 in Genl. Order No 68 Hd. Qrs.
 kept of the July May 22/65
 June & July 1865- Present
 Aug 1865- Absent
 Sept 1865- Los.: Resigned, accepted
 per S.O. 465- War kept. Adj't
 Genl. Office Washington D.C.
 Aug 29/65.

MAR 1947

JA | **4 Cav.** | **U.S.C.T.**

Andrew J. Whittier

2 Lt, Co. *15*, 4 Reg't U. S. Col'd Cavalry.

Appears on **Co. Muster-out Roll**, dated *New Orleans, La, Dec 20*, 186*6*.

Muster-out to date _____, 186 .

Last paid to _____, 186 .

Clothing account:

Last settled _____, 186 ; drawn since \$ _____ 100

Due soldier \$ _____ 100; due U. S. \$ _____ 100

Am't for cloth'g in kind or money adv'd \$ _____ 100

Due U. S. for arms, equipments, &c., \$ _____ 100

Bounty paid \$ _____ 100; due \$ _____ 100

Remarks: *Discharged to accept appointment as 1 Lieut. Co. "L."*

Book mark: _____

W. J. Anderson

W | **4 Cav.** | **U.S.C.T.**

Andrew J. Whittier
1 Lt., Co. F, 4 Reg't U. S. Col'd Cavalry.

Appears on **Co. Muster-out Roll**, dated
New Orleans, La. Mch. 20, 1866.

Muster-out to date _____, 186 .

Last paid to _____, 186 .

Clothing account:

Last settled _____, 186 ; drawn since \$ _____ 100

Due soldier \$ _____ 100; due U. S. \$ _____ 100

Am't for cloth'g in kind or money adv'd \$ _____ 100

Due U. S. for arms, equipments, &c., \$ _____ 100

Bounty paid \$ _____ 100; due \$ _____ 100

Remarks: Discharged per S. O.
467, W.D., A.G.O. Aug. 29, 65

Book mark: 3221 - C - T/86.
1193 - C - T - 83

(361)

Hibbard
Copyist.

N. 4 Cav. U.S.C.

*Andrew J. Whittier
1 Lieut, Co. L, 4th Reg't U.S.C. Cav.*

Book mark { *NOTATION. 887* with
3221 - 86
N. 714 C. I. 1864.

Record and Pension Office,

WAR DEPARTMENT,

Washington, *March 12, 1903.*

Under the provisions of the act of Congress, approved February 24, 1897, this officer is held and considered by this Department to have been mustered into the service of the United States in the grade of *1st Lieut.*

Co. L, 4th Reg't U.S.C. Cav.

to take effect from *August 18, 1864,*
to fill an original vacancy.

W. W. Gibson

Whittier, A. J.,
 Lt. Co. G, Reg't

6 Enclosures.

Bed Cards	Final Statements
Burial Records	Furloughs or L. of A.
Certs. of Dis. for Discharge	Med. Certificates
C. M. Charges	Med. Des. Lists
Descriptive Lists	Orders
Discharge Certificates	Pris. of War Record
Enlistment Papers	Resignations

Other papers relating to—

Admission to Hosp'l	Furlough or L. of A.
Casualty Sheet	Med. Examination
Confinement	Misc. Information
Contracts	Pay or Clothing
Death or Effects	Personal Reports
Desertion	Rank
Discharge from Hosp'l	Transfer to Hosp'l
Discharge from Service	Transfer to V. R. C.
Duty	Transportation

MICROFILM PUBLICATION M 1820

COMPILED MILITARY SERVICE RECORDS
OF VOLUNTEER UNION SOLDIERS WHO
SERVED WITH THE USCT (US COLORED TROOPS)
4TH REGIMENT OF CAVALRY

PERSONAL PAPERS' TARGET SHEET

PLEASE NOTE THE CHECKED INFORMATION ABOUT THE PERSONAL PAPERS IN
THIS FILE:

NO PERSONAL PAPERS WERE FOUND IN THIS FILE WHEN THE
RECORDS WERE ARRANGED FOR MICROFILMING.

7 PERSONAL PAPER(S) FOUND IN THIS FILE WHEN THE RECORDS
WERE ARRANGED FOR MICROFILMING.

N (S.Y.) 167 1864
New Orleans
Feb 8th 1864

Andrew J. Whittier

Application with certificate of
examination for a commission
as 2nd Lt. Cav (d)

4th U.S. C. Cav

Journal 1238
N.Y.
New York Commission

2nd Lieut

Office of Board of Examiners,

New Orleans, La., February 8th 1863.

To the

Assistant Adjutant General,
Department of the Gulf.

Sir:

I hereby respectfully make application for a commission

as 2^d Lieutenant in the First

Regiment of Cavalry Corps d'Afrique, according to the certificate
herewith enclosed.

Please send the Commission, if issued, to the following:

Address:

No 193 Camp Street in care of Major Mitchell

Respectfully, your obdt. servt.

Arthur J. Whittin

Approved for the 1st Regiment of Cavalry
Corps d'Afrique.

Brig. Gen. Vols., Commanding Corps d'Afrique.

[Signature]

New-Orleans, La., th February 8th 1864

This Certifies that Andrew J. Whittier
having been duly examined before the authorized Board of Examiners according
to instructions from proper authority, has been found qualified for the position
of 2^d Lieutenant in a Cavalry
Regiment of the Corps d'Afrique, and we respectfully recommend that he receive
a commission accordingly.

Col. Curran
Col. 133rd Regt. Inf.
President.

A. J. Kelly
Capt. 2nd Cav.

Members of the Board.

Samuel Hamilton
Capt. 8th Cav.

Approved,

[Signature]

Brig. Gen'l. Vol.,

[Signature]

Commanding Corps d'Afrique.

MS. A. 9. 2. 55

P. 9 D. 55. 1865.
New Orleans July 11th 1865

Barbours. Mechanical
1st Lieut & a alq

Extract of Special Order
no 185 ordering 1st Lieut
A. J. Whitely ^{H. N. S. C. Cavalry} to appear
before board of examiners
for re-ordination.

Also 4 U.S. Cavalry

What is the
order will certify to
the Hon. Secy of War
the contents of the order
of the President in
which is approved
This paper is filed
1865

Geo. Anderson

Rec'd at S. P. July 19th 1865.

File

Head Qu. Dept of the Gulf.
New Orleans, La. July 11th 1865.

Special orders
No 185.

Et cetera.

5. The following named officers of the 4th U.S. Colored Cavalry are hereby ordered to appear before the Board of Examiners for U.S. Colored Troops, of which Colonel S. M. Quincy, 73rd U.S. Colored Inf. is President, now in session in this city, for examination as to their qualifications and fitness to retain their present positions:
1st Lieut S. J. Whittier.

By order of Major General S. B. L. Canby.

J. Schuyler Crosby.
Acting Lieut. Col. U. S. C. A. A. General.

Official

(Signed) Nathaniel Burbank.
1st Lieut U. S. C. A. A. General

Board of Examiners New Orleans Dept of the Gulf
New Orleans Louisiana July 19-1865

All the members being present the Board proceeded to examine the
above named 1st Lieut R. J. Whitten, 4th U. S. Cavalry. The Board
do not find this officer incompetent for his position except that he
appears to consider himself, but in view of this fact & his strong
disinclination to remain in service, the Board would recommend
that his resignation be accepted.

Respectfully Submitted

B. M. Quincy
Col. 73rd U. S. C. Inf'y
President Exam'g Board

~~Geo. Saldey
Lt. Col. 68th U. S. C. Inf'y~~

Chas. H. Cain
1st Lieut Company 2nd U. S. Cavalry
Recorder Board of Examiners

a Winter
B. Winter

Head Quarters 4th U.S. Col'd Cav.

Port Hudson, La., Aug 18, 1864.

Brig Genl L. Thomas,

Adj't Genl U.S. Army:

General:

I have the honor to request that you promote Andrew J. Whittier Co "D" to a 1st Lieutenancy in Co "I," there being an original vacancy; and no officer is yet mustered into that Co.

He has served in the Regt since Feby 26th 1864, and is fully worthy of promotion.

Very Respectfully Your Obedt Servant

J. H. W. Garrison

1st. Col. - 69th Regiment

La. and Texas

Headquarters, Department of ~~the Gulf~~,
New Orleans, La., July 21st 1865.

1 Lieut. A. J. Whittier,
4th U. S. Cold. Cavalry.

Sir:

I am directed by the Maj. Genl. Comd'g to inform you, the recommendation of the Board of Examiners of which Col. S. M. Quincey 73rd U. S. Cold. Inftry. is Pres^t is as follows:

Board of Examin. 2^d Dist. of La. & Texas.
New Orleans, La. July 19th 1865.

"All the members being present. The Board
"proceeded to examine the above named Lieut
"A. J. Whittier, 4th U. S. Cold. Cavalry.
"The Board do not find this Officer incompetent
"for his position, except that he appears
"to consider himself, but in view of this
"fact ^{and} his strong disinclination to remain
"in service, the Board would recommend
"that his resignation be accepted."

(over)

Respectfully,
your obed^t serv^t
Wm. R. R. R.
Major and A. A. Genl.
of Dept. of La. and Texas.

1865.
Post Hudson La July 26/65

William A. J.

~~William A. J.~~

Truders his resignation as 2nd Lieut
Co "F" 4th U.S. C.

Headquarters Sub-District Port Hudson
and Baton Rouge,

Baton Rouge, La., July 27 1865

Respectfully forwarded to Headquarters
Eastern District of Louisiana.

Approved:

M. K. Lawler,
Brevet Major Gen. Commanding.

L. R. R. S. 339

Headquarters,
Department of Louisiana,
New Orleans, La. August 9th 1865.

Respectfully forwarded to Major
General P. W. Sheridan, Commanding
Military Division of the Gulf,
recommending that this resignation
be accepted.

P. W. Sheridan
Major General Commanding

1 Enclosure
Head Quarters 4th U.S. C.
Post Hudson La July 26/65

Respectfully forwarded
Approved

Samuel White,
Capt. Comdg. Regt.

Head Quarters U.S. Forces
Post Hudson La July 27/65

Respectfully forwarded

Approved
Wm. Mitchell
Col. Camp

Recd at Post July 26 1865

Head Quarters Eastern Dist. of La.
New Orleans Aug. 6. 1865

Respectfully forwarded.

J. W. McMan
Bvt. Maj. Genl. Comdg.

Recd at HQ Aug 24 65

Headquarters, Military Division of the Gulf,
New Orleans, La., Aug 11th 1865.

Respectfully forwarded to the Adjut-
ant General of the Army.

Approved:
P. W. Sheridan
Major Genl. Commanding

service, it is respectfully
recommended that
this resignation be
accepted.

Geo. S. Lazard

A. A. Genl. Volg.

U. S. A. 4. 10. 59.

Approved

E. D. Tompkins

Asst. Adj. General

U. S. O. {

Aug. 1865 }

Note: Note Sp. on A

465 of Aug 29¹⁸⁶⁵

Alj office

Adj't Gen's Office.

August 26th 1865.

1st Lieutenant, A. J. Whittier,
4th U. S. Colored Cavalry,
tenders his resignation,
assigning as a reason
therefor the close of
the war, and family and
business matters requiring
his attention. The resigna-
tion is forwarded through
the proper military
channels, receiving the
approval of every inter-
mediate Commander.
In view of this and
the fact that Lieutenant
and Whittier has been
examined by a Mil-
itary Board who re-
commended his discharge
on account of his dis-
inclination for the

MAR 1865

Camp 21st U. S. Cavalry
Post Hudson La July 26th 1863
Capt. Adjutant Genl. V.
Dept. of Louisiana & Texas.

Sir

Having entered
the service for the express
purpose of aiding in crushing
the Rebellion. That purpose
having now been accomplish-
ed. And having a family and
business that require my un-
interrupted attention. I have
the honor hereby to tender
my resignation as 1st Lieut
of the 4th U. S. Cavalry.

Very Respectfully
Yours obdt. Servt.

A. J. Whitten
1st Lieut Co. 4th U. S. Cavalry

Andrew J. Whitten was mustered in as 2d Lieut. March
 1st and as 1st Lieut. Aug 23, 1864 of the 4th Regt U.S.
 Col & Cavalry - On Return of that Regt for the month
 of July 1865, he is reported - present for duty
 Strength ... 23
 " ... 46 W.S.

1137-a

Wight, Marcus Jr.
Co. B, 4 U. S. Col'd Cav.

2 Lieutenant | *2 Lieutenant*

CARD NUMBERS.

1	5347398	26
2	5350280	27
3	5350360	28
4	5350508	29
5	5351187	30
6	40729380	31
7		32
8		33
9		34
10		35
11		36
12		37
13		38
14		39
15		40
16		41
17		42
18		43
19		44
20		45
21		46
22		47
23		48
24		49
25		50

Number of personal papers herein *2*

Book Mark: _____

See also *29 Mainel Vols.*

S 972786 - 2 aud
S 1076148 - 2 Land rtd
Rep 396640
S 2385746 P O m m

S. J. Muhlman
Eva.

W | *4, Cav,* | **U.S.C.T.**

Marcus Wright Jr.

2 *Co. B,* *4* Reg't U. S. Col'd. *Cav*

Age *25* years.

Appears on an

Individual Muster-in Roll

of the organization named above. Roll dated

New Orleans La, June 27, 1864.

Muster-in to date *June 27, 1864.*

Joined for duty and enrolled :

When *June 27*, 1864.

Where *New Orleans*

Period *3* years.

Valuation of horse, \$ *100*

Valuation of horse equipments, \$ *100*

Remarks: *Discharged as Private*
Co. I, in the 29th
Maine Volunteers in
Special Order No. 21 Dated

Book mark :

Permitted

over

JAN. - 8

5347398

1891

Remarks:
Head Gns. Dept. of the
Sulph. May 10th 1864 -
Vice Charles W. W. 2nd Lt.
... mustered out of Co.
B. June 23, 1864 -

H | **4 Cav.** | **U.S.C.T.**

Marcus Night Jr

2nd Lt., Co. B. 4 Reg't U. S. Col'd Cavalry.

Appears on

Company Muster Roll

for *July + Aug*, 1864.

Present or absent *Present*

Stoppage, \$ 100 for

Due Gov't, \$ 100 for

Valuation of horse, \$ 100

Valuation of horse equipments, \$ 100

Remarks: *Discharged as priv
ate, Co. D 29th Maine I.R. No.
121. Hd. Qu. Dept Gulf. Mar
10. '64*

Book mark:

(358)

[Signature]
Copyist.

M | **4 Cav.** | **U.S.C.T.**

Marcus Night Jr.
Jr., Co. B. 4 Reg't U. S. Col'd Cavalry.

Appears on

Company Muster Roll

for *Sept & Oct*, 186*4*.

Present or absent *Present*

Stoppage, \$ 100 for

Due Gov't, \$ 100 for

Valuation of horse, \$ 100

Valuation of horse equipments, \$ 100

Remarks :

Book mark :

Kmy
Copyist.

MAR 13 1873

OK | **4 Cav.** | **U.S.C.T.**

Marcus Wright, Jr.

2d Lt., Co. B. 4 Reg't U. S. Col'd Cavalry.

Appears on

Company Muster Roll

for *Nov & Dec*, 1864.

Present or absent

Stoppage, \$ 100 for

Due Gov't, \$ 100 for

Valuation of horse, \$ 100

Valuation of horse equipments, \$ 100

Remarks: *Discharged by
S.O. No 337 dated Hd. Qrs.
dept. of Gulf Dec 13/64.*

** Corrected Feb. 14, 1894. J.E.S.*

Book mark:

Lomax

W | **4 Cav.** | **U.S.C.T.**

Manous Wright Jr
227, Co. B., 4 Reg't U. S. Colored Cav.

Appears on **Returns** as follows:

July 1864 - Present reported to Co. July 12/64

Aug to Nov 1864 - Present
Dec 1864 - Loss: Port Hudson La.
which had per S.O. No. 337 par
1. Med. Gns. Dept of the Gulf, Dec
13, 1864.

Book mark :

W. R. See

W | **4 Cav. | U.S.C.T.**

Marcus Wight

2nd Lieut, Co. *B*, 4 Reg't U. S. Col'd Cavalry.

Appears on **Co. Muster-out Roll**, dated *New-Orleans, La. Mch. 20* 1865.

Muster-out to date _____, 186 .

Last paid to _____, 186 .

Clothing account:

Last settled _____, 186 ; drawn since \$ _____ 100

Due soldier \$ _____ 100; due U. S. \$ _____ 100

Am't for cloth'g in kind or money adv'd \$ _____ 100

Due U. S. for arms, equipments, &c., \$ _____ 100

Bounty paid \$ _____ 100; due \$ _____ 100

Remarks: *discharged Dec. 13/64*
per L. O. 337 dated Hd. Qrs.
Dept of the Gulf Series 1864.

Book mark: *86. 39 P.M.G. Feb. 5/65*

(361)

Chandler
Copyist.

Wright, M.

St., Co. , *14* Reg't *U.S.C. Cav.*

2 Enclosures.

Bed Cards	Final Statements
Burial Records	Furloughs or L. of A
Certs. of Dis. for Discharge	Med. Certificates
C. M. Charges	Med. Des. Lists
Descriptive Lists	Orders
Discharge Certificates	Pris. of War Record
Enlistment Papers	Resignations

Other papers relating to—

Admission to Hosp'l	Furlough or L. of A
Casualty Sheet	Med. Examination
Confinement	Misc. Information <i>2</i>
Contracts	Pay or Clothing
Death or Effects	Personal Reports
Desertion	Rank <i>/</i>
Discharge from Hosp'l	Transfer to Hosp'l
Discharge from Service	Transfer to V. R. C.
Duty	Transportation

MICROFILM PUBLICATION M 1820

COMPILED MILITARY SERVICE RECORDS
 OF VOLUNTEER UNION SOLDIERS WHO
 SERVED WITH THE USCT (US COLORED TROOPS)
 4TH REGIMENT OF CAVALRY

PERSONAL PAPERS' TARGET SHEET

PLEASE NOTE THE CHECKED INFORMATION ABOUT THE PERSONAL PAPERS IN
 THIS FILE:

NO PERSONAL PAPERS WERE FOUND IN THIS FILE WHEN THE
 RECORDS WERE ARRANGED FOR MICROFILMING.

4 PERSONAL PAPER(S) FOUND IN THIS FILE WHEN THE RECORDS
 WERE ARRANGED FOR MICROFILMING.

NOV 13 1864

W (D. G.) 325 1864

New Orleans, La.
May 10th 1864

Marcus Wright Jr

Accepts an appointment as
2nd Lieut in the 4th U.S. Cav (C)

4 U.S. Cav. Cav.

New Orleans La. May 10th 1864

To.

Capt. J. Schuyler Crosby

Actg. Asst. Adjutant General Dept of the Gulf.

Sir

I have the honor to acknowledge the receipt of an appointment as 2^d. Lieutenant in the 4th Regiment of U. S. Cavalry (Colored) and signify my acceptance of the same

I am very respectfully

Your obedient Servant

Marcus Wright Jr.

Headquarters, Department of the Gulf
 New Orleans, December 13th, 1864.
 Special Orders
 No. 337. (Extract)

1. The following named officers of the
 4th U. S. Colored Cavalry, having been ordered before
 a Board of Examiners and having been found de-
 ficient for the positions they now hold are hereby
 discharged the service of the United States, with
 condition that they shall receive no final pay-
 ment until they have satisfied the Pay Department
 that they are not indebted to the Government:

2nd Lieut. McNight, Jr.

By Command of
 Major General Hurlbut:
 (Signed) S. S. Sargent
 1st Lieutenant 2d Lt. Ws. and A. A. General

211

Feb 16. 1865.

Mo. Wright Co

2 St 4 sec cavy

New Orleans La February 16th 1865

To the Provost Marshal General

Department of the Gulf

Sir

I have the honor to present the following statement of fact and request. While serving in the 4th U.S. Col'd Cav. as a Lieutenant I purchased of one of my brother Officers a Carbine which I was assured was the personal property of the officer from whom I bought it. When I received my discharge (Dec 22nd 1864) I brought it to this city. I now wish your permission to send said carbine to my home in Merine, as I have no use for it here, and should I live to return home after the War it will be very useful to me there.

I am Very Respectfully

Your Obedt Servt

W. H. Wright Jr., Capt 2nd Lt
4th U.S. Col'd Cav.

W. H. Wright Jr.

Thion. -

2^d Lieut: Marcus Night Jr. C.B. 4th Col. Co.

- 2 certified

War Department, -

Adjutant General's Office,

COLORED TROOPS BRANCH,

November 28th, 1873 -

Vol. C. T., 187

Wanted in case of 2^d Lieut. Marcus Night Jr., Co. B,
4th Reg't U.S. Colored Cavalry - Copy of S. O. No. 337 -
dated H^d Q^r Dept of the Gulf - series of 1864

Respectfully,

E. A. Woodward

J. H. Dalton Chief Clerk.

Adjutant General's Office,

Mr. Thiers -

S. R. -

, 187

Vol. C. T., 187

Reply in case of _____, Co. _____,
Reg't _____

Previous number
1137

1138

Wiley George

Co A, 4 U. S. Col'd Cav.

Private

Private

CARD NUMBERS.

1	5352590	26
2	5352641	27
3	5352691	28
4	5352750	29
5	5352813	30
6	5352874	31
7	5352953	32
8	5353036	33
9	5353118	34
10	5353217	35
11	5353310	36
12	5353404	37
13	5353492	38
14	5353578	39
15	5353661	40
16	5353741	41
17	30847839	42
18	30848665	43
19	40729331	44
20		45
21		46
22		47
23		48
24		49
25		50

Book Mark:

See also

NOV 20 1900

P 1227542 P.O. in run

S A Mullen
Sts

4 | **4 Cav.** | **U.S.C.T.**

George Wile

Part, Co. D, 1 Reg't, Corps d'Afrique Cavalry.*

Age 21
Appears on

Company Muster-in Roll

of the organization named above. Roll dated

New Orleans La., Nov 26, 1863.

Muster-in to date Nov 26, 1863.

Joined for duty and enrolled:

When Nov 7, 186 .

Where New Orleans

Period 3 years.

Valuation of horse, \$ 100

Valuation of horse equipments, \$ 100

Remarks: _____

*This organization subsequently became Co. D, 4 Reg't U. S. Colored Cavalry.

Book mark: _____

Rosenbaum

44 4 Cav. U.S.C.T.

George Wiley

Pvt., Co. D, 1 Reg't Cav., Corps d'Afrique.*

Appears on

Company Muster Roll

for From Enlistment to Dec 31, 1863.

Present or absent Present

Stoppage, \$ 100 for

Due Gov't, \$ 100 for

Valuation of horse, \$ 100

Valuation of horse equipments, \$ 100

Remarks:

* This organization subsequently became Co. D, 4 Reg't U.S. Colored Cavalry.

Book mark:

Rosenbaum

4 4 Cav. | U.S C.T.

George Wiley

Pvt, Co. *D*, 1 Reg't Cav., Corps d'Afrique.*

Appears on

Company Muster Roll

for *Jan'y & Feby*, 1864.

Present or absent *absent*

Stoppage, \$ *100* for

Due Gov't, \$ *100* for

Valuation of horse, \$ *100*

Valuation of horse equipments, \$ *100*

Remarks: *Sick at General Hospital for the C.A.A since Feby 23 - 1864*

* This organization subsequently became Co. *D*, 4 Reg't U. S. Colored Cavalry.

Book mark: _____

Rosenbaum

W | 1 La. Cav. M.S.C.I.

George Wiley
Priv, Co. D, 1 Reg't La. Cav.

Appears on

Hospital Muster Roll

of **Corps d'Afrique U. S. A. General Hospital,**

at **New Orleans, La.,**

for Jan 2 + Feb, 1864.

Attached to hospital:

When....., 186 .

How employed.....

Last paid by Maj.

to, 186 .

Bounty paid \$ 100; due \$ 100

Present or absent I can't

Remarks: Never paid.

Book mark: 5-27-58

Morgan
Copyist.

H | **4 Cav.** | **U.S.C.T.**

George Wiley

Priv, Co. D. 4 Reg't U. S. Col'd Cavalry.

Appears on

Company Muster Roll

for *March & April*, 186*4*.

Present or absent *Present*

Stoppage, \$.....*100* for.....

Due Gov't, \$.....*100* for.....

Valuation of horse, \$.....*100*

Valuation of horse equipments, \$.....*100*

Remarks:.....

Book mark:.....

Rosenbaum

W | *1 Cav.* |

George Willey
E. Co. D, 1 Reg't Cav.

Appears on

Hospital Muster Roll

of Corps d'Afrique U. S. A. General Hospital,

at New Orleans, La.,

for *March & April*, 1864.

Attached to hospital:

When....., 186 .

How employed.....

Last paid by Maj.

to, 186 .

Bounty paid \$ 100; due \$ 100

Present or absent

Remarks: *Returned to duty*
Apr. 5/64.

Book mark :

Wm. J. ...

H | **4 Cav.** | **U.S.C.T.**

George Wiley

Priv, Co. D. 4 Reg't U. S. Col'd Cavalry.

Appears on

Company Muster Roll

for *May & June*, 186*4*.

Present or absent *Present*

Stoppage, \$ 100 for

Due Gov't, \$ 100 for

Valuation of horse, \$ 100

Valuation of horse equipments, \$ 100

Remarks:

Book mark:

(358)

Rosenbaum

Copyist.

H | **4 Cav.** | **U.S.C.T.**

George Wiley

Plt, Co. D. 4 Reg't U. S. Col'd Cavalry.

Appears on

Company Muster Roll

for July & Aug, 1864.

Present or absent Present

Stoppage, \$ 100 for

Due Gov't, \$ 100 for

Valuation of horse, \$ 100

Valuation of horse equipments, \$ 100

Remarks:

Book mark:

Rosenbourn

(358)

Copyist.

77 | **4 Cav.** | **U.S.C.T.**

George Wiley

Pvt., Co. D. 4 Reg't U. S. Col'd Cavalry.

Appears on

Company Muster Roll

for *Sept 4 Oct*, 186*4*.

Present or absent *Present*

Stoppage, \$ *100* for

Due Gov't, \$ *100* for

Valuation of horse, \$ *100*

Valuation of horse equipments, \$ *100*

Remarks: *Due U.S. for lost
ordnance \$5.00*

Book mark:

Rosenbaum

M | **4 Cav.** | **U.S.C.T.**

George Wiley
.....
P....., Co. D, 4 Reg't U. S. Col'd Cavalry.

Appears on

Company Muster Roll

for *Jan to Dec*....., 186*H*.

Present or absent *Present*.....

Stoppage, \$.....100 for.....

Due Gov't, \$.....100 for.....

Valuation of horse, \$.....100

Valuation of horse equipments, \$.....100

Remarks: *Due U.S. for Ord #811*.....

Book mark:.....

(358)

L. H. Wright.....
Copyist.

W | **4 Cav.** | **U.S.C.T.**

George Wiley

P, Co. D, 4 Reg't U. S. Col'd Cavalry.

Appears on

Company Muster Roll

for *Jan & Feb*, 186*5*.

Present or absent *Present*

Stoppage, \$ *100* for

Due Gov't, \$ *8* $\frac{11}{100}$ for *Arrears*

Valuation of horse, \$ *100*

Valuation of horse equipments, \$ *100*

Remarks: *Rec'd. 700 # 700 pr
Must include Arrears*

Book mark:

A. H. Wright

11 | **4 Cav. | U.S.C.T.**

George H. King
....., Co. D, 4 Reg't U. S. Col'd Cavalry.

Appears on

Company Muster Roll

for *March & April*, 1865.

Present or absent *Present*

Stoppage, \$.....100 for

Due Gov't, \$.....100 for

Valuation of horse, \$.....100

Valuation of horse equipments, \$.....100

Remarks:.....

Book mark:.....

George H. King
.....
Copyist.

11 | **4 Cav. | U.S.C.T.**

George Wiley
....., Co. D, 4 Reg't U. S. Col'd Cavalry.

Appears on

Company Muster Roll

for *May & June*, 186*5*.

Present or absent *Present*

Stoppage, \$ *100* for

Due Gov't, \$ *100* for

Valuation of horse, \$ *100*

Valuation of horse equipments, \$ *100*

Remarks:

Book mark:

W. H. H. H. H.
Copyist.

17 | **4 Cav. | U.S.C.T.**

George Wiley

P, Co. D, 4 Reg't U. S. Col'd Cavalry.

Appears on

Company Muster Roll

for *July & Aug*, 186*5*

Present or absent *Absent*

Stoppage, \$ *100* for

Due Gov't, \$ *100* for

Valuation of horse, \$ *100*

Valuation of horse equipments, \$ *100*

Remarks: *Absent - Sick at
Post Hudson Co*

Book mark:

J. H. Wright

W | **4 Cav.** | **U.S.C.T.**

George Tracy
.....
D, Co. D, 4 Reg't U. S. Col'd Cavalry.

Appears on

Company Muster Roll

for *Sept - Oct*, 186*5*.

Present or absent *Present*

Stoppage, \$ *100* for

Due Gov't, \$ *100* for

Valuation of horse, \$ *100*

Valuation of horse equipments, \$ *100*

Remarks:

Book mark:

George Tracy
.....
Copyist.

OK | 4 Cav. | U.S.C.T.

George Wiley

But, Co. D, 4 Reg't U. S. Col'd Cavalry.

Appears on

Company Muster Roll

for Nov + Dec, 1865.

Present or absent Present

Stoppage, \$ 100 for

Due Gov't, \$ 100 for

Valuation of horse, \$ 100

Valuation of horse equipments, \$ 100

Remarks:

Book mark:

(27), (28), (29)

17 | 4 Cav. | U.S.C.T.

George Wiley

Put, Co. D, 4 Reg't U. S. Col'd Cavalry.

Appears on

Company Muster Roll

for *Jan 1 Feb*, 1866.

Present or absent *Present*

Stoppage, \$ 100 for

Due Gov't, \$ 100 for

Valuation of horse, \$ 100

Valuation of horse equipments, \$ 100

Remarks:

Book mark:

Wm. C. C. C. C.

W | 4 Cav. | U.S.C.T.

George Wiley

Priv., Co. D, 4 Reg't U. S. Colored Cav.

Appears on Returns as follows:

Feb & March 1864. (1 Regt. Cavalry Corps
d'Afrique) absent sick at
C d'A. Genl Hospital.

Book mark:

W. R. Lee

A | **4 Cav.** | **U.S.C.T.**

George Wiley

Put, Co. *80*, 4 Reg't U. S. Col'd Cavalry.

Appears on **Co. Muster-out Roll**, dated

New Orleans, La, *Feb 20*, 1866.

Muster-out to date *Feb 20*, 1866.

Last paid to *June 30*, 1865.

Clothing account:

Last settled....., 186 ; drawn since \$.....100

Due soldier \$ *48 ⁵¹*/₁₀₀; due U. S. \$.....100

Am't for cloth'g in kind or money adv'd \$.....100

Due U. S. for arms, equipments, &c., \$.....100

Bounty paid \$.....100; due \$.....100

Remarks: *Joined Sig. Org.*

Book mark: *V83, P 248, 69.*

Wm. Anderson

1139 rd Doneda
Milkins, Doneda

Co A, 4 U. S. Col'd Cav.

Private

Private

CARD NUMBERS.

1	5347816	26
2	5353042	27
3	5353125	28
4	5353224	29
5	5353315	30
6	5353410	31
7	5353498	32
8	5353584	33
9	5353667	34
10	5353747	35
11		36
12		37
13		38
14		39
15		40
16		41
17		42
18		43
19		44
20		45
21		46
22		47
23		48
24		49
25		50

Book Mark:

See also

31 | **4 Cav. | U.S.C.T.**

Donald Wilkins

Appears with rank of *Capt.* on

Muster and Descriptive Roll of a Detachment of U. S. Vols. forwarded

for the 4 Reg't U. S. Col'd Cavalry. Roll dated *New Orleans, La., Nov. 25,* 1864.

Where born *Alabama*

Age *19* y'rs; occupation *Laborer*

When enlisted *Nov. 21*, 1864.

Where enlisted *New Orleans*

For what period enlisted *3* years.

Eyes *Black*; hair *Black*

Complexion *Dark*; height *5* ft. *7* in.

When mustered in *Nov. 25*, 1864.

Where mustered in *New Orleans*

Bounty paid \$ *100* 100; due \$ *200* 100

Where credited *1st Dist. 2 Ward Parish of Orleans New Orleans, La.*
Company to which assigned

Remarks:

Book mark:

(339) *J. H. Tyley* Copyist.

M | **4 Cav.** | **U.S.C.T.**

Amador Walker

1, Co. D, 4 Reg't U. S. Col'd Cavalry.

Appears on

Company Muster Roll

for *Nov Dec*, 186*7*.

Present or absent *Present*

Stoppage, \$ *100* for

Due Gov't, \$ *100* for

Valuation of horse, \$ *100*

Valuation of horse equipments, \$ *100*

Remarks:

Book mark:

A. H. [Signature]

M | 4 Cav. | U.S.C.T.

Donald McKinnis

....., Co. D, 4 Reg't U. S. Col'd Cavalry.

Appears on

Company Muster Roll

for *Sept 1865*, 1865.

Present or absent *Present*

Stoppage, \$ 100 for

Due Gov't, \$ 100 for

Valuation of horse, \$ 100

Valuation of horse equipments, \$ 100

Remarks: *# no bounty paid*
no fee

Book mark:

W. H. H. H. H.

25 | **4 Cav.** | **U.S.C.T.**

James McKim

D, Co. D, 4 Reg't U. S. Col'd Cavalry.

Appears on

Company Muster Roll

for March & April, 1865.

Present or absent Present

Stoppage, \$ 100 for

Due Gov't, \$ 100 for

Valuation of horse, \$ 100

Valuation of horse equipments, \$ 100

Remarks: # 1000 only paid
1000 dice

Book mark:

at night

M | 4 Cav. | U.S.C.T.

Domingo, Mariano
D

....., Co. D, 4 Reg't U. S. Col'd Cavalry.

Appears on

Company Muster Roll

for *May & June*, 1865.

Present or absent *Present*

Stoppage, \$.....100 for

Due Gov't, \$.....100 for

Valuation of horse, \$.....100

Valuation of horse equipments, \$.....100

Remarks: *# in present paid*
of

Book mark:

a. H. Wright
(358) Copyist.

17 4 Cav. U.S.C.T.

James M. Wilkin

2, Co. D. 4 Reg't U. S. Col'd Cavalry.

Appears on

Company Muster Roll

for July & Aug, 1865.

Present or absent Present

Stoppage, \$ 100 for

Due Gov't, \$ 100 for

Valuation of horse, \$ 100

Valuation of horse equipments, \$ 100

Remarks: From 12th musty paid
for 100

Book mark:

Wilkin

17- | **4 Cav.** | **U.S.C.T.**

Domenico Malheris

D, Co. D, 4 Reg't U. S. Col'd Cavalry.

Appears on

Company Muster Roll

for *Sep 1864*, 186*4*.

Present or absent *Present*

Stoppage, \$ 100 for

Due Gov't, \$ 100 for

Valuation of horse, \$ 100

Valuation of horse equipments, \$ 100

Remarks: *#100 Bounty paid*
#2 m. line

Book mark:

A. H. Wright

MAR 14 14

OK | **4 Cav.** | **U.S.C.T.**

Alonzo Milkins

Put, Co. D, 4 Reg't U. S. Col'd Cavalry.

Appears on

Company Muster Roll

for *Nov & Dec*, 1865.

Present or absent *Present*

Stoppage, \$ *100* for

Due Gov't, \$ *100* for

Valuation of horse, \$ *100*

Valuation of horse equipments, \$ *100*

Remarks: *Bounty paid \$100.00*
Bounty due \$200.00

Book mark:

B. J. Anderson

A | **4 Cav.** | **U.S.C.T.**

Alonzo Wilkins

Priv, Co. D, 4 Reg't U. S. Col'd Cavalry.

Appears on

Company Muster Roll

for *Jan 1 to Feb*, 186*6*.

Present or absent *Present*

Stoppage, \$ *100* for

Due Gov't, \$ *100* for

Valuation of horse, \$ *100*

Valuation of horse equipments, \$ *100*

Remarks: *Bounty paid \$100.00*
Bounty due \$200.00

Book mark:

J. J. Anderson

M | **4 Cav. | U.S.C.T.**

Honrado Wilkins

Put, Co. *D*, 4 Reg't U. S. Col'd Cavalry.

Appears on **Co. Muster-out Roll**, dated *New Orleans, La*, *Feb 20*, 1866.

Muster-out to date *Feb 20*, 1866.

Last paid to *June 30*, 1865.

Clothing account:

Last settled....., 186 ; drawn since \$.....100

Due soldier \$ *41* ^{*151*}/₁₀₀; due U. S. \$.....100

Am't for cloth'g in kind or money adv'd \$.....100

Due U. S. for arms, equipments, &c., \$.....100

Bounty paid \$ *100* ^{*100*}/₁₀₀; due \$ *none* ^{*100*}/₁₀₀

Remarks: *Joined as recruit.*

Book mark: *V 26. P. 245. 68*

M. A. Anderson

Wilkins Doneda

, Co. 4 Reg't U.S.C.C.

2 Enclosures.

Bed Cards	Final Statements
Burial Records	Furloughs or L. of A.
Certs. of Dis. for Discharge	Med. Certificates
C. M. Charges	Med. Des. Lists
Descriptive Lists	Orders
Discharge Certificates	Pris. of War Record
Enlistment Papers	Resignations

Other papers relating to—

Admission to Hosp'l	Furlough or L. of A.
Casualty Sheet	Med. Examination
Confinement	Misc. Information
Contracts	Pay or Clothing
Death or Effects	Personal Reports
Desertion	Rank
Discharge from Hosp'l	Transfer to Hosp'l
Discharge from Service	Transfer to V. R. C.
Duty	Transportation

NOTE 1.—This blank will be used for both enlistments and re-enlistments—enlistment of veterans, &c., &c., in the volunteer service. They will be made out in duplicate in all cases—one to accompany the recruiting return of the superintendent (not the recruiting officer) to the Adjutant General, and one to accompany the accounts of the officer who pays bounty, &c. The Regiment and Company in which the soldier last served should be given on the back.

NOTE 2.—An enlistment holds to service. A muster-in must, in all cases, precede payment of pay, bounty, pension, &c. A muster-in roll must, in all cases, be filed in the Adjutant General's Office as evidence of muster-in. The mustering officer, commissary, or assistant commissary of musters, as the case may be, will countersign both enlistments as having mustered the soldier into the service of the United States before either of them is given to the disbursing officer.

DECLARATION OF RECRUIT.

I, Donada Wilkins, desiring to VOLUNTEER as a Soldier in the Army of the United States, for the term of THREE YEARS, Do Declare, That I am thirteen years and _____ months of age; that I have never been discharged from the United States service on account of disability or by sentence of a court martial, or by order before the expiration of a term of enlistment; and I know of no impediment to my serving honestly and faithfully as a soldier for three years.

GIVEN at New Orleans La. the 21st day of November 1864

Witness:

Geo. E. Warner
1st Lt. 10th U.S. Col. 4th H.

Donada Wilkins
mark

entitled to bounty by Circular No. 2 of Provost Marshal General Office War Dept. of July 19th 1864

Discharged _____, 18 _____

Reg't of _____

enlistment, last served in Company () _____

No. _____
Donada Wilkins
Volunteered at New Orleans
November 21st 1864
By Geo. E. Warner
10th Regiment of U.S. Col. 4th H.
War Dept.

CONSENT IN CASE OF MINOR.

I, _____, Do CERTIFY, That I am the _____ of _____; that the said _____ is _____ years of age; and I do hereby freely give my CONSENT to his volunteering as a SOLDIER in the ARMY OF THE UNITED STATES for the period of THREE YEARS.

GIVEN at _____ the _____ day of _____

Witness:

VOLUNTEER ENLISTMENT.

STATE OF Louisiana TOWN OF New Orleans

I, Doneda Wilkine, born in Alabama, aged Nineteen years, and by occupation a Laborer, Do HEREBY ACKNOWLEDGE to have volunteered this Twenty first day of November, 1864, to serve as a Soldier in the Army of the United States of America, for the period of THREE YEARS, unless sooner discharged by proper authority: Do also agree to accept such bounty, pay, rations, and clothing, as are, or may be, established by law for volunteers. And I, Doneda Wilkine, do solemnly swear, that I will bear true faith and allegiance to the United States of America, and that I will serve them honestly and faithfully against all their enemies or opposers whomsoever; and that I will observe and obey the orders of the President of the United States, and the orders of the officers appointed over me, according to the Rules and Articles of War.

Sworn and subscribed to, at New Orleans this 21st day of Nov. 1864, BEFORE Geo. E. Warner 1st Lt. 10th U.S.C.A.

Doneda Wilkine mark

I CERTIFY, ON HONOR, that I have carefully examined the above-named Volunteer, agreeably to the General Regulations of the Army, and that, in my opinion, he is free from all bodily defects and mental infirmity, which would in any way disqualify him from performing the duties of a soldier.

A. S. Pitts, M.D. Surgeon U.S.A. EXAMINING SURGEON.

I CERTIFY, ON HONOR, That I have minutely inspected the Volunteer Doneda Wilkine previously to his enlistment, and that he was entirely sober when enlisted; that, to the best of my judgment and belief, he is of lawful age; and that, in accepting him as duly qualified to perform the duties of an able-bodied soldier, I have strictly observed the Regulations which govern the recruiting service. This soldier has Black eyes, Black hair, Dark complexion, is five feet seven inches high.

Geo. E. Warner 1st Lt. 10th Regiment of U.S.C.A. Volunteers, RECRUITING OFFICER.

(A. G. O. No. 74 & 76.)

Mustered into the service of the United States, for three years or during the war, from date of enlistment, in Company 4th Regiment of U.S. Col's Cavalry Volunteers, on the 25th day of November, 1864, at New Orleans La.

John W. Hamilton 2d Lieut 1st Dist Regt 4th U.S. Cavalry

NOV 21 1864

DECLARATION OF RECRUIT.

I, Goneda Wilkins, desiring to VOLUNTEER as a Soldier in the Army of the United States, for the term of THREE YEARS, Do Declare, That I am Twenty years and 0 months of age; that I have never been discharged from the United States service on account of disability or by sentence of a court martial, or by order before the expiration of a term of enlistment; and I know of no impediment to my serving honestly and faithfully as a soldier for three years.

GIVEN at New Orleans La. the 21st day of November 1864

Witness:

Geo. E. Mann
Adj. 10th Regt. A. H.

Goneda Wilkins
mark

4500

No. Goneda Wilkins

Enlisted at New Orleans

November 21st 1864

By Geo. E. Mann

10th Regiment of A. H.

enlistment; last served in Company ()

Regt of _____

Discharged _____, 18 _____

Original to County by Circular by 27 Goneda Marshal Superior Office New Orleans July 19 1864

Received from Second Auditor

NOTE 1.—This blank will be used for both enlistments and re-enlistments—enlistment of veterans, &c., &c., in the volunteer service. They will be made out in duplicate in all cases—one to accompany the recruiting return of the superintendent (not recruiting officer) to the Adjutant General, and one to accompany the accounts of the officer who pays bounty, &c. The Regiment and Company in which the soldier last served should be given on the back.
NOTE 2.—An enlistment holds to service. A muster-in must, in all cases, precede payment of pay, bounty, pension, &c. A muster-in roll must, in all cases, be filed in the Adjutant General's Office as evidence of muster-in. The mustering officer, commissary or assistant commissary of musters, as the case may be, will countersign both enlistments as having mustered the soldier into the service of the United States before either of them is given to the disbursing officer.

CONSENT IN CASE OF MINOR.

I, _____, Do CERTIFY, That I am the _____ of _____; that the said _____ is _____ years of age; and I do hereby freely give my CONSENT to his volunteering as a SOLDIER in the ARMY OF THE UNITED STATES for the period of THREE YEARS.

GIVEN at _____ the _____ day of _____

Witness:

Aug. 28 1892

VOLUNTEER ENLISTMENT.

STATE OF

Louisiana

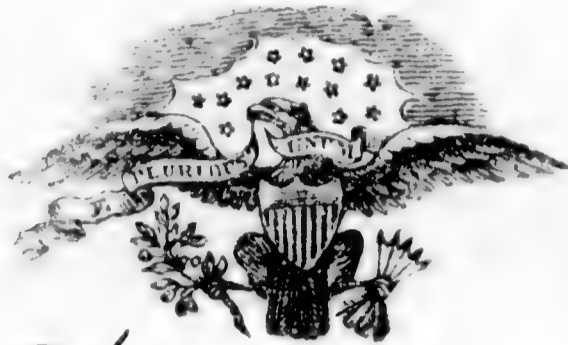

TOWN OF

New Orleans

I, Donada Wilkins, born in Alabama, aged Ninety years, and by occupation a Laborer, Do HEREBY ACKNOWLEDGE to have volunteered this Twenty first day of November, 1864, to serve as a Soldier in the Army of the United States of America, for the period of THREE YEARS, unless sooner discharged by proper authority: Do also agree to accept such bounty, pay, rations, and clothing, as are, or may be, established by law for volunteers. And I, Donada Wilkins, do solemnly swear, that I will bear true faith and allegiance to the United States of America, and that I will serve them honestly and faithfully against all their enemies or opposers whomsoever; and that I will observe and obey the orders of the President of the United States, and the orders of the officers appointed over me, according to the Rules and Articles of War.

Sworn and subscribed to, at New Orleans, this 21st day of Nov. 1864, before Geo. E. Warner, 1st Lt. 10th U.S.C. A.H., his mark.

I CERTIFY, ON HONOR, That I have carefully examined the above-named Volunteer, agreeably to the General Regulations of the Army, and that, in my opinion, he is free from all bodily defects and mental infirmity, which would in any way disqualify him from performing the duties of a soldier.

A. S. White, a Surgeon, U.S. EXAMINING SURGEON.

I CERTIFY, ON HONOR, That I have minutely inspected the Volunteer Donada Wilkins previously to his enlistment, and that he was entirely sober when enlisted; that, to the best of my judgment and belief, he is of lawful age; and that, in accepting him as duly qualified to perform the duties of an able-bodied soldier, I have strictly observed the Regulations which govern the recruiting service. This soldier has Black eyes, Black hair, Dark complexion, is five feet seven inches high.

Geo. E. Warner, 1st Lt. 10th Regiment of U.S.C. A.H. Volunteers, RECRUITING OFFICER.

Mustered into the service of the United States, for three years or during the war, from date of enlistment, in Company H of 4th Regiment of U.S. Col'd Cavalry Volunteers, on the 25th day of November 1864, at New Orleans La.

Handwritten signatures and notes on the right side of the document.

MAR 14 1922

1140

Wilkinson, Joseph

Co A, 4 U. S. Col'd Cav.

Private Private

CARD NUMBERS.

1	5347949	26
2	5352958	27
3	5353041	28
4	5353124	29
5	5353223	30
6	5353314	31
7	5353409	32
8	5353497	33
9	5353583	34
10	5353666	35
11	5353746	36
12	40729330	37
13		38
14		39
15		40
16		41
17		42
18		43
19		44
20		45
21		46
22		47
23		48
24		49
25		50

Book Mark

See also

MAR 14 23

D-1563264 - Aud WT

S 1733996 Aud WT

D 1905705 P. S. W. W. W.

S. A. Muhlenberg
948,

M | *4 Cav* | **U.S.C.T**

Joseph Wilkinson

Appears with rank of *Priv* on

Muster and Descriptive Roll of a Detachment of Drafted Men and Substitutes forwarded

for the *4* Reg't U.S. Col'd *Cav* Roll dated *New Orleans La, Sept 6, 1864*

Where born *St James Parish La*

Age *18* years; occupation *Laborer*

Drafted and mustered in:

When *Sept 1*, 186*4*.

Where *New Orleans*

Period *3* years.

Eyes *Blue*; hair *Black*

Complexion *Dark*; height *5 ft. 1 in.*

Paid bounty and advance pay, \$ *100*

Bounty due \$ *100* *none*

Where credited _____

Company to which assigned *D*

Remarks: _____

Book mark: _____

J. Underwood
Cap. 1st.

10 | 4 Cav. | U.S.C.T.

Joseph Wilkinson
Sgt, Co. D, 4 Reg't U. S. Colored Cav.

Appears on Returns as follows:

Sept 1864. Paris: Sept 3/64
Port Hudson, Enlisted

Book mark: _____

W. R. Lu

4 | **4 Cav.** | **U.S.C.T.**

^x
Joseph Walkerson

Priv., Co. D, 4 Reg't U. S. Col'd Cavalry.

Appears on

Company Muster Roll

for *Sept & Oct*, 1864.

Present or absent *Present*

Stoppage, \$ *100* for

Due Gov't, \$ *100* for

Valuation of horse, \$ *100*

Valuation of horse equipments, \$ *100*

Remarks:

^x *Name appears in lieu of*
Names Present as Joseph Walkerson

Book mark:

Rosenbaum

14 | **4 Cav.** | **U.S.C.T.**

Joseph Wilkerson

Co. D, 4 Reg't U. S. Col'd Cavalry.

Appears on

Company Muster Roll

for *Nov Dec*, 186*4*.

Present or absent *Present*

Stoppage, \$ *100* for

Due Gov't, \$ *100* for

Valuation of horse, \$ *100*

Valuation of horse equipments, \$ *100*

Remarks: *Due U.S. for Ord #750*

Book mark :

(358)

2 1/2 Night

Copyist.

11 | **4 Cav.** | **U.S.C.T.**

Joseph Peterson

....., Co. D, 4 Reg't U. S. Col'd Cavalry.

Appears on

Company Muster Roll

for Jan & Feb, 1865.

Present or absent Present

Stoppage, \$ 100 for

Due Gov't, \$ 50 for Ordinance

Valuation of horse, \$ 100

Valuation of horse equipments, \$ 100

Remarks:

Book mark:

(358) Joseph Peterson Copyist.

11 4 Cav. U.S.C.T.

Joseph Halberstam

P, Co. D, 4 Reg't U. S. Col'd Cavalry.

Appears on

Company Muster Roll

for *Nov & Dec*, 186*5*.

Present or absent *Present*

Stoppage, \$ 100 for

Due Gov't, \$ 100 for

Valuation of horse, \$ 100

Valuation of horse equipments, \$ 100

Remarks:

Book mark: *11429*

J. H. Wright
Copyist.

W | **4 Cav.** | **U.S.C.T.**

Joseph W. Bennett
10
....., Co. D, 4 Reg't U. S. Col'd Cavalry.

Appears on

Company Muster Roll

for *May & June*, 1865.

Present or absent *Present*

Stoppage, \$.....100 for

Due Gov't, \$.....100 for

Valuation of horse, \$.....100

Valuation of horse equipments, \$.....100

Remarks:

Book mark:

J. W. Bennett
Copyist.

4 Cav. | U.S.C.T.

Wm. H. Wilson

10, Co. D. 4 Reg't U. S. Col'd Cavalry.

Appears on

Company Muster Roll

for *July & Aug*, 1865.

Present or absent *Present*

Stoppage, \$ 100 for

Due Gov't, \$ 100 for

Valuation of horse, \$ 100

Valuation of horse equipments, \$ 100

Remarks:

Book mark:

W. H. Wilson

17 | **4 Cav. | U.S.C.T.**

Joseph Micherson
P

, Co. D, 4 Reg't U. S. Col'd Cavalry.

Appears on

Company Muster Roll

for *Sept - Oct*, 186*5*.

Present or absent *Present*

Stoppage, \$ 100 for

Due Gov't, \$ 100 for

Valuation of horse, \$ 100

Valuation of horse equipments, \$ 100

Remarks:

Book mark:

W. Wright

W | 4 Cav. | U.S.C.T.

Joseph Milner
Put, Co. D, 4 Reg't U. S. Col'd Cavalry.

Appears on

Company Muster Roll

for Apr + Dec, 1865.

Present or absent Present

Stoppage, \$ 100 for

Due Gov't, \$ 100 for

Valuation of horse, \$ 100

Valuation of horse equipments, \$ 100

Remarks:

Book mark:

Fry, (C. S. ...)

W | 4 Cav. | U.S.C.T.

Joseph Milken

Put, Co. D, 4 Reg't U. S. Col'd Cavalry.

Appears on

Company Muster Roll

for Jan 1 Feb, 1866.

Present or absent Present

Stoppage, \$ 100 for

Due Gov't, \$ 100 for

Valuation of horse, \$ 100

Valuation of horse equipments, \$ 100

Remarks:

Book mark:

D. D. Anderson

MAR 14 1865

W | **4 Cav. | U.S.C.T.**

Joseph Wilkerson
Put, Co. *10*, 4 Reg't U. S. Col'd Cavalry.

Appears on **Co. Muster-out Roll**, dated
New Orleans, La, *Feb 20*, 186*6*.
Muster-out to date *Feb 20*, 186*6*.
Last paid to *June 30*, 186*5*.

Clothing account:

Last settled....., 186 ; drawn since \$..... $\frac{100}{100}$
Due soldier \$..... $\frac{100}{100}$; due U. S. \$ *66* $\frac{58}{100}$
Am't for cloth'g in kind or money adv'd \$..... $\frac{100}{100}$

Due U. S. for arms, equipments, &c., \$..... $\frac{30}{100}$

Bounty paid \$..... $\frac{100}{100}$; due \$..... $\frac{100}{100}$

Remarks: *Joined as recruit*
Stop 1 Sabre Knot.

Book mark: *V25, P 230, 68.*

M. J. Andrews

(361)

Copyist.

1141
Mills, George

Co B, 4 U. S. Col'd Cav.

Private Private

CARD NUMBERS.

1		26
2	Su Wilts	27
3		28
4		29
5		30
6		31
7		32
8		33
9		34
10		35
11		36
12		37
13		38
14		39
15		40
16		41
17		42
18		43
19		44
20		45
21		46
22		47
23		48
24		49
25		50

Book Mark:

See also

1142

William Alexander

Co A, 4 U. S. Col'd Cav.

Private Private

CARD NUMBERS.

1	5348491	26
2	5348588	27
3	5348693	28
4	5348787	29
5	5348881	30
6	5348968	31
7	5349065	32
8	5349751	33
9	40729333	34
10		35
11		36
12		37
13		38
14		39
15		40
16		41
17		42
18		43
19		44
20		45
21		46
22		47
23		48
24		49
25		50

Book Mark:

See also

W | 4 Cav. | U.S.C.T.

Alexander Williams
Private, Co. *A*, 1 Reg't La. Cav., Corps d'Afrique.*

Appears on

Company Muster-in Roll

of the organization named above. Roll dated

New Orleans La, Sept 12, 1863.

Muster-in to date

Sept 12, 1863.

Joined for duty and enrolled:

When *Aug 30*, 1863.

Where *New Orleans*

Period *3* years.

Valuation of horse, \$ *100*

Valuation of horse equipments, \$ *100*

Remarks:

Age 21

*This organization subsequently became Co. *A*, 4 Reg't U. S. Colored Cavalry.

Book mark:

M. A. Michaels

W | **4 Cav. | U.S.C.T.**

Alexander Williams

Priv, Co. *A*, 1 Reg't La. Cav., Corps d'Afrique.*

Appears on

Company Muster Roll

for *Sept 12 to Dec 31*, 186*5*

Present or absent *Present*

Stoppage, \$ *100* for

Due Gov't, \$ *100* for

Valuation of horse, \$ *100*

Valuation of horse equipments, \$ *100*

Remarks:
.....
.....
.....
.....
.....
.....
.....

*This organization subsequently became Co. *A*, 4 Reg't U. S. Colored Cavalry.

Book mark:

R. Richardson

W

4 Cav. U.S.C.T.

Alexander Williams
Private, Co. A, 1 Reg't Cav., Corps d'Afrique.*

Appears on

Company Muster Roll

for Jan 1 Feb, 1864

Present or absent Present

Stoppage, \$ 100 for

Due Gov't, \$ 100 for

Valuation of horse, \$ 100

Valuation of horse equipments, \$ 100

Remarks:

* This organization subsequently became Co. A 4 Reg't U. S. Colored Cavalry.

Book mark:

A. S. Richardson

W | 4 Cav. | U.S.C.T.

Alexander Williams
Priv, Co. A, 4 Reg't U. S. Col'd Cavalry.

Appears on

Company Muster Roll

for March & April, 1864

Present or absent Present

Stoppage, \$ 100 for

Due Gov't, \$ 100 for

Valuation of horse, \$ 100

Valuation of horse equipments, \$ 100

Remarks:

Book mark:

R. S. Richardson

W | 4 Cav. | U.S.C.T.

Alexander Williams

Priv., Co. A, 4 Reg't U. S. Col'd Cavalry.

Appears on

Company Muster Roll

for May & June, 1864

Present or absent Present

Stoppage, \$ 100 for

Due Gov't, \$ 100 for

Valuation of horse, \$ 100

Valuation of horse equipments, \$ 100

Remarks:

Book mark:

R. S. Richardson

W | 4 Cav. | U.S.C.T.

Alexander Williams

Private, Co. A, 4 Reg't U. S. Col'd Cavalry.

Appears on

Company Muster Roll

for July & Aug, 1864

Present or absent Absent

Stoppage, \$ 100 for

Due Gov't, \$ 100 for

Valuation of horse, \$ 100

Valuation of horse equipments, \$ 100

Remarks: Died Aug 30th 1864 in Regimental Hospital of disability owes John Wile Sutter \$900

Book mark:

R. Richardson

W | 4 Cav. | U.S.C.T.

Alexander Williams

P₁, Co. A, 4 Reg't U. S. Col'd Cavalry.

Appears on

Company Muster Roll

for *Sept & Oct*, 186 *4*

Present or absent.....

Stoppage, \$..... *100* for.....

Due Gov't, \$..... *100* for.....

Valuation of horse, \$..... *100*

Valuation of horse equipments, \$..... *100*

Remarks: *died in Regt Hosp
Port Hudson La Aug 30. by
Owes butler John Wild
\$9. Inventory sent Aug
Sept 2/04*

Book mark:.....

Dornally

W | 4 Cav. | U.S.C.T.

Alexander Williams

Priv, Co. A, 4 Reg't U. S. Colored Cav.

Appears on Returns as follows:

Aug 1864. Term: Aug 30
Port Hudson held in
Regtl strength.

Book mark:

W. R. Lee

A | **4 Cav. | U.S.C.T.**

Alexander William
Put, Co. *A*, 4 Reg't U. S. Col'd Cavalry.

Appears on **Co. Muster-out Roll**, dated
New Orleans La; Mch 20, 186*6*.

Muster-out to date _____, 186 .

Last paid to _____, 186 .

Clothing account:

Last settled _____, 186 ; drawn since \$ _____ *100*

Due soldier \$ _____ *100*; due U. S. \$ _____ *100*

Am't for cloth'g in kind or money adv'd \$ _____ *100*

Due U. S. for arms, equipments, &c., \$ _____ *100*

Bounty paid \$ _____ *100*; due \$ _____ *100*

Remarks: *Joined at orig reg. Died*
Aug 30. 64. at Port Hudson La

Book mark: *V. 177 P. 283, 73*

(361) _____ *Crewitt* Copyist.

1143

Williams, Alexander

Co C, 4 U. S. Col'd Cav.

Private

Private

CARD NUMBERS.

1	5351289	26
2	5351345	27
3	5351422	28
4	5352536	29
5	40729332	30
6		31
7		32
8		33
9		34
10		35
11		36
12		37
13		38
14		39
15		40
16		41
17		42
18		43
19		44
20		45
21		46
22		47
23		48
24		49
25		50

Book Mark:

See also

W | 4 Cav. | U.S.C.T.

Alexander Williams
Sgt., Co. C, 1 Reg't La. Cav., Corps d'Afrique.*

Appears on

Company Muster-in Roll

of the organization named above. Roll dated

New Orleans, La, Nov 7, 1863.

Muster-in to date

Nov 7, 1863.

Joined for duty and enrolled:

When *Oct 6*, 1863.

Where *New Orleans city*

Period *3* years.

Valuation of horse, \$ 100

Valuation of horse equipments, \$ 100

Remarks:

Age: 18

*This organization subsequently became Co. C, 4 Reg't U. S. Colored Cavalry.

Book mark:

Robert

W | 4 Cav. | U.S.C.T.

Robert Williams
Co. *C*, 1 Reg't La. Cav., Corps d'Afrique.*

Appears on

Company Muster Roll

for *Nov 7 to Dec 31*, 186*3*.

Present or absent *Absent*

Stoppage, \$ 100 for

Due Gov't, \$ 100 for

Valuation of horse, \$ 100

Valuation of horse equipments, \$ 100

Remarks: *Absent without leave*

FROM SECOND AUDITOR'S HULL

*This organization subsequently became Co. *C* 4 Reg't U. S. Colored Cavalry.

Book mark: _____

Robert Williams

W | **4 Cav. | U.S.C.T.**

Alexander Williams
Pvt., Co. *C*, 1 Reg't La. Cav., Corps d'Afrique.*

Appears on

Company Muster Roll

for *Jan & Feb*, 186*4*.

Present or absent.....

Stoppage, \$.....100 for.....

Due Gov't, \$.....100 for.....

Valuation of horse, \$.....100

Valuation of horse equipments, \$.....100

Remarks: *Discharged January*
10th 1864

*This organization subsequently became Co. *C*, 4 Reg't U. S. Colored Cavalry.

Book mark:.....

Rochester

W | 4 Cav. | U.S.C.T.

Alex Williams

Priv, Co. B, 4 Reg't U. S. Colored Cav.

Appears on Returns as follows:

Jan 1861. (1 Regt. Cav., Corps d' Afrique) Los. Jan 21 61 New Orleans, Deserted

Book mark:

W. R. Lee

W | *4 Cav.* | **U.S.C.T.**

Alexander Williams

Private, Co. *C*, *4* Reg't U. S. Col'd *Cavalry*

Appears on **Co. Muster-out Roll**, dated

New Orleans La, *Mar 20*, 186*6*.

Muster-out to date _____, 186 .

Last paid to *Never paid*, 186 .

Clothing account:

Last settled _____, 186 ; drawn since \$ _____ ¹⁰⁰

Due soldier \$ _____ ¹⁰⁰; due U. S. \$ *46* ⁶³ ₁₀₀

Am't for cloth'g in kind or money adv'd \$ _____ ¹⁰⁰

Due U. S. for arms, equipments, &c., \$ _____ ¹⁰⁰

Bounty paid \$ _____ ¹⁰⁰; due \$ _____ ¹⁰⁰

Remarks: *Joined at Orig. Org.*
deserted Dec 1863 at
Fort Banks La.

Book mark : _____

M. A. Michaels

Williams, Alexander
 P, Co. A, 4 Reg't U. S. C. Cav.

1 Enclosures.

Bed Cards	Descriptive Lists
Burial Records	Final Statements 1
Certs. of Dis. for Discharge	Furloughs
C. M. Charges	Med. Des. Lists
Med. Certificates	Orders

Other papers relating to—

Admission to Hosp'l	Furlough
Casualty Sheet (Officer's)	Med. Examination
Confinement	Misc. Information
Contracts	Pay or Clothing
Death or Effects	Personal Reports
Desertions	Rank
Discharge from Hosp'l	Transfer to Hosp'l
Discharge from Service	Transfer to V. R. C.
Duty	Transportation

*Adj. Meins acct. for
effects sent 2d Auditor
S.*

FINAL STATEMENT

OF

Private Alexander Williams

4th Reg't of U.S. Col'd Cav

VOLUNTEERS.

Disch Aug 30th 1864

NOTE 1.—Two of these certificates (or duplicates) are to be given to each volunteer soldier who may be discharged previously to the discharge of his company, that he may at once receive from the Paymaster the pay, &c., due him, and the captain or other officer commanding the company will certify to the act of the delivery of the duplicate certificates; on these certificates the Soldier is "entitled to" his discharge, and should also present his discharge to the Paymaster to have the payment endorsed on it. The discharge is to be given back to the Soldier by the Paymaster; the latter only retaining as his voucher the duplicate certificates.

NOTE 2.—If the Soldier is entitled to pay for the use of his horse, the Company Commander will certify to that fact, and also to the time he has pay due for having been so mounted on his own horse.

NOTE 3.—Amounts due the Sutler and Laundress must be entered on the Muster Roll on which the death, desertion, &c., is reported, as well as on the final statement, otherwise the amount cannot be collected from the United States.

NOTE 4.—This blank will be used for deceased volunteers as well as others.

ADJUTANT GENERAL'S OFFICE.
Sept 20th 1864
Duplicate with Inventory sent 2d Auditor.

RECEIVED
SEPT 20 1864
Leitch

I certify, on honor, that Alexander Williams a Private of
 Captain John Kirk Company (A) of the 4th Regiment of U.S. Colored
VOLUNTEERS, of the State of _____, born in Vicksburg, State
 of Mississippi, aged 21 years; 5 feet 7/4 inches high; brun complexion,
brun eyes, black hair, and by occupation a Laborer, having joined the company on
 its original organization at New Orleans La, and enrolled in it at the muster into
 the service of the United States at New Orleans La, on the twelfth day
 of September, 1864, (or was mustered in service as a recruit, by _____
 _____, at _____, on the _____ day of _____,
 186 , to serve in the Regiment,) for the term of Three Years :

and having served **HONESTLY** and **FAITHFULLY** with his Company in the field
 to the present date, is now entitled to a **DISCHARGE** by reason of Death
died in Regt Hospital, Port Hudson August
30th 1864 of Genl Debility

The said Private Alexander Williams was last paid by Paymaster
Maj. Soffland to include the 30th day of April, 1864, and has
 pay due him from that time to the present date; he is entitled to pay and subsistence for
TRAVELING to place of enrollment and whatever other allowances are authorized to volunteer
 soldiers, or militia, so discharged. He has received _____ 18²⁸/100 dollars,
 advanced by the United States on account of **CLOTHING**.

There is to be stopped from him, on account of the State of _____, or other
 authorities for **CLOTHING, &c.**, received on entering service, Nothing/100 dollars; also,
 for expenses of **SUBSISTENCE** for **TRAVELING** from place of enrollment to the place of rendezvous,
 amounting to Nothing/100 dollars: and on account of the United States for **EXTRA**
CLOTHING received in kind from _____ and for other
 stoppages, viz:

_____ amounting to Nothing/100 dollars;
 and he has been **SUBSISTED** for **TRAVELING** to his place of enrollment, up to the _____
 _____, 186

He is indebted to James Hilda, **SUTLER**, _____ 9⁰⁰/100 dollars.
 He is indebted to _____, **LAUNDRESS**, Nothing/100 dollars.

Given in Duplicate, at Port Hudson La, this 1st day of September, 1864.

John Kirk
Captain

 Commanding Company.

1144

Williams Alfred

Co *H*, 4 U. S. Col'd Cav.

Prof

Private

CARD NUMBERS.

1	26
2	27
3	28
4	29
5	30
6	31
7	32
8	33
9	34
10	35
11	36
12	37
13	38
14	39
15	40
16	41
17	42
18	43
19	44
20	45
21	46
22	47
23	48
24	49
25	50

See Alfred William

Book Mark:

See also

1145

Williams Allen

Co *H, A* U. S. Col'd Cav.

Private

Private

CARD NUMBERS.

1	5347359	26
2	5358431	27
3	5358480	28
4	5358531	29
5	5358575	30
6	5358617	31
7	5348139	32
8	5357624	33
9	5357746	34
10	5357789	35
11	5357867	36
12	5357942	37
12	5358017	38
14	5358089	39
15	40729334	40
16		41
17		42
18		43
19		44
20		45
21		46
22		47
23		48
24		49
25		50

Book Mark:

See also

D. 2077117 And WD.
D. 2962370 Pointon
D. 2995550 And WD

S. A. Muhleman
S.A.

W | 4 Cav. | U.S.C.T.

Alex Williams

Appears with rank of *Sgt* on

Muster and Descriptive Roll of a Detachment of U. S. Vols. forwarded

for the 4 Reg't U. S. Col'd Cavalry. Roll dated *New Orleans La., May 9, 1864.*

Where born *Alexandria La.*

Age *20* y'rs; occupation *Laborer*

When enlisted *Apr. 30*, 1864.

Where enlisted *Alexandria*

For what period enlisted *3* years.

Eyes *Black*; hair *Black*

Complexion *Black*; height *5* ft. *4 1/2* in.

When mustered in *May 9*, 1864.

Where mustered in *New Orleans*

Premium paid \$ *2* ~~Bounty paid~~ \$ *100*; due \$ *100*

Where credited

Company to which assigned *K*

Remarks:

Book mark:

Easter

W | **4 Cav.** | **U.S.C.T.**

Allen Williams
Co. *K*, 4 Reg't U. S. Col'd Cavalry.

Age _____ years.

Appears on

Company Muster Roll*

for *May 9 to June 30*, 1864.

Joined for duty and enrolled:

When *Apr. 30*, 1864.

Where *Alexandria, La.*

Period *3* years.

Mustered in:

When *May 9*, 1864.

Where *New Orleans, La.*

Present or absent *(Present)*

Stoppage, \$ *100* for _____

Due Gov't, \$ *100* for _____

Valuation of horse, \$ *100*

Valuation of horse equipments, \$ *100*

Remarks : _____

* First current roll. No muster-in roll of this battery on file.

Book mark : _____

W. S. Thompson

H | **4 Cav. U.S.C.T.**

Allen Williams
Capt, Co. K, 4 Reg't U. S. Col'd Cav.

Appears on

Company Muster Roll

for *July & Aug.*, 186*4*.

Present or absent *Present*

Stoppage, \$ *100* for

Due Gov't, \$ *100* for

Valuation of horse, \$ *100*

Valuation of horse equipments, \$ *100*

Remarks:

Book mark:

H. S. Thompson

27

4 Cav. U.S.C.T.

Allen Williams

Co. K, 4 Reg't U. S. Col'd Cav.

Appears on

Company Muster Roll

for Sept. & Oct., 1864.

Present or absent Present

Stoppage, \$ 100 for

Due Gov't, \$ 100 for

Valuation of horse, \$ 100

Valuation of horse equipments, \$ 100

Remarks:

Book mark:

A. S. Thompson

M | **4 Cav.** | **U.S.C.T.**

Allen Williams
Co. K, Co. K, 4 Reg't U. S. Col'd Cav.

Appears on

Company Muster Roll

for *Nov. & Dec.*, 1864.

Present or absent *Present*

Stoppage, \$ *100* for

Due Gov't, \$ *100* for

Valuation of horse, \$ *100*

Valuation of horse equipments, \$ *100*

Remarks:

Book mark: -----

W. S. Thompson
(358) *W. S. Thompson* Copyist.

H

4 Cav. U.S.C.T.

A. Allen Williams

Private, Co. K, 4 Reg't U. S. Col'd Cav.

Appears on

Company Muster Roll

for *Jan. & Feb.*, 1865.

Present or absent *Present*

Stoppage, \$ *100* for

Due Gov't, \$ *100* for

Valuation of horse, \$ *100*

Valuation of horse equipments, \$ *100*

Remarks:

Book mark:

W. S. Thompson

W | 4 Cav. | U.S.C.T.

Allen Williams

Cvt., Co. H, 4 Reg't U. S. Col'd Cavalry.

Appears on

Company Muster Roll

for *Mich. & Apl.*, 186*5*.

Present or absent *Present*

Stoppage, \$ *100* for

Due Gov't, \$ *100* for

Valuation of horse, \$ *100*

Valuation of horse equipments, \$ *100*

Remarks: *Transferred from Co. K in consolidation by S. O. 28. Hdqrs. Dept. Qu. Jan. 28/65-*

Book mark:

Peaster

N | *4* *Co* | **U.S.C.T.**

Allen Williams
Co. N, 4 Reg't U. S. Col'd *Car.*

Appears on

M. and D. Roll of Men Transferred

to the organization named above, *by consol.*
from *Co. N*

Roll dated *Port Hudson La. Apr 29*, 1865.

When enlisted *Apr 30*, 1864.

Period for which enlisted *3* years.

When mustered in *May 9*, 1864.

Present or absent *not related*

Company to which assigned *A*

Remarks: _____

Book mark: _____

(342)

J. M. Leman

Copyist.

W | **4 Cav.** | **U.S.C.T.**

Allen Williams

Pop., Co. H, 4 Reg't U. S. Col'd Cavalry.

Appears on

Company Muster Roll

for *May & June*, 186*5*.

Present or absent *Present*

Stoppage, \$ *100* for

Due Gov't, \$ *100* for

Valuation of horse, \$ *100*

Valuation of horse equipments, \$ *100*

Remarks: *Stop. for one
Sabre knott \$30.*

Book mark:

Feaster

N | **4 Cav.** | **U.S.C.T.**

Allen Williams

Sgt., Co. H, 4 Reg't U. S. Col'd Cavalry.

Appears on

Company Muster Roll

for *July 8; Aug.*, 186*2*.

Present or absent *Present*

Stoppage, \$ *100* for

Due Gov't, \$ *100* for

Valuation of horse, \$ *100*

Valuation of horse equipments, \$ *100*

Remarks: *Stop for one
Sabre knot C. 30.*

Book mark:

Feaster

W | **4 Cav.** | **U.S.C.T.**

Allen Williams

Priv., Co. H, 4 Reg't U. S. Col'd Cavalry.

Appears on

Company Muster Roll

for *Sept. 1. Oct.*, 186*5*.

Present or absent *Present*

Stoppage, \$ 100 for

Due Gov't, \$ 100 for

Valuation of horse, \$ 100

Valuation of horse equipments, \$ 100

Remarks:

Book mark:

Heaster

W | **4 Cav.** | **U.S.C.T.**

Allen Williams
Co., Co. H, 4 Reg't U. S. Col'd Cavalry.

Appears on

Company Muster Roll

for *dated Dec 31*, 186 *1*.

Present or absent *Present*

Stoppage, \$ *100* for

Due Gov't, \$ *100* for

Valuation of horse, \$ *100*

Valuation of horse equipments, \$ *100*

Remarks:

Book mark: -----

A. G. Lewis
(358) Copyist.

W | **4 Cav.** | **U.S.C.T.**

Allen Williams
Pr, Co. H, 4 Reg't U. S. Col'd Cavalry.

Appears on

Company Muster Roll

for *Jan + Feb*, 186*6*.

Present or absent *Present*

Stoppage, \$ *100* for

Due Gov't, \$ *100* for

Valuation of horse, \$ *100*

Valuation of horse equipments, \$ *100*

Remarks:

Book mark:

A. C. Smith

115 | 4 Cav. | U.S.C.T.

Allen Williams

Port, Co. ^H 16, 4 Reg't U. S. Colored Cav.

Appears on Returns as follows:

June 1861. On duty Co. Cook

Jan 1865. On duty detailed
as Regd. Blacksmith

Feb 1865 On duty detailed as
teamster

June 1865 (P. 16) On duty de-
tailed in R. G. M. kept.

July 1865 On duty teamster

Book mark:

W. R. Lee

A | **4 Cav. U.S.C.T.**

Allen Williams

Cri, Co. *A*, 4 Reg't U. S. Col'd Cavalry.

Appears on **Co. Muster-out Roll**, dated *New Orleans La, Mar 20, 1866*.

Muster-out to date *Mar 20, 1866*.

Last paid to *June 30, 1865*.

Clothing account:

Last settled....., 186 ; drawn since \$..... 100

Due soldier \$..... 100; due U. S. \$ *24* ^{*99*}/_{*100*}

Am't for cloth'g in kind or money adv'd \$..... 100

Due U. S. for arms, equipments, &c., \$..... 100

Bounty paid \$..... 100; due \$..... 100

Remarks: *Joined by transfer from Co. "I" Mar 24/65 per S.O. 23. Ad. Des. Dept. Gulf series 1865*

Book mark: *V. 35. P. 7. 68*

H. E. Stuart

(361)

Copyist.

1146

Williams Augustus

Co B, 4 U.S. Col'd Cav.

Private Private

CARD NUMBERS.

1	5349872	26
2	5349968	27
3	5357062	28
4	5357169	29
5	5357263	30
6	5357350	31
7	5357430	32
8	5357504	33
9	5357579	34
10	5357665	35
11	5357757	36
12	5357844	37
13	5357930	38
14	5351014	39
15	5351096	40
16	5351177	41
17	57-CJ-1872	42
18	Pr-26-RCJ-1867	43
19	40729381	44
20		45
21		46
22		47
23		48
24		49
25		50

Book No. 5729 C.J. 72. W. 26
574 R.C.J. 67.

See also

W | **4 Cav. | U.S.C.T.**

Augustus Williams

Co. B, 1 Reg't La. Cav., Corps d'Afrique.*

Age 29
Appears on

Company Muster-in Roll

of the organization named above. Roll dated

New Orleans La Oct 27, 186*3*.

Muster-in to date *Oct 27*, 186*3*.

Joined for duty and enrolled:

When *Oct 19*, 186 .

Where *New Orleans*

Period *3* years.

Valuation of horse, \$ *100*

Valuation of horse equipments, \$ *100*

Remarks:

*This organization subsequently became Co. *B*, 4 Reg't U. S. Colored Cavalry.

Book mark:

King
Coytst.

W | **4 Cav. | U.S.C.T.**

Augustus Williams

Co. B, 1 Reg't La. Cav., Corps d'Afrique.*

Appears on

Company Muster Roll

for *Oct 27 to Dec 31*, 186*3*.

Present or absent *Present*

Stoppage, \$ *100* for

Due Gov't, \$ *100* for

Valuation of horse, \$ *100*

Valuation of horse equipments, \$ *100*

Remarks:

*This organization subsequently became Co. *B*, 4 Reg't U. S. Colored Cavalry.

Book mark:

King
Copyist.

N

4 Cav. U.S.C.T.

Augustus Williams
Pvt., Co. *B*, 1 Reg't Cav., Corps d'Afrique.*

Appears on

Company Muster Roll

for *Jan Feb*, 1864.

Present or absent *Present*

Stoppage, \$ *100* for

Due Gov't, \$ *100* for

Valuation of horse, \$ *100*

Valuation of horse equipments, \$ *100*

Remarks:

* This organization subsequently became Co. *B*, 4 Reg't U. S. Colored Cavalry.

Book mark:

(358)

Tracy
Copyist.

W | **4 Cav.** | **U.S.C.T.**

Augustus Williams

Co. B., Co. B. 4 Reg't U. S. Col'd Cavalry.

Appears on

Company Muster Roll

for *Mch. + Apr.*, 1864.

Present or absent *Absent*

Stoppage, \$ 100 for

Due Gov't, \$ 100 for

Valuation of horse, \$ 100

Valuation of horse equipments, \$ 100

Remarks : *In confinement*

Book mark :

(358)

C. W. Williams
Cpyist.

W | **4 Cav. | U.S.C.T.**

Augustus Williams
Pvt, Co. B. 4 Reg't U. S. Col'd Cavalry.

Appears on
Company Muster Roll

for *May & June*, 186*4*.

Present or absent *Absent*

Stoppage, \$ *100* for

Due Gov't, \$ *100* for

Valuation of horse, \$ *100*

Valuation of horse equipments, \$ *100*

Remarks: *In confinement*

Book mark:

(358)

[Signature]
Copyist.

W | **4 Cav. | U.S.C.T.**

Augustus Williams

Cvt., Co. B. 4 Reg't U. S. Col'd Cavalry.

Appears on

Company Muster Roll

for *July & Aug*, 186*C.*

Present or absent *Absent*

Stoppage, \$ *100* for

Due Gov't, \$ *100* for

Valuation of horse, \$ *100*

Valuation of horse equipments, \$ *100*

Remarks : *Absent in New Orleans in arrest*

Book mark :

(358)

K. J. [Signature]
Copyist.

W | **4 Cav. | U.S.C.T.**

Augustine Williams
Co. B., Co. B. 4 Reg't U. S. Col'd Cavalry.

Appears on

Company Muster Roll

for *Sept + Oct*, 1864.

Present or absent *Absent*

Stoppage, \$ *100* for

Due Gov't, \$ *100* for

Valuation of horse, \$ *100*

Valuation of horse equipments, \$ *100*

Remarks: *Absent in New Orleans in arrest*

Book mark:

[Signature]
Copyist.

OK | **4 Cav.** | **U.S.C.T.**

Augustus Williams

priv., Co. B. 4 Reg't U. S. Col'd Cavalry.

Appears on

Company Muster Roll

for *Nov + Dec*, 1864.

Present or absent *Absent*

Stoppage, \$ 100 for

Due Gov't, \$ 100 for

Valuation of horse, \$ 100

Valuation of horse equipments, \$ 100

Remarks: *Absent in arrest
in New Orleans La.*

Book mark:

Somers

A | **4 Cav.** | **U.S.C.T.**

Augustus Williams

priv, Co. B. 4 Reg't U. S. Col'd Cavalry.

Appears on

Company Muster Roll

for *Jan & Feb.*, 186*3*.

Present or absent *Absent*

Stoppage, \$ 100 for

Due Gov't, \$ 100 for

Valuation of horse, \$ 100

Valuation of horse equipments, \$ 100

Remarks: *Absent in arrest
in New Orleans La.*

Book mark :

S. J. ...

H | **4 Cav.** | **U.S.C.T.**

Augustus William

priv., Co. B. 4 Reg't U. S. Col'd Cavalry.

Appears on

Company Muster Roll

for *mch & apr*, 186*3*.

Present or absent *absent*

Stoppage, \$ *100* for

Due Gov't, \$ *100* for

Valuation of horse, \$ *100*

Valuation of horse equipments, \$ *100*

Remarks: *Absent in arrest
in New Orleans*

Book mark:

J. J. Jones

W | **4 Cav.** | **U.S.C.T.**

Augustus Williams

402, Co. B. 4 Reg't U. S. Col'd Cavalry.

Appears on

Company Muster Roll

for *May & June*, 1865.

Present or absent *absent*

Stoppage, \$ 100 for

Due Gov't, \$ 100 for

Valuation of horse, \$ 100

Valuation of horse equipments, \$ 100

Remarks: *absent in arrest since Mch 16/65*

Book mark:

Finney

W | **4 Cav. | U.S.C.T.**

Augustus Williams

Sgt, Co. B. 4 Reg't U. S. Col'd Cavalry.

Appears on

Company Muster Roll

for *July & Aug*, 186*1*.

Present or absent *Absent*

Stoppage, \$ 100 for

Due Gov't, \$ 100 for

Valuation of horse, \$ 100

Valuation of horse equipments, \$ 100

Remarks: *Absent in arrest*
since Mch 16/61

Book mark:

Sumner

W

4 Cav.

U.S.C.T.

Augustus Williams

priv., Co. B. 4 Reg't U. S. Col'd Cavalry.

Appears on

Company Muster Roll

for *Sept & Oct*, 186 *7*.

Present or absent *Absent*

Stoppage, \$ 100 for

Due Gov't, \$ 100 for

Valuation of horse, \$ 100

Valuation of horse equipments, \$ 100

Remarks: *Absent in arrest since Mch 16/64.*

Book mark:

Powers

W | **4 Cav.** | **U.S.C.T.**

Augustus Williams
Pot, Co. B. 4 Reg't U. S. Col'd Cavalry.

Appears on

Company Muster Roll

for Nov. & Dec., 1865.

Present or absent Absent

Stoppage, \$ 100 for

Due Gov't, \$ 100 for

Valuation of horse, \$ 100

Valuation of horse equipments, \$ 100

Remarks: Absent in arrest
since March 16, 1864.

Book mark : _____

Chandler
Copyist.

W

4 Cav. | U.S.C.T.

Augustus Williams

Priv, Co. B. 4 Reg't U. S. Col'd Cavalry.

Appears on

Company Muster Roll

for *Jan. & Feb.*, 186*6*.

Present or absent *Absent*

Stoppage, \$ 100 for

Due Gov't, \$ 100 for

Valuation of horse, \$ 100

Valuation of horse equipments, \$ 100

Remarks: *Absent in arrest since March 16, 1864.*

Book mark :

Chandler

(358)

Copyist.

W | 4 Cav. | U.S.C.T.

Augustus Williams

Port, Co. B, 4 Reg't U. S. Colored Cav.

Appears on Returns as follows:

Mich 1864 - (1 Regt Cav. Corps d'Afrique) Absent in
 arrest since Mar 6/64 at N. Orleans
 Apr to Oct 1864 - (4 Regt U.S. Col'd Cav.) Absent in
 arrest, in confinement at Parish Prison New
 Orleans La, sent since March 6/64
 Dec 1864 - Absent sent in arrest to Provost Marshal
 references of New Orleans March 6/64
 Jan & Feb 1865 - Absent in arrest, in confinement at New
 Orleans La.
 Mich 1865 - Absent in confinement at Port Hudson La.
 Apr 1865 - Absent in confinement at New Orleans, La.
 since Mar 14/64
 May & June 1865 - Absent in confinement at Port Hudson La
 July to Oct 1865 - Absent in arrest since Mar 16/64
 Nov 1865 - Absent in confinement at New Orleans La.
 since March 16/64
 Dec 1865 - Absent in arrest since Mich 16/65
 Jan & Feb 1866 - Absent in arrest confined at New
 Orleans La. since March 16/65

Book mark :

W. R. See

W | **4 Cav.** | **U.S.C.T.**

Augustus Williams
Priv, Co. B, 4 Reg't U. S. Col'd Cavalry.

Appears on **Co. Muster-out Roll**, dated
New Orleans, La., March 20 1866.

Muster-out to date _____, 186 .

Last paid to _____, 186 .

Pay due from enlistment

Clothing account:

Last settled _____, 186 ; drawn since \$ _____ 100

Due soldier \$ _____ 100; due U. S. \$ _____ 3 24 100

Am't for cloth'g in kind or money adv'd \$ _____ 100

Due U. S. for arms, equipments, &c., \$ _____ 100

Bounty paid \$ _____ 100; due \$ _____ 100

Remarks: Joined at Org'l Org.
Absent in arrest since March
16. 64. No record turned over
by previous Co. Comd. No
discharge furnished

Book mark: J. 17. V. 9. C. 7. 72 V. 141. P. 48-
72. one charge on file see ^{*26} we
* Corrected 7-31-1963. Austin (over)
Chandler

NR 1492

JAN. - 8

5351177

1891

B.V. 4. R. C. J. 67

W | 4th Cav. | U.S.C. I.

Augustus Williams

, Co. B, 4th Reg't U.S.C. Cav.

NOTATION.

Book mark: W-26-R-C-I-1867.

War Department,

Adjutant General's Office,

Washington, March 19, 1867.

Discharge on file.

M. Allen

Copyist.

M | *H Cav.* | *Wes*

Augustus Williams

, Co. *B*, *H* Reg't *Wes Cav.*

NOTATION.

Book mark: *J 57. C. D. 1872.*

War Department,

Adjutant General's Office,

Washington, *June 24th*, 1872.

Call from _____

returned with report.

The above book mark was noted on rolls in order to preserve results of search in this case.

A. M. Muzzey
Copyist.

Williams, Augustus
P, Co. *D*, *4* Reg't *U.S. Cavalry*

1 **Enclosures.**

Bed Cards	Final Statements
Burial Records	Furloughs or L. of A
Certs. of Dis. for Discharge	Med. Certificates
C. M. Charges <i>/</i>	Med. Des. Lists
Descriptive Lists	Orders
Discharge Certificates	Pris. of War Record
Enlistment Papers	Resignations

Other papers relating to—

Admission to Hosp'l	Furlough or L. of A
Casualty Sheet	Med. Examination
Confinement	Misc. Information <i>/</i>
Contracts	Pay or Clothing
Death or Effects	Personal Reports
Desertion	Rank
Discharge from Hosp'l	Transfer to Hosp'l
Discharge from Service	Transfer to V. R. C.
Duty	Transportation

MICROFILM PUBLICATION M 1820

COMPILED MILITARY SERVICE RECORDS
OF VOLUNTEER UNION SOLDIERS WHO
SERVED WITH THE USCT (US COLORED TROOPS)
4TH REGIMENT OF CAVALRY

PERSONAL PAPERS' TARGET SHEET

PLEASE NOTE THE CHECKED INFORMATION ABOUT THE PERSONAL PAPERS IN
THIS FILE:



NO PERSONAL PAPERS WERE FOUND IN THIS FILE WHEN THE
RECORDS WERE ARRANGED FOR MICROFILMING.



2 PERSONAL PAPER(S) FOUND IN THIS FILE WHEN THE RECORDS
WERE ARRANGED FOR MICROFILMING.

[Copy.]

Charges & Specifications
against

Private Augustus Williams,

Co. B. 1st Regiment

Corps d'Artillerie

Original Sent to H. B. L. C. B.
March 6th 1864

4th U. S. C. Cav

DEFENCE

Defences New Orleans,

Office Provost Marshal, No. 48 Baronne Street,

New Orleans,

1864.

Charges and Specifications against Private
Augustus Williams, Co. B. 1st Regt. Cavalry,
Corps d'Afrique.

Charge. Stealing while on guard.

Specification. In this: that he, Private
Augustus Williams, Co. B. 1st Regt. Cav.
Corps d'Afrique, while on guard over
the Commissary stores belonging to his
Company, did steal a revolver placed
there in charge of Commissary Sergeant,
and on being relieved from guard, did
give his pistol to private George Washing-
ton of the same Company, for the pur-
pose of having it sold. All this at
New Orleans, on or about the 27th day
of February, 1864.

Sidore M. Cormack,
Capt. Com. Co. B. 1st Regt.
Cavalry, Corps d'Afrique.

Witness:-

Private George Washington.

Ellerbrook . . .

Priv: Augustus Williams C.B. 4th W. I. C. Cav.

Completed —

War Department,

Adjutant General's Office,

COLORED TROOPS BRANCH,

November 26th, 1873

Vol. C. T., 187

Wanted in case of Private Augustus Williams, Co. "B",
4th Reg't W. I. Colored Cavalry - information as to
cause and date of his arrest and also of his trial, if tried.
He is reported absent in arrest from March 5th 1864 to 20th March
1866.

Respectfully,

W. A. Woodward

Pr. J. Dalton
Chief Clerk.

Adjutant General's Office,

Mr. Ellenbrooks -

Z. R. -

, 187

Vol. C. T., 187

Reply in case of _____, Co. _____,
Reg't _____

Received from the _____
Capt. _____ Corps of Artillery, _____
Prison by order of _____
Prison, Charge Stealing U.S. Arms, sentenced _____
for 30 days.
Records of _____
at _____ furnished no information.

97

1147
William Benjamin

Co B, 4 U. S. Col'd Cav.

Private Private

CARD NUMBERS.

1	5349873	26
2	5349989	27
3	5350084	28
4	5350170	29
5	5350284	30
6	5350351	31
7	5350431	32
8	5350505	33
9	5350578	34
10	5350684	35
11	5350749	36
12	5350843	37
12	5350929	38
14	5351013	39
15	5351095	40
16	5351176	41
17		42
18		43
19		44
20		45
21		46
22		47
23		48
24		49
25		50

Book Mark:

See also

W | **4 Cav.** | **U.S.C.T.**

Benjamin Williams
Co. B, Co. *B*, 1 Reg't La. Cav., Corps d'Afrique.*

Appears on

Company Muster-in Roll

of the organization named above. Roll dated
New Orleans La, Oct 27, 186 *B*.
Muster-in to date *Oct 27*, 186 *B*.

Joined for duty and enrolled:

When *Oct 13*, 186 .

Where *New Orleans*

Period *3* years.

Valuation of horse, \$.....*100*

Valuation of horse equipments, \$.....*100*

Remarks :
.....
.....
.....

*This organization subsequently became Co. *B*, 4 Reg't U. S. Colored Cavalry.

Book mark :
.....

Copyist.

W.

4 Cav. | U.S.C.T.

Benjamin Williams

Co. B, 1 Reg't La. Cav., Corps d'Afrique.*

Appears on

Company Muster Roll

for *(Oct 27 to Dec 31)*, 1863.

Present or absent *Present*

Stoppage, \$ *100* for

Due Gov't, \$ *100* for

Valuation of horse, \$ *100*

Valuation of horse equipments, \$ *100*

Remarks:

*This organization subsequently became Co. *B*, 4 Reg't U. S. Colored Cavalry.

Book mark:

Mary
Copyist.

W

4 Cav. U.S.C.T.

Benjamin Williams
Co. B, 1 Reg't Cav., Corps d'Afrique.*

Appears on

Company Muster Roll

for *Jan. Feb*, 1864.

Present or absent *Present*

Stoppage, \$ *100* for

Due Gov't, \$ *100* for

Valuation of horse, \$ *100*

Valuation of horse equipments, \$ *100*

Remarks: _____

* This organization subsequently became Co. *B*, 4 Reg't U. S. Colored Cavalry.

Book mark: _____

(358)

Copy
Copyist.

W | **4 Cav. | U.S.C.T.**

Benjamin
~~*Benjamin*~~ *Williams*

W, Co. B. 4 Reg't U. S. Col'd Cavalry.

Appears on

Company Muster Roll

for *March & Apr*, 1864.

Present or absent *Present*

Stoppage, \$ 100 for

Due Gov't, \$ 100 for

Valuation of horse, \$ 100

Valuation of horse equipments, \$ 100

Remarks :

connected by

Book mark :

Copy
Copyist.

MAR 1866

N | **4 Cav.** | **U.S.C.T.**

Benjamin Williams
Bob, Co. B. 4 Reg't U. S. Col'd Cavalry.

Appears on

Company Muster Roll

for *May & June*, 186*6*.

Present or absent *Present*

Stoppage, \$ 100 for

Due Gov't, \$ 100 for

Valuation of horse, \$ 100

Valuation of horse equipments, \$ 100

Remarks :

.....
.....
.....
.....
.....
.....
.....
.....

Book mark :

.....

(358)

Wm. H. [Signature]
Copyist.

NOV 1867

W | **4 Cav.** | **U.S.C.T.**

Benjamin Williams
Co, Co. B. 4 Reg't U. S. Col'd Cavalry.

Appears on

Company Muster Roll

for *July, & Aug.*, 1864.

Present or absent *Present*

Stoppage, \$ 100 for

Due Gov't, \$ 100 for

Valuation of horse, \$ 100

Valuation of horse equipments, \$ 100

Remarks :

Book mark :

(358)

W. L. King
Copyist.

W | **4 Cav.** | **U.S.C.T.**

Benjamin Williams

priv., Co. B. 4 Reg't U. S. Col'd Cavalry.

Appears on

Company Muster Roll

for Nov & Dec, 1864.

Present or absent present

Stoppage, \$ 100 for

Due Gov't, \$ 100 for

Valuation of horse, \$ 100

Valuation of horse equipments, \$ 100

Remarks :

Book mark :

Southern
Copyist.

W | **4 Cav. U.S.C.T.**

Benjamin Williams
pot, Co. B. 4 Reg't U. S. Col'd Cavalry.

Appears on

Company Muster Roll

for Jan & Feb., 1865.

Present or absent present

Stoppage, \$ 100 for

Due Gov't, \$ 100 for

Valuation of horse, \$ 100

Valuation of horse equipments, \$ 100

Remarks: Received only \$7 a
month to include Apr 30/64

Book mark:

Sumner
(358) Copyist.

W | **4 Cav.** | **U.S.C.T.**

Benjamin William

priv, Co. B. 4 Reg't U. S. Col'd Cavalry.

Appears on

Company Muster Roll

for *March & April*, 186 *5*.

Present or absent *present*

Stoppage, \$ 100 for

Due Gov't, \$ 100 for

Valuation of horse, \$ 100

Valuation of horse equipments, \$ 100

Remarks : *Stop for one spare horse.*

Book mark :

W

4 Cav. | U.S.C.T.

Benjamin Williams

priv., Co. B. 4 Reg't U. S. Col'd Cavalry.

Appears on

Company Muster Roll

for *May 1 June*, 186*2*.

Present or absent *present*

Stoppage, \$ *100* for

Due Gov't, \$ *100* for

Valuation of horse, \$ *100*

Valuation of horse equipments, \$ *100*

Remarks :

Book mark :

L. J. ...

M | **4 Cav.** | **U.S.C.T.**

Benjamin Williams
547, Co. B. 4 Reg't U. S. Col'd Cavalry.

Appears on

Company Muster Roll

for *July & Aug*, 186*5*.

Present or absent *present*

Stoppage, \$ *100* for

Due Gov't, \$ *100* for

Valuation of horse, \$ *100*

Valuation of horse equipments, \$ *100*

Remarks :

Book mark :

Sumner

(358) Copyist.

W

4 Cav. U.S.C.T.

Benjamin Williams

Sgt., Co. B. 4 Reg't U. S. Col'd Cavalry.

Appears on

Company Muster Roll

for *Sept & Oct*, 186 *3*.

Present or absent *present*

Stoppage, \$ 100 for

Due Gov't, \$ 100 for

Valuation of horse, \$ 100

Valuation of horse equipments, \$ 100

Remarks :

Book mark :

W

77 | **4 Cav.** | **U.S.C.T.**

Benjamin Williams
Priv., Co. B. 4 Reg't U. S. Col'd Cavalry.

Appears on

Company Muster Roll

for Nov. Dec., 1865.

Present or absent Present

Stoppage, \$ 100 for

Due Gov't, \$ 100 for

Valuation of horse, \$ 100

Valuation of horse equipments, \$ 100

Remarks :

Book mark :

Charles

W

4 Cav. U.S.C.T.

Benjamin Williams

Por, Co. B. 4 Reg't U. S. Col'd Cavalry.

Appears on

Company Muster Roll

for *Jan. & Feb.*, 1866.

Present or absent *Present*

Stoppage, \$ 100 for

Due Gov't, \$ 100 for

Valuation of horse, \$ 100

Valuation of horse equipments, \$ 100

Remarks :

Book mark :

Chandler

NARA 1517

W | **4 Cav. | U.S.C.T.**

Benjamin Williams
Priv, Co. B, 4 Reg't U. S. Col'd Cavalry.

Appears on **Co. Muster-out Roll**, dated
New Orleans, La. Feb. 20, 1866.

Muster-out to date Feb. 20, 1866.

Last paid to June 30, 1865.

Clothing account:

Last settled....., 186 ; drawn since \$.....100

Due soldier \$ 35-35-100; due U. S. \$.....100

Am't for cloth'g in kind or money adv'd \$.....100

Due U. S. for arms, equipments, &c., \$.....100

Bounty paid \$.....100; due \$.....100

Remarks: Joined as Org'l org.

Book mark: 2554 P.M. G. July 13. 66
V. 25. P. 83. 68

(361)

Chandler
Copyist.

1148
Williams Gakely

Co *K*, 4 U. S. Col'd Cav.

Private | *Private*

CARD NUMBERS.

1	5347583	26
2	5358437	27
3	5348198	28
4	40729335	29
5		30
6		31
7		32
8		33
9		34
10		35
11		36
12		37
13		38
14		39
15		40
16		41
17		42
18		43
19		44
20		45
21		46
22		47
23		48
24		49
25		50

Book Mark:

See also

W | **4 Cav. U.S.C.T.**

Blakey Williams

Appears with rank of *Priv.* on

Muster and Descriptive Roll of a Detachment of U. S. Vols. forwarded

for the 4 Reg't U. S. Col'd Cavalry. Roll dated

New Orleans La., May 9, 1864.

Where born *Bayou Boeuf La.*

Age *19* y'rs; occupation *Laborer*

When enlisted *May 4*, 1864.

Where enlisted *New Orleans*

For what period enlisted *3* years.

Eyes *Black*; hair *Black*

Complexion *Black*; height *5* ft. *3* in.

When mustered in *May 9*, 1864.

Where mustered in *New Orleans*

Bounty paid 2.
Bounty paid \$ *100*; due \$ *100*

Where credited

Company to which assigned *A*

Remarks:

Book mark:

T. Easter

24 | **4 Cav.** | **U.S.C.T.**

Blakely, Williams
....., Co. *K*, 4 Reg't U. S. Col'd Cavalry.

Age.....years.

Appears on

Company Muster Roll*

for *May 9 to June 30*, 186*4*.

Joined for duty and enrolled:

When *May 11*, 186*4*.

Where *New Orleans, La.*

Period *3* years.

Mustered in:

When *May 9*, 186*4*.

Where *New Orleans, La.*

Present or absent

Stoppage, \$.....¹⁰⁰ for.....

Due Gov't, \$.....¹⁰⁰ for.....

Valuation of horse, \$.....¹⁰⁰

Valuation of horse equipments, \$.....¹⁰⁰

Remarks: *Died in General Hospital New Orleans, La.*

* First current roll. No muster-in roll of this battery on file.

Book mark: *See muster out roll filed with co.*

W. S. Thompson

(358b)

Copyist.

(over)

RECEIVED

JAN. - 9

5358437

1891

June 11, '864. Drs. Roll
furnished

W | 4 Cav. | U.S.C.T.

Blakely Williams

Part, Co. K, 4 Reg't U. S. Colored Cav.

Appears on Returns as follows:

June 1864 - Loss: June 11/64
New Orleans died of disease
in hospital.

Book mark:

W. R. Lee

714 Co. K. 4 **U.S.C.T.**

Blakely, William

Co. K. 4 Reg't U. S. Col'd Co. K. 4

Appears on a

Detachment Muster-out Roll

of the organization named above. Roll dated
New Orleans La. June 20, 1864

Muster-out to date 186 .

Last paid to 186 .

Clothing account:

Last settled 186 ; drawn since \$ 100

Due soldier \$ 100; due U. S. \$ 100

Am't for cloth'g in kind or money adv'd \$ 100

Due U. S. for arms, equipments, &c., \$ 100

Bounty paid \$ 100; due \$ 100

Remarks: Wounded at Vicksburg
Organization. Died at
Camp of Instruction Gen. Hooker
New Orleans La. June 11, 1864.
Final statement forwarded.

Book mark: U.S. C. 245. 69.

Forsythe

Williams, Blakely
P, Co. K, 4 U.S.C. Cav.

3 Enclosures.

Bed Cards	Descriptive Lists
Burial Records	Final Statements 2
Certs. of Dis. for Discharge	Furloughs
C. M. Charges	Med. Des. Lists
Med. Certificates	Orders

Other papers relating to—

Admission to Hosp'l	Furlough
Casualty Sheet (Officer's)	Med. Examination
Confinement	Misc. Information
Contracts	Pay or Clothing
Death or Effects /	Personal Reports
Desertions	Rank
Discharge from Hosp'l	Transfer to Hosp'l
Discharge from Service	Transfer to V. R. C.
Duty	Transportation

June 11th 1864

FINAL STATEMENT

OF

Private Charles Williams

Co. 4th Reg't of W. I. & C. Inf.

VOLUNTEERS.

C. d'U. Hook

NOTE 1.—Two of these certificates (or duplicates) are to be given to each Volunteer Soldier or drafted man who may be discharged previously to the discharge of his company, that he may at once receive from the Paymaster the pay, &c., due him, and the captain or other COMMISSIONED officer commanding the company will certify to the act of the delivery of the duplicate certificates; on these certificates the Soldier is "entitled to" his discharge, and should also present his discharge to the Paymaster to have the payment endorsed on it. The discharge is to be given back to the Soldier by the Paymaster; the latter only retaining as his voucher the duplicate certificates.

NOTE 2.—If the Soldier is entitled to pay for the use of his horse, the Company Commander will certify to that fact on the back of both these final statements, and also to the time he has pay due for having been so mounted on his own horse.

NOTE 3.—When a Soldier is furnished with final statements, his descriptive list, if he has one, should be taken up by the officer who gives the Soldier these statements, and endorsed with a statement to this effect by the officer. This endorsement should exhibit a full statement of the time for which the Soldier was allowed pay on his final statements, the clothing account, and all other charges against him or in his favor, so as to comprise a complete exhibit of his account. It will then be transmitted to the company commander of the Soldier, who will enter all the data necessary to a full understanding of the Soldier's account on the muster roll upon which the Soldier's discharge is reported. The descriptive list will then be destroyed. The object of this is, that the remaining portion of the Soldier's account may be settled upon the receipt of these muster rolls, and the Soldier receive any pay or allowances that may be due him at the time of his discharge, and which may not appear on his final statements from the fact that his descriptive list is incomplete. These accounts for back pay, &c., are settled by the 2d Auditor of the Treasury Department.

NOTE 4.—Charges for loss or injury to ordnance, horse equipments, and other miscellaneous charges, should appear under the heading of "Other Stoppages."

NOTE 5.—Bounty paid by State authorities, and not by the United States, will not be entered on this statement.

NOTE 6.—Amounts due the Sutler and Laundress must be entered on the muster roll on which the discharge, death, desertion, &c., is reported, as well as on the final statement, otherwise the amount cannot be collected from the United States.

NOTE 7.—This blank will be used for deceased volunteers and drafted men, as well as for others.

NOTE 8.—Where a Soldier dies in Hospital or on detached service, his descriptive list, if he has one, should be sent with his final statements, in duplicate, to the Second Auditor, Washington, D. C.

I certify, on honor, that *Blakely Williams* ^{Late Private} of
 Captain *William Goodrich* Company No. of the *4th* Regiment of *U.S. Colored Cavalry*
VOLUNTEERS, of the State of _____, born in *Bayou Lafourche*, State
 of *Louisiana*, aged *19* years; *5* feet *3* inches high; *black* complexion,
black eyes, *black* hair, and by occupation a *Laborer*, having joined the company on
 its original organization at _____, and enrolled in it at the muster into
 the service of the United States at *New Orleans La.*, on the *4th* day
 of *May*, 186*4*; (or was mustered in service as a recruit, by *Sgt*
Chamberlin, at *New Orleans* on the *9th* day of *May*,
 186*4* or was drafted and mustered into the service of the United States from the _____
 Enrollment District of the State of _____, at _____,
 on the _____ day of _____, 186*4*.) to serve in the Regiment, for
 the term of *Three Years*; and having served **HONESTLY** and
FAITHFULLY with his Company in *this Department* to the present date, is ~~now~~
 entitled to a **DISCHARGE** by reason of *Died at the Camp & Spri Genl*
Hospital New Orleans La on the 11th day of June 1864

The said *Late Blakely Williams* was last paid by Paymaster
 _____ to include the _____ day of _____, 186*4*, and has
 pay due him from that time to the present date; he is entitled to pay and subsistence for
TRAVELING to place of enrollment, and whatever other allowances are authorized to volunteer
 soldiers, drafted men, or militia, so discharged. He has received from the United States **CLOTHING**
 amounting to *Thirty one 31* ^{*44*} _{*100*} dollars, since the _____ day of *enlistment*,
 186*4*, when his clothing account was last settled. He has received from the United States
Two dolls 2 ^{*00*} _{*100*} dollars advanced **BOUNTY**. *Premium*

There is to be stopped from him, on account of the State of _____, or other
 authorities, for **CLOTHING**, &c., received on entering service, _____ _{*100*} dollars; and
 for other stoppages, viz: _____

_____ _{*100*} dollars.
 He has been furnished with **TRANSPORTATION** in kind from the place of his discharge to
 _____; and he has been **SUBSISTED** for **TRAVELING** to his
 place of enrollment, up to the _____, 186*4*.

He is indebted to _____, **SUTLER**, _____ _{*100*} dollars.
 He is indebted to _____, **LAUNDRESS**, _____ _{*100*} dollars.

Given in Duplicate, at *Camp & Spri Genl. Camp N. Orleans La* this *11th* day
 of *June*, 186*4*

Surgeon in Charge of Camp & Spri Genl. Hosp

 Commanding Company.

copy,
Asst. Cash sent 2^d Auditor,
Sr.

Duplicates

FINAL STATEMENT

OF *Private*
Blatchy Williams
4 Reg't of *A S Co Calif*

VOLUNTEERS.

Acct June 11 1864

NOTE 1.—Two of these certificates (or duplicates) are to be given to each Volunteer Soldier or drafted man who may be discharged previously to the discharge of his company, that he may at once receive from the Paymaster the pay, &c., due him, and the captain or other COMMISSIONED officer commanding the company will certify to the act of the delivery of the duplicate certificates; on these certificates the Soldier is "entitled to" his discharge, and should also present his discharge to the Paymaster to have the payment endorsed on it. The discharge is to be given back to the Soldier by the Paymaster; the latter only retaining as his voucher the duplicate certificates.

NOTE 2.—If the Soldier is entitled to pay for the use of his horse, the Company Commander will certify to that fact on the back of both these final statements, and also to the time he has pay due for having been so mounted on his own horse.

NOTE 3.—When a Soldier is furnished with final statements, his descriptive list, if he has one, should be taken up by the officer who gives the Soldier these statements, and endorsed with a statement to this effect by the officer. This endorsement should exhibit a full statement of the time for which the Soldier was allowed pay on his final statements, the clothing account, and all other charges against him or in his favor, so as to comprise a complete exhibit of his account. It will then be transmitted to the company commander of the Soldier, who will enter all the data necessary to a full understanding of the Soldier's account on the muster roll upon which the Soldier's discharge is reported. The descriptive list will then be destroyed. The object of this is, that the remaining portion of the Soldier's account may be settled upon the receipt of these muster rolls, and the Soldier receive any pay or allowances that may be due him at the time of his discharge, and which may not appear on his final statements from the fact that his descriptive list is incomplete. These accounts for back pay, &c., are settled by the 2d Auditor of the Treasury Department.

NOTE 4.—Charges for loss or injury to ordnance, horse equipments, and other miscellaneous charges, should appear under the heading of "Other Stoppages."

NOTE 5.—Bounty paid by State authorities, and not by the United States, will not be entered on this statement.

NOTE 6.—Amounts due the Sutler and Laundress must be entered on the muster roll on which the discharge, death, desertion, &c., is reported, as well as on the final statement, otherwise the amount cannot be collected from the United States.

NOTE 7.—This blank will be used for deceased volunteers and drafted men, as well as for others.

NOTE 8.—Where a Soldier dies in Hospital or on detached service, his descriptive list, if he has one, should be sent with his final statements, in duplicate, to the Second Auditor, Washington, D. C.

ADJUTANT GENERAL'S OFFICE.
Aug 31 1864
Duplicate with Inventory sent 2d Auditor.



Leung

I certify, on honor, that W. H. Williams a Private of
 Captain Walter Goodrich Company (K) of the 4 Regiment of U. S. Col. Cav.
VOLUNTEERS, of the State of _____, born in Bayou Lafourche State
 of Louisiana, aged 19 years; 5-feet 5 inches high; Blk complexion,
Blk eyes, Blk hair, and by occupation a Saturner, having joined the company on
 its original organization at _____, and enrolled in it at the muster into
 the service of the United States at New Orleans La., on the 4th day
 of May, 1864 (or was mustered in service as a recruit, by Sent
Chamberlain, at New Orleans La. on the 9th day of May,
 1864 or was drafted and mustered into the service of the United States from the _____
 Enrollment District of the State of _____, at _____,
 on the _____ day of _____, 1864) to serve in the Regiment, for
 the term of 3 Years: and having served HONESTLY and
 FAITHFULLY with his Company in this Regt. to the present date, ~~is now~~
 entitled to a ~~DISCHARGE~~ by reason of died at the Corps Dépôt
Gen Hosp. New Orleans La. on the 11th day of June 1864
 The said W. H. Williams was ~~last~~ ^{never} paid by Paymaster
May to include the _____ day of _____, 1864, and has
 pay due him from that time to the present date; he is entitled to pay and subsistence for
 TRAVELING to place of enrollment, and whatever other allowances are authorized to volunteer
 soldiers, drafted men, or militia, so discharged. He has received from the United States **CLOTHING**
 amounting to Thirty One $\frac{1}{100}$ dollars, since the _____ day of Enlistment
 1864, when his clothing account was last settled. He has received from the United States
 _____ $\frac{1}{100}$ dollars advanced **BOUNTY**.

There is to be stopped from him, on account of the State of _____, or other
 authorities, for **CLOTHING**, &c., received on entering service, _____ $\frac{1}{100}$ dollars; and
 for other stoppages, viz: _____

_____ $\frac{1}{100}$ dollars.
 He has been furnished with TRANSPORTATION in kind from the place of his discharge to
 _____; and he has been SUBSISTED for TRAVELING to his
 place of enrollment, up to the _____, 1864.

He is indebted to _____, **SUTLER**, _____ $\frac{1}{100}$ dollars.
 He is indebted to _____, **LAUNDRESS**, _____ $\frac{1}{100}$ dollars.

Given in Duplicate, at Corps Dépôt Gen Hosp., this 11th day
 of June, 1864

F. E. Fiquette
Surgeon in Charge, Corps Dépôt Gen Hosp.
 Commanding Company

(Duplicate)

ARTICLES OF WAR.

ART. 95. When any non-commissioned officer or soldier shall die, or be killed in the service of the United States, the then commanding officer of the troop or company shall, in the presence of two other commissioned officers, take an account of what effects he died possessed of, above his arms and accoutrements, and transmit the same to the office of the Department of War, which said effects are to be accounted for, and paid to the representatives of such deceased non-commissioned officer or soldier. And in case any of the officers, so authorized to take care of the effects of deceased officers and soldiers, should, before they have accounted to their representatives for the same, have occasion to leave the regiment or post, by preferment or otherwise, they shall, before they be permitted to quit the same, deposit in the hands of the commanding officer, or of the assistant military agent, all the effects of such deceased non-commissioned officers and soldiers, in order that the same may be secured for, and paid to, their respective representatives.

ARMY REGULATIONS—EDITION OF 1861.

DECEASED SOLDIERS.

Par. 152. Inventories of the effects of deceased non-commissioned officers and soldiers, required by the 95th Article of War, will be forwarded to the Adjutant General, by the commander of the company to which the deceased belonged, and a duplicate of the same to the colonel of the regiment. Final statements of pay, clothing, &c., will be sent with the inventories. When a soldier dies at a post or station absent from his company, it will be the duty of his immediate commander to furnish the required inventory, and, at the same time, to forward to the commanding officer of the company to which the soldier belonged, a report of his death, specifying the date, place, and cause; to what time he was last paid, and the money or other effects in his possession at the time of his decease; which report will be noted on the next muster roll of the company to which the man belonged. Each inventory will be endorsed, "Inventory of the effects of _____, late of company (—) _____ regiment of _____, who died at _____, the _____ day of _____, 186—." If a legal representative receive the effects, it will be stated in the report. If the soldier leave no effects, the fact will be reported.

Par. 153. Should the effects of a deceased non-commissioned officer or soldier not be administered upon within a short period after his decease, they shall be disposed of by a Council of Administration, under the authority of the commanding officer of the post, and the proceeds deposited with the Paymaster, to the credit of the United States, until they shall be claimed by the legal representatives of the deceased.

Par. 154. In all such cases of sales by the Council of Administration, a statement in detail, or account of the proceeds, duly certified by the Council and commanding officer, accompanied by the Paymaster's receipt for the proceeds, will be forwarded by the commanding officer to the Adjutant General. The statement will be endorsed, "Report of the proceeds of the effects of _____, late of company (—) _____ regiment of _____, who died at _____, the _____ day of _____, 186—."

NOTE 1.—The effects in all cases, when called for, should be turned over to the legal representative, without further authority from the Adjutant General. When the effects are turned over to the relatives of the deceased before these inventories are sent to the Adjutant General, their receipts therefor should be attached to the inventories. In all other cases, one copy will be sent with a letter of transmittal direct to the Adjutant General, and a duplicate retained by the officer.

NOTE 2.—Particular care should be taken to take receipts in duplicate from the Paymaster for any funds turned over to him; one copy should be sent direct to the Adjutant General and one retained by the officer.

INVENTORY OF THE EFFECTS

OF

Private Blahely Williams

Late of Company K

4th Reg't of U.S. Colored Cavalry

Volunteers, who died at Camp of the 1st Div.

on the 11th day of June 1864

1149

Williams Charles

Co C, 4 U. S. Col'd Cav.

Private

Private

CARD NUMBERS.

1	5351288	26
2	5351344	27
3	5351396	28
4	5351479	29
5	5351546	30
6	5351604	31
7	5351640	32
8	5351701	33
9	5351766	34
10	5351916	35
11	5352019	36
12	5352116	37
12	5352214	38
14	5352307	39
15	5352395	40
16	5352484	41
17		42
18		43
19		44
20		45
21		46
22		47
23		48
24		49
25		50

Book Mark:

See also

A 2029277 Pointon
R4P653571

S-2055-688 And Mid. (2nd H)
S. 2214374 and 1031
S. 2294228. P.O. Rev
S. 2311629 P.O. Rev
S. 2983027 And with

J. A. Muhlman
1953

MAR 15 1863

W | 4 Cav. | U.S.C.T.

Charles Williams

Pvt, Co. *C*, 1 Reg't La. Cav., Corps d'Afrique.*

Appears on

Company Muster-in Roll

of the organization named above. Roll dated

New Orleans, La Nov 7, 186*3*.

Muster-in to date

Nov 7, 186*3*.

Joined for duty and enrolled:

When *Oct 10*, 186*3*.

Where *New Orleans city*

Period *3* years.

Valuation of horse, \$ *100*

Valuation of horse equipments, \$ *100*

Remarks:

Mar 24

*This organization subsequently became Co. *C*, 4 Reg't U. S. Colored Cavalry.

Book mark:

Reed

W | **4 Cav. | U.S.C.T.**

Charles Williams
Pt. *C*, Co. *C*, 1 Reg't La. Cav., Corps d'Afrique.*

Appears on

Company Muster Roll

for *Nov 7 to Dec 31*, 186*3*

Present or absent *Present*

Stoppage, \$ *100* for

Due Gov't, \$ *100* for

Valuation of horse, \$ *100*

Valuation of horse equipments, \$ *100*

Remarks:

FROM SECOND AUDITOR'S ROLL.

*This organization subsequently became Co. *C*, 4 Reg't U. S. Colored Cavalry.

Book mark:

Redeemer

W | 4 Cav. | U.S.C.T.

Charles Williams

Plt., Co. *C*, 1 Reg't La. Cav., Corps d'Afrique.*

Appears on

Company Muster Roll

for *Jan + Feb*, 1864.

Present or absent *Present*

Stoppage, \$ *100* for

Due Gov't, \$ *100* for

Valuation of horse, \$ *100*

Valuation of horse equipments, \$ *100*

Remarks:

*This organization subsequently became Co. *C*, 4 Reg't U. S. Colored Cavalry.

Book mark: *Present*

Becher

W | **4 Cav.** | **U.S.C.T.**

Charles Williams

Pvt., Co. C, 4 Reg't U. S. Colored Cavalry.

Appears on

Company Muster Roll

for *Nov 1st*, 1864.

Present or absent *Present*

Stoppage, \$ 100 for

Due Gov't, \$ 100 for

Valuation of horse, \$ 100

Valuation of horse equipments, \$ 100

Remarks :

Book mark :

Proctor

W | **4 Cav.** | **U.S.C.T.**

Charles Williams
Pvt, Co. C, 4 Reg't U. S. Colored Cavalry.

Appears on

Company Muster Roll

for *May & June*, 1864.

Present or absent *Present*

Stoppage, \$ 100 for

Due Gov't, \$ 100 for

Valuation of horse, \$ 100

Valuation of horse equipments, \$ 100

Remarks :

Book mark :

Reharter

W | **4 Cav.** | **U.S.C.T.**

Charles Williams
Pvt., Co. C, 4 Reg't U. S. Colored Cavalry.

Appears on

Company Muster Roll

for *July & Aug*, 186*4*.

Present or absent *Present*

Stoppage, \$ 100 for

Due Gov't, \$ 100 for

Valuation of horse, \$ 100

Valuation of horse equipments, \$ 100

Remarks :

Book mark :

W. S. Suter

W | **4 Cav.** | **U.S.C.T.**

Charles Williams
Corp, Co. C, 4 Reg't U. S. Colored Cavalry.

Appears on

Company Muster Roll

for *Sept 5th* 1864.

Present or absent *Present*

Stoppage, \$ 100 for

Due Gov't, \$ 100 for

Valuation of horse, \$ 100

Valuation of horse equipments, \$ 100

Remarks : *Promoted to Corp.*
Oct 1st 64

Book mark :

Reharter

H | 4 Cav. | U.S.C.T.

Charles Williams
Corpl, Co. C, 4 Reg't U. S. Colored Cavalry.

Appears on

Company Muster Roll

for *Nov & Dec*, 186 *4*

Present or absent *present*

Stoppage, \$ *2* ^{*23*}/₁₀₀ for *ordnance*

Due Gov't, \$ 100 for

Valuation of horse, \$ 100

Valuation of horse equipments, \$ 100

Remarks: *Lost ordnance*

Book mark:

(358)

Moy
Copyist.

M | 4 Cav. | U.S.C.T.

Charles Williams
Corpl, Co. C, 4 Reg't U. S. Colored Cavalry.

Appears on

Company Muster Roll

for *Jan & Feb* 186*5*.

Present or absent *present*

Stoppage, \$ *100* for

Due Gov't, \$ *100* for

Valuation of horse, \$ *100*

Valuation of horse equipments, \$ *100*

Remarks: *Received \$7.00 per month to include April 30, 1864. Stop for one saddle blanket.*

Book mark:

(358)

Mivy
Copyist.

MAR 15 1865

H | **4 Cav. U.S.C.T.**

Charles Williams
Priv, Co. C, 4 Reg't U. S. Colored Cavalry.

Appears on

Company Muster Roll

for Mohe Paper, 1865.

Present or absent present

Stoppage, \$ 100 for

Due Gov't, \$ 100 for

Valuation of horse, \$ 100

Valuation of horse equipments, \$ 100

Remarks:

Book mark:

(358)

Moyle
Copyist.

H | 4 Cav. | U.S.C.T.

Charles Williams
Priv, Co. C, 4 Reg't U. S. Colored Cavalry.

Appears on

Company Muster Roll

for *May & June*, 1865.

Present or absent *present*

Stoppage, \$ *100* for

Due Gov't, \$ *100* for

Valuation of horse, \$ *100*

Valuation of horse equipments, \$ *100*

Remarks: *Stop for one Sabre belt, one cart. box, one cap box, 2 canteens, 1 haversack,*

Book mark:

(358)

Moy
Copyist.

MAR 15 44

M | **4 Cav.** | **U.S.C.T.**

Charles Williams
Priv, Co. C, 4 Reg't U. S. Colored Cavalry.

Appears on

Company Muster Roll

for *July & Aug*, 186*5*.

Present or absent. *present*

Stoppage, \$ *100* for

Due Gov't, \$ *100* for

Valuation of horse, \$ *100*

Valuation of horse equipments, \$ *100*

Remarks: *Stop for 1 sabre, belt & plate, 1 cartdg. box, 1 cap box, 2 canteens, 1 haversack, Total \$5.70.*

Book mark: _____

(358)

Moy

Copyist.

A | **4 Cav.** | **U.S.C.T.**

Charles Williams

Priv, Co. C, 4 Reg't U. S. Colored Cavalry.

Appears on

Company Muster Roll

for Sept & Oct, 1865.

Present or absent present

Stoppage, \$ 100 for

Due Gov't, \$ 100 for

Valuation of horse, \$ 100

Valuation of horse equipments, \$ 100

Remarks: Stop for 1 surcingle
1.16, 1 saddle blanket 2.25,
1 pr spurs & straps 60cts, 1
curry comb & brush 87cts, 1
girth 66cts, 1 car socket &
strap 47cts, Total \$6.01

Book mark:

Moy

(358)

Copyist.

W | **4 Cav.** | **U.S.C.T.**

Charles Williams

Private, Co. C, 4 Reg't U. S. Colored Cavalry.

Appears on

Company Muster Roll

for *Nov + Dec*, 186*5*.

Present or absent *present*

Stoppage, \$ *9* ^{*17*}/_{*100*} for *Lost Ordnance*

Due Gov't, \$ *100* for

Valuation of horse, \$ *100*

Valuation of horse equipments, \$ *100*

Remarks:

Book mark:

M. A. Michaels

(358)

Copyist.

W | **4 Cav.** | **U.S.C.T.**

Charles Williams

Private, Co. C, 4 Reg't U. S. Colored Cavalry.

Appears on

Company Muster Roll

for *Jan'y + Febr*, 1866.

Present or absent *present*

Stoppage, \$ *27*/₁₀₀ for *cash*
Ordinance

Due Gov't, \$ *100* for

Valuation of horse, \$ *100*

Valuation of horse equipments, \$ *100*

Remarks:

Book mark: -----

M. A. Michaels

N | 4 Cav. | U.S.C.T.

Chas Williams

Private, Co. *C*, 4 Reg't U. S. Col'd Cavalry.

Appears on **Co. Muster-out Roll**, dated
New Orleans La Mar 20, 1866.

Muster-out to date *Mar 20*, 1866.

Last paid to *June 30*, 1866.

Clothing account:

Last settled....., 186 ; drawn since \$.....100

Due soldier \$.....100; due U. S. \$ *29* ⁴⁴/₁₀₀

Am't for cloth'g in kind or money adv'd \$.....100

Due U. S. for arms, equipments, &c., \$ *27* ⁶⁵/₁₀₀

Bounty paid \$.....100; due \$.....100

Remarks: *Joined Orig. Reg. Corp'l*
from Oct 1/64 to March 18/65 Stop
1 Belt, 1 Carbine Socket & Strap, 1
Amcingle, 1 Saddle Blanket 1 p Spurs
& Straps 1 Horsebrush, 1 Curry Comb,
1 Burnside Carbine

Book mark: *V 25 P. 119-68*

M. A. Michaels

1150

Williams Charles

Co A, 4 U. S. Col'd Cav.

Private Private

CARD NUMBERS.

1	5347947	26
2	5352956	27
3	5353039	28
4	5353121	29
5	5353220	30
6	5353312	31
7	5353406	32
8	5353494	33
9	5353581	34
10	5353663	35
11	5353743	36
12	40729336	37
13		38
14		39
15		40
16		41
17		42
18		43
19		44
20		45
21		46
22		47
23		48
24		49
25		50

Book Mark:

See also

1959

S-2061261 And W.D. (in HP 29)
D. 2197109 POWNM
R4 P. 701034
D. 2202525 And W.D.

S. J. Muhlman
S. J.

W | *4ca* | **U.S.C.T**

Charles Williams

Appears with rank of *Priv* on

Muster and Descriptive Roll of a Detachment of Drafted Men and Substitutes forwarded

for the *4* Reg't U.S. Col'd *Cav* Roll dated *New Orleans La Sept 1, 1864*

Where born *Lafourche La*

Age *18* years; occupation *Laborer*

Drafted and mustered in:

When *Sept 1*, 1864.

Where *New Orleans*

Period *3* years.

Eyes *Blk*; hair *Blk*

Complexion *Dark*; height *5* ft. *2* in.

Paid bounty and advance pay, \$ *100*

Bounty due \$ *100 none*

Where credited

Company to which assigned *D*

Remarks:

Book mark:

(340)

J. M. ...

Capt.

W | 4 Cav. | U.S.C.T.

Charles Williams

Priv., Co. D., 4 Reg't U. S. Colored Cav.

Appears on Returns as follows:

Sept 1864 - Gain: Sept 3/64
Port Hudson, enlisted

Book mark:

W. R. See

4 | 4 Cav. | U.S.C.T.

Charles Williams

Priv., Co. D, 4 Reg't U. S. Col'd Cavalry.

Appears on

Company Muster Roll

for Sept & Oct, 1864.

Present or absent Present

Stoppage, \$ 100 for

Due Gov't, \$ 100 for

Valuation of horse, \$ 100

Valuation of horse equipments, \$ 100

Remarks:

Book mark:

Rosenbaum

W | **4 Cav.** | **U.S.C.T.**

Charles Williams

P, Co. D, 4 Reg't U. S. Col'd Cavalry.

Appears on

Company Muster Roll

for *May + Dec*, 186*4*.

Present or absent *Present*

Stoppage, \$ 100 for

Due Gov't, \$ 100 for

Valuation of horse, \$ 100

Valuation of horse equipments, \$ 100

Remarks:

Book mark: -----

(358)

W. Williams

Copyist.

W | **4 Cav.** | **U.S.C.T.**

Charles Williams

D, Co. D, 4 Reg't U. S. Col'd Cavalry.

Appears on

Company Muster Roll

for *Jan & Feb*, 186*5*.

Present or absent *Present*

Stoppage, \$ *100* for

Due Gov't, \$ *100* for

Valuation of horse, \$ *100*

Valuation of horse equipments, \$ *100*

Remarks:

Book mark:

W. Williams
(358) Copyist.

11 | 4 Cav. | U.S.C.T.

Wm. Williams

....., Co. D, 4 Reg't U. S. Col'd Cavalry.

Appears on

Company Muster Roll

for *March 1865*, 1865.

Present or absent *Present*

Stoppage, \$ *100* for

Due Gov't, \$ *100* for

Valuation of horse, \$ *100*

Valuation of horse equipments, \$ *100*

Remarks: *Stop for lost card # 531*

Book mark: *2*

W. H. Bryant

A | **4 Cav.** | **U.S.C.T.**

Charles Williams

D, Co. D, 4 Reg't U. S. Col'd Cavalry.

Appears on

Company Muster Roll

for *May & June*, 1865.

Present or absent *Present*

Stoppage, \$ 100 for

Due Gov't, \$ 100 for

Valuation of horse, \$ 100

Valuation of horse equipments, \$ 100

Remarks: *sent for int. Cert # 331*

Book mark:

W. H. Bennett
Copyist.

W | **4 Cav.** | **U.S.C.T.**

Charles Williams

P, Co. D. 4 Reg't U. S. Col'd Cavalry.

Appears on

Company Muster Roll

for *July & Aug*, 186*5*.

Present or absent *Present*

Stoppage, \$ 100 for

Due Gov't, \$ 100 for

Valuation of horse, \$ 100

Valuation of horse equipments, \$ 100

Remarks:

Book mark:

W. H. ...

4 Cav. U.S.C.T.

Charles Williams

2, Co. D, 4 Reg't U. S. Col'd Cavalry.

Appears on

Company Muster Roll

for *Sept & Oct*, 186*5*.

Present or absent *Present*

Stoppage, \$ 100 for

Due Gov't, \$ 100 for

Valuation of horse, \$ 100

Valuation of horse equipments, \$ 100

Remarks:

Book mark:

(358)

W. H. Wright

Copyist.

A | **4 Cav.** | **U.S.C.T.**

Charles Williams

Priv, Co. D, 4 Reg't U. S. Col'd Cavalry.

Appears on

Company Muster Roll

for *Nov 4 Dec*, 1865.

Present or absent *Present*

Stoppage, \$ *100* for

Due Gov't, \$ *100* for

Valuation of horse, \$ *100*

Valuation of horse equipments, \$ *100*

Remarks:

Book mark:

J. M. Anderson

W | **4 Cav. | U.S.C.T.**

Charles Williams

Plt, Co. D, 4 Reg't U. S. Col'd Cavalry.

Appears on

Company Muster Roll

for *Jan & Feb*, 186*6*.

Present or absent *Present*

Stoppage, \$ *100* for

Due Gov't, \$ *100* for

Valuation of horse, \$ *100*

Valuation of horse equipments, \$ *100*

Remarks:

Book mark:

W. Williams

W | **4 Cav.** | **U.S.C.T.**

Charles Williams

Put, Co. *D*, 4 Reg't U. S. Col'd Cavalry.

Appears on **Co. Muster-out Roll**, dated *New Orleans, La*, *March 20*, 186*6*.

Muster-out to date *March 20*, 186*6*.

Last paid to *June 30*, 186*5*.

Clothing account:

Last settled....., 186 ; drawn since \$..... $\frac{100}{100}$

Due soldier \$..... $\frac{100}{100}$; due U. S. \$ *6* $\frac{01}{100}$

Am't for cloth'g in kind or money adv'd \$..... $\frac{100}{100}$

Due U. S. for arms, equipments, &c., \$..... $\frac{30}{100}$

Bounty paid \$..... $\frac{100}{100}$; due \$..... $\frac{100}{100}$

Remarks: *Joined as recruit*
Stop 1 Sabre Knot.

Book mark: *V192, P139. 74.*

W. Williams

Williams Charles

Co K, 4 U. S. Col'd Cav.

Private Private

CARD NUMBERS.

1	5347581	26
2	5358432	27
3	5358482	28
4	5358535	29
5	5348197	30
6	40729337	31
7		32
8		33
9		34
10		35
11		36
12		37
13		38
14		39
15		40
16		41
17		42
18		43
19		44
20		45
21		46
22		47
23		48
24		49
25		50

Book Mark:

See also

MAR 15 1964

S-206/26/ And W. 2 (M.H.P. 2570)

S. A. Muhlmann
S.A.

[Faint handwritten text]

N | 4 Cav. | U.S.C.T.

Charles Williams

Appears with rank of *Priv.* on

Muster and Descriptive Roll of a Detachment of U. S. Vols. forwarded

for the 4 Reg't U. S. Col'd Cavalry. Roll dated *New Orleans, La., May 9, 1864.*

Where born *N. C.*

Age *39* y'rs; occupation *Carpenter*

When enlisted *Apr. 23*, 1864.

Where enlisted *Alexandria*

For what period enlisted *3* years.

Eyes *Black*; hair *Black*

Complexion *Black*; height *5* ft. *7/2* in.

When mustered in *May 9*, 1864.

Where mustered in *New Orleans*

Passion paid 2.
~~Bounty~~ paid \$ *100*; due \$ *100*

Where credited

Company to which assigned *C*

Remarks:

Book mark:

W. A. Easter

H | **4 Cav.** | **U.S.C.T.**

Charles Williams
Pr., Co. *K*, 4 Reg't U. S. Col'd Cavalry.

Age years.

Appears on

Company Muster Roll*

for *May 7 to June 30*, 186*4*.

Joined for duty and enrolled:

When *Apr. 23*, 186*4*.

Where *Alexandria, La.*

Period *3* years.

Mustered in:

When *May 7*, 186*4*.

Where *New Orleans, La.*

Present or absent *Present*

Stoppage, \$ *100* for

Due Gov't, \$ *100* for

Valuation of horse, \$ *100*

Valuation of horse equipments, \$ *100*

Remarks: *Sick*

* First current roll. No muster-in roll of this battery on file.

Book mark :

H. S. Chapman
Copyist.

21 | **4 Cav.** | **U.S.C.T.**

Charles Williams

Co. K, Co. K, 4 Reg't U. S. Col'd Cav.

Appears on

Company Muster Roll

for *July & Aug.*, 1864.

Present or absent *Present*

Stoppage, \$ *100* for

Due Gov't, \$ *100* for

Valuation of horse, \$ *100*

Valuation of horse equipments, \$ *100*

Remarks:

Book mark:

H. A. Thompson

W | 4 Cav. | U.S.C.T.

Charles Williams

Port, Co. K, 4 Reg't U. S. Colored Cav.

Appears on Returns as follows:

Sept 1864 - Loss: Sept 6/64
Port Hudson died in
Regt Hospital.

Book mark:

W. R. Lee

N | **4 Cav.** | **U.S.C.T.**

Charles Williams

Co. K, Co. K, 4 Reg't U. S. Col'd Cav.

Appears on

Company Muster Roll

for *Sept. & Oct.*, 1864.

Present or absent

Stoppage, \$ 100 for

Due Gov't, \$ 100 for

Valuation of horse, \$ 100

Valuation of horse equipments, \$ 100

Remarks: *Died in Regtl. Hospital
Co. K, 4th Regt. U.S. Col'd Cav.
of Dysentery & Diarrhea
Died regtl. Duties 7/30*

Book mark:

W. S. Thompson

(358)

Copyist.

Y. I. Gandy | **U.S.C.T.**

Charles Williams

Co. I., 4th Reg't U. S. Col'd Army

Appears on a

Detachment Muster-out Roll

of the organization named above. Roll dated
Washington, D.C., Mar 20, 1866

Muster-out to date 186 .

Last paid to 186 .

Clothing account:

Last settled 186 ; drawn since \$ 100

Due soldier \$ 100 ; due U. S. \$ 100

Am't for cloth'g in kind or money adv'd \$ 100

Due U. S. for arms, equipments, &c., \$ 100

Bounty paid \$ 100 ; due \$ 100

Remarks: Arrived at irregular
Organization ... at
Fort Jackson La. Sept 5, 1864
Final statements forwarded

Book mark:

W. F. Fossitt

Williams, Charles

P, Co K, 4 U.S.C. Cav.

2 Enclosures.

Bed Cards	Descriptive Lists
Burial Records	Final Statements /
Certs. of Dis. for Discharge	Furloughs
C. M. Charges	Med. Des. Lists
Med. Certificates	Orders

Other papers relating to—

Admission to Hosp'l	Furlough
Casualty Sheet (Officer's)	Med. Examination
Confinement	Misc. Information
Contracts	Pay or Clothing
Death or Effects /	Personal Reports
Desertions	Rank
Discharge from Hosp'l	Transfer to Hosp'l
Discharge from Service	Transfer to V. R. C.
Duty	Transportation

1864

FINAL STATEMENT

OF

Charles Williams
4th Reg't of U.S. Colored Cavalry

VOLUNTEERS.

Rec'd Sept 6th 1864

NOTE 1.—Two of these certificates (or duplicates) are to be given to each Volunteer Soldier or drafted man who may be discharged previously to the discharge of his company, that he may at once receive from the Paymaster the pay, &c., due him, and the captain or other COMMISSIONED officer commanding the company will certify to the act of the delivery of the duplicate certificates; on these certificates the Soldier is "entitled to" his discharge, and should also present his discharge to the Paymaster to have the payment endorsed on it. The discharge is to be given back to the Soldier by the Paymaster; the latter only retaining as his voucher the duplicate certificates.

NOTE 2.—If the Soldier is entitled to pay for the use of his horse, the Company Commander will certify to that fact on the back of both these final statements, and also to the time he has pay due for having been so mounted on his own horse.

NOTE 3.—When a Soldier is furnished with final statements, his descriptive list, if he has one, should be taken up by the officer who gives the Soldier these statements, and endorsed with a statement to this effect by the officer. This endorsement should exhibit a full statement of the time for which the Soldier was allowed pay on his final statements, the clothing account, and all other charges against him or in his favor, so as to comprise a complete exhibit of his account. It will then be transmitted to the company commander of the Soldier, who will enter all the data necessary to a full understanding of the Soldier's account on the muster roll upon which the Soldier's discharge is reported. The descriptive list will then be destroyed. The object of this is, that the remaining portion of the Soldier's account may be settled upon the receipt of these muster rolls, and the Soldier receive any pay or allowances that may be due him at the time of his discharge, and which may not appear on his final statements from the fact that his descriptive list is incomplete. These accounts for back pay, &c., are settled by the 2d Auditor of the Treasury Department.

NOTE 4.—Charges for loss or injury to ordnance, horse equipments, and other miscellaneous charges, should appear under the heading of "Other Stoppages."

NOTE 5.—Bounty paid by State authorities, and not by the United States, will not be entered on this statement.

NOTE 6.—Amounts due the Sutler and Laundress must be entered on the muster roll on which the discharge, death, desertion, &c., is reported, as well as on the final statement, otherwise the amount cannot be collected from the United States.

NOTE 7.—This blank will be used for deceased volunteers and drafted men, as well as for others.

NOTE 8.—Where a Soldier dies in Hospital or on detached service, his descriptive list, if he has one, should be sent with his final statements, in duplicate, to the Second Auditor, Washington, D. C.

ADJUTANT GENERAL'S OFFICE.

Oct 5th 1864

Duplicate with Inventory sent 2d Auditor.



I certify, on honor, that Charles Williams a Private of
 Captain W. Goodrich Company (K) of the 4 Regiment of Colored Cavalry
VOLUNTEERS, of the State of United States, born in _____, State
 of North Carolina aged 37 years; 5 feet 7 1/2 inches high; Black complexion,
Black eyes, Black hair, and by occupation a Carpenter, having joined the company on
 its original organization at Alexandria La. Apr 25th 1864, and enrolled in it at the muster into
 the service of the United States at New Orleans La, on the 11th day
 of May, 1864, (or was mustered in service as a recruit, by _____
 _____, at _____, on the _____ day of _____,
 186 , or was drafted and mustered into the service of the United States from the _____
 Enrollment District of the State of _____, at _____,
 on the _____ day of _____, 186) to serve in the Regiment, for
 the term of Three years: and having served **HONESTLY** and
FAITHFULLY with his Company in the field to the present date, is now
 entitled to a **DISCHARGE** by reason of Death, Died in Regt. Hospital, Port Hudson La. Sept 6th 1864 of Dysentery

The said Charles Williams was ~~last~~ never paid by Paymaster
 _____ to include the _____ day of _____, 186 , and has
 pay due him from ~~that time~~ enlistment to the present date; he is entitled to pay and subsistence for
TRAVELING to place of enrollment, and whatever other allowances are authorized to volunteer
 soldiers, drafted men, or militia, so discharged. He has received from the United States **CLOTHING**
 amounting to 36 ¹⁹ ~~100~~ dollars, since the 25th day of April,
 1864, ~~when~~ never his clothing account was ~~last~~ settled. He has received from the United States
 _____ 100 dollars advanced **BOUNTY**.

There is to be stopped from him, on account of the State of _____, or other
 authorities, for **CLOTHING**, &c., received on entering service, _____ 100 dollars; and
 for other stoppages, viz: _____

_____ 100 dollars.
 He has been furnished with **TRANSPORTATION** in kind from the place of his discharge to
 _____; and he has been **SUBSISTED** for **TRAVELING** to his
 place of enrollment, up to the _____, 186 .

He is indebted to John Wild Regt. SUTLER, Seven 50 100 dollars.
 He is indebted to _____, **LAUNDRESS**, _____ 100 dollars.

Given in Duplicate, at Port Hudson La, this 12th day
 of September, 1864.

W. Goodrich
 Capt. Co. K. 4th U.S. Colored Cavalry
 Commanding Company

ARTICLES OF WAR.

ART. 95. When any non-commissioned officer or soldier shall die, or be killed in the service of the United States, the then commanding officer of the troop or company shall, in the presence of two other commissioned officers, take an account of what effects he died possessed of, above his arms and accoutrements, and transmit the same to the office of the Department of War, which said effects are to be accounted for, and paid to the representatives of such deceased non-commissioned officer or soldier. And in case any of the officers, so authorized to take care of the effects of deceased officers and soldiers, should, before they have accounted to their representatives for the same, have occasion to leave the regiment or post, by preferment or otherwise, they shall, before they be permitted to quit the same, deposit in the hands of the commanding officer, or of the assistant military agent, all the effects of such deceased non-commissioned officers and soldiers, in order that the same may be secured for, and paid to, their respective representatives.

ARMY REGULATIONS—EDITION OF 1861.

DECEASED SOLDIERS.

Par. 152. Inventories of the effects of deceased non-commissioned officers and soldiers, required by the 95th Article of War, will be forwarded to the Adjutant General, by the commander of the company to which the deceased belonged, and a duplicate of the same to the colonel of the regiment. Final statements of pay, clothing, &c., will be sent with the inventories. When a soldier dies at a post or station absent from his company, it will be the duty of his immediate commander to furnish the required inventory, and, at the same time, to forward to the commanding officer of the company to which the soldier belonged, a report of his death, specifying the date, place, and cause; to what time he was last paid, and the money or other effects in his possession at the time of his decease; which report will be noted on the next muster-roll of the company to which the man belonged. Each inventory will be endorsed, "Inventory of the effects of _____, late of company (—) _____ regiment of _____, who died at _____, the _____ day of _____, 186—." If a legal representative receive the effects, it will be stated in the report. If the soldier leave no effects, the fact will be reported.

Par. 153. Should the effects of a deceased non-commissioned officer or soldier not be administered upon within a short period after his decease, they shall be disposed of by a Council of Administration, under the authority of the commanding officer of the post, and the proceeds deposited with the Paymaster, to the credit of the United States, until they shall be claimed by the legal representatives of the deceased.

Par. 154. In all such cases of sales by the Council of Administration, a statement in detail, or account of the proceeds, duly certified by the Council and commanding officer, accompanied by the Paymaster's receipt for the proceeds, will be forwarded by the commanding officer to the Adjutant General. The statement will be endorsed, "Report of the proceeds of the effects of _____, late of company (—) _____ regiment of _____, who died at _____, the _____ day of _____, 186—."

NOTE 1.—The effects in all cases, when called for, should be turned over to the legal representative, without further authority from the Adjutant General. When the effects are turned over to the relatives of the deceased before these inventories are sent to the Adjutant General, their receipts therefor should be attached to the inventories. In all other cases, one copy will be sent with a letter of transmittal direct to the Adjutant General, and a duplicate retained by the officer.

NOTE 2.—Particular care should be taken to take receipts in duplicate from the Paymaster for any funds turned over to him; one copy should be sent direct to the Adjutant General and one retained by the officer.

INVENTORY OF THE EFFECTS

OF

Charles Williams

Late of Company *K*

the Reg't of *U. S. Colored Cav*

Volunteers, who died at *Fort Hudson*

on the *6th* day of *September* 186*4*



NO 99 575

Inventory of the effects of Charles Williams late
 a Private of Captain W. Goodrich Company R of
 the 4th Regiment of U.S. Colored Cavalry Volunteers, who was enrolled as
 a Private at Alexandria in the State of Louisiana on
 the 25th day of April 1864, and mustered into the service of the United
 States as a Private on the 9th day of May 1864, at New Orleans La
 in Company R, 4th Regiment of U.S. Colored Cavalry Volunteers, to serve 3rd
 years or during the war; he was born in _____ in the State
 of North Carolina; he was 37 years of age, 5 feet 7¹/₂ inches
 high, Black complexion, Black eyes, Black hair, and by occupation, when enrolled,
 a Carpenter; he died in Regtl Hospital, at
Port Hudson La on the 6th day of September 1864, by
 reason of Diarrhea

INVENTORY.					
ARTICLES.	No.	ARTICLES.	No.	ARTICLES.	No.
Hats		Pairs trousers	/	Knapsacks	
Caps		Pairs flannel drawers	/		
Forage caps		Pairs cotton drawers			
Great coats		Flannel shirts			
Uniform coats		Cotton shirts			
Uniform jackets	/	Pairs boots			
Flannel sack coats		Pairs shoes			
Blouses	/	Pairs socks			
Stable frocks		Blankets			
Fatigue overalls		Haversacks			
				MONEY.	
				Specie	\$
				Notes	\$

I CERTIFY, ON HONOR, that the above inventory comprises all the effects of Private
Charles Williams, deceased, and that the effects are in the hands
 of Willis Williams Brother of said Charles Williams
Turned over by me to be disposed of by a Council of Administration.
Willis is his nearest relative having ascertained that said

(DUPLICATES.)

STATION: Port Hudson La

W. Goodrich
Capt Co R 4th U.S. Colored Cavalry
 Commanding the Company.

DATE: Sept 12th 1864

ARTICLES OF WAR.

ART. 95. When any non-commissioned officer or soldier shall die, or be killed in the service of the United States, the then commanding officer of the troop or company shall, in the presence of two other commissioned officers, take an account of what effects he died possessed of, above his arms and accoutrements, and transmit the same to the office of the Department of War, which said effects are to be accounted for, and paid to the representatives of such deceased non-commissioned officer or soldier. And in case any of the officers, so authorized to take care of the effects of deceased officers and soldiers, should, before they have accounted to their representatives for the same, have occasion to leave the regiment or post, by preferment or otherwise, they shall, before they be permitted to quit the same, deposit in the hands of the commanding officer, or of the assistant military agent, all the effects of such deceased non-commissioned officers and soldiers, in order that the same may be secured for, and paid to, their respective representatives.

ARMY REGULATIONS—EDITION OF 1861.

DECEASED SOLDIERS.

Par. 152. Inventories of the effects of deceased non-commissioned officers and soldiers, required by the 95th Article of War, will be forwarded to the Adjutant General, by the commander of the company to which the deceased belonged, and a duplicate of the same to the colonel of the regiment. Final statements of pay, clothing, &c., will be sent with the inventories. When a soldier dies at a post or station absent from his company, it will be the duty of his immediate commander to furnish the required inventory, and, at the same time, to forward to the commanding officer of the company to which the soldier belonged, a report of his death, specifying the date, place, and cause; to what time he was last paid, and the money or other effects in his possession at the time of his decease; which report will be noted on the next muster-roll of the company to which the man belonged. Each inventory will be endorsed, "Inventory of the effects of _____, late of company (—) _____, regiment of _____, who died at _____, the _____ day of _____, 186—." If a legal representative receive the effects, it will be stated in the report. If the soldier leave no effects, the fact will be reported.

Par. 153. Should the effects of a deceased non-commissioned officer or soldier not be administered upon within a short period after his decease, they shall be disposed of by a Council of Administration, under the authority of the commanding officer of the post, and the proceeds deposited with the Paymaster, to the credit of the United States, until they shall be claimed by the legal representatives of the deceased.

Par. 154. In all such cases of sales by the Council of Administration, a statement in detail, or account of the proceeds, duly certified by the Council and commanding officer, accompanied by the Paymaster's receipt for the proceeds, will be forwarded by the commanding officer to the Adjutant General. The statement will be endorsed, "Report of the proceeds of the effects of _____, late of company (—) _____, regiment of _____, who died at _____, the _____ day of _____, 186—."

NOTE 1.—The effects in all cases, when called for, should be turned over to the legal representative, without further authority from the Adjutant General. When the effects are turned over to the relatives of the deceased before these inventories are sent to the Adjutant General, their receipts therefor should be attached to the inventories. In all other cases, one copy will be sent with a letter of transmittal direct to the Adjutant General, and a duplicate retained by the officer.

NOTE 2.—Particular care should be taken to take receipts in duplicate from the Paymaster for any funds turned over to him; one copy should be sent direct to the Adjutant General and one retained by the officer.

INVENTORY OF THE EFFECTS

OF

Charles Williams

Late of Company *K*

1st Reg't of W. S. Colored Cav.

Volunteers, who died at Fort Ord.

on the *6th* day of *September*, 1864.

Received of Capt. W. Goodrich Co. K, 4th W. S. Colored Cavalry
the following effects of Private Charles Williams
late of Co. K, 4th W. S. Colored Cavalry now deceased
which I claim as his, to-wit:
1 Jacket, 1 Blouse, 1 Pair Pants, 1 Pair Drawers,
Wm. Williams
Master



1152
Williams Cicero

Co *C*, 4 U. S. Col'd Cav.

Private | *Private*

CARD NUMBERS.

1	5347840	26
2	5351915	27
3	5352018	28
4	5352115	29
5	5352213	30
6	5352306	31
7	5352394	32
8	5352483	33
9	40729338	34
10		35
11		36
12		37
13		38
14		39
15		40
16		41
17		42
18		43
19		44
20		45
21		46
22		47
23		48
24		49
25		50

Book Mark:

See also

NOV 18 1870

\$ 1807220 P.O. money

J.A. Muhlenberg
Chs.

4 Cav. U.S.C.T.

William

Appears with rank of *Col.* on

Muster and Descriptive Roll of a Detachment of U. S. Vols. forwarded

for the 4 Reg't U. S. Col'd Cavalry. Roll dated

New Orleans, La., Nov. 8, 1865.

Where born *Mississippi Co., Miss.*

Age *18* y'rs; occupation *Laborer*

When enlisted *Apr. 20*, 186*5*.

Where enlisted *New Orleans*

For what period enlisted *3* years.

Eyes *dark*; hair *dark*

Complexion *dark*; height *5* ft. *6* in.

When mustered in *March 5*, 186*5*.

Where mustered in *New Orleans*

Bounty paid \$ *150* *100*; due \$ *200* *100*

Where credited *San East Peliciana*

Port Hudson, La.
Company to which assigned *C*

Remarks:

Book mark:

E. E. Dyer

W | 4 Cav. | U.S.C.T.

Bicero William

Priv, Co. C, 4 Reg't U. S. Colored Cav.

Appears on Returns as follows:

Nov 1865 - Gain: Mar 26/65
Port Hudson, La. Recruit
from depot.

Book mark:

W. R. Lee

H

4 Cav. U.S.C.T.

Cicero Williams

Priv., Co. C, 4 Reg't U. S. Colored Cavalry.

Appears on

Company Muster Roll

for *March 1865*, 1865.

Present or absent *present*

Stoppage, \$ 100 for

Due Gov't, \$ 100 for

Valuation of horse, \$ 100

Valuation of horse equipments, \$ 100

Remarks:

Book mark:

May

APR 1865

H | 4 Cav. | U.S.C.T.

Cicero Williams
Priv, Co. C, 4 Reg't U. S. Colored Cavalry.

Appears on

Company Muster Roll

for *May & June*, 1865.

Present or absent *present*

Stoppage, \$ *100* for

Due Gov't, \$ *100* for

Valuation of horse, \$ *100*

Valuation of horse equipments, \$ *100*

Remarks: *stop for one
Canteen & Haversack,
and one pair metallic
scale.*

Book mark: _____

(358)

May
Copyist.

A | 4 Cav. | U.S.C.T.

Cicero Williams
Priv, Co. C, 4 Reg't U. S. Colored Cavalry.

Appears on

Company Muster Roll

for July & Aug, 1865.

Present or absent present

Stoppage, \$ 100 for

Due Gov't, \$ 100 for

Valuation of horse, \$ 100

Valuation of horse equipments, \$ 100

Remarks: Stop for 1 canteen,
1 haversack, 1 pr metallic
scalis. Total \$ 2.30.

Book mark: _____

(358)

May

Copyist.

H | **4 Cav.** | **U.S.C.T.**

Cicero Williams

Priv, Co. C, 4 Reg't U. S. Colored Cavalry.

Appears on

Company Muster Roll

for *Sept & Oct*, 186*5*.

Present or absent *present*

Stoppage, \$ *100* for

Due Gov't, \$ *100* for

Valuation of horse, \$ *100*

Valuation of horse equipments, \$ *100*

Remarks :

Book mark :

Moy

(358)

Copyist.

W 1 | **4 Cav. | U.S.C.T.**

Cicero Williams

Private, Co. C, 4 Reg't U. S. Colored Cavalry.

Appears on

Company Muster Roll

for *Nov + Dec*, 186*5*.

Present or absent *present*

Stoppage, \$ *100* for

Due Gov't, \$ *100* for

Valuation of horse, \$ *100*

Valuation of horse equipments, \$ *100*

Remarks:

Book mark:

M. A. Michaels

(358)

Copyist.

NOV 17 1866

W | **4 Cav.** | **U.S.C.T.**

Cicero Williams
Private, Co. C, 4 Reg't U. S. Colored Cavalry.

Appears on

Company Muster Roll

for *Jan'y & Febr*, 1866.

Present or absent *present*

Stoppage, \$ 100 for

Due Gov't, \$ 100 for

Valuation of horse, \$ 100

Valuation of horse equipments, \$ 100

Remarks:
.....
.....
.....
.....
.....
.....
.....
.....

Book mark:

(358) *M. A. Michaels* Copyist.

MAR 1867

W | **4 Cav. U.S.C.T.**

Cicero Williams
Private, Co. *C*, 4 Reg't U. S. Col'd Cavalry.

Appears on **Co. Muster-out Roll**, dated
New Orleans La Mar 20, 1866.

Muster-out to date *Mar 20*, 1866.

Last paid to *June 30*, 1865.

Clothing account:

Last settled....., 186 ; drawn since \$..... 100

Due soldier \$ *11*^{*74*} 100; due U. S. \$..... 100

Am't for cloth'g in kind or money adv'd \$..... 100

Due U. S. for arms, equipments, &c., \$..... 100

Bounty paid \$ *100* 100; due \$..... 100

Remarks: *Joined as recruit*

Book mark :

(361)

M. A. Michaels
Copyist.

Williams, Cicero

....., Co., *4* Reg't *M.S.C.*

..... **Enclosures.**

Bed Cards	Final Statements
Burial Records	Furloughs or L. of A.
Certs. of Dis. for Discharge	Med. Certificates
C. M. Charges	Med. Des. Lists
Descriptive Lists	Orders
Discharge Certificates	Pris. of War Record
Enlistment Papers	Resignations

Other papers relating to—

Admission to Hosp'l	Furlough or L. of A.
Casualty Sheet	Med. Examination
Confinement	Misc. Information
Contracts	Pay or Clothing
Death or Effects	Personal Reports
Desertion	Rank
Discharge from Hosp'l	Transfer to Hosp'l
Discharge from Service	Transfer to V. R. C.
Duty	Transportation
.....

NOV 20 1892

NOTE 1.—This blank will be used for both enlistments and re-enlistments—enlistment of veterans, &c., &c., in the volunteer service. They will be made out in duplicate in all cases—one to accompany the recruiting return of the superintendent (not the recruiting officer) to the Adjutant General, and one to accompany the accounts of the officer who pays bounty, &c. The Regiment and Company in which the soldier last served should be given on the back.
NOTE 2.—An enlistment holds to service. A muster-in must, in all cases, precede payment of pay, bounty, pension, &c. A muster-in roll must, in all cases, be filed in the Adjutant General's Office as evidence of muster-in. The mustering officer, commissary, or assistant commissary of musters, as the case may be, will countersign both enlistments as having mustered the soldier into the service of the United States before either of them is given to the disbursing officer.

DECLARATION OF RECRUIT.

I, Cicero Williams, desiring to VOLUNTEER as a Soldier in the Army of the United States, for the term of THREE YEARS, Do Declare, That I am 18 years and _____ months of age; that I have never been discharged from the United States service on account of disability or by sentence of a court martial, or by order before the expiration of a term of enlistment; and I know of no impediment to my serving honestly and faithfully as a soldier for three years.

GIVEN at New Orleans La the 20th day of February 1865

Witness: Jacob Friedman Cicero Williams
1st Lt U.S.C. Art. 14 mark

Record entitled to the Bounty provided by Circular No. 27 Office Prof. Gen. Grant July 19 1864

Discharged _____ 18 _____
enlistment; last served in Company ()
Reg't of _____

No. _____
Cicero Williams
Volunteered at New Orleans
February 20th 1865
By Capt. Wm. Walker
1st Regt of Artillery

Received from Second Auditor
October 7th. 1892.

CONSENT IN CASE OF MINOR.

I, _____, Do CERTIFY, That I am _____ of _____; that the said _____ is _____ years of age; and I do hereby freely give my CONSENT to his volunteering as a SOLDIER in the ARMY OF THE UNITED STATES for the period of THREE YEARS.

GIVEN at _____ the _____ day of _____

Witness: _____

VOLUNTEER ENLISTMENT.

STATE OF

TOWN OF

Louisiana

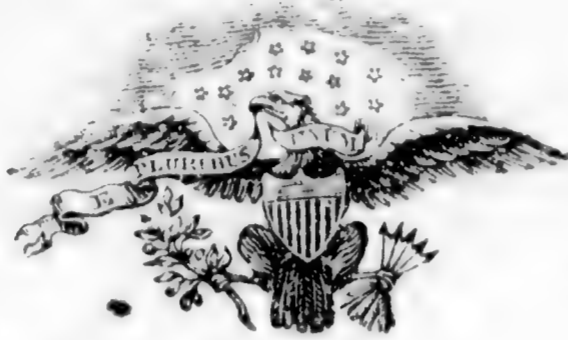

New Orleans

I, Cicero Williams, born in Miss. Co. in the State of Miss, aged 18 years, and by occupation a Laborer, Do HEREBY ACKNOWLEDGE to have volunteered this Twentieth day of February, 1865, to serve as a Soldier in the Army of the United States of America, for the period of THREE YEARS, unless sooner discharged by proper authority: Do also agree to accept such bounty, pay, rations, and clothing, as are, or may be, established by law for volunteers. And I, Cicero Williams, do solemnly swear, that I will bear true faith and allegiance to the United States of America, and that I will serve them honestly and faithfully against all their enemies or opposers whomsoever; and that I will observe and obey the orders of the President of the United States, and the orders of the officers appointed over me, according to the Rules and Articles of War.

Sworn and subscribed to, at New Orleans La. this 20th day of February, 1865, BEFORE John G. Friedman, 1st Lieut. 10th U.S. C. Art. 14y. Cicero Williams mark

I CERTIFY, ON HONOR, That I have carefully examined the above-named Volunteer, agreeably to the General Regulations of the Army, and that, in my opinion, he is free from all bodily defects and mental infirmity, which would in any way disqualify him from performing the duties of a soldier.

J. B. Curtis, Examining Surgeon.

I CERTIFY, ON HONOR, That I have minutely inspected the Volunteer Cicero Williams previously to his enlistment, and that he was entirely sober when enlisted; that, to the best of my judgment and belief, he is of lawful age; and that, in accepting him as duly qualified to perform the duties of an able-bodied soldier, I have strictly observed the Regulations which govern the recruiting service. This soldier has dark eyes, dark hair, dark complexion, is five feet six inches high.

A. M. Allison, Capt. 10th Regiment of U.S. Artillery, Recruiting Officer.

(A. G. O. No. 71 & 76.)

Mastered into the service of the United States, for three years or during the war, from date of enlistment, in Company 1st Regiment of U.S. Artillery Volunteers, on the 20th day of February, 1865, at New Orleans La.

Handwritten notes and signatures on the right side of the document, including names like 'John G. Friedman' and 'A. M. Allison'.

1865

VOLUNTEER ENLISTMENT.

STATE OF

TOWN OF

Louisiana

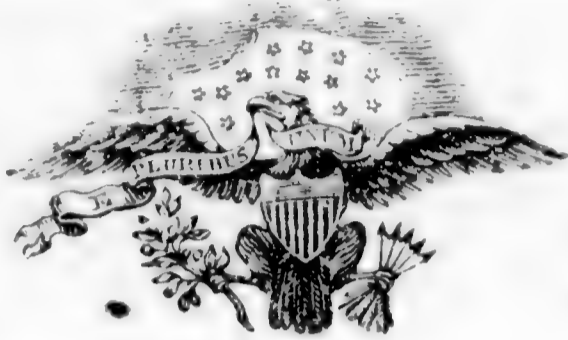

New Orleans

I, Cicero Williams, born in Miss. Co.

in the State of Miss, aged 18 years,

and by occupation a Laborer, Do HEREBY ACKNOWLEDGE to have

volunteered this Twentieth day of February, 1865,

to serve as a Soldier in the Army of the United States of America, for the period of THREE YEARS, unless sooner discharged by proper authority:

Do also agree to accept such bounty, pay, rations, and clothing, as are, or may be, established by law for volunteers. And I, Cicero Williams, do solemnly swear, that I will bear true faith and allegiance to the United States of America, and that I will serve them honestly and faithfully against all their enemies or opposers whomsoever; and that I will observe and obey the orders of the President of the United States, and the orders of the officers appointed over me, according to the Rules and Articles of War.

Sworn and subscribed to, at

this 20th day of February, 1865,

BEFORE

John Geo. Friedman, 1st Lieut. 10th U.S. C. Art. 1st Regt.

Cicero Williams mark

I CERTIFY, ON HONOR, That I have carefully examined the above-named Volunteer, agreeably to the General Regulations of the Army, and that, in my opinion, he is free from all bodily defects and mental infirmity, which would in any way disqualify him from performing the duties of a soldier.

J. B. Curtis, Examining Surgeon

I CERTIFY, ON HONOR, That I have minutely inspected the Volunteer Cicero Williams previously to his enlistment, and that he was entirely sober when enlisted; that, to the best of my judgment and belief, he is of lawful age; and that, in accepting him as duly qualified to perform the duties of an able-bodied soldier, I have strictly observed the Regulations which govern the recruiting service. This soldier has dark eyes, dark hair, dark complexion, is five feet six inches high.

A. M. Allison, Capt- 10th Regt of U.S. Artillery, Recruiting Officer.

(A. G. O. No. 71 & 76.)

Mustered into the service of the United States, for three years or during the war, from date of enlistment, in Company 1st of the 10th Regiment of U.S. Artillery, on the 20th day of February, 1865, at New Orleans, La.

Handwritten notes and signatures on the right side of the document.

1133

Williams Daniel

Co E H, 4 U. S. Col'd Cav.

Corporal Corporal

CARD NUMBERS.

1	5347928	26
2	5357225	27
3	5357236	28
4	5357292	29
5	5357350	30
6	5357404	31
7	5357452	32
8	5357500	33
9	5357627	34
10	5354365	35
11	5354450	36
12	5354589	37
13	5358096	38
14	5354892	39
15	S-73-05-1874	40
16		41
17		42
18		43
19		44
20		45
21		46
22		47
23		48
24		49
25		50

Book Mark: S-73-05-1874

See also

N | **4 Cav. | U.S.C.T.**

Daniel Williams

Appears with rank of *Private* on

Muster and Descriptive Roll of a Detachment of U. S. Vols. forwarded

for the 4 Reg't U. S. Col'd Cavalry. Roll dated

New Orleans on April 8, 1864

Where born *Prince Geo. Co. Md*

Age *20* y'rs; occupation *Farmer*

When enlisted *Mar 18*, 1864

Where enlisted *New Orleans*

For what period enlisted *3* years.

Eyes *Black*; hair *Black*

Complexion *DK*; height *5* ft. *0* in.

When mustered in *April 8*, 1864

Where mustered in *New Orleans*

Bounty paid \$ *100*; due \$ *100*

Where credited _____

Company to which assigned *A*

Remarks: _____

Book mark: *S 73 - 07 - 1874*

Sallade

NOV 17 94

W | **4 Cav.** | **U.S.C.T.**

Samuel Williams
Pvt., Co. H, 4 Reg't U. S. Col'd Cavalry.

Appears on

Company Muster-in and Descriptive Roll

of the organization named above. Roll dated

New Orleans, La. Apr. 8, 1864

Where born *Franklin Co. Ind.*

Age *20* y'rs; occupation *Farmer*

When enlisted *Mar. 18, 1864*

Where enlisted *New Orleans, La.*

For what period enlisted *3* years.

Eyes *black*; hair *black*

Complexion *dark*; height *5 ft. 6 in.*

When mustered in *Apr. 8, 1864*

Where mustered in *New Orleans, La.*

Bounty paid \$ *2* 100; due \$ 100

Where credited

Company to which assigned

Remarks:

.....
.....
.....

Book mark:

.....

S. Williams

(356d)

Copyist.

NOV 15 1895

W | **4 Cav.** | **U.S.C.T.**

Daniel Williams
Corp'l, Co. H, 4 Reg't U. S. Col'd Cavalry.

Appears on

Company Muster Roll

for *Apr 8 to 30*, 186*4*.

Present or absent *Present.*

Stoppage, \$.....100 for

Due Gov't, \$.....100 for

Valuation of horse, \$.....100

Valuation of horse equipments, \$.....100

Remarks:

Book mark:

(358) *D. Williams,*
Copyist.

W | **4 Cav.** | **U.S.C.T.**

Daniel Williams
Corpl, Co. H, 4 Reg't U. S. Col'd Cavalry.

Appears on

Company Muster Roll

for *May & June*, 1864.

Present or absent *Present*

Stoppage, \$ *100* for

Due Gov't, \$ *100* for

Valuation of horse, \$ *100*

Valuation of horse equipments, \$ *100*

Remarks:

Book mark:

D. Williams,
Copyist.

NOV 15 1897

W | **4 Cav. | U.S.C.T.**

Daniel Williams

Capt., Co. H, 4 Reg't U. S. Col'd Cavalry.

Appears on

Company Muster Roll

for *July & Aug.*, 186 *4*.

Present or absent *Present*

Stoppage, \$.....100 for

Due Gov't, \$.....100 for

Valuation of horse, \$.....100

Valuation of horse equipments, \$.....100

Remarks:.....

Book mark:.....

(358)

D. Williams,

Copyist.

W | **4 Cav.** | **U.S.C.T.**

Daniel Williams

Capt'l, Co. H, 4 Reg't U. S. Col'd Cavalry.

Appears on

Company Muster Roll

for *Sept. + Oct.*, 1864.

Present or absent *Present*

Stoppage, \$ 100 for

Due Gov't, \$ 20/100 for *lost ord-*

nance (wiper.)

Valuation of horse, \$ 100

Valuation of horse equipments, \$ 100

Remarks:

Book mark:

D. Williams,

W | **4 Cav.** | **U.S.C.T.**

Daniel Williams

Capt., Co. H, 4 Reg't U. S. Col'd Cavalry.

Appears on

Company Muster Roll

for *Nov, & Dec,*, 186*4*.

Present or absent *Present.*

Stoppage, \$ $\frac{26}{100}$ for *one wipe*.

Due Gov't, \$ $\frac{100}{100}$ for

Valuation of horse, \$ $\frac{100}{100}$

Valuation of horse equipments, \$ $\frac{100}{100}$

Remarks: *Free on or before
Apr 19 '61*

Book mark:

D. Williams

W | **4 Cav.** | **U.S.C.T.**

Daniel Williams

Sgt., Co. H, 4 Reg't U. S. Col'd Cavalry.

Appears on

Company Muster Roll

for *Company Feb*, 186*5*.

Present or absent *Present*

Stoppage, \$ *100* for

Due Gov't, \$ *100* for

Valuation of horse, \$ *100*

Valuation of horse equipments, \$ *100*

Remarks: *Free or before April 19, 1861. Appointed Jan '65 due U.S. (wiper) 20 Received but 7.00 per month up to Apr 30/64.*

Book mark:

Harlan

71 | 4 Cav. | U.S.C.T.

Daniel Williams

Sergt.; Co. H, 4 Reg't U. S. Col'd Cavalry.

Appears on

Company Muster Roll

for *Feb. 9. Apl.*, 1865.

Present or absent

Stoppage, \$ 100 for

Due Gov't, \$ 100 for

Valuation of horse, \$ 100

Valuation of horse equipments, \$ 100

Remarks: *Transferred to Co. E.
by S. O. 17. Adams & Wf.
to reg. Apr. 7, 1865.*

Book mark:

Measter

N | **4 Cav.** | **U.S.C.T.**

Daniel Williams
Cpl, Co. E, 4 Reg't U. S. Col'd Cav.

Appears on

Company Muster Roll

for *Mar & Apr*, 186 *5*.

Present or absent *Present*

Stoppage, \$ *100* for

Due Gov't, \$ *100* for

Valuation of horse, \$ *100*

Valuation of horse equipments, \$ *100*

Remarks: *Transferred from Co
H by order of Lt. Col. N. C.
Mitchell Comdg. Regt.*

Book mark:

Wines
(358) Copyist.

N | **4 Cav.** | **U.S.C.T.**

Daniel Williams

Cpl, Co. E, 4 Reg't U. S. Col'd Cav.

Appears on

Company Muster Roll

for *May & June*, 186 *J.*

Present or absent *Present*

Stoppage, \$ 100 for

Due Gov't, \$ 100 for

Valuation of horse, \$ 100

Valuation of horse equipments, \$ 100

Remarks: *Stop for 1 pr spurs & strap, 1 curry comb and 1 horse brush*

Book mark:

Wines

W | **4 Cav.** | **U.S.C.T.**

Daniel Williams

Corpl, Co. E, 4 Reg't U. S. Col'd Cav.

Appears on

Company Muster Roll

for *July & Aug*, 1865.

Present or absent *Present*

Stoppage, \$ 100 for

Due Gov't, \$ 100 for

Valuation of horse, \$ 100

Valuation of horse equipments, \$ 100

Remarks: *Died in Post Hospital, Port Hudson, La, Aug. 21, 1865.*

As shown on roll

Book mark:

(358)

Wines

Copyist.

MAR 16 1865

W | **4 Cav.** | **U.S.C.T.**

Daniel Williams

Pri., Co., 4 Reg't U. S. Col'd Cavalry.

Appears on **Co. Muster-out Roll**, dated
New Orleans La, Mar 20, 1866.

Muster-out to date 186 .

Last paid to 186 .

Clothing account:

Last settled 186 ; drawn since \$ 100

Due soldier \$ 100 ; due U. S. \$ 100

Am't for cloth'g in kind or money adv'd \$ 100

Due U. S. for arms, equipments, &c., \$ 100

Bounty paid \$ 100 ; due \$ 100

Remarks: *Joined at Vigil Orgi.*
Priv. Jan 1/65, Sergt.
Apr. 7/65, Trans. to Co.
"E" to accept promotion
per S. O. 17 Ad. Ins. 4"
U. S. C. C. Port Hudson La.
(over)

Book mark :

H. E. Stuart
(361) Copyist.

JAN - 8

5358096

★ 1891 ★

*Apr. 7/65. Free on
or before Apr 19/61*

W | **4 Cav.** | **U.S.C.T.**

Daniel Williams

Capt, Co. *E*, 4 Reg't U. S. Col'd Cavalry.

Appears on **Co. Muster-out Roll**, dated *New Orleans La Mch 20*, 186*6*.

Muster-out to date _____, 186 .

Last paid to _____, 186 .

Clothing account:

Last settled _____, 186 ; drawn since \$ _____ *100*

Due soldier \$ _____ *100*; due U. S. \$ _____ *100*

Am't for cloth'g in kind or money adv'd \$ _____ *100*

Due U. S. for arms, equipments, &c., \$ _____ *100*

Bounty paid \$ _____ *100*; due \$ _____ *100*

Remarks: *Joined by transfer from*
Co. M. per S.O. 28 Hd qrs D of S.
Jan'y 28/65. Died Aug 8/65
at Port Hudson La.

Book mark: *S 73 V 10 Co 7 74*

WAR 1600

W | 4th Cav | U. S. C. I.

Daniel Williams
, Co. E, 4 Reg't U. S. C. Cav

NOTATION.

Book mark: S-73-C-I-1874.

Record and Pension Office,

WAR DEPARTMENT.

This book mark refers only to a report from the medical records, made by the Surgeon General to the Adjutant General, relative to the above-named man. As the medical records have since been carded, no transcript of this report is made hereon.

(491)

W. Allen

Copyist.

Williams, Daniel
Corpl. Co. E, 4 Re U. S. C. Cav.

2 Enclosures.

Bed Cards	Descriptive Lists
Burial Records	Final Statements /
Certs. of Dis. for Discharge	Furloughs
C. M. Charges	Med. Des. Lists
Med. Certificates	Orders

Other papers relating to—

Admission to Hosp'l	Furlough
Casualty Sheet (Officer's) /	Med. Examination
Confinement	Misc. Information
Contracts	Pay or Clothing
Death or Effects	Personal Reports
Desertions	Rank
Discharge from Hosp'l	Transfer to Hosp'l
Discharge from Service	Transfer to V. R. C.
Duty	Transportation

WAR 1861

2 for 1 sent for to the Regt. 1863

CASUALTY SHEET

No.

Daniel Williams

Corpl of Company *"E"*

4 Regiment of *U.S. A.C.*

State Volunteers.

NATURE OF CASUALTY.

CASUALTY SHEET.

Name: *David Willigues*
Rank: *Compl* Company: *"C"* Regiment: *4*
Arm: *N. C. C.* State: _____
Nature of Casualty: _____
Disease

CAUSE OF CASUALTY—(NAME OF DISEASE, &c.)

BY WHOM DISCHARGED.

Disease

FROM WHAT SOURCE THIS INFORMATION WAS OBTAINED.

DEGREE OF DISABILITY.

*Gen Ret of dis'd Col'ds
for Gen Eng Dept 30/1/55*

BY WHOM CERTIFIED.

REMARKS.

*Saml White
Maj Comd*

DATE OF DISCHARGE, DEATH, &c.

Aug 3/1/55

PLACE OF DISCHARGE, DEATH, &c.

Port Hudson La

J. W. Kasper
Clerk.

Extract from Act of Congress.

SEC. 12. *And be it further enacted,* That the fees of agents and attorneys for making out and causing to be executed the papers necessary to establish a claim for a pension, bounty, and other allowance before the Pension Office, under this act, shall not exceed the following rates: For making out and causing to be duly executed a declaration by the applicant, with the necessary affidavits, and forwarding the same to the Pension Office, with the requisite correspondence, ten dollars; which sum shall be received by such agent or attorney in full for all services in obtaining such pension, and shall not be demanded or received, in whole or in part, until such pension shall be obtained; and the sixth and seventh sections of an act entitled "An act to grant pensions," approved July [fourteenth,] eighteen hundred and sixty-two, are hereby repealed.

SEC. 13. *And be it further enacted,* That any agent or attorney who shall, directly or indirectly, demand or receive any greater compensation for his services under this act than is prescribed in the preceding section of this act, or who shall contract or agree to prosecute any claim for a pension, bounty, or other allowance under this act, on the condition that he shall receive a per centum upon any portion of the amount of such claim, or who shall wrongfully withhold from a pensioner or other claimant the whole or any part of the pension or claim allowed and due to such pensioner or claimant, shall be deemed guilty of a high misdemeanor, and, upon conviction thereof, shall, for every such offense, be fined not exceeding three hundred dollars, or imprisoned at hard labor not exceeding two years, or both, according to the circumstances and aggravations of the offense.

Approved July 4, 1864.

NOTE 10.—If any soldier is charged a higher fee than that allowed by the above act, he should report the fact and the name of the agent to the Adjutant General, in order that steps may be taken to have the same refunded.

ADJUTANT GENERAL'S OFFICE
 Feby 13th 1866
 Duplicate with inventory sent 2d 4 1866

FINAL STATEMENT

OF

James Williams Co E
4th Reg't of A.S. Co Cavalry
VOLUNTEERS.
Dec Aug 3rd 1865

NOTE 1.—Two of these certificates (or duplicates) are to be given to each Volunteer Soldier or drafted man who may be discharged without being mustered out, (Final Statements are never given to men mustered out of service,) that he may at once receive from the Paymaster the pay, &c., due him, and the captain or other COMMISSIONED officer commanding the company will certify to the act of the delivery of the duplicate certificates; with these certificates the Soldier is "entitled to" his discharge, and should also present his discharge to the Paymaster to have the payment endorsed on it. The discharge is to be given back to the Soldier by the Paymaster; the latter only retaining as his vouchers the duplicate certificates.

NOTE 2.—If the Soldier is entitled to pay for the use of his horse, the Company Commander will certify to that fact on the back of both these final statements, and also to the time he has pay due for having been so mounted on his own horse.

NOTE 3.—When a Soldier is furnished with final statements, his descriptive list, if he has one, should be taken up by the officer who gives the Soldier these statements, and endorsed with a statement to this effect by the officer. The endorsement should exhibit a full statement of the time for which the Soldier was allowed pay on his final statements, the clothing account, and all other charges against him or in his favor, so as to comprise a complete exhibit of his account. It will then be transmitted to the Company Commander of the Soldier, who will enter all the data necessary to a full understanding of the Soldier's account on the muster roll upon which the Soldier's discharge is reported. The descriptive list will then be destroyed. The object of this is, that the remaining portion of the Soldier's account may be settled upon the receipt of these muster rolls, and the Soldier receive any pay or allowances that may be due him at the time of his discharge, and which may not appear on his last final statements from the fact that his descriptive list is incomplete. These accounts for back pay, &c., are settled by the 2d Auditor of the Treasury Department.

NOTE 4.—Charges for loss or injury to ordnance, horse equipments, and other miscellaneous charges, should appear under the heading of "Other Stoppages."

NOTE 5.—Bounty paid by State authorities, and not by the United States, will not be entered on this statement.

NOTE 6.—Amounts due the Sutler and Laundress must be entered on the muster roll on which the discharge, death, desertion, &c., is reported, as well as on the final statement, otherwise the amount cannot be collected from the United States.

NOTE 7.—This blank will be used for deceased volunteers and drafted men, as well as for others.

NOTE 8.—Where a Soldier dies in Hospital or on detached service, his descriptive list, if he has one, should be sent with his final statements, in duplicate, to the Adjutant General, Washington, D. C.

NOTE 9.—If the soldier is a drafted man or substitute, the space for time, &c., of enrolled, should contain only the word *drafted* or *substitute*, as the case may be. If the Soldier is a "VETERAN," (or RECRUIT,) the words *as a veteran*, (or *recruit*,) as the case may be, should be interlined after the words *mustered into the service of the U. S.* A statement of all the installments of *Veteran* or *Recruit* Bounty RECEIVED by the Soldier must be made on the back of each final statement.

[Signature]

I certify, on honor, that David Williams, a Corporal of
 Captain E. W. Bangs Company (E) of the 4th Regiment of Vol. Cavalry
VOLUNTEERS, of the State of _____, born in St. George County State
 of Maryland, aged 20 years; 5 feet 6 inches high; Black complexion,
Black eyes, Black hair, and by occupation a Furrier, who joined for service
 and was enrolled (see Note 9) on the 8 day of March, 1864, at New Orleans, La.
 by Genl. W. H. Blair, for the period of 3 years, and mustered into
 the service of the United States on the 8th day of April, 1864, at
New Orleans, La., by Genl. Chamberlain; and having served

HONESTLY and FAITHFULLY with his Company to the present date, is now entitled to a
DISCHARGE by reason of death having died of Small Pox
in Post Hospital Fort Hudson La August 3 1865

The said David Williams was last paid by Paymaster
Douglas, to include the 38 day of February, 1865, and
 has pay due him from that time to the present date; he is entitled to pay and subsistence for
TRAVELING to place of enrollment, and whatever other allowances are authorized to volunteer
 soldiers, drafted men, or militia, so discharged. He has received from the United States **CLOTHING**
 amounting to 33 $\frac{64}{100}$ dollars, since the 21st day of October,
 1864, when his clothing account was last settled. He has received from the United States
 _____ $\frac{100}{100}$ dollars advanced **BOUNTY**.

There is to be stopped from him, on account of the State of _____, or other
 authorities, for **CLOTHING**, &c., received on entering service, _____ $\frac{100}{100}$ dollars; and
 for other stoppages, viz: _____
 _____ $\frac{100}{100}$ dollars.

He has been furnished with **TRANSPORTATION** in kind from the place of his discharge to
 _____; and he has been **SUBSISTED** for **TRAVELING** to his
 place of enrollment, up to the _____, 186 .

He is indebted to _____, **SUTLER**, _____ $\frac{100}{100}$ dollars.
 He is indebted to _____, **LAUNDRESS**, _____ $\frac{100}{100}$ dollars.

Given in Duplicate, at Fort Hudson La, this 30 day
 of January, 1866.

Effects

Harrison Hubbard
1st Lieut

Commanding Company.

1134

William George

Co E, 4 U. S. Col'd Cav.

Sergeant Sergeant

CARD NUMBERS.

1	5356195	26
2	5356248	27
3	5356302	28
4	5356355	29
5	5356407	30
6	5356510	31
7	5356570	32
8	5356578	33
9	5356641	34
10	5356729	35
11	5356821	36
12	5356908	37
12	5356993	38
14	5357077	39
15		40
16		41
17		42
18		43
19		44
20		45
21		46
22		47
23		48
24		49
25		50

Book Mark: _____

See also _____

1815

2-1624286 Quaw.
RSP 525355

S. M. H. L. L. L. L.
177

H | 4 Cav. | U.S.C.T.

George Williams

Sgt, Co. *G*, 1 Reg't, Corps d'Afrique Cavalry.*
Appears on *Apr 25*

Company Muster-in Roll

of the organization named above. Roll dated
New Orleans, La., Feb. 8, 1864.

Muster-in to date *Feb. 8*, 1864.

Joined for duty and enrolled:

When *Nov. 29*, 1863.

Where *New Orleans, La.*

Period *3* years.

Valuation of horse, \$ *100*

Valuation of horse equipments, \$ *100*

Remarks: *Pl. to Crew.*

*This organization subsequently became Co. *G*, 4 Reg't U. S. Colored Cavalry.

Book mark:

Lowry
(356) Copyist.

71. **4 Cav. | U.S C.T.**

George Williams
Sgt, Co. *G*, 1 Reg't Cav., Corps d'Afrique.*

Appears on

Company Muster Roll

for *Enrollment to Feb 29*, 186 *4*.

Present or absent *Present*

Stoppage, \$ *100* for

Due Gov't, \$ *100* for

Valuation of horse, \$ *100*

Valuation of horse equipments, \$ *100*

Remarks:

* This organization subsequently became Co. *G*, 4 Reg't U. S. Colored Cavalry.

Book mark: -----

(358) *Lowry* Copyist.

H

4 Cav. | U. S. C. T.

George Williams
Sgt, Co. G, 4 Reg't U. S. Col'd Cavalry.

Appears on

Company Muster Roll

for *March & April*, 1864.

Present or absent *Present*

Stoppage, \$ *100* for

Due Gov't, \$ *100* for

Valuation of horse, \$ *100*

Valuation of horse equipments, \$ *100*

Remarks:

Book mark:

Loung

1/2

4 Cav. U.S.C.T.

George Williams
Sgt, Co. G, 4 Reg't U. S. Col'd Cavalry.

Appears on

Company Muster Roll

for May & June, 1864.

Present or absent Present

Stoppage, \$ 100 for

Due Gov't, \$ 100 for

Valuation of horse, \$ 100

Valuation of horse equipments, \$ 100

Remarks:

Book mark:

Lowny

(358)

Copyist.

4

4 Cav. | U. S. C. T.

George Williams
1st Sgt, Co. G, 4 Reg't U. S. Col'd Cavalry.

Appears on

Company Muster Roll

for *July & Aug*, 1864.

Present or absent *Present*

Stoppage, \$ *100* for

Due Gov't, \$ *100* for

Valuation of horse, \$ *100*

Valuation of horse equipments, \$ *100*

Remarks:

Book mark:

L. W. M.

4 | **4 Cav.** | **U. S. C. T.**

George Williams
Plot, Co. G, 4 Reg't U. S. Col'd Cavalry.

Appears on

Company Muster Roll

for *Sep & Oct*, 1864.

Present or absent *Present*

Stoppage, \$ 100 for

Due Gov't, \$ 100 for

Valuation of horse, \$ 100

Valuation of horse equipments, \$ 100

Remarks: *Reduced from 1st Sgt
to the ranks Oct 16/64*

Book mark:

(358)

Louvy

Copyist.

NOV 18 1864

H | **4 Cav. | U.S.C.T.**

George Williams

Pr, Co. G, 4 Reg't U. S. Col'd Cavalry.

Appears on

Company Muster Roll

for *Mr & Mrs*, 1864.

Present or absent *Present*

Stoppage, \$ *100* for

Due Gov't, \$ *100* for

Valuation of horse, \$ *100*

Valuation of horse equipments, \$ *100*

Remarks: *Reduced from
Sept to Private
Oct 1864*

Book mark:

(355)

Am
Copyist.

APR 1863

A | **4 Cav. | U. S. C. T.**

George Williams

Sgt, Co. G, 4 Reg't U. S. Col'd Cavalry.

Appears on

Company Muster Roll

for *Jan & Feb*, 1863.

Present or absent *Present*

Stoppage, \$ *100* for

Due Gov't, \$ *100* for

Valuation of horse, \$ *100*

Valuation of horse equipments, \$ *100*

Remarks: *Acc'd only \$ 7 per month in April 306 & was 1st Sgt from Feb 1864 to Aug 64 then private in Jan 1865 - from then Sgt*

Book mark:

[Signature]

(355)

Copyist.

M

4 Cav. | U. S. C. T.

George Williams

Sgt, Co. G, 4 Reg't U. S. Col'd Cavalry.

Appears on

Company Muster Roll

for *Men & ape*, 1862

Present or absent *Present*

Stoppage, \$ *100* for

Due Gov't, \$ *100* for

Valuation of horse, \$ *100*

Valuation of horse equipments, \$ *100*

Remarks:

Book mark:

Atwood

H | **4 Cav. | U. S. C. T.**

George Williams
Sgt, Co. G, 4 Reg't U. S. Col'd Cavalry.

Appears on

Company Muster Roll

for *May & June*, 186*5*.

Present or absent *Present*

Stoppage, \$ *100* for

Due Gov't, \$ *100* for

Valuation of horse, \$ *100*

Valuation of horse equipments, \$ *100*

Remarks:

.....
.....
.....
.....
.....
.....
.....
.....
.....

Book mark:

Amos
Copyist.

W

4 Cav. | U. S. C. T.

George Williams

W, Co. G, 4 Reg't U. S. Col'd Cavalry.

Appears on

Company Muster Roll

for *July & Aug*, 1865.

Present or absent *Present*

Stoppage, \$ *100* for

Due Gov't, \$ *100* for

Valuation of horse, \$ *100*

Valuation of horse equipments, \$ *100*

Remarks:

Book mark:

Wm. J. ...
Copyist.

W

4 Cav. | U.S.C.T.

George Williams
Sgt, Co. G, 4 Reg't U. S. Col'd Cavalry.

Appears on

Company Muster Roll

for *Sept & Oct*, 186*5*.

Present or absent *Present*

Stoppage, \$ *100* for

Due Gov't, \$ *100* for

Valuation of horse, \$ *100*

Valuation of horse equipments, \$ *100*

Remarks:

LIST ROLL ON FILE FEB 1866

Book mark:

Fletcher

W | **4 Cav.** | **U.S.C.T.**

George Williams
Sgt, Co. G, 4 Reg't U. S. Col'd Cavalry.

Appears on

Company Muster Roll

for *Jan & Feb*, 186*6*.

Present or absent *Present*

Stoppage, \$ *100* for

Due Gov't, \$ *100* for

Valuation of horse, \$ *100*

Valuation of horse equipments, \$ *100*

Remarks:
.....
.....
.....
.....
.....
.....
.....
.....
.....
.....

Book mark :

File

W | **4 Cav.** | **U.S.C.T.**

George Williams
Sgt, Co. *G*, 4 Reg't U. S. Col'd Cavalry.

Appears on **Co. Muster-out Roll**, dated
New Orleans, La. & Mch 20, 1866.

Muster-out to date *Mch 20*, 1866.

Last paid to *June 30*, 1865.

Clothing account:

Last settled _____, 186 ; drawn since \$ _____ 100

Due soldier \$ *40*^{*81*}/₁₀₀; due U. S. \$ _____ 100

Am't for cloth'g in kind or money adv'd \$ _____ 100

Due U. S. for arms, equipments, &c., \$ _____ 100

Bounty paid \$ _____ 100; due \$ _____ 100

Remarks: *Joined at orig. org.*
Sergt since Feb 8-64

Book mark: _____

Fletcher

1155

Williams George

Co G, 4 U. S. Col'd Cav.

Private Private

CARD NUMBERS.

1	5347657	26
2	5347687	27
3	5347868	28
4	5358863	29
5	5358708	30
6	5348209	31
7	5358707	32
8	5358800	33
9	5347967	34
10	5356719	35
11	5356806	36
12	5358897	37
13	5356982	38
14	5357070	39
15	5357175	40
16	40729341	41
17	40729340	42
18		43
19		44
20		45
21		46
22		47
23		48
24		49
25		50

Book Mark:

See also

W | **4 Cav. U.S.C.T.**

George Williams

Appears with rank of *P* on

Muster and Descriptive Roll of a Detachment of U. S. Vols. forwarded

for the 4 Reg't U. S. Col'd Cavalry. Roll dated

New Orleans La June 22, 1864

Where born *Clark Co Miss*

Age *19* y'rs; occupation *Laborer*

When enlisted *June 9*, 1864

Where enlisted *New Orleans*

For what period enlisted *3* years.

Eyes *Blk*; hair *Blk*

Complexion *Mr*; height *5 ft. 6 1/2 in.*

When mustered in _____, 186 .

Where mustered in *New Orleans*

Bounty paid \$ *21* ¹⁰⁰; due \$ ¹⁰⁰

Where credited *to New Orleans La*

Company to which assigned *L*

Remarks :

Book mark :

Wm Hunter

W | **4 Cav. | U.S.C.T.**

George Williams
Appears with rank of *Private* on

Muster and Descriptive Roll of a Detachment of U. S. Vols. forwarded

for the 4 Reg't U. S. Col'd Cavalry. Roll dated

New Orleans La July 18, 1864

Where born *Clark Co, Miss,*

Age *19* y'rs; occupation *Labour*

When enlisted *June 9, 1864*

Where enlisted *New Orleans*

For what period enlisted *3* years.

Eyes *Blue*; hair *Blue*

Complexion *Fair*; height *5 ft. 6 1/2 in.*

When mustered in *June 22, 1864*

Where mustered in *New Orleans*

Bounty paid \$ *100*; due \$ *100*

Where credited *to New Orleans La*

Company to which assigned *D*

Remarks:
.....
.....

Book mark:.....

Jan H. Smith

77 | 4 Cav. | U.S.C.T.

George Williams
Priv., Co. D, 4 Reg't U.S. Col'd Cavalry.

Age years.

Appears on

Company Muster Roll*

for Enrollment to Aug. 31, 1864.

Joined for duty and enrolled:

When June 9, 1864.

Where New Orleans La.

Period 3 years.

Mustered in:

When June 22, 1864.

Where New Orleans La.

Present or absent Present

Stoppage, \$ 100 for

Due Gov't, \$ 100 for

Valuation of horse, \$ 100

Valuation of horse equipments, \$ 100

Remarks :

* First current roll. No muster-in roll of this battery on file.

Book mark :

(3586) Leving Copyist.

W | 4 Cav. | U.S.C.T.

George Williams
Pvt., Co. L, 4 Reg't U. S. Col'd Cavalry.

Appears on

Company Muster Roll

for Sept & Oct, 1864.

Present or absent Present

Stoppage, \$ 100 for

Due Gov't, \$ 100 for

Valuation of horse, \$ 100

Valuation of horse equipments, \$ 100

Remarks:

Book mark:

(358)

W. J. ... Copyist.

W | 4 Cav. | U.S.C.T.

George Williams

Pvt., Co. L, 4 Reg't U. S. Col'd Cavalry.

Appears on

Company Muster Roll

for Nov. & Dec., 1864.

Present or absent

Stoppage, \$ 30 ⁰⁰/₁₀₀ for Ordnance

Due Gov't, \$ 100 for

Valuation of horse, \$ 100

Valuation of horse equipments, \$ 100

Remarks: Inserted Dec. 4th -
carrying away one Burn-
side Carbine

Book mark:

Lerrin

W *H^o Cav.* | **U.S.C.T.**

George Williams.

Pvt., Co. L, H^o Reg't U. S. Col'd Cav.

Appears on

Descriptive List of Deserters

dated *Pt. Hudson, La, Dec. 31, 1864.*

Deserted :

When *Dec. 4,* 1864.

Where *Port Hudson La.*

Arrested :

When _____, 186 .

Where _____

Remarks : _____

Book mark : _____

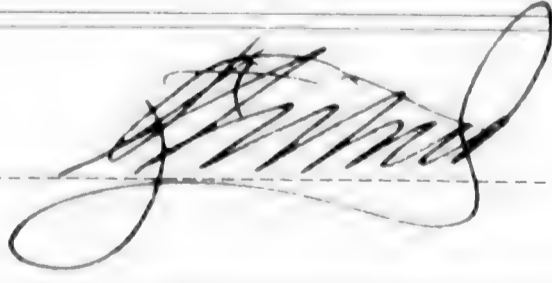

It | *4 Cav.* | **U.S.C.T**

George Williams
Art. Co. S., 4 Reg't U. S. Col'd Cav.

Appears on

Company Muster Roll

for *Jan. & Feb.*, 1865.

Present or absent *Not stated*

Stoppage, \$ *100* for

Due Gov't, \$ *100* for

Valuation of horse, \$ *100*

Valuation of horse equipments, \$ *100*

Remarks:

Book mark:

A. A. Hall

(358)

*Copyist.
Comp.*

A

4 Cav. | U. S. C. T.

George Williams

Private, Co. G, 4 Reg't U. S. Col'd Cavalry.

Appears on

Company Muster Roll

for *Men & APC*, 1865.

Present or absent *Absent*

Stoppage, \$ *100* for

Due Gov't, \$ *100* for

Valuation of horse, \$ *100*

Valuation of horse equipments, \$ *100*

Remarks: *found by transfer
in consolidation from
Co L Mar 24 per S.O. No 28
dated 1st 25s Dep
July Jan 250 s.*

Book mark:

Wm D
Coppist.

71 | **4 Cav.** | **U.S.C.T.**

George Williams

Appears with rank of Sgt. on

Muster and Descriptive Roll of a Detachment of U. S. Vols. forwarded

for the 4 Reg't U. S. Col'd Cavalry. Roll dated

Fort Monroe, Va., April 9, 1864.

Where born Walden, Pa., 1838

Age 27 y'rs; occupation Reverend

When enlisted June 9, 1864.

Where enlisted New Orleans

For what period enlisted 3 years.

Eyes Black; hair Black

Complexion Black; height 5 ft. 6 1/2 in.

When mustered in June 22, 1864.

Where mustered in New Orleans

Bounty paid \$ 100; due \$ 100

Where credited

Company to which assigned G

Remarks: Transferred from L Company in consolidation

Book mark:

G. C. Tyler

N *4 Cav.* | **U.S.C.T.**

George Williams
Pvt., Co. *G*, *4* Reg't U. S. Col'd *Cav.*

Appears on

M. and D. Roll of Men Transferred

to the organization named above, *by consol.*
from *Co. L*

Roll dated *Port Hudson La. Apr 29*, 1865.

When enlisted *June 9*, 1864.

Period for which enlisted *3* years.

When mustered in *June 22*, 1864.

Present or absent *Present*

Company to which assigned *L*

Remarks:

Book mark:

(342)

M. Leonard

Copyist.

4 Cav. | U. S. C. T.

George Williams

Pr., Co. G, 4 Reg't U. S. Col'd Cavalry.

Appears on

Company Muster Roll

for *May 1 1863*, 1863 :

Present or absent *Absent*

Stoppage, \$ *100* for

Due Gov't, \$ *100* for

Valuation of horse, \$ *100*

Valuation of horse equipments, \$ *100*

Remarks: *Absent in arrest
in New Orleans*

Book mark :

[Signature]
Copyist.

H

4 Cav. | U. S. C. T.

George Williams

Co., Co. G, 4 Reg't U. S. Col'd Cavalry.

Appears on

Company Muster Roll

for *July & Aug*, 186*5*

Present or absent *Present*

Stoppage, \$ *100* for

Due Gov't, \$ *100* for

Valuation of horse, \$ *100*

Valuation of horse equipments, \$ *100*

Remarks: *Present in arrest*

Book mark:

Atwood

W | **4 Cav. | U.S.C.T.**

George Williams
Priv, Co. G, 4 Reg't U. S. Col'd Cavalry.

Appears on

Company Muster Roll

for *Sept & Oct*, 186*5*.

Present or absent *Absent*

Stoppage, \$ *100* for

Due Gov't, \$ *100* for

Valuation of horse, \$ *100*

Valuation of horse equipments, \$ *100*

Remarks: *Absent in arrest*

ROLL ON FILE FEB 1866

Book mark:

Fletcher
Copyist.

W

4 Cav. | U. S. C. T.

George Williams

Priv, Co. G, 4 Reg't U. S. Col'd Cavalry.

Appears on

Company Muster Roll

for *Jan & Feb*, 186*6*.

Present or absent

Stoppage, \$ 100 for

Due Gov't, \$ 100 for

Valuation of horse, \$ 100

Valuation of horse equipments, \$ 100

Remarks: *Deserted.*

*Escaped from confinement
in New Orleans in 1865*

Book mark: *...*

Fletcher

W | 4 Cav. | U.S.C.T.

George Williams
 Pvt., Co. G, 4 Reg't U. S. Colored Cav.

Appears on Returns as follows:

May 1861. Absent sent to arrest
 deserters May 29.
 (back to Nov 1865. Absent in arrest,
 in confinement at New Orleans
 La.

Book mark:

W. R. Lee

111 | 4 Cav. | U.S.C.T.

George Williams

Port, Co. 2, 4 Reg't U. S. Colored Cav.

Appears on Returns as follows:

Dec 1864 - Dec 11/64
 Port Hudson La. Deserted
 Jan 1865 - Gain: Jan 17/65
 New Orleans, La. apprehend-
 ed from desertion
 Jan & Feb 1865. About in confine-
 ment at New Orleans, La.

Book mark:

W. R. Lee

W | **4 Cav.** | **U.S.C.T.**

George Williams
Priv, Co. *G*, 4 Reg't U. S. Col'd Cavalry.

Appears on **Co. Muster-out Roll**, dated
New Orleans, La. Mch 20, 186*6*.

Muster-out to date _____, 186 .

Last paid to *Aug 31*, 186*4*.

Clothing account:

Last settled _____, 186 ; drawn since \$ _____ *100*

Due soldier \$ _____ *100*; due U. S. \$ _____ *100*

Am't for cloth'g in kind or money adv'd \$ _____ *100*

Due U. S. for arms, equipments, &c., \$ _____ *100*

Bounty paid \$ _____ *100*; due \$ _____ *100*

Remarks: *Joined by transfer from*
Co. G 1st S. C. 28 Hd. Sq. Dept
July Jan'y 28. 65

Deserted, Escaped from con-
finement in New Orleans 1865

Book mark: *R. 14. 9*

Fletcher

Williams, George

P, Co. L, 4 Reg't U.S.C. Cad.

2 Enclosures.

Bed Cards	Final Statements
Burial Records	Furloughs or L. of A
Certs. of Dis. for Discharge	Med. Certificates
C. M. Charges	Med. Des. Lists
Descriptive Lists	Orders
Discharge Certificates	Pris. of War Record
Enlistment Papers	Resignations

Other papers relating to—

Admission to Hosp'l	Furlough or L. of A
Casualty Sheet	Med. Examination
Confinement	Misc. Information 2
Contracts	Pay or Clothing
Death or Effects	Personal Reports
Desertion	Rank
Discharge from Hosp'l	Transfer to Hosp'l
Discharge from Service	Transfer to V. R. C.
Duty	Transportation

MICROFILM PUBLICATION M 1820

COMPILED MILITARY SERVICE RECORDS
OF VOLUNTEER UNION SOLDIERS WHO
SERVED WITH THE USCT (US COLORED TROOPS)
4TH REGIMENT OF CAVALRY

PERSONAL PAPERS' TARGET SHEET

PLEASE NOTE THE CHECKED INFORMATION ABOUT THE PERSONAL PAPERS IN
THIS FILE:

- NO PERSONAL PAPERS WERE FOUND IN THIS FILE WHEN THE
RECORDS WERE ARRANGED FOR MICROFILMING.
- 3 PERSONAL PAPER(S) FOUND IN THIS FILE WHEN THE RECORDS
WERE ARRANGED FOR MICROFILMING.

L.R. 1449-65
Office of the Surgeon
New Orleans, La.

Ambrose A. J.

Report of

concerning the escape of

Geo. Williams & McCall

a prisoner at Barracks

at Prison

L.R. 1449-65 filed in "D"

Office of the Surgeon
New Orleans, La.

Respectfully forwarded
to you a copy of
a report

Dempsey Donnell
1st Major Army
Prison

L.R. 1449-65
Office of the Surgeon
New Orleans, La.

Respectfully forwarded to Head
Quarters of the Garrison of
Louisiana

R. J. Beaden
Capt. 26th Inf. U.S.A.
New Orleans, La.

Office of Warden of Penitentiary
New Orleans March 10th. 1855

Lucius Powell
County Warden Penitentiary

Dear Sir,

I have the honor to report that one prisoner made his escape from this Penitentiary, between the hours of 7 and 8 o'clock P.M. He was discovered climbing over the roof of Mr. Knight's stable, but he fell in with him again in the back yard. In making the report you are to be an interested person by the name of William Geo. 4th U.S. Cav. In my opinion he must have climbed over the roof on the back part of the building and from thence onto the roof of Mr. Knight's stable. I have provided the report of the relief there on duty and the sentinel nearest the place of escape, and will prefer charges against the same this morning, for neglect of duty.

I have the honor to be
Very respectfully
Yours Obedt. Servant
Sgt. Daniel Miller
2^d Regt. U.S. A.
County Guard

Office of Guard of Barronne Street Prison
New Orleans March 10th 1853

Genl. Powell

Comdg. Second Dist. Prison

Sir:

I have the honor to
advise that we were made prisoner
the night of the 8th of Oct. '52. He was discovered by the
1st Co. of the 1st Regt. Ill. Inf. but he had to wait until
the next day. I called the roll of the prisoners by the
name of William C. ... Co. ...
and checked over the roll of the fact book of the ...
house made the rest of that night. I have ...
found out the whole thing and ...
escape, and with proper charges against the ...
neglect of duty.

I have the honor to be

Very Respectfully

Wm. C. ...

Signed: ...

1st Lt. ...

Official Copy:

R. J. Beaman

Captain 26th Ind. Inf.

and Prov. Marshal

Is. of Orleans

Ellerbrook.

Priv: Geo. Williams C^o of 4th W. P. C. Cav.

Adjutant General's Office,

COLORED TROOPS BRANCH,

April 21st, 1874

Vol. C. T., 187

Wanted in case of Private George Williams, Co. "L", 4th Reg't W. S. Colored Cav. who is reported - "Deserted Dec: 4th '64" (Vide M. R. for Nov: & Dec: '64) - "Jan: 17th 1865 New Orleans, La: apprehended from desertion" - absent - "In Confinement at New Orleans La: - (Vide Reg't Ret: for January 1865) - Transferred to Co. "E" March 24th 1865 - (Vide M. R. - Co. "E" - for March & April 1865) - absent in arrest - (Vide M. R. of Co. "E" also Reg't Returns from Feb: 28th '65 to Nov: 30th '65) - Information as to trial and sentence

Respectfully,

J. A. Woodward
Chief Clerk

M: Ellerbrook

E. R.

Adjutant General's Office,

April 25th, 1874

Vol. C. T., 187

Reply in case of 4th Reg't U. S. C. Cav. of Mr. Williams, Co. "L",

Records of Mr. Wm. H. C. J. Lawrence St. Louis, Mo. Geo. Williams of Co. "L" U. S. C. Cav. arrived Mar. 4. '65, Released Mar. 11. '65. Records of Reg't W. C. C. Des. Cav. do not furnish any evidence relative to trial or sentence. There is no record of Reg't papers.

1670

1156

William Henry
Co — , 4 U. S. Col'd Cav.

Private | Private

CARD NUMBERS.

1	5347531	26
2		27
3		28
4		29
5		30
6		31
7		32
8		33
9		34
10		35
11		36
12		37
13		38
14		39
15		40
16		41
17		42
18		43
19		44
20		45
21		46
22		47
23		48
24		49
25		50

Book Mark:

See also

N | 4 Cav. | U.S.C.T.

Henry Williams

Appears with rank of *Private* on

Muster and Descriptive Roll of a Detachment of U. S. Vols. forwarded

for the 4 Reg't U. S. Col'd Cavalry. Roll dated

New Orleans, La, Apr. 25, 1865.

Where born *Easter Shore, Maryland*

Age *22* y'rs; occupation *Laborer*

When enlisted *Apr. 9*, 1865.

Where enlisted *New Orleans, La*

For what period enlisted *3* years.

Eyes *Black*; hair *Black*

Complexion *Black*; height *5 ft. 7 in.*

When mustered in *Apr. 25*, 1865.

Where mustered in *New Orleans*

Bounty paid \$ *100* ¹⁰⁰; due \$ *200* ¹⁰⁰

Where credited *1st Dist. 2nd Ward, Orleans }
New Orleans, La }*

Company to which assigned *C.*

Remarks: *Absent from Muster.*

Entry cancelled on Roll by line.

Book mark:

O. P. Taylor

1157

Williams Henry

Co A, 4. U. S. Col'd Cav.

Parente | Parente

CARD NUMBERS.

1	5352589	26
2	5352639	27
3	5352690	28
4	5352749	29
5	5352824	30
6	5352885	31
7	5352966	32
8	5353798	33
9	40729343	34
10		35
11		36
12		37
13		38
14		39
15		40
16		41
17		42
18		43
19		44
20		45
21		46
22		47
23		48
24		49
25		50

Book Mark:

See also

NOV 1959

S 844420 2 and
A 2402358 pencil

S. A. Muhlman
548

1959

4 | **4 Cav.** | **U.S.C.T.**

Henry Williams

Priv., Co. D, 1 Reg't, Corps d'Afrique Cavalry.*

Apr 28
Appears on

Company Muster-in Roll

of the organization named above. Roll dated

New Orleans La, Nov 26, 1863.

Muster-in to date Nov 26, 1863.

Joined for duty and enrolled:

When Oct-19, 186 .

Where New Orleans

Period 3 years.

Valuation of horse, \$ 100

Valuation of horse equipments, \$ 100

Remarks: _____

* This organization subsequently became Co. D, 4 Reg't U. S. Colored Cavalry.

Book mark: _____

Rosenbaum

H 4 Cav. U.S C.T.

Henry William
Pvt, Co. *D*, 1 Reg't Cav., Corps d'Afrique.*

Appears on

Company Muster Roll

for *From Enlistment to Dec 31, 1863.*

Present or absent *Present*

Stoppage, \$ 100 for

Due Gov't, \$ 100 for

Valuation of horse, \$ 100

Valuation of horse equipments, \$ 100

Remarks:

* This organization subsequently became Co. *D*, 4 Reg't U. S. Colored Cavalry.

Book mark:

Rosenbaum

H 4 Cav. U.S C.T.

Henry William
Pvt, Co. *D*, 1 Reg't Cav., Corps d'Afrique.*

Appears on

Company Muster Roll

for *Jan'y 7 Feby*, 1864.

Present or absent *Present*

Stoppage, \$ *100* for

Due Gov't, \$ *100* for

Valuation of horse, \$ *100*

Valuation of horse equipments, \$ *100*

Remarks:
.....
.....
.....
.....
.....

* This organization subsequently became Co. *D*, 4 Reg't U. S. Colored Cavalry.

Book mark:

Rosenbawm
(358) Copyist.

Yf | **4 Cav.** | **U.S.C.T.**

Henry Williams

Priv, Co. D. 4 Reg't U. S. Col'd Cavalry.

Appears on

Company Muster Roll

for *March & April*, 1864.

Present or absent *Present*

Stoppage, \$.....100 for

Due Gov't, \$.....100 for

Valuation of horse, \$.....100

Valuation of horse equipments, \$.....100

Remarks:

Book mark:

Rosenbaum

4 | **4 Cav.** | **U.S.C.T.**

Henry Williams

Plt., Co. D. 4 Reg't U. S. Col'd Cavalry.

Appears on

Company Muster Roll

for *May & June*, 186*4*.

Present or absent.....

Stoppage, \$.....100 for

Due Gov't, \$.....100 for

Valuation of horse, \$.....100

Valuation of horse equipments, \$.....100

Remarks: *Deserted from Camp
Parafet Carrolton La, June
19-1864*

Book mark:.....

Rosenbaum

44 | **4 Cav.** | **U.S.C.T.**

Henry Williams

Pvt, Co. D. 4 Reg't U. S. Col'd Cavalry.

Appears on

Company Muster Roll

for July & Aug, 1864.

Present or absent _____

Stoppage, \$ _____ 100 for _____

Due Gov't, \$ _____ 100 for _____

Valuation of horse, \$ _____ 100

Valuation of horse equipments, \$ _____ 100

Remarks: Deserted from camp
Parapet June 19-1864

Book mark: _____

(358)

Rosenbaum
Copyist.

71 | **4 Cav.** | **U.S.C.T.**

Henry Williams

Pvt., Co. D, 4 Reg't U. S. Col'd Cavalry.

Appears on

Company Muster Roll

for *Sept & Oct*, 186*4*.

Present or absent

Stoppage, \$ 100 for

Due Gov't, \$ 100 for

Valuation of horse, \$ 100

Valuation of horse equipments, \$ 100

Remarks: *Deserted from camp
Parapet June 19-1864*

Book mark:

Rosenbaum

W | 4 Cav. | U.S.C.T.

Henry Williams
Priv., Co. D, 4 Reg't U. S. Colored Cav.

Appears on Returns as follows:

June & July 1864 - Absent without
leave since June 22 from
Camp Parapet Va.
Aug 1864 - Does; June 22 Camp
Parapet described.

Book mark:

W. R. Lee

A | **4 Cav. | U.S.C.T.**

Henry Williams

Part, Co. *H*, 4 Reg't U. S. Col'd Cavalry.

Appears on **Co. Muster-out Roll**, dated *New Orleans, La, Feb 20*, 1866.

Muster-out to date _____, 186__.

Last paid to *Apr 30*, 1864.

Clothing account:

Last settled _____, 186__ ; drawn since \$ _____ $\overline{100}$

Due soldier \$ _____ $\overline{100}$; due U. S. \$ *33* $\overline{100}$ ^{*18*}

Am't for cloth'g in kind or money adv'd \$ _____ $\overline{100}$

Due U. S. for arms, equipments, &c., \$ _____ $\overline{100}$

Bounty paid \$ _____ $\overline{100}$; due \$ _____ $\overline{100}$

Remarks: *Joined 12th Reg. Dr. G.*
Deserted June 22/64 at
Camp Parapet, La.

Book mark : _____

M. Andrews.

1157

Williams Horace

Co ~~B~~, 4 U. S. Col'd Cav.

Private Private

CARD NUMBERS.

1	5349875	26
2	5349971	27
3	5350066	28
4	5350172	29
5	5350267	30
6	5350353	31
7	5350433	32
8	5350507	33
9	5350581	34
10	5350667	35
11	5350752	36
12	5350846	37
13	5350932	38
14	5351016	39
15	5351099	40
16	5351179	41
17		42
18		43
19		44
20		45
21		46
22		47
23		48
24		49
25		50

Book Mark:

See also

W | **4 Cav. | U.S.C.T.**

Horace Williams

Co. B, Co. *B*, 1 Reg't La. Cav., Corps d'Afrique.*

Age 22
Appears on

Company Muster-in Roll

of the organization named above. Roll dated

New Orleans La Oct 27, 186 *3*.

Muster-in to date *Oct 27*, 186 *3*.

Joined for duty and enrolled:

When *Oct 12*, 186 .

Where *New Orleans*

Period *3* years.

Valuation of horse, \$.....*100*

Valuation of horse equipments, \$.....*100*

Remarks:.....
.....
.....

*This organization subsequently became Co. *B*, 4 Reg't U. S. Colored Cavalry.

Book mark:.....

(356)

King
Coyast.

N | **4 Cav. | U.S.C.T.**

Norace Williams
Co. B, 1 Reg't La. Cav., Corps d'Afrique.*

Appears on

Company Muster Roll

for *Oct 27 to Dec 31*, 186*6*.

Present or absent *Present*

Stoppage, \$ *100* for

Due Gov't, \$ *100* for

Valuation of horse, \$ *100*

Valuation of horse equipments, \$ *100*

Remarks:
.....
.....
.....
.....
.....

*This organization subsequently became Co *B*, 4 Reg't U. S. Colored Cavalry.

Book mark:

King
Copyist.

W

4 Cav. U.S C.T.

Horace Williams
Co. B, 1 Reg't Cav., Corps d'Afrique.*

Appears on

Company Muster Roll

for *Jan Feb*, 186*4*.

Present or absent *Present*

Stoppage, \$ *100* for

Due Gov't, \$ *100* for

Valuation of horse, \$ *100*

Valuation of horse equipments, \$ *100*

Remarks:

* This organization subsequently became Co. *B*, 4 Reg't U. S. Colored Cavalry.

Book mark: -----

(358)

Copyist.

H | **4 Cav. | U.S.C.T.**

Horace Williams

Pvt, Co. B. 4 Reg't U. S. Col'd Cavalry.

Appears on

Company Muster Roll

for *March & April*, 1864.

Present or absent *present*

Stoppage, \$ 100 for

Due Gov't, \$ 100 for

Valuation of horse, \$ 100

Valuation of horse equipments, \$ 100

Remarks :

Book mark :

(358)

J. M. ...
Copyist.

21

4 Cav. U.S.C.T.

Horace Williams
Cov, Co. B. 4 Reg't U. S. Col'd Cavalry.

Appears on

Company Muster Roll

for May + June, 1864.

Present or absent Present

Stoppage, \$ 100 for

Due Gov't, \$ 100 for

Valuation of horse, \$ 100

Valuation of horse equipments, \$ 100

Remarks :

Book mark :

(358)

Copyist

Copyist.

4

4 Cav. U.S.C.T.

Horace Williams
Co. B. 4 Reg't U. S. Col'd Cavalry.

Appears on

Company Muster Roll

for July + Aug, 1864.

Present or absent Present

Stoppage, \$ 100 for

Due Gov't, \$ 100 for

Valuation of horse, \$ 100

Valuation of horse equipments, \$ 100

Remarks :

Book mark :

(358)

Copyist.

W | **4 Cav.** | **U.S.C.T.**

Horace Williams
W, Co. B. 4 Reg't U. S. Col'd Cavalry.

Appears on

Company Muster Roll

for *Sept + Oct*, 186*4*.

Present or absent *Present*

Stoppage, \$ 100 for

Due Gov't, \$ 100 for

Valuation of horse, \$ 100

Valuation of horse equipments, \$ 100

Remarks :

Book mark : _____

[Signature]

Copyist.

PA | **4 Cav.** | **U.S.C.T.**

Horace Williams

priv, Co. B. 4 Reg't U. S. Col'd Cavalry.

Appears on

Company Muster Roll

for Nov + Dec, 1864.

Present or absent present

Stoppage, \$ 100 for

Due Gov't, \$ 100 for

Valuation of horse, \$ 100

Valuation of horse equipments, \$ 100

Remarks: Stop for one cap pouch,
two spurs & straps.

Book mark:

Pomer

N | **4 Cav. | U.S.C.T.**

Harace Williams

priv., Co. B. 4 Reg't U. S. Col'd Cavalry.

Appears on

Company Muster Roll

for *Jan & Feb.*, 1865.

Present or absent *present*

Stoppage, \$ 100 for

Due Gov't, \$ 100 for

Valuation of horse, \$ 100

Valuation of horse equipments, \$ 100

Remarks: *Received only by a
month to include Apr 30/64
Stop for one cup pouch,
2 spurs & straps*

Book mark:

W | **4 Cav. | U.S.C.T.**

Horace William

priv, Co. B. 4 Reg't U. S. Col'd Cavalry.

Appears on

Company Muster Roll

for *March & April*, 186*5*.

Present or absent *present*

Stoppage, \$ 100 for

Due Gov't, \$ 100 for

Valuation of horse, \$ 100

Valuation of horse equipments, \$ 100

Remarks :

Book mark :

Wm

W | **4 Cav.** | **U.S.C.T.**

Marcell Williams

207, Co. B. 4 Reg't U. S. Col'd Cavalry.

Appears on

Company Muster Roll

for *May 1 June*, 186*5*.

Present or absent *Present*

Stoppage, \$ *100* for

Due Gov't, \$ *100* for

Valuation of horse, \$ *100*

Valuation of horse equipments, \$ *100*

Remarks: *Stop for 2 spurs & 2
strips and 2 sweat leather.*

Book mark :

*D
Dorner*

M

4 Cav. | U.S.C.T.

Harace Williams

4th, Co. B. 4 Reg't U. S. Col'd Cavalry.

Appears on

Company Muster Roll

for *July & Aug*, 186*5*.

Present or absent *present*

Stoppage, \$ 100 for

Due Gov't, \$ 100 for

Valuation of horse, \$ 100

Valuation of horse equipments, \$ 100

Remarks :

Book mark :

James

W | **4 Cav.** | **U.S.C.T.**

Harace Williams

priv., Co. B. 4 Reg't U. S. Col'd Cavalry.

Appears on

Company Muster Roll

for *Sept & Oct*, 186*3*.

Present or absent *present*

Stoppage, \$ *100* for

Due Gov't, \$ *100* for

Valuation of horse, \$ *100*

Valuation of horse equipments, \$ *100*

Remarks :

Book mark :

Forster

W | **4 Cav. | U.S.C.T.**

Horace Williams
For, Co. B. 4 Reg't U. S. Col'd Cavalry.

Appears on

Company Muster Roll

for *Nov & Dec*, 1865.

Present or absent *Present*

Stoppage, \$ 100 for

Due Gov't, \$ 100 for

Valuation of horse, \$ 100

Valuation of horse equipments, \$ 100

Remarks :

Book mark :

Chandler

NOV 16 1865

H | **4 Cav. | U.S.C.T.**

Horace Williams
Pvt, Co. B. 4 Reg't U. S. Col'd Cavalry.

Appears on

Company Muster Roll

for *Jan. & Feb.*, 1866.

Present or absent *Present*

Stoppage, \$ 100 for

Due Gov't, \$ 100 for

Valuation of horse, \$ 100

Valuation of horse equipments, \$ 100

Remarks :
.....
.....
.....
.....
.....
.....
.....
.....

Book mark :
.....

Chandler

W | **4 Cav.** | **U.S.C.T.**

Horace Williams

Priv, Co. *B*, 4 Reg't U. S. Col'd Cavalry.

Appears on **Co. Muster-out Roll**, dated *New Orleans, La. Feb. 20*, 1866.

Muster-out to date *Feb. 20*, 1866.

Last paid to *June 30*, 1865.

Clothing account:

Last settled....., 186 ; drawn since \$.....100

Due soldier \$ *5-35-* 100; due U. S. \$.....100

Am't for cloth'g in kind or money adv'd \$.....100

Due U. S. for arms, equipments, &c., \$.....100

Bounty paid \$.....100; due \$.....100

Remarks: *Joined at Orgil ng.*

Book mark :

Chandler

(361)

Copyist.

ROLL

59

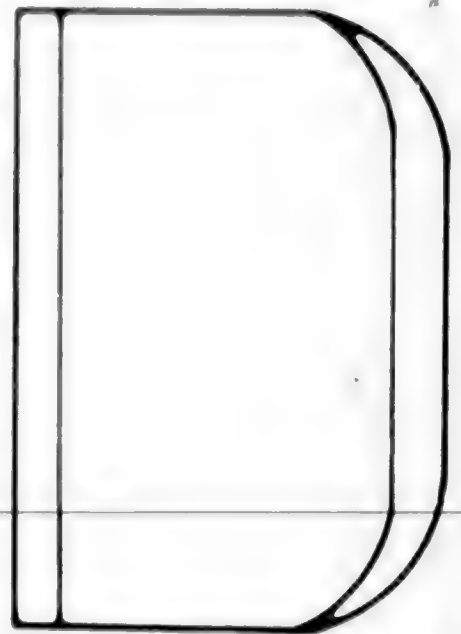
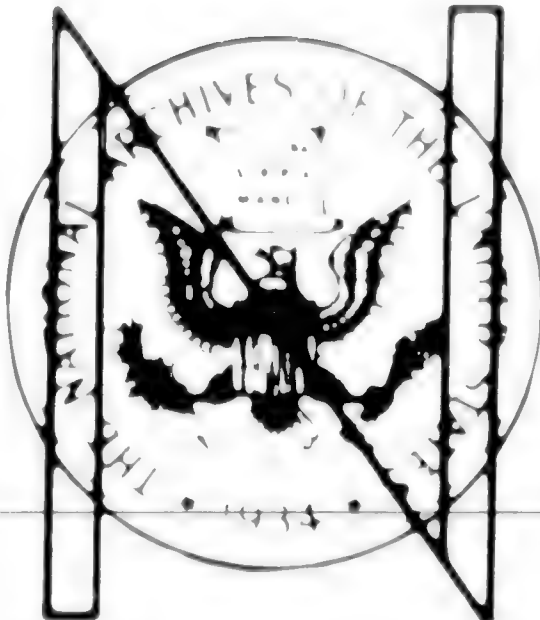
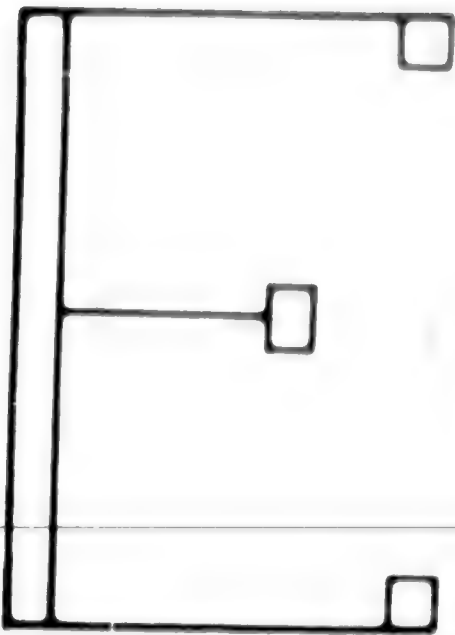

MICROSCOPY

1

8

1

7

IMAGE EVALUATION TEST TARGET (QA-3)

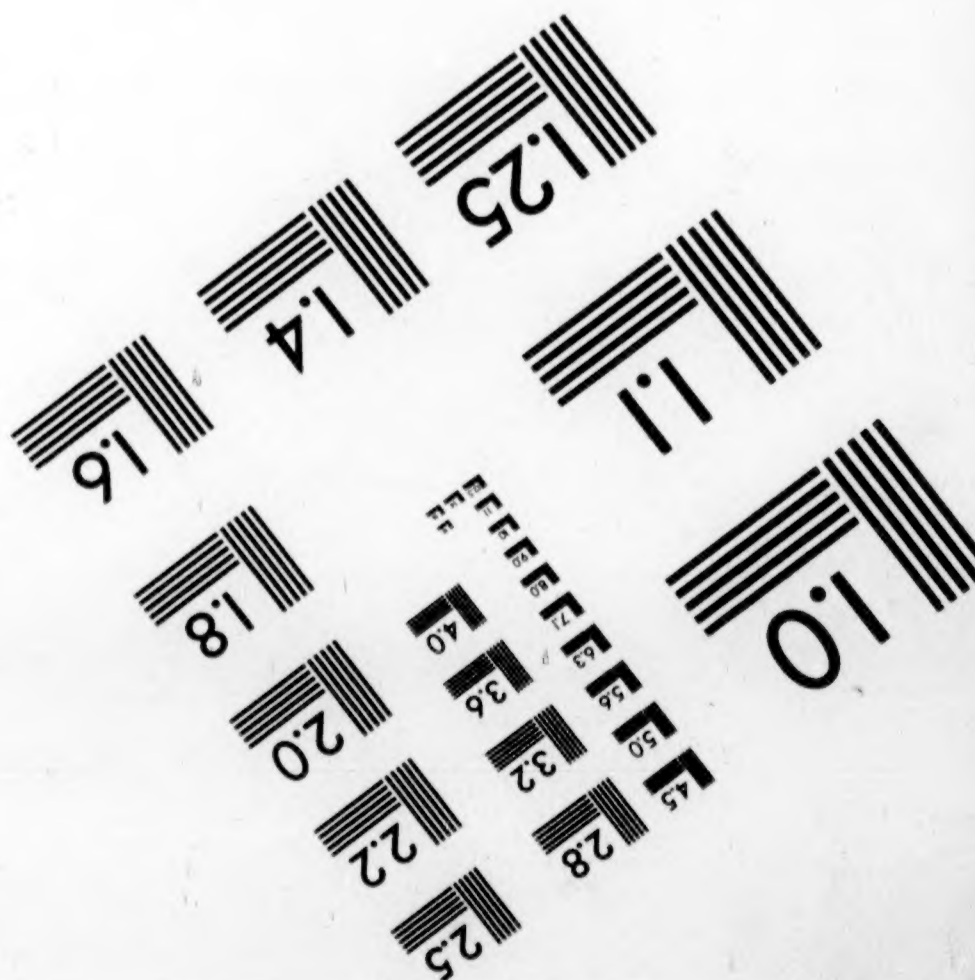
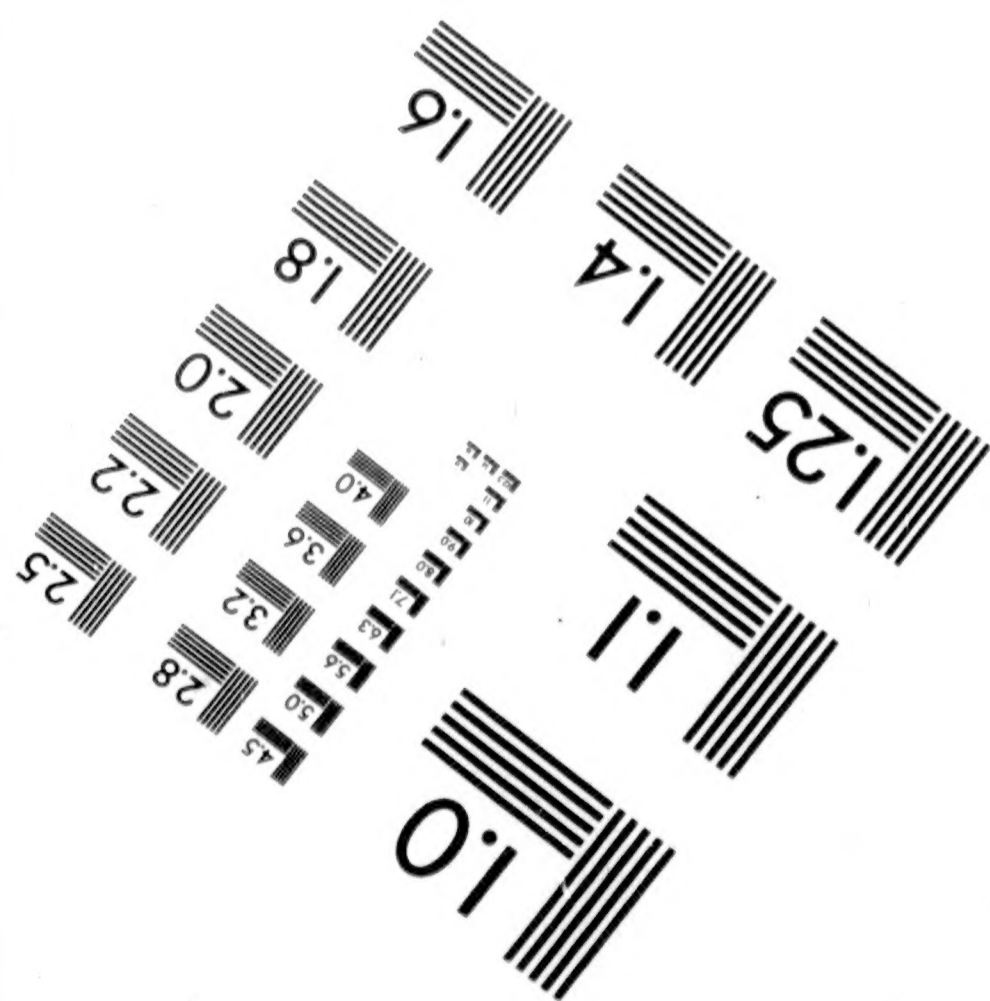
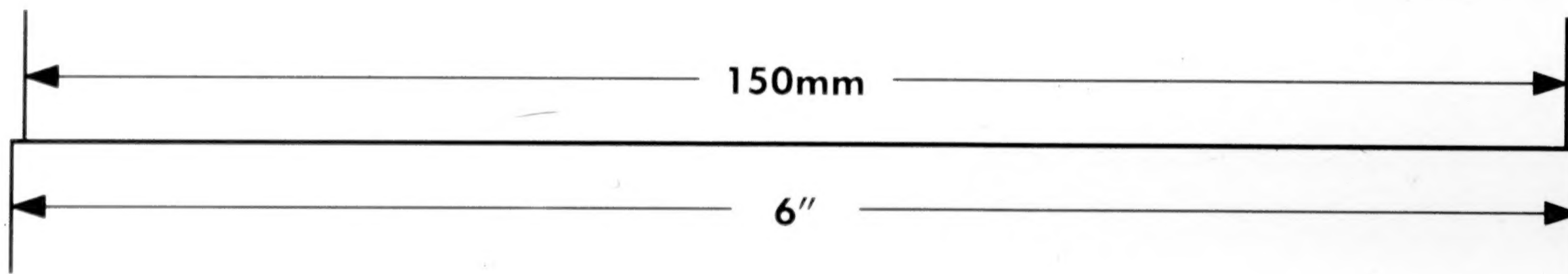
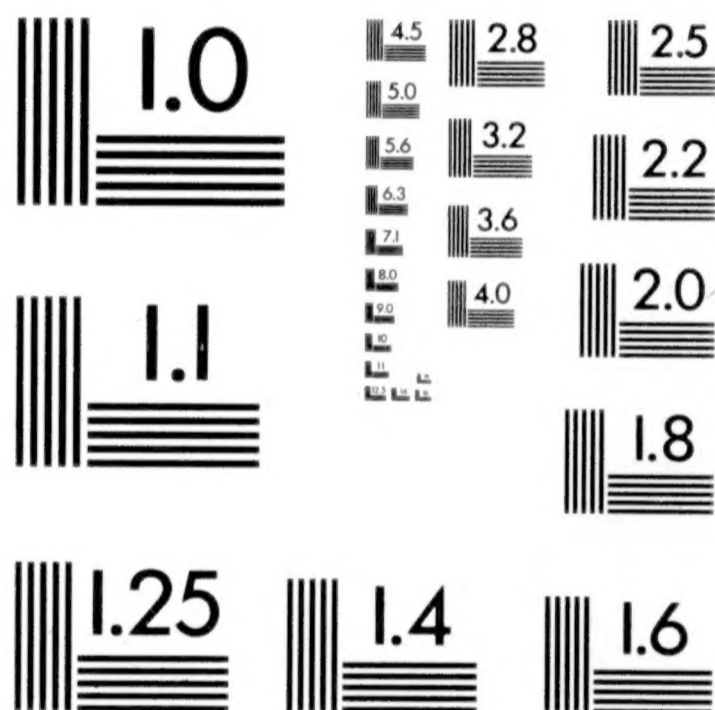
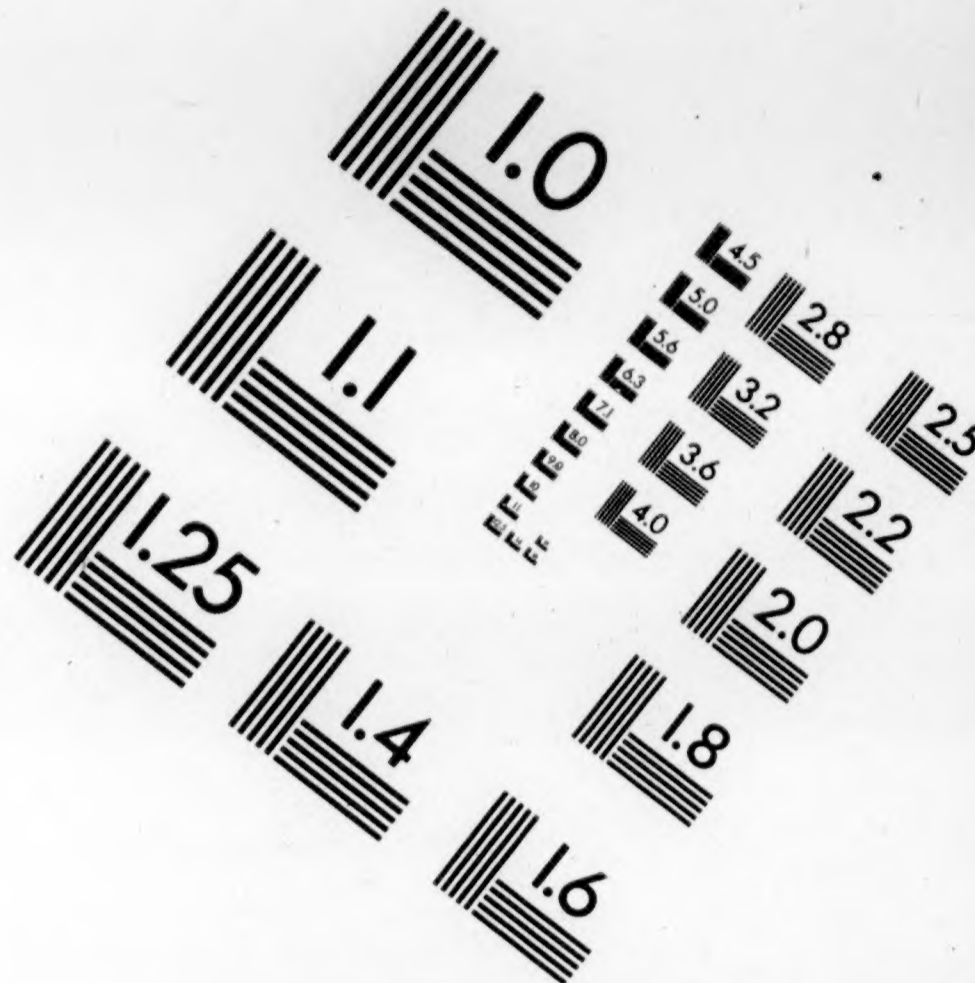
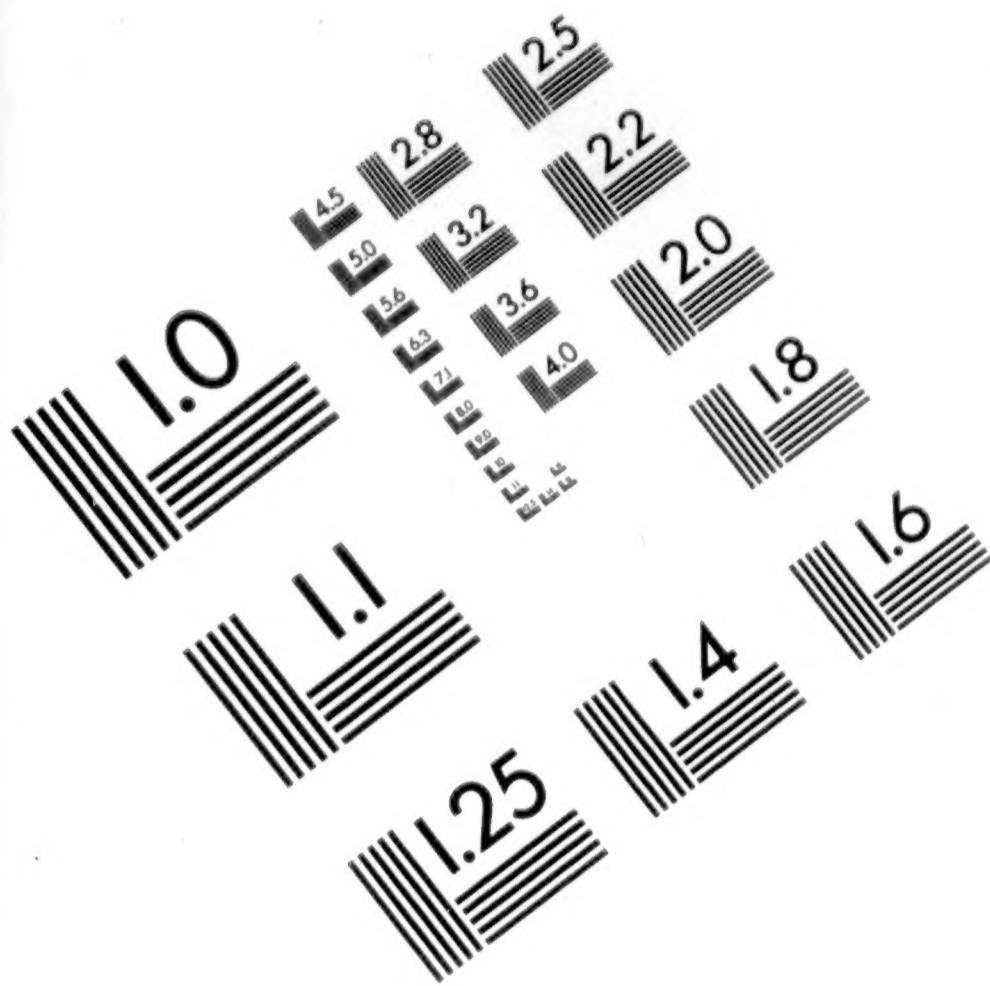

APPLIED IMAGE, Inc
 1653 East Main Street
 Rochester, NY 14609 USA
 Phone: 716/482-0300
 Fax: 716/288-5989

© 1993, Applied Image, Inc., All Rights Reserved

THE END

PLEASE

REWIND

