

NATIONAL
ARCHIVES
MICROFILM
PUBLICATION

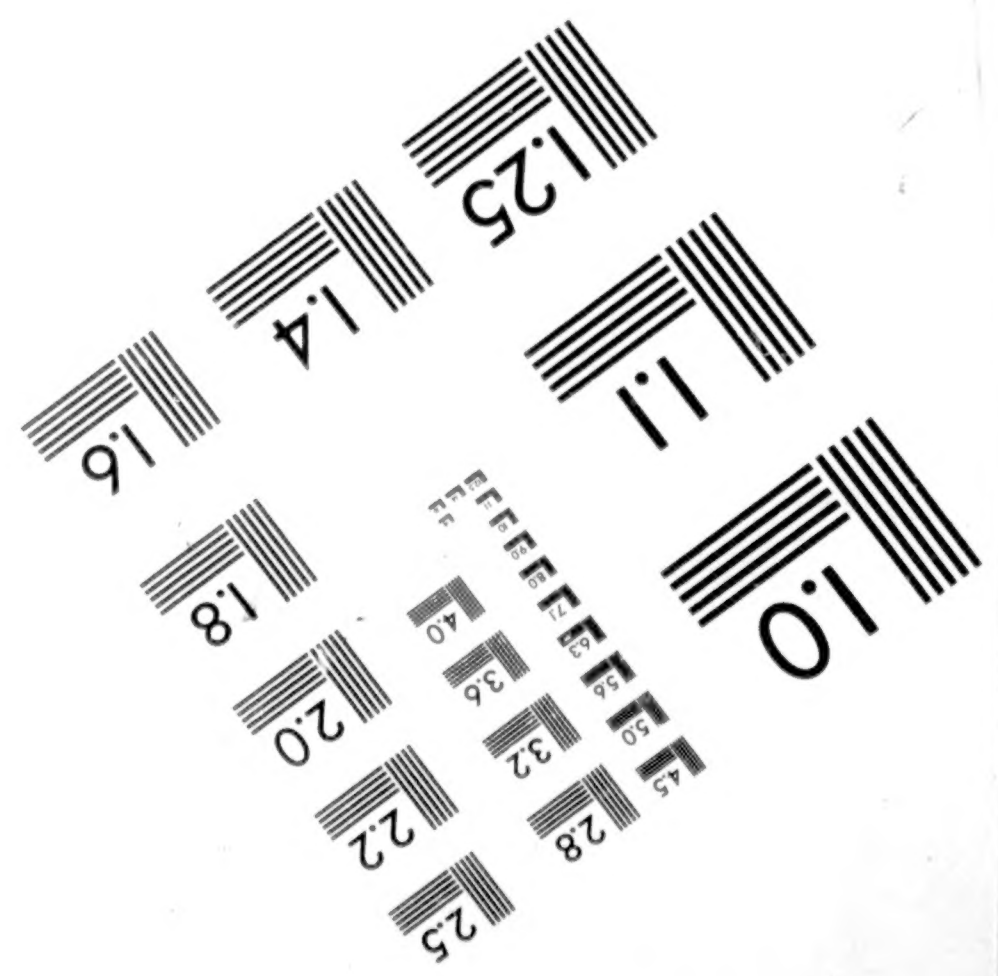

IMAGE EVALUATION TEST TARGET (QA-3)

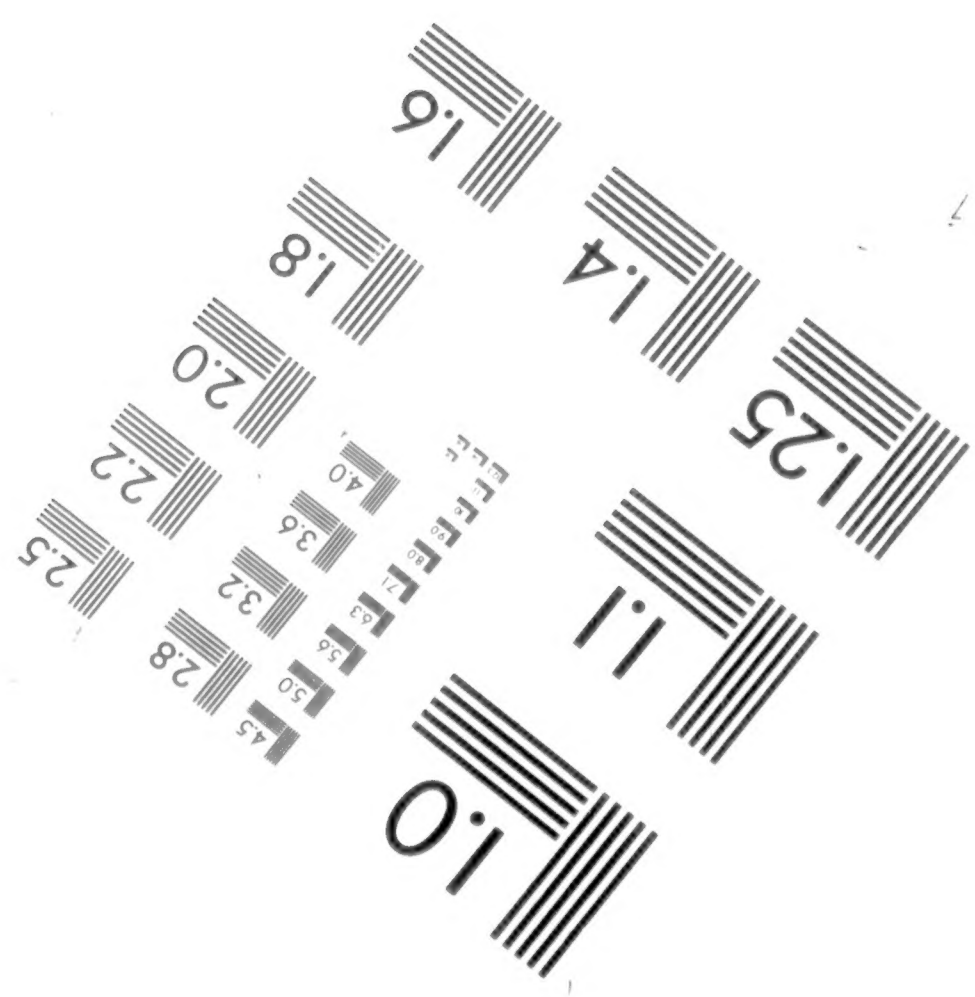
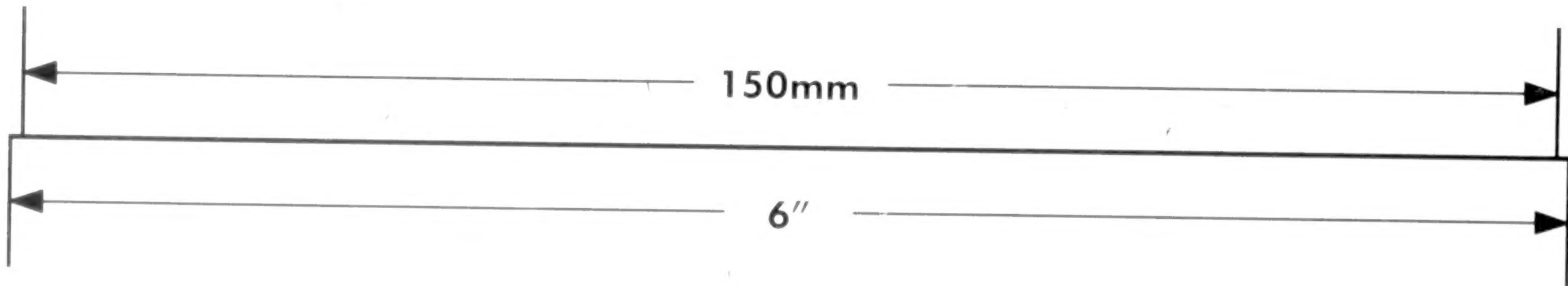
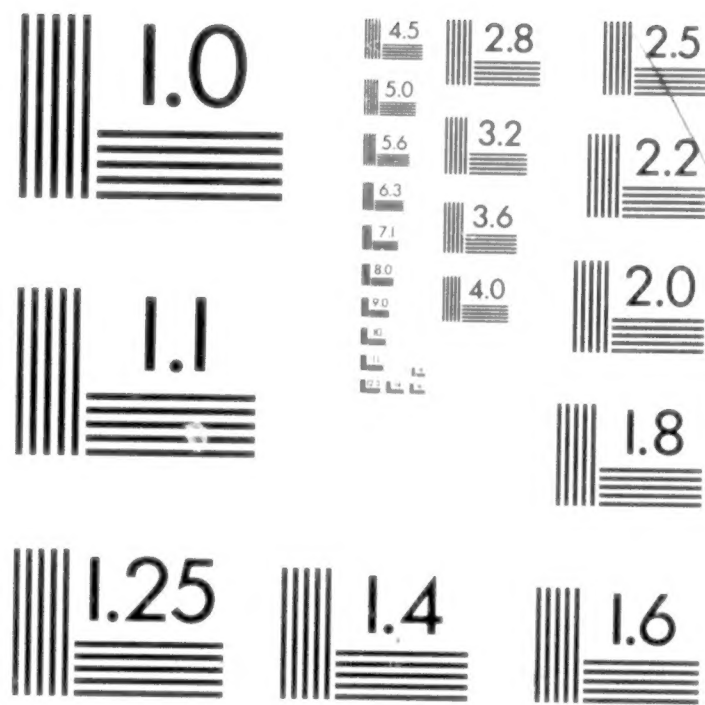
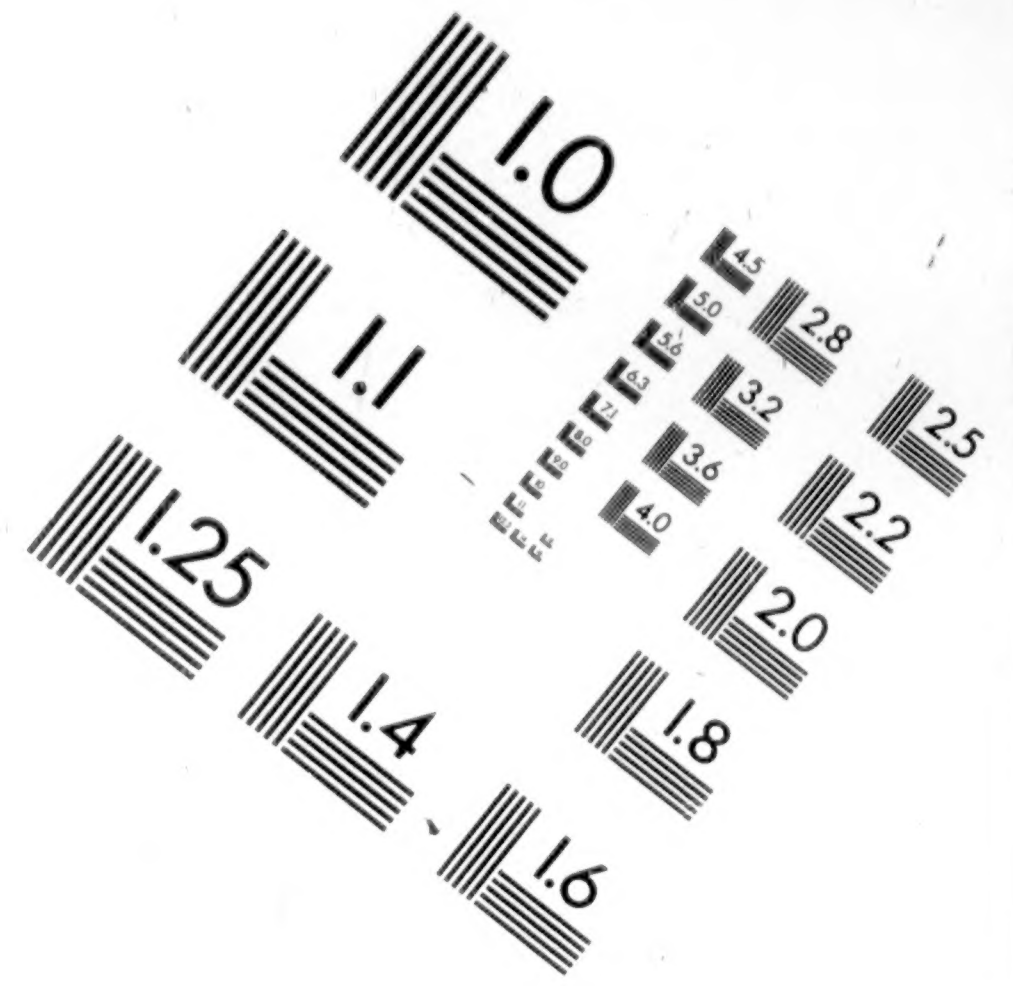
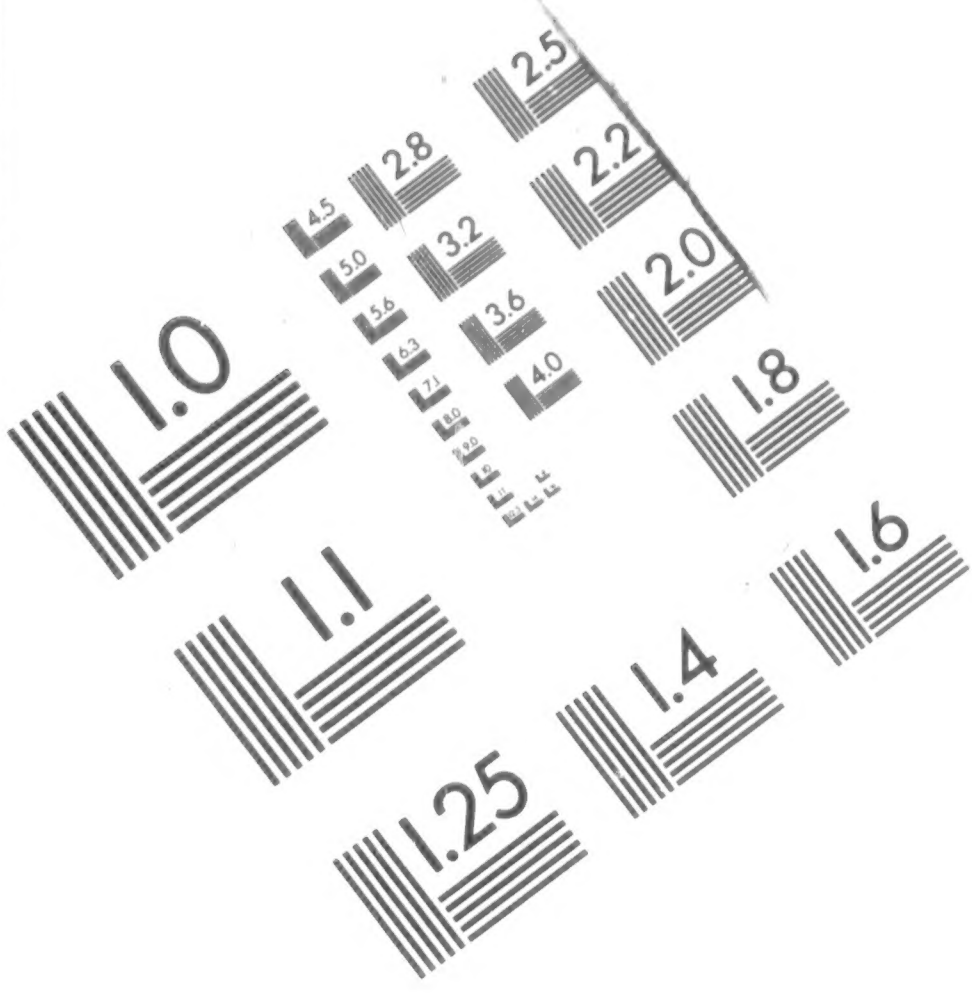

APPLIED IMAGE, Inc
 1653 East Main Street
 Rochester, NY 14609 USA
 Phone: 716/482-0300
 Fax: 716/288-5989

© 1993, Applied Image, Inc., All Rights Reserved

VW

National Archives at College Park



8601 Adelphi Road College Park MD 20740-6001

V WARE

OPERATOR

CAMERA

9-14-97

Z-4

DATE FILMED

REDUCTION RATIO

03510107

10X

FILM EMULSION NUMBER

M1817

64

PROJECT NUMBER

ROLL NUMBER

ROLL

6

4

MICROCOPY

1

8

1

7

NATIONAL ARCHIVES MICROFILM PUBLICATIONS

M1817

**COMPILED MILITARY SERVICE RECORDS OF
VOLUNTEER UNION SOLDIERS WHO SERVED WITH THE
UNITED STATES COLORED TROOPS:
1st Through 5th United States Colored Cavalry
5th Massachusetts Cavalry (Colored)
6th United States Colored Cavalry**

Introduction by Michael E. Pilgrim

Records prepared for microfilming by members of
the Civil War Conservation Corps

Budge Weidman, Project Director

Pat Alfredson	Naomi Glass	Dave Murray
Phyllis Altrogge	Sue Goward*	Ray Puzio
Kenneth Ashton	Bert Greenstein	Bill Schneider
Sue Barnard*	Anne Greenwood	Sylvia Scott
Dee Benson	Jim Harris	Lynn Shearouse
Ann N. Brown	Walter Hayden	Mary Stack-Dunne
Robert Budway	Mary Hayden	Ben Stearns
MaryAnn Castellana*	Pat Ikonen	Bill Stormer*
Mary Lou Cole	Dick Ives	Pat Sullivan
Marjory Cooper	Sarah Jaffe	Gorman Tidball*
Giovanni Croce	Barbara Kemp	Cathy Tinston
B. H. Custer	Bev Manypenny	John Toole
Bob Denney	Frank Masterson	Maryellen Toole
Richard Dow	Joe Mazur	Milt Weatherhead
Yvette Fallin	Sarah McDougall	C. Lois Young
	Ben Miles	

Team leaders are indicated by the asterisk.

National Archives and Records Administration
1997

NATIONAL ARCHIVES MICROFILM PUBLICATIONS

INTRODUCTION

On the 107 rolls of this microfilm publication, M1817, are reproduced the compiled military service records of volunteer Union soldiers belonging to the 1st through 5th United States Colored Cavalry, the 5th Massachusetts Cavalry (Colored), and the 6th United States Colored Cavalry. While the 5th Massachusetts did retain its state designation, these units were all part of the United States Colored Troops (USCT). The USCT included 7 numbered cavalry regiments; 14 numbered artillery regiments; 144 numbered infantry regiments; plus Brigade Bands Nos. 1 & 2 (Corps d'Afrique and US Colored Troops); Powell's Regiment Colored Infantry; Southard's Company Colored Infantry; Quartermaster Detachment; Pioneer Corps, 1st Division, 16th Army Corps; Unassigned Company A Colored Infantry and Unassigned USCT. The records reproduced are part of the Records of the Adjutant General's Office, 1780's-1917, Record Group (RG) 94.

Background

United States Colored Troops

Since the time of the American Revolution, African Americans have volunteered to serve their country in time of war. The Civil War was no exception. Official sanction was the difficulty. In the fall of 1862 there were four Union regiments of African Americans raised in New Orleans, LA: the 1st, 2d, and 3d Louisiana Native Guard, and the 1st Louisiana Heavy Artillery (African Descent). The 1st South Carolina Infantry (African Descent) was not officially organized until January 1863; however, three companies of the regiment were on coastal expeditions as early as November 1862. Similarly, the 1st Kansas Colored Infantry was not mustered into Federal service until January 1863, even though the regiment had already participated in the action at Island Mound, MO, on October 27, 1862. These early unofficial regiments received little Federal support, but they showed the strength of the African American soldier's desire to fight for freedom.

The first official authorization to employ African Americans in Federal service was the Second Confiscation and Militia Act of July 17, 1862. This act allowed President Abraham Lincoln to receive into the military or naval service persons of African descent and gave him permission to use them for any purpose "he may judge best for the public welfare." However, the President did not authorize use of African Americans until issuance of the Emancipation Proclamation on January 1, 1863.

In late January 1863, Gov. John Andrew of Massachusetts received permission to raise a regiment of African American soldiers. The pace of organizing additional regiments was very slow. In March Secretary of War Edwin M. Stanton sent Gen. Lorenzo Thomas to the lower Mississippi Valley to recruit

free and contraband African Americans. Thomas was given broad authority. He was to explain the administration's policy regarding African American soldiers and recruit volunteers to raise and command them. Stanton wanted all officers of such units to be white, but that policy was softened to allow African American surgeons and chaplains. By the end of the war, in addition to the chaplains and surgeons, there were some 87 African-American officers. Thomas's endeavor was very successful, and on May 22, 1863, the Bureau of Colored Troops was established to coordinate and organize regiments from all parts of the country. Created under War Department General Order No. 143, the bureau was responsible for handling "all matters relating to the organization of Colored Troops." The bureau was directly under the Adjutant General's Office and its procedures and rules were specific and strict. All African American regiments were now to be designated United States Colored Troops (USCT). At this time there were some African American regiments with state names and a few regiments in the Department of the Gulf designated as Corps d'Afrique. All these were ultimately assimilated into the USCT, even though some of the regiments, such as the 5th Massachusetts, retained their state designations.

To facilitate recruiting in the states of Maryland, Missouri, Tennessee, and eventually Kentucky, the War Department issued General Order No. 329 on October 3, 1863. Section 6 of the order stated that if any citizen should offer his or her slave for enlistment into the military service, that person would, "if such slave be accepted, receive from the recruiting officer a certificate thereof, and become entitled to compensation for the service or labor of said slave, not exceeding the sum of three hundred dollars, upon filing a valid deed of manumission and of release, and making satisfactory proof of title." For this reason, some records of manumission are contained in the compiled service records reproduced in this publication.

The USCT fought in 39 major engagements and over 400 lesser ones. Sixteen African American soldiers received Medals of Honor. As it was in other units, the death toll from disease was very high in the USCT. Deaths from disease and battle totaled 37,000. The last regiment of the USCT was mustered out of Federal service in December 1867.

Important sources for information about African American units in the Civil War are the War Department's *The War of the Rebellion: A Compilation of the Official Records of the Union and Confederate Armies* (Washington, DC: 1880-1901; reprinted Harrisburg, 1971 and 1985) and the Navy Department's *The War of the Rebellion; A Compilation of the Official Records of the Union and Confederate Navies* (Washington, DC: 1874-1922; reprinted Harrisburg, 1971 and 1985). These multivolume works contains reports of operations and other official correspondence.

1st United States Colored Cavalry

This regiment was organized at Camp Hamilton, VA, on December 22, 1863, and assigned to duty in the Department of Virginia and North Carolina. The 1st participated in Gen. Benjamin F. Butler's operations on the south side of the James River and against Petersburg and Richmond, May 4-28, 1864. These included the capture of Bermuda Hundred and City Point, VA, on May 5, and events leading up to and including the siege of Petersburg. In August 1864 it was transferred to the defenses of Portsmouth, District of Eastern Virginia. On June 10, 1865, the 1st sailed from City Point, VA, to Texas where it was assigned duty on the Rio Grande and various other areas of the state. The unit was mustered out on February 4, 1866. Compiled casualty figures are not available.

2d United States Colored Cavalry

This regiment was organized at Fort Monroe, VA, on December 22, 1863, and assigned to duty in the Department of Virginia and North Carolina. The 2d participated in Gen. Benjamin F. Butler's operations on the south side of the James River and against Petersburg and Richmond, May 4-28, 1864. These included the capture of Bermuda Hundred and City Point, VA, on May 5, and events leading up to and including the siege of Petersburg. In February 1865 it was transferred to Norfolk, District of Eastern Virginia. On June 10, 1865, the 2d sailed from City Point, VA, to Texas where it was assigned duty on the Rio Grande and various other areas of the state. The unit was mustered out on February 12, 1866. Losses included 19 killed in action and 161 dead from disease and other causes.

3d United States Colored Cavalry

Organized at Vicksburg, MS, on October 9, 1863, as the 1st Mississippi Cavalry (African Descent), this regiment was redesignated the 3d U.S. Colored Cavalry on March 11, 1864. From its organization until March 1864, the unit was attached to the District of Northeast Louisiana and from January to March 1864 participated in operations up the Yazoo River and the occupation of Yazoo City. The regiment was then transferred to the District of Vicksburg, Department of Tennessee, where it remained until December 1864. That month the unit moved to Memphis, TN, and from December 21, 1864, to January 5, 1865, participated in Gen. Benjamin Grierson's raid to destroy the Mobile & Ohio Railroad. The 3d remained on duty in Memphis and the District of West Tennessee and took part in the expedition from Memphis to Brownsville, MS, April 23-26, 1865. On April 29 the regiment returned to Vicksburg and operated around Natchez in search of fugitive Confederate President Jefferson Davis. The unit remained in the District of West Tennessee and Department of Mississippi until January 26, 1866, when it was mustered out. Losses included 37 killed in action and 367 dead from disease and other causes.

4th United States Colored Cavalry

Organized on September 12, 1863, as the 1st Corps d'Afrique Cavalry, this regiment was redesignated the 4th United States Colored Cavalry on April 4, 1864. From its organization until August 1864, it was attached to the Defenses of New Orleans, Department of the Gulf. On August 8, 1864, the 4th was ordered to Baton Rouge, LA, District of Port Hudson, and remained on duty at that post until July 1865 when it was transferred to the Department of Mississippi. It performed duties at various points in that department until it was mustered out on March 20, 1866. Compiled casualty figures are not available.

5th United States Colored Cavalry

This regiment was organized at Camp Nelson, KY, on October 24, 1864, and attached to the 1st Division, District of Kentucky, Department of Ohio. December 10-29, 1864, it participated in Stoneman's Raid into southwestern Virginia, including the capture of Saltville and the destruction of saltworks on December 20-21. In February 1865 the regiment was transferred to the Military District and Department of Kentucky until December of that year when it was ordered to the Department of Arkansas. During the latter period the unit performed mostly garrison duty. The regiment was mustered out March 20, 1866. Losses included 35 killed in action and 152 dead from disease and other causes.

5th Massachusetts Cavalry (Colored)

This regiment was organized at Camp Meigs, Reedville, MA, in the spring of 1864, and sent to Washington, DC, in May of that year. On May 13 the regiment moved to City Point, VA, where it was attached to the 18th Army Corps. Until June 16 it functioned as an infantry unit and participated in the siege of Petersburg. On June 30 it was moved to Point Lookout, MD, to guard prisoners of war. In July 1864 the regiment, still at Point Lookout, became part of the 22d Army Corps. It was transferred to the 25th Army Corps in March 1865 and ordered to the field near Richmond and Petersburg. In June the regiment was ordered to the Department of Texas where it was assigned duty at Clarksville until October 31, 1865, when it was mustered out. Losses included 7 men killed in action and 116 dead from disease and other causes.

6th United States Colored Cavalry

This regiment was organized at Camp Nelson, KY, on October 24, 1864, and attached to the 1st Division, District of Kentucky, Department of Ohio. December 10-29, 1864, it participated in Stoneman's Raid, including the destruction of the lead mines in southwestern Virginia. At the end of December the regiment returned to Camp Nelson and in February 1865 was transferred to the Military District and Department of Kentucky. It remained there until December

1865 when it was ordered to the Department of Arkansas. The unit was mustered out on April 15, 1866. Compiled casualty figures are not available.

Records Description

Compiled service records consist of a jacket-envelope for each soldier, labeled with his name, rank, unit, and card numbers. The compilation of service records of Union soldiers began in 1890 under the direction of Col. Fred C. Ainsworth, head of the Record and Pension Office of the Adjutant General's Office, Department of War. Information from muster rolls, regimental returns, descriptive books, and other records was copied verbatim onto cards. A separate card was prepared each time an individual name appeared on a document. These cards were numbered on the back, and these numbers were entered onto the outside jacket containing the cards. The carded information was verified by a separated operation of comparison; great care was taken to ensure that the cards were accurate.

A typical jacket contains card abstracts of entries found in original records relating to the soldier and original documents relating solely to that soldier. Examples of the latter include enlistment papers, substitute certificates, casualty sheets, death reports, prisoner-of-war memorandums, and correspondence. Unique to the records of the USCT are deeds of manumission, oaths of allegiance, proof of ownership, certificates of monetary award, and bills of sale. These items appear most frequently in units recruited in the border states of Kentucky, Missouri, and Maryland. These states remained in the Union but were slave states. Jackets and cards include a section labeled "bookmark" which was reserved for cross-references to other records relating to the individual or his unit. The service records are arranged by arm of service, thereunder numerically by regiment or independent battalion or company and thereunder alphabetically by name of the soldier. Records for officers are interfiled alphabetically by name with the records of enlisted men. If an individual served in more than one unit, which was typical for USCT officers, there will be a separate service record for each unit in which he served.

Related Records

Among the records of the Adjutant General's Office in the National Archives are many of the original records that were abstracted or "carded" by the Record and Pension Office. These include the individual unit's muster rolls, returns and descriptive books. Other series in RG 94 that contain information relating to volunteer Union soldiers who served with the USCT include carded records relating to Union staff officers, carded medical records of volunteer Union soldiers, unbound and bound regimental records and "record of events" cards. The regimental records of the 54th Massachusetts Infantry (Colored) have been

NATIONAL ARCHIVES MICROFILM PUBLICATIONS

reproduced as Microfilm Publication M1659, *Records of the Fifty-fourth Massachusetts Infantry Regiment (Colored), 1863-1865*.

The "record of events" cards include information copied from the unit's muster rolls and returns. They show the stations of the field and staff and those of the various companies of the regiment at the time the muster roll or return was prepared and sometimes mention battles, skirmishes, or other activities in which the regiment participated. The cards have been reproduced as Microfilm Publication M594 *Compiled Records Showing Service of Military Units in Volunteer Union Organizations*.

Record Group 94 also includes a card index for the USCT, reproduced as Microfilm Publication M589, *Index to Compiled Military Service Records of Volunteer Union Soldiers Who Served with U.S. Colored Troops*, which may be used to locate the regiment of USCT personnel. An index card gives the name of the soldier and his rank, as well as the unit in which he served; sometimes there is a cross-reference to his service in other units or organizations. The National Archives is continually producing microfilm publications of volunteer Union compiled military service records. A complete listing of finished publications can be found in the National Archives' *Microfilm Resources for Research: A Comprehensive Catalog* which is available online at <http://www.nara.gov>.

The Records of the Colored Troops Division, within RG 94, include division correspondence and records relating to recruiting, the appointment of officers, and the slave or free status of individuals; and a compilation of historical extracts and official papers concerning the military service of African Americans from the colonial period through the Civil War entitled *The Negro in the Military Service of the United States 1639-1886*. This compilation is reproduced as Microfilm Publication M858. The Records of the Bounty and Claims Division, also in RG 94, include correspondence of the division and records relating to bounties and claims paid to loyal owners of slaves by the Slave Claims Commissions of Delaware, Kentucky, Maryland, Missouri, Tennessee and West Virginia.

If an application for a pension was made, the pension application case file may be among the Records of the Veterans Administration (RG 15). Indexes to the pension applications have been reproduced as Microfilm Publication T288, *General Index to Pension Files, 1861-1934*, and T289, *Organizational Index to Pension Files of Veterans Who Served Between 1861 and 1900*.

If a soldier or officer was tried before a general court-martial or if an individual or his unit was the subject of a court of inquiry or military commission, transcripts of the proceedings may be among the Records of the Office of the Judge Advocate General (Army) (RG 153). The registers to the proceedings have been reproduced as Microfilm Publication M1105, *Registers of the Records of the Proceedings of the U.S. Army General Courts-Martial, 1809-1890*.

NATIONAL ARCHIVES MICROFILM PUBLICATIONS

Other record groups having information pertaining to the USCT include Records of the Bureau of Refugees, Freedmen, and Abandoned Lands (RG 105); Records of the Provost Marshal General's Bureau (Civil War) (RG 110); Records of the Accounting Officers of the Department of the Treasury (RG 217); and Records of U.S. Army Continental Commands, 1821-1920 (RG 393).

NATIONAL ARCHIVES MICROFILM PUBLICATIONS

ROLL LIST

Roll Description

1st United States Colored Cavalry

- 1 Akess, Alexander - Bom, John H.
- 2 Bomer, James - Cartwright, John
- 3 Casey, Thomas - Davenport, John J.
- 4 Davis, Augustus - Floyd, George
- 5 Fly, Benjamin - Griffin, Oliver
- 6 Griffin, Quinton - Holstead, Peter
- 7 Holt, George - Jones, Herbert
- 8 Jones, Howell - Macoy, Peter
- 9 Madry, Andrew - Mosley, Jacob
- 10 Moss, James - Polk, James
- 11 Pollard, Sipio - Sales, William
- 12 Sample, Abram (Abraham) - Smith, Ives
- 13 Smith, James - Times, Nelson
- 14 Tines, Archer - Wheldon, Charles M.
- 15 Whitby, Joseph - Wilson, Isaac
- 16 Wilson, James - Zoe (no first name)

2d United States Colored Cavalry

- 17 Abbot, John - Bell, Charles
- 18 Bell, Henry - Burns, Richard
- 19 Burroughs, George L. - Cotton, Samuel
- 20 Coues, Alexander - Duncan, Levi
- 21 Dunkins, Ezekiah James - Gardner, Richard
- 22 Garris, Henry - Harrison, Thomas
- 23 Harrison, William - Humphries, David
- 24 Hunter, Francis - Jones, Robert
- 25 Jones, Robert F. - Martin, Robert (Martin)
- 26 Martin, Thaddeus or Martin, Thaddeus W. - Osborne, Henry S.
- 27 Oulden, Jacob - Prior, Edward or Edmund
- 28 Proctor, David - Sawyer, Wilson
- 29 Scabber, Charles - Stanley, William
- 30 Stanley, Wright or Right - Upshear, Neverson
- 31 Upshear, Samuel - Whites, Joe
- 32 Whites, Silas - Zodrick, Isaiah A. or Isaiah

3d United States Colored Cavalry

- 33 Aaron, John - Black, David
- 34 Black, Richard - Cameron, Wyatt

NATIONAL ARCHIVES MICROFILM PUBLICATIONS

Roll	Description
35	Cammel, Austin - Cooper, Stephen
36	Coran, Joseph - Erving, Tilson
37	Erwin, Anderson - Gool, George
38	Gordon, Alfred - Haskins, Jasper
39	Hawkins, Frank - Jackson, Harvey
40	Jackson, Henry - Kembro, Abraham
41	Kenedy, Lemuel - Lott, Judge
42	Lott, Matton - Mitchell, Berry
43	Mitchell, George - Pettis, Edmond
44	Pettis, George - Roberson, Jefferson
45	Roberson, Wallace - Simpson, Levi
46	Sims, Anderson - Taylor, Phillip
47	Taylor, Richard - Washington, Isaac
48	Washington, Oscar - Williams, Mitchel
49	Williams, Moses - Young, Mathew

4th United States Colored Cavalry

50	Abraham, Randall - Blanchan, William
51	Blanchard, Moses - Clark, Moses
52	Clark, Theodore - Ellars, James
53	Ellars, John - Heath, Culbert
54	Henderson, George - Johnson, Henderson
55	Johnson, Henry - Mayberry, Nelson
56	Macomory, John - Oliver, Celestine
57	Olsten, Alexander - Robinson, William
58	Robinson, William E. - Thomas, Stephen
59	Thomas, William - Williams, Horace
60	Williams, Isaac - Zulia, Francois

5th United States Colored Cavalry

61	Abel, Fletcher - Biggs, Randall
62	Birch, Benjamin - Burly, Frank
63	Burly, James - Coffman, James D.
64	Coke, Samuel - Dudley, John
65	Duke, John - Givens, Peter
66	Glen, John - Harriden, Edmund
67	Harrigan, Harden - Hughes, Thomas
68	Hulse, James - Keller, Ephraim
69	Kelley, Franklin - Matthews, Benjamin
70	Maupin, Preston - Murry, Ned
71	Murtney, Morton - Ray, John
72	Ray, Thomas - Sherrod, William

NATIONAL ARCHIVES MICROFILM PUBLICATIONS

Roll Description

- 73 Shrewsbury, Joseph - Stone, John
- 74 Stone, Lewis - Trye, Benjamin
- 75 Trueheart, Samuel - Williams, James
- 76 Williams, Jerry - Yowell, Joseph

5th Massachusetts Cavalry (Colored)

- 77 Abbey, David - Biers, William
- 78 Billings, Jeremiah - Burgess, Williams
- 79 Burnett, Lewis - Cook, Joseph T.
- 80 Cooper, Isaac - Dunmore, William
- 81 Durbin, Stephen - Furman, Seneca A.
- 82 Gadson, James - Gurley, Joseph L.
- 83 Guy, James - Hill, John W.
- 84 Hill, Richard - Johns, Thomas H.
- 85 Johnson, Aaron - Lambert, William
- 86 Lancaster, James - Mason, John
- 87 Mason, John H. - Nelson, Philip
- 88 Nelson, Preston - Preston, Thomas
- 89 Price, Adam - Sampson, George P.
- 90 Sanborn, Madison - Stringer, William
- 91 Strother, Frank - Vance, William H.
- 92 Van Hoesen, Charles - Wilkinson, Simon
- 93 Williams, Abram H. - Young, Thomas

6th United States Colored Cavalry

- 94 Abbot, John - Birch, James
- 95 Bivins, Gabriel - Buckner, George
- 96 Buckner, Henderson - Compton, James
- 97 Cook, Benjamin - Ellis, William
- 98 Ellis, Wyatt - Godley, Isaac
- 99 Gooch, Alexander - Herston, Abraham
- 100 Heywood, John R. - Johnson, Jackson
- 101 Johnson, James M. - Marshall, Lyman
- 102 Marshall, William - Neihardt, Isaac D.
- 103 Nelson, Joseph - Redd, Tiney
- 104 Redway, Hamilton K. - Sebree, Bob Woodcock
- 105 Sebree, Crittenden - Sumpter, John
- 106 Sutherland, Williams - Washington, Charles
- 107 Washington, George - Wren (no first name)

NATIONAL ARCHIVES MICROFILM PUBLICATIONS

Roll Description

- 73 Shrewsbury, Joseph - Stone, John
- 74 Stone, Lewis - Trye, Benjamin
- 75 Trueheart, Samuel - Williams, James
- 76 Williams, Jerry - Yowell, Joseph

5th Massachusetts Cavalry (Colored)

- 77 Abbey, David - Biers, William
- 78 Billings, Jeremiah - Burgess, Williams
- 79 Burnett, Lewis - Cook, Joseph T.
- 80 Cooper, Isaac - Dunmore, William
- 81 Durbin, Stephen - Furman, Seneca A.
- 82 Gadson, James - Gurley, Joseph L.
- 83 Guy, James - Hill, John W.
- 84 Hill, Richard - Johns, Thomas H.
- 85 Johnson, Aaron - Lambert, William
- 86 Lancaster, James - Mason, John
- 87 Mason, John H. - Nelson, Philip
- 88 Nelson, Preston - Preston, Thomas
- 89 Price, Adam - Sampson, George P.
- 90 Sanborn, Madison - Stringer, William
- 91 Strother, Frank - Vance, William H.
- 92 Van Hoesen, Charles - Wilkinson, Simon
- 93 Williams, Abram H. - Young, Thomas

6th United States Colored Cavalry

- 94 Abbot, John - Birch, James
- 95 Bivins, Gabriel - Buckner, George
- 96 Buckner, Henderson - Compton, James
- 97 Cook, Benjamin - Ellis, William
- 98 Ellis, Wyatt - Godley, Isaac
- 99 Gooch, Alexander - Herston, Abraham
- 100 Heywood, John R. - Johnson, Jackson
- 101 Johnson, James M. - Marshall, Lyman
- 102 Marshall, William - Neihardt, Isaac D.
- 103 Nelson, Joseph - Redd, Tiney
- 104 Redway, Hamilton K. - Sebree, Bob Woodcock
- 105 Sebree, Crittenden - Sumpter, John
- 106 Sutherland, Williams - Washington, Charles
- 107 Washington, George - Wren (no first name)

NATIONAL
ARCHIVES
MICROFILM
PUBLICATION

IMAGE EVALUATION TEST TARGET (QA-3)

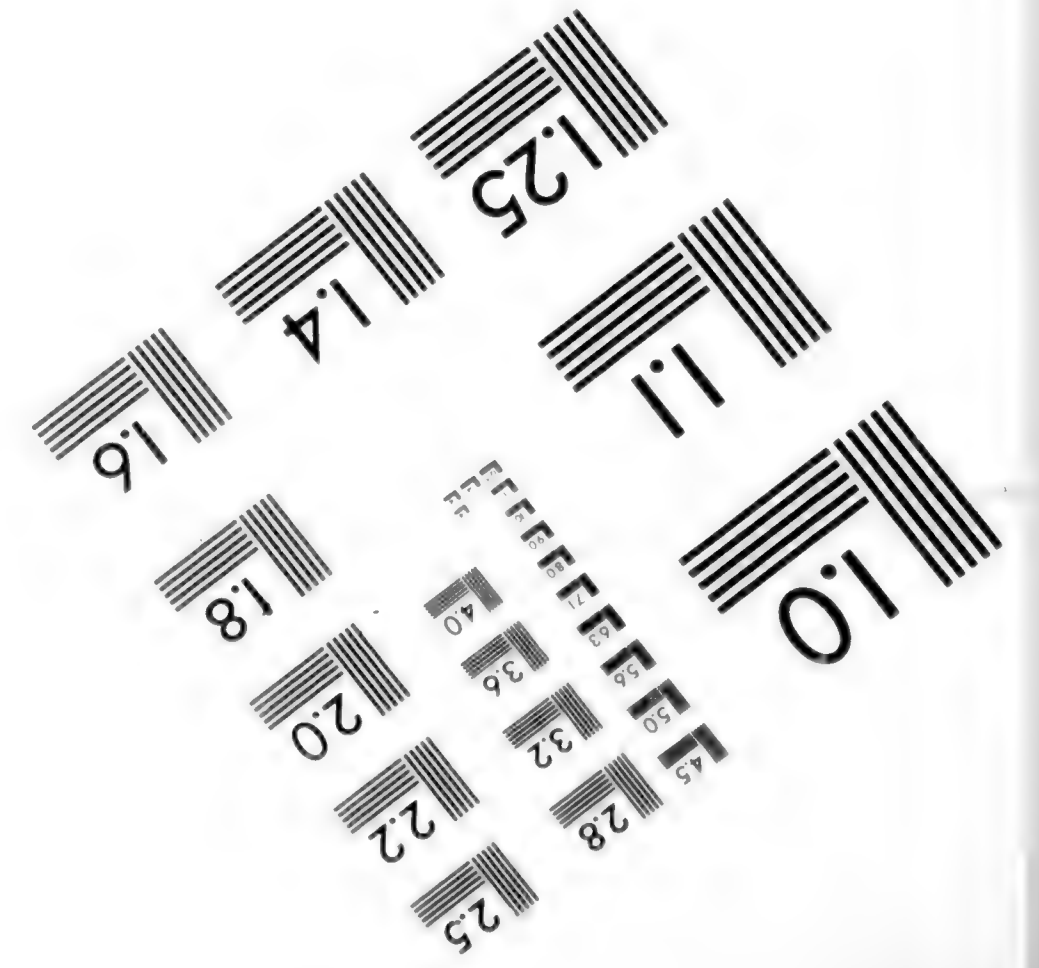
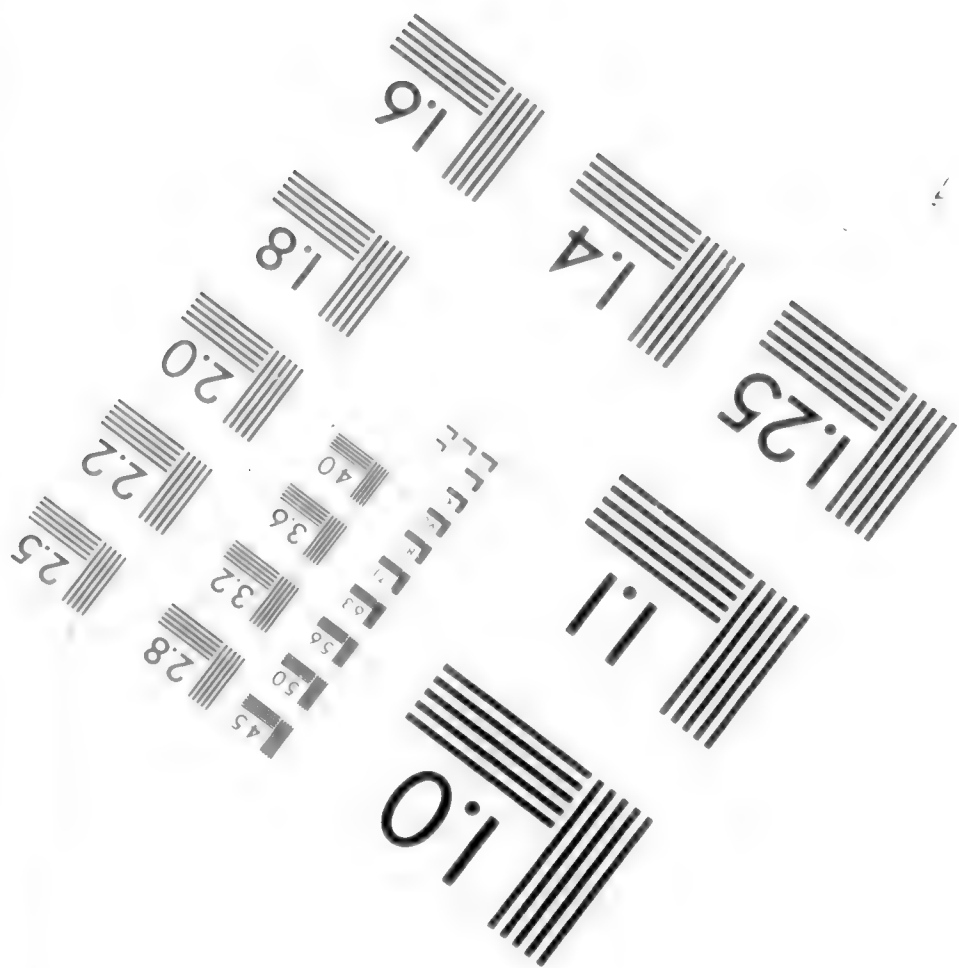
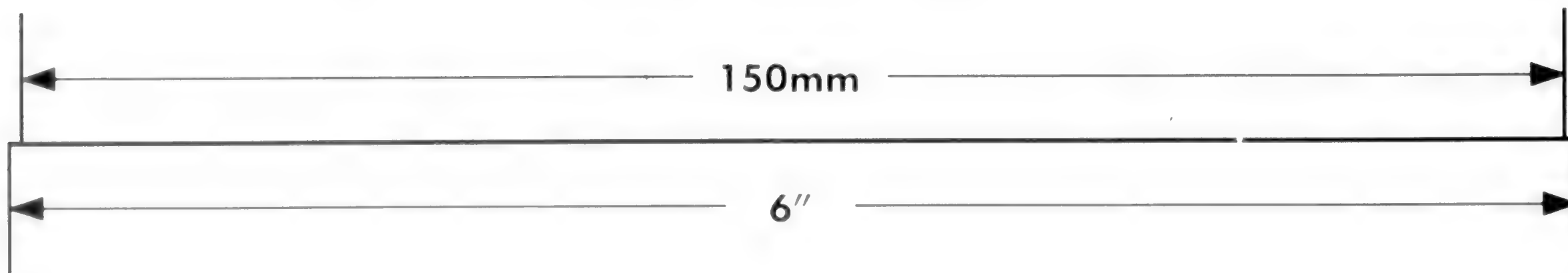
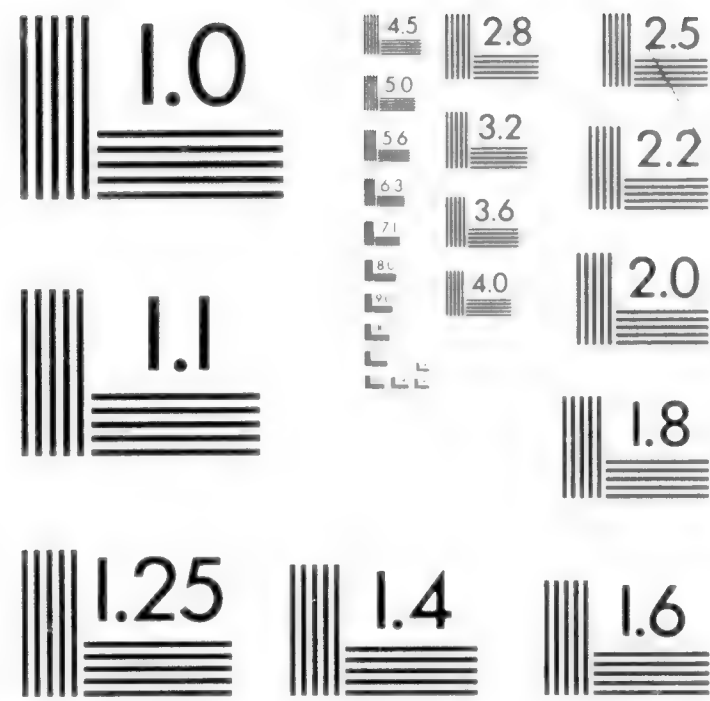
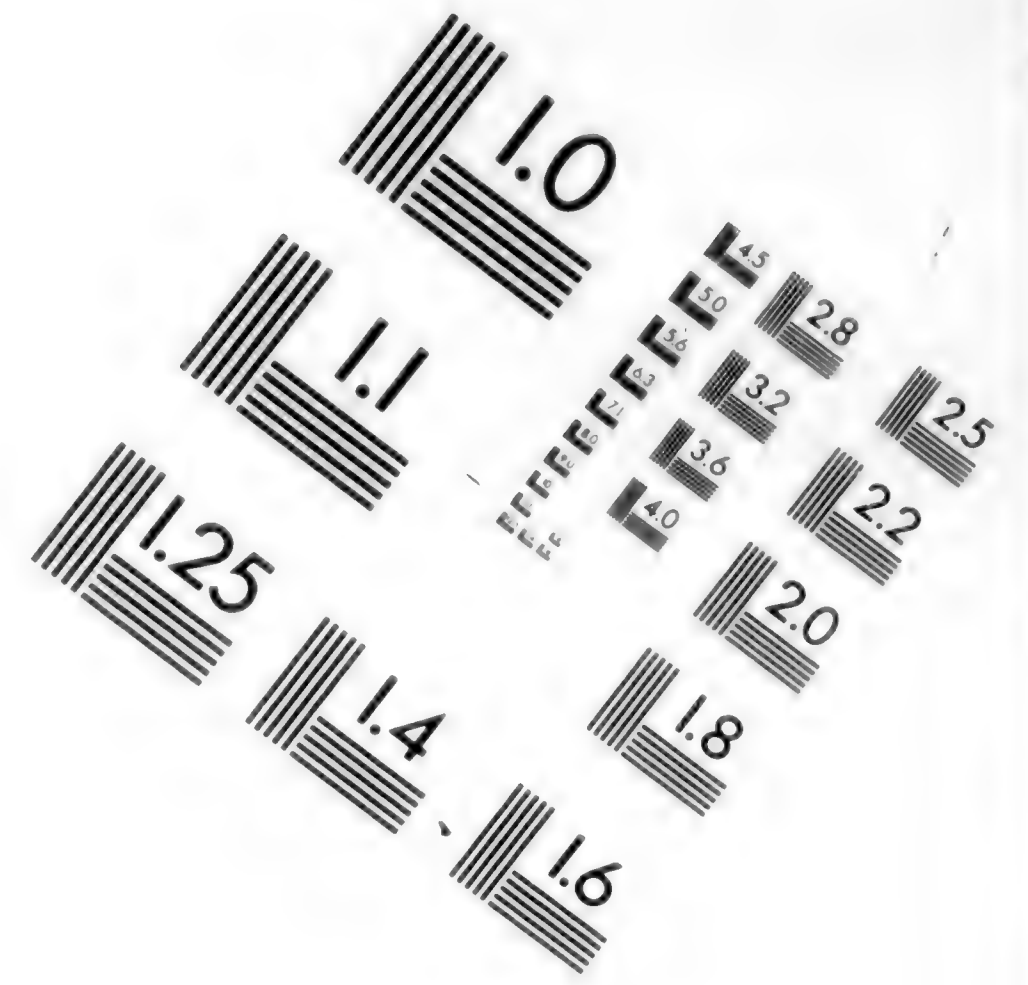
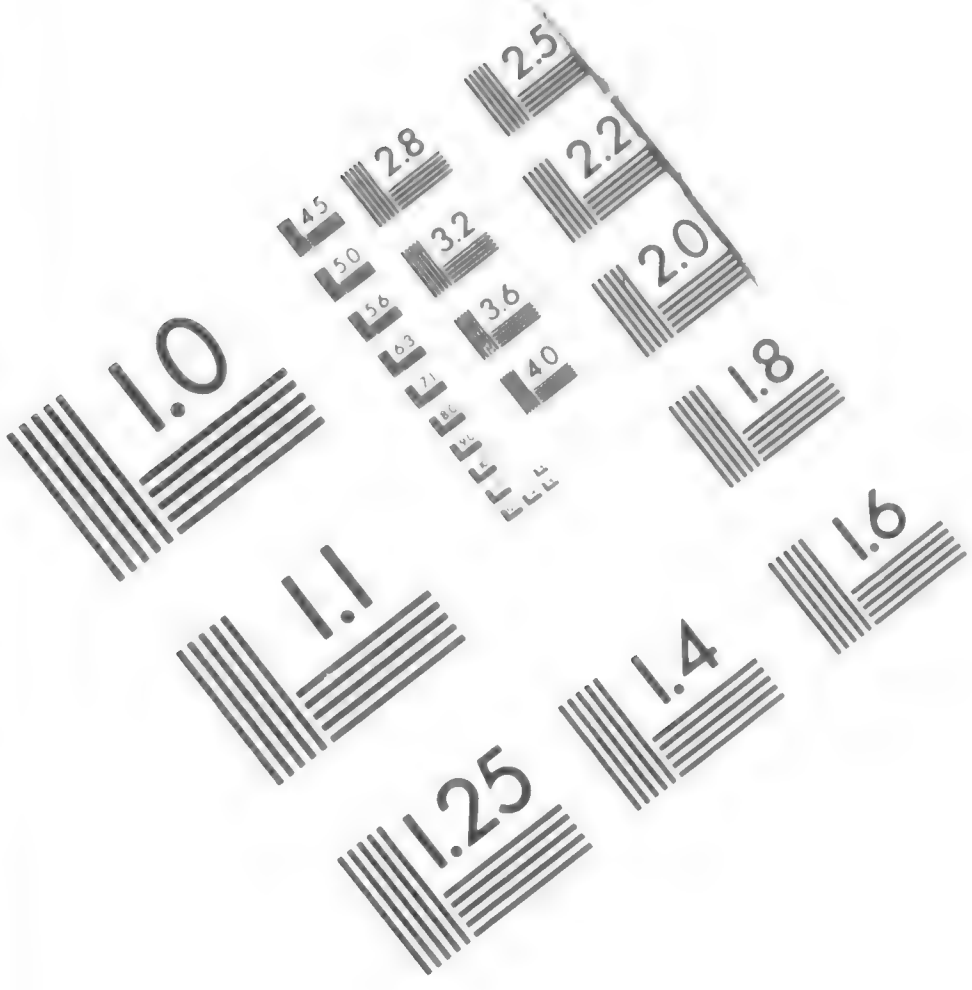

APPLIED IMAGE, Inc
 1653 East Main Street
 Rochester, NY 14609 USA
 Phone: 716/482-0300
 Fax: 716/288-5989

© 1993, Applied Image, Inc., All Rights Reserved

100

National Archives at College Park



8601 Adelphi Road College Park MD 20740-6001

V W A R E

OPERATOR

CAMERA

9-14-97

Z-4

DATE FILMED

REDUCTION RATIO

03510107

10X

FILM EMULSION NUMBER

M1817

64

PROJECT NUMBER

ROLL NUMBER

NOVELL

6

4

MICROCOPY

1

8

1

7

NATIONAL ARCHIVES MICROFILM PUBLICATIONS

M1817

**COMPILED MILITARY SERVICE RECORDS OF
VOLUNTEER UNION SOLDIERS WHO SERVED WITH THE
UNITED STATES COLORED TROOPS:
1st Through 5th United States Colored Cavalry
5th Massachusetts Cavalry (Colored)
6th United States Colored Cavalry**

Introduction by Michael E. Pilgrim

Records prepared for microfilming by members of
the Civil War Conservation Corps

Budge Weidman, Project Director

Pat Alfredson	Naomi Glass	Dave Murray
Phyllis Altrogge	Sue Goward*	Ray Puzio
Kenneth Ashton	Bert Greenstein	Bill Schneider
Sue Barnard*	Anne Greenwood	Sylvia Scott
Dee Benson	Jim Harris	Lynn Shearouse
Ann N. Brown	Walter Hayden	Mary Stack-Dunne
Robert Budway	Mary Hayden	Ben Stearns
MaryAnn Castellana*	Pat Ikonen	Bill Stormer*
Mary Lou Cole	Dick Ives	Pat Sullivan
Marjory Cooper	Sarah Jaffe	Gorman Tidball*
Giovanni Croce	Barbara Kemp	Cathy Tinston
B. H. Custer	Bev Manypenny	John Toole
Bob Denney	Frank Masterson	Maryellen Toole
Richard Dow	Joe Mazur	Milt Weatherhead
Yvette Fallin	Sarah McDougall	C. Lois Young
	Ben Miles	

Team leaders are indicated by the asterisk.

National Archives and Records Administration
1997

NATIONAL ARCHIVES MICROFILM PUBLICATIONS

INTRODUCTION

On the 107 rolls of this microfilm publication, M1817, are reproduced the compiled military service records of volunteer Union soldiers belonging to the 1st through 5th United States Colored Cavalry, the 5th Massachusetts Cavalry (Colored), and the 6th United States Colored Cavalry. While the 5th Massachusetts did retain its state designation, these units were all part of the United States Colored Troops (USCT). The USCT included 7 numbered cavalry regiments; 14 numbered artillery regiments; 144 numbered infantry regiments; plus Brigade Bands Nos. 1 & 2 (Corps d'Afrique and US Colored Troops); Powell's Regiment Colored Infantry; Southard's Company Colored Infantry; Quartermaster Detachment; Pioneer Corps, 1st Division, 16th Army Corps; Unassigned Company A Colored Infantry and Unassigned USCT. The records reproduced are part of the Records of the Adjutant General's Office, 1780's-1917, Record Group (RG) 94.

Background

United States Colored Troops

Since the time of the American Revolution, African Americans have volunteered to serve their country in time of war. The Civil War was no exception. Official sanction was the difficulty. In the fall of 1862 there were four Union regiments of African Americans raised in New Orleans, LA: the 1st, 2d, and 3d Louisiana Native Guard, and the 1st Louisiana Heavy Artillery (African Descent). The 1st South Carolina Infantry (African Descent) was not officially organized until January 1863; however, three companies of the regiment were on coastal expeditions as early as November 1862. Similarly, the 1st Kansas Colored Infantry was not mustered into Federal service until January 1863, even though the regiment had already participated in the action at Island Mound, MO, on October 27, 1862. These early unofficial regiments received little Federal support, but they showed the strength of the African American soldier's desire to fight for freedom.

The first official authorization to employ African Americans in Federal service was the Second Confiscation and Militia Act of July 17, 1862. This act allowed President Abraham Lincoln to receive into the military or naval service persons of African descent and gave him permission to use them for any purpose "he may judge best for the public welfare." However, the President did not authorize use of African Americans until issuance of the Emancipation Proclamation on January 1, 1863.

In late January 1863, Gov. John Andrew of Massachusetts received permission to raise a regiment of African American soldiers. The pace of organizing additional regiments was very slow. In March Secretary of War Edwin M. Stanton sent Gen. Lorenzo Thomas to the lower Mississippi Valley to recruit

free and contraband African Americans. Thomas was given broad authority. He was to explain the administration's policy regarding African American soldiers and recruit volunteers to raise and command them. Stanton wanted all officers of such units to be white, but that policy was softened to allow African American surgeons and chaplains. By the end of the war, in addition to the chaplains and surgeons, there were some 87 African-American officers. Thomas's endeavor was very successful, and on May 22, 1863, the Bureau of Colored Troops was established to coordinate and organize regiments from all parts of the country. Created under War Department General Order No. 143, the bureau was responsible for handling "all matters relating to the organization of Colored Troops." The bureau was directly under the Adjutant General's Office and its procedures and rules were specific and strict. All African American regiments were now to be designated United States Colored Troops (USCT). At this time there were some African American regiments with state names and a few regiments in the Department of the Gulf designated as Corps d'Afrique. All these were ultimately assimilated into the USCT, even though some of the regiments, such as the 5th Massachusetts, retained their state designations.

To facilitate recruiting in the states of Maryland, Missouri, Tennessee, and eventually Kentucky, the War Department issued General Order No. 329 on October 3, 1863. Section 6 of the order stated that if any citizen should offer his or her slave for enlistment into the military service, that person would, "if such slave be accepted, receive from the recruiting officer a certificate thereof, and become entitled to compensation for the service or labor of said slave, not exceeding the sum of three hundred dollars, upon filing a valid deed of manumission and of release, and making satisfactory proof of title." For this reason, some records of manumission are contained in the compiled service records reproduced in this publication.

The USCT fought in 39 major engagements and over 400 lesser ones. Sixteen African American soldiers received Medals of Honor. As it was in other units, the death toll from disease was very high in the USCT. Deaths from disease and battle totaled 37,000. The last regiment of the USCT was mustered out of Federal service in December 1867.

Important sources for information about African American units in the Civil War are the War Department's *The War of the Rebellion: A Compilation of the Official Records of the Union and Confederate Armies* (Washington, DC: 1880-1901; reprinted Harrisburg, 1971 and 1985) and the Navy Department's *The War of the Rebellion; A Compilation of the Official Records of the Union and Confederate Navies* (Washington, DC: 1874-1922; reprinted Harrisburg, 1971 and 1985). These multivolume works contains reports of operations and other official correspondence.

1st United States Colored Cavalry

This regiment was organized at Camp Hamilton, VA, on December 22, 1863, and assigned to duty in the Department of Virginia and North Carolina. The 1st participated in Gen. Benjamin F. Butler's operations on the south side of the James River and against Petersburg and Richmond, May 4-28, 1864. These included the capture of Bermuda Hundred and City Point, VA, on May 5, and events leading up to and including the siege of Petersburg. In August 1864 it was transferred to the defenses of Portsmouth, District of Eastern Virginia. On June 10, 1865, the 1st sailed from City Point, VA, to Texas where it was assigned duty on the Rio Grande and various other areas of the state. The unit was mustered out on February 4, 1866. Compiled casualty figures are not available.

2d United States Colored Cavalry

This regiment was organized at Fort Monroe, VA, on December 22, 1863, and assigned to duty in the Department of Virginia and North Carolina. The 2d participated in Gen. Benjamin F. Butler's operations on the south side of the James River and against Petersburg and Richmond, May 4-28, 1864. These included the capture of Bermuda Hundred and City Point, VA, on May 5, and events leading up to and including the siege of Petersburg. In February 1865 it was transferred to Norfolk, District of Eastern Virginia. On June 10, 1865, the 2d sailed from City Point, VA, to Texas where it was assigned duty on the Rio Grande and various other areas of the state. The unit was mustered out on February 12, 1866. Losses included 19 killed in action and 161 dead from disease and other causes.

3d United States Colored Cavalry

Organized at Vicksburg, MS, on October 9, 1863, as the 1st Mississippi Cavalry (African Descent), this regiment was redesignated the 3d U.S. Colored Cavalry on March 11, 1864. From its organization until March 1864, the unit was attached to the District of Northeast Louisiana and from January to March 1864 participated in operations up the Yazoo River and the occupation of Yazoo City. The regiment was then transferred to the District of Vicksburg, Department of Tennessee, where it remained until December 1864. That month the unit moved to Memphis, TN, and from December 21, 1864, to January 5, 1865, participated in Gen. Benjamin Grierson's raid to destroy the Mobile & Ohio Railroad. The 3d remained on duty in Memphis and the District of West Tennessee and took part in the expedition from Memphis to Brownsville, MS, April 23-26, 1865. On April 29 the regiment returned to Vicksburg and operated around Natchez in search of fugitive Confederate President Jefferson Davis. The unit remained in the District of West Tennessee and Department of Mississippi until January 26, 1866, when it was mustered out. Losses included 37 killed in action and 367 dead from disease and other causes.

4th United States Colored Cavalry

Organized on September 12, 1863, as the 1st Corps d'Afrique Cavalry, this regiment was redesignated the 4th United States Colored Cavalry on April 4, 1864. From its organization until August 1864, it was attached to the Defenses of New Orleans, Department of the Gulf. On August 8, 1864, the 4th was ordered to Baton Rouge, LA, District of Port Hudson, and remained on duty at that post until July 1865 when it was transferred to the Department of Mississippi. It performed duties at various points in that department until it was mustered out on March 20, 1866. Compiled casualty figures are not available.

5th United States Colored Cavalry

This regiment was organized at Camp Nelson, KY, on October 24, 1864, and attached to the 1st Division, District of Kentucky, Department of Ohio. December 10-29, 1864, it participated in Stoneman's Raid into southwestern Virginia, including the capture of Saltville and the destruction of saltworks on December 20-21. In February 1865 the regiment was transferred to the Military District and Department of Kentucky until December of that year when it was ordered to the Department of Arkansas. During the latter period the unit performed mostly garrison duty. The regiment was mustered out March 20, 1866. Losses included 35 killed in action and 152 dead from disease and other causes.

5th Massachusetts Cavalry (Colored)

This regiment was organized at Camp Meigs, Reedville, MA, in the spring of 1864, and sent to Washington, DC, in May of that year. On May 13 the regiment moved to City Point, VA, where it was attached to the 18th Army Corps. Until June 16 it functioned as an infantry unit and participated in the siege of Petersburg. On June 30 it was moved to Point Lookout, MD, to guard prisoners of war. In July 1864 the regiment, still at Point Lookout, became part of the 22d Army Corps. It was transferred to the 25th Army Corps in March 1865 and ordered to the field near Richmond and Petersburg. In June the regiment was ordered to the Department of Texas where it was assigned duty at Clarksville until October 31, 1865, when it was mustered out. Losses included 7 men killed in action and 116 dead from disease and other causes.

6th United States Colored Cavalry

This regiment was organized at Camp Nelson, KY, on October 24, 1864, and attached to the 1st Division, District of Kentucky, Department of Ohio. December 10-29, 1864, it participated in Stoneman's Raid, including the destruction of the lead mines in southwestern Virginia. At the end of December the regiment returned to Camp Nelson and in February 1865 was transferred to the Military District and Department of Kentucky. It remained there until December

NATIONAL ARCHIVES MICROFILM PUBLICATIONS

1865 when it was ordered to the Department of Arkansas. The unit was mustered out on April 15, 1866. Compiled casualty figures are not available.

Records Description

Compiled service records consist of a jacket-envelope for each soldier, labeled with his name, rank, unit, and card numbers. The compilation of service records of Union soldiers began in 1890 under the direction of Col. Fred C. Ainsworth, head of the Record and Pension Office of the Adjutant General's Office, Department of War. Information from muster rolls, regimental returns, descriptive books, and other records was copied verbatim onto cards. A separate card was prepared each time an individual name appeared on a document. These cards were numbered on the back, and these numbers were entered onto the outside jacket containing the cards. The carded information was verified by a separated operation of comparison; great care was taken to ensure that the cards were accurate.

A typical jacket contains card abstracts of entries found in original records relating to the soldier and original documents relating solely to that soldier. Examples of the latter include enlistment papers, substitute certificates, casualty sheets, death reports, prisoner-of-war memorandums, and correspondence. Unique to the records of the USCT are deeds of manumission, oaths of allegiance, proof of ownership, certificates of monetary award, and bills of sale. These items appear most frequently in units recruited in the border states of Kentucky, Missouri, and Maryland. These states remained in the Union but were slave states. Jackets and cards include a section labeled "bookmark" which was reserved for cross-references to other records relating to the individual or his unit. The service records are arranged by arm of service, thereunder numerically by regiment or independent battalion or company and thereunder alphabetically by name of the soldier. Records for officers are interfiled alphabetically by name with the records of enlisted men. If an individual served in more than one unit, which was typical for USCT officers, there will be a separate service record for each unit in which he served.

Related Records

Among the records of the Adjutant General's Office in the National Archives are many of the original records that were abstracted or "carded" by the Record and Pension Office. These include the individual unit's muster rolls, returns and descriptive books. Other series in RG 94 that contain information relating to volunteer Union soldiers who served with the USCT include carded records relating to Union staff officers, carded medical records of volunteer Union soldiers, unbound and bound regimental records and "record of events" cards. The regimental records of the 54th Massachusetts Infantry (Colored) have been

NATIONAL ARCHIVES MICROFILM PUBLICATIONS

reproduced as Microfilm Publication M1659, *Records of the Fifty-fourth Massachusetts Infantry Regiment (Colored), 1863-1865*.

The "record of events" cards include information copied from the unit's muster rolls and returns. They show the stations of the field and staff and those of the various companies of the regiment at the time the muster roll or return was prepared and sometimes mention battles, skirmishes, or other activities in which the regiment participated. The cards have been reproduced as Microfilm Publication M594 *Compiled Records Showing Service of Military Units in Volunteer Union Organizations*.

Record Group 94 also includes a card index for the USCT, reproduced as Microfilm Publication M589, *Index to Compiled Military Service Records of Volunteer Union Soldiers Who Served with U.S. Colored Troops*, which may be used to locate the regiment of USCT personnel. An index card gives the name of the soldier and his rank, as well as the unit in which he served; sometimes there is a cross-reference to his service in other units or organizations. The National Archives is continually producing microfilm publications of volunteer Union compiled military service records. A complete listing of finished publications can be found in the National Archives' *Microfilm Resources for Research: A Comprehensive Catalog* which is available online at <http://www.nara.gov>.

The Records of the Colored Troops Division, within RG 94, include division correspondence and records relating to recruiting, the appointment of officers, and the slave or free status of individuals; and a compilation of historical extracts and official papers concerning the military service of African Americans from the colonial period through the Civil War entitled *The Negro in the Military Service of the United States 1639-1886*. This compilation is reproduced as Microfilm Publication M858. The Records of the Bounty and Claims Division, also in RG 94, include correspondence of the division and records relating to bounties and claims paid to loyal owners of slaves by the Slave Claims Commissions of Delaware, Kentucky, Maryland, Missouri, Tennessee and West Virginia.

If an application for a pension was made, the pension application case file may be among the Records of the Veterans Administration (RG 15). Indexes to the pension applications have been reproduced as Microfilm Publication T288, *General Index to Pension Files, 1861-1934*, and T289, *Organizational Index to Pension Files of Veterans Who Served Between 1861 and 1900*.

If a soldier or officer was tried before a general court-martial or if an individual or his unit was the subject of a court of inquiry or military commission, transcripts of the proceedings may be among the Records of the Office of the Judge Advocate General (Army) (RG 153). The registers to the proceedings have been reproduced as Microfilm Publication M1105, *Registers of the Records of the Proceedings of the U.S. Army General Courts-Martial, 1809-1890*.

NATIONAL ARCHIVES MICROFILM PUBLICATIONS

Other record groups having information pertaining to the USCT include
Records of the Bureau of Refugees, Freedmen, and Abandoned Lands (RG 105);
Records of the Provost Marshal General's Bureau (Civil War) (RG 110); Records
of the Accounting Officers of the Department of the Treasury (RG 217); and
Records of U.S. Army Continental Commands, 1821-1920 (RG 393).

NATIONAL ARCHIVES MICROFILM PUBLICATIONS

ROLL LIST

Roll Description

1st United States Colored Cavalry

- 1 Akess, Alexander - Bom, John H.
- 2 Bomer, James - Cartwright, John
- 3 Casey, Thomas - Davenport, John J.
- 4 Davis, Augustus - Floyd, George
- 5 Fly, Benjamin - Griffin, Oliver
- 6 Griffin, Quinton - Holstead, Peter
- 7 Holt, George - Jones, Herbert
- 8 Jones, Howell - Macoy, Peter
- 9 Madry, Andrew - Mosley, Jacob
- 10 Moss, James - Polk, James
- 11 Pollard, Sipio - Sales, William
- 12 Sample, Abram (Abraham) - Smith, Ives
- 13 Smith, James - Times, Nelson
- 14 Tines, Archer - Wheldon, Charles M.
- 15 Whitby, Joseph - Wilson, Isaac
- 16 Wilson, James - Zoe (no first name)

2d United States Colored Cavalry

- 17 Abbot, John - Bell, Charles
- 18 Bell, Henry - Burns, Richard
- 19 Burroughs, George L. - Cotton, Samuel
- 20 Coues, Alexander - Duncan, Levi
- 21 Dunkins, Ezekiah James - Gardner, Richard
- 22 Garris, Henry - Harrison, Thomas
- 23 Harrison, William - Humphries, David
- 24 Hunter, Francis - Jones, Robert
- 25 Jones, Robert F. - Martin, Robert (Martin)
- 26 Martin, Thaddeus or Martin, Thaddeus W. - Osborne, Henry S.
- 27 Oulden, Jacob - Prior, Edward or Edmund
- 28 Proctor, David - Sawyer, Wilson
- 29 Scabber, Charles - Stanley, William
- 30 Stanley, Wright or Right - Upshear, Neverson
- 31 Upshear, Samuel - Whites, Joe
- 32 Whites, Silas - Zodrick, Isaiah A. or Isaiah

3d United States Colored Cavalry

- 33 Aaron, John - Black, David
- 34 Black, Richard - Cameron, Wyatt

NATIONAL ARCHIVES MICROFILM PUBLICATIONS

<u>Roll</u>	<u>Description</u>
35	Cammel, Austin - Cooper, Stephen
36	Coran, Joseph - Erving, Tilson
37	Erwin, Anderson - Gool, George
38	Gordon, Alfred - Haskins, Jasper
39	Hawkins, Frank - Jackson, Harvey
40	Jackson, Henry - Kembro, Abraham
41	Kenedy, Lemuel - Lott, Judge
42	Lott, Matton - Mitchell, Berry
43	Mitchell, George - Pettis, Edmond
44	Pettis, George - Roberson, Jefferson
45	Roberson, Wallace - Simpson, Levi
46	Sims, Anderson - Taylor, Phillip
47	Taylor, Richard - Washington, Isaac
48	Washington, Oscar - Williams, Mitchel
49	Williams, Moses - Young, Mathew

4th United States Colored Cavalry

50	Abraham, Randall - Blanchan, William
51	Blanchard, Moses - Clark, Moses
52	Clark, Theodore - Ellars, James
53	Ellars, John - Heath, Culbert
54	Henderson, George - Johnson, Henderson
55	Johnson, Henry - Mayberry, Nelson
56	Macomory, John - Oliver, Celestine
57	Olsten, Alexander - Robinson, William
58	Robinson, William E. - Thomas, Stephen
59	Thomas, William - Williams, Horace
60	Williams, Isaac - Zulia, Francois

5th United States Colored Cavalry

61	Abel, Fletcher - Biggs, Randall
62	Birch, Benjamin - Burly, Frank
63	Burly, James - Coffman, James D.
64	Coke, Samuel - Dudley, John
65	Duke, John - Givens, Peter
66	Glen, John - Harriden, Edmund
67	Harrigan, Harden - Hughes, Thomas
68	Hulse, James - Keller, Ephraim
69	Kelley, Franklin - Matthews, Benjamin
70	Maupin, Preston - Murry, Ned
71	Murtney, Morton - Ray, John
72	Ray, Thomas - Sherrod, Willliam

NATIONAL ARCHIVES MICROFILM PUBLICATIONS

Roll **Description**

- 73 Shrewsbury, Joseph - Stone, John
- 74 Stone, Lewis - Trye, Benjamin
- 75 Trueheart, Samuel - Williams, James
- 76 Williams, Jerry - Yowell, Joseph

5th Massachusetts Cavalry (Colored)

- 77 Abbey, David - Biers, William
- 78 Billings, Jeremiah - Burgess, Williams
- 79 Burnett, Lewis - Cook, Joseph T.
- 80 Cooper, Isaac - Dunmore, William
- 81 Durbin, Stephen - Furman, Seneca A.
- 82 Gadson, James - Gurley, Joseph L.
- 83 Guy, James - Hill, John W.
- 84 Hill, Richard - Johns, Thomas H.
- 85 Johnson, Aaron - Lambert, William
- 86 Lancaster, James - Mason, John
- 87 Mason, John H. - Nelson, Philip
- 88 Nelson, Preston - Preston, Thomas
- 89 Price, Adam - Sampson, George P.
- 90 Sanborn, Madison - Stringer, William
- 91 Strother, Frank - Vance, William H.
- 92 Van Hoesen, Charles - Wilkinson, Simon
- 93 Williams, Abram H. - Young, Thomas

6th United States Colored Cavalry

- 94 Abbot, John - Birch, James
- 95 Bivins, Gabriel - Buckner, George
- 96 Buckner, Henderson - Compton, James
- 97 Cook, Benjamin - Ellis, William
- 98 Ellis, Wyatt - Godley, Isaac
- 99 Gooch, Alexander - Herston, Abraham
- 100 Heywood, John R. - Johnson, Jackson
- 101 Johnson, James M. - Marshall, Lyman
- 102 Marshall, William - Neihardt, Isaac D.
- 103 Nelson, Joseph - Redd, Tiney
- 104 Redway, Hamilton K. - Sebree, Bob Woodcock
- 105 Sebree, Crittenden - Sumpter, John
- 106 Sutherland, Williams - Washington, Charles
- 107 Washington, George - Wren (no first name)

NATIONAL ARCHIVES MICROFILM PUBLICATIONS

Microfilm Publication M1817

COMPILED MILITARY SERVICE RECORDS OF VOLUNTEER UNION
SOLDIERS WHO SERVED WITH THE UNITED STATES COLORED
TROOPS: 1st Through 5th United States Colored Cavalry, 5th Massachusetts
Cavalry (Colored), 6th United States Colored Cavalry

Roll 64

5th United States Colored Cavalry

Coke, Samuel - Dudley, John

NATIONAL ARCHIVES AND RECORDS ADMINISTRATION

274

Coke Samuel

Co K, 5 U. S. Col'd Cav.

Private Private

CARD NUMBERS.

1	5368817	26
2	5368911	27
3	5369012	28
4	5369101	29
5	5369188	30
6	5369774	31
7	5369364	32
8	5369452	33
9	5369537	34
10	5369191	35
11		36
12		37
13		38
14	40729152	39
15		40
16		41
17		42
18		43
19		44
20		45
21		46
22		47
23		48
24		49
25		50

Book Mark:

See also

5 Cav. U.S.C.T.

William Clarke

, Co. *C*, 5 Reg't U. S. Col'd Cav.

Appears on

Company Descriptive Book

of the organization named above.

DESCRIPTION.

Age *46* years; height *5* feet *9* inches.

Complexion *Black*

Eyes *Blue*; hair *Black*

Where born *Washington City*

Occupation *carver*

ENLISTMENT.

When *Feb 7, 1864*

Where *Washington City*

By whom *W. H. ...*; term *3* y'rs.

Remarks: *Died in Post Hospital
Washington D.C. Dec 8/00
Final statement number
100-100*

W. H. ...

Copist.

5 Cav. U.S.C.T.

Samuel Cooke

Det., Co. A, 5 Reg't U. S. Col'd Cavalry.

Appears on

Company Muster-in and Descriptive Roll

of the organization named above. Roll dated

Camden N. Y., Oct 30, 1864.

Where born Hudson N.Y.

Age 40 y'rs; occupation Saborer

When enlisted Oct 1, 1864.

Where enlisted Lexington N.Y.

For what period enlisted 3 years.

Eyes Blue; hair Black

Complexion Blue; height 5 ft. 9 in.

When mustered in Oct 7, 1864.

Where mustered in Lexington N.Y.

Bounty paid \$ 100; due \$ 100

Where credited Hudson N.Y.

Company to which assigned

Remarks:

Book mark:

W. J. Collins

(356d)

Copyist.

6.

5 bar

U.S.A.

Samuel Hoke

Appears with rank of Private on

Muster and Descriptive Roll

of Detachment of U.S. Col'd Bnls.
for, awarded to Genl. Runderous,
Camp Nelson, Ky Roll dated
Lexington, Ky Oct. 7, 1864.

Where born Anderson Miss.

Age 46 years; occupation Laborer

When enlisted Oct. 7, 1864.

Where enlisted Lexington Ky

For what period enlisted 3 years.

Eyes Blk; hair Blk

Complexion Blk; height 5 ft. 9 in.

When mustered in _____, 186 .

Where mustered in _____

Bounty paid \$ 100; due \$ 100

Clothing account:

Last settled _____, 186 ; drawn since \$ 100

Date of first muster Oct. 7, 1864.

Company to which assigned _____

Remarks: To be credited to

Franklin Co. 7 Dis. Ky.

Book mark: _____

C. J. Harris

(356m)

Copyist.

6

5 Cav. U.S.C.T.

Samuel Coke

Pvt., Co. K, 5 Reg't U. S. Col'd Cav.

Appears on

Company Muster Roll

for Organization to Oct 31, 1864.

Present or absent Present

Stoppage, \$ 100 for

Due Gov't, \$ 100 for

Valuation of horse, \$ 100

Valuation of horse equipments, \$ 100

Remarks:

Book mark:

H. S. Miller

(358)

Copyist.

C

5 Cav. U.S.C.T.

Samuel Coke

Pvt., Co. K, 5 Reg't U. S. Col'd Cav.

Appears on

Company Muster Roll

for Nov & Dec, 1864.

Present or absent Present

Stoppage, \$ 100 for

Due Gov't, \$ 100 for

Valuation of horse, \$ 100

Valuation of horse equipments, \$ 100

Remarks: 1" & 2" installments
Bounty due

Book mark:

H Miller

(358)

Copyist.

C

5 Cav. U.S.C.T.

Samuel Coke

Plt, Co. K, 5 Reg't U. S. Col'd Cav.

Appears on

Company Muster Roll

for Jan 21 1865

Present or absent Present

Stoppage, \$ 100 for

Due Gov't, \$ 100 for

Valuation of horse, \$ 100

Valuation of horse equipments, \$ 100

Remarks: 1" & 2" installments \$300 Bounty due

Book mark:

H S Miller

(358)

Copyist.

6

5 Cav.

U.S.C.T.

Samuel Coke

Pvt., Co. K, 5 Reg't U. S. Col'd Cav.

Appears on

Company Muster Roll

for Mar U Apr, 1865.

Present or absent Present

Stoppage, \$ 100 for

Due Gov't, \$ 100 for

Valuation of horse, \$ 100

Valuation of horse equipments, \$ 100

Remarks: 1st installment of Bounty due \$100

Book mark:

H. Miller

(358)

Copyist.

6

5 Cav. U.S.C.T.

Samuel Coke

Prof., Co. K, 5 Reg't U. S. Col'd Cav.

Appears on

Company Muster Roll

for May & June, 1865.

Present or absent Present

Stoppage, \$ 100 for

Due Gov't, \$ 100 for

Valuation of horse, \$ 100

Valuation of horse equipments, \$ 100

Remarks: Fresh install amount
for duty done \$100

Book mark:

H. S. Carter

6

5 Cav. U.S.C.T.

Samuel Cone

Prof, Co. K, 5 Reg't U. S. Col'd Cav.

Appears on

Company Muster Roll

for July & Aug, 1865.

Present or absent Present

Stoppage, \$ 100 for

Due Gov't, \$ 100 for

Valuation of horse, \$ 100

Valuation of horse equipments, \$ 100

Remarks:

Book mark:

J. E. Foster

(358)

Copyist.

Samuel Cook

Cook, Co. K, 5 Reg't U. S. Col'd Cav.

Appears on

Company Muster Roll

for *Sept & Oct*, 186*9*.

Present or absent *Present*

Stoppage, \$ *100* for

Due Gov't, \$ *100* for

Valuation of horse, \$ *100*

Valuation of horse equipments, \$ *100*

Remarks: *Due U.S. for C & G E
1000s paid duty as
he mustered at R.R. M
Dept*

Book mark:

E. Porter

16

5 Cav. U.S.C.T.

Samuel Cook

Co. K, 5 Reg't U. S. Col'd Cav.

Appears on

Company Muster Roll

for Nov & Dec, 1865.

Present or absent Present

Stoppage, \$ 100 for

Due Gov't, \$ 100 for

Valuation of horse, \$ 100

Valuation of horse equipments, \$ 100

Remarks: Dis. U. S. for Ord.

100

Book mark:

J. Q. Carter

(358)

Copyist.

6

5 Cav. U.S.C.T.

Samuel Coke

Cot, Co. K, 5 Reg't U. S. Col'd Cav.

Appears on

Company Muster Roll

for Jan Feb, 1866.

Present or absent Absent

Stoppage, \$ 100 for

Due Gov't, \$ 100 for

Valuation of horse, \$ 100

Valuation of horse equipments, \$ 100

Remarks: Absent sick in hospital Helena Ark

Book mark:

E.H. Brown

C. | 5 Cav. | U.S.C.T.

Samuel Coke.

B Co. K, 5 Reg't U. S. Colored Cav.

Appears on Returns as follows:

May 1865: Absent sick in Hosp.,
Paris, Ky.

Sept. & Oct. 1865: On daily duty at
Regt. Q. M. Dept. as teamster.

Feb. 1866. Absent sick at Helena,
Ark.

Book mark :

(546)

J. Baker
Copyist.

6 | **5 Cav. U.S.C.T.**

Samuel Cooke
Capt, Co. *K*, 5 Reg't U. S. Col'd Cavalry.

Appears on **Co. Muster-out Roll**, dated
Vienna Ark *Jan 16*, 186*6*.

Muster-out to date _____, 186 .
Last paid to _____, 186 .

Clothing account:
Last settled _____, 186 ; drawn since \$ _____ 100
Due soldier \$ _____ 100; due U. S. \$ *22* ^{*39*} 100
Am't for cloth'g in kind or money adv'd \$ _____ 100

Due U. S. for arms, equipments, &c., \$ _____ 100
Bounty paid \$ *100* 100; due \$ _____ 100

Remarks: *died Jan 16 66 at*
Vienna Ark. Discharge certificate
for final statement forwarded

Book mark: *1958 2d Aud Dec 8/66 V. 100*
P. 69

E. H. Brown
(361) _____ Copyist.

Coke, Samuel

P, Co. K, 5 U.S.C. Cav.

Enclosures.

ed Cards
Burial Records
Certs. of Dis. for Discharge
C. M. Charges
Med. Certificates

Descriptive Lists
Final Statements /
Furloughs
Med. Des. Lists
Orders

Other papers relating to—

Admission to Hosp'l
Casualty Sheet (Officer's)
Confinement
Contracts
Death or Effects
Desertions
Discharge from Hosp'l
Discharge from Service
Duty

Furlough
Med. Examination
Misc. Information
Pay or Clothing
Personal Reports
Rank
Transfer to Hosp'l
Transfer to V. R. C.
Transportation

Extract from Act of Congress.

SEC. 12. And be it further enacted, That the fees of agents and attorneys for making out and causing to be executed the papers necessary to establish a claim for a pension, bounty, and other allowance before the Pension Office, under this act, shall not exceed the following rates: For making out and causing to be duly executed a declaration by the applicant, with the necessary affidavits, and forwarding the same to the Pension Office, with the requisite correspondence, ten dollars: which sum shall be received by such agent or attorney in full for all services in obtaining such pension, and shall not be demanded or received, in whole or in part, until such pension shall be obtained; and the sixth and seventh sections of an act entitled "An act to grant pensions," approved July [fourteenth,] eighteen hundred and sixty-two, are hereby repealed.

SEC. 13. And be it further enacted, That any agent or attorney who shall, directly or indirectly, demand or receive any greater compensation for his services under this act than is prescribed in the preceding section of this act, or who shall contract or agree to prosecute any claim for a pension, bounty, or other allowance under this act, on the condition that he shall receive a per centum upon any portion of the amount of such claim, or who shall wrongfully withhold from a pensioner or other claimant the whole or any part of the pension or claim allowed and due to such pensioner or claimant, shall be deemed guilty of a high misdemeanor, and, upon conviction thereof, shall, for every such offense, be fined not exceeding three hundred dollars, or imprisoned at hard labor not exceeding two years, or both, according to the circumstances and aggravations of the offense.

Approved July 4, 1864.

NOTE. 10.—If any soldier is charged a higher fee than that allowed by the above act, he should report the fact and the name of the agent to the Adjutant General, in order that steps may be taken to have the same refunded.

Handwritten notes:
2/18/64, forwarded to
Adjutant General's Office

ADJUTANT GENERAL'S OFFICE
Oct 22nd 64
sent to Auditor

FINAL STATEMENT.

OF

Private Samuel H. ...
5th Reg't of ...

VOLUNTEERS.

Died March 8th 61

NOTE 1.—Two of these certificates (or duplicates) are to be given to each Volunteer Soldier or drafted man who may be discharged without being mustered out (Final Statements are never given to men mustered out of service) that he may at once receive from the Paymaster the pay, &c., due to him, and the captain or other COMMISSIONED officer commanding the company will certify to the act of the delivery of the duplicate certificates; with these certificates the Soldier is "entitled to" his discharge, and should also present his discharge to the Paymaster to have the payment endorsed on it. The discharge is to be given back to the Soldier by the Paymaster; the latter only retaining as his vouchers the duplicate certificates.

NOTE 2.—If the Soldier is entitled to pay for the use of his horse, the Company Commander will certify to that fact on the back of both these final statements, and also to the time he has pay due for having been so mounted on his own horse.

NOTE 3.—When a Soldier is furnished with final statements, his descriptive list, if he has one, should be taken up by the officer who gives the Soldier these statements, and endorsed with a statement to this effect by the officer. The endorsement should exhibit a full statement of the time for which the Soldier was allowed pay on his final statements, the clothing account, and all other charges against him or in his favor, so as to comprise a complete exhibit of his account. It will then be transmitted to the Company Commander of the Soldier, who will enter all the data necessary to a full understanding of the Soldier's account on the muster roll upon which the Soldier's discharge is reported. The descriptive list will then be destroyed. The object of this is, that the remaining portion of the Soldier's account may be settled upon the receipt of these muster rolls, and the Soldier receive any pay or allowances that may be due him at the time of his discharge, and which may not appear on his last final statements from the fact that his descriptive list is incomplete. These accounts for back pay, &c., are settled by the 2d Auditor of the Treasury Department.

NOTE 4.—Charges for loss or injury to ordnance, horse equipments, and other miscellaneous charges, should appear under the heading of "Other Stoppages."

NOTE 5.—Bounty paid by State authorities, and not by the United States, will not be entered on this statement.

NOTE 6.—Amounts due the Sutler and Laundress must be entered on the muster roll on which the discharge, death, desertion, &c., is reported, as well as on the final statement, otherwise the amount cannot be collected from the United States.

NOTE 7.—This blank will be used for deceased volunteers and drafted men, as well as for others.

NOTE 8.—Where a Soldier dies in Hospital or on detached service, his descriptive list, if he has one, should be sent with his final statements, in duplicate, to the Adjutant General, Washington, D. C.

NOTE 9.—If the soldier is a drafted man or substitute, the space for time, &c., of enrolled, should contain only the word *drafted* or *substitute*, as the case may be. If the Soldier is a "VETERAN," (OF RECRUIT,) the words *as a veteran*, (or *recruit*,) as the case may be, should be interlined after the words *mustered into the service of the U. S.* A statement of all the installments of *Veteran* or *Recruit Bounty RECEIVED* by the Soldier must be made on the back of each final statement.

566

I certify, on honor, that Samuel Cook, a Private of
Captain S. T. Robinson's Company (X) of the 5th Regiment of W. Va. Cav.
Volunteers, of the State of _____, born in Anderson Co. State
of Kentucky, aged 46 years; 5 feet 7 inches high; Blk complexion,
Blk eyes, Blk hair, and by occupation a Labourer, who joined for service
and was enrolled (see Note 9) on the 7th day of October, 1864, at Seamington Ky
by Capt. Moore, for the period of 3 years, and mustered into
the service of the United States on the 7th day of October, 1864, at
Seamington Ky, by Capt. Moore; and having served
HONESTLY and **FATHFULLY** with his Company to the present date, is now entitled to a
DISCHARGE by reason of Death

Died March 8th 1865 (see B. 21)
The said Samuel Cook was last paid by Paymaster
Maj. Knapp, to include the 31st day of October, 1865, and
has pay due him from that time to the present date; he is entitled to pay and subsistence for
TRAVELING to place of enrollment, and whatever other allowances are authorized to volunteer
soldiers, drafted men, or militia, so discharged. He has received from the United States **CLOTHING**
amounting to 75- 34/₁₀₀ dollars, since the 31st day of March,
1865, when his clothing account was last settled. He has received from the United States
100/₁₀₀ dollars advanced **BOUNTY**.

There is to be stopped from him, on account of the State of _____, or other
authorities, for **CLOTHING**, &c., received on entering service, _____/100 dollars; and
for other stoppages, viz: _____

_____ dollars.
He has been furnished with **TRANSPORTATION** in kind from the place of his discharge to
_____ ; and he has been **Subsisted** for **Traveling** to his
place of enrollment, up to the _____, 186 .

He is indebted to _____, Sutler, _____/100 dollars.

He is indebted to _____, Laundress, _____/100 dollars.

Given in Duplicate, at Wilmington, this 8th day
of March, 1866.

S. T. Robinson
Capt 5th U.S.C.
Commanding Company.

275
Cole, Charles

Co G, 5 U. S. Col'd Cav.

Corporal

CARD NUMBERS.

1	26
2	27
3	28
4	29
5	30
6	31
7	32
8	33
9	34
10	35
11	36
12	37
13	38
14	39
15	40
16	41
17	42
18	43
19	44
20	45
21	46
22	47
23	48
24	49
25	50

Book Mark:

See also

276

Cole John C

Co A, 5 U. S. Col'd Cav.

Serjeant Com, Serjeant

CARD NUMBERS.

1	5359583	26
2	5359685	27
3	5359787	28
4	5359888	29
5	5359984	30
6	5360078	31
7	5360166	32
8	5360261	33
9	5360354	34
10	5360443	35
11	5360529	36
12	9089992	37
13	43146683	38
14	32115685	39
15	32115516	40
16	40729592	41
17		42
18		43
19		44
20		45
21		46
22		47
23		48
24		49
25		50

Book Mark:

See also

C | **5 Cav. | U.S.C.T.**

John C. Cole

Co. *F*, 5 Reg't U. S. Col'd Cav.

Appears on

Company Descriptive Book

of the organization named above.

DESCRIPTION.

Age *32* years; height *5* feet *4* inches.

Complexion *Dark*

Eyes *Dark*; hair *Dark*

Where born *Shelby Ky*

Occupation *Laborer*

ENLISTMENT.

When *Sept. 2*, 186 .

Where *Louisville*

By whom *Capt. Harn*; term *3* y'rs.

Remarks: _____

Hassen

6 | 5 bar 12.8.65

Jno. L. Cole

Appears with rank of Priv on

Muster and Descriptive Roll

of Detachment of U.S. Colored Troops
Mustered

Roll dated Louisville Ky, Sept 13, 1864.

Where born Shelby Co. Ky

Age 22 years; occupation Labourer

When enlisted Sept 12, 1864.

Where enlisted Louisville Ky

For what period enlisted 3 years.

Eyes _____; hair _____

Complexion _____; height _____ ft. _____ in.

When mustered in Sept 13, 1864.

Where mustered in Louisville Ky

Bounty paid \$ 100; due \$ 100

Clothing account:

Last settled _____, 186 _____; drawn since \$ 100

Date of first muster _____, 186 _____.

Company to which assigned _____

Remarks: credited to Shelby Co. 4th Dist Ky

Book mark: _____

J. M. Carter

(356m)

Copyist.

6 | **5 Cav. U.S.C.T.**

Robert Cole

1st Regt, Co. A, 5 Reg't U. S. Col'd Cavalry.

Appears on

Company Muster-in and Descriptive Roll

of the organization named above. Roll dated

Cp. Nelson Ky, N. Y., Oct. 24, 1864.

Where born Shelby Co. Kentucky

Age 30 y'rs; occupation Laborer

When enlisted Sept. 12, 1864.

Where enlisted Louisville Ky

For what period enlisted 3 years.

Eyes Ok; hair Ok

Complexion Ok; height 5 ft. 7 in.

When mustered in Sept. 13, 1864.

Where mustered in Louisville

Bounty paid \$ 100; due \$ 100

Where credited 4th District Kentucky

Company to which assigned A

Remarks:

Book mark:

(356d)

Castro
Copyist.

6

5 Cav. U.S.C.T.

John La Folle
Sergeant, Co. A, 5 Reg't U. S. Col'd Cavalry.

Appears on

Company Muster Roll

for *Oct. 31*, 1864.

Present or absent *Present*

Stoppage, \$ *100* for

Due Gov't, \$ *100* for

Valuation of horse, \$ *100*

Valuation of horse equipments, \$ *100*

Remarks:

Book mark:

O. A. T. King

(358)

Copyist.

16

5 Cav. U.S.C.T.

Robert C. Cole

Sergeant, Co. A, 5 Reg't U. S. Col'd Cavalry.

Appears on

Company Muster Roll

for Jan, 8 1864, 1864

Present or absent absent

Stoppage, \$ 100 for

Due Gov't, \$ 100 for

Valuation of horse, \$ 100

Valuation of horse equipments, \$ 100

Remarks: In place of fatal at
Camp in McComb Ky.
1st and 2d Reg't Cavalry
Barnes & Co.

Book mark:

Easterling

(358)

Copyist.

6 | 5 Cav. | U.S.C.T.

John E. Wile

Capt., Co. A, 5 Reg't U.S. Col'd Cavalry.

Appears on

Company Muster Roll

for *Jan. & Feb.*, 186*5*.

Present or absent *absent*

Stoppage, \$ *100* for

Due Gov't, \$ *100* for

Valuation of horse, \$ *100*

Valuation of horse equipments, \$ *100*

Remarks: *In Genl. Receipt
for my personal
2^d statement Bdsnty
see B. 100.*

Book mark: _____

(358)

W. A. Stearns
Copyist.

C. 15 Co. 11th Cal.

John C. Cole

Supt. Co. A, 5 Reg't 11th Cal.

Appears on

Hospital Muster Roll

of Nelson U. S. A. General Hospital,

at Camp Nelson, Ky.,

for *Jan'y & Feb'y*, 186*5*.

Attached to hospital:

When _____, 186*5*.

How employed _____

Last paid by Maj. _____

to *by the Gen'l Hospital*, 186*5*.

Bounty paid \$ 100; due \$ 100

Present or absent *Present*

Remarks: _____

Book mark: _____

M. C. Curtis

(843)

C. print

C

5 Cav. U.S.C.T.

Sam I Cole

Capt., Co. A, 5 Reg't U. S. Col'd Cavalry.

Appears on

Company Muster Roll

for *Jan. & Feb.*, 186*5*.

Present or absent *Absent*

Stoppage, \$ *100* for

Due Gov't, \$ *100* for

Valuation of horse, \$ *100*

Valuation of horse equipments, \$ *100*

Remarks: *In Camp kept
at Sustainment Company
due S.T.*

Book mark:

J. H. Alway

(358)

Copyist.

C 1 5 Cav USCT

John C. Cole
Regt Co A, 5 Reg't USCT

Appears on

Hospital Muster Roll

of Nelson U. S. A. General Hospital,

at Camp Nelson, Ky.,

for dated May 1, 1865.

Attached to hospital:

When....., 186 .

How employed.....

Last paid by Maj. Beecher

to July 28, 1865.

Bounty paid \$ 100; due \$ 100

Present or absent Present

Remarks:.....

Book mark :.....

M. C. [Signature]

5 Cav. U.S.C.T.

John C. Cole

Serjt, Co. A, 5 Reg't U. S. Col'd Cavalry.

Appears on

Company Muster Roll

for *May June* 1865.

Present or absent *Absent*

Stoppage, \$ *100* for

Due Gov't, \$ *100* for

Valuation of horse, \$ *100*

Valuation of horse equipments, \$ *100*

Remarks: *Sp. H. Dep. Serjt.
Camp Nelson, W.
County due S. J.*

Book mark:

J. M. [Signature]

(358)

Copyist.

6 | 5 Cav. | U.S.C.T.

John C. Cole

Serg't., Co. A, 5 Reg't U. S. Col'd Cavalry.

Appears on

Company Muster Roll

for *Jul. & Aug.*, 1865.

Present or absent *Present*

Stoppage, \$ 100 for

Due Gov't, \$ 100 for

Valuation of horse, \$ 100

Valuation of horse equipments, \$ 100

Remarks:

Book mark:

H. H. H. H.

(358)

Comjst.

5 Cav. U.S.C.T.

John G. Cole

Serjt., Co. A, 5 Reg't U. S. Col'd Cavalry.

Appears on

Company Muster Roll

for *dated Oct. 31*, 186*9*.

Present or absent *Present*

Stoppage, \$ *100* for

Due Gov't, \$ *100* for

Valuation of horse, \$ *100*

Valuation of horse equipments, \$ *100*

Remarks:

Book mark:

J. G. Cole
Copist.

C | 5 Cav. | U.S.C.T.

John C. Cole

Am Sgt, Co. A, 5 Reg't U.S. Col'd Cavalry.

Appears on

Company Muster Roll

for Nov 04th, 1865

Present or absent Present

Stoppage, \$ 100 for

Due Gov't, \$ 100 for

Valuation of horse, \$ 100

Valuation of horse equipments, \$ 100

Remarks: Present Sick

Book mark:

Wmsayre
Copyist.

C | 5 Cav. | U.S.C.T.

John C. Cole
Am Sgt, Co. A, 5 Reg't U. S. Col'd Cavalry.

Appears on

Company Muster Roll

for Jan & Feb, 1866

Present or absent Present

Stoppage, \$ 100 for

Due Gov't, \$ 100 for

Valuation of horse, \$ 100

Valuation of horse equipments, \$ 100

Remarks:

Book mark:

M. W. Payne
Copyist.

2 | 5 Cav. | U.S.C.T.

John C. Cole.

Serjt., Co. A, 5 Reg't U. S. Colored Cav.

Appears on Returns as follows:

Oct. 1864. On daily duty at Hdqrs. of
Battn.

Nov. 1864. In duty detail at Hdqrs.
Battn in Pioneer Corps.

Dec. 1864 to June 1865. Absent sick in
U. S. Gen. Hosp., Camp Nelson, Ky.

July 1865. Absent sick in Hosp. at
Paris, Ky.

Book mark:

(546)

J. Baker,
Copyist.

C

5 Cav. U.S.C.T.

John C. Cole
Comd'g Co. A, 5 Reg't U. S. Col'd Cavalry.

Appears on Co. Muster-out Roll, dated

Helena Ark March 16, 1866.

Muster-out to date March 16, 1866.

Last paid to Dec 31, 1865.

Clothing account:

Last settled....., 186 ; drawn since \$..... 100

Due soldier \$ 23³⁴/₁₀₀; due U. S. \$..... 100

Am't for cloth'g in kind or money adv'd \$..... 100

Due U. S. for arms, equipments, &c., \$..... 100

Bounty paid \$ 100/₁₀₀; due \$ 100/₁₀₀

Remarks: Reign from Orig
of Co. to Nov 17, 1864
then Com. Reign.

Book mark :

W. Mayre

(861)

Copyist.

277

Coleman Allen

Co E, 5 U. S. Col'd Cav.

Private Private

CARD NUMBERS.

1	5363692	26
2	5363791	27
3	5363893	28
4	5364024	29
5	5364640	30
6	9090430	31
7	40729613	32
8		33
9		34
10		35
11		36
12		37
13		38
14		39
15		40
16		41
17		42
18		43
19		44
20		45
21		46
22		47
23		48
24		49
25		50

Book Mark:

General Notation N. A. 407375.

See also

C

5 Cav. | U.S.C.T.

Allen C. Oman

....., Co. *E*, 5 Reg't U. S. Col'd Cav.

Appears on

Company Descriptive Book
of the organization named above.

DESCRIPTION.

Age *20* years; height *5* feet *4* inches.

Complexion *Black*

Eyes *Blk*; hair *Blk*

Where born *Scott Ky*

Occupation *farmer*

ENLISTMENT.

When *Sep 9*, 186 *4*.

Where *Camp Nelson*

By whom *J. B. Randolph* term *5* y'rs.

Remarks: *Missing in action*

J. E. Purvis

(383g)

Copist.

6 **5 Cav. U.S.C.T.**

Allen Coleman

Pvt., Co *E*, 5 Reg't U. S. Col'd Cavalry.

Appears on

Company Muster-in and Descriptive Roll

of the organization named above. Roll dated

Camp Nelson, N.Y., Oct 26, 1864.

Where born *Scott, Ky.*

Age *20* y'rs; occupation *Farmer*

When enlisted *Sept. 9*, 186*4*.

Where enlisted *Cp. Nelson Ky*

For what period enlisted *3* years.

Eyes *Black*; hair *Black*

Complexion *Black*; height *5* ft. *4* in.

When mustered in *Sept. 9*, 186*4*.

Where mustered in *Cp. Nelson Ky*

Bounty paid \$ *100*; due \$ *100*

Where credited

Company to which assigned

Remarks: *7th District Kentucky*
Richmond, Wagoner

Book mark: *H 2076 Ky.*

(356d)

W. Rowland

Copyist.

6 | **5 Cav.** | **U.S.C.T.**

Allen Coleman
Pvt., Co. E, 5 Reg't U. S. Col'd Cavalry.

Appears on

Company Muster Roll

for Enlistment to Feb 31, 1864.

Present or absent Present

Stoppage, \$ 100 for

Due Gov't, \$ 100 for

Valuation of horse, \$ 100

Valuation of horse equipments, \$ 100

Remarks:

Book mark: _____

(358)

Wm. [unclear]

Copyist.

6 | 5 Cav. | U.S.C.T.

Allen Coleman

Co. E, 5 Reg't U.S. Col'd Cavalry.

Appears on

Company Muster Roll

for Nov 7 Dec, 1864.

Present or absent Present

Stoppage, \$ 100 for

Due Gov't, \$ 100 for

Valuation of horse, \$ 100

Valuation of horse equipments, \$ 100

Remarks: "42" Instalments

of Bounty due

Book mark:

S. W. Ireland

6 | **5 Cav.** | **U.S.C.T.**

Allen Colman
1st Lt., Co. E, 5 Reg't U. S. Col'd Cavalry.

Appears on

Company Muster Roll

for Jan. & Feb., 1865.

Present or absent Absent

Stoppage, \$ 100 for

Due Gov't, \$ 100 for

Valuation of horse, \$ 100

Valuation of horse equipments, \$ 100

Remarks: Missing in action
at Simpsonville Ky
Jan. 25, 1865

Book mark:

(358) A. W. Corbitt Copyist.

Q. | 5 Cav. | U.S.C.T.

Allen Coleman.

Priv., Co. E, 5 Reg't U. S. Colored Cav.

Appears on Returns as follows:

Nov. & Dec. 1864. On daily duty as
Co. Cook.

Jan. 1865. Lost, Missing in action
near Simpsonville, Ky. Jan.
25/65.

Book mark:

(546)

H. Baker
Copyist.

5 Cav. U.S.C.T.

Allen Holleman
Co. E, 5 Reg't U. S. Col'd Cavalry.

Appears on Co. Muster-out Roll, dated
Hesperia, Ark March, 1866.

Muster-out to date _____, 1866 .

Last paid to *Pay due from subserment*, 1866 .

Clothing account:

Last settled _____, 1866 ; drawn since \$ _____ 100

Due soldier \$ _____ 100; due U. S. \$ *53* ⁰²/₁₀₀

Am't for cloth'g in kind or money adv'd \$ _____ 100

Due U. S. for arms, equipments, &c., \$ _____ 100

Bounty paid \$ _____ 100; due \$ _____ 100

Remarks: *Missing in action
at Pine Bluff Ark Ky
January 25 1865*

Book mark: *42076 Ky. 2209 P. 11. 74
4470. 1880*

(361)

Allen Holleman

Copyist.

Wheeler Allen

Pvt., Co. E,

5 Reg't U.S.C. Cav

Enclosures.

Bed Cards	Descriptive Lists
Burial Records	Final Statements
Certs. of Dis. for Discharge	Furloughs
C. M. Charges	Med. Des. Lists
Med. Certificates	Orders

Other papers relating to—

Admission to Hosp'l	Furlough
Casualty Sheet (Officer's)	Med. Examination
Confinement	Misc. Information
Contracts	Pay or Clothing
Death or Effects	Personal Reports
Desertions	Rank
Discharge from Hosp'l	Transfer to Hosp'l
Discharge from Service	Transfer to V. R. C.
Duty	Transportation

War Department,

ADJUTANT GENERAL'S OFFICE,

Washington, April 8th 1867.

Respectfully returned to the
Commission for the State of
Ky. with the informa-

tion that Allen Coleman
was enlisted at Camp Nelson Ky.

Sept 9th 1864. and was

mustered in as Pvt. in Co. "E"

5th U.S. Col. Inf. Sept 9/64.

W. Haggard

Asst. Adj't General.

W.B.

No. *2076*

APPLICATION OF

R. H. Haggard

of
Scott Co. Ky

FOR COMPENSATION FOR SLAVE,

Named *Allen Coleman*

Enlisted *Sept 9* 1864

In Com. *E 3* Regiment,

U. S. COLORED TROOPS.

Received *July 28*, 1867

Compensation Awarded

, 186...

Dollars.

President of Board of Claims.

Claimant's Attorney,

Robinson & Lane,

Claimant's Post-office address,

Washington

Ky

TRANSFORMED COMMONWEALTH PRINT.

No.

CLAIM OF

Richard H Haggard

FOR THE COMPENSATION OF SLAVE NAMED

Allen Coleman

I, *Richard H Haggard* a loyal citizen, and a resident of *the*,
 County of *Scott*, State of Kentucky, hereby claim compensation, under
 the provisions of Section 24, act approved February 24, 1864, and section 2, act approved July, 28,
 1866, for my slave *Allen Coleman*, enlisted *September 9th*,
 1864, at *Camp Nelson Ky*, by *Capt. V. C. Kenney*
 in the *3rd* regiment U. S. Colored Troops, Co. *20*; certificate of
 which enlistment, and a descriptive list, as required, accompany this application. That I did not ac-
 quire said slave subsequent to said enlistment, but had a valid title to him at the date of said enlist-
 ment, and previous thereto: I having acquired my title to him and my ownership over him as fol-
 lows, to-wit: *by purchase*

In proof of my loyalty to the Constitution and Government of the United States, I present the ac-
 companying oath, which I have taken, signed and acknowledged; to be filed with this application, in
 accordance with requirement of General Orders, No. 329, 1863, War Department, Adjutant General's
 Office.

R. H. Haggard

186

OATH OF ALLEGIANCE.

I, *Richard H Haggard*, the owner and Claimant, do solemnly swear that
 the foregoing claim is a just and true claim due to me as master and owner of the said slave, and that
 the facts alleged in said claim in respect to the draft or enlistment (as the case may be) of said slave
 into the Military service of the United States are true. And I do further swear that I have never
 joined, or been concerned in, any insurrection or rebellion; that I have never borne arms against the
 United States; that I have never given any aid, countenance, counsel or encouragement to any person
 or persons engaged, or whom I had reason to believe were about to engage, in insurrection, rebellion
 or armed hostility against the United States; that I have neither sought, nor accepted, nor attempted
 to exercise the functions of any office, civil or military, nor to perform any service whatever, under
 any authority or pretended authority in hostility to the United States; that I have not yielded a vol-
 untary support to any insurrection, rebellion or pretended government, authority, power or constitution
 within the United States hostile thereto. And I do further swear that, to the best of my knowledge
 and ability, I have supported and defended, and will continue to support and defend, the United
 States against all enemies, foreign and domestic; and that I have supported, defended and obeyed, and
 will continue to support, defend and obey, the Constitution and laws of the United States; that I will
 bear true faith and allegiance to the same; and that I take this oath freely, without any mental reserva-
 tion or purpose of evasion: So help me God.

R. H. Haggard

Sworn to and subscribed before me, at *Georgetown*
 this *7th* day of *July*, 1867.



W. M. Mace
M. P. C.

Headquarters Kentucky Volunteers,

Adjutant-General's Office,

Frankfort, Decr 21st, 1866.

I hereby certify, that it appears from the U. S. Muster-Ins
Rolls on file in this Office, that Allan Colman
was enrolled on the 9th day of September, 1864, at
Camp Nelson Ky., by J. C. Randolph,
and mustered into the U. S. service on the 9th day of September,
1864, at Camp Nelson Ky., by Capt N. C. Quincy
to serve Three years. Said Allan Colman
is described as follows: Age, 20 years; eyes, Black; hair, Black
complexion, Black; height, 5 feet 4 inches. It further
appears from said Rolls, that Allan Colman owed service
to Richard Haggard, was credited to Scott
County, Ky., and was assigned to Co. "E", 5th Regiment
U. S. C. Cavalry

In Testimony Whereof. I have hereunto set my
hand, and affixed my Official Seal, this
21st day of Decr, 1866.

D. W. Lindsey
Adjutant General Kentucky.

B. 217, R. 313



PROOF OF OWNERSHIP.

STATE OF KENTUCKY,

COUNTY OF *Scott*

} SS.

We *Nicholas Long* and *John B. Kinnery* each of lawful age, and resident citizens of the State and County aforesaid, do certify that

William H. Haggard of the State and County aforesaid, was on the *7th* day of *September* 1864, the lawful owner of the slave named *Allen Coleman*; referred to and described in the foregoing claim for compensation.

Sworn to and subscribed before me a *Notary Public* for the County of *Scott* State of Kentucky, this the *7* day of *July* 1864.

N. Long
J. B. Kinnery
W. H. Haggard

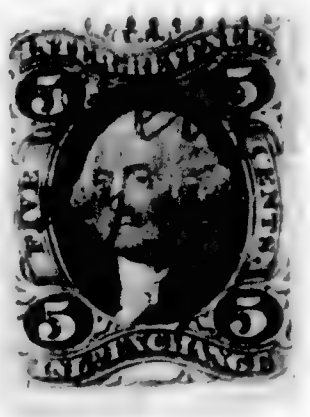

PROOF OF LOYALTY.

STATE OF KENTUCKY,

COUNTY OF *Scott*

} SS.

We *Nicholas Long* and *John B. Kinnery* loyal men and each of lawful age, and resident citizens of the

in the State and County aforesaid, upon our oaths declare that we have known *William H. Haggard* a resident of the State and County aforesaid, since the 4th day of March, 1861, and know that he has firmly and faithfully maintained his or her adherence and allegiance to the Government of the United States, by defending its cause against the Government and forces of the so-called Confederate States of America, in all suitable and practicable ways, and according to his or her ability and opportunity.

Sworn to and subscribed before me a *Notary Public* for the county of *Scott* State of Kentucky, this the *7* day of *July* 1864.

N. Long
J. B. Kinnery
W. H. Haggard

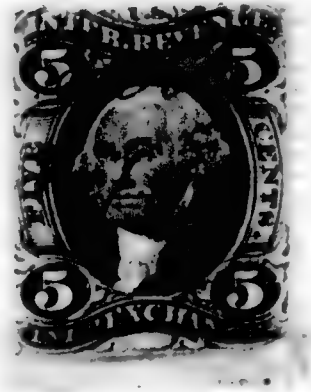

POWER OF ATTORNEY.

My Post-Office address is *Way Run* County of *Scott* State of Kentucky, and I hereby direct that all communications to me, touching this claim, be sent under cover to *John H. Watson & J. F. Lane*, who is hereby appointed and constituted my true and lawful attorney, to prosecute this claim for me, and who is hereby authorized and empowered to receive and receipt for any award, order, draft, certificate, voucher, warrant, papers or may be issued in the adjustment of this claim, or the payment thereof, the same as I could do in person were I present and acting for myself, and to file any additional evidence that may be required in the prosecution of this claim.

The owner signs here.

W. H. Haggard

Two witnesses to owner's signature sign here.

N. Long
J. B. Kinnery

Coleman ^{2nd} Henry

Co A, 5 U. S. Col'd Cav.

Private | Private

CARD NUMBERS.

1	5-362663	26
2	5-362767	27
3	5-362867	28
4	5-362958	29
5	5-363053	30
6	5-363141	31
7	5-363227	32
8	5-363321	33
9	5-363410	34
10	5-363497	35
11	5-363582	36
12	9090292	37
13	43146475	38
14	43155136	39
15	31413512	40
16	40729603	41
17		42
18		43
19		44
20		45
21		46
22		47
23		48
24		49
25		50

Book Mark:

See also

6 | **5 Cav. | U.S.C.T.**

Henry Colman
Co A, 5 Reg't U. S. Col'd Cav.

Appears on

Company Descriptive Book
of the organization named above.

DESCRIPTION.

Age 18 years; height 5 feet 7 inches.

Complexion Black

Eyes Blk; hair Blk

Where born Oldham Ky

Occupation Farmer

ENLISTMENT.

When Substitute, 186 .

Where 5th Dist Ky

By whom _____; term 3 y'rs.

Remarks: _____

J. E. P. [Signature]

61 5 bar 11385

Henry Coleman

Appears with rank of Act on

Muster and Descriptive Roll

of A Detachment of men Drafted and Mustered into Service of US

Roll dated Louisville Ky, Sept 1, 1864.

Where born Oldham Ky

Age 18 y'rs; occupation Laborer

Drafted and mustered in:

When Sept 1, 1864.

Where Louisville Ky

Enrollment district 5 Dist Ky

Period 3 years.

Eyes Black; hair Black

Complexion Black; height 5 ft. 7 in.

Bounty paid \$ 100; due \$ 100

Clothing account:

Last settled _____, 186 ; drawn since \$ 100

Date of commencement of service Sept 1, 1864.

Company to which assigned _____

Remarks: Substitute for Micajah
Leble Anti Draft
Issued clothing to Ant \$1957

Book mark: _____

Jacobson

(356m)

Copyist.

6 | 5 bar | U.S.C.T.

Henry Coleman

Appears with rank of Pvt on

Muster and Descriptive Roll

of a Detachment of U. S. Colored
Troops formed for U. S. Col
cer. at Lexington, Ky. Roll dated
Louisville, Ky., Sept. 7, 1864.

Where born Oldham, Ky.

Age 18 years; occupation Labrer

When enlisted Substitute, 186 .

Where enlisted _____

For what period enlisted 3 years.

Eyes Black; hair Black

Complexion Black; height 5 ft. 7 in.

When mustered in Sept. 1, 1864.

Where mustered in Louisville

Bounty paid \$ 100; due \$ 100

Clothing account:
Last settled _____, 186 ; drawn since \$ 1957
100

Date of first muster Sept. 1, 1864.

Company to which assigned _____

Remarks: 5 Dist. Ky.

Book mark: _____

R. J. Edmundo

(356m)

Copyist.

6 | **5 Cav.** | **U.S.C.T.**

Henry Coleman

Pvt., Co. *D*, 5 Reg't U. S. Col'd Cavalry.

Appears on

Company Muster-in and Descriptive Roll
of the organization named above. Roll dated

Camp Nelson, Ky. Oct. 24, 1864.

Where born *Oldham, Ky.*

Age *18* y'rs; occupation *Laborer*

When enlisted _____, 186 .

Where enlisted _____

For what period enlisted *3* years.

Eyes *BK*; hair *BK*

Complexion *BK*; height *5* ft. *7* in.

When mustered in *Sept. 1*, 1864.

Where mustered in *Louisville*

Bounty paid \$ *100*; due \$ *100*

Where credited *5 Dist. Ky.*

Company to which assigned _____

Remarks: _____

Book mark: _____

Wm. H. Scott

(356d)

Copyist.

6

5 Cav. U.S.C.T.

Henry Holman

Pvt., Co. D, 5 Reg't U. S. Col'd Cavalry.

Appears on

Company Muster Roll

for Dated Oct. 31, 1864.

Present or absent Absent

Stoppage, \$ 100 for

Due Gov't, \$ 100 for

Valuation of horse, \$ 100

Valuation of horse equipments, \$ 100

Remarks: Sick in Hospital, Lexington, Ky. (Substitute)

Book mark:

Wm H Scott

6

5 Cav. U.S.C.T.

Henry Coleman

Pvt., Co. D, 5 Reg't U. S. Col'd Cavalry.

Appears on

Company Muster Roll

for Nov. & Dec., 1864.

Present or absent Absent

Stoppage, \$ 100 for

Due Gov't, \$ 100 for

Valuation of horse, \$ 100

Valuation of horse equipments, \$ 100

Remarks: Sick in Hospital, Lexington, Ky. 1" & 2" in statements of Bounty dues

Book mark:

Wm. Scott

C | **5 Cav.** | **U.S.C.T.**

Henry Coleman
Plt., Co. D, 5 Reg't U. S. Col'd Cavalry.

Appears on

Company Muster Roll

for *Jan & Feb.*, 1865.

Present or absent *Present*

Stoppage, \$ *100* for

Due Gov't, \$ *100* for

Valuation of horse, \$ *100*

Valuation of horse equipments, \$ *100*

Remarks: ** First allotment of
Bounty due \$100.*

** Asson Roll.*

Book mark:

Wm. H. Scott

C. | 5 Cav | U.S.C.P.

Henry Clemens.
Priv., Co. D., 5 Reg't U.S.C.P.

Appears on

Hospital Muster Roll

of Convalescent Camp U. S. A. Hospital,

at Camp Nelson, Ky.,

for Jan. & Feb., 1865.

Attached to hospital:

When Jan. 20, 1865.

How employed Patient

Last paid by Maj. _____

to _____, 1865.

Bounty paid \$ 100; due \$ 100

Present or absent Present

Remarks: _____

Book mark: _____

Giberson

6

5 Cav. U.S.C.T.

Henry Coleman

Priv., Co. D, 5 Reg't U. S. Col'd Cavalry.

Appears on

Company Muster Roll

for March & April, 1865.

Present or absent Present

Stoppage, \$ 100 for

Due Gov't, \$ 100 for

Valuation of horse, \$ 100

Valuation of horse equipments, \$ 100

Remarks:

Book mark:

Mary Scott

(358)

Copyist.

6

5 Cav. U.S.C.T.

Henry Coleman

Private, Co. D, 5 Reg't U. S. Col'd Cavalry.

Appears on

Company Muster Roll

for May + June, 1865.

Present or absent Present.

Stoppage, \$ 100 for

Due Gov't, \$ 100 for

Valuation of horse, \$ 100

Valuation of horse equipments, \$ 100

Remarks:

Book mark:

Williker

(358)

Copyist.

6

5 Cav. U.S.C.T.

Henry Goldman

Priv., Co. D, 5 Reg't U. S. Col'd Cavalry.

Appears on

Company Muster Roll

for July & Aug., 1865.

Present or absent present.

Stoppage, \$ 100 for

Due Gov't, \$ 100 for

Valuation of horse, \$ 100

Valuation of horse equipments, \$ 100

Remarks:

Book mark:

Milliken

le | **5 Cav.** | **U.S.C.T.**

Henry Coleman

Priv., Co. D, 5 Reg't U. S. Col'd Cavalry.

Appears on

Company Muster Roll

for Sept. & Oct., 1865.

Present or absent present

Stoppage, \$ 100 for

Due Gov't, \$ 100 for

Valuation of horse, \$ 100

Valuation of horse equipments, \$ 100

Remarks: Due U.S. for Ordnance
\$9.50 Due U.S. for Camp &
Garrison \$9.50.

Book mark:

Milliken

(358)

Copyist.

6

5 Cav. U.S.C.T.

Henry Coleman

Priv., Co. D, 5 Reg't U. S. Col'd Cavalry.

Appears on

Company Muster Roll

for Nov. & Dec., 1865.

Present or absent Present.

Stoppage, \$ 100 for

Due Gov't, \$ 100 for

Valuation of horse, \$ 100

Valuation of horse equipments, \$ 100

Remarks:

Book mark:

Milliken

(358)

Copyist.

C. | 5 Cav. | U.S.C.T.

Henry Coleman,

Private, Co. D, 5 Reg't U. S. Col'd Cavalry.

Appears on

Company Muster Roll

for *Jan'y and Febr'y*, 186*e*.

Present or absent *Present*.

Stoppage, \$ *100* for

Due Gov't, \$ *100* for

Valuation of horse, \$ *100*

Valuation of horse equipments, \$ *100*

Remarks: *Due U. S. per Sentence
Regt. Court Martial Regt. Ord.
No. 23 Feb. 10, 1866. \$10.00*

Book mark : _____

(358)

W. D. Dummer

Copyist.

② | 5 Cav. | U.S.C.T.

Henry Coleman.

Priv., Co. D, 5 Reg't U. S. Colored Cav.

Appears on Returns as follows:

Oct. to Dec. 1864. Absent sick in
Hosp., Lexington, Ky.

Jan. 1865. Absent sick in Hosp.,
Camp Nelson, Ky.

Book mark:

(546)

A. Baker
Copyist.

C. | 5 Cav. | U.S.C.T.

Henry Coleman
Srv., Co. *D.*, 5 Reg't U. S. Col'd Cavalry.

Appears on Co. Muster-out Roll, dated
Selma, Ark, March 16, 1865.

Muster-out to date *March 16, 1865.*

Last paid to *Dec. 31, 1865.*

Clothing account:

Last settled....., 186 ; drawn since \$..... 100

Due soldier \$..... 100; due U. S. \$ *28.* ³⁹/₁₀₀

Am't for cloth'g in kind or money adv'd \$..... 100

Due U. S. for arms, equipments, &c., \$..... 100

Bounty paid \$..... 100; due \$..... 100

Remarks: *Due U. S. per sentence*
Regt. Court Martial Regt.
Cent. No 25 Feb. 10, 1865
\$ 10.

Book mark:

(861)

R. W. Brunner

Copyist.

Colman Henry

P, Co. D, 5 Reg't 1st Caval.

Enclosures.

Bed Cards	Final Statements
Burial Records	Furloughs or L. of A
Certs. of Dis. for Discharge	Med. Certificates
C. M. Charges	Med. Des. Lists
Descriptive Lists	Orders
Discharge Certificates	Pris. of War Record
Enlistment Papers	Resignations

Other papers relating to—

Admission to Hosp'l	Furlough or L. of A
Casualty Sheet	Med. Examination
Confinement	Misc. Information /
Contracts	Pay or Clothing
Death or Effects	Personal Reports
Desertion	Rank
Discharge from Hosp'l	Transfer to Hosp'l
Discharge from Service	Transfer to V. R. C.
Duty	Transportation

Henry Coleman.

Co. "H"

Adjutant General's Office,

COLORED TROOPS BRANCH,

Jan 21, 1871

Vol. C. T., 187

Wanted in case of Henry Coleman 1st Co. 5th Reg't U.S. Col. information relative to trial &c. New Orleans M.C. Reg't Army & U.S. Army sentenced Reg't Court Martial, Reg't Order No. 5, Feb 10, 1864, \$1000

Respectfully,

Wm. Woodward
Chief Clerk.

J. J. Dalton

Adjutant General's Office,

Rec'd Room

Jan 21, 1871

Vol. C. T., 187

Reply in case of Henry Coleman 1st Co. 5th Reg't U.S. Col.

Co. Manning Reg't. back home Jan 21 '66. Absent without leave. Jan 31 '66: from abs. without leave & confinement. Reg't & Co. orders books here. Trial before a Field Off. Court Martial. Order No. 25 M. G. U.S. C. C. Feb 10 '66. Charge: Absence without leave. Finding: Guilty. Sentence: To forfeit 6 Mo. U.S. & 10. for 1 Month.

App's (Bid) (Chas. Bentzen Col. 5th U.S. C.T. Comdg. St. Francis River Dist.

R. G. J.

W. J.

219

Coleman Isaac

Co E, 5 U. S. Col'd Cav.

Private Private

CARD NUMBERS.

1	5363693	26
2	5363792	27
3	5363894	28
4	5363973	29
5	5364065	30
6	5364155	31
7	5364241	32
8	5364334	33
9	5364422	34
10	5364505	35
11	5364582	36
12	9090435	37
13	43146536	38
14	31785591	39
15	40729614	40
16		41
17		42
18		43
19		44
20		45
21		46
22		47
23		48
24		49
25		50

Book Mark: General Notation R. b. E. 407376,

See also 1

6

5 Cav.

U.S.C.T.

Isaac Colman

Co. E, 5 Reg't U. S. Col'd Cav.

Appears on

Company Descriptive Book
of the organization named above.

DESCRIPTION.

Age 23 years; height 5 feet 4 inches.

Complexion Black

Eyes Black; hair Black

Where born Fayette Ky

Occupation farmer

ENLISTMENT.

When Sep 10, 1864

Where Camp Nelson

By whom J. B. Randolph, term 3 y'rs.

Remarks:

J. E. Purke

6

U.S.C.T.

Isaac Coleman

Appears with rank of Pvt on

Muster and Descriptive Roll

of a Detachment of U. S. Colored
Volunteers forwarded to camp

Bellevue, camp of Instruction. Roll dated
Lexington, Ky., Sept. 7, 1864.

Where born Fayette Co. Ky.

Age 24 years; occupation Labourer

When enlisted Sept. 6, 1864.

Where enlisted Lexington, Ky.

For what period enlisted 3 years.

Eyes Blue; hair Blue

Complexion Blue; height 5 ft. 5 in.

When mustered in _____, 186 .

Where mustered in _____

Bounty paid \$ 100; due \$ 100

Clothing account:

Last settled _____, 186 ; drawn since \$ 100

Date of first muster Sept. 6, 1864.

Company to which assigned _____

Remarks: Owner. Miss Elizabeth
Coleman. Fayette Co. To be
credited 7 Dist. Ky.

Book mark: _____

A. J. O'Sullivan

(356m)

Copyist.

Isaac Coonrod

Co. C 5 Reg't U. S. Col'd Cavalry.

Appears on

Company Muster-in and Descriptive Roll

of the organization named, above. Roll dated

Camp Union, N.Y., Oct 2, 1864.

Where born Fayette Ky

Age 23 y'rs; occupation Farmer

When enlisted Sept 1, 1864.

Where enlisted Camp Union N.Y.

For what period enlisted 3 years.

Eyes Blue; hair Black

Complexion Black; height 5 ft. 4 in.

When mustered in Sept 12, 1864.

Where mustered in Camp Union N.Y.

Bounty paid \$ 100; due \$ 100

Where credited

Company to which assigned

Remarks: 4th District Kentucky

* Eliza Coonrod

* [unclear]

[unclear]

Book mark: [unclear]

[Signature]

6

5 Cav.

U.S.C.T.

Isaac Coleman

Cvt., Co. E, 5 Reg't U. S. Col'd Cavalry.

Appears on

Company Muster Roll

for Enlistment to Oct. 31, 1864.

Present or absent Present

Stoppage, \$ 100 for

Due Gov't, \$ 100 for

Valuation of horse, \$ 100

Valuation of horse equipments, \$ 100

Remarks: Daily duty - Right
Hd. and Left

Book mark:

W. Cowland

(358)

Copyist.

George Coleman

27, Co. E, 5 Reg't U. S. Col'd Cavalry.

Appears on

Company Muster Roll

for *Nov, & Dec.*, 1864.

Present or absent *Present*

Stoppage, \$ 100 for

Due Gov't, \$ 100 for

Valuation of horse, \$ 100

Valuation of horse equipments, \$ 100

Remarks: *On detached service
Camp, Union "Nov. 2"
Feb. 1" & 2" Installments
of Bounties due.*

Book mark:

(358)

W. W. England

Copyist.

6 10 Cav. U.S.C.
Isaac Coleman
Priv., Co. E, 6 Reg't U.S.C. Cav.

Appears on

Descriptive List of Deserters

7 Dist. of Ky.

dated Jun., 1865.

Age 22 years; eyes *Blk*; hair *Blk*

Complexion *Blk*; height, 5 ft. 5 in.

Where born *Jayette Co. Ky.*

Occupation

Residence when enlisted *Jayette Co.*

Deserted:

When *Dec 31*, 1864.

Where *Alexington, Ky.*

Remarks:

Endorsement on list shows that the men named therein were received at

Off. of Mr. Mar. Lexington, Ky, Jan. 1, 1865.

Book mark:

I. H. ...

James C. ...
Co. E, 5 Reg't U. S. Col'd Cavalry.

Appears on

Company Muster Roll

for *June 7th 1865*, 1865.

Present or absent *Present*

Stoppage, \$ *100* for

Due Gov't, \$ *100* for

Valuation of horse, \$ *100*

Valuation of horse equipments, \$ *100*

Remarks: *With installment
of twenty due \$ 20
due 20th of advance
\$ 3, 5-2*

Book mark:

S. J. ...
(358) Copyist.

6

5 Cav. U.S.C.T.

Isaac Colman

Co. E, 5 Reg't U. S. Col'd Cavalry.

Appears on

Company Muster Roll

for March & April, 1865.

Present or absent Present

Stoppage, \$ 100 for

Due Gov't, \$ 100 for

Valuation of horse, \$ 100

Valuation of horse equipments, \$ 100

Remarks: 1st installment of Bounties due

Book mark:

J. W. Rowland

(358)

Copyist.

6

5 Cav. U.S.C.T.

Issac Colman
Put, Co. E, 5 Reg't U. S. Col'd Cavalry.

Appears on

Company Muster Roll

for May & June, 1865.

Present or absent present

Stoppage, \$ 100 for

Due Gov't, \$ 100 for

Valuation of horse, \$ 100

Valuation of horse equipments, \$ 100

Remarks: 1st Instalment of
Bounty due \$100.

Book mark:

Long

(358)

Copyist.

6

5 Cav.

U.S.C.T.

Isaac Colman

Pvt

Co. E, 5 Reg't U. S. Col'd Cavalry.

Appears on

Company Muster Roll

for July & Aug., 1865.

Present or absent present

Stoppage, \$ 100 for

Due Gov't, \$ 100 for

Valuation of horse, \$ 100

Valuation of horse equipments, \$ 100

Remarks:

Book mark:

Long

(358)

Copyist.

C

5 Cav.

U.S.C.T.

Isaac Colman

Priv, Co. E, 5 Reg't U. S. Col'd Cavalry.

Appears on

Company Muster Roll

for *Sept + Oct.*, 1865.

Present or absent *present*

Stoppage, \$ *100* for

Due Gov't, \$ *100* for

Valuation of horse, \$ *100*

Valuation of horse equipments, \$ *100*

Remarks:

Book mark:

Long

(358)

Copyist.

C | **5 Cav.** | **U.S.C.T.**

Isaac Coleman
Priv, Co. E, 5 Reg't U. S. Col'd Cavalry.

Appears on

Company Muster Roll

for *Nov & Dec*, 1865.

Present or absent *Present*

Stoppage, \$ 100 for

Due Gov't, \$ 100 for

Valuation of horse, \$ 100

Valuation of horse equipments, \$ 100

Remarks:

Book mark: -----

(358)

Long
Copyist.

10 | 5 Cav. | U.S.C.T.

Amos Colman

Private, Co. E, 5 Reg't U. S. Col'd Cavalry.

Appears on

Company Muster Roll

for Jan. & Feb., 1866.

Present or absent Present

Stoppage, \$ 100 for

Due Gov't, \$ 100 for

Valuation of horse, \$ 100

Valuation of horse equipments, \$ 100

Remarks: Present in
Confine ment

Book mark:

Edgemund

✓

C. | 5 Cav. | U.S.C.T.

Isaac Coleman.

Priv. Co. E, 5 Reg't U. S. Colored Cav.

Appears on Returns as follows:

Oct. 1864. On duty, det'd in I. M. Dept.

Nov. & Dec. 1864. Absent on special service, Camp Nelson, Ky., Oct. 2/64.

Book mark :

(546)

A. Baker
Copyist.

6

5 Cav. U.S.C.T.

Isaac Coleman

Priv., Co. B, 5 Reg't U. S. Col'd Cavalry.

Appears on Co. Muster-out Roll, dated
November 16, 1865.

Muster-out to date * Mar 3, 1866.

Last paid to Dec 31, 1865.

Clothing account:

Last settled _____, 186 ; drawn since \$ 100

Due soldier \$ 3 ⁵⁷/₁₀₀; due U. S. \$ 100

Am't for cloth'g in kind or money adv'd \$ 100

Due U. S. for arms, equipments, &c., \$ ⁹⁰/₁₀₀

Bounty paid \$ 100 ^{xx}/₁₀₀; due \$ 100 ^{xx}/₁₀₀

Remarks: None allowed for
Ordinances 30 1/2

* Records on file in 2nd. Audit
Office show this Co. Muste e out
to take effect Mch, 16th. 1866. and
paid to include Mch, 15th. 1866.

Book mark :

(361)

W. Demard

Copyist.

Coleman, Isaac

P. Co. C., 5 Reg't 11th Cav.

2 Enclosures.

Bed Cards	Final Statements
Burial Records	Furloughs or L. of A.
Certs. of Dis. for Discharge	Med. Certificates
C. M. Charges	Med. Des. Lists
Descriptive Lists	Orders
Discharge Certificates	Pris. of War Record
Enlistment Papers	Resignations

Other papers relating to—

Admission to Hosp'l	Furlough or L. of A.
Casualty Sheet	Med. Examination
Confinement	Misc. Information
Contracts	Pay or Clothing
Death or Effects	Personal Reports
Desertion	Rank
Discharge from Hosp'l	Transfer to Hosp'l
Discharge from Service	Transfer to V. R. C.
Duty	Transportation

NOTE 1.—This blank will be used for enlistments of United States colored troops. They will be made out in duplicate in all cases, one to accompany the recruiting return of the superintendent (not the recruiting officer) to the Adjutant General, and one to accompany the accounts of the officer who pays bounty, &c.

NOTE 2.—An enlistment holds to service. A muster-in must, in all cases, precede payment of pay, bounty, pension, &c. A muster-in roll, must in all cases, be filed in the Adjutant General's Office as evidence of muster-in. The mustering officer, commissary, or assistant commissary of musters, as the case may be, will countersign both enlistments as having mustered the soldiers into the service of the United States before either of them is given to the disbursing officer.

DECLARATION OF RECRUIT

I, Isaac Coleman, desiring to volunteer as a soldier in the ARMY OF THE UNITED STATES, for the term of Three Years, DO DECLARE That I am 23 years and months of age; that I have never been discharged from the United States service on account of disability or by sentence of a court-martial, or by order before the expiration of a term of enlistment; and I know of no impediment to my serving honestly and faithfully as a soldier for three years.

GIVEN at Camp Nelson, Ky the 10 day of September 1864

Witness W. L. Palmer

Isaac Coleman
parast

Major Elyan Coleman
or Magette

Volunteered at Camp Nelson
Sept 10 1864
Isaac Coleman
Sept 31 1864

James K. Appleby
John H. Appleby
No. 156

Consent of Parent or Guardian in case of a Minor, if a Free Man, or in the case of a Slave, of the Person to whom he owes Service:

I, Do CERTIFY, That I am the that the said is years of age; and I do freely give my CONSENT to his volunteering as a SOLDIER in the Army of the United States, for the period of THREE YEARS, under the conditions of the laws of the United States.

GIVEN at the day of

Witness :

UNITED STATES COLORED TROOPS ENLISTMENT.

STATE OF

TOWN OF

Kentucky

Camp Nelson

I, *Isaac Coleman* born in *Fayette Co*

in the State of *Kentucky* aged *Twenty three* years

and by occupation a *Farmer* Do HEREBY ACKNOWLEDGE to

have volunteered *Ten* day of *September* 186*4*

to serve as a **Soldier** in the **Army of the United States of America**, for the period of **THREE YEARS**, unless sooner discharged by proper authority: Do also agree to accept such bounty, pay, rations, and clothing, as are, or may be, established by law for the U. S. colored troops.

And I, *Isaac Coleman*

do solemnly swear that I will bear true faith and allegiance to the **United States of America**, and that I will serve them honestly and faithfully against all their enemies or opposers whomsoever; and that I will observe and obey the orders of the President of the United States, and the orders of the officers appointed over me, according to the Rules and Articles of War.

Sworn and subscribed to at *Camp Nelson*

this *10* day of *Sept* 186*4* *Isaac Coleman*

Before *J. C. Randolph* *D. P. M.*

I CERTIFY, ON HONOR, That I have carefully examined the above named Volunteer agreeably to the General Regulations of the Army, and that, in my opinion, he is free from all bodily defects and mental infirmity, which would in any way disqualify him from performing the duties of a soldier.

P. S. Barrett
Asst. Surg. U. S. A.
EXAMINING SURGEON.

I CERTIFY, ON HONOR, That I have minutely inspected the Volunteer, *I. Coleman* previously to his enlistment, and that he was entirely sober when enlisted; that, to the best of my judgment and belief, he is of lawful age; and that, in accepting him, as duly qualified to perform the duties of an able-bodied soldier, I have strictly observed the regulations which govern the recruiting service. This soldier has *dark* eyes, *dark* hair, *dark* complexion, is *five* feet *four* inches high.

J. C. Randolph
RECRUITING OFFICER OR AGENT.

Mustered into the United States Service *12* day of *September* 186*4*

W. C. Kinney
Mustering Officer.

Mustered into the service of the United States, for three years or during the war, from date of enlistment, in Company *...* Regiment of *...* Volunteers, on the *10* day of *Sept* 186*4* at *Camp Nelson*

Isaac Coleman
1811

Adjutant General's Office,

COLORED TROOPS BRANCH,

July 6th, 1874

Vol. C. T., 187

Wanted in case of *James C. ...*, Co. C,

5th Reg't

Respectfully,

W. A. Woodward

Chief Clerk.

J. J. Dalton

Adjutant General's Office,

Records Room

Feb 13th, 1874

Vol. C. T., 187

Reply in case of *Alfred Coleman*, Co. E,

5th Reg't *Colored Cav.*

Company, Morning Report book, reports him from confinement to duty, March 2nd 1866. Regimental Guard Report book, reports him confined (13th or 14th Feb 1866) by Officer of the Day with remark "to be confined in guard house for the period of 14 days, by order of Col. Carpenter."

W.A.W.

Coleman 2800 John

Co B, 5 U. S. Col'd Cav.

Private

Private

CARD NUMBERS.

1	5359243	26
2	5361210	27
3	5361305	28
4	5361389	29
5	5361471	30
6	5361553	31
7	9090098	32
8	40729584	33
9		34
10		35
11		36
12		37
13		38
14		39
15		40
16		41
17		42
18		43
19		44
20		45
21		46
22		47
23		48
24		49
25		50

Book Mark:

See also 72nd U.S. Col'd Troops

D 1664399 Pottery
S 29077 39 and W#
L. 2948004 Pottery
AL101323370

Chaffany Co

C | **5 Cav. | U.S.C.T.**

John Coleman
....., Co. B, 5 Reg't U. S. Col'd Cav.

Appears on

Company Descriptive Book
of the organization named above.

DESCRIPTION.

Age 22 years; height 5 feet 7 1/2 inches.

Complexion Blk

Eyes Blk; hair Blk

Where born Bourbon Co. Ky.

Occupation Farmer

ENLISTMENT.

When Dec. 17....., 1864.

Where Covington Ky.

By whom Maj. Mitchell; term 3.....y'rs.

Remarks:.....
.....
.....
.....
.....
.....
.....
.....
.....
.....

(383g)

A. A. Hall
~~Captain~~
Cmp.

6 5 Cav U.S.C.T.

John Coleman
Pvt, Co., 5 Reg't U. S. Col'd Cav

Appears on

M. and D. Roll of Men Transferred

to the organization named above,

from

Roll dated July 18, 1865.

When enlisted Dec 17, 1864.

Period for which enlisted 3 years.

When mustered in Dec 17, 1864.

Present or absent Not Stated

Company to which assigned

Remarks: 7 D Ky

Book mark :

(342)

Abbott

Copyist.

5

5 Cav.

U.S.C.T.

John Coleman

Priv., Co. B, 5 Reg't U. S. Col'd Cavalry.

Appears on

Company Muster Roll

for July & Aug., 1865.

Present or absent Present

Stoppage, \$ 100 for

Due Gov't, \$ 100 for

Valuation of horse, \$ 100

Valuation of horse equipments, \$ 100

Remarks: Transferred from 72 U.S. C. I. per sp. or. No. 132 Hd Qtrs Dep't Ky - dated July 27, 1865

Book mark:

R. E. Waldo

6

5 Cav. U.S.C.T.

John Coleman

Priv., Co. B, 5 Reg't U. S. Col'd Cavalry.

Appears on

Company Muster Roll

for Sept. & Oct., 1865.

Present or absent Absent

Stoppage, \$ 100 for

Due Gov't, \$ 100 for

Valuation of horse, \$ 100

Valuation of horse equipments, \$ 100

Remarks: Sick in Reg't Hospital near Lexington, Ky.

Book mark:

R. Curialo

5 Cav. U.S.C.T.

John Coleman

Priv., Co. B, 5 Reg't U. S. Col'd Cavalry.

Appears on

Company Muster Roll

for Nov. & Dec., 1865.

Present or absent Present

Stoppage, \$ 100 for

Due Gov't, \$ 100 for

Valuation of horse, \$ 100

Valuation of horse equipments, \$ 100

Remarks: Sick in Company quarters.

Book mark:

R. C. Walsor

C | **5 Cav.** | **U.S.C.T.**

John Coleman

Pvt, Co. B, 5 Reg't U. S. Col'd Cavalry.

Appears on

Company Muster Roll

for *Jan 1st*, 186*6*.

Present or absent *Present*

Stoppage, \$ *100* for

Due Gov't, \$ *100* for

Valuation of horse, \$ *100*

Valuation of horse equipments, \$ *100*

Remarks: *Yield in Co D's*

Book mark: _____

(358)

W. J. ...

Copyist.

② | 5 Cav. | U.S.C.T.

John Coleman.

Co. B, 5 Reg't U. S. Colored Cav.

Appears on Returns as follows:

July 1865. Gain, July 27/65, Paris,
Ky. Transf'd from '72 U.S.C.
Inf. per S. O. 127, Hdqrs. Dept.
of Ky., July 18/65.

Oct. 1865. Went sick, Regt. Hoop,
near Lexington, Ky.

Book mark :

(546)

M. Baker
Copyist.

C | 5 Cav. | U.S.C.T.

John Coleman
Pvt., Co. B., 5 Reg't U. S. Col'd Cavalry.

Appears on Co. Muster-out Roll, dated
Melona Ky, *Mar 16*, 186*6*.

Muster-out to date *Mar 16*, 186*6*.

Last paid to *Dec 31*, 186*5*.

Clothing account:

Last settled....., 186 ; drawn since \$..... 100

Due soldier \$..... 100; due U. S. \$ *36* ^{*64*}/₁₀₀

Am't for cloth'g in kind or money adv'd \$..... 100

Due U. S. for arms, equipments, &c., \$..... 100

Bounty paid \$ *100* 100; due \$..... 100

Remarks: *Transferred from the 2nd*

U.S. Cav. Reg't, per S.C.

No. 121, part 3. 1st Div. Dist,

Ky. Station Louisville Ky,

July 18. 1865 (age 27)

Book mark:

Wm. W. ...

281

Coleman, John

Co^d, 5 U. S. Col'd Cav.

Sergeant + Private

CARD NUMBERS.

1	5367770	26
2	5367868	27
3	5367968	28
4	5368062	29
5	5368155	30
6	5368276	31
7	5368367	32
8	5368456	33
9	5368598	34
10	5359445	35
11	5368778	36
12	9090934	37
13	9221594	38
14	42405-1888	39
15	43142432	40
16	40729644	41
17		42
18		43
19		44
20		45
21		46
22		47
23		48
24		49
25		50

Book Mark: 424 C. D. 1888

See also

6 | **5 Cav.** | **U.S.C.T.**

John Coleman

....., Co. *D*, 5 Reg't U. S. Col'd Cav.

Appears on

Company Descriptive Book
of the organization named above.

DESCRIPTION.

Age *27* years; height *5* feet *11* inches.

Complexion *yellow*

Eyes *Brown*; hair *Black*

Where born *Metcalf Ky*

Occupation *Farmer*

ENLISTMENT.

When *June 23*, 1864.

Where *B. Green*

By whom *Capt. Nelson*; term *3* y'rs.

Remarks: *Admitted to the ranks*
June 20 1865

(383g)

A. J. Anderson

Copist.

6 | 5 Cav. | 108 | U.S.C.T.

John Coleman

Co. A, 108 Reg't U. S. Col'd Infantry.

Appears on

Company Descriptive Book

of the organization named above.

DESCRIPTION.

Age 27 years; height 5 feet 11 inches.

Complexion Yellow

Eyes Blk; hair Blk.

Where born Metcalfe Ky

Occupation Farmer

ENLISTMENT.

When June 23", 1864.

Where Burlington Ky

By whom Capt Holson, term 3 y'rs

Remarks:

Enlisted for 108th U.S.C.T.
Transfer to 5th U.S.C. Cavalry
August 12, 1864. per S.O. 192. Head
Quarters Dist. of Ky.

D. M. Kennedy
Enlist.

(5837)

60

5 Co

U.S.C.T.

John Coleman

Appears with rank of Priv on

Muster and Descriptive Roll

of a detachment of U.S. Colored recruits forwarded

Roll dated

Bowling Green, Ky, June 23, 1864.

Where born Metcalfe Ky

Age 27 years; occupation farmer

When enlisted June 23, 1864.

Where enlisted Bowling Green

For what period enlisted 3 years.

Eyes Brown; hair Black

Complexion Yellow; height 5 ft. 11 in.

When mustered in _____, 186 .

Where mustered in _____

Bounty paid \$ _____ 100; due \$ _____ 100

Clothing account:

Last settled _____, 186 ; drawn since \$ 4¹³/₁₀₀

Date of first muster June 23, 1864.

Company to which assigned _____

Remarks: New recruit Metcalfe County. Owed service to Warren Coleman

Book mark: _____

J B Dowd

(356m)

Copyist.

C

5 Cav. U.S.C.T.

John Coleman
1st Srgt, Co. I, 5 Reg't U. S. Col'd Cavalry.

Appears on

Company Muster-in and Descriptive Roll

of the organization named above. Roll dated

Cp. Nelson, ~~N.Y.~~ ^{Ky.} Oct. 31, 1864.

Where born Metcalf, Ky.

Age 27 y'rs; occupation Farmer

When enlisted June 23, 1864.

Where enlisted Bowling Green

For what period enlisted 3 years.

Eyes Brown; hair Black

Complexion Yellow; height 5 ft. 11 in.

When mustered in June 23, 1864.

Where mustered in Bowling Green

Bounty paid \$ 100; due \$ 100

Where credited 3^d Dist. Kentucky

Company to which assigned

Remarks:

Enlisted for 108th U. S. C. T.
Transferred to 5th. U. S. C. Cavalry
August 12, 1864. per S. O. 192. Head
Quarters Dist. of Ky.

Book mark:

Philipson

(356d)

Copyist.

6 | **5 Cav.** | **U.S.C.T.**

John Coleman
1st Sgt, Co. I, 5 Reg't U. S. Col'd Cavalry.

Appears on

Company Muster Roll

for *from organiz^{tn} to Oct 3, 1864.*

Present or absent *Present*

Stoppage, \$ 100 for

Due Gov't, \$ 100 for

Valuation of horse, \$ 100

Valuation of horse equipments, \$ 100

Remarks: *Appointed per*
Regt. Order No. 12 to
date October 30, 1864

Book mark:

Philippen

(358)

Copyist.

C. | **5 Cav.** | **U.S.C.T.**

John Coleman

1st Sergt, Co. I, 5 Reg't U. S. Col'd Cavalry.

Appears on

Company Muster Roll

for *Nov. & Dec.*, 186*4*.

Present or absent *Present*.

Stoppage, \$ *100* for

Due Gov't, \$ *100* for

Valuation of horse, \$ *100*

Valuation of horse equipments, \$ *100*

Remarks: *First & Second*
installments Bounty due.

Book mark:

Philipson

C

5 Cav. U.S.C.T.

John Coleman

Serjt, Co. I, 5 Reg't U. S. Col'd Cavalry.

Appears on

Company Muster Roll

for Jan. & Feb., 1865.

Present or absent Present

Stoppage, \$ 100 for

Due Gov't, \$ 100 for

Valuation of horse, \$ 100

Valuation of horse equipments, \$ 100

Remarks: Appointed per Regt's Order No. 12, dated Oct. 30, 1864. 1st + 2d installments \$300. Bounty due.

Book mark:

Philipsen

(358)

Copyist.

6

5 Cav.

U.S.C.T.

John Coleman

1st Sergt, Co. I, 5 Reg't U. S. Col'd Cavalry.

Appears on

Company Muster Roll

for Mch. & apri, 1865.

Present or absent Present.

Stoppage, \$ 100 for

Due Gov't, \$ 100 for

Valuation of horse, \$ 100

Valuation of horse equipments, \$ 100

Remarks: 1st installment
bounty due. appointed
per Regl Order No. 12,
dated Oct. 30"/64.

Book mark:

P. Philipsen

C

5 Cav. U.S.C.T.

Private Coleman

Private, Co. I, 5 Reg't U. S. Col'd Cavalry.

Appears on

Company Muster Roll

for *May June*, 1865.

Present or absent *Present*

Stoppage, \$ 100 for

Due Gov't, \$ 100 for

Valuation of horse, \$ 100

Valuation of horse equipments, \$ 100

Remarks: *Install. bounty due \$100.*

Book mark:

Reed

C

5 Cav. U.S.C.T.

John Coleman

Pr, Co. I, 5 Reg't U. S. Col'd Cavalry.

Appears on

Company Muster Roll

for *July & Aug*, 1865.

Present or absent *Present*

Stoppage, \$ *100* for

Due Gov't, \$ *100* for

Valuation of horse, \$ *100*

Valuation of horse equipments, \$ *100*

Remarks:

Book mark: -----

(358)

Allen

Copyist.

C

5 Cav. U.S.C.T.

John Coleman

Pr, Co. I, 5 Reg't U. S. Col'd Cavalry.

Appears on

Company Muster Roll

for *Sept & Oct*, 186*7*.

Present or absent *Present*

Stoppage, \$ *100* for

Due Gov't, \$ *100* for

Valuation of horse, \$ *100*

Valuation of horse equipments, \$ *100*

Remarks:

Book mark:

Olms

(358)

Copyist.

C.

5 Cav. U.S.C.T.

James M. ...

Pat, Co. I, 5 Reg't U. S. Col'd Cavalry.

Appears on

Company Muster Roll

for *Pat*, 186*5*.

Present or absent

Stoppage, \$ 100 for

Due Gov't, \$ 100 for

Valuation of horse, \$ 100

Valuation of horse equipments, \$ 100

Remarks: *Resected Nov-26/65
at Louisville Ky
due ns for C. & G. 474
for ord. 83631*

Book mark:

Deer

(358)

Copyist.

C. H. Caw U.S.C.T.

John Coleman
Priv., Co. I, 5 Reg't U. S. Col'd Cav.

Appears on

Descriptive List of Deserters

dated Nov 30, 1865.

Deserted:

When Nov 26, 1865.

Where Louisville Ky

Arrested:

When _____, 186 .

Where _____

Remarks:

See US for
Ordinance # 3631

Book mark: _____

Rose

C. | 5 Cav. | U.S.C.T.

John Coleman.

Priv., Co. D, 5 Reg't U. S. Colored Cav.

Appears on Returns as follows:

Mar. 1865. Absent, detached at Hop-
kinsville, Ky. Mar. 14.

July 1865. On duty in D. M. Dept.

Nov. 1865. Deserted Nov. 28/65, at
Brown Barracks, Louisville, Ky.

Book mark :

(546)

A. Baker
Copyist.

C

5 Cav. | U.S.C.T.

John Coleman
Pvt, Co. *D*, 5 Reg't U. S. Col'd Cavalry.

Appears on **Co. Muster-out Roll**, dated
Helena, Ark, Mch. 16, 1866.

Muster-out to date _____, 186 .

Last paid to *Oct. 31*, 186*5*.

Clothing account:

Last settled _____, 186 ; drawn since \$ _____ 100

Due soldier \$ _____ 100; due U. S. \$ *25* ^{*18*}/₁₀₀

Am't for cloth'g in kind or money adv'd \$ _____ 100

Due U. S. for arms, equipments, &c., \$ _____ 100

Bounty paid \$ _____ 100; due \$ _____ 100

Remarks: *Deserted Nov. 26. '65*
Louisville Ky.

** Inserted by comparer.*

Book mark: *42,4, C. J. 1888 - L. B. 21/708.*

Crenshaw

(861)

Copyist.

6 5600 U.S.C.T.

John Coleman

, Co. I. 5 Reg't U.S.C. Can

NOTATION.

LB21/708

Book mark: 424. C.T. 1888

War Department,

Adjutant General's Office,

Washington, Feb 17, 1888.

The charge of desertion of November 26 1865

against this man is removed and he is discharged to date November 26, 1865, under the provisions of the act of Congress, approved July 5, 1884.

Discharge certificate furnished by Adjutant General's Office Feb 18, 1888.

(4436)

C. C. Carey Copyist.

Coleman Lewis

Co ^{2^d}, 5 U. S. Col'd Cav.

Private Private

CARD NUMBERS.

1	5369805	26
2	5369900	27
3	5369997	28
4	5370103	29
5	5370196	30
6	5370288	31
7	5370372	32
8	5370466	33
9	5370561	34
10	5370634	35
11	5370705	36
12	9091150	37
13	43148092	38
14	43154569	39
15	32111743	40
16	32111879	41
17	40729659	42
18		43
19		44
20		45
21		46
22		47
23		48
24		49
25		50

Book Mark:

See also

6 | **5 Cav. | U.S.C.T.**

Lewis Leland

Co. *D*, 5 Reg't U. S. Col'd Cav.

Appears on

Company Descriptive Book
of the organization named above.

DESCRIPTION.

Age *18* years; height *5* feet *7* inches.

Complexion *Black*

Eyes *Blue*; hair *Black*

Where born *Kentucky*

Occupation *Laborer*

ENLISTMENT.

When *September*, 186 .

Where *W. Va. City*

By whom; term *3* y'rs.

Remarks:

.....
.....
.....
.....
.....
.....
.....
.....

A. J. Anderson

(383g)

Copist.

C | 5 Cav | USC

Lewis Coleman
Pvt, Co. C, 5 Reg't USC Cav

Appears on

Hospital Muster Roll

of **U. S. A. General Hospital,**
(Branch B—Colored.)

at **Bowling Green, Ky.,**

for Sept & Oct, 1864

Attached to hospital :

When Oct 26, 1864.

How employed Patient

Last paid by Maj. _____

to _____, 186 .

Bounty paid \$ 100; due \$ 100

Present or absent Present

Remarks: _____

J. Duncan

Copyist.

5 bar

James Coleman

Appears with rank of Sgt on

Muster and Descriptive Roll

of Detachment of the 5th Colored
Regt. forwarded

Roll dated

Louisville, Ky., Oct 24, 1864.

Where born Kentucky

Age 18 years; occupation Laborer

When enlisted _____, 186

Where enlisted _____

For what period enlisted _____ years.

Eyes Black; hair Black

Complexion Black; height 5 ft. 7 in.

When mustered in Sept. 27, 1864

Where mustered in Lexington

Bounty paid \$ 100; due \$ 100

Clothing account:

Last settled _____, 186 ; drawn since \$ 17⁵⁰/100

Date of first muster Sept. 27, 1864

Company to which assigned _____

Remarks: credited to 7 days

rest by

substitute

Book mark: _____

M. N. Jackson

@

5 Cav.

U.S.C.T.

Lewis Coleman

Or

, Co. L, 5 Reg't U. S. Col'd Cavalry.

Appears on

Company Muster-in and Descriptive Roll

of the organization named above. Roll dated

Camp Nelson, ~~N.Y.~~ ^{N.Y.} Oct 30, 1864.

Where born Kentucky

Age 18 y'rs; occupation Laborer

When enlisted, 186 .

Where enlisted

For what period enlisted 3 years.

Eyes Black; hair Black

Complexion Black; height 5 ft. 7 in.

When mustered in Sept 27, 186 .

Where mustered in Lexington

Bounty paid \$ 100; due \$ 100

Where credited 7th Dist Ky

Company to which assigned

Remarks:

Substitute

Book mark:

Bradd

Q

5 Cav. U.S.C.T.

Lewis Coleman

Por, Co. L, 5 Reg't U.S. Col'd Cavalry.

Appears on

Company Muster Roll

for *dated Oct 31*, 186*4*

Present or absent *Absent*

Stoppage, \$ *100* for

Due Gov't, \$ *100* for

Valuation of horse, \$ *100*

Valuation of horse equipments, \$ *100*

Remarks: *On det serv
Nashville Tenn
Oct 15/64*

Book mark:

Bradley

C

5 Cav. U.S.C.T.

Lewis Coleman

Pr, Co. L, 5 Reg't U. S. Col'd Cavalry.

Appears on

Company Muster Roll

for *Nov & Dec*, 1864

Present or absent. *Absent*

Stoppage, \$ *100* for

Due Gov't, \$ *100* for

Valuation of horse, \$ *100*

Valuation of horse equipments, \$ *100*

Remarks: *On Det Serv
Nashville Tenn
Oct 13 / 64*

Book mark:

Prader

(358)

Copyist.

C | 5 Cav | USCA

Lewis Coleman

Priv., Co. C, 5 Reg't USCA

Appears on

Hospital Muster Roll

of U. S. A. General Hospital,
(Branch B—Colored.)

at Bowling Green, Ky.,

for Nov & Dec, 1864.

Attached to hospital:

When....., 186 .

How employed.....

Last paid by Maj.....

to....., 186 .

Bounty paid \$.....¹⁰⁰; due \$.....¹⁰⁰

Present or absent.....

Remarks: Returned to duty
November 11, 64

Book mark :.....

J. D. Dunean

(843)

Copyist.

C

5 Cav.

U.S.C.T.

Lewis Coleman

Pvt

, Co. L, 5 Reg't U.S. Col'd Cavalry.

Appears on

Company Muster Roll

for

June & July

, 1863.

Present or absent

Absent

Stoppage, \$

100 for

Due Gov't, \$

100 for

Valuation of horse, \$

100

Valuation of horse equipments, \$

100

Remarks

In Convalescent
Camp Camp Hill -
Dunbar

Book mark:

Braden

(358)

Copyist.

@

5 Cav. U.S.C.T.

Lewis Coleman

Pos, Co. L, 5 Reg't U. S. Col'd Cavalry.

Appears on

Company Muster Roll

for Must & Ape, 1865

Present or absent Present

Stoppage, \$ 100 for

Due Gov't, \$ 100 for

Valuation of horse, \$ 100

Valuation of horse equipments, \$ 100

Remarks:

Book mark:

Pos

(358)

Copyist.

C | 5 Cav. | U.S.C.T.

Lewis Coleman

Cpt, Co. L, 5 Reg't U. S. Col'd Cavalry.

Appears on

Company Muster Roll

for *May & June*, 1865.

Present or absent *Present*

Stoppage, \$ 100 for

Due Gov't, \$ 100 for

Valuation of horse, \$ 100

Valuation of horse equipments, \$ 100

Remarks:

Book mark:

W. J. [Signature]

(358)

Copyist.

5 | **5 Cav.** | **U.S.C.T.**

Lewis Coleman
Pvt., Co. L, 5 Reg't U.S. Col'd Cavalry.

Appears on

Company Muster Roll

for *July to Aug., 1865.*

Present or absent *Present*

Stoppage, \$ 100 for

Due Gov't, \$ 100 for

Valuation of horse, \$ 100

Valuation of horse equipments, \$ 100

Remarks:

Book mark:

Proctor

E

5 Cav.

U.S.C.T.

Lewis Coleman

Plt, Co. L, 5 Reg't U. S. Col'd Cavalry.

Appears on

Company Muster Roll

for *Sept 1865*, 1865.

Present or absent *Present*

Stoppage, \$ *100* for

Due Gov't, \$ *100* for

Valuation of horse, \$ *100*

Valuation of horse equipments, \$ *100*

Remarks:

Book mark:

Recher

C | File | U.S. G. O.

Lewis Coleman (Cald)

Appears with rank of Priv on

Muster and Descriptive Roll

of a Detachment of U.S. Substitutes
Enlisted & Mustered, forwarded

Roll dated Lexington, Ky Oct 30th, 1865.

Where born Kentucky

Age 18 years; occupation Laborer

When enlisted Sept 27, 1864.

Where enlisted Lexington, Ky.

For what period enlisted 3 years.

Eyes Blk; hair Blk

Complexion Blk; height 5 ft. 7 in.

When mustered in Sept 27, 1864.

Where mustered in Lexington, Ky.

Bounty paid \$ 100; due \$ 100

Clothing account:

Last settled _____, 186 _____; drawn since \$ 100

Date of first muster Sept 27, 1864.

Company to which assigned _____

Remarks: For whom substituted
Mrs. E. Darnaly, Draftee man
Credited to Scott Co. 7th D. Ky.

Book mark: _____

J. H. Morris

(356m)

Copyist.

6 | 5 Cav. | U.S.C.T.

Lewis Coleman
Sgt., Co. L, 5 Reg't U. S. Col'd Cavalry.

Appears on

Company Muster Roll

for Jan & Dec, 1860.

Present or absent Present

Stoppage, \$ 100 for

Due Gov't, \$ 100 for

Valuation of horse, \$ 100

Valuation of horse equipments, \$ 100

Remarks: Alue U. S. for Dec
\$1.85

Book mark:

W. Chester

6

5 Cav. | U.S.C.T.

Lewis Coleman

Pr

, Co. L, 5 Reg't U. S. Col'd Cavalry.

Appears on

Company Muster Roll

for *Jan'y Feb.*, 1866.

Present or absent *Present*

Stoppage, \$ *100* for

Due Gov't, \$ *100* for

Valuation of horse, \$ *100*

Valuation of horse equipments, \$ *100*

Remarks: *In Comp. Roll
Guard House.*

Book mark:

C. J. Taylor

(358)

Copyist.

Q. | 5 Cav. | U.S.C.T.

Lewis Coleman.

Regt. Co. L, 5 Reg't U. S. Colored Cav.

Appears on Returns as follows:

Oct. to Dec. 1864. Absent detailed service, Nashville, Tenn.

Jan. & Feb. 1865. Absent sick in Convalescent Camp, Camp Nelson, Ky.

Book mark:

(546)

J. Baker
Copyist.

6 | 5600 | U.S.C.T.

Lewis Coleman

Plt, Co L, 5th Reg't U. S. Col'd Cavalry

Appears on Co. Muster-out Roll, dated
Helena, Ark, Mar 16, 1866.

Muster-out to date Mar. 16, 1866.

Last paid to Dec. 31, 1865.

Clothing account:

Last settled _____, 186 ; drawn since \$ _____ 100

Due soldier \$ _____ 100; due U. S. \$ 3 ⁷¹/₁₀₀

Am't for cloth'g in kind or money adv'd \$ _____ 100

Due U. S. for arms, equipments, &c., \$ _____ ⁵³/₁₀₀

Bounty paid \$ _____ 100; due \$ _____ 100

Remarks: Slave. Due U. S.
for food, 55 cts.

Book mark: _____

(361)

O. T. Taylor

Copyist.

Coleman Lewis
P, Co. 6, 5 Reg't US Cavalry

Enclosures.

Bed Cards	Descriptive Lists
Burial Records	Final Statements
Certs. of Dis. for Discharge	Furloughs
C. M. Charges	Med. Des. Lists
Med. Certificates	Orders

Other papers relating to—

Admission to Hosp'l	Furlough
Casualty Sheet (Officer's)	Med. Examination
Confinement	Misc. Information
Contracts	Pay or Clothing
Death or Effects	Personal Reports
Desertions	Rank
Discharge from Hosp'l	Transfer to Hosp'l
Discharge from Service	Transfer to V. R. C.
Duty	Transportation

Hospital Number 210

Name Lewis Coleman

Age 28 Nativity Kentucky

Married or Single Single

Residence Fayette Co. Ky.

Post Office address of }
wife or nearest relative. }

Rank Private Co. C Regiment 2nd Inf. Co.

When admitted Oct. 26/64. Dist. of Co. Condo.

From what source Battle ground to Nashville

Diagnosis: (in surgical cases state explicitly seat and
character of wound or injury.)

Catarh

Branch B-G-H.
Bowling Green, Ky.

On what occasion wounded.....

Date.....

Nature of missile or weapon.....

TREATMENT.

[HERE NOTE IMPORTANT COMPLICATIONS AND ALL OPERATIONS.]

RESULT AND DATE.

Returned to duty Nov. 4th 1861

285

Coleman Richard

Co B, 5 U. S. Col'd Cav.

Private Corporal

CARD NUMBERS.

1	5360665	26
2	5360762	27
3	5360851	28
4	5360947	29
5	5361036	30
6	5361123	31
7	5361209	32
8	5361286	33
9	5361371	34
10	5361452	35
11	5361533	36
12	9090097	37
13		38
14		39
15		40
16		41
17		42
18		43
19		44
20		45
21		46
22		47
23		48
24		49
25		50

Book Mark:

See also

C | **5 Cav. | U.S.C.T.**

Richard Colman

....., Co. B, 5 Reg't U. S. Col'd Cav.

Appears on

Company Descriptive Book
of the organization named above.

DESCRIPTION.

Age 21 years; height 5 feet 9 inches.

Complexion Blk

Eyes Blk; hair Blk

Where born Woodford Co. Ky

Occupation Farmer

ENLISTMENT.

When Aug. 18, 1864.

Where Camp Nelson

By whom C. C. Randolph term 3 y'rs.

Remarks:

.....

.....

.....

.....

.....

.....

.....

.....

.....

.....

.....

.....

.....

.....

.....

.....

.....

.....

.....

.....

.....

.....

.....

.....

.....

.....

.....

.....

.....

.....

.....

.....

.....

.....

.....

.....

.....

.....

.....

6 | 5 Cav. | U.S.C.T.

Richard Coleman

Greene, Co. B, 5 Reg't U. S. Col'd Cavalry.

Appears on

Company Muster-in and Descriptive Roll

of the organization named above. Roll dated

Camp Nelson, ^{Stuy} N. Y., Oct 24, 1864.

Where born Woodford ^{Stuy}

Age 21 y'rs; occupation Farmer

When enlisted Aug 18, 1864.

Where enlisted Camp Nelson

For what period enlisted 3 years.

Eyes Blue; hair Blue

Complexion Blue; height 5' ft. 9 in.

When mustered in Aug 14, 1864.

Where mustered in Camp Nelson

Bounty paid \$ 100; due \$ 100

Where credited 7th Dist Ky

Company to which assigned B

Remarks: ^{*} Name of owner of Negro - John Skarse

* Corrected 5/12, 98 C.M.

Book mark:

Lauch

6

5 Cav.

U.S.C.T.

Richard Coleman

Private, Co. B, 5 Reg't U. S. Col'd Cavalry.

Appears on

Company Muster Roll

for Oct 31, 1864.

Present or absent Present

Stoppage, \$ 100 for

Due Gov't, \$ 100 for

Valuation of horse, \$ 100

Valuation of horse equipments, \$ 100

Remarks:

Book mark:

Lamb

6 | 5 Cav. | U.S.C.T.

Richard Coleman

Private, Co. B, 5 Reg't U. S. Col'd Cavalry.

Appears on

Company Muster Roll

for Moore & Doe, 1864.

Present or absent Present

Stoppage, \$ 100 for

Due Gov't, \$ 100 for

Valuation of horse, \$ 100

Valuation of horse equipments, \$ 100

Remarks: 1st & 2nd instalments
regularly due

Book mark:

Laurel

6

5 Cav.

U.S.C.T.

Richard Coleman

Private, Co. B, 5 Reg't U. S. Col'd Cavalry.

Appears on

Company Muster Roll

for Jan & Feb, 1865.

Present or absent Present

Stoppage, \$ 100 for

Due Gov't, \$ 100 for

Valuation of horse, \$ 100

Valuation of horse equipments, \$ 100

Remarks: 1st installment
bounty \$100 due

Book mark:

Lauels

(358)

Copyist.

6 | 5 Cav. | U.S.C.T.

Richard Coleman

Truitt, Co. B, 5 Reg't U. S. Col'd Cavalry.

Appears on

Company Muster Roll

for Feb 28 1863, 1863

Present or absent Present

Stoppage, \$ 100 for

Due Gov't, \$ 100 for

Valuation of horse, \$ 100

Valuation of horse equipments, \$ 100

Remarks: 1st installment
bond due \$100

Book mark:

Lamb,

6 | 5 Cav. | U.S.C.T.

Richard Coleman

Private, Co. B, 5 Reg't U.S. Col'd Cavalry.

Appears on

Company Muster Roll

for Feb 28 to April, 1867.

Present or absent Present

Stoppage, \$ 100 for

Due Gov't, \$ 100 for

Valuation of horse, \$ 100

Valuation of horse equipments, \$ 100

Remarks: 1st installment
bond due \$100

Book mark:

Lamb,

C | **5 Cav.** | **U.S.C.T.**

Richard Colman

Priv., Co. B, 5 Reg't U. S. Col'd Cavalry.

Appears on

Company Muster Roll

for *May & June, 1865.*

Present or absent *present*

Stoppage, \$ *100* for

Due Gov't, \$ *100* for

Valuation of horse, \$ *100*

Valuation of horse equipments, \$ *100*

Remarks: *1st installment
bounty due \$100*

Book mark:

R. C. Wilson

6 | 5 Cav. | U.S.C.T.

Richard Coleman

Priv., Co. B, 5 Reg't U. S. Col'd Cavalry.

Appears on

Company Muster Roll

for July & Aug., 1865.

Present or absent present

Stoppage, \$ 100 for

Due Gov't, \$ 100 for

Valuation of horse, \$ 100

Valuation of horse equipments, \$ 100

Remarks:

Book mark: -----

R. C. Wilson

5 Cav. U.S.C.T.

Richard Coleman

Corp., Co. B, 5 Reg't U. S. Col'd Cavalry.

Appears on

Company Muster Roll

for Sept & Octo., 1865.

Present or absent present

Stoppage, \$ 100 for

Due Gov't, \$ 100 for

Valuation of horse, \$ 100

Valuation of horse equipments, \$ 100

Remarks: Promoted from private to Corp. per R.O. No. 105 dated Sept. 21, 1865.

Book mark: _____

R. Cowles

Richard Coleman

Corp, Co. B, 5 Reg't U. S. Col'd Cavalry.

Appears on

Company Muster Roll

for *Nov. & Dec.*, 186*5*.

Present or absent *present*

Stoppage, \$ *100* for

Due Gov't, \$ *100* for

Valuation of horse, \$ *100*

Valuation of horse equipments, \$ *100*

Remarks:

Book mark: -----

R. E. Wilson

C | 5 Cav. | U.S.C.T.

Richard Cotten

Corp, Co. B, 5 Reg't U. S. Col'd Cavalry.

Appears on

Company Muster Roll

for *Jan & Feb*, 186*6*.

Present or absent *Present*

Stoppage, \$ *100* for

Due Gov't, \$ *100* for

Valuation of horse, \$ *100*

Valuation of horse equipments, \$ *100*

Remarks:

Book mark:

(358)

C. J. ...

Copyist.

C

5 Cav.

U.S.C.T.

Richard Coleman

Cap, Co. *B*, 5 Reg't U. S. Col'd Cavalry.

Appears on **Co. Muster-out Roll**, dated

Helena Ark, *Mar 16*, 1866.

Muster-out to date *Mar 16*, 1866.

Last paid to *Dec 31*, 1865.

Clothing account:

Last settled 186 ; drawn since \$ 100

Due soldier \$ 100; due U. S. \$ *7* ²²/₁₀₀

Am't for cloth'g in kind or money adv'd \$ 100

Due U. S. for arms, equipments, &c., \$ *2* ⁰⁰/₁₀₀

Bounty paid \$ *100* 100; due \$ *100* 100

Remarks: *Stave used 19. 1861*
Was Prom't from organization
of Co. to Sept 21, 1865, then
Capt. Due res for ord \$2.00

Book mark: *5 1939 Ky*

W. S. ...

Solomon Rich

Reg't B, Co.

Reg't 456605

Enclosures.

- | | |
|------------------------------------|-------------------------|
| Bed Cards | Descriptive Lists |
| Burial Records | Final Statements |
| Certs. of Dis. for Discharge | Furloughs |
| C. M. Charges | Med. Des. Lists |
| Med. Certificates | Orders |

SP

Other papers relating to—

- | | |
|----------------------------------|----------------------------|
| Admission to Hosp'l | Furlough |
| Casualty Sheet (Officer's) | Med. Examination |
| Confinement | Misc. Information |
| Contracts | Pay or Clothing |
| Death or Effects | Personal Reports |
| Desertions | Rank |
| Discharge from Hosp'l | Transfer to Hosp'l |
| Discharge from Service | Transfer to V. R. C. |
| Duty | Transportation |

MICROFILM PUBLICATION M.1821

COMPILED MILITARY SERVICE RECORDS
OF VOLUNTEER UNION SOLDIERS WHO
SERVED WITH THE USCT (US COLORED TROOPS)
5TH REGIMENT OF CAVALRY

PERSONAL PAPERS' TARGET SHEET

PLEASE NOTE THE CHECKED INFORMATION ABOUT THE PERSONAL PAPERS IN
THIS FILE:

- NO PERSONAL PAPERS WERE FOUND IN THIS FILE WHEN THE
RECORDS WERE ARRANGED FOR MICROFILMING.
- 2 PERSONAL PAPER(S) FOUND IN THIS FILE WHEN THE RECORDS
WERE ARRANGED FOR MICROFILMING.

NOTE 1.—This blank will be used for enlistments of United States colored troops. They will be made out in duplicate in all cases—one to accompany the recruiting return of the Superintendent (not the recruiting officer) to the Adjutant General, and one to accompany the accounts of the officer who pays bounty, &c.

NOTE 2.—An enlistment holds to service. A muster-in must, in all cases, precede payment of pay, bounty, pension, &c. A muster-in roll, must in all cases, be filed in the Adjutant General's Office as evidence of muster-in. The mustering officer, commissary, or assistant commissary of musters, as the case may be, will countersign both enlistments as having mustered the soldiers into the service of the United States before either of them is given to the disbursing officer.

DECLARATION OF RECRUIT.

I, Richard Coleman desiring to volunteer as a soldier in the ARMY OF THE UNITED STATES, for the term of Three Years, DO DECLARE That I am 21 years and months of age; that I have never been discharged from the United States service on account of disability or by sentence of court-martial, or by order before the expiration of a term of enlistment; and I know of no impediment to my serving honestly and faithfully as a soldier for three years.

GIVEN at Camp Nelson the 18th day of August 1864

Witness: W. L. Palmer

Richard Coleman
with mark

By John Chance
Adjutant General
in and for the
Department of
Camp Nelson
John Chance
131

Consent of Parent or Guardian in case of a Minor, if a Free Man, or in the case of a Slave, of the Person to whom he owes Service:

I, Do CERTIFY, That I am the that the said is years of age; and I do freely give my CONSENT to his volunteering as a SOLDIER in the Army of the United States, for the period of THREE YEARS, under the conditions of the laws of the United States.

GIVEN at the day of

Witness:

UNITED STATES COLORED TROOPS ENLISTMENT.

STATE OF

TOWN OF

Kentucky  *Camp Nelson*

I, *Richard Coleman* born in *Madford* in the State of *Kentucky* aged *Twenty one* years and by occupation a *Farmer* Do HEREBY ACKNOWLEDGE to

have volunteered *sixteenth* day of *August* 186 *4* to serve as a **Soldier** in the **Army of the United States of America**, for the period of **THREE YEARS**, unless sooner discharged by proper authority: Do also agree to accept such bounty, pay, rations, and clothing, as are, or may be, established by law for the U. S. colored troops.

And I, *Richard Coleman* do solemnly swear that I will bear true faith and allegiance to the **United States of America**, and that I will serve them honestly and faithfully against all their enemies or opposers whomsoever; and that I will observe and obey the orders of the President of the United States, and the orders of the officers appointed over me, according to the Rules and Articles of War.

Sworn and subscribed to, at *Camp Nelson* this *18th* day of *Aug 1864* *Richard Coleman* Before *J. L. Randolph* *D. P. M.*

I CERTIFY, ON HONOR, That I have carefully examined the above named Volunteer agreeably to the General Regulations of the Army, and that, in my opinion, he is free from all bodily defects and mental infirmity, which would in any way disqualify him from performing the duties of a soldier.

O. H. Colman
Asst Surg & Co Reg U S Inf
EXAMINING SURGEON.

I CERTIFY, ON HONOR, That I have minutely inspected the Volunteer *R Coleman* previously to his enlistment, and that he was entirely sober when enlisted; that, to the best of my judgment and belief, he is of lawful age; and that, in accepting him, as duly qualified to perform the duties of an able-bodied soldier, I have strictly observed the regulations which govern the recruiting service. This soldier has *Blue* eyes, *Blue* hair, *Blue* complexion; is *Five* feet *Seven* inches high.

J. L. Randolph
D. P. M.
RECRUITING OFFICER OR AGENT.

Mustered into the United States Service *19th* day of *August* 186 *4*

J. O. Hume
Capt 18th U S Inf
Mustering Officer.

Mustered into the service of the United States, for three years or during the war, from date of enlistment, in Company *.....*
Regiment of *2nd Colored Volunteers* on the *19th* day of *August* 186 *4* at *Camp Nelson*
J. O. Hume
Capt 18th U S Inf
M. S. Officer

John C. Seave

ENDORSEMENT.

No. 1639

APPLICATION OF

John C. Seave

OF

Woodford County Kentucky

for compensation for service of slave,

Richard Coleman

enlisted 18 day August 1864

in Co. B. 5th Regiment

U. S. Colored Troops.

Received July 25 1867

Compensation awarded

186

Dollars.

President Board of Claims.

P. O. ADDRESS OF CLAIMANT:

Catesby Barnes Atty
Versailles Woodford
County Ky

War Department,

ADJUTANT GENERAL'S OFFICE

Washington, April 8th 1867.

Respectfully returned to the
Commission for the State of
Ky.

with the informa-
tion that Richard Coleman
was enlisted at Camp Nelson Ky
Aug 18. 1864 and was
mustered in as Pvt. in Co. B
5th U. S. Colored Regt Aug 19/64.

J. H. Snygard

Asst. Adj't General.

CLAIM FOR COMPENSATION FOR ENLISTED SLAVE.

No. _____
 I, John C. Seearce, a loyal citizen, and a resident of
 the County of Woodford State of
Kentucky, hereby claim compensation, under the provisions of
 Section 24, Act approved February 24, 1864, and Section 2, Act approved July 28, 1866, for my slave
Richard Coleman alias Dick Coleman, enlisted on the 18 day of August
 1864, at Camp Nelson Ky. by Capt. Charles Randolph
and Mustered into in the U. S. Service 19 August 1864 as Corp Nelson
Co. B. 5th Regiment U. S. Colored Troops, certificate of which enlistment, and a descriptive list, as required, accompany
 this application.

In proof of my loyalty to the Constitution and Government of the United States, I present the accom-
 panying oath, which I have taken, signed and acknowledged; to be filed with this application, in accordance
 with requirement of General Orders, No. 329, 1863, War Department, Adjutant General's Office. Coastly Barrow
 And I do hereby constitute and appoint, with full power of substitution and revocation, David P. Robb, of
Lexington, Ky., my true and lawful Attorney to prosecute this claim for me, and in my name to receive and
 receipt for all orders or certificates that may be issued in payment thereof.

J. C. Seearce



OATH OF ALLEGIANCE.

I, John C. Seearce, the owner and claimant, do solemnly swear that the
 foregoing claim is a just and true claim due to me as master and owner of the said slave, and that the facts
 alleged in said claim in respect to the draft or enlistment (as the case may be) of said slave into the military
 service of the United States are true. And I do further swear that I have never joined, or been concerned in,
 any insurrection or rebellion; that I have never borne arms against the United States; that I have never given
 any aid, countenance, counsel or encouragement, to any person or persons engaged, or whom I had reason to
 believe were about to engage, in insurrection, rebellion or armed hostility against the United States; that I
 have neither sought, nor accepted, nor attempted to exercise the functions of any office, civil or military,
 nor to perform any service whatever, under any authority, or pretended authority, in hostility to the United
 States: that I have not yielded a voluntary support to any insurrection, rebellion or pretended government
 authority, power or constitution within the United States hostile thereto. And I do further swear that, to
 the best of my knowledge and ability, I have supported and defended, and will continue to support and defend
 the United States against all enemies, foreign and domestic, and that I have supported, defended and obeyed, and will
 continue to support, defend and obey, the Constitution and Laws of the United States; that I will bear true faith and
 allegiance to the same; and that I take this oath freely, without any mental reservation or purpose of evasion:
 So help me God.

J. C. Seearce

Sworn to and subscribed before me and the above power of attorney acknowledged at Versailles,
Kentucky this 5th day of August 1864

Attest
C. C. Higgins

David P. Robb

Thou two names
 should have signed
 above to the power of
 attorney instead of the
 att of the oath of
 Allegiance.



Headquarters Kentucky Volunteers,

Adjutant-General's Office,
Frankfort, Nov 27, 1866.

I hereby certify, that it appears from the U. S. Muster-
Rolls on file in this Office, that Richard Coleman
was enrolled on the 18th day of August, 1864, at
Camp Nelson Ky by J. C. Randolph
and mustered into the U. S. service on the 19th day of August,
1864, at Camp Nelson Ky by Capt A. C. Kinney
to serve three years. Said Richard Coleman
is described as follows: 21 yrs age, Black eyes, Black hair,
Black complexion, 5ft 9in height. It further appears from
said Rolls, that Richard Coleman owed service to
John Kearce and was credited to
Woodford County Ky and assigned to
Company 'B' 5th Regt. A. Cav.

rec

d



In Testimony Whereof, I have hereunto set my
hand, and affixed my Official Seal, this
27 day of Nov, 1866.

rec

D. W. Lindsay
Adjutant General of Kentucky.

13245 R 2112

Wm. Stearns

Sworn to and subscribed before me a ... for the county of
Woodford State of Kentucky, this the ... day of ... 1866

David P. Roberts



PROOF OF OWNERSHIP.

Kentucky,
City of Woodford } ss.
We, C. C. Roggins and Thos H Jesse each of law-
ful age, and resident citizens of the State and county aforesaid, do certify that John Le Seance
.....of the State and county aforesaid, was on the.....day of.....
186....., the lawful owner of the slave named Rich. Adams / Dick Coleman, referred
to and described in the foregoing claim for compensation.

C. C. Roggins
Thos H Jesse

Sworn to and subscribed before me a Notary Public for the county of Woodford
.....State of Kentucky, this the 5th day of Nov 1866

David P. Robb N.P.



PROOF OF LOYALTY.

State of Kentucky,
County of Woodford } ss.
We, C. C. Roggins and Wm Stevenson
each of lawful age, and resident citizens of the County of Woodford
in the State and county aforesaid, upon our oaths declare that we have known John Le Seance
a resident of the State and county aforesaid, since the 4th day of March, 1861, and know that he has firmly
and faithfully maintained his or her adherence and allegiance to the Government of the United States, by
defending its cause against the Government and forces of the so-called Confederate States of America, in
all suitable and practicable ways, and according to his ~~or her~~ ability and opportunity.

C. C. Roggins
Wm Stevenson

Sworn to and subscribed before me a Notary Public for the county of
Woodford State of Kentucky, this the.....day of.....1866

David P. Robb N.P.



284

Coleman, Samuel

Com., 5 U. S. Col'd Cav.

Private Corporal

CARD NUMBERS.

1	5370833	26
2	5370928	27
3	5371028	28
4	5371113	29
5	5371198	30
6	5371252	31
7	5371336	32
8	5371422	33
9	5371509	34
10	5371597	35
11	5371679	36
12	9091266	37
13		38
14		39
15		40
16		41
17		42
18		43
19		44
20		45
21		46
22		47
23		48
24		49
25		50

Book Mark:

See also

6 | 5 | 1864 | U.S.C.T.

Samuel Belmont
Co M, 5 Reg't U. S. Col'd

Appears on

Company Descriptive Book

of the organization named above.

DESCRIPTION.

Age 36 years; height 5 feet 7 inches.

Complexion Black

Eyes Blue; hair Black

Where born Scott Ky

Occupation Farmer

ENLISTMENT.

When Aug 29, 1864.

Where Camp Nelson

By whom W. H. Anderson; term 3 y'rs.

Remarks: Appointed corporal for
Reg't from 1st to 8th rank
from the twenty third day
of May 1865.

(383g)

W. H. Anderson

Copist.

Co **5 Cav. U.S.C.T.**

Samuel Coleman

Co. M, 5 Reg't U. S. Col'd Cavalry.

Appears on

Company Muster-in and Descriptive Roll

of the organization named above. Roll dated

Camp Nelson, *N.Y.*, *Oct 30*, 186*4*.

Where born *Scotts, Ky.*

Age *36* y'rs; occupation *Farmer*

When enlisted *Aug 29*, 186*4*.

Where enlisted *Camp Nelson, Ky.*

For what period enlisted *3* years.

Eyes *Black*; hair *Black*

Complexion *Black*; height *5* ft. *7* in.

When mustered in *Aug 30*, 186*4*.

Where mustered in *Camp Nelson, Ky.*

Bounty paid \$ *100*; due \$ *100*

Where credited *7 Dist. Ky.*

Company to which assigned

Remarks: *John Payne*

Samuel Coleman

16/9/64

Book mark:

W. S. Thompson

5 Cav. | U.S.C.T.

Samuel Chapman
.....
Port....., Co. M, 5 Reg't U. S. Col'd Cavalry.

Appears on

Company Muster Roll

for..... *to Oct 31*....., 186*1*.

Present or absent..... *Present*.....

Stoppage, \$..... *100* for.....

Due Gov't, \$..... *100* for.....

Valuation of horse, \$..... *100*

Valuation of horse equipments, \$..... *100*

Remarks:.....

Book mark:.....

M. S. Chapman

6 | 5 Cav. | U.S.C.T.

Samuel Cochran

Capt, Co. M, 5 Reg't U. S. Col'd Cavalry.

Appears on

Company Muster Roll

for *Nov. & Dec.*, 186*7*.

Present or absent *Present*

Stoppage, \$ *100* for

Due Gov't, \$ *100* for

Valuation of horse, \$ *100*

Valuation of horse equipments, \$ *100*

Remarks: *1st & 2nd installments
of bounty due.*

Book mark:

W. S. Thompson

(358)

Copyist.

C

5 Cav. | U.S.C.T.

J. W. Coleman

....., Co. M, 5 Reg't U. S. Col'd Cavalry.

Appears on

Company Muster Roll

for *Jan 10 Feb*, 186*5*.

Present or absent *Present*

Stoppage, \$..... *100* for

Due Gov't, \$..... *100* for

Valuation of horse, \$..... *100*

Valuation of horse equipments, \$..... *100*

Remarks: *100 of equipments of bounty due*

Book mark:

(358)

J. W. Coleman
.....
Copyist.

5 Cav. | U.S.C.T.

Samuel Colman

Pvt., Co. M, 5 Reg't U. S. Col'd Cavalry.

Appears on

Company Muster Roll

for *Mar. 8 1863*, 1863.

Present or absent *Present*

Stoppage, \$ *100* for

Due Gov't, \$ *100* for

Valuation of horse, \$ *100*

Valuation of horse equipments, \$ *100*

Remarks: *1st installment
sundry due \$100*

Book mark:

M. S. Thompson

C. | **5 Cav.** | **U.S.C.T.**

Samuel Colman
Capt, Co. M, 5 Reg't U. S. Col'd Cavalry.

Appears on

Company Muster Roll

for *May & June*, 186*5*.

Present or absent *Present*

Stoppage, \$ *100* for

Due Gov't, \$ *100* for

Valuation of horse, \$ *100*

Valuation of horse equipments, \$ *100*

Remarks: *Appointed Capt from private May 23. 1865*
as per Reg't order No 86.
1st Enlistment bounty
due \$100.

Book mark:

C. W. [Signature]
Copyist.

C.

5 Cav. U.S.C.T.

Samuel Colman
Corpl, Co. M, 5 Reg't U. S. Col'd Cavalry.

Appears on

Company Muster Roll

for July + Aug, 1865.

Present or absent Present

Stoppage, \$ 100 for

Due Gov't, \$ 100 for

Valuation of horse, \$ 100

Valuation of horse equipments, \$ 100

Remarks:

Book mark:

Copyist

C. | 5 Cav. | U.S.C.T.

Samuel Coleman

Capt, Co. M, 5 Reg't U. S. Col'd Cavalry.

Appears on

Company Muster Roll

for Sept & Oct, 1865.

Present or absent Present

Stoppage, \$ 100 for

Due Gov't, \$ 100 for

Valuation of horse, \$ 100

Valuation of horse equipments, \$ 100

Remarks: Due US for Advance
.55¢ for Capt
Garrison # 150

Book mark: _____

C. C. C.

Co. | **5 Cav. | U.S.C.T.**

Samuel Coleman
Capt., Co. M, 5 Reg't U. S. Col'd Cavalry.

Appears on

Company Muster Roll

for *Nov & Dec*, 1865.

Present or absent *Present*

Stoppage, \$ *100* for

Due Gov't, \$ *100* for

Valuation of horse, \$ *100*

Valuation of horse equipments, \$ *100*

Remarks:

Book mark:

C. W. Curtis
Copyist.

6 | **5 Cav. | U.S.C.T.**

Samuel Coleman
Corpl, Co. M, 5 Reg't U. S. Col'd Cavalry.

Appears on

Company Muster Roll

for *Jan + Feb*, 186*6*.

Present or absent *Present*

Stoppage, \$.....*100* for

Due Gov't, \$.....*100* for

Valuation of horse, \$.....*100*

Valuation of horse equipments, \$.....*100*

Remarks:

Book mark:

Hynes
Copyist.

6 | **5 Cav.** | **U.S.C.T.**

Samuel Coleman

Capt., Co *M*, 5 Reg't U. S. Col'd Cavalry.

Appears on **Co. Muster-out Roll**, dated
Helena Ark, *Mar 16*, 186*6*.

Muster-out to date *Mar 16*, 186*6*.

Last paid to *Dec. 31*, 186*6*.

Clothing account:

Last settled 186 ; drawn since \$ 100

Due soldier \$ 100; due U. S. \$ *11*^{*43*} / 100

Am't for cloth'g in kind or money adv'd \$ 100

Due U. S. for arms, equipments, &c., \$ ^{*40*} / 100

Bounty paid \$ *100* / 100; due \$ *100* / 100

Remarks: *Appointed Capt Per RO*
86 Par 7. May 23. 1865 Slave
Apr. 19 '61

Book mark:

285
Collins Shelby

Co. 5 U. S. Col'd Cav.

Private Private

CARD NUMBERS.

1	5367801	26
2	5367897	27
3	5367997	28
4	5368090	29
5	5368182	30
6	5368278	31
7	5368369	32
8	5368458	33
9	5368543	34
10	5368630	35
11	5368712	36
12	9090965	37
13	9221601	38
14	43143778	39
15		40
16		41
17		42
18		43
19		44
20		45
21		46
22		47
23		48
24		49
25		50

Book Mark:

See also

6 | *5 Cav.*
108 | **U.S.C.T.**

Shelby Collins

A, Co. *A*, 108 Reg't U. S. Col'd Infantry.

Appears on

Company Descriptive Book

of the organization named above.

DESCRIPTION.

Age *20* years; height *5* feet *9* inches.

Complexion *Dark*

Eyes *Dark*; hair *Dark*

Where born *Shelby Ky*

Occupation *Farmer*

ENLISTMENT.

When *June 29*, 186*4*.

Where *Louisville*

By whom *Capt Smith*, term *3* y'rs

Remarks:

Revised for 10th U.S.C.T.
Transferred to 5th U.S.C. Cavalry
August 12, 1864, per S.O. 192, Head
Quarters Dist. of Ky.

D. M. Kennedy

(1864)

Compt.

6 | **5 Cav. | U.S.C.T.**

Shelby Collins

....., Co. *D*, 5 Reg't U. S. Col'd Cav.

Appears on

Company Descriptive Book
of the organization named above.

DESCRIPTION.

Age *21* years; height *5* feet *9* inches.

Complexion *Dark*

Eyes *Dark*; hair *Dark*

Where born *Shelby Ky*

Occupation *Farmer*

ENLISTMENT.

When *July 29*, 1864.

Where *Lansville*

By whom *Capt Smith*; term *3* y'rs.

Remarks:

.....

.....

.....

.....

.....

.....

.....

.....

.....

.....

.....

.....

.....

.....

.....

.....

.....

.....

.....

.....

.....

.....

.....

.....

.....

.....

A. J. Anderson

(3830)

Copist.

C | 5 bar | U.S.A.

Shelby Collins

Appears with rank of Priv on

Muster and Descriptive Roll

of Detachment of U.S. Colored
Recruits mustered

Roll dated
Louisville Ky., July 2, 1864.

Where born Shelby Co Kentucky

Age 20 years; occupation Farmer

When enlisted June 29, 1864.

Where enlisted Louisville Ky.

For what period enlisted 3 years.

Eyes Dark; hair Dark

Complexion Dark; height 5 ft. 9 in.

When mustered in July 2, 1864

Where mustered in Louisville

Bounty paid \$ 100; due \$ 100

Clothing account:

Last settled , 186 ; drawn since \$ 100

Date of first muster , 186

Company to which assigned

Remarks: Accredited to Jef-

erson County, 5 Cong

Dist. Ky.

Book mark:

J. N. Wilkinson

(356m)

Copyist.

6

5 Cav. U.S.C.T.

Shelby Collins

Priv., Co. *I*, 5 Reg't U. S. Col'd Cavalry.

Appears on

Company Muster-in and Descriptive Roll

of the organization named above. Roll dated

Cp. Nelson, ^{*Ky.*} ~~*N.Y.*~~, *Oct. 31*, 1864.

Where born *Shelby, Ky*

Age *20* y'rs; occupation *Farmer*

When enlisted *June 29*, 1864.

Where enlisted *Louisville*

For what period enlisted *3* years.

Eyes *OK*; hair *DK*

Complexion *OK*; height *5* ft. *9* in.

When mustered in *July 2*, 1864.

Where mustered in *Louisville*

Bounty paid \$ *100*; due \$ *100*

Where credited *5th Dist. Kentucky*

Company to which assigned

Remarks:

Enlisted for 103th U.S.C.T.
Transferred to 5th U.S.C. Cavalry
August 12, 1864, per S.O. 192. Head
Quarters Dist of Ky.
Book mark:

Philipson

(356d)

Copyist.

6. | **5 Cav.** | **U.S.C.T.**

Shelby Collins

Priv., Co. I, 5 Reg't U. S. Col'd Cavalry.

Appears on

Company Muster Roll

for Organization to Oct. 31, 1864.

Present or absent Present

Stoppage, \$ 100 for

Due Gov't, \$ 100 for

Valuation of horse, \$ 100

Valuation of horse equipments, \$ 100

Remarks:

Book mark:

Philipson

C. | 5 Cav. | U.S.C.T.

Shelby Gallie

Priv., Co. I, 5 Reg't U. S. Col'd Cavalry.

Appears on

Company Muster Roll

for Nov. & Dec., 1864.

Present or absent Present

Stoppage, \$ 100 for

Due Gov't, \$ 100 for

Valuation of horse, \$ 100

Valuation of horse equipments, \$ 100

Remarks: 1st & 2^d installments

Bounty due.

Book mark:

Philipson

62 | **5 Cav. | U.S.C.T.**

Shelby Collins

Pr, Co, I, 5 Reg't U. S. Col'd Cavalry.

Appears on

Company Muster Roll

for *Jan. & Feb.*, 186*4*.

Present or absent *Present*

Stoppage, \$ *100* for

Due Gov't, \$ *100* for

Valuation of horse, \$ *100*

Valuation of horse equipments, \$ *100*

Remarks: *1st & 2^d installments
\$300^x Bounty due.*

Book mark:

Philipsen

C. | 5 Cav. | U.S.C.T.

Shelby Collins

Prv., Co. I, 5 Reg't U. S. Col'd Cavalry.

Appears on

Company Muster Roll

for *March & April*, 1865.

Present or absent *Present*

Stoppage, \$ *100* for

Due Gov't, \$ *100* for

Valuation of horse, \$ *100*

Valuation of horse equipments, \$ *100*

Remarks: *1st installment*

Bounty due.

Book mark:

Philipsen

(358)

Copyist.

C

5 Cav.

U.S.C.T.

Abel T. Adams

Pr, Co. I, 5 Reg't U. S. Col'd Cavalry.

Appears on

Company Muster Roll

for *May & June*, 1865.

Present or absent *Present*

Stoppage, \$ *100* for

Due Gov't, \$ *100* for

Valuation of horse, \$ *100*

Valuation of horse equipments, \$ *100*

Remarks: *Arrested & sent due*

\$100

Book mark:

Adams

C | **5 Cav.** | **U.S.C.T.**

Shelby Cullin

Pr, Co. I, 5 Reg't U. S. Col'd Cavalry.

Appears on

Company Muster Roll

for *July & Aug*, 186*5*.

Present or absent *Present*

Stoppage, \$.....¹⁰⁰ for.....

Due Gov't, \$.....¹⁰⁰ for.....

Valuation of horse, \$.....¹⁰⁰

Valuation of horse equipments, \$.....¹⁰⁰

Remarks:.....

Book mark:.....

allied

E

5 Cav. U.S.C.T.

Charles Collins

Plt, Co. I, 5 Reg't U. S. Col'd Cavalry.

Appears on

Company Muster Roll

for *Sept & Oct*, 186*5*.

Present or absent *Present*

Stoppage, \$ *100* for

Due Gov't, \$ *100* for

Valuation of horse, \$ *100*

Valuation of horse equipments, \$ *100*

Remarks:

Book mark:

Deed

J | **5 Cav. | U.S.C.T.**

Shelby Collins

Pr, Co. I, 5 Reg't U. S. Col'd Cavalry.

Appears on

Company Muster Roll

for *Nov & Dec*, 186*5*

Present or absent *Present*

Stoppage, \$ *100* for

Due Gov't, \$ *100* for

Valuation of horse, \$ *100*

Valuation of horse equipments, \$ *100*

Remarks *See M. for 3rd, 4th, 5th*

Book mark:

Aleno

6

5 Cav. U.S.C.T.

Shelby Collins

Priv., Co. I, 5 Reg't U. S. Col'd Cavalry.

Appears on

Company Muster Roll

for Jan'y. & Feby., 1866.

Present or absent Present

Stoppage, \$ 100 for

Due Gov't, \$ 100 for

Valuation of horse, \$ 100

Valuation of horse equipments, \$ 100

Remarks:

Book mark:

Crenshaw

60

5 Cav. U.S.C.T.

Shelby Collins

Pvt., Co. I., 5 Reg't U. S. Col'd Cavalry.

Appears on Co. Muster-out Roll, dated

Helena, Ark. Mch. 16, 1866.

Muster-out to date Mch. 16, 1866.

Last paid to Dec. 31, 1865.

Clothing account:

Last settled....., 186 ; drawn since \$ 100

Due soldier \$ 12 ⁴⁴/₁₀₀; due U. S. \$ 100

Am't for cloth'g in kind or money adv'd \$ 100

Due U. S. for arms, equipments, &c., \$ ⁷⁴/₁₀₀

Bounty paid \$ 100; due \$ 100

Remarks: Due U.S. for Ord. 74th.

Book mark: P.M.G. 4339 May 21/66.

Crenshaw

786
Conchman, Bill

Co K, 5 U. S. Col'd Cav.

Private Private

CARD NUMBERS.

1	5368818	26
2	5368912	27
3	5369013	28
4	5369102	29
5	5369189	30
6	5369275	31
7	5369365	32
8	5369451	33
9	5369538	34
10	5369625	35
11	5369708	36
12	9091054	37
13	43148254	38
14	40729651	39
15		40
16		41
17		42
18		43
19		44
20		45
21		46
22		47
23		48
24		49
25		50

Book Mark:

See also

6 | **5 Cav.** | **U.S.C.T.**

Bill Leachman

....., Co. K, 5 Reg't U. S. Col'd Cav.

Appears on

Company Descriptive Book
of the organization named above.

DESCRIPTION.

Age 18 years; height 5 feet 8 inches.

Complexion Dark

Eyes Blue; hair Blue

Where born Charlotte Co Ky

Occupation Laborer

ENLISTMENT.

When Oct 7, 1864.

Where Lexington Ky

By whom J. M. ...; term 3 y'rs.

Remarks:

.....

.....

.....

.....

.....

.....

.....

.....

.....

.....

.....

.....

.....

.....

.....

.....

.....

.....

.....

.....

.....

.....

.....

.....

.....

.....

W. J. Anderson

6 | 5 Cav. | U.S.C.T.

Bill Conchman

Pvt., Co. K, 5 Reg't U. S. Col'd Cavalry.

Appears on

Company Muster-in and Descriptive Roll

of the organization named above. Roll dated

Camp Nelson Ky, N. Y. Oct 30, 1864.

Where born Lexington Ky

Age 18 y'rs; occupation Laborer

When enlisted Oct 7, 1864.

Where enlisted Lexington Ky

For what period enlisted 3 years.

Eyes Blk; hair Blk

Complexion Blk; height 5 ft. 8 in.

When mustered in Oct 7, 1864.

Where mustered in Lexington Ky

Bounty paid \$ 100; due \$ 100

Where credited 7 Dist Ky

Company to which assigned

Remarks:

Book mark:

W. S. Miller

(356d)

Copyist.

5 bar USLT

Bill Touchman

Appears with rank of Priv. on

Muster and Descriptive Roll

of Detachment of US Old. Vols
forwarded Camp Nelson, Ky

Roll dated
Lexington, Ky, Oct. 7, 1864.

Where born Clark, Ky

Age 18 years; occupation Laborer

When enlisted Oct. 7, 186 .

Where enlisted Lexington, Ky

For what period enlisted 3 years.

Eyes Blk; hair Blk

Complexion Blk; height 5 ft. 8 in.

When mustered in _____, 186 .

Where mustered in _____

Bounty paid \$ _____ 100; due \$ _____ 100

Clothing account:

Last settled _____, 186 ; drawn since \$ _____ 100

Date of first muster Oct. 7, 1864.

Company to which assigned _____

Remarks: To be credited to
Clark Co. 7th Dist. Ky.

Book mark: _____

W. J. Hamil

6 | 5 Cav. | U.S.C.T.

Bill Conchman

Pvt., Co. K, 5 Reg't U. S. Col'd Cav.

Appears on

Company Muster Roll

for *Organization to Oct 31*, 1864.

Present or absent *Present*

Stoppage, \$ *100* for

Due Gov't, \$ *100* for

Valuation of horse, \$ *100*

Valuation of horse equipments, \$ *100*

Remarks:

Book mark:

H. J. Miller

(358)

Copyist.

C

5 Cav. U.S.C.T.

Bill Cochran

Priv., Co. K, 5 Reg't U. S. Col'd Cav.

Appears on

Company Muster Roll

for *Nov & Dec*, 186*4*.

Present or absent *Present*

Stoppage, \$ *100* for

Due Gov't, \$ *100* for

Valuation of horse, \$ *100*

Valuation of horse equipments, \$ *100*

Remarks: *1" & 2" installments*
Bounty due

Book mark:

H. Miller

6 | 5 Cav. | U.S.C.T.

Bill Conchman

Priv, Co. K, 5 Reg't U. S. Col'd Cav.

Appears on

Company Muster Roll

for *Jan & Feb*, 1865.

Present or absent *Present*

Stoppage, \$ *100* for

Due Gov't, \$ *100* for

Valuation of horse, \$ *100*

Valuation of horse equipments, \$ *100*

Remarks: *1" & 2" installments - \$300 Bounty due*

Book mark :

H. S. Miller

6 | 5 Cav. | U.S.C.T.

Bill Conchman

Pol, Co. K, 5 Reg't U. S. Col'd Cav.

Appears on

Company Muster Roll

for *Mar V-Apr*, 186*5*.

Present or absent *Present*

Stoppage, \$ *100* for

Due Gov't, \$ *100* for

Valuation of horse, \$ *100*

Valuation of horse equipments, \$ *100*

Remarks: *1st installment of bounty due \$100*

Book mark:

(358)

H. S. Miller

Copyist.

6. | **5 Cav.** | **U.S.C.T.**

Bill Buchanan

Prov., Co. K, 5 Reg't U. S. Col'd Cav.

Appears on

Company Muster Roll

for May & June, 1860

Present or absent Present

Stoppage, \$ 100 for

Due Gov't, \$ 100 for

Valuation of horse, \$ 100

Valuation of horse equipments, \$ 100

Remarks: Just installment
for duty due \$100

Book mark: _____

F. E. Porter

6

5 Cav. U.S.C.T.

Bill Conchman

Prov, Co. K, 5 Reg't U. S. Col'd Cav.

Appears on

Company Muster Roll

for July & Aug, 1865.

Present or absent Present

Stoppage, \$ 100 for

Due Gov't, \$ 100 for

Valuation of horse, \$ 100

Valuation of horse equipments, \$ 100

Remarks:

Book mark:

F. E. Porter

0

5 Cav. U.S.C.T.

Bill Couchman

Private, Co. K, 5 Reg't U. S. Col'd Cav.

Appears on

Company Muster Roll

for Sept & Oct, 1864.

Present or absent Present

Stoppage, \$ 100 for

Due Gov't, \$ 100 for

Valuation of horse, \$ 100

Valuation of horse equipments, \$ 100

Remarks: Dis. 21 Jan 65

Book mark:

F. S. Foster

6

5 Cav. U.S.C.T.

Bill Conchman

Prob., Co. K, 5 Reg't U. S. Col'd Cav.

Appears on

Company Muster Roll

for Nov & Dec, 1860.

Present or absent Present

Stoppage, \$ 100 for

Due Gov't, \$ 100 for

Valuation of horse, \$ 100

Valuation of horse equipments, \$ 100

Remarks: Due U.S. for Ard
Geo

Book mark:

F. E. Foster

(358)

Copyist.

C

5 Cav.

U.S.C.T.

Bill Couchman

Pat, Co. K, 5 Reg't U. S. Col'd Cav.

Appears on

Company Muster Roll

for Jan Feb, 1866.

Present or absent Present

Stoppage, \$ 100 for

Due Gov't, \$ 100 for

Valuation of horse, \$ 100

Valuation of horse equipments, \$ 100

Remarks:

Book mark:

E. H. Brown

C | 5 Cav. | U.S.C.T.

William Couchman.

Pvt., Co. *K*, 5 Reg't U. S. Colored Cav.

Appears on Returns as follows:

*May, 1860. Absent sick in Hoop,
Paris, Ky.*

Book mark :

(546)

A. Baker
Copyist.

A

5 Cav. U.S.C.T.

Gill *Coachman*

Co., Co. *K*, 5 Reg't U. S. Col'd Cavalry.

Appears on **Co. Muster-out Roll**, dated

March 16, 1860.

Muster-out to date

March 6, 1866.

Last paid to

Dec 31, 1865.

Clothing account:

Last settled....., 186 ; drawn since \$..... 100

Due soldier \$..... 100; due U. S. \$..... 21 100

Am't for cloth'g in kind or money adv'd \$..... 100

Due U. S. for arms, equipments, &c., \$..... 100

Bounty paid \$ *100* 100; due \$..... 100

Remarks:.....

Book mark: *869-1880*

E. H. B...

Couchman Bill

....., Co.,

Reg't

U.S.A.

Enclosures.

Bed Cards	Final Statements
Burial Records	Furloughs or L. of A.
Certs. of Dis. for Discharge	Med. Certificates
C. M. Charges	Med. Des. Lists
Descriptive Lists	Orders
Discharge Certificates	Pris. of War Record
Enlistment Papers	Resignations

Other papers relating to—

Admission to Hosp'l	Furlough or L. of A.
Casualty Sheet	Med. Examination
Confinement	Misc. Information
Contracts	Pay or Clothing
Death or Effects	Personal Reports
Desertion	Rank
Discharge from Hosp'l	Transfer to Hosp'l
Discharge from Service	Transfer to V. R. C.
Duty	Transportation

MICROFILM PUBLICATION M 1821

COMPILED MILITARY SERVICE RECORDS
OF VOLUNTEER UNION SOLDIERS WHO
SERVED WITH THE USCT (US COLORED TROOPS)
5TH REGIMENT OF CAVALRY

PERSONAL PAPERS' TARGET SHEET

PLEASE NOTE THE CHECKED INFORMATION ABOUT THE PERSONAL PAPERS IN
THIS FILE:

NO PERSONAL PAPERS WERE FOUND IN THIS FILE WHEN THE
RECORDS WERE ARRANGED FOR MICROFILMING.

1 PERSONAL PAPER(S) FOUND IN THIS FILE WHEN THE RECORDS
WERE ARRANGED FOR MICROFILMING.

NOTE 1.—This blank will be used for enlistments of United States colored troops. They will be made out in duplicate in all cases—one to accompany the recruiting return of the superintendent (not the recruiting officer) to the Adjutant General, and one to accompany the accounts of the officer who pays bounty, &c.

NOTE 2.—An enlistment holds to service. A muster-in must, in all cases, precede payment of pay, bounty, pension, &c. A muster-in roll, must in all cases, be filed in the Adjutant General's Office as evidence of muster-in. The mustering officer, commissary, or assistant commissary of musters, as the case may be, will countersign both enlistments as having mustered the soldiers into the service of the United States before either of them is given to the disbursing officer.

DECLARATION OF RECRUIT.

I, Bill Couchman desiring to volunteer as a soldier in the ARMY OF THE UNITED STATES, for the term of Three Years, DO DECLARE That I am eighteen years and months of age; that I have never been discharged from the United States service on account of disability or by sentence of a court-martial, or by order before the expiration of a term of enlistment; and I know of no impediment to my serving honestly and faithfully as a soldier for three years.

GIVEN at Lexington Kentucky the seventh day of October 1864

Witness: B. F. Turner

his Bill Couchman mark

By Wm. H. Moore for Major
Volunteer Regiment
No. 21st
394
Bill Couchman

Consent of Parent or Guardian in case of a Minor, if a Free Man, or in the case of a Slave, of the Person to whom he owes Service:

I, Wm. Couchman of Clark Co. Ky Do CERTIFY, That I am the father of Bill Couchman a Slave

that the said Bill Couchman is Eighteen years of age; and I do freely give my CONSENT to his volunteering as a SOLDIER in the Army of the United States, for the period of THREE YEARS, under the conditions of the laws of the United States.

GIVEN at Lexington Kentucky the 8th day of October 1864

Witness:

UNITED STATES COLORED TROOPS ENLISTMENT.

STATE OF

Kentucky

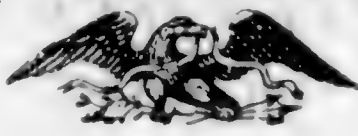

TOWN OF

Lexington

I, *Bill Couchman* born in *Clark County*

in the State of *Kentucky* aged *eighteen* years

and by occupation a *Laborer* Do HEREBY ACKNOWLEDGE to

have volunteered *seventh* day of *October* 186*4*

to serve as a **Soldier** in the **Army of the United States of America**, for the period of **THREE YEARS**, unless sooner discharged by proper authority: Do also agree to accept such bounty, pay, rations, and clothing, as are, or may be, established by law for the U. S. colored troops.

And I, *Bill Couchman*

do solemnly swear that I will bear true faith and allegiance to the **United States of America**, and that I will serve them honestly and faithfully against all their enemies or opposers whomsoever; and that I will observe and obey the orders of the President of the United States, and the orders of the officers appointed over me, according to the Rules and Articles of War.

Sworn and subscribed to, at *Lexington Ky* his
this *seventh* day of *Oct* 186*4* *Bill Couchman*

Before *John M Moore* mark
Capt & Pro Mar of Dist Ky

I CERTIFY, ON HONOR, That I have carefully examined the above named Volunteer agreeably to the General Regulations of the Army, and that, in my opinion, he is free from all bodily defects and mental infirmity, which would in any way disqualify him from performing the duties of a soldier.

J. J. Gano

EXAMINING SURGEON.

I CERTIFY, ON HONOR, That I have minutely inspected the Volunteer *Bill Couchman* previously to his enlistment, and that he was entirely sober when enlisted; that, to the best of my judgment and belief, he is of lawful age; and that, in accepting him as duly qualified to perform the duties of an able-bodied soldier, I have strictly observed the regulations which govern the recruiting service. This soldier has *Blue* eyes, *Black* hair, *Black* complexion, is *five* feet *5* inches high.

John M Moore
Capt & Pro Mar of Dist Ky
RECRUITING OFFICER OR AGENT.

Mustered into the United States Service.....day of.....186*4*

Mustering Officer.

..... Mustered into the service of the United States, for three years or during the war, from date of enlistment, in Company
..... Regiment of Volunteers, on the day of 186*4*, at

281

Conda Logan

Co. H, 5 U. S. Col'd Cav.

Private

CARD NUMBERS.

1	26
2	27
3	28
4	29
5	30
6	31
7	32
8	33
9	34
10	35
11	36
12	37
13	38
14	39
15	40
16	41
17	42
18	43
19	44
20	45
21	46
22	47
23	48
24	49
25	50

See Canday Logan

Book Mark:

See also

288

Comm Robert

Co D, 5 U.S. Col'd Cav.

Private Private

CARD NUMBERS.

1	5360666	26
2	5360763	27
3	5360852	28
4	5360948	29
5	5361038	30
6	5361125	31
7	5361212	32
8	5361302	33
9	5361386	34
10	5361468	35
11	5361550	36
12	9090099	37
13	40729585	38
14		39
15		40
16		41
17		42
18		43
19		44
20		45
21		46
22		47
23		48
24		49
25		50

Book Mark:

See also

| **5 Cav. | U.S.C.T.**

Robert Cassin

 , Co. B, 5 Reg't U. S. Col'd Cav.

Appears on

Company Descriptive Book
of the organization named above.

DESCRIPTION.

Age 27 years; height 5 feet 3 inches.

Complexion Blk

Eyes Blk; hair Blk

Where born Bourbon Co Ky

Occupation Severer

ENLISTMENT.

When Aug 17, 1864.

Where Lexington Ky

By whom Capt Moore; term 3 y'rs.

Remarks:

W. A. Miller

6

5 Cav.

U.S.C.T.

Robert Conner

Priv., Co. B, 5 Reg't U. S. Col'd Cavalry.

Appears on

Company Muster-in and Descriptive Roll

of the organization named above. Roll dated

Camp Keokuk, ^{Key} N. Y., Oct 24, 1864.

Where born Bourne Bour Key

Age 17 y'rs; occupation Laborer

When enlisted Aug 17, 1864.

Where enlisted Lexington

For what period enlisted 3 years.

Eyes Blue; hair Blue

Complexion Blue; height 5 ft. 3 in.

When mustered in Aug 17, 1864.

Where mustered in Lexington

Bounty paid \$ 100; due \$ 100

Where credited 1st Dist. Key

Company to which assigned B

Remarks: * Name of owner of Negro - William Conner.

* Added May 12, 1864 H. G.

Book mark:

Lamb

6

5 Cav.

U.S.C.T.

Robert Gour

Pew, Co. B, 5 Reg't U. S. Col'd Cavalry.

Appears on

Company Muster Roll

for Oct 31, 1864.

Present or absent Present

Stoppage, \$ 100 for

Due Gov't, \$ 100 for

Valuation of horse, \$ 100

Valuation of horse equipments, \$ 100

Remarks:

Book mark:

Lamb

6 | 5 Cav. | U.S.C.T.

Robert Cook

Private, Co. B, 5 Reg't U. S. Col'd Cavalry.

Appears on

Company Muster Roll

for Nov & Dec, 1864.

Present or absent Absent

Stoppage, \$ 100 for

Due Gov't, \$ 100 for

Valuation of horse, \$ 100

Valuation of horse equipments, \$ 100

Remarks: Sick in Hospital
Camp Nelson Ky
1st & 2nd instal bounty due

Book mark:

Lynch

| **5 Cav.** | **U.S.C.T.**

Robert Connor

Lee's, Co. B, 5 Reg't U. S. Col'd Cavalry.

Appears on

Company Muster Roll

for Jan & Feb, 1865.

Present or absent Present

Stoppage, \$ 100 for

Due Gov't, \$ 100 for

Valuation of horse, \$ 100

Valuation of horse equipments, \$ 100

Remarks: 1st instalment
owedly \$ 100 due

Book mark: _____

Lane

6

5 Cav. U.S.C.T.

Robert Coon

Prin, Co. B, 5 Reg't U. S. Col'd Cavalry.

Appears on

Company Muster Roll

for Feb 28 to Apr, 1865.

Present or absent Present

Stoppage, \$ 100 for

Due Gov't, \$ 100 for

Valuation of horse, \$ 100

Valuation of horse equipments, \$ 100

Remarks: 1" in salmout bounty due \$100

Book mark:

Lauch

(358)

Copyist.

6 | **5 Cav.** | **U.S.C.T.**

Robert Gunn

Priv., Co. B, 5 Reg't U. S. Col'd Cavalry.

Appears on

Company Muster Roll

for *May & June*, 186*5*.

Present or absent *present*

Stoppage, \$ *100* for

Due Gov't, \$ *100* for

Valuation of horse, \$ *100*

Valuation of horse equipments, \$ *100*

Remarks: *1st Installment
bond due \$100*

Book mark:

R. E. Wilson

6 | **5 Cav. | U.S.C.T.**

Robert Comu

Priv., Co. B, 5 Reg't U. S. Col'd Cavalry.

Appears on

Company Muster Roll

for *July & Aug.*, 186*5*.

Present or absent *present*

Stoppage, \$ *100* for

Due Gov't, \$ *100* for

Valuation of horse, \$ *100*

Valuation of horse equipments, \$ *100*

Remarks:

Book mark:

R. Cavilio

6 | **5 Cav. | U.S.C.T.**

Robert Horn

Priv., Co. B, 5 Reg't U. S. Col'd Cavalry.

Appears on

Company Muster Roll

for *Sept. & Oct.*, 186*5*.

Present or absent *present*

Stoppage, \$ *100* for

Due Gov't, \$ *100* for

Valuation of horse, \$ *100*

Valuation of horse equipments, \$ *100*

Remarks:

Book mark: -----

R. Couwiler

6 | **5 Cav.** | **U.S.C.T.**

Robert Bonn

Priv, Co. B, 5 Reg't U. S. Col'd Cavalry.

Appears on

Company Muster Roll

for *Nov. & Dec.*, 186*5*.

Present or absent *present*

Stoppage, \$ *100* for

Due Gov't, \$ *100* for

Valuation of horse, \$ *100*

Valuation of horse equipments, \$ *100*

Remarks:

Book mark:

R. Condit

(358)

Copyist.

4

5 Cav. U.S.C.T.

Robert Conn

121, Co. B, 5 Reg't U. S. Col'd Cavalry.

Appears on

Company Muster Roll

for *Jan & Feb*, 1864.

Present or absent *Present*

Stoppage, \$ *100* for

Due Gov't, \$ *100* for

Valuation of horse, \$ *100*

Valuation of horse equipments, \$ *100*

Remarks:

Book mark: -----

(358)

[Signature]

Copyist.

C.

5 Cav.

U.S.C.T.

Robert Conn.

Feb., Co. B, 5 Reg't U. S. Colored Cav.

Appears on Returns as follows:

Nov. & Dec. 1864. Absent sick, Hoop,
Camp Nelson, Ky.

Book mark:

.546)

A. Baker
Copyist.

C

5 Cav.

U.S.C.T.

Robert O'Connell

Private, Co. D, 5 Reg't U. S. Col'd Cavalry.

Appears on Co. Muster-out Roll, dated

Helena Ark, Mar 16, 1866.

Muster-out to date Mar 16, 1866.

Last paid to Dec 31, 1865.

Clothing account:

Last settled _____, 186 ; drawn since \$ 100

Due soldier \$ 100; due U. S. \$ 24 ⁵⁶/₁₀₀

Am't for cloth'g in kind or money adv'd \$ 100

Due U. S. for arms, equipments, &c., \$ 1 ¹⁸/₁₀₀

Bounty paid \$ 100 100; due \$ 100 100

Remarks: Slave April 19, 1861

Due 20 \$ for Ord \$1.18

Book mark:

Robert O'Connell

(861)

Copyist.

Conn, Robt

P, Co. B

5 Reg't W.C. Cav

Enclosures.

Bed Cards	Final Statements
Burial Records	Furloughs or L. of A
Certs. of Dis. for Discharge	Med. Certificates
C. M. Charges	Med. Des. Lists
Descriptive Lists	Orders
Discharge Certificates	Pris. of War Record
Enlistment Papers	Resignations

Other papers relating to—

Admission to Hosp'l	Furlough or L. of A
Casualty Sheet	Med. Examination
Confinement	Misc. Information
Contracts	Pay or Clothing
Death or Effects	Personal Reports
Desertion	Rank
Discharge from Hosp'l	Transfer to Hosp'l
Discharge from Service	Transfer to V. R. C.
Duty	Transportation

NOTE 1.—This blank will be given to the recruits of United States colored troops. They will be made out in duplicate in all cases—one to accompany the recruiting return of the recruiting officer to the Adjutant General, and one to accompany the accounts of the officer who pays bounty, &c.

NOTE 2.—An enlistment holds to service. A musser-in must, in all cases, prove payment of pay, bounty, pension, &c. A musser-in roll, must in all cases, be filed in the Adjutant General's Office as evidence of musser-in. The transfer of an officer, commissary, or assistant commissary of military stores, as the case may be, will countersign both enlistments as having mussered the soldiers into the service of the United States before either of them is given to the disbursing officer.

DECLARATION OF RECRUIT.

I, Robert Coon do hereby
 to volunteer as a soldier in the ARMY OF THE UNITED STATES, for the term of Three Years,
 DO DECLARE That I am 17 years and months of age; that I have
 never been discharged from the United States service on account of disability or by sentence of a
 court-martial, or by order before the expiration of a term of enlistment; and I know of no
 impediment to my serving honestly and faithfully as a soldier for three years.

GIVEN at Berlington Kentucky
 the 17 day of August 1864

Witness: J. P. Brown

Robert Coon
 By John S. H. Moore
 Capt. & In. Major
 Volunteered at Berlington Ky
August 17 1864
 No bounty given
Robert Coon (Slave)
 133

Consent of Parent or Guardian in case of a Minor, if a Free Man, or in the case of a Slave of the Person to whom he owes Service:

I, Wm Coon of Bowling Co Do CERTIFY, That I am
 the owner of Robert Coon
a Slave

that the said Robt. Coon is Seventeen years of age; and I
 do freely give my CONSENT to his volunteering as a SOLDIER in the Army of the United States,
 for the period of THREE YEARS, under the conditions of the laws of the United States.

GIVEN at Berlington Kentucky
 the 17 day of August 1864

Witness:

UNITED STATES COLORED TROOPS ENLISTMENT.

STATE OF

TOWN OF

Kentucky



Bexington
Bourbon County

I, Robert Coon born in Kentucky aged Seventeen years

in the State of Kentucky aged Seventeen years and by occupation a Laborer

Do HEREBY ACKNOWLEDGE to have volunteered 17th day of August 1864

to serve as a Soldier in the Army of the United States of America, for the period of THREE YEARS, unless sooner discharged by proper authority: Do also agree to accept such bounty, pay, rations, and clothing, as are, or may be, established by law for the U. S. colored troops.

And I, Robert Coon

do solemnly swear that I will bear true faith and allegiance to the United States of America, and that I will serve them honestly and faithfully against all their enemies or opposers whomsoever: and that I will observe and obey the orders of the President of the United States, and the orders of the officers appointed over me, according to the Rules and Articles of War.

Sworn and subscribed to, at Bexington Ky. this 17th day of Aug. 1864 Robert Coon his mark

Before Geo W Moore Capt. & Pro. Mar. 7 Dist. Ky. I CERTIFY, ON HONOR, That I have carefully examined the above named Volunteer agreeably to the General Regulations of the Army, and that, in my opinion, he is free from all bodily defects and mental infirmity, which would in any way disqualify him from performing the duties of a soldier.

J. J. Garro

EXAMINING SURGEON.

Robert Coon

I CERTIFY, ON HONOR, That I have minutely inspected the Volunteer, previously to his enlistment, and that he was entirely sober when enlisted; that, to the best of my judgment and belief, he is of lawful age, and that, in accepting him as duly qualified to perform the duties of an able-bodied soldier, I have strictly observed the regulations which govern the recruiting service. This soldier has 5 ft 10 in. eyes, Blue hair, Blue complexion, is 5 ft 10 in. tall, feet 10 in. high.

Geo W Moore Capt. & Pro. Mar. & RECRUITING OFFICER 7 Dist. Ky.

Mustered into the United States Service.....day of1864

Mustering Officer

Regiment of Volunteers, on the day of 1864, at Mustered into the service of the United States, for three years or during the war, from date of enlistment, in Company

Conn Thomas

Co *D*, 5 U. S. Col'd Cav.

Private Private

CARD NUMBERS.

5360667	26
5360764	27
5360853	28
5360949	29
5361039	30
5361126	31
5361213	32
5361303	33
5361387	34
5361469	35
5361551	36
9090100	37
40729586	38
	39
	40
	41
	42
	43
	44
	45
	46
	47
	48
	49
	50

Book Mark:

See also

C | **5 Cav.** | **U.S.C.T.**

Thomas Connor

....., Co. B, 5 Reg't U. S. Col'd Cav.

Appears on

Company Descriptive Book
of the organization named above.

DESCRIPTION.

Age 21 years; height 5 feet 5 inches.

Complexion Blk

Eyes Blk; hair Blk

Where born Bourbon Co Ky

Occupation Laborer

ENLISTMENT.

When Aug 17, 1864.

Where Lexington Ky

By whom Capt. Moore; term 3 y'rs.

Remarks:

.....

.....

.....

.....

.....

.....

.....

.....

6

5 Cav.

U.S.C.T.

Tom Conner

Quar., Co. B, 5 Reg't U. S. Col'd Cavalry.

Appears on

Company Muster-in and Descriptive Roll

of the organization named above. Roll dated

Camp Nelson, ^{Key} N. Y., Oct 24, 1864.

Where born Bourbon ^{Key}

Age 21 y'rs; occupation Laborer

When enlisted Aug 17, 1864.

Where enlisted Lexington

For what period enlisted 3 years.

Eyes Blue; hair Blue

Complexion Blue; height 5' ft. 5' in.

When mustered in Aug 17, 1864.

Where mustered in Lexington

Bounty paid \$ 100; due \$ 100

Where credited 7th Dist, Key

Company to which assigned B

Remarks: * Name of owner of Negro - William Conner

* Added May 12, 98 by H. J.

Book mark:

Lamb

6 | 5 Cav. | U.S.C.T.

Thomas Brown

Pew, Co. B, 5 Reg't U. S. Col'd Cavalry.

Appears on

Company Muster Roll

for Dec 31, 1864.

Present or absent Present

Stoppage, \$ 100 for

Due Gov't, \$ 100 for

Valuation of horse, \$ 100

Valuation of horse equipments, \$ 100

Remarks:

Book mark:

Lamb

6

5 Cav.

U.S.C.T.

Thomas Coon

Priv., Co. B, 5 Reg't U. S. Col'd Cavalry.

Appears on

Company Muster Roll

for Nov & Dec, 1864.

Present or absent Absent

Stoppage, \$ 100 for

Due Gov't, \$ 100 for

Valuation of horse, \$ 100

Valuation of horse equipments, \$ 100

Remarks: Sick in Knoxville Tenn, 1st & 2nd instal bounty due

Book mark:

Lamb

(358)

Copyist.

6

5 Cav.

U.S.C.T.

Thomas Brown

Priv, Co. B, 5 Reg't U. S. Col'd Cavalry.

Appears on

Company Muster Roll

for Jan & Feb, 1865.

Present or absent Present

Stoppage, \$ 100 for

Due Gov't, \$ 100 for

Valuation of horse, \$ 100

Valuation of horse equipments, \$ 100

Remarks: 1st instalment
county \$100 due

Book mark:

Lance

(358)

Copyist.

C

5 Cav. U.S.C.T.

Thomas Brown

Brown, Co. B, 5 Reg't U. S. Col'd Cavalry.

Appears on

Company Muster Roll

for Feb. 28 to Apr. 1, 1865.

Present or absent Present

Stoppage, \$ 100 for

Due Gov't, \$ 100 for

Valuation of horse, \$ 100

Valuation of horse equipments, \$ 100

Remarks: 1st instalment h
county due \$100

Book mark:

Lamb

5 | **5 Cav.** | **U.S.C.T.**

Thomas G. ...

Priv., Co. B, 5 Reg't U. S. Col'd Cavalry.

Appears on

Company Muster Roll

for *May & June, 1865.*

Present or absent *present*

Stoppage, \$ *100* for

Due Gov't, \$ *100* for

Valuation of horse, \$ *100*

Valuation of horse equipments, \$ *100*

Remarks: *Arrears installment from
by due \$100 -*

Book mark :

R. E. Wilson

6 | 5 Cav. | U.S.C.T.

Thomas Conner

Priv., Co. B, 5 Reg't U. S. Col'd Cavalry.

Appears on

Company Muster Roll

for July & Aug., 1865.

Present or absent present.

Stoppage, \$ 100 for

Due Gov't, \$ 100 for

Valuation of horse, \$ 100

Valuation of horse equipments, \$ 100

Remarks:

Book mark:

R. E. Wilson

6

5 Cav. U.S.C.T.

Thomas Brown

Pvt., Co. B, 5 Reg't U. S. Col'd Cavalry.

Appears on

Company Muster Roll

for Sept. & Oct., 1865.

Present or absent present

Stoppage, \$ 100 for

Due Gov't, \$ 100 for

Valuation of horse, \$ 100

Valuation of horse equipments, \$ 100

Remarks:

Book mark:

R. E. Wilson

5 | 5 Cav. | U.S.C.T.

Thomas Comu

Priv., Co. B, 5 Reg't U. S. Col'd Cavalry.

Appears on

Company Muster Roll

for Nov. & Dec., 1865.

Present or absent present

Stoppage, \$ 100 for

Due Gov't, \$ 100 for

Valuation of horse, \$ 100

Valuation of horse equipments, \$ 100

Remarks: Due U.S. for ordnance \$7.72

Book mark:

R. E. Wilson

4 | 5 Cav. | U.S.C.T.

Thomas Gunn

Plt, Co. B, 5 Reg't U. S. Col'd Cavalry.

Appears on

Company Muster Roll

for Jan, Feb, 1866.

Present or absent Present

Stoppage, \$ 100 for

Due Gov't, \$ 100 for

Valuation of horse, \$ 100

Valuation of horse equipments, \$ 100

Remarks:

Book mark:

(358)

copyist

Copyist.

C. | 5 Cav. | U.S.C.T.

Thomas Conn.

Priv., Co. B, 5 Reg't U. S. Colored Cav.

Appears on Returns as follows:

Dec. 1864. & Jan. 1865. Went sick,
Hosp. Knoxville, Tenn.

Book mark:

(546)

A. Baker
Copyist.

C

5 Cav.

U.S.C.T.

Thomas Conn

Pvt, Co. D, 5 Reg't U. S. Col'd Cavalry.

Appears on Co. Muster-out Roll, dated

Helena Ark, Mar 16, 1864.

Muster-out to date Mar 16, 1864.

Last paid to Dec 31, 1863.

Clothing account:

Last settled....., 186 ; drawn since \$..... 100

Due soldier \$..... 100; due U. S. \$ 31 11/100

Am't for cloth'g in kind or money adv'd \$..... 100

Due U. S. for arms, equipments, &c., \$ 1 18/100

Bounty paid \$ 100; due \$ 100

Remarks: *Given up 19. 1861*
Due U.S. for Cred \$ 1. 18

Book mark: *C. 369. 13m. 4. June 21. 66*

Thomas Conn

Com, Tom

P., Co.

Reg't

21st

Enclosures.

Bed Cards	Final Statements
Burial Records	Furloughs or L. of A.
Certs. of Dis. for Discharge	Med. Certificates
C. M. Charges	Med. Des. Lists
Descriptive Lists	Orders
Discharge Certificates	Pris. of War Record
Enlistment Papers	Resignations

Other papers relating to—

Admission to Hosp'l	Furlough or L. of A.
Casualty Sheet	Med. Examination
Confinement	Misc. Information
Contracts	Pay or Clothing
Death or Effects	Personal Reports
Desertion	Rank
Discharge from Hosp'l	Transfer to Hosp'l
Discharge from Service	Transfer to V. R. C.
Duty	Transportation

Note 1.—This blank will be used by the Adjutants of United States colored troops. There will be made out in duplicate in all cases—one to accompany the recruiting return of the superintendent and one for the recruiting officer to the Adjutant General, and one to accompany the returns of the officer who pays bounty, &c.

Note 2.—An enlistment holds to service. A muster-in must, in all cases, precede payment of pay, bounty, pension, &c. A muster-in roll, must in all cases, be filed in the Adjutant General's Office as evidence of muster-in. The mustering officer, commissary, or assistant commissary of purchases, as the case may be, will countersign both enlistments of having mustered the soldiers into the service of the United States in duplicate of them is given to the discharging officer.

DECLARATION OF RECRUIT.

I, Tom Conn desiring to volunteer as a soldier in the ARMY OF THE UNITED STATES, for the term of Three Years, DO DECLARE That I am 21 years and months of age; that I have never been discharged from the United States service on account of disability or by sentence of a court-martial, or by order before the expiration of a term of enlistment; and I know of no impediment to my serving honestly and faithfully as a soldier for three years.

GIVEN at Seymour Kentucky the 19 day of August 1864

Witness: J. R. Moore

Tom Conn

By Wm. H. Moore
 No. 1334
 Adjutant General's Office
 U. S. Army

Tom Conn (Slave)
 1334

Consent of Parent or Guardian in case of a Minor, if a Free Man, or in the case of a Slave of the Person to whom he owes Service:

I, William Conn of Bourbon Do CERTIFY, That I am the Owner of Tom Conn a Slave

that the said Tom Conn is Twenty one years of age; and I do freely give my CONSENT to his volunteering as a SOLDIER in the Army of the United States, for the period THREE YEARS, under the conditions of the Laws of the United States.

GIVEN at the day of

Witness:

UNITED STATES COLORED TROOPS ENLISTMENT.

STATE OF

TOWN OF

Kentucky



Lexington

I, *Tom Conn*

born in

Boalsboro County

in the State of

Kentucky

aged

Twenty one years

and by occupation a

Laborer

Do HEREBY ACKNOWLEDGE to

have volunteered

17

day of

August

186*4*

to serve as a **Soldier** in the **Army of the United States of America**, for the period of **THREE YEARS**, unless sooner discharged by proper authority: Do also agree to accept such bounty, pay, rations, and clothing, as are, or may be, established by law for the U. S. colored troops.

And I, *Tom Conn*

do solemnly swear that I will bear true faith and allegiance to the **United States of America**, and that I will serve them honestly and faithfully against all their enemies or opposers whomsoever: and that I will observe and obey the orders of the President of the United States, and the orders of the officers appointed over me, according to the Rules and Articles of War.

Sworn and subscribed to, at

Lexington Ky

this

17

day of

Aug. 1864

Tom Conn

Before

Geo H Moore

Capt. & Prov. Mar. 7 Dist. Ky.

I CERTIFY, ON HONOR, that I have carefully examined the above named Volunteer agreeably to the General Regulations of the Army, and that, in my opinion, he is free from all bodily defects and mental infirmity, which would in any way disqualify him from performing the duties of a soldier.

J. J. Gano

EXAMINING SURGEON.

I CERTIFY, ON HONOR, That I have minutely inspected the Volunteer, previously to his enlistment, and that he was entirely sober when enlisted; that, to the best of my judgment and belief, he is of lawful age; and that, in accepting him as duly qualified to perform the duties of an able-bodied soldier, I have strictly observed the regulations which govern the recruiting service. This soldier has *five* eyes, *dark* hair, *dark* complexion, is *five* feet *5* inches high.

Geo H Moore

Capt. & Prov. Mar. 7 Dist. Ky.

Mustered into the United States Service.....day of.....186

Mustering Officer

Mustered into the service of the United States, for three years or during the war, from date of enlistment, in Company
Regiment of
Volunteers, on the day of 186*4*, at

290

Comner Andrew

Co C, 5 U. S. Col'd Cav.

Private Private

CARD NUMBERS.

1	5361659	26
2	5361761	27
3	5361859	28
4	5361958	29
5	5362041	30
6	5362123	31
7	5362205	32
8	5362297	33
9	5362385	34
10	5362470	35
11	5362554	36
12	9090190	37
13	43145787	38
14	43146226	39
15	40729589	40
16		41
17		42
18		43
19		44
20		45
21		46
22		47
23		48
24		49
25		50

Book Mark:

See also

8.623339 2" aud.
8641142. P.O.
S. 1367705. P.O. ret'd

RMP 327057

82479105 P.O. aff

82481669 P.O. aff

Company En

C | **5 Cav. | U.S.C.T.**

Pedro Connor

....., Co. C, 5 Reg't U. S. Col'd Cav.

Appears on

Company Descriptive Book
of the organization named above.

DESCRIPTION.

Age 35 years; height 5 feet 7 inches.

Complexion Blk

Eyes Blk; hair Blk

Where born Adair Co, Ky

Occupation Farmer

ENLISTMENT.

When Aug. 1, 1864.

Where Lebanon

By whom Lt Crocker; term 3 y'rs.

Remarks:

.....

.....

.....

.....

.....

.....

.....

.....

.....

.....

.....

.....

.....

.....

.....

.....

.....

.....

.....

.....

.....

.....

.....

.....

.....

.....

.....

.....

.....

.....

.....

.....

.....

.....

.....

.....

.....

.....

.....

.....

.....

.....

.....

.....

.....

.....

Connor

6 | 5 bar | 1864

Andrew Conner

Appears with rank of _____ on

Muster and Descriptive Roll

of Detachment of U.S. Colored
Volunteer Recruits for-
warded

Roll dated
Lebanon Ky Aug 31, 1864

Where born Adair Ky

Age 35 years; occupation farmer

When enlisted Aug 1, 1864

Where enlisted Lebanon, Ky

For what period enlisted 3 years.

Eyes *Blk*; hair *Blk*

Complexion *Blk*; height 5 ft. 7 in.

When mustered in Aug 1, 1864

Where mustered in Lebanon Ky

Bounty paid \$ 100; due \$ 100

Clothing account:

Last settled _____, 1864; drawn since \$ 14²⁵/₁₀₀

Date of first muster Aug 1, 1864

Company to which assigned _____

Remarks: Owner, Heirs of Fielder
Conner,

Residence, Adair Co.
Without consent
(over)

Book mark: _____

(356m)

L. D. Garrison
Copyist.

OCT - 8.

43145787

1906.

4 long list, Ky

6 | 5 bar | U.S.C.T.

Andrew Corner

Appears with rank of Pr on

Muster and Descriptive Roll

of a Detachment of U.S. Colored
Troops transferred to U.S. Colored
Cor. at Lexington, Ky. Roll dated
Fruinville, Ky., Sept. 2, 1864.

Where born Adair, Ky.

Age 25 years; occupation Farmer

When enlisted Aug. 1, 1864.

Where enlisted Zebanon

For what period enlisted 3 years.

Eyes Blue; hair Blue

Complexion Blue; height 5 ft. 7 in.

When mustered in Aug. 1, 1864.

Where mustered in Zebanon

Bounty paid \$ 100; due \$ 100

Clothing account:

Last settled _____, 1864; drawn since \$ 14²⁵/₁₀₀

Date of first muster Aug. 1, 1864.

Company to which assigned _____

Remarks: credited to 4 Com. Dist.
Ky.

Book mark: _____

B. J. Steiner

(356m)

Copyist.

6

5 Cav.

U.S.C.T.

Andrew Conner

Pvt, Co. C, 5 Reg't U. S. Col'd Cavalry.

Appears on

Company Muster-in and Descriptive Roll

of the organization named above. Roll dated

Camp Nelson, ^{Ky} N.Y., Oct. 24, 1864.

Where born Adair, Ky.

Age 35 y'rs; occupation Farmer

When enlisted Aug. 1, 1864.

Where enlisted Lebanon

For what period enlisted 3 years.

Eyes Blk; hair Blk.

Complexion Blk; height 5 ft. 7 in.

When mustered in Aug. 1, 1864.

Where mustered in Lebanon

Bounty paid \$100; due \$100

Where credited 4th Dist. Ky.

Company to which assigned C

Remarks:

Book mark: M 957 Ky

Shill

6 | **5 Cav. | U.S.C.T.**

Andrew Connor

Pris, Co. C, 5 Reg't U. S. Col'd Cavalry.

Appears on

Company Muster Roll

for *to Oct. 31*, 186*4*.

Present or absent *Present*

Stoppage, \$ *100* for

Due Gov't, \$ *100* for

Valuation of horse, \$ *100*

Valuation of horse equipments, \$ *100*

Remarks:

Book mark:

Small

Andrew Conner

Pvt, Co. C, 5 Reg't U. S. Col'd Cavalry.

Appears on

Company Muster Roll

for *Nov. 1 Dec.*, 1864.

Present or absent *Absent*

Stoppage, \$ *100* for

Due Gov't, \$ *100* for

Valuation of horse, \$ *100*

Valuation of horse equipments, \$ *100*

Remarks: *Sick in Hospital Camp
Newm, Ky. First & Second in-
status cuts of bounty due
Due U.S. for Insurance
17.93*

Book mark:

Shull

Andrew Cannon

Private, Co. C, 5 Reg't U. S. Col'd Cavalry.

Appears on

Company Muster Roll

for *January & February*, 186*5*.

Present or absent *Present*

Stoppage, \$ *100* for

Due Gov't, \$ *100* for

Valuation of horse, \$ *100*

Valuation of horse equipments, \$ *100*

Remarks: *First instalment
Bounty due \$100*

Book mark:

Shull

6

5 Cav.

U.S.C.T.

Andrew Connor

Pis's, Co. C, 5 Reg't U. S. Col'd Cavalry.

Appears on

Company Muster Roll

for Mar. & Apr., 1865.

Present or absent Present

Stoppage, \$ 100 for

Due Gov't, \$ 100 for

Valuation of horse, \$ 100

Valuation of horse equipments, \$ 100

Remarks: First instalment of
Bounty due \$100

Book mark:

Shull

(358)

Copyist.

6 | 5 Cav. | U.S.C.T.

Andrew Connor

Det., Co. C, 5 Reg't U. S. Col'd Cavalry.

Appears on

Company Muster Roll

for *May & June*, 186*9*.

Present or absent *Present*

Stoppage, \$ *100* for

Due Gov't, \$ *100* for

Valuation of horse, \$ *100*

Valuation of horse equipments, \$ *100*

Remarks: *First instalment of
Dormitory due \$100*

Book mark:

Guiden

6 | 5 Cav. | U.S.C.T.

Andrew Connor

Private, Co. C, 5 Reg't U. S. Col'd Cavalry.

Appears on

Company Muster Roll

for July and Aug, 1865

Present or absent Present

Stoppage, \$ 100 for

Due Gov't, \$ 100 for

Valuation of horse, \$ 100

Valuation of horse equipments, \$ 100

Remarks:

Book mark:

Linden

(358)

Copyist.

6 | 5 Cav. | U.S.C.T.

Andrew Connor

Private, Co. C, 5 Reg't U. S. Col'd Cavalry.

Appears on

Company Muster Roll

for Sep. + Oct., 1865

Present or absent Present

Stoppage, \$ 100 for

Due Gov't, \$ 100 for

Valuation of horse, \$ 100

Valuation of horse equipments, \$ 100

Remarks:

Book mark:

(358)

Linder

Copyist.

5 Cav. U.S.C.T.

Andrew Connor

Plk., Co. C, 5 Reg't U. S. Col'd Cavalry.

Appears on

Company Muster Roll

for Nov Dec, 1865.

Present or absent Present

Stoppage, \$ 100 for

Due Gov't, \$ 100 for

Valuation of horse, \$ 100

Valuation of horse equipments, \$ 100

Remarks: In U.S. Army
Camp and War
"grip" #2 - x

x Roll mutilated

Book mark:

J. J. J. J.

C | **5 Cav.** | **U.S.C.T.**

Andrew Connor

Pat, Co. C, 5 Reg't U. S. Col'd Cavalry.

Appears on

Company Muster Roll

for *Jan and Feb*, 186 *6*

Present or absent *Present*

Stoppage, \$ *100* for

Due Gov't, \$ *100* for

Valuation of horse, \$ *100*

Valuation of horse equipments, \$ *100*

Remarks:

Book mark:

Rose

C | 5 Cav. | U.S.C.T.

Andrew Connor.

Plt., Co. C, 5 Reg't U. S. Colored Cav.

Appears on Returns as follows:

Dec. 1864 & Jan. 1865. Absent sick
in Hosp., Camp Nelson, Ky.

Sept. 1865. Absent, detached at
Lexington, Ky.

Oct. 1865. Absent, orderly at Brig.
Hdqrs., S. C. 13, Hdqrs. 1 B.,
1 Div. D. Ky.

Book mark :

A. Baker

Copyist.

C | 5 Cav. | U.S.C.T.

Andrew Connor

Put, Co. C, 5 Reg't U. S. Col'd Cavalry.

Appears on Co. Muster-out Roll, dated

Helena Ark. March 16, 1866.

Muster-out to date March 16, 1866.

Last paid to Dec 31, 1865.

Clothing account:

Last settled....., 186 ; drawn since \$..... 100

Due soldier \$..... 100; due U. S. \$ 77 ⁰⁹/₁₀₀

Am't for cloth'g in kind or money adv'd \$..... 100

Due U. S. for arms, equipments, &c., \$..... 100

Bounty paid \$ 100 ¹⁰⁰/₁₀₀; due \$ 100 ¹⁰⁰/₁₀₀

Remarks: See US for Ord 954

Book mark: M. 957. Ky

Roses

Bonner, Andrew

P, Co. *C*, **5** Reg **U.S.C. Cav.**

3 Enclosures.

Bed Cards	Descriptive Lists
Burial Records	Final Statements
Certs. of Dis. for Discharge	Furloughs
C. M. Charges	Med. Des. Lists
Med. Certificates	Orders

See papers 1

Other papers relating to—

Admission to Hosp'l	Furlough
Casualty Sheet (Officer's)	Med. Examination
Confinement	Misc. Information
Contracts	Pay or Clothing
Death or Effects	Personal Reports
Desertions	Rank
Discharge from Hosp'l	Transfer to Hosp'l
Discharge from Service	Transfer to V. R. C.
Duty	Transportation

Note 1.—This blank will be used for enlistments of United States colored troops. They will be made out in duplicate in all cases—one to accompany the recruiting return of the superintendent (not the recruiting officer) to the Adjutant General, and one to accompany the accounts of the officer who pays bounty, &c.

Note 2.—An enlistment holds to service. A muster-in roll, in all cases, for the payment of pay, bounty, fension, &c. A muster-in roll, must in all cases, be filed in the Adjutant General's Office as evidence of muster-in. The recruiting officer, commissary, or assistant commissary of musters, as the case may be, will countersign both columns as having received the soldiers into the service of the United States before either of them is given to the disbursing officer.

DECLARATION OF RECRUIT.

I, Andrew Connor desiring to volunteer as a soldier in the ARMY OF THE UNITED STATES, for the term of Three Years, DO DECLARE That I am 35 years and _____ months of age; that I have never been discharged from the United States service on account of disability or by sentence of a court-martial, or by order before the expiration of a term of enlistment; and I know of no impediment to my serving honestly and faithfully as a soldier for three years.

GIVEN at Seaboard Va the 28 day of August 1864

Witness: [Signature]

Andrew Connor
No. 111
Volunteered at Seaboard Va
August 28 1864
By [Signature]
235.

Business name
Henry Pickles Connor
Whitcomb Connor

Consent of Parent or Guardian in case of a Minor, if a Free Man, or in the case of a Slave, of the Person to whom he owes Service:

I, _____ Do CERTIFY, That I am the _____ that the said _____ is _____ years of age; and I do freely give my CONSENT to his volunteering as a SOLDIER in the Army of the United States, for the period of THREE YEARS, under the conditions of the laws of the United States.

GIVEN at _____ the _____ day of _____

Witness: _____

UNITED STATES COLORED TROOPS ENLISTMENT.

STATE OF



TOWN OF

I, Andrew Conner born in Adair County
 in the State of Mo aged 35 years
 and by occupation a Farmer Do HEREBY ACKNOWLEDGE to
 have volunteered 1st day of August 1864
 to serve as a **Soldier** in the **Army of the United States of America**, for the
 period of **THREE YEARS**, unless sooner discharged by proper authority: Do
 also agree to accept such bounty, pay, rations, and clothing, as are, or may be,
 established by law for the U. S. colored troops.

And I, Andrew Conner
 do solemnly swear that I will bear true faith and allegiance to the **United States
 of America**, and that I will serve them honestly and faithfully against all their
 enemies or opposers whomsoever; and that I will observe and obey the orders
 of the President of the United States, and the orders of the officers appointed
 over me, according to the Rules and Articles of War.

Sworn and subscribed to, at Sebanon Mo
 this 1st day of August 1864 Andrew Conner
 Before Rufus Crocker notary

I CERTIFY, ON HONOR, that I have carefully examined the above named Volunteer agree-
 ably to the General Regulations of the Army, and that, in my opinion, he is free from all bodily
 defects and mental infirmity, which would in any way disqualify him from performing the
 duties of a soldier.

John C. Maxwell

EXAMINING SURGEON.

I CERTIFY, ON HONOR, That I have minutely inspected the Volunteer, Andrew Conner
 previously to his enlistment, and that he was entirely sober when enlisted; that, to the best of
 my judgment and belief, he is of lawful age; and that, in accepting him as duly qualified to per-
 form the duties of an able-bodied soldier, I have strictly observed the regulations which govern
 the recruiting service. This soldier has blue eyes, black hair, light com-
 plexion, is 5 feet 7 inches high.

Rufus Crocker
Lt 7th Reg Col Prov RECRUITING OFFICER OR AGENT.

Mustered into the United States Service 1st day of August 1864.

Rufus Crocker
Lt 7th Reg Col Prov Mustering Officer

Mustered into the service of the United States, for three years or during the war, from date of enlistment, in Company
 Regiment of Volunteers, on the day of 1864, at

7th Div 1st Bn 1st Div Jky
Lx Jky Oct 30. 65

Special Order 23

Relieving Pri Andrea Connor
Co C 5th Cav from duty at
Brigade Hd Qrs

^{1st Regt}
Head-Quarters First Division Department of Ky.

Lexington, Ky., Oct 30th 1865.

SPECIAL ORDERS, }

No. 23

"EXTRACT"

III. Capt. Andrew Lamer, Co. 5th Md. Inf., is hereby relieved from duty at this Hd. Qrs. and will report to the commanding Officer of his company for duty without delay.

By Command of
John Jay Smith, Jr., Major,
Howard Smith
Capt. and A. A. A. G.

War Department,

ADJUTANT GENERAL'S OFFICE,

Washington, Feb'y 5. 1867.

Respectfully returned to the Commission for the State of Kentucky with the information that Andrew Conner was enlisted at Lebanon Ky August 1st 1864 and was mustered in as prv. in Co. "C" 5th U.S.C. Cav. Aug 1st '64

104
957

A. Rose

1863. 2

Asst. Adj't General.

No. 557

APPLICATION OF

Robt Miller

FOR COMPENSATION FOR SLAVE,
Named Andrew Conner
enlisted August 1 1864
In Com. Co, 5th Regiment,
U. S. COLORED TROOPS.

Received Jan'y 15, 1867.

Compensation Awarded

Tellus.

President of Board of Claims.

Claimant's Attorney,

Claimant's Post-office Address,

Robert Miller

Columbia Adams Co

Kentucky

FRANKFORT COMMONWEALTH PRINT.

No.

CLAIM OF

Robert Miller Administrator with the Will annexed of F. S. Conner

FOR THE COMPENSATION OF SLAVE NAMED

Andrew Conner

I. Robert Miller Adm^r with the Will annexed of F. S. Conner dec^d a loyal citizen, and a resident of Columbia, County of Meigs, State of Kentucky, hereby claim compensation, under the provisions of Section 21, act approved February 24, 1864, and section 2, act approved July, 28, 1866, for my slave Andrew Conner, enlisted 1st August, 1864, at Lebanon Ky, by St. R. Lelescher in the 5th regiment U. S. Colored Troops, Co. C;

certificate of which enlistment, and a descriptive list, as required, accompany this application. That I did not acquire said slave subsequent to said enlistment, but had a valid title to him at the date of said enlistment, and previous thereto: I having acquired my title to him and my ownership over him as follows, to-wit:

I am the Administrator with the Will annexed of F. S. Conner dec^d and as such said Andrew Conner came into my hands, as a gift, under the Will of said testator, in September 1863, and continued in my possession under my control as Adm^r up to and at the time of his enlistment aforesaid - Said, F. S. Conner was an unwavering Union Man and loyal to the Government of the United States up to his death.

In proof of my loyalty to the Constitution and Government of the United States, I present the accompanying oath, which I have taken, signed and acknowledged; to be filed with this application, in accordance with requirement of General Orders, No. 329, 1863, War Department, Adjutant General's Office. - Said F. S. Conner left two children at his death both of whom are now infants under 14 years of age.

Dec. 24th 1866

Robt Miller Adm^r of F. S. Conner dec^d

OATH OF ALLEGIANCE.

I. Robert Miller, the owner and Claimant, do solemnly swear that the foregoing claim is a just and true claim due to me as master and owner of the said slave, and that the facts alleged in said claim in respect to the draft or enlistment (as the case may be) of said slave into the Military service of the United States are true. And I do further swear that I have never joined, or been concerned in, any insurrection or rebellion; that I have never borne arms against the United States; that I have never given any aid, countenance, counsel or encouragement to any person or persons engaged, or whom I had reason to believe were about to engage, in insurrection, rebellion or armed hostility against the United States; that I have neither sought, nor accepted, nor attempted to exercise the functions of any office, civil or military, nor to perform any service whatever, under any authority or pretended authority in hostility to the United States; that I have not yielded a voluntary support to any insurrection, rebellion or pretended government, authority, power or constitution within the United States hostile thereto. And I do further swear that, to the best of my knowledge and ability, I have supported and defended, and will continue to support and defend, the United States against all enemies, foreign and domestic; and that I have supported, defended and obeyed, and will continue to support, defend and obey, the Constitution and laws of the United States; that I will bear true faith and allegiance to the same; and that I take this oath freely, without any mental reservation or purpose of evasion: So help me God.

Robt Miller

Sworn to and subscribed before me, at Columbia Ky, this 24th day of December, 1866.

R. H. Martin Notary Public



CERTIFICATE OF ENLISTMENT.

County of *Adair* Ky *Std.*
August 1st, 1864.

I certify, on honor, that *Heirs of Fielder Conner*
a citizen of *Adair* county, State of *Kentucky* ~~and~~ this day
had his ~~voluntarily offered his (or her)~~ slave, known as *Andrew Conner*
offer himself for enlistment into the SERVICE OF THE UNITED STATES, and that said slave has, after a careful *personal inspection*, been duly enlisted by me to serve in the ARMY OF THE UNITED STATES for the period of THREE YEARS OR DURING THE WAR.

Saml W. Hiler
~~is~~ *Capt and Pres Mar 2d* Reg't U. S. Col. Troops Recruiting Officer.

I certify, on honor, that I have carefully examined the above-named colored recruit, agreeably to the General Regulations of the Army, and that, in my opinion, he is free from all bodily defects and mental infirmity which would in any way disqualify him from performing the duties of a soldier.

John C. Maxwell
Examining Surgeon.

I hereby certify that the above-named recruit was duly mustered into the service of the United States on this *1st* day of *August*, 1864, to serve for *three years or during the war*.

Saml W. Hiler
Capt and Pres Mar 2d Mustering Officer.

NOTE 1.—The Mustering Officer will require the alleged owner, before furnishing him with this certificate, to make oath that the slave named is his property.

NOTE 2.—The Recruiting Officer will, after the recruit has been duly enlisted, furnish the owner with a descriptive list of the recruit, made out on the usual printed form, in addition to the foregoing certificate.

NOTE 3.—These certificates to be made in duplicate by the Recruiting Officer; one copy to be forwarded to the Mustering Officer, who, after mustering the recruit into service, will forward it, duly signed, to the Bureau for Colored Troops; the other copy to be given to the owner of said slave, who, after obtaining the certificate of the Surgeon and Mustering Officer thereto, will present it to the Board, accompanied with a valid deed of manumission and proof of title to the services of the person enlisted, together with an oath of allegiance to the Government of the United States; and having obtained the award of the Board thereon, will forward all the papers in the case to the Bureau for Colored Troops.

NOTE 4.—This certificate in no case to be given to a disloyal person, or to one who has been engaged in rebellion against the Government of the United States, or who has given aid or comfort to the enemies of said Government.

Headquarters Kentucky Volunteers,

Adjutant-General's Office,

Frankfort, Decr 20th, 1866.

I hereby certify, that it appears from the U. S. Muster-
in Polls on file in this Office, that Andrew Conner
was enrolled on the 12th day of August, 1864, at
Lebanon Ky, by Lt Crocker
and mustered into the U. S. service on the 12th day of Augt
1864, at Lebanon Ky, by Lt R. C. Crocker
to serve three years. Said Andrew Conner
is described as follows: Age, 35 years; eyes, black; hair, black;
complexion, black; height, 5 feet 7 inches. It further
appears from said Polls, that Andrew Conner owed service
to Heirs of Fielder Conner, was credited to Adair
County, Ky., and was assigned to Co. "C", 5th Regiment
U. S. C. Cavalry

In Testimony Whereof, I have hereunto set my
hand, and affixed my Official Seal, this
20th day of Decr, 1866.

D. W. Linasy
Adjutant General of Kentucky.

B. 40, R. 268



Kentucky Adair County Oct
County Court Special Term, September 14th 1868
William Stewart the executor mentioned in the
true last will & testament of J. S. Connor because
which was proved and ordered to be recorded at
the last regular term of this court. This day came
into court, and declined to qualify as executor of
said decedent's will. On the motion of Robert
Miller ordered that he be and he is hereby appointed
Administrator with the will annexed of said decedent.
Thereupon the said Robert Miller being in court
took the oath required by law, and executed and
acknowledged a covenant to the Commonwealth
of Kentucky with Samuel B. Field, Jesse Murrell
& Geo. R. Page his Sureties conditioned as required
by law. - A copy attested of W. Butler, C. C. C.

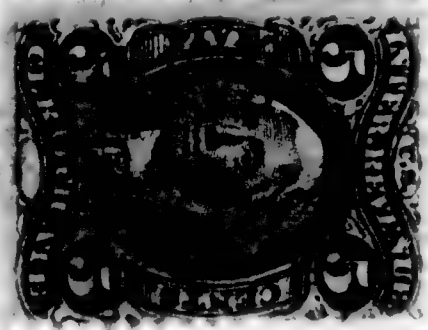

PROOF OF OWNERSHIP.

STATE OF KENTUCKY,

COUNTY OF *Adair*

} SS.

We *Wm Stewart* and *Geo R Page* each of lawful

age, and resident citizens of the State and County aforesaid, do certify that *Robert Miller* as *Surv of F.S. Courser* of the State and County aforesaid, was on the *1st* day of *August* 1864, the lawful owner of the slave named *Andrew Combs*; referred to and described in the foregoing claim for compensation.

Wm Stewart
Geo R Page

Sworn to and subscribed before me a *Notary Public* for the County of *Adair* State of Kentucky, this the *24th* day of *Dec* 186*6*

R. H. Martin Notary Public

5 CENT STAMP.



PROOF OF LOYALTY.

STATE OF KENTUCKY,

COUNTY OF *Adair*

} SS.

We *Wm Stewart* and *Geo R Page* loyal men and

each of lawful age, and resident citizens of the _____ of _____ in the State and County aforesaid, upon our oaths declare that we have known *Robert Miller* a resident of the State and County aforesaid, since the 4th day of March, 1861, and know that he has firmly and faithfully maintained his ~~own~~ adherence and allegiance to the Government of the United States, by defending its cause against the Government and forces of the so-called Confederate States of America, in all suitable and practicable ways, and according to his ~~own~~ ability and opportunity. *and we furthermore make the same statements in regard to the loyalty of F.S. Courser up to his death in the year 1863.*

Geo R Page

Sworn to and subscribed before me a *Notary Public* for the county of *Adair* State of Kentucky, this the *24th* day of *December* 186*6*.

R. H. Martin Notary Public

5 CENT STAMP.

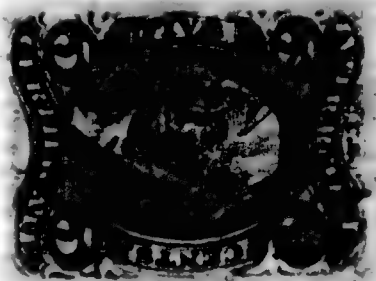

POWER OF ATTORNEY.

My Post-Office address is *Columbia* County of *Adair* State of Kentucky, and I hereby direct that all communications to me, touching this claim, be sent under cover to *Stewart to my address*, who is hereby appointed and constituted my true and lawful attorney, to prosecute this claim for me, and who is hereby authorized and empowered to receive and receipt for any award, order, draft, certificate, voucher, warrant, papers or money that may be issued in the adjustment of this claim, or the payment thereof, the same as I might or could do in person were I present and acting for myself, and to file any additional evidence or papers that may be required in the prosecution of this claim.

[WITNESS.]

The owner signs here.

Robert Miller

50 CENT STAMP.

Two witnesses to owner's signature sign here.

Conner John

Co. 5 U. S. Col'd Cav.

Private Corporal

CARD NUMBERS.

1	5367802	26
2	5367898	27
3	5367998	28
4	5368091	29
5	5368183	30
6	5368279	31
7	5368370	32
8	5368444	33
9	5368527	34
10	5368614	35
11	5368696	36
12	9090966	37
13	9221599	38
14	43143218	39
15	40729640	40
16		41
17		42
18		43
19		44
20		45
21		46
22		47
23		48
24		49
25		50

Book Mark:

See also

6 | 5 Cav. | U.S.C.T.

John Connor
....., Co. *D*, 5 Reg't U. S. Col'd Cav.

Appears on

Company Descriptive Book
of the organization named above.

DESCRIPTION.

Age *24* years; height *5* feet *10* inches.

Complexion *Copper*

Eyes *Brown*; hair *Black*

Where born *Washington City*

Occupation *Farmer*

ENLISTMENT.

When *June 28, 1864.*

Where *Lebanon*

By whom *Capt. Fuller*; term *3* y'rs.

Remarks: *Promotion to Corp.*

6 | 56ar
108 | U.S.C.T.

John Bonner

, Co. *A*, 108 Reg't U. S. Col'd Infantry.

Appears on

Company Descriptive Book

of the organization named above.

DESCRIPTION.

Age *20* years; height *5* feet *9* inches.

Complexion *Yellow*

Eyes *Bru*; hair *Blk*

Where born *Washington Co. Ky*

Occupation *Farmer*

ENLISTMENT.

When *June 28*, 186*4*

Where *Lebanon*

By whom *Capt Fidler*, term *3* y'rs

Remarks:

Enlisted for 108th U.S.C.T.
Transferred to 5th U.S.C. Cavalry
August 2, 1864, per S.O. 192, Head
Quarters 1st of Ky.

D. M. Kennedy
Compt.

6 | 5 bar U.S. C.T.

John Connor

Appears with rank of _____ on

Muster and Descriptive Roll

of a Detachment of U.S. Col'd Vol
recruits forwarded

Roll dated
Lebanon Ky, June 28, 1864.

Where born Washington Ky

Age 20 years; occupation Farmer

When enlisted June 28, 1864.

Where enlisted Lebanon Ky

For what period enlisted 3 years.

Eyes Brown; hair Blk

Complexion Blk; height 5 ft. 9 in.

When mustered in _____, 186 .

Where mustered in _____

Bounty paid \$ 100; due \$ 100

Clothing account:

Last settled _____, 186 ; drawn since \$ 13 58 / 100

Date of first muster June 28, 1864.

Company to which assigned _____

Remarks Owners name and residence

Sam Durham, Taylor

Enlisted without consent of owner

4th Dist Ky

Book mark: _____

(356m)

L. Murdock

Copyist.

C. | **5 Cav.** | **U.S.C.T.**

John Conner
....., Co. *I*, 5 Reg't U. S. Col'd Cavalry.

Appears on

Company Muster-in and Descriptive Roll

of the organization named above. Roll dated

Cp. Nelson, Ky., Oct. 31, 1864.

Where born *Washington, Ky.*

Age *20* y'rs; occupation *Farmer*

When enlisted *June 28*, 1864.

Where enlisted *Sebanon*

For what period enlisted *3* years.

Eyes *Brown*; hair *Black*

Complexion *Yellow*; height *5* ft. *9* in.

When mustered in *June 28*, 1864.

Where mustered in *Sebanon*

Bounty paid \$ *100*; due \$ *100*

Where credited *4th Dist. Kentucky.*

Company to which assigned

Remarks:

Enlisted for 108th U.S.C.T.

Transferred to 5th U.S.C. Cavalry

August 12, 1864. per S. G. 192. Head

Quarters Dist. of Ky.

Book mark:

(356d)

Philipson

Copyist.

C. | **5 Cav.** | **U.S.C.T.**

John Combes

Priv., Co. I, 5 Reg't U. S. Col'd Cavalry.

Appears on

Company Muster Roll

for *Organization to Oct. 31, 1864.*

Present or absent *Present.*

Stoppage, \$ 100 for

Due Gov't, \$ 100 for

Valuation of horse, \$ 100

Valuation of horse equipments, \$ 100

Remarks:

Book mark:

Philipson

(358)

Copyist.

C. | **5 Cav.** | **U.S.C.T.**

John Connor
Prv., Co. I, 5 Reg't U. S. Col'd Cavalry.

Appears on

Company Muster Roll

for *Nov. & Dec.*, 186*4*.

Present or absent *Present*

Stoppage, \$ 100 for

Due Gov't, \$ 100 for

Valuation of horse, \$ 100

Valuation of horse equipments, \$ 100

Remarks: *1st + 2^d installment*
Bounty due.

Book mark:

Philipsen

(358)

Copyist.

6

5 Cav.

U.S.C.T.

John Connor

Prs, Co. I, 5 Reg't U. S. Col'd Cavalry.

Appears on

Company Muster Roll

for *Jan. & Feb.*, 1865.

Present or absent *Present*

Stoppage, \$ 100 for

Due Gov't, \$ 100 for

Valuation of horse, \$ 100

Valuation of horse equipments, \$ 100

Remarks: *1st + 2^d installments
\$300⁺ Bounty due.*

Book mark:

Philipsen

6 | **5 Cav. | U.S.C.T.**

John Connor

Pr., Co. I, 5 Reg't U. S. Col'd Cavalry.

Appears on

Company Muster Roll

for Mch. + Apl., 1865.

Present or absent Present

Stoppage, \$ 100 for

Due Gov't, \$ 100 for

Valuation of horse, \$ 100

Valuation of horse equipments, \$ 100

Remarks: 1st installment
Bounty due.

Book mark:

Philipsen

3

5 Cav. U.S.C.T.

John Connor

Plt, Co. I, 5 Reg't U. S. Col'd Cavalry.

Appears on

Company Muster Roll

for May 1st June, 1865.

Present or absent Present

Stoppage, \$ 100 for

Due Gov't, \$ 100 for

Valuation of horse, \$ 100

Valuation of horse equipments, \$ 100

Remarks: Install bounty due \$100-

Book mark:

Handwritten signature

O

5 Cav. U.S.C.T.

John Connor

Pr, Co. I, 5 Reg't U. S. Col'd Cavalry.

Appears on

Company Muster Roll

for *July & Aug*, 186*0*.

Present or absent *Present*

Stoppage, \$ 100 for

Due Gov't, \$ 100 for

Valuation of horse, \$ 100

Valuation of horse equipments, \$ 100

Remarks:

Book mark: -----

W. C. C.

3

5 Cav. U.S.C.T.

John Connor

Sgt., Co. I, 5 Reg't U. S. Col'd Cavalry.

Appears on

Company Muster Roll

for 29th Oct, 1865.

Present or absent Present

Stoppage, \$ 100 for

Due Gov't, \$ 100 for

Valuation of horse, \$ 100

Valuation of horse equipments, \$ 100

Remarks:

[Empty lines for remarks]

Book mark:

[Empty line for book mark]

W. J. [Signature]

O

5 Cav. U.S.C.T.

John Connor

Connor, Co. I, 5 Reg't U. S. Col'd Cavalry.

Appears on

Company Muster Roll

for *Nov & Dec*, 1865.

Present or absent *Present*

Stoppage, \$ *100* for

Due Gov't, \$ *100* for

Valuation of horse, \$ *100*

Valuation of horse equipments, \$ *100*

Remarks: *Due M. for C & G, \$ 1.64*

Book mark:

Connor

(358)

Copyist.

6 | 5 Cav. | U.S.C.T.

John Comer

Corpl.; Co. I, 5 Reg't U. S. Col'd Cavalry.

Appears on

Company Muster Roll

for *Jan'y. & Feby., 1866.*

Present or absent *Present*

Stoppage, \$ *100* for

Due Gov't, \$ *100* for

Valuation of horse, \$ *100*

Valuation of horse equipments, \$ *100*

Remarks:

Book mark:

Crewshaw

(358)

Copyist.

Q.

5 Cav.

U.S.C.T.

John Connor.

Plt., Co. D, 5 Reg't U. S. Colored Cav.

Appears on Returns as follows:

May 1865: On daily duty as Provost Guard.

Book mark:

(546)

A. Baker

Copyist.

6

5 Cav. U.S.C.T.

John Connor
Corpl, Co. I, 5 Reg't U. S. Col'd Cavalry.

Appears on Co. Muster-out Roll, dated
Helena, Ark, Mch. 16, 1866.

Muster-out to date Mch. 16, 1866.

Last paid to Dec. 31, 1865.

Clothing account:

Last settled....., 186 ; drawn since \$..... 100

Due soldier \$ 3 ⁷³/₁₀₀; due U. S. \$..... 100

Am't for cloth'g in kind or money adv'd \$..... 100

Due U. S. for arms, equipments, &c., \$ ⁷⁴/₁₀₀

Bounty paid \$..... 100; due \$..... 100

Remarks: Private from enrollment
to Oct. 25, 1865 - then Corpl.
Due U.S. for Ord. 74¢.

Book mark:

Crenshaw

(361)

Copyist.

Conner, John

P. Co. I, 5 Reg't U.S.Cav

Enclosures.

Bed Cards	Final Statements
Burial Records	Furloughs or L. of A.
Certs. of Dis. for Discharge	Med. Certificates
C. M. Charges	Med. Des. Lists
Descriptive Lists	Orders
Discharge Certificates	Pris. of War Record
Enlistment Papers	Resignations

Other papers relating to—

Admission to Hosp'l	Furlough or L. of A.
Casualty Sheet	Med. Examination
Confinement	Misc. Information
Contracts	Pay or Clothing
Death or Effects	Personal Reports
Desertion	Rank
Discharge from Hosp'l	Transfer to Hosp'l
Discharge from Service	Transfer to V. R. C.
Duty	Transportation

NOTE 1.—This blank will be used for enlistments of United States colored troops. They will be made out in duplicate in all cases—one to accompany the recruiting return of the superintendent (not the recruiting officer) to the Adjutant General, and one to accompany the accounts of the officer who pays bounty, &c.

NOTE 2.—An enlistment holds to service. A muster-in must, in all cases, precede payment of pay, bounty, pension, &c. A muster-in roll, must in all cases, be filed in the Adjutant General's Office as evidence of muster-in. The mustering officer, commissary, or assistant commissary of musters, as the case may be, will countersign both enlistments as having mustered the soldiers into the service of the United States before either of them is given to the disbursing officer.

DECLARATION OF RECRUIT.

I, John Connor..... desiring to volunteer as a soldier in the ARMY OF THE UNITED STATES, for the term of *Three Years*, DO DECLARE That I am 20..... years and months of age; that I have never been discharged from the United States service on account of disability or by sentence of a court-martial, or by order before the expiration of a term of enlistment; and I know of no impediment to my serving honestly and faithfully as a soldier for three years.

GIVEN at Lebanon Ky..... the 28 day of June 1864.....

Witness: Geo B Brown

Walter Mann
Geo Connor
with out authority of Muster

John his
Mark Connor

Volunteered at
Lebanon Ky
June 25 1864
By Capt J W. Fuller
Co 4th Regt Ky

John
Connor
Volunteered at
Lebanon Ky
June 25 1864

241.

Consent of Parent or Guardian in case of a Minor, if a Free Man, or in the case of a Slave, of the Person to whom he owes Service:

I, Do CERTIFY, That I am the that the said..... is..... years of age; and I do freely give my CONSENT to his volunteering as a SOLDIER in the Army of the United States, for the period of THREE YEARS, under the conditions of the laws of the United States.

GIVEN at the day of

Witness:

UNITED STATES COLORED TROOPS ENLISTMENT.

STATE OF



TOWN OF

I, *John Conner* born in *Washington* County of *Washington* in the State of *Ky* aged *20* years and by occupation a *Harmer* Do HEREBY ACKNOWLEDGE to have volunteered *28th* day of *June* 186 *4*

to serve as a **Soldier** in the **Army of the United States of America**, for the period of **THREE YEARS**, unless sooner discharged by proper authority: Do also agree to accept such bounty, pay, rations, and clothing, as are, or may be, established by law for the U. S. colored troops.

And I, *John Conner* do solemnly swear that I will bear true faith and allegiance to the **United States of America**, and that I will serve them honestly and faithfully against all their enemies or opposers whomsoever; and that I will observe and obey the orders of the President of the United States, and the orders of the officers appointed over me, according to the Rules and Articles of War.

Sworn and subscribed to, at *Lipsum Ky* this *28th* day of *June 64* *John Conner* his mark

Before *M. Fuller* *Capt & Co Mar 4th Dist Ky* I CERTIFY, ON HONOR, That I have carefully examined the above named Volunteer agreeably to the General Regulations of the Army, and that, in my opinion, he is free from all bodily defects and mental infirmity, which would in any way disqualify him from performing the duties of a soldier.

John C. Maxwell

EXAMINING SURGEON.

I CERTIFY, ON HONOR, That I have minutely inspected the Volunteer, *John Conner* previously to his enlistment, and that he was entirely sober when enlisted, that, to the best of my judgment and belief, he is of lawful age; and that, in accepting him as duly qualified to perform the duties of an able-bodied soldier, I have strictly observed the regulations which govern the recruiting service. This soldier has *blue* eyes; *black* hair; *yellow* complexion, is *5* feet *9* inches high.

M. Fuller
Capt & Co Mar 4th Ky RECRUITING OFFICER OR AGENT

Mustered into the United States Service *28th* day of *June* 186 *4*

M. Fuller
Capt & Co Mar 4 Mustered Officer

Mustered into the service of the United States, for three years or during the war, from date of enlistment, in Company _____ Regiment of _____ Volunteers, on the _____ day of _____, 186, at _____

Conner, Nathan

Co A, 5 U. S. Col'd Cav.

Private Sergeant

CARD NUMBERS.

1	5362664	26
2	5362747	27
3	5362849	28
4	5362941	29
5	5363036	30
6	5363120	31
7	5363204	32
8	5363294	33
9	5363382	34
10	5363469	35
11	5363555	36
12	9090293	37
13	43145792	38
14	43146473	39
15		40
16		41
17		42
18		43
19		44
20		45
21		46
22		47
23		48
24		49
25		50

Book Mark:

See also

C | **5 Cav. | U.S.C.T.**

Nathan Leonard

....., Co. *10*, 5 Reg't U. S. Col'd Cav.

Appears on

Company Descriptive Book
of the organization named above.

DESCRIPTION.

Age *29* years; height *6* feet..... inches.

Complexion *Black*

Eyes *Blk*; hair *Blk*

Where born *Adair Ky*

Occupation *Farmer*

ENLISTMENT.

When *Aug 15*, 1864.

Where *Lebanon*

By whom *Capt Fidler*; term *3* y'rs.

Remarks: *Appointed
Sergt. 1864*

.....
.....
.....
.....
.....

J. E. Parker

(383g)

Copist.

6 | **5 Cav.** | **U.S.C.T.**

Nathan Conner

Pvt., Co. 10, 5 Reg't U. S. Col'd Cavalry.

Appears on

Company Muster-in and Descriptive Roll

of the organization named above. Roll dated

Camp Nelson, Ky., Oct. 24, 1864.

Where born Edgair, Ky.

Age 29 y'rs; occupation Farmer

When enlisted Aug. 15, 1864.

Where enlisted Lebanon

For what period enlisted 3 years.

Eyes Bk.; hair Bk.

Complexion Bk.; height 6 ft. in.

When mustered in Aug. 27, 1864.

Where mustered in Lebanon

Bounty paid \$ 100; due \$ 100

Where credited 4 Dist. Ky.

Company to which assigned

Remarks:

Book mark: M. 756 - Ky.

Wm. H. Scott

6 | 5 bar. | U.S. Col.

Nathan Conner

Appears with rank of _____ on

Muster and Descriptive Roll

of Detachment of U.S. Colored
Volunteer Recruits for-
warded _____ Roll dated

Lebanon Ky, Aug 31, 1864.

Where born Adair Ky

Age 29 years; occupation farmer

When enlisted Aug 15, 1864

Where enlisted Lebanon Ky

For what period enlisted 3 years.

Eyes Blk; hair Blk

Complexion Blk; height 5 ft. 7 in.

When mustered in Aug 15, 1864

Where mustered in Lebanon Ky

Bounty paid \$ 100; due \$ 100

Clothing account:

Last settled _____, 1864; drawn since \$ 17 ⁵⁰/₁₀₀

Date of first muster Aug 27, 1864.

Company to which assigned _____

Remarks: Owner, Felix Conner
Adair Co.

Without Consent
4 Long Dist Ky

Book mark: _____

(356m)

Lebanon
Copyist.

6 | 5 bar | U.S.C.T.

Nathan Corner

Appears with rank of Pvt on

Muster and Descriptive Roll

of a Detachment of U. S. colored
Troops forwarded for U. S. col'd
car. at Lexington, Ky.

Roll dated
Foumille, Ky., Sept. 7, 1864.

Where born Adair, Ky

Age 29 years; occupation Farmer

When enlisted Aug. 15, 1864.

Where enlisted Lebanon

For what period enlisted 3 years.

Eyes Blue; hair Blue

Complexion Blue; height 6 ft. in.

When mustered in Aug. 27, 1864.

Where mustered in Lebanon

Bounty paid \$ 100; due \$ 100

Clothing account:

Last settled _____, 186 ; drawn since \$ 17.50
100

Date of first muster Aug. 27, 1864.

Company to which assigned _____

Remarks: H Det. Ky.

Book mark: _____

B. J. D. D. D. D. D.

(356m)

Copyist.

6

5 Cav. U.S.C.T.

Nathan Corner

Sgt., Co. D, 5 Reg't U.S. Col'd Cavalry.

Appears on

Company Muster Roll

for Dated Oct 31, 1864.

Present or absent Present

Stoppage, \$ 100 for

Due Gov't, \$ 100 for

Valuation of horse, \$ 100

Valuation of horse equipments, \$ 100

Remarks:

Book mark:

Wm H. Scott

(358)

Copyist.

6

5 Cav. U.S.C.T.

Nathan Conner

Com. Sgt., Co. D, 5 Reg't U. S. Col'd Cavalry.

Appears on

Company Muster Roll

for Nov. & Dec., 1864.

Present or absent Present.

Stoppage, \$ 100 for

Due Gov't, \$ 100 for

Valuation of horse, \$ 100

Valuation of horse equipments, \$ 100

Remarks: Rec'd U.S. for Ord. nance \$ 17.93. 1st & 2nd in stallments Bounty due

Book mark:

Wm. H. Scott

6

5 Cav. U.S.C.T.

Nathan Conner

Com. Sgt., Co. D, 5 Reg't U. S. Col'd Cavalry.

Appears on

Company Muster Roll

for Jan & Feb, 1865.

Present or absent Present

Stoppage, \$ 100 for

Due Gov't, \$ 100 for

Valuation of horse, \$ 100

Valuation of horse equipments, \$ 100

Remarks: 1st installment of Bounty
due \$ 100

Book mark:

Wm. H. Scott

(358)

Copyist.

6

5 Cav. U.S.C.T.

Nathan Corner

Com. Sgt., Co. D, 5 Reg't U. S. Col'd Cavalry.

Appears on

Company Muster Roll

for March & April, 1865.

Present or absent Present.

Stoppage, \$ 100 for

Due Gov't, \$ 100 for

Valuation of horse, \$ 100

Valuation of horse equipments, \$ 100

Remarks: 1st installment of
Bounty due \$100.

Book mark:

Wm. H. Scott

(358)

Copyist.

6

5 Cav. U.S.C.T.

Nathan Conner

led. Sgt, Co. D, 5 Reg't U. S. Col'd Cavalry.

Appears on

Company Muster Roll

for May + June, 1865.

Present or absent Present

Stoppage, \$ 100 for

Due Gov't, \$ 100 for

Valuation of horse, \$ 100

Valuation of horse equipments, \$ 100

Remarks: 1st Instalment Bounty due \$ 100.00

Book mark:

Milliken

6 | 5 Cav. | U.S.C.T.

Nathan Conner

1st Srgt, Co. D, 5 Reg't U. S. Col'd Cavalry.

Appears on

Company Muster Roll

for *July & Augt*, 1865.

Present or absent *present*.

Stoppage, \$ 100 for

Due Gov't, \$ 100 for

Valuation of horse, \$ 100

Valuation of horse equipments, \$ 100

Remarks:

Book mark: -----

(358)

Williker

Copyist.

6

5 Cav. U.S.C.T.

Nathan Conner

Serjt, Co. D, 5 Reg't U. S. Col'd Cavalry.

Appears on

Company Muster Roll

for Sept. & Oct., 1865.

Present or absent present

Stoppage, \$ 100 for

Due Gov't, \$ 100 for

Valuation of horse, \$ 100

Valuation of horse equipments, \$ 100

Remarks: Due U.S. for lamp & Garrison \$5.36.

Book mark:

Milliken

(358)

Copyist.

le

5 Cav. U.S.C.T.

Nathan Conner

Sergeant, Co. D, 5 Reg't U. S. Col'd Cavalry.

Appears on

Company Muster Roll

for Nov. & Dec., 1865.

Present or absent present

Stoppage, \$ 100 for

Due Gov't, \$ 100 for

Valuation of horse, \$ 100

Valuation of horse equipments, \$ 100

Remarks:

Book mark:

Milliken

(358)

Copyist.

C.

5 Cav.

U.S.C.T.

Nathan Conner,

Serjt, Co. D, 5 Reg't U. S. Col'd Cavalry.

Appears on

Company Muster Roll

for *Jan'y 4th Febr'y*, 186*e*.

Present or absent *Present*

Stoppage, \$ 100 for

Due Gov't, \$ 100 for

Valuation of horse, \$ 100

Valuation of horse equipments, \$ 100

Remarks: *2^d Installment Bond -
ty due \$ 100.00.*

Book mark :

R. D. Danner

(358)

Copyist.

C. | 5 Cav. | U.S.C.T.

Nathan Conrad,
Serg't., Co. D., 5 Reg't U. S. Col'd Cavalry.

Appears on Co. Muster-out Roll, dated
Helena, Ark. March 16, 1866.

Muster-out to date *March 16,* 1866.

Last paid to *Dec. 31,* 1865.

Clothing account:

Last settled _____, 186 ; drawn since \$ _____ 100

Due soldier \$ _____ 100; due U. S. \$ *47. 29* / 100

Am't for cloth'g in kind or money adv'd \$ _____ 100

Due U. S. for arms, equipments, &c., \$ _____ 100

Bounty paid \$ *100. 00* / 100; due \$ *100. 00* / 100

Remarks: *Sergeant from organiza-*
tive.

Book mark: *(M. 956 Ky. 463. 188)*

N. S. Dranner

(361)

Copyist.

Comer Nathan

Art. Co. 2, 5 Reg't US Caval

Enclosures.

Bed Cards	Descriptive Lists
Burial Records	Final Statements
Certs. of Dis. for Discharge	Furloughs
C. M. Charges	Med. Des. Lists
Med. Certificates	Orders

Other papers relating to—

Admission to Hosp'l	Furlough
Casualty Sheet (Officer's)	Med. Examination
Confinement	Misc. Information
Contracts	Pay or Clothing
Death or Effects	Personal Reports
Desertions	Rank
Discharge from Hosp'l	Transfer to Hosp'l
Discharge from Service	Transfer to V. R. C.
Duty	Transportation

State Claim 1

War Department,
ADJUTANT GENERAL'S OFFICE.

Washington, Feb 5 1867.

Respectfully returned to the
Commission for the State of
Kentucky with the informa-

956. 167

tion that Nathan Combs
was enlisted at Lebanon Ky.
August 15th 1864 and was
mustered in as private Co 7th
5th U.S. Col. Cav. Aug 27th '64

A. R. R. R. R. R.

1437

Asst. Adj't General.

No. 956

APPLICATION OF

Robert Milesson Son

FOR COMPENSATION FOR SLAVE,
Named Nathan Combs
enlisted Aug 27th 1864
in Com. D, 5th Regiment,
U. S. COLORED TROOPS.

Received Jan 15, 1867.
Compensation Awarded

....., 48⁰⁰
.....
..... Dollars.

President of Board of Claims.

Claimant's Attorney,

Claimant's Post-office Address,
Columbia Adair Co
Ky

FRANKFORT COMMONWEALTH PRINT.

No.

CLAIM OF

Robt Miller Son^r with the Will amount of H. S. Conner dec^d

FOR THE COMPENSATION OF SLAVE NAMED

Nathan Conner

I, Robt Miller Son^r with the Will amount of H. S. Conner dec^d a loyal citizen and a resident of Columbia, County of Adams, State of Kentucky, hereby claim compensation, under the provisions of Section 24, act approved February 21, 1864, and section 2, act approved July, 28, 1866, for my slave Nathan Conner, enlisted 27th August, 1864, at Lebanon Ky, by Capt Fidler, 5th regiment U. S. Colored Troops, Co. D; certificate of which enlistment, and a descriptive list, as required, accompany this application. That I did not acquire said slave subsequent to said enlistment, but had a valid title to him at the date of said enlistment, and previous thereto; I having acquired my title to him and my ownership over him as follows, to-wit: I am the Administrator with the Will amount of H. S. Conner dec^d and as such said Nathan Conner came into my hands as a slave under the will of said Testator in September 1863 and continued in my possession and under my control as a slave up to and at the time of his enlistment aforesaid - said H. S. Conner was an unwavering Union Man and loyal to the Government of the United States up to his death - I have two children both infants under 14 years

In proof of my loyalty to the Constitution and Government of the United States, I present the accompanying oath, which I have taken, signed and acknowledged; to be filed with this application, in accordance with requirement of General Orders, No. 329, 1863, War Department, Adjutant General's Office.

Dec 24th

1866

Robt Miller, Admin^r of H. S. Conner, dec^d

OATH OF ALLEGIANCE.

I, Robt Miller, the owner and Claimant, do solemnly swear that the foregoing claim is a just and true claim due to me as master and owner of the said slave, and that the facts alleged in said claim in respect to the draft or enlistment (as the case may be) of said slave into the Military service of the United States are true. And I do further swear that I have never joined, or been concerned in, any insurrection or rebellion; that I have never borne arms against the United States; that I have never given any aid, countenance, counsel or encouragement to any person or persons engaged, or whom I had reason to believe were about to engage, in insurrection, rebellion or armed hostility against the United States; that I have neither sought, nor accepted, nor attempted to exercise the functions of any office, civil or military, nor to perform any service whatever, under any authority or pretended authority in hostility to the United States; that I have not yielded a voluntary support to any insurrection, rebellion or pretended government, authority, power or constitution within the United States hostile thereto. And I do further swear that, to the best of my knowledge and ability, I have supported and defended, and will continue to support and defend, the United States against all enemies, foreign and domestic; and that I have supported, defended and obeyed, and will continue to support, defend and obey, the Constitution and laws of the United States; that I will bear true faith and allegiance to the same; and that I take this oath freely, without any mental reservation or purpose of evasion: So help me God.

Robt Miller

Sworn to and subscribed before me, at Columbia, this 24 day of December, 1866.

Robt Miller
Notary Public



CERTIFICATE OF ENLISTMENT.

County of *Adair* *Ky* *Md.*
August 15th, 1864.

I certify, on honor, that *Heirs of Fielder Conner*
a citizen of *Adair's* county, State of *Virginia*, ~~did~~ this day
offer himself ~~voluntarily offer his (or her)~~ slave, known as *Nathan Conner*
for enlistment into the SERVICE OF THE UNITED STATES, and that said slave has, after a
careful *personal inspection*, been duly enlisted by me to serve in the ARMY OF THE UNITED
STATES for the period of THREE YEARS OR DURING THE WAR.

Law M. Hites
~~Capt~~ *Reg U. S. Col. Troops*, Recruiting Officer.

I certify, on honor, that I have carefully examined the above-named colored recruit,
agreeably to the General Regulations of the Army, and that, in my opinion, he is free from all
bodily defects and mental infirmity which would in any way disqualify him from performing the
duties of a soldier.

John C. Maxwell
Examining Surgeon.

I hereby certify that the above-named recruit was duly mustered into the service of the
United States on this *15th* day of *August*, 1864, to serve
for *three years or during the war*.

Law M. Hites
Capt & Col Mar Mustering Officer.

NOTE 1.—The Mustering Officer will require the alleged owner, before furnishing him with this certificate, to make oath that the slave named is his property.

NOTE 2.—The Recruiting Officer will, after the recruit has been duly enlisted, furnish the owner with a descriptive list of the recruit, made out on the usual printed form, in addition to the foregoing certificate.

NOTE 3.—These certificates to be made in duplicate by the Recruiting Officer; one copy to be forwarded to the Mustering Officer, who, after mustering the recruit into service, will forward it, duly signed, to the Bureau for Colored Troops; the other copy to be given to the owner of said slave, who, after obtaining the certificate of the Surgeon and Mustering Officer thereto, will present it to the Board, accompanied with a valid deed of manumission and proof of title to the services of the person enlisted, together with an oath of allegiance to the Government of the United States; and having obtained the award of the Board thereon, will forward all the papers in the case to the Bureau for Colored Troops.

NOTE 4.—This certificate in no case to be given to a disloyal person, or to one who has been engaged in rebellion against the Government of the United States, or who has given aid or comfort to the enemies of said Government.

20
Kentucky Adair County Set
County Court Special Term September 14th 1863
(William) Stewart the Executor mentioned in the true
last will & testament of F. L. Conner Deceased,
which was proved and ordered to be recorded
at the last regular term of this court
this day came into court and declined to
qualify as Executor of said decedent's will.
On the motion of Robert Miller ordered that
he be and he is hereby appointed Administrator
with the will annexed of said decedent.
Thereupon the said Robert Miller being in
court took the oath required by law, and
executed and acknowledged a covenant to
the Commonwealth of Kentucky with
Saml B Field Jesse Murrell & Geo R Page
his Sureties conditioned as required by law.

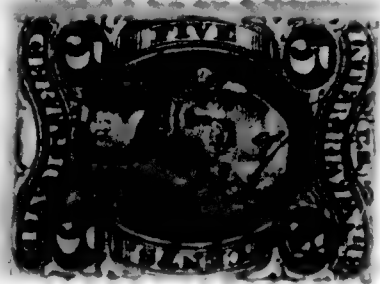

A Copy Test J. W. Butler
J. W. Butler

Headquarters Kentucky Volunteers,

Adjutant-General's Office,

Frankfort, Dec^r 20th, 1866.

I hereby certify, that it appears from the U. S. Muster-in
Rolls on file in this Office, that Nathan Corner
was enrolled on the 15th day of August, 1864, at
Lebanon Ky, by Cap^t Fidler
and mustered into the U. S. service on the 27th day of August,
1864, at Lebanon Ky, by Cap^t Fidler
to serve three years. Said Nathan Corner
is described as follows: Age, 29 years; eyes, black; hair, black;
complexion, black; height, 5 feet 7 inches. It further
appears from said Rolls, that Nathan Corner owed service
to Felix Corner, was credited to Adair
County, Ky., and was assigned to Co. "D", 5th Regiment
U. S. C. Cavalry

In Testimony Whereof, I have hereunto set my
hand, and affixed my Official Seal, this
20th day of Dec^r, 1866.

D. W. Lindsey

Adjutant-General of Kentucky.

B. 41, SR. 268

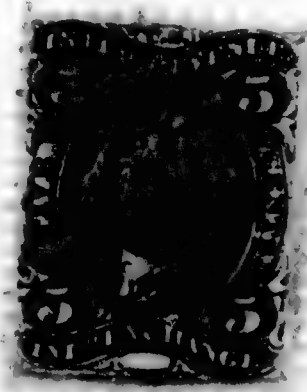

PROOF OF OWNERSHIP.

STATE OF KENTUCKY,

COUNTY OF

Adair

} SS.

We

Wm Stewart

and

Geo R Page

each of lawful

age, and resident citizens of the State and County aforesaid, do certify that Robt Miller as son of F L Conner dec'd of the State and County aforesaid, was on the 27th day of August 1864, the lawful owner of the slave named Nathan Conner; referred to and described in the foregoing claim for compensation.

Wm Stewart

Geo R Page

Sworn to and subscribed before me a

Notary Public

for the County of

Adair

State of Kentucky, this the

24

day of

December 1866.

R. H. Martin Notary Public

5 CENT STAMP.



PROOF OF LOYALTY.

STATE OF KENTUCKY.

COUNTY OF

Adair

} SS.

We

Wm Stewart

and

Geo R Page

loyal men and

each of lawful age, and resident citizens ~~of the~~ of Adair in the State and County aforesaid, upon our oaths declare that we have known Robert Miller a resident of the State and County aforesaid, since the 4th day of March, 1861, and know that he has firmly and faithfully maintained his ~~own~~ adherence and allegiance to the Government of the United States, by defending its cause against the Government and forces of the so-called Confederate States of America, in all suitable and practicable ways, and according to his ~~own~~ ability and opportunity and

we furthermore make the same statements in regard to the loyalty of F L Conner up to his death Wm Stewart in the year 1863.

Geo. R. Page

Sworn to and subscribed before me a

Notary Public

for the county of

Adair

State of Kentucky, this the

24th

day of

December 1866.

R. H. Martin Notary Public

5 CENT STAMP.



POWER OF ATTORNEY.

My Post-Office address is Columbia County of Adair State of Kentucky, and I hereby direct that all communications to me, touching this claim, be sent under cover to my address, who is hereby appointed and constituted my true and lawful attorney, to prosecute this claim for me, and who is hereby authorized and empowered to receive and receipt for any award, order, draft, certificate, voucher, warrant, papers or money that may be issued in the adjustment of this claim, or the payment thereof, the same as I might or could do in person were I present and acting for myself, and to file any additional evidence or papers that may be required in the prosecution of this claim.

[WITNESS.]

The owner signs here.

Robt Miller

50 CENT STAMP.

Two witnesses to owner's signature sign here.

Cook, Ralph

Coal, 5 U. S. Col'd Cav.

Private Private

CARD NUMBERS.

1	5362665	26
2	5362841	27
3	5363028	28
4	5363055	29
5	5363143	30
6	5363231	31
7	5363319	32
8	5363408	33
9	5363495	34
10	5363580	35
11	9090294	36
12	Claim No 3	37
13	43145797	38
14	43146471	39
15	40729604	40
16		41
17		42
18		43
19		44
20		45
21		46
22		47
23		48
24		49
25		50

Book Mark: Claim No 3

See also

62652000 off
S. 1638752, Aud. 2008
Ref. 661715
D. 2546576 P. 1000000

Apple Day Co

10 | **5 Cav. | U.S.C.T.**

Ralph Crook

....., Co. D, 5 Reg't U. S. Col'd Cav.

Appears on

Company Descriptive Book
of the organization named above.

DESCRIPTION.

Age 21 years; height 5 feet 7 inches.

Complexion White

Eyes Brown; hair Blk

Where born Marion Ky.

Occupation Farmer

ENLISTMENT.

When Aug 15, 1864

Where Lebanon

By whom Capt. Kiddle; term 3 y'rs.

Remarks: Missing in
action Salpville
(Oct. 7" 1864, returned
April 29" / 65

.....
.....
.....

J. E. Parker

6 | 5 bar | U.S.R.

Ralph Cook

Appears with rank of _____ on

Muster and Descriptive Roll

of detachment of US colored
volunteer recruits for-
warded

Roll dated
Lebanon Ky, Aug 31, 1864.

Where born Marion Ky

Age 21 years; occupation farmer

When enlisted Aug 15, 1864.

Where enlisted Lebanon, Ky

For what period enlisted 3 years.

Eyes Bro; hair Brk

Complexion white; height 5 ft. 7 in.

When mustered in Aug 15, 1864.

Where mustered in Lebanon Ky

Bounty paid \$ 100; due \$ 100

Clothing account:

Last settled _____, 1864; drawn since \$ 17 ⁵⁰/₁₀₀

Date of first muster Aug 27, 1864.

Company to which assigned _____

Remarks: wives, Martha

Cook Marion Co.

Without Consent (over)

Do on roll, in pencil

Book mark: _____

(356m) Y. G. Barton Copyist.

OCT. - 8.

43145797

1906.

H. Long Dist. Ky.

6 | 5 bar | U.S.C.T.

Ralph Cook

Appears with rank of Pvt on

Muster and Descriptive Roll

of a Detachment of U.S. Colored
Troops formed for U.S. Colored
Serv. at Lexington, Ky.

Roll dated

Fairville, Ky., Sept. 7, 1864.

Where born Marion, Ky.

Age 21 years; occupation Farmer

When enlisted Aug. 15, 1864.

Where enlisted Lebanon

For what period enlisted 3 years.

Eyes Brown; hair Black

Complexion White; height 5 ft. 7 in.

When mustered in Aug. 27, 1864.

Where mustered in Lebanon

Bounty paid \$ 100; due \$ 100

Clothing account:

Last settled _____, 1864; drawn since \$ 17.50
100

Date of first muster Aug. 27, 1864.

Company to which assigned _____

Remarks: 4 Dist. Ky.

Book mark: _____

R. J. G. [Signature]

(356m)

Copyist.

6

5 Cav. U.S.C.T.

Rolf Coole

Pvt., Co. H, 5 Reg't U. S. Col'd Cavalry.

Appears on

Company Muster-in and Descriptive Roll

of the organization named above. Roll dated

Camp Nelson, Ky., Oct. 24, 1864.

Where born Marion, Ky.

Age 21 y'rs; occupation Farmer

When enlisted Aug. 15, 1864.

Where enlisted Lebanon

For what period enlisted 3 years.

Eyes Brn; hair Br

Complexion White; height 5 ft. 7 in.

When mustered in Aug. 27, 1864.

Where mustered in Lebanon

Bounty paid \$ 100; due \$ 100

Where credited 4 Dist. Ky.

Company to which assigned

Remarks:

Book mark: 11111111

Wm. H. Scott

(356d)

Copyist.

6

5 Cav. U.S.C.T.

Ralph Cook

Priv., Co. D, 5 Reg't U. S. Col'd Cavalry.

Appears on

Company Muster Roll

for Dated Oct 31, 1864.

Present or absent

Stoppage, \$ 100 for

Due Gov't, \$ 100 for

Valuation of horse, \$ 100

Valuation of horse equipments, \$ 100

Remarks: Killed in battle of Saltville, Va Oct 2, '64

Roll for Jan + Feb 65 next on which name appears.

Book mark:

Wm H. Scott

(358)

Copyist.

6

5 Cav. U.S.C.T.

Ralph Cooke

Priv., Co. D, 5 Reg't U. S. Col'd Cavalry.

Appears on

Company Muster Roll

for *Jan. & Feb.*, 1865.

Present or absent

Stoppage, \$ 100 for

Due Gov't, \$ 100 for

Valuation of horse, \$ 100

Valuation of horse equipments, \$ 100

Remarks: *First installment of Bounty due \$100. Reported as having been killed in action erroneously on the Muster Roll of Oct. 31, '64. This man was missing in action at Battoville.*

Book mark:

Wm. H. Scott

(358)

Copyist.

over

JAN. - 9

5363028

1891

See Oct. 2, '64 as there is
no reliable evidence
as to his death.

6

5 Cav.

U.S.C.T.

Ralph Cook

Pvt., Co. D, 5 Reg't U. S. Col'd Cavalry.

Appears on

Company Muster Roll

for March & April, 1865.

Present or absent Present

Stoppage, \$ 100 for

Due Gov't, \$ 100 for

Valuation of horse, \$ 100

Valuation of horse equipments, \$ 100

Remarks: 1st installment of
Bounty due \$100.
Dropped on October
Roll. Erroneously re-
ported killed. Reported
for duty April 29 '65.

Book mark:

Wm H. Scott

(358)

Copyist.

6

5 Cav. U.S.C.T.

Ralph Cook

Priv., Co. D, 5 Reg't U. S. Col'd Cavalry.

Appears on

Company Muster Roll

for May + June, 1865.

Present or absent Present.

Stoppage, \$ 100 for

Due Gov't, \$ 100 for

Valuation of horse, \$ 100

Valuation of horse equipments, \$ 100

Remarks: 1st Instalmt' Bounty due \$100.00.

Book mark:

McLiken

(358)

Copyist.

6

5 Cav. U.S.C.T.

Ralph Cook

Private, Co. D, 5 Reg't U. S. Col'd Cavalry.

Appears on

Company Muster Roll

for July & August, 1865.

Present or absent present

Stoppage, \$ 100 for

Due Gov't, \$ 100 for

Valuation of horse, \$ 100

Valuation of horse equipments, \$ 100

Remarks:

Book mark:

Milliken

(358)

Copyist.

6

5 Cav. U.S.C.T.

Ralph Cook

Priv., Co. D, 5 Reg't U. S. Col'd Cavalry.

Appears on

Company Muster Roll

for Sept & Oct, 1865.

Present or absent present

Stoppage, \$ 100 for

Due Gov't, \$ 100 for

Valuation of horse, \$ 100

Valuation of horse equipments, \$ 100

Remarks: Due U.S. for transportation \$ 6.47. Daily duty company cook!

Book mark:

Milliken

6

5 Cav. U.S.C.T.

Ralph Cook

Priv., Co. D, 5 Reg't U. S. Col'd Cavalry.

Appears on

Company Muster Roll

for Nov. + Dec., 1865.

Present or absent present

Stoppage, \$ 100 for

Due Gov't, \$ 100 for

Valuation of horse, \$ 100

Valuation of horse equipments, \$ 100

Remarks: Daily duty, company cook.

Book mark:

Willeken

C.

5 Cav.

U.S.C.T.

Ralph Cook

Private, Co. D, 5 Reg't U. S. Col'd Cavalry.

Appears on

Company Muster Roll

for *Jan'y 2nd Febr'y*, 186*6*.

Present or absent *Present*.

Stoppage, \$ *100* for

Due Gov't, \$ *100* for

Valuation of horse, \$ *100*

Valuation of horse equipments, \$ *100*

Remarks: *On daily duty Compa-
ny Cook & Installment Boun-
ty due \$100.00.*

Book mark :

R. Draumer

(358)

Copyist.

Q | 5 Cav. U.S.C.T.

Ralph Cook.

Regt. Co. D, 5 Reg't U. S. Colored Cav.

Appears on Returns as follows:

Oct. 1864. Loss, Oct. 2/64, Saltville,
Va. Missing in action.

Apr. 1865. Gain, Apr. 29/65, Cynthia, La.
from missing in action. Erroneously reported killed Oct.
1864.

July to Sept. 1865. Co. Cook.

* Oct. 1865. Received furlough of 10
days Oct. 16/65, Lexington, Ky.
Returned Oct. 26/65.

Oct. 1865 to Feb. 1866. Co. Cook.

* Entry cancelled.

Book mark:

(546)

R Baker,
Copyist.

Ralph Cook,

Private, Co. *D*, 5 Reg't U. S. Col'd Cavalry.

Appears on Co. Muster-out Roll, dated
Selma, Ark., March 16, 1866.

Muster-out to date *March 16,* 1866.

Last paid to *Dec. 31,* 1865.

Clothing account:

Last settled....., 186 ; drawn since \$..... 100

Due soldier \$..... 100; due U. S. \$ *27*¹⁰/₁₀₀

Am't for cloth'g in kind or money adv'd \$..... 100

Due U. S. for arms, equipments, &c., \$..... 100

Bounty paid \$ *100*⁰⁰/₁₀₀; due \$ *100*⁰⁰/₁₀₀

Remarks: *Wounded in battle*

Saltrill, Va., Oct. 2, 1864.

*Taken Prisoner. Rejoined
Company Apr. 29, 1865.*

Book mark: *V. 122 P. 73. 71.*

1138 Dis. Apr. 19/67.

R. S. Drayton

C. | 5 Cav. U.S.C.

Ralph Cook,

, Co. D, 5 Reg't U.S.C. Cav.

NOTATION.

Book mark: *Claim No. 3,*

War Department,

Adjutant General's Office,

Washington, *April 11, 1871.*

Cook's name will be taken up on records of Pris. of War and note thereafter - Captured Oct. 2, 1864, held until April 15, 1865, when he escaped and reported within the Union lines at Knoxville, Tenn.

Wm E. Newman,

(438)

Copyist.

Cooper Ralph

P, Co. D., 5 Reg't U. S. C. C.

2 Enclosures.

Bed Cards	Final Statements
Burial Records	Furloughs or L. of A
Certs. of Dis. for Discharge	Med. Certificates
C. M. Charges	Med. Des. Lists
Descriptive Lists	Orders
Discharge Certificates	Pris. of War Record
Enlistment Papers	Resignations

Other papers relating to—

Admission to Hosp'l	Furlough or L. of A
Casualty Sheet	Med. Examination
Confinement	Misc. Information
Contracts	Pay or Clothing
Death or Effects	Personal Reports
Desertion	Rank
Discharge from Hosp'l	Transfer to Hosp'l
Discharge from Service	Transfer to V. R. C.
Duty	Transportation

Note 1.—This blank will be used in recruiting colored troops. There will be made out in duplicate in all cases, one to accompany the recruiting party of the company to which the recruit is attached, and the other to be retained by the Adjutant General, or the Adjutant of the company, as the case may be, with counterpoise both in the original and in the duplicate. A mustering roll, must, in all cases, be filed in the Adjutant General's Office, or the Adjutant's Office, as the case may be, at the time of mustering. The Adjutant General, or the Adjutant, as the case may be, will counterpoise both the original and the duplicate of the mustering roll, and the original of the mustering roll, as the case may be, will counterpoise both the original and the duplicate of the mustering roll.

DECLARATION OF RECRUIT.

I, Ralph Cook desiring to volunteer as a soldier in the ARMY OF THE UNITED STATES, for the term of Three Years, do DECLARE That I am 21 years and 7 months of age; that I have never been discharged from the United States service on account of disability or by sentence of a court-martial; or by order before the expiration of a term of enlistment; and I know of no impediment to my serving honestly and faithfully as a soldier for three years.

GIVEN at Sebastien the 15th day of August 1864.

Witness: Joseph Edell

Slave
 Muster Name
Martha Cook
 entered without consent

Ralph Cook
 mark
 Volunteered at
Sebastien
15th August 1864
Capt. Robert B. Brewster 1st Regt. Col. 1st Div. 1st Corps
 No. 100 100

Consent of Parent or Guardian in case of a Minor, if a Free Man, or in the case of a Slave, of the Person to whom he owes Service:

I, Do CERTIFY, That I am the that the said is years of age; and I do freely give my CONSENT to his volunteering as a SOLDIER in the Army of the United States, for the period of THREE YEARS, under the conditions of the Laws of the United States.

GIVEN at the day of

Witness:

UNITED STATES COLORED TROOPS ENLISTMENT.

STATE OF *Kentucky* TOWN OF *County Marion*

I, *Ralph Cook* born in *Marion* in the State of *Kentucky* aged *21* years

and by occupation a Do HEREBY ACKNOWLEDGE to have volunteered *15th* day of *August* 186*4*

to serve as a **Soldier** in the **Army of the United States of America**, for the period of **THREE YEARS**, unless sooner discharged by proper authority: Do also agree to accept such bounty, pay, rations, and clothing, as are, or may be, established by law for the U. S. colored troops.

And I, *Ralph Cook* do solemnly swear that I will bear true faith and allegiance to the **United States of America**, and that I will serve them honestly and faithfully against all their enemies or opposers whomsoever; and that I will observe and obey the orders of the President of the United States, and the orders of the officers appointed over me, according to the Rules and Articles of War.

Sworn and subscribed to, at *Lebanon Ky* this *15th* day of *August 1864* *Ralph Cook* his mark

Before *M. Fuller* *Capt & Prov Marshal 4th Dist Ky* I CERTIFY, ON HONOR, That I have carefully examined the above named Volunteer agreeably to the General Regulations of the Army, and that, in my opinion, he is free from all bodily defects and mental infirmity, which would in any way disqualify him from performing the duties of a soldier.

John C. Maxwell

EXAMINING SURGEON.

I CERTIFY, ON HONOR, That I have minutely inspected the Volunteer, *Ralph Cook* previously to his enlistment, and that he was entirely sober when enlisted; that, to the best of my judgment and belief, he is of lawful age; and that, in accepting him as duly qualified to perform the duties of an able-bodied soldier, I have strictly observed the regulations which govern the recruiting service. This soldier has *Brown* eyes, *black* hair, *white* complexion, is *5* feet *7* inches high.

M. Fuller

Capt & Prov Marshal 4th Ky RECRUITING OFFICER OR AGENT.

Mustered into the United States Service *27th* day of *Aug* 186*4*

M. Fuller

Capt & Prov Marshal 4th Dist Ky Mustering Officer

Mustered into the service of the United States, for three years or during the war, from date of enlistment, in Company *.....* Regiment of *.....* Volunteers, on the *.....* day of *.....* 186*4* at *.....*

MEMORANDUM FROM PRISONER OF WAR RECORDS.

No. _____

(This blank to be used only in the arrangement of said records.)

NAME.	RANK.	ORGANIZATION.				INFORMATION OBTAINED FROM—				
		No. of Reg't.	State.	Arm of Service.	Co.	Records of—	Vol.	Page.	Vol.	Page.
Cook, Ralph	P 5	USACE				MR	1	62		

Captured at _____, 1864, confined at Richmond, Va., _____, 1864.
 and held until Apr 15/65 when he escaped & repatriated in Union Run
 at Knoxville Tenn. claim 3-5-Usace

Admitted to Hospital at _____

where he died _____, 1864, of _____

Paroled at _____, 1864; reported at Camp Parole, Md., _____, 1864.

a.k.a. 41671

Copied by *J. Gu* ✓

Cook Samuel

Co *A*, 5 U. S. Col'd Cav.

Private | *Corporal*

CARD NUMBERS.

1	5362666	26
2	5362768	27
3	5362869	28
4	5362948	29
5	5363041	30
6	5363126	31
7	5363211	32
8	5363308	33
9	5363394	34
10	5363481	35
11	5363566	36
12	9090295	37
13	43154237	38
14	43146469	39
15	40729605	40
16		41
17		42
18		43
19		44
20		45
21		46
22		47
23		48
24		49
25		50

Book Mark:

See also

6 | **5 Cav. | U.S.C.T.**

Sam Cook

....., Co. 11, 5 Reg't U. S. Col'd Cav.

Appears on

Company Descriptive Book
of the organization named above.

DESCRIPTION.

Age 18 years; height 5 feet 5 1/2 inches.

Complexion yellow

Eyes Blk; hair Blk

Where born Nelson Ky.

Occupation farmer

ENLISTMENT.

When Substitute, 186 .

Where 7th Dist. Ky.

By whom; term 3 y'rs.

Remarks: Appointed Corp'l
Feb, 1st 1865

.....
.....
.....
.....
.....

J. E. Parker

C | 5 bar U.S.A.

Sam Cook

Appears with rank of _____ on

Muster and Descriptive Roll

of a Detachment of U.S. Representative
Substitutes

Roll dated
Lebanon Ky., Aug. 31, 1864.

Where born Nelson, Kentucky

Age 18 years; occupation farmer

When enlisted Aug 22, 1864.

Where enlisted Lebanon, Ky.

For what period enlisted 3 years.

Eyes blk; hair blk.

Complexion yell.; height 5 ft 5/2 in.

When mustered in Aug 22, 1864.

Where mustered in Lebanon

Bounty paid \$ 100; due \$ 100

Clothing account:

Last settled _____, 1864; drawn since \$17.50/100

Date of first muster Aug 22, 1864.

Company to which assigned _____

Remarks: 11th Cong. Dist., Ky.

Name & Residence of Enrolled man:

W. C. Duncan, Nelson County, Ky.

Book mark: _____

(356m)

J. Austin

Copyist.

6 | 5 bar | U.S.C.T.

Sam Cook

Appears with rank of Pvt on

Muster and Descriptive Roll

of a Detachment of U. S. Colonel
Troops forwarded for U. S. Col
cer. at Lexington, Ky. Roll dated

Louisville, Ky., Sept. 7, 1864.

Where born Wilson, Ky.

Age 18 years; occupation Farmer

When enlisted Substitute, 186 .

Where enlisted _____

For what period enlisted 3 years.

Eyes Blue; hair Black

Complexion Fair; height 5 ft. 5/2 in.

When mustered in Aug. 22, 1864.

Where mustered in Lebanon

Bounty paid \$ 100; due \$ 100

Clothing account:
Last settled _____, 186 ; drawn since \$ 17 50
100

Date of first muster Aug. 22, 1864.

Company to which assigned _____

Remarks: 4 Det. Ky.

Book mark : _____

(356m)

D. J. Patterson

Copyist.

6

5 Cav. U.S.C.T.

Sam Cook

Pvt., Co. D, 5 Reg't U. S. Col'd Cavalry.

Appears on

Company Muster-in and Descriptive Roll

of the organization named above. Roll dated

Camp Nelson, N.Y., Oct. 24, 1864.

Where born Nelson, Ky.

Age 18 y'rs; occupation Farmer

When enlisted, 186 .

Where enlisted

For what period enlisted 3 years.

Eyes Br; hair Br

Complexion Yellow; height 5 ft. 5 1/2 in.

When mustered in Aug. 22, 1864.

Where mustered in Lebanon

Bounty paid \$ 100; due \$ 100

Where credited 4 Dist. Ky.

Company to which assigned

Remarks:

Book mark:

Wm. H. Scott

(356d)

Copyist.

6 | **5 Cav. | U.S.C.T.**

Sam Cook

Pvt., Co. D, 5 Reg't U. S. Col'd Cavalry.

Appears on

Company Muster Roll

for Dated Oct. 31, 1864.

Present or absent Present

Stoppage, \$ 100 for

Due Gov't, \$ 100 for

Valuation of horse, \$ 100

Valuation of horse equipments, \$ 100

Remarks: (Substitute)

Book mark: _____

Amel Scott

b | **5 Cav.** | **U.S.C.T.**

Sam Cook

Pvt., Co. D, 5 Reg't U. S. Col'd Cavalry.

Appears on

Company Muster Roll

for *Nov. & Dec.*, 186 *4*.

Present or absent *Present*

Stoppage, \$ *100* for

Due Gov't, \$ *100* for

Valuation of horse, \$ *100*

Valuation of horse equipments, \$ *100*

Remarks:

Book mark:

Wm H Scott

6

5 Cav.

U.S.C.T.

Sam Cook,

Corp., Co. D, 5 Reg't U. S. Col'd Cavalry.

Appears on

Company Muster Roll

for *Jan & Feb.*, 1865.

Present or absent *Present*

Stoppage, \$ *100* for

Due Gov't, \$ *100* for

Valuation of horse, \$ *100*

Valuation of horse equipments, \$ *100*

Remarks: ** 1st installment of*

Bounty due \$100.

Appointed Corp from

private per P.O No. 27

22 Feb. '65 to date 1 Jan.

'65

** As on Roll.*

Book mark:

Wm B Scott

6 | 5 Cav. | U.S.C.T.

Samuel Cook,
Capt., Co. D, 5 Reg't U. S. Col'd Cavalry.

Appears on

Company Muster Roll

for *March & April*, 1865.

Present or absent *Present*

Stoppage, \$ *100* for

Due Gov't, \$ *100* for

Valuation of horse, \$ *100*

Valuation of horse equipments, \$ *100*

Remarks:

Book mark:

Wm. H. Scott

(358)

Copyist.

6

5 Cav. U.S.C.T.

Samuel Cook

Corp't., Co. D, 5 Reg't U. S. Col'd Cavalry.

Appears on

Company Muster Roll

for May & June, 1865.

Present or absent Present

Stoppage, \$ 100 for

Due Gov't, \$ 100 for

Valuation of horse, \$ 100

Valuation of horse equipments, \$ 100

Remarks:

Book mark:

Milliken

(358)

Copyist.

6 | **5 Cav. U.S.C.T.**

Samuel Cook

Corpl, Co. D, 5 Reg't U. S. Col'd Cavalry.

Appears on

Company Muster Roll

for July + Augt, 1865.

Present or absent present

Stoppage, \$ 100 for

Due Gov't, \$ 100 for

Valuation of horse, \$ 100

Valuation of horse equipments, \$ 100

Remarks:

Book mark: -----

Milliken

6 | 5 Cav. | U.S.C.T.

Samuel Cook

Corp'l, Co. D, 5 Reg't U. S. Col'd Cavalry.

Appears on

Company Muster Roll

for Sept. & Oct., 1865.

Present or absent present

Stoppage, \$ 100 for

Due Gov't, \$ 100 for

Valuation of horse, \$ 100

Valuation of horse equipments, \$ 100

Remarks: Daily duty Reg'l Commissary Dept.

Book mark:

Milliken

(358)

Copyist.

6

5 Cav. U.S.C.T.

Samuel Cook

Corp'l, Co. D, 5 Reg't U. S. Col'd Cavalry.

Appears on

Company Muster Roll

for Nov. & Dec., 1865.

Present or absent present

Stoppage, \$ 100 for

Due Gov't, \$ 100 for

Valuation of horse, \$ 100

Valuation of horse equipments, \$ 100

Remarks: On daily duty Reg't
Commissary Dept. per Reg't
order 24 Feb. 9/65.

Book mark:

Milliken

(358)

Copyist.

Samuel Cook,

Corpl., Co. D, 5 Reg't U. S. Col'd Cavalry.

Appears on

Company Muster Roll

for *Jan'y^{4th} Febr'y*, 186*6*.

Present or absent *Present.*

Stoppage, \$ *100* for

Due Gov't, \$ *100* for

Valuation of horse, \$ *100*

Valuation of horse equipments, \$ *100*

Remarks: *On daily duty Regt.
Commissary Dept.*

Book mark: _____

R. W. Brewer
Copyist.

Q | 5 Cav. | U.S.C.T.

Samuel Cook.

Corpl. Co. N, 5 Reg't U. S. Colored Cav.

Appears on Returns as follows:

Mar. to Aug. 1865. On daily duty,
Regt. Coms'y Dept.

Sept. 1865 to Feb. 1866. On duty
in Regt. Coms'y Dept.

Book mark:

(546)

H. Baker
Copyist.

C. | 5 Cav. | U.S.C.T.

Samuel Cook,
Corpl., Co. D., 5 Reg't U. S. Col'd Cavalry.

Appears on **Co. Muster-out Roll**, dated
Helena, Ark., March 16, 186*6.*

Muster-out to date *March 16,* 186*6.*

Last paid to *Dec. 31,* 186*5.*

Clothing account:

Last settled....., 186 ; drawn since \$..... 100

Due soldier \$ *10.*¹¹/₁₀₀; due U. S. \$..... 100

Am't for cloth'g in kind or money adv'd \$..... 100

Due U. S. for arms, equipments, &c., \$..... 100

Bounty paid \$..... 100; due \$..... 100

Remarks: *Appointed Corpl. Feb.*
1, 1865.

Book mark:

(361)

R. Bramer.

Copyist.

Cook, Sam

Co.

Reg't

U. S. C. 7

2

Enclosures.

Bed Cards	Final Statements
Burial Records	Furloughs or L. of A.
Certs. of Dis. for Discharge	Med. Certificates
C. M. Charges	Med. Des. Lists
Descriptive Lists	Orders
Discharge Certificates	Pris. of War Record
Enlistment Papers <i>2</i>	Resignations

Other papers relating to—

Admission to Hosp'l	Furlough or L. of A.
Casualty Sheet	Med. Examination
Confinement	Misc. Information
Contracts	Pay or Clothing
Death or Effects	Personal Reports
Desertion	Rank
Discharge from Hosp'l	Transfer to Hosp'l
Discharge from Service	Transfer to V. R. C.
Duty	Transportation

Sub Co 4/68

No. Nine

Sam Cook

Enlisted at Lebanon Ky

As Substitute for

Henry C Duncan

On the 22 day of August, 1864.

By

Capt James M Fidler

& B Merimee

John C Maxwell

Board of Enrollment,

4 Dist. of Ky

SUBSTITUTE VOLUNTEER ENLISTMENT.

STATE OF

TOWN OF

Kentucky

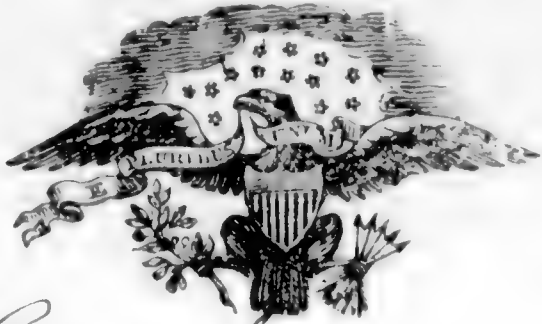

Nelson County

I, *Sam Cook* born in the State
of *Kentucky*, aged *18* years, and by
occupation a *Farmer* Do HEREBY ACKNOWLEDGE to have agreed with
Henry C Duncan, Esq., of *Nelson Co Ky*

to become his **SUBSTITUTE** in the Military Service, for a sufficient consideration paid and
delivered to me, on the *22nd* day of *August*, 1864;
and having thus agreed with said *Henry C Duncan*, I DO HEREBY
ACKNOWLEDGE to have enlisted this *22nd* day of *August*,
1864, to serve as a **Soldier** in the **Army of the United States of America**, for the period
of **THREE YEARS**, unless sooner discharged by proper authority: I do also agree to accept such
bounty, pay, rations, and clothing, as are, or may be, established by law for soldiers. And I do
solemnly swear that I will bear true and faithful allegiance to the **United States of America**;
that I will serve them honestly and faithfully against all their enemies or opposers whomsoever;
and that I will observe and obey the orders of the President of the United States, and the orders
of the Officers appointed over me, according to the Rules and Articles of War.

SWORN and subscribed to, at *Sebanon Ky*
this *22nd* day of *August* 1864.
BEFORE *W. Miller*
Capt. and Prov. Mar. 4th Dist. Ky

Sam^l Cook
mark

We certify, on honor, That we have carefully examined the above-named Volunteer Substitute
agreeably to the Regulations, and that, in our opinion, he is free from all bodily defects and mental infirmity
which would in any way disqualify him from performing the duties of a soldier; that he was entirely sober
when enlisted; that he is of lawful age, (not under 18 years;) and that, in accepting him as duly qualified to
perform the duties of an able-bodied soldier, and as a Substitute in lieu of *H. C. Duncan*
Enrolled, drafted in *5th Sub Dist - 4th Dist. Ky*
and not drafted, 1864, we have strictly observed the Regulations which govern
in such cases. This soldier has *Blk* eyes, *Blk* hair, *Yellow* complexion; is *5* feet *5 1/2*
inches high.

Sam^l W. Miller
Provost Marshal.

A. B. Murren
Commissioner of Board.

John C. Maxwell
Surgeon of Board.

DECLARATION OF SUBSTITUTE.

I, Sam Cook desiring to ENLIST
in the Army of the United States, for THREE YEARS, **Do declare**, That I am
18 years and _____ months of age; that I have
never been discharged from the United States service on account of disability or by sentence of
a court martial; and I know of no impediment to my serving honestly and faithfully as a soldier
for three years..

GIVEN at Lebanon Ky
the 22 day of August 1864

WITNESS:

L. J. Hoge

Sam Cook
mark

~~Co. 160~~ 283.
Co. 160 8 1/2

Sam Cook

Enlisted at Lebanon Ky

As Substitute for

Henry C. Duncan

On the 22 day of August, 1864.

By

Capt James M. Fuller

J. B. Merimee

John C. Maxwell

Board of Enrollment,

4 Dist. of Ky

[Faint signature]

SUBSTITUTE
VOLUNTEER ENLISTMENT.

STATE OF

TOWN OF

Kentucky

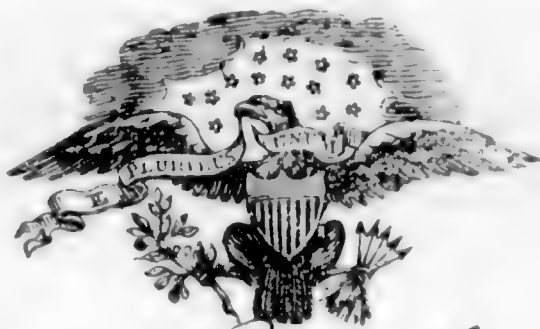

Nelson County

I, *Sam Cook* born in the State
of *Ky*, aged *18* years, and by
occupation a *Farmer* DO HEREBY ACKNOWLEDGE to have agreed with

Henry C. Duncan, Esq., of *Nelson Co Ky*

to become his **SUBSTITUTE** in the Military Service, for a sufficient consideration paid and
delivered to me, on the *22nd* day of *August*, 1864;

and having thus agreed with said *H. C. Duncan*, I DO HEREBY
ACKNOWLEDGE to have enlisted this *22* day of *August*,

186*4*, to serve as a **Soldier** in the **Army of the United States of America**, for the period
of **THREE YEARS**, unless sooner discharged by proper authority: I do also agree to accept such
bounty, pay, rations, and clothing, as are, or may be, established by law for soldiers. And I do
solemnly swear that I will bear true and faithful allegiance to the **United States of America**;
that I will serve them honestly and faithfully against all their enemies or opposers whomsoever;
and that I will observe and obey the orders of the President of the United States, and the orders
of the Officers appointed over me, according to the Rules and Articles of War.

SWORN and subscribed to, at *Sebanon Ky*

this *22nd* day of *August* 1864

BEFORE *Wm M Hill*

Capt 2nd Reg. Ma. 4th Dist. Ky

Sam^l Cook

mark

We certify, on honor, That we have carefully examined the above-named Volunteer Substitute
agreeably to the Regulations, and that, in our opinion, he is free from all bodily defects and mental infirmity
which would in any way disqualify him from performing the duties of a soldier; that he was entirely sober
when enlisted; that he is of lawful age, (not under 18 years;) and that, in accepting him as duly qualified to
perform the duties of an able-bodied soldier, and as a Substitute in lieu of *H. C. Duncan*
Enrolled, drafted in *5th Sub Dist; 4th Dist- Ky*
and not drafted, 186*4*, we have strictly observed the Regulations which govern
in such cases. This soldier has *Blk* eyes, *Blk* hair, *yellow* complexion; is *5⁶* feet *5²*
inches high.

Sam M Hill

Provost Marshal.

F. B. Merriam

Commissioner of Board.

John C Maxwell

Surgeon of Board.

Board of Enrollment of *4* Dist. of *Ky*

DECLARATION OF SUBSTITUTE.

I, Sam Cook desiring to ENLIST
in the Army of the United States, for THREE YEARS, **Do declare**, That I am
18 years and _____ months of age; that I have
never been discharged from the United States service on account of disability or by sentence of
a court martial; and I know of no impediment to my serving honestly and faithfully as a soldier
for three years.

GIVEN at Lebanon Ky
the 22 day of August 1864

WITNESS:

J. F. Hoge

Sam^{l's} Cook
Cook

Wagon 295 Thomas

Co 10, 5 U. S. Col'd Cav.

Private

CARD NUMBERS.

1	26
2	27
3	28
4	29
5	30
6	31
7	32
8	33
9	34
10	35
11	36
12	37
13	38
14	39
15	40
16	41
17	42
18	43
19	44
20	45
21	46
22	47
23	48
24	49
25	50

Book Mark:

See also

Cooney, Michael

Co. *A, d*, 5 U. S. Col'd Cav.

Captain

Captain

CARD NUMBERS.

1	5-359157	26
2	5-370074	27
3	5-370166	28
4	5-370257	29
5	5-370344	30
6	5-370444	31
7	5-370539	32
8	5-370612	33
9	5-370682	34
10	9435962	35
11	40729656	36
12		37
13		38
14		39
15		40
16		41
17		42
18		43
19		44
20		45
21		46
22		47
23		48
24		49
25		50

Book Mark:

See also

6th Reg. C. Cav.

AB1722562 -

P.O. Canal 2/10/24

Miss Mary Ann

C | 1st Cav. | **U.S.C.T.**

Michael Cooney

Capt, Co. L, 3^d Reg't U. S. Col'd Cav.

Appears on

Regimental Descriptive Book

(List of Commissioned Officers)

of the regiment named above.

Rank Captain

Date of appointment Dec 14 1864.

Remarks: Mustered Jan 1, 1865,
at Camp Nelson Ky
by Capt. N. C. Hinckley.

6 | 5 Cav. | U.S.C.T.

Michael Cooney

Capt, Co. H, 5 Reg't U. S. Col'd Cav.

Age 28 years.

Appears on an

Individual Muster-in Roll

of the organization named above. Roll dated

Camp Nelson Ky, Jan. 17, 1865.

Muster-in to date Jan. 1, 1865.

Joined for duty and enrolled:

When Jan. 1, 1865.

Where Camp Nelson Ky.

Period 3 years.

Valuation of horse, \$ 100

Valuation of horse equipments, \$ 100

Remarks: Mustered in upon appointment of the President of the U. S. dated Louisville Ky. December

Book mark:

Sarimer

JAN. - 9

5359157

1891 *

14 1864 to rank as
Captain in 5 U. S. Cavalry
Enlisted men of said
Company (H) were mustered
in to the minimum on
or before Jan'y. 1865

assigned to duty with
his Company (H) Jan'y 1
1865. Discharged as
Quartermaster Sergt. 6
U. S. C. Cavalry. December
31 1864

Q

5 Cav. U.S.C.T.

Michael Cooney

Capt, Co. L, 5 Reg't U. S. Col'd Cavalry.

Appears on

Company Muster Roll

for *June & July*, 186*5*

Present or absent *Absent*

Stoppage, \$ *100* for

Due Gov't, \$ *100* for

Valuation of horse, \$ *100*

Valuation of horse equipments, \$ *100*

Remarks: *Assigned to Co L by Order No 4 dated Camp Nelson June 17" 1865 to take effect June 1. /65 On duty with Detch Camp Nelson.*

Book mark:

Bridle

L

5 Cav. U.S.C.T.

Michael Cooney

Capt, Co. L, 5 Reg't U. S. Col'd Cavalry.

Appears on

Company Muster Roll

for *Mar & Apr*, 1865.

Present or absent *Present*

Stoppage, \$ 100 for

Due Gov't, \$ 100 for

Valuation of horse, \$ 100

Valuation of horse equipments, \$ 100

Remarks: *Assigned to
Command of Co L
per R O No 44 Mex
3/65*

Book mark:

Bridges

(358)

Copyist.

C

5 Cav. U.S.C.T.

Michael Cooney
Capt, Co. L, 5 Reg't U.S. Col'd Cavalry.

Appears on

Company Muster Roll

for May & June, 1865.

Present or absent Present

Stoppage, \$ 100 for

Due Gov't, \$ 100 for

Valuation of horse, \$ 100

Valuation of horse equipments, \$ 100

Remarks: Commanding Co. L
5th U.S. C. Co. since
March 23rd 65

Book mark:

Proctor

C | **5 Cav. | U.S.C.T.**

Michael Cooney
Capt, Co. L, 5 Reg't U. S. Col'd Cavalry.

Appears on

Company Muster Roll

for *July & Aug*, 1865.

Present or absent *Present*

Stoppage, \$ 100 for

Due Gov't, \$ 100 for

Valuation of horse, \$ 100

Valuation of horse equipments, \$ 100

Remarks:

Book mark:

Redacted

C

5 Cav.

U.S.C.T.

Michael Cooney

Capt, Co. L, 5 Reg't U. S. Col'd Cavalry.

Appears on

Company Muster Roll

for *Sept & Oct*, 1865.

Present or absent *Present*

Stoppage, \$ 100 for

Due Gov't, \$ 100 for

Valuation of horse, \$ 100

Valuation of horse equipments, \$ 100

Remarks:

Book mark:

Reuter

(358)

Copyist.

C

5 Cav. | U.S.C.T.

Michael Conroy
Capt, Co. L, 5 Reg't U. S. Col'd Cavalry.

Appears on

Company Muster Roll

for *Nov Dec*, 1865.

Present or absent *Present*

Stoppage, \$ 100 for

Due Gov't, \$ 100 for

Valuation of horse, \$ 100

Valuation of horse equipments, \$ 100

Remarks:

Book mark:

Redeater

B | **5 Cav. | U.S.C.T.**

Michael Conroy
Capt, Co. L, 5 Reg't U.S. Col'd Cavalry.

Appears on

Company Muster Roll

for *Jan. 7 Feb.*, 186*6*.

Present or absent *Present*

Stoppage, \$ *100* for

Due Gov't, \$ *100* for

Valuation of horse, \$ *100*

Valuation of horse equipments, \$ *100*

Remarks:

Book mark:

C. J. Taylor

(358)

Copyist.

C. | **5 Cav.** | **U.S.C.T.**

Michael Cooney.

Capt., Co. L, 5 Reg't U. S. Colored Cav.

Appears on Returns as follows:

*Jan. & Feb. 1865. Absent. Assigned
to Co. L by R. O. H. from Jan.
1/65. In duty with detach. 5th
U. S. at Camp Nelson, Ky.*

Mar 1865 to Feb. 1866. Present.

Book mark:

(546)

A. Baber
Copyist.

C | 5 Cav. | **U.S.C.T.**

Michael Conroy
Capt., Co. L, 5 Reg't U. S. Col'd Cavalry

Appears on **Co. Muster-out Roll**, dated
St. Louis, Mo., Mar. 16, 1866.
Muster-out to date Mar. 16, 1866.
Last paid to Dec. 31, 1865.

Clothing account:

Last settled _____, 186 ; drawn since \$ _____ 100
Due soldier \$ _____ 100; due U. S. \$ _____ 100
Am't for cloth'g in kind or money adv'd \$ _____ 100

Due U. S. for arms, equipments, &c., \$ _____ 100
Bounty paid \$ _____ 100; due \$ _____ 100

Remarks: Was Quartermaster Supt.
6th U.S. Cav. Rec'd & accepted
appointment Jan. 12th 1865, at
Winchester Va. Original entry
into service at Brandy Station,
Virginia.

Book mark: _____

A. P. Taylor

Corney Michael

Capt., Co.

5

Reg't

1st Reg't

18

Enclosures.

Bed Cards	Final Statements
Burial Records	Furloughs or L. of A.
Certs. of Dis. for Discharge	Med. Certificates
C. M. Charges	Med. Des. Lists
Descriptive Lists	Orders <i>8</i>
Discharge Certificates	Pris. of War Record
Enlistment Papers	Resignations

Other papers relating to—

Admission to Hosp'l	Furlough or L. of A.
Casualty Sheet	Med. Examination
Confinement	Misc. Information <i>1</i>
Contracts	Pay or Clothing
Death or Effects	Personal Reports <i>1</i>
Desertion	Rank
Discharge from Hosp'l	Transfer to Hosp'l
Discharge from Service	Transfer to V. R. C.
Duty	Transportation

MICROFILM PUBLICATION M 1821

COMPILED MILITARY SERVICE RECORDS
OF VOLUNTEER UNION SOLDIERS WHO
SERVED WITH THE USCT (US COLORED TROOPS)
5TH REGIMENT OF CAVALRY

PERSONAL PAPERS' TARGET SHEET

PLEASE NOTE THE CHECKED INFORMATION ABOUT THE PERSONAL PAPERS IN
THIS FILE:

- NO PERSONAL PAPERS WERE FOUND IN THIS FILE WHEN THE
RECORDS WERE ARRANGED FOR MICROFILMING.
- 11 PERSONAL PAPER(S) FOUND IN THIS FILE WHEN THE RECORDS
WERE ARRANGED FOR MICROFILMING.

Special Order No 92

File No 100507

Lexington Ky Jan 15. 55

Ordering Capt Cooney to
report for duty

Recd & Filed Jan 17. 1863

Head Quarters
Sept. 7, 1865.

Special Orders
No. 128 J. E. K.:

By order of the Genl. of the 5th U.S.C.
Bapt. Michael Conroy
with one hundred men, armed and
equipped, provided with five
days rations will proceed without
delay to Crab Orchard Ky, and bring
in, under guard, Company D
3rd U.S.C. (Inf) and report the same
at these Hd. Qrs.

The Dept will furnish the necessary
transportation.

By order of H. M. K. K. K.
Maj. 5th U.S.C. Cav. Inspr. Genl.
O. A. S. Lewis
Lt. J. A. A. I.

411
Copy to the 1st Lt. of the 5th U.S.C. Cav. Inspr. Genl.
H. M. K. K. K.

Special Order 128

Camp Nelson Ky
Sept. 9. 1865

Orders Capt Conroy & 100
men 5th U.S.C. to proceed
to Crab Orchard and
arrest C & L 13th U.S.C.

Head Quarters

Camp Nelson Ky

Sept 9th 1865

Special Order
No 128

Ext

II Capt Richard Cooney

5th U.S. Inf with one hundred men
armed & equipped provided with five
days rations will proceed without delay
to Crab Orchard Ky and bring under
Guard Company L 13th U.S. Inf
and report the same to these Head Quarters

U.S. Dept will furnish the
necessary transportation

By order of

H. M. Kidder

Major 5th U.S. Inf Comd Post

O. A. DeLew.

Lieut & a, a, a, G

A. d. G. s. Camp Nelson Ky.
Sep. 11. 1865.

*Transportation furnished from
1st Regt. 5th U.S.C. to
Camp Nelson Ky. by
order of Major G. W. Brown
of the 1st Regt. 5th U.S.C.*

d. us. J.
J. Est:-

In accordance with
instructions received from A. d. G. s.
1st Regt. 5th U.S.C. Capt. Michael Conroy
will proceed, with his company,
immediately, to Lexington Ky, upon
his arrival, report to Maj. A. H.
Brown - U. A. G. 1st Regt. 5th U.S.C.
Ky, for duty.
The Regt will furnish necessary
transportation.

By order of F. H. Bierbauer
Co. B. 124. U.S.C. Aug. Park
O. A. DeLew
Lt. General

To:
Capt. M. Conroy
5th U.S.C.

Special Order 130

Hd Qrs Camp Nelson Ky
Sept. 11. 1865

Orders Co L to proceed
to Lexington Ky

Head Quarters Camp, etc. etc.
Sept. 11th 1865

Special Orders

No. 131 D. Ext.

In accordance with instructions from Head Quarters 14th Dir. Dept. of Ky, Capt. Michael Conroy Fusce. will proceed, with his company, immediately to Lexington Ky, upon his arrival, reports to Maj. A. C. Dawson a. a. a. Genl. Ad. Pro. 14th Dir. D. of Ky for duty.
G. M. Dept. will furnish the necessary transportation.

By Order of G. H. Durbaker

Col. 124. U. S. A. Camp. Park

O. A. DeLew

Lt. and a. a. a. G.

30.
C. O. Fusce

West Liberty Morgan Co Ky
October 16th 1865

~~Company Mitchell~~
Capt 5th 16, S. C. Cav^y

Reports that he still at that
place and says that he has
discharged his duties to the best
of his abilities

West Liberty Morgan Co. Ky.
October 16th 1865.

Captain

I have the honor to report that I am still at this place, upon my arrival here last Monday. I reported to Division H^d. gr. by letter. I have received no orders or instructions since. I have to the best of my ability discharged the duty I was sent to discharge, but I have not caught any Guerrillas. The people say that they have not been troubled by any since the bands surrendered. Some of them saw J. J. Williams when he captured Mr. Gordon but most of them has seen none for six months. I was at the house of Williams last Wednesday. His wife says he left for North Carolina. The latest information I can get relative to him is that he crossed into Va., about one month since. The people seem to think there is no need of soldiers here and all blame Mr. Gordon for having us here.

some people think that there are some
Guerillas in the Country but don't know where
they are and are unable to accuse any one
of harbouring them. in general the people are
very poor. Being a class of people who trade
in cattle and distill whiskey, and farm but
very little I find it difficult to procure forage
without impoverishing the people and then
I have to send four or five miles after it, over
a country where there is no roads. on the
night of the 13th my guards discovered four
or five fellows loitering around and reported
it to me. I sent a party in quest of them &
in a few moments shooting became very brisk
and alarmed the people very much. They are
pronounced to be horse thieves by the inhabitants.
They made no fight - some of the men say they
fired pistols. there was none of my men hurt -
but - at least - one of the others was wounded
as I saw traces of blood - on the scene of action
next day. I made several arrests on suspi-
cion of complicity or cognizance of the affair
but for want of evidence released them

with this exception things are all
quiet. The local officers are all at their
stations and it is due to them to say that they
seem to regret this occurrence very much
& seem anxious to find the parties guilty -
nine or ten of them banded together on Saturday
night and went twelve miles in search of a
horse thief and found him. I offered to go or
send a party if they would furnish a guide
but they declined, asking only a horse & gun,
which I gave them, in conclusion. I will
state that I would wish to be out of here, or have
forage furnished, me, as I assume you I
would prefer any other duty to forcing forage
from those poor people, all profess to be loyal
and their tales of poverty need not be told, for that
is visible. I purpose leaving here on Sat-
urday, unless I receive other orders. -

I am Captain

very respectfully

Your obdt. servt.

Michl. Cooney
Capt - 1st Regt. C.

Capt. R. A. Forster

A. A. Co. G. 1st Div. P. M.

Head Quarters 1st Div of Ky

Lex Ky. Nov. 8. 1865-

Special Order 31

Orders Capt Covey Co. L.S. 4th Reg
to turn over all horse equipment
in his possession over to Capt
Campbell A.G.M. Lexington Ky

First Brigade
Head-Quarters, First Division Department of Ky.

Lexington, Ky., November 5th 1865.

SPECIAL ORDERS,

No. 21.

"EXTRACT"

It is ordered that Capt. Michael Conroy Co "G"
5th U. S. Colored Cavalry with immediacy
turn over to Capt. John B. Campbell
Asst. Quartermaster at Lexington Ky all horses
and horse equipments now in his possession for
which he is responsible.

By Command of Brig. Gen. *J. Wade* **JAS. S. BRISBEN,**

Commanding Officer
5th U. S. C. Cavalry.

J. Wade
Capt. and A. A. A. G.

Head M St Francis R D
Helena Ark Dec 31. 65

Special Order 155

Relieves Capt M Cooney
5th of ce from Board of
Survey

Head Quarters St. Francis River District.

Felena, Missouri, December 31st 1865-

SPECIAL ORDERS. }

NO. 155 }

EXTRACT.

II On account of his ill health
the following named officer is hereby relieved
from duty on the Board of Survey convened by
Pro. 3 Special Order No 151 Current Series from these
Head Quarters.

Capt. M. Corney 5th U. S. C. Co.

By order of Major Maj. Gen. E. A. CARR

M. A. Hayes

1st Lieut. and Act. Asst. Adj. Gen.

To

Col. F. A. Carpenter
Comd. 5th Reg. Cav.

M. Cooney
Capt, 5 U.S.C.C.
Order

Head Quarters St. Francis River District.

Felton, Arkansas, December 31st 1865

SPECIAL ORDERS. |

NO. 153- |

EXTRACT.

II On account of his ill health
the following named officer is hereby relieved
from duty on the Board of Survey convened by
Per 3 Special Orders No 151 Current Series from these
Head Quarters.

Capt. M. Carney 5th U.S. C. Cav.

By order ofrevet Maj. Gen. E. A. CARR.

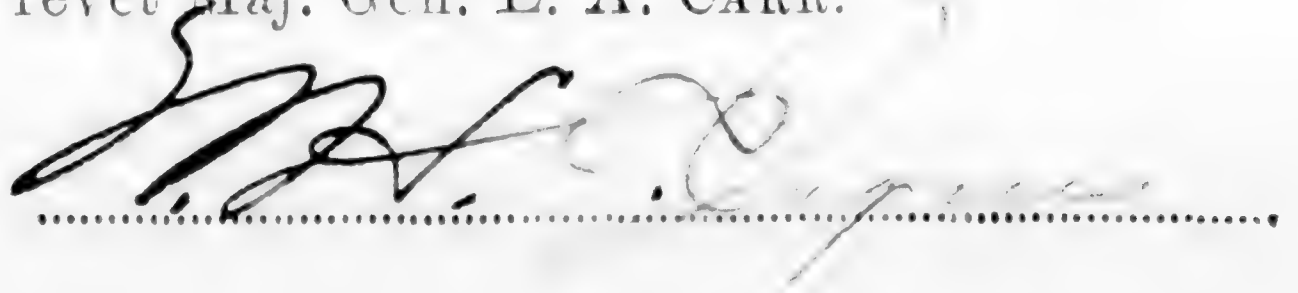

To

Capt. M. Carney
5th U.S. C. Cav.

1st Lieut. and Act. Asst. Adj. Gen.

Affidavit of Nonindebtedness to U. S.,

of Michael Courcy

late Capt. Co. G. 5th Reg't

U. S. Col. 1st Reg't on which was

based Certificate of Nonindebtedness
to U. S.,

Dated March 17th 1866.

STATE OF

Missouri

COUNTY

Phillips

} ss.

I, Michael Conroy
late Captain Co. 1st Regt. U. S. A. Cav.
do solemnly declare on oath, that I have duly accounted for all Public
Property, for which I have ever been responsible as an Officer of the Volunteer
Forces of the United States: that I have rendered all returns and reports, re-
quired by Revised Army Regulations of 1863 and existing orders: - that
I am not now, on any account whatever, indebted to the General Government
except as stated on Muster-out Rolls.

Michael Conroy
Late Capt. Co. 5th U. S. A. Cav.

Sworn and subscribed before me, at Neosho, Mo.
this 17th day of March 1866.

W. F. Morse
Capt. & Comdr. Muster
Capt. of Arkansas

~~Old files~~ :- Old Records Div.

Capt. Michael Cooney, served with
5th S Cold Cav Jan 1, 1865 to Mar 16, 1866;
appointed 1st Lt 9 Cav 7/28/66; promoted
Capt 1/1/68 & served with 9 Cav to
Dec 10, 1888

Trurson per Batson
7-12-24 442

RECEIVED
JUL 14 1924
OLD RECORDS DIVN.

Old Files: Please loan all 1722862.

Holmes

7/14/22.

herewith
Return
SMC - all Files
7-14-24

RECEIVED
JUL 14 1924
OLD RECORDS DIVN.

To All Rec. Div.

211
Cooper, John
Co I, 5 U.S. Col'd Cav.

Private

CARD NUMBERS.

1	26
2	27
3	28
4	29
5	30
6	31
7	32
8	33
9	34
10	35
11	36
12	37
13	38
14	39
15	40
16	41
17	42
18	43
19	44
20	45
21	46
22	47
23	48
24	49
25	50

Book Mark:

See also

Cooper, Lewis

Co A, 5 U. S. Col'd Cav.

Private Private

CARD NUMBERS.

1	5359618	26
2	5359720	27
3	5359821	28
4	5359922	29
5	5360020	30
6	5360113	31
7	5360202	32
8	5360293	33
9	5360385	34
10	5360474	35
11	5360561	36
12	9089991	37
13	43154953	38
14	40729577	39
15		40
16		41
17		42
18		43
19		44
20		45
21		46
22		47
23		48
24		49
25		50

Book Mark:

See also

C | 5 Cav. | U.S.C.T.

Lewis Cooper

, Co. A, 5 Reg't U. S. Col'd Cav.

Appears on

Company Descriptive Book

of the organization named above.

DESCRIPTION.

Age 18 years; height 5 feet 9 inches.

Complexion *Ok*

Eyes *Ok*; hair *Ok*

Where born *Henry, Ky.*

Occupation *Labourer*

ENLISTMENT.

When *Sept. 13*, 186 .

Where *Louisville*

By whom *Capt. Ham*, term *3* y'rs.

Remarks:

A. A. Hall

(383a)

~~Copist~~
Camp.

C

5 bar

U. S. & T.

Lewis Cooper

Appears with rank of *Private* on

Muster and Descriptive Roll

of *a detachment of U. S.*

Roll dated *Louisville Ky, Sept. 14, 1864.*

Where born *Henry Co. Kentucky*

Age *18* years; occupation *Laborer.*

When enlisted *Sept. 13, 1864.*

Where enlisted *Louisville, Ky*

For what period enlisted *3* years.

Eyes *dark*; hair *dark*

Complexion *dark*; height *5 ft. 9 in.*

When mustered in *Sept. 14, 1864*

Where mustered in *Louisville, Ky*

Bounty paid \$ *100*; due \$ *100*

Clothing account:

Last settled *186*; drawn since \$ *100*

Date of first muster *186*.

Company to which assigned

Remarks: *Credited to Henry Co. 5 Dist,*

Book mark:

J. Noach

(356m)

Copyist.

5

5 Cav.

U.S.C.T.

Lewis Cooper

Priv., Co. A, 5 Reg't U. S. Col'd Cavalry.

Appears on

Company Muster-in and Descriptive Roll

of the organization named above. Roll dated

Spitelsouky, N. Y., Oct. 24, 1864.

Where born Kentucky

Age 18 y'rs; occupation Laborer

When enlisted Sept. 13, 1864.

Where enlisted Louisville

For what period enlisted 3 years.

Eyes dk; hair dk

Complexion dk; height 5 ft. 9 in.

When mustered in Sept. 14, 1864.

Where mustered in Louisville

Bounty paid \$ 100; due \$ 100

Where credited 5th Dist, Kentucky

Company to which assigned 4.

Remarks:

Book mark:

(356d)

Castling

Copyist.

L

5 Cav. | U.S.C.T.

Lewis Cooper

Cpt., Co. A, 5 Reg't U. S. Col'd Cavalry.

Appears on

Company Muster Roll

for *5 Oct, 31*, 1864.

Present or absent *Present*

Stoppage, \$ *100* for

Due Gov't, \$ *100* for

Valuation of horse, \$ *100*

Valuation of horse equipments, \$ *100*

Remarks:

Book mark:

Easterling
Copyist.

(358)

Levin Cooper

Pr, Co. A, 5 Reg't U.S. Col'd Cavalry.

Appears on

Company Muster Roll

for *Nov & Dec*, 1864.

Present or absent *Present*

Stoppage, \$ *100* for

Due Gov't, \$ *100* for

Valuation of horse, \$ *100*

Valuation of horse equipments, \$ *100*

Remarks: *1st & 2^d installment
Bounty due*

Book mark:

Easterling

(358)

Copyist.

6

5 Cav.

U.S.C.T.

Levin Cooper

Pat, Co. A, 5 Reg't U. S. Col'd Cavalry.

Appears on

Company Muster Roll

for *Jan. 7 Feb.*, 186*4*.

Present or absent *Present*,

Stoppage, \$ *100* for

Due Gov't, \$ *100* for

Valuation of horse, \$ *100*

Valuation of horse equipments, \$ *100*

Remarks: *1st Installment
Barracks due \$100*

Book mark: _____

(358)

Pat Cooper

Copyist.

3

5 Cav. U.S.C.T.

Louis Cooper
Plt.

Co. A, 5 Reg't U. S. Col'd Cavalry.

Appears on

Company Muster Roll

for *March 1st*, 1865.

Present or absent

Present

Stoppage, \$ 100 for

Due Gov't, \$ 100 for

Valuation of horse, \$ 100

Valuation of horse equipments, \$ 100

Remarks:

*let installment
be sent due 4/15.*

Book mark:

H. A. W. 11

6 | 5 Cav. | U.S.C.T. |

Lewis Joseph

Plt., Co. A, 5 Reg't U. S. Col'd Cavalry.

Appears on

Company Muster Roll

for May 1863, 1863.

Present or absent Present

Stoppage, \$ 100 for

Due Gov't, \$ 100 for

Valuation of horse, \$ 100

Valuation of horse equipments, \$ 100

Remarks: At present
bounty due \$50.

Book mark:

J. A. [Signature]
Copist.

(358)

5 Cav. U.S.C.T.

William Joseph
217, Co. A, 5 Reg't U.S. Col'd Cavalry.

Appears on

Company Muster Roll

for *Sept 1865*, 1865

Present or absent *Present*

Stoppage, \$ *100* for

Due Gov't, \$ *100* for

Valuation of horse, \$ *100*

Valuation of horse equipments, \$ *100*

Remarks:

Book mark:

(358)

W. J. Joseph
Copist.

6 | 5 Cav. | U.S.C.T.

George Campbell
Pvt., Co. A, 5 Reg't U. S. Col'd Cavalry.

Appears on

Company Muster Roll
for *Dated Oct 31*, 186*5*.

Present or absent *Present*

Stoppage, \$ 100 for

Due Gov't, \$ 100 for

Valuation of horse, \$ 100

Valuation of horse equipments, \$ 100

Remarks:
.....
.....
.....
.....
.....
.....
.....
.....
.....
.....

Book mark:

J. A. [Signature]
(358) *[Signature]* (Copyist.)

C

5 Cav. U.S.C.T.

Lewis Cooper
Pvt

, Co. A, 5 Reg't U. S. Col'd Cavalry.

Appears on

Company Muster Roll

for Nov Dec, 1865.

Present or absent Present

Stoppage, \$ 100 for

Due Gov't, \$ 52 100 for Ord

Valuation of horse, \$ 100

Valuation of horse equipments, \$ 100

Remarks:

Book mark:

W. W. Sayre
Copyist.

C

5 Cav.

U.S.C.T.

Lewis Cooper
Pvt, Co. A, 5 Reg't U. S. Col'd Cavalry.

Appears on

Company Muster Roll

for Jan & Feb, 1866

Present or absent Present

Stoppage, \$ 100 for

Due Gov't, \$ 100 for

Valuation of horse, \$ 100

Valuation of horse equipments, \$ 100

Remarks:

Book mark:

M. W. Payne
Copyist.

(358)

C. | 5 Cav. | U.S.C.T.

Lewis Cooper.

Co. A, 5 Reg't U. S. Colored Cav.

Appears on Returns as follows:

Nov. 1864. Absent sick. Left at
Lexington, Ky., Nov. 22/64.

Book mark:

(546)

Baker
Copyist.

C

5 Cav.

U.S.C.T.

Jervis Cooper

Pvt, Co. A, 5 Reg't U. S. Col'd Cavalry.

Appears on Co. Muster-out Roll, dated

Alena Ark Mich 16, 1866.

Muster-out to date

Mich 16, 1866.

Last paid to

Dec 31, 1865.

Clothing account:

Last settled _____, 186 ; drawn since \$ _____ 100

Due soldier \$ _____ 100; due U. S. \$ 63¹⁹/₁₀₀

Am't for cloth'g in kind or money adv'd \$ _____ 100

Due U. S. for arms, equipments, &c., \$ 2⁰³/₁₀₀

Bounty paid \$ 100/₁₀₀; due \$ 100/₁₀₀

Remarks: Due U.S. for Ard

\$2.03

Book mark :

W. W. Payne

(361)

Copyist.

299

Cotton Fleming

Co B, 5 U. S. Col'd Cav.

Private

CARD NUMBERS.

1	5360854	26
2	5360950	27
3	5361040	28
4	5361127	29
5	5361214	30
6	5361304	31
7	5361388	32
8	5361470	33
9	5361552	34
10	9090101	35
11	43148523	36
12	40729587	37
13		38
14		39
15		40
16		41
17		42
18		43
19		44
20		45
21		46
22		47
23		48
24		49
25		50

Book Mark:

See also

C | **5 Cav. | U.S.C.T.**

Hemming Cotton

....., Co. *B*, 5 Reg't U. S. Col'd Cav.

Appears on

Company Descriptive Book
of the organization named above.

DESCRIPTION.

Age *39* years; height *5* feet *8* inches.

Complexion *Blk*

Eyes *Blk*; hair *Blk*

Where born *Lessamine Co Ky*

Occupation *laborer*

ENLISTMENT.

When *Oct 20*, 1864:

Where *Lexington Ky*

By whom *Capt Moore*; term *3* y'rs.

Remarks:

.....

.....

.....

.....

.....

.....

.....

.....

.....

.....

.....

.....

.....

.....

.....

.....

.....

.....

.....

.....

.....

.....

.....

.....

.....

.....

.....

.....

.....

.....

.....

.....

.....

.....

.....

.....

.....

.....

.....

A. | 5 bar | U.S.A.F.

Flemming Cotton

Appears with rank of Private on

Muster and Descriptive Roll

of Detacht. of U.S. Enlisted Colored Volunteers forwarded

Roll dated

Lexington, Ky Oct. 22, 1864.

Where born Jessamine Co. Ky

Age 39 years; occupation Laborer

When enlisted Oct. 20, 1864.

Where enlisted Lexington, Ky

For what period enlisted 3 years.

Eyes Blk; hair Blk

Complexion Blk; height 5 ft. 8 in.

When mustered in _____, 186 .

Where mustered in _____

Bounty paid \$ 100; due \$ 100

Clothing account:
Last settled _____, 186 ; drawn since \$ 100

Date of first muster Oct. 20, 1864.

Company to which assigned _____

Remarks: Credit Franklin Co., 7 Dist. Ky.

Book mark: _____

H. J. Harris

(356m)

Copyist.

6

5 Cav.

U.S.C.T.

Fleming Cotton

Pris, Co. B, 5 Reg't U. S. Col'd Cavalry.

Appears on

Company Muster Roll

for Nov & Dec, 1864.

Present or absent Absent

Stoppage, \$ 100 for

Due Gov't, \$ 100 for

Valuation of horse, \$ 100

Valuation of horse equipments, \$ 100

Remarks: Sick in Hospital

Camp Nelson Ky.

1858 2nd instalment

bounty due

Due U. S. for Ordnance #

(Unrolled per 90 at Lexington Ky

for Equip & Mus. in bet 22. at Lexington Ky)

Roll torn

Book mark:

Lauch

6 | 5 Cav. | U.S.C.T.

Flemming Cotton

Pvt., Co. B, 5 Reg't U. S. Col'd Cavalry.

Appears on

Company Muster Roll

for Jan & Feb, 1865.

Present or absent Present

Stoppage, \$ 100 for

Due Gov't, \$ 100 for

Valuation of horse, \$ 100

Valuation of horse equipments, \$ 100

Remarks: 1st instalment
bounty \$100 due

Book mark:

Lauch

(358)

Copyist

6 | 5 Cav. | U.S.C.T.

Fleming Cotton

Priv., Co. B, 5 Reg't U. S. Col'd Cavalry.

Appears on

Company Muster Roll

for Feb 28 to Apr, 1865.

Present or absent Present

Stoppage, \$ 100 for

Due Gov't, \$ 100 for

Valuation of horse, \$ 100

Valuation of horse equipments, \$ 100

Remarks: 1st instalment to bounty due \$100

Book mark:

Lamb

(358)

Copyist.

5 Cav. U.S.C.T.

Fleming Cotton

Priv., Co. B, 5 Reg't U. S. Col'd Cavalry.

Appears on

Company Muster Roll

for May & June, 1865.

Present or absent present

Stoppage, \$ 100 for

Due Gov't, \$ 100 for

Valuation of horse, \$ 100

Valuation of horse equipments, \$ 100

Remarks: 1st installment
bond due \$100

Book mark:

R. E. Wilson

6

5 Cav.

U.S.C.T.

Fleming Cotton

Priv., Co. B, 5 Reg't U. S. Col'd Cavalry.

Appears on

Company Muster Roll

for *July & Aug.*, 186*5*.

Present or absent *present*

Stoppage, \$ *100* for

Due Gov't, \$ *100* for

Valuation of horse, \$ *100*

Valuation of horse equipments, \$ *100*

Remarks:

Book mark:

R. E. Wilson

6

5 Cav.

U.S.C.T.

Fleming Cotton

Priv., Co. B, 5 Reg't U. S. Col'd Cavalry.

Appears on

Company Muster Roll

for Sept & Oct., 1865.

Present or absent Present

Stoppage, \$ 100 for

Due Gov't, \$ 100 for

Valuation of horse, \$ 100

Valuation of horse equipments, \$ 100

Remarks:

Book mark:

R. E. Wilson

(358)

Copyist.

6

5 Cav.

U.S.C.T.

Heming Cotton

Priv., Co. B, 5 Reg't U. S. Col'd Cavalry.

Appears on

Company Muster Roll

for *Nov & Dec.*, 1865.

Present or absent *present*

Stoppage, \$ *100* for

Due Gov't, \$ *100* for

Valuation of horse, \$ *100*

Valuation of horse equipments, \$ *100*

Remarks:

Book mark:

R. E. Wilson

(358)

Copyist.

C | **5 Cav.** | **U.S.C.T.**

Wesley Cotton

B, Co. B, 5 Reg't U. S. Col'd Cavalry.

Appears on

Company Muster Roll

for *Jan 1st*, 186*6*.

Present or absent *Present*

Stoppage, \$ *100* for

Due Gov't, \$ *100* for

Valuation of horse, \$ *100*

Valuation of horse equipments, \$ *100*

Remarks:

Book mark:

(358)

Wesley Cotton

Copyist.

C. | 5 Cav. | U.S.C.T.

Fleming Cotton.

Priv., Co. B, 5 Reg't U. S. Colored Cav.

Appears on Returns as follows:

Nov. 1864 to Jan. 1865. Absent sick
Hosp. Camp Nelson, Ky.

Book mark:

H. Zader
Copyist.

(546)

Y | **5 Cav.** | **U.S.C.T.**

Fleming Cotton

P, Co. *P*, 5 Reg't U. S. Col'd Cavalry.

Appears on **Co. Muster-out Roll**, dated

March 16, 1866.

Muster-out to date *March 16*, 1866.

Last paid to *Dec 31*, 1865.

Clothing account:

Last settled....., 186 ; drawn since \$..... 100

Due soldier \$..... 100; due U. S. \$ *17* ^{*87*}/₁₀₀

Am't for cloth'g in kind or money adv'd \$..... 100

Due U. S. for arms, equipments, &c., \$..... ^{*38*}/₁₀₀

Bounty paid \$ *100* 100; due \$..... 100

Remarks: *Star 19, 1861*

Due 200 for Cont \$ 40.38

(Age 39)

Book mark: *Reg. S. C. 439, 429, V 119*

Cotton J. Fleming

Co. B, 5 Reg't U.S.C. Cav

1 Enclosures.

Bed Cards	Descriptive Lists
Burial Records	Final Statements
Certs. of Dis. for Discharge	Furloughs
C. M. Charges	Med. Des. Lists
Med. Certificates	Orders

Other papers relating to—

Admission to Hosp'l	Furlough
Casualty Sheet (Officer's)	Med. Examination
Confinement	Misc. Information
Contracts	Pay or Clothing
Death or Effects	Personal Reports
Desertions	Rank
Discharge from Hosp'l	Transfer to Hosp'l
Discharge from Service	Transfer to V. R. C.
Duty	Transportation

War Department,
ADJUTANT GENERAL'S OFFICE.

Washington, *Sept. 17* 186*7*.

Respectfully returned to the
Commission for the State of
Kentucky, with the informa-
tion that *Fleming Cotton*
was enlisted at *Frankfort Ky*
Oct 20 1864 and was
mustered in as Private Co. "B",
5th U.S.C. Cav. Oct 22, 1864,

m 317

A. H. Lawrence

Asst. Adj't General.

A. H. L.

No. *317*-----

APPLICATION OF

Gen B + B Macklin Esq

OF

Frankfort Ky

FOR COMPENSATION FOR SLAVE,

Named *Fleming Cotton*

Enlisted *Oct 20 a* 186*4*

In Com. *B*, *5th* Regiment,

Cavalry
U. S. COLORED TROOPS.

Received *Dec 20*, 186*6*.

Compensation Awarded

-----, 186*6*-----

----- Dollars.

President of Board of Claims.

Claimant's Attorney,

Alfred Hensley

Frankfort Ky

Claimant's Post-office Address,

Frankfort

Ky

FRANKFORT COMMONWEALTH PRINT.

No.

CLAIM OF

Geo B & Benoni Macklin Exrs of A W Macklin

FOR THE COMPENSATION OF SLAVE NAMED

Fleming Cotton

We G B & Benoni Macklin a loyal citizen and a residents of Frankfort, County of Franklin, State of Kentucky, hereby claim compensation, under the provisions of Section 24, act approved February 24, 1864, and section 2, act approved July, 28, 1866, for ~~my~~ slave Fleming Cotton, enlisted October 20th, 1864, at Lexington Kentucky, by Mrs H Moore in the Fifth Cavalry 13th regiment U. S. Colored Troops, Co. 13; certificate of

which enlistment, and a descriptive list, as required, accompany this application. That I did not acquire said slave subsequent to said enlistment, but had a valid title to him at the date of said enlistment, and previous thereto: I having acquired my title to him and my ownership over him as follows, to-wit:

As Executor of the last will and testament of A W Macklin, an authenticated copy of which is filed herewith reference is made to affidavits marked A & B filed herewith

In proof of my loyalty to the Constitution and Government of the United States, I present the accompanying oath, which I have taken, signed and acknowledged; to be filed with this application, in accordance with requirement of General Orders, No. 329, 1863. War Department, Adjutant General's Office.

Dec 20th 1866. W Benoni Macklin Geo B Macklin

OATH OF ALLEGIANCE.

We G B & Benoni Macklin, the owners and Claimants do solemnly swear that the foregoing claim is a just and true claim due to me as master and owner of the said slave, and that the facts alleged in said claim in respect to the draft or enlistment (as the case may be) of said slave into the Military service of the United States are true. And I do further swear that I have never joined, or been concerned in, any insurrection or rebellion; that I have never borne arms against the United States; that I have never given any aid, countenance, counsel or encouragement to any person or persons engaged, or whom I had reason to believe were about to engage, in insurrection, rebellion or armed hostility against the United States; that I have neither sought, nor accepted, nor attempted to exercise the functions of any office, civil or military, nor to perform any service whatever, under any authority or pretended authority in hostility to the United States; that I have not yielded a voluntary support to any insurrection, rebellion or pretended government, authority, power or constitution within the United States hostile thereto. And I do further swear that, to the best of my knowledge and ability, I have supported and defended, and will continue to support and defend, the United States against all enemies, foreign and domestic; and that I have supported, defended and obeyed, and will continue to support, defend and obey, the Constitution and laws of the United States; that I will bear true faith and allegiance to the same; and that I take this oath freely, without any mental reservation or purpose of evasion: So help me God.

Benoni Macklin Geo B Macklin

Sworn to and subscribed before me, at Frankfort Kentucky, this 20th day of Dec, 1866.

John D Lunday Notary Public



Headquarters Kentucky Volunteers,

Adjutant-General's Office,

Frankfort, October 8, 1866.

I hereby certify, that it appears from the U. S. Muster-
Rolls on file in this Office, that Flummings Cotton
was enrolled on the 20th day of October, 1864, at
Lexington Ky., by Thomas H. Moore,
and mustered into the U. S. service on the 22nd day of October
1864, at Lexington Ky., by Thomas H. Moore
to serve three years. Said Flummings Cotton
is described as follows: Sixty years of age, Black eyes, Black hair,
Black complexion, 5ft 8 inches height and is reported
as having been Credited to Franklin
C. H. and was assigned to C. B. 5 reg C.

In Testimony Whereof, I have hereunto set my
hand, and affixed my Official Seal, this
8th day of October, 1866.

D. W. Lindsay

Adjutant General of Kentucky.



13227 R 414

PROOF OF OWNERSHIP.

STATE OF KENTUCKY,

COUNTY OF *Franklin*

} SS.

We *James W McCoy* and *J S McCoy* each of lawful age, and resident citizens of the State and County aforesaid, do certify that *the estate of A W Macklin* of the State and County aforesaid, was on the *20th* day of *October* 1864, the lawful owner of the slave named *Fleming Cotton*; referred to and described in the foregoing claim for compensation.

James W McCoy
J S McCoy

Sworn to and subscribed before me a *Notary public* for the County of *Franklin* State of Kentucky, this the *20th* day of *Nov* 186*4*.

John D Lindsay
Notary Public



PROOF OF LOYALTY.

STATE OF KENTUCKY,

COUNTY OF *Franklin*

} SS.

We *R H Woodson* and *J S Price* loyal men and each of lawful age, and resident citizens of the *County* of *Franklin* in the State and County aforesaid, upon our oaths declare that we have known *Geo B & B Macklin* a resident of the State and County aforesaid, since the 4th day of March, 1861, and know that he has firmly and faithfully maintained his or her adherence and allegiance to the Government of the United States, by defending its cause against the Government and forces of the so-called Confederate States of America, in all suitable and practicable ways, and according to his or her ability and opportunity.

R. H. Woodson
J S Price

Sworn to and subscribed before me a *Notary public* for the county of *Franklin* State of Kentucky, this the *20th* day of *Nov* 186*4*.

John D Lindsay
Notary Public



POWER OF ATTORNEY.

My Post-Office address is *Frankfort* County of *Franklin* State of Kentucky, and I hereby direct that all communications to me, touching this claim, be sent under cover to *Alfred Hensley Frankfort Kentucky*, who is hereby appointed and constituted my true and lawful attorney, to prosecute this claim for me, and who is hereby authorized and empowered to receive and receipt for any award, order, draft, certificate, voucher, warrant, papers or money that may be issued in the adjustment of this claim, or the payment thereof, the same as I might or could do in person were I present and acting for myself, and to file any additional evidence or papers that may be required in the prosecution of this claim.

[WITNESS.]

The owner signs here.

Benjamin Macklin
Geo B Macklin

Two witnesses to owner's signature sign here.

Wm Brown
R H Woodson

50 CENT STAMP.



Suchman Richard

Co K, 5 U. S. Col'd Cav.

Private Private

CARD NUMBERS.

5368819	26
5368913	27
5369014	28
5369157	29
5369767	30
9091055	31
143148224	32
40729650	33
	34
0	35
1	36
2	37
3	38
4	39
5	40
6	41
7	42
8	43
9	44
0	45
1	46
2	47
3	48
4	49
5	50

Book Mark:

See also

6

5 Cav. U.S.C.T.

Richard Couchman

Co. K, 5 Reg't U. S. Col'd Cav.

Appears on

Company Descriptive Book

of the organization named above.

DESCRIPTION.

Age 20 years; height 5 feet 6 inches.

Complexion Black

Eyes Blue; hair Blue

Where born Charleston S.C.

Occupation Laborer

ENLISTMENT.

When Oct 7, 1864.

Where Lexington S.C.

By whom J. H. Moore; term 3 y'rs.

Remarks: Died at Princeton S.C. Feb 4/65. Inventory and final statements forwarded to A. G. U. S. A. May 18, 1865

A. J. Couchman

(383g)

Copist.

Co. | 5600 | USV

Richard Gouchman

Appears with rank of Priv. on

Muster and Descriptive Roll

of Detachment of U.S. Col. Vols.
forwarded Camp Nelson, Ky.

Roll dated
Lexington, Ky. Oct. 7, 1864.

Where born Clark, Ky.

Age 20 years; occupation Laborer

When enlisted Oct. 7, 186 .

Where enlisted Lexington, Ky.

For what period enlisted 3 years.

Eyes blk; hair Blk

Complexion Blk; height 5 ft. 6 in.

When mustered in _____, 186 .

Where mustered in _____

Bounty paid \$ 100; due \$ 100

Clothing account:

Last settled _____, 186 ; drawn since \$ 100

Date of first muster Oct. 7, 1864.

Company to which assigned _____

Remarks: To be credited to

Clark Co. 7th Dist. Ky.

Book mark: _____

(356m)

C. J. Harris

Copyist.

6

5 Cav.

U.S.C.T.

Richard Conchman

Pvt., Co. K, 5 Reg't U. S. Col'd Cavalry.

Appears on

Company Muster-in and Descriptive Roll

of the organization named above. Roll dated

Camp Nelson Ky, N. Y., Oct 30, 1864.

Where born Lexington Ky

Age 20 y'rs; occupation Saborer

When enlisted Oct 7, 1864.

Where enlisted Lexington Ky

For what period enlisted 3 years.

Eyes Blk; hair Blk

Complexion Blk; height 5 ft. 6 in.

When mustered in Oct 7, 1864.

Where mustered in Lexington Ky

Bounty paid \$ 100; due \$ 100

Where credited 7 Dist Ky

Company to which assigned

Remarks:

Book mark:

H. S. Miller

(356d)

Copyist.

6

5 Cav.

U.S.C.T.

Richard Conchman

Pvt, Co. K, 5 Reg't U. S. Col'd Cav.

Appears on

Company Muster Roll

for *Organization to Oct 31, 1864.*

Present or absent *Present*

Stoppage, \$ 100 for

Due Gov't, \$ 100 for

Valuation of horse, \$ 100

Valuation of horse equipments, \$ 100

Remarks:

Book mark:

H. S. Miller

(358)

Copyist.

C

5 Cav.

U.S.C.T.

Richard Conchuan

Priv., Co. K, 5 Reg't U. S. Col'd Cav.

Appears on

Company Muster Roll

for Nov & Dec, 1864.

Present or absent Present

Stoppage, \$ 100 for

Due Gov't, \$ 100 for

Valuation of horse, \$ 100

Valuation of horse equipments, \$ 100

Remarks: 1" & 2" installments
Bounty due

Book mark:

(358)

H. J. Miller

Copyist.

C

5 Cav. U.S.C.T.

Richard Conchman
Pvt., Co. K, 5 Reg't U. S. Col'd Cav.

Appears on

Company Muster Roll

for *Jan & Feb*, 1865.

Present or absent.....

Stoppage, \$.....100 for.....

Due Gov't, \$.....100 for.....

Valuation of horse, \$.....100

Valuation of horse equipments, \$.....100

Remarks: *Died in Princeton*
Ky Feb 3" 1865 1" install
ment \$300 Bounty due

Book mark:.....

H. Miller

(358)

Copyist.

② | 5 Cav. | U.S.C.T.

Richard Conchman.

Bt., Co. K, 5 Reg't U. S. Colored Cav.

Appears on Returns as follows:

Feb. 1865. Lost, Feb. 3/65; Princeton,
Ky. Died of disease.

Book mark:

(546)

Baker
Copyist.

He | **5 Cav.** | **U.S.C.T.**

Richard Buchman
Capt, Co. *K*, 5 Reg't U. S. Col'd Cavalry.

Appears on **Co. Muster-out Roll**, dated
Helena Ark, *March 16*, 1866 .

Muster-out to date _____, 186 .

Last paid to *Pay due from enlistment*, 186 .

Clothing account:

Last settled _____, 186 ; drawn since \$ _____ 100

Due soldier \$ _____ 100; due U. S. \$ *32* ^{*61*}/₁₀₀

Am't for cloth'g in kind or money adv'd \$ _____ 100

Due U. S. for arms, equipments, &c., \$ _____ 100

Bounty paid \$ *100* 100; due \$ _____ 100

Remarks: *Died Feb 7 65 at Princeton*
Ky. disease of mind
Final statement forwarded

Book mark: *V. 65 P. 27. 69 See E. B. Vol 7 P. 27*

E. B. Brown

Bonchman, Richard

P, Co. K, 5 Reg U.S.C. Cav.

2 Enclosures.

Bed Cards	Descriptive Lists
Burial Records	Final Statements /
Certs. of Dis. for Discharge	Furloughs
C. M. Charges	Med. Des. Lists
Med. Certificates	Orders

Other papers relating to—

Admission to Hosp'l	Furlough
Casualty Sheet (Officer's)	Med. Examination
Confinement	Misc. Information
Contracts	Pay or Clothing
Death or Effects /	Personal Reports
Desertions	Rank
Discharge from Hosp'l	Transfer to Hosp'l
Discharge from Service	Transfer to V. R. C.
Duty	Transportation

INVENTORY OF THE EFFECTS

OF

Richard Lovell

Late of Company *K*

5th Reg't of *W S C Co*

Volunteers, who died at *Drumcabin Ky*

on the *2^d* day of *February* 1865.



er be
r of
med
his
De-
d to
dier.
fects
ed to
t or
d to
of the
oned
paid

icers
ed to
the
regi-
the
in his
b the
nding
leath.
d, and
eace;
ny to
ntory
ent of
legal
If the

er or
eace,
er the
depo-
l they

tion, a
y the
receipt
to the
of the

ed over
jutant
he de-
l, their
r cases,
djutant

uplicate
should
cer.

Inventory of the effects of Richard Gauchman late
a Private of Captain _____ Company K of
the 5 Regiment of W. S. 1st Regt Volunteers, who was enrolled as
a Private at Lexington in the State of Kentucky on
the 7 day of October 1864, and mustered into the service of the United
States as a Private on the 7 day of October 1864, at Lexington
in Company K, 5 Regiment of W. S. 1st Regt Volunteers, to serve three
years or during the war; he was born in Clark Co in the State
of Kentucky; he was 20 years of age, 5 feet 6 inches
high, Black complexion, Black eyes, Black hair, and by occupation, when enrolled,
a laborer; he died in his company, at
Princeton Ky on the third day of February 1865, by
reason of Cyphoid fever

INVENTORY.						
ARTICLES.	No.	ARTICLES.	No.	ARTICLES.	No.	
Hats.....	<u>no effects</u>	Pairs trousers.....	<u>no effects</u>	Knapsacks.....		
Caps.....		Pairs flannel drawers.....				
Forage caps.....		Pairs cotton drawers.....				
Great coats.....		Flannel shirts.....				
Uniform coats.....		Cotton shirts.....				
Uniform jackets.....		Pairs boots.....				
Flannel sack coats.....		Pairs shoes.....				
Blouses.....		Pairs socks.....				
Stable frocks.....		Blankets.....				
Fatigue overalls.....		Haversacks.....				
				MONEY.	Specie.....	\$
					Notes.....	\$

I CERTIFY, ON HONOR, that the above inventory comprises all the effects of _____
_____, deceased, and that the effects are in the hands
of _____ at _____
_____ to be disposed of by a Council of Administration.

(DUPLICATES.)

Henry Carter
1st Lt

Commanding the Company.

STATION: _____

DATE: _____

Adjutant General's Office
 Washington, D.C. May 5. 1864.
 E. B. rec. page 37
 The Muster-Roll of Co.
 "H" 5th U.S. Colored Cavalry
 reports the death of Private
 Richard Cushman Feb.
 ruary 4th 1865.

The Company Muster
 Roll for January and Feb.
 ruary 1865 and Final State-
 ment of the soldier reports
 the date of his death February
 3rd 1865.

The latter date (February
 third 1865) is held to be cor-
 rect and the Company Mus-
 ter Roll will be amend-
 ed accordingly.

J. B. R. [Signature]
 Major Brevet Colonel U.S.A.
 In Chg Bureau Col'd Troops.

dated May 11 1864 W.C.

ADJUTANT GENERAL'S OFFICE.

May 25th 1865

Duplicate with Inventory sent 2d Auditor.

FINAL STATEMENT

Co 'K'

OF

[Signature]

Reg't of *[Signature]*

VOLUNTEERS.

NOTE 1.—Two of these certificates (or duplicates) are to be given to each Volunteer Soldier or drafted man who may be discharged previously to the discharge of his company, that he may at once receive from the Paymaster the pay, &c., due him, and the captain or other COMMISSIONED officer commanding the company will certify to the act of the delivery of the duplicate certificates; on these certificates the Soldier is "entitled to" his discharge, and should also present his discharge to the Paymaster to have the payment endorsed on it. The discharge is to be given back to the Soldier by the Paymaster; the latter only retaining as his voucher the duplicate certificates.

NOTE 2.—If the Soldier is entitled to pay for the use of his horse, the Company Commander will certify to that fact on the back of both these final statements, and also to the time he has pay due for having been so mounted on his own horse.

NOTE 3.—When a Soldier is furnished with final statements, his descriptive list, if he has one, should be taken up by the officer who gives the Soldier these statements, and endorsed with a statement to this effect by the officer. This endorsement should exhibit a full statement of the time for which the Soldier was allowed pay on his final statements, the clothing account, and all other charges against him or in his favor, so as to comprise a complete exhibit of his account. It will then be transmitted to the company commander of the Soldier, who will enter all the data necessary to a full understanding of the Soldier's account on the muster roll upon which the Soldier's discharge is reported. The descriptive list will then be destroyed. The object of this is, that the remaining portion of the Soldier's account may be settled upon the receipt of these muster rolls, and the Soldier receive any pay or allowances that may be due him at the time of his discharge, and which may not appear on his final statements from the fact that his descriptive list is incomplete. These accounts for back pay, &c., are settled by the 2d Auditor of the Treasury Department.

NOTE 4.—Charges for loss or injury to ordnance, horse equipments, and other miscellaneous charges, should appear under the heading of "Other Stoppages."

NOTE 5.—Bounty paid by State authorities, and not by the United States, will not be entered on this statement.

NOTE 6.—Amounts due the Sutler and Laundress must be entered on the muster roll on which the discharge, death, desertion, &c., is reported, as well as on the final statement, otherwise the amount cannot be collected from the United States.

NOTE 7.—This blank will be used for deceased volunteers and drafted men, as well as for others.

NOTE 8.—Where a Soldier dies in Hospital or on detached service, his descriptive list, if he has one, should be sent with his final statements, in duplicate, to the Adjutant General, Washington, D. C.

[Signature]

I certify, on honor, that Richard Sanchezman a Private of
 Captain Henry Porter Company (K) of the 5 Regiment of North Carolina
VOLUNTEERS, of the State of Kentucky, born in Clark Co., State
 of Kentucky, aged 26 years; 5 feet 6 inches high; Black complexion,
Black eyes, Black hair, and by occupation a Labourer, having joined the company on
 its original organization at Lexington, Ky., and enrolled in it at the muster into
 the service of the United States at Lexington, Ky., on the Seventh day
 of October, 1864, (or was mustered in service as a recruit, by Capt
T. H. Gore, at Lexington, on the Seventh day of October,
 1864, or was drafted and mustered into the service of the United States from the
 Enrollment District of the State of _____, at _____,
 on the _____ day of _____, 186), to serve in the Regiment, for
 the term of _____: and having served **HONESTLY** and
FAITHFULLY with his Company in 5th U.S. Col. Inf., to the present date, is now
 entitled to a **DISCHARGE** by reason of Death Typhoid
Fever Princeton Feb 8 1865

The said Richard Sanchezman was last paid by Paymaster
H. H. ... to include the _____ day of _____, 186 , and has
 pay due him from that time to the present date; he is entitled to pay and subsistence for
TRAVELING to place of enrollment, and whatever other allowances are authorized to volunteer
 soldiers, drafted men, or militia, so discharged. He has received from the United States **CLOTHING**
 amounting to 5.00 dollars, since the _____ day of enlistment,
 186 , when his clothing account was last settled. He has received from the United States
1.00 dollars advanced **BOUNTY**.

There is to be stopped from him, on account of the State of _____, or other
 authorities, for **CLOTHING**, &c., received on entering service, _____ dollars; and
 for other stoppages, viz: _____

_____ dollars.
 He has been furnished with **TRANSPORTATION** in kind from the place of his discharge to
 _____; and he has been **SUBSISTED** for **TRAVELING** to his
 place of enrollment, up to the _____, 186 .

He is indebted to _____, **SUTLER**, _____ dollars.
 He is indebted to _____, **LAUNDRESS**, _____ dollars.

Given in Duplicate, at Paris, Ky., this 16th day
 of April, 1865.

Henry Porter
1st Lieut

Commanding Company.



307
Courtney, Lewis

Co A, 5 U. S. Col'd Cav.

Sergeant

Private

CARD NUMBERS.

1	5366735	26
2	5366837	27
3	5367022	28
4	5367760	29
5	9090822	30
6	9090914	31
7	Reel 796766	32
8	40730043	33
9		34
10		35
11		36
12		37
13		38
14		39
15		40
16		41
17		42
18		43
19		44
20		45
21		46
22		47
23		48
24		49
25		50

Book Mark: Reel 796766.

See also

Q 1773293 P.O. m + m
Q 2353680 P.O. Ret.
Q 2353679 P.O. aff
m. Q. 796766

Express Co

3

5 Cav. U.S.C.T.

Courtesy Lewis

Co. G, 5 Reg't U. S. Col'd Cav.

Appears on

Company Descriptive Book

of the organization named above.

DESCRIPTION.

Age 37 years; height 5 feet 11 inches.

Complexion Blue

Eyes Blue; hair Blue

Where born Indiana Ky

Occupation Farmer

ENLISTMENT.

When Sept 14, 186 .

Where Camp Decatur

By whom H. K. Anderson; term 3 y'rs.

Remarks: Died in Genl Hospital

Camp Decatur Ky Front

Statement forwarded

kind in Genl Hospital

Panama Dec 4 1864.

As it appears on 12-12-12

Filed with Lewis Courtesy

A. J. Anderson

(383g)

Copist.

L 5 Cav | **U.S.C.T.**

Courtney Lewis
Co. H, 5 Reg't U. S. Col'd Cav

Appears on

Company Descriptive Book

of the organization named above.

DESCRIPTION.

Age *37* years; height *5* feet *11* inches.

Complexion *Blk*

Eyes *Blk*; hair *Blk*

Where born *Woodford Ky*

Occupation *farmer*

ENLISTMENT.

When *Sep 14*, 186*4*

Where *Camp Nelson Ky*

By whom *W. Kuntolph*; term *3* yrs.

Remarks: *died in Ho-*
pital de Grange
Ky Dec, 23rd 1864

Filed with Lewis Courtney

W. Kuntolph

C | **5 Cav.** | **U.S.C.T.**

Lewis Courtney

Sergt, Co. *H*, 5 Reg't U. S. Col'd Cavalry.

Appears on

Company Muster-in and Descriptive Roll

of the organization named above. Roll dated

Camp Nelson Ky, N. Y., *Oct 29*, 1864.

Where born *Woodford Ky*

Age *37* y'rs; occupation *Farmer*

When enlisted *Sept 14*, 1864.

Where enlisted *Camp Nelson Ky*

For what period enlisted *3* years.

Eyes *Black*; hair *Black*

Complexion *Black*; height *5 ft. 11 in.*

When mustered in *Sept 15*, 1864.

Where mustered in *Camp Nelson Ky*

Bounty paid \$ *100*; due \$ *100*

Where credited

Company to which assigned

Remarks: *7th District*

Kentucky
Creney Wood

Supposed to be name of owner. Added May 17 1868

Book mark: *RA 796766.*

Reynolds

(356d)

Copyist.

C | **5 Cav.** | **U.S.C.T.**

Lewis Courtney

Sergt, Co. H, 5 Reg't U. S. Col'd Cavalry.

Appears on

Company Muster Roll

for *from enlistment to Oct 31*, 1864.

Present or absent *present*

Stoppage, \$ 100 for

Due Gov't, \$ 100 for

Valuation of horse, \$ 100

Valuation of horse equipments, \$ 100

Remarks: *Appointed October 29th 1864*

Book mark:

Reynolds

L

5 Cav.

U.S.C.T.

Courtney Lewis

2 Sergt.

Co. H, 5 Reg't U. S. Col'd Cavalry.

Appears on

Company Muster Roll

for Nov & Dec, 1864.

Present or absent

Stoppage, \$ 100 for

Due Gov't, \$ 100 for

Valuation of horse, \$ 100

Valuation of horse equipments, \$ 100

Remarks: 1st and 2^d Installments
Bounty due. Died La-
Grange Ky Dec #28
Due US for Ordnance
\$25.10

Corrected by P.J.G. June 18. 1904

Book mark:

Reynolds

(358)

Copyist.

L | 5 Cav. | U.S.C.T.

Courtney Lewis
Sergt., Co. I., 5 Reg't U. S. Colored Cav.

Appears on Returns as follows:

Dec 1864 Died of disease in
Detachment Hosp. Dec 28,
La Grange, Ky.

Book mark :

(546)

Austin

Copyist.

L

5 Cav. U.S.C.T.

Courtney Lewis

Priv., Co. H, 5 Reg't U. S. Col'd Cavalry.

Appears on Co. Muster-out Roll, dated

Helena, Ark, Mar. 16, 1866.

Muster-out to date _____, 186 .

Last paid to _____, 186 .

Clothing account:

Last settled _____, 186 ; drawn since \$ _____ 100

Due soldier \$ _____ 100; due U. S. \$ _____ 100

Am't for cloth'g in kind or money adv'd \$ _____ 100

Due U. S. for arms, equipments, &c., \$ _____ 100

Bounty paid \$ _____ 100; due \$ _____ 100

Remarks: Died of disease at

Lynchburg, Ky. Dec. 28, 65.

at Del. Hospital.

Final Statement forwarded.

Book mark: _____

J. Stewart

(361)

Copyist.

Co. 15 Cav. U.S.C.P.

Lewis Courtney
Sgt., Co. A, 5 Reg't U.S. Old Cavalry

NOTATION.

Book mark:

R.P. 796766

The Military Secretary's Office,

WAR DEPARTMENT,

Washington, July 22, 1904.

It has this day, (July 22, 1904)

been determined by this Department from the records
that the above-named soldier died January 1, 1865,
in regimental hospital.

J. W. Gibson

(440)

Copyist.

Lewis, Courtney

P, Co. H., 5 Reg U.S.C. Cav.

3

Enclosures.

Bed Cards	Descriptive Lists
Burial Records	Final Statements .. 1
Certs. of Dis. for Discharge	Furloughs
C. M. Charges	Med. Des. Lists
Med. Certificates	Orders

Other papers relating to—

Admission to Hosp'l	Furlough
Casualty Sheet (Officer's)	Med. Examination
Confinement	Misc. Information .. 1
Contracts	Pay or Clothing
Death or Effects .. 1	Personal Reports
Desertions	Rank
Discharge from Hosp'l	Transfer to Hosp'l
Discharge from Service	Transfer to V. R. C.
Duty	Transportation

Inventory of the effects of Samuel Lewis late
 a Private of Captain _____ Company H of
 the Fifth Regiment of U.S. Colored Volunteers, who was enrolled as
 a Private at Camp Nelson in the State of Kentucky on
 the 14th day of September 1864, and mustered into the service of the United
 States as Private on the 15th day of September 1864, at Camp Nelson
 in Company H, 5th Regiment of U.S. Colored Volunteers, to serve Three
 years or during the war; he was born in Waverly County in the State
 of Kentucky; he was 37 years of age, 5 feet 11 inches
 high, Black complexion, Black eyes, Black hair, and by occupation, when enrolled,
 a Farmer; he died in Det. Hosp, at
Saginaw on the 29 day of December 1864, by
 reason of Disease Not Known.

INVENTORY.					
ARTICLES.	No.	ARTICLES.	No.	ARTICLES.	No.
Hats.....		Pairs trousers.....		Knapsacks.....	
Caps.....		Pairs flannel drawers.....			
Forage caps.....		Pairs cotton drawers.....			
Great coats.....		Flannel shirts.....			
Uniform coats.....		Cotton shirts.....			
Uniform jackets.....		Pairs boots.....			
Flannel sack coats.....		Pairs shoes.....			
Blouses.....		Pairs socks.....			
Stable frocks.....		Blankets.....			
Fatigue overalls.....		Haversacks.....			
				MONEY.	
				Specie.....	\$
				Notes.....	\$

I CERTIFY, ON HONOR, that the above inventory comprises all the effects of _____
 _____, deceased, and that the effects are in the hands
 of _____ at _____
 _____ to be disposed of by a Council of Administration.

(DUPLICATES.)

Chas. Putter
Sargent
 Commanding the Company.

STATION: _____

DATE: _____

FINAL STATEMENT

OF

Courtney Lewis
1st Reg't of U.S. Cavalry

VOLUNTEERS.

Number 511 162

NOTE 1.—Two of these certificates (or duplicates) are to be given to each Volunteer Soldier or drafted man who may be discharged without being mustered out (Final Statements are never given to men mustered out of service) that he may at once receive from the Paymaster the pay, &c., due him, and the captain or other COMMISSIONED officer commanding the company will certify to the act of the delivery of the duplicate certificates; with these certificates the Soldier is "entitled to" his discharge, and should also present his discharge to the Paymaster to have the payment endorsed on it. The discharge is to be given back to the Soldier by the Paymaster; the latter only retaining as his vouchers the duplicate certificates.

NOTE 2.—If the Soldier is entitled to pay for the use of his horse, the Company Commander will certify to that fact on the back of both these final statements, and also to the time he has pay due for having been so mounted on his own horse.

NOTE 3.—When a Soldier is furnished with final statements, his descriptive list, if he has one, should be taken up by the officer who gives the Soldier these statements, and endorsed with a statement to this effect by the officer. The endorsement should exhibit a full statement of the time for which the Soldier was allowed pay on his final statements, the clothing account, and all other charges against him or in his favor, so as to comprise a complete exhibit of his account. It will then be transmitted to the Company Commander of the Soldier, who will enter all the data necessary to a full understanding of the Soldier's account on the muster roll upon which the Soldier's discharge is reported. The descriptive list will then be destroyed. The object of this is, that the remaining portion of the Soldier's account may be settled upon the receipt of these muster rolls, and the Soldier receive any pay or allowances that may be due him at the time of his discharge, and which may not appear on his last final statements from the fact that his descriptive list is incomplete. These accounts for back pay, &c., are settled by the 2d Auditor of the Treasury Department.

NOTE 4.—Charges for loss or injury to ordnance, horse equipments, and other miscellaneous charges, should appear under the heading of "Other Stoppages."

NOTE 5.—Bounty paid by State authorities, and not by the United States, will not be entered on this statement.

NOTE 6.—Amounts due the Sutler and Laundress must be entered on the muster roll on which the discharge, death, desertion, &c., is reported, as well as on the final statement, otherwise the amount cannot be collected from the United States.

NOTE 7.—This blank will be used for deceased volunteers and drafted men, as well as for others.

NOTE 8.—Where a Soldier dies in Hospital or on detached service, his descriptive list, if he has one, should be sent with his final statements, in duplicate, to the Adjutant General, Washington, D. C.

NOTE 9.—If the soldier is a drafted man or substitute, the space for time, &c., of enrolled, should contain only the word *drafted* or *substitute*, as the case may be. If the Soldier is a "VETERAN," (or RECRUIT,) the words *as a veteran*, (or *recruit*;) as the case may be, should be interlined after the words *mustered into the service of the U. S.* A statement of all the installments of *Veteran or Recruit Bounty RECEIVED* by the Soldier must be made on the back of each final statement.

ADJUTANT GENERAL'S OFFICE
Sec 30
Duplicate with Inventory of 21 Aug 1862

I certify, on honor, that Courtney Lewis, a Private of
Captain _____ Company (A) of the 5th Regiment of W. Va.
VOLUNTEERS, of the State of Kentucky, born in Wartford Co., State
of Kentucky, aged 27 years, 5 feet 11 inches high; Black complexion,
Black eyes, Black hair, and by occupation a Farmer, who joined for service
and was enrolled (see Note 9) on the 14th day of September 1864, at Camp Nelson
by J. B. Randolph, for the period of Three years, and mustered into
the service of the United States on the 15th day of September, 1864, at
Camp Nelson, by Capt H. C. Kinney; and having served
HONESTLY and FAITHFULLY with his Company to the present date, is now entitled to a
DISCHARGE by reason of Death. Died in Det. Hopt Layrange by
Disease entered on December 28th 1864

The said Courtney Lewis was last paid by Paymaster
Pay Due from Enlistment include the 15th day of September, 1864, and
has pay due him from that time to the 28th December 1864; he is entitled to pay and subsistence for
TRAVELING to place of enrollment, and whatever other allowances are authorized to volunteer
soldiers, drafted men, or militia, so discharged. He has received from the United States **CLOTHING**
amounting to 61 99/₁₀₀ dollars, since the 15th day of September
1864, when his clothing account was last settled. He has received from the United States
100 dollars advanced **BOUNTY**. First Installment \$100 Bounty Due

There is to be stopped from him, on account of the State of _____, or other
authorities, for **CLOTHING**, &c., received on entering service, _____/100 dollars; and
for other stoppages, viz: for arrears \$25.10^{cts} Due U.S.

_____ /100 dollars.
He has been furnished with **TRANSPORTATION** in kind from the place of his discharge to
_____; and he has been **SUBSISTED** for **TRAVELING** to his
place of enrollment, up to the _____, 186 .

He is indebted to _____, **SUTLER**, _____/100 dollars.

He is indebted to _____, **LAUNDRESS**, _____/100 dollars.

Given in Duplicate, at Helena Ark, this 20th day
of December, 1865.

Chas Parker
Lieutenant

Commanding Company.

2/20 of 1890 for the same 9/15/92

Country Lewis
Box Co "H"
5 My Cold Cavity
See Letter book
page 192.

Cowan Henry

Co. E, 5 U. S. Col'd Cav.

Private Private

CARD NUMBERS.

1	5365739	26
2	5365838	27
3	5365939	28
4	5366034	29
5	5366183	30
6	5366720	31
7	9090664	32
8	31407310	33
9	40729623	34
10		35
11		36
12		37
13		38
14		39
15		40
16		41
17		42
18		43
19		44
20		45
21		46
22		47
23		48
24		49
25		50

Book Mark:

See also

6 | 5 Cav. | U.S.C.T.

Henry Cowan
Co. G, 5 Reg't U. S. Col'd Cav.

Appears on

Company Descriptive Book
of the organization named above.

DESCRIPTION.

Age 18 years; height 5 feet 6 inches.

Complexion Black

Eyes Black; hair Black

Where born Pulaski Ky

Occupation Farmer

ENLISTMENT.

When Sep 8, 1864

Where Camp Nelson

By whom McRandolph, term 3 y'rs.

Remarks: Alid Camp

Nelson Ky March

18-65

A. E. Fiske

5
C | 6. Cav | U.S.C.

Henry Cowen

Pvt, Co. 6 Reg't U.S.C.

Appears on

Hospital Muster Roll

of U. S. A. General Hospital,

at Ashland, Ky.,

for Sept & Oct, 1864.

Attached to hospital:

When Oct 11, 1864.

How employed patient

Last paid by Maj. _____
to _____, 186 .

Bounty paid \$ 100; due \$ 100

Present or absent Present

Remarks: no descript Roll

Book mark : _____

(343)

J. Cowen

Copyist.

C

5 Cav.

U.S.C.T.

Henry Cowan

Pvt., Co., 5 Reg't U. S. Col'd Cavalry.

Appears on

Company Muster-in and Descriptive Roll

of the organization named above. Roll dated

Cp. Nelson ^{Ky.}, N. Y., Oct. 29, 1864.

Where born Pulaski ^{Ky.}

Age 18 y'rs; occupation Farmer.

When enlisted Sept. 8, 1864.

Where enlisted Camp Nelson ^{Ky.}

For what period enlisted 3 years.

Eyes Black; hair Black

Complexion Black; height 5 ft. 6 in.

When mustered in Sept. 9, 1864.

Where mustered in Cp. Nelson ^{Ky.}

Bounty paid \$ 100; due \$ 100

Where credited 8th Cong. Dist.

Company to which assigned

Remarks:

X Daisy Cowan,

supposed to be name of owner.

Added May 16, 98. H. A. J.

Book mark:

[Signature]

(356d)

Copyist.

C. | **5 Cav.** | **U.S.C.T.**

Henry Lawan
Pvt., Co. G, 5 Reg't U. S. Col'd Cavalry.

Appears on

Company Muster Roll

for Enlt. to Oct. 31., 1864.

Present or absent Absent

Stoppage, \$ _____ 100 for _____

Due Gov't, \$ _____ 100 for _____

Valuation of horse, \$ _____ 100

Valuation of horse equipments, \$ _____ 100

Remarks: In Gen. Hospital,
Ashland, Ky.

Book mark: _____

(358)

[Signature]

Copyist.

6

5 Cav.

U.S.C.T.

Henry Cowan,

Pvt., Co. G, 5 Reg't U. S. Col'd Cavalry.

Appears on

Company Muster Roll

for Nov. & Dec., 1864.

Present or absent Absent,

Stoppage, \$ 100 for

Due Gov't, \$ 100 for

Valuation of horse, \$ 100

Valuation of horse equipments, \$ 100

Remarks: In Gen. Hosptl., Ashland Ky. since Oct. 1864. 1st & 2d instalments, Bounty due.

Book mark:

(358)

[Signature] Copyist.

C. | **5 Cav.** | **U.S.C.T.**

Henry Conner,
Pvt., Co. G, 5 Reg't U. S. Col'd Cavalry.

Appears on

Company Muster Roll

for Jan. + Feb., 1865.

Present or absent Absent,

Stoppage, \$ 100 for

Due Gov't, \$ 100 for

Valuation of horse, \$ 100

Valuation of horse equipments, \$ 100

Remarks: Sick in Gen.
Hopt. Camp Nelson Ky,
1st Instalment Bounty
\$100.00 due.

Book mark: _____

(358)

[Signature]

Copyist.

C. | **5 Cav.** | **U.S.C.T.**

Henry Cowan.

Pvt., Co. G, 5 Reg't U. S. Col'd Cavalry.

Appears on

Company Muster Roll

for *March & April*, 186*5*.

Present or absent

Stoppage, \$ *100* for

Due Gov't, \$ *100* for

Valuation of horse, \$ *100*

Valuation of horse equipments, \$ *100*

Remarks: *died in hospital
Camp Nelson Ky. March
18. 1865.*

Book mark: *died March 12, '65 - EB 11 p 27*

(358)

J. M. [Signature]

Copyist.

Q

5 Cav.

U.S.C.T.

Henry Cowan.

Regt. Co. G, 5 Reg't U. S. Colored Cav.

Appears on Returns as follows:

Oct. to Dec. 1864. Absent sick
in Gen. Hoop, Ashland, Ky.,
since Oct. '64.

Jan. & Feb. 1865. Absent sick in
Gen. Hoop, Camp Nelson, Ky.

Mar. 1865. Died of disease Mar.
18/65, Camp Nelson.

Name appears also as Henry Cowin.
Henry Cowen.

Book mark:

(546)

A. Baker
Copyist.

Henry Cowan

Part, Co. *E*, 5 Reg't U. S. Col'd Cavalry.

Appears on **Co. Muster-out Roll**, dated *Helena, Ark. Mch. 16, 1866.*

Muster-out to date _____, 186 .

Last paid to _____, 186 .

Pay me from Enlistment

Clothing account:

Last settled _____, 186 ; drawn since \$ _____ 100

Due soldier \$ _____ 100 ; due U. S. \$ *23* ³⁰ 100

Am't for cloth'g in kind or money adv'd \$ _____ 100

Due U. S. for arms, equipments, &c., \$ _____ 100

Bounty paid \$ _____ 100 ; due \$ _____ 100

Remarks: *Slave - Rec'd Mch. 12/65.
Cowan, Helena, Ark. Rec'd
Final statements forwarded
Mar. 17, 1865.*

Book mark : _____

Cowan

(861)

Copyist.

Cowan, Henry

P, Co. I, 5 Reg't *U.S. Cavalry*

3 Enclosures.

Bed Cards

Burial Records /

Certs. of Dis. for Discharge

C. M. Charges

Med. Certificates

Descriptive Lists

Final Statements /

Furloughs

Med. Des. Lists

Orders

Other papers relating to—

Admission to Hosp'l

Casualty Sheet (Officer's)

Confinement

Contracts

Death or Effects /

Desertions

Discharge from Hosp'l

Discharge from Service

Duty

Furlough

Med. Examination

Misc. Information

Pay or Clothing

Personal Reports

Rank

Transfer to Hosp'l

Transfer to V. R. C.

Transportation

Henry Corwin

Pr. Co. Gth U.S.C.

Died March 12th 1862

Final Rest: Camp Nelson, Ky.

RECORD OF DEATH AND INTERMENT.

Name and number of person interred	Henry Cowan
Number and locality of the grave	1033
Hospital number of the deceased	5835
Regiment, rank and company	R. Co "G" 3 rd U.S.C.
Residence before enlistment	
Conjugal relation. (and if married the residence of the widow.)	
Cause of death	Memories
Age of the deceased.	
Nativity.	
References and remarks.	
Date of death and burial.	March 12 th 1865

- | | |
|-----------------|-------------------------|
| (1) Coat | Expended with
looper |
| (1) Dress Coat | |
| (1) P's Drawers | |
| (1) P's Boots | |
| | |
| | (1) Shirt |
| | (1) P's Socks |
| | (1) P's Pants |
| | (1) Dress Coat |

Inventory
of the effects of *W.*
Henry Cowan
late of Co. G. 5th Regiment
Inf. C., who died
at Camp Murphy General
Hospital March 12th
1864.



Co. G 5th Mass

Nelson U. S. Army General Hospital,
Camp Nelson Ky Mar 12th 1863.

Commanding Officer "G" Company,
5th Regt. Cyf. C.

I have to inform you
that Henry Cowan of your Company, died
in this Hospital on the 12th day of March 1863
of

I inclose ~~his descriptive list, with pay and clothing account, and~~
inventory of his effects.

Very respectfully yours, &c.,
Richard M. Wooster
Capt. Regt. Military Asst
Surgeon U. S.

~~In charge of General Hospital.~~

[OFFICE INDORSEMENT.]

War Department,

ADJUTANT GENERAL'S OFFICE,

March 25, 1874

The Adjutant General's Office,
Co. C, 5 Reg't U.S.

Colored Cavalry, is reported as follows:

On Company Muster Roll.
For March, 1863, March, 1863
Company Muster-out Roll.

March 12, 1863, 1863

Company Descriptive Book. , 1863

Company Morning Reports. , 1863

Soldier's Final Statement. , 1863

Soldier's Record of Death and Interment. , 1863

Soldier's Inventory of Effects. , 1863

Soldier's Certificate of Disability for Discharge. , 1863

Soldier's Individual Muster-out Roll. , 1863

Regimental Return. , 1863

For March, 1863, March, 1863
Regimental Quarterly Returns. , 1863

Regimental Descriptive Book. , 1863

By Surgeon General. , 1863

March 12, 1863, is held to be

the correct date, and the Company Muster

Roll will be amended accordingly.

Subscribed by
Thomas D. Stewart
EBH
27
Vol. 26, 11 - Assistant Adjutant General.

FINAL STATEMENT

Co. "G"
OF

Henry Cowan Co. G,
5th Reg't of U.S.C.

VOLUNTEERS.

March 12, 1863

NOTE 1.—Two of these certificates (or duplicates) are to be given to each Volunteer Soldier or drafted man who may be discharged without being mustered out (Final Statements are never given to men mustered out of service,) that he may at once receive from the Paymaster the pay, &c., due him, and the captain or other COMMISSIONED officer commanding the company will certify to the act of the delivery of the duplicate certificates; with these certificates the Soldier is "entitled" his discharge, and should also present his discharge to the Paymaster to have the payment endorsed on it. The discharge is to be given back to the Soldier by the Paymaster; the latter only retaining as his vouchers the duplicate certificates.

NOTE 2.—If the Soldier is entitled to pay for the use of his horse, the Company Commander will certify to that fact on the back of each of these final statements, and also to the time he has pay due for having been so mounted on his own horse.

NOTE 3.—When a Soldier is furnished with final statements, his descriptive list, if he has one, should be taken up by the officer who presents the Soldier these statements, and endorsed with a statement to this effect by the officer. The endorsement should exhibit a full statement of the time for which the Soldier was allowed pay on his final statements, the clothing account, and all other charges against him or in his favor, so as to comprise a complete exhibit of his account. It will then be transmitted to the Company Commander of the Soldier, who will enter all the data necessary to a full understanding of the Soldier's account on the muster roll upon which the Soldier's discharge is reported. The descriptive list will then be destroyed. The object of this is, that the remaining portion of the Soldier's account may be settled upon the receipt of these muster rolls, and the Soldier receive any pay or allowances that may be due him at the time of his discharge, and which may not appear on his last final statements from the fact that his descriptive list is incomplete. These accounts for back pay, &c., are settled by the 2d Auditor of the Treasury Department.

NOTE 4.—Charges for loss or injury to ordnance, horse equipments, and other miscellaneous charges, should appear under the heading of "Other Stoppages."

NOTE 5.—Bounty paid by State authorities, and not by the United States, will not be entered on this statement.

NOTE 6.—Amounts due the Sutler and Laundress must be entered on the muster roll on which the discharge, death, desertion, &c., is reported, as well as on the final statement, otherwise the amount cannot be collected from the United States.

NOTE 7.—This blank will be used for deceased volunteers and drafted men, as well as for others.

NOTE 8.—Where a Soldier dies in Hospital or on detached service, his descriptive list, if he has one, should be sent with his final statements, in duplicate, to the Adjutant General, Washington, D. C.

NOTE 9.—If the soldier is a drafted man or substitute, the space for time, &c., or enrolled, should contain only the word *drafted* or *substitute*, as the case may be. If the Soldier is a "VETERAN," (or RECRUIT,) the words *as a veteran*, (or *recruit*.) as the case may be, should be interlined after the words *mustered into the service of the U. S.* A statement of all the installments of *Veteran or Recruit Bounty RECEIVED* by the Soldier must be made on the back of each final statement.

I certify, on honor, that Henry Cowan, a Private of
 Captain Geo. Harling Company (G) of the 3rd Regiment of Ms to Caval
VOLUNTEERS, of the State of Kentucky, born in Palaski County, State
 of Kentucky, aged 18 years; 5 feet 6 inches high; Black complexion,
Black eyes, Black hair, and by occupation a Farmer, who joined for service
 and was enrolled (see Note 9) on the 8th day of September, 1864, at Camp Nelson Ky
 by J. B. Randolph H. P. M., for the period of Three years, and mustered into
 the service of the United States on the 9th day of September, 1864, at
Camp Nelson Ky, by Capt. H. C. Kinney, M. C.; and having served
 HONESTLY and FAITHFULLY with his Company to the present date, is now entitled to a
DISCHARGE by reason of Death
J. C. D. died March 12th 1865 see Ser 7110

The said Henry Cowan was last paid by Paymaster
+ + + + +, to include the Pay due day of from enlistment, 1864, and
 has pay due him from that time to the present date; he is entitled to pay and subsistence for
TRAVELING to place of enrollment, and whatever other allowances are authorized to volunteer
 soldiers, drafted men, or militia, so discharged. He has received from the United States **CLOTHING**
 amounting to Forty four $\frac{24}{100}$ dollars, since the 9th day of September,
 1864, when his clothing account was last settled. He has received from the United States
+ + + $\frac{+}{100}$ dollars advanced **BOUNTY**.

There is to be stopped from him, on account of the State of + + +, or other
 authorities, for **CLOTHING**, &c., received on entering service, + + + $\frac{+}{100}$ dollars; and
 for other stoppages, viz: + + + + + +
+ + + + + + $\frac{+}{100}$ dollars.
 He has been furnished with **TRANSPORTATION** in kind from the place of his discharge to
+ + +; and he has been **SUBSISTED** for **TRAVELING** to his
 place of enrollment, up to the + + +, 1864.

He is indebted to + + +, **SUTLER**, + + $\frac{+}{100}$ dollars.
 He is indebted to + + +, **LAUNDRESS**, + + $\frac{+}{100}$ dollars.

Given in Duplicate, at Camp Nelson Ky, this 12th day
 of March, 1865.

George B Taylor
2^d Lieutenant
 Commanding Company

503
Cowherd Lewis

Co C, 5 U. S. Col'd Cav.

Private | Private

CARD NUMBERS.

5361660	26
5361762	27
5361860	28
5361959	29
5362042	30
5362124	31
5362206	32
5362298	33
5362386	34
5362471	35
5362555	36
9090191	37
43145782	38
43146225	39
	40
	41
	42
	43
	44
	45
	46
	47
	48
	49
	50

Book Mark:

See also

C | **5 Cav. | U.S.C.T.**

Levi's Cowherd

....., Co. C, 5 Reg't U. S. Col'd Cav.

Appears on

Company Descriptive Book
of the organization named above.

DESCRIPTION.

Age 23 years; height 5 feet 6 inches.

Complexion Copper

Eyes Blk; hair Blk

Where born Green Co., Ky.

Occupation Farmer

ENLISTMENT.

When Aug. 1st, 1864.

Where Lebanon

By whom St. Crocker; term 3 y'rs.

Remarks:

.....

.....

.....

.....

.....

.....

.....

.....

.....

.....

.....

.....

.....

.....

.....

.....

.....

.....

.....

.....

.....

.....

.....

.....

.....

.....

.....

.....

.....

.....

.....

.....

.....

.....

.....

.....

.....

.....

.....

.....

.....

.....

Warren

6 | **5 Cav.** | **U.S.C.T.**

Lewis Cowherd

Pris, Co. *6*, 5 Reg't U. S. Col'd Cavalry.

Appears on

Company Muster-in and Descriptive Roll

of the organization named above. Roll dated

Camp Nelson, ^{*Ky*} ~~N. Y.~~, *Oct. 24*, 1864.

Where born *Green, Ky.*

Age *23* y'rs; occupation *Farmer*

When enlisted *Aug. 1*, 1864.

Where enlisted *Lebanon*

For what period enlisted *3* years.

Eyes *Blk.*; hair *Blk.*

Complexion *Copper*; height *5* ft. *6* in.

When mustered in *Aug. 1*, 1864.

Where mustered in *Lebanon*

Bounty paid \$ *100*; due \$ *100*

Where credited *4" Dist. Ky.*

Company to which assigned *6*

Remarks:

Book mark:

Shull

(356d)

Copyist.

6 | 5-bar | US 67

Lewis Lowhead

Appears with rank of _____ on

Muster and Descriptive Roll

of Detachment of US Colored Volunteer Recruits

forwarded _____ Roll dated Lebanon, Ky, Aug 31, 1864.

Where born Green Ky

Age 23 years; occupation farmer

When enlisted Aug 1, 1864

Where enlisted Lebanon Ky

For what period enlisted 3 years.

Eyes Blue; hair Blue

Complexion Cop.; height 5 ft. 6 in.

When mustered in Aug 1, 1864

Where mustered in Lebanon, Ky.

Bounty paid \$ 100; due \$ 100

Clothing account:

Last settled _____, 1864; drawn since \$ 17 ⁵⁰/₁₀₀

Date of first muster Aug 1, 1864.

Company to which assigned _____

Remarks: owner, Frank Lowhead, Green Co.

Without consent

4 Long Dist. Ky

Book mark: _____

L. H. Barton

(356m)

Copyist.

6

5 bar

U.S.C.T.

Lewis Bowherd

Appears with rank of Pvt on

Muster and Descriptive Roll

of a Detachment of U.S. Colored Troops Transferred to U.S. Colored

Reg. at Lexington, Ky. Roll dated Louisville, Ky., Sept. 2, 1864.

Where born Green, Ky.

Age 23 years; occupation Farmer

When enlisted Aug. 1, 1864.

Where enlisted Lebanon

For what period enlisted 1 years.

Eyes Blue; hair Blue

Complexion Copper; height 5 ft. 6 in.

When mustered in Aug. 1, 1864.

Where mustered in Lebanon

Bounty paid \$ 100; due \$ 100

Clothing account:

Last settled _____, 1864; drawn since \$ 17.50
100

Date of first muster Aug. 1, 1864.

Company to which assigned _____

Remarks: credited to H. Cong. Ser. Ky.

Book mark: _____

A. J. Patterson

(356m)

Copyist.

Lewis Comber

Pris, Co. C, 5 Reg't U. S. Col'd Cavalry.

Appears on

Company Muster Roll

for *to Oct. 31*, 1864.

Present or absent *Present*

Stoppage, \$ *100* for

Due Gov't, \$ *100* for

Valuation of horse, \$ *100*

Valuation of horse equipments, \$ *100*

Remarks:

Book mark:

Shull

Lewis Bondard

Priv, Co. C, 5 Reg't U. S. Col'd Cavalry.

Appears on

Company Muster Roll

for *Nov. & Dec.*, 1864.

Present or absent *Present*

Stoppage, \$ *100* for

Due Gov't, \$ *100* for

Valuation of horse, \$ *100*

Valuation of horse equipments, \$ *100*

Remarks: *First + Second instal-
ments of bounty due. Due
U.S. for Ordnance 1st 73*

Book mark:

Shull

C | **5 Cav. U.S.C.T.**

Lewis Cowherd

Priv, Co. C, 5 Reg't U. S. Col'd Cavalry.

Appears on

Company Muster Roll

for *Jany. & Feby.*, 186*3*.

Present or absent *Present*

Stoppage, \$ *100* for

Due Gov't, \$ *100* for

Valuation of horse, \$ *100*

Valuation of horse equipments, \$ *100*

Remarks: *First installment
Bounty due \$100*

Book mark:

Stuce

Lewis Sawyer

Co. C, 5 Reg't U. S. Col'd Cavalry.

Appears on

Company Muster Roll

for Mar. & Apr., 1865.

Present or absent Present

Stoppage, \$ 100 for

Due Gov't, \$ 100 for

Valuation of horse, \$ 100

Valuation of horse equipments, \$ 100

Remarks: First instalment of
Bounty due \$100

Book mark:

S. Hill

6

5 Cav. U.S.C.T.

Lewis, C. W. Howard

Pvt., Co. C, 5 Reg't U. S. Col'd Cavalry.

Appears on

Company Muster Roll

for May - June, 1865.

Present or absent Present

Stoppage, \$ 100 for

Due Gov't, \$ 100 for

Valuation of horse, \$ 100

Valuation of horse equipments, \$ 100

Remarks: First Instalment of Bounty due \$100

Book mark:

(358)

Lewis

Copyist.

6

5 Cav. U.S.C.T.

Lewis Howard

Sgt., Co. C, 5 Reg't U. S. Col'd Cavalry.

Appears on

Company Muster Roll

for July & Aug, 1862

Present or absent Present

Stoppage, \$ 100 for

Due Gov't, \$ 100 for

Valuation of horse, \$ 100

Valuation of horse equipments, \$ 100

Remarks:

Book mark:

Lundin

6 | 5 Cav. | U.S.C.T.

Lewis Gouhard
Sgt., Co. C, 5 Reg't U. S. Col'd Cavalry.

Appears on

Company Muster Roll

for Sep. 4 Oct., 1865.

Present or absent Present

Stoppage, \$ 100 for

Due Gov't, \$ 100 for

Valuation of horse, \$ 100

Valuation of horse equipments, \$ 100

Remarks:

Book mark:

(358)

Linden Copyist.

Jervis Cowherd

Det, Co. C, 5 Reg't U. S. Col'd Cavalry.

Appears on

Company Muster Roll

for *Nov Dec*, 186*5*.

Present or absent *Present*

Stoppage, \$ *100* for

Due Gov't, \$ *100* for

Valuation of horse, \$ *100*

Valuation of horse equipments, \$ *100*

Remarks: *Aug. 11. Camp and "Gar" equip" #1.31*

Book mark:

(358)

J. J. J. J.
Copyist.

C

5 Cav.

U.S.C.T.

Lewis Cowherd

Pvt, Co. C, 5 Reg't U. S. Col'd Cavalry.

Appears on

Company Muster Roll

for Jan and Feb, 1866

Present or absent Present

Stoppage, \$ 100 for

Due Gov't, \$ 100 for

Valuation of horse, \$ 100

Valuation of horse equipments, \$ 100

Remarks:

Book mark:

Rose

(358)

Copyist.

C

5 Cav.

U.S.C.T.

Lewis Cowherd

Priv., Co. C, 5 Reg't U. S. Col'd Cavalry.

Appears on Co. Muster-out Roll, dated

Helena Ark, March 16, 1866.

Muster-out to date March 16, 1866.

Last paid to Dec 31, 1865.

Clothing account:

Last settled....., 186 ; drawn since \$..... 100

Due soldier \$..... 100; due U. S. \$ 51⁴³/₁₀₀

Am't for cloth'g in kind or money adv'd \$..... 100

Due U. S. for arms, equipments, &c., \$..... 100

Bounty paid \$ 100 100; due \$ 100 100

Remarks: Due US for Ord 402

Book mark :

Rose

304
Cox Daniel

Co *B*, 5 U. S. Col'd Cav.

Private

Private

CARD NUMBERS.

1	5359244	26
2	5361215	27
3	5361306	28
4	5361390	29
5	5361472	30
6	5361554	31
7	9090103	32
8	40729579	33
9		34
10		35
11		36
12		37
13		38
14		39
15		40
16		41
17		42
18		43
19		44
20		45
21		46
22		47
23		48
24		49
25		50

Book Mark:

See also *72 n.f.c.5*

C

5 Cav. U.S.C.T.

Daniel Cox

Co. *B*, 5 Reg't U. S. Col'd Cav.

Appears on

Company Descriptive Book

of the organization named above.

DESCRIPTION.

Age *18* years; height *5* feet *3* inches.

Complexion *Blk*

Eyes *Blk*; hair *Blk*

Where born *Green Co. N.Y.*

Occupation *Labourer*

ENLISTMENT.

When *Feb. 9*, 1865.

Where *Schenectady N.Y.*

By whom *Capt. Hadden*; term *3* y'rs.

Remarks:

.....
.....
.....
.....
.....
.....
.....
.....

C 5 Cav | U.S.C.T.

Daniel Cox

Pvt, Co., 5 Reg't U. S. Col'd Cav

Appears on

M. and D. Roll of Men Transferred

to the organization named above,

from

Roll dated July 18, 1865.

When enlisted Feb 9, 1865.

Period for which enlisted 3 years.

When mustered in Feb 9, 1865.

Present or absent Not Stated

Company to which assigned

Remarks: 4 D K

Book mark :

Abbott

(342)

Copyist.

6 | **5 Cav. | U.S.C.T.**

Samuel Cox

Priv., Co. B, 5 Reg't U. S. Col'd Cavalry.

Appears on

Company Muster Roll

for *July & Aug.*, 186*5*.

Present or absent *present.*

Stoppage, \$ *100* for

Due Gov't, \$ *100* for

Valuation of horse, \$ *100*

Valuation of horse equipments, \$ *100*

Remarks: *Transferred from 72nd U. S. C. I.
per A.O. No. 132 Hdqrs Dept. of W. Va.
Dated July 27, 1865-*

Book mark:

R. E. Wilson

6 | **5 Cav.** | **U.S.C.T.**

Daniel Cox

Priv., Co. B, 5 Reg't U. S. Col'd Cavalry.

Appears on

Company Muster Roll

for *Sept & Octo.*, 186*5*.

Present or absent *present*

Stoppage, \$ *100* for

Due Gov't, \$ *100* for

Valuation of horse, \$ *100*

Valuation of horse equipments, \$ *100*

Remarks:

Book mark:

R. Cowles

6 | **5 Cav.** | **U.S.C.T.**

Daniel Cox

Priv., Co. B, 5 Reg't U. S. Col'd Cavalry.

Appears on

Company Muster Roll

for *Nov. & Dec.*, 186*5*.

Present or absent *present*

Stoppage, \$ *100* for

Due Gov't, \$ *100* for

Valuation of horse, \$ *100*

Valuation of horse equipments, \$ *100*

Remarks:

Book mark:

P. E. Walser

4

5 Cav.

U.S.C.T.

Samuel Cox

Plt, Co. B, 5 Reg't U. S. Col'd Cavalry.

Appears on

Company Muster Roll

for *Jan 1, Feb*, 186*6*.

Present or absent *Present*

Stoppage, \$ *100* for

Due Gov't, \$ *100* for

Valuation of horse, \$ *100*

Valuation of horse equipments, \$ *100*

Remarks:

Book mark:

(358)

copyist

Copyist.

C. | 5 Cav. | U.S.C.T.

Daniel Cox.

Co. B, 5 Reg't U. S. Colored Cav.

Appears on Returns as follows:

July 1865: Gain July 29/65 Paris, Ky,
Transferred from 72 U. S. C. Inf.,
per S. O. 127, Hdqrs. Dept. of Ky.
July 18/65.

Book mark:

(546)

Baker
Copyist.

Guinn Cox

Pvt, Co. *D*, 5 Reg't U. S. Col'd Cavalry.

Appears on Co. Muster-out Roll, dated *Helena Ark*, *Mar 14*, 1866.

Muster-out to date *Mar 11*, 1866.

Last paid to *Dec 31*, 1865.

Clothing account:

Last settled....., 186 ; drawn since \$..... 100

Due soldier \$..... 100; due U. S. \$ *35* ^{*91*}/₁₀₀

Am't for cloth'g in kind or money adv'd \$..... 100

Due U. S. for arms, equipments, &c., \$..... 100

Bounty paid \$ *100* 100; due \$..... 100

Remarks: *Stam April 19, 1861*
Transferred from the 2nd
U.S. Col'd Inftry for S.C. No 12,
par 3 114th Inf Dept Ky dated
Genierville Ky July 18, 1865
(Age 18)

Book mark: *Sgt. Capt*

Wm. W. ...

303
Cox John

Co D, 5 U. S. Col'd Cav.

Private

Private

CARD NUMBERS.

1	5359242	26
2	5361216	27
3	5361307	28
4	5361391	29
5	5361473	30
6	5361555	31
7	5361632	32
8	9090102	33
9	40729594	34
10		35
11		36
12		37
13		38
14		39
15		40
16		41
17		42
18		43
19		44
20		45
21		46
22		47
23		48
24		49
25		50

Book Mark:

See also

72 N. J. C. D.

C | 5 Cav. | U.S.C.T.

John Cox

, Co. B, 5 Reg't U. S. Col'd Cav.

Appears on

Company Descriptive Book

of the organization named above.

DESCRIPTION.

Age 19 years; height 5 feet 2 inches.

Complexion Blk

Eyes Blk; hair Blk

Where born Maine

Occupation Shoemaker

ENLISTMENT.

When See Institute, 186 .

Where

By whom; term 3 y'rs.

Remarks:

[Empty lines for remarks]

W. W. [Signature]

John Cox

Priv., Co. B, 5 Reg't U. S. Col'd Cavalry.

Appears on

Company Muster Roll

for July & Aug., 1865.

Present or absent Absent

Stoppage, \$ 100 for

Due Gov't, \$ 100 for

Valuation of horse, \$ 100

Valuation of horse equipments, \$ 100

Remarks: Transferred from 72 U.S. C.S. per S.O. No. 132 Hdqrs Dept. of Ky. Dated July 27, 1865.

Sentenced to penitentiary by Genl G.M. at Frankford, Ky. for 5 years.

Book mark:

R. E. Wilson

L | 5th Cav | U.S.C.T.

John Cox

Pvt, Co., 5th Reg't U. S. Cav

Appears on

M. and D. Roll of Men Transferred

to the organization named above,

from

Roll dated July 18, 1865.

When enlisted, 186 .

Period for which enlisted 3 years.

When mustered in Dec 21, 1864.

Present or absent

Company to which assigned

Remarks: 1 DO

Sub for Joseph Andrews
Absent since Jan 4 1865
Sentenced to five years in
the State Prison

Book mark :

(342)

Abbott

Copyist.

5 Cav. U.S.C.T.

John Cox

Priv., Co. B, 5 Reg't U. S. Col'd Cavalry.

Appears on

Company Muster Roll

for Sept. & Oct., 1865.

Present or absent Absent

Stoppage, \$ 100 for

Due Gov't, \$ 100 for

Valuation of horse, \$ 100

Valuation of horse equipments, \$ 100

Remarks: Sentenced to Penitentiary for 5 years by Gen. C. Martial

Book mark:

R. Currier

John Cox

Cris., Co. B, 5 Reg't U. S. Col'd Cavalry.

Appears on

Company Muster Roll

for Nov & Dec, 1865.

Present or absent absent

Stoppage, \$ 100 for

Due Gov't, \$ 100 for

Valuation of horse, \$ 100

Valuation of horse equipments, \$ 100

Remarks: Sentenced to Penitentiary for 5 years, at Frankford, Ky. by G.C.M.

Book mark:

Cox's

R. C. Miller

E

5 Cav.

U.S.C.T.

John Cox

Pt

, Co. B, 5 Reg't U. S. Col'd Cavalry.

Appears on

Company Muster Roll

for *Jan & Feb*, 186*6*.

Present or absent *absent*

Stoppage, \$ *100* for

Due Gov't, \$ *100* for

Valuation of horse, \$ *100*

Valuation of horse equipments, \$ *100*

Remarks: *Substitute*

Sentenced to Penitentiary for 5 years by G. C. M. at Fort-Myer

Book mark:

(358)

W. J. ...

Copyist.

Q | 5 Cav. | U.S.C.T.

John Cox.

Regt., Co. B, 5 Reg't U. S. Colored Cav.

Appears on Returns as follows:

July 1865. Gained July 29/65, Paris, Ky.
Transfd from 72^d U. S. C. Inf.
S. B. 127, Admrs. Dept. of Ky, July
18/65.

July to Dec. 1865. Absent in confine-
ment, Frankfort, Ky.

Jan. & Feb. 1866. Absent in confine-
ment, Frankfort, Ky. under
sentence of G. C. M.

Book mark:

(546)

Baker
Copyist.

C | 5 Cav. | U.S.C.T.

John Cox

Co. *B*, 5 Reg't U. S. Col'd Cavalry.

Appears on Co. Muster-out Roll, dated

Wetona Ark, *May 16*, 186*6*.

Muster-out to date _____, 186 .

Last paid to _____, 186 .

Clothing account:

Last settled _____, 186 ; drawn since \$ _____ 100

Due soldier \$ _____ 100 ; due U. S. \$ _____ 100

Am't for cloth'g in kind or money adv'd \$ _____ 100

Due U. S. for arms, equipments, &c., \$ _____ 100

Bounty paid \$ _____ 100 ; due \$ _____ 100

Remarks: *Discharged*

Aug 19

Book mark: _____

(361)

Wetona

Copyist.

John Cox
Pvt., Co. *D*, 5 Reg't U. S. Col'd Cavalry.

Appears on Co. Muster-out Roll, dated
Wilmington, N.C., 186*6*.

Muster-out to date _____, 186 .

Last paid to, *May, Dec from arrears*, 186 .

Clothing account:

Last settled _____, 186 ; drawn since \$ _____ 100

Due soldier \$ _____ 100; due U. S. \$ _____ 100

Am't for cloth'g in kind or money adv'd \$ _____ 100

Due U. S. for arms, equipments, &c., \$ _____ 100

Bounty paid \$ _____ 100; due \$ _____ 100

Remarks: *Substitute, Home Sept 19, 1861.*

*Transferred from 2^d U.S. Col'd Cav. to
1st Reg't S.C. No. 12th Jan 3 1862
Dpt. Ky, stated Louisville Ky July
18. 1863. Sentenced to the Peni-
tentiary at Frankfort, Ky, for 3*

Book mark: _____

JAN. - 9

5361555

☆ 1891 ☆

*years by S. C. M. No. 113 -
Charge given*

Cox William

Co^l, 5 U. S. Col'd Cav.

Private Corporal

CARD NUMBERS.

1	5361661	26
2	5361763	27
3	5361861	28
4	5361943	29
5	5362029	30
6	5362108	31
7	5362190	32
8	5362280	33
9	5362369	34
10	5362453	35
11	5362537	36
12	9090192	37
13	43145662	38
14	43146217	39
15	40729595	40
16		41
17		42
18		43
19		44
20		45
21		46
22		47
23		48
24		49
25		50

Book Mark:

See also

C | 5 Cav. | U.S.C.T.

William Cox

, Co. C, 5 Reg't U. S. Col'd Cav.

Appears on

Company Descriptive Book
of the organization named above.

DESCRIPTION.

Age 20 years; height 5 feet 10 1/4 inches.

Complexion r k

Eyes r k; hair r k

Where born Nelson Co., Ky.

Occupation Laborer

ENLISTMENT.

When Aug. 26, 1864.

Where Louisville

By whom Capt. Ham; term 3 y'rs.

Remarks: Made Corp'l Sec.
M. C. O.

Warren

6 | 56av | 11569

William Cox

Appears with rank of Priv. on

Muster and Descriptive Roll

of Detachment U. S. Colored

Recruits Mustered for U. S.

Colored Infy Roll dated

Louisville, Ky., Aug 30, 1864.

Where born Nelson Ky

Age 20 years; occupation laborer

When enlisted Aug 26, 1864.

Where enlisted Louisville Ky.

For what period enlisted 3 years.

Eyes dark; hair dark

Complexion dark; height 5 ft. 10 1/4 in.

When mustered in Aug 30, 1864.

Where mustered in Louisville, Ky.

Bounty paid \$ 100; due \$ 100

Clothing account:

Last settled , 186 ; drawn since \$ 100

Date of first muster , 186 .

Company to which assigned

Remarks: Cox to Nelson

H list.

Book mark:

(356m)

L. D. Burton

Copyist.

6

5 bar

U.S.C.T.

William Cox

Appears with rank of Pvt on

Muster and Descriptive Roll

of a Detachment of U. S. Colored
Troops transferred to U. S. Colored
Cav. at Lexington, Ky.

Roll dated

Louisville, Ky., Sept. 2, 1864.

Where born Nelson, Ky.

Age 20 years; occupation Labourer

When enlisted Aug. 26, 1864.

Where enlisted Louisville, Ky.

For what period enlisted 3 years.

Eyes brn; hair brn

Complexion brn; height 5 ft. 6/4 in.

When mustered in Aug. 30, 1864.

Where mustered in Louisville

Bounty paid \$ 100; due \$ 100

Clothing account:

Last settled _____, 1864; drawn since \$ 17 ⁵⁵/₁₀₀

Date of first muster Aug. 30, 1864.

Company to which assigned _____

Remarks: credited to 4 Comp. Dist Ky.

Book mark: _____

B. J. D. Russell

(356m)

Copyist.

6

5 Cav. U.S.C.T.

William Cox

Pris, Co. 6, 5 Reg't U. S. Col'd Cavalry.

Appears on

Company Muster-in and Descriptive Roll

of the organization named above. Roll dated

Camp Nelson, ^{Ky} N. Y., Oct. 24, 1864.

Where born Nelson, Ky.

Age 20 y'rs; occupation Laborer

When enlisted Aug. 26, 1864.

Where enlisted Louisville

For what period enlisted 3 years.

Eyes Dk.; hair Dk.

Complexion Dk.; height 5 ft. 10 1/4 in.

When mustered in Aug. 30, 1864.

Where mustered in Louisville

Bounty paid \$ 100; due \$ 100

Where credited 4" Dist. Ky.

Company to which assigned 6.

Remarks:

Book mark:

Shull

(356d)

Copyist.

5

5 Cav. U.S.C.T.

William Cox

Prm, Co. C, 5 Reg't U. S. Col'd Cavalry.

Appears on

Company Muster Roll

for *to Oct. 31*, 186*4*.

Present or absent *Present*

Stoppage, \$ *100* for

Due Gov't, \$ *100* for

Valuation of horse, \$ *100*

Valuation of horse equipments, \$ *100*

Remarks:

Book mark:

Shull

William Cox

William Cox, Co. C, 5 Reg't U. S. Col'd Cavalry.

Appears on

Company Muster Roll

for *Nov. 7 Dec.*, 1864.

Present or absent *Present*

Stoppage, \$ *100* for

Due Gov't, \$ *100* for

Valuation of horse, \$ *100*

Valuation of horse equipments, \$ *100*

Remarks: *First & Second mistrial-
ments to of bounty due due
U.S. for Ordinance 17.93*

Book mark:

Shull

William Cox
Corpl, Co. C, 5 Reg't U. S. Col'd Cavalry.

Appears on

Company Muster Roll

for *Jan'y. & Feby.*, 186*5*.

Present or absent *Present*

Stoppage, \$ *100* for

Due Gov't, \$ *100* for

Valuation of horse, \$ *100*

Valuation of horse equipments, \$ *100*

Remarks: *First instalment Bounty
Due \$100 Appointed Corpl. per
Regtl. Order No. 27 to rank
from Jan. 1, 1864*

Book mark:

Small

William Cox

Cox, Co. C, 5 Reg't U. S. Col'd Cavalry.

Appears on

Company Muster Roll

for *Mar. & Apr.*, 1865.

Present or absent *Present*

Stoppage, \$ *100* for

Due Gov't, \$ *100* for

Valuation of horse, \$ *100*

Valuation of horse equipments, \$ *100*

Remarks: *First installment of
Bounty due \$100*

Book mark:

Smith

6

5 Cav. U.S.C.T.

William Cox

Cpl, Co. C, 5 Reg't U. S. Col'd Cavalry.

Appears on

Company Muster Roll

for May 4 June, 1865.

Present or absent Present

Stoppage, \$ 100 for

Due Gov't, \$ 100 for

Valuation of horse, \$ 100

Valuation of horse equipments, \$ 100

Remarks: First installment of Bounty due # 101

Book mark:

J. Under

(358)

Copyist.

6

5 Cav. U.S.C.T.

William [unclear]

Spl., Co. C, 5 Reg't U. S. Col'd Cavalry.

Appears on

Company Muster Roll

for July & Aug., 1865

Present or absent Present

Stoppage, \$ 100 for

Due Gov't, \$ 100 for

Valuation of horse, \$ 100

Valuation of horse equipments, \$ 100

Remarks:

Book mark:

[Signature]

(358)

Copyist.

William Cox

Capt., Co. C, 5 Reg't U. S. Col'd Cavalry.

Appears on

Company Muster Roll

for *Sep* & *Oct*, 186*5*.

Present or absent *Present*

Stoppage, \$ *100* for

Due Gov't, \$ *100* for

Valuation of horse, \$ *100*

Valuation of horse equipments, \$ *100*

Remarks: *Reg. Band*

Book mark:

(358)

J. J. J. J.

Copyist.

h | **5 Cav. | U.S.C.T.**

William Cox
Cpl., Co. C, 5 Reg't U. S. Col'd Cavalry.

Appears on

Company Muster Roll

for *Nov* *1865*, 1865.

Present or absent *Present*

Stoppage, \$ *100* for

Due Gov't, \$ *100* for

Valuation of horse, \$ *100*

Valuation of horse equipments, \$ *100*

Remarks: *On Daily Duty with Regt Band*

Book mark: _____

(358)

J. J. J. J.
Copyist.

C

5 Cav.

U.S.C.T.

William Cox

Corp., Co. C, 5 Reg't U. S. Col'd Cavalry.

Appears on

Company Muster Roll

for Jan and Feb, 1866.

Present or absent Present

Stoppage, \$ 100 for

Due Gov't, \$ 100 for

Valuation of horse, \$ 100

Valuation of horse equipments, \$ 100

Remarks: On daily duty with Reg Band

Book mark:

Rose

(358)

Copyist.

Q | **5 Cav.** | **U.S.C.T.**

William Cox.

Corpl., Co. C, 5 Reg't U. S. Colored Cav.

Appears on Returns as follows:

*Feb. 1865. Feb. 22/65, Camp Nelson,
Ky. Appointed per Reg. Order
No. 27.*

*Sept. 1865 to Feb. 1866. On duty, dettd
with Reg. Band.*

Book mark:

(546)

A. Baker
Copyist.

C

5 Cav.

U.S.C.T.

William Cox

Corps, Co. C, 5 Reg't U. S. Col'd Cavalry.

Appears on Co. Muster-out Roll, dated

Helena Ark, March, 1866.

Muster-out to date March, 1866.

Last paid to Dec 31, 1865.

Clothing account:

Last settled....., 186 ; drawn since \$..... 100

Due soldier \$ 132 / 100; due U. S. \$..... 100

Am't for cloth'g in kind or money adv'd \$..... 100

Due U. S. for arms, equipments, &c., \$..... 100

Bounty paid \$ 100 / 100; due \$ 100 / 100

Remarks: Put from organization until Feb 22, 1865 when made Corps.

Due U.S. for Ord 80¢

Book mark : 291. 1882

Rose

301 O'Donovan

Craig Lyman

Co A, 5 U. S. Col'd Cav.

Private

Private

CARD NUMBERS.

1	5359237	26
2	5367337	27
3	5367483	28
4	5359298	29
5	5367766	30
6	9090762	31
7	40729637	32
8		33
9		34
10		35
11		36
12		37
13		38
14		39
15		40
16		41
17		42
18		43
19		44
20		45
21		46
22		47
23		48
24		49
25		50

Book Mark:

See also

C | 5 Cav. | U.S.C.T.

Gyman Craig
Co. *H*, 5 Reg't U. S. Col'd Cav.

Appears on

Company Descriptive Book
of the organization named above.

DESCRIPTION.

Age *30* years; height *5* feet *7* inches.

Complexion *Blk*

Eyes *Blk*; hair *Blk*

Where born *Drapped Ky*

Occupation *Laborer*

ENLISTMENT.

When *Oct 14*, 186 *4*.

Where *Canioville Dist of Ky*

By whom _____; term *1* y'rs.

Remarks: *discharged*
Oct 17 - expiration
of service

F E Rucke

6 5 Cav U.S.C.T.

Lyman Craig

Corpl, Co., 5 Reg't U. S. Col'd Cav

Appears on

M. and D. Roll of Men Transferred

to the organization named above,

from

Roll dated July 18, 1865.

When enlisted, 186 .

Period for which enlisted 1 years.

When mustered in Oct 14, 1864.

Present or absent Not Stated

Company to which assigned

Remarks: Drafted

Apppts Corpl June 23 1865

Book mark :

Abbott

(342)

Copyist.

6 5 Cav. U.S.C.T.

Simon Craig
Cvt., Co. H, 5 Reg't U. S. Col'd Cavalry.

Appears on

Company Muster Roll

for July & Aug., 1865.

Present or absent Present.

Stoppage, \$ 100 for

Due Gov't, \$ 100 for

Valuation of horse, \$ 100

Valuation of horse equipments, \$ 100

Remarks: Transferred to 5th U.S. Cavalry
by S.O. "127" 4th Co's Dept of Ky
Assigned to H Co. by Regt
Order "132"

(Drafted & Mustered in 1864
at Louisville Ky.)

Book mark:

(358) B. J. Cooke Copyist.

6 | 5 Cav. | U.S.C.T.

Lyman Craig

Cvt, Co. H, 5 Reg't U. S. Col'd Cavalry.

Appears on

Company Muster Roll

for *Sept. & Oct*, 1865.

Present or absent.....

Stoppage, \$.....100 for.....

Due Gov't, \$.....100 for.....

Valuation of horse, \$.....100

Valuation of horse equipments, \$.....100

Remarks: *Discharged. Ex-
piration of service.
(Drafted for 1 year)*

Book mark: *Disch'd Oct. 16/65 E.B.M.I.C. 45*

(358)

B. J. Cooke

Copyist.

6

5

U.S.C.T.

Lyman Craig

Co. H, 5 Reg't U. S. Col'd

Appears on an

Individual Muster-out Roll

of the organization named above. Roll dated

Washington Ky, Oct. 16, 1865.

Muster-out to date *Oct. 16, 1865.*

Last paid to *pay due from* *Carrollton*, 186 .

Clothing account:

Last settled, 186 ; drawn since \$ 100

Due soldier \$ *22* ^{*23*}/₁₀₀; due U. S. \$ 100

Am't for cloth'g in kind or money adv'd \$ 100

Due U. S. for arms, equipments, &c., \$ 100

Bounty paid \$ 100 due \$ 100

Remarks:

Discharged Oct 17, 1865, reason of expiration of term of service. Discharge furnished

Book mark:

H. J. Hughes

(348)

Copyist.

Lyman Craig.

Corpl., Co. *H*, 5 Reg't U. S. Colored Cav.
Pvt.

Appears on Returns as follows:

July 1865. Gain, July 31/65, Covington,
Ky. Transfer from 72 U.S.C.
Inf., S. O. 127, Hdqrs. Dept of
Ky., July 18/65.

Oct. 1865. Disch'd - expiration of
service - Oct. 17/65, Camp Bristol.
(Pvt.)

Book mark:

6

5 Cav.

U.S.C.T.

Sydney Craig

Pat, Co. *A*, 5 Reg't U. S. Col'd Cavalry.

Appears on **Co. Muster-out Roll**, dated

Helena, Ark, Mar 16, 1864.

Muster-out to date _____, 186 .

Last paid to _____, 186 .

Clothing account:

Last settled _____, 186 ; drawn since \$ _____ 100

Due soldier \$ _____ 100; due U. S. \$ _____ 100

Am't for cloth'g in kind or money adv'd \$ _____ 100

Due U. S. for arms, equipments, &c., \$ _____ 100

Bounty paid \$ _____ 100; due \$ _____ 100

Remarks: *Discharged Oct 17. 65,*
Camp Brisbane, Ky. on expiration
of service.
(Age 30)

Book mark: *Discharged Oct 16. 65.*
E.B.V. P. 45. 646. 1860

(361)

J. Stewart
Copyist.

Craig Moser

Co E, 5 U. S. Col'd Cav.

Sergeant Sergeant

CARD NUMBERS.

1	5363665	26
2	5363763	27
3	5363865	28
4	5363952	29
5	5364044	30
6	5364130	31
7	5364215	32
8	5364309	33
9	5364396	34
10	5364479	35
11	5364560	36
12	9090406	37
13	9090397	38
14	9090384	39
15	40729608	40
16		41
17		42
18		43
19		44
20		45
21		46
22		47
23		48
24		49
25		50

Book Mark:

General Notation N. & P. 407375,

See also

REP 395381
D1443875- P.O. mem

A. 2257502 And W.S.

O. 2269028 And W.S.

S 2611050 P.B. net

Empire Co

Sept 11/19

C | **5 Cav. | U.S.C.T.**

Moses Craig

....., Co. *E*, 5 Reg't U. S. Col'd Cav.

Appears on

Company Descriptive Book
of the organization named above.

DESCRIPTION.

Age *28* years; height *5* feet *9* inches.

Complexion *Black*

Eyes *Blk*; hair *Blk*

Where born *Lincoln Ky*

Occupation *farmer*

ENLISTMENT.

When *Sep 9*, 186*4*.

Where *Camp Nelson*

By whom *J. L. Sandolph* term *3* y'rs.

Remarks:

J. E. Purke

(383g)

Copist.

C | **5 Cav. U.S.C.T.**

Moses Craig
....., Co. *E*, 5 Reg't U. S. Col'd Cav.

Appears on

Company Descriptive Book
of the organization named above.

DESCRIPTION.

Age *28* years; height *5* feet *9* inches.

Complexion *Dark*

Eyes *Black*; hair *Black*

Where born *Lincoln Ky*

Occupation *farmer*

ENLISTMENT.

When *Sep 8*, 186 *4*.

Where *Camp Nelson*

By whom *J. Randolph* term *3* y'rs.

Remarks:

.....
.....
.....
.....

J. E. Purke

(383g)

Copist.

6 | 5 Cav. | U.S.C.T.

Moses Craig

, Co. E, 5 Reg't U. S. Col'd Cav.

Appears on

Company Descriptive Book

of the organization named above.

DESCRIPTION.

Age 28 years; height 5 feet 9 inches.

Complexion Black

Eyes Black; hair Black

Where born Lincoln Ky

Occupation farmer

ENLISTMENT.

When Sep 8, 1864.

Where Camp Nelson

By whom J. B. Randolph, term 3 y'rs.

Remarks:

J. E. Parks

C

5 Cav.

U.S.C.T.

Moses Craig

Sept, Co. *E*, 5 Reg't U. S. Col'd Cavalry.

Appears on

Company Muster-in and Descriptive Roll
of the organization named above. Roll dated

Camp Nelson, *N. Y.*, *Oct 26*, 1864.

Where born *Lincoln Ky*

Age *28* y'rs; occupation *Farmer*

When enlisted *Sept 3*, 1864.

Where enlisted *Cp Nelson Ky*

For what period enlisted *3* years.

Eyes *Black*; hair *Black*

Complexion *Black*; height *5* ft. *9* in.

When mustered in *Sept 7*, 1864.

Where mustered in *Cp Nelson Ky*

Bounty paid \$ *100*; due \$ *100*

Where credited

Company to which assigned

Remarks: *7 District Kentucky*
Gains Kriqy

Supposed to be same as above

Under no name

Book mark:

REGIMENTAL REGISTER, N. Y. P. 1864

W. R. Rowland

(356d)

Copyist.

Moses Craig
Sergt, Co. E, 5 Reg't U. S. Col'd Cavalry.

Appears on

Company Muster Roll

for *Enlistment to Oct 31*, 1864.

Present or absent *Present*

Stoppage, \$ *100* for

Due Gov't, \$ *100* for

Valuation of horse, \$ *100*

Valuation of horse equipments, \$ *100*

Remarks: *Appointed sergent*
Order No. 2 Oct 26, 64

Book mark:

(358)

A. W. Rossland

Copyist.

6

5 Cav. U.S.C.T.

* Mower
~~William Mower~~

Sergeant, Co. E, 5 Reg't U. S. Col'd Cavalry.

Appears on

Company Muster Roll

for Nov. 7 Dec., 1864

Present or absent Present

Stoppage, \$ 100 for

Due Gov't, \$ 100 for

Valuation of horse, \$ 100

Valuation of horse equipments, \$ 100

Remarks: 1st & 2nd Installments
Bounty due

* Corrected by C. W. Spang Esq

Book mark:

W. K. Gordon

C

5 Cav.

U.S.C.T.

Moses Crain

Serg't., Co. E, 5 Reg't U. S. Col'd Cavalry.

Appears on

Company Muster Roll

for Quarter Feb., 1865.

Present or absent Present

Stoppage, \$ 100 for

Due Gov't, \$ 100 for

Valuation of horse, \$ 100

Valuation of horse equipments, \$ 100

Remarks: promoted from sergeant to 1st sergeant to rank from Feb., 1865 as per G.O. No. 19 Dated Feb. 10th 65. First instalment of Bounty due \$100. Due U.S. for Ordnance \$4.22

Book mark:

M. Rowland

(358)

Copyist.

B | **5 Cav.** | **U.S.C.T.**

Moses Craig
Sergeant, Co. E, 5 Reg't U.S. Col'd Cavalry.

Appears on

Company Muster Roll

for *Mich. & Apr.*, 186 *5*.

Present or absent *Present*

Stoppage, \$ *100* for

Due Gov't, \$ *100* for

Valuation of horse, \$ *100*

Valuation of horse equipments, \$ *100*

Remarks: *1st installment of*
Bounty due

Book mark:

M. Rowland

(358)

Copyist.

6

5 Cav. U.S.C.T.

Moses Crain

1st Lt, Co. E, 5 Reg't U.S. Col'd Cavalry.

Appears on

Company Muster Roll

for May & June, 1865.

Present or absent present

Stoppage, \$ 100 for

Due Gov't, \$ 100 for

Valuation of horse, \$ 100

Valuation of horse equipments, \$ 100

Remarks: 1st Inst. Bounty due \$100

Book mark:

Loup

(358)

Copyist.

C

5 Cav. U.S.C.T.

Moses Craig

1st Sgt., Co. E, 5 Reg't U.S. Col'd Cavalry.

Appears on

Company Muster Roll

for *July - Aug.*, 1865.

Present or absent *Present*

Stoppage, \$ *100* for

Due Gov't, \$ *100* for

Valuation of horse, \$ *100*

Valuation of horse equipments, \$ *100*

Remarks:

Book mark:

Long
Copyist.

C

5 Cav.

U.S.C.T.

Moses Craig

1st Sgt.; Co. E, 5 Reg't U. S. Col'd Cavalry.

Appears on

Company Muster Roll

for *Sept. - Oct.*, 1865.

Present or absent *present*

Stoppage, \$ *100* for

Due Gov't, \$ *100* for

Valuation of horse, \$ *100*

Valuation of horse equipments, \$ *100*

Remarks:

Book mark:

Long

(358)

Copyist.

C

5 Cav.

U.S.C.T.

Mosses Craig

1st Sgt., Co. E, 5 Reg't U. S. Col'd Cavalry.

Appears on

Company Muster Roll

for Nov & Dec, 1865.

Present or absent present

Stoppage, \$ 100 for

Due Gov't, \$ 100 for

Valuation of horse, \$ 100

Valuation of horse equipments, \$ 100

Remarks:

Book mark:

(358)

Long Copyist.

6 | 5 Cav. | U.S.C.T.

Moses Craig

1st Sgt, Co. E, 5 Reg't U. S. Col'd Cavalry.

Appears on

Company Muster Roll

for Jan. & Feb, 1866.

Present or absent Present

Stoppage, \$ 100 for

Due Gov't, \$ 100 for

Valuation of horse, \$ 100

Valuation of horse equipments, \$ 100

Remarks:

Book mark:

(358)

Elbert

Copyist.

C | **5 Cav. | U.S.C.T.**

Moses Craig.

Serget. Co. E, 5 Reg't U. S. Colored Cav.

Appears on Returns as follows:

*Nov. 1865. Absent sick in Gen. Hosp.,
Camp Nelson, Ky, since Nov.
8/65.*

Book mark :

(546)

Baker
Copyist.

10

5 Cav. U.S.C.T.

Moses Leray

1st Lgt, Co. *E.*, 5 Reg't U. S. Col'd Cavalry.

Appears on **Co. Muster-out Roll**, dated *Memphis, Ark*, *Mar 16*, 1866.

Muster-out to date * *Mar 3*, 1866.

Last paid to *Dec 31*, 1865.

Clothing account:

Last settled....., 186 ; drawn since \$..... 100

Due soldier \$..... *2* ^{*44*}/₁₀₀; due U. S. \$..... 100

Am't for cloth'g in kind or money adv'd \$..... 100

Due U. S. for arms, equipments, &c., \$..... 100

Bounty paid \$..... *100* ^{*00*}/₁₀₀; due \$..... *100* ^{*00*}/₁₀₀

Remarks: *Sergh from Regt. of Co. to Feb 4 '66 when 1st Lgt.*

* **Records on file in 2nd. Auditor's Office show this Co. Mustered Out to take effect Mch, 16th. 1866. and paid to include Mch, 15th. 1866.**

Book mark: *V210 P 6, 74*

(361)

Jell K... ..
Copyist.

Craig Moses

Co.

5

Reg't

U.S.C. Cav.

2

Enclosures.

Bed Cards /	Final Statements
Burial Records	Furloughs or L. of A.
Certs. of Dis. for Discharge	Med. Certificates
C. M. Charges	Med. Des. Lists
Descriptive Lists	Orders
Discharge Certificates	Pris. of War Record
Enlistment Papers /	Resignations

Other papers relating to—

Admission to Hosp'l	Furlough or L. of A.
Casualty Sheet	Med. Examination
Confinement	Misc. Information
Contracts	Pay or Clothing
Death or Effects	Personal Reports
Desertion	Rank
Discharge from Hosp'l	Transfer to Hosp'l
Discharge from Service	Transfer to V. R. C.
Duty	Transportation <i>2</i>

UNITED STATES COLORED TROOPS ENLISTMENT.

STATE OF

TOWN OF

Kentucky

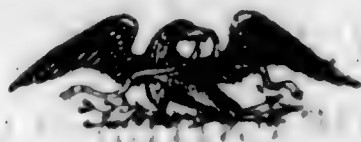

Camp Nelson

I, *Moses Craig* born in *Lincoln Co*
in the State of *Kentucky*, aged *Twenty eight* years
and by occupation a *Farmer* Do HEREBY ACKNOWLEDGE to
have volunteered *Eighth* day of *Sept* 1864

to serve as a **Soldier** in the **Army of the United States of America**, for the
period of **THREE YEARS**, unless sooner discharged by proper authority: Do
also agree to accept such bounty, pay, rations, and clothing, as are, or may be,
established by law for the U. S. colored troops.

And I, *Moses Craig*
do solemnly swear that I will bear true faith and allegiance to the **United States**
of America, and that I will serve them honestly and faithfully against all their
enemies or opposers whomsoever; and that I will observe and obey the orders
of the President of the United States, and the orders of the officers appointed
over me, according to the Rules and Articles of War.

Sworn and subscribed to, at *Camp Nelson*
this *8th* day of *Sept*, 1864. *Moses Craig*
Before *J. C. Randolph* *W. P. M.*

I CERTIFY, ON HONOR, That I have carefully examined the above named Volunteer agree-
ably to the General Regulations of the Army, and that, in my opinion, he is free from all bodily
defects and mental infirmity, which would in any way disqualify him from performing the
duties of a soldier.

J. G. Barrett
EXAMINING SURGEON.

I CERTIFY, ON HONOR, That I have minutely inspected the Volunteer *M. Craig*
previously to his enlistment, and that he was entirely sober when enlisted; that, to the best of
my judgment and belief, he is of lawful age; and that, in accepting him as duly qualified to per-
form the duties of an able-bodied soldier, I have strictly observed the regulations which govern
the recruiting service. This soldier has *blue* eyes, *black* hair, *black* complexion, is
five feet *three* inches high.

J. C. Randolph
and *W. P. M.*
RECRUITING OFFICER OR AGENT.

Mustered into the United States Service *Ninth* day of *Sept*, 1864.

N. Y. Ramsey
Mustering Officer.

Mustered into the service of the United States, for three years or during the war, from date of enlistment, in Company
Regiment of *Madison* Volunteers, on the *Ninth* day of *Sept*, 1864, at *Camp Nelson*

N. Y. Ramsey
Mustering Officer

UNITED STATES ORDER FOR TRANSPORTATION.

No. 2876

CAIRO, ILL., December 2nd 1866

THE QUARTERMASTER'S DEPARTMENT

Will furnish Transportation to 1 Supt. Moses Gregg, 5th U.S.C.
Cav. and Seven (7) men - (Convalescents)

From CAIRO, ILL., to Helena - Ark - En route
to rejoin their regiment.

BY ORDER OF COL. JOHN T. RINAHER, Commanding Post,
S. C. Skinner, 8th Regt. U.S.C.

M. Crawford 1st Lieut U.S.C.
Supt. Adjutant

Cairo, Ill., December 2^d 1864

Order No. 289¹/₂.

Requisition of 1st Sgt. Moses Gregg
5th U.S. Cavalry, and seven
(7) men - (Convalescents)

From Cairo - Ill.

To Helena, Ark.

Nature of Service in route, to rejoin
their regiment.

Ward 17
Hospital Number 16097. Bed 13

Name Messes Gregg

Age 36 Nativity Ky

~~Marrried~~ or Single

Residence Sanford Ky

Post Office address of wife or nearest relative. Abraham Gregg
Danville Ky

Rank Sergt. Co. E. Regiment 5th U.S. Cav

When admitted Nov 28 1863

From what source Camp Nelson Ky

Diagnosis: (in surgical cases state explicitly seat and character of wound or injury.)

Jefferson G. H.
Jeffersonville, Ind.

On what occasion wounded

Date

Nature of missile or weapon

TREATMENT.

[HERE NOTE IMPORTANT COMPLICATIONS AND ALL OPERATIONS.]

RESULT AND DATE.

*Bkts. No. 1. Louisville, Ky.
Sept. Novbr. 30. 65.*

307

Craig James

Co H, 5 U. S. Col'd Cav.

Corporal | Corporal

CARD NUMBERS.

1	5365717	26
2	5365818	27
3	5365918	28
4	5366013	29
5	5366106	30
6	5366194	31
7	5366283	32
8	5366373	33
9	5366463	34
10	5366552	35
11	5366638	36
12	9090640	37
13	40729620	38
14		39
15		40
16		41
17		42
18		43
19		44
20		45
21		46
22		47
23		48
24		49
25		50

Book Mark:

See also

C | **5 Cav. | U.S.C.T.**

James Craig
Copple, Co. G, 5 Reg't U. S. Col'd Cav.

Appears on

Company Descriptive Book
of the organization named above.

DESCRIPTION.

Age 27 years; height 5 feet 6 inches.

Complexion Black

Eyes Black; hair Black

Where born Franklin Ky

Occupation farmer

ENLISTMENT.

When Sep 8, 186 4.

Where Camp Nelson

By whom J. C. Rudolph, term 3 y'rs.

Remarks:

J. E. Rupp

C. 5 Cav. U.S.C.T.

James Craige.

Capt Co. G, 5 Reg't U. S. Col'd Cavalry.

Appears on

Company Muster-in and Descriptive Roll

of the organization named above. Roll dated

Camp Nelson, Ky., Oct. 29, 1864.

Where born Franklin Ky.

Age 22 y'rs; occupation Farmer.

When enlisted Sept. 8, 1864.

Where enlisted Camp Nelson Ky.

For what period enlisted 3 years.

Eyes Black; hair Black.

Complexion Black; height 5 ft. 6 in.

When mustered in Sept. 9, 1864.

Where mustered in Camp Nelson Ky.

Bounty paid \$ 100; due \$ 100

Where credited 8th Dist. Ky.

Company to which assigned

Remarks:

Robert Scott,

Supposed to be name of owner.

Added May 16, 98. H.A.J.

Book mark:

[Handwritten Signature]

(356d)

Copyist.

6

5 Cav. U.S.C.T.

James Craig

Capt, Co. G, 5 Reg't U. S. Col'd Cavalry.

Appears on

Company Muster Roll

for *Enll. to Oct. 31, 1864.*

Present or absent *Present*

Stoppage, \$ *100* for

Due Gov't, \$ *100* for

Valuation of horse, \$ *100*

Valuation of horse equipments, \$ *100*

Remarks: *Apptd for Rept. Ord
No. 12. Oct. 29/64*

Book mark:

(358)

James

Copyist.

C. | 5 Cav. | U.S.C.T.

James Craig
Copt., Co. G, 5 Reg't U. S. Col'd Cavalry.

Appears on

Company Muster Roll

for Nov. & Dec., 1864.

Present or absent Present,

Stoppage, \$ 100 for

Due Gov't, \$ 100 for

Valuation of horse, \$ 100

Valuation of horse equipments, \$ 100

Remarks: 1st & 2d instant,
Bounty due.

Book mark:

(358)

[Signature]
Copyist.

C.

5 Cav.

U.S.C.T.

James Craig

Capt., Co. G, 5 Reg't U. S. Col'd Cavalry.

Appears on

Company Muster Roll

for *Jan + Feb.*, 1865.

Present or absent *present.*

Stoppage, \$ *100* for

Due Gov't, \$ *100* for

Valuation of horse, \$ *100*

Valuation of horse equipments, \$ *100*

Remarks: *1st instalmt.*
Bounty due \$100⁰⁰

Book mark:

[Signature]
Copyist.

(358)

C.

5 Cav.

U.S.C.T.

James Craig
Croft, Co. G, 5 Reg't U. S. Col'd Cavalry.

Appears on

Company Muster Roll

for *March & April*, 1865.

Present or absent *present*

Stoppage, \$ *100* for

Due Gov't, \$ *100* for

Valuation of horse, \$ *100*

Valuation of horse equipments, \$ *100*

Remarks: *1st installment*
Bounty due.

Book mark:

[Signature]

(359)

Copyist.

L. J. | **5 Cav.** | **U.S.C.T.**

James Craig
L. J., Co. G, 5 Reg't U. S. Col'd Cavalry.

Appears on

Company Muster Roll

for *May 1 June*, 186*5*.

Present or absent *Present*

Stoppage, \$ *100* for

Due Gov't, \$ *100* for

Valuation of horse, \$ *100*

Valuation of horse equipments, \$ *100*

Remarks: *First installment*
Deanty due \$100

Book mark: _____

(358)

James Craig Copyist.

L. | **5 Cav.** | **U.S.C.T.**

James Craig
Craig, Co. G, 5 Reg't U. S. Col'd Cavalry.

Appears on

Company Muster Roll

for *July & Aug*, 1865 .

Present or absent *Present*

Stoppage, \$ *100* for

Due Gov't, \$ *100* for

Valuation of horse, \$ *100*

Valuation of horse equipments, \$ *100*

Remarks:

Book mark : -----

(358)

Geo. T. ... Copyist.

James Gray
Gray, Co. G, 5 Reg't U. S. Col'd Cavalry.

Appears on

Company Muster Roll

for *Sept - Oct*, 186*5*.

Present or absent *Present*

Stoppage, \$ 100 for

Due Gov't, \$ 100 for

Valuation of horse, \$ 100

Valuation of horse equipments, \$ 100

Remarks:

Book mark: _____

(358) *James Gray* Copyist.

James L. ...

Co. G, 5 Reg't U. S. Col'd Cavalry.

Appears on

Company Muster Roll

for *Nov. 30*, 186 *3*.

Present or absent *Present*

Stoppage, \$ *100* for

Due Gov't, \$ *100* for

Valuation of horse, \$ *100*

Valuation of horse equipments, \$ *100*

Remarks:

Book mark:

(358) *James L. ...* Copyist.

James Lewis
Cork, Co. G, 5 Reg't U. S. Col'd Cavalry.

Appears on

Company Muster Roll

for *Jan'y & Feb'y*, 1866.

Present or absent *Present*

Stoppage, \$ 100 for

Due Gov't, \$ 100 for

Valuation of horse, \$ 100

Valuation of horse equipments, \$ 100

Remarks: *See Reg't for Amt. 45*

Book mark: _____

Q | 5 Cav. | U.S.C.T.

Jas. Craig.

Corpl., Co. G, 5 Reg't U. S. Colored Cav.

Appears on Returns as follows:

May 1865. Absent sick in Regtl. Hosp,
Paris, Ky.

Book mark:

(546)

H. Baker
Copyist.

6 | 5 Cav. | U.S.C.T.

James Craig

Corp, Co. *4*, 5 Reg't U. S. Col'd Cavalry.

Appears on Co. Muster-out Roll, dated

Helena, Ark, March 16, 1866.

Muster-out to date *March 16,* 1866.

Last paid to *Dec. 31,* 1865.

Clothing account:

Last settled....., 186 ; drawn since \$..... 100

Due soldier \$..... 100; due U. S. \$ *17* ^{*72*}/₁₀₀

Am't for cloth'g in kind or money adv'd \$..... 100

Due U. S. for arms, equipments, &c., \$ ^{*40*}/₁₀₀

Bounty paid \$ *100* 100; due \$ *100* 100

Remarks: *Corp. from Org. of Company,*

due U.S. for Ordnance \$ ^{*40*}/₁₀₀

None.

Book mark :

James Craig

(861)

Copyist.

310
Crane Philip

Co M, 5 U. S. Col'd Cav.

Private Private

CARD NUMBERS.

1	5370834	26
2	5370929	27
3	5371029	28
4	5371114	29
5	5371199	30
6	5371284	31
7	5371368	32
8	5371455	33
9	5371540	34
10	5371626	35
11	5371709	36
12	9091266	37
13	40729662	38
14		39
15		40
16		41
17		42
18		43
19		44
20		45
21		46
22		47
23		48
24		49
25		50

Book Mark:

See also

C | 5th Cav | U.S.C.T.

Philip Corwin

, Co M, 5th Reg't U. S. Col'd Cav

Appears on

Company Descriptive Book

of the organization named above.

DESCRIPTION.

Age 37 years; height 5 feet 9 inches.

Complexion Black

Eyes Black; hair Black

Where born Meriden Ky

Occupation Farmer

ENLISTMENT.

When Aug 29, 1864

Where Camp Deton

By whom McRae; term 3 y'rs.

Remarks:

[Signature]

(383g)

Copyist.

6

5 Cav.

U.S.C.T.

Philip Crane

Priv., Co. M, 5 Reg't U. S. Col'd Cavalry.

Appears on

Company Muster-in and Descriptive Roll

of the organization named above. Roll dated

Camp Nelson, N. Y., Oct 30, 1864.

Where born Mercer, Ky

Age 37 y'rs; occupation Farmer

When enlisted Aug. 29, 1864.

Where enlisted Camp Nelson, Ky.

For what period enlisted 3 years.

Eyes Blue; hair Black

Complexion Black; height 5 ft. 9 in.

When mustered in Aug. 30, 1864.

Where mustered in Camp Nelson, Ky.

Bounty paid \$ 100; due \$ 100

Where credited 7 Dist Ky.

Company to which assigned

Remarks: ^{*} Jan. 1865

^{*} appeared as the holder of power
dated 10/10/64 &c

Book mark:

W. S. Thompson

(356d)

Copyist.

C

5 Cav. | U.S.C.T.

Philip Carver

Priv, Co. M, 5 Reg't U. S. Col'd Cavalry.

Appears on

Company Muster Roll

for *to Oct 31*, 186*4*.

Present or absent *Present*

Stoppage, \$ *100* for

Due Gov't, \$ *100* for

Valuation of horse, \$ *100*

Valuation of horse equipments, \$ *100*

Remarks:

Book mark:

H. S. Thompson

(358)

Copyist.

July Brown
Co. M, Co. M, 5 Reg't U. S. Col'd Cavalry.

Appears on

Company Muster Roll

for *Nov. 3 Dec.*, 1864.

Present or absent *Absent*

Stoppage, \$ *100* for

Due Gov't, \$ *100* for

Valuation of horse, \$ *100*

Valuation of horse equipments, \$ *100*

Remarks: *Returned government
mills to James Nelson Ky.
1864 as installments by
company due*

Book mark:

W. S. Thompson
Copyist.

Philip Crane

Philip Crane, Co. M, 5 Reg't U. S. Col'd Cavalry.

Appears on

Company Muster Roll

for *June 1st*, 1865.

Present or absent *present*

Stoppage, \$ *100* for

Due Gov't, \$ *100* for

Valuation of horse, \$ *100*

Valuation of horse equipments, \$ *100*

Remarks: *Returned from Louisville Ky. to Camp Nelson Va. 1st & 2d instalments of bounty due.*

Book mark: _____

W. H. Thompson

60 | **5 Cav. | U.S.C.T.**

Philip Corwin

Priv., Co. M, 5 Reg't U. S. Col'd Cavalry.

Appears on

Company Muster Roll

for *Mar. & Apr.*, 186*4*.

Present or absent *Present.*

Stoppage, \$ 100 for

Due Gov't, \$ 100 for

Valuation of horse, \$ 100

Valuation of horse equipments, \$ 100

Remarks: *1st installment
county due \$100*

Book mark:

E. S. Thompson

(358)

Copyist.

Co.

5 Cav. U.S.C.T.

Philip Crane

NW, Co. M, 5 Reg't U. S. Col'd Cavalry.

Appears on

Company Muster Roll

for *May & June*, 1865.

Present or absent *Present*

Stoppage, \$ *100* for

Due Gov't, \$ *100* for

Valuation of horse, \$ *100*

Valuation of horse equipments, \$ *100*

Remarks: *1st Enlistment bounty
due \$100.*

Book mark :

Crane

Copyist.

(358)

C.

5 Cav. | U.S.C.T.

Philip Crain

M, Co. M, 5 Reg't U. S. Col'd Cavalry.

Appears on

Company Muster Roll

for *July & Aug*, 186*5*.

Present or absent *Present*

Stoppage, \$ *100* for

Due Gov't, \$ *100* for

Valuation of horse, \$ *100*

Valuation of horse equipments, \$ *100*

Remarks:

Book mark:

(358)

C. Curtis
Copyist.

Co. | 5 Cav. | U.S.C.T.

Philip Crain

No., Co. M, 5 Reg't U. S. Col'd Cavalry.

Appears on

Company Muster Roll

for *Sept + Oct*, 186*7*.

Present or absent *Present*

Stoppage, \$ *100* for

Due Gov't, \$ *100* for

Valuation of horse, \$ *100*

Valuation of horse equipments, \$ *100*

Remarks: *Due U.S. for Camp & Allowance \$1.55-*

Book mark: _____

(358)

C. W. C.
Copyist.

Co.

5 Cav. | U.S.C.T.

Philip Leraie

P.M., Co. M, 5 Reg't U. S. Col'd Cavalry.

Appears on

Company Muster Roll

for *Nov & Dec*, 1865.

Present or absent *Present*

Stoppage, \$ *100* for

Due Gov't, \$ *100* for

Valuation of horse, \$ *100*

Valuation of horse equipments, \$ *100*

Remarks:

Book mark:

C. W. C.

Copyist.

C

5 Cav. U.S.C.T.

Phillip Crain

Plt, Co. M, 5 Reg't U. S. Col'd Cavalry.

Appears on

Company Muster Roll

for Jan + Feb, 1866.

Present or absent Present

Stoppage, \$ 100 for

Due Gov't, \$ 100 for

Valuation of horse, \$ 100

Valuation of horse equipments, \$ 100

Remarks:

Book mark:

Hays

(358)

Copyist.

Q. | 5 Cav. | U.S.C.T.

Philip Crain.*

Pvt., Co. M., 5 Reg't U. S. Colored Cav.

Appears on Returns as follows:

Nov. & Dec. 1864. Absent. Returned
from Louisville, Ky., to Camp
Nelson, Ky.

Jan. & Feb. 1865. Absent at Camp
Nelson, dismounted.

Mar. 1865. Absent, det. at Camp
Nelson.

*Name appears also as Phillip Crane.

Book mark :

(546)

A. Baker,
Copyist.

C

5 Cav. U.S.C.T.

Philip Crain

Pvt., Co. M., 5 Reg't U. S. Col'd Cavalry.

Appears on Co. Muster-out Roll, dated

Helena Ark, Mar 16, 1866.

Muster-out to date

Mar 16, 1866.

Last paid to

Dec. 31, 1865.

Clothing account:

Last settled....., 186 ; drawn since \$..... 100

Due soldier \$..... 100; due U. S. \$ 49 ⁵³/₁₀₀

Am't for cloth'g in kind or money adv'd \$..... 100

Due U. S. for arms, equipments, &c., \$ ⁴⁰/₁₀₀

Bounty paid \$ 100 100; due \$ 100 100

Remarks: Slave Apr 19. 61

Book mark:

(861)

Styer

Copyright.

Cravens Aaron

Co C, 5 U. S. Col'd Cav.

Private Private

CARD NUMBERS.

5361662	26
5361764	27
5361862	28
5361960	29
5362043	30
5362125	31
5362207	32
5362299	33
5362387	34
5362472	35
5362556	36
9090193	37
43146224	38
43145783	39
40729596	40
	41
	42
	43
	44
	45
	46
	47
	48
	49
	50

Book Mark:

See also

0

5 Cav. U.S.C.T.

Aaron Cravens

Co. C, 5 Reg't U. S. Col'd Cav.

Appears on

Company Descriptive Book

of the organization named above.

DESCRIPTION.

Age 26 years; height 5 feet 8 inches.

Complexion Blk

Eyes Blk; hair Blk

Where born Adair Co, Ky.

Occupation Farmer

ENLISTMENT.

When Aug 1, 1864.

Where Lebanon

By whom Lt Crocker; term 3 y'rs.

Remarks:

Warren

6 | 56ar | 4862

Aaron Cravens

Appears with rank of _____ on

Muster and Descriptive Roll

of Detachment of US Colored
Volunteer Recruits forwarded

_____ Roll dated
Lebanon Ky, Aug 31, 1864.

Where born Adair Ky

Age 25 years; occupation farmer

When enlisted Aug 1, 1864.

Where enlisted Lebanon Ky.

For what period enlisted 3 years.

Eyes Blue; hair Black

Complexion Black; height 5 ft. 8 in.

When mustered in Aug 1, 1864.

Where mustered in Lebanon Ky.

Bounty paid \$ 100; due \$ 100

Clothing account:

Last settled _____, 1864; drawn since \$ 17⁵⁰/₁₀₀

Date of first muster Aug 1, 1864.

Company to which assigned _____

Remarks: Owner, Timoleon

Cravens, Adair Co.

Without Consent

4 Long Dist, Ky

Book mark: _____

(356m)

A. B. Cravens

Copyist.

6 | 5600 | U.S.C.T.

Aaron Brarous

Appears with rank of Pvt on

Muster and Descriptive Roll

of a Detachment of U. S. Colored Troops Transferred to U. S. Colored Ser. at Lexington, Ky. Louisville, Ky. Roll dated Sept 2, 1864.

Where born Adair, Ky.

Age 25 years; occupation Farmer

When enlisted Aug. 1, 1864.

Where enlisted Lebanon.

For what period enlisted 3 years.

Eyes Blue; hair Blue

Complexion Blue; height 5 ft. 8 in.

When mustered in Aug. 1, 1864.

Where mustered in Lebanon

Bounty paid \$ 100; due \$ 100

Clothing account:

Last settled _____, 1864; drawn since \$ 17.50/100

Date of first muster Aug. 1, 1864.

Company to which assigned _____

Remarks; credited to 4 long Det. Ky.

Book mark: _____

A. J. B. [Signature]

(356m)

Copyist.

6 | **5 Cav.** | **U.S.C.T.**

Aaron Cravens

Priv, Co. *C*, 5 Reg't U. S. Col'd Cavalry.

Appears on

Company Muster-in and Descriptive Roll
of the organization named above. Roll dated

Camp Nelson, Ky, *N.Y.*, *Oct. 24*, 1864.

Where born *Adair, Ky.*

Age *25* y'rs; occupation *Farmer*

When enlisted *Aug. 1*, 186 .

Where enlisted *Lebanon*

For what period enlisted *3* years.

Eyes *Blk.*; hair *Blk.*

Complexion *Blk.*; height *5* ft. *8* in.

When mustered in *Aug. 1*, 186 .

Where mustered in *Lebanon*

Bounty paid \$ *100*; due \$ *100*

Where credited *4th Dist. Ky.*

Company to which assigned *C*

Remarks :
.....
.....
.....

Book mark :
.....

Shull

Aaron Williams

Pvt, Co. C, 5 Reg't U. S. Col'd Cavalry.

Appears on

Company Muster Roll

for *to Oct. 31*, 1864.

Present or absent *Present*

Stoppage, \$ *100* for

Due Gov't, \$ *100* for

Valuation of horse, \$ *100*

Valuation of horse equipments, \$ *100*

Remarks:

Book mark:

Small

6

5 Cav.

U.S.C.T.

Caron Brown

Pvt, Co. C, 5 Reg't U. S. Col'd Cavalry.

Appears on

Company Muster Roll

for *Nov. & Dec.*, 1864.

Present or absent *Present*

Stoppage, \$ *100* for

Due Gov't, \$ *100* for

Valuation of horse, \$ *100*

Valuation of horse equipments, \$ *100*

Remarks: *First & Second instalment for pay due (U.S. for Ordinance, 84 1/2)*

Book mark:

Skull

(358)

Copyist.

C | **5 Cav. | U.S.C.T.**

Amos Brown

Pvt, Co. C, 5 Reg't U. S. Col'd Cavalry.

Appears on

Company Muster Roll

for *Jan'y 7 1865*, 186*5*.

Present or absent *Present*

Stoppage, \$ *100* for

Due Gov't, \$ *100* for

Valuation of horse, \$ *100*

Valuation of horse equipments, \$ *100*

Remarks: *First instalment
Bounty due \$100*

Book mark:

Small

(358)

Copyist.

6 | **5 Cav. | U.S.C.T.**

Aaron Cravens

Co, Co. C, 5 Reg't U. S. Col'd Cavalry.

Appears on

Company Muster Roll

for *Mar. & Apr.*, 186*5*.

Present or absent *Present*

Stoppage, \$ *100* for

Due Gov't, \$ *100* for

Valuation of horse, \$ *100*

Valuation of horse equipments, \$ *100*

Remarks: *First instalment of
Bounty due \$100*

Book mark:

Shull

6 | 5 Cav. | U.S.C.T.

Aaron Craven
Priv., Co. C, 5 Reg't U. S. Col'd Cavalry.

Appears on

Company Muster Roll

for *May & June*, 186*9*.

Present or absent *Present*

Stoppage, \$ *100* for

Due Gov't, \$ *100* for

Valuation of horse, \$ *100*

Valuation of horse equipments, \$ *100*

Remarks: *First Instalment of Bounty due \$100*

Book mark:

(358)

Juida

Copyist.

6

5 Cav. U.S.C.T.

Saron Craven

Priv., Co. C, 5 Reg't U. S. Col'd Cavalry.

Appears on

Company Muster Roll

for *July & Aug.*, 186*5*

Present or absent *Present*

toppage, \$ 100 for

due Gov't, \$ 100 for

valuation of horse, \$ 100

valuation of horse equipments, \$ 100

Remarks:
.....
.....
.....
.....
.....
.....
.....
.....
.....
.....

Book mark:

358)

J. J. J. J.
Copyist.

C | 5 Cav. | U.S.C.T.

Naron Cravens
Put, Co. C, 5 Reg't U. S. Col'd Cavalry.

Appears on

Company Muster Roll

for *Jan^{mo} Feb*, 186*6*.

Present or absent *Present*

Stoppage, \$ *100* for

Due Gov't, \$ *100* for

Valuation of horse, \$ *100*

Valuation of horse equipments, \$ *100*

Remarks: *On daily duty
as CoCook*

Book mark :

Rose

C | **5 Cav.** | **U.S.C.T.**

Aaron Cravens.

Priv., Co. C, 5 Reg't U. S. Colored Cav.

Appears on Returns as follows:

*Mar. to July 1865. On daily duty
as Co. Cook.*

*Aug. 1865 to Feb. 1866, Det'd as
Co. Cook.*

Book mark:

(546)

A. Baker,
Copyist.

C

5 Cav. U.S.C.T.

Aaron Cravens

Pat, Co. C, 5 Reg't U. S. Col'd Cavalry.

Appears on Co. Muster-out Roll, dated Helena Ark, March 16 1866.

Muster-out to date March 16 1866.

Last paid to Dec 31, 1865.

Clothing account:

Last settled _____, 186 ; drawn since \$ _____ 100

Due soldier \$ 11 ⁰¹/₁₀₀; due U. S. \$ _____ 100

Am't for cloth'g in kind or money adv'd \$ _____ 100

Due U. S. for arms, equipments, &c., \$ _____ 100

Bounty paid \$ 100 100; due \$ 100 100

Remarks: Due U.S. for Ord 40¢

Book mark: 440.060

Rose

(361)

Copyist.

Craven Aaron

....., Co.,

Reg't

U.S.A.

/ **Enclosures.**

Bed Cards	Final Statements
Burial Records	Furloughs or L. of A.
Certs. of Dis. for Discharge	Med. Certificates
C. M. Charges	Med. Des. Lists
Descriptive Lists	Orders
Discharge Certificates	Pris. of War Record
Enlistment Papers	Resignations

Other papers relating to—

Admission to Hosp'l	Furlough or L. of A.
Casualty Sheet	Med. Examination
Confinement	Misc. Information
Contracts	Pay or Clothing
Death or Effects	Personal Reports
Desertion	Rank
Discharge from Hosp'l	Transfer to Hosp'l
Discharge from Service	Transfer to V. R. C.
Duty	Transportation

DECLARATION OF RECRUIT.

I, Harmon Braxton desiring to volunteer as a soldier in the ARMY OF THE UNITED STATES, for the term of Three Years, DO DECLARE That I am 25 years and months of age; that I have never been discharged from the United States service on account of disability or by sentence of a court-martial, or by order before the expiration of a term of enlistment; and I know of no impediment to my serving honestly and faithfully as a soldier for three years.

GIVEN at Sherman Ky the 1st day of August 1864

Witness: Geo B Braxton

Harmon Braxton his mark

Volunteered at Sherman Ky Aug 1st 1864
By St. Rufus Le Breton, 2nd Lt.
Adj. Gen. 1st Div. 1st Ky.
Harmon Braxton

Witness name
Harmon Braxton
Le Breton 2nd Lt.

Consent of Parent or Guardian in case of a Minor, if a Free Man, or in the case of a Slave, of the Person to whom he owes Service:

I, Do CERTIFY, That I am the that the said is years of age; and I do freely give my CONSENT to his volunteering as a SOLDIER in the Army of the United States, for the period of THREE YEARS, under the conditions of the laws of the United States.

GIVEN at the day of

Witness:

NOTE 1.—This blank will be used for enlistments of United States colored troops. They will be made out in duplicate in all cases—one to accompany the recruiting return of the superintendent (not the recruiting officer) to the Adjutant General, and one to accompany the accounts of the officer who pays bounty, &c.
NOTE 2.—An enlistment holds to service. A muster-in must, in all cases, precede payment of pay, bounty, fension, &c. A muster-in roll, must in all cases, be filed in the Adjutant General's Office as evidence of muster-in. The mustering officer, commissary, or assistant commissary of musters, as the case may be, will countersign both enlistments as having mustered the soldiers into the service of the United States before either of them is given to the disbursing officer.

UNITED STATES COLORED TROOPS ENLISTMENT.

STATE OF

TOWN OF



Ky County of *Adair*

I, *Aaron Gravus* born in *Adair Co*
in the State of *Ky* aged *25* years

and by occupation a *Farmer* Do HEREBY ACKNOWLEDGE to
have volunteered *1st* day of *August* 186*4*

to serve as a **Soldier** in the **Army of the United States of America**, for the
period of **THREE YEARS**, unless sooner discharged by proper authority: Do
also agree to accept such bounty, pay, rations, and clothing, as are, or may be,
established by law for the U. S. colored troops.

And I, *Aaron Gravus*
do solemnly swear that I will bear true faith and allegiance to the **United States
of America**, and that I will serve them honestly and faithfully against all their
enemies or opposers whomsoever; and that I will observe and obey the orders
of the President of the United States, and the orders of the officers appointed
over me, according to the Rules and Articles of War.

Sworn and subscribed to, at *Adair Co Ky*
this *1st* day of *Aug* 186*4* *Aaron Gravus*
Before *Wm Crocker* *his*
St. W. Crocker Acty Post Master 4th Dist Ky *mark*

I CERTIFY, ON HONOR, That I have carefully examined the above named Volunteer agree-
ably to the General Regulations of the Army, and that, in my opinion, he is free from all bodily
defects and mental infirmity, which would in any way disqualify him from performing the
duties of a soldier.

John C. Maxwell

EXAMINING SURGEON.

I CERTIFY, ON HONOR, That I have minutely inspected the Volunteer, *Aaron Gravus*
previously to his enlistment, and that he was entirely sober when enlisted; that, to the best of
my judgment and belief, he is of lawful age; and that, in accepting him as duly qualified to per-
form the duties of an able-bodied soldier, I have strictly observed the regulations which govern
the recruiting service. This soldier has *5 1/2* eyes, *black* hair, *black* com-
plexion, is *5* feet *8* inches high.

Wm Crocker

St. W. Crocker Acty Post Master 4th Dist Ky RECRUITING OFFICER OR AGENT.

Mustered into the United States Service *1st* day of *Aug* 186*4*

Wm Crocker

St. W. Crocker Acty Post Master 4th Dist Ky Mustering Officer

..... Mustered into the service of the United States, for three years or during the war, from date of enlistment, in Company
..... Regiment of Volunteers, on the day of 1864, at

Graveney Willie

Co *Q*, 5 U. S. Col'd Cav.

Private | *Private*

CARD NUMBERS.

1	5361663	26
2	5361765	27
3	5361922	28
4	5362044	29
5	5362109	30
6	5362191	31
7	5362279	32
8	5362368	33
9	5362452	34
10	5362557	35
11	9090194	36
12	Claim No. 2	37
13	43145784	38
14	43146223	39
15	40729590	40
16		41
17		42
18		43
19		44
20		45
21		46
22		47
23		48
24		49
25		50

Book Mark: *Claim No 2*

See also

C | **5 Cav.** | **U.S.C.T.**

Willie's Craven

Co. C, 5 Reg't U. S. Col'd Cav.

Appears on

Company Descriptive Book
of the organization named above.

DESCRIPTION.

Age 27 years; height 5 feet 8 inches.

Complexion Blk

Eyes Blk; hair Blk

Where born Adair Co., Ky.

Occupation Farmer

ENLISTMENT.

When Aug. 1, 1864.

Where Lebanon

By whom Lt Crocker; term 3 y'rs.

Remarks: Promoted to Capt
Jan 13/65 per Reg. Or-
der no 100

Warren

6 | 5 bar U.S.C.T.

Willis Craven

Appears with rank of Pvt on

Muster and Descriptive Roll

of a Detachment of U.S. Colored Troops transferred to U.S. Cavalry
at Lexington, Ky.

Roll dated

Louisville, Ky., Sept. 2, 1864.

Where born Adair, Ky.

Age 27 years; occupation Farmer

When enlisted Aug. 1, 1864.

Where enlisted Lebanon

For what period enlisted 3 years.

Eyes Blue; hair Blue

Complexion Blue; height 5 ft. 8 in.

When mustered in Aug. 1, 1864.

Where mustered in Lebanon

Bounty paid \$ 100; due \$ 100

Clothing account:
Last settled _____, 1864; drawn since \$ 14 25/100

Date of first muster Aug. 1, 1864.

Company to which assigned _____

Remarks: Created to 4 Comp. Det. Ky.

Book mark: _____

O. J. Stinson

b. | 5 bar | USLE P.

Willis Cravens

Appears with rank of _____ on

Muster and Descriptive Roll

of Detachment of US Colored
Volunteer Recruits for-
warded Roll dated

Lebanon Ky, Aug 31, 1864

Where born Adair Ky

Age 27 years; occupation farmer

When enlisted August 1, 1864

Where enlisted Lebanon Ky

For what period enlisted 3 years.

Eyes Blue; hair Blue

Complexion Blue; height 5 ft. 8 in.

When mustered in Aug 1, 1864

Where mustered in Lebanon Ky

Bounty paid \$ 100; due \$ 100

Clothing account:

Last settled _____, 1864; drawn since \$ 14.25/100

Date of first muster Aug 1, 1864

Company to which assigned _____

Remarks: owner, Pimoleon

Cravens, Adair Co.

Without consent

4 Long Dist. Ky

Book mark: _____

(356m)

W. D. Burton
Copyist.

C | **5 Cav.** | **U.S.C.T.**

Willis Cravens

Pvt, Co. *C*, 5 Reg't U. S. Col'd Cavalry.

Appears on

Company Muster-in and Descriptive Roll

of the organization named above. Roll dated

Camp Nelson, Ky, *N. Y.*, *Oct. 24*, 1864.

Where born *Adair, Ky.*

Age *27* y'rs; occupation *Farmer*

When enlisted *Aug. 1*, 186 .

Where enlisted *Lebanon*

For what period enlisted *3* years.

Eyes *Blk*; hair *Blk.*

Complexion *Blk*; height *5* ft. *8* in.

When mustered in *Aug. 1*, 186 .

Where mustered in *Lebanon*

Bounty paid \$ *100*; due \$ *100*

Where credited *4th Dist. Ky.*

Company to which assigned *C.*

Remarks:

Book mark: *AWO 710*

Shull

(356d)

Copyist.

8

5 Cav. U.S.C.T.

Willis Cowens

Pais, Co. C, 5 Reg't U. S. Col'd Cavalry.

Appears on

Company Muster Roll

for *to Oct. 31*, 1864.

Present or absent *Present*

Stoppage, \$ *100* for

Due Gov't, \$ *100* for

Valuation of horse, \$ *100*

Valuation of horse equipments, \$ *100*

Remarks:

Book mark:

Shull

Willis Cravens

Priv, Co. C, 5 Reg't U. S. Col'd Cavalry.

Appears on

Company Muster Roll

for *Nov. & Dec.*, 1864.

Present or absent *Absent*

Stoppage, \$ *100* for

Due Gov't, \$ *100* for

Valuation of horse, \$ *100*

Valuation of horse equipments, \$ *100*

Remarks: *Missing in action Saltville
Va. Dec. 20, 1864 First & Second
instalments of bounty due*

Book mark:

Shull

Willis Gannons

Pvt., Co. C, 5 Reg't U. S. Col'd Cavalry.

Appears on

Company Muster Roll

for *Mar. 7 1865*, 186*5*.

Present or absent*

Stoppage, \$ *100* for

Due Gov't, \$ *100* for

Valuation of horse, \$ *100*

Valuation of horse equipments, \$ *100*

Remarks: *This man was taken prisoner Dec. 24, 64. Made his escape and returned to company for duty May 1, 1865. Taken up from missing in action April 30, 1865. First list of Bounty due \$100*

* Name appears in returns, but not recorded by the 3000 roll

Book mark:

Stuart

William Craven

Sgt., Co. C, 5 Reg't U. S. Col'd Cavalry.

Appears on

Company Muster Roll

for May & June, 1865.

Present or absent Present

Stoppage, \$ 100 for

Due Gov't, \$ 100 for

Valuation of horse, \$ 100

Valuation of horse equipments, \$ 100

Remarks: Promoted to Sgt June 13/65 as per Reg Order No 100. Disat Instatement of Bounty due # 100

Book mark:

Linden

6

5 Cav.

U.S.C.T.

Willis Graves

Cpl., Co. C, 5 Reg't U. S. Col'd Cavalry.

Appears on

Company Muster Roll

for *July & Aug.*, 186 *9*.

Present or absent *Present*

Stoppage, \$ *100* for

Due Gov't, \$ *100* for

Valuation of horse, \$ *100*

Valuation of horse equipments, \$ *100*

Remarks:

Book mark:

J. Under

(358)

Copyist.

6 | 5 Cav. | U.S.C.T.

Willis Graves

Sgt., Co. C, 5 Reg't U. S. Col'd Cavalry.

Appears on

Company Muster Roll

for Sep 4th, 1865.

Present or absent Present

Stoppage, \$ 100 for

Due Gov't, \$ 100 for

Valuation of horse, \$ 100

Valuation of horse equipments, \$ 100

Remarks: Made Sgt Co C,
/ 65

Book mark:

Leider

6 | **5 Cav. U.S.C.T.**

Willie Craven

Sgt., Co. C, 5 Reg't U. S. Col'd Cavalry.

Appears on

Company Muster Roll

for *Nov + Dec*, 186*5*.

Present or absent *Present*

Stoppage, \$ *100* for

Due Gov't, \$ *100* for

Valuation of horse, \$ *100*

Valuation of horse equipments, \$ *100*

Remarks: *I am in for camp and "Gov" Equip. 69cts.*

Book mark : _____

(358)

J. Under

Copyist.

C | 5 Cav. | U.S.C.T.

Willis Ravens

Sgt, Co, C, 5 Reg't U. S. Col'd Cavalry.

Appears on

Company Muster Roll

for *Jan and Feb*, 186 *C*

Present or absent *Present*

Stoppage, \$ *100* for

Due Gov't, \$ *100* for

Valuation of horse, \$ *100*

Valuation of horse equipments, \$ *100*

Remarks:

Book mark:

Rose

C | **5 Cav.** | **U.S.C.T.**

Willis Cravens.

Plt., Co. C, 5 Reg't U. S. Colored Cav.

Appears on Returns as follows:

*Dec. 1864. Loss, Dec. 20/64, Saltille,
Va. Missing in action.*

*Apr. 1865. Gain Apr. 30/65, Cinthiana,
Ky. Taken up from missing in
action at Saltille, Va., Dec.
24/64.*

Book mark : _____

(546)

A. Baker

Copyist.

C | 5 Cav. | U.S.C.T.

Willis Cravens
Pot., Co. C, 5 Reg't U. S. Col'd Cavalry.

Appears on Co. Muster-out Roll, dated
Helena Ark, Mch 16, 1866.
Muster-out to date Mch 16, 1866.
Last paid to Dec 31, 1865.

Clothing account:

Last settled....., 186 ; drawn since \$ 100
Due soldier \$ 100; due U. S. \$ 49 ⁴¹/₁₀₀
Am't for cloth'g in kind or money adv'd \$ 100

Due U. S. for arms, equipments, &c., \$ 100
Bounty paid \$ 100 100; due \$ 100 100

Remarks: Reduced to Private
from Sgt as per Reg Order
No 33 Dated Feb 25, 1866 to
take effect Mch 1, 1866.
See US for Ord 409

Book mark: V105. P.156. 69

Rose

(361)

Copist.

6 | 5th Cav. U.S.C.
Willis Cravens,
Co. C, 5th Reg^t U.S.C. Cav.

NOTATION.

Book mark: *Claim No. 2.*

War Department,

Adjutant General's Office,

Washington, *April 8, 1871.*

Cravens' name will be taken up on records of Pris. of War and note thereafter Captured Dec. 24, 1864, and held until April 27, 1865, when he reported within the Union lines at Louisa Court House, Ky. also, correct Company records to show Dec. 24, 1864, as correct date of capture.

Wm E. Newman,

(438)

Copyist.

Cravens Nellis

P, Co. C,

5 Reg't U. S. C. C.

Enclosures.

Bed Cards	Final Statements
Burial Records	Furloughs or L. of A.
Certs. of Dis. for Discharge	Med. Certificates
C. M. Charges	Med. Des. Lists
Descriptive Lists	Orders
Discharge Certificates	Pris. of War Record
Enlistment Papers	Resignations

Other papers relating to—

Admission to Hosp'l	Furlough or L. of A.
Casualty Sheet	Med. Examination
Confinement	Misc. Information
Contracts	Pay or Clothing
Death or Effects	Personal Reports
Desertion	Rank
Discharge from Hosp'l	Transfer to Hosp'l
Discharge from Service	Transfer to V. R. C.
Duty	Transportation

MEMORANDUM FROM PRISONER OF WAR RECORDS.

No. _____

(This blank to be used only in the arrangement of said records.)

NAME.	RANK.	ORGANIZATION.				INFORMATION OBTAINED FROM—				
		No. of Reg't.	State.	Arm of Service.	Co.	Records of—	Vol.	Page.	Vol.	Page.
<i>Cravens Hillis</i>	<i>P</i>	<i>5</i>	<i>US</i>	<i>Col</i>	<i>C</i> <i>Co</i>	<i>MR</i>	<i>1</i>	<i>62</i>		

Captured at _____, *Dec 24*, 186*4*, confined at Richmond, Va., _____, 186 .

Admitted to Hospital at _____

where he died _____, 186 , of _____
Paroled at *and held until* *Apr 27*, 186*5*; *reported at* *Camp Parole, Md.*, _____, 186 .
at Louisa Ct, Ky *claim 2-5- USCC*

Copied by *J. Lee*

(Record continued.)

Furloughed _____, 186____, for _____ days; returned _____, 186____;
deserted _____, 186____; _____

Adjutant General's Office,

, 18____

This is accepted as referring to _____

Co. _____, _____ Reg't,

and records will be corrected accordingly.

Assistant Adjutant Gen'l.

*Parcels 408, 954, 96, 394. Paid O. A. to W. Sec Jan 4, 89
L" and 94713 ret'd Dec 3/89*

Copied by _____

313 or George

Crawford George F.

Co. C, 5 U. S. Col'd Cav.

Private Private

CARD NUMBERS.

1	5361664	26
2	5361766	27
8	5361863	28
4	5361961	29
5	5362045	30
6	5362126	31
7	5362209	32
8	5362300	33
9	5362388	34
10	5362473	35
11	5362558	36
12	9090193-	37
13	43145310	38
14	43146222	39
15		40
16		41
17		42
18		43
19		44
20		45
21		46
22		47
23		48
24		49
25		50

Book Mark:

See also

C

5 Cav. | U.S.C.T.

George F Crawford

, Co. *C*, 5 Reg't U. S. Col'd Cav.

Appears on

Company Descriptive Book

of the organization named above.

DESCRIPTION.

Age *23* years; height *5* feet *7* inches.

Complexion *Blk*

Eyes *Blk*; hair *Blk*

Where born *Bath Co Ky.*

Occupation *Farmer*

ENLISTMENT.

When *Aug*, 1864.

Where *Greensburg*

By whom *Capt. Grier*; term *3* y'rs.

Remarks:

.....
.....
.....
.....
.....
.....
.....
.....

Warren

6 | 5 bar | U.S.C.T.

Geo. F. Crawford

Appears with rank of Pt on

Muster and Descriptive Roll

of a Detachment of U. S. Colored Troops transferred to U. S. Cavalry at Lexington, Ky. Roll dated Louisville, Ky. Sept. 2, 1864.

Where born Bath, Ky.

Age 23 years; occupation Farmer

When enlisted Aug. 4, 1864.

Where enlisted Greensburg.

For what period enlisted 3 years.

Eyes Blue; hair Blue

Complexion Blue; height 5 ft. 9 in.

When mustered in Aug. 9, 1864.

Where mustered in Greensburg.

Bounty paid \$ 100; due \$ 100

Clothing account:
Last settled _____, 1864; drawn since \$ 17 ⁵⁵/₁₀₀

Date of first muster Aug. 9, 1864.

Company to which assigned _____

Remarks: Credited to 9 Comp. Dist. Ky.

Book mark: _____

(356m)

A. J. D. Jones

Copyist.

Co. | 5 bar U.S.A.

George F Crawford

Appears with rank of Priv. on

Muster and Descriptive Roll

of a Detachment of U.S. Colored
Recruits forwarded

Roll dated

Greensburg Ky, Aug 9, 1864.

Where born Bath Co. Ky.

Age 23 years; occupation Farmer

When enlisted Aug 4, 1864.

Where enlisted Greensburg Ky.

For what period enlisted 3 years.

Eyes Black; hair Black

Complexion Black; height 5 ft. 9 in.

When mustered in _____, 186 .

Where mustered in _____

Bounty paid \$ _____ 100; due \$ _____ 100

Clothing account:

Last settled _____, 186 ; drawn since \$ _____ 100

Date of first muster Aug 9, 1864.

Company to which assigned _____

Remarks: Credited to Carter Coy

Dist Ky.

Book mark: _____

W M Potter

(356m)

Copyist.

C

5 Cav. U.S.C.T.

George Crawford

Pris, Co. *C*, 5 Reg't U. S. Col'd Cavalry.

Appears on

Company Muster-in and Descriptive Roll

of the organization named above. Roll dated

Camp Nelson, *Ky*, *N.Y.*, *Oct. 24*, 1864.

Where born *Bath, Ky.*

Age *23* y'rs; occupation *Farmer*

When enlisted *Aug. 4*, 186 .

Where enlisted *Greensburg*

For what period enlisted *3* years.

Eyes *Blk.*; hair *Blk.*

Complexion *Blk.*; height *5* ft. *9* in.

When mustered in *Aug. 9*, 186 .

Where mustered in *Greensburg*

Bounty paid \$ *100*; due \$ *100*

Where credited *9" Dist. Ky.*

Company to which assigned *C*

Remarks :
.....
.....
.....

Book mark : *3 1852 Ky.*

Shull

(356d)

Copyist.

5 Cav. | U.S.C.T.

George J. Crawford

Private, Co. C, 5 Reg't U. S. Col'd Cavalry.

Appears on

Company Muster Roll

for *to Oct. 31*, 1864.

Present or absent *Present*

Stoppage, \$ *100* for

Due Gov't, \$ *100* for

Valuation of horse, \$ *100*

Valuation of horse equipments, \$ *100*

Remarks:

Book mark:

Small

(358)

Copyist.

George Crawford
Priv, Co. C, 5 Reg't U. S. Col'd Cavalry.

Appears on

Company Muster Roll

for *Nov. & Dec.*, 1864.

Present or absent *Present*

Stoppage, \$ *100* for

Due Gov't, \$ *100* for

Valuation of horse, \$ *100*

Valuation of horse equipments, \$ *100*

Remarks: *First & Second instalments bounty due*

Book mark:

Shull

George Crawford
Pais, Co. C, 5 Reg't U. S. Col'd Cavalry.

Appears on

Company Muster Roll

for *Jan'y. 1st*, 186*5*.

Present or absent *Present*

Stoppage, \$ *100* for

Due Gov't, \$ *100* for

Valuation of horse, \$ *100*

Valuation of horse equipments, \$ *100*

Remarks: *First instalment -
Bounty due \$100*

Book mark:

Shull

S | **5 Cav. | U.S.C.T.**

George S. Crawford
100, Co. C, 5 Reg't U. S. Col'd Cavalry.

Appears on

Company Muster Roll

for *Mar. 1 1865*, 186*5*.

Present or absent *Present*

Stoppage, \$ *100* for

Due Gov't, \$ *100* for

Valuation of horse, \$ *100*

Valuation of horse equipments, \$ *100*

Remarks: *First visitation of
Bondy due \$100*

Book mark:

Shull

George A Crawford
Prk, Co. C, 5 Reg't U. S. Col'd Cavalry.

Appears on

Company Muster Roll

for *May & June*, 1865.

Present or absent *Present*

Stoppage, \$ 100 for

Due Gov't, \$ 100 for

Valuation of horse, \$ 100

Valuation of horse equipments, \$ 100

Remarks: *First installment of Bounty due \$ 100*

Book mark:

(358)

Grider

Copyist.

6

5 Cav. U.S.C.T.

George D. Crawford

Private, Co. C, 5 Reg't U. S. Col'd Cavalry.

Appears on

Company Muster Roll

for July & Aug, 1865

Present or absent Present

Stoppage, \$ 100 for

Due Gov't, \$ 100 for

Valuation of horse, \$ 100

Valuation of horse equipments, \$ 100

Remarks:

Book mark:

(358)

J. W. ...

Copyist.

6

5 Cav. U.S.C.T.

George F. Crawford

Private, Co. C, 5 Reg't U. S. Col'd Cavalry.

Appears on

Company Muster Roll

for Sep. + Oct, 1865.

Present or absent Present

Stoppage, \$ 100 for

Due Gov't, \$ 100 for

Valuation of horse, \$ 100

Valuation of horse equipments, \$ 100

Remarks:

Book mark:

J. Under

(358)

Copyist.

6 | 5 Cav. | U.S.C.T.

George A. Crawford
Private, Co. C, 5 Reg't U. S. Col'd Cavalry.

Appears on

Company Muster Roll

for *Nov Dec*, 1865.

Present or absent *Present*

Stoppage, \$ *100* for

Due Gov't, \$ *100* for

Valuation of horse, \$ *100*

Valuation of horse equipments, \$ *100*

Remarks: *Due to for
Camp and Gear
"quip" # 1. 95*

Book mark:

(358)

Linden
Copyist.

C

5 Cav.

U.S.C.T.

George F Crawford
Pat

, Co. C, 5 Reg't U. S. Col'd Cavalry.

Appears on

Company Muster Roll

for

Jan and Feb, 186*6*.

Present or absent

Present

Stoppage, \$

100 for

Due Gov't, \$

100 for

Valuation of horse, \$

100

Valuation of horse equipments, \$

100

Remarks:

Book mark:

Rose

(358)

Copyist.

C

5 Cav. U.S.C.T.

George F. Crawford
Pvt., Co. C, 5 Reg't U. S. Col'd Cavalry.

Appears on Co. Muster-out Roll, dated

Helena Ark, March 16, 1866.

Muster-out to date March 16, 1866.

Last paid to Dec 31, 1865.

Clothing account:

Last settled _____, 186 ; drawn since \$ _____ 100

Due soldier \$ _____ 100; due U. S. \$ 43 ¹⁰/₁₀₀

Am't for cloth'g in kind or money adv'd \$ _____ 100

Due U. S. for arms, equipments, &c., \$ _____ 100

Bounty paid \$ 100 100; due \$ 100 100

Remarks: Due US for Ord 40¢

Book mark: 6, 1852, Ky.

Row

Crawford, Geo F

Reg't Co. C, 5 Reg't U.S.C. 2nd

Enclosures.

Bed Cards	Descriptive Lists
Burial Records	Final Statements
Certs. of Dis. for Discharge	Furloughs
C. M. Charges	Med. Des. Lists
Med. Certificates	Orders

Other papers relating to—

Admission to Hosp'l	Furlough
Casualty Sheet (Officer's)	Med. Examination
Confinement	Misc. Information
Contracts	Pay or Clothing
Death or Effects	Personal Reports
Desertions	Rank
Discharge from Hosp'l	Transfer to Hosp'l
Discharge from Service	Transfer to V. R. C.
Duty	Transportation

War Department,

ADJUTANT GENERAL'S OFFICE,

Washington, April 8th 1867.

Respectfully returned to the
Commission for the State of
Ky.

with the informa-
tion that George F. Crawford

was enlisted at Greensburg, Ky.

Aug. 4 1864 and was

mustered in as Pvt. in Co. "C"

5th U. S. Col. Inf. Aug. 9/64.

J. C. Hazard

Asst. Adj't General.

1859-1864

No. 1157

APPLICATION OF

George F. Crawford

OF

Warter County, Ky.

FOR COMPENSATION FOR SLAVE,

Named *Geo. F. Crawford*

Enlisted *4th August* 1864,

In Com. *C. 5th Cavalry* Regiment,

U. S. COLORED TROOPS.

Received *July 20*, 1867.

Compensation Awarded

....., 186.....

..... Dollars.

President of Board of Claims.

Claimant's Attorney,

Claimant's Post-office Address,

Truxton Cavalry Camp

No.

CLAIM OF

George W. Crawford

FOR THE COMPENSATION OF SLAVE NAMED

George J. Crawford

George W. Crawford a loyal citizen, and a resident of Grayson, County of Carter, State of Kentucky, hereby claim compensation, under the provisions of Section 24, act approved February 24, 1864, and section 2, act approved July, 28, 1866, for my slave George J. Crawford, enlisted August 4th, 1864, at Greensburg, Ky., by Wm. C. Grier Capt. & Pr. Mar. in the Fifth Cavalry regiment U. S. Colored Troops, Co. "C"; certificate of which enlistment, and a descriptive list, as required, accompany this application. That I did not acquire said slave subsequent to said enlistment, but had a valid title to him at the date of said enlistment, and previous thereto: I having acquired my title to him and my ownership over him as follows, to-wit: Said George J. Crawford being the slave and property of my wife at the time I married her in the year 1847, and I have since claimed and controlled him as a slave up to the time he enlisted in the service.

In proof of my loyalty to the Constitution and Government of the United States, I present the accompanying oath, which I have taken, signed and acknowledged; to be filed with this application, in accordance with requirement of General Orders, No. 329, 1863, War Department, Adjutant General's Office.

G. W. Crawford

, 1867.

OATH OF ALLEGIANCE.

I, George W. Crawford, the owner and Claimant, do solemnly swear that the foregoing claim is a just and true claim due to me as master and owner of the said slave, and that the facts alleged in said claim in respect to the draft or enlistment (as the case may be) of said slave into the Military service of the United States are true. And I do further swear that I have never joined, or been concerned in, any insurrection or rebellion; that I have never borne arms against the United States; that I have never given any aid, countenance, counsel or encouragement to any person or persons engaged, or whom I had reason to believe were about to engage, in insurrection, rebellion or armed hostility against the United States; that I have neither sought, nor accepted, nor attempted to exercise the functions of any office, civil or military, nor to perform any service whatever, under any authority or pretended authority in hostility to the United States; that I have not yielded a voluntary support to any insurrection, rebellion or pretended government, authority, power or constitution within the United States hostile thereto. And I do further swear that, to the best of my knowledge and ability, I have supported and defended, and will continue to support and defend, the United States against all enemies, foreign and domestic; and that I have supported, defended and obeyed, and will continue to support, defend and obey, the Constitution and laws of the United States; that I will bear true faith and allegiance to the same; and that I take this oath freely, without any mental reservation or purpose of evasion: So help me God.

G. W. Crawford

Sworn to and subscribed before me, at Frankfort Ky, } this 30 day of January, 1867. }

A. Adams

Notary Public



CENT, TAMP.

UNITED STATES COLORED TROOPS ENLISTMENT.

STATE OF

TOWN OF

Virginia *Greensboro*

I, *George W. Crawford* born in *Bath County*
in the State of *Kentucky* aged *Twenty Three* years

and by occupation a *Farmer* Do HEREBY ACKNOWLEDGE to
have volunteered *Fourth* day of *August* 186*4*

to serve as a **Soldier** in the **Army of the United States of America**, for the
period of **THREE YEARS**, unless sooner discharged by proper authority: Do
also agree to accept such bounty, pay, rations, and clothing, as are, or may be,
established by law for the U. S. colored troops.

And I, *George W. Crawford*
do solemnly swear that I will bear true faith and allegiance to the **United States**
of America, and that I will serve them honestly and faithfully against all their
enemies or opposers whomsoever; and that I will observe and obey the orders
of the President of the United States, and the orders of the officers appointed
over me, according to the Rules and Articles of War.

Sworn and subscribed to, at *Greensboro Va*
this *4th* day of *August* 186*4*
Before *Wm C. Steyer* *Capt*

I CERTIFY, ON HONOR, That I have carefully examined the above named Volunteer agree-
ably to the General Regulations of the Army, and that, in my opinion, he is free from all bodily
defects and mental infirmity, which would in any way disqualify him from performing the
duties of a soldier.

George W. Crawford
EXAMINING SURGEON.

I CERTIFY, ON HONOR, That I have minutely inspected the Volunteer, *George W. Crawford*
previously to his enlistment, and that he was entirely sober when enlisted; that, to the best of
my judgment and belief, he is of lawful age; and that, in accepting him as duly qualified to per-
form the duties of an able-bodied soldier, I have strictly observed the regulations which govern
the recruiting service. This soldier has *light* eyes, *black* hair, *well* complexion, is *5-10* feet *9* inches high.

Wm C. Steyer *Capt*
RECRUITING OFFICER OR AGENT.

Mustered into the United States Service.....*9th* day of *August* 186*4*.

Wm C. Steyer *Capt*
Mustering Officer.

Mustered into the service of the United States, for three years or during the war, from date of enlistment, in Company
Regiment of Volunteers, on the day of 186, at

Headquarters Kentucky Volunteers,

Adjutant-General's Office,

Frankfort, Jan'y 30, 1867.

I hereby certify, that it appears from the U. S. Muster-Draw Polls on file in this Office, that **George J. Crawford** was enrolled on the 4th day of August, 1864, at **Greensburg Ky** by **Capt Grier** and mustered into the U. S. service on the 9th day of August, 1864, at **Greensburg Ky** by **Capt Grier** to serve **Three** years. Said **George J. Crawford** is described as follows: Age, **23** years; eyes, **Black**; hair, **Black**; complexion, **Black**; height, **5** feet **9** inches. It further appears from said Polls, that **George J. Crawford** owed service to **_____**, was credited to **Carter** County, **Ky.**, and was assigned to **Co. G, 1st Regiment** **U. S. C. Cavalry**

In Testimony Whereof, I have hereunto set my hand, and affixed my Official Seal, this

3rd day of Jan'y, 1867.

D. Lindsey

Adjutant General of Kentucky.

B. 4, SR. 287.

PROOF OF OWNERSHIP.

KENTUCKY,

SS.

Carters }
John J. Shepherd and *Jackson B. Ward* each of lawful
resident citizens of the State and County aforesaid, do certify that *George W. Lerawford*
of the State and County aforesaid, was on the *4th* day of
August 1864, the lawful owner of the slave named *George J. Lerawford*;
referred to and described in the foregoing claim for compensation.

John J. Shepherd
J. B. Ward

Sworn to and subscribed before me a

Carters

State of Kentucky, this the

8th

day of *February* 1867.

for the County of

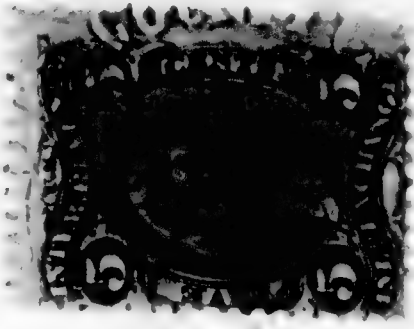

Elias P. Davis Clerk of the
Carter County Court

PROOF OF LOYALTY.

STATE OF KENTUCKY,

SS.

COUNTY OF

We and loyal men and
each of lawful age, and resident citizens of the of
in the State and County aforesaid, upon our oaths declare that we have known
a resident of the State and County aforesaid, since the 4th day of March, 1861, and know that he has
firmly and faithfully maintained his or her adherence and allegiance to the Government of the United
States, by defending its cause against the Government and forces of the so-called Confederate States
of America, in all suitable and practicable ways, and according to his or her ability and opportunity.

Wm Bowling
B. S. Stephens

Sworn to and subscribed before me a

Natary Public

for the county of

Franklin

State of Kentucky, this the

30th

day of *January*

1867.

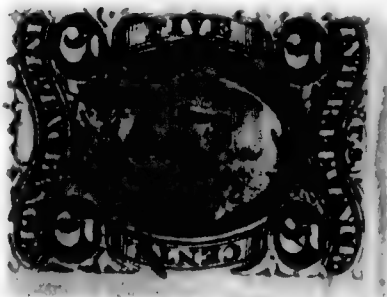

A. H. Adams

A. P. F. C.

POWER OF ATTORNEY.

My Post-Office address is County of State of
Kentucky, and I hereby direct that all communications to me, touching this claim, be sent under cover
to , who is hereby appointed and consti-
tuted my true and lawful attorney, to prosecute this claim for me, and who is hereby authorized and
empowered to receive and receipt for any award, order, draft, certificate, voucher, warrant, papers or
money that may be issued in the adjustment of this claim, or the payment thereof, the same as I
might or could do in person were I present and acting for myself, and to file any additional evidence
or papers that may be required in the prosecution of this claim.

[WITNESS.]

The owner
signs here.

50 CENT
STAMP.

Two witnesses to
owner's signature
sign here.

Crawford John

Co *A*, 5 U. S. Col'd Cav.

Private | *Private*

CARD NUMBERS.

1	5366766	26
2	5366867	27
3	5366966	28
4	5367058	29
5	5367148	30
6	5367244	31
7	5367332	32
8	5367424	33
9	5367516	34
10	5367608	35
11	5367693	36
12	9090849	37
13	9090737	38
14	33246653	39
15	40729638	40
16		41
17		42
18		43
19		44
20		45
21		46
22		47
23		48
24		49
25		50

Book Mark:

See also

5 Cav. | U.S.C.T.

John Crawford

Co. *76*, 5 Reg't U. S. Col'd Cav.

Appears on

Company Descriptive Book
of the organization named above.

DESCRIPTION.

Age *27* years; height *5* feet *10* inches.

Complexion *Blk*

Eyes *Blk*; hair *Blk*

Where born *Belmont Ky*

Occupation *Farmer*

ENLISTMENT.

When *Sept 17*, 186 .

Where *Camp Nelson*

By whom *J. G. Randolph*; term *3* y'rs.

Remarks:

.....
.....
.....
.....
.....
.....
.....
.....

(383g)

A. J. Anderson

Copist.

C | 5 Cav. | U.S.C.T.

John Crawford
Co. *H*, 5 Reg't U. S. Col'd Cav.

Appears on

Company Descriptive Book
of the organization named above.

DESCRIPTION.

Age *27* years; height *5* feet *10* inches.

Complexion *Blk*

Eyes *Blk*; hair *Blk*

Where born *Clark Ky*

Occupation *farmer*

ENLISTMENT.

When *Sep 17*, 186 *7*.

Where *Camp Nelson Ky*

By whom *W. Randolph*; term *3* y'rs.

Remarks:

J. E. Parker

C

5 Cav.

U.S.C.T.

John Crawford

Pvt, Co *H*, 5 Reg't U. S. Col'd Cavalry.

Appears on

Company Muster-in and Descriptive Roll

of the organization named above. Roll dated

Camp Nelson, Ky, N.Y., Oct 29, 1864.

Where born *Clark Ky*

Age *27* y'rs; occupation *Farmer*

When enlisted *Sept 17*, 1864.

Where enlisted *Camp Nelson Ky*

For what period enlisted *3* years.

Eyes *Black*; hair *Black*

Complexion *Black*; height *5 ft. 10 in.*

When mustered in *Sept 17*, 1864.

Where mustered in *Camp Nelson Ky*

Bounty paid \$ *100*; due \$ *100*

Where credited

Company to which assigned

Remarks: *7th Dist Ky*

* *J. J. Crawford*

* *Supposed to be name of owner!*

Added May 16. 98. H. H. J.

Book mark:

Reynolds

(356d)

Copyist.

C | **5 Cav.** | **U.S.C.T.**

John Crawford

Pvt, Co. H, 5 Reg't U. S. Col'd Cavalry.

Appears on

Company Muster Roll

for *from enlistment to Oct 31, 1864.*

Present or absent *present*

Stoppage, \$ *100* for

Due Gov't, \$ *100* for

Valuation of horse, \$ *100*

Valuation of horse equipments, \$ *100*

Remarks:

Book mark:

Reynolds

(358)

Copyist.

6

5 Cav.

U.S.C.T.

John Crawford

Put, Co. H, 5 Reg't U. S. Col'd Cavalry.

Appears on

Company Muster Roll

for Nov & Dec, 1864.

Present or absent Absent

Stoppage, \$ 100 for

Due Gov't, \$ 100 for

Valuation of horse, \$ 100

Valuation of horse equipments, \$ 100

Remarks: 1st and 2nd Installments
Bounty due. Sick
in Genl. Hus N. Albany
Ind since Dec 21st

Book mark:

Reynolds

(358)

Copyist.

C. | 5. Cav. U.S.C.A.

John Crawford,
Plt., Co. B., 5 Reg't U.S. Cav.

Appears on

Hospital Muster Roll

of U. S. A. General Floating Hospital Ohio,
New Albany, Ind.,

for Nov. & Dec., 1864.

Station New Albany Ind.

Attached to hospital :

When _____, 186 .

How employed _____

Last paid by Maj. _____

to _____, 186 .

Bounty paid \$ 100 ; due \$ 100

Present or absent Present

Remarks :

Book mark : _____

(343)

[Signature]

Copyist.

6 | 5 Cav. | U.S.C.T.

John Crawford
Pot, Co. H, 5 Reg't U. S. Col'd Cavalry.

Appears on

Company Muster Roll

for Jan & Feby, 1865.

Present or absent present

Stoppage, \$ 100 for

Due Gov't, \$ 100 for

Valuation of horse, \$ 100

Valuation of horse equipments, \$ 100

Remarks: 1st Installment of
Bounty Due \$100.00

Book mark:

(358)

Reynolds

Copyist.

6

5 Cav.

U.S.C.T.

John Crawford

Pvt., Co. H, 5 Reg't U. S. Col'd Cavalry.

Appears on

Company Muster Roll

for Mar & Apr, 1863.

Present or absent present

Stoppage, \$ 100 for

Due Gov't, \$ 100 for

Valuation of horse, \$ 100

Valuation of horse equipments, \$ 100

Remarks: 1st installment of
Bounty Due \$100

Book mark:

Reynolds

(358)

Copyist.

6 | 5 Cav. | U.S.C.T.

John Crawford
Cvt., Co. H, 5 Reg't U. S. Col'd Cavalry.

Appears on

Company Muster Roll
for May & June, 1865.
Present or absent Present.

Stoppage, \$ 100 for

Due Gov't, \$ 100 for

Valuation of horse, \$ 100

Valuation of horse equipments, \$ 100

Remarks: 1st Installment Bounty
due 8/24.

Book mark:

(358) *B. J. Cooke* Copyist.

O.

5 Cav. | U.S.C.T.

John Crawford
Pvt., Co. H, 5 Reg't U. S. Col'd Cavalry.

Appears on

Company Muster Roll

for *July & Aug.*, 186*5*.

Present or absent *Present.*

Stoppage, \$ 100 for

Due Gov't, \$ 100 for

Valuation of horse, \$ 100

Valuation of horse equipments, \$ 100

Remarks: _____

Book mark: _____

B. J. Cook

(358)

Copyist.

6 5 Cav. | U.S.C.T.

John Crawford
Pvt., Co. H, 5 Reg't U. S. Col'd Cavalry.

Appears on

Company Muster Roll

for Sept. & Oct., 1865.

Present or absent Present.

Stoppage, \$ 100 for

Due Gov't, \$ 100 for

Valuation of horse, \$ 100

Valuation of horse equipments, \$ 100

Remarks:

Book mark:-----

(358) B. J. Cooke Copyist.

C. | **5 Cav.** | **U.S.C.T.**

John Crawford
Cvt, Co. H, 5 Reg't U. S. Col'd Cavalry.

Appears on

Company Muster Roll

for *Nov. 1865*, 186*5*.

Present or absent *Present*

Stoppage, \$ 100 for

Due Gov't, \$ 100 for

Valuation of horse, \$ 100

Valuation of horse equipments, \$ 100

Remarks: _____

Book mark: _____

(358)

R J Cooke
Copyist.

6

5 Cav. U.S.C.T.

John Crawford

Pl, Co. H, 5 Reg't U. S. Col'd Cavalry.

Appears on

Company Muster Roll

for *Jan'y & Feby*, 186*6*.

Present or absent *Present*

Stoppage, \$ *100* for

Due Gov't, \$ *100* for

Valuation of horse, \$ *100*

Valuation of horse equipments, \$ *100*

Remarks:

Book mark: -----

(358) *J. Stewart* Copyist.

C. | 5 Cav. | U.S.C.T.

John Crawford.

Priv. , Co. H , 5 Reg't U. S. Colored Cav.

Appears on Returns as follows:

Dec. 1864. Absent sick in Gen. Hosp.
M. Albany, since Dec. 21/64.

July 1865. Absent sick in Gen. Hosp.
Covington, Ky. July 5/65.

Book mark :

(546)

A. Baker
Copyist.

6

5 Cav. U.S.C.T.

John Crawford

Opt, Co. H, 5 Reg't U. S. Col'd Cavalry.

Appears on Co. Muster-out Roll, dated

Helena Ark Mar 16, 1866.

Muster-out to date Mar 16, 1866.

Last paid to Dec 31, 1865.

Clothing account:

Last settled....., 186 ; drawn since \$ 100

Due soldier \$ 100; due U. S. \$ 8 4/100

Am't for cloth'g in kind or money adv'd \$ 100

Due U. S. for arms, equipments, &c., \$ 100

Bounty paid \$ 100 100; due \$ 100 100

Remarks:

Book mark:

(361)

J. Stewart

Copyist.

Crawford, John

Pvt., Co. A, 5 Reg't US 6 Cav

1 Enclosures.

Bed Cards	Descriptive Lists
Burial Records	Final Statements
Certs. of Dis. for Discharge	Furloughs
C. M. Charges	Med. Des. Lists
Med. Certificates	Orders

Other papers relating to—

Admission to Hosp'l	Furlough
Casualty Sheet (Officer's)	Med. Examination
Confinement	Misc. Information
Contracts	Pay or Clothing
Death or Effects	Personal Reports
Desertions	Rank
Discharge from Hosp'l	Transfer to Hosp'l
Discharge from Service	Transfer to V. R. C.
Duty	Transportation

War Department,
ADJUTANT GENERAL'S OFFICE.

Washington, *Sept 3* 1867.

Respectfully returned to the
Commission for the State of
Kentucky, with the informa-
tion that John Crawford
was enlisted at Camp Nelson Ky
September 17 1864 and was
mustered in as private in Co. "H"
5th West Cav. Sept. 17. 1864.

10
2431

[Signature]

Asst. Adj't General.

BMB.

ENDORSEMENT.

No. *1341*

APPLICATION OF

Thomas Crawford

OF

Boyle Co Ky

For compensation of service of slave,

John Crawford

Enlisted *Sept 17* 1864

in *H* Co. *5th* Regiment

U. S. Colored Troops.

Received *Jan 21* 1867

Compensation awarded

186

Dollars.

President Board of Claims.

CLAIMANT'S ATTORNEYS,

J. W. CARDWELL & CO.,

Cor. 5th & 1st LOUISVILLE, KY.

CLAIMANT'S P. O. ADDRESS,

Thomas Crawford
Boyle Co Ky

Thomas Crawford

CLAIM FOR COMPENSATION FOR ENLISTED SLAVE.

No.

I, ¹ *Thomas L. Crawford*, a loyal citizen, and
 a resident of ² *Kentucky* County of ³ *Boyer* State of
⁴ *Kentucky*, hereby claim compensation, under the provisions of
 section 24, Act approved February 24, 1864, and Section 2, Act approved July 28, 1866, for my
 slave ⁵ *John B. Crawford* enlisted ⁶ *17th*
 186 ⁷ at *Boyer, Ky.* by ⁸ *John J. P.*
Kennedy in the ⁹ *4th* Regiment U. S. Colored Troops,
 Co. ¹⁰ *H* certificate of enlistment, and a descriptive list, as required, accompany
 this application.

In proof of my loyalty to the Constitution and Government of the United States, I present
 the accompanying oath, which I have taken, signed and acknowledged; to be filed with this
 application, in accordance with requirement of General Orders, No. 329, 1863, War Department,
 Adjutant General's Office.

Witness: *Wallace Green* *Thomas Crawford* Applicant.
W J P M } Two witnesses to
 owner's signature
 sign here.

1867

OATH OF ALLEGIANCE.

I, *Thomas L. Crawford*, the owner and claimant, do solemnly swear that the foregoing
 claim is a just and true claim due to me as master and owner of the said slave, and that the facts alleged in said claim, in respect to the
 draft or enlistment (as the case may be) of said slave into the military service of the United States, are true. And I do further swear that I
 have never joined, or been concerned in, any insurrection or rebellion; that I have never borne arms against the United States; that I have
 never given any aid, countenance, counsel or encouragement, to any person or persons engaged, or whom I had reason to believe were about to
 engage, in insurrection, rebellion, or armed hostility against the United States; that I have neither sought, nor accepted, nor attempted to
 exercise the functions of any office, civil or military, nor to perform any service whatever, under any authority, or pretended authority, in
 hostility to the United States; that I have not yielded a voluntary support to any insurrection, rebellion, or pretended government
 authority, power or constitution within the United States hostile thereto. And I do further swear that, to the best of my knowledge and
 ability, I have supported and defended, and will continue to support and defend, the United States against all enemies foreign and domestic,
 and that I have supported, defended and obeyed, and will continue to support, defend and obey, the Constitution and laws of the United States;
 that I will bear true faith and allegiance to the same: and that I take this oath freely, without any mental reservation or purpose of
 evasion: So help me God.



5 CENT STAMP. The owner } *Thomas L. Crawford*
 signs here.

Sworn to and subscribed before me *a Notary Public*
 this *100* day of *January* 1867
 The officer swear- } *Wallace Green*
 ing the owner signs } *W J P M* } L. S.

POWER OF ATTORNEY.

My Post Office address is *Boyer, Ky.* County of *Boyer* State
 of Kentucky, and I hereby direct that all communications to me, touching this claim, may be sent under cover to
John J. P. Kennedy, who is hereby appointed and constituted my true and lawful attorney, to prose-
 cute this claim for me, and who is hereby authorized and empowered to receive and receipt for any award, order, draft, certificate, voucher,
 warrant, papers, or money that may be issued in the adjustment of this claim, or the payment thereof, the same as I might or could do in
 person were I present and acting for myself, and to file any additional evidence or papers that may be required in the prosecution of this
 claim.

Witness: *Wallace Green* The owner } *Thomas L. Crawford*
W J P M signs here. }
 50 CENT STAMP. } Two witnesses to
 owner's signature
 sign here.

DIRECTIONS FOR FILLING UP THE ABOVE BLANKS.

1. Name of claimant; his name must be given in full, and he must be the owner, in his own right, of the slave claimed at the time he was mustered into the United States service, and the time application is made.
 2. Name of city or town in which claimant lives.
 3. Name of county in which claimant lives.
 4. Name of State in which claimant lives.
 5. Name of slave for whom compensation is claimed.
 6. Date of his enlistment.
 7. Where he enlisted.
 8. By whom he was enlisted.
 9. Number of Regiment to which he was assigned.
 10. Letter of Company he served in.
- NOTE.—Where there is a doubt as to the fact stated in a blank, do not fill the blank.

Headquarters Kentucky Volunteers,

Adjutant-General's Office,

Frankfort, July 28th, 1865.

I hereby certify, that it appears from the U. S. Muster-in
Rolls on file in this Office, that John Crawford
was enrolled on the 17th day of September, 1864, at
Camp Nelson Ky, by J. C. Randolph D.P. 3rd,
and mustered into the U. S. service on the 17th day of September,
1865, at Camp Nelson Ky, by Capt R. C. Kinney U.S.A
to serve Three years ~~or during the war.~~ said John Crawford
as indicated by the rolls served service to
J. J. Crawford of Boyle Co Ky and was
assigned to Co H 5 US Cavalry

In Testimony Whereof, I have heretofore set my
hand and affixed my Official Seal, this 28th
day of July, 1865.

D. W. Lindsey
Adjutant General of Kentucky.

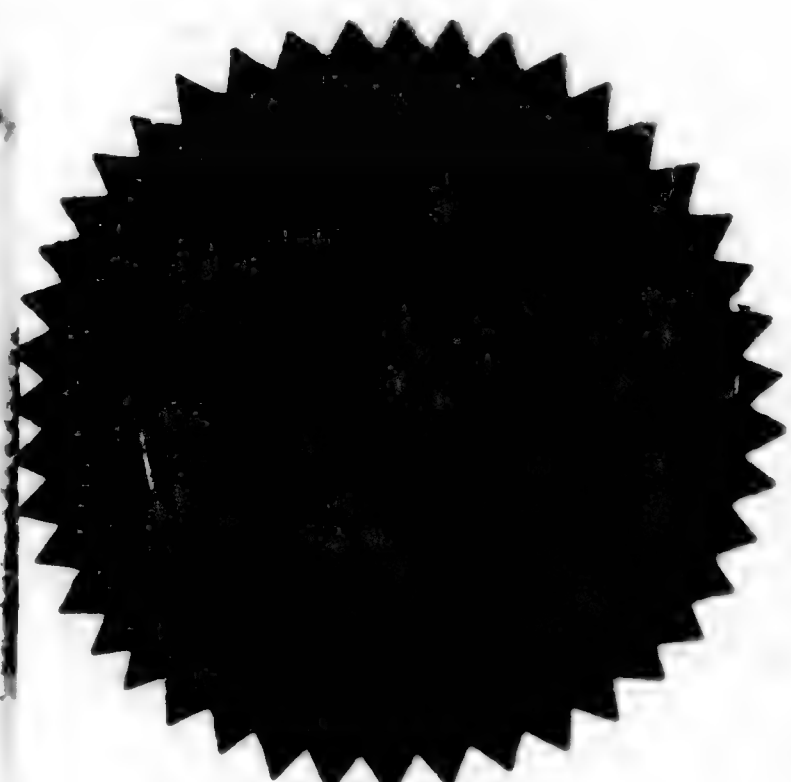

17 31
residents of the County of _____
do hereby on oath state that we are and have been for _____ years well acquainted with
_____ the applicant, and _____
and _____ his witnesses, and from our personal acquaintance with
them believe their statements to be entitled to full faith and credit.

J. S. Caldwell P.M.

Sworn to and subscribed before me, a _____ for the County
of _____ State of _____ this _____ day
of _____ 1865

5 CENT STAMP

NOTE.—If the applicant and his witnesses are not personally known to one or more of the Commissioners, the above certificate should
be signed by two citizens who are well known to the Commissioners, or by a Post Master or other Government officer; if signed by a United
States officer it need not be sworn to, but if by citizens it must be sworn to. When a United States officer signs it the witnesses need
not, and when the witnesses sign it the United States officer need not.

PROOF OF OWNERSHIP.

State of Kentucky, }
County of Boyle } ss.

We, W. J. Polk and Wallace Green, each of lawful age, and resident citizens of the State and County aforesaid, do certify that Wallace Green of the State and County aforesaid, was on the 27th day of September, 1866, the lawful owner of the Slave named James Green, referred to and described in the foregoing claim for compensation.

Two witnesses to ownership sign here.

W. J. Polk
Wallace Green

Sworn to and subscribed before me, a Justice of the Peace for the County of Boyle State of Kentucky, this, the 27th day of September, 1866



The officer swearing the witnesses signs here.

G. R. Patton

L. S.

PROOF OF LOYALTY.

State of Kentucky, }
County of Boyle } ss.

We, W. J. Polk and Wallace Green loyal men, and each of lawful age, and resident citizens of the County of Boyle in the State and County aforesaid, upon our oaths declare that we have known Wallace Green a resident of the State and County aforesaid, since the 4th day of March, 1861, and know that he has firmly and faithfully maintained his or her adherence and allegiance to the Government of the United States, by defending its cause against the Government and forces of the so-called Confederate States of America, in all suitable and practicable ways, and according to his or her ability and opportunity.



5 CENT STAMP.

W. J. Polk
Wallace Green

Sworn to and subscribed before me, a Justice of the Peace for the County of Boyle State of Kentucky this 27th day of September 1866

The officer swearing the witnesses signs here.

G. R. Patton

L. S.

We, W. J. Polk and Wallace Green each of us residents of the County of Boyle in the State of Kentucky on oath state that we are and have been for 5 years well acquainted with Wallace Green the applicant, and W. J. Polk his witnesses, and from our personal acquaintance with them believe their statements to be entitled to full faith and credit.

G. R. Patton

Sworn to and subscribed before me, a Justice of the Peace for the County of Boyle State of Kentucky this 27th day of September 1866

5 CENT STAMP

NOTE.—If the applicant and his witnesses are not personally known to one or more of the Commissioners, the above certificate should be signed by two citizens who are well known to the Commissioners, or by a Post Master or other Government officer; if signed by a United States officer it need not be sworn to, but if by citizens it must be sworn to. When a United States officer signs it the witnesses need not, and when the witnesses sign it the United States officer need not.

315
Creery Edward

Co E, 5 U. S. Col'd Cav.

Lieutenant Captain,

CARD NUMBERS.

1	5359159	26
2	5363950	27
3	5364042	28
4	5364128	29
5	5364213	30
6	5364307	31
7	5364394	32
8	5364554	33
9	5359299	34
10	5359160	35
11	5364477	36
12	5364558	37
13	9435972	38
14	9436000	39
15	40729615	40
16		41
17		42
18		43
19		44
20		45
21		46
22		47
23		48
24		49
25		50

Book Mark:

General Notation R. & P. 407375,

See also

6th U. S. Col'd Cav.

C | 5 car. U.S.A.

Edward Treacy

1st Lt., Co. C., 5th Reg't U.S. Col'd Calif.

Appears on

Regimental Descriptive Book

(List of Commissioned Officers)

of the regiment named above.

Rank 1st Lieutenant

Date of appointment Dec. 14, 1864.

Remarks: Enrolled at

Louisville Ky. by the

President Jan. 1. 1865. for 3 years.

Mustered Jan. 1. 1865. at

Louisville Ky. by

Capt. Smith.

Promoted to Capt.

Mustered out Dec 27. 65.

Treacy

B

5 Cav. U.S.C.T.

Edward Gerry

Lieut, Co. E, 5 Reg't U. S. Col'd Cavalry.

Appears on

Company Muster Roll

for *Jan, & Feb*, 1865.

Present or absent *Present*

Stoppage, \$ *100* for

Due Gov't, \$ *100* for

Valuation of horse, \$ *100*

Valuation of horse equipments, \$ *100*

Remarks: *See Command of
Company during the
months of February
& March for same*

Book mark:

M. R. Rowland

(358)

Copyist.

B | *5 Cav.* | **U.S.C.T.**

Edward Greery

1 Lt., Co., *5* Reg't U. S. Col'd *Cav*

Age *27* years.

Appears on an

Individual Muster-in Roll

of the organization named above. Roll dated

Louisville Ky, *Feb 6*, 1865.

Muster-in to date *Jan 1*, 1865.

Joined for duty and enrolled:

When *Jan. 1*, 1865.

Where *Louisville Ky*

Period *3* years.

Valuation of horse, \$ *100*

Valuation of horse equipments, \$ *100*

Remarks: *This muster to take effect Jan. 1 1865*

Book mark: *...*

GENERAL MUSTER R. & P. BOOKING.

Farmer

(336)

Copyist.

6 | 5 Cav. | U.S.C.T.

Edward Greary

1st Lieut, Co. E, 5 Reg't U. S. Col'd Cavalry.

Appears on

Company Muster Roll

for March, & Apr, 1865.

Present or absent Present

Stoppage, \$ 100 for

Due Gov't, \$ 100 for

Valuation of horse, \$ 100

Valuation of horse equipments, \$ 100

Remarks: In command
of Co. E 5th U.S. Cavalry
during the month of
March, '865

Book mark:

W. Rowland

(358)

Copyist.

6 | **5 Cav.** | **U.S.C.T.**

Edward Greery

1st Lt., Co. E, 5 Reg't U. S. Col'd Cavalry.

Appears on

Company Muster Roll

for *May & June*, 1865.

Present or absent *not stated*

Stoppage, \$ 100 for

Due Gov't, \$ 100 for

Valuation of horse, \$ 100

Valuation of horse equipments, \$ 100

Remarks:

Book mark:

(358)

Long Copyist.

C | **5 Cav.** | **U.S.C.T.**

Edward Creery

1st Lt, Co. E, 5 Reg't U. S. Col'd Cavalry.

Appears on

Company Muster Roll

for July - Aug., 1865.

Present or absent present

Stoppage, \$ 100 for

Due Gov't, \$ 100 for

Valuation of horse, \$ 100

Valuation of horse equipments, \$ 100

Remarks: Commanding Com-
pany as per R.O. No.
\$10. due for each of
the months of April, May
& June

Book mark: _____

(358)

Long

Copyist.

C

5 Cav. U.S.C.T.

Edward Greery

1st Lt., Co. E, 5 Reg't U.S. Col'd Cavalry.

Appears on

Company Muster Roll

for *Sept & Oct.*, 1865.

Present or absent *present*

Stoppage, \$ *100* for

Due Gov't, \$ *100* for

Valuation of horse, \$ *100*

Valuation of horse equipments, \$ *100*

Remarks: *In command of Company \$10. due for each of the months of April, May, June, ^{August} October 1865.*

Book mark:

Long

(358)

Copyist.

6

5 Cav. U.S.C.T.

Edward Greery

1st Lt., Co. E, 5 Reg't U. S. Col'd Cavalry.

Appears on

Company Muster Roll

for Nov & Dec, 1865.

Present or absent Present (signs roll)

Stoppage, \$ 100 for

Due Gov't, \$ 100 for

Valuation of horse, \$ 100

Valuation of horse equipments, \$ 100

Remarks:

Book mark:

Long

(358)

Copyist.

C 15 Cav. U.S.A.

Edward Erving

Capt, Co. C, 5th Reg't U.S. Col'd Cav

Appears on

Regimental Descriptive Book

(List of Commissioned Officers)

of the regiment named above.

Rank *Captain*

Date of appointment *Dec. 2*, 1865.

Remarks: *Mustered by Lt
O. J. Hussey Helena, Ark.
Dec. 28 1865;*

Hearst

6 | 5 Cav | U.S.C.T.

Edward Greery

Capt, Co. E, 5 Reg't U. S. Col'd Cav.

Age 27 years.

Appears on an

Individual Muster-in Roll

of the organization named above. Roll dated

Helena Ark, Dec 28, 1865.

Muster-in to date Dec. 28, 1865.

Joined for duty and enrolled:

When Dec 28, 1865.

Where Helena Ark

Period 3 years.

Valuation of horse, \$ 100

Valuation of horse equipments, \$ 100

Remarks: Promoted from
1 Lieut. Co. "E," 5 U.S. C. Cav.
to Captain Co "E" U.S.C. Cav.
to fill a vacancy caused by

Book mark:

Garmer

JAN. - 9

5359160

1891

(Vice) Capt. J. H. Schuck
5 U. S. C. Cav. Dismissed

Received and accepted
appointment December
27 1865.

Muster in to take
effect December 28

1865

6

5

U.S.C.T.

Edward Green

1st, Co. *C*, *5* Reg't U. S. Col'd *Ca*

Appears on an

Individual Muster-out Roll

of the organization named above. Roll dated

Atlanta Ga, *Apr 28*, 186*5*.

Muster-out to date *Dec 27*, 186*5*.

Last paid to *Oct 31*, 186*5*.

Clothing account:

Last settled 186 ; drawn since \$ 100

Due soldier \$ 100; due U. S. \$ 100

Am't for cloth'g in kind or money adv'd \$ 100

Due U. S. for arms, equipments, &c., \$ 100

Bounty paid \$ 100 due \$ 100

Remarks: *Promoted to Captain*
Co C 5th U.S. Cavalry by appointment
from the President of the United
States bearing date Dec. 27/65
Must be over to same office Dec 27/65

Book mark:

J. E. [Signature]

(348)

Copyist.

10

5 Cav. U.S.C.T.

Edward Greery

Capt, Co. E, 5 Reg't U. S. Col'd Cavalry.

Appears on

Company Muster Roll

for Jan & Feb, 1866.

Present or absent Present

Stoppage, \$ 100 for

Due Gov't, \$ 100 for

Valuation of horse, \$ 100

Valuation of horse equipments, \$ 100

Remarks: Ten dollars due for the months of November and to the 27th of December 65 as Quartermaster's Company

Book mark:

(358)

J. Leonard

Copyist.

6

5 Cav. U.S.C.T.

Edward Conroy
Co. E, 5 Reg't U. S. Col'd Cavalry.

Appears on

Company Muster Roll

for Jan & Feb, 1866.

Present or absent

Stoppage, \$ 100 for

Due Gov't, \$ 100 for

Valuation of horse, \$ 100

Valuation of horse equipments, \$ 100

Remarks: Mustered out
for promotion Dec.
29th 1866

Book mark:

(358)

[Signature]

Copyist.

Edward Creery.

1st Lt. Co. E, 5 Reg't U. S. Colored Cav.
Capt.

Appears on Returns as follows:

Jan. 1865. Absent, special duty in
Command of Co. F, R. O. 7, dated
Jan. 17/65.

Feb. 1865. Present. Comdg Co.

Mar. 1865. Present. Temporarily assigned
to duty with Co. D, R. C. 38. Signs
Return Comdg Co. D.

Apr. & May, 1865. Present. Comdg Co.

May & June, 1865. Present. Comdg Co. M.
Temporarily assigned to Co. M, Regt.
Order 88, dated Hdqrs. 5 U. S. C. Cav,
Paris, Ky., May 25/65. Signs Return
Comdg Co. M.

July to Dec. 1865. Present. Comdg Co., R. O.
129, dated Paris, Ky., July 24/65.

Jan. 1866. App'd Capt. Co. E, 5 U. S. C. Cav.
(Capt.) Present.

Feb. 1866. Present.

Book mark :

J. Baker
Copyist.

6 | 5 Cav. | U.S.C.T.

Edward Conery
Capt, Co. E, 5 Reg't U. S. Col'd Cavalry.

Appears on Co. Muster-out Roll, dated
St. Helena, Ark. Mar 16, 1866.

Muster-out to date _____, 186 .

Last paid to Pay due from Muster-out, 186 .

Clothing account:

Last settled _____, 186 ; drawn since \$ _____ 100

Due soldier \$ _____ 100; due U. S. \$ _____ 100

Am't for cloth'g in kind or money adv'd \$ _____ 100

Due U. S. for arms, equipments, &c., \$ _____ 100

Bounty paid \$ _____ 100; due \$ _____ 100

Remarks: 1st Lt to Dec 28, 65 then Capt
appointed from 5th Reg't U.S. Cavalry.
Absent with leave.
Was 1st Lt from July 1, 65 to Dec 28/65. Reported
from some place for Muster-out. Original
entry in service 6th U.S. Cav. Co. Philadelphia Pa.

Book mark: _____

(361) Edward Copyist.

Crary, Edward

1 Lt., Co.

5

U. S. C. Cav.

5

Enclosures.

Bed Cards	Descriptive Lists
Burial Records	Final Statements
Certs. of Dis. for Discharge	Furloughs
C. M. Charges	Med. Des. Lists
Med. Certificates	Orders <i>2</i>

Other papers relating to—

Admission to Hosp'l	Furlough <i>1</i>
Casualty Sheet (Officer's)	Med. Examination
Confinement	Misc. Information <i>1</i>
Contracts	Pay or Clothing
Death or Effects	Personal Reports <i>1</i>
Desertions	Rank
Discharge from Hosp'l	Transfer to Hosp'l
Discharge from Service	Transfer to V. R. C.
Duty	Transportation

Special Order No 92

Head Quarters S. O. U. S. C. 7

September 27 Jan 16. 65

Ordering Lt Greeng to report
for duty

Recd & Filed Jan 17. 1865

Head-Quarters U. S. Colored Troops,

Lexington, Ky. *January 1864*

Special Orders, }

No. 42 }

*To the Adjutant General's Office
The Adjutant General's Office is directed to
issue orders from Headquarters U. S. Colored Troops
to all units of the U. S. Colored Troops for
the purpose of the U. S. Colored Troops.
The Adjutant General's Office is directed to*

By order of COLONEL JAS. S. BRISBIN, S. O. U. S. C. T.

Geo. E. Goodyear

Act. Asst. Adj. General.

Paris, Kentucky
July 25th, 1865

Widder, Henry, W.
Maj 5th U.S.C. Comd'g Regt.

Acknowledges receipt
of telegram directing
St. Creery 5th U.S.C. to report
for duty at Lex. - respectfully
makes statement relative to
the disposition of Officers of
5th U.S.C. and requests that St.
Creery be returned to his
Regt.

Head Quarters 1st Inf. C. Cav.
Paris Kentucky

July 25th 1865

Capt. R. S. Foster

A. A. A. Genl

1st Div. Dept of Ky

Sir:

I have the honor to report
the receipt of a "Telegram" by
signed by the General Comdr of
directing Lieut Gury 1st Inf. C. Cav -
to report at once for temporary
duty. Lieut Gury is at
present the only officer with his
Company - Nor is there any
officers at present with the
Command who can be assigned
to duty with it. The Captains
of L. + M. Co's are at present
confin'd - to their rooms in care
of the surgeon - & with Lieut Gury
absent there are but three officers

left with a Battalion of 4 full
Companies; who are fit for duty
I have to request that these
Circumstances be taken into Con-
sideration and that Lieut
Gruy - be returned to his Regiment
as soon as possible.

I have the honor to be
very respectfully
Yours ob^d Serv^t

Henry M. Piddes
Major 5th U. S. Cav
Com^d of Regt

Special Order 149

Adm 1st W D W
Lexington Ky 26 July 65

Ordering J E Creery to
take charge of a prisoner
and proceed to Columbus
Ohio -

J E C

Head-Quarters First Division, Department of Kentucky.

Lexington, Kentucky, July 26th 1865.

Special Orders, }
No. 149 }

(Extract.)

* * * * *
Lieut. C. Crany 5th U.S.C. will proceed to Columbus Ohio, in charge of Thomas O. Payne, Citizen Prisoner, and will turn him over to the Warden of the State Prison at that place, taking receipt for him and the accompanying papers. This being accomplished he will return to these Head-Quarters without delay. Cf. War Dept. will furnish transportation.

* * * * *
By Command of ^{Col} Brigadier General E. H. HOBSON:

W. H. Bond

Captain and Acting Assistant Adjutant General.

W. H. Bond
July 26 1865

C. H. [unclear] [unclear]
Helena - Ark
Feb. 23. 1866

Brevet E
Capt. [unclear]

Application for leave
of absence for 7 days
State that [unclear] is in
study with the Co.

A. C. [unclear] [unclear]
Feb. 28. 1866.

State [unclear] [unclear]
Helena. Ark
Feb. 23. 1866

Respectfully forwarded
approved with the request
that the Col. [unclear] approve
this leave if he possibly
can

J. [unclear]
Colonel [unclear]
Comd [unclear]

To d [unclear] [unclear]
Helena Ark Feb 23^d 1866
Respectfully forwarded
Approved for 7 days
M. [unclear]
Commanding
Feb 23^d 1866

Helena Arkansas

February 23rd 1866

Sir

I have the honor to request a leave of
absence for seven (7) days for the purpose of visiting
St Louis Mo

I have not received a leave of absence
longer than two days since the 15th day of January 1865

I trust Augustus Flint is serving with
the Company to which I am attached, and my services
can readily be spared for the period desired of

I am Sir

Very Respectfully

Your obt Servant

Edw. Perry

Capt. 5th Regt

Visit Jacques

Adjutant General

St Francis River District -

Department of Arkansas

I Edward Green
late Captain Co & 5th U. S. Cal & Cav.
do solemnly declare on oath, that I
have duly accounted for all Public
Property for which I have been responsible
as an Officer of the Volunteer forces
of the United States; that I have
rendered all returns and reports
required by Revised Army Regulations
of 1863 and existing Orders - that
I am not now, on my account,
whatever is due to the Genl. Govt.,
except as stated on Muster and
Rolls.

Edward Green
Late Capt Co & 5th U. S. Cal. & Cav.

Sworn and subscribed before me
at Memphis Tenn. this 19th day of
March 1866,

W. F. Morse
Capt Henry Wilson
Dep't of Arkansas

Mittendon, Geo
Co F, 5 U. S. Col

Private

Priv.

CARD NUMBERS.

1	5364704	26
2	5364804	27
3	5364970	28
4	5365094	29
5	00913-30	30
6	40729616	31
7		32
8		33
9		34
10		35
11		36
12		37
13		38
14		39
15		40
16		41
17		42
18		43
19		44
20		45
21		46
22		47
23		48
24		49
25		50

Book Mark:

See also

316

Crittendon, George

Co F, 5 U. S. Col'd Cav.

Private

Private

CARD NUMBERS.

1	5364704	26
2	5364804	27
3	5364970	28
4	5365694	29
5	00915-30	30
6	40729616	31
7		32
8		33
9		34
10		35
11		36
12		37
13		38
14		39
15		40
16		41
17		42
18		43
19		44
20		45
21		46
22		47
23		48
24		49
25		50

Book Mark:

See also

6

5 Cav. U.S.C.T.

George Githenden

, Co. A, 5 Reg't U. S. Col'd Cav.

Appears on

Company Descriptive Book
of the organization named above.

DESCRIPTION.

Age 23 years; height 5 feet 6 inches.

Complexion Black

Eyes Blk; hair Blk

Where born Scot / Ky

Occupation farmer

ENLISTMENT.

When Sep 23, 1864

Where Camp Nelson

By whom H. Randolph term 5 y'rs.

Remarks:

H E Purkes

() | **5 Cav.** | **U.S.C.T.**

George Britton

C, Co. *F*, 5 Reg't U. S. Col'd Cavalry.

Appears on

Company Muster-in and Descriptive Roll

of the organization named above. Roll dated

Sept Nelson, N.Y., Oct 27, 1864

Where born *Scott Ky*

Age *23* y'rs; occupation *Farmer*

When enlisted *Sept 23*, 1864

Where enlisted *Sept Nelson Ky*

For what period enlisted *3* years.

Eyes *Blk*; hair *Blk*

Complexion *Blk*; height *5 ft. 6 in.*

When mustered in *Sept 23*, 1864

Where mustered in *Sept Nelson*

Bounty paid \$ *100*; due \$ *100*

Where credited *7 Dist Ky*

Company to which assigned *A*

Remarks: *Name of owner of Negro - Joseph Sutton*

** Checked by H. J. May 12 1865*

Book mark:

Sumner

6

5 Cav. U.S.C.T.

George Crittendon

Priv, Co. F, 5 Reg't U. S. Col'd Cavalry.

Appears on

Company Muster Roll

for to Oct 31, 1864

Present or absent Present

Stoppage, \$ 100 for

Due Gov't, \$ 100 for

Valuation of horse, \$ 100

Valuation of horse equipments, \$ 100

Remarks:

Book mark:

Currin

10 | 5 Cav. | U.S.C.T.

George Crittenden
Privt, Co. F, 5 Reg't U. S. Col'd Cavalry.

Appears on

Company Muster Roll

for Nov & Dec, 1864.

Present or absent

Stoppage, \$ 100 for

Due Gov't, \$ 100 for

Valuation of horse, \$ 100

Valuation of horse equipments, \$ 100

Remarks:

1st 2 Installment Bounty due
Paid in New. Paduach, Ky
Dec 10

Book mark:

Currin

(358)

Copyist.

P. | 5 Cav. | U.S.C.T.

George Crittenden.

Co., Co. *F*, 5 Reg't U. S. Colored Cav.

Appears on Returns as follows:

*Dec. 1864. Died of disease Dec 10/64,
Paducah, Ky.*

Book mark :

(546)

Baker
Copyist.

C | 5 Cav | U.S.C.T.

George Whittenden
Sgt., Co. F, 5 Reg't U. S. Col'd Cavalry

Appears on Co. Muster-out Roll, dated
Helena Ark, Mch 16, 1866.

Muster-out to date _____, 186 .

Last paid to _____, 186 .

Clothing account:

Last settled _____, 186 ; drawn since \$ _____ 100

Due soldier \$ _____ 100; due U. S. \$ _____ 100

Am't for cloth'g in kind or money adv'd \$ _____ 100

Due U. S. for arms, equipments, &c., \$ _____ 100

Bounty paid \$ _____ 100; due \$ _____ 100

Remarks: Died Dec 10. 64 Paducah
Kentucky, Pneumonia, Final
Statement furnished A.G.O.
Dec 20/64

Book mark : _____

(361)

J. W. Davis

Copyist.

Brittenden, George

P, Co. *A*, **5** Re **U.S.C. Cav.**

1 Enclosures.

Bed Cards	Descriptive Lists
Burial Records	Final Statements /
Certs. of Dis. for Discharge	Furloughs
C. M. Charges	Med. Des. Lists
Med. Certificates	Orders

Other papers relating to—

Admission to Hosp'l	Furlough
Casualty Sheet (Officer's)	Med. Examination
Confinement	Misc. Information
Contracts	Pay or Clothing
Death or Effects	Personal Reports
Desertions	Rank
Discharge from Hosp'l	Transfer to Hosp'l
Discharge from Service	Transfer to V. R. C.
Duty	Transportation

FINAL STATEMENT

See list of names...
OF
George B. ...

3rd Reg't of *...*

S. 5, Vol 3 R. 3, 1865
C. O. Jan 30 1865
VOLUNTEERS.

Died Dec 10th 64

NOTE 1.—Two of these certificates (or duplicates) are to be given to each Volunteer Soldier or drafted man who may be discharged previously to the discharge of his company, that he may at once receive from the Paymaster the pay, &c., due him, and the captain or other COMMISSIONED officer commanding the company will certify to the act of the delivery of the duplicate certificates; on these certificates the Soldier is "entitled to" his discharge, and should also present his discharge to the Paymaster to have the payment endorsed on it. The discharge is to be given back to the Soldier by the Paymaster; the latter only retaining as his voucher the duplicate certificates.

NOTE 2.—If the Soldier is entitled to pay for the use of his horse, the Company Commander will certify to that fact on the back of both these final statements, and also to the time he has pay due for having been so mounted on his own horse.

NOTE 3.—When a Soldier is furnished with final statements, his descriptive list, if he has one, should be taken up by the officer who gives the Soldier these statements, and endorsed with a statement to this effect by the officer. This endorsement should exhibit a full statement of the time for which the Soldier was allowed pay on his final statements, the clothing account, and all other charges against him or in his favor, so as to comprise a complete exhibit of his account. It will then be transmitted to the company commander of the Soldier, who will enter all the data necessary to a full understanding of the Soldier's account on the muster roll upon which the Soldier's discharge is reported. The descriptive list will then be destroyed. The object of this is, that the remaining portion of the Soldier's account may be settled upon the receipt of these muster rolls, and the Soldier receive any pay or allowances that may be due him at the time of his discharge, and which may not appear on his final statements from the fact that his descriptive list is incomplete. These accounts for back pay, &c., are settled by the 2d Auditor of the Treasury Department.

NOTE 4.—Charges for loss or injury to ordnance, horse equipments, and other miscellaneous charges, should appear under the heading of "Other Stoppages."

NOTE 5.—Bounty paid by State authorities, and not by the United States, will not be entered on this statement.

NOTE 6.—Amounts due the Sutler and Laundress must be entered on the muster roll on which the discharge, death, desertion, &c., is reported, as well as on the final statement, otherwise the amount cannot be collected from the United States.

NOTE 7.—This blank will be used for deceased volunteers and drafted men, as well as for others.

NOTE 8.—Where a Soldier dies in Hospital or on detached service, his descriptive list, if he has one, should be sent with his final statements, in duplicate, to the Adjutant General, Washington, D. C.

f

047

This man died in U.S.
General Hospital ...
Kentucky, ...
C.O. ...
R.C. 3, 1865.

[Faint handwritten notes]

February 19th 6

I certify, on honor, that George Seritenden a Private of
 Captain Isaac Gray Company (F) of the 7th Regiment of U S Col Cavalry
VOLUNTEERS, of the State of _____, born in Scott County, State
 of Kentucky, aged 23 years; 5 feet 6 inches high; Black complexion,
Black eyes, Black hair, and by occupation a Farmer, having joined the company on
 its original organization at Camp Nelson Ky, and enrolled in it at the muster into
 the service of the United States at _____, on the 23rd day
 of September, 1864 (or was mustered in service as a recruit, by Capt Kinney
 _____, at Camp Nelson on the 23rd day of September,
 1864 or was drafted and mustered into the service of the United States from the _____

Enrollment District of the State of _____, at _____,
 on the _____ day of _____, 1864 to serve in the Regiment, for
 the term of Three Years: and having served HONESTLY and
 FAITHFULLY with his Company in 3rd U S Col Cavalry to the present date, is now
 entitled to a **DISCHARGE** by reason of Death caused by Pneumonia

Inventory of effects is forwarded from West
 The said George Seritenden was last paid by Paymaster
Pay due from Enrollment to include the _____ day of _____, 1864, and has
 pay due him from that time to the present date; he is entitled to pay and subsistence for
 TRAVELING to place of enrollment, and whatever other allowances are authorized to volunteer
 soldiers, drafted men, or militia, so discharged. He has received from the United States **CLOTHING**
 amounting to Forty ⁵²/₁₀₀ dollars, since the _____ day of Enlistment,
 1864, when his clothing account was last settled. He has received from the United States
 _____ ¹⁰⁰/₁₀₀ dollars advanced **BOUNTY**.

There is to be stopped from him, on account of the State of _____, or other
 authorities, for **CLOTHING**, &c., received on entering service, _____ ¹⁰⁰/₁₀₀ dollars; and
 for other stoppages, viz: _____
 _____ ¹⁰⁰/₁₀₀ dollars.

He has been furnished with TRANSPORTATION in kind from the place of his discharge to
 _____; and he has been SUBSISTED for TRAVELING to his
 place of enrollment, up to the _____, 1864.

He is indebted to _____, **SUTLER**, _____ ¹⁰⁰/₁₀₀ dollars.
 He is indebted to _____, **LAUNDRESS**, _____ ¹⁰⁰/₁₀₀ dollars.

Given in Duplicate, at Camp Nelson Ky, this 23rd day
 of March, 1865.

W J Bishop
2d Lieut

 Commanding Company

Dues due 11th Oct

317
Croddane Milford

Co A, 5 U. S. Col'd Cav.

Private Private

CARD NUMBERS.

1	5366767	26
2	5366869	27
3	5366967	28
4	5367059	29
5	5367149	30
6	5367245	31
7	5367333	32
8	5367425	33
9	5367517	34
10	5367610	35
11	5367700	36
12	909075-8	37
13	909083-8	38
14		39
15		40
16		41
17		42
18		43
19		44
20		45
21		46
22		47
23		48
24		49
25		50

Book Mark:

See also

6 | **5 Cav. | U.S.C.T.**

Milford Crockett

, Co. *16*, 5 Reg't U. S. Col'd Cav.

Appears on

Company Descriptive Book
of the organization named above.

DESCRIPTION.

Age *20* years; height *5* feet *5* inches.

Complexion *Blk*

Eyes *Blk*; hair *Blk*

Where born *Marion Ky*

Occupation *Farmer*

ENLISTMENT.

When *Sept 16, 1864.*

Where *Camp Nelson*

By whom *J. C. Randolph*; term *3* y'rs.

Remarks:

A. J. Anderson

(383a)

Copist.

5 Cav. | U.S.C.T.

Milford Cradick
Co. H, 5 Reg't U. S. Col'd Cav.

Appears on

Company Descriptive Book
of the organization named above.

DESCRIPTION.

Age 21 years; height 5 feet 5 inches.

Complexion Blk

Eyes Blk; hair Blk

Where born Marion Ky

Occupation farmer

ENLISTMENT.

When Sep 6, 186 4

Where Camp Nelson Ky

By whom A. Randolph, term 3 y'rs.

Remarks:
.....
.....
.....
.....
.....
.....
.....
.....
.....
.....

A. G. Rankin

C | **5 Cav.** | **U.S.C.T.**

Milford Croddus

Pvt, Co. *H*, 5 Reg't U. S. Col'd Cavalry.

Appears on

Company Muster-in and Descriptive Roll

of the organization named above. Roll dated

Camp Nelson, N. Y., Oct 29, 1864.

Where born *Marion Ky*

Age *20* y'rs; occupation *Farmer*

When enlisted *Sept 16*, 1864.

Where enlisted *Camp Nelson Ky*

For what period enlisted *3* years.

Eyes *Black*; hair *Black*

Complexion *Black*; height *5 ft. 3 in.*

When mustered in *Sept 17*, 1864.

Where mustered in *Camp Nelson Ky*

Bounty paid \$ *100*; due \$ *100*

Where credited

Company to which assigned

Remarks: *4th Dist Ky*

* *James Croddus*

* *Supposed to be name of owner*

Added May 16, 98 H.A.J.

Book mark:

Reynolds

(356d)

Copyist.

C

5 Cav.

U.S.C.T.

Midford Croddus

Pvt, Co. H, 5 Reg't U. S. Col'd Cavalry.

Appears on

Company Muster Roll

for ~~from enlistment to~~ Oct 31, 1864.

Present or absent *present*

Stoppage, \$ 100 for

Due Gov't, \$ 100 for

Valuation of horse, \$ 100

Valuation of horse equipments, \$ 100

Remarks:

Book mark:

Reynolds

(358)

Copyist.

6

5 Cav.

U.S.C.T.

Milford Croddis

Pat, Co. H, 5 Reg't U. S. Col'd Cavalry.

Appears on

Company Muster Roll

for Nov & Dec, 1864.

Present or absent present

Stoppage, \$ 100 for

Due Gov't, \$ 100 for

Valuation of horse, \$ 100

Valuation of horse equipments, \$ 100

Remarks: 1st and 2nd Installments
Bounty due

Book mark:

Reynolds

(358)

Copyist.

C

5 Cav. U.S.C.T.

Milford Crockett

Pvt., Co. H, 5 Reg't U. S. Col'd Cavalry.

Appears on

Company Muster Roll

for *Jan 1 Feby*, 186*3*.

Present or absent *present*

Stoppage, \$ *100* for

Due Gov't, \$ *100* for

Valuation of horse, \$ *100*

Valuation of horse equipments, \$ *100*

Remarks: *1st Installment of
Bounty Due \$100.00*

Book mark:

Reynolds

(358)

Copyist.

6 | **5 Cav.** | **U.S.C.T.**

Milford Crockett
Pat, Co. H, 5 Reg't U. S. Col'd Cavalry.

Appears on

Company Muster Roll

for Mar & Apr, 1865.

Present or absent present

Stoppage, \$ 100 for

Due Gov't, \$ 100 for

Valuation of horse, \$ 100

Valuation of horse equipments, \$ 100

Remarks: 1st installment of
Penalty Due \$100

Book mark:

(358)

Reynolds Copyist.

6

5 Cav.

U.S.C.T.

Milford Croddie

Pvt., Co. H, 5 Reg't U. S. Col'd Cavalry.

Appears on

Company Muster Roll

for May & June, 1865.

Present or absent Present.

Stoppage, \$ 100 for

Due Gov't, \$ 100 for

Valuation of horse, \$ 100

Valuation of horse equipments, \$ 100

Remarks: 1st Installment Bounty Due \$100.

Book mark:

B. J. Cooke

(358)

Copyist.

O.

5 Cav. | U.S.C.T.

Milford Croddis
Prsnt, Co. H, 5 Reg't U. S. Col'd Cavalry.

Appears on

Company Muster Roll

for *July & Aug.*, 1865.

Present or absent *Present.*

Stoppage, \$ *100* for

Due Gov't, \$ *100* for

Valuation of horse, \$ *100*

Valuation of horse equipments, \$ *100*

Remarks:

Book mark: -----

B. J. Cooke

(358)

Copyist.

6

5 Cav. U.S.C.T.

Milford Gaddis
Cpt., Co. H, 5 Reg't U. S. Col'd Cavalry.

Appears on

Company Muster Roll

for *Sept. & Oct.*, 1865.

Present or absent *Present.*

Stoppage, \$ 100 for

Due Gov't, \$ 100 for

Valuation of horse, \$ 100

Valuation of horse equipments, \$ 100

Remarks:

Book mark: _____

(358) *A. J. Cook* Copyist.

NA 713

6

5 Cav. U.S.C.T.

Milford Gaddis
Cvt., Co. H, 5 Reg't U. S. Col'd Cavalry.

Appears on

Company Muster Roll

for Nov. 4 Dec., 1865.

Present or absent Present.

Stoppage, \$ 100 for

Due Gov't, \$ 100 for

Valuation of horse, \$ 100

Valuation of horse equipments, \$ 100

Remarks:

Book mark:

R. J. Cooke

(358)

Copyist.

6

5 Cav. U.S.C.T.

Milford Croddis
Capt, Co. H, 5 Reg't U. S. Col'd Cavalry.

Appears on

Company Muster Roll

for James V. Feby, 1866.

Present or absent Present

Stoppage, \$ 100 for

Due Gov't, \$ 100 for

Valuation of horse, \$ 100

Valuation of horse equipments, \$ 100

Remarks:

Book mark:

(358)

J. M. Stewart
Copyist.

6

5 Cav. U.S.C.T.

Millford Croddis,
Pat., Co. H, 5 Reg't U. S. Col'd Cavalry.

Appears on Co. Muster-out Roll, dated
Helena, Ark Mar. 16, 1866.

Muster-out to date Mar. 16, 1866.

Last paid to Dec. 31, 1865.

Clothing account:

Last settled....., 186 ; drawn since \$..... 100

Due soldier \$..... 100; due U. S. \$ 14 ⁵/₁₀₀

Am't for cloth'g in kind or money adv'd \$..... 100

Due U. S. for arms, equipments, &c., \$..... 100

Bounty paid \$100 100; due \$100 100

Remarks:

Book mark: 1 19 P 158 68 264 P 208 69

(861)

J. A. Stewart
Copyist.

310

Crosby John

Co C, 5 U. S. Col'd Cav.

Private Private

CARD NUMBERS.

1	5361665	26
2	5361767	27
3	5361864	28
4	5361962	29
5	5362046	30
6	5362127	31
7	5362208	32
8	5362301	33
9	5362389	34
10	5362474	35
11	5362559	36
12	9090196	37
13	43145666	38
14	43146219	39
15	31407317	40
16	40729597	41
17		42
18		43
19		44
20		45
21		46
22		47
23		48
24		49
25		50

Book Mark:

See also

51142105 P.O. m m m
MS. 1147267

A 2608241-56
A3003728 a w n

Company Rev

MS

C | 5 Cav. | U.S.C.T.

John Cross

Co. E, 5 Reg't U. S. Col'd Cav.

Appears on

Company Descriptive Book
of the organization named above.

DESCRIPTION.

Age 24 years; height 5 feet 7 inches.

Complexion Dark

Eyes Dark; hair Dark

Where born Lebanon Co, Pa.

Occupation Laborer

ENLISTMENT.

When Aug. 25th, 1864.

Where Danisville

By whom Capt. Wm.; term 3 y'rs.

Remarks: Detached as member
of Reg. l Band, 22 pr. or-
der no 13 Gen. 25/65

Warren

Co. | 5 bar | USCT

John Crooms

Appears with rank of Priv. on

Muster and Descriptive Roll

of Detachment U S Colored
Recruits mustered for U.S.
Colored Troop Roll dated

Louisville Ky, Aug 30, 1864.

Where born Nelson Co Ky

Age 24 years; occupation laborer

When enlisted Aug 27, 1864.

Where enlisted Louisville Ky

For what period enlisted 3 years.

Eyes dark; hair dark

Complexion dark; height 5 ft. 7 in.

When mustered in Aug 30, 1864.

Where mustered in Louisville Ky

Bounty paid \$ 100; due \$ 100

Clothing account:

Last settled _____, 186 ; drawn since \$ 100

Date of first muster _____, 186 .

Company to which assigned _____

Remarks: ser to Nelson Co
H List

Book mark: _____

C. D. Burton

(356m)

Copyist.

6 | 5600 | U.S.C.T.

John Croopus

Appears with rank of Pvt on

Muster and Descriptive Roll

of a Detachment of U.S. Cold
Troops transferred to U.S. Cold Co.
at Lexington, Ky

Roll dated
Louisville, Ky., Sept 2, 1864.

Where born Felson, Ky.

Age 24 years; occupation Laborer

When enlisted Aug. 27, 1864.

Where enlisted Louisville, Ky.

For what period enlisted 3 years.

Eyes brn; hair brn

Complexion brn; height 5 ft. 7 in.

When mustered in Aug. 30, 1864.

Where mustered in Louisville

Bounty paid \$ 100; due \$ 100

Clothing account:

Last settled 186; drawn since \$ 1755
100

Date of first muster Aug. 30, 1864.

Company to which assigned

Remarks: transferred to 4 Cong. Dist

Book mark:

B. J. Adair

(356m)

Copyist.

6

5 Cav.

U.S.C.T.

John Crooms

Priv, Co. B, 5 Reg't U. S. Col'd Cavalry.

Appears on

Company Muster-in and Descriptive Roll

of the organization named above. Roll dated

Camp Nelson, ^{Ky} N. Y., Oct. 24, 1864.

Where born Nelson, Ky

Age 21 y'rs; occupation Laborer

When enlisted Aug. 27, 186 .

Where enlisted Louisville

For what period enlisted 3 years.

Eyes *dk.*; hair *dk.*

Complexion *dk.*; height 5 ft. 7 in.

When mustered in Aug. 30, 186 .

Where mustered in Louisville

Bounty paid \$ 100; due \$ 100

Where credited 4" Dist. Ky.

Company to which assigned B

Remarks:

Book mark:

Shull

(356d)

Copyist.

C | **5 Cav.** | **U.S.C.T.**

John Brown

Priv., Co. C, 5 Reg't U. S. Col'd Cavalry.

Appears on

Company Muster Roll

for *to Oct. 31*, 186*4*.

Present or absent *Absent*

Stoppage, \$ *100* for

Due Gov't, \$ *100* for

Valuation of horse, \$ *100*

Valuation of horse equipments, \$ *100*

Remarks: *Wounded at the Battle of Sautterville, Va. Oct. 9, 1864. In Hospital*

Book mark: _____

Smith

6 | 5 Cav | U.S.C. & G.

John Corum
Obt., Co., 5 Reg't U.S.C. & G.

Appears on

Hospital Muster Roll

of U. S. A. General Hospital,

at Ashland, Ky.,

for Sept & Oct, 1864

Attached to hospital:

When Oct 14, 1864

How employed Patient

Last paid by Maj.

to _____, 186 .

Bounty paid \$ 100; due \$ 100

Present or absent Present

Remarks: No desert Holi

Book mark :

J. Brown
Copyist.

4 | **5 Cav. | U.S.C.T.**

John Thomas
Ohio, Co. C, 5 Reg't U. S. Col'd Cavalry.

Appears on

Company Muster Roll

for *Nov. & Dec.*, 186 4.

Present or absent *Present*

Stoppage, \$ *100* for

Due Gov't, \$ *100* for

Valuation of horse, \$ *100*

Valuation of horse equipments, \$ *100*

Remarks: *First & Second instal
ments bounty due*

Book mark:

Shull

6 | 5 Cav. | U.S.C.T.

John Crooms

Pvt, Co. C, 5 Reg't U. S. Col'd Cavalry.

Appears on

Company Muster Roll

for *Jan'y. & Feb'y*, 186*5*.

Present or absent *Absent*

Stoppage, \$ *100* for

Due Gov't, \$ *100* for

Valuation of horse, \$ *100*

Valuation of horse equipments, \$ *100*

Remarks: *Detached service member of Brigade Band First instalment Bounty due \$100*

Book mark: _____

Shull

(358)

Copyist.

11

5 Cav. U.S.C.T.

John Brown

1100, Co. C, 5 Reg't U. S. Col'd Cavalry.

Appears on

Company Muster Roll

for *Mar. 7 1867*, 186*7*.

Present or absent *Absent*

Stoppage, \$ *100* for

Due Gov't, \$ *100* for

Valuation of horse, \$ *100*

Valuation of horse equipments, \$ *100*

Remarks: *In Brigade Band
Louisville, Ky. First instal-
ment of Bounty due \$100*

Book mark:

Small

6 | 5 Cav. | U.S.C.T.

John ...
..., Co. C, 5 Reg't U. S. Col'd Cavalry.

Appears on

Company Muster Roll

for *May & June*, 1865.

Present or absent *Absent*

Stoppage, \$ 100 for

Due Gov't, \$ 100 for

Valuation of horse, \$ 100

Valuation of horse equipments, \$ 100

Remarks: *With Brigade to David
Louisville Ky. First
instalment of Bounty
due \$100*

Book mark:

(358)

J. ...

Copyist.

5 Cav. U.S.C.T.

John ...
... Co. C, 5 Reg't U. S. Col'd Cavalry.

Appears on

Company Muster Roll

for July to Aug., 1865

Present or absent Present

Stoppage, \$ 100 for

Due Gov't, \$ 100 for

Valuation of horse, \$ 100

Valuation of horse equipments, \$ 100

Remarks:

Book mark:

(358)

J. ...
Copyist.

6

5 Cav. U.S.C.T.

John Crockett
Sgt., Co. C, 5 Reg't U. S. Col'd Cavalry.

Appears on

Company Muster Roll

for Sep. + Oct, 1865.

Present or absent Present

Stoppage, \$ 100 for

Due Gov't, \$ 100 for

Valuation of horse, \$ 100

Valuation of horse equipments, \$ 100

Remarks: Reg. "Band"

Book mark:

(358)

Leider Copyist.

6

5 Cav. U.S.C.T.

John Crooms

Sgt., Co. C, 5 Reg't U. S. Col'd Cavalry.

Appears on

Company Muster Roll

for Nov Dec, 1865.

Present or absent Present

Stoppage, \$ 100 for

Due Gov't, \$ 100 for

Valuation of horse, \$ 100

Valuation of horse equipments, \$ 100

Remarks: In Daily Duty with Regt Band

Book mark:

(358)

Junder

Copyist.

C

5 Cav.

U.S.C.T.

John Crooms
Pat, Co. C, 5 Reg't U. S. Col'd Cavalry.

Appears on

Company Muster Roll

for Jan and Feb, 1866

Present or absent Present

Stoppage, \$ 100 for

Due Gov't, \$ 100 for

Valuation of horse, \$ 100

Valuation of horse equipments, \$ 100

Remarks: On daily duty
with Reg Band

Book mark:

Rose

(358)

Copyist.

C

5 Cav. U.S.C.T.

John Crooms.

Regt. Co. C, 5 Reg't U. S. Colored Cav.
Musen.

Appears on Returns as follows:

Oct. 1864. Absent sick. Act. Corpl.
at Saltville Battle. Wounded.

Nov. 1864. Absent sick, Hoop, Camp
Nelson.

Jan. 1865. Absent, detachd serv., member
of Brig. Band.

Feb. & Mar. 1865. (Musen) Absent on
detachd service with Brig. Band.

Apr. to July 1865. Absent with Brig.
Band, in Louisville, Ky. (Pvt.)

Aug. 1865. (Pvt.) Absent with Brig. Band
at Camp Nelson, Ky.

Sept. 1865. On duty with Reg. Band

Oct. 1865. (Corpl.) In duty, Corpl. Reg.
Band.

Nov. 1865 to Feb. 1865. (Pvt.) On duty,
detachd with Reg. Band.

Book mark :

(546)

Baker
Copyist.

C

5 Cav.

U.S.C.T.

John Crooms

Priv., Co. C, 5 Reg't U. S. Col'd Cavalry.

Appears on Co. Muster-out Roll, dated

Helena Ark, March 16, 1866.

Muster-out to date

March 16, 1866.

Last paid to

Dec 31, 1865.

Clothing account:

Last settled....., 186 ; drawn since \$..... 100

Due soldier \$ 20⁷⁰/₁₀₀; due U. S. \$..... 100

Am't for cloth'g in kind or money adv'd \$..... 100

Due U. S. for arms, equipments, &c., \$..... 100

Bounty paid \$ 100/₁₀₀; due \$ 100/₁₀₀

Remarks Due US for Ord 80¢

Book mark: Dis. 1196

Rose

(861)

Copyist.

Broome John

Co.

Reg't

U. S. C. I

Enclosures.

Bed Cards	Final Statements
Burial Records	Furloughs or L. of A
Certs. of Dis. for Discharge	Med. Certificates
C. M. Charges	Med. Des. Lists
Descriptive Lists	Orders
Discharge Certificates	Pris. of War Record
Enlistment Papers	Resignations

Other papers relating to—

Admission to Hosp'l	Furlough or L. of A
Casualty Sheet	Med. Examination
Confinement	Misc. Information
Contracts	Pay or Clothing
Death or Effects	Personal Reports
Desertion	Rank
Discharge from Hosp'l	Transfer to Hosp'l
Discharge from Service	Transfer to V. R. C.
Duty	Transportation

Note 1.—This blank will be used for enlistments of United States colored troops. They will be made out in duplicate in all cases—one to accompany the recruiting return of the superintendent (not the recruiting officer) to the Adjutant General, and one to accompany the accounts of the officer who pays bounty, &c.

Note 2.—An enlistment holds to service. A muster-in must, in all cases, precede payment of pay, bounty, pension, &c. A muster-in roll, must in all cases, be filed in the Adjutant General's Office as evidence of an enlistment. The mustering officer, commissary, or assistant commissary of musters, as the case may be, will countersign both enlistments as having mustered the soldiers into the service of the United States before either of them is given to the disbursing officer.

DECLARATION OF RECRUIT.

I, Joseph Adams desiring to volunteer as a soldier in the ARMY OF THE UNITED STATES, for the term of Three Years, DO DECLARE That I am 24 years and months of age; that I have never been discharged from the United States service on account of disability or by sentence of a court-martial, or by order before the expiration of a term of enlistment; and I know of no impediment to my serving honestly and faithfully as a soldier for three years.

GIVEN at Lancaster Pa the 27 day of Aug 1864

Witness: J. B. Watson

John Adams

No. 400
Volunteered at Lancaster Pa
Aug 27 1864
12 3rd Co. 2d Regt
Infy

143

Consent of Parent or Guardian in case of a Minor, if a Free Man, or in the case of a Slave, of the Person to whom he owes Service:

I, Do CERTIFY, That I am the that the said is years of age; and I do freely give my CONSENT to his volunteering as a ~~SOLDIER~~ in the Army of the United States, for the period of THREE YEARS, under the conditions of the laws of the United States.

GIVEN at the day of

Witness:

UNITED STATES COLORED TROOPS ENLISTMENT.

STATE OF

TOWN OF

Kentucky
I, *John Brown* born in *Louisville*
in the State of *Ky* aged *24* years

and by occupation a *Farmer* Do HEREBY ACKNOWLEDGE TO

have volunteered *27* day of *August* 186*4*

to serve as a **Soldier** in the **Army of the United States of America**, for the period of **THREE YEARS**, unless sooner discharged by proper authority: Do also agree to accept such bounty, pay, rations, and clothing, as are, or may be, established by law for the U. S. colored troops.

And I, *John Brown*

do solemnly swear that I will bear true faith and allegiance to the **United States of America**, and that I will serve them honestly and faithfully against all their enemies or opposers whomsoever; and that I will observe and obey the orders of the President of the United States, and the orders of the officers appointed over me, according to the Rules and Articles of War.

Sworn and subscribed to, at *Louisville Ky*
this *27* day of *Aug '64*
Before *Capt C. C. Ham* *John Brown*

I CERTIFY, ON HONOR, That I have carefully examined the above named Volunteer agreeably to the General Regulations of the Army, and that, in my opinion, he is free from all bodily defects and mental infirmity, which would in any way disqualify him from performing the duties of a soldier.

D. G. ... M.D.

EXAMINING SURGEON.

I CERTIFY, ON HONOR, That I have minutely inspected the Volunteer *J. Brown* previously to his enlistment, and that he was entirely sober when enlisted, that, to the best of my judgment and belief, he is of lawful age; and that, in accepting him, as duly qualified to perform the duties of an able-bodied soldier, I have minutely observed the regulations which govern the recruiting service. This soldier has *20* eyes, *20* hair, *20* complexion, is *5* feet *7* inches high.

C. C. Ham *Capt*
12th Ky Only
RECRUITING OFFICER OR AGENT.

Mustered into the United States Service *30th* day of *Aug* 186*4*

J. P. ...
Mustering Officer.

John Brown

Mustered into the service of the United States, for three years or during the war, from date of enlistment, in Company ...
Regiment of ...
Volunteers, on the ... day of ... 186, at ...

RECRUIT.

Wm desiring
ED STATES, for the term of *Three Years*,
..... months of age; that I have
n account of disability or by sentence of a
term of enlistment; and I know of no
soldier for three years.

Will
day of *Aug 1864*

Wm
John L. ...

Volunteered at
Aug 18 64
Co. C. 2d Regt
12 July
1864
12 July
1864

143

Minor, if a Free Man, or in the case of
ice:

..... Do CERTIFY, That I am

..... years of age; and I

..... in the Army of the United States,

..... of the laws of the United States.

day of

UNITED STATES COLORED TROOPS ENLISTMENT.

STATE OF

TOWN OF

Kentucky *Louisville*

I *John Brown* born in *Nelson Co*
in the State of *Ky* aged *24* years

and by occupation a *Farmer* Do HEREBY ACKNOWLEDGE TO

have volunteered *27* day of *August* 186*4*

to serve as a **Soldier** in the **Army of the United States of America**, for the period of **THREE YEARS**, unless sooner discharged by proper authority: Do also agree to accept such bounty, pay, rations, and clothing, as are, or may be, established by law for the U. S. colored troops.

And I, *John Brown* do solemnly swear that I will bear true faith and allegiance to the **United States of America**, and that I will serve them honestly and faithfully against all their enemies or opposers whomsoever; and that I will observe and obey the orders of the President of the United States, and the orders of the officers appointed over me, according to the Rules and Articles of War.

Sworn and subscribed to, at *Louisville Ky*
this *27* day of *Aug '64*
Before *Capt C. C. Ham* *John Brown*

I CERTIFY, ON HONOR, That I have carefully examined the above named Volunteer agreeably to the General Regulations of the Army, and that, in my opinion, he is free from all bodily defects and mental infirmity, which would in any way disqualify him from performing the duties of a soldier.

D. Curran M.D.

EXAMINING SURGEON.

I CERTIFY, ON HONOR, That I have minutely inspected the Volunteer, *J. Brown* previously to his enlistment, and that he was entirely sober when enlisted, that, to the best of my judgment and belief, he is of lawful age; and that, in accepting him, as duly qualified to perform the duties of an able-bodied soldier, I have strictly observed the regulations which govern the recruiting service. This soldier has *blue* eyes, *brn* hair, *fair* complexion, is *5* feet *10* inches high.

C. C. Ham *Capt*
12th Ky
RECRUITING OFFICER OR AGENT.

Mustered into the United States Service *30th* day of *Aug* 186*4*

J. P. C. *Capt*
Mustering Officer.

John Brown

Mustered into the service of the United States, for three years or during the war, from date of enlistment, in Company _____
Regiment of _____
Volunteers, on the _____ day of _____, 1864, at _____

319
Crutcher Andrew

Co D, 5 U. S. Col'd Cav.

Private Private

CARD NUMBERS.

1	5360668	26
2	5360765	27
3	5361607	28
4	9090104	29
5	40729580	30
6		31
7		32
8		33
9		34
10		35
11		36
12		37
13		38
14		39
15		40
16		41
17		42
18		43
19		44
20		45
21		46
22		47
23		48
24		49
25		50

Book Mark:

See also

C | **5 Cav. | U.S.C.T.**

Andrew Crutcher

Co. *B*, 5 Reg't U. S. Col'd Cav.

Appears on

Company Descriptive Book
of the organization named above.

DESCRIPTION.

Age *25* years; height *5* feet *7* inches.

Complexion *Blk*

Eyes *Blk*; hair *Blk*

Where born *Ferrisville Co Ky*

Occupation *Farmer*

ENLISTMENT.

When *Aug 16*, 1864.

Where *Camp Nelson*

By whom *J. C. Randolph*; term *3* y'rs.

Remarks: *Discharged in action*

at Smith's Cross, Va. Aug 24

Farmer

C

5 Cav.

U.S.C.T.

Andrew Crocker

Co. B, 5 Reg't U. S. Col'd Cavalry.

Appears on

Company Muster-in and Descriptive Roll

of the organization named above. Roll dated

Camp Nelson, ^{N.Y.} N. Y., Dec 24, 1864.

Where born Jessamine Ky

Age 25 y'rs; occupation Farmer

When enlisted Aug 16, 1864.

Where enlisted Co B Nelson

For what period enlisted 3 years.

Eyes Blue; hair Black

Complexion Blue; height 5 ft. 7 in.

When mustered in Aug 16, 1864.

Where mustered in Co B Nelson

Bounty paid \$ 100; due \$ 100

Where credited 7 Dist. Ky

Company to which assigned B

Remarks: * Name of owner of Negro James Crocker

* Added May 12 98. H. J.

Book mark:

Lauel

6

5 Cav.

U.S.C.T.

Andrew Grutcher
Andrew Grutcher

Rein, Co. B, 5 Reg't U. S. Col'd Cavalry.

Appears on

Company Muster Roll

for *Oct 31, 1864*, 1864.

Present or absent *Absent*

Stoppage, \$ *100* for

Due Gov't, \$ *100* for

Valuation of horse, \$ *100*

Valuation of horse equipments, \$ *100*

Remarks: *Prisoner at Salt-
ville Va. Oct 2, 1864*

+ Corrected by W. H. Spang. Ex.

Book mark:

Lauch

2 | 5 Cav. | U.S.C.T.

Andrew Crutcher.

Co. B . 5 Reg't U. S. Colored Cav.

Appears on Returns as follows:

From organization to Oct. 31/64. Ab-
sent, prisoner of war, Saltille,
Va., Oct. 2/64.

Book mark :

(546)

J. Baker
Copyist.

C

5 Cav.

U.S.C.T.

Andrew Crutchen

B, Co. B, 5 Reg't U. S. Col'd Cavalry.

Appears on Co. Muster-out Roll, dated Helena Ark, Mar 16, 1864.

Muster-out to date _____, 186 .

Last paid to . Due for Emptment _____, 186 .

Clothing account:

Last settled _____, 186 ; drawn since \$ _____ 100

Due soldier \$ _____ 100; due U. S. \$ 23 57/100

Am't for cloth'g in kind or money adv'd \$ _____ 100

Due U. S. for arms, equipments, &c., \$ _____ 100

Bounty paid \$ _____ 100; due \$ _____ 100

Remarks: • Missing after Battle of 2/24 Gettville Va. Mare apt 19. 1861

Book mark: 1633 1878

(261)

[Signature]

Copyist.

Scrutcher, Andrew

P, Co. B,

5

Reg't

U. S. C. Cav

R Enclosures.

Bed Cards	Descriptive Lists
Burial Records	Final Statements
Certs. of Dis. for Discharge	Furloughs
C. M. Charges	Med. Des. Lists
Med. Certificates	Orders

P. of W, 1

Other papers relating to—

Admission to Hosp'l	Furlough
Casualty Sheet (Officer's)	Med. Examination
Confinement	Misc. Information <i>/</i>
Contracts	Pay or Clothing
Death or Effects	Personal Reports
Desertions	Rank
Discharge from Hosp'l	Transfer to Hosp'l
Discharge from Service	Transfer to V. R. C.
Duty	Transportation

MEMORANDUM FROM PRISONER OF WAR RECORDS.

No. _____

(This blank to be used only in the arrangement of said records.)

NAME.	RANK.	ORGANIZATION.				INFORMATION OBTAINED FROM—				
		No. of Reg't.	State.	Arm of Service.	Co.	Records of—	Vol.	Page.	Vol.	Page.
<i>Crutcher Andrew</i>	<i>P</i>	<i>5</i>	<i>U.S. Col'd</i>	<i>6</i>	<i>B</i>	<i>Meis Index</i>				
						<i>R Book</i>				
						<i>Ex-11</i>				
						<i>No R.</i>	<i>14</i>	<i>+</i>	<i>39</i>	<i>69</i>

Captured at _____, 186 , confined at Richmond, Va., _____, 186 .

Admitted to Hospital at _____

where he died _____, 186 , of _____

Paroled at _____, 186 ; reported at Camp Parole, Md., _____, 186 .

No record subsequent to Oct 1/64.

Pen case 312437 to USCT Branch Oct 29/86 Copied by *E.C.C. 9-27-86.*

Mr. Bingham:

Please report from
Prisoner of War records

C. T. Div. Repts
Oct 23/86. W. Anderson
for D.W.P.
Andrew Crutcher,
Priv. Co. B-5th U.S.C. Cav.

Prisoner of War Records
furnish no information

PT
Oct 29 86
B.E.

6-452 $\frac{1}{85}$ Pension Register.

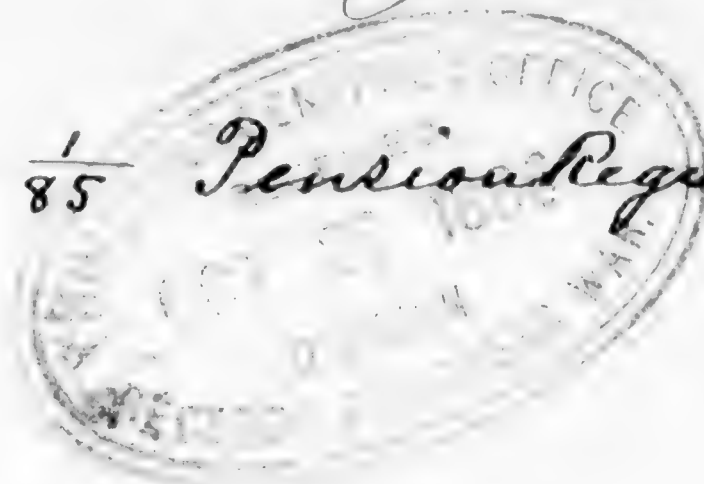

325

Cull Charles

Co, 5 U. S. Col'd Cav.

Corporal.

Private

CARD NUMBERS.

1	5-365-713	26
2	5-365-814	27
3	5-365-915	28
4	5-366-010	29
5	5-366-104	30
6	5-366-223	31
7	5-366-311	32
8	5-366-402	33
9	5-366-489	34
10	5-366-578	35
11	5-366-663	36
12	9090637	37
13	40729624	38
14		39
15		40
16		41
17		42
18		43
19		44
20		45
21		46
22		47
23		48
24		49
25		50

Book Mark:

See also

L. 1500789 Pomeroy
S. 1505579 Audubon
R. & P. 516027

Amesbury Co

6 | **5 Cav. | U.S.C.T.**

Charles Bull
Capt, Co. A, 5 Reg't U. S. Col'd Cav.

Appears on

Company Descriptive Book
of the organization named above.

DESCRIPTION.

Age 30 years; height 5 feet 6 inches.

Complexion Black

Eyes Black; hair Black

Where born Washington Ky

Occupation farmer

ENLISTMENT.

When Sept 8, 186 .

Where Camp Nelson

By whom J. C. Randolph, term 3 y'rs.

Remarks: _____

J. C. P. P. P.

(383g)

Copist.

C. | **5 Cav.** | **U.S.C.T.**

Charles Cole

Cole, Co. G, 5 Reg't U. S. Col'd Cavalry.

Appears on

Company Muster-in and Descriptive Roll
of the organization named above. Roll dated

Camp Nelson Ky, N. Y., Oct. 23, 1864.

Where born Washington Ky.

Age 30 y'rs; occupation Farmer.

When enlisted Sept. 8, 1864.

Where enlisted Camp Nelson Ky.

For what period enlisted 3 years.

Eyes Black; hair Black.

Complexion Black; height 5 ft. 6 in.

When mustered in Sept. 8, 1864.

Where mustered in Camp Nelson.

Bounty paid \$ 100; due \$ 100

Where credited 4th Dist. Ky.

Company to which assigned

Remarks:

X James Cole,

X

supposed to be name of owner

dated May 16. 98. H. A. F.

Filed with Charles Cole

Book mark:

[Signature]

(356d) Copyist.

C_o

5 Cav.

U.S.C.T.

Charles Bull,

Capt., Co. G, 5 Reg't U. S. Col'd Cavalry.

Appears on

Company Muster Roll

for *Enlt. to Oct. 31, 1864.*

Present or absent *present.*

Stoppage, \$ *100* for

Due Gov't, \$ *100* for

Valuation of horse, \$ *100*

Valuation of horse equipments, \$ *100*

Remarks:

Appointed per Reg'tl. Order No. 12, Oct. 29/64

Book mark:

(358)

[Signature]

Copyist.

C. | **5 Cav.** | **U.S.C.T.**

Charles Bull,

Corpl., Co. G, 5 Reg't U. S. Col'd Cavalry.

Appears on

Company Muster Roll

for Nov. + Dec., 1864.

Present or absent present,

Stoppage, \$ 100 for

Due Gov't, \$ 100 for

Valuation of horse, \$ 100

Valuation of horse equipments, \$ 100

Remarks: 1st + 2^d visit
Bounty due.

Book mark: _____

(358)

[Signature]
Copyist.

C. | **5 Cav.** | **U.S.C.T.**

Charles Bull,

Capt., Co. G, 5 Reg't U. S. Col'd Cavalry.

Appears on

Company Muster Roll

for *Jan. & Feby*, 1865.

Present or absent *present*.

Stoppage, \$ *100* for

Due Gov't, \$ *100* for

Valuation of horse, \$ *100*

Valuation of horse equipments, \$ *100*

Remarks:

*See U.S. for Ord. 25th
1st Inst. Brevet of 126th Regt.*

Book mark:

(358)

[Signature]

Copyist.

C. | 5 Cav. | U.S.C.T.

Charles Cull,

Cop^l, Co. G, 5 Reg't U. S. Col'd Cavalry.

Appears on

Company Muster Roll

for March + April, 1865.

Present or absent present.

Stoppage, \$ 100 for

Due Gov't, \$ 100 for

Valuation of horse, \$ 100

Valuation of horse equipments, \$ 100

Remarks: 1st instalment
Bounty of \$100⁰⁰ due.

Book mark: _____

(358)

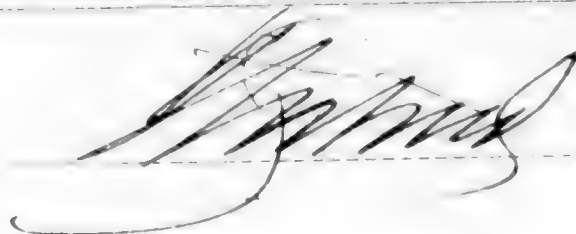

Copyist.

5 Cav. U.S.C.T.

Charles Zell

Co. G, 5 Reg't U. S. Col'd Cavalry.

Appears on

Company Muster Roll

for May - June, 1865.

Present or absent Present

Stoppage, \$ 100 for

Due Gov't, \$ 100 for

Valuation of horse, \$ 100

Valuation of horse equipments, \$ 100

Remarks: Reduced from
rank for B.O. No. 13,
dated Paris, Ky. May
1865. First Medal
Bounty due \$100

Book mark:

Copyist.

5 | **5 Cav.** | **U.S.C.T.**

Charles Hill
Sgt., Co. G, 5 Reg't U. S. Col'd Cavalry.

Appears on

Company Muster Roll

for *July 1865*, 1865.

Present or absent *Present*

Stoppage, \$ 100 for

Due Gov't, \$ 100 for

Valuation of horse, \$ 100

Valuation of horse equipments, \$ 100

Remarks:
.....
.....
.....
.....
.....
.....
.....
.....
.....
.....

Book mark :
.....
.....

(358) *[Signature]* Copyist.

62

5 Cav. U.S.C.T.

Charles Good

Sgt., Co. G, 5 Reg't U. S. Col'd Cavalry.

Appears on

Company Muster Roll

for Sept. 1st, 1865.

Present or absent Present

Stoppage, \$ 100 for

Due Gov't, \$ 100 for

Valuation of horse, \$ 100

Valuation of horse equipments, \$ 100

Remarks:

Book mark:

(358)

John [Signature]

Copyist.

Charles Hall
Co. G, 5 Reg't U. S. Col'd Cavalry.

Appears on

Company Muster Roll

for Nov. Dec., 1865.

Present or absent Present

Stoppage, \$ 100 for

Due Gov't, \$ 100 for

Valuation of horse, \$ 100

Valuation of horse equipments, \$ 100

Remarks: Daily duty
Reg't 5th Cav

Book mark:

Copyist.

Charles Bull

Sart., Co. G, 5 Reg't U. S. Col'd Cavalry.

Appears on

Company Muster Roll

for *January to Feb'y*, 1866.

Present or absent *Present*

Stoppage, \$ *100* for

Due Gov't, \$ *100* for

Valuation of horse, \$ *100*

Valuation of horse equipments, \$ *100*

Remarks: *Daily duty Reg't. War.*

Book mark: _____

Prater

(358)

Copyist.

C | **5 Cav.** | **U.S.C.T.**

Charles Cull.

Priv., Co. *G*, 5 Reg't U. S. Colored Cav.

Appears on **Returns** as follows:

*Sept. 1865. Absent on detached service
with Regt. Band.*

*Oct. 1865 to Feb. 1866. On duty with
Regt. Band.*

Book mark :

(546)

A. Baker
Copyist.

Charles Bull

Priv., Co. G, 5 Reg't U. S. Col'd Cavalry.

Appears on Co. Muster-out Roll, dated

Helena, Ark. Mich. 16, 1866.

Muster-out to date Mich. 16, 1866.

Last paid to Dec. 31, 1865.

Clothing account:

Last settled....., 186 ; drawn since \$ 100

Due soldier \$ 100; due U. S. \$ 14 ⁰⁹/₁₀₀

Am't for cloth'g in kind or money adv'd \$ 100

Due U. S. for arms, equipments, &c., \$ 100

Bounty paid \$ 100 100; due \$ 100 100

Remarks: Slave - Corp'l. from
Co. G until May 15/65;
then priv.

Book mark:

Tabler

Went, Charles

, Co. G, 5 Reg't U.S.C. Co.

3 Enclosures.

Bed Cards	Final Statements
Burial Records	Furloughs or L. of A
Certs. of Dis. for Discharge	Med. Certificates
C. M. Charges	Med. Des. Lists
Descriptive Lists	Orders /
Discharge Certificates	Pris. of War Record
Enlistment Papers ✓	Resignations

Other papers relating to—

Admission to Hosp'l	Furlough or L. of A
Casualty Sheet	Med. Examination
Confinement	Misc. Information
Contracts	Pay or Clothing
Death or Effects	Personal Reports
Desertion	Rank
Discharge from Hosp'l	Transfer to Hosp'l
Discharge from Service	Transfer to V. R. C.
Duty	Transportation

NOTE 1.—This blank will be used for enlistments of United States colored troops. They will be made out in duplicate in all cases—one to accompany the recruiting return of the superintendent, ~~not the recruiting officer~~, and one to accompany the accounts of the officer who pays bounty, &c.

NOTE 2.—An enlistment holds to service. A mustered-in must, in all cases, precede payment of pay, bounty, pension, &c. A muster-in roll, must in all cases, be filed in the Adjutant General's Office as evidence of muster-in. The mustering officer, commissary, or assistant commissary of musters, as the case may be, will countersign both enlistments as having mustered the soldiers into the service of the United States before either of them is given to the disbursing officer.

DECLARATION OF RECRUIT.

I, Charles Bull desiring to volunteer as a soldier in the ARMY OF THE UNITED STATES, for the term of Three Years, DO DECLARE That I am 30 years and months of age; that I have never been discharged from the United States service on account of disability, or by sentence of a court-martial, or by order before the expiration of a term of enlistment; and I know of no impediment to my serving honestly and faithfully as a soldier for three years.

GIVEN at Camp Nelson the 8 day of September 1864

Witness: George Hart

Charles Bull

By James Bull
at Washington
D.C.
Sept 8th 1864
Volunteered at Camp Nelson
No. 2000 100
George Bull

Consent of Parent or Guardian in case of a Minor, if a Free Man, or in the case of a Slave, of the Person to whom he owes Service:

I, Do CERTIFY, That I am the that the said is years of age; and I do freely give my CONSENT to his volunteering as a SOLDIER in the Army of the United States, for the period of THREE YEARS, under the conditions of the laws of the United States.

GIVEN at the day of

Witness:

UNITED STATES COLORED TROOPS ENLISTMENT.

STATE OF

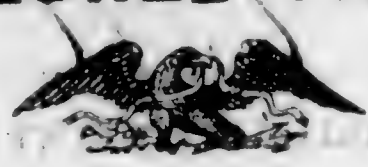

TOWN OF

I, Charles Bull born in Washington DC
 in the State of Kentucky aged Thirty years
 and by occupation a Printer Do HEREBY ACKNOWLEDGE to
 have volunteered Eight day of September 1864
 to serve as a **Soldier** in the **Army of the United States of America**, for the
 period of **THREE YEARS**, unless sooner discharged by proper authority: Do
 also agree to accept such bounty, pay, rations, and clothing, as are, or may be,
 established by law for the U. S. colored troops.

And I, Charles Bull
 do solemnly swear that I will bear true faith and allegiance to the **United States
 of America**, and that I will serve them honestly and faithfully against all their
 enemies or opposers whomsoever; and that I will observe and obey the orders
 of the President of the United States, and the orders of the officers appointed
 over me, according to the Rules and Articles of War.

Sworn and subscribed to, at Camp Nelson
 this 8th day of Sept. 1864 Charles Bull
 Before J. C. Randolph D. P. M.

I CERTIFY, ON HONOR, That I have carefully examined the above named Volunteer agree-
 ably to the General Regulations of the Army, and that, in my opinion, he is free from all bodily
 defects and mental infirmity, which would in any way disqualify him from performing the
 duties of a soldier.

J. G. Barrett
 Asst Surgt U.S.A.
 EXAMINING SURGEON.

I CERTIFY, ON HONOR, That I have minutely inspected the Volunteer, Charles Bull
 previously to his enlistment, and that he was entirely sober when enlisted; that, to the best of
 my judgment and belief, he is of lawful age; and that, in accepting him as duly qualified to per-
 form the duties of an able-bodied soldier, I have strictly observed the regulations which govern
 the recruiting service. This soldier has Blue eyes, Black hair, Black com-
 plexion, is Five feet Eight inches high.

J. C. Randolph
 and D. P. M.
 RECRUITING OFFICER OR AGENT.

Mustered into the United States Service Eight day of September 1864.

N. C. Kinney
 Capt 18th Inf
 Mustering Officer.

Mustered into the service of the United States, for three years or during the war, from date of enlistment, in Company 1
 Regiment of MS Colored Volunteers, on the Eight day of September 1864 at Camp Nelson
N. C. Kinney

Capt 18th Inf
Mustering Officer

This blank will be used for enlistments of United States colored troops. They will be made out in duplicate in all cases—one to accompany the recruiting return of the superintendent (not the recruiting officer) to the Adjutant General, and one to accompany the accounts of the officer who pays bounty, &c.

NOTE 2.—An enlistment holds ~~good~~ ^{void} only if must, in all cases, precede payment of pay, bounty, pension, &c. A muster-in roll, must in all cases, be filed in the Adjutant General's Office as evidence of muster-in. The mustering officer, commissary, or assistant commissary of musters, as the case may be, will countersign both enlistments as having mustered the soldiers into the service of the United States before either of them is given to the disbursing officer.

DECLARATION OF RECRUIT.

I, Charles Bull desiring to volunteer as a soldier in the ARMY OF THE UNITED STATES, for the term of Three Years, DO DECLARE That I am 30 years and months of age; that I have never been discharged from the United States service on account of disability or by sentence of a court-martial, or by order before the expiration of a term of enlistment; and I know of no impediment to my serving honestly and faithfully as a soldier for three years.

GIVEN at Camp Nelson Ky the 8 day of September 1864

Witness: Leroy Kirk

Charles Bull

[Faint circular stamp with text "1864" and "1861" visible]

James Bull
Washington Co

Charles Bull
 C. U. N. 18

Consent of Parent or Guardian in case of a Minor, if a Free Man, or in the case of a Slave, of the Person to whom he owes Service:

I, Do CERTIFY, That I am the that the said is years of age; and I do freely give my CONSENT to his volunteering as a SOLDIER in the Army of the United States, for the period of THREE YEARS, under the conditions of the laws of the United States.

GIVEN at the day of

Witness: [Signature]

UNITED STATES COLORED TROOPS ENLISTMENT.

STATE OF _____ TOWN OF _____

I, Charles Cull born in Camp Nelson
Washington Co
in the State of Kentucky aged Thirty years
and by occupation a Farmer Do HEREBY ACKNOWLEDGE to
have volunteered Eight day of September 1864
to serve as a **Soldier** in the **Army of the United States of America**, for the
period of **THREE YEARS**, unless sooner discharged by proper authority: Do
also agree to accept such bounty, pay, rations, and clothing, as are, or may be,
established by law for the U. S. colored troops.

And I, Charles Cull
do solemnly swear that I will bear true faith and allegiance to the **United States
of America**, and that I will serve them honestly and faithfully against all their
enemies or opposers whomsoever; and that I will observe and obey the orders
of the President of the United States, and the orders of the officers appointed
over me, according to the Rules and Articles of War.

Sworn and subscribed to, at Camp Nelson
this 8 day of Sept 1864 Charles Cull
Before J. C. Randolph notary

I CERTIFY, ON HONOR, That I have carefully examined the above named Volunteer agree-
ably to the General Regulations of the Army, and that, in my opinion, he is free from all bodily
defects and mental infirmity, which would in any way disqualify him from performing the
duties of a soldier.

J. G. Barrett
Asst Surg, U. S. A.
EXAMINING SURGEON.

I CERTIFY, ON HONOR, That I have minutely inspected the Volunteer C. Cull
previously to his enlistment, and that he was entirely sober when enlisted; that, to the best of
my judgment and belief, he is of lawful age; and that, in accepting him as duly qualified to per-
form the duties of an able-bodied soldier, I have strictly observed the regulations which govern
the recruiting service. This soldier has blue eyes, blue hair, fair com-
plexion, is five feet eight inches high.

J. C. Randolph
and D. P. M.
RECRUITING OFFICER OR AGENT.

Mustered into the United States Service... Eight day of September 1864

N. C. Finney
Capt U. S. Army
Mustering Officer.

Mustered into the service of the United States, for three years or during the war, from date of enlistment, in Company _____
Regiment of Miss Colored Volunteers, on the Eight day of September 1864 at Camp Nelson
N. C. Finney
Major-General

Sept 11th 1860

No. 495 5th Inf Co
Camp Nelson Ky Sept-1st 1862

Order
No. 147 } "Extract"

VIII. Private Charles Bull Co 5th Inf Co
is hereby detailed on daily duty with the band
5th Inf Co. He will report to St. Reed
for duty immediately

By order of
J. W. Anderson
Capt. Comdg Regt
W. Jackson
Lt. P. A. D. B.

Cunningham Charles

Co I, 5 U. S. Col'd Cav.

Private Private

CARD NUMBERS.

5367803	26
5367899	27
5367999	28
5368092	29
5368184	30
5368280	31
5368371	32
5368459	33
5368544	34
5368631	35
5368713	36
9090966	37
9221600	38
43143492	39
40729641	40
	41
	42
	43
	44
	45
	46
	47
	48
	49
	50

Book Mark:

See also

6 | **5 Cav. | U.S.C.T.**

Charles Cunningham

....., Co. I, 5 Reg't U. S. Col'd Cav.

Appears on

Company Descriptive Book
of the organization named above.

DESCRIPTION.

Age 19 years; height 5 feet 5 1/2 inches.

Complexion Yellow

Eyes Brown; hair Black

Where born Grayson Ky

Occupation Farmer

ENLISTMENT.

When June 27, 1864.

Where Lebanon

By whom Capt Fidler; term 3 y'rs.

Remarks:

.....

.....

.....

.....

.....

.....

.....

A. J. Anderson

C | *5 Cav.*
108 | **U.S.C.T.**

Charles Cunningham

C., Co. *A.*, 108 Reg't U. S. Col'd Infantry.

Appears on

Company Descriptive Book

of the organization named above.

DESCRIPTION.

Age *19* years; height *5* feet *5* inches.

Complexion *Yellow*

Eyes *Blk*; hair *Blk.*

Where born *Grayson Co. Ky*

Occupation *Farmer*

ENLISTMENT.

When *June 29*, 186*4*.

Where *Lebanon*

By whom *Capt Fidler*, term *3* y'rs

Remarks:

Enlisted for 100th U. S. C. T.
Transferred to 5th U. S. C. Cavalry
August 12, 1864. per S. O. 192. Head
Quarters Dist of Ky.

D. M. Kennedy

(3829)

T Copyist.

560 | 560 U.S. 65

Charles Cunningham

Appears with rank of _____ on _____

Muster and Descriptive Roll

of a Detachment of U.S. Cold Vol
Recruits forwarded

Roll dated
Lebanon Ky June 30, 1864.

Where born Lebanon Ky

Age 19 years; occupation Farmer

When enlisted June 29, 1864.

Where enlisted Lebanon Ky

For what period enlisted 3 years.

Eyes Blk; hair Blk

Complexion Yel; height 5 ft 1/2 in.

When mustered in _____, 186 .

Where mustered in _____

Bounty paid \$ 100; due \$ 100

Clothing account:

Last settled _____, 186 ; drawn since \$ 13 58
100

Date of first muster June 30, 1864.

Company to which assigned _____

Remarks Enlisted & Mustered at

Pro. Mar. Office 4th Dist Ky

Name & residence of Master John Cunningham

has, Harder without Consent

Book mark: _____

(356m)

L. Murdoch
Copyist.

C

5 Cav. U.S.C.T.

Charles Cunningham

Prv., Co. *D*, 5 Reg't U. S. Col'd Cavalry.

Appears on

Company Muster-in and Descriptive Roll

of the organization named above. Roll dated

Cp. Nelson, Ky., Oct. 31, 1864.

Where born *Grayson, Ky.*

Age *19* y'rs; occupation *Farmer*

When enlisted *June 29, 1864.*

Where enlisted *Lebanon*

For what period enlisted *3* years.

Eyes *Black*; hair *Black*

Complexion *Yellow*; height *5* ft. *5 1/2* in.

When mustered in *June 29, 1864.*

Where mustered in *Lebanon*

Bounty paid \$ *100*; due \$ *100*

Where credited *4th Dist, Kentucky.*

Company to which assigned

Remarks:

Enlisted for 100th U.S.C.T.
Transferred to 5th U.S.C. Cavalry
August 12, 1864, per S.O. 192, Head
Quarters, Dist, of Ky.
Book mark:

Philipson

(356d)

Copyist.

6.

5 Cav. U.S.C.T.

Charles Cunningham

Priv., Co. I, 5 Reg't U. S. Col'd Cavalry.

Appears on

Company Muster Roll

for Organization to Oct. 31, 1864.

Present or absent Present.

Stoppage, \$ 100 for

Due Gov't, \$ 100 for

Valuation of horse, \$ 100

Valuation of horse equipments, \$ 100

Remarks:

Book mark:

Philipson

(358)

Copyist.

C. | **5 Cav.** | **U.S.C.T.**

Charles Cunningham

Pr., Co. I, 5 Reg't U. S. Col'd Cavalry.

Appears on

Company Muster Roll

for *Nov. + Dec.*, 186*4*.

Present or absent *Present*

Stoppage, \$ 100 for

Due Gov't, \$ 100 for

Valuation of horse, \$ 100

Valuation of horse equipments, \$ 100

Remarks: *1st + 2^d installments*

Bounty due.

Book mark: _____

(358)

Philipsen

Copyist.

C. | 5 Cav. | U.S.C.T.

Charles Cunningham

Priv., Co. I, 5 Reg't U. S. Col'd Cavalry.

Appears on

Company Muster Roll

for Jan. & Feb., 1865.

Present or absent Present

Stoppage, \$ 100 for

Due Gov't, \$ 100 for

Valuation of horse, \$ 100

Valuation of horse equipments, \$ 100

Remarks: 1st + 2nd installments
\$300^y Bounty due.

Book mark:

Philipson

(358)

Copyist.

C. | **5 Cav.** | **U.S.C.T.**

Charles Cunningham

Pr., Co. I, 5 Reg't U. S. Col'd Cavalry.

Appears on

Company Muster Roll

for Mar. + Apr., 1865.

Present or absent Present

Stoppage, \$ 100 for

Due Gov't, \$ 100 for

Valuation of horse, \$ 100

Valuation of horse equipments, \$ 100

Remarks: 1st installment
Bounty due.

Book mark: _____

(358)

Philipson

Copyist.

C

5 Cav.

U.S.C.T.

Charles Cunningham

Pr, Co. I, 5 Reg't U. S. Col'd Cavalry.

Appears on

Company Muster Roll

for *May & June*, 1865.

Present or absent *Present*

Stoppage, \$ *100* for

Due Gov't, \$ *100* for

Valuation of horse, \$ *100*

Valuation of horse equipments, \$ *100*

Remarks: *Install. bounty due
9/100.*

Book mark:

W. C. C.

(358)

Copyist.

0

5 Cav. U.S.C.T.

Charles Cunningham

Private, Co. I, 5 Reg't U. S. Col'd Cavalry.

Appears on

Company Muster Roll

for July & Aug, 1865.

Present or absent Present

Stoppage, \$ 100 for

Due Gov't, \$ 100 for

Valuation of horse, \$ 100

Valuation of horse equipments, \$ 100

Remarks:

Book mark:

W. C. C.

C

5 Cav. U.S.C.T.

Charles Cunningham

Plt, Co. I, 5 Reg't U. S. Col'd Cavalry.

Appears on

Company Muster Roll

for *Nov + Dec*, 1860.

Present or absent *Present*

Stoppage, \$ *100* for

Due Gov't, \$ *100* for

Valuation of horse, \$ *100*

Valuation of horse equipments, \$ *100*

Remarks: *Due \$2.04 for C & G. Sick in quarters*

Book mark:

W. C. C.

6 | 5 Cav. | U.S.C.T.

Charles Cunningham

Priv., Co. I, 5 Reg't U. S. Col'd Cavalry.

Appears on

Company Muster Roll

for *Jan'y. & Feby.*, 1866.

Present or absent *Present*

Stoppage, \$ 100 for

Due Gov't, \$ 100 for

Valuation of horse, \$ 100

Valuation of horse equipments, \$ 100

Remarks:

Book mark:

Crenshaw

(358)

Copyist.

Q | 5 Cav. | U.S.C.T.

Charles Cunningham,

, Co. D, 5 Reg't U. S. Colored Cav.

Appears on Returns as follows:

Sept. 1865: On duty, Cook for Prison
No. 4.

Book mark :

(546)

A. Baker
Copyist.

6

5 Cav. U.S.C.T.

Charles Cunningham
Priv., Co. D, 5 Reg't U. S. Col'd Cavalry.

Appears on Co. Muster-out Roll, dated
Helena, Ark. *March 16*, 1866.

Muster-out to date *March 16*, 1866.

Last paid to *Dec. 31*, 1865.

Clothing account:

Last settled....., 186 ; drawn since \$..... 100

Due soldier \$..... 100; due U. S. \$ *51* ^{*92*}/₁₀₀

Am't for cloth'g in kind or money adv'd \$..... 100

Due U. S. for arms, equipments, &c., \$..... 100

Bounty paid \$..... 100; due \$..... 100

Remarks:.....

Book mark:.....

Crenshaw

Cum gratia
Cunningham Henry

Co. F, 5 U. S. Col'd Cav.

Private Private

CARD NUMBERS.

1	5366748	26
2	5366870	27
3	5366968	28
4	5367060	29
5	5367150	30
6	5367246	31
7	5367334	32
8	5367426	33
9	5367518	34
10	5367611	35
11	5367699	36
12	909073-7	37
13	909083-7	38
14	40729628	39
15		40
16		41
17		42
18		43
19		44
20		45
21		46
22		47
23		48
24		49
25		50

Book Mark:

See also

6 | **5 Cav. | U.S.C.T.**

Henry Cunningham

....., Co. *16*, 5 Reg't U. S. Col'd Cav.

Appears on

Company Descriptive Book
of the organization named above.

DESCRIPTION.

Age *37* years; height *5* feet *4* inches.

Complexion *12012*

Eyes *12012*; hair *12012*

Where born *Bonstons Ky*

Occupation *Farmer*

ENLISTMENT.

When *Sept 14, 1864.*

Where *Camp Nelson*

By whom *J. K. Anderson*; term *3* y'rs.

Remarks:

.....
.....
.....
.....
.....
.....
.....

(383g)

A. J. Anderson

Copist.

C | **5 Cav. | U.S.C.T.**

Henry Cunningham
....., Co *H* 5 Reg't U. S. Col'd Cav.

Appears on

Company Descriptive Book
of the organization named above.

DESCRIPTION.

Age *37* years; height *5* feet *4* inches.

Complexion *Blk*

Eyes *Blk*; hair *Blk*

Where born *Bamilton Ky*

Occupation *Farmer*

ENLISTMENT.

When *Sep 14*, 186 *4*

Where *Camp Nelson Ky*

By whom *H. Rudolph*; term *3* y'rs.

Remarks:

.....

.....

.....

.....

.....

.....

.....

H. E. Rucker

C

5 Cav. U.S.C.T.

Henry Cunningham

Pos, Co *H*, 5 Reg't U. S. Col'd Cavalry.

Appears on

Company Muster-in and Descriptive Roll

of the organization named above. Roll dated

Camp Nelson, N.Y. Oct 29, 1864.

Where born *Bourbon Ky*

Age *37* y'rs; occupation *Farmer*

When enlisted *Sept 14*, 1864.

Where enlisted *Camp Nelson Ky*

For what period enlisted *3* years.

Eyes *Black*; hair *Black*

Complexion *Black*; height *5 ft. 4 in.*

When mustered in *Sept 15*, 1864.

Where mustered in *Camp Nelson Ky*

Bounty paid \$ *100*; due \$ *100*

Where credited

Company to which assigned

Remarks: *7th Dist Ky*

* *John Cunningham*

* *Supposed to be name of owner.*

Adm'd May 16, 98. H.A. Jr.

Book mark:

Reynolds

(356d)

Copyist.

C

5 Cav.

U.S.C.T.

Henry Cunningham
Pvt, Co. H, 5 Reg't U. S. Col'd Cavalry.

Appears on

Company Muster Roll

for *from enlistment to Oct 31, 1864.*

Present or absent *present*

Stoppage, \$ *100* for

Due Gov't, \$ *100* for

Valuation of horse, \$ *100*

Valuation of horse equipments, \$ *100*

Remarks:

Book mark:

Reynolds

(358)

Copyist.

C

5 Cav.

U.S.C.T.

Henry Cunningham
Pat, Co. H, 5 Reg't U. S. Col'd Cavalry.

Appears on

Company Muster Roll

for *Nov & Dec*, 186*4*.

Present or absent *present*

Stoppage, \$ *100* for

Due Gov't, \$ *100* for

Valuation of horse, \$ *100*

Valuation of horse equipments, \$ *100*

Remarks: *1st and 2^d Installments*
Bounty due

Book mark:

Reynolds

(358)

Copyist.

6

5 Cav.

U.S.C.T.

Henry Cunningham
Pot, Co. H, 5 Reg't U. S. Col'd Cavalry.

Appears on

Company Muster Roll

for *January & February*, 186*3*.

Present or absent *present*

Stoppage, \$ *100* for

Due Gov't, \$ *100* for

Valuation of horse, \$ *100*

Valuation of horse equipments, \$ *100*

Remarks: *1st installment of
Bounty (Due \$100.00)*

Book mark:

Reynolds

(358)

Copyist.

C

5 Cav.

U.S.C.T.

Henry Cunningham

Put, Co. H, 5 Reg't U. S. Col'd Cavalry.

Appears on

Company Muster Roll

for *Mar & Apr*, 186*3*.

Present or absent *present*

Stoppage, \$ *100* for

Due Gov't, \$ *100* for

Valuation of horse, \$ *100*

Valuation of horse equipments, \$ *100*

Remarks: *1st installment of
Bounty Due \$100*

Book mark:

Reynolds

(358)

Copyist.

6 5 Cav. | U.S.C.T.

Henry Cunningham
Co. H, 5 Reg't U. S. Col'd Cavalry.

Appears on

Company Muster Roll

for *May & June*, 1865.

Present or absent *Absent*

Stoppage, \$ 100 for

Due Gov't, \$ 100 for

Valuation of horse, \$ 100

Valuation of horse equipments, \$ 100

Remarks: *Instalment Bounty
due \$100. Daily duty Regt
Hosp't Paris by June 1st 1865.*

Book mark: _____

(358)

R J Cooke
Copyist.

6

5 Cav. U.S.C.T.

Henry Cunningham
Co. H, 5 Reg't U. S. Col'd Cavalry.

Appears on

Company Muster Roll

for July & Aug., 1865.

Present or absent Present

Stoppage, \$ 100 for

Due Gov't, \$ 100 for

Valuation of horse, \$ 100

Valuation of horse equipments, \$ 100

Remarks:

Book mark:

P. J. Cooke

(358)

Copyist.

6 | 5 Cav. | U.S.C.T.

Henry Cunningham
Co. H, 5 Reg't U. S. Col'd Cavalry.

Appears on

Company Muster Roll

for *Sept. & Oct.*, 1865.

Present or absent *Present.*

Stoppage, \$ 100 for

Due Gov't, \$ 100 for

Valuation of horse, \$ 100

Valuation of horse equipments, \$ 100

Remarks:

Book mark : -----

(358)

A. J. Cooke
Copyist.

6 | 5 Cav. | U.S.C.T.

Henry Cunningham
Co. H, 5 Reg't U.S. Col'd Cavalry.

Appears on

Company Muster Roll
for *Nov. & Dec.*, 1865.

Present or absent *Present.*

Stoppage, \$ 100 for

Due Gov't, \$ 100 for

Valuation of horse, \$ 100

Valuation of horse equipments, \$ 100

Remarks: *On daily duty
as Cook in Reg't
Hospital.*

Book mark:

(358)

B. J. Cook

Copyist.

6 | 5 Cav. | U.S.C.T.

Henry Cunningham
Capt., Co. H, 5 Reg't U. S. Col'd Cavalry.

Appears on

Company Muster Roll

for *Jan'y. V. Teby*, 186*6*.

Present or absent *Present*

Stoppage, \$ *100* for

Due Gov't, \$ *100* for

Valuation of horse, \$ *100*

Valuation of horse equipments, \$ *100*

Remarks: *On duty in Reg't.
Haupt as Cook*

Book mark: *501 100 0*

(358)

J. A. Stewart
Copyist.

Q | 5 Cav. | U.S.C.T.

Henry Cunningham.

Plt., Co. A, 5 Reg't U. S. Colored Cav.

Appears on Returns as follows:

May, 1865. On daily duty, Regtl. Hosp.

June 1865 to Feb. 1866. On duty,
Cook at Regtl. Hosp.

Book mark :

(546)

A. Baker
Copyist.

6

5 Cav. U.S.C.T.

Henry Cunningham
Capt, Co. H, 5 Reg't U. S. Col'd Cavalry.

Appears on Co. Muster-out Roll, dated

Helena, Ark Mar. 16 1866.

Muster-out to date Mar. 16 1866.

Last paid to Dec 31, 1865.

Clothing account:

Last settled....., 186 ; drawn since \$ 100

Due soldier \$ 28 ²⁷/₁₀₀; due U. S. \$ 100

Am't for cloth'g in kind or money adv'd \$ 100

Due U. S. for arms, equipments, &c., \$ ⁵⁵/₁₀₀

Bounty paid \$ 100 100; due \$ 100 100

Remarks: Stop for ord. 55c

Book mark:

J. Stewart
Copied.

(261)

JLV

Cunningham James

Co M, 5 U. S. Col'd Cav.

Sergeant Sergeant

CARD NUMBERS.

1	5370798	26
2	5370898	27
3	5370999	28
4	5371081	29
5	5371162	30
6	5371249	31
7	5371333	32
8	5371419	33
9	5371506	34
10	5371592	35
11	5371676	36
12	9091261	37
13		38
14		39
15		40
16		41
17		42
18		43
19		44
20		45
21		46
22		47
23		48
24		49
25		50

Book Mark:

See also

6 | 5-600 | **U.S.C.T.**

James Cunningham
Com, 5 Reg't U. S. Col'd 600

Appears on

Company Descriptive Book

of the organization named above.

DESCRIPTION.

Age 19 years; height 5 feet 5 inches.

Complexion Black

Eyes BRN; hair BRN

Where born Leasey Ky

Occupation Farmer

ENLISTMENT.

When Aug 30, 1864.

Where Camp Nelson

By whom McKandless; term 3 y'rs.

Remarks:

A. J. Anderson

(383g)

Copyist.

James Cunningham

Serget., Co. M., 5 Reg't U. S. Col'd Cavalry.

Appears on

Company Muster-in and Descriptive Roll

of the organization named above. Roll dated

Camp Nelson, N. Y., Oct 30, 1864.

Where born Casey, Ky.

Age 19 y'rs; occupation Farmer

When enlisted Aug 30, 1864.

Where enlisted Camp Nelson, Ky.

For what period enlisted 3 years.

Eyes Black; hair Black

Complexion Black; height 5 ft. 5 in.

When mustered in Aug 30, 1864.

Where mustered in Camp Nelson, Ky.

Bounty paid \$ 100; due \$ 100

Where credited 7th Dist Ky.

Company to which assigned

Remarks: Thomas Dadiock

* Out, signed in the name of owner
Date May 16/68

Book mark:

H. S. Thompson

Co

5 Cav. | U.S.C.T.

James Cunningham
Sergeant, Co. M, 5 Reg't U. S. Col'd Cavalry.

Appears on

Company Muster Roll

for *to Oct 31*, 186*4*.

Present or absent *Present*

Stoppage, \$ *100* for

Due Gov't, \$ *100* for

Valuation of horse, \$ *100*

Valuation of horse equipments, \$ *100*

Remarks: *Appointed per Reg't Orders No. 10 to date Oct 30 1864*

Book mark:

H. S. Thompson

(358)

Copyist.

5 Cav. | U.S.C.T.

James Cunningham

Sergeant, Co. M, 5 Reg't U. S. Col'd Cavalry.

Appears on

Company Muster Roll

for *Nov. 1st Dec.*, 186*4*.

Present or absent *Present*

Stoppage, \$ *100* for

Due Gov't, \$ *100* for

Valuation of horse, \$ *100*

Valuation of horse equipments, \$ *100*

Remarks: *Appointed per Reg't. Order No. 12 to date 1st Dec 1864 first and second instalments of bounty due. In detached service at Fort Mifflin Oct. 1, 1864*

Book mark:

M. S. Thompson

C | **5 Cav. | U.S.C.T.**

James Cunningham
Sergt., Co. M, 5 Reg't U. S. Col'd Cavalry.

Appears on

Company Muster Roll

for *Jan. & Feb.*, 186*3*.

Present or absent *Present.*

Stoppage, \$ *100* for

Due Gov't, \$ *100* for

Valuation of horse, \$ *100*

Valuation of horse equipments, \$ *100*

Remarks: *As per order per*
Regt. orders No. 12. to date
Oct. 31 61. 1218 2d instal-
ments of bounty due.

Book mark: _____

W. S. Thompson

6

5 Cav. | U.S.C.T.

James Cunningham
Sergeant, Co. M, 5 Reg't U. S. Col'd Cavalry.

Appears on

Company Muster Roll

for *March Apr.*, 186*4*.

Present or absent *Present*

Stoppage, \$ *100* for

Due Gov't, \$ *100* for

Valuation of horse, \$ *100*

Valuation of horse equipments, \$ *100*

Remarks: *11 mistatement bounty
due \$100 (2/3 paid)
for Reg't order No. 12 to
date Oct. 3/64*

Book mark:

M. S. Thompson

(358)

Copyist.

Co.

5 Cav. | U.S.C.T.

James Cunningham

Serjt, Co. M, 5 Reg't U. S. Col'd Cavalry.

Appears on

Company Muster Roll

for *May & June*, 1865.

Present or absent *Present*

Stoppage, \$ *100* for

Due Gov't, \$ *100* for

Valuation of horse, \$ *100*

Valuation of horse equipments, \$ *100*

Remarks: *1st Encampment bounty
due \$100.*

Book mark: _____

C. W. Curtis

Copyist.

(358)

6

5 Cav. | U.S.C.T.

James Cunningham
Sgt., Co. M, 5 Reg't U. S. Col'd Cavalry.

Appears on

Company Muster Roll

for *July & Aug*, 186*5*.

Present or absent *Present*

Stoppage, \$ *100* for

Due Gov't, \$ *100* for

Valuation of horse, \$ *100*

Valuation of horse equipments, \$ *100*

Remarks:

Book mark:

C. W. ...
Copyist.

(358)

Co. | 5 Cav. | U. S. C. T.

James Cunningham

Sept, Co. M, 5 Reg't U. S. Col'd Cavalry.

Appears on

Company Muster Roll

for *Sept & Oct*, 1865.

Present or absent *Present*

Stoppage, \$ *100* for

Due Gov't, \$ *100* for

Valuation of horse, \$ *100*

Valuation of horse equipments, \$ *100*

Remarks: *Quell's for Camp & Garrison 75*

Book mark:

(358)

Leuty
Copyist.

lc

5 Cav. U.S.C.T.

James Cunningham

Sgt., Co. M, 5 Reg't U. S. Col'd Cavalry.

Appears on

Company Muster Roll

for Nov & Dec, 1865.

Present or absent Present

Stoppage, \$ 100 for

Due Gov't, \$ 100 for

Valuation of horse, \$ 100

Valuation of horse equipments, \$ 100

Remarks:

Book mark:

(358)

Copyist.

6

5 Cav. U.S.C.T.

James Cunningham

Sgt., Co. M, 5 Reg't U. S. Col'd Cavalry.

Appears on

Company Muster Roll

for Jan & Feb, 1866.

Present or absent Present

Stoppage, \$ 100 for

Due Gov't, \$ 100 for

Valuation of horse, \$ 100

Valuation of horse equipments, \$ 100

Remarks:

Book mark:

(358)

Hyman

Copyist.

6

5 Cav. U.S.C.T.

James Cunningham
Sgt, Co M, 5 Reg't U. S. Col'd Cavalry.

Appears on Co. Muster-out Roll, dated
Helena Ark, Mar 16, 1866.
Muster-out to date Mar 16, 1866.
Last paid to Dec 31, 1865.

Clothing account:

Last settled _____, 186 ; drawn since \$ 100
Due soldier \$ 100; due U. S. \$ 33/100
Am't for cloth'g in kind or money adv'd \$ 100

Due U. S. for arms, equipments, &c., \$ 25/100

Bounty paid \$ 100 100; due \$ 100 100

Remarks: *Accepted Sergt Per R.O. 12*
Per 12 Oct. 30. 64 Slave April 19
1861

Book mark: _____

(361)

Hyn
Copied.

Co. , 5 U. S. Col'd Cav.

Private

CARD NUMBERS.

1	5359228	26
2		27
3		28
4		29
5		30
6		31
7		32
8		33
9		34
0		35
1		36
2		37
3		38
4		39
5		40
6		41
7		42
8		43
9		44
0		45
1		46
2		47
3		48
4		49
5		50

Book Mark:

See also

C 5 Cav. | U.S.C.T.

William Curtis

Appears with rank of *Priv* on

Muster and Descriptive Roll of a Detachment of U. S. Vols. forwarded

for the *5* Reg't U. S. Col'd *Cav.* Roll dated

Janesville Wis. Nov 10, 1864.

Where born *Wisconsin*

Age *17* y'rs; occupation *Farmer*

When enlisted *Nov. 10*, 1864.

Where enlisted *Janesville Wis.*

For what period enlisted *1* years.

Eyes *Blk*; hair *Blk*

Complexion *Blk*; height *5* ft. *2* in.

When mustered in *Nov 10*, 1864.

Where mustered in *Janesville Wis.*

Bounty paid \$ *100*; due \$ *100*

Where credited *Vermont, Dan Co. 43^d Sub. Div 2^d Dist Wis.*

Company to which assigned.

Remarks:

Name not taken up on rolls of Regt

Book mark:

Valentine

Comdr. J. J. M.

Co.

5-

Reg't

1st Regt.

2-

Enclosures.

Bed Cards	Final Statements
Burial Records	Furloughs or L. of A.
Certs. of Dis. for Discharge	Med. Certificates
C. M. Charges	Med. Des. Lists
Descriptive Lists	Orders
Discharge Certificates	Pris. of War Record
Enlistment Papers <i>2</i>	Resignations

Other papers relating to—

Admission to Hosp'l	Furlough or L. of A.
Casualty Sheet	Med. Examination
Confinement	Misc. Information
Contracts	Pay or Clothing
Death or Effects	Personal Reports
Desertion	Rank
Discharge from Hosp'l	Transfer to Hosp'l
Discharge from Service	Transfer to V. R. C.
Duty	Transportation

NOTE 1.—This blank will be used for both enlistments and re-enlistments—enlistment of veterans, &c., &c., in the volunteer service. They will be made out in duplicate in all cases—one to accompany the recruiting return of the superintendent (not the recruiting officer) to the Adjutant General, and one to accompany the accounts of the officer who pays bounty, &c. The Regiment and Company in which the soldier last served should be given on the back.

NOTE 2.—An enlistment holds to service. A muster-in must, in all cases, precede payment of pay, bounty, pension, &c. A muster-in roll must, in all cases, be filed in the Adjutant General's Office as evidence of muster-in. The mustering officer, commissary, or assistant commissary of musters, as the case may be, will countersign both enlistments as having mustered the soldier into the service of the United States before either of them is given to the disbursing officer.

DECLARATION OF RECRUIT.

I, William Curtis, desiring to VOLUNTEER as a Soldier in the Army of the United States, for the term of ~~THREE~~ ^{ONE} YEARS, Do Declare, That I am Seventeen years and four months of age; that I have never been discharged from the United States service on account of disability or by sentence of a court martial, or by order before the expiration of a term of enlistment; and I know of no impediment to my serving honestly and faithfully as a soldier for ~~three~~ ^{one} years.

GIVEN at Janesville, Wis the 10th day of November 1864

Witness: N. M. Barnes William Curtis
mark

No. 1150

William Curtis
 Volunteered at Janesville, Wis
November 10th 1864.

By John H. Allison
 Regiment of U.S. Infantry

enlistment; last served in Company ()

Reg't of

Discharged 18

Committed to Service
Revised Standard

John H. Allison

John H. Allison
1864

CONSENT IN CASE OF MINOR.

I, W. H. Allison, DO CERTIFY, That I am the Guardian of William Curtis; that the said William Curtis is Seventeen years of age; and I do hereby freely give my CONSENT to his volunteering as a SOLDIER in the ARMY OF THE UNITED STATES for the period of ~~three~~ ^{one} YEARS.

GIVEN at Janesville, Wis the 10th day of November 1864

Witness: N. M. Barnes W. H. Allison

VOLUNTEER ENLISTMENT.

STATE OF

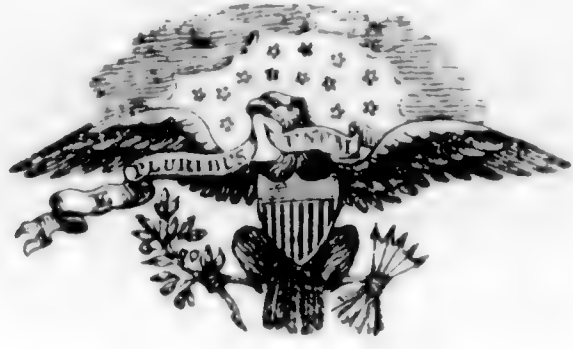

TOWN OF

Missouri

City of Jamesville

I, *William Curt*, born in _____, in the State of *Missouri*, aged *Seventeen* years, and by occupation a *Farmer*, Do HEREBY ACKNOWLEDGE to have volunteered this *22nd* day of *September*, 1864, to serve as a **Soldier** in the **Army of the United States of America**, for the period of ~~THREE~~ ^{ONE} ~~YEARS~~, unless sooner discharged by proper authority: Do also agree to accept such bounty, pay, rations, and clothing, as are, or may be, established by law for volunteers. And I, *William Curt*, do solemnly swear, that I will bear true faith and allegiance to the **United States of America**, and that I will serve them honestly and faithfully against all their enemies or opposers whomsoever; and that I will observe and obey the orders of the President of the United States, and the orders of the officers appointed over me, according to the Rules and Articles of War.

Sworn and subscribed to, at *Jamesville Mo* this *16th* day of *October*, 1864, *William Curt* BEFORE *J M Putnam*

I CERTIFY, ON HONOR, That I have carefully examined the above-named Volunteer, agreeably to the General Regulations of the Army, and that, in my opinion, he is free from all bodily defects and mental infirmity, which would in any way disqualify him from performing the duties of a soldier.

C. A. Head
Surgeon of Enlistment
EXAMINING SURGEON.

I CERTIFY, ON HONOR, That I have minutely inspected the Volunteer *Wm Curt* previously to his enlistment, and that he was entirely sober when enlisted; that, to the best of my judgment and belief, he is of lawful age; and that, in accepting him as duly qualified to perform the duties of an able-bodied soldier, I have strictly observed the Regulations which govern the recruiting service. This soldier has *Blue* eyes, *Black* hair, *White* complexion, is _____ feet _____ inches high.

J M Putnam
Cap and Pro Mgr 2nd Dist Mo
Regiment of _____ Volunteers,

RECRUITING OFFICER.

(A. G. O. No. 71 & 76.)

Mustered into the service of the United States, for ~~three~~ ^{One} years or during the war, from date of enlistment, in Company _____ 5th Regiment of *Missouri* Volunteers, on the *16th* day of *October*, 1864.

J M Putnam
Cap and Pro Mgr 2nd Dist Mo

NOTE 1.—This blank will be used for both enlistments and re-enlistments—enlistment of veterans, &c., &c., in the volunteer service. They will be made out in duplicate in all cases—one to accompany the recruiting return of the superintendent (not the recruiting officer) to the Adjutant General, and one to accompany the accounts of the officer who pays bounty, &c. The Regiment and Company in which the soldier last served should be given on the back.

NOTE 2.—An enlistment holds to service. A muster-in must, in all cases, precede payment of pay, bounty, pension, &c. A muster-in roll must, in all cases, be filed in the Adjutant General's Office as evidence of muster-in. The mustering officer, commissary, or assistant commissary of musters, as the case may be, will countersign both enlistments as having mustered the soldier into the service of the United States before either of them is given to the disbursing officer.

DECLARATION OF RECRUIT.

I, William Curtis, desiring to VOLUNTEER as a Soldier in the Army of the United States, for the term of ~~THREE~~ ^{ONE} YEARS, Do Declare, That I am Seventeen years and four months of age; that I have never been discharged from the United States service on account of disability or by sentence of a court martial, or by order before the expiration of a term of enlistment; and I know of no impediment to my serving honestly and faithfully as a soldier for ~~three~~ ^{one} years.

GIVEN at Janesville, Wis the 10th day of November 1864

Witness:

K. N. Bennis

William Curtis
mark

No. 1159
William Curtis
Volunteered at Janesville, Wis
November 10th, 1864
By Capt. S. P. M. Stewart
10th Regiment of U. S. Volunteers
..... enlistment; last served in Company ()
..... Reg't of

Discharged 18

Brother to D. Stewart
James Stewart
John Stewart
Regiment of U. S. Volunteers
20th Reg't Wis

CONSENT IN CASE OF MINOR.

I, W. H. Allison, Do CERTIFY, That I am the Guardian of William Curtis; that the said William Curtis is seventeen years of age; and I do hereby freely give my CONSENT to his volunteering as a SOLDIER in the ARMY OF THE UNITED STATES for the period of ~~THREE~~ ^{ONE} YEARS.

GIVEN at Janesville, Wis the 10th day of November 1864

Witness:

K. N. Bennis

W. H. Allison

VOLUNTEER ENLISTMENT.

STATE OF



TOWN OF

Wisconsin

City of Janesville

I, *William Curtis*, born in _____, in the State of *Wisconsin*, aged *Seventeen* years, and by occupation a *Fanner*, Do HEREBY ACKNOWLEDGE to have volunteered this *Tenth* day of *November*, 1864, to serve as a **Soldier** in the **Army of the United States of America**, for the period of ~~THREE YEARS~~ ^{One} *Year*, unless sooner discharged by proper authority: Do also agree to accept such bounty, pay, rations, and clothing, as are, or may be, established by law for volunteers. And I, *William Curtis*, do solemnly swear, that I will bear true faith and allegiance to the **United States of America**, and that I will serve them honestly and faithfully against all their enemies or opposers whomsoever; and that I will observe and obey the orders of the President of the United States, and the orders of the officers appointed over me, according to the Rules and Articles of War.

Sworn and subscribed to, at *Janesville, Wis.* this *10th* day of *November*, 1864, *William Curtis*
BEFORE *S. J. Putnam*
Capt. and 2^d Major 2^d Dist. Wis. Inf. 9th Me.

I CERTIFY, ON HONOR, That I have carefully examined the above-named Volunteer, agreeably to the General Regulations of the Army, and that, in my opinion, he is free from all bodily defects and mental infirmity, which would in any way disqualify him from performing the duties of a soldier.

C. R. Seady
Surg. G. of Enrollment
EXAMINING SURGEON.

I CERTIFY, ON HONOR, That I have minutely inspected the Volunteer *Wm Curtis* previously to his enlistment, and that he was entirely sober when enlisted; that, to the best of my judgment and belief, he is of lawful age; and that, in accepting him as duly qualified to perform the duties of an able-bodied soldier, I have strictly observed the Regulations which govern the recruiting service. This soldier has *Black* eyes, *Black* hair, *Black* complexion, is _____ feet _____ inches high.

S. J. Putnam
Capt. and 2^d Major 2^d Dist. Wis. Inf. 9th Me.
Regiment of _____ Volunteers.

RECRUITING OFFICER.

(A. G. O. No. 74 & 76.)

Mustered into the service of the United States, for ~~three~~ ⁽¹⁾ *one* year or during the war, from date of enlistment, in Company _____ Regiment of *2^d Dist. Wis. Inf. 9th Me.* Volunteers, on the *10th* day of *November*, 1864, at *Janesville, Wis.*

S. J. Putnam
Capt. and 2^d Major 2^d Dist. Wis. Inf. 9th Me.
Janesville, Wis.

325

Cushingberry, Frank

Co. H, 5 U. S. Col'd Cav.

Private Private

CARD NUMBERS.

1	5366769	26
2	5366868	27
3	5366969	28
4	5367061	29
5	5367151	30
6	5367247	31
7	5367335	32
8	5367427	33
9	5367519	34
10	5367612	35
11	5367698	36
12	9090756	37
13	9090856	38
14		39
15		40
16		41
17		42
18		43
19		44
20		45
21		46
22		47
23		48
24		49
25		50

Book Mark:

See also

6 | **5 Cav.** | **U.S.C.T.**

Frank Cushmanberry
....., Co H 5 Reg't U. S. Col'd Cav.

Appears on

Company Descriptive Book
of the organization named above.

DESCRIPTION.

Age 8 years; height 5 feet 7 inches.

Complexion Blk

Eyes Blk; hair Blk

Where born Clark Ky

Occupation Farmer

ENLISTMENT.

When Sep 19, 1865.

Where Camp Nelson Ky

By whom A. Randolph; term 3 y'rs.

Remarks:

.....
.....
.....
.....
.....
.....
.....
.....

T. E. Purke

C

5 Cav. U.S.C.T.

Frank Leushenberg

Co. H, 5 Reg't U. S. Col'd Cav.

Appears on

Company Descriptive Book of the organization named above.

DESCRIPTION.

Age 18 years; height 5 feet 7 inches.

Complexion BCR

Eyes BCR; hair BCR

Where born Tenn. Ky.

Occupation Farmer

ENLISTMENT.

When Sept-19, 1864.

Where Camp Nelson

By whom J. C. Anderson; term 3 y'rs.

Remarks:

[Empty lines for remarks]

A. J. Anderson

(383g)

Copist.

C

5 Cav.

U.S.C.T.

Frank Bushingberry

Put....., Co *H*, 5 Reg't U. S. Col'd Cavalry.

Appears on

Company Muster-in and Descriptive Roll

of the organization named above. Roll dated

Camp Nelson, N. Y., Oct 29, 1864.

Where born *Clarke Ky*

Age *18* y'rs; occupation *Farmer*

When enlisted *Sept 19*....., 1864.

Where enlisted *Camp Nelson Ky*

For what period enlisted *3*..... years.

Eyes *Black* ; hair *Black*

Complexion *Black* ; height *5 ft. 9 in.*

When mustered in *Sept 19*....., 1864.

Where mustered in *Camp Nelson Ky*

Bounty paid \$.....*100*; due \$.....*100*

Where credited.....

Company to which assigned.....

Remarks: *7th Dist Ky*

Saml Bushingberry

**Supposed to be name of owner.*

deced May 16. 45. H. A. J.

Book mark:.....

Reynolds

(356d)

Copyist.

C

5 Cav.

U.S.C.T.

Frank Cushingberry

Priv., Co. H, 5 Reg't U. S. Col'd Cavalry.

Appears on

Company Muster Roll

for *from enlistment to Oct 31, 1864.*

Present or absent *present*

Stoppage, \$ *100* for

Due Gov't, \$ *100* for

Valuation of horse, \$ *100*

Valuation of horse equipments, \$ *100*

Remarks: *Sick in Quarters*

Book mark:

Reynolds

(358)

Copyist.

C

5 Cav.

U.S.C.T.

Frank Cushingberry
Priv, Co. H, 5 Reg't U. S. Col'd Cavalry.

Appears on

Company Muster Roll

for *Nov & Dec*, 186*4*.

Present or absent *present*

Stoppage, \$ 100 for

Due Gov't, \$ 100 for

Valuation of horse, \$ 100

Valuation of horse equipments, \$ 100

Remarks: *1st and 2^d Installments*
Bounty due.
Due US for
Ordinance \$996

Book mark:

Reynolds

(358)

Copyist.

C

5 Cav.

U.S.C.T.

Frank Cushingbury

Pvt, Co. H, 5 Reg't U. S. Col'd Cavalry.

Appears on

Company Muster Roll

for *Jan & Feby*, 186*5*.

Present or absent *present*

Stoppage, \$ *100* for

Due Gov't, \$ *100* for

Valuation of horse, \$ *100*

Valuation of horse equipments, \$ *100*

Remarks: *1st installment of
Bounty Due \$100.00*

Book mark:

Reynolds

(358)

Copyist.

C | **5 Cav.** | **U.S.C.T.**

Frank Cushingbury
Pvt, Co. H, 5 Reg't U. S. Col'd Cavalry.

Appears on

Company Muster Roll

for *Mar & Apr*, 186*3*.

Present or absent *present*

Stoppage, \$ *100* for

Due Gov't, \$ *100* for

Valuation of horse, \$ *100*

Valuation of horse equipments, \$ *100*

Remarks: *1st installment of
Bounty Due \$100*

Book mark: _____

(358)

Reynolds
Copyist.

6 5 Cav. | U.S.C.T.

Frank Ashenbury
Cpt, Co. H, 5 Reg't U. S. Col'd Cavalry.

Appears on

Company Muster Roll

for *May & June*, 186*5*.

Present or absent *Present*

Stoppage, \$ *100* for

Due Gov't, \$ *100* for

Valuation of horse, \$ *100*

Valuation of horse equipments, \$ *100*

Remarks: *1st Regimental Bounty*
due \$100.

Book mark:

B. J. Cooke

(358)

Copyist.

5 Cav. U.S.C.T.

Frank Ashenberry
Cvt., Co. H, 5 Reg't U. S. Col'd Cavalry.

Appears on

Company Muster Roll

for *July & Aug.*, 1865.

Present or absent *Present.*

Stoppage, \$ 100 for

Due Gov't, \$ 100 for

Valuation of horse, \$ 100

Valuation of horse equipments, \$ 100

Remarks:

Book mark:-----

R J Cooke

(358)

Copyist.

6 | 5 Cav. | U.S.C.T.

Frank Ashenbury

Cvt., Co. H, 5 Reg't U. S. Col'd Cavalry.

Appears on

Company Muster Roll

for *Sept. & Oct.*, 186*5*.

Present or absent *Present*

Stoppage, \$ 100 for

Due Gov't, \$ 100 for

Valuation of horse, \$ 100

Valuation of horse equipments, \$ 100

Remarks:

Book mark:

B. J. Cooper

(358)

Copyist.

6 | 5 Cav. | U.S.C.T.

Paul Ashberry
Cvt, Co. H, 5 Reg't U. S. Col'd Cavalry.

Appears on

Company Muster Roll

for *Nov. & Dec.*, 186*5*

Present or absent *Present*

Stoppage, \$ 100 for

Due Gov't, \$ 100 for

Valuation of horse, \$ 100

Valuation of horse equipments, \$ 100

Remarks:

Book mark: -----

B. J. Cooke

(358)

Copyist.

6 | 5 Cav. | U.S.C.T.

Frank Lushington
Co., Co. H, 5 Reg't U. S. Col'd Cavalry.

Appears on

Company Muster Roll

for *James V. Libby*, 1866.

Present or absent *Present*

Stoppage, \$ *100* for

Due Gov't, \$ *100* for

Valuation of horse, \$ *100*

Valuation of horse equipments, \$ *100*

Remarks: *Sick in quarters.*

Book mark:

(358)

J. L. Stewart

Copyist.

6

5 Cav. U.S.C.T.

Frank Cushingberry,
Pat., Co. A, 5 Reg't U. S. Col'd Cavalry.

Appears on Co. Muster-out Roll, dated

Helena, Ark Mar. 16, 1866.

Muster-out to date Mar. 16, 1866.

Last paid to Dec. 31, 1865.

Clothing account:

Last settled....., 186 ; drawn since \$ 100

Due soldier \$ 100; due U. S. \$ 38 ²⁴/₁₀₀

Am't for cloth'g in kind or money adv'd \$ 100

Due U. S. for arms, equipments, &c., \$ 100

Bounty paid \$ 100 ¹⁰⁰/₁₀₀; due \$ 100

Remarks:

Book mark:

(361)

J. Stewart
Copyist.

Dale, Charles

Co A , 5 U. S. Col'd Cav.

Private

Private

CARD NUMBERS.

1	5359619	26
2	5359721	27
3	5359822	28
4	5359923	29
5	5365021	30
6	5360114	31
7	5360203	32
8	5360349	33
9	5359428	34
10	5360626	35
11	9089993	36
12	43154955	37
13	40729663	38
14		39
15		40
16		41
17		42
18		43
19		44
20		45
21		46
22		47
23		48
24		49
25		50

Book Mark:

See also

10

5 Cav. | U.S.C.T.

Charles Dale

, Co. A, 5 Reg't U. S. Col'd Cav.

Appears on

Company Descriptive Book

of the organization named above.

DESCRIPTION.

Age 22 years; height 5 feet 7 inches.

Complexion Dark

Eyes Dark; hair Dark

Where born Shelby Co Ky

Occupation Laborer

ENLISTMENT.

When Sept. 13th, 186 .

Where Louisville

By whom Capt. Warren; term 3 y'rs.

Remarks:

Warren

A | 5 bar | U. S. C. D.

Charles Dale,

Appears with rank of priv. on

Muster and Descriptive Roll

of a Detachment of U. S.

Roll dated Louisville Ky, Sept. 14, 1864.

Where born Shelby Co Kentucky

Age 22 years; occupation Laborer.

When enlisted Sept. 13, 1864.

Where enlisted Louisville Ky.

For what period enlisted 3 years.

Eyes Dark; hair Dark,

Complexion Dark; height 5 ft. 7 in.

When mustered in Sept. 14, 1864.

Where mustered in Louisville Ky

Bounty paid \$ 100; due \$ 100

Clothing account:
Last settled , 186 ; drawn since \$ 100

Date of first muster , 186 .

Company to which assigned

Remarks: Credited to Shelby

Co. 4 Dist.

Book mark:

J. Donohue,

(356m)

Copyist.

John Dale

Pvt, Co. *A*, 5 Reg't U. S. Col'd Cavalry.

Appears on

Company Muster-in and Descriptive Roll

of the organization named above. Roll dated

W. H. Kelso Ky, N. Y., *Oct 24*, 1864.

Where born *Shelby Ky*

Age *22* y'rs; occupation *Laborer*

When enlisted *Sept 13*, 1864.

Where enlisted *Louisville*

For what period enlisted *3* years.

Eyes *Ok*; hair *Ok*

Complexion *Ok*; height *5* ft. *7* in.

When mustered in *Sept 14*, 1864.

Where mustered in *Louisville*

Bounty paid \$ *100*; due \$ *100*

Where credited *4th Dist Kentucky*

Company to which assigned *A*

Remarks:

Book mark:

W. H. Kelso

(356d)

Copyist.

J | **5 Cav.** | **U.S.C.T.**

Charles Dale

Prst, Co. A, 5 Reg't U. S. Col'd Cavalry.

Appears on

Company Muster Roll

for *to Oct. 31*, 186*4*.

Present or absent *Present*.

Stoppage, \$ *100* for

Due Gov't, \$ *100* for

Valuation of horse, \$ *100*

Valuation of horse equipments, \$ *100*

Remarks:

Book mark:

(358)

E. A. ...

Copyist.

9

5 Cav. U.S.C.T.

Charles Dale

Capt., Co. A, 5 Reg't U. S. Col'd Cavalry.

Appears on

Company Muster Roll

for Nov. & Dec., 1864.

Present or absent Present

Stoppage, \$ 100 for

Due Gov't, \$ 100 for

Valuation of horse, \$ 100

Valuation of horse equipments, \$ 100

Remarks: Found & Discharged
Bounty due

Book mark:

Charles Dale

(358)

Copyist.

5 Cav. U.S.C.T.

Charles Dale

Pr, Co. A, 5 Reg't U. S. Col'd Cavalry.

Appears on

Company Muster Roll

for *Jan & Feb*, 186*5*.

Present or absent *Present*,

Stoppage, \$ *100* for

Due Gov't, \$ *100* for

Valuation of horse, \$ *100*

Valuation of horse equipments, \$ *100*

Remarks: *1st Installment
Bounty due \$100.*

Book mark:

Pasterling

(358)

Copyist.

27

5 Cav. U.S.C.T.

Ensign

Wm. J. ..., Co. A, 5 Reg't U. S. Col'd Cavalry.

Appears on

Company Muster Roll

for *Wm. J. ...* 1865.

Present or absent *Present*

Stoppage, \$ *100* for

Due Gov't, \$ *100* for

Valuation of horse, \$ *100*

Valuation of horse equipments, \$ *100*

Remarks: *Not installed in unit
County of ...*

Book mark:

G. M. ...

(358)

Copyist.

2

5 Cav. U.S.C.T.

Charles Deane

Pvt., Co. A, 5 Reg't U. S. Col'd Cavalry.

Appears on

Company Muster Roll

for May 1865, 1865.

Present or absent Present

Stoppage, \$ 100 for

Due Gov't, \$ 100 for

Valuation of horse, \$ 100

Valuation of horse equipments, \$ 100

Remarks: Shortly absent for duty \$ 5.

Book mark:

J. A. Deane

(358)

Copyist.

2

5 Cav. U.S.C.T.

James D. ...

..., Co. A, 5 Reg't U. S. Col'd Cavalry.

Appears on

Company Muster Roll

for *...*, 186 *...*

Present or absent *...*

Stoppage, \$ *...* 100 for *...*

Due Gov't, \$ *...* 100 for *...*

Valuation of horse, \$ *...* 100

Valuation of horse equipments, \$ *...* 100

Remarks: *...*
Without ...

Book mark: *...*

J. M. ...
Comjst.

(358)

D 5 Cav | U.S.C.T.

Charles Dale

Priv., Co. A, 5 Reg't U. S. Col'd Cav

Appears on

Descriptive List of Deserters

dated Oct 6, 1865.

Deserted:

When Sept 1, 1865.

Where Camp Nelson

Arrested:

When _____, 186 .

Where _____

Remarks: _____

Book mark: _____

Rose

2

5 Cav. U.S.C.T.

John Dale

(*W.*), Co. A, 5 Reg't U. S. Col'd Cavalry.

Appears on

Company Muster Roll

for *Dated Oct. 31*, 1865.

Present or absent

Stoppage, \$ 100 for

Due Gov't, \$ 100 for

Valuation of horse, \$ 100

Valuation of horse equipments, \$ 100

Remarks: *Deserted from
Camp, Va.
Sept. 5, 1865.*

Book mark :

J. H. [Signature]
Copyist.

(358)

10 | **5 Cav.** | **U.S.C.T.**

Chas. Dale

Pot. Co. A, 5 Reg't U. S. Colored Cav.

Appears on **Returns** as follows:

*Sept. 1865: Deserted, Sept. 1,
Camp Nelson, Ky.*

Book mark :

(546)

H. Baker
Copyist.

J

5 Cav. U.S.C.T.

Charles Hale

Priv, Co. *A*, 5 Reg't U. S. Col'd Cavalry.

Appears on Co. Muster-out Roll, dated

Helena Ark *March 16*, 1866.

Muster-out to date _____, 186 .

Last paid to

June 30 1865.

Clothing account:

Last settled _____, 186 ; drawn since \$ 100

Due soldier \$ 100; due U. S. \$ 35

Am't for cloth'g in kind or money adv'd \$ 100

Due U. S. for arms, equipments, &c., \$ 100

Bounty paid \$ 100; due \$ 100

Remarks:

Deserted Sept 18. 1865, Camp, Nelson, Ky.

Book mark: _____

W. W. Payne

(361)

Copyist.

327
Dandridge, David

Co A, 5 U. S. Col'd Cav.

Private

Private

CARD NUMBERS.

1	5359620	26
2	5359722	27
3	5359823	28
4	5359924	29
5	5360222	30
6	5360115	31
7	5360204	32
8	5360294	33
9	5360386	34
10	5360475	35
11	5360572	36
12	9089994	37
13	43154204	38
14	40729664	39
15		40
16		41
17		42
18		43
19		44
20		45
21		46
22		47
23		48
24		49
25		50

Book Mark:

See also

W. | 5 Cav. | U.S.C.T.

David Dandridge

, Co. F, 5 Reg't U. S. Col'd Cav.

Appears on

Company Descriptive Book

of the organization named above.

DESCRIPTION.

Age, 8 years; height 5 feet 8 inches.

Complexion, *blk*

Eyes *Blk*; hair *Blk*

Where born *city*

Occupation *Farmer*

ENLISTMENT.

When *Substitute*, 186 .

Where . . .

By whom . . . ; term *3* y'rs.

Remarks:

Hansen

10 | 56av | U.S.O.J.

David Dantridge

Appears with rank of _____ on _____

Muster and Descriptive Roll

of a Detachment of U.S. Volunteer
Substitutes.

Roll dated
Greensburg Ky, Aug 31, 1864.

Where born _____ Kentucky _____

Age 18 years; occupation farmer

When enlisted _____ Aug 25, 1864.

Where enlisted _____ Greensburg Ky. _____

For what period enlisted _____ three years.

Eyes black; hair black

Complexion black; height 5 ft. 8 in.

When mustered in _____ Aug 25, 1864.

Where mustered in _____ Greensburg Ky. _____

Bounty paid \$ 100; due \$ 100

Clothing account:

Last settled _____, 1864; drawn since \$ 100
none drawn.

Date of first muster _____ Aug 25, 1864.

Company to which assigned _____

Remarks: *Credited to Mason Co., 9th Dist.*

of Ky.

Note! Substitute for Wm Richardson

Mason Co., Ky.

Book mark: _____

J. Austin

(356m)

Copyist.

29

5 Cav.

U.S.C.T.

David Partridge

Co. A, 5 Reg't U. S. Col'd Cavalry.

Appears on

Company Muster-in and Descriptive Roll

of the organization named above. Roll dated

Albany, N. Y., Oct. 24, 1864.

Where born Albany

Age 18 y'rs; occupation Farmer

When enlisted Albany, 1864

Where enlisted Albany

For what period enlisted 3 years.

Eyes Blue; hair Blue

Complexion Blue; height 5 ft. 8 in.

When mustered in Albany, 1864.

Where mustered in Albany

Bounty paid \$100; due \$100

Where credited Albany

Company to which assigned

Remarks:

Book mark:

(356d)

Partridge

Copyist.

29

5 Cav. U.S.C.T.

David Sanbridge

21 X, Co. A, 5 Reg't U. S. Col'd Cavalry.

Appears on

Company Muster Roll

for Oct. 31, 1864.

Present or absent Present X,

Stoppage, \$ 100 for

Due Gov't, \$ 100 for

Valuation of horse, \$ 100

Valuation of horse equipments, \$ 100

Remarks:

Book mark:

Castling

(358)

Copyist.

① | 5 Cav. | U.S.C.T.

David Cartridge

Pvt., Co. A, 5 Reg't U. S. Col'd Cavalry.

Appears on

Company Muster Roll

for Nov, & Dec, 1864.

Present or absent absent,

Stoppage, \$ 100 for

Due Gov't, \$ 100 for

Valuation of horse, \$ 100

Valuation of horse equipments, \$ 100

Remarks: In Hospital at
Camp Nelson Ky.

Book mark:

(358)

Cartridge
Copyist.

David Sandridge

Bx, Co. A, 5 Reg't U.S. Col'd Cavalry.

Appears on

Company Muster Roll

for *Jan. & Feb.*, 186*5*.

Present or absent *Present*

Stoppage, \$ *100* for

Due Gov't, \$ *100* for

Valuation of horse, \$ *100*

Valuation of horse equipments, \$ *100*

Remarks:

Book mark:

Castellina

(358)

Copyist.

7

5 Cav. U.S.C.T.

David Dandridge
Sgt., Co. A, 5 Reg't U.S. Col'd Cavalry.

Appears on

Company Muster Roll

for *Mar. & Apr.*, 1865.

Present or absent *Present.*

Stoppage, \$ 100 for

Due Gov't, \$ 100 for

Valuation of horse, \$ 100

Valuation of horse equipments, \$ 100

Remarks:

Book mark: -----

J. M. [Signature]
(358) Copyist.

2

5 Cav. U.S.C.T.

David Dandridge
Plt., Co. A, 5 Reg't U. S. Col'd Cavalry.

Appears on

Company Muster Roll

for *May 1865*, 1865

Present or absent *Present*

Stoppage, \$ 100 for

Due Gov't, \$ 100 for

Valuation of horse, \$ 100

Valuation of horse equipments, \$ 100

Remarks: *at muster
present, due \$ 100.*

Book mark:

J. A. [Signature]

(358)

Copyist.

5 Cav. U.S.C.T.

David Danbridge
Plt., Co. A, 5 Reg't U.S. Col'd Cavalry.

Appears on

Company Muster Roll

for *Sept. 1st*, 186*5*.

Present or absent *Present*

Stoppage, \$ *100* for

Due Gov't, \$ *100* for

Valuation of horse, \$ *100*

Valuation of horse equipments, \$ *100*

Remarks:
.....
.....
.....
.....
.....
.....
.....
.....

Book mark:

W. H. W. W.
Compt.

2

5 Cav. U.S.C.T.

David Dantridge

Pvt., Co. A, 5 Reg't U. S. Col'd Cavalry.

Appears on

Company Muster Roll

for *Dated Oct. 31*, 1865.

Present or absent *Present*

Stoppage, \$ 100 for

Due Gov't, \$ 100 for

Valuation of horse, \$ 100

Valuation of horse equipments, \$ 100

Remarks:

Book mark:

(358)

[Signature]
Copyist.

D

5 Cav. U.S.C.T.

David Sandridge

Pvt, Co. A, 5 Reg't U. S. Col'd Cavalry.

Appears on

Company Muster Roll

for *Nov & Dec*, 1865.

Present or absent *Present*

Stoppage, \$ *100* for

Due Gov't, \$ *4⁴⁷*/₁₀₀ for *Ord*

Valuation of horse, \$ *100*

Valuation of horse equipments, \$ *100*

Remarks: *Substitute*

Book mark:

W W Sayre
Copyist.

(358)

D

5 Cav. U.S.C.T.

David Dandridge
Pvt, Co. A, 5 Reg't U.S. Col'd Cavalry.

Appears on

Company Muster Roll

for Jan & Feb, 1866

Present or absent Present

Stoppage, \$ 100 for

Due Gov't, \$ 30¹²/₁₀₀ for Ordnance

Valuation of horse, \$ 100

Valuation of horse equipments, \$ 100

Remarks: Sentenced by
Field Court Martial
to 30 days confinement
per R.O. No 14. Hd Qrs
5th U.S.C. Helena, Ark
date 25th Jan 1866
Substitute

Book mark:

W. W. Mayne

(358)

Compt.

10 | 5 Cav. | U.S.C.T.

David Dandridge.

Co. A, 5 Reg't U. S. Colored Cav.

Appears on Returns as follows:

Nov. 1864 to Jan. 1865. Present sick
in Gen. Hoop, Camp Nelson,
Ky.

Book mark:

(546)

A. Baker
Copyist.

D

5 Cav. U.S.C.T.

David Dandridge

Prst, Co. *A*, 5 Reg't U. S. Col'd Cavalry.

Appears on **Co. Muster-out Roll**, dated

Helena Ark *March 16*, 186 *6*.

Muster-out to date

March 16, 186 *6*.

Last paid to

Oct 31, 186 *5*.

Clothing account:

Last settled....., 186 ; drawn since \$..... 100

Due soldier \$..... 100; due U. S. \$ *25* ⁰⁰/₁₀₀

Am't for cloth'g in kind or money adv'd \$..... 100

Due U. S. for arms, equipments, &c., \$ *60* ⁰⁰/₁₀₀

Bounty paid \$..... 100; due \$..... 100

Remarks: *Due U.S. for Ord*
60 cts

Book mark :

W. W. Sayre

(361)

Copyright.

Dandridge, David

S, Co. A, 5 Reg U.S.C. Cav.

4 Enclosures.

Bed Cards	Descriptive Lists
Burial Records	Final Statements
Certs. of Dis. for Discharge	Furloughs
C. M. Charges	Med. Des. Lists
Med. Certificates	Orders

Other papers relating to—

Admission to Hosp'l	Furlough
Casualty Sheet (Officer's)	Med. Examination
Confinement	Misc. Information
Contracts	Pay or Clothing
Death or Effects	Personal Reports
Desertions	Rank
Discharge from Hosp'l	Transfer to Hosp'l
Discharge from Service	Transfer to V. R. C.
Duty	Transportation

Proceedings of a
Field Officers Court
in the case of
David Dandridge
Private A. Co. 5th U.S. Cal.

Head Quarters
Mexico Arkansas
24 Jan 1866

Respectfully forwarded
L. W. W. W. W.
Col 5th U.S. Cal
Company

Order No. 14

Henry Jackson

A. G. S. F. R. District

Jan 25 - 1866

Proceedings findings and returns
Approved: *[Signature]* *[Signature]*
Col. Currier

Proceedings of a Field Officers
Court convened at the Camp of the
5th U.S.C. Co. at Helena Ark. Jan.
22^d in conformity with Regimental
Order No 10 of which the following
is a copy.

Headquarters 5th U.S. Col. Camp
Helena Ark. 20th Jan. 1866
Order No 10

Extract

1- In compliance with the Provision
of the Act of Congress approved July
17th 1862, Chapter 201, Section 7. A Field
Officers Court Martial is hereby ordered
to convene at the Camp of the 5th U.S.C.
Helena, Ark. Monday January 22, 1866
or as soon thereafter as practicable for
the trial of such cases as may be
brought before it.

Detail for the Court
Major Clifford Thomson 5th U.S.C. Co.
By command of S. H. Carpenter, Col.
Henry Jackson
Lt. and Adjutant 5th U.S.C. Co.

The Court met pursuant to the above
orders. Present Major C. Thomson
5th U.S.C.C.

Private David Dandridge was
then brought into Court and the orders
concerning the Court, having been read to
him he was asked if he had any
objections to being tried by the Member
detailed there in to which he replied in
the negative.

Private David Dandridge Co. "A" 5th
U.S.C.C. was then arraigned and tried
upon the following Charges and Specifications

Charges and Specifications prepared against
Private David Dandridge Co. "A" Fifth U.S. Cav.

Charge - Larceny.

Specification That Private David Dandridge
Co. "A" Fifth U.S. Cavalry did steal or
feloniously take one Cavalry Great Coat
the property of Sergt. Robert Arthur Co. "A"
Fifth U.S. Cavalry.

This from a tent occupied by Sergt Robert
Arthur or quarters in the Camp of the Fifth
U.S. Cavalry near Helena Ark on or about

The Court met pursuant to the above
orders. Present Major C. Thomson
5th U.S.C.C.

Private David Dandridge was
then brought into Court and the orders
convening the Court, having been read to
him he was asked if he had any
objections to being tried by the Member
detailed therein to which he replied in
the negative.

Private David Dandridge Co. "A" 5th
U.S.C.C. was then arraigned and tried
upon the following Charge and Specification

Charges and Specifications prepared against
Private David Dandridge Co. "A" Fifth U.S. Cav.

Charge 1. - Larceny.

Specification That Private David Dandridge
Co. "A" Fifth U.S. Cavalry did steal or
feloniously take, one Cavalry Great Coat
the property of Sergt. Robert Arthur Co. "A"
Fifth U.S. Cavalry.

This from a tent occupied by Sergt Robert
Arthur or quarters in the Camp of the Fifth
U.S. Cavalry near Helena Ark on or about
the 9th of January 1866.

Charge 2 - Selling Government Clothing
Specification - That Private David
Dandridge Co. W. 5th U.S. Army did sell,
or dispose of one U.S. Cavalry Great
Coat. to a citizen, one C. C. Stone,

(See Par. 4. Genl. Order No. 23. War. Dept. U.S. Office Mich 24/6)

This at Helena, Ark, on or about the 9th of
January 1866.

To which charges and Specifications
the accused pleaded as follows:

To the Specification to first Charge Guilty

To the first Charge Guilty

To the Specification to the second Charge Guilty

To the second Charge Guilty

The Court having investigated
the case and maturely considered the evidence
adduced, finds the accused as follows

Of the Specification to 1st Charge Guilty

Of the first Charge Guilty

Of the Specification to 2^d Charge Guilty

Of the second Charge Guilty

And the Court does therefore sentence
him the said David Dandridge Private of Co. H.
To be confined at hard labor with his regiment for
the period of one month

Clifford Thomson
Major 5th U.S. Army
Acting Field Court.

David Handridge
Es. W.

Adjutant General's Office,

COLORED TROOPS BRANCH,

November 6, 1873

Vol. C. T., 187

Wanted in case of David Sandridge, Co. A,
5th Reg't U. S. C. Cav. Col. Information as to
cause of confinement. M. R. for army + July 1866
reports him "sentenced by Field Court Martial to
30 days confinement + promulgated per S. O. No. 14. Vol. 4
5th U. S. C. Cavalry Act. date 25 June 1866."

Respectfully,

E. A. Woodward

Chief Clerk.

J. H. Dalton

Adjutant General's Office,

Record Room

Nov. 13, 1873

Vol. C. T., 187

R. G.

Reply in case of David Sandridge, Co. A,
5th Reg't U. S. C. Cavalry. Co. M. G. Report book shows July 1866. Confined + Charges prof.
Reg't Order book shows Filed by F. O. O.
Order No. 14. M. G. 5 U. S. C. Cavalry. Charge 1st "Larceny"
Charge 2nd "Selling Gov't. Clothing." Finding "Guilty."
Sentence: To be confined at hard labor with his reg't for the
period of 1 month. — (Approved.)

W. J.

328

Dandridge, William
Co D, 5 U. S. Col'd Cav.

Private Corporal

CARD NUMBERS.

1	5-360669	26
2	5-360766	27
3	5-360855	28
4	5-360951	29
5	5-361041	30
6	5-361128	31
7	5-361217	32
8	5-361287	33
9	5-361440	34
10	5-3619439	35
11	5-361612	36
12	9090109-	37
13	40729665 .	38
14		39
15		40
16		41
17		42
18		43
19		44
20		45
21		46
22		47
23		48
24		49
25		50

Book Mark:

See also

5737691 P.C. 707m
Pop 385986.

G. A. Meyer
20

10 | 5 Cav. | U.S.C.T.

Wm. W. Cambridge

Co. B, 5 Reg't U. S. Col'd Cav.

Appears on

Company Descriptive Book
of the organization named above.

DESCRIPTION.

Age 50 years; height 5 feet 7 inches.

Complexion Blk

Eyes Blk; hair Blk

Where born Fayette Co. Ky

Occupation Farmer

ENLISTMENT.

When Aug 17, 1864.

Where Camp Nelson

By whom Capt Randolph term 3 y'rs.

Remarks: Promoted to Corp
per R.O. No. 155 dated
Sept 21 Reserted Nov 27
1864

Wm. W. Cambridge

D

5 Cav. U.S.C.T.

William Dandridge

Priv., Co. B., 5 Reg't U. S. Col'd Cavalry.

Appears on

Company Muster-in and Descriptive Roll

of the organization named above. Roll dated

Camp Nelson, Ky, Oct 24, 1864.

Where born Fayette, Ky

Age 30 y'rs; occupation Farmer

When enlisted Aug 19, 1864.

Where enlisted Co Nelson

For what period enlisted 3 years.

Eyes Blue; hair Blue

Complexion Blue; height 5 ft. 9 in.

When mustered in Aug 19, 1864.

Where mustered in Co Nelson

Bounty paid \$100; due \$100

Where credited 7 Dist. Ky

Company to which assigned B

Remarks: * Name of owner of Negro William M. Alister

* Added May 12, 98. by H. J.

Book mark:

Lamb

D

5 Cav. U.S.C.T.

William Dardridge

Priv, Co. B, 5 Reg't U. S. Col'd Cavalry.

Appears on

Company Muster Roll

for Oct 31, 1864.

Present or absent Present

Stoppage, \$ 100 for

Due Gov't, \$ 100 for

Valuation of horse, \$ 100

Valuation of horse equipments, \$ 100

Remarks:

Book mark:

Lamb

(358)

Copyist.

D

5 Cav. U.S.C.T.

William Daudridge

Serjeant, Co. B, 5 Reg't U. S. Col'd Cavalry.

Appears on

Company Muster Roll

for Nov & Dec, 1864

Present or absent Present

Stoppage, \$ 100 for

Due Gov't, \$ 100 for

Valuation of horse, \$ 100

Valuation of horse equipments, \$ 100

Remarks: 1st & 2nd instalments
bounty due,
Due el. A. for Ordnance #

Roll torn

Book mark:

Law

(358)

Copyist.

D

5 Cav.

U.S.C.T.

William Dandridge

Peis, Co. B, 5 Reg't U. S. Col'd Cavalry.

Appears on

Company Muster Roll

for Jan & Feb, 1865.

Present or absent Present

Stoppage, \$ 100 for

Due Gov't, \$ 100 for

Valuation of horse, \$ 100

Valuation of horse equipments, \$ 100

Remarks: 1st installment
Bounty \$100 due

Book mark:

Lacey

(358)

Copyist.

D

5 Cav. U.S.C.T.

William Daudbridge

Private, Co. B, 5 Reg't U. S. Col'd Cavalry.

Appears on

Company Muster Roll

for Feb 28 1860, 1860.

Present or absent Present

Stoppage, \$ 100 for

Due Gov't, \$ 100 for

Valuation of horse, \$ 100

Valuation of horse equipments, \$ 100

Remarks: 1st installment county dues \$100

Book mark:

Lamb

D

5 Cav. U.S.C.T.

William Danbridge

Priv., Co. B, 5 Reg't U. S. Col'd Cavalry.

Appears on

Company Muster Roll

for *May & June, 1865*.

Present or absent *present*

Stoppage, \$ *100* for

Due Gov't, \$ *100* for

Valuation of horse, \$ *100*

Valuation of horse equipments, \$ *100*

Remarks: *1st. installment
county due \$100 -*

Book mark:

R. C. Wilson

D

5 Cav. U.S.C.T.

William Dandridge

Priv., Co. B, 5 Reg't U. S. Col'd Cavalry.

Appears on

Company Muster Roll

for *July & Aug.*, 186*5*.

Present or absent *present*

Stoppage, \$ *100* for

Due Gov't, \$ *100* for

Valuation of horse, \$ *100*

Valuation of horse equipments, \$ *100*

Remarks:

Book mark: -----

A. E. Wilson

A

5 Cav.

U.S.C.T.

William Drumbridge
Corp., Co. B, 5 Reg't U. S. Col'd Cavalry.

Appears on

Company Muster Roll

for Sept. & Octo., 1865.

Present or absent present

Stoppage, \$ 100 for

Due Gov't, \$ 100 for

Valuation of horse, \$ 100

Valuation of horse equipments, \$ 100

Remarks: Promoted from Priv.
to Corp't per R.O. No 155, dated
Sept. 21, 1865.

Book mark:

R. Currier

A

5 Cav.

U.S.C.T.

William Danbridge
Corp, Co. B, 5 Reg't U. S. Col'd Cavalry.

Appears on

Company Muster Roll

for *Nov. & Dec.*, 186*5*.

Present or absent.....

Stoppage, \$.....100 for.....

Due Gov't, \$.....100 for.....

Valuation of horse, \$.....100

Valuation of horse equipments, \$.....100

Remarks: *Deserted November 27th*
1865 at Louisville Ky. Due U.S.
for ordnance \$36³¹

Book mark:.....

R. E. Wilson

(358)

Copyist.

A | *Flan* | U.S.C.T.

William Davtridge
Cop, Co. B, 5 Reg't U. S. Col'd *Flan*

Appears on

Descriptive List of Deserters

dated *Nov 30*, 186 *5*.

Deserted:

When *Nov 26*, 186 *5*.

Where *Louisville Ky*

Arrested:

When _____, 186 .

Where _____

Remarks: *Due US for Ord*
nance \$36³¹

Book mark: _____

Rose

(351)

Copyist.

D. | 5 Cav. | U.S.C.T.

William Dandridge.

Capt., Co. B, 5 Reg't U. S. Colored Cav.

Appears on Returns as follows:

Nov. 1865. Deserted Nov. 27/65.
Louisville, Ky.

Book mark :

(546)

A. Baker
Copyist.

D | **5 Cav. | U.S.C.T.**

William Dendridge
Corp., Co. *B*, 5 Reg't U. S. Col'd Cavalry.

Appears on **Co. Muster-out Roll**, dated
Melona Ark, *Mar 12*, 186*6*.

Muster-out to date _____, 186 .

Last paid to *Oct 31*, 186*5*.

Clothing account:

Last settled _____, 186 ; drawn since \$ _____ $\overline{100}$

Due soldier \$ _____ $\overline{100}$; due U. S. \$ *18* $\overline{100}$

Am't for cloth'g in kind or money adv'd \$ _____ $\overline{100}$

Due U. S. for arms, equipments, &c., \$ _____ $\overline{100}$

Bounty paid \$ _____ $\overline{100}$; due \$ _____ $\overline{100}$

Remarks: *Deserted Nov 27 65*
Yonville Ky
Starr Sept 19 1861

Book mark: _____

Dandridge William

, Co. B, 5 Reg't U.S. Cavalry

/ Enclosures.

Bed Cards	Final Statements
Burial Records	Furloughs or L. of A.
Certs. of Dis. for Discharge	Med. Certificates
C. M. Charges	Med. Des. Lists
Descriptive Lists	Orders
Discharge Certificates	Pris. of War Record
Enlistment Papers	Resignations

Other papers relating to—

Admission to Hosp'l	Furlough or L. of A.
Casualty Sheet	Med. Examination
Confinement	Misc. Information
Contracts	Pay or Clothing
Death or Effects	Personal Reports
Desertion	Rank
Discharge from Hosp'l	Transfer to Hosp'l
Discharge from Service	Transfer to V. R. C.
Duty	Transportation

NOTE 1.—This blank will be used for enlistments of United States colored troops. They will be made out in duplicate in all cases—one to accompany the recruiting return of the superintendent (not the recruiting officer) to the Adjutant General, and one to accompany the accounts of the officer who pays bounty, &c.

NOTE 2.—An enlistment holds to service. A muster-in must, in all cases, precede payment of pay, bounty, pension, &c. A muster-in roll, must in all cases, be filed in the Adjutant General's Office as evidence of muster-in. The mustering officer, commissary, or assistant commissary of musters, as the case may be, will countersign both enlistments as having mustered the soldiers into the service of the United States before either of them is given to the disbursing officer.

DECLARATION OF RECRUIT.

I, William Handridge desiring to volunteer as a soldier in the ARMY OF THE UNITED STATES, for the term of Three Years, DO DECLARE That I am 30 years and months of age; that I have never been discharged from the United States service on account of disability or by sentence of a court-martial, or by order before the expiration of a term of enlistment; and I know of no impediment to my serving honestly and faithfully as a soldier for three years.

GIVEN at Camp Nelson the 14 day of August 1864

Witness: John Diekem

William Handridge
Volunteered at Camp Nelson
Aug 19 1864
By Wm Handridge
Adjutant Gen
of the 1st Regt Colored Troops
of the Army of the Potomac

Dr Howard Murray 1868

Consent of Parent or Guardian in case of a Minor, if a Free Man, or in the case of a Slave, of the Person to whom he owes Service:

I, Do CERTIFY, That I am the that the said is years of age; and I do freely give my CONSENT to his volunteering as a SOLDIER in the Army of the United States, for the period of THREE YEARS, under the conditions of the laws of the United States.

GIVEN at the day of

Witness:

UNITED STATES COLORED TROOPS ENLISTMENT.

STATE OF



TOWN OF

Kentucky *Camp Nelson*

I, *William Sandridge* born in *Bayette* *20*
in the State of *Kentucky* aged *thirty* years

and by occupation a *Farmer* Do HEREBY ACKNOWLEDGE to
have volunteered *nineteenth* day of *August* 1864

to serve as a **Soldier** in the **Army of the United States of America**, for the
period of **THREE YEARS**, unless sooner discharged by proper authority: Do
also agree to accept such bounty, pay, rations, and clothing, as are, or may be,
established by law for the U. S. colored troops.

And I, *William Sandridge*
do solemnly swear that I will bear true faith and allegiance to the **United States
of America**, and that I will serve them honestly and faithfully against all their
enemies or opposers whomsoever; and that I will observe and obey the orders
of the President of the United States, and the orders of the officers appointed
over me, according to the Rules and Articles of War.

Sworn and subscribed to, at *Camp Nelson*
this *19* day of *August* 1864 *William Sandridge*
Before *J. Randolph* *notary*
D. P. 16

I CERTIFY, ON HONOR, That I have carefully examined the above named Volunteer agree-
ably to the General Regulations of the Army, and that, in my opinion, he is free from all bodily
defects and mental infirmity, which would in any way disqualify him from performing the
duties of a soldier.

C. E. Hollaway
assist surg 40th Reg vol inf
EXAMINING SURGEON.

I CERTIFY, ON HONOR, That I have minutely inspected the Volunteer, *W. Sandridge*
previously to his enlistment, and that he was entirely sober when enlisted; that, to the best of
my judgment and belief, he is of lawful age; and that, in accepting him as duly qualified to per-
form the duties of an able-bodied soldier, I have strictly observed the regulations which govern
the recruiting service. This soldier has *Blk* eyes, *Blk* hair, *Blk* com-
plexion, is *five* feet *nine* inches high.

J. Randolph
RECRUITING OFFICER OR AGENT.

Mustered into the United States Service *19th* day of *August* 1864

N. O. Trimmer
Capt 18th U.S. Inf and
Mustering Officer

Mustered into the service of the United States, for three years or during the war, from date of enlistment, in Company
Regiment of *1st Caval* *Parabola* Volunteers, on the *19th* day of *August* 1864 at *Camp Nelson*

N. O. Trimmer
Capt 18th U.S. Inf and
Mustering Officer

329

Daniel, Amos

Co K, 5 U. S. Col'd Cav.

Private

Sergeant

CARD NUMBERS.

1	5368821	26
2	5368914	27
3	5369015	28
4	5369103	29
5	5369190	30
6	5369276	31
7	5369366	32
8	5369436	33
9	5369518	34
10	5369604	35
1	5369688	36
2	2091057	37
3	43148225	38
4	40729666	39
5		40
6		41
7		42
8		43
9		44
10		45
		46
		47
		48
		49
		50

Book Mark:

See also

D | **5 Cav. | U.S.C.T.**

Amos Daniel

, Co. *K*, 5 Reg't U. S. Col'd Cav.

Appears on

Company Descriptive Book
of the organization named above.

DESCRIPTION.

Age *24* years; height *5* feet *3* inches.

Complexion *Black*

Eyes *Blk*; hair *Blk*

Where born *Bourbon Co Ky*

Occupation *Laborer*

ENLISTMENT.

When *Oct-7*, 1864.

Where *Dixington, Ky*

By whom *J. H. Mason*; term *3* y'rs.

Remarks:

(383g)

A. H. Anderson

Copist.

T. | 5 lev | U.S.A.

Amos Daniel

Appears with rank of Priv on

Muster and Descriptive Roll

of Detachment of U.S. Col. 10th
forwarded Camp Nelson, Ky.

Roll dated
Lexington, Ky, Oct. 7, 1864.

Where born Clark, Ky.

Age 20 years; occupation Laborer

When enlisted Oct. 7, 1864.

Where enlisted Lexington, Ky

For what period enlisted 3 years.

Eyes Blue; hair Black

Complexion Black; height 5 ft. 3 in.

When mustered in _____, 1864.

Where mustered in _____

County paid \$ 100; due \$ 100

Nothing account:

Last settled _____, 1864; drawn since \$ 100

Date of first muster Oct. 7, 1864.

Company to which assigned _____

Remarks: To be credited to

Clark Co. 7th Dist. Ky.

Book mark: _____

356m)

E. J. Harris

Copyist.

10

5 Cav.

U.S.C.T.

Amos Daniel

Pvt., Co. H., 5 Reg't U. S. Col'd Cavalry.

Appears on

Company Muster-in and Descriptive Roll

of the organization named above. Roll dated

Camp Nelson N.Y., Oct 30, 1864.

Where born Clark Ky

Age 20 y'rs; occupation Laborer

When enlisted Oct 7, 1864.

Where enlisted Lexington Ky

For what period enlisted 3 years.

Eyes Blk; hair Blk

Complexion Blk; height 5 ft. 3 in.

When mustered in Oct 7, 1864.

Where mustered in Lexington Ky

Bounty paid \$ 100; due \$ 100

Where credited 7 Dist Ky

Company to which assigned

Remarks:

Book mark:

H S Miller

(356d)

Copyist.

5 Cav. U.S.C.T.

Amos Daniel

Pvt., Co. K, 5 Reg't U. S. Col'd Cav.

Appears on

Company Muster Roll

for *Organization to Oct 31*, 1864.

Present or absent *Present*

Stoppage, \$ *100* for

Due Gov't, \$ *100* for

Valuation of horse, \$ *100*

Valuation of horse equipments, \$ *100*

Remarks:

Book mark:

H. J. Miller

(358)

Copyist.

D

5 Cav.

U.S.C.T.

Amos Daniel

Pvt., Co. K, 5 Reg't U. S. Col'd Cav.

Appears on

Company Muster Roll

for Nov & Dec, 1864.

Present or absent Present

Stoppage, \$ 100 for

Due Gov't, \$ 100 for

Valuation of horse, \$ 100

Valuation of horse equipments, \$ 100

Remarks: 1" & 2" installments
Bounty due.

Book mark:

H. S. Miller

(358)

Copyist.

10

5 Cav.

U.S.C.T.

Amos Daniel

Pvt., Co. K, 5 Reg't U. S. Col'd Cav.

Appears on

Company Muster Roll

for Jan & Feb, 1865.

Present or absent Present

Stoppage, \$ 100 for

Due Gov't, \$ 100 for

Valuation of horse, \$ 100

Valuation of horse equipments, \$ 100

Remarks: 1 "1/2" installments
\$300 Bounty due

Book mark:

W. S. Miller

(358)

Copyist.

20

5 Cav. U.S.C.T.

Amos Daniel

Pvt., Co. K, 5 Reg't U. S. Col'd Cav.

Appears on

Company Muster Roll

for Mar & Apr, 1865.

Present or absent Present

Stoppage, \$ 100 for

Due Gov't, \$ 100 for

Valuation of horse, \$ 100

Valuation of horse equipments, \$ 100

Remarks: 1st installment of
Bounty due

Book mark:

H. Miller

(358)

Copyist.

D

5 Cav.

U.S.C.T.

Amos Daniel

Co. K, 5 Reg't U. S. Col'd Cav.

Appears on

Company Muster Roll

for May & June, 1865.

Present or absent Present

Stoppage, \$ 100 for

Due Gov't, \$ 100 for

Valuation of horse, \$ 100

Valuation of horse equipments, \$ 100

Remarks: First installment
bounty due \$100

Book mark:

F. E. Porter

(358)

Copyist.

2

5 Cav. U.S.C.T.

Amos Daniel

Prov, Co. K, 5 Reg't U. S. Col'd Cav.

Appears on

Company Muster Roll

for July & Aug, 1863.

Present or absent Present

Stoppage, \$ 100 for

Due Gov't, \$ 100 for

Valuation of horse, \$ 100

Valuation of horse equipments, \$ 100

Remarks:

Book mark:

J. E. Porter

(358)

Copyist.

Amos Daniels

Wagon, Co. K, 5 Reg't U. S. Col'd Cav.

Appears on

Company Muster Roll

for *Sept & Oct*, 186*9*.

Present or absent *Present*

Stoppage, \$ *100* for

Due Gov't, \$ *100* for

Valuation of horse, \$ *100*

Valuation of horse equipments, \$ *100*

Remarks: *Dis. U. S. for
Co. G. & H. 1.6.4. Discharged
Compl. per R. O. No 100
Warren Nelson Key
Sept 8, 1869*

Book mark:

F. E. Porter

D

5 Cav. U.S.C.T.

Amos Daniels

Sgt., Co. K, 5 Reg't U. S. Col'd Cav.

Appears on

Company Muster Roll

for Nov & Dec, 1865.

Present or absent Present

Stoppage, \$ 100 for

Due Gov't, \$ 100 for

Valuation of horse, \$ 100

Valuation of horse equipments, \$ 100

Remarks: Promoted from
Corpl to Supt Ser A J
Nov 12th Dec 11th. Due
M. S. for Qrd 15

Book mark:

F. E. Porter

(358)

Copyist.

2

5 Cav. U.S.C.T.

Amos Daniels

591, Co. K, 5 Reg't U. S. Col'd Cav.

Appears on

Company Muster Roll

for *Jan 25*, 186*6*.

Present or absent *Present*

Stoppage, \$ *100* for

Due Gov't, \$ *100* for

Valuation of horse, \$ *100*

Valuation of horse equipments, \$ *100*

Remarks:

Book mark:

E. T. Dean

(358)

Copyist.

Amos Daniel.

Priv., Co. K, 5 Reg't U. S. Colored Cav.

Appears on Returns as follows:

May 1865: On daily duty, Provost Guard.

Book mark:

(546)

f. Baker
Copyist.

2

5 Cav. U.S.C.T.

James

5 Reg't U. S. Col'd Cavalry.

Appears on Co. Muster-out Roll, dated

March 16, 1866.

Muster-out to date March 16, 1866.

Last paid to Dec 31, 1865.

Clothing account:

Last settled, 186 ; drawn since \$ 100

Due soldier \$ 7 100; due U. S. \$ 100

Am't for cloth'g in kind or money adv'd \$ 100

Due U. S. for arms, equipments, &c., \$ 100

Bounty paid \$ 100; due \$ 100

Remarks: Partially settled to Dec 31, 65 then paid.

Book mark:

E. J. Brown

Daniel Amos

, Co. _____,

Reg't _____

U. S. C. T.

Enclosures.

Bed Cards	Final Statements
Burial Records	Furloughs or L. of A.
Certs. of Dis. for Discharge	Med. Certificates
C. M. Charges	Med. Des. Lists
Descriptive Lists	Orders
Discharge Certificates	Pris. of War Record
Enlistment Papers	Resignations

Other papers relating to—

Admission to Hosp'l	Furlough or L. of A.
Casualty Sheet	Med. Examination
Confinement	Misc. Information
Contracts	Pay or Clothing
Death or Effects	Personal Reports
Desertion	Rank
Discharge from Hosp'l	Transfer to Hosp'l
Discharge from Service	Transfer to V. R. C.
Duty	Transportation

NOTE 1.—This blank will be used for enlistments of United States colored troops. They will be made out in duplicate in all cases—one to accompany the recruiting return of the superintendent (not the recruiting officer) to the Adjutant General, and one to accompany the accounts of the officer who pays bounty, &c.

NOTE 2.—An enlistment holds to service. A muster-in must, in all cases, precede payment of pay, bounty, pension, &c. A muster-in roll, must in all cases, be filed in the Adjutant General's Office as evidence of muster-in. The mustering officer, commissary, or assistant commissary of musters, as the case may be, will countersign both enlistments as having mustered the soldiers into the service of the United States before either of them is given to the disbursing officer.

DECLARATION OF RECRUIT.

I, Amos Daniel desiring to volunteer as a soldier in the ARMY OF THE UNITED STATES, for the term of Three Years, DO DECLARE That I am 24 years and 7 months of age; that I have never been discharged from the United States service on account of disability or by sentence of a court-martial, or by order before the expiration of a term of enlistment; and I know of no impediment to my serving honestly and faithfully as a soldier for three years.

GIVEN at Lexington Ky the 7 day of October 1864

Witness: H. W. Kohler J. Amos Daniel
his
mark

9196
Amos Daniel
No. First
Volunteered at Lexington Ky
Oct 7 1864
By W. H. Moore, Sr. Major
7 Kentucky

Consent of Parent or Guardian in case of a Minor, if a Free Man, or in the case of a Slave, of the Person to whom he owes Service:

I, Fleury Daniel of Missouri Do CERTIFY, That I am the owner of Amos Daniel a Slave

that the said Amos Daniel is Twenty years of age; and I do freely give my CONSENT to his volunteering as a SOLDIER in the Army of the United States, for the period of THREE YEARS, under the conditions of the laws of the United States.

GIVEN at Lexington Kentucky the 7th day of October 1864

Witness: _____

UNITED STATES COLORED TROOPS ENLISTMENT.

STATE OF

TOWN OF

Kentucky  *Lexington*
I, *Amos Daniel* born in *Clarke, Co.*
in the State of *Kentucky* aged *Twenty* years
and by occupation a *Laborer* Do HEREBY ACKNOWLEDGE TO
have volunteered *Seventh* day of *Oct* 186 *4*

to serve as a **Soldier** in the **Army of the United States of America**, for the period of **THREE YEARS**, unless sooner discharged by proper authority: Do also agree to accept such bounty, pay, rations, and clothing, as are, or may be, established by law for the U. S. colored troops.

And I, *Amos Daniel*
do solemnly swear that I will bear true faith and allegiance to the **United States of America**, and that I will serve them honestly and faithfully against all their enemies or opposers whomsoever; and that I will observe and obey the orders of the President of the United States, and the orders of the officers appointed over me, according to the Rules and Articles of War.

Sworn and subscribed to, at *Lexington Ky*
this *Seventh* day of *Oct* 186 *4* *Amos X Daniel*
Before *J. H. Moon* *mak*
Cap & Pro Mar 7 dis Ky

I CERTIFY, ON HONOR, That I have carefully examined the above named Volunteer agreeably to the General Regulations of the Army, and that, in my opinion, he is free from all bodily defects and mental infirmity, which would in any way disqualify him from performing the duties of a soldier.

J. J. Gano

EXAMINING SURGEON.

I CERTIFY, ON HONOR, That I have minutely inspected the Volunteer, *Amos Daniel* previously to his enlistment, and that he was entirely sober when enlisted; that, to the best of my judgment and belief, he is of lawful age; and that, in accepting him as duly qualified to perform the duties of an able-bodied soldier, I have strictly observed the regulations which govern the recruiting service. This soldier has *Dark* eyes, *Dark* hair, *Dark* complexion, is *5* feet *3* inches high.

J. H. Moon

Cap & Pro Mar 7 dis Ky RECRUITING OFFICER OR AGENT

Mustered into the United States Service.....day of186 .

Mustered Officer.

Mustered into the service of the United States, for three years or during the war, from date of enlistment, in Company
Regiment of
Volunteers, on the day of 186 , at

330

Daniels, Dudley

Co K, 5 U. S. Col'd Cav.

Private

Private

CARD NUMBERS.

5-368822	26
5-368915	27
5-369016	28
5-369104	29
5-369191	30
5-369277	31
5-369367	32
5-369452	33
5-369539	34
5-369620	35
5-369709	36
909105-8	37
43148226	38
40729667	39
	40
	41
	42
	43
	44
	45
	46
	47
	48
	49
	50

Book Mark:

See also

19 | 5 Cav. | U.S.C.T.

Daniel Dudley

Co. K, 5 Reg't U. S. Col'd Cav.

Appears on

Company Descriptive Book
of the organization named above.

DESCRIPTION.

Age 24 years; height 5 feet 3 inches.

Complexion Black

Eyes Blue; hair Blue

Where born Atlantic City

Occupation Laborer

ENLISTMENT.

When July, 1864.

Where Livingston City

By whom J. M. ...; term 3 y'rs.

Remarks:

(383g)

R. J. Anderson

Copist.

D. | 5 bar | U.S.A.

Dudley Daniel

Private

Appears with rank of on

Muster and Descriptive Roll

of Detachment of U.S. Col. Vols
forwarded Camp Nelson, Ky

Roll dated
Lexington, Ky, Oct. 7, 1864.

Where born Alark, Ky

Age 20 years; occupation Laborer

When enlisted Oct. 7, 1864

Where enlisted Lexington, Ky

For what period enlisted 3 years.

Eyes Blue; hair Blue

Complexion Blue; height 5 ft. 3 in.

When mustered in, 1864

Where mustered in

Bounty paid \$ 100; due \$ 100

Clothing account:

Last settled, 1864; drawn since \$ 100

Date of first muster Oct. 7, 1864

Company to which assigned

Remarks: To be credited to

Alark Co. 7th Dist. Ky

Book mark:

H. J. Harris

(356m)

Copyist.

D

5 Cav.

U.S.C.T.

Dudley Daniel

Pvt, Co A, 5 Reg't U. S. Col'd Cavalry.

Appears on

Company Muster-in and Descriptive Roll

of the organization named above. Roll dated

Camp Nelson Ky, N. Y., Oct 30, 1864.

Where born Clark Ky

Age 24 y'rs; occupation Laborer

When enlisted Oct 7, 1864.

Where enlisted Lexington Ky

For what period enlisted 3 years.

Eyes Blk; hair Blk

Complexion Blk; height 5 ft. 3 in.

When mustered in Oct 7, 1864.

Where mustered in Lexington Ky

Bounty paid \$ 100; due \$ 100

Where credited T. List Ky

Company to which assigned

Remarks:

Book mark:

H. S. Miller

(356d)

Copyist.

D

5 Cav.

U.S.C.T.

Dudley Daniel

Priv., Co. K, 5 Reg't U. S. Col'd Cav.

Appears on

Company Muster Roll

for Organization to Oct 31, 1864.

Present or absent Present

Stoppage, \$ 100 for

Due Gov't, \$ 100 for

Valuation of horse, \$ 100

Valuation of horse equipments, \$ 100

Remarks:

Book mark:

A. J. Miller

(358)

Copyist.

20

5 Cav.

U.S.C.T.

Dudley Daniel

Pvt., Co. K, 5 Reg't U. S. Col'd Cav.

Appears on

Company Muster Roll

for Nov & Dec, 1864.

Present or absent Present

Stoppage, \$ 100 for

Due Gov't, \$ 100 for

Valuation of horse, \$ 100

Valuation of horse equipments, \$ 100

Remarks: 1st & 2nd installments -
Bounty due

Book mark:

J. S. Miller

58)

Copyist.

L

5 Cav.

U.S.C.T.

Dudley Daniel

Pvt, Co. K, 5 Reg't U. S. Col'd Cav.

Appears on

Company Muster Roll

for *Jan & Feb*, 1865.

Present or absent *Present*

Stoppage, \$ *100* for

Due Gov't, \$ *100* for

Valuation of horse, \$ *100*

Valuation of horse equipments, \$ *100*

Remarks: *1" & 2" installments - \$300 Bounty due*

Book mark:

A. Miller

(358)

Copyist.

10

5 Cav.

U.S.C.T.

Dudley Daniel

Pvt., Co. K, 5 Reg't U. S. Col'd Cav.

Appears on

Company Muster Roll

for Mar 31st, 1865

Present or absent Present

Stoppage, \$ 100 for

Due Gov't, \$ 100 for

Valuation of horse, \$ 100

Valuation of horse equipments, \$ 100

Remarks: 1st installment of bounty due \$100

Book mark:

J. S. Miller

(358)

Copyist.

D

5 Cav. U.S.C.T.

Dudley Daniel

Co. K, 5 Reg't U. S. Col'd Cav.

Appears on

Company Muster Roll

for May & June, 1865.

Present or absent Present

Stoppage, \$ 100 for

Due Gov't, \$ 100 for

Valuation of horse, \$ 100

Valuation of horse equipments, \$ 100

Remarks: First installment bounty due \$100

Book mark:

J. E. Porter

2

5 Cav. U.S.C.T.

Dudley Daniel
Troop, Co. K, 5 Reg't U. S. Col'd Cav.

Appears on

Company Muster Roll

for July & Aug, 1865.

Present or absent Present

Stoppage, \$ 100 for

Due Gov't, \$ 100 for

Valuation of horse, \$ 100

Valuation of horse equipments, \$ 100

Remarks:

Book mark:

F. E. Porter

(358)

Copyist.

2

5 Cav. U.S.C.T.

Frankly Daniels

Co. K, Co. K, 5 Reg't U. S. Col'd Cav.

Appears on

Company Muster Roll

for *Sept & Oct*, 186*4*.

Present or absent *Present*

Stoppage, \$ *100* for

Due Gov't, \$ *100* for

Valuation of horse, \$ *100*

Valuation of horse equipments, \$ *100*

Remarks: *Dis. U. S. for*
10. 1. 64

Book mark:

J. E. Porter

(358)

Copyist.

2

5 Cav. U.S.C.T.

Sudley Daniels

Co. K, 5 Reg't U. S. Col'd Cav.

Appears on

Company Muster Roll

for *Nov & Dec*, 186*6*.

Present or absent *Present*

Stoppage, \$ *100* for

Due Gov't, \$ *100* for

Valuation of horse, \$ *100*

Valuation of horse equipments, \$ *100*

Remarks: *Due U.S. for Ord.*
.30

Book mark:

F. E. Porter

(358)

Copyist.

2

5 Cav. U.S.C.T.

Dudley Daniels
Port, Co. K, 5 Reg't U. S. Col'd Cav.

Appears on

Company Muster Roll

for Jan 1st, 1866.

Present or absent Present

Stoppage, \$ 100 for

Due Gov't, \$ 100 for

Valuation of horse, \$ 100

Valuation of horse equipments, \$ 100

Remarks:

Book mark:

E. H. B. [Signature]

(358)

Copyist.

10

5 Cav.

U.S.C.T.

Dudley Daniel

Co. K, 5 Reg't U. S. Colored Cav.

Appears on Returns as follows:

Aug. 1865. On duty, Co. Cook.

Book mark:

(546)

Baker
Copyist.

9

5 Cav. U.S.C.T.

Andrew Daniels
Co. 4, 5 Reg't U. S. Col'd Cavalry.

Appears on Co. Muster-out Roll, dated
 Helena Ark, Dec 16, 1866.
 Muster-out to date Dec 16, 1866.
 Last paid to Dec 31, 1865.

Clothing account:

Last settled 186 ; drawn since \$ 100
 Due soldier \$ 100 ; due U. S. \$ 18
 Am't for cloth'g in kind or money adv'd \$ 100

Due U. S. for arms, equipments, &c., \$ 100
 Bounty paid \$ /ct 100; due \$ 100

Remarks:

Book mark: 389 Paid May 10/66

C. T. Brown

Carling, George A.
Co *G*, 5 U. S. Col'd Cav.

Captain

Captain

CARD NUMBERS.

1	5359161	26	42918391
2	5365989	27	40729668
3	5366001	28	S-425-e.T.64
4	5366095	29	
5	5366185	30	
6	5366273	31	
7	5366364	32	
8	5366453	33	
9	5366541	34	
10	5366627	35	
11	5359355	36	
12	9495960	37	
13	S 425-e.T.-1864	38	
14	42918154	39	
15	42918174	40	
16	42918195	41	
17	42918227	42	
18	42918262	43	
19	42918284	44	
20	42918299	45	
21	42918316	46	
22	42918331	47	
23	42918353	48	
24	42918368	49	
25	42689227	50	

Book Mark: { 1792-*Ch. 82*
S. 425-e.T.-1864

See also 119 "U. S. C. T.

D. 2597702 P.M.M.

And. N.D. 514167 3/30 - 5/6

4 4 4 4 4 4
7/13/14
7/23/14

G.A. Meyer
7

L 15th Cav. | U.S.C.T.

George A. Darling

Capt, Co. G, 5th Reg't U. S. Col'd Cav'y

Appears on

Regimental Descriptive Book

(List of Commissioned Officers)

of the regiment named above.

Rank *Captain*

Date of appointment.....186.....

Remarks: *Mustered Dec 9th 1864,
at Camp Henson. By
Capt Kinney.*

Hearst

D | 5 Cav. | U.S.C.T.

George A. Darling
Capt, Co. 4, 5 Reg't U. S. Col'd Cav.

Age years.

Appears on an

Individual Muster-in Roll

of the organization named above. Roll dated

Camp Nelson Ky Dec. 9, 1864.

Muster-in to date Dec. 9, 1864.

Joined for duty and enrolled :

When Dec. 9, 1864.

Where Camp Nelson Ky

Period 3 years.

Valuation of horse, \$ 100

Valuation of horse equipments, \$ 100

Remarks: Mustered in upon
appointment of the Pres-
ident of the United States
dated Baltimore Md.

Book mark: S-425-C-7-64

Sarimer

JAN. - 9

5359161

1891 *

Oct 1. 1864. To rank as
captain in 5 U. S.

Colored Cavalry from
said date. assigned
to duty in his company
(4) : December 9 1864

enlisted men of said
company were mustered
in to the maximum on
or before the 9 December
1864. Tenders his resig-
nation to take affect
immediately as 1st Lieut.
119. U. S. Colored Infantry
December 2. 1864

D | **5 Cav.** | **U.S.C.T.**

George A. Darling
Privt, Co. G, 5 Reg't U. S. Col'd Cavalry.

Appears on

Company Muster Roll

for *Nov. + Dec.*, 1864.

Present or absent *Absent*,

Stoppage, \$ *100* for

Due Gov't, \$ *100* for

Valuation of horse, \$ *100*

Valuation of horse equipments, \$ *100*

Remarks: *Attached service*
Hdqrs. S. O. U. S. C. T.
Lexington Ky.

Book mark: _____

(358)

[Signature]
Copyist.

D

5 Cav.

U.S.C.T.

George A. Darling

Private, Co. G, 5 Reg't U. S. Col'd Cavalry.

Appears on

Company Muster Roll

for *Jan. & Feb.*, 186*5*.

Present or absent *Absent*.

Stoppage, \$ *100* for

Due Gov't, \$ *100* for

Valuation of horse, \$ *100*

Valuation of horse equipments, \$ *100*

Remarks: *Detached Hdqrs. S. O. U. S. C. T. Lexington*

Book mark:

(358)

J. M. [Signature]

Copyist.

10 | 5 bar | U. S. C. T.

G. A. Darling
Lieutenant 5 Regt U. S. C. Cav.

Return

of the Department of Kentucky,

for the month of March, 1865,

dated Louisville, Ky.

May 5, 1865,

shows the following with regard to the officer
named above:

Post or station Louisville Kentucky

Remarks Gained: -

Assigned with Gen Brisson
Mar 13. 1865.

Book mark:

W. P. Lee

(546)

Copyist.

D

5 Cav.

U.S.C.T.

George A. Darling

Capt., Co. G, 5 Reg't U. S. Col'd Cavalry.

Appears on

Company Muster Roll

for *March & April*, 186*5*.

Present or absent *Absent*

Stoppage, \$ *100* for

Due Gov't, \$ *100* for

Valuation of horse, \$ *100*

Valuation of horse equipments, \$ *100*

Remarks: *Detached Hdqrs.*
S.O. U.S.C.T. Louisville
Reg. date and no. of order
not known.

Book mark:

[Signature]

(35c)

Copyist.

LD | 5 Co U.S.C.

G. A. Darling
1st Lieut 5 Regt U.S.C. Cav.

Return

of the Department of Kentucky,
for the month of April, 1865,
dated Louisville, Ky.
May, 1865,

shows the following with regard to the officer
named above:

Post or station Louisville Kentucky
Remarks Assd. with Gen
Briston Mar 13/65

Book mark:

W. P. Lee

(546)

Copyist.

10 | 5 Cav. | U.S.C.T.

G. A. Darling
Captani 5 Regt U.S.C. Cav

Return

of the Department of Kentucky,

for the month of May, 1865,

dated Louisville, Ky.

June 10, 1865,

shows the following with regard to the officer
named above:

Post or station Louisville, Ky.

Remarks Assigned as A.A.G.

M. Per A.O. No 66. Dept of Ky.
C. I.

Book mark:

W. R. Lee

(546)

Copyist.

George A. Darling
Capt., (Co. G), 5 Reg't U. S. Col'd Cavalry

Appears on

Company Muster Roll

for May + June, 1865.

Present or absent Absent

Stoppage, \$ 100 for

Due Gov't, \$ 100 for

Valuation of horse, \$ 100

Valuation of horse equipments, \$ 100

Remarks: Detached at
A. A. 2 M. Louisville,
Ky. date and no. of
order not known

Book mark:

[Signature]
Copyist.

10 | 5 bar | U.S.G.I.

G. A. Darling
Captain 5 Regt U. S. Col'd bar

Return

of the Department of Kentucky,
for the month of June, 1865,
dated Louisville, Ky.

July 5, 1865,
shows the following with regard to the officer
named above:

Post or station Louisville, Ky.

Remarks A. A. G. M.

Book mark: _____

(546) W. R. Lee Copyist.

20 | 5- bar | U.S. Col.

T. A. Darling
Captain 5 Regt U.S. Col.

Return

of the Department of Kentucky,
for the month of July, 1865,
dated Louisville Ky.
August 10, 1865,

shows the following with regard to the officer
named above :

Post or station Louisville Ky.
Remarks A. A. G. M.

Book mark: _____

(546) Let. R Lee Copyist.

George A. Darling
Capt., Co. G, 5 Reg't U. S. Col'd Cavalry.

Appears on

Company Muster Roll

for July & Aug., 1865.

Present or absent. Present

Stoppage, \$ 100 for

Due Gov't, \$ 100 for

Valuation of horse, \$ 100

Valuation of horse equipments, \$ 100

Remarks: Detached as
A. A. M. Louisville,
Ky., date and No. of
order not known

Book mark:

(358)

[Signature]

Copyist.

10 | 5 | Cav | U. S. C. T.

G. A. Harlin
Captain's Regt U. S. C. Cav

Return

of the Department of Kentucky,

for the month of August, 1865,

dated Louisville Ky

September, 1865,

shows the following with regard to the officer
named above :

Post or station Louisville, Ky.

Remarks A. A. G. M.

Book mark: _____

(546)

W. P. Lee

Copyist.

10 | 5 bar | U.S.C.P.

Geo A. Warling
Capt 5 Regt U.S.C. Cav.

Return

of the Department of Kentucky,
for the month of September, 1865,
dated Louisville Ky
October, 1865,

shows the following with regard to the officer
named above:

Post or station Louisville, Ky.
Remarks Acty Asst of M.
Dept of Ky.

Book mark: _____

(546) W. R. Lee Copyist.

D. | **5 Cav.** | **U.S.C.T.**

George A. Darling
Capt., (Co.) G, 5 Reg't U. S. Col'd Cavalry.

Appears on

Company Muster Roll

for Sept 1865, 1865.

Present or absent Absent

Stoppage, \$ 100 for

Due Gov't, \$ 100 for

Valuation of horse, \$ 100

Valuation of horse equipments, \$ 100

Remarks: Detached at
Louisville, Ky, for the
route D. B. Highway 10/25

Book mark: _____

(358)

George A. Darling

Copyist.

10 | 5 Cav. | U.S.C.D.

G. A. Warling
Captain 5 Regt U.S.C. Cav.

Return

of the Department of Kentucky,

for the month of October, 1865,

dated Louisville Ky.

October 31, 1865,

shows the following with regard to the officer
named above :

Post or station Louisville, Ky.

Remarks Acting Asst.
Quartermaster

Book mark: _____

(546)

W. R. Lee

Copyist.

D | Star | Vol. 6. 9.

George A. Darling

Capt. 5 Regt. U.S. Col.

Return

of the Department of Kentucky,

for the month of November, 1865,

dated Louisville Ky

November 30, 1865,

shows the following with regard to the officer
named above :

Post or station Louisville Ky

Remarks Acty Assistant
Quartermaster

Book mark :

(546)

Copyist.

D. | **5 Cav.** | **U.S.C.T.**

George A. Darling
Capt., Co. G, 5 Reg't U. S. Col'd Cavalry.

Appears on

Company Muster Roll

for Nov 1865, 1865.

Present or absent Absent

Stoppage, \$ 100 for

Due Gov't, \$ 100 for

Valuation of horse, \$ 100

Valuation of horse equipments, \$ 100

Remarks: Detached service

Wm. D. Dept. of Ky,
Louisville, Ky, per
order, dated
Wm. D. Dept. of Ky,
Louisville, Ky, May 10,
1865

Book mark:

(358)

George A. Darling

Copyist.

L. J. Van. No. 6

Major Adair
Capt. 5 Regt. 38th Caly

Return

of the Department of Kentucky,

for the month of December, 1865,

dated Franklin City

January, 1866,

shows the following with regard to the officer
named above :

Post or station Franklin City

Remarks Presented
Quarterly

Book mark: _____

(546)

W. J. Van

Copyist.

21 | 5 Cav. | U.S.

George A. Darling
Capt. 5 Regt. U.S. Cav.

Return

of the Department of Kentucky,

for the month of January, 1866,

dated Louisville Ky

February, 1866,

shows the following with regard to the officer
named above:

Post or station Louisville

Remarks Acting Asst Quarter
Master.

Book mark: _____

(546)

Copyist.

2

5 Cav.

U.S.C.T.

George A. Darling

Rank, Co. G, 5 Reg't U. S. Col'd Cavalry.

Appears on

Company Muster Roll

for *Jan'y & Feby*, 1866.

Present or absent *Absent*

Stoppage, \$ *100* for

Due Gov't, \$ *100* for

Valuation of horse, \$ *100*

Valuation of horse equipments, \$ *100*

Remarks: *Detained service, Ad. Drs. Wash. D.C. for S.O. No. 66, Ad. Drs. Dept. of Ky. Louisville, Ky. May 12/65.*

Book mark:

Faber

(358)

Copyist.

2 | 5600 U.S.C.

Geo A Darling
Cap^t, Co. 5th Reg^t U.S.C.

NOTATION.

Book mark: { 10-28-1866 with
1792 - C. 1882
1-425 - C. 1864

War Department,

Adjutant General's Office,

Washington, *Feb 1* , 1866

Call from

returned with report.

The above book mark was noted on rolls in order to
preserve results of search in this case.

(475)

C. C. Leuser Copyist.

15 | 1866

George A. Darling
5 Regt. U.S. Cavalry

Return

of the Department of Kentucky,
for the month of March, 1866,
dated London Ky
April 1, 1866,
shows the following with regard to the officer
named above :

Post or station _____

Remarks U.S. Cavalry

Detained from duty
per O.O. No. 67 Head Quarters
at London Ky 28 Dec

Book mark: _____

(546)

[Signature]

Copyist.

I | 3rd Cav. U.S.C.T.

George A. Darling
Capt 3rd U.S.C.T. A. & L. M.

Return

of the Post of Louisville, Ky.,

for the month of Mar, 1866,

dated Mar 31, 1866,

shows the following with regard to the person
named above:

Post or station Louisville Ky

Remarks:

Octy Post In Master
Received from duty per
special order No 67 dated
the Ins Dept of Ky March
28. 1866 and ordered to
report at once to the Chief
Mustering Office State
of Arkansas at Little
Rock Ark.

Book mark:

J. Meckert

(546)

Copyist.

9

U.S.C.T.

George A. Darling
Capt, Co. *G*, 5 Reg't U. S. Col'd *Ohio*

Appears on an

Individual Muster-out Roll

of the organization named above. Roll dated

Little Rock Ark, Apr 5, 1866.

Muster-out to date

Mar 16, 1866.

Last paid to

Feb 28, 1866.

Clothing account:

Last settled _____, 186 ; drawn since \$ _____ 100

Due soldier \$ _____ 100; due U. S. \$ _____ 100

Am't for cloth'g in kind or money adv'd \$ _____ 100

Due U. S. for arms, equipments, &c., \$ _____ 100

Bounty paid \$ _____ 100 due \$ _____ 100

Remarks:

*Appointed P M Sgt
Samuel Gary to be Capt.
Co. G. to fill original vacancy.
On detached service at Louisville
Mo by authority of H. No 64
Ad. Gen Dept of Ky Series of
(over)*

Book mark: _____

M. T. Hughes

(348)

Copyist.

JAN. - 9

5359300

1891

1865 at date when discharges
was mustered out, and
pay due to Baltimore Md.
Plan of original entry
into service

Reported for Discharge
April 5th 1866 per A. O.
No 6 of Hd Qrs Dept of
N.Y.

Mustered out to date
March 10th 1866 by virtue
of Mustering of Regt
under instruction from
Hqs Dept of N.Y. to
Major Genl J. J. Reynolds
Comd'g Dept of
Ark.

D. | 5 Cav. | U.S.C.T.

George A. Darling.
Capt. Co. G, 5 Reg't U. S. Colored Cav.

Appears on Returns as follows:

Dec. 1864 to May 1865. Absent, detached
Adjts. S. C., U. S. C. T.

June 1865 to Feb. 1866. Absent, detached
as A. A. S. M., Adjts. Dept. of
Ky., Louisville, Ky., S. C. 06,
Adjts. Dept. of Ky., Louisville,
Ky., May 10/65.

Book mark :

(546)

J. Baker
Copyist.

2

5 Cav.

U.S.C.T.

George A. Darling
Capt., Co. *G*, 5 Reg't U. S. Col'd Cavalry.

Appears on **Co. Muster-out Roll**, dated

Helena, Ark. Feb. 16, 1866.

Muster-out to date _____, 186 .

Last paid to _____, 186 .

Clothing account:

Last settled _____, 186 ; drawn since \$ _____ 100

Due soldier \$ _____ 100 ; due U. S. \$ _____ 100

Am't for cloth'g in kind or money adv'd \$ _____ 100

Due U. S. for arms, equipments, &c., \$ _____ 100

Bounty paid \$ _____ 100 ; due \$ _____ 100

Remarks: *Capt. since Dec. 9/64, on*
Det. service at N. A. Drs. Dept. at
Ky. Louisville, Ky. for S. O. No. 66,
from N. A. Drs. Dept. of Ky. May
10, 1865.

Book mark: *1792-6. 1. 182.*

Tabler

(361)

Copyist.

D | 5 Cav. | U.S.C.T.

George A. Darling
Captain, Co. G, 5 Reg't U.S. Col. Cav.

NOTATION.

Book mark: S. 425 C.T. '64

**The Adjutant General's Office,
WAR DEPARTMENT,**

Washington, July 28, 1914.

It has this day (July 28, 1914) been determined by this Department from the records that the above-named officer was mustered out of service April 5, 1866, on an individual muster-out roll of that date, he having been retained in service to that date by competent authority after the muster out of his company, and that so much of the individual muster-out roll as shows him mustered out to date March 16, 1866, is erroneous.

H. W. Gibson

Darling, George A.
Capt, Co. 5 Reg U.S.C. Cav

12 Enclosures.

Bed Cards	Descriptive Lists
Burial Records	Final Statements
Certs. of Dis. for Discharge	Furloughs
C. M. Charges	Med. Des. Lists
Med. Certificates	Orders

Other papers relating to—

Admission to Hosp'l	Furlough 1
Casualty Sheet (Officer's)	Med. Examination
Confinement	Misc. Information 8
Contracts	Pay or Clothing
Death or Effects	Personal Reports
Desertions	Rank
Discharge from Hosp'l	Transfer to Hosp'l
Discharge from Service	Transfer to V. R. C.
Duty	Transportation

MICROFILM PUBLICATION M 1821

COMPILED MILITARY SERVICE RECORDS
OF VOLUNTEER UNION SOLDIERS WHO
SERVED WITH THE USCT (US COLORED TROOPS)
5TH REGIMENT OF CAVALRY

PERSONAL PAPERS' TARGET SHEET

PLEASE NOTE THE CHECKED INFORMATION ABOUT THE PERSONAL PAPERS IN
THIS FILE:

- NO PERSONAL PAPERS WERE FOUND IN THIS FILE WHEN THE
RECORDS WERE ARRANGED FOR MICROFILMING.

- 13 PERSONAL PAPER(S) FOUND IN THIS FILE WHEN THE RECORDS
WERE ARRANGED FOR MICROFILMING.

24 March 1863

1.
Dr. 5. A. W. D. 1863.

Camp Nelson, Ky.
Jan'y 6th 1864-

This is to certify that G. A. Darling
was mustered by me as a Captain in
the 5th Regiment W. S. Colored Cavalry
on the ninth day of December 1864 -
in accordance with appointment of the
President of the United States dated
Baltimore, Md., October 31st 1864.

A. Kinney
Capt. 18th U. S. S.
Mustering Officer.

Hd Qrs S. O. U. S. A.,
Washington, D. C. Jan 10th 1865

Garling, George, et
Capt 5th U. S. A.,
C.

D. 14 - M.D.K. - 1865
Submits a statement of his military
history and encloses certificate
of muster as Captain, and
requests discharge as 1st Lieut
Sergeant 1st "K" Burnell Legion
Cavalry, Md. Vols.

One Enclosure.

S. O. 2, Part VI
June 13 1865
Recd M.D.K. July 13 1865
Gen. A. C. M. Jan 10 1865

Hd Qrs. S. O. U. S. A.,
Washington, D. C. Jan 10th 1865

Respectfully forwarded
Alvato

St Col, 4th S. O. U. S. A.,
C.

Adj. Gen. Mil. Dist. Ky.
Office Asst. Com. Quarter
Gen. Ky. Jan 13/65.

Reply forwarded to Capt. J.
Bass Dickson, Adj. with
the recommendation that
the applicant be discharged
in his old grade, to date
Dec. 8, 1864, the date previous
to his demotion in an office.

J. C. Henderson
Maj. Gen. U. S. A.

68-5. P. D. K. 1865

Head-Quarters U. S. Colored

Cavalry.

Lexington, Ky.

June 10th 1865.

Captain J. Bates, Dickson
A. A. Genl. Mil. Dist. Ky.
Lexington Ky.

Sir

I have the honor
to submit the following Statement of my
Military History and request my discharge
and final statements as Quartermaster Sergeant
Co "C" Purnell Regiment Cavalry, Md. Vol's.

I enlisted in Co "C" Purnell Regiment Cavalry, Md
Vol's on the 8th of September 1862, and was mustered
into the service as an Enlisted man on the 19th day
of September, 1862, by Col. B. D. Beall, and served
as such until the 9th day of December 1864, when
I was mustered as Captain in the 5th U.S. Col
Cavalry, by Capt Kemmy, whose certificate to
that effect is herewith enclosed.

Very Respectfully

Your Obedt Servant

George A. Darling

Capt. & A. A. General

Invoice Order No 66

Recd in Dept of
May 10. 1865-

F. H. Hartman
Capt & Co.

Amount per invoice \$100.00

Head-Quarters Department of Kentucky,

Louisville, Ky. May 10 1865.

Special Orders, }
No. 66 }

11th " " Capt George as a wing
Sergeant, is detailed as a a g. m.
at these headquarters and will at
once enter upon his duties as
such.

By order of MAJOR GENERAL PALMER.

W. H. ...
Assistant Adjutant General.

CO. 5th Regt

D-105-2R, Vol 2 - 105-

Sumner Co., N.Y.
June 12, 1862

Albany, N.Y.

Capt. A. A. Q. M. S. U. S. C. Co.

Request Order to get
Sumner Co. from Sumner
connected with the Office

With the bell

at the end

7-11-11

Head Quarters Dept of Ky. 1865
Office A. S. 2nd Reg. June 12th
Louisville Ky.

Capt C. D. Harlow
A. S. 2^d
Sir

I would respectfully
request an Order to go to Cincinnati
on business connected with the Office

Yours Respectfully

John C. Hart

1st Lieut

Co. A. S. 2^d Reg.

Head Quarters Dept of Ky.

Somerville. On Aug 13 1865
P. 164 - 2K - Vol. 7 - 1865

Caroline Lee A
Capt 5 US Cavalry
Virginia. Orders received
in view to go to Newport Sta
for the purpose of obtaining
two tickets for his Office
State of Massachusetts

S - O - 157 S -
Rec'd DK 8-15-

Head-Quarters Department of Kentucky,

Office Acting Assistant Quartermaster,

Louisville, Ky., Aug. 15th 1865.

Capt. E. B. Harlan
A. A. General
Dept of Kentucky.

Sir

I have the honor to request an Order to go to Newport Ky. for the purpose of selecting two Clerks for my office, the duties of which render them absolutely necessary.

I have but one clerk at the present time the others having been discharged the U. S. service, and I find it impossible to obtain competent ones at this place.

There being Regular Troops stationed at the above named place I feel confident I could obtain such men as I desire

Very respectfully
Yours Obdt Servt
E. B. Harlan
Capt 5th Reg. C. C. Ca. 9th
Head Qrs Dept Ky.

~~S~~ O-217-5K-V-1-2-1865

Head Quarters Dept of Ky
Office A. A. G. M.
Louisville Ky. Sept. 6th 1865

Darling Geo. A.
Capt & A. A. G. M.

5 Mo
Requests leave of absence
for twenty days for the pur-
pose of recuperating his
health.

S O-217-5K-V-1-2-1865
5 Mo

Head Qrs Dept of Ky.
Office A. A. G. 256 1865-
Louisville Ky Sept 6th

Capt E. P. Hagan

A. A. G.

Dept of Ky.

Captain

I have the honor to request a "leave of absence" for twenty days for the purpose of recuperating my health. The business of my office is in such a condition that I believe my services can be spared that length of time without detriment to the service. -

Very respectfully

Your Obedt Servt.

Geo. A. Darling

Capt & A. A. G. 256

Head Qrs Dept of Ky

Office C. C. C. M.
Louisville, Ky. Jan'y 20th 1866

Garling, Geo. A.
Capt. 5th U. S. 4. 4. X
C. C. C. M.
D. H. 8. Vol. 1. D. H. 00

Requests leave of absence
for twenty days with per-
mission to apply for an
extension of 10 days.

D. H. 8. Vol. 1. D. H. 00

Rec'd also Feb 14. 1866

Headquarters. Department of Ky.
Louisville, Ky. - January 31st 1866

(J. R.)

Respectfully referred
through Ky. Div. of Tenn.
to C. G. C. Washington D. C.
with recommendation that
twenty days leave be granted
this Officer, - as he has
been relieved from duty in
this Department and leave
of absence can not therefore
be granted from these Head-
quarters.

John M. Paine
Major General Commanding

D. H. 8. Vol. 1. D. H. 00

Adj. Gen. H. G. Timm
Nashville, Tenn. Feb. 10 1866

Respectfully Forwarded
to the Adjutant General
of the Army This Officer
having been ordered to
duty with his Command
in the Dept. of Arkansas
in compliance with in-
structions from War
Dept. A. G.'s Office.

Geo. H. Thomas
E. B.
2. 2.
2. 1. 1. Major General U. S. A.
Commanding

Office A. A. Q. M.
Louisville Ky. Jan. 29th '66.

Capt. E. B. Harlow.

A. A. S.

Dep't of Kentucky
Captains

I have the honor
to request a "Leave of Absence" for twenty days
with permission to apply for an extension
of ten days for the purpose of attending
to business which requires my personal
attendance at my home.

Very respectfully.

Your obt. servant.
E. B. Harlow
Capt. U. S. Army

War Department,
Adjutant General's Office,

February 21st 1866.

Respectfully referred
to Major General
J. J. Reynolds, Com-
manding Department
of Arkansas, Little
Rock, Ark.

By order of the
Secretary of War:

C. W. Felt

A. A. Genl. Vol.

E. B. Vol. 4. (A) Page 545.

Q. G. 12/1/1866
Quartermaster General's Office
February 13th 1866.

A. 2. Oct 1. 2. 7. 66.

Quartermasters Department
M. C. Meigs, Q. M. G.

Forwards extract of a private
letter from Colonel Batchelder
Chief Quartermaster Department
of Kentucky, relative to Cap-
tain G. A. Darling Acting
Post Quartermaster at Louisville,
recommends that he be relieved.

5 U. S. C. Case

Filed in July 1866.

S. O. 47-2-1866

Official extract respectfully
forwarded to the Adjutant-
General U. S. Army.

* * * * *
It is also recommended that
the necessary orders be issued to
relieve Captain G. A. Darling
of his duties as Acting Post
Quartermaster at Louisville Ky,
transferring the same with public
property etc, in his possession,
to Captain J. H. Belcher Assist-
ant Quartermaster Volunteers,
on duty under the supervision
of Colonel Batchelder, at
Louisville Ky.

(Signed) M. C. Meigs
Brig. Major General U. S. A.
Quartermaster General.

gmb:ol
13th Feb, 1866

Adjutant General's Office
February 23rd 1866
Respectfully referred to
the Commanding General of
the Department of Kentucky
for his action.

A. A. Willcox
Adjutant General

Head Quarters Dept of Ky
Louisville Feb 27. 66
Respectfully referred to
Col. R. W. Batchelder,
Dept of Ky for action

By Order of
Major General
A. A. General

Rec'd A. G. 2-27. 66

1 Copy 7

Extract from private letter of Colonel
R. W. Batchelder, Chief Quartermaster De-
partment, Kentucky, on the affairs of the Quar-
termaster's Department in said Department,
dated Louisville Ky. February 6th 1866.

"I think that Captain Belcher
and myself can transact all of the business,
and that Captain Darling
the acting Post Quartermaster can both be
relieved."

Official extract,

Signed, H. A. Royce

Captain and A. G. Woods

Adjutant General's Office

February 23rd 1866.

Official extract,

C. R. Miles

Assistant Adjutant General.

Head Qrs Dept of Ky
Louisville Ky Mar 25/66

Lawrence W W

Capt a g c t a a u g Dept Ky

Special Order: No 167 directs
Capt G A Garling 5th U.S. C. C.
be relieved from duty and report
to Arkansas to the Chief M. G. O
Little Rock Arkansas

Stg. Dipl of Kentucky
Louisville, Ky,
March 28, 1864.

Special Order
No. 67
Ex. 2.

Capt Darby

Res't & Report

April 5, 66

Washington D.C.

Memorandum

4" Navy, C.

Head-Quarters, Department of Kentucky,

Louisville, Ky. March 28th, 1866

Special Orders,

No. 1,

1. Captain S. A. Darling 5th. Regt. C. C.,
having completed the transfer of all public property
in his possession is relieved from duty in this
Dept. and will report at once to the Chief Mustering
Officer State of Arkansas at Little Rock Ark.

BY COMMAND OF MAJ. GEN'L J. M. PALMER.

M. M. Bennett
Capt. S. A. Darling, Assistant Adjutant Gen'l.

Chief Mustering Officer
Little Rock Ark.
March 28th 1866

D# 40. Vol. 1. D.K. - 66.

Office A. D. M.
Lancaster, Ky. Mar. 28/66

Genl. Geo. A. Capt
5th U.S. Col. & A. D. M.

States that he has
turned over all pub-
lic property in his
possession, and
reports for orders.

Filed in August

1866

Etc
A. D. M. - 2. 111

[Faint handwritten notes, possibly a signature or additional address]

HEAD-QUARTERS,
Office as above
DEPARTMENT OF KENTUCKY,
Louisville, Ky., *Feb. 28th* 1866.

Capt E. B. Harlan
a. a. g.

Captain

I have the honor
to inform you that I have completed
turning over all public property which
was in my possession, in obedience
to Special Order No 47 - dated 4th
Gen Dept of Ky - Louisville Ky - Feb
28th 1866 - and hereby respectfully
report for orders -

Very respectfully

Your Obedt Servt -

Geo. W. Darling

Capt 5th U.S. Infy

as above

Affidavit of Nonindebtedness to U. S.,

of Geo A Darling

late A G 3rd Reg't

USC Cav on which was

based Certificate of Nonindebtedness
to U. S.,

Dated April 6th 1866.

STATE OF Arkansas
COUNTY of Pulaski } ss.

I George A. Darling
late Capt. Co "G" 5th — Regiment U.S. Col'd Cavalry
& cts., do solemnly declare, on oath, that I have duly accounted for all Public
Property, for which I have ever been responsible as an Officer of the Volunteer
Forces of the United States: that I have rendered all returns and reports, re-
quired by Revised Army Regulations of 1863 and existing orders: that
I am not now, on any account whatever, indebted to the General Government,
except as stated on Muster out rolls.

Geo. A. Darling
Late Capt. Co "G" 5th U.S. Col'd Cavalry

Sworn and subscribed before me, at Little Rock, Pulaski Co. Ark.
this 25th day of April 1866.

W. F. Morse
Capt & Comdr. Muster
Act. Chief Musk. Officer
State of Arkansas

Statement of Service Reference Slip.

Office Auditor

Claim No. 514167

George A Darling (Name.)

Capt. Co. 5 Reg't USC Cav

To Arch Div. July 13, 1914

For Date appointed

A.A. 9 m per S.O. 66
Arpx of Ky 1865 and
Date relieved as such
per S.O. 67. Arpx of Ky
1866

Johnson
W.H.

Mr. V.R.R. Div.

S.O. 66 Dept. of Kentucky
Louisville, Ky May 10, 1865
Par. 10. Lt. G. M. Riddew,
25 Mich. Inf. Vols. is relieved
from duty as A. A. 2. M.

Statement furnished July 13, 1914

W.H.

at these Hd. Qrs. and will
turn over all Government
property in his possession
to Capt. Geo. A. Darling,
5th U.S.C., so soon as this
is accomplished & St. Kidding
will proceed to the Dept.
of North Carolina, and
report for duty to the C.O.
of his regiment.

Par 11. Capt George A. Darling
5th U.S.C. is detailed as
A.A. & M. at these Hd. Qrs.
and will at once enter
upon his duties as such.

x x x x

S.O. 67. Dept. of Kentucky
Louisville. Ky. March, 28, 1866,
Par Capt. G. A. Darling,
5th U.S.C., having completed
the transfer of all public
property in his possession
is relieved from duty in
this Department, and will

Write nothing above this line.

report at once to the
Chief Mustering Officer
State of Arkansas at Little
Rock, Ark.

x x x x

Harley
J. J.

David

Co M, 5 U. S. Col'd Cav

Private

Private

CARD NUMBERS:

1	5370835	26
2	5370930	27
3	5371030	28
4	5371115	29
5	5371255	30
6	5371280	31
7	5371370	32
8	5371457	33
9	5371522	34
10	5371628	35
11	5371711	36
12	9091268	37
13	40729700	38
14		39
15		40
16		41
17		42
18		43
19		44
20		45
21		46
22		47
23		48
24		49
25		50

Book Mark:

See also

29 | 5-60 | U.S.C.T.

David Davis

, Co. *M*, 5-Reg't U. S. Col'd *Cav.*

Appears on

Company Descriptive Book

of the organization named above.

DESCRIPTION.

Age *25* years; height *6* feet *—* inches.

Complexion *Black*

Eyes *Blk*; hair *Blk*

Where born *Fayette Ky*

Occupation *Farmer*

ENLISTMENT.

When *Aug 10, 1864.*

Where *Camp Nelson*

By whom *J. Hananeph*; term *3* y'rs.

Remarks:

A. J. Cannon

(383g)

Copyist.

D

5 Cav. U.S.C.T.

David Davis

Priv., Co. *M*, 5 Reg't U. S. Col'd Cavalry.

Appears on

Company Muster-in and Descriptive Roll

of the organization named above. Roll dated

Camp Nelson, N. Y., *Oct 30*, 1864.

Where born *Fayette, Ky.*

Age *25* y'rs; occupation *Farmer*

When enlisted *Aug 10*, 1864.

Where enlisted *Camp Nelson, Ky.*

For what period enlisted *3* years.

Eyes *Black*; hair *Black*

Complexion *Black*; height *6* ft. *0* in.

When mustered in *Aug 12*, 1864.

Where mustered in *Camp Nelson, Ky.*

Bounty paid \$ *100*; due \$ *100*

Where credited *7 Dist. Ky.*

Company to which assigned

Remarks: *James Miller*

* *I was in the same company*

from 10, 1863 to 1864

Book mark:

M. S. Thompson

(356d)

Copyist.

D

5 Cav. U.S.C.T.

Jared Jarvis

Pvt., Co. M, 5 Reg't U. S. Col'd Cavalry.

Appears on

Company Muster Roll

for Nov. Dec., 1864.

Present or absent absent

Stoppage, \$ 100 for

Due Gov't, \$ 100 for

Valuation of horse, \$ 100

Valuation of horse equipments, \$ 100

Remarks: 1st & 2nd installments of bounty due.

Book mark:

A. S. Thompson

(358)

Copyist.

5

5 Cav. U.S.C.T.

David Davis

Co. M, 5 Reg't U. S. Col'd Cavalry.

Appears on

Company Muster Roll

for Jan 1st Feb. 1865.

Present or absent absent

Stoppage, \$ 100 for

Due Gov't, \$ 100 for

Valuation of horse, \$ 100

Valuation of horse equipments, \$ 100

Remarks: 1st & 2d installments of bounty due. At Camp Nelson, Ky.

Book mark:

H. S. Thompson

(358)

Copyist.

D

5 Cav. | U.S.C.T.

David Davis

Plt., Co. M, 5 Reg't U. S. Col'd Cavalry.

Appears on

Company Muster Roll

for *Mar. & Apr.*, 186*4*.

Present or absent *Present*

Stoppage, \$ *100* for

Due Gov't, \$ *100* for

Valuation of horse, \$ *100*

Valuation of horse equipments, \$ *100*

Remarks: *1st mustatement
bonus due \$100*

Book mark:

W. S. Thompson

(358)

Copyist.

D

5 Cav. U.S.C.T.

David Davis

No. Co. M, 5 Reg't U. S. Col'd Cavalry.

Appears on

Company Muster Roll

for May & June, 1865.

Present or absent Present

Stoppage, \$ 100 for

Due Gov't, \$ 100 for

Valuation of horse, \$ 100

Valuation of horse equipments, \$ 100

Remarks: 1st Enlistment bounty due \$ 100.

Book mark:

Leuty

Copyist.

(358)

D

5 Cav. | U.S.C.T.

Dana Davis

M, Co. M, 5 Reg't U. S. Col'd Cavalry.

Appears on

Company Muster Roll

for *July + Aug*, 186*5*.

Present or absent *Present*

Stoppage, \$ *100* for

Due Gov't, \$ *100* for

Valuation of horse, \$ *100*

Valuation of horse equipments, \$ *100*

Remarks:

Book mark:

C. W. [Signature]

Copyist.

(358)

J

5 Cav. | U.S.C.T.

David Davis

M, Co. M, 5 Reg't U. S. Col'd Cavalry.

Appears on

Company Muster Roll

for *Sept & Oct*, 186 *J*.

Present or absent *Present*

Stoppage, \$ *100* for

Due Gov't, \$ *100* for

Valuation of horse, \$ *100*

Valuation of horse equipments, \$ *100*

Remarks: *Due M for leave & Garrison #155 Advance 55d*

Book mark:

(358)

Leuty
Copyist.

0

5 Cav. U.S.C.T.

David Davis

No. Co. M, 5 Reg't U. S. Col'd Cavalry.

Appears on

Company Muster Roll

for Nov & Dec, 1865.

Present or absent Present

Stoppage, \$ 100 for

Due Gov't, \$ 100 for

Valuation of horse, \$ 100

Valuation of horse equipments, \$ 100

Remarks:

Book mark:

Cutter

Copyist.

(358)

AD

5 Cav. | U.S.C.T.

David Davis

Plt, Co. M, 5 Reg't U. S. Col'd Cavalry.

Appears on

Company Muster Roll

for *Jan + Feb*, 186*6*.

Present or absent *Present*

Stoppage, \$ *100* for

Due Gov't, \$ *100* for

Valuation of horse, \$ *100*

Valuation of horse equipments, \$ *100*

Remarks:

Book mark:

Hijus

(358)

Copyist.

10. | 5 Cav. | U.S.C.T.

David Davis.

Plt., Co. M, 5 Reg't U. S. Colored Cav.

Appears on **Returns** as follows:

Nov. & Dec. 1864. Absent at Camp
Nelson, Ky.

Jan. & Feb. 1865. Absent at Camp
Nelson. Dismounted.

Mar. 1865. Absent, det. at Camp
Nelson.

Book mark :

(546)

J. Baker,
Copyist.

10 | 5 Cav. | U.S.C.T.

David Davis

Pvt., Co. M., 5 Reg't U. S. Col'd Cavalry.

Appears on Co. Muster-out Roll, dated

Helena, Ark., Mar 16, 1866.

Muster-out to date Mar 16, 1866.

Last paid to Dec. 31, 1865.

Clothing account:

Last settled....., 186 ; drawn since \$..... 100

Due soldier \$..... 100; due U. S. \$ 23 51/100

Am't for cloth'g in kind or money adv'd \$..... 100

Due U. S. for arms, equipments, &c., \$..... 100

Bounty paid \$ 100 100; due \$ 100 100

Remarks: Slave April 19 '61

Book mark:

(861)

J. H. Jones

Copyist.

Davis David

....., Co.,

Reg't *U S C Inf*

Enclosures.

Bed Cards	Final Statements
Burial Records	Furloughs or L. of A.
Certs. of Dis. for Discharge	Med. Certificates
C. M. Charges	Med. Des. Lists
Descriptive Lists	Orders
Discharge Certificates	Pris. of War Record
Enlistment Papers <i>/</i>	Resignations

Other papers relating to—

Admission to Hosp'l	Furlough or L. of A.
Casualty Sheet	Med. Examination
Confinement	Misc. Information
Contracts	Pay or Clothing
Death or Effects	Personal Reports
Desertion	Rank
Discharge from Hosp'l	Transfer to Hosp'l
Discharge from Service	Transfer to V. R. C.
Duty	Transportation

1.—This blank will be used for enlistments of United States colored troops. They will be made out in duplicate in all cases—one to accompany the recruiting return of the superintendent (not the recruiting officer) to the Adjutant General, and one to accompany the accounts of the officer who pays bounty, &c.

NOTE 2.—An enlistment holds to service. A muster-in must, in all cases, precede payment of pay, bounty, pension, &c. A muster-in roll, must in all cases, be filed in the Adjutant General's Office as evidence of muster-in. The mustering officer, commissary, or assistant commissary of musters, as the case may be, will countersign both enlistments as having mustered the soldiers into the service of the United States before either of them is given to the disbursing officer.

DECLARATION OF RECRUIT.

I, David David desiring to volunteer as a soldier in the ARMY OF THE UNITED STATES, for the term of *Three Years*, DO DECLARE That I am 29 years and months of age; that I have never been discharged from the United States service on account of disability or by sentence of a court-martial, or by order before the expiration of a term of enlistment; and I know of no impediment to my serving honestly and faithfully as a soldier for three years.

GIVEN at Camp Nelson the 14 day of August 1864

Witness: John Dickerson

David Lewis
 By James Butler
 Volunteered at Camp Nelson
Aug 10 1864
David Lewis
James Butler
 66
James Butler

Consent of Parent or Guardian in case of a Minor, if a Free Man, or in the case of a Slave, of the Person to whom he owes Service:

I, Do CERTIFY, That I am the that the said is years of age; and I do freely give my CONSENT to his volunteering as a SOLDIER in the Army of the United States, for the period of THREE YEARS, under the conditions of the laws of the United States.

GIVEN at the day of

Witness: [Signature]

UNITED STATES COLORED TROOPS ENLISTMENT.

STATE OF

TOWN OF

Kentucky
I *David Davis* born in *Camp Nelson Fayette*

in the State of *Kentucky* aged *twenty five* years
and by occupation a *Farmer* Do HEREBY ACKNOWLEDGE to

have volunteered *Seventh* day of *August* 1864,

to serve as a **Soldier** in the **Army of the United States of America**, for the period of **THREE YEARS**, unless sooner discharged by proper authority: Do also agree to accept such bounty, pay, rations, and clothing, as are, or may be, established by law for the U. S. colored troops.

And I, *David Davis*
do solemnly swear that I will bear true faith and allegiance to the **United States of America**, and that I will serve them honestly and faithfully against all their enemies or opposers whomsoever; and that I will observe and obey the orders of the President of the United States, and the orders of the officers appointed over me, according to the Rules and Articles of War.

Sworn and subscribed to, at *Camp Nelson*
this *10* day of *August* 1864 *David Davis*
Before *J. Randolph* *Mark*

I CERTIFY, ON HONOR, That I have carefully examined the above named Volunteer agreeably to the General Regulations of the Army, and that, in my opinion, he is free from all bodily defects and mental infirmity, which would in any way disqualify him from performing the duties of a soldier.

O. B. Hollaway
Asst Surg 4th Ky vol bregt
EXAMINING SURGEON.

I CERTIFY, ON HONOR, That I have minutely inspected the Volunteer *D. Davis* previously to his enlistment, and that he was entirely sober when enlisted; that, to the best of my judgment and belief, he is of lawful age; and that, in accepting him, as duly qualified to perform the duties of an able-bodied soldier, I have strictly observed the regulations which govern the recruiting service. This soldier has *5 1/2* eyes, *5 1/2* hair, *1 1/2* complexion, is *5 1/2* feet *7* inches high.

J. Randolph
and *J. P. M*
RECRUITING OFFICER OR AGENT.

Mustered into the United States Service..... *12th* day of *August* 1864

W. C. Kinney
Capt 18th U. S. Col
Mustered Officer.

Mustered into the service of the United States, for three years or during the war, from date of enlistment, in Company
Regiment of *11th Mass* Volunteers, on the *12th* day of *August* 1864 at *Camp Nelson Ky*

W. C. Kinney
Capt 18th U. S. Col
Must. Officer

Davis George

Co H, 5 U. S. Col'd Cav.

Private

Sergeant

CARD NUMBERS.

5-3 6 6 7 7 0	26
5-3 6 6 9 2 2	27
5-3 6 6 9 7 3	28
5-3 6 7 0 6 5	29
5-3 6 7 1 5 5	30
5-3 6 7 2 5 2	31
5-3 6 7 3 4	32
5-3 6 7 4 0 5	33
5-3 6 7 4 9 4	34
5-3 6 7 5 8 4	35
5-3 6 7 6 7 2	36
90 90 7 6 3	37
90 90 8 5 9	38
40 7 2 9 6 6 9	39
	40
	41
	42
	43
	44
	45
	46
	47
	48
	49
	50

Book Mark:

See also

115 | 5 | U.S.C.T.

George Davis

, Co. H 5 Reg't U. S. Col'd 1st

Appears on

Company Descriptive Book

of the organization named above.

DESCRIPTION.

Age 28 years; height 5 feet 7 inches.

Complexion BLK

Eyes BLK; hair BLK

Where born Bourbon Ky

Occupation Farmer

ENLISTMENT.

When Sep 14, 1864.

Where Camp Nelson Ky

By whom H. Randolph term 3 y'rs.

Remarks: Missing in action Saltville Va Oct 2nd 1864, taken up at Camp Nelson Ky Dec. 14th - 1864

J. E. Fucker

10 | 5 Cav. | U.S.C.T.

George Davis

, Co. *76*, 5 Reg't U. S. Col'd Cav.

Appears on

Company Descriptive Book
of the organization named above.

DESCRIPTION.

Age *28* years; height *5* feet *9* inches.

Complexion *Blk*

Eyes *Blk*; hair *Blk*

Where born *Barbours Ky*

Occupation *Farmer*

ENLISTMENT.

When *Sept 14, 1864*.

Where *Camp Nelson*

By whom *McCandless*; term *0* y'rs.

Remarks: *Promoted to Corporal in
Reg't Co. "139" Aug 18/65*

(383a)

A. J. Anderson

Copist.

0

5 Cav.

U.S.C.T.

George Davis

Pat, Co H, 5 Reg't U. S. Col'd Cavalry.

Appears on

Company Muster-in and Descriptive Roll

of the organization named above. Roll dated

Camp Nelson, ^{Ky} N. Y. Oct 29, 1864.

Where born Bourbon Ky

Age 28 y'rs; occupation Farmer

When enlisted Sept 14, 1864.

Where enlisted Camp Nelson Ky

For what period enlisted 3 years.

Eyes Black; hair Black

Complexion Black; height 5 ft. 9 in.

When mustered in Sept 15, 1864.

Where mustered in Camp Nelson Ky

Bounty paid \$ 100; due \$ 100

Where credited

Company to which assigned

Remarks: 7th Dist Ky

* Jesse H. Boldern

* supposed to be name of owner.

Added May 16. 98. H. J.

Book mark:

Reynolds

(356d)

Copyist.

D | 5 Cav. | U.S.C.T.

George Davis

Pvt., Co. H, 5 Reg't U. S. Col'd Cavalry.

Appears on

Company Muster Roll

for *from enlistment to Oct 31, 1864.*

Present or absent *Absent*

Stoppage, \$ *100* for

Due Gov't, \$ *100* for

Valuation of horse, \$ *100*

Valuation of horse equipments, \$ *100*

Remarks: *Missing in action
Saltville Va Oct 2^d 1864*

Book mark:

Reynolds

(358)

Copyist.

D

5 Cav.

U.S.C.T.

George Davis

Pot, Co. H, 5 Reg't U. S. Col'd Cavalry.

Appears on

Company Muster Roll

for Nov & Dec, 1864

Present or absent Absent

Stoppage, \$ 100 for

Due Gov't, \$ 100 for

Valuation of horse, \$ 100

Valuation of horse equipments, \$ 100

Remarks: 1st and 2^d Installments
Bounty due. On
Attached Service
Camp Nelson since
Dec 14" Returned
from missing in Action
Dec 14.

Book mark:

Reynolds

(358)

Copyist.

D

5 Cav.

U.S.C.T.

George Davis

Put, Co. H, 5 Reg't U. S. Col'd Cavalry.

Appears on

Company Muster Roll

for Jan'y & Feb'y, 1865.

Present or absent present

Stoppage, \$ 100 for

Due Gov't, \$ 100 for

Valuation of horse, \$ 100

Valuation of horse equipments, \$ 100

Remarks: 1st Installment of
Bounty Due \$100.00

Book mark:

Reynolds

(358)

Copyist.

D

5 Cav. U.S.C.T.

George Davis

Pat, Co. H, 5 Reg't U. S. Col'd Cavalry.

Appears on

Company Muster Roll

for *Mar & Apr*, 1865.

Present or absent *present*

Stoppage, \$ *100* for

Due Gov't, \$ *100* for

Valuation of horse, \$ *100*

Valuation of horse equipments, \$ *100*

Remarks: *1st installment of
Bounty*

Book mark:

Reynolds

(358)

Copyist.

N. | **5 Cav.** | **U.S.C.T.**

George Jarvis
Priv, Co. H, 5 Reg't U. S. Col'd Cavalry.

Appears on

Company Muster Roll
for *May & June*, 186*5*.

Present or absent *Present.*

Stoppage, \$ *100* for

Due Gov't, \$ *100* for

Valuation of horse, \$ *100*

Valuation of horse equipments, \$ *100*

Remarks: *1st Installment Bounty*
due \$100.

Book mark:

B. J. Cooke
(358) Copyist.

2. | 5 Cav. | U.S.C.T.

George Davis
Copt

Co. H, 5 Reg't U. S. Col'd Cavalry.

Appears on

Company Muster Roll

for July & Aug., 1865.

Present or absent Present.

Stoppage, \$ 100 for

Due Gov't, \$ 100 for

Valuation of horse, \$ 100

Valuation of horse equipments, \$ 100

Remarks: Promoted by order
"139" Hd Qrs 5th Cavalry, Aug.
8/1865 from a Private to
Copt.

Book mark:

B. J. Cooke

(358)

Copyist.

A. | **5 Cav.** | **U.S.C.T.**

George Davis

3rd Corp., Co. H, 5 Reg't U. S. Col'd Cavalry.

Appears on

Company Muster Roll

for *Sept. & Oct.*, 1865.

Present or absent *Present.*

Stoppage, \$ *100* for

Due Gov't, \$ *100* for

Valuation of horse, \$ *100*

Valuation of horse equipments, \$ *100*

Remarks:

Book mark:

(358)

B. J. Cooke

Copyist.

D. | **5 Cav.** | **U.S.C.T.**

George Davis
S. Sgt. Co. H, 5 Reg't U. S. Col'd Cavalry.

Appears on

Company Muster Roll

for *Nov. 4th Dec.*, 1865.

Present or absent *Present.*

Stoppage, \$.....100 for

Due Gov't, \$.....100 for

Valuation of horse, \$.....100

Valuation of horse equipments, \$.....100

Remarks: *Promoted to Sgt. Per*
Regt Order No. 1799 dated
Nov. 4th 1865.

Book mark:

(358)

B. J. Cooke

Copyist.

①

5 Cav. U.S.C.T.

George Davis

Sgt., Co. H, 5 Reg't U. S. Col'd Cavalry.

Appears on

Company Muster Roll

for James V. Seby, 1866.

Present or absent Present

Stoppage, \$ 100 for

Due Gov't, \$ 100 for

Valuation of horse, \$ 100

Valuation of horse equipments, \$ 100

Remarks:

[Empty lines for remarks]

Book mark:

J. C. Stewart Copyist.

(358)

10 | 5 Cav. | U.S.C.T.

George Davis.

Pvt., Co. H, 5 Reg't U. S. Colored Cav.

Appears on Returns as follows:

Oct. & Nov. 1864. Absent, missing
in action Oct. 2/64, Saltville,
Va.

Entry for Nov. 1864 cancelled.

Dec. 1864. Gained Dec. 14, Camp Nelson.

Returned from missing in action
Saltville, Va., Oct. 2/64.

Absent on detailed service, Camp
Nelson, since Dec. 14/64.

Book mark:

(546)

J. Baker
Copyist.

D

5 Cav. U.S.C.T.

George Davis

Sgt., Co. A., 5 Reg't U. S. Col'd Cavalry.

Appears on Co. Muster-out Roll, dated

Helena, Ark Mar. 16, 1866.

Muster-out to date Mar 16, 1866.

Last paid to Dec. 31, 1865.

Clothing account:

Last settled....., 186 ; drawn since \$ 100

Due soldier \$ 100; due U. S. \$ 75 ⁹⁴/₁₀₀

Am't for cloth'g in kind or money adv'd \$ 100

Due U. S. for arms, equipments, &c., \$ 100

Bounty paid \$ 100 100; due \$ 100 100

Remarks: Appointed Sgt. Apr 4. 65

Book mark :

J. C. Stewart

(361)

Copyist.

Davis, George

Co. C. Car. 5 Reg't U.S.

1 Inclosures.

Bed Cards	Final Statements
Burial Records	Furloughs or L. of A.
Certs. of Dis. for Discharge	Med. Certificates
C. M. Charges	Med. Des. Lists
Descriptive Lists	Orders
Discharge Certificates	Pris. of War Record
Enlistment Papers /	Resignations

Other papers relating to—

Admission to Hosp'l	Furlough or L. of A.
Casualty Sheet	Med. Examination
Confinement	Misc. Information
Contracts	Pay or Clothing
Death or Effects	Personal Reports
Desertion	Rank
Discharge from Hosp'l	Transfer to Hosp'l
Discharge from Service	Transfer to V. R. C.
Duty	Transportation

Section 1.—This blank will be used for enlistments of United States soldiers. They will be made out in duplicate in all cases—one to accompany the recruiting return of the superintendent (not the recruiting officer) to the Adjutant General, and one to accompany the accounts of the recruit, who always bounty, &c.

Section 2.—An enlistment holds to service. A muster-in must, in all cases, precede payment of pay, bounty, pension, &c. A muster-in roll, must in all cases, be filed in the Adjutant General's Office as evidence of muster-in. The mustering officer, commissary, or assistant commissary of musters, as the case may be, will countersign both enlistments as having mustered the soldiers into the service of the United States before either of them is given to the disbursing officer.

DECLARATION OF RECRUIT.

I, George Davis desiring to volunteer as a soldier in the ARMY OF THE UNITED STATES, for the term of Three Years, DO DECLARE That I am 28 years and months of age; that I have never been discharged from the United States service on account of disability or by sentence of a court-martial, or by order before the expiration of a term of enlistment; and I know of no impediment to my serving honestly and faithfully as a soldier for three years.

GIVEN at Camp Nelson Ky the 14th day of September 1864

Witness: J. C. Strook his
George X Davis
 mark

George Davis
Rec'd from the Adj. Gen.
No. 107
Sept 14 1864
at Camp Nelson
Wm H. Blair
Comdr
George H. Bodden

Consent of Parent or Guardian in case of a Minor, if a Free Man, or in the case of a Slave, of the Person to whom he owes Service:

I, Do CERTIFY, That I am the that the said is years of age; and I do freely give my CONSENT to his volunteering as a SOLDIER in the Army of the United States, for the period of THREE YEARS, under the conditions of the laws of the United States.

GIVEN at the day of

Witness:
 (A. G. O. No. 74 & 76.)

UNITED STATES COLORED TROOPS ENLISTMENT.

STATE OF

TOWN OF

Kentucky

Camp Nelson

I, *George Davis*

born in

Bourbon Co

in the State of

Kentucky

aged

Twenty eight years

and by occupation a

Farmer

Do HEREBY ACKNOWLEDGE TO

have volunteered

Fourteenth day of

September

186*4*

to serve as a **Soldier** in the **Army of the United States of America**, for the

period of **THREE YEARS**, unless sooner discharged by proper authority: Do

also agree to accept such bounty, pay, rations, and clothing, as are, or may be,

established by law for the U. S. colored troops.

And I,

George Davis

do solemnly swear that I will bear true faith and allegiance to the **United States**

of America, and that I will serve them honestly and faithfully against all their

enemies or opposers whomsoever; and that I will observe and obey the orders

of the President of the United States, and the orders of the officers appointed

over me, according to the Rules and Articles of War.

Sworn and subscribed to, at

Camp Nelson

this

14th

day of

Sept 1864

George Davis

Before

W. C. [Signature]

his mark

I CERTIFY, ON HONOR, That I have carefully examined the above named Volunteer agreeably to the General Regulations of the Army, and that, in my opinion, he is free from all bodily defects and mental infirmity, which would in any way disqualify him from performing the duties of a soldier.

P. G. Barrett
Asst Surg 7th, A.V.C

EXAMINING SURGEON,

I CERTIFY, ON HONOR, That I have minutely inspected the Volunteer, *G Davis* previously to his enlistment, and that he was entirely sober when enlisted; that, to the best of my judgment and belief, he is of lawful age; and that, in accepting him as duly qualified to perform the duties of an able-bodied soldier, I have strictly observed the regulations which govern the recruiting service. This soldier has *dark* eyes, *dark* hair, *dark* complexion, is *five* feet *nine* inches high.

W. C. [Signature]
RECRUITING OFFICER OR AGENT.

Mustered into the United States Service

15th

day of

Sept

186*4*

Capt 18th U.S.C.

Mustering Officer.

Mustered into the service of the United States, for three years or during the war, from date of enlistment, in Company

Regiment of *U.S. Colored Cavalry* Volunteers, on the

15th day of

September, 1864 at *Camp Nelson Ky*

Capt 18th U.S.C.

Private Officer

334
Davis, George

Co 6, 5 U.S. Col'd Cav.

Sergeant Com. Sergeant

CARD NUMBERS.

1	5361637	26
2	5361739	27
3	5361842	28
4	5361936	29
5	5362019	30
6	5362101	31
7	5362184	32
8	5362275	33
9	5362364	34
10	5362449	35
11	5362534	36
12	9090197	37
13	43146228	38
14		39
15		40
16		41
17		42
18		43
19		44
20		45
21		46
22		47
23		48
24		49
25		50

Book Mark:

See also

S. 1475583 POMM
D 1869792 P.L.O.

S. A. Weyburn
X

D | **5 Cav. | U.S.C.T.**

George Davis

Co. *C*, 5 Reg't U. S. Col'd Cav.

Appears on

Company Descriptive Book
of the organization named above.

DESCRIPTION.

Age *36* years; height *5* feet *6* inches.

Complexion *Dark*

Eyes *Dark*; hair *Dark*

Where born *Shelby Co. Ky.*

Occupation *Farmer*

ENLISTMENT.

When *Aug. 12*, 186*4*.

Where *Louisville*

By whom *Capt. Sam.*; term *3* y'rs.

Remarks: *Read 274 + Comm. **

Serg't. see N. C. O.

** written with lead pencil
+ as appears on roll*

Warner

9

5 Cav. U.S.C.T.

George Davis

Sergt., Co. C, 5 Reg't U. S. Col'd Cavalry.

Appears on

Company Muster-in and Descriptive Roll

of the organization named above. Roll dated

Camp Nelson, Ky, N. Y., Oct. 24, 1864.

Where born Shelby, Ky.

Age 26 y'rs; occupation Farmer

When enlisted Aug. 12, 1864.

Where enlisted Louisville

For what period enlisted 3 years.

Eyes Blk; hair Dh.

Complexion Dh; height 5 ft. 6 in.

When mustered in Aug. 12, 1864.

Where mustered in Louisville

Bounty paid \$ 100; due \$ 100

Where credited 4 Dist. Ky.

Company to which assigned C

Remarks:

Book mark: I 794 Ky

Shull

D | 5600 | 2d. Co. 5

George Davis

Appears with rank of Pvt on

Muster and Descriptive Roll

of a Detachment of U. S. Colored
Troops transferred to U. S. Colored
ser. at Lexington, Ky. Roll dated

Louisville, Ky., Sept. 2, 1864.

Where born Shelby, Ky.

Age 36 years; occupation Farmer

When enlisted Aug. 12, 1864.

Where enlisted Louisville

For what period enlisted 3 years.

Eyes brn; hair brn

Complexion brn; height 5 ft. 6 in.

When mustered in Aug. 12, 1864.

Where mustered in Louisville

Bounty paid \$ 100; due \$ 100

Clothing account:

Last settled _____, 1864; drawn since \$ 17.55
100

Date of first muster Aug. 12, 1864.

Company to which assigned _____

Remarks: Credited to 4 long. Det. Ky.

Book mark: _____

B. J. Stinson

Q

5 Cav. U.S.C.T.

George Davis

Serjt, Co. C, 5 Reg't U. S. Col'd Cavalry.

Appears on

Company Muster Roll

for *to Oct. 31*, 186*4*.

Present or absent *Present*

Stoppage, \$ *100* for

Due Gov't, \$ *100* for

Valuation of horse, \$ *100*

Valuation of horse equipments, \$ *100*

Remarks:

Book mark:

Shull

Q

5 Cav. U.S.C.T.

George Davis

Sgt, Co. C, 5 Reg't U. S. Col'd Cavalry.

Appears on

Company Muster Roll

for *Nov. & Dec.*, 1864.

Present or absent *Present*

Stoppage, \$ *100* for

Due Gov't, \$ *100* for

Valuation of horse, \$ *100*

Valuation of horse equipments, \$ *100*

Remarks: *First & Second instalments of bounty due*

Book mark:

Shull

9

5 Cav. U.S.C.T.

George Davis

Srnt, Co. C, 5 Reg't U. S. Col'd Cavalry.

Appears on

Company Muster Roll

for *Jan'y. & Feby.*, 1863.

Present or absent *Present*

Stoppage, \$ 100 for

Due Gov't, \$ 100 for

Valuation of horse, \$ 100

Valuation of horse equipments, \$ 100

Remarks: *First instalment of
Bounty due \$100*

Book mark:

Shull

(358)

Copyist.

9

5 Cav. U.S.C.T.

George Davis

Serjeant, Co. C, 5 Reg't U. S. Col'd Cavalry.

Appears on

Company Muster Roll

for Mar. & Apr., 1865.

Present or absent Present

Stoppage, \$ 100 for

Due Gov't, \$ 100 for

Valuation of horse, \$ 100

Valuation of horse equipments, \$ 100

Remarks: First installment of
Pay due \$100

Book mark:

Shull

J | **5 Cav. | U.S.C.T.**

George Davis

Com Sgt Co. C, 5 Reg't U. S. Col'd Cavalry.

Appears on

Company Muster Roll

for *May & June*, 1865.

Present or absent *Present*

Stoppage, \$ *100* for

Due Gov't, \$ *100* for

Valuation of horse, \$ *100*

Valuation of horse equipments, \$ *100*

Remarks: *First Instalment of Bounty due \$100*

Book mark :

J. Under

D

5 Cav. U.S.C.T.

George Davis

Co. C, 5 Reg't U. S. Col'd Cavalry.

Appears on

Company Muster Roll

for *July 1st*, 186*5*.

Present or absent *Absent*

Stoppage, \$ *100* for

Due Gov't, \$ *100* for

Valuation of horse, \$ *100*

Valuation of horse equipments, \$ *100*

Remarks:

Book mark:

J. J. J. J.

(358)

Copyist.

I

5 Cav. U.S.C.T.

George Davis

Com. Sgt. Co. C, 5 Reg't U. S. Col'd Cavalry.

Appears on

Company Muster Roll

for Sep. 4 Oct., 1863.

Present or absent Present

Stoppage, \$ 100 for

Due Gov't, \$ 100 for

Valuation of horse, \$ 100

Valuation of horse equipments, \$ 100

Remarks:

Book mark:

Linden

Copyist.

(358)

J | **5 Cav. | U.S.C.T.**

George Davis

b. J.; Co. C, 5 Reg't U. S. Col'd Cavalry,

Appears on

Company Muster Roll

for *Nov Dec*, 186*5*.

Present or absent *Present*

Stoppage, \$ *100* for

Due Gov't, \$ *100* for

Valuation of horse, \$ *100*

Valuation of horse equipments, \$ *100*

Remarks: _____

Book mark: _____

(358)

J. J. J. J.

Copyist.

D

5 Cav. U.S.C.T.

George Davis
Capt, Co. C, 5 Reg't U. S. Col'd Cavalry.

Appears on

Company Muster Roll

for *Jan and Feb*, 186 *6*

Present or absent *Present*

Stoppage, \$ *100* for

Due Gov't, \$ *100* for

Valuation of horse, \$ *100*

Valuation of horse equipments, \$ *100*

Remarks:

Book mark: -----

Rose

(358)

Copyist.

D | 5 Cav. | U.S.C.T.

George Davis
Com Sgt Co. C, 5 Reg't U. S. Col'd Cavalry.

Appears on Co. Muster-out Roll, dated
Helena Ark, March 16, 1866.

Muster-out to date March 16, 1866.

Last paid to Dec 31, 1865.

Clothing account:

Last settled....., 186 ; drawn since \$..... 100

Due soldier \$..... 100; due U. S. \$ 7 100

Am't for cloth'g in kind or money adv'd \$..... 100

Due U. S. for arms, equipments, &c., \$..... 100

Bounty paid \$ 100 100; due \$ 100 100

Remarks: Commissary Sgt
since the organization
of the Company.

Book mark: D. 794. K.

Rose

Davis, Geo

Co. 6, 5 Reg't US 6 Co

2 Enclosures.

Bed Cards	Descriptive Lists
Burial Records	Final Statements
Certs. of Dis. for Discharge	Furloughs
C. M. Charges	Med. Des. Lists
Med. Certificates	Orders
<i>Enlistments 1</i>	

Other papers relating to—

Admission to Hosp'l	Furlough
Casualty Sheet (Officer's)	Med. Examination
Confinement	Misc. Information 1
Contracts	Pay or Clothing
Death or Effects	Personal Reports
Desertions	Rank
Discharge from Hosp'l	Transfer to Hosp'l
Discharge from Service	Transfer to V. R. C.
Duty	Transportation

NOTE 1.—This blank will be used for enlistments of United States colored troops. They will be made out in duplicate in all cases—one to accompany the recruiting return of the superintendent (not the recruiting officer) to the Adjutant General, and one to accompany the accounts of the officer who pays bounty, &c.

NOTE 2.—An enlistment holds to service. A muster-in must, in all cases, precede payment of pay, bounty, pension, &c. A muster-in roll, must in all cases, be filed in the Adjutant General's Office as evidence of muster-in. The mustering officer, commissary, or assistant commissary of masters, as the case may be, will countersign both enlistments as having mustered the soldiers into the service of the United States before either of them is given to the disbursing officer.

DECLARATION OF RECRUIT.

I, George Davis desiring to volunteer as a soldier in the ARMY OF THE UNITED STATES for the term of Three Years, DO DECLARE That I am 36 years and 12 months of age; that I have never been discharged from the United States service on account of disability or by sentence of a court-martial, or by order before the expiration of a term of enlistment; and I know of no impediment to my serving honestly and faithfully as a soldier for three years.

GIVEN at Louisville Ky the 12th day of August 1864

Witness: J. H. Starnes

George Davis
with

Admitted at Louisville Ky
August 12th 1864
Accepted by W. H. B. B. B.

80.
George Davis
106

Consent of Parent or Guardian in case of a Minor, if a Free Man, or in the case of a Slave, of the Person to whom he owes Service:

I, Do CERTIFY, That I am the that the said is years of age; and I do freely give my CONSENT to his volunteering as a SOLDIER in the Army of the United States, for the period of THREE YEARS, under the conditions of the laws of the United States.

GIVEN at the day of

Witness:

UNITED STATES COLORED TROOPS ENLISTMENT.

STATE OF

TOWN OF

Kentucky

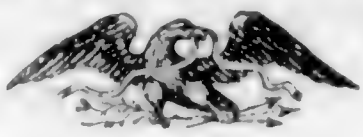

Louisville

I, *George Davis* born in *Shelby Co*

in the State of *Kentucky* aged *36* years

and by occupation a *Farmer* Do HEREBY ACKNOWLEDGE to

have volunteered *12th* day of *Aug* 186*4*

to serve as a **Soldier** in the **Army of the United States of America**, for the period of **THREE YEARS**, unless sooner discharged by proper authority: Do also agree to accept such bounty, pay, rations, and clothing, as are, or may be, established by law for the U. S. colored troops.

And I, *George Davis* do solemnly swear that I will bear true faith and allegiance to the **United States of America**, and that I will serve them honestly and faithfully against all their enemies or opposers whomsoever; and that I will observe and obey the orders of the President of the United States, and the orders of the officers appointed over me, according to the Rules and Articles of War.

Sworn and subscribed to, at *Louisville Ky*
on this *12th* day of *Aug 1864* *George Davis*

Before *Capt C. C. Hoam 12th Aug 1864*

I CERTIFY, ON HONOR, That I have carefully examined the above named Volunteer agreeably to the General Regulations of the Army, and that, in my opinion, he is free from all bodily defects and mental infirmity, which would in any way disqualify him from performing the duties of a soldier.

T. S. Bell

EXAMINING SURGEON

I CERTIFY, ON HONOR, That I have minutely inspected the Volunteer *George Davis* previously to his enlistment, and that he was entirely sober when enlisted; that, to the best of my judgment and belief, he is of lawful age; and that, in accepting him as duly qualified to perform the duties of an able-bodied soldier, I have strictly observed the regulations which govern the recruiting service. This soldier has *Dark* eyes, *Dark* hair, *Dark* complexion, is *5* feet *6* inches high.

C. C. Hoam Capt
12th Aug 1864 RECRUITING OFFICER OR AGENT.

Mustered into the United States Service *12th* day of *Aug* 186*4*

Walker Dannel *W. D. C.* Musterling Officer

Mustered into the service of the United States, for three years or during the war, from date of enlistment, in Company _____ Regiment of _____ Volunteers, on the _____ day of _____, 1864, at _____

War Department,

ADJUTANT GENERAL'S OFFICE

Washington, Feb 4th 1867.

Respectfully returned to the Commission for the State of Kentucky with the information that George Davis was enlisted at Louisville Ky Aug 12, 1864, and was mustered in as Pvt. Co. C, 5th U.S. Col., Aug 12, 1864.

D. H. H. Co.

[Signature]

[Signature]

Asst. Adj't General.

No. *[Handwritten]*

APPLICATION OF

Walker Davis

OF

Shelby Co. Ky.

FOR COMPENSATION FOR SLAVE, NAMED

George Davis

Enlisted *12th August*, 1864,

In Co. *C*, *5th Co.* Regiment,

U. S. COLORED TROOPS.

Received *Jan 12*, 1867

COMPENSATION AWARDED

March 16, 1867

Two hundred Dollars.

J. H. Moore

President Board of Claims.

Claimant's Attorney,

R. T. DURRETT,

Louisville, Ky.

Claimant's Post-office address,

Shelbyville

Shelby Co. Ky.

LOUISVILLE COURIER PRINT.

and made preliminary
Gen. D. Blakey

CLAIM OF

Walter Daniel

FOR COMPENSATION FOR SLAVE NAMED

George Davis

I, Walter Daniel, a loyal citizen and resident of Shelby County, State of Kentucky, upon oath, state that I am entitled to, and hereby claim compensation, under the provisions of the 24th section of the act of Congress, approved February 24th, 1864, and of the 2d section of the act, approved July 28th, 1866, for my slave named George Davis, who was enlisted into the military service of the United States on the 12th day of August, 1864, at Louisville, Ky. by Capt. Smith and assigned to the 5th Regiment of United States Colored Troops, Company C; that, at the date of said enlistment, I was a loyal citizen and resident of said county and State, and then and there owner of and entitled to the services of said slave; that I did not acquire said slave subsequent to said enlistment, but had a valid title to him at the date of said enlistment, and previous thereto: I having acquired my title to him and my ownership over him as follows, to wit: I owned the mother of said George Davis, and he was born to me and I have owned him ever since.

that when said slave went into the service he was able-bodied, sound of body and mind, and worth \$1200; that the claim I hereby make for compensation for said slave is just and true, and due me as owner of and entitled to his services, and I ought to recover for him the sum of \$300 under the provisions of said acts; that this claim for compensation, as owner, is for the identical slave who was a Sargent in Company C, of the 5th Regiment United States Colored Troops, as aforesaid; and that I have received from the Government no compensation or bounty for said slave, nor made any application except this, therefor.

I do further swear that I have never joined, or been concerned in, any insurrection or rebellion; that I have never borne arms against the United States; that I have never given any aid, countenance, counsel or encouragement to any person or persons engaged, or whom I had reason to believe were about to engage, in insurrection, rebellion, or armed hostility against the United States; that I have never sought nor accepted, nor attempted to exercise the functions of any office, civil or military, nor to perform any service whatever under any authority, or pretended authority in hostility to the United States; that I have not yielded a voluntary support to any insurrection, rebellion or pretended government, authority, power or constitution, within the United States, hostile thereto. And I do further swear that, to the best of my knowledge and ability, I have supported and defended, and will continue to support and defend, the United States, against all enemies, foreign and domestic; and that I have supported, defended and obeyed, and will continue to support, defend and obey, the Constitution and Laws of the United States; that I will bear true faith and allegiance to the same; and that I take this oath freely, without any mental reservation or purpose of evasion; So help me God.

And, in consideration of said enlistment and of said compensation, I, Walter Daniel, do hereby manumit, set free and forever release said George Davis from all service due me—his freedom to commence from the 12th day of August, 1864, the date of said enlistment into the military service of the United States.

I herewith file and make part hereof a certificate of enlistment and descriptive roll of said slave, and proof of my loyalty and ownership as required by said acts, and General Orders No. 329, 1863, War Department, Adjutant General's Office.

My Post-Office address is Shelbyville, County of Shelby, State of Kentucky, and I hereby direct that all communications to me, touching this claim, be sent under cover to R. T. DURRETT, of Louisville, Kentucky, who is hereby appointed and constituted my true and lawful attorney, to prosecute this claim for me, and who is hereby authorized and empowered to receive and receipt for any award, order, draft, certificate, voucher, warrant, papers or money that may be issued in the adjustment of this claim, or the payment thereof, the same as I might or could do in person were I present and acting for myself, and to file any additional evidence or papers that may be required in the prosecution of this claim.

[WITNESS.] The owner signs here. } Walter Daniel
Two witnesses to owner's signature sign here. } John W. Lyle, John C. Brown



STATE OF KENTUCKY,

County of Shelby } ss.

I, Hamilton Hargis, a Justice of the Peace in and for said County and State, duly commissioned and sworn, and authorized to administer oaths and take acknowledgments, hereby certify that on this day personally appeared before me Walker Daniel known to me to be the person he represents himself to be, and a loyal citizen and resident of said County and State, worthy of full faith and credit; and, after hearing the foregoing paper read, and understanding the meaning and purport of the same, subscribed and swore to the same, and acknowledged the power of attorney and deed of manumission therein to be his act and deed. I further certify that I have no interest, direct or indirect, in the prosecution of this claim.

Witness my hand and seal, this 22nd day of December, 1866

The officer swearing the owner signs here.

H. Hargis
H. H.



PROOF OF OWNERSHIP.

STATE OF KENTUCKY,

County of Shelby } ss.

We, Jos. W. Lyle and John C. Brown, each of lawful age, and loyal citizens of said County and State, upon our oaths declare that we are, and have been for 15 years, personally acquainted with Walker Daniel, and know that on the 12 day of August 1866 he was a loyal citizen of said County and State, and then and there as stated by him the owner of and entitled to the services of a slave, named George Davis referred to and described as a sergeant in Company C, of the 5th Cal. Regiment United States Colored Troops, in the foregoing claim for compensation; that the ownership of said Walker Daniel to said slave is not based upon any transfer made subsequent to said date, when said slave is alleged to have entered into the military service of the United States, but that said claimant's title to said slave was valid at the date of and previous to said enlistment, as stated in his own preceding affidavit.

Two witnesses to ownership sign here.

Jos. W. Lyle
John C. Brown

STATE OF KENTUCKY,

County of Shelby } ss.

I, Hamilton Hargis, a Justice of Peace in and for said County and State, duly commissioned and sworn, and authorized to administer oaths, do hereby certify that on this day personally appeared before me the above named Jos. W. Lyle and John C. Brown known to me to be the persons they represent themselves to be, and loyal citizens of said County and State, worthy of full faith and credit, and after hearing the foregoing statements read, and understanding the same, severally subscribed and swore to the same. I further certify that I have no interest, direct or indirect, in the prosecution of this claim.

Witness my hand and seal this 22nd day of December, 1866

The officer swearing the witnesses signs here.

H. Hargis
H. H.



PROOF OF LOYALTY.

STATE OF KENTUCKY,

County of Shelby } ss.

We, Jos. W. Lyle and John C. Brown, each of lawful age, and loyal citizens of said County and State, upon our oaths declare that we are, and have been for 15 years, acquainted with Walker Daniel, of said County and State, who is the applicant in the foregoing claim for compensation for a slave named George Davis, described as a sergeant in Company C, of the 5th Cal. Regiment of United States Colored Troops; that we have well known said Walker Daniel since the 4th day of March, 1861, and know that he has firmly and faithfully maintained his adherence and allegiance to the Government of the United States, by defending its cause against the Government of the so-called Confederate States of America, in all suitable and practicable ways, according to his ability and opportunity; that on the 12 day of August, 1866 when said slave is alleged to have entered the military service of the United States, the said Walker Daniel was a loyal citizen and resident of said County and State, and that he has been loyal ever since.

Two witnesses to loyalty sign here.

Jos. W. Lyle
John C. Brown

CERTIFICATE OF LOYALTY.

[FORM 7.]

STATE OF KENTUCKY,

COUNTY OF

Shelby } ss.

I, *John R. Beckley* Collector 4 Dist *Ky*

hereby certify, that I am personally, and by reputation, acquainted with *Walker*
Daniel, who, under the provisions of the 24th Section of the Act of
Congress, approved February 24th, 1864, and the 2d Section of the Act approved July 28th,
1866, is claiming compensation for a slave named *George Davis*,
alleged to have been mustered into the United States military service on the *1st* day
of *August* 186*4*, at *Louisville Ky*
and assigned to Company *A*, of the *5th* Regiment United States Colored Troops;
that at said date of enlistment, said *Walker Daniel* was a
loyal citizen and resident of said County and State; that *he* was loyal during the war
with the so-called Confederate States of America, and has been ever since; and that *he*
is worthy of full faith and credit in any statements *he* has or may make touching said
claim for compensation;

and that his neighbors John C. Brown and Joseph
W. Lyle are loyal and worthy of full faith and credit.

Witness my hand and official designation, at *Shelbyville* Kentucky, this
24 day of *December* 186*6*.

John R. Beckley
Collector 4 Dist Kentucky

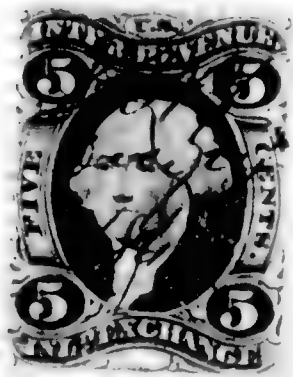

AFFIDAVIT OF THE SLAVE.

Sum ✓

State of *Kentucky*
County of *Shelby*

} s.s.

I *George Davis*
state upon oath, that I am the identical person who was a *Sergeant* in
~~Company~~ *XII* of the *5th U.S.C. Cav* Regiment United States Colored
Troops; that I was enrolled at *Louisville Ky* on the *12th* day
of *August* 1864, and discharged at *Helena Ark* on
the *16th* day of *March* 1866; that I now reside at
Shelbyville Ky and when I went into the U. S. Service I was the Slave
of *Master Daniel*, who is now applying for Bounty and Compens-
ation on account of my entering into the Service as above stated. I make this affidavit
to enable the said *Master Daniel* to whom I owed service as
aforesaid, to recover whatever is due him because of my going into the Service. I have
no personal interest in this claim, and make this voluntary statement as an act of justice
to my former owner. I was enlisted in *Co. C* of *summers made*
Company *Sergeant* of the Regiment —

Witness

W. H. H. H.

George X Davis
man

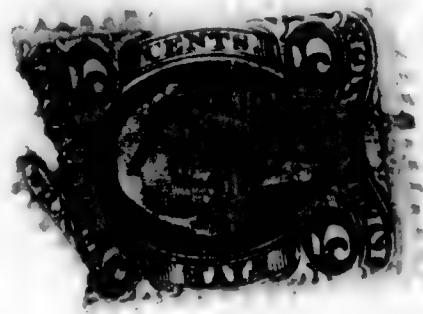

State of *Kentucky*
County of *Shelby*

} s.s.

I *H. H. H.* a *Justice of the Peace* in
and for said County and State, hereby certify that on this day personally appeared before me, the above named
George Davis, late a *Sergeant* of *Company* *XII*
of the *5th U.S.C. Cav* Regiment U. S. C. Troops, known to me to be the person he represents himself to
be, and after hearing the foregoing affidavit read and explained by me, and understanding the same, subscribed and
swore to the same. And I further certify that I have no interest in the prosecution of this claim.

Witness my hand and seal this *19th* day of *November* 1866.

H. H. H.

KENTUCKY,

County of *Shelby* } ss.

Hamilton Freyer a Justice of Peace in and for said County State, duly commissioned and sworn, and authorized to administer oaths, do hereby certify that on this day personally appeared before me the above named *Jos. W. Kyle* and *John C. Brown* known to me to be the persons they represent themselves to be, and loyal citizens of said County and State, worthy of full faith and credit, and after hearing the foregoing statement read, and understanding the same, severally subscribed and swore to the same. I further certify that I have no interest, direct or indirect, in the prosecution of this claim. Witness my hand and seal this *22nd* day of *December* 186*6*

The officer swearing the witnesses signs here.

H. Drayton
12/22/66



STATE OF KENTUCKY,

County of *Shelby* } ss.

I *Wm. D. Bullard* Clerk of the County Court, in and for said County and State, and keeper of its records and seal, do hereby certify that *H. Drayton*, whose signature and certificate appears to the foregoing oaths, statements and acknowledgments, was at the date thereof an acting Justice of the Peace within and for said County, duly commissioned and sworn; that his official acts as such are entitled to full faith and credit, and that his signature thereto is genuine. I further certify that said *Walter Daniel*, the applicant, and his witnesses *Joseph W. Kyle* and *John C. Brown* and *Hamilton Freyer* Justice of the Peace are loyal citizens of said County and State, and worthy of full faith and credit, and were so during the war.

In witness whereof, I have hereunto set my hand and affixed the seal of said County, at my office, in *Shelbyville Kentucky* this *24th* day of *December*, 186*6*



The County Clerk signs here and affixes the County Seal.

Wm. D. Bullard Clerk
Shelby County Court

Certificate of Award of. the Board of Claims.

OFFICE OF THE BOARD OF CLAIMS,
FOR SLAVES ENLISTED OR DRAFTED IN THE SERVICE OF THE U. S. }

Frankfort Ky
March 6th 186*7*

WE HEREBY CERTIFY, that *Walter Daniel*, of *Shelby* County, State of *Kentucky* having proved, under oath, his loyalty to the Constitution and Government of the United States, and established title as to the ownership of *George A. Daniel* a slave *Walter Daniel* and mustered at *Shelbyville Ky* on the *17* day of *August*, 186*4*, by *Capt Smith* in the service of the United States, in the *6th* Regiment of Colored Troops, Company *C*, the sum of *Three Hundred* dollars has been awarded to *him* by this Board, subject to the approval of the Secretary of War, as a compensation for the said slave, under the provisions of Section 24, Act approved February 24, 1864, and Section 2, Act approved July 28, 1866.

W. S. Moore, President of the Board.
Geo. W. Mack, Member of Board.
Member of Board.

To.....

Chief of the Bureau for the organization of Colored Troops, Washington, D. C.

330
Davis, Nathan

Co G, 5 U. S. Col'd Cav.

Private

Private

CARD NUMBERS.

1	5365741	26
2	5365840	27
3	5365941	28
4	5366036	29
5	5366132	30
6	5366224	31
7	5366314	32
8	5366403	33
9	5366490	34
10	5366579	35
11	5366730	36
12	9090666	37
13	31413521	38
14	32116076	39
15	32116318	40
16	32232695	41
17	32233014	42
18	40729670	43
19		44
20		45
21		46
22		47
23		48
24		49
25		50

Book Mark:

See also

W | **5 Cav. | U.S.C.T.**

Walter Davis

....., Co. G, 5 Reg't U. S. Col'd Cav.

Appears on

Company Descriptive Book
of the organization named above.

DESCRIPTION.

Age 25 years; height 5 feet 5 inches.

Complexion Black

Eyes Black; hair Black

Where born Maddison Ky

Occupation Farmer

ENLISTMENT.

When Sept 1, 1864.

Where Camp Nelson

By whom W. Randolph; term 3 y'rs.

Remarks:

.....
.....
.....
.....
.....
.....
.....
.....

J. E. Kupper

D 5 Cav. U.S.C.T.

Nathan Davis.

Plt., Co. *G*, 5 Reg't U. S. Col'd Cavalry.

Appears on

Company Muster-in and Descriptive Roll

of the organization named above. Roll dated

Camp Nelson Ky, N. Y., Oct. 29, 1864.

Where born *Madison Ky.*

Age *25* y'rs; occupation *Farmer.*

When enlisted *Sept. 1*, 1864.

Where enlisted *Camp Nelson Ky.*

For what period enlisted *3* years.

Eyes *Black*; hair *Black.*

Complexion *Black*; height *5 ft. 5 in.*

When mustered in *Sept. 1*, 1864.

Where mustered in *Camp Nelson*

Bounty paid \$ *100*; due \$ *100*

Where credited *7th Cav. Det.*

Company to which assigned

Remarks:

x Jackson Davis.

x *# Supposed to be name of owner.*

Added May 16. 98 H. A. J.

Book mark:

(356d)

[Signature]
Copyist.

J

5 Cav. | U.S.C.T.

Nathan Davis

Private, Co. G, 5 Reg't U. S. Col'd Cavalry.

Appears on

Company Muster Roll

for *Full to Oct. 31*, 1864.

Present or absent. *Absent*

Stoppage, \$ *100* for

Due Gov't, \$ *100* for

Valuation of horse, \$ *100*

Valuation of horse equipments, \$ *100*

Remarks: *Am detached ser-
vice Burnside Pt. Ky.
Oct. 4/64.*

Book mark:

[Signature]

(358)

Copyist.

D | **5 Cav.** | **U.S.C.T.**

Mathan Davis,

Pvt., Co. G, 5 Reg't U. S. Col'd Cavalry.

Appears on

Company Muster Roll

for *Nov. & Dec.,* 1864.

Present or absent *Absent*

Stoppage, \$ *100* for

Due Gov't, \$ *100* for

Valuation of horse, \$ *100*

Valuation of horse equipments, \$ *100*

Remarks: *Detached service
Camp Nelson Ky.
1st & 2^d instlt duty due.*

Book mark: _____

[Signature]

D. | 5 Cav | U.S.C.S.

Nathan Davis
Priv., Co. G., 5 Reg't U.S.C.C.

Appears on

Hospital Muster Roll

of Convalescent Camp U. S. A. Hospital,

at Camp Nelson, Ky.,

for Jan. + Feb., 1865.

Attached to hospital:

When Feb. 28, 1865.

How employed Patient

Last paid by Maj. Pay due from enlistment,
to _____, 1865.

Bounty paid \$ 100; due \$ 100

Present or absent Present

Remarks: _____

Book mark: _____

Dickerson

D

5 Cav. | U.S.C.T.

Nathan Davis

Privt., Co. G, 5 Reg't U. S. Col'd Cavalry.

Appears on

Company Muster Roll

for *Jan. & Feb.*, 186*5*.

Present or absent *Absent*.

Stoppage, \$ *100* for

Due Gov't, \$ *100* for

Valuation of horse, \$ *100*

Valuation of horse equipments, \$ *100*

Remarks: *Sick in Gen. Hospital Camp Nelson Ky. 1st Inst'd. Bounty due \$100.*

Book mark: _____

[Signature]

D | **5 Cav.** | **U.S.C.T.**

Nathan Davis

Privt., Co. G, 5 Reg't U. S. Col'd Cavalry.

Appears on

Company Muster Roll

for *March & April*, 1865.

Present or absent *Absent*

Stoppage, \$ *100* for

Due Gov't, \$ *100* for

Valuation of horse, \$ *100*

Valuation of horse equipments, \$ *100*

Remarks: *Detached service*

Camp Nelson Ky.

1st instant. Security

for 100 days.

Book mark: _____

[Signature]

5 Cav. U.S.C.T.

Nathan Davis

Davis, Co. G, 5 Reg't U. S. Col'd Cavalry.

Appears on

Company Muster Roll

for *May June*, 1865.

Present or absent *Absent*

Stoppage, \$ *100* for

Due Gov't, \$ *100* for

Valuation of horse, \$ *100*

Valuation of horse equipments, \$ *100*

Remarks: *Detached Service*

Camp Nelson Ky

Six Months

Book mark:

D | 56 | U.S.C.T

Nathan Davis

Pvt, Co. G, 5 Reg't U.S.C.C

Appears on

Hospital Muster Roll

of U. S. A. Post Hospital,

at Camp Nelson, Ky.,

for July & Aug, 1865.

Attached to hospital:

When, 186 .

How employed

Last paid by Maj.

to, 186 .

Bounty paid \$ 100; due \$ 100

Present or absent Present

Remarks:

.....
.....
.....
.....
.....
.....
.....
.....

Book mark:

C. L. Parker

L. | **5 Cav. | U.S.C.T.**

Nathan Davis

Pvt., Co. G, 5 Reg't U. S. Col'd Cavalry.

Appears on

Company Muster Roll

for *July 1st*, 1863.

Present or absent *Present*

Stoppage, \$ *100* for

Due Gov't, \$ *100* for

Valuation of horse, \$ *100*

Valuation of horse equipments, \$ *100*

Remarks: *Sick in service*

Wm. H. Nelson,
Copyist

Book mark: _____

Nathan Davis Copyist.

D | 5-6 | U.S.C.T

Nathan Davis

Pvt, Co. G, 5 Reg't U.S.C.C

Appears on

Hospital Muster Roll

of U. S. A. Post Hospital,

at Camp Nelson, Ky.,

for Sept + Oct, 1865.

Attached to hospital:

When _____, 186 .

How employed _____

Last paid by Maj. Beecher

to Feb 28, 1865.

Bounty paid \$ 100; due \$ 300 100

Present or absent Present

Remarks: _____

Book mark: _____

C. C. Parker

5 Cav. U.S.C.T.

William Davis

Reynolds, Co. G, 5 Reg't U. S. Col'd Cavalry.

Appears on

Company Muster Roll

for *Sept 10th*, 186*5*.

Present or absent *Absent*

Stoppage, \$ *100* for

Due Gov't, \$ *100* for

Valuation of horse, \$ *100*

Valuation of horse equipments, \$ *100*

Remarks: *Died in Hospital
at Camp Nelson, Ky.*

Book mark:

J. C. [Signature] Copyist.

2 | 5 Car | U.S.C.T.

Nathan Davis

Pri, Co. G, 5 Reg't U.S.C.C.

Appears on

Hospital Muster Roll

of Marine U. S. A. General Hospital,

at St. Louis, Mo.,

for Nov & Dec, 1865.

Attached to hospital:

When Dec 21, 1865.

How employed Patient

Last paid by Maj. Beecher

to Feb 28, 1865.

Bounty paid \$ 100; due \$ 300 100

Present or absent Present

Remarks: 1. 2. 3 & 4 inst. bounty due
\$100.

Book mark: _____

D. Waters

D. | 5 Cav. | U.S.C.T.

Nathan Davis

Brn., Co. G, 5 Reg't U. S. Col'd Cavalry.

Appears on

Company Muster Roll

for Nov. & Dec., 1865.

Present or absent. *Absent*

Stoppage, \$.....100 for

Due Gov't, \$.....100 for

Valuation of horse, \$.....100

Valuation of horse equipments, \$.....100

Remarks: *Sick in Genl*

Hosp. Camp Nelson,

Ky. since July 1865.

Not installed in

Bounty since 1865

Book mark:

(358)

J. J. [Signature]
Copyist.

D | *5 Car* | *U.S.C.T.*

Nathan Davis

Priv, Co. *G*, *5* Reg't *U.S.C. Car*

Appears on

Hospital Muster Roll

of **Marine U. S. A. General Hospital,**

at **St. Louis, Mo.,**

for *Jan & Feb*, 186*6*.

Attached to hospital:

When _____, 186 .

How employed _____

Last paid by Maj. _____

to _____, 186 .

Bounty paid \$ _____ 100; due \$ _____ 100

Present or absent _____

Remarks: *Discharged Jan 10.66*
Final St. Louis

Book mark: _____

Spencer

5 Cav. U.S.C.T.

Walter Lewis
Sgt., Co. G, 5 Reg't U. S. Col'd Cavalry.

Appears on

Company Muster Roll

for *Quincy & Kirby*, 1866.

Present or absent *absent*

Stoppage, \$ *100* for

Due Gov't, \$ *100* for

Valuation of horse, \$ *100*

Valuation of horse equipments, \$ *100*

Remarks: *Sick in San Angelo*
Camp Nelson, Tex since July
1865 - 1st instalment bounty
due \$ 100.

Book mark: *Discharged Jan. 12/66*
over.

(358)

Walker

Copyist.

JAN. - 9

5366579

1891

S. 73. 24 11 P. 21.

10 | 5 Cav. | U.S.C.T.

Nathan Davis.

Priv., Co. G, 5 Reg't U. S. Colored Cav.

Appears on Returns as follows:

Oct. 1864 to Jan. 1865. Absent on detail service at Camp Nelson, Ky.
Oct. 8/64.

Feb. 1865. Absent sick in Gen. Hosp., Camp Nelson, Ky.

Mar. to June, 1865. Absent, detail service, S. O. 13, dated Hdqrs. Camp Nelson, Ky. Mar. 11/65.

July 1865 to Feb. 1866. Absent sick in Gen. Hosp., Camp Nelson, Ky., since July 23/65.

Book mark :

2 | 5 Cav. | U.S.C.T.

Nathan Davis
.....
Park, Co. *A*, 5 Reg't U. S. Col'd Cavalry.

Appears on **Co. Muster-out Roll**, dated
Albany, Ark *March 16*, 1866.

Muster-out to date, 186 ..

Last paid to *Dec 31*, 1865.

Clothing account:

Last settled, 186 ; drawn since \$ 100

Due soldier \$ 100; due U. S. \$ *11* ^{*34*}/₁₀₀

Am't for cloth'g in kind or money adv'd \$ 100

Due U. S. for arms, equipments, &c., \$ 100

Bounty paid \$ *100* 100; due \$ 100

Remarks *Discharged Jan. 10, 1866*
St. Louis, Mo., Surgeons Certificate
of Disability

Book mark: *Discharged Jan. 10/66-*
over.

JAN. - 9

5366730

1891

E. B. U. 11 - P. 27.

J. H. P. 186.68. - 2658. 1878.

G. D. 260. 425

Davis Nathan

P. G., Co. *G.*

5 Reg. **U.S.C. Cav.**

5 Enclosures.

Bed Cards	<i>2</i>	Descriptive Lists	
Burial Records		Final Statements	<i>1</i>
Certs. of Dis. for Discharge	<i>1</i>	Furloughs	
C. M. Charges		Med. Des. Lists	
Med. Certificates		Orders	<i>1</i>

Other papers relating to—

Admission to Hosp'l	Furlough
Casualty Sheet (Officer's)	Med. Examination
Confinement	Misc. Information
Contracts	Pay or Clothing
Death or Effects	Personal Reports
Desertions	Rank
Discharge from Hosp'l	Transfer to Hosp'l
Discharge from Service	Transfer to V. R. C.
Duty	Transportation

NOTE 1.

The company commander will here add a statement of all the facts known to him concerning the disease or wound, or cause of disability of the soldier; the time, place, manner, and all the circumstances under which the injury occurred, or disease originated or appeared; the duty, or service, or situation of the soldier at the time the injury was received or disease contracted, stating particularly whether the injury was received or disease contracted in the line of his duty; and whatever other facts may aid a judgment as to the cause, immediate or remote, of the disability, and the circumstances attending it.

When the facts are not known to the company commander, the certificate of any officer, or affidavit of other person having such knowledge will be appended—as the surgeon in charge of a hospital, the officer commanding a detachment of recruits, &c., &c.

NOTE 2.

When a probable case for pension, special care must be taken to describe the degree of disability—as 2, 3, &c., &c.; to describe particularly the disability, wound or disease; the extent to which it deprives him of the use of any limb or faculty, or affects his health, strength, activity, constitution, or capacity to labor or earn his subsistence. The surgeon will add, from his knowledge of the facts and circumstances, and from the evidence in the case, his professional opinion of the cause or origin of the disability. In the case of discharges by Medical Inspectors, the last paragraph will state that the "discharge was given by consent of the soldier, after a personal examination, and for disability, the nature, degree, and origin of which are correctly described in the within certificate."

Par. 1260 Regulations, Edit. 1861.

Medical officers, in giving certificates of disability, are to take particular care in all cases that have not been under their charge; and especially in epilepsy, convulsions, chronic rheumatism, derangement of the urinary organs, ophthalmia, ulcers, or any obscure disease liable to be feigned or purposely produced; and in no case shall such certificate be given until after sufficient time and examination to detect any attempt at deception.

DIRECTIONS.

This certificate will be made out in duplicate by the soldier's company commander, or other officer commanding the separate detachment to which he belongs, and sent by him to the surgeon who has charge of the hospital where the soldier is sick. The surgeon will then fill out and sign the surgeon's certificate, and forward these papers to the regimental, detachment, or post commander, who will forward them, with his action endorsed thereon, through the proper channel to his division commander; or if the troops are not attached to a division, to his corps, department, or other commander or officer to whom the authority to discharge enlisted men may be specially delegated.

These certificates, after having received the action of the highest authority to which they are required to be sent, will be returned through the same channel to the regimental, post, or detachment commander, who will, if the discharge is authorized by the endorsement of the proper authority, sign the soldier's discharge, and the last certificate on this paper; see that the soldier is furnished with the proper final statements in duplicate, and forward both of these certificates direct to the Adjutant General United States Army, at Washington, D. C.; they will not under any circumstances be given into the hands of the soldier.

ADJUTANT GENERAL'S OFFICE

June 27th 1866

Duplicate sent to the Regimental Commander

Certificate of Disability for Discharge

In the case of

Nathan Davis Co. G.

Private "G" Co, 5th

5th Reg't of U.S.C. Army

APPROVED,

Medical Director.

HEAD QUARTERS, DISTRICT OF

Sept of the Missouri

1866

TO BE DISCHARGED.

By order of Brig. Gen'l

[Signature]

Assistant Adjutant General.

Received (A. G. Office)

1866

Ernest R. Collins

[OFFICE INDORSEMENT.]

War Department,

ADJUTANT GENERAL'S OFFICE,

March 25, 1874

The discharge of Nathan Davis

Colored Co., is reported as follows:

On Company Muster Roll, 1866

Company Muster-out Roll, 1865

Company Descriptive Book, 1866

Company Morning Reports, 1866

Soldier's Final Statement, 1866

Soldier's Record of Death and Interment, 1866

Soldier's Inventory of Effects, 1866

Soldier's Certificate of Disability for Discharge, 1866

Soldier's Individual Muster-out Roll, 1866

Regimental Return, 1866

Regimental Quarterly Returns, 1866

Regimental Descriptive Book, 1866

By Surgeon General, 1866

January 10, 1866, is held to be

the correct date, and the Company Muster

Roll will be amended accordingly.

Thomas M. Sweet

Assistant Adjutant General.

See letter of May 4, 1874

to forward.

ARMY OF THE UNITED STATES.



CERTIFICATE OF DISABILITY FOR DISCHARGE.

(To be used in duplicate in all cases of discharge on account of disability.)

Nathan Davis "Private" of Captain _____
 Company, [*G.*], of the *Fifth (13th)* Regiment of United States
Colored Cavalry, was enlisted by *J. C. Randolph*, of
 the _____ Regiment of _____ at *Camp Nelson Ky*
 on the *First* day of *September* 1864, to serve *three* years; he was born
 in *Madison County* in the State of *Kentucky*, is *Twenty five* years
 of age, *Five* feet *five* inches high, *Black* complexion, *Black* eyes,
Black hair, and by occupation when enlisted a *Farmer*. During the last two
 months said soldier has been unfit for duty *Sixty* days. (Here consult directions on Form 13, p. 325, par. 1340, p. 344, Rev. Army Reg.)

STATION: _____

DATE: _____

Commanding Company.

I CERTIFY That I have carefully examined the said *Nathan Davis* of
 Captain _____ "*G.*" Company, and find him incapable of performing the duties of a soldier
 because of (Here consult par. 1260, p. 284; also, par. 1638, p. 495, and directions on Form 13, p. 325, Revised Army Regulation.) *Chronic elon-*

gation, in consequence of which he has done
no duty for 13 months.

Miami Genl. Hosp. St Louis Mo
January 5th 1866

A. E. Weston,
13th Major and Surgeon. U.S.A.

DISCHARGED this *Tenth* day of *January* 1866, at *Miami General*
Hospital St Louis Mo, *J. C. Randolph,*

1st Lieut. and Surg. U.S.A.

NOTE 1—When a probable case for pension, special care must be taken to state the degree of disability.
 NOTE 2—The place where the soldier desires to be addressed may be here added.
 Town—*Nicholasville* County—*Jessamine* State—*Kentucky*
 [DUPLICATES]

FINAL STATEMENT

OF

Private Nathan Davis Co. G
5th Reg't of U. S. Colored Cavalry.

VOLUNTEERS.

NOTE 1.—Two of these certificates (or duplicates) are to be given to each Volunteer Soldier or drafted man who may be discharged previously to the discharge of his company, that he may at once receive from the Paymaster the pay, &c., due him, and the captain or other COMMISSIONED officer commanding the company will certify to the act of the delivery of the duplicate certificates; on these certificates the Soldier is "entitled to" his discharge, and should also present his discharge to the Paymaster to have the payment endorsed on it. The discharge is to be given back to the Soldier by the Paymaster; the latter only retaining as his voucher the duplicate certificates.

NOTE 2.—If the Soldier is entitled to pay for the use of his horse, the Company Commander will certify to that fact on the back of both these final statements, and also to the time he has pay due for having been so mounted on his own horse.

NOTE 3.—When a Soldier is furnished with final statements, his descriptive list, if he has one, should be taken up by the officer who gives the Soldier these statements, and endorsed with a statement to this effect by the officer. This endorsement should exhibit a full statement of the time for which the Soldier was allowed pay on his final statements, the clothing account, and all other charges against him or in his favor, so as to comprise a complete exhibit of his account. It will then be transmitted to the company commander of the Soldier, who will enter all the data necessary to a full understanding of the Soldier's account on the muster roll upon which the Soldier's discharge is reported. The descriptive list will then be destroyed. The object of this is, that the remaining portion of the Soldier's account may be settled upon the receipt of these muster rolls, and the Soldier receive any pay or allowances that may be due him at the time of his discharge, and which may not appear on his final statements from the fact that his descriptive list is incomplete. These accounts for back pay, &c., are settled by the 2d Auditor of the Treasury Department.

NOTE 4.—Charges for loss or injury to ordnance, horse equipments, and other miscellaneous charges, should appear under the heading of "Other Stoppages."

NOTE 5.—Bounty paid by State authorities, and not by the United States, will not be entered on this statement.

NOTE 6.—Amounts due the Sutler and Laundress must be entered on the muster roll on which the discharge, death, desertion, &c., is reported, as well as on the final statement, otherwise the amount cannot be collected from the United States.

NOTE 7.—This blank will be used for deceased volunteers and drafted men, as well as for others.

NOTE 8.—Where a Soldier dies in Hospital or on detached service, his descriptive list, if he has one, should be sent with his final statements, in duplicate, to the Adjutant General, Washington, D. C.

I certify, on honor, that Nathan Davis a Private of
Captain _____ Company (G) of the 5th Regiment of Colored Cavalry
VOLUNTEERS, of the State of United States, born in Madison, State
of Kentucky, aged 25 years; 5 feet 5 inches high; Black complexion,
Black eyes, Black hair, and by occupation a Farmer, having joined the company on
its original organization at _____, and enrolled in it at the muster into
the service of the United States at Camp Nelson Ky, on the First day
of September, 1864, (or was mustered in service as a recruit, by Captain
Kenny, at Camp Nelson Ky, on the First day of September,
1864, or was drafted and mustered into the service of the United States from the _____
Enrollment District of the State of _____, at _____,
on the _____ day of _____, 186), to serve in the Regiment, for
the term of Three Years: and having served **HONESTLY** and
FAITHFULLY with his Company in _____ to the present date, is now
entitled to a **DISCHARGE** by reason of Surgeon's Certificate of disability.

The said Nathan Davis was last paid by Paymaster
G. A. Mitchell to include the 31st day of December, 1865, and has
pay due him from that time to the present date; he is entitled to pay and subsistence for
TRAVELING to place of enrollment, and whatever other allowances are authorized to volunteer
soldiers, drafted men, or militia, so discharged. He has received from the United States **CLOTHING**
amounting to Eleven & 54/100 dollars, since the 31st day of March,
1865, when his clothing account was last settled. He has received from the United States
100 & 00/100 dollars advanced **BOUNTY**. There is due him two hundred dollars unpaid bounty.

There is to be stopped from him, on account of the State of _____, or other
authorities, for **CLOTHING**, &c., received on entering service, _____ dollars; and
for other stoppages, viz: _____

_____ dollars.
He has been furnished with **TRANSPORTATION** in kind from the place of his discharge to
_____; and he has been **SUBSISTED** for **TRAVELING** to his
place of enrollment, up to the _____, 186 .

He is indebted to _____, **SUTLER**, _____ dollars:

He is indebted to _____, **LAUNDRESS**, _____ dollars.

Given in Duplicate, at Marine General Hospital St Louis Mo, this 10 day
of January, 186 .

G. F. Randolph

Det. Lt. Col. Geo. S. ...
Commanding Company

Hospital Number 4472 { 75

Name Nathan Davis

Age 28 Nativity Ky

Married or Single Married

Residence Jefferson Co. Ky

Post Office address of } May Davis
wife or nearest relative, } Camp Nelson Ky

Rank Priv Co. B Regiment 5th Va. Col.

When admitted Dec 21st 1861

From what source Jefferson ^{Genl Scott} Mo

Diagnosis:—(In surgical cases state explicitly seat and character of wound or injury.)

Convalescent

X

Marine G. H.

St. Louis, Mo.

On what occasion wounded

Date

Nature of missile or weapon

TREATMENT.

[HERE NOTE IMPORTANT COMPLICATIONS AND ALL OPERATIONS.]

Convalescent

Off 113 Ave.

RESULT AND DATE.

Discharged

January 10' 1866

March 17 1865. Bed 47
Hospital Number

Name Nathan Davis

Age 27 Nativity Ky

Married ~~Single~~

Residence Jessamine Ky

Post Office address of wife or nearest relative. Mary J Davis
Ed Refuge Home Camp. Nelson Ky

Rank Priv Co. G Regiment 5th U.S. Cav

When admitted Nov 28th 65

From what source Camp Nelson Ky

Diagnosis: (in surgical cases state explicitly seat and character of wound or injury.)

Paralysis?

47

Jefferson G. H
Jeffersonville, Ind.

On what occasion wounded

Date

Nature of missile or weapon

TREATMENT.

[HERE NOTE IMPORTANT COMPLICATIONS AND ALL OPERATIONS.]

RESULT AND DATE.

A. Lewis, No. Decr. 20. 65.

Mar 11th C

Head-Quarters, Camp Nelson, Ky.

March 11th 1865

SPECIAL ORDERS.

Number

(EXTRACT.)

Private Nathan Davis Co. G. 5th U. S. C.
is hereby detailed for duty at the
Refugee Home for Colored women and Children
at this Post.

This detail to date from February 1st
1865

By Order of Brig. Genl. Spud. S. Dyer
Commanding Post.

Lieut. Col. A. A. Q.

Davis, Robert

Co A, 5 U. S. Col'd Cav.

Corporal

Sergeant

CARD NUMBERS.

1	5-35-93-88	28
2	5-35-96-90	27
3	5-35-97-90	28
4	5-35-98-91	29
5	5-36-00-71	30
6	5-36-00-10	31
7	989885-8-	32
8	40729673	33
9		34
10		35
11		36
12		37
13		38
14		39
15		40
16		41
17		42
18		43
19		44
20		45
21		46
22		47
23		48
24		49
25		50

Book Mark:

See also

D | **5 Cav. | U.S.C.T.**

Robert Davis

....., Co. *A*, 5 Reg't U. S. Col'd Cav.

Appears on

Company Descriptive Book
of the organization named above.

DESCRIPTION.

Age *22* years; height *5* feet *10* inches.

Complexion *Blk*

Eyes *Blk*; hair *Blk*

Where born *Taylor Co. Ky*

Occupation *Farmer*

ENLISTMENT.

When *Sept. 5*....., 186*4*.

Where *Lebanon*

By whom *Capt. Fiddler*; term *3* y'rs.

Remarks: *Killed by Patrol
guard Mar, 13/65-*

Warren

D

5 Cav. U.S.C.T.

Bob Davis

Corp., Co. A, 5 Reg't U. S. Col'd Cavalry.

Appears on

Company Muster-in and Descriptive Roll

of the organization named above. Roll dated

Cap. Nelson Ky., N. Y., Oct. 24, 1864.

Where born Taylor Ky.

Age 22 y'rs; occupation Farmer.

When enlisted Sept 5, 1864.

Where enlisted Lebanon

For what period enlisted 3 years.

Eyes Blk; hair Blk

Complexion Blk; height 5 ft. 10 in.

When mustered in Sept. 5, 1864.

Where mustered in Lebanon

Bounty paid \$ 100; due \$ 100

Where credited

Company to which assigned A

Remarks:

Book mark:

Castellano

(356d)

Copyist.

J | **5 Cav.** | **U.S.C.T.**

Robert Davis

Co. A, 5 Reg't U. S. Col'd Cavalry.

Appears on

Company Muster Roll

for *Oct. 31*, 1864.

Present or absent *Present*

Stoppage, \$ *100* for

Due Gov't, \$ *100* for

Valuation of horse, \$ *100*

Valuation of horse equipments, \$ *100*

Remarks:

Book mark:

(358)

E. A. Teuling
Copyist.

①

5 Cav. U.S.C.T.

Robert Davis
Capt, Co. A, 5 Reg't U. S. Col'd Cavalry.

Appears on

Company Muster Roll

for Nov, & Dec, 1864.

Present or absent Present

Stoppage, \$ 100 for

Due Gov't, \$ 100 for

Valuation of horse, \$ 100

Valuation of horse equipments, \$ 100

Remarks: 1st and 2^d Instalment
Bounty due.

Book mark:

Eastling

(358)

Copyist.

9

5 Cav. U.S.C.T.

Robert Davis
Sergeant, Co. A, 5 Reg't U.S. Col'd Cavalry.

Appears on

Company Muster Roll

for Jan 8 Feb, 1865.

Present or absent Present

Stoppage, \$ 100 for

Due Gov't, \$ 100 for

Valuation of horse, \$ 100

Valuation of horse equipments, \$ 100

Remarks: 1st Installment
Bounty due \$100.

Book mark:

D. A. Stealing

(358)

Copist.

D

5 Cav. U.S.C.T.

Robert Davis

Co. A, 5 Reg't U. S. Col'd Cavalry.

Appears on

Company Muster Roll

for *Mar 1865*, 1865.

Present or absent

Stoppage, \$ 100 for

Due Gov't, \$ 100 for

Valuation of horse, \$ 100

Valuation of horse equipments, \$ 100

Remarks: Killed by patrol
against Camp Wilson
Apr. 21st 3'55
at installation
bounty due \$ 50.

Book mark:

J. H. H. H.

(358)

Copyist.

10 | 5 Cav. | U.S.C.T.

Robert Davis.

Sergt. Co. A, 5 Reg't U. S. Colored Cav.

Appears on Returns as follows:

Jan. 1865. Absent sick in Gen. Hosp.,
Camp Nelson, Ky.

Mar. 1865. Killed by Patrol Guard,
Mar. 13/65, Camp Nelson.

Book mark :

(546)

R. Baber
Copyist.

D

5 Cav. U.S.C.T.

Robert Davis
Capt. Co. A, 5 Reg't U. S. Col'd Cavalry.

Appears on **Co. Muster-out Roll**, dated
Helena Ark, Nov 16, 1866.

Muster-out to date _____, 186 .

Last paid to *Dec 31*, 186 *4*

Clothing account:

Last settled _____, 186 ; drawn since \$ _____ 100

Due soldier \$ _____ 100; due U. S. \$ _____ 100

Am't for cloth'g in kind or money adv'd \$ _____ 100

Due U. S. for arms, equipments, &c., \$ _____ 100

Bounty paid \$ _____ 100; due \$ _____ 100

Remarks: *Died Cp Nelson Ky*
Mar 13th. 65 from
effects of wounds
given him by patrol
guard. Final statement
forwarded May 8. 65

Book mark: *V. 243 P. 60, 77.*

W. W. Daye

(361)

Copyed.

Davis, Robert

Sgt, Co. A, 6 U.S.C. Cav.,

2 Enclosures.

Bed Cards	Descriptive Lists
Burial Records	Final Statements /
Certs. of Dis. for Discharge	Furloughs
C. M. Charges	Med. Des. Lists
Med. Certificates	Orders

Other papers relating to—

Admission to Hosp'l	Furlough
Casualty Sheet (Officer's)	Med. Examination
Confinement	Misc. Information
Contracts	Pay or Clothing
Death or Effects /	Personal Reports
Desertions	Rank
Discharge from Hosp'l	Transfer to Hosp'l
Discharge from Service	Transfer to V. R. C.
Duty	Transportation

MICROFILM PUBLICATION M 1821

COMPILED MILITARY SERVICE RECORDS
OF VOLUNTEER UNION SOLDIERS WHO
SERVED WITH THE USCT (US COLORED TROOPS)
5TH REGIMENT OF CAVALRY

PERSONAL PAPERS' TARGET SHEET

PLEASE NOTE THE CHECKED INFORMATION ABOUT THE PERSONAL PAPERS IN
THIS FILE:

- NO PERSONAL PAPERS WERE FOUND IN THIS FILE WHEN THE
RECORDS WERE ARRANGED FOR MICROFILMING.

- 3 PERSONAL PAPER(S) FOUND IN THIS FILE WHEN THE RECORDS
WERE ARRANGED FOR MICROFILMING.

Extract from Act of Congress.

SEC. 12. *And be it further enacted*, That the fees of agents and attorneys for making out and causing to be executed the papers necessary to establish a claim for a pension, bounty, and other allowance before the Pension Office, under this act, shall not exceed the following rates: For making out and causing to be duly executed a declaration by the applicant, with the necessary affidavits, and forwarding the same to the Pension Office, with the requisite correspondence, ten dollars; which sum shall be received by such agent or attorney in full for all services in obtaining such pension, and shall not be demanded or received, in whole or in part, until such pension shall be obtained; and the sixth and seventh sections of an act entitled "An act to grant pensions," approved July [fourteenth,] eighteen hundred and sixty-two, are hereby repealed.

SEC. 13. *And be it further enacted*, That any agent or attorney who shall, directly or indirectly, demand or receive any greater compensation for his services under this act than is prescribed in the preceding section of this act, or who shall contract or agree to prosecute any claim for a pension, bounty, or other allowance under this act, on the condition that he shall receive a per centum upon any portion of the amount of such claim, or who shall wrongfully withhold from a pensioner or other claimant the whole or any part of the pension or claim allowed and due to such pensioner or claimant, shall be deemed guilty of a high misdemeanor, and, upon conviction thereof, shall, for every such offense, be fined not exceeding three hundred dollars, or imprisoned at hard labor not exceeding two years, or both, according to the circumstances and aggravations of the offense.

Approved July 4, 1864.

NOTE 10.—If any soldier is charged a higher fee than that allowed by the above act, he should report the fact and the name of the agent to the Adjutant General, in order that steps may be taken to have the same refunded.

FINAL STATEMENT

Sergt Robert Davis Co "A"
5th Reg't of U.S. Cavalry

RECEIVED

NOTE 1.—Two duplicate certificates (or duplicates) are to be given to each Volunteer Soldier or drafted man who may be discharged without being mustered out (Final Statements are never given to men mustered out of service) that he may at once receive from the Paymaster the pay, &c. due him, and the captain or other COMMISSIONED officer commanding the company will certify to the act of the delivery of the duplicate certificates; with these certificates the Soldier is "entitled to" his discharge, and should also present his discharge to the Paymaster to have the payment endorsed on it. The discharge is to be given back to the Soldier by the Paymaster; the latter only retaining as his vouchers the duplicate certificates.

NOTE 2.—If the Soldier is entitled to pay for the use of his horse, the Company Commander will certify to that fact on the back of both these final statements, and also to the time he has pay due for having been so mounted on his own horse.

NOTE 3.—When a Soldier is furnished with final statements, his descriptive list, if he has one, should be taken up by the officer who gives the Soldier these statements, and endorsed with a statement to this effect by the officer. The endorsement should exhibit a full statement of the time for which the Soldier was allowed pay on his final statements, the closing account, and all other charges against him or in his favor, so as to comprise a complete exhibit of his account. It will then be transmitted to the Company Commander of the Soldier, who will enter all the data necessary to a full understanding of the Soldier's account on the muster roll upon which the Soldier's discharge is reported. The descriptive list will then be destroyed. The object of this is, that the remaining portion of the Soldier's account may be settled upon the receipt of these muster rolls, and the Soldier receive any pay or allowances that may be due him at the time of his discharge, and which may not appear on his last final statement. The fact that his descriptive list is incomplete. These accounts for pay, &c., are settled by the 2d Auditor of the Treasury Department.

NOTE 4.—Charges for loss or injury to ordnance, horse equipment, and other miscellaneous charges, should appear under the heading of "Other Stoppages."

NOTE 5.—Bounty paid by State authorities, and not by the United States, will not be entered on this statement.

NOTE 6.—Amounts due the Sutler and Laundress must be entered on the muster roll on which the discharge, death, desertion, &c., is reported, as well as on the final statement, otherwise the amount cannot be collected from the United States.

NOTE 7.—This blank will be used for deceased volunteers and drafted men, as well as for others.

NOTE 8.—Where a Soldier dies in Hospital or on detached service, his descriptive list, if he has one, should be sent with his final statements, in duplicate, to the Adjutant General, Washington, D. C.

NOTE 9.—If the soldier is a drafted man or substitute, the space for time, &c., of enlistment, should contain only the word *drafted* or *substitute*, as the case may be. If the Soldier is a "VETERAN," (or RECRUIT,) the words *as a veteran*, (or *recruit*,) as the case may be, should be interlined after the words *mustered into the service of the U. S.* A statement of all the instatments of *Veteran* or *Recruit* Bounty RECEIVED by the Soldier must be made on the back of each final statement.

ADJUTANT GENERAL'S OFFICE.

May 12th 1862

Duplicate with Inventory sent 2d Auditor.

I certify, on honor, that Robert Davis, a Serjt of
Captain J. W. Anderson Company (a) of the 5th Regiment of U.S.Cas
VOLUNTEERS, of the State of _____, born in Taylor Co, State
of Kentucky, aged 22 years; 5 feet 10 inches high; Black complexion,
Blk eyes, Blk hair, and by occupation a Farmer, who joined for service
and was enrolled (see Note 9) on the 5th day of Sept, 1864, at Libanon
by Capt Fiedler, for the period of three years, and mustered into
the service of the United States on the 5th day of Sept, 1864, at
Libanon, by Capt Fiedler; and having served
HONESTLY and FAITHFULLY with his Company to the present date, is now entitled to a
DISCHARGE by reason of Death, being killed by Patrol Guard
at Camp Nelson "Ky" Mar 13. 65.

The said Serjt Robert Davis was last paid by Paymaster
May Kenyon, to include the 31st day of Dec, 1864, and
has pay due him from that time to the present date; he is entitled to pay and subsistence for
TRAVELING to place of enrollment, and whatever other allowances are authorized to volunteer
soldiers, drafted men, or militia, so discharged. He has received from the United States **CLOTHING**
amounting to thirty seven $\frac{70}{100}$ dollars, since the 5th day of Sept,
1864, when his clothing account was last settled. He has received from the United States
_____ $\frac{_____}{100}$ dollars advanced **BOUNTY**.

There is to be stopped from him, on account of the State of _____, or other
authorities, for **CLOTHING**, &c., received on entering service, _____ $\frac{_____}{100}$ dollars; and
for other stoppages, viz: _____

_____ $\frac{_____}{100}$ dollars.
He has been furnished with **TRANSPORTATION** in kind from the place of his discharge to
_____ ; and he has been **SUBSISTED** for **TRAVELING** to his
place of enrollment, up to the _____, 1864.

He is indebted to _____, **SUTLER**, _____ $\frac{_____}{100}$ dollars.

He is indebted to _____, **LAUNDRESS**, _____ $\frac{_____}{100}$ dollars.

Given in Duplicate, at Cynthiana "Ky", this 8th day
of May, 1865.

L. M. Booth 3rd Lt Co "H"
5th U.S.Cas

Extract from Act of Congress.

SEC. 12. And be it further enacted, That the fees of agents and attorneys for making out and causing to be executed the papers necessary to establish a claim for a pension, bounty, and other allowance before the Pension Office, under this act, shall not exceed the following rates: For making out and causing to be duly executed a declaration by the applicant, with the necessary affidavits, and forwarding the same to the Pension Office, with the requisite correspondence, ten dollars; which sum shall be received by such agent or attorney in full for all services in obtaining such pension, and shall not be demanded or received, in whole or in part, until such pension shall be obtained; and the sixth and seventh sections of an act entitled "An act to grant pensions," approved July [fourteenth,] eighteen hundred and sixty-two, are hereby repealed.

SEC. 13. And be it further enacted, That any agent or attorney who shall, directly or indirectly, demand or receive any greater compensation for his services under this act than is prescribed in the preceding section of this act, or who shall contract or agree to prosecute any claim for a pension, bounty, or other allowance under this act, on the condition that he shall receive a per centum upon any portion of the amount of such claim, or who shall wrongfully withhold from a pensioner or other claimant the whole or any part of the pension or claim allowed and due to such pensioner or claimant, shall be deemed guilty of a high misdemeanor, and, upon conviction thereof, shall, for every such offense, be fined not exceeding three hundred dollars, or imprisoned at hard labor not exceeding two years, or both, according to the circumstances and aggravations of the offense.

Approved July 4, 1854.

NOTE 10.—If any soldier is charged a higher fee than that allowed by the above act, he should report the fact and the name of the agent to the Adjutant General, in order that steps may be taken to have the same refunded.

Geo A
FINAL STATEMENT

Sergt Robert Davis
5th Reg't of U S Cavalry

VOLUNTEERS.

NOTE 1.—Two of these certificates (or duplicates) are to be given to each Volunteer Soldier or drafted man who may be discharged without being mustered out (Final Statements are never given to men mustered out of service) that he may at once receive from the Paymaster the pay, &c. due him, and the captain or other COMMISSIONED officer commanding the company will certify to the act of the delivery of the duplicate certificates; with these certificates the Soldier is "entitled to" his discharge, and should also present his discharge to the Paymaster to have the payment endorsed on it. The discharge is to be given back to the Soldier by the Paymaster, the latter only retaining as his vouchers the duplicate certificates.

NOTE 2.—If the Soldier is entitled to pay for the use of his horse, Company Commander will certify to that fact on the back of both final statements, and also to the time he has pay due for having been mounted on his own horse.

NOTE 3.—When a Soldier is furnished with final statements, his descriptive list, if he has one, should be taken up by the officer who gives the Soldier these statements, and endorsed with a statement to this effect, the officer. The endorsement should exhibit a full statement of the for which the Soldier was allowed pay on his final statements, the discharge, and all other charges against him or in his favor, so as to constitute a complete exhibit of his account. It will then be transmitted to the Company Commander of the Soldier, who will enter all the data necessary for a full understanding of the Soldier's account on the muster roll upon which the Soldier's discharge is reported. The descriptive list will then be destroyed. The object of this is, that the remaining portion of the Soldier's account may be settled upon the receipt of these muster rolls, and the Soldier receive any pay or allowances that may be due him at the time of his discharge, and which may not appear on his last final statement. The fact that his descriptive list is incomplete. These accounts for pay, &c., are settled by the 2d Auditor of the Treasury Department.

NOTE 4.—Charges for loss or injury to ordnance, horse equipments, and other miscellaneous charges, should appear under the heading of "Other Stoppages."

NOTE 5.—Bounty paid by State authorities, and not by the United States, will not be entered on this statement.

NOTE 6.—Amounts due the Sutler and Laundress must be entered on the muster roll on which the discharge, death, desertion, &c., is reported, as well as on the final statement, otherwise the amount cannot be collected from the United States.

NOTE 7.—This blank will be used for deceased volunteers and drafted men, as well as for others.

NOTE 8.—Where a Soldier dies in Hospital or on detached service, his descriptive list, if he has one, should be sent with his final statements, in duplicate, to the Adjutant General, Washington, D. C.

NOTE 9.—If the soldier is a drafted man or substitute, the space for time, &c., of enrolment, should contain only the word drafted or substitute, as the case may be. If the Soldier is a "VETERAN," (or RECRUIT,) the words as a veteran, (or recruit,) as the case may be, should be interlined after the words mustered into the service of the U. S. A statement of all the instansments of Veteran or Recruit Bounty RECEIVED by the Soldier must be made on the back of each final statement.

FORMATION in kind from

ADJUTANT GENERAL'S OFFICE
Recd 14 1855
Duplicate with file 121 A. 1855

I certify, on honor, that Sergt Robert Davis, a Sergt of
Captain J. W. Anderson's Company (A) of the Fifth Regiment of U. S. C. lev
VOLUNTEERS, of the State of _____, born in Saylor County, State
of Kentucky, aged 23 years; 5 feet 7 inches high; Black complexion,
Blue eyes, Black hair, and by occupation a Farmer, who joined for service
and was enrolled (see Note 9) on the Fifth day of September, 1864, at Lebanon
by Captain Fiddler, for the period of three years, and mustered into
the service of the United States on the Fifth day of September, 1864, at
Lebanon, by Captain Fiddler; and having served
HONESTLY and FAITHFULLY with his Company to the present date, is now entitled to a
DISCHARGE by reason of being killed by Patroll Guard on the
13th day of March 1865 at Camp Nelson Kentucky

The said Sergt Robert Davis was last paid by Paymaster
Maj Kennon, to include the 31st day of December, 1864, and
has pay due him from that time to the present date; he is entitled to pay and subsistence for
TRAVELING to place of enrollment, and whatever other allowances are authorized to volunteer
soldiers, drafted men, or militia, so discharged. He has received from the United States **CLOTHING**
amounting to Seven ten $\frac{50}{100}$ dollars, since the Fifth day of September,
1864, when his clothing account was last settled. He has received from the United States
_____ $\frac{100}{100}$ dollars advanced **BOUNTY**.

There is to be stopped from him, on account of the State of _____, or other
authorities, for **CLOTHING**, &c., received on entering service, _____ $\frac{100}{100}$ dollars; and
for other stoppages, viz: _____

_____ $\frac{100}{100}$ dollars.
He has been furnished with **TRANSPORTATION** in kind from the place of his discharge to
_____; and he has been **SUBSISTED** for **TRAVELING** to his
place of enrollment, up to the _____, 186_____.

He is indebted to _____ **SUTLER**, _____ $\frac{100}{100}$ dollars.

He is indebted to _____ **LAUNDRESS**, _____ $\frac{100}{100}$ dollars.

Given in Duplicate, at Camp Nelson "Ky", this 30th day
of March, 1865.

L. M. Booth
2nd Lieut

Commanding Company.

INVENTORY OF THE EFFECTS

OF

Serg't Robert Davis

Late of Company A

7th Reg't of W S Cavalry

Volunteers, who died at Camp Union "Eg"

on the 13 day of March 1865



Inventory of the effects of Robert Davis late
 a Sergeant of Captain J. W. Anderson's Company A of
 the Fifth Regiment of U. S. Cavalry Volunteers, who was enrolled as
 a Private at Lebanon in the State of Kentucky on
 the Fifth day of September 1864, and mustered into the service of the United
 States as a Private on the 5th day of September 1864, at Lebanon
 in Company , 5th Regiment of U. S. Cavalry Volunteers, to serve three
 years or during the war; he was born in Saylor County in the State
 of Kentucky; he was 23 years of age, 5 feet 7 inches
 high, Black complexion, Black eyes, Black hair, and by occupation, when enrolled,
 a Farmer; he died in , at
Camp Nelson "Ky" on the 15th day of March 1865, by
 reason of being killed by Patrol Guard

INVENTORY.					
ARTICLES.	No.	ARTICLES.	No.	ARTICLES.	No.
Hats.....		Pairs trousers.....		Knapsacks.....	
Caps.....		Pairs flannel drawers.....		<i>No Effects</i>	
Forage Caps.....		Pairs cotton drawers.....			
Great coats.....		Flannel shirts.....			
Uniform coats.....		Cotton shirts.....			
Uniform jackets.....		Pairs boots.....			
Flannel sack coats.....		Pairs shoes.....			
Blouses.....		Pairs socks.....			
Stable frocks.....		Blankets.....			
Fatigue overalls.....		Haversacks.....			
					MONEY.
				Specie.....	\$
				Notes.....	\$

I CERTIFY, ON HONOR, that the above inventory comprises all the effects of Sergeant
Robert Davis, deceased, and that the effects are in the hands
 of at
 to be disposed of by a Council of Administration.

(DUPLICATES.)

STATION: Camp Nelson "Ky"

DATE: March 30th 1865

L. M. Booth
3rd Lieut
 Commanding the Company.

351
Davis, Robert

Co 6, 5 U. S. Col'd Cav.

Private

Private

CARD NUMBERS.

1	5361666	26
2	5361768	27
3	5354364	28
4	5362636	29
5	9190199	30
6	43146230	31
7	43146476	32
8	43154470	33
9	40729672	34
10		35
11		36
12		37
13		38
14		39
15		40
16		41
17		42
18		43
19		44
20		45
21		46
22		47
23		48
24		49
25		50

Book Mark:

See also

10 | 5 Cav. | U.S.C.T.

Robert Harris

Co. C, 5 Reg't U. S. Col'd Cav.

Appears on

Company Descriptive Book

of the organization named above.

DESCRIPTION.

Age 18 years; height 5 feet 10 inches.

Complexion rdk

Eyes blk; hair blk

Where born Ky

Occupation Farmer

ENLISTMENT.

When Aug. 22, 1864

Where Substitute

By whom; term 5 y'rs.

Remarks: deserted

Harris

(383g)

Copist.

D

U.S.C.T.

Bob Jarvis

Appears with rank of Pr on

Muster and Descriptive Roll

of a Detachment of U.S. Colored
Troops transferred to U.S. Col
Co. at Lexington, Ky

Roll dated

Louisville, Ky., Sept 2, 1864.

Where born Kentucky

Age 18 years; occupation Laborer

When enlisted Substitute, 186 .

Where enlisted

For what period enlisted 3 years.

Eyes Blue; hair Blue

Complexion Blue; height 5 ft. 10 in.

When mustered in Aug. 22, 1864.

Where mustered in Lexington

Bounty paid \$ 100; due \$ 100

Clothing account:

Last settled _____, 186 ; drawn since \$ 17.55
100

Date of first muster Aug. 22, 1864.

Company to which assigned

Remarks: credited to 7 cong. Dist.

Ky.

Book mark:

A. J. Russell

(356m)

Copyist.

D

U.S.C.T.

Bob Davis

Appears with rank of Pvt on

Muster and Descriptive Roll

of a Detachment of U.S. Colored Troops forwarded for U.S. Col'd Cav. at Lexington, Ky.

Roll dated

Louisville, Ky., Sept. 7, 1864.

Where born Shelby, Ky.

Age 18 years; occupation Farmer

When enlisted Substitute, 186

Where enlisted

For what period enlisted 3 years.

Eyes Brown; hair Black

Complexion Black; height 5 ft. 7 in.

When mustered in Aug. 22, 1864.

Where mustered in Lebanon

Bounty paid \$ 100; due \$ 100

Clothing account:

Last settled _____, 186 ; drawn since \$ 17 ⁵⁰/₁₀₀

Date of first muster Aug. 22, 1864.

Company to which assigned

Remarks: 4 Dist. Ky.

Book mark: _____

B. J. O'Driscoll

(356m)

Copyist.

D

5 Cav. U.S.C.T.

Robert Davis

Paris, Co. *C*, 5 Reg't U. S. Col'd Cavalry.

Appears on

Company Muster-in and Descriptive Roll
of the organization named above. Roll dated

Camp Nelson, *Ky*, *N.Y.*, *Oct. 24*, 1864.

Where born *Kentucky*

Age *18* y'rs; occupation *Laborer*

When enlisted _____, 186 .

Where enlisted _____

For what period enlisted _____ *3* years.

Eyes *Blk.*; hair *Blk.*

Complexion *Blk.*; height *5* ft. *10* in.

When mustered in *Aug. 20*, 186 .

Where mustered in *Lexington*

Bounty paid \$ *100*; due \$ *100*

Where credited *7th Dist. Ky.*

Company to which assigned *C.*

Remarks : _____

Book mark : _____

Shull

(356d)

Copyist.

Q

5 Cav.

U.S.C.T.

Robert Davis

Prio, Co. C, 5 Reg't U. S. Col'd Cavalry.

Appears on

Company Muster Roll

for to Oct 31, 1864.

Present or absent Absent

Stoppage, \$ 100 for

Due Gov't, \$ 100 for

Valuation of horse, \$ 100

Valuation of horse equipments, \$ 100

Remarks: Deserted

Book mark:

Hull

D | 5 Cav | U.S.C.T.

Robert Davis
Priv., Co. C, 5 Reg't U. S. Col'd Cav

Appears on

Descriptive List of Deserters

dated Oct 31, 1864.

Deserted:

When Sep 17, 1864.

Where Lexington

Arrested:

When _____, 186 .

Where _____

Remarks:

Book mark:

Rose

(351)

Copyist.

2

U.S.C.S.

Bob Davis (Cald)

Appears with rank of Priv on

Muster and Descriptive Roll

of a Detachment of U.S. Substitutes
Enlisted & Mustered forwarded

Roll dated Lexington, Ky Oct 30, 1865.

Where born Kentucky

Age 18 years; occupation Laborer

When enlisted Aug 22, 1864.

Where enlisted Lexington, Ky

For what period enlisted 3 years.

Eyes Blk; hair Blk

Complexion Blk; height 5 ft. 10 in.

When mustered in Aug 22, 1864.

Where mustered in Lexington, Ky

Bounty paid \$ 100; due \$ 100

Clothing account:

Last settled _____, 186 ____; drawn since \$ 100

Date of first muster Aug 22, 1864.

Company to which assigned _____

Remarks For whom substituted
W. A. Ferguson, Enroller man
Credited to Fayette Co. 7th Div

Book mark: _____

J. H. Harris

(356m)

Copyist.

D. | 5 Cav. | U.S.C.T.

Robert Davis.

Prob. Co. C, 5 Reg't U. S. Colored Cav.

Appears on Returns as follows:

From organization to Oct. 31/64. Loss.
Deserted at Lexington, Ky.

Nov. 1864. Loss. Deserted. Arrested.
Said to be in jail at Lexington.
ton.

Book mark : _____

(546)

A. Baker
Copyist.

D

5 Cav. U.S.C.T.

Robert Davis

Pat, Co. C, 5 Reg't U. S. Col'd Cavalry.

Appears on Co. Muster-out Roll, dated

Helena Ark. March 16, 1866.

Muster-out to date _____, 186 .

Last paid to _____, 186 .

Pay due from enlistment.

Clothing account:

Last settled _____, 186 ; drawn since \$ _____ 100

Due soldier \$ _____ 100; due U. S. \$ _____ 100

Am't for cloth'g in kind or money adv'd \$ _____ 100

Due U. S. for arms, equipments, &c., \$ _____ 100

Bounty paid \$ _____ 100; due \$ _____ 100

Remarks: Deserted Sep 1864 Lexington Ky.

Book mark: _____

Rose

(361)

Copyist.

Bob Davis

, Co. , 5 Reg't 48th Cav

3 Inclosures.

Bed Cards	Final Statements
Burial Records	Furloughs or L. of A.
Certs. of Dis. for Discharge	Med. Certificates
C. M. Charges	Med. Des. Lists
Descriptive Lists	Orders
Discharge Certificates	Pris. of War Record
Enlistment Papers 3	Resignations

Other papers relating to—

Admission to Hosp'l	Furlough or L. of A.
Casualty Sheet	Med. Examination
Confinement	Misc. Information
Contracts	Pay or Clothing
Death or Effects	Personal Reports
Desertion	Rank
Discharge from Hosp'l	Transfer to Hosp'l
Discharge from Service	Transfer to V. R. C.
Duty	Transportation

MICROFILM PUBLICATION M 1821

COMPILED MILITARY SERVICE RECORDS
OF VOLUNTEER UNION SOLDIERS WHO
SERVED WITH THE USCT (US COLORED TROOPS)
5TH REGIMENT OF CAVALRY

PERSONAL PAPERS' TARGET SHEET

PLEASE NOTE THE CHECKED INFORMATION ABOUT THE PERSONAL PAPERS IN
THIS FILE:



NO PERSONAL PAPERS WERE FOUND IN THIS FILE WHEN THE
RECORDS WERE ARRANGED FOR MICROFILMING.



4 PERSONAL PAPER(S) FOUND IN THIS FILE WHEN THE RECORDS
WERE ARRANGED FOR MICROFILMING.

51.

Dan 85

No. Ten

Bob Davis

Enlisted at Lebanon Ky

As Substitute for

Alexander Veuch

On the 22 day of August, 1864.

By

Capt. M. Fidler

J. B. Merimee

John O. Maxwell

Board of Enrollment,

4 Dist. of Ky

Brigs.

SUBSTITUTE
VOLUNTEER ENLISTMENT.

STATE OF

TOWN OF

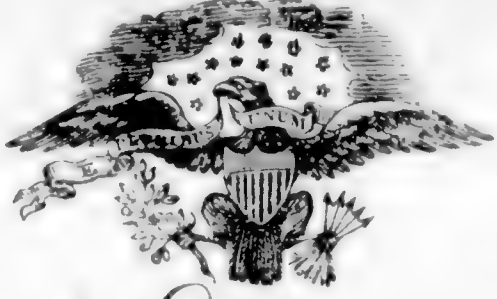

Kentucky *Shelby County*
I, *Bob Davis* born in the State
of *Ky*, aged *18* years, and by
occupation a *Farmer* Do HEREBY ACKNOWLEDGE to have agreed with
Alexander Veach, Esq., of *Shelby County*

to become his **SUBSTITUTE** in the Military Service, for a sufficient consideration paid and delivered to me, on the *22nd* day of *August*, 1864; and having thus agreed with said *Alexander Veach*, I DO HEREBY ACKNOWLEDGE to have enlisted this *22nd* day of *August* 1864, to serve as a **Soldier** in the **Army of the United States of America**, for the period of **THREE YEARS**, unless sooner discharged by proper authority: I do also agree to accept such bounty, pay, rations, and clothing, as are, or may be, established by law for soldiers. And I do solemnly swear that I will bear true and faithful allegiance to the **United States of America**; that I will serve them honestly and faithfully against all their enemies or opposers whomsoever; and that I will observe and obey the orders of the President of the United States, and the orders of the Officers appointed over me, according to the Rules and Articles of War.

SWORN and subscribed to *Sebastian Ky*
this *22nd* day of *August* 1864
BEFORE *John M. Yule* *Bob Davis*
Capt and Provost Marshal

We certify, on honor, That we have carefully examined the above-named Volunteer Substitute agreeably to the Regulations, and that, in our opinion, he is free from all bodily defects and mental infirmity which would in any way disqualify him from performing the duties of a soldier; that he was entirely sober when enlisted; that he is of lawful age, (not under 18 years;) and that, in accepting him as duly qualified to perform the duties of an able-bodied soldier, and as a Substitute in lieu of *Alexander Veach* *Enrolled* drafted in *1st Sub Dist 4th Dist Ky* *and not drafted* 1864, we have strictly observed the Regulations which govern in such cases. This soldier has *Bro* eyes, *Blk* hair, *Blk* complexion; is *5* feet *7* inches high.

John M. Yule Provost Marshal.
F. B. Merwin Commissioner of Board.
John C. Maxwell Surgeon of Board.

Board of Enrollment of *4* Dist. of *Ky*

DECLARATION OF SUBSTITUTE.

I, Bob Davis desiring to ENLIST
in the Army of the United States, for THREE YEARS, **Do declare**, That I am
18 years and _____ months of age; that I have
never been discharged from the United States service on account of disability or by sentence of
a court martial; and I know of no impediment to my serving honestly and faithfully as a soldier
for three years.

GIVEN at Lebanon Ky
the 22 day of August 1864

WITNESS:

L. J. Hooge

Bob^{th's} Davis
mark

Da 85

No. Len

Bob Davis

Enlisted at Lebanon Ky

As Substitute for

Alexander Veach

On the 22 day of August, 186 4.

By

Capt J M Fidler

J B Merimee

John C Maxwell

Board of Enrollment,

4 Dist. of Ky

[Faint signature]

SUBSTITUTE
VOLUNTEER ENLISTMENT.

STATE OF

TOWN OF

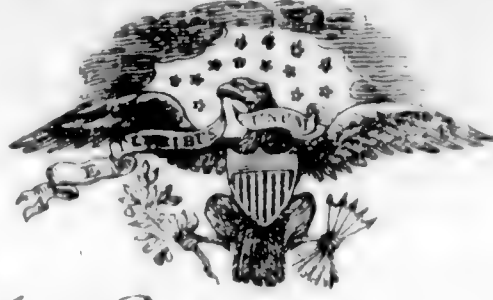

Kentucky *Shelby County*
I, *Bob Davis* born in the State
of *Ky*, aged *18* years, and by
occupation a *Farmer* Do HEREBY ACKNOWLEDGE to have agreed with
Alexander Veach Esq., of *Shelby County Ky*

to become his **SUBSTITUTE** in the Military Service, for a sufficient consideration paid and
delivered to me, on the *22* day of *August*, 1864;
and having thus agreed with said *Alexander Veach*, I DO HEREBY
ACKNOWLEDGE to have enlisted this *22* day of *August*
1864, to serve as a **Soldier** in the **Army of the United States of America**, for the period
of **THREE YEARS**, unless sooner discharged by proper authority: I do also agree to accept such
bounty, pay, rations, and clothing, as are, or may be, established by law for soldiers. And I do
solemnly swear that I will bear true and faithful allegiance to the **United States of America**;
that I will serve them honestly and faithfully against all their enemies or opposers whomsoever;
and that I will observe and obey the orders of the President of the United States, and the orders
of the Officers appointed over me, according to the Rules and Articles of War.

SWORN and subscribed to, at *Seaburn Ky*
this *22* day of *August* 1864.
BEFORE *Wm M Fuller*
Capt and Pro-Mar 4th Dist

Bob Davis
mark

We certify, on honor, That we have carefully examined the above-named Volunteer Substitute
agreeably to the Regulations, and that, in our opinion, he is free from all bodily defects and mental infirmity
which would in any way disqualify him from performing the duties of a soldier; that he was entirely sober
when enlisted; that he is of lawful age, (not under 18 years;) and that, in accepting him as duly qualified to
perform the duties of an able-bodied soldier, and as a Substitute in lieu of *Alexander Veach*
Enrolled drafted in *1st Sub Dist 4th Dist Ky*
and not drafted, 186, we have strictly observed the Regulations which govern
in such cases. This soldier has *Bro* eyes, *Blk* hair, *Blk* complexion; is *5* feet *7*
inches high.

Wm M Fuller Capt
Provost Marshal.

A B Merriam
Commissioner of Board.

John C. Maxwell
Surgeon of Board.

Board of Enrollment of *4* Dist. of *Ky*

DECLARATION OF SUBSTITUTE.

I, Bob Davis desiring to ENLIST
in the Army of the United States, for THREE YEARS, **Do declare**, That I am
18 years and _____ months of age; that I have
never been discharged from the United States service on account of disability or by sentence of
a court martial; and I know of no impediment to my serving honestly and faithfully as a soldier
for three years.

GIVEN at Sebanon Ky
the 22nd day of August 1864

WITNESS:

L. J. Hooge

Bob ^{his} Davis
mark

D
64

Dr 83

No. 12.

1 Bob Davis (Col.)

Enlisted at Lexington Ky

As Substitute for

Noah S. Ferguson

On the 22 day of Aug. 1864.

By

Geo. H. Munn

Calender Brown

S. J. Lane

Board of Enrollment,

7 Dist. of Kentucky

SUBSTITUTE
VOLUNTEER ENLISTMENT.

STATE OF *Kentucky* TOWN OF *Burlington*

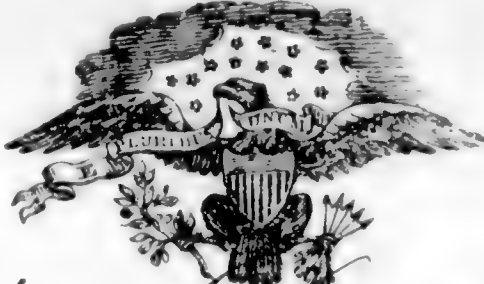

I, *Bob Hair's (colored)* born in the State of *Kentucky*, aged *Eighteen* years, and by occupation a *Gabner* Do HEREBY ACKNOWLEDGE to have agreed with *Noah S. Ferguson, Esq., of Fayette County of the Congressional District of Kentucky* to become his **SUBSTITUTE** in the Military Service, for a sufficient consideration paid and delivered to me, on the *Twenty Second* day of *August*, 1864; and having thus agreed with said *Noah S. Ferguson* I DO HEREBY ACKNOWLEDGE to have enlisted this *Twenty Second* day of *August*, 1864, to serve as a **Soldier** in the **Army of the United States of America**, for the period of **THREE YEARS**, unless sooner discharged by proper authority: I do also agree to accept such bounty, pay, rations, and clothing, as are, or may be, established by law for soldiers. And I do solemnly swear that I will bear true and faithful allegiance to the **United States of America**; that I will serve them honestly and faithfully against all their enemies or opposers whomsoever; and that I will observe and obey the orders of the President of the United States, and the orders of the Officers appointed over me, according to the Rules and Articles of War.

SWORN and subscribed to, at *Burlington Ky.* this *22* day of *August* 1864
BEFORE *Geo H Moore* *Bob Hair's*
Capt. & Prov. Mar. *mark*
of Dist. Ky.

We certify, on honor, That we have carefully examined the above-named Volunteer Substitute agreeably to the Regulations, and that, in our opinion, he is free from all bodily defects and mental infirmity which would in any way disqualify him from performing the duties of a soldier; that he was entirely sober when enlisted; that he is of lawful age, (not under 18 years;) and that, in accepting him as duly qualified to perform the duties of an able-bodied soldier, and as a Substitute in lieu of *Noah S. Ferguson*, drafted in _____, 1864, we have strictly observed the Regulations which govern in such cases. This soldier has *Blue* eyes, *Blue* hair, *Blue* complexion; is *5* feet *10* inches high.

Geo H Moore
Capt *Provost Marshal.*
Alman Brown
Commissioner of Board.
J. J. Lane
Surgeon of Board.
Board of Enrollment of *7* Dist. of *Kentucky*.

DECLARATION OF SUBSTITUTE.

I, Bob Davis (Colored) desiring to ENLIST
in the Army of the United States, for THREE YEARS, **Do declare,** That I am
Eighteen years and months of age; that I have
never been discharged from the United States service on account of disability or by sentence of
a court martial; and I know of no impediment to my serving honestly and faithfully as a soldier
for three years.

GIVEN at Lexington Kentucky
the 22 day of August 1864

WITNESS:

J. P. Brown.

Bob ^{his} Davis
mark

A. A. 853

No. 12.

Bob Davis (Col.)

Enlisted at Lexington Ky.

As Substitute for

Noah S. Ferguson.

On the 22 day of Aug., 1864

By

Thos W. Moore

Oliver Brown.

J. J. Lane

Board of Enrollment,

Dist. of

Kentucky

Moore

SUBSTITUTE VOLUNTEER ENLISTMENT.

STATE OF

TOWN OF

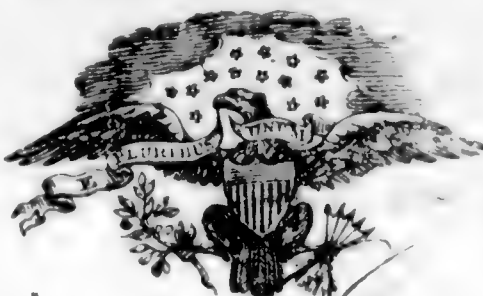
Kentucky  *Lexington*

I, *Bob Davis (Colored)* born in the State of *Kentucky*, aged *Eighteen* years, and by occupation a *Farmer*

Do HEREBY ACKNOWLEDGE to have agreed with *Asa W. Ferguson*, Esq., of *Fayette County* of the *Congressional District of Kentucky*

to become his **SUBSTITUTE** in the Military Service, for a sufficient consideration paid and delivered to me, on the *Twenty Second* day of *August*, 186*4*

and having thus agreed with said *Asa W. Ferguson* I DO HEREBY ACKNOWLEDGE to have enlisted this *Twenty Second* day of *August*, 186*4*

to serve as a **Soldier** in the **Army of the United States of America**, for the period of **THREE YEARS**, unless sooner discharged by proper authority: I do also agree to accept such bounty, pay, rations, and clothing, as are, or may be, established by law for soldiers. And I do solemnly swear that I will bear true and faithful allegiance to the **United States of America**; that I will serve them honestly and faithfully against all their enemies or opposers whomsoever; and that I will observe and obey the orders of the President of the United States, and the orders of the Officers appointed over me, according to the Rules and Articles of War.

SWORN and subscribed to, at *Lexington Ky*
this *22* day of *August* 186*4* *Bob Davis*
BEFORE *Thos W Moore* *mark*
Capt. & Prov. Mar.
7 Dist. Ky.

We certify, on honor, That we have carefully examined the above-named Volunteer Substitute agreeably to the Regulations, and that, in our opinion, he is free from all bodily defects and mental infirmity which would in any way disqualify him from performing the duties of a soldier; that he was entirely sober when enlisted; that he is of lawful age, (not under 18 years;) and that, in accepting him as duly qualified to perform the duties of an able-bodied soldier, and as a Substitute in lieu of *Asa W. Ferguson*, drafted in

....., 186*4*, we have strictly observed the Regulations which govern in such cases. This soldier has *Blk* eyes, *Blk* hair, *Blk* complexion; is *5* feet *10* inches high.

Thos W Moore
Capt & Provost Marshal.
Alonso Brown
Commissioner of Board.
J. F. Gano
Surgeon of Board.

Board of Enrollment of *7* Dist. of *Kentucky*

DECLARATION OF SUBSTITUTE.

I, Bob Harris (Colored) desiring to ENLIST
in the Army of the United States, for THREE YEARS, **Do declare,** That I am
Eighteen years and months of age; that I have
never been discharged from the United States service on account of disability or by sentence of
a court martial; and I know of no impediment to my serving honestly and faithfully as a soldier
for three years.

GIVEN at Beyington Kentucky
the 22 day of August 1864

WITNESS:

J. P. Brown.

Bob Harris
mark

30.0
Davis, Robert

Co D, 5 U. S. Col'd Cav.

Private | Private

CARD NUMBERS.

1	5352667	26
2	5362769	27
3	5302870	28
4	5302960	29
5	5363056	30
6	5363144	31
7	5363232	32
8	5363377	33
9	5363636	34
10	9090296	35
11	43154238	36
12	40729671	37
13		38
14		39
15		40
16		41
17		42
18		43
19		44
20		45
21		46
22		47
23		48
24		49
25		50

Book Mark:

See also

M | **5 Cav. | U.S.C.T.**

Robert Davis

, Co. *M*, 5 Reg't U. S. Col'd Cav.

Appears on

Company Descriptive Book
of the organization named above.

DESCRIPTION.

Age *18* years; height *5* feet *7* inches.

Complexion *Black*

Eyes *Black*; hair *Black*

Where born *Shelby Ky.*

Occupation *Farmer*

ENLISTMENT.

When *Substitute*, 186 .

Where *4th Dist, Ky.*

By whom; term *3* y'rs.

Remarks: *Died of disability*
in W. S. Genl. Hosp.
pital, Camp Nelson
Ky. Sep 13th 1865
final statements
and inventory for
warded Sep. 16th
1865

A. E. Purke

520
D | 5 car U.S.C.T.
Bob Davis

Appears with rank of _____ on _____

Muster and Descriptive Roll

of a Detachment of U.S. Representative
Substitutes.

Roll dated
Lebanon, Ky., Aug. 31, 1864.

Where born Shelby Kentucky

Age 18 years; occupation farmer

When enlisted Aug. 22, 1864.

Where enlisted Lebanon, Ky.

For what period enlisted 3 years.

Eyes brn; hair blk

Complexion blk; height 5 ft. 7 in.

When mustered in Aug. 22, 1864.

Where mustered in Lebanon

Bounty paid \$ 100; due \$ 100

Clothing account:

Last settled _____, 1864; drawn since \$ 17⁵⁰/₁₀₀

Date of first muster Aug. 22, 1864.

Company to which assigned _____

Remarks: 4th Cong. Dist., Ky.

Name & Residence of Enrolled man:
Alexander Veach, Shelby County, Ky.

Book mark: _____

(356m) J. Austin Copyist.

10

5 Cav.

U.S.C.T.

Bob Davis

Pvt, Co 10, 5 Reg't U. S. Col'd Cavalry.

Appears on

Company Muster-in and Descriptive Roll

of the organization named above. Roll dated

Camp Nelson, Ky, N. Y., Oct. 24, 1864.

Where born Shelby, Ky

Age y'rs; occupation

When enlisted, 186 .

Where enlisted

For what period enlisted 3 years.

Eyes Brown; hair Br

Complexion Br; height 5 ft. 7 in.

When mustered in Aug. 22, 1864.

Where mustered in Lebanon

Bounty paid \$ 100; due \$ 100

Where credited 4 Dist Ky.

Company to which assigned

Remarks:

Book mark:

Wm H. Scott

(356d)

Copyist.

10 | 5 Cav. | U.S.C.T.

Bob Davis

Plt., Co. D, 5 Reg't U. S. Col'd Cavalry.

Appears on

Company Muster Roll

for Dated Oct 31, 1864.

Present or absent Present

Stoppage, \$ 100 for

Due Gov't, \$ 100 for

Valuation of horse, \$ 100

Valuation of horse equipments, \$ 100

Remarks:

Book mark : -----

Wm. H. Scott

Bob Davis

Plt, Co. D, 5 Reg't U. S. Col'd Cavalry.

Appears on

Company Muster Roll

for Nov & Dec, 1864.

Present or absent Absent

Stoppage, \$ 100 for

Due Gov't, \$ 100 for

Valuation of horse, \$ 100

Valuation of horse equipments, \$ 100

Remarks: Sick in Hospital, Cumberland Gap, Tenn.

Book mark:

Wm. H. Scott

H

5 Cav. U.S.C.T.

Bob Davis

Bob, Co. D, 5 Reg't U. S. Col'd Cavalry.

Appears on

Company Muster Roll

for *Jan. & Feb*, 1865.

Present or absent *Present*

Stoppage, \$ *100* for

Due Gov't, \$ *100* for

Valuation of horse, \$ *100*

Valuation of horse equipments, \$ *100*

Remarks: *1st installment of
Bounty due \$100*

Book mark :

Wm. Scott

10

5 Cav. U.S.C.T.

Bob Davis

Pvt., Co. D, 5 Reg't U. S. Col'd Cavalry.

Appears on

Company Muster Roll

for March & April, 1865.

Present or absent Present.

Stoppage, \$ 100 for

Due Gov't, \$ 100 for

Valuation of horse, \$ 100

Valuation of horse equipments, \$ 100

Remarks:

Book mark:

Wm H. Scott

L

5 Cav. | U.S.C.T.

Bob David

Priv., Co. D, 5 Reg't U. S. Col'd Cavalry.

Appears on

Company Muster Roll

for *May + June*, 1865.

Present or absent *present*

Stoppage, \$ *100* for

Due Gov't, \$ *100* for

Valuation of horse, \$ *100*

Valuation of horse equipments, \$ *100*

Remarks: *1st Instalment Bounties
due \$100.00*

Book mark:

Milliken

(358)

Copyist.

2

5 Cav. U.S.C.T.

Job Davis

Priv., Co. D, 5 Reg't U. S. Col'd Cavalry.

Appears on

Company Muster Roll

for July & Aug., 1865.

Present or absent present

Stoppage, \$ 100 for

Due Gov't, \$ 100 for

Valuation of horse, \$ 100

Valuation of horse equipments, \$ 100

Remarks:

Book mark:

Milliken

(358)

Copyist.

D

5 Cav. U.S.C.T.

Robert Davis

Priv., Co. D, 5 Reg't U. S. Col'd Cavalry.

Appears on

Company Muster Roll

for *Sept & Oct*, 1865.

Present or absent

Stoppage, \$ 100 for

Due Gov't, \$ 100 for

Valuation of horse, \$ 100

Valuation of horse equipments, \$ 100

Remarks: *Died of Debility
Post Hosp'l Camp Nelson
Ky Sept 1st 1865.*

Book mark:

Milliken

(358)

Copyist.

D. | 5 Cav. | U.S.C.T.

Robert Davis.

Priv., Co. D., 5 Reg't U. S. Colored Cav.

Appears on Returns as follows:

Nov. & Dec. 1864. Absent sick in
Hosp., Cumberland Gap, Tenn.

Mar. 1865. Absent, detached at Post
Orders, guard duty.

Sept. 1865. Died of debility Sept.
13/65, Post Hosp., Camp Nelson.

Book mark :

(546)

J. Baker
Copyist.

D.

5 Cav.

U.S.C.T.

Robert Davis,

Priv., Co. *D.*, 5 Reg't U. S. Col'd Cavalry.

Appears on **Co. Muster-out Roll**, dated

Helena, Ark., March 16, 186*6.*

Muster-out to date _____, 186 .

Last paid to *June 30,* 186 *5.*

Clothing account:

Last settled _____, 186 ; drawn since \$ _____ *100*

Due soldier \$ _____ *100*; due U. S. \$ _____ *100*

Am't for cloth'g in kind or money adv'd \$ _____ *100*

Due U. S. for arms, equipments, &c., \$ _____ *100*

Bounty paid \$ _____ *100*; due \$ _____ *100*

Remarks: *Died at Camp Nelson,*

Ky., Sept. 13/65 of Debility.

Final statements forwarded

Sept. 16, 1865.

Book mark: _____

A. D. Brewer

(361)

Copyright.

Davis, Robert
P, Co. D, 5 U.S.C. Cav.
Reg't

2 Enclosures.

Bed Cards	Descriptive Lists
Burial Records	Final Statements /
Certs. of Dis. for Discharge	Furloughs
C. M. Charges	Med. Des. Lists
Med. Certificates	Orders

Other papers relating to—

Admission to Hosp'l	Furlough
Casualty Sheet (Officer's)	Med. Examination
Confinement	Misc. Information
Contracts	Pay or Clothing
Death or Effects /	Personal Reports
Desertions	Rank
Discharge from Hosp'l	Transfer to Hosp'l
Discharge from Service	Transfer to V. R. C.
Duty	Transportation

Extract from Act of Congress.

SEC. 12. And be it further enacted, That the fees of agents and attorneys for making out and causing to be executed the papers necessary to establish a claim for a pension, bounty, and other allowance before the Pension Office, under this act, shall not exceed the following rates: For making out and causing to be duly executed a declaration by the applicant, with the necessary affidavits, and forwarding the same to the Pension Office, with the requisite correspondence, ten dollars; which sum shall be received by such agent or attorney in full for all services in obtaining such pension, and shall not be demanded or received, in whole or in part, until such pension shall be obtained; and the sixth and seventh sections of an act entitled "An act to grant pensions," approved July [fourteenth,] eighteen hundred and sixty-two, are hereby repealed.

SEC. 13. And be it further enacted, That any agent or attorney who shall, directly or indirectly, demand or receive any greater compensation for his services under this act than is prescribed in the preceding section of this act, or who shall contract or agree to prosecute any claim for a pension, bounty, or other allowance under this act, on the condition that he shall receive a per centum upon any portion of the amount of such claim, or who shall wrongfully withhold from a pensioner or other claimant the whole or any part of the pension or claim allowed and due to such pensioner or claimant, shall be deemed guilty of a high misdemeanor, and, upon conviction thereof, shall, for every such offense, be fined not exceeding three hundred dollars, or imprisoned at hard labor not exceeding two years, or both, according to the circumstances and aggravations of the offense.

Approved July 4, 1864.

NOTE 10.—If any soldier is charged a higher fee than that allowed by the above act, he should report the fact and the name of the agent to the Adjutant General, in order that steps may be taken to have the same refunded.

FINAL STATEMENT

Co "G"
OF
Robert Davis
5th Regt of W C Cav
VOLUNTEERS.
April 13, 1865

NOTE 1.—Two of these certificates (or duplicates) are to be given to each Volunteer Soldier or drafted man who may be discharged without being mustered out (Final Statements are never given to men mustered out of service) that he may at once receive from the Paymaster the pay, &c. due to him, and the captain or other COMMISSIONED officer commanding the company will certify to the act of the delivery of the duplicate certificates; with these certificates the Soldier is "entitled to" his discharge, and should also present his discharge to the Paymaster to have the payment endorsed on it. The discharge is to be given back to the Soldier by the Paymaster; the latter only retaining as his vouchers the duplicate certificates.

NOTE 2.—If the Soldier is entitled to pay for the use of his horse, the Company Commander will certify to that fact on the back of both these final statements, and also to the time he has pay due for having been so mounted on his own horse.

NOTE 3.—When a Soldier is furnished with final statements, his descriptive list, if he has one, should be taken up by the officer who gives the Soldier these statements, and endorsed with a statement to this effect by the officer. The endorsement should exhibit a full statement of the time for which the Soldier was allowed pay on his final statements, the clothing account, and all other charges against him or in his favor, so as to comprise a complete exhibit of his account. It will then be transmitted to the Company Commander of the Soldier, who will enter all the data necessary to a full understanding of the Soldier's account on the muster roll upon which the Soldier's discharge is reported. The descriptive list will then be destroyed. The object of this is, that the remaining portion of the Soldier's account may be settled upon the receipt of these muster rolls, and the Soldier receive any pay or allowances that may be due him at the time of his discharge, and which may not appear on his last final statements from the fact that his descriptive list is incomplete. These accounts for back pay, &c., are settled by the 2d Auditor of the Treasury Department.

NOTE 4.—Charges for loss or injury to ordnance, horse equipments, and other miscellaneous charges, should appear under the heading of "Other Stoppages."

NOTE 5.—Bounty paid by State authorities, and not by the United States, will not be entered on this statement.

NOTE 6.—Amounts due the Sutler and Laundress must be entered on the muster roll on which the discharge, death, desertion, &c., is reported, as well as on the final statement, otherwise the amount cannot be collected from the United States.

NOTE 7.—This blank will be used for deceased volunteers and drafted men, as well as for others.

NOTE 8.—Where a Soldier dies in Hospital or on detached service, his descriptive list, if he has one, should be sent with his final statements, in duplicate, to the Adjutant General, Washington, D. C.

NOTE 9.—If the soldier is a drafted man or substitute, the space for time, &c., of enrolled, should contain only the word *drafted* or *substitute*, as the case may be. If the Soldier is a "VETERAN," (or RECRUIT,) the words *as a veteran*, (or *recruit*), as the case may be, should be interlined after the words *mustered into the service of the U. S.* A statement of all the installments of *Veteran or Recruit Bounty RECEIVED* by the Soldier must be made on the back of each final statement.

ADJUTANT GENERAL'S OFFICE
April 11, 1865
Duplicate with inventory...

I certify, on honor, that Robert Davis, a private of
Captain H. P. Wade's Company (D) of the Fifth Regiment of U. S. Col. Cav
Volunteers, of the State of _____, born in Shelby State
of Kentucky, aged 18 years; 5 feet 7 inches high; Black complexion,
Black eyes, Black hair, and by occupation a Farmer, who joined for service
and was enrolled (see Note 9) on the Substitute day of _____, 1865, at _____
by _____, for the period of Three years, and mustered into
the service of the United States on the 22nd day of August, 1865, at
Lebanon, by Capt. Fidler; and having served

HONESTLY and **FAITHFULLY** with his Company to the present date, is now entitled to a
DISCHARGE by reason of Death.

Died of Disability. Camp Nelson Ky. Sept. 13th 1865
The said Private Robert Davis was last paid by Paymaster
May Holloway, to include the 30th day of June, 1865, and
has pay due him from that time to the present date; he is entitled to pay and subsistence for
TRAVELING to place of enrollment, and whatever other allowances are authorized to volunteer
soldiers, drafted men, or militia, so discharged. He has received from the United States **CLOTHING**
amounting to Fourteen ⁰⁴/₁₀₀ dollars, since the 31st day of March,
1865, when his clothing account was last settled. He has received from the United States
_____ ⁰⁰/₁₀₀ dollars advanced **BOUNTY**.

There is to be stopped from him, on account of the State of _____, or other
authorities, for **CLOTHING**, &c., received on entering service, _____ ⁰⁰/₁₀₀ dollars; and
for other stoppages, viz: _____

_____ ⁰⁰/₁₀₀ dollars.
He has been furnished with **TRANSPORTATION** in kind from the place of his discharge to
_____ ; and he has been **Subsisted** for **Traveling** to his
place of enrollment, up to the _____, 1865.

He is indebted to _____, **Sutler**, _____ ⁰⁰/₁₀₀ dollars.

He is indebted to _____, **Laundress**, _____ ⁰⁰/₁₀₀ dollars.

Given in Duplicate, at Camp Nelson Ky, this 14th day
of September 1865.

David S. Gordon
Lieut 3rd U. S. Col. Cav
Commanding Company.

INVENTORY OF THE EFFECTS

OF

Priv Robert Davis

Late of Company *D*

5th Reg't of *2^d U. S. Cav*

Volunteers, who died at *Camp Nelson*

on the *3rd* day of *Sept* 186*2*



Inventory of the effects of Robert Davis late
a private of Captain N. P. Wades Company D of
the Fifth Regiment of U. S. C. Cav Volunteers, who was enrolled as
a _____ at Substitute in the State of _____ on
the _____ day of _____ 1865, and mustered into the service of the United
States as a private on the 22 day of August 1865, at Sebanon
in Company D, 5th Regiment of U. S. C. Cav Volunteers, to serve 3
years or during the war; he was born in Shelby in the State
of Kentucky; he was 18 years of age, 5 feet 7 inches
high, Blk complexion, Blk eyes, Blk hair, and by occupation, when enrolled,
a Farmer; he died in Int Hospital, at
Camp Nelson Ky on the 13 day of Sept. 1865, by
reason of Disability

INVENTORY.					
ARTICLES.	No.	ARTICLES.	No.	ARTICLES.	No.
Hats.....		Pairs trousers.....	1	Knapsacks.....	
Caps.....	1	Pairs flannel drawers.....			
Forage caps.....		Pairs cotton drawers.....	1		
Great coats.....		Flannel shirts.....	1		
Uniform coats.....		Cotton shirts.....			
Uniform jackets.....		Pairs boots.....			
Flannel sack coats.....		Pairs shoes.....			
Blouses.....		Pairs socks.....			
Stable frocks.....		Blankets.....	2	MONEY.	
Fatigue overalls.....		Haversacks.....		Specie.....	\$
				Notes.....	\$

I CERTIFY, ON HONOR, that the above inventory comprises all the effects of Private
Robert Davis, deceased, and that the effects are in the hands
of A. C. Rautin A. A. Surber at Int Hospital
Camp Nelson Ky to be disposed of by a Council of Administration.

(DUPLICATES.)

STATION: Camp Nelson Ky

DATE: Sept 14th 1865

David G Gordon
1st Lt. 5th U. S. C. Cav
Commanding the Company.

Lawsley, George

Co A, 5 U. S. Col'd Cav.

Private

Private

CARD NUMBERS.

1	5359621	26
2	5359723	27
3	5350884	28
4	5308007	29
5	9090061	30
6	43146622	31
7	40729674	32
8		33
9		34
10		35
11		36
12		37
13		38
14		39
15		40
16		41
17		42
18		43
19		44
20		45
21		46
22		47
23		48
24		49
25		50

Book Mark:

See also

20 | **5 Cav. | U.S.C.T.**

George Lawrence

, Co. *A*, 5 Reg't U. S. Col'd Cav.

Appears on

Company Descriptive Book

of the organization named above.

DESCRIPTION.

Age *23* years; height *5* feet *9* inches.

Complexion *Yellow*

Eyes *Blk*; hair *Blk*

Where born *Shelby Co Ky*

Occupation *Laborer*

ENLISTMENT.

When *Sept. 8th*, 186 .

Where *Louisville*

By whom *Capt. Adams*; term *3* y'rs.

Remarks: *Killed in action at
Marion Va, Dec, 1864*

Lawrence

D

5 bar

U.S.C.T.

George Sawzey

Appears with rank of Pvt on

Muster and Descriptive Roll

of a Detachment of U. S. Colored
Recruits, Mustered for U. S. Colored

at Taylor Mt. Louisville, Ky. Roll dated
Louisville, Ky, Sept 9, 1864.

Where born Shelby, Ky

Age 27 years; occupation Laborer

When enlisted Sept 8, 1864.

Where enlisted Louisville, Ky

For what period enlisted 3 years.

Eyes Blue; hair Brn

Complexion Yellow; height 5 ft. 9 in.

When mustered in Sept 9, 1864.

Where mustered in Louisville, Ky

Bounty paid \$ 100; due \$ 100

Clothing account:

Last settled _____, 186 ; drawn since \$ 100

Date of first muster _____, 186 .

Company to which assigned _____

Remarks: by Shelby Co. 4 Dist

Book mark : _____

B. J. Duseall

(356m)

Copyist.

9

5 Cav. U.S.C.T.

George Lawsey

Priv., Co. A, 5 Reg't U. S. Col'd Cavalry.

Appears on

Company Muster-in and Descriptive Roll

of the organization named above. Roll dated

Spilltown Ky, N. Y., Oct. 24, 1864.

Where born Spilltown Ky

Age 23 y'rs; occupation Soldier

When enlisted Sept 8, 1864, 1864.

Where enlisted Louisville

For what period enlisted 3 years.

Eyes Blue; hair Red

Complexion Yellow; height 5 ft. 9 in.

When mustered in Sept 21, 1864.

Where mustered in Louisville

Bounty paid \$100; due \$100

Where credited 17th Ky. Kentucky

Company to which assigned 4.

Remarks:

Book mark:

George Lawsey

(356d)

Copyist.

9

5 Cav. U.S.C.T.

George Darrow
Pvt., Co. A, 5 Reg't U.S. Col'd Cavalry.

Appears on

Company Muster Roll

for Oct 31, 1864.

Present or absent Present.

Stoppage, \$ 100 for

Due Gov't, \$ 100 for

Valuation of horse, \$ 100

Valuation of horse equipments, \$ 100

Remarks:

Book mark:

B. A. [Signature]

(358)

Copyist.

2

5 Cav. U.S.C.T.

George Dawsey

Prvt, Co. A, 5 Reg't U. S. Col'd Cavalry.

Appears on

Company Muster Roll

for Nov, & Dec, 1864.

Present or absent

Stoppage, \$ 100 for

Due Gov't, \$ 100 for

Valuation of horse, \$ 100

Valuation of horse equipments, \$ 100

Remarks: killed in action at Marion Va, Dec. 18, 1864.

Book mark:

Castling

(358)

Copyist.

D | 5 Cav. | U.S.C.T.

George Dawsey.

Co. A, 5 Reg't U. S. Colored Cav.

Appears on Returns as follows:

Dec. 1864. Killed in action at
Marion, Va. Dec. 18/64.

Book mark :

(546)

A. Bader,
Copyist.

D

5 Cav. U.S.C.T.

George Sawney
Pvt A, Co. *A*, 5 Reg't U. S. Col'd Cavalry.

Appears on **Co. Muster-out Roll**, dated *Helena Ark* *Nov 16*, 186*6*.

Muster-out to date _____, 186 .

Last paid to *Pay due from*, 186 .
enlistment

Clothing account:

Last settled _____, 186 ; drawn since \$ _____ 100

Due soldier \$ _____ 100; due U. S. \$ _____ 100

Am't for cloth'g in kind or money adv'd \$ _____ 100

Due U. S. for arms, equipments, &c., \$ _____ 100

Bounty paid \$ _____ 100; due \$ _____ 100

Remarks: *Killed in Battle*
Marion, Va. Dec 18, 1864
while skirmishing with
the enemy. Final State
ments forwarded Jan
20. 65

Book mark: *V. 50, P. 52-69*

W. Mayre

(361)

Copyist.

Dawsey, George

P, Co. A, 5 Regt. U.S. Cav.

2 Enclosures.

Bed Cards	Descriptive Lists
Burial Records	Final Statements /
Certs. of Dis. for Discharge	Furloughs
C. M. Charges	Med. Des. Lists
Med. Certificates	Orders

Other papers relating to—

Admission to Hosp'l	Furlough
Casualty Sheet (Officer's)	Med. Examination
Confinement	Misc. Information
Contracts	Pay or Clothing
Death or Effects /	Personal Reports
Desertions	Rank
Discharge from Hosp'l	Transfer to Hosp'l
Discharge from Service	Transfer to V. R. C.
Duty	Transportation

✓ FINAL STATEMENT

OF

Geo H
George Dawson Capt
5th Reg't of U. S. C. Cav.

VOLUNTEERS.

11/11/11

NOTE 1.—Two of these certificates (or duplicates) are to be given to each Volunteer Soldier or drafted man who may be discharged previously to the discharge of his company, that he may at once receive from the Paymaster the pay, &c., due him, and the captain or other COMMISSIONED officer commanding the company will certify to the act of the delivery of the duplicate certificates; on these certificates the Soldier is "entitled to" his discharge, and should also present his discharge to the Paymaster to have the payment endorsed on it. The discharge is to be given back to the Soldier by the Paymaster; the latter only retaining as his voucher the duplicate certificates.

NOTE 2.—If the Soldier is entitled to pay for the use of his horse, the Company Commander will certify to that fact on the back of both these final statements, and also to the time he has pay due for having been so mounted on his own horse.

NOTE 3.—When a Soldier is furnished with final statements, his descriptive list, if he has one, should be taken up by the officer who gives the Soldier these statements, and endorsed with a statement to this effect by the officer. This endorsement should exhibit a full statement of the time for which the Soldier was allowed pay on his final statements, the clothing account, and all other charges against him or in his favor, so as to comprise a complete exhibit of his account. It will then be transmitted to the company commander of the Soldier, who will enter all the data necessary to a full understanding of the Soldier's account on the muster roll upon which the Soldier's discharge is reported. The descriptive list will then be destroyed. The object of this is, that the remaining portion of the Soldier's account may be settled upon the receipt of these muster rolls, and the Soldier receive any pay or allowances that may be due him at the time of his discharge, and which may not appear on his final statements from the fact that his descriptive list is incomplete. These accounts for back pay, &c., are settled by the 2d Auditor of the Treasury Department.

NOTE 4.—Charges for loss or injury to ordnance, horse equipments, and other miscellaneous charges, should appear under the heading of "Other Stoppages."

NOTE 5.—Bounty paid by State authorities, and not by the United States, will not be entered on this statement.

NOTE 6.—Amounts due the Sutler and Laundress must be entered on the muster roll on which the discharge, death, desertion, &c., is reported, as well as on the final statement, otherwise the amount cannot be collected from the United States.

NOTE 7.—This blank will be used for deceased volunteers and drafted men, as well as for others.

NOTE 8.—Where a Soldier dies in Hospital or on detached service, his descriptive list, if he has one, should be sent with his final statements, in duplicate, to the Adjutant General, Washington, D. C.

ADJUTANT GENERAL'S OFFICE

July 1st 1865.

Duplicate with Inventory sent 2d Auditor.

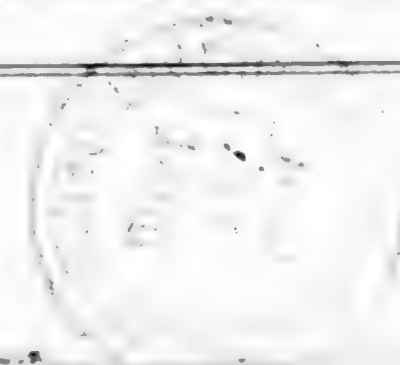

I certify, on honor, that George Dawson a Private of
Captain Anderson's Company (a) of the 5th Regiment of U. S. C. Cal.
VOLUNTEERS, of the State of _____, born in Shelby Co., State
of Kentucky, aged 33 years; 5 Feet 9 inches high; Yellow complexion,
Blue eyes, Black hair, and by occupation a Laborer, having joined the company on
its original organization at Camp Nelson, and enrolled in it at the muster into
the service of the United States at Lonsouth, on the 9th day
of September, 1864, (or was mustered in service as a recruit, by Capt Smith
M. V., at Lonsouth, on the 9th day of September
1864, or was drafted and mustered into the service of the United States from the
Enrollment District of the State of _____, at _____,
on the _____ day of _____, 1864,) to serve in the Regiment, for
the term of Three Years: and having served **HONESTLY** and
FAITHFULLY with his Company in the 5th U. S. C. Cal. to the present date, is now
entitled to a **DISCHARGE** by reason of death from a Gun shot
wound received in action at Marion Va 18 Dec 1864

The said George Dawson was last paid by Paymaster
pay due from date of enlistment to include the _____ day of _____, 1864, and has
pay due him from that time to the present date; he is entitled to pay and subsistence for
TRAVELING to place of enrollment, and whatever other allowances are authorized to volunteer
soldiers, drafted men, or militia, so discharged. He has received from the United States **CLOTHING**
amounting to Thirty four $\frac{35}{100}$ dollars, since the _____ day of October,
1864, when his clothing account was last settled. He has received from the United States
100 dollars advanced **BOUNTY**.

There is to be stopped from him, on account of the State of United States, or other
authorities, for **CLOTHING**, &c., received on entering service, Seventeen $\frac{00}{100}$ dollars; and
for other stoppages, viz: _____

_____ dollars.
He has been furnished with **TRANSPORTATION** in kind from the place of his discharge to
_____ ; and he has been **SUBSISTED** for **TRAVELING** to his
place of enrollment, up to the _____, 1864.

He is indebted to _____, **SUTLER**, _____ dollars.

He is indebted to _____, **LAUNDRESS**, _____ dollars.

Given in Duplicate, at In the field, this 31 day
of December, 1864

J. M. Anderson
Capt Co "U"

Commanding Company

INVENTORY OF THE EFFECTS

OF

George Darosey

Late of Company A

8th Reg't of U.S. Cavalry

Volunteers, who died at Marion "Tex"

on the 18th day of December 1864



Inventory of the effects of George Darosay late
 a Private of Captain J. W. Anderson's Company A of
 the Fifth Regiment of U. S. Cavalry Volunteers, who was enrolled as
 a Private at Louisville in the State of Kentucky on
 the 5th day of September 1864, and mustered into the service of the United
 States as a Private on the 9th day of September 1864, at Louisville
 in Company A, 5th Regiment of U. S. Cavalry Volunteers, to serve 3
 years or during the war; he was born in Shelby County in the State
 of Kentucky; he was 23 years of age, 5 feet 9 inches
 high, Yellow complexion, Blue eyes, Black hair, and by occupation, when enrolled,
 a Laborer; he died in Action, at
Marion Virginia on the 18 day of December 1864 by
 reason of a Gun shot wound in leg and Blow on the
head by a Butt of a Musket

INVENTORY.					
ARTICLES.	No.	ARTICLES.	No.	ARTICLES.	No.
Hats.....	No Effects	Pairs trousers.....	No Effects	Knapsacks.....	
Caps.....		Pairs flannel drawers.....			
Forage caps.....		Pairs cotton drawers.....			
Great coats.....		Flannel shirts.....			
Uniform coats.....		Cotton shirts.....			
Uniform jackets.....		Pairs boots.....			
Flannel sack coats.....		Pairs shoes.....			
Blouses.....		Pairs socks.....			
Stable frocks.....		Blankets.....			
Fatigue overalls.....		Haversacks.....			
				MONEY.	
				Specie.....	\$
				Notes.....	\$

I CERTIFY, ON HONOR, that the above inventory comprises all the effects of George
Darosay, deceased, and that the effects are in the hands
 of _____ at _____
 _____ to be disposed of by a Council of Administration.

(DUPLICATES.)

STATION: In the Field

DATE: 18th Dec 1864

J. W. Anderson
Capt
 Commanding the Company.

Dawson, Lewis

Co A, 5 U. S. Col'd Cav.

Private | Private

CARD NUMBERS.

1	5-3 6 6 7 7 1	26
2	5-3 6 6 8 7 1	27
3	5-3 6 6 9 7 0	28
4	5-3 6 7 0 6 2	29
5	5-3 6 7 1 5 2	30
6	5-3 6 7 2 4 9	31
7	5-3 6 7 3 3 8	32
8	5-3 6 7 4 2 9	33
9	5-3 6 7 5 2 2	34
10	5-3 6 7 6 1 5	35
11	5-3 6 7 7 0 3	36
12	9 0 9 0 7 6 3	37
13	9 0 9 0 8 6 1	38
14		39
15		40
16		41
17		42
18		43
19		44
20		45
21		46
22		47
23		48
24		49
25		50

Book Mark:

See also

Rep 345983,
R & P. 644133.

S-2074289 P.O. m m

-2866376 m m,

J.S. m m. 4-17-21
a

L. A. Wright
X^m

W 5 Cav | **U. S. C. T.**

Amie Dawson
....., Co 75 Reg't U. S. Col'd Cav

Appears on

Company Descriptive Book

of the organization named above.

DESCRIPTION.

Age 20 years; height 5 6 feet 6 inches.

Complexion Blk

Eyes Blk; hair Blk

Where born Virginia

Occupation farmer

ENLISTMENT.

When Sep. 17, 186 4

Where Camp Nelson Ky

By whom J. Randolph, term 3 y'rs.

Remarks:

.....

.....

.....

.....

.....

.....

.....

.....

.....

J. E. Purks

n^o | **5 Cav. | U.S.C.T.**

Lewis Dawson

, Co. *A*, 5 Reg't U. S. Col'd Cav.

Appears on

Company Descriptive Book

of the organization named above.

DESCRIPTION.

Age *26* years; height *5* feet *6* inches.

Complexion *Blk*

Eyes *Blk*; hair *Blk*

Where born *Virginia*

Occupation *Farmer*

ENLISTMENT.

When *Sept 17*, 1864.

Where *Camp Steen*

By whom *W. R. Ransom*, term *3* y'rs.

Remarks:

A. J. Anderson

(383g)

Copist.

D

5 Cav.

U.S.C.T.

Lewis Dawson

Pvt, Co. H, 5 Reg't U. S. Col'd Cavalry.

Appears on

Company Muster-in and Descriptive Roll

of the organization named above. Roll dated

Camp Nelson, ^{Ky} N. Y. Oct 27, 1864.

Where born Virginia

Age 20 y'rs; occupation Farmer

When enlisted Sept 17, 1864.

Where enlisted Camp Nelson Ky

For what period enlisted 3 years.

Eyes Black; hair Black

Complexion Black; height 5 ft. 6 in.

When mustered in Sept 17, 1864.

Where mustered in Camp Nelson Ky

Bounty paid \$ 100; due \$ 100

Where credited

Company to which assigned

Remarks: 7th Dist Ky

*William Dawson.

*Supposed to be name of mine.

Adm May 16, 98 H. J.

Book mark:

Reynolds

D

5 Cav. U.S.C.T.

Lewis Dawson

Put, Co. H, 5 Reg't U. S. Col'd Cavalry.

Appears on

Company Muster Roll

for from enlistment to Oct 31, 1864.

Present or absent present

Stoppage, \$ 100 for

Due Gov't, \$ 100 for

Valuation of horse, \$ 100

Valuation of horse equipments, \$ 100

Remarks:

[Empty lines for remarks]

Book mark:

Reynolds

(358)

Copyist.

D

5 Cav. U.S.C.T.

Lewis Dawson

Pos., Co. H, 5 Reg't U. S. Col'd Cavalry.

Appears on

Company Muster Roll

for Nov & Dec, 1864.

Present or absent present

Stoppage, \$ 100 for

Due Gov't, \$ 100 for

Valuation of horse, \$ 100

Valuation of horse equipments, \$ 100

Remarks: 1st and 2d Installments
Bounty due
Due U.S. for Ordnance
\$9.90

Book mark:

Reynolds

(358)

Copyist.

Lewis Dawson

Put, Co. H, 5 Reg't U. S. Col'd Cavalry.

Appears on

Company Muster Roll

for *Jan & Feb*, 1863.

Present or absent *present*

Stoppage, \$ *100* for

Due Gov't, \$ *100* for

Valuation of horse, \$ *100*

Valuation of horse equipments, \$ *100*

Remarks: *1st installment of
Bounty Due \$100.00*

Book mark:

Reynolds

D | **5 Cav. U.S.C.T.**

Lewis Dawson
Pat, Co. H, 5 Reg't U. S. Col'd Cavalry.

Appears on

Company Muster Roll

for *Mar & Apr*, 186*5*.

Present or absent *present*

Stoppage, \$ *100* for

Due Gov't, \$ *100* for

Valuation of horse, \$ *100*

Valuation of horse equipments, \$ *100*

Remarks: *1st installment of*
Bounty Due \$100

Book mark:

Reynolds

(358)

Copyist.

L. | **5 Cav.** | **U.S.C.T.**

Lewis Dawson

Priv., Co. H, 5 Reg't U. S. Col'd Cavalry.

Appears on

Company Muster Roll

for *(May & June)*, 1865.

Present or absent *Present.*

Stoppage, \$ 100 for

Due Gov't, \$ 100 for

Valuation of horse, \$ 100

Valuation of horse equipments, \$ 100

Remarks: *1st Installment Bounty due \$100.*

Book mark:

(358)

R. J. Crooke

Copyist.

N. | **5 Cav. | U.S.C.T.**

Lewis Dawson

Priv., Co. H, 5 Reg't U. S. Col'd Cavalry.

Appears on

Company Muster Roll

for *July & Aug.*, 1885.

Present or absent *Present.*

Stoppage, \$ 100 for

Due Gov't, \$ 100 for

Valuation of horse, \$ 100

Valuation of horse equipments, \$ 100

Remarks: _____

Book mark: _____

B. J. Cooke

(358)

Copyist.

J. | **5 Cav.** | **U.S.C.T.**

Lewis Dawson
Cvt., Co. H, 5 Reg't U. S. Col'd Cavalry.

Appears on

Company Muster Roll

for *Sept. & Oct.*, 186*5*.

Present or absent *Present.*

Stoppage, \$ *100* for

Due Gov't, \$ *100* for

Valuation of horse, \$ *100*

Valuation of horse equipments, \$ *100*

Remarks:

Book mark:

(358)

P. J. Case

Copyist.

J.

5 Cav. U.S.C.T.

Lewis Dawson

Pvt., Co. H, 5 Reg't U. S. Col'd Cavalry.

Appears on

Company Muster Roll

for *Nov. & Dec.*, 1865.

Present or absent *Present.*

Stoppage, \$ *100* for

Due Gov't, \$ *100* for

Valuation of horse, \$ *100*

Valuation of horse equipments, \$ *100*

Remarks:

Book mark:

R. J. Cooke

(358)

Copyist.

D

5 Cav. U.S.C.T.

Lewis Dawson

Plt, Co. H, 5 Reg't U. S. Col'd Cavalry.

Appears on

Company Muster Roll

for *January 1 Feb'y*, 186*6*.

Present or absent *Present*

Stoppage, \$ *100* for

Due Gov't, \$ *100* for

Valuation of horse, \$ *100*

Valuation of horse equipments, \$ *100*

Remarks:

Book mark:

(358)

J. A. Stewart

Copyist.

D

5 Cav. | U.S.C.T.

Lewis Dawson

Pat, Co. *A*, 5 Reg't U. S. Col'd Cavalry.

Appears on **Co. Muster-out Roll**, dated

Albany, Ark Mar. 16, 1866.

Muster-out to date *Mar. 16*, 1866.

Last paid to *Dec. 31*, 1865.

Clothing account:

Last settled....., 186 ; drawn since \$ 100

Due soldier \$ 100; due U. S. \$ *29* ^{*23*}/₁₀₀

Am't for cloth'g in kind or money adv'd \$ 100

Due U. S. for arms, equipments, &c., \$ 100

Bounty paid \$ *100* 100; due \$ *100* 100

Remarks:

Book no.

(361)

A. Stewart
Copyist.

Dawson, Lewis

, Co.

Reg't *25th*

Enclosures.

Bed Cards	Final Statements
Burial Records	Furloughs or L. of A
Certs. of Dis. for Discharge	Med. Certificates
C. M. Charges	Med. Des. Lists
Descriptive Lists	Orders
Discharge Certificates	Pris. of War Record
Enlistment Papers	Resignations

Other papers relating to—

Admission to Hosp'l	Furlough or L. of A
Casualty Sheet	Med. Examination
Confinement	Misc. Information
Contracts	Pay or Clothing
Death or Effects	Personal Reports
Desertion	Rank
Discharge from Hosp'l	Transfer to Hosp'l
Discharge from Service	Transfer to V. R. C.
Duty	Transportation

NOTE 1. This blank will be used for enlistments of United States colored troops. They will be made out in duplicate in all cases—one to accompany the recruiting return of the superintendent (not the recruiting officer) to the Adjutant-General, and one to accompany the accounts of the officer who pays bounty, &c.

NOTE 2. An enlistment holds to service. A muster-in must, in all cases, precede payment of pay, bounty, pension, &c. A muster-in roll must in all cases be filed in the Adjutant-General's Office as evidence of muster-in. The mustering officer, commissary, or assistant commissary of musters, as the case may be, will countersign both enlistments as having mustered the soldiers into the service of the United States before either of them is given to the disbursing officer.

DECLARATION OF RECRUIT.

1. *Lewis Dawson* desiring to volunteer as a soldier in the ARMY OF THE UNITED STATES, for the term of *Three Years*, DO DECLARE that I am *20* years and _____ months of age; that I have never been discharged from the United States service on account of disability or by sentence of a court-martial, or by order before the expiration of a term of enlistment; and I know of no impediment to my serving honestly and faithfully as a soldier for three years.

GIVEN at *Camp Nelson* the *17th* day of *September* 1864
Witness: *J. C. Strack*

Lewis Dawson
mark
By *J. C. Strack*
Volunteered at Camp Nelson
Sept 17th, 1864
Co. 1st Regt. Col. Boyle Co. Va.
160th Regt. Col. Boyle Co. Va.
Co. 1st Regt. Col. Boyle Co. Va.
No. *69*

Consent of Parent or Guardian in case of a Minor, of a Free Man, or in the case of a Slave, of the Person to whom he owes Service:

I, _____ Do CERTIFY, That I am the _____ that the said _____ is _____ years of age; and I do freely give my CONSENT to his volunteering as a SOLDIER in the Army of the United States, for the period of THREE YEARS, under the conditions of the laws of the United States.

GIVEN at _____ the _____ day of _____
Witness: _____

UNITED STATES COLORED TROOPS ENLISTMENT.

Mustered into the service of the United States, for three years or during the war, from date of enlistment, in Company

STATE OF Kentucky TOWN OF Camp Nelson

I, Lewis Dawson, born in
 in the State of Virginia, aged Twenty years,
 and by occupation a Farmer, Do HEREBY ACKNOWLEDGE to
 have volunteered Seventeenth day of September 1864,
 to serve as a Soldier in the Army of the United States of America, for the period of
THREE YEARS, unless sooner discharged by proper authority: Do also agree to
 accept such bounty, pay, rations, and clothing, as are, or may be, established by law for
 the U. S. colored troops.

And I, Lewis Dawson
 do solemnly swear that I will bear true faith and allegiance to the United States of
America, and that I will serve them honestly and faithfully against all their enemies
 or opposers whomsoever; and that I will observe and obey the orders of the President
 of the United States, and the orders of the officers appointed over me, according to the
 Rules and Articles of War.

Sworn and subscribed to, at Camp Nelson this 17th day of Sept 1864, Lewis Dawson
 Before J. G. Barrett mark
J. G. Barrett

I CERTIFY, ON HONOR, That I have carefully examined the above named Volunteer agreeably to the General Regula-
 tions of the Army, and that, in my opinion, he is free from all bodily defects and mental infirmity, which would in any
 way disqualify him from performing the duties of a soldier.

J. G. Barrett
 Asst Surg 7th Col Examining Surgeon.

I CERTIFY, ON HONOR, That I have minutely inspected the Volunteer, L. Dawson previously to
 his enlistment, and that he was entirely sober when enlisted; that, to the best of my judgment and belief, he is of law-
 ful age, and that, in accepting him as duly qualified to perform the duties of an able bodied soldier, I have strictly ob-
 served the regulations which govern the recruiting service. This soldier has Blue eyes, Black hair,
Dark complexion, is five feet Six inches high.

J. G. Barrett
 Recruiting Officer or Agent.

Mustered into the United State service 17th day of Sept, 1864.

J. G. Barrett
Capt 18th U.S.C. Mustering Officer.

Regiment of U.S. Cavalry Volunteers, on the 17th day of September 1864, at Camp Nelson Ky
W. C. Johnson
 Capt 18th U.S.C.
 Mustering Officer

341

Dawson, Preston

Co A, 5 U. S. Col'd Cav.

Private

Private

CARD NUMBERS.

1	5366772	26
2	5366872	27
3	5366971	28
4	5367003	29
5	5367103	30
6	5367200	31
7	5367339	32
8	5367430	33
9	5367570	34
10	5367614	35
11	5367705	36
12	9090768	37
13	9090862	38
14	40729675	39
15		40
16		41
17		42
18		43
19		44
20		45
21		46
22		47
23		48
24		49
25		50

Book Mark:

See also

S 713441 P.O. 0/6

8-945-715 - P.O. Ref.
A 945-148 - P.O. 0/6

S-1234500 - And US, N.

O, 1345462 and n. 10

04.1979542

P.O. m.m. © 1073728 - 10/24/1954

Eng. History 10/26/55

L.A. Wright
9th

10 | 5 Cav. | U.S.C.T.

Justin Kamm

....., Co. *76*, 5 Reg't U. S. Col'd Cav.

Appears on

Company Descriptive Book
of the organization named above.

DESCRIPTION.

Age *19* years; height *5* feet *9* inches.

Complexion *300*

Eyes *1200*; hair *1200*

Where born *Virginia*

Occupation *Farmer*

ENLISTMENT.

When *Sept 17*, 1864.

Where *Sam's Tavern*

By whom *McKinnon*; term *3* y'rs.

Remarks:

(383g)

A. J. Anderson

Copist.

W. S. Carr | U.S.C.T.

Preston Lawson
, Co. H, 5 Reg't U. S. Col'd Carr

Appears on

Company Descriptive Book

of the organization named above.

DESCRIPTION.

Age 19 years; height 5 feet 9 inches.

Complexion BLK

Eyes BLK; hair BLK

Where born Virginia

Occupation farmer

ENLISTMENT.

When Sept. 17, 1864.

Where Camp Nelson Ky

By whom G. Randolph, term 3 yrs.

Remarks: Died Helena
Ark Dec. 26 - 1865
Taken up he not
being dead Jan.
9 - 1866

W. S. Carr

D **5 Cav. U.S.C.T.**

Piston Dawson

Put, Co. *H*, 5 Reg't U. S. Col'd Cavalry.

Appears on

Company Muster-in and Descriptive Roll
of the organization named above. Roll dated

Camp Nelson, N.Y., Oct 29, 1864.

Where born *Virginia*

Age *19* y'rs; occupation *Farmer*

When enlisted *Sept 17*, 1864.

Where enlisted *Cp Nelson N.Y.*

For what period enlisted *3* years.

Eyes *Black*; hair *Black*

Complexion *Black*; height *5 ft. 9 in.*

When mustered in *Sept 17*, 1864.

Where mustered in *Cp Nelson N.Y.*

Bounty paid \$ *100*; due \$ *100*

Where credited

Company to which assigned

Remarks: *4th Dist N.Y.*

* *William Dawson*

* *Supposed to be name of owner.*

added May 16. 90. H.A.J.

Book mark:

Reynolds

(356d)

Copyist.

D

5 Cav. | U.S.C.T.

Preston Dawson

Priv, Co. H, 5 Reg't U. S. Col'd Cavalry.

Appears on

Company Muster Roll

for *from enlistment to Oct 31*, 1864.

Present or absent *present*

Stoppage, \$ *100* for

Due Gov't, \$ *100* for

Valuation of horse, \$ *100*

Valuation of horse equipments, \$ *100*

Remarks:

Book mark:

Reynolds

(358)

Copyist.

D

5 Cav. U.S.C.T.

Boston Dawson

Put, Co. H, 5 Reg't U. S. Col'd Cavalry.

Appears on

Company Muster Roll

for *Nov 1864*, 1864.

Present or absent *present*

Stoppage, \$ *100* for

Due Gov't, \$ *100* for

Valuation of horse, \$ *100*

Valuation of horse equipments, \$ *100*

Remarks: *Hand 2^d installment
Borrowing due*

Book mark:

Reynolds

(358)

Copyist.

D

5 Cav.

U.S.C.T.

Boston Dawson

Put, Co. H, 5 Reg't U. S. Col'd Cavalry.

Appears on

Company Muster Roll

for *January & Feby*, 186 *3*.

Present or absent *present*

Stoppage, \$ *100* for

Due Gov't, \$ *100* for

Valuation of horse, \$ *100*

Valuation of horse equipments, \$ *100*

Remarks: *1st installment of
Bounty Due \$100.00*

Book mark:

Reynolds

(358)

Copyist.

D | **5 Cav. | U.S.C.T.**

Boston Dawson

Pvt, Co. H, 5 Reg't U. S. Col'd Cavalry.

Appears on

Company Muster Roll

for *Mar & Apr*, 186*3*.

Present or absent *Present*

Stoppage, \$ *100* for

Due Gov't, \$ *100* for

Valuation of horse, \$ *100*

Valuation of horse equipments, \$ *100*

Remarks: *1st installment of
Bounty Due \$100*

Book mark:

(358)

Reynolds

Copyist.

S.

5 Cav. U.S.C.T.

Preston Dawson
Pr, Co. H, 5 Reg't U. S. Col'd Cavalry.

Appears on

Company Muster Roll

for *May & June*, 1865.

Present or absent *Present.*

Stoppage, \$ 100 for

Due Gov't, \$ 100 for

Valuation of horse, \$ 100

Valuation of horse equipments, \$ 100

Remarks: *"Installation Bounty due \$100."*

Book mark: _____

B. J. Cooke

(358)

Copyist.

S. | **5 Cav.** | **U.S.C.T.**

Preston Dawson

Pr, Co. H, 5 Reg't U. S. Col'd Cavalry.

Appears on

Company Muster Roll

for *July and Aug.*, 186*5*.

Present or absent *Present.*

Stoppage, \$ *100* for

Due Gov't, \$ *100* for

Valuation of horse, \$ *100*

Valuation of horse equipments, \$ *100*

Remarks:

Book mark:

A. J. Cooper

(358)

Copyist.

J.

5 Cav. | U.S.C.T.

Gaston Lawson

Cvt., Co. H, 5 Reg't U. S. Col'd Cavalry.

Appears on

Company Muster Roll

for *Sept. & Oct.*, 1865.

Present or absent *Present.*

Stoppage, \$ 100 for

Due Gov't, \$ 100 for

Valuation of horse, \$ 100

Valuation of horse equipments, \$ 100

Remarks:

Book mark: -----

B. J. Locke

(358)

Copyist.

S. | **5 Cav. | U.S.C.T.**

Preston Dawson

Cvt, Co. H, 5 Reg't U. S. Col'd Cavalry.

Appears on

Company Muster Roll

for *Nov. & Dec.*, 1865.

Present or absent.....

Stoppage, \$.....100 for.....

Due Gov't, \$.....100 for.....

Valuation of horse, \$.....100

Valuation of horse equipments, \$.....100

Remarks: *Died in Pest Hospital
Alexandria, Va. Dec. 26"
1865.*

Book mark:.....

(358)

B. J. Cooke

Copyist.

①

5 Cav. U.S.C.T.

Preston Dawson
Pvt., Co. H, 5 Reg't U. S. Col'd Cavalry.

Appears on

Company Muster Roll

for *Jan'y, V Feby*, 186*6*

Present or absent *Present*

Stoppage, \$ *100* for

Due Gov't, \$ *100* for

Valuation of horse, \$ *100*

Valuation of horse equipments, \$ *100*

Remarks: *Dropped erroneously
as dead by Surgeon Charge
of Hospital Helena, Ark
Dec. 27.65. Returned
from dead Jan'y 9.66*

Book mark:

(358)

J. M. Stewart
Copyist.

D | 5 Cav. | U.S.C.T.

Preston Dawson.

Regt. Co. H, 5 Reg't U. S. Colored Cav.

Appears on Returns as follows:

Jan. 1865. Absent sick in Hosp.,
Camp Nelson, Ky.

Apr. to Sept. 1865. On daily duty,
Co. Cook.

Dec. 1865. Died in Post Hosp., Helena,
Ark. Dec. 26/65.

Jan. 1866. Gave up, Jan. 9/66, Helena, Ark.
Taken up, having been erroneously
reported dead.

Book mark:

(546)

J. Baker
Copyist.

D

5 Cav. U.S.C.T.

Preston Dawson

Pat, Co. *H*, 5 Reg't U. S. Col'd Cavalry.

Appears on **Co. Muster-out Roll**, dated

Helena, Ark Mar. 16, 1866.

Muster-out to date *Mar. 16* 1866.

Last paid to *Oct. 31*, 1865.

Clothing account:

Last settled....., 186 ; drawn since \$..... 100

Due soldier \$..... 100; due U. S. \$ *73*^{*44*} 100

Am't for cloth'g in kind or money adv'd \$..... 100

Due U. S. for arms, equipments, &c., \$..... 100

Bounty paid \$ *100* 100; due \$ *100* 100

Remarks:

Book mark:

(861)

J. Stewart
Copyist.

Dawson, Preston

Co. H, 5 Reg't USC Co

4 Enclosures.

Bed Cards	Final Statements <u>2</u>
Burial Records	Furloughs or L. of A.
Certs. of Dis. for Discharge	Med. Certificates
C. M. Charges	Med. Des. Lists
Descriptive Lists	Orders
Discharge Certificates	Pris. of War Record
Enlistment Papers	Resignations

Other papers relating to—

Admission to Hosp'l	Furlough or L. of A.
Casualty Sheet <u>1</u>	Med. Examination
Confinement	Misc. Information
Contracts	Pay or Clothing
Death or Effects	Personal Reports
Desertion	Rank
Discharge from Hosp'l	Transfer to Hosp'l
Discharge from Service	Transfer to V. R. C.
Duty	Transportation

NOTE 1.—This blank will be used for enlistments of United States colored troops. They will be made out in duplicate in all cases—one to accompany the recruiting return of the superintendent (not the recruiting officer) to the Adjutant General, and one to accompany the accounts of the officer who pays bounty, &c.

NOTE 2.—An enlistment holds to service. A muster-in must, in all cases, precede payment of pay, bounty, pension, &c. A muster-in roll, must in all cases, be filed in the Adjutant General's Office as evidence of muster-in. The mustering officer, commissary, or assistant commissary of musters, as the case may be, will countersign both enlistments as having mustered the soldiers into the service of the United States before either of them is given to the disbursing officer.

DECLARATION OF RECRUIT.

I, Preston Dudson desiring to volunteer as a soldier in the ARMY OF THE UNITED STATES, for the term of Three Years, DO DECLARE That I am 19 years and months of age; that I have never been discharged from the United States service on account of disability or by sentence of a court-martial, or by order before the expiration of a term of enlistment; and I know of no impediment to my serving honestly and faithfully as a soldier for three years.

GIVEN at Cornwall New York the 17 day of September 1864

Witness: George H. Hill

Preston Dudson
By John W. Hill
John W. Hill
1864
John W. Hill
1864
John W. Hill
1864
John W. Hill
1864

Consent of Parent or Guardian in case of a Minor, if a Free Man, or in the case of a Slave, of the Person to whom he owes Service:

I, DO CERTIFY, That I am the that the said is years of age; and I do freely give my CONSENT to his volunteering as a SOLDIER in the Army of the United States, for the period of THREE YEARS, under the conditions of the laws of the United States.

GIVEN at the day of

Witness:

UNITED STATES COLORED TROOPS ENLISTMENT.

STATE OF

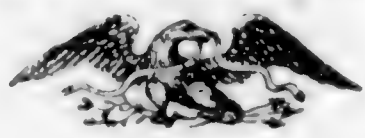

TOWN OF

Kentucky *Camp Nelson*

I, *Preston Dawson* born in _____
in the State of *Virginia* aged *Twenty* years
and by occupation a *Farmer* Do HEREBY ACKNOWLEDGE TO
have volunteered *seventeenth* day of *September* 186*4*
to serve as a **Soldier** in the **Army of the United States of America**, for the
period of **THREE YEARS**, unless sooner discharged by proper authority: Do
also agree to accept such bounty, pay, rations, and clothing, as are, or may be,
established by law for the U. S. colored troops.

And I, *Preston Dawson*
do solemnly swear that I will bear true faith and allegiance to the **United States
of America**, and that I will serve them honestly and faithfully against all their
enemies or opposers whomsoever; and that I will observe and obey the orders
of the President of the United States, and the orders of the officers appointed
over me, according to the Rules and Articles of War.

Sworn and subscribed to, at *Camp Nelson*
this *17th* day of *September* 186*4* *Preston Dawson*
Before *W. Barrett* *W. P. M.*

I CERTIFY, ON HONOR, That I have carefully examined the above named Volunteer agree-
ably to the General Regulations of the Army, and that, in my opinion, he is free from all bodily
defects and mental infirmity, which would in any way disqualify him from performing the
duties of a soldier.

P. G. Barrett
Asst Surg 7th Regt
EXAMINING SURGEON.

I CERTIFY, ON HONOR, That I have minutely inspected the Volunteer *P. Dawson*
previously to his enlistment, and that he was entirely sober when enlisted; that, to the best of
my judgment and belief, he is of lawful age; and that, in accepting him as duly qualified to per-
form the duties of an able-bodied soldier, I have strictly observed the regulations which govern
the recruiting service. This soldier has *dark* eyes, *dark* hair, *dark* complexion, is
5 feet *8* inches high.

J. C. ...
RECRUITING OFFICER OR AGENT.

Mustered into the United States Service *17th* day of *Sept* 186*4*

W. P. M.
Capt 18th U.S.C. Mustering Officer

Mustered into the service of the United States, for three years or during the war, from date of enlistment, in Company _____
Regiment of *U.S. Colored Volunteers*, on the *17th* day of *September* 186*4* at *Camp Nelson Ky*

Joseph 18th U.S.C.

Mustering Officer

FINAL STATEMENT

of July 2/66.
68 OF 76
Preston Dawson

5th Reg't of U.S. Cavalry

This man not to be

P. 53, Vol. 3, R. C. S., 1866
to remain on file until

VOLUNTEERS.

NOTE 1.—Two of these certificates (or duplicates) are to be given to each Volunteer Soldier or drafted man who may be discharged without being mustered out (Final Statements may never be given to those mustered out of service) and he may at once receive from the Paymaster the pay, &c., due him, and the captain or other COMMISSIONED officer commanding the company will certify to the fact of the delivery of the duplicate certificates; with these certificates the Soldier is "entitled to" his discharge, and should also present his discharge to the Paymaster to have the payment endorsed on it. The discharge is to be given back to the Soldier by the Paymaster; the latter only retaining as his vouchers the duplicate certificates.

NOTE 2.—If the Soldier is entitled to pay for the use of his horse, the Company Commander will certify to that fact on the back of both these final statements, and also to the time he has pay due for having been so mounted on his own horse.

NOTE 3.—When a Soldier is furnished with final statements, his descriptive list, if he has one, should be taken up by the officer who gives the Soldier these statements, and endorsed with a statement to this effect by the officer. The endorsement should exhibit a full statement of the time for which the Soldier was allowed pay on his final statements, the clothing account, and all other charges against him or in his favor, so as to comprise a complete exhibit of his account. It will then be transmitted to the Company Commander of the Soldier, who will enter all the data necessary to a full understanding of the Soldier's account on the muster roll upon which the Soldier's discharge is reported. The descriptive list will then be destroyed. The object of this is, that the remaining portion of the Soldier's account may be settled upon the receipt of these muster rolls, and the Soldier receive any pay or allowances that may be due him at the time of his discharge, and which may not appear on his last final statements from the fact that his descriptive list is incomplete. These accounts for back pay, &c., are settled by the 2d Auditor of the Treasury Department.

NOTE 4.—Charges for loss or injury to ordnance, horse equipments, and other miscellaneous charges, should appear under the heading of "Other Stoppages."

NOTE 5.—Bounty paid by State authorities, and not by the United States, will not be entered on this statement.

NOTE 6.—Amounts due the Sutler and Laundress must be entered on the muster roll on which the discharge, death, desertion, &c., is reported, as well as on the final statement, otherwise the amount cannot be collected from the United States.

NOTE 7.—This blank will be used for deceased volunteers and drafted men, as well as for others.

NOTE 8.—Where a Soldier dies in Hospital or on detached service, his descriptive list, if he has one, should be sent with his final statements, in duplicate, to the Adjutant General, Washington, D. C.

NOTE 9.—If the soldier is a drafted man or substitute, the space for time, &c., or enrolled, should contain only the word *drafted* or *substitute*, as the case may be. If the Soldier is a "VETERAN," (or RECRUIT,) the words *as a veteran*, (or *recruit*,) as the case may be, should be interlined after the words *mustered into the service of the U. S.* A statement of all the installments of *Veteran or Recruit Bounty RECEIVED* by the Soldier must be made on the back of each final statement.

erroneously reported "Dead"
see Muster Roll of Co. for Jan'y
8 Feb'y, 1866 and Letter on file
P 53 Vol. 3 R C S. 1866

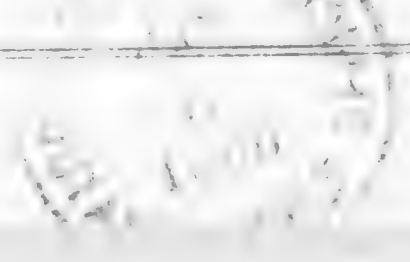

FINAL STATEMENT

OF

Preston Dawson
5th Regt of U. S. Col.

VOLUNTEERS.

NOTE 1.—Two of these certificates (or duplicates) are to be given to each Volunteer Soldier or drafted man who may be discharged without being mustered out (Final Statements are never given to men mustered out of service,) that he may at once receive from the Paymaster the pay, &c. due him, and the captain or other COMMISSIONED officer commanding the company will certify to the act of the delivery of the duplicate certificates with these certificates the Soldier is "entitled to" his discharge, and should also present his discharge to the Paymaster to have the payment endorsed on it. The discharge is to be given back to the Soldier by the Paymaster the latter only retaining as his vouchers the duplicate certificates.

NOTE 2.—If the Soldier is entitled to pay for the use of his horse, the Company Commander will certify to that fact on the back of both these final statements, and also to the time he has pay due for having been mounted on his own horse.

NOTE 3.—When a Soldier is furnished with final statements, his descriptive list, if he has one, should be taken up by the officer who gives the Soldier these statements, and endorsed with a statement to this effect by the officer. The endorsement should exhibit a full statement of the time for which the Soldier was allowed pay on his final statements, the clothing account, and all other charges against him or in his favor, so as to comprise a complete exhibit of his account. It will then be transmitted to the Company Commander of the Soldier, who will enter all the data necessary to full understanding of the Soldier's account on the muster roll upon which the Soldier's discharge is reported. The descriptive list will then be destroyed. The object of this is, that the remaining portion of the Soldier's account may be settled upon the receipt of these muster rolls, and that the Soldier receive any pay or allowances that may be due him at the time of his discharge, and which may not appear on his last final statements from the fact that his descriptive list is incomplete. These accounts for back pay, &c., are settled by the 2d Auditor of the Treasury Department.

NOTE 4.—Charges for loss or injury to ordnance, horse equipments, or other miscellaneous charges, should appear under the heading of "Other Stoppages."

NOTE 5.—Bounty paid by State authorities, and not by the United States will not be entered on this statement.

NOTE 6.—Amounts due the Sutler and Laundress must be entered on the muster roll on which the discharge, death, desertion, &c., is reported, well as on the final statement, otherwise the amount cannot be collected from the United States.

NOTE 7.—This blank will be used for deceased volunteers and drafted men, as well as for others.

NOTE 8.—Where a Soldier dies in Hospital or on detached service, his descriptive list, if he has one, should be sent with his final statement, duplicate, to the Adjutant General, Washington, D. C.

NOTE 9.—If the soldier is a drafted man or substitute, the space for the &c., of enrolled, should contain only the word *drafted* or *substitute*, as the case may be. If the Soldier is a "VETERAN," (or RECRUIT,) the words *as a veteran*, (or *recruit*,) as the case may be, should be interlined after the words *mustered into the service of the U. S.* A statement of all installments of *Veteran* or *Recruit* Bounty RECEIVED by the Soldier must be made on the back of each final statement.

I certify, on honor, that Preston Dawson, a Private of
Captain _____ Company (D) of the 5th Regiment of U.S. Colored
VOLUNTEERS, of the State of Kentucky, born in Shelburne, State
of Kentucky, aged 19 years; 5 feet 9 inches high; Black complexion,
Black eyes, Black hair, and by occupation a Farmer, who joined for service
and was enrolled (see Note 9) on the 17th day of September, 1864, at Camp Nelson
by J. C. Randolph, for the period of Three years, and mustered into
the service of the United States on the 17th day of September, 1864, at
Camp Nelson, by Capt. J. P. Ringoff; and having served
HONESTLY and FAITHFULLY with his Company to the present date, is now entitled to a
DISCHARGE by reason of Death, Died of Variola in Post
Hospital at Helena Ark, Died Dec 26, 1865

The said Preston Dawson was last paid by Paymaster
Wm Knapp, to include the 31st day of October, 1865, and
has pay due him from that time to the 26th Dec 1865 present date; he is entitled to pay and subsistence for
TRAVELING to place of enrollment, and whatever other allowances are authorized to volunteer
soldiers, drafted men, or militia, so discharged. He has received from the United States **CLOTHING**
amounting to 83 ³³/₁₀₀ dollars, since the 31st day of March,
1865, when his clothing account was last settled. He has received from the United States
100 ⁰⁰/₁₀₀ dollars advanced **BOUNTY**.

There is to be stopped from him, on account of the State of _____, or other
authorities, for **CLOTHING**, &c., received on entering service, 19 ³⁹/₁₀₀ dollars; and
for other stoppages, viz: _____

_____ dollars
He has been furnished with **TRANSPORTATION** in kind from the place of his discharge to
_____; and he has been **SUBSISTED** for **TRAVELING** to his
place of enrollment, up to the _____, 186 .

He is indebted to John W. Carson, **SUTLER**, 5 ⁰⁰/₁₀₀ dollars.

He is indebted to _____, **LAUNDRESS**, _____ ⁰⁰/₁₀₀ dollars.

Given in Duplicate, at Helena Ark, this 28 day
of December, 1865.

Geo. Parker
Sargent

Commanding Company.

25 v South for No Jan, 25/66

CASUALTY SHEET.

No. _____
Preston Dawson
_____ of Company *N*
5 " Regiment of *W. C. East*
State Volunteers.

NATURE OF CASUALTY.

.....

CASUALTY SHEET.

Name: *Preston Dawson*

Rank: *Pvt* Company: *N* Regiment: *5*

Arm: *U.S.A.R.* State: _____

Nature of Casualty: *Disease*

CAUSE OF CASUALTY—(NAME OF DISEASE, &c.)

Disease

BY WHOM DISCHARGED.

FROM WHAT SOURCE THIS INFORMATION WAS

OBTAINED.

*Gen. H. of Gen. Satch
for Gen. Eng. rec 3/16/5*

DEGREE OF DISABILITY.

BY WHOM CERTIFIED.

*J. Young (Assistant
Colonel)*

DATE OF DISCHARGE, DEATH, &c.

Dec 26/65

PLACE OF DISCHARGE, DEATH, &c.

W. Va. Ark

REMARKS

H. H. H. H.

Clerk.

342

Dawson, Samuel

Co A, 5 U. S. Col'd Cav.

Private

Private

CARD NUMBERS.

1	5366773	26
2	5366873	27
3	5366942	28
4	5367064	29
5	5367154	30
6	5367251	31
7	5367340	32
8	5367431	33
9	5367529	34
10	5367616	35
11	5367704	36
12	9090767	37
13	9090863	38
14		39
15		40
16		41
17		42
18		43
19		44
20		45
21		46
22		47
23		48
24		49
25		50

Book Mark:

See also

29 | 5 Cav. | U.S.C.T.

Samuel Dawson

Co. 76, 5 Reg't U. S. Col'd Cav.

Appears on

Company Descriptive Book
of the organization named above.

DESCRIPTION.

Age 19 years; height 5 feet 9 inches.

Complexion *Blk*

Eyes *Blk*; hair *Blk*

Where born *N.C.*

Occupation *Farmer*

ENLISTMENT.

When *Sept-15, 1864.*

Where *Camp Deton*

By whom *J. C. Landwehr*, term *3* y'rs.

Remarks: *Promoted to Corporal by
Supt order "147" Sept-1"/65*

A. J. Anderson

(383g)

Copist.

Al | *5 Cav* | **U.S.C.T.**

Samuel Dawson

....., Co. *H* 5 Reg't U. S. Col'd *Cav*

Appears on

Company Descriptive Book

of the organization named above.

DESCRIPTION.

Age *19* years; height *5* feet *9* inches.

Complexion *Black*

Eyes *Black*, hair *Black*

Where born *Al. Co.*

Occupation *farmer*

ENLISTMENT.

When *Sep 15*, 186 *4*.

Where *Camp Nelson*

By whom *J. B. Randolph*, term *3* y'rs.

Remarks:

.....
.....
.....
.....
.....
.....
.....
.....
.....
.....

J. E. Parks

D

5 Cav. U.S.C.T.

Samuel Dawson

Put, Co. *H*, 5 Reg't U. S. Col'd Cavalry.

Appears on

Company Muster-in and Descriptive Roll

of the organization named above. Roll dated

Camp Nelson, N.Y. Oct 29, 1864.

Where born *D. Y.*

Age *19* y'rs; occupation *Farmer*

When enlisted *Sept 15*, 1864.

Where enlisted *Camp Nelson N.Y.*

For what period enlisted *3* years.

Eyes *Black*; hair *Black*

Complexion *Black*; height *5 ft. 9 in.*

When mustered in *Sept 15*, 1864.

Where mustered in *Camp Nelson N.Y.*

Bounty paid \$ *100*; due \$ *100*

Where credited

Company to which assigned

Remarks: *7th Dist N.Y.*

* *Free*

* *Added May 16, 98. H. J.*

Book mark:

Reynolds

(356d)

Copyist.

D

5 Cav. | U.S.C.T.

Samuel Dawson

Priv, Co. H, 5 Reg't U. S. Col'd Cavalry.

Appears on

Company Muster Roll

for *from enlistment to Oct 31*, 1864.

Present or absent *present*

Stoppage, \$ *100* for

Due Gov't, \$ *100* for

Valuation of horse, \$ *100*

Valuation of horse equipments, \$ *100*

Remarks:

Book mark:

Reynolds

(358)

Copyist.

D | **5 Cav.** | **U.S.C.T.**

Samuel Dawson

Pat, Co. H, 5 Reg't U. S. Col'd Cavalry.

Appears on

Company Muster Roll

for *Nov & Dec*, 1864.

Present or absent *present*

Stoppage, \$ *100* for

Due Gov't, \$ *100* for

Valuation of horse, \$ *100*

Valuation of horse equipments, \$ *100*

Remarks: *1st and 2^d Installments
Bounty due*

Book mark: _____

Reynolds

(358)

Copyist.

D | **5 Cav. | U.S.C.T.**

Samuel Dawson

Private Co. H, 5 Reg't U. S. Col'd Cavalry.

Appears on

Company Muster Roll

for *Jan'y & Feby*, 186*5*.

Present or absent *present*

Stoppage, \$ *100* for

Due Gov't, \$ *100* for

Valuation of horse, \$ *100*

Valuation of horse equipments, \$ *100*

Remarks: *1st Installment of Bouncey Due \$100.00*

Book mark: *.*

(358)

Reynolds Copyist.

D

5 Cav. U.S.C.T.

Samuel Dawson

Pvt, Co. H, 5 Reg't U. S. Col'd Cavalry.

Appears on

Company Muster Roll

for Mar & Apr, 1865.

Present or absent present

Stoppage, \$ 100 for

Due Gov't, \$ 100 for

Valuation of horse, \$ 100

Valuation of horse equipments, \$ 100

Remarks: 1st installment of
Bounty Due \$100

Book mark:

Reynolds

(358)

Copyist.

2

5 Cav. U.S.C.T.

Samuel Dawson

Co. H, 5 Reg't U. S. Col'd Cavalry.

Appears on

Company Muster Roll

for May & June, 1865.

Present or absent Present.

Stoppage, \$ 100 for

Due Gov't, \$ 100 for

Valuation of horse, \$ 100

Valuation of horse equipments, \$ 100

Remarks: 1st Installment Bounty due \$100.

Book mark:

B. J. Crooke

(358)

Copyist.

A. | **5 Cav.** | **U.S.C.T.**

Sam Dawson

Priv, Co. H, 5 Reg't U. S. Col'd Cavalry.

Appears on

Company Muster Roll

for *July & Aug. 1865*, 1865.

Present or absent *Present*

Stoppage, \$ *100* for

Due Gov't, \$ *100* for

Valuation of horse, \$ *100*

Valuation of horse equipments, \$ *100*

Remarks: _____

Book mark: _____

(358)

R. J. [Signature]

Copyist.

S.

5 Cav. | U.S.C.T.

Samuel Sawson

Pvt, Co. H, 5 Reg't U. S. Col'd Cavalry.

Appears on

Company Muster Roll

for *Sept. & Oct.*, 1865.

Present or absent *Present.*

Stoppage, \$ 100 for

Due Gov't, \$ 100 for

Valuation of horse, \$ 100

Valuation of horse equipments, \$ 100

Remarks: *Reduced to the ranks by S.O. No. 177 Sept Regt H's Co Oct 30 '65. Promoted Sept 1 '65 by S.O. No. 147 dated Regt H's Co.*

Book mark: _____

B. J. Cooke

(358)

Copyist.

S.

5 Cav. U.S.C.T.

Samuel Dawson

Cvt, Co. H, 5 Reg't U. S. Col'd Cavalry.

Appears on

Company Muster Roll

for *Nov. & Dec.*, 1865.

Present or absent *Present*

Stoppage, \$ 100 for

Due Gov't, \$ 100 for

Valuation of horse, \$ 100

Valuation of horse equipments, \$ 100

Remarks:

Book mark:

B. J. Cooke

(358)

Copyist.

D

5 Cav. U.S.C.T.

Samuel Dawson

Pat, Co. H, 5 Reg't U. S. Col'd Cavalry.

Appears on

Company Muster Roll

for *Jan'y. & Feby*, 1866.

Present or absent *Present*

Stoppage, \$ *100* for

Due Gov't, \$ *100* for

Valuation of horse, \$ *100*

Valuation of horse equipments, \$ *100*

Remarks:

Book mark:

(358)

J. M. Stewart
Copyist.

D

5 Cav. U.S.C.T.

Samuel Dawson

Pat, Co. *A*, 5 Reg't U. S. Col'd Cavalry.

Appears on **Co. Muster-out Roll**, dated

Helena, Ark Mar. 16, 1866.

Muster-out to date *Mar. 16*, 1866.

Last paid to *Dec. 31*, 1865.

Clothing account:

Last settled....., 186 ; drawn since \$..... 100

Due soldier \$..... 100; due U. S. \$ *26* ^{*3*}/₁₀₀

Am't for cloth'g in kind or money adv'd \$..... 100

Due U. S. for arms, equipments, &c., \$..... 100

Bounty paid \$ *100* 100; due \$ *100* 100

Remarks:.....

Book mark:.....

(361)

J. A. Stewart
Copyist.

343

Day, David

Co I, 5 U. S. Col'd Cav.

Private

Private

CARD NUMBERS.

1	5367864	26
2	5367961	27
3	5368771	28
4	9090967	29
5	9221581	30
6	9221602	31
7		32
8		33
9		34
10		35
11		36
12		37
13		38
14		39
15		40
16		41
17		42
18		43
19		44
20		45
21	Cards withdrawn and filed	
22	in jacket of Day, David	
23	108 U.S. C. Inf. office they	
24	properly belong. J.W. Sp. 24/95.	
25		50

Book Mark:

See also

344

Dehoney, Peter

Co A, **5** U. S. Col'd Cav.

Private

Private

CARD NUMBERS.

1	5359622	26
2	5359724	27
3	5359824	28
4	5359925	29
5	5360023	30
6	5360116	31
7	5360205	32
8	5360295	33
9	5360387	34
10	5360477	35
11	5360563	36
12	9089995	37
13		38
14		39
15		40
16		41
17		42
18		43
19		44
20		45
21		46
22		47
23		48
24		49
25		50

Book Mark:

See also

10 | 5 Cav. | U.S.C.T.

Peter Kehoney

....., Co. A, 5 Reg't U. S. Col'd Cav.

Appears on

Company Descriptive Book
of the organization named above.

DESCRIPTION.

Age 8 years; height 5 feet 8 inches.

Complexion Blk

Eyes Blk; hair Blk

Where born Jefferson, Ky

Occupation Laborer

ENLISTMENT.

When Substitute, 186 .

Where

By whom; term 3 y'rs.

Remarks:

.....
.....
.....
.....
.....
.....
.....
.....

Harvey

D

5 Cav.

U.S.C.T.

Peter Schoney

Co. A, Co. *A*, 5 Reg't U. S. Col'd Cavalry.

Appears on

Company Muster-in and Descriptive Roll

of the organization named above. Roll dated

Sp. Nelson Ky, N. Y., Oct. 24, 1864.

Where born *Jefferson Ky*,

Age *18* y'rs; occupation *Laborer*

When enlisted *Sept 11*, 186 .

Where enlisted *Sp. Nelson Ky*

For what period enlisted *3* years.

Eyes *Blk*; hair *Blk*

Complexion *Blk*; height *5* ft. *8* in.

When mustered in *Sept 11*, 1864.

Where mustered in *Louisville*

Bounty paid \$ *100*; due \$ *100*

Where credited *2nd Dist, Kentucky*

Company to which assigned *A*

Remarks:

Book mark:

Erasmus

(356d)

Copyist.

9

5 Cav. U.S.C.T.

Peter Schoney

Pat, Co. A, 5 Reg't U. S. Col'd Cavalry.

Appears on

Company Muster Roll

for *7 Oct. 31*, 1864.

Present or absent *Present*

Stoppage, \$ *100* for

Due Gov't, \$ *100* for

Valuation of horse, \$ *100*

Valuation of horse equipments, \$ *100*

Remarks:

Book mark:

Ernstling

Copyist.

(358)

29

5 Cav. U.S.C.T.

Peter Dehoney

Pvt, Co. A, 5 Reg't U. S. Col'd Cavalry.

Appears on

Company Muster Roll

for *Apr. & Dec.*, 186 *4*.

Present or absent *Present*

Stoppage, \$ *100* for

Due Gov't, \$ *100* for

Valuation of horse, \$ *100*

Valuation of horse equipments, \$ *100*

Remarks:

Book mark:

(358)

Easterling Copyist.

Peter Delaney

Pvt, Co. A, 5 Reg't U.S. Col'd Cavalry.

Appears on

Company Muster Roll

for *Jan & Feb*, 186*5*

Present or absent *Present*,

Stoppage, \$ *100* for

Due Gov't, \$ *100* for

Valuation of horse, \$ *100*

Valuation of horse equipments, \$ *100*

Remarks:

Book mark:

P. Sterling
Copyist.

5 Cav. U.S.C.T.

City Delmore

Rt., Co. A, 5 Reg't U.S. Col'd Cavalry.

Appears on

Company Muster Roll

for *Wm. D. Dyer*, 1867.

Present or absent *Present*

Stoppage, \$ 100 for

Due Gov't, \$ 100 for

Valuation of horse, \$ 100

Valuation of horse equipments, \$ 100

Remarks:

Book mark:

[Signature]
Copyist.

2

5 Cav. U.S.C.T.

Peter Dehoney

Pvt., Co. A, 5 Reg't U. S. Col'd Cavalry.

Appears on

Company Muster Roll

for *May 1st 1865*

Present or absent *Present*

Stoppage, \$ *100* for

Due Gov't, \$ *100* for

Valuation of horse, \$ *100*

Valuation of horse equipments, \$ *100*

Remarks: *Some statement
bounty due \$ 50.*

Book mark:

H. A. ...

(358)

Copyist.

2

5 Cav. U.S.C.T.

John J. ...

..., Co. A, 5 Reg't U.S. Col'd Cavalry.

Appears on

Company Muster Roll

for *John J. ...*, 1865.

Present or absent *Present*

Stoppage, \$ 100 for

Due Gov't, \$ 100 for

Valuation of horse, \$ 100

Valuation of horse equipments, \$ 100

Remarks:

Book mark:

John J. ...

(358)

Comjist.

2

5 Cav. U.S.C.T.

Peter Depon

Plt., Co. A, 5 Reg't U. S. Col'd Cavalry.

Appears on

Company Muster Roll

for *dated Feb 8/*, 1865.

Present or absent *Present*

Stoppage, \$ *100* for

Due Gov't, \$ *100* for

Valuation of horse, \$ *100*

Valuation of horse equipments, \$ *100*

Remarks:

Book mark:

J. H. Talbot
Copyist.

(358)

D

5 Cav. U.S.C.T.

Peter Kehoney
Pvt

Co. A, 5 Reg't U.S. Col'd Cavalry.

Appears on

Company Muster Roll

for Nov 20th, 1865

Present or absent Present

Stoppage, \$ 100 for

Due Gov't, \$ 52 100 for Ord

Valuation of horse, \$ 100

Valuation of horse equipments, \$ 100

Remarks: Substitute

Book mark:

W. W. Sayre
Copyist.

(358)

D | **5 Cav. U.S.C.T.**

Peter Dehoney
Pvt, Co. A, 5 Reg't U. S. Col'd Cavalry.

Appears on

Company Muster Roll
for *Jan & Feb*, 1866
Present or absent *Present*

Stoppage, \$ *100* for

Due Gov't, \$ *100* for

Valuation of horse, \$ *100*

Valuation of horse equipments, \$ *100*

Remarks: *Substitute*

Book mark:

W. W. Sayre
(358) Copyist.

D

5 Cav. U.S.C.T.

Peter Dehoney

Pvt, Co. A, 5 Reg't U. S. Col'd Cavalry.

Appears on Co. Muster-out Roll, dated

Helena Ark Mich 16, 1866.

Muster-out to date Mich 16, 1866.

Last paid to Dec 31, 1865.

Clothing account:

Last settled....., 186 ; drawn since \$ 100

Due soldier \$ 100; due U. S. \$ 3200/100

Am't for cloth'g in kind or money adv'd \$ 100

Due U. S. for arms, equipments, &c., \$ 100

Bounty paid \$ 100; due \$ 100

Remarks:

Book ma

W. W. Dayre

(361)

Copyist.

Dehonny, Peter

, Co. _____,

5 Reg't *U.S.C.B.*

2 Enclosures.

Bed Cards	Final Statements
Burial Records	Furloughs or L. of A
Certs. of Dis. for Discharge	Med. Certificates
C. M. Charges	Med. Des. Lists
Descriptive Lists	Orders
Discharge Certificates	Pris. of War Record
Enlistment Papers <i>2</i>	Resignations

Other papers relating to—

Admission to Hosp'l	Furlough or L. of A
Casualty Sheet	Med. Examination
Confinement	Misc. Information
Contracts	Pay or Clothing
Death or Effects	Personal Reports
Desertion	Rank
Discharge from Hosp'l	Transfer to Hosp'l
Discharge from Service	Transfer to V. R. C.
Duty	Transportation

Filed Mar. 14, 1906

~~D-2 35~~

No. 225

Peter Dehoney

Enlisted at Leicester N.Y.

5th Co. Can.

As Substitute for

A. S. Platt

On the 9 day of Sept, 1864

By

Wm Mack Pursat

W. P. Harvey Secty

E. S. Bell Surg^r

Board of Enrollment,

5 Dist. of N.Y.

Deup.



SUBSTITUTE
VOLUNTEER ENLISTMENT.

STATE OF

TOWN OF

Kentucky

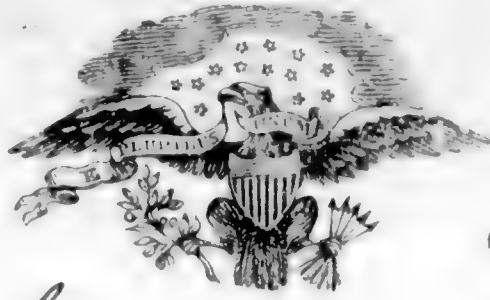

Louisville

I, *Peter Deheney* born in the State
of *Kentucky*, aged *18* years, and by
occupation a *laborer*

Do HEREBY ACKNOWLEDGE to have agreed with
J. S. Platt, Esq., of *Louisville*
Dufferson County Ky

to become his **SUBSTITUTE** in the Military Service, for a sufficient consideration paid and
delivered to me, on the *9* day of *Sept*, 186*4*

and having thus agreed with said *J. S. Platt*, I DO HEREBY
ACKNOWLEDGE to have enlisted this *9* day of *Sept*,

186*4*, to serve as a **Soldier** in the **Army of the United States of America**, for the period
of **THREE YEARS**, unless sooner discharged by proper authority: I do also agree to accept such

bounty, pay, rations, and clothing, as are, or may be, established by law for ^{*land troops*} soldiers. And I do
solemnly swear that I will bear true and faithful allegiance to the **United States of America**;
that I will serve them honestly and faithfully against all their enemies or opposers whomsoever;
and that I will observe and obey the orders of the President of the United States, and the orders
of the Officers appointed over me, according to the Rules and Articles of War.

SWORN and subscribed to, at *Louisville Ky*
this *9* day of *Sept*, 186*4*

BEFORE *J. M. Munnich*
Capt & Prov Mar
5 Dist Ky

Peter Deheney
mark

We certify, on honor, That we have carefully examined the above-named Volunteer Substitute
agreeably to the Regulations, and that, in our opinion, he is free from all bodily defects and mental infirmity
which would in any way disqualify him from performing the duties of a soldier; that he was entirely sober
when enlisted; that he is of lawful age, (not under 18 years;) and that, in accepting him as duly qualified to
perform the duties of an able-bodied soldier, and as a Substitute in lieu of *J. S. Platt*
of Louisville Ky, drafted in *5th Ceny Dist Ky*
and draft, we have strictly observed the Regulations which govern
in such cases. This soldier has *Black* eyes, *Black* hair, *Black* complexion; is *5* feet *8*
inches high.

J. M. Munnich
Provost Marshal.
Will R. Kersey
Commissioner of Board.
J. S. Bell
Surgeon of Board.

Board of Enrollment of *5* Dist. of *Ky*

DECLARATION OF SUBSTITUTE.

I, Peter Dehoney desiring to ENLIST
in the **Army of the United States**, for **THREE YEARS**, **Do declare**, That I am
18 years and months of age; that I have
never been discharged from the United States service on account of disability or by sentence of
a court martial; and I know of no impediment to my serving honestly and faithfully as a soldier
for three years.

GIVEN at Louisville Ky
the 9 day of Sept 1864

WITNESS:
J. Holman

Peter Dehoney
mark

A. D. B. 5

No. 275

Peter Dehner

Enlisted at Louisville Ky

As Substitute for

A. S. Platt

On the 9 day of Sept, 1864

By

Wm. M. Adams Pres

W. R. Mervin Secy

W. S. Bell Surgn

Board of Enrollment,

5 Dist. of Ky

Druf



DECLARATION OF SUBSTITUTE.

I, Peter Dehner desiring to ENLIST
in the **Army of the United States**, for **THREE YEARS**, **Do declare**, That I am
18 years and — months of age; that I have
never been discharged from the United States service on account of disability or by sentence of
a court martial; and I know of no impediment to my serving honestly and faithfully as a soldier
for three years.

GIVEN at

Lewisville Ky
the 9 day of Sept 1864

WITNESS:

J. C. Chuman

Peter Dehner
mark

³⁴⁵
DeLa, S. A.

Col., 5 U. S. Col'd Cav.

1st Lieutenant | 1st Lieutenant.

CARD NUMBERS.

1	5359162	26
2	5362181	27
3	5362272	28
4	5362361	29
5	5362440	30
6	5362530	31
7	9433-975	32
8	42892949	33
9	40729677	34
10		35
11		36
12		37
13		38
14		39
15		40
16		41
17		42
18		43
19		44
20		45
21		46
22		47
23		48
24		49
25		50

Book Mark:

See also 12 Ohio Cav.

S. 919435 - 80. Ret.
AM. 1800771

G. A. Mayhew
Lth

L | 500 | U.S.A.

Samuel A. Lela

1st Lt., Co. C, 5th Reg't U.S. Col'd Cav.

Appears on

Regimental Descriptive Book

(List of Commissioned Officers)

of the regiment named above.

Rank 1st Lieutenant

Date of appointment....., 186 .

Remarks: Enrolled at

Louisville, Ky by the
President July 14, 1865

3 years,

Mustered July 14, 1865 at
Louisville, Ky by
Capt. Fletcher.

Hearn

D | 5 Cav. | U.S.C.T.

Samuel A. Dela

St, Co. C, 5 Reg't U. S. Col'd Cav.

Age 28 years.

Appears on an

Individual Muster-in Roll

of the organization named above. Roll dated

Louisville Ky, July 14, 1865.

Muster-in to date July 14, 1865.

Joined for duty and enrolled :

When July 14, 1865.

Where Louisville Ky

Period 3 years.

Valuation of horse, \$ 100

Valuation of horse equipments, \$ 100

Remarks : Discharged from
12 Ohio Cav. Vols. July
13/65 by order Genl. Palmer to
accept Commission as 1 Lieut.

Book mark :

Palmer

JAN. - 9

5359162

1891 *

Co C 5 U.S. C. Cav.

S

5 Cav. | U.S.C.T.

S. A. Dela

1st Lieut, Co. C, 5 Reg't U. S. Col'd Cavalry.

Appears on

Company Muster Roll

for *July & Aug*, 1865.

Present or absent *Present*

Stoppage, \$ 100 for

Due Gov't, \$ 100 for

Valuation of horse, \$ 100

Valuation of horse equipments, \$ 100

Remarks: *Assigned to Co
July 13/65 per Regt.
Order No 1220 at
Paris Ky.*

Book mark: _____

(358)

Linden

Copyist.

J. | **5 Cav.** | **U.S.C.T.**

J. A. De La

1st Lt., Co. C, 5 Reg't U. S. Col'd Cavalry.

Appears on

Company Muster Roll

for *Nov* *Dec*, 186*5*.

Present or absent *Present*

Stoppage, \$ *100* for

Due Gov't, \$ *100* for

Valuation of horse, \$ *100*

Valuation of horse equipments, \$ *100*

Remarks: *Twenty Dollars*
due for responsibility
of Arms + Clothing
from Sep. 17/ 65 to Dec.
31/ 65

Book mark:

Linder

(358)

Copyist.

9 | 5 Car U.S.C.T.

S. A. Dela

Lieut 5 Regt U.S. Col. Cav.

Return

of the Saint Francis River District, Department
of Arkansas,

for the month of January, 1866,

dated Helena Arkansas

February 5, 1866.

shows the following with regard to the officer
named above :

Post or station

Remarks: Asst. Pro. Mar.

Date of Commission Jun 6, 1865

Date of Muster July 12, 1865

Assigned to duty per S. O. No.
10, C. 5. Dist Hdqrs.

Book mark:

W. B. Mitchell

(546)

Copist.

D

5 Cav. U.S.C.T.

S. G. DeLa

1st Lt, Co. C, 5 Reg't U. S. Col'd Cavalry.

Appears on

Company Muster Roll

for Jan and Feb, 1866.

Present or absent Absent

Stoppage, \$ 100 for

Due Gov't, \$ 100 for

Valuation of horse, \$ 100

Valuation of horse equipments, \$ 100

Remarks: On detached duty as per Order No 10 Hd Qtrs Dpt St Francis River Jan 17, 1866 Twenty dollars due for responsibility of Arms and Clothing from Sep 1st to Oct 31st 1865.

Book mark:

Rose

Sam'l A. Dela.

1st Lt. Co. C, 5 Reg't U. S. Colored Cav.

Appears on Returns as follows:

July, 1865. Present. Reported to Co. for duty per Regtl. Order 122, Paris, Ky, dated July 13/65.

Aug. & Sept. 1865. Present. Sign Return Comdg Co.

Oct. 1865. Present. Temporarily assigned to command of Co. G until Officer return, per Regtl. Order.

Nov. 1865. Present.

Dec. 1865. Present. Signs Return Comdg Co.

Jan. & Feb. 1866. Absent. Detch'd as Asst. Prov. Marshal, Helena, Ark., S. O. 10, dated Jan. 17/66, Hdqrs. Dept. St. Francis River, Helena, Ark.

Book mark:

D

5 Cav. U.S.C.T.

J. A. DeLa

1st Lt., Co. C., 5 Reg't U. S. Col'd Cavalry.

Appears on Co. Muster-out Roll, dated

Helena Ark, Mch 16, 1866.

Muster-out to date

Mch 16, 1866.

Last paid to

Jan 31, 1866.

Clothing account:

Last settled....., 186 ; drawn since \$..... 100

Due soldier \$..... 100; due U. S. \$..... 100

Am't for cloth'g in kind or money adv'd \$..... 100

Due U. S. for arms, equipments, &c., \$..... 100

Bounty paid \$..... 100; due \$..... 100

Remarks: *Originally joined service in 12th U.S. Cav at Hillsboro, O. Oct 21, 1863. Appointed 1st Lt 5th U.S. Cav June 6, 1865.*

Stop. for Rations furnished in kind \$53.15.

Book mark:

Rose

Det. Samuel A.

Sear, Co. *5* Reg't *Ufcar.*

H Enclosures.

Bed Cards	Final Statements
Burial Records	Furloughs or L. of A.
Certs. of Dis. for Discharge	Med. Certificates
C. M. Charges	Med. Des. Lists
Descriptive Lists	Orders <i>2</i>
Discharge Certificates	Pris. of War Record
Enlistment Papers	Resignations

Other papers relating to—

Admission to Hosp'l	Furlough or L. of A. <i>/</i>
Casualty Sheet	Med. Examination
Confinement	Misc. Information <i>)</i>
Contracts	Pay or Clothing
Death or Effects	Personal Reports
Desertion	Rank
Discharge from Hosp'l	Transfer to Hosp'l
Discharge from Service	Transfer to V. R. C.
Duty	Transportation
.....

Special Order No 75

Head in Dept of War
of U.S.A.

July 18. 1865

Ordering Lt Dela to report
to Regt —

J. W. V. C. C.

Head-Quarters Department of Kentucky,

OFFICE ORGANIZATION U. S. TROOPS,

Louisville, Kentucky,

July 12th 1865.

Special Orders,)

No. 73.)

1

1st Lt. Daniel A. Peta 5th Regt. U.S. Col

having reported at this Head Quarters in obedience to
order will proceed without delay to Paris Ky. relative on his
arrival to the Commanding Officer of his Regt for duty.

The S. M. Dept will furnish necessary transportation

July 10th 1865
1st Lt. Daniel A. Peta
5th Regt. U.S. Col

By Command of Brig. Gen. JAS. S. BRISBIN,
Superintendent Organization U. S. Troops.

Act. Ass't Adj. General.

Camp Bushin Ky

20 Oct. 1865

G. # 276. - Vol 2. - D. K. - 1865

De la. Samuel a

1st Lt Co C. 5th Cav

Request a leave of absence

for four days for the

purpose of visiting Hillsdale

this

Head Quarters 5th Cav

Camp Bushin Ky

26 Oct. 1865

Approved and respectfully
forwarded.

Henry D. Waddell

Major 5th Cav

Comd Regt

Wm. H. ...
General ... Oct. 31/65

Respectfully forwarded.

J. H. ...
Comd ...

1st Lt ...
Louisville Oct 31/65

Respectfully forwarded.
Approved.

John ...
Prov. ...
Comd ...

O. O. 220.2

Recd, DK-10-31/65

Camp Bristol Ky
October 26 1863-

Sir,

I have the honor to ask for a leave of absence of four (4) days to visit my family at Hillsboro Ohio. I have been in the U. S. Service since October 1863, and have never had a Furlough or leave of absence. There are at present two officers with my company, the captain and myself.

Very respectfully

Your obedient servant

S. A. DeLa

1st Lt Co C 5th W. I. C. C.

Wd Ho Dept of Hy.

Louisville Ky Nov 1. 1865

Special Order No 220

Leave of absence for S. J. A.
Det. 5th Inf C. Cav.

For H. Ho. No. 11. 1865

Affidavit of Nonindebtedness to U. S.,

of Samuel C. De La

late 1st Lieut. Co. "B" 5th Reg't

U. S. Col'd. Cav. on which was
based Certificate of Nonindebtedness
to U. S.,

Dated March 17th 1866.

STATE OF

Missouri
COUNTY *Phillips* } ss.

late 1st Lt. Co "C"

I,

David A. Le La
5th Regiment U. S. Col & Cavalry

do solemnly declare on oath, that I have duly accounted for all Public Property, for which I have ever been responsible as an Officer of the Volunteer Forces of the United States: that I have rendered all returns and reports, required by Revised Army Regulations of 1863 and existing orders; that I am not now, on any account whatever, indebted to the General Government except as stated on Muster-out Rolls.

David A. Le La

1st Lt. Co "C" 5th Regt. Cavalry

Sworn and subscribed before me, at *Neuman Ark*

this 17th day of March 1866

W. J. Myers

Cap & Comdr. Muster
Capt of *Missouri*

346
Demar, Washington

Co D, 5 U. S. Col'd Cav.

Private

Private

CARD NUMBERS.

1	5-360856	26
2	5-360952	27
3	5-361042	28
4	5-361129	29
5	5-361218	30
6	5-361308	31
7	5-361392	32
8	5-361474	33
9	5-361556	34
10	9090106	35
11	43148519	36
12	40729678	37
13		38
14		39
15		40
16		41
17		42
18		43
19		44
20		45
21		46
22		47
23		48
24		49
25		50

Book Mark:

See also

20 | 5 Cav. | U.S.C.T.

Washington Warner

Co. B, 5 Reg't U. S. Col'd Cav.

Appears on

Company Descriptive Book

of the organization named above.

DESCRIPTION.

Age 18 years; height 5 feet 10 inches.

Complexion Blk

Eyes Blk; hair Blk

Where born Franklin Co. Ky

Occupation Laborer

ENLISTMENT.

When Oct 20, 1864.

Where Lexington Ky

By whom Capt Moore; term 3 y'rs.

Remarks:

Warner

D.

5600

US 65

Washington Demas

Appears with rank of Private on

Muster and Descriptive Roll

of Detachment of U.S. Enlisted Colored
Volunteers Forwarded

Roll dated
Lexington, Ky, Oct. 22, 1864.

Where born Franklin Co., Ky

Age 18 years; occupation Laborer

When enlisted Oct. 20, 1864.

Where enlisted Lexington, Ky

For what period enlisted 3 years.

Eyes Grey; hair Black

Complexion Mulatto; height 5 ft. 10 in.

When mustered in _____, 186 .

Where mustered in _____

Bounty paid \$ _____ 100; due \$ _____ 100

Clothing account:

Last settled _____, 186 ; drawn since \$ _____ 100

Date of first muster Oct. 20, 1864.

Company to which assigned _____

Remarks: Credit Franklin Co.

7 Dist. Ky.

Book mark: _____

E. J. Harris

(356m)

Copyist.

D

5 Cav.

U.S.C.T.

Washington Demar

Fair, Co. B, 5 Reg't U. S. Col'd Cavalry.

Appears on

Company Muster Roll

for Nov & Dec, 1864.

Present or absent Present

Stoppage, \$ 100 for

Due Gov't, \$ 100 for

Valuation of horse, \$ 100

Valuation of horse equipments, \$ 100

Remarks: 1st & 2nd instalments

bounty due

Due U. S. for Ordnance⁺

(Enrolled Oct 20 9 m.i.
Oct 22-1864 at Lexington
Ky for 3 years)
Roll taken

Book mark:

Lauch

D

5 Cav.

U.S.C.T.

Washington Demare

Pris, Co. B, 5 Reg't U. S. Col'd Cavalry.

Appears on

Company Muster Roll

for Jan & Feb, 1865.

Present or absent Present

Stoppage, \$ 100 for

Due Gov't, \$ 100 for

Valuation of horse, \$ 100

Valuation of horse equipments, \$ 100

Remarks: 1st instalment
bounty \$100 due

Book mark:

Luce

(358)

Copyist.

D

5 Cav. U.S.C.T.

Washington Demas
Pier, Co. B, 5 Reg't U. S. Col'd Cavalry.

Appears on

Company Muster Roll

for Feb 28 to Apr, 1865.

Present or absent Present

Stoppage, \$ 100 for

Due Gov't, \$ 100 for

Valuation of horse, \$ 100

Valuation of horse equipments, \$ 100

Remarks: 1st instalment
bounty due \$100

Book mark:

Lamb

A

5 Cav.

U.S.C.T.

Washington Dumar

Priv., Co. B, 5 Reg't U. S. Col'd Cavalry,

Appears on

Company Muster Roll

for *May & June, 1865*.

Present or absent *present*

Stoppage, \$ *100* for

Due Gov't, \$ *100* for

Valuation of horse, \$ *100*

Valuation of horse equipments, \$ *100*

Remarks: *1st Installment
county due \$100*

Book mark:

R. E. Wilson

D | **5 Cav.** | **U.S.C.T.**

Washington Drumer
Priv., Co. B, 5 Reg't U. S. Col'd Cavalry.

Appears on

Company Muster Roll

for *July & Aug.*, 186*5*.

Present or absent *present*

Stoppage, \$ *100* for

Due Gov't, \$ *100* for

Valuation of horse, \$ *100*

Valuation of horse equipments, \$ *100*

Remarks:

Book mark: -----

R. C. Wilson

D

5 Cav. U.S.C.T.

Washington Demar

Co., Co. B, 5 Reg't U. S. Col'd Cavalry.

Appears on

Company Muster Roll

for *Sept & Octo.*, 186*5*.

Present or absent *Absent*

Stoppage, \$ *100* for

Due Gov't, \$ *100* for

Valuation of horse, \$ *100*

Valuation of horse equipments, \$ *100*

Remarks: *Detached service at
London, Ky. pr. A.O. No. 167 H.Q.
Camp Nelson, Ky.*

Book mark:

R. E. Wilson

A | **5 Cav. U.S.C.T.**

Washington Orman

Priv., Co. B, 5 Reg't U. S. Col'd Cavalry.

Appears on

Company Muster Roll

for *Nov. & Dec.*, 186*5*.

Present or absent *present*

Stoppage, \$ *100* for

Due Gov't, \$ *100* for

Valuation of horse, \$ *100*

Valuation of horse equipments, \$ *100*

Remarks:

Book mark: -----

J. L. ...

Q

5 Cav.

U.S.C.T.

Washington

Demas

14

, Co. B, 5 Reg't U. S. Col'd Cavalry.

Appears on

Company Muster Roll

for *Jan, Feb*, 186*6*.

Present or absent *Present*

Stoppage, \$ *100* for

Due Gov't, \$ *100* for

Valuation of horse, \$ *100*

Valuation of horse equipments, \$ *100*

Remarks:

Book mark:

(358)

W. J. ...

Copyist.

D. | 5 Cav. | U.S.C.T.

Washington Demar.

Pvt., Co. B, 5 Reg't U. S. Colored Cav.

Appears on Returns as follows:

Oct. 1865. Absent, detached service,
London, Ky.

Book mark :

(546)

H. Baber,
Copyist.

9

5 Cav.

U.S.C.T.

Washington D.C.

1st, Co. B, 5 Reg't U. S. Col'd Cavalry.

Appears on Co. Muster-out Roll, dated

October 1st, 1866.

Muster-out to date

Nov 1st 1866.

Last paid to

Dec 31, 1866.

Clothing account:

Last settled....., 186 ; drawn since \$ 100

Due soldier \$ 100; due U. S. \$ 1 87 / 100

Am't for cloth'g in kind or money adv'd \$ 100

Due U. S. for arms, equipments, &c., \$ 100

Bounty paid \$ 100 100; due \$ 100

Remarks: Free Apr 19, 1861

Book mark: 1791. 1852

(361)

W. J. ...

Copyist.

34
Donney, Benjamin

Co M, 5 U. S. Col'd Cav.

Private

Private

CARD NUMBERS.

5370836	26
5370921	27
5371031	28
5371116	29
5371201	30
5371287	31
5371371	32
5371458	33
5371543	34
5371629	35
5371712	36
9891269	37
40729697	38
	39
	40
	41
	42
	43
	44
	45
	46
	47
	48
	49
	50

Book Mark:

See also

19 | 5-leaf | U.S.C.T.

Benjamin Denny

, Co M, 5-Reg't U. S. Col'd leaf

Appears on

Company Descriptive Book

of the organization named above.

DESCRIPTION.

Age 26 years; height 5 feet 8 inches.

Complexion Black

Eyes Blue; hair Black

Where born Gerard Ky

Occupation Farmer

ENLISTMENT.

When Aug 29, 1864.

Where Camp Nelson

By whom J. C. Randolph, term 3 y'rs.

Remarks:

A. J. Anderson

(383g)

Copyist.

Benjamin Denney
....., Co. *M*, 5 Reg't U. S. Col'd Cavalry.

Appears on

Company Muster-in and Descriptive Roll

of the organization named above. Roll dated

Camp Nelson, N.Y., Oct. 30, 186*4*.

Where born *Warrenton, Ky.*

Age *26* y'rs; occupation *Farmers*

When enlisted *Aug. 29*, 186*4*.

Where enlisted *Camp Nelson, Ky.*

For what period enlisted *3* years.

Eyes *Black*; hair *Black*

Complexion *Black*; height *5* ft. *8* in.

When mustered in *Aug. 30*, 186*4*.

Where mustered in *Camp Nelson, Ky.*

Bounty paid \$ *100*; due \$ *100*

Where credited *Warrenton, Ky.*

Company to which assigned

Remarks: *George Denney*

** appeared in name of owner
of horse named [unclear]*

Book mark:

H. S. Thompson
(356d) Copyist.

9

5 Cav. | U.S.C.T.

Benjamin Gurney
Capt, Co. M, 5 Reg't U. S. Col'd Cavalry.

Appears on

Company Muster Roll

for *to Oct 31*, 186*4*.

Present or absent *Absent*

Stoppage, \$ *100* for

Due Gov't, \$ *100* for

Valuation of horse, \$ *100*

Valuation of horse equipments, \$ *100*

Remarks: *On detached service
at Miller, Texas, Oct 13/64*

Book mark:

W. L. Thompson

(358)

Copyist.

2

5 Cav. | U.S.C.T.

Benjamin Daniels
Co. M, 5 Reg't U. S. Col'd Cavalry.

Appears on

Company Muster Roll

for *Nov 8 Dec*, 1864.

Present or absent *Absent*

Stoppage, \$ 100 for

Due Gov't, \$ 100 for

Valuation of horse, \$ 100

Valuation of horse equipments, \$ 100

Remarks: *Was detached from
at Washburn Mass. Oct. 4 1864
1st Reg't U.S. Cavalry
by order of
Genl. Ave.*

Book mark:

M. S. Thompson

D

5 Cav. U.S.C.T.

Benjamin Denny
Capt. V., Co. M, 5 Reg't U. S. Col'd Cavalry.

Appears on

Company Muster Roll

for *Jan. & Feb.*, 1865.

Present or absent *Absent*

Stoppage, \$ *100* for

Due Gov't, \$ *100* for

Valuation of horse, \$ *100*

Valuation of horse equipments, \$ *100*

Remarks: *1st & 2d musters
of bounty due.
In detached service
Nashville Tenn. Oct. 4/64*

Book mark:

M. J. Thompson

D

5 Cav. | U. S. C. T.

Benjamin Denning
Co. M, Co. M, 5 Reg't U. S. Col'd Cavalry.

Appears on

Company Muster Roll

for *Mar 5 Apr*, 1865.

Present or absent *Present*

Stoppage, \$ *100* for

Due Gov't, \$ *100* for

Valuation of horse, \$ *100*

Valuation of horse equipments, \$ *100*

Remarks: *1st installment*
company due \$100

Book mark:

(358)

W. S. Thompson

Copyist.

D

5 Cav. U.S.C.T.

Benjamin Denny

Private, Co. M, 5 Reg't U. S. Col'd Cavalry.

Appears on

Company Muster Roll

for May & June, 1865.

Present or absent Present

Stoppage, \$ 100 for

Due Gov't, \$ 100 for

Valuation of horse, \$ 100

Valuation of horse equipments, \$ 100

Remarks: 1st Enlistment bounty due \$ 100.

Book mark:

C. W. [Signature]
Copist.

(358)

D

5 Cav. U.S.C.T.

Benjamin Denny
No. , Co. M, 5 Reg't U. S. Col'd Cavalry.

Appears on

Company Muster Roll

for July & Aug, 1865.

Present or absent Present

Stoppage, \$ 100 for

Due Gov't, \$ 100 for

Valuation of horse, \$ 100

Valuation of horse equipments, \$ 100

Remarks:

[Empty lines for remarks]

Book mark:

[Empty line for book mark]

Cutter
Copyist.

J

5 Cav. U.S.C.T.

Benjamin Deane

No., Co. M, 5 Reg't U. S. Col'd Cavalry.

Appears on

Company Muster Roll

for *Sept & Oct*, 186 *J.*

Present or absent *Present*

Stoppage, \$ *100* for

Due Gov't, \$ *100* for

Valuation of horse, \$ *100*

Valuation of horse equipments, \$ *100*

Remarks: *Due Mt for Camp & Quarters # 155*

Book mark:

C. W. C.
Copyist.

D

5 Cav. | U.S.C.T.

Benjamin Denny
No. _____, Co. M, 5 Reg't U. S. Col'd Cavalry.

Appears on

Company Muster Roll

for *Nov & Dec*, 186 *J.*

Present or absent *Present*

Stoppage, \$ _____ *100* for _____

Due Gov't, \$ _____ *100* for _____

Valuation of horse, \$ _____ *100*

Valuation of horse equipments, \$ _____ *100*

Remarks: _____

Book mark: _____

(358)

Cutter
Copyist.

Q

5 Cav. | U.S.C.T.

Benjamin Denney

Co, Co. M, 5 Reg't U. S. Col'd Cavalry.

Appears on

Company Muster Roll

for *January & July*, 1866.

Present or absent *Present*

Stoppage, \$ 100 for

Due Gov't, \$ 100 for

Valuation of horse, \$ 100

Valuation of horse equipments, \$ 100

Remarks:

Book mark: -----

Denney

(358)

Copyist.

10 | 5 Cav. | U.S.C.T.

Benjamin Denny.

Priv., Co. M, 5 Reg't U. S. Colored Cav.

Appears on Returns as follows:

Oct. to Dec. 1864. Absent on detail service Oct. 4/64, Nashville, Tenn.

Jan. & Feb. 1865. Absent at Camp Nelson. Dismounted.

Mar. 1865. Absent, det. at Camp Nelson.

Book mark :

(546)

J. Baker
Copyist.

10

5 Cav.

U.S.C.T.

Benjamin Henry

Plt, Co. M, 5 Reg't U. S. Col'd Cavalry.

Appears on Co. Muster-out Roll, dated

Helena Ark, Mar 16, 1866.

Muster-out to date

Mar 16, 1866.

Last paid to

Dec 31, 1865.

Clothing account:

Last settled....., 186 ; drawn since \$..... 100

Due soldier \$..... 100; due U. S. \$ 51 ³⁴/₁₀₀

Am't for cloth'g in kind or money adv'd \$..... 100

Due U. S. for arms, equipments, &c., \$..... 100

Bounty paid \$ 100 100; due \$ 100 100

Remarks: Slave Apr. 19. 66

Book mark: 217. S. 6

(361)

Styus

Copyist.

Denney, Benj.

Pvt. Co. M,

5 Reg't U.S.C. Cav.

1 Enclosures.

Bed Cards	Descriptive Lists
Burial Records	Final Statements
Certs. of Dis. for Discharge	Furloughs
C. M. Charges	Med. Des. Lists
Med. Certificates	Orders

Other papers relating to—

Admission to Hosp'l	Furlough
Casualty Sheet (Officer's)	Med. Examination
Confinement	Misc. Information /
Contracts	Pay or Clothing
Death or Effects	Personal Reports
Desertions	Rank
Discharge from Hosp'l	Transfer to Hosp'l
Discharge from Service	Transfer to V. R. C.
Duty	Transportation

War Department,
ADJUTANT GENERAL'S OFFICE,

Washington, Dec 29 1866.

Respectfully returned to the
Commission for the State of
Kentucky, with the informa-
tion that Benjamin "Dennis"
was enlisted at Camp Nelson Ky
August 29 1864. and was
mustered in as a priv. in Co.
"76" 5th U.S. Col. Cav. Aug 30. 64.
18227

A. Pyronville
A. A. S.

H. B. V.

No. 217

APPLICATION OF

George Dennis

OF

Warrenton Ky

FOR COMPENSATION FOR SLAVE,

Named Benj Dennis

Enlisted Aug 29 1864

In Com. 76, 5th Regiment,
cavalry

U. S. COLORED TROOPS.

Received Dec 18, 1866

Compensation Awarded

....., 1866

..... Dollars.

President of Board of Claims.

Claimant's Attorney,

Claimant's Post-office Address,

Paris Ky

Warrenton Ky

No.

CLAIM OF

George Denny

FOR THE COMPENSATION OF SLAVE NAMED

Benjamin Dennis

I, George Denny a loyal citizen, and a resident of _____,
 County of Warrard, State of Kentucky, hereby claim compensation, under
 the provisions of Section 24, act approved February 24, 1864, and section 2, act approved July, 28,
 1866, for my slave Benj Dennis, enlisted August 29th,
 1864, at Camp Nelson Ky, by J. H. Randolph
 in the Fifth Cavalry Regiment U. S. Colored Troops, Co. M; certificate of
 which enlistment, and a descriptive list, as required, accompany this application. That I did not ac-
 quire said slave subsequent to said enlistment, but had a valid title to him at the date of said enlist-
 ment, and previous thereto: I having acquired my title to him and my ownership over him as fol-
 lows, to-wit: By purchase from Samuel Campbell of
Madison County Ky about the year 1845
and a slave for life

In proof of my loyalty to the Constitution and Government of the United States, I present the ac-
 companying oath, which I have taken, signed and acknowledged; to be filed with this application, in
 accordance with requirement of General Orders, No. 329, 1863, War Department, Adjutant General's
 Office.

Geo. Denny

Dec 11 1866

OATH OF ALLEGIANCE.

I, Geo. Denny, the owner and Claimant, do solemnly swear that
 the foregoing claim is a just and true claim due to me as master and owner of the said slave, and that
 the facts alleged in said claim in respect to the draft or enlistment (as the case may be) of said slave
 into the Military service of the United States are true. And I do further swear that I have never
 joined, or been concerned in, any insurrection or rebellion; that I have never borne arms against the
 United States; that I have never given any aid, countenance, counsel or encouragement to any person
 or persons engaged, or whom I had reason to believe were about to engage, in insurrection, rebellion
 or armed hostility against the United States; that I have neither sought, nor accepted, nor attempted
 to exercise the functions of any office, civil or military, nor to perform any service whatever, under
 any authority or pretended authority in hostility to the United States; that I have not yielded a vol-
 untary support to any insurrection, rebellion or pretended government, authority, power or constitution
 within the United States hostile thereto. And I do further swear that, to the best of my knowledge
 and ability, I have supported and defended, and will continue to support and defend, the United
 States against all enemies, foreign and domestic; and that I have supported, defended and obeyed, and
 will continue to support, defend and obey, the Constitution and laws of the United States; that I will
 bear true faith and allegiance to the same; and that I take this oath freely, without any mental reserva-
 tion or purpose of evasion: So help me God.

Geo. Denny

Sworn to and subscribed before me, at Office in Lancaster Ky
 this 17th day of Dec, 1866.

W. H. Whinnick
Jarrard County, Ky



Headquarters Kentucky Volunteers,

Adjutant-General's Office,

Frankfort, Dec 13, 1866.

I hereby certify, that it appears from the U. S. Muster-Dr
Rolls on file in this Office, that Bey Rennie
was enrolled on the 29 day of Augt, 1864, at
Camp Nelson Ky, by J. B. Randolph,
and mustered into the U. S. service on the 30 day of Augt,
1864, at Camp Nelson Ky, by Capt J. Kinney,
to serve three years. Said Bey Rennie
is described as follows: Age, 26 years; eyes, Black; hair, Black
complexion, Black; height, 5 feet 8 inches. It further
appears from said Rolls, that Bey Rennie owed service
to Geo Rennie, was credited to Garrard
County, Ky., and was assigned to Co. K, 5 Regiment
U. S. Cav

In Testimony Whereof, I have hereunto set my
hand, and affixed my Official Seal, this
13 day of Dec, 1866.

D. W. Lindsey
Adjutant General of Kentucky.

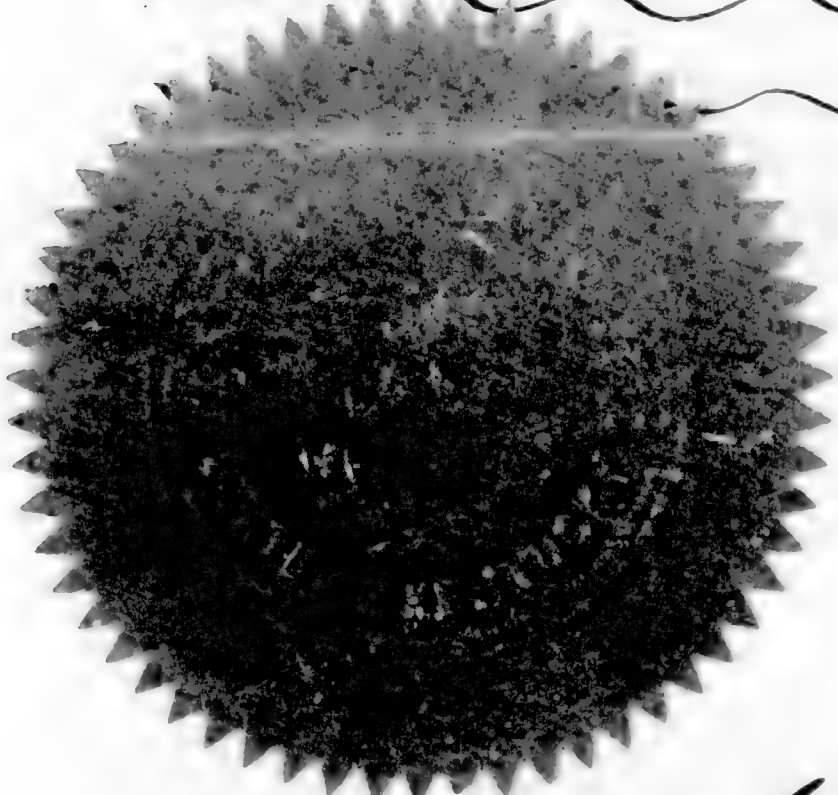

B. 216, R. 264



POWER OF ATTORNEY.

My Post-Office address is _____ County of _____ State of
Kentucky, and I hereby direct that all communications to me, touching this claim, be sent under cover
to _____ who is hereby appointed and consti-
tuted my true and lawful attorney, to prosecute this claim for me, and who is hereby authorized and
empowered to receive and receipt for any award, order, draft, certificate, voucher, warrant, papers or
money that may be issued in the adjustment of this claim, or the payment thereof, the same as I
might or could do in person were I present and acting for myself, and to file any additional evidence
or papers that may be required in the prosecution of this claim.

[WITNESS.]

The owner
signs here.

Two witnesses to
owner's signature
sign here.

50 CENT
STAMP.

PROOF OF OWNERSHIP.

STATE OF KENTUCKY.

COUNTY OF *Garrard* } SS.

We *J. W. Walker* and *J. K. Faulkner* each of lawful age, and resident citizens of the State and County aforesaid, do certify that *Geo Denny* of the State and County aforesaid, was on the *29th* day of *Aug.* 186*4*, the lawful owner of the slave named *Bery Dennie*; referred to and described in the foregoing claim for compensation.

J. W. Walker
J. K. Faulkner

Sworn to and subscribed before me a *Ch. County Court* for the County of *Garrard* State of Kentucky, this the *17th* day of *Decr* 186*6*.



H. H. ...

PROOF OF LOYALTY.

STATE OF KENTUCKY.

COUNTY OF *Garrard* } SS.

We *W. H. Kernan* and *J. K. Faulkner* loyal men and each of lawful age, and resident citizens of the *County of Garrard* in the State and County aforesaid, upon our oaths declare that we have known *Geo Denny* a resident of the State and County aforesaid, since the 4th day of March, 1861, and know that he has firmly and faithfully maintained his or her adherence and allegiance to the Government of the United States, by defending its cause against the Government and forces of the so-called Confederate States of America, in all suitable and practicable ways, and according to his or her ability and opportunity.

W. H. Kernan
J. K. Faulkner

Sworn to and subscribed before me a *Ch. County Court* for the county of *Garrard* State of Kentucky, this the *17th* day of *Decr* 186*6*.



H. H. ...

POWER OF ATTORNEY.

My Post-Office address is _____ County of _____ State of Kentucky, and I hereby direct that all communications to me, touching this claim, be sent under cover to _____, who is hereby appointed and constituted my true and lawful attorney, to prosecute this claim for me, and who is hereby authorized and empowered to receive and receipt for any award, order, draft, certificate, voucher, warrant, papers or money that may be issued in the adjustment of this claim, or the payment thereof, the same as I might or could do in person were I present and acting for myself, and to file any additional evidence or papers that may be required in the prosecution of this claim.

[WITNESS.]

The owner signs here. }

Two witnesses to owner's signature sign here. }

50 CENT STAMP.

378

De Tavernier, Frederick

Co , 5 U. S. Col'd Cav.

Major

Major

CARD NUMBERS.

1	5359198	26
2	5359574	27
3	5359514	28
4	5359565	29
5	9495-948	30
6	42608041	31
7	42608101	32
8	40729696	33
9		34
10		35
11		36
12		37
13		38
14		39
15		40
16		41
17		42
18		43
19		44
20		45
21		46
22		47
23		48
24		49
25		50

Book Mark:

See also

611049 P.O. 90
A. 1685879

L. A. Wright
Xth

15 Cav. U.S.C.T.

Friedrich de Tavernier

Major, Co. ---, 5 Reg't U. S. Col'd Cav

Appears on

Regimental Descriptive Book

(List of Commissioned Officers)

of the regiment named above.

Rank Major

Date of appointment May 7 1865

Remarks: Mustered May 1st 1865, Louisville Ky. by capt. J. H. Smith.

Enrolled by President at Louisville Ky May 6/65, for 3 yrs.

Discharged per S.O. 481 War Dept Washington D.C. Sept 4, 1865. and relieved from duty per R.O. 154 Sept. 19, 1865.

Hear

T | *5 Cav.* | **U.S.C.T.**

Frederick de Lavernier

Major, Co., *5* Reg't U. S. Col'd *Cav*

Age *29* years.

Appears on an

Individual Muster-in Roll

of the organization named above. Roll dated

Louisville Ky, *May 17*, 1865.

Muster-in to date *May 8*, 1865.

Joined for duty and enrolled :

When *May 8*, 1865.

Where *Louisville Ky*

Period *3* years.

Valuation of horse, \$ *100*

Valuation of horse equipments, \$ *100*

Remarks : *This muster to
take effect May 8
1865*

Book mark :

Lavernier

D | 5 Cav.

U.S.C.T.

Frederick de Tarnovian

Rank *Major*, 5 Reg't U. S. Col'd *Cav*

Appears on

Field and Staff Muster Roll

for *May + June* 186*5*.

Present or absent *absent*

Stoppage, \$ *100* for

Due Gov't, \$ *100* for

Valuation of horse, \$ *100*

Valuation of horse equipments, \$ *100*

Remarks: *Comdy Post per
C. 174 P. D. of Reg. 28
June 1865*

Book mark:

[Signature]

1 | 4 Car | **U.S.C.T.**

F. de Turmeric

Rank *Major*, Reg't U. S. Col'd *Car*

Appears on

Field and Staff Muster Roll

for *July Aug* 186*5*.

Present or absent *Absent*

Stoppage, \$ *100* for

Due Gov't, \$ *100* for

Valuation of horse, \$ *100*

Valuation of horse equipments, \$ *100*

Remarks: *Absent sick*

Book mark:

Ed. Egan

D 15 Cav U.S.C. I
F. de Tavernier
Major 5 U.S.C. Cav

Return

of the Post of Covington and Newport, Ky.,
for the month of Aug, 1865,
dated Aug 31, 1865,
shows the following with regard to the person
named above :

Post or station

Remarks: Relieved from command
Aug 1 1865 and ordered to
report to Camp Nelson, Ky

Book mark :

J. R. Meleach
(546) Copyist.

D. | 5 Cav. | U.S.C.T.

Frederick de Tavernier.

Major, Co. _____, 5 Reg't U. S. Colored Cav.

Appears on Returns as follows:

May, 1865. Present. Mustered & assigned May 8/65.

June, 1865 & July, 1865. Absent, Comd'g Post, per S. O. 124, Hdqrs. 1st D. R. of Ky., June 28/65. Covington.

Aug. 1865. Absent sick. Lexington.

Sept. 1865. Resigned. Resignation accepted and discharge ordered per S. O. 481, War Dept., Washington, D. C., Sept. 7/65. Relieved from duty R. O. 154, Sept. 19/65.

Book mark :

(540)

J. Baker,
Copyist.

5 Cav | **U.S.C.T.**

Fred de Tavernier

Rank *Major*, 5 Reg't U. S. Col'd *Cav*

Appears on a

Field and Staff Muster-out Roll

of the organization named above. Roll dated *Helena, Ark. Mar 16, 1865*.

Muster-out to date _____, 186 .

Last paid to _____, 186 .

Clothing account:

Last settled _____, 186 ; drawn since \$ _____ 100

Due soldier \$ _____ 100; due U. S. \$ _____ 100

Am't for cloth'g in kind or money adv'd \$ _____ 100

Due U. S. for arms, equipments, &c., \$ _____ 100

Bounty paid \$ _____ 100; due \$ _____ 100

Remarks: *Major from 1 May 65 to Sept 19 65 when discharged per No. 481 (Cav) Sept 10. Sept 7 1865*

Book mark: _____

(360)

E. W. [Signature]

Copyist.

De Savsmier Fred. K

Capt, Co.
Major

5

Reg'

W. C. C. W.

14

Enclosures.

Bed Cards	Final Statements
Burial Records	Furloughs or L. of A.
Certs. of Dis. for Discharge	Med. Certificates 2
C. M. Charges	Med. Des. Lists
Descriptive Lists	Orders 2
Discharge Certificates	Pris. of War Record
Enlistment Papers	Resignations 1

Other papers relating to—

Admission to Hosp'l	Furlough or L. of A.
Casualty Sheet	Med. Examination
Confinement	Misc. Information 3
Contracts	Pay or Clothing
Death or Effects	Personal Reports
Desertion	Rank 1
Discharge from Hosp'l	Transfer to Hosp'l
Discharge from Service	Transfer to V. R. C.
Duty 1	Transportation

MICROFILM PUBLICATION M 1821

COMPILED MILITARY SERVICE RECORDS
OF VOLUNTEER UNION SOLDIERS WHO
SERVED WITH THE USCT (US COLORED TROOPS)
5TH REGIMENT OF CAVALRY

PERSONAL PAPERS' TARGET SHEET

PLEASE NOTE THE CHECKED INFORMATION ABOUT THE PERSONAL PAPERS IN
THIS FILE:

- NO PERSONAL PAPERS WERE FOUND IN THIS FILE WHEN THE
RECORDS WERE ARRANGED FOR MICROFILMING.
- 15 PERSONAL PAPER(S) FOUND IN THIS FILE WHEN THE RECORDS
WERE ARRANGED FOR MICROFILMING.

Special Order 33

Warrenton Ore

May 8. 1865

Thomas

May 8

Appointement of J. de Laverne
Capt. 1st Ill. Vol. in to be
Major 3rd Ill. C.

Louisville Ky.
May 8th 1865.

Special Orders
No. 33.

Extract.

III * * * The following promotions and appointments to fill original vacancies in U. S. Colored Troops are announced. The enlisted men will be discharged from their present service on being mustered into the colored organization:

1st U. S. Colored Cavalry.
Capt. Frederick de Javernier, 16th Illinois Cavalry to be Major.

By order of the Secretary of War
Official copy / sig: J. C. S. Thomas
/ sig: J. Bates Siskson, Adjutant General.
Capt^g A. S. G.

E. A. Parker
Col. 33 U. S. Colored Troops

20 No 86

Major F S Sanner

520 fcs

Headquarters

Paris Reg. May 23. 1865

Order

No. 863

Extract

11. Major J. de Tavernier 5th Regt. Col. Cav. having reported for duty with his Regiment, is directed to inspect the companies of the 5th Regt. Col. Cav. now stationed on the line of the Reg. Central Railroad, at least once every two weeks.

He will examine in these inspections the condition of the arms, clothing and general appearance of the troops and will call the attention of the commanding Officer to such alterations and improvements as may be necessary from time to time.

Major de Tavernier will establish his quarters at Paris Reg. until further orders.

By order of

L. Henry Carpenter

L. Col. Sup. C. Comd.

C. J. Carpenter

1st Lt. J. H. H.

Special Order 174

Mr. Wm. 1st & Wm. 2^d
Lexington June 28. 1863

Detail for May 7 de Tennesse
3rd U.S. Cav

Head-Quarters 1st Division, Department of Kentucky,

Lexington, Kentucky, June 28 1865.

Special Orders, }

No. 124 }

(Extract.)

* * * * *

I. Maj. G. DeGavernier ^{5th} U.S.C. is hereby detached from his regt. and will assume command of Post of Lexington & Newport Ky. Col Duncan on being relieved will report to Camp Nelson Ky to take command of his regt. 72^d U.S.C.

* * * * *

* * * * *

By Command of Brigadier General ^{Wade} ~~J. H. HOBSON~~ :

M. M. Andrews
Lieut & actg Assistant Adjutant General.

1st Lt. W. H. H. H.
Paris Ky

Fredrick de Tavernier was mustered in as Major
5th Regt U.S.C. Cavalry May 8. 1865. On Return of
that Regt for the month of July 1865. he is reported
present for duty.

Strength

Com. Co 38

S. J. Officer

Enlisted 1048

Special Order 157

Hd Qrs 1 Div. V. Inf.

Let My 28 July 1865.

Ordering My Quartermaster to
report to Regt for duty

F. V. C. C.

Head-Quarters First Division, Department of Kentucky.

Lexington, Kentucky, July 28th 1865.

Special Orders, }
No. 157 }

(Extract.)

* * * * *
Major G. De Gavemier 5th Ill
S. C. Co. is hereby relieved of the command
of the Post of Covington & Newport Ky. and
will report to the Comd'g Officer of his Reg't.
for duty.

* * * * *
By Command of Brigadier General *J. G. Wade*
E. H. HOBSON:

N. R. Gonster

Captain and Acting Assistant Adjutant General.

40

U. S. G. O.

No 112-11-11-2-1-65
Q 54 C. S. M. (under) 1865

124 7/12/65
Fredrik de Savornier
Major 5th U.S. I. Cav.

Sends his Resignation
based on Surgeons Certi-
ficate of disability -
herein inclosed. -

Original

Head Quarters 5th U.S. Cav.
Lexington Kentucky
Aug 21st 1865

Respectfully forwarded
approved and recom-
mended.

Henry M. Riddle,
Major 5th U.S. Cav.
Comd. Regt.

Head Quarters 5th U.S. Cav.
Lexington Ky August 21st 1865

Respectfully forwarded
Approved

C. H. Johnson
Princ. Secy
Head Quarters

Head Quarters Dept of War
Washington D.C. Aug 23rd 1865

Respectfully forwarded to
Gen. G. B. Gordon
Commanding
5th U.S. Cavalry

Gen. W. G. Sullivan
Adj. Gen.

Note: Vide Op. or
No 481 of Sept 2nd
1865. as approved

Recd at Dept of War
Washington D.C.

Head Quarters Dept of War
Office of the Secy of War
Washington D.C. Aug 24. 65

Respectfully returned to Genl
B. H. Sullivan, Adj. Gen. Dept
of War, approved and it is
strongly recommended that this
Officers resignation be accepted
for the good of the service, as he
is not a valuable officer.

J. A. J. Bristow
P. C. Howard Smith
Capt 4th U.S. Inf.

Done

Lexington Ky, August 21st 1865

Adjutant General
U. S. Army

Sir

The War being over I desire
to return to my native Country (Prussia) which I left 3½ years
ago, in order to participate in the great struggle, now ended,
and therefore respectfully tender my Resignation as a Major
in the 5th U. S. C. Cavalry. - I am sick, moreover, and
unfit for further Military duty, as the annexed Surgeons
Certificate shows, - and being anxious to go through a
thorough Medical treatment in one of the Water-Cure-
Establishment of the Northern Lake-shores, - I beg, that my
Resignation might be speedily accepted. -

I certify that I am not indebted or responsible to the United-
States for any property except which am prepared to turn over
to the proper Authority.

I am Sir most respectfully

Your obedient servant

Fr. deFavermis
Major 5th U. S. Col. Cavalry.

D 1321 777 2 1/16

6-182-510-Vol-2-1862

Head Qrs 1st Div Dept of W

Exington Va Aug 21/5

Approved and respectfully
forwarded - Maj de Garnier's

health is so bad that he is
entirely unfit for service.

He was under my charge
for some weeks last winter,

and is still suffering greatly

Wm. M. Mearns

Surgeon U. S. A.

Chief Surg 1st Div Dept of W

Head Quarters Medical Dept 5th U. S. C. C.

Lexington Ky August 21st 1863

Frederick de Gavernier Major 5th U. S. Cavalry
having applied for a certificate upon which to ground
an application for ~~discharge~~ ^{resignation} I do hereby certify that
I have carefully examined this Officer and find
that he has been suffering for some time with a
low fever of an intermittent type, and that he
is troubled upon slight exposure to changes of the
weather to severe rheumatic pains of the joints
his system is at present somewhat debilitated, so
that in my opinion he is incapacitated for
further ^{active} service in the Cavalry Service.

L. W. Bowen
Surgeon 5th U. S. C. C.

Captain!

You would greatly oblige me, if you had my application ready for tomorrow morning's mail. - Should it be granted at Louisville, it would be here by Monday night ~~off~~ Thursday morning; as Capt. H. H. H. has provided me the utmost dispatch in this case. I am going to Camp Nelson tomorrow morning and shall be back Monday night, when I will call personally on you and see whether my papers have returned from Louisville.

Your obedient servant

F. D. S.
Major 5th U.S. C. Cavalry.

Hd. Qtrs 1st Division Depot Ky
Leavington Ky Sept. 8th 1865

Approved and respectfully
forwarded.

Wm. McCreew Surg 6010

Chie Surg 15th Bri Sept 19

Office Post Surgeon
Lexington Ky
Sept 24 1863

Major Fred. de Favermier U.S.
Having applied for a
Certificate on which to ground
an application for leave of absence
I hereby certify that I have carefully
examined said officer and find him
suffering from Chronic inflammatory
Rheumatism with Swellings of several
joints. The necessary treatment in his
Case can not be furnished at this
Place Sulphur-on Russian Steam-
baths being chiefly required, & therefore
recommended a change of Place as
necessary to prevent the permanent
disability of said Officer, and Certify
that his health could not be restored
in less than twenty days

Ed. A. Pryce,
Post Surgeon
Lexington Ky

Approved
at J. J. J. J.
Med. Dir.

0

De Trossart, Fred.

Maj. v. U. S. A. Cav.

E

SPECIAL ORDERS,
No. 481.

WAR DEPARTMENT,
ADJUTANT GENERAL'S OFFICE,
Washington, September 7th, 1865.

(Extract.)

* * * * *

27. Major *Frederick De Tavernier*, 5th U. S. Colored Cavalry, having tendered his resignation, is hereby honorably discharged the service of the United States, on account of physical disability, with condition that he shall receive no final payments, until he has satisfied the Pay Department that he is not indebted to the Government.

* * * * *

By order of the Secretary of War:

E. D. TOWNSEND,

Assistant Adjutant General.

OFFICIAL:

Assistant Adjutant General.

Colonel Foster

SPECIAL ORDERS, }
No. 481. }

WAR DEPARTMENT,
ADJUTANT GENERAL'S OFFICE,
Washington, September 7th, 1865.

(Extract.)

* * * * *
✓ 27. Major *Frederick De Tavernier*, 5th U. S. Colored Cavalry, having
tendered his resignation, is hereby honorably discharged the service of
the United States, on account of physical disability, with condition that
he shall receive no final payments, until he has satisfied the Pay Depart-
ment that he is not indebted to the Government.

* * * * *
By order of the Secretary of War:

E. D. TOWNSEND,

Assistant Adjutant General.

OFFICIAL:

Assistant Adjutant General.

Colonel Foster

Genl

Sept. 7. 1865-

J. de Looemier
Mag. 5. H. S. C. C.
under "D"

Ky & Cairo. Ills
Lewer

(2)
Sept. 7, 1865

Dr. deTavernier
Major 5th U.S. Cal. Cavalry.

Applies for 20 days leave of absence
on Surgeon's Certificate of Disease.

B. C. ...

4d 2nd Div Dept of Ky
Lexington Ky
Sept 9 1865

Approved and Respectfully
forwarded

D. H. Pierson.

Col Family Dir

F. B. ... F. ... P. 44 No. 866 ... 1865.

HEAD-QUARTERS DEPARTMENT OF KENTUCKY,
MEDICAL DIRECTOR'S OFFICE,

Louisville, Ky Sept 13th 1865.

Respectfully forwarded, approved.

C. J. Phelps
Colonel U. S. Vols.,
Med. Dir. Dept of Ky.

Lexington Ky September 7th 1865

Captains E. B. Harlan
a. a. G. Dept^{mt} of Kentucky

Sir

I most respectfully
apply for a leave of absence for 20 days, founded on a
Surgeon's Certificate of sickness, to enable me to get proper
treatment in a Water-cure - Establishment in Ohio. -
I am on the Sick-Report, having tendered my Resignation
on Surgeon's Certificate of Disability; - so my presence
or absence would not be of any consequence to the
Service. -

I am Sir

Most Respectfully
Your obedient servant

J. de Tavernier
Major 5th U. S. Cavalry.

Special Order #51

War Department.

Washington D.C

Sept. 7. 1865

Discharging Maj. F. A.
Javernier 5th U.S.C. by reason
of the acceptance of his
resignation as an Officer
in the U.S. Service.

War Department, A. J. O.
Washington, Sep. 4th 1865

Special Orders
No 481 O. G. S.

27. Major Fredrick de Bavenier, 5th U. S. Cavalry
having tendered his resignation, is hereby honorably
discharged, the service of the United States, on account
of physical disability, with condition that he
shall receive no final payments, until he has
satisfied the Pay Department, that he is not
indebted to the Government.

By Order of the Secretary of War
(Signed) E. M. Hammond
Asst. Adj. Genl.

Official:
(Signed) A. R. Fowler
Capt. U. S. A.

O. A. Liden

Special Order No 179

Hd Qrs 8 Reg

Louisville Sept. 15. 65

Leave of absence for 20
days for Maj J de Taverne
O'Connell

Lord de Taverne

Maj.

Headquarters Department of Kentucky,

Louisville Ky. Sept 15th 1865.

Special Orders, }
No. 179 }

(Extract.)

* * * * *

On Surgeon's Certificate, approved by Medical Director, leave of absence is hereby granted the following named officers, for the number of days set opposite their respective names:

Maj. Fred A. Duvernier 5th
U.S. Cavalry (26) days

* * * * *

The following extracts from Regulations and General Orders, relative to leaves of absence, will be strictly observed:

"When not otherwise specified, leaves of absence will commence the day an officer is relieved from duty at his post, after receiving the order granting him leave.

"At the expiration of his leave, the officer must report in person with his command, and not at the office from which his leave issued.

"No officer is permitted to visit Washington without special permission from the Secretary of War, which must be stated in the order granting leave of absence.

"If an officer be not able to travel at the expiration of his sick leave, he must report his address to the commander of his post, regiment or corps, and also to the Adjutant General of the Army; and in his first report state the day when his leave of absence commenced. These reports must be repeated every twenty days, and each one must be accompanied by the certificate of a medical officer of the army, made in the usual form, and stating that the officer is not able to travel. If there is no army physician in the place where the officer resides, the certificate of a citizen physician, the truth of which must be sworn to before a civil magistrate, may be substituted. Extensions of leave are not granted in orders.

"Officers absent from duty without leave, or beyond the time of their leaves, will not be allowed to draw pay until a court or commission, which will be ordered on their return to their post or command, shall determine whether there was sufficient cause for their absence. They will accordingly provide themselves with a full description of the nature and cause of their disability, certified by the proper medical authority as required by existing orders and regulations."

By command of Major General

[Handwritten signature]

Chief of Staff

Assistant Adjutant General.

C. O. S. 713
C. Duvernier 1st Lieut

Devol, Adam

Co A, 5 U. S. Col'd Cav.

Sergeant

Sergeant

CARD NUMBERS.

5-366736	26
5-366838	27
5-366939	28
5-367030	29
5-367122	30
5-367214	31
5-367315	32
5-367397	33
5-367488	34
5-367578	35
5-367666	36
9090769	37
9090426	38
	39
	40
	41
	42
	43
	44
	45
	46
	47
	48
	49
	50

Book Mark:

See also

2mg Hdstone 11/19/25 WTZ

S. A. Wright
L²

9 | **5 Cav. | U.S.C.T.**

Adam Reese

Co. 16, 5 Reg't U. S. Col'd Cav.

Appears on

Company Descriptive Book
of the organization named above.

DESCRIPTION.

Age 36 years; height 5 feet 6 inches.

Complexion Blk

Eyes Blk; hair Blk

Where born North Carolina

Occupation Farmer

ENLISTMENT.

When Sept 13, 1864.

Where Camp Nelson

By whom J. C. Randolph; term 3 y'rs.

Remarks:

(383g)

A. J. Anderson

Copist.

U 5 Co | **U.S.C.T.**

Adam Devoal
Co. G 5 Reg't U. S. Col'd Cav

Appears on

Company Descriptive Book

of the organization named above.

DESCRIPTION.

Age *36* years; height *5* feet *6* inches.

Complexion *Blk*

Eyes *Blk*; hair *Blk*

Where born *North Carolina*

Occupation *Farmer*

ENLISTMENT.

When *Sep 17*, 186 *4*.

Where *Camp Nelson Ky*

By whom *H. Randolph* term *3* yrs.

Remarks:

F. E. Purke

(383g)

Compt.

D

5 Cav. U.S.C.T.

Adam Devol

Serjt, Co. H, 5 Reg't U. S. Col'd Cavalry.

Appears on

Company Muster-in and Descriptive Roll

of the organization named above. Roll dated

Camp Nelson^{Ky}, N.Y., Oct 29, 1864.

Where born N Carolina

Age 36 y'rs; occupation Farmer

When enlisted Sept 17, 1864.

Where enlisted Camp Nelson^{Ky}

For what period enlisted 3 years.

Eyes Black; hair Black

Complexion Black; height 5 ft. 6 in.

When mustered in Sept 17, 1864.

Where mustered in Camp Nelson^{Ky}

Bounty paid \$ 100; due \$ 100

Where credited

Company to which assigned

Remarks: 7th Dist Ky.

* Thomas Brantlett

* supposed to be name of owner

under May 16, 48 H of

Book mark:

Reynolds

(356d)

Copyist.

D

5 Cav. U.S.C.T.

Adam Devol

Sergt., Co. H, 5 Reg't U. S. Col'd Cavalry.

Appears on

Company Muster Roll

for from enlistment to Oct 31, 1864.

Present or absent present

Stoppage, \$ 100 for

Due Gov't, \$ 100 for

Valuation of horse, \$ 100

Valuation of horse equipments, \$ 100

Remarks: Appointed October 29th 1864

Book mark:

Reynolds

(358)

Copyist.

D

5 Cav. | U.S.C.T.

Adam Devol

Sgt, Co. H, 5 Reg't U. S. Col'd Cavalry.

Appears on

Company Muster Roll

for *Nov & Dec*, 1864.

Present or absent *present*

Stoppage, \$ *100* for

Due Gov't, \$ *100* for

Valuation of horse, \$ *100*

Valuation of horse equipments, \$ *100*

Remarks: *1st and 2^d Installment
Bounty due*

Book mark:

Reynolds

(358)

Copyist.

D | **5 Cav.** | **U.S.C.T.**

Adam Purval

2nd Supt, Co. H, 5 Reg't U. S. Col'd Cavalry.

Appears on

Company Muster Roll

for *Jan & Feb*, 186*5*.

Present or absent *present*

Stoppage, \$ *100* for

Due Gov't, \$ *100* for

Valuation of horse, \$ *100*

Valuation of horse equipments, \$ *100*

Remarks: *1st installment of
Bounty Due \$100.00*

Book mark:

Reynolds

(358)

Copyist.

D

5 Cav. U.S.C.T.

Adam Devol

Serjt, Co. H, 5 Reg't U. S. Col'd Cavalry.

Appears on

Company Muster Roll

for Mar & Apr, 1865.

Present or absent present

Stoppage, \$ 100 for

Due Gov't, \$ 100 for

Valuation of horse, \$ 100

Valuation of horse equipments, \$ 100

Remarks: 1st Installment of
Bounty Due \$100.

Book mark:

Reynolds

S. | **5 Cav.** | **U.S.C.T.**

Adam Sewell

Serg't, Co. H, 5 Reg't U. S. Col'd Cavalry.

Appears on

Company Muster Roll

for May & June, 1865.

Present or absent Present.

Stoppage, \$ 100 for

Due Gov't, \$ 100 for

Valuation of horse, \$ 100

Valuation of horse equipments, \$ 100

Remarks: 1st Installment Bounty due \$100.

Book mark: _____

B J Cooke

(358)

Copyist.

A.

5 Cav.

U.S.C.T.

Adam Devol

Serjeant, Co. H, 5 Reg't U. S. Col'd Cavalry.

Appears on

Company Muster Roll

for July & Aug., 1865.

Present or absent Present.

Stoppage, \$ 100 for

Due Gov't, \$ 100 for

Valuation of horse, \$ 100

Valuation of horse equipments, \$ 100

Remarks:

Book mark:

(358)

B. J. Cooke

Copyist.

2.

5 Cav. U.S.C.T.

Adam Sewal

2nd Sergt, Co. H, 5 Reg't U. S. Col'd Cavalry.

Appears on

Company Muster Roll

for Sept. & Oct, 1865.

Present or absent Present.

Stoppage, \$ 100 for

Due Gov't, \$ 100 for

Valuation of horse, \$ 100

Valuation of horse equipments, \$ 100

Remarks:

Book mark:

B. J. Cook Copyist.

2

5 Cav. U.S.C.T.

Adam Seurof

2^d Supt, Co. H, 5 Reg't U. S. Col'd Cavalry.

Appears on

Company Muster Roll

for Nov. 4th Dec., 1865.

Present or absent Present

Stoppage, \$ 100 for

Due Gov't, \$ 100 for

Valuation of horse, \$ 100

Valuation of horse equipments, \$ 100

Remarks:

Book mark:

B. J. Cook

(358)

Copyist.

D

5 Cav. U.S.C.T.

Adam Derrvol

Sgt, Co. H, 5 Reg't U. S. Col'd Cavalry.

Appears on

Company Muster Roll

for *Jan'y, 1866*, 1866.

Present or absent *Present*

Stoppage, \$ *100* for

Due Gov't, \$ *100* for

Valuation of horse, \$ *100*

Valuation of horse equipments, \$ *100*

Remarks:

Book mark:

J. A. Stewart

(358)

Copyist.

D

5 Cav. U.S.C.T.

Adam Dewool

Sgt., Co. A., 5 Reg't U. S. Col'd Cavalry.

Appears on Co. Muster-out Roll, dated

Helena, Ark Mar. 16 1866.

Muster-out to date

Mar. 16, 1866.

Last paid to

Dec. 31, 1865.

Clothing account:

Last settled....., 186 ; drawn since \$..... 100

Due soldier \$ 14 ⁸⁰/₁₀₀; due U. S. \$..... 100

Am't for cloth'g in kind or money adv'd \$..... 100

Due U. S. for arms, equipments, &c., \$..... ⁵⁵/₁₀₀

Bounty paid \$ 100 ¹⁰⁰/₁₀₀; due \$ 100 ¹⁰⁰/₁₀₀

Remarks: App'd. Sergt.

Sept. 17. 64.

Stop pay for Ord. 55.

Book mark :

J. Stewart

(361)

Copyist.

Deval, Adam

Pvt, Co. H, 5 Reg' US Caval

Enclosures.

Bed Cards	Descriptive Lists
Burial Records	Final Statements
Certs. of Dis. for Discharge	Furloughs
C. M. Charges	Med. Des. Lists
Med. Certificates	Orders

Other papers relating to—

Admission to Hosp'l	Furlough
Casualty Sheet (Officer's)	Med. Examination
Confinement	Misc. Information
Contracts	Pay or Clothing
Death or Effects	Personal Reports
Desertions	Rank
Discharge from Hosp'l	Transfer to Hosp'l
Discharge from Service	Transfer to V. R. C.
Duty	Transportation

War Department,
ADJUTANT GENERAL'S OFFICE.
Washington, Dec 27 1866.

Respectfully returned to the
Commission for the State of
Kentucky, with the informa-
tion that Adam Deroe
was enlisted at Camp Nelson
Ky. Sept. 17, 1864, and was
mustered in as Priv. in Co. "C."
5th U.S. Col. Cav. Sept 17, 1864.
Do 165.

A. R. Moore

W. C. G.

W. C. G.

No. 165

APPLICATION OF

Thos E Bramlette

OF

Frankfort Ky

FOR COMPENSATION FOR SLAVE,

Named Adam Deroe

Enlisted Sept 17th 1864

In Com. Co. 5th Regiment,

Cavalry
U. S. COLORED TROOPS.

Received Near 14th, 1866.

Compensation Awarded

....., 1866

..... Dollars.

President of Board of Claims.

Claimant's Attorney,

Thos E Bramlette

Frankfort Ky

Claimant's Post-office Address,

Frankfort

Kentucky

FRANKFORT COMMONWEALTH PRINT.

No.

CLAIM OF

Thomas E Bramlette

FOR THE COMPENSATION OF SLAVE NAMED

Adam Devoe

I, *Thomas E Bramlette* a loyal citizen, and a resident of *Frankfort*,
 County of *Franklin*, State of Kentucky, hereby claim compensation, under
 the provisions of Section 24, act approved February 24, 1864, and section 2, act approved July, 28,
 1866, for my slave *Adam Devoe*, enlisted *September 17th*,
 1864, at *Camp Nelson Ky*, by *J C Randolph*
 in the *Fifth* regiment U. S. Colored *Cavalry* Co. *A*; certificate of
 which enlistment, and a descriptive list, as required, accompany this application. That I did not ac-
 quire said slave subsequent to said enlistment, but had a valid title to him at the date of said enlist-
 ment, and previous thereto: I having acquired my title to him and my ownership over him as fol-
 lows, to-wit: *purchased of Lewis Devoe in 1854 to keep*
him with his wife and children at the price of \$1000.
the bill of sale now lost or mislaid so I can
not find it -

In proof of my loyalty to the Constitution and Government of the United States, I present the ac-
 companying oath, which I have taken, signed and acknowledged; to be filed with this application, in
 accordance with requirement of General Orders, No. 329, 1863, War Department, Adjutant General's
 Office.

December 13th 1866.

Thomas E Bramlette

OATH OF ALLEGIANCE.

I, *Thomas E Bramlette*, the owner and Claimant, do solemnly swear that
 the foregoing claim is a just and true claim due to me as master and owner of the said slave, and that
 the facts alleged in said claim in respect to the draft or enlistment (as the case may be) of said slave
 into the Military service of the United States are true. And I do further swear that I have never
 joined, or been concerned in, any insurrection or rebellion; that I have never borne arms against the
 United States; that I have never given any aid, countenance, counsel or encouragement to any person
 or persons engaged, or whom I had reason to believe were about to engage, in insurrection, rebellion
 or armed hostility against the United States; that I have neither sought, nor accepted, nor attempted
 to exercise the functions of any office, civil or military, nor to perform any service whatever, under
 any authority or pretended authority in hostility to the United States; that I have not yielded a vol-
 untary support to any insurrection, rebellion or pretended government, authority, power or constitution
 within the United States hostile thereto. And I do further swear that, to the best of my knowledge
 and ability, I have supported and defended, and will continue to support and defend, the United
 States against all enemies, foreign and domestic; and that I have supported, defended and obeyed, and
 will continue to support, defend and obey, the Constitution and laws of the United States; that I will
 bear true faith and allegiance to the same; and that I take this oath freely, without any mental reserva-
 tion or purpose of evasion: So help me God.

Thomas E Bramlette

Sworn to and subscribed before me, at *Frankfort Ky*,
 this *13th* day of *Dec*, 1866.

John B. Lindsey
 Notary Public



Headquarters Kentucky Volunteers,

Adjutant-General's Office,

Frankfort, December 3rd, 1866.

I hereby certify, that it appears from the U. S. Muster- in
Rolls on file in this Office, that Adam Devoe —
was enrolled on the 17th day of September, 1864, at
Camp Nelson Ky, by J. C. Randolph,
and mustered into the U. S. service on the 17th day of Septe
1864, at Camp Nelson Ky, by Capt R. C. Kinney,
to serve three years. Said Adam Devoe
is described as follows: 36 yrs age, Black eyes, Black hair,
Black complexion, 5ft 6 in height. It further appears from
said Rolls, that he owed service to Thomas Bramlette
and was credited to Franklin County Ky.
He was assigned to Company H 3rd Regt
U. S. Cold Cavalry

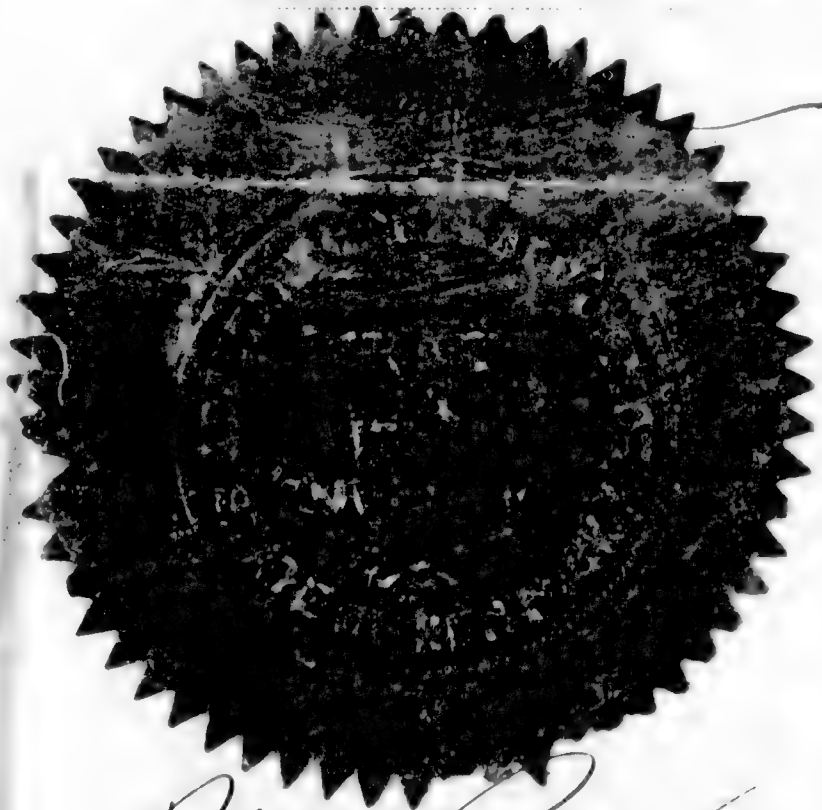

B171 R 316

In Testimony Whereof, I have hereunto set my
hand, and affixed my Official Seal, this
3rd day of Decr, 1866.



D. W. Lindsey
Adjutant General of Kentucky.

PROOF OF OWNERSHIP.

STATE OF KENTUCKY,

COUNTY OF *Franklin* } SS.

We *B W Lindsey* and *Jno B Telford Jr* each of lawful age, and resident citizens of the State and County aforesaid, do certify that *Thomas E Bramlette* of the State and County aforesaid, was on the *17th* day of *Sept* 1864, the lawful owner of the slave named *Adam Devor*; referred to and described in the foregoing claim for compensation.

B W Lindsey
Jno. B. Telford Jr

Sworn to and subscribed before me a *Notary public* for the County of *Franklin* State of Kentucky, this the *13th* day of *Decr* 1866.

John B Lindsey
Notary Public



PROOF OF LOYALTY.

STATE OF KENTUCKY.

COUNTY OF *Franklin* } SS.

We *Jno. S. Van Winkle* and *B W Lindsey* loyal men and each of lawful age, and resident citizens of the *City* of *Frankfort* in the State and County aforesaid, upon our oaths declare that we have known *Thos. E. Bramlette* a resident of the State and County aforesaid, since the 4th day of March, 1861, and know that he has firmly and faithfully maintained his or her adherence and allegiance to the Government of the United States, by defending its cause against the Government and forces of the so-called Confederate States of America, in all suitable and practicable ways, and according to his or her ability and opportunity.

Jno. S. Van Winkle
B W Lindsey

Sworn to and subscribed before me a *Notary public* for the county of *Franklin* State of Kentucky, this the *13th* day of *Decr* 1866.

John B Lindsey
Notary Public



POWER OF ATTORNEY.

My Post-Office address is *Frankfort* County of *Franklin* State of Kentucky, and I hereby direct that all communications to me, touching this claim, be sent under cover to _____, who is hereby appointed and constituted my true and lawful attorney, to prosecute this claim for me, and who is hereby authorized and empowered to receive and receipt for any award, order, draft, certificate, voucher, warrant, papers or money that may be issued in the adjustment of this claim, or the payment thereof, the same as I might or could do in person were I present and acting for myself, and to file any additional evidence or papers that may be required in the prosecution of this claim.

[WITNESS.]

The owner signs here. }

Thos E Bramlette

Two witnesses to owner's signature sign here. }

50 CENT STAMP.

330
Diddo, George

Coel, 5 U. S. Col'd Cav.

Private | *Private*

CARD NUMBERS.

1	<i>5367805</i>	26
2	<i>5367900</i>	27
3	<i>5368000</i>	28
4	<i>5368093</i>	29
5	<i>5368185</i>	30
6	<i>5368281</i>	31
7	<i>5368372</i>	32
8	<i>5368460</i>	33
9	<i>5368545</i>	34
10	<i>5368632</i>	35
11	<i>5368714</i>	36
12	<i>9090968</i>	37
13	<i>9221603</i>	38
14	<i>43142964</i>	39
15	<i>40729699</i>	40
16		41
17		42
18		43
19		44
20		45
21		46
22		47
23		48
24		49
25		50

Book Mark:

See also

D | *5 Cav.*
108 | **U.S.C.T.**

George Diddo

Co. *A*, 108 Reg't U. S. Col'd Infantry.

Appears on
Company Descriptive Book
of the organization named above.

DESCRIPTION.

Age *20* years; height *5* feet *4 1/2* inches.

Complexion *Blk*

Eyes *Blk*; hair *Blk*

Where born *Louisville Ky*

Occupation *Wagoner*

ENLISTMENT.

When *June 25*, 186*4*

Where *Louisville Ky*

By whom *Capt Womack*, term *3* y'rs

Remarks:
.....
.....
.....

Enlisted for 108th U.S.C.T.
Transferred to 5th U.S.C. Cavalry
August 12, 1864, per S.O. 192. Head
Quarters 1st of Ky.

D. M. Kennedy
Compt.

29 | **5 Cav. | U.S.C.T.**

George Widels
Co. I, 5 Reg't U. S. Col'd Cav.

Appears on

Company Descriptive Book
of the organization named above.

DESCRIPTION.

Age 21 years; height 5 feet 4 1/2 inches.

Complexion Black

Eyes Black; hair Black

Where born Louisiana Ky

Occupation Wagoner

ENLISTMENT.

When June 25, 186 .

Where Louisville

By whom Capt. W. M. ...; term 3 y'rs.

Remarks:

.....
.....
.....
.....
.....
.....
.....
.....

(383g)

W. J. Anderson

Copist.

D | 5 bar U.S.C.T.

George Diddo

Appears with rank of Rec't on

Muster and Descriptive Roll

of a detachment of U.S. Colored Troops forwarded

Roll dated Louisville, Ky, June 25, 1864.

Where born Louisville, Ky

Age 20 years; occupation wagoner

When enlisted June 25, 1864.

Where enlisted Louisville, Ky

For what period enlisted 3 years.

Eyes Black; hair Black

Complexion Black; height 5 ft. 4 1/2 in.

When mustered in June 25, 1864.

Where mustered in Louisville

Bounty paid \$ 100; due \$ 100

Clothing account:

Last settled , 186 ; drawn since \$ 100

Date of first muster , 186 .

Company to which assigned

Remarks: 5 Cong. Dist. Ky

Book mark:

J. B. Dowd

D. 5 Cav. U.S.C.T.

George Diddo

Private, Co. I, 5 Reg't U. S. Col'd Cavalry.

Appears on

Company Muster-in and Descriptive Roll of the organization named above. Roll dated

Cpt. Nelson, ^{Ky.} N. Y., Oct. 31, 1864.

Where born Louisville, Ky

Age 20 y'rs; occupation Wagoner

When enlisted June 25, 1864.

Where enlisted Louisville

For what period enlisted 3 years.

Eyes Black; hair Black

Complexion Yellow; height 5 ft. 4 1/2 in.

When mustered in June 25, 1864.

Where mustered in Louisville

Bounty paid \$ 100; due \$ 100

Where credited 5th Dist. Kentucky

Company to which assigned

Remarks:

Enlisted for 103th U.S.C.T.

Transferred to 5th U.S.C. Cavalry

August 12, 1864, per S.C. 192. Head

Quarters 1st of Ky.

Book mark:

Philipson

(356d)

Copyist.

D. | **5 Cav.** | **U.S.C.T.**

George Diddo

Prv., Co. I, 5 Reg't U. S. Col'd Cavalry.

Appears on

Company Muster Roll

for *Organization to Oct. 31, 1864*

Present or absent *Present*

Stoppage, \$ 100 for

Due Gov't, \$ 100 for

Valuation of horse, \$ 100

Valuation of horse equipments, \$ 100

Remarks:

Book mark:

Philipson

10 | **5 Cav.** | **U.S.C.T.**

George Didda

Priv., Co. I, 5 Reg't U. S. Col'd Cavalry.

Appears on

Company Muster Roll

for *Nov. + Dec.*, 1864.

Present or absent *Present*

Stoppage, \$ *100* for

Due Gov't, \$ *100* for

Valuation of horse, \$ *100*

Valuation of horse equipments, \$ *100*

Remarks: *1st + 2^d installments*
Bounty due.

Book mark:

Philipson

(358)

Copyist.

J | **5 Cav.** | **U.S.C.T.**

George Bidda

Priv, Co. I, 5 Reg't U. S. Col'd Cavalry.

Appears on

Company Muster Roll

for *Jan. & Feb.*, 186*5*.

Present or absent *Present*

Stoppage, \$ *100* for

Due Gov't, \$ *100* for

Valuation of horse, \$ *100*

Valuation of horse equipments, \$ *100*

Remarks: *1st & 2^d installments*
\$300^x Bounty due.

Book mark: _____

Philipson

D. | 5 Cav. | U.S.C.T.

George Diddo

Priv., Co. I, 5 Reg't U. S. Col'd Cavalry.

Appears on

Company Muster Roll

for *Mch. + Apl.*, 1865.

Present or absent *Present*

Stoppage, \$ 100 for

Due Gov't, \$ 100 for

Valuation of horse, \$ 100

Valuation of horse equipments, \$ 100

Remarks: *1st installment*

Bounty due,

Book mark:

Philipsen

(358)

Copyist.

2

5 Cav. U.S.C.T.

George Giddo

Pr, Co. I, 5 Reg't U. S. Col'd Cavalry.

Appears on

Company Muster Roll

for *May June*, 186*5*.

Present or absent *Present*

Stoppage, \$ *100* for

Due Gov't, \$ *100* for

Valuation of horse, \$ *100*

Valuation of horse equipments, \$ *100*

Remarks: *Install bounty due \$100-*

Book mark:

Reed

(358)

Copyist.

G | **5 Cav.** | **U.S.C.T.**

George Diddo

Pr, Co. I, 5 Reg't U. S. Col'd Cavalry.

Appears on

Company Muster Roll

for *Sept & Oct*, 186*5*

Present or absent *Present*

Stoppage, \$ *100* for

Due Gov't, \$ *100* for

Valuation of horse, \$ *100*

Valuation of horse equipments, \$ *100*

Remarks:

Book mark: _____

(358)

[Signature]

Copyist.

D

5 Cav. U.S.C.T.

George Biddle

B, Co. I, 5 Reg't U. S. Col'd Cavalry.

Appears on

Company Muster Roll

for *Nov & Dec*, 186*6*.

Present or absent *Present*

Stoppage, \$ *100* for

Due Gov't, \$ *100* for

Valuation of horse, \$ *100*

Valuation of horse equipments, \$ *100*

Remarks: *Quar. for Co. 5. 69*

Book mark: _____

(358)

[Signature]
Copyist.

10

5 Cav. U.S.C.T.

George Diddo

Priv., Co. I, 5 Reg't U. S. Col'd Cavalry.

Appears on

Company Muster Roll

for Jan'y. & Feby., 1866.

Present or absent Present

Stoppage, \$ 100 for

Due Gov't, \$ 100 for

Valuation of horse, \$ 100

Valuation of horse equipments, \$ 100

Remarks:

Book mark:

Cresshaw

L. | 5 Cav. | U.S.C.T.

George Didds.

Priv., Co. I, 5 Reg't U. S. Colored Cav.

Appears on Returns as follows:

Mar. 1865. Absent, detached at Hopkinsville, Ky. Mar. 14.

Sept. 1865. On duty, Teamster.

Nov. 1865. Absent sick in Gen. Hosp., Lexington, Ky. Nov. 27/65.

Book mark :

(546)

A. Baker
Copyist.

D

5 Cav. U.S.C.T.

George Diddo
Pvt., Co. *D*, 5 Reg't U. S. Col'd Cavalry.

Appears on **Co. Muster-out Roll**, dated

Helena, Ark, Mch. 16, 1866.

Muster-out to date *Mch. 16*, 1866.

Last paid to *Dec. 31*, 1865.

Clothing account:

Last settled....., 186 ; drawn since \$..... 100

Due soldier \$..... 100; due U. S. \$ *64* ^{*26*}/₁₀₀

Am't for cloth'g in kind or money adv'd \$..... 100

Due U. S. for arms, equipments, &c., \$..... 100

Bounty paid \$..... 100; due \$..... 100

Remarks:.....

Book mark:.....

Creshaw

(861)

Copyist.

MICROFILM PUBLICATION M 1821

COMPILED MILITARY SERVICE RECORDS
OF VOLUNTEER UNION SOLDIERS WHO
SERVED WITH THE USCT (US COLORED TROOPS)
5TH REGIMENT OF CAVALRY

PERSONAL PAPERS' TARGET SHEET

PLEASE NOTE THE CHECKED INFORMATION ABOUT THE PERSONAL PAPERS IN
THIS FILE:

- NO PERSONAL PAPERS WERE FOUND IN THIS FILE WHEN THE
RECORDS WERE ARRANGED FOR MICROFILMING.
- 1 PERSONAL PAPER(S) FOUND IN THIS FILE WHEN THE RECORDS
WERE ARRANGED FOR MICROFILMING.

Ward 17

Bed 59

Hospital Number 16065

Name George Ditto

Age 21 Nativity Ky

Married or ~~Single~~

Residence Louisville Ky

Post Office address of } Nelly Ditto
wife or nearest relative. } Louisville Ky

Rank Priv Co. I Regiment 1st US Cav

When admitted Nov 20th 65

From what source Lexington Ky

Diagnosis: (in surgical cases state explicitly seat and character of wound or injury.)

*Dislocation of
Shoulder*

Jefferson G. H.
Jeffersonville, Ind.

On what occasion wounded _____

Date _____

Nature of missile or weapon _____

351

Didds, Charles

Co A , 5 U. S. Col'd Cav.

Private

Private

CARD NUMBERS.

1	5350523	26
2	5359425	27
3	53591825	28
4	5360618	29
5	9891063	30
6	43146577	31
7	40729679	32
8		33
9		34
10		35
11		36
12		37
13		38
14		39
15		40
16		41
17		42
18		43
19		44
20		45
21		46
22		47
23		48
24		49
25		50

Book Mark:

See also

D | **5 Cav. | U.S.C.T.**

Charles Widdis

, Co. *A*, 5 Reg't U. S. Col'd Cav.

Appears on

Company Descriptive Book

of the organization named above.

DESCRIPTION.

Age *24* years; height *5* feet *7* inches.

Complexion *Blk*

Eyes *Blk*; hair *Blk*

Where born *Shelby Co Ky*

Occupation *Labourer*

ENLISTMENT.

When *Sept. 8*, 186 .

Where *Louisville*

By whom *Capt. Ham.*; term *3* y'rs.

Remarks: *Killed in action
at Manassas Va. Dec.
8/64*

Warren

5 Cav. U.S.C.T.

Charles Cidda

Co. A, 5 Reg't U. S. Col'd Cavalry.

Appears on

Company Muster-in and Descriptive Roll

of the organization named above. Roll dated

Sept 24, 1864, N. Y.

Where born Shelby Ky.

Age 24 y'rs; occupation Laborer

When enlisted Sept 8, 1864.

Where enlisted Louisville

For what period enlisted 3 years.

Eyes Ok; hair Ok

Complexion Ok; height 5 ft. 7 in.

When mustered in Sept 9, 1864.

Where mustered in Louisville

Bounty paid \$100; due \$100

Where credited 1st Dist Kentucky

Company to which assigned A

Remarks:

Book mark:

W. A. ... Copyist.

(356d)

D

5 bar

U.S.C.T.

Charles Diddoe

Appears with rank of Pvt on

Muster and Descriptive Roll

of a Detachment of U. S. colored
Recruits mustered for U. S. colored

at Taylor Sts. Louisville, Ky. Roll dated
Louisville, Ky., Sept. 9, 1864.

Where born Shelby, Ky

Age 24 years; occupation Leather

When enlisted Sept. 8, 1864.

Where enlisted Louisville, Ky

For what period enlisted 3 years.

Eyes brn; hair brn

Complexion brn; height 5 ft. 7 in.

When mustered in Sept. 9, 1864.

Where mustered in Louisville, Ky.

Bounty paid \$ 100; due \$ 100

Clothing account:

Last settled _____, 186 ; drawn since \$ 100

Date of first muster _____, 186 .

Company to which assigned _____

Remarks: for to Shelby @ Dist.

Book mark: _____

B. J. D. Diddoe

(356m)

Copyist.

J

5 Cav. U.S.C.T.

Charles Dedds

Pvt, Co. A, 5 Reg't U.S. Col'd Cavalry.

Appears on

Company Muster Roll

for *to Oct. 31*, 1864.

Present or absent *absent*

Stoppage, \$ *100* for

Due Gov't, \$ *100* for

Valuation of horse, \$ *100*

Valuation of horse equipments, \$ *100*

Remarks: *Sick in Hospital
at Camp Nelson Ky.*

Book mark:

E. A. Stealing

Copyist.

(358)

29

5 Cav. U.S.C.T.

Charles Liddell

Prx, Co. A, 5 Reg't U.S. Col'd Cavalry.

Appears on

Company Muster Roll

for Nov, & Dec, 1864.

Present or absent

Stoppage, \$ 100 for

Due Gov't, \$ 100 for

Valuation of horse, \$ 100

Valuation of horse equipments, \$ 100

Remarks: Killed in Action at Manassas, Dec. 18, 1864, 1st U.S. Cavalry, 2nd Regiment, 3rd Squadron.

Book mark:

Handwritten signature

(358)

Copyist.

R. | 5 Cav. | U.S.C.T.

Charles Didds.

Regt. ; Co. A, 5 Reg't U. S. Colored Cav.

Appears on Returns as follows:

Oct. & Nov. 1864. Absent sick in
Hosp. Camp Nelson, Ky.

Dec. 1864. Killed in action at
Marion, Va. Dec. 18/64.

Book mark :

(546)

A. Baker
Copyist.

J

5 Cav. U.S.C.T.

Charles Didds

Private, Co. A, 5 Reg't U. S. Col'd Cavalry.

Appears on Co. Muster-out Roll, dated Helena Ark. Mar 16, 1866.

Muster-out to date _____, 1866.

Last paid to *Pay due from enlistment*, 1866.

Clothing account:

Last settled _____, 1866; drawn since \$ 100

Due soldier \$ 100; due U. S. \$ 100

Am't for cloth'g in kind or money adv'd \$ 100

Due U. S. for arms, equipments, &c., \$ 100

Bounty paid \$ 100; due \$ 100

Remarks: Killed in Battle, Monrovia, Va., Dec 18. 64 while skirmishing with the enemy. Final statements forwarded Jan 20. 65

Book mark N. 1018, Ky-2712-1879

W. M. Sayre

(361)

Copyright.

Didds, Charles

P, Co. A, 5 Regt U.S.C. Cav.

4 Enclosures.

Bed Cards (Descriptive Lists
Burial Records	Final Statements /
Certs. of Dis. for Discharge	Furloughs
C. M. Charges	Med. Des. Lists
Med. Certificates	Orders

Other papers relating to—

Admission to Hosp'l	Furlough
Casualty Sheet (Officer's)	Med. Examination
Confinement	Misc. Information
Contracts	Pay or Clothing
Death or Effects /	Personal Reports
Desertions	Rank
Discharge from Hosp'l	Transfer to Hosp'l
Discharge from Service	Transfer to V. R. C.
Duty	Transportation
	<i>See Serial 1</i>

MICROFILM PUBLICATION M 1821

COMPILED MILITARY SERVICE RECORDS
OF VOLUNTEER UNION SOLDIERS WHO
SERVED WITH THE USCT (US COLORED TROOPS)
5TH REGIMENT OF CAVALRY

PERSONAL PAPERS' TARGET SHEET

PLEASE NOTE THE CHECKED INFORMATION ABOUT THE PERSONAL PAPERS IN
THIS FILE:

- NO PERSONAL PAPERS WERE FOUND IN THIS FILE WHEN THE
RECORDS WERE ARRANGED FOR MICROFILMING.
- 3 PERSONAL PAPER(S) FOUND IN THIS FILE WHEN THE RECORDS
WERE ARRANGED FOR MICROFILMING.

War Department,

ADJUTANT GENERAL'S OFFICE,

Washington, Feb 8 1867.

Respectfully returned to the Commission for the State of Kentucky, with the information that Charles Diddie was enlisted at Louisville Ky., September 9, 1864 and was mustered in as private in Co. "H." 5th U.S.C. Sept. 9 1864.

A. R. Anderson

Asst. Adj't General.

BAB.

No. 1018

APPLICATION OF

Hilding Neel

OF Shelbyville Ky

FOR COMPENSATION FOR SLAVE.

Named Charles Diddie

Enlisted _____ 186__

In Com. A, 5th Regiment,

U. S. COLORED TROOPS.

Received Jan 17, 1867

Compensation Awarded

_____, 186__

Dollars.

President of Board of Claims.

Claimant's Attorney,

M. C. Taylor

Shelbyville Ky

Claimant's Post-office Address,

Shelbyville

Kentucky

FRANKFORT COMMONWEALTH PRINT.

No.

OFFICE

Headquarters Kentucky Volunteers,

Adjutant-General's Office,

Frankfort, Jan 8th, 1867

I hereby certify, that it appears from the U. S. Muster- in
 Rolls on file in this Office, that Cha^d Diddoe
 was enrolled on the 8th day of Sep^r, 1864, at
 Louisville Ky, by Cap^t C. C. Ham,
 and mustered into the U. S. service on the 9th day of Sep^r,
 1864, at Louisville, by Cap^t J. H. Smith,
 to serve three years. Said Charles Diddoe
 is described as follows: Age, 24 years; eyes, dark; hair, dark;
 complexion, dark; height, 5 feet 7 inches. It further
 appears from said Rolls, that Cha^d Diddoe owed service
 to _____, was credited to Shelby
 County, Ky., and was assigned to Co. 'A', 5th Regiment
 U. S. C. Cavalry _____



B. _____, R. 340.

In Testimony Whereof, I have hereunto set my
 hand, and affixed my Official Seal, this
 8th day of Jan, 1867.

J. W. Lindsey
 Adjutant General of Kentucky.

and ability, I have supported and defended, and will continue to support and defend, the United States against all enemies, foreign and domestic; and that I have supported, defended and obeyed, and will continue to support, defend and obey, the Constitution and laws of the United States; that I will bear true faith and allegiance to the same; and that I take this oath freely, without any mental reservation or purpose of evasion: So help me God.

Frederic Keel

Sworn to and subscribed before me, at *Shelleyville Ky,*
 this 5th day of *January*, 1867.

John Edmonson M.P.
for Shelby Co Kentucky

Sta.

CLAIM OF

Fielding Neil

FOR THE COMPENSATION OF SLAVE NAMED

Charles Diddoe

I, Fielding Neil a loyal citizen, and a resident of Shelbyville,
 County of Shelby State of Kentucky, hereby claim compensation, under
 the provisions of Section 24, act approved February 24, 1864, and section 2, act approved July, 28,
 1866, for my slave Charles Diddoe, enlisted Sept 8th,
 1864, at Louville Ky, by Capt CC Ham
 in the 5 Cavalry regiment U. S. Colored Troops, Co. A; certificate of
 which enlistment, and a descriptive list, as required, accompany this application. That I did not ac-
 quire said slave subsequent to said enlistment, but had a valid title to him at the date of said enlist-
 ment, and previous thereto: I having acquired my title to him and my ownership over him as fol-
 lows, to-wit: I had purchased said Charles Diddoe
in the year 186 and have held said Charles Diddoe
as my property in my possession from date of purchase
until he enlisted in the United States Army.

In proof of my loyalty to the Constitution and Government of the United States, I present the ac-
 companying oath, which I have taken, signed and acknowledged; to be filed with this application, in
 accordance with requirement of General Orders, No. 329, 1863, War Department, Adjutant General's
 Office.

Fielding Neil

January 5th, 1867

OATH OF ALLEGIANCE.

I, Fielding Neil, the owner and Claimant, do solemnly swear that
 the foregoing claim is a just and true claim due to me as master and owner of the said slave, and that
 the facts alleged in said claim in respect to the draft or enlistment (as the case may be) of said slave
 into the Military service of the United States are true. And I do further swear that I have never
 joined, or been concerned in, any insurrection or rebellion; that I have never borne arms against the
 United States; that I have never given any aid, countenance, counsel or encouragement to any person
 or persons engaged, or whom I had reason to believe were about to engage, in insurrection, rebellion
 or armed hostility against the United States; that I have neither sought, nor accepted, nor attempted
 to exercise the functions of any office, civil or military, nor to perform any service whatever, under
 any authority or pretended authority in hostility to the United States; that I have not yielded a vol-
 untary support to any insurrection, rebellion or pretended government, authority, power or constitution
 within the United States hostile thereto. And I do further swear that, to the best of my knowledge
 and ability, I have supported and defended, and will continue to support and defend, the United
 States against all enemies, foreign and domestic; and that I have supported, defended and obeyed, and
 will continue to support, defend and obey, the Constitution and laws of the United States; that I will
 bear true faith and allegiance to the same; and that I take this oath freely, without any mental reserva-
 tion or purpose of evasion: So help me God.

Fielding Neil

Sworn to and subscribed before me, at Shelbyville Ky,
 this 5th day of January, 1867.

John Edmonate Notary
for Shelby Co Kentucky

✓ FINAL STATEMENT

Co H
OF

Charles Didds Capt

5th Reg't of U. S. Col'd Cav.

VOLUNTEERS.

And Rec'd 11/11/11

NOTE 1.—Two of these certificates (or duplicates) are to be given to each Volunteer Soldier or drafted man who may be discharged previously to the discharge of his company, that he may at once receive from the Paymaster the pay, &c., due him, and the captain or other COMMISSIONED officer commanding the company will certify to the act of the delivery of the duplicate certificates; on these certificates the Soldier is "entitled to" his discharge, and should also present his discharge to the Paymaster to have the payment endorsed on it. The discharge is to be given back to the Soldier by the Paymaster; the latter only retaining as his voucher the duplicate certificates.

NOTE 2.—If the Soldier is entitled to pay for the use of his horse, the Company Commander will certify to that fact on the back of both these final statements, and also to the time he has pay due for having been so mounted on his own horse.

NOTE 3.—When a Soldier is furnished with final statements, his descriptive list, if he has one, should be taken up by the officer who gives the Soldier these statements, and endorsed with a statement to this effect by the officer. This endorsement should exhibit a full statement of the time for which the Soldier was allowed pay on his final statements, the clothing account, and all other charges against him or in his favor, so as to comprise a complete exhibit of his account. It will then be transmitted to the company commander of the Soldier, who will enter all the data necessary to a full understanding of the Soldier's account on the muster roll upon which the Soldier's discharge is reported. The descriptive list will then be destroyed. The object of this is, that the remaining portion of the Soldier's account may be settled upon the receipt of these muster rolls, and the Soldier receive any pay or allowances that may be due him at the time of his discharge, and which may not appear on his final statements from the fact that his descriptive list is incomplete. These accounts for back pay, &c., are settled by the 2d Auditor of the Treasury Department.

NOTE 4.—Charges for loss or injury to ordnance, horse equipments, and other miscellaneous charges, should appear under the heading of "Other Stoppages."

NOTE 5.—Bounty paid by State authorities, and not by the United States, will not be entered on this statement.

NOTE 6.—Amounts due the Sutler and Laundress must be entered on the muster roll on which the discharge, death, desertion, &c., is reported, as well as on the final statement, otherwise the amount cannot be collected from the United States.

NOTE 7.—This blank will be used for deceased volunteers and drafted men, as well as for others.

NOTE 8.—Where a Soldier dies in Hospital or on detached service, his descriptive list, if he has one, should be sent with his final statements, in duplicate, to the Adjutant General, Washington, D. C.

ADJUTANT GENERAL'S OFFICE

July 19th 1865

Duplicate with inventory sent 2d Auditor.

I certify, on honor, that Charles Didds a Private of
 Captain Anderson's Company (a) of the 5th Regiment of U. S. C. Cav
VOLUNTEERS, of the State of _____, born in Melby Co., State
 of Kentucky, aged 24 years; 5 feet 7 inches high; Rash complexion,
Dark eyes, Dark hair, and by occupation a Labourer, having joined the company on
 its original organization at Camp Nelson, and enrolled in it at the muster into
 the service of the United States at Louiseville, on the 8th day
 of September, 1864, (or was mustered in service as a recruit, by Captain
Smith, at Louiseville, on the 8th day of September
 1864, or was drafted and mustered into the service of the United States from the _____
 Enrollment District of the State of Kentucky, at Louiseville,
 on the 8th day of September, 1864.) to serve in the Regiment, for
 the term of Three years: and having served HONESTLY and
 FAITHFULLY with his Company in the 5th U. S. C. Cav to the present date, is now
 entitled to a **DISCHARGE** by reason of death from a gunshot
wound received in action at Marion Va. 18 Dec. 1864

The said Charles Didds was last paid by Paymaster
pay due him to include the from date of enlistment day of _____, 1864, and has
 pay due him from that time to the present date; he is entitled to pay and subsistence for
 TRAVELING to place of enrollment, and whatever other allowances are authorized to volunteer
 soldiers, drafted men, or militia, so discharged. He has received from the United States **CLOTHING**
 amounting to Thirty four $\frac{35}{100}$ dollars, since the 1st day of October,
 1864, when his clothing account was last settled. He has received from the United States
 _____ $\frac{00}{100}$ dollars advanced **BOUNTY**.

There is to be stopped from him, on account of the ~~State of~~ United States, or other
 authorities, for **CLOTHING**, &c., received on entering service, Seventeen $\frac{50}{100}$ dollars; and
 for other stoppages, viz: _____

_____ dollars.
 He has been furnished with TRANSPORTATION in kind from the place of his discharge to _____;
 and he has been SUBSISTED for TRAVELING to his
 place of enrollment, up to the _____, 1864.

He is indebted to _____, **SUTLER**, _____ dollars.
 He is indebted to _____, **LAUNDRESS**, _____ dollars.

Given in Duplicate, at In the field, this 31 day
 of December, 1864

J. H. Anderson

Capt. Co. "A"

 Commanding Company

INVENTORY OF THE EFFECTS

OF

Charles Deeds

Late of Company *A*

5th Reg't of *U.S. Cavalry*

Volunteers, who died at *Marion "Va"*

on the *18* day of *December* 186*4*



Inventory of the effects of Charles Didds late
 a Private of Captain Anderson's Company A of
 the 5th Regiment of U. S. Col. Cav Volunteers, who was enrolled as
 a Private at Louisville in the State of Kentucky on
 the 8th day of September 1864 and mustered into the service of the United
 States as a private on the 9 day of September 1864, at Louisville
 in Company A, 5th Regiment of U. S. Col. Cav Volunteers, to serve 3 years
 years or during the war; he was born in Shelby County in the State
 of Kentucky; he was 24 years of age, 5 feet 7 inches
 high, DK complexion, DK eyes, DK hair, and by occupation, when enrolled,
 a Laborer; he died in action, at
Marion Va on the 18 day of December 1864 by
 reason of gun shot wound in head

INVENTORY.					
ARTICLES.	No.	ARTICLES.	No.	ARTICLES.	No.
Hats.....	No Effects	Pairs trousers.....	No Effects	Knapsacks.....	
Caps.....		Pairs flannel drawers.....			
Forage caps.....		Pairs cotton drawers.....			
Great coats.....		Flannel shirts.....			
Uniform coats.....		Cotton shirts.....			
Uniform jackets.....		Pairs boots.....			
Flannel sack coats.....		Pairs shoes.....			
Blouses.....		Pairs socks.....			
Stable frocks.....		Blankets.....			
Fatigue overalls.....		Haversacks.....			
				MONEY.	
				Specie.....	\$
				Notes.....	\$

I CERTIFY, ON HONOR, that the above inventory comprises all the effects of Charles Didds, deceased, and that the effects are in the hands of _____ at _____ to be disposed of by a Council of Administration.

(DUPLICATES.)

J. H. Anderson
Capt
 Commanding the Company.

STATION: In the field
 DATE: 18 Dec 1864

352

Dominick, Pius

Co 6, 5 U. S. Col'd Cav.

Private

Private

CARD NUMBERS.

1	5361667	26
2	5361769	27
3	5361926	28
4	5362614	29
5	5362632	30
6	9090200	31
7	D-62-07-1871	32
8	43145798	33
9	43146227	34
10	40729680	35
11		36
12		37
13		38
14		39
15		40
16		41
17		42
18		43
19		44
20		45
21		46
22		47
23		48
24		49
25		50

Book Mark: D-62-07-1871

See also

10 | 5 Cav. | U.S.C.T.

James Dominick

, Co. *E*, 5 Reg't U. S. Col'd Cav.,

Appears on

Company Descriptive Book
of the organization named above.

DESCRIPTION.

Age *30* years; height *5* feet *5* inches.

Complexion *Brn*

Eyes *Brn*; hair *Brn*

Where born *Hackington Co., Ky.*

Occupation *Farmer*

ENLISTMENT.

When *Aug.*, 186*4*.

Where *Lebanon*

By whom *St. Enoch*; term *3* y'rs.

Remarks: *Recd - see death*

J. J. Jansen

20 | 5600 | U.S.G.T.

Piers Dominick

Appears with rank of _____ on _____

Muster and Descriptive Roll

of detachment of U.S. colored
Volunteer Recruits for-
warded.

Roll dated Lebanon Ky, Aug 31, 1864.

Where born Washington Ky

Age 30 years; occupation farmer

When enlisted Aug 1, 1864.

Where enlisted Lebanon Ky

For what period enlisted 3 years.

Eyes Blk; hair Blk

Complexion Blk; height 5 ft. 5 in.

When mustered in Aug 1, 1864.

Where mustered in Lebanon Ky

Bounty paid \$ 100; due \$ 100

Clothing account:

Last settled _____, 1864; drawn since \$ 14.25
100

Date of first muster Aug 1, 1864.

Company to which assigned _____

Remarks: Owner, Martha

Walker, Washington D.C.

Without consent.

H Long Dist Ky

Book mark: _____

(356m)

L. B. Barton

Copyist.

D | 5 bar | U.S.C.T.

Pius Dominick

Appears with rank of Pvt on

Muster and Descriptive Roll

of a Detachment of U.S. Colored
Troops transferred to U.S. Colored
ser. at Lexington, Ky.

Roll dated

Lebanon, Ky., Sept. 2, 1864.

Where born Washington, Ky.

Age 20 years; occupation Farmer

When enlisted Aug. 1, 1864.

Where enlisted Lebanon

For what period enlisted 3 years.

Eyes Blue; hair Blue

Complexion Blue; height 5 ft. 5 in.

When mustered in Aug. 1, 1864.

Where mustered in Lebanon

Bounty paid \$ 100; due \$ 100

Clothing account:

Last settled _____, 186 ; drawn since \$ 14 25
100

Date of first muster Aug. 1, 1864.

Company to which assigned _____

Remarks: Credited to H. Cong. Dist. Ky.

Book mark: _____

B. J. Stenall

9

5 Cav.

U.S.C.T.

Pius Dominick

Piv, Co. *C*, 5 Reg't U. S. Col'd Cavalry.

Appears on

Company Muster-in and Descriptive Roll

of the organization named above. Roll dated

Camp Nelson, *Ky*, *N. Y.*, *Oct. 24*, 1864.

Where born *Washington, Ky.*

Age *30* y'rs; occupation *Farmer*

When enlisted *Aug. 1*, 186 .

Where enlisted *Lebanon*

For what period enlisted *3* years.

Eyes *Blk*; hair *Blk.*

Complexion *Blk*; height *5* ft. *5* in.

When mustered in *Aug. 1*, 186 .

Where mustered in *Lebanon*

Bounty paid \$ *100*; due \$ *100*

Where credited *4" Dist. Ky.*

Company to which assigned *C.*

Remarks :
.....
.....
.....

Book mark :
.....

Shull

(356d)

Copyist.

0

5 Cav. U.S.C.T.

Pius Dominick

Pius, Co. C, 5 Reg't U. S. Col'd Cavalry.

Appears on

Company Muster Roll

for *to Oct. 31*, 1864.

Present or absent *Absent*

Stoppage, \$ *100* for

Due Gov't, \$ *100* for

Valuation of horse, \$ *100*

Valuation of horse equipments, \$ *100*

Remarks: *Wounded at the Battle of Saltville, Va. Oct. 2, 1864. In Hospital on Field*

Book mark:

Small

9

5 Cav. U.S.C.T.

Pius Dominick

Pius, Co. C, 5 Reg't U. S. Col'd Cavalry.

Appears on

Company Muster Roll

for *Nov. & Dec.*, 1864.

Present or absent

Stoppage, \$ 100 for

Due Gov't, \$ 100 for

Valuation of horse, \$ 100

Valuation of horse equipments, \$ 100

Remarks: *Died of wounds (recd. in action at Saltville, Va. on 2 Oct.) in Nov. 1864. First & Second installments of bounty due*

Book mark *D. 62 Vol. 9 Co. C 176.*

Shull

D. | 5 Cav. | U.S.C.T.

Pius Dominick.

Priv., Co. C, 5 Reg't U. S. Colored Cav.

Appears on Returns as follows:

Oct. 1864. Absent sick. Act. Corp.
at Saltville Battle. Wounded.

Nov. 1864. Absent. Wounded at
Saltville.

Book mark:

(546)

J. Baker
Copyist.

D

5 Cav. U.S.C.T.

* Pius Dominick

Plaf, Co. C, 5 Reg't U. S. Col'd Cavalry.

Appears on Co. Muster-out Roll, dated Helena Ark, March 16, 1866.

Muster-out to date _____, 186 .

Last paid to _____ 186 .
Pay due from enlistment

Clothing account:

Last settled _____, 186 ; drawn since \$ _____ 100

Due soldier \$ _____ 100; due U. S. \$ _____ 100

Am't for cloth'g in kind or money adv'd \$ _____ 100

Due U. S. for arms, equipments, &c., \$ _____ 100

Bounty paid \$ _____ 100; due \$ _____ 100

Remarks: Died Nov 1, 1864.
Was Saltoville, Va, of
wounds received
Dec 31, 1864. Final
Statements furnished
* Name canceled by line.

Book mark: _____

Rose

D

5 Cav. U.S.C.T.

Pius Diminick

Por, Co. C, 5 Reg't U. S. Col'd Cavalry.

Appears on Co. Muster-out Roll, dated

Helena Ark, Mch 16, 1866.

Muster-out to date, 186 .

Last paid to, 186 .

Clothing account:

Last settled, 186 ; drawn since \$ 100

Due soldier \$ 100; due U. S. \$ 100

Am't for cloth'g in kind or money adv'd \$ 100

Due U. S. for arms, equipments, &c., \$ 100

Bounty paid \$ 100; due \$ 100

Remarks:

Book mark: V. 120. P. 44. 70.

D. 6 2. Vol. 9. C. 5/71. { PV 23. P. 92. 71.

Rose

No. | 5th Cav. U.S.C.T.
Soldier

Pius Romnick
P. Co. 6, 5th U.S.C. Cav
Reg't

NOTATION.

Book mark: *N, Co. 6, U.S.C.T. 1841*

Record and Pension Office.

WAR DEPARTMENT.

This book mark refers only to a report from the medical records, made by the Surgeon General to the Adjutant General, relative to the above-named man. As the medical records have since been carded, no transcript of this report is made hereon.

A. W. Tonsawille

(491)

Copyist.

Dominick, Pius

P, Co. C, 5 Regt U. S. C. Cav.

2 Enclosures.

Bed Cards	Descriptive Lists
Burial Records	Final Statements /
Certs. of Dis. for Discharge	Furloughs
C. M. Charges	Med. Des. Lists
Med. Certificates	Orders

Other papers relating to—

Admission to Hosp'l	Furlough
Casualty Sheet (Officer's)	Med. Examination
Confinement	Misc. Information
Contracts	Pay or Clothing
Death or Effects /	Personal Reports
Desertions	Rank
Discharge from Hosp'l	Transfer to Hosp'l
Discharge from Service	Transfer to V. R. C.
Duty	Transportation

Extract from Act of Congress.

SEC. 12. *And be it further enacted,* That the fees of agents and attorneys for making out and causing to be executed the papers necessary to establish a claim for a pension, bounty, and other allowance before the Pension Office, under this act, shall not exceed the following rates: For making out and causing to be duly executed a declaration by the applicant, with the necessary affidavits, and forwarding the same to the Pension Office, with the requisite correspondence, ten dollars: which sum shall be received by such agent or attorney in full for all services in obtaining such pension, and shall not be demanded or received, in whole or in part, until such pension shall be obtained; and the sixth and seventh sections of an act entitled "An act to grant pensions," approved July [fourteenth,] eighteen hundred and sixty-two, are hereby repealed.

SEC. 13. *And be it further enacted,* That any agent or attorney who shall, directly or indirectly, demand or receive any greater compensation for his services under this act than is prescribed in the preceding section of this act, or who shall contract or agree to prosecute any claim for a pension, bounty, or other allowance under this act, on the condition that he shall receive a per centum upon any portion of the amount of such claim, or who shall wrongfully withhold from a pensioner or other claimant the whole or any part of the pension or claim allowed and due to such pensioner or claimant, shall be deemed guilty of a high misdemeanor, and, upon conviction thereof, shall, for every such offense, be fined not exceeding three hundred dollars, or imprisoned at hard labor not exceeding two years, or both, according to the circumstances and aggravations of the offense.

Approved July 4, 1864.

NOTE 10.—If any soldier is charged a higher fee than that allowed by the above act, he should report the fact and the name of the agent to the Adjutant General, in order that steps may be taken to have the same refunded.

ADJUTANT GENERAL'S OFFICE.

McCall " 1865.

Duplicate with Inventory sent 2d Auditor.

FINAL STATEMENT

60 "6"
OF
Pers Dominick
5th Reg't of *Infantry*
VOLUNTEERS.
Am't \$11.14

NOTE 1.—Two of these certificates (or duplicates) are to be given to each Volunteer Soldier or drafted man who may be discharged without being mustered out (Final Statements are never given to men mustered out of service,) that he may at once receive from the Paymaster the pay, &c., due him, and the captain or other COMMISSIONED officer commanding the company will certify to the act of the delivery of the duplicate certificates; with these certificates the Soldier is "entitled to" his discharge and should also present his discharge to the Paymaster to have the payment endorsed on it. The discharge is to be given back to the Soldier by the Paymaster; the latter only retaining as his vouchers the duplicate certificates.

NOTE 2.—If the Soldier is entitled to pay for the use of his horse, the Company Commander will certify to that fact on the back of both these final statements, and also to the time he has pay due for having been so mounted on his own horse.

NOTE 3.—When a Soldier is furnished with final statements, his descriptive list, if he has one, should be taken up by the officer who gives the Soldier these statements, and endorsed with a statement to this effect by the officer. The endorsement should exhibit a full statement of the time for which the Soldier was allowed pay on his final statements, the clothing account, and all other charges against him or in his favor, so as to comprise a complete exhibit of his account. It will then be transmitted to the Company Commander of the Soldier, who will enter all the data necessary to a full understanding of the Soldier's account on the muster roll upon which the Soldier's discharge is reported. The descriptive list will then be destroyed. The object of this is, that the remaining portion of the Soldier's account may be settled upon the receipt of these muster rolls, and the Soldier receive any pay or allowances that may be due him at the time of his discharge, and which may not appear on his last final statements from the fact that his descriptive list is incomplete. These accounts for back pay, &c., are settled by the 2d Auditor of the Treasury Department.

NOTE 4.—Charges for loss or injury to ordnance, horse equipments, and other miscellaneous charges, should appear under the heading of "Other Stoppages."

NOTE 5.—Bounty paid by State authorities, and not by the United States, will not be entered on this statement.

NOTE 6.—Amounts due the Sutler and Laundress must be entered on the muster roll on which the discharge, death, desertion, &c., is reported, as well as on the final statement, otherwise the amount cannot be collected from the United States.

NOTE 7.—This blank will be used for deceased volunteers and drafted men, as well as for others.

NOTE 8.—Where a Soldier dies in Hospital or on detached service, his descriptive list, if he has one, should be sent with his final statements, in duplicate, to the Adjutant General, Washington, D. C.

NOTE 9.—If the soldier is a drafted man or substitute, the space for time, &c., or enrolled, should contain only the word *drafted* or *substitute*, as the case may be. If the Soldier is a "VETERAN," (or RECRUIT) the words as a *veteran*, (or *recruit*.) as the case may be, should be interlined after the words *mustered into the service of the U. S.* A statement of all the installments of *Veteran* or *Recruit* *Bounty RECEIVED* by the Soldier must be made on the back of each final statement.

I certify, on honor, that Pius Dominick, a Private of
Captain DC Hones Company (C) of the 5th Regiment of U.S. Cav
VOLUNTEERS, of the State of _____, born in Washington Co. State
of Kentucky, aged 30 years; 5 feet 5 inches high; Blk complexion,
Blu eyes, Blk hair, and by occupation a Farmer, who joined for service
and was enrolled (see Note 9) on the 1 day of Aug, 1864, at Sebanon Ky
by Lt Crocher, for the period of Three years, and mustered into
the service of the United States on the 1 day of August, 1864, at
Sebanon Ky, by Lt Crocher; and having served
HONESTLY and FAITHFULLY with his Company to the present date, is now entitled to a
DISCHARGE by reason of Death (Died of wounds received in
action at Saltville Va. 2 Oct 64)

The said Pius Dominick was last paid by Paymaster
Pay due from enlistment to include the _____ day of _____, 186 , and
has pay due him from that time to the present date; he is entitled to pay and subsistence for
TRAVELING to place of enrollment, and whatever other allowances are authorized to volunteer
soldiers, drafted men, or militia, so discharged. He has received from the United States **CLOTHING**
amounting to Twenty one ¹⁵/₁₀₀ dollars, since the 1 day of August,
1864, when his clothing account was last settled. He has received from the United States
_____ ^{_____}/₁₀₀ dollars advanced **BOUNTY**. First Instalment of bounty due \$100

There is to be stopped from him, on account of the State of _____, or other
authorities, for **CLOTHING**, &c., received on entering service, _____ ^{_____}/₁₀₀ dollars; and
for other stoppages, viz: _____

_____ ^{_____}/₁₀₀ dollars.
He has been furnished with **TRANSPORTATION** in kind from the place of his discharge to
_____ ; and he has been **SUBSISTED** for **TRAVELING** to his
place of enrollment, up to the _____, 186 .

He is indebted to _____, **SUTLER**, _____ ^{_____}/₁₀₀ dollars.

He is indebted to _____, **LAUNDRESS**, _____ ^{_____}/₁₀₀ dollars.

Given in Duplicate, at Camp Nelson Ky, this 31 day
of December, 186 4

S. T. Robinson

Lt 5th U.S. Caval

Commanding Company

INVENTORY OF THE EFFECTS

OF

Pius Dominich

Late of Company *C*

5th Reg't of *A B C Co*

Volunteers, who died at *Saltillo Va*

on the *1* day of *November* 186*4*



Inventory of the effects of Pius Dominick late
 a Private of Captain D. C. Strick Company C of
 the 5th Regiment of U. S. Cavalry Volunteers, who was enrolled as
 a Volunteer at Sebourn in the State of Kentucky on
 the 1 day of August 1864, and mustered into the service of the United
 States as a Volunteer on the 1 day of August 1864, at Sebourn
 in Company C, 5th Regiment of U. S. Cavalry Volunteers, to serve three
 years or during the war; he was born in Washington County in the State
 of Kentucky; he was 30 years of age, 5 feet 5 inches
 high, Black complexion, Black eyes, Black hair, and by occupation, when enrolled,
 a Farmer; he died in Hospital, at
Saltsville Va on the 1 day of November 1864, by
 reason of wounds recd in action at Saltsville Oct 2-1864
The exact date of his death is not known but is supposed to be as above

INVENTORY.					
ARTICLES.	No.	ARTICLES.	No.	ARTICLES.	No.
Hats.....	No Effect	Pairs trousers.....	No Effect	Knapsacks.....	No Effect
Caps.....		Pairs flannel drawers.....			
Forage caps.....		Pairs cotton drawers.....			
Great coats.....		Flannel shirts.....			
Uniform coats.....		Cotton shirts.....			
Uniform jackets.....		Pairs boots.....			
Flannel sack coats.....		Pairs shoes.....			
Blouses.....		Pairs socks.....			
Stable frocks.....		Blankets.....			
Fatigue overalls.....		Haversacks.....			
				MONEY.	
				Specie.....	\$
				Notes.....	\$

I CERTIFY, ON HONOR, that the above inventory comprises all the effects of Private
Pius Dominick, deceased, and that the effects are in the hands
 of _____ at _____
 _____ to be disposed of by a Council of Administration.

(DUPLICATES.)

A. T. Robinson
Lieut
 Commanding the Company.

STATION: Camp Nelson Ky
 DATE: March 23rd 1865

333
Dooly, Willis

Co F, 5 U. S. Col'd Cav.

Private

Private

CARD NUMBERS.

1	5-3 64-7 55	26
2	5-3 6 48 55	27
3	5-3 6 49 0 7	28
4	5-3 6 49 9 7	29
5	5-3 6 53 8 7	30
6	5-3 6 51 7 7	31
7	5-3 6 52 6 6	32
8	5-3 6 53 5 6	33
9	5-3 6 54 4 4	34
10	5-3 6 55 3 3	35
11	5-3 6 56 2 3	36
12	90905-3 2	37
13	Rt P 440,956.	38
14	40729681	39
15		40
16		41
17		42
18		43
19		44
20		45
21		46
22		47
23		48
24		49
25		50

Book Mark: Rt P 440,956.

See also

111 | **5 Cav. | U.S.C.T.**

Willie Hooley

....., Co. *F*, 5 Reg't U. S. Col'd Cav.

Appears on

Company Descriptive Book
of the organization named above.

DESCRIPTION.

Age *18* years; height *5* feet *5* inches.

Complexion *Black*

Eyes *Blk*; hair *Blk*

Where born *Clark Ky*

Occupation *farmer*

ENLISTMENT.

When *Sept 13*, 186 *4*.

Where *Camp Nelson*

By whom *J. C. Randolph*, term *3* y'rs.

Remarks:

.....
.....
.....
.....

J. C. Randolph

9

5 Cav.

U.S.C.T.

Willis Dooly

Privt, Co. F, 5 Reg't U. S. Col'd Cavalry.

Appears on

Company Muster-in and Descriptive Roll

of the organization named above. Roll dated

by Nelson, N. Y., Oct 27, 1864.

Where born Clark Ky

Age 18 y'rs; occupation Farmer

When enlisted Sept 23, 1864.

Where enlisted by Nelson Ky

For what period enlisted 3 years.

Eyes Blk; hair Blk

Complexion Blk; height 5 ft. 5 in.

When mustered in Sept 23, 1864.

Where mustered in by Nelson

Bounty paid \$100; due \$100

Where credited 7 Dist Ky

Company to which assigned F

Remarks * Name of owner of Negro - O. Dooly

* Added May 12, 98 by H. J.

Book mark: R. 440, 956.

~~J 1950 Ky~~

Currier

D

5 Cav. U.S.C.T.

Willis Dooley

Pris, Co. F, 5 Reg't U. S. Col'd Cavalry.

Appears on

Company Muster Roll

for to Oct 31, 1864

Present or absent Present

Stoppage, \$ 100 for

Due Gov't, \$ 100 for

Valuation of horse, \$ 100

Valuation of horse equipments, \$ 100

Remarks: Sick in Quarters.

Book mark:

Currier

D

5 Cav. U.S.C.T.

Willis Gulcy

1001, Co. F, 5 Reg't U. S. Col'd Cavalry.

Appears on

Company Muster Roll

for Jan + Dec, 1864.

Present or absent Present

Stoppage, \$ 100 for

Due Gov't, \$ 100 for

Valuation of horse, \$ 100

Valuation of horse equipments, \$ 100

Remarks:

1 + 2 Installment Bounty due

Book mark:

Lewis

(358)

Copyist.

D

5 Cav.

U.S.C.T.

Willis Dooley

Privt, Co. F, 5 Reg't U. S. Col'd Cavalry.

Appears on

Company Muster Roll

for *Jan & Feb*, 186*5*.

Present or absent *Present.*

Stoppage, \$ *100* for

Due Gov't, \$ *100* for

Valuation of horse, \$ *100*

Valuation of horse equipments, \$ *100*

Remarks:

Installment Bounty \$100 due

Book mark:

Currin

(358)

Copyist.

2

5 Cav. U.S.C.T.

Willis Dooley

Pvt

Co. F, 5 Reg't U. S. Col'd Cavalry.

Appears on

Company Muster Roll

for Mar & Apr, 1865

Present or absent Present

Stoppage, \$ 100 for

Due Gov't, \$ 100 for

Valuation of horse, \$ 100

Valuation of horse equipments, \$ 100

Remarks:

First installment Bounty due

Book mark:

Currin

D | **5 Cav.** | **U.S.C.T.**

William Dooley

Pvt, Co. F, 5 Reg't U. S. Col'd Cavalry.

Appears on

Company Muster Roll

for May & June, 1865.

Present or absent Present

Stoppage, \$ 100 for

Due Gov't, \$ 100 for

Valuation of horse, \$ 100

Valuation of horse equipments, \$ 100

Remarks: 1st Instalment Bounty
due \$100.

Book mark :

(358)

Hart
Copyist.

D

5 Cav. U.S.C.T.

Willis Dooley

Porh, Co. F, 5 Reg't U. S. Col'd Cavalry.

Appears on

Company Muster Roll

for *July & Aug*, 1865.

Present or absent *Present*

Stoppage, \$ *100* for

Due Gov't, \$ *100* for

Valuation of horse, \$ *100*

Valuation of horse equipments, \$ *100*

Remarks:

Book mark: -----

(358)

Mark
Copyist.

20 | 5 Cav. | U.S.C.T

Willis Dooley

Cpt, Co. F, 5 Reg't U. S. Col'd Cav.

Appears on

Company Muster Roll

for Sept. & Oct., 1865.

Present or absent Present

Stoppage, \$ 100 for

Due Gov't, \$ 100 for

Valuation of horse, \$ 100

Valuation of horse equipments, \$ 100

Remarks: Due U.S. for Ord. \$0.45.

Book mark:

(358)

Fitz Copyist
Hampson

D

5 Cav. U.S.C.T.

Willis Dooley

Priv, Co. F, 5 Reg't U. S. Col'd Cavalry.

Appears on

Company Muster Roll

for Nov & Dec, 1865.

Present or absent Absent

Stoppage, \$ 100 for

Due Gov't, \$ 100 for

Valuation of horse, \$ 100

Valuation of horse equipments, \$ 100

Remarks: Sick in Post Hospital Helena Ark since Dec 28-1865.

Book mark:

Mark Copyist.

N

5 Cav. U.S.C.T.

Willis Dooley

Pvt, Co. F, 5 Reg't U. S. Col'd Cavalry.

Appears on

Company Muster Roll

for *Jan & Feb*, 186*6*

Present or absent *Present*

Stoppage, \$ *100* for

Due Gov't, \$ *100* for

Valuation of horse, \$ *100*

Valuation of horse equipments, \$ *100*

Remarks:

Book mark:

W. Davis

(358)

Copyist.

D. | 5 Cav. | U.S.C.T.

Willis Dooley.
Pt., Co. F, 5 Reg't U. S. Colored Cav.

Appears on Returns as follows:

Dec. 1865. Absent sick, Gen. Hosp.,
Helena, Ark., since Dec. 30/
65.

Book mark:

(546)

Baker
Copyist.

D

5 Cav. U.S.C.T.

Willis Sooley

Pvt., Co. F, 5 Reg't U. S. Col'd Cavalry.

Appears on Co. Muster-out Roll, dated Helena Ark, Mch 16, 1866.

Muster-out to date Mch 16, 1866.

Last paid to Dec 31, 1865.

Clothing account:

Last settled _____, 186 ; drawn since \$ _____ 100

Due soldier \$ _____ 100; due U. S. \$ 32 ⁵⁹/₁₀₀

Am't for cloth'g in kind or money adv'd \$ _____ 100

Due U. S. for arms, equipments, &c., \$ _____ 100

Bounty paid \$ 100 ⁰⁰/₁₀₀; due \$ _____ 100

Remarks: _____

Book mark: D 1950 Ky

(361)

W. S. D. A. W.
Copyist.

Co. 5 Cav. U.S.A.
Willis Dooly
Sgt. Co. F, 5 Reg't U.S. Cav.

NOTATION.

Book mark: R. P. 440956

Record and Pension Office,

WAR DEPARTMENT,

Washington, July 1, 1896.

Discharge certificate
on file.

A. G. M.

Dooley Miller's

Reg't 7, Co.

Reg't US 660

Enclosures.

Bed Cards	Descriptive Lists
Burial Records	Final Statements
Certs. of Dis. for Discharge	Furloughs
C. M. Charges	Med. Des. Lists
Med. Certificates	Orders

Other papers relating to—

Admission to Hosp'l	Furlough
Casualty Sheet (Officer's)	Med. Examination
Confinement	Misc. Information
Contracts	Pay or Clothing
Death or Effects	Personal Reports
Desertions	Rank
Discharge from Hosp'l	Transfer to Hosp'l
Discharge from Service	Transfer to V. R. C.
Duty	Transportation

War Department,

ADJUTANT GENERAL'S OFFICE,

Washington, April 8th 1867.

Respectfully returned to the
Commission for the State of
Ky., with the informa-

tion that Willis Dooley

was enlisted at Camp Morton Ky.

Sept. 23, 1864, and was

mustered in as Priv. in Co. "F"

5th U. S. Col. Cav. Sept. 23/64.

1950
No. 1950

W. H. Hazard
Asst. Adj't General.

No. 1950

APPLICATION OF

Abraham Dooley

OF

Blount County Kentucky

FOR COMPENSATION FOR SLAVE.

Named Willis Dooley

Enlisted _____, 186__

In Com. "F", 5th Regiment,

U. S. COLORED TROOPS.

Received July 25, 1867.

Compensation Awarded

_____, 186__

Dollars.

President of Board of Claims.

Claimant's Attorney,

John Legerton,
Winchester Kent

Claimant's Post-office Address,

FRANKFORT COMMONWEALTH PRINT.

No.

CLAIM OF

Obadiah Dooley of Clark County Kentucky

FOR THE COMPENSATION OF SLAVE NAMED

Willis Dooley

I, *Obadiah Dooley* a loyal citizen, and a resident of *the* County of *Clark*, State of Kentucky, hereby claim compensation, under the provisions of Section 24, act approved February 24, 1864, and section 2, act approved July, 28, 1866, for my slave *Willis Dooley*, enlisted *Sept 23* 1864, at *Camp Nelson Kentucky*, by *Capt McHarris* in the *"5th Cavalry* regiment U. S. Colored Troops, Co. *"F"*; certificate of which enlistment, and a descriptive list, as required, accompany this application. That I did not acquire said slave subsequent to said enlistment, but had a valid title to him at the date of said enlistment, and previous thereto: I having acquired my title to him and my ownership over him as follows, to-wit: *he was born my property - I being the owner of his mother - and continued uninterrupted by his owner until the time of the above enlistment*

In proof of my loyalty to the Constitution and Government of the United States, I present the accompanying oath, which I have taken, signed and acknowledged; to be filed with this application, in accordance with requirement of General Orders, No. 329, 1863, War Department, Adjutant General's Office.

January 4th, 1867. *Obadiah Dooley*

OATH OF ALLEGIANCE.

I, *Obadiah Dooley*, the owner and Claimant, do solemnly swear that the foregoing claim is a just and true claim due to me as master and owner of the said slave, and that the facts alleged in said claim in respect to the ~~draft~~ enlistment (~~or the case may be~~) of said slave into the Military service of the United States are true. And I do further swear that I have never joined, or been concerned in, any insurrection or rebellion; that I have never borne arms against the United States; that I have never given any aid, countenance, counsel or encouragement to any person or persons engaged, or whom I had reason to believe were about to engage, in insurrection, rebellion or armed hostility against the United States; that I have neither sought, nor accepted, nor attempted to exercise the functions of any office, civil or military, nor to perform any service whatever, under any authority or pretended authority in hostility to the United States; that I have not yielded a voluntary support to any insurrection, rebellion or pretended government, authority, power or constitution within the United States hostile thereto. And I do further swear that, to the best of my knowledge and ability, I have supported and defended, and will continue to support and defend, the United States against all enemies, foreign and domestic; and that I have supported, defended and obeyed, and will continue to support, defend and obey, the Constitution and laws of the United States; that I will bear true faith and allegiance to the same; and that I take this oath freely, without any mental reservation or purpose of evasion: So help me God.

Obadiah Dooley

Sworn to and subscribed before me, at *Winchester Clark,* }
County Kentucky, }
 this *4* day of *January*, 1867.

E. Woodward Jr.

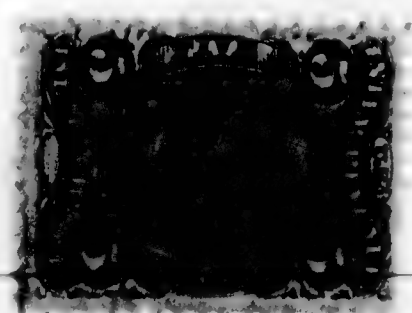

PROOF OF OWNERSHIP.

STATE OF KENTUCKY,

COUNTY OF *Blount*

} SS.

We *Samuel G. Stuart* and *George Stephenson* each of lawful age, and resident citizens of the State and County aforesaid, do certify that *Obadiah Dooley* of the State and County aforesaid, was on the *23^d* day of *September* 186*4*, the lawful owner of the slave named *Willie Dooley* referred to and described in the foregoing claim for compensation.

Sam G. Stuart
Geo Stephenson

Sworn to and subscribed before me a *Justice of the Peace* for the County of *Blount* State of Kentucky, this the *4th* day of *January* 186*7*.

J. Woodward Jr



PROOF OF LOYALTY.

STATE OF KENTUCKY,

COUNTY OF *Blount*

} SS.

We *Samuel G. Stuart* and *George Stephenson* loyal men and each of lawful age, and resident citizens of the *County of Blount* in the State and County aforesaid, upon our oaths declare that we have known *Obadiah Dooley* a resident of the State and County aforesaid, since the *4th* day of *March*, 186*1*, and know that he has firmly and faithfully maintained his ~~own~~ adherence and allegiance to the Government of the United States, by defending its cause against the Government and forces of the so-called Confederate States of America, in all suitable and practicable ways, and according to his ~~own~~ ability and opportunity.

Sam G. Stuart
Geo Stephenson

Sworn to and subscribed before me a *Justice of the Peace* for the county of *Blount* State of Kentucky, this the *4* day of *January* 186*7*.

J. Woodward



POWER OF ATTORNEY.

My Post-Office address is _____ County of _____ State of Kentucky, and I hereby direct that all communications to me, touching this claim, be sent under cover to _____, who is hereby appointed and constituted my true and lawful attorney, to prosecute this claim for me, and who is hereby authorized and empowered to receive and receipt for any award, order, draft, certificate, voucher, warrant, papers or money that may be issued in the adjustment of this claim, or the payment thereof, the same as I might or could do in person were I present and acting for myself, and to file any additional evidence or papers that may be required in the prosecution of this claim.

[WITNESS.]

The owner signs here.

Obadiah Dooley

50 CENT STAMP.

Sam G. Stuart
Geo Stephenson

Two witnesses to owner's signature sign here.

354

Dorey, John

Co E 5 U. S. Col'd Cav.

Sergeant | Sergeant.

CARD NUMBERS.

5363664	26
5363766	27
5363868	28
5363956	29
5364048	30
5364134	31
5364300	32
5364676	33
9090387	34
9090395	35
9090405	36
32109786	37
32109635	38
40729682	39
	40
	41
	42
	43
	44
	45
	46
	47
	48
	49
	50

Book Mark: General Notation R. & P. 407375.

See also

AL

5 Cav.

U.S.C.T.

John Horsey

Co. *E*, 5 Reg't U. S. Col'd Cav.

Appears on

Company Descriptive Book

of the organization named above.

DESCRIPTION.

Age years; height feet inches.

Complexion

Eyes; hair

Where born

Occupation

ENLISTMENT.

When, 186

Where

By whom; term y'rs.

Remarks:

.....
.....
.....
.....
.....

J. E. K. M. S.

(383g)

Copist.

10 | **5 Cav. | U.S.C.T.**

John Horsey
Co. *E*, 5 Reg't U. S. Col'd Cav.

Appears on

Company Descriptive Book
of the organization named above.

DESCRIPTION.

Age *27* years; height *5* feet *6* inches.

Complexion *Black*

Eyes *Blk*; hair *Blk*

Where born *Scott Ky*

Occupation *farmer*

ENLISTMENT.

When *Sep 9*, 186*4*.

Where *Camp Nelson*

By whom *J. Randolph* term *3* y'rs.

Remarks:

J E Parks

(383a)

Copist.

W | **5 Cav.** | **U.S.C.T.**

John Worsey
....., Co. *E*, 5 Reg't U. S. Col'd Cav.

Appears on

Company Descriptive Book
of the organization named above.

DESCRIPTION.

Age *27* years; height *5* feet *6* inches.

Complexion *Black*

Eyes *Blk*; hair *Blk*

Where born *Scott Ky*

Occupation *farmer*

ENLISTMENT.

When *Sep 9*, 186*4*.

Where *Camp Nelson*

By whom *J. Randolph*; term *3* y'rs.

Remarks: **Discharged July 13. 1865 for disability from wounds.*

**Inserted by compiler.*

J. E. Parker

(383g)

Copist.

A

5 Cav.

U.S.C.T.

John Dorse

Serjt, Co. *E*, 5 Reg't U. S. Col'd Cavalry.

Appears on

Company Muster-in and Descriptive Roll

of the organization named above. Roll dated

Camp Nelson, *Ky*, *N. Y.*, *Oct. 26*, 1864.

Where born *Scott* *Ky.*

Age *22* y'rs; occupation *Farmer*

When enlisted *Sept. 9*, 1864.

Where enlisted *C. Nelson* *Ky*

For what period enlisted *3* years.

Eyes *Black*; hair *Black*

Complexion *Black*; height *5* ft. *6* in.

When mustered in *Sept. 9*, 1864.

Where mustered in *C. Nelson* *Ky*

Bounty paid \$ *100*; due \$ *100*

Where credited *Dist* *Ky*

Company to which assigned

Remarks: *Berry Quinn*

* *Suppose it is name of owner*

address may be in end

Book mark: *See List of Dis*

General Exchange Bk. No. 407370.

H. W. [Signature]

(356d)

Copyist.

2 | **5 Cav.** | **U.S.C.T.**

John L. Lonsley
Sergeant, Co. E, 5 Reg't U. S. Col'd Cavalry.

Appears on

Company Muster Roll

for Enlistment to Oct 31, 1864.

Present or absent Present

Stoppage, \$ 100 for

Due Gov't, \$ 100 for

Valuation of horse, \$ 100

Valuation of horse equipments, \$ 100

Remarks: Appointed private
Order No. 19 Oct 26 64

Book mark:

(358)

W. H. [Signature]

Copyist.

2 | **5 Cav. | U.S.C.T.**

John Dorsey
Sgt., Co. E, 5 Reg't U. S. Col'd Cavalry.

Appears on

Company Muster Roll

for Nov. & Dec., 1864.

Present or absent Present

Stoppage, \$ 100 for

Due Gov't, \$ 100 for

Valuation of horse, \$ 100

Valuation of horse equipments, \$ 100

Remarks: 1st & 2^d Installments
of Bounty due

Book mark:

M. R. [Signature]

(358)

Copyist.

21 May 1867

John D. [unclear]
Regt

Appears on

Hospital Muster Roll

of Corps d'Afrique U. S. A. General Hospital,

at New Albany, Ind.,

for August 1867

Attached to hospital :

When _____, 186 .

How employed _____

Last paid by Maj. _____

to _____, 186 .

Bounty paid \$ 100 ; due \$ 100

Present or absent Present

Remarks : _____

Book mark : _____

Q | **5 Cav.** | **U.S.C.T.**

John Conroy
Serg't., Co. E, 5 Reg't U. S. Col'd Cavalry.

Appears on

Company Muster Roll

for Jan. 1, Feb., 1865.

Present or absent Absent

Stoppage, \$ 100 for

Due Gov't, \$ 100 for

Valuation of horse, \$ 100

Valuation of horse equipments, \$ 100

Remarks: In Hospital. New Albany Ind. since Feb. 2nd - 6th from Wounds Received in action at Antietam Md.

Book mark: _____

(358)

H. W. Garrison Copyist.

21st May 1865

John D. Kelly

Chgt., Co. E, 5th Reg't Ill. Cav.

Appears on

Hospital Muster Roll

of Corps d'Afrique U. S. A. General Hospital,

at New Albany, Ind.,

for *March 1865*, 1865.

Attached to hospital:

When _____, 1865.

How employed _____

Last paid by Maj. _____

to *never paid*, 1865.

Bounty paid \$ *100*; due \$ *100*

Present or absent *absent*

Remarks: *paid for bounty
- copy sent to War Dept.*

Book mark; _____

W. H. F.

B

John Corsey

Sgt., Co. E, 5 Reg't U.S. Col'd Cavalry.

Appears on

Company Muster Roll

for *Mich. 7 Apr.*, 186 *5.*

Present or absent *Absent*

Stoppage, \$ *100* for

Due Gov't, \$ *100* for

Valuation of horse, \$ *100*

Valuation of horse equipments, \$ *100*

Remarks: *Absent sick in
Hosp. New Albany Ind.
since Jan. 25, '65.
"instalment of Bounty
due.*

Book mark:

J. Rowland

D

5 Cav. U.S.C.T.

John Dorsey

Sgt., Co. E, 5 Reg't U.S. Col'd Cavalry.

Appears on

Company Muster Roll

for May & June, 1865.

Present or absent absent

Stoppage, \$ 100 for

Due Gov't, \$ 100 for

Valuation of horse, \$ 100

Valuation of horse equipments, \$ 100

Remarks: Absent sick in Genl. Hospl. New Albany Ind. since Jan. 25/65. 1st Instalment of Bounty due \$100.

Book mark:

Lou Copyist.

D

5 Cav. U.S.C.T.

John Dorsey

Sgt., Co. E, 5 Reg't U. S. Col'd Cavalry.

Appears on

Company Muster Roll

for *July & Aug*, 1865.

Present or absent

Stoppage, \$ 100 for

Due Gov't, \$ 100 for

Valuation of horse, \$ 100

Valuation of horse equipments, \$ 100

Remarks:

*Discharged
July 13/65 on Surgeons
Certificate of Disability
from wounds received.*

Book mark:

(358)

Long
Copyist.

D | 5 Cav. | U.S.C.T.

John Dorsey.
Sergt, Co. E, 5 Reg't U. S. Colored Cav.

Appears on Returns as follows:

Jan. 1865. Loss, Jan. 25/65, Simpsonville, Ky. Missing in action.

Feb. 1865. Gain, Jan. 25, Simpsonville, Ky. Taken up from missing in action.

Absent. Wounded in action Jan. 25. Feb. 1, in Gen. Hoop, New Albany, Ind.

Mar. to July, 1865. Absent sick in Gen. Hoop, New Albany, Ind., since Feb. 2/65; from wounds rec'd in action.

Aug. 1865. Loss, July 13, New Albany, Ind. Discharged on Surg's Cert. of Disability.

Book mark :

(546)

Baker,
Copyist.

(11)

5 Cav. U.S.C.T.

John Perry
Co. 5, 5 Reg't U. S. Col'd Cavalry.

Appears on **Co. Muster-out Roll**, dated
March 16, 186*6*.

Muster-out to date _____, 186*6*.

Last paid to *pay due from* _____, 186*6*.

Clothing account:

Last settled _____, 186*6*; drawn since \$ _____ $\overline{100}$

Due soldier \$ _____ $\overline{100}$; due U. S. \$ _____ $\frac{38}{100}$

Am't for cloth'g in kind or money adv'd \$ _____ $\overline{100}$

Due U. S. for arms, equipments, &c., \$ _____ $\overline{100}$

Bounty paid \$ _____ $\overline{100}$; due \$ _____ $\overline{100}$

Remarks: *Discharged at*
New Albany Ind. July
13 1865 on Surgeons
Certificate of disability
recd. from Surg. of Co.

Book mark: *217 P. 18. 73, 22. 28 P. 117*
1873

(361)

J. W. [Signature]

Copyist.

Dorsey, John
Sgt., Co. E, 5 Regt. U. S. C. Cav.

Enclosures.

Bed Cards	Descriptive Lists
Burial Records	Final Statements
Certs. of Dis. for Discharge	Furloughs
C. M. Charges	Med. Des. Lists
Med. Certificates	Orders

Other papers relating to—

Admission to Hosp'l	Furlough
Casualty Sheet (Officer's)	Med. Examination
Confinement	Misc. Information
Contracts	Pay or Clothing
Death or Effects	Personal Reports
Desertions	Rank
Discharge from Hosp'l	Transfer to Hosp'l
Discharge from Service	Transfer to V. R. C.
Duty	Transportation

1865

DB D 52 OK 165
CERTIFICATE OF DISABILITY FOR DISCHARGE

46212 of his

John Dorsey

a Sergeant Co. E

26th P.
3rd Cavalry Reg't of 1st Fed Corps

Received (A. G. Office) _____, 186

Em on O R of Ls

ADJUTANT GENERAL'S OFFICE

August 11th 1865

Duplicate sent the Pension Office.

ARMY OF THE UNITED STATES
 CERTIFICATE
 OF DISABILITY FOR DISCHARGE.

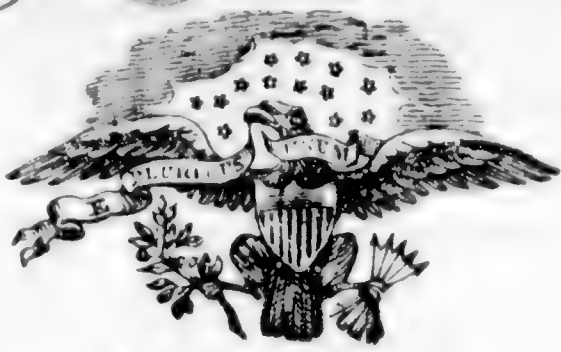

John D. Sawyer
Beaver Dam, Wis.
Sept. 1865
Wm. J. Sawyer
Beaver Dam, Wis.
Dr. J. S. Sawyer
Beaver Dam, Wis.
in absence of
Beaver Dam, Wis.

John D. Sawyer Lieutenant, of *Captain* *Edwin*
Beaver Dam Company, (No. *10*) of the *5th* Cavalry Regiment of the United States
Beaver Dam, Wis. was enlisted by *J. C. Randolph* of
 the *5th* Regiment of *Wisconsin* at *Camp Johnson*
 on the *10th* day of *September*, 1864, to serve *three* years; he was born
 in *Scott Co.* in the State of *Kentucky*, is *twenty*
 years of age, *five* feet *six* inches high, *Black* complexion, *Black* eyes,
Black hair, and by occupation when enlisted a *Farmer*. During the last two
 months said soldier has been unfit for duty *thirty* days.*

Floating Hospital
 STATION: *New Albany, Ind.*
 DATE: *June 28, 1865*

P. F. Harvey
 a. a. s. u. s. a. c. c. e.
 Commanding Company.

I CERTIFY, that I have carefully examined the said *John Sawyer*
 of Captain *Edwin Sawyer* Company, and find him incapable of performing the duties of a
 soldier because of *a perforating gunshot wound of abdomen*
with lesion of intestines, Ric's in action.
Unfit for U. S. A. Disability 1/3

P. F. Harvey
 a. a. s. Surgeon. u. s. a.
 in charge

DISCHARGED, this *fourteenth* day of *July*, 1865, at *New Albany*
Indiana

P. F. Harvey
Henry Louis Foster Commanding the Reg't

The Soldier desires to be addressed at
 Town *Georgetown* County *Scott* State *Ky.*

* See Note 1 on the back of this. † See Note 2 on the back of this.
 [A. G. O. No. 100 & 101—First.] [DUPLICATES.]

355

Douglass, Ned

Co M, 5 U. S. Col'd Cav.

Corporal

Private

CARD NUMBERS.

1	5370805	26
2	5370905	27
3	5359369	28
4	5371074	29
5	5359413	30
6	5371172	31
7	5371285	32
8	5371369	33
9	5371456	34
10	537154	35
11	5371627	36
12	5371710	37
13	9091267	38
14	D-47-05-1874	39
15	40729683	40
16		41
17		42
18		43
19		44
20		45
21		46
22		47
23		48
24		49
25		50

Book Mark: D-47-05-1874

See also

J 1336707 Permit

S. 1633077 P.O. Per

D 1633078 P.O. aff

R.P. 724393

\$ 2455392 - Aud. WD

Al. 171950

Al. 2103740

P.O. aff. 10/1/20

S.A. Wagner
Xth

9 | 5-leaf | U.S.C.T.

Ned Douglas

, Com., 5-Reg't U. S. Col'd 6av

Appears on

Company Descriptive Book

of the organization named above.

DESCRIPTION.

Age 21 years; height 5 feet 5 inches.

Complexion Black

Eyes BRK; hair BRK

Where born Lafayette Ky

Occupation Farmer

ENLISTMENT.

When Aug 29, 1864.

Where Camp Nelson

By whom W. Hancock; term 3 y'rs.

Remarks:

A. J. Anderson

(383g)

Copyist.

9

5 Cav.

U.S.C.T.

Red Douglass

Corpl, Co. *M*, 5 Reg't U. S. Col'd Cavalry.

Appears on

Company Muster-in and Descriptive Roll

of the organization named above. Roll dated

Camp Nelson, *N. Y.*, *Oct 30*, 1864.

Where born *Franklin Ky.*

Age *21* y'rs; occupation *Farmer*

When enlisted *Aug 29*, 1864.

Where enlisted *Camp Nelson, Ky.*

For what period enlisted *?* years.

Eyes *Black*; hair *Black*

Complexion *Black*; height *5* ft. *5* in.

When mustered in *Aug 29*, 1864.

Where mustered in *Camp Nelson, Ky.*

Bounty paid \$ *100*; due \$ *100*

Where credited *7th Dist. Ky.*

Company to which assigned

Remarks: *Always seen*

Emitted a name of...

...

Book mark: *2407 Ky*

D-47-CJ-1874

W.S. Thompson

(356d)

Copyist.

Med Douglas
Co. M, 5 Reg't U. S. Col'd Cavalry.

Appears on

Company Muster Roll

for *to Oct. 31*, 186*4*.

Present or absent *Present*

Stoppage, \$ *100* for

Due Gov't, \$ *100* for

Valuation of horse, \$ *100*

Valuation of horse equipments, \$ *100*

Remarks: *as per order No 12 in date Oct. 30, 1864*

Book mark:

A. S. Thompson

D | 5 Cav | U.S.C.T.

Med Douglas
Corp, Co. M, 5 Reg't U. S. Col'd Cav

Appears on

Descriptive List of Deserters

dated *Nov 30*, 186*4*.

Deserted:

When *Nov 4*, 186*4*.

Where *Livington*

Arrested:

When _____, 186 .

Where _____

Remarks :

Book mark : _____

Russel

D

5 Cav. | U.S.C.T.

Red Douglass

Corp'l, Co. M, 5 Reg't U. S. Col'd Cavalry.

Appears on

Company Muster Roll

for *Mar & Dec*, 1864.

Present or absent

Stoppage, \$ 100 for

Due Gov't, \$ 100 for

Valuation of horse, \$ 100

Valuation of horse equipments, \$ 100

Remarks: *Deserted at Camp*
for by Prov. 11, 1864

Roll for Mar & Apr 65 -
next on which name
appears.

Book mark:

M. S. Thompson

(358)

Copyist.

4

5 Cav. U.S.C.T.

Red Douglas

Capt., Co. M, 5 Regt U. S. Col'd Cavalry.

Appears on

Company Muster Roll

for March 1st 1865.

Present or absent Present

Stoppage, \$ 100 for

Due Gov't, \$ 100 for

Valuation of horse, \$ 100

Valuation of horse equipments, \$ 100

Remarks: 1st installment bounty due \$ 100 is forfeited for death under No. 12. The date Oct. 3/64 returned from desertion on 28/64

Book mark:

M. S. Carpenter

(358)

Copyist.

D 5110 U.S.C.T.

Merck Douglass
Corp., Co. 7th, 5th Reg't U. S. Col'd Cav

Appears on

Descriptive List of Deserters

dated April 30, 1865.

Deserted:

When _____, 186 .

Where _____

Arrested:

When _____, 186 .

Where _____

Remarks: Taken up April 13
at Camp Nelson.

This man has been
erroneously reported as
deserter, he having been
absent sick.

Book mark: _____

Rose

D

5 Cav. U.S.C.T.

Red Douglas

No, Co. M, 5 Reg't U. S. Col'd Cavalry.

Appears on

Company Muster Roll

for *May & June*, 1865.

Present or absent *Present*

Stoppage, \$ *100* for

Due Gov't, \$ *100* for

Valuation of horse, \$ *100*

Valuation of horse equipments, \$ *100*

Remarks: *Reduced from Capt to
Privt May 23. 1845 as per
R.O. No 86. 1st Enlistment
bounty due \$ 100.*

Book mark: _____

Cutter
Copyist.

(358)

Wm *W. Douglas*

Wm....., Co. M, 5 Reg't U. S. Col'd Cavalry.

Appears on

Company Muster Roll

for *Sept & Oct*....., 186*5*.

Present or absent *Present*

Stoppage, \$.....¹⁰⁰ for

Due Gov't, \$.....¹⁰⁰ for

Valuation of horse, \$.....¹⁰⁰

Valuation of horse equipments, \$.....¹⁰⁰

Remarks: *Due U.S. for Camp +*
Gamias 4 153

.....
.....
.....
.....
.....
.....
.....
.....

Book mark:

W. C. C. C.
Copyist.

D

5 Cav. U.S.C.T.

Nea Douglas

Mr., Co. M, 5 Reg't U. S. Col'd Cavalry.

Appears on

Company Muster Roll

for Nov Dec, 1865.

Present or absent Present

Stoppage, \$ 100 for

Due Gov't, \$ 100 for

Valuation of horse, \$ 100

Valuation of horse equipments, \$ 100

Remarks:

Book mark:

C. W. ... Copyist.

21

5 Cav. | U.S.C.T.

Ned Douglass

Prh, Co. M, 5 Reg't U. S. Col'd Cavalry.

Appears on

Company Muster Roll

for Jan + Feb, 1866.

Present or absent Present

Stoppage, \$ 100 for

Due Gov't, \$ 100 for

Valuation of horse, \$ 100

Valuation of horse equipments, \$ 100

Remarks:

Book mark:

Hyes

(358)

Copyist.

D. | 5 Cav. | U.S.C.T.

Nea. Douglass
Corpl. Co. M, 5 Reg't U. S. Colored Cav.

Appears on Returns as follows:

Nov. 1864. Loss, Nov. 4/64, Lexington, Ky. Deserted.

Apr. 1865. Gain, Erroneously reported a deserter being absent sick in Hoop.

Book mark :

(546)

H. Baker
Copyist.

D

5 Cav. U.S.C.T.

Ned Douglass

Prs, Co. *M*, 5 Reg't U. S. Col'd Cavalry.

Appears on **Co. Muster-out Roll**, dated
Helena Ark, *Mar 16*, 1866.

Muster-out to date *Mar 16*, 1866.

Last paid to *Dec 31*, 1865.

Clothing account:

Last settled _____, 186 ; drawn since \$ _____ 100

Due soldier \$ _____ 100; due U. S. \$ *4* ⁶⁶/₁₀₀

Am't for cloth'g in kind or money adv'd \$ _____ 100

Due U. S. for arms, equipments, &c., \$ _____ 100

Bounty paid \$ *100* 100; due \$ *100* 100

Remarks: *Appointed Corp'l Per R.O. 12 Per 12 Oct 30 '64. Reduced to ranks Per R.O. 86 Per 6 May 23 '65 Slave April 19 '61*

Book mark: *A 2407 Ky*

(361)

J. H. ...

Copyist.

D 1 5th Cav. U.S.C.

Ned Douglass

, Co. No. 5th Regt. U.S.C. Cav.

NOTATION.

Book mark: D. 47. C. J. 1874

War Department,

Adjutant General's Office,

Washington, Aug. 1st 1874.

Call from

returned with report.

The above book mark was noted on rolls in order to preserve results of search in this case.

E. P. Conroy.

(475)

Copyist.

Douglas, Ned
Pvt M, 5 Reg't U.S. Cavalry
Co. M, 5 Reg't U.S. Cavalry

3 Enclosures.

Bed Cards	Descriptive Lists
Burial Records	Final Statements
Certs. of Dis. for Discharge	Furloughs
C. M. Charges	Med. Des. Lists
Med. Certificates	Orders

E. paper 1

Other papers relating to—

Admission to Hosp'l	Furlough
Casualty Sheet (Officer's)	Med. Examination
Confinement	Misc. Information
Contracts	Pay or Clothing
Death or Effects	Personal Reports
Desertions	Rank
Discharge from Hosp'l	Transfer to Hosp'l
Discharge from Service	Transfer to V. R. C.
Duty	Transportation

ENDORSEMENT.

No. 2401

APPLICATION OF

Albert Allen

of
Haystack Co

for compensation for service of slave,

Ned Douglass

enlisted August 29 1864

in M Co 5th Regiment

U. S. Colored Troops.

Received March 25th 1867

Compensation awarded

186

Dollars.

President Board of Claims.

P. O. ADDRESS OF CLAIMANT:

Saml J Hayes
Lexington Ky

War Department,

ADJUTANT GENERAL'S OFFICE,

Washington, April 12 1867.

Respectfully returned to the
Commission for the State of
Kentucky, with the informa-
tion that Ned Douglass
was enlisted at Camp Nelson Ky
August 29 1864 and was
mustered in as private in Co M
5th U.S.C.T. Aug. 29 1864

No. 2401 Ky

J. B. Safford

Asst. Adj't General.

BAB

CLAIM FOR COMPENSATION FOR ENLISTED SLAVE.

No. _____
I, Albert Allen a loyal citizen, and a resident of
County of Fayette State of Kentucky,
hereby claim compensation, under the provisions of
Section 24, Act approved February 24, 1864, and Section 2, Act approved July 28, 1866, for my slave
Ned Douglas, enlisted August 29th
1864, at Camp Nelson Ky by Capt. T. C. Kinney
in the 5th Regiment U. S. Colored Troops,
Co. M certificate of which enlistment, and a descriptive list, as required, accompany
this application

In proof of my loyalty to the Constitution and Government of the United States, I present the accom-
panying oath, which I have taken, signed and acknowledged; to be filed with this application, in accordance
with requirement of General Orders, No. 329, 1863, War Department, Adjutant General's Office.

And I do hereby constitute and appoint, with full power of substitution and revocation, _____
Saml Hayes of Fayette County Ky
my true and lawful Attorney to prosecute this claim for me and in my name to receive and receipt for all
orders or certificates that may be issued in payment thereof.

Albert Allen
Lexington Ky Dec 18th, 1866



50 cent
Stamp

OATH OF ALLEGIANCE.

I, Albert Allen, the owner and claimant, do solemnly swear that the
foregoing claim is a just and true claim due to me as master and owner of the said slave, and that the facts
alleged in said claim in respect to the draft or enlistment (as the case may be) of said slave into the military
service of the United States are true. And I do further swear that I have never joined, or been concerned in,
any insurrection or rebellion; that I have never borne arms against the United States; that I have never given
any aid, countenance, counsel or encouragement, to any person or persons engaged, or whom I had reason to
believe were about to engage, in insurrection, rebellion or armed hostility against the United States; that I
have neither sought, nor accepted, nor attempted to exercise the functions of any office, civil or military,
nor to perform any service whatever, under any authority, or pretended authority, in hostility to the United
States: that I have not yielded a voluntary support to any insurrection, rebellion or pretended government
authority, power or constitution within the United States hostile thereto. And I do further swear that, to
the best of my knowledge and ability, I have supported and defended, and will continue to support and defend
the United States against all enemies, foreign and domestic, and that I have supported, defended and obeyed, and will
continue to support, defend and obey, the Constitution and Laws of the United States; that I will bear true faith and
allegiance to the same; and that I take this oath freely, without any mental reservation or purpose of evasion:
So help me God.

Albert Allen

Sworn to and subscribed before me and the above power of attorney acknowledged at Lexington
Ky this 12th day of Decr 1866
Saml Hayes
Notary Public of Ky

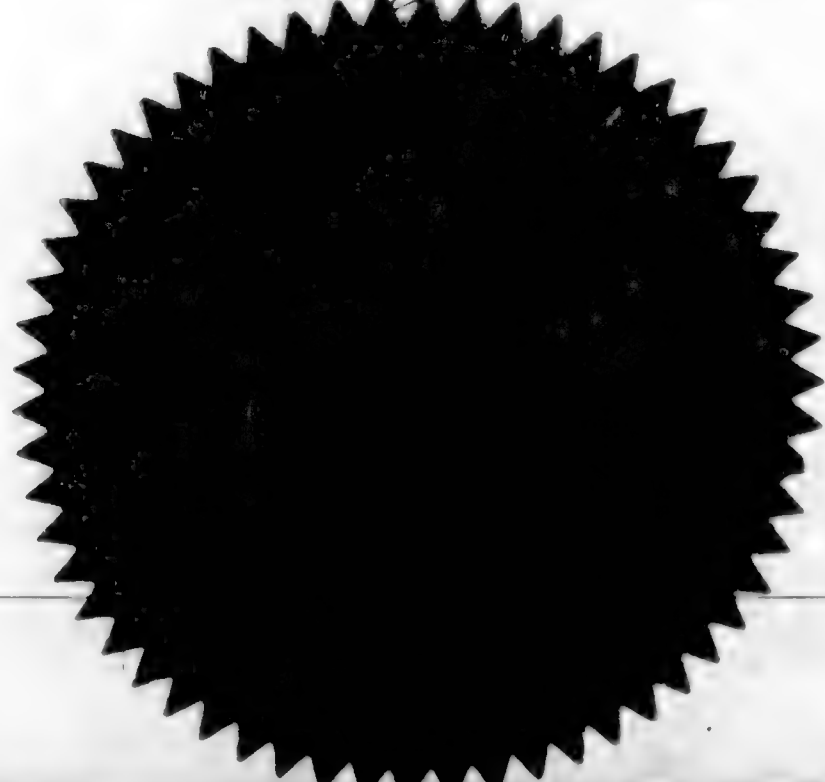

PROOF OF OWNERSHIP.

State of Kentucky,

County of Fayette } ss.

We... John Allen and Edward Allen each of lawful age, and resident citizens of the State and county aforesaid, do certify that... Albert Allen... of the State and county aforesaid, was on the 29th day of August 1864, the lawful owner of the slave named... Ned Douglas...; referred to and described in the foregoing claim for compensation.

John Allen

Headquarters Kentucky Volunteers,

Adjutant-General's Office,

Frankfort, Nov 14, 1866.

I hereby certify, that it appears from the U. S. Muster-In Rolls on file in this Office, that Ned Douglas was enrolled on the 29 day of August, 1864, at Camp Nelson Ky. by J. C. Randolph and mustered into the U. S. service on the 29 day of August 1864, at Camp Nelson by Capt J. C. Kinney to serve Three years. Said Ned Douglas is described as follows: Twenty One age, Black eyes, Black hair, Black complexion, 5 ft 5 inches height. It further appears from said Rolls, that Ned Douglas owed service to Albert Allen and is credited to Fayette County Kentucky and was assigned to Company, "M" 5th Regt U. S. C. Cavalry

In Testimony Whereof, I have hereunto set my hand, and affixed my Official Seal, this 14 day of Nov, 1866.

D. W. Lindsey
Adjutant General of Kentucky.

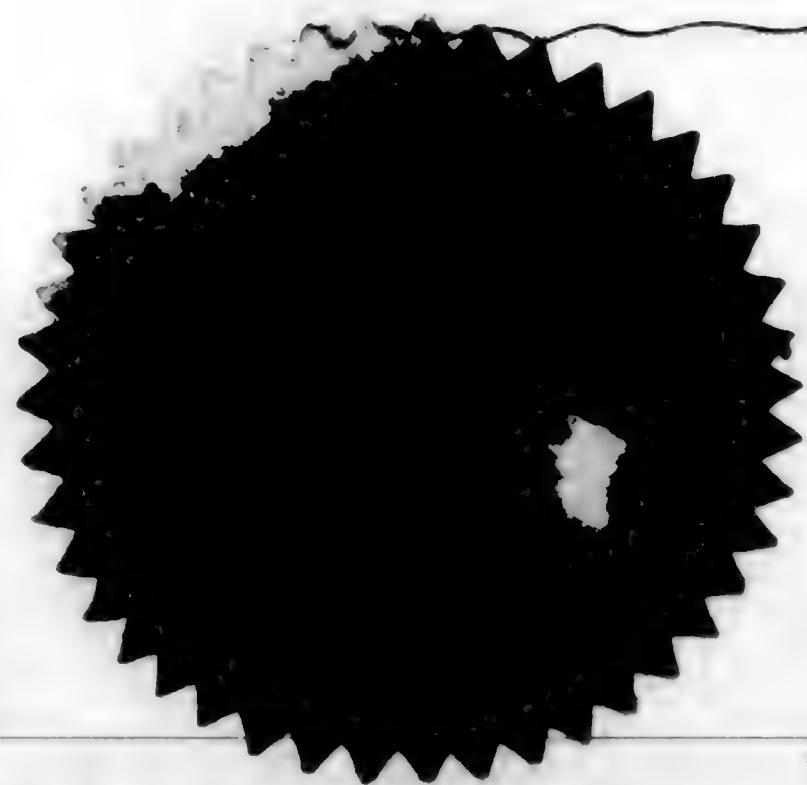

18531 R 264

PROOF OF OWNERSHIP.

State of Kentucky,

County of Fayette } ss.

We... John Allen and Edward Allen each of lawful age, and resident citizens of the State and county aforesaid, do certify that Albert Allen of the State and county aforesaid, was on the 29th day of August 1864, the lawful owner of the slave named Ted Douglas; referred to and described in the foregoing claim for compensation.

John Allen
Edward Allen

Sworn to and subscribed before me a Notary Public for the county of
Fayette State of Kentucky, this the 18th day of Dec 1866.

Saml Hayes Notary Public



PROOF OF LOYALTY.

State of Kentucky,

County of Fayette } ss.

We... John Pearson and And Steele each of lawful age, and a resident citizen of the... County of Fayette in the State and county aforesaid, upon our oaths declare that we have known Albert Allen a resident of the State and county aforesaid, since the 4th day of March, 1861, and know that he has firmly and faithfully maintained his or her adherence and allegiance to the Government of the United States, by defending its cause against the Government and forces of the so-called Confederate States of America, in all suitable and practicable ways, and according to his or her ability and opportunity.

John S Pearson
And Steele

Sworn to and subscribed before me a Notary Public for the county of
Fayette State of Kentucky, this the 24 day of Dec 1866.

Saml Hayes Notary Public

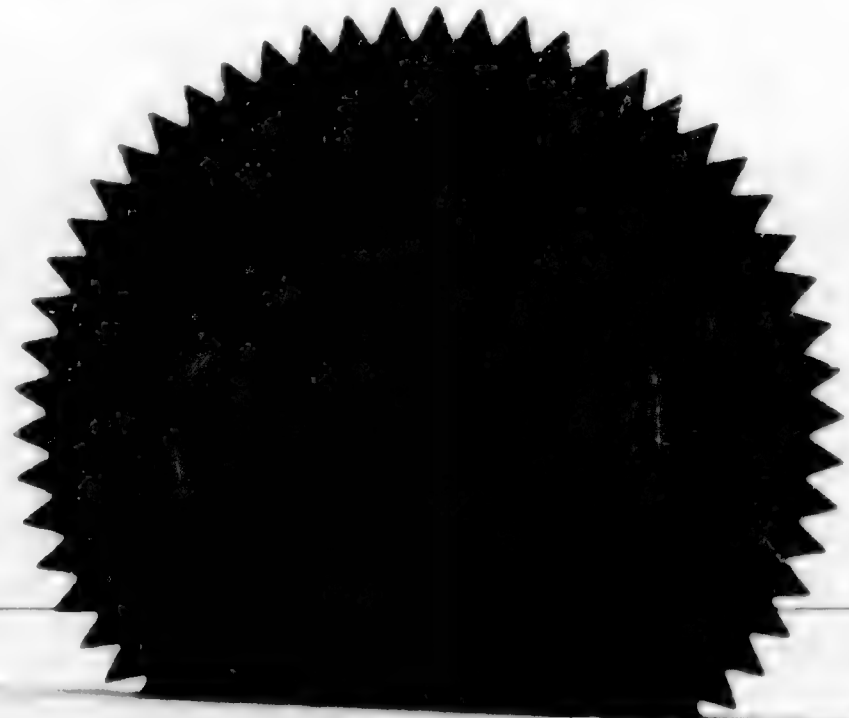
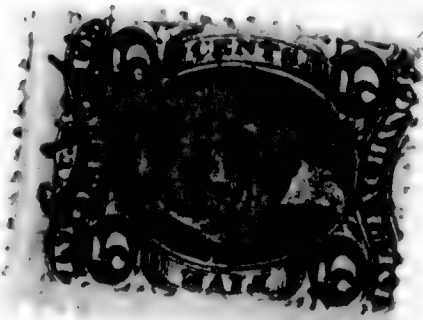

NOTE 1.—This blank will be used for enlistments of United States colored troops. They will be made out in duplicate in all cases—one to accompany the recruiting return of the superintendent (not the recruiting officer) to the Adjutant General, and one to accompany the accounts of the officer who pays bounty, &c.

NOTE 2.—An enlistment holds to service. A muster-in must, in all cases, precede payment of pay, bounty, pension, &c. A muster-in roll, must in all cases, be filed in the Adjutant General's Office as evidence of muster-in. The mustering officer, commissary, or assistant commissary of musters, as the case may be, will countersign both enlistments as having mustered the soldiers into the service of the United States before either of them is given to the disbursing officer.

DECLARATION OF RECRUIT.

I, Ned Douglas desiring to volunteer as a soldier in the ARMY OF THE UNITED STATES, for the term of Three Years, DO DECLARE That I am 21 years and months of age; that I have never been discharged from the United States service on account of disability or by sentence of a court-martial, or by order before the expiration of a term of enlistment; and I know of no impediment to my serving honestly and faithfully as a soldier for three years.

GIVEN at Camp Nelson Co the 29th day of August 1864

Witness: J. B. Stock

Ned Douglas
mark

Volunteered at Camp Nelson
Aug 29 1864

Ans Howard
No. 800
Ned Douglas

By J. E. Remondino
Wm. J. Blair
Co 200
1st Regt Colored
Inf

Consent of Parent or Guardian in case of a Minor, if a Free Man, or in the case of a Slave, of the Person to whom he owes Service:

I, Do CERTIFY, That I am the

that the said is years of age; and I do freely give my CONSENT to his volunteering as a SOLDIER in the Army of the United States, for the period of THREE YEARS, under the conditions of the laws of the United States.

GIVEN at the day of

Witness:

UNITED STATES COLORED TROOPS ENLISTMENT.

STATE OF

TOWN OF

Kentucky



Camp Nelson

I, *Ned Douglas* born in *Fayette co*
in the State of *Kentucky* aged *Twenty one* years
and by occupation a *Farmer* Do HEREBY ACKNOWLEDGE to
have volunteered *Twenty Ninth* day of *August* 186*2*
to serve as a **Soldier** in the **Army of the United States of America**, for the
period of **THREE YEARS**, unless sooner discharged by proper authority: Do
also agree to accept such bounty, pay, rations, and clothing, as are, or may be,
established by law for the U. S. colored troops.

And I, *Ned Douglas*
do solemnly swear that I will bear true faith and allegiance to the **United States
of America**, and that I will serve them honestly and faithfully against all their
enemies or opposers whomsoever; and that I will observe and obey the orders
of the President of the United States, and the orders of the officers appointed
over me, according to the Rules and Articles of War.

Sworn and subscribed to, at *Camp Nelson*
this *29th* day of *August 1862* *Ned Douglas*
Before *J. C. Randolph* *mark*
S. P. M.

I CERTIFY, ON HONOR, That I have carefully examined the above named Volunteer agree-
ably to the General Regulations of the Army, and that, in my opinion, he is free from all bodily
defects and mental infirmity, which would in any way disqualify him from performing the
duties of a soldier.

P. G. Barrett
Asst Surg 7th C. C. T.
EXAMINING SURGEON.

I CERTIFY, ON HONOR, That I have minutely inspected the Volunteer *Ned Douglas*
previously to his enlistment, and that he was entirely sober when enlisted; that, to the best of
my judgment and belief, he is of lawful age; and that, in accepting him as duly qualified to per-
form the duties of an able-bodied soldier, I have strictly observed the regulations which govern
the recruiting service. This soldier has *both* eyes, *both* hair, *both* com-
plexion, is *five* feet *five* inches high.

J. C. Randolph
and *S. P. M.*
RECRUITING OFFICER OR AGENT.

Mustered into the United States Service *29th* day of *August* 186*2*.

A. C. Manning
Capt 10th C. C. T. Mustering Officer

Mustered into the service of the United States, for three years or during the war, from date of enlistment, in Company
.....
Regiment of *Missouri* Volunteers, on the *29th* day of *August* 186*2* at *Camp Nelson*
Company

Ned Douglas
Farmer
Capt 10th C. C. T.

Northampton
100 m.

Adjutant General's Office,

COLORED TROOPS BRANCH,

June 12, 1874

Vol. C. T., 187

Wanted in case of *Herbert Douglass*, Co. *116*

*5th Reg't U. S. Col'd Cav., Department of the South
Virginia Cavalry '101' re '1864, report in 'records'
of Virginia Cavalry '101, 4, 600"*

Respectfully,

W. A. Woodward
P. J. Fulton Chief Clerk.

Adjutant General's Office,

Division of Records & Plans.

June 12, 1874.

Vol. C. T., 187

Reply in case of *Herbert Douglass*, *Art. Co. M.*

5th Reg't U. S. Col'd Cav.

*Reg't D & S Bk. Deserted at Lexington Ky Nov 4. 1864. Taken
up from desertion Camp Nelson April 3. 1865. Co D & S
Bk. Boone as Corporal with remark - Deserted Oct 4. 1864
at Lexington Ky. Returned from desertion day and date
unknown - Returned to duty April 1865. Co Moring's Rpts
are incomplete for April 1865, and furnish no information
as to date of return &c. May 20. Reduced to the ranks
per Reg'l Order No 86. This order is dated May 23. 1865 and
reduces Corp Douglass to the ranks "for incompetency and
disobedience of orders" - No record of trial or restoration
to duty.*

B. B. K.

336

Downing, Henry

Co A, 5 U. S. Col'd Cav.

Private

Private

CARD NUMBERS.

1	5368823	26
2	5368974	27
3	5369453	28
4	5369541	29
5	5369627	30
6	5369710	31
7	9091059	32
8	43145532	33
9	40729654	34
10		35
11		36
12		37
13		38
14		39
15		40
16		41
17		42
18		43
19		44
20		45
21		46
22		47
23		48
24		49
25		50

Book Mark:

See also

0793976. *Handwritten*
D 1718537 P.O. 711-24
as 1749048
D. 2998197 *Handwritten*

G. A. Wright
X²

29

5 Cav. | U.S.C.T.

Henry Downing

, Co. K, 5 Reg't U. S. Col'd Cav.

Appears on

Company Descriptive Book

of the organization named above.

DESCRIPTION.

Age 18 years; height 5 feet 4 inches.

Complexion Black

Eyes Blue; hair Blue

Where born Fayette Co Ky

Occupation Laborer

ENLISTMENT.

When Aug 27, 186 .

Where Lexington Ky

By whom J. H. Moore; term 3 y'rs.

Remarks: missing in action
Saltville Va Oct 2/64

(383g)

A. J. Anderson

Copist.

D

5 Cav.

U.S.C.T.

Henry Downing

Priv., Co. K, 5 Reg't U. S. Col'd Cavalry.

Appears on

Company Muster-in and Descriptive Roll

of the organization named above. Roll dated

Camp Nelson N. Y., Oct 30, 1864.

Where born Fayette Ky

Age 18 y'rs; occupation Laborer

When enlisted Aug 22, 1864.

Where enlisted Lexington Ky

For what period enlisted 3 years.

Eyes Blk, hair Blk

Complexion Blk; height 5 ft. 4 in.

When mustered in Aug 22, 1864.

Where mustered in Lexington Ky

Bounty paid \$ 100; due \$ 100

Where credited 7 Dist Ky

Company to which assigned

Remarks: * James Downing

* Supposed to be name of owner

Book mark:

H S Miller

D | 5 bar | USCJ

Henry Downing

Appears with rank of Priv 1 on

Muster and Descriptive Roll

of a Detachment of U.S. Colored Vols.
forwarded to Camp Nelson Ky.

Camp of instruction Roll dated
Lexington Ky, Aug 27, 1864.

Where born Fayette Co. Ky.

Age 15 years; occupation Laborer

When enlisted Aug. 27, 1864.

Where enlisted Lexington Ky.

For what period enlisted 3 years.

Eyes Blk; hair Blk

Complexion Blk; height 5 ft. 4 in.

When mustered in _____, 186 .

Where mustered in _____

Bounty paid \$ _____ 100; due \$ _____ 100

Clothing account:
Last settled _____, 186 ; drawn since \$ _____ 100

Date of first muster Aug. 27, 1864.

Company to which assigned _____

Remarks: owner James Downing
Fayette Co to be credited 7
rest Ky

Book mark : _____

W. W. Potter

(356m)

Copyist.

10

5 Cav. U.S.C.T.

Henry Downing
Pot, Co. K, 5 Reg't U. S. Col'd Cav.

Appears on

Company Muster Roll

for Organization to Oct 31, 1864.

Present or absent

Stoppage, \$ 100 for

Due Gov't, \$ 100 for

Valuation of horse, \$ 100

Valuation of horse equipments, \$ 100

Remarks: Missing in action
Saltville Va Oct 2 1864

Book mark:

H S Miller

(358)

Copyist.

2

5 Cav. U.S.C.T.

Henry Downing
Priv., Co. K, 5 Reg't U. S. Col'd Cav.

Appears on

Company Muster Roll

for *Sept & Oct*, 186*5*.

Present or absent *Present*

Stoppage, \$ *100* for

Due Gov't, \$ *100* for

Valuation of horse, \$ *100*

Valuation of horse equipments, \$ *100*

Remarks: *Taken up from missing in action Oct 16. 1865*

Book mark: _____

F. E. Porter

(358)

Copyist.

9

5 Cav.

U.S.C.T.

Henry Downing
Prov, Co. K, 5 Reg't U. S. Col'd Cav.

Appears on

Company Muster Roll

for Nov + Dec, 1865.

Present or absent Present

Stoppage, \$ 100 for

Due Gov't, \$ 100 for

Valuation of horse, \$ 100

Valuation of horse equipments, \$ 100

Remarks: Due U.S. for Aed
30. Present Sick in
Quarters

Book mark:

J. E. Porter

(358)

Copyist.

2

5 Cav. U.S.C.T.

Henry Downing
Co. K, 5 Reg't U.S. Col'd Cav.

Appears on

Company Muster Roll

for *Jan. Feb*, 1866.

Present or absent *Present*

Stoppage, \$ *100* for

Due Gov't, \$ *100* for

Valuation of horse, \$ *100*

Valuation of horse equipments, \$ *100*

Remarks: *2 instalment bounty due \$100*

Book mark:

E. H. Bann

(358)

Copyist.

D. | 5 Cav. | U.S.C.T.

Henry Downing.

Pvt., Co. K, 5 Reg't U. S. Colored Cav.

Appears on Returns as follows:

Oct. 1864. Loss, Oct. 2/64, Saltville,
Va., Missing in action.

Oct. 1865. Gain, Oct. 15/65, Lex., Ky.,
taken up from missing in
action, having been a prisoner.

Jan. 1866. Absent sick in Helena,
Ark.

Book mark:

(546)

A. Baker
Copyist.

2

5 Cav. U.S.C.T.

James Downing
Capt, Co. *A*, 5 Reg't U. S. Col'd Cavalry.

Appears on **Co. Muster-out Roll**, dated
Indiana Ark, *Mich 16*, 1866.
Muster-out to date *Mich 16*, 1866.
Last paid to *Dec 31*, 1865.

Clothing account:

Last settled....., 186 ; drawn since \$ 100

Due soldier \$ *79* ^{*24*}/₁₀₀; due U. S. \$ 100

Am't for cloth'g in kind or money adv'd \$ 100

Due U. S. for arms, equipments, &c., \$ 100

Bounty paid \$ *100* 100; due \$ *100* 100

Remarks:
.....
.....
.....
.....
.....

Book mark:

E. W. Brown

Downing, Henry
Co. K, 5 Reg't U.S. Cavalry

1 Enclosures.

Bed Cards	Final Statements
Burial Records	Furloughs or L. of A.
Certs. of Dis. for Discharge	Med. Certificates
C. M. Charges	Med. Des. Lists
Descriptive Lists	Orders
Discharge Certificates	Pris. of War Record
Enlistment Papers /	Resignations

Other papers relating to—

Admission to Hosp'l	Furlough or L. of A.
Casualty Sheet	Med. Examination
Confinement	Misc. Information
Contracts	Pay or Clothing
Death or Effects	Personal Reports
Desertion	Rank
Discharge from Hosp'l	Transfer to Hosp'l
Discharge from Service	Transfer to V. R. C.
Duty	Transportation

ARTICLE 1.—This blank will be filled in by the recruiting officers of United States colored troops. They will be made out in duplicate in all cases—one to accompany the recruiting officer and the other to accompany the Adjutant General, and one to accompany the accounts of the officer who pays bounty, &c.

ARTICLE 2.—An enlistment holds to service. A master-in-charge, in all cases, precedes payment of pay, bounty, pension, &c. A master-in-charge, must in all cases, be filed in the Adjutant General's Office. The commanding officer, commissary, or assistant commissary of masters, as the case may be, will countersign both enlistments as having witnessed the soldier, into the service of the United States or copy of them is given to the disbursing officer.

DECLARATION OF RECRUIT.

I, Nary Hanning, desiring to volunteer as a soldier in the ARMY OF THE UNITED STATES, for the term of Three Years, DO DECLARE That I am 18 years and 0 months of age; that I have never been discharged from the United States service on account of disability or by sentence of a court-martial, or by order before the expiration of a term of enlistment; and I know of no impediment to my serving honestly and faithfully as a soldier for three years.

GIVEN at Lexington Kentucky the 2^d day of August 1864

Witness: J. P. Brown

Nary's Hanning

Volunteered at Lexington
Aug. 27th 1864
By J. P. Brown
Capt. J. P. Brown
of Kentucky

Consent of Parent or Guardian in case of a Minor, if a Free Man, or in the case of a Slave, of the Person to whom he owes Service:

I, James Hanning of Fayette Co. Do CERTIFY, That I am the Owner of Nary Hanning a Slave

that the said Nary Hanning is Eighteen years of age; and I

do freely give my consent to his volunteering as a SOLDIER in the Army of the United States, for the period of THREE YEARS, under the conditions of the laws of the United States.

GIVEN at Lexington Kentucky the 2^d day of August 1864

Witness:

UNITED STATES COLORED TROOPS ENLISTMENT.

STATE OF

Kentucky



TOWN OF

Lexington

I, *Henry Downing*

born in

Payette County

in the State of

Kentucky

aged

Eighteen years

and by occupation a

Laborer

Do HEREBY ACKNOWLEDGE TO

have volunteered

27th

day of

August 186*4*

to serve as a **Soldier** in the **Army of the United States of America**, for the period of **THREE YEARS**, unless sooner discharged by proper authority: Do also agree to accept such bounty, pay, rations, and clothing, as are, or may be, established by law for the U. S. colored troops.

And I, *Henry Downing*

do solemnly swear that I will bear true faith and allegiance to the **United States of America**, and that I will serve them honestly and faithfully against all their enemies or opposers whomsoever; and that I will observe and obey the orders of the President of the United States, and the orders of the officers appointed over me, according to the Rules and Articles of War.

Sworn and subscribed to, at

Lexington Ky

this

27th

day of

Aug. 1864

Henry Downing
in's
mark

Before

John H. Moore
Capt & Pro. Major 7th dist Ky.

I CERTIFY, ON HONOR, That I have carefully examined the above named Volunteer agreeably to the General Regulations of the Army, and that, in my opinion, he is free from all bodily defects and mental infirmity, which would in any way disqualify him from performing the duties of a soldier.

J. J. Gave

EXAMINING SURGEON.

I CERTIFY, ON HONOR, That I have minutely inspected the Volunteer, *Henry Downing* previously to his enlistment, and that he was entirely sober when enlisted; that, to the best of my judgment and belief, he is of legal age, and that, in accepting him as duly qualified to perform the duties of an able-bodied soldier, I have strictly observed the regulations which govern the recruiting service. This soldier has *five* eyes, *five* hair, *dark* complexion, is *five* feet *inches* high.

John H. Moore

Capt & Pro. Major
RECRUITING OFFICER OF *7th dist Ky.*

Mustered into the United States Service.....day of.....186

Mustering Officer

Mustered into the service of the United States, for three years or during the war, from date of enlistment, in Company Regiment of Volunteers, on the day of 1864 at

Doyle, Green

Co G, 5 U.S. Col'd Cav.

Private

Private

CARD NUMBERS.

5365742	26
5365841	27
5365942	28
5366037	29
5366184	30
5366721	31
9090667	32
40729685	33

26

27

28

29

30

31

32

33

34

35

36

37

38

39

40

41

42

43

44

45

46

47

48

49

50

Book Mark:

See also

Al 5 Cav. | U.S.C.T.

Green Hoyle
Co. G, 5 Reg't U. S. Col'd Cav.

Appears on

Company Descriptive Book
of the organization named above.

DESCRIPTION.

Age 27 years; height 5 feet 5 inches.

Complexion Black

Eyes Black; hair Black

Where born Maddison Ky

Occupation farmer

ENLISTMENT.

When Sep 8, 186 4.

Where Camp Nelson

By whom W. Randolph, term 3 y'rs.

Remarks: died Camp Nelson Feb. 23-65

T. E. Purse

D. | **5 Cav.** | **U.S.C.T.**

Green Doyle

Pvt., Co. G, 5 Reg't U. S. Col'd Cavalry.

Appears on

Company Muster-in and Descriptive Roll

of the organization named above. Roll dated

Camp Nelson, N. Y., Oct. 27, 1864.

Where born Madison Ky.

Age 27 y'rs; occupation Farmer.

When enlisted Sept. 8, 1864.

Where enlisted Camp Nelson Ky.

For what period enlisted 3 years.

Eyes Black; hair Black.

Complexion Black; height 5 ft. 5 in.

When mustered in Sept. 9, 1864.

Where mustered in Camp Nelson Ky.

Bounty paid \$ 100; due \$ 100

Where credited 8th Dist. Ky.

Company to which assigned

Remarks:

x Heating Doyle

x Supposed to be name of owner

x Added May 16, 98 H. J.

Book mark:

[Signature]

(356d)

Copyist.

I

5 Cav.

U.S.C.T.

Green Doyle

Pvt., Co. G, 5 Reg't U. S. Col'd Cavalry.

Appears on

Company Muster Roll

for *Sept. to Oct. 31, 1864.*

Present or absent *Absent*

Stoppage, \$ *100* for

Due Gov't, \$ *100* for

Valuation of horse, \$ *100*

Valuation of horse equipments, \$ *100*

Remarks: *In Gen. Haslett,
Camp Nelson Ky.*

Book mark:

(358)

[Signature]

Copyist.

D

5 Cav.

U.S.C.T.

Green Doyle

Priv, Co. G, 5 Reg't U. S. Col'd Cavalry.

Appears on

Company Muster Roll

for *Nov. & Dec.*, 1864.

Present or absent *Absent*

Stoppage, \$ *100* for

Due Gov't, \$ *100* for

Valuation of horse, \$ *100*

Valuation of horse equipments, \$ *100*

Remarks: *In Genl. Hosptl.
at Camp Nelson Ky.
since Oct. 1864*

Book mark:

[Signature]

(358)

Copyist.

J

5 Cav.

U.S.C.T.

Green Doyle,

Pvt., Co. G, 5 Reg't U. S. Col'd Cavalry.

Appears on

Company Muster Roll

for *Jan. & Feb.,* 186*5.*

Present or absent *Absent*

Stoppage, \$ *100* for

Due Gov't, \$ *100* for

Valuation of horse, \$ *100*

Valuation of horse equipments, \$ *100*

Remarks: *Sick in Gen
Hospital, Camp Stanton
1st ~~used~~ Bountif,
\$100⁰⁰ due*

Book mark:

[Signature]

(358)

Copyist.

D. | **5 Cav.** | **U.S.C.T.**

Green Doyle

Pvt., Co. G, 5 Reg't U. S. Col'd Cavalry.

Appears on

Company Muster Roll

for *March & April*, 1865.

Present or absent

Stoppage, \$ 100 for

Due Gov't, \$ 100 for

Valuation of horse, \$ 100

Valuation of horse equipments, \$ 100

Remarks: *Deaf in Hospital,
Camp Nelson Ky, Feb. 23/65.
Notice not recd. until
March 23/65.*

Book mark:

(358)

[Signature]

Copyist.

D. | 5 Cav. | U.S.C.T.

Green Doyle.

Priv., Co. G., 5 Reg't U. S. Colored Cav.

Appears on Returns as follows:

Oct. 1864 to Feb. 1865. Wasent sick
in Gen. Hosp. at Camp Nelson,
Ky., since Oct. '64.

Mar. 1865. Died of disease Feb.
23/65; Camp Nelson. No
notification rec'd until Mar.
22/65.

Book mark:

(546)

A. Baker
Copyist.

Green Doyle

Park, Co. *G*, 5 Reg't U. S. Col'd Cavalry.

Appears on **Co. Muster-out Roll**, dated

Helena, Ark. Mch. 16, 1866.

Muster-out to date _____, 186 .

Last paid to _____, 186 .

Pay due from Enlistment.

Clothing account:

Last settled _____, 186 ; drawn since \$ _____ 100

Due soldier \$ _____ 100; due U. S. \$ *21* ⁸⁴ 100

Am't for cloth'g in kind or money adv'd \$ _____ 100

Due U. S. for arms, equipments, &c., \$ _____ 100

Bounty paid \$ _____ 100; due \$ _____ 100

Remarks: *Slave - died Feb. 23, 1865.*

*Went to prison by at Helena,
Final statement forwarded Mar.
12, 1865.*

Book mark: _____

Robert

Doyle, Green
P., Co. G., 5 Reg't U.S.C. Cav.

3 Enclosures.

Bed Cards	Descriptive Lists
Burial Records	Final Statements /
Certs. of Dis. for Discharge	Furloughs
C. M. Charges	Med. Des. Lists
Med. Certificates	Orders

Other papers relating to—

Admission to Hosp'l	Furlough
Casualty Sheet (Officer's)	Med. Examination
Confinement	Misc. Information
Contracts	Pay or Clothing
Death or Effects 2	Personal Reports
Desertions	Rank
Discharge from Hosp'l	Transfer to Hosp'l
Discharge from Service	Transfer to V. R. C.
Duty	Transportation

Inventory

of the effects of *Pvt*
Green Doyle
late of Co. "G" 6th Regiment
Inf. C., who died
at *Camp Wilson* General
Hospital *Feb 23^d*,
1863.



7

64

Nelson U. S. Army General Hospital,
Camp Nelson Ky Feb 23^d 1865.

Commanding Officer "G" Company,
5th "C" Regt. U.S.C.

I have to inform you
of your Company, died
that Green Doyle
in this Hospital on the 23^d day of February 1865
of Oueda

I inclose ~~his descriptive list, with pay and clothing account, and~~
inventory of his effects.

Very respectfully yours, &c.,

Richard M. Cochrane
Capt and Military Ass't

Surgeon U. S.

~~In charge of General Hospital.~~

V
FINAL STATEMENT

Co "G"
OF

Green Hoyle Co G
5th Reg't of U.S.C.

4
VOLUNTEERS.

1st Reg't 23rd U.S.C.

NOTE 1.—Two of these certificates (or duplicates) are to be given to each Volunteer Soldier or drafted man who may be discharged without being mustered out (Final Statements are never given to men mustered out of service,) that he may at once receive from the Paymaster the pay, &c., due him, and the captain or other COMMISSIONED officer commanding the company will certify to the act of the delivery of the duplicate certificates; with these certificates the Soldier is "entitled to" his discharge, and he will also present his discharge to the Paymaster to have the payment endorsed on it. The discharge is to be given back to the Soldier by the Paymaster; the latter only retaining as his vouchers the duplicate certificates.

NOTE 2.—If the Soldier is entitled to pay for the use of his horse, the Company Commander will certify to that fact on the back of both these final statements, and also to the time he has pay due for having been so mounted on his own horse.

NOTE 3.—When a Soldier is furnished with final statements, his descriptive list, if he has one, should be taken up by the officer who gives the Soldier these statements, and endorsed with a statement to this effect by the officer. The endorsement should exhibit a full statement of the time for which the Soldier was allowed pay on his final statements, the crediting account, and all other charges against him or in his favor, so as to comprise a complete exhibit of his account. It will then be transmitted to the Company Commander of the Soldier, who will enter all the data necessary to a full understanding of the Soldier's account on the muster roll upon which the Soldier's discharge is reported. The descriptive list will then be destroyed. The object of this is, that the remaining portion of the Soldier's account may be settled upon the receipt of these muster rolls, and the Soldier receive any pay or allowances that may be due him at the time of his discharge, and which may not appear on his last final statements from the fact that his descriptive list is incomplete. These accounts for back pay, &c., are settled by the 2d Auditor of the Treasury Department.

NOTE 4.—Charges for loss or injury to ordnance, horse equipments, and other miscellaneous charges, should appear under the heading of "Other Stoppages."

NOTE 5.—Bounty paid by State authorities, and not by the United States, will not be entered on this statement.

NOTE 6.—Amounts due the Sutler and Laundress must be entered on the muster roll on which the discharge, death, desertion, &c., is reported, as well as on the final statement, otherwise the amount cannot be collected from the United States.

NOTE 7.—This blank will be used for deceased volunteers and drafted men, as well as for others.

NOTE 8.—Where a Soldier dies in Hospital or on detached service, his descriptive list, if he has one, should be sent with his final statements, in duplicate, to the Adjutant General, Washington, D. C.

NOTE 9.—If the soldier is a drafted man or substitute, the space for time, &c., of enrolled, should contain only the word *drafted* or *substitute*, as the case may be. If the Soldier is a "VETERAN," (or RECRUIT,) the words *as a veteran*, (or *recruit*,) as the case may be, should be interlined after the words *mustered into the service of the U. S.* A statement of all the installments of *Veteran* or *Recruit* Bounty RECEIVED by the Soldier must be made on the back of each final statement.

ADJUTANT GENERAL'S OFFICE.

Mar 29th 1865

Duplicate with Inventory sent 2d Auditor.

I certify, on honor, that Green Hoyle, a Printer of
 Captain Geo A. Hurling Company (G) of the 5th Regiment of Vol of
VOLUNTEERS, of the State of _____, born in Middlebury County, State
 of Kentucky, aged 21 years; 5 feet 5 inches high; Black complexion,
Black eyes, Black hair, and by occupation a Farmer, who joined for service
 and was enrolled (see Note 9) on the 8th day of September, 1864, at Camp Nelson Ky
 by plc Randolph H.P.M., for the period of Three years, and mustered into
 the service of the United States on the 9th day of September, 1864, at
Camp Nelson Ky, by Capt. N. C. Kinney; and having served
 HONESTLY and FAITHFULLY with his Company to the present date, is now entitled to a
DISCHARGE by reason of Death
Attended Feb 23rd 1865 see Ser No 712

The said Green Hoyle was last paid by Paymaster
Pay due from enlistment, to include the _____ day of _____, 186____, and
 has pay due him from that time to the present date; he is entitled to pay and subsistence for
TRAVELING to place of enrollment, and whatever other allowances are authorized to volunteer
 soldiers, drafted men, or militia, so discharged. He has received from the United States **CLOTHING**
 amounting to Forty $\frac{99}{100}$ dollars, since the 9th day of September.
 1864, when his clothing account was last settled. He has received from the United States
 _____ $\frac{1}{100}$ dollars advanced **BOUNTY**.

There is to be stopped from him, on account of the State of _____, or other
 authorities, for **CLOTHING**, &c., received on entering service, _____ $\frac{1}{100}$ dollars; and
 for other stoppages, viz: _____

 _____ $\frac{1}{100}$ dollars.
 He has been furnished with **TRANSPORTATION** in kind from the place of his discharge to
 _____; and he has been **SUBSISTED** for **TRAVELING** to his
 place of enrollment, up to the _____, 186____.

He is indebted to _____, **SUTLER**, _____ $\frac{1}{100}$ dollars.
 He is indebted to _____, **LAUNDRESS**, _____ $\frac{1}{100}$ dollars.

Given in Duplicate, at Camp Nelson Ky, this 23 day
 of February, 1865.

George B. Taylor
2 Lieut
 Commanding Company

Queen Beyle
W. S.

Adjutant General's Office,

COLORED TROOPS BRANCH,

Mar 30, 1874

Vol. C. T., 187

Wanted in case of Green, Co. G,

2 Reg't

in connection with
a duty, 1st Co. 1st Reg't in
Camp "Hess" near "Camp"

Respectfully,

W. A. Woodward
Chief Clerk.

P. H. Patton

Adjutant General's Office,

Record Room

April 2, 1874

Vol. C. T., 187

Reply in case of

5 Reg't

Green, Doyle Pvt., Co. G,
W. S. C. Cav.

Reg't. Descriptive Book and Co. Descriptive, Mg.
Report & Clothing book show. Died Feb. 23 1865 at
Camp Melesh Ky of Disease.

mg

35712

Drain John
Co H, 5 U.S. Col'd Troops. ^{Cav.}

Pvt

CARD NUMBERS.

1	26
2	27
3	28
4	29
5	30
6	31
7	32
8	33
9	34
10	35
11	36
12	37
13	38
14	39
15	40
16	41
17	42
18	43
19	44
20	45
21	46
22	47
23	48
24	49
25	50

See Drees, John

Number of personal papers herein.....

Book Mark:

See also

358

Drake, George W.

Co D, 5 U. S. Col'd Cav.

Private

Private

CARD NUMBERS.

1	5362568	26
2	5362770	27
3	5362871	28
4	5363120	29
5	5363654	30
6	9090297	31
7	43146478	32
8	43155139	33
9	40729687	34
10		35
11		36
12		37
13		38
14		39
15		40
16		41
17		42
18		43
19		44
20		45
21		46
22		47
23		48
24		49
25		50

Book Mark:

See also

M | **5 Cav.** | **U.S.C.T.**

George W. Drake
Co. M, 5 Reg't U. S. Col'd Cav.

Appears on

Company Descriptive Book
of the organization named above.

DESCRIPTION.

Age 18 years; height 5 feet 7 inches.

Complexion Black

Eyes Blk; hair Blk

Where born Louisville Ky.

Occupation Laborer

ENLISTMENT.

When Substitute, 186 .

Where 5th Dist. Ky.

By whom _____; term 3 y'rs.

Remarks: Discharged
on Surgeon's cer-
tificate of disabil-
ity Dec 31st 1864

X E Drake

D | 5 bar | 1864

Geo W. Drake

Appears with rank of Rec't on

Muster and Descriptive Roll

of a Detachment of men drafted and mustered into service of U.S.

Roll dated Louisville Ky, Sep. 2, 1864.

Where born Louisville Ky

Age 18 y'rs; occupation Labourer

Drafted and mustered in:

When Sep 2, 1864.

Where Louisville Ky

Enrollment district 5 Dist Ky

Period 3 years.

Eyes Black; hair Black

Complexion Black; height 5 ft. 6 in.

Bounty paid \$ 100; due \$ 100

Clothing account:

Last settled _____, 186 ; drawn since \$ 100

Date of commencement of service Sep 2, 1864.

Company to which assigned _____

Remarks: Substitute for J. T. Mc Ferrin Auto Draft Issued clothing to amt of \$19.57

Book mark: _____

(356m)

Jacobson

Copyist.

J | 5 bar | U.S.C.T.

George W. Drake

Appears with rank of Pvt on

Muster and Descriptive Roll

of a Detachment of U.S. colored
Troops forwarded for U.S. colic
cer. at Lexington, Ky Roll dated
Louisville, Ky, Sept. 7, 1864.

Where born Louisville, Ky

Age 18 years; occupation Laborer

When enlisted Substitute, 186

Where enlisted

For what period enlisted 3 years.

Eyes Black; hair Black

Complexion Black; height 5 ft. 6 in.

When mustered in Sept. 2, 1864.

Where mustered in Louisville

Bounty paid \$ 100; due \$ 100

Clothing account:

Last settled _____, 186 ; drawn since \$ 1957
100

Date of first muster Sept. 2, 1864.

Company to which assigned

Remarks: 5 Dist. Ky.

Book mark: -----

(356m)

A. J. Dueser

Copyist.

10

5 Cav. U.S.C.T.

George M. Drake

Pvt., Co. D, 5 Reg't U. S. Col'd Cavalry.

Appears on

Company Muster-in and Descriptive Roll

of the organization named above. Roll dated

Camp Nelson, N.Y., Oct. 24, 1864.

Where born Louisville, Ky

Age 18 y'rs; occupation Laborer

When enlisted, 186 .

Where enlisted

For what period enlisted 3 years.

Eyes Br; hair Br

Complexion Br; height 5 ft. 6 in.

When mustered in Sept. 2, 1864.

Where mustered in Louisville

Bounty paid \$ 100; due \$ 100

Where credited 5 Dist. Ky.

Company to which assigned

Remarks:

Book mark:

Wm. H. Scott

10

5 Cav. U.S.C.T.

George H. Drake
Pvt., Co. D, 5 Reg't U. S. Col'd Cavalry.

Appears on

Company Muster Roll

for Dated Oct. 31, 1864.

Present or absent Absent

Stoppage, \$ 100 for

Due Gov't, \$ 100 for

Valuation of horse, \$ 100

Valuation of horse equipments, \$ 100

Remarks: Sick in Hospital,
Camp Nelson, Ky.

Book mark:

Wm. H. Scott

(358)

Copyist.

10

5 Cav. U.S.C.T.

George W. Drake

Plt, Co. D, 5 Reg't U. S. Col'd Cavalry.

Appears on

Company Muster Roll

for Nov. & Dec., 1864.

Present or absent Absent.

Stoppage, \$ 100 for

Due Gov't, \$ 100 for

Valuation of horse, \$ 100

Valuation of horse equipments, \$ 100

Remarks: Sick in Hospital, Camp Nelson Ky.

Book mark :

Wm. Scott

N | **5 Cav. U.S.C.T.**

George H. Drake
Priv., Co. D, 5 Reg't U. S. Col'd Cavalry.

Appears on

Company Muster Roll

for *Jan. & Feb.*, 1865.

Present or absent

Stoppage, \$ 100 for

Due Gov't, \$ 100 for

Valuation of horse, \$ 100

Valuation of horse equipments, \$ 100

Remarks: *Discharged on
Surgeons Certificate of
Disability Dec. 31 '64
Notification not received
until January '65.*

Book mark:

Wm. H. Scott

(358)

Copyist.

N.

5 Cav.

U.S.C.T.

George W. Drake.

Co. N, 5 Reg't U. S. Colored Cav.

Appears on Returns as follows:

Oct. to Dec. 1864. Absent sick in
Hoop, Camp Nelson, Ky.

Feb. 1865. Discharged Dec. 31/64,
Camp Nelson, on Surg. Cert.
of disability. No notification
rec'd until Feb.

Book mark :

(546)

J. Baker
Copyist.

D. | *Car.* | **U. S. C. T.**

George W. Drake,
Prn, Co. *D,* *5* Reg't U. S. Col'd *Car.*

Appears on **Co. Muster-out Roll,** dated
Helena, Ark., (March 16, 1866)

Muster-out to date _____, 186 .

Last paid to *Enlistment*, 186 .

Clothing account:

Last settled _____, 186 ; drawn since \$ _____ 100

Due soldier \$ _____ 100; due U. S. \$ _____ 100

Am't for cloth'g in kind or money adv'd \$ _____ 100

Due U. S. for arms, equipments, &c., \$ _____ 100

Bounty paid \$ _____ 100 due \$ _____ 100

Remarks: *Discharged on Sur-*
geon's Certificate of dis-
ability, Dec. 31/64.

Book mark: _____

M. J. Spawyer

(361)

Copyist.

Drake Geo W.

Co. *10*, *B* Reg't *U.S. Caval.*

3

Enclosures.

Bed Cards	Final Statements
Burial Records	Furloughs or L. of A.
Certs. of Dis. for Discharge <i>1</i>	Med. Certificates
C. M. Charges	Med. Des. Lists
Descriptive Lists	Orders
Discharge Certificates	Pris. of War Record
Enlistment Papers <i>2</i>	Resignations

Other papers relating to—

Admission to Hosp'l	Furlough or L. of A.
Casualty Sheet	Med. Examination
Confinement	Misc. Information
Contracts	Pay or Clothing
Death or Effects	Personal Reports
Desertion	Rank
Discharge from Hosp'l	Transfer to Hosp'l
Discharge from Service	Transfer to V. R. C.
Duty	Transportation

NOTE 1.

The company commander will here add a statement of all the facts known to him concerning the disease or wound, or cause of disability of the soldier; the time, place, manner, and all the circumstances under which the injury occurred, or disease originated or appeared; the duty, or service, or situation of the soldier at the time the injury was received or disease contracted, stating particularly whether the injury was received or the disease contracted in the line of his duty; and whatever other facts may aid a judgment as to the cause, immediate or remote, of the disability, and the circumstances attending it.

When the facts are not known to the company commander, the certificate of any officer, or affidavit of other person having such knowledge, will be appended—as the surgeon in charge of a hospital, the officer commanding a detachment of recruits, &c., &c.

NOTE 2.

When a probable case for pension, special care must be taken to state the degree of disability—as $\frac{1}{2}$, $\frac{3}{4}$, &c., &c.; to describe particularly the disability, wound, or disease: the extent of which it deprives him of the use of any limb or faculty, or affects his health, strength, activity, constitution, or capacity to labor or earn his subsistence. The surgeon will add, from his knowledge of the facts and circumstances, and from the evidence in the case, his professional opinion of the cause or origin of the disability. In the case of discharges by Medical Inspectors, the last paragraph will state that the "discharge was given by consent of the soldier, after a personal examination, and for disability, the nature, degree, and origin of which are correctly described in the within certificate."

Par. 1260 Regulations, Edit. 1861.

Medical officers, in giving certificates of disability, are to take particular care in all cases that have not been under their charge; and especially in epilepsy, convulsions, chronic rheumatism, derangement of the urinary organs, ophthalmia, ulcers, or any obscure disease liable to be feigned or purposely produced; and in no case shall such certificate be given until after sufficient time and examination to detect any attempt at deception.

DIRECTIONS.

This certificate will be made out in duplicate by the soldier's company commander, or other officer commanding the separate detachment to which he belongs, and sent by him to the surgeon who has charge of the hospital where the soldier is sick. The surgeon will then fill out and sign the surgeon's certificate, and forward these papers to the regimental, detachment, or post commander, who will forward them, with his action endorsed thereon, through the proper channel, to his division commander; or, if the troops are not attached to a division, to his corps, department, or other commander or officer to whom the authority to discharge enlisted men may be specially delegated.

These certificates, after having received the action of the highest authority to which they are required to be sent, will be returned through the same channel to the regimental, post, or detachment commander, who will, if the discharge is authorized by the endorsement of the proper authority, sign the soldier's discharge, and the last certificate on this paper; see that the soldier is furnished with the proper final statements in duplicate, and forward BOTH of these certificates, direct to the Adjutant General United States Army, at Washington, D. C.; they will not, under any circumstances, be given to the soldier.

ADJUTANT GENERAL'S OFFICE.

Jan 26 1865

Duplicate sent the Pension Office.

461 R of His 1864

CERTIFICATE OF DISABILITY FOR DISCHARGE

IN THE CASE OF

Private George H. Drake
a Private Co. 4th
5th Regt of U. S. Col.

Dr. Geo. W. S. H. H.
Sp. Secy, U. S. A.
Dec. 11 '64

Observed and resp.
forwarded with the recom-
mendation, that a discharge
may be granted to this sol-
dier, as he is entirely unfit
for service.

J. H. Sargent
5th U. S. Col.
Commanding



Received (A. G. Office) 1865

En on Order of

25 10

No. 205

G. W. Drut

Enlisted at Lowell, Me.

As Substitute for

J. M. Ferris

On the 2 day of Sept, 1864

By

Amos A. Fernald
W. R. Hensley Secy
G. S. Bell Surg

Board of Enrollment,

Dist. of Me.

SUBSTITUTE
VOLUNTEER ENLISTMENT.

STATE OF

TOWN OF

Kentucky

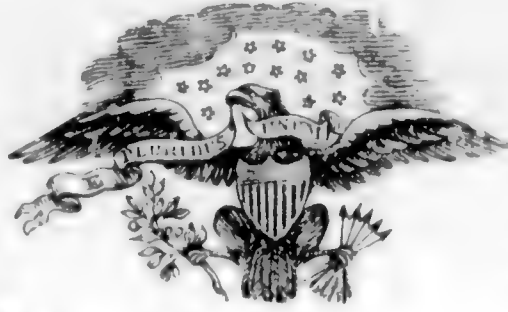

Louisville

I, *Geo W Drake* born in the State
of *Alabama*, aged *18* years, and by
occupation a *laborer*

Do HEREBY ACKNOWLEDGE to have agreed with

J B Mc Ferrin, Esq., of *Louisville*
Jefferson County Ky

to become his **SUBSTITUTE** in the Military Service, for a sufficient consideration paid and
delivered to me, on the *20* day of *Sept*, 186*4*

and having thus agreed with said *J B Mc Ferrin*, I DO HEREBY
ACKNOWLEDGE to have enlisted this *20* day of *Sept*,

186*4*, to serve as a **Soldier** in the **Army of the United States of America**, for the period
of **THREE YEARS**, unless sooner discharged by proper authority: I do also agree to accept such
bounty, pay, rations, and clothing, as are, or may be, established by law for ^{*enlisted troops*} **soldiers**. And I do

solemnly swear that I will bear true and faithful allegiance to the **United States of America**;
that I will serve them honestly and faithfully against all their enemies or opposers whomsoever;
and that I will observe and obey the orders of the President of the United States, and the orders
of the Officers appointed over me, according to the Rules and Articles of War.

SWORN and subscribed to, at *Louisville Ky*

this *20* day of *Sept*, 186*4*

BEFORE *G W Munnick*

Capt & Prov Mar
5 Dist Ky

Geo W Drake
mark

We certify, on honor, That we have carefully examined the above-named Volunteer Substitute
agreeably to the Regulations, and that, in our opinion, he is free from all bodily defects and mental infirmity
which would in any way disqualify him from performing the duties of a soldier; that he was entirely sober
when enlisted; that he is of lawful age, (not under 18 years;) and that, in accepting him as duly qualified to
perform the duties of an able-bodied soldier, and as a Substitute in lieu of *J B Mc Ferrin*
Louisville Ky, drafted in *5th Regt Dist Ky*
Arch Drift, 186*4*, we have strictly observed the Regulations which govern
in such cases. This soldier has *black* eyes, *black* hair, *black* complexion; is *5* feet *6*
inches high.

G W Munnick

Provost Marshal.

Will R Hervey

Commissioner of Board.

J S Bell

Surgeon of Board.

Board of Enrollment of *5* Dist. of *Ky*

DECLARATION OF SUBSTITUTE.

I, Geo M Drake desiring to ENLIST
in the Army of the United States, for THREE YEARS, **Do declare**, That I am
18 years and 2 months of age; that I have
never been discharged from the United States service on account of disability or by sentence of
a court martial; and I know of no impediment to my serving honestly and faithfully as a soldier
for three years.

GIVEN at Louisville Ky
the 2 day of Sept 1864

WITNESS:

E Hedeman

Geo M Drake
mark

No. 305

G. Drake

Enlisted at Lowell, N.H.

As Substitute for

A. M. Ferris

On the 2^d day of Sept., 1864

By

Amos A. Curtis

Wm. H. Searcy, Secy.

J. S. Bell, Surg.

Board of Enrollment,

Dist. of N.H.

SUBSTITUTE VOLUNTEER ENLISTMENT.

STATE OF

TOWN OF

Kentucky

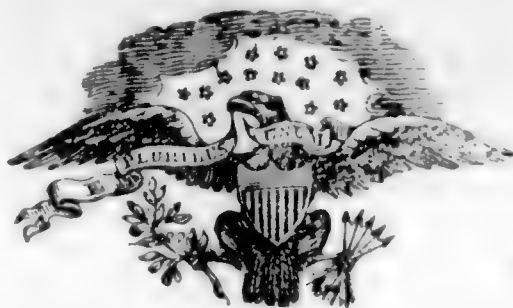

Louisville

I, *Geo W Drake* born in the State of *Alabama*, aged *18* years, and by occupation a *laborer* Do HEREBY ACKNOWLEDGE to have agreed with

J B McFerrin, Esq., of *Louisville Jefferson County Ky*

to become his **SUBSTITUTE** in the Military Service, for a sufficient consideration paid and delivered to me, on the *2^o* day of *Sept*, 186*4* and having thus agreed with said *J B McFerrin*, I DO HEREBY ACKNOWLEDGE to have enlisted this *2^o* day of *Sept*, 186*4*, to serve as a **Soldier** in the **Army of the United States of America**, for the period of **THREE YEARS**, unless sooner discharged by proper authority: I do also agree to accept such bounty, pay, rations, and clothing, as are, or may be, established by law for ^{enlisted troops} soldiers. And I do solemnly swear that I will bear true and faithful allegiance to the **United States of America**; that I will serve them honestly and faithfully against all their enemies or opposers whomsoever; and that I will observe and obey the orders of the President of the United States, and the orders of the Officers appointed over me, according to the Rules and Articles of War.

SWORN and subscribed to, at *Louisville Ky* this *2^o* day of *Sept* 186*4* BEFORE *G M Munnach* Capt *5th Dist Ky*

Geo W Drake
mark

We certify, on honor, That we have carefully examined the above-named Volunteer Substitute agreeably to the Regulations, and that, in our opinion, he is free from all bodily defects and mental infirmity which would in any way disqualify him from performing the duties of a soldier; that he was entirely sober when enlisted; that he is of lawful age, (not under 18 years;) and that, in accepting him as duly qualified to perform the duties of an able-bodied soldier, and as a Substitute in lieu of *J B McFerrin of Louisville Ky*, drafted in *5th Regt Dist Ky* *Ant Draft*, we have strictly observed the Regulations which govern in such cases. This soldier has *Black* eyes, *Black* hair, *Black* complexion; is *5* feet *6* inches high.

G M Munnach
Provost Marshal.

Will R Hervey
Commissioner of Board.

T S Bell
Surgeon of Board.

Board of Enrollment of *5* Dist. of *Ky*

DECLARATION OF SUBSTITUTE.

I, Geo W Drake desiring to ENLIST
in the **Army of the United States**, for **THREE YEARS**, **Do declare**, That I am
18 years and 2 months of age; that I have
never been discharged from the United States service on account of disability or by sentence of
a court martial; and I know of no impediment to my serving honestly and faithfully as a soldier
for three years.

GIVEN at Louiseville Ky
the 2 day of Sept 1864

WITNESS:

S. Holman

Geo W Drake
mark

³⁵⁹
Drake, William

Co C, 5 U. S. Col'd Cav.

Sergeant | Corporal

CARD NUMBERS.

5-361638	26
5-361740	27
5-361843	28
5-361937	29
5-362020	30
5-362102	31
5-362210	32
5-362302	33
5-362390	34
5-362460	35
5-362544	36
9091198	37
43146229	38
43154469	39
34451765	40
40729688	41
	42
	43
	44
	45
	46
	47
	48
	49
	50

Book Mark:

See also

al | **5 Cav. | U.S.C.T.**

William Drake

....., Co. *C*, 5 Reg't U. S. Col'd Cav.

Appears on

Company Descriptive Book
of the organization named above.

DESCRIPTION.

Age *18* years; height *5* feet *7* inches.

Complexion *Dark*

Eyes *Dark*; hair *Dark*

Where born *Shelby Co, Ky.*

Occupation *Laborer*

ENLISTMENT.

When *Aug. 17*, 1864.

Where *Substitute*

By whom *Capt. Moore*; term *3* y'rs.

Remarks: *Made En. Sgt. Sec*
N.C.C.

.....
.....
.....
.....
.....
.....

Warren

D

5 Cav. U.S.C.T.

William Drake

Srjt, Co. *C*, 5 Reg't U. S. Col'd Cavalry.

Appears on

Company Muster-in and Descriptive Roll

of the organization named above. Roll dated

Camp Nelson, Ky, *N.Y.*, *Oct. 24*, 1864.

Where born *Shelby, Ky.*

Age *18* y'rs; occupation *Labourer*

When enlisted....., 186 .

Where enlisted

For what period enlisted *3* years.

Eyes *Blk*; hair *Blk*

Complexion *Brown*; height *5* ft. *7* in.

When mustered in *Aug. 19*, 1864.

Where mustered in *Lexington*

Bounty paid \$ *100*; due \$ *100*

Where credited *7th Dist. Ky.*

Company to which assigned *C*

Remarks:

Book mark:

Shull

(356d)

Copyist.

D

5 bar

U.S.C.T.

William Drake

Appears with rank of Pvt on

Muster and Descriptive Roll

of a Detachment of U. S. Colored Troops transferred to U. S. Cavalry at Lexington, Ky.

Roll dated Franklin, Ky., Sept. 2, 1864.

Where born Kentucky

Age 18 years; occupation Laborer

When enlisted Substitute, 186 .

Where enlisted

For what period enlisted 3 years.

Eyes Blue; hair Blue

Complexion Brown; height 5 ft. 7 in.

When mustered in Aug. 19, 1864.

Where mustered in Lexington

Bounty paid \$ 100; due \$ 100

Clothing account:

Last settled _____, 186 ; drawn since \$ 17.55/100

Date of first muster Aug. 19, 1864.

Company to which assigned

Remarks: Credited to 7 Regt Dist. Ky.

Book mark:

A. J. [Signature]

(356m)

Copyist.

Q

5 Cav. U.S.C.T.

William Drake

Sergeant, Co. C, 5 Reg't U. S. Col'd Cavalry.

Appears on

Company Muster Roll

for *to Oct. 31*, 186*4*.

Present or absent *Present*

Stoppage, \$ *100* for

Due Gov't, \$ *100* for

Valuation of horse, \$ *100*

Valuation of horse equipments, \$ *100*

Remarks:

Book mark:

Shull

(358)

Copyist.

Q

5 Cav.

U.S.C.T.

William Drake

Serjt, Co. C, 5 Reg't U. S. Col'd Cavalry.

Appears on

Company Muster Roll

for *Nov. & Dec.*, 186*4*.

Present or absent *Present*

Stoppage, \$ *100* for

Due Gov't, \$ *100* for

Valuation of horse, \$ *100*

Valuation of horse equipments, \$ *100*

Remarks:

Book mark:

Shull

(358)

Copyist.

2

5 Cav. U.S.C.T.

William Drake

Serjt, Co. C, 5 Reg't U. S. Col'd Cavalry.

Appears on

Company Muster Roll

for *Jan'y, & Feby.*, 186*5*.

Present or absent *Present*

Stoppage, \$ 100 for

Due Gov't, \$ 100 for

Valuation of horse, \$ 100

Valuation of horse equipments, \$ 100

Remarks:

Book mark:

Shull

(358)

Copyist.

William Drake

Sgt, Co. C, 5 Reg't U. S. Col'd Cavalry.

Appears on

Company Muster Roll

for *Mar. 1867*, 186*7*.

Present or absent *Present*

Stoppage, \$ *100* for

Due Gov't, \$ *100* for

Valuation of horse, \$ *100*

Valuation of horse equipments, \$ *100*

Remarks:

Book mark:

S. Hall

I

5 Cav.

U.S.C.T.

William Drake

Sgt, Co. C, 5 Reg't U. S. Col'd Cavalry.

Appears on

Company Muster Roll

for *May & June*, 1865.

Present or absent *Absent*

Stoppage, \$ *100* for

Due Gov't, \$ *100* for

Valuation of horse, \$ *100*

Valuation of horse equipments, \$ *100*

Remarks *Absent in
Arrest*

Book mark:

(358)

J. J. Jorden

Copyist.

I

5 Cav. U.S.C.T.

William Drake

Private, Co. C, 5 Reg't U. S. Col'd Cavalry.

Appears on

Company Muster Roll

for *July & Aug*, 1865.

Present or absent *Absent*

Stoppage, \$ *100* for

Due Gov't, \$ *100* for

Valuation of horse, \$ *100*

Valuation of horse equipments, \$ *100*

Remarks: *Absent in Confinement Lexington Ky. Reduced to Rank & date from Aug. 6th 1865 as per Reg't Order No 145*

Book mark:

(358)

J. J. J. J.

Copyist.

I

5 Cav. U.S.C.T.

William Drake

Private, Co. C, 5 Reg't U. S. Col'd Cavalry.

Appears on

Company Muster Roll

for *Sep. + Oct.*, 1865.

Present or absent *Absent*

Stoppage, \$ 100 for

Due Gov't, \$ 100 for

Valuation of horse, \$ 100

Valuation of horse equipments, \$ 100

Remarks: *Absent in Arrest.
Reduced from Sgt to
Private Aug 6/65*

Book mark: _____

(358)

J. J. J. J.
Copyist.

D. 1 5 Cav 185. C. T.

William Drake
Sgt. Co. G. 5 Regt. Ill. C.

Appears on

Muster Roll

of Military Prison at Camp Nelson, Kentucky,

for Sept 4 - Oct, 1863.

Station Camp Nelson Ky

Clothing account:

Last settled _____, 184 ; drawn since \$ _____ 100

Present or absent Not stated

Remarks: Sentenced Per G. C. M.
G. C. No. 66, Hd. Qrs.
Dept of Ky
Three months Hard Labor.

Book mark: _____

(520)

Joiner

Copyist.

D | 5 bar | U.S.C.T.

William Drake (Cold)

Appears with rank of Priv on

Muster and Descriptive Roll

of a Detachment of U.S. Substitutes
Enlisted & Mustered, forwarded

Roll dated
Harrison, Ky Oct 30th, 1865.

Where born Kentucky

Age 18 years; occupation laborer

When enlisted Aug 19, 1864.

Where enlisted Harrison, Ky

For what period enlisted 3 years.

Eyes Blk; hair Blk

Complexion Blk; height 5 ft. 7 in.

When mustered in Aug 19, 1864.

Where mustered in Harrison, Ky

Bounty paid \$ 100, due \$ 100

Clothing account:

Last settled 186, 186 ; drawn since \$ 100

Date of first muster Aug 19, 1864.

Company to which assigned

Remarks: For whom substituted
L.J. Rouse, Enrolled man
Credited to Fayette Co. 7th D. Ky

Book mark:

(356m) J. H. Harris Copyist.

D

5 Cav. U.S.C.T.

William J. McK

Prk, Co. C, 5 Reg't U. S. Col'd Cavalry.

Appears on

Company Muster Roll

for *Nov Dec*, 1865.

Present or absent *Absent*

Stoppage, \$ *100* for

Due Gov't, \$ *100* for

Valuation of horse, \$ *100*

Valuation of horse equipments, \$ *100*

Remarks: *Absent Sick in
West Hospital Helena
Ark. Due 11/11 fortd.
H. 1. 4/1 " " " camp
& " " Equip". 65cts.
Durst.*

Book mark:

J. J. J. J.

D

5 Cav.

U.S.C.T.

William Drake
Corps, Co. C, 5 Reg't U. S. Col'd Cavalry.

Appears on

Company Muster Roll

for Jan^{and Feb}, 1866

Present or absent Present

Stoppage, \$ 100 for

Due Gov't, \$ 100 for

Valuation of horse, \$ 100

Valuation of horse equipments, \$ 100

Remarks:

Book mark:

Rose

(358)

Copyist.

D. | 5 Cav. | U.S.C.T.

William Drake.

Sgt, Co. C, 5 Reg't U. S. Colored Cav.
Pot.

Appears on Returns as follows:

June & July 1865. Absent, prisoner
at Lexington, Ky.

Aug. to Oct. 1865. (Pot.) Absent in
Confinement at Camp Nelson,
Ky.

Dec. 1865. Absent sick, Pest Hosp.,
at Helena, Ark.

Book mark :

(546)

A. Baker
Copyist.

D

5 Cav.

U.S.C.T.

William Drake

Corp., Co. C, 5 Reg't U. S. Col'd Cavalry.

Appears on Co. Muster-out Roll, dated

Helena Ark, March 16, 1866.

Muster-out to date

March 16, 1866.

Last paid to

Dec 31, 1865.

Clothing account:

Last settled....., 186 ; drawn since \$..... 100

Due soldier \$..... 100; due U. S. \$..... 18 ⁷³/₁₀₀

Am't for cloth'g in kind or money adv'd \$..... 100

Due U. S. for arms, equipments, &c., \$..... 100

Bounty paid \$..... 100; due \$..... 100

Remarks: Sgt from organization
until Aug 6, 1865 when reduced
to Private. Put until Jan 7, 1865
when made Corp

Book mark :

Rose

(261)

Copyist.

Drake Wm

Capt. Co. C., 5 Reg't U.S. Caval.

1 Enclosures.

Bed Cards	Final Statements
Burial Records	Furloughs or L. of A
Certs. of Dis. for Discharge	Med. Certificates
C. M. Charges	Med. Des. Lists
Descriptive Lists	Orders
Discharge Certificates	Pris. of War Record
Enlistment Papers	Resignations

Other papers relating to—

Admission to Hosp'l	Furlough or L. of A
Casualty Sheet	Med. Examination
Confinement /	Misc. Information
Contracts	Pay or Clothing
Death or Effects	Personal Reports
Desertion	Rank
Discharge from Hosp'l	Transfer to Hosp'l
Discharge from Service	Transfer to V. R. C.
Duty	Transportation

William Brewster
1862

Adjutant General's Office,

COLORED TROOPS BRANCH,

January 5th, 1871

Vol. C. T., 187

Wanted in case of William R. Carter, Co. C,
5th Reg't Col. [unclear]
at [unclear] M. R. [unclear] [unclear]

Respectfully,

W. A. Woodward

Chief Clerk.

J. H. Halkon

Adjutant General's Office,

Record Room

Jan'y 12th, 1871

Vol. C. T., 187

Reply in case of Wm Drake, Co. C,
5th Reg't U. S. Col. [unclear]

Co. Descript. book shows: Reduced to the ranks from Sergeant Aug. 5th 1865.
Co. Mg. Report book shows June 14th '65. From present in arrest & absent in arrest.
Nov. 10th '65. From absent as a Prisoner at Camp Nelson Ky. & present for duty, his
sentence having expired. Sentence promulgated in

G.O.M. Order No. 66. M. Gen. Dept. of Ky. Aug. 6th '65.
Charge - Conduct prej. to good order & mil. discipline. Finding Guilty.

Sentence: To be reduced to the ranks & confined at hard labor for 3 months, at
such place as the Genl. Comd'g may direct.

Approved at Camp Nelson, Ky. designated as the place of Conf't.

By (Comd'g) of Maj. Genl. Palmer
(Sgd) W. B. Stanton

A. A. G.

W.S.

Dreen, John

Co A, 5 U. S. Col'd Cav.

Private

Private

CARD NUMBERS.

1	5366774	26
2	5366874	27
3	5366974	28
4	5367114	29
5	5367454	30
6	9090766	31
7	9090862	32
8	40729686	33
9		34
10		35
11		36
12		37
13		38
14		39
15		40
16		41
17		42
18		43
19		44
20		45
21		46
22		47
23		48
24		49
25		50

Book Mark:

See also

29

5 Cav. U.S.C.T.

John Drann

Co. 76, 5 Reg't U. S. Col'd Cav.

Appears on

Company Descriptive Book of the organization named above.

DESCRIPTION.

Age 24 years; height 5 feet 10 inches.

Complexion Bk

Eyes Bk; hair Bk

Where born Washington D.C.

Occupation Farmer

ENLISTMENT.

When Sept 17, 1864.

Where Camp Nelson

By whom J. C. Randolph; term 3 y'rs.

Remarks: Died in Genl. Kersh's Camp Nelson Ky Feb 16/65

A. J. Anderson

(3830)

Copist.

Al 5 Co | U.S.C.T.

John Drain

Co H 5 Reg't U. S. Col'd

Appears on

Company Descriptive Book

of the organization named above.

DESCRIPTION.

Age *24* years; height *5* feet *70* inches.

Complexion *Blk*

Eyes *Blk*; hair *Blk*

Where born *Washington Ky*

Occupation *farmer*

ENLISTMENT.

When *Sep 17*, 186*4*.

Where *Camp Nelson Ky*

By whom *H. Randolph*; term *3* y'rs.

Remarks: *died in hos-
pital Camp Nelson
Feb, 16" - 1865*

J. E. Rupp

D

5 Cav. U.S.C.T.

John Dreier

Put Co. H, 5 Reg't U. S. Col'd Cavalry.

Appears on

Company Muster-in and Descriptive Roll of the organization named above. Roll dated

Camp Nelson, Ky, N. Y., Oct 29, 1864.

Where born Washington Ky

Age 24 y'rs; occupation Farmer

When enlisted Sept 17, 1864.

Where enlisted Cp. Nelson Ky

For what period enlisted 3 years.

Eyes Black; hair Black

Complexion Black; height 5 ft. 10 in.

When mustered in Sept 17, 1864.

Where mustered in Cp. Nelson Ky

Bounty paid \$ 100; due \$ 100

Where credited

Company to which assigned

Remarks: 4th Dist Ky

* Nathan Dreier

* supposed to be name of owner.

Added May 16, 98. H.A.J.

Book mark:

Reynolds

(356d)

Copyist.

D

5 Cav.

U.S.C.T.

John Drain

Priv., Co. H, 5 Reg't U. S. Col'd Cavalry.

Appears on

Company Muster Roll

for from enlistment to Oct 31, 1864.

Present or absent present

Stoppage, \$ 100 for

Due Gov't, \$ 100 for

Valuation of horse, \$ 100

Valuation of horse equipments, \$ 100

Remarks:

Book mark:

Reynolds Copyist.

D

5 Cav. U.S.C.T.

John Drain

Pat, Co. H, 5 Reg't U. S. Col'd Cavalry.

Appears on

Company Muster Roll

for *Nov & Dec*, 1864.

Present or absent *present*

Stoppage, \$ 100 for

Due Gov't, \$ 100 for

Valuation of horse, \$ 100

Valuation of horse equipments, \$ 100

Remarks: *1st and 2^d Installments
Bounty due.
Due U.S. for Ordnance
\$25.10*

Book mark:

Reynolds

(358)

Copyist.

D | 5 Cav. | U.S.C.T.

John Drain

Plt, Co. H, 5 Reg't U. S. Col'd Cavalry.

Appears on

Company Muster Roll

for June & July, 1865.

Present or absent

Stoppage, \$ 100 for

Due Gov't, \$ 100 for

Valuation of horse, \$ 100

Valuation of horse equipments, \$ 100

Remarks: Died in Genl Hospital Camp Nelson Ky of Disease July 16 "1865

Book mark: V 59 P. 112. 69.

(358)

Reynolds

Copyist.

10

5 Cav. U.S.C.T.

John Drain.

Priv., Co. H, 5 Reg't U. S. Colored Cav.

Appears on Returns as follows:

Jan. 1865. Absent sick in Camp Nelson, Ky.

Feb. 1865. Died of disease Feb. 16/¹⁸⁶⁵ in Hosp. at Camp Nelson, Ky.

Book mark:

(546)

A. Baker
Copyist.

D

5 Cav.

U.S.C.T.

John Drain

Pat, Co. *H*, 5 Reg't U. S. Col'd Cavalry.

Appears on **Co. Muster-out Roll**, dated

Helena, Ark Mar 16, 1866.

Muster-out to date _____, 186 .

Last paid to _____, 186 .

Clothing account:

Last settled _____, 186 ; drawn since \$ _____ 100

Due soldier \$ _____ 100 ; due U. S. \$ _____ 100

Am't for cloth'g in kind or money adv'd \$ _____ 100

Due U. S. for arms, equipments, &c., \$ _____ 100

Bounty paid \$ _____ 100 ; due \$ _____ 100

Remarks: *Died of disease at*

Camp Nelson, Ky, Feby. 16, 65,
in Genl. Hospital.

Final status. forwarded.

Book mark: *P. V. 18. P. 192. 71.*

(861)

J. Stewart

Copyist.

Drain, John

P, Co H, 5 Reg U.S.C. Cav.

3 Enclosures.

Bed Cards	Descriptive Lists
Burial Records	Final Statements
Certs. of Dis. for Discharge	Furloughs
C. M. Charges	Med. Des. Lists
Med. Certificates	Orders

Other papers relating to—

Admission to Hosp'l	Furlough
Casualty Sheet (^{Pvt.} Officer's)	Med. Examination
Confinement	Misc. Information
Contracts	Pay or Clothing
Death or Effects	Personal Reports
Desertions	Rank
Discharge from Hosp'l	Transfer to Hosp'l
Discharge from Service	Transfer to V. R. C.
Duty	Transportation

MICROFILM PUBLICATION M 1821

COMPILED MILITARY SERVICE RECORDS
OF VOLUNTEER UNION SOLDIERS WHO
SERVED WITH THE USCT (US COLORED TROOPS)
5TH REGIMENT OF CAVALRY

PERSONAL PAPERS' TARGET SHEET

PLEASE NOTE THE CHECKED INFORMATION ABOUT THE PERSONAL PAPERS IN
THIS FILE:

- NO PERSONAL PAPERS WERE FOUND IN THIS FILE WHEN THE
RECORDS WERE ARRANGED FOR MICROFILMING.
- 4 PERSONAL PAPER(S) FOUND IN THIS FILE WHEN THE RECORDS
WERE ARRANGED FOR MICROFILMING.

Inventory

of the effects of Private
John. Frem

late of Co^{"H"} 5, Regiment

U.S.C., who died

at Nelson General

Hospital Ky Feb 7,

1864.

No record on Register of Regt,

Vol. 11.

Nelson U. S. Army General Hospital,
Camp Nelson Ky Feb 7 1865.

Commanding Officer "H" Company,
5 Regt. U.S.C.

I have to inform you
that P. John Gram of your Company, died
in this Hospital on the 7th day of February 1865
of Chills & fever

I inclose ~~his descriptive list, with pay and clothing account, and~~
inventory of his effects.

Very respectfully yours, &c.,

Richard H. Voorhes
Capt of Military Dist

Surgeon U. S.

In charge of General Hospital.

INVENTORY OF THE EFFECTS of *P. John Francis*
Company "H" 5 Regiment U.S.C.
who died in the Nelson General Hospital Camp
Nelson Bay Feb 7 1862

CAPS,.....	/	BLANKETS,.....	/
DRESS COATS,.....		KNAPSACKS,.....	
OVERCOATS,.....	/	CANTEENS,.....	
JACKETS,.....		HAVERSACKS,.....	
TROUSERS,.....		MUSKETS,.....	
SHIRTS,.....	/	BAYONETS,.....	
DRAWERS,.....		CARTRIDGE BOX,.....	
BOOTS, pairs,.....		BELT,.....	
SHOES, pairs,.....	/	MONEY,.....	
STOCKINGS,.....			

John Bram
Pr. Co. "H" 5 U.S.C.
(Died Feb. 7, 1865.
Gen'l Hosp: Camp Nelson, Ky.

sent for to Co. C. Jan 30 '66
R.C. Mch 21 '66

CASUALTY SHEET.

No.

John Dray

Private

of Company

H

5th Regiment of

Michigan

State Volunteers.

March 18/65

NATURE OF CASUALTY.

.....

CASUALTY SHEET.

Name: *John Train*

Rank: *Priv* Company: *H* Regiment: *F*

Arm: *U.S. Army* State: _____

Nature of Casualty: *Death*

CAUSE OF CASUALTY—(NAME OF DISEASE, &c.)

Dysentery

BY WHOM DISCHARGED.

FROM WHAT SOURCE THIS INFORMATION WAS
OBTAINED.

*Atty. Gen. Desjardins
March 31st 1865*

DEGREE OF DISABILITY.

BY WHOM CERTIFIED.

*L. H. Carpenter
Lt. Colonel*

REMARKS.

DATE OF DISCHARGE, DEATH, &c.

Feb'y 16th 1865

PLACE OF DISCHARGE, DEATH, &c.

Gen. Hospital Camp Nelson

R. S. Cole

Clerk.

Massachusetts
CASUALTY SHEET

No.

John Fram

of Company

Regiment of

State Volunteers.

NATURE OF CASUALTY.

Died Feb 7th 1865.

CASUALTY SHEET.

Name: *John Fram*

Rank: _____ Company: _____ Regiment: _____

Arm: _____ State: _____

Nature of Casualty: *Death*

CAUSE OF CASUALTY—(NAME OF DISEASE, &C.)

Chilblains

BY WHOM DISCHARGED.

FROM WHAT SOURCE THIS INFORMATION WAS OBTAINED.

Inventories of effects

DEGREE OF DISABILITY.

BY WHOM CERTIFIED.

*Richard M. Voorhees
Capt & Asst.*

DATE OF DISCHARGE, DEATH, &C.

Feb. 17th 1865,

PLACE OF DISCHARGE, DEATH, &C.

U.S. General Hospital Jan 3rd 1866.

Camp Nelson, Ky.

REMARKS.

This man never belonged to 5th Va S, Cold Cav. as reported by Inv. of effects see, b. 518, Vol. 3 R.C.S., 1865. Inv. of effects sent 2^d Auditor

*James R. Kurth,
Clerk.*

Dudley, John

Co D, 5 U. S. Col'd Cav.

Private

Private

CARD NUMBERS.

1	5362669	26
2	5362771	27
3	5362872	28
4	5362961	29
5	5363057	30
6	5363145	31
7	5363233	32
8	5363322	33
9	5363411	34
10	5363498	35
11	5363583	36
12	9090298	37
13	43145799	38
14	43146477	39
15	34451695	40
16	40729689	41
17		42
18		43
19		44
20		45
21		46
22		47
23		48
24		49
25		50

Book Mark:

See also

M | **5 Cav.** | **U.S.C.T.**

John Dudley

, Co. *M*, 5 Reg't U. S. Col'd Cav.

Appears on

Company Descriptive Book

of the organization named above.

DESCRIPTION.

Age *41* years; height *5* feet *11 1/2* inches.

Complexion *Black*

Eyes *Black*; hair *Blk*

Where born *Admir N.Y.*

Occupation *farmer*

ENLISTMENT.

When *Aug 15*, 186 *4*

Where *Schenectady*

By whom *Capt. Fidler*; term *3* y'rs.

Remarks: *In confinement*
April 1st under
charge of theft

X E Parker

20

5 Cav.

U.S.C.T.

John Rudley

Priv., Co. 20, 5 Reg't U. S. Col'd Cavalry.

Appears on

Company Muster-in and Descriptive Roll
of the organization named above. Roll dated

Camp Nelson, N.Y., Oct. 24, 1864.

Where born Adair, Ky.

Age 21 y'rs; occupation Farmer

When enlisted Aug. 15, 1864.

Where enlisted Lebanon

For what period enlisted 3 years.

Eyes Br; hair Br

Complexion Br; height 5 ft. 11 1/2 in.

When mustered in Aug. 24, 1864.

Where mustered in Lebanon

Bounty paid \$ 100; due \$ 100

Where credited 4 Dist. Ky.

Company to which assigned

Remarks:

Book mark:

Wm. H. Scott

(356d)

Copyist.

52 | 5 bar | 2369.

John Audley

Appears with rank of _____ on

Muster and Descriptive Roll

of Detachment of 40 colored
Volunteer Recruits for-
warded

Roll dated
Lebanon Ky, Aug 31, 1864.

Where born Adair Ky

Age 21 years; occupation farmer

When enlisted Aug 15, 1864.

Where enlisted Lebanon Ky

For what period enlisted 3 years.

Eyes Blk; hair Blk

Complexion Blk; height 5 ft. 11 1/2 in.

When mustered in Aug 15, 1864.

Where mustered in Lebanon Ky

Bounty paid \$ 100; due \$ 100

Clothing account:

Last settled _____, 1864; drawn since \$ 17 ⁵⁰/₁₀₀

Date of first muster Aug 27, 1864.

Company to which assigned _____

Remarks: Free man

4 Cong Dist Ky.

Book mark: _____

(356m)

U. S. Marshall

Copyist.

J | 56ar | U.S.C.T.

John Dudley

Appears with rank of Pt on

Muster and Descriptive Roll

of a Detachment of U.S. colored
Troops formed for U.S. Col'd
Reg. at Lexington, Ky. Roll dated
Louisville, Ky., Sept. 7, 1864.

Where born Adair, Ky.

Age 21 years; occupation Farmer

When enlisted Aug. 15, 1864.

Where enlisted Lebanon

For what period enlisted 3 years.

Eyes Blue; hair Black

Complexion Black; height 5 ft. 1 1/2 in.

When mustered in Aug. 27, 1864.

Where mustered in Lebanon

Bounty paid \$ 100; due \$ 100

Clothing account:

Last settled _____, 1864; drawn since \$ 17.50
100

Date of first muster Aug. 27, 1864.

Company to which assigned _____

Remarks: H. Dist. Ky.

Book mark: _____

R. J. G. Driscoll

(356m)

Copyist.

10 | 5 Cav. | U.S.C.T.

John Dudley
Pot., Co. D, 5 Reg't U. S. Col'd Cavalry.

Appears on

Company Muster Roll

for dated Oct. 31, 1864.

Present or absent Present.

Stoppage, \$ 100 for

Due Gov't, \$ 100 for

Valuation of horse, \$ 100

Valuation of horse equipments, \$ 100

Remarks:
.....
.....
.....
.....
.....
.....
.....
.....
.....
.....

Book mark:

Wm B Scott

(358)

Copyist.

10 | 5 Cav. | U.S.C.T.

John Dudley
Pvt., Co. D, 5 Reg't U. S. Col'd Cavalry.

Appears on

Company Muster Roll

for *Nov & Dec*, 1864.

Present or absent *Present*

Stoppage, \$ *100* for

Due Gov't, \$ *100* for

Valuation of horse, \$ *100*

Valuation of horse equipments, \$ *100*

Remarks: *Due N. S. for Ord-
nance \$17.93 1/2 in
statements of Security
due.*

Book mark:

Wm. H. Scott

(358)

Copyist.

10

5 Cav. U.S.C.T.

John Rudley

Plt., Co. D, 5 Reg't U.S. Col'd Cavalry.

Appears on

Company Muster Roll

for Jan. & Feb., 1865.

Present or absent Present.

Stoppage, \$ 100 for

Due Gov't, \$ 100 for

Valuation of horse, \$ 100

Valuation of horse equipments, \$ 100

Remarks: 1st installment of
Bounty due \$ 100

Book mark :

Wm. H. Scott

(358)

Copyist.

10

5 Cav. U.S.C.T.

John Dudley

Plt, Co. D, 5 Reg't U. S. Col'd Cavalry.

Appears on

Company Muster Roll

for March & April, 1865.

Present or absent Absent.

Stoppage, \$ 100 for

Due Gov't, \$ 100 for

Valuation of horse, \$ 100

Valuation of horse equipments, \$ 100

Remarks: 1st installment of
Bounty due \$100.
In confinement at Camp
Nelson under charge
of theft.

Book mark:

Wm H Scott

D | 5 Cav | U.S.C.T. |

John Dudley
Priv Co I 5 Regt U.S.C.T.

Appears on

Muster Roll

of Military Prison at Camp Nelson, Kentucky,

for dated Apr 30, 1865.

Station Camp Nelson Ky

Clothing account:

Last settled _____, 184 ; drawn since \$ _____ 100

Present or absent Present

Remarks: Awaiting Trial,
Charge Stealing

Book mark :

Jones Copyist.

D

5 Cav. U.S.C.T.

John Dudley
Priv., Co. D, 5 Reg't U.S. Col'd Cavalry.

Appears on

Company Muster Roll

for May & June, 1865.

Present or absent Absent

Stoppage, \$ 100 for

Due Gov't, \$ 100 for

Valuation of horse, \$ 100

Valuation of horse equipments, \$ 100

Remarks: 1st Instalmt Bounties
due \$100.00. In confinement,
Camp Nelson Ky.

Book mark:

Milliken

(358)

Copyist.

D | **5 Cav.** | **U.S.C.T.**

John Dudley
Priv., Co. D, 5 Reg't U. S. Col'd Cavalry.

Appears on

Company Muster Roll

for *July & Aug.*, 1865.

Present or absent *Absent*

Stoppage, \$ *100* for

Due Gov't, \$ *100* for

Valuation of horse, \$ *100*

Valuation of horse equipments, \$ *100*

Remarks: *In confinement, Frankfort Ky.*

Book mark :

(358)

Milliken

Copyist.

D

5 Cav.

U.S.C.T.

John Dudley
Priv.

Co. D, 5 Reg't U. S. Col'd Cavalry.

Appears on

Company Muster Roll

for Sept. + Oct., 1865.

Present or absent absent

Stoppage, \$ 100 for

Due Gov't, \$ 100 for

Valuation of horse, \$ 100

Valuation of horse equipments, \$ 100

Remarks: In confinement
Frankfort Ky

Book mark:

William

(358)

Copyist.

D

5 Cav. U.S.C.T.

John Dudley

Private, Co. D, 5 Reg't U. S. Col'd Cavalry.

Appears on

Company Muster Roll

for *Nov. & Dec.*, 186 *J.*

Present or absent *Absent*

Stoppage, \$ *100* for

Due Gov't, \$ *100* for

Valuation of horse, \$ *100*

Valuation of horse equipments, \$ *100*

Remarks: *In confinement
Frankfort Ky.*

Book mark *N 2404. 96 M. O. W. 10*
Feb. 10/66

Milliken

(358)

Copyist.

C.

5 Cav.

U.S.C.T.

John Dudley,

Private, Co. D, 5 Reg't U. S. Col'd Cavalry.

Appears on

Company Muster Roll

for *Jan'y 4th Febr'y*, 186 *C.*

Present or absent. *Absent*,

Stoppage, \$ *100* for

Due Gov't, \$ *100* for

Valuation of horse, \$ *100*

Valuation of horse equipments, \$ *100*

Remarks: *On confinement Frankfort Ky. 1st 4th Ist Installments Bounty due \$ 200.00.*

Book mark :

R. S. Brauner

(358)

Copyist.

10 | 5 Cav. U.S.C.T.

John Dudley,
Det., Co. 10, 5 Reg't U. S. Colored Cav.

Appears on Returns as follows:

Apr. to June 1865. Absent in confinement at Camp Nelson, Ky. for theft.

July 1865 to Feb. 1866. Absent in confinement, Frankfort, Ky.

Book mark:

(546)

A. Baker
Copyist.

D.

5 Cav. U.S.C.T.

John Dudley
Snr., Co. *D.*, 5 Reg't U. S. Col'd Cavalry.

Appears on **Co. Muster-out Roll**, dated
Selma, Ark., March 16, 1866.

Muster-out to date *March 16,* 1866.

Last paid to *Feb. 28,* 1865.

Clothing account:

Last settled....., 186 ; drawn since \$..... 100

Due soldier \$ *39.80* / 100; due U. S. \$..... 100

Am't for cloth'g in kind or money adv'd \$..... 100

Due U. S. for arms, equipments, &c., \$..... 100

Bounty paid \$..... 100; due \$ *20.*⁰⁰ / 100

Remarks: *Absent in confinement*
Frankfort, Ky. sentenced
3 years hard labor for theft,
per Gen. Court Martial Or-
der No. 23 Hd. Qu. D. of
Ky. of 1865.

Book mark:

R. D. Danner

Dudley J

Reg't, Co. D, 5th Reg't U.S.C. Cav

2 Enclosures.

Bed Cards	Final Statements
Burial Records	Furloughs or L. of A.
Certs. of Dis. for Discharge	Med. Certificates
C. M. Charges	Med. Des. Lists
Descriptive Lists	Orders
Discharge Certificates	Pris. of War Record
Enlistment Papers	Resignations

Other papers relating to—

Admission to Hosp'l	Furlough or L. of A. /
Casualty Sheet	Med. Examination
Confinement	Misc. Information
Contracts	Pay or Clothing
Death or Effects	Personal Reports
Desertion	Rank
Discharge from Hosp'l	Transfer to Hosp'l
Discharge from Service	Transfer to V. R. C.
Duty	Transportation

1
July 31, 1866

J. Dudley
Co. D, 5. U. S. C. C.

Remit

see name of

S. Stubblefield
Co. A, 4. U. S. C. A. N.

S. Kentucky.

FURLOUGH.
OR
RESTORATION.

John Hedges
U.S.

Adjutant General's Office,

COLORED TROOPS BRANCH,

Jan 26, 1874

Vol. C. T., 187

Wanted in case of John Dudley, Co. A, 5th Reg't U.S.C. Col. information as to cause of confinement, trial, &c. M.C. R. & Co. records show "Absent in confinement Frankfort Ky, sentenced to hard labor for 3 years, per G.C.M. order 1123 Hd. Qrs Dept. of Ky. of 1865, 'No discharge given'"

Respectfully,

R. A. Woodward

Chief Clerk.

P. H. Dalton

Adjutant General's Office,

Record Room

Jan 26, 1874

Vol. C. T., 187

Reply in case of John Dudley, Co. A, 5th Reg't U.S.C. Col.

Co. Descriptive book and Morning Rep. book show absent in confinement April 1 '65, under charge of "Theft" - records of the War Dept. Dept. of Ky. show "Confined March 9 '65 by Col. Carpenter for Stealing. - Sentenced at hard labor for 3 years July 1 '65 - G.C.M. Order no. 43 Hd. Qrs. S. Ky. July 1 '65. Sent to Frankfort Ky."

Order monthly returns in file with Reg't., are the only G.C.M. Order books Hd. Qrs. Dept. Ky., and records of Frankfort Prison on file.

M.S.

ROLL

6

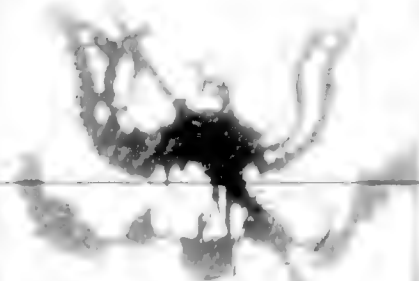

MICROCOPY

1817

ROLL

IMAGE EVALUATION TEST TARGET (QA-3)

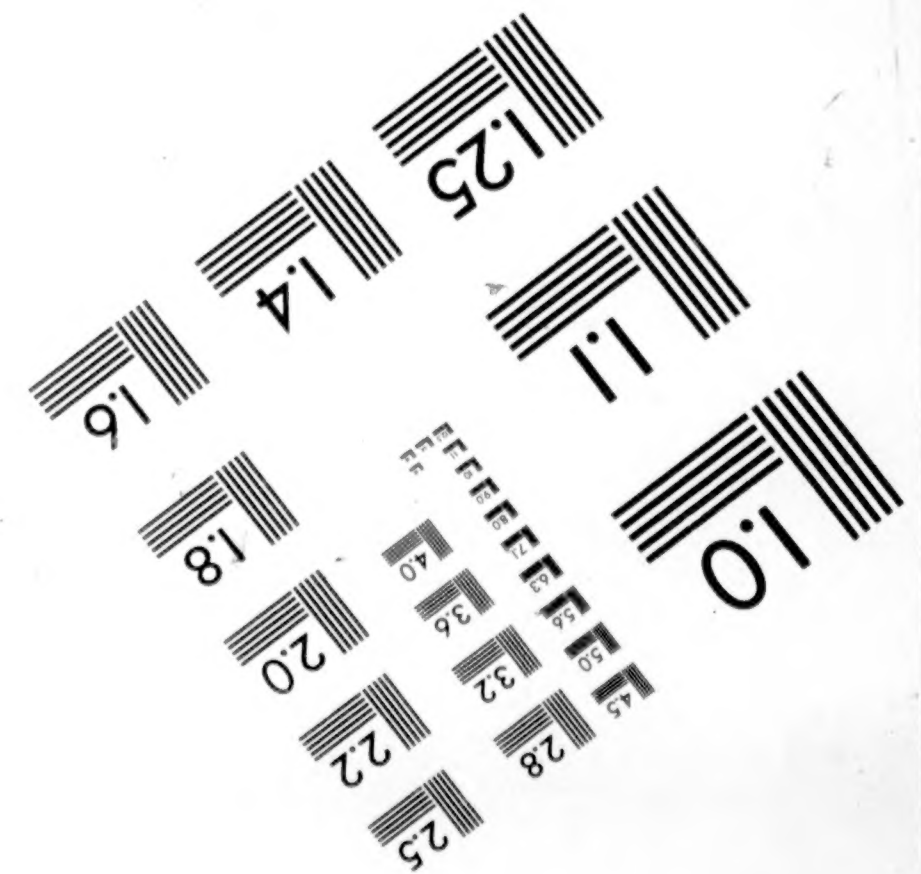
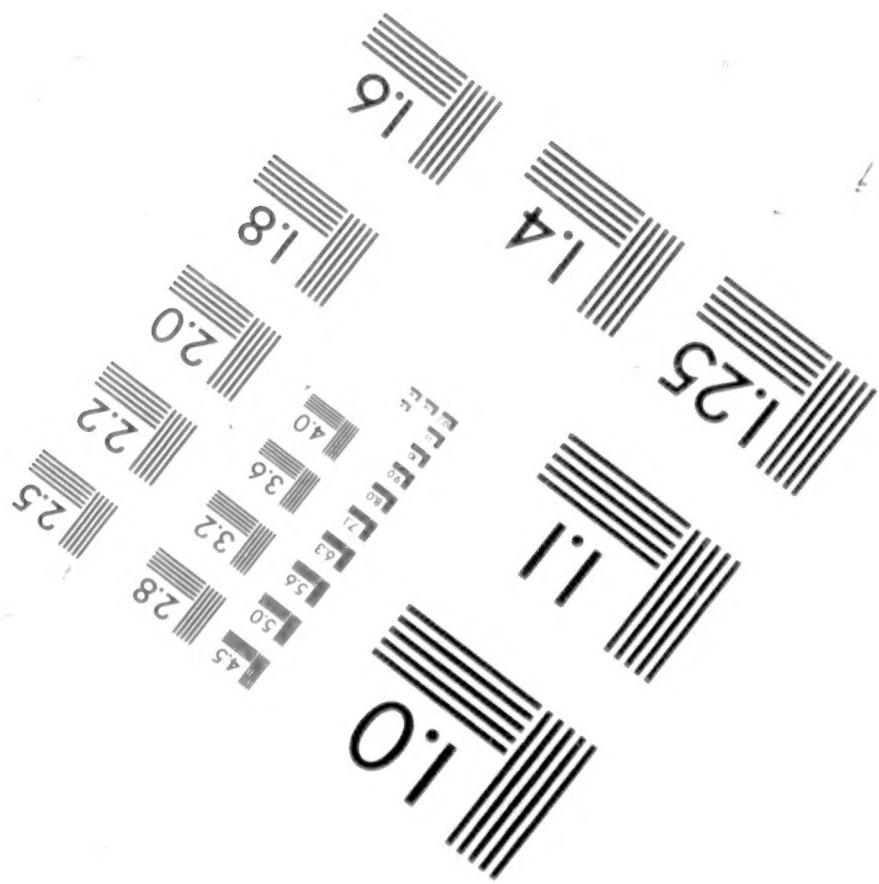
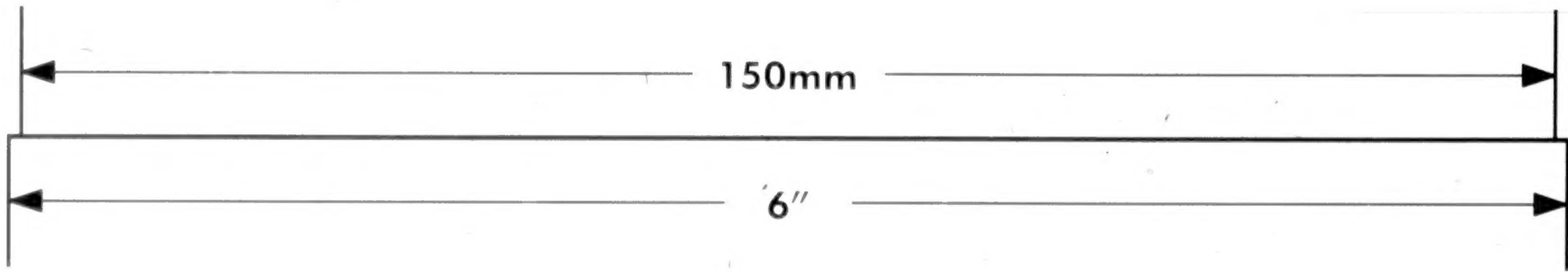
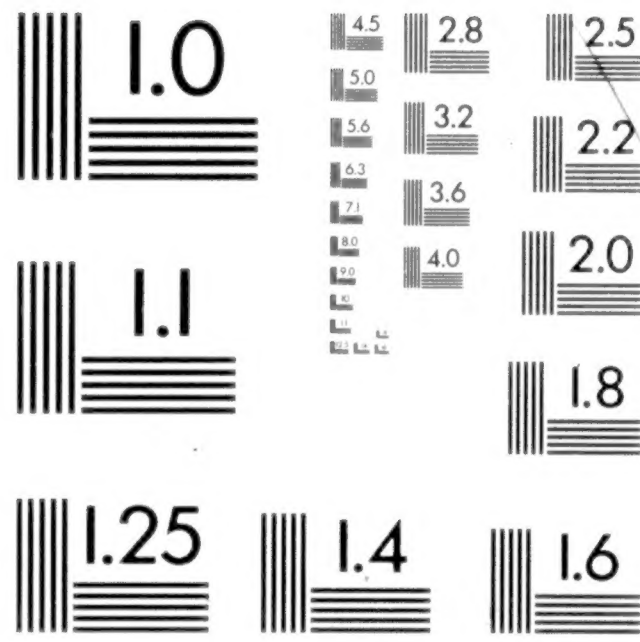
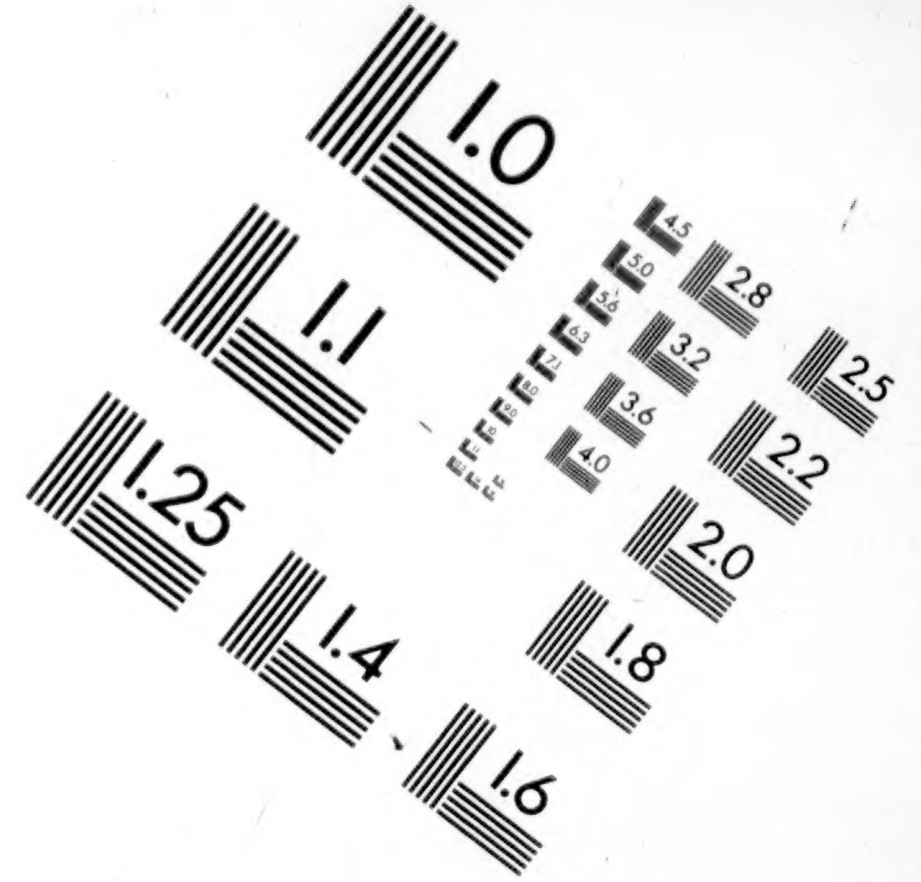
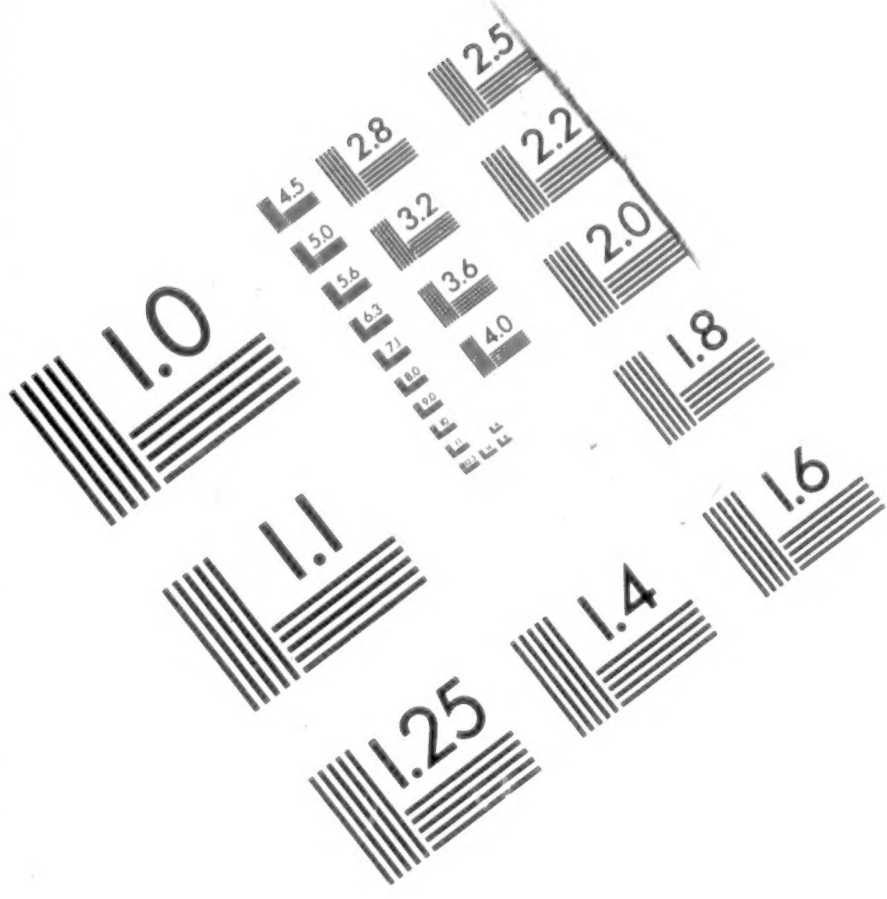

APPLIED IMAGE, Inc
 1653 East Main Street
 Rochester, NY 14609 USA
 Phone: 716/482-0300
 Fax: 716/288-5989

© 1993, Applied Image, Inc., All Rights Reserved

THE END

PLEASE

REWIND

