

**NATIONAL
ARCHIVES
MICROFILM
PUBLICATIONS**

IMAGE EVALUATION TEST TARGET (QA-3)

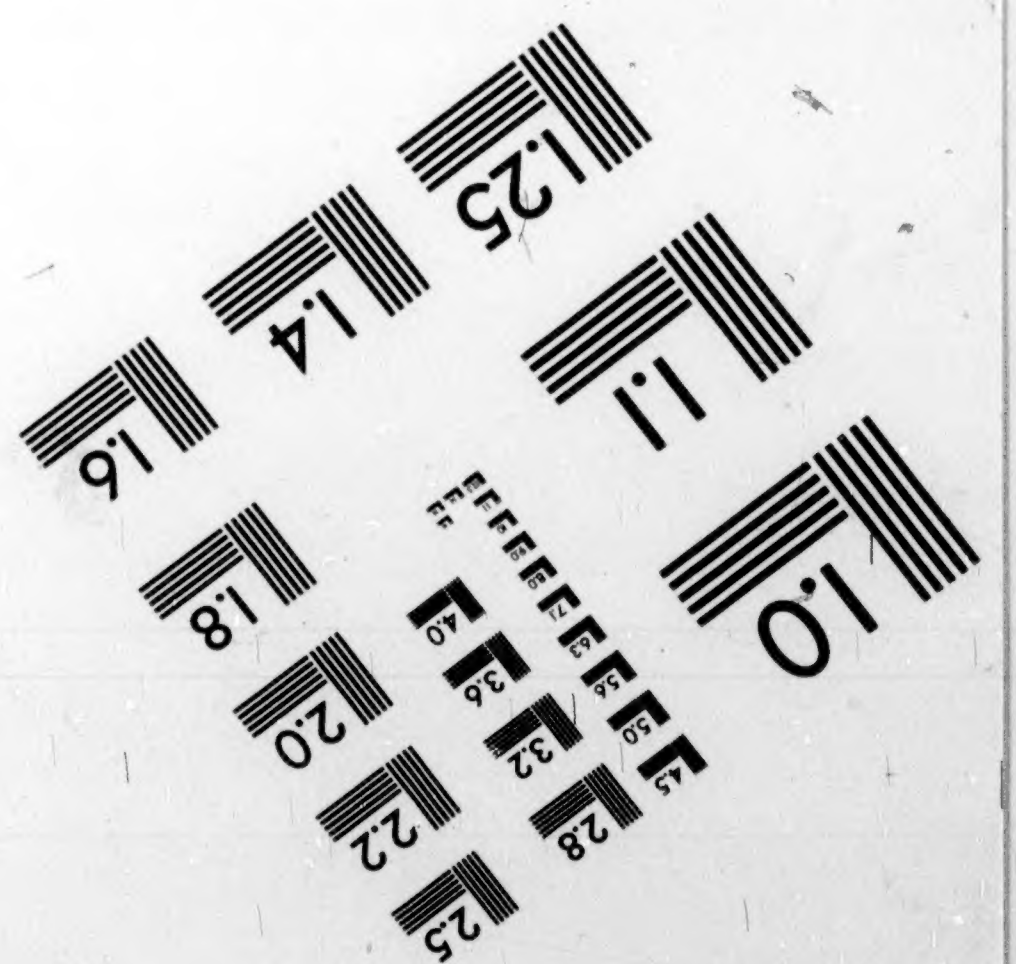
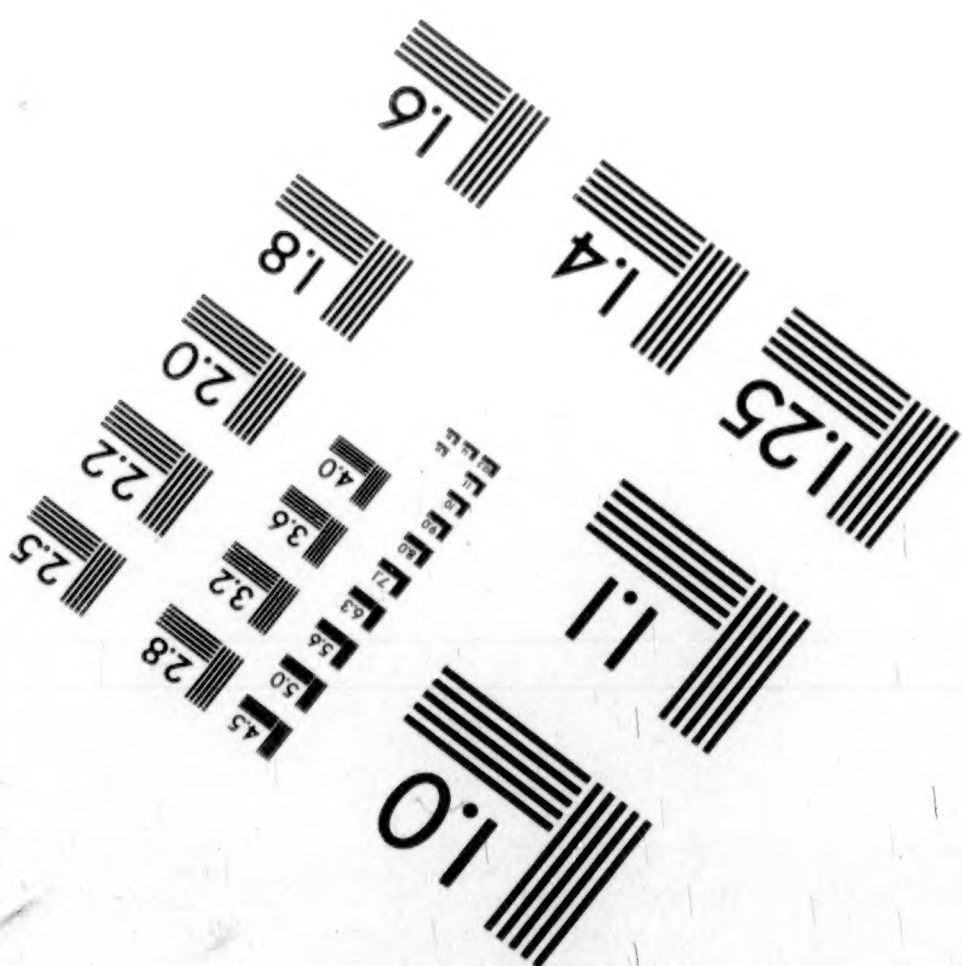
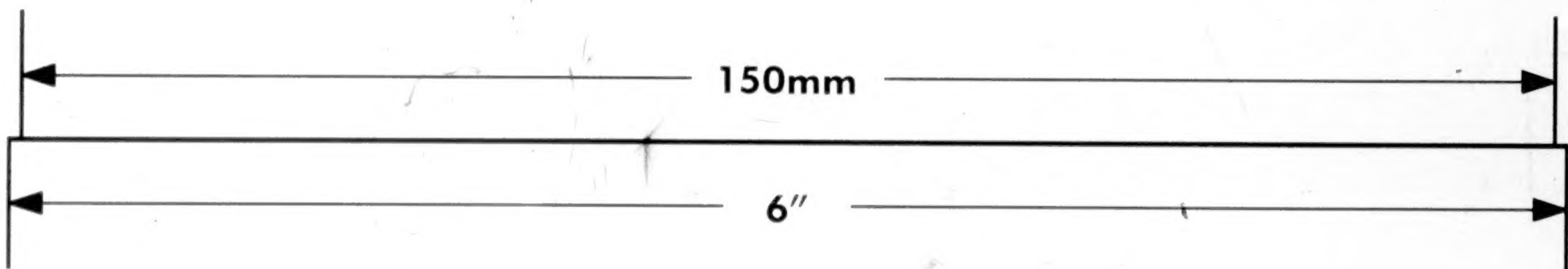
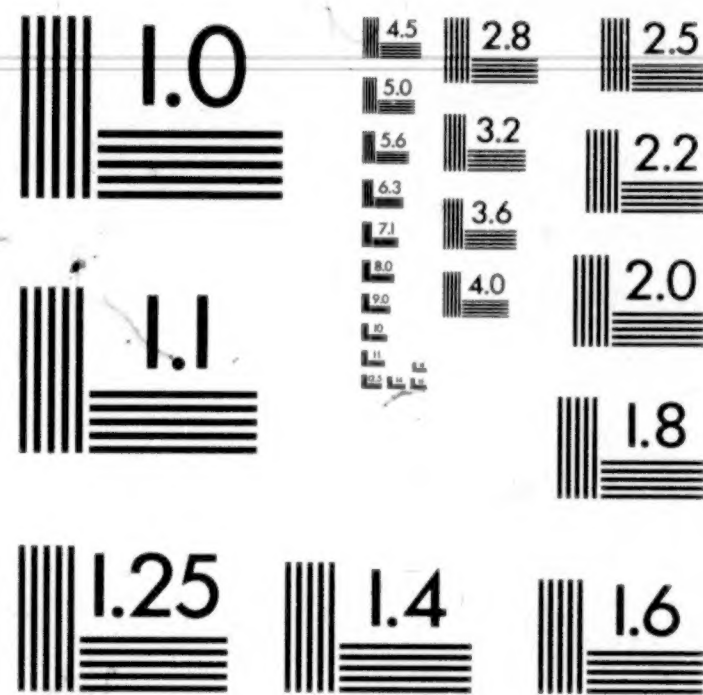
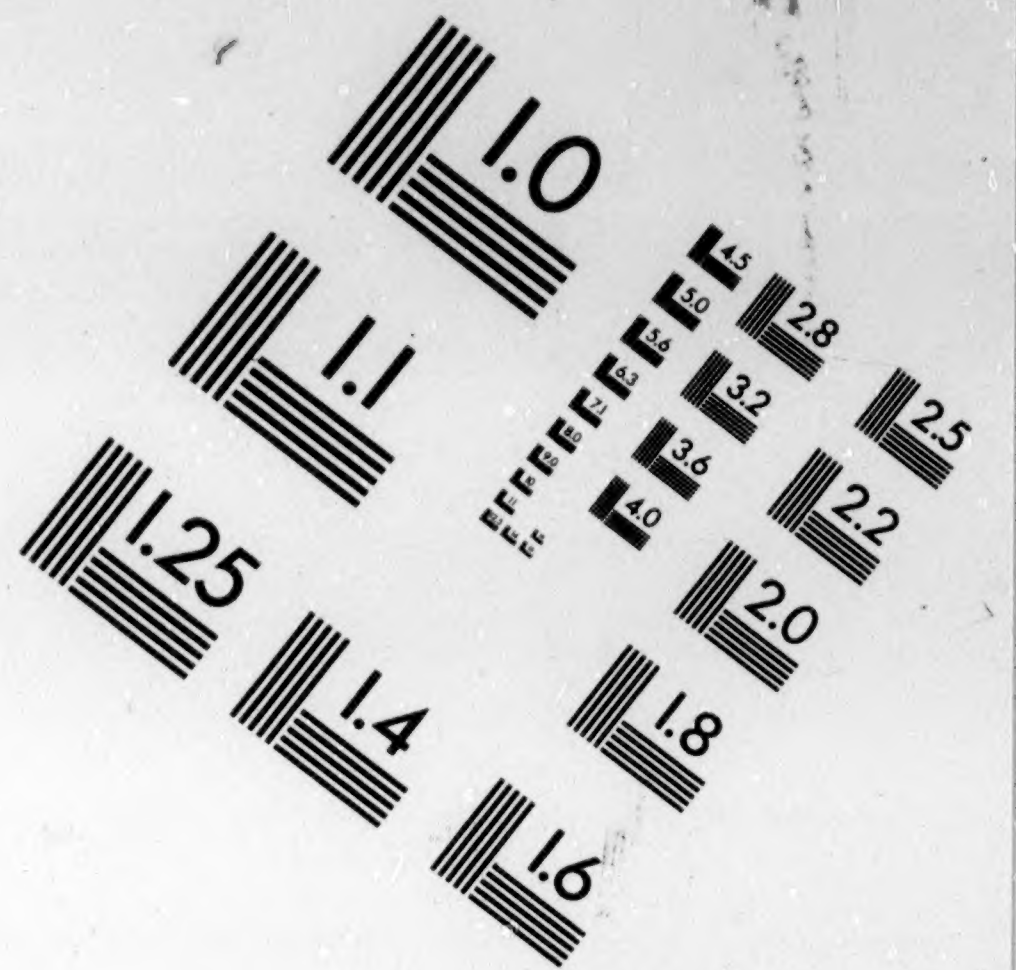
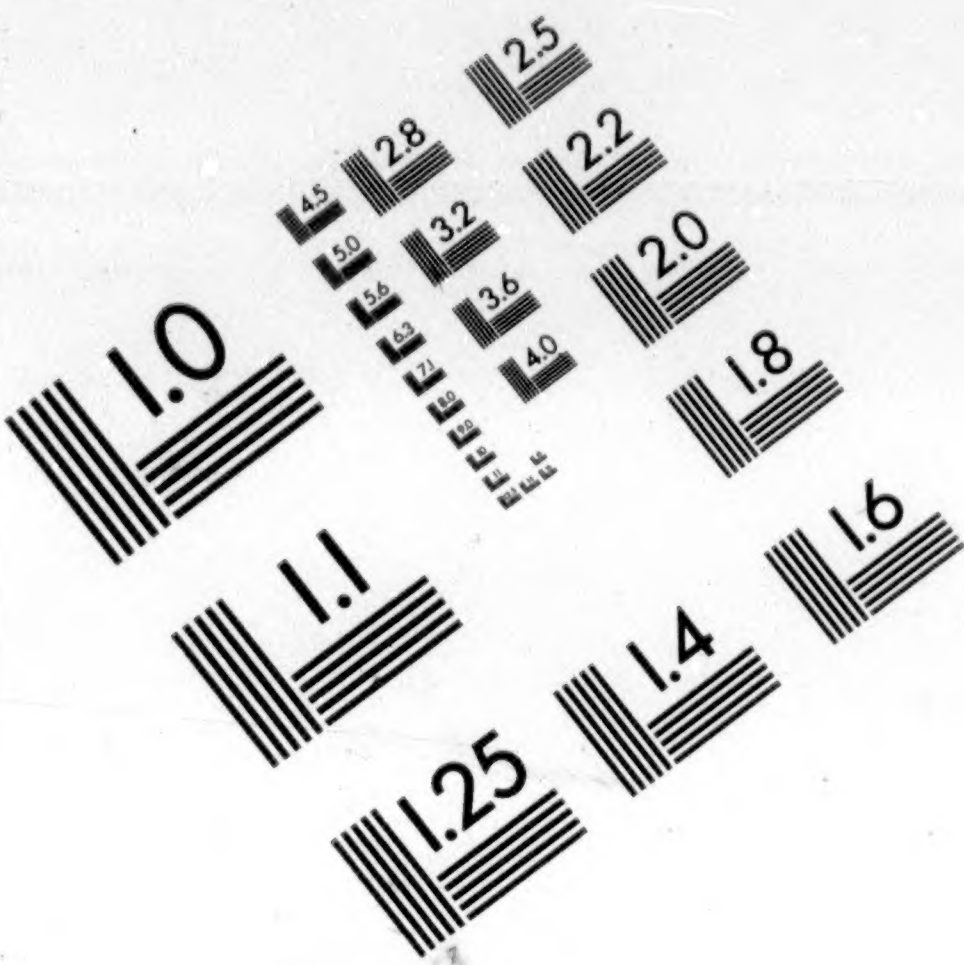

APPLIED IMAGE, Inc
 1653 East Main Street
 Rochester, NY 14609 USA
 Phone: 716/482-0300
 Fax: 716/288-5989

© 1993, Applied Image, Inc., All Rights Reserved

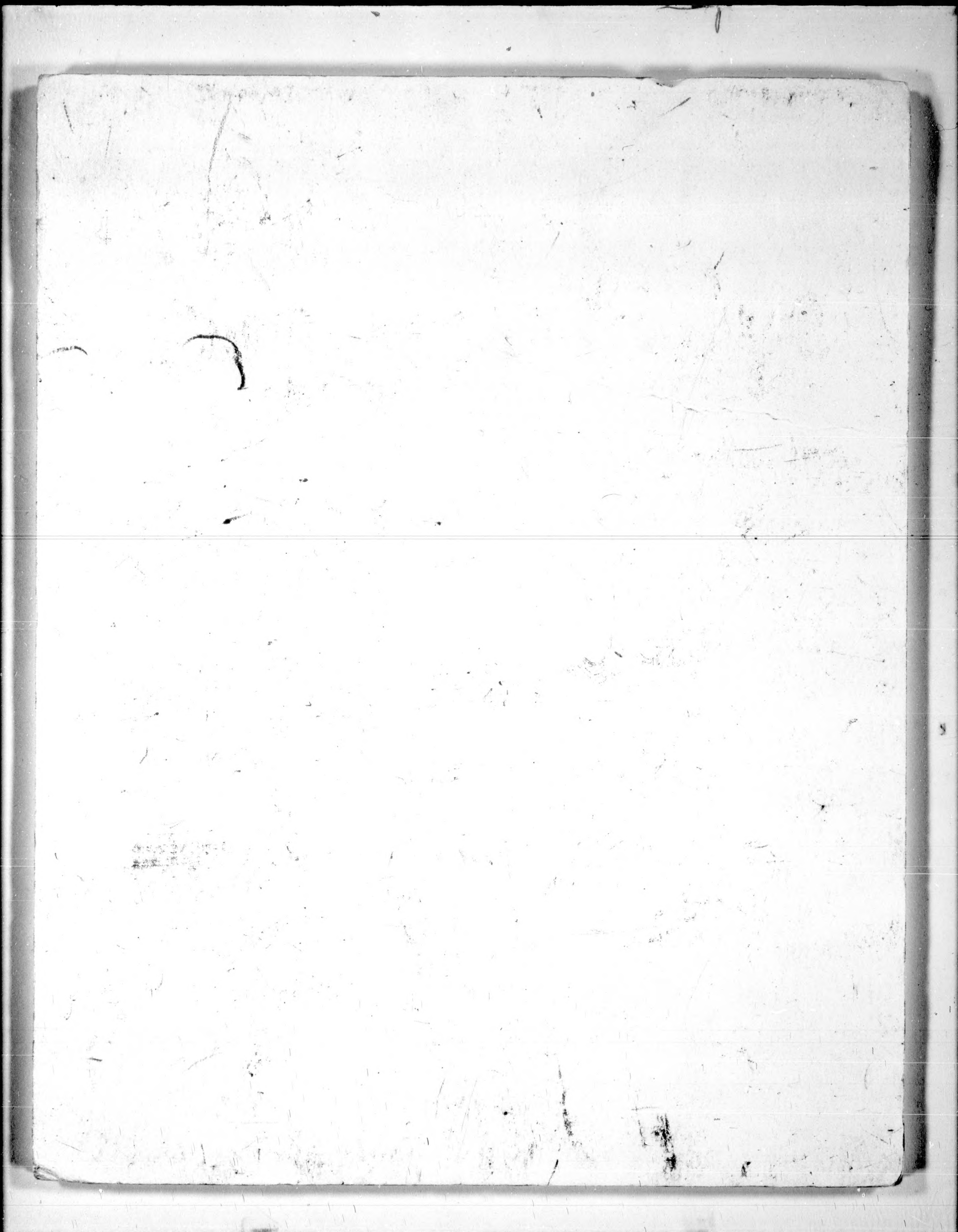

National Archives at College Park



8601 Adelphi Road College Park MD 20740-6001

Twison

OPERATOR

CAMERA

4-21-99

Z-5

DATE FILMED

REDUCTION RATIO

244-0576-014-03 10X

FILM EMULSION NUMBER

1820

68

PROJECT NUMBER

ROLL NUMBER

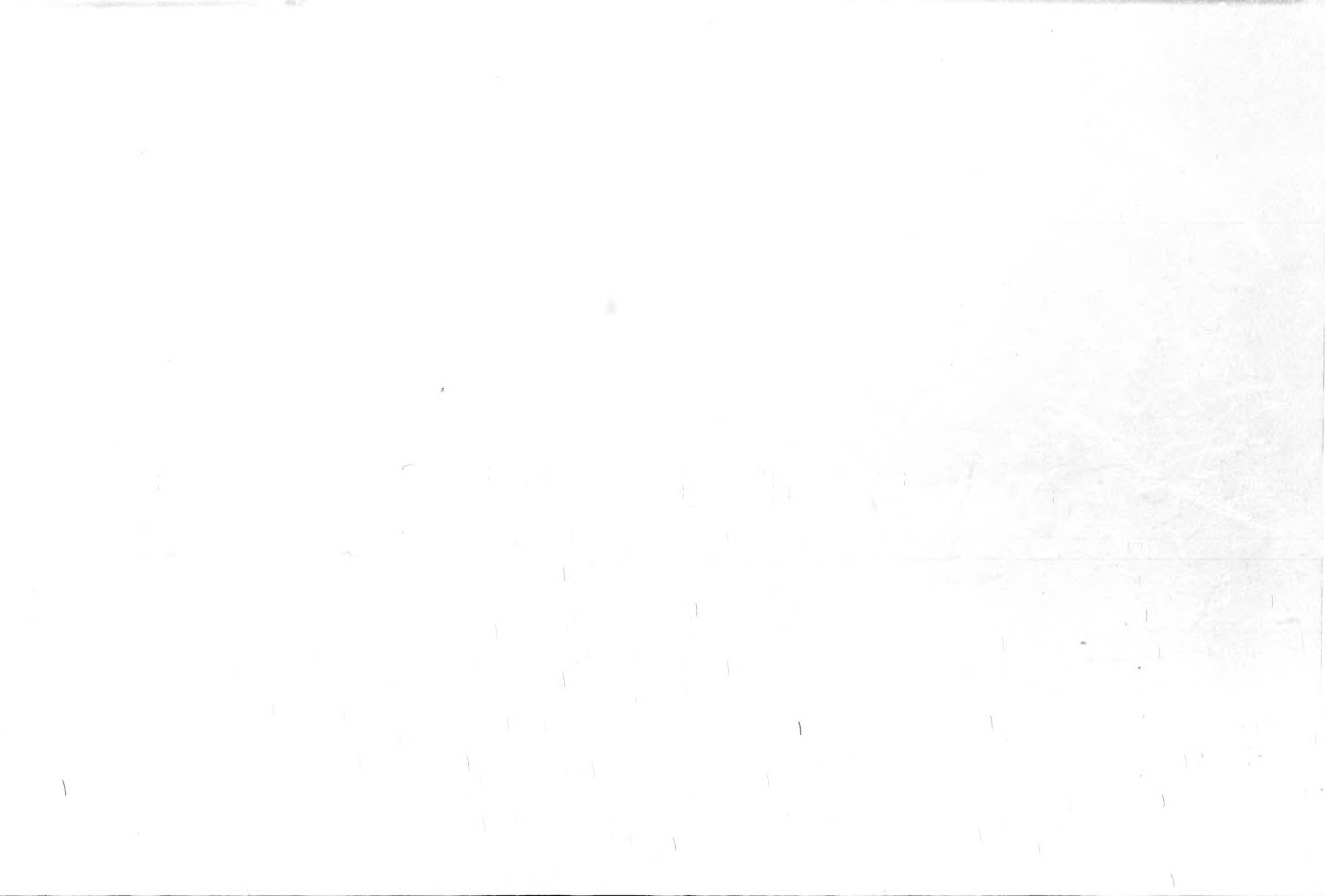

NATIONAL ARCHIVES MICROFILM PUBLICATIONS

M1820

COMPILED MILITARY SERVICE RECORDS OF
VOLUNTEER UNION SOLDIERS WHO SERVED WITH THE
UNITED STATES COLORED TROOPS:
2d Through 7th Colored Infantry, Including
3d Tennessee Volunteers (African Descent)
6th Louisiana Infantry (African Descent)
7th Louisiana Infantry (African Descent)

Introduction written by Budge Weidman, Project Manager

Records prepared for microfilming by volunteers of
the Civil War Conservation Corps

Pat Alfredson
Phyllis Altrogge
Kenneth Ashton
Sue Barnard*
Rex Bowser
Ann N. Brown
Jerry Brown
Robert Budway
Randy Caldwell
Mary Ann Castellana*
Mary Lou Cole
Giovanni Croce
B. H. Custer
Bob Denney
Earl Dunn
Yvette Fallin
Maria Flesher
Naomi Glass

Sue Goward*
Bert Greenstein
Anne Greenwood
Jim Harris
Walter Hayden
Mary Hayden
Pat Ikonen
Dick Ives
Sarah Jaffe
Barbara Kemp
Bev Manypenny
Frank Masterson
Joe Mazur
Kathleen McCarthy
Catherine McManus
Ben Miles
Dave Murray
Mary Poggioli

Peggy Pratt
Ray Puzio
Sylvia Scott
Lynn Shearouse
Charles Spencer
Mary Stack-Dunne
Ben Stearns
Bill Stormer*
Pat Sullivan
Gorman Tidball*
John Toole
Maryellen Toole
Dean Warner
Melody Warner
Milt Weatherhead
Russ Weidman
Robert Young

Team leaders are indicated by the asterisk.

National Archives and Records Administration
Washington, DC
1999

NATIONAL ARCHIVES MICROFILM PUBLICATIONS

INTRODUCTION

On the 116 rolls of this microfilm publication, M1820, are reproduced the compiled military service records of volunteer Union soldiers belonging to the 2d through the 7th United States Colored Infantry units, including the 3d Tennessee Volunteers (African Descent) and the 6th and 7th Louisiana Infantries (African Descent). These units were part of the United States Colored Troops (USCT). The USCT included 7 numbered cavalry regiments; 13 numbered artillery regiments plus 1 independent battery; 144 numbered infantry regiments; Brigade Bands Nos. 1 & 2 (Corps d'Afrique and US Colored Troops); Powell's Regiment Colored Infantry; Southard's Company Colored Infantry; Quartermaster Detachment; Pioneer Corps, 1st Division, 16th Army Corps; Pioneer Corps, Cavalry Division, 16th Army Corps; Unassigned Company A Colored Infantry; and Unassigned USCT. There are also miscellaneous service cards arranged alphabetically by surname at the end of the unit records. The records reproduced are part of the Records of the Adjutant General's Office, 1780's-1917, Record Group (RG) 94.

Background

United States Colored Troops

Since the time of the American Revolution, African Americans have volunteered to serve their country in time of war. The Civil War was no exception. Official sanction was the difficulty. In the fall of 1862 there were four Union regiments of African Americans raised in New Orleans, LA: the 1st, 2d, and 3d Louisiana Native Guard, and the 1st Louisiana Heavy Artillery (African Descent). The 1st South Carolina Infantry (African Descent) was not officially organized until January 1863; however, three companies of the regiment were on coastal expeditions as early as November 1862. The 1st Kansas Colored Infantry was not mustered into Federal service until January 1863, even though the regiment had already participated in the action at Island Mound, MO, on October 27, 1862. These early unofficial regiments received little Federal support, but they showed the strength of the African American soldier's desire to fight for freedom.

The first official authorization to employ African Americans in Federal service was the Second Confiscation and Militia Act of July 17, 1862. This act allowed President Abraham Lincoln "to receive [African Americans] into the service of the United States, for the purpose of constructing entrenchments, or performing camp service, or any other labor, or any military or naval service for which they may be found competent." The President did not authorize use of African Americans in combat, however, until issuance of the Emancipation Proclamation on January 1, 1863.

In late January 1863 Governor John Andrew of Massachusetts received permission to raise a regiment of African American soldiers. The pace of organizing additional regiments was very slow. In March Secretary of War Edwin M. Stanton sent Gen. Lorenzo Thomas to the lower Mississippi Valley to recruit free and

contraband African Americans. Thomas was given broad authority. He was to explain the administration's policy regarding African American soldiers and recruit volunteers to raise and command them. Stanton wanted all officers of such units to be white, but that policy was softened to allow African American surgeons and chaplains. By the end of the war, in addition to the chaplains and surgeons, there were 87 African American officers. Thomas's endeavor was very successful, and on May 22, 1863, the Bureau of Colored Troops was established to coordinate and organize regiments from all parts of the country. Created under War Department General Order No. 143, the bureau was responsible for handling "all matters relating to the organization of Colored Troops." The bureau was directly under the Adjutant General's Office and its procedures and rules were specific and strict. All African American regiments were now to be designated United States Colored Troops (USCT). At this time there were some African American regiments with state names and a few regiments in the Department of the Gulf designated as Corps d'Afrique. The Corps d'Afrique units ultimately became numbered regiments in the USCT. The 54th and 55th Massachusetts Infantries (Colored), the 5th Massachusetts Cavalry (Colored), the 29th Connecticut Infantry (Colored), the 6th and 7th Louisiana Infantries (African Descent), the 3d Tennessee Volunteers (African Descent), and the 1st South Carolina Volunteers (Colored) retained their number and state designations.

To facilitate recruiting in the states of Maryland, Missouri, Tennessee, and eventually Kentucky, the War Department issued General Order No. 329 on October 3, 1863. Section 6 of the order stated that if any citizen should offer his or her slave for enlistment into the military service, that person would, "if such slave be accepted, receive from the recruiting officer a certificate thereof, and become entitled to compensation for the service or labor of said slave, not exceeding the sum of three hundred dollars, upon filing a valid deed of manumission and of release, and making satisfactory proof of title." For this reason, some records of manumission are contained in the compiled service records reproduced in this publication.

The USCT fought in 39 major engagements and over 400 lesser ones. Sixteen African American soldiers received the Congressional Medal of Honor. As it was in other units, the death toll from disease was very high in the USCT. Deaths from disease and battle totaled 37,000. The last regiment of the USCT was mustered out of Federal service in December 1867.

Important sources for information about African American units in the Civil War are the War Department's *The War of the Rebellion: A Compilation of the Official Records of the Union and Confederate Armies* (Washington, DC: 1880-1901; reprinted Harrisburg, PA, 1971 and 1985) and the Navy Department's *The War of the Rebellion: A Compilation of the Official Records of the Union and Confederate Navies* (Washington, DC: 1874-1922; reprinted Harrisburg, PA, 1971 and 1985). These multivolume works contain reports of operations and other official correspondence.

2d United States Colored Infantry

This regiment was organized at Arlington, VA, from June 23 to November 11, 1863, to serve 3 years. During its existence, the regiment served in New Orleans, LA, and Ship Island, MI. In 1864 the unit moved to Key West and participated in operations on the west coast of Florida. On February 20, 1865, Companies D and I took part in the attack on Fort Myers, FL. Subsequent service took place in the District of Florida until the regiment was mustered out on January 5, 1866.

3d United States Colored Infantry

This regiment was organized at Camp William Penn, Philadelphia, PA, from August 3 to 10, 1863, to serve 3 years. The regiment participated in the siege of Fort Wagner, SC, and operations against Charleston, SC. In 1864 the unit moved to Jacksonville, FL, and maintained duty in the area until being mustered out October 31, 1865.

3d Tennessee Volunteers (African Descent)

This regiment was organized in the spring of 1864 in Memphis, TN, for the defense of that city. Most of the men were transferred to the 7th United States Colored Heavy Artillery, which was redesignated the 11th United States Colored Infantry (New) on January 23, 1865. There are service records pertaining to the officers and men in the 3d Tennessee Volunteers as well as in the 11th United States Colored Infantry (New).

4th United States Colored Infantry

The regiment was organized at Baltimore, MD, July 15 to September 1, 1863, to serve 3 years. The unit participated in actions in Virginia at Bermuda Hundred, Petersburg, Dutch Gap, and Chaffin's Farm. In North Carolina the regiment took part in the battle and capture of Fort Fisher, Sugar Loaf Hill, and the city of Wilmington. In these actions the regiment sustained losses of 355 officers and men wounded, missing, or killed. The regiment was mustered out of service May 6, 1866.

5th United States Colored Infantry

This regiment was organized at Camp Delaware, OH, from August 6, 1863, to January 15, 1864, to serve 3 years. In Virginia the regiment served at Norfolk and Portsmouth and participated in major battles at Petersburg, Chaffin's Farm, and Fair Oaks. The regiment took part in the capture of Fort Fisher and the city of Wilmington in North Carolina. Its remaining service took place in North Carolina until it was mustered out on September 20, 1865.

6th United States Colored Infantry

This regiment was organized at Camp William Penn, Philadelphia, PA, from July 28 to September 12, 1863, to serve 3 years. The unit participated in battles at Chaffin's Farm, Williamsburg, and Petersburg in Virginia and at Sugar Loaf Hill, NC. During these actions the regiment sustained losses of 237 killed, wounded, or missing. The regiment was mustered out September 20, 1865.

6th Louisiana Infantry (African Descent)

This regiment was organized for 60 days in New Orleans, LA, on July 4, 1863. The unit served at New Orleans and was mustered out August 13, 1863.

7th United States Colored Infantry

This regiment was organized at Baltimore, MD, from September 26 to November 12, 1863, to serve 3 years. The unit served in Virginia, Florida, and South Carolina. It was mustered out of service October 13, 1866.

7th Louisiana Infantry (African Descent)

This regiment was organized for 60 days in New Orleans, LA, on July 10, 1863. It served in New Orleans until it was mustered out on August 6, 1863.

Records Description

Compiled service records consist of a jacket-envelope for each soldier, labeled with his name, rank, unit, and card numbers. The compilation of service records of Union soldiers began in 1890 under the direction of Col. Fred C. Ainsworth, head of the Record and Pension Office of the Adjutant General's Office, Department of War. Information from muster rolls, regimental returns, descriptive books, and other records was copied verbatim onto cards. A separate card was prepared each time an individual name appeared on a document. These cards were numbered on the back, and these numbers were entered onto the outside jacket containing the cards. The carded information was verified by a separated operation of comparison; great care was taken to ensure that the cards were accurate.

A typical jacket contains card abstracts of entries found in original records relating to the soldier and original documents relating solely to that soldier. Examples of the latter include enlistment papers, substitute certificates, casualty sheets, death reports, prisoner-of-war memorandums, and correspondence. Unique to the records of the USCT are deeds of manumission, oaths of allegiance, proof of ownership, certificates of monetary award, and bills of sale. These items appear most frequently in units recruited in the border states of Kentucky, Missouri, and Maryland. These states remained in the Union but were slave states. Jackets and cards include a section labeled "bookmark," which was reserved for cross-references to other records relating to the individual or his unit. The service records are

NATIONAL ARCHIVES MICROFILM PUBLICATIONS

arranged by arm of service, thereunder numerically by regiment or independent battalion or company, and thereunder alphabetically by name of the soldier. Records for officers are interfiled alphabetically by name with the records of enlisted men. If an individual served in more than one unit, which was typical for USCT officers, there will be a separate service record for each unit in which he served.

The unjacketed miscellaneous cards were accumulated by the War Department with the expectation that they would be incorporated in individual compiled service records. This expectation was never fulfilled, however, because either insufficient or contradictory information made it impossible to associate the cards or papers with a particular soldier's service records.

Related Records

Among the records of the Adjutant General's Office in the National Archives are many of the original records that were abstracted or "carded" by the Record and Pension Office. These include the individual unit's muster rolls, returns, and descriptive books. Other series in RG 94 that contain information relating to volunteer Union soldiers who served with the USCT include carded records relating to Union staff officers, carded medical records of volunteer Union soldiers, unbound and bound regimental records and "record of events" cards. The regimental records of the 54th Massachusetts Infantry (Colored) have been reproduced as Microfilm Publication M1659, *Records of the Fifty-fourth Massachusetts Infantry Regiment (Colored), 1863-1865*.

The "record of events" cards include information copied from the unit's muster rolls and returns. They show the stations of the field and staff and the companies of the regiment at the time the muster roll or return was prepared and sometimes mention battles, skirmishes, or other activities in which the regiment participated. The cards have been reproduced as Microfilm Publication M594, *Compiled Records Showing Service of Military Units in Volunteer Union Organizations*.

Record Group 94 also includes a card index for the USCT, reproduced as Microfilm Publication M589, *Index to Compiled Military Service Records of Volunteer Union Soldiers Who Served with U.S. Colored Troops*, which may be used to locate the regiment of a USCT soldier. An index card gives the name of the soldier and his rank, as well as the unit in which he served; sometimes there is a cross-reference to his service in other units or organizations. The National Archives is continually producing microfilm publications of volunteer Union compiled military service records. A complete listing of finished publications can be found in the National Archives *Microfilm Resources for Research: A Comprehensive Catalog*, which is available online at <http://www.nara.gov>.

The records of the Colored Troops Division, within RG 94, include division correspondence and records relating to recruiting, the appointment of officers, and the slave or free status of individuals, as well as a compilation of historical extracts

NATIONAL ARCHIVES MICROFILM PUBLICATIONS

and official papers concerning the military service of African Americans from the colonial period through the Civil War entitled *The Negro in the Military Service of the United States, 1639-1886*. This compilation is reproduced as Microfilm Publication M858. The records of the Bounty and Claims Division, also in RG 94, include correspondence of the division and records relating to bounties and claims paid to loyal owners of slaves by the Slave Claims Commissions of Delaware, Kentucky, Maryland, Missouri, Tennessee, and West Virginia.

If a soldier applied for a pension, the pension application case file may be among the Records of the Veterans Administration (RG 15). Indexes to the pension applications have been reproduced as Microfilm Publications T288, *General Index to Pension Files, 1861-1934*, and T289, *Organizational Index to Pension Files of Veterans Who Served Between 1861 and 1900*.

If a soldier or officer was tried before a general court-martial or if an individual or his unit was the subject of a court of inquiry or military commission, transcripts of those proceedings may be among the Records of the Office of the Judge Advocate General (Army) (RG 153). The registers to the proceedings have been reproduced as Microfilm Publication M1105, *Registers of the Records of the Proceedings of the U.S. Army General Courts-Martial, 1809-1890*.

Other record groups having information pertaining to the USCT include Records of the Bureau of Refugees, Freedmen, and Abandoned Lands (RG 105); Records of the Provost Marshal General's Bureau (Civil War) (RG 110); Records of the Accounting Officers of the Department of the Treasury (RG 217); and Records of U.S. Army Continental Commands, 1821-1920 (RG 393).

Holdings of the National Archives relating to the Civil War are outlined in Kenneth W. Munden and Henry Putnam Beers, *Guide to Federal Archives Relating to the Civil War* (Washington, DC: National Archives, 1962) and Henry Putnam Beers, *Guide to the Archives of the Government of the Confederate States of America* (Washington, DC: National Archives, 1968), which were reprinted as *The Union* (1986) and *The Confederacy* (1986).

NATIONAL ARCHIVES MICROFILM PUBLICATIONS

ROLL LIST

Roll Description

2d United States Colored Infantry

1 Abram, Abraham - Bell, Daniel A.
2 Bell, Henry - Brown, Thomas
3 Brown, William - Clark, Moses
4 Clark, Stephen - Downing, Dennis
5 Downs, John - Gavin, Benjamin
6 Gibbs, Paton - Haskins, Iverson
7 Hasler, William - Jenkins, Charles
8 Johnson, Albert - Kratzenberg, Augusta
9 Kratzenberg, Charles - Miller, Thomas
10 Mills, John Q. - Pettis, Alfred
11 Pettis, Frank - Russ, Charles
12 Russell, Charles - Spindle, James E.
13 Sprague, Benedict - Thoroughgood, Miles E.
14 Thornson, Charles H. - West, James
15 West, Nimrod - Woodson, William
16 Woodward, George G. - Young, William A.

2d United States Colored Infantry Miscellaneous Service Cards

16 Ackis, George - Young, Samuel

3d United States Colored Infantry

17 Abbot, Charles S. - Bohlen, John
18 Bond, Charles - Clemens, William
19 Clemmons, Joseph - Fernow, Edward B. F.
20 Fields, Alfred - Harmon, William K.
21 Harris, George - Jackson, Frederick
22 Jackson, George - LaCount, Charles J.
23 Ladson, Thomas - Miller, Henry
24 Miller, John - Preslin, Stephen
25 Preston, Joseph - Shorter, Daniel
26 Shorter, John W. - Thompson, George A.
27 Thompson, John - Williams, Edward
28 Williams, Enoch - Young, William H.

3d United States Colored Infantry Miscellaneous Service Cards

29 Abbott, Chas. - Wright, Lorenzo

NATIONAL ARCHIVES MICROFILM PUBLICATIONS

3d Tennessee Volunteers (African Descent)

30 Ady, George - Young, Samuel

4th United States Colored Infantry

31 Abney, Richard - Bass, James
32 Batsom, David - Brown, Stephen R.
33 Brown Uriah - Cherry, Thomas
34 Chew, Josiah - Davis, Jeremiah
35 Davis, John H. J. - Ellis, John J.
36 Emery, Enoch - Gray, James
37 Grayson, Noble - Hause, William
38 Hawkins, Alexander - Jackson, John
39 Jackson, John Daniel - Jones, John
40 Jones, John Robert - Linthicum, Dennis C.
41 Linthicum, George L. - Mercer, Benjamin F.
42 Mickens, Thomas H. - Novel, Charles
43 Odiorne George G. - Reynolds, S. Walter
44 Rezin, George F. - Seymour, George W.
45 Seymour, Thomas - Stockett, Samuel
46 Stokes, George E. W. - Veal, Charles
47 Viney, Richard - Willett, James
48 Williams, Adam - Zimmons, Charles

4th United States Colored Infantry Miscellaneous Service Cards

49 Adams, James O. - Juricks, Jacob
50 Kane, Chas. - Zook, Gray

5th United States Colored Infantry

51 Adams, John - Black, Edward
52 Blackburn, Daniel - Brown, James
53 Brown, J. R. - Coleman, James
54 Coleman, Thornton - Duckwilder, Clayburn
55 Dudley, George - Gilson, James
56 Glasgow, James - Herse, Jerry
57 Hervit, John - Johnson, Arthur B.
58 Johnson, Charles - Lett, William
59 Levis, Hezekiah - McFarland, Allen
60 McFarland, John - Page, David
61 Page, Isaiah - Rider, William H.
62 Ridgeway, John - Sloan, Samuel
63 Sly, William - Teeters, Charles
64 Teeters, Henry W. - Walker, William
65 Walker, Willis - Winters, James

NATIONAL ARCHIVES MICROFILM PUBLICATIONS

66 Winters, Oscar - Zimmerman, Henry

5th United States Colored Infantry Miscellaneous Service Cards

66 Alexander, Arthur - Kyser, Henry

67 Ladd, Andrew - Young, Thomas

6th United States Colored Infantry

68 Abraham, Jacob - Bolier, Abram

69 Boo, David - Carey, Walter

70 Carr, William - Davis, Peter

71 Davis, Robert - Fiderman, William C.

72 Field, Edward - Gustus, John R.

73 Guy, William - Hopkins, James

74 Hosfield, Lewis M. - Johnson, John Henry

75 Johnson, John W. - Lemon, George

76 Lett, Nelson - Miller, John

77 Miller, Lawson L. - Pierce, Alfred B.

78 Pierce, George - Ruff, Jacob

79 Russell, Lloyd - Smith, William H.

80 Snowden, Henry - Van Clief, Emanuel

81 Van Vrankin, William H. - Wilson, Anthony

82 Wilson, Charles - Young, John

6th United States Colored Infantry Miscellaneous Service Cards

82 Abrams, Jacob - Furgerson, Henry

83 Gadsby, John - Young, Richard

6th Louisiana Infantry (African Descent)

84 Aaron, Koff - Chevarre, Ernest

85 Cheveau, Auguste - Guimiase, Julian

86 Gusman, Thomas - Meyer, Wilson

87 Michael, Louis - Sorza, Antoine

88 Span, Octavus - Zenon, Aristide

7th United States Colored Infantry

89 Abraham, John - Bardy, Joseph

90 Bargas, James J. - Bowyer, Littleton

91 Bowzer, Emory - Bundick, Henry

92 Burden, Daniel - Chase, Henry

93 Chase, Isaac - Crawford, George W.

94 Cray, Charles M. - Drummond, William

NATIONAL ARCHIVES MICROFILM PUBLICATIONS

- 95 Dumpson, George - Gale, Joseph
- 96 Gamby, Charles - Griffin, Charles W.
- 97 Griffin, George E. - Hazelton, William
- 98 Hearn, William E. - Jackson, George H.
- 99 Jackson, Henry - Johnson, Samuel
- 100 Johnson, Stephen - Landsell, William
- 101 Lane, William - Melvin, Sime
- 102 Merrill, Lewis - Nichols, Lloyd
- 103 Noonan, William F. - Purnell, James
- 104 Purnell, John H. - Russell, Thomas
- 105 Russum, Alexander - Smith, James R.
- 106 Smith, James W. - Taylor, Daniel
- 107 Taylor, Levin H. - Vaughn, John H.
- 108 Veasey, Edward - Whitman, Moses P.
- 109 Whittica, James - Wright, John Wesley
- 110 Wright, Joseph - Young, Thomas

7th United States Colored Infantry Miscellaneous Service Cards

- 110 Adams, Gilbert - Kutchumber, Jacob
- 111 Landon, Perry H. - Young, Stephen

7th Louisiana Infantry (African Descent)

- 112 Able, Alfred - Colar, Manuel
- 113 Cole, Arnold - Holland, John C.
- 114 Holland, Jules - Myers, Victor
- 115 Narcisse, James - Swails, George A.
- 116 Sylvester, Joseph - Zoodrick, Dick

7th Louisiana Infantry (African Descent) Miscellaneous Service Cards

- 116 Allen, Charles - Whittey, Hiram C.

NATIONAL ARCHIVES MICROFILM PUBLICATIONS

Microfilm Publication M1820

COMPILED MILITARY SERVICE RECORDS OF VOLUNTEER UNION
SOLDIERS WHO SERVED WITH THE UNITED STATES COLORED TROOPS:
2d Through 7th United States Colored Infantry, Including 3d Tennessee Volunteers
(African Descent), 6th Louisiana Infantry (African Descent), 7th Louisiana Infantry
(African Descent)

Roll 68

6th United States Colored Infantry

Abraham, Jacob - Bolier, Abram

NATIONAL ARCHIVES AND RECORDS ADMINISTRATION

6 U.S. Col'd Inf

Private Private

CARD NUMBERS.

1	5377079	26
2	5577161	27
3	5377246	28
4	5377327	29
5	5377407	30
6	5577485	31
7	5377558	32
8	5577627	33
9	5577699	34
10	5577794	35
11	5577888	36
12	5577978	37
13	5368833	38
14	5378063	39
15	9065511	40
16		41
17		42
18		43
19		44
20		45
21		46
22		47
23		48
24		49
25		50

Book Mark:

See also

04 | 6 | U.S.C.T.

Jacob Abraham,
Co. H, 6 Reg't U. S. Col'd Inf.

Appears on
Company Descriptive Book
of the organization named above.

DESCRIPTION.

Age 20 years; height 5 feet 7 inches.

Complexion *Blk*

Eyes *Blk*; hair *Blk*

Where born *West Chester Pa.*

Occupation *Lab.*

ENLISTMENT.

When *July 16*, 186*3*.

Where *Leicester Pa.*

By whom *J. D. Pa.*; term *3* y'rs.

Remarks: *Mustered by Capt
Bolman.*

Jenkins
Copyist.

A | 6 | U.S.C.T.

Jacob Abraham
Cot, Co. H, 6 Reg't U. S. Col'd Infantry.

Age 20 years.

Appears on

Company Muster-in Roll

of the organization named above. Roll dated

Phila Pa July 14, 1863.

Muster-in to date July 16, 1863

Joined for duty and enrolled:

When July 16, 1863.

Where Lancaster, Pa

Period 3 years.

Remarks: Mustd. by Capt
Bolmins P.M. July 16/63.
Dfted

Book mark :

W. H. Thompson

A | 6 | U.S.C.T.

Jacob Abraham
Priv., Co. H, 6 Reg't U. S. Col'd Infantry.

Appears on

Company Muster Roll
for Sept 14 to Oct 31, 1863.

Present or absent Present

Stoppage, \$ 100 for

Due Gov't, \$ 100 for

Remarks:

Book mark:

(358)

M. A. Thompson
Copyist.

A | **6** | **U.S.C.T.**

Jacob Abraham
Priv, Co. H, 6 Reg't U. S. Col'd Infantry.

Appears on

Company Muster Roll
for *Nov. & Dec*, 1863.

Present or absent *Present*

Stoppage, \$ *100* for

Due Gov't, \$ *100* for

Remarks:

Book mark:

(358)

W. H. Thompson
Copyist.

A | 6 | U.S.C.T.

Jacob Abram
Cvt, Co. H, 6 Reg't U. S. Col'd Infantry.

Appears on

Company Muster Roll

for Jany & Febry, 1864

Present or absent Present

Stoppage, \$ 100 for

Due Gov't, \$ 100 for

Remarks:

Book mark:

W. H. Thompson
Copyist.

A | 6 | U.S.C.T.

Jacob Abraham
Pvt, Co. H, 6 Reg't U. S. Col'd Infantry.

Appears on

Company Muster Roll
for Mch & Apr, 1864

Present or absent Present

Stoppage, \$ 100 for

Due Gov't, \$ 100 for

Remarks:

Book mark:

M. H. Thompson
Copyist.

A | 6 | U.S.C.T.

Jacob Abram

Priv, Co. H, 6 Reg't U. S. Col'd Infantry.

Appears on

Company Muster Roll

for *May & June*, 1864.

Present or absent *Absent*

Stoppage, \$ 100 for

Due Gov't, \$ 100 for

Remarks: *Absent sick in
Gen'l Hosp. City
Point since June
19, 1864*

Book mark:

C. A. Harper

A

6

U.S.C.T.

Jacob Abram
Priv, Co. H, 6 Reg't U. S. Col'd Infantry.

Appears on

Company Muster Roll

for *July & Aug*, 186 *4*.

Present or absent *Present*

Stoppage, \$ *100* for

Due Gov't, \$ *100* for

Remarks: *Free April 19/61*

Book mark:

C. A. Sawyer

(358)

Copyist.

CA | **6** | **U.S.C.T.**

Saer-Abraham
Riv, Co. H, 6 Reg't U. S. Col'd Infantry.

Appears on

Company Muster Roll

for *Sept & Oct*, 1864.

Present or absent *Absent*

Stoppage, \$ 100 for

Due Gov't, \$ 100 for

Remarks: *Free April 19/61*
Sick in Hosp. since
April 29/64

NEXT ROLL ON FILE FEB 1865

Book mark:

C. F. Harper

CA | 6 | U.S.C.T.

Jacob Abrams
Priv, Co. H, 6 Reg't U. S. Col'd Infantry.

Appears on

Company Muster Roll
for Jan & Feb, 1865.

Present or absent Absent

Stoppage, \$ 100 for

Due Gov't, \$ 100 for

Remarks: Free April 19/61
Absent Sick
Due U.S. for transport
white on Guelough
\$529

Book mark:

C. A. Harper

CA

6

U.S.C.T.

Jaest-Abrams

Priv, Co. H, 6 Reg't U. S. Col'd Infantry.

Appears on

Company Muster Roll

for *Mar & April*, 1865.

Present or absent *Absent*

Stoppage, \$ 100 for

Due Gov't, \$ 100 for

Remarks: *Free April 19/61*
Absent Sick
Due U.S. for transp.
while on furlough
\$5.29

Book mark:

C. A. Harper

a

6

U.S.C.T.

Jacob Abrams
Pvt., Co. H, 6 Reg't U. S. Col'd Infantry.

Appears on

Company Muster Roll

for May & June, 1865.

Present or absent Absent

Stoppage, \$ 100 for

Due Gov't, \$ 100 for

Remarks: Absent sick. Stopped
for transportation on furlough
\$5.29.

Book mark:

Holcomb

a

6

U.S.C.T.

Jacob Abrams
Pvt., Co. H, 6 Reg't U. S. Col'd Infantry.

Appears on

Company Muster Roll

for July & Aug, 1865.

Present or absent Absent

Stoppage, \$ 100 for

Due Gov't, \$ 100 for

Remarks: Absent in hospital, stop
for transportation, while on
furlough 5²⁹/₁₀₀ x

Book mark:

Holeman

A 16 | **U.S.C.T.**

Jacob Abrams
P, Co. H, 1 Reg't U. S. Col'd Infantry.

Appears on a

List of Discharges furnished by C. M. O. of State,
under the provisions of circular dated A. G. O.,
June 29, 1865.

Discharge furnished Oct-17, 1865,

to date from _____, 186 .

Remarks: Absent-Sick-
Stop for transportation #529
"No discharge furnished"

Book Mark: 1228 Dis May 25/69

J. H. Wright
(350) Copyist.

U. | 6 | U.S.C.T.

Jacob Abrams

Private, Co. H, 6 Reg't U. S. Col'd Infantry.

Appears on Co. Muster-out Roll, dated
Wilmington N.C., Sep 20, 1865.

Muster-out to date _____, 186 .

Last paid to April 30, 1864 .

Clothing account:

Last settled June 30, 1864; drawn since \$ 100

Due soldier \$ 100; due U. S. \$ 100

Am't for cloth'g in kind or money adv'd \$ 100

Due U. S. for arms, equipments, &c., \$ 100

Bounty paid \$ 100; due \$ 100 100

Remarks: Due Wm Beisben Reg't.

Sutler \$ 8. \$ 6 per mo. due from enlist-

ment to April 30/64. Absent sick

Supposed to be at Lowell Genl.

Hospital R.I. no discharge furnished.

Book mark: M.O. on file = 1228 Dis May 21/67

Halecomb

(361)

Copyist.

Jacob
 Co. A, 6 U.S. Col'd Inf

Private | *Private*

CARD NUMBERS.

1	26
2	27
3	28
4	<i>See Abraham, Jacob.</i>
5	30
6	31
7	32
8	33
9	34
10	35
11	36
12	37
13	38
14	39
15	40
16	41
17	42
18	43
19	44
20	45
21	46
22	47
23	48
24	49
25	50

Book Mark:

See also:

Abrams Jacob

Co *A*, 6 U.S. Col'd Inf.

Private | *Private*

CARD NUMBERS.

1	26
2	27
3	28
4	<i>See Abraham, Jacob.</i>
5	30
6	31
7	32
8	33
9	34
10	35
11	36
12	37
13	38
14	39
15	40
16	41
17	42
18	43
19	44
20	45
21	46
22	47
23	48
24	49
25	50

Book Mark:

See also

James Dwyer
 Co *SB*, 6 U.S. Col'd Inf.

Private | *Private*

CARD NUMBERS.

1	5570159	26
2	5568392	27
3	5570242	28
4	5570326	29
5	5570406	30
6	5570484	31
7	5570560	32
8	5570697	33
9	5571279	34
10	9064542	35
11		36
12		37
13		38
14		39
15		40
16		41
17		42
18		43
19		44
20		45
21		46
22		47
23		48
24		49
25		50

Book Mark:

See also

A

6

U.S.C.T.

George W. Adams

Co. B, 6 Reg't U. S. Col'd Inf.

Appears on

Company Descriptive Book

of the organization named above.

DESCRIPTION.

Age 20 years; height 5 feet 2 inches.

Complexion *Ben*

Eyes *Ben*; hair *Ben*

Where born *Westchester Pa*

Occupation *Laborer*

ENLISTMENT.

When *July 24*, 186*3*

Where *Lancaster*

By whom *9th Dr. Pa*; term *3* y'rs.

Remarks: *Substitute, Killed July 30/64. Final statement forwarded*

W. J. Roe

A | 6 | U.S.C.T.

George H. Adams
Priv., Co. D, 6 Reg't U. S. Col'd Infantry.

Age 20 years.

Appears on

Company Muster-in Roll

of the organization named above. Roll dated
Philadelphia Pa. Aug 3rd, 1863.

Muster-in to date July 24th, 1863.

Joined for duty and enrolled:

When July 24th, 1863

Where West Chester Pa.

Period 3 years.

Remarks:

Book mark:

H. E. Brandon

A | 6 | U.S.C.T.

George W. Adams

Appears with rank of Priv. on
**Muster and Descriptive Roll of a Detach-
ment of Drafted Men and Substitutes
forwarded**

for the 6 Reg't U. S. Col'd Inf. Roll dated
West Chester Pa, Aug 1, 1863.

Where born Penn.

Age 20 years; occupation Laborer

Drafted and mustered in:

When July 24, 1863.

Where West Chester 10 Dist.

Period 3 years.

Eyes black; hair black

Complexion black; height 5 ft. 2 in.

Paid bounty and advance pay, \$ 100

Bounty due \$ 100

Where credited

Company to which assigned

Remarks: substitute for John Smith,
Edgmont Del. Co. Pa.

Book mark:

Sarimer

A | 6 | U.S.C.T.

George W. Adams
Prvt, Co. B, 6 Reg't U. S. Col'd Infantry.

Appears on

Company Muster Roll

for From Muster in to Oct. 31, 1863.

Present or absent Present

Stoppage, \$ 100 for

Due Gov't, \$ 100 for

Remarks:

Book mark:

H. S. Brandon

A. | 6 | U.S.C.T.

George V. Adams
Priv., Co. B, 6 Reg't U. S. Col'd Infantry.

Appears on

Company Muster Roll

for Nov. & Dec, 1863.

Present or absent Present

Stoppage, \$ 100 for

Due Gov't, \$ 100 for

Remarks:

Book mark:

H. S. Brandon

A. | 6 | U.S.C.T.

George W. Adams
Priv., Co. B, 6 Reg't U. S. Col'd Infantry.

Appears on

Company Muster Roll

for *Jan. & Feb.*, 1864.

Present or absent *Present*

Stoppage, \$ *100* for

Due Gov't, \$ *100* for

Remarks: *L*

Book mark:

J. E. Brandon

A. | 6 | U.S.C.T.

George H. Adams
Priv., Co. B, 6 Reg't U. S. Col'd Infantry.

Appears on

Company Muster Roll

for *Mar. & Apr.*, 1864

Present or absent *Present*

Stoppage, \$ *100* for

Due Gov't, \$ *100* for

Remarks:

Book mark:

H. E. Brandon

41

6

U.S.C.T.

George W. Adams
Private, Co. B, 6 Reg't U. S. Col'd Infantry.

Appears on

Company Muster Roll

for *March*, 1864

Present or absent *Present*

Stoppage, \$ 100 for

Due Gov't, \$ 100 for

Remarks:

Book mark:

(358)

W. Leonard

Copyist

W | **6** | **U.S.C.T.**

George W. Adams
Priv, Co. B, 6 Reg't U. S. Col'd Infantry.

Appears on

Company Muster Roll

for *July & Aug.*, 1864.

Present or absent

Stoppage, \$ 100 for

Due Gov't, \$ 100 for

Remarks: *Killed in Battle
near Petersburg Va
July 30/64*

Book mark: *No. 735, Dec 12 1864*

W. Leonard

A. | 6 | U.S.C.T.

George W. Adams
Priv., Co. B, 6 Reg't U. S. Col'd Infantry.

Appears on Co. Muster-out Roll, dated
Wilmington, N.C. Sept. 20, 1865.

Muster-out to date _____, 186 .

Last paid to _____, 186 .

Clothing account:

Last settled _____, 186 ; drawn since \$ _____ 100

Due soldier \$ _____ 100; due U. S. \$ _____ 100

Am't for cloth'g in kind or money adv'd \$ _____ 100

Due U. S. for arms, equipments, &c., \$ _____ 100

Bounty paid \$ _____ 100; due \$ _____ 100

Remark: Killed in front of
Petersburg July 30, 1864

Book mark: 67.7387S.7129P184.71

(361) *B. J. Cooke* Copyist.

Adams George

A, Co. B, 6 Regt U.S.C. Inf.

4 Enclosures.

Bed Cards	Descriptive Lists
Burial Records	Final Statements 2
Certs. of Dis. for Discharge	Furloughs
C. M. Charges	Med. Des. Lists
Med. Certificates	Orders

Other papers relating to—

Admission to Hosp'l	Furlough
Casualty Sheet (Officer's) /	Med. Examination
Confinement	Misc. Information
Contracts	Pay or Clothing
Death or Effects /	Personal Reports
Desertions	Rank
Discharge from Hosp'l	Transfer to Hosp'l
Discharge from Service	Transfer to V. R. C.
Duty	Transportation

ARTICLES OF WAR.

ART. 95. When any non-commissioned officer or soldier shall die, or be killed in the service of the United States, the then commanding officer of the troop or company shall, in the presence of two other commissioned officers, take an account of what effects he died possessed of, above his arms and accoutrements, and transmit the same to the office of the Department of War, which said effects are to be accounted for, and paid to the representatives of such deceased non-commissioned officer or soldier. And in case any of the officers, so authorized to take care of the effects of deceased officers and soldiers, should, before they have accounted to their representatives for the same, have occasion to leave the regiment or post, by preferment or otherwise, they shall, before they be permitted to quit the same, deposit in the hands of the commanding officer, or of the assistant military agent, all the effects of such deceased non-commissioned officers and soldiers, in order that the same may be secured for, and paid to, their respective representatives.

ARMY REGULATIONS—EDITION OF 1861.

DECEASED SOLDIERS.

Par. 152. Inventories of the effects of deceased non-commissioned officers and soldiers, required by the 95th Article of War, will be forwarded to the Adjutant General, by the commander of the company to which the deceased belonged, and a duplicate of the same to the colonel of the regiment. Final statements of pay, clothing, &c., will be sent with the inventories. When a soldier dies at a post or station absent from his company, it will be the duty of his immediate commander to furnish the required inventory, and, at the same time, to forward to the commanding officer of the company to which the soldier belonged, a report of his death, specifying the date, place, and cause; to what time he was last paid, and the money or other effects in his possession at the time of his decease; which report will be noted on the next muster roll of the company to which the man belonged. Each inventory will be endorsed, "Inventory of the effects of ———, late of company (—) ——— regiment of ———, who died at ———, the ——— day of ———, 186—." If a legal representative receive the effects, it will be stated in the report. If the soldier leave no effects, the fact will be reported.

Par. 153. Should the effects of a deceased non-commissioned officer or soldier not be administered upon within a short period after his decease, they shall be disposed of by a Council of Administration, under the authority of the commanding officer of the post, and the proceeds deposited with the Paymaster, to the credit of the United States, until they shall be claimed by the legal representatives of the deceased.

Par. 154. In all such cases of sales by the Council of Administration, a statement in detail, or account of the proceeds, duly certified by the Council and commanding officer, accompanied by the Paymaster's receipt for the proceeds, will be forwarded by the commanding officer to the Adjutant General. The statement will be endorsed, "Report of the proceeds of the effects of ———, late of company (—) ——— regiment of ———, who died at ———, the ——— day of ———, 186—."

NOTE 1.—The effects in all cases, when called for, should be turned over to the legal representative, without further authority from the Adjutant General. When the effects are turned over to the relatives of the deceased before these inventories are sent to the Adjutant General, their receipts therefor should be attached to the inventories. In all other cases, one copy will be sent with a letter of transmittal direct to the Adjutant General, and a duplicate retained by the officer.

NOTE 2.—Particular care should be taken to take receipts in duplicate from the Paymaster for any funds turned over to him; one copy should be sent direct to the Adjutant General and one retained by the officer.

INVENTORY OF THE EFFECTS

OF

Private George Adams

Late of Company *B.*

6th Reg't of *U. S. L. Troops*

Volunteers, who died at *New Orleans*

on the *3rd* day of *July* 1864.



Inventory of the effects of George Adams late
a Private of Captain Charles Hooker Company B of
the Sixth Regiment of U.S.C. Troops Volunteers, who was enrolled as
a Private at Lancaster in the State of Pennsylvania on
the 27th day of July 1863, and mustered into the service of the United
States as a Substitute on the 24th day of July 1863, at Lancaster, Pa.
in Company B, Sixth Regiment of U.S. Colored Troops Volunteers, to serve Three
years or during the war; he was born in Watchhater in the State
of Pennsylvania; he was 20 years of age, 5 feet 3 inches
high, Black complexion, Black eyes, Black hair, and by occupation, when enrolled,
on the 30th day of July 1864, by
reason of being shot by the enemy

INVENTORY.					
ARTICLES.	No.	ARTICLES.	No.	ARTICLES.	No.
Hats.....		Pairs trousers.....		<div style="display: flex; justify-content: space-between;"> <div style="writing-mode: vertical-rl; transform: rotate(180deg);">MONEY.</div> <div> Knapsacks..... Specie..... \$ Notes..... \$ </div> </div>	
Caps.....		Pairs flannel drawers.....			
Forage caps.....		Pairs cotton drawers.....			
Great coats.....		Flannel shirts.....			
Uniform coats.....		Cotton shirts.....			
Uniform jackets.....		Pairs boots.....			
Flannel sack coats.....		Pairs shoes.....			
Blouses.....		Pairs socks.....			
Stable frocks.....		Blankets.....			
Fatigue overalls.....		Haversacks.....			

I CERTIFY, ON HONOR, that the above inventory comprises all the effects of George Adams, deceased, and that the effects are in the hands of _____ at _____ to be disposed of by a Council of Administration.

(DUPLICATES.)

Charles Hooker
Captain
 Commanding the Company.

STATION: Lancaster, Pa.

DATE: Aug 24 1864

FINAL STATEMENT

OF

Private George Adams

6th Reg't of U.S. Troop

VOLUNTEERS.

Disd July 30th 1864

NOTE 1.—Two of these certificates (or duplicates) are to be given to each volunteer soldier who may be discharged previously to the discharge of his company, that he may at once receive from the Paymaster the pay, &c., due him, and the captain or other officer commanding the company will certify to the act of the delivery of the duplicate certificates; on these certificates the Soldier is "entitled to" his discharge, and should also present his discharge to the Paymaster to have the payment endorsed on it. The discharge is to be given back to the Soldier by the Paymaster; the latter only retaining as his voucher the duplicate certificates.

NOTE 2.—If the Soldier is entitled to pay for the use of his horse, the Company Commander will certify to that fact, and also to the time he has pay due for having been so mounted on his own horse.

NOTE 3.—Amounts due the Sutler and Laundress must be entered on the Muster Roll on which the death, desertion, &c., is reported, as well as on the final statement, otherwise the amount cannot be collected from the United States.

NOTE 4.— This blank will be used for deceased volunteers as well as others.

ADJUTANT GENERAL'S OFFICE.

Aug 1st 1864

Duplicate with Inventory sent 2d Auditor.



Anton K. [Signature]

I certify, on honor, that George B. Adams a Private of
 Captain C. V. York Company (B) of the 6th Regiment of Ind. Inf.
VOLUNTEERS, of the State of Indiana, born in Scottsbluff, State
 of Indiana, aged 20 years; 5 feet 2 inches high; blue complexion,
blue eyes, blue hair, and by occupation a laborer, having joined the company on
 its original organization at Scottsbluff, Pa., and enrolled in it at the muster into
 the service of the United States at Scottsbluff, Pa., on the 24th day
 of July, 1863, (or was mustered in service as a recruit, by Substitute
Lawrence, at Scottsbluff, Pa., on the 24th day of July,
 1863, to serve in the Regiment,) for the term of 3 years
 and having served **HONESTLY** and **FAITHFULLY** with his Company in Indiana
 to the present date, is now entitled to a **DISCHARGE** by reason of Death,
(Died July 30th 1864 see inventory)

The said Private George B. Adams was last paid by Paymaster
Major McHenry to include the 30th day of April, 1864, and has
 pay due him from that time to the present date; he is entitled to pay and subsistence for
TRAVELING to place of enrollment and whatever other allowances are authorized to volunteer
 soldiers, or militia, so discharged. He has received \$ 66 37/₁₀₀ dollars,
 advanced by the United States on account of **CLOTHING**.

There is to be stopped from him, on account of the State of _____, or other
 authorities for **CLOTHING, &c.**, received on entering service, _____ dollars; also,
 for expenses of **SUBSISTENCE** for **TRAVELING** from place of enrollment to the place of rendezvous,
 amounting to _____ dollars; and on account of the United States for **EXTRA**
CLOTHING received in kind from C Company Command and for other
 stoppages, viz:

_____ amounting to \$ 27 37/₁₀₀ dollars;
 and he has been **SUBSISTED** for **TRAVELING** to his place of enrollment, up to the _____
 _____, 186 .

He is indebted to _____, **SUTLER**, _____ dollars.
 He is indebted to _____, **LAUNDRESS**, _____ dollars.

Given in Duplicate, at _____, this _____ day of August, 1864.

Charles York

 Commanding Company.

1864

No. 1

FINAL STATEMENT

John
Hell

Private George Adams

6th Reg't of *U. S. C. Troop*

VOLUNTEERS.

NOTE 1.—Two of these certificates (or duplicates) are to be given to each volunteer soldier who may be discharged previously to the discharge of his company, that he may at once receive from the Paymaster the pay, &c., due him, and the captain or other officer commanding the company will certify to the act of the delivery of the duplicate certificates; on these certificates the Soldier is "entitled to" his discharge, and should also present his discharge to the Paymaster to have the payment endorsed on it. The discharge is to be given back to the Soldier by the Paymaster; the latter only retaining as his voucher the duplicate certificates.

NOTE 2.—If the Soldier is entitled to pay for the use of his horse, the Company Commander will certify to that fact, and also to the time he has pay due for having been so mounted on his own horse.

NOTE 3.—Amounts due the Sutler and Laundress must be entered on the Muster Roll on which the death, desertion, &c., is reported, as well as on the final statement, otherwise the amount cannot be collected from the United States.

NOTE 4.— This blank will be used for deceased volunteers as well as others.



I certify, on honor, that George B. Adams a Private of
 Captain G. H. Carter Company (B) of the 6th Regiment of U. S. Army
VOLUNTEERS, of the State of Massachusetts, born in Westchester, State
 of Massachusetts, aged 20 years; 3 feet 2 inches high; Blond complexion,
Blue eyes, Blue hair, and by occupation a Sapper, having joined the company on
 its original organization at Worcester Pa, and enrolled in it at the muster into
 the service of the United States at Worcester Pa, on the 24th day
 of July, 1863, (or was mustered in service as a recruit, by Substitute
Worcester, at Worcester Pa, on the 24th day of July,
 1863, to serve in the Regiment,) for the term of Three Years
 and having served **HONESTLY** and **FAITHFULLY** with his Company in U. S. Army
 to the present date, is now entitled to a **DISCHARGE** by reason of Death

The said Private George Adams was last paid by Paymaster
Major McKinney to include the 30th day of April, 1864, and has
 pay due him from that time to the present date; he is entitled to pay and subsistence for
TRAVELING to place of enrollment and whatever other allowances are authorized to volunteer
 soldiers, or militia, so discharged. He has received Sixty Dollars 50/100 dollars,
 advanced by the United States on account of **CLOTHING**.

There is to be stopped from him, on account of the State of _____, or other
 authorities for **CLOTHING**, &c., received on entering service, _____ 100/100 dollars; also,
 for expenses of **SUBSISTENCE** for **TRAVELING** from place of enrollment to the place of rendezvous,
 amounting to _____ 100/100 dollars; and on account of the United States for **EXTRA**
CLOTHING received in kind from Company Commandant and for other
 stoppages, viz:

_____ amounting to 27 50/100 dollars;
 and he has been **SUBSISTED** for **TRAVELING** to his place of enrollment, up to the _____
 _____, 1864.

He is indebted to _____, **SUTLER**, _____ 100/100 dollars.

He is indebted to _____, **LAUNDRESS**, _____ 100/100 dollars.

Given in Duplicate, at Worcester Pa, this 4 day of May, 1864.

G. H. Carter
 Capt.
 Commanding Company.

CASUALTY SHEET

No.

G Adams

Private of Company *B*

6th Regiment of *USC Troops*

State Volunteers.

NATURE OF CASUALTY.

Killed

CASUALTY SHEET.

Name: G. Adams

Rank: Private Company: "B" Regiment: 6th

Arm: U.S. Troops State: _____

Nature of Casualty: Killed

CAUSE OF CASUALTY—(NAME OF DISEASE, &c.)	BY WHOM DISCHARGED.
<p>DEGREE OF DISABILITY.</p>	<p>FROM WHAT SOURCE THIS INFORMATION WAS OBTAINED.</p>
<p>BY WHOM CERTIFIED.</p>	<p>REMARKS.</p>
<p><u>Saml A. Duncan</u></p>	<p><u>List of casualties 2nd Brig</u></p>
<p><u>Col Comdy</u></p>	<p><u>3rd Div. 18th Army Corps</u></p>
<p>DATE OF DISCHARGE, DEATH, &c.</p>	<p><u>Index 50 G. no 134</u></p>
<p>PLACE OF DISCHARGE, DEATH, &c.</p>	<p><u>W.F. Thompson</u></p>
<p><u>Assault on Petersburg Va.</u> <u>(from end)</u></p>	<p>Clerk.</p>

6

Inf.

Private Private

CARD NUMBERS.

1	5568606	26
2	5580022	27
3	5380122	28
4	5580219	29
5	5580314	30
6	9065751	31
7		32
8		33
9		34
10		35
11		36
12		37
13		38
14		39
15		40
16		41
17		42
18		43
19		44
20		45
21		46
22		47
23		48
24		49
25		50

Mark:

also

2-767835-222

A | *6* | U.S.C.T.

John Adams,
....., *Co H,* *6* Reg't U. S. Col'd *Inf.*

Appears on

Company Descriptive Book
of the organization named above.

DESCRIPTION.

Age *23* years; height *5* feet *3 1/2* inches.

Complexion *Black*

Eyes *Black*; hair *Black*

Where born *Honolulu Sandwich Ids*

Occupation *Sailor*

ENLISTMENT.

When *Jan.* *3*....., 186 *5*.

Where *Portsmouth N.H.*

By whom *"Dis N.H."*; term *3* y'rs.

Remarks: *Substitute*

.....
.....
.....
.....
.....
.....
.....
.....
.....

Jenkins

A | *5* | **U.S.C.T.**

John Adams

Appears with rank of *Pri* on

Muster and Descriptive Roll of a Detachment of Drafted Men and Substitutes forwarded

for the *5* Reg't U. S. Col'd Inf. Roll dated

San Pedro Concord Mt. Falls, 1865.

Where born *Samueloa Sandwich Islands*

Age *23* years; occupation *Sailor*

Drafted and mustered in:

When *Jan 3*, 1865.

Where *Portsmouth Mt.*

Period *3* years.

Eyes *Black*; hair *Black*

Complexion *Black*; height *5* ft. *3* in.

Paid bounty and advance pay, \$ *100*

Bounty due \$ *100*

Where credited *1 Em Dist Mt.*

Company to which assigned

Remarks *Substitute for Herman*

Dunghin Freedom Mt.

Book mark:

J. E. Knight

A | 6 | U.S.C.T.

John Adams
Pi, Co. K, 6 Reg't U. S. Col'd Infantry.

Appears on

Company Muster Roll

for *Jan 1861*, 1861

Present or absent *Present*

Stoppage, \$ 100 for

Due Gov't, \$ 100 for

Remarks:

(First on which borne)

Book mark:

C. H. Moore

A

6

U.S.C.T.

John Adams
Pr, Co. K, 6 Reg't U. S. Col'd Infantry.

Appears on

Company Muster Roll

for *May & June*, 1865.

Present or absent *Present*

Stoppage, \$ 100 for

Due Gov't, \$ 100 for

Remarks: *Substitute*

Book mark:

H. Anderson

A

6

U.S.C.T.

John Adams

Priv, Co. K, 6 Reg't U. S. Col'd Infantry.

Appears on

Company Muster Roll

for *July & Aug.*, 1865.

Present or absent *Present*

Stoppage, \$ *100* for

Due Gov't, \$ *100* for

Remarks: *Substitute*

Book mark:

W. Anderson

(358)

Copyist.

A | 6 | U.S.C.T.

John Adams

Put, Co. *K*, 6 Reg't U. S. Col'd Infantry.

Appears on **Co. Muster-out Roll**, dated
Wilmington, N.C., Sept 20, 1865.

Muster-out to date *Sept 20*, 1865.

Last paid to *Apr 30*, 1865.

Clothing account:

Last settled *Nov. 1*, 1865; drawn since \$ *45* ^{*99*}/₁₀₀

Due soldier \$ 100; due U. S. \$ 100

Am't for cloth'g in kind or money adv'd \$ 100

Due U. S. for arms, equipments, &c., \$ 100

Bounty paid \$ 100; due \$ 100

Remarks: *due Wm. Bisher, Regtl Suttler \$17.*

Book mark : _____

M. Andrews

U.S. Col'd Inf.

Corporal Private

CARD NUMBERS.

1	5369062	26
2	5569152	27
3	5569235	28
4	5569307	29
5	5569381	30
6	5569450	31
7	5569520	32
8	5569590	33
9	5569659	34
10	5569751	35
11	5569924	36
12	5570108	37
13	5568753	38
14	9064672	39
15		40
16		41
17		42
18		43
19		44
20		45
21		46
22		47
23		48
24		49
25		50

Book Mark: *EP-12-140,*

See also

A | 6 | U.S.C.T.

William Adams^x

....., Co. A, 6 Reg't U. S. Col'd Inf.

Appears on

Company Descriptive Book
of the organization named above.

DESCRIPTION.

Age 41 years; height 6 feet 4 inches.

Complexion Black

Eyes Brown; hair Black

Where born Loudon, Va

Occupation Farmer

ENLISTMENT.

When July 17, 1863.

Where Pittsburg, Pa

By whom Capt Foster; term 3 y'rs.

Remarks: Substitute for
Leopold Eustine,
2^d ward 32^d Dist, Pa.
Appointed Corp. Aug
30/63 per So. No 2,
1st & 2^d Camp 2nd
Penn. Pa. Reduced
to ranks for unso-
l-
dierlike conduct Sept. 1863

W J Roy

MAY. 11

9064672

1891

28/63 per Co. A &
Camp Wm Penn. Pa
In Hampton Guil
Hospitals from
Apr 30/64. descrip-
tive list forward-
ed same day -
Discharged May 20
65 by order Secy
of War at Fort
Monroe, Va

* Name cancelled

A | 6 | U.S.C.T.

William Adams
Coper Co., 6 Reg't U. S. Col'd Infantry.
Age 41 years.

Appears on

Company Muster-in Roll

of the organization named above. Roll dated

Phila Pa, Oct 13, 1863.

Muster-in to date

July 23, 1863

Joined for duty and enrolled:

When July 17, 1863.

Where Gettysburg Pa

Period 3 years.

Remarks: Sub.

Book mark:

Heard

A | **6** | **U.S.C.T.**

William Adams
Pvt., Co. A, 6 Reg't U. S. Col'd Infantry.

Appears on

Company Muster Roll

for *Nov & Dec*, 1863.

Present or absent *Present*

Stoppage, \$ 100 for

Due Gov't, \$ 100 for

Remarks:

Book mark:

(358)

Wm Adams
Copyist.

A | **6** | **U.S.C.T.**

William Adams

1st, Co. A, 6 Reg't U. S. Col'd Infantry.

Appears on

Company Muster Roll

for *Jan & Feb*, 186*4*.

Present or absent *Present*

Stoppage, \$ *100* for

Due Gov't, \$ *100* for

Remarks:

Book mark:

(358)

Devo

Copyist.

A | **6** | **U.S.C.T.**

William Adams
Pr, Co. A, 6 Reg't U. S. Col'd Infantry.

Appears on

Company Muster Roll

for *March & April*, 1864.

Present or absent *Absent*

Stoppage, \$ 100 for

Due Gov't, \$ 100 for

Remarks: *Absent sick in
McClellan's Hosp.
New Hampton Va
since April 29/64*

Book mark :

(358)

Wells
Copyist.

A | 6 | U.S.C.T.

William Adams
Priv., Co. A, 6 Reg't U. S. Col'd Infantry.

Appears on

Company Muster Roll

for May & June, 1864

Present or absent absent

Stoppage, \$ 100 for

Due Gov't, \$ 100 for

Remarks: Sick in McClellan
Gen. Hospl. Hampton Va.
since Apl. 30. 1864

Book mark:

Crenshaw

A | 6 | U.S.C.T.

William Adams
Priv., Co. A, 6 Reg't U. S. Col'd Infantry.

Appears on

Company Muster Roll

for July & Aug., 1864.

Present or absent Absent

Stoppage, \$ 100 for

Due Gov't, \$ 100 for

Remarks: Free April 19, 1864.
Absent sick since
April 30/64 at Hampton
Genl. Hospital. Substitute.

Book mark:

Crenshaw

A | 6 | U.S.C.T.

William Adams
Priv., Co. A, 6 Reg't U. S. Col'd Infantry.

Appears on

Company Muster Roll
for Sept. & Oct., 1864
Present or absent Absent

Stoppage, \$ 100 for

Due Gov't, \$ 100 for

Remarks: Free Apl. 19/61.
Sick in Hos. since
April 30/64. Sub-
stitute.

NEXT ROLL ON FILE FEB 1865

Book mark:

Crenshaw

A | 6 | U.S.C.T.

William Adams
Pvt., Co. A, 6 Reg't U. S. Col'd Infantry.

Appears on

Company Muster Roll

for *Jan'y. & Feby.*, 186*5*.

Present or absent *absent*

Stoppage, \$ *100* for

Due Gov't, \$ *100* for

Remarks: *Free April 19/61.
Sick in Hosptl. since
April 30/64. Substitute.*

Book mark:

Crenshaw

A | 6 | U.S.C.T.

William Adams

Pvt, Co. A, 6 Reg't U. S. Col'd Infantry.

Appears on

Company Muster Roll

for Mch. & Apl., 1865.

Present or absent absent

Stoppage, \$ 100 for

Due Gov't, \$ 100 for

Remarks: Substitute.

Free apl. 19/61. Sick in Hosptl. since Apl. 20/64. Due U.S. for 1 Tumbler & band Spring punch 20¢, 1 canteen 65¢.

Book mark: Must'd out at Fort (over)

Crenshaw

JAN. 20

5569751

1891

Monroe Va. May 19/65
By order A.G.O. See Muster
Out Roll on file.

7

7 | 6 | U.S.C.T.

William Adams
Sgt., Co. A, 6 Reg't U. S. Col'd Infantry.

Appears on

Company Muster Roll

for *May & June*, 1865.

Present or absent

Stoppage, \$ 100 for

Due Gov't, \$ 100 for

Remarks:

*Discharged Nov 25/65
at Fort Monroe by
order of Gen. Sherman*

Book mark: *Discharged May 1865
(over)*

(358)

W. A. Edwards
Copyist.

JAN. 20

5569924

1891

E. S. W. 12 P. 50

3908. PM 9. May 11/66

A | 6 | U.S.C.T.

William Adams

Pvt., Co. A, 6 Reg't U. S. Col'd Infantry.

Appears on an

Individual Muster-out Roll

of the organization named above. Roll dated
 Fort Monroe Va. May 19, 1865.

Muster-out to date May 19, 1865.

Last paid to Dec 31, 1864.

Clothing account:

Last settled never, 186 ; drawn since \$ 100

Due soldier \$ 100; due U. S. \$ 100

Am't for cloth'g in kind or money adv'd \$ 45 ⁷³/₁₀₀

Due U. S. for arms, equipments, &c., \$ 100

Bounty paid \$ 100; due \$ 100

Remarks: Mustered out by Order
 of the War Dept. dated
 May 3^d 1864.

Book mark: V 230. P 80. 76. See
 Over

Bowman

JAN. 20

5568753

1891 *

Letter to 2^d Auditor Sept-19
1876. E. B. $\frac{12}{140}$

A | **6** | **U.S.C.T.**

William Adams
Privt., Co. *A*, 6 Reg't U. S. Col'd Infantry.

Appears on **Co. Muster-out Roll**, dated
Wilmington N.C., Sept 20 1865 .

Muster-out to date _____, 186 .

Last paid to _____, 186 .

Clothing account:

Last settled _____, 186 ; drawn since \$ _____ 100

Due soldier \$ _____ 100; due U. S. \$ _____ 100

Am't for cloth'g in kind or money adv'd \$ _____ 100

Due U. S. for arms, equipments, &c., \$ _____ 100

Bounty paid \$ _____ 100; due \$ _____ 100

Remarks: _____

Discharged May 20/65
at Ft. Monroe Va. by
order of Secy of War.

Book mark: *M. G. on file. V 230*
(over)

(361)

A. A. Edwards
Copyist.

JAN. 20

5570108

1891 *

P. 80, 70. Discard
Jan 19 65 - E. B. 12
(H)

6 U.S. Col'd Inf

Private Private

CARD NUMBERS.

1	5373600	26
2	5573684	27
3	5573767	28
4	5573845	29
5	5573918	30
6	5373989	31
7	5374057	32
8	5574192	33
9	5574658	34
10	9065156	35
11		36
12		37
13		38
14		39
15		40
16		41
17		42
18		43
19		44
20		45
21		46
22		47
23		48
24		49
25		50

Book Mark:

See also

A | 6 | U.S.C.T.

Richard Addison

, Co. C, 6 Reg't U. S. Col'd Inf.

Appears on

Company Descriptive Book

of the organization named above.

DESCRIPTION.

Age 24 years; height 5 feet 2 1/2 inches.

Complexion black

Eyes black; hair black

Where born Leesburg Va

Occupation Waiter

ENLISTMENT.

When Aug 17, 1863.

Where Philad Pa

By whom Hbd Wagner; term 3 y'rs.

Remarks: Killed in action at New Market Heights Va Sept 29, 1864.

J. G. Reeves
Copyist.

A | 6 | U.S.C.T.

Richard F Addison

Pvt., Co. E, 6 Reg't U. S. Col'd Infantry.

Age 24 years.

Appears on

Company Muster-in Roll

of the organization named above. Roll dated

Philada Pa, Oct 13, 1863.

Muster-in to date Aug 17, 1863

Joined for duty and enrolled:

When Aug 17, 1863.

Where Philadelphia Pa

Period 3 years.

Remarks:

Book mark:

Lucas

A | **6** | **U.S.C.T.**

Richard F Addison

Priv, Co. E, 6 Reg't U. S. Col'd Infantry.

Appears on

Company Muster Roll

for *Muster in to Oct 31*, 1863

Present or absent *Present*

Stoppage, \$ 100 for

Due Gov't, \$ 100 for

Remarks:

Book mark:

Lucas

A | 6 | U.S.C.T.

Richard F Addison

Priv., Co. E, 6 Reg't U. S. Col'd Infantry.

Appears on

Company Muster Roll

for Nov. + Dec, 1863

Present or absent Present

Stoppage, \$ 100 for

Due Gov't, \$ 100 for

Remarks:

Book mark:

Lucas

A | 6 | U.S.C.T.

Richd F Addison

Pr-, Co. E, 6 Reg't U. S. Col'd Infantry.

Appears on

Company Muster Roll

for Jan + Feby, 1864

Present or absent Present-

Stoppage, \$ 100 for

Due Gov't, \$ 100 for

Remarks:

Book mark:

Lucas

A | 6 | U.S.C.T.

Richard Addison

Pvt, Co. E, 6 Reg't U. S. Col'd Infantry.

Appears on

Company Muster Roll

for *March & April*, 1864

Present or absent *Present*

Stoppage, \$ 100 for

Due Gov't, \$ 100 for

Remarks:

Book mark:

Lucas

A | 6 | U.S.C.T.

Richard F. Addison
Pvt., Co. E, 6 Reg't U. S. Col'd Infantry.

Appears on

Company Muster Roll

for *May & June*, 1864

Present or absent *Absent*

Stoppage, \$ 100 for

Due Gov't, \$ 100 for

Remarks: *Wounded in action -
June 15 " Absent in Genl.
Hospital at City Point Va.*

Book mark:

Harris

A | 6 | U.S.C.T.

Richard F. Addison

Prk, Co. E, 6 Reg't U. S. Col'd Infantry.

Appears on

Company Muster Roll

for July & Aug, 1864

Present or absent Present

Stoppage, \$ 100 for

Due Gov't, \$ 100 for

Remarks: Paid in Gen. Hospital \$32.00

Free on or before Apr 19/61

Book mark:

Harris

A | 6 | U.S.C.T.

Richard F. Addison,
Pvt., Co. E, 6 Reg't U. S. Col'd Infantry.

Appears on Co. Muster-out Roll, dated
Wilmington, N.C., Sep. 20, 1865.

Muster-out to date _____, 186 .

Last paid to _____, 186 .

Clothing account:

Last settled _____, 186 ; drawn since \$ _____ 100

Due soldier \$ _____ 100; due U. S. \$ _____ 100

Am't for cloth'g in kind or money adv'd \$ _____ 100

Due U. S. for arms, equipments, &c., \$ _____ 100

Bounty paid \$ _____ 100; due \$ _____ 100

Remarks: Killed in action
at New Market Heights
Va., Sept. 29, 1864.

Book mark: 2^d Aud. Feb. 27/66.
147687, May 12, 1868.

J. Pool,

Addison, Richard F.

B, Co. E, 6 Reg't U.S.C. Inf.

Enclosures.

Bed Cards	Descriptive Lists
Burial Records	Final Statements /
Certs. of Dis. for Discharge	Furloughs
C. M. Charges	Med. Des. Lists
Med. Certificates	Orders

Other papers relating to—

Admission to Hosp'l	Furlough
Casualty Sheet (Officer's)	Med. Examination
Confinement	Misc. Information
Contracts	Pay or Clothing
Death or Effects	Personal Reports
Desertions	Rank
Discharge from Hosp'l	Transfer to Hosp'l
Discharge from Service	Transfer to V. R. C.
Duty	Transportation

FINAL STATEMENT

OF

*Private Richard T. Addison
Co. B. Regt of W. S. C. Troops*

VOLUNTEERS.

Admitted Sept 29 1864

NOTE 1.—Two of these certificates (or duplicates) are to be given to each Volunteer Soldier or drafted man who may be discharged previously to the discharge of his company, that he may at once receive from the Paymaster the pay, &c., due him, and the captain or other COMMISSIONED officer commanding the company will certify to the act of the delivery of the duplicate certificates; on these certificates the Soldier is "entitled to" his discharge, and should also present his discharge to the Paymaster to have the payment enforced on it. The discharge is to be given back to the Soldier by the Paymaster; the latter only retaining as his voucher the duplicate certificates.

NOTE 2.—If the Soldier is entitled to pay for the use of his horse, the Company Commander will certify to that fact on the back of both these final statements, and also to the time he has pay due for having been so mounted on his own horse.

NOTE 3.—When a Soldier is furnished with final statements, his descriptive list, if he has one, should be taken up by the officer who gives the Soldier these statements, and endorsed with a statement to this effect by the officer. This endorsement should exhibit a full statement of the time for which the Soldier was allowed pay on his final statements, the clothing account, and all other charges against him or in his favor, so as to comprise a complete exhibit of his account. It will then be transmitted to the company commander of the Soldier, who will enter all the data necessary to a full understanding of the Soldier's account on the muster roll upon which the Soldier's discharge is reported. The descriptive list will then be destroyed. The object of this is, that the remaining portion of the Soldier's account may be settled upon the receipt of these muster rolls, and the Soldier receive any pay or allowances that may be due him at the time of his discharge, and which may not appear on his final statements from the fact that his descriptive list is incomplete. These accounts for back pay, &c., are settled by the 2d Auditor of the Treasury Department.

NOTE 4.—Charges for loss or injury to ordnance, horse equipments, and other miscellaneous charges, should appear under the heading of "Other Stoppages."

NOTE 5.—Bounty paid by State authorities, and not by the United States, will not be entered on this statement.

NOTE 6.—Amounts due the Sutler and Laundress must be entered on the muster roll on which the discharge, death, desertion, &c., is reported, as well as on the final statement, otherwise the amount cannot be collected from the United States.

NOTE 7.—This blank will be used for deceased volunteers and drafted men, as well as for others.

NOTE 8.—Where a Soldier dies in Hospital or on detached service, his descriptive list, if he has one, should be sent with his final statements, in duplicate, to the Second Auditor, Washington, D. C.

ADJUTANT GENERAL'S OFFICE.

Dec 3 1864

Duplicate with Inventory sent 2d Auditor.



Richard T. Addison

Arto - Given on or before April 19. 78. 1.
"Specimen of Sub \$7.00 per month for
the period paid for"

I certify, on honor, that Richard Addison a Private of
Captain E. Barkup' Company (E.) of the 6th Regiment of W. S. Troops
VOLUNTEERS, of the State of _____, born in Seesburg, State
of Virginia, aged _____ years; 5 feet 2 1/2 inches high; black complexion,
black eyes, black hair, and by occupation a Writer, having joined the company on
its original organization at Philadelphia Pa., and enrolled in it at the muster into
the service of the United States at Philadelphia Pa., on the Seventeenth day
of August, 1864, or was mustered in service as a recruit, by Captain
Sergeant, at Phila. Pa., on the Seventeenth day of August
1863, or was drafted and mustered into the service of the United States from the _____

Enrollment District of the State of _____, at _____
on the _____ day of _____, 186 .) to serve in the Regiment, for
the term of Three Years; and having served **HONESTLY** and
FAITHFULLY with his Company in the 6th W. S. Troops to the present date, is now
entitled to a **DISCHARGE** by reason of being killed in the action
of September 29th 1864

The said Richard Addison was last paid by Paymaster
Wm. Walker to include the 30th day of June, 1864, and has
pay due him from that time to Sept. 29th 1864 ~~the present date~~; he is entitled to pay and subsistence for
TRAVELING to place of enrollment, and whatever other allowances are authorized to volunteer
soldiers, drafted men, or militia, so discharged. He has received from the United States **CLOTHING**
amounting to 2- 20/100 dollars, since the 30th day of June,
1864, when his clothing account was last settled. He has received from the United States
_____ 100 dollars advanced **BOUNTY**.

There is to be stopped from him, on account of the State of _____, or other
authorities, for **CLOTHING, &c.**, received on entering service, _____ 100 dollars; and
for other stoppages, viz: _____
_____ 100 dollars.

He has been furnished with **TRANSPORTATION** in kind from the place of his discharge to
_____ ; and he has been **SUBSISTED** for **TRAVELING** to his
place of enrollment, up to the _____, 186 .
He is indebted to Wm. Brisbane, **SUTLER**, _____ 7- 00/100 dollars.
He is indebted to _____, **LAUNDRESS**, _____ 100 dollars.

Given in Duplicate, at Camp C. W. S. & Co. in the field Va., this 19th day
of November, 1864

W. R. Cannon
2nd Regt. C. W. S. & Co.
Commanding Company.

6 U.S. Col'd Inf.

Private Private

CARD NUMBERS.

1 5567773	26
2 5567780	27
3 5574125	28
4 5574214	29
5 5574305	30
6 5574405	31
7 5574496	32
8 5574582	33
9 9065233	34
10	35
11	36
12	37
13	38
14	39
15	40
16	41
17	42
18	43
19	44
20	45
21	46
22	47
23	48
24	49
25	50

Book Mark:

See also

NARA 82

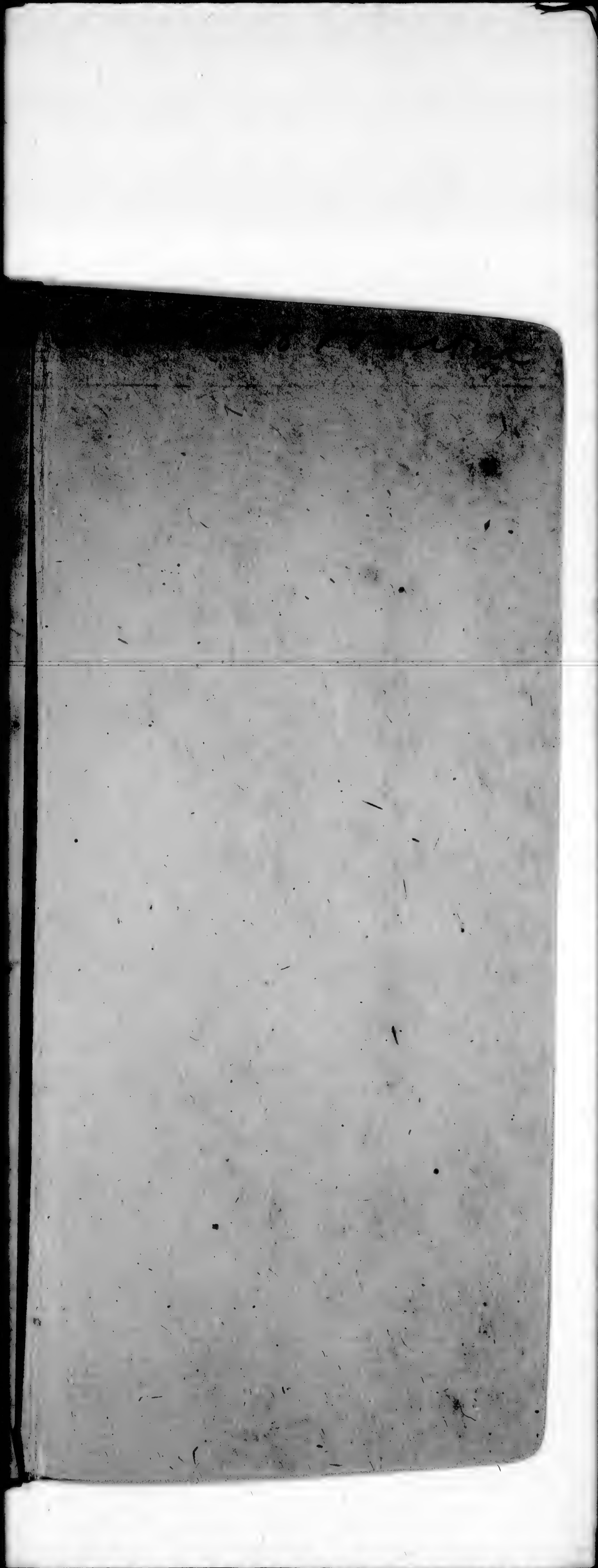

71 6 U.S.C.T.

John Adkins
Co. E, 6 Reg't U. S. Col'd Inf.

Appears on
Company Descriptive Book
of the organization named above.

DESCRIPTION.

Age 24 years; height 5 feet 6 inches.
Complexion blk
Eyes blk; hair blk
Where born Balston New York
Occupation Foster

ENLISTMENT.

When Sept 7, 1864.
Where Schenectady
By whom Capt Butler; term 1 y'rs.

Remarks: Recd \$33.33. Bounty
for one Year

J. G. Reeves
Copyst.

A | 6 | U.S.C.T.

John Adkins

Appears with rank of *Priv* on

Muster and Descriptive Roll of a Detachment of U. S. Vols. forwarded

for the *6* Reg't U. S. Col'd Infantry. Roll dated *Hart Island*, *Sept. 21*, 1864.

Where born *Ballston N.Y.*

Age *24* y'rs; occupation *Hostler*

When enlisted *Sept. 7*, 1864.

Where enlisted *Schenectady*

For what period enlisted *1* years.

Eyes *Blk*; hair *Blk*

Complexion *Blk*; height *5* ft. *6* in.

When mustered in *Sept. 7*, 1864.

Where mustered in *Schenectady*

Bounty paid \$ *33* ^{*33*}/_{*100*}; due \$ *100*/_{*100*}

Where credited *18 Dist. 18 Sub. Dist.*

Company to which assigned

Remarks:

Book mark:

W. H. Bogan

A | 6 | U.S.C.T.

John Adkins
Priv, Co. E, 6 Reg't U. S. Col'd Infantry.

Appears on

Company Muster Roll

for Sept + Oct, 1864

Present or absent Present

Stoppage, \$ 100 for _____

Due Gov't, \$ 100 for _____

Remarks: Recruit from Depot

NEXT ROLL ON FILE FEB 1865

Book mark: _____

Harris

A | 6 | U.S.C.T.

John Adkins
Pvt, Co. E, 6 Reg't U. S. Col'd Infantry.

Appears on

Company Muster Roll

for Jan & Feby, 1865

Present or absent Present

Stoppage, \$ 100 for

Due Gov't, \$ 100 for

Remarks:

Book mark:

Harris

A | 6 | U.S.C.T.

John Adkins

Pvt, Co. E, 6 Reg't U. S. Col'd Infantry.

Appears on

Company Muster Roll

for *March & April*, 1865

Present or absent *Present*

Stoppage, \$ *1.00* for

Due Gov't, \$ *1.00* for

Remarks: *Rec'd \$33³³ Bountty.
Stop for 1 Antew. 65. 1 Haversack
95 Total \$1.60.*

Book mark:

Harris

A

6

U.S.C.T.

John Atkins
Pvt, Co. E, 6 Reg't U. S. Col'd Infantry.

Appears on

Company Muster Roll

for *May + June*, 1865

Present or absent *Present*

Stoppage, \$ *100* for

Due Gov't, \$ *100* for

Remarks *Rec'd \$33³³ Bounty.*

Book mark:

J. Pool,

A | 6 | U.S.C.T.

John Adkins,
Pvt, Co. E, 6 Reg't U. S. Col'd Infantry.

Appears on

Company Muster Roll

for July & Aug., 1865

Present or absent Present

Stoppage, \$ 100 for

Due Gov't, \$ 100 for

Remarks:

Book mark:

P. Pool,

A | 6 | U.S.C.T.

John Adkins

Appears with rank of *Pvt.* on

Muster and Descriptive Roll of a Detachment of U. S. Vols. forwarded

for the *6* Reg't U. S. Col'd Infantry. Roll dated

Schenectady N.Y., Sept. 12, 1864.

Where born *Pallett N.Y.*

Age *24* y'rs; occupation *Hostler*

When enlisted *Sept. 7, 1864.*

Where enlisted *Saratoga Springs*

For what period enlisted *1* years.

Eyes *Blk*; hair *Blk.*

Complexion *Blk*; height *5 ft. 6 in.*

When mustered in *Sept. 8, 1864.*

Where mustered in *Schenectady*

Bounty paid \$ *33*^{*33*}/_{*100*}; due \$ *100*/_{*100*}

Where credited *18 D. N.Y. 18 Sub. Dist.*

Company to which assigned

Remarks:

Book mark:

W.H. Bogart

A | 6 | U.S.C.T.

John Adkins,
Pvt., Co. E, 6 Reg't U. S. Col'd Infantry.

Appears on Co. Muster-out Roll, dated
Wilmington, N.C., Sep. 20, 1865.

Muster-out to date Sep. 20, 1865.

Last paid to Apr. 30, 1865.

Clothing account:

Last settled *Never*, 186 ; drawn since \$ $75 \frac{44}{100}$

Due soldier \$ $\frac{100}{100}$; due U. S. \$ $\frac{100}{100}$

Am't for cloth'g in kind or money adv'd \$ $\frac{100}{100}$

Due U. S. for arms, equipments, &c., \$ $\frac{100}{100}$

Bounty paid \$ $33 \frac{33}{100}$; due \$ $66 \frac{66}{100}$

Remarks: *Due Wm. Brashear.*
Regt. Suttler \$13.00. Due
U.S. for 1 wiper 8/100.

Book mark:

O'Pool

Adkins, John

Co. *20* Reg't *Col.*

Enclosures.

Bed Cards	Final Statements
Burial Records	Furloughs or L. of A.
Certs. of Dis. for Discharge	Med. Certificates
C. M. Charges	Med. Des. Lists
Descriptive Lists	Orders
Discharge Certificates	Pris. of War Record
Enlistment Papers <i>/</i>	Resignations

Other papers relating to—

Admission to Hosp'l	Furlough or L. of A.
Casualty Sheet	Med. Examination
Confinement	Misc. Information
Contracts	Pay or Clothing
Death or Effects	Personal Reports
Desertion	Rank
Discharge from Hosp'l	Transfer to Hosp'l
Discharge from Service	Transfer to V. R. C.
Duty	Transportation

NOTE 1.—This blank will be used for both enlistments and re-enlistments—enlistment of veterans, &c., in the volunteer service. They will be made out in duplicate in all cases—one to accompany the recruiting return of the superintendent (not the recruiting officer) to the Adjutant General, and one to accompany the accounts of the officer who pays bounty, &c. The Regiment and Company in which the soldier last served should be given on the back.

NOTE 2.—An enlistment holds to service. A muster-in must, in all cases, precede payment of pay, bounty, pension, &c. A muster-in roll must, in all cases, be filed in the Adjutant General's office as evidence of muster-in. The mustering officer, commissary, or assistant commissary of musters, as the case may be, will countersign both enlistments as having mustered the soldier into the service of the United States before either of them is given to the disbursing officer.

DECLARATION OF RECRUIT.

I, John Adams desiring to VOLUNTEER as a Soldier in the Army of the United States, for the term of one ~~THREE YEARS~~, Do Declare, That I am 24 years and _____ months of age; that I have never been discharged from the United States service on account of disability or by sentence of a court-martial, or by order before the expiration of a term of enlistment; and I know of no impediment to my serving honestly and faithfully as a soldier for one ~~three~~ year.

GIVEN at Scherestady

Witness: Frank Seymour the 7 day of Sept 1864
John Adams
mark

Discharged 6 20 1864
 18

Regt of _____

enlistment; last served in Company ()

Regiment of _____

By John Adams

1864

Volunteered at Scherestady

John Adams

No. 2322

2096807

CONSENT IN CASE OF MINOR.

I, _____ Do CERTIFY, That I am the _____ of _____; that the said _____ is _____ years of age; and I do hereby freely give my CONSENT to his volunteering as a SOLDIER in the ARMY OF THE UNITED STATES for the period of THREE YEAR.

GIVEN at _____

the _____ day of _____

Witness: _____

VOLUNTEER ENLISTMENT.

STATE OF  OF

I, John Adams born in Saratoga Springs
 in the State of New York aged 24 years.
 and by occupation a Hostler DO HEREBY ACKNOWLEDGE to have
 volunteered this 2nd day of Sept 1864
 to serve as a **Soldier** in the **Army of the United States of America**, for the period
 of ~~THE~~ ^{one} ~~YEARS~~, unless sooner discharged by proper authority: Do also agree to accept
 such bounty, pay, rations and clothing, as are, or may be, established by law for volunteers.
 And I, John Adams - do solemnly swear, that I will bear true
 faith, and allegiance, to the **United States of America**, and that I will serve them honestly
 and faithfully against all their enemies or opposers whomsoever; and that I will observe and obey
 the orders of the President of the United States, and the orders of the officers appointed over
 me, according to the Rules and Articles of War.

Sworn and subscribed to at Saratoga
 this 2 day of Sept 1864 } John X Adams
 BEFORE Allyn Justice Mark

I CERTIFY, ON HONOR, That I have carefully examined the above-named Volunteer, agreeably
 to the General Regulations of the Army, and that, in my opinion, he is free from all bodily defects and
 mental infirmity, which would in any way disqualify him from performing the duties of a soldier.

W. K. Patton
18 Sept 1864
 EXAMINING SURGEON.

I CERTIFY, ON HONOR, That I have minutely inspected the Volunteer, _____
 previously to his enlistment, and that he was entirely sober when enlisted; that, to the best of my
 judgement and belief, he is of lawful age; and that, in accepting him as duly qualified to perform the
 duties of an able-bodied soldier, I have strictly observed the Regulations which govern the recruiting
 service. This soldier has dark eyes, black hair, dark complexion, is 5 feet
8 inches high.

John Adams
Capt. August Marshall
 _____ Volunteers.
W. K. Patton RECRUITING OFFICER.
Capt. August Marshall
18 Sept

(A. G. O. No. 74 & 76.)

14-95

Mustered into the service of the United States, in Company
 the 18th day of Sept, 1864, at Saratoga
 for Recruit
20th Regiment of
Volunteers, on
18th Sept
W. K. Patton
Examining Surgeon
John Adams
Volunteer
18th Sept

Co. E, 6 U.S. Col'd Inf.

Private Private

CARD NUMBERS.

1	5367774	26
2	5367781	27
3	5374126	28
4	5374215	29
5	5574307	30
6	5574406	31
7	5574497	32
8	5574583	33
9	9065234	34
10		35
11		36
12		37
13		38
14		39
15		40
16		41
17		42
18		43
19		44
20		45
21		46
22		47
23		48
24		49
25		50

Book Mark:

See also

A | 6 | U.S.C.T.

William Adkins
Co. E, 6 Reg't U.S. Col'd Inf.

Appears on
Company Descriptive Book
of the organization named above.

DESCRIPTION.

Age 37 years; height 5 feet 8 inches.
Complexion Black
Eyes black; hair black
Where born Balston New York
Occupation Farmer

ENLISTMENT.

When Sept 7, 1864.
Where Schneclady
By whom Capt Butler; term 1 y'rs.
Remarks: Rec'd \$33.33
Bounty

J. G. Reeves
Copyist.

A | 6 | U.S.C.T.

William Adkins

Appears with rank of *Pvt.* on

Muster and Descriptive Roll of a Detachment of U. S. Vols. forwarded

for the *6* Reg't U. S. Col'd Infantry. Roll dated *Schenectady N.Y. Sept. 12*, 1864.

Where born *Ballston N.Y.*

Age *37* y'rs; occupation *Barber*

When enlisted *Sept. 7*, 1864

Where enlisted *Saratoga Springs*

For what period enlisted *1* years.

Eyes *Blk*; hair *Blk.*

Complexion *Ok*; height *5 ft. 8* in.

When mustered in *Sept. 8*, 1864.

Where mustered in *Schenectady*

Bounty paid \$ *33* ^{*97*}/₁₀₀; due \$ *100*

Where credited *18 D. N.Y. 18 Sub. Dist.*

Company to which assigned

Remarks:

Book mark:

W.H. Bogan

A | 6 | U.S.C.T.

William Adkins

Appears with rank of *Pvt.* on

Muster and Descriptive Roll of a Detachment of U. S. Vols. forwarded

for the *6* Reg't U. S. Col'd Infantry. Roll dated *Hart Island, Sept. 21, 1864*

Where born *Ballston N.Y.*

Age *37* y'rs; occupation *Barber*

When enlisted *Sept. 7, 1864*

Where enlisted *Schenectady*

For what period enlisted *1* years.

Eyes *Ok*; hair *Ok*

Complexion *Blk*; height *5 ft. 8 in.*

When mustered in *Sept. 7, 1864*

Where mustered in *Schenectady*

Bounty paid \$ *33* ^{*33*}/_{*100*}; due \$ *100*

Where credited *18 Dist. 18 Sub. Dist.*

Company to which assigned

Remarks:

Book mark:

W. H. Bogar

A | 6 | U.S.C.T.

William Adkins
Priv, Co. E, 6 Reg't U. S. Col'd Infantry.

Appears on

Company Muster Roll
for *Sept & Oct*, 186*4*
Present or absent *Present*

Stoppage, \$ 100 for

Due Gov't, \$ 100 for

Remarks: *Recruit from Depot.*

NEXT ROLL ON FILE FEB 1865

Book mark:

Harris

A | 6 | U.S.C.T.

William Adkins
Pvt., Co. E, 6 Reg't U. S. Col'd Infantry.

Appears on

Company Muster Roll

for Jan & Feby, 1865

Present or absent Present

Stoppage, \$ 100 for

Due Gov't, \$ 100 for

Remarks:

Book mark:

Harris

A | 6 | U.S.C.T.

William Adkins

Pvt, Co. E, 6 Reg't U. S. Col'd Infantry.

Appears on

Company Muster Roll

for *March & April*, 1865

Present or absent *Present*

Stoppage, \$ 100 for

Due Gov't, \$ 100 for

Remarks: *Rec'd \$33³³/₁₀₀ Bounty
Stop for 1 Canton. 65. 1/2 Harnes
95. Total \$1.60*

Book mark: _____

Harris

A | 6 | U.S.C.T.

William Atkins
Pr, Co. E, 6 Reg't U. S. Col'd Infantry.

Appears on

Company Muster Roll

for *May & June*, 186 *5*

Present or absent *Present*

Stoppage, \$ *100* for

Due Gov't, \$ *100* for

Remarks: *Rec'd \$33³³ Bounty.*

Book mark:

P. Pool,

A | **6** | **U.S.C.T.**

William Adkins,
Priv., Co. E, 6 Reg't U. S. Col'd Infantry.

Appears on

Company Muster Roll

for July & Aug., 1865

Present or absent, Present.

Stoppage, \$ 100 for

Due Gov't, \$ 100 for

Remarks: Stop for 1 Santeen
65. Haversack 95. Total
\$160. On detached service.

As shown on roll.

Book mark: _____

J. Pool,

A

6

U.S.C.T.

William Atkins

Pvt., Co. E, 6 Reg't U. S. Col'd Infantry.

Appears on Co. Muster-out Roll, dated

Wilmington, N.C. Sep. 20, 1865.

Muster-out to date Sep. 20, 1865.

Last paid to Apr. 30, 1865.

Clothing account:

Last settled *Never*, 186 ; drawn since \$ *74* ⁶⁶/₁₀₀

Due soldier \$ 100; due U. S. \$ 100

Am't for cloth'g in kind or money adv'd \$ 100

Due U. S. for arms, equipments, &c., \$ 100

Bounty paid \$ *33* ³³/₁₀₀; due \$ *66* ⁶⁷/₁₀₀

Remarks: *Due Wm. Presben, Regt. Suttler \$800. Due U.S. for 1 wiper 8/100.*

Book mark:

O'Pool

6

Adkins William

....., Co., ⁶ 211 Reg't U.S.C.A.

2 Enclosures.

Bed Cards	Final Statements
Burial Records	Furloughs or L. of A
Certs. of Dis. for Discharge	Med. Certificates
C. M. Charges	Med. Des. Lists
Descriptive Lists	Orders
Discharge Certificates	Pris. of War Record
Enlistment Papers 2	Resignations

Other papers relating to—

Admission to Hosp'l	Furlough or L. of A
Casualty Sheet	Med. Examination
Confinement	Misc. Information
Contracts	Pay or Clothing
Death or Effects	Personal Reports
Desertion	Rank
Discharge from Hosp'l	Transfer to Hosp'l
Discharge from Service	Transfer to V. R. C.
Duty	Transportation

NOTE 1.—This blank will be used for both enlistments and re-enlistments—enlistment of veterans, &c., &c., in the volunteer service. They will be made out in duplicate in all cases—one to accompany the recruiting return of the superintendent (not the recruiting officer) to the Adjutant General, and one to accompany the accounts of the officer who pays bounty, &c. The Regiment and and Company in which the soldier last served should be given on the back.

NOTE 2.—An enlistment holds to service: A muster-in must, in all cases, precede payment of pay, bounty, pension, &c. A muster-in roll must, in all cases, be filed in the Adjutant General's office as evidence of muster-in. The mustering officer, commissary, or assistant commissary of musters, as the case may be, will countersign both enlistments as having mustered the soldier into the service of the United States before either of them is given to the disbursing officer.

DECLARATION OF RECRUIT.

I, Wm Adams desiring to VOLUNTEER as a Soldier in the Army of the United States, for the term of ~~THREE YEARS~~ one Do Declare, That I am 27 years and _____ months of age; that I have never been discharged from the United States service on account of disability or by sentence of a court-martial, or by order before the expiration of a term of enlistment; and I know of no impediment to my serving honestly and faithfully as a soldier for ~~three~~ one year.

GIVEN at Scherregetady the 7th day of Sept 1864
 Witness: Frank Seymour Wm X Adams
 Mark

Discharged _____
 Reg't of _____
 enlistment; last served in Company () _____
 By Patrick H. Murray
 Regiment of _____
 Volunteered at Scherregetady
Sept 7 1864
Wm Adams
 No. 2321
2091807

CONSENT IN CASE OF MINOR.

I, _____ Do CERTIFY, That I am the _____ of _____; that the said _____ is _____ years of age; and I do hereby freely give my CONSENT to his volunteering as a SOLDIER in the ARMY OF THE UNITED STATES for the period of THREE YEAR.

GIVEN at _____ the _____ day of _____
 Witness: _____

VOLUNTEER ENLISTMENT.

STATE OF

New York



TOWN OF

Saratoga Springs
Ballston

I, *Wm. Adkins* born in

in the State of *New York* aged *37* years,

and by occupation a *Barber* DO HEREBY ACKNOWLEDGE to have

volunteered this *7th* day of *Sept* 1864,

to serve as a **Soldier** in the **Army of the United States of America**, for the period

of ~~THREE~~ ^{one} ~~YEARS~~, unless sooner discharged by proper authority: Do also agree to accept

such bounty, pay, rations and clothing, as are, or may be, established by law for volunteers.

And I, *Wm. Adkins* do solemnly swear, that I will bear true

faith, and allegiance, to the **United States of America**, and that I will serve them honestly

and faithfully against all their enemies or opposers whomsoever; and that I will observe and obey

the orders of the President of the United States, and the orders of the officers appointed over

me, according to the Rules and Articles of War.

Sworn and subscribed to at *Saratoga Springs*

this *7* day of *Sept* 1864, *Wm. Adkins*

BEFORE *Justice* *Mark*

I CERTIFY, ON HONOR, That I have carefully examined the above-named Volunteer, agreeably

to the General Regulations of the Army, and that, in my opinion, he is free from all bodily defects and

mental infirmity, which would in any way disqualify him from performing the duties of a soldier.

U. S. Coltr
18th Dist N.Y.

EXAMINING SURGEON.

I CERTIFY, ON HONOR, That I have minutely inspected the Volunteer,

previously to his enlistment, and that he was entirely sober when enlisted; that, to the best of my

judgement and belief, he is of lawful age; and that, in accepting him as duly qualified to perform the

duties of an able-bodied soldier, I have strictly observed the Regulations which govern the recruiting

service. This soldier has *Black* eyes, *Black* hair, *Dark* complexion, is *5* feet

8 inches high.

W. M. Marshall
Capt. 18th Dist N.Y.

Regiment of *18th Dist N.Y.* Volunteers.

RECRUITING OFFICER.

(A. G. O. No. 74 & 76)

14-95

Mustered into the service of the United States, in Company
the *1st* day of *Sept*, 1864, at *Saratoga Springs*
20 Regiment of *18th Dist N.Y.* Volunteers, on
Wm. Adkins
18th Dist N.Y.

Note 1.—This blank will be used for both enlistments and re-enlistments—enlistment of veterans, &c., &c., in the volunteer service. They will be made out in duplicate in all cases—one to accompany the recruiting return of the superintendent (not the recruiting officer) to the Adjutant General, and one to accompany the accounts of the officer who pays bounty, &c. The Regiment and and Company in which the soldier last served should be given on the back.

Note 2.—An enlistment holds to service. A muster-in must, in all cases, precede payment of pay, bounty, pension, &c. A muster-in roll must, in all cases, be filed in the Adjutant General's office as evidence of muster-in. The mustering officer, commissary, or assistant commissary of musters, as the case may be, will countersign both enlistments as having mustered the soldier into the service of the United States before either of them is given to the disbursing officer.

DECLARATION OF RECRUITION

I, Wm Adkins desiring to VOLUNTEER as a Soldier in the Army of the United States, for the term of one ~~THREE YEARS~~ Do Declare, That I am 27 years and one months of age; that I have never been discharged from the United States service on account of disability or by sentence of a court-martial, or by order before the expiration of a term of enlistment; and I know of no impediment to my serving honestly and faithfully as a soldier for one year.

GIVEN at Schenectady the 7 day of Sept 1864

Witness: Frankby Wm Adkins
mark

Discharged _____
Regt of _____
enlistment; last served in Company () _____
By Wm Adkins
1864
Volunteered at Schenectady
Wm Adkins
No. 2820
W. F. G. J.

CONSENT IN CASE OF MINOR.

I, _____ Do CERTIFY, That I am the _____ of _____; that the said _____ is _____ years of age; and I do hereby freely give my CONSENT to his volunteering as a SOLDIER in the ARMY OF THE UNITED STATES for the period of THREE YEAR.

GIVEN at _____ the _____ day of _____

Witness: _____

VOLUNTEER ENLISTMENT.

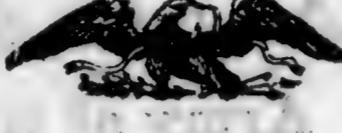
STATE OF *New York*  ~~TOWN~~ OF *Saratoga Springs*

I, *William Adams* born in *Ballston*
 in the State of *New York* aged *37* years,
 and by occupation a *Barber* DO HEREBY ACKNOWLEDGE to have
 volunteered this *7th* day of *Sept* 1864
 to serve as a **Soldier** in the **Army of the United States of America**, for the period
 of ~~THREE~~ ^{one} YEARS, unless sooner discharged by proper authority: Do also agree to accept
 such bounty, pay, rations and clothing, as are, or may be, established by law for volunteers.
 And I, *Wm Adams* do solemnly swear, that I will bear true
 faith, and allegiance, to the **United States of America**, and that I will serve them honestly
 and faithfully against all their enemies or opposers whomsoever; and that I will observe and obey
 the orders of the President of the United States, and the orders of the officers appointed over
 me, according to the Rules and Articles of War.

Sworn and subscribed to at *Saratoga Springs*
 this *7th* day of *Sept* 1864 by *Wm Adams*
 BEFORE *James Mark*

I CERTIFY, ON HONOR, That I have carefully examined the above-named Volunteer, agreeably
 to the General Regulations of the Army, and that, in my opinion, he is free from all bodily defects and
 mental infirmity, which would in any way disqualify him from performing the duties of a soldier.

U. Potter
 185th Regt NY
 EXAMINING SURGEON.

I CERTIFY, ON HONOR, That I have minutely inspected the Volunteer, *Wm Adams*
 previously to his enlistment, and that he was entirely sober when enlisted; that, to the best of my
 judgement and belief, he is of lawful age; and that, in accepting him as duly qualified to perform the
 duties of an able-bodied soldier, I have strictly observed the Regulations which govern the recruiting
 service. This soldier has *Black* eyes, *Black* hair, *dark* complexion, is *5⁷* feet
8 inches high.

Wm Smith
 Capt. 185th Regt NY
 Recruiting Officer

Mustered into the service of the United States, in Company
B, of the *185th* Regiment of *Volunteers*, on
 the *8th* day of *Sept*, 1864, at *Saratoga Springs*
Wm Adams
James Mark
U. Potter
Wm Smith

6 U.S. COLLEGE

Apporal Private

CARD NUMBERS.

1	26
2	27
3	28
4	29
5	30
6	31
7	32
8	33
9	34
10	35
11	36
12	37
13	38
14	39
15	40
16	41
17	42
18	43
19	44
20	45
21	46
22	47
23	48
24	49
25	50

See Aston, Thomas A.

Book Mark:

See also

Co. 4, 6 U.S. Cold Mt.

Capital Capital

CARD NUMBERS.

1	5575852	26
2	5575934	27
3	5576017	28
4	5576099	29
5	5576176	30
6	5576255	31
7	5576333	32
8	5576405	33
9	5576477	34
10	5576575	35
11	5576668	36
12	5576764	37
13	5576858	38
14	5576950	39
15	9065398	40
16		41
17		42
18		43
19		44
20		45
21		46
22		47
23		48
24		49
25		50

Book Mark:

See also

2A | 6 | U.S.C.T.

Oliver Albert,

G, Co. *G*, 6 Reg't U. S. Col'd Inf.

Appears on

Company Descriptive Book
of the organization named above.

DESCRIPTION.

Age *19* years; height *6* feet _____ inches.

Complexion *Brown*

Eyes *Brown*; hair *Black*

Where born *Washington Co. Pa.*

Occupation *Farmer*

ENLISTMENT.

When *Aug. 31*, 186*3*.

Where *Pittsburg Pa.*

By whom *C. H. Benghless*; term *3* y'rs.

Remarks *Promoted to Corporal*
Sept. 6, 1864. Reduced to
rankes. Descriptive list
dates May 26/65 sent to
Hospital Wilmington N. C.

As it appears.

Jenkins

A

6

U.S.C.T.

Oliver Albert
Corpl, Co. G., 6 Reg't U. S. Col'd Infantry.

Age *19* years.

Appears on

Company Muster-in Roll

of the organization named above. Roll dated

Philadelphia Pa Sept 14, 1863.

Muster-in to date

Sept 14, 1863

Joined for duty and enrolled:

When *Aug 31*, 1863.

Where *Pittsburg Pa*

Period *3* years.

Remarks: *Recd on enlistment papers + mustered by Lt. Pierce U.S.A. Sept 14-1863 Co. to 24 Dist Pa.*

Book mark:

M. A. Michaels

A | **6** | **U.S.C.T.**

Oliver Albert

Corpl, Co. G, 6 Reg't U. S. Col'd Infantry.

Appears on

Company Muster Roll

for *Enrollment to Oct 31, 1863*

Present or absent *Present*

Stoppage, \$ *100* for

Due Gov't, \$ *100* for

Remarks: *Promoted to Corporal
Sept. 9 '63*

Book mark:

(358) *M. A. Michaels* Copyist.

A | 6 | U.S.C.T.

Oliver Albert
Corpl., Co. G, 6 Reg't U. S. Col'd Infantry.

Appears on

Company Muster Roll

for Nov & Dec....., 1863.

Present or absent Present.....

Stoppage, \$.....100 for

Due Gov't, \$.....100 for

Remarks:.....
.....
.....
.....
.....
.....
.....
.....
.....
.....

Book mark:.....

M. A. Michaels
Copyist.

A | **6** | **U.S.C.T.**

Oliver Albert

Private, Co. G, 6 Reg't U. S. Col'd Infantry.

Appears on

Company Muster Roll

for *Jan & Febr*, 1864.

Present or absent *Present*

Stoppage, \$ 100 for

Due Gov't, \$ 100 for

Remarks: *Reduced to the ranks from Corporal by order Col. J. W. Ames*

Book mark:

M. A. Michaels

(358)

Copyist.

A

6

U.S.C.T.

Oliver Albert

Private, Co. G, 6 Reg't U. S. Col'd Infantry.

Appears on

Company Muster Roll

for *March & Apr*, 1864.

Present or absent *Present*

Stoppage, \$.....100 for.....

Due Gov't, \$.....100 for.....

Remarks: *Stop for 1 Canteen 41 cts*

Book mark:.....

M. A. Michaels

(358)

Copyist.

A | 6 | U.S.C.T.

Oliver Albenh
Priv, Co. G, 6 Reg't U. S. Col'd Infantry.

Appears on

Company Muster Roll

for *May & June*, 1864.

Present or absent *Present*

Stoppage, \$ *100* for

Due Gov't, \$ *100* for

Remarks: *On daily duty
as Regt Pioneer*

Book mark:

E. J. Hogan

A | 6 | U.S.C.T.

Oliver Albert
Prin, Co. G, 6 Reg't U. S. Col'd Infantry.

Appears on

Company Muster Roll

for *July & Aug*, 186*4*

Present or absent *Present*

Stoppage, \$ *100* for

Due Gov't, \$ *100* for

Remarks:

From April, 19, 1861
on det service in Pioneer
Corp Janine Div.

Book mark:

Grogan

A | **6** | **U.S.C.T.**

Oliver Albeck
Prv, Co. G, 6 Reg't U. S. Col'd Infantry.

Appears on

Company Muster Roll
for *Sept. & Oct.*, 186*4*
Present or absent *Present*
Stoppage, \$ *100* for

Due Gov't, \$ *100* for

Remarks: *On Det. Service*
in Pioneer Corps 3 Div.
H. A. C.

Book mark:

Grogan
Copyist.

A + 6 U.S.C.T.

Oliver Albert
Copt., Co. G, 6 Reg't U. S. Col'd Infantry.

Appears on

Company Muster Roll

for Nov. & Dec, 1864

Present or absent Present

Stoppage, \$ 100 for

Due Gov't, \$ 100 for

Remarks: Appointed
Corporal in accordance
to Special order no 31.
Nov. 1, 1864.

Book mark:

Grogan

A | 6 | U.S.C.T.

Oliver Albert
Corp., Co. G, 6 Reg't U. S. Col'd Infantry.

Appears on

Company Muster Roll

for Jan. & Feb., 1865.

Present or absent Absent

Stoppage, \$ 100 for

Due Gov't, \$ 100 for

Remarks: Appointed Corporal
in accordance to Special
order No. 31, Nov 1, 1864.
On set service at Sugar
Loaf S.C.

Book mark:

Grogan

A | 6 | U.S.C.T.

Oliver Albert
Corpl, Co. G, 6 Reg't U. S. Col'd Infantry.

Appears on

Company Muster Roll

for March & Apr, 1865.

Present or absent present

Stoppage, \$ 100 for

Due Gov't, \$ 100 for

Remarks: Appointed corporal
in accordance to Special
Order No 31, Nov 1. 64. Stop
for 1 screw driver 23,
1 Tompion 02 (125)

Book mark:

Moy Copyist.

A | 6 | U.S.C.T.

Oliver Albert

Corpl, Co. G, 6 Reg't U. S. Col'd Infantry.

Appears on

Company Muster Roll

for *May & June*, 1865.

Present or absent *present*

Stoppage, \$ *25* for *ordnance*

Due Gov't, \$ *100* for

Remarks: *App'ted Corp. per
SQ 17 to date from Nov 1/61.*

Book mark:

(358)

Moy
Copyist.

A | 6 | U.S.C.T.

Oliver Albert

Co. G, Co. G, 6 Reg't U. S. Col'd Infantry.

Appears on

Company Muster Roll

for *July & Aug*, 1865.

Present or absent *present*

Stoppage, \$ *100* for

Due Gov't, \$ *100* for

Remarks: *Stop for Springfield Rifled Musket \$ 19.25.*

Book mark:

(358)

Moy
Copyist.

A | 6 | U.S.C.T.

Oliver Albert
Corpl, Co. *G*, 6 Reg't U. S. Col'd Infantry.

Appears on **Co. Muster-out Roll**, dated
Wilmington NC, Sept 20, 1865.

Muster-out to date *Sept 20*, 1865.
 Last paid to *Apr 30*, 1865.

Clothing account:

Last settled *June 30*, 1864; drawn since \$ *77*^{*48*}/₁₀₀
 Due soldier \$ 100; due U. S. \$ 100
 Am't for cloth'g in kind or money adv'd \$ 100

Due U. S. for arms, equipments, &c., \$ 100

Bounty paid \$ *None*/₁₀₀; due \$ *100*/₁₀₀

Remarks: *Due Mrs Brisben*
Regt Suther \$10.00.
Appointed Nov 1/64, Due U S
for 1 Springfield Rifled
Musket Comp'l \$19.25.

Book mark: _____

Moy Copyist.

Albert Olive

..... Co., Reg't

2 Enclosures.

Bed Cards	Final Statements
Burial Records	Furloughs or L. of A.
Certs. of Dis. for Discharge	Med. Certificates
C. M. Charges	Med. Des. Lists
Descriptive Lists	Orders
Discharge Certificates	Pris. of War Record
Enlistment Papers <i>2</i>	Resignations

Other papers relating to—

Admission to Hosp'l	Furlough or L. of A.
Casualty Sheet	Med. Examination
Confinement	Misc. Information
Contracts	Pay or Clothing
Death or Effects	Personal Reports
Desertion	Rank
Discharge from Hosp'l	Transfer to Hosp'l
Discharge from Service	Transfer to V. R. C.
Duty	Transportation

DECLARATION OF RECRUIT.

I, *Oliver Albert* desiring to VOLUNTEER as a Soldier in the Army of the United States, for the term of THREE YEARS, Do declare, That I am *thirteen* years and *two (2)* months of age; that I have never been discharged from the United States service on account of disability or by sentence of court martial, or by order before the expiration of a term of enlistment; and I know of no impediment to my serving honestly and faithfully as a soldier for three years.

at *Pittsburgh Penna*
31st day of *August 1863*

Witness:

Rufus S. Jones

Oliver Albert

By *[Redacted]*
Volunteered at *[Redacted]* 18
No. *1163*
Co B
1st
Regiment of *[Redacted]*
enlistment; last served in Company ()
Reg't of *[Redacted]*
Discharged 18

CONSENT IN CASE OF MINOR.

I, _____ Do CERTIFY, That I am the _____ of _____; that the said _____ is _____ years of age; and I do hereby freely give my CONSENT to his volunteering as a SOLDIER in the ARMY OF THE UNITED STATES for the period of THREE YEARS.

GIVEN at _____ The _____ day of _____

Witness:

[Faint handwritten signature]

VOLUNTEER ENLISTMENT.

STATE OF *Penn* TOWN OF *Pittsburgh*



I, *Clair Albert* born in *Washington County*
in the State of *Penn* aged *twenty (29) years*
and by occupation a *farmer* Do HEREBY ACKNOWLEDGE to have
volunteered this *31st* day of *August* 18 *63*
to serve as a **Soldier** in the **Army of the United States of America**, for the
period of **THREE YEARS**, unless sooner discharged by proper authority: Do also
agree to accept such bounty, pay, rations, and clothing, as are, or may be, estab-
lished by law for volunteers. And I, *Clair Albert* do
solemnly swear, that I will bear true faith and allegiance to the **United States**
of America, and that I will serve them honestly and faithfully against all
their enemies or opposers whomsoever; and that I will observe and obey the
orders of the President of the United States, and the orders of the officers
appointed over me, according to the Rules and Articles of War.

Sworn and subscribed to, at *Pittsburgh*
this *7th* day of *Sept* 18 *63* *Clair Albert*
BEFORE *A. S. Scholman* *ad*

I CERTIFY, ON HONOR, That I have carefully examined the above named Volunteer, agreeably to
the General Regulations of the Army, and that in my opinion he is free from all bodily defects and mental
infirmity, which would, in any way, disqualify him from performing the duties of a soldier.

[Signature]
EXAMINING SURGEON.

I CERTIFY, ON HONOR, That I have minutely inspected the Volunteer,
previously to his enlistment, and that he was entirely sober when enlisted; that, to the best of my
judgment and belief, he is of lawful age; and that, in accepting him as duly qualified to perform the duties
of an able-bodied soldier, I have strictly observed the Regulations which govern the recruiting service.
This soldier has *brun* eyes, *black* hair, *brun* complexion, is *6* feet *inches*
high.

Wm M. Bengel
Sixth Regiment of Colored Volunteers,
RECRUITING OFFICER

DECLARATION OF RECRUIT

I, *Oliver Albert* desiring to VOLUNTEER as a Soldier in the Army of the United States, for the term of THREE YEARS, Do declare, That I am *nineteen (19)* years and *two (2)* months of age; that I have never been discharged from the United States service on account of disability or by sentence of court martial, or by order before the expiration of a term of enlistment; and I know of no impediment to my serving honestly and faithfully as a soldier for three years.

GIVEN at *Stirlingburg Tenn*
The *21st* day of *August 1863*

Witness:
Rufus S. Jones
" " "

Oliver Albert

Sept. 30, 1863. This paper was forwarded to the Enrollment Div. S. & F. 1863

enlistment; last served in Company ()
Reg't of
Discharged 18

By
Volunteered at
18
Regiment of

No. *1000*
W. R. V. T.

CONSENT IN CASE OF MINOR.

I, _____ of _____ is _____ years of age; and I do hereby freely give my consent to his volunteering as a SOLDIER in the ARMY OF THE UNITED STATES for the period of THREE YEARS.

GIVEN at
The _____ day of _____

Witness:

VOLUNTEER ENLISTMENT.

STATE OF



TOWN OF

Pittsburgh

I, *Oliver Albert*
in the State of *Penn*
and by occupation a *farmer*
volunteered this *31st*

born in *Washington County*
aged *nineteen (19)* years,
Do HEREBY ACKNOWLEDGE to have
day of *August* 18 *63*

to serve as a **Soldier** in the **Army of the United States of America**, for the period of **THREE YEARS**, unless sooner discharged by proper authority: Do also agree to accept such bounty, pay, rations, and clothing, as are, or may be, established by law for volunteers. And I, *Oliver Albert* do solemnly swear, that I will bear true faith and allegiance to the **United States of America**, and that I will serve them honestly and faithfully against all their enemies or opposers whomsoever; and that I will observe and obey the orders of the President of the United States, and the orders of the officers appointed over me, according to the Rules and Articles of War.

Sworn and subscribed to, at *Pittsburgh*
this *1st* day of *Sept* 18 *63* *Oliver Albert*
BEFORE *A. Schickel*

I CERTIFY, ON HONOR, That I have carefully examined the above named Volunteer, agreeably to the General Regulations of the Army, and that in my opinion he is free from all bodily defects and mental infirmity, which would, in any way, disqualify him from performing the duties of a soldier.

A. Schickel
EXAMINING SURGEON.

I CERTIFY, ON HONOR, That I have minutely inspected the Volunteer, previously to his enlistment, and that he was entirely sober when enlisted; that, to the best of my judgment and belief, he is of lawful age; and that, in accepting him as duly qualified to perform the duties of an able-bodied soldier, I have strictly observed the Regulations which govern the recruiting service. This soldier has *brown* eyes, *black* hair, *brown* complexion, is *6* feet *0* inches high.

Wm. H. Berg
Sixth Regiment of *Pa.* *Cal.* Volunteers,
RECRUITING OFFICER

6 U.S. Col'd Inf

Private | Corporal.

CARD NUMBERS.

1	5569070	26
2	5569146	27
3	5569289	28
4	5570107	29
5	9064671	30
6		31
7		32
8		33
9		34
10		35
11		36
12		37
13		38
14		39
15		40
16		41
17		42
18		43
19		44
20		45
21		46
22		47
23		48
24		49
25		50

Book Mark: *69-2-10-8-42*

See also



2537673 And W. V. (same of this)

A | 6 | U.S.C.T.

Solomon Alberts

, Co. A, 6 Reg't U. S. Col'd Inf.

Appears on

Company Descriptive Book

of the organization named above.

DESCRIPTION.

Age 21 years; height 5 feet 6 inches.

Complexion Dark

Eyes Dark; hair Black

Where born Washington, Pa

Occupation Farmer

ENLISTMENT.

When July 16, 1863

Where Pittsburg, Pa

By whom Capt Foster, term 3 yrs.

Remarks: Substitute for Robert St Clair, Upper St Clair, 22 Dist. Pa - Appointed Corporal Aug 30/63 per 20. Hd 2 26 d 2rs. Camp Wm Penn. Discharged Nov 17/63 on Cert. (etc)

W F Roy

MAY. 11

9064671

★ 1891 ★

*of Disability at
Camp near Peru,
Pa -*

x Name cancelled

A

6

U.S.C.T.

Albert, Solomon

Co. C, 6 Reg't U. S. Col'd Infantry.

Age *21* years.

Appears on

Company Muster-in Roll

of the organization named above. Roll dated

Philu Pa, *Oct 13*, 18*63*.

Muster-in to date

July 23, 18*63*

Joined for duty and enrolled:

When *July 16*, 18*63*.

Where *Pittsburg Pa*

Period *3* years.

Remarks: *Sub*

Book mark:

Heers

A | **6** | **U.S.C.T.**

Solomon Alberts
Capt, Co. A, 6 Reg't U. S. Col'd Infantry.

Appears on

Company Muster Roll

for *to Oct 31*, 186*3*.

Present or absent *Absent*

Stoppage, \$ *100* for

Due Gov't, \$ *100* for

Remarks: *Appointed by C.O. No. 2*
to date Aug 1st 1863
Absent sick in hospital
at Phila Penna. since Oct.
14 at Camp 11th Penn

~~*Enrolled & mustered in*~~
~~*July 25, 63 at Phila*~~
~~*for 3 years*~~

Book mark :

Alvo

A | **6** | **U.S.C.T.**

Colman Alberts
Cope, Co. A, 6 Reg't U. S. Col'd Infantry.

Appears on

Company Muster Roll

for *Nov & Dec*, 1863.

Present or absent

Stoppage, \$ 100 for

Due Gov't, \$ 100 for

Remarks: *Discharged Nov*
17 1863. for disability at
Camp Wm Penn Penna.

Book mark: *Discharged Nov. 9/63*
EPB, No. 42

(358)

Deer
Copyist.

A | **6** | **U.S.C.T.**

Solomon Alberts

Corpl, Co. B, 6 Reg't U. S. Col'd Infantry.

Appears on **Co. Muster-out Roll**, dated
Wilmington, N.H., Sept 29, 1865.

Muster-out to date _____, 186 .

Last paid to _____, 186 .

Clothing account:

Last settled _____, 186 ; drawn since \$ _____ 100

Due soldier \$ _____ 100; due U. S. \$ _____ 100

Am't for cloth'g in kind or money adv'd \$ _____ 100

Due U. S. for arms, equipments, &c., \$ _____ 100

Bounty paid \$ _____ 100; due \$ _____ 100

Remarks:

Discharged Nov.
17/65 at Chilada, Pa.
on Surgeon's Certificate
of Disability.

Book mark : 369.136, V.161, P.237, 73
(over)

(361)

M. A. Edwards
Copyist.

JAN. 20

5570107

1891 *

*Discharged Nov. 9/63
L.S. O. 15 P. 420*

Alberto, Solomon

Capt, Co. *A*

6

Reg't

U.S.C. Inf.

Enclosures.

Bed Cards	Descriptive Lists
Burial Records	Final Statements
Certs. of Dis. for Discharge	Furloughs
C. M. Charges	Med. Des. Lists
Med. Certificates	Orders

Other papers relating to—

Admission to Hosp'l	Furlough
Casualty Sheet (Officer's)	Med. Examination
Confinement	Misc. Information
Contracts	Pay or Clothing
Death or Effects	Personal Reports
Desertions	Rank
Discharge from Hosp'l	Transfer to Hosp'l
Discharge from Service	Transfer to V. R. C.
Duty	Transportation

NOTE 1.

The company commander will here add a statement of all the facts known to him concerning the disease or wound, or cause of disability of the soldier; the time, place, manner, and all the circumstances under which the injury occurred, or disease originated or appeared; the duty, or service, or situation of the soldier at the time the injury was received or disease contracted, stating particularly whether the injury was received or the disease contracted in the line of his duty; and whatever other facts may aid a judgment as to the cause, immediate or remote, of the disability, and the circumstances attending it.

When the facts are not known to the company commander, the certificate of any officer, or affidavit of other person having such knowledge, will be appended—as the surgeon in charge of a hospital, the officer commanding a detachment of recruits, &c., &c.

NOTE 2.

When a probable case for pension, special care must be taken to state the degree of disability—as $\frac{1}{2}$, $\frac{3}{4}$, &c., &c.; to describe particularly the disability, wound, or disease; the extent to which it deprives him of the use of any limb or faculty, or affects his health, strength, activity, constitution, or capacity to labor or earn his subsistence. The surgeon will add, from his knowledge of the facts and circumstances, and from the evidence in the case, his professional opinion of the cause or origin of the disability. In the case of discharges by Medical Inspectors, the last paragraph will state that the "discharge was given by consent of the soldier, after a personal examination, and for disability, the nature, degree, and origin of which are correctly described in the within certificate."

Par. 1260 Regulations, Edit. 1861.

Medical officers, in giving certificates of disability, are to take particular care in all cases that have not been under their charge; and especially in epilepsy, convulsions, chronic rheumatism, derangement of the urinary organs, ophthalmia, ulcers, or any obscure disease liable to be feigned or purposely produced; and in no case shall such certificate be given until after sufficient time and examination to detect any attempt at deception.

DIRECTIONS.

This certificate will be made out in duplicate by the soldier's company commander, or other officer commanding the separate detachment to which he belongs and sent by him to the surgeon who has charge of the hospital where the soldier is sick. The surgeon will then fill out and sign the surgeon's certificate, and forward these papers to the regimental, detachment, or post commander, who will forward them, with his action endorsed thereon, through the proper channel, to his division commander; or, if the troops are not attached to a division, to his corps, department, or other commander or officer to whom the authority to discharge enlisted men may be specially delegated.

These certificates, after having received the action of the highest authority to which they are required to be sent, will be returned through the same channel to the regimental, post, or detachment, commander, who will, if the discharge is authorized by the endorsement of the proper authority, sign the soldier's discharge, and the last certificate on this paper; see that the soldier is furnished with the proper final statements in duplicate, and forward BOTH of these certificates direct to the Adjutant General United States Army, at Washington, D. C.; they will not under any circumstances be given into the hands of the soldier.

B. 71; A. of Reg. 1863
CERTIFICATE OF DISABILITY FOR DISCHARGE

IN THE CASE OF

Solomon Alberts
 a *Corporal* Co. *A*
6th Reg't of *U. S. C. A.*

War Department
 Adjutant General's Office
 July 23^d 1873

Approved
John Leun Bell
 Surg. med. Dir. USA

TO BE DISCHARGED

By command of
 Major-General Cadwalader.

John S. Cadman
 Assistant Adjutant-General.

Adjutant General's Office,

Nov 14 1863

Duplicate sent the Pension Office

Received (A. G. Office) *Nov 10, 1863*

Ent. on O.R. of Cas. B

The muster-roll of C. A. —
 5th U. S. C. A. for Nov. & Dec. 1863
 and the muster-roll report of *Corporal Solomon Alberts*
 discharged November 17th 1863.

The Surgeon's Certificate of Disability, however gives Nov. 9th 1863 as date of discharge

The latter date — (Nov. 9th 1863) — is held to be correct, and the C. A. Roll cited will be amended accordingly.

E. B. 10
420
J. M. Watson
 Assistant Adjutant General

Letter to 2^d Auditor Aug 9th 1873.

ARMY OF THE UNITED STATES CERTIFICATE OF DISABILITY FOR DISCHARGE.



Corp. Solomon Alberts of Captain Robert B. Bishop's Company, (A) of the 11th Regiment of United States Infantry was enlisted by John Foster Troop Marshal of the 22nd Dist. Regiment of Penn. at Wilkes Barre Pa. on the 16th day of July 1863, to serve three years; he was born in Washington Co. in the State of Penn. is Twenty-one years of age, 5 feet 6 inches high, Black complexion, Black eyes, Black hair, and by occupation when enlisted a Farmer. During the last two months said soldier has been unfit for duty _____ days* was left at this Post on departure of his reg't Oct. 14. 63 since which time he has been in the Post Hospital.

STATION: Camp Wm Penn Cheltenham Hills Pa
 DATE: October 26th 1866

Louis Wagner
St. Col. 8th Reg. U.S.A.
 Commanding ~~Company~~ Camp
Wm Penn

I CERTIFY, that I have carefully examined the said Corp. Solomon Alberts of Captain R. B. Bishop's Company, and find him incapable of performing the duties of a soldier because of Functional derangement of the heart with Rheumatic arthritis.

A. P. Keckhohl
 Surgeon.
8th Reg. U. S. A.

DISCHARGED, this 26th day of November 1866, at Camp Wm Penn Cheltenham Hills Pa.

Louis Wagner
St. Col. 8th Reg. U.S.A.
 Commanding the Reg't. Post

The soldier desires to be addressed at
 Town Lanhamstown County Washington State Penn.

* See Note 1 on the back of this. † See Note 2 on the back of this.

No. 4, 6 U.S. Court

Private Private

CARD NUMBERS.

1	5375860	26
2	5575942	27
3	5576022	28
4	5576101	29
5	5576177	30
6	5576257	31
7	5576335	32
8	5576407	33
9	5576481	34
10	5376579	35
11	5576672	36
12	5576768	37
13	5576863	38
14	5576955	39
15	9065400	40
16		41
17		42
18		43
19		44
20		45
21		46
22		47
23		48
24		49
25		50

Book Mark:

See also

229626 P.O. M.M.

WPA 61708.

S. 1401126 Audubon.

1406446 Audubon

CA | **6** | **U.S.C.T.**

Charles Alexander

....., Co. *G*, 6 Reg't U. S. Col'd Inf.

Appears on

Company Descriptive Book

of the organization named above.

DESCRIPTION.

Age *19* years; height *5* feet *6 1/2* inches.

Complexion *colored*

Eyes *Black*; hair *Black*

Where born *Wilmington Del.*

Occupation *Laborer*

ENLISTMENT.

When *Sept* *7*, 186*3*.

Where *Smypna Del. 1st Dist.*

By whom *Capt Wilmer P.M.*; term *3* y'rs.

Remarks: *Substitute*

Jenkins

A

6

U.S.C.T.

Charles L. Alexander
Private, Co. G., 6 Reg't U. S. Col'd Infantry.

Age 19 years.

Appears on

Company Muster-in Roll

of the organization named above. Roll dated
Philadelphia Pa, Sept 14, 1863.

Muster-in to date

Sept 14, 1863

Joined for duty and enrolled:

When

Sept. 2, 1863.

Where

Smypna Del.

Period

3 years.

Remarks:

Mustered by Capt
Wilmer P.M. Sept 2-1863.
Sub. co. to 1st Regt Delaware

Book mark:

M. A. Michaels

A

6

U.S.C.T.

Charles L. Alexander

Private, Co. G, 6 Reg't U. S. Col'd Infantry.

Appears on

Company Muster Roll

for *Enrollment to Oct. 31, 1863.*

Present or absent *Present*

Stoppage, \$..... *100* for

Due Gov't, \$..... *100* for

Remarks: *Due the United States*
(44) (1 Canteen)

Book mark:

(358)

M. A. Michaels
Copyist.

A

6

U.S.C.T.

Charles L. Alexander
Private, Co. G, 6 Reg't U. S. Col'd Infantry.

Appears on

Company Muster Roll

for *Nov & Dec*, 1863.

Present or absent *Present*

Stoppage, \$ 100 for

Due Gov't, \$ 100 for

Remarks: *Due the United States*
for one-half shelter tent \$1.62 x
on canteen, 44¢ (\$2.06)

Book mark:

(358)

M. A. Michael
Copyist.

W | **6** | **U.S.C.T.**

Charles L. Alexander
Private, Co. G, 6 Reg't U. S. Col'd Infantry.

Appears on

Company Muster Roll

for *Jan. & Feb*, 1864.

Present or absent *Present*

Stoppage, \$ 100 for

Due Gov't, \$ 100 for

Remarks: *Due the United States*
for one half Shelter Tent \$1.62
for one canteen 44 cts (\$2.00)

Book mark:

(358) *M. A. Michaels* Copyist.

A | **6** | **U.S.C.T.**

Charles L. Alexander

Private, Co. G, 6 Reg't U. S. Col'd Infantry.

Appears on

Company Muster Roll

for *March + Apr.*, 1864.

Present or absent *Present*.

Stoppage, \$ *100* for

Due Gov't, \$ *100* for

Remarks:

Book mark:

(358)

M. A. Michaels
Copyist.

A | 6 | U.S.C.T.

Charles L. Alexander
Priv., Co. G, 6 Reg't U. S. Col'd Infantry.

Appears on

Company Muster Roll

for *May & June*, 1864

Present or absent *Absent*

Stoppage, \$ *100* for

Due Gov't, \$ *100* for

Remarks: *Absent sick at
New Hospital since
June 15, 1864*

Book mark:

G. S. G. A. N.
Copyist.

A | 6 | U.S.C.T.

Charles L. Alexander
Priv., Co. G, 6 Reg't U. S. Col'd Infantry.

Appears on

Company Muster Roll

for July & Aug., 1864

Present or absent Absent

Stoppage, \$ 100 for

Due Gov't, \$ 100 for

Remarks:

From April 19, 1861.
Absent sick in Gen.
Hospital since June 15
1864

Book mark:

Grogan

A | **6** | **U.S.C.T.**

Charles L. Alexander
Priv., Co. G, 6 Reg't U. S. Col'd Infantry.

Appears on

Company Muster Roll

for *Sept. & Oct.*, 186*4*.

Present or absent *Present*

Stoppage, \$ *100* for

Due Gov't, \$ *100* for

Remarks:

Book mark:

Grogan

A | 6 | U.S.C.T.

Charles L. Alexander
Priv., Co. G, 6 Reg't U. S. Col'd Infantry.

Appears on

Company Muster Roll

for Nov. & Dec. 1864.

Present or absent Present

Stoppage, \$ 100 for

Due Gov't, \$ 100 for

Remarks: Stop for 1 Screw-
Driver 23 - 1 Tompin. 02 -
(Wiper 20 = (.45))

Book mark:

Grogan
Copyist.

A | 6 | U.S.C.T.

Charles L. Alexander
Priv., Co. G, 6 Reg't U. S. Col'd Infantry.

Appears on

Company Muster Roll

for Jan. 5 Feb. 1865.

Present or absent Present

Stoppage, \$ 100 for

Due Gov't, \$ 100 for

Remarks: Stop for one
Jersey Amix. 23. 1 Tompin
02 / Wiper 20. (46)

Book mark:

Grogan

A | 6 | U.S.C.T.

Charles L. Alexander

Priv, Co. G, 6 Reg't U. S. Col'd Infantry.

Appears on

Company Muster Roll

for Men & app, 1863

Present or absent present

Stoppage, \$ 100 for

Due Gov't, \$ 100 for

Remarks: Stopp'd on priv's
Rolls for ordnance (.45)

Book mark: _____

(358)

Moy Copyist.

A | 6 | U.S.C.T.

Charles S. Alexander

Priv, Co. G, 6 Reg't U. S. Col'd Infantry.

Appears on

Company Muster Roll

for May & June, 1865

Present or absent present

Stoppage, \$ 45/100 for ordnance

Due Gov't, \$ 100 for

Remarks: Stop for 1 Quarter
65 cts.

Book mark:

May

A | 6 | U.S.C.T.

Charles L. Alexander

Priv, Co. G, 6 Reg't U. S. Col'd Infantry.

Appears on

Company Muster Roll

for July & Aug, 1865.

Present or absent Present

Stoppage, \$ 100 for

Due Gov't, \$ 100 for

Remarks: Stopped on prov
Rolls for 1 canteen 65 &

Book mark:

Moy Copyist.

A | 6 | U.S.C.T.

Charles Alexander
Priv, Co. G, 6 Reg't U. S. Col'd Infantry.

Appears on Co. Muster-out Roll, dated
Wilmington N.C., Sept 20, 1865.

Muster-out to date Sept 20, 1865.

Last paid to Apr 30, 1865.

Clothing account:

Last settled June 30, 1864; drawn since \$ 81 ⁸⁰/₁₀₀

Due soldier \$ 100; due U. S. \$ 100

Am't for cloth'g in kind or money adv'd \$ 100

Due U. S. for arms, equipments, &c., \$ 100

Bounty paid \$ none 100; due \$ 100 ¹⁰⁰/₁₀₀

Remarks: Due Mr Brisben, Reg't
Sutler \$15.00, due US for
1 canteen 65¢, Substitute
for a colored man drafted
under act of March 3/63.

Book mark: V230. P237, 76

(361)

Moy

Copyist.

Alexander, Charles

P., Co., 6 Reg't U S C. Infy

3 Enclosures.

Bed Cards	Final Statements
Burial Records	Furloughs or L. of A
Certs. of Dis. for Discharge	Med. Certificates
C. M. Charges	Med. Des. Lists
Descriptive Lists	Orders
Discharge Certificates	Pris. of War Record
Enlistment Papers 2	Resignations

Other papers relating to—

Admission to Hosp'l	Furlough or L. of A 1
Casualty Sheet	Med. Examination
Confinement	Misc. Information
Contracts	Pay or Clothing
Death or Effects	Personal Reports
Desertion	Rank
Discharge from Hosp'l	Transfer to Hosp'l
Discharge from Service	Transfer to V. R. C.
Duty	Transportation

DECLARATION OF SUBSTITUTE.

I, desiring to ENLIST in the Army of the United States, for THREE YEARS, **Do declare**, That I am years and months of age; that I have never been discharged from the United States service on account of disability or by sentence of a court martial; and I know of no impediment to my serving honestly and faithfully as a soldier for three years.

GIVEN at the day of

WITNESS:

L. D. Mah *Charles ^{his} L. Alexander*
Wach

DP/63

No 18

Charles Lewis Alexander for

Enlisted at *Proyama* *see*

As Substitute for

Ball Jenkins (see)

On the *2nd* day of *Sept*, 1863.

By

Edwin Wilmer

Leonard S. Moore

Samuel S. Fisher

Board of Enrollment,

Cong Dist. of Alabama

(No. 40.)

SUBSTITUTE VOLUNTEER ENLISTMENT.

STATE OF

TOWN OF



I, Charles L. Alexander (colored) born in the State of Delaware, aged twenty one years, and by occupation a laborer DO HEREBY ACKNOWLEDGE to have agreed with Caleb Jenkins (colored), Esq. of Mill Creek & Newcastle County, Delaware to become his SUBSTITUTE in the Military Service, for a sufficient consideration paid and delivered to me, on the second day of September, 1863; and having thus agreed with said Caleb Jenkins, I DO HEREBY ACKNOWLEDGE to have enlisted this second day of September, 1863, to serve as a Soldier in the Army of the United States of America, for the period of THREE YEARS, unless sooner discharged by proper authority: I do also agree to accept such bounty, pay, rations, and clothing, as are, or may be, established by law for soldiers. And I do solemnly swear that I will bear true and faithful allegiance to the United States of America; that I will serve them honestly and faithfully against all their enemies or opposers whomsoever; and that I will observe and obey the orders of the President of the United States, and the orders of the Officers appointed over me, according to the Rules and Articles of War.

SWORN and subscribed to, at Smyrna this 20 day of September 1863 BEFORE William Miller Provost

Charles L. Alexander mark

We certify, on honor, That we have carefully examined the above-named Volunteer Substitute agreeably to the Regulations, and that, in our opinion, he is free from all bodily defects and mental infirmity which would in any way disqualify him from performing the duties of a soldier; that he was entirely sober when enlisted; that he is of lawful age, (not under 18 years;) and that, in accepting him as duly qualified to perform the duties of an able-bodied soldier, and as a Substitute in lieu of Caleb Jenkins, drafted in Smyrna August 13, 1863, we have strictly observed the Regulations which govern in such cases. This soldier has black eyes, black hair, dark complexion; is five feet 6 1/2 inches high.

William Miller Provost Marshal.

Leonard E. Kelly Commissioner of Board.

Daniel Fisher Surgeon of Board.

Board of Enrollment of the Dist. of Delaware

DECLARATION OF SUBSTITUTE.

I, Charles Lewis Alexander desiring to ENLIST in the Army of the United States, for THREE YEARS, **Do declare**, That I am thirteen years and months of age; that I have never been discharged from the United States service on account of disability or by sentence of a court martial; and I know of no impediment to my serving honestly and faithfully as a soldier for three years.

GIVEN at Myra Del
the 2^d day of September 1863

WITNESS:

S. Maly

Charles Lewis Alexander
man

No. 18

24/63

Charles Lewis Alexander (col)

Enlisted at Myra Del

As Substitute for

Robert Lawrence (col)

On the 2nd day of September, 1863.

By

Edwin Pickens

Leonard B. Parks

D. H. Stibor

Board of Enrollment,

1st Dist. of Delaware

(No. 40.)

SUBSTITUTE VOLUNTEER ENLISTMENT.

STATE OF

TOWN OF



Delaware

Smyma

Charles Louis Alexander I,

Charles Louis Alexander (son) born in the State of Delaware, aged nineteen years, and by occupation a Laborer

Do HEREBY ACKNOWLEDGE to have agreed with Caleb Jenkins Col, Esq., of Mill Creek and New Castle County Delaware

to become his SUBSTITUTE in the Military Service, for a sufficient consideration paid and delivered to me, on the second day of September, 1863;

and having thus agreed with said Caleb Jenkins Col, I DO HEREBY ACKNOWLEDGE to have enlisted this second day of September

1863, to serve as a Soldier in the Army of the United States of America, for the period of THREE YEARS, unless sooner discharged by proper authority: I do also agree to accept such bounty, pay, rations, and clothing, as are, or may be, established by law for soldiers. And I do solemnly swear that I will bear true and faithful allegiance to the United States of America; that I will serve them honestly and faithfully against all their enemies or opposers whomsoever; and that I will observe and obey the orders of the President of the United States, and the orders of the Officers appointed over me, according to the Rules and Articles of War.

SWORN and subscribed to, at Smyma this 2nd day of Sept. 1863 BEFORE Othmar Miller Prov. Mar

Charles Louis Alexander

We certify, on honor, That we have carefully examined the above-named Volunteer Substitute agreeably to the Regulations, and that, in our opinion, he is free from all bodily defects and mental infirmity which would in any way disqualify him from performing the duties of a soldier; that he was entirely sober when enlisted; that he is of lawful age, (not under 18 years;) and that, in accepting him as duly qualified to perform the duties of an able-bodied soldier, and as a Substitute in lieu of Caleb Jenkins Col, drafted in Smyma Delaware August 12th, 1863, we have strictly observed the Regulations which govern in such cases. This soldier has black eyes, black hair, white complexion; is 5 feet 6 1/2 inches high.

Othmar Miller Provost Marshal.

Samuel E. Kelly Commissioner of Board.

Daniel Fisher Surgeon of Board.

Board of Enrollment of the Dist. of Delaware

Camp 6th U. S. C. Troops
Near Wilmington N.C. Aug 16 /65

J. B. No. 20, D. M. B. 8, 26, 65
Chamberlain M. J.
1st Lieut - 6th U. S. C. I.

Requests that a furlough
of thirty (30) days be granted
Priv. Charles Alexander
Co "G" 6th U. S. C. I.

Head Quarters 6th U. S. C. I.
Wilmington Aug 16, 1865

Respectfully forwarded
approved
I certify that
there are 572 enlisted men
present with the regiment
and that there are no
absent on furlough - no
applications forwarded
not acted upon

D. M. Bell
Capt 6th U. S. C. I.
Comd'g Regt

30 days

Head Quarters 3rd Brig 3rd Div
East of Wilmington
Wilmington N.C.
August 21, 1865

Respectfully forwarded
approved - I have
inspected this man
and find his equipments
& clothing in good con-
dition

A. Jeff Sr
Col, Comd'g

Head Quarters 3rd Div of Wilmington
Wilmington N.C. Aug 21st 65
Vol. 38 of W - 1865
Respectfully forwarded approval

J. W. Ames
Adj Brig East of Wilmington

Head Quarters East of Wilmington, Aug 21/65
E. W. Me - 734

Camp 6th U. S. C. Troops
Near Wilmington N.C. Aug. 16 1865

Let. L. D. Phillips
Actg. Adjt. 6th U. S. C. T.

Sir:

I have the honor to request
that a furlough of thirty (30) days be granted
to Charles Alexander-private, Company "G" 6th
U. S. C. T. for the purpose of visiting his home
in Wilmington, Delaware.

I am very respectfully
your obedient servant
M. J. Chamberlain
1st Lt. 6th U. S. C. T. Comdy. Co.

Charles Alexander
Priv. 6th U. S. C. T.

6 U.S. Gold Inc.

Private Private

CARD NUMBERS.

578819	26
578914	27
5379012	28
5579104	29
5579187	30
9065634	31
	32
	33
	34
	35
	36
	37
	38
	39
	40
	41
	42
	43
	44
	45
	46
	47
	48
	49
	50

Book Mark:

See also

1949

CA | 6 | U.S.C.T.

George Allen,
Co. C, 6 Reg't U. S. Col'd Inf.

Appears on

Company Descriptive Book
of the organization named above.

DESCRIPTION.

Age 30 years; height 5 feet 5 1/2 inches.

Complexion Copper

Eyes Brown; hair Black

Where born Maryland

Occupation Laborer

ENLISTMENT.

When Nov. 23, 1864.

Where Washington D.C.

By whom 4" Sub Dis; term 1 y'rs.

Remarks: Drafted

Jenkins

A. | 6 | U.S.C.T.

George Allen
Priv., Co. I, 6 Reg't U. S. Colored Infantry.

Appears on

Company Muster Roll
for *Jan. & Feb.*, 186*5*
Present or absent *Absent.*

Stoppage, \$ *100* for

Due Gov't, \$ *100* for

Remarks: *On detached service
with Capt. Dill*

*(Drafted and mustered in
Nov. 23, 64 at Washington
for 1 year)*

Book mark:

A. M. Reed

A. | 6 | U.S.C.T.

George Allen
Priv., Co. I, 6 Reg't U. S. Colored Infantry.

Appears on

Company Muster Roll

for dated May 3, 1865.

Present or absent Not stated.

Stoppage, \$ 100 for

Due Gov't, \$ 100 for

Remarks: Free Apr. 19/61.
Due U. S. 1 haversack
95-cs. / Canteen 65-cs.
\$1.60.

Book mark:

A. M. Reed

A | 6 | U.S.C.T.

George Allen

Pvt., Co. I, 6 Reg't U. S. Colored Infantry.

Appears on

Company Muster Roll

for *May & June*, 186*V*.

Present or absent *Present*

Stoppage, \$ *100* for

Due Gov't, \$ *100* for

Remarks: *Charged on past rolls for CC & G. Eq. \$ 1.61*

Book mark: _____

(858)

Vosey

Copyist.

A | 6 | U.S.C.T.

George Allen

Pvt., Co. I, 6 Reg't U. S. Colored Infantry.

Appears on

Company Muster Roll

for *July & Aug*, 186*5*.

Present or absent *Present*

Stoppage, \$ *100* for

Due Gov't, \$ *1 61/100* for *C. C. and G. Eq.*

Remarks:

Book mark:

Posley

A | 6 | U.S.C.T.

George Allen
Pot., Co. I, 6 Reg't U. S. Col'd Infantry.

Appears on Co. Muster-out Roll, dated
Wilmington N.C. Sept 20, 1865.

Muster-out to date Sept 21, 1865.

Last paid to _____, 1865.
Pay due from enrolment

Clothing account:

Last settled Nov, 1865; drawn since \$ 22 75/100

Due soldier \$ 100; due U. S. \$ 100

Am't for cloth'g in kind or money adv'd \$ 100

Due U. S. for arms, equipments, &c., \$ 6 100 ^{retained}

Bounty paid \$ 100; due \$ 100

Remarks: Due Mr. Boiston Rept
sutler \$ 21.

Book mark 3723 P. m. 9 May 15 1866 - 863 - 1882

Posley

Co. *D*, 6 U.S. Col'd Inf.

Private | *Private*

CARD NUMBERS.

1	5572459	26
2	5572541	27
3	5572627	28
4	5572705	29
5	5572782	30
6	5572859	31
7	5572934	32
8	5573007	33
9	5573080	34
10	5573173	35
11	5573278	36
12	5573371	37
13	5573464	38
14	9065022	39
15		40
16		41
17		42
18		43
19		44
20		45
21		46
22		47
23		48
24		49
25		50

Book Mark:

See also

A | 6 | U.S.C.T.

Joseph Allen

Co. D, 6 Reg't U. S. Col'd Inf.

Appears on

Company Descriptive Book
of the organization named above.

DESCRIPTION.

Age 23 years; height 5 feet 8 inches.

Complexion Dark

Eyes Brown; hair Black

Where born Philadelphia Pa

Occupation Laborer

ENLISTMENT.

When July 15, 1863.

Where Philadelphia Pa

By whom 4 D. Pa; term 3 y'rs.

Remarks: Drafted Detached
in Brig 2 U Dept Aug
1865. Ret'd to Co for duty
May 14, 65. Detailed as
teamster at Brig Hd 2nd
May 17, 65.

J G Reeves

A.

6

U.S.C.T.

Josiah Allen.

Pop, Co. *D*, 6 Reg't U. S. Col'd Infantry.

Age *23* years.

Appears on

Company Muster-in Roll

of the organization named above. Roll dated

Philadelphia, Pa., Aug. 14, 1863.

Muster-in to date

July 15, 1863.

Joined for duty and enrolled:

When

July 15, 186*3*

Where

Phila, Pa.

Period

3 years.

Remarks:

Book mark:

A.

6

U.S.C.T.

Josiah Allen.

Regt., Co. D, 6 Reg't U. S. Col'd Infantry.

Appears on

Company Muster Roll

for to Oct. 31, 1863.

Present or absent present.

Stoppage, \$ 100 for

Due Gov't, \$ 100 for

Remarks:

Book mark:

Baker,

(358)

Copyist.

A.

6

U.S.C.T.

Josiah Allen.

Priv., Co. D, 6 Reg't U. S. Col'd Infantry.

Appears on

Company Muster Roll

for Nov & Dec., 1868.

Present or absent present.

Stoppage, \$ 100 for

Due Gov't, \$ 100 for

Remarks:

Book mark:

Baker,

a.

6

U.S.C.T.

Josiah Allen.

Priv., Co. D, 6 Reg't U. S. Col'd Infantry.

Appears on

Company Muster Roll

for Jan & Feb, 1864

Present or absent present

Stoppage, \$ 100 for

Due Gov't, \$ 100 for

Remarks:

Book mark:

Baker
Copys.

A. | 6 | U.S.C.T.

Josiah Allen.

Pvt., Co. D, 6 Reg't U. S. Col'd Infantry.

Appears on

Company Muster Roll

for March & April, 1864.

Present or absent present.

Stoppage, \$ 100 for

Due Gov't, \$ 100 for

Remarks:

Book mark:

Baker

U

6

U.S.C.T.

Private Josiah Allen

Co. D, 6 Reg't U. S. Col'd Infantry.

Appears on

Company Muster Roll

for *May & June*, 186*4*

Present or absent

Present

Stoppage, \$ 100 for

Due Gov't, \$ 100 for

Remarks:

Book mark:

Perf

(858)

Copyist.

A

6

U.S.C.T.

Private Josiah Allen

Private, Co. D, 6 Reg't U. S. Col'd Infantry.

Appears on

Company Muster Roll

for *July & Aug.*, 186*4*

Present or absent *Present*

Stoppage, \$ *100* for

Due Gov't, \$ *100* for

Remarks: *Detained as Turnster*
Aug. 12 64

Book mark:

(358)

Reif

Copyist.

W

6

U.S.C.T.

Pr Josiah Allen
Co. D, 6 Reg't U. S. Col'd Infantry.

Appears on

Company Muster Roll

for *Sept & Oct*, 1864

Present or absent *Present*

Stoppage, \$ *100* for

Due Gov't, \$ *100* for

Remarks: *Detailed as teamster*
Aug. 12 64

NEXT ROLL ON FILE FEB 1865

Book mark: *100*

(858)

Pr

Copyis..

U

16

U.S.C.T.

Josiah Allen

Pl

, Co. D, 6 Reg't U. S. Col'd Infantry.

Appears on

Company Muster Roll

for

Jan. 1st to Feb. 5th, 1865

Present or absent

absent

Stoppage, \$

100 for

Due Gov't, \$

100 for

Remarks:

Detained as Drunker
at Brig. Hd. Aug. 12 64
Free. Apr. 19 61

Book mark:

(858)

Reif

Copyis..

U

6

U.S.C.T.

Josiah Allen
Pl, Co. D, 6 Reg't U. S. Col'd Infantry.

Appears on

Company Muster Roll

for *Mch. & apr.*, 186 *5*

Present or absent *absent*

Stoppage, \$ *100* for

Due Gov't, \$ *100* for

Remarks *Detached. as teamster*
at Brig. Hd., Ws. - Aug. 12
1864 Free apr. 19 61

Book mark ::

Ref

(858)

Copyis..

A. | 6 | U.S.C.T.

Josiah Allen
Pvt., Co. D, 6 Reg't U. S. Col'd Infantry.

Appears on

Company Muster Roll

for May and June, 1860

Present or absent Present

Stoppage, \$ 11 ⁹⁴/₁₀₀ for l. l. & H. E.

Due Gov't, \$ 100 for

Remarks: Detailed as team-

ster: at Brig Hd Qr. Aug 12,

64

Free Apr. 19, 61

Book mark:

Rhett

A.

6

U.S.C.T.

Josiah Allen

P.M., Co. D, 6 Reg't U. S. Col'd Infantry.

Appears on

Company Muster Roll

for *July and Aug.*, 1865.

Present or absent *Present*

Stoppage, \$ 100 for

Due Gov't, \$ 100 for

Remarks: *Reported to Co for
duty from detach service
Aug 17th 1865
Free April 19th 1861*

Book mark:

Phute

A. | 6 | U.S.C.T.

Josiah Allen
 Pvt., Co. 2, 6 Reg't U. S. Col'd Infantry.

Appears on **Co. Muster-out Roll**, dated
 Wilmington N. C., Sept. 20, 1865.
 Muster-out to date Sept. 20, 1865.
 Last paid to April 30, 1866.

Clothing account:

Last settled June 30, 1864; drawn since \$60 ³⁴/₁₀₀
 Due soldier \$100; due U. S. \$100
 Am't for cloth'g in kind or money adv'd \$100

Due U. S. for arms, equipments, &c., \$100

Bounty paid \$00 ¹⁰⁰/₁₀₀; due \$100 ¹⁰⁰/₁₀₀

Remarks: Due W^m Brisbane Regt.
 Sutter \$5.00

Free on or before April 19th 1861,
 Due \$6.00 pr month from En-
 listment to April 19th 1864.
 Drafted under act March 3^d 1863

Book mark:

Rhett

6 U.S. Col'd Inf.

Private Private

CARD NUMBERS.

1	5567818	26
2	43147153	27
3		28
4		29
5		30
6		31
7		32
8		33
9		34
10		35
11		36
12		37
13		38
14		39
15		40
16		41
17		42
18		43
19		44
20		45
21		46
22		47
23		48
24		49
25		50

Book Mark:

See also:

A | **6** | **U.S.C.T.**

John G. Allick

Appears with rank of *Plt* on
**Muster and Descriptive Roll of a Detach-
 ment of U. S. Vols. forwarded**

for the 6 Reg't U. S. Col'd Infantry. Roll dated

Harb Isl. N.Y. Sep 24, 1864.

Where born *E. Troy N.Y.*

Age *38* y'rs; occupation *laborn*

When enlisted *Sept 15*, 1864.

Where enlisted *Buffalo*

For what period enlisted *3* years.

Eyes *Blk*; hair *blk*

Complexion *blk*; height *5 ft. 6 3/4 in.*

When mustered in *Sept 15*, 1864.

Where mustered in *Buffalo*

Bounty paid \$ *100*⁰⁰; due \$ *100*

Where credited *30 Cong Dist Buffalo*

Company to which assigned

Remarks: *(not borne on must-
 ter rolls of Regt)*

Book mark:

M Jones

A 1 6 1865

John G. Allick

Appears with rank of Pvt on

Muster and Descriptive Roll

of Detachment of U.S. Volunteers

forwarded by

Roll dated Yorks Island N.Y. 26, Sept. 24, 1864.

Where born East Troy N.Y.

Age 38 years; occupation Labourer

When enlisted Sept. 15, 1864.

Where enlisted Buffalo

For what period enlisted 3 years.

Eyes Black; hair Black

Complexion Blauw; height 5 ft. 6 3/4 in.

When mustered in Sept. 15, 1864.

Where mustered in Buffalo

Bounty paid \$ 100 / 100; due \$ 100 / 100

Clothing account:

Last settled _____, 186 ; drawn since \$ 17 / 100

Date of first muster Sept. 15, 1864.

Company to which assigned _____

Remarks: been Dist 30 Dist Dist Buffalo

Extra Co. \$7.50

Book mark : _____

Allick

Allick, John G.

....., Co., *6* Reg't *U.S.C. Infy*

2 Enclosures.

Bed Cards	Final Statements
Burial Records	Furloughs or L. of A.
Certs. of Dis. for Discharge	Med. Certificates
C. M. Charges	Med. Des. Lists
Descriptive Lists	Orders
Discharge Certificates	Pris. of War Record
Enlistment Papers <i>2</i>	Resignations

Other papers relating to—

Admission to Hosp'l	Furlough or L. of A.
Casualty Sheet	Med. Examination
Confinement	Misc. Information
Contracts	Pay or Clothing
Death or Effects	Personal Reports
Desertion	Rank
Discharge from Hosp'l	Transfer to Hosp'l
Discharge from Service	Transfer to V. R. C.
Duty	Transportation

NOTE 1.—This blank will be used for both enlistments and re-enlistments—enlistment of veterans, &c., &c., in the volunteer service. They will be made out in duplicate in all cases—one to accompany the recruiting return of the superintendent (not the recruiting officer) to the Adjutant General, and one to accompany the accounts of the officer who pays bounty, &c. The Regiment and Company in which the soldier last served should be given on the back.

NOTE 2.—An enlistment holds to service. A muster-in must, in all cases, precede payment of pay, bounty, pension, &c. A muster-in roll must, in all cases, be filed in the Adjutant General's Office as evidence of muster-in. The mustering officer, commissary, or assistant commissary of musters, as the case may be, will countersign both enlistments as having mustered the soldier into the service of the United States before either of them is given to the disbursing officer.

DECLARATION OF RECRUIT.

I, John G. Allcock, desiring to VOLUNTEER as a Soldier in the Army of the United States, for the term of THREE YEARS. Do Declare, That I am Thirty Eight years and _____ months of age; that I have never been discharged from the United States service on account of disability or by sentence of a court martial, or by order before the expiration of a term of enlistment; and I know of no impediment to my serving honestly and faithfully as a soldier for three years.

GIVEN at Buffalo, N.Y. the 15th day of Sept 1867

Witness: Leslie Vallin John G. Allcock

No. 2292
Volunteered at Buffalo, N.Y.
Sept 15th 1867
By Leslie Vallin
6th Regiment of Col'd Troops
_____ enlistment; last served in Company ()
Reg't of _____
Discharged _____, 18 _____

CONSENT IN CASE OF MINOR.

I, _____, Do CERTIFY, That I am _____; that the _____ of _____; that the said _____ is _____ years of age; and I do hereby freely give my CONSENT to his volunteering as a SOLDIER in the ARMY OF THE UNITED STATES for the period of THREE YEARS.

GIVEN at _____ the _____ day of _____

Witness: _____

(A. G. O. No. 74 & 76.)

VOLUNTEER ENLISTMENT.

STATE OF

New York



TOWN OF

Holland
Erie Co. 80th Div

I, John G. Allick, born in East Troy
in the State of New York, aged thirty eight years,
and by occupation a Laborer, DO HEREBY ACKNOWLEDGE to have
volunteered this fifteenth day of Sept, 1864

to serve as a **Soldier** in the **Army of the United States of America**, for
the period of **THREE YEARS**, unless sooner discharged by proper authority:
Do also agree to accept such bounty, pay, rations, and clothing, as are, or may be,
established by law for volunteers. And I, John G. Allick, do
solemnly swear, that I will bear true faith and allegiance to the **United States
of America**, and that I will serve them honestly and faithfully against all
their enemies or opposers whomsoever; and that I will observe and obey the
orders of the President of the United States, and the orders of the officers
appointed over me, according to the Rules and Articles of War.

Sworn and subscribed to, at Buffalo N.Y.
this 15 day of Sept, 1864
BEFORE Capt. Geo. W. ...

I CERTIFY, ON HONOR, That I have carefully examined the above-named Volunteer, agreeably
to the General Regulations of the Army, and that, in my opinion, he is free from all bodily defects and
mental infirmity, which would in any way disqualify him from performing the duties of a soldier.

[Signature]
3rd Dist N.Y.
EXAMINING SURGEON.

I CERTIFY, ON HONOR, That I have minutely inspected the Volunteer John G. Allick
previously to his enlistment, and that he was entirely sober when enlisted; that, to the best of my
judgment and belief, he is of lawful age; and that, in accepting him as duly qualified to perform the
duties of an able-bodied soldier, I have strictly observed the Regulations which govern the recruiting
service. This soldier has Black eyes, Black hair, Black complexion, is 5
feet 6 3/4 inches high.

[Signature]
Capt and Prov Mar 3rd Dist N.Y.
RECRUITING OFFICER.

(A. G. O. No. 74 & 76.)

Mustered into the service of the United States, for three years or during the war, from date of enlistment, in Company ...
Regiment of ... Volunteers, on the 15 day of Sept, 1864 at Buffalo N.Y.

[Signature]
Capt and Prov Mar 3rd Dist N.Y.

NOTE 1.—This blank will be used for both enlistments and re-enlistments—enlistment of veterans, &c., &c., in the volunteer service. They will be made out in duplicate in all cases—one to accompany the recruiting return of the superintendent (not the recruiting officer) to the Adjutant General, and one to accompany the accounts of the officer who pays bounty, &c. The Regiment and Company in which the soldier last served should be given on the back.

NOTE 2.—An enlistment holds to service. A muster-in must, in all cases, precede payment of pay, bounty, pension, &c. A muster-in roll must, in all cases, be filed in the Adjutant General's Office as evidence of muster-in. The mustering officer, commissary, or assistant commissary of musters, as the case may be, will countersign both enlistments as having mustered the soldier into the service of the United States before either of them is given to the disbursing officer.

DECLARATION OF RECRUIT.

I, John G. Allick, desiring to VOLUNTEER as a Soldier in the Army of the United States, for the term of THREE YEARS, Do Declare, That I am Thirty eight years and _____ months of age; that I have never been discharged from the United States service on account of disability or by sentence of a court martial, or by order before the expiration of a term of enlistment; and I know of no impediment to my serving honestly and faithfully as a soldier for three years.

GIVEN at Suffalo, N.Y. the 15 day of Sept 1864

Witness: Levi Vallui John G. Allick

Re-entered at Suffalo, N.Y. Sept 15, 1864
 No. 4440
John G. Allick
 By Levi Vallui
Col's Troop Regiment of Col's Troop
 Discharged _____, 18____
 Reg't of _____
 Enlistment; last served in Company () _____

Received

CONSENT IN CASE OF MINOR.

I, _____, Do CERTIFY, That I am the _____ of _____; that the said _____ is _____ years of age; and I do hereby freely give my CONSENT to his volunteering as a SOLDIER in the ARMY OF THE UNITED STATES for the period of THREE YEARS.

GIVEN at _____ the _____ day of _____

Witness: _____

(A. G. O. No. 74 & 76.)

VOLUNTEER ENLISTMENT.

STATE OF

New York



TOWN OF

*Holland
Eric Co. 30th Dist*

I, *John G. Allick*, born in *East Troy*
in the State of *New York*, aged *thirty eight* years,
and by occupation a *laborer*, DO HEREBY ACKNOWLEDGE to have
volunteered this *fifteenth* day of *Sept*, 1864,
to serve as a **Soldier** in the **Army of the United States of America**, for
the period of **THREE YEARS**, unless sooner discharged by proper authority:
Do also agree to accept such bounty, pay, rations, and clothing, as are, or may be,
established by law for volunteers. And I, *John G. Allick*, do
solemnly swear, that I will bear true faith and allegiance to the **United States
of America**, and that I will serve them honestly and faithfully against all
their enemies or opposers whomsoever; and that I will observe and obey the
orders of the President of the United States, and the orders of the officers
appointed over me, according to the Rules and Articles of War.

Sworn and subscribed to, at *Ruffalo NY*
this *13* day of *Sept*, 1864, *John G. Allick*
BEFORE *Mr. [Signature]*
Capt and Quar Master 30th Dist NY

I CERTIFY, ON HONOR, That I have carefully examined the above-named Volunteer, agreeably
to the General Regulations of the Army, and that, in my opinion, he is free from all bodily defects and
mental infirmity, which would in any way disqualify him from performing the duties of a soldier.

[Signature]
30th Dist NY
EXAMINING SURGEON.

I CERTIFY, ON HONOR, That I have minutely inspected the Volunteer *John G. Allick*
previously to his enlistment, and that he was entirely sober when enlisted; that, to the best of my
judgment and belief, he is of lawful age; and that, in accepting him as duly qualified to perform the
duties of an able-bodied soldier, I have strictly observed the Regulations which govern the recruiting
service. This soldier has *Black* eyes, *Black* hair, *Black* complexion, is
feet *6 3/4* inches high.

[Signature]
Capt and Quar Master 30th Dist NY
REGIMENT OF *Volunteers*,
RECRUITING OFFICER.

(A. G. O. No. 74 & 76.)

Mustered into the service of the United States, for three years or during the war from date of enlistment, in Company
6th Regiment of *6th Sharpshooters* Volunteers, on the *15* day of *Sept*, 1864 at *Ruffalo NY*

[Signature]
Capt and Quar Master 30th Dist NY
Mustering Officer

6 U.S. Card Int.

Colonial Private

CARD NUMBERS.

1	5577070	26
2	5577153	27
3	5577237	28
4	5577318	29
5	5577399	30
6	5577486	31
7	5577559	32
8	5577628	33
9	5577700	34
10	5577795	35
11	5577889	36
12	5577979	37
13	5578064	38
14	9065512	39
15	P-156-RCY-1866	40
16		41
17		42
18		43
19		44
20		45
21		46
22		47
23		48
24		49
25		50

Book Mark: *P-156-Vol. 4-RC*
2/66

See also

A | **6** | **U.S.C.T.**

Francis Allison,
 _____, Co. *A*, 6 Reg't U. S. Col'd Inf.

Appears on
Company Descriptive Book
 of the organization named above.

DESCRIPTION.

Age *19* years; height *5* feet *5* inches.

Complexion *Blk*

Eyes *Blk*; hair *Blk*

Where born *Boston Mass.*

Occupation *Sailor*

ENLISTMENT.

When *Aug. 1*, 186*3*.

Where *Phil. Pa.*

By whom *Lt Col Wagner*; term *3* y'rs.

Remarks: _____

Jenkins

 (383g) Copyist.

A | **6** | **U.S.C.T.**

Francis Allison
 Corp'l, Co. *H*, 6 Reg't U. S. Col'd Infantry.

Age *19* years.

Appears on

Company Muster-in Roll

of the organization named above. Roll dated

Phila. Pa Sept 14, 1863.

Muster-in to date

Sept 7, 1863

Joined for duty and enrolled:

When *Aug. 1*, 1863.

Where *Phila. Pa*

Period *3* years.

Remarks: *Mustered by Lt. Pierce*
U.S.A. Sept 7/63.

Book mark:

M. H. Thompson

A | 6 | U.S.C.T.

Francis Allison
Corpl, Co. H, 6 Reg't U. S. Col'd Infantry.

Appears on

Company Muster Roll
for *Sept 14 to Oct 31*, 1863.
Present or absent *Present*

Stoppage, \$ 100 for

Due Gov't, \$ 100 for

Remarks:

Book mark:

(358)

W. H. Thompson
Copyist.

A | 6 | U.S.C.T.

Francis Allison
Corpl, Co. H, 6 Reg't U. S. Col'd Infantry.

Appears on

Company Muster Roll

for Nov x Dec, 1863.

Present or absent Present

Stoppage, \$ 100 for

Due Gov't, \$ 100 for

Remarks:

Book mark:

W. H. Thompson
Copyist.

A | 6 | U.S.C.T.

Francis Allison

Corpl, Co. H, 6 Reg't U. S. Col'd Infantry.

Appears on

Company Muster Roll

for *Jan'y & Feby*, 1864.

Present or absent *present*

Stoppage, \$ *100* for

Due Gov't, \$ *1* ^{*62*}/_{*100*} for *1/2 Shelter tent*

Remarks:

Book mark:

W. G. Thompson
Copyist.

A | 6 | U.S.C.T.

Francis Allison

Corpl, Co. H, 6 Reg't U. S. Col'd Infantry.

Appears on

Company Muster Roll

for *Mch + Apl*, 186 *4*.

Present or absent *Absent*

Stoppage, \$ 100 for

Due Gov't, \$ 1 ^{*62*}/_{*100*} for *1/2 Shelter tent*

Remarks: *Due U.S. for ordnance stores 65¢ - Sick in McClellan Hospl. Va.*

Book mark:

W. H. Thompson
Copyist.

A

6

U.S.C.T.

Francis Allison

Priv, Co. H, 6 Reg't U. S. Col'd Infantry.

Appears on

Company Muster Roll

for May & June, 1864.

Present or absent Absent

Stoppage, \$ 100 for

Due Gov't, \$ 100 for

Remarks: Absent sick in
McClellan Gen Hosp.
since April 29, 1864
Reduced per S. O. No
29 H. Q. 6: U.S.C.T.
May 17 1864

Book mark:

L. A. Haizer

A

6

U.S.C.T.

Francis Allison

Priv, Co. H, 6 Reg't U. S. Col'd Infantry.

Appears on

Company Muster Roll

for July & Aug, 1864.

Present or absent Present

Stoppage, \$ 100 for

Due Gov't, \$ 100 for

Remarks: Free April 19/61

Book mark:

L. A. Harper

CA | 6 | U.S.C.T.

Francis Allison
Priv, Co. H, 6 Reg't U. S. Col'd Infantry.

Appears on

Company Muster Roll
for Sept & Oct, 1864.

Present or absent Absent

Stoppage, \$ 100 for

Due Gov't, \$ 100 for

Remarks: Free April 19/64
Sick in Hospital
since April 29/64

NEXT ROLL ON FILE FEB 1865

Book mark:

C. A. Taylor

CA

6

U.S.C.T.

Francis Allison

Priv., Co. H, 6 Reg't U. S. Col'd Infantry.

Appears on

Company Muster Roll

for Jan & Feb, 1865.

Present or absent Absent

Stoppage, \$ 100 for

Due Gov't, \$ 100 for

Remarks: Free April 19/61
Absent Sick

Book mark:

CA Harper

CA

6

U.S.C.T.

Francis Allison

Priv., Co. H, 6 Reg't U. S. Col'd Infantry.

Appears on

Company Muster Roll

for *Mar & April*, 186*5*

Present or absent *Absent*

Stoppage, \$ *100* for

Due Gov't, \$ *100* for

Remarks: *Free April 19/61*
Absent - Sick

Book mark:

C. A. Harper

(358)

Copyist.

A

6

U.S.C.T.

Francis Allison

Prk, Co. H, 6 Reg't U. S. Col'd Infantry.

Appears on

Company Muster Roll

for May & June, 1865.

Present or absent Absent

Stoppage, \$ 100 for

Due Gov't, \$ 100 for

Remarks: Absent sick.

Book mark:

Halcomb

A | 6 | U.S.C.T.

Francis Allison

Pvt, Co. H, 6 Reg't U. S. Col'd Infantry.

Appears on

Company Muster Roll

for July & Aug, 1865.

Present or absent Absent

Stoppage, \$ 100 for

Due Gov't, \$ 100 for

Remarks: Absent in hospital.

Book mark:

Halscomb

A

6

U.S.C.T.

Francis Allison
Pvt., Co. H, 6 Reg't U. S. Col'd Infantry.

Appears on Co. Muster-out Roll, dated
Wilmington, N.C., Sep 20, 1863.

Muster-out to date _____, 186 .

Last paid to Feb 28, 1864.

Clothing account:

Last settled June 30, 1864; drawn since \$ 100

Due soldier \$ 100; due U. S. \$ 100

Am't for cloth'g in kind or money adv'd \$ 100

Due U. S. for arms, equipments, &c., \$ 100

Bounty paid \$ 100; due \$ 100

Remarks: Due Wm. Pariseben Reg't Settler #9 x #6 per new
due from enlistment to April 30/64 x Absent
sick x supposed to be at Philadelphia
hospital, no discharge furnished.

x So on Roll

Book mark: Pen 112, 205, 2 and, Mar 1/66
(over)

(361)

Halcomb
Copyist.

JAN 20

5578064

★ 1891 ★

Killed in action Sept-29/64 at
Deep Bottom Va. see P 156 Vol. 4 R. C
2/66x

A 1 Co 1 U.S.G.I

Francis Allison

, Co. H, 6th Reg't U.S.G.I.

NOTATION.

Book mark: P. 156. Re. G. I. 1866.

War Department,

Adjutant General's Office,

Washington, June 20th, 1866.

Call from

returned with report.

The above book mark was noted on rolls in order to preserve results of search in this case.

(475)

E. P. Conroy

Copyist.

General Brantley
CARD NUMBERS.

1	5568896	26
2	5568903	27
3	5568915	28
4	5568928	29
5	5568940	30
6	5568952	31
7	5268964	32
8	5568976	33
9	5568988	34
10	5568999	35
11	5569010	36
12	5569021	37
13	5569032	38
14	9428627	39
15	43217591	40
16		41
17		42
18		43
19		44
20		45
21		46
22		47
23		48
24		49
25		50

Book Mark: 1153 - CA-78

See also U.S. Army

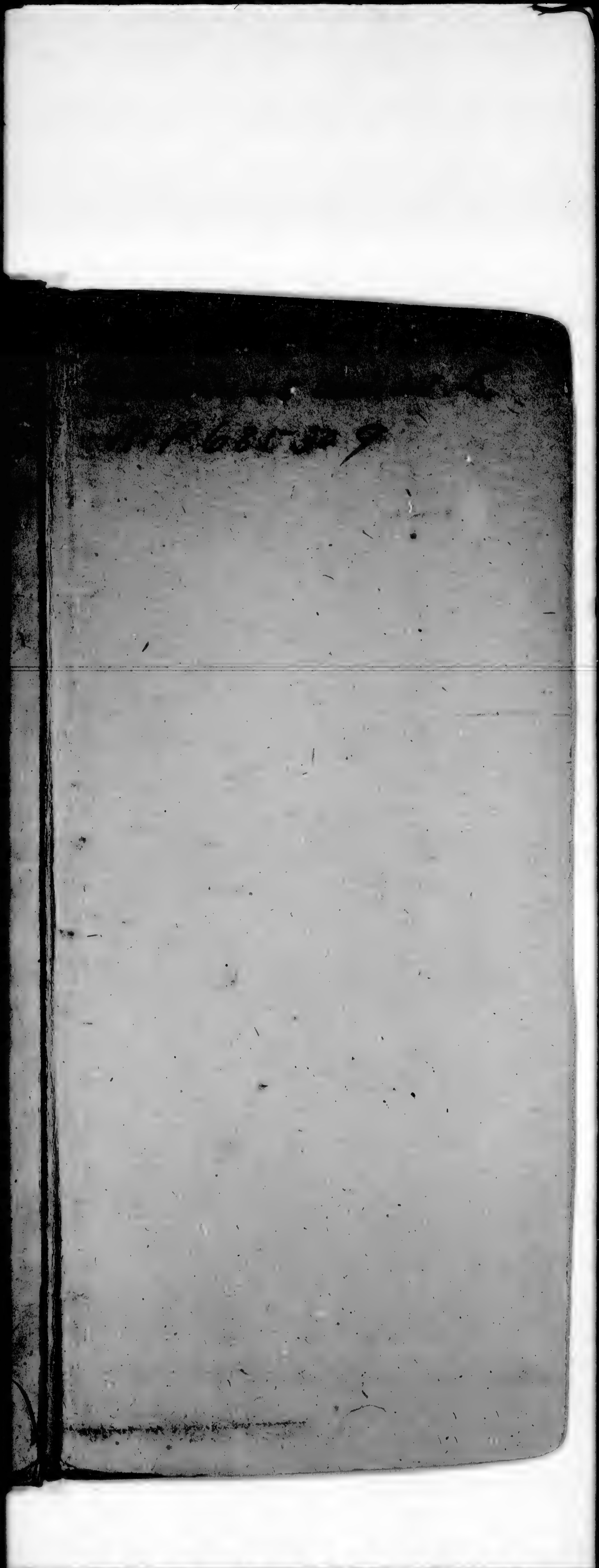

A | *6* | **U.S.C.T.**

John W. Ames
col, Co., *6* Reg't U. S. Col'd Inf.

Appears on

Regimental Descriptive Book

(List of Commissioned Officers)

of the regiment named above.

Rank *col.*

Date of appointment *Sept 16* 186*3*.

Remarks: *Appointment accepted*
Sept. 23,
Mustered Sept 28, 1863.

G. W. Chase

A | 6 | **U.S.C.T.**

Geo W Amos

Rank Col, 6 Reg't U. S. Col'd Infantry.

Age 29 years.

Appears on

Field and Staff Muster-in Roll

of the organization named above. Roll dated

Phila Pa Sept 28, 1863.

Muster-in to date * _____, 186 ____.

Joined for duty and enrolled:

When Sept 28, 1863.

Where * Phila Washington

Period 3 years.

Valuation of horse, \$ _____ 100

Valuation of horse equipments, \$ _____ 100

Remarks: * Appr by Secty of war
Sept 16 63 Appr accepted
Sept 23, 63 Mustered by
St Puirce USA Sept 28, 63

Joined for duty Sept 29, 63
* As on Roll

Book mark: _____

Amos

A 6 U.S.C.T.

John A. Ames
Rank *Col*, *6* Reg't U. S. Col'd Infantry.

Appears on

Field and Staff Muster Roll

for *to Oct 31*, 186*3*.

Present or absent *Present*

Stoppage, \$ *100* for

Due Gov't, \$ *100* for

Valuation of horse, \$ *100*

Valuation of horse equipments, \$ *100*

Remarks:

Book mark:

Ames
Original

410

U.S.C.T.

Saml H Ames

Rank *Col*, *6* Reg't U. S. Col'd Infantry.

Appears on

Field and Staff Muster Roll

for *Nov & Dec*, 1863

Present or absent *Present*

Stoppage, \$ *100* for

Due Gov't, \$ *100* for

Valuation of horse, \$ *100*

Valuation of horse equipments, \$ *100*

Remarks :

Book mark :

[Signature]

A | 6 | U.S.C.T.

John W. Amis

Rank *Col*, *6* Reg't U. S. Col'd Infantry.

Appears on
Field and Staff Muster Roll

for *Jan & Feb*, 1864.

Present or absent *Present*

Stoppage, \$ *100* for

Due Gov't, \$ *100* for

Valuation of horse, \$ *100*

Valuation of horse equipments, \$ *100*

Remarks:

Book mark:

Amis
Copyist

216 U.S.C.T.

John H. Arms

Rank *Col*, *6* Reg't U. S. Col'd Infantry.

Appears on

Field and Staff Muster Roll

for *March & Apr*, 1864.

Present or absent *Present*

Stoppage, \$ *100* for

Due Gov't, \$ *100* for

Valuation of horse, \$ *100*

Valuation of horse equipments, \$ *100*

Remarks: *Present with leave
on 50 74 rd 21st 2 pr Gov't
Twenty days from March 21
to April 12 inclusive*

Book mark:

Arms
Copyist

A 6

U.S.C.T.

John W Amis

Rank *Col*, 6 Reg't U. S. Col'd Infantry.

Appears on

Field and Staff Muster Roll

for *May & June*, 1864.

Present or absent *Present*

Stoppage, \$ 100 for

Due Gov't, \$ 100 for

Valuation of horse, \$ 100

Valuation of horse equipments, \$ 100

Remarks:

Book mark:

[Signature]

N 6

U.S.C.T.

John W Ames

Rank *Col*, *6* Reg't U. S. Col'd Infantry.

Appears on

Field and Staff Muster Roll

for *July & Aug*, 1864.

Present or absent *Present*

Stoppage, \$ *100* for

Due Gov't, \$ *100* for

Valuation of horse, \$ *100*

Valuation of horse equipments, \$ *100*

Remarks: *Present Sick*

Book mark:

Ames

416 U.S.C.T.

John W. Ames

Rank Col, 6 Reg't U. S. Col'd Infantry.

Appears on

Field and Staff Muster Roll

for Sept & Oct, 1864.

Present or absent Absent

Stoppage, \$ 100 for

Due Gov't, \$ 100 for

Valuation of horse, \$ 100

Valuation of horse equipments, \$ 100

Remarks: *In detached serv
pu SD 142 Va 215 3 Div
18ac 4 Command 3 Div
3 Div 18ac*

NEXT ROLL ON FILE 1 FEB 1865

Book mark:

Ames

(357)

Copyist

A | 6 | U.S.C.T.

John W Ames

Rank *Col*, *6* Reg't U. S. Col'd Infantry.

Appears on

Field and Staff Muster Roll

for *Jan & Feb*, 186*7*.

Present or absent *Present*

Stoppage, \$ *100* for

Due Gov't, \$ *100* for

Valuation of horse, \$ *100*

Valuation of horse equipments, \$ *100*

Remarks :

Book mark :

[Signature]

A | 6 U.S.C.T.

John W. Ames

Rank *Col*, *6* Reg't U. S. Col'd Infantry.

Appears on

Field and Staff Muster Roll

for *March & April*, 1865?

Present or absent *Present*

Stoppage, \$ 100 for

Due Gov't, \$ 100 for

Valuation of horse, \$ 100

Valuation of horse equipments, \$ 100

Remarks:

Book mark:

[Signature]

6

A. | U.S.C.T.

John W. Ames
Col. U.S.C.T.

Appears on

General Order

No. 97, dated War Department, Adjutant Gen-
eral's Office, May 26, 1865.

Appointed to be

Brigadier General

BY BREVET

in the Volunteer Force, Army of the United
States, for

To date from Jan. 15, 1865.

(400)

L. P. Atcher

Copyist.

A | 6

U.S.C.T.

John H. Amis

Rank *1st Lt* Reg't U. S. Col'd Infantry.

Appears on

Field and Staff Muster Roll

for *May & June*, 1865.

Present or absent *Absent*

Stoppage, \$ 100 for

Due Gov't, \$ 100 for

Valuation of horse, \$ 100

Valuation of horse equipments, \$ 100

Remarks: *On detached
Service Comd'g Dist
of Wilmington NC*

Book mark:

[Signature]

A | 6 | U.S.C.T.

John H Ames
Rank *Col & Capt* *6* Reg't U. S. Col'd Infantry.

Appears on
Field and Staff Muster Roll
for *July & Aug*, 1865.
Present or absent *absent*

Stoppage, \$ 100 for

Due Gov't, \$ 100 for

Valuation of horse, \$ 100

Valuation of horse equipments, \$ 100

Remarks *On detached service
Comd' Dist of Wilmington
NC*

Book mark:

Ames
(357) Copyist

8 | 6 | **U.S.C.T.**

John A Ames

Rank *Col* ~~1st Regt~~ *6* Reg't U. S. Col'd Inf.

Appears on

Field and Staff Muster-out Roll

of the organization named above. Roll dated

Wilmington N.C. Sept 20, 1865.

Muster-out to date *Sept 20, 1865.*

Last paid to *July 31, 1865.*

Clothing account:

Last settled....., 186 ; drawn since \$..... 100

Due soldier \$..... 100; due U. S. \$..... 100

Am't for cloth'g in kind or money adv'd \$..... 100

Due U. S. for arms, equipments, &c., \$..... 100

Bounty paid \$..... 100; due \$..... 100

Remarks:.....

Book mark *115307.78*

W. W. Wood
Copyist.

Ames, J. W.

Col., Co.

6

Reg't

U.S.C. Inf.

12 Enclosures.

Bed Cards	Descriptive Lists
Burial Records	Final Statements
Certs. of Dis. for Discharge	Furloughs
C. M. Charges	Med. Des. Lists
Med. Certificates	Orders 3

Other papers relating to—

Admission to Hosp'l	Furlough 3
Casualty Sheet (Officer's)	Med. Examination
Confinement	Misc. Information 6
Contracts	Pay or Clothing
Death or Effects	Personal Reports
Desertions	Rank
Discharge from Hosp'l	Transfer to Hosp'l
Discharge from Service	Transfer to V. R. C.
Duty	Transportation

John Ames
Carl Gustaf

John C. ...
(2016) ...
Carl John H. ...
C. ...

Jan. 1895
with the ...
County ...

...
...
L.W. Foster

War Department,

ADJUTANT GENERAL'S OFFICE,

Washington, D. C., July 17th 1863.

Colonel:

I have pleasure to announce here-
with your appointment as Colonel C^t.
Regt U. S. Cavalry Troops, and am instructed
by the Secretary of War to say that should you
accept the same, you will proceed immedi-
ately to Camp William Penn, near Philadelphia
Pa., and take command of your regiment,
which will be turned over to you by Lieut
Colonel Wagner, 5th Regt. U. S. Cavalry in
command of the Post.

It is not intended that your appoint-
ment shall cause any interference with
the command of the Post, which will be
retained by Lieut Colonel Wagner.

Very Respectfully,
Samuel C. Terry

Head Quarters Dept. of Virginia and North Carolina,

Fort Monroe, Va. Feb. 17th 1864.

SPECIAL ORDERS, }

No. 48 }

I

Extract

A Court of Enquiry is hereby appointed, in accordance with Sec 10 of the Act of Congress approved July 22^d 1861 to meet at Fort Monroe on Thursday the 18th inst. to examine into and report upon the capacity, qualification, propriety of conduct and efficiency of Col. John A. Nelson 10th U.S. C.T. and also to investigate into ~~the~~ fact whether unwilling recruits have been forced into said regt. The Court will form and give ~~an~~ opinion on the case

Detail for the Court.

Col. J. W. Ames 6th U.S. C Troops.

By Command of Major General BUTLER:

R. D. Davis
Assistant Adjutant General.

To Col. Ames
The Gen. Muster

AC 10. Hd. Qrs. Brigade U.S.C.T. No 3 ✓

Camp in Yorktown Va. March 14 1864

A. S. B. Hd. Qrs. U.S.C.T. Yorktown Va. J. W. Ames, Col. 6th Regt. U.S.C.T. applies for a leave of absence for twenty days.

Field & Staff 6 th U.S.C.T.	
present for duty	8
Field & Staff - in arrest	0
" " Sick	0
" " Absent	0
Line Officers present for duty	25
" " in arrest	3
" " Sick	1
" " absent with leave	0
" " detached	5

Hd Qrs. 6th U.S.C.T. Camp in Yorktown Va. March 14th 64
Respectfully forwarded.
J. W. Ames
Col. 6th U.S.C.T.

Hd Qrs U.S.C.T. Yorktown. March 14, 1864
Hd. Qrs. Brigade U.S.C.T. March 14/64

Hd. Qrs. Brigade U.S.C.T. Yorktown Va: March 14/64

Approved and respectfully forwarded

Saml. A. Drucan
Capt. Comdr

Hd. Qrs. U.S. Army, Yorktown Va
March 14th 64

Respectfully forwarded

Approved J. Wistar
B.C.

Grant

J. W. Ames
Col. 6th U.S.C.T.

S.O. 74-5 1864

Camp nr. Yorktown Va.

March 14th 1864

Major R. J. Davis Ast. Adj. Genl.
Dept. of Va. and No. Ca.

Sir

I have the honor to request
a leave of absence for twenty days to visit my
home in Boston, Mass. I have been in
the military service since May 14th 1861, and
have ever since been on duty, with but one
leave of absence, of fifteen days, during the
winter of 1862-63 -

I am Sir, very respectfully

Yours Obedt. Servt.

J. W. Ames

Col. 6th Regt. U. S. C. T.

Head Quarters Dept. of Virginia and North Carolina,

Fort Monroe, Va., March 15th 1864.

SPECIAL ORDERS,

No. 74

EXTRACT.

Leaves of Absence to go out of the Department are hereby granted to the following named Officers:

Col. J. W. Ames. 1st U.S. C Troops for twenty (20) days.

+ x x x x x

Stacy
Feb 22 1864
to the

Done for the

779 G-A M.A.C. 1865.
Hd Qrs Examining Board
April 3-1865.

Ames John W.
Col 6 US Corps

Respectfully requests to
be relieved from the within
detail

Hd. Qrs. Exam & Board
April 4th, 1865.

Respectfully forwarded for
the favorable consideration
of the Maj. Gen. Com of the
10th Corps.

Col. Ames can
not be spared from the
Mil. Exam. Board of which
he is a member without
seriously interfering with
the business now before it,
and which seems to be of
an imperative character.

Saml. A. Duncan
Brig. Surgeon &
Asst. Dir. of Gen. Hosp.

Head Quarters 10th Army Corps
Jailers Station N.C. April 3rd 1865
Respectfully referred to Brig
Gen. Charles J. Paine with the
request that he will name
some Colonel from his command
for duty as President of General
Court Martial in the place
of Colonel Ames.

By Order of
Major Gen. A. H. Terry
Adrian Terry
Major & A. S. S.

H. Q. 3rd Div. 10th Corps
Apr. 4. 1865

I wd respdy suggest the
name of Col. ~~Stuart~~
~~5th U.S.C.T.~~ mustered Col. Holman
(John H.) 1st U.S.C.T. Comdg
3rd Brig; Mustered May 22, 1863.
C. J. Paine Brig Genl. 10th Corps

Head Qrs. Examining Board -
 April 21st - 1865

Major

I have the honor to acknowledge the receipt of Special Order No. 2. Hd. Qrs. 10th Corps of date April 3rd. - detailing me as a general Court-Martial to meet at Hd. Qrs. 10th Corps at 10 o'clock A.M. on the 21st day of April '65.

I also have the honor to respectfully request to be relieved from the said detail, on account of being at present engaged upon duty by virtue of Special Order No. 33 - Par. 1. Hd. Qrs. Dept. of North Carolina - Army of the Ohio, - dated March 20th - 1865, - which duty occupies my entire time from 9 o'clock A.M. - to 1 o'clock P.M. daily, and also for or five hours of the afternoon besides. And this duty is furthermore likely to continue for several days to come.

I have the honor to be Sir, very respectfully
 Your obedient servant,

Adrian Terry
 Major - Act. Adj. Gen.
 10th Army Corps.

J. J. [Signature]
 Col 5th U.S. Inf.

810.

U. S. MILITARY TELEGRAPH

P. Williams

D.A.S.

Washington

July 11th

Blunt

Williams

Col. G. U.S. C.A.

File

2307

U. S. MILITARY TELEGRAPH.

July 11th 1865.

By Telegraph from Washn D.C. 1865.

To Comdg Gen Dept-Fla

The Lieut-Gen Comdg authorizes
 you to grant fifteen (15) days
 leave from 16th inst to Brig
 Genl J. H. Ames M. S. F. S.
 a graduate of Howard University
 Cambridge Mass. Provided he
 can be spared to enable him
 to attend commemorative exercises
 to be held at that place
 July 21st. Please acknowledge
 receipt by telegraph

R. Williams
 A. S.

820

DEPARTMENT OF THE ARMY

Saml H Duncan
P. P. Gent
New York N.Y.
July 13th 1863

Genl. Amos

Col. G. W. G. J.

File

U. S. MILITARY TELEGRAPH.

July 13th 1865.

By Telegraph from New Bern 1865.

To Maj. C. A. Killey
D. D. G.

Gen Paine desires to enquire
of you the occasion of Gen
Ames leave of absence, if a
particular one, also when he
will leave Wilmington

Saml A Durcan
B. D. Genl

#31.

DEPARTMENT OF THE ARMY

U. S. MILITARY

Edward E. Vatiner
Capt. A. S.

Wilmington

July 11/65

Genl. Ames

Col. G. U. S. G. S.

File

U. S. MILITARY TELEGRAPH.

July 14 1865.

By Telegraph from Charleston 1865.

To Maj C A Kelley
D. S. S.

Bvt-Maj Genl Ames is
not going North at present,
he is present today at
Chang's Sound

Edward E. Latimer
Capt U. S. A.

G. O. No. 67
3rd Divi
July 14th

Ames, J. H. Col.

62507

[Faint, illegible handwritten text, likely bleed-through from the reverse side of the page]

Headquarters 3^d Div 18th A.C.
Ditho field on July 1st 1867

General Order }
No 67 }

Colonel J. W. Ames 610 Regt
U.S.C. is hereby announced
as Division Officer of the Day
for to morrow, July 1st 1867 and
will report at these Headquarters a
9 o'clock A.M. and at Corps Headquarters a
9 o'clock A.M.

By Command of Col J. H. Coleman
Sgt. John Carter
Capt. A. A. G.

Official
Henry Debus
Capt. A. A. G.

C. J. (C. J. 216) 1865
3rd Div. 25th Ala 1865

Aid. Qu. 2nd Brig. 1st Div. 25th A. C.
In the Field Va. Dec. 31. 1864

Ames J. W. Col. 6th U. S. C. T.
Comd'g Brig.

Applies for twenty five
days leave of absence
A. J. (C. J. 216) 1865

Rec'd. 6th Feb 3

Head Quarters 3rd Div. 25th A. C.
In the field Va. Jan. 1. 1865

Respectfully forwarded
Approved

C. J. Paine
Brig Gen.
c-2

Hedges 25th A. C.
On the field Va
Jan. 1st 1865
2 A B 1-25 A B

Respectfully for-
warded. Cordially
Approved.

G. Wertz
Maj. Gen.

Std. Qu. Dept. Va & M. C.
Army of the James
In the field Jan 4th 1865.

Respectfully returned
to the Commanding General
25th Army Corps. for re-
port whether this officer
accompanied the
expedition.

By Command of
Maj. Gen. Butler:
~~Israel Peck~~
A. A. Galt



Hd. Qu. 3rd Div. 25th Ala. Jan 1 1865.

1
 Hd. Qrs. 2nd Brig. 1st Div. 25th Corps
 Camp on Chaffin's farm Dec. 31st 1864 -
 Lieut. Col. Ed. W. Smith Asst. Adjt. Genl -
 Army of the James

Sir -

I have the honor to request
 a leave of absence for twenty five, (25),
 days, that I may visit my home in
 Boston Massachusetts -

I am Sir, very respectfully
 your Obedt. Servt.

D. W. James
 Col. comdg. Brig. -

Recd Apr. 25 ac
In the field, on Jan 4/65
L. A. B. - 65

Respectfully reforwarded
Col. Ames accompanied the
expedition with Gen Paine

C. C. Hooker

Post Office

file at present -

J. M. Ames
Col. 6. U.S.A.

A. 30 3rd Div. 10th A. C. 1865
 Head Quarters 3rd Brig. 3rd Div. 10th A. C.
 Camp Pir. Raleigh N. C. Apr. 22 1865
 A 104-Vol I-D. M. C-1865

Ames; J. M.
 Col. Comd'g.
 6. M. S. Co. Inf

Requests leave of absence
 for thirty (30) days to visit
 Massachusetts on import-
 tant private business.

318

Head Quarters 3rd Div. 10th A. C. Apr. 22 1865

J. M. Ames Col.
 H. Co 3rd Div 10th A. C.
 near Raleigh Apr. 22/65

Respy forwarded
 Approved

Chas. J. Paine
 Brig Genl Comd'g

S. B.
 granted
 J. M.

Head Quarters 10th A. C.,
 Raleigh, N. C.,
 April 24. 1865.

Respy forwarded
 Approved

Reuben S. King
 Major Genl
 Com.

254

318

S. O. #46. Part 1. 5/2/65

Head Qrs. 3^d Brig. 3^d Div. 10th Corps.
Camp nr. Raleigh N. C. April 22^d 1865

Major

I have the honor to respectfully request a leave of absence for thirty days, that I may visit the State of Massachusetts on a matter of much importance to myself. I have been under obligation in this matter for some time, but have been prevented from obtaining a leave by the two expeditions against Fort Fisher, and the subsequent active operations. I have had no leave for more than a year.

I am Sir, very respectfully
Your Obedt. Servt.

J. W. Ames

Col. comd'g. Brig.

J. A. Campbell
Maj. & Act. Adj. Genl.
Dept. of North Carolina

135

U. S. MILITARY TELEGRAPH

J. H. Ames
By B. B. Hunt
New York

July 15th 1865

Genl. Ames

~~Col. G. U. S. C. A.~~
C. H. S. C. A.

File

U. S. MILITARY TELEGRAPH.

July 15th 1865.

By Telegraph from Wilmington 1865.

To Maj' C. S. Kelley

I accept the leave of
absence to visit Howard
College Commemorative exercises
Gen Linnear has arrived
to relieve me

J. W. Ames
Brigadier General

Private Private

CARD NUMBERS.

5567880	26
5570711	27
5570805	28
5570906	29
5571006	30
5571101	31
5571192	32
9064543	33
	34
10	35
11	36
12	37
13	38
14	39
15	40
16	41
17	42
18	43
19	44
20	45
21	46
22	47
23	48
24	49
25	50

Book Mark: _____

See also _____

A 6 U.S.C.T.

Charles Anderson

, Co. B, 6 Reg't U. S. Col'd Inf.

Appears on

Company Descriptive Book

of the organization named above.

DESCRIPTION.

Age 24 years; height 5 feet 3 inches.

Complexion *Black*

Eyes *Black*; hair *Black*

Where born *Canada*

Occupation *Laborer*

ENLISTMENT.

When *Oct 4*, 186*4*.

Where *Buffalo N.Y.*

By whom *Capt Rodges*; term *3* y'rs.

Remarks: *Received on
Enlistment 100
U.S. Bounty*

W J Roe

2

A | 6 | U.S.C.T.

Charles Anderson

Appears with rank of *Private* on
**Muster and Descriptive Roll of a Detach-
 ment of U. S. Vols. forwarded**

for the 6 Reg't U. S. Col'd Infantry. Roll dated
Stark Id. M. H., Oct 11, 1864.

Where born *Canada*

Age *24* y'rs; occupation *labors*

When enlisted *Oct 4*, 1864.

Where enlisted *Buffalo*

For what period enlisted *3* years.

Eyes *black*; hair *black*

Complexion *black*; height *5* ft. *3* in.

When mustered in *Oct 4*, 1864.

Where mustered in *Buffalo*

Bounty paid \$ *100*⁰⁰; due \$ *100*

Where credited *30 Cong Dist Buffalo*

Company to which assigned

Remarks:

Book mark:

M Jones

W **6** | **U.S.C.T.**

Charles Anderson
Pr, Co. B, 6 Reg't U. S. Col'd Infantry.

Appears on

Company Muster Roll

for *Dephock*, 1864.

Present or absent *Present*

Stoppage, \$ *100* for

Due Gov't, \$ *100* for

Remarks:

NEXT ROLL ON FILE FEB 1865

Book mark:

J. A. Lemar
Copyist

A | 6 | U.S.C.T.

Charles Anderson

Priv, Co. B, 6 Reg't U. S. Col'd Infantry.

Appears on

Company Muster Roll

for Jan. & Feb, 1865.

Present or absent Present

Stoppage, \$ 100 for

Due Gov't, \$ 100 for

Remarks:

Book mark:

M. L. ...

A

6

U.S.C.T.

Charles Anderson
Priv, Co. B, 6 Reg't U. S. Col'd Infantry.

Appears on

Company Muster Roll

for *Mar. & Apr*, 1865.

Present or absent *Present*

Stoppage, \$ *100* for

Due Gov't, \$ *100* for

Remarks: *Received on*
Enlistment #100
U.S. Army.
See U.S. for
Wiper. 20, Tompkins
.02

Book mark:

J. W. Leonard

(358)

Copyist

A. | 6 | U.S.C.T.

Charles Anderson
Priv., Co. B, 6 Reg't U. S. Col'd Infantry.

Appears on

Company Muster Roll

for May & June, 1865.

Present or absent Present

Stoppage, \$ 0 22 100 for Order Articles
on last Rolls.

Due Gov't, \$ 100 for

Remarks:

Book mark:

(358)

B. J. Cooke

Copyist

A. | **6** | **U.S.C.T.**

Charles Anderson
Pvt., Co. B, 6 Reg't U. S. Col'd Infantry.

Appears on

Company Muster Roll

for *July & Aug.*, 1865.

Present or absent *Present*

Stoppage, \$ 100 for

Due Gov't, \$ 100 for

Remarks:

Book mark:

B. J. Cooke

A. | 6 | U.S.C.T.

Charles Anderson
Pvt., Co. B, 6 Reg't U. S. Col'd Infantry.

Appears on Co. Muster-out Roll, dated
Wilmington, N.C., Sept. 20, 1865.

Muster-out to date Sept. 20, 1865.

Last paid to Apr. 30, 1865.

Clothing account:

Last settled Nov., 186 ; drawn since \$ 45.71

Due soldier \$ 1.00; due U. S. \$ 1.00

Am't for cloth'g in kind or money adv'd \$ 1.00

Due U. S. for arms, equipments, &c., \$ 1.00

Bounty paid \$ 1.00; due \$ 1.00

Remarks: Due Mr. Priben Regtl
Sutter \$18.00

Book mark: V. 230. P. 78. 76.

(861)

B. J. Cooke
Copyist.

Anderson, Charles

Co. 6 Reg't U S C. Infy

2 Enclosures.

Bed Cards	Final Statements
Burial Records	Furloughs or L. of A.
Certs. of Dis. for Discharge	Med. Certificates
C. M. Charges	Med. Des. Lists
Descriptive Lists	Orders
Discharge Certificates	Pris. of War Record
Enlistment Papers 2	Resignations

Other papers relating to—

Admission to Hosp'l	Furlough or L. of A.
Casualty Sheet	Med. Examination
Confinement	Misc. Information
Contracts	Pay or Clothing
Death or Effects	Personal Reports
Desertion	Rank
Discharge from Hosp'l	Transfer to Hosp'l
Discharge from Service	Transfer to V. R. C.
Duty	Transportation

NOTE 1.—This blank will be used for both enlistments and re-enlistments—enlistment of veterans, &c., &c., in the volunteer service. They will be made out in duplicate in all cases—one to accompany the recruiting return of the superintendent (not the recruiting officer) to the Adjutant General, and one to accompany the accounts of the officer who pays bounty, &c. The Regiment and Company in which the soldier last served should be given on the back.

NOTE 2.—An enlistment holds to service. A muster-in must, in all cases, precede payment of pay, bounty, pension, &c. A muster-in roll must, in all cases, be filed in the Adjutant General's Office as evidence of muster-in. The mustering officer, commissary, or assistant commissary of musters, as the case may be, will countersign both enlistments as having mustered the soldier into the service of the United States before either of them is given to the disbursing officer.

DECLARATION OF RECRUIT.

I, Charles Anderson, desiring to VOLUNTEER as a Soldier in the Army of the United States, for the term of THREE YEARS, Do Declare, That I am Twenty four years and _____ months of age; that I have never been discharged from the United States service on account of disability or by sentence of a court martial, or by order before the expiration of a term of enlistment; and I know of no impediment to my serving honestly and faithfully as a soldier for three years.

GIVEN at Pittsford N.Y. the 4 day of October 1864

Witness: Geo Phillips Charles Anderson
mark

Discharged _____, 18 .

Reg't of _____

enlistment; last served in Company ()

By Geo W Allen
Regiment of 22nd 1st Regt

Volunteered at Pittsford N.Y. 18 64

386116 B Co 3rd
Charles Anderson
No. 2000

CONSENT IN CASE OF MINOR.

I, _____, Do CERTIFY, That I am the _____ of _____; that the said _____ is _____ years of age; and I do hereby freely give my CONSENT to his volunteering as a SOLDIER in the ARMY OF THE UNITED STATES for the period of THREE YEARS.

GIVEN at _____ the _____ day of _____

Witness: _____

VOLUNTEER ENLISTMENT.

STATE OF *New York* TOWN OF *Hamburg*
Ein Regiment 30th Dist



I, *Charles Anderson*, born in *Canada*
in the State of _____, aged *Twenty four* years,
and by occupation a *Laborer*, DO HEREBY ACKNOWLEDGE to have
volunteered this *fourth* day of *October*, 186 *4*
to serve as a **Soldier** in the **Army of the United States of America**, for
the period of **THREE YEARS**, unless sooner discharged by proper authority:
Do also agree to accept such bounty, pay, rations, and clothing, as are, or may be,
established by law for volunteers. And *Charles Anderson*, do
solemnly swear, that I will bear true faith and allegiance to the **United States
of America**, and that I will serve them honestly and faithfully against all their
enemies or opposers whomsoever; and that I will observe and obey the orders of
the President of the United States, and the orders of the officers appointed over
me, according to the Rules and Articles of War.

Sworn and subscribed to, at *Buffalo NY* his
this *4* day of *October*, 186 *4* of *Charles Anderson*
BEFORE *Wm Rogers*
Capt & Prov Marshal 30th Dist

I CERTIFY, ON HONOR, That I have carefully examined the above-named Volunteer, agreeably
to the General Regulations of the Army, and that, in my opinion, he is free from all bodily defects and
mental infirmity, which would in any way disqualify him from performing the duties of a soldier.

*Stephell
Smyth*
EXAMINING SURGEON.

I CERTIFY, ON HONOR, That I have minutely inspected the Volunteer *Charles Anderson*
previously to his enlistment; and that he was entirely sober when enlisted; that, to the best of my
judgment and belief, he is of lawful age; and that, in accepting him as duly qualified to perform the
duties of an able-bodied soldier, I have strictly observed the Regulations which govern the recruiting
service. This soldier has *Black eyes, Black hair, Black complexion*, is *five*
feet *3* inches high

Wm Rogers
Capt & Prov Marshal
Regiment of _____ Volunteers
30th Dist RECRUITING OFFICER.

(A. G. O. No. 74 & 76.)

Mustered into the service of the United States, for three years or during the war, from date of enlistment, in Company
_____ Regiment of *Volunteers*, on the *4* day of *October*, 186 *4*, at *Buffalo NY*

Wm Rogers
Capt & Prov Marshal 30th Dist
Mustering Officer

NOTE 1.—This blank will be used for both enlistments and re-enlistments—enlistment of veterans, &c., &c., in the volunteer service. They will be made out in duplicate in all cases—one to accompany the recruiting return of the superintendent (not the recruiting officer) to the Adjutant General, and one to accompany the accounts of the officer who pays bounty, &c. The Regiment and Company in which the soldier last served should be given on the back.

NOTE 2.—An enlistment holds to service. A muster-in must, in all cases, precede payment of pay, bounty, pension, &c. A muster-in roll must, in all cases, be filed in the Adjutant General's Office as evidence of muster-in. The mustering officer, commissary, or assistant commissary of musters, as the case may be, will countersign both enlistments as having mustered the soldier into the service of the United States before either of them is given to the disbursing officer.

DECLARATION OF RECRUIT.

I, Charles Anderson desiring to VOLUNTEER as a Soldier in the Army of the United States, for the term of two YEAR Do Declare, That I am thirty seven years and _____ months of age; that I have never been discharged from the United States service on account of disability or by sentence of a court martial, or by order before the expiration of a term of enlistment; and I know of no impediment to my serving honestly and faithfully as a soldier for three year

GIVEN at Buffalo N.Y. the 4 day of October, 1864

Witness: James Phillip Charles Anderson

State	District of	County	Town	Ward
N. Y.				

EXTRACT FROM ARMY REGULATIONS, EDITION 1861.
940. Enlistments must in all cases be taken in triplicate. The recruiting officer will send one copy to the Second Auditor with his monthly accounts, a second to the Superintendent with his monthly return, and a third to the depot at the time the recruits are sent there. In cases of soldiers re-enlisted in a regiment, or of regimental recruits, the third copy of the enlistment will be sent at its date to regimental headquarters for file.

Discharged _____, 18 _____

By Levi Wallace
6th Regiment of Artillery

enlistment: last served in Company _____

Volunteered at Buffalo N.Y.
October 21, 1864
No. 7641
Charles Anderson

CONSENT IN CASE OF MINOR.

I, _____ Do CERTIFY, That I am the _____ of _____; that the said _____ is _____ years of age; and I do hereby freely give my CONSENT to his volunteering as a SOLDIER in the ARMY OF THE UNITED STATES for the period of _____ year

GIVEN at _____ the _____ day of _____

Witness: _____

VOLUNTEER ENLISTMENT.

STATE OF
NEW YORK,

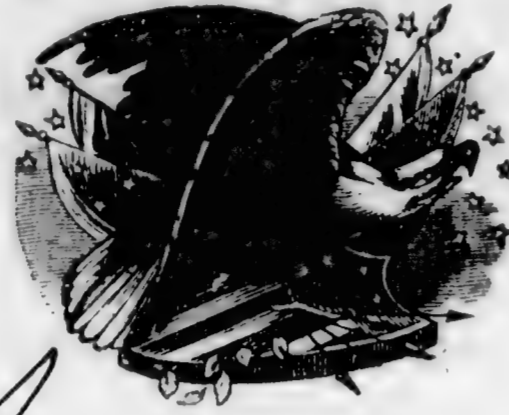

TOWN OF *Hamburg*
City 30th Dist

I, *Leahy, Andrew*, born in *Canada*
in the State of *Ontario*, aged *Twenty four* years,
and by occupation a *Farmer*, Do HEREBY ACKNOWLEDGE to have
volunteered this *Tenth* day of *October*, 1864,
to serve as a **Soldier** in the **Army of the United States of America**, for
the period of *Three* YEARS unless sooner discharged by proper authority.
Do also agree to accept such bounty, pay, rations and clothing, as are, or may be,
established by law for volunteers. And I, *Leahy, Andrew*
do solemnly swear, that I will bear true faith and allegiance to the **United States
of America**, and that I will serve them honestly and faithfully against all their
enemies or opposers whomsoever; and that I will observe and obey the orders of the
President of the United States, and the orders of the officers appointed over me, ac-
cording to the Rules and Articles of War.

Sworn and subscribed to, at Buffalo, N. Y.,

this *4th* day of *Oct*, 1864,

BEFORE

W. Rogers
Capt. & Provost Marshal 30th Dist. N. Y.

Leahy, Andrew
mark

I CERTIFY, ON HONOR, That I have carefully examined the above-named Volunteer, agreeably
to the General Regulations of the Army, and that, in my opinion, he is free from all bodily defects and
mental infirmity, which would in any way disqualify him from performing the duties of a soldier.

Henry M. ...
Examining Surgeon.

I CERTIFY, ON HONOR, That I have minutely inspected the Volunteer *Leahy, Andrew*
previously to his enlistment, and that he was entirely sober
when enlisted; that, to the best of my judgment and belief, he is of lawful age; and that, in accepting
him as duly qualified to perform the duties of an able-bodied soldier, I have strictly observed the Regu-
lation which govern the recruiting service. This soldier has *black* eyes, *black* hair,
black complexion, is *5* feet *3* inches high.

W. Rogers
Capt. & Provost Marshal 30th District, N. Y.,
Recruiting Officer.

(A. G. O. No. 74 & 76.)

Mustered into the service of the United States, for *Three* year *3* or during the war, from date of enlistment, in Company *1st*
Regiment of *11th N. Y. Cavalry* Volunteers, on the *4th* day of *October*, 1864, at *Buffalo, N. Y.*
Capt. & Provost Marshal 30th District, N. Y.,
Mustering Officer.

6 U.S. Col'd Inf.

Private Corporal

CARD NUMBERS.

1	5578196	26
2	5578277	27
3	5578360	28
4	5578444	29
5	5578520	30
6	5578596	31
7	5578671	32
8	5578745	33
9	5578813	34
10	5578908	35
11	5579006	36
12	5579096	37
13	5579179	38
14	9065632	39
15		40
16		41
17		42
18		43
19		44
20		45
21		46
22		47
23		48
24		49
25		50

Book Mark:

See also

A | **6** | **U.S.C.T.**

Elias Anderson,

Co. A, 6 Reg't U. S. Col'd Inf.

Appears on

Company Descriptive Book
of the organization named above.

DESCRIPTION.

Age *20* years; height *5* feet *5* inches.

Complexion *black*

Eyes *black*; hair *black*

Where born *Mifflin Co. Penn.*

Occupation *Labourer*

ENLISTMENT.

When *Sept 11*, 186*8*.

Where *Philadelphia*

By whom *Capt. Sargent*; term *3* y'rs.

Remarks: *Enlisted 2^d D. Penn.*
Corporal.

Jenkins

A. | **6** | **U.S.C.T.**

Elias Anderson.
Pat., Co. I, 6 Reg't U. S. Col'd Infantry.

Age 20 years.

Appears on

Company Muster-in Roll

of the organization named above. Roll dated
Philada, Pa., Sept. 11, 1863.

Muster-in to date Sept. 11, 1863

Joined for duty and enrolled:

When Sept. 10, 1863.

Where Philadelphia, Pa.

Period 3 years.

Remarks: Enlisted Penna. 17
Dis. Mustered by Lieut.
Price U.S.A. Sept. 11, 63.

Book mark: _____

Ar.

6

U.S.C.T.

Elias Anderson

Prvt., Co. I, 6 Reg't U. S. Colored Infantry.

Appears on

Company Muster Roll

for *Sept. & Oct.*, 1863.

Present or absent *Present.*

Stoppage, \$ *100* for

Due Gov't, \$ *100* for

Remarks:

Book mark:

(858)

Ar.
Copyist.

A.

6

U.S.C.T.

Elias Anderson

Pat., Co. I, 6 Reg't U. S. Colored Infantry.

Appears on

Company Muster Roll

for *Nov. & Dec.*, 1863.

Present or absent *Present*

Stoppage, \$ *100* for

Due Gov't, \$ *100* for

Remarks: *Due U.S. for one
Haversack 56cts.*

Book mark:

(853)

Ash
Copyist.

A.

6

U.S.C.T.

Elias Anderson

Priv. Co. I, 6 Reg't U. S. Colored Infantry.

Appears on

Company Muster Roll

for *Jan'y & Feby.*, 186*4*.

Present or absent *Present*.

Stoppage, \$ *100* for

Due Gov't, \$ *100* for

Remarks:

Book mark:

A. H.

Copyist.

A.

6

U.S.C.T.

Elias Anderson

Corpl, Co. I, 6 Reg't U. S. Colored Infantry.

Appears on

Company Muster Roll

for *Mar & Apr*, 1864.

Present or absent *Present*

Stoppage, \$ *100* for

Due Gov't, \$ *100* for

Remarks: *Promoted to Corporal
March 27. 64.*

Book mark:

Ash
Copyist.

A. | 6 | U.S.C.T.

Elias Andersson

Capt. Co. I, 6 Reg't U. S. Colored Infantry.

Appears on

Company Muster Roll

for May & June, 1864.

Present or absent Present.

Stoppage, \$ 100 for

Due Gov't, \$ 100 for

Remarks:

Book mark:

H. W. Reed

(853)

Copyist.

A. | 6 | U.S.C.T.

Elias Andersson
Corpl., Co. I, 6 Reg't U. S. Colored Infantry.

Appears on

Company Muster Roll
for July & Aug., 1864.
Present or absent Present.

Stoppage, \$ 100 for

Due Gov't, \$ 100 for

Remarks: Free April 19th 63.

Book mark:

A. W. Reed

A. | 6 | U.S.C.T.

Elias Anderson

Capt., Co. I, 6 Reg't U. S. Colored Infantry.

Appears on

Company Muster Roll

for Sept. & Oct., 1864

Present or absent Present

Stoppage, \$ 100 for

Due Gov't, \$ 100 for

Remarks:

NEXT ROLL ON FILE FEB 1865

Book mark:

A. M. Reed

(353)

Copyist.

A. | 6 | U.S.C.T.

Elias Anderson

Coyl Co. I, 6 Reg't U. S. Colored Infantry.

Appears on

Company Muster Roll

for *Jan. & Feb.*, 1865.

Present or absent *Present.*

Stoppage, \$ *100* for

Due Gov't, \$ *100* for

Remarks: *Free Apr. 19/61.*

Book mark:

H. W. Reed

A. | 6 | U.S.C.T.

Elias Andersson
Copt. Co. I, 6 Reg't U. S. Colored Infantry.

Appears on

Company Muster Roll

for dated May 3, 1865.

Present or absent Present.

Stoppage, \$ 100 for

Due Gov't, \$ 100 for

Remarks: Free Apr. 19/61.

Due U.S. Chaversack
67 cts. / canteen 45 cts.
1 ball screw 13 cts. / wiper
20 cts. \$1.45.

Book mark:

A. H. Reed

A

6

U.S.C.T.

Elias Anderson

Capt, Co. I, 6 Reg't U. S. Colored Infantry.

Appears on

Company Muster Roll

for *May & June*, 186*7*.

Present or absent *Present*

Stoppage, \$ *100* for

Due Gov't, \$ *100* for

Remarks: *Charged on prev Rolls
for ordinance 33
Charged on past Rolls for
C.C. & G. Eq. 8/1/7*

Book mark: _____

(358)

Vosley

Copyist.

A | 6 | U.S.C.T.

Elias Anderson

Capt., Co. I, 6 Reg't U. S. Colored Infantry.

Appears on

Company Muster Roll

for *July & Aug*, 186*5*.

Present or absent *Present*

Stoppage, \$ *100* for

Due Gov't, \$ *36* ^{*95*}/_{*100*} for *Claw & Eq.*

Remarks: *Due us transportation*

6.16.

ordnance charged 33^c

Book mark: _____

(858)

Paley

Copyist.

A | 6 | U.S.C.T.

Elias Anderson

Corpl, Co., 6 Reg't U. S. Col'd Infantry.

Appears on Co. Muster-out Roll, dated
Wilmington N.C. Sept 20, 1865.

Muster-out to date *Sept 20*, 1865.

Last paid to *Apr 30*, 1865.

Clothing account:

Last settled *June 29*, 1864; drawn since \$ *34*⁴⁵/₁₀₀

Due soldier \$ 100; due U. S. \$ 100

Am't for cloth'g in kind or money adv'd \$ 100

Due U. S. for arms, equipments, &c., \$ 100

Bounty paid \$ *None* 100; due \$ 100¹⁰⁰

Remarks: *Due Mr. Brisbane Regt. Suttler # 27. Pay on Rolls for Apr 19, 1861, due \$6 per month from date of enlistment to Apr 30, 1864. Due U.S. transportation \$6.66*

Book mark *2115-1882*

Posey

Private

Co. A, 6 U.S. Col'd Inf

Private Private

CARD NUMBERS.

1	5568500	26
2	5577703	27
3	5577798	28
4	5577892	29
5	5577981	30
6	5578066	31
7	9065599	32
8		33
9		34
10		35
11		36
12		37
13		38
14		39
15		40
16		41
17		42
18		43
19		44
20		45
21		46
22		47
23		48
24		49
25		50

Book Mark:

See also

H | **6** | **U.S.C.T.**

Frank Anderson

....., Co. *H*, 6 Reg't U. S. Col'd Inf.

Appears on

Company Descriptive Book
of the organization named above.

DESCRIPTION.

Age *30* years; height *5* feet *6* inches.

Complexion *Blk*

Eyes *Blk* ; hair *Blk*

Where born *Wilmington Del.*

Occupation *Lab.*

ENLISTMENT.

When *Nov. 17*, 1864.

Where *Wilmington Del.*

By whom ; term *1* y'rs.

Remarks: *Drafted 3rd Disty.*
Del.

Jenkins

A 1 6 | U.S.C.T.

Frank Anderson

Appears with rank of _____ on
**Muster and Descriptive Roll of a Detach-
 ment of Drafted Men and Substitutes**
 forwarded

for the *6* Reg't U. S. Col'd Inf. Roll dated
Baltimore Md, Nov 19, 1864.

Where born *Delaware*

Age *30* years; occupation *Laborer*

Drafted and mustered in:

When *Nov 19*, 1864.

Where *Wilmington*

Period *1* years.

Eyes *Blk*; hair *Drk*

Complexion *Drk*; height *5* ft. *6* in.

Paid bounty and advance pay, \$ *100*

Bounty due \$ *100*

Where credited _____

Company to which assigned _____

Remarks *Drafted from Wil-*
mington Del

Book mark: _____

J. H. Wright

CA

6

U.S.C.T.

Frank Anderson

Priv., Co. H, 6 Reg't U. S. Col'd Infantry.

Appears on

Company Muster Roll

for Jan & Feb, 1865.

Present or absent Present

Stoppage, \$ 100 for

Due Gov't, \$ 100 for

Remarks:

Book mark:

W. Harper

(858)

Copyist.

CA | 6 | U.S.C.T.

Frank Anderson

Priv, Co. H, 6 Reg't U. S. Col'd Infantry.

Appears on

Company Muster Roll

for Mar & April, 1865.

Present or absent Present

Stoppage, \$ 100 for

Due Gov't, \$ 100 for

Remarks:

Book mark:

CA Haizer

A

6

U.S.C.T.

Frank Anderson

Pvt, Co. H, 6 Reg't U. S. Col'd Infantry.

Appears on

Company Muster Roll

for Mayo June, 1865.

Present or absent Present

Stoppage, \$ 100 for

Due Gov't, \$ 100 for

Remarks:

Book mark:

Haleomb

(358)

Copyist.

A

6

U.S.C.T.

Frank Anderson

Pvt., Co. H, 6 Reg't U. S. Col'd Infantry.

Appears on

Company Muster Roll

for July 1865, 1865.

Present or absent Present

Stoppage, \$ 100 for

Due Gov't, \$ 100 for

Remarks: due U.S. for 1 mifer 20/100x

Book mark:

Holeman

(858)

Copyist.

A1

6

U.S.C.T.

Frank Anderson

Pvt, Co. H, 6 Reg't U. S. Col'd Infantry.

Appears on Co. Muster-out Roll, dated

Wilmington N.C., Sep 20, 1865.

Muster-out to date

Sep 20, 1865.

Last paid to

Apr 30, 1865.

Clothing account:

Last settled *Never*, 186 ; drawn since \$ $72 \frac{13}{100}$

Due soldier \$ 100 ; due U. S. \$ 100

Am't for cloth'g in kind or money adv'd \$ 100

Due U. S. for arms, equipments, &c., \$ 6 100

Bounty paid \$ 100 ; due \$ 100 100

Remarks: *Due Wm Guoben Reg't 11x*

Stop for 1 wife 20¢x

Book mark: *P.M.Y. 7574 July 13/66*

Holcomb

(361)

Copyst.

Co , 6 U.S. Col'd Inf

Private Private

CARD NUMBERS.

1 5568271	26
2	27
3	28
4	29
5	30
6	31
7	32
8	33
9	34
10	35
11	36
12	37
13	38
14	39
15	40
16	41
17	42
18	43
19	44
20	45
21	46
22	47
23	48
24	49
25	50

Book Mark:

See also

a | 6 | U.S.C.T.

Henry Anderson

Appears with rank of *Pvt.* on

Muster and Descriptive Roll of a Detachment of U. S. Vols. forwarded

for the 6 Reg't U. S. Col'd Infantry. Roll dated

....., 186 .

Where born *Washington Co. Penna.*

Age *18* y'rs; occupation *Laborer*

When enlisted *Sept. 2*, 1863 .

Where enlisted *Pittsburgh Pa.*

For what period enlisted *3* years.

Eyes *Bro.*; hair *Blk.*

Complexion *Bro.*; height *5 ft. 7 in.*

When mustered in, 186 .

Where mustered in

Bounty paid \$.....¹⁰⁰; due \$.....¹⁰⁰

Where credited

Company to which assigned

Remarks: *Sp at home on muster rolls of Regiment I*

Book mark:

W. H. Bogar

Anderson, Henry

....., Co., Reg't

2 Enclosures.

Bed Cards	Final Statements
Burial Records	Furloughs or L. of A.
Certs. of Dis. for Discharge	Med. Certificates
C. M. Charges	Med. Des. Lists
Descriptive Lists	Orders
Discharge Certificates	Pris. of War Record
Enlistment Papers 2	Resignations

Other papers relating to—

Admission to Hosp'l	Furlough or L. of A.
Casualty Sheet	Med. Examination
Confinement	Misc. Information
Contracts	Pay or Clothing
Death or Effects	Personal Reports
Desertion	Rank
Discharge from Hosp'l	Transfer to Hosp'l
Discharge from Service	Transfer to V. R. C.
Duty	Transportation

DECLARATION OF RECRUIT.

I, *Henry Anderson* desiring to VOLUNTEER as a Soldier in the Army of the United States, for the term of THREE YEARS, Do declare, That I am *eighteen (18)* years and _____ months of age; that I have never been discharged from the United States service on account of disability or by sentence of court martial, or by order before the expiration of a term of enlistment; and I know of no impediment to my serving honestly and faithfully as a soldier for three years.

GIVEN at *Pittsburgh Pa*
The *2d* day of *Sept 1862*

Witness:

Rufus S. Jones
" " "

Henry Anderson

By

Henry Anderson
Volunteered at *Sept 2 1862*

No.

Regiment of

enlistment; last served in Company ()

Reg't of

Discharged

18

C. H.

Jan 11 1863

FILED

CONSENT IN CASE OF MINOR.

I, _____ Do CERTIFY, That I am the _____ of _____; that the _____ is _____ years of age; and I do hereby freely give my CONSENT to his volunteering as a SOLDIER in the ARMY OF THE UNITED STATES for the period of THREE YEARS.

GIVEN at _____
The _____ day of _____

Witness:

NARA 298

VOLUNTEER ENLISTMENT.

STATE OF



TOWN OF

Pittsburgh

I, *Henry Anderson*
in the State of *Penna*
and by occupation a *laborer*
volunteered this *20*

born in *Washington County*
aged *eighteen* years,
Do HEREBY ACKNOWLEDGE to have
day of *Sept* 18 *63*

to serve as a **Soldier** in the **Army** of the **United States of America**, for the period of **THREE YEARS**, unless sooner discharged by proper authority: Do also agree to accept such bounty, pay, rations, and clothing, as are, or may be, established by law for volunteers. And I, *Henry Anderson* do solemnly swear, that I will bear true faith and allegiance to the **United States of America**, and that I will serve them honestly and faithfully against all their enemies or opposers whomsoever; and that I will observe and obey the orders of the President of the United States, and the orders of the officers appointed over me, according to the Rules and Articles of War.

Sworn and subscribed to, at *Pittsburgh*
this *20* day of *Sept* 18 *63* *Henry Anderson*

BEFORE

A. Schickelruehr, a/c

I CERTIFY, ON HONOR, That I have carefully examined the above named Volunteer, agreeably to the General Regulations of the Army, and that in my opinion he is free from all bodily defects and mental infirmity, which would, in any way, disqualify him from performing the duties of a soldier.

[Signature]
EXAMINING SURGEON.

I CERTIFY, ON HONOR, That I have minutely inspected the Volunteer, previously to his enlistment, and that he was entirely sober when enlisted; that, to the best of my judgment and belief, he is of lawful age; and that, in accepting him as duly qualified to perform the duties of an able-bodied soldier, I have strictly observed the Regulations which govern the recruiting service. This soldier has *brown* eyes, *black* hair, *brown* complexion, is *5* feet *7* inches high.

Thos H Bengler
Sixth Regiment of *U.S.* *Colored* Volunteers,
RECRUITING OFFICER

DECLARATION OF RECRUIT.

I, *Henry Anderson* desiring to VOLUNTEER as a Soldier in the Army of the United States, for the term of THREE YEARS, Do declare, That I am *eighteen (18)* years and *1* months of age; that I have never been discharged from the United States service on account of disability or by sentence of court martial, or by order before the expiration of a term of enlistment; and I know of no impediment to my serving honestly and faithfully as a soldier for three years.

GIVEN at *Washington Tenn*
The *20* day of *Sept 1863*

Witness:

Henry Anderson

No. *Anderson*
Volunteered at *Anderson*

By *Anderson* 18

Regiment of *Anderson*

enlistment; last served in Company ()

Reg't of *Anderson*

Discharged *Anderson* 18

CONSENT IN CASE OF MINOR.

I, _____ Do CERTIFY, That I am the _____ of _____; that the _____ said _____ is _____ years of age; and I do hereby freely give my CONSENT to his volunteering as a SOLDIER in the ARMY OF THE UNITED STATES for the period of THREE YEARS.

GIVEN at _____
The _____ day of _____

Witness:

VOLUNTEER ENLISTMENT.

STATE OF



TOWN OF

Pittsburgh

I, *Henry Anderson* — born in *Washington County*
in the State of *Pennsylvania* — aged *eighteen (18)* years,
and by occupation a *laborer* — Do HEREBY ACKNOWLEDGE to have
volunteered this *20* — day of *Sept* 18 *63*

to serve as a **Soldier** in the **Army of the United States of America**, for the
period of **THREE YEARS**, unless sooner discharged by proper authority: Do also
agree to accept such bounty, pay, rations, and clothing, as are, or may be, estab-
lished by law for volunteers. And I, *Henry Anderson* do
solemnly swear, that I will bear true faith and allegiance to the **United States**
of America, and that I will serve them honestly and faithfully against all
their enemies or opposers whomsoever; and that I will observe and obey the
orders of the President of the United States, and the orders of the officers
appointed over me, according to the Rules and Articles of War.

Sworn and subscribed to, at *Pittsburgh* *Henry Anderson*
this *3^d* day of *Sept* 18 *63*

BEFORE

A. Schickel, ad

I CERTIFY, ON HONOR, That I have carefully examined the above named Volunteer, agreeably to
the General Regulations of the Army, and that in my opinion he is free from all bodily defects and mental
infirmity, which would, in any way, disqualify him from performing the duties of a soldier.

A. Schickel
EXAMINING SURGEON.

I CERTIFY, ON HONOR, That I have minutely inspected the Volunteer,
previously to his enlistment, and that he was entirely sober when enlisted; that, to the best of my
judgment and belief, he is of lawful age; and that, in accepting him as duly qualified to perform the duties
of an able-bodied soldier, I have strictly observed the Regulations which govern the recruiting service.
This soldier has *blue* eyes, *black* hair, *brown* complexion, is *5* feet *7* inches
high.

Thomas H. Bengel
Sixth Regiment of U.S. Colored Volunteers,
RECRUITING OFFICER

6. U.S. Cold Inf.

Private Private

CARD NUMBERS.

1 5568534	26
2 5568023	27
3 5569660	28
4 5569752	29
5 5569851	30
6 5569943	31
7 5570034	32
8 9064751	33
9 43156054	34
10	35
11	36
12	37
13	38
14	39
15	40
16	41
17	42
18	43
19	44
20	45
21	46
22	47
23	48
24	49
25	50

Book Mark:

See also

A | 6 | U.S.C.T.

Michel Anderson

Co. A, 6 Reg't U. S. Col'd Inf.

Appears on

Company Descriptive Book

of the organization named above.

DESCRIPTION.

Age 42 years; height 5 feet 9 inches.

Complexion Chestnut

Eyes Blue; hair Blue

Where born Kent Co. Md

Occupation Laborer

ENLISTMENT.

When Sept 20, 1864

Where Easton, Md

By whom Capt Hafford; term 1 y'rs.

Remarks: Drafted

W J Roy

A 1 6

U.S.C.T.

Michael Anderson

Appears with rank of _____ on
**Muster and Descriptive Roll of a Detach-
ment of Drafted Men and Substitutes
forwarded**

for the *6* Reg't U. S. Col'd Inf. Roll dated
Baltimore Md, Nov 30, 1864.

Where born *Cent Co Md*
Age *42* years; occupation *Labourer*

Drafted and mustered in:

When *Sept - 20*, 1864.

Where *Cent Co Md*

Period *1* years.

Eyes *Black*; hair *Black*

Complexion *Chestnut*; height *5 ft. 9 in.*

Paid bounty and advance pay, \$ *100*

Bounty due \$ *100*

Where credited _____

Company to which assigned _____

Remarks: *Drafted 1 Cent Md*

Book mark: _____

W. H. Wright

A | 6 | USCT

Michael Anderson

Appears with rank of _____ on _____

Muster and Descriptive Roll

of Detachment of US Substitutes
& Drafted men forwarded to
Camp Bradford, Dec 4, 1864
Camp Birney Balto Md. Roll dated _____

Where born West Co Maryland

Age 42 years; occupation Laborer

When enlisted Sept 20, 1864

Where enlisted Easton Md

For what period enlisted _____ years.

Eyes Black; hair Black

Complexion Chestnut; height 5 ft. 9 in.

When mustered in Sept 20, 1864

Where mustered in _____

Bounty paid \$ _____ 100; due \$ _____ 100

Clothing account:

Last settled _____, 1864; drawn since \$ 27.86 100

Date of first muster _____, 1864

Company to which assigned _____

Remarks: Drafted man
1st Dist Md

Book mark: _____

J. W. McLean

(356m) Copyist.

A | **6** | **U.S.C.T.**

Michael Anderson

Appears with rank of on
**Muster and Descriptive Roll of a Detach-
 ment of U. S. Vols. forwarded**

for the 6 Reg't U. S. Col'd Infantry. Roll dated
Camp near Fort.
Burnham Va, Dec 13, 1864.

Where born *Kent Co Maryland*

Age *42* y'rs; occupation *Laborer*

When enlisted *Sept. 20*, 1864.

Where enlisted *Eastern Md*

For what period enlisted *one* years.

Eyes *Blk*; hair *Blk*.

Complexion *Shesnut*; height *5* ft. *9* in.

When mustered in *Nov 20*, 186 .

Where mustered in

Bounty paid \$.....100; due \$.....100

Where credited *1st Dist Md.*

Company to which assigned

Remarks: *Drafted*
(No Roll Dec. 31. 64 on file)

Book mark:

.....

Hoyberger

A | 6 | U.S.C.T.

Michel Anderson
Pvt, Co. A, 6 Reg't U. S. Col'd Infantry.

Appears on

Company Muster Roll

for Jan'y. 1 Feby, 1865.

Present or absent absent

Stoppage, \$ 100 for

Due Gov't, \$ 100 for

Remarks: On detached service
near Chapine Farm Va.
Substitute.

Book mark:

Crenshaw

A | 6 | U.S.C.T.

Michel Anderson
Priv., Co. A, 6 Reg't U. S. Col'd Infantry.

Appears on

Company Muster Roll

for Mch. & Apl., 1865.

Present or absent Present

Stoppage, \$ 100 for

Due Gov't, \$ 100 for

Remarks: Due U.S. for 1 screw driver 23¢, 1 wiper 20 cts, 1 canteen 65¢, substitute.

Book mark:

Ovenshaw

A | **6** | **U.S.C.T.**

Michael Anderson
Privt, Co. A, 6 Reg't U. S. Col'd Infantry.

Appears on

Company Muster Roll

for Jan 7 June, 1865.

Present or absent Present

Stoppage, \$ 100 for

Due Gov't, \$ 100 for

Remarks:

Admitted on 10th
with 100 dollars
in to his advance
45th

Book mark:

(358)

W. A. Edwards

Copyist.

A

6

U.S.C.T.

Michel Anderson
Private, Co. A, 6 Reg't U. S. Col'd Infantry.

Appears on

Company Muster Roll

for *July & Aug*, 186*7*.

Present or absent *Present*

Stoppage, \$ *100* for

Due Gov't, \$ *100* for

Remarks:

Book mark:

W. A. Edwards

(358)

Copyist.

A | **6** | **U.S.C.T.**

Michael Anderson
Privt., Co. A., 6 Reg't U. S. Col'd Infantry.

Appears on **Co. Muster-out Roll**, dated
Wilmington, N.C., Sept 20, 1865.

Muster-out to date Sept 20, 1865.

Last paid to Apr. 30, 1865.

Clothing account:

Last settled Nov 186; drawn since \$ 3.72 / 100

Due soldier \$ 100; due U. S. \$ 100

Am't for cloth'g in kind or money adv'd \$ 100

Due U. S. for arms, equipments, &c., \$ 100

Bounty paid \$ 100; due \$ 100

Remarks: Due U.S. for Ord.
ret'd per G.O. 101
65.00
Due U.S. for 69.48
65.00 + for ord. 43.00

Book mark: _____

(361) W. A. Edwards Copyist.

6 U.S. Col'd Inf

Private Private

CARD NUMBERS.

1 5578818	26
2 5578913	27
3 5579011	28
4 5579103	29
5 5579186	30
6 9065633	31
7	32
8	33
9	34
10	35
11	36
12	37
13	38
14	39
15	40
16	41
17	42
18	43
19	44
20	45
21	46
22	47
23	48
24	49
25	50

Book Mark: /

See also

A 1973674 P.O. Box
St. 2130176 P.O. Box

A

6

U.S.C.T.

Robert Anderson,

A, Co. *A*, 6 Reg't U. S. Col'd Inf.

Appears on

Company Descriptive Book

of the organization named above.

DESCRIPTION.

Age *38* years; height *5* feet *0* inches.

Complexion *Brown*

Eyes *Black*; hair *Black*

Where born *Virginia*

Occupation *Labourer*

ENLISTMENT.

When *Nov. 24*, 186*4*.

Where *Washington D.C.*

By whom *1st Sub. Dis*; term *1* y'rs.

Remarks: *Drafted*

Jenkins

A. | 6 | U.S.C.T.

Robert Anderson

Pvt., Co. I, 6 Reg't U. S. Colored Infantry.

Appears on

Company Muster Roll

for Jan. & Feb., 1865.

Present or absent Absent.

Stoppage, \$ 100 for

Due Gov't, \$ 100 for

Remarks: On detached service with Capt. Dill.

(Drafted and mustered in Nov. 24, 64 at Washington, for 1 year.)

Book mark:

A. W. Reed

A. | 6 | U.S.C.T.

Robert Anderson
Privt, Co. I, 6 Reg't U. S. Colored Infantry.

Appears on

Company Muster Roll
for Dated May 3, 1865.

Present or absent Present.

Stoppage, \$ 100 for

Due Gov't, \$ 100 for

Remarks: Free Apr. 19/61,
Due U.S. 1 haversack
95-cts. / Conten 65-cts,
\$1.60

Book mark:

A. M. Beck

A

6

U.S.C.T.

Robert Anderson
Pat, Co. I, 6 Reg't U. S. Colored Infantry.

Appears on

Company Muster Roll

for May + June, 1864.

Present or absent Present

Stoppage, \$ 100 for

Due Gov't, \$ 100 for

Remarks: Charged on past Rolls
for CC + G. Eq. \$ 1.61

Book mark:

(353)

Posley
Copyist.

A | 6 | U.S.C.T.

Robert Anderson
Pot., Co. I, 6 Reg't U. S. Colored Infantry.

Appears on

Company Muster Roll

for July 1865, 1865

Present or absent Present

Stoppage, \$ 1.00 for

Due Gov't, \$ 1 ⁶¹/₁₀₀ for C. C. and G. Eq

Remarks:

Book mark:

(858)

Posey

Copyist.

A | 6 | U.S.C.T.

Robert Anderson

Pat, Co. *I*, 6 Reg't U. S. Col'd Infantry.

Appears on **Co. Muster-out Roll**, dated

Hilmington N. C. Sept 20, 186*5*.

Muster-out to date *Sept 20*, 186*5*.

Last paid to *apl 30*, 186*5*.

Clothing account:

Last settled *Nov 1*, 186*5*; drawn since \$ *17*/₁₀₀

Due soldier \$ *100*; due U. S. \$ *100*

Am't for cloth'g in kind or money adv'd \$ *100*

Due U. S. for arms, equipments, &c., \$ ^{*retained*} *6*/₁₀₀

Bounty paid \$ *100*; due \$ *100*

Remarks: *due Mr. B. W. Ben Reyl*
Sutler & Co.

Book mark *P. M. G. Mch 20/66*

T. J. J. Copyist.

Company
Co. *A*, 6 U.S. Col'd Inf.

Private | *Private*

CARD NUMBERS.

1	5575859	26
2	5575941	27
3	5576021	28
4	5576100	29
5	5576178	30
6	5576256	31
7	5576334	32
8	5576406	33
9	5576480	34
10	5576578	35
11	5576671	36
12	5576767	37
13	5576862	38
14	5576954	39
15	9065399	40
16		41
17		42
18		43
19		44
20		45
21		46
22		47
23		48
24		49
25		50

Book Mark: _____

See also _____

517-2491000

MS. 937520

A. 2565627 Po. Ret.

A | **6** | **U.S.C.T.**

Samuel Anderson,
 _____, Co. *G*, 6 Reg't U. S. Col'd Inf.

Appears on
Company Descriptive Book
 of the organization named above.

DESCRIPTION.

Age *23* years; height *5* feet *6* inches.

Complexion *colored*

Eyes *Black*; hair *Black*

Where born *New Castle Del.*

Occupation *Labourer.*

ENLISTMENT.

When *Sept. 2*, 186*3*.

Where *Smymna Del.* *1st Dist.*

By whom *Capt. Wilmer P. M.*, term *3* y'rs.

Remarks: *Substitute*

* *Descriptive list states*
May 20/65. Sent to
Hospital Wilmington N.C.
Charged on D. L. \$5.00
and sutter.

* *As it appears.*

Jenkins

A | 6 | U.S.C.T.

Samuel Anderson
Private, Co. G, 6 Reg't U. S. Col'd Infantry.

Age *23* years.

Appears on

Company Muster-in Roll

of the organization named above. Roll dated
Philadelphia Pa, Sept 14, 1863.

Muster-in to date *Sept 14, 1863*

Joined for duty and enrolled:

When *Sept. 21,* 1863.

Where *Impsona Del*

Period *3* years.

Remarks: *Mustered by Capt
Wilmer P M Sept 2 - 1863.
Sub. Co to 1 Dist Delaware*

Book mark:

M. A. Michaels

(856)

Copyist.

A

6

U.S.C.T.

Samuel Anderson
Private, Co. G, 6 Reg't U. S. Col'd Infantry.

Appears on

Company Muster Roll

for *Enrollment to Oct 31*, 1863.

Present or absent *Present*

Stoppage, \$ *100* for

Due Gov't, \$ *100* for

Remarks:

Book mark:

M. A. Michaels
Copyist.

A

6

U.S.C.T.

Samuel Anderson

Private, Co. G, 6 Reg't U. S. Col'd Infantry.

Appears on

Company Muster Roll

for *Nov & Dec*, 1863.

Present or absent *Present*

Stoppage, \$ 100 for

Due Gov't, \$ 100 for

Remarks:

Book mark:

M. A. Michaels
Copyist.

A | **6** | **U.S.C.T.**

Samuel Anderson
Private, Co. G, 6 Reg't U. S. Col'd Infantry.

Appears on

Company Muster Roll

for *Jan + Febr*, 186*4*.

Present or absent *Present*

Stoppage, \$ 100 for

Due Gov't, \$ 100 for

Remarks:

Book mark:

(358)

M. A. Michaels

Copyist.

A | 6 | U.S.C.T.

Samuel Anderson
Private, Co. G, 6 Reg't U. S. Col'd Infantry.

Appears on

Company Muster Roll

for *March & Apr.*, 1864.

Present or absent *Present*

Stoppage, \$..... 100 for

Due Gov't, \$..... 100 for

Remarks: *Stop for 1 Centen 41 cts*

Book mark :

M. A. Michaels
Copyist.

(358)

A | **6** | **U.S.C.T.**

Samuel Anderson
Priv, Co. G, 6 Reg't U. S. Col'd Infantry.

Appears on

Company Muster Roll

for *May to June*, 186*4*

Present or absent *Present*

Stoppage, \$ 100 for

Due Gov't, \$ 100 for

Remarks:

Book mark:

Brogan

A | **6** | **U.S.C.T.**

Samuel Anderson
Priv, Co. G, 6 Reg't U. S. Col'd Infantry.

Appears on

Company Muster Roll

for *July & Aug.*, 1864

Present or absent *Present*

Stoppage, \$ *100* for

Due Gov't, \$ *100* for

Remarks:
Dis April 19, 1861

Book mark:

Grogan

A | **6** | **U.S.C.T.**

Samuel Anderson
Pri., Co. G, 6 Reg't U. S. Col'd Infantry.

Appears on

Company Muster Roll

for *Sept. & Oct.*, 186*4*

Present or absent. *Absent*

Stoppage, \$.....*100* for

Due Gov't, \$.....*100* for

Remarks: *Wounded at New Market Heights Va Sept. 29, 1864. - in Hospital since that date.*

Book mark:

E. J. Hogan

A | **6** | **U.S.C.T.**

Samuel Anderson
Priv., Co. G, 6 Reg't U. S. Col'd Infantry.

Appears on

Company Muster Roll

for *Nov. & Dec.*, 1864.

Present or absent *Absent*

Stoppage, \$ *100* for

Due Gov't, \$ *100* for

Remarks: *Wounded at New Market Heights, Va. and in hospital since that date. Sept. 29, 1864.*

Book mark:

Grogan
Copyist.

A | 6 | U.S.C.T.

Samuel Anderson
Priv., Co. G, 6 Reg't U. S. Col'd Infantry.

Appears on

Company Muster Roll

for Jan. & Feb., 1865.

Present or absent Absent

Stoppage, \$ 100 for

Due Gov't, \$ 100 for

Remarks: Wounded New Market Heights Va. Sept. 29. 64 & in Hospital since that date.

Book mark:

Grogan

A | 6 | U.S.C.T.

Samuel Anderson
Priv, Co. G, 6 Reg't U. S. Col'd Infantry.

Appears on

Company Muster Roll

for *Mch & Apr*, 1863.

Present or absent *absent*

Stoppage, \$ 100 for

Due Gov't, \$ 100 for

Remarks: *Wounded at New Market Heights Va, Sept 29, 64, & in hospital since that date.*

Book mark:

(358)

Moy Copyist.

A | 6 | U.S.C.T.

Samuel Anderson

Priv, Co. G, 6 Reg't U. S. Col'd Infantry.

Appears on

Company Muster Roll

for May & June, 1865.

Present or absent absent

Stoppage, \$ 100 for

Due Gov't, \$ 100 for

Remarks: Wounded at New Market Heights Va. Sept 29/64, in Hosp since that date.

Book mark:

May

A | 6 | U.S.C.T.

Samuel Anderson

Priv, Co. G, 6 Reg't U. S. Col'd Infantry.

Appears on

Company Muster Roll

for July & Aug, 1865.

Present or absent present

Stoppage, \$ 100 for

Due Gov't, \$ 100 for

Remarks:

Book mark:

(358)

Moy Copyist.

A | 6 | U.S.C.T.

Samuel Anderson

Priv, Co. *G*, 6 Reg't U. S. Col'd Infantry.

Appears on **Co. Muster-out Roll**, dated *Wilmington NC, Sept 20*, 1865.

Muster-out to date *Sept 20*, 1865.

Last paid to *Aug 31*, 1864.

Clothing account:

Last settled *June 30*, 1864; drawn since \$ *37*^{*78*}/₁₀₀

Due soldier \$ 100; due U. S. \$ 100

Am't for cloth'g in kind or money adv'd \$ 100

Due U. S. for arms, equipments, &c., \$ 100

Bounty paid \$ *none* 100; due \$ *100* 100

Remarks: *Due Wm Brisben Regtl Suttler \$22.00. Substitute for a colored man drafted under act of Mech 3/63.*

Book mark: *V730 P239, 76. 2433*
PM G Apr 4/66.

Moy

Anderson Samuel

Co. 6 Reg't U.S.C. Inf.

3

Enclosures.

Bed Cards	Final Statements
Burial Records	Furloughs or L. of A.
Certs. of Dis. for Discharge	Med. Certificates
C. M. Charges	Med. Des. Lists
Descriptive Lists	Orders
Discharge Certificates	Pris. of War Record
Enlistment Papers 2	Resignations

Other papers relating to—

Admission to Hosp'l	Furlough or L. of A.
Casualty Sheet	Med. Examination
Confinement	Misc. Information /
Contracts	Pay or Clothing
Death or Effects	Personal Reports
Desertion	Rank
Discharge from Hosp'l	Transfer to Hosp'l
Discharge from Service	Transfer to V. R. C.
Duty	Transportation

S.P. filed 1/13/02
MBS

DECLARATION OF SUBSTITUTE.

I, Samuel Anderson (col) desiring to ENLIST in the Army of the United States, for THREE YEARS, **Do declare**, That I am Twenty three years and three months of age; that I have never been discharged from the United States service on account of disability or by sentence of a court martial; and I know of no impediment to my serving honestly and faithfully as a soldier for three years.

GIVEN at Smyrna Delaware the 2nd day of Sept-1863

WITNESS:

[Signature]

Samuel ^{his} Anderson
mark

[Faint signature]

04/03

No. 19

Samuel Anderson (col)

Enlisted at Smyrna Del

As Substitute for

Anthony Hopkins (col)

On the 2nd day of Sept, 1863.

By

Edwin Miller

Leonard E. Parks

J. G. Foster

Board of Enrollment,

of Dist. of Delaware

(No. 40.)

SUBSTITUTE VOLUNTEER ENLISTMENT.

STATE OF

TOWN OF

Delaware

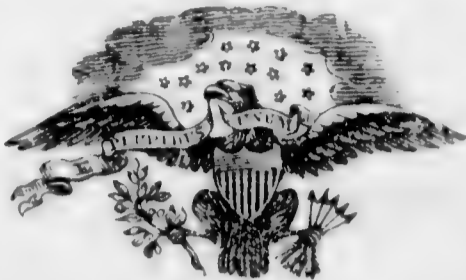

Smyrna

I, Samuel Anderson (col) born in the State of Delaware, aged Twenty three years, and by occupation a Laborer Do HEREBY ACKNOWLEDGE to have agreed with Anthony Godding (col), Esq., of Christina Neck New Castle County Delaware to become his SUBSTITUTE in the Military Service, for a sufficient consideration paid and delivered to me, on the Second day of Sept, 1863; and having thus agreed with said Anthony Godding I DO HEREBY ACKNOWLEDGE to have enlisted this Second day of Sept, 1863, to serve as a Soldier in the Army of the United States of America, for the period of THREE YEARS, unless sooner discharged by proper authority: I do also agree to accept such bounty, pay, rations, and clothing, as are, or may be, established by law for soldiers. And I do solemnly swear that I will bear true and faithful allegiance to the United States of America; that I will serve them honestly and faithfully against all their enemies or opposers whomsoever; and that I will observe and obey the orders of the President of the United States, and the orders of the Officers appointed over me, according to the Rules and Articles of War.

SWORN and subscribed to, at Smyrna Del this 2nd day of Sept, 1863. BEFORE [Signatures]

his Samuel X Anderson man

We certify, on honor, That we have carefully examined the above-named Volunteer Substitute agreeably to the Regulations, and that, in our opinion, he is free from all bodily defects and mental infirmity which would in any way disqualify him from performing the duties of a soldier; that he was entirely sober when enlisted; that he is of lawful age, (not under 18 years;) and that, in accepting him as duly qualified to perform the duties of an able-bodied soldier, and as a Substitute in lieu of Anthony Godding (col), drafted in Smyrna Delaware August 12th, 1863, we have strictly observed the Regulations which govern in such cases. This soldier has Black eyes, Black hair, Color of complexion; is 5 feet 6 inches high.

[Signature] Provost Marshal.

[Signature] Commissioner of Board.

[Signature] Surgeon of Board.

Board of Enrollment of 1st Dist. of Delaware.

DECLARATION OF SUBSTITUTE.

Samuel Anderson (col) desiring to ENLIST in the Army of the United States, for THREE YEARS, **Do declare**, That I am *Twenty three* years and *three* months of age; that I have never been discharged from the United States service on account of disability or by sentence of a court martial; and I know of no impediment to my serving honestly and faithfully as a soldier for three years.

GIVEN at *Smyrna Delaware* the *2nd* day of *Sept* 1863

WITNESS:

S. Maly *Samuel Anderson*
mark

Samuel Anderson
mark

A
24/63

No. *19*

Samuel Anderson (col)

Enlisted at *Smyrna Del*

As Substitute for

Anthony Harding

On the *2nd* day of *Sept*, 1863.

By

Samuel Anderson

Leonard E. Brady

D. G. Fisher

Board of Enrolment,

Smyrna Delaware

(No. 40.)

SUBSTITUTE VOLUNTEER ENLISTMENT.

STATE OF

TOWN OF

Delaware



Smyrna

I, Samuel Anderson (col) born in the State of Delaware, aged Twenty three years, and by occupation a Laborer

Do HEREBY ACKNOWLEDGE to have agreed with

Anthony Gooding, Esq., of Christiana Co., New Castle County Delaware

to become his SUBSTITUTE in the Military Service, for a sufficient consideration paid and delivered to me, on the Second day of Sept, 1863;

and having thus agreed with said Anthony Gooding, I DO HEREBY ACKNOWLEDGE to have enlisted this Second day of Sept, 1863,

to serve as a Soldier in the Army of the United States of America, for the period of THREE YEARS, unless sooner discharged by proper authority: I do also agree to accept such bounty, pay, rations, and clothing, as are, or may be, established by law for soldiers. And I do solemnly swear that I will bear true and faithful allegiance to the United States of America; that I will serve them honestly and faithfully against all their enemies or opposers whomsoever; and that I will observe and obey the orders of the President of the United States, and the orders of the Officers appointed over me, according to the Rules and Articles of War.

SWORN and subscribed to, at Smyrna del this 2nd day of Sept, 1863.

BEFORE [Signature]

[Signature] Samuel Anderson

We certify, on honor, That we have carefully examined the above-named Volunteer Substitute agreeably to the Regulations, and that, in our opinion, he is free from all bodily defects and mental infirmity which would in any way disqualify him from performing the duties of a soldier; that he was entirely sober when enlisted; that he is of lawful age, (not under 18 years;) and that, in accepting him as duly qualified to perform the duties of an able-bodied soldier, and as a Substitute in lieu of Anthony Gooding, drafted in Smyrna Delaware August 12th, 1863, we have strictly observed the Regulations which govern in such cases. This soldier has Black eyes, Black hair, Color complexion; is 5 feet 6 inches high.

[Signature] Provost Marshal.

[Signature] Commissioner of Board.

[Signature] Surgeon of Board.

Board of Enrollment of any Dist. of Delaware

Sam'l Anderson

6 U.S.C.3

WAR DEPARTMENT,
BUREAU OF REFUGEES, FREEDMEN, AND ABANDONED LANDS.

Washington, January 11th, 1868.

Wm D. Wiggins, Esq.

Attorney. &c. Wilmington, D. C.

Sir

I am directed to acknowledge receipt of your letter of the 8th Dec. 1868. and to state in reply that upon investigation of the facts in the case of Samuel Anderson, late Pvt. Co. "G", 62nd Regt. Col. the claim referred to, it is learned that his claim has been rejected by reason of his having been a substitute, and his discharge sent to J. H. Joseph's Attorney. &c. Philadelphia, Pa.

The Agent of this Bureau at Philadelphia, to whom the case was referred, with instructions to, if practicable, procure the discharge of Anderson and forward same to this office, reports that Joseph is a fugitive from justice.

and that Messrs George Cragg & 1³rs Attorneys
of Philadelphia, who are understood to
have charge of the unfinished business of Mr.
Joseph, state that the discharge of Jammel
Anderson cannot be found among the papers
on file in their office.

Receipt for discharge herewith
returned.

Very respectfully
your obt servant
William S. Treat
Agent & R. Treat
Chief of Claim Division

U.S. Cold War

Private Private

CARD NUMBERS.

5573601	26
5573685	27
5573768	28
5573846	29
5573919	30
5573990	31
5574058	32
5574129	33
5574284	34
5574660	35
11 9065155	36
12	37
13	38
14	39
15	40
16	41
17	42
18	43
19	44
20	45
21	46
22	47
23	48
24	49
25	50

Book Mark: *EB-12-249*

See also

A | 6 | U.S.C.T.

Thomas Anderson

Co. E, 6 Reg't U.S. Col'd Inf.

Appears on

Company Descriptive Book

of the organization named above.

DESCRIPTION.

Age 20 years; height 5 feet 9 inches.

Complexion Yellow

Eyes black; hair black

Where born Bucks Co Penna

Occupation Farmer

ENLISTMENT.

When Aug 18, 1863

Where Phila Pa

By whom Capt Sergt; term 3 y'rs.

Remarks: Engaged with the regiment in all marches & battles up to date of death. Wounded in action Sept 29 1864. and death caused by hemorrhaging. He jumped from Hospital Summer when insane from the effects of his wounds and was dismissed Oct 3^d

J G Reeves ^{over}
Copyist.

MAY. 11

9065155

1891

1864.

A | 6 | U.S.C.T.

Thomas Anderson
Pvt., Co. E, 6 Reg't U. S. Col'd Infantry.

Age 20 years.

Appears on

Company Muster-in Roll

of the organization named above. Roll dated
Philadelphia, Oct 13, 1863.

Muster-in to date Aug 18, 1863

Joined for duty and enrolled:

When Aug 18, 1863

Where Philadelphia Pa.

Period 3 years.

Remarks:

Book mark:

Lucas

A | 6 | U.S.C.T.

Thomas Anderson

Pvt, Co. E, 6 Reg't U. S. Col'd Infantry.

Appears on

Company Muster Roll

for Muster in to Oct 31, 1863

Present or absent Present

Stoppage, \$ 100 for

Due Gov't, \$ 100 for

Remarks:

Book mark:

Lucas

A | 6 | U.S.C.T.

Thomas Anderson

Plt., Co. E, 6 Reg't U. S. Col'd Infantry.

Appears on

Company Muster Roll

for Nov. & Dec, 1863

Present or absent Present

Stoppage, \$ 100 for

Due Gov't, \$ 100 for

Remarks: Stop for one quarter

Book mark:

Lucas

A | 6 | U.S.C.T.

Thomas Anderson

Pvt., Co. E, 6 Reg't U. S. Col'd Infantry.

Appears on

Company Muster Roll

for Jan + Feby, 1864

Present or absent Present

Stoppage, \$ 100 for

Due Gov't, \$ 100 for

Remarks: Stop for 1/2 shelter
Temp. \$162

Book mark: _____

Lucas

A | 6 | U.S.C.T.

Thomas Anderson

Priv., Co. E, 6 Reg't U. S. Col'd Infantry.

Appears on

Company Muster Roll

for Mch + Apl, 1864

Present or absent Present

Stoppage, \$ 100 for

Due Gov't, \$ 100 for

Remarks:

Book mark:

Lucas

A | 6 | U.S.C.T.

Thomas Anderson

Priv., Co. E, 6 Reg't U. S. Col'd Infantry.

Appears on

Company Muster Roll

for May & June, 1864

Present or absent Present

Stoppage, \$ 100 for

Due Gov't, \$ 100 for

Remarks:

Book mark:

Harris

A | 6 | U.S.C.T.

Thomas Anderson

Priv., Co. E, 6 Reg't U. S. Col'd Infantry.

Appears on

Company Muster Roll

for July & Aug, 1864

Present or absent Present

Stoppage, \$ 100 for

Due Gov't, \$ 100 for

Remarks: On Extra duty digging Canal at Dutch Gap Va. Free on or before Apr 19/61

Book mark:

Harris

A | 6 | U.S.C.T.

Thomas Anderson

Priv, Co. E, 6 Reg't U. S. Col'd Infantry.

Appears on

Company Muster Roll

for *Sept & Oct*, 186*4*

Present or absent *Absent*

Stoppage, \$ 100 for

Due Gov't, \$ 100 for

Remarks: *Absent wounded since Sept 29/64. Free Apr 19/61.*

NEXT ROLL ON FILE FEB 1865

Book mark: _____

Harris

A | 6 | U.S.C.T.

Thomas Anderson

Pvt, Co. E, 6 Reg't U. S. Col'd Infantry.

Appears on

Company Muster Roll

for Jan & Feby, 1865.

Present or absent

Stoppage, \$ 100 for

Due Gov't, \$ 100 for

Remarks: Wounded in action Sept 29/64
and jumped overboard while being
conveyed from Point of Rocks -
Hospital Va - to U. S. Gen. Hospital
at Hampton Va. by Steamer "Thos.
Powell" Oct 3/64. His wound
produced insanity which caused
the act. Free Apr 19/61. Due to
Breben Sutter \$4.00

Book mark: Died Oct 3/64 E.B. 12/24/7

Harris

A | 6 | U.S.C.T.

Thomas Anderson
Priv., Co. *E*, 6 Reg't U. S. Col'd Infantry.

Appears on **Co. Muster-out Roll**, dated
Wilmington, N.C., Sep. 20, 1865.

Muster-out to date _____, 186 .
 Last paid to _____, 186 .

Clothing account:

Last settled _____, 186 ; drawn since \$ _____ 100
 Due soldier \$ _____ 100; due U. S. \$ _____ 100
 Am't for cloth'g in kind or money adv'd \$ _____ 100

Due U. S. for arms, equipments, &c., \$ _____ 100
 Bounty paid \$ _____ 100; due \$ _____ 100

Remarks: *Drowned in James River while suffering from a wound rec'd at Dutch Gap, Va.*

Book mark: *2391-1880, 267,372,*
Died Oct. 3/64, E.B. '247'

P. Pool

Anderson, Thos.

B, Co. *8*

6

Reg't **U.S.C. Inf.**

2 Enclosures.

Bed Cards.....	Descriptive Lists.....
Burial Records.....	Final Statements /.....
Certs. of Dis. for Discharge.....	Furloughs.....
C. M. Charges.....	Med. Des. Lists.....
Med. Certificates.....	Orders.....

Other papers relating to—

Admission to Hosp'l.....	Furlough.....
Casualty Sheet (Officer's).....	Med. Examination.....
Confinement.....	Misc. Information.....
Contracts.....	Pay or Clothing.....
Death or Effects /.....	Personal Reports.....
Desertions.....	Rank.....
Discharge from Hosp'l.....	Transfer to Hosp'l.....
Discharge from Service.....	Transfer to V. R. C.....
Duty.....	Transportation.....

[OFFICE ENDORSEMENT.]

War Department,

ADJUTANT GENERAL'S OFFICE,

February 27, 1877

The Death of Pvt Thomas Anderson, Co. C, 6th Reg't U. S. Colored Troops, is reported as follows:

On Company Muster Roll.

For 186 , 186

Company Muster-out Roll.

~~Drawn~~ ~~no date~~ 186

Company Descriptive Book.

....., 186

Company Morning Reports.

....., 186

Soldier's Final Statement.

..... Oct 3^d, 1864

Soldier's Record of Death and Interment.

....., 186

Soldier's Inventory of Effects.

..... Oct 3^d, 1864

Soldier's Certificate of Disability for Discharge.

....., 186

Soldier's Individual Muster-out Roll.

....., 186

Regimental Return.

For 186 , 186

Regimental Quarterly Returns.

....., 186

Regimental Descriptive Book.

....., 186

By Surgeon General.

(.....) 186

Oct 3, 1864 is held to be the correct date, and the Company Muster Roll will be amended accordingly.

Thomas M. Sweet

Assistant Adjutant General.
E. B. 447, noted roll.

Vertical handwritten note: *See Anderson's papers - 207.*

3.

✓ FINAL STATEMENT

OF

Pvt Thomas Anderson

6th Reg't of U. S. Infantry

VOLUNTEERS.

Rec'd Oct 3rd 1864

NOTE 1.—Two of these certificates (or duplicates) are to be given to each Volunteer Soldier or drafted man who may be discharged previously to the discharge of his company, that he may at once receive from the Paymaster the pay, &c., due him, and the captain or other COMMISSIONED officer commanding the company will certify to the act of the delivery of the duplicate certificates; on these certificates the Soldier is "entitled to" his discharge, and should also present his discharge to the Paymaster to have the payment endorsed on it. The discharge is to be given back to the Soldier by the Paymaster; the latter only retaining as his voucher the duplicate certificates.

NOTE 2.—If the Soldier is entitled to pay for the use of his horse, the Company Commander will certify to that fact on the back of both these final statements, and also to the time he has pay due for having been so mounted on his own horse.

NOTE 3.—When a Soldier is furnished with final statements, his descriptive list, if he has one, should be taken up by the officer who gives the Soldier these statements, and endorsed with a statement to this effect by the officer. This endorsement should exhibit a full statement of the time for which the Soldier was allowed pay on his final statements, the clothing account, and all other charges against him or in his favor, so as to comprise a complete exhibit of his account. It will then be transmitted to the company commander of the Soldier, who will enter all the data necessary to a full understanding of the Soldier's account on the muster roll upon which the Soldier's discharge is reported. The descriptive list will then be destroyed. The object of this is, that the remaining portion of the Soldier's account may be settled upon the receipt of these muster rolls, and the Soldier receive any pay or allowances that may be due him at the time of his discharge, and which may not appear on his final statements from the fact that his descriptive list is incomplete. These accounts for back pay, &c., are settled by the 2d Auditor of the Treasury Department.

NOTE 4.—Charges for loss or injury to ordnance, horse equipments, and other miscellaneous charges, should appear under the heading of "Other Stoppages."

NOTE 5.—Bounty paid by State authorities, and not by the United States, will not be entered on this statement.

NOTE 6.—Amounts due the Sutler and Laundress must be entered on the muster roll on which the discharge, death, desertion, &c., is reported, as well as on the final statement, otherwise the amount cannot be collected from the United States.

NOTE 7.—This blank will be used for deceased volunteers and drafted men, as well as for others.

NOTE 8.—Where a Soldier dies in Hospital or on detached service, his descriptive list, if he has one, should be sent with his final statements, in duplicate, to the Second Auditor, Washington, D. C.

ADJUTANT GENERAL'S OFFICE.
Mar 14th 1865.
 Duplicate with Inventory sent 2d Auditor.

Enhance R. [Signature]

I certify, on honor, that Thomas Anderson a Private of
 Captain Hartness' Company (E) of the 6th Regiment of U.S. Infantry
VOLUNTEERS, of the State of _____, born in Queks County, State
 of Pennsylvania, aged 20 years; 5 feet 8 inches high; Red complexion,
Blue eyes, Red hair, and by occupation a Farmer, having joined the company on
 its original organization at Camp 4th Penn^a Pa, and enrolled in it at the muster into
 the service of the United States at _____, on the _____ day
 of _____, 1863, ^{and} (or was mustered in service as a recruit, by Captain
Sergeant, at Phila Pa, on the Eighteenth day of August,
 1863, or was drafted and mustered into the service of the United States from the
 Enrollment District of the State of _____, at _____
 on the _____ day of _____, 186) to serve in the Regiment, for
 the term of Three Years unless sooner discharged and having served **HONESTLY** and
FAITHFULLY with his Company in The field to the present date, is now
 entitled to a **DISCHARGE** by reason of Death

The said Thomas Anderson was last paid by Paymaster
M. Kenney to include the 29th day of January, 1864, and has
 pay due him from that time to the present date; he is entitled to pay and subsistence for
~~TRAVELING~~ ^{from date of enrollment - he having received \$7.00 per month, and} to place of enrollment, and whatever other allowances are authorized to volunteer
~~soldiers, drafted men, or militia, so discharged.~~ ^{time provided. it has been paid.} He has received from the United States **CLOTHING**
 amounting to Eighty three ²⁹/₁₀₀ dollars, since the 18th day of August 1863, ^{Autops}
 186 , when his clothing account was last settled. He has received from the United States
 _____ dollars advanced **BOUNTY**.

There is to be stopped from him, on account of the State of _____, or other
 authorities, for **CLOTHING**, &c., received on entering service, _____ dollars; and
 for other stoppages, viz: _____

_____ dollars.
 He has been furnished with **TRANSPORTATION** in kind from the place of his discharge to
 _____; and he has been **SUBSISTED** for **TRAVELING** to his
 place of enrollment, up to the _____, 186 .

He is indebted to W. C. ... esben, **SUTLER**, _____ ⁴/₁₀₀ dollars.
 He is indebted to _____, **LAUNDRESS**, _____ ⁵/₁₀₀ dollars.

Given in Duplicate, at North East Station, this 10th day
 of March, 1865.

Edwin J. Hartness
Captain

 Commanding Company.

H. G. O. Davis Oct 30 / 1874
 Recd from 3749

*Recd from Liv of Discontinued No. 3
Commands; filed June 23, 1875*

ARTICLES OF WAR.

ART. 95. When any non-commissioned officer or soldier shall die, or be killed in the service of the United States, the then commanding officer of the troop or company shall, in the presence of two other commissioned officers, take an account of what effects he died possessed of, above his arms and accoutrements, and transmit the same to the office of the Department of War, which said effects are to be accounted for, and paid to the representatives of such deceased non-commissioned officer or soldier. And in case any of the officers, so authorized to take care of the effects of deceased officers and soldiers, should, before they have accounted to their representatives for the same, have occasion to leave the regiment or post, by preferment or otherwise, they shall, before they be permitted to quit the same, deposit in the hands of the commanding officer, or of the assistant military agent, all the effects of such deceased non-commissioned officers and soldiers, in order that the same may be secured for, and paid to, their respective representatives.

ARMY REGULATIONS—EDITION OF 1863.

DECEASED SOLDIERS.

Par. 152. Inventories of the effects of deceased non-commissioned officers and soldiers, required by the 95th Article of War, will be forwarded to the Adjutant General, by the commander of the company to which the deceased belonged, and a duplicate of the same to the colonel of the regiment. Final statements of pay, clothing, &c., in duplicate, will be sent to the Adjutant General with one copy of the inventory. When a soldier dies at a post or station absent from his company, it will be the duty of his immediate commander to furnish the required inventory and final statements, and, at the same time, to forward to the commanding officer of the company to which the soldier belonged, a report of his death, specifying the date, place, and cause; to what time he was last paid, and the money or other effects in his possession at the time of his decease; which report will be noted on the next muster roll of the company to which the man belonged. Each inventory will be endorsed, "Inventory of the effects of _____, late of company (—) _____ regiment of _____, who died at _____, the _____ day of _____, 186—." If a legal representative receive the effects, it will be stated in the report. If the soldier leave no effects, the fact will be reported.

Par. 153. Should the effects of a deceased non-commissioned officer or soldier not be administered upon within a short period after his decease, they shall be disposed of by a Council of Administration, under the authority of the commanding officer of the post, and the proceeds deposited with the Paymaster, to the credit of the United States, until they shall be claimed by the legal representatives of the deceased.

Par. 154. In all such cases of sales by the Council of Administration, a statement in detail, or account of the proceeds, duly certified by the Council and commanding officer, accompanied by the Paymaster's receipt for the proceeds, will be forwarded by the commanding officer to the Adjutant General. The statement will be endorsed, "Report of the proceeds of the effects of _____, late of company (—) _____ regiment of _____, who died at _____, the _____ day of _____, 186—."

NOTE 1.—The effects in all cases, when called for, should be turned over to the legal representative, without further authority from the Adjutant General. When the effects are turned over to the relatives of the deceased before these inventories are sent to the Adjutant General, their receipts therefor should be attached to the inventories. In all other cases, one copy will be sent with a letter of transmittal direct to the Adjutant General, and a duplicate retained by the officer.

NOTE 2.—Particular care should be taken to take receipts in duplicate from the Paymaster for any funds turned over to him; one copy should be sent direct to the Adjutant General and one retained by the officer.

INVENTORY OF THE EFFECTS

OF

Thomas Anderson

Late of Company "E"

6th Reg't of U.S. Infantry

Volunteers, who died ^{on} ~~at~~ *James River*

on the *3d* day of *October* 1864.



Inventory of the effects of Thomas Anderson late
a Private of Captain E. J. Backus Company "E" of
the 6th Regiment of U. S. Colored Troops Volunteers, who was enrolled as
a Enlisted at Camp Wm. T. Sherman in the State of Pennsylvania on
the 18th day of August 1863, and mustered into the service of the United
States as a Private on the 18th day of August 1863, at Rich Pa assigned
to Company E, 6th Regiment of U. S. C. Troops Volunteers, to serve three
years or ^{uniform discharge} during the war; he was born in Pratts County in the State
of Pennsylvania; he was 21 years of age, 5 feet 8 inches
high, Blk complexion, Blk eyes, Blk hair, and by occupation, when enrolled,
a Farmer; he died in James River between City Point at
and Newport News Va on the 3d day of October 1864, by
reason of drowning, was scoldered in sea by a wind in the head and
pumped overboard while sleeping

INVENTORY.					
ARTICLES.	No.	ARTICLES.	No.	ARTICLES.	No.
Hats.....		Pairs trousers.....		Knapsacks.....	
Caps.....		Pairs flannel drawers.....			
Forage caps.....		Pairs cotton drawers.....			
Great coats.....		Flannel shirts.....			
Uniform coats.....		Cotton shirts.....			
Uniform jackets.....		Pairs boots.....			
Flannel sack coats.....		Pairs shoes.....			
Blouses.....		Pairs socks.....			
Stable frocks.....		Blankets.....			
Fatigue overalls.....		Haversacks.....			
				MONEY.	
				Specie.....	\$
				Notes.....	\$

I CERTIFY, ON HONOR, that the above inventory comprises all the effects of Private
Thomas Anderson, deceased, and that the effects are in the hands
of _____ at _____
_____ to be disposed of by a Council of Administration.

(DUPLICATES.)

Edson J. Backus
Captain
Commanding the Company.

STATION: North East Station Va

DATE: March 10th 1865

6 U.S. COPIES

Private Private

CARD NUMBERS.

1	5578195	26
2	5578276	27
3	5578358	28
4	5578443	29
5	5578522	30
6	5578598	31
7	5578673	32
8	5578747	33
9	5578896	34
10	5579274	35
11	9065601	36
12		37
13		38
14		39
15		40
16		41
17		42
18		43
19		44
20		45
21		46
22		47
23		48
24		49
25		50

Book Mark:

See also

A | **6** | **U.S.C.T.**

William H. Anderson,

....., Co. *A*, 6 Reg't U. S. Col'd Inf.

Appears on

Company Descriptive Book
of the organization named above.

DESCRIPTION.

Age *24* years; height *5* feet *1* inches.

Complexion *light*

Eyes *black*; hair *black*

Where born *Mercer Co. New Jersey*

Occupation *Farmer*

ENLISTMENT.

When *Sept 11*, 186 *3*

Where *Philadelphia*

By whom *Capt Ed Palmer*; term *3* y'rs.

Remarks: *Substitute 2^d D. Penn.*

Discharged on
Surgeon's certificate
and death Feb 3^d 1865.

Jenkins

W.

6

U.S.C.T.

William W. Anderson.
Pat., Co. *I*, 6 Reg't U. S. Col'd Infantry.

Age *24* years.

Appears on

Company Muster-in Roll

of the organization named above. Roll dated

Philada, Pa., *Sept. 11*, 1863.

Muster-in to date

Sept. 11, 1863

Joined for duty and enrolled:

When *Sept. 11*, 1863.

Where *Philadelphia, Pa.*

Period *3* years.

Remarks: *Sub. Penna. 2 Dis.*
Musters by Capt. Palmer
P.M. Sept. 11, '63

Book mark:

Aslv.
Copyist.

A.

6

U.S.C.T.

William W. Anderson
Pat., Co. I, 6 Reg't U. S. Colored Infantry.

Appears on

Company Muster Roll

for *Sept. & Oct.*, 186*3*.

Present or absent *Present*

Stoppage, \$ *100* for

Due Gov't, \$ *100* for

Remarks:

Book mark:

A.

6

U.S.C.T.

William H. Anderson.
Priv., Co. I, 6 Reg't U. S. Colored Infantry.

Appears on

Company Muster Roll

for *Nov & Dec.*, 1863.

Present or absent *Present.*

Stoppage, \$ *100* for

Due Gov't, \$ *100* for

Remarks:

Book mark:

(353)

Ash.
Copyist.

Ar. | **6** | **U.S.C.T.**

William M. Anderson.
Priv., Co. I, 6 Reg't U. S. Colored Infantry.

Appears on

Company Muster Roll

for Jan'y & Feby., 1864.

Present or absent Present.

Stoppage, \$ 100 for

Due Gov't, \$ 100 for

Remarks: Due U.S. for one
Knap sack complete &
Doll. 14 cts.

Book mark: _____

(353)

Asst.
Copyist.

A.

6

U.S.C.T.

William Anderson
Part; Co. I, 6 Reg't U. S. Colored Infantry.

Appears on

Company Muster Roll

for *Mar. & April*, 1864.

Present or absent *Present*.

Stoppage, \$ *100* for

Due Gov't, \$ *100* for

Remarks:

Book mark:

Ash
Copyist.

A. | 6 | U.S.C.T.

William Anderson

Pvt., Co. I, 6 Reg't U. S. Colored Infantry.

Appears on

Company Muster Roll

for May & June, 1864.

Present or absent Present

Stoppage, \$ 1.00 for

Due Gov't, \$ 1.00 for

Remarks: Due U.S. for Piece Shelter tent and 1 canteen 2 6/100 Doll.

Book mark:

A. H. Reed

A. | 6 | U.S.C.T.

William Anderson
Priv., Co. I, 6 Reg't U. S. Colored Infantry.

Appears on

Company Muster Roll

for July & Aug. 1864.

Present or absent Present.

Stoppage, \$ 100 for

Due Gov't, \$ 100 for

Remarks: Free April 19-63,
Due U.S. 1/2 S. tent & Canteen
\$2 ⁶/₁₀₀, On extra duty since
Aug. 9, 64.

Book mark:

A. H. Reed.

A. | 6 | U.S.C.T.

William Anderson
Priv., Co. I, 6 Reg't U. S. Colored Infantry.

Appears on

Company Muster Roll
for Sept. & Oct., 1864.
Present or absent Present.

Stoppage, \$ 100 for

Due Gov't, \$ 100 for

Remarks:

NEXT ROLL ON FILE FEB 1865

Book mark:

A. H. Reed

(358)

Copyist.

A. | 6 | U.S.C.T.

William Anderson,
Priv., Co. I, 6 Reg't U. S. Colored Infantry.

Appears on

Company Muster Roll
for Jan. & Feb., 1865.

Present or absent

Stoppage, \$ 100 for

Due Gov't, \$ 100 for

Remarks: Free Apr. 19/61.
Died of disease Feb.
3rd. 1864.

Book mark:

A. M. Rude

A | **6** | **U.S.C.T.**

William H. Anderson

Pvt, Co. *I*, 6 Reg't U. S. Col'd Infantry.

Appears on **Co. Muster-out Roll**, dated
Wilmington, N.C. Sept 20, 186*5*.

Muster-out to date _____, 186*5*.

Last paid to _____, 186*5*.

Clothing account:

Last settled _____, 186*5* ; drawn since \$ _____ *100*

Due soldier \$ _____ *100*; due U. S. \$ _____ *100*

Am't for cloth'g in kind or money adv'd \$ _____ *100*

Due U. S. for arms, equipments, &c., \$ _____ *100*

Bounty paid \$ _____ *100*; due \$ _____ *100*

Remarks: *Dead Feb 3 1865*
of disease

Book mark: *F.S.*

Anderson Wm H.

P, Co. I, 6 Reg't U.S.C. Infan'y

2 Enclosures.

Bed Cards	Final Statements /
Burial Records	Furloughs or L. of A.
Certs. of Dis. for Discharge	Med. Certificates
C. M. Charges	Med. Des. Lists
Descriptive Lists	Orders
Discharge Certificates	Pris. of War Record
Enlistment Papers	Resignations

Other papers relating to—

Admission to Hosp'l	Furlough or L. of A.
Casualty Sheet	Med. Examination
Confinement	Misc. Information
Contracts	Pay or Clothing
Death or Effects /	Personal Reports
Desertion	Rank
Discharge from Hosp'l	Transfer to Hosp'l
Discharge from Service	Transfer to V. R. C.
Duty	Transportation

Inventary of the effects
of Priv William Anderson
late of Co. I. 6th U.S.C.T.

1865

Recd from Dir of Discontinued
Command, filed June 25
/75



Inventory of the effects of Priv William Andersson late
of Co. B. 6th U.S. C.S. who died at the Base Hospital near
Fort Fisher N.C. on the 3rd day of Feb 1865.

Inventory

Articles

Articles

1 pr Stockings

1 Knapsack

1 W. Blanket

1 pr Drawers

1 Overcoat

1^{1/2} Pants

1 Handkerchief

1 Shirt

Base Hospital near Fort Fisher N.C.
Feb 3rd 1865

J. W. Mitchell
Surgeon 4th U.S. C.S.
In charge of Base Hospital
Fort Fisher N.C.

Extract from Act of Congress.

SEC. 12. And be it further enacted, That the fees of agents and attorneys for making out and causing to be executed the papers necessary to establish a claim for a pension, bounty, and other allowance before the Pension Office, under this act shall not exceed the following rates: For making out and causing to be duly executed a declaration by the applicant, with the necessary affidavits, and forwarding the same to the Pension Office, with the requisite correspondence, ten dollars; which sum shall be received by such agent or attorney in full for all services in obtaining such pension, and shall not be demanded or received, in whole or in part, until such pension shall be obtained; and the sixth and seventh sections of an act entitled "An act to grant pensions," approved July [fourteenth,] eighteen hundred and sixty-two, are hereby repealed.

SEC. 13. And be it further enacted, That any agent or attorney who shall, directly or indirectly, demand or receive any greater compensation for his services under this act than is prescribed in the preceding section of this act, or who shall contract or agree to prosecute any claim for a pension, bounty, or other allowance under this act, on the condition that he shall receive a per centum upon any portion of the amount of such claim, or who shall wrongfully withhold from a pensioner or other claimant the whole or any part of the pension or claim allowed and due to such pensioner or claimant, shall be deemed guilty of a high misdemeanor, and, upon conviction thereof, shall, for every such offense, be fined not exceeding three hundred dollars, or imprisoned at hard labor not exceeding two years, or both, according to the circumstances and aggravations of the offense.

Approved July 4, 1864.

NOTE 10.—If any soldier is charged a higher fee than that allowed by the above act, he should report the fact and the name of the agent to the Adjutant General, in order that steps may be taken to have the same refunded.

ADJUTANT GENERAL'S OFFICE
April 14th 1865
Duplicate with Inventory sent 2d Auditor.

FINAL STATEMENT

William H. Anderson Priv. Co. D
6th Reg't of U. S. Colored Troops

VOLUNTEERS.

Rec'd July 3rd 1865

NOTE 1.—Two of these certificates (or duplicates) are to be given to each Volunteer Soldier or drafted man who may be discharged without being mustered out. (Final Statements are never given to men mustered out of service) that he may at once receive from the Paymaster the pay, &c. due him, and the captain or other COMMISSIONED officer commanding the company will certify to the act of the delivery of the duplicate certificates; with these certificates the Soldier is "entitled to" his discharge, and should also present his discharge to the Paymaster to have the payment endorsed on it.—The discharge is to be given back to the Soldier by the Paymaster; the latter only retaining as his vouchers the duplicate certificates.

NOTE 2.—If the Soldier is entitled to pay for the use of his horse, the Company Commander will certify to that fact on the back of both these final statements, and also to the time he has pay due for having been so mounted on his own horse.

NOTE 3.—When a Soldier is furnished with final statements, his descriptive list, if he has one, should be taken up by the officer who gives the Soldier these statements, and endorsed with a statement to this effect by the officer. The endorsement should exhibit a full statement of the time for which the Soldier was allowed pay on his final statements, the clothing account, and all other charges against him or in his favor, so as to comprise a complete exhibit of his account. It will then be transmitted to the Company Commander of the Soldier, who will enter all the data necessary to a full understanding of the Soldier's account on the muster roll upon which the Soldier's discharge is reported. The descriptive list will then be destroyed. The object of this is, that the remaining portion of the Soldier's account may be settled upon the receipt of these muster rolls, and the Soldier receive any pay or allowances that may be due him at the time of his discharge, and which may not appear on his last final statements from the fact that his descriptive list is incomplete. These accounts for back pay, &c., are settled by the 2d Auditor of the Treasury Department.

NOTE 4.—Charges for loss or injury to ordnance, horse equipments, and other miscellaneous charges, should appear under the heading of "Other Stoppages."

NOTE 5.—Bounty paid by State authorities, and not by the United States, will not be entered on this statement.

NOTE 6.—Amounts due the Sutler and Laundress must be entered on the muster roll on which the discharge, death, desertion, &c., is reported, as well as on the final statement, otherwise the amount cannot be collected from the United States.

NOTE 7.—This blank will be used for deceased volunteers and drafted men, as well as for others.

NOTE 8.—Where a Soldier dies in Hospital or on detached service, his descriptive list, if he has one, should be sent with his final statements, in duplicate, to the Adjutant General, Washington, D. C.

NOTE 9.—If the soldier is a drafted man or substitute, the space for time, &c., of enrolled, should contain only the word *drafted* or *substitute*, as the case may be. If the Soldier is a "VETERAN," (or RECRUIT,) the words *as a veteran*, (or *recruit*,) as the case may be, should be interlined after the words *mustered into the service of the U. S.* A statement of all the instatments of *Veteran or Recruit Bounty RECEIVED* by the Soldier must be made on the back of each final statement.

Subscribed by [Signature]

I certify, on honor, that William H. Anderson, a Private of
 Captain John F. Devereux's Company (1) of the Sixth Regiment of U.S. Colored Troops
VOLUNTEERS, of the State of New Jersey, born in Mercer County, State
 of New Jersey, aged 24 years; 5 feet 1 inches high; light complexion,
black eyes, black hair, and by occupation a Farmer, who joined for service
 and was enrolled (see Note 9) on the Substitute day of 186, at Philadelphia
 by Capt. Ed. Palmer, for the period of Three years, and mustered into
 the service of the United States on the 19th day of September, 1865, at
Philadelphia, by _____; and having served
HONESTLY and **FAITHFULLY** with his Company to the present date, is now entitled to a
DISCHARGE by reason of _____

Death

The said William H. Anderson was last paid by Paymaster
Mr. McKeeney, to include the 21st day of August, 1865, and
 has pay due him from that time to the present date; he is entitled to pay and subsistence for
TRAVELING to place of enrollment, and whatever other allowances are authorized to volunteer
 soldiers, drafted men, or militia, so discharged. He has received from the United States **CLOTHING**
 amounting to Fifty Six $\frac{72}{100}$ dollars, since the _____ day of _____,
 1865, when his clothing account was last settled. He has received from the United States
 _____ $\frac{100}{100}$ dollars advanced **BOUNTY**.

There is to be stopped from him, on account of the State of _____, or other
 authorities, for **CLOTHING, &c.**, received on entering service, _____ $\frac{100}{100}$ dollars; and
 for other stoppages, viz: _____

_____ $\frac{100}{100}$ dollars.

He has been furnished with **TRANSPORTATION** in kind from the place of his discharge to
 _____; and he has been **SUBSISTED** for **TRAVELING** to his
 place of enrollment, up to the _____, 1865.

He is indebted to _____ **SUTLER**, _____ $\frac{100}{100}$ dollars.

He is indebted to _____ **LAUNDRESS**, _____ $\frac{100}{100}$ dollars.

Given in Duplicate, at Station in field, this 21st day
 of March, 1865.

John F. Devereux
Captain

Commanding Company.

A.G.O. No. 40 - First
 Acc. No. 1211

U.S. COLLECTOR

Private Corporal

CARD NUMBERS.

77080	26
77162	27
5577247	28
5577328	29
5577467	30
5578169	31
9065513	32
8	33
9	34
10	35
11	36
12	37
13	38
14	39
15	40
16	41
17	42
18	43
19	44
20	45
21	46
22	47
23	48
24	49
25	50

Book Mark:

See also

OA

6

U.S.C.T.

Richard C. Armstead,

Co. N, 6 Reg't U. S. Col'd Inf.

Appears on

Company Descriptive Book

of the organization named above.

DESCRIPTION.

Age 41 years; height 5 feet 6 inches.

Complexion Yellow

Eyes Blk; hair Blk

Where born Richmond Virginia

Occupation Barber

ENLISTMENT.

When Sept 4, 1863

Where Pila. Pa.

By whom Lt. Col. Wagner; term 3 y'rs.

Remarks: Captured by guerrillas Feb. 26 1864 near Williamsburg Va.

Jenkins

A | 6 | U.S.C.T.

Richard P. Armistead
Pot, Co. H, 6 Reg't U. S. Col'd Infantry.

Age 41 years.

Appears on

Company Muster-in Roll

of the organization named above. Roll dated

Phila., Pa, Sept 14, 1863.

Muster-in to date Sept 17, 1863

Joined for duty and enrolled:

When Sept 4, 1863.

Where Phila., Pa

Period 3 years.

Remarks: Must abt Lt. Pierce
U.S.A. Sept 17/63.

Book mark:

W.H. Thompson

A | 6 | U.S.C.T.

Richard P. Armistead
Priv, Co. H, 6 Reg't U. S. Col'd Infantry.

Appears on

Company Muster Roll
for Sept. 14 to Oct 31, 1863.

Present or absent Present

Stoppage, \$ 100 for _____

Due Gov't, \$ 100 for _____

Remarks: _____

Book mark: _____

M. A. Thompson
(858) Copyist.

A

6

U.S.C.T.

R. P. Armistead

Priv., Co. H, 6 Reg't U. S. Col'd Infantry.

Appears on

Company Muster Roll

for Nov & Dec, 1863.

Present or absent Present

Stoppage, \$ 100 for

Due Gov't, \$ 100 for

Remarks: Pioneer per S.O. No 28
Ad. 2rs. Cause Nov. 15/63.

Book mark:

M. H. Thompson
Copyist.

A | 6 | U.S.C.T.

R. P. Armistead
Priv., Co. H, 6 Reg't U. S. Col'd Infantry.

Appears on

Company Muster Roll
for *Jerry & Leby*, 1864
Present or absent *Present*
Stoppage, \$ 100 for

Due Gov't, \$ 1 62 1/2 for *1/2 Shelter tent*

Remarks: *Pioneer since Nov. 15/63.*

Book mark:

W. H. Thompson
Copyist.

A | 6 | U.S.C.T.

R. P. Armistean

Priv., Co. H, 6 Reg't U. S. Col'd Infantry.

Appears on

Company Muster Roll

for *Mch & Apl*, 1864.

Present or absent

Stoppage, \$ 100 for

Due Gov't, \$ 100 for

Remarks *Deserter Missing since
Mch 1st/64 - owes for ordnance,
arms and accoutrements \$ 23.46,
C. & G. Equip. - - \$ 4.68
* Probably taken prisoner between
Williamsburg and Burnt Ordinary
March.*

* Taken Record of events, *Mch & Apl* Roll ('64)

Book mark:

W. H. Thompson

A

6

U.S.C.T.

Richard Armistead

Capt., Co. H., 6 Reg't U. S. Col'd Infantry.

Appears on Co. Muster-out Roll, dated
Wilmington, Sep 20, 1865.

Muster-out to date _____, 186 .

Last paid to _____, 186 .

Clothing account:

Last settled _____, 186 ; drawn since \$ _____ 100

Due soldier \$ _____ 100; due U. S. \$ _____ 100

Am't for cloth'g in kind or money adv'd \$ _____ 100

Due U. S. for arms, equipments, &c., \$ _____ 100

Bounty paid \$ _____ 100; due \$ _____ 100

Remarks: Missing Feb 26/64 near
Williamsburg Va. Supposed to
be taken by Gen. Lee

Book mark: 3682 and, apr 2/66 98508 HBV

Halecomb

(361)

Copyist.

W. E. ...
 '6 U.S. Col'd Inf.
Private Private

CARD NUMBERS.

1	5573548	26
2	5568622	27
3	5573681	28
4	5573764	29
5	5573842	30
6	5573915	31
7	5573986	32
8	5574055	33
9	5574127	34
10	5574659	35
11	19122279	36
12	9065157	37
13		38
14		39
15		40
16		41
17		42
18		43
19		44
20		45
21		46
22		47
23		48
24		49
25		50

Book Mark:

See also

A | 6 | U.S.C.T.

Harrison Armstrong
Co. E, 6 Reg't U. S. Col'd Inf.

Appears on
Company Descriptive Book
of the organization named above.

DESCRIPTION.

Age 23 years; height 5 feet 6 1/2 inches.

Complexion Olive

Eyes black; hair black

Where born Washington Penna

Occupation Farmer

ENLISTMENT.

When July 14, 1863.

Where Ill

By whom; term 3 y'rs.

Remarks: Drafted, Died of
Disease on board Steamer
Gen Washington Nov 12
1864.

J G Reeves
Copyist.

a | 6 | **U.S.C.T.**

Harrison Armstrong

Appears with rank of _____ on
**Muster and Descriptive Roll of a Detach-
 ment of Drafted Men and Substitutes
 forwarded**

for the 6 Reg't U. S. Col'd Inf. Roll dated
not Dated, _____, 186 .

Where born Westmoreland Co Penn.

Age 23 years; occupation Farmer

Drafted and mustered in:

When July 14, 186 .

Where Greenburg Pa 21 Dist

Period 3 years.

Eyes brown; hair black

Complexion olive; height 5 ft. 6 1/2 in.

Paid bounty and advance pay, \$ 100

Bounty due \$ 100

Where credited _____

Company to which assigned _____

Remarks: Principal

Book mark: _____

Farmer

A 1 6 1 U.S.C.T.

Harrison Armstrong

Appears with rank of _____ on

Muster and Descriptive Roll of a Detachment of Drafted Men and Substitutes forwarded

for the 6 Reg't U.S.C.T. Roll dated Greensburg Pa Aug 18, 1863

Where born Westmoreland Pa

Age 23 y'rs; occupation Farmer

Drafted and mustered in :

When July 14, 1863

Where Greensburg

Period 3 years.

Eyes Brown; hair Black

Complexion Olive; height 5 ft. 6¹¹/₂ in.

Paid bounty and advance pay, \$ 100

Bounty due, \$ 100

Where credited _____

Company to which assigned E

Remarks Principal

Book mark : _____

Reeves
Copyist.

A | 6 | U.S.C.T.

Harrison Armstrong
Pvt., Co. *E*, 6 Reg't U. S. Col'd Infantry.

Age *23* years.

Appears on

Company Muster-in Roll

of the organization named above. Roll dated

Philada Pa, *Oct 13*, 1863.

Muster-in to date *July 14*, 1863

Joined for duty and enrolled:

When *July 14*, 1863.

Where *Greensburg Pa*

Period *3* years.

Remarks: _____

Book mark: _____

Lucas

A

6

U.S.C.T.

Harrison Armstrong

Plt, Co. E, 6 Reg't U. S. Col'd Infantry.

Appears on

Company Muster Roll

for *Muster roll to Oct 31*, 186 *3*

Present or absent *Present*

Stoppage, \$ *100* for

Due Gov't, \$ *100* for

Remarks:

Book mark:

Lucas

A | 6 | U.S.C.T.

Harrison Armstrong

Pvt., Co. E, 6 Reg't U. S. Col'd Infantry.

Appears on

Company Muster Roll

for *Nov & Dec*, 186 *3*

Present or absent *Present*

Stoppage, \$ *100* for

Due Gov't, \$ *100* for

Remarks:

Book mark:

Lucas

A | 6 | U.S.C.T.

Harrison Armstrong
Plt-, Co. E, 6 Reg't U. S. Col'd Infantry.

Appears on

Company Muster Roll

for *Jan + Feby*, 1864

Present or absent *Present-*

Stoppage, \$ *100* for

Due Gov't, \$ *100* for

Remarks:

Book mark:

Lucas

A | 6 | U.S.C.T.

Harrison Armstrong
Pvt., Co. E, 6 Reg't U. S. Col'd Infantry.

Appears on

Company Muster Roll

for *March + April*, 186 *4*

Present or absent *Present*

Stoppage, \$ 100 for

Due Gov't, \$ 100 for

Remarks:

Book mark:

Lucas

A | 6 | **U.S.C.T.**

Harrison Armstrong
Prk, Co. E, 6 Reg't U. S. Col'd Infantry.

Appears on

Company Muster Roll

for *May & June*, 1864

Present or absent *Present*

Stoppage, \$ 100 for

Due Gov't, \$ 100 for

Remarks:

Book mark:

Harris

A | 6 | U.S.C.T.

Harrison Armstrong
Pvt, Co. E, 6 Reg't U. S. Col'd Infantry.

Appears on

Company Muster Roll

for *July & Aug*, 186*4*

Present or absent *Present*

Stoppage, \$ 100 for

Due Gov't, \$ 100 for

Remarks: *On Extra duty digging*
Canal at Dutch Gap Va.
Free on or before Apr 19/61

Book mark:

Harris

A | 6 | U.S.C.T.

Harrison Armstrong
Pvt., Co. E, 6 Reg't U. S. Col'd Infantry.

Appears on

Company Muster Roll
for *Sept & Oct*, 186*4*

Present or absent *Present*

Stoppage, \$ *100* for

Due Gov't, \$ *100* for

Remarks:

NEXT ROLL ON FILE FEB 1865

Book mark:

Harris

A | **6** | **U.S.C.T.**

Harrison Armstrong,
Priv., Co. E, 6 Reg't U. S. Col'd Infantry.

Appears on **Co. Muster-out Roll**, dated
Wilmington, N.C., Sep 20, 1865.

Muster-out to date _____, 186 .

Last paid to _____, 186 .

Clothing account:

Last settled _____, 186 ; drawn since \$ _____ 100

Due soldier \$ _____ 100; due U. S. \$ _____ 100

Am't for cloth'g in kind or money adv'd \$ _____ 100

Due U. S. for arms, equipments, &c., \$ _____ 100

Bounty paid \$ _____ 100; due \$ _____ 100

Remarks: *Died of disease on*
board of Hos. Boat in
James River, Nov. 2, 1864.

Book mark : _____

J. Pool,

Armstrong, Harrison

P, Co. E, 6 Reg't U S C Inf

8 Enclosures.

Bed Cards	Final Statements 2
Burial Records	Furloughs or L. of A.
Certs. of Dis. for Discharge	Med. Certificates
C. M. Charges	Med. Des. Lists
Descriptive Lists	Orders
Discharge Certificates	Pris. of War Record
Enlistment Papers	Resignations

Other papers relating to—

Admission to Hosp'l	Furlough or L. of A.
Casualty Sheet 2	Med. Examination
Confinement	Misc. Information
Contracts	Pay or Clothing
Death or Effects 4	Personal Reports
Desertion	Rank
Discharge from Hosp'l	Transfer to Hosp'l
Discharge from Service	Transfer to V. R. C.
Duty	Transportation

MICROFILM PUBLICATION M 1848

COMPILED MILITARY SERVICE RECORDS
OF VOLUNTEER UNION SOLDIERS WHO SERVED WITH
THE UNITED STATES COLORED TROOPS (USCT)
6TH REGIMENT OF INFANTRY

PERSONAL PAPERS' TARGET SHEET

PLEASE NOTE THE CHECKED INFORMATION ABOUT THE PERSONAL PAPERS IN
THIS FILE:

- NO PERSONAL PAPERS WERE FOUND IN THIS FILE WHEN THE
RECORDS WERE ARRANGED FOR MICROFILMING.
- 9 PERSONAL PAPER(S) FOUND IN THIS FILE WHEN THE RECORDS
WERE ARRANGED FOR MICROFILMING.

2/5. 7. in sent for to Mrs. Prof.

Completed
CASUALTY SHEET
No. _____

J. Armstrong
Priv of Company C

6th Regiment of V.S.C. I.

State Volunteers.

NATURE OF CASUALTY.

Died Nov. 12, 1864

He was killed in
Co. E. supposed to
be the same as mentioned

Ent. on Prof. Co.

CASUALTY SHEET.

Name: J. Armstrong
 Rank: Priv Company: C & S Regiment: 6th
 Arm: Reg. Co. T State: _____
 Nature of Casualty: Death

CAUSE OF CASUALTY—(NAME OF DISEASE, &c.)

BY WHOM DISCHARGED.

DEGREE OF DISABILITY.

FROM WHAT SOURCE THIS INFORMATION WAS OBTAINED.

BY WHOM CERTIFIED.

REMARKS.

E. McClure
a.o. vs. Jas. M. Moore
A. J. M.

DATE OF DISCHARGE, DEATH, &c.

Nov. 12, 1864

PLACE OF DISCHARGE, DEATH, &c.

onboard Steamer
Geo Washington,

Buried Hampton, Va

Div. of effects
Roll of Honor Pg 35
Hampton & Ft Monroe, Va

Div. of effects sent 2^d
Audited Sept 18th 1866

B. James DeKroth
 Clerk.

Inventory

No 5

of the effects of Private
 H. Armstrong -
 late of Co. E. 6th W. I. Co.
 was brought dead to U.S. Gen
 Hospital - Fort Monroe Va
 November - 12. 1864

Recd from Div. of Discontinued
 Commands, filed June 23/75



U. S. General Hospital -
Fort Mifflin - Pa.

November 12. 1864

Commanding Officer E. Company
6th Reg't U. S. C. S.

I have the honor to inform you that
Private H. Armstrong of your Co. was brought
dead to this Hospital on November 12. 1864 of
having died on board of Steamer George
Washington; and to forward Inventory of effects.

No.	Articles.	No.	Articles.
1.	Great Coat. F. S. S.	1.	Knapsack.
1.	Blanket Sack Coat.	1.	Hooversack.
1.	Pair Boots.		
1.	Wool Blanket.		

Very Respectfully Yours
(Signed) E. McClellan
Asst. Surgeon U. S. Army
In charge Hospital.

I certify that the above is a true copy.
Edson J. Harkness.
Capt. U. S. C. S.
Comdg. Co. E.

INVENTORY OF THE EFFECTS

OF

Private J Armstrong
Late of Company "E"

6 Reg't of W. I. Co.

Volunteers, who died at Fort Monroe Va,
on the 12th day of November 1864.

Surgeon General's Office,

RECORD & PENSION BUREAU,

Washington, Dec 17th 1864

The within Inventory is a true copy from the records
of Fort Monroe Hospital
on file in
this Office, and contains all the information in the case that
can be found.

BY ORDER OF THE SURGEON GENERAL:

See Claim No. 1412
Vol. 4,

Bvt. Major, Assistant Surgeon, U. S. A.

Dep Copy of Certificate
forwarded to A. G. O. Washington D.C.
Dec 16th 64

Inventory of the effects of J. Armstrong late
a Private of Captain _____ Company E. of
the 6th Regiment of U.S. Co. Volunteers, who was enrolled as
a _____ at _____ in the State of _____ on
the _____ day of _____ 1864, and mustered into the service of the United
States as a _____ on the _____ day of _____ 1864, at _____
in Company _____, _____ Regiment of _____ Volunteers, to serve _____
years or during the war; he was born in _____ in the State
of _____; he was _____ years of age, _____ feet _____ inches
high, _____ complexion, _____ eyes, _____ hair, and by occupation, when enrolled,
a _____; he died in was brought dead to Regt. Hospital, at
Fort Monroe Va on the 12th day of November 1864, by
reason of Having died on Board of Steamer "Gen Washington",

INVENTORY.					
ARTICLES.	No.	ARTICLES.	No.	ARTICLES.	No.
Hats.....		Pairs trousers.....		Knapsacks.....	/
Caps.....		Pairs flannel drawers.....			
Forage caps.....		Pairs cotton drawers.....			
Great coats.....	/	Flannel shirts.....			
Uniform coats.....		Cotton shirts.....			
Uniform jackets.....		Pairs boots.....	/		
Flannel sack coats.....		Pairs shoes.....			
Blouses.....	/	Pairs socks.....			
Stable frocks.....		Blankets.....	/	MONEY.	
Fatigue overalls.....		Haversacks.....	/	Specie.....	\$
				Notes.....	\$

I CERTIFY, ON HONOR, that the above inventory comprises all the effects of _____
J. Armstrong, deceased, and that the effects are in the hands
of E. McClellan Asst. Surgeon U.S. Army Regt. Hospital
Fort Monroe Va to be disposed of by a Council of Administration,
or turned over to legal Representatives of Deceased.

(DUPLICATES.) (Signed) E. McClellan
Asst. Surgeon U.S. Army
Commanding the Company
Hospital

STATION: U.S.G.H. Fort Monroe Va
DATE: November 12th 1864

INVENTORY OF THE EFFECTS

OF

Private of Armstrong

late of Company *E*

6 Reg't of *U.S. C.S.*

~~Volunteers~~, who died at *U.S. G. H. Fort Monroe Va*

on the *12th* day of *September* 186*4*.



*Dupl. Copy of Certificate
forn. to A. G. O. Wash DC
Decr 16/64*

Inventory of the effects of J. Armstrong late
a Private of Captain C. E. Company E of
the 6 Regiment of U.S.C.A. **Volunteers**, who was enrolled as
a _____ at _____ in the State of _____ on
the _____ day of _____ 186 , and mustered into the service of the United
States as a _____ on the _____ day of _____ 186 , at _____
in Company _____, _____ Regiment of _____ Volunteers, to serve _____
years or during the war; he was born in _____ in the State
of _____; he was _____ years of age, _____ feet _____ inches
high, _____ complexion, _____ eyes, _____ hair, and by occupation, when enrolled,
a _____; he died in U.S. Genl Hospital, at
Fort Monroe Va on the 12th day of November 1864, by
reason of Heaving died on Board of Steamer "Gen Washington"

INVENTORY.					
ARTICLES.	No.	ARTICLES.	No.	ARTICLES.	No.
Hats.....		Pairs trousers.....		Knapsacks.....	/
Caps.....		Pairs flannel drawers.....			
Forage caps.....		Pairs cotton drawers.....			
Great coats.....	/	Flannel shirts.....			
Uniform coats.....		Cotton shirts.....			
Uniform jackets.....		Pairs boots.....	/		
Flannel sack coats.....		Pairs shoes.....			
Blouses.....	/	Pairs socks.....			
Stable frocks.....		Blankets.....	/		
Fatigue overalls.....		Haversacks.....	/		
				MONEY.	
				Specie.....	\$ —
				Notes.....	\$ —

I CERTIFY, ON HONOR, that the above inventory comprises all the effects of _____
J. Armstrong deceased, and that the effects are in the hands
of C. M. McEllan Asst Surgeon U.S.A. at U.S. Genl Hospital
Fort Monroe Va to be disposed of by a Council of Administration.
returned over to legal Representatives of Deceased

(DUPLICATES.)

STATION: U.S.G. H. Fort Monroe Va

DATE: November 12th 1864

C. M. McEllan
Asst Surgeon U.S. Army
 Commanding the Company.
Hospital

6 Jan 14 1865
of ... sent ...
at ...

5.6 5.
FINAL STATEMENT

OF

Private Harrison Armstrong
Co. C Reg't of W. I. C. Troops

VOLUNTEERS.

Final Statement

NOTE 1.—Two of these certificates (one duplicate) are to be given to each Volunteer Soldier or drafted man who may be discharged previously to the discharge of his company, that he may at once receive from the Paymaster the pay, &c., due him, and the captain or other COMMISSIONED officer commanding the company will certify to the act of the delivery of the duplicate certificates; on these certificates the Soldier is "entitled to" his discharge, and should also present his discharge to the Paymaster to have the payment endorsed on it. The discharge is to be given back to the Soldier by the Paymaster; the latter only retaining as his voucher the duplicate certificates.

NOTE 2.—If the Soldier is entitled to pay for the use of his horse, the Company Commander will certify to that fact on the back of both these final statements, and also to the time he has pay due for having been so mounted on his own horse.

NOTE 3.—When a Soldier is furnished with final statements, his descriptive list, if he has one, should be taken up by the officer who gives the Soldier these statements, and endorsed with a statement to this effect by the officer. This endorsement should exhibit a full statement of the time for which the Soldier was allowed pay on his final statements, the clothing account, and all other charges against him or in his favor, so as to comprise a complete exhibit of his account. It will then be transmitted to the company commander of the Soldier, who will enter all the data necessary to a full understanding of the Soldier's account on the muster roll upon which the Soldier's discharge is reported. The descriptive list will then be destroyed. The object of this is, that the remaining portion of the Soldier's account may be settled upon the receipt of these muster rolls, and the Soldier receive any pay or allowances that may be due him at the time of his discharge, and which may not appear on his final statements from the fact that his descriptive list is incomplete. These accounts for back pay, &c., are settled by the 2d Auditor of the Treasury Department.

NOTE 4.—Charges for loss or injury to ordnance, horse equipments, and other miscellaneous charges, should appear under the heading of "Other Stoppages."

NOTE 5.—Bounty paid by State authorities, and not by the United States, will not be entered on this statement.

NOTE 6.—Amounts due the Sutler and Laundress must be entered on the muster roll on which the discharge, death, desertion, &c., is reported, as well as on the final statement, otherwise the amount cannot be collected from the United States.

NOTE 7.—This blank will be used for deceased volunteers and drafted men, as well as for others.

NOTE 8.—Where a Soldier dies in Hospital or on detached service, his descriptive list, if he has one, should be sent with his final statements, in duplicate, to the Second Auditor, Washington, D. C.

ANT GENERAL'S OFFICE.

Dec 14 1864
ite with Inventory sent 2d Auditor.



Cut on ...

ADJUT

Duplic

I certify, on honor, that Harrison Armstrong Private of
 Captain E. J. Hartness Company (E.) of the 6th Regiment of U. S. C. Troops
VOLUNTEERS, of the State of _____, born in Washington, State
 of Pennsylvania, aged 23 years; 5 feet 6 1/2 inches high; Olive complexion,
Brown eyes, Blad hair, and by occupation a Farmer, having joined the company on
 its original organization at Camp William Penn and enrolled in it at the muster into
 the service of the United States at Philada Penna, on the _____ day
 of _____, 1864, (or was mustered in service as a recruit, by _____
 _____, at _____, on the _____ day of _____,
 1864, or was drafted and mustered into the service of the United States from the 21st
 Enrollment District of the State of Pennsylvania at Greensburg,
 on the fourteenth day of July, 1863,) to serve in the Regiment, for
 the term of Three Years: and having served HONESTLY and
 FAITHFULLY with his Company in the 6th U. S. C. T. to the present date, is now
 entitled to a **DISCHARGE** by reason of death died on board Steamer
George Washington - November 12th 1864.

The said Harrison Armstrong was last paid by Paymaster
Maj. McKenny to include the 31st day of August, 1864, and has
 pay due him from that time to November 12th 1864 ~~the present date~~; he is entitled to pay and subsistence for
 TRAVELING to place of enrollment, and whatever other allowances are authorized to volunteer
 soldiers, drafted men, or militia, so discharged. He has received from the United States **CLOTHING**
 amounting to 26 - 69 dollars, since the 30th day of June,
 1864, when his clothing account was last settled. He has received from the United States
100 dollars advanced **BOUNTY**.

There is to be stopped from him, on account of the State of _____, or other
 authorities, for **CLOTHING, &c.**, received on entering service, _____ dollars; and
 for other stoppages, viz: 1. Cartew - 1. Price Out & Fabri -

 _____ 2 - 75 dollars.

He has been furnished with **TRANSPORTATION** in kind from the place of his discharge to
 _____; and he has been **SUBSISTED** for TRAVELING to his
 place of enrollment, up to the _____, 1864.

He is indebted to Wm. M. Brisben, **SUTLER**, _____ 9 dollars.
 He is indebted to _____, **LAUNDRESS**, _____ dollars.

Given in Duplicate, at Camp 6th U. S. C. T. Pa, this 6th day
 of December, 1864.

Edson J. Hartness
Capt. 6th U. S. C. T.
 Commanding Company.

Medical Director's Office.
Dept of the Army
Richmond Va Sept 15, 1866.

Respectfully returned
with copy of Inventory
of Effects. There are
no data from which
Final Statements can
be furnished.

L. H. ...
Lieut Col. U. S. Army
Medical Director



53-18 1250-100-2/1-66

WAR DEPARTMENT,

ADJUTANT GENERAL'S OFFICE,

WASHINGTON, *Aug 31*, 186*6*.

SIR:

Final Statements in the cases of deceased soldiers are required to be sent to the Adjutant General's Office in duplicate, with one copy of the Inventory of Effects. The Descriptive List should also be sent to this Office in cases where the soldier was absent from his Company at the time of his death. Where there were no effects, it should be so stated on a blank Inventory, properly signed.

Certificates of Disability should be sent in duplicate. Special care should be taken that the date of discharge and signature of the discharging officer should be affixed.

Two of the Final Statement *or* Inventory, has been received in the case of *Priv. J. Armstrong*, of Co. *D*, *6th* Regiment of *U. S. C. V.* Volunteers, whose papers were forwarded to this Office. You will please forward the missing papers without delay.

I have the honor to be, sir,

Very respectfully,

Your obedient servant,

*Reported on Burial Records
Died Nov. 12, 1864.
Buried Hampton, Va.*

W. H. Hazard

Assistant Adjutant General.
(110)

~~COMMANDING OFFICER~~

Medical Director, Dept. Potomac,

*If you cannot furnish final papers please give date
place and cause of death if possible.*

D.

MODEL FOR SET OF PAPERS FOR A DECEASED SOLDIER.

FORM 1.—FINAL STATEMENT.

I CERTIFY, ON HONOR, that *John Smith*, a Private of Captain *J. Brown's* Company, (A.) of the 1st Regiment of Pennsylvania Volunteers, of the State of Pennsylvania, born in *Pittsburg*, State of Pennsylvania, aged 21 years, 5 feet 10 inches high, light complexion, blue eyes, dark hair, and by occupation a Farmer, having joined the Company on its original organization at *Pittsburg*, and enrolled in it at the muster into the service of the United States at *Pittsburg*, on the 1st day of *July*, 1861, (or was mustered in service as a recruit, by _____, at _____, on the _____ day of _____, 186—, or was drafted and mustered into the service of the United States from the _____ Enrollment District of the State of _____, at _____, on the _____ day of _____, 186—,) to serve in the Regiment for the term of Three Years, and having served *honestly and faithfully* with his Company in the field to the present date, is now entitled to a DISCHARGE by reason of death. Died in Regimental Hospital, *Fort Brown, Texas*, December 31, 1863, of typhoid fever.

The said *John Smith* was last paid by Paymaster *Major Morse*, to include the 31st day of *October*, 1863, and has pay due him from that time to the present date. He is entitled to pay and subsistence for *traveling* to place of enrollment, and whatever other allowances are authorized to volunteer soldiers, drafted men, or militia, so discharged. He has received from the United States clothing amounting to 20.00 dollars, since the 31st day of *December*, 1862, when his clothing account was last settled. He has received from the United States 25.00 dollars advanced bounty.

There is to be stopped from him on account of the State of _____, or other authorities, for *clothing, &c.*, received on entering service, nothing, 0.00 dollars; and for other stoppages, viz: nothing, 0.00 dollars. He has been furnished with no transportation in kind from the place of his discharge to _____; and he has not been subsisted for *traveling* to his place of enrollment up to the _____, 186—.

He is indebted to _____, Sutler, _____ dollars.
 He is indebted to _____, Laundress, _____ dollars.

GIVEN, IN DUPLICATE, at *Fort Brown, Texas*, this 31st day of *December*, 1863.

JAMES BROWN,
Captain Co. A, 1st Penn. Vols.,
Commanding Company.

FORM 2.

INVENTORY of the effects of *John Smith*, late a Private of Captain *J. Brown's* Company, (A.) of the 1st Regiment of Pennsylvania Volunteers, who was enrolled as a Private at *Pittsburg*, in the State of Pennsylvania, on the 1st day of *July*, 1861, and mustered into the service of the United States as a Private on the 1st day of *July*, 1861, at *Pittsburg*, in Company A, 1st Regiment of Pennsylvania Volunteers, to serve three years or during the war. He was born in *Pittsburg*, in the State of Pennsylvania; he was 21 years of age, 5 feet 10 inches high, light complexion, blue eyes, dark hair, and by occupation, when enrolled, a Farmer. He died in Regimental Hospital, at *Fort Brown, Texas*, on the 31st day of *December*, 1863, of typhoid fever.

INVENTORY.					
ARTICLES.	No.	ARTICLES.	No.	ARTICLES.	No.
Hats.....		Pairs trousers.....		Knapsacks.....	
Caps.....		Pairs flannel drawers.....		Watch, silver.....	1
Forage caps.....	1	Pairs cotton drawers.....	1	MONEY.	
Great coats.....		Flannel shirts.....			Specie.....
Uniform coats.....		Cotton shirts.....		Notes.....	\$50 00
Uniform jackets.....		Pairs boots.....			
Flannel sack coats.....		Pairs shoes.....			
Blouses.....		Pairs socks.....			
Stable frocks.....		Blankets.....			
Fatigue overalls.....		Haversacks.....			

I CERTIFY, ON HONOR, that the above inventory comprises all the effects of Private *John Smith*, deceased, and that the effects are in the hands of *Captain J. Brown*, at *Fort Brown, Texas*, to be disposed of by a Council of Administration, except the money, which has been turned over to *Major Wm. C. Morse*, Paymaster, U. S. Army, whose receipt is hereto annexed.*

STATION: *Fort Brown, Texas.*
 DATE: *December 31, 1863.*
 (Duplicates.)

JAMES BROWN,
Captain Co. A, 1st Penn. Vols.,
Commanding the Company.

*NOTE.—If the effects have been turned over to relatives of deceased, so state on certificate, instead of "in the hands of Captain," &c., and give the names of the persons, and their relation to the deceased person.

FORM 3.—HEIR'S RECEIPT FOR EFFECTS.

RECEIVED of *Captain John Brown*, Company A, 1st Regiment of Pennsylvania Volunteers, the following effects of Private *John Smith*, late of Company A, 1st Regiment of Pennsylvania Volunteers, now deceased, which I claim as his wife:

1 great coat, 1 flannel shirt, 1 silver watch, fifty dollars in notes, and two dollars in specie.

MARY SMITH.

FORM 4.—PAYMASTER'S RECEIPT FOR MONEY.

RECEIVED, this 31st day of *December*, 1863, at *Fort Brown, Texas*, of *Captain James Brown*, of Company A, 1st Pennsylvania Volunteers, fifty dollars in Treasury notes and two dollars in specie, the property of the late Private *John Smith*, of Company A, 1st Pennsylvania Volunteers, who died at *Fort Brown, Texas*, on the 31st day of *December*, 1863.

WM. C. MORSE, *Paymaster, U. S. A.*

FORM 5.—PROCEEDINGS OF A COUNCIL OF ADMINISTRATION.

Convened at *Fort Brown, Texas*, pursuant to Orders, No. 1, dated Post Headquarters, *Fort Brown, Texas*, January 2, 1864—consisting of *Captain James Keith*, Company C, 1st Pennsylvania Volunteers; *Captain John Brown*, Company D, 1st Pennsylvania Volunteers; and *Lieutenant William Roe*, Company E, 1st Pennsylvania Volunteers—for the purpose of disposing of the effects of the late *John Smith*, of Company A, 1st Pennsylvania Volunteers:

The Council found that the effects consisted of the following articles. They were ordered to be sold at auction, which was accordingly done, and the amount set opposite the articles respectively obtained, for which the receipt of the Paymaster is annexed:

AT AUCTION.		
1 shirt	brought.....	\$1 00
1 great coat	".....	2 50
1 silver watch	".....	25 00
		\$28 50

JAMES KEITH,
Capt. Co. C, 1st Penn. Vols., President.
 WILLIAM ROE,
Lieut. Co. E, 1st Penn. Vols., Recorder.

APPROVED: JOHN SANDERS,
Colonel 1st Penn. Vols.,
Commanding Post.

FORM 6.—PAYMASTER'S RECEIPT.

RECEIVED from *Captain John Brown*, Company A, 1st Pennsylvania Volunteers, at *Fort Brown, Texas*, January 10, 1864, twenty-eight dollars and fifty cents, the result of the sale of the effects of the late Private *John Smith*, of Company A, 1st Pennsylvania Volunteers.

WM. C. MORSE, *Paymaster U. S. Army.*

ARTICLES OF WAR.

ART. 95. When any non-commissioned officer or soldier shall die, or be killed in the service of the United States, the then commanding officer of the troop or company shall, in the presence of two other commissioned officers, take an account of what effects he died possessed of, above his arms and accoutrements, and transmit the same to the office of the Department of War, which said effects are to be accounted for, and paid to the representatives of such deceased non-commissioned officer or soldier. And in case any of the officers, so authorized to take care of the effects of deceased officers and soldiers, should, before they have accounted to their representatives for the same, have occasion to leave the regiment or post, by preferment or otherwise, they shall, before they be permitted to quit the same, deposit in the hands of the commanding officer, or of the assistant military agent, all the effects of such deceased non-commissioned officers and soldiers, in order that the same may be secured for, and paid to, their respective representatives.

DIRECTIONS.

- NOTE 1.—One copy of the inventories of the effects of deceased non-commissioned officers and soldiers, required by the 95th Article of War, will be forwarded to the Adjutant General, by the commander of the company to which the deceased belonged, and a duplicate of the same to the colonel of the regiment. Final statements of pay, clothing, &c., in duplicate, will be sent to the Adjutant General with one copy of the inventory. Both inventory and final statements should be forwarded, as a general rule, through Regimental Headquarters. When a soldier dies at a post or station absent from his company, it will be the duty of his immediate commander to furnish, direct to the Adjutant General, the required inventory and final statements, and, at the same time, to forward to the commanding officer of the company to which the soldier belonged, a report of his death, specifying the date, place, and cause; to what time he was last paid, and the money or other effects in his possession at the time of his decease; which report will be noted on the next muster roll of the company to which the man belonged. Each inventory will be endorsed "Inventory of the effects of _____, late of company (—) _____ regiment of _____, who died at _____ the _____ day of _____, 186—." If a legal representative receive the effects, it will be stated in the report. If the soldier leave no effects, the fact will be reported on the blank for inventory.
- NOTE 2.—Should the effects of a deceased non-commissioned officer or soldier not be administered upon within a short period after his decease, they shall be disposed of by a Council of Administration under the authority of the commanding officer of the post, and the proceeds deposited with the Paymaster, to the credit of the United States, until they shall be claimed by the legal representatives of the deceased. This should be done according to Forms 5 and 6, and one copy of each sent to the Adjutant General. No copy of the order convening the board is required, the approval of the commanding officer being sufficient.
- NOTE 3.—In all such cases of sales by the Council of Administration, a statement in detail, or account of the proceeds duly certified by the Council and commanding officer, (Form 5.) accompanied by the Paymaster's receipt of the proceeds, will be forwarded by the commanding officer to the Adjutant General. The statement will be endorsed "Report of the proceeds of the effects of _____, late of company (—) _____ regiment of _____, who died at _____ the _____ day of _____, 186—."
- NOTE 4.—The effects in all cases, when called for, should be turned over to the legal representative, without further authority from the Adjutant General. When the effects are turned over to the relatives of the deceased before these inventories are sent to the Adjutant General, their receipts therefor should be attached to the inventories. In all other cases, one copy will be sent with a letter of transmittal direct to the Adjutant General, and a duplicate retained by the officer.
- NOTE 5.—Particular care should be taken to take receipts in duplicate from the Paymaster for any funds turned over to him; one copy should be sent direct to the Adjutant General, and one retained by the officer.
- NOTE 6.—Where a soldier dies in hospital or on detached service, his descriptive list, if he has one, should be sent with his final statements, in duplicate, to the Adjutant General, Washington, D. C.
- NOTE 7.—Form 1 will be forwarded in duplicate to the Adjutant General, through Regimental Headquarters, as soon as possible after the death of the soldier, accompanied by one copy of Forms 2 and 3, or 4, as the case may require. A duplicate of the inventory (Form 2) should be retained until the articles are finally disposed of.
- NOTE 8.—The papers for each man should be made SEPARATELY for each man, and, when possible, fastened together. This is especially necessary, and must be done in all cases. The papers cannot be properly disposed of at the Adjutant General's Office unless this is done, and must be returned for correction.
- NOTE 9.—Where there are no line officers, as for instance, a general hospital without a line officer to command the guard, the Council of Administration may be made up from other commissioned officers, in the same way as prescribed for line officers.
- NOTE 10.—Where a soldier dies away from his company or regiment, and the officer having charge of him cannot furnish Final Statements by reason of not being able to obtain a Descriptive List, he should notify the regimental or company commander, (giving him full particulars as to history and description of the man, as far as possible,) whose duty it will then be, in such case, to furnish the necessary papers from the best data he can obtain.

Su

RCFA
AP 1412
VOL. 2

APR 19 1942

17
277

WAR DEPARTMENT,

ADJUTANT GENERAL'S OFFICE,

WASHINGTON, Nov. 14, 1866.

SIR:

Final Statements in the cases of deceased soldiers are required to be sent to the Adjutant General's Office in duplicate, with one copy of the Inventory of Effects. The Descriptive List should also be sent to this Office in cases where the soldier was absent from his Company at the time of his death. Where there were no effects, it should be so stated on a blank Inventory, properly signed.

Certificates of Disability should be sent in duplicate. Special care should be taken that the date of discharge and signature of the discharging officer should be affixed.

Two of the Final Statement *or* Inventory, has been received in the case of *J. Armstrong*, of Co. *E, 6th* Regiment of *U.S.C.V.* Volunteers, whose papers were forwarded to this Office. You will please forward the missing papers without delay.

I have the honor to be, sir,

Very respectfully,

Your obedient servant,

*Pro. of C. of Ad. recd from
Foot Moun. Va*

F. W. Hazard

Assistant Adjutant General.
(110)

COMMANDING OFFICER

J. J. Woodward
Adj. U.S.A.

J.S.

MODEL FOR SET OF PAPERS FOR A DECEASED SOLDIER.

FORM 1.—FINAL STATEMENT.

I CERTIFY, ON HONOR, that *John Smith*, a Private of Captain *J. Brown's* Company, (A,) of the 1st Regiment of Pennsylvania Volunteers, of the State of Pennsylvania, born in Pittsburg, State of Pennsylvania, aged 21 years, 5 feet 10 inches high, light complexion, blue eyes, dark hair, and by occupation a Farmer, having joined the Company on its original organization at Pittsburg, and enrolled in it at the muster into the service of the United States at Pittsburg, on the 1st day of July, 1861, (or was mustered in service as a recruit, by _____, at _____, on the _____ day of _____, 186—, or was drafted and mustered into the service of the United States from the _____ Enrollment District of the State of _____, at _____, on the _____ day of _____, 186—,) to serve in the Regiment for the term of Three Years, and having served *honestly* and *faithfully* with his Company in the field to the present date, is now entitled to a DISCHARGE by reason of death. Died in Regimental Hospital, Fort Brown, Texas, December 31, 1863, of typhoid fever.

The said *John Smith* was last paid by Paymaster Major *Morse*, to include the 31st day of October, 1863, and has pay due him from that time to the present date. He is entitled to pay and subsistence for *traveling* to place of enrollment, and whatever other allowances are authorized to volunteer soldiers, drafted men, or militia, so discharged. He has received from the United States clothing amounting to 20.00 dollars, since the 31st day of December, 1862, when his clothing account was last settled. He has received from the United States 25.00 dollars advanced *bounty*.

There is to be stopped from him on account of the State of _____, or other authorities, for *clothing, &c.*, received on entering service, nothing, .00 dollars; and for other stoppages, viz: nothing, .00 dollars. He has been furnished with no *transportation* in kind from the place of his discharge to _____; and he has not been *subsisted* for *traveling* to his place of enrollment up to the _____, 186—.

He is indebted to _____, *Sutler*, _____ dollars.

He is indebted to _____, *Laundress*, _____ dollars.

GIVEN, IN DUPLICATE, at Fort Brown, Texas, this 31st day of December, 1863.

JAMES BROWN,
Captain Co. A, 1st Penn. Vols.,
Commanding Company.

FORM 2.

INVENTORY of the effects of *John Smith*, late a Private of Captain *J. Brown's* Company, (A,) of the 1st Regiment of Pennsylvania Volunteers, who was enrolled as a Private at Pittsburg, in the State of Pennsylvania, on the 1st day of July, 1861, and mustered into the service of the United States as a Private on the 1st day of July, 1861, at Pittsburg, in Company A, 1st Regiment of Pennsylvania Volunteers, to serve three years or during the war. He was born in Pittsburg, in the State of Pennsylvania; he was 21 years of age, 5 feet 10 inches high, light complexion, blue eyes, dark hair, and by occupation, when enrolled, a Farmer. He died in Regimental Hospital, at Fort Brown, Texas, on the 31st day of December, 1863, of typhoid fever.

INVENTORY.					
ARTICLES.	No.	ARTICLES.	No.		
Hats.....	1	Pairs trousers.....	1		
Caps.....		Pairs flannel drawers.....			
Forage caps.....		Pairs cotton drawers.....			
Great coats.....		Flannel shirts.....			
Uniform coats.....		Cotton shirts.....			
Uniform jackets.....		Pairs boots.....			
Flannel sack coats.....		Pairs shoes.....			
Blouses.....		Pairs socks.....			
Stable frocks.....		Blankets.....			
Fatigue overalls.....		Haversacks.....			
				Knapsacks.....	
				Watch, silver.....	1

I CERTIFY, ON HONOR, that the above inventory comprises all the effects of Private *John Smith*, deceased, and that the effects are in the hands of *Captain J. Brown*, at Fort Brown, Texas, to be disposed of by a Council of Administration, except the money, which has been turned over to Major *Wm. C. Morse*, Paymaster, U. S. Army, whose receipt is hereto annexed.*

STATION: Fort Brown, Texas.

DATE: December 31, 1863.

(Duplicates.)

JAMES BROWN,
Captain Co. A, 1st Penn. Vols.,
Commanding the Company.

*NOTE.—If the effects have been turned over to relatives of deceased, so state on certificate, instead of "in the hands of Captain," &c., and give the names of the persons, and their relation to the deceased person.

FORM 3.—HEIR'S RECEIPT FOR EFFECTS.

RECEIVED of Captain *John Brown*, Company A, 1st Regiment of Pennsylvania Volunteers, the following effects of Private *John Smith*, late of Company A, 1st Regiment of Pennsylvania Volunteers, now deceased, which I claim as his wife:

1 great coat, 1 flannel shirt, 1 silver watch, fifty dollars in notes, and two dollars in specie.

MARY SMITH.

FORM 4.—PAYMASTER'S RECEIPT FOR MONEY.

RECEIVED, this 31st day of December, 1863, at Fort Brown, Texas, of Captain *James Brown*, of Company A, 1st Pennsylvania Volunteers, fifty dollars in Treasury notes and two dollars in specie, the property of the late Private *John Smith*, of Company A, 1st Pennsylvania Volunteers, who died at Fort Brown, Texas, on the 31st day of December, 1863.

WM. C. MORSE, Paymaster, U. S. A.

FORM 5.—PROCEEDINGS OF A COUNCIL OF ADMINISTRATION.

Convened at Fort Brown, Texas, pursuant to Orders, No. 1, dated Post Headquarters, Fort Brown, Texas, January 2, 1864—consisting of Captain *James Keith*, Company C, 1st Pennsylvania Volunteers; Captain *John Brown*, Company D, 1st Pennsylvania Volunteers; and Lieutenant *William Roe*, Company E, 1st Pennsylvania Volunteers—for the purpose of disposing of the effects of the late *John Smith*, of Company A, 1st Pennsylvania Volunteers:

The Council found that the effects consisted of the following articles. They were ordered to be sold at auction, which was accordingly done, and the amount set opposite the articles respectively obtained, for which the receipt of the Paymaster is annexed:

AT AUCTION.		
1 shirt brought.....		\$1 00
1 great coat ".....		2 50
1 silver watch ".....		25 00
		<u>\$28 50</u>

JAMES KEITH,
Capt. Co. C, 1st Penn. Vols., President.
WILLIAM ROE,
Lieut. Co. E, 1st Penn. Vols., Recorder.

APPROVED: JOHN SANDERS,
Colonel 1st Penn. Vols.,
Commanding Post.

FORM 6.—PAYMASTER'S RECEIPT.

RECEIVED from Captain *John Brown*, Company A, 1st Pennsylvania Volunteers, at Fort Brown, Texas, January 10, 1864, twenty-eight dollars and fifty cents, the result of the sale of the effects of the late Private *John Smith*, of Company A, 1st Pennsylvania Volunteers.

WM. C. MORSE, Paymaster U. S. Army.

ARTICLES OF WAR.

ART. 95. When any non-commissioned officer or soldier shall die, or be killed in the service of the United States, the then commanding officer of the troop or company shall, in the presence of two other commissioned officers, take an account of what effects he died possessed of, above his arms and accoutrements, and transmit the same to the office of the Department of War, which said effects are to be accounted for, and paid to the representatives of such deceased non-commissioned officer or soldier. And in case any of the officers, so authorized to take care of the effects of deceased officers and soldiers, should, before they have accounted to their representatives for the same, have occasion to leave the regiment or post, by preferment or otherwise, they shall, before they be permitted to quit the same, deposit in the hands of the commanding officer, or of the assistant military agent, all the effects of such deceased non-commissioned officers and soldiers, in order that the same may be secured for, and paid to, their respective representatives.

DIRECTIONS.

NOTE 1.—One copy of the inventories of the effects of deceased non-commissioned officers and soldiers, required by the 95th Article of War, will be forwarded to the Adjutant General, by the commander of the company to which the deceased belonged, and a duplicate of the same to the colonel of the regiment. Final statements of pay, clothing, &c., in duplicate, will be sent to the Adjutant General with one copy of the inventory. Both inventory and final statements should be forwarded, as a general rule, through Regimental Headquarters. When a soldier dies at a post or station absent from his company, it will be the duty of his immediate commander to furnish, direct to the Adjutant General, the required inventory and final statements, and, at the same time, to forward to the commanding officer of the company to which the soldier belonged, a report of his death, specifying the date, place, and cause; to what time he was last paid, and the money or other effects in his possession at the time of his decease; which report will be noted on the next muster roll of the company to which the man belonged. Each inventory will be endorsed "Inventory of the effects of _____, late of company (—) _____ regiment of _____, who died at _____ the _____ day of _____, 186—." If a legal representative receive the effects, it will be stated in the report. If the soldier leave no effects, the fact will be reported on the blank for inventory.

NOTE 2.—Should the effects of a deceased non-commissioned officer or soldier not be administered upon within a short period after his decease, they shall be disposed of by a Council of Administration under the authority of the commanding officer of the post, and the proceeds deposited with the Paymaster, to the credit of the United States, until they shall be claimed by the legal representatives of the deceased. This should be done according to Forms 5 and 6, and one copy of each sent to the Adjutant General. No copy of the order convening the board is required, the approval of the commanding officer being sufficient.

NOTE 3.—In all such cases of sales by the Council of Administration, a statement in detail, or account of the proceeds duly certified by the commanding officer, (Form 5,) accompanied by the Paymaster's receipt of the proceeds, will be forwarded by the commanding officer to the Adjutant General. The statement will be endorsed "Report of the proceeds of the effects of _____, late of company (—) _____ regiment of _____, who died at _____ the _____ day of _____, 186—."

NOTE 4.—The effects in all cases, when called for, should be turned over to the legal representative, without further authority from the Adjutant General. When the effects are turned over to the relatives of the deceased before these inventories are sent to the Adjutant General, their receipts therefor should be attached to the inventories. In all other cases, one copy will be sent with a letter of transmittal direct to the Adjutant General, and a duplicate retained by the officer.

NOTE 5.—Particular care should be taken to take receipts in duplicate from the Paymaster for any funds turned over to him; one copy should be sent direct to the Adjutant General, and one retained by the officer.

NOTE 6.—Where a soldier dies in hospital or on detached service, his descriptive list, if he has one, should be sent with his final statements, in duplicate, to the Adjutant General, Washington, D. C.

NOTE 7.—Form 1 will be forwarded in duplicate to the Adjutant General, through Regimental Headquarters, as soon as possible after the death of the soldier, accompanied by one copy of Forms 2 and 3, or 4, as the case may require. A duplicate of the inventory (Form 2) should be retained until the articles are finally disposed of.

NOTE 8.—The papers for each man should be made SEPARATELY for each man, and, when possible, fastened together. This is especially necessary, and must be done in all cases. The papers cannot be properly disposed of at the Adjutant General's Office unless this is done, and must be returned for correction.

NOTE 9.—Where there are no line officers, as for instance, a general hospital without a line officer to command the guard, the Council of Administration may be made up from other commissioned officers, in the same way as prescribed for line officers.

NOTE 10.—Where a soldier dies away from his company or regiment, and the officer having charge of him cannot furnish Final Statements by reason of not being able to obtain a Descriptive List, he should notify the regimental or company commander, (giving him full particulars as to history and description of the man, as far as possible,) whose duty it will then be, in such case, to furnish the necessary papers from the best data he can obtain.

2pts. + in. cent post St. C. 2.
Nov 14 1862

CASUALTY SHEET

No.

F. Armstrong

of Company *E*

6th Regiment of *U.S.C.V.*

State Volunteers.

NATURE OF CASUALTY.

*Went out with Armstrong
company on Nov 14
to the fort at Pilot -*

*Went out with on E
company to the fort
at Armstrong.*

Ent on OR of Cas

CASUALTY SHEET.

Name: *J. Armstrong*
 Rank: _____ Company: *E* Regiment: *6th*
 Arm: *U.S.C.I.* State: _____
 Nature of Casualty: *Death*

CAUSE OF CASUALTY—(NAME OF DISEASE, &c.)

BY WHOM DISCHARGED.

FROM WHAT SOURCE THIS INFORMATION WAS OBTAINED.

DEGREE OF DISABILITY.

Pro. of C. of ad recd from Fort Monroe, Va.

BY WHOM CERTIFIED.

*J. H. Grant
C. of U.S.A.*

REMARKS.

Pro. of C. of ad + P.M. recd for \$3.95, sent 2^d Auditor, Nov. 14, 1866

DATE OF DISCHARGE, DEATH, &c.

PLACE OF DISCHARGE, DEATH, &c.

James Beckwith
Clerk.
(170)

E. B., S. G. O.

Surgeon General's Office

Record and Pension Bureau,

Dec. 17th 1866.

Respectfully returned, with Inventory of Effects enclosed, in case of the within named man.

No evidence on file from which Final Statements can be prepared.

*Inscribed of J. Amending
Co "E" 8th U. S. C. Troops.
Filed*

By Order of the Surgeon General:

J. Woodward

Brevet Major and Assistant Surgeon, U. S. A.

1412
U. S. A.

G. W. B.

U.S. GOVERNMENT

Private Private

CARD NUMBERS.

5568145	26
5572111	27
5572421	28
9064791	29
	30
	31
	32
	33
	34
	35
	36
	37
	38
	39
	40
	41
	42
	43
	44
	45
	46
	47
	48
	49
	50

Book Mark:

See also

A 6 U.S.C.T.

Renty Ash

Co. C, 6 Reg't U. S. Col'd Inf.

Appears on

Company Descriptive Book

of the organization named above.

DESCRIPTION.

Age 43 years; height 5 feet 5 inches.

Complexion Dark

Eyes Blue; hair Black

Where born Brunswick, NC

Occupation Laborer

ENLISTMENT.

When Oct 4, 1865.

Where Wilmington, NC

By whom Capt Riley; term 3 y'rs.

Remarks: Mustered by Lt. Hughes at No. East Sta. Mar 13 65

W J Roe

A | 6 | U.S.C.T.

Rentz Ash

Appears with rank of *Pvt* on

Muster and Descriptive Roll of a Detachment of U. S. Vols. forwarded

for the 6 Reg't U. S. Col'd Infantry. Roll dated

North East Station N.C., Mar 13, 1865.

Where born *Brunswick Co N.C.*

Age *43* y'rs; occupation *Labourer*

When enlisted *Mar 4, 1865.*

Where enlisted *Wilmington*

For what period enlisted *3* years.

Eyes *Dark*; hair *Black*

Complexion *Dark*; height *5 ft. 5 in.*

When mustered in *Mar 13, 1865.*

Where mustered in *North East Sta N.C.*

Bounty paid \$ *100*; due \$ *300* ^{*00*}/_{*100*}

Where credited

Company to which assigned

Remarks:

Book mark:

A

6

U.S.C.T.

Renty Ash

Priv., Co. C, 6 Reg't U. S. Col'd Infantry.

Appears on

Company Muster Roll

for March & April, 1865.

Present or absent

Stoppage, \$ 100 for

Due Gov't, \$ 100 for

Remarks: Deserted April 26/65
Due U.S. for Ord. \$ 23.97
Due U.S. for C. & G.E. \$ 9.50

Book mark:

J. Fletcher

A. | 6 | U.S.C.T.

Reuty Ash

Co. C, 6 Reg't U. S. Col'd Infantry.

Appears on **Co. Muster-out Roll**, dated *Washington Sept 20*, 1865.

Muster-out to date _____, 186 .

Last paid to _____, 186 .

Clothing account:

Last settled _____, 186 ; drawn since \$ _____ 100

Due soldier \$ _____ 100; due U. S. \$ _____ 100

Am't for cloth'g in kind or money adv'd \$ _____ 100

Due U. S. for arms, equipments, &c., \$ _____ 100

Bounty paid \$ _____ 100; due \$ _____ 100

Remarks: *Reserted April 26, 1865,*

Book mark: *2130 P159, 71*

Beach

William Chapman

CARD NUMBERS.

1	5567628	26
2	5568923	27
3	5568935	28
4	5568947	29
5	5568954	30
6	5568971	31
7	5568983	32
8	5568992	33
9	5569003	34
10	5569015	35
11	5569027	36
12	5569048	37
13		38
14		39
15		40
16		41
17		42
18		43
19		44
20		45
21		46
22		47
23		48
24		49
25		50

Book Mark: 1731-CD-771

See also

NARA 428

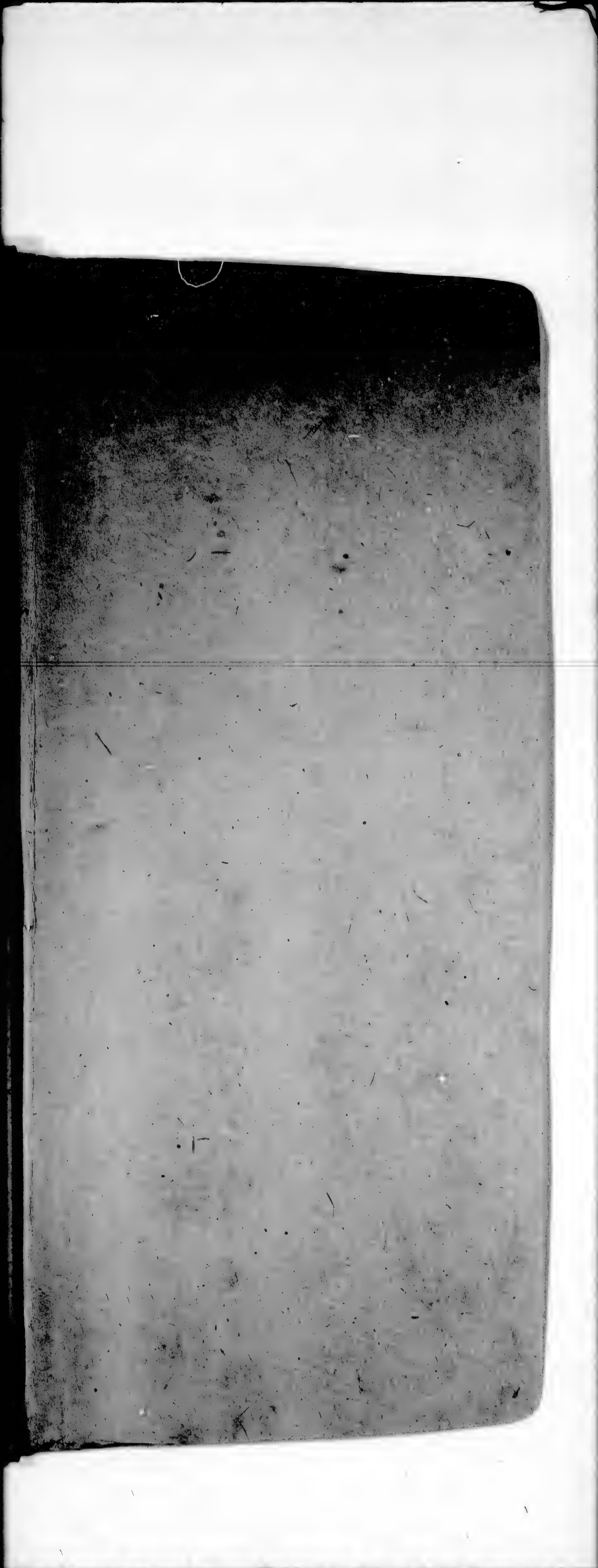

91 6

U.S.C.T.

Seremiah Asher

Chapt. Co. *6* Reg't U. S. Col'd Infantry.

Age *57* years.

Appears on an

Individual Muster-in Roll

of the organization named above. Roll dated

St Mansuetas, Dec 24, 186 *3*.

Muster-in to date *Dec 24*, 186 *3*.

Joined for duty and enrolled:

When *Dec 24*, 186 *3*

Where *Yorktown*

Period *3* years.

Remarks :

Book mark :

[Signature]

A | 6 | U.S.C.T.

Jeremiah Asher

Rank *Chaplain, 6* Reg't U. S. Col'd Infantry.

Appears on

Field and Staff Muster Roll

for *Nov & Dec*, 186*3*

Present or absent *Present*

Stoppage, \$ 100 for

Due Gov't, \$ 100 for

Valuation of horse, \$ 100

Valuation of horse equipments, \$ 100

Remarks: *Pay due ^{from} Dec 22, 63*

Book mark:

[Signature]

K 1 6

U.S.C.T.

Samuel Asher

Rank *Captain, Co* Reg't U. S. Col'd Infantry.

Appears on

Field and Staff Muster Roll

for *Jan & Feb*, 1864.

Present or absent *Present*

Stoppage, \$ *100* for

Due Gov't, \$ *100* for

Valuation of horse, \$ *100*

Valuation of horse equipments, \$ *100*

Remarks *Pay due from
appointment*

Book mark:

Quinn

A | *6* | **U.S.C.T.**

Jeremiah Asher

Rank *Chaplain*, *6* Reg't U. S. Col'd Infantry.

Appears on

Field and Staff Muster Roll

for *Men & Am*, 186*4*.

Present or absent *Present*

Stoppage, \$ *100* for

Due Gov't, \$ *100* for

Valuation of horse, \$ *100*

Valuation of horse equipments, \$ *100*

Remarks:

Book mark:

(357)

[Signature]

Copyist

A 1 6

U.S.C.T.

Minian Asher

Rank *Chaplain*, Reg't U. S. Col'd Infantry.

Appears on

Field and Staff Muster Roll

for *May & June*, 1864.

Present or absent *Present*

Stoppage, \$ 100 for

Due Gov't, \$ 100 for

Valuation of horse, \$ 100

Valuation of horse equipments, \$ 100

Remarks:

Book mark:-----

Asher

A | 6

U.S.C.T.

Josiah Arthur

Rank *Chaplain*, 6 Reg't U. S. Col'd Infantry.

Appears on

Field and Staff Muster Roll

for *July & Aug*, 186*4*.

Present or absent *Present*

Stoppage, \$ 100 for

Due Gov't, \$ 100 for

Valuation of horse, \$ 100

Valuation of horse equipments, \$ 100

Remarks:

Book mark:

Arthur

(357)

Capt

N 1 6 U.S.C.T.

Frederick Robert

Rank Chaplain, 6 Reg't U. S. Col'd Infantry.

Appears on

Field and Staff Muster Roll

for Sept & Oct, 1864.

Present or absent Present

Stoppage, \$ 100 for

Due Gov't, \$ 100 for

Valuation of horse, \$ 100

Valuation of horse equipments, \$ 100

Remarks :

NEXT ROLL ON FILE 1-21-1865

Book mark :

[Signature]

(357)

Copied

A 1 6 U.S.C.T.

Jeremiah Asher

Rank Chaplain, 6 Reg't U. S. Col'd Infantry.

Appears on

Field and Staff Muster Roll

for Jan & Feb, 1865.

Present or absent Present

Stoppage, \$ 100 for

Due Gov't, \$ 100 for

Valuation of horse, \$ 100

Valuation of horse equipments, \$ 100

Remarks:

Book mark:

(357)

[Signature]
Copyist

A | 6 | U.S.C.T.

Jeremiah Asher
Rank *Chaplain*, Reg't U. S. Col'd Infantry.

Appears on

Field and Staff Muster Roll

for *Men & age*, 1865:

Present or absent *Present*

Stoppage, \$ *100* for

Due Gov't, \$ *100* for

Valuation of horse, \$ *100*

Valuation of horse equipments, \$ *100*

Remarks:

Book mark:

[Signature]

(357)

Copyist

A | 6 U.S.C.T.

Premiah Asher

Rank *Captain*, Reg't U. S. Col'd Infantry.

Appears on

Field and Staff Muster Roll

for *May & June*, 1865:

Present or absent *Present*

Stoppage, \$ 100 for

Due Gov't, \$ 100 for

Valuation of horse, \$ 100

Valuation of horse equipments, \$ 100

Remarks:

Book mark:

[Signature]

A | 6. | U.S.C.T.

Frederick Asher

Rank *Chaplain*, 6 Reg't U. S. Col'd Infantry.

Appears on

Field and Staff Muster Roll

for *July & Aug*, 1865.

Present or absent

Stoppage, \$ 100 for

Due Gov't, \$ 100 for

Valuation of horse, \$ 100

Valuation of horse equipments, \$ 100

Remarks: *Wid of Typhoid
died July 27, 65.*

Book mark:

[Signature]

A | 6 | U.S.C.T.

Freeman Arthur

Rank *Captain*, 6 Reg't U. S. Col'd Inf.

Appears on

Field and Staff Muster-out Roll

of the organization named above. Roll dated

Wilmington N.C. Sept 20, 1865.

Muster-out to date _____, 186 .

Last paid to *Sept 30*, 1863 .

Clothing account:

Last settled _____, 186 ; drawn since \$ _____ 100

Due soldier \$ _____ 100; due U. S. \$ _____ 100

Am't for cloth'g in kind or money adv'd \$ _____ 100

Due U. S. for arms, equipments, &c., \$ _____ 100

Bounty paid \$ _____ 100; due \$ _____ 100

Remarks *Wid of deceased at
Wilmington N.C. July 27, 65*

Book mark *173105-77-122622*

Arthur
Copyist.

Asher, Jeremiah
Chaplain, Co. **6 U.S.C. Inf.**
 Reg't

14 Enclosures.

Bed Cards	Descriptive Lists
Burial Records	Final Statements
Certs. of Dis. for Discharge	Furloughs
C. M. Charges	Med. Des. Lists
Med. Certificates <i>1</i>	Orders <i>5</i>

Other papers relating to—

Admission to Hosp'l	Furlough <i>2</i>
Casualty Sheet (Officer's)	Med. Examination
Confinement	Misc. Information <i>45</i>
Contracts	Pay or Clothing
Death or Effects	Personal Reports
Desertions	Rank
Discharge from Hosp'l	Transfer to Hosp'l
Discharge from Service	Transfer to V. R. C.
Duty	Transportation

6 U.S.C. Inf.

MICROFILM PUBLICATION M 1848

COMPILED MILITARY SERVICE RECORDS
OF VOLUNTEER UNION SOLDIERS WHO SERVED WITH
THE UNITED STATES COLORED TROOPS (USCT)
6TH REGIMENT OF INFANTRY

PERSONAL PAPERS' TARGET SHEET

PLEASE NOTE THE CHECKED INFORMATION ABOUT THE PERSONAL PAPERS IN
THIS FILE:



NO PERSONAL PAPERS WERE FOUND IN THIS FILE WHEN THE
RECORDS WERE ARRANGED FOR MICROFILMING.



19 PERSONAL PAPER(S) FOUND IN THIS FILE WHEN THE RECORDS
WERE ARRANGED FOR MICROFILMING.

Camp nr. Yorktown Va
Nov. 1st 1863

Recommending
the appointment of
the Rev. Jeremiah
Asher - to the position
of Chaplain in the
6th Regt. U.S. Colored
Troops -

A 96. A. G. O. 65-1863

Camp nr. Yorktown Va - Nov. 1st 1863

We, the undersigned Officers of the 6th U.S. Colored Troops, unite in recommending the appointment of the Rev. Jeremiah Asher of Philadelphia Pa - as Chaplain of this Regiment.

(Signs)

C. E. Boyce	Lieut-Col. 6 th U.S. C-T
J. B. Kiddoo	Major - " "
Chas. V. York	Adj " "
Leamer Barnes	Surgeon - " "
G. V. R. Merrill	" " " "
Lewis M. Horsfield	R.Q.M. " "
Robt. B. Beattie	Captain Co. A. " "
Man J. Chamberlain	1 st Lieut. Co. A. " "
Newton J. Hotchkiss	Captain Co. F. " "
Philipp Weinman	Captain Co. D. " "
L. Landon	1 st Lieut. " " " "
A. N. Buckman	1 st Lieut. Co. F. " "
J. B. Johnson	2 nd Lieut. Co. D. " "
Enoch F. Jackson	Lt. Co. C. " "
N. H. Edgerton	1 st Lieut. Co. H. " "
E. D. Harkness	Captain Co. E. " "
Will. A. Glass	1 st Lieut. Co. E. " "
R. N. Verplanck	2 nd Lieut. Co. H. " "
G. P. Riley	Capt. Co. K. " "
J. H. Goulding	2 nd Lieut. Co. K. " "
James Woodward	1 st Lieut. Co. K. " "
Henry Herbert	Capt. Co. G. " "
M. C. Kingsbury	1 st Lieut. Co. G. " "
Geo. W. Sheldon	Capt. Co. H. " "
Pr. Meyer	2 nd Lieut. Co. B. " "
Nathaniel N. Hubbard	1 st Lieut. Co. B. " "

A true Copy -
 J. W. Ames
 Col. 6th Regt. C-T.

Camp on Yorktown Va.
Dec. 18th 1863
Application for permission
& pass for Rev. J. Asher
Chaplain 6th Regt. U.S.C.T.
to join his Regiment.

A 12th

1863

Va + M C
Let an order be
issued ^{for the} ~~for the~~ ^{officer} ~~for the~~
1863

Camp on Yorktown Va.
Respectfully for-
warded. —

J. W. Ames
Col. 6th Regt. U.S.C.T.
a s 21.9. Yorktown 1863 6
Ad. Ins. U.S. Forces
Yorktown, Va, Dec. 18th 1863

Respectfully forwarded
approval in deference
to the wishes of ~~the~~
Not because I consider
Chaplain a useful ad-
dition to the Regt. - in
general - J. W. Ames
B.S.

Recd 21.9. Yorktown Dec. 1863

Head Quarters 6th Regt U S C. I.

Camp near Yorktown Va.

Nov 1st 1863

General Order

No 11

In accordance with the recommendation of the Field Staff, and Co. officers of the 6th U. S. C. I. the Reverend Jeremiah Asher a clergyman of the Baptist denomination of Phila Pa. is hereby appointed Chaplain of this Regt. He will join his Regiment without delay.

By order of
Col John W Ames

Comdg 6th Regt U.S.C.I.

Chas W York
Lieut & Adjt

A true Copy

J. W. Ames

Col - 6th Regt U.S.C.I.

Camp near Yorktown Va. Nov. 12. 1863
Hd. Qrs. 6th Regt. U.S.C.T.

General Order }
No. 11 }

In accordance with the recommen-
- dation of the Field - Staff, and Company officers of
the 6th Regt. U.S. Colored Troops, the Reverend
Jeremiah Asher, a clergyman of the Baptist
Denomination, of Philadelphia Pa. is hereby
appointed, Chaplain of this Regiment. - His will
join his Regiment without delay.

By order of

Col. J. W. Ames

Comdr. 6th U.S.C.T.

(signed)

Chas. V. York

1st Lieut. & Adj.

A true copy.

Camp near Fort Mifflin Pa.
Nov 12 1863

Appointed as Chaplain
of the 5th Regt. U.S. Colored
Troops - the New Jerusalem
Order of Philadelphia Pa

2

696 - A.G.O C.S. - 1863

Camp on Yorktown Va. Nov 1st 1863
 Hd Qrs. 5th Regt. U.S.C.T.

General Order }
 No. 11. }

In accordance with the recommendation of the "Field and Staff" and "Company" officers of the 5th Regiment U.S. Colored Troops, the Reverend Jeremiah Asher, a clergyman of the Baptist denomination of Philadelphia Pa; is hereby appointed Chaplain of this Regiment. He will join his Regiment without delay -

By order of

Col. D. W. Ames

Comd. 5th U.S.C.T.

(Signed)

Chas. V. York

1st Lieut & Adj.

A true copy

D. W. Ames

Col. 5th U.S.C.T.

A 96. 65-1863

New York
No 3. 1863

J. M. Ames
Co 6th Regt

Reports having appeared
of certain persons
to the 6th Regt C.S.
forwarded order to

(2 En)

Recd HQ Nov 6. 1863

War Department, A.C.O.

Nov. 28th 1863.

Respectfully returned to
Col. J. M. Ames, Comdg. 6th
Regt. U.S. Colored Troops.

The testimony of "some
authorized ecclesiastical
body" or not less than five
accredited Ministers"
with the certificate of the
Mustering Officer are ne-
cessary to complete the
record in this case.

See Genl. Orders No. 126

War Dept. 1863.

By order:

L. W. Foster
Asst. Adjt. Genl. Vol.

E. B. Vol. 0. Page 326

Camp on Yorktown Va - Nov. 3^d 1863

Sir

In accordance with Article 24. par. 208. "Revised Army Regulations", I have appointed the Rev. Jeremiah Asher, chaplain of this Regt., on the nomination of the Company Commanders, and on the recommendation of the Field, Staff & Company Officers of the Regt. - Mr Asher is a colored clergyman of the Baptist denomination, from the City of Philadelphia Penn. I transmit herewith a copy of the order appointing him, and a copy of the officers' recommendation for his appointment.

I have the honor to be Sir

very respectfully

Yr dt. servt.

J. W. Ames

Col. 6th Regt. U. S. C. T.

Adjutant General U. S. A.

Washington D. C.

Co. 80th 25th Feb
Dec 31, 1864

Respectfully transmitted to
Chaplain Asha through
mediate command with
Reference to previous endorse-
ment

By command of
C. J. Paine
Solo A. C. B.
A. A. G.

Co. 23rd 25th Feb
Dec 31, 1864

Respectfully returned to
Co. 6 and Co. with
reference to previous endorse-
ment

By command of
Col. J. W. M.
S. H. B. M.
Solo A. A. G.

Co. 6th 27th July 1864

Respectfully returned with
reference to previous en-
dorsement

By command of
S. H. C. M.
N. K. H. C.
+ A. D. T.

No welcome
MS 8/16-855

Hdqn. 6th Ill. Inf. S. I. S. Va. Nov. 21. 1864

Arthur Bennett Chaplain 6th Ill. Inf.

Requests that his commission as Chaplain 6th Ill. Inf. be forwarded to him

Hdqn. 6th Ill. Inf. New Chaplain
S. I. S. Va. Nov. 22. 1864

Respectfully forwarded approved
O. E. Ryan
Lieut. Col. 23rd

Hdqn. 3rd Div. 3rd Div. 1st Ab. S. I. S. Va. Nov. 22. 1864
Respectfully forwarded approved

Dev. Com.
Col. Comd. Proj.

Hdqn. 3rd Div. 4th Ab. S. I. S. Va. Nov. 22. 1864

Respectfully forwarded

A. T. Paine

Pres. Gen. Vols.
Gen.

Hdqn. 18th Ab. Army of the James
S. I. S. Va. Nov. 22. 1864

Respectfully forwarded

W. W. Witzel
Maj. Gen. Comd.

Hdqn. Dept. Va. & N. C. Army
of the James In the field Dec. 20. 1864

Respectfully forwarded approved
A. G. V. Gen. J. Buller

Maj. Gen. Comd.

War. Dept. A. G. Office Dec. 2. 1864
Respectfully returned to Major General J. T. Buller Commanding Department of Virginia and North Carolina (For Members Regimental Chaplains are not appointed by the War Department)

Appointments were issued to Chaplain Hunter and Turner through misapprehension
Chaplain Arthur Bennett was appointed by the com.

meaning of the office of Chaplain in accordance with the Revised Army Regulations (see Par. 208) and mustered in on said appointment no further action is called for
By order of the Secy of War

A. T. Rockwell
Adj. Gen. Vols

Hdqn. Dept. Va. & N. C. Army
of the James In the field Dec. 20. 1864
Respectfully returned to Chaplain Arthur Bennett and attention invited to endorsement of the War Department

By command of
Maj. Gen. O. S.
H. P. Scott
Adj. Gen.

Hdqn. 2nd Ab. S. I. S. Va. Dec. 2. 1864
Respectfully returned to Chaplain Arthur and attention invited to endorsement of the War Dept
By order of Brig. Gen. Fredman
W. W. Witzel
Adj.

A 127 ✓ 1863
 Yorktown Dec 17 1863

Col J. N. Ames
 6th U. S. C. T.

Asks for a pass for
Rev Jeremiah Asher
 to come to Yorktown,
 he having been appoint-
 ed Chaplain of 6th U. S. C. T.

1 Enclosure

~~12-6-93~~

filed 12-6-93

No Receipt Given Dec 21 63

Camp nr. Yorktown Va -

Dec. 17th 1863 -

Capt. Stephen R. Reynolds -

Asst. Adj. Genl.

Sir -

I have the honor to request that permission be given, and a "pass" from Philadelphia to Yorktown Va - furnished, for the Rev. Jeremiah Asher of Philadelphia, Chaplain of the 6th Regt. U.S. Colored Troops, to join his Regt. in the field without delay -

Mr Asher has recently been appointed to the position of Chaplain of this Regt.; and as he was not mustered into service with the field staff of the Regt. - he not being appointed until after the Regt. had joined this command, - he can now only be mustered by the "Commissary of Musters" of this command, - see Par. IV. of General Order No. 218 Adj. Genl. Office Washington D.C. Feb. 25. 63 - It is therefore necessary that he have a "pass" to enable him to join his Regt.; and in order that he may be duly ~~mustered~~ entered into service, and enter upon his duties without delay. I append a copy of the order applying Mr Asher to the Chaplaincy -

Very respectfully yr obdt. servt -

J. W. Ames
Col. 6th Regt. U.S.C.T.

J. Asher

Chaplain U.S. Army



Head Quarters Dept. of Virginia and North Carolina,

Fort Monroe, Va. Dec. 22^d 1863

SPECIAL ORDERS,

No. 153

III

EXTRACT.

The following Appointments are hereby made in the Sixth (Col.) U.S. Colored Infantry. subject to the approval of the President of the United States.

Rev. Jeremiah Ashur. to be Chaplain.



By Command of Major General BUTLER.

A. P. Davis

Assistant Adjutant General.

To Adjt. Genl.
W.D.A.

Camp in Yorktown Va -
Jan. 1st 1863

Recommendation of Field
+ Staff - June Office of
Rev. J. Asha of Philadelphia
as Chaplain of 5th U.S. C.T.

No. 1

H. J. R. C. J. 1863

Camp nr. Yorktown Va. Nov. 1st: 1863

We, the undersigned Officers of the 6th U.S. Colored Troops, unite in recommending the appointment of the Rev. Jeremiah Asher of Philadelphia, as chaplain of this Regiment.

(Signed)

- C. E. Royce (Lieut. Col. 6th U.S.C.T.)
- J. B. Kiddoo Maj. " "
- Chas. V. York Adj. " "
- Leann Barnes Art-Surg. " "
- G. V. R. Merrill " " " "
- Louis M. Horsfield R. Q. M. " "
- Robt. B. Beath Capt. Co. "I" "
- Mass J. Chamberlain 1st Lt. " " "
- Newton J. Hotchkiss Capt. Co. "F" "
- Philipp Weinman " " " " "
- L. Landon 1st Lt. " " "
- A. N. Buckman " " " " "F" "
- J. B. Johnson 2^d Lt. Co. "D" "
- Evack Jackson Lt. Co. "C" "
- N. H. Edgerton 1st Lt. Co. "H" "
- E. J. Harkness Capt. Co. "E" "
- Will A. Glass 1st Lt. Co. "E" "
- R. N. Verplank 2^d Lt. Co. "H" "
- G. P. Riley Capt. Co. "K" "
- J. H. Guilding 2^d Lt. Co. "K" "
- Jas. Woodward 1st Lt. Co. "K" "
- Henry Herbert Capt. Co. "G" "
- M. C. Kingsbury 1st Lt. " " " "
- Geo. M. Sheldon Capt. Co. "H" "
- for Meyer 2^d Lt. Co. "B" "
- Nathaniel M. Hubbard 1st Lt. Co. "B" "

(A true copy)

J. W. Ames
Col. 6th U.S.C.T.

W. Horton
Lieut. 6th U.S.C.T.

Application for 15 Days -
leave of absence -
Rev. D. Asher Chaplain 6th U.S.C.T.

Camp on Yorktown Dec 26th /63

Approved and respectfully forwarded
I have the honor to request that
the within be granted. Mr Asher
came to the Dpt. before his appoint-
ment was concluded - to see if he
would receive it, and to know how
and when to be mustered in. He
came therefore with the prepara-
tion to stay, and without arrange-
ing his affairs at home. He finds
himself here in the military
service and subject to military
rules in regard to leaves of
absence &c, - and he is very
anxious to be at home long
enough to conclude his
connection with the church
there of which he was formerly
pastor.

J. W. Ames
Col. 6th Regt. U.S.C.T.
Adj. Gen. U.S. Forces
Yorktown, Va., Dec. 26th 1863

Respectfully forwarded
Approved J. W. Ames
B. G.

Adj. Gen. U.S. Forces Yorktown, Va. 1863
A 136 ✓
Yorktown, Dec. 26th /63

Asher, Chaplain, 6th U.S.C. Troops

Requests leave of absence
for 15 days to attend to
important private business

Approved

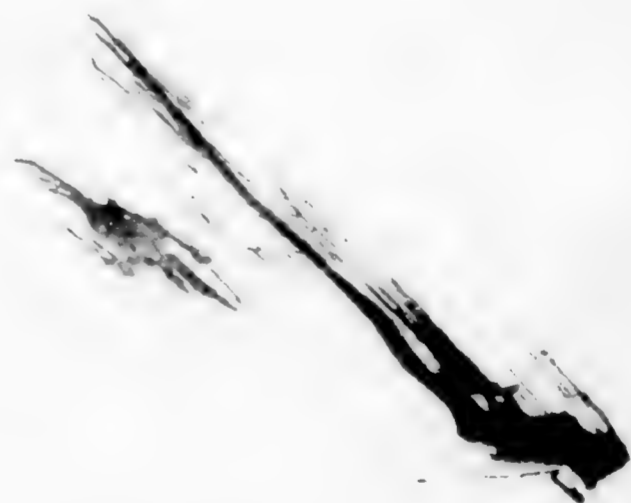

S. O. 161 (4)
Adj. Gen. U.S. Forces Yorktown, Va. Dec 29 63
Adj. Gen. U.S. Forces Yorktown, Va. Dec 29 63

Camp near Yorktown V^a
December 26th 1863

Lieut Chas V York
Adjutant 6th Regt U.S. Col^d Troops

Sir

I have the honor to apply for leave of absence for fifteen days
to go to Philadelphia P^a to transact urgent and very important business.

I am respectfully

Your O^bd^t Servant
Jeremiah Asher.

Chaplain 6th Regt U.S. Col^d Troops

E. M. 139 - Hager 3^a / 2^a / 1^a

Head Quarters Dept. of Virginia and North Carolina.

In the Field, Va., August 9th 1864.

SPECIAL ORDERS,

No. 217.

EXTRACT.

10. Leaves of Absence to go out of the Department are hereby granted to the following named Officers:

Chaplain Jeremiah Asher 6th U. S. C. T.
for five (5) days
to date from August 11th 1864.

By Command of Major General BUTLER.

A. P. Davis

Assistant Adjutant General.

C. O. 6th U. S. C. T. }
thru Gen. Ord }
}

3/2/65

S. O. 15. N. C.

Adj. Gen. Dept. N. Carolina -
 Wilmington N. C.
 February, 26. 1865.

Special Order No. 15.

Schofield. Major Genl -

Granting Permission to Capt. Hily,
 and Chaplain Asher - to go to
 Wilmington N. C. on recruiting
 service.

Department of North Carolina
Headquarters ~~Army of the Ohio,~~

~~In the Field,~~ Wilmington, N. C. Feb. 26th, 1865

Special ~~Field~~ Orders, }

No. 15

XI " " Permission is hereby given to Captains
G. S. Riley and Chaplain J. Asher with three
Privates and two Musicians of the 6th W. S. C. I.
to remain in Wilmington six (6) days for the
purpose of recruiting.

By Command of Major General Schofield:

Assistant Adjutant General.

C. O. 6th W. S. C. I.

Through - Genl. Terry.

192nd Regt. U.S. Col. 1865
Wilmington N.C.
July 16 1865

Alban Fremont
Captain 6th Mass.

Makes Application for leave
of absence grounded on
accompanying Surgeons
Certificate

30 days

CAE

S.O. 1258 Par. 1 July 21. 1865

HEADQUARTERS Post of Wilmington
WILMINGTON, N. C., July 17 1865.
Respectfully forwarded

J. M. Sornellan
Bot. Brig. Gen.
Lt-Col Comdg

10-2506 2-19 of 1865
Head Quarters Post of Wilmington
Wilmington July 17 1865

Respectfully forwarded
Approved
Lamuel A. Symeau
Brevet Brig. Genl

Rec'd Hd Quarters of N July 17, 65

No 644, July 17, 1865 Page 231. Hd Quarters Post of N.

Hdqrs. Dept of N.C.
Army of the Ohio
Raleigh N.C. July 18/65

Respectfully referred
to Surgeon A.S. Barnes
Acty Med. Dir. Army of
the Ohio -

By command of
Bvt. Maj. Gen. Robert
Austin Gilley
Majt a. acty.

Med. Director Office
Army of the Ohio
Raleigh N.C. July 20 65
Respectfully forwarded
Approved
A.S. Barnes
Surgeon, U.S.A.
Act. Med. Director



Wilmington N.C. July 16 1865

Sir:

I have the honor
to request a leave of absence for
thirty days to visit Philadelphia Pa. on ac-
count of my health. I have the honor to
forward Surgeons certificate herewith

I am Sir

Most Respy

Your Obedt Servt

Frederick Astor

Chaplain 6th MSgt.

Jeremiah Asher
~~Capt.~~ 6. U.S.A.
Chaplain

[Faint, illegible handwriting]

Head Quarters Department of North Carolina,

ARMY OF THE OHIO,

Raleigh, N. C. July 21, 1865.

Special Orders, }
No. 128 }

[EXTRACT.]

* * * * *

Par. 1 On Surgeon's Certificate, approved by Med. Dir. Leave of Absence is hereby granted the following named officers, for the number of days set opposite their respective names:

Jeremiah Asher Chaplain 6th U.S.C.T. 30 days

With permission to go beyond the limits of the Department

* * * * *

Per Ruger

By Command of MAJOR GENERAL ~~SCHIFFELD~~:

Clinton A. Hilley

Assistant Adjutant General.

The following extracts from Regulations and General Orders, relative to Leaves of Absence, will be strictly observed:

- "When not otherwise specified, leaves of absence will commence the day an officer is relieved from duty at his post, after receiving the order granting him leave.
- "At the expiration of his leave, the officer must report in person *with his command*, and *not* at the office from which his leave issued.
- "No officer is permitted to visit Washington without special permission from the Secretary of War, which must be stated in the order granting leave of absence.
- "If an officer be not able to travel at the expiration of his sick leave, he must report his address to the commander of his post, regiment, or corps, and also to the Adjutant General of the Army; and in his first report state the day when his leave of absence commenced. These reports must be repeated every twenty days, and each one must be accompanied by the certificate of a *medical officer of the army*, made in the usual form and stating that the officer is not able to travel. If there is no army physician in the place where the officer resides, the certificate of a citizen physician, the truth of which must be sworn to before a *civil magistrate*, may be substituted. *Extensions of leave are not granted in orders.*
- "Officers absent from duty without leave, or beyond the time of their leaves, will not be allowed to draw pay until a court or commission, which will be ordered on their return to their post or command, shall determine whether there was sufficient cause for their absence. They will accordingly provide themselves with a full description of the nature and cause of their disability, certified by the proper medical authority as required by existing orders and regulations.

C.O. 6th U.S.C.T.
thru Dist. of 20.

Head. Qu. Station
 Roanoke Old Ch. Co.
 Sept. 4, 1865

Adj. 6th U. S. Co. Troops

Sir;

Your note in reference to the horse. I sold Chaplain Fisher of your regiment is just received.

The Chaplain gave me his note for \$125 for the horse payable on demand, on which nothing has been paid. I do not wish to take the horse back for what I sold him, unless it is impossible to raise the full amount due me for him. Please send the money by express to my address New Bern Ch. Co., and I will send the note receipted to you by return mail. Should it be impossible for you to do this please see that the horse is forwarded to me at Roanoke Old Ch. Co.

Very respectfully,

Your obedt. servt.

Nathan L. Bishop

1st Lt Adj. Gen.

1st U. S. Co. Troops

1

Jeremiah Asher, Chaplain of
the C. & W. C. S. having applied to me
for a certificate on which to ground
an application for a leave of absence
I certify that I have carefully exam-
ined this officer and find that
he is suffering from the effects of
Remittent fever - and that a change
of location is necessary for his re-
covery and to prevent loss of life

I further certify that in my
opinion he will not be able to re-
sume his duties in a less period
than thirty (30) days.

Surgeon General Barnes
C. & W. C. S.

Head Quarters Dept. of Virginia and North Carolina,

Fort Monroe, Va. Dec. 22^d 1863.

SPECIAL ORDERS,

No. 153.

III

EXTRACT.

The following Appointments are hereby made in the Service of the U.S.
Colored Infantry subject to the approval of the President of the
United States.

General Jeremiah Asher to be Chaplain.



By Command of Major General BUTLER.

R. P. Davis

Assistant Adjutant General.

To Chap. Asher.
W. Boston Stream

No. 4
H. J. R. Co. D. 1000

No. 3
H. G. R. C. S. M.

8

W. G. M.

Camp near Yorktown Va. Nov 1st 63.
Head Quarters 6th Regt. U.S.C.T.

General Order
No 111

In accordance with the recomen-
dation of the Field-Staff and Company Officers of the
6th Regt. U. S. Colored Troops - the Reverend Jeremiah
Asher, a clergyman of the Baptist denomination
of Philadelphia Pa. is hereby appointed Chaplain
of this Regiment - He will join his Regiment
without delay -

By Order of
Col. John W. Ames
Commanding 6th Regt. U.S.C.T.
Charles E. York
1st Lt & adjt -

M. J. Horton
Lieut & adjt -

100

[Faint handwritten text, likely bleed-through from the reverse side of the page]

No. 2.
No. 9. R. C. S. 1864.

[Faint handwritten text, likely bleed-through from the reverse side of the page]

[Faint handwritten text, likely bleed-through from the reverse side of the page]

James G. Thompson

Mr. Boston
Ermen

Philadelphia August 1st 1863

This certifies that the Rev Jeremiah Asher
is a regularly ordained minister of the
Baptist Denomination - that he has been for
fourteen years the pastor of the Sixth Baptist
Church in this city - that he is an earnest
& faithful man, and that as such we
recommend him for appointment as a
Chaplain in the army

Wheaton Smith Pastor Sp St Bap Ch. Phila

Thomas S. Malcom, Pastor of Bap. Ch.
on Germantown Avenue

Howard Malcom

Reuben Jeffery Pastor Fourth Bap. Ch. Phil

Jno. H. Castle Pastor First Bap. Ch. West Philad

James Cooper Pastor of the African Baptist Church

Daniel C. Eddy

Tabernacle Church

West Philadelphia

James B. Simmons Pastor of 18th & Spring Garden St. Bap. Ch.

Private Private

CARD NUMBERS.

5568022	26
5568013	27
5571950	28
5572037	29
5572137	30
5572232	31
5572322	32
9064913	33
9064790	34
10	35
11	36
12	37
13	38
14	39
15	40
16	41
17	42
18	43
19	44
20	45
21	46
22	47
23	48
24	49
25	50

Book Mark:

See also

A	6	U.S.C.T.
James Adkins		
, Co. B, 6 Reg't U.S. Col'd Inf.		
Appears on		
Company Descriptive Book		
of the organization named above.		
DESCRIPTION.		
Age	42	years; height 5 feet 3 inches.
Complexion	Blk	
Eyes	Blk	; hair Blk
Where born	Va	
Occupation	Laborer	
ENLISTMENT.		
When	Dec 13	, 1864.
Where	N.Y. City	
By whom	Lt. Payne	; term 3 y'rs.
Remarks:	Mustered by Lt. Payne at New York City, Dec 13 64. Received 1st installment US Bounty \$100	
W. F. Roe		
(383a)		Copyist.

A | 6 | U.S.C.T.

James Adkins

Co. B, 6 Reg't U.S. Col'd Inf.

Appears on

Company Descriptive Book

of the organization named above.

DESCRIPTION.

Age 42 years; height 5 feet 3 inches.

Complexion Blk

Eyes Blk; hair Blk

Where born Va

Occupation Laborer

ENLISTMENT.

When Dec 13, 1864 ✓

Where N.Y. City

By whom Lt. Pyne; term 3 y'rs.

Remarks: Mustered by Lt Pyne at N.Y. City, Dec 13/64, Received 1st installment US Bounty 100

W J Row

A | **6** | **U.S.C.T.**

James McKinnis

Appears with rank of *9th Lt.* on

Muster and Descriptive Roll of a Detachment of U. S. Vols. forwarded

for the 6 Reg't U. S. Col'd Infantry. Roll dated

Castle Garden New York, Dec 13, 1864.

Where born *Virginia*

Age *42* y'rs; occupation *Laborer*

When enlisted *Dec 13th*, 1864.

Where enlisted *New York*

For what period enlisted *1³* years.

Eyes *Black*; hair *Black*.

Complexion *Black*; height *5 ft. 3* in.

When mustered in *Dec 13*, 1864.

Where mustered in *New York*.

Bounty paid \$ *100⁰⁰*; due \$ *100*

Where credited *5th Reg. Dist*

Company to which assigned

Remarks:

Book mark:

(339) *Spilberger* Copyist.

A | **6** | **U.S.C.T.**

James Atkins
 Appears with rank of *Pvt.* on
**Muster and Descriptive Roll of a Detach-
 ment of U. S. Vols. forwarded**

for the 6 Reg't U. S. Col'd Infantry. Roll dated
Fort Island N.Y. Dec 21, 1864.

Where born *va*

Age *42* y'rs; occupation *Labourer*

When enlisted *Dec 13*, 1864.

Where enlisted *N.Y. City*

For what period enlisted *3* years.

Eyes *Blk.*; hair *Blk.*

Complexion *Blk.*; height *5* ft. *3* in.

When mustered in *Dec 13*, 1864.

Where mustered in *N.Y. City*

Bounty paid \$ *100*⁰⁰/₁₀₀; due \$ *100*⁰⁰/₁₀₀

Where credited *5 reg. dist. N.Y. City*

Company to which assigned

Remarks:

Book mark:

(339) *Hoyberger* Copyist.

A

6

U.S.C.T.

James Atkins
Priv, Co. C, 6 Reg't U. S. Col'd Infantry.

Appears on

Company Muster Roll

for *Jan & Feb*, 1865.

Present or absent *Present*

Stoppage, \$ *100* for

Due Gov't, \$ *100* for

Remarks:

Book mark:

Fletcher

A

6

U.S.C.T.

James A. Trine
Co., Co. C, 6 Reg't U. S. Col'd Infantry.

Appears on

Company Muster Roll

for *March & April, 1865.*

Present or absent *Present*

Stoppage, \$ *100* for

Due Gov't, \$ *100* for

Remarks:

Book mark:

Fletcher

(358)

Copyist.

A | 6 | U.S.C.T.

James Atking
Bob, Co. C, 6 Reg't U. S. Col'd Infantry.

Appears on

Company Muster Roll
for *May & June*, 186 *5*.
Present or absent *Present*
Stoppage, \$ *100* for

Due Gov't, \$ *100* for

Remarks:

Book mark:

Beach

A | **6** | **U.S.C.T.**

James Atkin

Co. C, Co. *C*, 6 Reg't U. S. Col'd Infantry.

Appears on **Co. Muster-out Roll**, dated *Wilmington N.C., Sept 20*, 1865.

Muster-out to date *Sept 20*, 1865.

Last paid to *Oct 30*, 1865.

Clothing account:

Last settled *Nov*, 186 ; drawn since \$ *62* ^{*16*}/_{*100*}

Due soldier \$ 100; due U. S. \$ 100

Am't for cloth'g in kind or money adv'd \$ 100

Due U. S. for arms, equipments, &c., \$ 100

Bounty paid \$ *100* 100; due \$ 100

Remarks: *Due U S for*
1 S Driver 23 cts; P.M.S.
punch 20 cts. total 43 cts.

Book mark : _____

Beach

Adkins, James

....., Co. *6* Reg't *U.S.C. Inf.*

2 Enclosures.

Bed Cards	Final Statements
Burial Records	Furloughs or L. of A.
Certs. of Dis. for Discharge	Med. Certificates
C. M. Charges	Med. Des. Lists
Descriptive Lists	Orders
Discharge Certificates	Pris. of War Record
Enlistment Papers <i>2</i>	Resignations

Other papers relating to

Admission to Hosp'l	Furlough or L. of A.
Casualty Sheet	Med. Examination
Confinement	Misc. Information
Contracts	Pay or Clothing
Death or Effects	Personal Reports
Desertion	Rank
Discharge from Hosp'l	Transfer to Hosp'l
Discharge from Service	Transfer to V. R. C.
Duty	Transportation

MICROFILM PUBLICATION M 1848

COMPILED MILITARY SERVICE RECORDS
OF VOLUNTEER UNION SOLDIERS WHO SERVED WITH
THE UNITED STATES COLORED TROOPS (USCT)
6TH REGIMENT OF INFANTRY

PERSONAL PAPERS' TARGET SHEET

PLEASE NOTE THE CHECKED INFORMATION ABOUT THE PERSONAL PAPERS IN
THIS FILE:



NO PERSONAL PAPERS WERE FOUND IN THIS FILE WHEN THE
RECORDS WERE ARRANGED FOR MICROFILMING.



3 PERSONAL PAPER(S) FOUND IN THIS FILE WHEN THE RECORDS
WERE ARRANGED FOR MICROFILMING.

AFFIDAVIT OF

James Adkins

Dated *December 3rd* 1864.

James Adkins
of the County of ... State of ...
do hereby certify that ...
...
...
...

STATE OF NEW YORK,

County of *Schoharie*

} SS:

I, *James Adkins*, do solemnly swear
that I am between the age of eighteen and forty-five years,
~~and not subject to draft, by reason of~~

James + Adkins
His
mark

SWORN TO BEFORE ME,

This *13th* day of *December* 1864. }

Charles H. Pyne
1st Lieut Ch. Inf.

Mustering Officer.

DECLARATION OF RECRUIT.

I, James Adkins desiring to VOLUNTEER as a Soldier in the Army of the United States, for the term of THREE YEARS, Do Declare, That I am forty two years and _____ months of age; that I have never been discharged from the United States service on account of disability or by sentence of a court-martial, or by order before the expiration of a term of enlistment; and I know of no impediment to my serving honestly and faithfully as a soldier for three years.

GIVEN at NEW YORK,

the 13th day of December 1864.

Witness:

E. Cheney

James Adkins
Male

6 U. S. Colored Inf

No. 48971

James Adkins

Volunteered at New York,

December 13th 1864,

By St. Johnston, Sergeant

6th Regiment of U. S. Infantry

enlistment; last served in Company ()

Regt of _____

Discharged _____ 18

MAY 1864 This record was formerly filed in the Enrollment Div. H. & P. O.

27
12 05

E

CONSENT IN CASE OF MINOR.

I, _____ Do CERTIFY, That I am the _____ of _____, that the said _____ is _____ years of age; and I do hereby freely give my CONSENT to his volunteering as a SOLDIER in the ARMY OF THE UNITED STATES for the period of THREE YEARS.

GIVEN at _____ the _____ day of _____

Witness: _____

VOLUNTEER ENLISTMENT.

STATE OF NEW YORK.



CITY OF NEW YORK.

I, Jam. Adkin born in Buffalo Co
 in the State of Virginia aged Forty two years,
 and by occupation of Labor Do HEREBY ACKNOWLEDGE to have
 volunteered this thirteenth day of December 1864,
 to serve as a **Soldier** in the **Army of the United States of America**, for the
 period of **THREE YEARS** unless sooner discharged by proper authority: Do also
 agree to accept such bounty, pay, rations, and clothing, as are, or may be, estab-
 lished by law for volunteers. And I, Jam. Adkin do
 solemnly swear, that I will bear true faith and allegiance to the **United States**
of America, and that I will serve them honestly and faithfully against all their
 enemies or opposers whomsoever; and that I will observe and obey the orders of
 the President of the United States, and the orders of the officers appointed over
 me, according to the Rules and Articles of War.

Sworn and subscribed to, at NEW YORK,
 this 13 day of December 1864.
 BEFORE Charles Pyne
1st Lt. 6th W. S. Infy

Jam. Adkin
 Make

I CERTIFY, ON HONOR, That I have carefully examined the above-named Volunteer, agreeably
 to the General Regulations of the Army, and that, in my opinion, he is free from all bodily defects and
 mental infirmity, which would in any way disqualify him from performing the duties of a soldier.

W. S. D. M. G.
 EXAMINING SURGEON

I CERTIFY, ON HONOR, That I have minutely inspected the Volunteer Jam. Adkin
 previously to his enlistment, and that he was entirely sober when enlisted; that, to the best of my
 judgment and belief, he is of lawful age; and that, in accepting him as duly qualified to perform the duties
 of an able-bodied soldier, I have strictly observed the Regulations which govern the recruiting service.

This soldier has Black eyes, Red hair, Red complexion, is 5 feet
3 inches high,

Charles Pyne
1st Lt. 6th W. S. Infy
 Regiment of W. S. Infy
M. G.

RECRUITING OFFICER.

the day of, 1864, at NEW YORK

Mustered into the service of the United States, in Company

W. N. S. Guards Regiment of New York's

Volunteers, on

Charles Pyne
1st Lt. 6th W. S. Infy
M. G.

DECLARATION OF RECRUIT.

I, James Adkin desiring to VOLUNTEER as a Soldier in the Army of the United States, for the term of THREE YEARS, Do Declare, That I am Twenty Two years and _____ months of age; that I have never been discharged from the United States service on account of disability or by sentence of a court-martial, or by order before the expiration of a term of enlistment; and I know of no impediment to my serving honestly and faithfully as a soldier for three years.

GIVEN at NEW YORK,

the 13th day of December 1864.

Witness:

E. Cheney

James Adkin
li
man

Discharged

18

Regt of

enlistment; last served in Company ()

By Dr. Charles M. Stone

6th Regiment of A. S. Infantry

Volunteered at New York,

December 13th, 1864.

James Adkin

No.

4871

CONSENT IN CASE OF MINOR.

I, _____ Do CERTIFY, That I am the _____ of _____, that the said _____ is _____ years of age; and I do hereby freely give my CONSENT to his volunteering as a SOLDIER in the ARMY OF THE UNITED STATES for the period of THREE YEARS.

GIVEN at _____

the _____ day of _____

Witness:

VOLUNTEER ENLISTMENT.

STATE OF NEW YORK.



CITY OF NEW YORK.

I, James Adkins Col^d born in Suffolk Co.
 in the State of Virginia aged forty two years,
 and by occupation a Labourer DO HEREBY ACKNOWLEDGE to have
 volunteered this thirteenth day of December 1864,
 to serve as a **Soldier** in the **Army of the United States of America**, for the
 period of **THREE YEARS** unless sooner discharged by proper authority: Do also
 agree to accept such bounty, pay, rations, and clothing, as are, or may be, estab-
 lished by law for volunteers. And I, James Adkins do
 solemnly swear, that I will bear true faith and allegiance to the **United States**
of America, and that I will serve them honestly and faithfully against all their
 enemies or opposers whomsoever; and that I will observe and obey the orders of
 the President of the United States, and the orders of the officers appointed over
 me, according to the Rules and Articles of War.

Sworn and subscribed to, at NEW YORK,
 this 13th day of December 1864.
 BEFORE Charles DePuy
W. Lt. Col. U.S. Infy

James Adkins
 Made

I CERTIFY, ON HONOR, That I have carefully examined the above-named Volunteer, agreeably
 to the General Regulations of the Army, and that, in my opinion, he is free from all bodily defects and
 mental infirmity, which would in any way disqualify him from performing the duties of a soldier.

Moses
M. D.

EXAMINING SURGEON.

I CERTIFY, ON HONOR, That I have minutely inspected the Volunteer James Adkins
 previously to his enlistment, and that he was entirely sober when enlisted; that, to the best of my
 judgment and belief, he is of lawful age; and that, in accepting him as duly qualified to perform the duties
 of an able-bodied soldier, I have strictly observed the Regulations which govern the recruiting service.

This soldier has Black eyes, Black hair, Black complexion, is 5 feet
3 inches high,

Charles DePuy
1st Lt. Col. 6th Regiment of U.S. Infy Volunteers

M. D. RECRUITING OFFICER.

(A. G. O. No 74 & 76.)

the day of, 1864, at NEW YORK.

Mustered into the service of the United States, in Company

B. N. S. Col

Regiment of

New York

Volunteers, on

Charles DePuy
W. Lt. Col. U.S. Infy

M. D.

and Private
 CARD NUMBERS.

1	5577074	26
2	5577221	27
3	5577248	28
4	5577329	29
5	5577408	30
6	5577487	31
7	5577560	32
8	5577629	33
9	5577701	34
10	5577796	35
11	5577890	36
12	5577980	37
13	5578065	38
14	9065514	39
15	390-CT-1884	40
16		41
17		42
18		43
19		44
20		45
21		46
22		47
23		48
24		49
25		50

Book Mark: *Card, 390 - CT - 84,*

See also

A | **6** | **U.S.C.T.**

Thomas Aston,

....., Co. *N*, 6 Reg't U. S. Col'd Inf.

Appears on

Company Descriptive Book
of the organization named above.

DESCRIPTION.

Age *25* years; height *5* feet *6* inches.

Complexion *Blk*

Eyes *Blk*; hair *Blk*

Where born *Alleghany Co. Penn.*

Occupation *Boat.*

ENLISTMENT.

When *July 13*, 186 *3*.

Where *Alleghany City Pa*

By whom *23 D. Pa.*; term *3* y'rs.

Remarks: *Mustered by*
Capt. Kirken

Jenkins

A | 6 | U.S.C.T.

Thomas A. Aiken
Corpl, Co H, 6 Reg't U. S. Col'd Infantry.

Age 25 years.

Appears on

Company Muster-in Roll

of the organization named above. Roll dated
Phila Pa, Sept 14, 1863.

Muster-in to date July 12, 1863

Joined for duty and enrolled:

When July 13, 1863.

Where Alleghany City, Pa.

Period 3 years.

Remarks: Mustd. by Capt
Kirker P.M. July 12/63
Drafted.

(Filed with Thom at
St. Astor)

Book mark:

W. H. Thompson
Copyist.

A | 6 | U.S.C.T.

Thomas A Aston
Priv, Co. H, 6 Reg't U. S. Col'd Infantry.

Appears on

Company Muster Roll
for Sept 14 to Oct 31, 1863.

Present or absent Present

Stoppage, \$ 100 for

Due Gov't, \$ 100 for

Remarks: By error called
"Aiken" in Muster
In Roll. Reduced to
rank for G.O. No 3 Hd
Qrs Camp Wm Penn, Pa.
Sept 23/63.

Book mark:

(358)

M. H. Thompson
Copyist.

A | **6** | **U.S.C.T.**

Thomas Aston

Priv, Co. H, 6 Reg't U. S. Col'd Infantry.

Appears on

Company Muster Roll

for *Nov. & Dec*, 1863.

Present or absent *Present*

Stoppage, \$ 100 for

Due Gov't, \$ 100 for

Remarks:

Book mark:

M. H. Thompson
Copyist.

A | 6 | U.S.C.T.

Thomas Astor
Priv, Co. H, 6 Reg't U. S. Col'd Infantry.

Appears on

Company Muster Roll

for James & Geby, 1864.
Present or absent Present

Stoppage, \$ 100 for

Due Gov't, \$ 1 62/100 for 1/2 Shetter
tent

Remarks:

Book mark:

(358)

W. H. Thompson
Copyist.

A

6

U.S.C.T.

Thomas Ashton

Pvt., Co. H, 6 Reg't U. S. Col'd Infantry.

Appears on

Company Muster Roll

for March & April, 1864.

Present or absent Present

Stoppage, \$ 100 for

Due Gov't, \$ 1 ⁶²/₁₀₀ for 1/2 shelter tent
and - ⁵⁴/₁₀₀ " 1 Haversack

Remarks:

Book mark:

W. H. Thompson
Copyist.

(858)

A | 6 | U.S.C.T.

Thomas Astor

Priv, Co. H, 6 Reg't U. S. Col'd Infantry.

Appears on

Company Muster Roll

for *May & June*, 1864.

Present or absent *Absent*

Stoppage, \$ 100 for _____

Due Gov't, \$ 100 for _____

Remarks: *Wounded May 31. Absent in Gen. Hosp. City Point*

Book mark: _____

C. A. Harper

A

6

U.S.C.T.

Thomas Aston

Riv, Co. H, 6 Reg't U. S. Col'd Infantry.

Appears on

Company Muster Roll

for *July & Aug*, 1864.

Present or absent *Present*

Stoppage, \$ *100* for

Due Gov't, \$ *100* for

Remarks: *Free April 19/61
Received full pay for
May & June only/64
of May Walker
Pay due immediate of
enlistment*

Book mark:

C. Harper

CA

6

U.S.C.T.

Thomas A. Ston

Priv, Co. H, 6 Reg't U. S. Col'd Infantry.

Appears on

Company Muster Roll

for *Sept & Oct*, 1864.

Present or absent

Present

Stoppage, \$ 100 for

Due Gov't, \$ 100 for

Remarks:

NEXT ROLL ON FILE FEB 1865

Book mark:

C. A. Harper

(858)

Copyist.

CA | 6 | U.S.C.T.

Thomas Aston

Priv, Co. H, 6 Reg't U. S. Col'd Infantry.

Appears on

Company Muster Roll

for Jan & Feb, 1865.

Present or absent Present

Stoppage, \$ 100 for

Due Gov't, \$ 100 for

Remarks:

Book mark:

C. A. Harper

24

6

U.S.C.T.

Thomas Astor

Pvt, Co. H, 6 Reg't U. S. Col'd Infantry.

Appears on

Company Muster Roll

for *Mar & April*, 1865.

Present or absent *Present*

Stoppage, \$ 100 for

Due Gov't, \$ 100 for

Remarks:

Book mark:

A. S. Harper

(358)

Copyist.

A | 6 | U.S.C.T.

Thomas Aston

Pvt, Co. H, 6 Reg't U. S. Col'd Infantry.

Appears on

Company Muster Roll

for May & June, 1865.

Present or absent Present

Stoppage, \$ 100 for

Due Gov't, \$ 100 for

Remarks:

Book mark:

Holcomb

(358)

Copyist.

A | 6 | U.S.C.T.

Thomas Aston

Prk, Co. H, 6 Reg't U. S. Col'd Infantry.

Appears on

Company Muster Roll

for July Aug, 1865.

Present or absent Absent

Stoppage, \$ 100 for

Due Gov't, \$ 100 for

Remarks: Absent in confinement.

Book mark:

Halecomb

A

6

U.S.C.T.

Thomas Aston

Pvt., Co. H, 6 Reg't U. S. Col'd Infantry.

Appears on Co. Muster-out Roll, dated

Wilmington No. Sep 20, 1865.

Muster-out to date Sep 20, 1865.

Last paid to Apr 30, 1865.

Clothing account:

Last settled June 30, 1864; drawn since \$107 ⁶¹/₁₀₀

Due soldier \$100; due U. S. \$100

Am't for cloth'g in kind or money adv'd \$100

Due U. S. for arms, equipments, &c., \$6 ¹⁰⁰/₁₀₀

Bounty paid \$100; due \$100 ¹⁰⁰/₁₀₀

Remarks: Due Wm. Beisben Regt. Sutter \$28.
\$6 for ms due from Enlistment to Apr. 30/64.

Book mark: Cas 390 C.Y. 84

Holcomb

(361)

Copyist.

A. | 6th U.S.C.

Thomas Astor

, Co. H, 6th Reg't U.S.C.

NOTATION.

Book mark: 390. U.S.C. 1884

War Department,

Adjutant General's Office,

Washington, Feb'y 7th, 1884.

Call from

returned with report.

The above book mark was noted on rolls in order to preserve results of search in this case.

E. P. Conzies.

Aston, Mass.

Co. H, 6 Reg't M.C.T.

Enclosures.

Bed Cards	Final Statements
Burial Records	Furloughs or L. of A
Certs. of Dis. for Discharge	Med. Certificates
C. M. Charges	Med. Des. Lists
Descriptive Lists	Orders
Discharge Certificates	Pris. of War Record
Enlistment Papers	Resignations

Other papers relating to—

Admission to Hosp'l	Furlough or L. of A
Casualty Sheet	Med. Examination
Confinement	Misc. Information
Contracts	Pay or Clothing
Death or Effects	Personal Reports
Desertion	Rank
Discharge from Hosp'l	Transfer to Hosp'l
Discharge from Service	Transfer to V. R. C.
Duty	Transportation

GENERAL SERVICES ADMINISTRATION - NATIONAL ARCHIVES AND RECORDS SERVICE.						DATE	NO.
REFERENCE SERVICE SLIP						8-7-75	
NAME OF REQUESTOR				AGENCY OR ADDRESS			
W. HANE							
UNITS OF SERVICE						AUG 5 8 01	
INFORMATION SERVICE (Number of replies)		RECORDS FURNISHED (Number of items)	REPRODUCTION ORDERED			SOURCE OF REQUEST (Check)	
			TEXTUAL, STILL PICTURES, ETC. (Number of pages)	MOTION PICTURES (Number of feet)	SOUND RECORDINGS (Number of feet)	NA ADMINISTRATIVE USE	AGENCY OF ORIGIN
WRITTEN	ORAL					OTHER GOVERNMENT	
						NONGOVERNMENT	
						REQUEST HANDLED BY	
						JSD	
RG NO.	STACK AREA	ROW	COMPARTMENT	SHELF	OUTCARD NO.		
109	7W3				76171		
RECORD IDENTIFICATION							
AIKEN, THOMAS A.				CIVIL WPA			
Under custody				CORP.			
				CO. H.			
				6TH U.S. COL. INF.			
RECEIVED BY			DATE	RETURNED TO		DATE	

Mr. Ellertson

Thomas Astor

Co. H. 6. U.S. Troop

✓

Adjutant General's Office,

COLORED TROOPS BRANCH,

May 3^d, 1877

Vol. C. T., 187

Wanted in the case of Thomas Aston, Co. "H",
6th Reg't U.S.C.T.

Cause of confinement and if tried
Musters Roll for July and
August '65 reports him "Absent in confinement"

Respectfully,

R. A. Woodward
Chief Clerk.

J. D. Halton

Adjutant General's Office,

Div. Records discontinued Comdt. &c

May 10th, 1877

Vol. C. T., 187

Reply in case of Thos. Aston, Co. H,
6th Reg't U.S.C.T.

Cr. Morning Rep. book shows July 27 '65: In confinement.
Aug. 24 '65: To absent in conf't.

No evidence of trial.

G.O. books Dist. Wilmington & Prison records Wilmington N.C. not on file.

W.F.

6 U.S. Col'd Inf.

Private | Corporal

CARD NUMBERS.

1 5573599
 2 5573682
 3 5573765
 4 5573843
 5 5573916
 6 5573987
 7 5574052
 8 5574121
 9 5574656
 10 9065153
 11
 12
 13
 14
 15
 16
 17
 18
 19
 20
 21
 22
 23
 24
 25

26
 27
 28
 29
 30
 31
 32
 33
 34
 35
 36
 37
 38
 39
 40
 41
 42
 43
 44
 45
 46
 47
 48
 49
 50

Book Mark:

See also

7 | 6 | U.S.C.T.

Charles H. Augustus

, Co. E, 6 Reg't U. S. Col'd Inf.

Appears on

Company Descriptive Book

of the organization named above.

DESCRIPTION.

Age 20 years; height 5 feet 7 inches.

Complexion Yellow

Eyes Black; hair Black

Where born Newark Delaware

Occupation Bricklayer

ENLISTMENT.

When Aug 14, 1863.

Where Philada Pa

By whom Capt Sargeant; term 3 y'rs.

Remarks: Died at U. S. Gen-
eral Hospital Fort Mifflin

Munroe Oct 14 1864

Engaged in the actions

of June 15-64, Before Pe-

tersburg Va and June

22 and all Engagements

in which the regiment par-

ticipated up to the date

over

J. G. Reeves

MAY. 11

9065153

1891

of death he was present.

A | 6 | U.S.C.T.

Charles H. Augusto

Priv., Co. E, 6 Reg't U. S. Col'd Infantry.

Age _____ years.

Appears on

Company Muster-in Roll

of the organization named above. Roll dated

Philada Pa, Oct 13, 1863.

Muster-in to date Aug 14, 1863

Joined for duty and enrolled:

When Aug 14, 1863.

Where Philadelphia Pa

Period 3 years.

Remarks: _____

Book mark: _____

Lucas

A | 6 | U.S.C.T.

Chas H. Augustus
Pr-, Co. E, 6 Reg't U. S. Col'd Infantry.

Appears on

Company Muster Roll

for *Muster in to Oct 31*, 186 *3*

Present or absent *Present*

Stoppage, \$ *100* for

Due Gov't, \$ *100* for

Remarks:

Book mark:

Lucas

A

6

U.S.C.T.

Charles H. Augustus

Priv, Co. E, 6 Reg't U. S. Col'd Infantry.

Appears on

Company Muster Roll

for *Nov. & Dec*, 186 *3*

Present or absent *Present*

Stoppage, \$ *100* for

Due Gov't, \$ *100* for

Remarks:

Book mark:

Lucas

A | **6** | **U.S.C.T.**

Chas H. Augustus

Plt, Co. E, 6 Reg't U. S. Col'd Infantry.

Appears on

Company Muster Roll

for *Jan + Feby*, 1864

Present or absent *Present-*

Stoppage, \$ *100* for

Due Gov't, \$ *100* for

Remarks:

Book mark:

Lucas

A | 6 | U.S.C.T.

Charles H Augustus

Pvt-, Co. E, 6 Reg't U. S. Col'd Infantry.

Appears on

Company Muster Roll

for *Mich + April*, 1864

Present or absent *Present-*

Stoppage, \$ *100* for

Due Gov't, \$ *100* for

Remarks: *Due U. S. for Ordnance*
52 50

Book mark:

Lucas

A | 6 | U.S.C.T.

Charles H. Augustus
Pol, Co. E, 6 Reg't U. S. Col'd Infantry.

Appears on

Company Muster Roll

for *May & June*, 186*4*

Present or absent *Present*

Stoppage, \$ 100 for _____

Due Gov't, \$ 100 for _____

Remarks: _____

Book mark: _____

Harris

A | 6 | U.S.C.T.

Charles H. Augustus
Corp, Co. E, 6 Reg't U. S. Col'd Infantry.

Appears on

Company Muster Roll

for July & Aug, 1864

Present or absent Present

Stoppage, \$ 100 for

Due Gov't, \$ 100 for

Remarks: Promoted to Corp. July 1/64
On Extra duty digging Canal at
Dutch Gap Va. Free on or
before Apr 19/61

Book mark:

Harris

A | 6 | U.S.C.T.

Charles H. Augustus
Corpl, Co. E, 6 Reg't U. S. Col'd Infantry.

Appears on

Company Muster Roll
for Sept & Oct, 1864

Present or absent Absent

Stoppage, \$ 100 for

Due Gov't, \$ 100 for

Remarks: Absent wounded since
Sept 29/64. App'd Corp. July 1/64
Free Apr. 19/61

NEXT ROLL ON FILE FEB 1865

Book mark:

Harris

A | 6 | U.S.C.T.

Charles H. Augustus,
Corpl., Co. E, 6 Reg't U. S. Col'd Infantry.

Appears on Co, Muster-out Roll, dated
Wilmington, N.C., Sep. 20, 1865.

Muster-out to date _____, 186 .

Last paid to _____, 186 .

Clothing account:

Last settled _____, 186 ; drawn since \$ _____ 100

Due soldier \$ _____ 100; due U. S. \$ _____ 100

Am't for cloth'g in kind or money adv'd \$ _____ 100

Due U. S. for arms, equipments, &c., \$ _____ 100

Bounty paid \$ _____ 100; due \$ _____ 100

Remarks: Died of wounds rec'd
in action at New Market
Heights Oct. 14, 1864, at
Fort Monroe.

Book mark : _____

O'Pool

(361)

Copyist.

Augustus, Charles H.

Comp. Co. E, 6 Reg't USCT

2 Enclosures.

Bed Cards	Descriptive Lists
Burial Records	Final Statements /
Certs. of Dis. for Discharge	Furloughs
C. M. Charges	Med. Des. Lists
Med. Certificates	Orders

Other papers relating to—

Admission to Hosp'l	Furlough
Casualty Sheet (Officer's)	Med. Examination
Confinement	Misc. Information
Contracts	Pay or Clothing
Death or Effects /	Personal Reports
Desertions	Rank
Discharge from Hosp'l	Transfer to Hosp'l
Discharge from Service	Transfer to V. R. C.
Duty	Transportation

O. Feb. 24, 1865

v. of effects sent 2d Auditor

...

B. ...

... April 6/66

... of ...

... 40 ...

...

...

...

...

...

...

...

...

...

...

...

...

...

...

...

...

...

...

...

FINAL STATEMENT

OF

Corps Charles H. Augustus
Co. 10 Reg't of N. S. C. Troops.

VOLUNTEERS.

NOTE 1.—Two of these certificates (or duplicates) are to be given to each Volunteer Soldier or drafted man who may be discharged previously to the discharge of his company, that he may at once receive from the Paymaster the pay, &c., due him, and the captain or other COMMISSIONED officer commanding the company will certify to the act of the delivery of the duplicate certificates; on these certificates the Soldier is "entitled to" his discharge, and should also present his discharge to the Paymaster to have the payment endorsed on it. The discharge is to be given back to the Soldier by the Paymaster; the latter only retaining as his voucher the duplicate certificates.

NOTE 2.—If the Soldier is entitled to pay for the use of his horse, the Company Commander will certify to that fact on the back of both these final statements, and also to the time he has pay due for having been so mounted on his own horse.

NOTE 3.—When a Soldier is furnished with final statements, his descriptive list, if he has one, should be taken up by the officer who gives the Soldier these statements, and endorsed with a statement to this effect by the officer. This endorsement should exhibit a full statement of the time for which the Soldier was allowed pay on his final statements, the clothing account, and all other charges against him or in his favor, so as to comprise a complete exhibit of his account. It will then be transmitted to the company commander of the Soldier, who will enter all the data necessary to a full understanding of the Soldier's account on the muster roll upon which the Soldier's discharge is reported. The descriptive list will then be destroyed. The object of this is, that the remaining portion of the Soldier's account may be settled upon the receipt of these muster rolls, and the Soldier receive any pay or allowances that may be due him at the time of his discharge, and which may not appear on his final statements from the fact that his descriptive list is incomplete. These accounts for back pay, &c., are settled by the 2d Auditor of the Treasury Department.

NOTE 4.—Charges for loss or injury to ordnance, horse equipments, and other miscellaneous charges, should appear under the heading of "Other Stoppages."

NOTE 5.—Bounty paid by State authorities, and not by the United States, will not be entered on this statement.

NOTE 6.—Amounts due the Sutler and Laundress must be entered on the muster roll on which the discharge, death, desertion, &c., is reported, as well as on the final statement, otherwise the amount cannot be collected from the United States.

NOTE 7.—This blank will be used for deceased volunteers and drafted men, as well as for others.

NOTE 8.—Where a Soldier dies in Hospital or on detached service, his descriptive list, if he has one, should be sent with his final statements, in duplicate, to the Second Auditor, Washington, D. C.

ADJUTANT GENERAL'S OFFICE.
1503 1864
Duplicate with Inventory sent 2d Auditor.

Entoul
RECEIVED
ADJUTANT GENERAL'S OFFICE
3

ADJ

Duf

I certify, on honor, that Charles H. Augustus Corporal of
 Captain E. Hartshorn's Company (E) of the 6th Regiment of U. S. C. I.
VOLUNTEERS, of the State of _____, born in Newark, State
 of Delaware, aged 20 years; 5 feet 9 inches high; yellow complexion,
black eyes, black hair, and by occupation a brick layer, having joined the company on
 its original organization at Camp 1st Penn Pa, and enrolled in it at the muster into
 the service of the United States at Philada Penna, on the _____ day
 of _____, 1863, (or was mustered in service as a recruit, by Captain
Sergeant, at Philada Pa, on the fourteenth day of August,
 1863, or was drafted and mustered into the service of the United States from the _____
 Enrollment District of the State of _____, at _____,
 on the _____ day of _____, 186), to serve in the Regiment, for
 the term of Three Years: and having served HONESTLY and
 FAITHFULLY with his Company in the 6th U. S. C. I. to the present date, is now
 entitled to a **DISCHARGE** by reason of death. Died at Genl. Joseph
Fortak Moore Va - Oct. 14th 1864 of gunshot wounds.

The said Cpl - Charles H. Augustus was last paid by Paymaster
Maj. McKim to include the 31st day of April, 1864, and has
 pay due him from that time to the present date, he is entitled to pay and subsistence for
TRAVELING to place of enrollment, and whatever other allowances are authorized to volunteer
 soldiers, drafted men, or militia, so discharged. He has received from the United States **CLOTHING**
 amounting to 73 ⁵⁶ ₁₀ dollars, since the _____ day of enrollment,
 1863, ~~when~~ his clothing account was ~~last~~ ^{never} settled. He has received from the United States
 _____ ₁₀₀ dollars advanced **BOUNTY**.

There is to be stopped from him, on account of the State of _____, or other
 authorities, for **CLOTHING, &c.**, received on entering service, _____ ₁₀₀ dollars; and
 for other stoppages, viz: 1 Knapsack - 1 Haversack - 1 Canteen
1 Piece Tent Fabric - and 1 Screw Driver & screw
wrench - 5 - ₁₀₀ 80 dollars.

He has been furnished with **TRANSPORTATION** in kind from the place of his discharge to
 _____; and he has been **SUBSISTED** for **TRAVELING** to his
 place of enrollment, up to the _____, 186 .

He is indebted to Mrs. W. Brien, **SUTLER**, _____ ₁₀₀ 6 dollars.
 He is indebted to _____, **LAUNDRESS**, _____ ₁₀₀ dollars.

Given in Duplicate, at Camp 6th U.S. C. I. Va, this 23rd day
 of November, 1864.

W. R. Hammond
1st Lieut. 6th U.S. C. I.
 Commanding Company. E

Note: Given on or before April - 19th 1864.
 Received only \$7.00 per month for the period
 equal for
 appointed a Corporal July. 14th 1864.

INVENTORY OF THE EFFECTS

OF

Capt Charles Augustus

Late of Company E

6 Reg't of U.S. Art

Volunteers, who died at Fort Monroe Va

on the 14 day of October 1864.

Duplicate copy with certificate
sent to A. S. O. Wash. D.C.
Nov 26th 1864.

Inventory of the effects of Charles C. Augustus late
 a Corporal of Captain W. T. S. Company E. of
 the 6 Regiment of U. S. V. ~~Volunteers~~, who was enrolled as
 a _____ at _____ in the State of _____ on
 the _____ day of _____ 186 , and mustered into the service of the United
 States as a _____ on the _____ day of _____ 186 , at _____
 in Company _____, _____ Regiment of _____ Volunteers, to serve _____
 years or during the war; he was born in _____ in the State
 of _____; he was _____ years of age, _____ feet _____ inches
 high, _____ complexion, _____ eyes, _____ hair, and by occupation, when enrolled,
 a _____; he died in U. S. Genl. Hospital, at
Fort Monroe Va on the 14 day of October 1864, by
 reason of G. S. Wound R. S. Injury

INVENTORY.					
ARTICLES.	No.	ARTICLES.	No.	ARTICLES.	No.
Hats.....		Pairs trousers.....	/	Knapsacks.....	
Caps.....		Pairs flannel drawers.....			
Forage caps.....		Pairs cotton drawers.....			
Great coats.....	/	Flannel shirts.....			
Uniform coats.....		Cotton shirts.....			
Uniform jackets.....		Pairs boots.....			
Flannel sack coats.....		Pairs shoes.....	/		
Blouses.....	/	Pairs socks.....			
Stable frocks.....		Blankets.....			
Fatigue overalls.....		Haversacks.....			
				MONEY.	
				Specie.....	\$ _____
				Notes.....	\$ _____

I CERTIFY, ON HONOR, that the above inventory comprises all the effects of _____
Charles C. Augustus deceased, and that the effects are in the hands
 of E. M. Callan Asst. Surg. U. S. A. at U. S. Genl. Hospital
Fort Monroe Va to be disposed of by a Council of Administration.
as turned over to legal representatives of deceased.

(DUPLICATES.)

STATION: U. S. Genl. Hospital Fort Monroe Va
 DATE: October 14 1864

E. M. Callan
Asst. Surgeon U. S. Army
 Commanding the Company.
Hospital

U. S. COLLECTOR

Private *Private*

CARD NUMBERS.

	74718	26
	74800	27
	55-74884	28
	55-74964	29
	55-75044	30
	55-75124	31
	55-75204	32
	55-75281	33
	55-75354	34
10	55-75452	35
11	55-75550	36
12	55-75712	37
13	55-75827	38
14	9065279	39
15		40
16		41
17		42
18		43
19		44
20		45
21		46
22		47
23		48
24		49
25		50

Book Mark: *EB-12-281*

See also

6

6

U.S.C.T.

Augustus Clarkson

, Co. *F*, 6 Reg't U. S. Col'd Inf.

Appears on

Company Descriptive Book

of the organization named above.

DESCRIPTION.

Age *21* years; height *5* feet *3 1/2* inches.

Complexion *Brown*

Eyes *Black*; hair *Black*

Where born *Leicester Pa*

Occupation *Farmer*

ENLISTMENT.

When *Aug 24*, 1863.

Where *Philadelphia*

By whom *2 D. Pa*; term *3* y'rs.

Remarks: *Substitute. Died in U.S. Genl Hospital New Berne N.C. June 28 1865. Final Statement and List forwarded to A.C.S. Aug 3, 1865*

(383g)

J. G. Peew

Copyist.

A. | 6 | U.S.C.T.

Clarkson Augustus
Pot, Col F., 6 Reg't U.S. Col'd Infantry.

Age 21 years.

Appears on

Company Muster-in Roll

of the organization named above. Roll dated

Phila Pa, Oct 15, 1863.

Muster-in to date Aug 24, 1863

Joined for duty and enrolled:

When Aug 24, 1863.

Where Phila Pa

Period 3 years.

Remarks:

Book mark:

E. H. Beorn

4 | **6** | **U.S.C.T.**

Clarkson Augustus
Cot, Co. F, 6 Reg't U. S. Col'd Infantry.

Appears on

Company Muster Roll

for *Muster in to Oct*, 1863.

Present or absent *Present*

Stoppage, \$ *100* for

Due Gov't, \$ *100* for

Remarks:

Book mark:

E. H. Brown

4 | **6** | **U.S.C.T.**

Clarkson Augustus

Cot, Co. F, 6 Reg't U. S. Col'd Infantry.

Appears on

Company Muster Roll

for *Nov Dec*, 186³.

Present or absent *Present*

Stoppage, \$ *100* for

Due Gov't, \$ *100* for

Remarks:

Book mark:

E. H. Brown

A. | **6** | **U.S.C.T.**

Clackson Augustus
Pat, Co. F, 6 Reg't U. S. Col'd Infantry.

Appears on

Company Muster Roll

for Jan & Feb, 1864.

Present or absent Present

Stoppage, \$ 100 for

Due Gov't, \$ 100 for

Remarks:

Book mark:

E. H. Baum

A | 6 | **U.S.C.T.**

Clarkson Augustus
Cot, Co. F, 6 Reg't U. S. Col'd Infantry.

Appears on

Company Muster Roll

for Mar & April, 1864.

Present or absent Present

Stoppage, \$ 100 for

Due Gov't, \$ 100 for

Remarks:

Book mark:

C. H. Brown

a

6

U.S.C.T.

Clarkson Augustus
Pvt., Co. F, 6 Reg't U. S. Col'd Infantry.

Appears on

Company Muster Roll

for May & June, 1864.

Present or absent Present.

Stoppage, \$ 100 for

Due Gov't, \$ 100 for

Remarks:

Book mark:

W. Davis

9

6

U.S.C.T.

Clarkson Augustus
Put, Co. F, 6 Reg't U. S. Col'd Infantry.

Appears on

Company Muster Roll

for July & Aug., 1864

Present or absent Present

Stoppage, \$ 100 for

Due Gov't, \$ 100 for

Remarks: Free April 19, 1861.

Book mark: _____

McDavis

a | 6 | U.S.C.T.

Clarkson Augustus
Pvt., Co. F, 6 Reg't U. S. Col'd Infantry.

Appears on

Company Muster Roll

for Sept. & Oct., 1864.

Present or absent Present.

Stoppage, \$ 100 for

Due Gov't, \$ 100 for

Remarks:

NEXT ROLL ON FILE FEB 1865

Book mark:

W. Davis

(358)

Copyist.

a | 6 | U.S.C.T.

Clarkson Augustus
Put, Co. F, 6 Reg't U. S. Col'd Infantry.

Appears on

Company Muster Roll

for Jan + Feb, 1865.

Present or absent Present.

Stoppage, \$ 100 for

Due Gov't, \$ 100 for

Remarks:

Book mark:

McDaris

2

6

U.S.C.T.

Clarkson Augustus
Put, Co. F, 6 Reg't U. S. Col'd Infantry.

Appears on

Company Muster Roll

for Mich - Spi, 1865

Present or absent Present

Stoppage, \$ 100 for

Due Gov't, \$ 100 for

Remarks:

Book mark:

W. D. ...

(858)

Copyist.

A | **6** | **U.S.C.T.**

Clarkson Augustus

Priv, Co. F, 6 Reg't U. S. Col'd Infantry.

Appears on

Company Muster Roll

for May & June, 1865

Present or absent Absent

Stoppage, \$ 100 for

Due Gov't, \$ 100 for

Remarks: Sick in U.S.A. New-
berne N.C. since June 6/65

Book mark: _____

Lawrence

A

6

U.S.C.T.

Clarkson Augustus

Priv, Co. F, 6 Reg't U. S. Col'd Infantry.

Appears on

Company Muster Roll

for July & Aug, 1835.

Present or absent ✓

Stoppage, \$ 100 for

Due Gov't, \$ 100 for

Remarks: died of disease in
Hosp: New Bern N.C.
June 28/65 - F. S. paid to
A 40

Book mark: 10622. 2nd. June 8/65

Laurence

9

6

U.S.C.T.

Clarkson Augustus

Priv., Co. J., 6 Reg't U. S. Col'd Infantry.

Appears on Co. Muster-out Roll, dated

Wilmington N.C. Sept 20, 1865.

Muster-out to date _____, 186 .

Last paid to _____, 186 .

Clothing account:

Last settled _____, 186 ; drawn since \$ _____ 100

Due soldier \$ _____ 100; due U. S. \$ _____ 100

Am't for cloth'g in kind or money adv'd \$ _____ 100

Due U. S. for arms, equipments, &c., \$ _____ 100

Bounty paid \$ _____ 100; due \$ _____ 100

Remarks: Died of disease

Aug 28/65

Book mark: 257408 Dred Jones

28/65 212
281

Lawrence

Augustus Clarkson

D. Co. F, 6. Reg't USC I

6 Enclosures.

Bed Cards	1	Final Statements	1
Burial Records	2	Furloughs or L. of A	
Certs. of Dis. for Discharge		Med. Certificates	
C. M. Charges		Med. Des. Lists	
Descriptive Lists		Orders	
Discharge Certificates		Pris. of War Record	
Enlistment Papers		Resignations	

Other papers relating to—

Admission to Hosp'l		Furlough or L. of A	
Casualty Sheet		Med. Examination	
Confinement		Misc. Information	
Contracts		Pay or Clothing	
Death or Effects	1	Personal Reports	
Desertion		Rank	
Discharge from Hosp'l		Transfer to Hosp'l	
Discharge from Service		Transfer to V. R. C.	
Duty		Transportation	

MICROFILM PUBLICATION M 1848

COMPILED MILITARY SERVICE RECORDS
OF VOLUNTEER UNION SOLDIERS WHO SERVED WITH
THE UNITED STATES COLORED TROOPS (USCT)
6TH REGIMENT OF INFANTRY

PERSONAL PAPERS' TARGET SHEET

PLEASE NOTE THE CHECKED INFORMATION ABOUT THE PERSONAL PAPERS IN
THIS FILE:

- NO PERSONAL PAPERS WERE FOUND IN THIS FILE WHEN THE
RECORDS WERE ARRANGED FOR MICROFILMING.
- 5 PERSONAL PAPER(S) FOUND IN THIS FILE WHEN THE RECORDS
WERE ARRANGED FOR MICROFILMING.

TREATMENT.

[HERE NOTE IMPORTANT COMPENSATIONS AND ALL OPERATIONS.]

RESULT and DATE.

Did at 6 O'clock
P.M. June 25th 1825
X

Hospital Number 105

Name Clarkson Augustus

Age 20 Nativity Pa

~~Married or Single~~

Residence Pa

Post Office address of wife or nearest relative } No friends known

Rank Priv Co 7 Regiment 6 U.S. Cd.

When admitted June 28th 1865

From what source Field

Diagnosis: (in surgical cases state explicitly seat and character of wound or injury.)

Typhoid Fever

Post Hospital,
New Berne, N. C.

On what occasion wounded

Date

Nature of missile or weapon

[OFFICE ENDORSEMENT.]

War Department,

ADJUTANT GENERAL'S OFFICE,

March 23rd, 1871

The Death of Pvt. Clark Augustus, Co. F, 6th Reg't U. S. Colored Troops, is reported as follows:

On Company Muster Roll. For July and August, 1865, June 28th, 1865 Company Muster-out Roll.

Company Descriptive Book. January 28, 1865

Company Morning Reports. 1866

Soldier's Final Statement. 1866

Soldier's Record of Death and Interment. June 28, 1865

Soldier's Inventory of Effects. June 28, 1865

Soldier's Certificate of Disability for Discharge. 1866

Soldier's Individual Muster-out Roll. 1866

Regimental Return. 1866

For 186, Regimental Quarterly Returns. 1866

Regimental Descriptive Book. 1866

By Surgeon General. 1866

() June 28th, 1865, is held to be

the correct date, and the Company Muster-out Roll will be amended accordingly,

Thomas M. Vincent

Assistant Adjutant General. Noted M.H.

CPB 12 287

Vertical handwritten note: Letter to Lt. Col. Putnam to be June 28, 1865

A.G.O.
No inv. of effects can
be obtained in this
case. See
S. 278. Vol 4, A.C. 2, 1866.

A.G.O. June 5th 1866
Also list sent 2nd Aud.

772

ADJUTANT GENERAL'S OFFICE.
June 5th 1866
2d Auditor.

801/65 3
FINAL STATEMENT
OF
2.60 mch 1866
Private Clarkson Augustus
1st Reg't of U. S. Col'd Troops.
Co "F"
Dec June 28th 1865
VOLUNTEERS.

NOTE 1.—Two of these certificates (or duplicates) are to be given to each Volunteer Soldier or drafted man who may be discharged without being mustered out (Final Statements are never given to men mustered out of service) that he may at once receive from the Paymaster the pay, &c., due him, and the captain or other COMMISSIONED officer commanding the company will certify to the act of the delivery of the duplicate certificates; with these certificates the Soldier is "entitled to" his discharge, and should also present his discharge to the Paymaster to have the payment endorsed on it. The discharge is to be given back to the Soldier by the Paymaster; the latter only retaining as his vouchers the duplicate certificates.

NOTE 2.—If the Soldier is entitled to pay for the use of his horse, the Company Commander will certify to that fact on the back of both these final statements, and also to the time he has pay due for having been so mounted on his own horse.

NOTE 3.—When a Soldier is furnished with final statements, his descriptive list, if he has one, should be taken up by the officer who gives the Soldier these statements, and endorsed with a statement to this effect by the officer. The endorsement should exhibit a full statement of the time for which the Soldier was allowed pay on his final statements, the clothing account, and all other charges against him or in his favor, so as to comprise a complete exhibit of his account. It will then be transmitted to the Company Commander of the Soldier, who will enter all the data necessary to a full understanding of the Soldier's account on the muster roll upon which the Soldier's discharge is reported. The descriptive list will then be destroyed. The object of this is, that the remaining portion of the Soldier's account may be settled upon the receipt of these muster rolls, and the Soldier receive any pay or allowances that may be due him at the time of his discharge, and which may not appear on his last final statements from the fact that his descriptive list is incomplete. These accounts for back pay, &c., are settled by the 2d Auditor of the Treasury Department.

NOTE 4.—Charges for loss or injury to ordnance, horse equipments, and other miscellaneous charges, should appear under the heading of "Other Stoppages."

NOTE 5.—Bounty paid by State authorities, and not by the United States, will not be entered on this statement.

NOTE 6.—Amounts due the Sutler and Laundress must be entered on the muster roll on which the discharge, death, desertion, &c., is reported, as well as on the final statement, otherwise the amount cannot be collected from the United States.

NOTE 7.—This blank will be used for deceased volunteers and drafted men, as well as for others.

NOTE 8.—Where a Soldier dies in Hospital or on detached service, his descriptive list, if he has one, should be sent with his final statements, in duplicate, to the Adjutant General, Washington, D. C.

NOTE 9.—If the soldier is a drafted man or substitute, the space for time, &c., of enrolled, should contain only the word *drafted* or *substitute*, as the case may be. If the Soldier is a "VETERAN," (or RECRUIT,) the words *as a veteran*, (or *recruit*.) as the case may be, should be interlined after the words *mustered into the service of the U. S.* A statement of all the installments of *Veteran* or *Recruit* Bounty RECEIVED by the Soldier must be made on the back of each final statement.

Ant and Prof. (C.)

I certify, on honor, that Clarkson Augustus, a Private of
 Captain A. W. Buckman's Company (F) of the 6th Regiment of W. S. Colored Troops
VOLUNTEERS, of the State of Pennsylvania, born in Lancaster, State
 of Pennsylvania, aged 21 years; 5 feet 3 inches high; Black complexion,
Black eyes, Black hair, and by occupation a Farmer, who joined for service
 and was enrolled (see Note 9) on the _____ day of _____, 1863, at _____
 by J. Substrate, for the period of Three years, and mustered into
 the service of the United States on the 24th day of August, 1863 at
Philadelphia, by Enlist. Philade.; and having served
 HONESTLY and FAITHFULLY with his Company to the present date, is now entitled to a
DISCHARGE by reason of Death. He died in hospital at
New Bern, N. C. on the 28th day of June 1865, of typhoid fever.

The said Private Clarkson Augustus was last paid by Paymaster
Wm. J. McKenny, to include the 31st day of August, 1864, and
 has pay due him from that time to the present date; he is entitled to pay and subsistence for
TRAVELING to place of enrollment, and whatever other allowances are authorized to volunteer
 soldiers, drafted men, or militia, so discharged. He has received from the United States **CLOTHING**
 amounting to Eighteen $\frac{51}{100}$ dollars, since the 30th day of June
 1864 when his clothing account was last settled. He has received from the United States
 _____ $\frac{100}{100}$ dollars advanced **BOUNTY**.

There is to be stopped from him, on account of the State of _____, or other
 authorities, for **CLOTHING**, &c., received on entering service, _____ $\frac{100}{100}$ dollars; and
 for other stoppages, viz: _____
 _____ $\frac{100}{100}$ dollars.

He has been furnished with **TRANSPORTATION** in kind from the place of his discharge to
 _____; and he has been **SUBSISTED** for **TRAVELING** to his
 place of enrollment, up to the _____, 1864.

He is indebted to William Briston, **SUTLER**, Seven $\frac{00}{100}$ dollars.
 He is indebted to _____, **LAUNDRESS**, _____ $\frac{100}{100}$ dollars.

Given in Duplicate, at Wilmington, N. C., this 3rd day
 of August, 1865.

W. J. Roberts
Enlist. Philade.

 Commanding Company.

Clarkeston Augustus
Pri. 46 U. S. A.
June 28. 65.
P. H. New-Berne N. C.

HOSPITAL RECORD,

SUBJECT TO THE

ORDER OF THE SURGEON GENERAL

UNITED STATES ARMY.

No. 1.

RECORD OF DEATH AND INTERMENT.

Name and number of person interred. *Clarkeson Augustus 1155*

Number and locality of the grave . *No 11, row 5, Colored lot,*

Hospital number of the deceased . . *105*

Regiment, rank, and company . . . *6 U.S. C. S. Private. "A"*

Residence before enlistment *Pa.*

Conjugal condition, (and if married, } *Single No. Friends Known*
 the residence of the widow) . . . }

Cause of death } *Typhoid Fever*

Age of the deceased } *20 yrs*

Nativity } *Pa.*

References and remarks }

Date of death and burial *June 28th Buried June 29th, 1863*

Duplicates sent to the Adjutant General of the United States Army, and to the Sexton of the Cemetery.

Memoranda:

COPY OF RECORD

Handwritten initials

FOR THE

ADJUTANT GENERAL U. S. ARMY.



Faint, illegible handwritten text covering the majority of the page.

No. 2.

RECORD OF DEATH AND INTERMENT.

Name and number of person interred.	Clarkson Augustus No 5
Number and locality of the grave . . .	No 11 row 5. Colored lot.
Hospital number of the deceased . . .	103
Regiment, rank, and company . . .	6 U.S.C. 3. Private "A" 7
Residence before enlistment . . .	Pa
Conjugal condition, (and if married, } the residence of the widow) . . . }	Single No. Ground Known.
Cause of death }	Typhoid Fever
Age of the deceased	20 yrs.
Nativity	Pa.
References and remarks }	
Date of death and burial	June 28 th Buried June 29, 1863

[A duplicate of this Record has been forwarded to the Sexton, and another remains at this Hospital.]

To

Brig. Gen. L. Thomas,
Adj. Gen. U.S.A.

It becomes my duty to inform you that the person above described died at this Hospital as herein stated; and that it is desired his remains should be interred with the usual military honors.

Respectfully,

W. H. Landers
A. A. Surgeon U. S. Army.

Post
MILITARY HOSPITAL, New Bern N.C.

This copy of Record is to be transmitted to the Adjutant General at Washington immediately after the place of burial and the number of the grave have been ascertained and registered. The above notification is to remain attached.

1865
Duplicate

1865

INVENTORY

OF THE EFFECTS OF

Clarkson Augustus

Late of Company ³ 7, 6 Regiment

U.S.C. Troops, who died

at New Bern N.C. ^{Post} General

Hospital June 28,

1865.

New York, 3, 1865.

JUL 15 1871

Inventory of the effects of *Priv Clarkson Augustus*
 Company *7*, *6* Regiment *U.S.C. Troops*
 who died in the *Post General Hospital at*
Newbern N.C June 28th, 1865.

CAPS		BLANKETS. <i>Wool</i>	<i>1</i>
DRESS COATS		KNAPSACKS	<i>1</i>
OVERCOATS		CANTEENS	
JACKETS		HAVERSACKS	<i>1</i>
TROUSERS		MUSKETS	
SHIRTS		BAYONETS	
DRAWERS	<i>1</i>	CARTRIDGE BOX	
BOOTS, pairs		BELT	
SHOES, pairs		MONEY	
STOCKINGS		<i>Blankets Rubber</i>	<i>1</i>

1865
Duplicate

INVENTORY

OF THE EFFECTS OF

Clarkson Augustus
 Late of Company *7*, *6* Regiment
U.S.C. Troops, who died
 at *Newbern N.C*
 Hospital *June 28*
1865.

Recd July 8, 1865.



Post
U. S. Army General Hospital,

New Bern N. C. June 29, 1865.

Commanding Officer, *E* Company,

6th Regiment U. S. C Troops

I have to inform you

that Priv *Clarkson Augustus* of your Company died in this
Hospital on the 28th day of June 1865 of
Typhoid Fever

I enclose ~~his Description, Rank, and Clothing Account,~~
and an Inventory of his effects. *D*

Very respectfully, yours, &c.,

Wm. Sanders
A. A. Surgeon U. S. A.,

In charge of *Post* General Hospital

6 U.S. COLLEGE

Private Corporal

CARD NUMBERS.

5573619	26
5573683	27
5573766	28
5573844	29
5573917	30
5573988	31
5574056	32
5574128	33
5574216	34
10 5574306	35
11 5574407	36
12 5574498	37
13 5574578	38
14 9065154	39
15	40
16	41
17	42
18	43
19	44
20	45
21	46
22	47
23	48
24	49
25	50

Book Mark:

See also

A | 6 | U.S.C.T.

John R Augustus

Co. *E*, 6 Reg't U. S. Col'd Inf.

Appears on

Company Descriptive Book

of the organization named above.

DESCRIPTION.

Age *20* years; height *5* feet *5-1/4* inches.

Complexion *Black*

Eyes *black*; hair *Black*

Where born *Laucaster Penna*

Occupation *Farmer*

ENLISTMENT.

When *Aug 15*, 186 *3*.

Where *1st D Pa*

By whom *P W*; term *3* y'rs.

Remarks: *Substitute for George
Sawyer*

J G Rees

Copyist.

G

6

U.S.C.T.

John R Gustus
 Pvt., Co. *E*, 6 Reg't U. S. Col'd Infantry.

Age *20* years.

Appears on

Company Muster-in Roll

of the organization named above. Roll dated

Philada Pa, Oct 13, 1863.

Muster-in to date

Aug 15, 1863

Joined for duty and enrolled:

When *Aug 15*, 1863.

Where *Philadelphia*

Period *3* years.

Remarks:

*(Filed with John R,
 Augustus,*

Book mark:

Lucas

A | 6 | U.S.C.T.

Jno R. Augustus

Priv., Co. E, 6 Reg't U. S. Col'd Infantry.

Appears on

Company Muster Roll

for *Muster in to Oct 31*, 1863

Present or absent *Present*

Stoppage, \$ 100 for

Due Gov't, \$ 100 for

Remarks:

(Enrolled as a substitute Aug. 15, 63 at Phila. Pa. for 3 years, Muster in not shown)

Book mark:

Lucas

A | **6** | **U.S.C.T.**

John R. Augustus

Priv, Co. E, 6 Reg't U. S. Col'd Infantry.

Appears on

Company Muster Roll

for *Nov. & Dec*, 1863

Present or absent *Present*

Stoppage, \$ *100* for

Due Gov't, \$ *100* for

Remarks:

Book mark:

Lucas

A | 6 | U.S.C.T.

John R Augustus
Pl-, Co. E, 6 Reg't U. S. Col'd Infantry.

Appears on

Company Muster Roll

for *Jan + Feby*, 1864

Present or absent *Present*

Stoppage, \$ 100 for

Due Gov't, \$ 100 for

Remarks:

Book mark:

Lucas

A | 6 | U.S.C.T.

John R. Augustus

Pr, Co. E, 6 Reg't U. S. Col'd Infantry.

Appears on

Company Muster Roll

for *Mar + Apr*, 1864

Present or absent *Present*

Stoppage, \$ 100 for

Due Gov't, \$ 100 for

Remarks:

Book mark:

Lucas

A | 6 | U.S.C.T.

John R. Augustus
Priv., Co. E, 6 Reg't U. S. Col'd Infantry.

Appears on

Company Muster Roll
for May & June, 1864
Present or absent Present

Stoppage, \$ 100 for _____

Due Gov't, \$ 100 for _____

Remarks: _____

Book mark: _____

Harris

A | 6 | U.S.C.T.

John R. Augustus
Pvt., Co. E, 6 Reg't U. S. Col'd Infantry.

Appears on

Company Muster Roll

for July & Aug, 1864

Present or absent Present

Stoppage, \$ 100 for

Due Gov't, \$ 100 for

Remarks: Free on or before
April 19/61

Book mark:

Harris

A | 6 | U.S.C.T.

John R. Augustus
Pvt., Co. E, 6 Reg't U. S. Col'd Infantry.

Appears on

Company Muster Roll
for Sept & Oct, 1864

Present or absent Present

Stoppage, \$ 100 for

Due Gov't, \$ 100 for

Remarks:

NEXT ROLL ON FILE FEB 1865

Book mark:

Harris

A | 6 | U.S.C.T.

John R. Augustus
Pvt, Co. E, 6 Reg't U. S. Col'd Infantry.

Appears on

Company Muster Roll

for Jan & Feb, 1865

Present or absent Present

Stoppage, \$ 100 for

Due Gov't, \$ 100 for

Remarks:

Book mark:

Harris

A | 6 | U.S.C.T.

John R. Augustus
Rh, Co. E, 6 Reg't U. S. Col'd Infantry.

Appears on

Company Muster Roll

for March & April, 1865.

Present or absent Present

Stoppage, \$ 100 for _____

Due Gov't, \$ 100 for _____

Remarks: _____

Book mark: _____

Harris

A | 6 | U.S.C.T.

John R. Augustus
Pvt, Co. E, 6 Reg't U. S. Col'd Infantry.

Appears on

Company Muster Roll

for May & June, 1865

Present or absent Present

Stoppage, \$ 100 for

Due Gov't, \$ 100 for

Remarks:

Book mark:

P. Pool

A | 6 | U.S.C.T.

John C. Augustus,
Pvt., Co. E, 6 Reg't U. S. Col'd Infantry.

Appears on

Company Muster Roll

for July & Aug., 1865

Present or absent Present.

Stoppage, \$ 100 for

Due Gov't, \$ 100 for

Remarks:

Book mark:

P. Pool,

A | 6 | U.S.C.T.

John R. Augustus
 Corpl, Co. E, 6 Reg't U. S. Col'd Infantry.

Appears on Co. Muster-out Roll, dated
 Wilmington, N.C. Sep. 20, 1865.

Muster-out to date Sep. 20, 1865.

Last paid to Apr. 30, 1865.

Clothing account:

Last settled June 30, 1864; drawn since \$ ⁹⁴/₁₀₀

Due soldier \$ 100; due U. S. \$ 100

Am't for cloth'g in kind or money adv'd \$ 100

Due U. S. for arms, equipments, &c., \$ 100

Bounty paid \$ None 100; due \$ 100 100

Remarks: Due Wm. Bresben, Regt.
 Suttler # 57th. Borne on muster
 rolls as free on or before Apr. 1/61.
 Promoted to Corpl. Sept. 4/65, vice Rich-
 ards, discharged. Subs. for Col'd man.
 Drafted under act of Mar. 3/63. Absent
 on furlough.
 Book mark: V 230. P 219. 76.

J. Pool

6 U.S. Col'd

Private Private

CARD NUMBERS.

5567836	26
5567869	27
5567909	28
5577675	29
5577702	30
5577797	31
5577891	32
5578045	33
5578134	34
10 5568754	35
11 9065592	36
12 43146654	37
13	38
14	39
15	40
16	41
17	42
18	43
19	44
20	45
21	46
22	47
23	48
24	49
25	50

Book Mark: EB, V-11 P-258

See also

A | **6** | **U.S.C.T.**

Augustus Ayres,

, Co. *A*, 6 Reg't U. S. Col'd Inf.

Appears on

Company Descriptive Book

of the organization named above.

DESCRIPTION.

Age *43* years; height *5* feet *6* inches.

Complexion *Blk*

Eyes *Blk*; hair *Blk*

Where born *Me*

Occupation *Lab.*

ENLISTMENT.

When *Sept 27*, 1864.

Where *Jamaica N. Y.*

By whom *Capt. Fowler*; term *1* yr.

Remarks: *Mustered out per order War Department dated May 3, 1865 at Hospital City Monroe Va. June 24/65.*

Jenkins

A | **6** | **U.S.C.T.**

Augustus Ayres

Appears with rank of *Private* on

Muster and Descriptive Roll of a Detachment of U. S. Vols. forwarded

for the 6 Reg't U. S. Col'd Infantry. Roll dated

Brooklyn N.Y. Sep 27, 1864.

Where born *Maryland*

Age *43* y'rs; occupation *laborer*

When enlisted *Sept 27, 1864.*

Where enlisted *Brooklyn N.Y.*

For what period enlisted *1* years.

Eyes *black*; hair *black*

Complexion *black* height *5 ft. 6 in.*

When mustered in *Sept 27, 1864.*

Where mustered in *Brooklyn N.Y.*

Bounty paid \$ *33³³* / 100; due \$ *100*

Where credited *1 Comp. Dish*

Company to which assigned

Remarks:

Book mark:

M Jones

(339) Coryist.

A | 6 | U.S.C.T.

Augustus Ayers

Appears with rank of Pvt on

Muster and Descriptive Roll

of a Detachment of U. S. Volunteer
Infantry for the 6 Regt U. S. C. T.

Roll dated Fort Island, F. J. H. Oct. 7, 1864.

Where born Sea

Age 43 years; occupation Laborer

When enlisted Sept. 27, 1864.

Where enlisted Jamaica, F. J.

For what period enlisted 1 years.

Eyes Red; hair Red

Complexion Red; height 5 ft. 6 in.

When mustered in Sept. 27, 1864.

Where mustered in Jamaica

Bounty paid \$ 33 ³⁵ / 100; due \$ 100

Clothing account:

Last settled _____, 1864; drawn since \$ 14 ⁹⁵ / 100

Date of first muster Sept. 27, 1864.

Company to which assigned _____

Remarks: 1 Sub Dist. Jamaica

Book mark: _____

B. J. O'Donnell

A | **6** | **U.S.C.T.**

Augustus Ayers

Appears with rank of *Private* on

Muster and Descriptive Roll of a Detachment of U. S. Vols. forwarded

for the 6 Reg't U. S. Col'd Infantry. Roll dated

North Isl NYH, Oct 7, 1864.

Where born *Md*

Age *43* y'rs; occupation *laborer*

When enlisted *Sept 27*, 1864.

Where enlisted *Jamaica NY.*

For what period enlisted *1* years.

Eyes *blk*; hair *blk*

Complexion *blk*; height *5* ft. *6* in.

When mustered in *Sept 27*, 1864.

Where mustered in *Jamaica NY.*

Bounty paid \$ *33*^{*33*} 100; due \$ *100*

Where credited *1 Dist Jamaica Co NY.*

Company to which assigned

Remarks:

Book mark:

M Jones

A | 6 | U.S.C.T.

Augustus Ayres

Appears with rank of Private on

Muster and Descriptive Roll of a Detachment of U. S. Vols. forwarded

for the 6 Reg't U. S. Col'd Infantry. Roll dated

Sept 23, 1864

Where born Md.

Age 43 y'rs; occupation laborer

When enlisted Sept 27, 1864

Where enlisted Jamaica

For what period enlisted 1 years.

Eyes blk; hair blk

Complexion blk; height 5 ft. 6 in.

When mustered in Sept 27, 1864

Where mustered in Jamaica

Bounty paid \$ 33³³ 100; due \$ 100

Where credited Coy 115 Jamaica

Company to which assigned

Remarks:

Book mark:

M Jones

A

6

U.S.C.T.

Augustus Ayres

Regt, Co. H, 6 Reg't U. S. Col'd Infantry.

Appears on

Company Muster Roll

for *Sept & Oct*, 186*4*.

Present or absent *Present*

Stoppage, \$ *100* for

Due Gov't, \$ *100* for

Remarks:

NEXT ROLL ON FILE FEB 1865

Book mark: *1865*

C. A. Harper

(858)

Copyist.

CA

6

U.S.C.T.

Augustus Ayers

Priv, Co. H, 6 Reg't U. S. Col'd Infantry.

Appears on

Company Muster Roll

for Jan & Feb, 1865.

Present or absent Absent

Stoppage, \$ 100 for

Due Gov't, \$ 100 for

Remarks: Received \$33 33/100
U. S. Bounty Oct. 22
1864. Absent-Sick

Book mark:

CA Harper

(358)

Copyist.

CA

6

U.S.C.T.

Augustus Ayers

Pvt., Co. H, 6 Reg't U. S. Col'd Infantry.

Appears on

Company Muster Roll

for Mar & April, 1865.

Present or absent Absent

Stoppage, \$ 100 for

Due Gov't, \$ 100 for

Remarks: Absent Sick

Book mark:

A. J. Harper

A | 6 | U.S.C.T.

Augustus Ayers
Pvt Co. H, 6 Reg't U. S. Col'd Infantry.

Appears on

Company Muster Roll

for May June, 1865

Present or absent Absent

Stoppage, \$ 100 for

Due Gov't, \$ 100 for

Remarks: Absent sick in jail.
Prof. F. Monroe.

Book mark:

Halecomb

A | **6** | **U.S.C.T.**

Augustus Ayers

Prvt, Co. H, 6 Reg't U. S. Col'd Infantry.

Appears on

Company Muster Roll

for July & Aug, 1865.

Present or absent _____

Stoppage, \$ 100 for _____

Due Gov't, \$ 100 for _____

Remarks: Mustered out at Fortress
Monroe Va. July 24/65 per
order from War Department
dated May 3/65.

Book mark: Discharged June 24/65 EB V. 11
P258.

Hobbes

A | 6 | **U.S.C.T.**

Augustus Ayers
Pvt, Co. *H*, *6* Reg't U. S. Col'd Infantry.

Appears on an

Individual Muster-out Roll

of the organization named above. Roll dated

Fort Monroe Va June 24, 1865.

Muster-out to date *June 24*, 1865.

Last paid to *Pay due from enlistment* 186 .

Clothing account:

Last settled....., 186 ; drawn since \$..... 100

Due soldier \$..... 100; due U. S. \$..... 100

Am't for cloth'g in kind or money adv'd \$ *30* ^{*86*}/₁₀₀

Due U. S. for arms, equipments, &c., \$..... 100

Bounty paid \$..... 100; due \$..... 100

Remarks: *mustered out by Order*
War Dept. Dated May 3rd 1865
Patient in U.S. Genl Hospital
Fort Monroe Va

Book mark: *E.B. 458* See letter to *Over*

Bowman

JAN. 20

5568754

1891 *

2^d Quad of March 6" 1875

U. S.

6

U.S.C.T.

Augustus Ayers

Priv. H., Co. *H.*, 6 Reg't U. S. Col'd Infantry.

Appears on **Co. Muster-out Roll**, dated
Wilmington N.C., Sep. 20, 186*5*.

Muster-out to date _____, 186 .

Last paid to _____, 186 .

Clothing account:

Last settled _____, 186 ; drawn since \$ _____ 100

Due soldier \$ _____ 100; due U. S. \$ _____ 100

Am't for cloth'g in kind or money adv'd \$ _____ 100

Due U. S. for arms, equipments, &c., \$ _____ 100

Bounty paid \$ _____ 100; due \$ _____ 100

Remarks: *Mustered out for serv. war.*
Dept. June 24/64 at Dept.
for money.

Book mark: *EB V 11 P. 258 Disch'd June 24/65*
P 32 P 46-75 no on file

Xoleoud

Ayres, Augustus

J., Co.

6 Reg't *U.S.C.*

2 Enclosures.

Bed Cards	Final Statements
Burial Records	Furloughs or L. of A.
Certs. of Dis. for Discharge	Med. Certificates
C. M. Charges	Med. Des. Lists
Descriptive Lists	Orders
Discharge Certificates	Pris. of War Record
Enlistment Papers <i>3</i>	Resignations

Other papers relating to—

Admission to Hosp'l	Furlough or L. of A.
Casualty Sheet	Med. Examination
Confinement	Misc. Information <i>1</i>
Contracts	Pay or Clothing
Death or Effects	Personal Reports
Desertion	Rank
Discharge from Hosp'l	Transfer to Hosp'l
Discharge from Service	Transfer to V. R. C.
Duty	Transportation
.....

MICROFILM PUBLICATION M 1848

COMPILED MILITARY SERVICE RECORDS
OF VOLUNTEER UNION SOLDIERS WHO SERVED WITH
THE UNITED STATES COLORED TROOPS (USCT)
6TH REGIMENT OF INFANTRY

PERSONAL PAPERS' TARGET SHEET

PLEASE NOTE THE CHECKED INFORMATION ABOUT THE PERSONAL PAPERS IN
THIS FILE:

- NO PERSONAL PAPERS WERE FOUND IN THIS FILE WHEN THE
RECORDS WERE ARRANGED FOR MICROFILMING.
- 4 PERSONAL PAPER(S) FOUND IN THIS FILE WHEN THE RECORDS
WERE ARRANGED FOR MICROFILMING.

Kings County
State of New York

Augustus Ayres of New Jersey do solemnly swear that
I am between the age of Eighteen and Forty-five years.

Given at Brooklyn NY
This 27th day of Sep. 1864

Augustus^{his} Ayres
made

John
Cape & Pa Mar 3 1864

*Affidavit of
Augustus Ayres
Sept. 24th 1864*

NOTE 1.—This blank will be used for both enlistments and re-enlistments—enlistment of veterans, &c., &c., in the volunteer service. They will be made out in duplicate in all cases—one to accompany the recruiting return of the superintendent (not the recruiting officer) to the Adjutant General, and one to accompany the accounts of the officer who pays bounty, &c. The Regiment and Company in which the soldier last served should be given on the back.

NOTE 2.—An enlistment holds to service. A muster-in must, in all cases, precede payment of pay, bounty, pension, &c. A muster-in roll must, in all cases, be filed in the Adjutant General's Office as evidence of muster-in. The mustering officer, commissary, or assistant commissary of musters, as the case may be, will countersign both enlistments as having mustered the soldier into the service of the United States before either of them is given to the disbursing officer.

DECLARATION OF RECRUIT.

I, Augustus Ayres desiring to VOLUNTEER as a Soldier in the Army of the United States, for the term of one YEARS, Do Declare, That I am Twenty Two years and _____ months of age; that I have never been discharged from the United States service on account of disability or by sentence of a court martial, or by order before the expiration of a term of enlistment; and I know of no impediment to my serving honestly and faithfully as a soldier for one years.

GIVEN at Brooklyn N.Y the 27 day of Sept

Witness: J. H. Davis Augustus Ayres

..... enlistment; last served in Company ()
C Co Regt of 21st Inf
Discharged 18

No. 944
Augustus Ayres
Volunteer
Sept 27 1864
By John C. [unclear]
Adjutant of [unclear]

CONSENT IN CASE OF MINOR.

I, Do CERTIFY, That I am the of; that the said is years of age; and I do hereby freely give my CONSENT to his volunteering as a SOLDIER in the ARMY OF THE UNITED STATES for the period of THREE YEARS.

GIVEN at the day of

Witness:

VOLUNTEER ENLISTMENT.

STATE OF

New York



TOWN OF

Queens Co

I, *Augustus Ayres* born in *Eastern Shore*
 in the State of *Maryland* aged *Forty three* years,
 and by occupation a *Laborer* DO HEREBY ACKNOWLEDGE to have
 volunteered this *Twenty seventh* day of *Sept* 1864
 to serve as a **Soldier** in the **Army of the United States of America**, for
 the period of ~~TWO~~ *THREE* YEARS, unless sooner discharged by proper authority:
 Do also agree to accept such bounty, pay, rations, and clothing, as are, or may be,
 established by law for volunteers. And I, *Augustus Ayres* do
 solemnly swear, that I will bear true faith and allegiance to the **United States**
of America, and that I will serve them honestly and faithfully against all
 their enemies or opposers whomsoever; and that I will observe and obey the
 orders of the President of the United States, and the orders of the officers
 appointed over me, according to the Rules and Articles of War.

Sworn and subscribed to, at

this

BEFORE

Brooklyn N.Y.
27 day of *Sept* 1864
Robert

Augustus Ayres
mail

Capt. Wm. M. M. M. M.
 I CERTIFY, ON HONOR, That I have carefully examined the above-named Volunteer, agreeably
 to the General Regulations of the Army, and that, in my opinion, he is free from all bodily defects and
 mental infirmity, which would in any way disqualify him from performing the duties of a soldier.

J. M. M. M.
 EXAMINING SURGEON.

I CERTIFY, ON HONOR, That I have minutely inspected the Volunteer, *Augustus Ayres*
 previously to his enlistment, and that he was entirely sober when enlisted; that, to the best of my
 judgment and belief, he is of lawful age; and that, in accepting him as duly qualified to perform the
 duties of an able-bodied soldier, I have strictly observed the Regulations which govern the recruiting
 service. This soldier has *Black* eyes, *Black* hair, *Black* complexion, is *five*
 feet *six* inches high.

Robert

Capt. Wm. M. M. M.
 RECRUITING OFFICER.

Mustered into the service of the United States, for ~~three~~ *three* years or during the war, from date of enlistment, in Company
C Regiment of *Volunteers*, on the *27* day of *Sept* 1864 at *Brooklyn N.Y.*

W. M. M. M.

W. M. M. M.

DECLARATION OF RECRUIT.

NOTE 1.—This blank will be used for both enlistments and re-enlistments—enlistment of veterans, &c., &c., in the volunteer service. They will be made out in duplicate in all cases—one to accompany the recruiting return of the superintendent (not the recruiting officer) to the Adjutant General, and one to accompany the accounts of the officer who pays bounty, &c. The Regiment and Company in which the soldier last served should be given on the back.
NOTE 2.—An enlistment holds to service. A muster-in must, in all cases, precede payment of pay, bounty, pension, &c. A muster-in roll must, in all cases, be filed in the Adjutant General's Office as evidence of muster-in. The mustering officer, commissary, or assistant commissary of musters, as the case may be, will countersign both enlistments as having mustered the soldier into the service of the United States before either of them is given to the disbursing officer.

I, Augustus Ayre desiring to VOLUNTEER as a Soldier in the Army of the United States, for the term of THREE YEARS, Do Declare, That I am Forty three years and _____ months of age; that I have never been discharged from the United States service on account of disability or by sentence of a court martial, or by order before the expiration of a term of enlistment; and I know of no impediment to my serving honestly and faithfully as a soldier for three years.

GIVEN at Brooklyn N.Y. the 27 day of Sept 1862

Witness: J. H. Davis Augustus Ayre mark

FILED IN THE ENLISTMENT OFFICE

Discharged _____ 18 _____

enlistment; last served in Company () Regt of _____

Volunteered at Brooklyn N.Y.
By John S. [unclear] 1862
Regiment 1st Regt

No. 1092
1

CONSENT IN CASE OF MINOR.

I, _____ Do CERTIFY, That I am the _____ of _____; that the said _____ is _____ years of age; and I do hereby freely give my CONSENT to his volunteering as a SOLDIER in the ARMY OF THE UNITED STATES for the period of THREE YEARS.

GIVEN at _____ the _____ day of _____

Witness: _____

VOLUNTEER ENLISTMENT.

STATE OF

New York



TOWN OF

Queens Co

I, *Augustus Ayres* born in *Eastern Shore*
in the State of *Maryland* aged *Forty three* years,
and by occupation a *Laborer* Do HEREBY ACKNOWLEDGE to have
volunteered this *Twenty seventh* day of *Sept* 186*4*,
to serve as a **Soldier** in the **Army of the United States of America**, for
the period of ~~TWO~~ *THREE* YEARS, unless sooner discharged by proper authority:
Do also agree to accept such bounty, pay, rations, and clothing, as are, or may be,
established by law for volunteers. And I, *Augustus Ayres* do
solemnly swear, that I will bear true faith and allegiance to the **United States**
of America, and that I will serve them honestly and faithfully against all
their enemies or opposers whomsoever; and that I will observe and obey the
orders of the President of the United States, and the orders of the officers
appointed over me, according to the Rules and Articles of War.

Sworn and subscribed to, at *Brooklyn N.Y.*
this *27* day of *Sept* 186*4*
BEFORE *Augustus Ayres*

Capt. J. P. Mac J. Quincy
I CERTIFY, ON HONOR, That I have carefully examined the above-named Volunteer, agreeably
to the General Regulations of the Army, and that, in my opinion, he is free from all bodily defects and
mental infirmity, which would in any way disqualify him from performing the duties of a soldier.

G. Woodrington
EXAMINING SURGEON.

I CERTIFY, ON HONOR, That I have minutely inspected the Volunteer, *Augustus Ayres*
previously to his enlistment, and that he was entirely sober when enlisted: that, to the best of my
judgment and belief, he is of lawful age; and that, in accepting him as duly qualified to perform the
duties of an able-bodied soldier, I have strictly observed the Regulations which govern the recruiting
service. This soldier has *Black* eyes, *Black* hair, *Black* complexion, is *five*
feet *Six* inches high.

Robert
Capt. J. P. Mac J. Quincy
RECRUITING OFFICER.

Mustered into the service of the United States, for ~~two~~ *three* years or during the war, from date of enlistment, in Company
 E Regiment of *Volunteers* on the *27* day of *Sept* 186*4* at *Brooklyn N.Y.*
 W. J. East
 W. J. East

DECLARATION OF RECRUIT.

I, Augustus Ayres, desiring to VOLUNTEER as a Soldier in the Army of the United States, for the term of ~~THREE~~ one YEARS, Do Declare, That I am Thirty three years and _____ months of age; that I have never been discharged from the United States service on account of disability or by sentence of a court martial, or by order before the expiration of a term of enlistment; and I know of no impediment to my serving honestly and faithfully as a soldier for ~~three~~ one years.

GIVEN at Brooklyn, N.Y. the 27 day of Sept 1864

Witness: J. S. Davis Augustus Ayres

NOTE 1.—This blank will be used for both enlistments and re-enlistments—enlistment of veterans, &c., &c., in the volunteer service. They will be made out in duplicate in all cases—one to accompany the recruiting return of the superintendent (not the recruiting officer) to the Adjutant General, and one to accompany the accounts of the officer who pays bounty, &c. The Regiment and Company in which the soldier last served should be given on the back.
NOTE 2.—An enlistment holds to service. A muster-in must, in all cases, precede payment of pay, bounty, pension, &c. A muster-in roll must, in all cases, be filed in the Adjutant General's Office as evidence of muster-in. The mustering officer, commissary, or assistant commissary of musters, as the case may be, will countersign both enlistments as having mustered the soldier into the service of the United States before either of them is given to the disbursing officer.

14.95

THIS FORM IS THE PROPERTY OF THE GOVERNMENT AND IS LOANED TO YOU BY THE ADJUTANT GENERAL'S OFFICE

No. 62225
Augustus Ayres
Volunteered at Brooklyn, N.Y.
Sept 27 1864
By John C. B. Smith
Adjutant Gen'l's Office

enlistment; last served in Company ()

Reg't of _____

Discharged _____ 18 _____

CONSENT IN CASE OF MINOR.

I, _____, Do CERTIFY, That I am the _____ of _____; that the said _____ is _____ years of age; and I do hereby freely give my CONSENT to his volunteering as a SOLDIER in the ARMY OF THE UNITED STATES for the period of THREE YEARS.

GIVEN at _____ the _____ day of _____

Witness: _____

(A. G. O. No. 74 & 76.)

VOLUNTEER ENLISTMENT.

STATE OF

TOWN OF

New York



Queens Co

I, *Augustus Ayres*, born in *Easton, Md*
 in the State of *Maryland*, aged *Forty three* years,
 and by occupation a *Laborer*. Do HEREBY ACKNOWLEDGE to have
 volunteered this *Small month* day of *Sept*, 1864,
 to serve as a **Soldier** in the **Army of the United States of America**, for
 the period of ~~Three~~ *Three* YEARS, unless sooner discharged by proper authority:
 Do also agree to accept such bounty, pay, rations, and clothing, as are, or may be,
 established by law for volunteers. And I, *Augustus Ayres*, do
 solemnly swear, that I will bear true faith and allegiance to the **United States
 of America**, and that I will serve them honestly and faithfully against all
 their enemies or opposers whomsoever; and that I will observe and obey the
 orders of the President of the United States, and the orders of the officers
 appointed over me, according to the Rules and Articles of War.

Sworn and subscribed to, at *Brooklyn, NY*
 this *27* day of *Sept*, 1864, by *Augustus Ayres*
 BEFORE *John W. ...*
Capt. Wm. ...

I CERTIFY, ON HONOR, That I have carefully examined the above-named Volunteer, agreeably
 to the General Regulations of the Army, and that, in my opinion, he is free from all bodily defects and
 mental infirmity, which would in any way disqualify him from performing the duties of a soldier.

A. Meadows
 EXAMINING SURGEON.

I CERTIFY, ON HONOR, That I have minutely inspected the Volunteer *Augustus Ayres*
 previously to his enlistment, and that he was entirely sober when enlisted; that, to the best of my
 judgment and belief, he is of lawful age; and that, in accepting him as duly qualified to perform the
 duties of an able-bodied soldier, I have strictly observed the Regulations which govern the recruiting
 service. This soldier has *Black* eyes, *Black* hair, *Black* complexion, is *pure*
 feet *Six* inches high.

John W. ...
Capt. Wm. ...
 REGIMENT OF *3rd* *Volunteers*
 RECRUITING OFFICER.

(A. G. O. No. 74 & 75.)

Mustered into the service of the United States, for ~~three~~ *three* years or during the war, from date of enlistment, in Company *B*
 of the *6th* Regiment of *Infantry* Volunteers, on the *27* day of *Sept*, 1864, at *Brooklyn, NY*
W. C. ...
John W. ...
Capt. Wm. ...

U.S. GOVERNMENT

Private

Private

CARD NUMBERS.

5568412	26
5573607	27
5573691	28
5573773	29
5573924	30
5573995	31
5574063	32
5574137	33
5574223	34
5574314	35
5574414	36
5574564	37
9065158	38
	39
	40
	41
	42
	43
	44
	45
	46
	47
	48
	49
	50

Book Mark: B. 25 V9 C J 72

See also

B | 6 | U.S.C.T.

William Bacon

Co. C, 6 Reg't U. S. Col'd Inf.

Appears on
Company Descriptive Book
of the organization named above.

DESCRIPTION.

Age 29 years; height 5 feet 7 inches.
 Complexion Black
 Eyes Black; hair Black
 Where born Leicester Penna
 Occupation Farmer

ENLISTMENT.

When July 17, 1863.
 Where P. D. Pa
 By whom P. M.; term 3 y'rs.

Remarks: Wounded in action
June 13th 1864 during action
in which he was over en-
gaged. Died of Disease
at Smithville U. S. A Gen-
eral Hospital June 29, 1868.

(383g)

J. G. Rees
 Copyist.

B | 6 | U.S.C.T.

William Bakon

Appears with rank of *Priv* on
**Muster and Descriptive Roll of a Detach-
 ment of Drafted Men and Substitutes
 forwarded**

for the *6* Reg't U. S. Col'd Inf. Roll dated
Lancaster Penna, Aug. 20, 1863.

Where born *Lancr. Co. Penna.*

Age *29* years; occupation *Farmer*

Drafted and mustered in:

When *July 17*, 186 .

Where *Lancaster Pa. Little Britain*

Period *3* years.

Eyes *black*; hair *black*

Complexion *black*; height *5 ft. 7 in.*

Paid bounty and advance pay, \$ *100*

Bounty due \$ *100*

Where credited _____

Company to which assigned _____

Remarks: _____

Book mark: _____

Larimer

B. | 6 | U.S.C.T.

William Bakon

Pr-, Co. *E*, 6 Reg't U. S. Col'd Infantry.

Age *29* years.

Appears on

Company Muster-in Roll

of the organization named above. Roll dated

Philada Pa, *Oct 13*, 1863.

Muster-in to date *July 17*, 1863

Joined for duty and enrolled:

When *July 17*, 1863.

Where *Lancaster Pa*

Period *3* years.

Remarks:

Book mark:

Lucas

B | 6 | U.S.C.T.

William Bacon
Priv., Co. E, 6 Reg't U. S. Col'd Infantry.

Appears on

Company Muster Roll

for July & Aug., 1865

Present or absent _____

Stoppage, \$ _____ 100 for _____

Due Gov't, \$ _____ 100 for _____

Remarks: Died in U.S. Gen'l
Hospl., Smithville, N.C.,
June 29, 1865. Due U.S.
for 1/2 Hunt \$240, Wm
Brisben Sutler \$800.

Book mark: 2 Aug, Mar. 19/66.
121,336.

P. Pool,

B

6

U.S.C.T.

William Bacon

Priv, Co. E, 6 Reg't U. S. Col'd Infantry.

Appears on

Company Muster Roll

for *Muster in to Oct 31*, 186*3*

Present or absent *Present*

Stoppage, \$ *100* for

Due Gov't, \$ *100* for

Remarks:

Book mark:

Lucas

B | 6 | U.S.C.T.

William Bacon

Pr, Co. E, 6 Reg't U. S. Col'd Infantry.

Appears on

Company Muster Roll

for Nov. & Dec, 1863

Present or absent Present

Stoppage, \$ 100 for

Due Gov't, \$ 100 for

Remarks:

Book mark:

Lucas

B

6

U.S.C.T.

William Bacon

Private, Co. E, 6 Reg't U. S. Col'd Infantry.

Appears on

Company Muster Roll

for Jan & Feby, 1864

Present or absent Absent

Stoppage, \$ 100 for

Due Gov't, \$ 100 for

Remarks: Confined at Yorktown Va by order Col West

Book mark:

Lucas

B.

6

U.S.C.T.

William Bacon

Pr., Co. E, 6 Reg't U. S. Col'd Infantry.

Appears on

Company Muster Roll

for Mar. & Apr., 1864

Present or absent Present

Stoppage, \$100 for

Due Gov't, \$100 for

Remarks: Awaiting sentence
G. C. M.

Book mark:

Lucas

B | 6 | U.S.C.T.

William Bacon

Pr, Co. E, 6 Reg't U. S. Col'd Infantry.

Appears on

Company Muster Roll

for *May & June*, 186*4*

Present or absent *Absent*

Stoppage, \$ 100 for

Due Gov't, \$ 100 for

Remarks: *Wounded in Action
June 15 " Absent in Gen.
Hospital at City Point Va.*

Book mark: _____

Harris

B | 6 | U.S.C.T.

William Bacon

Pvt, Co. E, 6 Reg't U. S. Col'd Infantry.

Appears on

Company Muster Roll

for *July & Aug*, 186*4*

Present or absent *Absent*

Stoppage, \$ *100* for

Due Gov't, \$ *100* for

Remarks: *Wounded in Action June 15/64 in Gen. Hospital Since Free on or before Apr 19/61*

Book mark: *23087*

Harris

B | **6** | **U.S.C.T.**

William Bacon
Priv, Co. E, 6 Reg't U. S. Col'd Infantry.

Appears on

Company Muster Roll

for *Sept & Oct*, 186*4*

Present or absent *Present*

Stoppage, \$ *100* for

Due Gov't, \$ *100* for

Remarks:

NEXT ROLL ON FILE FEB 1865

Book mark:

Harris

B | 6 | U.S.C.T.

William Bacon
Pvt., Co. E, 6 Reg't U. S. Col'd Infantry.

Appears on

Company Muster Roll

for Jan & Feby, 1865

Present or absent Absent

Stoppage, \$ 100 for

Due Gov't, \$ 100 for

Remarks: Absent Sick in Hospital
Due U.S. for 1/2 Shelter Tent
\$240.

Book mark:

Harris

B | 6 | U.S.C.T.

William Bacon

Pat., Co. E, 6 Reg't U. S. Col'd Infantry.

Appears on

Company Muster Roll

for *March & April*, 1865

Present or absent *Absent*

Stoppage, \$ *100* for

Due Gov't, \$ *100* for

Remarks: *Absent sick in U. S. Gen Hospital, Stop on fir's rolls \$2.40*

Book mark:

Harris

B | 6 | U.S.C.T.

William Bacon,
Pot, Co. E, 6 Reg't U. S. Col'd Infantry.

Appears on

Company Muster Roll

for May & June, 1865

Present or absent Absent.

Stoppage, \$ 100 for

Due Gov't, \$ 100 for

Remarks: Absent sick in
U.S. Gen. Hospital.

Book mark:

P. Pool.

B | 6 | U.S.C.T.

William Bacon
Pot., Co. E, 6 Reg't U. S. Col'd Infantry.

Appears on Co. Muster-out Roll, dated
Wilmington, N.C., Sep. 20, 1865.

Muster-out to date _____, 186 .
Last paid to _____, 186 .

Clothing account:

Last settled _____, 186 ; drawn since \$ _____ 100

Due soldier \$ _____ 100; due U. S. \$ _____ 100

Am't for cloth'g in kind or money adv'd \$ _____ 100

Due U. S. for arms, equipments, &c., \$ _____ 100

Bounty paid \$ _____ 100; due \$ _____ 100

Remarks: Died of disease at
U.S. Gen. Hospl. Smithville,
N.C., June 29, 1865.

Book mark: 121336. B25. V9. C9. 72.

J' Pool,

Bacon William

P, Co. E, 6 Regt U S C T.

5 Enclosures.

Bed Cards	/	Descriptive Lists
Burial Records	/	Final Statements
Certs. of Dis. for Discharge		Furloughs
C. M. Charges		Med. Des. Lists
Med. Certificates		Orders

Other papers relating to—

Admission to Hosp'l		Furlough
Casualty Sheet (Officer's)		Med. Examination
Confinement	/	Misc. Information
Contracts		Pay or Clothing
Death or Effects	/	Personal Reports
Desertions		Rank
Discharge from Hosp'l		Transfer to Hosp'l
Discharge from Service		Transfer to V. R. C.
Duty		Transportation

95

MICROFILM PUBLICATION M 1848

COMPILED MILITARY SERVICE RECORDS
OF VOLUNTEER UNION SOLDIERS WHO SERVED WITH
THE UNITED STATES COLORED TROOPS (USCT)
6TH REGIMENT OF INFANTRY

PERSONAL PAPERS' TARGET SHEET

PLEASE NOTE THE CHECKED INFORMATION ABOUT THE PERSONAL PAPERS IN
THIS FILE:

- NO PERSONAL PAPERS WERE FOUND IN THIS FILE WHEN THE
RECORDS WERE ARRANGED FOR MICROFILMING.
- 6 PERSONAL PAPER(S) FOUND IN THIS FILE WHEN THE RECORDS
WERE ARRANGED FOR MICROFILMING.

TREATMENT.

[HERE NOTE IMPORTANT COMPLICATIONS AND ALL OPERATIONS.]

To Sopo Camp

RESULT AND DATE.

Improved
Transferred to Guard

Sept 16-64

Returned to Duty Sept 27/64

J. Haslam
Army

Hospital Number 3674

8

Name William Bacon

Age 29 Nativity America

Married or Single Married

Residence Lancaster Co. Pa.

Post Office address of wife or nearest relative. } North Queen

Rank Private Co. 8 Regiment 6th Regt. C. H. 47

When admitted Aug 17th 1864

From what source The German

Diagnosis: (in surgical cases state explicitly seat and character of wound or injury.)

Contusion from
Shell - Right
side of Summit House
Philadelphia, Pa.

On what occasion wounded Paris being

Date June 15th 1864

Nature of missile or weapon Gun of 12 lb

Handwritten signature or initials, possibly "C. S. G."

HOSPITAL RECORD,

SUBJECT TO THE

ORDER OF THE SURGEON GENERAL
UNITED STATES ARMY.

*Wm. P. Brown
Proc. G. N. J. O. G.
June 29. 65.
Smithville N. C.*

No. 1.

RECORD OF DEATH AND INTERMENT.

Name and number of person interred.	<i>William Bacon</i>
Number and locality of the grave . . .	<i>M 36</i>
Hospital number of the deceased . . .	<i>675</i>
Regiment, rank, and company . . .	<i>Private Co. C 4th U.S.C.T.</i>
Residence before enlistment . . .	
Conjugal condition, (and if married,) the residence of the widow) . . . }	
Cause of death }	<i>Chronic Diarrhoea</i>
Age of the deceased	
Nativity	
References and remarks }	
Date of death and burial	<i>June 29th June 29, 1864</i>

Duplicates sent to the Adjutant General of the United States Army, and to the Sexton of the Cemetery.

Memoranda:

This man was admitted into the sep. without a Descriptive List.

FINAL STATEMENT

OF

Private William Bacon
Co. 6th Reg't of U. S. C. Troops

Due June 29 1865
VOLUNTEERS.

NOTE 1.—Two of these certificates (or duplicates) are to be given to each Volunteer Soldier or drafted man who may be discharged without being mustered out (Final Statements are never given to men mustered out of service) that he may at once receive from the Paymaster the pay, &c., due him, and the captain or other COMMISSIONED officer commanding the company will certify to the act of the delivery of the duplicate certificates; with these certificates the Soldier is "entitled to" his discharge, and should also present his discharge to the Paymaster to have the payment endorsed on it. The discharge is to be given back to the Soldier by the Paymaster; the latter only retaining as his vouchers the duplicate certificates.

NOTE 2.—If the Soldier is entitled to pay for the use of his horse, the Company Commander will certify to that fact on the back of both these final statements, and also to the time he has pay due for having been so mounted on his own horse.

NOTE 3.—When a Soldier is furnished with final statements, his descriptive list, if he has one, should be taken up by the officer who gives the Soldier these statements, and endorsed with a statement to this effect by the officer. The endorsement should exhibit a full statement of the time for which the Soldier was allowed pay on his final statements, the clothing account, and all other charges against him or in his favor, so as to comprise a complete exhibit of his account. It will then be transmitted to the Company Commander of the Soldier, who will enter all the data necessary to a full understanding of the Soldier's account on the muster roll upon which the Soldier's discharge is reported. The descriptive list will then be destroyed. The object of this is, that the remaining portion of the Soldier's account may be settled upon the receipt of these muster rolls, and the Soldier receive any pay or allowances that may be due him at the time of his discharge, and which may not appear on his last final statements from the fact that his descriptive list is incomplete. These accounts for back pay, &c., are settled by the 2d Auditor of the Treasury Department.

NOTE 4.—Charges for loss or injury to ordnance, horse equipments, and other miscellaneous charges, should appear under the heading of "Other Stoppages."

NOTE 5.—Bounty paid by State authorities, and not by the United States, will not be entered on this statement.

NOTE 6.—Amounts due the Sutler and Laundress must be entered on the muster roll on which the discharge, death, desertion, &c., is reported, as well as on the final statement, otherwise the amount cannot be collected from the United States.

NOTE 7.—This blank will be used for deceased volunteers and drafted men, as well as for others.

NOTE 8.—Where a Soldier dies in Hospital or on detached service, his descriptive list, if he has one, should be sent with his final statements, in duplicate, to the Adjutant General, Washington, D. C.

NOTE 9.—If the soldier is a drafted man, substitute, the space for time, &c., of enrolled, should contain only the word *drafted* or *substitute*, as the case may be. If the Soldier is a "VETERAN," (or RECRUIT,) the words as a *veteran*, (or *recruit*.) as the case may be, should be interlined after the words *mustered into the service of the U. S.* A statement of all the installments of *Veteran* or *Recruit* Bounty RECEIVED by the Soldier must be made on the back of each final statement.

ADJUTANT GENERAL'S OFFICE.
Aug 30 1865
Duplicate with inventory sent 2d Auditor.

[Handwritten signature]
1865
ADJUTANT GEN'L'S

I certify, on honor, that William Bacon, a Private of
 Captain Haskins Company (E) of the Sixth Regiment of U. S. Corps
VOLUNTEERS, of the State of _____, born in Laureaster, State
 of Penna, aged 29 years; 5 feet 7 inches high; Blk complexion,
Blk eyes, Blk hair, and by occupation a Farmer, who joined for service
 and was enrolled (see Note 9) on the 17 day of July, 1863, at Laureaster Pa
 by Provost Marshal, for the period of 3 years, and mustered into
 the service of the United States on the 17 day of July, 1863, at
Laureaster, by Provost Marshal; and having served

HONESTLY and FAITHFULLY with his Company to the present date, is now entitled to a
DISCHARGE by reason of Death died of disease at U.S.
Gen Hospital Smithville Va. June 29. 1863

The said William Bacon was last paid by Paymaster
W. H. Horney, to include the 31st day of August, 1863, and
 has pay due him from that time to the ~~present~~ ^{death} date; he is entitled to pay and subsistence for
TRAVELING to place of enrollment, and whatever other allowances are authorized to volunteer
 soldiers, drafted men, or militia, so discharged. He has received from the United States **CLOTHING**
 amounting to \$ 42 ⁵⁹/₁₀₀ dollars, since the 30 day of June
 1864, when his clothing account was last settled. He has received from the United States
_____ ^{_____}/₁₀₀ dollars advanced **BOUNTY**.

There is to be stopped from him, on account of the State of _____, or other
 authorities, for **CLOTHING**, &c., received on entering service, _____ ^{_____}/₁₀₀ dollars; and
 for other stoppages, viz: _____

for 1/2 Shelter Tent 5 ⁴¹/₁₀₀ dollars.
 He has been furnished with **TRANSPORTATION** in kind from the place of his discharge to
 _____; and he has been **SUBSISTED** for **TRAVELING** to his
 place of enrollment, up to the _____, 186 .

He is indebted to Wm. Brister, **SUTLER**, 8 ⁰⁰/₁₀₀ dollars.
 He is indebted to _____, **LAUNDRESS**, _____ ^{_____}/₁₀₀ dollars.

Given in Duplicate, at Wilmington Va., this 21st day
 of August, 1865.

Edson J. Haskins
Capt. 6th U.S.C.
 Commanding Company.

A.G.O.
Recd Sept 2nd 1866
H.

14
FINAL STATEMENT

OF
William Bacon
6th Reg't of *W. Colwell*

VOLUNTEERS.

Sept 29 1866

NOTE 1.—Two of these certificates (or duplicates) are to be given to each Volunteer Soldier or drafted man who may be discharged previously to the discharge of his company, that he may at once receive from the Paymaster the pay, &c., due him, and the captain or other COMMISSIONED officer commanding the company will certify to the act of the delivery of the duplicate certificates; on these certificates the Soldier is "entitled to" his *discharge*, and should also present his discharge to the Paymaster to have the payment endorsed on it. The discharge is to be given back to the Soldier by the Paymaster; the latter only retaining as his voucher the duplicate certificates.

NOTE 2.—If the Soldier is entitled to pay for the use of his horse, the Company Commander will certify to that fact on the back of both these final statements, and also to the time he has pay due for having been so mounted on his own horse.

NOTE 3.—When a Soldier is furnished with final statements, his descriptive list, if he has one, should be taken up by the officer who gives the Soldier these statements, and endorsed with a statement to this effect by the officer. This endorsement should exhibit a full statement of the time for which the Soldier was allowed pay on his final statements, the clothing account, and all other charges against him or in his favor, so as to comprise a complete exhibit of his account. It will then be transmitted to the company commander of the Soldier, who will enter all the data necessary to a full understanding of the Soldier's account on the muster roll upon which the Soldier's discharge is reported. The descriptive list will then be destroyed. The object of this is, that the remaining portion of the Soldier's account may be settled upon the receipt of these muster rolls, and the Soldier receive any pay or allowances that may be due him at the time of his discharge, and which may not appear on his final statements from the fact that his descriptive list is incomplete. These accounts for back pay, &c., are settled by the 2d Auditor of the Treasury Department.

NOTE 4.—Charges for loss or injury to ordnance, horse equipments, and other miscellaneous charges, should appear under the heading of "Other Stoppages."

NOTE 5.—Bounty paid by State authorities, and not by the United States, will not be entered on this statement.

NOTE 6.—Amounts due the Sutler and Laundress must be entered on the muster roll on which the discharge, death, desertion, &c., is reported, as well as on the final statement, otherwise the amount cannot be collected from the United States.

NOTE 7.—This blank will be used for deceased volunteers and drafted men, as well as for others.

NOTE 8.—Where a Soldier dies in Hospital or on detached service, his descriptive list, if he has one, should be sent with his final statements, in duplicate, to the Adjutant General, Washington, D. C.

ADJUTANT GENERAL'S OFFICE.
Aug 1st 1866
Duplicate with Inventory sent 2d Auditor.

Edw. Roy

I certify, on honor, that William Gaem a Private of
 Captain Company (6) of the 6 Regiment of Colored
VOLUNTEERS, of the State of United States born in Lancaster, State
 of Pennsylvania aged 20 years; 5 feet 7 inches high; Dark complexion,
Dark eyes Dark hair, and by occupation a Farmer, having joined the company on
 its original organization at, and enrolled in it at the muster into
 the service of the United States at, on the day
 of, 186 , (or was mustered in service as a recruit, by,
 at, on the day of,
 186 , or was drafted and mustered into the service of the United States from the
 Enrollment District of the State of, at Lancaster Penn
 on the 17 day of July, 1863,) to serve in the Regiment, for
 the term of Three Years: and having served **HONESTLY** and
FAITHFULLY with his Company in to the present date, is now
 entitled to a **DISCHARGE** by reason of Death.

The said William Gaem was last paid by Paymaster
Mat. McHenry to include the 31 day of August; 1864, and has
 pay due him from that time to the present date; he is entitled to pay and subsistence for
TRAVELING to place of enrollment, and whatever other allowances are authorized to volunteer
 soldiers, drafted men, or militia, so discharged. He has received from the United States **CLOTHING**
 amounting to 41 39 dollars, since the 17 day of July,
 1864, when his clothing account was last settled. He has received from the United States
 100 dollars advanced **BOUNTY**.

There is to be stopped from him, on account of the State of, or other
 authorities, for **CLOTHING**, &c., received on entering service, 100 dollars; and
 for other stoppages, viz: one piece of Shell
rent 40 dollars.

He has been furnished with **TRANSPORTATION** in kind from the place of his discharge to
 ; and he has been **SUBSISTED** for **TRAVELING** to his
 place of enrollment, up to the, 186 .

He is indebted to, **SUTLER**, 8 00 dollars.
 He is indebted to, **LAUNDRESS**, 100 dollars.

Given in Duplicate, at Smithville Mo. this 25 day
 of July, 1863.

J. M. Palmer
3rd Regt of M. Chap
 Commanding Company
W. Army Gen Hospital

INVENTORY OF THE EFFECTS

OF

William Paetz

Late of Company

C Reg't of *W.S. Colored*

Volunteers, who died at

Smithville MS

on the

day of

June

186



Inventory of the effects of William Paem late
a Private of Captain _____ Company 6 of
the 6th Regiment of United States Col^d Volunteers, who was enrolled as
a _____ at _____ in the State of _____ on
the _____ day of _____ 1863, and mustered into the service of the United
States as a drafted man on the 17th day of July 1863, at Launcaster, Penn
in Company 6, 6 Regiment of U.S. Colored Volunteers, to serve three
years or during the war; he was born in Launcaster in the State
of Pennsylvania; he was 20 years of age, 5 feet 7 inches
high, Black complexion, Black eyes, Black hair, and by occupation, when enrolled,
a Farmer; he died in U.S. Army Gen Hospital at
Smithville Mo on the 29th day of June 1863, by
reason of Cholera Diarrhoea

INVENTORY.

ARTICLES.	No.	ARTICLES.	No.	ARTICLES.	No.
Hats.....		Pairs trousers.....		Knapsacks.....	/
Caps.....		Pairs flannel drawers.....			
Forage caps.....		Pairs cotton drawers.....			
Great coats.....	/	Flannel shirts.....			
Uniform coats.....		Cotton shirts.....			
Uniform jackets.....		Pairs boots.....			
Flannel sack coats.....		Pairs shoes.....	/		
Blouses.....	/	Pairs socks.....			
Stable frocks.....		Blankets.....	/		
Fatigue overalls.....		Haversacks.....			
				MONEY.	
				Specie.....	\$
				Notes.....	\$

I CERTIFY, ON HONOR, that the above inventory comprises all the effects of William Paem
deceased, and that the effects are in the hands
of Surg. J. M. Palmer at U.S. Army Gen Hospital
Smithville Mo to be disposed of by a Council of Administration.

(DUPLICATES.)

STATION: Smithville Mo B New York Inf. in Charge
Smithville Mo U.S. Army Gen Hospital
DATE: July 23 1865
Surf.
Commanding the Company.

Mr Ellsbrook

William Bacon

Co. E 6th U.S.C. Troops

Adjutant General's Office,

COLORED TROOPS BRANCH,

January 26th, 1877

Mr. Ellertson Vol.

C. T., 187

Wanted in the case of

William Bacon

, Co. "C",

6th Reg't U. S. Troops

Cause of Court and if tried

Muster Roll for Jan'y

and Feb'y 1864 reports him absent, "Confined" at Yorktown Va by order of Col. West.

Respectfully,

L. A. Woodward

Chief Clerk.

J. H. Hartman

Adjutant General's Office,

Record Room

Jan 31st, 1877.

Vol.

C. T., 187

Reply in case of

Wm Bacon

, Co. "E",

6th Reg't U. S. C. T.

G.O. 53 H. Q. Dept Va. + N.C Apr 28. 64 - Charge - Leaving his Post before being regularly relieved in violation of 46th Article of War. Sentence To be confined at hard labor at such place as the Comdg. Genl. may direct for two months, to date from date of arrest. App'd. Sentence will be carried into effect at any fortified place in the U.S.

G.B.

W., **6** U.S. Col'd Inf.

Private

Private

CARD NUMBERS.

5578200	26
5578340	27
5578419	28
5578361	29
5568878	30
5578451	31
5578529	32
5578605	33
5578680	34
5578752	35
5578824	36
5578919	37
5578076	38
5579254	39
9065641	40
9065643	41
	42
	43
	44
	45
	46
	47
	48
	49
	50

Book Mark:

See also

B

6

U.S.C.T.

William Badger,

, Co. D, 6 Reg't U. S. Col'd Inf.

Appears on

Company Descriptive Book

of the organization named above.

DESCRIPTION.

Age *42* years; height *5* feet *7* inches.

Complexion *Mulatto*

Eyes *hazel*; hair *black*

Where born *New Castle Co. Del*

Occupation *Labourer*

ENLISTMENT.

When *Aug. 12*, 186*3*

Where *Smymna Del.*

By whom *Capt. Ed. Willmer*; term *3* y'rs.

Remarks: *gained from*

Desertion Nov. 17 '63.

Discharged apr 14/64

Surgeon's certificate of

Disability.

D. L. Smith to F

Mem Dec. 6.

Jenkins

B

6

U.S.C.T.

William Badger,

, Co. A, 6 Reg't U. S. Col'd Inf.

Appears on

Company Descriptive Book

of the organization named above.

DESCRIPTION.

Age *42* years; height *5* feet *7* inches.

Complexion *Mulatto*

Eyes *Hazel*; hair *Black*

Where born *New Castle Co. Del.*

Occupation *Labourer*

ENLISTMENT.

When *Aug. 12*, 186*3*.

Where *Smyrna Del.*

By whom *Capt Ed Willmer*; term *3* y'rs.

Remarks: *Transferred to the Register of men deserted. Drafted.*

*Discharged Apr 14, 1865
Surgeons Certificate
Disability*

** Name cancelled by line*

Jenkins

B. | 6 | U.S.C.T.

William Badger
Part; Co. I., 6 Reg't U. S. Col'd Infantry.

Age *42* years.

Appears on

Company Muster-in Roll

of the organization named above. Roll dated

Philad. Pa., Sept. 11, 1863.

Muster-in to date *Aug. 12, 1863*

Joined for duty and enrolled:

When *Aug. 12*, 1863.

Where *Smyrna, Del.*

Period *3* years.

Remarks: *Wfted. Delaware, 1*
Dis. Mustered by Capt.
Wilmer P.M. Aug. 12, '63.

Book mark: _____

B.

6

U.S.C.T.

William Badger
Pvt., Co. I, 6 Reg't U. S. Colored Infantry.

Appears on

Company Muster Roll

for *Sept & Oct.*, 1863.

Present or absent

Stoppage, \$ 100 for

Due Gov't, \$ 100 for

Remarks: *Due U.S. for Camp
& Garrison Equipage \$ 3.14,
for Ord. & Ord. Stores \$ 6.23.
Deserted from Camp Wil-
liam Penn, Pa, October
4, 1863.*

Book mark:

(853)

Asht.
Copyist.

B | 6

U.S.C.T.

Wm. Badger

....., Co....., *6* Reg't U. S. Col'd Infantry.

Appears on

Descriptive List of Deserters

dated *Dec 11*, 1863 .

Deserted :

When , 186 .

Where *Camp New Run Pa*

Arrested :

When , 186 .

Where

Remarks :

Book mark :

Source

B.

6

U.S.C.T.

William Badger
Part., Co. I, 6 Reg't U. S. Colored Infantry.

Appears on

Company Muster Roll

for *Nov & Dec*, 1863.

Present or absent ^x

Stoppage, \$ 100 for

Due Gov't, \$ 100 for

Remarks: *Gain from Desertion*

^x *Name borne under head of
"Gain from Desertion"*

Book mark:

B.

6

U.S.C.T.

William Badger
Pat., Co. I, 6 Reg't U. S. Colored Infantry.

Appears on

Company Muster Roll

for *Nov. & Dec.*, 1863.

Present or absent *Present*

Stoppage, \$ *100* for

Due Gov't, \$ *100* for

Remarks: *Joined from Desertion
November 2 63 and returned
to duty. Surrendered himself
at Camp William Penn,
Novemb. 19. 63. Due U.S. for
one Knapsack, one Haversack,
one Canteen & 1/2 Shelter Tent
4 Doll. 76 cts. Deserted Octob.
4. 63.*

Book mark:

(853)

Asst.
Copyist.

B. | 6 | U.S.C.T.

William Badger

Pat., Co. I, 6 Reg't U. S. Colored Infantry.

Appears on

Company Muster Roll

for *Jan'y 7 Feby.*, 1864.

Present or absent *Present.*

Stoppage, \$ *100* for

Due Gov't, \$ *100* for

Remarks: *Deserted Oct. 4, 63.*

*Surrendered himself at
Camp William Penn, Pa.
and returned to duty by
order of Col. Wagner, Comdg
Camp. Nov. 19, 63.*

*Due U.S. for 1 Knapsack,
2aversack, canteen, and
1 piece of Shelter Tent 4 Doll.
75 cts.*

Book mark:

Ash

B. | 6 | U.S.C.T.

William Badger
Pot., Co. I, 6 Reg't U. S. Colored Infantry.

Appears on

Company Muster Roll

for *Mar & Apr.*, 1864.

Present or absent *Present.*

Stoppage, \$ *100* for

Due Gov't, \$ *100* for

Remarks: *Stopped for 1 Week -
each 56¢*

Book mark:

(353)

C. L. H.
Copyist.

B. | 6 | U.S.C.T.

William Badger
Priv. Co. I, 6 Reg't U. S. Colored Infantry.

Appears on

Company Muster Roll

for May & June, 1864

Present or absent Present

Stoppage, \$ 100 for

Due Gov't, \$ 100 for

Remarks:

Book mark:

A. M. Reed

(863)

Copyist.

B. | 6 | U.S.C.T.

William Badger
Priv., Co. I, 6 Reg't U. S. Colored Infantry.

Appears on

Company Muster Roll
for *July & Aug.*, 1864.
Present or absent *Present.*

Stoppage, \$ *100* for _____

Due Gov't, \$ *100* for _____

Remarks: *Free April 19th 63,*

Book mark: _____

A. W. Reed

(858)

Copyist.

B. | 6 | U.S.C.T.

William Badger

Pvt., Co. I, 6 Reg't U. S. Colored Infantry.

Appears on

Company Muster Roll

for *Sept. & Oct.*, 1864.

Present or absent *Absent.*

Stoppage, \$ *100* for

Due Gov't, \$ *100* for

Remarks: *Free Apr. 19/61.
Wounded sent to Gen
Hos. Sept. 29/64.*

NEXT ROLL ON FILE FEB 1865

Book mark:

A. W. Reed

(358)

Copyist.

B. | 6 | U.S.C.T.

William Badger
Priv., Co. I, 6 Reg't U. S. Colored Infantry.

Appears on

Company Muster Roll
for Jan. & Feb., 1865.

Present or absent Absent.

Stoppage, \$ 100 for

Due Gov't, \$ 100 for

Remarks: Free Apr. 19/61.
Wounded sent to gen.
hos. Sept. 29/64.

Book mark:

A. W. Reed

B.

6

U.S.C.T.

William Badger
Privt., Co. I, 6 Reg't U. S. Colored Infantry.

Appears on

Company Muster Roll

for dated May 3, 1865.

Present or absent Absent.

Stoppage, \$ 100 for

Due Gov't, \$ 100 for

Remarks: Free Apr. 19/61,
Wounded Sept. 29/64.

Book mark:

A. M. Reed

B

6

U.S.C.T.

William Budget

Priv., Co. I, 6 Reg't U. S. Colored Infantry.

Appears on

Company Muster Roll

for *May + June*, 1865.

Present or absent

Stoppage, \$ *100* for

Due Gov't, \$ *100* for

Remarks: *Discharged Apr 14-65 at hos. Surgeons certificate of disability*

Book mark:

(858)

Posy

Copyist.

B

6

U.S.C.T.

William Boggs

Pot, Co. *D*, 6 Reg't U. S. Col'd Infantry.

Appears on **Co. Muster-out Roll**, dated *Wilmington, N.C. Sept 20*, 1865.

Muster-out to date _____, 186 .

Last paid to _____, 186 .

Clothing account:

Last settled _____, 186 ; drawn since \$ _____ 100

Due soldier \$ _____ 100; due U. S. \$ _____ 100

Am't for cloth'g in kind or money adv'd \$ _____ 100

Due U. S. for arms, equipments, &c., \$ _____ 100

Bounty paid \$ _____ 100; due \$ _____ 100

Remarks: *Discharged April 14, 1865*

Issued certificate of disability

Book mark *V66P.137-69.4230-6.240-76 2*

(361)

Posy

Copyist.

Badger, Thos

B., Co. *I*, *6* Reg't **U.S.C. Inf.**

3 Enclosures.

Bed Cards	Descriptive Lists
Burial Records	Final Statements
Certs. of Dis. for Discharge	Furloughs
C. M. Charges	Med. Des. Lists
Med. Certificates	Orders

Other papers relating to—

Admission to Hosp'l	Furlough
Casualty Sheet (Officer's)	Med. Examination
Confinement	Misc. Information
Contracts	Pay or Clothing
Death or Effects	Personal Reports
Desertions	Rank
Discharge from Hosp'l	Transfer to Hosp'l
Discharge from Service	Transfer to V. R. C.
Duty	Transportation

CASUALTY SHEET

No.

Wm V. Badger

M of Company *I*

6 Regiment of *US Col*

State Volunteers.

NATURE OF CASUALTY.

Dischd April 14 65

CASUALTY SHEET.

Name: *Wm Badger*

Rank: *M* Company: *I* Regiment: *6*

Arm: *Inf* State: *MS 650*

Nature of Casualty: *Disch*

CAUSE OF CASUALTY—(NAME OF DISEASE, &C.)

BY WHOM DISCHARGED.

FROM WHAT SOURCE THIS INFORMATION WAS OBTAINED.

DEGREE OF DISABILITY.

Roll 48 Grant Corps

BY WHOM CERTIFIED.

Willis P Myer

REMARKS.

A H Houston

Sing MS 9

DATE OF DISCHARGE, DEATH, &c.

Apr 14 65

PLACE OF DISCHARGE, DEATH, &c.

Willis P Myer

Sporth

Clerk.

NOTE 1.

The company commander will here add a statement of all the facts known to him concerning the disease or wound, or cause of disability of the soldier; the time, place, manner, and all the circumstances under which the injury occurred, or disease originated or appeared; the duty, or service, or situation of the soldier at the time the injury was received or disease contracted, stating particularly whether the injury was received or the disease contracted in the line of his duty; and whatever other facts may aid a judgment as to the cause, immediate or remote, of the disability, and the circumstances attending it.

When the facts are not known to the company commander, the certificate of any officer, or affidavit of other person having such knowledge, will be appended—as the surgeon in charge of a hospital, the officer commanding a detachment of recruits, &c., &c.

NOTE 2.

When a probable case for pension, special care must be taken to state the degree of disability—as $\frac{1}{2}$, $\frac{3}{4}$, &c., &c.; to describe particularly the disability, wound, or disease; the extent of which it deprives him of the use of any limb or faculty, or affects his health, strength, activity, constitution, or capacity to labor or earn his subsistence. The surgeon will add, from his knowledge of the facts and circumstances, and from the evidence in the case, his professional opinion of the cause or origin of the disability. In the case of discharges by Medical Inspectors, the last paragraph will state that the "discharge was given by consent of the soldier, after a personal examination, and for disability, the nature, degree, and origin of which are correctly described in the within certificate."

Par. 1260 Regulations, Edit. 1861.

Medical officers, in giving certificates of disability, are to take particular care in all cases that have not been under their charge; and especially in epilepsy, convulsions, chronic rheumatism, derangement of the urinary organs, ophthalmia, ulcers, or any obscure disease liable to be feigned or purposely produced; and in no case shall such certificate be given until after sufficient time and examination to detect any attempt at deception.

DIRECTIONS.

This certificate will be made out in duplicate by the soldier's company commander, or other officer commanding the separate detachment to which he belongs, and sent by him to the surgeon who has charge of the hospital where the soldier is sick. The surgeon will then fill out and sign the surgeon's certificate, and forward these papers to the regimental, detachment, or post commander, who will forward them, with his action endorsed thereon, through the proper channel, to his division commander; or, if the troops are not attached to a division, to his corps, department, or other commander or officer to whom the authority to discharge enlisted men may be specially delegated.

These certificates, after having received the action of the highest authority to which they are required to be sent, will be returned through the same channel to the regimental, post, or detachment commander, who will, if the discharge is authorized by the endorsement of the proper authority, sign the soldier's discharge, and the last certificate on this paper; see that the soldier is furnished with the proper final statements in duplicate, and forward ~~copies~~ of these certificates direct to the Adjutant General United States Army, at Washington, D. C.; they will not, under any circumstances, be given to the hands of the soldier.

Cpl 24" 1865

Duplicate sent the Pension Office.

D. 53 R. of Dis. 4.

1865.

CERTIFICATE OF DISABILITY FOR DISCHARGE

IN THE CASE OF

William Baepa

a *private* Co. *"E"*

5th Reg't of *U.S.C.*

APPROVED

Wm. H. Sloan

Surgeon, U. S. A.,

Director Dep't of the East.

HEADQUARTERS DEPARTMENT OF THE EAST,

NEW YORK CITY, April 10th, 1865.

To be discharged.

BY COMMAND OF MAJOR GENERAL PECK

Wm. H. Sloan

Capt. and A. D. C., A. A. A. G.

Received (A. G. Office) 186

En on 11/1/65

ARMY OF THE UNITED STATES. CERTIFICATE OF DISABILITY FOR DISCHARGE.

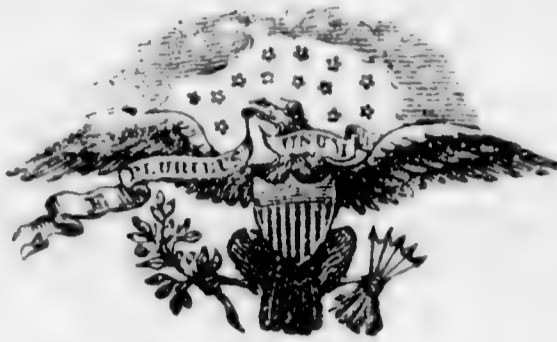

Pvt. William Bauger of Captain *Leut. Alonzo W. Grow* Company, ("8") of the *5th* Regiment of the United States *Artillery* was enlisted by *Myrna Bell* of the *5th* Regiment of *Artillery* at *Myrna Bell* on the *12th* day of *Dec*, 1863, to serve *three* years; he was born in *New Castle Co* in the State of *Delaware*, is *forty two* years of age, *five* feet *seven* inches high, *Mulatto* complexion, *black* eyes, *black* hair, and by occupation when enlisted a *Laborer*. During the last two months said soldier has been unfit for duty *_____* days.*

Soldier states that he was wounded in action and on the line of duty at Deep Bottom Va Sept 29, 1864

STATION: *Grant Genl Hosp*
DATE: *April 3, 1865*

Wm J. Hunt
Surj. U.S.A.
Commanding Company *100th*

I CERTIFY, that I have carefully examined the said *William Bauger* of Captain *Grow* Company, and find him incapable of performing the duties of a soldier because of *amputation of left arm, the result of a gunshot wound*

Disability total

Wm J. Hunt
Surgeon *U.S.A.*
in charge of Hospital

DISCHARGED, this *fourteenth* day of *April*, 1865, at *Grant Genl Hosp*
Hosp. Mills Point N.Y.

Wm J. Hunt
Surgeon *U.S.A.*
Commanding the Regt. *100th*

The Soldier desires to be addressed at
Town *Glasgow* County *New Castle* State *Del.*

* See Note 1 on the back of this. † See Note 2 on the back of this.

Mr Ellertson

William Badger

Co I. 6. W. C. Troops

✓

Adjutant General's Office,

COLORED TROOPS BRANCH,

June 11th, 1877

Mr. Ellertson Vol. C. T., 187
Wanted in the case of William Badger, Co. I,
6th Reg't U. S. C. T.
Copy of trial & Muster Roll for Novth and Decth 63 reports
him "Deserted Oct 4/63 joined from desertion
Nov 13/63 and returned to duty"

Respectfully,

W. A. Woodward
Chief Clerk.

In J. Halton

Adjutant General's Office,

Div. Records discontinued records re

June 14th, 1877

Vol. C. T., 187
Reply in case of Wm Badger Co. I,
6th Reg't U. S. C. T.
Co. Morning Rep. book shows Oct. 4 1863. From absent without leave
to desertion. - Nov. 19 '63. Gained from desertion.
Co. Descript. book: Deserted at camp Wm Penn. Pa. Oct. 4 '63.
Gained from desertion Nov. 17 '63.
Name not borne as Prisoner on Guard Reports. - Was a member of Guard Nov 21/63.
Records of Col. Legt. Dept Va. M.C. do not furnish any
evidence relative to Charges trial re. -
Nothing in S. O. Dept. Va. M.C. -
G. O. and J. O. U. S. F. Yorktown for 1863 are not in file.

W.F.

6 U.S. Col'd Inf.

Private Private

CARD NUMBERS.

1	5570166	26
2	5568395	27
3	5570303	28
4	5568849	29
5	5571303	30
6	9064551	31
7		32
8		33
9		34
10		35
11		36
12		37
13		38
14		39
15		40
16		41
17		42
18		43
19		44
20		45
21		46
22		47
23		48
24		49
25		50

Book Mark:

See also

B | 6 | U.S.C.T.

Citizen Baden

Co. B, 6 Reg't U. S. Col'd Inf.

Appears on

Company Descriptive Book

of the organization named above.

DESCRIPTION.

Age 19 years; height 5 feet 10 inches.

Complexion Bek

Eyes Bek; hair Bek

Where born Westchester, Pa

Occupation Farmer

ENLISTMENT.

When July 31, 1863

Where Westchester

By whom W. D. Pa; term 3 y'rs.

Remarks: Substitute, Deserted from Camp Wm Penn. Pa. Sept 25/63

W. J. Roe

P | **6** | **U.S.C.T.**

Citizen Radson
Priv. P., Co. *B*, 6 Reg't U. S. Col'd Infantry.

Age *19* years.

Appears on

Company Muster-in Roll

of the organization named above. Roll dated

Philadelphia Pa., Aug. 3, 186*3*.

Muster-in to date *July 31*, 186*3*.

Joined for duty and enrolled:

When *July 31*, 186*3*

Where *West Chester Pa.*

Period *3* years.

Remarks:
.....
.....
.....
.....
.....

Book mark:

H. S. Brandon

B | 6 | U.S.C.T.

Citizen Badson

Appears with rank of *Priv* on

Muster and Descriptive Roll of a Detachment of Drafted Men and Substitutes forwarded

for the *6* Reg't U. S. Col'd Inf. Roll dated

West Chester Pa, Aug 1, 1863.

Where born *Penna.*

Age *19* years; occupation *farmer*

Drafted and mustered in:

When *July 31*, 1863.

Where *West Chester 6 Dist.*

Period *3* years.

Eyes *Hazel*; hair *black*

Complexion *dark*; height *5 ft. 10 in.*

Paid bounty and advance pay, \$ *100*

Bounty due \$ *100*

Where credited _____

Company to which assigned _____

Remarks: *substitute for John Miller Concord*

Book mark: _____

Larimer

P

6

U.S.C.T.

Citizen Padsen

Privt, Co. B, 6 Reg't U. S. Col'd Infantry.

Appears on

Company Muster Roll

for *From Muster in to Oct 31*, 1863.

Present or absent

Stoppage, \$ 100 for

Due Gov't, \$ 100 for

Remarks: *Deserted from
Camp "Perry Pa.
Sept. 2" 1863 - Due
U. S. for Knapsack
& G. Coat strap \$2.42*

Book mark:

H. E. Brandon

B | 6

U.S.C.T.

Citizen Badger

pt., Co. B., 6 Reg't U. S. Col'd Infantry.

Appears on

Descriptive List of Deserters

dated *Dec 11*, 1863.

Deserted :

When *Sept 25*, 1863.

Where *Camp near Rome Pa*

Arrested :

When _____, 186 .

Where _____

Remarks : *No knowledge of him*

Filed with Citizen Badson

Book mark : _____

Same

B. 6 | U.S.C.T.

Citizen Badson
Co. B, 6 Reg't U. S. Col'd Infantry.

Appears on **Co. Muster-out Roll**, dated
Wilmington, N.C., Sept. 20, 1865.

Muster-out to date _____, 186 .

Last paid to _____, 186 .

Clothing account:

Last settled _____, 186 ; drawn since \$ _____ 100

Due soldier \$ _____ 100; due U. S. \$ _____ 100

Am't for cloth'g in kind or money adv'd \$ _____ 100

Due U. S. for arms, equipments, &c., \$ _____ 100

Bounty paid \$ _____ 100; due \$ _____ 100

Remarks: *Deserted from Camp*
Wm. Penn Penna. Sept. 25.
1863.

Book mark: *W 29 P 206.71*

(861)

B. J. Cooke
Copyist.

Army, 1862

K. 6 U.S. Col'd Inf.

Private

Private

CARD NUMBERS.

<i>5579432</i>	26
<i>5570026</i>	27
<i>5580126</i>	28
<i>5580222</i>	29
<i>5580317</i>	30
<i>9065760</i>	31
<i>43136178</i>	32
	33
	34
	35
	36
	37
	38
	39
	40
	41
	42
	43
	44
	45
	46
	47
	48
	49
	50

Book Mark:

See also

37083-00. Rtd.
S. 1640268 Po aff
S. 1789646 Po aff
A. 2513624 And. WD

B | *6* | **U.S.C.T.**

Lewis Bailey
 , Co *H*, *6* Reg't U. S. Col'd *Inf.*

Appears on

Company Descriptive Book

of the organization named above.

DESCRIPTION.

Age *26* years; height *5* feet *5* inches.

Complexion *Brown*

Eyes *Black*; hair *Black*

Where born *Eastern Shore Md.*

Occupation *Laborer*

ENLISTMENT.

When *Dec. 7*, 186*4*.

Where *Washington D.C.*

By whom *2^d Dist Dis D.C.*; term *1* y'rs.

Remarks: *Drafted*

Jenkins

B | 6 U.S.C.T.

Lewis Bailey

Appears with rank of *Post* on

Muster and Descriptive Roll

of a detachment of men drafted
& M. In. U.S. Service found
for 6 Regt U.S.C.T. Roll dated
Washington D.C., Dec 8, 1864.

Where born *Md.*

Age *26* y'rs; occupation *laborer*

Drafted and mustered in:

When *Dec 7*, 1864.

Where *Washington D.C.*

Enrollment district *12 Sub out D.C.*

Period *1* years.

Eyes *brown*; hair *blk*

Complexion *brown*; height *5 ft. 5 in.*

Bounty paid \$ *100*; due \$ *100*

Clothing account:

Last settled *861 34*, 186 ; drawn since \$ *18 100*

Date of commencement of service *Dec 7*, 1864.

Company to which assigned

Remarks: *Drafted man
accepted*

Book mark:

G. C. Post

B

6

U.S.C.T.

Elmer Bailey

Pri., Co. K, 6 Reg't U. S. Col'd Infantry.

Appears on

Company Muster Roll

for *Dated Feb 28*, 186*5*.

Present or absent *Present*

Stoppage, \$ *100* for

Due Gov't, \$ *100* for

Remarks:

*Drafted & Mustered in
Dec. 7/64. at Washington
D.C. for one year.*

Book mark:

E. Moore

B

6

U.S.C.T.

Lewis Bailey
Pri, Co. K, 6 Reg't U. S. Col'd Infantry.

Appears on

Company Muster Roll

for Jan & Apr, 1865.

Present or absent Present

Stoppage, \$ 100 for

Due Gov't, \$ 100 for

Remarks:

Book mark:

D. Moore

B

6

U.S.C.T.

Lewis Bailey

Priv, Co. K, 6 Reg't U. S. Col'd Infantry.

Appears on

Company Muster Roll

for *May & June*, 1865.

Present or absent *Present*

Stoppage, \$ *100* for

Due Gov't, \$ *100* for

Remarks: *Drafted*

Book mark:

H. Anderson

(358)

Copyist.

B

6

U.S.C.T.

Lewis Bailey

Plt., Co. K, 6 Reg't U. S. Col'd Infantry.

Appears on

Company Muster Roll

for *July & Aug*, 1865.

Present or absent *Present*

Stoppage, \$ 100 for

Due Gov't, \$ 100 for

Remarks: *Drafted*

Book mark:

W. Anderson

B

6

U.S.C.T.

x Lewis Bailey

Put, Co. K, 6 Reg't U. S. Col'd Infantry.

Appears on Co. Muster-out Roll, dated
Wilmington, N.C., Sept. 20, 1865.

Muster-out to date Sept. 20, 1865.

Last paid to Apr. 30, 1865.

Clothing account:

Last settled ^{March} 1865; drawn since \$ 55 ³⁴/₁₀₀

Due soldier \$ 100; due U. S. \$ 100

Am't for cloth'g in kind or money adv'd \$ 100

Due U. S. for arms, equipments, &c., \$ ^{Retained for U. S. 701} 6 ₁₀₀

Bounty paid \$ ¹ 100; due \$ ¹ 100 ₁₀₀

Remarks: Blue, Wm. Brisbane, Regtl
Sutler, \$ 8. Drafted under act
of Mar 3, 1863.

x R. ... name copied from M. Roll.
1 Erased on roll by line.

Book mark:

M. J. Andrews

Richard

F, **6** U.S. Col'd Inf.

Private

Private

CARD NUMBERS.

1	5574719	26
2	5574802	27
3	5574886	28
4	5574966	29
5	5575046	30
6	5575126	31
7	5575206	32
8	5575283	33
9	5575356	34
10	5575434	35
11	5575526	36
12	5575552	37
13	5575644	38
14	5575735	39
15	9065281	40
16		41
17		42
18		43
19		44
20		45
21		46
22		47
23		48
24		49
25		50

Book Mark: *S. 1231 Vol. 5 R.C.T. 1867.*

See also

B | 6 | U.S.C.T.

Richard Baker

Co. H, 6 Reg't U. S. Col'd Inf.

Appears on

Company Descriptive Book

of the organization named above.

DESCRIPTION.

Age 37 years; height 6 feet 12 inches.

Complexion Blk

Eyes Blk; hair Blk

Where born Cumberland Co Pa

Occupation Farmer

ENLISTMENT.

When Aug 22, 1863

Where Mills Run

By whom 2 D. Pa; term 3 y'rs.

Remarks: Substitute

J. G. Reever
Copyist.

Q

6

U.S.C.T.

Richard Baker
Pot, Co. F, 6 Reg't U. S. Col'd Infantry.

Age 51 years.

Appears on

Company Muster-in Roll

of the organization named above. Roll dated

Phila Pa, Oct 15, 1863.

Muster-in to date

Aug 22, 1863

Joined for duty and enrolled:

When Aug 22, 1863.

Where Phila Pa.

Period 3 years.

Remarks:

Book mark:

E. H. Brown

D

6

U.S.C.T.

Richard Baker

Cot, Co. F, 6 Reg't U. S. Col'd Infantry.

Appears on

Company Muster Roll

for *Muster in to Oct 31, 1863.*

Present or absent *Present*

Stoppage, \$ *100* for

Due Gov't, \$ *100* for

Remarks:

Book mark:

C. H. Baum

B | **6** | **U.S.C.T.**

Richard Baker

Cot, Co. F, 6 Reg't U. S. Col'd Infantry.

Appears on

Company Muster Roll

for Nov Dec, 1863.

Present or absent Present

Stoppage, \$ 100 for

Due Gov't, \$ 100 for

Remarks: Detailed as Pioneer for
S. R. O. No 28 dated Oct 20
6th of Nov 13/63

Book mark: _____

A. B. Brown

Q | **6** | **U.S.C.T.**

Richard Baker
Cot, Co. F, 6 Reg't U. S. Col'd Infantry.

Appears on

Company Muster Roll

for Jan & Feb, 1864.

Present or absent Present

Stoppage, \$ 100 for

Due Gov't, \$ 100 for

Remarks:

Book mark:

E H Brown

(358)

Copyist.

D

6

U.S.C.T.

Richard Baker
Pvt, Co. F, 6 Reg't U. S. Col'd Infantry.

Appears on

Company Muster Roll

for *Mar & July*, 1864.

Present or absent *Present*

Stoppage, \$ *100* for

Due Gov't, \$ *100* for

Remarks:

Book mark:

E. H. Brown

B

6

U.S.C.T.

Richard Baker
Pvt., Co. F, 6 Reg't U. S. Col'd Infantry.

Appears on

Company Muster Roll

for May + June, 1864

Present or absent Present

Stoppage, \$ 100 for

Due Gov't, \$ 100 for

Remarks:

Book mark:

J. C. Davis

D

6

U.S.C.T.

Richard Baker
Pvt, Co. F, 6 Reg't U. S. Col'd Infantry.

Appears on

Company Muster Roll

for July & Aug., 1864

Present or absent Present.

Stoppage, \$ 100 for

Due Gov't, \$ 100 for

Remarks: Free April 19, 1864.
Detached in Div.
Pioneer Corps.

Book mark:

McDunn

B

6

U.S.C.T.

Richard Baker

Private, Co. F, 6 Reg't U. S. Col'd Infantry.

Appears on

Company Muster Roll

for Sept. 1864, 1864

Present or absent Present

Stoppage, \$ 100 for

Due Gov't, \$ 100 for

Remarks:

NEXT ROLL ON FILE FEB 1865

Book mark:

McDawis

(358)

Copyist.

B

6

U.S.C.T.

Richard Baker

Pvt, Co. F, 6 Reg't U. S. Col'd Infantry.

Appears on

Company Muster Roll

for Jan. & Feb., 1865.

Present or absent Absent.

Stoppage, \$ 100 for

Due Gov't, \$ 100 for

Remarks: In Genl Hospital since Jan. 3, 1865.

Book mark:

McDavis

B

6

U.S.C.T.

Richard Baker

Private, Co. F, 6 Reg't U. S. Col'd Infantry.

Appears on

Company Muster Roll

for March - April, 1865.

Present or absent Absent.

Stoppage, \$ 100 for

Due Gov't, \$ 100 for

Remarks: In Genl Hospital
Wilmington, N.C. since
Jan. 15, 1865.

Book mark:

D. Davis

B | 6 | U.S.C.T.

* Richard Baker
Put, Co. F, 6 Reg't U. S. Col'd Infantry.

Appears on

Company Muster Roll

for March - April, 1865.

Present or absent

Stoppage, \$ 100 for

Due Gov't, \$ 100 for

Remarks: Died in hospital
Wilmington, N.C.
March 18, 65.

* Name borne in red ink.

Book mark:

McDavis.

19

6

U.S.C.T.

Richard Baker

Plt, Co. F, 6 Reg't U. S. Col'd Infantry.

Appears on

Company Muster Roll

for *May & June*, 186*8*.

Present or absent *Absent*

Stoppage, \$ *100* for

Due Gov't, \$ *100* for

Remarks: *In U.S.A. N. M. Service*

Va. since May 25/68

Book mark: _____

Sumner

B

6

U.S.C.T.

Richard Baker

Priv., Co. F, 6 Reg't U. S. Col'd Infantry.

Appears on

Company Muster Roll

for *July & Aug.*, 186*5*:

Present or absent *absent.*

Stoppage, \$ *100* for

Due Gov't, \$ *100* for

Remarks: *In U.S.A.N. Ft. Monroe
Va. since Apr 1865*

Book mark:

Lawrence

B

6

U.S.C.T.

Richard Baker

Priv., Co. D, 6 Reg't U. S. Col'd Infantry.

Appears on Co. Muster-out Roll, dated
Wilmington N.C. Sept 20, 1865.

Muster-out to date _____, 186 .

Last paid to Apr 30, 186 4.

Clothing account:

Last settled *never*, 186 ; drawn since \$ *38* ⁴⁹/₁₀₀

Due soldier \$ 100; due U. S. \$ 100

Am't for cloth'g in kind or money adv'd \$ 100

Due U. S. for arms, equipments, &c., \$ 100

Bounty paid \$ 100; due \$ *100* 100

Remarks *By Wm Barber Royal Seller*
600 Name on previous rolls as
free or before Apr 19/61 absent
sick Ft Monroe Va. No disch'g fur-
nished sub for man drafted under
act Mar 3/63 Due US for 4866 \$470

Book mark *P 12 P 235. 69*
1231. 205 OCT 1867
Drawn in Hospital Wilmington from 16 Mar 65

L. Crockett

Paker, Rich E

P, Co. *F*, *6* Reg't *USCT*

3 Enclosures.

Bed Cards	Final Statements
Burial Records	Furloughs or L. of A
Certs. of Dis. for Discharge	Med. Certificates
C. M. Charges	Med. Des. Lists
Descriptive Lists	Orders
Discharge Certificates	Pris. of War Record
Enlistment Papers	Resignations

Other papers relating to—

Admission to Hosp'l	Furlough or L. of A
Casualty Sheet	Med. Examination
Confinement	Misc. Information
Contracts	Pay or Clothing
Death or Effects	Personal Reports
Desertion	Rank
Discharge from Hosp'l	Transfer to Hosp'l
Discharge from Service	Transfer to V. R. C.
Duty	Transportation

S 231 vol 5-267, 1867 '9

Washington, D.C.
Dec. 14 1887

Surg. General

Private
Richard Baker
Co. F
61st Mass.

Cas. sheet made out.

Noted W.S.

119
Read file see 16, 1867

Surgeon General's Office,

Record and Pension Division,

December 14, 1867

Respectfully returned to the Adjutant General's Office, U.S. Army, Sir R. Baker, Co. F, 61st Mass., was admitted to service at Washington, D.C., March 4, 1865, diagnosis "Pneumonia" - disposition not stated. He is known to have died at the above named place March 8, 1865. Cause not stated.

BY ORDER OF THE SURGEON GENERAL:

J. Woodward

Bvt. Lt. Col. and Asst. Surgeon, U. S. A.

(58)

R. of A., Vol. 15 No. 119



Adjutant General's Office
Washington, D.C., July 19, 1887
E. N. Vol 7, Page 515.

The Muster and Muster Out Rolls of Co. F, 61st Mass., Le Grays, report Private Richard Baker absent in hospital, no record of death.

The Surgeon General reports that the soldier died in hospital at Wilmington, N.C., March 8, 1865.

The fact and date of death as reported by the Surgeon General will be noted on the Rolls as a part of the record of the soldier.

J. R. Ricketts
Brevet Colonel, U.S.A.
Adj. Gen. Bureau Col. & Drums

E. M. J. Adams

See letter July 27, '87
& aud.

Adjutant General's Office,

Washington, Dec 4th 1865.

Surgeon General, U. S. Army,

Washington, D. C.

General:

I have the honor to request that this office be furnished such information as can be obtained from the records of your office in regard to the final disposition made of Private Richard Baker.

Company "F," 6th U. S. Colored Troops
 who is reported on the muster-out roll of his Company dated Sept 20th 1865,
 as "Absent sick at Fort Monroe, Va. No Discharge
 given."

On Company Muster Rolls for Mar. & April, 1865,
 he is borne as "In General Hospital, Wilmington,
 N. C., since Jan 15th 1865." — On Muster Rolls for May
 & June, 1865, as "In U. S. General Hospital, Fort
 Monroe, Va, since May 25th 1865."

I have the honor to be,

Very respectfully,

Your obedient servant,

L. H. Snow

Assistant Adjutant General.

10 1/2.

CASUALTY SHEET

Complete,
No. _____

Richard Baker

Private of Company F

6th Regiment of Light Troops

State Volunteers.

NATURE OF CASUALTY.

Died March 8th 1865.

Not mentioned in
Notes on Roll
108 p. 18 18 7

Amount of Cas.

CASUALTY SHEET.

Name: Richard Baker
 Rank: Private Company: F Regiment: 6th
 Arm: U.S. Colored Troops State: _____
 Nature of Casualty: Death

CAUSE OF CASUALTY—(NAME OF DISEASE, &C.)

BY WHOM DISCHARGED.

DEGREE OF DISABILITY.

FROM WHAT SOURCE THIS INFORMATION WAS OBTAINED.

S. 281. Vol 5, RC, 1864.

BY WHOM CERTIFIED.

REMARKS.

A. J. Woodward.
Asst Surg. U.S. Army

DATE OF DISCHARGE, DEATH, &C.

March 8th 1865.

PLACE OF DISCHARGE, DEATH, &C.

Wilmington. N.C.

Princy Townsend,

Clerk.

Surgeon General's Office,
Record and Pension Division,

6 January 15th, 1867.

Respectfully returned to *the Adjutant*

General *W. S. Brown*
Regt. 2nd U.S. Col.
was admitted to the service by
order of 4th August 1865
in consequence of which
the same was dated the 15th
of that month and the same
was dated as above stated
of the 8th 1865, and not later.
There is no evidence from the
the desired final paper can
be prepared.

No 119 - Vol 15

233
14

RECEIVED
DEC 20
1866

RECEIVED ADJUTANT
JAN 15
1867

BY ORDER OF THE SURGEON GENERAL

W. S. Brown

Brevet Lt. Col. and Asst. Surgeon, U. S. A.
(50)

R. of A., Vol. *11* No. *233*

WAR DEPARTMENT,

ADJUTANT GENERAL'S OFFICE,

WASHINGTON, 186 .

SIR:

Final Statements in the cases of deceased soldiers are required to be sent to the Adjutant General's Office in duplicate, with one copy of the Inventory of Effects. The Descriptive List should also be sent to this Office in cases where the soldier was absent from his Company at the time of his death. Where there were no effects, it should be so stated on a blank Inventory, properly signed.

Certificates of Disability should be sent in duplicate. Special care should be taken that the date of discharge and signature of the discharging officer should be affixed.

Cts of the Final Statement *s* or Inventory, has been received in the case of *Private Richard Baker*, of Co. *F*, *6th* Regiment of *U.S. Troops* Volunteers, whose papers were forwarded to this Office. You will please forward the missing papers without delay.

I have the honor to be, sir,

Very respectfully,

Your obedient servant,

L. H. Peltz
Assistant Adjutant General.
(110)

Bat St Colo.
~~COMMANDING OFFICER~~
J. J. Woodward,
Asst Surgeon. U.S. Army.

Note; In report from J. G. O. of Dec 14/67. it is stated that Pvt Re Baker. Co. "F." 6th U.S. T., died Mar 8/65. at General Hospital. Wilmington. N. C.

P. Please make but one application in any case. Ask for all information required - at the same time.

William
Co E, 6 U.S. Col'd Inf

Private

CARD NUMBERS.

1		26	
2		27	
3	<i>See Bacon</i>	28	<i>William</i>
4		29	
5		30	
6		31	
7		32	
8		33	
9		34	
10		35	
11		36	
12		37	
13		38	
14		39	
15		40	
16		41	
17		42	
18		43	
19		44	
20		45	
21		46	
22		47	
23		48	
24		49	
25		50	

Book Mark:

See also

Call, Cyrus A.
Co. A, U. S. Col'd Inf.

CARD NUMBERS.

1	<i>9064673</i>	26
2		27
3		28
4		29
5		30
6		31
7		32
8		33
9		34
10		35
11		36
12		37
13		38
14		39
15		40
16		41
17		42
18		43
19		44
20		45
21		46
22		47
23		48
24		49
25		50

Number of personal papers herein.....

Book Mark:

See also

B | 6 | U.S.C.T.

Cyrus A Ball

, Co. A, 6 Reg't U. S. Col'd Inf.

Appears on

Company Descriptive Book

of the organization named above.

DESCRIPTION.

Age 20 years; height 5 feet 8 1/2 inches.

Complexion Dark

Eyes Blk; hair Blk

Where born Winchester, Va

Occupation

ENLISTMENT.

When July 15, 1863

Where Pittsburg, Pa

By whom Capt Foster, term 3 y'rs.

Remarks: Substitute for

Rev. Father Vincent

Upper St Clair, 22^d

Dist, Pa, Discharg

ed Aug 25/63 by

Judge Ludlow at

Phila, Pa on account

of minority

x Name cancelled

W. F. Roe

Ball, Cyrus A.

....., Co. *6* Reg't *U.S.C.*

..... *1* Enclosures.

Bed Cards	Final Statements
Burial Records	Furloughs or L. of A.
Certs. of Dis. for Discharge	Med. Certificates
C. M. Charges	Med. Des. Lists
Descriptive Lists	Orders
Discharge Certificates	Pris. of War Record
Enlistment Papers <i>/</i>	Resignations

Other papers relating to—

Admission to Hosp'l	Furlough or L. of A.
Casualty Sheet	Med. Examination
Confinement	Misc. Information
Contracts	Pay or Clothing
Death or Effects	Personal Reports
Desertion	Rank
Discharge from Hosp'l	Transfer to Hosp'l
Discharge from Service	Transfer to V. R. C.
Duty	Transportation

S. P. H. 2/4/02
MSB

DECLARATION OF RECRUIT.

I, desiring to VOLUNTEER as a Soldier in the Army of the United States, for the term of THREE YEARS. Do declare, That I am years and months of age; that I have never been discharged from the United States service on account of disability or by sentence of court martial, or by order before the expiration of a term of enlistment; and I know of no impediment to my serving honestly and faithfully as a soldier for three years.

GIVEN at *Pittsburgh*
The *10* day of *July*

Cyrus A Ball
mark

Witness:

B/63/10

No. *372*

Cyrus Augustus Ball
Volunteered at Pittsburgh, Pa.

Pa. July 15, 183,

By *Capt. J. H. Stearns* Regiment of *22^d Pa.*

enlistment; last served in Company ()

Reg't of

Discharged

18

Must be 18 years of age
Placed in the 22^d Regt of Pa.

CONSENT IN CASE OF MINOR.

I, of is said Do CERTIFY, That I am the years of age; and I do hereby freely give my CONSENT to his volunteering as a SOLDIER in the ARMY OF THE UNITED STATES for the period of THREE YEARS.

GIVEN at
The day of

Witness:

VOLUNTEER ENLISTMENT.

STATE OF
Pennsylvania



TOWN OF
Pittsburgh

I, *Cyrus Augustus Ball* born in *Winchester*
 in the State of *Virginia* aged *20* years,
 and by occupation a *Sixteenth* Do HEREBY ACKNOWLEDGE to have
 volunteered this *15th* day of *July* 1863
 to serve as a **Soldier** in the **Army of the United States of America**, for the
 period of **THREE YEARS**, unless sooner discharged by proper authority: Do also
 agree to accept such bounty, pay, rations, and clothing, as are, or may be, estab-
 lished by law for volunteers. And I, *Cyrus A. Ball* do
 solemnly swear, that I will bear true faith and allegiance to the **United States**
of America, and that I will serve them honestly and faithfully against all
 their enemies or opposers whomsoever; and that I will observe and obey the
 orders of the President of the United States, and the orders of the officers
 appointed over me, according to the Rules and Articles of War.

Sworn and subscribed to, at *Pittsburgh* } *Cyrus A. Ball*
 this *15th* day of *July* 1863 } *Mark*

BEFORE

Capt. L. Provost Marshall
2nd. District Penna.

I CERTIFY, ON HONOR, That I have carefully examined the above named Volunteer, agreeably to
 the General Regulations of the Army, and that in my opinion he is free from all bodily defects and mental
 infirmity, which would, in any way, disqualify him from performing the duties of a soldier.

W. B. Simpson

EXAMINING SURGEON.

recruit

I CERTIFY, ON HONOR, That I have minutely inspected the Volunteer,
 previously to his enlistment, and that he was entirely sober when enlisted; that, to the best of my
 judgment and belief, he is of lawful age; and that, in accepting him as duly qualified to perform the duties
 of an able-bodied soldier, I have strictly observed the Regulations which govern the recruiting service.
 This soldier has *Black eyes, Black hair, Black complexion,* is *5* feet *8 1/2* inches
 high.

Capt. L. Provost Marshall
2nd. District Penna.
 Regiment of *Volunteers,*

RECRUITING OFFICER

Co D, 6 U.S. Col'd Inf.

Corporal | Corporal

CARD NUMBERS.

1	5572455
2	5572534
3	5572619
4	5572698
5	5572783
6	5572860
7	5572935
8	5573008
9	5573077
10	5573170
11	5573273
12	5573366
13	5573459
14	9065023
15	
16	
17	
18	
19	
20	
21	
22	
23	
24	
25	

26
27
28
29
30
31
32
33
34
35
36
37
38
39
40
41
42
43
44
45
46
47
48
49
50

Book Mark:

See also

B | 6 | U.S.C.T.

William H. Ballott

, Co. 2, 6 Reg't U. S. Col'd Inf.

Appears on

Company Descriptive Book

of the organization named above.

DESCRIPTION.

Age 24 years; height 5 feet 4^{1/2} inches.

Complexion Black

Eyes Brown; hair Black

Where born Philadelphia Pa

Occupation Servant

ENLISTMENT.

When Aug 10, 1863.

Where Philadelphia Pa

By whom Stbd Wagner; term 3 y'rs.

Remarks: Detailed for duty
at Brig Hd 2rs June 11
1865 - deta to Co for duty
June 28 1865-

J. G. Reeves
 Copyist.

B.

6

U.S.C.T.

W^m H. Ballett.

Corpl, Co. D, 6 Reg't U. S. Col'd Infantry.

Age 24 years.

Appears on

Company Muster-in Roll

of the organization named above. Roll dated

Philadelphia, Pa., Aug. 14, 1863.

Muster-in to date Aug. 10, 1863.

Joined for duty and enrolled:

When Aug. 10, 1863

Where Phila., Pa.

Period 3 years.

Remarks:

Book mark:

Baker,

Copyist.

B.

6

U.S.C.T.

William H. Ballott.

Corpl., Co. D, 6 Reg't U. S. Col'd Infantry.

Appears on

Company Muster Roll

for Nov. & Dec., 1863.

Present or absent present.

Stoppage, \$ 100 for

Due Gov't, \$ 100 for

Remarks: Due U.S. for one
haversack 56 cts.

Book mark:

Baker,

Copyist.

(858)

B.

6

U.S.C.T.

William H. Ballott.
Corpl., Co. D, 6 Reg't U. S. Col'd Infantry.

Appears on

Company Muster Roll

for Jan & Feb, 1864

Present or absent present

Stoppage, \$ 100 for

Due Gov't, \$ 100 for

Remarks:

Book mark:

Baker

Copyrs.

B.

6

U.S.C.T.

William H. Ballott.

Priv., Co. D, 6 Reg't U. S. Col'd Infantry.

Appears on

Company Muster Roll

for March & April, 1864.

Present or absent present.

Stoppage, \$ 100 for

Due Gov't, \$ 100 for

Remarks: Reduced from Corp'l. April 15, 1864, by S. R. Order.

Book mark:

Baker,

43

6

U.S.C.T.

William H. Ballot

Pu, Co. D, 6 Reg't U. S. Col'd Infantry.

Appears on

Company Muster Roll

for May & June, 1864

Present or absent Present

Stoppage, \$ 100 for

Due Gov't, \$ 100 for

Remarks:

Book mark:

Reif

MB

6

U.S.C.T.

William H. Ballet

Pr, Co. D, 6 Reg't U. S. Col'd Infantry.

Appears on

Company Muster Roll

for July & Aug, 1864

Present or absent Present

Stoppage, \$ 1.00 for

Due Gov't, \$ 1.00 for

Remarks: Detached by order of Genl. Butler Aug. 9 64 Due Reg. for one barr. 44 cts

Note. Still detached but after these Rolls were made out an order came that they should be mustd. with their company. and reported on extra duty.

Book mark:

Pr

MB

6

U.S.C.T.

William H. Ballet

Private, Co. D, 6 Reg't U. S. Col'd Infantry.

Appears on

Company Muster Roll

for Sept. & Oct., 1864

Present or absent Present

Stoppage, \$ 100 for

Due Gov't, \$ 100 for

Remarks: Ret'd to Co, Sept - 64

NEXT ROLL ON FILE FEB 1865

Book mark:

Reif

B

6

U.S.C.T.

William H. Ballet

lpl, Co. D, 6 Reg't U. S. Col'd Infantry.

Appears on

Company Muster Roll

for Jan. & Feb., 1865

Present or absent Present

Stoppage, \$ 100 for

Due Gov't, \$ 100 for

Remarks: apptd. lpl. Dec. 1 64.
also ref. for two M ar.
\$ 1.34

Book mark:

Reif

(858)

Copyis..

MB

6

U.S.C.T.

Wm H. Ballott

Sept, Co. D, 6 Reg't U. S. Col'd Infantry.

Appears on

Company Muster Roll

for Mch. & April, 1865

Present or absent Present

Stoppage, \$ 100 for

Due Gov't, \$ 100 for

Remarks: aptd. Sept. Dec. 1 64
Due ref. for 2 Haversacks
\$ 1.34

Book mark:

Reif

(858)

Copyist.

B

6

U.S.C.T.

William H. Ballou

Corp., Co. D, 6 Reg't U. S. Col'd Infantry.

Appears on

Company Muster Roll

for May 1864, 1864

Present or absent Present

Stoppage, \$ $\frac{34}{100}$ for b. b. & b. e.

Due Gov't, \$ 100 for

Remarks: Appointed Corp Dec 1st 64

Book mark:

Phillips

B

6

U.S.C.T.

William A. Ballou
Corp., Co. D, 6 Reg't U. S. Col'd Infantry.

Appears on

Company Muster Roll

for July and Aug., 1865

Present or absent Present

Stoppage, \$ 100 for

Due Gov't, \$ 100 for

Remarks:

Book mark:

Phelps

B. | 6 | U.S.C.T.

William H. Ballou
Corp., Co. D, 6 Reg't U. S. Col'd Infantry.

Appears on Co. Muster-out Roll, dated
Wilmington N.C., Sept. 20, 1865.

Muster-out to date Sept. 20, 1865.

Last paid to April 30, 1865.

Clothing account:

Last settled June 30, 1864; drawn since \$61 ⁸⁶/₁₀₀

Due soldier \$100; due U. S. \$100

Am't for cloth'g in kind or money adv'd \$100

Due U. S. for arms, equipments, &c., \$100

Bounty paid \$60 ⁰⁰/₁₀₀; due \$100 ⁰⁰/₁₀₀

Remarks: Due Wm Bushen
Right Suttler \$11.00
Paid on or before April 19th 1861

Book mark:

Phitts

Ballott, Wm H.

Co. D, 6 Reg't U.S.C.

Enclosures.

Bed Cards	Final Statements
Burial Records	Furloughs or L. of A
Certs. of Dis. for Discharge	Med. Certificates
C. M. Charges	Med. Des. Lists
Descriptive Lists	Orders
Discharge Certificates	Pris. of War Record
Enlistment Papers	Resignations

Other papers relating to—

Admission to Hosp'l	Furlough or L. of A
Casualty Sheet	Med. Examination
Confinement	Misc. Information
Contracts	Pay or Clothing
Death or Effects	Personal Reports
Desertion	Rank
Discharge from Hosp'l	Transfer to Hosp'l
Discharge from Service	Transfer to V. R. C.
Duty	Transportation

Mr. Ellwood

William H. Balliett
Co. 1st U.S.C. Troops

Adjutant General's Office,

COLORED TROOPS BRANCH,

December 2^d, 1876.

Mr. Herbert Vol. C. T., 187
Wanted in the case of William H. Ballott, Co. D;
6 Reg't U.S.C.T.

Copy of S. R. Cade Muster Roll for March 1864 to April
1864 reports him "Reduced from Corporal April 15th 1864
by S. R. Cade."
Respectfully,

W. A. Woodward
Chief Clerk.
J. H. Barton

Adjutant General's Office,

Division of Discontinued Commands.

Dec 6th, 1876.

Vol. C. T., 187
Reply in case of Wm H. Ballott, Co. (D)
6 Reg't U.S.C.T.

Reduced to the ranks from Corporal "for drunkenness,"
to date from May 1st 64, per S.O. no 36 Reg'te Hd Qrs
July 5th 64.

W.A.W.

6 U.S. Col'd Inf

Leutenant | 2^d Lieutenant

CARD NUMBERS.

5567630	26
5578803	27
5578898	28
5578996	29
5579089	30
5579172	31
	32
	33
	34
	35
	36
	37
	38
	39
	40
	41
	42
	43
	44
	45
	46
	47
	48
	49
	50

Book Mark: A 419 C 7 83.

See also

6875248 - 25 Ind. R.C.
Aerod mil 131394 4/16 7K5
P.O. M. 400. N. 6. 215. 266. 10. 6. 17. ~~22~~

B | 6 | U.S.C.T.

Wynward Ballou
 2^d, Co., 6 Reg't U. S. Col'd Infantry.

Age 20 years.

Appears on an

Individual Muster-in Roll

of the organization named above. Roll dated
 Fort Wall Point, Feb 9, 1863.

Muster-in to date Nov 19, 1864.

Joined for duty and enrolled:

When Nov 19, 1864.

Where Fort Wall, Va.

Period 3 years.

Remarks: Promoted from
 Sgt 1st New Hamp-
 shire Vols Vice
 McGary dec 4. 1863
 changed date North
 Muster on the Commis

Book mark :

Combs

JAN. 20

5567630

1891 *

son of Major
General Butler la-
ted Oct. 23. 1864

B, | 6 | U.S.C.T.

Wayland Ballou
2 Lt., Co. I, 6 Reg't U. S. Colored Infantry.

Appears on

Company Muster Roll
for Jan. & Feb., 1865.
Present or absent Present.

Stoppage, \$ 100 for

Due Gov't, \$ 100 for

Remarks:

Book mark:

H. W. Reed

B. | 6 | U.S.C.T.

Wayland Ballou
2 Lt., Co. I, 6 Reg't U. S. Colored Infantry.

Appears on

Company Muster Roll

for dated May 3, 1865.

Present or absent Present.

Stoppage, \$ 100 for

Due Gov't, \$ 100 for

Remarks: Mustered into service
Nov. 18/64.

Book mark:

W. H. Reed

B

6

U.S.C.T.

Hayland Ballou
2d, Co. I, 6 Reg't U. S. Colored Infantry.

Appears on

Company Muster Roll

for *May & June*, 186*5*.

Present or absent *Present*

Stoppage, \$ *100* for

Due Gov't, \$ *100* for

Remarks:

Book mark:

15225

(858)

Jossey

Copyist.

B

6

U.S.C.T.

Rayland Ballou
2nd, Co. I, 6 Reg't U. S. Colored Infantry.

Appears on

Company Muster Roll

for *July & Aug*, 186*5*.

Present or absent *Present*

Stoppage, \$ *100* for

Due Gov't, \$ *100* for

Remarks:

Book mark:

(858)

Posey

Copyist.

B

6

U.S.C.T.

Hayland Ballou

2nd Lt., Co. I, 6 Reg't U. S. Col'd Infantry.

Appears on Co. Muster-out Roll, dated

Wilmington, N. C., Sept 20, 1865.

Muster-out to date Sept 20, 1865.

Last paid to _____, 186 .

Clothing account:

Last settled _____, 186 ; drawn since \$ _____ 100

Due soldier \$ _____ 100; due U. S. \$ _____ 100

Am't for cloth'g in kind or money adv'd \$ _____ 100

Due U. S. for arms, equipments, &c., \$ _____ 100

Bounty paid \$ _____ 100; due \$ _____ 100

Remarks: _____

Book mark: 1419 - C. I. 83

(361)

Josey

Copyist.

Ballow, Maryland
Lt. Col. I, 6th Reg't USCT.

Enclosures.

Bed Cards	Final Statements
Burial Records	Furloughs or L. of A.
Certs. of Dis. for Discharge	Med. Certificates
C. M. Charges	Med. Des. Lists
Descriptive Lists	Orders
Discharge Certificates	Pris. of War Record
Enlistment Papers	Resignations

Other papers relating to—

Admission to Hosp'l	Furlough or L. of A.
Casualty Sheet	Med. Examination
Confinement	Misc. Information /
Contracts	Pay or Clothing
Death or Effects	Personal Reports
Desertion	Rank
Discharge from Hosp'l	Transfer to Hosp'l
Discharge from Service	Transfer to V. R. C.
Duty	Transportation

Camp 4th N. H. Vols.
Nov. 12, 1864.

B. 33 (C. I. V. A. N. C.) 1864
Ballou Maryland
Sergt. 4th N. H. V.

609

Accepts 2d Lieut. in 6th U.S.
Col'd Troops.

Home com.

were there made by
"order" or abstr.

App'd in order -
should they be
ordered to report?

Yes

[Handwritten signature]

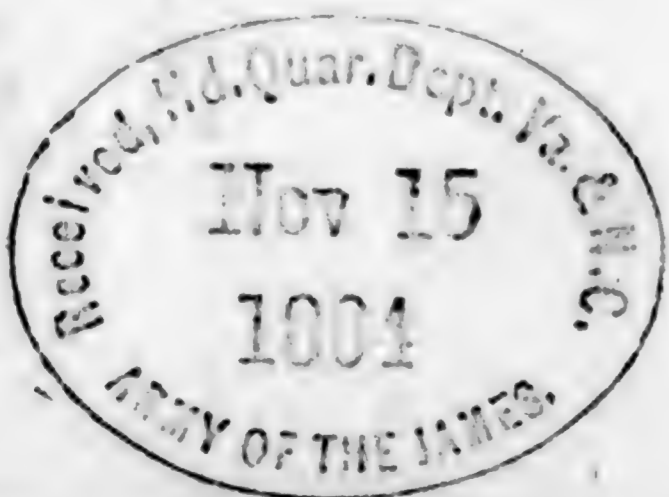

Ad. M. 4th N. H. Vols
Nov. 13, 1864.

Respectfully forwarded

John H. Roberts
S. Comdg Regt.

Head Qrs 3rd Brig 2nd Div
10th Me Nov 13 1864
E. B. 263
Respectfully forwarded

Louis Bell
Col Comdg Brig

Ad. Qrs 2nd Div 10th Me
In the Field N. Nov 14 1864

Respectfully forwarded.
E. B. 170

R. S. Foster
Brig Genl Comdg

Ad. Qrs. 10th A. C.
Intified to Nov. 15th
(E. B. 2638)

Respectfully forwarded

A. Amos
Brig. Genl.

Camp 4th N. H. Vols.
Nov. 12, 1864.

Lt. J. W. Challis,
Act. Adjt., 4th N. H. V.
Lieut.

I have the honor to state that I accept the appointment of 2d Lieutenant in 6th U. S. Col'd Inftry. tendered me by Major Gen. Comdg.

Age	Place of Birth	Permanent Residence
20	Piscataway, N. H.	Shill N. Hamp.

I have the honor to be
Very Respectfully
Your Obedt. Servt.,
Wayland Ballou.
Sergt. Co. "H." 4th N. H. V.

James

6 U.S. Col'd Inf.

Private | *Private*

CARD NUMBERS.

1	5571339	26
2	5568306	27
3	5571423	28
4	5571305	29
5	5571583	30
6	5571660	31
7	5571734	32
8	5571807	33
9	5571876	34
10	5571953	35
11	5572040	36
12	5572140	37
13	5572236	38
14	5572326	39
15	9064798	40
16	9064798	41
17		42
18		43
19		44
20		45
21		46
22		47
23		48
24		49
25		50

Book Mark:

See also

B | 6 | U.S.C.T.

James Banks

Co. B, 6 Reg't U. S. Col'd Inf.

Appears on
Company Descriptive Book
of the organization named above.

DESCRIPTION.

Age 22 years; height 5 feet 6 inches.

Complexion *Blk*

Eyes *Blk*; hair *Blk*

Where born *Washington Co. Pa.*

Occupation *Laborer*

ENLISTMENT.

When *July 14*, 186*3*

Where *New Brighton*

By whom *W.D. Pa.*; term *3* y'rs.

Remarks: *Drafted*

W. J. Roe

B | **6** | **U.S.C.T.**

James Banks

....., Co. *C*, 6 Reg't U. S. Col'd Inf.

Appears on

Company Descriptive Book

of the organization named above.

DESCRIPTION.

Age *22* years; height *5* feet *6* inches.

Complexion *Blk*

Eyes *Blu*; hair *Blk*

Where born *Washington Co. Pa*

Occupation *Labourer*

ENLISTMENT.

When *July 14*, 186 *3*

Where *New Brighton*

By whom *24 D. Pa*; term *3* y'rs.

Remarks: *Drafted*

W F Roe

B

6

U.S.C.T.

James Banks

Pho, Co. *C*, 6 Reg't U. S. Col'd Infantry.

Age *22* years.

Appears on

Company Muster-in Roll

of the organization named above. Roll dated

Philadelphia, Pa., Aug. 8, 186*3*.

Muster-in to date

July 14, 186*3*

Joined for duty and enrolled:

When *July 14*, 186*3*.

Where *New Brighton, Pa.*

Period *3* years.

Remarks:

Book mark:

80

Shull

B

6

U.S.C.T.

James Banks

Appears with rank of _____ on
**Muster and Descriptive Roll of a Detach-
 ment of Drafted Men and Substitutes**
 forwarded

for the *6* Reg't U. S. Col'd Inf. Roll dated
New Brighton Pa, Aug 5, 1863.

Where born *Washington Co. Pa*

Age *22* years; occupation *Labourer*

Drafted and mustered in:

When *July 14*, 1862.

Where *New Brighton Pa 24 Dist.*

Period *3* years.

Eyes *black*; hair *black*

Complexion *black*; height *5 ft. 6 in.*

Paid bounty and advance pay, \$ *100*

Bounty due \$ *100*

Where credited _____

Company to which assigned _____

Remarks: *Drafted Colored*

Book mark: _____

Sarimer

B

6

U.S.C.T.

James Banks
Priv, Co. C, 6 Reg't U. S. Col'd Infantry.

Appears on

Company Muster Roll

for *to Oct. 31"*, 1863.

Present or absent *Present*

Stoppage, \$ *100* for

Due Gov't, \$ *100* for

Remarks:

Book mark:

Shull

B

6

U.S.C.T.

James Banks
Priv., Co. C, 6 Reg't U. S. Col'd Infantry.

Appears on

Company Muster Roll

for *Nov. & Dec.*, 186*3*.

Present or absent *Present*

Stoppage, \$ *100* for

Due Gov't, \$ *100* for

Remarks:

Book mark:

Shull

B

6

U.S.C.T.

James Banks

Priv., Co. C, 6 Reg't U. S. Col'd Infantry.

Appears on

Company Muster Roll

for *Jan'y. & Feb'y.*, 1864.

Present or absent *Present*

Stoppage, \$ 100 for

Due Gov't, \$ 100 for

Remarks:

Book mark:

Shull

B

6

U.S.C.T.

James Banks
Priv., Co. C, 6 Reg't U. S. Col'd Infantry.

Appears on

Company Muster Roll

for *Mar. & Apr.*, 1864.

Present or absent *Present*

Stoppage, \$ *100* for

Due Gov't, \$ *100* for

Remarks: *Due U.S. for 1 Haver-*
sack 48 cts. 1 Canteen 44¢

Book mark: *45-83*

Shull

B

6

U.S.C.T.

James Banks

Private, Co. C, 6 Reg't U. S. Col'd Infantry.

Appears on

Company Muster Roll

for *May & June*, 186*4*

Present or absent *Absent*

Stoppage, \$ *100* for

Due Gov't, \$ *100* for

Remarks: *Absent in hospital
wounded since June
15, 64.*

Book mark:

Fletcher

B

6

U.S.C.T.

James Banks

Pvt, Co. C, 6 Reg't U. S. Col'd Infantry.

Appears on

Company Muster Roll

for July & Aug, 1864.

Present or absent Present

Stoppage, \$ 100 for

Due Gov't, \$ 100 for

Remarks: * ~~Wound in his Hospital~~
Free Apr 19th 1861

* Appears so on roll

Book mark:

J. Fletcher

Copist.

(358)

B

6

U.S.C.T.

James Banks

Co. C, 6 Reg't U. S. Col'd Infantry.

Appears on

Company Muster Roll

for Sept & Oct, 1864.

Present or absent Absent

Stoppage, \$ 100 for

Due Gov't, \$ 100 for

Remarks: Wounded Sept 29.64 - In Hospital Free April 19.61

NEXT ROLL ON FILE FEB 1865

Book mark:

Fletcher

B

6

U.S.C.T.

James Banks
Private

, Co. C, 6 Reg't U. S. Col'd Infantry.

Appears on

Company Muster Roll

for *Jan & Feb*, 1865.

Present or absent *Present*

Stoppage, \$ *100* for

Due Gov't, \$ *100* for

Remarks: *Free Apr 19. 61*

Book mark:

Fletcher

(358)

Copyist.

B

6

U.S.C.T.

James Banks

Priv, Co. C, 6 Reg't U. S. Col'd Infantry.

Appears on

Company Muster Roll

for March & April, 1865.

Present or absent Present

Stoppage, \$ 100 for

Due Gov't, \$ 100 for

Remarks: Free April 19. 61

Book mark:

Fletcher

43 | 6 | U.S.C.T

James Banks
Pvt, Co. C, 6 Reg't U. S. Col'd Inftry

Appears on

Company Muster Roll

for May & June, 1865.

Present or absent present

Stoppage, \$ 100 for

Due Gov't, \$ 100 for

Valuation of horse, \$ 100

Valuation of horse equipments, \$ 100

Remarks: Free April 19. 65

Book mark:

E. P. Masi
Compr.

18

6

U.S.C.T.

James Banks

Co. C, 6 Reg't U. S. Col'd Infantry.

Appears on

Company Muster Roll

for July & Aug, 1865

Present or absent Present

Stoppage, \$ 100 for

Due Gov't, \$ 100 for

Remarks:

Book mark:

Beach

B

6

U.S.C.T.

James Bonks

Pvt., Co. C, 6 Reg't U. S. Col'd Infantry.

Appears on Co. Muster-out Roll, dated

Wilmington N.C., Sept 20, 1865.

Muster-out to date Sept 20, 1865.

Last paid to Oct 30, 1865.

Clothing account:

Last settled June 30, 1864; drawn since \$52 ⁴¹/₁₀₀

Due soldier \$100; due U. S. \$100

Am't for cloth'g in kind or money adv'd \$100

Due U. S. for arms, equipments, &c., \$100

Bounty paid \$None 100; due \$100 100

Remarks: Due Wm Resbon
Sutler \$3.00 Due U.S. for
1st Driver 23.¢ 1 wiper 20 cts
total 43 cts.

Book mark:

Beach

C, 6 U.S. Col'd Inf.

Private

Private

CARD NUMBERS.

1	5567979	26
2	5571957	27
3	5572043	28
4	5572143	29
5	5572296	30
6	5568755	31
7	5572386	32
8	9064802	33
9	-9064924	34
10	43148050	35
11		36
12		37
13		38
14		39
15		40
16		41
17		42
18		43
19		44
20		45
21		46
22		47
23		48
24		49
25		50

Book Mark:

See also

01003870. P.O. Mann
A1521444 P.O. Mann

B

6

U.S.C.T.

William H. Bannister

Co. C, 6 Reg't U. S. Col'd Inf.

Appears on

Company Descriptive Book

of the organization named above.

DESCRIPTION.

Age 29 years; height 5 feet 10 1/4 inches.

Complexion *Bea*

Eyes *Blue*; hair *Blue*

Where born *Mich*

Occupation *Sailor*

ENLISTMENT.

When *Oct 6*, 186*4*

Where *Bergen, N.Y.*

By whom *Capt Bowen*; term *3* y'rs.

Remarks: *Mustered by
Capt Bowen at
Lockport, N.Y.
Oct 6/64. Received
1st Lieutenant
U.S. Bounty 100*

W J Roe

B | 6 | U.S.C.T.

William H. Bannister

Co. C, 6 Reg't U. S. Col'd Inf.

Appears on

Company Descriptive Book

of the organization named above.

DESCRIPTION.

Age 29 years; height 5 feet 10 1/4 inches.

Complexion *Blk*

Eyes *Blk*; hair *Blk*

Where born *Mich*

Occupation *Sailor*

ENLISTMENT.

When *Oct 6*, 186*4*

Where *Bergen, N.J.*

By whom *Capt Bowen*; term *3* y'rs.

Remarks: *Mustered by Capt Bowen at Lockport, N.Y. Oct 6/64. Received 1st installment U.S. Bounty, 100*

W J Roe

B. | 6 Inf | 11th Reg

William H. Bannister

Appears with rank of Priv on

Muster and Descriptive Roll

of Detachment of U.S. Vols.
forwarded for the 6 Regt U.S.
Inf. Roll dated

Lockport, N.Y., Oct 11, 1864.

Where born Mississippi

Age 24 years; occupation Sailor

When enlisted Oct. 6, 1864

Where enlisted Bergen, N.Y.

For what period enlisted 3 years.

Eyes Blk; hair Blk

Complexion Blk; height 5 ft. 10 in.

When mustered in Oct. 6, 1864.

Where mustered in Lockport

Bounty paid \$ 100 100; due \$ 100

Clothing account:

Last settled _____, 186 ; drawn since \$ 17 100

Date of first muster _____, 186 .

Company to which assigned _____

Remarks: 24 Regt, Bergen
Genesee Co., N.Y.

Book mark: _____

(856m)

W. H. [Signature]
Copyist.

B | 6 | U.S.C.T.

William H. Bunnister

Appears with rank of *Pl.* on

Muster and Descriptive Roll of a Detachment of U. S. Vols. forwarded

for the 6 Reg't U. S. Col'd Infantry. Roll dated

Chamira N.Y., *Dec 5*, 1864.

Where born *Michigan*

Age *29* y'rs; occupation *Sailor*

When enlisted *Oct. 6*, 1864.

Where enlisted *Bergen N.Y.*

For what period enlisted *3* years.

Eyes *Blk.*; hair *Blk.*

Complexion *Blk.*; height *5* ft. *10 1/4* in.

When mustered in *Oct. 6*, 1864.

Where mustered in *Lockport*

Bounty paid \$ *100*⁰⁰; due \$ *200*⁰⁰

Where credited *29 Cong. Dist. Bergen*
Genesee Co.

Company to which assigned

Remarks:

Book mark:

B

6

U.S.C.T.

William H. Barnister

Pvt, Co. C, 6 Reg't U. S. Col'd Infantry.

Appears on

Company Muster Roll

for Jan & Feb, 1865.

Present or absent Absent

Stoppage, \$ 100 for

Due Gov't, \$ 100 for

Remarks: Absent sick

Book mark:

Fletcher

B

6

U.S.C.T.

Wm H. Bamister
Priv, Co. C, 6 Reg't U. S. Col'd Infantry.

Appears on

Company Muster Roll

for March & April, 1865

Present or absent Absent

Stoppage, \$ 100 for

Due Gov't, \$ 100 for

Remarks: Absent sick

Book mark:

Fletcher

B

6

U.S.C.T.

William H. Bomster

Co, Co. C, 6 Reg't U. S. Col'd Infantry.

Appears on

Company Muster Roll

for *May & June*, 186*5*.

Present or absent *Absent*

Stoppage, \$ *100* for

Due Gov't, \$ *100* for

Remarks: *Absent Sick*

Book mark:

Beach

B

6

U.S.C.T.

William H. Bannister
Pvt, Co. *C*, 6 Reg't U. S. Col'd Infantry.

Appears on an

Individual Muster-out Roll

of the organization named above. Roll dated

Fort Monroe Va June 23, 1865.

Muster-out to date *June 23*, 1865.

Last paid to *Pay due from enlistment*, 186 .

Clothing account:

Last settled *never*, 186 ; drawn since \$ 100

Due soldier \$ 100; due U. S. \$ 100

Am't for cloth'g in kind or money adv'd \$ *7* ⁵⁰/₁₀₀

Due U. S. for arms, equipments, &c., \$ 100

Bounty paid \$ *100* ¹⁰⁰/₁₀₀; due \$ 100

Remarks: *mustered out by order of War Dept Dated May 3^d 1865 Fort Monroe Va Patient in U.S. Genl Hospital*

Book mark:

Bowman

J | **6** | **U.S.C.T.**

Amos H. Fannister

103, Co. C, 6 Reg't U. S. Col'd Infantry.

Appears on

Company Muster Roll
for *July to Aug*, 186*5*.

Present or absent _____

Stoppage, \$ _____ 100 for _____

Due Gov't, \$ _____ 100 for _____

Remarks: *Discharged
Mustered out of service
June 23, 65, at Fort
Monroe Va.*

Book mark: _____

Beach

18 | 6 | U.S.C.T.

William H. Somister

Co. C, 6 Reg't U. S. Col'd Infantry.

Appears on **Co. Muster-out Roll**, dated

Wilmington N.C. Sep 12, 1865.

Muster-out to date _____, 186 .

Last paid to _____, 186 .

Clothing account:

Last settled _____, 186 ; drawn since \$ _____ 100

Due soldier \$ _____ 100; due U. S. \$ _____ 100

Am't for cloth'g in kind or money adv'd \$ _____ 100

Due U. S. for arms, equipments, &c., \$ _____ 100

Bounty paid \$ _____ 100; due \$ _____ 100

Remarks: *Mustered out at Fort Monroe Va June 2, 1865.*

Book mark *U.S.P. 55. 237*
over

Beach

NARA 759

JAN. 20

5572386

1891

230. F. 230. 1/6.

Pannister, Wm H

P., Co. , *6* Reg't *U.S.C.*

2 Enclosures.

Bed Cards	Final Statements
Burial Records	Furloughs or L. of A
Certs. of Dis. for Discharge	Med. Certificates
C. M. Charges	Med. Des. Lists
Descriptive Lists	Orders
Discharge Certificates	Pris. of War Record
Enlistment Papers	<i>2</i> Resignations

Other papers relating to—

Admission to Hosp'l	Furlough or L. of A
Casualty Sheet	Med. Examination
Confinement	Misc. Information
Contracts	Pay or Clothing
Death or Effects	Personal Reports
Desertion	Rank
Discharge from Hosp'l	Transfer to Hosp'l
Discharge from Service	Transfer to V. R. C.
Duty	Transportation

NOTE 1.—This blank will be used for both enlistments and re-enlistments—enlistment of veterans, &c., &c., in the volunteer service. They will be made out in duplicate in all cases—one to accompany the recruiting return of the superintendent (not the recruiting officer) to the Adjutant General, and one to accompany the accounts of the officer who pays bounty, &c. The Regiment and Company in which the soldier last served should be given on the back.

NOTE 2.—An enlistment holds to service. A muster-in must, in all cases, precede payment of pay, bounty, pension, &c. A muster-in roll must, in all cases, be filed in the Adjutant General's Office as evidence of muster-in. The mustering officer, commissary, or assistant commissary of musters, as the case may be, will countersign both enlistments as having mustered the soldier into the service of the United States before either of them is given to the disbursing officer.

DECLARATION OF RECRUIT.

I, William H. Bannister, desiring to VOLUNTEER as a Soldier in the Army of the United States, for the term of THREE YEARS, Do Declare, That I am Twenty three years and three months of age; that I have never been discharged from the United States service on account of disability or by sentence of a court martial, or by order before the expiration of a term of enlistment; and I know of no impediment to my serving honestly and faithfully as a soldier for three years.

GIVEN at Lockport NY the 6 day of October 1864

Witness: A. Bert

William H. Bannister
mohr

W. H. Bannister
No. 200

Volunteered at Bergham NY
Co. H, 18
By Robert D. F. Bennett
6th Regiment of N.Y. Colored
enlistment; last served in Company ()
Regt of
Discharged , 18

CONSENT IN CASE OF MINOR.

I, _____, Do CERTIFY, That I am the _____ of _____; that the said _____ is _____ years of age; and I do hereby freely give my CONSENT to his Volunteering as a SOLDIER in the ARMY OF THE UNITED STATES for the period of THREE YEARS.

GIVEN at _____ the _____ day of _____

Witness: _____

VOLUNTEER ENLISTMENT.

STATE OF
NEW YORK

TOWN OF

Perfree

I, *William H. Bannister*, born in
in the State of *Michigan*, aged *Twenty Nine* years,
and by occupation a *Miller*, Do HEREBY ACKNOWLEDGE to have
volunteered this *29th* day of *October*, 1864
to serve as a Soldier in the Army of the United States of America, for
the period of **THREE YEARS**, unless sooner discharged by proper authority: Do also agree
to accept such bounty, pay, rations, and clothing, as are, or may be, established by law for volunteers.

William H. Bannister solemnly swears that I will bear
true faith and allegiance to the United States of America, and that I will serve them honest-
ly and faithfully against all their enemies or opposers whomsoever; and that I will observe and
obey the orders of the President of the United States, and the orders of the officers appointed
over me, according to the Rules and Articles of War.

Sworn and subscribed to, at Lockport, N. Y.,
this *6* day of *October*, 1864.

William H. Bannister
mark

BEFORE *L. J. Bowen*
Capt 29th Regt NY

I CERTIFY, ON HONOR, That I have carefully examined the above-named Volun-
teer, agreeably to the General Regulations of the Army, and that, in my opinion, he is free from
all bodily defects and mental infirmity, which would in any way disqualify him from performing
the duties of a soldier.

J. Root

EXAMINING SURGEON.

I CERTIFY, ON HONOR, That I have minutely inspected the Volunteer
William H. Bannister previously to his enlistment, and that he was entirely sober
when enlisted; that, to the best of my knowledge and belief, he is of lawful age; and that, in
accepting him as duly qualified to perform the duties of an able-bodied soldier, I have strictly
observed the Regulations which govern the recruiting service. This soldier has *black*
eyes, *black* hair, *black* complexion, is *5* feet *10 1/2*
inches high.

L. J. Bowen
Capt 29th Regt NY
Regiment of *29th Regt NY*

Volunteers,
RECRUITING OFFICER.

Regiment of *29th Regt NY*
Mustered into the service of the United States, for three years or during the war, from date of enlistment, in Company
W. B. Colwell Volunteers, on the *6* day of *October*, 1864, at *Lockport NY*

29th Regt NY
L. J. Bowen

NOTE 1.—This blank will be used for both enlistments and re-enlistments—enlistment of veterans, &c., &c., in the volunteer service. They will be made out in duplicate in all cases—one to accompany the recruiting return of the superintendent (not the recruiting officer) to the Adjutant General, and one to accompany the accounts of the officer who pays bounty, &c. The Regiment and Company in which the soldier last served should be given on the back.

NOTE 2.—An enlistment holds to service. A muster-in must, in all cases, precede payment of pay, bounty, pension, &c. A muster-in roll must, in all cases, be filed in the Adjutant General's Office as evidence of muster-in. The mustering officer, commissary, or assistant commissary of musters, as the case may be, will countersign both enlistments as having mustered the soldier into the service of the United States before either of them is given to the disbursing officer.

DECLARATION OF RECRUIT.

I, William A. Bammeter, desiring to VOLUNTEER as a Soldier in the Army of the United States, for the term of THREE YEARS, Do Declare, That I am Twenty Nine years and Three months of age; that I have never been discharged from the United States service on account of disability or by sentence of a court martial, or by order before the expiration of a term of enlistment; and I know of no impediment to my serving honestly and faithfully as a soldier for three years.

GIVEN at Sackett's N. Y. the 6 day of October, 1864

Witness: G. Burt William A. Bammeter

Rec'd from 2nd Ad. Gen. 16 1893

Volunteered at Sackett's N. Y.
Oct. 6, 1864
By Col. G. P. Bennett
6th Regiment of U.S. Artillery
enlistment; last served in Company ()
Reg't of
Discharged 18

William A. Bammeter

60 7.00

CONSENT IN CASE OF MINOR.

I, _____, Do CERTIFY, That I am the _____ of _____; that the said _____ is _____ years of age; and I do hereby freely give my CONSENT to his Volunteering as a SOLDIER in the ARMY OF THE UNITED STATES for the period of THREE YEARS.

GIVEN at _____ the _____ day of _____

Witness: _____

VOLUNTEER ENLISTMENT.

STATE OF
NEW YORK.

TOWN OF

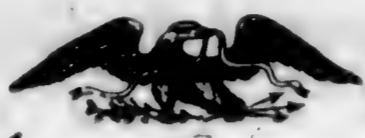

Bergen

I, *William H. Bamister*, born in *Ms*
in the State of *Michigan*, aged *twenty nine* years,
and by occupation a *tailor*, Do HEREBY ACKNOWLEDGE to have
volunteered this *12th* day of *October*, 1864,

to serve as a Soldier in the Army of the United States of America, for
the period of **THREE YEARS**, unless sooner discharged by proper authority: Do also agree
to accept such bounty, pay, rations, and clothing, as are, or may be, established by law for volunteers.
And I, *William H. Bamister*, do solemnly swear, that I will bear
true faith and allegiance to the United States of America, and that I will serve them honest-
ly and faithfully against all their enemies or opposers whomsoever; and that I will observe and
obey the orders of the President of the United States, and the orders of the officers appointed
over me, according to the Rules and Articles of War.

Sworn and subscribed to, at Lockport, N. Y.,

this *4* day of *October*, 1864.

BEFORE

L. H. Bowen
Capt & Provost Marshal

William H. Bamister
Mark

I CERTIFY, ON HONOR, That I have carefully examined the above-named Volun-
teer, agreeably to the General Regulations of the Army, and that, in my opinion, he is free from
all bodily defects and mental infirmity, which would in any way disqualify him from performing
the duties of a soldier.

J. Root

EXAMINING SURGEON.

I CERTIFY, ON HONOR, That I have minutely inspected the Volunteer
Wm H. Bamister previously to his enlistment, and that he was entirely sober
when enlisted; that, to the best of my knowledge and belief, he is of lawful age; and that, in
accepting him as duly qualified to perform the duties of an able-bodied soldier, I have strictly
observed the Regulations which govern the recruiting service. This soldier has *black*
eyes, *black* hair, *black* complexion, is *5* feet *10 1/4*
inches high.

L. H. Bowen

Capt & Provost Marshal
Lockport, N. Y.

RECRUITING OFFICER.

Mustered into the service of the United States, for three years or during the war, from date of enlistment, in Company
Regiment of *N. S. Clark's* Volunteers, on the *6* day of *October*, 1864, at *Lockport, N. Y.*

L. H. Bowen
Capt & Provost Marshal

6

Baptist, Jesse

Co ^F, 6 U.S. Col'd Inf.

Private

Private

CARD NUMBERS.

1	5574722	26
2	5568340	27
3	5574801	28
4	5574885	29
5	5574965	30
6	5575045	31
7	5575125	32
8	5575205	33
9	5575282	34
10	5575355	35
11	5575453	36
12	5575551	37
13	5568750	38
14	5575643	39
15	5575734	40
16		41
17		42
18		43
19		44
20		45
21		46
22		47
23		48
24		49
25		50

Book Mark:

See also

B | 6 | U.S.C.T.

Jesse Babbist
Co. F, 6 Reg't U. S. Col'd Inf.

Appears on

Company Descriptive Book
of the organization named above.

DESCRIPTION.

Age 32 years; height 6 feet 11 1/4 inches.

Complexion Blk

Eyes Blk; hair Blk

Where born Hartford Co Md

Occupation Bricklayer

ENLISTMENT.

When July 20, 1863.

Where Lancaster Pa

By whom J. D. Pa; term 3 y'rs.

Remarks: Drafted

J. G. Reeves
Copyist.

B | 6 | U.S.C.T.

Jesse Babbist

Appears with rank of *Priv* on

Muster and Descriptive Roll of a Detachment of Drafted Men and Substitutes forwarded

for the *6* Reg't U. S. Col'd Inf. Roll dated

Lancaster Pa Aug 26, 1863.

Where born *Harford Co. Maryland*

Age *32* years; occupation *Brick Layer*

Drafted and mustered in:

When *July 20*, 1863.

Where *Lancaster Pa Sadsbury*

Period *3* years.

Eyes *Black*; hair *black*

Complexion *black*; height *6 ft. 1/4 in.*

Paid bounty and advance pay, \$ *100*

Bounty due \$ *100*

Where credited _____

Company to which assigned _____

Remarks: _____

Book mark: _____

Sarimer

B

6

U.S.C.T.

Jesse Baptist
Co. *F*, 6 Reg't U. S. Col'd Infantry.

Age *32* years.

Appears on

Company Muster-in Roll

of the organization named above. Roll dated

Phila Pa, *Oct. 15*, 1863.

Muster-in to date *July 20*, 1863

Joined for duty and enrolled:

When *July 20*, 1863.

Where *Launcaster Pa*

Period *3* years.

Remarks:

Book mark:

E. T. Brown

9

6

U.S.C.T.

Jessie Baptist
Co., Co. F, 6 Reg't U. S. Col'd Infantry.

Appears on

Company Muster Roll

for Muster in to Oct-31, 1863.

Present or absent Present

Stoppage, \$ 100 for

Due Gov't, \$ 100 for

Remarks:

Book mark:

E. H. Brown

B

6

U.S.C.T.

Jesse Galtist
Pr

Co. F, 6 Reg't U. S. Col'd Infantry.

Appears on

Company Muster Roll

for *Nov & Dec*, 1863.

Present or absent *Present*

Stoppage, \$ 100 for

Due Gov't, \$ 100 for

Remarks:

Book mark:

E. H. Brown

Q. | **6** | **U.S.C.T.**

Jeese Babbit
Cot., Co. F, 6 Reg't U. S. Col'd Infantry.

Appears on

Company Muster Roll

for Jan + Feb, 1864.

Present or absent Present

Stoppage, \$ 100 for

Due Gov't, \$ 100 for

Remarks:

Book mark: _____

E. H. Brown

B

6

U.S.C.T.

Jesse Baptist

Cot, Co. F, 6 Reg't U. S. Col'd Infantry.

Appears on

Company Muster Roll

for Mar & Apr, 1864

Present or absent Present

Stoppage, \$ ⁴¹/₁₀₀ for 1 Panteen

Due Gov't, \$ 100 for

Remarks: Teamster at Dir Hd Qrs since Apr 27/64

Book mark:

E. H. Brown

B

6

U.S.C.T.

Jesse Baptist
Put, Co. F, 6 Reg't U. S. Col'd Infantry.

Appears on

Company Muster Roll

for *May & June*, 1864

Present or absent *Present.*

Stoppage, \$ *100* for

Due Gov't, \$ *100* for

Remarks: *On detached service
in Division Quartermaster
Dept. since April 25, 1864*

Book mark:

McDavi

B

6

U.S.C.T.

Jesse Baptist.
Apt., Co. F, 6 Reg't U. S. Col'd Infantry.

Appears on

Company Muster Roll

for July & Aug., 1864

Present or absent Present.

Stoppage, \$ 100 for

Due Gov't, \$ 100 for

Remarks: Free April 19, 1861.
Detached in Div. 2, M.
Dept. since April 25, 1864

Book mark:

[Signature]

B

6

U.S.C.T.

Jesse Baptist

Private, Co. F, 6 Reg't U. S. Col'd Infantry.

Appears on

Company Muster Roll

for Sept. 1864, 1864

Present or absent Present

Stoppage, \$ 100 for

Due Gov't, \$ 100 for

Remarks:

NEXT ROLL ON FILE FEB 1865

Book mark:

McDawis

(358)

Copyist.

B

6

U.S.C.T.

Jesse Baptist
Plt, Co. F, 6 Reg't U. S. Col'd Infantry.

Appears on

Company Muster Roll

for Jan. & Feb., 1865.

Present or absent Absent.

Stoppage, \$ 100 for

Due Gov't, \$ 100 for

Remarks: In Div. S. M. Dept.
since May 4, 1864.

Book mark:

McDaris

B

6

U.S.C.T.

Jesse Baptist
Co. F, 6 Reg't U. S. Col'd Infantry.

Appears on

Company Muster Roll

for March & April, 1865.

Present or absent Absent.

Stoppage, \$ 100 for

Due Gov't, \$ 100 for

Remarks: In Div. 2. m. Dept.
Since May 4, 1864.

Book mark:

McDawie

13

6

U.S.C.T.

Jesse Baptist

Priv., Co. F, 6 Reg't U. S. Col'd Infantry.

Appears on

Company Muster Roll

for May & June, 1865.

Present or absent absent

Stoppage, \$ 100 for

Due Gov't, \$ 100 for

Remarks: In Div Commission, Sgt.
since May 4/64

Book mark:

Lawrence

B. | 6

U.S.C.T.

Jesse Babbis

Priv., Co. "F", 6 Reg't U. S. Col'd Inf.

Appears on a

Detachment Muster Roll

of the organization named above

for May & June, 1865.

Station New Bern, N. C.

Present or absent Present.

Stoppage, \$ 100 for

Due Gov't, \$ 100 for

Remarks: On duty as Provost Guard 3^d Div. 10th A. C. per S. O. No. 12 dated Hd. Qrs. 3^d Div. 10th A. C.

Book mark:

Sittler

18 | 6 | U.S.C.T.

Jesse Baptist
Pvt., Co. F, 6 Reg't U. S. Col'd Infantry.

Appears on

Company Muster Roll

for July & Aug, 186 J.

Present or absent Absent

Stoppage, \$ 1.00 for

Due Gov't, \$ 1.00 for

Remarks: Detach with wagon
train stop for one screw
driver washer + Tom pin
45 cts stop for 1 knob box
+ button lost

Book mark:

Lawrence

13

6

U.S.C.T.

Jessie Bartlett

Priv., Co. I, 6 Reg't U. S. Col'd Infantry.

Appears on Co. Muster-out Roll, dated
Wilmington N.C. Sept 20, 1865.

Muster-out to date Sept 20, 1865.

Last paid to Feb 29, 1864.

Clothing account:

Last settled *never*, 186 ; drawn since \$ *69* ⁸³/₁₀₀

Due soldier \$ 100; due U. S. \$ 100

Am't for cloth'g in kind or money adv'd \$ 100

Due U. S. for arms, equipments, &c., \$ 100

Bounty paid \$ 100; due \$ *100* 100

Remarks: *due U.S. for O.M. retained for
Borne on previous roll, as free
on or before Apr 19, 61 stop for Seno
Driver ar per + Impem 48^{cts} drafted
under act Mar 3/63 due U.S.
per 406 E #470*

Book mark:

Lawrence

6 U.S. Col'd Inf

CARD NUMBERS.

1	5572387	26
2		27
3		28
4		29
5		30
6		31
7		32
8		33
9		34
10		35
11		36
12		37
13		38
14		39
15		40
16		41
17		42
18		43
19		44
20		45
21		46
22		47
23		48
24		49
25		50

Book Mark:

See also

B

6

U.S.C.T.

* *Wm Barger*

....., Co. *C*, 6 Reg't U. S. Col'd Infantry.

Appears on **Co. Muster-out Roll**, dated

Wilmington Nc, Sept 2, 1865.

Muster-out to date, 186 .

Last paid to, 186 .

Clothing account:

Last settled, 186 ; drawn since \$ 100

Due soldier \$ 100; due U. S. \$ 100

Am't for cloth'g in kind or money adv'd \$ 100

Due U. S. for arms, equipments, &c., \$ 100

Bounty paid \$ 100; due \$ 100

Remarks: *Discharged*

Not borne on prior rolls of Co. C.

Name borne in red ink.

Book mark:

Beach

0, 6 U.S. Col'd Inf.

Private Private

CARD NUMBERS.

5573604	26
5573688	27
5573771	28
5573849	29
5573922	30
5573993	31
5574061	32
5574135	33
5574222	34
5574313	35
5574413	36
5574503	37
5574587	38
9065166	39
	40
	41
	42
	43
	44
	45
	46
	47
	48
	49
	50

Book Mark: L. 79 Vol. 3 RCJ 66

See also

B. 6 U.S.C.T.

James O. Banks

Co. E, 6 Reg't U. S. Col'd Inf.

Appears on

Company Descriptive Book

of the organization named above.

DESCRIPTION.

Age 20 years; height 6 feet 1/8 inches.

Complexion *Blk*

Eyes *dark*; hair *curly*

Where born *Gordonsville Va*

Occupation *Farmer*

ENLISTMENT.

When *Aug 20*, 1863.

Where *3rd D. Pa*

By whom *P. M.*; term *3* y'rs.

Remarks: *Substitute for Geo Woodard*

J. G. Reeves

B. | 6 | U.S.C.T.

James Oliver Barks
Pvt., Co. E, 6 Reg't U. S. Col'd Infantry.

Age 20 years.

Appears on

Company Muster-in Roll

of the organization named above. Roll dated

Philada Pa, Oct 13, 1863.

Muster-in to date Aug 20, 1863

Joined for duty and enrolled:

When Aug 20, 1863.

Where Philadelphia Pa

Period 3 years.

Remarks:.....

Book mark:.....

Lucas

B

6

U.S.C.T.

James O. Barks

Pr-, Co. E, 6 Reg't U. S. Col'd Infantry.

Appears on,

Company Muster Roll

for Muster in to Oct 31, 1863

Present or absent Present-

Stoppage, \$ 100 for

Due Gov't, \$ 100 for

Remarks:

Book mark:

Lucas

B

6

U.S.C.T.

James O. Barks.

Priv., Co. E, 6 Reg't U. S. Col'd Infantry.

Appears on

Company Muster Roll

for *Nov. + Dec*, 1863

Present or absent *Present*

Stoppage, \$ 100 for

Due Gov't, \$ 100 for

Remarks: *Stop for 1/2 of shelter tent*

Book mark:

Lucas

B

6

U.S.C.T.

James O. Barks.

Pvt, Co. E, 6 Reg't U. S. Col'd Infantry.

Appears on

Company Muster Roll

for Jan & Feby, 1864

Present or absent Present

Stoppage, \$ 100 for

Due Gov't, \$ 100 for

Remarks:

Book mark:

Lucas

B

6

U.S.C.T.

James O. Barks

Priv., Co. E, 6 Reg't U. S. Col'd Infantry.

Appears on

Company Muster Roll

for *March & April*, 1864

Present or absent *Present*

Stoppage, \$ *100* for

Due Gov't, \$ *100* for

Remarks:

Book mark:

Lucas

B

6

U.S.C.T.

James O. Parks

Priv., Co. E, 6 Reg't U. S. Col'd Infantry.

Appears on

Company Muster Roll

for May & June, 1864

Present or absent Present

Stoppage, \$ 100 for

Due Gov't, \$ 100 for

Remarks:

Book mark:

Harris

B | 6 | U.S.C.T.

James O. Barks
Prk, Co. E, 6 Reg't U. S. Col'd Infantry.

Appears on

Company Muster Roll

for July & Aug, 1864

Present or absent Present

Stoppage, \$ 100 for

Due Gov't, \$ 100 for

Remarks: Free on or before
Apr 19/61

Book mark: 235061

Harris

B

6

U.S.C.T.

James C. Barks
Pvt., Co. E, 6 Reg't U. S. Col'd Infantry.

Appears on

Company Muster Roll

for Sept & Oct, 1864

Present or absent Present

Stoppage, \$ 100 for

Due Gov't, \$ 100 for

Remarks:

NEXT ROLL ON FILE FEB 1865

Book mark:

Harris

(358)

Copyist

B | 6 | U.S.C.T.

James O Barks
Plt, Co. E, 6 Reg't U. S. Col'd Infantry.

Appears on

Company Muster Roll

for Jan & Feby, 1865

Present or absent Present

Stoppage, \$ 100 for

Due Gov't, \$ 100 for

Remarks:

Book mark:

Harris

B

6

U.S.C.T.

James O. Parks
Cpt, Co. E, 6 Reg't U. S. Col'd Infantry.

Appears on

Company Muster Roll

for *Mch & Apr*, 1865

Present or absent *Present*

Stoppage, \$ *100* for

Due Gov't, \$ *100* for

Remarks: *Stop for 1 Knapsack \$3.10
1 pr. G. Coat Straps .12, 1 Canteen
.65, 1 Haversack .95 Total \$4.82*

Book mark:

Harris

B | 6 | U.S.C.T.

James O Barks
Pvt, Co. E, 6 Reg't U. S. Col'd Infantry.

Appears on

Company Muster Roll

for May & June, 1865

Present or absent * Present.

Stoppage, \$ 100 for

Due Gov't, \$ 100 for

Remarks: On D.S. per S.O. No 39
Hd. Qrs. Post of Wilmington,
N.C. June 1, 1865.

* As shown on roll.

Book mark:

O'Cool

B | 6 | U.S.C.T.

James O. Barks,
Pvt, Co. E, 6 Reg't U. S. Col'd Infantry.

Appears on

Company Muster Roll

for July & Aug., 1865

Present or absent Present.

Stoppage, \$ 100 for

Due Gov't, \$ 100 for

Remarks: Absent sick in
Post Hospital.

x As shown on roll.

Book mark:

P. Pool,

B

6

U.S.C.T.

James S. Barks,
 Pvt., Co. E, 6 Reg't U. S. Col'd Infantry.

Appears on Co. Muster-out Roll, dated
 Wilmington, N.C., Sep. 20, 1865.

Muster-out to date Sep. 20, 1865.

Last paid to Apr. 30, 1865.

Clothing account:

Last settled June 30, 1864; drawn since \$105 ⁴⁷/₁₀₀

Due soldier \$100; due U. S. \$100

Am't for cloth'g in kind or money adv'd \$100

Due U. S. for arms, equipments, &c., \$100

Bounty paid \$None 100; due \$100 100

Remarks: Due Wm. Bresben, Regtl.
 Sutler \$15⁰⁰. Borne on muster
 rolls as free or before Apr. 1/61.
 Substitute for colored man.
 Drafted under Act of Mar. 3/63,
 Absent in Gen'l Hospl. No discharge
 furnished. 579, Vol 3, R.C.G., 66,
 Book mark: Muster out on file.

J. Pool.

Banks James O

, Co. *E*, *6* Reg't *U.S.C. Inf*

3

Enclosures.

Bed Cards	Final Statements
Burial Records	Furloughs or L. of A.
Certs. of Dis. for Discharge	Med. Certificates
C. M. Charges	Med. Des. Lists
Descriptive Lists	Orders
Discharge Certificates	Pris. of War Record
Enlistment Papers <i>2</i>	Resignations

Other papers relating to—

Admission to Hosp'l	Furlough or L. of A.
Casualty Sheet	Med. Examination
Confinement <i>1</i>	Misc. Information
Contracts	Pay or Clothing
Death or Effects	Personal Reports
Desertion	Rank
Discharge from Hosp'l	Transfer to Hosp'l
Discharge from Service	Transfer to V. R. C.
Duty	Transportation

E.P. filed 2/7/02
MS

DECLARATION OF SUBSTITUTE.

I, *James Oliver Banks* desiring to ENLIST in the Army of the United States, for THREE YEARS, **Do declare**, That I am 20 years and _____ months of age; that I have never been discharged from the United States service on account of disability or by sentence of a court martial; and I know of no impediment to my serving honestly and faithfully as a soldier for three years.

GIVEN at *Philadelphia* the 20th day of August 1863

WITNESS:

Harry K. Rieple *James Oliver Banks*

13 B/63

No.

James Oliver Banks (Grand)

Enlisted at

Phila

As Substitute for

John Peraway (Grand)

On the

29 day of July, 1863

By

Edw. Herbert S. Hatch

Franklin W. Turner

Alex. G. Scott

Board of Enrollment,

3^d Dist. of Phila

(No. 40.)

**SUBSTITUTE
VOLUNTEER ENLISTMENT.**

STATE OF *Pennsylvania* TOWN OF *Philadelphia*
Indiantown.
 I, *James Oliver Barks. (Col)* born in the State
 of *Penna*, aged *20* years, and by
 occupation a *Farmer.* Do HEREBY ACKNOWLEDGE to have agreed with
John Woodward (Col) Esq., of *6th Dist 10th 3rd Cong*
Dis. Penna (19th Ward) Philadelphia

to become his **SUBSTITUTE** in the Military Service, for a sufficient consideration paid and
 delivered to me, on the *Twentieth* day of *August*, 186*3* ;
 and having thus agreed with said *John Woodward (Col)*, I DO HEREBY
 ACKNOWLEDGE to have enlisted this *20th* day of *August*,
 186*3*, to serve as a **Soldier** in the **Army of the United States of America**, for the period
 of **THREE YEARS**, unless sooner discharged by proper authority : I do also agree to accept
 such bounty, pay, rations, and clothing, as are, or may be, established by law for soldiers.
 And I do solemnly swear that I will bear true and faithful allegiance to the **United States
 of America** : that I will serve them honestly and faithfully against all their enemies or
 opposers whomsoever ; and that I will observe and obey the orders of the President of the
 United States, and the orders of the Officers appointed over me, according to the Rules and
 Articles of War.

Sworn and subscribed to, at *Philadelphia*
 this *20th* day of *August*, 186*3*
 BEFORE *Jacob A. Thetford*
Captain & Provost Marshal
3rd District, Penna *James Oliver Barks*

We certify, on honor, That we have carefully examined the above-named Volunteer Substitute
 agreeably to the Regulations, and that, in our opinion, he is free from all bodily defects and mental infirmity
 which would in any way disqualify him from performing the duties of a soldier ; that he was entirely sober
 when enlisted ; that he is of lawful age, (not under 18 years ;) and that in accepting him as duly qualified to
 perform the duties of an able-bodied soldier, and as a Substitute in lieu of *John Woodward (Col)*
19th Ward) July 20th, 1863, drafted in *6th Dist 10th 3rd Cong Dis. Penna*
 in such cases. This soldier has *Black* eyes, *Curly* hair, *Washed* complexion ; is *6* feet *10*
 inches high.

Jacob A. Thetford
 Provost-Marshal.
Franklin D. Steiner
 Commissioner of Board.
Alex. Hart
 Surgeon of Board.

Board of Enrolment of *3rd* Dist. of *Pennsylvania*

DECLARATION OF SUBSTITUTE.

I, *James Oliver Banks (Colt)* desiring to ENLIST in the Army of the United States, for THREE YEARS, **Do declare**, That I am 20 years and _____ months of age; that I have never been discharged from the United States service on account of disability or by sentence of a court martial; and I know of no impediment to my serving honestly and faithfully as a soldier for three years.

GIVEN at *Philadelphia* the *20th* day of *August* 1863

WITNESS: *Henry Kiehl* *James Oliver Banks*

B *B/163⁵¹*

No. _____
Oliver Banks (Colt)
Enlisted at *Phila*

As Substitute for
Pro Proctor (Place)
On the *20th* day of *Aug*, 1863

By
Col Proctor of Shute
Franklin H. Steiner
Wm & Henry P

Board of Enrolment,
3^d Dist. of *Phila*

(No. 40.)

SUBSTITUTE

VOLUNTEER ENLISTMENT.

STATE OF

TOWN OF

Pennsylvania

Philadelphia



I, *James Oliver Parks (Col)*
of *Penna*, aged *20*

Bordantown
born in the State
years, and by

occupation a *Farmer*
John Woodward (Col)
Wis. Penna 19th Ward Philadelphia

Do HEREBY ACKNOWLEDGE to have agreed with
Esq. of *6th Dist. 18th Cong.*

to become his **SUBSTITUTE** in the Military Service, for a sufficient consideration paid and
delivered to me, on the *Twentieth* day of *August*, 1863 ;

and having thus agreed with said *John Woodward (Col)*, I DO HEREBY
ACKNOWLEDGE to have enlisted this *20th* day of *August*

1863, to serve as a **Soldier** in the **Army of the United States of America**, for the period
of **THREE YEARS**, unless sooner discharged by proper authority : I do also agree to accept
such bounty, pay, rations, and clothing, as are, or may be, established by law for soldiers.
And I do solemnly swear that I will bear true and faithful allegiance to the **United States
of America** : that I will serve them honestly and faithfully against all their enemies or
opposers whomsoever ; and that I will observe and obey the orders of the President of the
United States, and the orders of the Officers appointed over me, according to the Rules and
Articles of War.

Sworn and subscribed to, at *Philadelphia*
this *20* day of *August*, 1863

BEFORE *Jacob S. Potts*
Captain & Prov. Marshal
3rd District Penna

James Oliver Parks

We certify, on honor, That we have carefully examined the above-named Volunteer Substitute
agreeably to the Regulations, and that, in our opinion, he is free from all bodily defects and mental infirmity
which would in any way disqualify him from performing the duties of a soldier : that he was entirely sober
when enlisted ; that he is of lawful age, (not under 18 years ;) and that in accepting him as duly qualified to
perform the duties of an able-bodied soldier, and as a Substitute in lieu of *John Woodward (Col)*

19th Ward, drafted in *6th Dist. 18th Cong. 18th Cong. Wis. Penna*
July 25, 1863, we have strictly observed the Regulations which govern
in such cases. This soldier has *Black* eyes, *Curl* hair, *Dark* complexion : is *6* feet *1/2*
inches high.

Jacob S. Potts
Provost-Marshal.

William D. Steiner
Commissioner of Board.

Alex. C. Hart
Surgeon of Board.

Board of Enrolment of *3rd Dist.* of *Pennsylvania*

THE AMERICAN TELEGRAPH CO. 1141

Jas. C. Barks

George Crook

6.11.57

Major Genl.

suitable provision in
Wilmington for such

persons

Geo Crook
Major Genl

official

H. E. Tremain
B. H. C. C.

Form No. 4.

THE AMERICAN TELEGRAPH CO.

SOUTHERN DISTRICT,

Under Control and Supervision of United States Military Telegraph

CONNECTING ALL THE PRINCIPAL CITIES AND TOWNS IN THE UNITED STATES.

Terms and Conditions on which this and all Messages are received by this Company.

In order to guard against and correct as much as possible some of the errors arising from atmospheric and other causes appertaining to telegraphy, every important message should be REPEATED, by being sent back from the station at which it is to be received to the station from which it is originally sent. Half the usual price will be charged for repeating the message, and while this Company in good faith will endeavor to send messages correctly and promptly, it will not be responsible for errors or delays in the transmission or delivery, nor for the non-delivery of REPEATED MESSAGES, beyond TWO HUNDRED times the sum paid for sending the message, unless a special agreement for insurance be made in writing, and the amount of risk specified on this agreement, and paid for at the time of sending the message. Nor will the Company be responsible for any error or delay in the transmission or delivery, or for the non-delivery, of ANY UNREPEATED MESSAGE, beyond the amount paid for sending the same, unless in like manner specially insured, and amount of risk stated hereon, and paid for at the time. No liability is assumed for errors in cipher or obscure messages; nor is any liability assumed by this Company for any error or neglect by any other Company over whose lines this message may be sent to reach its destination, and this Company is hereby made the agent of the sender of this message to forward it over the lines extending beyond those of this Company. No agent or employee is allowed to vary these terms, or make any other or verbal agreement, nor any promise as to the time of performance, and no one but a superintendent is authorized to make a special agreement for insurance. These terms apply through the whole course of this message on all lines by which it may be transmitted.

CAMBRIDGE LIVINGSTON, Sec'y. MARSHALL LEFFERTS, Eng. E S. SANFORD, Pres't.

Dated *Wilmington 14* 1865.

Received at

To *Col C A Cilly*
ad G/H

*Col, there is an insane
soldier now confined in the
Jail here James O
Barks to E 6th Regt of
Ct, whose Regt was
discharged last month
cannot authorily be sent
here to have him removed
to State Lunatic asylum
or elsewhere. There are no*

U.S. Coast Inf.

Surgeon | *Surgeon*

CARD NUMBERS

1	5567631	26
2	5568901	27
3	5568907	28
4	5568921	29
5	5568933	30
6	5568945	31
7	5568957	32
8	5568756	33
9	5567632	34
10	5568968	35
11	5568979	36
12	5568990	37
13	5569000	38
14	5569011	39
15	5569022	40
16	5569033	41
17	9428632	42
18		43
19		44
20		45
21		46
22		47
23		48
24		49
25		50

Book Mark: 1466 C.J. 84,

See also

NARA 886

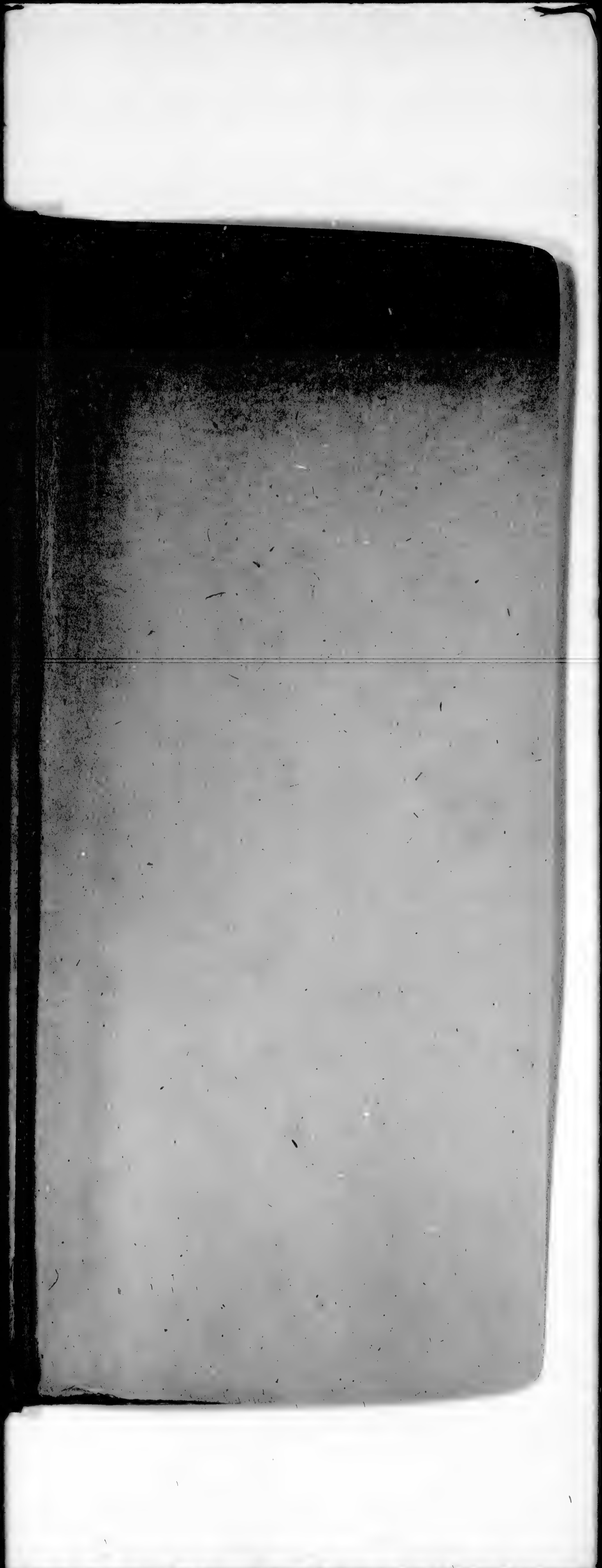

B | 6 | **U.S.C.T.**

Leeman Barnes

Asst. Surg. Co., 6 Reg't U. S. Col'd Inf.

Appears on

Regimental Descriptive Book

(List of Commissioned Officers)

of the regiment named above.

Rank Asst. Surg.

Date of appointment Sept 8 1863.

Remarks: Appointment accepted

Sept. 18, 1863

Mustered Oct. 5, 1863.

Appointed Surg.

G. W. Chase

B | 6

U.S.C.T.

Leemon Barnes

Asst
Surg., Co. 6 Reg't U. S. Col'd Infantry.

Age *33* years.

Appears on an

Individual Muster-in Roll

of the organization named above. Roll dated
Yorktown Virginia, Apr. 14, 1864.

Muster-in to date *Sept 25, 1863.*

Joined for duty and enrolled:

When *Sept 23*, 1863.

Where *Camp Wm Penn, near Philadelphia Penna.*

Period *3* years.

Remarks: *Appointed by the President Sept 8. His officer was first mustered into service by St. Hilderburn to date Oct. 5. 1863 and*

Book mark :

Combs

(336)

Copyist.

JAN. 20

5567631

1891*

is now remustered in
 obedience to instructions
 from the War Dept.,
 A.G.O. "Apr. 7. 1864"
 signed by command of
 the Secy. of War, C.W.
 Foster Asst. Adj't. Genl
 which directs that all
 officers of the 6th U.S.
 Colored Troops, who were origi-
 nally mustered into service
 as of the dates, on which
 they respectively joined
 for duty, to be remustered
 as of said dates. Asst. Sur-
 geon S. B. Green's pay
 from Octo 5. 1863
 to Dec. 31. 1863.

B | 6 | U.S.C.T.

Seman Barnes

Surg, Co. *6*, Reg't U. S. Col'd Infantry.

Age *38* years.

Appears on an

Individual Muster-in Roll

of the organization named above. Roll dated

N. Petersburg, V. A., Aug 20, 186*4*.

Muster-in to date *July 31*, 186*4*.

Joined for duty and enrolled:

When *July 30*, 186*4*.

Where *In the field, V. A.*

Period *3* years.

Remarks: *Mustered in to fill vacancy Vice Surgeon Stedman transferred, mustered out as Asst Surgeon July 4, 1864. Commis.*

Book mark :

Combs

WAR 811

JAN. 20

5567632

1891 *

received from Major
General Butler, July
4th, 1864

- Affidavit appended -

Date of this receipt
July 30. 1864

B | 6 | U.S.C.T.

Leeman Barnes

Rank *Asst Surg* Reg't U. S. Col'd Infantry.

Age *33* years.

Appears on

Field and Staff Muster-in Roll

of the organization named above. Roll dated

Phila Pa *Sept 28*, 1863.

Muster-in to date *....., 186 .

Joined for duty and enrolled:

When *Sept 8*....., 1863 .

Where *Washington DC*.....

Period *3* years.

Valuation of horse, \$.....100

Valuation of horse equipments, \$.....100

Remarks * *Appointed by the Secy of War Sept 8, 63 appointment accept Sept 25-63 Mustered by Lt Medburn MS a Oct 5, 63*
Joined for duty Sept 25-63

Book mark :

[Signature]

B | 6 U.S.C.T.

L. Barnes

Rank *Asst. Surg, 6* Reg't U. S. Col'd Infantry.

Appears on

Field and Staff Muster Roll

for *4 Oct 31*, 1863.

Present or absent *Present*

Stoppage, \$ *100* for

Due Gov't, \$ *100* for

Valuation of horse, \$ *100*

Valuation of horse equipments, \$ *100*

Remarks:

Book mark:

[Signature]

B | 6

U.S.C.T.

Simon Barnes

Rank *Post Surg* 6 Reg't U. S. Col'd Infantry.

Appears on

Field and Staff Muster Roll

for *Nov & Dec*, 1863.

Present or absent *Present*

Stoppage, \$ 100 for

Due Gov't, \$ 100 for

Valuation of horse, \$ 100

Valuation of horse equipments, \$ 100

Remarks: *Pay due from Sept 125 -
is Oct 5, 43*

Book mark:

[Signature]

B | *6* | U.S.C.T.

Leeman, James

Rank *Private*, 6 Reg't U. S. Col'd Infantry.

Appears on

Field and Staff Muster Roll

for *Jan & Feb*, 1864

Present or absent *Absent*

Stoppage, \$ *100* for

Due Gov't, \$ *100* for

Valuation of horse, \$ *100*

Valuation of horse equipments, \$ *100*

Remarks: *Absent sick since
Jul 23 64 with leave
since Jul 3, 64*

Book mark:

James Leeman

B | 6 | U.S.C.T.

Leeman Barnes

Rank *Adj. Sg.*, 6 Reg't U. S. Col'd Infantry.

Appears on

Field and Staff Muster Roll

for *Nov & Dec*, 1864

Present or absent *Present*

Stoppage, \$ 100 for

Due Gov't, \$ 100 for

Valuation of horse, \$ 100

Valuation of horse equipments, \$ 100

Remarks: *Re-mustered on 50
Sept 7, 64 & 4 dalt
from Sept 8, 63 pay adv
from Sept 8, 63 Dec 5, 63*

Book mark:

[Signature]

B | 6 U.S.C.T.

Lemon Barnes

Rank *Adj. Surg.*, 6 Reg't U. S. Col'd Infantry.

Appears on

Field and Staff Muster Roll

for *May & June*, 1864.

Present or absent *Present*

Stoppage, \$ 100 for

Due Gov't, \$ 100 for

Valuation of horse, \$ 100

Valuation of horse equipments, \$ 100

Remarks:

Book mark:

[Signature]
Coppet

B | 6 | U.S.C.T.

Leman Barnes

Asst Surg, Co. 6 Reg't U. S. Col'd Infantry.

Appears on an

Individual Muster-out Roll

of the organization named above. Roll dated

near Petersburg Va, Aug 20, 1864.

Muster-out to date *July 29, 1864.*

Last paid to *May 1, 1864.*

Clothing account:

Last settled, 186 ; drawn since \$ 100

Due soldier \$ 100; due U. S. \$ 100

Am't for cloth'g in kind or money adv'd \$ 100

Due U. S. for arms, equipments, &c., \$ 100

Bounty paid \$ 100; due \$ 100

Remarks: *Mustered out for promotion as Surgeon Vice Surgeon Stedman transferred per Par VII Special Orders No 181.*

Dated Head Quarters Dept of Va and North Carolina July 4, 1864. Date of
Over

Book mark:

Bowman

JAN. 20

5568756

1891 *

this muster July 29th 1864

B | 6

U.S.C.T.

Lemon Barner

Rank *1st Sgt*, Reg't U. S. Col'd Infantry.

Appears on

Field and Staff Muster Roll

for *July & Aug*, 1864

Present or absent *Present*

Stoppage, \$ *100* for

Due Gov't, \$ *100* for

Valuation of horse, \$ *100*

Valuation of horse equipments, \$ *100*

Remarks: *See due as cash
for 3064
3064*

Book mark:

[Signature]

315

U.S.C.T.

Leon Barnes

Rank *Sgt*, 6 Reg't U. S. Col'd Infantry.

Appears on

Field and Staff Muster Roll

for *Sept & Oct*, 1864

Present or absent *Present*

Stoppage, \$ 100 for

Due Gov't, \$ 100 for

Valuation of horse, \$ 100

Valuation of horse equipments, \$ 100

Remarks:

NEXT ROLL ON FILE FEB 1865

NEXT ROLL ON FILE FEB 1865

Book mark:

[Signature]

(357)

Copyist

B | 6

U.S.C.T.

Leemon Barnes

Rank *Surgeon*, 6 Reg't U. S. Col'd Infantry.

Appears on

Field and Staff Muster Roll

for *Jan & Feb*, 1865:

Present or absent *Absent*

Stoppage, \$ 100 for

Due Gov't, \$ 100 for

Valuation of horse, \$ 100

Valuation of horse equipments, \$ 100

Remarks *Detached at field*

*Wash DC 50, 2 & 25
US Forces Fort Fisher
NC Jan 23, 65 -*

Book mark:

[Signature]

B | 6 U.S.C.T.

Leyman Barnes

Rank *Surgeon, 6* Reg't U. S. Col'd Infantry.

Appears on

Field and Staff Muster Roll

for *Men & Ap*, 186*4*.

Present or absent *Absent*

Stoppage, \$ 100 for

Due Gov't, \$ 100 for

Valuation of horse, \$ 100

Valuation of horse equipments, \$ 100

Remarks: *Surgeon in Chief 5.
Div for G O / ND Feb 3
Div 1000. Apr 865 -*

Book mark:

[Signature]

B | 6 | U.S.C.T.

Leman Barnes

Rank Surgeon, 6 Reg't U. S. Col'd Infantry.

Appears on

Field and Staff Muster Roll

for May & June, 186 5

Present or absent Present

Stoppage, \$ 100 for

Due Gov't, \$ 100 for

Valuation of horse, \$ 100

Valuation of horse equipments, \$ 100

Remarks:

Book mark:

[Signature]
Coytist

B | 6 | U.S.C.T.

Leeman Barnes

Rank *Surgeon*, 6 Reg't U. S. Col'd Infantry.

Appears on

Field and Staff Muster Roll

for *July & Aug*, 1865,

Present or absent *Present*

Stoppage, \$ 100 for

Due Gov't, \$ 100 for

Valuation of horse, \$ 100

Valuation of horse equipments, \$ 100

Remarks: *Acty Medical Director Dist of Md No pu 50, 102 rd 2 Dist of Md No July 19, 65.*

Book mark:

[Signature] Copyist.

B | 6 | U.S.C.T.

Leeman Barnes

Rank *Surgeon* 6 Reg't U. S. Col'd Inf.

Appears on

Field and Staff Muster-out Roll

of the organization named above. Roll dated

Wilmington N.C. Sept 20, 1865.

Muster-out to date *Sept 20, 1865.*

Last paid to *July 31, 1865.*

Clothing account:

Last settled....., 186 ; drawn since \$..... 100

Due soldier \$..... 100; due U. S. \$..... 100

Am't for cloth'g in kind or money adv'd \$..... 100

Due U. S. for arms, equipments, &c., \$..... 100

Bounty paid \$..... 100; due \$..... 100

Remarks:.....
.....
.....
.....
.....

Book mark *46627 84-8195-Pm 3*

(360)

[Signature]
Copyist.

James Leeman

Asst. Surg., 6 Reg't U.S. C.

21 Enclosures.

Bed Cards	Descriptive Lists
Burial Records	Final Statements
Certs. of Dis. for Discharge	Furloughs
C. M. Charges	Med. Des. Lists
Med. Certificates	Orders <i>9</i>

Other papers relating to—

Admission to Hosp'l	Furlough <i>1</i>
Casualty Sheet (Officer's)	Med. Examination
Confinement	Misc. Information <i>2</i>
Contracts	Pay or Clothing
Death or Effects	Personal Reports <i>6</i>
Desertions	Rank <i>3</i>
Discharge from Hosp'l	Transfer to Hosp'l
Discharge from Service	Transfer to V. R. C.
Duty	Transportation

A 28 W F 1864
Recommendation
Proposition of Asst
Surgeon J. D. Barnes
6th Regt. U.S.C.T.
G 23 1864

Camp near Yorktown Va.
Jan. 19th '64
Respectfully forward-
ed -
J. W. Ames
Col. 6th U.S.C.T.
1864

Camp near
Yorktown, Va.
Jan 12. '64.

J. W. Ames
Col 6th U.S.C.T.

Reports that Surgeon
Hodge Dept Va etc / 10th Nov / Aug 27

Stegman has never re-
ported either in person
or by letter & has been
informed that he has
been ordered to report
to A. G. of the Army.
Requests promotion of
Asst Surgeon Barnes to
Surgeon of that Regt.

War Department, A. G. O.
Camp. 23rd 1864.
Respectfully ret'd. through
Ad. Ins. Dept. of Va. & N.C.
to Col. J. W. Ames, Comdg.
6th U.S. Cold. Troops, with
the information that Surg.
Stegman was relieved from
Rec'd A. G. O. Jan 22. '64.

duty in the Dept. of the
Cumberland by S. O.
No. 556, Dec. 16th 1863. from
this office, and ordered
to report to the Surgeon
General of the Army,
with a view to his being
assigned to duty with
the 6th U.S. Cold. Troops.

By order
L. W. Foster
Asst. Adj. Gen. Vol.
E. B. Vol. 0. Page 444.

Camp in Yorktown Va.

Jan. 9th 1864

Major E. W. Foster

Act Adj. Genl. U. S. A.

Sir

I have the honor to report that
 Surgeon Stegman 6th U. S. C. T. - had never reported
 to his regimental commander either in person or
 by letter; and I have lately been notified
 that he has been ordered to report to the
 Adj. Genl. at Washington D. C.. I therefore
 respectfully request that Act. Surgeon
 Leeman Barnes 6th U. S. C. T. be promoted
Surgeon & assigned to this regiment. I
 understand that Dr. Barnes passed the
 medical examination as a full surgeon, but
 from want of experience in the troops in the
 field was assigned only as an act. surgeon.

No 2nd Dept Va & N. C
 Ft Monroe Jan'y 27 '64
 Respectfully returned
 to Col J. W. Ames 6th
 U.S. C. T. with reference
 to endorsement from
 the War Dept.

Col Ames is also re=
 spectfully referred to
 par 456 Rev Army Reg=
 ulations, in accordance
 with which he will here=
 after communicate with
 the War Dept

By com^d of Maj Gen Butler
 Henry Johnson
 Lt. A. A. G.

Feb 26 1864

Head Quarters Dept. of Virginia and North Carolina,

Fort Monroe, Va., *Jan'y 30th* 1864.

SPECIAL ORDERS,

No. *30*

I

EXTRACT.

Leaves of Absence to go out of the Department are hereby granted to the following named Officers:

Asst. Surg. L. Barnes 6th U.S.C.T. for twenty (20) days.

By Command of Major General BUTLER:

Official

Signed

P. P. Davis

Henry J. Schroeder
Assistant Adjutant General.

A. A. S.

J. C. O. 6th U.S.C.T.

Gen. Wistar

1
M. Quar 3rd Div - 10th Co. B.
Raleigh, N.C. (M 24-65)

Make official copy

James Leman
Surg - 6th N. J. C. I.

Requests official
Copy of his Commission
the original having been
lost.

Official copy made
May 4th 1865. Sent
to Surg Bureau Hd
Quar 3rd Div - 10th Co. B.
Raleigh N.C.



Hq. Div. 3^d Div.: 10th A. C.
 Raleigh, N. C. April 24th 1865

Major.

I have the honor to
 state that I was commissioned as
 Surgeon of the 6th U. S. C. I. on the 4th of
 July 1864. by Major General Butler
 Comd. Dept of Va. N. C.

I further certify that said
 Commission was lost in transportation
 with baggage. Soon after the capture of
 Fort Fisher Jan 15th 1865

I therefore respectfully
 apply for an official copy of my
 original Commission

To—
 - C. A. General }
 Dept. Va. }

Very Respectfully
 your obt. Servt:
 Leeman Barnes
 Surgeon 6th U. S. C. I.

Act. Surg. in ship 3^d Div. 10th A. C.

P. S. I think my name in the Commission
 is worded Lyman Barnes —

B. 269 ✓
B. 311 B. 411 - 1864 1864

Head Quarters Hinks Division
City Point Va. June 14, 1864

Barnes, Surgeon U.S.

Recommends that Asst
Surgeon L. Barnes 6th U.S.C.
I. be promoted to Surgeon
same Regt.

Co. 124 6th Div. 8th Div. 8th A.C. 1864
Head Quarters 3rd Div. 18th A.C.
In the Field June 22, 1864.

Respectfully forwarded ap-
proved and with the accom-
modation that the appoint-
ment be made at once

Wm. M. Hinkley

Brig Gen. Vols.

filed 12-7-93



Recd Hd Qrs. 18th Army Corps. June 24/64
Hd Qrs. 18th Army Corps. June 24, 1864.

Hd Qrs 18th A.C.

June 24 1864

Reply forwarded Ak-

proved.

Wm. M. Hinkley

Major Genl. Cundy

Appointment

S. O. 181/4 - - - 1864

Head Quarters Hinks' Division

City Point Va. June 14th 1864

General,

I have the honor to recommend for
Surgeancy in Colonel Troops, Asst. Surgeon Lemuel
Barnes, 6th U.S. C. T.

I would not recommend this office for
promotion did I not think him fully qualified
for the position. Dr. Barnes has a liberal
education having graduated at the Michigan
University. He also possesses, in no small
degree, the peculiar fitness required for Army
Surgeons.

The 6th Regt. U.S. C. Troops has no Surgeon,
and I believe it is the wish of the Officers
of the Regt. that Asst. Surg. Barnes have the
Surgeancy of that Regiment.

Very Respectfully

Your Obedient Servant

Norman S. Barnes

Surgeon U.S. V.

Surgeon-in-Chief

Brig. Gen. Hinks

Comd'g Division

Barnes L.
A. J. U. S. C. T.
(personal report)

Cth U.S. 2^d Brig 3^d Div 18.6.C.
 In the field, Va
 June 30th 1864

Sir:

I have the honor to
 report myself on duty with my Regt
 I was appointed asst surg Cth U.S. the
 8th of Sept 1863 by the Pres of the United
 States under whose order I am acting.

I am very Respectfully
 Your Obedt Servt

Surg W^m Connick U.S.
 Asst. Dir. Dept War M.C.

S. Barnes
 Asst Surg Cth U.S.

Leeman Barnes
Surgeon U.S.A.

No 24, 10th St.
Raleigh N.C. June 22/65.
Receipt forwarded
Approved
A. Ames.
Post Major Genl.

Grant
June 22/65
J.C.



New Bern, N.C.

June 18th 1864

Col.

I have the honor to request leave of absence of (8) Eight days to visit Norfolk Va. for the purpose of obtaining some personal baggage which has been lost in transportation. This baggage is of very great value to me and unless I look after it in person I have no reasonable hope of ever recovering it.

Very respectfully
 your obt. Servt.
 Leeman Barnes
 Surgeon 6th U.S.C.,
 in charge 4th U.S.C.

W. Col. Campbell }
 A. A. Genl }
 Dept N.C. }

8" N 224 No. 193. 3' 10" in. 1830 a. c.

No. 193. 3' 10" in. 1830 a. c. July 5th 64

Head Quarters Department of Virginia and North Carolina,

In the Field,

Fort Monroe, Va., July 4th 1864.

SPECIAL ORDERS, }

No. 181 }

EXTRACT.

Promotions
VII The following ~~appointments~~ are hereby made in the 6th U. S.
Colored Troops - subject to the approval of the President of the
United States:

Assistant Surgeon Leman Barnes to be Surgeon.

By Command of Major General BUTLER.

H. J. ...
L. H. ...
Assistant Adjutant General.

copy sent to ...
the ...

Parnes L.
Surg. 6 USC T
(personal report)

18th A. C. Hospital Va
July 31st 1864

Sir:

I have the honor
to report that I was appointed
Surgeon 6th U.S. July 4th 1864
by Major General B. B. Butler
I have been on duty with my Regiment
up to July 21st inst - Since that time
I have been in 18th A. C. Hospital
Sick - I return to duty with my Regiment
to-morrow Aug 1st 64

I am very Respectfully
Your obt Servt -

S. Burnes
Surge 6th U.S.

Chas M. Cormick
Surgeon and Med
Dir Dept Va & N.C.

B 120 Hd Qrs 3rd Brig 3rd Div 18th A.C. 1864
 Camp of Cth M.S.T.
 B 58 3rd Div 18th A.C. 3rd 1864
 1864
 James Lemon
 B. 219
 Surg^y Cth M.S.T.

States that he has received a Commission as Surgeon from Maj Gen B. F. Butler dated July 4th 64. but that the Commissary of Musters for 3rd Div 18th Corps declined to muster him as such owing to the aggregate of the regt falling below the minimum.

Asks that action be taken in the premises
 filed 12-7-93
 18th A.C. Aug 8th 64
 18th A.C. Aug 6th 64
 18th A.C. Aug 5th 64
 18th A.C. Aug 1st 64

Hd. Qrs. 6th U.S. Cth.
 August 5th 1864
 Respectfully forwarded - approved. I hope that the difficulties in the way of this matter may be avoided; the regiment has been only reduced below the minimum by the recent actions - Dr. Barnes has been the acting surgeon of the regiment from its organization.

J. W. Ames
 Col. 6th U.S. Cth

Hd. Qrs. 3rd Brig, 3rd Div.,
 18th A.C.; Aug. 6th 1864

Respectfully forwarded. It seems exceedingly desirable that Dr. Barnes should be mustered as full Surgeon, if it can be done consistently with existing regulations on the subject.

Samuel Duncan
 S. O. No. 325-VI

Hd. Qrs. 3rd Div. 18th Corps
 In the Field Aug. 7. 64

Respy forwarded
 C. J. Paine
 Brig Genl

Hd Qrs 18th A.C.
 Aug 8th 1864

Respectfully forwarded for the action report of the Act Comy of Musters of the 3rd Div.

By command of
 Maj Gen O. M. Smith
 Brig Genl

Maj. Genl
 Smith

Bermuda Hundred Va
 Aug 6th 1864

Sir;

I have the honor to inform you, that I have received a Commission, dated 4th July 1864, appointing me Surgeon of 6 U.S.C.T. by Maj. Genl. B. F. Butler

I have applied to the Commissary of Muster of 3^d Div 18. Ar. to be mustered, but he declined to Muster me, on the ground that the Regiment had not the required strength viz: minimum. The strength of the Regiment is seven hundred & forty (740)

I respectfully submit that I have a right to be mustered for the following reason:

I have been on duty with the regiment since its organization, as Asst Surgeon in charge, when its strength was above the minimum and my appointment is a promotion.

The Regiment has but one asst Surgeon.

The Regiment is entitled to a Surgeon.

I therefore respectfully request some action in reference to my case.

Majr R. S. Davis

a. a. S.

Dep. 7th & A. C.

I am very Respectfully

Your obed^t Servant

L. Barneby
 Surg 6 U.S.C.T.

Head Quarters 3^d Div. 18th A.C.

Aug. 9. 1864

Respectfully referred to Lt. Col.
S. Millard A. C. M. 3^d Div for
report.

By command of
Brig. Gen. C. J. Paine
Colon A. Carter
Capt. & absent.

Office of the Major
3^d Division 18th A.C.
August 9th 1864.

This officer was refused
muster as a Surgeon, for the
reason that the Regiment
to which he belongs was
numerically below the minimum
standard. Orders from the
W. D. A. G. O. direct that in
such cases no muster
can be made.

Chas. H. H. H.
1st Lt. A. C. M.

H. G. 3^d Div. 18th Corps In the Field
Aug. 9. 64

Respy forwarded -
If existing orders permit this officer to be mustered
as Surgeon it will be an advantage to this
Command
C. J. Paine
Brig. Genl. Comd.

Std En 18th Mo
Augth 10th 1864

Respectfully forwarded
Approved

Second
Maj Genl Comdg

Adm - for the
Muster

Barnes, My
Gussie

Dutch Gap, Va. Aug. 31st 1864

Sir:

I have the honor to
report my self on duty with my reg-
iment - 6th U.S.C. Troops - in the field

I am very Respectfully
your Obedt Servt -

L Barney
Surgeon 6th U.S.C., I

Charles M. Cormick -
Surgeon U. S. Army
Medical Director -
Dept Van N. C.

L Barnes
Aug 6 USC 7

Camp 6th U.S.C. Troops
 Before Richmond Va
 Oct 31/64

Sir:

I have the honor
 to report my self on duty with my
 regiment in the field.

Very respectfully
 your Obedt Servant

T. Barnes
 Surgeon 6th U.S.C.

Chas. M. Comstock

Surgeon U.S.A.

Med. Dir. Dept 10th U.S.C.

Before Richmond Va
In the Field. Nov 30 (64)

Seemow Barnes
Surj. 6th U.S.C. B.

Monthly Report
of
Station & Duty

Camp 6th U.S.C. I. in the field -
 Before Richmond Va.
 November 30th 1864

Sir:

I have the honor to
 report myself on duty with my
 Regiment - in the field -

I am very Respectfully
 Your Obedt. Servt.

Leemon Barnes
 Surgeon 6th U.S.C. I.

Chas. McCornick
 Surgeon U.S. A
 Medical Director
 Dept of War N.C.

D. 69 3rd Div. 10th A.C. 1865

Head Quarters 3rd Div. 10th A.C.
Goldston N.C. May 30th

W. Dill. Daniel M.
Capt. Comdg. Co. 1st U.S.A.

Report of circumstances attend-
ing the absence of Surgeon
German Barnes Co. 1st U.S.A.

File

Head Quarters 3rd Div. 10th A.C.
571. Rec Hd Qrs 3rd Div 10th A.C. May 31/65

Head Qrs 3rd Div. 10th A.C.
Goldston N.C. May 31st 1865

Respectfully forwarded

W. W. W. W.
Colonel Comdg

Head Quarters 3rd Div. 10th A.C.
Goldston N.C. June 3 1865

Respectfully forwarded

C. J. Faine
Brig Genl Comdg

Head Qrs. 10th A.C.
Raleigh N.C. June 15th 1865

Respectfully forwarded.

Ames.

Brig Genl.

Head Quarters 6th U. S. C. S.
 Coldbrooks N. Y. May 30. 1865.

J. A. Campbell.
 Asst. Adj't. Gen'l. Dept. of A. C.

Sir.

I have the honor to make
 the following report of the absence of Lemuel
 Barnes - Surgeon 6th U. S. C. S. - in accordance with
 General Order No. 39 from the Dept. of A. C.

Surgeon Barnes - was Detached April
 18th 1865. as Division Surgeon in Chief - per. S. O. No.
 12. Head Quarters 3rd Division - 10th A. C. and in
 which capacity he is still serving.

I have the honor to be
 Very Respectfully
 Your Obedt. Serv't.

D. M. Dix
 Capt. 6th U. S. C. S.
 Comd'g Reg't.

P.

1865.

Head-Quarters, 3d Div, 10th Army Corps,
DISTRICT OF BEAUFORT,

NEW BERNE, N. C., 1865.

PAINE, C. J.,

Brevet Major General, Commanding. .

Received 1865.

NARA 859

Head-Quarters, 3d Division, 10th Army Corps,

DISTRICT OF BEAUFORT,

New Berne, N. C., June 11th 1865.

SPECIAL ORDERS, }

No. 49. }

EXTRACT.

I * Surgeon P. B. Rice, 102nd N. Y. Infy. having
been assigned to duty as Medical Director of this District
by Special Orders No 81. Sav. 2 dated Head Quarters Dept of
C. O. 6th U. S. C. Raleigh N. C. June 5th 1865. Surgeon L. Barnes 6th U. S. C.
3rd U. S. C. is relieved from duty as Surgeon in Chief of this Division
Brigade will report to Brevet Brigadier General Saml. A. Duncan for
assignment to duty in his Brigade

By Command of Brevet Major General C. J. PAINE:

W. H. Allen
Assistant Adjutant General.

P.

1865.

Head-Quarters, 3d Div. 10th Army Corps,
DISTRICT OF BEAUFORT,

NEW BERNE, N. C.,1865.

PAINE, C. J.,

Brevet Major General, Commanding.

Received 1865.

Head-Quarters, 3d Division, 10th Army Corps,

DISTRICT OF BEAUFORT,

New Berne, N. C., June 22^d 1865.

SPECIAL ORDERS,)

No. 60)

*

EXTRACT.

*

✓ Surgeon Leman Barnes 6th U.S.C.S.

is hereby relieved from duty with the 2^d Brigade and will report to the Comd'g Officer of his Regt at Wilmington N.C.

The 2^d M. Dept will furnish necessary

C. O. 6th U.S.C.S. ^{TC}
thru

C. O. 3^d Brig. Transportation

By Command of Brevet Major General C. J. Paine :

Solom A. Carter,

Assistant Adjutant General.

W....., 1865.

HEADQUARTERS DIST. OF WILMINGTON.

WILMINGTON, N. C., , 1865.

Wilmington, District of

Commanding

S. O. Par.

Received , 1865.

Headquarters District of Wilmington,

Wilmington, N. C., June 28th, 1865.

SPECIAL ORDERS

No. 27....

(Extract)

* * * * *

III Surgeon L. Barnes 6th W. I. C. I., is hereby relieved from duty with his regiment, and assigned to the charge of the Medical property of the Post Hospital at Wilmington, which property he will turn over to the Medical Purvey or at Newberne, N. C., having accomplished which, he will report to the commanding officer of his regiment for duty.

* * * * *

By order of Brig. General ^{Brot} ^{Ames} HAWLEY.

Edwin C. Salmer
Captain & A. A. General.

Comd'g Officer
6th W. I. C. I.

m. Sep 7th 1865



2 + M. 417-3: W. 10th A.P. 1865

Head Quarters Department of North Carolina,

ARMY OF THE OHIO,

Raleigh N.C. June 24th 1865

Special Orders, }
No. 101 }

[EXTRACT.]

* * * * *

5. On Surgeon's Certificate,

Leave of Absence is hereby granted the following named officers, for the numbers of days, set opposite their respective names:

Surg. L. Barnes 6th U.S.C.A. Five (5) days Personal Reasons with permission to go beyond the limits of this Department.

* * * * *

J. W. Cook

By Command of MAJOR GENERAL SCHOFIELD:

J. R. Gibson
Assistant Adjutant General.

The following extracts from Regulations and General Orders, relative to Leaves of Absence, will be strictly observed:

- "When not otherwise specified, leaves of absence will commence the day an officer is relieved from duty at his post, after receiving the order granting him leave.
- "At the expiration of his leave, the officer must report in person with his command, and not at the office from which his leave issued.
- "No officer is permitted to visit Washington without special permission from the Secretary of War, which must be stated in the order granting leave of absence.
- "If an officer be not able to travel at the expiration of his sick leave, he must report his address to the commander of his post, regiment, or corps, and also to the Assistant General of the Army; and in his first report state the day when his leave of absence commenced. These reports must be repeated every twenty days, and each one must be accompanied by the certificate of a medical officer of the army, made in the usual form and stating that the officer is not able to travel. If there is no army physician in the place where the officer resides, the certificate of a citizen physician, the truth of which must be sworn to before a civil magistrate, may be substituted. Extensions of leave are not granted in orders.
- "Officers absent from duty without leave, or without the expiration of their leaves, will not be allowed to draw pay until a court or commission, which will be ordered on their return to their post or command, shall determine whether there was sufficient cause for their absence. They will accordingly provide themselves with a full description of the nature and cause of their disability, certified by the proper medical authority as required by existing orders and regulations.

Thos. O'Ab

W....., 1865.

HEADQUARTERS DIST. OF WILMINGTON.

WILMINGTON, N. C., , 1865.

Wilmington, District of

Commanding.

S. O. Par.

Received , 1865.

Headquarters District of Wilmington,

Wilmington, N. C., July 19th, 1865.

SPECIAL ORDERS

No. 112

Extract

1st Surgeon L. Barnes, 7th W.S. C.A., being the senior officer of his Department in this District is hereby detached from his regiment and assigned to duty as Medical Director, District of Wilmington.

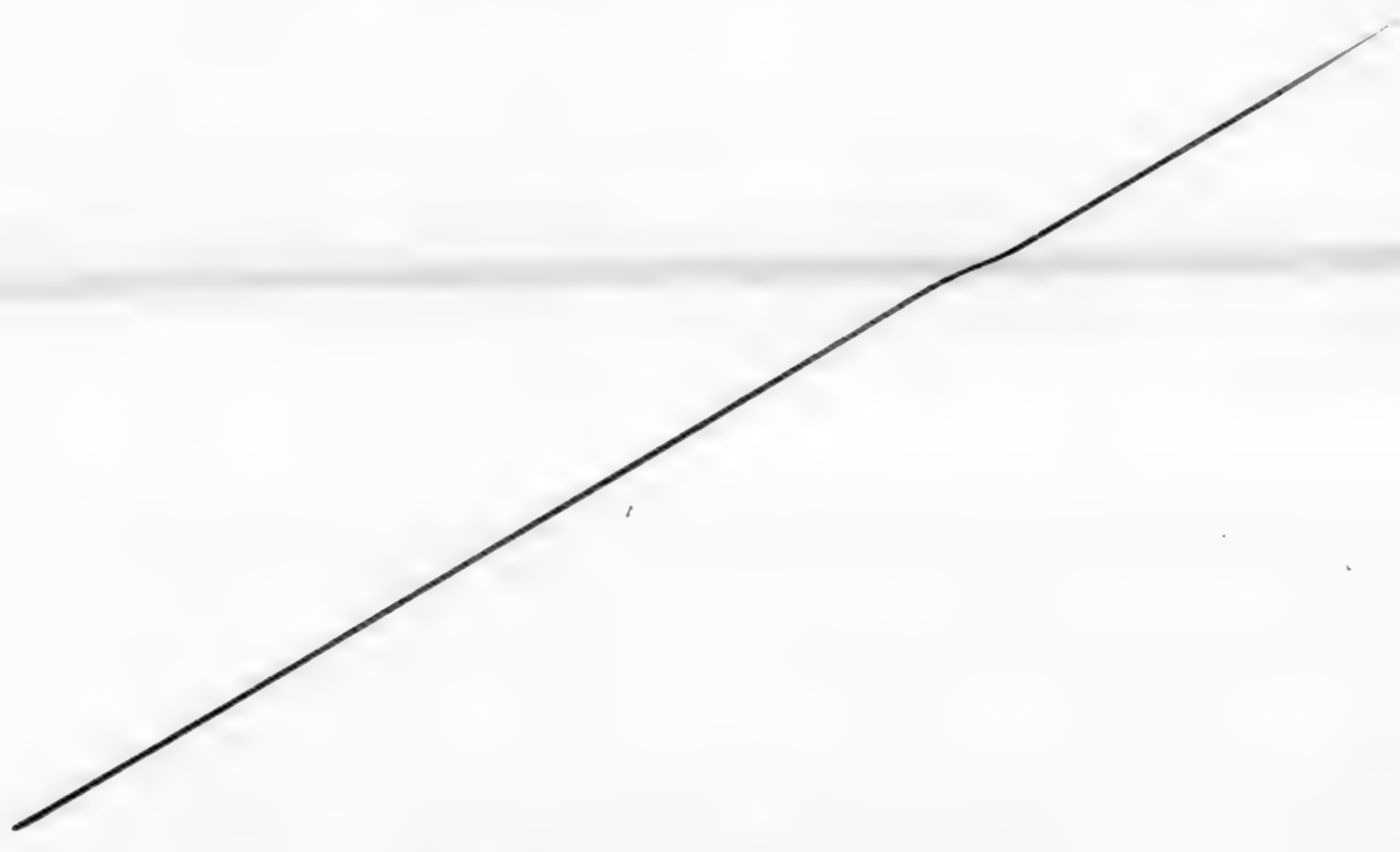

Bt. Duncan

By order of Brig. General HAWLEY.

[Faint, illegible handwritten notes]

Edwin C. Salinger
Captain & A. A. General.

3^d Div. 10th U.S.C.
Goldsboro N.C. May 31st 1865

L. Barnes, Surg: 6th U.S.C.F.

Makes personal report
to Adjutant 6th U.S.C.F.
for the month of May 1865

W^o Div 3^d Div: 10th C. C.
 Galston N.C. May 31st 1865

Lieut W. R. Hammond
C Adjutant 6th U.S.P.

Sir:

I have the honor to report that I have been on duty during the present month as Surgeon in Chief on the Staff of Brig: Gen: C. J. Paine Commanding 3^d Div: 10th C. C. at Galston N.C. in obedience to General Order No. 1 dated W^o Div 3^d Div: 10th C. C. April 4th 1865

Very Respectfully
 Yours
 W. R. Hammond

Lieut W. R. Hammond
 Surg: 6th U.S.P. Surgeon in Chief
 3^d Div: 10th C. C.

Barnes, Leeman
Ass Surg. 6th U. S. C. I

V

6

SPECIAL ORDERS, } WAR DEPARTMENT,
No. 448. } ADJUTANT GENERAL'S OFFICE,
Washington, August 19th, 1865.

(Extract.)

* * * * *

30. By direction of the President, the following appointment in the 6th U. S. Colored Troops, made July 4th, 1864, by Major-General *Butler*, Commanding Department of Virginia and North Carolina, is hereby confirmed:—

Assistant Surgeon *Leeman Barnes*, to be Surgeon.

* * * * *

By order of the Secretary of War:

E. D. TOWNSEND,
Assistant Adjutant General.

OFFICIAL:

Assistant Adjutant General.

Col Foster

SPECIAL ORDERS, } WAR DEPARTMENT,
No. 448. } ADJUTANT-GENERAL'S OFFICE,
Washington, August 19th, 1865.

(Extract.)

* * * * *

30. By direction of the President, the following appointment in the 6th U. S. Colored Troops, made July 4th, 1864, by Major-General *Butler*, Commanding Department of Virginia and North Carolina, is hereby confirmed:—

Assistant Surgeon *Leeman Barnes*, to be Surgeon.

* * * * *

By order of the Secretary of War:

E. D. TOWNSEND,
Assistant Adjutant General.

OFFICIAL:

Assistant Adjutant General.

St. Col. Brooke.

Private | *Private*
CARD NUMBERS.

68501	26
577711	27
577805	28
5577898	29
5577988	30
5578073	31
0065600	32
	33
	34
	35
	36
	37
	38
	39
	40
	41
	42
	43
	44
	45
	46
	47
	48
	49
	50

Book Mark:

See also

B | **6** | **U.S.C.T.**

Walter Bassett,

N, 6 Reg't U. S. Col'd Inf.

Appears on

Company Descriptive Book

of the organization named above.

DESCRIPTION.

Age *30* years; height *5* feet *5* inches.

Complexion *Blk*

Eyes *Blk*; hair *Blk*

Where born *Maryland*

Occupation *Lab.*

ENLISTMENT.

When *Oct 29*, 186*4*.

Where *Baltimore Md.*

By whom _____; term *1* y'rs.

Remarks: *Drafted 3^d Dist Del.*

Jenkins

B | 6 | U.S.C.T.

Nutter Barnett

Appears with rank of _____ on
**Muster and Descriptive Roll of a Detach-
 ment of Drafted Men and Substitutes
 forwarded**

for the *6* Reg't U. S. Col'd Inf. Roll dated
Baltimore Md, Nov 19, 1864.

Where born *Md*

Age *30* years; occupation *Laborer*

Drafted and mustered in:

When *Oct-29*, 1864

Where *Baltimore*

Period *1* years.

Eyes *Blk*; hair *Blk*

Complexion *Blk*; height *5ft 5in*

Paid bounty and advance pay, \$ *100*

Bounty due \$ *100*

Where credited _____

Company to which assigned _____

Remarks: *Drafted from 3 Dist
 Md*

Book mark: *34*

L. B. Wright

78

6

U.S.C.T.

Walter Barnett

Priv., Co. H, 6 Reg't U. S. Col'd Infantry.

Appears on

Company Muster Roll

for Jan & Feb, 1865.

Present or absent Absent

Stoppage, \$ 100 for

Due Gov't, \$ 100 for

Remarks: Absent Sick

Book mark:

W. H. Harper

(858)

Copyist.

13 | 6 | U.S.C.T.

Walter Barnett

Priv, Co. H, 6 Reg't U. S. Col'd Infantry.

Appears on

Company Muster Roll
for Mar & April, 1865.

Present or absent Present

Stoppage, \$ 100 for

Due Gov't, \$ 100 for

Remarks: Stop for 1 term -
priv \$100

Book mark:

A. H. Taylor

B1

6

U.S.C.T.

Walter Barnett

Prk, Co. H, 6 Reg't U. S. Col'd Infantry.

Appears on

Company Muster Roll

for May & June, 1865.

Present or absent Present

Stoppage, \$ 100 for

Due Gov't, \$ 100 for

Remarks:

Book mark:

Kolombe

(358)

Copyist.

B

6

U.S.C.T.

Walton Barnett

Pat., Co. H, 6 Reg't U. S. Col'd Infantry.

Appears on

Company Muster Roll

for July & Aug, 1865.

Present or absent Present

Stoppage, \$ 100 for

Due Gov't, \$ 100 for

Remarks: due U.S. for timber and
band spring fund 20/00+

Book mark:

Halecomb

(358)

Copyist.

3

6

U.S.C.T.

Walter Barnett

Pvt, Co. H, 6 Reg't U. S. Col'd Infantry.

Appears on Co. Muster-out Roll, dated
Wilmington, N.C., Sep 20, 1865.

Muster-out to date Sep 20, 1865.

Last paid to April 30, 1865.

Clothing account:

Last settled Nov, 186 ; drawn since \$ 56 ³³/₁₀₀

Due soldier \$ 100; due U. S. \$ 100

Am't for cloth'g in kind or money adv'd \$ 100

Due U. S. for arms, equipments, &c., \$ 100

Bounty paid \$ 100; due \$ 100

Remarks: Due Wm Bisher Regtl. Sutter \$10.

Staf for 1 tumbler punch 20¢

Book mark:

Hobbs

Copyist.

U.S. Col'd Inf

Pirate Pirate

CARD NUMBERS.

1	5577082	26
2	5577164	27
3	5577249	28
4	5577330	29
5	5577409	30
6	5577488	31
7	5577561	32
8	5577638	33
9	5577704	34
10	5577799	35
11	5577958	36
12	5578136	37
13	9065527	38
14		39
15		40
16		41
17		42
18		43
19		44
20		45
21		46
22		47
23		48
24		49
25		50

Book Mark: 1859. C.J. 1879

See also

S. 2024160 P.O. m m

B | **6** | **U.S.C.T.**

William H. Barrett,

....., Co. *H*....., 6 Reg't U. S. Col'd Inf.

Appears on

Company Descriptive Book

of the organization named above.

DESCRIPTION.

Age *35* years; height *5* feet *8* inches.

Complexion *Yellow*

Eyes *Blk*; hair *Blk*

Where born *Phila. Penn.*

Occupation *Miner*

ENLISTMENT.

When *July 18*....., 186*5*.

Where *Alleghany City, Pa.*

By whom *L. S. D. Pa.*.....; term *3* y'rs.

Remarks: *Mustered by Capt*
Yardley.

Discharged

May 29, 1865 From

U.S. Hospital

Willetts Point, New York.

Jenkins

B

6

U.S.C.T.

William H Barrett

Pvt, Co H, 6 Reg't U. S. Col'd Infantry.

Age 35 years.

Appears on

Company Muster-in Roll

of the organization named above. Roll dated

Phila. Pa Sept 14, 1863.

Muster-in to date

July 18, 1863

Joined for duty and enrolled:

When July 18, 1863.

Where Alleghany City Pa

Period 3 years.

Remarks

Mustd. by Capt. Kirker
P.M. July 18/63.
D.H.A.

Book mark:

W.H. Thompson

B

6

U.S.C.T.

William A. Barrett

Priv., Co. H, 6 Reg't U. S. Col'd Infantry.

Appears on

Company Muster Roll

for Sept. 14 to Oct 31, 1863.

Present or absent Present

Stoppage, \$ 100 for

Due Gov't, \$ 100 for

Remarks:

Book mark:

(358)

W. A. Thompson Copyist.

B | 6 | U.S.C.T.

William A. Barrett

Cook, Co. H, 6 Reg't U. S. Col'd Infantry.

Appears on

Company Muster Roll

for Nov. & Dec., 1863.

Present or absent Present

Stoppage, \$ 100 for

Due Gov't, \$ 100 for

Remarks: On daily duty as Co. Cook

Book mark:

W. A. Thompson Copyist.

B

6

U.S.C.T.

William Barrett
Pvt., Co. H, 6 Reg't U. S. Col'd Infantry.

Appears on

Company Muster Roll

for James T. Feby, 1864
Present or absent Present

Stoppage, \$ 100 for

Due Gov't, \$ 100 for

Remarks: Co. Cook

Book mark:

W. A. Thompson
Copyist.

B

6

U.S.C.T.

William Barrett

Pvt., Co. H, 6 Reg't U. S. Col'd Infantry.

Appears on

Company Muster Roll

for *Mich & Apl*, 1864.

Present or absent *Present*

Stoppage, \$ 100 for

Due Gov't, \$ 100 for

Remarks: *Co. Cook*

Book mark:

W. H. Thompson

(358)

Copyist.

B

6

U.S.C.T.

William Barrett

Priv, Co. H, 6 Reg't U. S. Col'd Infantry.

Appears on

Company Muster Roll

for May & June, 1864.

Present or absent Present

Stoppage, \$ 100 for

Due Gov't, \$ 100 for

Remarks: Regimental Pioneer

Book mark:

C. A. Harper

B

6

U.S.C.T.

William Barret

Priv, Co. H, 6 Reg't U. S. Col'd Infantry.

Appears on

Company Muster Roll

for July & Aug, 1864.

Present or absent Present

Stoppage, \$ 100 for

Due Gov't, \$ 100 for

Remarks: Free April 19/61
Siv Pioneer Order of
Genl Price

Book mark:

C. A. Harper

(358)

Copyist.

B

6

U.S.C.T.

William Barrett

Priv, Co. H, 6 Reg't U. S. Col'd Infantry.

Appears on

Company Muster Roll

for Sept Dec, 1864

Present or absent Absent

Stoppage, \$ 100 for

Due Gov't, \$ 100 for

Remarks: Free April 19/61
Div Pioneer for
Order Brig. Gen'l
Paine Comby Div

NEXT ROLL ON FILE FEB 1865

Book mark:

C. P. Harper

(358)

Copyist.

B

6

U.S.C.T.

William Barrett

Priv, Co. H, 6 Reg't U. S. Col'd Infantry.

Appears on

Company Muster Roll

for Jan & Feb, 1865.

Present or absent Absent

Stoppage, \$ 100 for

Due Gov't, \$ 100 for

Remarks: In Priv Pioneer Corps

Book mark:

A. A. Harper

(358)

Copyist.

73

6

U.S.C.T.

William Barrett

Priv, Co. H, 6 Reg't U. S. Col'd Infantry.

Appears on

Company Muster Roll

for *Mar & April*, 1865.

Present or absent *Absent*

Stoppage, \$ 100 for

Due Gov't, \$ 100 for

Remarks: *Indiv Pioneer
Corps*

Book mark:

A. J. Harper

(358)

Copyist.

B

6

U.S.C.T.

William H Barrett

Priv, Co. H, 6 Reg't U. S. Col'd Infantry.

Appears on

Company Muster Roll

for May & June, 1865.

Present or absent

Stoppage, \$ 100 for

Due Gov't, \$ 100 for

Remarks: Discharged

Book mark: Dis 1572

(358)

J. L. ...

Copyist.

B | 6 | U.S.C.T.

William L. Barrett

Pvt, Co. K, 6 Reg't U. S. Col'd Infantry.

Appears on Co. Muster-out Roll, dated
Wilmington N.C., Sep 20, 1865.

Muster-out to date _____, 186 .

Last paid to _____, 186 .

Clothing account:

Last settled _____, 186 ; drawn since \$ _____ 100

Due soldier \$ _____ 100; due U. S. \$ _____ 100

Am't for cloth'g in kind or money adv'd \$ _____ 100

Due U. S. for arms, equipments, &c., \$ _____ 100

Bounty paid \$ _____ 100; due \$ _____ 100

Remarks: Dischg'd from Hospital May 29
1865+

Book mark: CD 2742-1860-286, 201-1859071879

Dis 1072

Holcomb

(361)

Copyist.

Barrett, M. H.

B, Co. A, 6 Reg U.S.C. Inf.

2 Enclosures.

Bed Cards	Descriptive Lists
Burial Records	Final Statements
Certs. of Dis. for Discharge	Furloughs
C. M. Charges	Med. Des. Lists
Med. Certificates	Orders

Other papers relating to—

Admission to Hosp'l	Furlough
Casualty Sheet (Officer's)	Med. Examination
Confinement	Misc. Information
Contracts	Pay or Clothing
Death or Effects	Personal Reports
Desertions	Rank
Discharge from Hosp'l	Transfer to Hosp'l
Discharge from Service	Transfer to V. R. C.
Duty	Transportation

CASUALTY SHEET

No.

Wm H Barrett

W of Company *H*

6 Regiment of *US Col*

State Volunteers.

NATURE OF CASUALTY.

Dischd May 29/65

CASUALTY SHEET.

Name: *Wm H Parrott*

Rank: *Pl* Company: *H* Regiment: *6*

Arm: *Inf* State: *US Col*

Nature of Casualty: *Disch*

CAUSE OF CASUALTY—(NAME OF DISEASE, &C.)

BY WHOM DISCHARGED.

DEGREE OF DISABILITY.

FROM WHAT SOURCE THIS INFORMATION WAS OBTAINED.

BY WHOM CERTIFIED.

*Roll 72 Grand Corp
Willis P. My H*

REMARKS.

W H Thurston

Surg US A

DATE OF DISCHARGE, DEATH, &C.

May 29 65

PLACE OF DISCHARGE, DEATH, &C.

Willis P. My H

J. Smith

Clerk:

NOTE 1.

The company commander will here add a statement of all the facts known to him concerning the disease or wound, or cause of disability of the soldier: the time, place, manner, and all the circumstances under which the injury occurred, or disease originated or appeared; the duty, or service, or situation of the soldier at the time the injury was received or disease contracted, stating particularly whether the injury was received or the disease contracted in the line of his duty: and whatever other facts may aid a judgment as to the cause, immediate or remote, of the disability, and the circumstances attending it.

When the facts are not known to the company commander, the certificate of any officer, or affidavit of other person having such knowledge, will be appended—as the surgeon in charge of a hospital, the officer commanding a detachment of recruits, &c., &c.

NOTE 2.

When a probable case for pension, special care must be taken to state the degree of disability—as 1, 2, &c., &c.; to describe particularly the disability, wound, or disease; the extent of which it deprives him of the use of any limb or faculty, or affects his health, strength, activity, constitution, or capacity to labor or earn his subsistence. The surgeon will add, from his knowledge of the facts and circumstances, and from the evidence in the case, his professional opinion of the cause or origin of the disability. In the case of discharges by Medical Inspectors, the last paragraph will state that the "discharge was given by consent of the soldier, after a personal examination, and for disability, the nature, degree, and origin of which are correctly described in the within certificate."

Par. 1260 Regulations, Edit 1861.

Medical officers, in giving certificates of disability, are to take particular care in all cases that have not been under their charge; and especially in epilepsy, convulsions, chronic rheumatism, derangement of the urinary organs, ophthalmia, ulcers, or any obscure disease liable to be feigned or purposely produced; and in no case shall such certificate be given until after sufficient time and examination to detect any attempt at deception.

DIRECTIONS.

This certificate will be made out in duplicate by the soldier's company commander, or other officer commanding the separate detachment to which he belongs, and sent by him to the surgeon who has charge of the hospital where the soldier is sick. The surgeon will then fill out and sign the surgeon's certificate, and forward these papers to the regimental detachment, or post commander, who will forward them, with his action endorsed thereon, through the proper channel, to his division commander, or, if the troops are not attached to a division, to his corps, department, or other commander or officer to whom the authority to discharge enlisted men may be specially delegated.

These certificates, after having received the action of the highest authority to which they are required to be sent, will be returned through the same channel to the regimental post, or detachment commander, who will if the discharge is authorized by the endorsement of the proper authority, sign the soldier's discharge, and the last certificate on this paper; see that the soldier is furnished with the proper final statements in duplicate, and forward BOTH of these certificates direct to the Adjutant General United States Army, at Washington D C, they will not, under any circumstances, be given into the hands of the soldier.

1865
P. 54. R. of Dis.
CERTIFICATE OF DISABILITY FOR DISCHARGE

IN THE CASE OF

William H. Barrett
a Private Co. C
1st Reg't of U.S.C.T.

APPROVED

W. H. Sloan

Surgeon, U. S. A.,

Medical Director Dep't of the East.

HEADQUARTERS DEPARTMENT OF THE EAST,

NEW YORK CITY, May 24th, 1865.

To be discharged.

BY COMMAND OF MAJOR GENERAL DIX:

W. H. Sloan

Capt. and A. D. C., A. A. A. G.

Received (A. G. Office) 1865

Enrolled by Cas

ADJUTANT GENERAL'S OFFICE

June 5th 1865

Duplicate sent the Pension Office.

U.S. Gold & Silver

Private

Private

CARD NUMBERS.

1	5577084	26
2	5577166	27
3	5577250	28
4	5577331	29
5	5577410	30
6	5577489	31
7	5577562	32
8	5577631	33
9	5577705	34
10	5577800	35
11	5577893	36
12	5577982	37
13	5578067	38
14	9065521	39
15		40
16		41
17		42
18		43
19		44
20		45
21		46
22		47
23		48
24		49
25		50

Book Mark:

See also:

1009246 *Journal*

S 2921578 *and*

04. 1912467

S - Sol. Stone. Bath N.Y. 6/22/31 - area

NS UB 6/27/31 *etc*

2 ms. *Holston* 12/28/32

B | **6** | **U.S.C.T.**

Alfred Bates,
 _____, Co. *A*, 6 Reg't U. S. Col'd Inf.

Appears on
Company Descriptive Book
 of the organization named above.

DESCRIPTION.

Age *20* years; height *5* feet *3* inches.

Complexion *Yellow*

Eyes *Blk*; hair *Blk*

Where born *New Jersey*

Occupation *Team*

ENLISTMENT.

When *Sept 7*, 186*3*

Where *Harrisburg*

By whom *H. D. Pa.*; term *3* y'rs.

Remarks: *Mustered by Capt. Clement*

Jenkins

B

6

U.S.C.T.

Alfred Bates

Priv., Co. H, 6 Reg't U. S. Col'd Infantry.

Age 20 years.

Appears on

Company Muster-in Roll

of the organization named above. Roll dated

Phila Pa, Sept 14, 1863.

Muster-in to date

Sept 7, 1863

Joined for duty and enrolled:

When Sept 7, 1863.

Where Harrisburg, Pa

Period 3 years.

Remarks: Mustd. by Capt
Clement P. M. Sept 17/63.
Sub.

Book mark:

W. H. Thompson

(856)

Copyist.

B

6

U.S.C.T.

Alfred Bates

Priv

, Co. H, 6 Reg't U. S. Col'd Infantry.

Appears on

Company Muster Roll

for Sept 14 to Oct 31, 1863.

Present or absent

Present

Stoppage, \$ 100 for

Due Gov't, \$ 100 for

Remarks:

Book mark:

M. A. Thompson Copyist.

(358)

B | 6 | U.S.C.T.

Alfred Bates

Priv, Co. H, 6 Reg't U. S. Col'd Infantry.

Appears on

Company Muster Roll

for *Nov & Dec*, 1863.

Present or absent *Present*

Stoppage, \$ 100 for

Due Gov't, \$ *2* ^{*50*}/₁₀₀ for *ordnance*

Remarks:

Book mark:

W. H. Thompson

(358)

Copyist.

B | 6 | U.S.C.T.

Alfred Bates
Priv, Co. H, 6 Reg't U. S. Col'd Infantry.

Appears on

Company Muster Roll

for *Jany & Geby*, 1864

Present or absent *Present*

Stoppage, \$ *100* for

Due Gov't, \$ *100* for *1/2 Shelta*
term

Remarks:

Book mark:

M. H. Thompson
Copyist.

B

6

U.S.C.T.

Alfred Bates
Priv

Co. H, 6 Reg't U. S. Col'd Infantry.

Appears on

Company Muster Roll

for *Mich & Cpl*, 1864.

Present or absent *Present*

Stoppage, \$ 100 for

Due Gov't, \$ 100 for

Remarks:

Book mark:

W. H. Thompson

(358)

Copyist.

B

6

U.S.C.T.

Alfred Bates

Bili, Co. H, 6 Reg't U. S. Col'd Infantry.

Appears on

Company Muster Roll

for May & June, 1864.

Present or absent Present

Stoppage, \$ 100 for

Due Gov't, \$ 100 for

Remarks:

Book mark:

C. A. [Signature]

B

6

U.S.C.T.

Alfred Bates

Priv., Co. H, 6 Reg't U. S. Col'd Infantry.

Appears on

Company Muster Roll

for July & Aug, 1864.

Present or absent Present

Stoppage, \$ 100 for

Due Gov't, \$ 100 for

Remarks: Free April 19/61
Extra Duty

Book mark:

C. A. Harper

(358)

Copyist.

B

6

U.S.C.T.

Alfred Bates

Priv, Co. H, 6 Reg't U. S. Col'd Infantry.

Appears on

Company Muster Roll

for *Sept Oct*, 1864

Present or absent *Present*

Stoppage, \$ 100 for

Due Gov't, \$ 100 for

Remarks:

NEXT ROLL ON FILE FEB 1865

Book mark:

O. A. Harper

(358)

Copyist.

B

6

U.S.C.T.

Alfred Bates

Priv, Co. H, 6 Reg't U. S. Col'd Infantry.

Appears on

Company Muster Roll

for Jan 0 Feb, 1863

Present or absent Present

Stoppage, \$ 100 for

Due Gov't, \$ 100 for

Remarks:

Book mark:

A. A. Harper

(358)

Copyist.

73

6

U.S.C.T.

Alfred Bates
Pvt., Co. H, 6 Reg't U. S. Col'd Infantry.

Appears on

Company Muster Roll
for *Mar & April*, 1865.

Present or absent *Present*

Stoppage, \$ 100 for

Due Gov't, \$ 100 for

Remarks: *Stop for 1 wiper
and 1 cone worth
43 cts*

Book mark:

A. H. Ayres

(358)

Copyist.

13

6

U.S.C.T.

Alfred Bates
Pvt., Co. H, 6 Reg't U. S. Col'd Infantry.

Appears on

Company Muster Roll

for May & June, 1865.

Present or absent Present

Stoppage, \$ 100 for

Due Gov't, \$ 100 for

Remarks: Stopped for 1 ball
- screw 13/100

Book mark:

Hobson

(358)

Copyist.

121

6

U.S.C.T.

Alfred Bates

Pvt

Co. H, 6 Reg't U. S. Col'd Infantry.

Appears on

Company Muster Roll

for July Aug, 1863.

Present or absent Present

Stoppage, \$ 100 for

Due Gov't, \$ 100 for

Remarks: due U.S. for 1 tumbler and band spring punch 20/100, 1 canteen 65/100, 1 Haversack 95/100, total 190/100 x

Book mark:

Malcomb

(358)

Copyist.

B |

6

U.S.C.T.

Alfred Bates

Prk., Co. H, 6 Reg't U. S. Col'd Infantry.

Appears on Co. Muster-out Roll, dated
Wilmington Nc. Sep 20, 1865.

Muster-out to date Sep 20, 1865.

Last paid to Apr 30, 1865.

Clothing account:

Last settled June 30, 1864; drawn since \$ 140⁴⁹/₁₀₀

Due soldier \$ 100; due U. S. \$ 100

Am't for cloth'g in kind or money adv'd \$ 100

Due U. S. for arms, equipments, &c., \$ 6⁰⁰/₁₀₀

Bounty paid \$ 100; due \$ 100⁰⁰/₁₀₀

Remarks: Due Wm G's been Reg't. Settled \$ 21.
\$ 6 per mo. due from enlistment to Apr. 30/64.
Stop for lumber March 20, 1864, 1 canteen 65¢
Larissa's 95¢, ord. charged on previous rolls
55¢. Sub. for man drafted under act
March 3/63

Book mark:

Halecomb

(361)

Copyist.

Bates, Alfred

, Co. H,

6

Reg't

U.S. Inf.

Inclosures.

Bed Cards	Final Statements
Burial Records	Furloughs or L. of A.
Certs. of Dis. for Discharge	Med. Certificates
C. M. Charges	Med. Des. Lists
Descriptive Lists	Orders
Discharge Certificates	Pris. of War Record
Enlistment Papers	Resignations

Other papers relating to—

Admission to Hosp'l	Furlough or L. of A.
Casualty Sheet	Med. Examination
Confinement	Misc. Information
Contracts	Pay or Clothing
Death or Effects	Personal Reports
Desertion	Rank
Discharge from Hosp'l	Transfer to Hosp'l
Discharge from Service	Transfer to V. R. C.
Duty	Transportation

MICROFILM PUBLICATION M1848

COMPILED MILITARY SERVICE RECORDS
OF VOLUNTEER UNION SOLDIERS WHO SERVED WITH
THE UNITED STATES COLORED TROOPS (USCT)
6TH REGIMENT OF INFANTRY

PERSONAL PAPERS' TARGET SHEET

PLEASE NOTE THE CHECKED INFORMATION ABOUT THE PERSONAL PAPERS IN
THIS FILE:

- NO PERSONAL PAPERS WERE FOUND IN THIS FILE WHEN THE
RECORDS WERE ARRANGED FOR MICROFILMING.
- 2 PERSONAL PAPER(S) FOUND IN THIS FILE WHEN THE RECORDS
WERE ARRANGED FOR MICROFILMING.

DECLARATION OF SUBSTITUTE.

I, _____ desiring to ENLIST in the Army of the United States, for THREE YEARS, **Do declare**, That I am Twenty years and _____ months of age; that I have never been discharged from the United States service on account of disability or by sentence of a court martial; and I know of no impediment to my serving honestly and faithfully as a soldier for three years.

GIVEN at Warrensburg Penn
the 7 day of Sept. 1863

WITNESS:

Geo. J. Clement Alfred P. Bates
man

George
CON GRACE SUB

Alfred P. Bates

Enlisted at Warrensburg

As Substitute for

William Cannon

On the _____ day of _____, 186 .

By

Board of Enrollment,

Dist. of _____

(No. 40.)

SUBSTITUTE
VOLUNTEER ENLISTMENT.

STATE OF

TOWN OF

Pennsylvania



Harrisburg

I, *Alfred Bates* born in the State
of *New Jersey*, aged *Twenty* years, and by
occupation a *Teamster* Do HEREBY ACKNOWLEDGE to have agreed with
William James Esq., of *Lower Paxton*
Township, Dauphin Co. Pennsylvania
to become his **SUBSTITUTE** in the Military Service, for a sufficient consideration paid and
delivered to me, on the *Seventh* day of *September* 1863;
and having thus agreed with said *William James*, I DO HEREBY
ACKNOWLEDGE to have enlisted this *Seventh* day of *September*
1863, to serve as a **Soldier** in the **Army of the United States of America**, for the period
of **THREE YEARS**, unless sooner discharged by proper authority: I do also agree to accept such
bounty, pay, rations, and clothing, as are, or may be, established by law for soldiers. And I do
solemnly swear that I will bear true and faithful allegiance to the **United States of America**;
that I will serve them honestly and faithfully against all their enemies or opposers whomsoever;
and that I will observe and obey the orders of the President of the United States, and the orders
of the Officers appointed over me, according to the Rules and Articles of War.

SWORN and subscribed to, at *Harrisburg*
this *7th* day of *Sept* 1863
BEFORE *Eno Kay Clement*
Capt & Marshal

Alfred Bates
enok

We certify, on honor, That we have carefully examined the above-named Volunteer Substitute
agreeably to the Regulations, and that, in our opinion, he is free from all bodily defects and mental infirmity
which would in any way disqualify him from performing the duties of a soldier; that he was entirely sober
when enlisted; that he is of lawful age, (not under 18 years;) and that, in accepting him as duly qualified to
perform the duties of an able-bodied soldier, and as a Substitute in lieu of *William*
James, drafted in *Lower Paxton T. Dauphin*
County *August 12th*, 1863, we have strictly observed the Regulations which govern
in such cases. This soldier has *Black* eyes, *Black* hair, *Black* complexion; is *5* feet *3*
inches high.

Eno Kay Clement
Provost Marshal.

W. A. B. B. B.
Commissioner of Board.

J. T. Charleston
Surgeon of Board.

Board of Enrollment of *14th* Dist. of *Pennsylvania*

Alfred Bates
Substitute for
Wm James

Accepted Sept 7th 1863.

No.

NAME,

Alfred Bates

Age, *Twenty*

Height, *5* ft *3* in.

Complexion, *Black*

Eyes, *Black*

Hair, *Black*

WHERE BORN—

Town or Co. *Sussex Co.*

State, *New Jersey*

Occupation, *Solider*

ENLISTMENT.

When, *Sept 7th* 1863.

Where, *Harrisburg Pa.*

By Whom—JOHN KAY CLEMENT,

Capt. and Prov. Marshal, 14th Dist. Pa.

Term, 3 years or during the war.

Substitute for

William James

Drafted in

Lower Paxton Tp.

Dauphin County, Pa.

HARRISBURG, PA., *Sept 7th* 1863.

Board of Enrollment 14th District of Pennsylvania,

GENTLEMEN:

I will on *the 7th* day of *Sept. 63* present to

you the Substitute described on the margin of this notice. He resides at

Wilkesbary Wyoming Co Penna
William James

Drafted in *Lower Paxton Tp. Dauphin Co*
14th Dist. Penn'a,

 Enclose notice of draft with this application.

 Where the substitute is UNDER TWENTY-ONE YEARS of age, the party must bring with him the written consent of the parent or guardian, on THREE blank forms of enlistment.

6 U.S. Col'd Inf.

Private

Private

CARD NUMBERS.

5574723	26
5568311	27
5568424	28
5574803	29
5574887	30
5574967	31
5575047	32
5575184	33
5575808	34
9065282	35
	36
	37
	38
	39
	40
	41
	42
	43
	44
	45
	46
	47
	48
	49
	50

Book Mark:

See also:

B | 6 | U.S.C.T.

Samuel Bayard

Co. *F*, 6 Reg't U. S. Col'd Inf.

Appears on

Company Descriptive Book

of the organization named above.

DESCRIPTION.

Age *24* years; height *5* feet *7* inches.

Complexion *Blk*

Eyes *Dark*; hair *Blk*

Where born *New Castle Delaware*

Occupation *Laborer*

ENLISTMENT.

When *Aug 12*, 186 *3*.

Where *Superior Del*

By whom *1 Q. Del*; term *3* y'rs.

Remarks: *Drafted killed in action at Baglarz House Va by a grape shot Feb 10, while charging a rebel work*

J. G. Reevs

B | 6 | U.S.C.T.

Samuel Bayard

Appears with rank of *Priv* on
**Muster and Descriptive Roll of a Detach-
 ment of Drafted Men and Substitutes
 forwarded**

for the *6* Reg't U. S. Col'd Inf. Roll dated
Smyrna Del, Aug 29, 1863.

Where born *New Castle City Del.*
 Age *24* years; occupation *Salver*

Drafted and mustered in:

When *Aug 12*, 1863.

Where *Smyrna Del. 1 Dist Del.*

Period *3* years.

Eyes *Dark*; hair *black*

Complexion *black*; height *5 ft. 7 in.*

Paid bounty and advance pay, \$ *100*

Bounty due \$ *100*

Where credited _____

Company to which assigned _____

Remarks: *Drafted*

Book mark: _____

Lawmer

B | 6

U.S.C.T.

Samuel Bayard

Appears with rank of *Pri* on

Muster and Descriptive Roll of a Detachment of Drafted Men and Substitutes forwarded

for the *6* Reg't U. S. Col'd Inf. Roll dated

Smymna Del, Aug 29, 1863.

Where born *New Castle Co Del*

Age *24* years; occupation *Laborer*

Drafted and mustered in:

When *Aug 12*, 1863.

Where *Smymna Del*

Period *3* years.

Eyes *Dark*; hair *Blk*

Complexion *Blk*; height *5* ft *7* in.

Paid bounty and advance pay, \$ *100*

Bounty due \$ *100*

Where credited *1 Dist Del*

Company to which assigned

Remarks: *Drafted*

Book mark:

L. H. Wright

3

6

U.S.C.T.

Samuel Bayard
Capt, Co. F, 6 Reg't U. S. Col'd Infantry.

Age 24 years.

Appears on

Company Muster-in Roll

of the organization named above. Roll dated

Phila Pa, Oct 15, 1863.

Muster-in to date

Aug 12, 1863

Joined for duty and enrolled:

When Aug 12, 1863.

Where Smyrna Del.

Period 3 years.

Remarks:

Book mark:

C. H. Brown

6 | **6** | **U.S.C.T.**

Samuel Gayard
Cot, Co. F, 6 Reg't U. S. Col'd Infantry.

Appears on

Company Muster Roll

for Muster in to Oct 31, 1863.

Present or absent Present

Stoppage, \$ 100 for _____

Due Gov't, \$ 100 for _____

Remarks: On daily duty as G. Cook

Book mark: _____

E. H. Brown.

B | 6 | U.S.C.T.

Samuel Payard
Priv, Co. F, 6 Reg't U. S. Col'd Infantry.

Appears on

Company Muster Roll

for Nov & Dec, 1863.

Present or absent Present

Stoppage, \$ 100 for

Due Gov't, \$ 100 for

Remarks:

Book mark:

E. H. Baum

Q

6

U.S.C.T.

Samuel Gayard
Pot, Co. F, 6 Reg't U. S. Col'd Infantry.

Appears on

Company Muster Roll

for Jan Feb, 1864.

Present or absent Present

Stoppage, \$ 100 for

Due Gov't, \$ 100 for

Remarks:

Book mark:

E. H. Bann

(358)

Copyist.

S | **6** | **U.S.C.T.**

Samuel Gayard
Priv, Co. F, 6 Reg't U. S. Col'd Infantry.

Appears on

Company Muster Roll

for *Mar + Apr*, 186*4*.

Present or absent *Present*

Stoppage, \$ *100* for

Due Gov't, \$ *100* for

Remarks:

Book mark:

C. H. Brown

B

6

U.S.C.T.

Samuel Bayard.
Put, Co. F, 6 Reg't U. S. Col'd Infantry.

Appears on

Company Muster Roll

for May + June, 1864

Present or absent

Stoppage, \$ 100 for

Due Gov't, \$ 100 for

Remarks: Killed in action
before Petersburg, Va.
June 15. Due U. S.
for extra clothing \$6.75

Book mark:

McDavis

P.

6

U.S.C.T.

Emuel Bayard

Priv, Co. *F*, 6 Reg't U. S. Col'd Infantry.

Appears on **Co. Muster-out Roll**, dated
Wilmington N.C., Sept. 24, 1865.

Muster-out to date _____, 186 .

Last paid to _____, 186 .

Clothing account:

Last settled _____, 186 ; drawn since \$ _____ 100

Due soldier \$ _____ 100; due U. S. \$ _____ 100

Am't for cloth'g in kind or money adv'd \$ _____ 100

Due U. S. for arms, equipments, &c., \$ _____ 100

Bounty paid \$ _____ 100; due \$ _____ 100

Remarks: *Killed in action before
Petersburgh Va June 18/64*

**Supplied from May to June 64 Roll*

Book mark: *2241 P 163 78*

Lawrence

(361)

Copyist.

Bayard, Samuel

B, Co. F

6 Reg' U.S.C. Inf.

Enclosures.

Bed Cards	Descriptive Lists
Burial Records	Final Statements /
Certs. of Dis. for Discharge	Furloughs
C. M. Charges	Med. Des. Lists
Med. Certificates	Orders

Other papers relating to—

Admission to Hosp'l	Furlough
Casualty Sheet (Officer's)	Med. Examination
Confinement	Misc. Information
Contracts	Pay or Clothing
Death or Effects	Personal Reports
Desertions	Rank
Discharge from Hosp'l	Transfer to Hosp'l
Discharge from Service	Transfer to V. R. C.
Duty	Transportation

✓

G.

FINAL STATEMENT

OF

Private Samuel Raymond Co. "I"

6th Reg't of U.S. Colored Troops

VOLUNTEERS.

Disd June 15th 1864

NOTE 1.—Two of these certificates (or duplicates) are to be given to each Volunteer Soldier or drafted man who may be discharged previously to the discharge of his company, that he may at once receive from the Paymaster the pay, &c., due him, and the captain or other COMMISSIONED officer commanding the company will certify to the act of the delivery of the duplicate certificates; on these certificates the Soldier is "entitled to" his discharge, and should also present his discharge to the Paymaster to have the payment endorsed on it. The discharge is to be given back to the Soldier by the Paymaster; the latter only retaining as his voucher the duplicate certificates.

NOTE 2.—If the Soldier is entitled to pay for the use of his horse, the Company Commander will certify to that fact on the back of both these final statements, and also to the time he has pay due for having been so mounted on his own horse.

NOTE 3.—When a Soldier is furnished with final statements, his descriptive list, if he has one, should be taken up by the officer who gives the Soldier these statements, and endorsed with a statement to this effect by the officer. This endorsement should exhibit a full statement of the time for which the Soldier was allowed pay on his final statements, the clothing account, and all other charges against him or in his favor, so as to comprise a complete exhibit of his account. It will then be transmitted to the company commander of the Soldier, who will enter all the data necessary to a full understanding of the Soldier's account on the muster roll upon which the Soldier's discharge is reported. The descriptive list will then be destroyed. The object of this is, that the remaining portion of the Soldier's account may be settled upon the receipt of these muster rolls, and the Soldier receive any pay or allowances that may be due him at the time of his discharge, and which may not appear on his final statements from the fact that his descriptive list is incomplete. These accounts for back pay, &c., are settled by the 2d Auditor of the Treasury Department.

NOTE 4.—Charges for loss or injury to ordnance, horse equipments, and other miscellaneous charges, should appear under the heading of "Other Stoppages."

NOTE 5.—Bounty paid by State authorities, and not by the United States, will not be entered on this statement.

NOTE 6.—Amounts due the Sutler and Laundress must be entered on the muster roll on which the discharge, death, desertion, &c., is reported, as well as on the final statement, otherwise the amount cannot be collected from the United States.

NOTE 7.—This blank will be used for deceased volunteers and drafted men, as well as for others.

NOTE 8.—Where a Soldier dies in Hospital or on detached service, his descriptive list, if he has one, should be sent with his final statements, in duplicate, to the Second Auditor, Washington, D. C.

ADJUTANT GENERAL'S OFFICE.

July 5th 1864

Duplicate with inventory sent 2d Auditor.

Ent on Recd. Cert. [Circular Stamp]

I certify, on honor, that Samuel Bayard a private of
 Captain A. G. Wotchkiss' Company (II) of the A Regiment of U. S. Colored Troops
VOLUNTEERS, of the State of Delaware, born in New Castle, State
 of Delaware, aged 24 years; 5 feet 7 inches high; Dark complexion,
Dark eyes, Black hair, and by occupation a Laborer, having joined the company on
 its original organization at Camp William Penn, and enrolled in it at the muster into
 the service of the United States at Philadelphia Pa, on the 12th day
 of August, 1863, (or was mustered in service as a recruit, by
 _____, at _____, on the _____ day of _____,
 186 , or was drafted and mustered into the service of the United States from the _____
 Enrollment District of the State of _____, at _____,
 on the _____ day of _____, 186) to serve in the Regiment, for
 the term of Three Years: and having served HONESTLY and
 FAITHFULLY with his Company in 6th U. S. Colored Troops to the present date, is now
 entitled to a **DISCHARGE** by reason of Death
(Died June 15th 1864 see inventory)

The said Samuel Bayard was last paid by Paymaster
Maj. M. Keenan to include the 30th day of April, 1864, and has
 pay due him from that time to the present date; he is entitled to pay and subsistence for
TRAVELING to place of enrollment, and whatever other allowances are authorized to volunteer
 soldiers, drafted men, or militia, so discharged. He has received from the United States **CLOTHING**
 amounting to 42 ¹⁰/₁₀₀ dollars, since the _____ day of enlistment,
 186 , when his clothing account was last settled. He has received from the United States
 _____ ¹⁰⁰/₁₀₀ dollars advanced **BOUNTY**.

There is to be stopped from him, on account of the State of _____, or other
 authorities, for **CLOTHING**, &c., received on entering service, _____ ¹⁰⁰/₁₀₀ dollars; and
 for other stoppages, viz: _____
 _____ ¹⁰⁰/₁₀₀ dollars.

He has been furnished with **TRANSPORTATION** in kind from the place of his discharge to
 _____; and he has been **SUBSISTED** for **TRAVELING** to his
 place of enrollment, up to the _____, 186 .

He is indebted to _____, **SUTLER**, _____ ¹⁰⁰/₁₀₀ dollars.
 He is indebted to _____, **LAUNDRESS**, _____ ¹⁰⁰/₁₀₀ dollars.

Given in Duplicate, at New Petersburg Va, this 27th day
 of June, 1864.

Newton J. Wotchkiss

 Captain
 Commanding Company

William
W. W. W., **6** U.S. Col'd Inf.

Private

Private

CARD NUMBERS.

1	5577081	26
2	5577163	27
3	5577251	28
4	5577332	29
5	5577411	30
6	5577490	31
7	5577563	32
8	5577632	33
9	5577706	34
10	5577869	35
11	5578135	36
12	19122267	37
13	9065515	38
14		39
15		40
16		41
17		42
18		43
19		44
20		45
21		46
22		47
23		48
24		49
25		50

Book Mark: *EP. 12/331.*

See also _____

B

6

U.S.C.T.

Patterson Ogier,

A, Co *A*, 6 Reg't U. S. Col'd Inf.

Appears on

Company Descriptive Book

of the organization named above.

DESCRIPTION.

Age *28* years; height *6* feet *1* inches.

Complexion *Blk*

Eyes *Blk*; hair *Blk*

Where born *Westmoreland Penn.*

Occupation *Farmer*

ENLISTMENT.

When *Sept 5*, 186 *3*.

Where *Phila. Pa.*

By whom *6 D. Pa.*; term *3* y'rs.

Remarks: *Mustered by Capt*
Coulter.

Discharged for
Physical Disability.

Jenkins

B 1 6 U.S.G.T

Statterson Bazier

Appears with rank of _____ on

Muster and Descriptive Roll of a Detachment of Drafted Men and Substitutes forwarded

for the *6* Reg't *U.S.G.T*. Roll dated *Greensburg Pa Sept 3*, 1863.

Where born *Westmoreland Co Pa*

Age *28* y'rs; occupation *Farmer*

Drafted and mustered in:

When *July 16*, 186 .

Where *Greensburg Pa*

Period *3* years.

Eyes *Black*; hair *Curly*

Complexion *Black*; height *6 ft 1* in.

Paid bounty and advance pay, \$ *100*

Bounty due, \$ *100*

Where credited _____

Company to which assigned *A*

Remarks *Principal*

Book mark: _____

Reeves

B | **6** | **U.S.C.T.**

Patterson Bazier

Priv, Co. *H*, 6 Reg't U. S. Col'd Infantry.

Age *28* years.

Appears on

Company Muster-in Roll

of the organization named above. Roll dated

Phila. Pa Sept 14, 186*3*.

Muster-in to date *July 16*, 186*3*

Joined for duty and enrolled:

When *July 16*, 186*3*.

Where *Greensburg Pa*

Period *3* years.

Remarks: *mustd. by Capt. Boultier*
P.M. July 16/63.
drifted.

Book mark :

W. H. Thompson

B

6

U.S.C.T.

Patterson Bazier
Cvt, Co. H, 6 Reg't U. S. Col'd Infantry.

Appears on

Company Muster Roll

for Sept 14 to Oct 31, 1863.

Present or absent Present

Stoppage, \$ 100 for

Due Gov't, \$ 100 for

Remarks: On Daily duty
as Co. Cook

Book mark:

W. H. Thompson
Copyist.

B

6

U.S.C.T.

Patterson Bazier

Pr, Co. H, 6 Reg't U. S. Col'd Infantry.

Appears on

Company Muster Roll

for *Nov. & Dec*, 1863.

Present or absent *Present*

Stoppage, \$ *100* for

Due Gov't, \$ *100* for

Remarks: *On daily duty as
Co. Cook*

Book mark:

W. A. Simpson
Copyist.

B | 6 | U.S.C.T.

Patterson Bazier
Pvt., Co. H, 6 Reg't U. S. Col'd Infantry.

Appears on

Company Muster Roll
for *Jerry & Leby*, 1864.

Present or absent *Absent*

Stoppage, \$ 100 for

Due Gov't, \$ 100 for

Remarks: *Co. Cook*

Book mark:

(358)

W. H. Thompson
Copyist.

B | 6 | U.S.C.T.

Patterson Bazier
Pvt, Co. H, 6 Reg't U. S. Col'd Infantry.

Appears on

Company Muster Roll

for Mehrapl, 1864.

Present or absent Absent

Stoppage, \$ 100 for

Due Gov't, \$ 65 for Ordnance stores

Remarks: Sick in McClellan Hosp'l
Va.

Book mark: _____

M. H. Thompson

(358)

Copyist.

B

6

U.S.C.T.

Patterson Bazier

Priv, Co. H, 6 Reg't U. S. Col'd Infantry.

Appears on

Company Muster Roll

for *May & June*, 1864.

Present or absent *Absent*

Stoppage, \$ *100* for

Due Gov't, \$ *100* for

Remarks: *Absent sick in
McClellan Genl Hosp
since April 29, 1864*

Book mark:

C. H. Harper

B

6

U.S.C.T.

Patterson Bazier

Priv, Co. H, 6 Reg't U. S. Col'd Infantry.

Appears on

Company Muster Roll

for *July & Aug*, 1864.

Present or absent *Absent*

Stoppage, \$ *100* for

Due Gov't, \$ *100* for

Remarks: *Free April 19/61*
Absent sick since
April 29/64

Book mark:

C. Harper

B

6

U.S.C.T.

Patterson Brazier

Pri, Co. H, 6 Reg't U. S. Col'd Infantry.

Appears on

Company Muster Roll

for *Sept Oct*, 1864.

Present or absent *Absent*

Stoppage, \$ *100* for

Due Gov't, \$ *100* for

Remarks: *Free April 19/61*
Absent Sick since
April 29/64

NEXT ROLL ON FILE FEB 1865

Book mark:

C. H. Payne

(358)

Copyist.

B | 6 | U.S.C.T.

Patterson Bazier
Priv, Co. H, 6 Reg't U. S. Col'd Infantry.

Appears on

Company Muster Roll

for *Jan & Feb*, 1865.

Present or absent *Absent*

Stoppage, \$ 100 for

Due Gov't, \$ 100 for

Remarks: *Free April 19/61*
Absent Sick
Received \$7.00 to May
1st 1864

Book mark:

C. A. Harper

(858)

Copyist.

68

6

U.S.C.T.

Patterson Bazier

Priv, Co. H, 6 Reg't U. S. Col'd Infantry.

Appears on

Company Muster Roll

for *Mar & April*, 186*5*.

Present or absent _____

Stoppage, \$ _____ 100 for _____

Due Gov't, \$ _____ 100 for _____

Remarks: *# Died. Discharged
Jan, 3, '65 at DeCamp
Gen. Hosp. Harids
Island N.Y.*

*#
As says Roll*

Book mark: _____

C. A. Harper

(358)

Copyist.

3

6

U.S.C.T.

Patterson Bazier

Prvt, Co H, 6 Reg't U. S. Col'd Infantry.

Appears on Co. Muster-out Roll, dated
Wilmington N.C., Sep 20, 1865.

Muster-out to date _____, 186 .

Last paid to _____, 186 .

Clothing account:

Last settled _____, 186 ; drawn since \$ _____ 100

Due soldier \$ _____ 100; due U. S. \$ _____ 100

Am't for cloth'g in kind or money adv'd \$ _____ 100

Due U. S. for arms, equipments, &c., \$ _____ 100

Bounty paid \$ _____ 100; due \$ _____ 100

Remarks: Discharged from Hospital Jan 20/65

Book mark: 1624-1882-343,071

Disch'd Jan 3/65 EB 12/33

Italcampa

(361)

Copyist.

Dazier, Patterson

P, Co. *H*, *6* Reg't *USCJ*

2 Enclosures.

Bed Cards	Final Statements
Burial Records	Furloughs or L. of A
Certs. of Dis. for Discharge /	Med. Certificates
C. M. Charges	Med. Des. Lists
Descriptive Lists	Orders
Discharge Certificates	Pris. of War Record
Enlistment Papers	Resignations

Other papers relating to—

Admission to Hosp'l	Furlough or L. of A
Casualty Sheet /	Med. Examination
Confinement	Misc. Information
Contracts	Pay or Clothing
Death or Effects	Personal Reports
Desertion	Rank
Discharge from Hosp'l	Transfer to Hosp'l
Discharge from Service	Transfer to V. R. C.
Duty	Transportation

WAR 951

[OFFICE ENDORSEMENT.]

War Department,

ADJUTANT GENERAL'S OFFICE,

May 21, 18*71*

The Discharge of *Pvt Patterson*
Barber, Co. *100*, *6th* Reg't U.S.
Colored *Troops*, is reported as follows:

On Company Muster Roll.
For *March & April*, 1865, *January*, 1865
Company Muster-out Roll.

..... *January 20*, 1865
Company Descriptive Book.

..... 186
Company Morning Reports.

..... 186
Soldier's Final Statement.

..... 186
Soldier's Record of Death and Interment.

..... 186
Soldier's Inventory of Effects.

..... 186
Soldier's Certificate of Disability for Discharge.

..... *January*, 1865
Soldier's Individual Muster-out Roll.

..... 186
Regimental Return.

For 186, 186
Regimental Quarterly Returns.

..... 186
Regimental Descriptive Book.

..... 186
By Surgeon General.

(.....) *January 31*, 1865, is held to be
the correct date, and the Company Muster
Roll will be amended accordingly.

Thomas M. Sweet

Assistant Adjutant General.

Noted H.M.

613 1/2
331

Letter to Patterson

NOTE 1.

The company commander will here add a statement of all the facts known to him concerning the disease or wound, or cause of disability of the soldier; the time, place, manner, and all the circumstances under which the injury occurred, or disease originated or appeared; the duty, or service, or situation of the soldier at the time the injury was received or disease contracted, stating particularly whether the injury was received or the disease contracted in the line of his duty; and whatever other facts may aid a judgment as to the cause, immediate or remote, of the disability, and the circumstances attending it.

When the facts are not known to the company commander, the certificate of any officer, or affidavit of other person having such knowledge, will be appended—as the surgeon in charge of a hospital, the officer commanding a detachment of recruits, &c., &c.

NOTE 2.

When a probable case for pension, special care must be taken to state the degree of disability—as $\frac{1}{2}$, $\frac{2}{3}$, &c., &c.; to describe particularly the disability, wound, or disease; the extent of which it deprives him of the use of any limb or faculty, or affects his health, strength, activity, constitution, or capacity to labor or earn his subsistence. The surgeon will add, from his knowledge of the facts and circumstances, and from the evidence in the case, his professional opinion of the cause or origin of the disability. In the case of discharges by Medical Inspectors, the last paragraph will state that the "discharge was given by consent of the soldier, after a personal examination, and for disability, the nature, degree, and origin of which are correctly described in the within certificate."

Par. 1260 Regulations, Edit. 1861.

Medical officers, in giving certificates of disability, are to take particular care in all cases that have not been under their charge; and especially in epilepsy, convulsions, chronic rheumatism, derangement of the urinary organs, ophthalmia, ulcers, or any obscure disease liable to be feigned or purposely produced; and in no case shall such certificate be given until after sufficient time and examination to detect any attempt at deception.

DIRECTIONS.

This certificate will be made out in duplicate by the soldier's company commander, or other officer commanding the separate detachment to which he belongs, and sent by him to the surgeon who has charge of the hospital where the soldier is sick. The surgeon will then fill out and sign the surgeon's certificate, and forward these papers to the regimental, detachment, or post commander, who will forward them, with his action endorsed thereon, through the proper channel, to his division commander; or, if the troops are not attached to a division, to his corps, department, or other commander or officer to whom the authority to discharge enlisted men may be specially delegated.

These certificates, after having received the action of the highest authority to which they are required to be sent, will be returned through the same channel to the regimental, post, or detachment commander, who will, if the discharge is authorized by the endorsement of the proper authority, sign the soldier's discharge, and the last certificate on this paper; see that the soldier is furnished with the proper final statements in duplicate, and forward BOTH of these certificates direct to the Adjutant General United States Army, at Washington, D. C.; they will not, under any circumstances, be given on the hands of the soldier.

ADJUTANT GENERAL'S OFFICE
Jan 4th 1865
Duplicate sent the Pension Office.

P. H. Prof Dis. 2.
1865

CERTIFICATE OF DISABILITY FOR DISCHARGE

IN THE CASE OF

Patterson Bazier
a Private Co. "H"
6th Reg't of U.S.C.T.

APPROVED

Cellhouseyell
Surgeon, U. S. A.,
Medical Director Dept of the East

HEADQUARTERS DEPARTMENT OF THE EAST,

NEW YORK CITY, Dec. 27th, 1864.

To be discharged.

BY COMMAND OF MAJOR GENERAL DIX:

W. L. W.

Capt. and A. D. C., A. A. A. G.

Received (A. G. Office)



186

On on [Handwritten signature]

ARMY OF THE UNITED STATES. CERTIFICATE OF DISABILITY FOR DISCHARGE.



Private *Patterson Bazier*, of Captain *George W. Sheldon's* Company, (*No.*) of the *Ninth* Regiment of the United States *Cold Troops* was enlisted by *Drafted* of the _____ Regiment of _____ at *Harrisburg Penn.* on the *Sixteenth* day of *July*, 1863, to serve *three* years; he was born in *Watson and Co.* in the State of *Penn.* is *Twenty eight* years of age, *six* feet _____ inches high, *black* complexion, *black* eyes, *black* hair, and by occupation when enlisted a *Farmer*. During the last two months said soldier has been unfit for duty *61* days.*

St Camp Genl Hospital
STATION: *David's Island N.Y.*
DATE: *Dec. 23 1864*

Warren Webster
Asst. Surg. USA
Commanding Company Hosp.

I CERTIFY, that I have carefully examined the said *Patterson Bazier* of Captain *Geo. W. Sheldon's* Company, and find him incapable of performing the duties of a soldier because of *Right inguinal hernia the result of injury received in the line of his duty* degree of disability *two thirds*.

Being a negro he is not a subject for the Vet Res Corps
Warren Webster
Asst. Surgeon, USA
In charge

DISCHARGED, this *Third* day of *January*, 1865, at *St Camp Genl Hospital David's Island N.Y.*
Warren Webster
Asst. Surg. USA
Commanding the Regt. Hosp.

The Soldier desires to be addressed at
Town *Brownville* County *Payette* State *Penn.*

* See Note 1 on the back of this. † See Note 2 on the back of this

CASUALTY SHEET

No.

Patterson Bazier

Priv of Company *A*

6 Regiment of *U.S.C.T.*

State Volunteers.

NATURE OF CASUALTY.

Discharge Jan 3, 65



CASUALTY SHEET.

Name: *Patterson Bazier*
 Rank: *Pop* Company: *N* Regiment: *6*
 Arm: *Inf* State: *USCT*
 Nature of Casualty: *Discharge*

CAUSE OF CASUALTY—(NAME OF DISEASE, &c.)	BY WHOM DISCHARGED.
<i>Disability</i>	
DEGREE OF DISABILITY.	FROM WHAT SOURCE THIS INFORMATION WAS OBTAINED.
BY WHOM CERTIFIED.	<i>Roll no 39. De Camp</i>
<i>Warren Webster</i>	<i>Hospl. Recd.</i>
<i>a. Surg USA</i>	REMARKS.
DATE OF DISCHARGE, DEATH, &c.	
<i>Janry 3. 65</i>	
PLACE OF DISCHARGE, DEATH, &c.	
<i>Davidson N.Y.N.</i>	

A.D. Bailie
 Clerk.

800

6 U.S. Gold Inf.

Private

Private

CARD NUMBERS.

557 0160	26
557 0243	27
557 0328	28
557 0407	29
557 0482	30
557 0563	31
557 0638	32
557 0712	33
557 0889	34
557 1305	35
906 45-45	36
	37
	38
	39
	40
	41
	42
	43
	44
	45
	46
	47
	48
	49
	50

Book Mark:

See also

B

6

U.S.C.T.

John Beecham

B, Co. *B*, 6 Reg't U. S. Col'd Inf.

Appears on

Company Descriptive Book

of the organization named above.

DESCRIPTION.

Age *21* years; height *5* feet *5* inches.

Complexion *Brown*

Eyes *Blue*; hair *Black*

Where born *Dover, Del*

Occupation *Hostler*

ENLISTMENT.

When *July 29*, 186*3*.

Where *Philada, Pa*

By whom *Lt Col. Wagner*, term *3* y'rs.

Remarks: *Deserted Oct 15/65 at Chapins Farm, Va*

W J Roe

J | **6** | **U.S.C.T.**

John Prachman
Co. *B*, 6 Reg't U. S. Col'd Infantry.

Age *20* years.

Appears on

Company Muster-in Roll

of the organization named above. Roll dated
Philadelphia Pa., Aug. 3rd, 1863.

Muster-in to date *July 29th, 1863.*

Joined for duty and enrolled:

When *July 29th*, 186*3*

Where *Phila. Pa.*

Period *3* years.

Remarks:
.....
.....
.....
.....
.....
.....

Book mark:

H. S. Branden

B.

6

U.S.C.T.

John Beeham

Priv., Co. B, 6 Reg't U. S. Col'd Infantry.

Appears on

Company Muster Roll

for *From Muster in to Oct 31*, 1863.

Present or absent *Present*

Stoppage, \$ *100* for

Due Gov't, \$ *100* for

Remarks:

Book mark:

H. E. Brandon

P.

6

U.S.C.T.

John Beecham
Priv't, Co. B, 6 Reg't U. S. Col'd Infantry.

Appears on

Company Muster Roll

for *Nov. & Dec.*, 1863.

Present or absent *Present*

Stoppage, \$ *100* for

Due Gov't, \$ *100* for

Remarks:

Book mark: _____

J. R. Brandon

P.

6

U.S.C.T.

John Beecham
Priv't, Co. B, 6 Reg't U. S. Col'd Infantry.

Appears on

Company Muster Roll

for *Jan. & Feb.*, 1864.

Present or absent *Present*

Stoppage, \$ *100* for

Due Gov't, \$ *100* for

Remarks:

Book mark:

J. E. Brandon

P.

6

U.S.C.T.

John Peckham
Priv't, Co. B, 6 Reg't U. S. Col'd Infantry.

Appears on

Company Muster Roll
for *Mar. & Apr.*, 1864.

Present or absent *Present*

Stoppage, \$ 100 for

Due Gov't, \$ 100 for

Remarks:

Book mark:

H. S. Brandon

B

6

U.S.C.T.

John Beecham

Priv, Co. B, 6 Reg't U. S. Col'd Infantry.

Appears on

Company Muster Roll

for *May & June, 1864*

Present or absent *Present*

Stoppage, \$ 100 for

Due Gov't, \$ 100 for

Remarks:

Book mark:

J. M. Leonard

(358)

Copyist

B | 6 | U.S.C.T.

John Peachum

Private, Co. B, 6 Reg't U. S. Col'd Infantry.

Appears on

Company Muster Roll

for July & Aug, 1864.

Present or absent Present

Stoppage, \$ 1.00 for

Due Gov't, \$ 1.00 for

Remarks: Extra duty on Canal. Free apl. 19/61

Book mark:

M. Leonard

S

6

U.S.C.T.

John Beacham

Pr, Co. B, 6 Reg't U. S. Col'd Infantry.

Appears on

Company Muster Roll

for *Sept 8, 1864*, 1864.

Present or absent *Absent*

Stoppage, \$ *100* for

Due Gov't, \$ *100* for

Remarks: *Absent without leave*

NEXT ROLL ON FILE FEB 1865

Book mark:

J. W. Leonard

(358)

Copyist

B | 6 | U.S.C.T.

John Beacham
Pvt, Co. B, 6 Reg't U. S. Col'd Infantry.

Appears on

Company Muster Roll

for Jan. & Feb., 1865.

Present or absent

Stoppage, \$ 100 for

Due Gov't, \$ 100 for

Remarks: Deserted Oct
15/64 at Chapin's
Farm, Va

Book mark:

J. L. ...
(358) Copyist

B. 1 6 | U.S.C.T.

John Beacham
Co. B, 6 Reg't U. S. Col'd Infantry.

Appears on Co. Muster-out Roll, dated
Wilmington, NC, Sept 24, 1865.

Muster-out to date _____, 186 .

Last paid to _____, 186 .

Clothing account:

Last settled _____, 186 ; drawn since \$ _____ 100

Due soldier \$ _____ 100; due U. S. \$ _____ 100

Am't for cloth'g in kind or money adv'd \$ _____ 100

Due U. S. for arms, equipments, &c., \$ _____ 100

Bounty paid \$ _____ 100; due \$ _____ 100

Remarks: Deserted from Chapins
Farm N. Oct. 15, 1864

Book mark: 71290208.71

(861)

B. J. Cook
Copyist.

Beachman, John

Co. *D*, Reg't *USCT*

Enclosures.

Bed Cards	Final Statements
Burial Records	Furloughs or L. of A
Certs. of Dis. for Discharge	Med. Certificates
C. M. Charges	Med. Des. Lists
Descriptive Lists	Orders
Discharge Certificates	Pris. of War Record
Enlistment Papers	Resignations

Other papers relating to—

Admission to Hosp'l	Furlough or L. of A
Casualty Sheet	Med. Examination
Confinement	Misc. Information <i>/</i>
Contracts	Pay or Clothing
Death or Effects	Personal Reports
Desertion	Rank
Discharge from Hosp'l	Transfer to Hosp'l
Discharge from Service	Transfer to V. R. C.
Duty	Transportation

My Ellerbrook

John Beaehman

Co "D" 6th U.S.C.T.

Adjutant General's Office,

COLORED TROOPS BRANCH,

Sept 14th, 1876

Mr. Elliott Vol. C. T., 187
Wanted in the case of John Beauchamp, Co. "B",
Reg't U. S. C. Troops

When returned and if true
and Cert for reports from "Absent without leave"

Respectfully,

E. A. Woodward
Chief Clerk.

Adjutant General's Office,

, 187

Vol. C. T., 187
Reply in case of John Beauchamp, Co. "B",
Reg't U. S. C. T.

Mo. reports from Sept. 8th 64. to March 1st 65
are missing. Dr. Book reports John Beauchamp
deserted Oct. 15th 1865 at Chapin's Farm Va.
Records of regt. - no evidence of trial.

Sept. 16th 76. B.

U.S. GOVERNMENT

Private | *Private*

CARD NUMBERS.

	26	
<i>Boacham</i>	27	<i>John</i>
	28	
	29	
	30	
	31	
	32	
	33	
	34	
	35	
	36	
	37	
	38	
	39	
	40	
15	41	
17	42	
18	43	
19	44	
20	45	
21	46	
22	47	
23	48	
24	49	
25	50	

Book Mark:

See also

Captain

Captain

CARD NUMBERS.

5569050	26
5569134	27
5569218	28
5569290	29
5569362	30
5569432	31
5569502	32
5569572	33
5569642	34
5569735	35
5569835	36
5569927	37
5570016	38
9428635	39
	40
	41
	42
	43
	44
	45
	46
	47
	48
	49
	50

Book Mark:

See also

1500771
8/14/44 J.L.C.

55 pt. Robt. B. Hook, 19032484 422011
Marchfield, Riverside, Calif. 2/14/44

B | 6 | U.S.C.T.

Robert B. Beath

Capt, Co., 6 Reg't U. S. Col'd Inf.

Appears on

Regimental Descriptive Book

(List of Commissioned Officers)

of the regiment named above.

Rank *Capt*

Date of appointment *Aug 26* 1863.

Remarks: *Accepted Aug. 29/63.*

Mustered Sept. 1/63.

*Wounded, and left leg
amputated at action at
New Market Heights
Sept. 29, 1864.*

G. W. Chase

P

6

U.S.C.T.

Robert B. Beuth
Capt. Co. A., 6 Reg't U. S. Col'd Infantry.

Age 24 years.

Appears on

Company Muster-in Roll

of the organization named above. Roll dated
Phila Pa Oct 13, 1863.

Muster-in to date Sept 1, 1863

Joined for duty and enrolled:

When Aug 26, 1863.

Where Washington D.C.

Period 3 years.

Remarks: Appointed by the
Secty of War Aug. 26/63
appointment accepted Aug
29/63. Assigned by Col Wagner
to Co. A. Mustered by Lieut
Hildeburn W.A. Oct 7/63
Joined for duty Sept. '63

Book mark:

over
Deeds

JAN. 20

5569050

1891

from roll for Nov + Dec 20

P | **6** | **U.S.C.T.**

Robert P. Death

Capt, Co. A, 6 Reg't U. S. Col'd Infantry.

Appears on

Company Muster Roll

for *to Oct 31*, 1863.

Present or absent *Present*

Stoppage, \$ *100* for

Due Gov't, \$ *100* for

Remarks: *Appointed Aug 26/63. Accepted appointment Aug 29/63 + joined for duty at Camp Ft. Jennet. 1st 1863.*

Book mark :

Deus

P

6

U.S.C.T.

Robert B. Death

Capt, Co. A, 6 Reg't U. S. Col'd Infantry.

Appears on

Company Muster Roll

for *Nov & Dec*, 1863.

Present or absent *Present*

Stoppage, \$ *100* for

Due Gov't, \$ *100* for

Remarks:

Book mark:

(358)

Allen

Copyist.

P

6

U.S.C.T.

Robert P. Beuth

Capt, Co. A, 6 Reg't U. S. Col'd Infantry.

Appears on

Company Muster Roll

for

June & July, 1864

Present or absent

Present

Stoppage, \$

100 for

Due Gov't, \$

100 for

Remarks:

Book mark:

(358)

Allen

Copyist.

P | **6** | **U.S.C.T.**

Robert J. South

Capt, Co. A, 6 Reg't U. S. Col'd Infantry.

Appears on

Company Muster Roll

for *March + April*, 1864.

Present or absent *Present*

Stoppage, \$ *100* for

Due Gov't, \$ *100* for

Remarks: *Absent with leave
for 14 days per S.O. no 71
H.Q. Dept Va + Ch. C.
from March 25 to April 7*

Book mark:

Deer
Copyist.

B

6

U.S.C.T.

Robert B. Beath

Capt., Co. A, 6 Reg't U. S. Col'd Infantry.

Appears on

Company Muster Roll

for

May & June, 1864.

Present or absent

Present

Stoppage, \$ 100 for

Due Gov't, \$ 100 for

Remarks:

Book mark:

Ovenshaw

(358)

Copyist.

B

6

U.S.C.T.

Robert B. Beath

Capt., Co. A, 6 Reg't U. S. Col'd Infantry.

Appears on

Company Muster Roll

for July & Aug., 1864.

Present or absent Present

Stoppage, \$ 100 for

Due Gov't, \$ 100 for

Remarks:

Book mark:

Crenshaw

(358)

Copyist.

B

6

U.S.C.T.

Robert B. Beath

Capt., Co. A, 6 Reg't U. S. Col'd Infantry.

Appears on

Company Muster Roll

for Sept. & Oct., 1864.

Present or absent absent

Stoppage, \$ 100 for

Due Gov't, \$ 100 for

Remarks: Wounded in action near New Market Heights Sept. 29/64. Sent to Genl. Hospl. Ft. Monroe.

NEXT ROLL ON FILE FEB 1865

Book mark:

Crenshaw

B | **6** | **U.S.C.T.**

Robert B. Beath
Capt., Co. A, 6 Reg't U. S. Col'd Infantry.

Appears on

Company Muster Roll

for *Jan'y. & Feby.*, 1865.

Present or absent *absent*

Stoppage, \$ *100* for

Due Gov't, \$ *100* for

Remarks: *On Detached Service at Camp Wm Penn Pa., per special order dated Jan'y. 25/65 War Dept.*

Book mark:

Crenshaw

B | 6 | U.S.C.T.

Robert B. Beath
Capt., Co. A, 6 Reg't U. S. Col'd Infantry.

Appears on

Company Muster Roll

for *Mch. & Apl.*, 1865.

Present or absent *absent*

Stoppage, \$ 100 for

Due Gov't, \$ 100 for

Remarks: *Wounded Sept. 29"*
near New Market Heights
Va. On detached service
at Camp Wm Penn Pa.
per S.O. no. 25 dated Jan'y 17,
1865 War Dept.

Book mark:

Overshaw

C

6

U.S.C.T.

Robert B. Beach
Co. A, 6 Reg't U. S. Col'd Infantry.

Appears on

Company Muster Roll

for Nov 9 1865, 1865.

Present or absent Absent

Stoppage, \$ 100 for

Due Gov't, \$ 100 for

Remarks:

Wounded Sept. 28
1864 in action near
New Market Heights
Va. on detached service
at Camp Wm Penn Pa.
per S.O. No. 25 Dated
Jan. 17 65 War Dept.

Book mark:

W. A. Edwards

(358)

Copyist.

B

6

U.S.C.T.

Robert B. Beath

Capt., Co. A, 6 Reg't U. S. Col'd Infantry.

Appears on

Company Muster Roll

for *July & Aug*, 1865.

Present or absent *Absent*

Stoppage, \$ 100 for

Due Gov't, \$ 100 for

Remarks:

*In detached service
in Freedman's Bureau
Southern Dist. Va.*

Book mark:

W. A. Edwards
Copyist.

B

6

U.S.C.T.

Robert B. Beath

Capt., Co. A., 6 Reg't U. S. Col'd Infantry.

Appears on Co. Muster-out Roll, dated
Wilmington, N. C., Sept 20, 1865.

Muster-out to date Sept 20, 1865.

Last paid to July 31, 1865.

Clothing account:

Last settled....., 186 ; drawn since \$..... 100

Due soldier \$..... 100; due U. S. \$..... 100

Am't for cloth'g in kind or money adv'd \$..... 100

Due U. S. for arms, equipments, &c., \$..... 100

Bounty paid \$..... 100; due \$..... 100

Remarks:

Rel'd from detached
service in Freedmen's
Bureau Sept. 14 65
per S. O. No. 146 Regrs.
Dist. of Wilmington
over

Book mark:

A. R. Edwards

JAN. 20

5570016

1891 *

*\$10 due for bond,
No. 2, in Sept. '86.*

Death, Robt D

Capt, Co. A, 6 Regt USCT

13 Enclosures.

Bed Cards	Final Statements
Burial Records	Furloughs or L. of A
Certs. of Dis. for Discharge	Med. Certificates 1
C. M. Charges	Med. Des. Lists
Descriptive Lists	Orders 7
Discharge Certificates	Pris. of War Record
Enlistment Papers	Resignations

Other papers relating to—

Admission to Hosp'l	Furlough or L. of A 1
Casualty Sheet	Med. Examination
Confinement	Misc. Information 2
Contracts	Pay or Clothing
Death or Effects	Personal Reports 2
Desertion	Rank
Discharge from Hosp'l	Transfer to Hosp'l 1
Discharge from Service	Transfer to V. R. C.
Duty	Transportation

MICROFILM PUBLICATION M 1848

COMPILED MILITARY SERVICE RECORDS
OF VOLUNTEER UNION SOLDIERS WHO SERVED WITH
THE UNITED STATES COLORED TROOPS (USCT)
6TH REGIMENT OF INFANTRY

PERSONAL PAPERS' TARGET SHEET

PLEASE NOTE THE CHECKED INFORMATION ABOUT THE PERSONAL PAPERS IN
THIS FILE:

- NO PERSONAL PAPERS WERE FOUND IN THIS FILE WHEN THE
RECORDS WERE ARRANGED FOR MICROFILMING.
- 17 PERSONAL PAPER(S) FOUND IN THIS FILE WHEN THE RECORDS
WERE ARRANGED FOR MICROFILMING.

B. 16. Hd. Quarters 1864
Brooklyn
Capl 5th Regt. U.S. C. Troops.

B. 20. 12th U.S. Inf. Yorktown Va
Application for 4
days leave.

filed & Staff present for duty	8
" " " in arrest	—
" " " Sick	—
" " " absent	—
Line Officers present for duty	20
" " " in arrest	3
" " " Sick	1
" " " absent without leave	—
" " " out	—
" " Detached	5

Hd. Qrs. 5th Regt. U.S.C.T.
Camp near Yorktown Va
March 14/64.

Approved & respectfully
forwarded,
J. W. Ames
Col. 6th U.S. Inf.

Hd. Quarters U.S. C. T.
Yorktown Va: March 15/64

Approved & respectfully
forwarded.

Saml. A. Duncan
Col. Comdg.

Hd. Qrs. U.S. 4th Inf., Yorktown, Va.
March 15th 1864

Respectfully forwarded
approved J. M. [Signature]

just

J. O. 76-3

1864

12th U.S. Inf. Yorktown Va. 15. 1864
Hd. Quarters U.S. C. T. March 15/64

Camp of 6th Regt US Colored Troops
near Yorktown Va
March 14th 1864

Major R. S. Davis
Asst Adjt General
Dep^t of Virginia & N. Carolina
Sir

I have the honor to request leave of
absence for Fourteen days to go to Salem Co New Jersey
in order to effect a settlement of guardianship for
a younger orphan brother and sister.

Hoping that this may meet your approval
I am Sir

Your O^bd^t Servant

Rob^t B Beatty

Capt Co A

6th Regt US Colored Troops

B 1868 - p a o w
B 271. M. D. O. 1864
Wear Phila 8th Dec. 1864

Chesapeake H.

J. H. Butler.

Requests the transfer of
Capt. Robt. B. Beath to
Col. Surgeon from Chesapeake and
Hosp. to Philadelphia.

Va.

Respectfully referred to
Asst Medical Director
M. C. Bellaw. M.D. for
report and recommendation.

By Order of the
Surgeon General
L. P. Gaine
Surgeon M.D.

S.G.O.
Dec 12. 64

RECEIVED.
U. S. GENERAL HOSPITAL
Dec 15, 1864
FT. MONROE

Dec 15 1864

Medical Director's Office,
Dept. Va., & North Carolina,
Fortress Monroe, Va.

December 16th 1864.

Respectfully returned:

I have the honor to report
that Capt Beath is suffering
from Amputation of right Leg.
(Operation performed Oct 1st 64)

He is convalescent and might
bear transportation, but I con-
sider it advisable that he
should not be moved for a week
or two.



M. C. Bellaw
Asst Surgeon M.D.
Asst Medical Director
Dept.

I am in
agreement with the Surgeon
of the Decision

West Phila. Dec^r 8. 1864

Surgeon-General Barnes

Dear Sir

Two gentlemen, active & prominent merchants of Phila. as well as efficient & liberal supporters of the Gov^t., request me, because themselves entirely unknown to you, to solicit, if it be proper, the transfer of Capt Robert B. Beath of 6th Reg^t. U.S.C.T. (wounded at Deep Bottom Sept. 29th and leg amputated) from the Chesapeake Gen^l Hospital to Philadelphia.

I am led to prefer this request simply by the singularly self-sacrificing character of one of the gentlemen referred to. I think you, Sir, will agree with me in thinking that he who gives freely himself & his means to the service of God & his country has the highest ground for favorable consideration in an unselfish request.

Very truly yours - J. G. Butler.

B 1868 p a a w
B 271 M.D.O. 1864
Wear Phila 8 Dec. 1864

Chesapeake H.
J. H. Butler.

Requests the transfer of
Capt. Robt. B. Beath to
Co. Troops from Chesapeake and
Hosp. to Philadelphia.
Va.

Transferred to Hospital
Respectfully referred to
Asst Medical Director
M. C. Clellan, M.D. for
report and recommendation.

By Order of the
Surgeon General
L. P. France
Surgeon M.D.

S.G.O.
Dec 12, 64

RECEIVED.
U. S. GENERAL HOSPITAL
Dec 15, 1864
FT. MONROE

15 Dec 1864

Medical Director's Office,
Dept. Va., & North Carolina,
Fortress Monroe, Va.

December 16th 1864.

Respectfully returned:

I have the honor to report
that Capt Beath is suffering
from amputation of right leg.
(Operation performed Oct 1st 64)

He is convalescent and might
bear transportation, but I con-
sider it advisable that he
should not be moved for a week
or two.



M. C. Clellan
Asst Surgeon M.D.
Asst Medical Director
Dept.

File +
Upon the Order
of the Director

B. 137 fd (mvo) 1864
U. S. Gen. Supt:
Fort Monroe Va
Dec: 20th 1864

Beath - Capt: R. B.
Co: A 6th U. S. I.

Application for Leave of Absence

M. D. Dept. Va and No. Va.
In the Files V. Dec. 31st 1864

Respy. forwarded approved

[Signature]
Surgeon Major
actg. Med. Director

[Signature]
1/1



Rec'd M. D. Dept. Va. Dec 30/64

R B Beath
Capt "A" 6th U. S. I.

Officers Division
 U. S. General Hospital
 Fortress Monroe Va.
 December 20th 1862.

Colonel -

I have the honor to request a leave of absence, based on
 the accompanying Surgeon's Certificate of Disability.

Very respectfully,

Your obedient servant:

Robert B. Smith

Capt. 1st Lt. A. 6th U.S. I. S.

1st Lt. Col. E. W. Smith -

Asst. Adj. General

Department of Va. and D. C.

U. S. General Hospital
Fort Monroe Va.
Dec: 20th 1862

E. M. Keenan U.S.A
Surgeon in Charge

Certified of disability in case
of Capt: R. B. Beuth, 6th U. S. C. I.

Capt. R. B. Beale Co A 6th U. S. I., having applied for a Certificate on which to base an application for leave of absence, I do hereby certify that I have carefully examined this Officer, and find him suffering from amputation right leg, result of gun shot wound, received in action. And that in consequence thereof he is in my opinion unfit for duty. I further declare my belief that he will not be able to perform his duties in a less period than twenty days.

U. S. General Hospital }
 Fort Monmouth, N. J. Dec: 20th 64.

E. M. Allen
 Asst. Surg. U. S. A.
 In charge.

SPECIAL ORDERS, } WAR DEPARTMENT,
No. 25. } ADJUTANT GENERAL'S OFFICE,
Washington, January 17th, 1865.

(Extract.)

* * * * *

9. Captain R. B. Beath, 6th U. S. Colored Troops, now on leave of absence, granted from Headquarters, Department of Virginia and North Carolina, in consequence of wounds received in action, is hereby detailed for duty at Camp William Penn, Philadelphia, Pennsylvania, and will report in person, without delay, to the Commanding Officer of that post.

* * * * *

By order of the Secretary of War :

W. A. NICHOLS,

Assistant Adjutant General.

OFFICIAL :

Assistant Adjutant General.

R. B. Beath

Beath, R. B.
Capt 6th U.S.C.T.

Expt

SPECIAL ORDERS, } WAR DEPARTMENT,
No. 25. } ADJUTANT GENERAL'S OFFICE,
Washington, January 17th, 1865.

(Extract.)

* * * * *
9. Captain *R. B. Beath*, 6th U. S. Colored Troops, now on leave of absence, granted from Headquarters, Department of Virginia and North Carolina, in consequence of wounds received in action, is hereby detailed for duty at Camp William Penn, Philadelphia, Pennsylvania, and will report in person, without delay, to the Commanding Officer of that post.
* * * * *

By order of the Secretary of War :

W. A. NICHOLS,

Assistant Adjutant General.

OFFICIAL:

Assistant Adjutant General.

R. B. Beath

R. B. Beach
Capt. 6 USC

a. b. o. Jan. 17. 65

Special Order 25
Extract 9

detailing Capt R. B.
Beach of Co. U. S. C. T.
for duty here.

Jan. 1899. This paper is to be used
with the records of Com. U. S. C. T. and
Troops, in the Enrollment Div. R. & H. O.

Rec'd 1908

SPECIAL ORDERS, } WAR DEPARTMENT,
No. 25. } ADJUTANT GENERAL'S OFFICE,
Washington, January 17th, 1865.

(Extract.)

* * * * *
9. Captain *R. B. Beath*, 6th U. S. Colored Troops, now on leave of absence, granted from Headquarters, Department of Virginia and North Carolina, in consequence of wounds received in action, is hereby detailed for duty at Camp William Penn, Philadelphia, Pennsylvania, and will report in person, without delay, to the Commanding Officer of that post.
* * * * *

By order of the Secretary of War :

W. A. NICHOLS,

Assistant Adjutant General.

OFFICIAL:



Assistant Adjutant General.

RECEIVED
HEAD QUARTERS,
DEPT. OF PENNSYLVANIA,
JAN 18, 1865.

(Faint handwritten notes)

Head Quarters Camp No. 1
Chelton Hills, Panama
January 24/65.

Wagner Louis Supt. Col. Condy Camp

Reports the joining for duty at the
camp of C. O. Beath Capt. Regt.

Verification of Capt. C. O.
Beath, 6th U.S. Co. I. reporting
for duty at Camp No. 1
Shows to St. Paul

Head-Quarters Camp "William Penn,"

CHELTEN HILLS, PA.

January 24th 1865.

Commanding Officer,

6th Regt. U. S. C. T.

Sir:

I have the honor to report that Capt. R. B. Beath reported for duty at this Post, by Special Order No. 25. Adj. Genl. Office dated January 17th 1865.

I have the honor to be, very respectfully

Your obedient servant

Erwin Wagner

Lt.-Col. 88th P. V., Comd'g Post.

69. 5. 10. 10. 11. 1865
Head Quarters 3rd Div. 10th A.C.
Goldboro N. C.
May 30. 1865.
Ditt. D. M.
Capt. Brudg. C. U.S. A.

Reports circumstances attending the absence of
Capt. R. B. Beath C. U.S. A.

Head Quarters 3rd Div. 10th A.C.
Goldboro N. C. June 3 1865
Respectfully forwarded
C. J. Paine
Brig Genl C & G

Head Quarters 3rd Div. 10th A.C.
Goldboro N. C. May 31st 1865
Respectfully forwarded
C. W. Wiggins
Colonel Comdg.

Head Quarters 3rd Div. 10th A.C.
Goldboro N. C. June 3 1865
Respectfully forwarded
C. J. Paine
Brig Genl C & G

Head Quarters 3rd Div. 10th A.C.
Goldboro N. C.
June 15. 1865.
Respectfully returned to
know what duty this
affairs is performing.
By order of
Brig. Genl. Geo. A. Carter
Maj. & A. A. G.

Head Quarters 3rd Div. 10th A.C.
Dist. of Beaufort.
New Bern N. C. June 19. 1865.
Respectfully returned with refer-
ence to endorsement from
Corps. Head Quarters.
By command of
Brig. Genl. Paine
Solon A. Carter
A. A. G.

Head Quarters 3rd Div. 10th A.C.
Hammonton N. C. June 23
Respectfully returned
with reference to endorse-
ment from Corps Head Quarters
By order of
Brig. Genl. Geo. A. Carter
Capt. D. A. Carter
JUN 17 1865
HEAD QUARTERS 3RD DIVISION 10TH A. C.

Head Quarters 3rd Div. 10th A.C.
571. See Hd Quarters 3rd Div. 10th A.C. May 31/65

Headquarters C. B. S. C. I.
Soldsboro N. C. May 30. 1865.

J. A. Campbell,
Asst. Adjt. Genl. Dept. of N. C.

Sir,

I have the honor to make
the following report of the absence of Robert B.
Beath Capt. C. B. S. C. I.

Capt. Beath was absent from
wounds received Sept. 29. 1865. till January 17. 1865.
when he was placed on duty at Camp M. S. Dem. Anna
per. S. O. 25. A. G. O. Washington D. C. His right
leg was amputated on account of wounds received
as above stated.

I have the honor to be

Very Respectfully

Your Obedt. Servt.

D. M. Dill

Captain C. B. S. C. I.

Comdg. Regt.

L 12 V 3 Dec 1865

Head Qrs 6th U.S.C.I.

Goldsbro. N.C.

May 31st 1865

Dill, D. M.

Capt. Comdg 6th U.S.C.I.

Reports circumstances attend-
ing the absence of Capt.
R. B. Beath 6th U.S.C.I.

Head Quarters 6th U.S.C.I.
Wilmington N.C. June 23/65

Special Order No. 25-
dated War Department
No. O. January 17th 1865.
details Captain R. B. Beath
6th U.S.C.I. for duty at Camp
M. in Penna. Phila. Penna.
but does not state the kind
and as Capt. Beath has
failed to report in accord-
ance with Par. 468, Revised
U.S. Army Regulations, the
duty he is performing is
not known -

D. M. Dill
Capt. 6th U.S.C.I.
Comdg. Regt.

Head Qrs. 3rd Brig 5th Div. 10th U.C.
Wilmington N.C. June 24. 1865

Respectfully forwarded.

A. S. Chamberlain

Lieut Colonel
Comdg.

HEADQUARTERS DIST. OF WILMINGTON.

Wilmington, N. C., June 23rd 1865.

E. B. (A.S.4.) Vol. (...2...) D. of W., 1865.

Respectfully forwarded,



D. W. James

Brig. Gen. Comd'g.

File

R. J. Beak
Reports for June 1868

Headquarters Post, Camp Wm. Penn,

Philadelphia, July 1st, 1865.

Commanding Officer
 C^o Regt U.S. Colored Troops

Sir

In accordance with Par 408 Revised Regulations
 I have the honor to report that I am on 'Detached
 service' at this Post by virtue of Special Orders No 25
 War Department A. G. O. dated Washington D. C.
 January 17 1865. and am on duty here as
 Adjutant of the Post.

Very Respectfully

Your Obedt Servant

Robt F. Heath

Capt U.S.A.

Head-Quarters Camp "William Penn,"

CHELTEN HILLS, PA.

August 7th 1865

Commanding Officer
6th U.S. Colored Troops
Sir

I have the honor to report, in conformity with Par 468 Rev Regulations that I am on Detached Service by virtue of S. O. No 25 War Department A. G. O. dated Washington January 17 1865.

I am on duty as Post Adjutant.

Very Respectfully

Your Obedt Servt

J Robt Deatto

Capt 6th U.S. C.T.

SPECIAL ORDERS, }
No. 421. }

WAR DEPARTMENT,
ADJUTANT GENERAL'S OFFICE,
Washington, August 5th, 1865.

(Extract.)

* * * * *
17. Upon being notified by Brevet Major *W. B. Lane*, Chief Mustering Officer, Eastern Division of Pennsylvania, that their services are no longer needed at Camp William Penn, Philadelphia, the following officers will proceed immediately to join their regiments:—

Captain *R. B. Beath*, 6th U. S. Colored Troops.

* * * * *

By order of the Secretary of War:

R. WILLIAMS,
Assistant Adjutant General.

OFFICIAL:

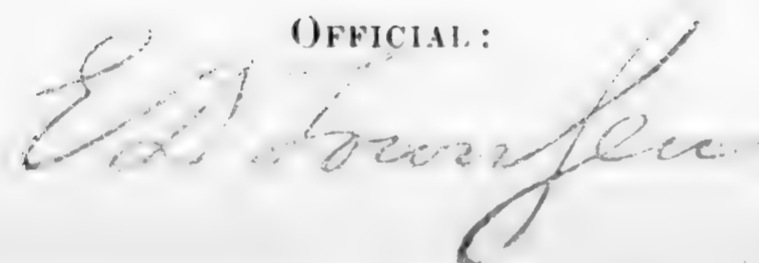

Assistant Adjutant General.

*Co. 6th U. S. Colored Troops
The Dept. of North Carolina*

SPECIAL ORDERS, }
No. 421. }

WAR DEPARTMENT,
ADJUTANT GENERAL'S OFFICE,
Washington, August 5th, 1865.

(Extract.)

* * * * *
17. Upon being notified by Brevet Major W. B. Lane, Chief Muster-
ing Officer, Eastern Division of Pennsylvania, that their services are no
longer needed at Camp William Penn, Philadelphia, the following
officers will proceed immediately to join their regiments:—

Captain R. B. Beath, 6th U. S. Colored Troops.

* * * * *

By order of the Secretary of War:

R. WILLIAMS,
Assistant Adjutant General.

OFFICIAL:



Assistant Adjutant General.

Capt. of North Carolina

The honor therefore to request
that Capt. Beach be retained

and ordered to his Regiment.

Very Respectfully

E. Whittier

Col. Am. Art. Corps.

Refer to letter
memo for the division
informant

War Dept. U. S. Office
August. 24th 1865

Respectfully referred to Major
General George G. Meade, Com-
manding Military Division
of the Atlantic, Philadelphia
Penna., to know if this officer
is now on duty at Camp Cad-
wallader, and if so, by what
authority and what duties he
is performing.

Please return this paper with
the information called for.

By order of the
Secretary of War.

E. S. Sargent
A. A. Gen. Vol.

E. O. M. 4 (A. P. 32)

#122. in Sept 1855
H. 197. Volume 1865.

Railroad, A. S.

Aug 17th 1865
N. 73. MDA. 1865

E. Whittier

A. A. Gen. Vol.

Is informed that Capt
K. S. Beach 6th U. S. Art

is now on duty at
Camp Cadwallader
Pa. where his services are
not required.

Feb. 1896. This paper was formerly filed
with the records of the Art Branch
at Camp Cadwallader, Phila. Pa. It
is now in the hands of the
The Adjutant Div. R. & P. O.

Received by 27000
Recd to 90 Aug 23 1865

NARRA 1017

Bureau of Refugees, Freedmen and Abandoned Lands,

Head-Quarters, Asst. Commissioner, State of North Carolina,

Raleigh, N. C., Aug. 17th 1865.

Col. C. W. Foster

A. A. General

Sir

I am informed that Capt. Robt. B. Beach 6th U. S. C. T. is detained at Camp Cadwallader Phila. by the want of an order to report to his Regt. although the Commander of the Camp affirms that there is no further need for Capt. B's services there, and he is very anxious to be relieved. The District Commander in which the 6th is serving, has consented to detail Capt. B. for duty in the Bureau of Refugees Freedmen &c. I very much need his help. It is very difficult to find officers for the pressing work of this Bureau. I have

Head-Quarters, District of Pennsylvania,

Philadelphia, Pa., Sept 2^d, 1865.

Respectfully referred to

Brigadier General A. Cummings,
 Commanding Camp Cadwalader
 for the desired information

By Command of

Major General Humphreys

Wm. S. Schuylt

403 Asst. Adjt. Genl.

E. B., 116 Vol. 1. Dist. of Pa.

Head Quarters
 Camp Cadwalader
 Philad^a, Sept. 6. 1865

Respectfully returned to Br^g Col. J. S. Schultz,
 asst. Adjt. Genl. with the information
 that Capt. Beath 6th U.S.C.T. has not
 been on duty at this camp - He was
 on duty at Camp W^m Penn & when
 that camp was broken up, he
 was ordered to his Regt.

Br^g Brig. Gen. U.S.A.

MAR 10 1865

F. 18. 5. P. 22 (1)
 Head Quarters,
 Mil'y Div: of the Atlantic
 Phila Aug 26. 1865.
 Respectfully referred to
 the Comdg Officer, Middle
 Department, who will
 please furnish the
 information called for
 in the endorsement
 from the Adj't Gen'l's office,
 of the 24th inst.

By command of
 Major General Meade:
 C. F. Beerler,
 Asst Adj't Gen'l.

Head Quarters, Middle Department.
 Baltimore Md. Aug. 28th 1865
 Respectfully referred to the Comdg Officer
 District of Pennsylvania, for information
 called for. These papers to
 returned.

By command of
 Maj. Gen. Humphreys:
 J. H. Frost,
 Asst Adj't Gen'l.

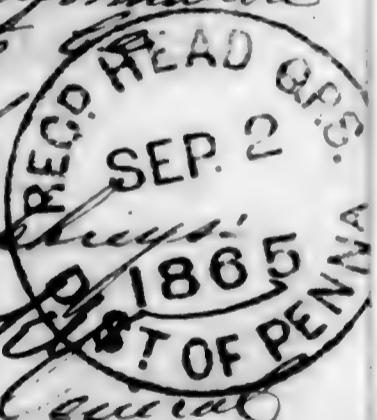

26849
 27

Headquarters District of Wilmington,

Wilmington, N. C., August 19th, 1865.

SPECIAL ORDERS, }

No. }

Contract
The _____ *Capt. Robert D. Beach* ^{U.S.A.}
is hereby detailed as *Asst. Supt.* of the Bureau of
Refuges, Freedmen (and) Mandred Lands for the
Southern District Dept. of North Carolina and
will report at once for duty and instructions to Major
Nickerson *Asst. Gen. Supt. Southern*
District.

BY COMMAND OF BREVET BRIG. GENERAL AMES.

Wm. C. ...

Wm. C. ...
Captain & A. A. General.

Private

CARD NUMBERS.

571337	26
571420	27
571503	28
571581	29
571658	30
571732	31
571805	32
571874	33
571951	34
5572038	35
5572138	36
5572233	37
5572323	38
9064793	39
9064915	40
8-RCJ-1868	41
	42
	43
	44
	45
	46
	47
	48
	49
	50

Book Mark: *B. 8. Vol. 5 RCJ 68*

See also

B | 6 | U.S.C.T.

Alfred Becket

Co. C, 6 Reg't U. S. Col'd Inf.

Appears on

Company Descriptive Book

of the organization named above.

DESCRIPTION.

Age 21 years; height 5 3/2 feet inches.

Complexion *Ben*

Eyes *Ben*; hair *Blk*

Where born *Wilmington, Del*

Occupation *Farmer*

ENLISTMENT.

When *Aug 4*, 1863

Where *Phila. Pa*

By whom *Plat. Wagner*, term *3* y'rs.

Remarks: *Mustered by Capt Sergeant Aug 4/63. Phila. Pa*

W F Roy

B | 6 | U.S.C.T.

Alfred Becket

Co. C, 6 Reg't U.S. Col'd Inf.

Appears on

Company Descriptive Book

of the organization named above.

DESCRIPTION.

Age 21 years; height 5 feet 5 1/2 inches.

Complexion Ben

Eyes Ben; hair Ben

Where born Wilmington, Del

Occupation Farmer

ENLISTMENT.

When Aug 4, 1863.

Where Philad. Pa

By whom Lt Col. Wagner; term 3 y'rs.

Remarks: Mustered by Capt Surgeant, Aug 4/63. Phila. Pa

W F Roe

B

6

U.S.C.T.

Alfred Becket

Priv. Co. C, 6 Reg't U. S. Col'd Infantry.

Age *21* years.

Appears on

Company Muster-in Roll

of the organization named above. Roll dated

Philadelphia, Pa., Aug. 8, 186 *3*.

Muster-in to date *Aug. 4*, 186 *3*

Joined for duty and enrolled:

When *Aug. 4*, 186 *3*.

Where *Philadelphia, Pa.*

Period *3* years.

Remarks:

Book mark:

Shull

B

6

U.S.C.T.

Alfred Becket

Priv, Co. C, 6 Reg't U. S. Col'd Infantry.

Appears on

Company Muster Roll

for *to Oct. 31"*, 186 *3*.

Present or absent *Present*

Stoppage, \$ *100* for

Due Gov't, \$ *100* for

Remarks:

Book mark:

Shull

B

6

U.S.C.T.

Alfred Becket

Priv., Co. C, 6 Reg't U. S. Col'd Infantry.

Appears on

Company Muster Roll

for *Nov. & Dec.*, 186*3*.

Present or absent *Present*

Stoppage, \$ *100* for

Due Gov't, \$ *100* for

Remarks:

Book mark:

Shull

B

6

U.S.C.T.

Alfred Becket

Priv., Co. C, 6 Reg't U. S. Col'd Infantry.

Appears on

Company Muster Roll

for *Jan'y. & Feby.*, 1864.

Present or absent *Present*

Stoppage, \$ *100* for

Due Gov't, \$ *100* for

Remarks:

Book mark:

Shull

B

6

U.S.C.T.

Alfred Becket

Priv., Co. C, 6 Reg't U. S. Col'd Infantry.

Appears on

Company Muster Roll

for *Mar. & Apr.*, 186 ~~4~~

Present or absent *Present*

Stoppage, \$ 100 for

Due Gov't, \$ 100 for

Remarks:

Book mark:

80
11
*

Shull

B

6

U.S.C.T.

Alfred Becket
Pis, Co. C, 6 Reg't U. S. Col'd Infantry.

Appears on

Company Muster Roll

for May & June, 1864

Present or absent Present

Stoppage, \$ 100 for

Due Gov't, \$ 100 for

Remarks:

Book mark:

Fletcher

B

6

U.S.C.T.

Alfred Becket

Private, Co. C, 6 Reg't U. S. Col'd Infantry.

Appears on

Company Muster Roll

for July & Aug, 1864.

Present or absent Absent

Stoppage, \$ 100 for

Due Gov't, \$ 100 for

Remarks: Absent sick since July 28. Free April 19 - 1864

Book mark:

Fletcher

B

6

U.S.C.T.

Alfred Becket

Pvt., Co. C, 6 Reg't U. S. Col'd Infantry.

Appears on

Company Muster Roll

for Sept & Oct, 1864.

Present or absent Absent

Stoppage, \$ 100 for

Due Gov't, \$ 100 for

Remarks: Absent sick.
Wounded Sept 29, 64
Free April 19, 61

NEXT ROLL ON FILE FEB 1865

Book mark:

J. Fletcher

B

6

U.S.C.T.

Alfred Becket
Priv, Co. C, 6 Reg't U. S. Col'd Infantry.

Appears on

Company Muster Roll

for Jan & Feb, 1865

Present or absent Absent

Stoppage, \$ 100 for

Due Gov't, \$ 100 for

Remarks: Wounded Sept 29, 64
In Hosp.
Free Apr 19, 61

Book mark:

Fletcher

(358)

Copyist.

B

6

U.S.C.T.

Alfred Becket

Priv, Co. C, 6 Reg't U. S. Col'd Infantry.

Appears on

Company Muster Roll

for March & April, 1865.

Present or absent Absent

Stoppage, \$ 100 for

Due Gov't, \$ 100 for

Remarks: In Hosp. since Sept 29/64
Free April 19. 61

Book mark:

Fletcher

B

6

U.S.C.T.

Alfred Beecher

Josh, Co. C, 6 Reg't U. S. Col'd Infantry.

Appears on

Company Muster Roll

for *May & June*, 186*5*.

Present or absent *Absent*

Stoppage, \$ *100* for

Due Gov't, \$ *100* for

Remarks: *Absent Sick*
Free April 19th 65.

* *Discharged by company.*

Book mark:

Beecher

P. | **6** | **U.S.C.T.**

Alfred Becker

P., Co. C, 6 Reg't U. S. Col'd Infantry.

Appears on

Company Muster Roll

for *July & Aug*, 186*5*.

Present or absent *Absent*

Stoppage, \$ *100* for

Due Gov't, \$ *100* for

Remarks: *Missing in action
since Sept 29, 64*

Book mark: *358*

Beach

B | 6 | U.S.C.T.

Alfred Decker

Bot, Co. B, 6 Reg't U. S. Col'd *Duffly*

Appears on **Co. Muster-out Roll**, dated
Wilmington N.C., Sept 20, 1865.

Muster-out to date _____, 186 .

Last paid to *Apr 30, 1865.*

Clothing account:

Last settled _____, 186 ; drawn since \$ _____ 100

Due soldier \$ _____ 100; due U. S. \$ _____ 100

Am't for cloth'g in kind or money adv'd \$ _____ 100

Due U. S. for arms, equipments, &c., \$ _____ 100

Bounty paid \$ *None* 100; due \$ *100* 100

Remarks: *Due Wm Boston*

*Supler \$ 2.00 Due U S for
18 Drivers 23.4 / 17 W B S punches 30¢
total 43¢ Absent Dickie
Koop's No Discharge furnished*

Book mark: *B8 Vol 5 R. C. S. 1868*

Deach

B | C. *Use*

Alfred Becket

, Co. *C*, *6* Reg't *Use Proofs*

NOTATION.

Book mark: *A. S. F. C. D. 1868.*

Record and Pension Office,

WAR DEPARTMENT.

This book mark refers only to a report from the medical records, made by the Surgeon General to the Adjutant General, relative to the above-named man. As the medical records have since been carded, no transcript of this report is made hereon.

A. M. Muzzey
Copyist.

John Jones

Only

U.S. Col'd Inf

Private

Private

CARD NUMBERS.

1	5575865	26
2	5575947	27
3	5576027	28
4	5576106	29
5	5576182	30
6	5576261	31
7	5576339	32
8	5576462	33
9	5577032	34
10	9065404	35
11		36
12		37
13		38
14		39
15		40
16		41
17		42
18		43
19		44
20		45
21		46
22		47
23		48
24		49
25		50

Book Mark:

See also

B

6

U.S.C.T.

* John Beckey

, Co. G, 6 Reg't U. S. Col'd Inf.

Appears on

Company Descriptive Book
of the organization named above.

DESCRIPTION.

Age 40 years; height 5 feet 4 ³/₄ inches.

Complexion Black

Eyes Black; hair Black

Where born Northampton Co. Va.

Occupation Waiter

ENLISTMENT.

When July 30, 1863.

Where Philadelphia Pa. 1st Dist

By whom Capt. Lehman P.M.; term 3 y'rs.

Remarks: Drafted.

Killed in action at
New Market Heights
Va. Sept 29

* Name cancelled by line.

Jenkins

B

6

U.S.C.T.

John Becker

Private, Co. G., 6 Reg't U. S. Col'd Infantry.

Age *40* years.

Appears on

Company Muster-in Roll

of the organization named above. Roll dated

Philadelphia Pa., Sept 14, 1863.

Muster-in to date

Sept 14, 1863

Joined for duty and enrolled:

When *July 30*, 186*3*.

Where *Philadelphia Pa.*

Period *3* years.

Remarks: *Mustered by Capt.*

Lehman P. M. July 30 - 1863.

Drafted Co to 1st Regt Pa.

Book mark:

M. A. Michaels

(856)

Copyist.

B

6

U.S.C.T.

John Becker

Private, Co. G, 6 Reg't U. S. Col'd Infantry.

Appears on

Company Muster Roll

for *Enrollment to Oct 31*, 186*3*.

Present or absent *Present*.

Stoppage, \$..... *100* for

Due Gov't, \$..... *100* for

Remarks:

Book mark:

(358)

M. A. Michaels

Copyist.

D

6

U.S.C.T.

John Decket

Private, Co. G, 6 Reg't U. S. Col'd Infantry.

Appears on

Company Muster Roll

for *Nov. + Dec.*, 186*3*.

Present or absent *Present*

Stoppage, \$ *100* for

Due Gov't, \$ *100* for

Remarks:

Book mark:

(358)

M. A. Michaels
Copyist.

B.

6

U.S.C.T.

John Becket

Private, Co. G, 6 Reg't U. S. Col'd Infantry.

Appears on

Company Muster Roll

for *Jan & Febr*, 186*4*.

Present or absent *Present*

Stoppage, \$ *100* for

Due Gov't, \$ *100* for

Remarks:

Book mark:

M. A. Michaels

(358)

Copyist.

B

6

U.S.C.T.

John Becket
Private, Co. G, 6 Reg't U. S. Col'd Infantry.

Appears on

Company Muster Roll

for *March & April*, 1864.

Present or absent *Present*.

Stoppage, \$ *100* for

Due Gov't, \$ *100* for

Remarks:

Book mark:

(358)

M. A. Michael
Copyist.

B

6

U.S.C.T.

John Becker

Priv., Co. G, 6 Reg't U. S. Col'd Infantry.

Appears on

Company Muster Roll

for *May & June*, 186*4*

Present or absent *Present*

Stoppage, \$.....*100* for

Due Gov't, \$.....*100* for

Remarks:.....

Book mark:.....

Grogan

(358)

Copyist.

B | 6 | U.S.C.T.

John Becker
Pri., Co. G, 6 Reg't U. S. Col'd Infantry.

Appears on

Company Muster Roll

for July & Aug., 1864

Present or absent Present

Stoppage, \$ 100 for

Due Gov't, \$ 100 for

Remarks:

Pres April 19, 1861

Book mark:

Gogan

B | 6 | U.S.C.T.

John Becker
Priv., Co. G, 6 Reg't U. S. Col'd Infantry.

Appears on

Company Muster Roll

for Sept. & Oct., 1864.

Present or absent

Stoppage, \$ 100 for

Due Gov't, \$ 100 for

Remarks Killed in action near Deep Bottom (near Market Heights) Va., Sept. 29, 1864. Final statements sent to adpt. Genl. on April 19, 1861. See Wm M. Brisbane letter #6.

Book mark:

Grogan

B | 6 | U.S.C.T.

John Becket
Priv, Co. G, 6 Reg't U. S. Col'd Infantry.

Appears on Co. Muster-out Roll, dated
Wilmington NC, Sept 20, 1865.

Muster-out to date _____, 186 .

Last paid to _____, 186 .

Clothing account:

Last settled _____, 186 ; drawn since \$ _____ 100

Due soldier \$ _____ 100; due U. S. \$ _____ 100

Am't for cloth'g in kind or money adv'd \$ _____ 100

Due U. S. for arms, equipments, &c., \$ _____ 100

Bounty paid \$ _____ 100; due \$ _____ 100

Remarks: Killed in action
at New Market Heights
Va. Sept 29/64.

Book mark: _____

(361)

Moy

Copyist.

Becker, John

B, Co. *4*, **6** Reg **U.S.C. Inf.**

Enclosures.

Bed Cards.....	Descriptive Lists.....
Burial Records.....	Final Statements <input checked="" type="checkbox"/>
Certs. of Dis. for Discharge.....	Furloughs.....
C. M. Charges.....	Med. Des. Lists.....
Med. Certificates.....	Orders.....

Other papers relating to—

Admission to Hosp'l.....	Furlough.....
Casualty Sheet (Officer's).....	Med. Examination.....
Confinement.....	Misc. Information.....
Contracts.....	Pay or Clothing.....
Death or Effects.....	Personal Reports.....
Desertions.....	Rank.....
Discharge from Hosp'l.....	Transfer to Hosp'l.....
Discharge from Service.....	Transfer to V. R. C.....
Duty.....	Transportation.....

FINAL STATEMENT

10.

OF

John Becker
6th Reg't of A. S. C. T.

VOLUNTEERS.

Rec'd Sept 29th 1864

NOTE 1.—Two of these certificates (or duplicates) are to be given to each Volunteer Soldier or drafted man who may be discharged previously to the discharge of his company, that he may at once receive from the Paymaster the pay, &c., due him, and the captain or other COMMISSIONED officer commanding the company will certify to the act of the delivery of the duplicate certificates; on these certificates the Soldier is "entitled to" his discharge, and should also present his discharge to the Paymaster to have the payment endorsed on it. The discharge is to be given back to the Soldier by the Paymaster; the latter only retaining as his voucher the duplicate certificates.

NOTE 2.—If the Soldier is entitled to pay for the use of his horse, the Company Commander will certify to that fact on the back of both these final statements, and also to the time he has pay due for having been so mounted on his own horse.

NOTE 3.—When a Soldier is furnished with final statements, his descriptive list, if he has one, should be taken up by the officer who gives the Soldier these statements, and endorsed with a statement to this effect by the officer. This endorsement should exhibit a full statement of the time for which the Soldier was allowed pay on his final statements, the clothing account, and all other charges against him or in his favor, so as to comprise a complete exhibit of his account. It will then be transmitted to the company commander of the Soldier, who will enter all the data necessary to a full understanding of the Soldier's account on the muster roll upon which the Soldier's discharge is reported. The descriptive list will then be destroyed. The object of this is, that the remaining portion of the Soldier's account may be settled upon the receipt of these muster rolls, and the Soldier receive any pay or allowances that may be due him at the time of his discharge, and which may not appear on his final statements from the fact that his descriptive list is incomplete. These accounts for back pay, &c., are settled by the 2d Auditor of the Treasury Department.

NOTE 4.—Charges for loss or injury to ordnance, horse equipments, and other miscellaneous charges, should appear under the heading of "Other Stoppages."

NOTE 5.—Bounty paid by State authorities, and not by the United States, will not be entered on this statement.

NOTE 6.—Amounts due the Sutler and Laundress must be entered on the muster roll on which the discharge, death, desertion, &c., is reported, as well as on the final statement, otherwise the amount cannot be collected from the United States.

NOTE 7.—This blank will be used for deceased volunteers and drafted men, as well as for others.

NOTE 8.—Where a Soldier dies in Hospital or on detached service, his descriptive list, if he has one, should be sent with his final statements, in duplicate, to the Second Auditor, Washington, D. C.

ADJUTANT GENERAL'S OFFICE.
Nov 22nd 1864
Duplicate with Inventory sent 2d Auditor.

Cont
Nov 22 1864
ADJUTANT GENERAL'S OFFICE
WASHINGTON D. C.

I certify, on honor, that John Becket a Private of
 Captain H. Herberts Company (G) of the 6th Regiment of U. S. C. T.
VOLUNTEERS, of the State of _____, born in Northampton Co, State
 of Pa, aged 41 years; 5 feet 4 3/4 inches high; Blk complexion,
Blk eyes, Blk hair, and by occupation a Printer, having joined the company on
 its original organization at _____, and enrolled in it at the muster into
 the service of the United States at _____, on the _____ day
 of _____, 186-, (or was mustered in service as a recruit, by _____
 _____, at _____, on the _____ day of _____,

186-, or was drafted and mustered into the service of the United States from the 1st
 Enrollment District of the State of Pa, at Philadelphia Pa,
 on the 30th day of July, 1864 to serve in the Regiment, for
 the term of three years: and having served HONESTLY and
 FAITHFULLY with his Company in 6th U. S. C. T. to the present date, is now
 entitled to a **DISCHARGE** by reason of Death arising from wounds
received in action at New Market Heights Va on the 29 day of Sept. 1864

The said John Becket was last paid by Paymaster
May Henry to include the 30 day of April, 1864, and has
 pay due him from that time to the present date; he is entitled to pay and subsistence for
TRAVELING to place of enrollment, and whatever other allowances are authorized to volunteer
 soldiers, drafted men, or militia, so discharged. He has received from the United States **CLOTHING**
 amounting to Fifty 00 ¹⁰⁰ dollars, since the _____ day of _____,
 186-, when his clothing account was last settled. He has received from the United States
 _____ dollars advanced **BOUNTY**.

There is to be stopped from him, on account of the State of _____, or other
 authorities, for **CLOTHING**, &c., received on entering service, _____ dollars; and
 for other stoppages, viz: _____

_____ dollars.

He has been furnished with **TRANSPORTATION** in kind from the place of his discharge to
 _____; and he has been **SUBSISTED** for **TRAVELING** to his
 place of enrollment, up to the _____, 186-.

He is indebted to William M. Bristow, **SUTLER**, 50 dollars.
 He is indebted to _____, **LAUNDRESS**, _____ dollars.

Given in Duplicate, at Camp 6th U. S. C. T. near Dutch Gap, this 25 day
 of October, 1864.

Henry Herberts
Captain
 Commanding Company

6 U.S. GOVERNMENT PRINTING OFFICE

Minutes

Minutes

CARD NUMBERS.

5568122	26
5568130	27
5570813	28
5570914	29
5571084	30
5571292	31
9064555	32
	33
	34
	35
	36
	37
	38
	39
	40
	41
	42
	43
	44
	45
	46
	47
	48
	49
	50

Book Mark: *EB. V. 9 P 462*

See also

B

6

U.S.C.T.

Mortimer Beckler

Co. B 6 Reg't U. S. Col'd Inf.

Appears on

Company Descriptive Book

of the organization named above.

DESCRIPTION.

Age 20 years; height 5 feet 6 ³/₄ inches.

Complexion *Beck*

Eyes *Gray*; hair *Beck*

Where born *Ms*

Occupation *Labourer*

ENLISTMENT.

When *Feb 4*, 1865

Where *Ferrytown*

By whom *Capt Pierson*; term *3* y'rs.

Remarks: *5.00, U.S. Bounty on Enlistment. Died at Wilmington, N.C. Mar 26/65. Final Statements given.*

W. F. Roe

B | 6 | U.S.C.T.

Martimer Bechler

Appears with rank of *Priv* on

Muster and Descriptive Roll of a Detachment of U. S. Vols. forwarded

for the 6 Reg't U. S. Col'd Infantry. Roll dated

Tarrytown, *Feb 6*, 1865.

Where born *Maryland*

Age *20* y'rs; occupation *Labourer*

When enlisted *Feb 4*, 1865.

Where enlisted *Tarrytown N.Y.*

For what period enlisted *3* years.

Eyes *Grey*; hair *Blk*

Complexion *Blk*; height *5* ft. *6 1/2* in.

When mustered in *Feb 4*, 1865.

Where mustered in *Tarrytown*

Bounty paid \$ *100* ⁰⁰; due \$ *100*

{ Where credited *10 Cong Dist Ramapo*
Rockland Co. New York
Company to which assigned

Remarks: *Received Knapsack 2.15*

{ *Shavershoe 45. Canteen 67. also Knife*
Fork. Plate. Spoon & Cup

Book mark:

Wark

B

6

U.S.C.T.

Mortimer Becker

Appears with rank of *Priv* on

Muster and Descriptive Roll of a Detachment of U. S. Vols. forwarded

for the 6 Reg't U. S. Col'd Infantry. Roll dated *Walt Island N.Y. No, Feb 9, 1865.*

Where born *Maryland*

Age *20* y'rs; occupation *Labourer*

When enlisted *Feb 4*, 186 .

Where enlisted *Tarrytown*

For what period enlisted *3* years.

Eyes *Grey*; hair *Blk*

Complexion *Blk*; height *5* ft. *6 3/4* in.

When mustered in *Feb 4*, 186 .

Where mustered in *Tarrytown*

Bounty paid \$ *100* ⁰⁰; due \$ *100*

Where credited *10th Bang Air Ranch*

Company to which assigned

Remarks: *Received 1. Knapsack \$2.15*

7. Kammack .67. 1 Canteen .45

Book mark:

Hark

(339)

Copyist.

8

6

U.S.C.T.

Montimer Beckler

Pw, Co. B, 6 Reg't U. S. Col'd Infantry.

Appears on

Company Muster Roll

for Jan. & Feb, 1865.

Present or absent Present

Stoppage, \$ 100 for

Due Gov't, \$ 100 for

Remarks:

Book mark:

J. M. Lemant

(358)

Copyist

P

6

U.S.C.T.

Mustmus Beckler

Priv, Co. B, 6 Reg't U. S. Col'd Infantry.

Appears on

Company Muster Roll

for Mar & Apr, 1865

Present or absent Absent

Stoppage, \$ 100 for

Due Gov't, \$ 100 for

Remarks: Received on
Enlistment 100,
U.S. Army.
absent sick

Book mark:

A. Leonard

B

6

U.S.C.T.

Mortimer Beckler

Private, Co. B, 6 Reg't U. S. Col'd Infantry.

Appears on

Company Muster Roll

for May June, 1865.

Present or absent

Stoppage, \$ 100 for

Due Gov't, \$ 100 for

Remarks:

Dead of disease at Genl Hospital Wilmington, N.C. Aug 26/65 Descriptive List furnished Drawn Clothing since enlistment #36.05"

Book mark:

B. J. Crote

Copyist

A. D. Dusew. emp.

B. | **6** | **U.S.C.T.**

Martimer Bickley
Priv., Co. *B*, 6 Reg't U. S. Col'd Infantry.

Appears on **Co. Muster-out Roll**, dated
Wilmington, N.C. Sept. 24 186*5*.

Muster-out to date _____, 186 .

Last paid to _____, 186 .

Clothing account:

Last settled _____, 186 ; drawn since \$ _____ 100

Due soldier \$ _____ 100; due U. S. \$ _____ 100

Am't for cloth'g in kind or money adv'd \$ _____ 100

Due U. S. for arms, equipments, &c., \$ _____ 100

Bounty paid \$ _____ 100; due \$ _____ 100

Remarks *Died of Disease at*
Genl Hosp. Wilmington, N.C.
Mar. 26. 65

Book mark: *7.129 P 20. 71 FS. Died May*
26. 65 EP 21. 9. P 462.

(361)

B. J. Cooke
 Copyist.

Beckler, Mortimer

B, Co. *B*

6

U.S.C. Inf.

Reg't

3

Enclosures.

Bed Cards

Descriptive Lists

Burial Records

Final Statements /

Certs. of Dis. for Discharge

Furloughs

C. M. Charges

Med. Des. Lists

Med. Certificates

Orders

Enlist. Paper

2

Other papers relating to—

Admission to Hosp'l

Furlough

Casualty Sheet (Officer's)

Med. Examination

Confinement

Misc. Information

Contracts

Pay or Clothing

Death or Effects

Personal Reports

Desertions

Rank

Discharge from Hosp'l

Transfer to Hosp'l

Discharge from Service

Transfer to V. R. C.

Duty

Transportation

NOTE 1.—This blank will be used for both enlistments and re-enlistments—enlistment of veterans, &c., &c., in the volunteer service. They will be made out in duplicate in all cases—one to accompany the recruiting return of the superintendent (not the recruiting officer) to the Adjutant General, and one to accompany the accounts of the officer who pays bounty, &c. The Regiment and Company in which the soldier last served should be given on the back.

NOTE 2.—An enlistment holds to service. A muster-in must, in all cases, precede payment of pay, bounty, pension, &c. A muster-in roll must, in all cases, be filed in the Adjutant General's Office as evidence of muster-in. The mustering officer, commissary, or assistant commissary of musters, as the case may be, will countersign both enlistments as having mustered the soldier into the service of the United States before either of them is given to the disbursing officer.

DECLARATION OF RECRUIT.

Mortimer Beckler, desiring to VOLUNTEER as a Soldier in the Army of the United States, for the term of THREE YEARS, Do Declare, That I am 20 years and _____ months of age; that I have never been discharged from the United States service on account of disability or by sentence of a court martial, or by order before the expiration of a term of enlistment; and I know of no impediment to my serving honestly and faithfully as a soldier for three years.

GIVEN at Ad. Depot, No. 10, New York the 4 day of February 1865

Witness: Chas. H. Budge Mortimer Beckler
mark

May 1895 This paper was formerly filed in the Enrollment Office, N.Y. & P.O.

Discharged _____, 18 _____

Reg't of _____

enlistment; last served in Company () _____

No. 5643
Mortimer Beckler
Enlisted at New York
March 4 1865
Eighty-fifth Regiment
Regiment of U.S. Art.

4

X

CONSENT IN CASE OF MINOR.

I, _____, Do CERTIFY, That I am the _____ of _____; that the said _____ is _____ years of age; and I do hereby freely give my CONSENT to his volunteering as a SOLDIER in the ARMY OF THE UNITED STATES for the period of THREE YEARS.

GIVEN at _____ the _____ day of _____

Witness: _____

VOLUNTEER ENLISTMENT.

STATE OF

TOWN OF

New York



Hamapo

I, Mortimer Beckler, born in _____
 in the State of Massachusetts, aged 24 years,
 and by occupation a Laborer, DO HEREBY ACKNOWLEDGE to have
 volunteered this 4 day of February, 1865,
 to serve as a **Soldier** in the **Army of the United States of America**, for
 the period of **THREE YEARS**, unless sooner discharged by proper authority:
 Do also agree to accept such bounty, pay, rations, and clothing, as are, or may be,
 established by law for volunteers. And I, Mortimer Beckler do
 solemnly swear, that I will bear true faith and allegiance to the **United States**
of America, and that I will serve them honestly and faithfully against all
 their enemies or opposers whomsoever; and that I will observe and obey the
 orders of the President of the United States, and the orders of the officers
 appointed over me, according to the Rules and Articles of War.

Sworn and subscribed to, at

this 4 day of Feb, 1865,

BEFORE

Harry Loring } Mortimer Beckler
John P. Pearsall } mark
Captain }

I CERTIFY, ON HONOR, That I have carefully examined the above-named Volunteer, agreeably
 to the General Regulations of the Army, and that, in my opinion, he is free from all bodily defects and
 mental infirmity, which would in any way disqualify him from performing the duties of a soldier.

L. L. Pelton
10 West St.
 EXAMINING SURGEON.

I CERTIFY, ON HONOR, That I have minutely inspected the Volunteer Mortimer Beckler
 previously to his enlistment, and that he was entirely sober when enlisted; that, to the best of my
 judgment and belief, he is of lawful age; and that, in accepting him as duly qualified to perform the
 duties of an able-bodied soldier, I have minutely observed the Regulations which govern the recruiting
 service. This soldier has gray eyes, black hair, black complexion, is
 feet 6 3/4 inches high.

John P. Pearsall
6th Regiment of U.S. (col) Volunteers,
 RECRUITING OFFICER.

Mustered into the service of the United States, for three years or during the war, from date of enlistment, in Company _____
 Regiment of _____ Volunteers, on the _____ day of _____, 1865, at _____

NOTE 1.—This blank will be used for both enlistments and re-enlistments—enlistment of veterans, &c., &c., in the volunteer service. They will be made out in duplicate in all cases—one to accompany the recruiting return of the superintendent (not the recruiting officer) to the Adjutant General, and one to accompany the accounts of the officer who pays bounty, &c. The Regiment and Company in which the soldier last served should be given on the back.

NOTE 2.—An enlistment holds to service. A muster-in must, in all cases, precede payment of pay, bounty, pension, &c. A muster-in roll must, in all cases, be filed in the Adjutant General's Office as evidence of muster-in. The mustering officer, commissary, or assistant commissary of musters, as the case may be, will countersign both enlistments as having mustered the soldier into the service of the United States before either of them is given to the disbursing officer.

DECLARATION OF RECRUIT.

I, _____, desiring to VOLUNTEER as a Soldier in the Army of the United States, for the term of THREE YEARS, Do Declare, That I am _____ years and _____ months of age; that I have never been discharged from the United States service on account of disability or by sentence of a court martial, or by order before the expiration of a term of enlistment; and I know of no impediment to my serving honestly and faithfully as a soldier for three years.

GIVEN at Scranton N.Y. the 4th day of February 1863.

Witness:

B. A. Clapp

Montgomery Beck Per
man

July 1895. This paper was formerly filed in the Enrollment Div. R. & P.

C
given

Discharged _____, 18 _____

Reg't of _____

enlistment; last served in Company () _____

By Capt W. W. Brown
6 Regiment of 21st Ill

Volunteered at Scranton Pa for _____

Re-enrolled Sept 4th, 1865.

No. _____
Montgomery Beck Per

John
C. R.

CONSENT IN CASE OF MINOR.

I, _____, Do CERTIFY, That I am the _____ of _____; that the said _____ is _____ years of age; and I do hereby freely give my CONSENT to his volunteering as a SOLDIER in the ARMY OF THE UNITED STATES for the period of THREE YEARS.

GIVEN at _____ the _____ day of _____

Witness: _____

8200

VOLUNTEER ENLISTMENT.

STATE OF



TOWN OF

Sev. Oak

Ramapo

I, *Mortimore Beckler*, born in _____
 in the State of *Maryland*, aged *20* years,
 and by occupation a *Labourer*, Do HEREBY ACKNOWLEDGE to have
 volunteered this *4th* day of *February*, 1864,
 to serve as a **Soldier** in the **Army of the United States of America**, for
 the period of **THREE YEARS**, unless sooner discharged by proper authority:
 Do also agree to accept such bounty, pay, rations, and clothing, as are, or may be,
 established by law for volunteers. And I, *Mortimore Beckler*, do
 solemnly swear, that I will bear true faith and allegiance to the **United States
 of America**, and that I will serve them honestly and faithfully against all
 their enemies or opposers whomsoever; and that I will observe and obey the
 orders of the President of the United States, and the orders of the officers
 appointed over me, according to the Rules and Articles of War.

Sworn and subscribed to, at *Sev. Oak*
 this *4th* day of *Feb*, 1864, } *Mortimore Beckler*
 BEFORE *W. W. Pusey* } *capt*
W. W. Pusey } *W. W. Pusey*

I CERTIFY, ON HONOR, That I have carefully examined the above-named Volunteer, agreeably
 to the General Regulations of the Army, and that, in my opinion, he is free from all bodily defects and
 mental infirmity, which would in any way disqualify him from performing the duties of a soldier.

L. F. Patton

EXAMINING SURGEON.

I CERTIFY, ON HONOR, That I have minutely inspected the Volunteer *M. Beckler*
 previously to his enlistment, and that he was entirely sober when enlisted; that, to the best of my
 judgment and belief, he is of lawful age; and that, in accepting him as duly qualified to perform the
 duties of an able-bodied soldier, I have strictly observed the Regulations which govern the recruiting
 service. This soldier has *Deep* eyes, *Black* hair, *Black* complexion, is *5'*
 feet *6 3/4* inches high.

W. W. Pusey
W. W. Pusey
 Capt. Pusey
 6th Regiment of *U. S. Col^d* Volunteers,

(A. G. O. No. 74 & 76.)

RECRUITING OFFICER.

Mustered into the service of the United States, for three years or during the war, from date of enlistment, in Company _____
 Regiment of _____ Volunteers, on the _____ day of _____, 1864, at _____

FINAL STATEMENT

OF

The 1st Cavalry Reg't

1864 Reg't of *U.S.C.*

VOLUNTEERS.

NOTE 1.—Two of these certificates (or duplicates) are to be given to each Volunteer Soldier or drafted man who may be discharged previously to the discharge of his company, that he may at once receive from the Paymaster the pay, &c., due him, and the captain or other COMMISSIONED officer commanding the company will certify to the act of the delivery of the duplicate certificates; on these certificates the Soldier is "entitled to" his discharge, and should also present his discharge to the Paymaster to have the payment endorsed on it. The discharge is to be given back to the Soldier by the Paymaster; the latter only retaining as his voucher the duplicate certificates.

NOTE 2.—If the Soldier is entitled to pay for the use of his horse, the Company Commander will certify to that fact on the back of both these final statements, and also to the time he has pay due for having been so mounted on his own horse.

NOTE 3.—When a Soldier is furnished with final statements, his descriptive list, if he has one, should be taken up by the officer who gives the Soldier these statements, and endorsed with a statement to this effect by the officer. This endorsement should exhibit a full statement of the time for which the Soldier was allowed pay on his final statements, the clothing account, and all other charges against him or in his favor, so as to comprise a complete exhibit of his account. It will then be transmitted to the Company Commander of the Soldier, who will enter all the data necessary to a full understanding of the Soldier's account on the muster roll upon which the Soldier's discharge is reported. The descriptive list will then be destroyed. The object of this is, that the remaining portion of the Soldier's account may be settled upon the receipt of these muster rolls, and the Soldier receive any pay or allowances that may be due him at the time of his discharge, and which may not appear on his final statements from the fact that his descriptive list is incomplete. These accounts for back pay, &c., are settled by the 2d Auditor of the Treasury Department.

NOTE 4.—Charges for loss or injury to ordnance, horse equipments, and other miscellaneous charges, should appear under the heading of "Other Stoppages."

NOTE 5.—Bounty paid by State authorities, and not by the United States, will not be entered on this statement.

NOTE 6.—Amounts due the Sutler and Laundress must be entered on the muster roll on which the discharge, death, desertion, &c., is reported, as well as on the final statement, otherwise the amount cannot be collected from the United States.

NOTE 7.—This blank will be used for deceased volunteers and drafted men, as well as for others.

NOTE 8.—Where a Soldier dies in Hospital or on detached service, his descriptive list, if he has one, should be sent with his final statements, in duplicate, to the Adjutant General, Washington, D. C.

By
Adj. Gen. [Signature]

War Department,
Adjutant General's Office,
Washington, D.C. Nov. 6, 1871.

The Muster Out Roll of Company "B" 6th U.S. Troops reports the death of Private Mortimer Beckley March 26, 1865.

The Muster Roll of the Company for May and June 1865—and the Final Statement of the soldier report date of death May 26, 1865.

The latter date (May twenty sixth 1865) is held to be correct and the Company Muster Out Roll will be amended accordingly.

Thomas M. Vincent
Assist. Adj't General.
8 B. 2
462
Found
Noted
H.M.

A letter Nov 10. 71 to 2nd Auditor

ADJUTANT GENERAL'S OFFICE
Aug 11 1865
Duplicate of this inventory sent 2d Auditor.

I certify, on honor, that Martinez Beckler a Private of
 Captain W. H. Smith Company (B) of the 6th Regiment of U.S.C.
VOLUNTEERS, of the State of _____, born in _____, State
 of Maryland, aged 20 years; 5 feet 6 3/4 inches high; Black complexion,
Gray eyes, Black hair, and by occupation a Seaman, having joined the company on
 its original organization at _____, and enrolled in it at the muster into
 the service of the United States at _____, on the _____ day
 of _____, 186____, (or was mustered in service as a recruit, by Captain
Liearsens, at Langston Md on the Fourth day of January,
 186____, or was drafted and mustered into the service of the United States from the
 Enrollment District of the State of _____, at _____,
 on the _____ day of _____, 186____) to serve in the Regiment, for
 the term of Three years: and having served **HONESTLY** and
FAITHFULLY with his Company in The field to the present date, is now
 entitled to a **DISCHARGE** by reason of Death. Having died of Disease
at Fort Kasplate Wilmington Md. Aug 26th 1865.

The said Private Martinez Beckler was last paid by Paymaster
 _____ to include the _____ day of _____, 186____, and has
 pay due him from Date of Enrollment to date of death ~~that time to the present date~~; he is entitled to pay and subsistence for
TRAVELING to place of enrollment, and whatever other allowances are authorized to volunteer
 soldiers, drafted men, or militia, so discharged. He has received from the United States **CLOTHING**
 amounting to 36 46/₁₀₀ dollars, since the _____ day of Enlistment,
 186____, when his clothing account was last settled. He has received from the United States
\$ 100/₁₀₀ dollars advanced **BOUNTY**.

There is to be stopped from him, on account of the State of _____, or other
 authorities, for **CLOTHING**, &c., received on entering service, _____/100 dollars; and
 for other stoppages, viz: _____

_____ dollars.
 He has been furnished with **TRANSPORTATION** in kind from the place of his discharge to
 _____; and he has been **SUBSISTED** for **TRAVELING** to his
 place of enrollment, up to the _____, 186____.

He is indebted to _____, **SUTLER**, _____/100 dollars.
 He is indebted to _____, **LAUNDRESS**, _____/100 dollars.

Given in Duplicate, at Wilmington Md, this 3rd day
 of August, 186____.

Wm H Smith
Capt. C. H. H. H.

 Commanding Company.

6 U.S. Col'd I

Private

Private

CARD NUMBERS.

	25	
	26	
Beacham	27	John
	28	
	29	
	30	
	31	
	32	
	33	
	34	
	35	
	36	
	37	
	38	
	39	
	40	
	41	
	42	
	43	
	44	
	45	
	46	
	47	
	48	
	49	
	50	

Book Mark:

See also

W. J. ...
Det., **6** U.S. Col'd Inf.

Private | *Private*
CARD NUMBERS.

1	5-5-67802	26
2		27
3		28
4		29
5		30
6		31
7		32
8		33
9		34
10		35
11		36
12		37
13		38
14		39
15		40
16		41
17		42
18		43
19		44
20		45
21		46
22		47
23		48
24		49
25		50

Book Mark: _____

See also _____

B | 6 | U.S.C.T.

James W. Beer

Appears with rank of _____ on

Muster and Descriptive Roll of a Detachment of U. S. Vols. forwarded

for the *6* Reg't U. S. Col'd Infantry. Roll dated

Dunkirk N.Y., Sept. 16, 1864.

Where born *Levies Pa.*

Age *20* y'rs; occupation *Laborer*

When enlisted *Sept. 7, 1864.*

Where enlisted *Olean N.Y.*

For what period enlisted *1* years.

Eyes *Blk*; hair *Blk.*

Complexion *Col'd*; height *5 ft. 4 1/2 in.*

When mustered in *Sept. 7, 1864.*

Where mustered in *Dunkirk N.Y.*

Bounty paid \$ *33* ^{*33*}/_{*100*}; due \$ *66* ^{*66*}/_{*100*}

Where credited _____

Company to which assigned _____

Remarks: *57 Sub. Dist town of Olean,*

Call. Co. 31 Dist N.Y.

Not borne on Muster Roll of the regiment

Book mark: _____

W. H. Bogar

Beer, James W.

, Co. , 6 Reg't U.S.C.S.

1 Enclosures.

Bed Cards	Final Statements
Burial Records	Furloughs or L. of A.
Certs. of Dis. for Discharge	Med. Certificates
C. M. Charges	Med. Des. Lists
Descriptive Lists	Orders
Discharge Certificates	Pris. of War Record
Enlistment Papers 2	Resignations

Other papers relating to—

Admission to Hosp'l	Furlough or L. of A.
Casualty Sheet	Med. Examination
Confinement	Misc. Information
Contracts	Pay or Clothing
Death or Effects	Personal Reports
Desertion	Rank
Discharge from Hosp'l	Transfer to Hosp'l
Discharge from Service	Transfer to V. R. C.
Duty	Transportation

E.P. filed 2/26/02
WBS

MICROFILM PUBLICATION M 1848

COMPILED MILITARY SERVICE RECORDS
OF VOLUNTEER UNION SOLDIERS WHO SERVED WITH
THE UNITED STATES COLORED TROOPS (USCT)
6TH REGIMENT OF INFANTRY

PERSONAL PAPERS' TARGET SHEET

PLEASE NOTE THE CHECKED INFORMATION ABOUT THE PERSONAL PAPERS IN
THIS FILE:

- NO PERSONAL PAPERS WERE FOUND IN THIS FILE WHEN THE
RECORDS WERE ARRANGED FOR MICROFILMING.
- 2 PERSONAL PAPER(S) FOUND IN THIS FILE WHEN THE RECORDS
WERE ARRANGED FOR MICROFILMING.

NOTE 1.—This blank will be used for both enlistments and re-enlistments—enlistment of veterans, &c., &c., in the volunteer service. They will be made out in duplicate in all cases—one to accompany the recruiting return of the superintendent (not the recruiting officer) to the Adjutant General, and one to accompany the accounts of the officer who pays bounty, &c. The Regiment and Company in which the soldier last served should be given on the back.

NOTE 2.—An enlistment holds to service. A muster-in must, in all cases, precede payment of pay, bounty pension, &c. A muster-in roll must, in all cases, be filed in the Adjutant-General's Office as evidence of muster-in. The mustering officer, commissary, or assistant commissary of musters, as the case may be, will countersign both enlistments as having mustered the soldier into the service of the United States before either of them is given to the disbursing officer.

DECLARATION OF RECRUIT.

I, *James Wesley Beer*, desiring to VOLUNTEER as a Soldier in the Army of the United States, for the term of *One* YEAR, Do Declare, That I am ~~Twenty~~ years and months of age; that I have never been discharged from the United States service on account of disability or by sentence of a court martial, or by order before the expiration of a term of enlistment; and I know of no impediment to my serving honestly and faithfully as a soldier for *One* years.

GIVEN at *Olean* the *7th* day of *September* 18*91*

Witness: *Fred Eaton* *James W. Beer*
Mark

Rec'd from 2nd. Aud. June 16 1893.

Discharged *Catonsville* 18.....
enlisted: last served in Company (.....)
Regiment of
mustered at *Olean*
Sept. 7th 1891
in one year
2452
James W. Beer
3205

CONSENT IN CASE OF MINOR.

I,, Do CERTIFY, That I am the of; that the said is years of age; and I do hereby freely give my CONSENT to his volunteering as a SOLDIER in the ARMY OF THE UNITED STATES for the period of YEARS.

GIVEN at the day of

Witness:

VOLUNTEER ENLISTMENT.

STATE OF *New York* TOWN OF *Olean*



I, *James Wesley Beer*, born in *Keers* in the State of *Pennsylvania* aged *Twenty* years, and by occupation a *Laborer*, Do HEREBY ACKNOWLEDGE to have volunteered this *Seventh* day of *September*, 186*4* to serve as a SOLDIER in the ARMY OF THE UNITED STATES OF AMERICA, for the period of *One* YEARS, unless sooner discharged by proper authority: Do also agree to accept such bounty, pay, rations and clothing, as are, or may be, established by law for volunteers. And I, *James W. Beer*, do solemnly swear that I will bear true faith and allegiance to the UNITED STATES OF AMERICA, and that I will serve them honestly and faithfully against all their enemies or opposers whomsoever; and that I will observe and obey the orders of the President of the United States, and the orders of the officers appointed over me, according to the Rules and Articles of War.

Sworn and subscribed to, at *Olean* this *7th* day of *September*, 186*4*. BEFORE *Wm. A. Blakelee* Notary Public *James W. Beer* mark

I CERTIFY, ON HONOR, That I have carefully examined the above-named Volunteer, agreeably to the General Regulations of the Army, and that, in my opinion, he is free from all bodily defects and mental infirmity, which would in any way disqualify him from performing the duties of a soldier.

H. H. Giddens EXAMINING SURGEON.

I CERTIFY, ON HONOR, That I have minutely inspected the Volunteer *J. W. Beer* previously to his enlistment, and that he was entirely sober when enlisted; that, to the best of my judgment and belief, he is of lawful age; and that in accepting him as duly qualified to perform the duties of an able-bodied soldier, I have strictly observed the Regulations which govern the recruiting service. This soldier has *Dark* eyes, *Black* hair, *Colored* complexion, is *5 feet 4 inches* tall, *130 lbs* weight, *18* years of age, *Single* marital status, *NA* Religion, *3rd* Regiment of *Volunteers*.

(A. G. O. No. 74 & 76.)

RECRUITING OFFICER.

Mustered into the service of the United States, for *One* year or during the War, from date of enlistment, in *Company* *Volunteers*, on the *7th* day of *September*, 186*4*, at *Olean*. *James W. Beer* *3rd* *Regiment of*

Note 1.—This blank will be used for both enlistments and re-enlistments—enlistment of veterans, &c., &c., in the volunteer service. They will be made out in duplicate in all cases—one to accompany the recruiting return of the superintendent (not the recruiting officer) to the Adjutant General, and one accompanying the accounts of the officer who pays bounty, &c. The Regiment and Company in which the soldier last served should be given on the back.

Note 2.—An enlistment holds to service. A muster-in must, in all cases, precede payment of pay, bounty pension, &c. A muster-in roll must, in all cases, be filed in the Adjutant General's Office as evidence of muster-in. The mustering officer, commissary, or assistant commissary of musters, as there may be, will countersign both enlistments as having mustered the soldier into the service of the United States before either of them is given to the disbursing officer.

DECLARATION OF RECRUIT.

I, *James Westley Beer*, desiring to VOLUNTEER as a Soldier in the Army of the United States, for the term of *One* YEAR, Do Declare, That I am *Twenty* years and months of age; that I have never been discharged from the United States service on account of disability or by sentence of a court martial, or by order before the expiration of a term of enlistment; and I know of no impediment to my serving honestly and faithfully as a soldier for *One* year.

GIVEN at *Olean* the *7* day of *September* *1864*

Witness: *Jack Cairn* *James Westley Beer* mark

Volonce

Discharged 18

Regt of

enlisted: last served in Company (.....)

Regiment of

in One year

Sept 7 1864

Volunteered at *Olean*

James Westley Beer

139 B 74-10

CONSENT IN CASE OF MINOR.

I,, Do CERTIFY, That I am the of; that the said is years of age; and I do hereby freely give my CONSENT to his volunteering as a SOLDIER in the ARMY OF THE UNITED STATES for the period of YEARS.

GIVEN at the day of

Witness:

VOLUNTEER ENLISTMENT.

STATE OF

TOWN OF

New York



Olean

I, *James Walter Beer*, born in *Leeres* in the State of *Pennsylvania* aged *Twenty* years, and by occupation a *Laborer*, Do HEREBY ACKNOWLEDGE to have volunteered this *Seventh* day of *September*, 186*4* to serve as a SOLDIER in the ARMY OF THE UNITED STATES OF AMERICA, for the period of *One* YEARS, unless sooner discharged by proper authority : Do also agree

to accept and obey the law for volunteers. And I, *James W. Beer*, do solemnly swear that I will bear true faith and allegiance to the UNITED STATES OF AMERICA, and that I will serve them honestly and faithfully against all their enemies or opposers whomsoever ; and that I will observe and obey the orders of the President of the United States, and the orders of the officers appointed over me, according to the Rules and Articles of War.

Sworn and subscribed to, at *Olean* this *7th* day of *September*, 186*4*.
BEFORE *Me, A. Blakelee* } *James W. Beer*
Notary Public } *mark*

I CERTIFY, ON HONOR, That I have carefully examined the above-named Volunteer, agreeably to the General Regulations of the Army, and that, in my opinion, he is free from all bodily defects and mental infirmity, which would in any way disqualify him from performing the duties of a soldier.

H. H. Miller
EXAMINING SURGEON.

I CERTIFY, ON HONOR That I have minutely inspected the Volunteer *J. W. Beer* previously to his enlistment, and that he was entirely sober when enlisted ; that, to the best of my judgment and belief, he is of lawful age ; and that in accepting him as duly qualified to perform the duties of an able-bodied soldier, I have strictly observed the Regulations which govern the recruiting service. This soldier has *Blue* eyes, *Blue* hair, *Colorful* complexion, is *5* feet *4 1/2* inches high.
Capt J. W. Palmer
Capt of 3rd Mass 31st Dist A.
Regiment of Volunteers.

(A. G. O. No. 74 & 76.)

RECRUITING OFFICER.

Mustered into the service of the United Sta for *One* years or during the war, from date of enlistment, in Company *C* of *1st* Regiment of *Volunteers*, on the *7th* day of *September*, 186*4* at *Olean*.
James W. Beer
Capt of 3rd Mass 31st Dist A.
Regiment of

U.S. Gold Inf

Pirate | Pirate

CARD NUMBERS.

5567778	26
5574130	27
5574217	28
5574308	29
5574408	30
5574499	31
5574584	32
9065237	33
43156768	34
	35
	36
	37
	38
	39
	40
	41
	42
	43
	44
	45
	46
	47
	48
	49
	50

Book Mark:

See also

NARA 1977

A. 1363081, *Роман*

B | 6 | U.S.C.T.

Edman Bell

, Co. I, 6 Reg't U.S. Col'd Inf.

Appears on

Company Descriptive Book

of the organization named above.

DESCRIPTION.

Age 23 years; height 5 feet 6 1/2 inches.

Complexion Black

Eyes Black; hair Black

Where born Maryland N. Y.

Occupation Lab

ENLISTMENT.

When Sept 7, 1864

Where Edman N. Y.

By whom Edman; term 1 y'rs.

Remarks: Recd \$33.33/100

Bounty Died of Disease in Regt Hospital near Wilmington N. C. Sept 10. 1864.

6
A 1 | US 23

Isolman Bell

Appears with rank of Priv on

Muster and Descriptive Roll
of a Detachment of US Volunteers,
forwarded.

Roll dated Goshen NY Sept 17, 1864

Where born Maryland

Age 23 years; occupation laborer

When enlisted Sept 7, 1864

Where enlisted Deep Park NY

For what period enlisted 1 years.

Eyes blk; hair blk

Complexion blk; height 5 ft. 6 1/2 in.

When mustered in Sept 7, 1864

Where mustered in Goshen NY

Bounty paid \$ 100; due \$ 100

Clothing account:
Last settled _____, 186 ; drawn since \$ 17 91/100

Date of first muster Sept 7, 1864

Company to which assigned _____

Remarks: Credited to 11th Long Dist NY
Sub. Dist No. 17. Misassigned.
No bounty paid misassigned men until
assigned to Regiment

Book mark : _____

J. J. Jones

P | 6 | **U.S.C.T.**

Coleman Bell

Appears with rank of Prst. on

Muster and Descriptive Roll of a Detachment of U. S. Vols. forwarded

for the 6 Reg't U. S. Col'd Infantry. Roll dated Hart Island, Sept. 21, 1864.

Where born Md.

Age 23 y'rs; occupation Laborer

When enlisted Sept. 7, 1864.

Where enlisted Goshen

For what period enlisted 1 years.

Eyes Blk; hair Blk.

Complexion Blk; height 5 ft. 6 1/2 in.

When mustered in Sept. 7, 1864.

Where mustered in Goshen

Bounty paid \$ 33 ³³/₁₀₀; due \$ 100

Where credited 11 Dist. 17 Sub. Dist.

Company to which assigned _____

Remarks: _____

Book mark: _____

W. A. Bogan

B

6

U.S.C.T.

Coleman Bell

Priv, Co. E, 6 Reg't U. S. Col'd Infantry.

Appears on

Company Muster Roll

for *Sept & Oct*, 186*4*

Present or absent *Present*

Stoppage, \$ *100* for

Due Gov't, \$ *100* for

Remarks:

NEXT ROLL ON FILE FEB 1865

Book mark:

Harris

(358)

Copyist

D | 6 | U.S.C.T.

Coleman Bell
Pvt., Co. E, 6 Reg't U. S. Col'd Infantry.

Appears on

Company Muster Roll

for Jan & Feby, 1865

Present or absent Present

Stoppage, \$ 100 for

Due Gov't, \$ 100 for

Remarks: Stop for 1 H sack 6 yds.

Book mark:

Harris

B | 6 | U.S.C.T.

Coleman Bell

Prk, Co. E, 6 Reg't U. S. Col'd Infantry.

Appears on

Company Muster Roll

for Mch & Apr, 1865

Present or absent Present

Stoppage, \$ 100 for

Due Gov't, \$ 100 for

Remarks: Stop on file .67 Stop for
1 gun sling, 30, 1 C Box Belt
Plate .09, 1 cap pouch .45
Total \$1.52. Rec'd \$33⁰⁰ Bounty.

Book mark:

Harris

B

6

U.S.C.T.

Coleman Bell

Port, Co. E, 6 Reg't U. S. Col'd Infantry.

Appears on

Company Muster Roll

for May & June, 1865

Present or absent Present

Stoppage, \$ 100 for

Due Gov't, \$ 100 for

Remarks: Rec'd \$33³³ Bounty

Book mark:

F. Pool

13

6

U.S.C.T.

Coleman Bell,
Priv., Co. E, 6 Reg't U. S. Col'd Infantry.

Appears on

Company Muster Roll

for July & Aug., 1865

Present or absent Present.

Stoppage, \$ 100 for _____

Due Gov't, \$ 100 for _____

Remarks: _____

Book mark: _____

P. Pool

B

6

U.S.C.T.

Coleman Bell,
Priv. Co. E, 6 Reg't U. S. Col'd Infantry.

Appears on **Co. Muster-out Roll**, dated
Wilmington, N.C., Sep. 20, 1865.

Muster-out to date *Sep. 20,* 1865.

Last paid to *Apr. 30,* 1865.

Clothing account:

Last settled *Never,* 186 ; drawn since \$ *63*¹⁵/₁₀₀

Due soldier \$ 100; due U. S. \$ 100

Am't for cloth'g in kind or money adv'd \$ 100

Due U. S. for arms, equipments, &c., \$ 100

Bounty paid \$ *33*¹/₃ 100; due \$ *66*²/₃ 100

Remarks: *Due Wm. Presben, Regt. Suttler \$500. Due U. S. for 1 Wiper \$100.*

Book mark:

J' Pool,

(361)

Copyist.

Pell, Coleman

D, Co.

6 Reg't *U.S.C.T.*

Enclosures.

Bed Cards	Final Statements
Burial Records	Furloughs or L. of A
Certs. of Dis. for Discharge	Med. Certificates
C. M. Charges	Med. Des. Lists
Descriptive Lists	Orders
Discharge Certificates	Pris. of War Record
Enlistment Papers	Resignations

Other papers relating to—

Admission to Hosp'l	Furlough or L. of A
Casualty Sheet	Med. Examination
Confinement	Misc. Information
Contracts	Pay or Clothing
Death or Effects	Personal Reports
Desertion	Rank
Discharge from Hosp'l	Transfer to Hosp'l
Discharge from Service	Transfer to V. R. C.
Duty	Transportation

NOTE 1.—This blank will be used for both enlistments and re-enlistments—enlistment of veterans, &c., &c., in the volunteer service. They will be made out in duplicate in all cases—one to accompany the recruiting return of the superintendent (not the recruiting officer) to the Adjutant General, and one to accompany the accounts of the officer who pays bounty, &c. The Regiment and Company in which the soldier last served should be given on the back.

NOTE 2.—An enlistment holds to service. A muster-in must, in all cases, precede payment of pay, bounty, pension, &c. A muster-in roll must, in all cases, be filed in the Adjutant General's Office as evidence of muster-in. The mustering officer, commissary, or assistant commissary of musters, as the case may be, will countersign both enlistments as having mustered the soldier into the service of the United States before either of them is given to the disbursing officer.

DECLARATION OF RECRUIT.

I, Coleman Bell, desiring to VOLUNTEER as a Soldier in the Army of the United States, for the term of THREE YEARS. Do Declare, That I am 23 years and 11 months of age; that I have never been discharged from the United States service on account of disability or by sentence of a court martial, or by order before the expiration of a term of enlistment; and I know of no impediment to my serving honestly and faithfully as a soldier for three years.

GIVEN at Joshua NY the 7th day of September 1864.

Witness:

A. R. [Signature]

Coleman Bell
man

10" U. S. A. 11, 12, 13, 14, 15, 16, 17, 18, 19, 20, 21, 22, 23, 24, 25, 26, 27, 28, 29, 30, 31, 32, 33, 34, 35, 36, 37, 38, 39, 40, 41, 42, 43, 44, 45, 46, 47, 48, 49, 50, 51, 52, 53, 54, 55, 56, 57, 58, 59, 60, 61, 62, 63, 64, 65, 66, 67, 68, 69, 70, 71, 72, 73, 74, 75, 76, 77, 78, 79, 80, 81, 82, 83, 84, 85, 86, 87, 88, 89, 90, 91, 92, 93, 94, 95, 96, 97, 98, 99, 100
No. 1088
Coleman Bell
Volunteered at Joshua NY
September 7th 1864
By Capt. [Signature]
1st U.S. Regiment of Cavalry

Discharged 18
enlistment; last served in Company ()
Reg't of

CONSENT IN CASE OF MINOR.

I, _____, Do CERTIFY, That I am the _____ of _____; that the said _____ is _____ years of age; and I do hereby freely give my CONSENT to his volunteering as a SOLDIER in the ARMY OF THE UNITED STATES for the period of THREE YEARS.

GIVEN at _____ the _____ day of _____

Witness:

VOLUNTEER ENLISTMENT.

STATE OF

TOWN OF

New York

Deer Park



I, *Coleman Bell*, born in *Maryland*

in the State of _____, aged *twenty three* years, and by occupation a *Soldier*, Do HEREBY ACKNOWLEDGE to have volunteered this *seventh* day of *September*, 1864,

to serve as a **Soldier** in the **Army of the United States of America**, for the period of **THREE YEARS**, unless sooner discharged by proper authority: Do also agree to accept such bounty, pay, rations, and clothing, as are, or may be, established by law for volunteers. And I, *Coleman Bell*, do solemnly swear, that I will bear true faith and allegiance to the **United States of America**, and that I will serve them honestly and faithfully against all their enemies or opposers whomsoever; and that I will observe and obey the orders of the President of the United States, and the orders of the officers appointed over me, according to the Rules and Articles of War.

Sworn and subscribed to, at *Sarban N.Y.* this *7th* day of *September*, 1864, *Coleman Bell* mark

BEFORE *J. J. Smith* Capt. 1st Regt. 11th Dist. N.Y. I CERTIFY, ON HONOR, That I have carefully examined the above-named Volunteer, agreeably to the General Regulations of the Army, and that, in my opinion, he is free from all bodily defects and mental infirmity, which would in any way disqualify him from performing the duties of a soldier.

J. J. Boyd 11th Dist. N.Y. EXAMINING SURGEON.

I CERTIFY, ON HONOR, That I have minutely inspected the Volunteer *C. Bell* previously to his enlistment, and that he was entirely sober when enlisted; that, to the best of my judgment and belief, he is of lawful age; and that, in accepting him as duly qualified to perform the duties of an able-bodied soldier, I have strictly observed the Regulations which govern the recruiting service. This soldier has *black* eyes, *black* hair, complexion, is *fair* feet *6 1/2* inches high. *Black gran*

J. J. Smith Capt. 1st Regt. 11th Dist. N.Y. Recruiting Officer.

(A. G. O. No. 74 & 76.)

Mustered into the service of the United States, for *Three* years or during the war, from date of enlistment, in Company *F* of the *11th* Regt. of *Volunteers*, on the *7th* day of *September*, 1864, at *Sarban N.Y.* *John W. Smith* Capt. 1st Regt. 11th Dist. N.Y.

Samuel

W.A., **6** U.S. Col'd Inf.

Musician

Musician

CARD NUMBERS.

1	5577077	26
2	5577159	27
3	5577244	28
4	5577325	29
5	5577405	30
6	5577483	31
7	5577556	32
8	5577625	33
9	5577697	34
10	5577792	35
11	5577886	36
12	5577976	37
13	5578061	38
14	9065516	39
15		40
16		41
17		42
18		43
19		44
20		45
21		46
22		47
23		48
24		49
25		50

Book Mark:

See also

B | **6** | **U.S.C.T.**

Samuel Bell

, Co. *H*, 6 Reg't U. S. Col'd Inf.

Appears on

Company Descriptive Book

of the organization named above.

DESCRIPTION.

Age *21* years; height *5* feet *8 1/2* inches.

Complexion *Blk*

Eyes *Blk*; hair *Blk*

Where born *Chambersburg Penn.*

Occupation *Carb.*

ENLISTMENT.

When *July 13*, 186 *3*.

Where *All. City Pa.*

By whom *27th Pa*; term *3* y'rs.

Remarks: *Mustered by Capt. Kirken.*

Jenkins

B | 6 | U.S.C.T.

Samuel Bell

Mus'n. Co., 6 Reg't U. S. Col'd Infantry.

Age 21 years.

Appears on

Company Muster-in Roll

of the organization named above. Roll dated,

Phila Pa, Sept 14, 1863.

Muster-in to date July 13, 1863

Joined for entry and enrolled:

When July 13, 1863.

Where Alleghany City Pa

Period 3 years.

Remarks: Mustd by Capt. Kirker
P.M. July 13/63.
Dfted.

Book mark :

H. H. Thompson
Copyist.

B

6

U.S.C.T.

Samuel Bell

Muster, Co. H, 6 Reg't U. S. Col'd Infantry.

Appears on

Company Muster Roll

for Sept 14 to Oct 31, 1863.

Present or absent Present

Stoppage, \$ 100 for

Due Gov't, \$ 100 for

Remarks:

Book mark:

M. H. Thompson Copyist.

(358)

B | 6 | U.S.C.T.

Samuel Bell

Man, Co. H, 6 Reg't U. S. Col'd Infantry.

Appears on

Company Muster Roll

for November, 1863.

Present or absent Present

Stoppage, \$ 100 for

Due Gov't, \$ 100 for

Remarks:

Book mark:

W. H. Thompson

(358)

Copyist.

B | 6 | U.S.C.T.

Samuel Bell

Musir, Co. H, 6 Reg't U. S. Col'd Infantry.

Appears on

Company Muster Roll

for Jerry & Geby, 1864.

Present or absent Present

Stoppage, \$ 100 for

Due Gov't, \$ 100 for

Remarks:

Book mark:

M. H. Thompson

B

6

U.S.C.T.

Samuel Bell

Musn, Co. H, 6 Reg't U. S. Col'd Infantry.

Appears on

Company Muster Roll

for *Mch & Apl*, 1864

Present or absent *Present*

Stoppage, \$ 100 for

Due Gov't, \$ 100 for

Remarks:

Book mark:

W. H. Thompson

(358)

Copyist.

B

6

U.S.C.T.

Samuel Bell
Tifer, Co. H, 6 Reg't U. S. Col'd Infantry.

Appears on

Company Muster Roll

for May & June, 1864.

Present or absent Present

Stoppage, \$ 100 for

Due Gov't, \$ 100 for

Remarks:

Book mark:

C. A. Hayden

(858)

Copyist.

B

6

U.S.C.T.

Samuel Bell

Musie, Co. H, 6 Reg't U. S. Col'd Infantry.

Appears on

Company Muster Roll

for *July & Aug*, 1864.

Present or absent *Present*

Stoppage, \$ 100 for

Due Gov't, \$ 100 for

Remarks: *Free April 19/61*

Book mark:

C. A. Harper

(358)

Copyist.

B

6

U.S.C.T.

Samuel Bell

Musico Co. H, 6 Reg't U. S. Col'd Infantry.

Appears on

Company Muster Roll

for *Sept-Oct*, 1864.

Present or absent *Present*

Stoppage, \$ 100 for

Due Gov't, \$ 100 for

Remarks:

NEXT ROLL ON FILE FEB 1865

Book mark:

A. J. Sawyer

(358)

Copyist.

B

6

U.S.C.T.

Samuel Bell

Musie, Co. H, 6 Reg't U. S. Col'd Infantry.

Appears on

Company Muster Roll

for *Jan & Feb*, 186*5*.

Present or absent *Present*

Stoppage, \$ *100* for

Due Gov't, \$ *100* for

Remarks:

Book mark:

C. A. Harper

73

6

U.S.C.T.

Samuel Bell

Musie, Co. H, 6 Reg't U. S. Col'd Infantry.

Appears on

Company Muster Roll

for *Mar & April*, 1865.

Present or absent *Present*

Stoppage, \$ 100 for

Due Gov't, \$ 100 for

Remarks:

Book mark:

C. A. Harper

(358)

Copyist.

B

6

U.S.C.T.

Samuel Bell

Muricians Co. H, 6 Reg't U. S. Col'd Infantry.

Appears on

Company Muster Roll

for May & June, 1863.

Present or absent Present

Stoppage, \$ 100 for

Due Gov't, \$ 100 for

Remarks:

Book mark:

Halecomb

B |

6

U.S.C.T.

Samuel Bell

Mus., Co. H, 6 Reg't U. S. Col'd Infantry.

Appears on

Company Muster Roll

for July 1865, 1865

Present or absent Present

Stoppage, \$ 100 for

Due Gov't, \$ 100 for

Remarks:

Book mark:

Holeman

(358)

Copyist.

B1

6

U.S.C.T.

Samuel Bell

Musn, Co. I, 6 Reg't U. S. Col'd Infantry.

Appears on Co. Muster-out Roll, dated
Wilmington N.C., Sep 20, 1865.

Muster-out to date Sep 20, 1865.

Last paid to Apr 30, 1865.

Clothing account:

Last settled June 30, 1864; drawn since \$ 57/100

Due soldier \$ 100; due U. S. \$ 100

Am't for cloth'g in kind or money adv'd \$ 100

Due U. S. for arms, equipments, &c., \$ 100

Bounty paid \$ 100; due \$ 100 100

Remarks: Due Wm. Busben Regtl. Sutter
\$47.50 per mo due from Enlistment to Apr 30/64

Book mark: V231P26776

Holecomb

(361)

Copyist.

John Henry
Co. 6 U.S. Col'd Inf

Private | *Private*

CARD NUMBERS.

1	5569072	26
2	5568287	27
3	5569154	28
4	5569237	29
5	5569309	30
6	5569380	31
7	5569451	32
8	5569521	33
9	5569591	34
10	5569661	35
11	5569753	36
12	5569852	37
13	5569944	38
14	5570033	39
15	9064674	40
16		41
17		42
18		43
19		44
20		45
21		46
22		47
23		48
24		49
25		50

Book Mark:

See also

B | 6 | U.S.C.T.

Henry Belfield

Co. A, 6 Reg't U. S. Col'd Inf.

Appears on

Company Descriptive Book
of the organization named above.

DESCRIPTION.

Age 18 years; height 5 feet 4 inches.

Complexion *Blk*

Eyes *Blk*; hair *Blk*

Where born *Petersburg, Va*

Occupation *Linner*

ENLISTMENT.

When *July 13*, 1863.

Where *Greensburg, Pa*

By whom *W.B. Coulter*, term *3* y'rs.

Remarks:

W. J. Rose

B

U.S.C.T.

Henry Belfield

Appears with rank of _____ on
**Muster and Descriptive Roll of a Detach-
 ment of Drafted Men and Substitutes
 forwarded**

for the *6* Reg't U. S. Col'd Inf. Roll dated
Greenburg, Pa *July 24*, 186*3*.

Where born *Va.*

Age *20* years; occupation *Lab*

Drafted and mustered in:

When *July 13*, 186 .

Where *Greenburg Pa. 21 Dis. Pa.*

Period *3* years.

Eyes *blk*; hair *curly*

Complexion *blk*; height *5 ft. 4 in.*

Paid bounty and advance pay, \$ *100*

Bounty due \$ *100*

Where credited _____

Company to which assigned _____

Remarks: *substitute*

Book mark: _____

Sarimer

(340)

Copyist

P

6

U.S.C.T.

Henry Selfield

Pvt, Co. *A*, 6 Reg't U. S. Col'd Infantry.

Age *20* years.

Appears on

Company Muster-in Roll

of the organization named above. Roll dated

Phil Pa, *Oct 13*, 186*3*.

Muster-in to date

July 24, 186*3*

Joined for duty and enrolled:

When *July 13*, 186*3*.

Where *Greensburg Pa*

Period *2* years.

Remarks: *Sub.*

Book mark:

Selfield

P

6

U.S.C.T.

Henry Selfield

Pvt, Co. A, 6 Reg't U. S. Col'd Infantry.

Appears on

Company Muster Roll

for *to Oct 31*, 186*3*.

Present or absent *Present*

Stoppage, \$ *100* for

Due Gov't, \$ *100* for

Remarks:

Book mark:

(358)

Henry
Copyist.

P

6

U.S.C.T.

Henry Seffien
H

, Co. A, 6 Reg't U. S. Col'd Infantry.

Appears on

Company Muster Roll

for *Nov & Dec*, 1863.

Present or absent *Present*

Stoppage, \$ *100* for

Due Gov't, \$ *100* for

Remarks:

Book mark:

Devo

Q

6

U.S.C.T.

Henry Seffried

Pr, Co. A, 6 Reg't U. S. Col'd Infantry.

Appears on

Company Muster Roll

for *June 5th*, 1864

Present or absent *Present*

Stoppage, \$ *100* for

Due Gov't, \$ *100* for

Remarks: *Stop for one week
20¢. Stop for one half
shelter tents / 29*

Book mark :

(358)

Deed

Copyist.

D

6

U.S.C.T.

Henry Seffield

Pr, Co. A, 6 Reg't U. S. Col'd Infantry.

Appears on

Company Muster Roll

for *Jan 5th*, 1864

Present or absent *Present*

Stoppage, \$ *100* for

Due Gov't, \$ *100* for

Remarks: *Stop for one week
20th, stop for one half
shelter tents / 29*

Book mark :

(358)

Reed

Copyist.

P

6

U.S.C.T.

Henry Seffield

Plt, Co. A, 6 Reg't U. S. Col'd Infantry.

Appears on

Company Muster Roll

for *Mo. & Apr*, 1864.

Present or absent *Present*

Stoppage, \$ 100 for

Due Gov't, \$ 100 for

Remarks:

Book mark:

(358)

W. C. ...

Copyist.

B

6

U.S.C.T.

Henry Belfield

Pat., Co. A, 6 Reg't U. S. Col'd Infantry.

Appears on

Company Muster Roll

for May & June, 1864.

Present or absent Present

Stoppage, \$ 100 for

Due Gov't, \$ 100 for

Remarks:

Book mark:

Crenshaw

(358)

Copyist.

B | 6 | U.S.C.T.

Henry Belfield

Priv., Co. A, 6 Reg't U. S. Col'd Infantry.

Appears on

Company Muster Roll

for July & Aug., 1864.

Present or absent Present

Stoppage, \$ 100 for

Due Gov't, \$ 100 for

Remarks: Free apl. 19. 1861.
Due U.S. for Hatchet &
Handle 52¢. Extra Duty
on Canal at Dutch Gap Va.
Substitute.

Book mark:

Carrshaw

B | **6** | **U.S.C.T.**

Henry Bellfield
Priv, Co. A, 6 Reg't U. S. Col'd Infantry.

Appears on

Company Muster Roll

for *Sept. 1. Oct.*, 186*4*.

Present or absent *Present*

Stoppage, \$ *100* for

Due Gov't, \$ *100* for

Remarks:

NEXT ROLL ON FILE FEB 1865

Book mark:

Crewshaw

B

6

U.S.C.T.

Henry Bellfield
Priv., Co. A, 6 Reg't U. S. Col'd Infantry.

Appears on

Company Muster Roll

for Jan'y. & Feby., 1865.

Present or absent Present

Stoppage, \$ 100 for

Due Gov't, \$ 100 for

Remarks: Substitute.

Book mark :

Crenshaw

B

6

U.S.C.T.

Henry Bellfield

Priv., Co. A, 6 Reg't U. S. Col'd Infantry.

Appears on

Company Muster Roll

for *Mch. & Apr.*, 1865.

Present or absent

Present

Stoppage, \$ 100 for

Due Gov't, \$ 100 for

Remarks:

Substitute.

*Due U.S. for 1 screw
driven 23¢, 1 wiper 20¢
1 canteen, 65¢.*

Book mark:

Crenshaw

B | 6 | U.S.C.T.

Henry Bellfield
Prvt, Co. A, 6 Reg't U. S. Col'd Infantry.

Appears on

Company Muster Roll

for May + June, 1865.

Present or absent Present

Stoppage, \$ 100 for

Due Gov't, \$ 100 for

Remarks:

On detached service
in Wilmington N.C.
Charleston River
with ordnance
etc.

Book mark:

M. A. Edwards

(358)

Copyist.

B

6

U.S.C.T.

Henry Bellfield
Private, Co. A, 6 Reg't U. S. Col'd Infantry.

Appears on

Company Muster Roll

for July 9 Aug, 1865.

Present or absent Present

Stoppage, \$ 100 for

Due Gov't, \$ 100 for

Remarks:

Total due U.S.
\$25.59

Book mark:

(358)

W. A. Edwards

Copyist.

B

6

U.S.C.T.

Henry Beffield

Capt., Co. A., 6 Reg't U. S. Col'd Infantry.

Appears on Co. Muster-out Roll, dated

Wilmington, N.C., Sept 20, 1865.

Muster-out to date Sept 20, 1865.

Last paid to Apl. 30, 1865.

Clothing account:

Last settled June 30, 1864; drawn since \$ 7.⁸⁷/₁₀₀

Due soldier \$ 100; due U. S. \$ 100

Am't for cloth'g in kind or money adv'd \$ 100

Due U. S. for arms, equipments, &c., \$ 100

Bounty paid \$ None 100; due \$ 100.⁰⁰/₁₀₀

Remarks: Due U.S. for Ord.

retd. per G.O. 101 to S.

O.R. 3600, Free Apl.

1961. Substitute

under Act March

3/63. Due U.S. for 67 1/2

65 th & for ord. 43 th

Book mark: 4-230, P. 238, 76

A. A. Edwards

(361)

Copyist.

Wm. Thomas
Co. , 6 U. S. Col'd Inf.

Private | *Private*

CARD NUMBERS.

1	43148067	20
2		21
3		22
4		23
5		24
6		25
7		26
8		27
9		28
10		29
11		30
12		31
13		32
14		33
15		34
16		35
17		36
18		37
19		38

Number of medical cards herein 0

Number of personal papers herein 0

BOOK MARK: _____

See also _____

B. I. U.S.A.

Thomas Belmont

Appears with rank of *Priv* on

Muster and Descriptive Roll

of Detachment of U.S. Vol.
 forwarded for the Regt
U.S.A. Roll dated

Sackport, N.Y., Oct 4, 1864.

Where born *Nashville, Tenn*

Age *27* years; occupation *Laborer*

When enlisted *Sept. 30, 1864.*

Where enlisted *Alexander, N.Y.*

For what period enlisted *3* years.

Eyes *Blk*; hair *Blk*

Complexion *Blk*; height *5 ft. 7 1/2 in.*

When mustered in *Sept. 30, 1864.*

Where mustered in *Sackport*

Bounty paid \$ *100*; due \$ *100*

Clothing account:

Last settled _____, 186 ; drawn since \$ *17-100*

Date of first muster _____, 186 .

Company to which assigned _____

Remarks: *29 Dist. Alexander
 General Co. N.Y.*

Book mark: _____

N. N. Jackson

Public | *Private*

CARD NUMBERS.

557 865-	26
557 7776	27
557 4131	28
557 4218	29
557 4309	30
557 4409	31
557 4565-	32
557 4662	33
2345 235-	34
	35
	36
	37
	38
	39
	40
	41
	42
	43
	44
	45
	46
	47
	48
	49
	50

Book Mark:

See also

B | **6** | **U.S.C.T.**

Lewis A. Burnett

....., Co. *E*....., 6 Reg't U. S. Col'd Inf.

Appears on
Company Descriptive Book
of the organization named above.

DESCRIPTION.

Age *33* years; height *5* feet *9* inches.

Complexion *black*

Eyes *black*; hair *black*

Where born *Delhi New York*

Occupation *Trimmer*

ENLISTMENT.

When *Sept 6*....., 186*4*.

Where *New York*

By whom *Capt. Gordon*; term *1* y'rs.

Remarks: *Rec'd \$33. ³³/₁₀₀*

*Bounty. Died of Disease
in U.S. Gen Hospital Wil-
mington N.C. May 18. 1868*

.....
.....
.....
.....

.....
J. H. Reeves
Copist.

B

6

U.S.C.T.

Lewis A. Bennett

Appears with rank of *Private* on

Muster and Descriptive Roll of a Detachment of U. S. Vols. forwarded

for the 6 Reg't U. S. Col'd Infantry. Roll dated

Norwich N.Y. Sep 15, 1864

Where born *Delhi N.Y.*

Age *35* y'rs; occupation *farmer*

When enlisted *Sept 6*, 1864.

Where enlisted *Orange N.Y.*

For what period enlisted *1* years.

Eyes *black*; hair *black*

Complexion *black*; height *5 ft. 3 in.*

When mustered in *Sept 13*, 1864.

Where mustered in *Norwich N.Y.*

Bounty paid \$ *100*; due \$ *100*

Where credited *13 Cong Dist 55 sub*

Company to which assigned *dist -*

Remarks: *Enlisted to bounty -*

No bounty paid unassigned (over)

Book mark:

H Jones

NARA 1127

JAN. 20

5567865

★ 1891 ★

*Remarks - men until
assigned to regiments*

B | 6 | U.S.C.T.

Lewis A. Bennett

Appears with rank of *Priv.* on

Muster and Descriptive Roll of a Detachment of U. S. Vols. forwarded

for the *6* Reg't U. S. Col'd Infantry. Roll dated

Heart Island, Sept. 21, 1864.

Where born *Delhi N.Y.*

Age *35* y'rs; occupation *Farmer*

When enlisted *Sept. 6, 1864*

Where enlisted *Norwich*

For what period enlisted *1* years.

Eyes *Blk*; hair *Blk*

Complexion *Blk*; height *5* ft. *9* in.

When mustered in *Sept. 6, 1864*

Where mustered in *Norwich*

Bounty paid \$ *33*^{*33*} *100*; due \$ *100*

Where credited *19 Dist. 55 Sub. Dist.*

Company to which assigned

Remarks:

Book mark:

W. H. Bogan

(340)

Copyist.

B

6

U.S.C.T.

Lewis A. Bennett

Priv., Co. E, 6 Reg't U. S. Col'd Infantry.

Appears on

Company Muster Roll

for Sept & Oct, 1864

Present or absent Absent

Stoppage, \$ 100 for

Due Gov't, \$ 100 for

Remarks: Absent in General Hospital,

NEXT ROLL ON FILE FEB 1865

Book mark:

Harris

(358)

Copyist

B | 6 | U.S.C.T.

Lewis A. Bennet

Priv., Co. E, 6 Reg't U. S. Col'd Infantry.

Appears on

Company Muster Roll

for *Jan & Feby*, 1865

Present or absent *Present*

Stoppage, \$ 100 for

Due Gov't, \$ 100 for

Remarks:

Book mark:

Harris

B | 6 | U.S.C.T.

Lewis A. Bennet

Prvt, Co. E, 6 Reg't U. S. Col'd Infantry.

Appears on

Company Muster Roll

for *Mch & Apr*, 1865

Present or absent *Absent*

Stoppage, \$ 100 for

Due Gov't, \$ 100 for

Remarks: *Rec'd \$33³³ Bountty,
Absent Sick since Apr 9/65*

Book mark: *100*

Harris

B | 6 | U.S.C.T.

Lewis A. Bennett,
Priv., Co. E, 6 Reg't U. S. Col'd Infantry.

Appears on

Company Muster Roll

for May & June, 1865

Present or absent Absent

Stoppage, \$ 100 for

Due Gov't, \$ 100 for

Remarks: Rec'd \$33³³ Bounty,
Absent sick in U.S. Gen.
Hospital.

Book mark:

P. Pool,

B

6

U.S.C.T.

Lewis A. Burnett

Priv., Co. E, 6 Reg't U. S. Col'd Infantry.

Appears on

Company Muster Roll

for July & Aug., 1865

Present or absent

Stoppage, \$ 100 for

Due Gov't, \$ 100 for

Remarks: Died in U.S. Gen. Hosp. May, 1865.

Book mark: 117287, 516, 2 and Apr. 12, 1866.

P. Pool

B | **6** | **U.S.C.T.**

Lewis A. Bennett

Pvt, Co. *E*, 6 Reg't U. S. Col'd Infantry.

Appears on **Co. Muster-out Roll**, dated
Wilmington, N.C., Sep. 20, 1865.

Muster-out to date _____, 186 .

Last paid to _____, 186 .

Clothing account:

Last settled _____, 186 ; drawn since \$ _____ 100

Due soldier \$ _____ 100; due U. S. \$ _____ 100

Am't for cloth'g in kind or money adv'd \$ _____ 100

Due U. S. for arms, equipments, &c., \$ _____ 100

Bounty paid \$ _____ 100; due \$ _____ 100

Remarks: *Died of disease at
U.S. Gen. Hspl. Wilmington,
N.C., May 18, 1865.*

Book mark: *117587,*

P. Pool,

Bennett, Lewis A.

B, Co. S, 6 Reg U.S.C. Inf.

2 Enclosures.

Bed Cards.....	Descriptive Lists.....
Burial Records.....	Final Statements /.....
Certs. of Dis. for Discharge.....	Furloughs.....
C. M. Charges.....	Med. Des. Lists.....
Med. Certificates.....	Orders.....

E.P.

1

Other papers relating to—

Admission to Hosp'l.....	Furlough.....
Casualty Sheet (Officer's).....	Med. Examination.....
Confinement.....	Misc. Information.....
Contracts.....	Pay or Clothing.....
Death or Effects.....	Personal Reports.....
Desertions.....	Rank.....
Discharge from Hosp'l.....	Transfer to Hosp'l.....
Discharge from Service.....	Transfer to V. R. C.....
Duty.....	Transportation.....

E.P. filed 3/5/02

NRB

DECLARATION OF RECRUIT.

I, Lewis A Bennett desiring to VOLUNTEER as a Soldier in the ARMY OF THE UNITED STATES, for the term of one year, Do Declare, That I am 25 years and 8 months of age; that I have never been discharged from the United States service, on account of disability or by sentence of a court-martial, or by order before the expiration of a term of enlistment; and I know of no impediment to my serving honestly and faithfully as a soldier for one year.

Given at Norwich the 6th day of Sept 1864
Witness: A.P. Bates Lewis A Bennett

Volunteered at Orange
By A.P. Bates 1864
Regiment of
enlistment; last served in Com-
pany () Reg't of
Discharged 1864
No Rec'd

CONSENT IN CASE OF MINOR.

I, Do certify that I am the
of that the said
is years of age; and I do hereby freely give my consent to
his volunteering as a Soldier in the Army of the United States for the period of
year.

Given at the day of 186
Witness:

VOLUNTEER ENLISTMENT.

STATE OF

New York



TOWN OF

Uttergo

I, Lewis A Bennett born in Delhi
 in the State of N.Y. aged 35 years,
 and by occupation a Farmer Do HEREBY ACKNOWLEDGE to have
 volunteered this fifth day of Sept 1864
 to serve as a SOLDIER in the Army of the United States of America, for the period of
one Year, unless sooner discharged by proper authority: Do also agree to accept
 such bounty, pay, rations and clothing, as are, or may be, established by law for volun-
 teers. And I, Lewis A Bennett, do solemnly swear,
 that I will bear true faith and allegiance to the United States of America, and that I will
 serve them honestly and faithfully against all their enemies or opposers whomsoever;
 and that I will observe and obey the orders of the President of the United States, and
 the orders of the officers appointed over me, according to the Rules and Articles of
 War.

Sworn and subscribed to, at
 this 6th day of Sept, 1864
 Before M. Thompson
Norwich
County Clerk

Lewis A Bennett

I CERTIFY, ON HONOR, That I have carefully examined the above-named Volunteer, agreeably to the General Regu-
 lations of the Army, and that, in my opinion, he is free from all bodily defects and mental infirmity, which would in any
 way disqualify him from performing the duties of a soldier.

Surgeon Board of Enrollment, 19th District, N. Y.,

EXAMINING SURGEON.

I CERTIFY, ON HONOR, That I have minutely inspected the Volunteer, Lewis A Bennett
 previously to his enlistment, and that he was entirely sober when enlisted; that, to the best of my judgment and belief, he
 is of lawful age; and that, in accepting him as duly qualified to perform the duties of an able-bodied soldier, I have strictly
 observed the Regulations which govern the recruiting service.

This soldier has Black eyes, Black hair, Black complexion, is 5
 feet 3 inches high.

Regiment of 1st Regt Volunteers.
M. A. Burt RECRUITING OFFICER.

Mastered into the service of the United States, in Company
 Volunteers, on the 13 day of Sept,
 1864, at Norwich (N. Y.) Headquarters.
1st Regt
19th Dist., N. Y.

Wm. Thompson
1st Regt
19th Dist., N. Y.

FINAL STATEMENT *6.*

OF

Private Lewis A Bennett
96.6th Reg't of U.S. C. Troops

VOLUNTEERS.

Due May 15. 1865

NOTE 1.—Two of these certificates (or duplicates) are to be given to each Volunteer Soldier or drafted man who may be discharged without being mustered out. (Final Statements are never given to men mustered out of service) that he may at once receive from the Paymaster the pay, &c., due him, and the captain or other COMMISSIONED officer commanding the company will certify to the act of the delivery of the duplicate certificates; with these certificates the Soldier is "entitled to" his discharge, and should also present his discharge to the Paymaster to have the payment endorsed on it. The discharge is to be given back to the Soldier by the Paymaster; the latter only retaining as his vouchers the duplicate certificates.

NOTE 2.—If the Soldier is entitled to pay for the use of his horse, the Company Commander will certify to that fact on the back of both these final statements, and also to the time he has pay due for having been so mounted on his own horse.

NOTE 3.—When a Soldier is furnished with final statements, his descriptive list, if he has one, should be taken up by the officer who gives the Soldier these statements, and endorsed with a statement to this effect by the officer. The endorsement should exhibit a full statement of the time for which the Soldier was allowed pay on his final statements, the clothing account, and all other charges against him or in his favor, so as to comprise a complete exhibit of his account. It will then be transmitted to the Company Commander of the Soldier, who will enter all the data necessary to a full understanding of the Soldier's account on the muster roll upon which the Soldier's discharge is reported. The descriptive list will then be destroyed. The object of this is, that the remaining portion of the Soldier's account may be settled upon the receipt of these muster rolls, and the Soldier receive any pay or allowances that may be due him at the time of his discharge, and which may not appear on his last final statements from the fact that his descriptive list is incomplete. These accounts for back pay, &c., are settled by the 2d Auditor of the Treasury Department.

NOTE 4.—Charges for loss or injury to ordnance, horse equipments, and other miscellaneous charges, should appear under the heading of "Other Stoppages."

NOTE 5.—Bounty paid by State authorities, and not by the United States, will not be entered on this statement.

NOTE 6.—Amounts due the Sutler and Laundress must be entered on the muster roll on which the discharge, death, desertion, &c., is reported, as well as on the final statement, otherwise the amount cannot be collected from the United States.

NOTE 7.—This blank will be used for deceased volunteers and drafted men, as well as for others.

NOTE 8.—Where a Soldier dies in Hospital or on detached service, his descriptive list, if he has one, should be sent with his final statements, in duplicate, to the Adjutant General, Washington, D. C.

NOTE 9.—If the soldier is a drafted man or substitute, the space for time, &c., of enrolled, should contain only the word *drafted* or *substitute*, as the case may be. If the Soldier is a "VETERAN," (or RECRUIT,) the words *as a veteran*, (or *recruit*.) as the case may be, should be interlined after the words *mustered into the service of the U. S.* A statement of all the installments of *Veteran* or *Recruit Bounty RECEIVED* by the Soldier must be made on the back of each final statement.

Adjutant General
1865

ADJUTANT GENERAL'S OFFICE.

Aug 30 1865

Duplicate with Inventory sent 2d Auditor.

I certify, on honor, that Lewis A Bennett, a Private of
 Captain Harkup Company (E) of the 6th Regiment of U.S.C.T.
VOLUNTEERS, of the State of _____, born in Delhi, State
 of New York, aged 35 years; 5 feet 9 inches high; Blk complexion,
Blu eyes, Blk hair, and by occupation a Farmer, who joined for service
 and was enrolled (see Note 9) on the 8th day of Sept, 1864, at Norwich
 by Capt Gordon, for the period of 1 years, and mustered into
 the service of the United States on the 6th day of September, 1864, at
Norwich N.Y., by Capt Gordon; and having served

HONESTLY and FAITHFULLY with his Company to the present date, is now entitled to a
DISCHARGE by reason of Death, died of disease at U.S.
Gen Hospital Wilmington N.C. May 18. 1865

The said Lewis A. Bennett was last paid by Paymaster
 _____, to include the _____ day of _____, 186____, and
 has pay due him from that ^{date of enlistment to May 18, 1865} ~~time to the present date~~; he is entitled to pay and subsistence for
TRAVELING to place of enrollment, and whatever other allowances are authorized to volunteer
 soldiers, drafted men, or militia, so discharged. He has received from the United States **CLOTHING**
 amounting to \$ 34 ⁷⁹/₁₀₀ dollars, since the 6th day of September,
 1864, ^{date of enlistment} ~~when his clothing account was last settled~~. He has received from the United States
\$ 33 ²³/₁₀₀ dollars advanced **BOUNTY**. \$ 66 2/3 U.S. Bounty

There is to be stopped from him, on account of the State of _____, or other
 authorities, for **CLOTHING**, &c., received on entering service, _____ ¹⁰⁰/₁₀₀ dollars; and
 for other stoppages, viz: _____

_____ ¹⁰⁰/₁₀₀ dollars.
 He has been furnished with **TRANSPORTATION** in kind from the place of his discharge to
 _____; and he has been **SUBSISTED** for **TRAVELING** to his
 place of enrollment, up to the _____, 186____.

He is indebted to _____, **SUTLER**, _____ ¹⁰⁰/₁₀₀ dollars.
 He is indebted to _____, **LAUNDRESS**, _____ ¹⁰⁰/₁₀₀ dollars.

Given in Duplicate, at Wilmington N.C., this 24 day
 of August, 1865.

Ephraim J. Harkup
Capt 6th U.S.C.T.

 Commanding Company.

6 U.S. CO.

Private

Private

CARD NUMBERS.

5579314	26
5567691	27
5579399	28
5579482	29
5579565	30
5579643	31
5579717	32
5579790	33
5579860	34
5579929	35
5580030	36
5580130	37
5580226	38
5580321	39
9065753	40
B-66-09-1869	41
	42
	43
	44
	45
	46
	47
	48
	49
	50

Book Mark: S. 304. V. 5 A.C.T. 67
 B-66-09-1869

See also

J | *6* | U.S.C.T.

Charles Berry
 _____, Co *H*, _____ 6 Reg't U.S. Col'd *Inf*

Appears on

Company Descriptive Book

of the organization named above.

DESCRIPTION.

Age *21* years; height *5* feet *8* inches.

Complexion *Black*

Eyes *Black*; hair *Black*

Where born *New Delaware*

Occupation _____

ENLISTMENT.

When *Aug. 13*, 186*3*.

Where *Smymna Del*

By whom *4th D Del*; term *3* y'rs.

Remarks: *Drafted -*
Del Service in Div.
Supply Train -

Jenkins

B

6

U.S.C.T.

Charles Berry
Pvt., Co. *K*, 6 Reg't U. S. Col'd Infantry.

Age *21* years.

Appears on

Company Muster-in Roll

of the organization named above. Roll dated
Philadelphia Pa., *Sep. 12*, 1863.

Muster-in to date *Sep. 12*, 1863

Joined for duty and enrolled:

When *Aug. 13*, 1863.

Where *Smymna, Del.*

Period *3* years.

Remarks: *Mustered by Capt.*
Wilmer A. M. Aug.
13/63.

Book mark: *B-66-07-1869*

S. A. Fitch

B | **6** | **U.S.C.T.**

Charles Perry

Appears with rank of *Pvt.* on

Muster and Descriptive Roll of a Detachment of U. S. Vols. forwarded

for the 6 Reg't U. S. Col'd Infantry. Roll dated

Smyma Del., *Sept. 12*, 1863.

Where born *Kent Coy Delaware*

Age *21* y'rs; occupation *Laborer*

When enlisted *Aug. 13*, 1863.

Where enlisted *Smyma Del.*

For what period enlisted *3* years.

Eyes *Blk*; hair *Blk*

Complexion *Blk*; height *5* ft. *7* in.

When mustered in *Sept. 9*, 1863.

Where mustered in

Bounty paid \$ *100*; due \$ *100*

Where credited

Company to which assigned

Remarks: *Drafted*

Book mark:

W. H. Bogar

B | **6** | **U.S.C.T.**

Charles Berry
Pat., Co. K, 6 Reg't U. S. Col'd Infantry.

Appears on

Company Muster Roll

for *Muster in to Oct 31 1863.*

Present or absent *Present*

Stoppage, \$ *100* for

Due Gov't, \$ *100* for

Remarks:

Book mark:

A. A. Hitch
Copy. st.

B | **6** | **U.S.C.T.**

Charles Perry
Pvt., Co. K, 6 Reg't U. S. Col'd Infantry.

Appears on

Company Muster Roll

for *Nov. 1st Dec.*, 1863.

Present or absent *Present*

Stoppage, \$ *100* for

Due Gov't, \$ *100* for

Remarks: *Steps for plantation*

Book mark:

(358)

C. A. Fitch
Copyist.

B

6

U.S.C.T.

Charles Berry

Pvt., Co. K, 6 Reg't U. S. Col'd Infantry.

Appears on

Company Muster Roll

for Jan. & Feb., 1864.

Present or absent Present

Stoppage, \$ 100 for

Due Gov't, \$ 100 for

Remarks:

Book mark:

A. A. Pritch

(358)

Copyist.

B | **6** | **U.S.C.T.**

Charles Berry
Sgt, Co. K, 6 Reg't U. S. Col'd Infantry.

Appears on

Company Muster Roll

for *Mar. & Apr.*, 1864

Present or absent *Present*

Stoppage, \$ *100* for

Due Gov't, \$ *100* for

Remarks:

Book mark:

A. A. Fitch
Coyist.

B

6

U.S.C.T.

Charles Berry
Pri, Co. K, 6 Reg't U. S. Col'd Infantry.

Appears on

Company Muster Roll

for May & June, 1864.

Present or absent Present

Stoppage, \$ 100 for

Due Gov't, \$ 100 for

Remarks:

Book mark:

J. Moore

B

6

U.S.C.T.

Charles Berry

Pr, Co. K, 6 Reg't U. S. Col'd Infantry.

Appears on

Company Muster Roll

for July & Aug, 1864.

Present or absent Present

Stoppage, \$ 100 for

Due Gov't, \$ 100 for

Remarks: Free Apr 19/61

On extra duty on Caval
Dutch Gap Va

Book mark:

J. W. Moore

B

6

U.S.C.T.

Charles Berry

Co. K, 6 Reg't U. S. Col'd Infantry.

Appears on

Company Muster Roll

for Sept & Oct, 1864.

Present or absent Absent

Stoppage, \$ 100 for

Due Gov't, \$ 100 for

Remarks: Absent wounded since Sept 29/64

NEXT ROLL ON FILE FEB 1865

Book mark:

J. Moore

(358)

Copyist.

B

6

U.S.C.T.

Charles Berry

Pvt., Co. K, 6 Reg't U. S. Col'd Infantry.

Appears on

Company Muster Roll

for Dated Feb 28, 1865.

Present or absent Absent

Stoppage, \$ 100 for

Due Gov't, \$ 100 for

Remarks: Detached in Div
wagon train Jan'y 1865

Book mark:

B. Moore

(358)

Copyist.

B

6

U.S.C.T.

Charles Berrey

Ki, Co. K, 6 Reg't U. S. Col'd Infantry.

Appears on

Company Muster Roll

for May 7, 1865

Present or absent Absent

Stoppage, \$ 100 for

Due Gov't, \$ 100 for

Remarks: Detached in
wagon train

Book mark:

J. Moore

B

6

U.S.C.T.

Charles Berry

Plt, Co. K, 6 Reg't U. S. Col'd Infantry.

Appears on

Company Muster Roll

for *May & June*, 1865.

Present or absent *Absent*

Stoppage, \$ *100* for

Due Gov't, \$ *100* for

Remarks: *Det. Ser. Quartermaster
in Div. Supply Train.
Drafted.*

Book mark:

M. Anderson

(358)

Copyist.

B

6

U.S.C.T.

Charles Berry

Pvt., Co. K, 6 Reg't U. S. Col'd Infantry.

Appears on

Company Muster Roll

for *July & Aug.*, 1865.

Present or absent *Absent*

Stoppage, \$ *100* for

Due Gov't, \$ *100* for

Remarks: *Det. Ser. Dis. Safely
train*

Drafted

Book mark:

W. Anderson

(358)

Copyist.

B | 6 | U.S.C.T.

Charles Berry

Put, Co. K, 6 Reg't U. S. Col'd Infantry.

Appears on Co. Muster-out Roll, dated
Wilmington, N.C., Sept 20, 1865.

Muster-out to date _____, 186 .

Last paid to Aug 31, 1864 .

Clothing account:

Last settled *Mchs*, 1865; drawn since \$ 100

Due soldier \$ 100; due U. S. \$ 100

Am't for cloth'g in kind or money adv'd \$ 100

Due U. S. for arms, equipments, &c., \$ 100

Bounty paid \$ *Some* 100; due \$ 100 100

Remarks: *Alms Wm. Fishers, Regtl Supt,*
#13. Free on or before Apr. 19/61.

Abraham Delt.

Drafted under act of Mar 3, 1863.

No discharge furnished.

Book mark: *S. 304, U.S. R. & J. 67.*

J. S. Anderson

B. 1 Co. M.S. 6. J

Charles Berry

, Co. 10, 6 Reg't U.S. 6. J.

NOTATION.

S-304-REG-1867 with

Book mark: B. 66. 6. J. 1869.

War Department,

Adjutant General's Office,

Washington, Feb. 18th, 1869.

Discharge on file.

E. P. Conroy

6 U.S. GOVERNMENT

Colonel

Colonel

CARD NUMBERS.

1	5575849	26
2	5575932	27
3	5576015	28
4	5576094	29
5	5576171	30
6	5576250	31
7	5576326	32
8	5576460	33
9	5577031	34
10	9865403	35
11		36
12		37
13		38
14		39
15		40
16		41
17		42
18		43
19		44
20		45
21		46
22		47
23		48
24		49
25		50

Book Mark:

See also

B | **6** | **U.S.C.T.**

** Charles W. Berry,*
 _____, Co. *G*, 6 Reg't U. S. Col'd Inf.

Appears on

Company Descriptive Book
 of the organization named above.

DESCRIPTION.

Age *19* years; height *5* feet *4* inches.

Complexion *L. Brown*

Eyes *Brown*; hair *Black*

Where born *Washington Co. Pa.*

Occupation *Labourer,*

ENLISTMENT.

When *Aug. 31*, 186*3*.

Where *Pittsburg Pa.*

By whom *A. Bughless*; term *3* y'rs.

Remarks *Killed in action
 at New Market Heights
 Va. Sept 29, 1864.*

** Name cancelled by line.*

Justins

B

6

U.S.C.T.

Charles W. Berry
 Copt., Co. G., 6 Reg't U. S. Col'd Infantry.

Age *19* years.

Appears on

Company Muster-in Roll

of the organization named above. Roll dated
Philadelphia Pa, Sept 4, 1863.

Muster-in to date *Sept 14, 1863*

Joined for duty and enrolled:

When *Aug. 31*, 1863.

Where *Pittsburg Pa*

Period *3* years.

Remarks: *Recd on enlistment papers & mustered by Lt. Pierce U.S.A. Sept. 4 - 1863. Enlisted in 24 Dist Pa.*

Book mark :

M. A. Michaels

(856)

Copyist.

D

6

U.S.C.T.

Charles W. Berry
Corpl., Co. G, 6 Reg't U. S. Col'd Infantry.

Appears on

Company Muster Roll

for *Enrollment to Oct 31, 1863.*

Present or absent *Present*

Stoppage, \$ *100* for

Due Gov't, \$ *100* for

Remarks: *Promoted to Corporal
Sept 9-63*

Book mark:

(358)

M. A. Michaels
Copyist.

P | **6** | **U.S.C.T.**

Charles W. Berry
Corpl, Co. G, 6 Reg't U. S. Col'd Infantry.

Appears on

Company Muster Roll

for *Nov & Dec*, 1863.

Present or absent *Present*

Stoppage, \$ *100* for

Due Gov't, \$ *100* for

Remarks:

Book mark:

(358) *M. A. Michaels* Copyist.

B | 6 | U.S.C.T.

Charles W. Perry
Corpl, Co. G, 6 Reg't U. S. Col'd Infantry.

Appears on

Company Muster Roll

for Jan & Febr, 1864.
Present or absent Present.

Stoppage, \$ 100 for

Due Gov't, \$ 100 for

Remarks:

Book mark:

(358)

M. A. Michaels
Copyist.

B

6

U.S.C.T.

Charles W. Berry

Corpl, Co. G, 6 Reg't U. S. Col'd Infantry.

Appears on

Company Muster Roll

for *March & Apr*, 1864.

Present or absent *Present*

Stoppage, \$ *100* for

Due Gov't, \$ *100* for

Remarks: *Stop for 1 Cauteer 41^d*

Book mark:

M. A. Michaels
Copyist.

(358)

B | 6 | U.S.C.T.

Charles W. Bury
Copl., Co. G, 6 Reg't U. S. Col'd Infantry.

Appears on

Company Muster Roll

for May & June, 1864

Present or absent Present

Stoppage, \$ 100 for

Due Gov't, \$ 100 for

Remarks:

Book mark:

Grogan

B | 6 | U.S.C.T.

Charles W Berry
Cnpl, Co. G, 6 Reg't U. S. Col'd Infantry.

Appears on

Company Muster Roll

for July & Aug., 1864

Present or absent Present

Stoppage, \$ 100 for

Due Gov't, \$ 100 for

Remarks:

Free April 19, 1861.
Appointed Cnpl in accor-
dance with special order No.
4, Sept. 6, 1863, on Extra
Duty.

Book mark:

E. Hogan

B | 6 | U.S.C.T.

Charles W. Berry
Cnpl., Co. G, 6 Reg't U. S. Col'd Infantry.

Appears on

Company Muster Roll

for Sept. & Oct., 1864.

Present or absent

Stoppage, \$ 100 for

Due Gov't, \$ 100 for

Remarks: Killed in action
near Deep Bottom (near
Market Street) Va. Sept. 29,
1864. Final statement
sent to adjt. Genl.
From April 19, 1861,
due William M. Brisbane,
sutler, \$7-

Book mark:

Grogan
Copyist.

B | 6 | U.S.C.T.

Charles W. Berry
Corpl, Co. G, 6 Reg't U. S. Col'd Infantry.

Appears on Co. Muster-out Roll, dated
Wilmington N.C., Sept 20, 1865.

Muster-out to date _____, 186 .
Last paid to _____, 186 .

Clothing account:

Last settled _____, 186 ; drawn since \$ _____ 100

Due soldier \$ _____ 100; due U. S. \$ _____ 100

Am't for cloth'g in kind or money adv'd \$ _____ 100

Due U. S. for arms, equipments, &c., \$ _____ 100

Bounty paid \$ _____ 100; due \$ _____ 100

Remarks: Killed in action
at New Market Heights
Va. Sept 29/64.

Book mark : _____

(361)

Moy Copyist.

Berry, Charles H.

B Co. 4

6 Reg't U.S.C. Inf.

3 Enclosures.

Bed Cards	Descriptive Lists
Burial Records	Final Statements /
Certs. of Dis. for Discharge	Furloughs
C. M. Charges	Med. Des. Lists
Med. Certificates	Orders

Enlist. Papers. 2

Other papers relating to—

Admission to Hosp'l	Furlough
Casualty Sheet (Officer's)	Med. Examination
Confinement	Misc. Information
Contracts	Pay or Clothing
Death or Effects	Personal Reports
Desertions	Rank
Discharge from Hosp'l	Transfer to Hosp'l
Discharge from Service	Transfer to V. R. C.
Duty	Transportation

DECLARATION OF RECRUIT.

I, *Charles M. Berry* desiring to VOLUNTEER as a Soldier in the Army of the United States, for the term of THREE YEARS, Do declare, That I am *Twenty (20)* years and _____ months of age; that I have never been discharged from the United States service on account of disability or by sentence of court martial, or by order before the expiration of a term of enlistment; and I know of no impediment to my serving honestly and faithfully as a soldier for three years.

GIVEN at *Pittsburgh, Penna*
The *21st* day of *August 1863*

Witness:

Rufus S. Jones

Charles W. Berry

108

Volunteered at _____
Charles W. Berry
No. _____

By *6*
Regiment of *11th*

enlistment; last served in Company ()
Reg't of _____
Discharged _____ 18 _____

Sept. 1865. This paper was formerly filed in the Bureau of War, & P. O.

CONSENT IN CASE OF MINOR.

I, _____ Do CERTIFY, That I am the _____ of _____; that the said _____ is _____ years of age; and I do hereby freely give my CONSENT to his volunteering as a SOLDIER in the ARMY OF THE UNITED STATES for the period of THREE YEARS.

GIVEN at _____
The _____ day of _____

Witness:

VOLUNTEER ENLISTMENT.

STATE OF *Penn*  TOWN OF *Pittsburgh*

I, *Chas M. Perry* born in *Washington County*
in the State of *Tenn* aged *nineteen (19)* years,
and by occupation a *labourer* Do HEREBY ACKNOWLEDGE to have
volunteered this *31st* day of *August* 1863

to serve as a **Soldier** in the **Army of the United States of America**, for the
period of **THREE YEARS**, unless sooner discharged by proper authority: Do also
agree to accept such bounty, pay, rations, and clothing, as are, or may be, estab-
lished by law for volunteers. And I, *Chas M. Perry* do
solemnly swear, that I will bear true faith and allegiance to the **United States**
of America, and that I will serve them honestly and faithfully against all
their enemies or opposers whomsoever; and that I will observe and obey the
orders of the President of the United States, and the orders of the officers
appointed over me, according to the Rules and Articles of War.

Sworn and subscribed to, at *Pittsburgh*
this *1st* day of *Sept* 1863 *Charles M. Perry*
BEFORE *A. S. Nicholson, ad*

I CERTIFY, ON HONOR, That I have carefully examined the above named Volunteer, agreeably to
the General Regulations of the Army, and that in my opinion he is free from all bodily defects and mental
infirmity, which would, in any way, disqualify him from performing the duties of a soldier.

A. S. Nicholson
EXAMINING SURGEON.

I CERTIFY, ON HONOR, That I have minutely inspected the Volunteer,
previously to his enlistment, and that he was entirely sober when enlisted; that, to the best of my
judgment and belief, he is of lawful age; and that, in accepting him as duly qualified to perform the duties
of an able-bodied soldier, I have strictly observed the Regulations which govern the recruiting service.
This soldier has *brown* eyes, *black* hair, *fair* complexion, is *5* feet *4* inches
high.

Thos M. Brown
Sixth Regiment of *U.S. Colored* Volunteers,
RECRUITING OFFICER.

✓ FINAL STATEMENT //

OF

Charles H. Berry
6th Reg't of U. S. C.

VOLUNTEERS.

Rec'd Sep 29 1864

NOTE 1.—Two of these certificates (or duplicates) are to be given to each Volunteer Soldier or drafted man who may be discharged previously to the discharge of his company, that he may at once receive from the Paymaster the pay, &c., due him, and the captain or other COMMISSIONED officer commanding the company will certify to the act of the delivery of the duplicate certificates; on these certificates the Soldier is "entitled to" his discharge, and should also present his discharge to the Paymaster to have the payment endorsed on it. The discharge is to be given back to the Soldier by the Paymaster; the latter only retaining as his voucher the duplicate certificates.

NOTE 2.—If the Soldier is entitled to pay for the use of his horse, the Company Commander will certify to that fact on the back of both these final statements, and also to the time he has pay due for having been so mounted on his own horse.

NOTE 3.—When a Soldier is furnished with final statements, his descriptive list, if he has one, should be taken up by the officer who gives the Soldier these statements, and endorsed with a statement to this effect by the officer. This endorsement should exhibit a full statement of the time for which the Soldier was allowed pay on his final statements, the clothing account, and all other charges against him or in his favor, so as to comprise a complete exhibit of his account. It will then be transmitted to the company commander of the Soldier, who will enter all the data necessary to a full understanding of the Soldier's account on the muster roll upon which the Soldier's discharge is reported. The descriptive list will then be destroyed. The object of this is, that the remaining portion of the Soldier's account may be settled upon the receipt of these muster rolls, and the Soldier receive any pay or allowances that may be due him at the time of his discharge, and which may not appear on his final statements from the fact that his descriptive list is incomplete. These accounts for back pay, &c., are settled by the 2d Auditor of the Treasury Department.

NOTE 4.—Charges for loss or injury to ordnance, horse equipments, and other miscellaneous charges, should appear under the heading of "Other Stoppages."

NOTE 5.—Bounty paid by State authorities, and not by the United States, will not be entered on this statement.

NOTE 6.—Amounts due the Sutler and Laundress must be entered on the muster roll on which the discharge, death, desertion, &c., is reported, as well as on the final statement, otherwise the amount cannot be collected from the United States.

NOTE 7.—This blank will be used for deceased volunteers and drafted men, as well as for others.

NOTE 8.—Where a Soldier dies in hospital or on detached service, his descriptive list, if he has one, should be sent with his final statements, in duplicate, to the Second Auditor, Washington, D. C.

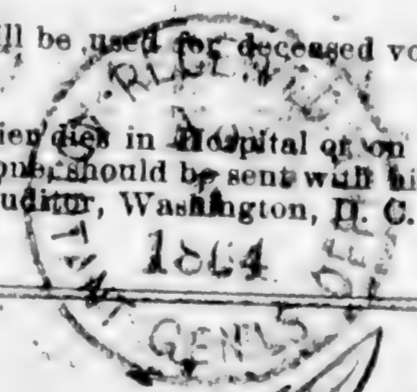

Edward D. Smith

ADJUTANT GENERAL'S OFFICE.

Nov 22 1864

Duplicate with Inventory sent 2d Auditor.

I certify, on honor, that Charles St Berry a Corporal of
 Captain H. Herbert Company (G) of the Sixth Regiment of U. S. C. I.
VOLUNTEERS, of the State of _____, born in Washington Co., State
 of Ill. Ill., aged 19 years; 5 feet 4 inches high; Light complexion,
Brown eyes, black hair, and by occupation a Farmer, having joined the company on
 its original organization at Camp W. S. C. I., and enrolled in it at the muster into
 the service of the United States at Philadelphia Pa., on the twenty first day
 of August, 1864, (or was mustered in service as a recruit, by _____
 _____, at _____, on the _____ day of _____,
 186-, or was drafted and mustered into the service of the United States from the _____
 Enrollment District of the State of _____, at _____,
 on the _____ day of _____, 186-) to serve in the Regiment, for
 the term of _____ years; and having served **HONESTLY** and
FAITHFULLY with his Company in 6th U. S. C. I. to the present date, is now
 entitled to a **DISCHARGE** by reason of Death arising from wounds
received in battle at New Market Heights Va on the 27th day of Sept. 1864

The said Charles St Berry was last paid by Paymaster
Major H. Berry to include the 30 day of April, 1864, and has
 pay due him from that time to the present date; he is entitled to pay and subsistence for
TRAVELING to place of enrollment, and whatever other allowances are authorized to volunteer
 soldiers, drafted men, or militia, so discharged. He has received from the United States **CLOTHING**
 amounting to seventy five dollars, since the _____ day of _____,
 186-, when his clothing account was last settled. He has received from the United States
 _____ dollars advanced **BOUNTY**.

There is to be stopped from him, on account of the State of _____, or other
 authorities, for **CLOTHING**, &c., received on entering service, _____ dollars; and
 for other stoppages, &c.: _____
 _____ dollars.

He has been furnished with **TRANSPORTATION** in kind from the place of his discharge to
 _____; and he has been **SUBSISTED** for **TRAVELING** to his
 place of enrollment, up to the _____, 186-.

He is indebted to William M. Baisens, **SUTLER**, Seven dollars.
 He is indebted to _____, **LAUNDRESS**, _____ dollars.

Given in Duplicate, at Camp U.S.C.I. near Durock Gap, this 25th day
 of October, 1864.

Henry Herbert
Captain

Commanding Company

DECLARATION OF RECRUIT

I, *Charles Henry*, desiring to VOLUNTEER as a Soldier in the Army of the United States, for the term of THREE YEARS, months Do declare, That I am *nineteen* years and of age; that I have never been discharged from the United States service on account of disability or by sentence of court martial, or by order before the expiration of a term of enlistment; and I know of no impediment to my serving honestly and faithfully as a soldier for three years.

GIVEN at *Leedsburgh, Iowa* The *21st* day of *August* 1863

Witness:

James Smith, James Charles W. Berry

CS

No. _____

Charles H. Berry
Volunteered at _____ 18 ,

By _____

6 Regiment of *USA*

enlistment; last served in Company ()

Reg't of _____

Discharged _____ 18

Sept. 1895. This paper was formerly filed in the Department Div. H. & P. O.

CONSENT IN CASE OF MINOR.

I, _____ Do CERTIFY, That I am the said _____ of _____ years of age; and I do hereby freely give my consent to his volunteering as a SOLDIER in the ARMY OF THE UNITED STATES for the period of THREE YEARS.

GIVEN at _____ The _____ day of _____

Witness:

VOLUNTEER ENLISTMENT.

STATE OF



TOWN OF

Pittsburgh

I, *Chas. W. Berry*
in the State of *Penn'a*
and by occupation a *laborer*
volunteered this *21st*

born in *Washington County*
aged *nineteen (19)* years,
Do HEREBY ACKNOWLEDGE to have
day of *August* 18 *63*

to serve as a **Soldier** in the **Army of the United States of America**, for the period of **THREE YEARS**, unless sooner discharged by proper authority: Do also agree to accept such bounty, pay, rations, and clothing, as are, or may be, established by law for volunteers. And I, *Chas. W. Berry* do solemnly swear, that I will bear true faith and allegiance to the **United States of America**, and that I will serve them honestly and faithfully against all their enemies or opposers whomsoever; and that I will observe and obey the orders of the President of the United States, and the orders of the officers appointed over me, according to the Rules and Articles of War.

Sworn and subscribed to, at *Pittsburgh*
this *1st* day of *Sept* 18 *63*
BEFORE *A. Schickel*

Charles W. Berry

I CERTIFY, ON HONOR, That I have carefully examined the above named Volunteer, agreeably to the General Regulations of the Army, and that in my opinion he is free from all bodily defects and mental infirmity, which would, in any way, disqualify him from performing the duties of a soldier.

A. Schickel
EXAMINING SURGEON.

I CERTIFY, ON HONOR, That I have minutely inspected the Volunteer, previously to his enlistment, and that he was entirely sober when enlisted; that, to the best of my judgment and belief, he is of lawful age; and that, in accepting him as duly qualified to perform the duties of an able-bodied soldier, I have strictly observed the Regulations which govern the recruiting service. This soldier has *brown* eyes, *black* hair, *fair* complexion, is *5* feet *4* inches high.

Thomas H. Brungler
Sixth Regiment of U.S. Colored Volunteers,
RECRUITING OFFICER

VOLUNTEER ENLISTMENT.

STATE OF *Penn* TOWN OF *Pittsburgh*



I, *Chas M. Berry* born in *Washington County*
in the State of *Penn* aged *nineteen (19)* years,
and by occupation a *laborer* Do HEREBY ACKNOWLEDGE to have
volunteered this *31st* day of *August* 18*63*
to serve as a **Soldier** in the **Army of the United States of America**, for the
period of **THREE YEARS**, unless sooner discharged by proper authority: Do also
agree to accept such bounty, pay, rations, and clothing, as are, or may be, estab-
lished by law for volunteers. And I, *Chas M. Berry* do
solemnly swear, that I will bear true faith and allegiance to the **United States**
of America, and that I will serve them honestly and faithfully against all
their enemies or opposers whomsoever; and that I will observe and obey the
orders of the President of the United States, and the orders of the officers
appointed over me, according to the Rules and Articles of War.

Sworn and subscribed to, at *Pittsburgh*
this *1st* day of *Sept* 18*63* *Charles M. Berry*
BEFORE *A. S. Nicholson, ald*

I CERTIFY, ON HONOR, That I have carefully examined the above named Volunteer, agreeably to
the General Regulations of the Army, and that in my opinion he is free from all bodily defects and mental
infirmity, which would, in any way, disqualify him from performing the duties of a soldier.

A. S. Nicholson
EXAMINING SURGEON.

I CERTIFY, ON HONOR, That I have minutely inspected the Volunteer,
previously to his enlistment, and that he was entirely sober when enlisted; that, to the best of my
judgment and belief, he is of lawful age; and that, in accepting him as duly qualified to perform the duties
of an able-bodied soldier, I have strictly observed the Regulations which govern the recruiting service.
This soldier has *brown* eyes, *black* hair, *whom* complexion, is *5* feet *4* inches
high.

Thos M. Bronght
Sixth Regiment of *U.S. Colored* Volunteers,
RECRUITING OFFICER.

DECLARATION OF RECRUIT.

I, *Chas H Berry* desiring to VOLUNTEER as a Soldier in the Army of the United States, for the term of THREE YEARS, Do declare, That I am *nineteen (19)* years and months of age; that I have never been discharged from the United States service on account of disability or by sentence of court martial, or by order before the expiration of a term of enlistment; and I know of no impediment to my serving honestly and faithfully as a soldier for three years.

GIVEN at *Chillicothe Tenn* The *21st* day of *August* 18*63*

Witness: *Rufus S. Jones*

Chas H Berry

No. *Chas H Berry*
Volunteered at _____ 18 _____
By *6* Regiment of *USA*
_____ 18 _____
enlistment; last served in Company ()
Reg't of _____
Discharged _____ 18 _____

Filed in the _____

CONSENT IN CASE OF MINOR.

I, _____ of _____ is said _____ years of age; and I do hereby freely give my consent to his volunteering as a SOLDIER in the ARMY OF THE UNITED STATES for the period of THREE YEARS.

GIVEN at _____ The _____ day of _____

Witness: _____

6 U.S. Gold Ltd.

Private | *Original*

CARD NUMBERS.

5579315	26
5567692	27
5579394	28
5579477	29
5579359	30
5579637	31
5579711	32
5579784	33
5579910	34
5580401	35
9065754	36
	37
	38
	39
	40
	41
	42
	43
	44
	45
	46
	47
	48
	49
	50

Book Mark: _____

See also _____

B | 6 | U.S.C.T.

+ Vincent Berry,
Co. H, 6 Reg't U.S. Col'd Inf

Appears on
Company Descriptive Book
of the organization named above.

DESCRIPTION.

Age 31 years; height 5 feet 7 1/2 inches.
Complexion Brown
Eyes Black; hair Black
Where born Kent Delaware
Occupation Farmer

ENLISTMENT.

When Aug. 31, 1863
Where Smyrna Del.
By whom 1st D. Del; term 3 y'rs.

Remarks: Drafted. Promoted to
corporal. Died in
U.S. Genl. Hospital
St. Monroe Sept 2/64
from wounds received
in Right Arm near
Petersburg Va. July 25/64
Final statements sent
July 25. 1865.

* Name cancelled by line.

Jenkins

B

6

U.S.C.T.

Vincent Berry
Pt., Co. K, 6 Reg't U. S. Col'd Infantry.

Age 31 years.

Appears on

Company Muster-in Roll

of the organization named above. Roll dated

Philadelphia Pa., Sep 12, 1863.

Muster-in to date

Sep 12, 1863

Joined for duty and enrolled:

When Aug. 13, 1863

Where Smyrna, Del.

Period 3 years.

Remarks: Mustered by Capt.
Wilmer P. M. Aug.
13/63.

Book mark:

S. A. Kitch

P | 6 | U.S.C.T.

Vincent Berry

Appears with rank of *Priv* on

Muster and Descriptive Roll of a Detachment of U. S. Vols. forwarded

for the 6 Reg't U. S. Col'd Infantry. Roll dated

Smyrna Del., *Sept. 12*, 1863.

Where born *Kent Coy Del.*

Age *31* y'rs; occupation *Laborer*

When enlisted *Aug. 13*, 1863.

Where enlisted *Smyrna Del.*

For what period enlisted *3* years.

Eyes *Blk*; hair *Blk*

Complexion *light*; height *5 ft. 8 in.*

When mustered in *Sept. 9*, 1863.

Where mustered in

Bounty paid \$ *100*; due \$ *100*

Where credited

Company to which assigned

Remarks: *Drafted*

Book mark:

W. H. Bogar

(339) *Copyist.*

Bz

6

U.S.C.T.

Vincent Berry
Corp, Co. K, 6 Reg't U. S. Col'd Infantry.

Appears on

Company Muster Roll

for Muster roll Oct. 3, 1863.

Present or absent Present

Stoppage, \$ 100 for

Due Gov't, \$ 100 for

Remarks: Appointed corporal
Oct. 29/63 per per SR.
O. No. 21.

Book mark:

A. A. Fitch

Coplist.

(358)

Bg | **6** | **U.S.C.T.**

Vincent Perry
Corp, Co. K, 6 Reg't U. S. Col'd Infantry.

Appears on

Company Muster Roll

for *Nov. 8th Dec.*, 1863.

Present or absent *Present*

Stoppage, \$ *100* for

Due Gov't, \$ *100* for

Remarks: *Stop for Haversack and 1 canteen.*

Book mark:

S. A. Fitch

(358)

Copyist.

B | **6** | **U.S.C.T.**

Vincent Berry
Corp, Co. K, 6 Reg't U. S. Col'd Infantry.

Appears on

Company Muster Roll

for *Jan & Feb.*, 186*4*.

Present or absent *Present*

Stoppage, \$ *100* for

Due Gov't, \$ *100* for

Remarks:

Book mark:

S. A. Hitch

B

6

U.S.C.T.

Vincent Berry
Corp, Co. K, 6 Reg't U. S. Col'd Infantry.

Appears on

Company Muster Roll

for Mar. & Apr, 1864

Present or absent Present

Stoppage, \$ 100 for

Due Gov't, \$ 100 for

Remarks:

Book mark:

(358)

S. A. Pritch
Copyist.

B

6

U.S.C.T.

Vincent Berry

Serjeant, Co. K, 6 Reg't U. S. Col'd Infantry.

Appears on

Company Muster Roll

for May & June, 1864.

Present or absent Present

Stoppage, \$ 100 for

Due Gov't, \$ 100 for

Remarks:

Book mark:

J. Moore

(358)

Copyist.

B

6

U.S.C.T.

Vincent Berry

Capt, Co. K, 6 Reg't U. S. Col'd Infantry.

Appears on

Company Muster Roll

for July & Aug, 1864.

Present or absent Absent

Stoppage, \$ 100 for

Due Gov't, \$ 100 for

Remarks: Free Apr 19/61.

Absent wounded since July 28/64. In US Genl Hosp Fortres Monroe

Book mark:

D. W. Moore

(358)

Copyist.

B

6

U.S.C.T.

Vincent Berry

Capt, Co. K, 6 Reg't U. S. Col'd Infantry.

Appears on

Company Muster Roll

for Sept + Oct, 1864.

Present or absent _____

Stoppage, \$ _____ 100 for _____

Due Gov't, \$ _____ 100 for _____

Remarks: Died Sept 25 at Genl
Herst Fortres Monroe of
Pyæmia from G.S. wound
right arm recd in action
near Petersburg July 29/64.
Free Apr 19/64

NEXT ROLL ON FILE FEB 1865

Book mark: 6072893, Feb 6/65-

J. Moore

(358)

Copyist.

B

6

U.S.C.T.

Vincent Berry

Corp, Co. K, 6 Reg't U. S. Col'd Infantry.

Appears on Co. Muster-out Roll, dated
 Wilmington, N.C., Sept. 20, 1865.

Muster-out to date _____, 186 .

Last paid to _____, 186 .

Clothing account:

Last settled _____, 186 ; drawn since \$ _____ 100

Due soldier \$ _____ 100; due U. S. \$ _____ 100

Am't for cloth'g in kind or money adv'd \$ _____ 100

Due U. S. for arms, equipments, &c., \$ _____ 100

Bounty paid \$ _____ 100; due \$ _____ 100

Remarks: Died Sept. 2, 1864,
 at N. S. G. Hrs. F. Manual, Va.
 of wounds.

Book mark: 72,893, F. S.

M. J. Andrews

(361)

Copyist.

Berry, Vincent -
 Corp, Co. K 1, 6 Reg't USCT.

5 Enclosures.

Bed Cards	Descriptive Lists
Burial Records	Final Statements /
Certs. of Dis. for Discharge	Furloughs
C. M. Charges	Med. Des. Lists
Med. Certificates	Orders

Other papers relating to—

Admission to Hosp'l	Furlough
Casualty Sheet (Officer's) 2	Med. Examination
Confinement	Misc. Information /
Contracts	Pay or Clothing
Death or Effects /	Personal Reports
Desertions	Rank
Discharge from Hosp'l	Transfer to Hosp'l
Discharge from Service	Transfer to V. R. C.
Duty	Transportation

CASUALTY SHEET
OF WOUNDED.

V. Berry

Private Company *"K"*

6th Regiment of *N. S. I. S.*

Volunteers at the battle of _____

July 30/64

CASUALTY SHEET.

Name, W. Berry
 Rank, Private, Company "K", Regiment, 60th
 Arm, U.S. Army, State, Ill.
 Place of casualty, _____
 Nature of casualty, wounded in action

Date of casualty, July 30th 1864

FROM WHAT SOURCE THIS INFORMATION WAS OBTAINED.

Report of Killed, Wounded, and Missing of the _____ Regiment,
2nd Brigade, 3rd Division, 18th Corps, dated _____
Sgt. J. W. Duncan
Coat. Comdg.

Ind. Inf. no 911

W. P. Brainerd
 Clerk.

4
(2)

CASUALTY SHEET
OF WOUNDED.

V Berry

Private Company "K"

6th Regiment of USCS

Volunteers at the battle of Assault

on Petersburg Va.

(from end)

CASUALTY SHEET.

Name, V Berry
 Rank, Private, Company "K", Regiment, 6th
 Arm, USCA, State, _____
 Place of casualty, Assault on Petersburg Va.
(from said)
 Nature of casualty, Wounded.
 Date of casualty, _____

FROM WHAT SOURCE THIS INFORMATION WAS OBTAINED.

Report of Killed, Wounded, and Missing of the 6th Regiment, USCA
2nd Brigade, 3rd Division, 18th Corps, dated In the field Va.
Aug 3rd 1864. Signed Sam'l A. Duncan
col comdg
Index 50 G no 134.

W.F. Thompson
 Clerk.

12.

FINAL STATEMENT

OF

Corporal Vincenc Berry
Co. Reg't of W. S. Col. Troops

VOLUNTEERS.

Disch. Sept 2 1864

NOTE 1.—Two of these certificates (or duplicates) are to be given to each Volunteer Soldier or drafted man who may be discharged without being mustered out (Final Statements are never given to men mustered out of service) that he may at once receive from the Paymaster the pay, &c., due him, and the captain or other COMMISSIONED officer commanding the company will certify to the act of the delivery of the duplicate certificates; with these certificates the Soldier is "entitled to" his discharge, and should also present his discharge to the Paymaster to have the payment endorsed on it. The discharge is to be given back to the Soldier by the Paymaster; the latter only retaining as his vouchers the duplicate certificates.

NOTE 2.—If the Soldier is entitled to pay for the use of his horse, the Company Commander will certify to that fact on the back of both these final statements, and also to the time he has pay due for having been so mounted on his own horse.

NOTE 3.—When a Soldier is furnished with final statements, his descriptive list, if he has one, should be taken up by the officer who gives the Soldier these statements, and endorsed with a statement to this effect by the officer. The endorsement should exhibit a full statement of the time for which the Soldier was allowed pay on his final statements, the clothing account, and all other charges against him or in his favor, so as to comprise a complete exhibit of his account. It will then be transmitted to the Company Commander of the Soldier, who will enter all the data necessary to a full understanding of the Soldier's account on the muster roll upon which the Soldier's discharge is reported. The descriptive list will then be destroyed. The object of this is, that the remaining portion of the Soldier's account may be settled upon the receipt of these muster rolls, and the Soldier receive any pay or allowances that may be due him at the time of his discharge, and which may not appear on his last final statements from the fact that his descriptive list is incomplete. These accounts for back pay, &c., are settled by the 2d Auditor of the Treasury Department.

NOTE 4.—Charges for loss or injury to ordnance, horse equipments, and other miscellaneous charges, should appear under the heading of "Other Stoppages."

NOTE 5.—Bounty paid by State authorities, and not by the United States, will not be entered on this statement.

NOTE 6.—Amounts due the Sutler and Laundress must be entered on the muster roll on which the discharge, death, desertion, &c., is reported, as well as on the final statement, otherwise the amount cannot be collected from the United States.

NOTE 7.—This blank will be used for deceased volunteers and drafted men, as well as for others.

NOTE 8.—Where a Soldier dies in Hospital or on detached service, his descriptive list, if he has one, should be sent with his final statements, in duplicate, to the Adjutant General, Washington, D. C.

NOTE 9.—If the soldier is a drafted man or substitute, the space for time, &c., of enrolled, should contain only the word *drafted* or *substitute*, as the case may be. If the Soldier is a "VETERAN," (or RECRUIT,) the words as a *veteran*, (or *recruit*), as the case may be, should be interlined after the words *mustered into the service of the U. S.* A statement of all the installments of *Veteran or Recruit Bounty RECEIVED* by the Soldier must be made on the back of each final statement.

Was Capt. A.G.O.
July 12, 1865.
Receipt ret'd, for correction.
It appears from the inventory
of effect on hand that this
man died Sept. 2, 1864
By order:

[Signature]
Adj. G. O.

L. 127 Vol 2 R. C. T. 1865

also
cannot be completed owing
to incomplete records, see

L. 127, Vol. 2, R. C. T. 1865
B.

L. 139 Vol 2. P. L. 2 1865

A. G. O. April 6/66
P. O. of 11 div & P. 7 m.
get for 1/2 1/2 - April 2
Acc 8, 1866

ADJUTANT GENERAL'S OFFICE

Aug 8 1866

Duplicate with Inventory sent 2d Auditor.

I certify, on honor, that Vincent Berry, a Private of
 Captain J. J. Riley's Company (4) of the 64th Regiment of W. B. Cold Springs
VOLUNTEERS, of the State of _____, born in _____, State
 of _____, aged 31 years; _____ feet _____ inches high; _____ complexion,
 _____ eyes, _____ hair, and by occupation a _____, who joined for service
 and was enrolled (see Note 9) on the _____ day of drafted, 186 _____, at _____
 by _____, for the period of Three years, and mustered into
 the service of the United States on the 13th day of August, 1863, at
Smyma Del, by 1st Dis. Del.; and having served
 HONESTLY and FAITHFULLY with his Company to Sept 2nd 1864, is now entitled to a
DISCHARGE by reason of Death caused by wounds received in
right shoulder near Petersburg Va July 25th 1864

Died Sept 2nd 1864

The said Private Vincent Berry was last paid by Paymaster
Wm. C. Kinney, to include the 20th day of April, 1864, and
 has pay due him from that time to Sept 2nd 1864; he is entitled to pay and subsistence for
TRAVELING to place of enrollment, and whatever other allowances are authorized to volunteer
 soldiers, drafted men, or militia, so discharged. He has received from the United States **CLOTHING**
 amounting to _____ 100 dollars, since the _____ day of _____
 186 _____, when his clothing account was last settled. He has received from the United States
 _____ 100 dollars advanced **BOUNTY**.

There is to be stopped from him, on account of the State of _____, or other
 authorities, for **CLOTHING**, &c., received on entering service, _____ 100 dollars; and
 for other stoppages, viz: _____
 _____ 100 dollars.
 He has been furnished with **TRANSPORTATION** in kind from the place of his discharge to
 _____; and he has been **SUBSISTED** for **TRAVELING** to his
 place of enrollment, up to the _____, 186 _____.

He is indebted to William M. Brisson **SUTLER**, 813 100 dollars.
 He is indebted to _____, **LAUNDRESS**, _____ 100 dollars.
 Given in Duplicate, at Wilmington, N. C., this 24th day
 of June, 1865.

Samuel P. Greenwell
1st Dis. Del.
 Commanding Company.

ARTICLES OF WAR.

ART. 95. When any non-commissioned officer or soldier shall die, or be killed in the service of the United States, the then commanding officer of the troop or company shall, in the presence of two other commissioned officers, take an account of what effects he died possessed of, above his arms and accoutrements, and transmit the same to the office of the Department of War, which said effects are to be accounted for, and paid to the representatives of such deceased non-commissioned officer or soldier. And in case any of the officers, so authorized to take care of the effects of deceased officers and soldiers, should, before they have accounted to their representatives for the same, have occasion to leave the regiment or post, by preferment or otherwise, they shall, before they be permitted to quit the same, deposit in the hands of the commanding officer, or of the assistant military agent, all the effects of such deceased non-commissioned officers and soldiers, in order that the same may be secured for, and paid to, their respective representatives.

ARMY REGULATIONS—EDITION OF 1863.

DECEASED SOLDIERS.

Par. 152. Inventories of the effects of deceased non-commissioned officers and soldiers, required by the 95th Article of War, will be forwarded to the Adjutant General, by the commander of the company to which the deceased belonged, and a duplicate of the same to the colonel of the regiment. Final statements of pay, clothing, &c., in duplicate, will be sent to the Adjutant General with one copy of the inventory. When a soldier dies at a post or station absent from his company, it will be the duty of his immediate commander to furnish the required inventory and final statements, and, at the same time, to forward to the commanding officer of the company to which the soldier belonged, a report of his death, specifying the date, place, and cause; to what time he was last paid, and the money or other effects in his possession at the time of his decease; which report will be noted on the next muster roll of the company to which the man belonged. Each inventory will be endorsed, "Inventory of the effects of _____, late of company (—) _____ regiment of _____, who died at _____, the _____ day of _____, 186—." If a legal representative receive the effects, it will be stated in the report. If the soldier leave no effects, the fact will be reported.

Par. 153. Should the effects of a deceased non-commissioned officer or soldier not be administered upon within a short period after his decease, they shall be disposed of by a Council of Administration, under the authority of the commanding officer of the post, and the proceeds deposited with the Paymaster, to the credit of the United States, until they shall be claimed by the legal representatives of the deceased.

Par. 154. In all such cases of sales by the Council of Administration, a statement in detail, or account of the proceeds, duly certified by the Council and commanding officer, accompanied by the Paymaster's receipt for the proceeds, will be forwarded by the commanding officer to the Adjutant General. The statement will be endorsed, "Report of the proceeds of the effects of _____, late of company (—) _____ regiment of _____, who died at _____, the _____ day of _____, 186—."

NOTE 1.—The effects in all cases, when called for, should be turned over to the legal representative, without further authority from the Adjutant General. When the effects are turned over to the relatives of the deceased before these inventories are sent to the Adjutant General, their receipts therefor should be attached to the inventories. In all other cases, one copy will be sent with a letter of transmittal direct to the Adjutant General, and a duplicate retained by the officer.

NOTE 2.—Particular care should be taken to take receipts in duplicate from the Paymaster for any funds turned over to him; one copy should be sent direct to the Adjutant General and one retained by the officer.

INVENTORY OF THE EFFECTS

OF
Corporal Vincent Berry

Late of Company *K*

6th Reg't of *U. S. G. I.*

~~Volunteers~~, who died at *U. S. G. Hosp Fort Monroe Va*

on the *3rd* day of *September* 186*4*.

*Duplicate kept with certificate
for the A. G. Wash. D. C.
on 23rd Sept 64*

Inventory of the effects of Vincent Barry late
 a Sergeant of Captain _____ Company _____ of
 the _____ Regiment of U.S.V. ~~Volunteers~~, who was enrolled as
 a _____ at _____ in the State of _____ on
 the _____ day of _____ 186 , and mustered into the service of the United
 States as a _____ on the _____ day of _____ 186 , at _____
 in Company _____, _____ Regiment of _____ Volunteers, to serve _____
 years or during the war; he was born in _____ in the State
 of _____; he was _____ years of age, _____ feet _____ inches
 high, _____ complexion, _____ eyes, _____ hair, and by occupation, when enrolled,
 a _____; he died in U.S. Genl Hospital, at
Fort Monroe Va on the 30th day of September 1864, by
 reason of Gyemia from U.S. Wound of R. Arm

INVENTORY.					
ARTICLES.	No.	ARTICLES.	No.	ARTICLES.	No.
Hats.....		Pairs trousers.....	1	Knapsacks.....	
Caps.....	1	Pairs flannel drawers.....		<u>Testament</u>	1
Forage Caps.....		Pairs cotton drawers.....		<u>Ambrolife</u>	1
Great coats.....		Flannel shirts.....			
Uniform coats.....		Cotton shirts.....			
Uniform jackets.....		Pairs boots.....			
Flannel sack coats.....		Pairs shoes.....	1		
Blouses.....	1	Pairs socks.....			
Stable frocks.....		Blankets.....			
Fatigue overalls.....		Haversacks.....			
				MONEY.	
				Specie.....	\$ —
				Notes.....	\$ —

I CERTIFY, ON HONOR, that the above inventory comprises all the effects of _____
Vincent Barry, deceased, and that the effects are in the hands
 of C. M. McEllan Asst Surgeon U.S.A. at U.S. Genl Hospital
Fort Monroe Va to be disposed of by a Council of Administration.
or turned over to legal Representatives of Deceased.

(DUPLICATES.)

C. M. McEllan

Asst Surgeon U.S. Army
 Commanding the Company.
Hospital

STATION: U.S. Genl Hosp. Fort Monroe Va.

DATE: September 30th 1864.

Vincent Perry

6th U. S. C. O.

Sp. 1 in old. in cos
Date of death. July 12, 1865.

Sp.

U. S. GENERAL HOSPITAL,

Fort Monroe, Va.

Sept 30th, 1864.

I Herely Certify that no Descriptive List, for Corporal
Vincent Perry, Co., K, 6 Reg't U.S.A.
has been received at this Hospital from his Company Commander, and in con-
sequence thereof, I am unable to furnish Final Statements.

His Company Commander has been notified of the Date and Cause
of his Death, and an Inventory of Effects has also been forwarded to him.

Em Cullen

Assistant Surgeon, U. S. Army,

In Charge Hospital.

6 U.S. Col'd Inf

Private

Sergeant

CARD NUMBERS.

5572463	26
5572544	27
5572630	28
5572708	29
5572786	30
5572863	31
5572923	32
5572999	33
5573069	34
5573162	35
5573265	36
5573358	37
5573451	38
9065024	39
	40
	41
	42
	43
	44
	45
	46
	47
	48
	49
	50

Book Mark:

See also

B | 6 | U.S.C.T.

Robert Biles

, Co. D, 6 Reg't U. S. Col'd Inf.

Appears on

Company Descriptive Book

of the organization named above.

DESCRIPTION.

Age 20 years; height 5 feet 7 inches.

Complexion Dark

Eyes Brown; hair Black

Where born Monmouth New Jersey

Occupation Laborer

ENLISTMENT.

When Aug 10, 1863.

Where Philadelphia Pa

By whom H. H. Wagner; term 3 y'rs.

Remarks: Wounded Sept 29, 64 sent to Hospital Ret'd to Co for duty Dec 64.

J. G. Reeves

B.

6

U.S.C.T.

Robert Biles.

Pvt., Co., 6 Reg't U. S. Col'd Infantry.

Age 20 years.

Appears on

Company Muster-in Roll

of the organization named above. Roll dated
Philadelphia, Pa., Aug. 14, 1863.

Muster-in to date Aug. 12, 1863.

Joined for duty and enrolled:

When Aug. 12, 1863

Where Phila., Pa.

Period 0 years.

Remarks:

Book mark:

Baker,
Copyist.

B.

6

U.S.C.T.

Robert Biles.

Priv., Co. D, 6 Reg't U. S. Col'd Infantry.

Appears on

Company Muster Roll

for to Oct. 31, 1863.

Present or absent present.

Stoppage, \$ 100 for

Due Gov't, \$ 100 for

Remarks:

Book mark:

(858)

Baker
Copyist.

B

6

U.S.C.T.

Robert Biles

Priv, Co. D, 6 Reg't U. S. Col'd Infantry.

Appears on

Company Muster Roll

for Jan & Feb, 1864

Present or absent present

Stoppage, \$ 100 for

Due Gov't, \$ 100 for

Remarks:

Book mark:

Baker,

B.

6

U.S.C.T.

Robert Biles.

Pvt., Co. D, 6 Reg't U. S. Col'd Infantry.

Appears on

Company Muster Roll

for March & April, 1864.

Present or absent present.

Stoppage, \$ 100 for

Due Gov't, \$ 100 for

Remarks:

Book mark:

Baker,

173

6

U.S.C.T.

Robert Biles

P1

, Co. D, 6 Reg't U. S. Col'd Infantry.

Appears on

Company Muster Roll

for

May, June, 1864

Present or absent

Present

Stoppage, \$100 for

Due Gov't, \$100 for

Remarks:

Book mark:

(858)

Reif

Copy 18..

B | 6 | U.S.C.T.

Robert Biles

Capt, Co. D, 6 Reg't U. S. Col'd Infantry.

Appears on

Company Muster Roll

for July, Aug., 1864

Present or absent absent

Stoppage, \$ 100 for

Due Gov't, \$ 100 for

Remarks: apptd. Capt. from Pvt. July 7 64
due pay for one Mar. 58 cts
one Jan. 44 cts.
Absent in Field Hospital.

Book mark:

Reif

(358)

Copyis.

73

6

U.S.C.T.

Robert Biles

Sgt, Co. D, 6 Reg't U. S. Col'd Infantry.

Appears on

Company Muster Roll

for Sept. & Oct., 1864

Present or absent absent

Stoppage, \$ 100 for

Due Gov't, \$ 100 for

Remarks: Wounded Sept. 29 64. In Hospital.

NEXT ROLL ON FILE FEB 1865

Book mark:

(358)

Reif

Copyist.

MB

6

U.S.C.T.

Robert Miles

Sgt, Co. D, 6 Reg't U. S. Col'd Infantry.

Appears on

Company Muster Roll

for Jan. & Feb., 1865

Present or absent Present

Stoppage, \$ 100 for

Due Gov't, \$ 100 for

Remarks:

Book mark:

O. Peif

B

6

U.S.C.T.

Robert Biles

sgt., Co. D, 6 Reg't U. S. Col'd Infantry.

Appears on

Company Muster Roll

for *mch. & apr.*, 186 *5*

Present or absent *Present*

Stoppage, \$ *100* for

Due Gov't, \$ *100* for

Remarks:

Book mark

(358)

R. Biles

Copyist.

B. | 6 | U.S.C.T.

Robert Biles

Sergr., Co. D, 6 Reg't U. S. Col'd Infantry.

Appears on

Company Muster Roll

for May and June, 1866

Present or absent Present

Stoppage, \$ 100 for

Due Gov't, \$ 100 for

Remarks:

Book mark:

Rhett

B.

6

U.S.C.T.

Robert Biles

Sgt., Co. D, 6 Reg't U. S. Col'd Infantry.

Appears on

Company Muster Roll

for July and Aug, 1865.

Present or absent Present

Stoppage, \$100 for

Due Gov't, \$100 for

Remarks: Due U.S. for Trans-
portation while on fur-
ough - \$21.11

Book mark:

Phelps

B

6

U.S.C.T.

Robert Biles

Serjt., Co. D, 6 Reg't U. S. Col'd Infantry.

Appears on **Co. Muster-out Roll**, dated
Wilmington N.C., Sept. 20, 1865.

Muster-out to date Sept. 20, 1865.

Last paid to April 30, 1865.

Clothing account:

Last settled June 30, 1864; drawn since \$ 38 98 / 100

Due soldier \$ 100; due U. S. \$ 100

Am't for cloth'g in kind or money adv'd \$ 100

Due U. S. for arms, equipments, &c., \$ 100

Bounty paid \$ 00 100; due \$ 100 100

Remarks: Due Wm Brisben

Regt Dutten \$8.00

Free on or before April 19th 1865

Due U.S. for Transporta-
tion while on Purlough
\$20.11

Book mark:

R. Sheets

Piles, Robt

Sgt., Co. D,

6 Reg't USCJ

Enclosures.

Bed Cards	Final Statements
Burial Records	Furloughs or L. of A
Certs. of Dis. for Discharge	Med. Certificates
C. M. Charges	Med. Des. Lists
Descriptive Lists	Orders
Discharge Certificates	Pris. of War Record
Enlistment Papers	Resignations

Other papers relating to—

Admission to Hosp'l	Furlough or L. of A /
Casualty Sheet	Med. Examination
Confinement	Misc. Information
Contracts	Pay or Clothing
Death or Effects	Personal Reports
Desertion	Rank
Discharge from Hosp'l	Transfer to Hosp'l
Discharge from Service	Transfer to V. R. C.
Duty	Transportation

Comd'g 6th Regt. U.S. Inf.
in care of the P. O. Genl
6th Regt. U.S. Inf.

Applies for a furlough of
thirty days for Sergeant
Robert Biles of Co. D.
6th Regt. U.S. Inf.

Head Quarters 6th Regt. U.S. Inf.
Wilmington N. C. June 21/65

Respectfully forwarded
Approved. There are 475
men present for duty with
the regiment with none
absent with leave and
no application forwarded
not acted on.

D. M. Lill
Capt. 6th Regt. U.S. Inf.
Comd'g Regt.

Head Qrs. 3rd Brig 3rd Div. 10th A.C.
The Post of Wilmington
Wilmington N. C. June 21/65

Respectfully forwarded Approved
I have inspected this man, and find clothing
arms, and equipments in a good condition

A. G. Chamberlain
Lieut. Colonel
Comd'g

Robert Biles
Sgt. 6th Regt. U.S. Inf.
HEADQUARTERS DIST. OF WILMINGTON.

Wilmington, N. C., June 27th, 1865.

E. B. (No. 188) Vol. (.....) D. of W., 1865.

Respectfully forwarded,

Approved

W. B. Rives

Brig. Gen. Comd'g.

Brig. Gen. Comd'g.



See Post Office...

6/24/65

Camp 5th U.S. Colored Troops
 Wilmington N.C. June 21st 1865

Lieut G. R. Hammond

Adj't 6th U.S. Col.

Sir

I have the honor to request that a furlough of thirty days be granted to Serg't Robert Biles of Co "D" 6th U.S. Colored Troops for the purpose of visiting his home in the State of New Jersey. He has always been a good and efficient Soldier and in my opinion is deserving of it.

I have the honor to be
 Very Respectfully

Your Obedt. Serv't.

Thos. P. McCree

2^d Lieut Com^d Co "D" 6th U.S. Col.

6 U.S. GOVERNMENT

Private

Private

CARD NUMBERS.

1	5577086	26
2	5577168	27
3	5577252	28
4	5577333	29
5	5577412	30
6	5577491	31
7	5577564	32
8	5577633	33
9	5577707	34
10	5577801	35
11	5577894	36
12	5577983	37
13	5578068	38
14	9065517	39
15	9010-RCJ-1867	40
16		41
17		42
18		43
19		44
20		45
21		46
22		47
23		48
24		49
25		50

Book Mark: S. 210 Vol. 5 RCJ 1867

See also

B | **6** | **U.S.C.T.**

Joseph Binn,
....., Co. *H*, 6 Reg't U.S. Col'd Inf.

Appears on
Company Descriptive Book
of the organization named above.

DESCRIPTION.

Age *24* years; height *5* feet *7 1/2* inches.

Complexion *Blk*

Eyes *Blk*; hair *Blk*

Where born *Ocean Co. New Jersey*

Occupation *Lat*

ENLISTMENT.

When *Sep. 5*....., 186*9*

Where *Phila. Pa.*

By whom *J. D. Pa*.....; term *3* y'rs.

Remarks: *Mustered by Capt
Yardley.*

.....
.....
.....
.....
.....
.....

Jenkins

B | 6 | U.S.C.T.

Joseph Birn

Priv, Co H, 6 Reg't U. S. Col'd Infantry.

Age 24 years.

Appears on

Company Muster-in Roll

of the organization named above. Roll dated

Phila Pa Sept 14, 1863.

Muster-in to date Sept 5, 1863

Joined for duty and enrolled:

When Sept 5, 1863.

Where Phila, Pa

Period 3 years.

Remarks: Must by Capt Gardley P. M. Sept 5 763 Sub.

Book mark:

M. H. Thompson

B | 6 | U.S.C.T.

Joseph Birn
Priv, Co. H, 6 Reg't U. S. Col'd Infantry.

Appears on

Company Muster Roll
for Sept 14 to Oct 31, 1863.

Present or absent Present

Stoppage, \$ 100 for

Due Gov't, \$ 100 for

Remarks:

Book mark:

M. J. Thompson

B | 6 | U.S.C.T.

Joseph Binn
Pvt., Co. H, 6 Reg't U. S. Col'd Infantry.

Appears on

Company Muster Roll

for Nov & Dec, 1863.

Present or absent Present

Stoppage, \$ 100 for

Due Gov't, \$ 100 for

Remarks: Sick in Hospl.

Book mark:

(358)

W. A. Thompson
Copyist.

B | 6 | U.S.C.T.

Joseph Binn
Cvt., Co. H, 6 Reg't U. S. Col'd Infantry.

Appears on

Company Muster Roll

for *Jan'y & Feb'y*, 1864.

Present or absent *Present*

Stoppage, \$ *100* for

Due Gov't, \$ *1 62* / *100* for *1/2 Sheltin*
tent

Remarks:

Book mark:

M. A. Thompson

B

6

U.S.C.T.

Joseph Birn
Priv

Co. H, 6 Reg't U. S. Col'd Infantry.

Appears on

Company Muster Roll

for Meh ~~rape~~ , 1864.

Present or absent Present

Stoppage, \$ 100 for

Due Gov't, \$ 100 for

Remarks:

Book mark:

M. A. Thompson
Copyist.

B

6

U.S.C.T.

Joseph Binn

Binn, Co. H, 6 Reg't U. S. Col'd Infantry.

Appears on

Company Muster Roll

for May & June, 1864.

Present or absent Present

Stoppage, \$ 100 for

Due Gov't, \$ 100 for

Remarks:

Book mark:

C. B. Harper

B

6

U.S.C.T.

Joseph Binn

Priv., Co. H, 6 Reg't U. S. Col'd Infantry.

Appears on

Company Muster Roll

for July & Aug, 1864.

Present or absent Absent

Stoppage, \$ 100 for

Due Gov't, \$ 100 for

Remarks: Free April 19/61
Absent sick since
July 11/64

Book mark:

A. Harper

B | 6 | U.S.C.T.

Joseph Binn
Priv, Co. H, 6 Reg't U. S. Col'd Infantry.

Appears on

Company Muster Roll

for Sept & Oct, 1864.

Present or absent Absent

Stoppage, \$ 100 for

Due Gov't, \$ 100 for

Remarks: Free April 19/64
Absent sick since
July 11/64

NEXT ROLL ON FILE FEB 1865

Book mark:

C. Harper

73

6

U.S.C.T.

Joseph Binn

Priv, Co. H, 6 Reg't U. S. Col'd Infantry.

Appears on

Company Muster Roll

for *Jan & Feb*, 1865.

Present or absent *Absent*

Stoppage, \$ 100 for

Due Gov't, \$ 100 for

Remarks: *Free April 19/61*
Absent Sick

Book mark:

C. A. Harper

(858)

Copyist.

75

6

U.S.C.T.

Joseph Binn
Priv, Co. H, 6 Reg't U. S. Col'd Infantry.

Appears on

Company Muster Roll

for Mar & April, 1865.

Present or absent Absent

Stoppage, \$ 100 for

Due Gov't, \$ 100 for

Remarks: Free April 19/61
Absent Sick

Book mark:

C. A. Harper

(858)

Copyist.

B

6

U.S.C.T.

Joseph Binn
Prtd, Co. H, 6 Reg't U. S. Col'd Infantry.

Appears on

Company Muster Roll

for *May & June*, 1864

Present or absent *Absent*

Stoppage, \$ *100* for

Due Gov't, \$ *100* for

Remarks: *Absent sick*

Book mark:

Holcomb

(358)

Copyist.

B | 6 | U.S.C.T.

Joseph Binn
Prd, Co. H, 6 Reg't U. S. Col'd Infantry.

Appears on

Company Muster Roll

for July 1863, 1863.

Present or absent Absent

Stoppage, \$ 100 for

Due Gov't, \$ 100 for

Remarks: Absent sick

Book mark:

Holcomb

(358)

Copyist.

B1

6

U.S.C.T.

Joseph Dinn
Pr 51, Co. 51, 6 Reg't U. S. Col'd Infantry.

Appears on Co. Muster-out Roll, dated
Helmington Va, Sep 20, 1865.

Muster-out to date _____, 186 .

Last paid to _____, 1865.

Clothing account:

Last settled June 30, 1864; drawn since \$ 100

Due soldier \$ 100; due U. S. \$ 100

Am't for cloth'g in kind or money adv'd \$ 100

Due U. S. for arms, equipments, &c., \$ 100

Bounty paid \$ 100; due \$ 100

Remarks: Due Wm Buisben Reg't. Butler \$ 2.
\$6 per mo. due from enlistment to Apr 30/64.
Absent sick in Baltimore, no discharge
furnished. Sub. for man drafted under
act March 3/63.

Book mark: V 215 P 236/75 = 2" aud. 6221 Dec 20/67
P.V. 37 P. 199-76 = S 210 Vol 5. R.E. J 1867.

Holecomb

(361)

Copyist.

Brinn Joseph

, Co. *6* Reg't *U.S.C.T.*

2 Enclosures.

Bed Cards	Final Statements
Burial Records	Furloughs or L. of A.
Certa. of Dis. for Discharge	Med. Certificates
C. M. Charges	Med. Des. Lists
Descriptive Lists	Orders
Discharge Certificates	Pris. of War Record
Enlistment Papers <i>2</i>	Resignations

Other papers relating to—

Admission to Hosp'l	Furlough or L. of A.
Casualty Sheet	Med. Examination
Confinement	Misc. Information
Contracts	Pay or Clothing
Death or Effects	Personal Reports
Desertion	Rank
Discharge from Hosp'l	Transfer to Hosp'l
Discharge from Service	Transfer to V. R. C.
Duty	Transportation

E. P. filed 3/11/02
MS

DECLARATION OF SUBSTITUTE.

Joseph Binn (Colonel) desiring to ENLIST in the Army of the United States, for THREE YEARS, **Do declare**, That I am *Twenty four* years and _____ months of age; that I have never been discharged from the United States service on account of disability or by sentence of a court martial; and I know of no impediment to my serving honestly and faithfully as a soldier for three years.

GIVEN at *Frankford* the *3rd* day of *September* 1863.

WITNESS:

[Handwritten signature of witness]

Joseph Binn
[Handwritten signature]

B
3/63
6.

No. *733*

Joseph Binn (Col)

Enlisted at *Frankford*

As Substitute for

Benjamin Mather

On the *3rd* day of *Sept*, 1863.

By

John M. Shuler
Major in 5th Regt Pa

J. P. Diller
Surg

Board of Enrollment,

5th Dist. of *Penn*

(No. 40.)

SUBSTITUTE VOLUNTEER ENLISTMENT.

STATE OF

TOWN OF

Penn^a



Frankford

I, Joseph Binn (Colored) born in the State of New Jersey, aged Twenty four years, and by occupation a Cabinet

Do HEREBY ACKNOWLEDGE to have agreed with Benjamin Mablack Esq., of 47th Sub dist 5th Dist Penn^a

to become his SUBSTITUTE in the Military Service, for a sufficient consideration paid and delivered to me, on the 5th day of September, 1863; and having thus agreed with said Benjamin Mablack, I DO HEREBY ACKNOWLEDGE to have enlisted this 5th day of September, 1863, to serve as a Soldier in the Army of the United States of America, for the period of THREE YEARS, unless sooner discharged by proper authority: I do also agree to accept such bounty, pay, rations, and clothing, as are, or may be, established by law for soldiers. And I do solemnly swear that I will bear true and faithful allegiance to the United States of America; that I will serve them honestly and faithfully against all their enemies or opposers whomsoever; and that I will observe and obey the orders of the President of the United States, and the orders of the Officers appointed over me, according to the Rules and Articles of War.

SWORN and subscribed to, at Frankford this 5th day of September, 1863.

BEFORE Joseph Binn and [Signature]

We certify, on honor, That we have carefully examined the above-named Volunteer Substitute agreeably to the Regulations, and that, in our opinion, he is free from all bodily defects and mental infirmity which would in any way disqualify him from performing the duties of a soldier; that he was entirely sober when enlisted; that he is of lawful age, (not under 18 years;) and that, in accepting him as duly qualified to perform the duties of an able-bodied soldier, and as a Substitute in lieu of Benjamin Mablack, drafted in 47th Sub dist 5th Dist Penn^a July 24th, 1863, we have strictly observed the Regulations which govern in such cases. This soldier has Black eyes, Black hair, Black complexion; is 5 feet 7 1/2 inches high.

M. Yonckley Provost Marshal.

[Signature] Commissioner of Board.

C. F. Lake Surgeon of Board.

DECLARATION OF SUBSTITUTE.

I, Joseph Binn (Colo) desiring to ENLIST in the Army of the United States, for THREE YEARS, **Do declare**, That I am Twenty four years and _____ months of age; that I have never been discharged from the United States service on account of disability or by sentence of a court martial; and I know of no impediment to my serving honestly and faithfully as a soldier for three years.

GIVEN at Frankford, Pa. the 5th day of September.

WITNESS:

[Signature] Joseph Binn
[Signature]

B/63 B.

30

No. 733

Joseph Binn (Colo)

Enlisted at Frankford, Pa.

As Substitute for

Benjamin Mattick

On the 5th day of Sept, 186 2

By

Capt M. Mendenhall

Spqr W. H. Taylor

Chas. Lewis

Board of Enrollment,
5th Dist. of Primes

(No. 40.)

SUBSTITUTE
VOLUNTEER ENLISTMENT.

STATE OF

TOWN OF

Penn^a Frankford



I, Joseph B. Binn (Codd) born in the State of Penn^a, aged twenty years, and by occupation a Soldier

Do HEREBY ACKNOWLEDGE to have agreed with Benjamin Mattock, Esq., of 47th Dist. District of 5th Dist Penn^a

to become his **SUBSTITUTE** in the Military Service, for a sufficient consideration paid and delivered to me, on the 5th day of September, 1863; and having thus agreed with said Benjamin Mattock, I DO HEREBY ACKNOWLEDGE to have enlisted this 5th day of September, 1863, to serve as a **Soldier** in the **Army of the United States of America**, for the period of **THREE YEARS**, unless sooner discharged by proper authority: I do also agree to accept such bounty, pay, rations, and clothing, as are, or may be, established by law for soldiers. And I do solemnly swear that I will bear true and faithful allegiance to the **United States of America**; that I will serve them honestly and faithfully against all their enemies or opposers whomsoever; and that I will observe and obey the orders of the President of the United States, and the orders of the Officers appointed over me, according to the Rules and Articles of War.

SWORN and subscribed to, at Frankford Pa. this 5th day of September 1863

BEFORE J. H. [Signature] Joseph B. Binn [Signature]

We certify, on honor, That we have carefully examined the above-named Volunteer Substitute agreeably to the Regulations, and that, in our opinion, he is free from all bodily defects and mental infirmity which would in any way disqualify him from performing the duties of a soldier; that he was entirely sober when enlisted; that he is of lawful age, (not under 18 years;) and that, in accepting him as duly qualified to perform the duties of an able-bodied soldier, and as a Substitute in lieu of Benjamin Mattock, drafted in 47th Dist Dist of 5th District Penn^a Aug 24th, 1863, we have strictly observed the Regulations which govern in such cases. This soldier has Black eyes, Black hair, Black complexion; is 5 feet 7 1/2 inches high.

M. Garaley
Provost Marshal.
Wm. O. N. [Signature]
Commissioner of Board.
E. J. [Signature]
Surgeon of Board.

Board of Enrollment of 5th Dist. of Penn^a

6 U.S. Cold List

Private

Private

CARD NUMBERS.

5577090	26
5577172	27
5577253	28
5577334	29
5577413	30
5577492	31
5577565	32
5577634	33
5577708	34
5577802	35
5577895	36
5577984	37
5578069	38
9065518	39
	40
	41
	42
	43
	44
	45
	46
	47
	48
	49
	50

Book Mark:

See also

B

6

U.S.C.T.

William Binn

, Co *A*, 6 Reg't U. S. Col'd Inf.

Appears on

Company Descriptive Book

of the organization named above.

DESCRIPTION.

Age *7* years; height *5* feet *3* inches.

Complexion *Blk*

Eyes *Blk*; hair *Blk*

Where born *Ocean Co. New Jersey*

Occupation *Farm*

ENLISTMENT.

When *Sept 1*, 186*3*

Where *Phila. Pa.*

By whom *Lt Col. Wagner*, term *3* y'rs.

Remarks:

.....

Jenkins

B | 6 | U.S.C.T.

William H Binn

Priv, Co. H, 6 Reg't U. S. Col'd Infantry.

Age 17 years.

Appears on

Company Muster-in Roll

of the organization named above. Roll dated

Phila. Pa, Sept 14, 1863.

Muster-in to date Sept 14, 1863

Joined for duty and enrolled:

When Sept 1, 1863

Where Phila, Pa

Period 3 years.

Remarks: Must by Lt. Pierce
USA Sept. 14/63

Book mark:

W H Thompson

B

6

U.S.C.T.

William H. Binn

Priv, Co. H, 6 Reg't U. S. Col'd Infantry.

Appears on

Company Muster Roll
for *Sept 14 to Oct 31*, 1863.

Present or absent *Present*

Stoppage, \$ *100* for

Due Gov't, \$ *100* for

Remarks:

Book mark:

W. H. Thompson
Copyist.

(358)

B | 6 | U.S.C.T.

William Beinn
Sgt., Co. H, 6 Reg't U. S. Col'd Infantry.

Appears on

Company Muster Roll
for Nov & Dec, 1863

Present or absent Present

Stoppage, \$ 100 for

Due Gov't, \$ 100 for

Remarks:

Book mark:

(358)

W.A. Thompson
Copyist.

B | 6 | U.S.C.T.

William Binn
Pvt., Co. H, 6 Reg't U. S. Col'd Infantry.

Appears on

Company Muster Roll
for James & Geby, 1864
Present or absent Present

Stoppage, \$ 100 for

Due Gov't, \$ 1 ⁶²/₁₀₀ for 1/2 Shelter
term

Remarks:

Book mark:

(358)

M. A. Thompson
Copyist.

B

6

U.S.C.T.

William Binn

Priv., Co. H, 6 Reg't U. S. Col'd Infantry.

Appears on

Company Muster Roll

for *March + April*, 1864

Present or absent *Present*

Stoppage, \$ 100 for

Due Gov't, \$ 44 / 100 for *Canteen*

Remarks:

Book mark:

W. H. Thompson
Copyist.

B

6

U.S.C.T.

William Binn

Priv., Co. H, 6 Reg't U. S. Col'd Infantry.

Appears on

Company Muster Roll

for May & June, 1864.

Present or absent Present

Stoppage, \$ 100 for

Due Gov't, \$ 100 for

Remarks:

Book mark:

C. A. Harper

B

6

U.S.C.T.

William Binn

Priv., Co. H, 6 Reg't U. S. Col'd Infantry.

Appears on

Company Muster Roll

for July & Aug, 1864.

Present or absent Present

Stoppage, \$ 100 for

Due Gov't, \$ 100 for

Remarks: Free April 19/61

Extra Duty

Book mark:

C. A. Hager

B

6

U.S.C.T.

William Binn

Priv, Co. H, 6 Reg't U. S. Col'd Infantry.

Appears on

Company Muster Roll

for *Sept Oct*, 1864.

Present or absent *Absent*

Stoppage, \$ 100 for

Due Gov't, \$ 100 for

Remarks: *Free April 19/61*
Absent sick since
Sept 29/64

NEXT ROLL ON FILE FEB 1865

Book mark:

C. J. Harper

(358)

Copyist.

B

6

U.S.C.T.

William Binn

Priv, Co. H, 6 Reg't U. S. Col'd Infantry.

Appears on

Company Muster Roll

for Jan Feb, 1865

Present or absent Present

Stoppage, \$ 100 for

Due Gov't, \$ 100 for

Remarks: Free April 19/61

Book mark:

C. A. Harper

(858)

Copyist.

B

6

U.S.C.T.

William Binn

Priv., Co. H, 6 Reg't U. S. Col'd Infantry.

Appears on

Company Muster Roll

for *March & April*, 1865.

Present or absent *Present*

Stoppage, \$ *100* for

Due Gov't, \$ *100* for

Remarks: *Stop for 100 days
2000*

Book mark:

C. S. Hayden

(358)

Copyist.

B

6

U.S.C.T.

William Birm

Pvt, Co. H, 6 Reg't U. S. Col'd Infantry.

Appears on

Company Muster Roll

for May & June, 1865

Present or absent Present

Stoppage, \$ 100 for

Due Gov't, \$ 100 for

Remarks:

Book mark:

Holecomb

(358)

Copyist.

B | 6 | U.S.C.T.

William Birm

Prvt, Co. H, 6 Reg't U. S. Col'd Infantry.

Appears on

Company Muster Roll

for July & Aug, 1865

Present or absent Present

Stoppage, \$ 100 for

Due Gov't, \$ 100 for

Remarks:

Book mark:

Holecomb

B

6

U.S.C.T.

William Binn

Prvt, Co. H, 6 Reg't U. S. Col'd Infantry.

Appears on **Co. Muster-out Roll**, dated
Wilmington Nc, Sep 20, 1865.

Muster-out to date Sep 20, 1865.

Last paid to Oct 30, 1865.

Clothing account:

Last settled June 30, 1864; drawn since \$ 74 92 / 100

Due soldier \$ 100; due U. S. \$ 100

Am't for cloth'g in kind or money adv'd \$ 100

Due U. S. for arms, equipments, &c., \$ 6 100

Bounty paid \$ 100; due \$ 100 100

Remarks: Due Wm. Bisher Regtl. Suttler
\$23, \$6 per mo. due from enlistment to
Apr. 30/64. Stop for ord. charged on
previous rolls 20¢x

Book mark: Pv 36 P 103, 76 = V 235 P 50, 76.

Hulcomb

W. M. ...
Co. D, 6 U.S. Col'd Inf.

Private | *Private*

CARD NUMBERS.

1	5568121	26
2	5568131	27
3	5570814	28
4	5570986	29
5	5571308	30
6	9064556	31
7		32
8		33
9		34
10		35
11		36
12		37
13		38
14		39
15		40
16		41
17		42
18		43
19		44
20		45
21		46
22		47
23		48
24		49
25		50

Book Mark:

See also

B | 6 | U.S.C.T.

Malachi Bird

Co. B, 6 Reg't U. S. Col'd Inf.

Appears on
Company Descriptive Book
of the organization named above.

DESCRIPTION.

Age 26 years; height 5 feet 5 inches.

Complexion *Ben*

Eyes *Ben*; hair *Ben*

Where born *Phila. Pa*

Occupation *Barber*

ENLISTMENT.

When *Feb 7*, 186⁵.

Where *Ferrytown*

By whom *Capt Person*; term *3* y'rs.

Remarks: *\$100 U.S. Bounty
on Enlistment,
Deserted Mch 5/65
at North East Sta-
tion, A.C.*

W J. Roe

S

6

U.S.C.T.

Malachi Pond

M, Co. B, 6 Reg't U. S. Col'd Infantry.

Appears on

Company Muster Roll

for *Jan & Feb*, 1865.

Present or absent *Present*

Stoppage, \$ *100* for

Due Gov't, \$ *100* for

Remarks:

Book mark: *20872*

(358)

M. H. ...

Copyist

B

6

U.S.C.T.

Malachi Bird

Appears with rank of Priv on

Muster and Descriptive Roll of a Detachment of U. S. Vols. forwarded

for the 6 Reg't U. S. Col'd Infantry. Roll dated

Tarrytown N.Y., Feby 7, 1865.

Where born Phila Penna

Age 26 y'rs; occupation Barber

When enlisted Feb 7, 1865.

Where enlisted Tarrytown

For what period enlisted 3 years.

Eyes Blk; hair Blk

Complexion Blk; height 5 ft. 5 in.

When mustered in Feby 7, 1865.

Where mustered in Tarrytown

Bounty paid \$ 100 ⁰⁰; due \$ 100

{ Where credited 10 Cong Dist. Westchester Westchester Co N York

Company to which assigned

Remarks: Received one Knapsack 215

one Haversack 45 one Canteen .67
(also Knife Fork Plate Spoon & Cup

Book mark:

Mark

Copyist.

B | 6 | U.S.C.T.

Malichi Bird

Appears with rank of *Pvt* on
Muster and Descriptive Roll of a Detachment of U. S. Vols. forwarded

for the 6 Reg't U. S. Col'd Infantry. Roll dated
Hart. Island N.Y. No. Feb 9, 1865.

Where born *Phila Penn*

Age *26* y'rs; occupation *Barber*

When enlisted *Feb 7*, 1865

Where enlisted *Tarrytown*

For what period enlisted *3* years.

Eyes *Blk*; hair *Blk*

Complexion *Blk*; height *5* ft. *5* in.

When mustered in *Feb 7*, 1865

Where mustered in *Tarrytown*

Bounty paid \$ *100* ⁰⁰; due \$ *100*

Where credited *10th Regt. Dist. Westchester*

Company to which assigned

Remarks: *Received 1 Knapsack \$ 2.15*

1 Haversack .67 1 Canteen .45

Book mark:

Wark

P

6

U.S.C.T.

Malachi Bird

Pw, Co. B, 6 Reg't U. S. Col'd Infantry.

Appears on

Company Muster Roll

for Mar. & Apr, 1865!

Present or absent

Stoppage, \$ 100 for

Due Gov't, \$ 100 for

Remarks: Deserted Mar. 5/65 at N.E. Station N.C.

Due U.S. for 1 P.R. Muster 19.25 for one set of accoutrements 4.07

Book mark:

J. W. Leonard

(358)

Copyist

B. | 6 | U.S.C.T.

Malachi Bond

Co. B, 6 Reg't U. S. Col'd Infantry.

Appears on Co. Muster-out Roll, dated
Wilmington, N.C. Sept. 20, 1865.

Muster-out to date _____, 186 .

Last paid to _____, 186 .

Clothing account:

Last settled _____, 186 ; drawn since \$ _____ 100

Due soldier \$ _____ 100; due U. S. \$ _____ 100

Am't for cloth'g in kind or money adv'd \$ _____ 100

Due U. S. for arms, equipments, &c., \$ _____ 100

Bounty paid \$ _____ 100; due \$ _____ 100

Remarks Deserted from N.E. Station
N.C. Mar. 5, 1865

Book mark 7/29 P 2/11.71

(861)

B. J. Cooke

Copyist.

Bird, Malachi

Co.

Reg't

U.S. Army

2 Enclosures.

Bed Cards	Final Statements
Burial Records	Furloughs or L. of A.
Certs. of Dis. for Discharge	Med. Certificates
C. M. Charges	Med. Des. Lists
Descriptive Lists	Orders
Discharge Certificates	Pris. of War Record
Enlistment Papers <i>2</i>	Resignations

Other papers relating to—

Admission to Hosp'l	Furlough or L. of A.
Casualty Sheet	Med. Examination
Confinement	Misc. Information
Contracts	Pay or Clothing
Death or Effects	Personal Reports
Desertion	Rank
Discharge from Hosp'l	Transfer to Hosp'l
Discharge from Service	Transfer to V. R. C.
Duty	Transportation

NOTE 1.—This blank will be used for both enlistments and re-enlistments—enlistment of veterans, &c., &c. in the volunteer service. They will be made out in duplicate in all cases—one to accompany the recruiting return of the superintendent (not the recruiting officer) to the Adjutant General, and one to accompany the accounts of the officer who pays bounty, &c. The Regiment and Company in which the soldier last served should be given on the back.

NOTE 2.—An enlistment holds to service. A muster-in must, in all cases, precede payment of pay, bounty, pension, &c. A muster-in roll must, in all cases, be filed in the Adjutant General's Office as evidence of muster-in. The mustering officer, commissary, or assistant commissary of musters, as the case may be, will countersign both enlistments as having mustered the soldier into the service of the United States before either of them is given to the disbursing officer.

DECLARATION OF RECRUIT.

I, Malachi Bird, desiring to VOLUNTEER as a Soldier in the Army of the United States, for the term of THREE YEARS, Do Declare, That I am 26 years and _____ months of age; that I have never been discharged from the United States service on account of disability or by sentence of a court martial, or by order before the expiration of a term of enlistment; and I know of no impediment to my serving honestly and faithfully as a soldier for three years.

GIVEN at Red Brz, Proctor the 7 day of February 1865

Witness: Chas W. Briggs Malachi Bird

MAY 1865 THE ADJUTANT GENERAL'S OFFICE

No. 5562
Malachi Bird
Volunteered at Lynn town
Westchester July 3, 1865
By Capt W. W. Perce
C Regiment of U.S. Col
enlistment; last served in Company ()
Reg't of _____
Discharged _____, 18 _____

CONSENT IN CASE OF MINOR.

I, _____, Do CERTIFY, That I am _____; that the _____ of _____; that the _____ years of age; and I do hereby freely give my CONSENT to his volunteering as a SOLDIER in the ARMY OF THE UNITED STATES for the period of THREE YEARS.

GIVEN at _____ the _____ day of _____

Witness: _____

(A. G. O. No. 74 & 76.)

7

X

VOLUNTEER ENLISTMENT.

STATE OF

New York



TOWN OF

Westchester

I, *Malachi Bird*, born in *Philadelphia*
 in the State of *Penna*, aged *26* years,
 and by occupation a *Barber*, Do HEREBY ACKNOWLEDGE to have
 volunteered this *7* day of *July*, 1865,
 to serve as a **Soldier** in the **Army of the United States of America**, for
 the period of **THREE YEARS**, unless sooner discharged by proper authority:
 Do also agree to accept such bounty, pay, rations, and clothing, as are, or may be,
 established by law for volunteers. And I, *Malachi Bird*, do
 solemnly swear, that I will bear true faith and allegiance to the **United States
 of America**, and that I will serve them honestly and faithfully against all
 their enemies or opposers whomsoever; and that I will observe and obey the
 orders of the President of the United States, and the orders of the officers
 appointed over me, according to the Rules and Articles of War.

Sworn and subscribed to, at *Sarzynow*
 this *7* day of *July*, 1865,
 BEFORE *Wm. P. ...* } *Malachi Bird*
Capt. P. ...

I CERTIFY, ON HONOR, That I have carefully examined the above-named Volunteer, agreeably
 to the General Regulations of the Army, and that, in my opinion, he is free from all bodily defects and
 mental infirmity, which would in any way disqualify him from performing the duties of a soldier.

L. F. ...
10 ...
 EXAMINING SURGEON.

I CERTIFY, ON HONOR, That I have minutely inspected the Volunteer *M. Bird*
 previously to his enlistment, and that he was entirely sober when enlisted; that, to the best of my
 judgment and belief, he is of lawful age; and that, in accepting him as duly qualified to perform the
 duties of an able-bodied soldier, I have strictly observed the regulations which govern the recruiting
 service. This soldier has *Black* eyes, *Black* hair, *Black* complexion, is *5*
 feet *5* inches high.

Wm. P. ...
 Regiment of *U.S.* Volunteers,
 RECRUITING OFFICER.

Mustered into the service of the United States, for three years or during the war, from date of enlistment, in Company _____
 Regiment of _____ Volunteers, on the _____ day of _____, 1865, at _____

NOTE 1.—This blank will be used for both enlistments and re-enlistments—callistment of veterans, &c., &c., in the volunteer service. They will be made out in duplicate in all cases—one to accompany the recruiting return of the superintendent (not the recruiting officer) to the Adjutant General, and one to accompany the accounts of the officer who pays bounty, &c. The Regiment and Company in which the soldier last served should be given on the back.

NOTE 2.—An enlistment holds to service. A muster-in must, in all cases, precede payment of pay, bounty, pension, &c. A muster-in roll must, in all cases, be filed in the Adjutant General's Office as evidence of muster-in. The mustering officer, commissary, or assistant commissary of musters, as the case may be, will countersign both enlistments as having mustered the soldier into the service of the United States before either of them is given to the disbursing officer.

DECLARATION OF RECRUIT.

I, Malachi Bird, desiring to VOLUNTEER as a Soldier in the Army of the United States, for the term of THREE YEARS, Do Declare, That I am 26 years and _____ months of age; that I have never been discharged from the United States service on account of disability or by sentence of a court martial, or by order before the expiration of a term of enlistment; and I know of no impediment to my serving honestly and faithfully as a soldier for three years.

GIVEN at Sarrystown N.Y. the 7th day of February, 1865.

Witness:

B. A. Clapp

Malachi Bird

July 1910. This paper was formerly used in the Enrollment Division & P.

Volunteered at Sarrystown for Wentworth's Regt, Feb 7th, 1865, by Capt Wm Wm Gibson of 110th Regiment enlistment; last served in Company (4) of _____ Regiment of _____ Discharged _____, 1865 Sutcliffe

No. Malachi Bird

P 3

CONSENT IN CASE OF MINOR.

I, _____, Do CERTIFY, That I am _____; that the _____ of _____ is _____ years of age; and I do hereby freely give my CONSENT to his volunteering as a SOLDIER in the ARMY OF THE UNITED STATES for the period of THREE YEARS.

GIVEN at _____ the _____ day of _____

Witness:

1600

VOLUNTEER ENLISTMENT.

STATE OF

TOWN OF

New York



Westchester

I, *Malachi Bird*, born in *Philadelphia*
 in the State of *Penn*, aged *26* years,
 and by occupation a *Barber*, Do HEREBY ACKNOWLEDGE to have
 volunteered this *Seventh* day of *February*, 186*3*,
 to serve as a **Soldier** in the **Army of the United States of America**, for
 the period of **THREE YEARS**, unless sooner discharged by proper authority:
 Do also agree to accept such bounty, pay, rations, and clothing, as are, or may be,
 established by law for volunteers. And I, *Malachi Bird*, do
 solemnly swear, that I will bear true faith and allegiance to the **United States
 of America**, and that I will serve them honestly and faithfully against all
 their enemies or opposers whomsoever; and that I will observe and obey the
 orders of the President of the United States, and the orders of the officers
 appointed over me, according to the Rules and Articles of War.

Sworn and subscribed to, at *Tarrytown*
 this *7th* day of *Feb*, 1863, } *Malachi Bird*
 BEFORE *W. P. Person* }
Capt. Person

I CERTIFY, ON HONOR, That I have carefully examined the above-named Volunteer, agreeably
 to the General Regulations of the Army, and that, in my opinion, he is free from all bodily defects and
 mental infirmity, which would in any way disqualify him from performing the duties of a soldier.

L. F. Belton

EXAMINING SURGEON.

I CERTIFY, ON HONOR, That I have minutely inspected the Volunteer *M. Bird*
 previously to his enlistment, and that he was entirely sober when enlisted; that, to the best of my
 judgment and belief, he is of lawful age; and that, in accepting him as duly qualified to perform the
 duties of an able-bodied soldier, I have strictly observed the Regulations which govern the recruiting
 service. This soldier has *Black* eyes, *Black* hair, *Black* complexion, is *5'*
 feet *5* inches high.

W. P. Person
Capt. Person
 Co. Regiment of *91st* Volunteers,

RECRUITING OFFICER.

(A. G. O. No. 74 & 76.)

Mustered into the service of the United States, for three years or during the war, from date of enlistment, in Company _____
 Regiment of _____ Volunteers, on the _____ day of _____, 1863, at _____

6 U.S. Col'd Inf

Private

Private

CARD NUMBERS.

3575864	26
3575946	27
3576026	28
5576105	29
5576239	30
5577027	31
19122259	32
9065401	33
	34
	35
	36
	37
	38
	39
	40
	41
	42
	43
	44
	45
	46
	47
	48
	49
	50

Book Mark: *CB. 12*
294.

See also

B

6

U.S.C.T.

* *Edwin J. Black,*

Co. G, 6 Reg't U. S. Col'd Inf.

Appears on

Company Descriptive Book

of the organization named above.

DESCRIPTION.

Age *24* years; height *5* feet *8* inches.

Complexion *Olive*

Eyes *Black*; hair *Curly*

Where born *Fayette Co. Pa.*

Occupation *Farmer*

ENLISTMENT.

When *July 16*, 186*3*.

Where *Greensburg Pa. 21st Dist.*

By whom *Capt. Walter B. M.*; term *3* y'rs.

Remarks: *Drafted.*

Discharged for

Disability at Camp

Hamilton Va. Apr 29, 1864

* *Name cancelled by line*

Jenkins

B 16 U.S.C.T.

Edward Jackson Black

Appears with rank of _____ on

Muster and Descriptive Roll of a Detachment of Drafted Men and Substitutes forwarded

for the 6 Reg't U.S.C.T. Roll dated Greensburg Pa Aug 27, 1863.

Where born Fayette Co Pa

Age 24 y'rs; occupation farmer

Drafted and mustered in:

When July 16, 186 .

Where Greensburg Pa

Period 3 years.

Eyes Black; hair curly

Complexion Olive; height 3 ft. 8 in.

Paid bounty and advance pay, \$ 100

Bounty due, \$ 100

Where credited _____

Company to which assigned G.

Remarks Principal

Book mark: _____

Reeves

D

6

U.S.C.T.

Edward Jackson Black
Private, Co. *A*, 6 Reg't U. S. Col'd Infantry.

Age *24* years.

Appears on

Company Muster-in Roll

of the organization named above. Roll dated

Philadelphia Pa Sept 14, 1863.

Muster-in to date *Sept 14, 1863*

Joined for duty and enrolled:

When *July 16*, 1863.

Where *Greensburg Pa*

Period *3* years.

Remarks: *Mustered by Capt*
Couteer PM July 16-1863.
Drafted Co to 2 Dist, Pa

Book mark:

M. A. Michaels

(356)

Copyist.

B.

6

U.S.C.T.

Edward J. Black

Private, Co. G, 6 Reg't U. S. Col'd Infantry.

Appears on

Company Muster Roll

for Enrollment to Oct. 31, 1863.

Present or absent Present

Stoppage, \$ 100 for

Due Gov't, \$ 100 for

Remarks:

Book mark:

M. A. Michaels
Copyist.

D

6

U.S.C.T.

Edwin J. Black
Private, Co. G, 6 Reg't U. S. Col'd Infantry.

Appears on

Company Muster Roll

for Nov & Dec, 1863.

Present or absent Present

Stoppage, \$ 100 for

Due Gov't, \$ 100 for

Remarks:

Book mark:

M. A. Michaels
Copyist.

B | **6** | **U.S.C.T.**

Edwin L. Black
Private, Co. G, 6 Reg't U. S. Col'd Infantry.

Appears on

Company Muster Roll

for *Jan & Febr*, 186 *4*.

Present or absent *Present*

Stoppage, \$ *100* for

Due Gov't, \$ *100* for

Remarks:

Book mark:

M. A. Michaels
(358) Copyist.

B

6

U.S.C.T.

Edwin J. Black
Private, Co. G, 6 Reg't U. S. Col'd Infantry.

Appears on

Company Muster Roll

for *March & Apr.*, 1864.

Present or absent

Stoppage, \$..... 100 for

Due Gov't, \$..... 100 for

Remarks: *Discharged by reason of Disability April 26, 1864 Discharge & final statements given*

Book mark:

(358)

M. A. Michaels
Copyist.

B | 6 | U.S.C.T.

Edwin J. Black
Priv, Co. G, 6 Reg't U. S. Col'd Infantry.

Appears on **Co. Muster-out Roll**, dated
Wilmington NC, Sept 20, 1865.

Muster-out to date _____, 186 .

Last paid to _____, 186 .

Clothing account:

Last settled _____, 186 ; drawn since \$ _____ 100

Due soldier \$ _____ 100; due U. S. \$ _____ 100

Am't for cloth'g in kind or money adv'd \$ _____ 100

Due U. S. for arms, equipments, &c., \$ _____ 100

Bounty paid \$ _____ 100; due \$ _____ 100

Remarks: Discharged at
Camp Hamilton Va April
29/64, for disability, by
order of Maj Gen Butler.

Book mark: Co. Discharged Apr 26/64
E B 294.

(361)

Moy

Copyist.

Black, Edwin J.

B. G., Co. _____,

6

Reg't

U.S.C. Inf.

----- / -----
Enclosures.

Bed Cards -----	Descriptive Lists -----
Burial Records -----	Final Statements -----
Certs. of Dis. for Discharge / -----	Furloughs -----
C. M. Charges -----	Med. Des. Lists -----
Med. Certificates -----	Orders -----

Other papers relating to—

Admission to Hosp'l -----	Furlough -----
Casualty Sheet (Officer's) -----	Med. Examination -----
Confinement -----	Misc. Information -----
Contracts -----	Pay or Clothing -----
Death or Effects -----	Personal Reports -----
Desertions -----	Rank -----
Discharge from Hosp'l -----	Transfer to Hosp'l -----
Discharge from Service -----	Transfer to V. R. C. -----
Duty -----	Transportation -----

[OFFICE ENDORSEMENT.]

War Department,

ADJUTANT GENERAL'S OFFICE,

April 14", 1877

The Discharge of Pvt Edward J. Black, Co. I, 6th Reg't U.S. Colored Troops, is reported as follows.

- On Company Muster Roll. For March-April, 1864, April 26, 1864
- Company Muster-out Roll. April 29, 1864
- Company Descriptive Book. 186
- Company Morning Reports. 186
- Soldier's Final Statement. 186
- Soldier's Record of Death and Interment. 186
- Soldier's Inventory of Effects. 186
- Soldier's Certificate of Disability for Discharge. April 26, 1864
- Soldier's Individual Muster-out Roll. 186
- Regimental Return. 186
- For 186, Regimental Quarterly Returns. 186
- Regimental Descriptive Book. 186
- By Surgeon General. 186

() April 26", 1864, is held to be the correct date, and the Company Muster-out Roll will be amended accordingly.

Thomas M. Swann
Assistant Adjutant General.

CS 12
294. Noted H.M.

Letter to be sent to the Adjutant General's Office

NOTE 1.

The company commander will here add a statement of all the facts known to him concerning the disease or wound, or cause of disability of the soldier: the time, place, manner, and all the circumstances under which the injury occurred, or disease originated or appeared; the duty, or service, or situation of the soldier at the time the injury was received or disease contracted, stating particularly whether the injury was received or the disease contracted in the line of his duty; and whatever other facts may aid a judgment as to the cause, immediate or remote, of the disability, and the circumstances attending it.

When the facts are not known to the company commander, the certificate of any officer, or affidavit of other person having such knowledge, will be appended—as the surgeon in charge of a hospital, the officer commanding a detachment of recruits, &c., &c.

NOTE 2.

When a probable case for pension, special care must be taken to state the degree of disability—as $\frac{1}{2}$, $\frac{3}{4}$, &c., &c.; to describe particularly the disability, wound, or disease; the extent to which it deprives him of the use of any limb or faculty, or affects his health, strength, activity, constitution, or capacity to labor or earn his subsistence. The surgeon will add, from his knowledge of the facts and circumstances, and from the evidence in the case, his professional opinion of the cause or origin of the disability. In the case of discharges by Medical Inspectors, the last paragraph will state that the "discharge was given by consent of the soldier, after a personal examination, and for disability, the nature, degree, and origin of which are correctly described in the within certificate."

Par. 1260 Regulations, Edit. 1861.

Medical officers, in giving certificates of disability, are to take particular care in all cases that have not been under their charge; and especially in epilepsy, convulsions, chronic rheumatism, derangement of the urinary organs, ophthalmia, ulcers, or any obscure disease liable to be feigned or purposely produced; and in no case shall such certificate be given until after sufficient time and examination to detect any attempt at deception.

DIRECTIONS

This certificate will be made out in duplicate by the soldier's company commander, or other officer commanding the separate detachment to which he belongs and sent by him to the surgeon who has charge of the hospital where the soldier is sick. The surgeon will then fill out and sign the surgeon's certificate, and forward these papers to the regimental, detachment, or post commander, who will forward them, with his action endorsed thereon, through the proper channel, to his division commander; or, if the troops are not attached to a division, to his corps, department, or other commander or officer to whom the authority to discharge enlisted men may be specially delegated.

These certificates, after having received the action of the highest authority to which they are required to be sent, will be returned through the same channel to the regimental, post, or detachment commander, who will, if the discharge is authorized by the endorsement of the proper authority, sign the soldier's discharge, and the last certificate on this paper, see that the soldier is furnished with the proper final statements in duplicate, and forward both of these certificates direct to the Adjutant General United States Army, at Washington, D. C.; they will not under any circumstances be given to the hands of the soldier.

ADJUTANT GENERAL'S OFFICE.

May 12th 1864

Duplicate sent the Pension Office.

B. 48. R. of Dix 3
1864
CERTIFICATE OF DISABILITY FOR DISCHARGE

IN THE CASE OF

Edwin J. Black
Private Co. G
Sixth Reg't of U.S. Col. Troops
Md. & Dept. Va. & N.C.
Fort Monroe Va. 25. Apr. 64

Approved
Charles J. Formick
Surgeon U.S.A.
Dist. Va. Dept.

Head Quarters 7th U.S. C.
Fort Monroe, April 25, 1864

To be discharged
By Command of
Major Gen. Butler
P. R. Davis
a. a. g.

Received (A. G. Office) _____, 186 .

Ernest R. Cas

ARMY OF THE UNITED STATES CERTIFICATE OF DISABILITY FOR DISCHARGE.



Private Edward Black of Captain Henry
Herbert Company, (G.) of the sixth Regiment of United States
Cal Troops was ^{drafted} enlisted by Capt. Walter Forest Marshall of
the 21st Regiment of Scout at Greenburg Pa
on the twentieth day of July 1862, to serve three years; he was born
in Hayette Va in the State of Pennsylvania is twenty four
years of age, five feet eight inches high, olive complexion, black eyes,
brunet hair, and by occupation when enlisted a Farmer During the last two
months said soldier has been unfit for duty 40 days.*

STATION: Camp near Williamsburg Va
DATE: Feb 21 1864 Henry Herbert
Capt
Commanding Company.

I CERTIFY, that I have carefully examined the said Private Edwin J. Black of
Captain Henry Herbert's Company, and find him incapable of performing the duties of a soldier
because of † Varicose Veins of the left leg. They are numerous, large
and knotted, and have been considerably aggravated during
the past months. He is not a fit subject for the Invalid Reg't,
and is not entitled to pension.

G. W. Merrill
apt. Surgeon.
In ch. of Reg't.
Camp

DISCHARGED, this Twenty Fifth day of April 1864, at Camp
Williamsburg Va.

C. E. Brown
Col. 6th U.S. Art.
Commanding the Reg't.

The soldier desires to be addressed at
Town _____ County _____ State _____

* See Note 1 on the back of this. † See Note 2 on the back of this.

U.S. GOVERNMENT

Private

Private

CARD NUMBERS.

5571338	26
5571421	27
5571504	28
5571582	29
5571659	30
5571733	31
5571806	32
5571875	33
5571952	34
5572039	35
5572139	36
5572235	37
5572325	38
9064797	39
9064919	40
	41
	42
	43
	44
	45
	46
	47
	48
	49
	50

See Mark:

See also

NARA 1279

0022/10/14

B

6

U.S.C.T.

James Black

, Co. C, 6 Reg't U. S. Col'd Inf.

Appears on

Company Descriptive Book

of the organization named above.

DESCRIPTION.

Age 23 years; height 5 feet 9 1/2 inches.

Complexion *Blk*

Eyes *Blk*; hair *Blk*

Where born *Cecilia, Mo*

Occupation *Farmers*

ENLISTMENT.

When *Aug 4*, 186*3*

Where *Philada. Pa*

By whom *Sted. Wagner*; term *3* y'rs.

Remarks: *Mustered by
Capt Sergeant
Aug 4/63, Philada
Pa. D.C. furnish-
ed July 5/64*

W. J. Roe

B | **6** | **U.S.C.T.**

James Black
 _____, Co. *A*, 6 Reg't U. S. Col'd Inf.

Appears on

Company Descriptive Book

of the organization named above.

DESCRIPTION.

Age *23* years; height *5* feet *9*/₁₆ inches.

Complexion *Blk*

Eyes *Blk*; hair *Blk*

Where born *Geard Co. Md*

Occupation *Farmer*

ENLISTMENT.

When *Aug 4*, 186*3*.

Where *Phila Pa*

By whom *Lt Col. Wagner*; term *3* y'rs.

Remarks: *Mustered by
 Capt Sergeant, Aug
 4/64. Phila, Pa*

W J Roe

B

6

U.S.C.T.

James Black
Priv, Co. *C*, 6 Reg't U. S. Col'd Infantry.

Age *23* years.

Appears on

Company Muster-in Roll

of the organization named above. Roll dated

Philadelphia, Pa., Aug. 8, 1863.

Muster-in to date

Aug. 1, 1863

Joined for duty and enrolled:

When *Aug. 1*, 186 *3*.

Where *Philadelphia, Pa.*

Period *3* years.

Remarks:

Book mark:

8
C
C
C

Shull

B

6

U.S.C.T.

James Black
Pri., Co. C, 6 Reg't U. S. Col'd Infantry.

Appears on

Company Muster Roll

for *to Oct. 31"*, 186 *3*.

Present or absent *Present*

Stoppage, \$ *100* for

Due Gov't, \$ *100* for

Remarks:

Book mark:

Shull

B

6

U.S.C.T.

James Black
Priv., Co. C, 6 Reg't U. S. Col'd Infantry.

Appears on

Company Muster Roll

for *Nov. & Dec.*, 186 *3*.

Present or absent *Present*

Stoppage, \$ 100 for

Due Gov't, \$ 100 for

Remarks:

Book mark:

Shull

B

6

U.S.C.T.

James Black

Priv., Co. C, 6 Reg't U. S. Col'd Infantry.

Appears on

Company Muster Roll

for *Jan'y. & Feb'y.*, 1864.

Present or absent *Present*

Stoppage, \$ 100 for

Due Gov't, \$ 100 for

Remarks:

Book mark:

Shull

B

6

U.S.C.T.

James Black
Priv., Co. C, 6 Reg't U. S. Col'd Infantry.

Appears on

Company Muster Roll

for *Mar. & Apr.*, 1864.

Present or absent *Present*

Stoppage, \$ *100* for

Due Gov't, \$ *100* for

Remarks: *Due U.S. for 1 Haversack 48 cts / Canteen 44 cts.*

Book mark: *3*

Shull

B

6

U.S.C.T.

James Black

Private, Co. C, 6 Reg't U. S. Col'd Infantry.

Appears on

Company Muster Roll

for May + June, 1864.

Present or absent Present

Stoppage, \$ 100 for

Due Gov't, \$ 100 for

Remarks:

Book mark:

Fletcher

B

6

U.S.C.T.

James Black

Pvt, Co. C, 6 Reg't U. S. Col'd Infantry.

Appears on

Company Muster Roll

for July & Aug, 1864

Present or absent Present

Stoppage, \$ 100 for

Due Gov't, \$ 100 for

Remarks: On daily duties at Ferry.

Free Apr 19 - 1861

Book mark:

J. Fletcher

B

6

U.S.C.T.

James Black
Priv, Co. C, 6 Reg't U. S. Col'd Infantry.

Appears on

Company Muster Roll

for Sept & Oct, 1864.

Present or absent Present

Stoppage, \$ 100 for

Due Gov't, \$ 100 for

Remarks:

NEXT ROLL ON FILE FEB 1865

Book mark:

J. Fletcher

B

6

U.S.C.T.

James Black

Priv., Co. C, 6 Reg't U. S. Col'd Infantry.

Appears on

Company Muster Roll

for Jan & Feb, 1865.

Present or absent Present

Stoppage, \$ 100 for

Due Gov't, \$ 100 for

Remarks:

Book mark:

Fletcher

(358)

Copyist.

B

6

U.S.C.T.

James Black

Pvt., Co. C, 6 Reg't U. S. Col'd Infantry.

Appears on

Company Muster Roll

for March & April, 1865.

Present or absent Present

Stoppage, \$ 100 for

Due Gov't, \$ 100 for

Remarks:

Book mark:

Fletcher

B

6

U.S.C.T.

James Beach

Co. C, 6 Reg't U. S. Col'd Infantry.

Appears on

Company Muster Roll

for May & June, 1864

Present or absent Present

Stoppage, \$ 100 for

Due Gov't, \$ 100 for

Remarks:

Book mark:

Beach

B

6

U.S.C.T.

James Black

203, Co. C, 6 Reg't U. S. Col'd Infantry.

Appears on

Company Muster Roll

for *July & Aug*, 1865.

Present or absent *Present*

Stoppage, \$ *100* for

Due Gov't, \$ *100* for

Remarks:

Book mark:

Beach

13

6

U.S.C.T.

James Black,
Co. C, 6 Reg't U. S. Col'd Infantry.

Appears on Co. Muster-out Roll, dated
Milmington N.C., Sept 20, 1865.

Muster-out to date Sept 20, 1865.

Last paid to Oct 30, 1865.

Clothing account:

Last settled June 30, 1864; drawn since \$46 ⁴³/₁₀₀

Due soldier \$100; due U. S. \$100

Am't for cloth'g in kind or money adv'd \$100

Due U. S. for arms, equipments, &c., \$100

Bounty paid \$None ¹⁰⁰/₁₀₀; due \$100 ¹⁰⁰/₁₀₀

Remarks Due U.S. for ordnance
per G.O. No 101. C.S. N. \$6.00
Due Wm Boston Supt
\$9.00. Due U.S. for 1. S Driven
23 cts.

Book mark:

Beach

James
Col. , 6 U.S. Col'd Inf

Private | *Private*

CARD NUMBERS.

1	5575863	26
2	5575945	27
3	5576025	28
4	5576104	29
5	5576181	30
6	5576260	31
7	5576338	32
8	5576410	33
9	5576484	34
10	5576582	35
11	5576675	36
12	5576770	37
13	5576865	38
14	5576957	39
15	19122260	40
16	9065410	41
17		42
18		43
19		44
20		45
21		46
22		47
23		48
24		49
25		50

Book Mark:

See also

NARRA 1296

J. 20 55098 P.O. m.m.

B | **6** | **U.S.C.T.**

James Black

....., Co. *G*....., 6 Reg't U. S. Col'd Inf.

Appears on

Company Descriptive Book
of the organization named above.

DESCRIPTION.

Age *30* years; height *5* feet *10 1/4* inches.

Complexion *Black*

Eyes *Black*; hair *Curly*

Where born *Fayette Co. Pa.*

Occupation *Farmer*

ENLISTMENT.

When *July 16*....., 186 ..

Where *Greensburg Pa. 21 Dist*

By whom *Capt. Luther P.M.*; term *3* y'rs.

Remarks: *Drafted.*

Jenkins

B 1 6 U.S.C.T.

James Black

Appears with rank of _____ on

Muster and Descriptive Roll of a Detachment of Drafted Men and Substitutes forwarded

for the 6 Reg't U.S.C.T. Roll dated Greensburg Pa Aug 27, 1863.

Where born Fayette Co, Pa

Age 30 y'rs; occupation farmer

Drafted and mustered in:

When July 16, 1863

Where Greensburg Pa

Period 3 years.

Eyes Black; hair Curly

Complexion Black; height 5-10¹/₄ in.

Paid bounty and advance pay, \$ 100

Bounty due, \$ 100

Where credited _____

Company to which assigned G

Remarks Principal

Book mark: _____

Reeves

J

6

U.S.C.T.

James Black

Private, Co. G, 6 Reg't U. S. Col'd Infantry.

Age 30 years.

Appears on

Company Muster-in Roll

of the organization named above. Roll dated

Philadelphia Pa Sept 14, 1863.

Muster-in to date

Sept 14, 1863

Joined for duty and enrolled:

When

July 16, 1863.

Where

Greensburg Pa

Period

3 years.

Remarks:

Mustered by Capt.
Couteer P.M. July 16, 1863.
Drafted Co. to 21 Dist. Pa

Book mark:

M. A. Michaels

(856)

Copyist.

D

6

U.S.C.T.

James Black
Private, Co. G, 6 Reg't U. S. Col'd Infantry.

Appears on

Company Muster Roll

for *Enrollment to Oct 31, 1863*

Present or absent *Present*

Stoppage, \$ 100 for

Due Gov't, \$ 100 for

Remarks:

Book mark:

(358)

M. A. Michaels
Copyist.

B

6

U.S.C.T.

James Black
Private, Co. G, 6 Reg't U. S. Col'd Infantry.

Appears on

Company Muster Roll

for *Nov & Dec*, 1863.

Present or absent *Present*

Stoppage, \$ *100* for

Due Gov't, \$ *100* for

Remarks: *Due the United States
for one-half Shelter Tent
\$1.62*

Book mark:

M. A. Nichols
(358) Copyist.

B

6

U.S.C.T.

James Black
Private, Co. G, 6 Reg't U. S. Col'd Infantry.

Appears on

Company Muster Roll

for *Jan + Febr*, 1864.

Present or absent *Present*

Stoppage, \$ *100* for

Due Gov't, \$ *100* for

Remarks: *Due the United States
for one Half Shelter Tent
(\$1.62)*

Book mark:

(358)

M. A. Michael
Copyist.

B

6

U.S.C.T.

James Black
Private, Co. G, 6 Reg't U. S. Col'd Infantry.

Appears on

Company Muster Roll

for March & Apr., 1864.

Present or absent Present

Stoppage, \$ 100 for

Due Gov't, \$ 100 for

Remarks:

Book mark:

M. A. Nichols

(358)

Copyist.

B

6

U.S.C.T.

James Black
Prv., Co. G, 6 Reg't U. S. Col'd Infantry.

Appears on

Company Muster Roll

for May & June, 1864

Present or absent Present

Stoppage, \$ 100 for

Due Gov't, \$ 100 for

Remarks:

Book mark:

(358)

Grogan

Copyist.

B

6

U.S.C.T.

James Black
Priv, Co. G, 6 Reg't U. S. Col'd Infantry.

Appears on

Company Muster Roll

for *July & Aug.*, 1864

Present or absent *Present*

Stoppage, \$ *100* for

Due Gov't, \$ *100* for

Remarks:

Pres April 19, 1861.

Book mark:

E. J. Hogan

(358)

Copyist.

D

6

U.S.C.T.

James Black
Priv., Co. G, 6 Reg't U. S. Col'd Infantry.

Appears on

Company Muster Roll

for *Sept. & Oct.*, 186*4*

Present or absent *Not sent*

Stoppage, \$ *100* for

Due Gov't, \$ *100* for

Remarks: *Wounded at Deep Bottom Va. Sept. 29, '64 & in Hospital since that date. In April 19, '61. (new market Heights.)*

Book mark:

E. J. Hogan

B | 6 | U.S.C.T.

James Black
Priv., Co. G, 6 Reg't U. S. Col'd Infantry.

Appears on

Company Muster Roll

for Nov. & Dec., 1864.

Present or absent Absent

Stoppage, \$ 100 for

Due Gov't, \$ 100 for

Remarks: Wounded at
New Market Heights,
Va., Sept. 29, '64 and
in hospital since
that date.
From April 19, '61.

Book mark:

Grogan

B | 6 | U.S.C.T.

James Black
Priv., Co. G, 6 Reg't U. S. Col'd Infantry.

Appears on

Company Muster Roll

for Jan. & Feb., 1865.

Present or absent Present

Stoppage, \$ 100 for

Due Gov't, \$ 100 for

Remarks: Present April 19, 1861
Hos 1 Wiper 20, 1 Tompin
02, 1 Sewer Iron, 23 = (45)

Book mark:

Grogan

B

6

U.S.C.T.

James Black
Priv

, Co. G, 6 Reg't U. S. Col'd Infantry.

Appears on

Company Muster Roll

for *March & Apr*, 1865.

Present or absent *absent*

Stoppage, \$ *100* for

Due Gov't, \$ *100* for

Remarks: *Free April 19, 61.*

Absent sick in Hosptl.

Stopp'd on priv's Rolls

for ordnance (45)

Book mark:

Moy

B | 6 | U.S.C.T.

James Black
Priv, Co. G, 6 Reg't U. S. Col'd Infantry.

Appears on

Company Muster Roll

for May & June, 1865.

Present or absent presents

Stoppage, \$ 45 100 for Ordnance.

5 29 for O O Y G E.

Due Gov't, \$ 100 for

Remarks: Returned from
absent, sick since
May 14/65.

Book mark:

May

B | 6 | U.S.C.T.

James Black
Priv, Co. G, 6 Reg't U. S. Col'd Infantry.

Appears on

Company Muster Roll

for July & Aug, 1865.
Present or absent *present*

Stoppage, \$ 100 for

Due Gov't, \$ 100 for

Remarks:

Book mark:

(358)

Moy Copyist.

B

6

U.S.C.T.

James Black

Priv, Co. G, 6 Reg't U. S. Col'd Infantry.

Appears on Co. Muster-out Roll, dated

Wilmington NC, Sept 20, 1865.

Muster-out to date

Sept 20, 1865.

Last paid to

Apr 30, 1865.

Clothing account:

Last settled June 30, 1864; drawn since \$ 70 ⁶⁰/₁₀₀

Due soldier \$ 100; due U. S. \$ 100

Am't for cloth'g in kind or money adv'd \$ 100

Due U. S. for arms, equipments, &c., \$ 6 ⁰⁰/₁₀₀

Bounty paid \$ none 100; due \$ 100 ¹⁰⁰/₁₀₀

Remarks: Drafted under act of March 3, 1863.

Book mark: PV5 P110, 68, 1129, 1879

Moy

6 U.S. Cold Int

Private Private

CARD NUMBERS.

5578198	26
5578279	27
5578362	28
5578448	29
5578526	30
5578602	31
5578677	32
5578797	33
5579275	34
9065639	35

26
27
28
29
30
31
32
33
34
35
36
37
38
39
40
41
42
43
44
45
46
47
48
49
50

Mark: *EB.* $\frac{12}{245}$

See also

B | **6** | **U.S.C.T.**

Henry Blackiston,
Co. *D*, 6 Reg't U. S. Col'd Inf.

Appears on
Company Descriptive Book
of the organization named above.

DESCRIPTION.

Age *23* years; height *5* feet *8* inches.

Complexion *dark*

Eyes *black*; hair *curly*

Where born *New Castle Co. Del.*

Occupation *Labourer*

ENLISTMENT.

When *Sept 7*, 186*3*.

Where *Myrna Del.*

By whom *Capt. Edw. Wilmer*; term *3* y'rs.

Remarks: *Substitute -
Final Statement sent
Nov. 15.*

Jenkins

B. | 6 | U.S.C.T.

Henry Blackiston
Pat. Co. I, 6 Reg't U. S. Col'd Infantry.

Age 23 years.

Appears on

Company Muster-in Roll

of the organization named above. Roll dated
Philada. Pa., Sept. 11, 1863.

Muster-in to date Sept. 7, 1863

Joined for duty and enrolled:

When Sept. 7, 1863.

Where Smyrna, Del.

Period 3 years.

Remarks: Sub. Delaware, 1
Dis. Mustered by Capt.
Wilmer P.M. Sept. 7, '63.

Book mark:

B.

6

U.S.C.T.

Henry Blackiston
Pat., Co. I, 6 Reg't U. S. Colored Infantry.

Appears on

Company Muster Roll

for *Sept. & Oct.*, 186*3*.

Present or absent *Present*.

Stoppage, \$ *100* for

Due Gov't, \$ *100* for

Remarks:

Book mark:

(858)

Aslv.
Copyist.

B. | 6 | U.S.C.T.

Henry Blackiston
Priv., Co. I, 6 Reg't U. S. Colored Infantry.

Appears on

Company Muster Roll

for Nov & Dec, 1863.

Present or absent Present.

Stoppage, \$ 100 for

Due Gov't, \$ 100 for

Remarks: Due U.S. for Bugle
Letter, and Number 5 etc.

Book mark:

(358)

ASH
Copyist.

B.

6

U.S.C.T.

Henry Blackiston.
Pat.; Co. I, 6 Reg't U. S. Colored Infantry.

Appears on

Company Muster Roll

for Jan'y 7 Feby., 1864.

Present or absent Present.

Stoppage, \$ 100 for

Due Gov't, \$ 100 for

Remarks: Due U.S. for 1 hour
ersack 56 cts.

Book mark:

(853)

Ash
Copyist.

B. | 6 | U.S.C.T.

Henry Blacketer
Pat., Co. I, 6 Reg't U. S. Colored Infantry.

Appears on

Company Muster Roll

for *Mar & Apr*, 1864

Present or absent *Present*

Stoppage, \$ *100* for

Due Gov't, \$ *100* for

Remarks:

Book mark:

B. | 6 | U.S.C.T.

Henry Blackiston
Priv., Co. I, 6 Reg't U. S. Colored Infantry.

Appears on

Company Muster Roll

for *May & June* 1864.

Present or absent *Present*

Stoppage, \$ 100 for

Due Gov't, \$ 100 for

Remarks:

Book mark:

A. W. Reed

(858)

Copyist.

B.

6

U.S.C.T.

Henry Blackiston
Priv. Co. I, 6 Reg't U. S. Colored Infantry.

Appears on

Company Muster Roll

for July & Aug., 1864.
Present or absent Present.

Stoppage, \$ 100 for

Due Gov't, \$ 100 for

Remarks: Free April 19, 63
On extra duty since Aug.
9, 64.

Book mark:

A. W. Reed

(358)

Copyist.

B. | 6 | U.S.C.T.

Henry Blackiston
Priv. Co. II 6 Reg't U. S. Colored Infantry.

Appears on

Company Muster Roll
for Sept. & Oct., 1864

Present or absent

Stoppage, \$ 100 for

Due Gov't, \$ 100 for

Remarks: Free Apr. 19/61
Killed in action near
New Market Heights
Sept. 29/64
Due Wm. Briske Sutter
\$8.00

NEXT ROLL ON FILE FEB 1865

Book mark:

W. H. Ruse

(863)

Copyist.

B | **6** | **U.S.C.T.**

Henry Blackstone
Pvt, Co. *I*, 6 Reg't U. S. Col'd Infantry.

Appears on **Co. Muster-out Roll**, dated
Wilmington, N.C., Sept 20, 186*5*.

Muster-out to date _____, 186 .

Last paid to _____, 186 .

Clothing account:

Last settled _____, 186 ; drawn since \$ _____ 100

Due soldier \$ _____ 100; due U. S. \$ _____ 100

Am't for cloth'g in kind or money adv'd \$ _____ 100

Due U. S. for arms, equipments, &c., \$ _____ 100

Bounty paid \$ _____ 100; due \$ _____ 100

Remarks: *Dead Sept 29 - Kill*
in action New Market
heights.

Book mark: *Dies Sept 29/64 I.O. 12*
545

(361)

Posey

Copyist.

WARREN 1924

JAN. 20

5579275

1891 *

J. S. 279-030

Blackstone, Henry

B, Co. I, 6 U.S.C. Inf. Reg't

3 Enclosures.

Bed Cards	Descriptive Lists
Burial Records	Final Statements /
Certs. of Dis. for Discharge	Furloughs
C. M. Charges	Med. Des. Lists
Med. Certificates	Orders

E.P. 2

Other papers relating to—

Admission to Hosp'l	Furlough
Casualty Sheet (Officer's)	Med. Examination
Confinement	Misc. Information
Contracts	Pay or Clothing
Death or Effects	Personal Reports
Desertions	Rank
Discharge from Hosp'l	Transfer to Hosp'l
Discharge from Service	Transfer to V. R. C.
Duty	Transportation

E.P. filed 3/19/02
MBS

DECLARATION OF SUBSTITUTE.

I, Henry Blackstone desiring to ENLIST in the Army of the United States, for THREE YEARS, **Do declare**, That I am Twenty three years and two months of age; that I have never been discharged from the United States service on account of disability or by sentence of a court martial; and I know of no impediment to my serving honestly and faithfully as a soldier for three years.

GIVEN at Empira, Pa
the 7 day of September 1863

WITNESS:

L. J. Mah Henry T. Blackstone
sub

W B/63

No.

Henry Blackstone (call)

Enlisted at Empira Pa

As Substitute for

Thomas Jackson

On the 7 day of Sept, 1863.

By

Exam. Wilson

Thomas B. Smith

A. J. Fisher

Board of Enrollment,

Co. Dist. of Empira

(No. 40.)

SUBSTITUTE VOLUNTEER ENLISTMENT.

STATE OF

TOWN OF



I, Henry Blackiston (wrote) born in the State of Delaware, aged twenty three years, and by occupation a laborer Do HEREBY ACKNOWLEDGE to have agreed with Andrew Jackson (col'd), Esq., of Brandywine Hundred New Castle county, Delaware to become his SUBSTITUTE in the Military Service, for a sufficient consideration paid and delivered to me, on the seventh day of September, 1863; and having thus agreed with said Andrew Jackson, I DO HEREBY ACKNOWLEDGE to have enlisted this seventh day of September 1863, to serve as a Soldier in the Army of the United States of America, for the period of THREE YEARS, unless sooner discharged by proper authority: I do also agree to accept such bounty, pay, rations, and clothing, as are, or may be, established by law for soldiers. And I do solemnly swear that I will bear true and faithful allegiance to the United States of America; that I will serve them honestly and faithfully against all their enemies or opposers whomsoever; and that I will observe and obey the orders of the President of the United States, and the orders of the Officers appointed over me, according to the Rules and Articles of War.

SWORN and subscribed to, at Smyrna this 7th day of September 1863. BEFORE [Signatures]

Henry Blackiston

We certify, on honor, That we have carefully examined the above-named Volunteer Substitute agreeably to the Regulations, and that, in our opinion, he is free from all bodily defects and mental infirmity which would in any way disqualify him from performing the duties of a soldier; that he was entirely sober when enlisted; that he is of lawful age, (not under 18 years;) and that, in accepting him as duly qualified to perform the duties of an able-bodied soldier, and as a Substitute in lieu of Andrew Jackson, drafted in Brandywine Hundred, Delaware, August 12, 1863, we have strictly observed the Regulations which govern in such cases. This soldier has black eyes, black hair, black complexion; is five feet eight inches high.

[Signature] Provost Marshal.

[Signature] Commissioner of Board.

[Signature] Surgeon of Board.

Board of Enrollment of New Castle Dist. of Delaware.

DECLARATION OF SUBSTITUTE.

I, *Henry Blackiston (col)* desiring to ENLIST in the Army of the United States, for THREE YEARS, **Do declare,** That I am *Twenty three* years and *two* months of age; that I have never been discharged from the United States service on account of disability or by sentence of a court martial; and I know of no impediment to my serving honestly and faithfully as a soldier for three years.

GIVEN at *Sumner Delaware* the *7th* day of *Sept* 1863

WITNESS:

L. M. ...

his
Henry + Blackiston
with

13/63

No. *32*

Henry Blackiston (col)

Enlisted at *Sumner Del*

As Substitute for

Andrew Jackson (col)

On the *7th* day of *Sept*, 1863.

By

Samuel ...

Samuel B. ...

D. G. ...

Board of Enrollment,

By Dist. of *Delaware*

(No. 40.)

SUBSTITUTE VOLUNTEER ENLISTMENT.

STATE OF

TOWN OF

Delaware



Smyrna

I, Henry Blackiston (col.) born in the State of Delaware, aged Twenty three years, and by occupation a Laborer Do HEREBY ACKNOWLEDGE to have agreed with Andrew Jackson (col.), Esq., of Brandywine Road, New Castle County Delaware to become his SUBSTITUTE in the Military Service, for a sufficient consideration paid and delivered to me, on the Seventh day of Sept, 1863; and having thus agreed with said Andrew Jackson, I DO HEREBY ACKNOWLEDGE to have enlisted this Seventh day of Sept, 1863, to serve as a Soldier in the Army of the United States of America, for the period of THREE YEARS, unless sooner discharged by proper authority: I do also agree to accept such bounty, pay, rations, and clothing, as are, or may be, established by law for soldiers. And I do solemnly swear that I will bear true and faithful allegiance to the United States of America; that I will serve them honestly and faithfully against all their enemies or opposers whomsoever; and that I will observe and obey the orders of the President of the United States, and the orders of the Officers appointed over me, according to the Rules and Articles of War.

SWORN and subscribed to, at Smyrna Del this 7th day of Sept 1863. BEFORE Edw. Miller Provost

Henry Blackiston

We certify, on honor, That we have carefully examined the above-named Volunteer Substitute agreeably to the Regulations, and that, in our opinion, he is free from all bodily defects and mental infirmity which would in any way disqualify him from performing the duties of a soldier; that he was entirely sober when enlisted; that he is of lawful age, (not under 18 years;) and that, in accepting him as duly qualified to perform the duties of an able-bodied soldier, and as a Substitute in lieu of Andrew Jackson, drafted in Smyrna Delaware August 12th, 1863, we have strictly observed the Regulations which govern in such cases. This soldier has Black eyes, Black hair, Black complexion; is 5 feet 8 inches high.

Edw. Miller Provost Marshal.

Louis Stiles Commissioner of Board.

J. G. Fisher Surgeon of Board.

Board of Enrollment of Delaware Dist. of Delaware

DECLARATION OF SUBSTITUTE.

I, *Henry Blackiston (col)* desiring to ENLIST in the Army of the United States, for THREE YEARS, **Do declare**, That I am *Twenty three* years and *two* months of age; that I have never been discharged from the United States service on account of disability or by sentence of a court martial; and I know of no impediment to my serving honestly and faithfully as a soldier for three years.

GIVEN at *Simpura Belawan* the *7th* day of *Sept 1863*

WITNESS:

L. Mahy

his
Henry + Blackiston
with

13/63

No. *39*

Henry Blackiston (col)

Enlisted at *Simpura Bel*

As Substitute for

Andrew Jackson (col)

On the *7th* day of *Sept*, 1863.

By

Edwin Melner

Levanat B. Hall

D. G. Fisher

Board of Enrollment,

Sy Dist. of *Belawan*

FINAL STATEMENT

OF

Private Henry Blackstone "I"
6th Reg't of U.S. Col'd Troop

VOLUNTEERS.

NOTE 1.—Two of these certificates (or duplicates) are to be given to each Volunteer Soldier or drafted man who may be discharged previously to the discharge of his company, that he may at once receive from the Paymaster the pay, &c., due him, and the captain or other COMMISSIONED officer commanding the company will certify to the act of the delivery of the duplicate certificates; on these certificates the Soldier is "entitled to" his discharge, and should also present his discharge to the Paymaster to have the payment endorsed on it. The discharge is to be given back to the Soldier by the Paymaster; the latter only retaining as his voucher the duplicate certificates.

NOTE 2.—If the Soldier is entitled to pay for the use of his horse, the Company Commander will certify to that fact on the back of both these final statements, and also to the time he has pay due for having been so mounted on his own horse.

NOTE 3.—When a Soldier is furnished with final statements, his descriptive list, if he has one, should be taken up by the officer who gives the Soldier these statements, and endorsed with a statement to this effect by the officer. This endorsement should exhibit a full statement of the time for which the Soldier was allowed pay on his final statements, the clothing account, and all other charges against him or in his favor, so as to comprise a complete exhibit of his account. It will then be transmitted to the company commander of the Soldier, who will enter all the data necessary to a full understanding of the Soldier's account on the muster roll upon which the Soldier's discharge is reported. The descriptive list will then be destroyed. The object of this is, that the remaining portion of the Soldier's account may be settled upon the receipt of these muster rolls, and the Soldier receive any pay or allowances that may be due him at the time of his discharge, and which may not appear on his final statements from the fact that his descriptive list is incomplete. These accounts for back pay, &c., are settled by the 2d Auditor of the Treasury Department.

NOTE 4.—Charges for loss or injury to ordnance, horse equipments, and other miscellaneous charges, should appear under the heading of "Other Stoppages."

NOTE 5.—Bounty paid by State authorities, and not by the United States, will not be entered on this statement.

NOTE 6.—Amounts due the Sutler and Laundress must be entered on the muster roll on which the discharge, death, desertion, &c., is reported, as well as on the final statement, otherwise the amount cannot be collected from the United States.

NOTE 7.—This blank will be used for deceased volunteers and drafted men, as well as for others.

NOTE 8.—Where a Soldier dies in Hospital or on detached service, his descriptive list, if he has one, should be sent with his final statements, in duplicate, to the Adjutant General, Washington, D. C.

ADJUTANT GENERAL'S OFFICE.

Nov 23rd 1864

Duplicate with Inventory sent 2d Auditor.



[OFFICE ENDORSEMENT.]

War Department,

ADJUTANT GENERAL'S OFFICE,

June 18, 1864

The Death of Private Henry Blackstone, Co. I, 6th Reg't U.S. Colored Troops, is reported as follows

On Company Muster Roll For Sept & Oct, 1864, September 29, 1864

Company Muster-out Roll. September 29, 1864

Company Descriptive Book. 1864

Company Morning Reports. 1864

Soldier's Final Statement. September 29, 1864

Soldier's Record of Death and Interment. 1864

Soldier's Inventory of Effects. 1864

Soldier's Certificate of Disability for Discharge. 1864

Soldier's Individual Muster-out Roll. 1864

Regimental Return. For 1864, 1864

Regimental Quarterly Returns. 1864

Regimental Descriptive Book. 1864

By Surgeon General. 1864

September 29, 1864, is held to be the correct date, and the Company Muster Roll will be amended accordingly

L. H. Perry Assistant Adjutant General.

Noted H.M. EPB 345

I certify, on honor, that Henry Blackston a Private of
 Captain P. Weimann Company (B) of the 6th Regiment of U.S. Col. Troops
VOLUNTEERS, of the State of _____, born in New Castle Co, State
 of Delaware, aged 23 years; 5 feet 8 inches high; Dark complexion,
Black eyes, Curly hair, and by occupation a Laborer, having joined the company on
 its original organization at _____, and enrolled in it at the muster into
 the service of the United States at _____, on the _____ day
 of _____, 186____, (or was mustered in service as a recruit, by _____
 _____, at _____, on the _____ day of _____,
 186____, or was drafted and mustered into the service of the United States from the First-
 Enrollment District of the State of Delaware, at Smyma,
 on the Seventh day of September, 1863,) to serve in the Regiment, for
 the term of Three Years; and having served **HONESTLY** and
FAITHFULLY with his Company in The Field to the present date, is now
 entitled to a **DISCHARGE** by reason of Death caused Minnie bullet in
the battle of New Market Heights Va September 29th 1864

The said Private Henry Blackston was last paid by Paymaster
May McKenny to include the thirtieth day of April, 1864, and has
 pay due him from that time to the present date; he is entitled to pay and subsistence for
TRAVELING to place of enrollment, and whatever other allowances are authorized to volunteer
 soldiers, drafted men, or militia, so discharged. He has received from the United States **CLOTHING**
 amounting to \$75.13 dollars, since the _____ day of enrollment,
 186____, when his clothing account was last settled. He has received from the United States
 _____ dollars advanced **BOUNTY**.

There is to be stopped from him, on account of the State of _____, or other
 authorities, for **CLOTHING, &c.**, received on entering service, _____ dollars; and
 for other stoppages, viz: _____

_____ dollars.
 He has been furnished with **TRANSPORTATION** in kind from the place of his discharge to
 _____; and he has been **SUBSISTED** for **TRAVELING** to his
 place of enrollment, up to the _____, 186____

He is indebted to William Barber, **SUTLER**, \$8.00 dollars.

He is indebted to _____, **LAUNDRESS**, _____ dollars.

Given in Duplicate, at Camp 6th U.S.C. Troops near Chaffin Run Va, this 17th day
 of November, 1864.

Alonso W. Brown
1st Lieut. 6th U.S.C. Troops
 Commanding Company B

This soldier was free April 18/64
 as never received over \$7.00 per month
 from the Government

Private

CARD NUMBERS.

68535	26
68024	27
69665	28
69757	29
69856	30
569948	31
570038	32
0064752	33
	34
	35
	36
	37
	38
	39
	40
	41
	42
	43
	44
	45
	46
	47
	48
	49
	50

Book Mark:

See also

2771 P.O. Box 1111
 44996070 4/14/67 MA
 (a 20 3/4 minute serial) 3-19-67
 201 - 4-21-42 C.F.H.

B | 6 | U.S.C.T.

Robert Blackwood

Co. A, 6 Reg't U. S. Col'd Inf.

Appears on

Company Descriptive Book
of the organization named above.

DESCRIPTION.

Age 19 years; height 5 feet 5 inches.

Complexion *Blk*

Eyes *Blk*; hair *Blk*

Where born *Kent Co, Md*

Occupation *Laborer*

ENLISTMENT.

When *Nov 22*, 186*4*

Where *Baltimore*

By whom *Capt Dimonk*, term *1* y'rs.

Remarks: *Substitute*

W F Roe

B | 6

U.S.C.T.

Robert Blackwood

Appears with rank of _____ on
**Muster and Descriptive Roll of a Detach-
ment of Drafted Men and Substitutes**
forwarded

for the 6 Reg't U. S. Col'd Inf. Roll dated
Baltimore Md, Apr 30, 1864.

Where born Virginia

Age 19 years; occupation Laborer

Drafted and mustered in:

When Apr 29, 1864.

Where Baltimore Md

Period 1 years.

Eyes Blk; hair Blk

Complexion Blk; height 5 ft. 5 in.

Paid bounty and advance pay, \$ 100

Bounty due \$ 100

Where credited _____

Company to which assigned _____

Remarks Subs for Joseph W
Caulk 3 Dist. Md

Book mark: _____

W. H. Wright

B | 6 | U.S.C.T.

Robert Blackwood

Appears with rank of on
**Muster and Descriptive Roll of a Detach-
 ment of U. S. Vols. forwarded**

for the 6 Reg't U. S. Col'd Infantry. Roll dated
Camp near Fort
Burnham Va, Dec 13, 1864.

Where born *Va*

Age *19* y'rs; occupation *Laborer*

When enlisted *Nov 22*, 1864.

Where enlisted *Baltimore*

For what period enlisted *one* years.

Eyes *Blk.*; hair *Blk*

Complexion *Blk.*; height *5* ft. *5* in.

When mustered in *Nov 22*, 186 .

Where mustered in

Bounty paid \$ *100*; due \$ *100*

Where credited *3rd Dist Md.*

Company to which assigned

Remarks: *Substitute for Joseph*
W. Caulk.

Book mark:

B

6

U.S.C.T.

Robert Blackwood

Pvt., Co. A, 6 Reg't U. S. Col'd Infantry.

Appears on

Company Muster Roll

for Jan'y. 1st Feby., 1865.

Present or absent absent

Stoppage, \$ 100 for

Due Gov't, \$ 100 for

Remarks: On detached service near Chapin's Farm Va. Substitute,

No roll for Dec. 31/64.

Book mark:

Crenshaw

B

6

U.S.C.T.

Robert Blackwood

Pvt, Co. A, 6 Reg't U. S. Col'd Infantry.

Appears on

Company Muster Roll

for *Mch. & Apr.*, 1865.

Present or absent *Present*

Stoppage, \$ *100* for

Due Gov't, \$ *100* for

Remarks: *Due U.S. for 1 screw driver 23¢, 1 wiper 20¢, 1 canteen 65¢. Substitute.*

Book mark:

Creshaw

3 | 6 | U.S.C.T.

Robert Blackwood
Co. A, 6 Reg't U. S. Col'd Infantry.

Appears on

Company Muster Roll

for *Nov & Dec*, 1865.

Present or absent *Present*

Stoppage, \$ *100* for

Due Gov't, \$ *100* for

Remarks:

*Charged on Prior
roll for 100.00
65.00 for advance
1.30*

Book mark:

(358)

W. A. Edwards

Copyist.

B

6

U.S.C.T.

Robert Blackwood

Privt., Co. A, 6 Reg't U. S. Col'd Infantry.

Appears on

Company Muster Roll

for July & Aug, 1865.

Present or absent Present

Stoppage, \$ 100 for

Due Gov't, \$ 100 for

Remarks:

Book mark:

W. A. Edwards

(358)

Copyist.

B | 6 | U.S.C.T.

Robert Blackwood
Priv., Co. A., 6 Reg't U. S. Col'd Infantry.

Appears on Co. Muster-out Roll, dated
Wilmington, N.C., Sept 20, 1865.

Muster-out to date Sept 20, 1865.

Last paid to April 30, 1865.

Clothing account:

Last settled Never, 186 ; drawn since \$ 67. ⁴/₁₀₀

Due soldier \$ 100; due U. S. \$ 100

Am't for cloth'g in kind or money adv'd \$ 100

Due U. S. for arms, equipments, &c., \$ 100

Bounty paid \$ 100; due \$ 100

Remarks:
Done (U.S.) for 4 1/2
months pay, 43 1/2

Book mark:

(361) W. A. Edwards
Copyist.

Blackwood Robert

....., Co., *6* Reg't *4069*

3 Enclosures.

Bed Cards.....	Final Statements.....
Burial Records.....	Furloughs or L. of A.....
Certs. of Dis. for Discharge.....	Med. Certificates.....
C. M. Charges.....	Med. Des. Lists.....
Descriptive Lists.....	Orders.....
Discharge Certificates.....	Pris. of War Record.....
Enlistment Papers <i>2</i>	Resignations.....

Other papers relating to—

Admission to Hosp'l.....	Furlough or L. of A.....
Casualty Sheet.....	Med. Examination.....
Confinement.....	Misc. Information.....
Contracts.....	Pay or Clothing.....
Death or Effects.....	Personal Reports.....
Desertion.....	Rank.....
Discharge from Hosp'l.....	Transfer to Hosp'l.....
Discharge from Service.....	Transfer to V. R. C.....
Duty.....	Transportation.....
<i>A.S.</i>	

E.P. filed 3/20/02
WDS

DECLARATION OF SUBSTITUTE.

Robert Blackwood desiring to ENLIST
in the Army of the United States, for ~~THREE~~ ^{one} YEARS, **Do declare**, That I am
one year years and _____ months of age; that I have
never been discharged from the United States service on account of disability or by sentence of
a court martial; and I know of no impediment to my serving honestly and faithfully as a soldier
for ~~three years~~ *one year*

GIVEN at *Baltimore*
the *22* day of *November* *1864*

WITNESS: *Am. S. S. S. S.* *Robert Blackwood*
mark

61

No. *465*

Robert Blackwood

Enlisted at *Baltimore Md*

As Substitute for

Christopher Myers

On the *22* day of *Nov* 1864

By

Robert Blackwood

Am. S. S. S. S.

John C. ...

Board of Enrollment,
Dist. of *Maryland*

MAR 1865

(No. 39.)

SUBSTITUTE VOLUNTEER ENLISTMENT.

STATE OF



CITY TOWN OF

Maryland Baltimore

I, Robert Blackwood born in the State
of Virginia, aged fifteen years, and by
occupation a Salpeter Do HEREBY ACKNOWLEDGE to have agreed with

Christopher Myers Esq., of 9th Ward Baltimore City State of Maryland

to become his **SUBSTITUTE** in the Military Service, for a sufficient consideration paid and delivered to me, on the twenty second day of November, 1864; and having thus agreed with said Christopher Myers I DO HEREBY ACKNOWLEDGE to have enlisted this twenty second day of November 1864, to serve as a **Soldier** in the **Army of the United States of America**, for the period of **THREE YEARS**, unless sooner discharged by proper authority: I do also agree to accept such bounty, pay, rations, and clothing, as are, or may be, established by law for soldiers. And I do solemnly swear that I will bear true and faithful allegiance to the **United States of America**; that I will serve them honestly and faithfully against all their enemies or opposers whomsoever; and that I will observe and obey the orders of the President of the United States, and the orders of the Officers appointed over me, according to the Rules and Articles of War.

SWORN and subscribed to, at Baltimore
this 22 day of November 1864.
BEFORE Capt L. Blumentberg
Pro Mar 3rd Dist Md

Robert Blackwood
made

We certify, on honor, That we have carefully examined the above-named Volunteer Substitute agreeably to the Regulations, and that, in our opinion, he is free from all bodily defects and mental infirmity which would in any way disqualify him from performing the duties of a soldier; that he was entirely sober when enlisted; that he is of lawful age, (not under 18 years;) and that, in accepting him as duly qualified to perform the duties of an able-bodied soldier, and as a Substitute in lieu of Christopher Myers, drafted in 9th Ward Baltimore City Md Oct 29 1864, we have strictly observed the Regulations which govern in such cases. This soldier has Black eyes, Wavy hair, Fair complexion; is 5 feet 9 inches high.

James M. Mendenhall
Provost Marshal
William Brooks
Commissioner of Board
John T. Mendenhall
Surgeon of Board.

Board of Enrollment of 8 Dist. of Maryland

DECLARATION OF SUBSTITUTE.

I, Robert Blackwood desiring to ENLIST in the Army of the United States, for THREE YEARS, **Do declare**, That I am Nineteen years and _____ months of age; that I have never been discharged from the United States service on account of disability or by sentence of a court martial; and I know of no impediment to my serving honestly and faithfully as a soldier for ~~three years.~~ one year

GIVEN at Baltimore
the 22 day of November 1864

WITNESS: Mark Noel Robert Blackwood
Mark

6

No. 463

Robert Blackwood
Enlisted at Washington Md

As Substitute for

Christopher Hygens

On the 22 day of Nov 1864

By

Robert G. Zimmerman

John Brooks

Chas G. Woodard

Board of Enrollment,

3 Dist. of Maryland

(No. 39.)

SUBSTITUTE
VOLUNTEER ENLISTMENT.

STATE OF

~~CITY~~
TOWN OF

Maryland  *Baltimore*

I, *Robert Blackwood* born in the State
of *Virginia*, aged *nineteen* years, and by
occupation a *Labourer* Do HEREBY ACKNOWLEDGE to have agreed with

Christopher Myers, Esq., of *9th Ward Baltimore City State of Maryland*

to become his **SUBSTITUTE** in the Military Service, for a sufficient consideration paid and
delivered to me, on the *twenty second* day of *November*, 186*4*;
and having thus agreed with said *Christopher Myers*, I DO HEREBY
ACKNOWLEDGE to have enlisted this *twenty second* day of *November*
186*4*, to serve as a **Soldier** in the **Army of the United States of America**, for the period
of **THREE YEARS**, unless sooner discharged by proper authority: I do also agree to accept such
bounty, pay, rations, and clothing, as are, or may be, established by law for soldiers. And I do
solemnly swear that I will bear true and faithful allegiance to the **United States of America**;
that I will serve them honestly and faithfully against all their enemies or opposers whomsoever;
and that I will observe and obey the orders of the President of the United States, and the orders
of the Officers appointed over me, according to the Rules and Articles of War.

SWORN and subscribed to, at *Baltimore*
this *22nd* day of *November* 186*4*
BEFORE *L. J. Hammerberg*
Capt. U.S.A. 5th Dist. Md.

Robert Blackwood
Mark

We certify, on honor, That we have carefully examined the above-named Volunteer Substitute
agreeably to the Regulations, and that, in our opinion, he is free from all bodily defects and mental infirmity
which would in any way disqualify him from performing the duties of a soldier; that he was entirely sober
when enlisted; that he is of lawful age, (not under 18 years;) and that, in accepting him as duly qualified to
perform the duties of an able-bodied soldier, and as a Substitute in lieu of *Christopher Myers*
Oct 29th, drafted in *9th Ward Balto city Md.*
186*4*, we have strictly observed the Regulations which govern
in such cases. This soldier has *Black* eyes, *Reddy* hair, *Yellow* complexion; is *5* feet *5*
inches high.

Charles Mendenhall
Provost Marshal.

William Bivick
Commissioner of Board.

W. J. Mendenhall
Surgeon of Board.

Board of Enrollment of *3d* Dist. of *Maryland*

Statement of Service Reference Slip.

Office Pension

Claim No. 996070

Robert Blackwood
(Name.)

, Co. A, 6 Reg't USC Ky

To Arch Div. Apr 14, 1916

For name of former
owner.

acc as sub. Nov 22. 1864
at Baltimore Md from
3rd Dist Md.

Johnson
M.S.

V.R.R. Sec.
Name of former owner
not found.

Harley
J.M.

R.R. Div
Not found
over Harley
J.M.

Statement furnished APR 14 1916, 191

Stu.

span
Med Sec
for history
no med for pps
Johnson
M.H. 70.

No medical record found.

Am.

Private

6 U.S. Col'd Inf

Private

Private

CARD NUMBERS.

1	5-5-69071	26
2	5-5-68291	27
3	5-5-69153	28
4	5-5-69238	29
5	5-5-69310	30
6	5-5-69382	31
7	5-5-69452	32
8	5-5-69522	33
9	5-5-69592	34
10	5-5-69662	35
11	5-5-69754	36
12	5-5-69853	37
13	5-5-69946	38
14	5-5-70055	39
15	9064675	40
16		41
17		42
18		43
19		44
20		45
21		46
22		47
23		48
24		49
25		50

Book Mark: *HB.V414.375*

See also

B | 6 | U.S.C.T.

David J. Blain

Co. A, 6 Reg't U. S. Col'd Inf.

Appears on

Company Descriptive Book
of the organization named above.

DESCRIPTION.

Age 36 years; height 5 feet 8 inches.

Complexion *Beck*

Eyes *Beck*; hair *Curly*

Where born *Mifflin, Pa*

Occupation *Laborer*

ENLISTMENT.

When *July 16*, 1863.

Where *Greensburg Pa*

By whom *W B Coulter*; term *3* y'rs.

Remarks: *Wounded on picket June 29/64. Sent to Dist Hospital City Point Va. Descriptive List sent to Surgeon in chief DeCamp Gen Hoop Davids Island, Md. Aug 9/64. Returned to duty Aug 16, charge (over)*

W. J. Roe

NARA 1352

MAY. 11

9064675

* 1891 *

of clothing entered
Descriptive List
received back
Aug 29/64. Not
paid in Hospital

B | 6 | U.S.C.T.

David S. Blane

Appears with rank of _____ on
**Muster and Descriptive Roll of a Detach-
 ment of Drafted Men and Substitutes
 forwarded**

for the 6 Reg't U. S. Col'd Inf. Roll dated
 Greenburg Pa., July 24, 1863.

Where born Pa

Age 36 years; occupation Lab.

Drafted and mustered in:

When July 16, 186

Where Greenburg Pa., 21 Dis. Pa.

Period 3 years.

Eyes black; hair curly

Complexion black; height 5 ft. 8 in.

Paid bounty and advance pay, \$ 100

Bounty due \$ 100

Where credited _____

Company to which assigned _____

Remarks: substitute

Book mark: _____

Sarimer

P

6

U.S.C.T.

David S. Plain

1st Co., 6 Reg't U. S. Col'd Infantry.

Age *21* years.

Appears on

Company Muster-in Roll

of the organization named above. Roll dated

Plain Pa Oct 13, 1863.

Muster-in to date

July 24, 1863

Joined for duty and enrolled:

When *July 16*, 1863.

Where *Greensburg Pa*

Period *3* years.

Remarks: *Sub.*

Book mark:

Plain

P

6

U.S.C.T.

David S. Plain

Plt, Co. A, 6 Reg't U. S. Col'd Infantry.

Appears on

Company Muster Roll

for *to Oct 31*, 186*3*.

Present or absent *Present*

Stoppage, \$ *100* for

Due Gov't, \$ *100* for

Remarks:

Book mark:

Devo

P

6

U.S.C.T.

David S. Plain

Pl, Co. A, 6 Reg't U. S. Col'd Infantry.

Appears on

Company Muster Roll

for *Nov & Dec*, 1863.

Present or absent *Present*

Stoppage, \$ *100* for

Due Gov't, \$ *100* for

Remarks:

Book mark:

Deer

P

6

U.S.C.T.

David Blair

Rt, Co. A, 6 Reg't U. S. Col'd Infantry.

Appears on

Company Muster Roll

for *Jan & Feb*, 1864.

Present or absent *Present*

Stoppage, \$ *100* for

Due Gov't, \$ *100* for

Remarks:

Book mark:

Blair

P

6

U.S.C.T.

David H. Plain

Int, Co. A, 6 Reg't U. S. Col'd Infantry.

Appears on

Company Muster Roll

for *March + April*, 1864.

Present or absent *Present*

Stoppage, \$ *100* for

Due Gov't, \$ *100* for

Remarks:

Book mark:

(358)

Allen

Copyist.

B

6

U.S.C.T.

David S. Blain

Pvt, Co. A, 6 Reg't U. S. Col'd Infantry.

Appears on

Company Muster Roll

for May & June, 1864.

Present or absent absent

Stoppage, \$ 100 for

Due Gov't, \$ 100 for

Remarks: Wounded on Picket near Petersburg Va. June 29, 1864. Sent to Field Hospital of 18th Corps.

Book mark:

Crenshaw

(358)

Copyist.

B

6

U.S.C.T.

David S. Blain

Pvt., Co. A, 6 Reg't U. S. Col'd Infantry.

Appears on

Company Muster Roll

for July & Aug., 1864.

Present or absent Present

Stoppage, \$ 100 for

Due Gov't, \$ 100 for

Remarks: Free April 19, 1861. Extra Duty on Canal at Dutch Gap, Substitute.

Book mark:

Censhaw

B

6

U.S.C.T.

David S. Blain

Priv, Co. A, 6 Reg't U. S. Col'd Infantry.

Appears on

Company Muster Roll

for Sept. & Oct., 1864.

Present or absent Present

Stoppage, \$ 100 for

Due Gov't, \$ 100 for

Remarks:

NEXT ROLL ON FILE FEB 1865

Book mark:

Crewshaw

(358)

Copyist.

B

6

U.S.C.T.

David S. Blain

Priv., Co. A, 6 Reg't U. S. Col'd Infantry.

Appears on

Company Muster Roll

for Jan'y. & Feby., 1865.

Present or absent Present

Stoppage, \$ 100 for

Due Gov't, \$ 100 for

Remarks: Substitute.

Book mark:

Crenshaw

B

6

U.S.C.T.

David S. Blain
Priv., Co. A, 6 Reg't U. S. Col'd Infantry.

Appears on

Company Muster Roll

for

Mich. T. apl., 1865

Present or absent

Present

Stoppage, \$

100 for

Due Gov't, \$

100 for

Remarks:

Substitute.

Due U.S. for 1 screw driver 23¢, 1 wiper 20¢, 1 Canteen 65¢, 1 Knapsack.

Book mark:

Ovenshaw

(358)

Copyist.

B | 6 | U.S.C.T.

David S. Beaman

Prvt., Co. A, 6 Reg't U. S. Col'd Infantry.

Appears on

Company Muster Roll

for May & June, 1863.

Present or absent Present

Stoppage, \$ 100 for

Due Gov't, \$ 100 for

Remarks:

On detached service
in Wilmington Mass
March & April
present
500, for 2 months
300

Book mark:

(358) W. J. Edwards Copyist.

3 | **6** | **U.S.C.T.**

David S. Blain

Privat, Co. A, 6 Reg't U. S. Col'd Infantry.

Appears on

Company Muster Roll

for July 9 Aug, 1865.

Present or absent Present

Stoppage, \$ 100 for

Due Gov't, \$ 100 for

Remarks:

Total Due Ad.
58.46

Book mark:

W.A. Edwards
(358) Copyist.

B | **6** | **U.S.C.T.**

David Blair

Privt., Co. C., 6 Reg't U. S. Col'd Infantry.

Appears on **Co. Muster-out Roll**, dated Winnington N.C., Sept 23, 1865.

Muster-out to date Sept 23, 1865.

Last paid to Apr. 30, 1865.

Clothing account:

Last settled June 30, 1864; drawn since \$ 70.56 100

Due soldier \$ 100; due U. S. \$ 100

Am't for cloth'g in kind or money adv'd \$ 100

Due U. S. for arms, equipments, &c., \$ 100

Bounty paid \$ None 100; due \$ 100.00 100

Remarks: Due M. S. for Ord.
red. for 4.5.71
ad. 4.6.00
5.00 10/10
Substitute under ad.
of March 5 '63

Book mark: 4-30-P-236-76 (over)
120.603, 4.B.V. 44, 375

Wm. Edwards
Copyist.

MARK 1367

JAN. 20

5570035

1891

*Due Wm. for ...
\$3.75 + for ord. 23 ds.*

Plane, David E

, Co. A, 6 Reg't USCJ

Enclosures.

Bed Cards	Final Statements
Burial Records	Furloughs or L. of A
Certs. of Dis. for Discharge	Med. Certificates
C. M. Charges	Med. Des. Lists
Descriptive Lists	Orders
Discharge Certificates	Pris. of War Record
Enlistment Papers	Resignations

Other papers relating to—

Admission to Hosp'l	Furlough or L. of A
Casualty Sheet	Med. Examination
Confinement	Misc. Information
Contracts	Pay or Clothing
Death or Effects	Personal Reports
Desertion	Rank
Discharge from Hosp'l	Transfer to Hosp'l
Discharge from Service	Transfer to V. R. C.
Duty	Transportation

3¹/₂CASUALTY SHEET
OF WOUNDED.*David E. Blane*Company *A**6* Regiment of *U.S.C.T.*

Volunteers, at the battle of

(see inside)

CASUALTY SHEET.

Name, David E. Blane
 Rank, _____, Company A, Regiment, 6
 Arm, _____, State, U. S. C. T.
 Place of casualty, _____
 Nature of casualty, gun shot wound lower jaw
Arrived July 13 Dr Camp Hospital
 Date of casualty, _____

FROM WHAT SOURCE THIS INFORMATION WAS OBTAINED.

Report of Killed, Wounded, and Missing of the _____ Regiment,
 _____ Brigade, _____ Division, _____ Corps, dated _____
Has Reg Adv Eng Sol. Rel as r
Book 4 page 30

W North
May 7. 1885 Clerk.

ASB

Angel

CARD NUMBERS.

77073	26
68260	27
77156	28
77238	29
77319	30
77400	31
77475	32
77548	33
77618	34
3577689	35
5577782	36
5577876	37
5577964	38
5578049	39
9065519	40

- 41
- 42
- 43
- 44
- 45
- 46
- 47
- 48
- 49
- 50

Book Mark:

See also

NARA 1372



D | **6** | **U.S.C.T.**

David Blair,

Co. *N*, 6 Reg't U. S. Col'd Inf.

Appears on

Company Descriptive Book

of the organization named above.

DESCRIPTION.

Age *18* years; height *5* feet *7 1/2* inches.

Complexion *Yellow*

Eyes *Blk*; hair *Blk*

Where born *Washington Penn.*

Occupation *Writer*

ENLISTMENT.

When *Aug. 31*, 186 *3*

Where *Pittsburg Pa.*

By whom *J. H. Angless*; term *3* y'rs.

Remarks:

.....
.....
.....
.....
.....
.....
.....
.....
.....
.....

Justin

P | 6 | U.S.C.T.

David Blair

Appears with rank of *Priv.* on

Muster and Descriptive Roll of a Detachment of U. S. Vols. forwarded

for the 6 Reg't U. S. Col'd Infantry. Roll dated

....., 186 .

Where born *Washington Penna.*

Age *18* y'rs; occupation *waiter*

When enlisted *Aug. 31*, 1863.

Where enlisted *Pitts. Penna.*

For what period enlisted *3* years.

Eyes *Bro.*; hair *Blk.*

Complexion *Mulatta*; height *5* ft. *7 1/2* in.

When mustered in, 186 .

Where mustered in

Bounty paid \$ *100*; due \$ *100*

Where credited

Company to which assigned

Remarks:

Book mark:

W. H. Bogan

B

6

U.S.C.T.

David Blair

Corpl, Co. H, 6 Reg't U. S. Col'd Infantry.

Age 18 years.

Appears on

Company Muster-in Roll

of the organization named above. Roll dated

Phila. Pa, Sept. 14, 1863.

Muster-in to date

Sept 14, 1863

Joined for duty and enrolled:

When Aug, 31, 1863.

Where Pittsburg, Pa.

Period 3 years.

Remarks Recd. on Enlist. papers
& mustd. by Lt. Pierce U.S.A.
Sept. 14 '63.

Book mark:

A. H. Thompson

B | **6** | **U.S.C.T.**

David Blair

Corpl, Co. H, 6 Reg't U. S. Col'd Infantry.

Appears on

Company Muster Roll

for *Sept 14 to Oct 31*, 1863.

Present or absent *Present*

Stoppage, \$ *100* for

Due Gov't, \$ *100* for

Remarks:

Book mark:

M. H. Thompson
Copyist.

B

6

U.S.C.T.

David Blair

Corpl, Co. H, 6 Reg't U. S. Col'd Infantry.

Appears on

Company Muster Roll

for *Nov & Dec*, 1863.

Present or absent *Present*

Stoppage, \$ 100 for

Due Gov't, \$ 100 for

Remarks:

Book mark:

W. H. Thompson
Copyist.

(358)

B

6

U.S.C.T.

David Blair

Corpl, Co. H, 6 Reg't U. S. Col'd Infantry.

Appears on

Company Muster Roll

for *Jany & Feby*, 1864.

Present or absent *Present*

Stoppage, \$ 100 for

Due Gov't, \$ 1 ⁶²/₁₀₀ for *1/2 Shelter tent*

Remarks:

Book mark:

W. H. Thompson
Copyist.

B

6

U.S.C.T.

David Blair

Corpl, Co. H, 6 Reg't U. S. Col'd Infantry.

Appears on

Company Muster Roll

for *Mich & Apl.*, 1864.

Present or absent *Present*

Stoppage, \$ 100 for

Due Gov't, \$ 44/100 for *Canteen*

Remarks:

Book mark:

N. H. Thompson

(358)

Copyist.

B

6

U.S.C.T.

David Blair

Serjt, Co. H, 6 Reg't U. S. Col'd Infantry.

Appears on

Company Muster Roll

for May & June, 1864.

Present or absent

Present

Stoppage, \$ 100 for

Due Gov't, \$ 100 for

Remarks:

Promoted Serjt
Jan S. O. No 29 H. L.
6, U.S.C. Troops - May
17, 1864

Book mark:

C. Haysen

(858)

Copyist.

B

6

U.S.C.T.

David Blair

Sgt, Co. H, 6 Reg't U. S. Col'd Infantry.

Appears on

Company Muster Roll

for July & Aug, 1864.

Present or absent Present

Stoppage, \$ 100 for

Due Gov't, \$ 100 for

Remarks: Free April 19/61
Sgt since May 17/64

Book mark:

L. A. Barber

B

6

U.S.C.T.

David Blair

Serjt, Co. H, 6 Reg't U. S. Col'd Infantry.

Appears on

Company Muster Roll

for Sept & Oct, 1864.

Present or absent Not Stated

Stoppage, \$ 100 for

Due Gov't, \$ 100 for

Remarks:

NEXT ROLL ON FILE FEB 1865

Book mark:

C. A. Harper

(358)

Copyist.

B

6

U.S.C.T.

David Blair

Sgt, Co. H, 6 Reg't U. S. Col'd Infantry.

Appears on

Company Muster Roll

for *Jan & Feb*, 186 *5*.

Present or absent *Present*

Stoppage, \$ *100* for

Due Gov't, \$ *100* for

Remarks:

Book mark:

C. A. Harper

(858)

Copyist.

73

6

U.S.C.T.

David Blair

Sergt, Co. H, 6 Reg't U. S. Col'd Infantry.

Appears on

Company Muster Roll

for *Mar & April*, 186*5*.

Present or absent *Present*

Stoppage, \$ *100* for

Due Gov't, \$ *100* for

Remarks:

Book mark:

C. A. Harper

(358)

Copyst.

B

6

U.S.C.T.

David Blair

Sgt, Co. H, 6 Reg't U. S. Col'd Infantry.

Appears on

Company Muster Roll

for May & June, 1864.

Present or absent Present

Stoppage, \$ 100 for

Due Gov't, \$ 100 for

Remarks:

Book mark:

Holscomb

(358)

Copyist.

9

6

U.S.C.T.

David Blair

1st Seryt, Co. H, 6 Reg't U. S. Col'd Infantry.

Appears on

Company Muster Roll

for July & Aug, 1865.

Present or absent Present

Stoppage, \$ 100 for

Due Gov't, \$ 100 for

Remarks: Promoted 1st Seryt. per S.O. no. 49
Ad. Am. 6th U.S. C. I. July 20/65. For
transportation while on furlough \$27 23/100
Dues U.S. for 1 wipe 20/100 1 screw driver
23/100 total 43/100.

Book mark:

Holcomb

(358)

Copyist.

21 | 6 | U.S.C.T.

David Blain

Sgt., Co. K, 6 Reg't U. S. Col'd Infantry.

Appears on Co. Muster-out Roll, dated Wilmington No. Sep 20, 1865.

Muster-out to date Sep 20, 1865.

Last paid to April 30 1865.

Clothing account:

Last settled June 30, 1864; drawn since \$ 74 ³⁷/₁₀₀

Due soldier \$ 100; due U. S. \$ 100

Am't for cloth'g in kind or money adv'd \$ 100

Due U. S. for arms, equipments, &c., \$ 6 100

Bounty paid \$ 100; due \$ 100 100

Remarks: Due Wm Brisbane Reg't. Sutter #15. Stop for transportation \$27.22; 1 wipe #20/100; 1 screw driver #23/100. Promoted / Sgt. S.O. 49 Hd. Qrs. 6 U.S. I. July 20/65. \$6 per mo. due from enlistment to April 30/64.

Book mark:

Halcomb Copyist.

Blair, David

Sgt., Co. A, 6 Reg't U.S.C.

3 Enclosures.

Bed Cards	Final Statements
Burial Records	Furloughs or L. of A
Certs. of Dis. for Discharge	Med. Certificates
C. M. Charges	Med. Des. Lists
Descriptive Lists	Orders
Discharge Certificates	Pris. of War Record
Enlistment Papers <i>2</i>	Resignations

Other papers relating to—

Admission to Hosp'l	Furlough or L. of A <i>/</i>
Casualty Sheet	Med. Examination
Confinement	Misc. Information
Contracts	Pay or Clothing
Death or Effects	Personal Reports
Desertion	Rank
Discharge from Hosp'l	Transfer to Hosp'l
Discharge from Service	Transfer to V. R. C.
Duty	Transportation

DECLARATION OF RECRUIT.

I, *David Blair* desiring to VOLUNTEER as a Soldier in the Army of the United States, for the term of THREE YEARS, Do declare, That I am *eighteen (18)* years and ~~month~~ of age; that I have never been discharged from the United States service on account of disability or by sentence of court martial, or by order before the expiration of a term of enlistment; and I know of no impediment to my serving honestly and faithfully as a soldier for three years.

GIVEN at *Pittsburgh Penna*
The *21st* day of *August 1863*

Witness:
Robert Jones
" " "

David Blair

60000
No. *David Blair*
Volunteered at _____ 18
By _____
Regiment of _____
enlistment; last served in Company ()
Reg't of _____
Discharged _____ 18

CONSENT IN CASE OF MINOR.

I, _____ Do CERTIFY, That I am the
of _____; that the
said _____ is _____ years of age; and I
do hereby freely give my CONSENT to his volunteering as a SOLDIER in the ARMY OF THE UNITED STATES
for the period of THREE YEARS.

GIVEN at _____
The _____ day of _____

Witness:

*Washington
Washington*

VOLUNTEER ENLISTMENT.

STATE OF *Penn*



TOWN OF *Pittsburgh*

I, *David Blair* born in *Washington County*
 in the State of *Penn* aged *eighteen (18)* years,
 and by occupation a *Writer* Do HEREBY ACKNOWLEDGE to have
 volunteered this *31st* day of *August* 18 *63*
 to serve as a **Soldier** in the **Army of the United States of America**, for the
 period of **THREE YEARS**, unless sooner discharged by proper authority: Do also
 agree to accept such bounty, pay, rations, and clothing, as are, or may be, estab-
 lished by law for volunteers. And I, *David Blair* do
 solemnly swear, that I will bear true faith and allegiance to the **United States**
of America, and that I will serve them honestly and faithfully against all
 their enemies or opposers whomsoever; and that I will observe and obey the
 orders of the President of the United States, and the orders of the officers
 appointed over me, according to the Rules and Articles of War.

Sworn and subscribed to, at *Pittsburgh*
 this *31st* day of *August* 18 *63* *David Blair*
 BEFORE *A. Schmalzer*

I CERTIFY, ON HONOR, That I have carefully examined the above named Volunteer, agreeably to
 the General Regulations of the Army, and that in my opinion he is free from all bodily defects and mental
 infirmity, which would, in any way, disqualify him from performing the duties of a soldier.

[Signature]
 EXAMINING SURGEON.

I CERTIFY, ON HONOR, That I have minutely inspected the Volunteer,
 previously to his enlistment, and that he was entirely sober when enlisted; that, to the best of my
 judgment and belief, he is of lawful age; and that, in accepting him as duly qualified to perform the duties
 of an able-bodied soldier, I have strictly observed the Regulations which govern the recruiting service.
 This soldier has *blue* eyes, *black* hair, *medium* complexion, is *5* feet *7/8* inches
 high.

[Signature]
Sixth Regiment of U.S. Colored Volunteers,
 RECRUITING OFFICER

DECLARATION OF RECRUIT.

I, *David Blair* desiring to VOLUNTEER as a Soldier in the Army of the United States, for the term of THREE YEARS, Do declare, That I am *eighteen (18)* years and _____ months of age; that I have never been discharged from the United States service on account of disability or by sentence of court martial, or by order before the expiration of a term of enlistment; and I know of no impediment to my serving honestly and faithfully as a soldier for three years.

GIVEN at *Pittsburgh Penna*
The _____ day of _____

Witness:
Rufus S. Jones

David Blair

✓

No. *1021*

Volunteered at *Pittsburgh* 18*63*

By *David Blair*

Regiment of _____

enlistment; last served in Company ()

Reg't of _____

Discharged _____ 18 _____

Co No.

Company 67

CONSENT IN CASE OF MINOR.

I, _____ of _____ is _____ years of age; and I do hereby freely give my CONSENT to his volunteering as a SOLDIER in the ARMY OF THE UNITED STATES for the period of THREE YEARS.

GIVEN at _____
The _____ day of _____

Witness:

VOLUNTEER ENLISTMENT.

STATE OF



TOWN OF

Pittsburgh

I, *David Blair*
in the State of *Penna*
and by occupation a *Miller*
volunteered this *31st*

born in *Washington County*
aged *Eighteen (18)* years,
Do HEREBY ACKNOWLEDGE to have
day of *August*, 18 *63*

to serve as a **Soldier** in the **Army of the United States of America**, for the period of **THREE YEARS**, unless sooner discharged by proper authority: Do also agree to accept such bounty, pay, rations, and clothing, as are, or may be, established by law for volunteers. And I, *David Blair* do solemnly swear, that I will bear true faith and allegiance to the **United States of America**, and that I will serve them honestly and faithfully against all their enemies or opposers whomsoever; and that I will observe and obey the orders of the President of the United States, and the orders of the officers appointed over me, according to the Rules and Articles of War.

Sworn and subscribed to, at *Pittsburgh*
this *31st* day of *August* 18 *63*

David Blair

BEFORE *J. S. McWhorter, M.D.*

I CERTIFY, ON HONOR, That I have carefully examined the above named Volunteer, agreeably to the General Regulations of the Army, and that in my opinion he is free from all bodily defects and mental infirmity, which would, in any way, disqualify him from performing the duties of a soldier.

J. S. McWhorter
EXAMINING SURGEON.

I CERTIFY, ON HONOR, That I have minutely inspected the Volunteer, previously to his enlistment, and that he was entirely sober when enlisted; that, to the best of my judgment and belief, he is of lawful age; and that, in accepting him as duly qualified to perform the duties of an able-bodied soldier, I have strictly observed the Regulations which govern the recruiting service. This soldier has *blue* eyes, *black* hair, *ruddy* complexion, is *5* feet *7 1/2* inches high.

Wm. H. Brangley
Sixth Regiment of *N. V. (Colo.)* Volunteers,
RECRUITING OFFICER

Camp of 6th N.S.M.T.
Wilmington N.C.
June 20th 1865

Edgerton A. H.
Capt. 6th N.S.M.T.

Makes Application for
Furlough of thirty days
for Seryt^r Saulie Blair
of Co. 74: 6th N.S.M.T.

Head Quarters 6th U.S. C. I.
Wilmington N.C. June 20/65

Respectfully forwarded
Approved Thru 47.5;
men present for duty with
the regiment - with none
absent on furlough - and
no applications forwarded
not acted on.

J. M. Hill
Capt. 6th U.S. C. I.
Comdy Regt.

Head qrs. 3rd Div. 10th U.S. A.
Post of Wilmington
Wilmington N.C. June 26th 65

Respectfully forwarded approved
I have inspected this man, and find his
clothing arms and equipments in a good
condition.

A. Chamberlain
Lieut Colonel
Comdy

HEADQUARTERS DIST. OF WILMINGTON.

Wilmington, N. C., June 27th, 1865.

E. B. (S... 92) Vol. (... 2...) D. of W., 1865.

Respectfully forwarded,

Approved

J. W. Ames
Brig. Gen. Comd'g.

J. M. Hill

See Roll. P. B. July 18th 1865-

65. 21. 21. 3. 21. 21. 21. 21. 21. 21.

David Blair
Sgt. 6th M.S.T.

Camp of 6th M.S.T.
Wilmington N.C. June 20 1865

Let W. R. Hammond
Adj. 6th M.S.T.

Sir:

I have the honor
to make application for a furlough
of thirty (30) days for Sergt. David Blair
of Co 7th M.S.T. to visit Washington Wash-
ington Co. Penna.

There are (49) forty-nine enlisted men
reported present with the Co. and none
absent on furlough from it.
Sergeant Blair has shown himself to be
an efficient and deserving Soldier

I have the honor to be
Very Respectfully
Your Obedient Servant
A. R. Edgerton
Capt. 6th M.S.T.
Comd Co 7th

6 U. S. Col'd H

Private | Private

CARD NUMBERS.

43148045

- 20
- 21
- 22
- 23
- 24
- 25
- 26
- 27
- 28
- 29
- 30
- 31
- 32
- 33
- 34
- 35
- 36
- 37
- 38

Number of medical cards herein 0

Number of personal papers herein 4

BOOK MARK: _____

See also _____

NARA 1396

C. H. Underwood
Exr.

William Blain
with rank of Private

Muster and Descriptive Report

Detachment of U.S.A. 1st
forwarded for info &
U.S.A. 1st

Lockport, N.Y., Oct. 4, 1864
Where born Ohio, Warren

Age 21 years; occupation Laborer

When enlisted Oct. 4, 1864

Where enlisted Bergen, N.Y.

For what period enlisted 3 months

Eyes Blue; hair Black

Complexion Black; height 5 ft 10 in

When mustered in Oct. 4, 1864

Where mustered in Lockport

Bounty paid \$100; due \$100

Clothing account:
Last settled _____, 1864; drawn since _____

Date of first muster _____

Company to which assigned _____

Remarks: 29 Dist. Bergen
Genesee Co. N.Y.

Book mark: _____

W. W. Jackson

Blair Wm

D, Co., *6* Reg't *USCA*

4 Enclosures.

Bed Cards	Final Statements
Burial Records	Furloughs or L. of A
Certs. of Dis. for Discharge	Med. Certificates
C. M. Charges	Med. Des. Lists
Descriptive Lists	Orders
Discharge Certificates	Pris. of War Record
Enlistment Papers <i>3</i>	Resignations

Other papers relating to—

Admission to Hosp'l	Furlough or L. of A
Casualty Sheet <i>/</i>	Med. Examination
Confinement	Misc. Information
Contracts	Pay or Clothing
Death or Effects	Personal Reports
Desertion	Rank
Discharge from Hosp'l	Transfer to Hosp'l
Discharge from Service	Transfer to V. R. C.
Duty	Transportation

18
1178

NOTE 1.—This blank will be used for both enlistments and re-enlistments—enlistment of veterans, &c., &c., in the volunteer service. They will be made out in duplicate in all cases—one to accompany the recruiting return of the superintendent (not the recruiting officer) to the Adjutant General, and one to accompany the accounts of the officer who pays bounty, &c. The Regiment and Company in which the soldier last served should be given on the back.

NOTE 2.—An enlistment holds to service. A muster-in must be made in all cases, precede payment of pay, bounty, pension, &c. A muster-in roll must, in all cases, be filed in the Adjutant General's Office as evidence of muster-in. The mustering officer, commissary, or assistant commissary of musters, as the case may be, will countersign both enlistments as having mustered the soldier into the service of the United States before either of them is given to the disbursing officer.

DECLARATION OF RECRUIT.

I, William Blair, desiring to VOLUNTEER as a Soldier in the Army of the United States, for the term of THREE YEARS, Do Declare, That I am _____ years and _____ months of age; that I have never been discharged from the United States service on account of disability or by sentence of a court martial, or by order before the expiration of a term of enlistment; and I know of no impediment to my serving honestly and faithfully as a soldier for three years.

GIVEN at Lockport N.Y. the 4 day of October 1864.

Witness: John F. Davison William Blair
Mark

NOV 1901

Discharged

Discharged _____, 18 _____

Regt of _____

enlistment; last served in Company ()

By Captain S. O. Bennett
6th Regiment of W. I. Wood

Volunteered at Lockport N.Y. 1864

William Blair
No. 199

CONSENT IN CASE OF MINOR.

I, _____, Do CERTIFY, That I am _____ the _____ of _____; that the said _____ is _____ years of age; and I do hereby freely give my CONSENT to his Volunteering as a SOLDIER in the ARMY OF THE UNITED STATES for the period of THREE YEARS.

GIVEN at _____ the _____ day of _____

Witness: _____

VOLUNTEER ENLISTMENT.

STATE OF NEW YORK TOWN OF Bergen

I, William Blair, born in Warren Co in the State of Ohio, age thirty one years, and by occupation a Labourer, Do HEREBY ACKNOWLEDGE to have volunteered this fourth day of October, 1864 to serve as a Soldier in the Army of the United States of America, for the period of THREE YEARS, unless sooner discharged by proper authority: Do also agree to accept such bounty, pay, rations, and clothing, as are, or may be, established by law for volunteers. And I, William Blair, do solemnly swear, that I will bear true faith and allegiance to the United States of America, and that I will serve them honestly and faithfully against all their enemies or opposers whomsoever; and that I will observe and obey the orders of the President of the United States, and the orders of the officers appointed over me, according to the Rules and Articles of War.

Sworn and subscribed to, at Lockport N.Y. this 4th day of October, 1864, before L. H. Bowen Capt. & Provost Marshal 29 Dist. N. Y. his William Blair Musk

I CERTIFY, ON HONOR, That I have carefully examined the above-named Volunteer, agreeably to the General Regulations of the Army, and that, in my opinion, he is free from all bodily defects and mental infirmity, which would in any way disqualify him from performing the duties of a soldier.

[Signature] 29th Dist. N.Y. EXAMINING SURGEON.

I CERTIFY, ON HONOR, That I have minutely inspected the Volunteer William Blair previously to his enlistment, and that he was entirely sober when enlisted; that, to the best of my knowledge and belief, he is of lawful age; and that, in accepting him as duly qualified to perform the duties of an able-bodied soldier, I have strictly observed the Regulations which govern the recruiting service. This soldier has black eyes, black hair, black complexion, is 5 feet 7 inches high.

L. H. Bowen Capt. & Provost Marshal 29th Dist. N.Y. Regiment of Volunteers RECRUITING OFFICER.

(A. G. O. No. 74 & 76.)

Mustered into the service of the United States, for three years or during the war, from date of enlistment, in Company of the 29th Dist. N.Y. Volunteers, on the 4th day of October, 1864, at Lockport N.Y.

[Signature] Capt. & Provost Marshal 29th Dist. N.Y.

NOTE 1.—This blank will be used for both enlistments and re-enlistments—enlistment of veterans, &c., &c., in the volunteer service. They will be made out in duplicate in all cases—one to accompany the recruiting return of the superintendent (not the recruiting officer) to the Adjutant General, and one to accompany the accounts of the officer who pays bounty, &c. The Regiment and Company in which the soldier last served should be given on the back.

NOTE 2.—An enlistment holds to service. A muster-in must, in all cases, precede payment of pay, bounty, pension, &c. A muster-in roll must, in all cases, be filed in the Adjutant General's Office as evidence of muster-in. The mustering officer, commissary, or assistant commissary of musters, as the case may be, will countersign both enlistments as having mustered the soldier into the service of the United States before either of them is given to the disbursing officer.

DECLARATION OF RECRUIT.

I, William Blair, desiring to VOLUNTEER as a Soldier in the Army of the United States, for the term of THREE YEARS, Do Declare, That I am thirty one years and seven months of age; that I have never been discharged from the United States service on account of disability or by sentence of a court martial, or by order before the expiration of a term of enlistment; and I know of no impediment to my serving honestly and faithfully as a soldier for three years.

GIVEN at Lockport N.Y. the 4 day of October 1864

Witness: John J. Davison William Blair
Mark

Discharged _____, 18__

Regt of _____

enlistment; last served in Company ()

By John J. Davison Regiment of W. D. Colored

Volunteered at Lockport N.Y. Oct 4, 1864

William Blair
No. 15-611

CONSENT IN CASE OF MINOR.

I, _____, Do CERTIFY, That I am the _____ of _____; that the said _____ is _____ years of age; and I do hereby freely give my CONSENT to his Volunteering as a SOLDIER in the ARMY OF THE UNITED STATES for the period of THREE YEARS.

GIVEN at _____ the _____ day of _____

Witness: _____

VOLUNTEER ENLISTMENT.

STATE OF NEW YORK TOWN OF Bergen

I, William Blair, born in Warren Co Ohio, aged thirty one years, and by occupation a Labourer, Do HEREBY ACKNOWLEDGE to have volunteered this fourth day of October, 1864

to serve as a Soldier in the Army of the United States of America, for the period of THREE YEARS, unless sooner discharged by proper authority: Do also agree to accept such bounty, pay, rations, and clothing, as are, or may be, established by law for volunteers. And I, William Blair, do solemnly swear, that I will bear true faith and allegiance to the United States of America, and that I will serve them honestly and faithfully against all their enemies or opposers whomsoever; and that I will observe and obey the orders of the President of the United States, and the orders of the officers appointed over me, according to the Rules and Articles of War.

Sworn and subscribed to, at Lockport, N.Y. this 4 day of October, 1864, before L. J. Bowen, his William Blair, Examining Surgeon.

I CERTIFY, ON HONOR, That I have carefully examined the above-named Volunteer, agreeably to the General Regulations of the Army, and that, in my opinion, he is free from all bodily defects and mental infirmity, which would in any way disqualify him from performing the duties of a soldier.

I CERTIFY, ON HONOR, That I have minutely inspected the Volunteer William Blair previously to his enlistment, and that he was entirely sober when enlisted; that, to the best of my knowledge and belief, he is of lawful age; and that, in accepting him as duly qualified to perform the duties of an able-bodied soldier, I have strictly observed the Regulations which govern the recruiting service. This soldier has Black eyes, Black hair, Black complexion, is 5 feet 7 inches high.

(A. G. O. No. 74 & 76.)

RECRUITING OFFICER.

Mustered into the service of the United States, for three years or during the war, from date of enlistment, in Company ... Regiment of ... Volunteers, on the ... day of ... 1864, at ...

L. J. Bowen

L. J. Bowen, Capt. & Pas. Com. 29th Dist. N.Y.

DECLARATION OF RECRUIT.

I, William Blair, desiring to VOLUNTEER as a Soldier in the Army of the United States; for the term of THREE YEARS, Do Declare, That I am Thirty one years and Seven months of age; that I have never been discharged from the United States service on account of disability or by sentence of a court martial, or by order before the expiration of a term of enlistment; and I know of no impediment to my serving honestly and faithfully as a soldier for three years.

GIVEN at Lockport N.Y. the 4 day of October 1864

Witness: John F. Davison William Blair
Mark

Aug. 1893. This paper was formerly filed in the Recruitment Div. R. & P. O.

2
477

Volunteered at Bergen N.J.
Oct 11, 1864
By John F. Davison
1st Regiment of Vol. Soldiers
Discharged 18 ..
Regt of
enlistment; last served in Company ()

William Blair
No. 1993

CONSENT IN CASE OF MINOR.

I,, Do CERTIFY, That I am the of; that the said is years of age; and I do hereby freely give my CONSENT to his Volunteering as a SOLDIER in the ARMY OF THE UNITED STATES for the period of THREE YEARS.

GIVEN at the day of

Witness:

NOTE 1.—This blank will be used for both enlistments and re-enlistments—enlistment of veterans, &c., &c., in the volunteer service. They will be made out in duplicate in all cases—one to accompany the recruiting return of the superintendent (not the recruiting officer) to the Adjutant General, and one to accompany the accounts of the officer who pays bounty, &c. The Regiment and Company in which the soldier last served should be given on the back.

NOTE 2.—An enlistment holds to service. A muster-in must, in all cases, precede payment of pay, bounty, pension, &c. A muster-in roll must, in all cases, be filed in the Adjutant General's Office as evidence of muster-in. The mustering officer, commissary, or assistant commissary of musters, as the case may be, will countersign both enlistments as having mustered the soldier into the service of the United States before either of them is given to the disbursing officer.

3 Years

VOLUNTEER ENLISTMENT.

STATE OF NEW YORK.



TOWN OF

Bergen

I, William Blair, born in

Warren Co

in the State of Ohio, aged

thirty one years,

and by occupation a Labourer,

Do HEREBY ACKNOWLEDGE to have

volunteered this fourth day of October, 1864

to serve as a Soldier in the Army of the United States of America, for the period of THREE YEARS, unless sooner discharged by proper authority: Do also agree to accept such bounty, pay, rations, and clothing, as are, or may be, established by law for volunteers.

And I, William Blair, do solemnly swear, that I will bear true faith and allegiance to the United States of America, and that I will serve them honestly and faithfully against all their enemies or opposers whomsoever; and that I will observe and obey the orders of the President of the United States, and the orders of the officers appointed over me, according to the Rules and Articles of War.

Sworn and subscribed to, at

this 4 day of October, 1864

William Blair
his
Prink

BEFORE L. H. Bowen
Capt 9th Mass

I CERTIFY, ON HONOR, That I have carefully examined the above-named Volunteer, agreeably to the General Regulations of the Army, and that, in my opinion, he is free from all bodily defects and mental infirmity, which would in any way disqualify him from performing the duties of a soldier.

J. R. Cox
29th Mass

EXAMINING SURGEON.

I CERTIFY, ON HONOR, That I have minutely inspected the Volunteer William Blair previously to his enlistment, and that he was entirely sober when enlisted; that, to the best of my knowledge and belief, he is of lawful age; and that, in accepting him as duly qualified to perform the duties of an able-bodied soldier, I have strictly observed the Regulations which govern the recruiting service. This soldier has black eyes, black hair, black complexion, is five feet seven inches high.

L. H. Bowen
Capt 9th Mass

Regiment of Volunteers,

RECRUITING OFFICER.

(A. G. O. No. 74 & 76.)

Mustered into the service of the United States, for three years or during the war, from date of enlistment, in Company W. D. ... Regiment of Volunteers, on the 4 day of October, 1864, at Warren Co

L. H. Bowen
Capt 9th Mass

Bergen Co

New York 5

CASUALTY SHEET

No.

William Blaine (Col'd)

Recruit of Company

Regiment of

State Volunteers.

NATURE OF CASUALTY.

Deserted Nov 16/64.



CASUALTY SHEET.

Name: *William Blair (Col'd)*

Rank: *Recruit* Company: _____ Regiment: _____

Arm: _____ State: _____

Nature of Casualty: *Desertion*

CAUSE OF CASUALTY—(NAME OF DISEASE, &c.)

BY WHOM DISCHARGED.

DEGREE OF DISABILITY.

FROM WHAT SOURCE THIS INFORMATION WAS OBTAINED.

BY WHOM CERTIFIED.

Roll 14 Alterations of Draft
Reidy vms Elmira N.Y. 1864

Capt Chas C. Barton

REMARKS.

DATE OF DISCHARGE, DEATH, &c.

Nov 16 1864

PLACE OF DISCHARGE, DEATH, &c.

Elmira N.Y.

Frank M. [unclear]

Clerk.

2

W. H. ... *...*
CARD NUMBERS.

72460	26
72542	27
72628	28
72706	29
72784	30
72861	31
68644	32
72936	33
68653	34
73009	35
68674	36
73081	37
68706	38
73174	39
68725	40
73279	41
68733	42
73372	43
73465	44
65025	45
	46
	47
	48
	49
	50

NARR 1488

Handwritten scribble

B | 6 | U.S.C.T.

James Boggs

, Co. D, 6 Reg't U. S. Col'd Inf.

Appears on

Company Descriptive Book

of the organization named above.

DESCRIPTION.

Age 35 years; height 5 feet 11 inches.

Complexion Dark

Eyes Brown; hair Black

Where born Ringgold Pennsylvania

Occupation Laborer

ENLISTMENT.

When July 15, 1863.

Where Philadelphia Pa

By whom 4 Dis Pa; term 3 y'rs.

Remarks:

Substitute Detailed in
Dis Am Train May
6th 1864.

J G Reers
Copist.

B.

6

U.S.C.T.

James Boggs.

Priv., Co. D, 6 Reg't U. S. Col'd Infantry.

Age 35 years.

Appears on

Company Muster-in Roll

of the organization named above. Roll dated

Philadelphia, Pa., Aug. 14, 1863.

Muster-in to date July 15, 1863.

Joined for duty and enrolled:

When July 15, 1863

Where Phila., Pa.

Period 3 years.

Remarks:

Book mark:

B.

6

U.S.C.T.

James Boggs.

Priv., Co. D, 6 Reg't U. S. Col'd Infantry.

Appears on

Company Muster Roll

for to Oct. 31, 1868

Present or absent: present

Stoppage, \$ 100 for

Due Gov't, \$ 100 for

Remarks:

Book mark:

Baker,

(858)

Copyist.

B. | 6 | U.S.C.T.

James Boggs.

Pop., Co. D, 6 Reg't U. S. Col'd Infantry.

Appears on

Company Muster Roll

for Nov & Dec, 1863.

Present or absent present.

Stoppage, \$ 100 for

Due Gov't, \$ 100 for

Remarks: Due US for one
haversack 56 lbs.

Book mark:

Raker,
Copyist.

(358)

B.

6

U.S.C.T.

James Roggs.

Regt, Co. D, 6 Reg't U. S. Col'd Infantry.

Appears on

Company Muster Roll

for *Jan & Feb*, 1864

Present or absent *present*

Stoppage, \$ *100* for

Due Gov't, \$ *100* for

Remarks:

Book mark:

Baker

Copyist..

B.

6

U.S.C.T.

James Roggs.

Pvt., Co. D, 6 Reg't U. S. Col'd Infantry.

Appears on

Company Muster Roll

for March & April, 1864.

Present or absent present.

Stoppage, \$ 100 for

Due Gov't, \$ 100 for

Remarks:

Book mark:

Baker

Copy 18.

MB

6

U.S.C.T.

Pr James Boggs
Co. D, 6 Reg't U.S. Col'd Infantry.

Appears on

Company Muster Roll

for *May & June*, 186*4*

Present or absent *absent*

Stoppage, \$ *100* for

Due Gov't, \$ *100* for

Remarks *Detached, in Div. amb. corps May 6 64*

Book mark :

Prif

B. | 6 U.S.C.T.

James Boggs
Priv, Co. "D", 6 Reg't U. S. Col'd Inf.

Appears on a
Detachment Muster Roll

of the organization named above
for *May & June*, 1864.
Station *Near Petersburg, Va.*
Present or absent *Present*

Stoppage, \$ 100 for

Due Gov't, \$ 100 for

Remarks: *In Ambulance
Corps, 3^d Div 18th A.C.*

Book mark :

Sitter

MB

6

U.S.C.T.

James Boggs
P4

Co. D, 6 Reg't U. S. Col'd Infantry.

Appears on

Company Muster Roll

for July & Aug, 1864

Present or absent Absent

Stoppage, \$ 100 for

Due Gov't, \$ 100 for

Remarks Detailed in Div. Ambl. Corps May 6 64

Book mark:

Reif

B. | 6 | U.S.C.T.

James Boggs.
Priv., Co. "D", 6 Reg't U. S. Col'd Inf.

Appears on a
Detachment Muster Roll

of the organization named above
for July & Aug., 1864.
Station In the field, Va.
Present or absent Present

Stoppage, \$ 100 for

Due Gov't, \$ 100 for

Remarks: In Ambulance
Corps. 3^d Div. 18th A.C.

Book mark:

Sitter.

B

6

U.S.C.T.

James Boggs

Pr, Co. D, 6 Reg't U. S. Col'd Infantry.

Appears on

Company Muster Roll

for *Sept. & Oct.*, 1864.

Present or absent *Absent*

Stoppage, \$ *100* for

Due Gov't, \$ *100* for

Remarks: *Detailed in Div. Amb. Corps May 6 64*

NEXT ROLL ON FILE FEB 1865

Book mark:

(858)

Boyer
Copyist..

B | 6 · U.S.C.T.

James Boggs.
Priv, Co. "D", 6 Reg't U. S. Col'd Inf.

Appears on a

Detachment Muster Roll

of the organization named above

for Sept. & Oct., 1864.

Station: Before Richmond, Va,

Present or absent Present.

Stoppage, \$ 100 for

Due Gov't, \$ 100 for

Remarks: Ambulance Corps,
3^d Div. 18th A.C.

Dif of pay between white
and colored soldiers due
from enrollment to
Feb. 29, '64.

Book mark :

Sitter.

B | 6

U.S.C.T.

James Boggs.
Priv, Co. "D", 6 Reg't U. S. Col'd Inf.

Appears on a

Detachment Muster Roll

of the organization named above

for Oct. 31, '64 to Feb. 28, 1865.

Station Bermuda Hundred, Va.

Present or absent Absent.

Stoppage, \$ 100 for

Due Gov't, \$ 100 for

Remarks: Amb. Corps 3^d
Div. 25th A.C.

Absent with com-
mand at Wilming-
ton N. C.

Book mark :

Sitter.

MB

6

U.S.C.T.

James Briggs

Pr., Co. D, 6 Reg't U. S. Col'd Infantry.

Appears on

Company Muster Roll

for Jan. & Feb., 1865

Present or absent absent

Stoppage, \$ 100 for

Due Gov't, \$ 100 for

Remarks: Detailed in Div. Amb. Corps May 6 '64 Pres. apl. 19 61

Book mark:

Reif

MB

6

U.S.C.T.

James Briggs

Pr

Co. D, 6 Reg't U. S. Col'd Infantry.

Appears on

Company Muster Roll

for

March & April, 1865

Present or absent

Absent

Stoppage, \$

100 for

Due Gov't, \$

100 for

Remarks:

Detached, in div. ambul. corps May 6 1864. Free April 19 1861

Book mark:

(358)

Reif

Copyis.

B | 6

U.S.C.T.

James Boggs,
Priv., Co. "D", 6 Reg't U. S. Col'd Inf.

Appears on a

Detachment Muster Roll

of the organization named above

for Mar. & Apr., 1865.

Station Near Goldsboro, N.C.

Present or absent Present.

Stoppage, \$ 100 for

Due Gov't, \$ 100 for

Remarks: Free April 19, '61
Has recd but \$7 per
mo. from enlistment
to Feb. 29, '64.
In Amb. Corps
3^d Div. 10th A.C.

Book mark:

Sitter.

B.

6

U.S.C.T.

James B. Oggs

Private, Co. D, 6 Reg't U.S. Col'd Infantry.

Appears on

Company Muster Roll

for May and June, 1865

Present or absent Absent

Stoppage, \$ 42⁸⁰/₁₀₀ for B. C. & H. E.

Due Gov't, \$ 100 for

Remarks: Detailed in Div
Ambulance Corp May 6, '64
Free Apr. 19, 61

Book mark:

Rhodes

B. | 6 | U.S.C.T.

James Boggs,
Priv., Co. "D", 6 Reg't U. S. Col'd Inf.

Appears on a

Detachment Muster Roll

of the organization named above

for *May & June*, 1865.

Station *New Bern, N. C.*

Present or absent *Present.*

Stoppage, \$ *100* for

Due Gov't, \$ *100* for

Remarks: *Free April 19, '61.
Paid but \$7 per mo.
from enlistment to
Feb. 29, '64.*

*Amb. Corps 3^d
Div. 10th A. C.*

Book mark :

Sitter

B.

6

U.S.C.T.

James Boggs
Private, Co. D, 6 Reg't U. S. Col'd Infantry.

Appears on

Company Muster Roll

for July and Aug., 1865

Present or absent Absent

Stoppage, \$ 1.00 for

Due Gov't, \$ 1.00 for

Remarks: Detailed in 1st
Army Corps May 6th 1865
Disced April 19th 1861

Book mark:

Rhett

R.

6

U.S.C.T.

James Boggs

Pat., Co., 6 Reg't U. S. Col'd Infantry.

Appears on Co. Muster-out Roll, dated
Wilmington N.C., Sept 20, 1865.

Muster-out to date Sept. 20, 1865.

Last paid to Feb. 28, 1865.

Clothing account:

Last settled June 30, 1864; drawn since \$ 46 ⁸¹/₁₀₀

Due soldier \$ 100; due U. S. \$ 100

Am't for cloth'g in kind or money adv'd \$ 100

Due U. S. for arms, equipments, &c., \$ 100

Bounty paid \$ 00 ¹⁰⁰/₁₀₀; due \$ 100 ¹⁰⁰/₁₀₀

Remarks: Due W^m Brisbane

Regt Sutter \$10.00

Free on or before April 19th 1861

\$6.00 per month due from enlistment to April 19th 1864. Substitute for a man drafted under act March 3^d 1863.

Book mark: V. 231 P. 51. 76

Rhees

Boggs James

....., Co., Reg't *U.S.A.*

2 **Enclosures.**

Bed Cards	Final Statements
Burial Records	Furloughs or L. of A.
Certs. of Dis. for Discharge	Med. Certificates
C. M. Charges	Med. Des. Lists
Descriptive Lists	Orders
Discharge Certificates	Pris. of War Record
Enlistment Papers <i>2</i>	Resignations

Other papers relating to—

Admission to Hosp'l	Furlough or L. of A.
Casualty Sheet	Med. Examination
Confinement	Misc. Information
Contracts	Pay or Clothing
Death or Effects	Personal Reports
Desertion	Rank
Discharge from Hosp'l	Transfer to Hosp'l
Discharge from Service	Transfer to V. R. C.
Duty	Transportation

DECLARATION OF SUBSTITUTE.

I, James Boygs desiring to ENLIST in the Army of the United States, for THREE YEARS, **Do declare**, That I am thirty five years and _____ months of age; that I have never been discharged from the United States service on account of disability or by sentence of a court martial; and I know of no impediment to my serving honestly and faithfully as a soldier for three years.

GIVEN at Philadelp
the _____ day of August 1863

WITNESS:

William E McClain James ^{lid} X Boygs
mark

14
B/696

No. 1444

James Boygs (capt)

Enlisted at Philadelphia

As Substitute for

Archibud Anthony

On the 6 day of August, 1863.

By

Edm Lane Capt

John B. Bennett Com

J. Ralston Wells Major

Board of Enrollment,

H. Dim. of War

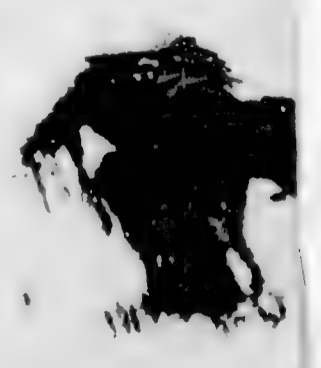

(No. 40.)

SUBSTITUTE VOLUNTEER ENLISTMENT.

STATE OF

TOWN OF

Pennsylvania



Philadelphia

I, James Briggs born in the State of Pennsylvania, aged 35 years, and by occupation a Laborer Do HEREBY ACKNOWLEDGE to have agreed with Archer Dabney, Esq., of 1237 Wood St S. District

to become his SUBSTITUTE in the Military Service, for a sufficient consideration paid and delivered to me, on the 8 day of August, 1863; and having thus agreed with said Archer Dabney, I DO HEREBY ACKNOWLEDGE to have enlisted this 8 day of August, 1863 to serve as a Soldier in the Army of the United States of America, for the period of THREE YEARS, unless sooner discharged by proper authority: I do also agree to accept such bounty, pay, rations, and clothing, as are, or may be, established by law for soldiers. And I do solemnly swear that I will bear true and faithful allegiance to the United States of America; that I will serve them honestly and faithfully against all their enemies or opposers whomsoever; and that I will observe and obey the orders of the President of the United States, and the orders of the Officers appointed over me, according to the Rules and Articles of War.

SWORN and subscribed to, at Philadelphia this 8 day of August 1863.

BEFORE James Briggs (with mark) Provost Marshal William E. McClain

We certify, on honor, That we have carefully examined the above-named Volunteer Substitute agreeably to the Regulations, and that, in our opinion, he is free from all bodily defects and mental infirmity which would in any way disqualify him from performing the duties of a soldier; that he was entirely sober when enlisted; that he is of lawful age, (not under 18 years;) and that, in accepting him as duly qualified to perform the duties of an able-bodied soldier, and as a Substitute in lieu of Archer Dabney, drafted in S. District July 15th, 1863, we have strictly observed the Regulations which govern in such cases. This soldier has black eyes, black hair, black complexion; is 5 feet 8 3/4 inches high.

Provost Marshal

Commissioner of Board

Surgeon of Board

Board of Enrollment of S. District of Pennsylvania

DECLARATION OF SUBSTITUTE.

I, James Boggs desiring to ENLIST in the Army of the United States, for THREE YEARS, **Do declare**, That I am thirty-five years and X months of age; that I have never been discharged from the United States service on account of disability or by sentence of a court martial; and I know of no impediment to my serving honestly and faithfully as a soldier for three years.

GIVEN at Philadelphia the 8th day of August 1863.

WITNESS:

William E. K. Blair James Boggs
mark

14

B63B

No. 1444

James Boggs (extend)

Enlisted at Philadelphia

As Substitute for

Archer Aubrey

On the 8 day of August, 1863.

By

Wm Lane Capt

John B. Barrett Com

J. Robert Wells Surg

Board of Enrollment,

4 Div. of Penn

(No. 40.)

SUBSTITUTE VOLUNTEER ENLISTMENT.

STATE OF

TOWN OF

Pennsylvania

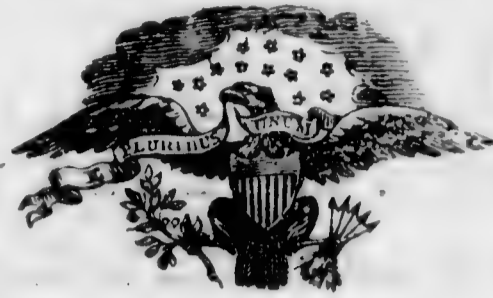

Philadelphia

I, *James Boggs* born in the State
of *Pennsylvania*, aged *35* years, and by
occupation a *Sabrer* Do HEREBY ACKNOWLEDGE to have agreed with
Archer Dabney, Esq., of *1237 Wood St.*
(4th District)

to become his **SUBSTITUTE** in the Military Service, for a sufficient consideration paid and
delivered to me, on the *8th* day of *August*, 1863;
and having thus agreed with said *Archer Dabney*, I DO HEREBY
ACKNOWLEDGE to have enlisted this *8th* day of *August*,
1863, to serve as a **Soldier** in the **Army of the United States of America**, for the period
of **THREE YEARS**, unless sooner discharged by proper authority: I do also agree to accept such
bounty, pay, rations, and clothing, as are, or may be, established by law for soldiers. And I do
solemnly swear that I will bear true and faithful allegiance to the **United States of America**;
that I will serve them honestly and faithfully against all their enemies or opposers whomsoever;
and that I will observe and obey the orders of the President of the United States, and the orders
of the Officers appointed over me, according to the Rules and Articles of War.

SWORN and subscribed to, at *Philadelphia*
this *8th* day of *August*, 1863.

BEFORE

J. M. Lane Capt
Provost Marshal
H. J. ...

James X Boggs
his
mark

Witness *William E McClain*

We certify, on honor, That we have carefully examined the above-named Volunteer Substitute
agreeably to the Regulations, and that, in our opinion, he is free from all bodily defects and mental infirmity
which would in any way disqualify him from performing the duties of a soldier; that he was entirely sober
when enlisted; that he is of lawful age, (not under 18 years;) and that, in accepting him as duly qualified to
perform the duties of an able-bodied soldier, and as a Substitute in lieu of *Archer*
Dabney, drafted in *4th District*
July 13th, 1863, we have strictly observed the Regulations which govern
in such cases. This soldier has *black* eyes, *black* hair, *black* complexion; is *5* feet *8 3/4*
inches high.

J. M. Lane Capt
Provost Marshal.

Charles H. Davis
Commissioner of Board.

Matthias Wells
Surgeon of Board.

Board of Enrollment of *4th* Dist. of *Pennsylvania*

6 U.S. COLO.

Private

Private

CARD NUMBERS.

Buhen

Asbury

- 26
- 27
- 28
- 29
- 30
- 31
- 32
- 33
- 34
- 35
- 36
- 37
- 38
- 39
- 40
- 41
- 42
- 43
- 44
- 45
- 46
- 47
- 48
- 49
- 50

Book Mark:

See also

6 U.S. Col.

Private Private

CARD NUMBERS.

1	26.
2	27
3	28
4	29
5	30
6	31
7	32
8	33
9	34
10	35
11	36
12	37
13	38
14	39
15	40
16	41
17	42
18	43
19	44
20	45
21	46
22	47
23	48
24	49
25	50

See Boulder Gorge

Book Mark:

See also

Vol. 6 U.S. Col.

Private Private

CARD NUMBERS.

5567816	26
	27
	28
	29
	30
	31
	32
	33
	34
	35
	36
	37
	38
	39
	40
	41
	42
	43
	44
	45
	46
	47
	48
	49
	50

Book Mark:

See also

B

6

U.S.C.T.

James Bolden

Appears with rank of *Private* on

Muster and Descriptive Roll of a Detachment of U. S. Vols. forwarded

for the 6 Reg't U. S. Col'd Infantry Roll dated

Lockport N.Y., Sep 23, 1864.

Where born *Canada*

Age *23* y'rs; occupation *laborer*

When enlisted *Sept 20*, 1864

Where enlisted *Le Roy N.Y.*

For what period enlisted *3* years.

Eyes *Black*; hair *black*

Complexion *black* height *5 ft. 8 in.*

When mustered in *Sept 20*, 1864.

Where mustered in *Lockport N.Y.*

Bounty paid \$ *100*; due \$ *100*

Where credited *29 Dist Le Roy Genesser Co N.Y.*

Company to which assigned

Remarks:

Not taken up on Muster Rolls of the regiment!

Book mark:

H Jones

Golden, Jas.
P., Co., *6* Reg't *USCT*

2 Enclosures.

Bed Cards	Final Statements
Burial Records	Furloughs or L. of A
Certs. of Dis. for Discharge	Med. Certificates
C. M. Charges	Med. Des. Lists
Descriptive Lists	Orders
Discharge Certificates	Pris. of War Record
Enlistment Papers	Resignations

Other papers relating to—

Admission to Hosp'l	Furlough or L. of A
Casualty Sheet	Med. Examination
Confinement	Misc. Information
Contracts	Pay or Clothing
Death or Effects	Personal Reports
Desertion	Rank
Discharge from Hosp'l	Transfer to Hosp'l
Discharge from Service	Transfer to V. R. C.
Duty	Transportation

NOTE 1.—This blank will be used for both enlistments and re-enlistments—enlistment of veterans, &c., &c., in the volunteer service. They will be made out in duplicate in all cases—one to accompany the recruiting return of the superintendent (not the recruiting officer) to the Adjutant General, and one to accompany the accounts of the officer who pays bounty, &c. The Regiment and Company in which the soldier last served should be given on the back.

NOTE 2.—An enlistment holds to service. A muster-in must, in all cases, precede payment of pay, bounty, pension, &c. A muster-in roll must, in all cases, be filed in the Adjutant General's Office as evidence of muster-in. The mustering officer, commissary, or assistant commissary of musters, as the case may be, will countersign both enlistments as having mustered the soldier into the service of the United States before either of them is given to the disbursing officer.

DECLARATION OF RECRUIT.

I, James Bolden, desiring to VOLUNTEER as a Soldier in the Army of the United States, for the term of THREE YEARS, Do Declare, That I am twenty three years and _____ months of age; that I have never been discharged from the United States service on account of disability or by sentence of a court martial, or by order before the expiration of a term of enlistment; and I know of no impediment to my serving honestly and faithfully as a soldier for three years.

GIVEN at Le Reput the 20 day of Sept

Witness: C. S. Seaver James Bolden

35-
No. 99
James Bolden
Volunteered at Le Reput MS
September 14th 1864
By Wm. J. Bowen
Regiment of W. D. Colored
Private
enlistment; last served in Company ()
Reg't of _____
Discharged _____, 18 _____

CONSENT IN CASE OF MINOR.

I, _____, Do CERTIFY, That I am the _____ of _____; that the said _____ is _____ years of age; and I do hereby freely give my CONSENT to his volunteering as a SOLDIER in the ARMY OF THE UNITED STATES for the period of THREE YEARS.

GIVEN at _____ the _____ day of _____

Witness: _____

VOLUNTEER ENLISTMENT.

STATE OF

TOWN OF

New York



Le Roy

I, *James Bolden*, born in _____, in the State of *Canada*, aged *twenty three* years, and by occupation a *Soldier*, DO HEREBY ACKNOWLEDGE to have volunteered this *20* day of *Sept*, 186*4*, to serve as a **Soldier** in the **Army of the United States of America**, for the period of **THREE YEARS**, unless sooner discharged by proper authority: Do also agree to accept such bounty, pay, rations, and clothing, as are, or may be, established by law for volunteers. And I, *James Bolden*, do solemnly swear, that I will bear true faith and allegiance to the **United States of America**, and that I will serve them honestly and faithfully against all their enemies or opposers whomsoever; and that I will observe and obey the orders of the President of the United States, and the orders of the officers appointed over me, according to the Rules and Articles of War.

Sworn and subscribed to, at *Lockport* }
 this *20* day of *Sept*, 186*4*, } *James Bolden*
 BEFORE *L. H. Brown* }
Capt & Provost Marshal 29th Dist reg

I CERTIFY, ON HONOR, That I have carefully examined the above-named Volunteer, agreeably to the General Regulations of the Army, and that, in my opinion, he is free from all bodily defects and mental infirmity, which would in any way disqualify him from performing the duties of a soldier.

John Ross
29th Dist reg
 EXAMINING SURGEON.

I CERTIFY, ON HONOR, That I have minutely inspected the Volunteer *J. Bolden* previously to his enlistment, and that he was entirely sober when enlisted; that, to the best of my judgment and belief, he is of lawful age; and that, in accepting him as duly qualified to perform the duties of an able-bodied soldier, I have strictly observed the Regulations which govern the recruiting service. This soldier has *Black* eyes, *Black* hair, *Black* complexion, is *5* feet *8* inches high

L. H. Brown
Capt & Provost Marshal 29th Dist reg
 RECRUITING OFFICER.

Mustered into the service of the United States, for three years or during the war, from date of enlistment, in Company _____
 6th Regiment of *Volunteers*, on the *20* day of *Sept* 186*4*, at *Lockport reg*

L. H. Brown
Capt & Provost Marshal 29th Dist reg

11

NOTE 1.—This blank will be used for both enlistments and re-enlistments—enlistment of veterans, &c., &c., in the volunteer service. They will be made out in duplicate in all cases—one to accompany the recruiting return of the superintendent (not the recruiting officer) to the Adjutant General, and one to accompany the accounts of the officer who pays bounty, &c. The Regiment and Company in which the soldier last served should be given on the back.

NOTE 2.—An enlistment holds to service. A muster-in must, in all cases, precede payment of pay, bounty, pension, &c. A muster-in roll must, in all cases, be filed in the Adjutant General's Office as evidence of muster-in. The mustering officer, commissary, or assistant commissary of musters, as the case may be, will countersign both enlistments as having mustered the soldier into the service of the United States before either of them is given to the disbursing officer.

DECLARATION OF RECRUIT.

I, James Bolden, desiring to VOLUNTEER as a Soldier in the Army of the United States, for the term of THREE YEARS, Do Declare, That I am Twenty years and _____ months of age; that I have never been discharged from the United States service on account of disability or by sentence of a court martial, or by order before the expiration of a term of enlistment; and I know of no impediment to my serving honestly and faithfully as a soldier for three years.

GIVEN at Lockport the 20 day of Sept

Witness: C. S. Saw James Bolden

Volunteered at Lockport Ind
September 20th 1864
 By W. A. D. Brown
 Regiment of Volunteers

No. 1706
James Bolden

enlistment; last served in Company ()
 Reg't of _____
 Discharged _____, 18 _____

Aug. 1895. This paper was formerly filed in the Enrollment Div. R. & F. O.

CONSENT IN CASE OF MINOR.

I, _____, Do CERTIFY, That I am _____ the _____ of _____; that the said _____ is _____ years of age; and I do hereby freely give my CONSENT to his volunteering as a SOLDIER in the ARMY OF THE UNITED STATES for the period of THREE YEARS.

GIVEN at _____ the _____ day of _____

Witness: _____

(A. G. O. No. 74 & 76.)

VOLUNTEER ENLISTMENT.

STATE OF

New Jersey



TOWN OF

Le Roy

I, *James Bolden*, born in _____, in the State of *Canada*, aged *twenty* years, and by occupation a *Laborer*, Do HEREBY ACKNOWLEDGE to have volunteered this *20* day of *Sept*, 186*4* to serve as a **Soldier** in the **Army of the United States of America**, for the period of **THREE YEARS**, unless sooner discharged by proper authority: Do also agree to accept such bounty, pay, rations, and clothing, as are, or may be, established by law for volunteers. And I, *James Bolden*, do solemnly swear, that I will bear true faith and allegiance to the **United States of America**, and that I will serve them honestly and faithfully against all their enemies or opposers whomsoever; and that I will observe and obey the orders of the President of the United States, and the orders of the officers appointed over me, according to the Rules and Articles of War.

Sworn and subscribed to, at

this *20* day of *Sept*, 186*4*

BEFORE

L. H. Brown
Capt & Co. m. 29 Dist N.Y.

I CERTIFY, ON HONOR, That I have carefully examined the above-named Volunteer, agreeably to the General Regulations of the Army, and that, in my opinion, he is free from all bodily defects and mental infirmity, which would in any way disqualify him from performing the duties of a soldier.

John Roor
29 Dist N.Y.
EXAMINING SURGEON.

I CERTIFY, ON HONOR, That I have minutely inspected the Volunteer *James Bolden* previously to his enlistment, and that he was entirely sober when enlisted; that, to the best of my judgment and belief, he is of lawful age; and that, in accepting him as duly qualified to perform the duties of an able-bodied soldier, I have strictly observed the Regulations which govern the recruiting service. This soldier has *Black* eyes, *Black* hair, *Black* complexion, is *5* feet _____ inches high

L. H. Brown
Capt & Co. m. 29 Dist N.Y.
REGIMENT OF _____ VOLUNTEERS.
RECRUITING OFFICER.

(A. G. O. No. 74 & 76.)

Mustered into the service of the United States, for three years or during the war, from date of enlistment, in Company _____ 6th Regiment of *Volunteers*, on the *20* day of *Sept* 186*4*, at *Le Roy N.Y.*

L. H. Brown
Capt & Co. m. 29 Dist N.Y.

SEARCHED

6 U.S. Col'd

Private

Private

CARD NUMBERS.

5573606	26
5567685	27
5573690	28
5573772	29
5573850	30
5573923	31
5573994	32
5574062	33
5574136	34
5574210	35
5574301	36
5574401	37
5574505	38
5574589	39
9065162	40
	41
	42
	43
	44
	45
	46
	47
	48
	49
	50

Book Mark:

See also:

NARR 1444

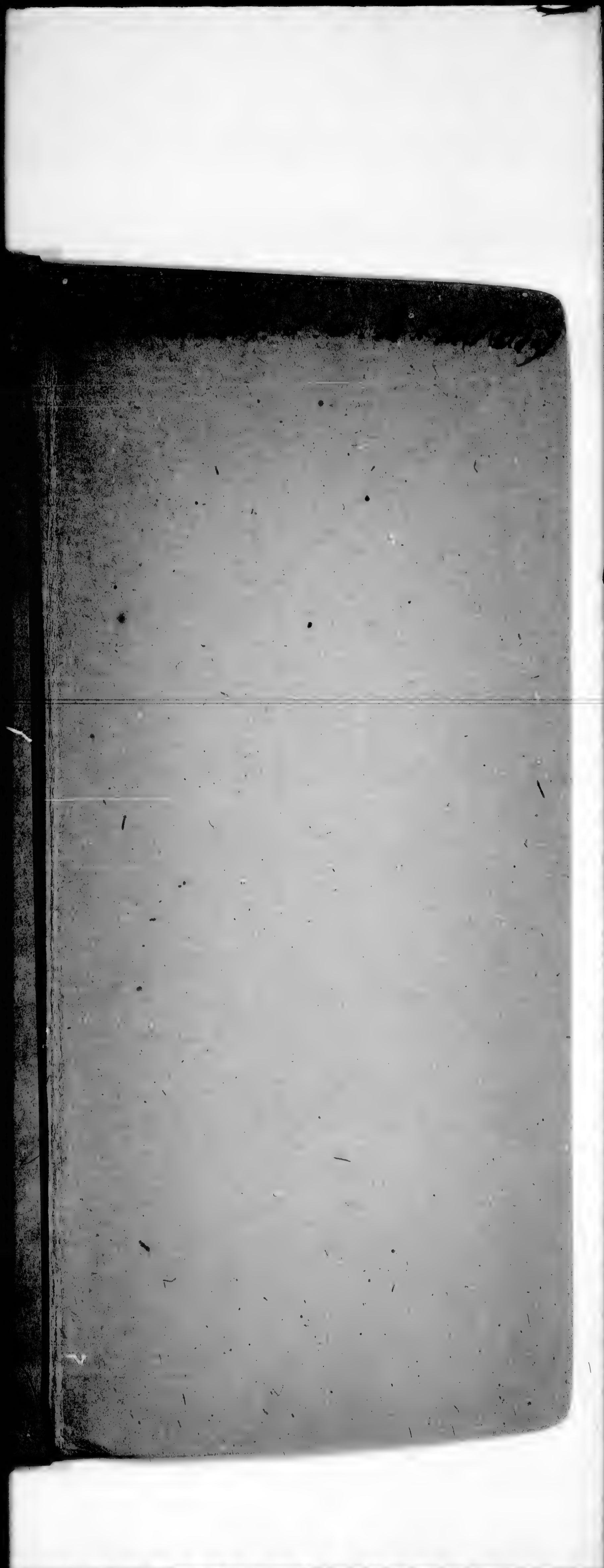

B | **6** | **U.S.C.T.**

Jeremiah Bolder

....., Co. *E*, 6 Reg't U. S. Col'd Inf.

Appears on

Company Descriptive Book
of the organization named above.

DESCRIPTION.

Age *22* years; height *5* feet *6* inches.

Complexion *Blk*

Eyes *Blk*; hair *Blk*

Where born *Penn*

Occupation *Miner*

ENLISTMENT.

When *Aug 13*, 186 *3*.

Where *23 D. Pa*

By whom *P. M*; term *3* y'rs.

Remarks: *Substitute for Richd Bogler*

.....
.....
.....
.....
.....

(383g)

J. G. Reeves

Copyist.

MB

6

U.S.C.T.

Jeremiah Bolder (bol)

Appears with rank of _____ on

Muster and Descriptive Roll of a Detachment of U. S. Vols. forwarded

for the 6 Reg't U. S. Col'd Infantry. Roll dated
Alleghany City Pa Aug. 13, 1863.

Where born _____ Penna.

Age 22 y'rs; occupation Coal digger

When enlisted Aug. 13, 1863.

Where enlisted Alleghany City Pa. 23rd West Pa.

For what period enlisted 3 years.

Eyes Black; hair Black

Complexion Black; height 5 ft. 6 in.

When mustered in Aug. 13, 1863.

Where mustered in _____

Bounty paid \$ 100; due \$ 100

Where credited _____

Company to which assigned _____

Remarks Substitute for Richard
Berghes (Ref. Dr. Alleghany
Co. Pa.)

Book mark: _____

Reif

B

6

U.S.C.T.

Jeremiah Bolden

Private, Co. *E*, 6 Reg't U. S. Col'd Infantry.

Age *22* years.

Appears on

Company Muster-in Roll

of the organization named above. Roll dated

Philada Pa, *Oct 13*, 186 *3*.

Muster-in to date *Aug 13*, 186 *3*

Joined for duty and enrolled:

When *Aug 13*, 186 *3*.

Where *Alleghana Pa*

Period *3* years.

Remarks:

Book mark:

Lucas

B

6

U.S.C.T.

Jeremiah Bolden

Priv, Co. E, 6 Reg't U. S. Col'd Infantry.

Appears on

Company Muster Roll

for *Muster in to Oct 31*, 186 *3*

Present or absent *Present*

Stoppage, \$ *100* for

Due Gov't, \$ *100* for

Remarks:

Book mark:

Lucas

B | 6 | U.S.C.T.

Jeremiah Bolden

Private, Co. E, 6 Reg't U. S. Col'd Infantry.

Appears on

Company Muster Roll

for *Nov. + Dec*, 1863

Present or absent *Present*

Stoppage, \$ 100 for

Due Gov't, \$ 100 for

Remarks: *In confinement in Camp.*

Book mark:

Lucas

B

6

U.S.C.T.

Jimmiah Bolden

Priv., Co. E, 6 Reg't U. S. Col'd Infantry.

Appears on

Company Muster Roll

for *Jan + Feby*, 1864

Present or absent *Present*

Stoppage, \$ *100* for

Due Gov't, \$ *100* for

Remarks: *Confined in Reg't
guard house.*

Book mark: _____

B

6

U.S.C.T.

Jeremiah Bolden

Pr-, Co. E, 6 Reg't U. S. Col'd Infantry.

Appears on

Company Muster Roll

for *Mar + Apr*, 1864

Present or absent *Present*

Stoppage, \$ *100* for

Due Gov't, \$ *100* for

Remarks: *Sentence to forfeit all pay and allowances for three months to U.S. by G.C.M. omitted by mistake on last roll.*

Book mark:

Lucas

1864

B | 6 | U.S.C.T.

Jeremiah Bolden
Pvt, Co. E, 6 Reg't U. S. Col'd Infantry.

Appears on

Company Muster Roll

for *May & June*, 186*4*

Present or absent *Present*

Stoppage, \$ 100 for

Due Gov't, \$ 100 for

Remarks: *Sentenced by G. C. M. to forfeit all pay and allowances to the U. S. Government for three months.*

Book mark: _____

Harris

B

6

U.S.C.T.

Jeremiah Bolden
Pvt, Co. E, 6 Reg't U. S. Col'd Infantry.

Appears on

Company Muster Roll

for *July & Aug*, 186*4*

Present or absent *Present*

Stoppage, \$ *100* for

Due Gov't, \$ *100* for

Remarks: *Sentenced by Gen. Court Martial to forfeit all pay and allowances to U. S. Government for 3 months. Free on or before Apr 19/61*

Book mark:

[Signature]

B

6

U.S.C.T.

Jeremiah Bolden
Pvt., Co. E, 6 Reg't U. S. Col'd Infantry.

Appears on

Company Muster Roll

for Sept & Oct, 1864

Present or absent Present

Stoppage, \$ 100 for

Due Gov't, \$ 100 for

Remarks: Sentenced by G. C. M.
Announced Feby 27/64 to lose
three mos. pay ✕ was
stopped on last ✕ still due
Soldier \$4.00

NEXT ROLL ON FILE FEB 1865

✕ Torn from Roll.

Book mark:

Harris

B

6

U.S.C.T.

Jeremiah Golden
Corpl, Co. E, 6 Reg't U. S. Col'd Infantry.

Appears on

Company Muster Roll

for Jan & Feby, 1865

Present or absent Present

Stoppage, \$ 100 for

Due Gov't, \$ 100 for

Remarks:

Book mark:

Harris

B | 6 | U.S.C.T.

Jeremiah Bolden
Corp., Co. E, 6 Reg't U. S. Col'd Infantry.

Appears on

Company Muster Roll

for *Mich & Apr*, 1865

Present or absent *Present*

Stoppage, \$ 100 for

Due Gov't, \$ 100 for

Remarks: *Stop for 1 Tompion (or) 1 Wiper*
(20) 1 Screwdriver (23) 1 Cap punch
(45) Total 90 App'd Corporal
Sept 29/64

Book mark: _____

Harris

B

6

U.S.C.T.

Jeremiah Bolden,
Corpl, Co. E, 6 Reg't U. S. Col'd Infantry.

Appears on

Company Muster Roll

for *May & June*, 1865

Present or absent *Present.*

Stoppage, \$ *100* for

Due Gov't, \$ *100* for

Remarks:

Book mark:

J. Pool

B

6

U.S.C.T.

Jeremiah Balden,
Priv, Co. E, 6 Reg't U. S. Col'd Infantry.

Appears on

Company Muster Roll

for *July & Aug.*, 1865

Present or absent *Present*

Stoppage, \$ *100* for

Due Gov't, \$ *100* for

Remarks: *Reduced to ranks*
per S.O. No. Aug. 20, 1865.

Book mark: _____

P. Pool

(358)

Copyist

B

6

U.S.C.T.

Jeremiah Golden

Priv., Co. E, 6 Reg't U. S. Col'd Infantry.

Appears on Co. Muster-out Roll, dated
Wilmington, N.C., Sep. 20, 1865.

Muster-out to date Sep. 20, 1865.

Last paid to Apr. 20, 1865.

Clothing account:

Last settled June 30, 1864; drawn since \$80 ³⁷/₁₀₀

Due soldier \$100; due U. S. \$100

Am't for cloth'g in kind or money adv'd \$100

Due U. S. for arms, equipments, &c., \$6 ⁰⁰/₁₀₀

Bounty paid \$None ⁰⁰/₁₀₀; due \$100 ⁰⁰/₁₀₀

Remarks: Due Wm. Presben, Regt. Sutler \$20 ⁰⁰. Borne on muster rolls as free once before Apr. 1/61. Reduced from Corpl. Aug. 18/65. Subs. for Col'd man. Drafted under act of March 3, 1863.

Book mark:

O'Pool

(361)

Copyist.

Golden, Jered

, Co. E, 6 Reg't U.S.C.T.

2 Enclosures.

Bed Cards	Final Statements
Burial Records	Furloughs or L. of A
Certs. of Dis. for Discharge	Med. Certificates
C. M. Charges	Med. Des. Lists
Descriptive Lists	Orders
Discharge Certificates	Pris. of War Record
Enlistment Papers	Resignations

Other papers relating to—

Admission to Hosp'l	Furlough or L. of A
Casualty Sheet	Med. Examination
Confinement	Misc. Information
Contracts	Pay or Clothing
Death or Effects	Personal Reports
Desertion	Rank
Discharge from Hosp'l	Transfer to Hosp'l
Discharge from Service	Transfer to V. R. C.
Duty	Transportation

for three months, and to forfeit all pay and
allowances for the same period. Appd.
To be confined at any place in the U. S.

Mr. Ellsworth

Jessie's Orders

to D. & W. S. C. Brooks

Adjutant General's Office,

COLORED TROOPS BRANCH,

January 26th, 1874

Mr. Ellertson Vol.

C. T., 187

Wanted in the case of Jeremiah Bolden, Co. C,
6th Reg't U.S.C.T.

Cause of confinement and if tried
for January and February for reports him Present
"Confined in Reg't Guard House"

Respectfully,

W. A. Woodward
Chief Clerk.

J. J. Halton

Adjutant General's Office,

Record Room

Jan. 31st, 1877.

Vol. C. T., 187

Reply in case of Jeremiah Bolden, Co. C,
6th Reg't U.S.C.T.

Reg't. Gd. Report Book March 1st 1864. reports
him Conf'd Oct. 24th 1863 - Charge - Sleeping
on "Post." Sentenced to be confined for three
months with loss of pay.
No evidence of trial with Reg't. Records.
G.O. Wietar's Div. 18th A.C. not on file

G.O. 37. 26th Q. Dept. Va. + N.C. Nov. 24th 1863 - Charge
Sleeping on Post. To be conf'd. at hard labor
G.O. at such place as the Comdg. Genl. may direct (over)

Mr Ellbrook

Jeremiah Boldeu

Co E 6th U.S.C. Troops

✓

Adjutant General's Office,

COLORED TROOPS BRANCH,

January 26th, 1877

Mr. Ellersbark, Vol.

C. T., 187

Wanted in the case of

Jeremiah Bolden

, Co. "E",

6th Reg't U.S.C.T.

Cause of reduction

Mustering Roll for July and

August 1865 reports him "Reduced to the ranks

August 20/65.

Respectfully,

R. A. Woodward

Chief Clerk.

J. H. J.

Adjutant General's Office,

Record Room

Jan 31st, 1877.

Vol.

C. T., 187

Reply in case of

Jeremiah Bolden

, Co. "E",

6th Reg't

U.S.C.T.

Reduced from Corp. by S. O. 54 H. O. 6"

U.S.C.T. Aug. 21 1865 for drunkenness on duty.

G.B.

1 2 3 4 5 6 7 8 9 10 11 12

to | *Prima*

CARD NUMBERS.

	26	
<i>Bolen</i>	27	<i>Elijah</i>
	28	
	29	
	30	
	31	
	32	
	33	
	34	
	35	
	36	
	37	
	38	
	39	
	40	
	41	
	42	
	43	
	44	
	45	
	46	
	47	
	48	
	49	
	50	

Mark:

etc | *Pr...*

CARD NUMBERS.

578202	26
578282	27
578365	28
578447	29
578524	30
578601	31
578676	32
578749	33
578823	34
578918	35
579016	36
579108	37
579191	38
9065637	39

- 26
- 27
- 28
- 29
- 30
- 31
- 32
- 33
- 34
- 35
- 36
- 37
- 38
- 39
- 40
- 41
- 42
- 43
- 44
- 45
- 46
- 47
- 48
- 49
- 50

Not Mark:

See also

BRAND

1000

1000

B

6

U.S.C.T.

Elijah Boler,

Co. C, 6 Reg't U. S. Col'd Inf.

Appears on

Company Descriptive Book

of the organization named above.

DESCRIPTION.

Age *19* years; height *5* feet *4 1/2* inches.

Complexion *Dark*

Eyes *Black*; hair *Black*

Where born *Bedford Co. Penn.*

Occupation *Laborer*

ENLISTMENT.

When *Sept 11*, 186*3*.

Where *Philadelphia*

By whom *Capt. Surgeant*; term *3* y'rs.

Remarks: *Enlisted -*

*D. L. sent to Ft. Mifflin
Dec. 1*

Sentinel

NARA 1469
B. | 6 | U.S.C.T.

Elijah Boler.
Part. Co. I, 6 Reg't U. S. Col'd Infantry.

Age *19* years.

Appears on

Company Muster-in Roll

of the organization named above. Roll dated

Philada, Pa. Sept. 11, 1863.

Muster-in to date

Sept. 11, 1863

Joined for duty and enrolled:

When *Sept. 4*, 1863.

Where *Philadelphia*

Period *3* years.

Remarks: *Enlisted Penna. 16*
Dis. Mustered by Lieut.
Price Mgt. Sept. 1, '63

Book mark:

(856)

ash.
Copyist.

B. | 6 | U.S.C.T.

Elijah Bolent

Pat., Co. I, 6 Reg't U. S. Colored Infantry.

Appears on

Company Muster Roll

for *Sept. & Oct.*, 1863.

Present or absent *Present*.

Stoppage, \$ *100* for

Due Gov't, \$ *100* for

Remarks: -----

Book mark: -----

(868)

Asst.

Coryist.

B.

6

U.S.C.T.

Elijah Bolen

Priv., Co. I, 6 Reg't U. S. Colored Infantry.

Appears on

Company Muster Roll

for *Nov. & Dec.*, 186*3*.

Present or absent *Present*

Stoppage, \$ *100* for

Due Gov't, \$ *100* for

Remarks:

Book mark:

(858)

Ash
Copyist.

B.

6

U.S.C.T.

Elijah Bolen.
Pat., Co. I, 6 Reg't U. S. Colored Infantry.

Appears on

Company Muster Roll

for *Jan'y 7 Feby.*, 1864.

Present or absent *Present.*

Stoppage, \$ *100* for

Due Gov't, \$ *100* for

Remarks: *Due U.S. for 1 Wiper
20 cts; for one Canteen
44 cts.*

Book mark:

Asht.
Copyist.

(858)

B. | 6 | U.S.C.T.

Elijah Boleyn
Part., Co. I, 6 Reg't U. S. Colored Infantry.

Appears on

Company Muster Roll

for *Month of April*, 1864.

Present or absent *Present*.

Stoppage, \$ *100* for

Due Gov't, \$ *100* for

Remarks:

Book mark:

(858)

Asst.
Copyist.

B. | 6 | U.S.C.T.

Elijah Bolen

Private, Co. I, 6 Reg't U. S. Colored Infantry.

Appears on

Company Muster Roll

for *May & June*, 1864.

Present or absent

Present.

Stoppage, \$ 100 for

Due Gov't, \$ 100 for

Remarks:

Book mark:

A. M. Reed

(868)

Copyist.

B. | 6 | U.S.C.T.

Elijah Bolen

Pvt., Co. I, 6 Reg't U. S. Colored Infantry.

Appears on

Company Muster Roll

for July & Aug., 1864

Present or absent Present

Stoppage, \$ 1.00 for

Due Gov't, \$ 1.00 for

Remarks: Free Apr. 19. 63,
On extra duty since
Aug. 9. 64.

Book mark:

H. W. Reed

(358)

Copyist.

B.

6

U.S.C.T.

Elijah Bolen

Priv., Co. I, 6 Reg't U. S. Colored Infantry.

Appears on

Company Muster Roll

for *Sept. & Oct.*, 186*4*.

Present or absent *Absent.*

Stoppage, \$ *100* for

Due Gov't, \$ *100* for

Remarks: *Absent sick in
Hos. since Oct. 20, 64.*

NEXT ROLL ON FILE FEB 1865

Book mark:

A. W. Reed

(358)

Copyist.

B. | 6 | U.S.C.T.

Elijah Bolen

Priv., Co. I, 6 Reg't U. S. Colored Infantry.

Appears on

Company Muster Roll

for Jan. & Feb., 1865.

Present or absent Absent.

Stoppage, \$ 100 for

Due Gov't, \$ 100 for

Remarks: Free Apr. 19/61,
Absent sick in hos.
since Oct. 20/64.

Book mark:

A. H. Reed

(358)

Copyist.

B. | 6 | U.S.C.T.

Elijah Boulden

Pvt., Co. I, 6 Reg't U. S. Colored Infantry.

Appears on

Company Muster Roll

for dated May 3, 1865.

Present or absent Present.

Stoppage, \$ 100 for

Due Gov't, \$ 100 for

Remarks: Free Apr. 19/61.
Due U.S. 1 haversack
95^{cts.} / Canteen 65^{cts.}
1/2 tent D' Abri 4, 90.
\$6.50.

Book mark:

H. M. Reed

(858)

Copyist.

B

6

U.S.C.T.

Elijah Bowden
Pot, Co. I, 6 Reg't U. S. Colored Infantry.

Appears on

Company Muster Roll

for *May & June*, 1865.

Present or absent *Present*

Stoppage, \$ *100* for

Due Gov't, \$ *100* for

Remarks: *Charged on past rolls
for C.C. & G. Eq. \$6.50*

Book mark:

(353)

Posley
Copyist.

B

6

U.S.C.T.

Elijah Boulden
Pot, Co. I, 6 Reg't U. S. Colored Infantry.

Appears on

Company Muster Roll

for July & Aug, 1865.

Present or absent Present

Stoppage, \$ 100 for

Due Gov't, \$ 100 for

Remarks: Due us, transportation
\$ 13.56
due from us, \$ 1.93

Book mark:

(858)

Losey

Copyist.

B

6

U.S.C.T.

Elijah Boulden

Pat, Co. I, 6 Reg't U. S. Col'd Infantry.

Appears on Co. Muster-out Roll, dated

Wilmington N.C. Sept 20, 1865.

Muster-out to date Sept 20, 1865.

Last paid to Apl 30, 1865.

Clothing account:

Last settled June 20, 1864; drawn since \$24.30/100

Due soldier \$100; due U. S. \$100

Am't for cloth'g in kind or money adv'd \$100

Due U. S. for arms, equipments, &c., \$100

Bounty paid \$None 100; due \$100 100

Remarks: Due Mr. Bristow Rept
sutler & J. S. Dues, U.S.
transportation &c.

Book mark:

Lozey

(361)

Copyist.

Polen, Elijah

I, Co. *I*, *6* Reg't *USC I*

Enclosures.

Bed Cards	Final Statements
Burial Records	Furloughs or L. of A.
Certs. of Dis. for Discharge	Med. Certificates
C. M. Charges	Med. Des. Lists
Descriptive Lists	Orders
Discharge Certificates	Pris. of War Record
Enlistment Papers	Resignations

Other papers relating to—

Admission to Hosp'l	Furlough or L. of A. <i>/</i>
Casualty Sheet	Med. Examination
Confinement	Misc. Information
Contracts	Pay or Clothing
Death or Effects	Personal Reports
Desertion	Rank
Discharge from Hosp'l	Transfer to Hosp'l
Discharge from Service	Transfer to V. R. C.
Duty	Transportation

Camp 3rd U.S. C.S.
Wilmington N.C. June 20th 65

Deveraux John F.
Capt. Co. 3rd U.S. C.S.

Makes application for a
furlough of 30 days for
Private Elijah Bolen
of his Company.

Head Quarters 6th U.S. C.S.
Wilmington June 21st 65

respectfully forwarded.
Approved. Shaw 475.
man present for duty
with the regiment, with
none absent with leave
and no applications
forwarded not acted
on-

J. M. Dill
Capt. Co. 6th U.S. C.S.
Comdg. Regt.

HEADQUARTERS DIST. OF WILMINGTON:

Wilmington, N. C., June 27th, 1865.

E. B. (D. 84) Vol. (...2...) D. of W., 1865.

Respectfully forwarded,

Approved,

J. Swann

Brig. Gen. Comd'g.

Head Qrs. 3rd Brig. 3rd Div. 10th A.C.
Post of Wilmington Wilmington N.C. June 26th 65

Respectfully forwarded Approved
I have inspected this man, and find
his clothing, arms and equipments in a
good condition.

A. G. Chamberlin
Lieut-Colonel
Comdg.

Approved
J. A. J.

See H. 72. 25 11. 4 July 1st 65-

W. Miller No June 2nd 165

I have most respectfully applied
to you for a discharge for
Private Elijah Bowen Co I Cavalry
United States
Army

Most respectfully yours
John F. Severance
Capt Cavalry Co I 6000

Elijah Bowen
Feb. 6. M. I. C. T.

U.S.C.

Sumato

Pivato

CARD NUMBERS.

5570163	26
5570246	27
5570330	28
5570411	29
5570487	30
5570566	31
5570640	32
5570715	33
5570806	34
5570907	35
5571007	36
5571103	37
5571194	38
9064548	39
	40
	41
	42
	43
	44
	45
	46
	47
	48
	49
	50

Book Mark:

See also

NARA 1486

10379 P.O. A.

B

6

U.S.C.T.

Abram Bolier

Co. B, 6 Reg't U. S. Col'd Inf.

Appears on

Company Descriptive Book

of the organization named above.

DESCRIPTION.

Age 20 years; height 5 feet 9 1/2 inches.

Complexion *Black*

Eyes *Black*; hair *Black*

Where born *Hopewille Pa*

Occupation *Farmer*

ENLISTMENT.

When *July 29*, 186³.

Where *Philada, Pa*

By whom *Col. Wagner*, term *3* y'rs.

Remarks:

W J Roy

P

6

U.S.C.T.

Abram Polier

Priv, Co. *P*, 6 Reg't U. S. Col'd Infantry.

Age *20* years.

Appears on

Company Muster-in Roll

of the organization named above. Roll dated

Philadelphia Pa Aug 3, 1863.

Muster-in to date

July 29, 1863.

Joined for duty and enrolled:

When

July 29, 1863

Where

Phila. Pa

Period

3 years.

Remarks:

Book mark:

H. E. Brandon

P.

6

U.S.C.T.

Abram Fisher

Privt, Co. B, 6 Reg't U. S. Col'd Infantry.

Appears on

Company Muster Roll

for *From Muster in to Oct 31, 1863.*

Present or absent *Present*

Stoppage, \$ 100 for

Due Gov't, \$ 100 for

Remarks:

Book mark:

J. S. Brandon

P | 6 | U.S.C.T.

Abram Polier

Prvt, Co. B, 6 Reg't U. S. Col'd Infantry.

Appears on

Company Muster Roll
for *Nov. & Dec.*, 1863.

Present or absent *Present*

Stoppage, \$ *100* for

Due Gov't, \$ *100* for

Remarks:

Book mark:

A. S. Brandon

P

6

U.S.C.T.

Abram Solier

Priv't, Co. B, 6 Reg't U. S. Col'd Infantry.

Appears on

Company Muster Roll

for *Jan. & Feb.*, 186 *4*

Present or absent *Present*

Stoppage, \$ *100* for

Due Gov't, \$ *100* for

Remarks:

Book mark:

H. E. Brandon

P.

6

U.S.C.T.

Abram Polier

Priv, Co. B, 6 Reg't U. S. Col'd Infantry.

Appears on

Company Muster Roll

for *Mar. & Apr.*, 1864.

Present or absent *Present*

Stoppage, \$ 100 for

Due Gov't, \$ 100 for

Remarks:

Book mark:

H. F. Brandon

P

6

U.S.C.T.

Abram Solien

Sm, Co. B, 6 Reg't U. S. Col'd Infantry.

Appears on

Company Muster Roll

for *May & June*, 1864.

Present or absent *Present*

Stoppage, \$ *100* for

Due Gov't, \$ *100* for

Remarks:

Book mark:

A. Leonard

(358)

Copyist

6

U.S.C.T.

Abram Polner

Private, Co. B, 6 Reg't U. S. Col'd Infantry.

Appears on

Company Muster Roll

for *July & Aug*, 1864.

Present or absent *Present*

Stoppage, \$ *100* for

Due Gov't, \$ *100* for

Remarks: *See April 1864*

Book mark:

J. W. [unclear]

(358)

Copyist

B

6

U.S.C.T.

Abram Polier

1st, Co. B, 6 Reg't U. S. Col'd Infantry.

Appears on

Company Muster Roll

for *Lehigh*, 1864.

Present or absent *Present*

Stoppage, \$ *100* for

Due Gov't, \$ *100* for

Remarks:

NEXT ROLL ON FILE FEB 1865

Book mark:

J. A. Kennard

8

6

U.S.C.T.

Abram Polier

Priv., Co. B, 6 Reg't U. S. Col'd Infantry.

Appears on

Company Muster Roll

for Jan & Feb, 1865.

Present or absent Present

Stoppage, \$ 100 for

Due Gov't, \$ 100 for

Remarks: Due U.S. for
1 Canteen 45, 1 Haversack by

Book mark:

M. L. ...

B

6

U.S.C.T.

Abram Polier

Priv, Co. B, 6 Reg't U. S. Col'd Infantry.

Appears on

Company Muster Roll

for *March, 1865*, 1865.

Present or absent *Present*

Stoppage, \$ *100* for

Due Gov't, \$ *100* for

Remarks: *Due U.S. for 1
Canteen .45, one Hammer
.67 for 1 Tipper 20, 1
Tompson .02*

Book mark:

J. L. Lewis

B. | 6 | U.S.C.T.

Abraham Bolier

Priv, Co. B, 6 Reg't U. S. Col'd Infantry.

Appears on

Company Muster Roll

for *May & June*, 1865.

Present or absent *Present*

Stoppage, \$ *22* for *Adv Article*
on Last Roll.

Due Gov't, \$ *100* for

Remarks: *Stopped for C & G.*
Equippage \$12.

Book mark:

B. J. Cooke

B. | **6** | **U.S.C.T.**

Abram Bolien
Priv, Co. B, 6 Reg't U. S. Col'd Infantry.

Appears on

Company Muster Roll

for *July & Aug.*, 1865.

Present or absent *Present*

Stoppage, \$ 100 for

Due Gov't, \$ 100 for

Remarks:

Book mark:

B. J. Cook

B.

6

U.S.C.T.

Abram Bolier

Priv., Co. *B*, 6 Reg't U. S. Col'd Infantry.

Appears on Co. Muster-out Roll, dated

Wilmington, NC, Sept. 20, 1865.

Muster-out to date

Sept. 20, 1865.

Last paid to

Apr. 20, 1865.

Clothing account:

Last settled *June 20, 1864*; drawn since \$ *146.52* 100

Due soldier \$ 100; due U. S. \$ 100

Am't for cloth'g in kind or money adv'd \$ 100

Due U. S. for arms, equipments, &c., \$ 100

Bounty paid \$ *none* 100; due \$ *100* 100

Remarks: *Due Mrs. Crisben Regtl Suttler \$12.00*

Book mark:

(861)

B J Cooke

Copyist.

PHOTO COPY



IMAGE EVALUATION TEST TARGET (QA-3)

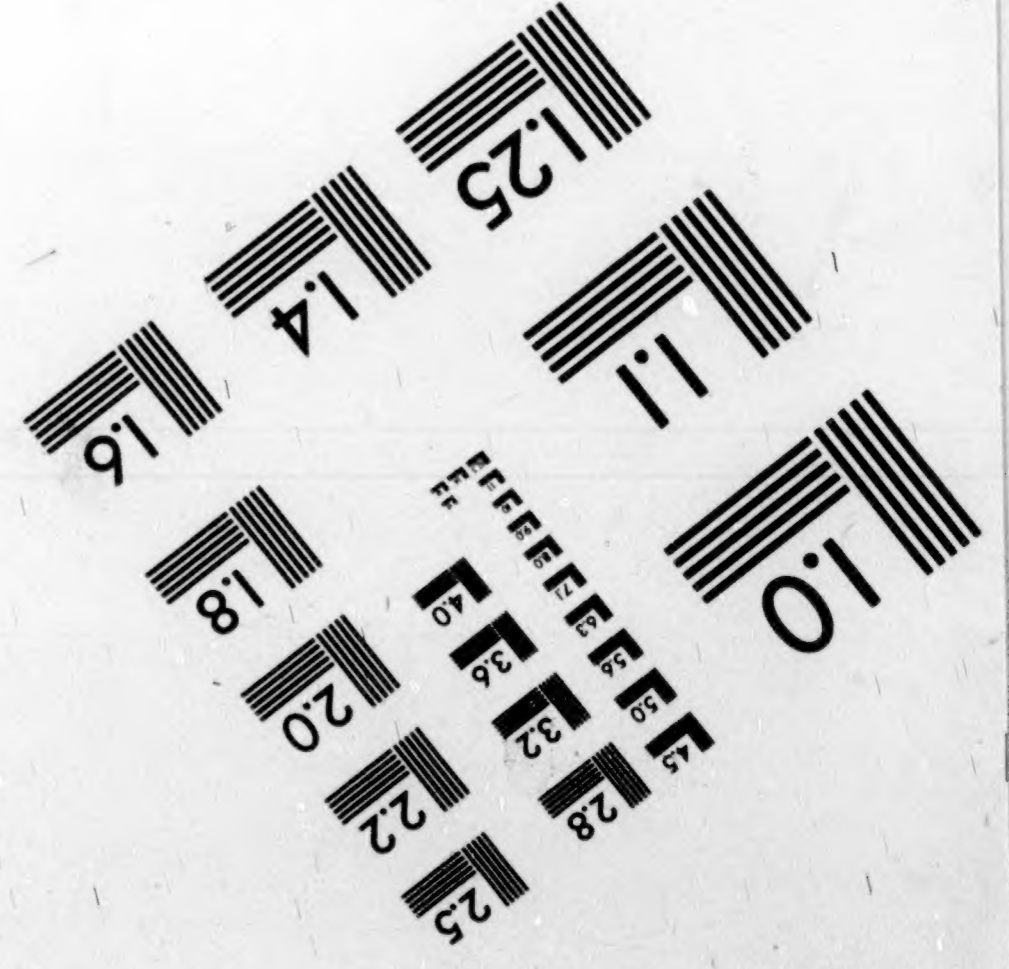
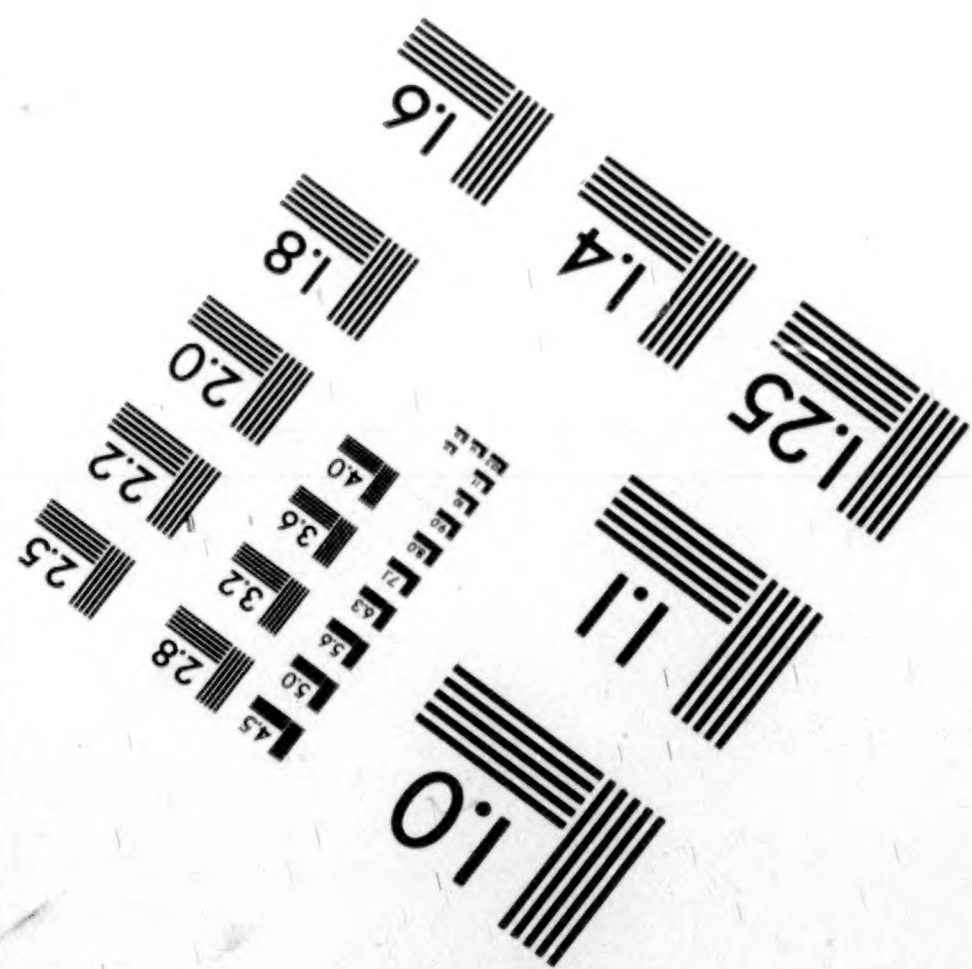
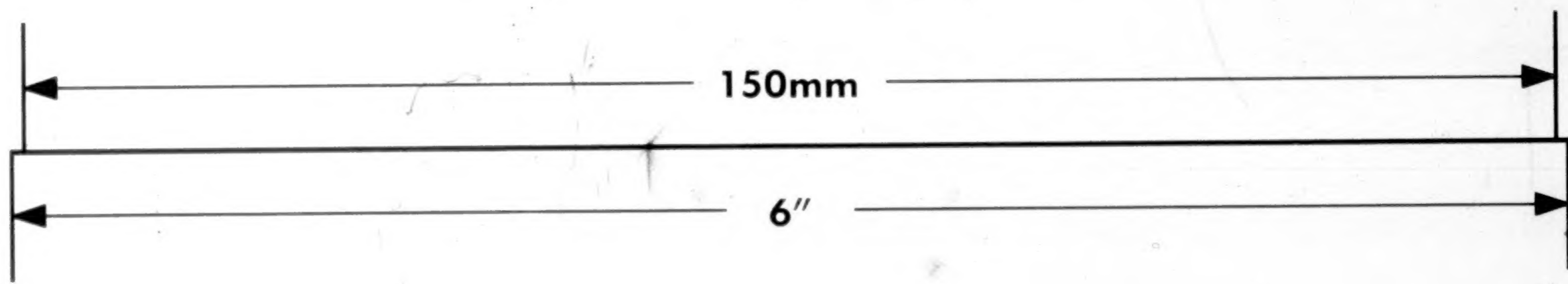
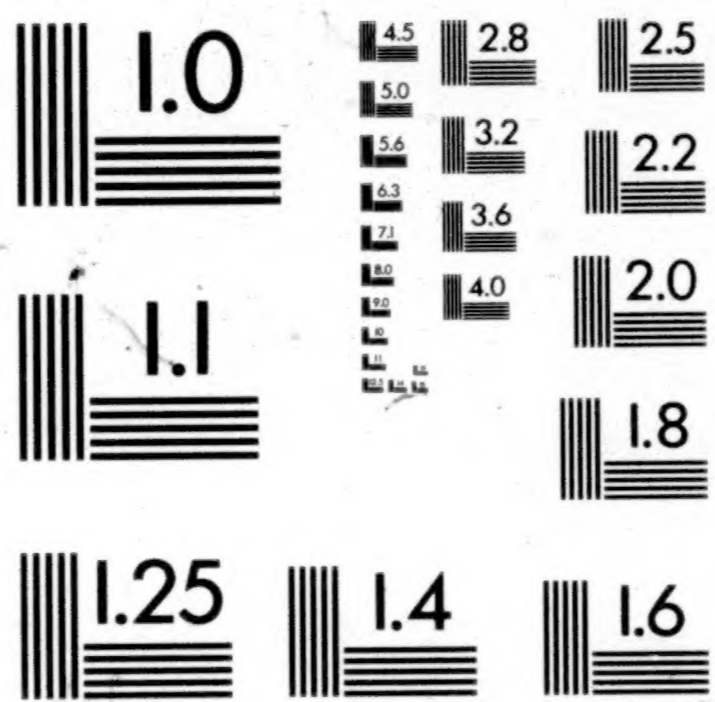
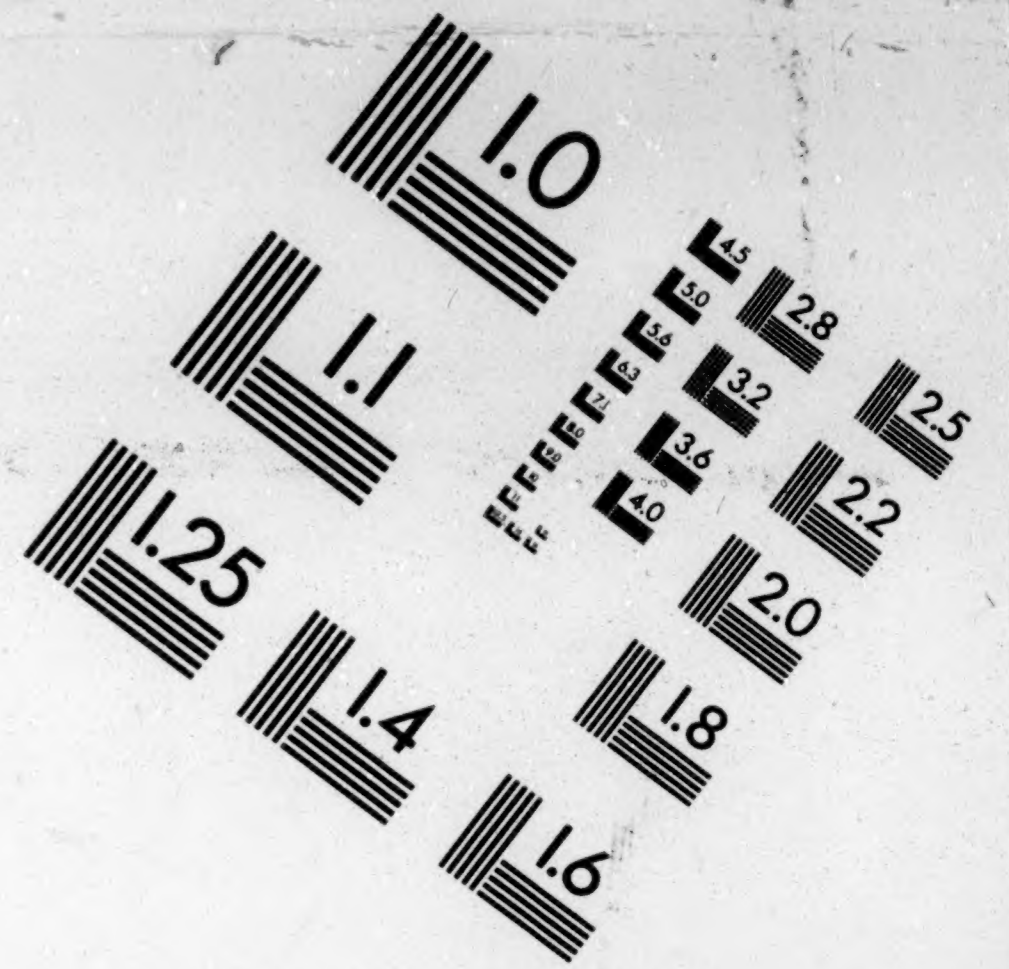
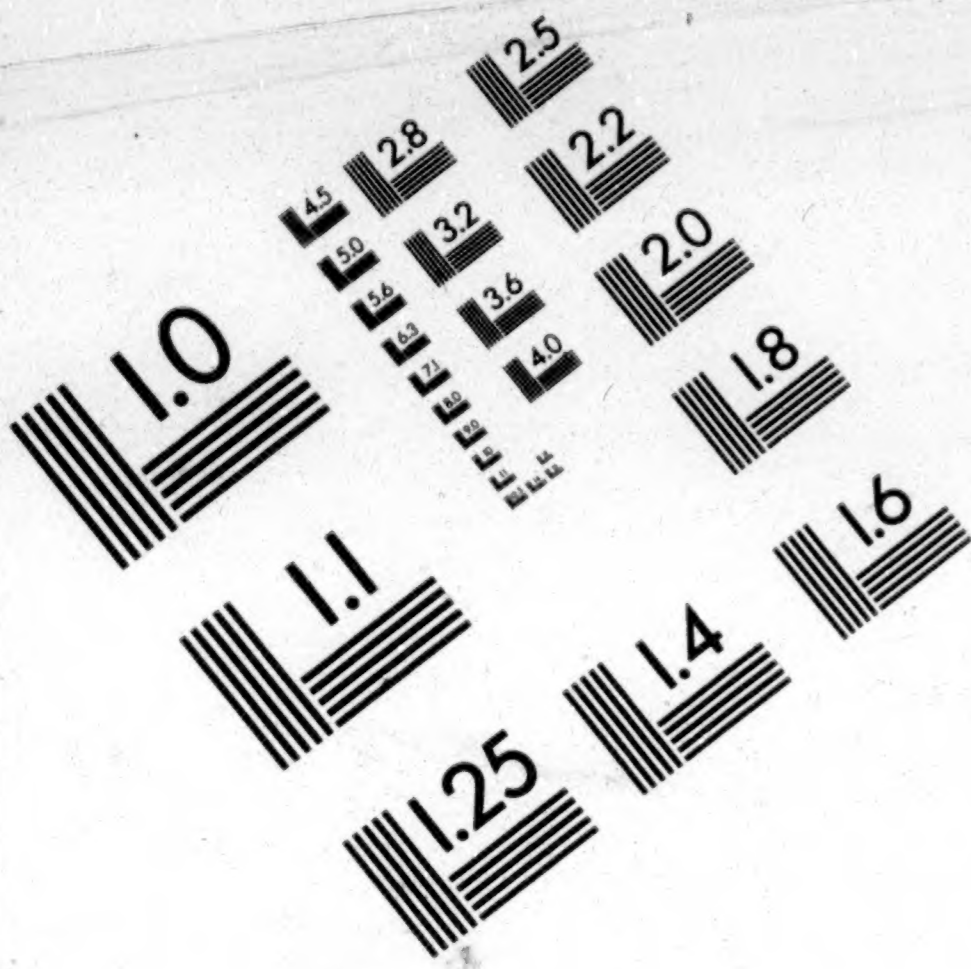

APPLIED IMAGE, Inc
 1653 East Main Street
 Rochester, NY 14609 USA
 Phone: 716/482-0300
 Fax: 716/288-5989

© 1993, Applied Image, Inc., All Rights Reserved

THE END

PLEASE

REWIND