

**THE END**

**PLEASE**

**REWIND**

# IMAGE EVALUATION TEST TARGET (QA-3)

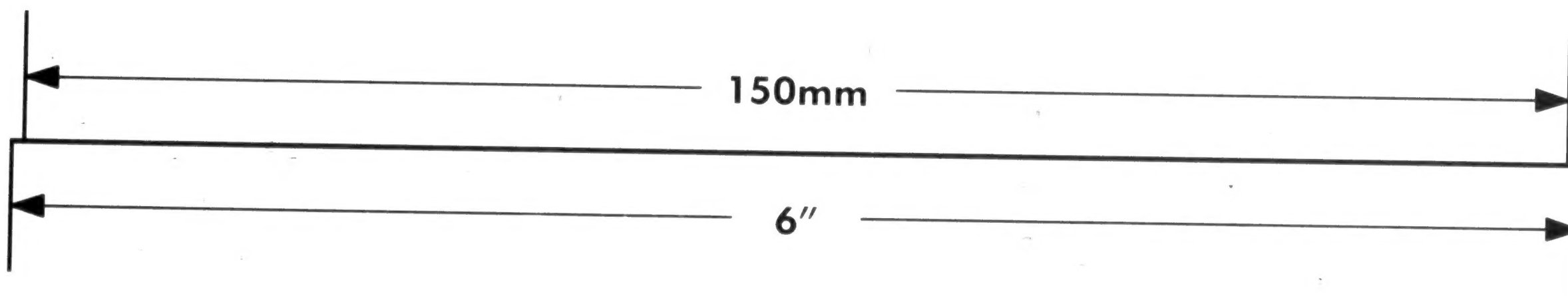
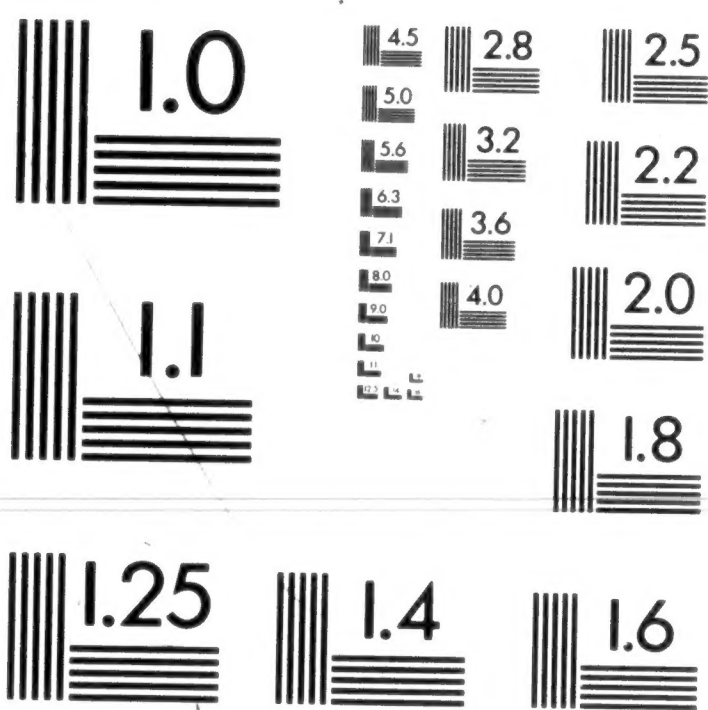
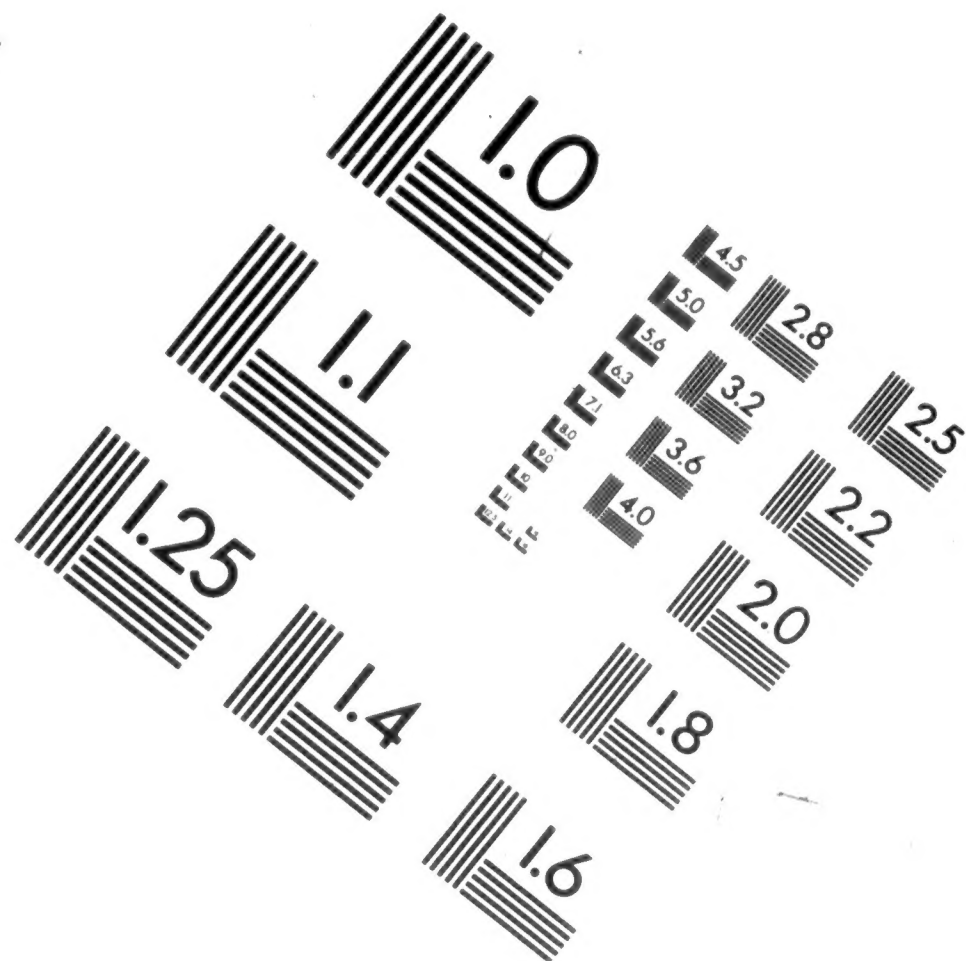
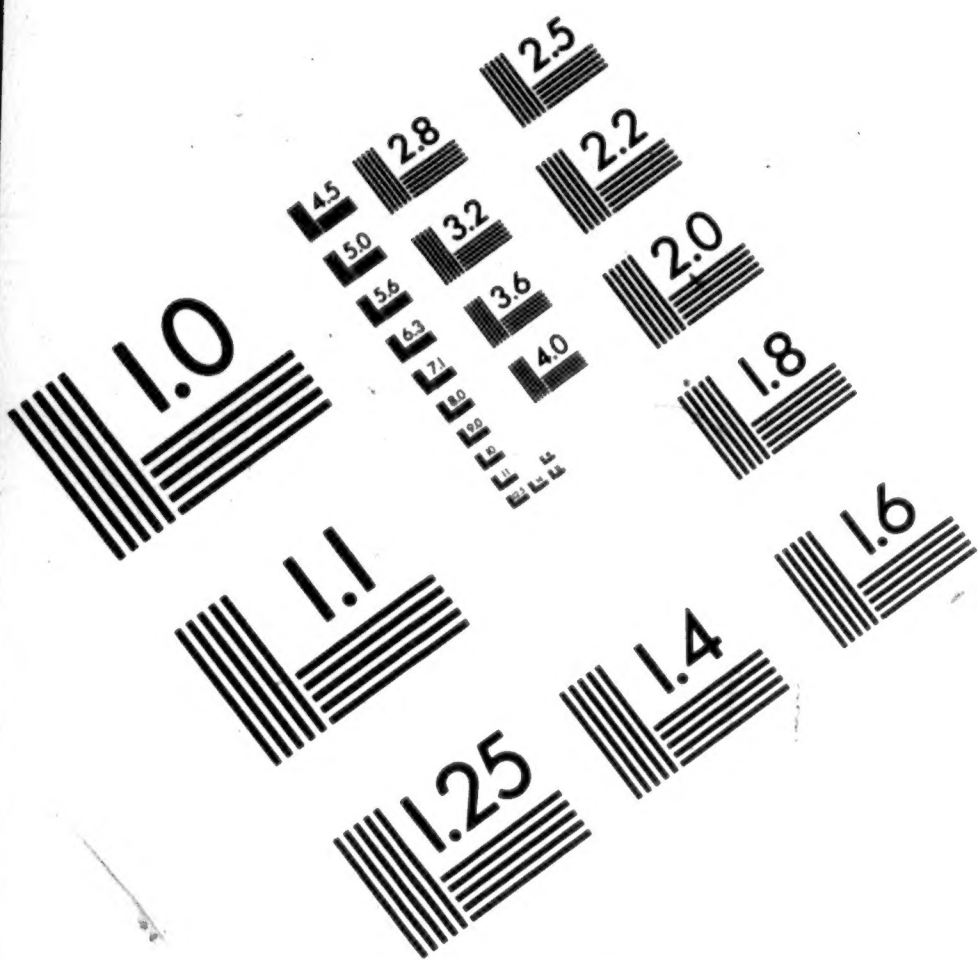

**APPLIED IMAGE, Inc**  
 1653 East Main Street  
 Rochester, NY 14609 USA  
 Phone: 716/482-0300  
 Fax: 716/288-5989

© 1993, Applied Image, Inc., All Rights Reserved

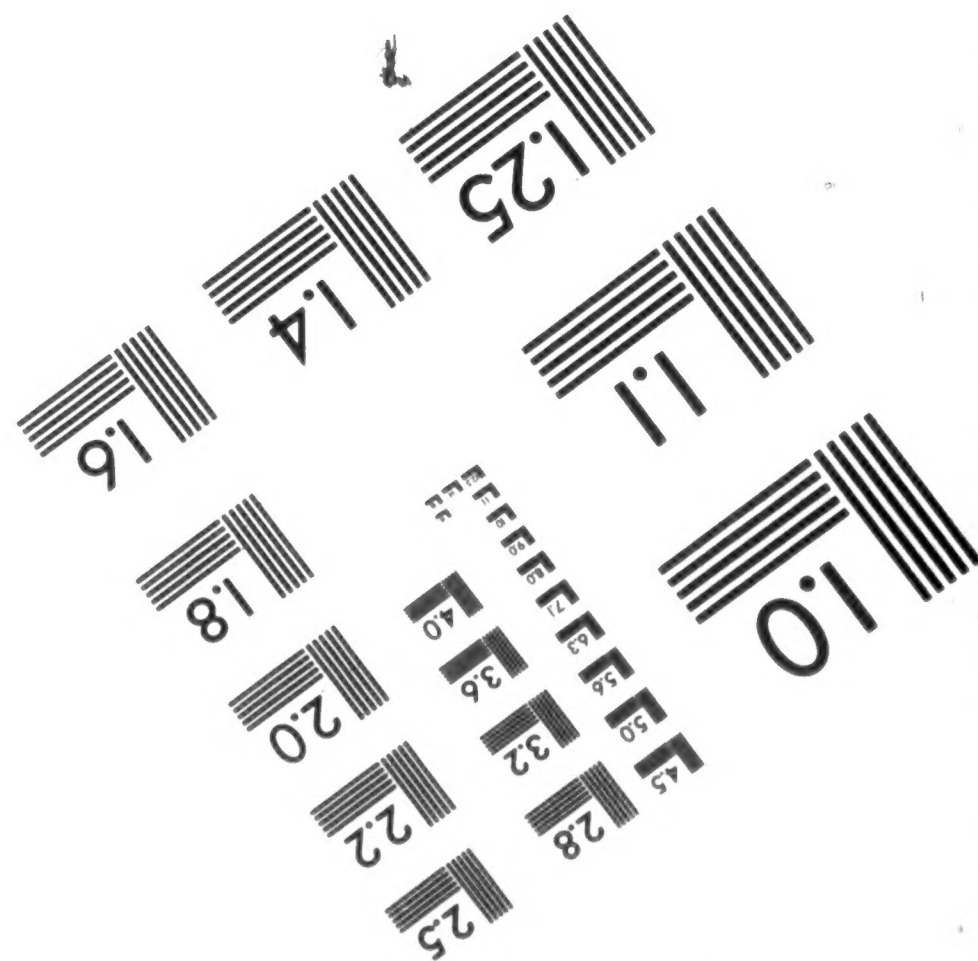
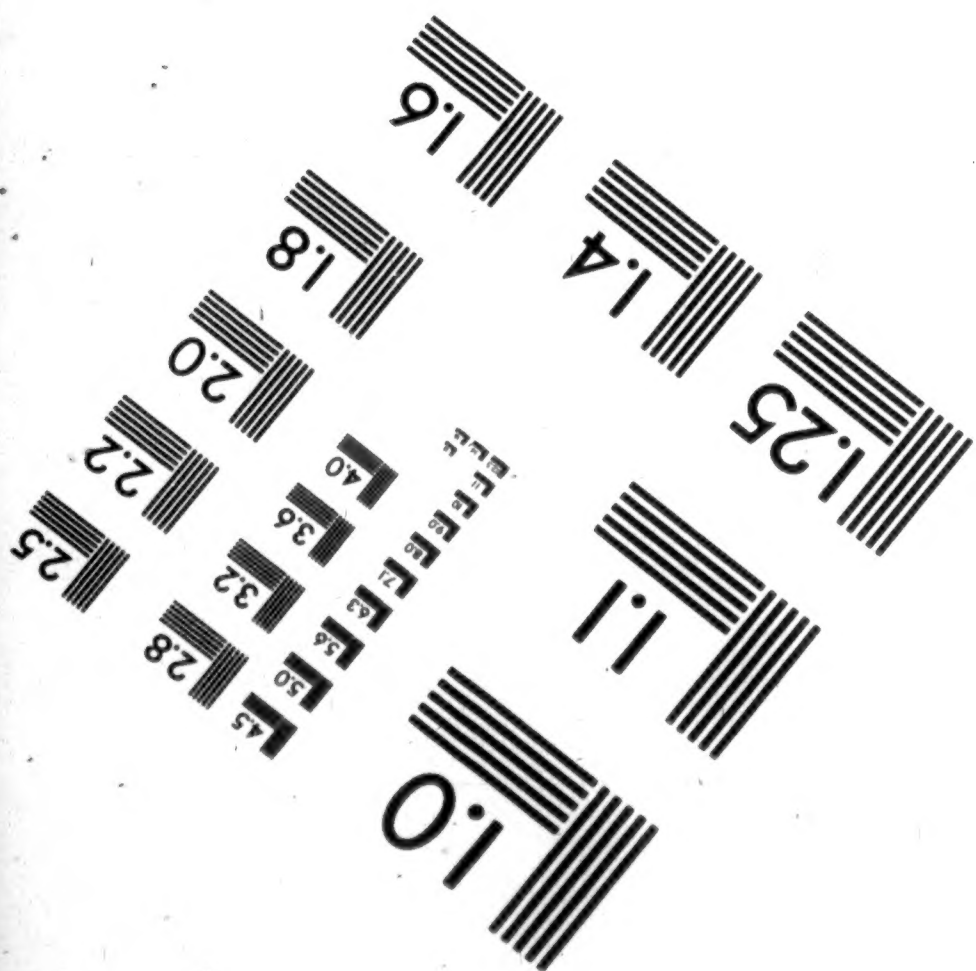



MICROCOPIA

1111

1111

END



Hospital Number 258

Name *C. Harrison*

Age 18 Nativity *Kentucky*

Married or Single *Single*

Residence *Franklin Co. Ky.*

Post Office address of

wife or nearest relative.

Rank *Private* Co. *2* Regiment *1st*

When admitted *November 2, 1861*

From what source *Recruited*

Diagnosis: (in surgical cases, state explicitly seat and character of wound or injury.)

*Wound of the arm*

On what occasion wounded

Date

Nature of missile or weapon

*22* *Branch B. G. H.*  
*Bowling Green, Ky.*

TREATMENT.

[HERE NOTE IMPORTANT COMPLICATIONS AND ALL OPERATIONS.]

---

RESULT AND DATE.

*Admitted July 10 1891*  
*Discharged July 11 1891*  
*at 11:00 A.M.*



Keller, Ephraim  
Co. I, 5 Reg't U.S. Cav

Enclosures.

Bed Cards	Descriptive Lists
Burial Records	Final Statements
Certs. of Dis. for Discharge	Furloughs
C. M. Charges	Med. Des. Lists
Med. Certificates	Orders

Other papers relating to—

Admission to Hosp'l	Furlough
Casualty Sheet (Officer's)	Med. Examination
Confinement	Misc. Information
Contracts	Pay or Clothing
Death or Effects	Personal Reports
Desertions	Rank
Discharge from Hosp'l	Transfer to Hosp'l
Discharge from Service	Transfer to V. R. C.
Duty	Transportation

MARK 1585

JAN. - 9

5368729

1891

147391 - R. & P. D. - 90.

*K* | **5 Cav.** | **U.S.C.T.**

*Ephraim Keller*

*Pvt. Co. D*, 5 Reg't U. S. Col'd Cavalry.

Appears on **Co. Muster-out Roll**, dated

*Helena, Ark, Mch. 16*, 1866.

Muster-out to date *Mch. 16*, 1866.

Last paid to *Dec. 31*, 1865.

**Clothing account:**

Last settled....., 186 ; drawn since \$..... 100

Due soldier \$..... 100; due U. S. \$ *68*<sup>*27*</sup>/<sub>100</sub>

Am't for cloth'g in kind or money adv'd \$..... 100

Due U. S. for arms, equipments, &c., \$..... 100

Bounty paid \$..... 100; due \$..... 100

Remarks:.....

Book mark: *482.625-V168, P204, 73*  
*(over)*

*Crenshaw*

(861)

Copyright.



*A* | **5 Cav. | U.S.C.T.**

*Ephraim Keller*<sup>\*</sup>

....., Co. *D*, 5 Reg't U. S. Colored Cav.

Appears on **Returns** as follows:

*Nov. 1864 to Mar. 1865. Absent  
sick in Gen. Hospital Bowling  
Green, Ky. since Nov 25/64*

*\* Name appears also as Ephraim Kelley*

Book mark : .....

(546)

*Huston*

Copyist.

*K* | **5 Cav.** | **U.S.C.T.**

*Ephraim Kelley*  
*Priv*, Co. I, 5 Reg't U. S. Col'd Cavalry.

Appears on

**Company Muster Roll**

for *Jany. & Feby*, 1866.

Present or absent *Present*

Stoppage, \$ 100 for

Due Gov't, \$ 100 for

Valuation of horse, \$ 100

Valuation of horse equipments, \$ 100

Remarks:

Book mark:

*Creshaw*



*F* | **5 Cav.** | **U.S.C.T.**

*Ephraim Keller*  
....., Co. I, 5 Reg't U. S. Col'd Cavalry.

Appears on

**Company Muster Roll**

for *Nov & Dec* ....., 186*0*.

Present or absent *Present*

Stoppage, \$.....*100* for.....

Due Gov't, \$.....*100* for.....

Valuation of horse, \$.....*100*

Valuation of horse equipments, \$.....*100*

Remarks: *Due us for 64*

Book mark: .....

*Devo*



*16*

**5 Cav. U.S.C.T.**

*Ephraim Keller*  
.....  
*Pr.*, Co. I, 5 Reg't U. S. Col'd Cavalry.

Appears on

**Company Muster Roll**

for *Sept & Oct* ....., 186 *5*.

Present or absent *Present* .....

Stoppage, \$ ..... *100* for .....

Due Gov't, \$ ..... *100* for .....

Valuation of horse, \$ ..... *100*

Valuation of horse equipments, \$ ..... *100*

Remarks: .....

.....

.....

.....

.....

.....

.....

.....

Book mark: .....

.....

..... *[Signature]* .....  
Copyist.

*15* | **5 Cav.** | **U.S.C.T.**

*Ephraim Keller*  
*Pr*, Co. I, 5 Reg't U. S. Col'd Cavalry.

Appears on

**Company Muster Roll**

for *July & Aug*, 1865.

Present or absent *Present*

Stoppage, \$ 100 for

Due Gov't, \$ 100 for

Valuation of horse, \$ 100

Valuation of horse equipments, \$ 100

Remarks:

Book mark:

*Keller*  
(358) Copyist.

*H* | **5 Cav.** | **U.S.C.T.**

*Ephraim Keller*  
*Pr*, Co. I, 5 Reg't U. S. Col'd Cavalry.

Appears on

**Company Muster Roll**

for *May & June*, 186*7*.

Present or absent *Present*

Stoppage, \$ 100 for

Due Gov't, \$ 100 for

Valuation of horse, \$ 100

Valuation of horse equipments, \$ 100

Remarks: *Install bounty due \$100.*

-----  
-----  
-----  
-----  
-----  
-----  
-----

Book mark: -----

*Alfred*  
-----  
Copyist.



*K.* | **5 Cav.** | **U.S.C.T.**

*Ephraim Keller*

*Priv.*, Co. I, 5 Reg't U. S. Col'd Cavalry.

Appears on

**Company Muster Roll**

for *Mch. & Apl.*, 186*5*.

Present or absent *Present*

Stoppage, \$ *100* for

Due Gov't, \$ *100* for

Valuation of horse, \$ *100*

Valuation of horse equipments, \$ *100*

Remarks: *1st installment*  
*Bounty due.*

Book mark:

*Philipson*  
Copyist.

K. | **5 Cav.** | **U.S.C.T.**

Ephraim Keller

Priv., Co. I, 5 Reg't U. S. Col'd Cavalry.

Appears on

**Company Muster Roll**

for Jan. & Feb., 1865.

Present or absent Absent

Stoppage, \$ 100 for

Due Gov't, \$ 100 for

Valuation of horse, \$ 100

Valuation of horse equipments, \$ 100

Remarks: 1<sup>st</sup> & 2<sup>d</sup> installments  
300<sup>x</sup> Bounty due.  
In Gen'l Hospital  
Bowling Green, Ky. Since  
Nov. 25<sup>th</sup>, 1864.

Book mark: \_\_\_\_\_

Philipsen

K. | **5 Cav.** | **U.S.C.T.**

Ephraim Keller

Priv., Co. I, 5 Reg't U. S. Col'd Cavalry.

Appears on

**Company Muster Roll**

for Nov. + Dec., 1864.

Present or absent Absent

Stoppage, \$ 100 for

Due Gov't, \$ 100 for

Valuation of horse, \$ 100

Valuation of horse equipments, \$ 100

Remarks: 1<sup>st</sup> + 2<sup>d</sup> installments

Bounty due. Sick  
in hosp. Bowling  
Green, Ky., Nov. 25<sup>th</sup>/64.

Book mark:

Philipson  
Copyist.

K. | **5 Cav.** | **U.S.C.T.**

Ephraim Keller

Priv., Co. I, 5 Reg't U. S. Col'd Cavalry.

Appears on

**Company Muster Roll**

for organization to Oct. 31, 1864.

Present or absent Present

Stoppage, \$ 100 for

Due Gov't, \$ 100 for

Valuation of horse, \$ 100

Valuation of horse equipments, \$ 100

Remarks:

Book mark:

Philipsen

(358)

Copyist.



5 Cao

K 1

U.S.C.T.

Ephraim Kellar

Appears with rank of *Rec't* on

**Muster and Descriptive Roll**

of a detachment of U.S. Colored Troops forwarded

Roll dated Louisville, Ky, June 25, 1864.

Where born Jefferson Co., Ky

Age 17 years; occupation Farm hand

When enlisted June 25, 1864.

Where enlisted Louisville, Ky

For what period enlisted 3 years.

Eyes Black; hair Black

Complexion Black; height 5 ft 7/4 in.

When mustered in June 25, 1864.

Where mustered in Louisville, Ky

Bounty paid \$ 100; due \$ 100

Clothing account:

Last settled, 186 ; drawn since \$ 100

Date of first muster, 186 .

Company to which assigned

Remarks: 5 Cong. Dist. Ky.

Book mark:

J. B. Dowd

(356m)

Copyist.

K. | 5 Cav. | U. S. C. T.

Ephraim Keller

Priv., Co. I, 5 Reg't U. S. Col'd Cav.

Appears on

**Company Muster-in and Descriptive Roll**  
of the organization named above. Roll dated

Cap. Nelson, Ky., Oct. 31, 1864.

Where born Jefferson, Ky.

Age 17 yrs; occupation Farmer

When enlisted June 25, 1864.

Where enlisted Louisville

For what period enlisted 3 years.

Eyes Black; hair Black

Complexion Black; height 5 ft. 7/4 in.

When mustered in June 25, 1864.

Where mustered in Louisville

Bounty paid \$ 100; due \$ 100

Where credited 5<sup>d</sup> Dist. Kentucky.

Company to which assigned \_\_\_\_\_

Remarks:

Enlisted for 100th U. S. C. T.

Transferred to 5th U. S. C. Cavalry

Aug. 12, 1864, per S. O. 102, Head

Quarters Dist. of Ky. 1 - R. & P. D. 90.  
Book mark: 147 391 - R. & P. D. 90.

Philipson

(356d)

Copyist.

*K* | **5 Cav.** | **U.S.C.T.**

*Ephraim Keller*  
....., Co. *J*, 5 Reg't U. S. Col'd Cav.

Appears on

**Company Descriptive Book**  
of the organization named above.

**DESCRIPTION.**

Age *17* years; height *5* feet *7 1/4* inches.

Complexion *Rosy*

Eyes *Blue*; hair *Blue*

Where born *Jefferson Ky*

Occupation *Farmer*

**ENLISTMENT.**

When *June 25, 1864.*

Where *Louisville*

By whom *Capt. L. Mark*; term *3* y'rs.

Remarks: .....

.....

.....

.....

.....

.....

.....

.....

.....

.....

*A. J. Anderson*



5 Cav.  
No | 108 | U.S.C.T.

Ephraim Keller  
Co. A, 108 Reg't U. S. Col'd Infantry.

Appears on

**Company Descriptive Book**

of the organization named above.

**DESCRIPTION.**

Age 17 years; height 5 feet 5 1/4 inches.

Complexion *Blk.*

Eyes *Blk.*; hair *Blk.*

Where born Jefferson Co. Ky.

Occupation *Farmer*

**ENLISTMENT.**

When June 28<sup>th</sup>, 1864.

Where Louisville

By whom *Capt Womack*, term 3 y'rs

Remarks:

Enlisted for 103th U. S. C. T.  
and transferred to 5th. U. S. C. Cavalry  
April 2, 1864. per S. O. 192. Head  
Quarters Dist. of Ky.

*D. M. Kennedy*

753  
Keller, Ephraim

Co. d, 5 U. S. Col'd Cav.

Private

Private

CARD NUMBERS.

1	5367822	26
2	5367915	27
3	5368016	28
4	5368108	29
5	5368200	30
6	5368295	31
7	5368386	32
8	5368474	33
9	5368560	34
10	5368647	35
11	5368729	36
12	9090984	37
13	9221625	38
14	43142960	39
15	40730006	40
16		41
17		42
18		43
19		44
20		45
21		46
22		47
23		48
24		49
25		50

Book Mark:

See also



PROOF OF OWNERSHIP.

State of Kentucky,

County of Jefferson } ss.

We, Martha McDonald and L. D. Pearson each of lawful age, and resident citizens of the State and County aforesaid, do certify that Louisa R. Glafé of the State and County aforesaid, was on the 5<sup>th</sup> day of September 1864 the lawful owner of the Slave named John H. Keen referred to and described in the foregoing claim for compensation, & that she had owned him from his birth he being borne by a slave woman in her possession.

Two witnesses to ownership sign here.

Martha McDonald,  
L. D. Pearson

Sworn to and subscribed before me, a Notary Public for the County of Jefferson State of Kentucky, this the 4<sup>th</sup> day of January, 1867

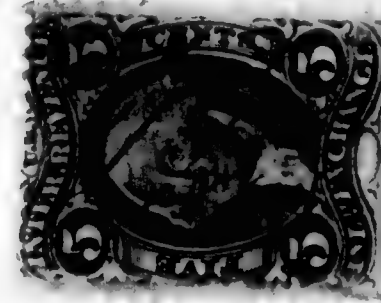

The officer swearing the witnesses signs here.

F. W. Gibson  
Notary Public

L. S.

PROOF OF LOYALTY.

State of Kentucky,

County of Jefferson } ss.

We, Martha McDonald and L. D. Pearson loyal men, and each of lawful age, and resident citizens of the city of Louisville in the State and County aforesaid, upon our oaths declare that we have known Louisa R. Glafé a resident of the State and County aforesaid, since the 4th day of March, 1861, and know that she has firmly and faithfully maintained her adherence and allegiance to the Government of the United States, by defending its cause against the Government and forces of the so-called Confederate States of America, in all suitable and practicable ways, and according to her ability and opportunity.



Martha McDonald,  
L. D. Pearson

Sworn to and subscribed before me, a Notary Public for the County of Jefferson State of Kentucky this fourth day of January 1867

The officer swearing the witnesses signs here.

F. W. Gibson  
Notary Public

L. S.

We, Chas. Southwick and J. S. Morris each of us residents of the County of Jefferson in the State of Kentucky

on oath state that we are and have been for years well acquainted with Louisa R. Glafé the applicant, and Martha McDonald and Louisa R. Glafé her witnesses, and from our personal acquaintance with them believe their statements to be entitled to full faith and credit.

Chas. Southwick  
J. S. Morris

Sworn to and subscribed before me, a Notary Public for the County of Jefferson State of Kentucky this 4<sup>th</sup> day of January 1867

5 CENT STAMP

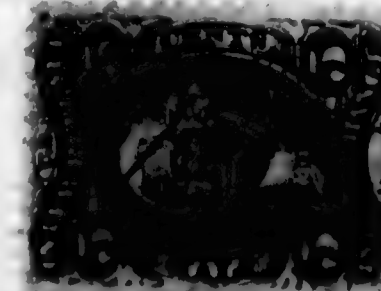

F. W. Gibson  
Notary Public

NOTE.—If the applicant and his witnesses are not personally known to one or more of the Commissioners, the above certificate should be signed by two citizens who are well known to the Commissioners, or by a Post Master or other Government officer; if signed by a United States officer it need not be sworn to, but if by citizens it must be sworn to. When a United States officer signs it the witnesses need not, and when the witnesses sign it the United States officer need not.

Certificate of Award of the Board of Claims.

OFFICE OF THE BOARD OF CLAIMS,  
For Slaves Enlisted or Drafted in the Service of the United States.

We hereby certify, that

County, State of

186

having proved, under oath, loyalty to the Constitution and Government of the United States, and established title as to the ownership of

a Slave enlisted or drafted (as the case may be) and mustered at

on the day of

in the service of the United States, in the Regiment

of Colored Troops, Co. the sum of

dollars has been awarded

to by this Board, subject to the approval of the Secretary of War as a compensation for the said Slave, under the provisions of Section 24, Act approved February 24, 1864, and Section 2, Act approved July 28, 1866.

President of the Board.

Member of the Board.

Member of the Board.

Chief of the Bureau for the Organization of Colored Troops,  
Washington, D. C.



# CLAIM FOR COMPENSATION FOR ENLISTED SLAVE.

No.

I, Louisa R. Glass, a loyal citizen, and  
 a resident of Louisville County of Jefferson State of  
Kentucky, hereby claim compensation, under the provisions of

section 24, Act approved February 24, 1864, and Section 2, Act approved July 28, 1866, for my  
 slave John H. Keen enlisted September 5<sup>th</sup>

1864, at Louisville Kentucky by Capt. G. C. Ham of the  
13, Regt. Ky. Inftry. Recruiting <sup>officer</sup> in the 5<sup>th</sup> Cavalry Regiment U. S. Colored Troops,  
 Co. A

certificate of enlistment, and a descriptive list, as required, accompany  
 this application. I have owned the said John H. Keen from his birth  
as my slave, until enlistment.

In proof of my loyalty to the Constitution and Government of the United States, I present  
 the accompanying oath, which I have taken, signed and acknowledged; to be filed with this  
 application, in accordance with requirement of General Orders, No. 329, 1863, War Department,  
 Adjutant General's Office.

Louisa R. Glass  
Applicant.

Witness: Henry S. Aourse

James Smith  
January 14 } Two witnesses to  
 1867 } owner's signature  
 sign here.

## OATH OF ALLEGIANCE.

I, Louisa R. Glass, the owner and claimant, do solemnly swear that the foregoing  
 claim is a just and true claim due to me as master and owner of the said slave, and that the facts alleged in said claim, in respect to the  
 draft or enlistment (as the case may be) of said slave into the military service of the United States, are true. And I do further swear that I  
 have never joined, or been concerned in, any insurrection or rebellion; that I have never borne arms against the United States; that I have  
 never given any aid, countenance, counsel or encouragement, to any person or persons engaged, or whom I had reason to believe were about to  
 engage, in insurrection, rebellion, or armed hostility against the United States; that I have neither sought, nor accepted, nor attempted to  
 exercise the functions of any office, civil or military, nor to perform any service whatever, under any authority, or pretended authority, in  
 hostility to the United States; that I have not yielded a voluntary support to any insurrection, rebellion, or pretended government  
 authority, power or constitution within the United States hostile thereto. And I do further swear that, to the best of my knowledge and  
 have supported and defended, and will continue to support and defend, the United States against all enemies foreign and domestic,  
 have supported, defended and obeyed, and will continue to support, defend and obey, the Constitution and laws of the United States;  
 bear true faith and allegiance to the same; and that I take this oath freely, without any mental reservation or purpose of  
 So help me God.



AMP. Henry S. Aourse The owner }  
 signs here. } Louisa R. Glass

Sworn to and subscribed before me a Notary Public  
 this fourth day of January 1867

The officer swear- }  
 ing the owner signs } John W. Gibson  
 here. } Notary Public { L. S. }

Know all men by these Presents, that I, Louisa R. Glass of Louisville, Jefferson  
 County, State of Kentucky do hereby constitute and appoint, with full power of  
 substitution and revocation, H. W. Carr of the City of Louisville, in the County of Jefferson, State of Kentucky, my  
 true and lawful Attorneys, irrevocable, to prosecute my claims against the United States Government, for slave named John  
H. Keen and to receive and receipt for all orders or certificates that may be issued in payment thereof

Witness: Henry S. Aourse Louisa R. Glass  
 Applicant.



### DIRECTIONS FOR FILLING UP THE ABOVE BLANKS.

1. Name of slave, and the time application is made.  
 2. Name of city or town in which claimant lives.  
 3. Name of county in which claimant lives.  
 4. Name of State in which claimant lives.  
 5. Name of slave for whom compensation is claimed.  
 6. Date of his enlistment.  
 7. Where he enlisted.  
 8. By whom he was enlisted.  
 9. Number of Regiment to which he was assigned.  
 10. Letter of Company he served in.
- NOTE.—Where there is a doubt as to the fact stated in a blank, do not fill the blank.



War Department,

ADJUTANT GENERAL'S OFFICE,

Washington, *Mar 5 1867*

Respectfully returned to the Commission for the State of Kentucky, with the information that *John H. Keen* was enlisted at Louisville Ky September 5 1864 and was mustered in as sergt in Co "A" 5<sup>th</sup> U.S.C. Cav. Sept 5, 1864,

*5-1460 Ky*

*A. F. Rowan*

Asst. Adj't General.

*D.A.B.*

*State of Kentucky }  
County of Jefferson } for.*

*I certify that J. H. Gibson attous and affidavits were made, authorized to administer oaths, and*

*in witness whereof I have here seal this fourth day of March*

*John H. Keen*



**ENDORSEMENT.**

No. \_\_\_\_\_

APPLICATION OF

*Louisa R. Glafs.*

OF  
*Louisville, Kentucky*

For compensation of service of slave,

*John H. Keen*

Enlisted *September 5<sup>th</sup>* 1864

in *A. Co. 5<sup>th</sup> Cavalry* Regiment  
U. S. Colored Troops.

Received *Jan'y 30* 1867

Compensation awarded

186

Dollars.

President Board of Claims.

CLAIMANT'S ATTORNEYS,

*H. M. Carr*  
*Louisville Ky*

CLAIMANT'S P. O. ADDRESS,

*Louisville*  
*Kentucky*



State of Kentucky }  
County of Jefferson } S.S.

Before me F. W. Gibson a Notary Public in and for the County and State aforesaid, and duly authorized to administer oaths, personally appeared John H. Keen who being duly sworn according to law on his oath declares that he enlisted in Co. "H" of the 5th Regt. U. S. Colored Cavalry on the 5th day of September 1864, for a period of 3 years. And was honorably discharged therefrom as a 1st Sergeant, on the 16th day of March 1866, at Helena Ark. on account of the Government no longer requiring his services. That he was born the slave of Louisa R. Glass and remained her slave until the date of his enlistment aforesaid. That she was loyal to the United States Government during the whole of the war of the Rebellion, actively so, and her son was a Private of Co. "I" 5th Regt. Ky. Vol. Inftry.

Attest

Henry S. Hourse  
J. W. H. Keen

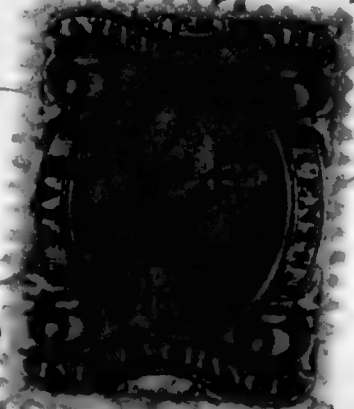

John H. Keen  
mark

Sworn to and subscribed before me at my office in Louisville Ky.

This 16th day of November 1866.

F. W. Gibson  
Notary Public



State of Kentucky  
Jefferson County

I certify that F. H. Gibson, before whom  
the foregoing declaration and affidavit were made  
is a Notary Public duly authorized to administer  
oaths, and that the signature on the foregoing  
page is true and genuine as his signature.

In witness whereof I have hereunto  
set my hand and official seal this the  
day of                      a. d. 186

clerk  
Jefferson County Court

# UNITED STATES COLORED TROOPS ENLISTMENT.

STATE OF

TOWN OF

*Kentucky*  *Searsville*

I, *John H. Heen*, born in *Jefferson Co*  
in the State of *Kentucky* aged *22* years  
and by occupation a *Farmer* Do, HEREBY ACKNOWLEDGE to  
have volunteered *5<sup>th</sup>* day of *September* 1864

to serve as a **Soldier** in the **Army of the United States of America**, for the  
period of **THREE YEARS**, unless sooner discharged by proper authority: Do  
also agree to accept such bounty, pay, rations, and clothing, as are, or may be,  
established by law for the U. S. colored troops.

And I, *John H. Heen*  
do solemnly swear that I will bear true faith and allegiance to the **United States  
of America**, and that I will serve them honestly and faithfully against all their  
enemies or opposers whomsoever; and that I will observe and obey the orders  
of the President of the United States, and the orders of the officers appointed  
over me, according to the Rules and Articles of War.

Sworn and subscribed to, at *Searsville*  
this *5<sup>th</sup>* day of *Sept 1864* *John H. Heen*  
Before *Capt W. H. Hager* *mark*  
*12" High*

I CERTIFY, ON HONOR, That I have carefully examined the above named Volunteer agree-  
ably to the General Regulations of the Army, and that, in my opinion, he is free from all bodily  
defects and mental infirmity, which would in any way disqualify him from performing the  
duties of a soldier.

(Signed) *W. H. Hager*  
*Adj. Supt Surgeon*  
EXAMINING SURGEON

I CERTIFY, ON HONOR, That I have minutely inspected the Volunteer, *John H. Heen*,  
previously to his enlistment, and that he was entirely sober when enlisted, that, to the best of  
my judgment and belief, he is of lawful age; and that, in accepting him, as duly qualified to per-  
form the duties of an able-bodied soldier, I have strictly observed the regulations which govern  
the recruiting service. This soldier has *black* eyes, *black* hair, *black* com-  
plexion, is *5'* feet *8 1/2* inches high.

(Signed) *W. H. Hager*  
*12" High*  
RECRUITING OFFICER OR AGENT.

Mustered into the United States Service *5<sup>th</sup>* day of *Sept* 1864.

(Signed) *J. A. Smith*  
Mustering Officer.

Mustered into the service of the United States, for three years or during the war, from date of enlistment, in Company  
..... Regiment of ..... Volunteers, on the *5<sup>th</sup>* day of *Sept* 1864, at *Searsville*  
*John H. Heen*

*W. H. Hager*  
*John H. Heen*



**NOTE 1.**—This blank will be used for enlistments of United States colored troops. They will be made out in duplicate in all cases—one to accompany the recruiting return of the superintendent (not the recruiting officer) to the Adjutant General, and one to accompany the accounts of the officer who pays bounty, &c.

**NOTE 2.**—An enlistment holds to service. A muster-in must, in all cases, precede payment of pay, bounty, pension, &c. A muster-in roll, must in all cases, be filed in the Adjutant General's Office as evidence of muster-in. The mustering officer, commissary, or assistant commissary of musters, as the case may be, will countersign both enlistments as having mustered the soldiers into the service of the United States before either of them is given to the disbursing officer.

DECLARATION OF RECRUIT.

I, John H Keen ..... desiring to volunteer as a soldier in the ARMY OF THE UNITED STATES, for the term of *Three Years*, DO DECLARE That I am 22 years and ..... months of age; that I have never been discharged from the United States service on account of disability or by sentence of court-martial, or by order before the expiration of a term of enlistment; and I know of no impediment to my serving honestly and faithfully as a soldier for three years.

GIVEN at Louisville Ky the 5<sup>th</sup> day of Sept 1864

Witness:

Signed J. H. Harrison

John H Keen

Enlistment at  
No. ....

Consent of Parent or Guardian in case of a Minor, if a Free Man, or in the case of a Slave, of the Person to whom he owes Service:

I, ..... DO CERTIFY, That I am the ..... that the said ..... is ..... years of age; and I do freely give my CONSENT to his volunteering as a SOLDIER in the Army of the United States, for the period of THREE YEARS, under the conditions of the laws of the United States.

GIVEN at ..... the ..... day of .....

Witness:



# UNITED STATES COLORED TROOPS ENLISTMENT.

STATE OF

TOWN OF

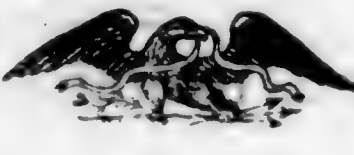
*Kentucky*  *Louisville*

I, *John W Keen* born in *Jefferson, Co*  
in the State of *Kentucky* aged *Twenty two* years  
and by occupation a *Laborer* Do HEREBY ACKNOWLEDGE to  
have volunteered *5<sup>th</sup>* day of *Sept* 1864

to serve as a **Soldier** in the **Army of the United States of America**, for the  
period of **THREE YEARS**, unless sooner discharged by proper authority: Do  
also agree to accept such bounty, pay, rations, and clothing, as are, or may be,  
established by law for the U. S. colored troops.

And I, *John W Keen*  
do solemnly swear that I will bear true faith and allegiance to the **United States  
of America**, and that I will serve them honestly and faithfully against all their  
enemies or opposers whomsoever; and that I will observe and obey the orders  
of the President of the United States, and the orders of the officers appointed  
over me, according to the Rules and Articles of War.

Sworn and subscribed to, at *Louisville*  
this *5<sup>th</sup>* day of *Sept 1864* *John W Keen*  
Before *Capt C C Keam* *mark*  
*12<sup>th</sup> Ky Coy*

I CERTIFY, ON HONOR, That I have carefully examined the above named Volunteer agree-  
ably to the General Regulations of the Army, and that, in my opinion, he is free from all bodily  
defects and mental infirmity, which would in any way disqualify him from performing the  
duties of a soldier.

*Wm R Van Hook*  
*A. A. Ferguson*

EXAMINING SURGEON.

I CERTIFY, ON HONOR, That I have minutely inspected the Volunteer,.....  
previously to his enlistment, and that he was entirely sober when enlisted; that, to the best of  
my judgment and belief, he is of lawful age; and that, in accepting him, as duly qualified to per-  
form the duties of an able-bodied soldier, I have strictly observed the regulations which govern  
the recruiting service. This soldier has *Black* eyes, *Black* hair, *Yellow*  
plexion, is *5* feet *8 1/2* inches high.

*C C Keam Capt*  
*12<sup>th</sup> Ky Coy*  
RECRUITING OFFICER OR AGENT.

Mustered into the United States Service..... *5<sup>th</sup>* day of *Sept* 1864

*Mrs L B Glass, P. O. Co*  
*J. P. Smith Capt*  
Mustering Officer.

Mustered into the service of the United States, for three years or during the war, from date of enlistment, in Company .....  
Regiment of ..... Volunteers, on the ..... day of ..... 1864, at .....

NOTE 1.—This blank will be used for enlistments of United States colored troops. They will be made out in duplicate in all cases—one to accompany the recruiting return of the superintendent (not the recruiting officer) to the Adjutant General, and one to accompany the accounts of the officer who pays bounty, &c.

NOTE 2.—An enlistment holds to service. A muster-in must, in all cases, precede payment of pay, bounty, pension, &c. A muster-in roll, must in all cases, be filed in the Adjutant General's Office as evidence of muster-in. The mustering officer, commissary, or assistant commissary of muster-in, as the case may be, will countersign both enlistments as having mustered the soldiers into the service of the United States before either of them is given to the disbursing officer.

DECLARATION OF RECRUIT.

I, John W. Keen..... desiring to volunteer as a soldier in the ARMY OF THE UNITED STATES, for the term of Three Years, DO DECLARE That I am 18 years and ..... months of age; that I have never been discharged from the United States service on account of disability or by sentence of a court-martial, or by order before the expiration of a term of enlistment; and I know of no impediment to my serving honestly and faithfully as a soldier for three years.

GIVEN at Leicester, Ky the 5<sup>th</sup> day of Sept 1864

Witness:

G. W. Stites

John W. Keen  
mark

Volunteered at Leicester, Ky  
By John W. Keen  
Sept 5 1864  
John W. Keen

One hundred and eighty seven

Consent of Parent or Guardian in case of a Minor, if a Free Man, or in the case of a Slave, of the Person to whom he owes Service:

I, ..... Do CERTIFY, That I am the ..... that the said ..... is ..... years of age; and I do freely give my CONSENT to his volunteering as a SOLDIER in the Army of the United States, for the period of THREE YEARS, under the conditions of the laws of the United States.

GIVEN at ..... the ..... day of .....

Witness:



MICROFILM PUBLICATION M 1821

COMPILED MILITARY SERVICE RECORDS  
OF VOLUNTEER UNION SOLDIERS WHO  
SERVED WITH THE USCT (US COLORED TROOPS)  
5TH REGIMENT OF CAVALRY

PERSONAL PAPERS' TARGET SHEET

PLEASE NOTE THE CHECKED INFORMATION ABOUT THE PERSONAL PAPERS IN  
THIS FILE:

- NO PERSONAL PAPERS WERE FOUND IN THIS FILE WHEN THE  
RECORDS WERE ARRANGED FOR MICROFILMING.
- 4 PERSONAL PAPER(S) FOUND IN THIS FILE WHEN THE RECORDS  
WERE ARRANGED FOR MICROFILMING.



*Keen* *John H.*  
 \_\_\_\_\_, Co. \_\_\_\_\_, Reg't *USCIS*

*2* Enclosures.

Bed Cards .....	Final Statements .....
Burial Records .....	Furloughs or L. of A .....
Certs. of Dis. for Discharge .....	Med. Certificates .....
C. M. Charges .....	Med. Des. Lists .....
Descriptive Lists .....	Orders .....
Discharge Certificates .....	Pris. of War Record .....
Enlistment Papers / .....	Resignations .....

Other papers relating to—

Admission to Hosp'l .....	Furlough or L. of A .....
Casualty Sheet .....	Med. Examination / .....
Confinement .....	Misc. Information .....
Contracts .....	Pay or Clothing .....
Death or Effects .....	Personal Reports .....
Desertion .....	Rank .....
Discharge from Hosp'l .....	Transfer to Hosp'l .....
Discharge from Service .....	Transfer to V. R. C. .....
Duty .....	Transportation .....

K | 5 Cav | U.S.C.T.

John H Keene  
Rgt, Co. A, 5 Reg't U. S. Col'd Cav

Appears on Co. Muster-out Roll, dated  
Helena Ark March 16, 1866.

Muster-out to date March 16, 1866.

Last paid to Dec 31, 1865.

Clothing account:

Last settled \_\_\_\_\_, 186 ; drawn since \$ \_\_\_\_\_  $\frac{100}{100}$

Due soldier \$ \_\_\_\_\_  $\frac{100}{100}$ ; due U. S. \$ 29<sup>34</sup>  $\frac{100}{100}$

Am't for cloth'g in kind or money adv'd \$ \_\_\_\_\_  $\frac{100}{100}$

Due U. S. for arms, equipments, &c., \$ 90  $\frac{100}{100}$

Bounty paid \$ 100  $\frac{100}{100}$ ; due \$ 100  $\frac{100}{100}$

Remarks: Recd from Or g.  
of Co to Nov 17, 65, then  
1st Regt. Due U.S. for  
Ord 90 cts.

Book mark: G 1460 Ky

W Mayre

(361)

Copyist.

*K* | **5 Cav. | U.S.C.T.**

*John W Keene*  
*Sergeant*, Co. *A*, 5 Reg't U. S. Colored Cav.

Appears on **Returns** as follows:

*Mar 1865 Absent sick in Genl  
Hospl Camp Nelson, Ky*

Book mark :

(546)

*J. Austin*

Copyist.



K | **5 Cav.** | **U.S.C.T.**

John H. Keene  
1 Regt, Co. A, 5 Reg't U. S. Col'd Cavalry.

Appears on

**Company Muster Roll**  
for Jan & Feb, 1866  
Present or absent Present

Stoppage, \$.....100 for.....

Due Gov't, \$.....100 for.....

Valuation of horse, \$.....100

Valuation of horse equipments, \$.....100

Remarks:.....  
.....  
.....  
.....  
.....  
.....  
.....  
.....

Book mark:.....

M Wayne  
(358) Copyist.

K | 5 Cav. | U.S.C.T.

J. H. Keen  
1st Sgt, Co. A, 5 Reg't U. S. Col'd Cavalry.

Appears on

**Company Muster Roll**

for Nov & Dec, 1865.

Present or absent Present

Stoppage, \$ 100 for

Due Gov't, \$ 100 for

Valuation of horse, \$ 100

Valuation of horse equipments, \$ 100

Remarks up't 1 Reg't from  
Reg't as per R.O.  
No 181

Book mark:

W. Sayre  
Copyist.



5 Cav. U.S.C.T.

*John S. [unclear]*  
Sgt., Co. A, 5 Reg't U. S. Col'd Cavalry.

Appears on

**Company Muster Roll**

for *dated Oct. 31*, 186*5*.

Present or absent *(Present)*

Stoppage, \$ 100 for

Due Gov't, \$ 100 for

Valuation of horse, \$ 100

Valuation of horse equipments, \$ 100

Remarks:

Book mark:

*[Signature]*  
Copyist.

5 Cav. U.S.C.T.

*John J. Allen*  
Sergeant; Co. A, 5 Reg't U.S. Col'd Cavalry.

Appears on

Company Muster Roll

for *W. J. Allen*, 1865.

Present or absent *Present*

Stoppage, \$ 100 for

Due Gov't, \$ 100 for

Valuation of horse, \$ 100

Valuation of horse equipments, \$ 100

Remarks:

Book mark:

(358)

*J. J. Allen*  
Sergeant



1865

**5 Cav. U.S.C.T.**

*K*  
*John S. Keene*  
*Serjt.*

Co. A, 5 Reg't U. S. Col'd Cavalry.

Appears on

**Company Muster Roll**

for *May 1865*, 186*5*.

Present or absent *Present*

Stoppage, \$ *100* for

Due Gov't, \$ *100* for

Valuation of horse, \$ *100*

Valuation of horse equipments, \$ *100*

Remarks: *At installation  
bonded all \$ 50*

Book mark:

*Keene*

(358)

Copyist.

5 Cav. U.S.C.T.

John H. Keene  
Sergeant; Co. A, 5 Reg't U. S. Col'd Cavalry.

Appears on

Company Muster Roll

for Dec 1st 1865

Present or absent Present

Stoppage, \$ 100 for

Due Gov't, \$ 100 for

Valuation of horse, \$ 100

Valuation of horse equipments, \$ 100

Remarks: Desertion  
for arrears due \$ 50

Book mark:

J. M. Alby  
Company



*2* | **5 Cav.** | **U.S.C.T.**

*John H. Keene*

*Serjeant*, Co. A, 5 Reg't U. S. Col'd Cavalry.

Appears on

**Company Muster Roll**

for *Jan & Feb*, 186*5*.

Present or absent *absent*.

Stoppage, \$ *100* for

Due Gov't, \$ *100* for

Valuation of horse, \$ *100*

Valuation of horse equipments, \$ *100*

Remarks: *In Genl. Report,*  
*Camp Nelson Va.*  
*1<sup>st</sup> installment Bounty*  
*\$100.*

Book mark:

*Castling*

(358)

Copyist.

*H* | **5 Cav.** | **U.S.C.T.**

*John H. Keen*

*Sgt*, Co. A, 5 Reg't U.S. Col'd Cavalry.

Appears on

**Company Muster Roll**

for *Nov. & Dec.*, 1864.

Present or absent *Present*.

Stoppage, \$ *100* for

Due Gov't, \$ *100* for

Valuation of horse, \$ *100*

Valuation of horse equipments, \$ *100*

Remarks: *1<sup>st</sup> and 2<sup>d</sup> instalment  
Bounty paid.*

Book mark: \_\_\_\_\_

(358)

*E. A. ...*  
Copyist.



K | **5 Cav.** | **U.S.C.T.**

*John H. Keen*  
Sergeant, Co. A, 5 Reg't U. S. Col'd Cavalry.

Appears on

**Company Muster Roll**

for *to Oct 31*, 186*4*.

Present or absent *Present*

Stoppage, \$ 100 for

Due Gov't, \$ 100 for

Valuation of horse, \$ 100

Valuation of horse equipments, \$ 100

Remarks:

Book mark:

(358)

*Castellina*  
Copyist.

R | 5 bar | U.S.C.T.

John H. Keen

Appears with rank of Private on

**Muster and Descriptive Roll**

of a Detachment of U.S. Colored  
Recruits mustered for the Dept. of D.C.

at Taylor Bks. Louisville. Ky. Roll dated  
Louisville. Ky., Sept. 5, 1864.

Where born Jefferson. Ky.

Age 18 years; occupation Laborer

When enlisted Sept. 5, 1864.

Where enlisted Louisville. Ky.

For what period enlisted 3 years.

Eyes Dark; hair Dark

Complexion Dark; height 5 ft. 8 1/2 in.

When mustered in Sept. 5, 1864.

Where mustered in Louisville. Ky.

Bounty paid \$ 100; due \$ 100

Clothing account:

Last settled \_\_\_\_\_, 186 ; drawn since \$ 100

Date of first muster \_\_\_\_\_, 186 .

Company to which assigned \_\_\_\_\_

Remarks: Co to Jefferson Co. 5 Dist

\_\_\_\_\_

\_\_\_\_\_

\_\_\_\_\_

\_\_\_\_\_

Book mark: \_\_\_\_\_

\_\_\_\_\_

\_\_\_\_\_

\_\_\_\_\_

\_\_\_\_\_

\_\_\_\_\_

\_\_\_\_\_

\_\_\_\_\_

\_\_\_\_\_

\_\_\_\_\_

\_\_\_\_\_

\_\_\_\_\_

\_\_\_\_\_

\_\_\_\_\_

\_\_\_\_\_

\_\_\_\_\_

\_\_\_\_\_

A. J. Stinson

*H* | **5 Cav.** | **U.S.C.T.**

*John H. Keen*

*Sergt.*, Co. *A*, 5 Reg't U. S. Col'd Cavalry.

Appears on

**Company Muster-in and Descriptive Roll**  
of the organization named above. Roll dated

*Lep. Nelson Ky.*, ~~N.Y.~~, *Oct. 24*, 1864.

Where born *Jefferson Kentucky*

Age *20* y'rs; occupation *Laborer*

When enlisted *Sept. 5*, 1864.

Where enlisted *Louisville Ky.*

For what period enlisted *3* years.

Eyes *Blk*; hair *Blk*

Complexion *Blk*; height *5 ft. 7 1/2 in.*

When mustered in *Sept. 5*, 1864.

Where mustered in *Louisville*

Bounty paid \$ *100*; due \$ *100*

Where credited *5th District Kentucky*

Company to which assigned *A*

Remarks:

Book mark:

*E. A. [Signature]*  
(356d) Copyist.



*OK* | **5 Cav. | U.S.C.T.**

*John M. Keene*

....., Co. *A*, 5 Reg't U. S. Col'd Cav.

Appears on

**Company Descriptive Book**  
of the organization named above.

**DESCRIPTION.**

Age *20* years; height *5* feet *11 1/2* inches.

Complexion *Dark*

Eyes *OK*; hair *OK*

Where born *Jefferson Co Ky*

Occupation *Labourer*

**ENLISTMENT.**

When *Sept. 5*, 186 .

Where *Louisville*

By whom *Capt. Ham.*; term *3* y'rs.

Remarks: .....

.....  
.....  
.....  
.....  
.....  
.....  
.....  
.....

*Warren*



*Keen John H*

Co. A., 5 U. S. Col'd Cav.

*Sergeant* | *Sergeant*

CARD NUMBERS.

1	5359584	26
2	5359686	27
3	5359788	28
4	5359889	29
5	5359985	30
6	5360079	31
7	5360167	32
8	5360262	33
9	5360352	34
10	5360441	35
11	5360528	36
12	9090029	37
13	43146362	38
14	40730007	39
15		40
16		41
17		42
18		43
19		44
20		45
21		46
22		47
23		48
24		49
25		50

Book Mark:

See also



*Handwritten initials*  
LBR

1st Ind.

War Dept., A.G.O., Oct. 4, 1915-To the Governor, National Military Home,  
Montgomery County, Ohio.

(Attach this end.)

The records of this office show that Jordan Turner, Company A, 5th U.S.  
Colored Cavalry, was mustered into service September 14, 1864, and that he  
was honorably discharged March 16, 1866, as a private.

*Handwritten signature*  
The Adjutant General.

Statement of Service Reference Slip.

*Turner Jordan*  
(Name.)  
*Co A 5 USC Cal*  
(Rank and organization.)

Request for military record of the above-named by applicant whose name and address are shown by attached carbon copy of answer.

The above named  
Enrolled Sept 13. 1864  
for 3 yrs  
M.S. Sept 14. 64 as  
Pvt Co A 5 USC Cal.  
M.O. with Co Mch 16. 1866  
as Pvt  
10 65  
10-4-15  
Johnson  
M.S.

MARK 1368

# UNITED STATES COLORED TROOPS ENLISTMENT.

STATE OF

TOWN OF

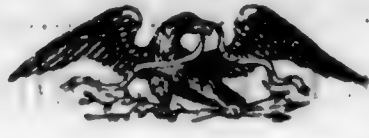

*Kentucky* *Lancaster*

I, *James Jordan* born in *Hammond*

in the State of *Ky* aged *22* years

and by occupation a *Laborer* Do HEREBY ACKNOWLEDGE to

have volunteered \_\_\_\_\_ day of \_\_\_\_\_ 186 ,

to serve as a **Soldier** in the **Army of the United States of America**, for the period of **THREE YEARS**, unless sooner discharged by proper authority: Do also agree to accept such bounty, pay, rations, and clothing, as are, or may be, established by law for the U. S. colored troops.

And I, *James Jordan* do solemnly swear that I will bear true faith and allegiance to the **United States of America**, and that I will serve them honestly and faithfully against all their enemies or opposers whomsoever; and that I will observe and obey the orders of the President of the United States, and the orders of the officers appointed over me, according to the Rules and Articles of War.

Sworn and subscribed to, at *Lancaster*

this *13* day of *Sept* 186*4* *James Jordan*

Before *Wm C. Stewart*

I CERTIFY, ON HONOR, That I have carefully examined the above named Volunteer agreeably to the General Regulations of the Army, and that, in my opinion, he is free from all bodily defects and mental infirmity, which would in any way disqualify him from performing the duties of a soldier.

*Wm C Stewart*  
EXAMINING SURGEON.

I CERTIFY, ON HONOR, That I have minutely inspected the Volunteer, *James Jordan* previously to his enlistment, and that he was entirely sober when enlisted; that, to the best of my judgment and belief, he is of lawful age; and that, in accepting him as duly qualified to perform the duties of an able-bodied soldier, I have strictly observed the regulations which govern the recruiting service. This soldier has *dark* eyes, *dark* hair, *dark* complexion, is *5* feet *7* inches high.

*Wm C Stewart*  
RECRUITING OFFICER OR AGENT.

Mustered into the United States Service \_\_\_\_\_ day of *Sept* 186*4*

*James Jordan*  
*Wm C Stewart*  
Mustered Officer.

Mustered into the service of the United States, for three years or during the war, from date of enlistment, in Company \_\_\_\_\_ Regiment of \_\_\_\_\_ Volunteers, on the \_\_\_\_\_ day of \_\_\_\_\_ 186*4*, at \_\_\_\_\_



NOTE 1.—This blank will be used for enlistments of United States colored troops. They will be made out in duplicate in all cases—one to accompany the recruiting return of the superintendent (not the recruiting officer) to the Adjutant General, and one to accompany the accounts of the officer who pays bounty, &c.

NOTE 2.—An enlistment holds to service. A muster-in must, in all cases, precede payment of pay, bounty, pension, &c. A muster-in roll, must in all cases, be filed in the Adjutant General's Office as evidence of muster-in. The mustering officer, commissary, or assistant commissary of musters, as the case may be, will countersign both enlistments as having mustered the soldiers into the service of the United States before either of them is given to the disbursing officer.

DECLARATION OF RECRUIT

I, William J. Williams desiring to volunteer as a soldier in the ARMY OF THE UNITED STATES, for the term of Three Years, DO DECLARE That I am 22 years and          months of age; that I have never been discharged from the United States service on account of disability or by sentence of a court-martial, or by order before the expiration of a term of enlistment; and I know of no impediment to my serving honestly and faithfully as a soldier for three years.

GIVEN at Fort Leavenworth, Mo. the 12 day of Sept. 1864

Witness:         

Volunteered at Fort Leavenworth, Mo.  
No. 522  
By William J. Williams  
12

Consent of Parent or Guardian in case of a Minor, if a Free Man, or in the case of a Slave, of the Person to whom he owes Service:

I,          Do CERTIFY, That I am the          that the said          is          years of age; and I do freely give my CONSENT to his volunteering as a SOLDIER in the Army of the United States, for the period of THREE YEARS, under the conditions of the laws of the United States.

GIVEN at          the          day of         

Witness:

--	--	--

*Jordan Turner*  
*P*, Co. *A*, *5* Reg't *USC 10*

*2* Enclosures.

Bed Cards .....	Final Statements .....
Burial Records .....	Furloughs or L. of A .....
Certs. of Dis. for Discharge .....	Med. Certificates .....
C. M. Charges .....	Med. Des. Lists .....
Descriptive Lists .....	Orders .....
Discharge Certificates .....	Pris. of War Record .....
Enlistment Papers <i>/</i> .....	Resignations .....

Other papers relating to—

Admission to Hosp'l .....	Furlough or L. of A .....
Casualty Sheet .....	Med. Examination .....
Confinement .....	Misc. Information .....
Contracts .....	Pay or Clothing .....
Death or Effects .....	Personal Reports .....
Desertion .....	Rank .....
Discharge from Hosp'l .....	Transfer to Hosp'l .....
Discharge from Service .....	Transfer to V. R. C. .....
Duty .....	Transportation .....

*AA /*

*9* | **5 Cav. U.S.C.T.**

*Turner Jordan*  
*Pvt A*, Co. *A*, 5 Reg't U. S. Col'd Cavalry.

Appears on **Co. Muster-out Roll**, dated  
*Helena Ark Mch 16*, 1866.

Muster-out to date *Mch 16*, 1866.

Last paid to *Dec 31*, 1865.

Clothing account:

Last settled....., 186 ; drawn since \$..... 100

Due soldier \$..... 100; due U. S. \$ *13* <sup>*33*</sup>/<sub>100</sub>

Am't for cloth'g in kind or money adv'd \$..... 100

Due U. S. for arms, equipments, &c., \$..... 100

Bounty paid \$ *100* 100; due \$ *100* 100

Remarks:.....

Book mark:.....

(361)

*W. W. Payne*  
Copyist.



J | 5 Cav. | U.S.C.T.  
Turner Jordan  
Part, Co. A, 5 Reg't U. S. Colored Cav.

Appears on Returns as follows:

Sept 1865 + Nov 1865 to Feb 1866, Co.  
Cook

Book mark :

(546)

Austin

Copyist.

*J* | **5 Cav. | U.S.C.T.**  
*Turner Jordan*  
*Pr*, Co. A, 5 Reg't U. S. Col'd Cavalry.

Appears on

**Company Muster Roll**  
for *Jan & Feb*, 186*6*  
Present or absent *Present*

Stoppage, \$.....100 for .....

Due Gov't, \$.....100 for .....

Valuation of horse, \$.....100

Valuation of horse equipments, \$.....100

Remarks: *Co. Cook*

Book mark: .....

*W. W. Sayre*  
(358) Copyist.

J | 5 Cav. | U.S.C.T.

Turner Jordan  
Pvt

, Co. A, 5 Reg't U.S. Col'd Cavalry.

Appears on

Company Muster Roll

for Nov & Dec, 1865

Present or absent Present

Stoppage, \$ 100 for

Due Gov't, \$ 52 / 100 for Ord

Valuation of horse, \$ 100

Valuation of horse equipments, \$ 100

Remarks:

Book mark:

W. W. Mayne  
(358) Copyist.



*I* | **5 Cav. U.S.C.T.**

*James Condon*  
*Pvt.*, Co. A, 5 Reg't U. S. Col'd Cavalry.

Appears on

**Company Muster Roll**

for *Roll of Feb. 31*, 186*5*.

Present or absent *Present*

Stoppage, \$.....100 for.....

Due Gov't, \$.....100 for.....

Valuation of horse, \$.....100

Valuation of horse equipments, \$.....100

Remarks:.....

Book mark:.....

(358)

*J. A. Condon*  
Coppist.

**5 Cav. U.S.C.T.**

*J. Jordan*  
*Pr.*, Co. A, 5 Reg't U. S. Col'd Cavalry.

Appears on

**Company Muster Roll**

for *Co. A, 5 Reg't U.S. Col'd Cavalry*, 1865.

Present or absent *Present*

Stoppage, \$ 100 for

Due Gov't, \$ 100 for

Valuation of horse, \$ 100

Valuation of horse equipments, \$ 100

Remarks:

Book mark:

*J. M. M. M.*  
Copist.

2 | 5 Cav. | U.S.C.T.

*James Gordon*  
*Plt.*, Co. A, 5 Reg't U.S. Col'd Cavalry.

Appears on

*James Gordon*  
**Company Muster Roll**

for *May 1865*, 1865.

Present or absent *Present*

Stoppage, \$ *100* for

Due Gov't, \$ *100* for

Valuation of horse, \$ *100*

Valuation of horse equipments, \$ *100*

Remarks: *At present  
boarding due \$ 10.*

Book mark: \_\_\_\_\_

*J. H. H. H.*

(358)

(Copyist.)

5



5 Cav. U.S.C.T.

*J*  
*Emma Jordan*  
*Plt.*, Co. A, 5 Reg't U.S. Col'd Cavalry.

Appears on

Company Muster Roll

for *W. A. [unclear]*, 1865.

Present or absent *Present*

Stoppage, \$ 100 for

Due Gov't, \$ 100 for

Valuation of horse, \$ 100

Valuation of horse equipments, \$ 100

Remarks: *at present [unclear]*  
*to [unclear] \$ 50.*

Book mark:

*Hathaway*

(358)

Copyist.

1 | **5 Cav.** | **U.S.C.T.**

Warren Jordan  
Co. A, Co. A, 5 Reg't U. S. Col'd Cavalry.

Appears on

**Company Muster Roll**

for Jan. & Feb., 1865.

Present or absent Present.

Stoppage, \$ 100 for

Due Gov't, \$ 100 for

Valuation of horse, \$ 100

Valuation of horse equipments, \$ 100

Remarks: 1<sup>st</sup> Installment  
Bounty due \$100.

Book mark: \_\_\_\_\_

(358)

Easterling  
Copyist.

*A* | **5 Cav.** | **U.S.C.T.**

*Turner Jordan*

*Cvt*, Co. A, 5 Reg't U.S. Col'd Cavalry.

Appears on

**Company Muster Roll**

for *Nov. & Dec.*, 1864.

Present or absent *Present*

Stoppage, \$ *100* for

Due Gov't, \$ *100* for

Valuation of horse, \$ *100*

Valuation of horse equipments, \$ *100*

Remarks: *1<sup>st</sup> & 2<sup>d</sup> Installment  
Bounty due.*

Book mark: \_\_\_\_\_

(358)

*Castling*  
Copyist.



5 Cav. U.S.C.T.

*James Jordan*  
*Pvt*, Co. A, 5 Reg't U.S. Col'd Cavalry.

Appears on

**Company Muster Roll**

for *to Oct, 31*, 186*4*.

Present or absent *Present*,

Stoppage, \$ *100* for

Due Gov't, \$ *100* for

Valuation of horse, \$ *100*

Valuation of horse equipments, \$ *100*

Remarks:

Book mark:

(358)

*Easterling*  
Copyist.

*L* | **5 Cav.** | **U.S.C.T.**

*Sumner Jordan*  
-----  
*Priv*, Co. *A*, 5 Reg't U. S. Col'd Cavalry.

Appears on

**Company Muster-in and Descriptive Roll**  
of the organization named above. Roll dated

*Sept. Nelson Ky, N. Y., Oct 24, 1864.*

Where born *Delaware, Ky.*

Age *22* y'rs; occupation *Labourer*

When enlisted *Sept. 13*, 1864.

Where enlisted *Louisville*

For what period enlisted *3* years.

Eyes *Bl.*; hair *Bl.*

Complexion *Bl.*; height *5* ft. *9* in.

When mustered in *Sept. 14*, 1864.

Where mustered in *Louisville*

Bounty paid \$ *100*; due \$ *100*

Where credited *7th Dist. Kentucky*

Company to which assigned *1*

Remarks: -----  
-----  
-----

Book mark: -----  
-----

(356d)

*Ca. 1864*

Copyist.

J | 5 bar | U.S.C.T.

Turner Jordan.

Appears with rank of Priv. on

**Muster and Descriptive Roll**

of a Detachment of U.S.

Louisville Ky, Sept. 14, 1864. Roll dated

Where born Flemmin Co Kentucky

Age 22 years; occupation Labourer

When enlisted Sept. 13, 1864.

Where enlisted Louisville Ky

For what period enlisted 3 years.

Eyes Dark; hair Dark

Complexion Dark; height 5 ft. 9 in.

When mustered in Sept. 14, 1864.

Where mustered in Louisville, Ky

Bounty paid \$ 100; due \$ 100

**Clothing account:**

Last settled \_\_\_\_\_, 186 ; drawn since \$ 100

Date of first muster \_\_\_\_\_, 186 .

Company to which assigned \_\_\_\_\_

Remarks: Credited to Flem-  
men Co. 9 Dist.

Book mark : \_\_\_\_\_

J. Donohue,



C | **5 Cav.** | **U.S.C.T.**

Ermer Jordan

....., Co. A, 5 Reg't U. S. Col'd Cav.

Appears on

**Company Descriptive Book**  
of the organization named above.

**DESCRIPTION.**

Age 22 years; height 5 feet 9 inches.

Complexion Blk

Eyes Blk; hair Blk

Where born  Fleming Co Ky

Occupation  Laborer

**ENLISTMENT.**

When  Sept 15, 186 .

Where  Linnville

By whom  Capt F Morgan, term  3 y'rs.

Remarks: .....

.....  
.....  
.....  
.....  
.....  
.....  
.....  
.....  
.....

Warren

2363657 P. Ennis  
PAID 10-4-15 JND

Wm. Ennis

151

*Jordan Turner*  
Co A, 5 U. S. Col'd Cav.

*Private* | *Private*

CARD NUMBERS.

5359654	26
5359754	27
5359854	28
5359951	29
5360046	30
5360138	31
5360227	32
5360319	33
5360410	34
5360498	35
5360585	36
9090027	37
43154972	38
40730002	39
	40
	41
	42
	43
	44
	45
	46
	47
	48
	49
	50

Book Mark: .....

See also .....



Inventory of the effects of Neville Jordan late  
a Private of Captain D. B. Stone Company "B" of  
the 5<sup>th</sup> Regiment of U.S. Cavalry Volunteers, who was enrolled as  
a Substitute at Louisville in the State of Kentucky on  
the 25 day of August 1864 and mustered into the service of the United  
States as a Substitute on the 25 day of August 1864, at Louisville  
in Company \_\_\_\_\_, \_\_\_\_\_ Regiment of \_\_\_\_\_ Volunteers, to serve 3  
years or during the war; he was born in \_\_\_\_\_ in the State  
of Kentucky; he was 18 years of age, 5 feet 3 inches  
high, Black complexion, Black eyes, Black hair, and by occupation, when enrolled,  
a Labourer; he died in Battle, at  
Balville Va on the 2<sup>nd</sup> day of October 1864, by  
reason of Wounds received there

INVENTORY.							
ARTICLES.	No.	ARTICLES.	No.	ARTICLES.	No.		
Hats.....	No Effects	Pairs trousers.....	No Effects	Knapsacks.....	No Effects		
Caps.....		Pairs flannel drawers.....					
Forage caps.....		Pairs cotton drawers.....					
Great coats.....		Flannel shirts.....					
Uniform coats.....		Cotton shirts.....					
Uniform jackets.....		Pairs boots.....					
Flannel sack coats.....		Pairs shoes.....					
Blouses.....		Pairs socks.....					
Stable frocks.....		Blankets.....					
Fatigue overalls.....		Haversacks.....					
				MONEY.		Specie.....	\$
						Notes.....	\$

I CERTIFY, ON HONOR, that the above inventory comprises all the effects of Neville  
Jordan, deceased, and that the effects are in the hands  
of \_\_\_\_\_ at \_\_\_\_\_  
\_\_\_\_\_ to be disposed of by a Council of Administration.

(DUPLICATES.)

STATION: Camp Nelson Ky  
DATE: Dec 31<sup>st</sup> 1864

B. J. Robinson  
1<sup>st</sup> 5<sup>th</sup> U.S. Cavalry  
Commanding the Company.

ARTICLES OF WAR.

ART. 95. When any non-commissioned officer or soldier shall die, or be killed in the service of the United States, the then commanding officer of the troop or company shall, in the presence of two other commissioned officers, take an account of what effects he died possessed of, above his arms and accoutrements, and transmit the same to the office of the Department of War, which said effects are to be accounted for, and paid to the representatives of such deceased non-commissioned officer or soldier. And in case any of the officers, so authorized to take care of the effects of deceased officers and soldiers, should, before they have accounted to their representatives for the same, have occasion to leave the regiment or post, by preferment or otherwise, they shall, before they be permitted to quit the same, deposit in the hands of the commanding officer, or of the assistant military agent, all the effects of such deceased non-commissioned officers and soldiers, in order that the same may be secured for, and paid to, their respective representatives.

ARMY REGULATIONS—EDITION OF 1861.

DECEASED SOLDIERS.

Par. 152. Inventories of the effects of deceased non-commissioned officers and soldiers, required by the 95th Article of War, will be forwarded to the Adjutant General, by the commander of the company to which the deceased belonged, and a duplicate of the same to the colonel of the regiment. Final statements of pay, clothing, &c., will be sent with the inventories. When a soldier dies at a post or station absent from his company, it will be the duty of his immediate commander to furnish the required inventory; and, at the same time, to forward to the commanding officer of the company to which the soldier belonged, a report of his death, specifying the date, place, and cause; to what time he was last paid, and the money or other effects in his possession at the time of his decease; which report will be noted on the next muster roll of the company to which the man belonged. Each inventory will be endorsed, "Inventory of the effects of \_\_\_\_\_, late of company (—) \_\_\_\_\_ regiment of \_\_\_\_\_, who died at \_\_\_\_\_, the \_\_\_\_\_ day of \_\_\_\_\_, 186—." If a legal representative receive the effects, it will be stated in the report. If the soldier leave no effects, the fact will be reported.

Par. 153. Should the effects of a deceased non-commissioned officer or soldier not be administered upon within a short period after his decease, they shall be disposed of by a Council of Administration, under the authority of the commanding officer of the post, and the proceeds deposited with the Paymaster, to the credit of the United States, until they shall be claimed by the legal representatives of the deceased.

Par. 154. In all such cases of sales by the Council of Administration, a statement in detail, or account of the proceeds, duly certified by the Council and commanding officer, accompanied by the Paymaster's receipt for the proceeds, will be forwarded by the commanding officer to the Adjutant General. The statement will be endorsed, "Report of the proceeds of the effects of \_\_\_\_\_, late of company (—) \_\_\_\_\_ regiment of \_\_\_\_\_, who died at \_\_\_\_\_, the \_\_\_\_\_ day of \_\_\_\_\_, 186—."

NOTE 1.—The effects in all cases, when called for, should be turned over to the legal representative, without further authority from the Adjutant General. When the effects are turned over to the relatives of the deceased before these inventories are sent to the Adjutant General, their receipts therefor should be attached to the inventories. In all other cases, one copy will be sent with a letter of transmittal direct to the Adjutant General, and a duplicate retained by the officer.

NOTE 2.—Particular care should be taken to take receipts in duplicate from the Paymaster for any funds turned over to him; one copy should be sent direct to the Adjutant General and one retained by the officer.

INVENTORY OF THE EFFECTS

OF

*Neville Jordan*

Late of Company *C*

*3<sup>rd</sup>* Reg't of *U.S. Cavalry*

Volunteers, who died at *Batavia*

on the *23<sup>rd</sup>* day of *October* 186*4*

*To Col. J. G. ...*

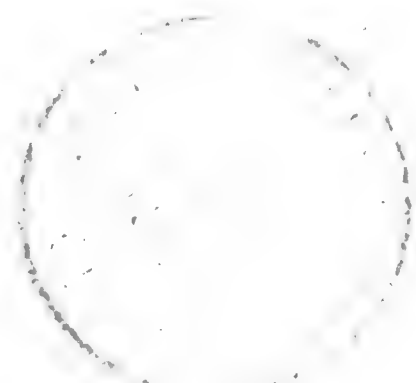



I certify, on honor, that Neville Jordan, a Private of  
Captain D C Jones's Company (C) of the 5<sup>th</sup> Regiment of U S C  
**VOLUNTEERS**, of the State of \_\_\_\_\_, born in \_\_\_\_\_, State  
of Kentucky, aged 18 years; 5 Feet 3 inches high; W complexion,  
W eyes, W hair, and by occupation a Laborer, who joined for service  
and was enrolled (see Note 9) on the \_\_\_\_\_ day of \_\_\_\_\_, 186\_\_\_\_, at \_\_\_\_\_  
by Substitute, for the period of Three years, and mustered into  
the service of the United States on the 25 day of August, 1864, at  
Louisville Ky. by Capt Womack; and having served  
**HONESTLY** and **FAITHFULLY** with his Company to the present date, is now entitled to a  
**DISCHARGE** by reason of Death (being killed in Action  
Salvado Va. 2 Oct 64)

The said Neville Jordan was last paid by Paymaster  
Pay due from date of muster to include the \_\_\_\_\_ day of \_\_\_\_\_, 186\_\_\_\_, and  
has pay due him from that time to the present date; he is entitled to pay and subsistence for  
**TRAVELING** to place of enrollment, and whatever other allowances are authorized to volunteer  
soldiers, drafted men, or militia, so discharged. He has received from the United States **CLOTHING**  
amounting to Twenty five<sup>39</sup>/<sub>100</sub> dollars, since the 25 day of August  
1864, when his clothing account was last settled. He has received from the United States  
\_\_\_\_\_ <sub>100</sub> dollars advanced **BOUNTY**.

There is to be stopped from him, on account of the State of \_\_\_\_\_, or other  
authorities, for **CLOTHING**, &c., received on entering service, \_\_\_\_\_ <sub>100</sub> dollars; and  
for other stoppages, viz: \_\_\_\_\_

\_\_\_\_\_ <sub>100</sub> dollars.  
He has been furnished with **TRANSPORTATION** in kind from the place of his discharge to  
\_\_\_\_\_; and he has been **SUBSISTED** for **TRAVELING** to his  
place of enrollment, up to the \_\_\_\_\_, 186\_\_\_\_.

He is indebted to \_\_\_\_\_, **SUTLER**, \_\_\_\_\_ <sub>100</sub> dollars.

He is indebted to \_\_\_\_\_, **LAUNDRESS**, \_\_\_\_\_ <sub>100</sub> dollars.

Given in Duplicate, at Camp Nelson Ky, this 31 day  
of December, 1864

B. T. Robinson

Lt Col U S A

Commanding Company



FINAL STATEMENT

OF

*Neville Jordan*  
*57 Reg't of U.S. Cav*

VOLUNTEERS.

NOTE 1.—Two of these certificates (or duplicates) are to be given to each Volunteer Soldier or drafted man who may be discharged without being mustered out (Final Statements are never given to men mustered out of service) that he may at once receive from the Paymaster the pay, &c., due him, and the captain or other COMMISSIONED officer commanding the company will certify to the act of the delivery of the duplicate certificates; with these certificates the Soldier is "entitled to" his discharge, and should also present his discharge to the Paymaster to have the payment endorsed on it. The discharge is to be given back to the Soldier by the Paymaster; the latter only retaining as his vouchers the duplicate certificates.

NOTE 2.—If the Soldier is entitled to pay for the use of his horse, the Company Commander will certify to that fact on the back of both these final statements, and also to the time he has pay due for having been so mounted on his own horse.

NOTE 3.—When a Soldier is furnished with final statements, his descriptive list, if he has one, should be taken up by the officer who gives the Soldier these statements, and endorsed with a statement to this effect by the officer. The endorsement should exhibit a full statement of the time for which the Soldier was allowed pay on his final statements, the clothing account, and all other charges against him or in his favor, so as to comprise a complete exhibit of his account. It will then be transmitted to the Company Commander of the Soldier, who will enter all the data necessary to a full understanding of the Soldier's account on the muster roll upon which the Soldier's discharge is reported. The descriptive list will then be destroyed. The object of this is, that the remaining portion of the Soldier's account may be settled upon the receipt of these muster rolls, and the Soldier receive any pay or allowances that may be due him at the time of his discharge, and which may not appear on his last final statements from the fact that his descriptive list is incomplete. These accounts for back pay, &c., are settled by the 2d Auditor of the Treasury Department.

NOTE 4.—Charges for loss or injury to ordnance, horse equipments, and other miscellaneous charges, should appear under the heading of "Other Stoppages."

NOTE 5.—Bounty paid by State authorities, and not by the United States, will not be entered on this statement.

NOTE 6.—Amounts due the Sutler and Laundress must be entered on the muster roll on which the discharge, death, desertion, &c., is reported, as well as on the final statement, otherwise the amount cannot be collected from the United States.

NOTE 7.—This blank will be used for deceased volunteers and drafted men, as well as for others.

NOTE 8.—Where a Soldier dies in Hospital or on detached service, his descriptive list, if he has one, should be sent with his final statements, in duplicate, to the Adjutant General, Washington, D. C.

NOTE 9.—If the soldier is a drafted man or substitute, the space for time &c., of enrolled, should contain only the word *drafted* or *substitute*, as the case may be. If the Soldier is a "VETERAN," (or RECRUIT,) the word as a *veteran*, (or *recruit*,) as the case may be, should be interlined after the words *mustered into the service of the U. S.* A statement of all the installments of *Veteran* or *Recruit* Bounty RECEIVED by the Soldier must be made on the back of each final statement.

kl  
th  
of  
ar  
pt  
th  
A  
of  
th  
pe  
qt  
as  
of  
to

an  
th  
de  
m  
in  
co  
re  
of  
sp  
th  
wl  
of  
re  
so  
so  
th  
nu  
sit  
sh  
stt  
Cc  
for  
Ac  
pr  
rej

to  
G  
ce  
re  
on  
G  
fr  
be

*Val of 10500*

ADJUTANT GENERAL'S OFFICE.  
*Mich 16<sup>th</sup> 1865.*  
Duplicate with Inventory sent 2d Auditor.



I certify, on honor, that Neville Jordan, a Private of  
Captain D C Stoner Company (C) of the 5 Regiment of W J C Cav  
**VOLUNTEERS**, of the State of \_\_\_\_\_, born in \_\_\_\_\_, State  
of Kentucky, aged 18 years; 5 feet 3 inches high; W complexion,  
W eyes, W hair, and by occupation a Laborer, who joined for service  
and was enrolled (see Note 9) on the \_\_\_\_\_ day of \_\_\_\_\_, 186\_\_\_\_, at \_\_\_\_\_  
by Substitute, for the period of Three years, and mustered into  
the service of the United States on the 25 day of August, 1864, at  
Louisville Ky., by Capt Wornach; and having served  
HONESTLY and FAITHFULLY with his Company to the present date, is now entitled to a  
**DISCHARGE** by reason of Death (being killed in action  
Saltsville Va. 2 Oct 64)

The said Neville Jordan was last paid by Paymaster  
Pay due from date of muster to include the \_\_\_\_\_ day of \_\_\_\_\_, 186\_\_\_\_, and  
has pay due him from that time to the present date; he is entitled to pay and subsistence for  
**TRAVELING** to place of enrollment, and whatever other allowances are authorized to volunteer  
soldiers, drafted men, or militia, so discharged. He has received from the United States **CLOTHING**  
amounting to Twenty five<sup>39</sup> dollars, since the 25 day of August  
1864, when his clothing account was last settled. He has received from the United States  
\_\_\_\_\_ dollars advanced **BOUNTY**.

There is to be stopped from him, on account of the State of \_\_\_\_\_, or other  
authorities, for **CLOTHING**, &c., received on entering service, \_\_\_\_\_ dollars; and  
for other stoppages, viz: \_\_\_\_\_

\_\_\_\_\_ dollars.  
He has been furnished with **TRANSPORTATION** in kind from the place of his discharge to  
\_\_\_\_\_; and he has been **SUBSISTED** for **TRAVELING** to his  
place of enrollment, up to the \_\_\_\_\_, 186\_\_\_\_.

He is indebted to \_\_\_\_\_, **SUTLER**, \_\_\_\_\_ dollars.

He is indebted to \_\_\_\_\_, **LAUNDRESS**, \_\_\_\_\_ dollars.

Given in Duplicate, at Camp Nelson Ky, this 31 day  
of December, 1864

S. J. Robinson

1st 5th W J C Cav

Commanding Company



[OFFICE INDORSEMENT.]  
**War Department,**

ADJUTANT GENERAL'S OFFICE,

187

The *Company* of *Men*,  
*Company*, Co. *C*, *Reg't U. S.*  
 Colored *Company*, is reported as follows:

On Company Muster Roll.

From *Sept 10 1864*, *March 1865*

Company Muster-out Roll.

*March 16 1866*

Company Descriptive Book.

186

Company Morning Reports.

186

Soldier's Final Statement.

*March 16 1865*

*March 16 1865*

*Returned March 1865*

**FINAL STATEMENT**

*60*  
 of *60*  
*Neville Jordan*  
 Reg't of *U. S. Colored*

**VOLUNTEERS.**

NOTE 1.—Two of these certificates (or duplicates) are to be given to each Volunteer Soldier or drafted man who may be discharged without being mustered out. Final Statements are never given to a man that is out of service, that he may at once receive from the Paymaster, Pay, &c., due him, and the captain or other COMMISSIONED officer commanding the company will certify to the act of the delivery of the duplicate certificate; with these certificates the Soldier is "credited" for his absence and should also present his discharge to the Paymaster to have the payment ordered on it, the discharge is to be given back to the Soldier by the Paymaster; the latter only retaining as his vouchers the duplicate certificates.

NOTE 2.—If the Soldier is entitled to pay for the use of his horse, the Company Commander will certify to that fact on the back of both these final statements, and also to the time he has pay due for having been so mounted on his own horse.

NOTE 3.—When a Soldier is furnished with final statements, his descriptive list, &c., should be taken up by the officer who gives the Soldier these statements, and endorsed with a statement to this effect by the officer. The endorsement should exhibit a full statement of the time for which the Soldier was allowed pay on his final statements, the clothing account, and all other charges against him or in his favor, so as to comprise a complete exhibit of his account. It will then be transmitted to the Company Commander of the Soldier, who will enter all the data necessary to a full understanding of the Soldier's account on the muster roll upon which the Soldier's discharge is reported. The descriptive list will then be destroyed. The effect of this is, that the remaining portion of the Soldier's account may be settled upon the receipt of these muster rolls, and the Soldier receive any pay allowable, but may be due him at the time of his discharge, and which may not appear on his last final statements from the fact that his descriptive list is incomplete. These accounts for back pay, &c., are settled by the Auditor of the Treasury Department.

NOTE 4.—Charges for loss or injury to ordnance, horse equipments, and other miscellaneous charges, should appear under the heading of "Other Stoppages."

NOTE 5.—Bounty paid by State authorities, and not by the United States, will not be entered on this statement.

NOTE 6.—Amounts due the Soldier and Laundress must be entered on the muster roll on which the discharge, death, desertion, &c., is reported, as well as on the final statement, otherwise the amount cannot be collected from the United States.

NOTE 7.—This blank will be used for deceased volunteers and drafted men, as well as for others.

NOTE 8.—Where a Soldier dies in Hospital or in detached service, his descriptive list, if he has one, should be sent with his final statements, in duplicate, to the Adjutant General, Washington, D. C.

NOTE 9.—If the soldier or a drafted man or substitute, the space for time, &c., of enrolled, should contain only the word *drafted* or *substitute*, as the case may be. If the Soldier is a "VETERAN," (or RECRUIT,) the words *as a veteran*, (or *recruit*.) as the case may be, should be interlined after the words *mustered into the service of the U. S.* A statement of all the installments of *Veteran* or *Recruit* Bounty RECEIVED by the Soldier must be made on the back of each final statement.

ADJUTANT GENERAL'S OFFICE  
*March 16 1865*  
 Duplicate with Inventory sent 2d Auditor.



[OFFICE INDORSEMENT.]

# War Department,

ADJUTANT GENERAL'S OFFICE,

....., 187

The ..... of .....  
....., Co. C, ..... Reg't U. S.  
Colored ..... is reported as follows:

- On Company Muster Roll.  
From ..... 1864, ..... 1864  
..... 1866  
Company Muster-out Roll. ..... 1866  
Company Descriptive Book. ...., 186
- Company Morning Reports. ...., 186
- Soldier's Final Statement.  
..... 1864  
..... 1865  
Soldier's Inventory of Effects. ...., 186
- Soldier's Certificate of Disability for Discharge. ...., 186
- Soldier's Individual Muster-out Roll. ...., 186
- Regimental Return.  
For ..... 1864, ..... 1864  
Regimental Quarterly Returns. ...., 186
- Regimental Descriptive Book. ...., 186
- By Surgeon General.  
(.....) ....., 186  
....., 186, is held to be

the correct date, and the Company Muster Roll will be amended accordingly.

Assistant Adjutant General.

## FINAL STATEMENT

60 of  
*Revilo Jordan*  
Reg't of *U.S. Col.*

### VOLUNTEERS.

NOTE 1.—Two of these certificates (or duplicates) are to be given to each Volunteer Soldier or drafted man who may be discharged without being mustered out. Final Statements are to be given to each mustered out of service, that he may at once receive from the Paymaster, the Pay, &c., due him, and the Captain or other COMMISSIONED OFFICER commanding the company will certify to the date of the discharge of the Soldier; with these certificates the Soldier is entitled to his discharge and should also present his discharge to the Paymaster to have the payment ordered on it, the discharge is to be given back to the Soldier by the Paymaster; the latter only retaining as his vouchers a duplicate certificate.

NOTE 2.—If the Soldier is entitled to pay for the use of his horse, the Company Commander will certify to that fact on the back of both these final statements, and also to the time he has pay due for having been so mounted on his own horse.

NOTE 3.—When a Soldier is furnished with final statements, his descriptive list, if he has one, should be taken up by the Officer who gives the Soldier these statements, and endorsed with a statement to this effect by the Officer. The enclosures should exhibit a full statement of the time for which the Soldier was allowed pay on his final statements, the clothing received, and all other charges against him or in his favor, such as to complete a complete exhibit of his account. It will then be transmitted to the Company Commander of the Soldier, who will enter all the data necessary to a full understanding of the Soldier's position on the muster roll upon which the Soldier's discharge is reported. The descriptive list will then be destroyed. The effect of this is, that the remaining portion of the Soldier's account may be settled upon the receipt of these muster rolls, and the Soldier receive any pay or allowance that may be due him at the time of his discharge, and which may not appear on his last final statements from the fact that his descriptive list is incomplete. These accounts for back pay, &c., are settled by the Auditor of the Treasury Department.

NOTE 4.—Charges for loss or injury to ordnance, horse equipments, and other miscellaneous charges, should appear under the heading of "Other Stoppages."

NOTE 5.—Bounty paid by State authorities, and not by the United States, will not be entered on this statement.

NOTE 6.—Amounts due the Soldier and Laundress must be entered on the muster roll on which the discharge, death, desertion, &c., is reported, as well as on the final statement, otherwise the amount cannot be collected from the United States.

NOTE 7.—This blank will be used for deceased volunteers and drafted men, as well as for substitutes.

NOTE 8.—Where a Soldier dies in Hospital or on detached service, his descriptive list, if he has one, should be sent with his final statements, in duplicate, to the Adjutant General, Washington, D. C.

NOTE 9.—If the soldier or drafted man or substitute, the space for time, &c., of enrolled, should contain only the word *drafted* or *substitute*, as the case may be. If the Soldier is a "VETERAN," (or RECRUIT,) the words *as a veteran*, (or *recruit*.) as the case may be, should be interlined after the words *mustered into the service of the U. S.* A statement of all the instalments of *Veteran* or *Recruit* Bounty RECEIVED by the Soldier must be made on the back of each final statement.

MICROFILM PUBLICATION M 1821

COMPILED MILITARY SERVICE RECORDS  
OF VOLUNTEER UNION SOLDIERS WHO  
SERVED WITH THE USCT (US COLORED TROOPS)  
5TH REGIMENT OF CAVALRY

PERSONAL PAPERS' TARGET SHEET

PLEASE NOTE THE CHECKED INFORMATION ABOUT THE PERSONAL PAPERS IN  
THIS FILE:

- NO PERSONAL PAPERS WERE FOUND IN THIS FILE WHEN THE  
RECORDS WERE ARRANGED FOR MICROFILMING.
- 3 PERSONAL PAPER(S) FOUND IN THIS FILE WHEN THE RECORDS  
WERE ARRANGED FOR MICROFILMING.

Jordan, Neville

P, Co. C, 5 Reg U.S.C. Cav.

2 Enclosures.

Bed Cards	Descriptive Lists
Burial Records	Final Statements /
Certs. of Dis. for Discharge	Furloughs
C. M. Charges	Med. Des. Lists
Med. Certificates	Orders

Other papers relating to—

Admission to Hosp'l	Furlough
Casualty Sheet (Officer's)	Med. Examination
Confinement	Misc. Information
Contracts	Pay or Clothing
Death or Effects /	Personal Reports
Desertions	Rank
Discharge from Hosp'l	Transfer to Hosp'l
Discharge from Service	Transfer to V. R. C.
Duty	Transportation



*J* | **5 Cav. | U.S.C.T.**  
*Deville Jordan*  
*Priv*, Co. *C*, 5 Reg't U. S. Col'd Cavalry.

Appears on **Co. Muster-out Roll**, dated  
*Helena Ark, July 16*, 186*6*.  
Muster-out to date *March*, 186*6*.  
Last paid to *Dec 31*, 186*5*.

Clothing account:  
Last settled....., 186 ; drawn since \$..... 100  
Due soldier \$..... 100; due U. S. \$ *109*<sup>10</sup>/<sub>100</sub>  
Am't for cloth'g in kind or money adv'd \$..... 100

Due U. S. for arms, equipments, &c., \$..... 100  
Bounty paid \$..... 100; due \$..... 100

Remarks: *Due U.S. for Ord 75c*  
.....  
.....  
.....  
.....

Book mark: .....

.....  
*Rose*  
.....

J | 5 Cav. | U.S.C.T.

Neville Jordan  
Priv., Co. C, 5 Reg't U. S. Colored Cav.

Appears on Returns as follows:

From organization to Oct 31, 1864  
Killed in fight Oct 2/64  
Saltville, Va.

May 1865 Gain. May 24/65 Cyn-  
thiana, Ky. Taken up  
from missing in action  
at Saltville, Va., Oct 2/64

Book mark :

(540)

Huston

Copyist.

**5 Cav. U.S.C.T.**

*Jordan*

*Pat*, Co. C, 5 Reg't U. S. Col'd Cavalry.

Appears on

**Company Muster Roll**

for *Jan and Feb*, 186*6*

Present or absent *Present*

Stoppage, \$ *100* for

Due Gov't, \$ *100* for

Valuation of horse, \$ *100*

Valuation of horse equipments, \$ *100*

Remarks:

Book mark:

*Rose*



*J* | **5 Cav. | U.S.C.T.**

*Neville Jordan*  
*Private*, Co. C, 5 Reg't U. S. Col'd Cavalry.

Appears on

**Company Muster Roll**

for *Nov 1865*, 1865.

Present or absent *Present*

Stoppage, \$ *100* for

Due Gov't, \$ *100* for

Valuation of horse, \$ *100*

Valuation of horse equipments, \$ *100*

Remarks: *Spec mfg for camp  
and Gar Equip # 36*

Book mark:

(358)

*Jordan*

Copyist.

*J*

**5 Cav. | U.S.C.T.**

*Neville Jordan*

*Plt*, Co. C, 5 Reg't U. S. Col'd Cavalry.

Appears on

**Company Muster Roll**

for *Sep. 4* to *Oct*, 186*5*.

Present or absent *Present*

Stoppage, \$.....*100* for.....

Due Gov't, \$.....*100* for.....

Valuation of horse, \$.....*100*

Valuation of horse equipments, \$.....*100*

Remarks:.....

.....  
.....  
.....  
.....  
.....  
.....

Book mark:.....

(358)

*J. Under*

Copyist.

*J* | **5 Cav. | U.S.C.T.**

*Neville Jordan*  
*Pvt.*, Co. C, 5 Reg't U. S. Col'd Cavalry.

Appears on

**Company Muster Roll**

for *July + Aug.*, 186*3*.

Present or absent *Present*

Stoppage, \$.....100 for .....

Due Gov't, \$.....100 for .....

Valuation of horse, \$.....100

Valuation of horse equipments, \$.....100

Remarks: .....

Book mark: .....

*Leider*



*J* | **5 Cav.** | **U.S.C.T.**

*Neville Jordan*  
*Fitz*, Co. C, 5 Reg't U. S. Col'd Cavalry.

Appears on

**Company Muster Roll**

for *May & June*, 186*5*.

Present or absent *Present*

Stoppage, \$ *100* for

Due Gov't, \$ *100* for

Valuation of horse, \$ *100*

Valuation of horse equipments, \$ *100*

Remarks: *Taken up as dropped  
from the roll. Killed  
killed in action at  
Saltville Va Oct 21/64  
Returned May 24/65*

Book mark:

*Jordan*

*J* | **5 Cav.** | **U.S.C.T.**

*Aville Jordan*  
*Pris*, Co. C, 5 Reg't U. S. Col'd Cavalry.

Appears on

**Company Muster Roll**

for *to Oct. 31*, 1864.

Present or absent *Absent*

Stoppage, \$ *100* for

Due Gov't, \$ *100* for

Valuation of horse, \$ *100*

Valuation of horse equipments, \$ *100*

Remarks: *Killed at the Battle of  
Saltville, Va. Oct. 2, 1864*

Book mark:

*Shull*

J | **5 Cav.** | **U.S.C.T.**

Merrill Jordan

Pais, Co. C, 5 Reg't U. S. Col'd Cavalry.

Appears on

**Company Muster-in and Descriptive Roll**

of the organization named above. Roll dated

Camp Nelson, <sup>Ky</sup> N. Y., Oct. 24, 1864.

Where born Kentucky

Age 18 y'rs; occupation Laborer

When enlisted Substitute, 186

Where enlisted

For what period enlisted 3 years.

Eyes Blk; hair Blk.

Complexion Blk; height 5 ft. 3 in.

When mustered in Aug. 25, 186

Where mustered in Louisville

Bounty paid \$ 100; due \$ 100

Where credited 5" Dist. Ky.

Company to which assigned C

Remarks:

\* Entered by Townsend Ex.

Book mark:

Shull



5 bar U.S.C.

Neville Jordan

Appears with rank of Pvt on

**Muster and Descriptive Roll**

of a Detachment of U.S. Colored  
Troops Transferred to U.S. Col  
Cor. at Lexington, Cor. Roll dated

Louisville Ky. Sept 2, 1864.

Where born Ky.

Age 18 years; occupation Labourer

When enlisted Substitute, 186

Where enlisted

For what period enlisted 3 years.

Eyes Blue; hair Blue

Complexion Blue; height 5 ft. 3 in.

When mustered in Aug. 25, 1864.

Where mustered in Louisville

Bounty paid \$ 100; due \$ 100

Clothing account:

Last settled 186; drawn since \$ 18 19/100

Date of first muster Aug. 25, 1864.

Company to which assigned

Remarks: Credited to 5 Regt. Inf.

Ky.

Book mark:

A. J. Dinsell

(356m) Copyist.

J 1 5 bar US65

Neville Jordan  
Appears with rank of Rec't on

**Muster and Descriptive Roll**

of a Detachment of men Drafted  
and Mustered into service of US

Roll dated  
Louisville Ky, Aug 25 1864.

Where born Kentucky

Age 18 y'rs; occupation Laborer

**Drafted and mustered in:**

When Aug 20, 1864.

Where Louisville Ky

Enrollment district 5 Dist Ky

Period 3 years.

Eyes Black; hair Black

Complexion Black; height 5 ft. 3 in.

Bounty paid \$ 100; due \$ 100

**Clothing account:**

Last settled 186; drawn since \$ 100

Date of commencement of service Aug 25 1864

Company to which assigned

Remarks: Substitute for Wm Mux

Anti draft

Issued Clothing Ant 1819

Book mark:

Jacobson

C | **5 Cav. | U.S.C.T.**

Herille Jordan

....., Co. C, 5 Reg't U. S. Col'd Cav.

Appears on

**Company Descriptive Book**  
of the organization named above.

**DESCRIPTION.**

Age 18 years; height 5 feet 3 inches.

Complexion Light

Eyes Dark; hair Dark

Where born Ky.

Occupation Labourer

**ENLISTMENT.**

When ....., 186 .

Where substitute

By whom .....; term 5 y'rs.

Remarks: .....

.....  
W. W. W.



150 Neville  
Jordan Merrill  
Co E, 5 U. S. Col'd Cav.

Private | Private

CARD NUMBERS.

1	5361696	26
2	5361798	27
3	5362149	28
4	5362237	29
5	5362327	30
6	5362413	31
7	5362497	32
8	5362582	33
9	9090235	34
10	43146260	35
11	43155113	36
12	40730001	37
13		38
14		39
15		40
16		41
17		42
18		43
19		44
20		45
21		46
22		47
23		48
24		49
25		50

Book Mark: .....

See also .....

Statement of Service Reference Slip.

Office Pension

Claim No. W.O. 1021996

Jerry Jordan  
(Name.)

, Co. D, 5 Reg't U.S.C. Cav.

To Med. Sec. Div. 12-7, 1915

For med. record statement

no med. p.p.

Johnson  
per R.S. 72

med. stmt. made,  
vs cards ret'd,

Statement furnished 12-7, 1915

[Signature]

DECLARATION OF SUBSTITUTE.

I, Jerry Jordan desiring to ENLIST  
in the **Army of the United States**, for **THREE YEARS**, **Do declare**, That I am  
18 years and 2 months of age; that I have  
never been discharged from the United States service on account of disability or by sentence of  
a court martial; and I know of no impediment to my serving honestly and faithfully as a soldier  
for three years.

GIVEN at

the

day of

Rousesville Ky  
1<sup>st</sup> day of Sept 1864

WITNESSES:

S. Coleman

Jerry Jordan  
mark



SUBSTITUTE  
VOLUNTEER ENLISTMENT.

STATE OF

TOWN OF

*Kentucky*  *Louisville*

I, *Jerry Jordan* born in the State  
of *Ohio*, aged *18* years, and by  
occupation a *laborer* DO HEREBY ACKNOWLEDGE to have agreed with  
*J. B. Murdoff*, Esq., of *Owen County*  
*Kentucky*

to become his **SUBSTITUTE** in the Military Service, for a sufficient consideration paid and  
delivered to me, on the *1st* day of *Sept*, 186*4*;  
and having thus agreed with said *J. B. Murdoff* I DO HEREBY  
ACKNOWLEDGE to have enlisted this *1st* day of *Sept*,  
186*4*, to serve as a **Soldier** in the **Army of the United States of America**, for the period  
of **THREE YEARS**, unless sooner discharged by proper authority: I do also agree to accept such  
bounty, pay, rations, and clothing, as are, or may be, established by law for *enlisted troops* soldiers. And I do  
solemnly swear that I will bear true and faithful allegiance to the **United States of America**;  
that I will serve them honestly and faithfully against all their enemies or opposers whomsoever;  
and that I will observe and obey the orders of the President of the United States, and the orders  
of the Officers appointed over me, according to the Rules and Articles of War.

SWORN and subscribed to, at *Louisville Ky*  
this *1st* day of *Sept* 186*4*  
BEFORE *G. M. Munnach*  
*Capt & Prov Mar 5th Reg*  
*104*

*Jerry Jordan*  
*mark*

We certify, on honor, That we have carefully examined the above-named Volunteer Substitute  
agreeably to the Regulations, and that, in our opinion, he is free from all bodily defects and mental infirmity  
which would in any way disqualify him from performing the duties of a soldier; that he was entirely sober  
when enlisted; that he is of lawful age, (not under 18 years;) and that, in accepting him as duly qualified to  
perform the duties of an able-bodied soldier, and as a Substitute in lieu of *J. B. Murdoff*  
*of Owen County Ky, drafted in 5th Reg 1st Div 104*  
*Anti Draft*, 186*4*, we have strictly observed the Regulations which govern  
in such cases. This soldier has *Black* eyes, *Black* hair, *Black* complexion; is *5* feet *6*  
inches high.

*G. M. Munnach*  
Provost Marshal.  
*Will R. Hervey*  
Commissioner of Board.  
*T. S. Bell*  
Surgeon of Board.

Board of Enrollment of *5* Dist. of *Kentucky*

182

No. 201

Lerry Jordan

Enlisted at Louisville Ky

As Substitute for

S. B. Mandiff

On the 1 day of Sept, 1864

By

G. M. Monack Presdt

W. R. Hervey Secy

J. S. Bell Surgn

Board of Enrollment,

Dist. of Ky

Sup

DECLARATION OF SUBSTITUTE.

I, Jerry Jordan desiring to ENLIST  
in the Army of the United States, for THREE YEARS, **Do declare**, That I am  
18 years and 2 months of age; that I have  
never been discharged from the United States service on account of disability or by sentence of  
a court martial; and I know of no impediment to my serving honestly and faithfully as a soldier  
for three years.

GIVEN at Lewisville N.C.  
the 1<sup>st</sup> day of Sept 1864.

WITNESS:

E. H. Cochran

Jerry Jordan  
his Quart



# SUBSTITUTE VOLUNTEER ENLISTMENT.

STATE OF

TOWN OF

*Kentucky*



*Louisville*

I, *Jerry Jordan* born in the State of *Ohio*, aged *18* years, and by occupation a *labourer*

Do HEREBY ACKNOWLEDGE to have agreed with *J. B. Murdoff*, Esq., of *Owen County Kentucky*

to become his **SUBSTITUTE** in the Military Service, for a sufficient consideration paid and delivered to me, on the *1<sup>st</sup>* day of *Sept*, 186*4*

and having thus agreed with said *J. B. Murdoff* I DO HEREBY ACKNOWLEDGE to have enlisted this *1<sup>st</sup>* day of *Sept*, 186*4*

to serve as a **Soldier** in the **Army of the United States of America**, for the period of **THREE YEARS**, unless sooner discharged by proper authority: I do also agree to accept such bounty, pay, rations, and clothing, as are, or may be, established by law for *land troops* soldiers. And I do solemnly swear that I will bear true and faithful allegiance to the **United States of America**; that I will serve them honestly and faithfully against all their enemies or opposers whomsoever; and that I will observe and obey the orders of the President of the United States, and the orders of the Officers appointed over me, according to the Rules and Articles of War.

SWORN and subscribed to, at *Louisville Ky*

this *1* day of *Sept*, 186*4*

BEFORE *G. M. Mouch*  
*Capt & Pro Mar*  
*5<sup>th</sup> Dist Ky*

*Jerry Jordan*  
mark

We certify, on honor, That we have carefully examined the above-named Volunteer Substitute agreeably to the Regulations, and that, in our opinion, he is free from all bodily defects and mental infirmity which would in any way disqualify him from performing the duties of a soldier; that he was entirely sober when enlisted; that he is of lawful age, (not under 18 years;) and that, in accepting him as duly qualified to perform the duties of an able-bodied soldier, and as a Substitute in lieu of *J. B. Murdoff* of *Owen Co Ky*, drafted in *5<sup>th</sup> Dist Ky* *Anti Draft*, 186*4*, we have strictly observed the Regulations which govern in such cases. This soldier has *black* eyes, *black* hair, *black* complexion; is *5* feet *6* inches high.

*G. M. Mouch*

Provost Marshal.

*Will R. Hervey*

Commissioner of Board.

*J. S. Bell*

Surgeon of Board.

Board of Enrollment of *5<sup>th</sup>* Dist. of *Ky*

17. ~~172~~

No. 201

Larry Jordan

Enlisted at Louisville Ky

As Substitute for

I B Mudoff

On the 1 day of Sept, 1864.

By

G W Monack Presnt  
W R Harvey Secy  
J S Bell Surgn

Board of Enrollment,

5 Dist. of Ky

501



MICROFILM PUBLICATION M 1821

COMPILED MILITARY SERVICE RECORDS  
OF VOLUNTEER UNION SOLDIERS WHO  
SERVED WITH THE USCT (US COLORED TROOPS)  
5TH REGIMENT OF CAVALRY

PERSONAL PAPERS' TARGET SHEET

PLEASE NOTE THE CHECKED INFORMATION ABOUT THE PERSONAL PAPERS IN  
THIS FILE:

- NO PERSONAL PAPERS WERE FOUND IN THIS FILE WHEN THE  
RECORDS WERE ARRANGED FOR MICROFILMING.
- 3 PERSONAL PAPER(S) FOUND IN THIS FILE WHEN THE RECORDS  
WERE ARRANGED FOR MICROFILMING.



Jordan  
Co.

Jerry  
Reg't USCT

2 Enclosures.

- |                              |                       |
|------------------------------|-----------------------|
| Bed Cards                    | Final Statements      |
| Burial Records               | Furloughs or L. of A. |
| Certs. of Dis. for Discharge | Med. Certificates     |
| C. M. Charges                | Med. Des. Lists       |
| Descriptive Lists            | Orders                |
| Discharge Certificates       | Pris. of War Record   |
| Enlistment Papers 2          | Resignations          |

S.S.

Other papers relating to—

- |                        |                      |
|------------------------|----------------------|
| Admission to Hosp'l    | Furlough or L. of A. |
| Casualty Sheet         | Med. Examination     |
| Confinement            | Misc. Information    |
| Contracts              | Pay or Clothing      |
| Death or Effects       | Personal Reports     |
| Desertion              | Rank                 |
| Discharge from Hosp'l  | Transfer to Hosp'l   |
| Discharge from Service | Transfer to V. R. C. |
| Duty                   | Transportation       |

J. | 5 Cav. | U.S.C.T.

*Jerry Jordan,*  
Private, Co. *D*, 5 Reg't U. S. Col'd Cavalry.

Appears on Co. Muster-out Roll, dated  
*Helena, Ark., March 16, 1866.*

Muster-out to date *March 16, 1866.*

Last paid to *Dec 31, 1865.*

Clothing account:

Last settled....., 186 ; drawn since \$..... 100

Due soldier \$ *28. 02*..... 100; due U. S. \$..... 100

Am't for cloth'g in kind or money adv'd \$..... 100

Due U. S. for arms, equipments, &c., \$..... 100

Bounty paid \$..... 100; due \$..... 100

Remarks: *Corporal from organization till reduced to rank, Jan'y 23, 1865.*

Book mark:

(861)

*M. D. Grainger,*  
Copyist.

J | 5 Cav. | U.S.C.T.  
Jerry Jordan  
Pvt., Co. D, 5 Reg't U. S. Colored Cav.

Appears on Returns as follows:

Nov & Dec 1864 Absent sick in  
Hospl. Ghent, Ky  
Jan. 1865 Absent detached with  
1<sup>st</sup> Brig Band, Lexington Jan.  
23/65  
Feb to Aug 1865 Absent detached  
with 1<sup>st</sup> Brig Band per R.O.  
#13 dated Jan 23/65  
Sept 1865 to Feb 1866, On duty  
with Regt. Band

Book mark :

(540) *Justin* Copyist.



J. | 5 Cav. | U.S.C.T.

Jerry Jordan,  
Private, Co. D, 5 Reg't U. S. Col'd Cavalry.

Appears on

**Company Muster Roll**

for Jan'y<sup>4<sup>th</sup></sup> & Febr'y, 1866.

Present or absent Present.

Stoppage, \$ 100 for

Due Gov't, \$ 100 for

Valuation of horse, \$ 100

Valuation of horse equipments, \$ 100

Remarks: On daily duty Regt.  
Band.

Book mark:

R. S. Trauer

**5 Cav. U.S.C.T.**

*Jerry Jordan*  
*Priv.*, Co. D, 5 Reg't U. S. Col'd Cavalry.

Appears on

**Company Muster Roll**

for *Nov. & Dec.*, 186*5*.

Present or absent *present*

Stoppage, \$ *100* for

Due Gov't, \$ *100* for

Valuation of horse, \$ *100*

Valuation of horse equipments, \$ *100*

Remarks: *Daily duty Reg't Band.*

Book mark:

*Williker*

*J* | **5 Cav. | U.S.C.T.**  

---

*Jerry Jordan*  
*Priv.*, Co. D, 5 Reg't U. S. Col'd Cavalry.

Appears on

**Company Muster Roll**

for *Sept. & Oct.*, 1865.

Present or absent *present*

Stoppage, \$ *100* for

Due Gov't, \$ *100* for

Valuation of horse, \$ *100*

Valuation of horse equipments, \$ *100*

Remarks: *Daily duty Reg't Bands*

Book mark: \_\_\_\_\_

*Milliken*  
(358) Copyist.



J | 5 Cav. | U.S.C.T.

Jerry Jordan  
Priv., Co. D, 5 Reg't U. S. Col'd Cavalry.

Appears on

**Company Muster Roll**

for July & Aug., 1865.

Present or absent present

Stoppage, \$ 100 for

Due Gov't, \$ 100 for

Valuation of horse, \$ 100

Valuation of horse equipments, \$ 100

Remarks: Detached Brigade Band  
per Reg. Ord. No. 13 Jan. 23 1865.

Book mark:

Milliken  
(358) Copyist.

*J* | **5 Cav. U.S.C.T.**

*Jerry Jordan*  
Private, Co. D, 5 Reg't U. S. Col'd Cavalry.

Appears on

**Company Muster Roll**

for *May & June*, 1865.

Present or absent *absent.*

Stoppage, \$ *100* for

Due Gov't, \$ *100* for

Valuation of horse, \$ *100*

Valuation of horse equipments, \$ *100*

Remarks: *Detached - Brigade Band  
per R.O. No. 13 Jan. 23 1865.*

Book mark:

(358)

*Williker*  
Copyist.

*J* | **5 Cav. | U.S.C.T.**

*Jerry Jordan*

*Priv.*, Co. D, 5 Reg't U. S. Col'd Cavalry.

Appears on

**Company Muster Roll**

for *March & April*, 186*5*.

Present or absent *Absent.*

Stoppage, \$ *100* for

Due Gov't, \$ *100* for

Valuation of horse, \$ *100*

Valuation of horse equipments, \$ *100*

Remarks: *Detached Brigade  
Band per Regt. Order  
No. 13 Jan. 23, 1865.*

Book mark:

*Wm. H. Scott*



JAN. - 9

5362974

1891

\* Remarks cancelled  
as shown on Roll.

J | 5 Cav. | U.S.C.T.

Jerry Jordan  
Pvt., Co. D, 5 Reg't U. S. Col'd Cavalry.

Appears on

Company Muster Roll

for Jan. & Feb., 1865.

Present or absent Absent.

Stoppage, \$ 100 for

Due Gov't, \$ 100 for

Valuation of horse, \$ 100

Valuation of horse equipments, \$ 100

Remarks: Detached with  
Brigade Band R.O. 13  
23 Jan '65. First install-  
ment of Bounty due  
\$100. Reduced from  
Cook to Private per  
R.O. No. 27 dated 22 Feb.  
'65 to take effect 1 Jan. '65.

Book mark:

Wm. B. Scott

(358)

Copyist.

over

J | **5 Cav. | U.S.C.T.**

*Jerry Jordan*  
Corp., Co. D, 5 Reg't U. S. Col'd Cavalry.

Appears on

**Company Muster Roll**

for *Nov + Dec*, 186*4*.

Present or absent *Absent*

Stoppage, \$ *100* for

Due Gov't, \$ *100* for

Valuation of horse, \$ *100*

Valuation of horse equipments, \$ *100*

Remarks: *Sick in Hospital  
Spent Reg.*

Book mark:

*Wm. Scott*



J | **5 Cav. | U.S.C.T.**

*Jerry Jordan*  
.....  
*Corporal*, Co. D, 5 Reg't U. S. Col'd Cavalry.

Appears on

**Company Muster Roll**

for *Rated Oct. 31* ....., 186 *4*.

Present or absent *Present* .....

Stoppage, \$ ..... *100* for .....

Due Gov't, \$ ..... *100* for .....

Valuation of horse, \$ ..... *100*

Valuation of horse equipments, \$ ..... *100*

Remarks: .....

.....  
.....  
.....  
.....  
.....

Book mark: .....

*Wm B Scott*

**5 Cav. U.S.C.T.**

*J*  
*Jerry Jordan*

*Priv.*, Co. *D*, 5 Reg't U. S. Col'd Cavalry.

Appears on

**Company Muster-in and Descriptive Roll**  
of the organization named above. Roll dated

*Camp Nelson N.Y.*, *Oct. 24*, 1864.

Where born *Hamilton, Ohio*

Age *18* y'rs; occupation *Laborer*

When enlisted *Substitute*, 186 .

Where enlisted

For what period enlisted *3* years.

Eyes *Br*; hair *Br*

Complexion *Br*; height *5 ft. 6 in.*

When mustered in *Sept. 1*, 1864.

Where mustered in *Louisville*

Bounty paid \$ *100*; due \$ *100*

Where credited *5 Dist. Ky.*

Company to which assigned

Remarks:

*\* Inserted by Townsend Ex*

Book mark:

*Wm. H. Scott*

*J* | 5 bar | U.S.C.T.  
*Jerry Jordan*

Appears with rank of PT on

**Muster and Descriptive Roll**

of a Detachment of U. S. Colored  
Troops formed for U. S. Col  
scr. at Lexington. Ky. Roll dated  
Louisville. Ky., Sept. 7, 1864.

Where born Hamilton. Ohio

Age 18 years; occupation Labourer

When enlisted Substitute, 186

Where enlisted

For what period enlisted 3 years.

Eyes Blue; hair Blue

Complexion Blue; height 5 ft. 6 in.

When mustered in Sept. 1, 1864.

Where mustered in Louisville

Bounty paid \$ 100; due \$ 100

Clothing account:

Last settled 186; drawn since \$ 1957  
100

Date of first muster Sept. 1, 1864.

Company to which assigned

Remarks: Granted to 5000  
Dist. Ky.

Book mark:

*D. J. Jordan*



5 bar USA  
Jerry Jordan

Appears with rank of Act on

**Muster and Descriptive Roll**

of A Detachment of men Drafted  
and Mustered into service of US

Roll dated  
Louisville Ky, Sept 1, 1864.

Where born Camilton Ohio  
Age 18 y'rs; occupation Subver

Drafted and mustered in:

When Sept 1, 1864

Where Louisville Ky

Enrollment district 5 Dist Ky

Period 3 years.

Eyes Black; hair Black

Complexion Black; height 5 ft. 6 in.

Bounty paid \$ 100; due \$ 100

Clothing account:

Last settled 186; drawn since \$ 100

Date of commencement of service Sept 1, 1864

Company to which assigned

Remarks: Substitute for J. B.  
Murdock Ant. Draft  
Issued clothing to ant  
\$19<sup>57</sup>

Book mark:

(356m)

J. Jacobson

Copyist.

*J* | **5 Cav. | U.S.C.T.**

*Jerry Jordan*  
....., Co. *K*, 5 Reg't U. S. Col'd Cav.

Appears on

**Company Descriptive Book**  
of the organization named above.

**DESCRIPTION.**

Age *18* years; height *5* feet *4* inches.

Complexion *Black*

Eyes *Blk*; hair *Blk*

Where born *Hamilton Ohio*

Occupation *Laborer*

**ENLISTMENT.**

When *Substitute*, 186 .

Where *5<sup>th</sup> Dist, C*

By whom .....; term *3* y'rs.

Remarks: .....  
.....  
.....  
.....  
.....  
.....  
.....  
.....

*J. E. Parks*

D. 2677581 Pencil

D. 1539180

D. 2846175 And wd

D. 2895616 And wd

D. 2993917 Pencil

D. 3077167 And. W. D.

P.O. med. No 1021996-12-7-15-510

Sturment & Co



149

Jordan Jerry  
Co 2, 5 U. S. Col'd Cav.

Private | Private

CARD NUMBERS.

1	5362688	26
2	5362752	27
3	5362854	28
4	5362974	29
5	5363070	30
6	5363158	31
7	5363248	32
8	5363334	33
9	5363421	34
10	5363508	35
11	5363596	36
12	9090317	37
13	4314649	38
14	40730000	39
15		40
16		41
17		42
18		43
19		44
20		45
21		46
22		47
23		48
24		49
25		50

Book Mark: .....

See also .....

# UNITED STATES COLORED TROOPS ENLISTMENT.

STATE OF



TOWN OF

*Kentucky*  
 I, *Haskins Gordon* born in *Anderson*  
 in the State of *Kentucky* aged *Twenty* years  
 and by occupation a *Farmer* Do HEREBY ACKNOWLEDGE to  
 have volunteered *Twenty* day of *September* 1864  
 to serve as a **Soldier** in the **Army of the United States of America**, for the  
 period of **THREE YEARS**, unless sooner discharged by proper authority: Do  
 also agree to accept such bounty, pay, rations, and clothing, as are, or may be,  
 established by law for the U. S. colored troops.

And I, *Haskins Gordon*  
 do solemnly swear that I will bear true faith and allegiance to the **United States**  
**of America**, and that I will serve them honestly and faithfully against all their  
 enemies or opposers whomsoever; and that I will observe and obey the orders  
 of the President of the United States, and the orders of the officers appointed  
 over me, according to the Rules and Articles of War.

Sworn and subscribed to, at *Camp Miller*  
 this *11th* day of *September* *Haskins Gordon*  
 Before *J. G. Randolph* *marks*

I CERTIFY, ON HONOR, That I have carefully examined the above named Volunteer agree-  
 ably to the General Regulations of the Army, and that, in my opinion, he is free from all bodily  
 defects and mental infirmity, which would in any way disqualify him from performing the  
 duties of a soldier.

*J. G. Russell*  
*Adj. Surg. 4th Reg. Col. Col.*  
 EXAMINING SURGEON.

I CERTIFY, ON HONOR, That I have minutely inspected the Volunteer, *H. Gordon*  
 previously to his enlistment, and that he was entirely sober when enlisted; that, to the best of  
 my judgment and belief, he is of lawful age; and that, in accepting him as duly qualified to per-  
 form the duties of an able-bodied soldier, I have strictly observed the regulations which govern  
 the recruiting service. This soldier has *Blue* eyes, *Black* hair, *Black* com-  
 plexion, is *5 ft 10 in* feet *10* inches high.

*J. G. Randolph*  
*and J. P. M.*  
 RECRUITING OFFICER OR AGENT.

Mustered into the United States Service *11th* day of *September* 1864.

*J. W. Currier*  
*Capt. U. S. Army*  
 Mustering Officer.

Mustered into the service of the United States, for three years or during the war, from date of enlistment. in Company  
 Regiment of *Miller's* Volunteers, on the *11th* day of *September* 1864 at *Camp Miller*

*Sept 11 11 2 1864*  
*Miller - Miller*



NOTE 1.—This blank will be used for enlistments of United States colored troops. They will be made out in duplicate in all cases—one to accompany the recruiting return of the superintendent (not the recruiting officer) to the Adjutant General, and one to accompany the accounts of the officer who pays bounty, &c.  
 NOTE 2.—An enlistment holds to service. A muster-in must, in all cases, precede payment of pay, bounty, pension, &c. A muster-in roll, must in all cases, be filed in the Adjutant General's Office as evidence of muster-in. The mustering officer, commissary, or assistant commissary of musters, as the case may be, will countersign both enlistments as having mustered the soldiers into the service of the United States before either of them is given to the disbursing officer.

DECLARATION OF RECRUIT

I, Robertus Jordan desiring to volunteer as a soldier in the ARMY OF THE UNITED STATES, for the term of Three Years, DO DECLARE THAT I am 20 years and 0 months of age; that I have never been discharged from the United States service on account of disability or by sentence of a court-martial, or by order before the expiration of a term of enlistment; and I know of no impediment to my serving honestly and faithfully as a soldier for three years.

GIVEN at Seam's Station the 9<sup>th</sup> day of September 1864

Witness: M. Palmer

Casimir Jordan  
 No. 64  
 Volunteered at Camp Lebanon  
 By John R. ...  
or Undersecretary  
Robert Jordan

Consent of Parent or Guardian in case of a Minor, if a Free Man, or in the case of a Slave, of the Person to whom he owes Service:

I, ..... Do CERTIFY, That I am the ..... that the said ..... is ..... years of age; and I do freely give my CONSENT to his volunteering as a SOLDIER in the Army of the United States, for the period of THREE YEARS under the conditions of the laws of the United States.

GIVEN at ..... the ..... day of .....

Witness:



Jordan Haskins  
 \_\_\_\_\_  
 \_\_\_\_\_, Co. \_\_\_\_\_, \_\_\_\_\_ Reg't USCI

----- / **Enclosures.**

- |                                    |                            |
|------------------------------------|----------------------------|
| Bed Cards .....                    | Final Statements .....     |
| Burial Records .....               | Furloughs or L. of A. .... |
| Certs. of Dis. for Discharge ..... | Med. Certificates .....    |
| C. M. Charges .....                | Med. Des. Lists .....      |
| Descriptive Lists .....            | Orders .....               |
| Discharge Certificates .....       | Pris. of War Record .....  |
| Enlistment Papers / .....          | Resignations .....         |

Other papers relating to—

- |                              |                           |
|------------------------------|---------------------------|
| Admission to Hosp'l .....    | Furlough or L. of A. .... |
| Casualty Sheet .....         | Med. Examination .....    |
| Confinement .....            | Misc. Information .....   |
| Contracts .....              | Pay or Clothing .....     |
| Death or Effects .....       | Personal Reports .....    |
| Desertion .....              | Rank .....                |
| Discharge from Hosp'l .....  | Transfer to Hosp'l .....  |
| Discharge from Service ..... | Transfer to V. R. C. .... |
| Duty .....                   | Transportation .....      |

**5 Cav. U.S.C.T.**

*J*  
*Nashim Jordan*  
*Pvt*, Co. *E*, 5 Reg't U. S. Col'd Cavalry.

Appears on **Co. Muster-out Roll**, dated  
*Nelema Ark, Mar 16*, 1866.

Muster-out to date \* *Mar 3*, 1866.

Last paid to *Dec 31*, 1865.

**Clothing account:**

Last settled....., 186 ; drawn since \$..... 100

Due soldier \$..... 100; due U. S. \$ *47*  $\frac{35}{100}$

Am't for cloth'g in kind or money adv'd \$..... 100

Due U. S. for arms, equipments, &c., \$ *55*  $\frac{5}{100}$

Bounty paid \$ *100*  $\frac{00}{100}$ ; due \$ *100*  $\frac{00}{100}$

Remarks: *Due to*  
*Co. Mustered out*

\* **Records on file in 2nd. Auditor's Office show this Co. Mustered Out to take effect Mch, 16th. 1866. and paid to include Mch, 15th. 1866.**

Book mark: .....

(361)

*Nashim Jordan*  
Copyist.

J | 5 Cav. | U.S.C.T.

Haskin Jordan  
Priv., Co. E, 5 Reg't U. S. Colored Cav.

Appears on Returns as follows:

Oct 1864. Absent sick in Genl. Hospital. Oct. 7/64  
Nov. & Dec. 1864 Absent sick in Genl Hospital since Sept. 25/64.

Name appears also as Haskin Jordan

Book mark :

Austin

(546)

Copyist.



J | **5 Cav. | U.S.C.T.**

William Jordan  
Pr, Co. E, 5 Reg't U. S. Col'd Cavalry.

Appears on

**Company Muster Roll**

for Jan & Feb, 1866.

Present or absent Present

Stoppage, \$ 100 for

Due Gov't, \$ 100 for

Valuation of horse, \$ 100

Valuation of horse equipments, \$ 100

Remarks: \_\_\_\_\_

\_\_\_\_\_  
\_\_\_\_\_  
\_\_\_\_\_  
\_\_\_\_\_  
\_\_\_\_\_  
\_\_\_\_\_

Book mark: \_\_\_\_\_

(358)

W. J. Jordan

Copyist.

J | 5 Cav. | U.S.C.T.

Haskin Jordan

Priv., Co. E, 5 Reg't U.S. Col'd Cavalry.

Appears on

Company Muster Roll

for Nov & Dec, 1865.

Present or absent Present

Stoppage, \$ 100 for

Due Gov't, \$ 100 for

Valuation of horse, \$ 100

Valuation of horse equipments, \$ 100

Remarks:

Book mark:

Long

Copyist.

(358)

I | **5 Cav. | U.S.C.T.**

Waskin Jordan  
Priv, Co. E, 5 Reg't U. S. Col'd Cavalry.

Appears on

**Company Muster Roll**

for Sept. Oct., 1863.

Present or absent present

Stoppage, \$ 100 for

Due Gov't, \$ 100 for

Valuation of horse, \$ 100

Valuation of horse equipments, \$ 100

Remarks:

Book mark:

(358)

Long  
Copyist.



*J* | **5 Cav. | U.S.C.T.**

*Haskin Jordan*  
*Pvt*, Co. E, 5 Reg't U. S. Col'd Cavalry.

Appears on

**Company Muster Roll**

for *July & Aug*, 1863.

Present or absent *present*

Stoppage, \$ *100* for

Due Gov't, \$ *100* for

Valuation of horse, \$ *100*

Valuation of horse equipments, \$ *100*

Remarks:

Book mark:

(358)

*Long*  
Copyist.

*J* | **5 Cav.** | **U.S.C.T.**

*Haskin Jordan*  
*Pnt* ..... , Co. E, 5 Reg't U. S. Col'd Cavalry.

Appears on

**Company Muster Roll**

for *May - June* ..... , 186 *5*.

Present or absent *present* .....

Stoppage, \$ ..... *100* for .....

Due Gov't, \$ ..... *100* for .....

Valuation of horse, \$ ..... *100*

Valuation of horse equipments, \$ ..... *100*

Remarks: *1<sup>st</sup> Instalment*  
*Bounty due \$100.*

Book mark: .....

(358)

*Long*  
Copyist.

**5 Cav. U.S.C.T.**

*Hastin Jordan*

*Priv.*, Co. E, 5 Reg't U. S. Col'd Cavalry.

Appears on

**Company Muster Roll**

for *March & April*, 1865.

Present or absent *Present*

Stoppage, \$ *100* for

Due Gov't, \$ *100* for

Valuation of horse, \$ *100*

Valuation of horse equipments, \$ *100*

Remarks: *Discontinued  
of service*

Book mark:

*W. L. Land*



J | 5 Cav. | U.S.C.T.

*Justin Jordan*  
*Capt.*, Co. E, 5 Reg't U. S. Col'd Cavalry.

Appears on

**Company Muster Roll**

for *Jan & Feb*, 1865.

Present or absent *Present*

Stoppage, \$ 100 for

Due Gov't, \$ 100 for

Valuation of horse, \$ 100

Valuation of horse equipments, \$ 100

Remarks *First instalment*  
*of Bounty due \$100*  
*Due U. S. Ordnance \$350*

Book mark:

*M. R. Rowland*

9 | **5 Cav. | U.S.C.T.**

Washington Jordan  
Pvt., Co. E, 5 Reg't U. S. Col'd Cavalry.

Appears on

**Company Muster Roll**

for Nov. & Dec., 1864.

Present or absent Absent

Stoppage, \$ 100 for

Due Gov't, \$ 100 for

Valuation of horse, \$ 100

Valuation of horse equipments, \$ 100

Remarks: Absent sick, Gen.  
Hospital Oct. 1<sup>st</sup> '64  
1<sup>st</sup> and 2<sup>d</sup> instalment of  
Bounty due

Book mark:

W. T. Keeland

7 | **5 Cav. | U.S.C.T.**

*Caspius Jordan*  
....., Co. E, 5 Reg't U. S. Col'd Cavalry.

Appears on

**Company Muster Roll**

for *Enlistment to Oct 31*, 1864.

Present or absent.....

Stoppage, \$.....100 for.....

Due Gov't, \$.....100 for.....

Valuation of horse, \$.....100

Valuation of horse equipments, \$.....100

Remarks: *Absent sick - General Hospital since October 7, 64*

*name of horse given, cancelled by line*

Book mark:.....

(358)

*W. Rowland*

Copyist.



5 Cav. U.S.C.T.

*John Jordan*

*Co. B*, Co. *B* 5 Reg't U. S. Col'd Cavalry.

Appears on

**Company Muster-in and Descriptive Roll**

of the organization named above. Roll dated

*Camp Nelson, N.Y., Oct. 26*, 1864.

Where born *Anderson Ky.*

Age *20* y'rs; occupation *Farmer*

When enlisted *Sept. 9*, 1864.

Where enlisted *Cp. Nelson Ky.*

For what period enlisted *3* years.

Eyes *Black*; hair *Black*

Complexion *Black*; height *5* ft. *6* in.

When mustered in *Sept. 9*, 1864.

Where mustered in *Cp. Nelson Ky.*

Bounty paid \$ *100*; due \$ *100*

Where credited

Company to which assigned

Remarks: *4<sup>th</sup> District Kentucky*

\* *John Jordan*

\* *supposed to be name of owner.*

*Added May 17. 98. H. A. J.*

Book mark:

*General Notation R. & P. 407375.*

*H. W. Rowland*

(356d)

Copyist.

*J* | **5 Cav.** | **U.S.C.T.**

*Haskin Jordan*

....., Co. *E*, 5 Reg't U. S. Col'd Cav.

Appears on

**Company Descriptive Book**  
of the organization named above.

**DESCRIPTION.**

Age *20* years; height *5* feet *6* inches.

Complexion *Black*

Eyes *Blk*; hair *Blk*

Where born *Anderson Ky*

Occupation *farmer*

**ENLISTMENT.**

When *Sep 9*, 186

Where *Camp Nelson*

By whom *J. C. Randolph*; term *3* y'rs.

Remarks:

.....  
.....  
.....  
.....

*J. E. Fikes*

S 151567 ✓ Audew  
S 1612133 Aud. W. D.  
02080724 P O aff  
J2293545 P. C. Wm

*St. Vincent Co*



748

Jordan Haskin

Co E, 5 U. S. Col'd Cav.

Private | Private

CARD NUMBERS.

1	5363716	26
2	5363810	27
3	5363912	28
4	5363987	29
5	5364086	30
6	5364174	31
7	5364258	32
8	5364352	33
9	5364437	34
10	5364520	35
11	5364597	36
12	9090463	37
13	40729999	38
14		39
15		40
16		41
17		42
18		43
19		44
20		45
21		46
22		47
23		48
24		49
25		50

Book Mark: General Notation H. & P. 407375,

See also

I certify, on honor, that William Jones a Private of  
Captain ..... Company (L.) of the 5<sup>th</sup> Regiment of U.S. Col<sup>d</sup> Regt.  
**VOLUNTEERS**, of the State of ....., born in Mason County, State  
of Kentucky, aged 19 years; 5 feet 4 inches high; Dark complexion,  
Dark eyes, Dark hair, and by occupation a Labourer, having joined the company on  
its original organization at ....., and enrolled in it at the muster into  
the service of the United States at ....., on the ..... day  
of ....., 1864, (or was mustered in service as a recruit, by Capt. A. M.  
....., at Louisville, on the 23<sup>rd</sup> day of Sept.,  
1864, or was drafted and mustered into the service of the United States from the  
Enrollment District of the State of ....., at .....,  
on the ..... day of ....., 1864,) to serve in the Regiment, for  
the term of Three Years: and having served HONESTLY and  
FAITHFULLY with his Company in ..... to the present date, is now  
entitled to a **DISCHARGE** by reason of Death in Gen. Hosp. Camp  
Melrose, Dec. 1<sup>st</sup> 1864. Cause not stated

The said William Jones was last paid by Paymaster  
..... to include the ..... day of ....., 1864, and has  
pay due him ~~from that time~~ to the present date; he is entitled to pay and subsistence for  
TRAVELING to place of enrollment, and whatever other allowances are authorized to volunteer  
soldiers, drafted men, or militia, so discharged. He has received from the United States **CLOTHING**  
amounting to 80<sup>ty</sup> dollars, since the ..... day of Enlistment,  
1864, when his clothing account was last settled. He has received from the United States  
..... dollars advanced **BOUNTY**.

There is to be stopped from him, on account of the State of ....., or other  
authorities, for **CLOTHING**, &c., received on entering service, ..... dollars; and  
for other stoppages, viz:

..... dollars.  
He has been furnished with TRANSPORTATION in kind from the place of his discharge to  
.....; and he has been SUBSISTED for TRAVELING to his  
place of enrollment, up to the ....., 1864.

He is indebted to ....., **SUTLER**, ..... dollars.

He is indebted to ....., **LAUNDRESS**, ..... dollars.

Given in Duplicate, at Pimmiton Ky., this 1<sup>st</sup> day  
of January, 1865.

Geo. M. Bates 1<sup>st</sup> Lieut.  
Co. H, 6<sup>th</sup> U.S. Col. Regt.

Commanding Company



FINAL STATEMENT

Co "G"  
OF  
William Jones  
3<sup>rd</sup> Reg't of A.S. Col - Cav

VOLUNTEERS.

Rec'd Dec 1<sup>st</sup> 1864

NOTE 1.—Two of these certificates (or duplicates) are to be given to each Volunteer Soldier or drafted man who may be discharged previously to the discharge of his company, that he may at once receive from the Paymaster the pay, &c., due him, and the captain or other COMMISSIONED officer commanding the company will certify to the act of the delivery of the duplicate certificates; on these certificates the Soldier is "entitled to" his discharge, and should also present his discharge to the Paymaster to have the payment endorsed on it. The discharge is to be given back to the Soldier by the Paymaster; the latter only retaining as his voucher the duplicate certificates.

NOTE 2.—If the Soldier is entitled to pay for the use of his horse, the Company Commander will certify to that fact on the back of both these final statements, and also to the time he has pay due for having been so mounted on his own horse.

NOTE 3.—When a Soldier is furnished with final statements, his descriptive list, if he has one, should be taken up by the officer who gives the Soldier these statements, and endorsed with a statement to this effect by the officer. This endorsement should exhibit a full statement of the time for which the Soldier was allowed pay on his final statements, the clothing account, and all other charges against him or in his favor, so as to comprise a complete exhibit of his account. It will then be transmitted to the company commander of the Soldier, who will enter all the data necessary to a full understanding of the Soldier's account on the muster roll upon which the Soldier's discharge is reported. The descriptive list will then be destroyed. The object of this is, that the remaining portion of the Soldier's account may be settled upon the receipt of these muster rolls, and the Soldier receive any pay or allowances that may be due him at the time of his discharge, and which may not appear on his final statements from the fact that his descriptive list is incomplete. These accounts for back pay, &c., are settled by the 2d Auditor of the Treasury Department.

NOTE 4.—Charges for loss or injury to ordnance, horse equipments, and other miscellaneous charges, should appear under the heading of "Other Stoppages."

NOTE 5.—Bounty paid by State authorities, and not by the United States, will not be entered on this statement.

NOTE 6.—Amounts due the Sutler and Laundress must be entered on the muster roll on which the discharge, death, desertion, &c., is reported, as well as on the final statement, otherwise the amount cannot be collected from the United States.

NOTE 7.—This blank will be used for deceased volunteers and drafted men, as well as for others.

NOTE 8.—Where a Soldier dies in Hospital or on detached service, his descriptive list, if he has one, should be sent with his final statements, in duplicate, to the Adjutant General, Washington, D. C.

Was Capt. H. D. W.  
Knew of 1863  
Bucks returned in  
account of pay  
By order of  
J. H. Sargent  
1864

A.S. Col. May 3<sup>rd</sup> 1865  
Inc. of 1000  
A.S. Col. Sept 1<sup>st</sup> 1865  
M.G. M. Approved  
value of Effects Cent  
\$ 5.50 Sent 2<sup>d</sup> Auditor

ADJUTANT GENERAL'S OFFICE  
April 14<sup>th</sup> 1865  
Duplicate with Inventory sent 2d Auditor.

RECEIVED  
ADJUTANT GENERAL'S OFFICE  
WASHINGTON, D. C.  
APR 14 1865



Inventory of the effects of William Jones late  
 a Private of Captain \_\_\_\_\_ Company D of  
 the 5<sup>th</sup> Regiment of U.S. Vol. Inf. Volunteers, who was enrolled as  
 a Recruit at Louisville in the State of Kentucky on  
 the 23<sup>rd</sup> day of September 1864, and mustered into the service of the United  
 States as a Private on the 24<sup>th</sup> day of September 1864, at Louisville  
 in Company \_\_\_\_\_, 5<sup>th</sup> Regiment of U.S. Vol. Inf. Volunteers, to serve Three  
 years or during the war; he was born in Nelson County in the State  
 of Kentucky; he was 19 years of age, 5 feet 8 inches  
 high, Dark complexion, Dark eyes, Dark hair, and by occupation, when enrolled,  
 a Sawyer; he died in Nelson Gen. Hosp, at  
Camp Nelson Ky. on the 1<sup>st</sup> day of December 1864, by  
 reason of cause not stated

INVENTORY.					
ARTICLES.	No.	ARTICLES.	No.	ARTICLES.	No.
Hats.....		Pairs trousers.....		Knapsacks.....	
Caps.....	One	Pairs flannel drawers.....			
Forage Caps.....		Pairs cotton drawers.....	One		
Great coats.....	One	Flannel shirts.....			
Uniform coats.....		Cotton shirts.....			
Uniform jackets.....		Pairs boots.....			
Flannel sack coats.....		Pairs shoes.....	One		
Blouses.....	One	Pairs socks.....			
Stable frocks.....		Blankets.....	One	MONEY.	
Fatigue overalls.....		Haversacks.....		Specie.....	\$
				Notes.....	\$

I CERTIFY, ON HONOR, that the above inventory comprises all the effects of Private  
William Jones, deceased, and that the effects are in the hands  
 of Surgeon in Charge of Nelson's U.S. Gen. Hosp Camp  
Nelson Ky. to be disposed of by a Council of Administration.

(DUPLICATES.)

Geo. W. Bates "St. Co. 10"  
U.S. Vol. Inf.

STATION: \_\_\_\_\_

Commanding the Company.

DATE: \_\_\_\_\_

ARTICLES OF WAR.

ART. 95. When any non-commissioned officer or soldier shall die, or be killed in the service of the United States, the then commanding officer of the troop or company shall, in the presence of two other commissioned officers, take an account of what effects he died possessed of, above his arms and accoutrements, and transmit the same to the office of the Department of War, which said effects are to be accounted for, and paid to the representatives of such deceased non-commissioned officer or soldier. And in case any of the officers, so authorized to take care of the effects of deceased officers and soldiers, should, before they have accounted to their representatives for the same, have occasion to leave the regiment or post, by preferment or otherwise, they shall, before they be permitted to quit the same, deposit in the hands of the commanding officer, or of the assistant military agent, all the effects of such deceased non-commissioned officers and soldiers, in order that the same may be secured for, and paid to, their respective representatives.

ARMY REGULATIONS—EDITION OF 1863.

DECEASED SOLDIERS.

Par. 152. Inventories of the effects of deceased non-commissioned officers and soldiers, required by the 95th Article of War, will be forwarded to the Adjutant General, by the commander of the company to which the deceased belonged, and a duplicate of the same to the colonel of the regiment. Final statements of pay, clothing, &c., in duplicate, will be sent to the Adjutant General with one copy of the inventory. When a soldier dies at a post or station absent from his company, it will be the duty of his immediate commander to furnish the required inventory and final statements, and, at the same time, to forward to the commanding officer of the company to which the soldier belonged, a report of his death, specifying the date, place, and cause; to what time he was last paid, and the money or other effects in his possession at the time of his decease; which report will be noted on the next muster roll of the company to which the man belonged. Each inventory will be endorsed, "Inventory of the effects of \_\_\_\_\_, late of company (—) \_\_\_\_\_ regiment of \_\_\_\_\_, who died at \_\_\_\_\_, the \_\_\_\_\_ day of \_\_\_\_\_, 186—." If a legal representative receive the effects, it will be stated in the report. If the soldier leave no effects, the fact will be reported.

Par. 153. Should the effects of a deceased non-commissioned officer or soldier not be administered upon within a short period after his decease, they shall be disposed of by a Council of Administration, under the authority of the commanding officer of the post, and the proceeds deposited with the Paymaster, to the credit of the United States, until they shall be claimed by the legal representatives of the deceased.

Par. 154. In all such cases of sales by the Council of Administration, a statement in detail, or account of the proceeds, duly certified by the Council and commanding officer, accompanied by the Paymaster's receipt for the proceeds, will be forwarded by the commanding officer to the Adjutant General. The statement will be endorsed, "Report of the proceeds of the effects of \_\_\_\_\_, late of company (—) \_\_\_\_\_ regiment of \_\_\_\_\_, who died at \_\_\_\_\_, the \_\_\_\_\_ day of \_\_\_\_\_, 186—."

NOTE 1.—The effects in all cases, when called for, should be turned over to the legal representative, without further authority from the Adjutant General. When the effects are turned over to the relatives of the deceased before these inventories are sent to the Adjutant General, their receipts therefor should be attached to the inventories. In all other cases, one copy will be sent with a letter of transmittal direct to the Adjutant General, and a duplicate retained by the officer.

NOTE 2.—Particular care should be taken to take receipts in duplicate from the Paymaster for any funds turned over to him; one copy should be sent direct to the Adjutant General and one retained by the officer.

INVENTORY OF THE EFFECTS

OF

*William Jones*

*Late of Company 'L'*

*5<sup>th</sup> Reg't of W.S. Cal<sup>d</sup> Cav.*

*Volunteers, who died at Gen. Hosp. Camp, Maryland.*

*on the 1<sup>st</sup> day of December 1864*





Nelson U. S. Army General Hospital,

Dec 1<sup>st</sup> 1864.

Commanding Officer Company A  
5. Regt U.S.C.

I have to inform you  
that *St. John Jones* of your Company, died  
in this hospital on the 1<sup>st</sup> day of Dec<sup>r</sup> 1864

X

I enclose his descriptive list, with pay and clothing account,  
~~with~~ inventory of his effects.

Very respectfully yours, &c.,

*Daniel McKee*

Surgeon U. S. A.

In charge of General Hospital.



Inventory of the effects of *Wm Jones 1<sup>st</sup>*  
 Company *"A" 5<sup>th</sup>* Regiment *U.S.A.*  
 who died in the *Nelson General Hospital Camp*  
*Nelson N<sup>o</sup> 1<sup>st</sup>* Dec<sup>r</sup> 1<sup>st</sup> 1864.

CAPS.....	/	BLANKETS.....	/
DRESS COATS.....		KNAPSACKS.....	
OVERCOATS.....	/	CANTEENS.....	
JACKETS.....		HIVERSACKS.....	
TROUSERS.....		MUSKETS.....	
SHIRTS.....		BAYONETS.....	
DRAWERS.....	/	CARTRIDGE BOXES.....	
BOOTS, p <sup>s</sup> .....		BELT.....	
SHOES, p <sup>s</sup> .....	/	MONEY.....	
STOCKINGS.....		<i>Blouse</i>	/

*Inventory*  
 of the effects of *Private*  
*Wm Jones*  
 late of *Co "A" 5<sup>th</sup>* Regiment  
*U.S.A.* who died  
 at *Nelson General*  
*Hospital Camp N<sup>o</sup> 1<sup>st</sup>*  
 1864.



No. 1.

RECORD OF DEATH AND INTERMENT.

Name and number of person interred.....	<i>John Jones</i>
Number and locality of the grave.....	<i>548</i>
Hospital number of the deceased.....	
Regiment, rank and company.....	<i>1st U.S.C.</i>
Residence before enlistment.....	
Conjugal relation, (and if married the residence of the widow).....	<i>Typhoid Fever</i>
Cause of death.....	
Age of the deceased.....	
Nativity .....	
References and remarks.....	
Date of death and burial.....	<i>Dec 18 1861</i>

~~Duplicates sent to the Adjutant General of the United States Army, and to the Sexton of the Cemetery.~~

*Memoranda*

*Over Coat 1*

*Memoranda: 1*

*to house 1*

*papers 1*

*Shoes 1*

*Books 1*

*Uniform coat 1*

*Cap 1*

*Shoes 1*

*Articles 1*

From Bonds  
at 5. U.S. G. S.

William D. ...  
57 W. ...  
December 1st 1861  
Genl. Wm. Campbell Nelson, Ky.



MICROFILM PUBLICATION M 1821

COMPILED MILITARY SERVICE RECORDS  
OF VOLUNTEER UNION SOLDIERS WHO  
SERVED WITH THE USCT (US COLORED TROOPS)  
5TH REGIMENT OF CAVALRY

PERSONAL PAPERS' TARGET SHEET

PLEASE NOTE THE CHECKED INFORMATION ABOUT THE PERSONAL PAPERS IN  
THIS FILE: —

- NO PERSONAL PAPERS WERE FOUND IN THIS FILE WHEN THE  
RECORDS WERE ARRANGED FOR MICROFILMING.
- 4 PERSONAL PAPER(S) FOUND IN THIS FILE WHEN THE RECORDS  
WERE ARRANGED FOR MICROFILMING.

Jones, William J  
 P, Co. L, 5 Reg't U.S.C. Cav  
 5 Enclosures. 3 Items

Bed Cards .....	Descriptive Lists .....
Burial Records <i>/</i> .....	Final Statements <i>7</i> .....
Certs. of Dis. for Discharge .....	Furloughs .....
C. M. Charges .....	Med. Des. Lists .....
Med. Certificates .....	Orders .....

Other papers relating to—

Admission to Hosp'l .....	Furlough .....
Casualty Sheet (Officer's) .....	Med. Examination .....
Confinement .....	Misc. Information .....
Contracts .....	Pay or Clothing .....
Death or Effects <i>2</i> .....	Personal Reports .....
Desertions .....	Rank .....
Discharge from Hosp'l .....	Transfer to Hosp'l .....
Discharge from Service .....	Transfer to V. R. C. .....
Duty .....	Transportation .....

*J* | *5 Cav* | **U.S.C.T.**  
*William Jones*  
*Pr*, Co *L*, *5* Reg't U. S. Col'd *Cavalry*

Appears on **Co. Muster-out Roll**, dated  
*Atleu, Ark. March*, 186*6*.

Muster-out to date \_\_\_\_\_, 186 .

Last paid to *never Paid* \_\_\_\_\_, 186 .

Clothing account:

Last settled \_\_\_\_\_, 186 ; drawn since \$ \_\_\_\_\_ 100

Due soldier \$ \_\_\_\_\_ 100; due U. S. \$ *2* <sup>50</sup>/<sub>100</sub>

Am't for cloth'g in kind or money adv'd \$ \_\_\_\_\_ 100

Due U. S. for arms, equipments, &c., \$ \_\_\_\_\_ 100

Bounty paid \$ \_\_\_\_\_ 100; due \$ *100* 100

Remarks: *Died at Camp Nelson*  
*Ky Dec. 1<sup>st</sup>, 64. Disease un-*  
*known. Final state-*  
*ments forwarded.*

Book mark: \_\_\_\_\_

*C. P. Taylor*  
(361) \_\_\_\_\_ Copyist.



J | **5 Cav. | U.S.C.T.**  

---

*William Jones*  
*Priv*, Co. *L*, 5 Reg't U. S. Colored Cav.

Appears on **Returns** as follows:

*Oct 1864 Absent, detach. service  
Nashville Tenn.*  
*Nov 1864 Absent sick in Genl.  
Hosp'l Camp Nelson Ky.*  
*Dec 1864 Died in Genl Hosp'l  
Camp Nelson Ky. Dec 1/64.  
cause not stated.*

Book mark :

(546)

*Austin*

Copist.

J. | 5 Cav. | U.S.C.T.

William Jones

Pvt., Co. L, 5 Reg't U. S. Col'd Cavalry.

Appears on

Company Muster Roll

for Nov & Dec, 1864.

Present or absent

Stoppage, \$ 100 for

Due Gov't, \$ 100 for

Valuation of horse, \$ 100

Valuation of horse equipments, \$ 100

Remarks: Died in Seal  
Hosp Camp Nelson  
Dec 1. 1864. 1 & 2  
install of Bounty  
due

Book mark:

Bridger

9 | **5 Cav.** | **U.S.C.T.**

William Jones  
Capt, Co. L, 5 Reg't U. S. Col'd Cavalry.

Appears on  
**Company Muster Roll**  
for dated Oct 31, 1864

Present or absent Absent

Stoppage, \$.....100 for .....

Due Gov't, \$.....100 for .....

Valuation of horse, \$.....100

Valuation of horse equipments, \$.....100

Remarks: On det serv  
Nashville Tenn  
Oct 15/64

Book mark: .....

Brady  
(358) Copyist.





1 5 bar U.S.C.

William Jones

Appears with rank of Pvt on

**Muster and Descriptive Roll**

of Detachment of U.S. Colored Recruits  
mustered for U.S.C. at Taylor Bls

Louisville Ky Roll dated  
Louisville Ky, Sept. 24, 1864.

Where born Nelson Ky

Age 19 years; occupation laborer

When enlisted Sept. 22, 1864.

Where enlisted Louisville Ky

For what period enlisted 3 years.

Eyes Dark; hair Dark

Complexion Dark; height 5 ft. 8 in.

When mustered in Sept. 24, 1864.

Where mustered in Louisville Ky

Bounty paid \$ 100; due \$ 100

**Clothing account:**

Last settled \_\_\_\_\_, 186 \_\_\_\_; drawn since \$ 100

Date of first muster \_\_\_\_\_, 186 \_\_\_\_

Company to which assigned \_\_\_\_\_

Remarks: credited to Nelson Co. 4<sup>th</sup> Dist

Book mark : \_\_\_\_\_

W. M. Allen

*J.* | **5 Cav.** | **U.S.C.T.**

*William Jones*

*Priv*, Co. *R*, 5 Reg't U. S. Col'd Cavalry.

Appears on

**Company Muster-in and Descriptive Roll**

of the organization named above. Roll dated

*Camp Nelson, Ky*, ~~N. Y.~~ *Oct 30*, 186 *4*

Where born *Nelson Ky*

Age *19* y'rs; occupation *Labourer*

When enlisted *Sept 23*, 186 .

Where enlisted *Ronsville*

For what period enlisted *3* years.

Eyes *DK*; hair *DK*

Complexion *DK*; height *5* ft. *8* in.

When mustered in *Sept 24*, 186 .

Where mustered in *Ronsville*

Bounty paid \$ *100*; due \$ *100*

Where credited *H<sup>rd</sup> Det Ky*

Company to which assigned

Remarks:

Book mark:

*Biddle*



A | **5 Cav. | U.S.C.T.**

William Jones

....., Co. L, 5 Reg't U. S. Col'd Cav.

Appears on  
**Company Descriptive Book**  
of the organization named above.

**DESCRIPTION.**

Age 27 years; height 5 feet 8 inches.

Complexion Dark

Eyes Dark; hair Dark

Where born Keokuk Iowa

Occupation Laborer

**ENLISTMENT.**

When Sept 23, 1866

Where Louisville

By whom Capt. Ham; term 3 y'rs.

Remarks: Lied Dec 1<sup>st</sup> / 64

.....  
.....  
.....  
.....  
.....  
.....  
.....  
.....  
.....  
.....

A. J. Anderson

8.1326693 Acad. N.D.

Stewart Co

.747

Jones William  
Co ~~to~~, 5 U. S. Col'd Cav.

Private | Private

CARD NUMBERS.

1	5369824	26
2	5369919	27
3	5370073	28
4	5370754	29
5	9091170	30
6	43147151	31
7	43148112	32
8	40729998	33
9		34
10		35
11		36
12		37
13		38
14		39
15		40
16		41
17		42
18		43
19		44
20		45
21		46
22		47
23		48
24		49
25		50

Book Mark: .....

See also .....



**5 Cav. U.S.C.T.**

*J*  
*Washington Jones*  
Bugler, Co. E, 5 Reg't U. S. Col'd Cavalry.

Appears on **Co. Muster-out Roll**, dated  
*Wheeler Ark. Mar 16*, 1866.

Muster-out to date \* *Mar. 3*, 1866.

Last paid to *Dec 31*, 1865.

Clothing account:

Last settled....., 186 ; drawn since \$..... 100

Due soldier \$ *10 75* / 100; due U. S. \$..... 100

Am't for cloth'g in kind or money adv'd \$..... 100

Due U. S. for arms, equipments, &c., \$..... 100

Bounty paid \$ *100* <sup>xx</sup> / 100; due \$ *100* <sup>xx</sup> / 100

Remarks: *Private from Org. of*  
*Co to Dec 29/65 then Bugler*

\* **Records on file in 2nd. Auditor's**  
**Office show this Co. Mustered Out**  
**to take effect Mch, 16th. 1866. and**  
**paid to include Mch, 15th. 1866.**

Book mark: .....

(361)

*J. L. Leonard*

Copyist.

1864

J | 5 Cav. | U.S.C.T.

Washington Jones  
Priv., Co. E, 5 Reg't U. S. Colored Cav.

Appears on Returns as follows:

Oct. to Dec. 1864, Absent on de-  
tached service, at Burn-  
side Point, Ky, Sept 30/64

Book mark :

(546)

Austin

Copyist.

5 Cav. U.S.C.T.

Washington Jones  
Sergeant, Co. E, 5 Reg't U.S. Col'd Cavalry.

Appears on

Company Muster Roll

for Jan 1866, 1866.

Present or absent Present

Stoppage, \$ 100 for

Due Gov't, \$ 100 for

Valuation of horse, \$ 100

Valuation of horse equipments, \$ 100

Remarks:

Book mark:

(358)

J. H. Leonard  
Copyist.



J | **5 Cav. U.S.C.T.**

*Washington Jones*  
*Bugler*, Co. E, 5 Reg't U.S. Col'd Cavalry.

Appears on

**Company Muster Roll**

for *Nov + Dec*, 1865.

Present or absent *present*

Stoppage, \$ *100* for

Due Gov't, \$ *100* for

Valuation of horse, \$ *100*

Valuation of horse equipments, \$ *100*

Remarks: *Appointed Bugler*  
*from Private per*  
*R.O. no. 210 dated*  
*Dec. 29/65.*

Book mark:

*Long*

(358)

Copyist.

*J* | **5 Cav. U.S.C.T.**

*Washington Jones*  
*Priv*....., Co. E, 5 Reg't U. S. Col'd Cavalry.

Appears on

**Company Muster Roll**

for *Sept. - Oct.*....., 1865.

Present or absent *present*.....

Stoppage, \$.....100 for .....

Due Gov't, \$.....100 for .....

Valuation of horse, \$.....100

Valuation of horse equipments, \$.....100

Remarks:.....

.....  
.....  
.....  
.....  
.....  
.....  
.....

Book mark:.....

.....  
.....  
*Long*  
.....  
.....

(358)

Copyist.

*J* | **5 Cav.** | **U.S.C.T.**

*Washington Jones*  
*Privt*, Co. E, 5 Reg't U.S. Col'd Cavalry.

Appears on

**Company Muster Roll**

for *July & Aug.*, 1865.

Present or absent *present*

Stoppage, \$ *100* for

Due Gov't, \$ *100* for

Valuation of horse, \$ *100*

Valuation of horse equipments, \$ *100*

Remarks:

Book mark:

(358)

*Long*  
Copyist.



*J* | **5 Cav. | U.S.C.T.**

*Washington Jones*  
*Privt*, Co. E, 5 Reg't U.S. Col'd Cavalry.

Appears on

**Company Muster Roll**

for *May, June*, 1865.

Present or absent *present*

Stoppage, \$ *100* for

Due Gov't, \$ *100* for

Valuation of horse, \$ *100*

Valuation of horse equipments, \$ *100*

Remarks: *1<sup>st</sup> Instalment*  
*Bounty due \$100*

Book mark: \_\_\_\_\_

(358)

*Long*  
Copyist.

17 | **5 Cav. | U.S.C.T.**

*Washington Jones*  
*Sub.*, Co. E, 5 Reg't U.S. Col'd Cavalry.

Appears on

**Company Muster Roll**

for *March & April*, 1865.

Present or absent *Present*

Stoppage, \$ 100 for

Due Gov't, \$ 100 for

Valuation of horse, \$ 100

Valuation of horse equipments, \$ 100

Remarks: *First instalment of Bounty due*

Book mark:

*W. P. ...*

9 | **5 Cav. | U.S.C.T.**

Washington Jones  
Cvt., Co. E, 5 Reg't U.S. Col'd Cavalry.

Appears on

**Company Muster Roll**

for Jan. 7<sup>th</sup> Feb., 1865.

Present or absent Present

Stoppage, \$ 100 for

Due Gov't, \$ 100 for

Valuation of horse, \$ 100

Valuation of horse equipments, \$ 100

Remarks: First installment  
of Bounty due \$100  
due to Co. for Ordnance  
\$31.72

Book mark: \_\_\_\_\_

(358)

M. H. [Signature]

Copyist.



5 Cav. U.S.C.T.

Washington Jones  
Pvt., Co. E, 5 Reg't U.S. Col'd Cavalry.

Appears on

Company Muster Roll

for Nov. 9 Dec., 1864.

Present or absent Present

Stoppage, \$ 100 for

Due Gov't, \$ 100 for

Valuation of horse, \$ 100

Valuation of horse equipments, \$ 100

Remarks: See detached service  
at Burnside Point  
to Sept. 30, 64. 1st  
regiment of Heavy  
Arty

Book mark:

(358) J. L. [Signature] Copyist.

*J* | **5 Cav.** | **U.S.C.T.**

*Washington Jones*  
*Private*, Co. E, 5 Reg't U.S. Col'd Cavalry.

Appears on

**Company Muster Roll**

for *Enlistment to Oct 31*, 1864.

Present or absent.....

Stoppage, \$.....100 for .....

Due Gov't, \$.....100 for .....

Valuation of horse, \$.....100

Valuation of horse equipments, \$.....100

Remarks: *On Detached ser*  
*vice Riverside Point*

*Name appears in column of*  
*names present. Cancelled by*  
*line*

Book mark: .....

*H. M. Cowlan*

J | **5 Cav.** | **U.S.C.T.**

Washington Jones

Ct., Co. E, 5 Reg't U. S. Col'd Cavalry.

Appears on

**Company Muster-in and Descriptive Roll**

of the organization named above. Roll dated

Camp Nelson, N. Y., Oct 26, 1864.

Where born Franklin Ky.

Age 9 y'rs; occupation Farmer

When enlisted Sept 9, 1864.

Where enlisted Cp. Nelson Ky.

For what period enlisted 3 years.

Eyes Black; hair Black

Complexion Black; height 5 ft. 4 in.

When mustered in Sept 9, 1864.

Where mustered in Cp. Nelson Ky.

Bounty paid \$ 100; due \$ 100

Where credited

Company to which assigned

Remarks: 7<sup>th</sup> District Kentucky

\* Nicholas Green

\* Supposed to be name of owner.

Added May 18. 98. H.A.J.

Book mark:

General Notation H. & T. 107375.

S. W. Rowland



*J* | **5 Cav. | U.S.C.T.**

*Washington Jones*  
....., Co. *E*, 5 Reg't U. S. Col'd Cav.

Appears on

**Company Descriptive Book**  
of the organization named above.

**DESCRIPTION.**

Age *19* years; height *5* feet *4* inches.

Complexion *Black*

Eyes *Blk*; hair *Blk*

Where born *Franklin Ky*

Occupation *farmer*

**ENLISTMENT.**

When *Sep 9*, 186 .

Where *Camp Nelson*

By whom *J. H. Lydolph* term *3* y'rs.

Remarks:

*J. E. Purke*

Q 15-60 672 Pom + m  
Q 1570 910 P + Ret.

Johnson & Co

746

Jones Washington  
Co E, 5 U. S. Col'd Cav.

Private | Bugler

CARD NUMBERS.

1	5363715	26
2	5363809	27
3	5363911	28
4	5363986	29
5	5364085	30
6	5364173	31
7	5364257	32
8	5364351	33
9	5364413	34
10	5364496	35
11	5364573	36
12	9090462	37
13	40730005	38
14		39
15		40
16		41
17		42
18		43
19		44
20		45
21		46
22		47
23		48
24		49
25		50

Book Mark:

General Patton H. & P. 407375,

See also



...DORSEMENT.]

# War Department,

ADJUTANT GENERAL'S OFFICE,

*February 25, 1874.*

The discharge of *Thomas Jones*  
*Quint*, Co. *C*, *5* Reg't U. S.

Colored *Company*, is reported as follows:

On Company Muster Roll.

For *March*, 1865, *rec. 8*, 1865

Company Muster-out Roll.

*December 11*, 1865

Company Descriptive Book.

....., 186

Company Morning Reports.

....., 186

Soldier's Final Statement.

....., 186

Soldier's Record of Death and Interment.

....., 186

Soldier's Inventory of Effects.

....., 186

Soldier's Certificate of Disability for Discharge.

....., 186

Soldier's Individual Muster-out Roll.

*December 11*, 1865

Regimental Return.

For *all*, 1865, *rec 9*, 1865

Regimental Quarterly Returns.

....., 186

Regimental Descriptive Book.

....., 186

By Surgeon General.

(.....), 186

*Dec 19*, 1865, is held to be  
the correct date, and the Company ~~Muster~~  
Roll will be amended accordingly.

*Thomas M. Incent*

E.B. 11

Assistant Adjutant General.

Noted *4* per letter to *2d* *1865*

*April 2<sup>d</sup> 1874*

Jones Thomas  
Co. E, 5 Reg U.S.C. Cav.

Enclosures.

Bed Cards	Descriptive Lists
Burial Records	Final Statements
Certs. of Dis. for Discharge	Furloughs
C. M. Charges	Med. Des. Lists
Med. Certificates	Orders

Other papers relating to—

Admission to Hosp'l	Furlough
Casualty Sheet (Officer's)	Med. Examination
Confinement	Misc. Information
Contracts	Pay or Clothing
Death or Effects	Personal Reports
Desertions	Rank
Discharge from Hosp'l	Transfer to Hosp'l
Discharge from Service	Transfer to V. R. C.
Duty	Transportation

JAN. - 9

5359312

1891 \*

Light Circular No. 111  
of 1864 to take  
effect Dec 19.65



J. 5 U.S.C.T.

Thomas Jones  
Priv, Co. E, 5 Reg't U. S. Col'd Calif

Appears on an

**Individual Muster-out Roll**

of the organization named above. Roll dated

Adm'd Act, Dec 19, 1865.

Muster-out to date Dec 19, 1865.

Last paid to Oct 31, 1865.

**Clothing account:**

Last settled Aug 31, 1865; drawn since \$ 37 <sup>67</sup>/<sub>100</sub>

Due soldier \$ 100; due U. S. \$ 100

Am't for cloth'g in kind or money adv'd \$ 100

Due U. S. for arms, equipments, &c., \$ 100

Bounty paid \$ 100 due \$ 100

Remarks: Substitute. Private  
from Enrollment. This man was  
transferred from the 72<sup>d</sup> U.S.C. by  
Gen. S. O. 127 Par 3 Hd Qrs Dept Ky  
July 1865. - Mustered out  
under provisions of War  
(over)

Book mark:

M. J. Hughes

5 Cav. U.S.C.T.

Thomas Jones  
Pvt., Co. E, 5 Reg't U. S. Col'd Cavalry.

Appears on Co. Muster-out Roll, dated  
Helena, Ark, March, 1861.

Muster-out to date \_\_\_\_\_, 1861.

Last paid to \_\_\_\_\_, 1861.

Clothing account:

Last settled \_\_\_\_\_, 1861; drawn since \$ \_\_\_\_\_ 100

Due soldier \$ 31 <sup>00</sup>/<sub>100</sub>; due U. S. \$ \_\_\_\_\_ 100

Am't for cloth'g in kind or money adv'd \$ \_\_\_\_\_ 100

Due U. S. for arms, equipments, &c., \$ \_\_\_\_\_ 100

Bounty paid \$ \_\_\_\_\_ 100; due \$ \_\_\_\_\_ 100

Remarks: Discharged at  
Helena, Ark, Nov 8  
1863 expiration of  
term of service

Book mark: Discharged Dec 19/65  
E.B. 711 Pet.

(861)

J. M. [Signature]  
Copyist.

5 Cav. | U.S.C.T.

Thomas Jones  
Priv., Co. E, 5 Reg't U. S. Colored Cav.

Appears on Returns as follows:

July 1865 Gam. July 27 Paris,  
Ky. Transf. to Co E as per  
Regt. Order No. 132

Dec 1865 Disch<sup>d</sup> expiration  
of term of service Dec.  
19/65 Helena, Ark.

Book mark :

(546)

Huston

Copyist.



*J* | **5 Cav. | U.S.C.T.**  
*Thomas Jones*  
*Priv.*, Co. E, 5 Reg't U. S. Col'd Cavalry.

Appears on

**Company Muster Roll**

for *Nov & Dec.*, 1865.

Present or absent.....

Stoppage, \$.....100 for.....

Due Gov't, \$.....100 for.....

Valuation of horse, \$.....100

Valuation of horse equipments, \$.....100

Remarks: *Discharged Dec. 8<sup>th</sup>*  
*1865 by expiration of*  
*service.*

Book mark: *Discharged Dec. 19/65*  
*E. B. V. 11 P. 4*

(358)

*Long*  
Copyist.

*J* | **5 Cav.** | **U.S.C.T.**

*Thomas Jones*  
*Put.*, Co. E, 5 Reg't U.S. Col'd Cavalry.

Appears on

**Company Muster Roll**

for *Sept. Oct.*, 1865.

Present or absent *present*

Stoppage, \$ *100* for

Due Gov't, \$ *100* for

Valuation of horse, \$ *100*

Valuation of horse equipments, \$ *100*

Remarks:

Book mark:

(358)

*Long*  
Copyist.

J | **5 Cav. | U.S.C.T.**

*Thomas Jones*  
-----  
*Privt.*, Co. E, 5 Reg't U. S. Col'd Cavalry.

Appears on

**Company Muster Roll**

for *July & Aug.*, 1865.

Present or absent *present*

Stoppage, \$ *100* for

Due Gov't, \$ *100* for

Valuation of horse, \$ *100*

Valuation of horse equipments, \$ *100*

Remarks: *Received by transfer*  
*from 72 C. I. per S. O. No. 127*  
*dated D. of Ky July 18/65*  
*Assigned to Co. per*  
*R. O. No. 132 dated July 27,*  
*'65. Appointed Sergt.*  
*Dec. 1/64, Reduced to Private*  
*per R. O. No. 145.*

Book mark: -----

(358)

*Louy*  
-----  
Copyist.



*G* | *5 Cav* | **U.S.C.T.**  
*Thomas Jones*

*Serjt*, Co. ...., *5* Reg't U. S. Col'd *Leav*  
Appears on

**M. and D. Roll of Men Transferred**

to the organization named above,

from .....

Roll dated *July 18*, 1865.

When enlisted ....., 186 .

Period for which enlisted *1* years.

When mustered in *Dec 1*, 1864.

Present or absent *Not Stated*

Company to which assigned .....

Remarks: *Apts Serjt Feb 18 1865*

*Due US for Camp & Gar B \$1.60*  
*Sub for Michael Brown*  
*Substitute*

Book mark : .....

*General Notation N. S. P. 407875,*

*Abbott*

*J* | **5 Cav. | U.S.C.T.**

*Thomas Jones*  
....., Co. *B*, 5 Reg't U. S. Col'd Cav.

Appears on

**Company Descriptive Book**  
of the organization named above.

**DESCRIPTION.**

Age *27* years; height *5* feet *6* inches.

Complexion *Black*

Eyes *Blk*; hair *Blk*

Where born *Ohio*

Occupation *farmer*

**ENLISTMENT.**

When *Substitute*, 186 .

Where

By whom ; term *1* y'rs.

Remarks: *Discharged*  
*Dec. 8 - 1865*  
*Expiration of*  
*Service*

*J. E. Parks*

745  
Jones Thomas  
Co E, 5 U. S. Col'd Cav.

Sergeant | Private

CARD NUMBERS.

1	5359233	26
2	5364262	27
3	5364356	28
4	5364474	29
5	5359312	30
6	5364680	31
7	9090457	32
8	40729997	33
9		34
10		35
11		36
12		37
13		38
14		39
15		40
16		41
17		42
18		43
19		44
20		45
21		46
22		47
23		48
24		49
25		50

Book Mark: General Notation R. & P. 407375.

See also 72 U.S.C. Inf.



I certify, on honor, that Spencer Jones, a Private of  
 Captain \_\_\_\_\_ Company (B) of the Fifth Regiment of the 1st Col Cav  
**VOLUNTEERS**, of the State of \_\_\_\_\_, born in Woodford Co, State  
 of Kentucky, aged 18 years; 5 feet 9 inches high; Blk complexion,  
Blk eyes, Blk hair, and by occupation a Farmer, who joined for service  
 and was enrolled (see Note 9) on the 10<sup>th</sup> day of September, 1864, at Camp Nelson Ky  
 by J C Randolph, for the period of three years, and mustered into  
 the service of the United States on the Twelfth day of September, 1864, at  
Camp Nelson Ky, by Capt J C Ramsey; and having served  
 HONESTLY and FAITHFULLY with his Company to the present date, is now entitled to a  
**DISCHARGE** by reason of Death caused by wounds re-  
ceived in action

The said Spencer Jones ~~was last paid by Paymaster~~  
has pay due him, to include the Tenth day of September, 1864, and  
 has pay due him from that time to the present date; he is entitled to pay and subsistence for  
**TRAVELING** to place of enrollment, and whatever other allowances are authorized to volunteer  
 soldiers, drafted men, or militia, so discharged. He has received from the United States **CLOTHING**  
 amounting to 77  $\frac{25}{100}$  dollars, since the 10<sup>th</sup> day of September,  
 1864, when his clothing account was last settled. He has received from the United States  
\_\_\_\_\_ dollars advanced **BOUNTY**. due \$100, 1<sup>st</sup> installment

There is to be stopped from him, on account of the State of \_\_\_\_\_, or other  
 authorities, for **CLOTHING**, &c., received on entering service, \_\_\_\_\_ 100 dollars; and  
 for other stoppages, viz: \_\_\_\_\_  
 \_\_\_\_\_ 100 dollars.

He has been furnished with **TRANSPORTATION** in kind from the place of his discharge to  
 \_\_\_\_\_; and he has been **SUBSISTED** for **TRAVELING** to his  
 place of enrollment, up to the \_\_\_\_\_, 1864.

He is indebted to \_\_\_\_\_, **SUTLER**, \_\_\_\_\_ 100 dollars.  
 He is indebted to \_\_\_\_\_, **LAUNDRESS**, \_\_\_\_\_ 100 dollars.

Given in Duplicate, at Camp Nelson Ky, this 14<sup>th</sup> day  
 of October, 1865.

Augustus Flint  
2<sup>d</sup> Lieut 5<sup>th</sup> U S C  
 Commanding Company. B



Extract from Act of Congress.

SEC. 12. And be it further enacted, That the fees of agents and attorneys for making out and causing to be executed the papers necessary to establish a claim for a pension, bounty, and other allowance before the Pension Office, under this act, shall not exceed the following rates: For making out and causing to be duly executed a declaration by the applicant, with the necessary affidavits, and forwarding the same to the Pension Office, with the requisite correspondence, ten dollars; which sum shall be received by such agent or attorney in full for all services in obtaining such pension, and shall not be demanded or received, in whole or in part, until such pension shall be obtained; and the sixth and seventh sections of an act entitled "An act to grant pensions," approved July [fourteenth,] eighteen hundred and sixty-two, are hereby repealed.

SEC. 13. And be it further enacted, That any agent or attorney who shall, directly or indirectly, demand or receive any greater compensation for his services under this act than is prescribed in the preceding section of this act, or who shall contract or agree to prosecute any claim for a pension, bounty, or other allowance under this act, on the condition that he shall receive a per centum upon any portion of the amount of such claim, or who shall wrongfully withhold from a pensioner or other claimant the whole or any part of the pension or claim allowed and due to such pensioner or claimant, shall be deemed guilty of a high misdemeanor, and, upon conviction thereof, shall, for every such offense, be fined not exceeding three hundred dollars, or imprisoned at hard labor not exceeding two years, or both, according to the circumstances and aggravations of the offense.

Approved July 4, 1834.

NOTE 10.—If any soldier is charged a higher fee than that allowed by the above act, he should report the fact and the name of the agent to the Adjutant General, in order that steps may be taken to have the same refunded.

*A.G.C. Oct 18 1865*  
*P. O. of Adams & M. seat.*  
*100 2<sup>d</sup> sent to Adams*

ADJUTANT GENERAL'S OFFICE  
*Oct 18 1865*  
 Duplicate with Inventory sent 2d Auditor.

FINAL STATEMENT

*100 2<sup>d</sup>*  
*Spencer Jones*  
*5<sup>th</sup> Reg't of U.S. Col.*

VOLUNTEERS.  
*Enl July 17 1865*

NOTE 1.—Two of these certificates (or duplicates) are to be given to each Volunteer Soldier or drafted man who may be discharged without being mustered out. (Final Statements are never given to men mustered out of service) that he may at once receive from the Paymaster the pay, &c. due him, and the captain or other COMMISSIONED officer commanding the company will certify to the act of the delivery of the duplicate certificates; with these certificates the Soldier is "entitled to" his discharge, and should also present his discharge to the Paymaster to have the payment endorsed on it. The discharge is to be given back to the Soldier by the Paymaster; the latter only retaining as his vouchers the duplicate certificates.

NOTE 2.—If the Soldier is entitled to pay for the use of his horse, the Company Commander will certify to that fact on the back of both these final statements, and also to the time he has pay due for having been so mounted on his own horse.

NOTE 3.—When a Soldier is furnished with final statements, his descriptive list, if he has one, should be taken up by the officer who gives the Soldier these statements, and endorsed with a statement to this effect by the officer. The endorsement should exhibit a full statement of the time for which the Soldier was allowed pay on his final statements, the clothing account, and all other charges against him or in his favor, so as to comprise a complete exhibit of his account. It will then be transmitted to the Company Commander of the Soldier, who will enter all the data necessary to a full understanding of the Soldier's account on the muster roll upon which the Soldier's discharge is reported. The descriptive list will then be destroyed. The object of this is, that the remaining portion of the Soldier's account may be settled upon the receipt of these muster rolls, and the Soldier receive any pay or allowances that may be due him at the time of his discharge, and which may not appear on his last final statements from the fact that his descriptive list is incomplete. These accounts for back pay, &c., are settled by the 2d Auditor of the Treasury Department.

NOTE 4.—Charges for loss or injury to ordnance, horse equipments, and other miscellaneous charges, should appear under the heading of "Other Stoppages."

NOTE 5.—Bounty paid by State authorities, and not by the United States, will not be entered on this statement.

NOTE 6.—Amounts due the Sutler and Laundress must be entered on the muster roll on which the discharge, death, desertion, &c., is reported, as well as on the final statement, otherwise the amount cannot be collected from the United States.

NOTE 7.—This blank will be used for deceased volunteers and drafted men, as well as for others.

NOTE 8.—Where a Soldier dies in Hospital or on detached service, his descriptive list, if he has one, should be sent with his final statements, in duplicate, to the Adjutant General, Washington, D. C.

NOTE 9.—If the soldier is a drafted man or substitute, the space for time, &c., of enrolled, should contain only the words *drafted* or *substitute*, as the case may be. If the Soldier is a *VETERAN* (or *RECRUIT*) the words *as a veteran*, (or *recruit*) as the case may be, should be interlined after the words *mustered into the service of the U. S.* A statement of all the installments of *Veteran* or *Recruit* Bounty RECEIVED by the Soldier must be made on the back of each final statement.

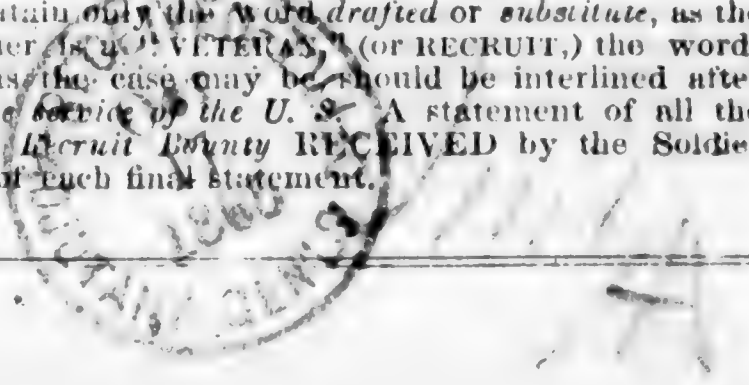

[OFFICE INDORSEMENT.]

War Department,

ADJUTANT GENERAL'S OFFICE,

May 5, 1874

The death of *Spencer Jones*,  
*5<sup>th</sup> Reg't U. S.*  
 Colored *Co. C*, is reported as follows:

- On Company Muster Roll. For *Jan. 1865*, *1865*
- Company Muster-out Roll. *February 1<sup>st</sup>*, 1865
- Company Descriptive Book. *February 1<sup>st</sup>*, 1865
- Company Morning Reports. *February 1<sup>st</sup>*, 1865
- Soldier's Final Statement. *February 1<sup>st</sup>*, 1865
- Soldier's Record of Death and Interment. *February 1<sup>st</sup>*, 1865
- Soldier's Inventory of Effects. *February 1<sup>st</sup>*, 1865
- Soldier's Certificate of Disability for Discharge. *February 1<sup>st</sup>*, 1865
- Soldier's Individual Muster-out Roll. *February 1<sup>st</sup>*, 1865

- Regimental Return. For *March 1865*, *March 21, 1865*
- Regimental Quarterly Returns. *March 21, 1865*
- Regimental Descriptive Book. *March 21, 1865*

By Surgeon General.  
*(25) 10 OCT 74*  
*Feb 17, 1865*  
*July 17, 1865, is held to be*  
 the correct date, and the Company Muster Roll will be amended accordingly.  
*See 2<sup>d</sup> to 2<sup>d</sup> page. June 9. 1874.*  
*Wm. M. E.B. 11/58*  
 Assistant Adjutant General.



PROOF OF OWNERSHIP.

STATE OF KENTUCKY,

COUNTY OF Woodford } SS.

We Peter & Raely and A. L. New each of lawful age, and resident citizens of the State and County aforesaid, do certify that Humphrey Jones of the State and County aforesaid, was on the 10th day of September 1864, the lawful owner of the slave named Spencer Jones referred to and described in the foregoing claim for compensation. as they described

P. J. Raely  
A. L. New

Sworn to and subscribed before me a Justice of the Peace for the County of Woodford State of Kentucky, this the 8th day of December 1866.

W. M. Dickey, J.P.W.



PROOF OF LOYALTY.

STATE OF KENTUCKY,

COUNTY OF Woodford } SS.

We Lewis A. Berry and B. Craig loyal men and each of lawful age, and resident citizens of the Woodford County in the State and County aforesaid, upon our oaths declare that we have known Humphrey Jones a resident of the State and County aforesaid, since the 4th day of March, 1861, and know that he has firmly and faithfully maintained his or her adherence and allegiance to the Government of the United States, by defending its cause against the Government and forces of the so-called Confederate States of America, in all suitable and practicable ways, and according to his or her ability and opportunity.

L. A. Berry  
B. Craig

Sworn to and subscribed before me a Justice of the Peace for the county of Woodford State of Kentucky, this the 8th day of December 1866.

W. M. Dickey, J.P.W.



POWER OF ATTORNEY.

My Post-Office address is \_\_\_\_\_ County of \_\_\_\_\_ State of Kentucky, and I hereby direct that all communications to me, touching this claim, be sent under cover to \_\_\_\_\_, who is hereby appointed and constituted my true and lawful attorney, to prosecute this claim for me, and who is hereby authorized and empowered to receive and receipt for any award, order, draft, certificate, voucher, warrant, papers or money that may be issued in the adjustment of this claim, or the payment thereof, the same as I might or could do in person were I present and acting for myself, and to file any additional evidence or papers that may be required in the prosecution of this claim.

[WITNESS.]

The owner signs here. }

Two witnesses to owner's signature sign here. }

50 CENT STAMP.



CERTIFICATE OF AWARD OF THE BOARD OF CLAIMS.

OFFICE OF THE BOARD OF CLAIMS  
FOR SLAVES ENLISTED OR DRAFTED IN THE SERVICE OF THE U. S. }

We hereby certify, that \_\_\_\_\_ of \_\_\_\_\_ county, State of Kentucky, having proved, under oath, \_\_\_\_\_ loyalty to the Constitution and Government of the United States, and established \_\_\_\_\_ title as to the ownership of \_\_\_\_\_, a slave, \_\_\_\_\_ and mustered at \_\_\_\_\_ on the \_\_\_\_\_ day of \_\_\_\_\_, 186\_\_\_\_, by \_\_\_\_\_ in the service of the United States, in the \_\_\_\_\_ Regiment of Colored Troops, Co. \_\_\_\_\_, the sum of \_\_\_\_\_ dollars has been awarded to \_\_\_\_\_ by this Board, subject to the approval of the Secretary of War, as a compensation for the said slave, under the provisions of section 24, Act approved February 24, 1864, and section 2, Act approved July 28, 1866.

\_\_\_\_\_, President of the Board.  
\_\_\_\_\_, Member of the Board.  
\_\_\_\_\_, Member of the Board.

To \_\_\_\_\_  
Chief of the Bureau for the Organization of Colored Troops, Washington, D. C.

Headquarters Kentucky Volunteers,

Adjutant-General's Office,

Frankfort, November 6<sup>th</sup>, 1864.

I hereby certify, that it appears from the U. S. Muster-In Rolls on file in this Office, that Spencer Jones was enrolled on the 6<sup>th</sup> day of September, 1864, at Lexington Ky, by Tho<sup>s</sup> H. Moore and mustered into the U. S. service on the 6<sup>th</sup> day of September, 1864, at Lexington Ky, by Tho<sup>s</sup> H. Moore to serve three years. Said Spencer Jones is described as follows: 19 years age, Black eyes, Black hair, Copper complexion, 5ft 10in height. It further appears from said Rolls, that Spencer Jones was credited to Woodford County Ky and owed service to Humphrey Jones and was assigned to Company "E" 5<sup>th</sup> Regt U. S. C. Cavalry

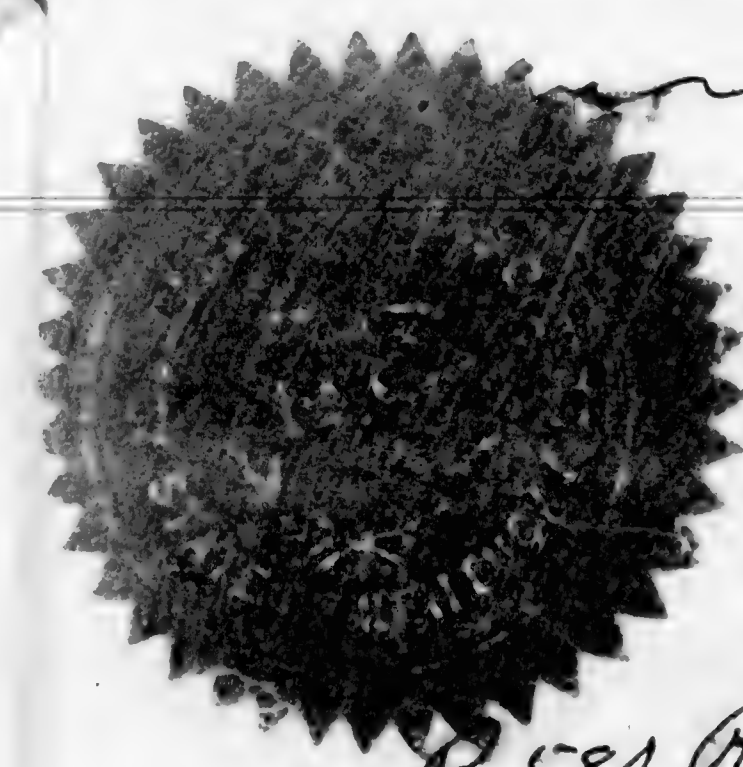

In Testimony Whereof, I have hereunto set my hand, and affixed my Official Seal, this 6<sup>th</sup> day of November, 1864.

D. W. Lindsey  
Adjutant General of Kentucky.

B 580. R. 391

POWER OF ATTORNEY.

My Post-Office address is \_\_\_\_\_ County of \_\_\_\_\_ State of Kentucky, and I hereby direct that all communications to me, touching this claim, be sent under cover to \_\_\_\_\_, who is hereby appointed and constituted my true and lawful attorney, to prosecute this claim for me, and who is hereby authorized and empowered to receive and receipt for any award, order, draft, certificate, voucher, warrant, papers or money that may be issued in the adjustment of this claim, or the payment thereof, the same as I might or could do in person were I present and acting for myself, and to file any additional evidence or papers that may be required in the prosecution of this claim.

[WITNESS.]

The owner signs here.

50 CENT STAMP.

Two witnesses to owner's signature sign here.



No.

CLAIM OF

Humphrey Jones

FOR THE COMPENSATION OF SLAVE NAMED

Spencer Jones

I, Humphrey Jones, a loyal citizen, and a resident of Woodford County of Kentucky, hereby claim compensation, under the provisions of Section 24, act approved February 24, 1864, and section 2, act approved July, 28, 1866, for my slave Spencer Jones, enlisted September 6<sup>th</sup>, 1864, at Lexington Kentucky, by Thomas H Moore in the 5<sup>th</sup> regiment U. S. Colored Troops, Co. "E"; certificate of

which enlistment, and a descriptive list, as required, accompany this application. That I did not acquire said slave subsequent to said enlistment, but had a valid title to him at the date of said enlistment, and previous thereto: I having acquired my title to him and my ownership over him as follows, to-wit: By deed of conveyance made 5<sup>th</sup> April 1859 & recorded in clerk's office of Woodford county court, Willis F Jones & others conveyed said slave Spencer Jones to Ophelia Jones wife of claimant Humphrey Jones -

In proof of my loyalty to the Constitution and Government of the United States, I present the accompanying oath, which I have taken, signed and acknowledged; to be filed with this application, in accordance with requirement of General Orders, No. 329, 1863, War Department, Adjutant General's Office.

December 8, 1866.

Humphrey Jones

OATH OF ALLEGIANCE.

I, Humphrey Jones, the owner and Claimant, do solemnly swear that the foregoing claim is a just and true claim due to me as master and owner of the said slave, and that the facts alleged in said claim in respect to the draft or enlistment (as the case may be) of said slave into the Military service of the United States are true. And I do further swear that I have never joined, or been concerned in, any insurrection or rebellion; that I have never borne arms against the United States; that I have never given any aid, countenance, counsel or encouragement to any person or persons engaged, or whom I had reason to believe were about to engage, in insurrection, rebellion or armed hostility against the United States; that I have neither sought, nor accepted, nor attempted to exercise the functions of any office, civil or military, nor to perform any service whatever, under any authority or pretended authority in hostility to the United States; that I have not yielded a voluntary support to any insurrection, rebellion or pretended government, authority, power or constitution within the United States hostile thereto. And I do further swear that, to the best of my knowledge and ability, I have supported and defended, and will continue to support and defend, the United States against all enemies, foreign and domestic; and that I have supported, defended and obeyed, and will continue to support, defend and obey, the Constitution and laws of the United States; that I will bear true faith and allegiance to the same; and that I take this oath freely, without any mental reservation or purpose of evasion: So help me God.

Humphrey Jones

Sworn to and subscribed before me, at Versailles Ky, this 8<sup>th</sup> day of December, 1866.

W. M. Dickey, Justice of the Peace, Woodford County Ky





War Department,  
ADJUTANT GENERAL'S OFFICE.

Washington, Dec 27 1866.

Respectfully returned to the  
Commission for the State of  
Kentucky, with the informa-  
tion that Spencer Jones  
was enlisted at Camp Nelson  
Ky. September 10<sup>th</sup> 1864 and was  
mustered in as Private Co "E" 5<sup>th</sup>  
W.S.C. Cav. Sept 12<sup>th</sup> 1864.

JOS

A. J. Williams

AA

A. A. G. vote

No. 55

APPLICATION OF  
Amphury Jones  
of  
Woodford Co. Ky

FOR COMPENSATION FOR SLAVE,

Named Spencer Jones

Enlisted September 6<sup>th</sup> 1864,

In Com. "E", 5<sup>th</sup> Regiment,

U.S. COLORED TROOPS.

Received Dec 10<sup>th</sup>, 1866.

Compensation Awarded

....., 1866.

..... Dollars.

President of Board of Claims.

Claimant's Attorney,

Claimant's Post-office Address,

Versailles

FRANKFORT COMMONWEALTH PRINT.



# UNITED STATES COLORED TROOPS ENLISTMENT.

STATE OF

TOWN OF

*Kentucky*  *Crossfield*

I, *Spencer Jones* born in *Woodford Co*  
in the State of *Kentucky* aged *Eighteen* years

and by occupation a *Farmer* Do HEREBY ACKNOWLEDGE to  
have volunteered *Tenth* day of *September* 1864

to serve as a **Soldier** in the **Army of the United States of America**, for the  
period of **THREE YEARS**, unless sooner discharged by proper authority: Do  
also agree to accept such bounty, pay, rations, and clothing, as are, or may be,  
established by law for the U. S. colored troops.

And I, *Spencer Jones*  
do solemnly swear that I will bear true faith and allegiance to the **United States  
of America**, and that I will serve them honestly and faithfully against all their  
enemies or opposers whomsoever; and that I will observe and obey the orders  
of the President of the United States, and the orders of the officers appointed  
over me, according to the Rules and Articles of War.

Sworn and subscribed to, at *Camp Nelson*  
this *10<sup>th</sup>* day of *Sept* 1864 } *Spencer Jones*  
Before *J. L. ...* } *mark*

I CERTIFY, ON HONOR, That I have carefully examined the above named Volunteer agree-  
ably to the General Regulations of the Army, and that, in my opinion, he is free from all bodily  
defects and mental infirmity, which would in any way disqualify him from performing the  
duties of a soldier.

*P. G. Barrett*  
Assistant Surgeon  
EXAMINING SURGEON.

I CERTIFY, ON HONOR, That I have minutely inspected the Volunteer, *Spencer Jones*,  
previously to his enlistment, and that he was entirely sober when enlisted; that, to the best of  
my judgment and belief, he is of lawful age; and that, in accepting him as duly qualified to per-  
form the duties of an able-bodied soldier, I have strictly observed the regulations which govern  
the recruiting service. This soldier has *dark* eyes, *dark* hair, *dark* com-  
plexion, is *5.4* feet *1.5* inches high.

*J. L. ...*  
and *M. P. M.*  
RECRUITING OFFICER OR AGENT.

Mustered into the United States Service *12<sup>th</sup>* day of *September* 1864.

*W. C. ...*  
Mustering Officer.

Mustered into the service of the United States, for three years or during the war, from date of enlistment, in Company *...*  
Regiment of *...* Volunteers, on the *10<sup>th</sup>* day of *September*, 1864, at *Camp Nelson*.



NOTE 1.—This blank will be used for enlistments of United States colored troops. They will be made out in duplicate in all cases—one to accompany the recruiting return of the superintendent (not the recruiting officer) to the Adjutant General, and one to accompany the accounts of the officer who pays bounty, &c.

NOTE 2.—An enlistment holds to service. A muster-in must, in all cases, precede payment of pay, bounty, pension, &c. A muster-in roll, must in all cases, be filed in the Adjutant General's Office as evidence of muster-in. The mustering officer, commissary, or assistant commissary of musters, as the case may be, will countersign both enlistments as having mustered the soldiers into the service of the United States before either of them is given to the disbursing officer.

DECLARATION OF RECRUIT.

I, *Spencer James* desiring to volunteer as a soldier in the ARMY OF THE UNITED STATES, for the term of *Three Years*, DO DECLARE That I am *18* years and ..... months of age; that I have never been discharged from the United States service on account of disability or by sentence of a court-martial, or by order before the expiration of a term of enlistment; and I know of no impediment to my serving honestly and faithfully as a soldier for three years.

GIVEN at *Camp Nelson Ky* the *10<sup>th</sup>* day of *September 1864*

Witness: *J. K. Strook*

*Spencer James*  
Volunteered at *Camp Nelson*  
No. *10*  
1864  
By *J. K. Strook*  
Sr. Woodford Co Ky  
*Humphrey Jones*

Consent of Parent or Guardian in case of a Minor, if a Free Man, or in the case of a Slave, of the Person to whom he owes Service:

I, ..... Do CERTIFY, That I am the ..... that the said ..... is ..... years of age; and I do freely give my CONSENT to his volunteering as a SOLDIER in the Army of the United States, for the period of THREE YEARS, under the conditions of the laws of the United States.

GIVEN at ..... the ..... day of .....

Witness: .....



# UNITED STATES COLORED TROOPS ENLISTMENT.

STATE OF *Kentucky*



TOWN OF *Lexington*

I, *Spencer Jones* born in *Woodford County*

in the State of *Kentucky* aged *thirty* years

and by occupation a *Laborer* Do HEREBY ACKNOWLEDGE to

have volunteered *Sixth* day of *September* 186*4*

to serve as a **Soldier** in the **Army of the United States of America**, for the period of **THREE YEARS**, unless sooner discharged by proper authority: Do also agree to accept such bounty, pay, rations, and clothing, as are, or may be, established by law for the U. S. colored troops.

And I, *Spencer Jones* do solemnly swear that I will bear true faith and allegiance to the **United States of America**, and that I will serve them honestly and faithfully against all their enemies or opposers whomsoever; and that I will observe and obey the orders of the President of the United States, and the orders of the officers appointed over me, according to the Rules and Articles of War.

Sworn and subscribed to, at *Lexington Ky* this *Sixth* day of *Sept* 186*4* *Spencer Jones* his mark

Before *Thos W Moore* Capt & Co. Mas. of Dist Ky

I CERTIFY, ON HONOR, That I have carefully examined the above named Volunteer agreeably to the General Regulations of the Army, and that, in my opinion, he is free from all bodily defects and mental infirmity, which would in any way disqualify him from performing the duties of a soldier.

*J. P. Shaw*

EXAMINING SURGEON.

I CERTIFY, ON HONOR, That I have minutely inspected the Volunteer, *Spencer Jones* previously to his enlistment, and that he was entirely sober when enlisted; that, to the best of my judgment and belief, he is of lawful age; and that, in accepting him, as duly qualified to perform the duties of an able-bodied soldier, I have strictly observed the regulations which govern the recruiting service. This soldier has *Blue* eyes, *Dark* hair, *Copper* complexion, is *five* feet *10* inches high.

*Thos W Moore*

*Capt & Co. Mas. of Dist Ky* RECRUITING OFFICER OR AGENT

Mustered into the United States Service.....day of.....186*4*

Mustering Officer.

Mustered into the service of the United States, for three years or during the war, from date of enlistment, in Company ..... Regiment of ..... Volunteers, on the ..... day of ..... 186*4*, at .....



DECLARATION OF RECRUIT.

I, Spencer Jones desiring to volunteer as a soldier in the ARMY OF THE UNITED STATES, for the term of Three Years, DO DECLARE That I am 19 years and ..... months of age; that I have never been discharged from the United States service on account of disability or by sentence of a court-martial, or by order before the expiration of a term of enlistment; and I know of no impediment to my serving honestly and faithfully as a soldier for three years.

GIVEN at Lexington Kentucky the Eight day of September 1864

Witness: J. P. Brown

Spencer Jones  
Volunteered at Lexington Ky  
By Thos M. Murrell  
No. 1864  
Capt. & Pr. Wm. H. ...

NOTE 1.—This blank will be used for enlistments of United States colored troops. They will be made out in duplicate in all cases—one to accompany the recruiting return of the superintendent (not the recruiting officer) to the Adjutant General, and one to accompany the accounts of the officer who pays bounty, &c.  
NOTE 2.—An enlistment holds to service. A muster-in must, in all cases, precede payment of pay, bounty, pension, &c. A muster-in roll, must in all cases, be filed in the Adjutant General's Office as evidence of muster-in. The mustering officer, commissary, or assistant commissary of musters, as the case may be, will countersign both enlistments as having mustered the soldiers into the service of the United States before either of them is given to the disbursing officer.

Consent of Parent or Guardian in case of a Minor, if a Free Man, or in the case of a Slave, of the Person to whom he owes Service:

I, Humphrey Jones of Woodford Co Do CERTIFY, That I am the owner of Spencer Jones a Slave

that the said Spencer Jones is Nineteen years of age; and I do freely give my CONSENT to his volunteering as a SOLDIER in the Army of the United States, for the period of THREE YEARS, under the conditions of the laws of the United States.

GIVEN at Lexington Kentucky the Eight day of September 1864

Witness: .....

Jones, Spencer

P, Co. E, 5 Reg U.S.C. Cav.

2 Enclosures.

Bed Cards .....

Burial Records .....

Certs. of Dis. for Discharge .....

C. M. Charges .....

Med. Certificates .....

Descriptive Lists .....

Final Statements .....

Furloughs .....

Med. Des. Lists .....

Orders .....

E P

2

Other papers relating to—

Admission to Hosp'l .....

Casualty Sheet (Officer's) .....

Confinement .....

Contracts .....

Death or Effects .....

Desertions .....

Discharge from Hosp'l .....

Discharge from Service .....

Duty .....

Furlough .....

Med. Examination .....

Misc. Information .....

Pay or Clothing .....

Personal Reports .....

Rank .....

Transfer to Hosp'l .....

Transfer to V. R. C. ....

Transportation .....

*f* | *5<sup>th</sup> Cav.*      *U.S.C.S.*

*Spencer Jones*

*, Co. E , 5<sup>th</sup> Reg't U.S.C. Cav.*

**NOTATION.**

Book mark: *S. 57. C. J. 1874.*

**Record and Pension Office.**

WAR DEPARTMENT.

This book mark refers only to a report from the medical records, made by the Surgeon General to the Adjutant General, relative to the above-named man. As the medical records have since been carded, no transcript of this report is made hereon.

(491)

*W. Allen*

Copyist.



**5 Cav. U.S.C.T.**

*James Jones*  
Co. *B*, 5 Reg't U. S. Col'd Cavalry.

Appears on **Co. Muster-out Roll**, dated  
*Nov 11 1864*, 186*4*.

Muster-out to date \_\_\_\_\_, 186 .

Last paid to *pay due from enlistment* 186 .

**Clothing account:**

Last settled \_\_\_\_\_, 186 ; drawn since \$ \_\_\_\_\_ 100

Due soldier \$ \_\_\_\_\_ 100; due U. S. \$ *57*/<sub>100</sub>

Am't for cloth'g in kind or money adv'd \$ \_\_\_\_\_ 100

Due U. S. for arms, equipments, &c., \$ \_\_\_\_\_ 100

Bounty paid \$ \_\_\_\_\_ 100; due \$ \_\_\_\_\_ 100

Remarks: *Disch'd at New Albany  
Ind. Feb 19 1865 from  
wounds. Final statement  
forwarded Sept 3 1865*

Book mark: *P. 5 P 207. 68; P 572 Vol 10 C. 74  
V 176 P 59. 71 55 S. C.*

(361) *J. M. Leonard* Copyist.

J | 5 Cav. | U.S.C.T.  
Spencer Jones  
Priv., Co. E, 5 Reg't U. S. Colored Cav.

Appears on Returns as follows:

Jan 1865 Absent sick in Genl. Hospital, New Albany, Ind.  
Jan 25/65

Feb 1865 Loss: Jan 25, Simpsonville Ky. Dropped from in Genl Hospital to missing in action at Simpsonville, Ky. Jan 25/65

Mar 1865 Loss: Jan 25/65 Simpsonville, Ky. From missing in action at Simpsonville Ky. to died in Hospital, New Albany, Ind.

Book mark :

(546)

Huston

Copyist.

*J* | **5 Cav. | U.S.C.T.**

*Spencer Jones*

*Priv*, Co. E, 5 Reg't U. S. Col'd Cavalry.

Appears on

**Company Muster Roll**

for *July & Aug.*, 1865.

Present or absent

Stoppage, \$.....100 for .....

Due Gov't, \$.....100 for .....

Valuation of horse, \$.....100

Valuation of horse equipments, \$.....100

Remarks: *Taken up from missing in action at Saltville, Va. Oct. 2/64. Received notice of death from A. G. Office - date and place not given.*

Book mark: *Died Feb. 17/65.*  
*E. B. V. 11 P. 58 S. 59 V. 10 6. 774*

(358)

*Long*

Copyist.



9 | **5 Cav. | U.S.C.T.**

Spencer Jones  
Cpt., Co. E, 5 Reg't U. S. Col'd Cavalry.

Appears on

**Company Muster Roll**

for Jan. 4 Feb., 1865\*

Present or absent Present

Stoppage, \$ 100 for

Due Gov't, \$ 100 for

Valuation of horse, \$ 100

Valuation of horse equipments, \$ 100

Remarks: Missing in action  
at Simpsonville Ky.  
Jan. 25, 1865

Roll Aug 31/65 next on which name  
appears

\* Inserted by Townsend Exr

Book mark: PV 5 p. 207. 68

A. W. Rowland

5 Cav. U.S.C.T.

*James Jones*

Co. E, 5 Reg't U. S. Col'd Cavalry.

Appears on

Company Muster Roll

for *Nov & Dec*, 1867.

Present or absent *Present*

Stoppage, \$ 100 for

Due Gov't, \$ 100 for

Valuation of horse, \$ 100

Valuation of horse equipments, \$ 100

Remarks: *"9" installment of 12 months due*

Book mark:

*W. England*

17 | **5 Cav. | U.S.C.T.**

*James Jones*  
....., Co. E, 5 Reg't U. S. Col'd Cavalry.

Appears on

**Company Muster Roll**

for *Continued to 1/21*, 186 *1*.

Present or absent *Present*

Stoppage, \$.....100 for .....

Due Gov't, \$.....100 for .....

Valuation of horse, \$.....100

Valuation of horse equipments, \$.....100

Remarks: .....

.....  
.....  
.....  
.....  
.....  
.....  
.....

Book mark: .....

*Alfred [Signature]*  
.....  
Copyist.



2 | **5 Cav. | U.S.C.T.**

*Spencer Jones*

*C. Co. E*, Co. *E*, 5 Reg't U. S. Col'd Cavalry.

Appears on

**Company Muster-in and Descriptive Roll**

of the organization named above. Roll dated

*Camp Nelson, N.Y., Oct 26*, 1864.

Where born *Woodford Ky.*

Age *8* y'rs; occupation *Farmer*

When enlisted *Sept 10*, 1864.

Where enlisted *Cp. Nelson Ky.*

For what period enlisted *3* years.

Eyes *Black*; hair *Black*

Complexion *Black*; height *5* ft. *9* in.

When mustered in *Sept 2*, 1864.

Where mustered in *Cp. Nelson Ky.*

Bounty paid \$ *100*; due \$ *100*

Where credited

Company to which assigned

Remarks: *7<sup>th</sup> District Kentucky*

*\* Humphrey Jones*

*\* Supposed to be name of owner.*

*Added May 17, 1898. H.A.J.*

Book mark:

General Notation R. & P. 407 276.

*W. R. ...*

I | 5 bar | U.S.C.T.

Spencer Jones

Appears with rank of Pvt on

**Muster and Descriptive Roll**

of a Detachment of U. S. Colored  
Volunteers from camp  
Nelson. camp of Instruction. Roll dated

Livingston, Ky., Sept. 7, 1864.

Where born Woodford Co. Ky

Age 19 years; occupation Labourer

When enlisted Sept. 6, 1864.

Where enlisted Livingston, Ky.

For what period enlisted 3 years.

Eyes Blue; hair Blue

Complexion Copy; height 5 ft. 10 in.

When mustered in \_\_\_\_\_, 186 .

Where mustered in \_\_\_\_\_

Bounty paid \$ \_\_\_\_\_ 100; due \$ \_\_\_\_\_ 100

Clothing account:

Last settled \_\_\_\_\_, 186 ; drawn since \$ \_\_\_\_\_ 100

Date of first muster Sept. 6, 1864.

Company to which assigned \_\_\_\_\_

Remarks: owned - Humphrey Jones

Woodford Co. To be credited

7 Dist. Ky.

Book mark: \_\_\_\_\_

W. B. Dussell

(356m)

Copyist.

*J* | **5 Cav. | U.S.C.T.**

*Spencer Jones*  
....., Co. *E*, 5 Reg't U. S. Col'd Cav.

Appears on

**Company Descriptive Book**  
of the organization named above.

**DESCRIPTION.**

Age *18* years; height *5* feet *9* inches.

Complexion *Black*

Eyes *Blk*; hair *Blk*

Where born *Woodford Ky*

Occupation *farmer*

**ENLISTMENT.**

When *Sep 10*, 186 .

Where *Camp Nelson*

By whom *J. B. Randolph*, term *3* y'rs.

Remarks: *Killed Feb. 17<sup>th</sup> 1865 of wounds recd. in action*

*J. E. Quicke*



144  
Jones Spencer  
Co E 5 U. S. Col'd Cav.

Private | Private

CARD NUMBERS.

1	5363714	26
2	5363808	27
3	5363910	28
4	5364029	29
5	5364305	30
6	5364665	31
7	9090458	32
8	57-03-1874	33
9	43146531	34
10	40729996	35
11		36
12		37
13		38
14		39
15		40
16		41
17		42
18		43
19		44
20		45
21		46
22		47
23		48
24		49
25		50

Book Mark: S. 57 Vol. 10 L.P. 74

See also  
General Notation R. & P. 407375.

No. 1.

RECORD OF DEATH AND INTERMENT.

Name and number of person interred . . . . .	<i>Reason Jones</i>
Number and locality of the grave . . . . .	<i>1101</i>
Hospital number of the deceased . . . . .	<i>6528</i>
Regiment, rank and company . . . . .	<i>Pt Co "B" 5<sup>th</sup> U.S.C.</i>
Residence before enlistment.	
Conjugal relation, (and if married the residence of the widow.)	
Cause of death.	<i>Chronic Diarrhoea</i>
Age of the deceased.	
Nativity.	
References and remarks.	
Date of Death and burial.	<i>April 21<sup>st</sup> 1865</i>

MEMORANDA OF EFFECTS.

Hat.	Cap.	Shirts	Drawers/	Pants.
Stockings, prs.	Boots.	Shoes.	Haversack.	Canteen.
Knapsack.	Money <i>\$29.50</i>	<i>Overcoat, Blanket</i>		

*Surgeon W. J. W. in charge.*

Reason Jones  
Pl Co "B" 5<sup>th</sup> U.S.C.

Died April 21<sup>st</sup> 1845

Genl Hosp: Camp Nelson, Ky.



I certify, on honor, that Reasan James, a Private of  
 Captain Chas. J. Green Company (B) of the 5th Regiment of W. S. Caval  
Volunteers, of the State of \_\_\_\_\_, born in Madison Co State  
 of Kentucky, aged 18 years; 5 feet 3 inches high; Blk complexion,  
Blk eyes, Blk hair, and by occupation a Farmer, who joined for service  
 and was enrolled (see Note 9) on the 19th day of August, 1864, at Camp Nelson Ky  
 by He Standolph, for the period of Three years, and mustered into  
 the service of the United States on the 19th day of August, 1864, at  
Camp Nelson Ky, by Capt. Henry Mc; and having served  
**HONESTLY** and **FAITHFULLY** with his Company to the present date, is now entitled to a  
**DISCHARGE** by reason of death died in line  
at Camp Nelson Ky

The said Reasan James was last paid by Paymaster  
Maj. Beecher, to include the 28th day of February, 1865, and  
 has pay due him from that time to the present date; he is entitled to pay and subsistence for  
**TRAVELING** to place of enrollment, and whatever other allowances are authorized to volunteer  
 soldiers, drafted men, or militia, so discharged. He has received from the United States **CLOTHING**  
 amounting to \$84 12 <sup>100</sup> dollars, since the 17th day of August,  
 1864, when his clothing account was last settled. He has received from the United States  
<sup>100</sup> dollars advanced **BOUNTY**.

There is to be stopped from him, on account of the State of \_\_\_\_\_, or other  
 authorities, for **CLOTHING**, &c., received on entering service, \_\_\_\_\_ dollars; and  
 for other stoppages, viz:

\_\_\_\_\_ dollars.

He has been furnished with **TRANSPORTATION** in kind from the place of his discharge to  
 \_\_\_\_\_; and he has been **Subsisted** for **Traveling** to his  
 place of enrollment, up to the \_\_\_\_\_, 186\_\_\_\_\_.

He is indebted to \_\_\_\_\_, **Sutler**, \_\_\_\_\_ dollars.  
 He is indebted to \_\_\_\_\_, **Laundress**, \_\_\_\_\_ dollars.

Given in Duplicate, at Heleno Ark, this 20th day  
 of Decr 1863.

Chas. J. Green  
Capt. Co. 5th Regt. W. S. Caval  
 Commanding Company.



and attorneys for making out and causing to be executed the papers necessary to establish a claim for a pension, bounty, and other allowance before the Pension Office, under this act, shall not exceed the following rates: For making out and causing to be duly executed a declaration by the applicant, with the necessary affidavits, and forwarding the same to the Pension Office, with the requisite correspondence, ten dollars; which sum shall be received by such agent or attorney in full for all services in obtaining such pension, and shall not be demanded or received, in whole or in part, until such pension shall be obtained; and the sixth and seventh sections of an act entitled "An act to grant pensions," approved July [fourteenth,] eighteen hundred and sixty-two, are hereby repealed.

SEC. 13. *And be it further enacted,* That any agent or attorney who shall, directly or indirectly, demand or receive any greater compensation for his services under this act than is prescribed in the preceding section of this act, or who shall contract or agree to prosecute any claim for a pension, bounty, or other allowance under this act, on the condition that he shall receive a per centum upon any portion of the amount of such claim, or who shall wrongfully withhold from a pensioner or other claimant the whole or any part of the pension or claim allowed and due to such pensioner or claimant, shall be deemed guilty of a high misdemeanor, and, upon conviction thereof, shall, for every such offense, be fined not exceeding three hundred dollars, or imprisoned at hard labor not exceeding two years, or both, according to the circumstances and aggravations of the offense.

Approved July 4, 1864.

NOTE 10.—If any soldier is charged a higher fee than that allowed by the above act, he should report the fact and the name of the agent to the Adjutant General, in order that steps may be taken to have the same refunded.

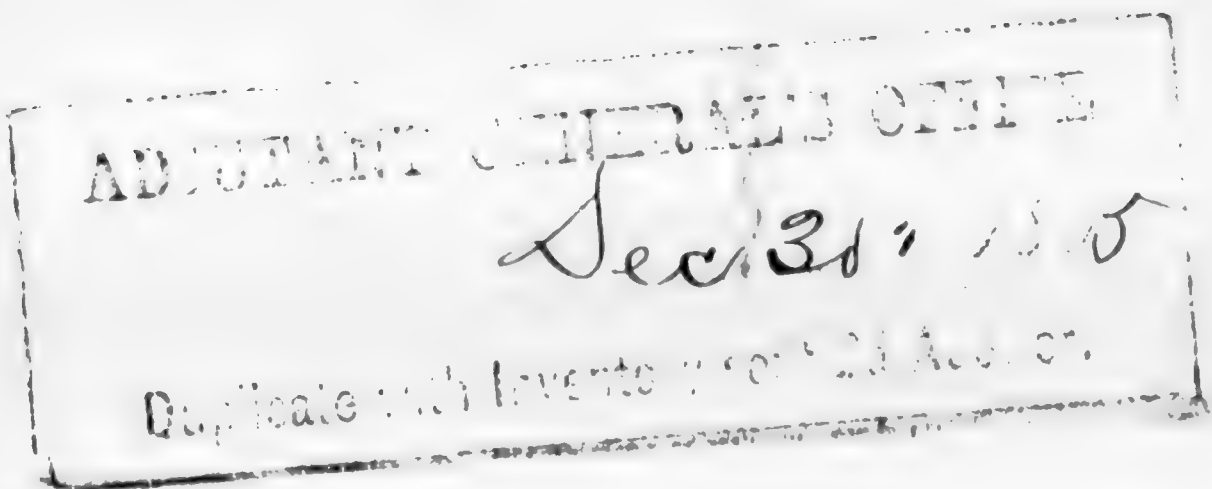

FINAL STATEMENT.

Co "B"

OF

Reuben James & Co  
5th Regt of U.S.C.

VOLUNTEERS.

NOTE 1.—Two of these certificates (or duplicates) are to be given to each Volunteer Soldier or drafted man who may be discharged without being mustered out (Final Statements are never given to men mustered out of service) that he may at once receive from the Paymaster the pay, &c., due to him, and the captain or other COMMISSIONED officer commanding the company will certify to the act of the delivery of the duplicate certificates; with these certificates the Soldier is "entitled to" his discharge, and should also present his discharge to the Paymaster to have the payment endorsed on it. The discharge is to be given back to the Soldier by the Paymaster; the latter only retaining as his vouchers the duplicate certificates.

NOTE 2.—If the Soldier is entitled to pay for the use of his horse, the Company Commander will certify to that fact on the back of both these final statements, and also to the time he has pay due for having been so mounted on his own horse.

NOTE 3.—When a Soldier is furnished with final statements, his descriptive list, if he has one, should be taken up by the officer who gives the Soldier these statements, and endorsed with a statement to this effect by the officer. The endorsement should exhibit a full statement of the time for which the Soldier was allowed pay on his final statements, the clothing account, and all other charges against him or in his favor, so as to comprise a complete exhibit of his account. It will then be transmitted to the Company Commander of the Soldier, who will enter all the data necessary to a full understanding of the Soldier's account on the muster roll upon which the Soldier's discharge is reported. The descriptive list will then be destroyed. The object of this is, that the remaining portion of the Soldier's account may be settled upon the receipt of these muster rolls, and the Soldier receive any pay or allowances that may be due him at the time of his discharge, and which may not appear on his last final statements from the fact that his descriptive list is incomplete. These accounts for back pay, &c., are settled by the 2d Auditor of the Treasury Department.

NOTE 4.—Charges for loss or injury to ordnance, horse equipments, and other miscellaneous charges, should appear under the heading of "Other Stoppages."

NOTE 5.—Bounty paid by State authorities, and not by the United States, will not be entered on this statement.

NOTE 6.—Amounts due the Sutler and Laundress must be entered on the muster roll on which the discharge, death, desertion, &c., is reported, as well as on the final statement, otherwise the amount cannot be collected from the United States.

NOTE 7.—This blank will be used for deceased volunteers and drafted men, as well as for others.

NOTE 8.—Where a Soldier dies in Hospital or on detached service, his descriptive list, if he has one, should be sent with his final statements, in duplicate, to the Adjutant General, Washington, D. C.

NOTE 9.—If the soldier is a drafted man or substitute, the space for time, &c., of enrolled, should contain only the word *drafted* or *substitute*, as the case may be. If the Soldier is a "VETERAN," (OR RECRUIT,) the words *as a veteran*, (or *recruit*), as the case may be, should be interlined after the words *mustered into the service of the U. S.* A statement of all the installments of *Veteran or Recruit Bounty RECEIVED* by the Soldier must be made on the back of each final statement.

[OFFICE INDORSEMENT.]

War Department,

ADJUTANT GENERAL'S OFFICE

12, 1875

The ... of ... Co. B, 2<sup>nd</sup> Reg't U. S. Colored ... is reported as follows:—

On Company Muster Roll. For ... 1865, ... 1865

Company Muster-out Roll. ... 1865

Company Descriptive Book. ... 186

Company Morning Reports. ... 186

Soldier's Final Statement. ... 1865

Soldier's Record of Death and Interment. ... 186

Soldier's Inventory of Effects. ... 186

Soldier's Certificate of Disability for Discharge. ... 186

Soldier's Individual Muster-out Roll. ... 186

Regimental Return. For ... 1865, ... 1865

Regimental Quarterly Returns. ... 186

Regimental Descriptive Book. ... 186

By Surgeon General. ... 186

April 21, 1865, is held to be the correct date, and the Company Muster Roll will be amended accordingly.

Thomas M. ... Asst. Adj. Gen. E. B. ... 542, ... 1874

FINAL STATEMENT.

Co "B"

OF ... REASON JAMES ... 5<sup>th</sup> Reg't of U.S.C.

VOLUNTEERS.

NOTE 1.—Two of these certificates (or duplicates) are to be given to each Volunteer Soldier or drafted man who may be discharged without being mustered out (Final Statements are never given to men mustered out of service) that he may at once receive from the Paymaster the pay, &c., due to him, and the captain or other commissioned officer commanding the company will certify to the act of the delivery of the duplicate certificates; with these certificates the Soldier is "entitled to" his discharge, and should also present his discharge to the Paymaster to have the payment endorsed on it. The discharge is to be given back to the Soldier by the Paymaster; the latter only retaining as his vouchers the duplicate certificates.

NOTE 2.—If the Soldier is entitled to pay for the use of his horse, the Company Commander will certify to that fact on the back of both these final statements, and also to the time he has pay due for having been so mounted on his own horse.

NOTE 3.—When a Soldier is furnished with final statements, his descriptive list, if he has one, should be taken up by the officer who gives the Soldier these statements, and endorsed with a statement to this effect by the officer. The endorsement should exhibit a full statement of the time for which the Soldier was allowed pay on his final statements, the clothing account, and all other charges against him or in his favor, so as to comprise a complete exhibit of his account. It will then be transmitted to the Company Commander of the Soldier, who will enter all the data necessary to a full understanding of the Soldier's account on the muster roll upon which the Soldier's discharge is reported. The descriptive list will then be destroyed. The object of this is, that the remaining portion of the Soldier's account may be settled upon the receipt of these muster rolls, and the Soldier receive any pay or allowances that may be due him at the time of his discharge, and which may not appear on his last final statements from the fact that his descriptive list is incomplete. These accounts for back pay, &c., are settled by the 3d Auditor of the Treasury Department.

NOTE 4.—Charges for loss or injury to ordnance, horse equipments, and other miscellaneous charges, should appear under the heading of "Other Stoppages."

NOTE 5.—Bounty paid by State authorities, and not by the United States, will not be entered on this statement.

NOTE 6.—Amounts due the Sutler and Laundress must be entered on the muster roll on which the discharge, death, desertion, &c., is reported, as well as on the final statement, otherwise the amount cannot be collected from the United States.

NOTE 7.—This blank will be used for deceased volunteers and drafted men, as well as for others.

NOTE 8.—Where a Soldier dies in Hospital or on detached service, his descriptive list, if he has one, should be sent with his final statements, in duplicate, to the Adjutant General, Washington, D. C.

NOTE 9.—If the soldier is a drafted man or substitute, the space for time, &c., of enrolled, should contain only the word drafted or substitute, as the case may be. If the Soldier is a "VETERAN," (or RECRUIT,) the words as a veteran, (or recruit,) as the case may be, should be interlined after the words mustered into the service of the U. S. A statement of all the installments of Veteran or Recruit Bounty RECEIVED by the Soldier must be made on the back of each final statement.



Jones, Reason  
 P. Co. B, 5 Reg't 1122 Cav

**2 Enclosures.**

Bed Cards .....	Descriptive Lists .....
Burial Records .....	Final Statements / .....
Certs. of Dis. for Discharge .....	Furloughs .....
C. M. Charges .....	Med. Des. Lists .....
Med. Certificates .....	Orders .....

Other papers relating to—

Admission to Hosp'l .....	Furlough .....
Casualty Sheet (Officer's) .....	Med. Examination .....
Confinement .....	Misc. Information .....
Contracts .....	Pay or Clothing .....
Death or Effects / .....	Personal Reports .....
Desertions .....	Rank .....
Discharge from Hosp'l .....	Transfer to Hosp'l .....
Discharge from Service .....	Transfer to V. R. C. .....
Duty .....	Transportation .....

*J* | **5 Cav. | U.S.C.T.**

*Roason Jones*

*Pvt*, Co. *B*, 5 Reg't U. S. Col'd Cavalry.

Appears on **Co. Muster-out Roll**, dated  
*October 1st*, *1864*.

Muster-out to date \_\_\_\_\_, 186 .

Last paid to *Dec 28*, 186 *5* .

**Clothing account:**

Last settled \_\_\_\_\_, 186 ; drawn since \$ \_\_\_\_\_ 100

Due soldier \$ \_\_\_\_\_ 100; due U. S. \$ *42* <sup>*00*</sup>/<sub>100</sub>

Am't for cloth'g in kind or money adv'd \$ \_\_\_\_\_ 100

Due U. S. for arms, equipments, &c., \$ \_\_\_\_\_ 100

Bounty paid \$ \_\_\_\_\_ 100; due \$ \_\_\_\_\_ 100

Remarks: *Died Sept 21 '65, Camp Nelson Ky, cause Disease. Final statements forwarded June 19. 1866*

Book mark: *V 229. P. 91. 75*

J | 5 Cav. | U.S.C.T.

Reason Jones  
Priv., Co. B, 5 Reg't U. S. Colored Cav.

Appears on Returns as follows:

From organization to Oct 31, 1864 to Jan. 1865  
Absent sick, Hospl. Camp Nelson, Ky.

Mar. 1865 Absent sick Hospl. Camp Nelson Ky.

Apr. 1865 Died in Genl Hospl. Apr. '65 Camp Nelson,

Book mark :

Austin



5 Cav. U.S.C.T.

J Reason Jones

Priv, Co. B, 5 Reg't U. S. Col'd Cavalry.

Appears on

Company Muster Roll

for Feb 28 to Apr, 1865.

Present or absent

Stoppage, \$ 100 for

Due Gov't, \$ 100 for

Valuation of horse, \$ 100

Valuation of horse equipments, \$ 100

Remarks: Died in Hospital  
Camp Nelson Ky  
Apr 1/65  
1<sup>st</sup> instalment bounty  
due \$100

Book mark: Died Apr 21/65 E.B.C.  
Cox

Lamb



**5 Cav. U.S.C.T.**

*J*

*Reason Jones*

*Priv*, Co. B, 5 Reg't U. S. Col'd Cavalry.

Appears on

**Company Muster Roll**

for *Nov & Dec*, 1864.

Present or absent *Absent*

Stoppage, \$ *100* for

Due Gov't, \$ *100* for

Valuation of horse, \$ *100*

Valuation of horse equipments, \$ *100*

Remarks: *Sick in Hospital  
Camp Nelson Ky  
1st & 2nd instalments  
bounty due.*

Book mark:

*Laurel*



4 | **5 Cav. | U.S.C.T.**

Reason Jones  
Pvt., Co. B, 5 Reg't U. S. Col'd Cavalry.

Appears on

**Company Muster Roll**

for Oct 31, 1864.

Present or absent Absent

Stoppage, \$ 100 for

Due Gov't, \$ 100 for

Valuation of horse, \$ 100

Valuation of horse equipments, \$ 100

Remarks: Sick in hospital  
at Camp Nelson Ky

Book mark: \_\_\_\_\_

Lamb

4 | 5<sup>th</sup> Cav | U.S.C.T.

Rossou Jones

1st, Co B, 5<sup>th</sup> Reg't U. S. Col'd Cav

Appears on

Company Muster-in and Descriptive Roll  
of the organization named above. Roll dated

Camp Nelson Ky Dec 24 1864.

Where born Madison Ky

Age 18 y'rs; occupation Farmer

When enlisted Aug 19, 1864.

Where enlisted Camp Nelson

For what period enlisted 3 years.

Eyes Blue; hair Blue

Complexion Blue; height 5<sup>ft.</sup> 5<sup>in.</sup>

When mustered in Aug 19, 1864.

Where mustered in Camp Nelson

Bounty paid \$ 100; due \$ 100

Where credited 5<sup>th</sup> Dist Ky

Company to which assigned B

Remarks: \* Name of owner of

Negro - William Jones.

\* Taken May 12 95 by H. J.

Book mark:

Lamb

*J* | **5 Cav. | U.S.C.T.**

*Reason Jones*

....., Co. *B*, 5 Reg't U. S. Col'd Cav.

Appears on

**Company Descriptive Book**  
of the organization named above.

**DESCRIPTION.**

Age *18* years; height *5* feet *5* inches.

Complexion *Blk*

Eyes *Blk*; hair *Blk*

Where born *Madison Co. Ky*

Occupation *Ferrier*

**ENLISTMENT.**

When *Aug 17*....., 1864.

Where *Camp Nelson*

By whom *A. C. Randolph*; term *3* y'rs.

Remarks: *Died in Hospital  
Camp Nelson Ky Apr.  
21 1865*

.....  
.....  
.....  
.....  
.....  
.....

*Warren*



743

Jones Reason

Co B, 5 U. S. Col'd Cav.

Private

Private

CARD NUMBERS.

1	5360697	26
2	5360794	27
3	5360882	28
4	5360978	29
5	5361096	30
6	5361623	31
7	9090135	32
8	40729995	33
9		34
10		35
11		36
12		37
13		38
14		39
15		40
16		41
17		42
18		43
19		44
20		45
21		46
22		47
23		48
24		49
25		50

Book Mark:

See also

2 | **5 Cav.** | **U.S.C.T.**

Serry James  
Sgt., Co. G, 5 Reg't U. S. Col'd Cavalry.

Appears on

**Company Muster Roll**

for Jan'y & Feb'y, 1866.

Present or absent Present

Stoppage, \$ 100 for

Due Gov't, \$ 100 for

Valuation of horse, \$ 100

Valuation of horse equipments, \$ 100

Remarks: Due self for ord. \$100

Book mark: \_\_\_\_\_

Dabler  
Copyist.

5 Cav. U.S.C.T.

*Henry Jones*  
*Sam*, Co. G, 5 Regt U. S. Col'd Cavalry.

Appears on

**Company Muster Roll**

for *Nov 1865*, 1865.

Present or absent *Present*

Stoppage, \$ *100* for

Due Gov't, \$ *100* for

Valuation of horse, \$ *100*

Valuation of horse equipments, \$ *100*

Remarks:

Book mark:

(358)

*Jones*  
Copyist.



**5 Cav. U.S.C.T.**

*Henry Jones*  
\_\_\_\_\_  
*Henry Jones*, Co. G, 5 Reg't U. S. Col'd Cavalry.

Appears on

**Company Muster Roll**

for *Sept. 1864*, 1864.

Present or absent *Present*

Stoppage, \$ \_\_\_\_\_ 100 for \_\_\_\_\_

Due Gov't, \$ \_\_\_\_\_ 100 for \_\_\_\_\_

Valuation of horse, \$ \_\_\_\_\_ 100

Valuation of horse equipments, \$ \_\_\_\_\_ 100

Remarks: \_\_\_\_\_  
\_\_\_\_\_  
\_\_\_\_\_  
\_\_\_\_\_  
\_\_\_\_\_  
\_\_\_\_\_  
\_\_\_\_\_  
\_\_\_\_\_  
\_\_\_\_\_  
\_\_\_\_\_  
\_\_\_\_\_

Book mark: \_\_\_\_\_

(358) \_\_\_\_\_ *Henry Jones* Copyist.

**5 Cav. U.S.C.T.**

*S. Jones*  
Sav., Co. G, 5 Reg't U. S. Col'd Cavalry.

Appears on

**Company Muster Roll**

for *July 1863*, 1863.

Present or absent *Present*

Stoppage, \$ *100* for

Due Gov't, \$ *100* for

Valuation of horse, \$ *100*

Valuation of horse equipments, \$ *100*

Remarks:

Book mark:

(358)

*J. A. Jones*  
Copyist.

5 Cav. U.S.C.T.

*James Jones*

*Sgt.*, Co. G, 5 Reg't U. S. Col'd Cavalry.

Appears on

**Company Muster Roll**

for *May & June*, 1865.

Present or absent *Present*

Stoppage, \$ *100* for

Due Gov't, \$ *100* for

Valuation of horse, \$ *100*

Valuation of horse equipments, \$ *100*

Remarks: *First Installment*

*Quarterly due \$100.*

Book mark:

(358)

*James Jones*

Copyist.



*J* | **5 Cav.** | **U.S.C.T.**

*Perry Jones,*  
*Privt.,* Co. G, 5 Reg't U. S. Col'd Cavalry.

Appears on

**Company Muster Roll**

for *March & April,* 1865.

Present or absent *present.*

Stoppage, \$ *100* for

Due Gov't, \$ *100* for

Valuation of horse, \$ *100*

Valuation of horse equipments, \$ *100*

Remarks: *1<sup>st</sup> instalment*  
*Bounty \$ 100<sup>00</sup> due.*

Book mark:

(358)

*[Signature]*  
Copyist.

*J* | **5 Cav.** | **U.S.C.T.**

*Gerry Jones*  
-----  
*Pvt*, Co. G, 5 Reg't U. S. Col'd Cavalry.

Appears on

**Company Muster Roll**

for *Jan 5 Feb*, 186*5*.

Present or absent *present*.

Stoppage, \$ *100* for

Due Gov't, \$ *100* for

Valuation of horse, \$ *100*

Valuation of horse equipments, \$ *100*

Remarks:

*See U. S. for Ord of 1,77*  
*1<sup>st</sup> Instat<sup>t</sup> Security*  
*\$100<sup>00</sup> see.*

Book mark: -----

(358)

*[Signature]*

Copyist.

*J* | **5 Cav.** | **U.S.C.T.**

*Perry Jones,*  
*Pvt.,* Co. G, 5 Reg't U. S. Col'd Cavalry.

Appears on

**Company Muster Roll**

for *Nov. & Dec.*, 1864.

Present or absent *present*

Stoppage, \$ *100* for

Due Gov't, \$ *100* for

Valuation of horse, \$ *100*

Valuation of horse equipments, \$ *100*

Remarks: *1st & 2d mustered*  
*Bounty due.*

Book mark: \_\_\_\_\_

(358)

*[Signature]*

Copyist.



*J* | **5 Cav. U.S.C.T.**

*Perry Jones,*  
*Privt.,* Co. G, 5 Reg't U. S. Col'd Cavalry.

Appears on

**Company Muster Roll**

for *Full, to Oct. 31,* 1864.

Present or absent *present.*

Stoppage, \$ *100* for

Due Gov't, \$ *100* for

Valuation of horse, \$ *100*

Valuation of horse equipments, \$ *100*

Remarks: \_\_\_\_\_

Book mark: \_\_\_\_\_

(358)

*[Signature]*

Copyist.

**5 Cav. U.S.C.T.**

*J*  
*Perry Jones,*

*Privt.*, Co. ...., 5 Reg't U. S. Col'd Cavalry.

Appears on

**Company Muster-in and Descriptive Roll**

of the organization named above. Roll dated

*Camp Nelson Ky N. Y., Oct. 27,* 1864.

Where born *Wayne Ky,*

Age *18* y'rs; occupation *Farmer,*

When enlisted *Sept. 8*, 1864.

Where enlisted *Camp Nelson Ky,*

For what period enlisted *3* years.

Eyes *Black*; hair *Black*

Complexion *Black*; height *5 ft. 8 in.*

When mustered in *Sept. 7,* 1864.

Where mustered in *Camp Nelson Ky,*

Bounty paid \$ *100*; due \$ *100*

Where credited *Co. Nelson Ky,*

Company to which assigned .....

Remarks: .....

*\* James Jones,*

*\* supposed to be name of owner,*

*\* Adm'd May 17, 93. N. Y.*

Book mark: .....

*[Signature]*  
Copyist.





J | **5 Cav.** | **U.S.C.T.**

Perry Jones

Pvt., Co. G, 5 Reg't U. S. Col'd Cavalry.

Appears on **Co. Muster-out Roll**, dated  
Helena, Ark, March 16, 1866.

Muster-out to date March 16, 1866.

Last paid to Dec. 31, 1865.

**Clothing account:**

Last settled....., 186 ; drawn since \$..... 100

Due soldier \$..... 100; due U. S. \$ 42 <sup>87</sup>/<sub>100</sub>

Am't for cloth'g in kind or money adv'd \$..... 100

Due U. S. for arms, equipments, &c., \$ <sup>15</sup>/<sub>100</sub>

Bounty paid \$ 100 100; due \$ 100 100

Remarks: Slave - due U.S. for ord.

\$ 100 <sup>15</sup>

Book mark : .....

Parker

748-742

Jones Jones Perry.  
Co G, 5 U. S. Col'd Cav.

Private | Private

CARD NUMBERS.

1	5365763	26
2	5365858	27
3	5365958	28
4	5366050	29
5	5366147	30
6	5366239	31
7	5366330	32
8	5366419	33
9	5366506	34
10	5366595	35
11	5366680	36
12	9090688	37
13		38
14		39
15		40
16		41
17		42
18		43
19		44
20		45
21		46
22		47
23		48
24		49
25		50

Book Mark:

See also

Adjutant General's Office,

Washington, July 7<sup>th</sup>, 1868.

Surgeon General, U. S. Army,

Washington, D. C.

General.

I have the honor to request that this office be furnished such information as can be obtained from the records of your office in regard to the final disposition made of

Private Manuel Jones

Company "I," 5<sup>th</sup> U. S. Colored Cavalry,

who is reported on the muster-out roll of his Company "Absent sick in Hospital at Covington, Ky., since May 7<sup>th</sup> 1865. No Discharge furnished."

If evidence of death is found, please furnish final papers if possible.

I have the honor to be,

Very respectfully,

Your obedient servant,

Samuel J. Vincent

Assistant Adjutant General.

1. 2 P.



Pension Number.....  
B. of.....A., Vol. No. 2194

**WAR DEPARTMENT,**  
**Surgeon General's Office,**  
**RECORD AND PENSION DIVISION,**

Washington, D. C., July 21, 1865.

[CERTIFICATE FROM RECORDS.]

It appears, from the records filed in this Office, that Frank M. Mearns  
..... Co. D. 12 Regt. 11 Vol. 1  
was admitted to Wm. W. Wood Hospital, Washington D.C.  
May 5<sup>th</sup>, 1865, from West Point for treatment for  
and also of Sanctioned May 11<sup>th</sup> 65.

It also appears, as reported by..... Surgeon.....  
....., that....., Co.....  
..... Reg't..... Vol....., 1865, at

Remarks: Medical papers can be furnished in this  
case.

**BY ORDER OF THE SURGEON GENERAL:**

J. Woodrow  
Brev. Lieut. Col. and Asst. Surgeon, U. S. Army.

(64)

(NOTE. This certificate should not be detached from the accompanying papers.)

J. 10.37d. 1868  
Washington D.C.  
July 29<sup>th</sup> 1868

Manuel Jones  
Priv. O. S. 5<sup>th</sup> U.S. C. Army

Report in case of from  
Surgeon General's Office  
Sold Return

Note; May 5<sup>th</sup> 1865 a portion of  
the enlisted men of the 92<sup>nd</sup> Regt.  
were transferred to the 5<sup>th</sup> U.S. C. Army.  
It is not believed that this man  
was so transferred, inasmuch as  
being done upon the rolls of the  
5<sup>th</sup> U.S. C. Army prior to that date;  
A Cas. sheet of him is on file  
with the 92<sup>nd</sup> Regt. -

R.O.F.A.  
No. 2994  
VOL. 16

Surgeon General's Office,

Record and Pension Division,

July 29<sup>th</sup>, 1868.

Respectfully returned to  
Major General Samuel M. ...  
The enclosed certificate from  
wards is supposed to relate  
to the soldier described within

BY ORDER OF THE SURGEON GENERAL:

Wm. Woodrow  
Bvt. Lt. Col. and Asst. Surgeon, U. S. A.

R. of A., Vol. 16 No. 2994

RECEIVED, ADJ. GEN.  
JUL 31  
1868  
OFFICE



CASUALTY SHEET.

Name: Manuel Jones  
Rank: Private Company: "I" Regiment: 5th  
Arm: U.S. Cav. State:  
Nature of Casualty: Death

CAUSE OF CASUALTY—(NAME OF DISEASE, &c.)

Pneumonia

BY WHOM DISCHARGED.

FROM WHAT SOURCE THIS INFORMATION WAS OBTAINED.

G. 103. Vol. 5. R. C. 7868.

DEGREE OF DISABILITY.

BY WHOM CERTIFIED.

J. J. Woodward  
Asst Surg. U.S.A.

DATE OF DISCHARGE, DEATH, &c.

May 11th 1865.

PLACE OF DISCHARGE, DEATH, &c.

Covington, Ky.

REMARKS.

James Powers

Clerk.



CASUALTY SHEET

Complete,  
No. \_\_\_\_\_

Manuel Jones,

Private of Company I

5<sup>th</sup> Regiment of U. S. Cavalry,

State Volunteers

NATURE OF CASUALTY.

Died, May 11<sup>th</sup> 1865.

See Cas. Sheet with

732403 -

Jones, Marion  
P, Co. I

5 Reg U.S.C. Cav.

2 Enclosures.

Bed Cards	Descriptive Lists
Burial Records	Final Statements
Certs. of Dis. for Discharge	Furloughs
C. M. Charges	Med. Des. Lists
Med. Certificates	Orders

Other papers relating to—

Admission to Hosp'l	Furlough
Casualty Sheet ( <del>Officer's</del> ) /	Med. Examination
Confinement	Misc. Information /
Contracts	Pay or Clothing
Death or Effects	Personal Reports
Desertions	Rank
Discharge from Hosp'l	Transfer to Hosp'l
Discharge from Service	Transfer to V. R. C.
Duty	Transportation

**5 Cav. | U.S.C.T.**

*J*  
Manuel Jones  
Pot., Co. *D*, 5 Reg't U. S. Col'd Cavalry.

Appears on **Co. Muster-out Roll**, dated  
*Helena, Ark. Mch. 16*, 1866.

Muster-out to date \_\_\_\_\_, 186 .

Last paid to \_\_\_\_\_, 186 .

Pay due from Enlistment

Clothing account:

Last settled \_\_\_\_\_, 186 ; drawn since \$ \_\_\_\_\_ 100

Due soldier \$ \_\_\_\_\_ 100; due U. S. \$ \_\_\_\_\_ 100

Am't for cloth'g in kind or money adv'd \$ \_\_\_\_\_ 100

Due U. S. for arms, equipments, &c., \$ \_\_\_\_\_ 100

Bounty paid \$ \_\_\_\_\_ 100; due \$ \_\_\_\_\_ 100

Remarks: *Sick in Genl. Hosp. Coalington, Ky., since May 7<sup>th</sup> 1865, - Descriptive List furnished - No Discharge given.*

Book mark: *J. 103. Vol 5. R.C.S. 1868*

*Crenshaw*



J | 5 Cav. | U.S.C.T.  
Manuel Jones  
Priv., Co. D, 5 Reg't U. S. Colored Cav.

Appears on Returns as follows:

Mar 1865 Absent detached at  
Hopkinsville, Ky. Mch. 14.

May 1865 to Feb. 1866 Absent  
sick in Gen Washl Cov-  
ington, Ky. since May 7,  
'65

Book mark :

(546)

Houston

Copyist.

**5 Cav. | U.S.C.T.**

*Manuel Jones*

*Priv*, Co. I, 5 Reg't U. S. Col'd Cavalry.

Appears on

**Company Muster Roll**

for *Jan'y. & Feby.*, 1866.

Present or absent *absent*

Stoppage, \$ *100* for

Due Gov't, \$ *100* for

Valuation of horse, \$ *100*

Valuation of horse equipments, \$ *100*

Remarks: *Sick in Hospital  
Covington Ky. since  
7<sup>th</sup> May 1865.*

Book mark:

*Crenshaw*

5 Cav. U.S.C.T.

*Mannell Jones*

*Pr*, Co. I, 5 Reg't U. S. Col'd Cavalry.

Appears on

Company Muster Roll

for *Nov & Dec*, 1865.

Present or absent *Absent*

Stoppage, \$ *100* for

Due Gov't, \$ *100* for

Valuation of horse, \$ *100*

Valuation of horse equipments, \$ *100*

Remarks: *Sick in Gen Hosp  
Corington Ky sick  
May 7/65*

Book mark:

*Allen*



5 Cav. U.S.C.T.

*Manuel Jones*

*Pr*, Co. I, 5 Reg't U. S. Col'd Cavalry.

Appears on

Company Muster Roll

for *Sept & Oct*, 186*6*.

Present or absent *Absent*

Stoppage, \$ *100* for

Due Gov't, \$ *100* for

Valuation of horse, \$ *100*

Valuation of horse equipments, \$ *100*

Remarks: *Sick in Gen Hosp.  
Carrington Ky since  
May 7/65*

Book mark:

*Devo*

**5 Cav. U.S.C.T.**

*Manuel Jones*

*Pr*, Co. I, 5 Reg't U. S. Col'd Cavalry.

Appears on

**Company Muster Roll**

for *July & Aug*, 1865.

Present or absent *Absent*

Stoppage, \$ 100 for

Due Gov't, \$ 100 for

Valuation of horse, \$ 100

Valuation of horse equipments, \$ 100

Remarks: *Sick in Hospital  
Covington Ky since  
7 May 1865*

Book mark:

*Allen*

**5 Cav. | U.S.C.T.**

*Samuel Jones*

*Private*, Co. I, 5 Reg't U. S. Col'd Cavalry.

Appears on

**Company Muster Roll**

for *May 1865*, 1865.

Present or absent *Present*

Stoppage, \$ *100* for

Due Gov't, \$ *100* for

Valuation of horse, \$ *100*

Valuation of horse equipments, \$ *100*

Remarks: *Contract for duty due \$100.*

*sick in San Angelo  
Arvington Ky since May  
3 1865*

Book mark:

*[Signature]*



J. | **5 Cav.** | **U.S.C.T.**

*Manuel Jones*  
....., Co. I, 5 Reg't U. S. Col'd Cavalry.

Appears on

**Company Muster Roll**

for *March & April*, 1865.

Present or absent *Present*

Stoppage, \$..... 100 for.....

Due Gov't, \$..... 100 for.....

Valuation of horse, \$..... 100

Valuation of horse equipments, \$..... 100

Remarks: *1st installment*  
*Bounty due.*

Book mark: .....

*Philipson*

J. | **5 Cav.** | **U.S.C.T.**

*Manuel Jones*

*Priv.*, Co. I, 5 Reg't U. S. Col'd Cavalry.

Appears on

**Company Muster Roll**

for *Jan. & Feb.*, 1865.

Present or absent *Present*

Stoppage, \$ *100* for

Due Gov't, \$ *100* for

Valuation of horse, \$ *100*

Valuation of horse equipments, \$ *100*

Remarks: *1<sup>st</sup> + 2<sup>d</sup> installments  
300<sup>y</sup> Bounty due.*

Book mark:

*Philipsen*

J. | **5 Cav.** | **U.S.C.T.**

*Manual Jones*  
-----  
*Prv.*, Co. I, 5 Reg't U. S. Col'd Cavalry.

Appears on

**Company Muster Roll**

for *Nov. + Dec.*, 186*7*.

Present or absent *Present*

Stoppage, \$ *100* for

Due Gov't, \$ *100* for

Valuation of horse, \$ *100*

Valuation of horse equipments, \$ *100*

Remarks: *1<sup>st</sup> + 2<sup>d</sup> installment*

*Bounty due.*

Book mark: -----

*Philipsen*  
-----  
Copyist.



J. | **5 Cav.** | **U.S.C.T.**

*Manuel Jones*

*Priv.*, Co. I, 5 Reg't U. S. Col'd Cavalry.

Appears on

**Company Muster Roll**

for *Organization to Oct. 31, 1864.*

Present or absent *Present*

Stoppage, \$ 100 for

Due Gov't, \$ 100 for

Valuation of horse, \$ 100

Valuation of horse equipments, \$ 100

Remarks:

-----  
-----  
-----  
-----  
-----  
-----  
-----

Book mark: -----

*Philipsen*

(358)

Copyist.

9 | 56av U.S.C.T.

Manuel Jones

Appears with rank of Private on

**Muster and Descriptive Roll**

of a Detachment of U.S. Col'd recruits  
mustered by Capt. J. H. Smith pursuant to  
Orders dated June 9, 1864 Roll dated  
Louisville Ky, June 30, 1864.

Where born Shelby Ky

Age 18 years; occupation Farm hand

When enlisted June 30, 1864.

Where enlisted Louisville Ky

For what period enlisted 3 years.

Eyes Dark; hair Dark

Complexion Dark; height 5 ft. 9 in.

When mustered in June 30, 1864.

Where mustered in Louisville Ky

Bounty paid \$ 100; due \$ 100

Clothing account:  
Last settled         , 186         ; drawn since \$ 100

Date of first muster         , 186         .

Company to which assigned         

Remarks Accredited to Jefferson  
County Ky 5th Cong. District

Book mark:         

L. Murchy  
Copyist.

J. 5 Cav. U. S. C. T.  
Manuel Jones  
Priv., Co. I, 5 Reg't U. S. Col'd Cav.

Appears on

**Company Muster-in and Descriptive Roll**  
of the organization named above. Roll dated

Cp. Nelson, Ky., Oct. 31, 1864.

Where born Shelby, Ky.

Age 18 y'rs; occupation Farmer

When enlisted June 30, 1864.

Where enlisted Louisville

For what period enlisted 3 years.

Eyes OK; hair OK

Complexion OK; height 5 ft. 4 in.

When mustered in June 30, 1864.

Where mustered in Louisville

Bounty paid \$ 100; due \$ 100

Where credited 5<sup>th</sup> Dist. Kentucky.

Company to which assigned \_\_\_\_\_

Remarks: Enlisted for 102th. U. S. C. T.

Transfered to 5th. U. S. C. Cavalry

August 2, 1864. per S. O. 192. Head

Quarters Dist of Ky.

Book mark: \_\_\_\_\_

Philipsen



5 Cav.

108

U.S.C.T.

J | Manuel Jones

Co. A, 108 Reg't U. S. Col'd Infantry.

Appears on

**Company Descriptive Book**

of the organization named above.

**DESCRIPTION.**

Age 18 years; height 5 feet 4 inches.

Complexion Dark

Eyes Dark; hair Dark

Where born Shell Co. Ky

Occupation Farmer

**ENLISTMENT.**

When June 30, 1864.

Where Louisville

By whom Capt. Smith, term 3 y'rs

Remarks:

.....  
.....  
.....

Enlisted for 108th U. S. C. T.

Transferred to 5th U. S. C. Cavalry

August 2, 1864. per S. O. 192. Head

Quarters Dist of Ky.

D. M. Kennedy

(383g)

Copist.

g | **5 Cav. | U.S.C.T.**

Mannel Jones

....., Co. 2, 5 Reg't U. S. Col'd Cav.

Appears on

**Company Descriptive Book**  
of the organization named above.

**DESCRIPTION.**

Age 18 years; height 5 feet 4 inches.

Complexion Dark

Eyes Dark; hair Dark

Where born Shelby Ky

Occupation Farmer

**ENLISTMENT.**

When June 21, 1864

Where Louisville

By whom Capt. Smith; term 3 y'rs.

Remarks: .....

.....  
.....  
.....  
.....  
.....  
.....  
.....  
.....  
.....  
.....

A. J. Anderson  
(383a) Coppist.

142141

*Jones Manuel*  
Co B, 5 U. S. Col'd Cav.

*Private* | *Private*

CARD NUMBERS.

1	5367821	26
2	536794	27
3	5368015	28
4	5368107	29
5	5368199	30
6	5368294	31
7	5368385	32
8	5368473	33
9	5368559	34
10	5368646	35
11	5368728	36
12	9090983	37
13	9221622	38
14	143143544	39
15	40729994	40
16		41
17		42
18		43
19		44
20		45
21		46
22		47
23		48
24		49
25		50

Book Mark *J. 103. H. 5-A. C. T. 1868*

See also



J. | 5. Gary | U.S.C

Lewis Jones

, Co. E., 5 Reg't. U.S.C. Gary

**NOTATION.**

Book mark :

8014 B 1889.

**War Department,**

Record and Pension Division,

Washington, December 14<sup>th</sup>, 1889.

Investigation fails to elicit any further information relative to this soldier.

Muzzey

**5 Cav. U.S.C.T.**

*James J. Jones*  
Co. B, 5 Reg't U. S. Col'd Cavalry.

Appears on **Co. Muster-out Roll**, dated  
*Nelson (Ark) March*, 186*6*.

Muster-out to date \_\_\_\_\_, 186 .

Last paid to *Pay due from interest* 186 .

**Clothing account:**

Last settled \_\_\_\_\_, 186 ; drawn since \$ \_\_\_\_\_ 100

Due soldier \$ \_\_\_\_\_ 100; due U. S. \$ *37* <sup>*13*</sup>/<sub>100</sub>

Am't for cloth'g in kind or money adv'd \$ \_\_\_\_\_ 100

Due U. S. for arms, equipments, &c., \$ \_\_\_\_\_ 100

Bounty paid \$ \_\_\_\_\_ 100; due \$ \_\_\_\_\_ 100

Remarks: *Missing in action*  
*at Camp Perreille,*  
*January 23 1865*

Book mark: *0014 5 59*

*J. H. Keenan*  
(861) Copyist.

J | 5 Cav. | U.S.C.T.

Lewis Jones  
Sadr, Co. C, 5 Reg't U. S. Colored Cav.

Appears on Returns as follows:

Jan 1865 Loss; Jan 25/65 Simp-  
sonville Ky. Missing in  
action near Simpsonville,  
Ky.

Book mark :

(540)

Huston

Copyist.



9 | **5 Cav.** | **U.S.C.T.**

*Lewis Jones*  
Saddler, Co. E, 5 Reg't U. S. Col'd Cavalry.

Appears on

**Company Muster Roll**

for *Jan. 1 Feb.*, 1865.

Present or absent *Absent*

Stoppage, \$ 100 for

Due Gov't, \$ 100 for

Valuation of horse, \$ 100

Valuation of horse equipments, \$ 100

Remarks: *Missing in action  
at Simssville Ky.  
Jan. 25-1865*

*McCall next on which name  
appears*

Book mark:

(358) *W. R. Cowland* Copyist.

*J* | **5 Cav. | U.S.C.T.**

*Lewis Jones*  
Saddler, Co. E, 5 Reg't U. S. Col'd Cavalry.

Appears on

**Company Muster Roll**

for *Nov. & Dec.*, 1864.

Present or absent *Present*

Stoppage, \$ *100* for

Due Gov't, \$ *100* for

Valuation of horse, \$ *100*

Valuation of horse equipments, \$ *100*

Remarks: *1<sup>st</sup> & 2<sup>nd</sup> Instalment  
of Bounty due*

Book mark: *21*

*W. Rowland*  
(358) Copyist.

9 | **5 Cav.** | **U.S.C.T.**

*Lewis Jones*  
Saddler, Co. E, 5 Reg't U. S. Col'd Cavalry.

Appears on

**Company Muster Roll**

for *Enlistment to Oct. 31, 1864.*

Present or absent *Present*

Stoppage, \$ 100 for

Due Gov't, \$ 100 for

Valuation of horse, \$ 100

Valuation of horse equipments, \$ 100

Remarks:

Book mark:

*M. R. ...*



**5 Cav. U.S.C.T.**

*J*  
*Levir Jones*

*Sadler*, Co. *E*, 5 Reg't U. S. Col'd Cavalry.

Appears on

**Company Muster-in and Descriptive Roll**

of the organization named above. Roll dated

*Amey Nelson*, *N.Y.*, *Oct 26*, 1864.

Where born *Knox* *Ty.*

Age *19* y'rs; occupation *Farmer*

When enlisted *Sept. 9*, 1864.

Where enlisted *Cp. Nelson Ky*

For what period enlisted *3* years.

Eyes *Black*; hair *Black*

Complexion *Black*; height *5* ft. *3<sup>3</sup>* in.

When mustered in *Sept. 9*, 1864.

Where mustered in *Cp. Nelson Ky*

Bounty paid \$ *100*; due \$ *100*

Where credited

Company to which assigned

Remarks: *8<sup>th</sup> District Kentucky*

\* *E. Jones.*

\* *Supposed to be name of owner.*

*Added May 16. 98. H. H. J.*

Book mark: *See 80. 4. B. 59*

General Notation R. & P. 407375.

*W. Rowland*

(356d)

Copyist.

*J* | **5 Cav. | U.S.C.T.**  
*Lewis Jones*  
....., Co. *E*, 5 Reg't U. S. Col'd Cav.

Appears on

**Company Descriptive Book**  
of the organization named above.

**DESCRIPTION.**

Age *17* years; height *5* feet *3* inches.

Complexion *Black*

Eyes *Blk*; hair *Blk*

Where born *Mox Ky*

Occupation *farmer*

**ENLISTMENT.**

When *Sep 9*, 186

Where *Camp Nelson*

By whom *J. Randolph*, term *3* y'rs.

Remarks: *Missing in  
action*

*J. E. Purke*  
Coppist.

140

Lewis

U. S. Col'd Cav.

Private

NUMBERS.

- 26
- 27
- 28
- 29
- 30
- 31
- 32
- 33
- 34
- 35
- 36
- 37
- 38
- 39
- 40
- 41
- 42
- 43
- 44
- 45
- 46
- 47
- 48
- 49
- 50

(E.B.) 1889  
P. 407375,



**5 Cav. U.S.C.T.**

*Leander Jones*  
Co., 5 Reg't U. S. Col'd Cavalry.

Appears on **Co. Muster-out Roll**, dated  
*Sciota Ark*, *March*, 1866.

Muster-out to date \_\_\_\_\_, 186 .

Last paid to *Pay due from enlistment*, 186 .

**Clothing account:**

Last settled \_\_\_\_\_, 186 ; drawn since \$ \_\_\_\_\_ 100

Due soldier \$ *62* <sup>*27*</sup>/<sub>*100*</sub>; due U. S. \$ \_\_\_\_\_ 100

Am't for cloth'g in kind or money adv'd \$ \_\_\_\_\_ 100

Due U. S. for arms, equipments, &c., \$ \_\_\_\_\_ 100

Bounty paid \$ \_\_\_\_\_ 100; due \$ \_\_\_\_\_ 100

Remarks: *Deserted Jan 26/66 at Louisville Ky transferred from 72 U.S.I. to 5th U.S.I. at Sciota Ark July 1865-*

Book mark: \_\_\_\_\_

*E. H. Brown*

J | 5 Cav. | U.S.C.T.

Leander Jones  
Priv., Co. K, 5 Reg't U. S. Colored Cav.

Appears on Returns as follows:

July 1865 Gain; July 27/65  
Paris, Ky by transfer  
Assigned to Co. K, 5 U.S.C.C.  
per R.O. No. 132

Aug to Dec 1865 Absent sick in  
G. Hospl. Louisville, Ky  
Jan 1866 Log: Louisville. De-  
serted. Transf. from 72 U.S.  
C.C. to 5 U.S.C.C. as absent  
sick in Hospl. at Louisville  
Ky. Dropped as deserter Jan.  
26/66 as Notice was then re-  
ceived that no such man  
had ever been in Hospl. at  
that place

Book mark :

(546)

Austin

Copyist.

5 Cav. U.S.C.T.

Leander Jones  
Cor

, Co. K, 5 Reg't U. S. Col'd Cav.

Appears on

Company Muster Roll

for Jan & Feb, 1866.

Present or absent

Stoppage, \$ 100 for

Due Gov't, \$ 100 for

Valuation of horse, \$ 100

Valuation of horse equipments, \$ 100

Remarks: transferred from 72 U.S.C. & as absent sick in hospital at Louisville Ky. Discharged as deserter Jan 26/66 as notice was then received that no such man had ever been in Hospital at that place

Book mark:

E. H. Bacon



J. | 5 Cav | U.S.C.T.  
Leander Jones  
Priv., Co. K, 5<sup>th</sup> Reg't U. S. Col'd Cav

Appears on

**Descriptive List of Deserters**

dated Jan 31, 1866.

Deserted:

When Unknown, 1866.

Where Unknown

Arrested:

When \_\_\_\_\_, 1866.

Where \_\_\_\_\_

Remarks: This man was transferred from 72 US Cav as absent sick in Hospl Louisville, Ky.

Notice received 26 Jan 1866 that no such man had ever been in Hospital at that place.

Book mark: \_\_\_\_\_

Rose

*J* | **5 Cav.** | **U.S.C.T.**

*Leander Jones*  
*Cross*, Co. K, 5 Reg't U. S. Col'd Cav.

Appears on

**Company Muster Roll**

for *Nov & Dec*, 186*7*.

Present or absent *Absent*

Stoppage, \$.....*100* for .....

Due Gov't, \$.....*100* for .....

Valuation of horse, \$.....*100*

Valuation of horse equipments, \$.....*100*

Remarks: *Absent. Sick in*  
*Hospital, Louisville,*  
*Ky.*

Book mark: .....

*F. E. Porter*

*J* | **5 Cav.** | **U.S.C.T.**

*Leander James*  
*Prov.*, Co. K, 5 Reg't U. S. Col'd Cav.

Appears on

**Company Muster Roll**

for *Sept & Oct*, 186*0*.

Present or absent *Absent*

Stoppage, \$ *100* for

Due Gov't, \$ *100* for

Valuation of horse, \$ *100*

Valuation of horse equipments, \$ *100*

Remarks: *Down with horse  
and is absent  
sick at Louisville Ky*

Book mark:

*F. E. Porter*



*J* | **5 Cav.** | **U.S.C.T.**

*Leander Jones*  
*Prov*, Co. K, 5 Reg't U. S. Col'd Cav.

Appears on

**Company Muster Roll**

for *July & Aug*, 186*0*.

Present or absent *absent*

Stoppage, \$ *100* for

Due Gov't, \$ *100* for

Valuation of horse, \$ *100*

Valuation of horse equipments, \$ *100*

Remarks: *Absent in Hospital  
Lansville Ky.  
Assigned to Co "K" 5th U.S.  
Cav. for R.O No 132  
July 27, 60*

Book mark:

*F. E. Porter*

*J* | *5<sup>th</sup> leav* | **U.S.C.T.**  
*Leander Jones*  
*Pvt*, Co. ...., *5<sup>th</sup>* Reg't U. S. Col'd *leav*

Appears on

**M. and D. Roll of Men Transferred**

to the organization named above,

from .....

Roll dated *July 18*, 1865.

When enlisted ....., 186 .

Period for which enlisted *1* years.

When mustered in *Jan 6*, 1865.

Present or absent .....

Company to which assigned .....

Remarks *Absent sick since Feb 18, 1865*

*Sub for Wardsmall*

Book mark : .....

*Abbot*

J | 5 Cav. | U.S.C.T.

Leander Jones

, Co. R, 5 Reg't U. S. Col'd Cav.

Appears on

Company Descriptive Book  
of the organization named above.

DESCRIPTION.

Age 23 years; height 5 feet 10 inches.

Complexion Black

Eyes Blue; hair Black

Where born North Carolina

Occupation Farmer

ENLISTMENT.

When Substitute, 186 .

Where

By whom; term 1 y'rs.

Remarks: Resigned to Co. K per  
R.O. No 182 July 27/65

(383a)

A. J. Anderson

Copist.



749

Jones Leander

Co No. 5 U. S. Col'd Cav.

Private

Private

CARD NUMBERS.

1	5359259	26
2	5369388	27
3	5369477	28
4	5369563	29
5	5369676	30
6	5359461	31
7	5369783	32
8	9091129	33
9	40729992	34
10		35
11		36
12		37
13		38
14		39
15		40
16		41
17		42
18		43
19		44
20		45
21		46
22		47
23		48
24		49
25		50

Book Mark:

See also 72 US Col'd Cav

J. | 5<sup>th</sup> Cav. | U.S.C.A.  
Joshua Jones  
, Co. E, | 5<sup>th</sup> Reg't U.S.C.A.

**NOTATION.**

Book mark : J. 20. 6. J. 1868

**Record and Pension Office,**

WAR DEPARTMENT.

This book mark refers only to a report from the medical records, made by the Surgeon General to the Adjutant General, relative to the above-named man. As the medical records have since been carded, no transcript of this report is made hereon.

(491)

E. P. Conziger

Copyist.

5 Cav. U.S.C.T.

Joshua Jones  
Co. E, 5 Reg't U. S. Col'd Cavalry.

Appears on Co. Muster-out Roll, dated

November, Ark. Mar 16, 1861.

Muster-out to date \_\_\_\_\_, 1861.

Last paid to Pay due from Enlistment, 1861.

Clothing account:

Last settled \_\_\_\_\_, 1861 ; drawn since \$ 100

Due soldier \$ 102 <sup>30</sup>/<sub>100</sub>; due U. S. \$ 100

Am't for cloth'g in kind or money adv'd \$ 100

Due U. S. for arms, equipments, &c., \$ 100

Bounty paid \$ 100; due \$ 200 <sup>xx</sup>/<sub>100</sub>

Remarks: Absent on a term from  
Hosp New Albany Ind  
since Jan 25/61  
descriptive Roll furnished  
(no discharge given)

Book mark J 20 vol. 7 of '68

W. Leonard



J | 5 Cav. | U.S.C.T.

Joshua Jones

Priv., Co. E, 5 Reg't U. S. Colored Cav.

Appears on Returns as follows:

Oct. 1864 Absent sick in Genl. Hospl. Oct 5/64

Nov. 1864 to Mar. 1865 Absent sick in Genl Hospl. Sept 25/64

Apr. to Aug. 1865 Absent sick in Genl Hospl. Ashland, Ky. since Oct. 30/64

Sept. 1865 Absent sick in Hospl. Ashland, Ky. since Oct 30/64 from wounds.

Oct. 1865 Absent sick in Hospl. Paducah, Ky. since Oct 30/64 from disease

Nov. 1865 to Feb. 1866 Absent sick in Hospl. Ashland Ky. since Oct 30/64

Book mark :

(546)

Austin

Copyist.

5 Cav. U.S.C.T.

*Joshua Jones*  
Private, Co. E, 5 Reg't U.S. Col'd Cavalry.

Appears on

**Company Muster Roll**

for *Jan & Feb*, 1866.

Present or absent *Absent*

Stoppage, \$ 100 for

Due Gov't, \$ 100 for

Valuation of horse, \$ 100

Valuation of horse equipments, \$ 100

Remarks: *Absent sick  
in Hospital New  
Albany Ind June  
June 25 1863*

Book mark:

(358)

*W. Leonard*  
Copyist.

J | 5 Cav. | U.S.C.T.

Joshua Jones  
Pvt., Co. E, 5 Reg't U. S. Col'd Cavalry.

Appears on

Company Muster Roll

for Nov & Dec, 1865.

Present or absent absent

Stoppage, \$ 100 for

Due Gov't, \$ 100 for

Valuation of horse, \$ 100

Valuation of horse equipments, \$ 100

Remarks: Absent sick in  
Hospl. New Albany Ind.  
since Jan. 25/65.

Book mark:

Long

(358)

Copyist.



*J* | **5 Cav. | U.S.C.T.**

*Joshua Jones*

*Put.*, Co. E, 5 Reg't U. S. Col'd Cavalry.

Appears on

**Company Muster Roll**

for *Sept & Oct.*, 1865.

Present or absent *absent*

Stoppage, \$ *100* for

Due Gov't, \$ *100* for

Valuation of horse, \$ *100*

Valuation of horse equipments, \$ *100*

Remarks: *Absent sick in Hospl. New Albany, Ind. since Jan. 25/65.*

Book mark:

(358)

*Long*

Copyist.

*J* | **5 Cav.** | **U.S.C.T.**

*Joshua Jones*  
*Privt*, Co. E, 5 Reg't U. S. Col'd Cavalry.

Appears on

**Company Muster Roll**

for *July & Aug.*, 1865.

Present or absent *absent*

Stoppage, \$ *100* for

Due Gov't, \$ *100* for

Valuation of horse, \$ *100*

Valuation of horse equipments, \$ *100*

Remarks: *Absent sick in  
Hospl. New Albany,  
Ind. since Jan. 25/65  
from wounds.*

Book mark:

(358)

*Long*  
Copyist.

J | 5 Cav. | U.S.C.T.

Joshua Jones  
Pvt, Co. E, 5 Reg't U. S. Col'd Cavalry.

Appears on

**Company Muster Roll**

for May June, 1865

Present or absent absent

Stoppage, \$ 100 for

Due Gov't, \$ 100 for

Valuation of horse, \$ 100

Valuation of horse equipments, \$ 100

Remarks Absent sick in  
Gen. Hoopl. New Albany,  
Ind. since Jan. 25/65.  
1<sup>st</sup> Instalment  
Bounty due \$100.

Book mark:

Long  
Copyist.



J | 5 Cav. | U.S.C.T.

Joshua Jones

Cvt., Co. E, 5 Reg't U. S. Col'd Cavalry.

Appears on

Company Muster Roll

for March & April, 1865.

Present or absent Absent

Stoppage, \$ 100 for

Due Gov't, \$ 100 for

Valuation of horse, \$ 100

Valuation of horse equipments, \$ 100

Remarks: Absent sick in  
Hosp. New Albany Ind.  
since Jan. 25/65  
First instalment of  
Bounty due

Book mark:

M. Rowland

J | **5 Cav.** | **U.S.C.T.**

Joshua Jones  
Capt., Co. E, 5 Reg't U.S. Col'd Cavalry.

Appears on

**Company Muster Roll**

for Jan 1 Feb, 1865.

Present or absent Absent

Stoppage, \$ 100 for

Due Gov't, \$ 100 for

Valuation of horse, \$ 100

Valuation of horse equipments, \$ 100

Remarks: In Hospital New  
Orleans Ark since Feb  
25-65 from wounds Re-  
ceived in action at  
Dempsonville Ky. Jan  
25-65

Book mark:

M. Rowland  
(358) Copyist.

J | **5 Cav.** | **U.S.C.T.**

Joshua Jones  
Pr., Co. E, 5 Reg't U. S. Col'd Cavalry.

Appears on

**Company Muster Roll**

for Nov. & Dec., 1864.

Present or absent Absent

Stoppage, \$ 100 for

Due Gov't, \$ 100 for

Valuation of horse, \$ 100

Valuation of horse equipments, \$ 100

Remarks: Absent sick Gen.  
Hospital Oct 8<sup>th</sup> 1864  
1<sup>st</sup> & 2<sup>nd</sup> instalment  
of Bounty due

Book mark: \_\_\_\_\_

M. Rowland



J | **5 Cav. | U.S.C.T.**

Joshua Jones  
Private, Co. E, 5 Reg't U. S. Col'd Cavalry.

Appears on

**Company Muster Roll**

for Enlistment to Oct 31, 1864.

Present or absent ✓

Stoppage, \$ 100 for

Due Gov't, \$ 100 for

Valuation of horse, \$ 100

Valuation of horse equipments, \$ 100

Remarks: Absent sick - General Hospital since Oct 5, 1864

Name appears in column of names present, Canceled by line

Book mark:

(358) M. Rowland Copyist.

7 | 5 Cav. | U.S.C.T.

Joshua Jones

Cvt., Co. E, 5 Reg't U. S. Col'd Cavalry.

Appears on

**Company Muster-in and Descriptive Roll**

of the organization named above. Roll dated  
Camp Nelson, N.Y., Oct 26, 1864.

Where born Bome Ky.

Age 22 y'rs; occupation Farmer

When enlisted Sept. 9, 1864.

Where enlisted Cp. Nelson Ky.

For what period enlisted 3 years.

Eyes Black; hair Black

Complexion Black; height 5 ft. 10 in.

When mustered in Sept. 9, 1864.

Where mustered in Cp. Nelson Ky.

Bounty paid \$ 100; due \$ 100

Where credited

Company to which assigned

Remarks: 7<sup>th</sup> District Kentucky  
\* Edmund Price.

\* Supposed to be name of owner.

Added May 17, 98. H.A.J.

Book mark:

General Notation R. & P. 407375.

H.R. Rowland

(356d)

Copyist.

*J* | **5 Cav. | U.S.C.T.**

*Joshua Jones*

....., Co. *E*, 5 Reg't U. S. Col'd Cav.

Appears on

**Company Descriptive Book**  
of the organization named above.

**DESCRIPTION.**

Age *27* years; height *5* feet *10* inches.

Complexion *Black*

Eyes *Blk*; hair *Blk*

Where born *Boon Ky*

Occupation *farmer*

**ENLISTMENT.**

When *Sep 9*, 186

Where *Camp Nelson*

By whom *J. Randolph* term *3* y'rs.

Remarks:

.....  
.....  
.....  
.....  
.....

*J. E. Burke*



150

Jones Joshua  
Co E, 5 U. S. Col'd Cav.

Private | Private

CARD NUMBERS.

1	5363713	26
2	5363807	27
3	5363909	28
4	5363985	29
5	5364089	30
6	5364177	31
7	5364261	32
8	5364355	33
9	5364440	34
10	5364521	35
11	5364598	36
12	9098486	37
13	J 20-07-1868	38
14	40729991	39
15		40
16		41
17		42
18		43
19		44
20		45
21		46
22		47
23		48
24		49
25		50

Book Mark:

J. 20 M. 7. 6 P. 68

General Notation R. & P. 407375.

See also



**Proof of Ownership.**

State of Kentucky, }  
COUNTY OF Fayette } SS.  
We, Joseph Rutledge and John Crowl, each  
of lawful age, and resident citizens of the State and County aforesaid, do certify that Wm S Walls  
of the State ~~and County~~ aforesaid, was, on the 1st day  
of Jan, 1866, the lawful owner of the slave named James Jones,  
referred to and described in the foregoing claim for compensation.

Sworn to and subscribed before me, a Notary Public for the County of  
Fayette, State of Kentucky, this the 10 day of Dec, 1866.  
J B Davidson  
Notary Public



**Proof of Loyalty.**

State of Kentucky, }  
COUNTY OF Fayette } SS.  
We, Joseph Rutledge and John Crowl, loyal  
men, and each of lawful age, and resident citizens of the County of Jessamine,  
in the State ~~and County~~ aforesaid, upon our oaths declare that we have known Wm S Walls  
a resident of the State and County aforesaid, since the 4th day of March, 1861, and  
know that he has firmly and faithfully maintained his adherence and allegiance to the Government of the  
United States, by defending its cause against the Government and forces of the so-called Confederate States of  
America, in all suitable and practicable ways, and according to his ability and opportunity.

Sworn to and subscribed before me, a Notary Public for the County of  
Fayette, State of Kentucky, this the 10 day of Dec, 1866.  
J B Davidson  
Notary Public

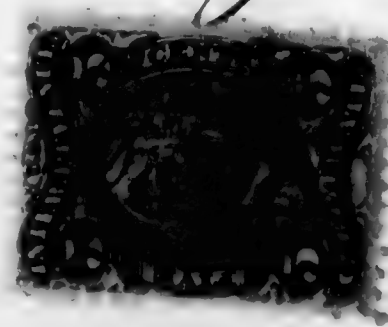

**CERTIFICATE OF AWARD OF THE BOARD OF CLAIMS.**

Office of the Board of Claims,  
For Slaves Enlisted or Drafted in the Service of the United States.

We HEREBY CERTIFY, That  
County, State of \_\_\_\_\_, having proved under  
oath, \_\_\_\_\_, loyalty to the Constitution and Government of the United States, and established  
title as to the ownership of \_\_\_\_\_, a slave, enlisted or drafted  
[as the case may be] and mustered at \_\_\_\_\_ on the \_\_\_\_\_ day  
of \_\_\_\_\_, 1866, by \_\_\_\_\_, in the service  
of the United States, in the \_\_\_\_\_ Regiment Colored Troops, Company \_\_\_\_\_, the sum  
of \_\_\_\_\_ dollars has been awarded to \_\_\_\_\_ by this Board, subject to the  
approval of the Secretary of War, as a compensation for the said slave, under the provisions of section 24, Act  
approved February 24, 1864, and section 2, Act approved July 28, 1866.

\_\_\_\_\_, President of the Board.  
\_\_\_\_\_, Member of the Board.  
\_\_\_\_\_, Member of the Board.

To \_\_\_\_\_,  
Chief of the Bureau for the Organization of Colored Troops,  
Washington, D. C.



**Claim for Compensation for Enlisted Slave.**

No. \_\_\_\_\_

I, Wm J Walls, a loyal citizen, and a resident of \_\_\_\_\_, County of Jessamine, State of Kentucky, hereby claim compensation, under the provisions of section 24, Act approved February 24, 1864, and section 2, Act approved July 28, 1866, for my slave James Jones, enlisted \_\_\_\_\_, 186\_\_\_\_, at \_\_\_\_\_, by \_\_\_\_\_, in the 5th Cavalry Regiment U. S. Colored Troops, Co. M; certificate of which enlistment, and a descriptive list, as required, accompany this application.

In proof of my loyalty to the Constitution and Government of the United States, I present the accompanying oath, which I have taken, signed and acknowledged, to be filed with this application, in accordance with requirement of General Orders No. 329, 1863, War Department, Adjutant General's Office. *He was a slave for life*

Sept 10 1866 William J Walls

**Oath of Allegiance.**

I, Wm J Walls, the owner and claimant, do solemnly swear

that the foregoing claim is a just and true claim due to me as master and owner of the said slave, and that the facts alleged in said claim in respect to the draft or enlistment [as the case may be] of said slave into the military service of the United States are true. And I do further swear, that I have never joined, or been concerned in, any insurrection or rebellion; that I have never borne arms against the United States; that I have never given any aid, countenance, counsel, or encouragement to any person or persons engaged, or whom I had reason to believe were about to engage, in insurrection, rebellion, or armed hostility against the United States; that I have neither sought nor accepted, nor attempted to exercise the functions of any office, civil or military, nor to perform any service whatever, under any authority, or pretended authority, in hostility to the United States; that I have not yielded a voluntary support to any insurrection, rebellion, or pretended government, authority, power, or constitution within the United States, hostile thereto. And I do further swear, that, to the best of my knowledge and ability, I have supported and defended, and will continue to support and defend, the United States, against all enemies, foreign and domestic; and that I have supported, defended, and obeyed, and will continue to support, defend, and obey, the Constitution and laws of the United States; that I will bear true faith and allegiance to the same; and that I take this oath freely, without any mental reservation or purpose of evasion: So help me God.

William J Walls

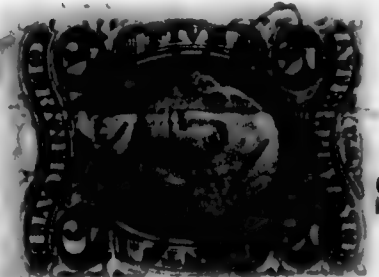

Sworn to and subscribed before me, a Notary Public,  
this 10 day of Dec, 1866  
J B Davidson  
Notary Public



**Claim for Compensation for Enlisted Slave.**

No. \_\_\_\_\_

I, *Wm T Walls*, a loyal citizen, and a resident of \_\_\_\_\_, County of *Jessamine*, State of *Kentucky*, hereby claim compensation, under the provisions of section 24, Act approved February 24, 1864, and section 2, Act approved July 28, 1866, for my slave *James Jones*, enlisted \_\_\_\_\_, 186\_\_\_\_, at \_\_\_\_\_, by \_\_\_\_\_, in the *5th Cavalry* Regiment U. S. Colored Troops, Co. *M*; certificate of which enlistment, and a descriptive list, as required, accompany this application.

In proof of my loyalty to the Constitution and Government of the United States, I present the accompanying oath, which I have taken, signed and acknowledged, to be filed with this application, in accordance with requirement of General Orders No. 329, 1863, War Department, Adjutant General's Office. *He was a slave for life*

*Sept 10th My Dec 10 1866.* *William T Walls*

**Oath of Allegiance.**

I, *Wm T Walls*, the owner and claimant, do solemnly swear

that the foregoing claim is a just and true claim due to me as master and owner of the said slave, and that the facts alleged in said claim in respect to the draft or enlistment [as the case may be] of said slave into the military service of the United States are true. And I do further swear, that I have never joined, or been concerned in, any insurrection or rebellion; that I have never borne arms against the United States; that I have never given any aid, countenance, counsel, or encouragement to any person or persons engaged, or whom I had reason to believe were about to engage, in insurrection, rebellion, or armed hostility against the United States; that I have neither sought nor accepted, nor attempted to exercise the functions of any office, civil or military, nor to perform any service whatever, under any authority, or pretended authority, in hostility to the United States; that I have not yielded a voluntary support to any insurrection, rebellion, or pretended government, authority, power, or constitution within the United States, hostile thereto. And I do further swear, that, to the best of my knowledge and ability, I have supported and defended, and will continue to support and defend, the United States, against all enemies, foreign and domestic; and that I have supported, defended, and obeyed, and will continue to support, defend, and obey, the Constitution and laws of the United States; that I will bear true faith and allegiance to the same; and that I take this oath freely, without any mental reservation or purpose of evasion: So help me God.

*William T Walls*

**POWER OF ATTORNEY.**

My Post-office address is *Nicholasville*, County of *Jessamine*, State of Kentucky, and I hereby direct that all communications to me, touching this claim, be sent under cover to *B. C. Bruce & Co*, who is hereby appointed and constituted my lawful attorney, to prosecute this claim for me, and who is hereby authorized and empowered to receive and for any award, order, draft, certificate, voucher, warrant, papers, or money that may be issued in the adjustment claim, or the payment thereof, the same as I might or could do in person were I present and acting for myself, file any additional evidence or papers that may be required in the prosecution of this claim.

WITNESSES.]

The owner signs here.

*William T Walls*

Post Stamp.]

*C. B. Thomas*  
*L. C. Bruce*

Two witnesses to owner's signature sign here.



War Department,

ADJUTANT GENERAL'S OFFICE,

Washington, April 20<sup>th</sup> 1867.

Respectfully returned to the  
Commission for the State of  
Ky., with the informa-

tion that James Jones  
was enlisted at Camp Nelson Ky  
Aug. 29 1864, and was  
mustered in as Pvt. in Co. "M"  
5<sup>th</sup> U. S. Col. Cav. Aug 30/64.

*John Hayward*  
Asst. Adj't General.

*H.B.*

ENDORSEMENT.

No. 179

APPLICATION OF

*William J. Walls*

OF

*Greenup County Ky*

For Compensation for Service of Slave,

*James Jones*

Enlisted , 186 .

In M Co., 3<sup>rd</sup> Cav Regiment

U. S. Colored Troops.

Received *July 16* , 1867.

Compensation Awarded

, 186 ,

Dollars.

President Board of Claims.

P. O. ADDRESS OF CLAIMANT: *J. ally*  
*Nicholasville*

*B & Brouce & Co*

*Lexington Ky*



Jones, James

Art. Co. No. 5 Reg't U.S. Caval

**Enclosures.**

Bed Cards	Descriptive Lists
Burial Records	Final Statements
Certs. of Dis. for Discharge	Furloughs
C. M. Charges	Med. Des. Lists
Med. Certificates	Orders

**Other papers relating to—**

Admission to Hosp'l	Furlough
Casualty Sheet (Officer's)	Med. Examination
Confinement	Misc. Information
Contracts	Pay or Clothing
Death or Effects	Personal Reports
Desertions	Rank
Discharge from Hosp'l	Transfer to Hosp'l
Discharge from Service	Transfer to V. R. C.
Duty	Transportation



J | 5<sup>th</sup> Cav. | U.S.C.S.

James Jones

, Co. M, 5<sup>th</sup> Reg't U.S.C. Cav.

**NOTATION.**

Book mark: 1169-C-J-1877.

**War Department,**

Adjutant General's Office,

Washington, June 13, 1877.

Call from

returned with report.

The above book mark was noted on rolls in order to  
preserve results of search in this case.

(475)

W. Allen

Copyist.

5 Cav. U.S.C.T.

*James Jones*

Co. 5 Reg't U. S. Col'd Cavalry.

Appears on Co. Muster-out Roll, dated  
*Helena Ark*, *Mar 16*, 1866.  
Muster-out to date *Mar 16*, 1866.  
Last paid to *Dec 31*, 1865.

Clothing account:

Last settled....., 186 ; drawn since \$ 100

Due soldier \$ 100; due U. S. \$ *16* <sup>32</sup>/<sub>100</sub>

Am't for cloth'g in kind or money adv'd \$ 100

Due U. S. for arms, equipments, &c., \$ <sup>40</sup>/<sub>100</sub>

Bounty paid \$ *100* 100; due \$ *100* 100

Remarks: *Slave April 19. 61*

Book mark: *N. 1798*

*Hyman*

J | 5 Cav. | U.S.C.T.  
James Jones  
Priv., Co. M, 5 Reg't U. S. Colored Cav.

Appears on Returns as follows:

Nov 1864 Absent Returned  
from Louisville Ky. to  
Camp Nelson Ky.  
Dec 1864 Absent at Camp  
Nelson Ky.  
Jan to Mar 1865 Absent sick  
at Camp Nelson,

Book mark :

(546)

J. Austin

Copyist.



1866

**5 Cav. U.S.C.T.**

*J*  
*James Jones*

*Pl*, Co. M, 5 Reg't U. S. Col'd Cavalry.

Appears on

**Company Muster Roll**

for *Jan + Feb*, 186*6*.

Present or absent *Present*

Stoppage, \$ *100* for

Due Gov't, \$ *100* for

Valuation of horse, \$ *100*

Valuation of horse equipments, \$ *100*

Remarks:

Book mark:

*Stys*

(358)

Copyist.

*J*

**5 Cav. | U.S.C.T.**

*James Jones*

*No.*, Co. M, 5 Reg't U. S. Col'd Cavalry.

Appears on

**Company Muster Roll**

for *Nov + Dec*, 1865.

Present or absent *Present*

Stoppage, \$ *100* for

Due Gov't, \$ *100* for

Valuation of horse, \$ *100*

Valuation of horse equipments, \$ *100*

Remarks:

Book mark:

(358)

*Levy*  
Copyist.

J | 5 Cav. | U.S.C.T.

James Jones  
Mr., Co. M, 5 Reg't U. S. Col'd Cavalry.

Appears on

Company Muster Roll

for Sept & Oct, 1865.

Present or absent Present

Stoppage, \$ 100 for

Due Gov't, \$ 100 for

Valuation of horse, \$ 100

Valuation of horse equipments, \$ 100

Remarks: Due Mt for Company &  
Quinn # 155 Advance  
15c

Book mark:

Copyist.



*J* | **5 Cav. | U.S.C.T.**

*James Jones*

*Plu*, Co. M, 5 Reg't U. S. Col'd Cavalry.

Appears on

**Company Muster Roll**

for *July to Aug*, 1865.

Present or absent *Present*

Stoppage, \$ *100* for

Due Gov't, \$ *100* for

Valuation of horse, \$ *100*

Valuation of horse equipments, \$ *100*

Remarks:

Book mark:

*C. Curtis*  
Copyist.

*J* | **5 Cav. | U.S.C.T.**

*James Jones*  
*Pvt.*, Co. M, 5 Reg't U. S. Col'd Cavalry.

Appears on

**Company Muster Roll**

for *May & June*, 186*J.*

Present or absent *Present*

Stoppage, \$ *100* for

Due Gov't, \$ *100* for

Valuation of horse, \$ *100*

Valuation of horse equipments, \$ *100*

Remarks: *1<sup>st</sup> Enstalment bounty due \$100.*

Book mark: \_\_\_\_\_

(358)

*Leuts*  
Copyist.

**5 Cav. | U.S.C.T.**

*James Jones*  
*Plt*, Co. M, 5 Reg't U. S. Col'd Cavalry.

Appears on

**Company Muster Roll**

for *Mar's Ops.*, 1865.

Present or absent *Present*

Stoppage, \$ *100* for

Due Gov't, \$ *100* for

Valuation of horse, \$ *100*

Valuation of horse equipments, \$ *100*

Remarks: *1st installment  
bounty due \$100*

Book mark:

*W. S. Thompson*  
Copyist.



*J*

**5 Cav. | U.S.C.T.**

*James Jones*  
*1st Lt*, Co. M, 5 Reg't U. S. Col'd Cavalry.

Appears on

**Company Muster Roll**

for *Jan 1st*, 1865.

Present or absent *Absent*

Stoppage, \$ *100* for

Due Gov't, \$ *100* for

Valuation of horse, \$ *100*

Valuation of horse equipments, \$ *100*

Remarks: *1st Lt. at instance of bounty due at Camp Nelson, Va.*

Book mark:

*W. S. Thompson*

*J* | **5 Cav. | U.S.C.T.**

*James Jones*  
....., Co. M, 5 Reg't U. S. Col'd Cavalry.

Appears on

**Company Muster Roll**

for *Nov & Dec.* ....., 186*4*.

Present or absent *Absent* .....

Stoppage, \$ ..... *100* for .....

Due Gov't, \$ ..... *100* for .....

Valuation of horse, \$ ..... *100*

Valuation of horse equipments, \$ ..... *100*

Remarks: *At Camp Wilson, Ky.  
lost 2 instruments of  
horsemanship.*

Book mark: .....

(358) *W.S. Thompson* Copyist.

NOV 1864

*J* | **5 Cav. | U.S.C.T.**

*James Jones*  
*Prvt.*, Co. M, 5 Reg't U. S. Col'd Cavalry.

Appears on

**Company Muster Roll**

for *to Oct. 31*, 186*4*.

Present or absent *Present*

Stoppage, \$ *100* for

Due Gov't, \$ *100* for

Valuation of horse, \$ *100*

Valuation of horse equipments, \$ *100*

Remarks:

Book mark:

*N. S. Thompson*

(358)

Copyist.



**5 Cav. | U.S.C.T.**

*James Jones*

*Co. M*, 5 Reg't U. S. Col'd Cavalry.

Appears on

**Company Muster-in and Descriptive Roll**

of the organization named above. Roll dated

*Camp Nelson, N.Y., Oct 30*, 1864.

Where born *Scott, Pa.*

Age *28* y'rs; occupation *Farmer*

When enlisted *Aug. 29*, 1864.

Where enlisted *Camp Nelson, N.Y.*

For what period enlisted *3* years.

Eyes *Black*; hair *Black*

Complexion *Black*; height *5* ft. *6* in.

When mustered in *Aug. 30*, 1864.

Where mustered in *Camp Nelson, N.Y.*

Bounty paid \$ *100*; due \$ *100*

Where credited *7/25/48 by*

Company to which assigned

Remarks *Benjamin Osborn*

*\*Supposed to be name of owner.*

*Added May 16. 48. H.D.J.*

Book mark: *1169-05-1847*

*M.S. Thompson*

(356d)

Copyist.

J 15 Cav | **U.S.C.T.**

James Jones  
....., Com, 5 Reg't U. S. Col'd leav

Appears on

**Company Descriptive Book**

of the organization named above.

**DESCRIPTION.**

Age 28 years; height 5 feet 6 inches.

Complexion Black

Eyes Blk; hair Blk

Where born Scott Ky

Occupation Farmer

**ENLISTMENT.**

When Aug 29, 1864.

Where Camp Nelson

By whom McRaudolph; term 3 y'rs.

Remarks: Missing in  
action

\* Inserted by comparer.

A. J. Anderson

(383g)

Copyist.

131  
Jones James

Co No, 5 U. S. Col'd Cav.

Private-

Private-

CARD NUMBERS.

1	5370861	26
2	5370947	27
3	5371047	28
4	5371132	29
5	5371219	30
6	5371305	31
7	5371388	32
8	5371476	33
9	5371560	34
10	5371646	35
11	5371729	36
12	9091293-	37
13	1169-05-1877	38
14	40729990	39
15		40
16		41
17		42
18		43
19		44
20		45
21		46
22		47
23		48
24		49
25		50

Book Mark: 1169-05-1877

See also



# UNITED STATES COLORED TROOPS ENLISTMENT.

STATE OF Kentucky TOWN OF Camp Nelson  
 I, James Jones, born in Pulaski Co,  
 in the State of Kentucky, aged Eighteen years,  
 and by occupation a Farmer, DO HEREBY ACKNOWLEDGE to  
 have volunteered Fifteenth day of September, 1864,  
 to serve as a Soldier in the Army of the United States of America, for the period of  
**THREE YEARS**, unless sooner discharged by proper authority: Do also agree to  
 accept such bounty, pay, rations, and clothing, as are, or may be, established by law for  
 the U. S. colored troops.

And I, James Jones  
 do solemnly swear that I will bear true faith and allegiance to the United States of  
 America, and that I will serve them honestly and faithfully against all their enemies  
 or opposers whomsoever; and that I will observe and obey the orders of the President  
 of the United States, and the orders of the officers appointed over me, according to the  
 Rules and Articles of War.

Sworn and subscribed to, at Camp Nelson  
 this 15<sup>th</sup> day of Sept, 1864. James Jones his  
 Before J. B. Randolph mark

I CERTIFY, ON HONOR, That I have carefully examined the above named Volunteer agreeably to the General Regula-  
 tions of the Army, and that, in my opinion, he is free from all bodily defects and mental infirmity, which would in any  
 way disqualify him from performing the duties of a soldier.

P. G. Barrett  
 Capt Surg 7<sup>th</sup> Reg Examining Surgeon.

I CERTIFY, ON HONOR, That I have minutely inspected the Volunteer James Jones previously to  
 his enlistment, and that he was entirely sober when enlisted; that, to the best of my judgment and belief, he is of law-  
 ful age; and that, in accepting him as duly qualified to perform the duties of an able bodied soldier, I have strictly ob-  
 served the regulations which govern the recruiting service. This soldier has dark eyes, dark hair,  
dark complexion, is 5 ft 10 in tall, 150 lbs weight.

J. B. Randolph  
 Recruiting Officer or Agent.

Mustered into the United State service Fifteenth day of September 1864.

W. C. Kinney  
 Capt 18<sup>th</sup> U.S. Col Mustering Officer.

Mustered into the service of the United States, for three years or during the war, from date of enlistment, in Company Barrett Regiment of U.S. Colored Volunteers, on the 15<sup>th</sup> day of September, 1864, at Camp Nelson Ky

W. C. Kinney  
 Capt 18<sup>th</sup> U.S. Col  
 Mustering Officer



NOTE 1. This blank will be used for enlistments of United States colored troops. They will be made out in duplicate in all cases—one to accompany the recruiting return of the superintendent (not the recruiting officer) to the Adjutant-General, and one to accompany the accounts of the officer who pays bounty, &c.

NOTE 2. An enlistment holds to service. A muster-in must, in all cases, precede payment of pay, bounty, pension, &c. A muster-in roll must in all cases be filed in the Adjutant-General's Office as evidence of muster-in. The mustering officer, commissary, or assistant commissary of musters, as the case may be, will countersign both enlistments as having mustered the soldiers into the service of the United States before either of them is given to the disbursing officer.

DECLARATION OF RECRUIT.

I, *James Jones*, desiring to volunteer as a soldier in the ARMY OF THE UNITED STATES, for the term of *Three Years*, DO DECLARE that I am *18* years and \_\_\_\_\_ months of age; that I have never been discharged from the United States service on account of disability or by sentence of a court-martial, or by order before the expiration of a term of enlistment; and I know of no impediment to my serving honestly and faithfully as a soldier for three years.

GIVEN at *Camp Nelson* the *14<sup>th</sup>* day of *September 1864*

Witness: *J. Hardy*

*James Jones*  
By *J. C. [unclear]*  
or *James [unclear]*  
*James Jones*  
Volunteered at *Camp Nelson*  
*Sept 14, 1864*  
*358*  
*1864*

Consent of Parent or Guardian in case of a Minor, if a Free Man, or in the case of a Slave, of the Person to whom he owes Service:

I, \_\_\_\_\_ Do CERTIFY. That I am the \_\_\_\_\_ that the said \_\_\_\_\_ is \_\_\_\_\_ years of age; and I do freely give my CONSENT to his volunteering as a SOLDIER in the Army of the United States, for the period of THREE YEARS, under the conditions of the laws of the United States.

GIVEN at \_\_\_\_\_ the \_\_\_\_\_ day of \_\_\_\_\_

Witness: \_\_\_\_\_

Jones, James

Co.

A

5

Reg't

McClellan

1 Inclosures.

Bed Cards

Burial Records

Certs. of Dis. for Discharge

C. M. Charges

Descriptive Lists

Discharge Certificates

Enlistment Papers

Final Statements

Furloughs or L. of A.

Med. Certificates

Med. Des. Lists

Orders

Pris. of War Record

Resignations

Other papers relating to—

Admission to Hosp'l

Casualty Sheet

Confinement

Contracts

Death or Effects

Desertion

Discharge from Hosp'l

Discharge from Service

Duty

Furlough or L. of A.

Med. Examination

Misc. Information

Pay or Clothing

Personal Reports

Rank

Transfer to Hosp'l

Transfer to V. R. C.

Transportation



*J* | **5 Cav. | U.S.C.T.**

*James James*  
*Plt*, Co. *H*, 5 Reg't U. S. Col'd Cavalry.

Appears on **Co. Muster-out Roll**, dated  
*Helena, Ark. Mar. 16*, 1866.

Muster-out to date *Mar 16*, 1866.

Last paid to *Dec 31*, 1865.

**Clothing account:**

Last settled....., 186 ; drawn since \$..... 100

Due soldier \$..... 100; due U. S. \$ *2* <sup>36</sup>/<sub>100</sub>

Am't for cloth'g in kind or money adv'd \$..... 100

Due U. S. for arms, equipments, &c., \$..... 100

Bounty paid \$ *100* 100; due \$ *100* 100

Remarks:.....  
.....  
.....  
.....  
.....  
.....

Book mark:.....

*J. A. Stewart*  
Copyist.

J | 5 Cav. | U.S.C.T.

James Jones  
Pvt., Co. H, 5 Reg't U. S. Colored Cav.

Appears on Returns as follows:

Mar. 1865, On daily duty Hd  
Qrs 5 U.S. C. Orderly

Sept & Oct. 1865 Absent sick in  
Genl Hospital, Camp Nelson,  
Ky., Sept. 9/65.

Book mark :

(546)

Austin

Copyist.

*J* | **5 Cav.** | **U.S.C.T.**

*James James*  
*Pvt.*, Co. H, 5 Reg't U. S. Col'd Cavalry.

Appears on

**Company Muster Roll**  
for *Jan'y. & Feby*, 1866.  
Present or absent *Present*

Stoppage, \$.....100 for .....

Due Gov't, \$.....100 for .....

Valuation of horse, \$.....100

Valuation of horse equipments, \$.....100

Remarks: *Sick in Post Hosp.*

Book mark: .....

(358)

*J. Stewart*  
Copyist.



*J.* | **5 Cav.** | **U.S.C.T.**  
*James Jones*  
*Plt*, Co. H, 5 Reg't U. S. Col'd Cavalry.

Appears on

**Company Muster Roll**  
for *Nov. & Dec.*, 1865.

Present or absent *Present.*

Stoppage, \$ *100* for

Due Gov't, \$ *100* for

Valuation of horse, \$ *100*

Valuation of horse equipments, \$ *100*

Remarks:

Book mark:

(358)

*B. J. Cook*

Copyist.

J | 5-C | U.S.C.T

James Jones  
Pvt, Co. H, 5 Reg't U.S.C.C

Appears on

**Hospital Muster Roll**

of U. S. A. Post Hospital,

at Camp Nelson, Ky.,

for Sept + Oct, 1865.

Attached to hospital:

When \_\_\_\_\_, 186 .

How employed \_\_\_\_\_

Last paid by Maj. Hallaway

to June 30, 1865.

Bounty paid \$ 100; due \$ 100

Present or absent Present

Remarks: \_\_\_\_\_

\_\_\_\_\_  
\_\_\_\_\_  
\_\_\_\_\_  
\_\_\_\_\_  
\_\_\_\_\_  
\_\_\_\_\_  
\_\_\_\_\_

Book mark: \_\_\_\_\_

C. C. Parker

J. | 5 Cav. | U.S.C.T.

James Jones  
Cvt., Co. H, 5 Reg't U. S. Col'd Cavalry.

Appears on

Company Muster Roll

for Sept. & Oct., 1865.

Present or absent Absent.

Stoppage, \$ 100 for

Due Gov't, \$ 100 for

Valuation of horse, \$ 100

Valuation of horse equipments, \$ 100

Remarks: Sick in Genl. Hosp.  
Camp Nelson Ky since  
Sept. 10 / 65.

Book mark:

(358)

B. J. Cooke

Copyist.



J. | **5 Cav.** | **U.S.C.T.**

*James Jones*  
*Plt*, Co. H, 5 Reg't U. S. Col'd Cavalry.

Appears on

**Company Muster Roll**

for *July & Aug.*, 1865.

Present or absent *Present.*

Stoppage, \$.....100 for .....

Due Gov't, \$.....100 for .....

Valuation of horse, \$.....100

Valuation of horse equipments, \$.....100

Remarks: .....

Book mark: .....

*B. J. Cooke*

(358)

Copyist.



*J* | **5 Cav.** | **U.S.C.T.**

*James Jones*  
*Pvt*, Co. H, 5 Reg't U. S. Col'd Cavalry.

Appears on

**Company Muster Roll**

for *Mar & Apr*, 1865.

Present or absent *present*

Stoppage, \$ *100* for

Due Gov't, \$ *100* for

Valuation of horse, \$ *100*

Valuation of horse equipments, \$ *100*

Remarks: *1st statement of  
Bounty (Due \$100)*

Book mark:

*Reynolds*  
(358) Copyist.



*J* | **5 Cav.** | **U.S.C.T.**

*James Jones*

*Pvt.*, Co. H, 5 Reg't U. S. Col'd Cavalry.

Appears on

**Company Muster Roll**

for *Jan & Feb*, 1863.

Present or absent *present*

Stoppage, \$ *100* for

Due Gov't, \$ *100* for

Valuation of horse, \$ *100*

Valuation of horse equipments, \$ *100*

Remarks: *1<sup>st</sup> installment of  
Bounty Due \$100.00*

Book mark: \_\_\_\_\_

*Reynolds* Copyist.

*J* | **5 Cav.** | **U.S.C.T.**

*James Jones*

*Priv*, Co. H, 5 Reg't U. S. Col'd Cavalry.

Appears on

**Company Muster Roll**

for *Nov & Dec*, 186 *4*.

Present or absent *present*

Stoppage, \$ *100* for

Due Gov't, \$ *100* for

Valuation of horse, \$ *100*

Valuation of horse equipments, \$ *100*

Remarks: *1<sup>st</sup> and 2<sup>d</sup> Installments*  
*Bounty due*

Book mark: \_\_\_\_\_

(358)

*Reynolds*

Copyist.

J | **5 Cav.** | **U.S.C.T.**

*James Jones*

*Pvt.*, Co. H, 5 Reg't U. S. Col'd Cavalry.

Appears on

**Company Muster Roll**

for *from enlistment to Oct 31, 1864.*

Present or absent *present*

Stoppage, \$ *100* for

Due Gov't, \$ *100* for

Valuation of horse, \$ *100*

Valuation of horse equipments, \$ *100*

Remarks:

Book mark:

*Reynolds*



*J* | **5 Cav.** | **U.S.C.T.**

*James Jones*

*Priv*, Co. *H*, 5 Reg't U. S. Col'd Cavalry.

Appears on

**Company Muster-in and Descriptive Roll**

of the organization named above. Roll dated

*Camp Nelson, N.Y. Oct 29*, 1864.

Where born *Pulaski Ky*

Age *18* y'rs; occupation *Farmer*

When enlisted *Sept 15*, 1864.

Where enlisted *Camp Nelson Ky*

For what period enlisted *3* years.

Eyes *Black*; hair *Black*

Complexion *Black*; height *5 ft. 4 in.*

When mustered in *Sept 15*, 1864.

Where mustered in *Camp Nelson Ky*

Bounty paid \$ *100*; due \$ *100*

Where credited

Company to which assigned

Remarks: *7th Dist Ky*

\* *Isaac Jones.*

\* *Supposed to be name of owner.*

*Added May 17. 98. H.A.J.*

Book mark:

*Reynolds*

J | **5 Cav. | U.S.C.T.**

James Jones  
....., Co. 76, 5 Reg't U. S. Col'd Cav.

Appears on  
**Company Descriptive Book**  
of the organization named above.

**DESCRIPTION.**

Age 18 years; height 5 feet 4 inches.  
Complexion Blk  
Eyes Blk; hair Blk  
Where born Pulaski Ky  
Occupation Farmer

**ENLISTMENT.**

When Sept 15, 1864.  
Where Camp Nelson  
By whom J. C. Raudenber; term 3 y'rs.

Remarks: .....

.....

.....

.....

.....

.....

.....

.....

.....

(383g) A. J. Anderson Copist

*J* | *5<sup>th</sup>* | **U.S.C.T.**

*James Jones*  
....., Co. *H* 5 Reg't U. S. Col'd *Car*

Appears on

**Company Descriptive Book**

of the organization named above.

**DESCRIPTION.**

Age *18* years; height *5* feet *4* inches.

Complexion *Blk*

Eyes *Blk*; hair *Blk*

Where born *Pulaski Ky*

Occupation *Farmer*

**ENLISTMENT.**

When *Sep. 15*, 186 *4*

Where *Camp Nelson Ky*

By whom *H. Randolph*, term *3* yrs.

Remarks: .....

.....  
.....  
.....  
.....  
.....  
.....  
.....  
.....

*H. E. Parks*



A 2359303 common

J. H. Townsend Esq

186  
Jones James

Co No, 5 U. S. Col'd Cav.

Private - Private

CARD NUMBERS.

1	5366818	26
2	5366908	27
3	5367008	28
4	5367099	29
5	5367191	30
6	5367287	31
7	5367376	32
8	5367464	33
9	5367553	34
10	5367645	35
11	5367731	36
12	9090819	37
13	32116336	38
14	40729988	39
15		40
16		41
17		42
18		43
19		44
20		45
21		46
22		47
23		48
24		49
25		50

Book Mark: .....

See also .....

WAR DEPARTMENT,

ADJUTANT GENERAL'S OFFICE,

WASHINGTON, *Oct 8*, 186*6*

SIR:

Final Statements in the cases of deceased soldiers are required to be sent to the Adjutant General's Office in duplicate, with one copy of the Inventory of Effects. The Descriptive List should also be sent to this Office in cases where the soldier was absent from his Company at the time of his death. Where there were no effects, it should be so stated on a blank Inventory, properly signed.

Certificates of Disability should be sent in duplicate. Special care should be taken that the date of discharge and signature of the discharging officer should be affixed.

*No* of the Final Statement & *No* Inventory, has been received in the case of *Frank Jones*, of *Co. Cold River* Regiment of *Unassigned* Volunteers, whose papers were forwarded to this Office. You will please forward the missing papers without delay.

I have the honor to be, sir,

Very respectfully,

Your obedient servant,

*W. H. L. Hazard*

Assistant Adjutant General.

(110)

COMMANDING OFFICER

*Apt. Surg. J. J. Woodman U.S.A.*

*Died in U.S. Joseph Camp Nelson Ky  
date & cause of death unknown*

*Boyd*



MODEL FOR SET OF PAPER

FORM 1.—FINAL STATEMENT.

I CERTIFY, ON HONOR, that *John Smith*, a Private of Captain J. Brown's Company, (A.) of the 1st Regiment of Pennsylvania Volunteers, of the State of Pennsylvania, born in Pittsburgh, State of Pennsylvania, aged 21 years, 5 feet 10 inches high, light complexion, blue eyes, dark hair, and by occupation a Farmer, having joined the Company on its original organization at Pittsburgh, and enrolled in it at the muster into the service of the United States at Pittsburgh, on the 1st day of July, 1861, (or was mustered in service as a recruit, by \_\_\_\_\_, at \_\_\_\_\_, on the \_\_\_\_\_ day of \_\_\_\_\_, 186—, or was drafted and mustered into the service of the United States from the \_\_\_\_\_ Enrollment District of the State of \_\_\_\_\_, at \_\_\_\_\_, on the \_\_\_\_\_ day of \_\_\_\_\_, 186—,) to serve in the Regiment for the term of Three Years, and having served *honestly and faithfully* with his Company in the field to the present date, is now entitled to a DISCHARGE by reason of death. Died in Regimental Hospital, Fort Brown, Texas, December 31, 1863, of typhoid fever. The said John Smith was last paid by Paymaster Major Morse, to include the 31st day of October, 1863, and has pay due him from that time to the present date. He is entitled to pay and subsistence for *traveling* to place of enrollment, and whatever other allowances are authorized to volunteer soldiers, drafted men, or militia, so discharged. He has received from the United States *clothing* amounting to 20<sup>00</sup>/<sub>100</sub> dollars, since the 31st day of December, 1862, when his clothing account was last settled. He has received from the United States 25<sup>00</sup>/<sub>100</sub> dollars advanced *bonny*. There is to be stopped from him on account of the State of \_\_\_\_\_, or other authorities, for *clothing*, &c., received on entering service, nothing, <sup>00</sup>/<sub>100</sub> dollars; and for other stoppages, viz: nothing, <sup>00</sup>/<sub>100</sub> dollars. He has been furnished with no *transportation* in kind from the place of his discharge to \_\_\_\_\_; and he has not been *subsisted for traveling* to his place of enrollment up to the \_\_\_\_\_, 186—. He is indebted to \_\_\_\_\_, Sautler, \_\_\_\_\_ <sup>00</sup>/<sub>100</sub> dollars. He is indebted to \_\_\_\_\_, Laundress, \_\_\_\_\_ <sup>00</sup>/<sub>100</sub> dollars.

By Order of the Surgeon General, 1903

E. B. S. G. O.

Surgeon General's Office,

Record and Pension Bureau.

*October 30<sup>th</sup> 1866*

Respectfully returned, with Inventory of Effects enclosed, in case of the ~~within~~ named man. *Frank Jones, Co. 5th U. S. Colored Cavalry*

No evidence on file from which Final Statements can be prepared. *in this case, no pensioned Grants granted Col. Bennett*

By Order of the Surgeon General.

*J. J. Woodward*  
Lieut. Major and Assistant Surgeon, U. S. A.

Which has been turned over to \_\_\_\_\_

STATION: Fort Brown, Texas.

DATE: December 31, 1863.

(Duplicates.)

\*NOTE.—If the effects have been turned over to relatives of deceased, so state on certificate, instead of "in the hands of Captain," &c., and give the names of the persons, and their relation to the deceased person.

JAMES BROWN,  
Captain Co. A, 1st Penn. Vols.,  
Commanding the Company.

FORM 3.—HEIR'S RECEIPT FOR EFFECTS.

Received of Captain John Brown, Company A, 1st Regiment of Pennsylvania Volunteers, the following effects of Private John Smith, late of Company A, 1st Regiment of Pennsylvania Volunteers, now deceased, which I claim as his wife:  
1 great coat, 1 flannel shirt, 1 silver watch, fifty dollars in notes, and two dollars in specie.

MARY SMITH

FORM 4.—PAYMASTER'S RECEIPT FOR MONEY.

Received, this 31st day of December, 1863, at Fort Brown, Texas, of Captain James Brown, of Company A, 1st Pennsylvania Volunteers, fifty dollars in Treasury notes and two dollars in specie, the property of the late Private John Smith, of Company A, 1st Pennsylvania Volunteers, who died at Fort Brown, Texas, on the 31st day of December, 1863.

WM. C. MORSE, Paymaster, U. S. A.

CASUALTY SHEET.

Name: .....

Rank: ..... Company: ..... Regiment: .....

Arm: ..... State: .....

Nature of Casualty: .....

Send for Dep. 124  
Frank Jones

Col Ret

U.S.A. Sept 12<sup>th</sup> 65  
U.S.A. appraised value  
of Effects. \$335 sent  
2' Und. H.

Acid Nelson Grob  
Hospital Camp Nelson  
Ky.

PLACE OF DISCHARGE, DEATH, &c.

Clerk.

(170)



*Complete*  
CASUALTY SHEET

No. \_\_\_\_\_

*Frank Jones.*

*Col. Rec<sup>t</sup> of Company* \_\_\_\_\_

\_\_\_\_\_ Regiment of *Unafgd.*

*State Volunteers.*

NATURE OF CASUALTY.

*Died.*



No. 1.  
RECORD OF DEATH AND INTERMENT.

Name and number of person interred.....	<i>Frank Jones</i>
Number and locality of the grave . . . . .	<i>772</i>
Hospital number of the deceased. . . . .	<i>4780</i>
Regiment, rank and company. . . . .	<i>5<sup>th</sup> U. S. C. Co. Pr</i>
Residence before enlistment. . . . .	
Conjugal relation, [and if married the residence of the widow.)	}
Cause of death	
Age of the deceased.	}
Nativity.	
References and remarks.	}
Date of death and burial.	

Memoranda of effects.

*Rubber Blanket Canton Drawers  
Boots Soap Haussack.  
Expended with corpse  
Uniform Coat. Pants. Shirt.*

Franki Jones

5<sup>th</sup> U.S. Cavalry

October 30<sup>th</sup> 1864,

Gen'l Hosp: Camp Nelson,  
Ky.

Inventory of the effects of Frank Jones late  
a \_\_\_\_\_ of Captain \_\_\_\_\_ Company \_\_\_\_\_ of  
the 5<sup>th</sup> Regiment of U. S. Colored Cav. Volunteers, who was enrolled as  
a \_\_\_\_\_ at \_\_\_\_\_ in the State of \_\_\_\_\_ on  
the \_\_\_\_\_ day of \_\_\_\_\_ 186 , and mustered into the service of the United  
States as \_\_\_\_\_ on the \_\_\_\_\_ day of \_\_\_\_\_ 186 , at \_\_\_\_\_  
in Company \_\_\_\_\_, \_\_\_\_\_ Regiment of \_\_\_\_\_ Volunteers, to serve \_\_\_\_\_  
years or during the war; he was born in \_\_\_\_\_ in the State  
of \_\_\_\_\_; he was \_\_\_\_\_ years of age, \_\_\_\_\_ feet \_\_\_\_\_ inches  
high, \_\_\_\_\_ complexion, \_\_\_\_\_ eyes, \_\_\_\_\_ hair, and by occupation, when enrolled,  
a \_\_\_\_\_; he died in Nelson General Hospital, at  
Camp Nelson Ky on the 23<sup>rd</sup> day of October 1864, by  
reason of Malaria

INVENTORY.					
ARTICLES.	No.	ARTICLES.	No.	ARTICLES.	No.
Hats.....		Pairs trousers.....		Knapsacks.....	
Caps.....	/	Pairs <del>flannel</del> drawers.....	/	<u>Canteen</u>	/
Forage caps.....		Pairs cotton drawers.....			
Great coats.....		Flannel shirts.....			
Uniform coats.....		Cotton shirts.....			
Uniform jackets.....		Pairs boots.....	/		
Flannel sack coats.....		Pairs shoes <u>Boots</u> .....	/		
Blouses.....		Pairs socks.....			
Stable frocks.....		Blankets <u>Blanket</u> .....	/	MONEY.	Specie..... \$
Fatigue overalls.....		Haversacks.....	/		Notes..... \$

I CERTIFY, ON HONOR, that the above inventory comprises all the effects of \_\_\_\_\_  
Frank Jones, deceased, and that the effects ~~are in the hands~~  
of were appraised at \$3 <sup>25</sup>/<sub>100</sub> at Camp Nelson Ky by Capt. E. B. W. Postle  
H. A. M. to be disposed of by a Council of Administration.  
1 Coat, Pants, & Shirt expended on corpse

(DUPLICATES.)

STATION: \_\_\_\_\_

\_\_\_\_\_  
Commanding the Company.

DATE: \_\_\_\_\_



ARTICLES OF WAR.

ART. 95. When any non-commissioned officer or soldier shall die, or be killed in the service of the United States, the then commanding officer of the troop or company shall, in the presence of two other commissioned officers, take an account of what effects he died possessed of, above his arms and accoutrements, and transmit the same to the office of the Department of War, which said effects are to be accounted for, and paid to the representatives of such deceased non-commissioned officer or soldier. And in case any of the officers, so authorized to take care of the effects of deceased officers and soldiers, should, before they have accounted to their representatives for the same, have occasion to leave the regiment or post, by preference or otherwise, they shall, before they be permitted to quit the same, deposit in the hands of the commanding officer, or of the assistant military agent, all the effects of such deceased non-commissioned officers and soldiers, in order that the same may be secured for, and paid to, their respective representatives.

DIRECTIONS.

NOTE 1.—One copy of the inventories of the effects of deceased non-commissioned officers and soldiers, required by the 95th Article of War, will be forwarded to the Adjutant General, by the commander of the company to which the deceased belonged, and a duplicate of the same to the colonel of the regiment. Final statements of pay, clothing, &c., in duplicate, will be sent to the Adjutant General with one copy of the inventory. Both inventory and final statements should be forwarded, as a general rule, through Regimental Headquarters. When a soldier dies at a post or station absent from his company, it will be the duty of his immediate commander to furnish, direct to the Adjutant General, the required inventory and final statements, and, at the same time, to forward to the commanding officer of the company to which the soldier belonged, a report of his death, specifying the date, place, and cause; to what time he was last paid, and the money or other effects in his possession at the time of his decease; which report will be noted on the next muster roll of the company to which the man belonged. Each inventory will be endorsed, "Inventory of the effects of ———, late of company (—) — regiment of ———, who died at ———, the ——— day of ———, 186—." If a legal representative receive the effects, it will be stated in the report. If the soldier leave no effects, the fact will be reported on the blank for inventory.

NOTE 2.—Should the effects of a deceased non-commissioned officer or soldier not be administered upon within a short period after his decease, they shall be disposed of by a Council of Administration, under the authority of the commanding officer of the post, and the proceeds deposited with the Paymaster, to the credit of the United States, until they shall be claimed by the legal representatives of the deceased.

NOTE 3.—In all such cases of sales by the Council of Administration, a statement in detail, or account of the proceeds duly certified by the Council and commanding officer, (Form 5) accompanied by the Paymaster's receipt for the proceeds, will be forwarded by the commanding officer to the Adjutant General. The statement will be endorsed, "Report of the proceeds of the effects of ———, late of company (—) — regiment of ———, who died at ———, the ——— day of ———, 186—."

NOTE 4.—The effects in all cases, when called for, should be turned over to the legal representative, without further authority from the Adjutant General. When the effects are turned over to the relatives of the deceased before these inventories are sent to the Adjutant General, their receipts therefor should be attached to the inventories. In all other cases, one copy will be sent with a letter of transmittal direct to the Adjutant General, and a duplicate retained by the officer.

NOTE 5.—Particular care should be taken to take receipts in duplicate from the Paymaster for any funds turned over to him; one copy should be sent direct to the Adjutant General and one retained by the officer.

INVENTORY OF THE EFFECTS

OF

*Frank Jones*

Late of Company \_\_\_\_\_

*5<sup>th</sup> Reg't of U. S. Colored Cav.*

*Volunteers, who died at Camp Nelson Ky*  
*on the 25<sup>th</sup> day of October 1864.*

Surgeon General's Office,

RECORD & PENSION BUREAU,

*Washington, October 30<sup>th</sup> 1866*

*The within Inventory is a true copy from the records*

*Hilson General Hospital*  
*Camp Nelson Ky on file in*

*this Office, and contains all the information in use the*  
*can be found.*

BY ORDER OF THE SURGEON GENERAL:



*J. J. Woodward*  
*Maj. Assistant Surgeon, U. S. A.*

*G. W. F.*



I certify, on honor, that Frank Jones, a Private of  
Captain W Anderson's Company (A) of the 5<sup>th</sup> Regiment of U.S. Colored  
**VOLUNTEERS**, of the State of \_\_\_\_\_, born in Sabine State  
of Texas, aged 18 years; 5 feet 5 inches high; Black complexion,  
Blk eyes, Blk hair, and by occupation a Laborer, who joined for service  
and was enrolled (see Note 9) on the 14<sup>th</sup> day of Sept, 1864, at Louisville  
by Capt Morgan, for the period of three years, and mustered into  
the service of the United States on the 14<sup>th</sup> day of Sept, 1864, at  
Louisville, by Capt Hammack; and having served

HONESTLY and FAITHFULLY with his Company to the present date, is now entitled to a  
**DISCHARGE** by reason of Death in U.S. Genl Hospit at  
Camp Nelson "Ky" Oct 2<sup>nd</sup> 1864 Disease not known

The said Frank Jones has pay due from date of  
Enlistment, to include the \_\_\_\_\_ day of \_\_\_\_\_, 1864, and  
has pay due him from that time to the present date; he is entitled to pay and subsistence for  
**TRAVELING** to place of enrollment, and whatever other allowances are authorized to volunteer  
soldiers, drafted men, or militia, so discharged. He has received from the United States **CLOTHING**  
amounting to Seventeen  $\frac{50}{100}$  dollars, since the 14<sup>th</sup> day of September,  
1864, when his clothing account was last settled. He has received from the United States  
\_\_\_\_\_  $\frac{100}{100}$  dollars advanced **BOUNTY**.

There is to be stopped from him, on account of the State of \_\_\_\_\_, or other  
authorities, for **CLOTHING**, &c., received on entering service, \_\_\_\_\_  $\frac{100}{100}$  dollars; and  
for other stoppages, viz: \_\_\_\_\_

\_\_\_\_\_  $\frac{100}{100}$  dollars.  
He has been furnished with **TRANSPORTATION** in kind from the place of his discharge to \_\_\_\_\_  
; and he has been **SUBSISTED** for **TRAVELING** to his  
place of enrollment, up to the \_\_\_\_\_, 1864.

He is indebted to \_\_\_\_\_, **SUTLER**, \_\_\_\_\_  $\frac{100}{100}$  dollars.

He is indebted to \_\_\_\_\_, **LAUNDRESS**, \_\_\_\_\_  $\frac{100}{100}$  dollars.

Given in Duplicate, at Camp Nelson "Ky", this 31<sup>st</sup> day  
of December, 1864.

John W. Anderson  
Capt Co A  
Commanding Company.



SEC. 12. *And be it further enacted,* That the fees of agents and attorneys for making out and causing to be executed the papers necessary to establish a claim for a pension, bounty, and other allowance before the Pension Office, under this act, shall not exceed the following rates: For making out and causing to be duly executed a declaration by the applicant, with the necessary affidavits, and forwarding the same to the Pension Office, with the requisite correspondence, ten dollars: which sum shall be received by such agent or attorney in full for all services in obtaining such pension, and shall not be demanded or received, in whole or in part, until such pension shall be obtained; and the sixth and seventh sections of an act entitled "An act to grant pensions," approved July [fourteenth,] eighteen hundred and sixty-two, are hereby repealed.

SEC. 13. *And be it further enacted,* That any agent or attorney who shall, directly or indirectly, demand or receive any greater compensation for his services under this act than is prescribed in the preceding section of this act, or who shall contract or agree to prosecute any claim for a pension, bounty, or other allowance under this act, on the condition that he shall receive a per centum upon any portion of the amount of such claim, or who shall wrongfully withhold from a pensioner or other claimant the whole or any part of the pension or claim allowed and due to such pensioner or claimant, shall be deemed guilty of a high misdemeanor, and, upon conviction thereof, shall, for every such offense, be fined not exceeding three hundred dollars, or imprisoned at hard labor not exceeding two years, or both, according to the circumstances and aggravations of the offense.

Approved July 4, 1864.

NOTE 10.—If any soldier is charged a higher fee than that allowed by the above act, he should report the fact and the name of the agent to the Adjutant General, in order that steps may be taken to have the same refunded.

ADJUTANT GENERAL'S OFFICE.

Sept 25. 1865

Duplicate with Inventory sent 2d Auditor.

FINAL STATEMENT

*Co. H*  
OF  
*Frank Jones*  
*3<sup>rd</sup> Reg't of U.S. Cavalry*  
VOLUNTEERS.  
*Disch Oct 23. 1864*

NOTE 1.—Two of these certificates (or duplicates) are to be given to each Volunteer Soldier or drafted man who may be discharged without being mustered out (Final Statements are never given to men mustered out of service,) that he may at once receive from the Paymaster the pay, &c., due him, and the captain or other COMMISSIONED officer commanding the company will certify to the act of the delivery of the duplicate certificates; with these certificates the Soldier is "entitled to" his discharge, and should also present his discharge to the Paymaster to have the payment endorsed on it. The discharge is to be given back to the Soldier by the Paymaster; the latter only retaining as his vouchers the duplicate certificates.

NOTE 2.—If the Soldier is entitled to pay for the use of his horse, the Company Commander will certify to that fact on the back of both these final statements, and also to the time he has pay due for having been so mounted on his own horse.

NOTE 3.—When a Soldier is furnished with final statements, his descriptive list, if he has one, should be taken up by the officer who gives the Soldier these statements, and endorsed with a statement to this effect by the officer. The endorsement should exhibit a full statement of the time for which the Soldier was allowed pay on his final statements, the clothing account, and all other charges against him or in his favor, so as to comprise a complete exhibit of his account. It will then be transmitted to the Company Commander of the Soldier, who will enter all the data necessary to a full understanding of the Soldier's account on the muster roll upon which the Soldier's discharge is reported. The descriptive list will then be destroyed. The object of this is, that the remaining portion of the Soldier's account may be settled upon the receipt of these muster rolls, and the Soldier receive any pay or allowances that may be due him at the time of his discharge, and which may not appear on his last final statements from the fact that his descriptive list is incomplete. These accounts for back pay, &c., are settled by the 2d Auditor of the Treasury Department.

NOTE 4.—Charges for loss or injury to ordnance, horse equipments, and other miscellaneous charges, should appear under the heading of "Other Stoppages."

NOTE 5.—Bounty paid by State authorities, and not by the United States, will not be entered on this statement.

NOTE 6.—Amounts due the Sutler and Laundress must be entered on the muster roll on which the discharge, death, desertion, &c., is reported, as well as on the final statement, otherwise the amount cannot be collected from the United States.

NOTE 7.—This blank will be used for deceased volunteers and drafted men, as well as for others.

NOTE 8.—Where a Soldier dies in Hospital or on detached service, his descriptive list, if he has one, should be sent with his final statements, in duplicate, to the Adjutant General, Washington, D. C.

NOTE 9.—If the soldier is a drafted man or substitute, the space for time, &c., or enrolled, should contain only the word *drafted* or *substitute*, as the case may be. If the Soldier is a "VETERAN," (or RECRUIT,) the words *as a veteran*, (or *recruit*.) as the case may be, should be interlined after the words *mustered into the service of the U. S.* A statement of all the installments of *Veteran or Recruit Bounty* RECEIVED by the Soldier must be made on the back of each final statement.

OFFICE OF THE ADJUTANT GENERAL  
WASHINGTON, D. C.  
1865  
RECEIVED

*War Dept. A. G. O.*  
*August 31/65*  
*Respy ret'd for Examination.*  
*Attention call'd to date*  
*of death*  
*By order*  
*J. C. Hazard*  
*A. G. O.*



[OFFICE ENDORSEMENT.]

War Department,  
ADJUTANT GENERAL'S OFFICE,

See 23<sup>rd</sup>, 1860.

The death of Priv. Frank Jones  
of Co. A, 5<sup>th</sup> Reg't U. S. Colored Cavalry, is reported as follows:

- On Company Muster Roll. *from Org to Oct 31, 1864, no date.*
- Company Muster-out Roll. *Oct 23.*
- Company Descriptive Book. *1864*
- Company Morning Reports. *1864*
- Soldier's Final Statement. *Oct 23.*
- Soldier's Record of Death and Interment. *1864*
- Soldier's Inventory of Effects. *Oct 23.*
- Soldier's Certificate of Disability for Discharge. *1864*
- Soldier's Individual Muster-out Roll. *1864*
- Regimental Return. *1864*
- For *1864*, Regimental Quarterly Returns. *1864*
- Regimental Descriptive Book. *1864*
- By Surgeon General. *1864*

*October 23*, 1864 is held to be the correct date, and the Company Muster Roll will be amended accordingly.

*J. M. McKusick*  
Assistant Adjutant General

*13/13/594*  
*1864*

*see 23rd Oct 1864*  
FINAL STATEMENT

*Co. A*  
OF  
Frank Jones  
of 5<sup>th</sup> Reg't of U.S. Col. Cav

Priv. Oct 23, 1864  
VOLUNTEERS.

NOTE 1.—Two of these certificates (or duplicates) are to be given to each Volunteer Soldier or drafted man who may be discharged without being mustered out (Final Statements are never given to men mustered out of service), that he may at once receive from the Paymaster the pay, &c., due him, and the captain or other COMMISSIONED officer commanding the company will certify to the act of the delivery of the duplicate certificates; with these certificates the Soldier is "entitled to" his discharge, and should also present his discharge to the Paymaster to have the payment endorsed on it. The discharge is to be given back to the Soldier by the Paymaster; the latter only retaining as his vouchers the duplicate certificates.

NOTE 2.—If the Soldier is entitled to pay for the use of his horse, the Company Commander will certify to that fact on the back of both these final statements, and also to the time he has pay due for having been so mounted on his own horse.

NOTE 3.—When a Soldier is furnished with final statements, his descriptive list, if he has one, should be taken up by the officer who gives the Soldier these statements, and endorsed with a statement to this effect by the officer. The endorsement should exhibit a full statement of the time for which the Soldier was allowed pay on his final statements, the clothing account, and all other charges against him or in his favor, so as to comprise a complete exhibit of his account. It will then be transmitted to the Company Commander of the Soldier, who will enter all the data necessary to a full understanding of the Soldier's account on the muster roll upon which the Soldier's discharge is reported. The descriptive list will then be destroyed. The object of this is, that the remaining portion of the Soldier's account may be settled upon the receipt of these muster rolls, and the Soldier receive any pay or allowances that may be due him at the time of his discharge, and which may not appear on his last final statements from the fact that his descriptive list is incomplete. These accounts for back pay, &c., are settled by the 2d Auditor of the Treasury Department.

NOTE 4.—Charges for loss or injury to ordnance, horse equipments, and other miscellaneous charges, should appear under the heading of "Other Stoppages."

NOTE 5.—Bounty paid by State authorities, and not by the United States, will not be entered on this statement.

NOTE 6.—Amounts due the Sutler and Laundress must be entered on the muster roll on which the discharge, death, desertion, &c., is reported, as well as on the final statement, otherwise the amount cannot be collected from the United States.

NOTE 7.—This blank will be used for deceased volunteers and drafted men, as well as for others.

NOTE 8.—Where a Soldier dies in Hospital or on detached service, his descriptive list, if he has one, should be sent with his final statements, in duplicate, to the Adjutant General, Washington, D. C.

NOTE 9.—If the soldier is a drafted man or substitute, the space for time, &c., or enrolled, should contain only the word *drafted* or *substitute*, as the case may be. If the Soldier is a "VETERAN," (or RECRUIT,) the words *as a veteran*, (or *recruit*;) as the case may be, should be interlined after the words *mustered into the service of the U. S.* A statement of all the instalments of *Veteran* or *Recruit* *Bounty* RECEIVED by the Soldier must be made on the back of each final statement.

OFFICE  
1864  
ADJUTANT GENERAL'S OFFICE  
RECEIVED

*War Dept. A. G. O.*  
*August 31/65*  
*Reported for Commission*  
*Attention called to date*  
*of death*  
*By order*  
*W. B. Hazard*  
*A. G. O.*

*James Frank*  
*P. A.*, Co. *5* Reg't *156 Cav*

*5* Enclosures.

Bed Cards .....	Final Statements /
Burial Records .....	Furloughs or L. of A. /
Certs. of Dis. for Discharge .....	Med. Certificates .....
C. M. Charges .....	Med. Des. Lists .....
Descriptive Lists .....	Orders .....
Discharge Certificates .....	Pris. of War Record .....
Enlistment Papers .....	Resignations .....

Other papers relating to—

Admission to Hosp'l .....	Furlough or L. of A. .....
Casualty Sheet .....	Med. Examination .....
Confinement .....	Misc. Information .....
Contracts .....	Pay or Clothing .....
Death or Effects .....	Personal Reports .....
Desertion .....	Rank .....
Discharge from Hosp'l .....	Transfer to Hosp'l .....
Discharge from Service .....	Transfer to V. R. C. .....
Duty .....	Transportation .....



*J* | **5 Cav. | U.S.C.T.**  
*Frank Jones*  
*Pvt*, Co. *A*, 5 Reg't U. S. Col'd Cavalry.

Appears on **Co. Muster-out Roll**, dated  
*Helena Ark* *March 16*, 1866.

Muster-out to date \_\_\_\_\_, 186 .

Last paid to *Pay due from* \_\_\_\_\_, 186 .  
*enlistment*

**Clothing account:**

Last settled \_\_\_\_\_, 186 ; drawn since \$ \_\_\_\_\_ 100

Due soldier \$ \_\_\_\_\_ 100; due U. S. \$ \_\_\_\_\_ 100

Am't for cloth'g in kind or money adv'd \$ \_\_\_\_\_ 100

Due U. S. for arms, equipments, &c., \$ \_\_\_\_\_ 100

Bounty paid \$ \_\_\_\_\_ 100; due \$ \_\_\_\_\_ 100

Remarks: *Died Cp Nelson, Ky,*  
*Oct 23, 1864. Disease*  
*unknown. Final*  
*Statements Forwarded*  
*Dec 31, 1864*

Book mark: *4794, 1880*

*W M Sayre*  
(861) Copied.



**5 Cav. | U.S.C.T.**

*J*  
*Frank Jones*  
*Priv*, Co. *A*, 5 Reg't U. S. Colored Cav.

Appears on **Returns** as follows:

*Nov 1864 Died in Hospital*  
*Nov. 1/64 Camp Nelson,*

Book mark :

(548)

*Austin*

Copyist.

*I* | **5 Cav.** | **U.S.C.T.**

*Frank Jones*  
*Prvt*, Co. A, 5 Reg't U.S. Col'd Cavalry.

Appears on

**Company Muster Roll**

for *To Oct. 31*, 1864.

Present or absent

Stoppage, \$ 100 for

Due Gov't, \$ 100 for

Valuation of horse, \$ 100

Valuation of horse equipments, \$ 100

Remarks: *Died in Hospital  
at Camp Nelson  
Ky.*

Book mark: *Died Oct. 23, 1864.*  
*S.B. 594*

(358)

*Easterling*

Copyist.

*J* | **5 Cav.** | **U.S.C.T.**

*Frank Jones*

*Cpt*, Co. *A*, 5 Reg't U. S. Col'd Cavalry.

Appears on

**Company Muster-in and Descriptive Roll**

of the organization named above. Roll dated

*Capt. Nelson, N.Y., Oct. 24, 1864.*

Where born *Sabiner, Texas*

Age *18* y'rs; occupation *Labourer*

When enlisted *Sept. 14*, 1864.

Where enlisted *Louisville*

For what period enlisted *3* years.

Eyes *Blk.*; hair *Blk.*

Complexion *Blk.*; height *5* ft. *5* in.

When mustered in *Sept. 14*, 1864.

Where mustered in *Louisville*

Bounty paid \$ *100*; due \$ *100*

Where credited *5<sup>th</sup> Dist, Kentucky*

Company to which assigned *A*

Remarks:

Book mark:

(356d)

*Eustisling*

Copyist.



9 | 5 bar | US 67.

Frank Jones  
Reet

Appears with rank of \_\_\_\_\_ on \_\_\_\_\_

**Muster and Descriptive Roll**

of a Detachment of US Colored Troops  
Mustered by Capt G. W. N. Mack

5<sup>th</sup> Dist Ky Roll dated  
Louisville Ky, Sept 14, 1864.

Where born Sabine Texas

Age 18 years; occupation laborer

When enlisted Sep 14, 1864.

Where enlisted Louisville Ky

For what period enlisted 3 years.

Eyes black; hair black

Complexion black; height 5 ft. 5 in.

When mustered in Sep 14, 1864.

Where mustered in Louisville Ky

Bounty paid \$ 100; due \$ 100

Clothing account:  
Last settled \_\_\_\_\_, 186 ; drawn since \$ 100

Date of first muster Sep 14, 1864.

Company to which assigned \_\_\_\_\_

Remarks: 5<sup>th</sup> Dist Ky

Book mark: \_\_\_\_\_

J. E. Jones

| **5 Cav.** | **U.S.C.T.**

Frank Jones

    , Co. A, 5 Reg't U. S. Col'd Cav.

Appears on

**Company Descriptive Book**  
of the organization named above.

**DESCRIPTION.**

Age 8 years; height 5 feet 5 inches.

Complexion dark

Eyes dark; hair dark

Where born Saline Tex.

Occupation Farmer

**ENLISTMENT.**

When Sept. 14, 1866

Where Louisville

By whom Capt. Morgan, term 3 y'rs.

Remarks: Rec'd Oct 1st 64

Warren

935

ank)

U. S. Col'd Cav.

Private

MEMBERS.

6

7

8

9

0

1

2

3

4

5

6

7

8

9

0

1

2

3

4

5

6

7

8

9

0

1

2

3

4

5

6

7

8

9

0

1

2

3

4

5

6



Head Qrs 5<sup>th</sup> Regt Cavalry  
Helena Ark 7 Dec. 1865

Order No 192

Extract

VI Upon the representation of their respective  
Company Commanders the following  
non commissioned officers in the 5<sup>th</sup> Regt  
are hereby reduced to the ranks to take  
effect from this date.

In Company "L"

Corporal Clement Jones

for drunk ramp and disorderly conduct

By command of  
Col L H Carpenter  
Comd Regt

J Jackson  
S. H. H. H.

To C. O.  
Co "L"  
5<sup>th</sup> Regt Cavalry

Cairo, Ill., *July 8<sup>th</sup>* 1864

Order No. *30*

Requisition of *Mr. Lem Jones*  
*Co "L" 5<sup>th</sup> A. S. C.*

From *Cairo Ill*

To *Landusky Ohio*

Nature of Service *en route to receive*  
*final paymen & disch*

*Jones, Clement*  
*Regt. L., 5* Reg **U.S.C. Cav.**

*2* Enclosures.

Bed Cards .....	Descriptive Lists .....
Burial Records .....	Final Statements .....
Certs. of Dis. for Discharge .....	Furloughs .....
C. M. Charges .....	Med. Des. Lists .....
Med. Certificates .....	Orders .....

Other papers relating to—

Admission to Hosp'l .....	Furlough .....
Casualty Sheet (Officer's) .....	Med. Examination .....
Confinement .....	Misc. Information .....
Contracts .....	Pay or Clothing .....
Death or Effects .....	Personal Reports .....
Desertions .....	Rank .....
Discharge from Hosp'l .....	Transfer to Hosp'l .....
Discharge from Service .....	Transfer to V. R. C. .....
Duty .....	Transportation .....



*J* | *5 Cav,* | **U.S.C.T.**  
*Clement Jones*  
*Priv, Co. L, 5 Reg't U. S. Col'd Cavalry*

Appears on **Co. Muster-out Roll**, dated  
*Helena, Ark, Mar. 16,* 1866 .

Muster-out to date \_\_\_\_\_, 186 .

Last paid to *Oct. 31,* 1865 .

Clothing account:

Last settled \_\_\_\_\_, 186 ; drawn since \$ \_\_\_\_\_ 100

Due soldier \$ \_\_\_\_\_ 100; due U. S. \$ *56*<sup>*13*</sup>/<sub>*100*</sub>

Am't for cloth'g in kind or money adv'd \$ \_\_\_\_\_ 100

Due U. S. for arms, equipments, &c., \$ \_\_\_\_\_ 100

Bounty paid \$ \_\_\_\_\_ 100; due \$ \_\_\_\_\_ 100

Remarks: *Discharged Jan. 16,*  
*66, at Helena, Ark. Trans-*  
*ferred from 72<sup>d</sup> U.S.C. I. per S.O.*  
*No. 127, Par. 3 Ad. ops. dept. Ky.*  
*July 18<sup>th</sup> 65, as Capt. Mustered*  
*out for Expiration of service.*

Book mark: \_\_\_\_\_

(361)

*O. P. Taylor*

Copyist.

JAN. - 9

5359311

\* 1891 \*

Mustered out under  
provisions of War Dept  
Cir. 910 11 of 1864  
to take effect Jan 18. 1866

J. | 5 | U.S.C.T.

Clement Jones

Priv., Co. L, 5 Reg't U. S. Col'd Calif

Appears on an

**Individual Muster-out Roll**

of the organization named above. Roll dated

Albion Ark Jan 18, 1866.

Muster-out to date Jan 18, 1866.

Last paid to Oct 31, 1865.

**Clothing account:**

Last settled <sup>never settled</sup> ..... 186 ; drawn since \$ 130 00

Due soldier \$ ..... 100; due U. S. \$ ..... 100

Am't for cloth'g in kind or money adv'd \$ ..... 100

Due U. S. for arms, equipments, &c., \$ ..... 100

Bounty paid \$ ..... 100 due \$ ..... 100

Remarks: Substitute. Private since

Dec 7<sup>th</sup> Corp't until that time.

This man was transferred from

72<sup>d</sup> U.S.C. Reg't per S.O. 127 Par 3

Adj Gen Dept of War 18<sup>th</sup> July 1865.

Due 100 for Ordn. & etc  
(over)

Book mark: .....

M. G. Hughes



J | 5 Cav. | U.S.C.T.

Clement Jones  
Corpl } Co L, 5 Reg't U. S. Colored Cav.  
Priv }

Appears on Returns as follows:

July 1865 Gain July 27/65  
Paris, Ky, Grady's Co

Feb. 1866 (Priv) Mustered out for  
expiration of service Jan 18  
66, Helena, Ark.

Book mark :

(546)

Austin

Copyist.

*J* | **5 Cav.** | **U.S.C.T.**

*Clement Jones*  
*Priv*, Co. L, 5 Reg't U. S. Col'd Cavalry.

Appears on

**Company Muster Roll**  
for *Jan. & Feb.*, 1866.

Present or absent.....

Stoppage, \$.....100 for.....

Due Gov't, \$.....100 for.....

Valuation of horse, \$.....100

Valuation of horse equipments, \$.....100

Remarks: *Mustered out for  
Expiration of Service!*

Book mark:.....

*O. P. Taylor*  
(358) Copyist.

2 | 5 Cav. | U.S.C.T.

*Clement Jones*

*27*, Co. L, 5 Reg't U. S. Col'd Cavalry.

Appears on

**Company Muster Roll**

for *Nov Dec*, 186*5*

Present or absent *Present*

Stoppage, \$ *100* for

Due Gov't, \$ *100* for

Valuation of horse, \$ *100*

Valuation of horse equipments, \$ *100*

Remarks: *Reduced to the rank  
from Capt. Dec 7th 65  
Per R. O. No 192 Que  
U. S. Gov Ord. 55cts.*

Book mark:

*Proctor*



2 | 5 Cav. | U.S.C.T.

Clement Innes  
Corps, Co. L, 5 Reg't U. S. Col'd Cavalry.

Appears on

Company Muster Roll

for Sept & Oct, 1865.

Present or absent Present

Stoppage, \$ 100 for

Due Gov't, \$ 100 for

Valuation of horse, \$ 100

Valuation of horse equipments, \$ 100

Remarks: Dis Soldier for  
like amt. dep't under  
G.O. No. 300, W.D. A.G.O.  
Dec 27, 64 \$90.00  
Due U.S. for C & G.E.  
\$7.07

Book mark:

Rochester

2 | 5 Cav. | U.S.C.T.

Clement Jones  
Corpl, Co. L, 5 Reg't U. S. Col'd Cavalry.

Appears on

Company Muster Roll

for July & Aug, 1865.

Present or absent Present

Stoppage, \$ 100 for

Due Gov't, \$ 100 for

Valuation of horse, \$ 100

Valuation of horse equipments, \$ 100

Remarks. Transfd from 72 U.S.C.T.  
per A.O. No 127 Ad. Dep. of  
War July 18. 65. Assign. to Co. per R.  
O. 132 July 27. Due U.S. Gov  
C.C. & G.E. 7.07 Due  
Soldier for like amt. Dep.  
under G.O. No. 300 A.G.O. War  
Dept. Dec 27. 64 \$90.00

Book mark:

W. J. Chester

J | 5<sup>th</sup> Cav | U.S.C.T.

Clement Jones  
Corpl Co., 5 Reg't U. S. Col'd Cav

Appears on

**M. and D. Roll of Men Transferred**

to the organization named above,

from .....

Roll dated July 18, 1865.

When enlisted ....., 186 .

Period for which enlisted 1 years.

When mustered in Jan 10, 1865.

Present or absent Not Stated

Company to which assigned .....

Remarks: Substitute

Deposit under 40 305 a 40 \$90.

Due US for Camp & 48 \$-77

Book mark : .....

Abbot  
Copyist.



C   | **5 Cav. | U.S.C.T.**

  C   + Clement Jones

....., Co.   L  , 5 Reg't U. S. Col'd Cav.

Appears on

**Company Descriptive Book**  
of the organization named above.

**DESCRIPTION.**

Age.....years; height.....feet.....inches.

Complexion.....

Eyes.....; hair.....

Where born.....

Occupation.....

**ENLISTMENT.**

When.....  Substitute  , 186 .

Where.....

By whom.....; term.....  1  y'rs.

Remarks:.....  
.....  
.....  
.....  
.....

  +   Entire entry cancelled by a  
line drawn through it

  W J Anderson    
(383g) Coppist.

2 | **5 Cav. | U.S.C.T.**

Clement Jones

....., Co. L, 5 Reg't U. S. Col'd Cav.

Appears on

**Company Descriptive Book**  
of the organization named above.

**DESCRIPTION.**

Age 21 years; height 5 feet 7 inches.

Complexion Black

Eyes Blk; hair Blk

Where born La

Occupation Laborer

**ENLISTMENT.**

When Substituted, 186 .

Where .....

By whom .....; term 1 y'rs.

Remarks: .....

A. J. Anderson

REP 350 380.

*J. H. Munroe & Co*



734

Jones Clement

Co L, 5 U. S. Col'd Cav.

Corporal

Private

CARD NUMBERS.

1	5359241	26
2	5370359	27
3	5370457	28
4	5370573	29
5	5370679	30
6	5359311	31
7	5370768	32
8	9091109	33
9	9091171	34
10	40729986	35
11		36
12		37
13		38
14		39
15		40
16		41
17		42
18		43
19		44
20		45
21		46
22		47
23		48
24		49
25		50

Book Mark:

See also 72 U.S. Cav. Inf.

J. 5<sup>th</sup> Cav. U.S.C. I.  
Berry Jones  
Co. M, 5<sup>th</sup> Reg't U.S.C. Cav.

**NOTATION.**

Book mark:

J. 51. 6. I. 1874.

**Record and Pension Office.**

WAR DEPARTMENT.

This book mark refers only to a report from the medical records, made by the Surgeon General to the Adjutant General, relative to the above-named man. As the medical records have since been carded, no transcript of this report is made hereon.

(491)

E. P. Conroy

Copyist.

J | 5 Cav. | U.S.C.T.  
Berry Jones  
Priv., Co. M, 5 Reg't U. S. Colored Cav.

Appears on Returns as follows:

Oct 1864 Loss; Oct 6/64 Saltville, Va. missing in action

Apr 1865 Gain; Returned from missing in action Oct 20, '64

Apr 1865 to Feb 1866, Absent sick in Gen Hospital, at Camp Nelson, Ky.

Book mark :

(546)

Austin

Copyist.



*J* | **5 Cav. | U.S.C.T.**

*Berry Jones*  
*Plt*, Co *M*, 5 Reg't U. S. Col'd Cavalry.

Appears on **Co. Muster-out Roll**, dated  
*Helena Ark Mar 16*, 186*6*.

Muster-out to date \_\_\_\_\_, 186 .

Last paid to \_\_\_\_\_, 186 .  
*Pay due from enlistment*

Clothing account:  
Last settled \_\_\_\_\_, 186 ; drawn since \$ \_\_\_\_\_ 100  
Due soldier \$ \_\_\_\_\_ 100 ; due U. S. \$ \_\_\_\_\_ 100  
Am't for cloth'g in kind or money adv'd \$ \_\_\_\_\_ 100

Due U. S. for arms, equipments, &c., \$ \_\_\_\_\_ 100  
Bounty paid \$ \_\_\_\_\_ 100 ; due \$ \_\_\_\_\_ 100

Remarks: *Absent sick in Genl Strop*  
*Camp Nelson Ky since organization*  
*of Co. No discharge furnished*  
*Slave Apt. 19. 61*

Book mark: \_\_\_\_\_

(861) \_\_\_\_\_ *Styer* Copyright.

*J* | 5 Cav. | U.S.C.T.

*Berry Jones*

*Pvt*, Co. M, 5 Reg't U. S. Col'd Cavalry.

Appears on

Company Muster Roll

for *Jan + Feb*, 186*6*.

Present or absent *Absent*

Stoppage, \$ *100* for

Due Gov't, \$ *100* for

Valuation of horse, \$ *100*

Valuation of horse equipments, \$ *100*

Remarks: *1 + 2 months bounty due \$200, Absent sick in U.S. Gen Hosp Camp Nelson, Ky.*

Book mark: \_\_\_\_\_

(358)

*Styer*  
Copyist.

J

5 Cav. | U.S.C.T.

Berry Jones

Nov, Co. M, 5 Reg't U. S. Col'd Cavalry.

Appears on

Company Muster Roll

for Nov + Dec, 1865.

Present or absent Absent

Stoppage, \$ 100 for

Due Gov't, \$ 100 for

Valuation of horse, \$ 100

Valuation of horse equipments, \$ 100

Remarks: Sick in U.S. Genl Hospital  
Camp Nelson Kentucky

Book mark:

(358)

Quinn  
Copyist.



*J* | **5 Cav. | U.S.C.T.**

*Berry Jones*

*Pr*, Co. M, 5 Reg't U. S. Col'd Cavalry.

Appears on

**Company Muster Roll**

for *Sept & Oct*, 1865.

Present or absent *Absent*

Stoppage, \$ *100* for

Due Gov't, \$ *100* for

Valuation of horse, \$ *100*

Valuation of horse equipments, \$ *100*

Remarks: *Absent sick Genl  
Hapl Camp Nelson Ky*

Book mark: \_\_\_\_\_

(358)

*Cutter*  
Copyist.

*J*

**5 Cav. | U.S.C.T.**

*Berry Jones*

*Dr*, C6. M, 5 Reg't U. S. Col'd Cavalry.

Appears on

**Company Muster Roll**

for *July + Aug*, 186*J*.

Present or absent *Absent*

Stoppage, \$ *100* for

Due Gov't, \$ *100* for

Valuation of horse, \$ *100*

Valuation of horse equipments, \$ *100*

Remarks: *Absent sick in Hospital  
at Camp Nelson Ky.*

Book mark:

*Quinn*

Copyist.

(358)

J

5 Cav. U.S.C.T.

Berry Jones

Nr, Co. M, 5 Reg't U. S. Col'd Cavalry.

Appears on

Company Muster Roll

for Mayo June, 1865.

Present or absent Absent

Stoppage, \$ 100 for

Due Gov't, \$ 100 for

Valuation of horse, \$ 100

Valuation of horse equipments, \$ 100

Remarks: Went sick in  
Huptl Camp Nelson Ky  
1<sup>st</sup> Enstalment bounty  
Due \$100

Book mark:

Cutter

(358)

Copyist.



5 Cav. U.S.C.T.

*Berry Jones*

*Cpt.*, Co. M, 5 Reg't U. S. Col'd Cavalry.

Appears on

**Company Muster Roll**

for *Mar. & Apr.*, 1865.

Present or absent *Absent*

Stoppage, \$ *100* for

Due Gov't, \$ *100* for

Valuation of horse, \$ *100*

Valuation of horse equipments, \$ *100*

Remarks: *1<sup>st</sup> in Regiment  
Company since 4/100  
Retired 10/24 from  
Missing in action at  
Sullivan Bay Oct. 2/64  
Sick in General Hospital  
at Camp Nelson*

Book mark:

*M. S. Thompson*

*J* | **5 Cav. | U.S.C.T.**

*Henry Jones*  
*P.M.*, Co. M, 5 Reg't U.S. Col'd Cavalry.

Appears on

**Company Muster Roll**

for *to Oct. 31*, 186*4*.

Present or absent *Absent*

Stoppage, \$ *100* for

Due Gov't, \$ *100* for

Valuation of horse, \$ *100*

Valuation of horse equipments, \$ *100*

Remarks: *Missing in Action*  
*Oct. 2 1864, Slaterville, Va.*

Book mark: \_\_\_\_\_

*H. S. Thompson*  
Copyist.

*J* | **5 Cav. U.S.C.T.**

*Benny Jones*

*Cpt.*, Co. *M*, 5 Reg't U. S. Col'd Cavalry.

Appears on

**Company Muster-in and Descriptive Roll**

of the organization named above. Roll dated

*Camp Nelson, N.Y., Oct 30*, 1864.

Where born *Waynes, Ky.*

Age *27* y'rs; occupation *Farmer*

When enlisted *Aug. 19*, 1864.

Where enlisted *Camp Nelson, Ky.*

For what period enlisted *3* years.

Eyes *Black*; hair *Black*

Complexion *Black*; height *5* ft. *11* in.

When mustered in *Aug. 20*, 1864.

Where mustered in *Camp Nelson, Ky.*

Bounty paid \$ *100*; due \$ *100*

Where credited *8 Dist. Ky.*

Company to which assigned

Remarks: *Jefferson Jones*

*\*Supposed to be name of owner*

*Added May 16, 98. H.A.J.*

Book mark: *851-05-1874*

*H. S. Thompson*

(356d)

Copyist.



J | 5 leaf | **U.S.C.T.**

Berry Jones  
, Co. M, 5 Reg't U. S. Col'd leaf

Appears on

**Company Descriptive Book**

of the organization named above.

**DESCRIPTION.**

Age 27 years; height 5 feet 11 inches.

Complexion Black

Eyes Blk; hair Blk

Where born Wayne Ky

Occupation Farmer

**ENLISTMENT.**

When Aug 19, 1864.

Where Camp Nelson

By whom J. C. Anderson; term 3 y'rs.

Remarks:

-----  
-----  
-----  
-----  
-----  
-----  
-----  
-----  
-----  
-----

(383g)

A. J. Anderson

Copyist.

733

Jones Berry

Co. No. 5 U. S. Col'd Cav.

Private

Private

CARD NUMBERS.

1	5370860	26
2	5370983	27
3	5371218	28
4	5371304	29
5	5371389	30
6	5371475	31
7	5371559	32
8	5371645	33
9	5371728	34
10	9091294	35
11	51-05-1874	36
12	40729985	37
13		38
14		39
15		40
16		41
17		42
18		43
19		44
20		45
21		46
22		47
23		48
24		49
25		50

Book Mark: 51-05-1874

See also

J | 5 Cav | **U.S.C.T.**

Ben Jones

Pvt, Co. L, 5 Reg't U. S. Col'd Cavalry

Appears on **Co. Muster-out Roll**, dated Helena Ark, Mar 16, 1866.

Muster-out to date Mar 16, 1866.

Last paid to Dec 31, 1865.

Clothing account:

Last settled \_\_\_\_\_, 186 ; drawn since \$ \_\_\_\_\_ 100

Due soldier \$ \_\_\_\_\_ 100; due U. S. \$ 16 27 / 100

Am't for cloth'g in kind or money adv'd \$ \_\_\_\_\_ 100

Due U. S. for arms, equipments, &c., \$ \_\_\_\_\_ 100

Bounty paid \$ \_\_\_\_\_ 100; due \$ \_\_\_\_\_ 100

Remarks: Slave.

Book mark: \_\_\_\_\_

O. T. Taylor

(361)

Copyist.



J | 5 Cav. | U.S.C.T.  
Ben Jones  
Priv., Co. L., 5 Reg't U. S. Colored Cav.

Appears on Returns as follows:

Mar. 1865 Absent detached with  
3<sup>d</sup> Bat. at Princeton, Ky.

Book mark : .....

(540)

Huston

Copyist.

1251

*J* | **5 Cav.** | **U.S.C.T.**

*Ben Jones*

*Plt*, Co. L, 5 Reg't U.S. Col'd Cavalry.

Appears on

**Company Muster Roll**

for *Jan. 7 Feb.*, 186*6*.

Present or absent *Present*

Stoppage, \$ *100* for

Due Gov't, \$ *100* for

Valuation of horse, \$ *100*

Valuation of horse equipments, \$ *100*

Remarks:

-----  
-----  
-----  
-----  
-----  
-----  
-----  
-----  
-----

Book mark: -----

*O. P. Taylor*  
Copyist.

1871 12 31

*J* | **5 Cav. | U.S.C.T.**  
*Ben Jones*  
*Plt*, Co. L, 5 Reg't U.S. Col'd Cavalry.

Appears on

**Company Muster Roll**

for *Company*, 1865.

Present or absent *Present*

Stoppage, \$ 100 for

Due Gov't, \$ 100 for

Valuation of horse, \$ 100

Valuation of horse equipments, \$ 100

Remarks:

Book mark:

(358)

*Rehder*

Copyist.



*I* | **5 Cav. | U.S.C.T.**

*Ben Jones*  
*2nd*, Co. L, 5 Reg't U. S. Col'd Cavalry.

Appears on

**Company Muster Roll**

for *Sept & Oct*, 1865.

Present or absent *Present*

Stoppage, \$ *100* for

Due Gov't, \$ *100* for

Valuation of horse, \$ *100*

Valuation of horse equipments, \$ *100*

Remarks: *Due U.S. for Oct*  
*40 cts*

Book mark:

(358)

*Recorder*

Copyist.

*2* | **5 Cav. | U.S.C.T.**

*Ben Jones*  
*Capt*, Co. L, 5 Reg't U. S. Col'd Cavalry.

Appears on

**Company Muster Roll**

for *July & Aug*, 1865.

Present or absent *Present*

Stoppage, \$ *100* for

Due Gov't, \$ *100* for

Valuation of horse, \$ *100*

Valuation of horse equipments, \$ *100*

Remarks *Alia U.S. Gen'l. Adjt.*  
*to etc.*

Book mark:

*Reister*

*J* | **5 Cav.** | **U.S.C.T.**  
*Ben Jones*  
*Co.*, Co. L, 5 Reg't U. S. Col'd Cavalry.

Appears on

**Company Muster Roll**

for *May & June*, 186*5*.

Present or absent *Present*

Stoppage, \$.....100 for .....

Due Gov't, \$.....100 for .....

Valuation of horse, \$.....100

Valuation of horse equipments, \$.....100

Remarks: *Rec'd U.S. for*  
*Ord. \$1.85*

Book mark: .....

(358)

*W. J. [Signature]*

Copyist.



*J* | **5 Cav.** | **U.S.C.T.**

*Ben Jones*

*Private*, Co. L, 5 Reg't U.S. Col'd Cavalry.

Appears on

**Company Muster Roll**

for *March*, 1865

Present or absent *Present*

Stoppage, \$ 100 for

Due Gov't, \$ 100 for

Valuation of horse, \$ 100

Valuation of horse equipments, \$ 100

Remarks: *Due US for  
Ord. \$1.85*

Book mark: \_\_\_\_\_

*Biddle*

*J* | **5 Cav.** | **U.S.C.T.**

*Bew Jones*  
*Priv*, Co. L, 5 Reg't U. S. Col'd Cavalry.

Appears on

**Company Muster Roll**  
for *January Feb*, 1865.  
Present or absent *Present*

Stoppage, \$ *100* for

Due Gov't, \$ *100* for

Valuation of horse, \$ *100*

Valuation of horse equipments, \$ *100*

Remarks: *Due US for Ordnance \$1.85*

Book mark:

*Bridges*  
(358) Copyist.

J. | 5 Cav. | U.S.C.T.  
Ben Jones  
Por, Co. L, 5 Reg't U.S. Col'd Cavalry.

Appears on

Company Muster Roll

for Nov 1864, 1864

Present or absent Present

Stoppage, \$ 100 for

Due Gov't, \$ 100 for

Valuation of horse, \$ 100

Valuation of horse equipments, \$ 100

Remarks:

Book mark:

Bradley

(358)

Copyist.



*J* | **5 Cav.** | **U.S.C.T.**

*Ben Jones*

*Priv*, Co. L, 5 Reg't U.S. Col'd Cavalry.

Appears on

**Company Muster Roll**

for *dated Oct 31*, 186*x*

Present or absent. *Present*

Stoppage, \$.....*100* for .....

Due Gov't, \$.....*100* for .....

Valuation of horse, \$.....*100*

Valuation of horse equipments, \$.....*100*

Remarks: .....

Book mark: .....

*Biddle*

*J.* | **5 Cav.** | **U.S.C.T.**

*Ben Jones*

*Priv*, Co. *L*, 5 Reg't U. S. Col'd Cavalry.

Appears on

**Company Muster-in and Descriptive Roll**

of the organization named above. Roll dated

*Camp Nelson, Ky*, ~~NY~~, *Oct 30*, 1864.

Where born *Kentucky*

Age *18* y'rs; occupation *Laborer*

When enlisted \_\_\_\_\_, 186 .

Where enlisted \_\_\_\_\_

For what period enlisted *3* years.

Eyes *Black*; hair *Black*

Complexion *Black*; height *5* ft. *6* in.

When mustered in *Sept 24*, 186 .

Where mustered in *Lexington*

Bounty paid \$ *100*; due \$ *100*

Where credited *7<sup>th</sup> West Ky*

Company to which assigned \_\_\_\_\_

Remarks:

*Substitute*

Book mark: \_\_\_\_\_

*Bridd*

9 | 5 bar W.B.B.J.

Benn Jones (Cold)

Appears with rank of Priv on

**Muster and Descriptive Roll**

of a Detachment of U.S. Substitutes  
Enlisted & Mustered forwarded

Roll dated  
Lexington, Ky Oct 30, 1865.

Where born Kentucky

Age 28 years; occupation Laborer

When enlisted Sept 24, 1864.

Where enlisted Lexington, Ky.

For what period enlisted 3 years.

Eyes Blk; hair Blk

Complexion Blk; height 5 ft. 6 in.

When mustered in Sept 24, 1864.

Where mustered in Lexington, Ky.

Bounty paid \$ 100; due \$ 100

**Clothing account:**

Last settled \_\_\_\_\_, 186 ; drawn since \$ 100

Date of first muster Sept 24, 1864.

Company to which assigned

Remarks For whom substituted  
Parker & Artis, Drafted man  
Credited to Clark Co. 7<sup>th</sup> D. Ky

Book mark :

(356m)

J. W. Morris

Copyist.



5 bar U.S.A.

Ben Jones

Appears with rank of Pvt on

**Muster and Descriptive Roll**

of Detachment of U.S. Colored Troops, forwarded

Roll dated Louisville, Ky. Oct. 4, 1864.

Where born Kentucky

Age 18 years; occupation Laborer

When enlisted , 186 .

Where enlisted

For what period enlisted 3 years.

Eyes Black; hair Black

Complexion Black; height 5 ft. 6 in.

When mustered in Sept. 24, 1864.

Where mustered in Lexington

Bounty paid \$ 100; due \$ 100

Clothing account:

Last settled , 186 ; drawn since \$ 17<sup>50</sup>/<sub>100</sub>

Date of first muster Sept. 24, 1864.

Company to which assigned

Remarks: Credited to 7" Long West. Ky. Substitute

Book mark:

(356m) W. W. Jackson Copyist.

J | **5 Cav.** | **U.S.C.T.**

Ben Jones  
....., Co. D, 5 Reg't U. S. Col'd Cav.

Appears on  
**Company Descriptive Book**  
of the organization named above.

**DESCRIPTION.**

Age 18 years; height 5 feet 6 inches.

Complexion Black

Eyes BRN; hair BRN

Where born Kentucky

Occupation Laborer

**ENLISTMENT.**

When Substituted, 186 .

Where 7 Dist Ky

By whom .....; term 3 y'rs.

Remarks :  
.....  
.....  
.....  
.....  
.....  
.....  
.....  
.....

(383g) A. J. Anderson Coppist.

132

Jones Ben

Co L, 5 U. S. Col'd Cav.

Private | Private

CARD NUMBERS.

5369823	26
5369918	27
5370012	28
5370117	29
5370208	30
5370299	31
5370384	32
5370477	33
5370572	34
5370645	35
5370716	36
9091168	37
43148113	38
43154532	39
40729984	40
	41
	42
	43
	44
	45
	46
	47
	48
	49
	50

Book Mark: .....

See also .....



*J* | **5 Cav.** | **U.S.C.T.**

*Anthony Jones*  
*Pat*, Co. *D*, 5 Reg't U. S. Col'd Cavalry.

Appears on **Co. Muster-out Roll**, dated  
*Helena, Ark. Mar. 16,* 1866.

Muster-out to date *Mar 16,* 1866.

Last paid to *Dec 31,* 1865.

**Clothing account:**

Last settled....., 186 ; drawn since \$..... 100

Due soldier \$..... 100; due U. S. \$ *58<sup>48</sup>* 100

Am't for cloth'g in kind or money adv'd \$..... 100

Due U. S. for arms, equipments, &c., \$..... 100

Bounty paid \$ *100* 100; due \$ *100* 100

Remarks:.....  
.....  
.....  
.....  
.....  
.....

Book mark:.....

(861)

*J. Stewart*  
Copyist.

*J*

**5 Cav. | U.S.C.T.**

*Anthony Jones*  
*Pvt.*, Co. H, 5 Reg't U. S. Col'd Cavalry.

Appears on

**Company Muster Roll**

for *Jany. V. Liby*, 1866.

Present or absent *Present*

Stoppage, \$ 100 for

Due Gov't, \$ 100 for

Valuation of horse, \$ 100

Valuation of horse equipments, \$ 100

Remarks:

Book mark:

(358)

*J. A. Stewart*  
Copyist.

J. | 5 Cav. | U.S.C.T.

*Anthony Jones*  
Cvt., Co. H, 5 Reg't U. S. Col'd Cavalry.

Appears on

**Company Muster Roll**

for *Nov. 4 Dec*, 1865.

Present or absent *Present*

Stoppage, \$ *100* for

Due Gov't, \$ *100* for

Valuation of horse, \$ *100*

Valuation of horse equipments, \$ *100*

Remarks:

-----  
-----  
-----  
-----  
-----  
-----  
-----  
-----

Book mark:

(358)

*B. H. Cooke*  
Copyist.



S. | **5 Cav.** | **U.S.C.T.**

*Anthony Jones*  
Cvt., Co. H, 5 Reg't U. S. Col'd Cavalry.

Appears on

**Company Muster Roll**

for *Sept. & Oct.*, 1865.

Present or absent *Present.*

Stoppage, \$ 100 for

Due Gov't, \$ 100 for

Valuation of horse, \$ 100

Valuation of horse equipments, \$ 100

Remarks:

-----  
-----  
-----  
-----  
-----  
-----  
-----  
-----

Book mark:

(358)

*A. J. Cook*  
Copyist.

J. | **5 Cav.** | **U.S.C.T.**

*Anthony Jones*  
Co. H, 5 Reg't U. S. Col'd Cavalry.

Appears on

**Company Muster Roll**

for *July & Aug.*, 186*5*.

Present or absent *Present*.

Stoppage, \$ 100 for .....

Due Gov't, \$ 100 for .....

Valuation of horse, \$ 100

Valuation of horse equipments, \$ 100

Remarks: .....

.....  
.....  
.....  
.....  
.....  
.....

Book mark: .....

*R. J. Cooke*

J. | 5 Cav. | U.S.C.T.

Anthony Jones  
Cpt., Co. H, 5 Reg't U. S. Col'd Cavalry.

Appears on

Company Muster Roll

for May & June, 1865.

Present or absent Present.

Stoppage, \$ 100 for

Due Gov't, \$ 100 for

Valuation of horse, \$ 100

Valuation of horse equipments, \$ 100

Remarks: 1<sup>st</sup> Installment Bounty  
due \$100.

Book mark:

(358)

B. J. Cooke  
Copyist.



*J* | **5 Cav.** | **U.S.C.T.**

*Anthony Jones*  
*Priv*, Co. H, 5 Reg't U. S. Col'd Cavalry.

Appears on

**Company Muster Roll**

for *Mar & Apr*, 186 *5*.

Present or absent *present*

Stoppage, \$ *100* for

Due Gov't, \$ *100* for

Valuation of horse, \$ *100*

Valuation of horse equipments, \$ *100*

Remarks: *1<sup>st</sup> installment of  
Bounty Due \$100*

Book mark: \_\_\_\_\_

(358)

*Reynolds*

Copyist.

*J* | **5 Cav.** | **U.S.C.T.**

*Anthony Jones*  
*Pat*, Co. H, 5 Reg't U. S. Col'd Cavalry.

Appears on

**Company Muster Roll**

for *Jan & Feb*, 1865.

Present or absent *present*

Stoppage, \$ *100* for

Due Gov't, \$ *100* for

Valuation of horse, \$ *100*

Valuation of horse equipments, \$ *100*

Remarks: *1st Installment of  
Bounty Due \$100, 00*

Book mark: \_\_\_\_\_

*Reynolds*

(358)

Copyist.

*J* | **5 Cav.** | **U.S.C.T.**

*Anthony Jones*  
*Priv*, Co. H, 5 Reg't U. S. Col'd Cavalry.

Appears on

**Company Muster Roll**

for *Nov & Dec*, 1864.

Present or absent *present*

Stoppage, \$ *100* for

Due Gov't, \$ *100* for

Valuation of horse, \$ *100*

Valuation of horse equipments, \$ *100*

Remarks: *1<sup>st</sup> and 2<sup>d</sup> Installments  
Bounty Due. Due  
US for Ordnance \$9.90*

Book mark:

*Reynolds*

(358)

Copyist.



J | **5 Cav. | U.S.C.T.**

*Anthony Jones*

*Pat*, Co. H, 5 Reg't U. S. Col'd Cavalry.

Appears on

**Company Muster Roll**

for *from enlistment to Oct 31, 1864.*

Present or absent *present*

Stoppage, \$ *100* for

Due Gov't, \$ *100* for

Valuation of horse, \$ *100*

Valuation of horse equipments, \$ *100*

Remarks:

Book mark:

*Reynolds*

*J* | **5 Cav.** | **U.S.C.T.**

*Anthony Jones*

*Priv*, Co *H*, 5 Reg't U. S. Col'd Cavalry.

Appears on

**Company Muster-in and Descriptive Roll**

of the organization named above. Roll dated

*Camp Nelson, Ky*, *Oct 29*, 1864.

Where born *Scott* *Ky*

Age *18* y'rs; occupation *Farmer*

When enlisted *Sept 15*, 1864.

Where enlisted *Camp Nelson Ky*

For what period enlisted *3* years.

Eyes *Black*; hair *Black*

Complexion *Black*; height *5 ft. 3 in.*

When mustered in *Sept 15*, 1864.

Where mustered in *Camp Nelson Ky*

Bounty paid \$ *100*; due \$ *100*

Where credited

Company to which assigned

Remarks: *7th Dist. Ky*

\* *Frank Finley*

\* *Supposed to be name of owner.*

*Added May 17, 98. H. J.*

Book mark:

*Reynolds*

2 | **5 Cav. | U.S.C.T.**

Anthony Jones  
....., Co. H, 5 Reg't U. S. Col'd Cav.

Appears on  
**Company Descriptive Book**  
of the organization named above.

**DESCRIPTION.**

Age 18 years; height 5 feet 3 inches.  
Complexion Beu  
Eyes Beu; hair Beu  
Where born Scott Ky  
Occupation Farmer

**ENLISTMENT.**

When Sept 15, 1864.  
Where Camp W. Lee  
By whom W. Landwehr, term 3 y'rs.

Remarks: .....

A. J. Anderson  
(383g) Coppist.



*Q 15 Cur* | **U. S. C. T.**

*Anthony Jones*  
*H. G.* Reg't U. S. Col'd *Cur*

Appears on

**Company Descriptive Book**

of the organization named above.

**DESCRIPTION.**

Age *18* years; height *5* feet *3* inches.

Complexion *Blk*

Eyes *Blk*; hair *Blk*

Where born *Scott Ky*

Occupation *farmer*

**ENLISTMENT.**

When *Sep. 15*, 186 *4*.

Where *Camp Nelson Ky*

By whom *H. Randolph* term *3* y'rs.

Remarks:

-----  
-----  
-----  
-----  
-----  
-----  
-----  
-----  
-----  
-----

*H. Randolph*

REP 340867.  
6776717-PO90  
D-926119-P.O, Mx M.

*Document Co*

131

Jones Anthony  
Co B, 5 U.S. Col'd Cav.

Private | Private

CARD NUMBERS.

1	5366816	26
2	5366907	27
3	5367004	28
4	5367098	29
5	5367190	30
6	5367286	31
7	5367375	32
8	5367463	33
9	5367552	34
10	5367644	35
11	5367730	36
12	9090810	37
13	9090902	38
14		39
15		40
16		41
17		42
18		43
19		44
20		45
21		46
22		47
23		48
24		49
25		50

Book Mark: .....

See also .....



I certify, on honor, that Alexander Jones, a Private of  
 Captain C. F. Greer's Company (B) of the 5th Regiment of U. S. Cavalry  
Volunteers, of the State of \_\_\_\_\_, born in Garrard Co., State  
 of Kentucky, aged 20 years; 5 feet 5 inches high; Blk complexion,  
Blk eyes, Blk hair, and by occupation a Farmer, who joined for service  
 and was enrolled (see Note 9) on the 11th day of August, 1864 at Camp Nelson Ky  
 by He Randolph, for the period of Three years, and mustered into  
 the service of the United States on the 12th day of August, 1864, at  
Camp Nelson Ky, by Capt Kinney; and having served  
**HONESTLY** and **FAITHFULLY** with his Company to the present date, is now entitled to a  
**DISCHARGE** by reason of Death He died in Hospital  
Helena Arkansas Dec 26, 1865 of Variola

The said Alexander Jones was last paid by Paymaster  
Maj Knapp, to include the 31st day of October, 1865, and  
 has pay due him from that time to the 26th day Decr ~~present date~~; he is entitled to pay and subsistence for  
**TRAVELING** to place of enrollment, and whatever other allowances are authorized to volunteer  
 soldiers, drafted men, or militia, so discharged. He has received from the United States **CLOTHING**  
 amounting to \$ 34 <sup>48</sup> <sub>100</sub> dollars, since the 31st day of March,  
 1865, when his clothing account was last settled. He has received from the United States  
\$ 100 <sub>100</sub> ~~dollars~~ **BOUNTY**.

There is to be stopped from him, on account of the State of \_\_\_\_\_, or other  
 authorities, for **CLOTHING**, &c., received on entering service, \_\_\_\_\_ dollars; and  
 for other stoppages, viz: \_\_\_\_\_  
 \_\_\_\_\_  
 \_\_\_\_\_ dollars.

He has been furnished with **TRANSPORTATION** in kind from the place of his discharge to  
 \_\_\_\_\_; and he has been **Subsisted** for **Traveling** to his  
 place of enrollment, up to the \_\_\_\_\_, 1864

He is indebted to \_\_\_\_\_, **Sutler**, \_\_\_\_\_ dollars.  
 He is indebted to \_\_\_\_\_, **Laundress**, \_\_\_\_\_ dollars.

Given in Duplicate, at Helena Arkansas, this 30th day  
 of December 1865.

Chas. Greer  
Capt C. F. Greer  
 Commanding Company.



[OFFICE INDORSEMENT.]

# War Department,

ADJUTANT GENERAL'S OFFICE,

....., 1875

The ..... of .....  
..... Co. B, ..... Reg't U. S.  
Colored ..... is reported as follows:—

On Company Muster Roll.

For ..... 1865, ..... 1865

Company Muster-out Roll.

..... 1865

Company Descriptive Book.

, 186

Company Morning Reports.

, 186

Soldier's Final Statement.

, 186

Soldier's Record of Death and Interment.

, 186

Soldier's Inventory of Effects.

, 186

Soldier's Certificate of Disability for Discharge.

, 186

Soldier's Individual Muster-out Roll.

, 186

Regimental Return.

For ..... 1865, ..... 1865

Regimental Quarterly Returns.

, 186

Regimental Descriptive Book.

, 186

By Surgeon General.

(.....) ..... 186

..... 1865 is held to be

the correct date, and the Company Muster Roll will be amended accordingly.

*Thoma M. Smeent*

E. B. Co.  
543

Ast. Adj. Gen.

Rec'd letter to 2d rank  
Jan 10/1874

Notes on Reg. Ret.

## FINAL STATEMENT.

Co "B"

OF

*Alexander James*  
5<sup>th</sup> Reg't of "U. S. Cavalry"

### VOLUNTEERS.

NOTE 1.—Two of these certificates (or duplicates) are to be given to each Volunteer Soldier or drafted man who may be discharged without being mustered out (Final Statements are never given to men mustered out of service) that he may at once receive from the Paymaster the pay, &c., due to him, and the captain or other COMMISSIONED officer commanding the company will certify to the act of the delivery of the duplicate certificates; with these certificates the Soldier is "entitled to" his discharge, and should also present his discharge to the Paymaster to have the payment endorsed on it. The discharge is to be given back to the Soldier by the Paymaster; the latter only retaining as his vouchers the duplicate certificates.

NOTE 2.—If the Soldier is entitled to pay for the use of his horse, the Company Commander will certify to that fact on the back of both these final statements, and also to the time he has pay due for having been so mounted on his own horse.

NOTE 3.—When a Soldier is furnished with final statements, his descriptive list, if he has one, should be taken up by the officer who gives the Soldier these statements, and endorsed with a statement to this effect by the officer. The endorsement should exhibit a full statement of the time for which the Soldier was allowed pay on his final statements, the clothing account, and all other charges against him or in his favor, so as to comprise a complete exhibit of his account. It will then be transmitted to the Company Commander of the Soldier, who will enter all the data necessary to a full understanding of the Soldier's account on the muster roll upon which the Soldier's discharge is reported. The descriptive list will then be destroyed. The object of this is, that the remaining portion of the Soldier's account may be settled upon the receipt of these muster rolls, and the Soldier receive any pay or allowances that may be due him at the time of his discharge, and which may not appear on his last final statements from the fact that his descriptive list is incomplete. These accounts for back pay, &c., are settled by the 2d Auditor of the Treasury Department.

NOTE 4.—Charges for loss or injury to ordnance, horse equipments, and other miscellaneous charges, should appear under the heading of "Other Stoppages."

NOTE 5.—Bounty paid by State authorities, and not by the United States, will not be entered on this statement.

NOTE 6.—Amounts due the Sutler and Laundress must be entered on the muster roll on which the discharge, death, desertion, &c., is reported, as well as on the final statement, otherwise the amount cannot be collected from the United States.

NOTE 7.—This blank will be used for deceased volunteers and drafted men, as well as for others.

NOTE 8.—Where a Soldier dies in Hospital or on detached service, his descriptive list, if he has one, should be sent with his final statements, in duplicate, to the Adjutant General, Washington, D. C.

NOTE 9.—If the soldier is a drafted man or substitute, the space for time, &c., of enrolled, should contain only the word *drafted* or *substitute*, as the case may be. If the Soldier is a "VETERAN," (OR RECRUIT,) the words *as a veteran*, (or *recruit*,) as the case may be, should be interlined after the words *mustered into the service of the U. S.* A statement of all the installments of *Veteran* or *Recruit* Bounty RECEIVED by the Soldier must be made on the back of each final statement.

U. S. Army <sup>Post</sup> General-Hospital,

February 23<sup>rd</sup>, 1866.

Commanding Officer, B Company,

3<sup>rd</sup> Regiment U. S. Cav.

I have to inform you  
that Alexander Jones of your Company died in this  
Hospital on December 26<sup>th</sup> 1865 of  
Small Pox

I enclose his Descriptive List, with Pay and Clothing Account,  
and Inventory of his effects.

Very respectfully, yours, &c.,

A. I. Lamer

Surgeon U. S.

In charge of General-Hospital

Post



Inventory of the effects of *Alexander Jones*  
 Company *B*, *5<sup>th</sup>* Regiment *M. C. Cav*  
 who died in the *Post General Hospital Helena Ark*  
*December 26<sup>th</sup>*, 1865.

CAPS .....	BLANKETS .....
DRESS COATS .....	KNAPSACKS .....
OVERCOATS .....	CANTEENS .....
JACKETS .....	HIVERSACKS .....
TROUSERS .....	MUSKETS .....
SHIRTS .....	BAYONETS .....
DRAWERS .....	CARTRIDGE BOX .....
BOOTS, pairs .....	BELT .....
SHOES, pairs .....	MONEY .....
STOCKINGS .....	

INVENTORY

OF THE EFFECTS OF

*Alexander Jones*  
 Late of Company *B*, *5<sup>th</sup>* Regiment  
*M. C. Cav*, who died  
 at *Post General*  
 Hospital *Helena Ark*, Dec *26<sup>th</sup>*,  
 1865.



Jones, Alexander  
P, Co. B, 5 Reg U.S.C. Cav.

2 Enclosures.

Bed Cards	Descriptive Lists
Burial Records	Final Statements /
Certs. of Dis. for Discharge	Furloughs
C. M. Charges	Med. Des. Lists
Med. Certificates	Orders

Other papers relating to—

Admission to Hosp'l	Furlough
Casualty Sheet (Officer's)	Med. Examination
Confinement	Misc. Information
Contracts	Pay or Clothing
Death or Effects /	Personal Reports
Desertions	Rank
Discharge from Hosp'l	Transfer to Hosp'l
Discharge from Service	Transfer to V. R. C.
Duty	Transportation

JAN. - 9

5361622

1891

*Died Dec 26/66. E.P.N. 10. P.  
343*



*J* | **5 Cav. | U.S.C.T.**

*Alexander Jones*

*Pvt.*, Co. *B*, 5 Reg't U. S. Col'd Cavalry.

Appears on **Co. Muster-out Roll**, dated  
*Wetona Ark*, *Mar 16*, 186*6*.

Muster-out to date \_\_\_\_\_, 186*6*.

Last paid to *Oct 31*, 186*5*.

Clothing account:

Last settled \_\_\_\_\_, 186*6* ; drawn since \$ \_\_\_\_\_ *100*

Due soldier \$ *19* <sup>*22*</sup>/<sub>*100*</sub>; due U. S. \$ \_\_\_\_\_ *100*

Am't for cloth'g in kind or money adv'd \$ \_\_\_\_\_ *100*

Due U. S. for arms, equipments, &c., \$ \_\_\_\_\_ *100*

Bounty paid \$ \_\_\_\_\_ *100*; due \$ \_\_\_\_\_ *100*

Remarks: *Died Dec 25 '65 Wetona Ark cause Varicella. Final statements forwarded Mare April 19. 1861*

Book mark: *V. 218. P. 128. 75*

*Wetona*  
*Wetona*

J | 5 Cav. | U.S.C.T.  
Alexander Jones  
Priv., Co. D, 5 Reg't U. S. Colored Cav.

Appears on Returns as follows:

Mar. 1865 Absent sick, Hospl,  
Camp Nelson, Ky.

Sept 1865 Absent sick Gen Hospl.  
Camp Nelson, Ky.

Dec 1865 Died in Post Hospl.  
Dec 26, Helena, Ark.

Book mark :

(546)

Austin

Copyist.

*J.* | **5 Cav. U.S.C.T.**

*Alexander Jones*

*Civ.*, Co. B, 5 Reg't U. S. Col'd Cavalry.

Appears on

**Company Muster Roll**

for *Nov. & Dec.*, 186*5*.

Present or absent

Stoppage, \$ 100 for

Due Gov't, \$ 100 for

Valuation of horse, \$ 100

Valuation of horse equipments, \$ 100

Remarks: *Died at Port Hospital, Helena, Ark. Dec. 26, 1865.*

Book mark:

*R. E. Wilson*



*J.* | **5 Cav.** | **U.S.C.T.**

*Alexander Jones*

*Priv.*, Co. B, 5 Reg't U. S. Col'd Cavalry.

Appears on

**Company Muster Roll**

for *Sept. & Oct.*, 186*5*.

Present or absent *present*

Stoppage, \$ *100* for

Due Gov't, \$ *100* for

Valuation of horse, \$ *100*

Valuation of horse equipments, \$ *100*

Remarks:

-----  
-----  
-----  
-----  
-----  
-----  
-----  
-----  
-----  
-----

Book mark:

*R. Cowles*

*J.* | **5 Cav.** | **U.S.C.T.**

*Alexander Jones*

*Priv.*, Co. B, 5 Reg't U. S. Col'd Cavalry.

Appears on

**Company Muster Roll**

for *July & Aug.*, 186<sup>5</sup>.

Present or absent *present*

Stoppage, \$ 100 for

Due Gov't, \$ 100 for

Valuation of horse, \$ 100

Valuation of horse equipments, \$ 100

Remarks:

Book mark:

*R. E. Wilson*

*J* | **5 Cav.** | **U.S.C.T.**

*Alexander Jones*  
*Priv.*, Co. B, 5 Reg't U. S. Col'd Cavalry.

Appears on

**Company Muster Roll**

for *May & June*, 186*5*.

Present or absent *present*

Stoppage, \$ *100* for

Due Gov't, \$ *100* for

Valuation of horse, \$ *100*

Valuation of horse equipments, \$ *100*

Remarks: *1st installment*  
*Arrears due \$100*

Book mark: \_\_\_\_\_

*R. G. Wilson*



g | **5 Cav. | U.S.C.T.**

Alexander Jones  
Scis, Co. B, 5 Reg't U. S. Col'd Cavalry.

Appears on

**Company Muster Roll**

for Feb 25 to Apr, 1865.

Present or absent Present

Stoppage, \$ 100 for

Due Gov't, \$ 100 for

Valuation of horse, \$ 100

Valuation of horse equipments, \$ 100

Remarks: 1st instalment  
county due \$100

Book mark: \_\_\_\_\_

Lauch

7 | **5 Cav.** | **U.S.C.T.**

Alexander Jones

Private, Co. B, 5 Reg't U. S. Col'd Cavalry.

Appears on

**Company Muster Roll**

for Jan & Feb, 1865.

Present or absent Present

Stoppage, \$ 100 for

Due Gov't, \$ 100 for

Valuation of horse, \$ 100

Valuation of horse equipments, \$ 100

Remarks: 1" installment  
owed by \$100 due

Book mark: \_\_\_\_\_

Lamb

J | **5 Cav.** | **U.S.C.T.**

Alexander Jones  
Priv, Co. B, 5 Reg't U.S. Col'd Cavalry.

Appears on

**Company Muster Roll**

for Nov & Dec, 1864.

Present or absent Present

Stoppage, \$ 100 for

Due Gov't, \$ 100 for

Valuation of horse, \$ 100

Valuation of horse equipments, \$ 100

Remarks: 1<sup>st</sup> & 2<sup>nd</sup> instal-  
ments bounty due

Book mark: \_\_\_\_\_

Lamb



7 | **5 Cav. U.S.C.T.**

Alexander Jones  
Priv., Co. B, 5 Reg't U. S. Col'd Cavalry.

Appears on

**Company Muster Roll**

for Oct 31, 1864.

Present or absent Present

Stoppage, \$ 100 for \_\_\_\_\_

Due Gov't, \$ 100 for \_\_\_\_\_

Valuation of horse, \$ 100

Valuation of horse equipments, \$ 100

Remarks: \_\_\_\_\_

Book mark: \_\_\_\_\_

Lamb  
Copyist.

7 | 5 Cav. | **U.S.C.T.**

Alexander Jones  
Private, Co. B, 5<sup>th</sup> Reg't U. S. Col'd Cav

Appears on

**Company Muster-in and Descriptive Roll**  
of the organization named above. Roll dated

Camp Nelson Ky Oct 24, 1864.

Where born Virard Ky

Age 20 y'rs; occupation Farmer

When enlisted Aug 11, 1864.

Where enlisted Camp Nelson

For what period enlisted 3 years.

Eyes Blk; hair Blk

Complexion Blk; height 5 ft. 5 in.

When mustered in Aug 12, 1864.

Where mustered in Camp Nelson

Bounty paid \$ 100; due \$ 100

Where credited 7 Dist Ky

Company to which assigned B

Remarks Name of owner of

steer - Brier Jones

\* added May 12, 98. by H.A.J.

Book mark : \_\_\_\_\_

Laub

*J* | **5 Cav. | U.S.C.T.**

*Alexander James*

....., Co. *B*, 5 Reg't U. S. Col'd Cav.

Appears on

**Company Descriptive Book**  
of the organization named above.

**DESCRIPTION.**

Age *20* years; height *5* feet *5* inches.

Complexion *blk*

Eyes *blk*; hair *blk*

Where born *Warren Co. N.Y.*

Occupation *Farmer*

**ENLISTMENT.**

When *Aug 11*, 1864.

Where *Camp Nelson*

By whom *J. C. Randolph* term *3* y'rs.

Remarks: *Wied in Hosp. at*

*Bellevue Wash. Dec. 26/65*

.....

.....

.....

.....

.....

.....

*Warren*



8730546 L & Aud.

J. H. Townsend Esq

730

Jones Alexander

Co B, 5 U. S. Col'd Cav.

Private

Private

CARD NUMBERS.

1	5360696	26
2	5360793	27
3	5360881	28
4	5360977	29
5	5361067	30
6	5361153	31
7	5361241	32
8	5361331	33
9	5361439	34
10	5361622	35
11	9090134	36
12	40729983	37
13		38
14		39
15		40
16		41
17		42
18		43
19		44
20		45
21		46
22		47
23		48
24		49
25		50

Book Mark:

See also

I 15 Cav. U.S.C.

William R. Johnson  
, Co. D, 5<sup>th</sup> Regt. U.S.C. Cav.

**NOTATION.**

Book mark: 7416 D, 1888.

**War Department,**

Adjutant General's Office,

Washington, Jan'y 7, 1889.

Application for certificate in lieu of lost discharge.

One Certificate furnished.

(476)

Warren  
Copyist.



J. | 5 Cav. | U.S.C.T.

*William B. Johnson,*  
*Priv., Co. D,* 5 Reg't U. S. Col'd Cavalry.

Appears on **Co. Muster-out Roll**, dated

*Helena, Ark., March 16,* 1866.

Muster-out to date *March 16,* 1866.

Last paid to *Dec. 31,* 1865.

Clothing account:

Last settled....., 186 ; drawn since \$..... 100

Due soldier \$..... 100; due U. S. \$ *M.*<sup>52</sup> 100

Am't for cloth'g in kind or money adv'd \$..... 100

Due U. S. for arms, equipments, &c., \$..... 100

Bounty paid \$..... 100; due \$ *67* 100

Remarks: *Transferred from 72*  
*N. S. C. I. per S. O. 127 Hd.*  
*Qu. Dept. of Ky. of 1865.*

Book mark: *7416 D. 88.*

J. | 5 Cav. | U.S.C.T.

William B. Johnson,  
Sgt., Co. D, 5 Reg't U. S. Col'd Cavalry.

Appears on Co. Muster-out Roll, dated  
Helena, Ark., March 16, 1866.

Muster-out to date March 16, 1866.

Last paid to Dec. 31, 1865.

Clothing account:

Last settled....., 186 ; drawn since \$..... 100

Due soldier \$..... 100; due U. S. \$ *M.*<sup>52</sup> 100

Am't for cloth'g in kind or money adv'd \$..... 100

Due U. S. for arms, equipments, &c., \$..... 100

Bounty paid \$..... 100; due \$ *67* 100

Remarks: *Transferred from 72*  
*N. S. C. I. per S. O. 127 Hd.*  
*Qrs. Dept. of Ky. of 1865.*

Book mark: *7416 D. 88.*

(361)

*W. D. Grainger*  
Copyist.

J | 5 Cav. | U.S.C.T.  
William R Johnson  
Priv. Unass. Co. D, 5 Reg't U. S. Colored Cav.

Appears on Returns as follows:

July 1865 (Unass.) Gain: July 27  
'65 Paris, Ky. Transf. from  
the 72 U.S. Inf. per P.O. 127  
Adprs. Dept. of Ky, 18 July  
'65  
Aug 1865 Transf. from 72 U.S.  
Cav. Assigned to Co D Aug 1,  
'65 Covington per P.O. #35,  
July 27/65 (Co D)

Book mark :

(546)

Austin

Copyist.



J. | 5 Cav. | U.S.C.T.

William B. Johnson,  
Private, Co. D, 5 Reg't U. S. Col'd Cavalry.

Appears on

**Company Muster Roll**

for *Jan'y and Febr'y*, 186*6*.

Present or absent *Present.*

Stoppage, \$ *100* for

Due Gov't, \$ *100* for

Valuation of horse, \$ *100*

Valuation of horse equipments, \$ *100*

Remarks:

-----  
-----  
-----  
-----  
-----  
-----  
-----  
-----

Book mark:

-----

(358)

*W. D. Kramer*

Copyist.

263500

**5 Cav. U.S.C.T.**

*Wm B. Johnson*

*Private*, Co. D, 5 Reg't U. S. Col'd Cavalry.

Appears on

**Company Muster Roll**

for *Nov. & Dec.*, 1865.

Present or absent *present*

Stoppage, \$ *100* for

Due Gov't, \$ *100* for

Valuation of horse, \$ *100*

Valuation of horse equipments, \$ *100*

Remarks: *Sick in Quarters.*

Book mark:

*Milliken*

*J* | **5 Cav.** | **U.S.C.T.**

*William B. Johnson*  
*Priv.*, Co. D, 5 Reg't U. S. Col'd Cavalry.

Appears on

**Company Muster Roll**

for *Sept. + Oct.*, 186*5*.

Present or absent *present*

Stoppage, \$ *100* for

Due Gov't, \$ *100* for

Valuation of horse, \$ *100*

Valuation of horse equipments, \$ *100*

Remarks: *Due soldier deposited under G.O. 300. War Dept. H.Q., Dec. 17/64 \$200.00.*

Book mark: \_\_\_\_\_

*Williken*

(358)

Copyist.



**5 Cav. U.S.C.T.**

*William D. Johnson*

*Priv.*, Co. D, 5 Reg't U. S. Col'd Cavalry.

Appears on

**Company Muster Roll**

for *July & Aug't*, 1865.

Present or absent *present*.

Stoppage, \$ *100* for

Due Gov't, \$ *100* for

Valuation of horse, \$ *100*

Valuation of horse equipments, \$ *100*

Remarks: *Assigned to Co. D, 5th Cav. R.C. 132, 27th July 65. Due Soldier, deposited under G.O. 300, War Dept. A.G.O. Dec. 27th 1864 \$200.00.*

Book mark:

*Milliken*

7 | 5 Cav | U.S.C.T.

William R Johnson  
Pvt, Co....., 5 Reg't U. S. Col'd Cav

Appears on

**M. and D. Roll of Men Transferred**

to the organization named above,

from .....

Roll dated July 18, 1865.

When enlisted Mch 24, 1865.

Period for which enlisted ..... years.

When mustered in Mch 24, 1865.

Present or absent Not Stated

Company to which assigned .....

Remarks: 13 D.C.

Deposit under 90 305 240 \$200

Book mark: 7416-D-1888

Abbott

(342)

Copyist.

*J* | **5 Cav.** | **U.S.C.T.**

*William R Johnson*

....., Co. *D*, 5 Reg't U. S. Col'd Cav.

Appears on

**Company Descriptive Book**  
of the organization named above.

**DESCRIPTION.**

Age *35* years; height *5* feet *4* inches.

Complexion *Yellow*

Eyes *Blk*; hair *Blk*.

Where born *Franklin, O*

Occupation *Shoemaker*

**ENLISTMENT.**

When *Mar. 24*, 186*5*.

Where *Newark, O.*

By whom *Capt. Simet*; term *1* y'rs.

Remarks: *Transfd from*  
*72 U.S.C. Aug. 1. '65.*

.....  
.....  
.....  
.....  
.....  
.....

*C. A. Hall*

(383g)

~~Captain~~  
*Camp.*



REP 316084.

*St. Vincent Co.*

729

Johnson William B

Co D, 5 U. S. Col'd Cav.

Private

Private

CARD NUMBERS.

1	535-9254	26
2	5363245	27
3	5363331	28
4	5363479	29
5	5363506	30
6	5363592	31
7	9090380	32
8	7416-D-1888	33
9	40729932	34
10		35
11		36
12		37
13		38
14		39
15		40
16		41
17		42
18		43
19		44
20		45
21		46
22		47
23		48
24		49
25		50

Book Mark: 7416 D. (E B) 1888

See also 72 U.S.C.

MARINE U. S. GENERAL HOSPITAL,

Saint Louis, Missouri.

Partial Descriptive List and account of Clothing, &c., of *Private Wm Johnson*  
Co. "D" 5<sup>th</sup> Reg't. U. S. Col. Cav. while in this Hospital.

Admitted into Hospital, *Dec. 21<sup>st</sup>* 1865.

*Marine General Hospital  
St Louis Mo Jan 25<sup>th</sup> 1866  
Issued this saddle clothing  
the amount of \$15.10*

*Charge and receipt  
for saddle clothing  
issued to this soldier  
the amount of \$15.10*

*D. C. McLean*

*D. C. McLean*

*Transportation furnished to Louisville Ky. \$5.65*

*Notice received from G. P. Webster, Capt. & A. Q. M.*

*M. F. Randolph*

*20.63  
10.10  
55.73*

*Bvt. Lt. Colonel & Surgeon U. S. Army  
in charge*

I Certify, that the above is a correct account of Clothing, &c., issued to the above named soldier in this Hospital.

MARINE U. S. GENERAL HOSPITAL,

SAINT LOUIS, MISSOURI.

DATE: *Jan. 27<sup>th</sup>* 1866

*M. F. Randolph*

Bvt. Lt. Colonel & Surgeon U. S. A. in charge.



PARTIAL DESCRIPTIVE LIST AND  
CLOTHING ACCOUNT

OF  
Private *Wm* Johnson  
" *D 5<sup>th</sup>* Reg't. U. S. Col. Co. Cal.

Discharged Apr 23. 66

Discharge M. Roll

TREATMENT.

[HERE NOTE IMPORTANT COMPLICATIONS AND ALL OPERATIONS.]

RESULT AND DATE.

Purloughed Jan. 31<sup>st</sup> 66  
Returned from Purlough Febr. 26<sup>th</sup> 66  
Returned to duty April 9<sup>th</sup> 66

Hospital Number

4484 38 1/2

Name *William Johnson*

Age *21* Nativity *Kentucky*

Married or Single *Single*

Residence *Georgetown Ky.*

Post Office address of wife or nearest relative, *John Catel  
Georgetown, Ky.*

Rank *Private* Co. *D.* Regiment *5th U.S. Col. Cav.*

When admitted *Dec. 25 1865*

From what source *Jeffersonville Ky.*

Diagnosis:—(In surgical cases state explicitly seat and character of wound or injury.)

*Frost bite  
of Right Foot*

On what occasion wounded *Marine G.H.*

Date *St. Louis, Mo.*

Nature of missile or weapon



ward of Bed 7  
Hospital Number 16108

+ Johnson

Name *Wm Johnston*  
Age *18* Nativity *Ky*  
~~Married~~ or Single  
Residence *Scott Co Ky*  
Post Office address of }  
wife or nearest relative. }

Rank *Priv* Co. *D* Regiment *5* Caval

When admitted *Nov 29 1861*  
From what source *Camp Nelson Ky*

Diagnosis: (in surgical cases, state explicitly seat and character of wound or injury.)

*From bite*  
*7*

Jefferson G. H.  
On what occasion wounded  
Date *Jeffersonville, Ind.*  
Nature of missile or weapon

+ Jul. 190

TREATMENT.

[HERE NOTE IMPORTANT COMPLICATIONS AND ALL OPERATIONS.]

---

RESULT AND DATE.

*St. Louis, Mo. Decer. 20. 1865.*

Adjutant General's Office,

COLORED TROOPS BRANCH,

Jan 21, 1874

Vol. C. T., 187

Wanted in case of William Johnson, Priv., Co. K,  
5<sup>th</sup> Reg't U. S. Col., information relative to trial &c.

Barren M. R. for Jan'y 1865 as "Reported deserter"  
Oct. 1864, joined - and desertion Dec. 1864, & &  
deserted again from Camp Nelson Ky, Jan'y 1865."

Respectfully,

W. A. Woodward

P. J. Hallow Chief Clerk.

16

Adjutant General's Office,

Record Room

Jan'y 27, 1874

Vol. C. T., 187

Reply in case of John Johnson, Co. - Q,  
5<sup>th</sup> Reg't U. S. Col.

Reg't. Description book shows: Deserted Oct. 1864 at Lexington Ky -

took up from desertion Jan'y 9 '65. -

Co. Description book shows: "Deserted Jan'y '65 from Camp Nelson Ky.

Notice of his being in U. S. Marine Hosp. St. Louis, Mo. rec'd Jan'y 10 '65. -

Co. Reg. Rep. book shows Jan'y 9 '65: From desertion to absent sick; notification  
of his being in U. S. Marine Hospital St. Louis Mo. rec'd -

No evidence relative to trial &c.

W. J.



William Johnson  
"W. J."

Johnson, William

P, Co. A, 5 Reg't USMC

4 Enclosures.

Bed Cards	2	Descriptive Lists
Burial Records		Final Statements
Certs. of Dis. for Discharge		Furloughs
C. M. Charges		Med. Des. Lists
Med. Certificates		Orders

Other papers relating to—

Admission to Hosp'l	Furlough
Casualty Sheet (Officer's)	Med. Examination
Confinement	Misc. Information
Contracts	Pay or Clothing /
Death or Effects	Personal Reports
Descriptions /	Rank
Discharge from Hosp'l	Transfer to Hosp'l
Discharge from Service	Transfer to V. R. C.
Duty	Transportation

J. | 5<sup>th</sup> Cav. | U.S.C.I  
William Johnson  
, Co. "D", 5<sup>th</sup> Reg't U.S.C. Cav.

**NOTATION.**

Book mark:

J. 98. R. C. I. 1868.

**Record and Pension Office,**

WAR DEPARTMENT.

This book mark refers only to a report from the medical records, made by the Surgeon General to the Adjutant General, relative to the above-named man. As the medical records have since been carded, no transcript of this report is made hereon.

(491)

E. P. Conroyer.

Copyist.



J. | **5 Cav.** | **U.S.C.T.**

William Johnson,  
Priv., Co. D, 5 Reg't U. S. Col'd Cavalry.

Appears on **Co. Muster-out Roll**, dated  
Helena, Ark., March 16, 1866.

Muster-out to date March 16, 1866.

Last paid to Enlistment, 1866.

Clothing account:

Last settled....., 1866 ; drawn since \$..... 100

Due soldier \$ 71. 10 / 100 ; due U. S. \$..... 100

Am't for cloth'g in kind or money adv'd \$..... 100

Due U. S. for arms, equipments, &c., \$..... 100

Bounty paid \$..... 100 ; due \$..... 100

Remarks: Deserted from Camp  
Nelson, Ky. Jan'y. 1865.

Received notice of his being  
in Shop. St. Louis, Mo.  
Jan'y. 10, 1866. No discharge  
given.

Book mark: J. 987.5 R. C. T. 1868.

**5 Cav. | U.S.C.T.**

*William Johnson*  
Pvt, Co. *D*, 5 Reg't U. S. Colored Cav.

Appears on **Returns** as follows:

*Oct. 1864, Loss; Oct. 1864, Lexington, Ky. Deserted*

*Feb. 1865, Loss; Jan '65, Camp Nelson, Deserted*

*Jan 1866, Gain Jan 9 Helena, Ark. Ark. from desertion to absent sick U.S. Marine Hosp., St. Louis, Mo.*

*Jan + Feb 1866, Absent sick Hosp., St. Louis, Mo.*

Book mark :

*Austin*

(646)

Copyist.

J | 5 Cav | U.S.C.S.

William Johnson

Pvt, Co. D, 5 Reg't U.S. Cav

Appears on

**Hospital Muster Roll**

of Marine U. S. A. General Hospital,

at St. Louis, Mo.,

for *Uch 5 Apr*, 1866.

Attached to hospital:

When \_\_\_\_\_, 186 .

How employed \_\_\_\_\_

Last paid by Maj \_\_\_\_\_

to \_\_\_\_\_, 186 .

Bounty paid \$ 100; due \$ 100

Present or absent \_\_\_\_\_

Remarks: *Returned to Duty  
Apr. 9. 66*

Book mark: \_\_\_\_\_

*D. J. Bates*



J | 5 Cav | U.S.C.T.

William Johnson

Priv, Co. D, 5 Reg't U.S.C. Cav

Appears on

**Hospital Muster Roll**

of Marine U. S. A. General Hospital,

at St. Louis, Mo.,

for Jan & Feb, 1866.

Attached to hospital:

When Dec 21, 1865.

How employed Patient

Last paid by Maj.

to, 186 .

Bounty paid \$ 100; due \$ 100

Present or absent Present.

Remarks:

Book mark:

J. H. Waters

J. | 5 Cav. | U.S.C.T.

William Johnson,  
Private, Co. D, 5 Reg't U. S. Col'd Cavalry.

Appears on

Company Muster Roll

for Jan'y<sup>1<sup>st</sup></sup> Feb'y, 1865.

Present or absent Absent.

Stoppage, \$ 100 for

Due Gov't, \$ 100 for

Valuation of horse, \$ 100

Valuation of horse equipments, \$ 100

Remarks: In Hospital, St. Louis,  
Mo.

From desertion, dropped  
on Roll Feb. 28, 1865.

Book mark:

(358) W. Brauner Copyist.

*J* | *5 Cav* | *U.S.C.S.*

*Wm. Johnson*

*Priv*, Co *D*, *5* Reg't *U.S. Col'd Cav*

Appears on

**Hospital Muster Roll**

of **Marine U. S. A. General Hospital,**

at **St. Louis, Mo.,**

for *Nov & Dec*, 1865.

Attached to hospital:

When *Dec 21*, 1865?

How employed *Patient*

Last paid by Maj. \_\_\_\_\_

to \_\_\_\_\_, 186 .

Bounty paid \$ 100; due \$ 100

Present or absent *Present*

Remarks: \_\_\_\_\_

\_\_\_\_\_  
\_\_\_\_\_  
\_\_\_\_\_  
\_\_\_\_\_  
\_\_\_\_\_  
\_\_\_\_\_  
\_\_\_\_\_  
\_\_\_\_\_

Book mark: \_\_\_\_\_

*J. M. Muten*



9 | 5 bar 165.65.  
William Johnson (Cald)

Appears with rank of Priv on

**Muster and Descriptive Roll**

of a Detachment of U.S. Substitutes  
Enlisted & Mustered, forwarded

Roll dated  
Lexington, Ky Oct 30, 1865.  
Where born Kentucky  
Age 18 years; occupation Laborer  
When enlisted Aug 29, 1864.  
Where enlisted Lexington, Ky  
For what period enlisted 3 years.  
Eyes Blk; hair Blk.  
Complexion Cap; height 5 ft. 8 in.  
When mustered in Aug 29, 1864.  
Where mustered in Lexington, Ky  
Bounty paid \$ 100; due \$ 100

**Clothing account:**

Last settled \_\_\_\_\_, 186 ; drawn since \$ 100

Date of first muster Aug 29, 1864.

Company to which assigned \_\_\_\_\_

Remarks: For whom substituted

W. C. Pindell. Enrolled man  
Credited to Fayette Co. 7<sup>th</sup> D. Ky

Book mark : \_\_\_\_\_

(356m)

J. H. Morris

Copyist.

J | 5-6 | U.S.C.T

William Johnson

Priv, Co. D, 5 Reg't U.S.C.C

Appears on

**Hospital Muster Roll**

of **U. S. A. Post Hospital,**

at **Camp Nelson, Ky.,**

for Sept + Oct, 1865.

Attached to hospital:

When \_\_\_\_\_, 186 .

How employed \_\_\_\_\_

Last paid by Maj. \_\_\_\_\_

to \_\_\_\_\_, 186 .

Bounty paid \$ 100; due \$ 100

Present or absent Present

Remarks: \_\_\_\_\_

\_\_\_\_\_

\_\_\_\_\_

\_\_\_\_\_

\_\_\_\_\_

\_\_\_\_\_

\_\_\_\_\_

\_\_\_\_\_

Book mark: \_\_\_\_\_

C. L. Parker

*J.* | *5 Cav.* | *U.S.C.*

*William Johnson*  
*Pvt., Co. B, 5 Reg't U.S.C.C.*

Appears on

**Hospital Muster Roll**

of **U. S. A. General Hospital,**

at **Lexington, Ky.,**

for *March 1865*, 186 *5*

Attached to hospital:

When *Feb. 16*, 186 *5*

How employed *sick*

Last paid by Maj. \_\_\_\_\_

to \_\_\_\_\_, 186 .

Bounty paid \$ 100; due \$ 100

Present or absent *Present*

Remarks: \_\_\_\_\_

Book mark: \_\_\_\_\_

*Hastie*



J | **5 Cav. U.S.C.T.**

*William Johnson*  
*Priv.*, Co. D, 5 Reg't U. S. Col'd Cavalry.

Appears on

**Company Muster Roll**

for *Jan. & Feb.*, 186*5*.

Present or absent.....

Stoppage, \$.....100 for.....

Due Gov't, \$.....100 for.....

Valuation of horse, \$.....100

Valuation of horse equipments, \$.....100

Remarks: *Deserted from camp Nelson Ky Jan. '65. Reported Deserted Oct. 31 '64. Joined from Desertion Dec. '64 and carried on Dec. Roll as present. Deserted again as above.*

Book mark:.....

*Wm. H. Scott*

J | 5<sup>th</sup> Cav | U. S. C. T.  
William Johnson  
Priv., Co. D, 5<sup>th</sup> Reg't U. S. Col'd Cav

Appears on

**Descriptive List of Deserters**

dated Jan 31, 1866.

Deserted:

When Oct 18, 1864.

Where Lexington Ky

Arrested:

When \_\_\_\_\_, 186 .

Where \_\_\_\_\_

Remarks: Taken up from desertion during the month.

Notice received Jan 9, 1866 from Marine Hospl St Louis Mo that this man is a patient in said Hospl.

Book mark: \_\_\_\_\_

Rose

J | **5 Cav. | U.S.C.T.**

*William Johnson*

*Priv*, Co. D, 5 Reg't U. S. Col'd Cavalry.

Appears on

**Company Muster Roll**

for *Nov. & Dec.*, 1864.

Present or absent *Present.*

Stoppage, \$ *100* for

Due Gov't, \$ *100* for

Valuation of horse, \$ *100*

Valuation of horse equipments, \$ *100*

Remarks:

Book mark:

*Wm. H. Scott*



1864

*J* | *5 Cav* | **U.S.C.T.**  
*William Johnson*  
*Priv*, Co. *D*, *3* Reg't U. S. Col'd *Cav*

Appears on

**Descriptive List of Deserters**

dated *Oct 31*, 186*4*.

Deserted:

When *Oct 18*, 186*4*.

Where *Lexington*

Arrested:

When ....., 186 .

Where .....

Remarks : .....

Book mark : .....

*Rose*

*J* | **5 Cav. U.S.C.T.**

*William Johnson*

*Rob.*, Co. D, 5 Reg't U. S. Col'd Cavalry.

Appears on

**Company Muster Roll**

for *Dated Oct. 31*, 186*4*.

Present or absent

Stoppage, \$ 100 for

Due Gov't, \$ 100 for

Valuation of horse, \$ 100

Valuation of horse equipments, \$ 100

Remarks: *Wounded Lexington, Ky. Oct. 18, '64.*

Book mark:

*Wm H Scott*

*J* | **5 Cav. | U.S.C.T.**

*William Johnson*

*Bot.*, Co. *D*, 5 Reg't U. S. Col'd Cavalry.

Appears on  
**Company Muster-in and Descriptive Roll**  
of the organization named above. Roll dated

*Camp Nelson, N.Y.,* <sup>*N.Y.*</sup> Oct. 24, 1864.

Where born *Kentucky*

Age *18* y'rs; occupation *Laborer*

When enlisted <sup>\*</sup> *Substituted*, 186 .

Where enlisted

For what period enlisted *3* years.

Eyes *Bk.*; hair *Bk.*

Complexion *Bk.*; height *5* ft. *8* in.

When mustered in *Aug. 22*, 1864.

Where mustered in *Lexington*

Bounty paid \$ *100*; due \$ *100*

Where credited *5 Dist. Ky.*

Company to which assigned

Remarks:

*\* Inserted by General Cox*

Book mark:

*Wm. Scott*



9 | 5 bar | U.S.C.T.

William Johnson

Appears with rank of PT on

**Muster and Descriptive Roll**

of a Detachment of U. S. Cavalry  
Troop formed for U. S. Cold  
Car. at Lexington. Ky. Roll dated  
Louisville. Ky., Sept. 7, 1864.

Where born Ky.

Age 18 years; occupation Laborer

When enlisted Substitute, 186

Where enlisted

For what period enlisted 3 years.

Eyes Blue; hair Blue

Complexion Blue; height 5 ft. 8 in.

When mustered in Aug. 29, 1864.

Where mustered in Lexington

Bounty paid \$ 100; due \$ 100

Clothing account:

Last settled \_\_\_\_\_, 186 ; drawn since \$ 17 50/100

Date of first muster Aug. 29, 1864.

Company to which assigned

Remarks: Credited to 5 Army Dist.

Ky.

Book mark:

D. J. O. Dennis

J | **5 Cav. | U.S.C.T.**

*William Johnston*

....., Co....., 5 Reg't U. S. Col'd Cav.

Appears on

**Company Descriptive Book**  
of the organization named above.

**DESCRIPTION.**

Age *18* years; height *5* feet *8* inches.

Complexion *Black*

Eyes *Blk*; hair *Blk*

Where born *Albany N.Y.*

Occupation *鞍手*

**ENLISTMENT.**

When *Substitute*, 186 .

Where *5 Dist N.Y.*

By whom.....; term *3* y'rs.

Remarks: *Resorted from*  
*Camp Nelson Jan.*  
*1865, Notice of his*  
*being in U. S. Marine*  
*Hospital St Louis Mo.*  
*recd. Jan. 10 - 66*

*J E Parks*

126  
Johnson William

Co D, 5 U. S. Col'd Cav.

Private

Private

CARD NUMBERS.

1	5362687	26
2	5362786	27
3	5359356	28
4	5362887	29
5	5363023	30
6	5363510	31
7	5359460	32
8	5363595	33
9	9090316	34
10	J 98-REC-68	35
11	43146489	36
12	43154475	37
13	32123528	38
14	32116337	39
15	32232774	40
16	32232946	41
17	32233159	42
18	40729981	43
19		44
20		45
21		46
22		47
23		48
24		49
25		50

Book Mark: J 98.7.3269.1868

See also



# UNITED STATES COLORED TROOPS ENLISTMENT.

STATE OF

TOWN OF

*Kentucky*  *Camp Nelson*

I, *William Johnson* born in *Woodford*  
in the State of *Kentucky* aged *Forty three* years  
and by occupation a *Farmer* Do HEREBY ACKNOWLEDGE to

have volunteered *twentieth* day of *August* 1864  
to serve as a **Soldier** in the **Army of the United States of America**, for the  
period of **THREE YEARS**, unless sooner discharged by proper authority: Do  
also agree to accept such bounty, pay, rations, and clothing, as are, or may be,  
established by law for the U. S. colored troops.

And I, *William Johnson*  
do solemnly swear that I will bear true faith and allegiance to the **United States  
of America**, and that I will serve them honestly and faithfully against all their  
enemies or opposers whomsoever: and that I will observe and obey the orders  
of the President of the United States, and the orders of the officers appointed  
over me, according to the Rules and Articles of War.

Sworn and subscribed to, at *Camp Nelson*  
this *19<sup>th</sup>* day of *Aug 1864* *William Johnson*  
Before *J. B. Randolph* *D. P. M.* *marks*

I CERTIFY, ON HONOR, That I have carefully examined the above named Volunteer agree-  
ably to the General Regulations of the Army, and that, in my opinion, he is free from all bodily  
defects and mental infirmity, which would in any way disqualify him from performing the  
duties of a soldier.

*O. E. Hollaway*  
*Asst. Surg. U. S. Army* *Examining Surgeon*

I CERTIFY, ON HONOR, That I have minutely inspected the Volunteer, *W. Johnson*  
previously to his enlistment, and that he was entirely sober when enlisted; that, to the best of  
my judgment and belief, he is of lawful age; and that, in accepting him as duly qualified to per-  
form the duties of an able-bodied soldier, I have strictly observed the regulations which govern  
the recruiting service. This soldier has *blue* eyes, *brn* hair, *brn* complexion, is *5 ft 10 in* feet *10* inches high.

*J. B. Randolph*  
*D. P. M.*  
RECRUITING OFFICER OR AGENT.

Mustered into the United States Service, *twentieth* day of *August* 1864

*W. O. Kinney*  
*Capt. 18<sup>th</sup> U.S. Inf* *Mustering Officer*

Mustered into the service of the United States, for three years or during the war, from date of enlistment, in Company  
Regiment of *W. L. Cabell* Volunteers on the *19<sup>th</sup>* day of *August* 1864 at *Camp Nelson*

*W. O. Kinney*  
*Capt. 18<sup>th</sup> U.S. Inf*  
*Mustering Officer*

NOTE 1.—This blank will be used for enlistments of United States colored troops. They will be made out in duplicate in all cases—one to accompany the recruiting return of the superintendent (not the recruiting officer) to the Adjutant General, and one to accompany the accounts of the officer who pays bounty, &c.

NOTE 2.—An enlistment holds to service. A muster-in must, in all cases, precede payment of pay, bounty, pension, &c. A muster-in roll, must in all cases, be filed in the Adjutant General's Office as evidence of muster-in. The mustering officer, commissary, or assistant commissary of musters, as the case may be, will countersign both enlistments as having mustered the soldiers into the service of the United States before either of them is given to the disbursing officer.

DECLARATION OF RECRUIT.

I, William Johnson desiring to volunteer as a soldier in the ARMY OF THE UNITED STATES, for the term of Three Years, DO DECLARE That I am 43 years and ..... months of age; that I have never been discharged from the United States service on account of disability or by sentence of a court-martial, or by order before the expiration of a term of enlistment; and I know of no impediment to my serving honestly and faithfully as a soldier for three years.

GIVEN at Camp Nelson the 19<sup>th</sup> day of August 1864

Witne W. A. Palmer

William Johnson  
Volunteered at Camp Nelson  
Aug 19 1864  
By Wm. J. ...  
on Shoptford Co  
John ...  
No. 298  
Two thousand ...

Consent of Parent or Guardian in case of a Minor, if a Free Man, or in the case of a Slave, of the Person to whom he owes Service:

I, ..... Do CERTIFY, That I am the ..... that the said ..... is ..... years of age; and I do freely give my CONSENT to his volunteering as a SOLDIER in the Army of the United States, for the period of THREE YEARS, under the conditions of the laws of the United States.

GIVEN at ..... the ..... day of .....

Witness: .....



Johnson, William

Co. B, 5 Reg't U.S.C. Co.

1 Inclosures.

Bed Cards .....	Final Statements .....
Burial Records .....	Furloughs or L. of A. ....
Certs. of Dis. for Discharge .....	Med. Certificates .....
C. M. Charges .....	Med. Des. Lists .....
Descriptive Lists .....	Orders .....
Discharge Certificates .....	Pris. of War Record .....
Enlistment Papers / .....	Resignations .....

Other papers relating to—

Admission to Hosp'l .....	Furlough or L. of A. ....
Casualty Sheet .....	Med. Examination .....
Confinement .....	Misc. Information .....
Contracts .....	Pay or Clothing .....
Death or Effects .....	Personal Reports .....
Desertion .....	Rank .....
Discharge from Hosp'l .....	Transfer to Hosp'l .....
Discharge from Service .....	Transfer to V. R. C. ....
Duty .....	Transportation .....



*J* | **5 Cav. | U.S.C.T.**

*William Johnson*

*1st*, Co. *B*, 5 Reg't U. S. Col'd Cavalry.

Appears on **Co. Muster-out Roll**, dated  
*October 1st*, 186*6*.

Muster-out to date *Nov 11*, 186*6*.

Last paid to *Dec 31*, 186*6*.

**Clothing account:**

Last settled....., 186 ; drawn since \$..... 100

Due soldier \$ *11 59* / 100; due U. S. \$..... 100

Am't for cloth'g in kind or money adv'd \$..... 100

Due U. S. for arms, equipments, &c., \$ ..... 100

Bounty paid \$ *100* / 100; due \$ *100* / 100

Remarks: *Slave since 19. 1861*

Book mark: *V 210 P 3. 74*

*William Johnson* Copyist.

5 Cav. U.S.C.T.

William Johnson  
Priv., Co. B, 5 Reg't U. S. Colored Cav.

Appears on Returns as follows:

From organization to Oct 31, 1864 to Jan 1865  
Absent sick, Hospl. Camp  
Nelson, Ky.

Mar. & Apl. 1865, Absent sick,  
Hospl. Camp Nelson, Ky.

July to Dec 1865, On daily duty  
Co. Cook

Book mark :

(546)

Austin

Copyist.

*S* | **5 Cav.** | **U.S.C.T.**

*William Johnson*  
*Pvt*, Co. B, 5 Reg't U. S. Col'd Cavalry.

Appears on

**Company Muster Roll**

for *Jan - Feb*, 186*6*.

Present or absent *Present*

Stoppage, \$ *100* for

Due Gov't, \$ *100* for

Valuation of horse, \$ *100*

Valuation of horse equipments, \$ *100*

Remarks:

Book mark:

*W. Johnson*



*J.* | **5 Cav.** | **U.S.C.T.**

*William Johnson*

*Priv.*, Co. B, 5 Reg't U. S. Col'd Cavalry.

Appears on

**Company Muster Roll**

for *Nov. & Dec.*, 186*5*.

Present or absent *present*

Stoppage, \$ *100* for

Due Gov't, \$ *100* for

Valuation of horse, \$ *100*

Valuation of horse equipments, \$ *100*

Remarks: *On daily duty as Co. cook.*

Book mark: \_\_\_\_\_

*R. E. Wilson*

J. | **5 Cav.** | **U.S.C.T.**

*William Johnson*

*Priv.*, Co. B, 5 Reg't U. S. Col'd Cavalry.

Appears on

**Company Muster Roll**

for *Sept. & Oct.*, 186*5*.

Present or absent, *present*

Stoppage, \$ *100* for

Due Gov't, \$ *100* for

Valuation of horse, \$ *100*

Valuation of horse equipments, \$ *100*

Remarks:

Book mark:

*R. E. Wier*

J. | **5 Cav.** | **U.S.C.T.**

William Johnson

Priv., Co. B, 5 Reg't U. S. Col'd Cavalry.

Appears on

**Company Muster Roll**

for July & Aug., 1865.

Present or absent present

Stoppage, \$ 100 for

Due Gov't, \$ 100 for

Valuation of horse, \$ 100

Valuation of horse equipments, \$ 100

Remarks:

-----  
-----  
-----  
-----  
-----  
-----  
-----  
-----

Book mark: -----

R. E. Wilson



*J.* | **5 Cav.** | **U.S.C.T.**

*William Johnson*

*Priv.*, Co. B, 5 Reg't U. S. Col'd Cavalry.

Appears on

**Company Muster Roll**

for *May & June*, 186*5*.

Present or absent *present*

Stoppage, \$ *100* for

Due Gov't, \$ *100* for

Valuation of horse, \$ *100*

Valuation of horse equipments, \$ *100*

Remarks: *1st installment from  
by due \$100*

Book mark: \_\_\_\_\_

*R. C. Wilson*

A | **5 Cav.** | **U.S.C.T.**

William Johnson

Priv, Co. B, 5 Reg't U. S. Col'd Cavalry.

Appears on

**Company Muster Roll**

for Feb 28 to April, 1865.

Present or absent Absent

Stoppage, \$ 100 for

Due Gov't, \$ 100 for

Valuation of horse, \$ 100

Valuation of horse equipments, \$ 100

Remarks: Kept at Camp Nelson, Ky. 1st installment bounty \$100

Book mark: \_\_\_\_\_

Lamb

4 | **5 Cav.** | **U.S.C.T.**

William Johnson  
Private, Co. B, 5 Reg't U. S. Col'd Cavalry.

Appears on

**Company Muster Roll**

for Jan & Feb, 1865.

Present or absent Present

Stoppage, \$ 100 for \_\_\_\_\_

Due Gov't, \$ 100 for \_\_\_\_\_

Valuation of horse, \$ 100

Valuation of horse equipments, \$ 100

Remarks: \_\_\_\_\_

Book mark: \_\_\_\_\_

Lamb



REF ID: A61134

  J   | **5 Cav.** | **U.S.C.T.**

William Johnson  
  , Co. B, 5 Reg't U.S. Col'd Cavalry.

Appears on

**Company Muster Roll**

for   Noel & Lee  , 186  4  .

Present or absent   Absent  

Stoppage, \$   100   for   

Due Gov't, \$   100   for   

Valuation of horse, \$   100  

Valuation of horse equipments, \$   100  

Remarks:   Sick in Hospital  
  Camp Nelson Ky  
  1<sup>st</sup> & 2<sup>nd</sup> instalments  
  bounty due

  Enrolled Aug 17/64 & must in  
  Aug 19/64.

Book mark:   

  Laub

J | **5 Cav.** | **U.S.C.T.**

William Johnson

Priv, Co. B, 5 Reg't U. S. Col'd Cavalry.

Appears on

**Company Muster Roll**

for Oct 31, 1864.

Present or absent Absent

Stoppage, \$ 100 for

Due Gov't, \$ 100 for

Valuation of horse, \$ 100

Valuation of horse equipments, \$ 100

Remarks: Sick in Hospital  
at Camp Nelson, Ky

Book mark: \_\_\_\_\_

Lamb

1st Cav U.S.C.T.

William Johnson  
1st Reg't U.S. Col'd Cav

Appears on

Company Muster-in and Descriptive Roll  
of the organization named above. Roll dated

Camp Nelson Ky, Dec 24, 1864.

Where born Woodford Ky

Age 43 y'rs; occupation Farmer

When enlisted Aug 14, 1864.

Where enlisted Camp Nelson

For what period enlisted 3 years.

Eyes Blue; hair Blue

Complexion Blue; height 5' 6 in.

When mustered in Aug 18, 1864.

Where mustered in Camp Nelson

Bounty paid \$ 100; due \$ 100

Where credited 7 Dist Ky

Company to which assigned B

Remarks: \* Name of owner of

Acres - John Garrett

\* Added May 12, 98. by H.H.G.

Book mark:

Laub



**5 Cav. | U.S.C.T.**

*J* | *William Johnson*

....., Co. *B*, 5 Reg't U. S. Col'd Cav.

Appears on

**Company Descriptive Book**  
of the organization named above.

**DESCRIPTION.**

Age *43* years; height *5* feet *6* inches.

Complexion *Blk*

Eyes *Blk*; hair *Blk*

Where born *Woodford Co Ky*

Occupation *Farmer*

**ENLISTMENT.**

When *Aug, 19*....., 1864:

Where *Camp Nelson*

By whom *J. C. Randolph*, term *3* y'rs.

Remarks: .....

.....

.....

.....

.....

.....

.....

.....

.....

*Warren*

A 2268360 Pompano  
S. 1082241

W. H. Townsend Esq

127

Johnson William

Co B, 5 U. S. Col'd Cav.

Private | Private

CARD NUMBERS.

1	5360695	26
2	5360792	27
3	5360880	28
4	5360976	29
5	5361066	30
6	5361152	31
7	5361240	32
8	5361330	33
9	5361413	34
10	5361495	35
11	5361577	36
12	9090133	37
13	40729980	38
14		39
15		40
16		41
17		42
18		43
19		44
20		45
21		46
22		47
23		48
24		49
25		50

Book Mark:

See also



J. 1 5<sup>th</sup> Cav. U.S.C. I.  
Thomas Johnson  
, Co. F, 5<sup>th</sup> Regt U.S.C. Cav

**NOTATION.**

Book mark: J. 107. R. G. J. 1868

**Record and Pension Office,**

WAR DEPARTMENT.

This book mark refers only to a report from the medical records, made by the Surgeon General to the Adjutant General, relative to the above-named man. As the medical records have since been carded, no transcript of this report is made hereon.

E. P. Conroy

JAN. - 9

5365631

1891 \*

*discharged furnished*

*J* | **5 Cav. U.S.C.T.**

*Thomas Johnson*

*Pvt*, Co. *F*, 5 Reg't U. S. Col'd Cavalry.

Appears on **Co. Muster-out Roll**, dated  
*Helena Ark Mch 16*, 1866.

Muster-out to date \_\_\_\_\_, 186 .

Last paid to *Pay due from enlistment*, 186 .

**Clothing account:**

Last settled \_\_\_\_\_, 186 ; drawn since \$ \_\_\_\_\_ 100

Due soldier \$ \_\_\_\_\_ 100; due U. S. \$ \_\_\_\_\_ 100

Am't for cloth'g in kind or money adv'd \$ \_\_\_\_\_ 100

Due U. S. for arms, equipments, &c., \$ \_\_\_\_\_ 100

Bounty paid \$ \_\_\_\_\_ 100; due \$ \_\_\_\_\_ 100

Remarks: *Absent sick in Genl Hoop  
Louisville Ky since Feby 24. 1865  
5<sup>th</sup> D. of Ky. Sub for J Veal, Trans.  
from 72 Col. Inf to 5<sup>th</sup> Cav per S.O.  
No 127, dated Hd Qrs Dept of Ky  
Louisville Ky July 18. 65. No  
(over)*

Book mark: *107. Vol 5 R.R. J. 1868*

\_\_\_\_\_  
*W. D. Row*  
Copyist.



J | 5 Cav. | U.S.C.T.  
Thomas Johnson  
Priv., Co. F, 5 Reg't U. S. Colored Cav.

Appears on Returns as follows:

July 1865 Gain July 29/65 Paris,  
Ky Transf. from the 72 Inf.  
Cold  
July to Nov 1865 + Jan + Feb 1866 Absent  
sick in Genl Hosp. Louis-  
ville, Ky.

Book mark :

(546)

Austin

Copyist.

**5 Cav. U.S.C.T.**

*Thomas Johnson*

Co. F, 5 Reg't U. S. Col'd Cavalry.

Appears on

**Company Muster Roll**

for *Jan & Feb*, 1866

Present or absent *Absent*

Stoppage, \$ *100* for

Due Gov't, \$ *100* for

Valuation of horse, \$ *100*

Valuation of horse equipments, \$ *100*

Remarks: *Absent to sick Genl Hoop. Louisville, Ky since Feb 2, 1865.*

Book mark:

*JW Davis*

*J* | **5 Cav. | U.S.C.T.**

*Thomas Johnson*

*Pvt*, Co. F, 5 Reg't U.S. Col'd Cavalry.

Appears on

**Company Muster Roll**

for *Nov & Dec*, 1865.

Present or absent *absent*

Stoppage, \$ *100* for

Due Gov't, \$ *100* for

Valuation of horse, \$ *100*

Valuation of horse equipments, \$ *100*

Remarks: *Sick in Genl Hosp  
Louisville Ky since Feb  
14-65.*

Book mark: \_\_\_\_\_

*Wark*  
Copyist.



J | 5 Cav. | U.S.C.T.

Thomas Johnson

Pvt, Co. F, 5 Reg't U. S. Col'd Cavalry.

Appears on

**Company Muster Roll**

for Sept & Oct, 1865.

Present or absent. Not stated

Stoppage, \$ 100 for

Due Gov't, \$ 100 for

Valuation of horse, \$ 100

Valuation of horse equipments, \$ 100

Remarks: Transferred to Reg't from  
72 Col'd Infy By Dept order  
no 124 dated July 26.  
substitute for J Beul Louisiana

Book mark:

Howe

J | 5 Cav. | U.S.C.T.

Thomas Johnson

Priv., Co. F, 5 Reg't U. S. Col'd Cavalry.

Appears on

Company Muster Roll

for July & Aug, 1865.

Present or absent absent

Stoppage, \$ 100 for

Due Gov't, \$ 100 for

Valuation of horse, \$ 100

Valuation of horse equipments, \$ 100

Remarks: assigned to Co from 72<sup>d</sup>  
Coal Dept by Regt order - dated  
July 28. Sub for J Neal Louisville  
Ky. Transferred by Sept 14  
order no 127.

Served in West Louisville Ky  
since Feb 18-65.

Book mark:

J | 5 leave | U.S.C.T.

Thomas Johnson

Pvt, Co., 5 Reg't U. S. Col'd leave

Appears on

**M. and D. Roll of Men Transferred**

to the organization named above,

from .....

Roll dated July 18, 1865.

When enlisted ....., 186 .

Period for which enlisted 3 years.

When mustered in Jan 10, 1865.

Present or absent .....

Company to which assigned .....

Remarks: Substitute for J Veal

Absent without leave since  
Feb 18 1865

5 D Ky

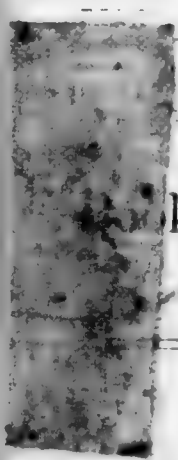

mark :

Abbott



7 | **5 Cav. | U.S.C.T.**

Johnson Thomas  
....., Co. 7, 5 Reg't U. S. Col'd Cav.

Appears on

**Company Descriptive Book**  
of the organization named above.

**DESCRIPTION.**

Age 19 years; height 5 feet 4 inches.

Complexion Blk

Eyes Blk; hair Blk

Where born Tennessee

Occupation carpenter

**ENLISTMENT.**

When ....., 186 .

Where Substitute

By whom .....; term 3 y'rs.

Remarks: at Danville  
by Sub. for J  
Went 5" West Ky

J E Fuks

126

Johnson Thomas  
Co F, 5 U. S. Col'd Cav.

Private | Private

CARD NUMBERS.

1	5359256 1/2	26
2	5365275	27
3	5365365	28
4	5365453	29
5	5365541	30
6	5365631	31
7	9090629	32
8	107-REC-68	33
9	40729979	34
10		35
11		36
12		37
13		38
14		39
15		40
16		41
17		42
18		43
19		44
20		45
21		46
22		47
23		48
24		49
25		50

Book Mark: J. 107. Rec. 5-6. 6. 1868

See also 72 U.S. 6 Inf.

Adjutant General's Office,

COLORED TROOPS BRANCH,

December, 1875

Vol. C. T., 187

Wanted in case of James Johnson, Co. C.,

5th Reg't 1st Col. Colored Troops, 24th Army Corps, Dept. of the South, West Virginia. Report in "Case" must.

Respectfully,

W. A. Woodward

Chief Clerk.

J. J. Galton

Adjutant General's Office,

, 187

Vol. C. T., 187

Reply in case of \_\_\_\_\_, Co. \_\_\_\_\_,

Reg't \_\_\_\_\_

Co. Morning Report Book repts Dec 7/6 from at present, to present, for duty. Co. and Reg't Records furnish no evidence of trial.

207



James Johnson  
1866

did obtain Whiskey by threat. This near  
Cyathraud Ky. on or about the 27<sup>th</sup> May  
1865

Henry Jackson  
Lt Col 5<sup>th</sup> Regt

Witnesses

Lt Col L. H. Carpenter 5<sup>th</sup> Regt

Capt W. C. Stone 5<sup>th</sup> Regt

Private R. English Co. C. 5<sup>th</sup> Regt

— R. Johnson —

— N. Lewis —

Charges & Specifications preferred against  
Private Thomas Johnson Co. C. 5<sup>th</sup> Regt. C. Cav

Charge 1<sup>st</sup> Conduct to the prejudice of good  
order and military discipline

Specification In this that he the said Thomas  
Johnson Pri. Co. C. 5<sup>th</sup> Regt. C. Cav did on  
the night of the 27<sup>th</sup> of May 1865, proceed  
with others from a block house where  
he was on duty near Cythiana Ky, to  
the Distillery of M<sup>r</sup> J. J. McGibben, near  
Cythiana Ky and did call for Whiskey  
This being refused him, he insisted on  
having it anyhow, and finally compelled  
the persons in charge of said Distillery  
to give it to him, saying that if they  
(the party he was with) were informed on  
they would burn the Distillery and  
shoot the hands employed there. This  
near Cythiana Ky on or about the  
27<sup>th</sup> of May 1865.

Charge II Violation of the 54<sup>th</sup> Article of War

Specification In this that he the said  
Thomas Johnson Pri. Co. C. 5<sup>th</sup> Regt. C. Cav  
did in Company with others, break  
into the Whiskey Distillery of M<sup>r</sup> J. J.  
McGibben near Cythiana Ky and



Charges & Specifications  
preferred against  
Thomas Johnson. Pki  
Co C. 3<sup>rd</sup> U.S. Col. Cav

*Credited to Scott Co. Ky*

VOLUNTEER ENLISTMENT.

STATE OF

TOWN OF

*Kentucky*

*Co. of Des Moines*

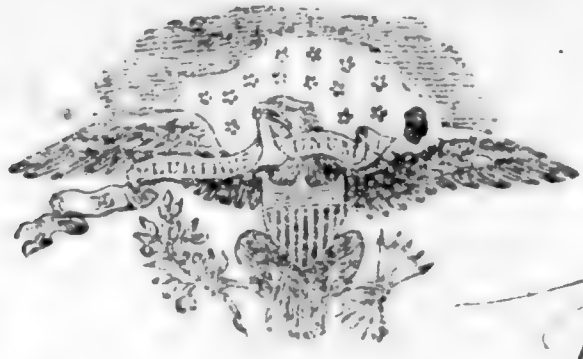

I, *Thomas Johnson*, born in *Scott Co.* in the State of *Kentucky*, aged *Eighteen* years, and by occupation a *Farmer*, Do HEREBY ACKNOWLEDGE to have volunteered this *First* day of *April*, 1865 to serve as a **Soldier** in the **Army of the United States of America**, for the period of **THREE YEARS**, unless sooner discharged by proper authority: Do also agree to accept such bounty, pay, rations, and clothing, as are, or may be, established by law for volunteers. And I, *Thomas Johnson*, do solemnly swear, that I will bear true faith and allegiance to the **United States of America**, and that I will serve them honestly and faithfully against all their enemies or opposers whomsoever; and that I will observe and obey the orders of the President of the United States, and the orders of the officers appointed over me, according to the Rules and Articles of War.

Bounty paid at time of Muster-in:  
U. S. Bounty,  
Local Bounty.

*Certify for the Signature of the Mustering Officer, Commissary, or Assistant Commissary of Mustering, as the case may be*  
Mustered into the service of the United States, for three years or during the war, from date of enlistment, in Co. *of the*  
Regiment of *McClellan's* Volunteers, on the *1<sup>st</sup>* day of *April*, 1865, at *Paris, Taylor Ky*  
and credited to *1<sup>st</sup>* Ward, (or Sub-district,) in the Town of *Paris*, in the County of *Franklin*, in the State of *Kentucky*

Sworn and subscribed to, at *Camp Nelson* this *1<sup>st</sup>* day of *April*, 1865, BEFORE *J. F. Passand Lieut & Adj. 5<sup>th</sup> U.S. Col. etc.* *Thomas Johnson* *Wash*

I CERTIFY, ON HONOR, That I have carefully examined the above-named Volunteer, agreeably to the General Regulations of the Army, and that, in my opinion, he is free from all bodily defects and mental infirmity, which would in any way disqualify him from performing the duties of a soldier.

*John Swan*  
*Capt. Surgeon 5<sup>th</sup> U.S. Col. etc.*  
EXAMINING SURGEON.

I CERTIFY, ON HONOR, That I have minutely inspected the Volunteer *Thomas Johnson* previously to his enlistment, and that he was entirely sober when enlisted; that, to the best of my judgment and belief, he is of lawful age; and that, in accepting him as duly qualified to perform the duties of an able-bodied soldier, I have strictly observed the Regulations which govern the recruiting service. This soldier has *Blue* eyes, *Blk* hair, *Blk* complexion, is *Five* feet *5<sup>11</sup>* inches high.

*J. F. Passand Lieut & Adj. 5<sup>th</sup> U.S. Col. etc.*  
Regiment of *McClellan's* Volunteers,  
RECRUITING OFFICER.

*William Strickland*  
*Capt. & Quar. Master 5<sup>th</sup> U.S. Col. etc.*



NOTE 1.—This blank will be used for both enlistments and re-enlistments—enlistment of veterans, &c., &c., in the volunteer service. They will be made out in duplicate in all cases—one to accompany the recruiting return of the superintendent (not the recruiting officer) to the Adjutant General, and one to accompany the accounts of the officer who pays bounty, &c. The Regiment and Company in which the soldier last served should be given on the back.

NOTE 2.—An enlistment holds to service. A muster-in must, in all cases, precede payment of pay, bounty, pension, &c. A muster-in roll must, in all cases, be filed in the Adjutant General's Office as evidence of muster-in. The mustering officer, commissary, or assistant commissary of musters, as the case may be, will countersign both enlistments as having mustered the soldier into the service of the United States before either of them is given to the disbursing officer.

DECLARATION OF RECRUIT.

I, Thomas Johnson, desiring VOLUNTEER as a Soldier in the Army of the United States, for the term of THREE YEARS, Do Declare, That I am Eighteen years and \_\_\_\_\_ months of age; that I have never been discharged from the United States service on account of disability or by sentence of a court martial, or by order before the expiration of a term of enlistment; and I know of no impediment to my serving honestly and faithfully as a soldier for three years.

GIVEN at Camp Nelson the 1 day of April 1865

Witness:

Johnson

Thomas Johnson

enlistment; last served in Company ( )  
 Reg't of \_\_\_\_\_  
 Discharged \_\_\_\_\_, 1865.

Trust

No. \_\_\_\_\_  
Shaw Johnson (Co. 1)  
 Volunteered at Camp Nelson  
April 1st, 1865  
 By J. Fairbank  
 Regiment of 10th Ark

On Muster-roll & Discharge 2553

CONSENT IN CASE OF MINOR.

I, Jas Jones Secretary, Do CERTIFY, That I am the \_\_\_\_\_ of \_\_\_\_\_; that the said \_\_\_\_\_ is \_\_\_\_\_ years of age; and I do hereby freely give my CONSENT to his volunteering as a SOLDIER in the ARMY OF THE UNITED STATES for the period of THREE YEARS.

GIVEN at \_\_\_\_\_ the \_\_\_\_\_ day of \_\_\_\_\_

Witness:



Credited To Scott Co 7 St.

VOLUNTEER ENLISTMENT.

STATE OF

TOWN OF

Kentucky

Co of Danville

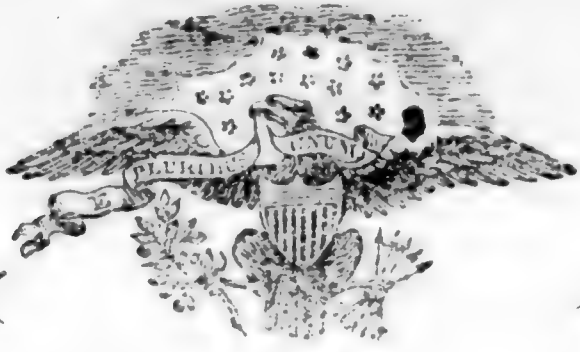

I, Thomas Johnson, born in Scott Co, in the State of Kentucky, aged Eighteen years, and by occupation a Farmer, Do HEREBY ACKNOWLEDGE to have volunteered this First day of April, 1865, to serve as a Soldier in the Army of the United States of America, for the period of THREE YEARS, unless sooner discharged by proper authority: Do also agree to accept such bounty, pay, rations, and clothing, as are, or may be, established by law for volunteers. And I, Thomas Johnson do solemnly swear, that I will bear true faith and allegiance to the United States of America, and that I will serve them honestly and faithfully against all their enemies or opposers whomsoever; and that I will observe and obey the orders of the President of the United States, and the orders of the officers appointed over me, according to the Rules and Articles of War.

Sworn and subscribed to, at Camp Nelson this 1st day of April, 1865.

BEFORE H. J. Parson, Lieut. Colonel, 5th U.S. C. Co.

his Thomas Johnson Mark

I CERTIFY, ON HONOR, That I have carefully examined the above-named Volunteer, agreeably to the General Regulations of the Army, and that, in my opinion, he is free from all bodily defects and mental infirmity, which would in any way disqualify him from performing the duties of a soldier.

John Swan Capt. Surgeon 5th U.S. C. Co. EXAMINING SURGEON.

I CERTIFY, ON HONOR, That I have minutely inspected the Volunteer Thomas Johnson previously to his enlistment, and that he was entirely sober when enlisted; that, to the best of my judgment and belief, he is of lawful age; and that, in accepting him as duly qualified to perform the duties of an able-bodied soldier, I have strictly observed the Regulations which govern the recruiting service. This soldier has Blue eyes, Brown hair, Fair complexion, is five feet four inches high.

H. J. Parson, Lieut. Colonel, 5th U.S. C. Co. RECRUITING OFFICER.

Certificate for the Signature of the Mustering Officer, Commissary, or Assistant Commissary of Musters, as the case may be. Mustered into the service of the United States, for three years or during the war, from date of enlistment, in Co. H of the 1st Kentucky Volunteers, on the 1st day of April, 1865, at Lexington, Ky. and credited to 5th Congressional District, in the State of Kentucky, in the County of Boone. Bounty paid at time of Muster-in: U. S. Bounty, Local Bounty.



NOTE 1.—This blank will be used for both enlistments and re-enlistments—enlistment of veterans, &c., &c., in the volunteer service. They will be made out in duplicate in all cases—one to accompany the recruiting return of the superintendent (not the recruiting officer) to the Adjutant General, and one to accompany the accounts of the officer who pays bounty, &c. The Regiment and Company in which the soldier last served should be given on the back.

NOTE 2.—An enlistment holds to service. A muster-in must, in all cases, precede payment of pay, bounty, pension, &c. A muster-in roll must, in all cases, be filed in the Adjutant General's Office as evidence of muster-in. The mustering officer, commissary, or assistant commissary of musters, as the case may be, will countersign both enlistments as having mustered the soldier into the service of the United States before either of them is given to the disbursing officer.

DECLARATION OF RECRUIT.

I, Thomas Johnson, desiring  
 VOLUNTEER as a Soldier in the Army of the United States, for the term of THREE YEARS,  
 Do Declare, That I am Eighteen years and \_\_\_\_\_ months  
 of age; that I have never been discharged from the United States service on account of disability or by  
 sentence of a court martial, or by order before the expiration of a term of enlistment; and I know of no  
 impediment to my serving honestly and faithfully as a soldier for three years.

GIVEN at Camp Nelson  
 the 1 day of April 1865

Witness:

Johnson his  
Thomas Johnson  
private

273  
 No. \_\_\_\_\_  
 Volunteered at Camp Nelson  
1 April, 1865  
 By \_\_\_\_\_  
 Regiment of \_\_\_\_\_  
3rd  
 enlistment; last served in Company ( ) \_\_\_\_\_  
 Regt of \_\_\_\_\_  
 Discharged \_\_\_\_\_, 18 \_\_\_\_\_

CONSENT IN CASE OF MINOR.

I, Joe Free Scotland, Do CERTIFY, That I am  
 the \_\_\_\_\_ of \_\_\_\_\_; that the  
 said \_\_\_\_\_ is \_\_\_\_\_ years of age; and I  
 do hereby freely give my CONSENT to his volunteering as a SOLDIER in the ARMY OF THE UNITED STATES  
 for the period of THREE YEARS.

GIVEN at \_\_\_\_\_  
 the \_\_\_\_\_ day of \_\_\_\_\_

Witness:

Johnson Thomas

Co. C, 5 Reg't U. S. Col.

4 Enclosures.

Bed Cards .....	Final Statements .....
Burial Records .....	Furloughs or L. of A. ....
Certs. of Dis. for Discharge .....	Med. Certificates .....
C. M. Charges 1 .....	Med. Des. Lists .....
Descriptive Lists .....	Orders .....
Discharge Certificates .....	Pris. of War Record .....
Enlistment Papers 2 .....	Resignations .....

Other papers relating to—

Admission to Hosp'l .....	Furlough or L. of A. ....
Casualty Sheet .....	Med. Examination .....
Confinement .....	Misc. Information ✓ .....
Contracts .....	Pay or Clothing .....
Death or Effects .....	Personal Reports .....
Desertion .....	Rank .....
Discharge from Hosp'l .....	Transfer to Hosp'l .....
Discharge from Service .....	Transfer to V. R. C. ....
Duty .....	Transportation .....



*J* | **5 Cav.** | **U.S.C.T.**  

---

*Thomas Johnson*  

---

*Priv*, Co. *C*, 5 Reg't U. S. Col'd Cavalry.

Appears on **Co. Muster-out Roll**, dated  
*Helena Ark*, *March*, 186*6*.  
Muster-out to date *March*, 186*6*.  
Last paid to *Dec 31*, 186*5*.

**Clothing account:**

Last settled....., 186 ; drawn since \$..... 100  
Due soldier \$..... 100; due U. S. \$ *2* <sup>*64*</sup>/<sub>100</sub>  
Am't for cloth'g in kind or money adv'd \$..... 100  

---

Due U. S. for arms, equipments, &c., \$..... 100  
Bounty paid \$ *100* 100; due \$..... 100

Remarks:.....  
.....  
.....  
.....  
.....  
.....

Book mark:.....

*Rose*

5 Cav. U.S.C.T.

J  
Thomas Johnson<sup>+</sup>  
Priv. Co. C. 5 Reg't U. S. Colored Cav.

Appears on Returns as follows:

Apr. 18/65, Gain Apr. 17/65, Camp  
Nelson, Ky. Enlisted in Co.

\* Entry appears on Reg'tl Return as:  
Thomas Jackson, Recruit, (Gain)  
Apr. 19/65 Camp Nelson, assigned to Co.  
C, per R.O. 54, 18 Apr. '65

Book mark:

J Austin

(546)

Copyist.

APR 1861

J | 5 Cav. | U.S.C.T.

Thomas Johnson  
Pvt . Co. C . 5 Reg't U. S. Colored Cav.

Appears on Returns as follows:

Nov 1864, Absent sick Hoapl.  
Camp Nelson.

June & July 1865 Absent prisoner  
at Lexington, Ky.

Aug & Sept 1865 Absent in confine-  
ment at Camp Nelson, Ky.

Oct. & Nov 1865 Absent prisoner  
at Camp Nelson, Ky.

Book mark :

Austin

(546)  
70

Copyist.



2.

*J* | **5 Cav.** | **U.S.C.T.**  
*Thomas Johnson*  
*Pat*, Co. C, 5 Reg't U. S. Col'd Cavalry.

Appears on

**Company Muster Roll**  
for *Jan to Feb*, 186 *6*  
Present or absent *Present*

Stoppage, \$ *100* for

Due Gov't, \$ *100* for

Valuation of horse, \$ *100*

Valuation of horse equipments, \$ *100*

Remarks:

Book mark:

*Rose*

*J* | **5 Cav. | U.S.C.T.**

*Thomas Johnson*  
*Sgt.*, Co. C, 5 Reg't U. S. Col'd Cavalry.

Appears on

**Company Muster Roll**

for *Nov Dec*, 186*9*.

Present or absent *Present*

Stoppage, \$ *100* for

Due Gov't, \$ *100* for

Valuation of horse, \$ *100*

Valuation of horse equipments, \$ *100*

Remarks: *First installment*  
*of bounty due (\$100)*  
*due 11/1 for transportation*  
*Dr 1/10, Sick in*  
*Det.*

Book mark: \_\_\_\_\_

*Leiden*

*J* | **5 Cav.** | **U.S.C.T.**

*Thomas Johnson*  
*Prt* ..., Co. C, 5 Reg't U. S. Col'd Cavalry.

Appears on

**Company Muster Roll**

for *Sep. 4 - Oct* ..., 186 *5*

Present or absent *Absent*

Stoppage, \$ ..... *100* for .....

Due Gov't, \$ ..... *100* for .....

Valuation of horse, \$ ..... *100*

Valuation of horse equipments, \$ ..... *100*

Remarks: *Absent in August*  
*At Drs Dep Ky G.C.M.O.*  
*N. 126*

Book mark: *H. Sec. Dep. Ky G.C.M.O. 26*

(358) *Jordan* Copyist.  
*x inserted by computer*



J | 5. Cav | U.S.C.T.  
Thomas Johnson,  
Pvt C Co 5 Regt U.S.C.T.

Appears on

**Muster Roll**

of Military Prison at Camp Nelson, Kentucky,

for Sept & Oct, 1865.

Station Camp Nelson Ky

Clothing account:

Last settled, 184 ; drawn since \$ 100

Present or absent Not stated

Remarks: Sentenced Per G.C.M.  
G.O. No 66 Hol Dep. Deph  
of Ky. Six months hard  
labor

Book mark :

Jones

*J* | **5 Cav.** | **U.S.C.T.**

*Thomas Johnson*  
*Priv.*, Co. C, 5 Reg't U. S. Col'd Cavalry.

Appears on

**Company Muster Roll**

for *July & Aug.*, 186*9*.

Present or absent *Absent*

Stoppage, \$ *100* for

Due Gov't, \$ *100* for

Valuation of horse, \$ *100*

Valuation of horse equipments, \$ *100*

Remarks: *Absent in Arrest*

Book mark: \_\_\_\_\_

*Guiden*

*I* | **5 Cav.** | **U.S.C.T.**

*Thomas Johnson*  
*Pvt.*, Co. C, 5 Reg't U. S. Col'd Cavalry.

Appears on

**Company Muster Roll**

for *May & June*, 1865.

Present or absent *Absent*

Stoppage, \$ *100* for

Due Gov't, \$ *100* for

Valuation of horse, \$ *100*

Valuation of horse equipments, \$ *100*

Remarks: *Absent in arrest*

Book mark:

*Jander*



MAR 1864

1 | **5 Cav.** | **U.S.C.T.**

*Thomas Johnson*

*Pvt*, Co. C, 5 Reg't U. S. Col'd Cavalry.

Appears on

**Company Muster Roll**

for *Mar. 7* *Apr.*, 186*4*.

Present or absent *Present*

Stoppage, \$ 100 for

Due Gov't, \$ 100 for

Valuation of horse, \$ 100

Valuation of horse equipments, \$ 100

Remarks:

-----  
-----  
-----  
-----  
-----  
-----  
-----  
-----

Book mark:

*Shull*

*J* | *5 Cav* | **U. S. C. T.**  
*Thomas Johnson,*

Appears with rank of *Pvt* on

**Muster and Descriptive Roll of a Detachment of U. S. Vols. forwarded**

for the *5* Reg't U. S. Col'd *Cav*, Roll dated  
*Lexington Ky, April 17, 1865.*

Where born *Kentucky, Scott Co.*

Age *18* y'rs; occupation *Farmer*

When enlisted *April 1*, 1865.

Where enlisted *Camp Nelson*

For what period enlisted *3* years.

Eyes *Blk*; hair *Blk*

Complexion *Blk*; height *5 ft. 6 in.*

When mustered in *April 17, 1865.*

Where mustered in *Lexington Ky*

Bounty paid \$ *100*; due \$ *100*

Where credited *Scott Co. 7 Dist. Ky*

Company to which assigned

Remarks:

Book mark:

*Valentine*

*f* | **5 Cav. | U.S.C.T.**

*Thomas Johnson*  
-----, Co. *C*, 5 Reg't U. S. Col'd Cav.

Appears on

**Company Descriptive Book**  
of the organization named above.

**DESCRIPTION.**

Age *8* years; height *5* feet *6* inches.

Complexion *Blk*

Eyes *Blk*; hair *Blk*

Where born *Scott Co. Ky.*

Occupation *Farmer*

**ENLISTMENT.**

When *Apr 1st*, 186 *5*.

Where *Camp Nelson*

By whom *# Cassand*; term *3* y'rs.

Remarks: *recruit see*  
*men listed*

-----  
-----  
-----  
-----  
-----  
-----

*Warren*



Q 1449265 PORMA  
Q 1524318 PORMA  
Q 2360225 PORMA  
M.S. 948837  
Q. 2617405 And. n. o.  
Q. 1739332  
Q. 2763333 And. n. o.

*Thurston*

725

Johnson Thomas

---

Co C, 5 U. S. Col'd Cav.

Private | Private

CARD NUMBERS.

1	5359213	26
2	5362067	27
3	5362148	28
4	5362236	29
5	5362326	30
6	5362412	31
7	5362496	32
8	5362581	33
9	9090236	34
10	34451767	35
11	40729976	36
12	40729978	37
13		38
14		39
15		40
16		41
17		42
18		43
19		44
20		45
21		46
22		47
23		48
24		49
25		50

Book Mark: .....

See also .....



# UNITED STATES COLORED TROOPS ENLISTMENT.

STATE OF

TOWN OF

*Kentucky*



*Camp Nelson*

I, *Simpson Johnson* born in *Madison Co*  
in the State of *Kentucky* aged *twenty* years  
and by occupation a *Farmer* Do HEREBY ACKNOWLEDGE to

have volunteered *Twenty ninth* day of *August* 186 *4*  
to serve as a **Soldier** in the **Army of the United States of America**, for the  
period of **THREE YEARS**, unless sooner discharged by proper authority: Do  
also agree to accept such bounty, pay, rations, and clothing, as are, or may be,  
established by law for the U. S. colored troops.

And I, *Simpson Johnson*  
do solemnly swear that I will bear true faith and allegiance to the **United States  
of America**, and that I will serve them honestly and faithfully against all their  
enemies or opposers whomsoever; and that I will observe and obey the orders  
of the President of the United States, and the orders of the officers appointed  
over me, according to the Rules and Articles of War.

Sworn and subscribed to, at *Camp Nelson*  
this *29<sup>th</sup>* day of *Aug 1864* *Simpson Johnson*  
Before *Alexander G. Barrett* *Wm. M. ...*

I CERTIFY, ON HONOR, That I have carefully examined the above named Volunteer agree-  
ably to the General Regulations of the Army, and that, in my opinion, he is free from all bodily  
defects and mental infirmity, which would in any way disqualify him from performing the  
duties of a soldier.

*A. G. Barrett*  
Asst Surg 7<sup>th</sup> Reg  
EXAMINING SURGEON.

I CERTIFY, ON HONOR, That I have minutely inspected the Volunteer, *S. Johnson*  
previously to his enlistment, and that he was entirely sober when enlisted; that to the best of  
my judgment and belief, he is of lawful age; and that, in accepting him as duly qualified to per-  
form the duties of an able-bodied soldier, I have strictly observed the regulations which govern  
the recruiting service. This soldier has *blue* eyes, *black* hair, *light* com-  
plexion, is *five* feet *seven* inches high.

*Alexander G. Barrett*  
and *Wm. M. ...*  
RECRUITING OFFICER OR AGENT.

Mustered into the United States Service. *29<sup>th</sup>* day of *August* 186 *4*

*W. M. ...*  
Capt. 18<sup>th</sup> U.S. Col. Mustering Officer

Mustered into the service of the United States, for three years or during the war, from date of enlistment, in Company  
Regiment of *U.S. Colored* Volunteers, on the *29<sup>th</sup>* day of *August* 1864, at *Camp Nelson*

*W. M. ...*  
Capt. 18<sup>th</sup> U.S. Col.



1864

NOTE 1.—This blank will be used for enlistments of United States colored troops. They will be made out in duplicate in all cases—one to accompany the recruiting return of the superintendent (not the recruiting officer) to the Adjutant General, and one to accompany the accounts of the officer who pays bounty, &c.  
NOTE 2.—An enlistment holds to service. A muster-in must, in all cases, precede payment of pay, bounty, pension, &c. A muster-in roll, must in all cases, be filed in the Adjutant General's Office as evidence of muster-in. The mustering officer, commissary, or assistant commissary of musters, as the case may be, will countersign both enlistments as having mustered the soldiers into the service of the United States before either of them is given to the disbursing officer.

DECLARATION OF RECRUIT.

I, Simpson Johnson desiring to volunteer as a soldier in the ARMY OF THE UNITED STATES, for the term of Three Years, DO DECLARE That I am 20 years and ..... months of age; that I have never been discharged from the United States service on account of disability or by sentence of a court-martial, or by order before the expiration of a term of enlistment; and I know of no impediment to my serving honestly and faithfully as a soldier for three years.

GIVEN at Cassopolis, Wilson Ky the 29<sup>th</sup> day of August 1864

Witness: W. L. Palmer

Simpson Johnson  
By James Johnson  
Volunteered at Camp Miller  
Aug 29 1864  
P. M. Y. M. Y.  
C. Johnson Co  
No. 272  
James Johnson

Consent of Parent or Guardian in case of a Minor, if a Free Man, or in the case of a Slave, of the Person to whom he owes Service:

I, ..... Do CERTIFY, That I am the ..... that the said ..... is ..... years of age; and I do freely give my CONSENT to his volunteering as a SOLDIER in the Army of the United States, for the period of THREE YEARS, under the conditions of the laws of the United States.

GIVEN at ..... the ..... day of .....

Witness: .....

*Johnson Simpson*

....., Co. ....

Reg't *U.S. 67*

**Enclosures.**

Bed Cards .....	Final Statements .....
Burial Records .....	Furloughs or L. of A. ....
Certs. of Dis. for Discharge .....	Med. Certificates .....
C. M. Charges .....	Med. Des. Lists .....
Descriptive Lists .....	Orders .....
Discharge Certificates .....	Pris. of War Record .....
Enlistment Papers <i>/</i> .....	Resignations .....

**Other papers relating to—**

Admission to Hosp'l .....	Furlough or L. of A. ....
Casualty Sheet .....	Med. Examination .....
Confinement .....	Misc. Information .....
Contracts .....	Pay or Clothing .....
Death or Effects .....	Personal Reports .....
Desertion .....	Rank .....
Discharge from Hosp'l .....	Transfer to Hosp'l .....
Discharge from Service .....	Transfer to V. R. C. ....
Duty .....	Transportation .....

*J* | **5 Cav. U.S.C.T.**

*Simpson Johnson*  
*Pat*, Co. *M* 5 Reg't U. S. Col'd Cavalry.

Appears on **Co. Muster-out Roll**, dated  
*Helena Ark*, *Mar 16*, 186*6*.  
Muster-out to date *Mar 16*, 186*6*.  
Last paid to *Dec. 31*, 186*5*.

**Clothing account:**

Last settled....., 186 ; drawn since \$ ..... 100  
Due soldier \$ ..... 100; due U. S. \$ *29* <sup>*17*</sup>/<sub>100</sub>  
Am't for cloth'g in kind or money adv'd \$ ..... 100

Due U. S. for arms, equipments, &c., \$ ..... 100

Bounty paid \$ *100* 100; due \$ *100* 100

Remarks: *Slave Apr. 19 '61*

Book mark: .....

*Hyde*  
Copyist.



*J* | **5 Cav. U.S.C.T.**

*Simpson Johnson*

*Pl*, Co. M, 5 Reg't U. S. Col'd Cavalry.

Appears on

**Company Muster Roll**

for *Jan + Feb*, 186*6*.

Present or absent *Present*

Stoppage, \$ 100 for

Due Gov't, \$ 100 for

Valuation of horse, \$ 100

Valuation of horse equipments, \$ 100

Remarks:

Book mark:

*Steyn*

*J* | **5 Cav. | U.S.C.T.**

*Simpson Johnson*  
*Pr*, Co. M, 5 Reg't U. S. Col'd Cavalry.

Appears on

**Company Muster Roll**

for *Nov & Dec*, 186*J*.

Present or absent *Present*

Stoppage, \$.....*100* for .....

Due Gov't, \$.....*100* for .....

Valuation of horse, \$.....*100*

Valuation of horse equipments, \$.....*100*

Remarks: .....

.....  
.....  
.....  
.....  
.....  
.....  
.....  
.....

Book mark: .....

*Lewis*  
Copyist.

*J* | **5 Cav. | U.S.C.T.**

*Simpson Johnson*  
*M*, Co. M, 5 Reg't U. S. Col'd Cavalry.

Appears on

**Company Muster Roll**

for *Sept & Oct*, 186*J*.

Present or absent *Present*

Stoppage, \$ *100* for

Due Gov't, \$ *100* for

Valuation of horse, \$ *100*

Valuation of horse equipments, \$ *100*

Remarks:

Book mark:

(358)

*Cutus*  
Copyist.



1865

*J* | **5 Cav. | U.S.C.T.**

*Simpson Johnston*  
*no*, Co. M, 5 Reg't U. S. Col'd Cavalry.

Appears on

**Company Muster Roll**

for *July & Aug*, 1865.

Present or absent *Present*

Stoppage, \$ *100* for

Due Gov't, \$ *100* for

Valuation of horse, \$ *100*

Valuation of horse equipments, \$ *100*

Remarks:

-----  
-----  
-----  
-----  
-----  
-----  
-----

Book mark:

-----  
*Quinn*  
Copyist.

J | 5 Cav. | U.S.C.T.

Simpson Johnston  
Priv., Co. M, 5 Reg't U. S. Col'd Cavalry.

Appears on

Company Muster Roll

for May & June, 1865.

Present or absent Present

Stoppage, \$ 100 for

Due Gov't, \$ 100 for

Valuation of horse, \$ 100

Valuation of horse equipments, \$ 100

Remarks: No Encumbrance bounty  
due \$100.

Book mark:

Copyist.

*A* | **5 Cav. | U.S.C.T.**

*Simpson Johnson*  
*Priv.*, Co. M, 5 Reg't U. S. Col'd Cavalry.

Appears on

**Company Muster Roll**

for *Mar. & Apr.*, 1865.

Present or absent *Present.*

Stoppage, \$ *100* for

Due Gov't, \$ *100* for

Valuation of horse, \$ *100*

Valuation of horse equipments, \$ *100*

Remarks: *1<sup>st</sup> installment  
bonvily due \$100*

Book mark:

*M. S. Thompson*  
Copyist.



*10* | **5 Cav. | U.S.C.T.**

*Simpson Johnson*  
....., Co. M, 5 Reg't U. S. Col'd Cavalry.

Appears on

**Company Muster Roll**

for *Jan & Feb*, 1863.

Present or absent *Present.*

Stoppage, \$ *100* for .....

Due Gov't, \$ *100* for .....

Valuation of horse, \$ *100*

Valuation of horse equipments, \$ *100*

Remarks: *1st & 2d mts. instruments  
of bounty due.*

Book mark: .....

(358)

*M. S. Thompson*

Copyist.

*J* | **5 Cav. | U.S.C.T.**

*Simpson, Johnson*  
*Priv*, Co. M, 5 Reg't U. S. Col'd Cavalry.

Appears on

**Company Muster Roll**

for *Nov. & Dec.*, 186*4*.

Present or absent *Present.*

Stoppage, \$ *100* for

Due Gov't, \$ *100* for

Valuation of horse, \$ *100*

Valuation of horse equipments, \$ *100*

Remarks: *1000 2<sup>d</sup> installment  
of bounty due.*

Book mark:

(358)

*W. S. Thompson*

Copyist.

*1* | **5 Cav. | U.S.C.T.**

*Simpson, Johnson*  
*Priv.*, Co. M, 5 Reg't U. S. Col'd Cavalry.

Appears on

**Company Muster Roll**

for *to Oct. 31*, 186*1*.

Present or absent *Present.*

Stoppage, \$ *100* for

Due Gov't, \$ *100* for

Valuation of horse, \$ *100*

Valuation of horse equipments, \$ *100*

Remarks: *Sick in quarters.*

Book mark:

*W. S. Thompson*



5 Cav. U.S.C.T.

*James Johnson*  
Co. M, 5 Reg't U. S. Col'd Cavalry.

Appears on

**Company Muster-in and Descriptive Roll**

of the organization named above. Roll dated

*Camp Nelson, N.Y., Oct 30,* 1864.

Where born *Madison, Ky*

Age *20* y'rs; occupation *Farmers*

When enlisted *Aug. 29*, 1864.

Where enlisted *Camp Nelson Ky.*

For what period enlisted *3* years.

Eyes *Black*; hair *Black*

Complexion *Black*; height *5* ft. *7* in.

When mustered in *Aug. 29*, 1864.

Where mustered in *Camp Nelson Ky.*

Bounty paid \$ *100*; due \$ *100*

Where credited *Dist. Ky.*

Company to which assigned

Remarks: *James Johnson*

*\*Supposed to be name of owner.*

*Added May 16. 98, H.A.J.*

Book mark:

*M. S. Johnson*

J | 5<sup>th</sup> Cav | **U.S.C.T.**

Simpson Johnson  
Com, 5<sup>th</sup> Reg't U. S. Col'd Cav

Appears on

**Company Descriptive Book**

of the organization named above.

**DESCRIPTION.**

Age 21 years; height 5 feet 7 inches.

Complexion Black

Eyes BR; hair BR

Where born Maddison Ky

Occupation Farmer

**ENLISTMENT.**

When Aug 29, 1864.

Where Camp Nelson

By whom McRandolph; term 3 y'rs.

Remarks: \_\_\_\_\_  
\_\_\_\_\_  
\_\_\_\_\_  
\_\_\_\_\_  
\_\_\_\_\_  
\_\_\_\_\_  
\_\_\_\_\_  
\_\_\_\_\_  
\_\_\_\_\_  
\_\_\_\_\_

(383g)

A. J. Anderson

Copyist.





124

Johnson Simpson  
Co No, 5 U. S. Col'd Cav.

Private | Private

CARD NUMBERS.

1	5370859	26
2	5370946	27
3	5371046	28
4	5371131	29
5	5371217	30
6	5371303	31
7	5371387	32
8	5371474	33
9	5371557	34
10	5371643	35
11	5371726	36
12	9091293	37
13		38
14		39
15		40
16		41
17		42
18		43
19		44
20		45
21		46
22		47
23		48
24		49
25		50

Book Mark: .....

See also .....

J. | **5 Cav.** | **U.S.C.T.**

*Samuel E. Johnson,*  
*Priv., Co. D., 5 Reg't U. S. Col'd Cavalry.*

Appears on **Co. Muster-out Roll**, dated  
*Helena, Ark., March 16,* 1866.

Muster-out to date *March 16,* 1866.

Last paid to *Dec. 31,* 1865.

Clothing account:

Last settled....., 186 ; drawn since \$..... 100

Due soldier \$ *58*..... 100; due U. S. \$..... 100

Am't for cloth'g in kind or money adv'd \$..... 100

Due U. S. for arms, equipments, &c., \$..... 100

Bounty paid \$..... 100; due \$..... 100

Remarks: *Transferred from 72*  
*U. S. C. I. per S. C. 127 Hd.*  
*Ar. Dept. of Ky. of 1865.*

*\*Account by Personal Ex.*

Book mark: .....

*M. Spamer.*

5 Cav. U.S.C.T.

Samuel E Johnson  
Unass. v.  
Pvt. Co. D. 5 Reg't U. S. Colored Cav.

Appears on Returns as follows:

July 1865 Gain July 27/65 Paris  
Ky. Transf. from the 72 U.S.  
Inf per O. O. 127 Hd. Qrs Dept.  
of Ky July 18/65  
Aug 1865 Transf. from 72 U.S. Inf  
Assigned to Co D Aug 1/65  
Covington, per R.O. 132, July  
27/65  
Aug to Nov. 1865 (Co D) Absent  
sick in Hospital Camp Nelson,  
Ky.

Book mark :

Austin



*S.* | **5 Cav.** | **U.S.C.T.**

*Samuel E. Johnson,*  
*Private*, Co. D, 5 Reg't U. S. Col'd Cavalry.

Appears on

**Company Muster Roll**

for *Jan'y 4<sup>th</sup> Febr'y*, 186*6*.

Present or absent *Present.*

Stoppage, \$ 100 for

Due Gov't, \$ 100 for

Valuation of horse, \$ 100

Valuation of horse equipments, \$ 100

Remarks:

Book mark:

(358)

*R. S. Dramer*

Copyist.

*J* | **5 Cav. | U.S.C.T.**  

---

*Samuel E. Johnson*  
*Priv.*, Co. D, 5 Reg't U. S. Col'd Cavalry.

Appears on

**Company Muster Roll**

for *Nov. & Dec.*, 1865.

Present or absent *present.*

Stoppage, \$ *100* for

Due Gov't, \$ *100* for

Valuation of horse, \$ *100*

Valuation of horse equipments, \$ *100*

Remarks:

-----  
-----  
-----  
-----  
-----  
-----  
-----  
-----

Book mark:

*Milliken*  
Copyist.

*J* | **5 Cav. | U.S.C.T.**

*Samuel E. Johnson*

*Priv.*, Co. D, 5 Reg't U. S. Col'd Cavalry.

Appears on

**Company Muster Roll**

for *Sept. + Oct.*, 186*5*.

Present or absent *absent*

Stoppage, \$ *100* for

Due Gov't, \$ *100* for

Valuation of horse, \$ *100*

Valuation of horse equipments, \$ *100*

Remarks: *In Hospital Camp  
Nelson Ky.*

Book mark:

*Williken*



*J* | **5 Cav.** | **U.S.C.T.**

*Samuel E. Johnson*  
*Priv.*, Co. D, 5 Reg't U. S. Col'd Cavalry.

Appears on

**Company Muster Roll**

for *July & Aug.*, 1865.

Present or absent *absent*

Stoppage, \$ *100* for

Due Gov't, \$ *100* for

Valuation of horse, \$ *100*

Valuation of horse equipments, \$ *100*

Remarks: *Assigned to Co. D /  
R.C. 132, 27 July/65. In  
Hospital Camp Nelson Ky.*

Book mark:

*Milliken*

(358)

Copyist.

J | 5 Coor | U.S.C.T.

Samuel Johnson

Pvt, Co., 5 Reg't U. S. Col'd Coor

Appears on

**M. and D. Roll of Men Transferred**

to the organization named above,

from

Roll dated July 18, 1865.

When enlisted, 186 .

Period for which enlisted 3 years.

When mustered in Dec 20, 1864.

Present or absent Not Stated

Company to which assigned

Remarks: 700

Sub for Clement Schechley

Book mark :

Abbott

(342)

Copyist.

*J* | **5 Cav. | U.S.C.T.**

*Samuel E. Johnson*

....., Co. *10*, 5 Reg't U. S. Col'd Cav.

Appears on

**Company Descriptive Book**  
of the organization named above.

**DESCRIPTION.**

Age *37* years; height *5* feet *8 1/2* inches.

Complexion *Black*

Eyes *BLK*; hair *BLK*

Where born *Tennessee*

Occupation .....

**ENLISTMENT.**

When *Dec 20*, 1864

Where *Substitute*  
*Columbus* *(O)*

By whom *Capt Nesbitt*; term *3* y'rs.

Remarks: *Transferred*  
*from 72 M. S. Co. I.*  
*Aug. 1<sup>st</sup> 1865.*

*F. E. Purke*



REP 341172

P 1805401 And. W. 2

REP 309456

52929131 (unreadable)

8-3038745- Pomm

*W. H. ...*

125

Johnson Samuel &  
Co D, 5 U. S. Col'd Cav.

Private | Private

CARD NUMBERS.

1	5359256	26
2	5363247	27
3	5363333	28
4	5363420	29
5	5363507	30
6	5363593	31
7	9090382	32
8	40729977	33
9		34
10		35
11		36
12		37
13		38
14		39
15		40
16		41
17		42
18		43
19		44
20		45
21		46
22		47
23		48
24		49
25		50

Book Mark:

See also 72 US Col'd Cav





SUBSTITUTE  
VOLUNTEER ENLISTMENT.

STATE OF

TOWN OF

*Kentucky*  *Lexington*

I, *Samuel Johnson (colored)* born in the State of *Virginia*, aged *Eighteen* years, and by occupation a *Sabotier*

Do HEREBY ACKNOWLEDGE to have agreed with *William P. Ross*, Esq., of *Nicholas County Kentucky*

to become his **SUBSTITUTE** in the Military Service, for a sufficient consideration paid and delivered to me, on the *1st* day of *September*, 186*4*;

and having thus agreed with said *William P. Ross* I DO HEREBY ACKNOWLEDGE to have enlisted this *1st* day of *September*

186*4*, to serve as a **Soldier** in the **Army of the United States of America**, for the period of **THREE YEARS**, unless sooner discharged by proper authority: I do also agree to accept such bounty, pay, rations, and clothing, as are, or may be, established by law for soldiers. And I do solemnly swear that I will bear true and faithful allegiance to the **United States of America**; that I will serve them honestly and faithfully against all their enemies or opposers whomsoever; and that I will observe and obey the orders of the President of the United States, and the orders of the Officers appointed over me, according to the Rules and Articles of War.

SWORN and subscribed to, at

this *1st* day of *Sept*, 186*4*

BEFORE

*Samuel Johnson*  
*his*  
*man*  
*Thos W Moore*  
*Capt. & Prov. Mar.*  
*7 Dist. Ky.*

We certify, on honor, That we have carefully examined the above-named Volunteer Substitute agreeably to the Regulations, and that, in our opinion, he is free from all bodily defects and mental infirmity which would in any way disqualify him from performing the duties of a soldier; that he was entirely sober when enlisted; that he is of lawful age, (not under 18 years;) and that, in accepting him as duly qualified to perform the duties of an able-bodied soldier, and as a Substitute in lieu of *William P. Ross*

, drafted in \_\_\_\_\_, 186*4*, we have strictly observed the Regulations which govern in such cases. This soldier has *Dark* eyes, *Dark* hair, *Copper* complexion; is *5* feet *6* inches high.

*Thos W Moore*

Provost Marshal.

*Orlando Brown*

Commissioner of Board.

*J. F. Gano*

Surgeon of Board.

Board of Enrollment of *7* Dist. of *Kentucky*

264

No. 2

Paul Johnson (Col.)

Enlisted at

Buxington Ky.

As Substitute for

Wm P Ross,

On the

1<sup>st</sup>

day of

Sept 1864

By

Geo H Moore

Deane Bump

J. J. Gano

Board of Enrollment

7 Dist. of

Ky.

*[Signature]*



DECLARATION OF SUBSTITUTE.

I, Samuel Johnson (colored) desiring to ENLIST  
in the Army of the United States, for THREE YEARS, **Do declare**, That I am  
Eighteen years and — months of age; that I have  
never been discharged from the United States service on account of disability or by sentence of  
a court martial; and I know of no impediment to my serving honestly and faithfully as a soldier  
for three years.

GIVEN at Georgetown Kentucky  
the 1<sup>st</sup> day of September 1864

WITNESS:

J. P. Brown.

Samuel Johnson  
mark



(No. 40.)

SUBSTITUTE  
VOLUNTEER ENLISTMENT.

STATE OF

TOWN OF

*Kentucky*

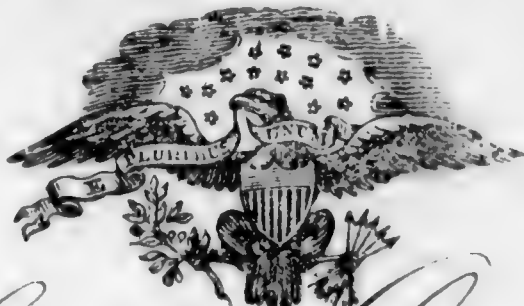

*Beyington*

I, *Samuel Johnson (Colored)* born in the State  
of *Virginia*, aged *Eighteen* years, and by  
occupation a *Sabotier* Do HEREBY ACKNOWLEDGE to have agreed with

*William J. Ross*, Esq., of *Nicholas County*  
*Kentucky*

to become his **SUBSTITUTE** in the Military Service, for a sufficient consideration paid and  
delivered to me, on the *First* day of *September*, 1864;

and having thus agreed with said *William J. Ross*, I DO HEREBY  
ACKNOWLEDGE to have enlisted this *First* day of *September*

1864, to serve as a **Soldier** in the **Army of the United States of America**, for the period  
of **THREE YEARS**, unless sooner discharged by proper authority: I do also agree to accept such  
bounty, pay, rations, and clothing, as are, or may be, established by law for soldiers. And I do  
solemnly swear that I will bear true and faithful allegiance to the **United States of America**;  
that I will serve them honestly and faithfully against all their enemies or opposers whomsoever;  
and that I will observe and obey the orders of the President of the United States, and the orders  
of the Officers appointed over me, according to the Rules and Articles of War.

SWORN and subscribed to, at *Beyington Ky.*  
this *1st* day of *Sept*, 1864 *Samuel Johnson*  
BEFORE *Thos H Moore* *mark*  
*Capt. & Prov. Mar.*  
*1st Dist. Ky.*

We certify, on honor, That we have carefully examined the above-named Volunteer Substitute  
agreeably to the Regulations, and that, in our opinion, he is free from all bodily defects and mental infirmity  
which would in any way disqualify him from performing the duties of a soldier; that he was entirely sober  
when enlisted; that he is of lawful age, (not under 18 years;) and that, in accepting him as duly qualified to  
perform the duties of an able-bodied soldier, and as a Substitute in lieu of *William J. Ross*  
....., drafted in .....

....., 1864, we have strictly observed the Regulations which govern  
in such cases. This soldier has *Dark* eyes, *Dark* hair, *Copper* complexion; is *5* feet *6*  
inches high.

*Thos H Moore*  
Provost Marshal.  
*Richard Brown*  
Commissioner of Board.  
*J. J. Gano*  
Surgeon of Board.

Board of Enrollment of *1st* Dist. of *Kentucky*

J

264

2

No.

Sam. Johnson (Co. 3)

Enlisted at

Burington Ky.

As Substitute for

Wm P. Ross

In the

1<sup>st</sup>

day of

Sept., 1864.

By

Geo H Moon

Commander

J J Gano

Board of Enrollment,

Dist. of

Ky.

Duf



JOHN 1300  
Johnson, Samuel  
Co. D, Reg't 5th U.S. Cavalry

2 Enclosures.

Red Cards .....	Final Statements .....
Burial Records .....	Furloughs or L. of A. ....
Certs. of Dis. for Discharge .....	Med. Certificates .....
C. M. Charges .....	Med. Des. Lists .....
Descriptive Lists .....	Orders .....
Discharge Certificates .....	Pris. of War Record .....
Enlistment Papers .....	Resignations .....

Other papers relating to—

Admission to Hosp'l .....	Furlough or L. of A. ....
Casualty Sheet .....	Med. Examination .....
Confinement .....	Misc. Information .....
Contracts .....	Pay or Clothing .....
Death or Effects .....	Personal Reports .....
Desertion .....	Rank .....
Discharge from Hosp'l .....	Transfer to Hosp'l .....
Discharge from Service .....	Transfer to V. R. C. ....
Duty .....	Transportation .....



*J 15* Cav. U.S.C.  
Samuel Johnson  
Pot., Co. *D*, *5* Reg't U.S. Cav.

**NOTATION.**

Book mark:

*R. P. 305794*

**War Department,**

Record and Pension Division,

Washington, *Aug. 5*, 18*92*.

The charge

*of desertion*  
*of Feb. 24, 1866*

against this man *is* removed and he is discharged  
to date *Feb. 24*, 186*6*, under the pro-  
visions of the act of Congress, approved March 2, 1889.

Discharge certificate *prepared* furnished by War Department

*Aug. 5*, 189*2*, and filed.

*Moran*

J. | 5 Cav. | U. S. C. T.

Samuel Johnson,  
Priv., Co D., 5 Reg't U. S. Col'd Cary.

Appears on Co. Muster-out Roll, dated  
Helena, Ark., March 16, 1866.

Muster-out to date \_\_\_\_\_, 186 .

Last paid to Dec. 31, 1865.

Clothing account:

Last settled \_\_\_\_\_, 186 ; drawn since \$ \_\_\_\_\_ 100

Due soldier \$ 39.19; due U. S. \$ \_\_\_\_\_ 100

Am't for cloth'g in kind or money adv'd \$ \_\_\_\_\_ 100

Due U. S. for arms, equipments, &c., \$ \_\_\_\_\_ 100

Bounty paid \$ \_\_\_\_\_ 100 due \$ \_\_\_\_\_ 100

Remarks: Deserted at Helena,

Ark., Feb 24/65

Appointed Serg't, Feb 1/1865

Reduced to Rank (May

1, 1865.

Book mark : . . . . .

M. B. G. . . . .

1870

J | 5 Cav. | U.S.C.T.  
Samuel Johnson  
Priv. Co. D, 5 Reg't U. S. Colored Cav.

Appears on Returns as follows:

Oct. 1864 to Jan. 1865 Absent sick  
in Hospl. Camp Nelson, Ky.  
date not known.

Feb. 1866 Los Angeles, Feb 24, Helena Ark  
Deserted.

Book mark:

*Austin*

(546)

Copyist.





J. 5 Cav | U.S.C.T.  
Samuel Johnson  
Reg't U. S. Col'd Cav.  
Put, Co. D, 5

Appears on

**Descriptive List of Deserters**

dated March, 1866

Deserted:

When Feb 24, 1866.

Where Helena Ark

Arrested:

When \_\_\_\_\_, 1866.

Where \_\_\_\_\_

Remarks:

Due US for  
Ordinance \$4.80

Book mark:

Rose

J | 5 Cav | U.S.C.T.  
Samuel Johnson  
Priv., Co. D, 5<sup>th</sup> Reg't U. S. Col'd Cav

Appears on

**Descriptive List of Deserters**

dated Feb 28, 1866

Deserted:

When Feb 24, 1866

Where Helena Ark

Arrested:

When, 1866

Where

Remarks: Due US for  
Ordnance \$4.00

Book mark: 54000

Rose

J. | 5 Cav. | U.S.C.T.

*Samuel Johnson,*  
*Private,* Co. D, 5 Reg't U. S. Col'd Cavalry.

Appears on

**Company Muster Roll**

for *Jan'y<sup>4<sup>th</sup></sup> Feb'y*, 186*e*.

Present or absent

Stoppage, \$ 100 for

Due Gov't, \$ 100 for

Valuation of horse, \$ 100

Valuation of horse equipments, \$ *4*, *80*/100

Remarks: *Deserted from Helena,*  
*Ark., Feb. 24/66.*

Book mark:

(358)

*R. Brauner*

Copyist.



**5 Cav. U.S.C.T.**

*J*  
*Samuel Johnson*  
*Priv.*, Co. D, 5 Reg't U. S. Col'd Cavalry.

Appears on

**Company Muster Roll**

for *Nov. + Dec.*, 1865.

Present or absent *present*

Stoppage, \$ *100* for

Due Gov't, \$ *100* for

Valuation of horse, \$ *100*

Valuation of horse equipments, \$ *100*

Remarks:

Book mark:

*Williker*

9 | 5 bar U.S.C.T.

Saml Johnson (old)

Appears with rank of Priv on

**Muster and Descriptive Roll**

of a Detachment of U.S. Substitutes  
Enlisted & Mustered, forwarded

Roll dated Lexington, Ky Oct 30<sup>th</sup>, 1865.

Where born Virginia

Age 18 years; occupation Laborer

When enlisted Sept 1, 1864.

Where enlisted Lexington, Ky.

For what period enlisted 3 years.

Eyes Blk; hair Blk

Complexion Coppr; height 5 ft. 6 in.

When mustered in Sept 1, 1864.

Where mustered in Lexington, Ky.

Bounty paid \$ 100; due \$ 100

**Clothing account:**

Last settled \_\_\_\_\_, 186 ; drawn since \$ 100

Date of first muster Sept 1, 1864.

Company to which assigned \_\_\_\_\_

Remarks: For whom substituted,  
Wm P. Ross, Enrolled man  
Credited to Nicholas Co. 7<sup>th</sup> D. Ky.

Book mark : \_\_\_\_\_

(356m) J. H. Harris Copyist.

*J* | **5 Cav. U.S.C.T.**

*Samuel Johnson*  
*Priv.*, Co. D, 5 Reg't U. S. Col'd Cavalry.

Appears on

**Company Muster Roll**

for *Sept. + Oct.*, 1865.

Present or absent *present.*

Stoppage, \$ *100* for

Due Gov't, \$ *100* for

Valuation of horse, \$ *100*

Valuation of horse equipments, \$ *100*

Remarks:

Book mark:



*J* | **5 Cav.** | **U.S.C.T.**

*Samuel Johnson*  
*Priv.*, Co. D, 5 Reg't U. S. Col'd Cavalry.

Appears on

**Company Muster Roll**

for *July & Aug.*, 186*5*.

Present or absent *present.*

Stoppage, \$ *100* for

Due Gov't, \$ *100* for

Valuation of horse, \$ *100*

Valuation of horse equipments, \$ *100*

Remarks:

Book mark:

(358) *Milliken* Copyist.

*f* | **5 Cav. U.S.C.T.**

*Samuel Johnson*

*Priv.*, Co. D, 5 Reg't U. S. Col'd Cavalry.

Appears on

**Company Muster Roll**

for *May + June*, 1865.

Present or absent *present*

Stoppage, \$ *100* for

Due Gov't, \$ *100* for

Valuation of horse, \$ *100*

Valuation of horse equipments, \$ *100*

Remarks: *Reduced from Serg't  
May 1<sup>st</sup> 1860. R.C. No. 70.*

Book mark:

(358)

*W. Williken*

Copyist.

J | **5 Cav. | U.S.C.T.**

*Samuel Johnson*  
*Pvt*, Co. D, 5 Reg't U. S. Col'd Cavalry.

Appears on

**Company Muster Roll**

for *March & April*, 1865.

Present or absent *Present.*

Stoppage, \$ *100* for

Due Gov't, \$ *100* for

Valuation of horse, \$ *100*

Valuation of horse equipments, \$ *100*

Remarks: *Reduced from Sergt.*  
*for disobedience, April*  
*27 '65 per Regt. Ord. No.*  
*70.*

Book mark: \_\_\_\_\_

*Wm. B. Scott*



*J* | **5 Cav. | U.S.C.T.**

*Samuel Johnson*

*Sgt.*, Co. D, 5 Reg't U. S. Col'd Cavalry.

Appears on

**Company Muster Roll**

for *Jan. & Feb.*, 186*5*.

Present or absent *Present.*

Stoppage, \$ *100* for

Due Gov't, \$ *100* for

Valuation of horse, \$ *100*

Valuation of horse equipments, \$ *100*

Remarks: *\* 1<sup>st</sup> installment of  
Bounty due \$100  
Appointed Sgt from  
Private per R.O. No. 27. 22  
Feb. '65 to date 1<sup>st</sup> Jan. '65.  
\* As on roll.*

Book mark:

*Amos Scott*

J. | 5 Cav. | U.S.C.P.

Samuel Johnson.  
Priv., Co. D., 5 Reg't U.S.C.C.

Appears on

**Hospital Muster Roll**

of Convalescent Camp U. S. A. Hospital,

at Camp Nelson, Ky.,

for Nov. & Dec., 1864.

Attached to hospital:

When Nov. 3, 1864.

How employed Patient.

Last paid by Maj. \_\_\_\_\_

to \_\_\_\_\_, 186 .

Bounty paid \$ 100; due \$ 100

Present or absent Present.

Remarks: \_\_\_\_\_

\_\_\_\_\_

\_\_\_\_\_

\_\_\_\_\_

\_\_\_\_\_

\_\_\_\_\_

Book mark: \_\_\_\_\_

\_\_\_\_\_

Dickerson,  
(343) Copvist.

*J* | **5 Cav. | U.S.C.T.**

*Samuel Johnson*

*Priv.*, Co. D, 5 Reg't U. S. Col'd Cavalry.

Appears on

**Company Muster Roll**

for *Nov. & Dec.*, 1864.

Present or absent *Absent.*

Stoppage, \$ *100* for

Due Gov't, \$ *100* for

Valuation of horse, \$ *100*

Valuation of horse equipments, \$ *100*

Remarks: *Sick in Hospital,  
Camp Nelson, Ky.*

Book mark:

*Wm H. Scott*



*J* | **5 Cav.** | **U.S.C.T.**

*Samuel Johnson*  
*Plt.*, Co. D, 5 Reg't U. S. Col'd Cavalry.

Appears on

**Company Muster Roll**

for *Dated Oct. 31*, 186 *4*

Present or absent *Absent*

Stoppage, \$ *100* for

Due Gov't, \$ *100* for

Valuation of horse, \$ *100*

Valuation of horse equipments, \$ *100*

Remarks: *Sick in Hospital,*  
*Camp Nelson, Ky.*

Book mark: \_\_\_\_\_

*Wm. Scott*

J | **5 Cav. U.S.C.T.**

*Samuel Johnson*

*Roll*, Co. *10*, 5 Reg't U. S. Col'd Cavalry.

Appears on

**Company Muster-in and Descriptive Roll**

of the organization named above. Roll dated

*Camp Nelson, N.Y., Oct. 24*, 1864.

Where born *Virginia*

Age *18* y'rs; occupation *Labourer*

When enlisted *Salisbury*, 186 .

Where enlisted

For what period enlisted *3* years.

Eyes *BK*; hair *BK*

Complexion *Copper*; height *5 ft. 6* in.

When mustered in *Sept. 1*, 1864.

Where mustered in *Lexington*

Bounty paid \$ *100*; due \$ *100*

Where credited *7 Dist. Ky.*

Company to which assigned

Remarks:

*\* Inherited by Townsend E. J.*

Book mark: *R. 9 305, 794*

*Amos B. Scott*

J | 5 bar | U.S.C.T.  
Saml. Johnson

Appears with rank of Private on

**Muster and Descriptive Roll**

of a Detachment of U. S. colored  
Troops forwarded for U. S. Col  
Co. at Lexington, Ky. Roll dated  
Louisville, Ky., Sept. 7, 1864.

Where born Virginia

Age 18 years; occupation Labourer

When enlisted Substitute, 186  

Where enlisted

For what period enlisted 3 years.

Eyes Blue; hair Blue

Complexion Copper; height 5 ft. 6 in.

When mustered in Sept. 1, 1864.

Where mustered in Lexington

Bounty paid \$ 100; due \$ 100

**Clothing account:**

Last settled   , 186  ; drawn since \$ 17<sup>50</sup>/<sub>100</sub>

Date of first muster Sept. 1, 1864.

Company to which assigned

Remarks: transferred to 7<sup>th</sup> Coy. Dist.  
Ky.

Book mark:

B. J. C. Turner



J | **5 Cav. U.S.C.T.**

Samuel Johnston

....., Co. W, 5 Reg't U. S. Col'd Cav.

Appears on

**Company Descriptive Book**  
of the organization named above.

**DESCRIPTION.**

Age 18 years; height 5 feet 6 inches.

Complexion Copper

Eyes BLK; hair BLK

Where born Adair Va.

Occupation Laborer

**ENLISTMENT.**

When Substitute, 186 .

Where 7 Dist. Va.

By whom .....; term 3 y'rs.

Remarks: Appointed  
Ser'gt. Feb. 1<sup>st</sup> 1865  
reduced to ranks  
for disobedience  
May. 1<sup>st</sup> 1865

A E Pucke

REP 341172

S. 1270569. P.O. NUM

Q.V.P. 554703

R.Y.P. 309456

A.Y. 1682230

S. 3036683 P.O. REF

P. 3089446 " Ref-

A.Y. 1933525

*J. H. Vincent Co*

122  
Johnson Samuel

Co D, 5 U. S. Col'd Cav.

Private | Private

CARD NUMBERS.

1	5362686	26
2	5362785	27
3	5362886	28
4	5362944	29
5	5363069	30
6	5363157	31
7	5363244	32
8	5363335	33
9	5363422	34
10	5363550	35
11	5359463	36
12	5359466	37
13	5363649	38
14	9090313-	39
15	R.P. 305,794	40
16	43146490	41
17	43154477	42
18	31413349	43
19	40729975	44
20		45
21		46
22		47
23		48
24		49
25		50

Book Mark: R.P. 305,794

See also



PROOF OF OWNERSHIP.

STATE OF KENTUCKY,  
COUNTY OF *Franklin* } SS.

We *Joseph Clarke* and *A. C. Keenon* each of lawful age, and resident citizens of the State and County aforesaid, do certify that *Ann A. S. Richardson* of the State and County aforesaid, was on the *16th* day of *September* 1864 the lawful owner of the slave named *Robert Johnson* referred to and described in the foregoing claim for compensation.

*J. Clarke*  
*A. C. Keenon*

Sworn to and subscribed before me a *Justus of the Peace* for the County of *Franklin* State of Kentucky, this the *16th* day of *December* 1864.

*Geo W Erwin - Justice Peace*  
*Franklin County Ky*



PROOF OF LOYALTY.

STATE OF KENTUCKY,  
COUNTY OF *Franklin* } SS.

We *Joseph Clarke* and *A. C. Keenon* loyal men and each of lawful age, and resident citizens of the \_\_\_\_\_ of \_\_\_\_\_ in the State and County aforesaid, upon our oaths declare that we have known *Ann A. S. Richardson* a resident of the State and County aforesaid, since the 4th day of March, 1861, and know that she has firmly and faithfully maintained his or her adherence and allegiance to the Government of the United States, by defending its cause against the Government and forces of the so-called Confederate States of America, in all suitable and practicable ways, and according to his or her ability and opportunity.

*J. Clarke*  
*A. C. Keenon*

Sworn to and subscribed before me a *Justus of the Peace* for the county of *Franklin* State of Kentucky, this the *16th* day of *December* 1864.

*Geo W Erwin - Justice Peace*  
*Franklin County Ky*



POWER OF ATTORNEY.

My Post-Office address is \_\_\_\_\_ County of \_\_\_\_\_ State of Kentucky, and I hereby direct that all communications to me, touching this claim, be sent under cover to \_\_\_\_\_, who is hereby appointed and constituted my true and lawful attorney, to prosecute this claim for me, and who is hereby authorized and empowered to receive and receipt for any award, order, draft, certificate, voucher, warrant, papers or money that may be issued in the adjustment of this claim, or the payment thereof, the same as I might or could do in person were I present and acting for myself, and to file any additional evidence or papers that may be required in the prosecution of this claim.

[WITNESS.]

The owner  
sign here.

Two witnesses to  
owner's signature  
sign here.

50 CENT  
STAMP.



Headquarters Kentucky Volunteers,

Adjutant-General's Office,

Frankfort, October 29 1866.

I hereby certify, that it appears from the U. S. Muster and Polls on file in this Office, that Robert Johnson was enrolled on the 16<sup>th</sup> day of September, 1864, at Camp Nelson Ky, by D. B. Randolph, and mustered into the U. S. service on the 16<sup>th</sup> day of September 1864, at Camp Nelson Ky, by H. C. Kinney, to serve three years. Said Robert Johnson is described as follows: Twenty age, Black eyes, Black hair, Black complexion, 5<sup>ft</sup> 7<sup>in</sup> height, and is reported as having owed service to Daniel Richardson and is credited to Franklin Co and was assigned to Co. # 5 U. S. Cavalry

In Testimony Whereof, I have hereunto set my hand, and affixed my Official Seal, this 29<sup>th</sup> day of October, 1866.

A. D. Lindsay

Adjutant General of Kentucky.



19.176 R. 167



CERTIFICATE OF AWARD OF THE BOARD OF CLAIMS.

OFFICE OF THE BOARD OF CLAIMS  
FOR SLAVES ENLISTED OR DRAFTED IN THE SERVICE OF THE U. S.

Frankfort, Kentucky,  
February 6<sup>th</sup>, 1867.

We hereby certify, that Ann J. Richardson of Franklin county, State of Kentucky, having proved, under oath, her loyalty to the Constitution and Government of the United States, and established her title as to the ownership of Robert Johnson, a slave, enlisted and mustered at Kearns Nelson, on the 16 day of Sept, 1864, by J. C. Randolph in the service of the United States, in the 5th Cavalry Regiment of Colored Troops, Co. D, the sum of Three Hundred dollars has been awarded to her by this Board, subject to the approval of the Secretary of War, as a compensation for the said slave, under the provisions of section 24, Act approved February 24, 1864, and section 2, Act approved July 28, 1866.

H. S. Mason, President of the Board.  
Geo. W. Blakey, Member of the Board.  
A. W. Atwater, Member of the Board.

To  
Chief of the Bureau for the Organization of Colored Troops, Washington, D. C.

James Richardson states that he never was the lawful owner of the negro man Robert Johnson named in the within Certificate but that said boy named him as his owner through mistake. He states that Robert Johnson was the property of said man owned by his sister Ann A. S. Richardson at the date mentioned in the within Certificate to wit the 16th day of Sept 1864 and that she is entitled to whatever compensation the U. S. Government will allow for the said Robert Johnson, he has no claim to any portion of said compensation. Subscribed and sworn to before me a Justice of the Peace for Franklin County this 6th day of Dec 1866  
Geo W Lewis J.P.C.



Franklin County, Ky

POWER OF ATTORNEY.

My Post-Office address is \_\_\_\_\_ County of \_\_\_\_\_ State of Kentucky, and I hereby direct that all communications to me, touching this claim, be sent under cover to \_\_\_\_\_, who is hereby appointed and constituted my true and lawful attorney, to prosecute this claim for me, and who is hereby authorized and empowered to receive and receipt for any award, order, draft, certificate, voucher, warrant, papers or money that may be issued in the adjustment of this claim, or the payment thereof, the same as I might or could do in person were I present and acting for myself, and to file any additional evidence or papers that may be required in the prosecution of this claim.

[WITNESS.]

The owner signs here.

Two witnesses to owner's signature sign here.

50 CENT STAMP.



No.

**C L A I M O F**

*Miss Ann A. S. Richardson*

**FOR THE COMPENSATION OF SLAVE NAMED**

*Robert Johnson*

I, *Ann A. S. Richardson* a loyal citizen, and a resident of \_\_\_\_\_,  
 County of *Franklin*, State of Kentucky, hereby claim compensation, under  
 the provisions of Section 24, act approved February 24, 1864, and section 2, act approved July, 28,  
 1866, for my slave *Robert Johnson*, enlisted *on the 16th day September*  
 1864, at *Camp Nelson Ky*, by *L. C. Randolph*  
 in the *5th* regiment U. S. Colored *Cavalry*, Co. "*H*"; certificate of  
 which enlistment, and a descriptive list, as required, accompany this application. That I did not ac-  
 quire said slave subsequent to said enlistment, but had a valid title to him at the date of said enlist-  
 ment, and previous thereto: I having acquired my title to him and my ownership over him as fol-  
 lows, to-wit: *I inherited said boy Robert Johnson*  
*from my father Geo. A. Richardson Decd*

In proof of my loyalty to the Constitution and Government of the United States, I present the ac-  
 companying oath, which I have taken, signed and acknowledged; to be filed with this application, in  
 accordance with requirement of General Orders, No. 329, 1863, War Department, Adjutant General's  
 Office.

*Ann A. S. Richardson*

, 186

**OATH OF ALLEGIANCE.**

I, *Ann A. S. Richardson*, the owner and Claimant, do solemnly swear that  
 the foregoing claim is a just and true claim due to me as <sup>*mistress*</sup> ~~master~~ and owner of the said slave, and that  
 the facts alleged in said claim in respect to the draft or enlistment (as the case may be) of said slave  
 into the Military service of the United States are true. And I do further swear that I have never  
 joined, or been concerned in, any insurrection or rebellion; that I have never borne arms against the  
 United States; that I have never given any aid, countenance, counsel or encouragement to any person  
 or persons engaged, or whom I had reason to believe were about to engage, in insurrection, rebellion  
 or armed hostility against the United States; that I have neither sought, nor accepted, nor attempted  
 to exercise the functions of any office, civil or military, nor to perform any service whatever, under  
 any authority or pretended authority in hostility to the United States; that I have not yielded a vol-  
 untary support to any insurrection, rebellion or pretended government, authority, power or constitution  
 within the United States hostile thereto. And I do further swear that, to the best of my knowledge  
 and ability, I have supported and defended, and will continue to support and defend, the United  
 States against all enemies, foreign and domestic; and that I have supported, defended and obeyed, and  
 will continue to support, defend and obey, the Constitution and laws of the United States; that I will  
 bear true faith and allegiance to the same; and that I take this oath freely, without any mental reserva-  
 tion or purpose of evasion: So help me God.

*Ann A. S. Richardson*

Sworn to and subscribed before me, at *Frankfort Ky*,  
 this *6th* day of *December*, 186*6*.



*Geo. W. Loring Justice Peace*  
*Franklin County Ky*



War Department,

ADJUTANT GENERAL'S OFFICE,

Washington, Dec 27. 1866.

Respectfully returned to the Commission for the State of Kentucky with the information that Robert Johnson was enlisted at Cassport Nelson Ky Sept 16/64, and was mustered in as Pvt. in Co. "H" 5<sup>th</sup> U.S. Col. Cav. Sept 16/64, R.S.

A. F. Rowell

W. C. H.

was,

J. B. Taylor, J. B. Taylor  
No. 1.-----

APPLICATION OF

Amos A. S. Richardson

OF

Franklin's County Ky.

FOR COMPENSATION FOR SLAVE,

Named Robert Johnson

Enlisted Sept 16<sup>th</sup> 1864,

In Com. "H", 5<sup>th</sup> Regiment,

U. S. COLORED TROOPS

Received Dec 6<sup>th</sup>, 1866

Compensation Awarded

February 6<sup>th</sup>, 1867

Three Hundred Dollars.

A. J. Moore

President of Board of Claims.

Claimant's Attorney,

Claimant's Post-office Address,

Frankfort

Ky.

FRANKFORT COMMONWEALTH PRINT.

Recd. J. B. Taylor, 18. 1867



I certify, on honor, that Sabert Harrison, a Private of  
Captain \_\_\_\_\_ Company (H) of the 5<sup>th</sup> Regiment of Vol.  
**VOLUNTEERS**, of the State of Kentucky, born in Franklin Co, State  
of Kentucky, aged 20 years; 5 feet 7 inches high; Blk complexion,  
Blk eyes, Blk hair, and by occupation a Farmer, who joined for service  
and was enrolled (see Note 9) on the 16<sup>th</sup> day of September, 1864, at Camp  
by Ch. S. Randall, for the period of Three years, and mustered into  
the service of the United States on the 16<sup>th</sup> day of September, 1864, at  
Camp, by Capt. H. C. Henry; and having served  
HONESTLY and FAITHFULLY with his Company to the present date, is now entitled to a  
**DISCHARGE** by reason of Death. Died of Inflammation  
of the Brain at Camp Dept. Jeffersonville Ind. 20. Oct. 65

The said Sabert Harrison was last paid by Paymaster  
Prof. Fisher, to include the 28<sup>th</sup> day of February, 1865, and  
has pay due him from that time to the present date; he is entitled to pay and subsistence for  
**TRAVELING** to place of enrollment, and whatever other allowances are authorized to volunteer  
soldiers, drafted men, or militia, so discharged. He has received from the United States **CLOTHING**  
amounting to 76 <sup>4.00</sup>/<sub>100</sub> dollars, since the 16<sup>th</sup> day of September  
1864, when his clothing account was last settled. He has received from the United States  
\_\_\_\_\_/<sub>100</sub> dollars advanced **BOUNTY**. First Instalment of Bounty due \$100

There is to be stopped from him, on account of the State of \_\_\_\_\_, or other  
authorities, for **CLOTHING**, &c., received on entering service, \_\_\_\_\_/100 dollars; and  
for other stoppages, viz: \_\_\_\_\_

\_\_\_\_\_ /100 dollars.  
He has been furnished with **TRANSPORTATION** in kind from the place of his discharge to  
\_\_\_\_\_; and he has been **SUBSISTED** for **TRAVELING** to his  
place of enrollment, up to the \_\_\_\_\_, 1865.

He is indebted to \_\_\_\_\_, **SUTLER**, \_\_\_\_\_/100 dollars.

He is indebted to \_\_\_\_\_, **LAUNDRESS**, \_\_\_\_\_/100 dollars.

Given in Duplicate, at Camp this 16<sup>th</sup> day  
of October, 1865.

Chas. P. Fisher

Assistant

Commanding Company.



FINAL STATEMENT

Co. "G"

*[Handwritten name]*

Reg't of *[Handwritten number]*

VOLUNTEERS.

*[Handwritten name]*

NOTE 1.—Two of these certificates (or duplicates) are to be given to each Volunteer Soldier or drafted man who may be discharged without being mustered out (Final Statements are never given to men mustered out of service) that he may at once receive from the Paymaster the pay, &c., due him, and the captain or other COMMISSIONED officer commanding the company will certify to the act of the delivery of the duplicate certificates; with these certificates the Soldier is "entitled to" his discharge, and should also present his discharge to the Paymaster to have the payment endorsed on it. The discharge is to be given back to the Soldier by the Paymaster; the latter only retaining as his vouchers the duplicate certificates.

NOTE 2.—If the Soldier is entitled to pay for the use of his horse, the Company Commander will certify to that fact on the back of both these final statements, and also to the time he has pay due for having been so mounted on his own horse.

NOTE 3.—When a Soldier is furnished with final statements, his descriptive list, if he has one, should be taken up by the officer who gives the Soldier these statements, and endorsed with a statement to this effect by the officer. The endorsement should exhibit a full statement of the time for which the Soldier was allowed pay on his final statements, the clothing account, and all other charges against him or in his favor, so as to comprise a complete exhibit of his account. It will then be transmitted to the Company Commander of the Soldier, who will enter all the data necessary to a full understanding of the Soldier's account on the muster roll upon which the Soldier's discharge is reported. The descriptive list will then be destroyed. The object of this is, that the remaining portion of the Soldier's account may be settled upon the receipt of these muster rolls, and the Soldier receive any pay or allowances that may be due him at the time of his discharge, and which may not appear on his last final statements from the fact that his descriptive list is incomplete. These accounts for back pay, &c., are settled by the 2d Auditor of the Treasury Department.

NOTE 4.—Charges for loss or injury to ordnance, horse equipments, and other miscellaneous charges, should appear under the heading of "Other Stoppages."

NOTE 5.—Bounty paid by State authorities, and not by the United States, will not be entered on this statement.

NOTE 6.—Amounts due the Sutler and Laundress must be entered on the muster roll on which the discharge, death, desertion, &c., is reported, as well as on the final statement, otherwise the amount cannot be collected from the United States.

NOTE 7.—This blank will be used for deceased volunteers and drafted men, as well as for others.

NOTE 8.—Where a Soldier dies in Hospital or on detached service, his descriptive list, if he has one, should be sent with his final statements, in duplicate, to the Adjutant General, Washington, D. C.

NOTE 9.—If the soldier is a drafted man or substitute, the space for time, &c., of enrolled, should contain only the word *drafted* or *substitute*, as the case may be. If the Soldier is a "VETERAN," (or RECRUIT,) the words as a *veteran*, (or *recruit*.) as the case may be, should be interlined after the words *mustered into the service of the U. S.* A statement of all the instalments of *Veteran* or *Recruit* *Bounty* RECEIVED by the Soldier must be made on the back of each final statement.

ADJUTANT GENERAL'S OFFICE

*[Handwritten signature]*

Duplicate with Inventory sent 2d Auditor.

RECORD OF DEATH AND INTERMENT.

Name and number of person interred.	<i>Robert Johnston 582.</i>
Number and locality of the grave . . .	<i>26 W. Military Cemetery</i>
Hospital number of the deceased . . .	<i>15837</i>
Regiment, rank, and company . . .	<i>Private Co. Ky 5<sup>th</sup> W. S. Cav.</i>
Residence before enlistment . . .	<i>Unknown</i>
Conjugal condition, (and if married, ) the residence of the widow) . . .	
Cause of death . . . . .	<i>Inflammation of the Brain.</i>
Age of the deceased . . . . .	<i>17</i>
Nativity . . . . .	<i>Kentucky</i>
References and remarks . . . . .	
Date of death and burial . . . . .	<i>Died Oct. 20<sup>th</sup> Buried Oct. 21<sup>st</sup>, 1865.</i>

[A duplicate of this Record has been forwarded to the Sexton, and another remains at this Hospital.]

To

*Adjutant Gen. U.S.A.*

SIR:

It becomes my duty to inform you that the person above described died at this Hospital as herein stated; and that it is desired his remains should be interred with the usual military honors.

Respectfully,

*S. H. Morrison*  
*Surgeon U. S. Army.*  
*2<sup>nd</sup> Lieut. U. S. A.*  
*and Mil. Asst.*

*Jefferson U.S.A.*  
MILITARY HOSPITAL,  
*Jeffersville Ind.*  
*Oct. 21<sup>st</sup> 1865*

This copy of Record is to be transmitted to the Adjutant General at Washington immediately after the place of burial and the number of the grave have been ascertained and registered. The above notification is to remain attached.

COPY OF RECORD

FOR THE

ADJUTANT GENERAL U. S. ARMY.





Jefferson U. S. Army General Hospital,

Jeffersonville Ind<sup>a</sup> Oct 20 , 1865-

Commanding Officer K Company,

5<sup>th</sup> Regt. W of Col Carl Volk

I have to inform you  
that Private Robert Johnson of your Company, died  
in this Hospital on the 20<sup>th</sup> of October 1865  
of Inflammation of Brain.

I enclose ~~his descriptive list, with pay and clothing account,~~  
~~and inventory of his effects.~~ *Trans Descriptive list in this file*

Very respectfully, yours, &c.,

S. H. Morrison  
Surgeon U. S. Army

In Charge of General Hospital.

Inventory of the effects of Private Robert Johnson  
 Company "K" 5<sup>th</sup> Regiment U.S. Col. Cav. Vol.  
 who died in the Jefferson U.S. General Hospital, Jeffersonville  
 Ind. October 20 1865.

CAPS.....	BLANKETS.....
DRESS COATS.....	KNAPSACKS.....
OVERCOATS.....	CANTEENS.....
JACKETS.....	HAVERSACKS.....
TROUSERS.....	MUSKETS.....
SHIRTS.....	BAYONETS.....
DRAWERS.....	CARTRIDGE BOX.....
BOOTS, prs.....	BELT.....
SHOES, prs.....	MONEY.....
STOCKINGS.....	

By Effect

Inventory  
 of the effects of Private  
 Robert Johnson  
 late of Co. K, 5<sup>th</sup> Regiment  
 U.S. Col. Cav., who died  
 at Jefferson U.S. General  
 Hospital Oct. 20  
 1865.  
 does not belong  
 to Co. "K"  
 S. T. Robinson  
 or Company Co





Johnson, Robert

P, Co. H.,

5

Reg

U.S.C. Cav.

4

Enclosures.

Bed Cards .....	Descriptive Lists .....
Burial Records ..... /	Final Statements ..... /
Certs. of Dis. for Discharge .....	Furloughs .....
C. M. Charges .....	Med. Des. Lists .....
Med. Certificates .....	Orders .....

Other papers relating to—

Admission to Hosp'l .....	Furlough .....
Casualty Sheet (Officer's) .....	Med. Examination .....
Confinement .....	Misc. Information .....
Contracts .....	Pay or Clothing .....
Death or Effects ..... /	Personal Reports .....
Desertions .....	Rank .....
Discharge from Hosp'l .....	Transfer to Hosp'l .....
Discharge from Service .....	Transfer to V. R. C. ....
Duty .....	Transportation .....



*J* | **5 Cav. | U.S.C.T.**

*Robert Johnson*  
*Pat*, Co. *H*, 5 Reg't U. S. Col'd Cavalry.

Appears on **Co. Muster-out Roll**, dated  
*Helena, Ark, Mar 16*, 186*6*.

Muster-out to date \_\_\_\_\_, 186 .

Last paid to \_\_\_\_\_, 186 .

**Clothing account:**

Last settled \_\_\_\_\_, 186 ; drawn since \$ \_\_\_\_\_ 100

Due soldier \$ \_\_\_\_\_ 100; due U. S. \$ \_\_\_\_\_ 100

Am't for cloth'g in kind or money adv'd \$ \_\_\_\_\_ 100

Due U. S. for arms, equipments, &c., \$ \_\_\_\_\_ 100

Bounty paid \$ \_\_\_\_\_ 100; due \$ \_\_\_\_\_ 100

Remarks: *Died of disease at*  
*Camp Jeffersonville Ind. Oct. 20. 65.*  
*in Genl. Hospital.*  
*Final Muster's forwarded.*

Book mark: \_\_\_\_\_

(861)

*J. Stewart*

Copyist.

J | 5 Cav. | U.S.C.T.  
Robert Johnson  
Priv. Co. H. 5 Reg't U. S. Colored Cav.

Appears on Returns as follows:

Jan 1865 Loss: Deserted Jan 25,  
'65 Camp Nelson.

Aug & Sept 1865 Absent sick in  
Genl Hospl, Covington, Ky  
July 20/65

Oct 1865 Died in Genl Hospl  
Oct. 20/65 Jeffersonville, Ind.

Dec 1865 Gain: Dec 1865 Helena,  
Ark Taken up from deser-  
tion, erroneously reported as  
such, having been absent  
sick, to date Jan 1865

Book mark :

Austin

*J* | *5 Cav* | **U. S. C. T.**

*Robert Johnson*  
*Priv*, Co. *H*, *5* Reg't U. S. Col'd *Cav*

Appears on

**Descriptive List of Deserters**

dated *Dec 31*, 186 *5*

Deserted:

When ....., 186 .

Where .....

Arrested:

When ....., 186 .

Where .....

Remarks: *Taken up from*  
*Desertion.*

*This man was erroneously*  
*dropped as deserter*  
*having been absent,*  
*sick, Louisville Ky.*

Book mark: .....

*Rose*



J. | 5 Cav. | U.S.C.T.

Robert Johnson  
Pvt., Co. H, 5 Reg't U. S. Col'd Cavalry.

Appears on

Company Muster Roll

for Sept. & Oct., 1865.

Present or absent

Stoppage, \$ 100 for

Due Gov't, \$ 100 for

Valuation of horse, \$ 100

Valuation of horse equipments, \$ 100

Remarks: Died in Genl Hoop's  
Jeffersonville, Ind. Sept.  
20<sup>th</sup> / 65

Book mark:

(358)

B. J. Cooke  
Copyist.

J. | **5 Cav.** | **U.S.C.T.**

*Robert Johnson*  
*Pvt*, Co. H, 5 Reg't U. S. Col'd Cavalry.

Appears on

**Company Muster Roll**

for *July & Aug.*, 1865.

Present or absent *Absent.*

Stoppage, \$ 100 for

Due Gov't, \$ 100 for

Valuation of horse, \$ 100

Valuation of horse equipments, \$ 100

Remarks: *Sick in Hospital*  
*Covington Ky July 20 1865.*

Book mark:

*B J Cooke*

*J.* | **5 Cav.** | **U.S.C.T.**

*Robert Johnson*

*Pvt.*, Co. H, 5 Reg't U. S. Col'd Cavalry.

Appears on

**Company Muster Roll**

for *May & June*, 1865.

Present or absent *Present.*

Stoppage, \$ *100* for

Due Gov't, \$ *100* for

Valuation of horse, \$ *100*

Valuation of horse equipments, \$ *100*

Remarks: *1<sup>st</sup> Installment Bounty due \$100.*

Book mark: \_\_\_\_\_

*A. J. Cooke*



*J* | **5 Cav.** | **U.S.C.T.**

*Robert Johnson*

*Pat*, Co. H, 5 Reg't U. S. Col'd Cavalry.

Appears on

**Company Muster Roll**

for *Mar & Apr*, 1865.

Present or absent *present*

Stoppage, \$ *100* for

Due Gov't, \$ *100* for

Valuation of horse, \$ *100*

Valuation of horse equipments, \$ *100*

Remarks: *1st installment of  
Bounty Due \$100*

Book mark:

*Reynolds*

J | 5 Cav | U.S.C.T.  
Robert Johnson  
Priv., Co. H 5 Reg't U. S. Col'd Cav

Appears on

**Descriptive List of Deserters**

dated Jan 31, 1865

Deserted:

When Jan 25, 1865  
Where Camp Nelson

Arrested:

When \_\_\_\_\_, 186 .  
Where \_\_\_\_\_

Remarks :  
\_\_\_\_\_  
\_\_\_\_\_  
\_\_\_\_\_  
\_\_\_\_\_

Book mark :  
\_\_\_\_\_  
Rose

J | **5 Cav. | U.S.C.T.**

*Robert Johnson*  
Put, Co. H, 5 Reg't U. S. Col'd Cavalry.

Appears on

**Company Muster Roll**

for *Jan & Feb*, 1865.

Present or absent *present*

Stoppage, \$ *100* for

Due Gov't, \$ *100* for

Valuation of horse, \$ *100*

Valuation of horse equipments, \$ *100*

Remarks: *1<sup>st</sup> Installment of  
Bounty (Due \$100,00*

Book mark: \_\_\_\_\_

*Reynolds*



*J* | **5 Cav.** | **U.S.C.T.**

*Robert Johnson*  
*Pat*, Co. H, 5 Reg't U. S. Col'd Cavalry.

Appears on

**Company Muster Roll**

for *Nov & Dec*, 1864.

Present or absent *present*

Stoppage, \$ *100* for

Due Gov't, \$ *100* for

Valuation of horse, \$ *100*

Valuation of horse equipments, \$ *100*

Remarks: *1<sup>st</sup> and 2<sup>d</sup> Installments*  
*Bonnty due. Due*  
*U.S. for Ordnance \$9.90*

Book mark:

*Reynolds*

*J* | **5 Cav.** | **U.S.C.T.**

*Robert Johnson*

*Priv*, Co. H, 5 Reg't U. S. Col'd Cavalry.

Appears on

**Company Muster Roll**

for *from enlistment to Oct 31, 1864.*

Present or absent *present*

Stoppage, \$ *100* for

Due Gov't, \$ *100* for

Valuation of horse, \$ *100*

Valuation of horse equipments, \$ *100*

Remarks:

Book mark:

*Reynolds*

J | **5 Cav.** | **U.S.C.T.**

Robert Johnson

Put, Co. H, 5 Reg't U. S. Col'd Cavalry.

Appears on

**Company Muster-in and Descriptive Roll**

of the organization named above. Roll dated

Camp Nelson, <sup>Ky</sup> N. Y., Oct 29, 1864.

Where born Franklin, Ky

Age 20 y'rs; occupation Farmer

When enlisted Sept 16, 1864.

Where enlisted Camp Nelson, Ky

For what period enlisted 3 years.

Eyes Black; hair Black

Complexion Black; height 5 ft. 7 in.

When mustered in Sept 16, 1864.

Where mustered in Camp Nelson, Ky

Bounty paid \$ 100; due \$ 100

Where credited

Company to which assigned

Remarks: 7th Dist Ky

<sup>x</sup> James Richardson

<sup>x</sup> Supposed to be name of owner

Added May 17. 98 H.A.J.

Book mark:

Reynolds



J | 5 Cav. | U.S.C.T.

Robert Johnson

Co. G, 5 Reg't U. S. Col'd Cav.

Appears on

Company Descriptive Book  
of the organization named above.

DESCRIPTION.

Age 24 years; height 5 feet 7 inches.

Complexion *Blk*

Eyes *Blk*; hair *Blk*

Where born *Franklin Ky*

Occupation *Farmer*

ENLISTMENT.

When *Sept 16, 1864*.

Where *Camp Decatur*

By whom *Capt. Canfield*; term *3* y'rs.

Remarks:

-----  
-----  
-----  
-----  
-----  
-----  
-----  
-----

*A. J. Anderson*

J 5 Cav | U.S.C.T.

Robert Johnson  
Co H 5 Reg't U.S. Col'd Cav

Appears on

**Company Descriptive Book**

of the organization named above.

**DESCRIPTION.**

Age 20 years; height 5 feet 7 inches.

Complexion Blk

Eyes Blk; hair Blk

Where born Franklin Ky

Occupation farmer

**ENLISTMENT.**

When Sep 16, 1864

Where Camp Nelson Ky

By whom H. Randolph, term 3 yrs.

Remarks: deserted Camp Nelson Ky, Jan. 21-1865, 2d Reg't, and died in Genl Hospital Jefferson Ind Oct. 20-1865

J E Parks  
Compt.

121

Johnson Robert

Co H, 5 U. S. Col'd Cav.

Priva-

Priva-

CARD NUMBERS.

1	5366815	26
2	5366906	27
3	5367006	28
4	5367097	29
5	5359384	30
6	5367189	31
7	5367285	32
8	5367374	33
9	5367481	34
10	5359456	35
11	5367259	36
12	9090817	37
13	9090903	38
14	40730004	39
15		40
16		41
17		42
18		43
19		44
20		45
21		46
22		47
23		48
24		49
25		50

Book Mark:

See also



JAN. - 9

5359310

★ 1891 ★

Dept. Circular.  
Letter dated A. G. P.  
June 29<sup>th</sup> 1865.

J | 5 | U.S.C.T.

Richard Johnson  
Priv., Co. M., 5<sup>th</sup> Reg't U. S. Col'd Calif.

Appears on an  
**Individual Muster-out Roll**  
of the organization named above. Roll dated  
Little Rock Ark, May 1, 1866.  
Muster-out to date Feb 16, 1866.  
Last paid to Oct 31, 1865.

Clothing account:  
Last settled ..... 186 ; drawn since \$ ..... 100  
Due soldier \$ ..... 100; due U. S. \$ 37<sup>44</sup> 100  
Am't for cloth'g in kind or money adv'd \$ ..... 100

Due U. S. for arms, equipments, &c., \$ ..... 100  
Bounty paid \$ 100<sup>00</sup> 100 due \$ 100<sup>00</sup> 100

Remarks: Admitted sick in Genl  
Hospital at Louisville Ky since  
Nov. 27. 65. No Discharge furnished  
stop for Ordnance cost \$ - 65<sup>00</sup>  
Mustered out to take effect  
Feb 16. 66 under War  
(over)

Book mark: .....

M. G. Hughes  
(348) Copyist.

*J* | **5 Cav. U.S.C.T.**

*Richard Johnson*  
*Prs*, Co. *M*, 5 Reg't U. S. Col'd Cavalry.

Appears on **Co. Muster-out Roll**, dated  
*Helena Ark*, *Mar 16*, 186*6*.

Muster-out to date \_\_\_\_\_, 186 .

Last paid to *Oct. 31*, 186*5*.

**Clothing account:**

Last settled \_\_\_\_\_, 186 ; drawn since \$ \_\_\_\_\_ 100

Due soldier \$ \_\_\_\_\_ 100; due U. S. \$ *37* <sup>*44*</sup>/<sub>100</sub>

Am't for cloth'g in kind or money adv'd \$ \_\_\_\_\_ 100

Due U. S. for arms, equipments, &c., \$ \_\_\_\_\_ <sup>*65*</sup>/<sub>100</sub>

Bounty paid \$ *100* 100; due \$ *100* 100

Remarks: *Absent sick in Genl Strp*  
*at Louisville, Ky since Nov. 27 '65*  
*No discharge furnished*  
*Slave Apr 19 '61*

Book mark: *V. 231 P P 64 76. Muster out*  
*in file P 7. 24 & 215. V. 142 P. 1477*

(861)

*Hyman*  
Copied.



J | 5 Cav. | U.S.C.T.  
Richard Johnson  
Privt., Co. M., 5 Reg't U. S. Colored Cav.

Appears on Returns as follows:

Oct 1864 Loss; Oct 6/64 Saltville  
Va missing in action

Nov 1865 to Feb 1866, Absent sick  
in U.S. Genl Hosp, Louis-  
ville, Ky.

Book mark :

(546)

Hustin

Copist.

1866

*J* | **5 Cav. U.S.C.T.**  
*Richard Johnson*  
*Pl*, Co. M, 5 Reg't U. S. Col'd Cavalry.

Appears on  
**Company Muster Roll**  
for *Jan + Feb*, 186*b*.  
Present or absent *Absent*

Stoppage, \$ *100* for

Due Gov't, \$ *100* for

Valuation of horse, \$ *100*

Valuation of horse equipments, \$ *100*

Remarks: *Absent pick in US Gen  
Stops Louisville, Ky.*

Book mark:

(358)

*H. J. ...*  
Copyist.

J | 3 Cav U.S.C.  
Richard Johnson  
Co. M, 3 Reg't U.S.C.

Appears on  
**Hospital Muster Roll**

of **Eruptive U. S. A. General Hospital,**

at **Louisville, Ky.,**

for Jan Feb, 1866

Attached to hospital :

When....., 186 .

How employed.....

Last paid by Maj. ....

to....., 186 .

Bounty paid \$ 100; due \$ 100

Present or absent Present

Remarks: No des Roll

Book mark : .....

Nowlin



J | 5 Cav. | U.S.C.T.

Richard Johnson

Private, Co. M, 5 Reg't U. S. Col'd Cavalry.

Appears on

Company Muster Roll

for Nov & Dec, 1865.

Present or absent Absent

Stoppage, \$ 100 for

Due Gov't, \$ 100 for

Valuation of horse, \$ 100

Valuation of horse equipments, \$ 100

Remarks: Sick in U.S. Gen Hospital  
Louisville Ky.

Book mark:

Cutes  
Copyist.

J. | 5 Car | USCT

Richard Johnson

Priv, Co. M., 5 Reg't USCT Car

Appears on

**Hospital Muster Roll**

of **U. S. A. Post Hospital,**  
**(Eruptive Branch.)**

at **Louisville, Ky.,**

for *Nov v Dec*, 186<sup>5</sup>.

**Attached to hospital:**

When ....., 186 .

How employed .....

Last paid by Maj. ....

to ....., 186 .

Bounty paid \$ 100; due \$ 100

Present or absent *Present*

Remarks :  
.....  
.....  
.....  
.....  
.....  
.....  
.....  
.....

Book mark: .....

*Og Davis*

J | 5 Cav. | U.S.C.T.

Richard Johnson

Mr., Co. M, 5 Reg't U. S. Col'd Cavalry.

Appears on

Company Muster Roll

for Sept & Oct, 186 J.

Present or absent Present

Stoppage, \$ 100 for

Due Gov't, \$ 100 for

Valuation of horse, \$ 100

Valuation of horse equipments, \$ 100

Remarks: Due US for Camp & Garrison # 155

Book mark:

Cutus

Copyist.



*J* | **5 Cav. | U.S.C.T.**  
*Richard Johnston*

*Pr*, Co. M, 5 Reg't U. S. Col'd Cavalry.

Appears on

**Company Muster Roll**

for *July + Aug*, 186*5*.

Present or absent *Present*

Stoppage, \$ 100 for

Due Gov't, \$ 100 for

Valuation of horse, \$ 100

Valuation of horse equipments, \$ 100

Remarks:

Book mark:

*Quin*

*J* | **5 Cav. | U.S.C.T.**

*Richard Johnston*  
*No.*, Co. M, 5 Reg't U.S. Col'd Cavalry.

Appears on  
**Company Muster Roll**  
for *May + June*, 1865.

Present or absent *Present*

Stoppage, \$ *100* for

Due Gov't, \$ *100* for

Valuation of horse, \$ *100*

Valuation of horse equipments, \$ *100*

Remarks: *1<sup>st</sup> Enlistment bounty*  
*due \$100*

Book mark :

*Quinn*  
Copyist.

*A.* | **5 Cav. | U.S.C.T.**

*Richard Johnson*  
*Priv.*, Co. M, 5 Reg't U. S. Col'd Cavalry.

Appears on

**Company Muster Roll**

for *Mar & Apr.*, 186*5*.

Present or absent *Present.*

Stoppage, \$ *100* for

Due Gov't, \$ *100* for

Valuation of horse, \$ *100*

Valuation of horse equipments, \$ *100*

Remarks: *1st instalment*  
*bounty due \$100*  
*Refused Apr. 28*  
*from Missing in Action*  
*at Gallville Va. Oct 2/64*

Book mark:

(358)

*M. S. Thompson*  
Copyist.



*A* | **5 Cav. | U.S.C.T.**

*Richard Johnson*  
*Co. M*, Co. M, 5 Reg't U. S. Col'd Cavalry.

Appears on

**Company Muster Roll**

for *to Oct. 31*, 186*1*.

Present or absent *Absent*

Stoppage, \$ *100* for

Due Gov't, \$ *100* for

Valuation of horse, \$ *100*

Valuation of horse equipments, \$ *100*

Remarks: *Missing in action*  
*at Ft. Sully, S. Dak. 1861.*

Book mark: \_\_\_\_\_

*W. S. Thompson*  
(358) Copyist.

J | 5 Cav. | U.S.C.T.

Richard Johnson  
Pos., Co. M, 5 Reg't U. S. Col'd Cavalry.

Appears on

**Company Muster-in and Descriptive Roll**

of the organization named above. Roll dated

Camp Nelson, N.Y., Oct 30, 1864.

Where born Lincoln Ky.

Age 30 y'rs; occupation Farmer

When enlisted Aug. 29, 1864.

Where enlisted Camp Nelson Ky.

For what period enlisted 3 years.

Eyes Black; hair Black

Complexion Black; height 5 ft. 3 in.

When mustered in Aug. 29, 1864.

Where mustered in Camp Nelson Ky.

Bounty paid \$ 100; due \$ 100

Where credited 7 Dist Ky.

Company to which assigned

Remarks: \* John Grigsby

\* Supposed to be name of owner.

Added May 16, 98. H.A.J.

Book mark:

W.S. Thompson

(356d)

Copyist.

9 | 5-lev | **U.S.C.T.**

Richard Johnson  
....., Co. M, 50 Reg't U. S. Col'd lev

Appears on

**Company Descriptive Book**

of the organization named above.

**DESCRIPTION.**

Age 37 years; height 5- feet 5- inches.

Complexion Black

Eyes BRN; hair BRN

Where born Lincoln Ky

Occupation Farmer

**ENLISTMENT.**

When Aug 24, 1864.

Where Camp Nelson

By whom J. Randolph; term 3 y'rs.

Remarks: .....

.....  
.....  
.....  
.....  
.....  
.....  
.....  
.....

R. J. Anderson



S-1480749-P.O.-m+n  
PSP 632377

*J. Townsend Esq*

120

Johnson Richard  
Co No, 5 U. S. Col'd Cav.

Private | Private

CARD NUMBERS.

1	5370858	26
2	5370982	27
3	5371216	28
4	5371302	29
5	5371386	30
6	5371473	31
7	5371558	32
8	5371644	33
9	5359310	34
10	5371727	35
11	9091292	36
12	32151191	37
13	32129444	38
14	40730003	39
15		40
16		41
17		42
18		43
19		44
20		45
21		46
22		47
23		48
24		49
25		50

Book Mark: .....

See also .....

**5 Cav. U.S.C.T.**

*J*  
*Richard Johnson*  
*Put*, Co. *C*, 5 Reg't U. S. Col'd Cavalry.

Appears on **Co. Muster-out Roll**, dated  
*Mobile Ala, March 16*, 1866.

Muster-out to date *March 16*, 1866.

Last paid to *Dec 31*, 1865.

Clothing account:

Last settled....., 186 ; drawn since \$..... 100

Due soldier \$..... 100; due U. S. \$ *129*<sup>19</sup>/<sub>100</sub>

Am't for cloth'g in kind or money adv'd \$..... 100

Due U. S. for arms, equipments, &c., \$..... 100

Bounty paid \$..... 100; due \$..... 100

Remarks *Due U.S. for Ar 75¢*

Book mark:

*Rose*



**5 Cav. U.S.C.T.**

*J*  
*Richard Johnson*  
*Priv. Co. C, 5 Reg't U. S. Colored Cav.*

Appears on Returns as follows:

*Nov 1864, Absent sick Hospl,  
Camp Nelson*

*Apr. 1865, Absent sick in Hospl  
Camp Nelson, Ky.*

*Dec 1865 Absent sick Post Hospl.  
at Helena, Ark.*

Book mark:

*Austin*

4077 500

*J* | **5 Cav.** | **U.S.C.T.**  
*Richard Johnson*  
*Pat*, Co. C, 5 Reg't U. S. Col'd Cavalry.

Appears on

**Company Muster Roll**  
for *Jan and Feb*, 1866.

Present or absent *Present*

Stoppage, \$ *100* for

Due Gov't, \$ *100* for

Valuation of horse, \$ *100*

Valuation of horse equipments, \$ *100*

Remarks:

-----  
-----  
-----  
-----  
-----  
-----  
-----  
-----

Book mark:

-----  
*Rose*





5 Cav. U.S.C.T.

*J*  
*Richard Johnson*

*Priv.*, Co. C, 5 Reg't U. S. Col'd Cavalry.

Appears on

**Company Muster Roll**

for *Sep. + Oct.*, 1865.

Present or absent *Present*

Stoppage, \$ *100* for

Due Gov't, \$ *100* for

Valuation of horse, \$ *100*

Valuation of horse equipments, \$ *100*

Remarks:

Book mark:

(358)

*Luider*  
Copyist.

**5 Cav. U.S.C.T.**

*J*  
*Richard Johnson*  
*Private*, Co. C, 5 Reg't U. S. Col'd Cavalry.

Appears on

**Company Muster Roll**

for *July & Aug*, 186*5*.

Present or absent *Present*

Stoppage, \$ *100* for

Due Gov't, \$ *100* for

Valuation of horse, \$ *100*

Valuation of horse equipments, \$ *100*

Remarks:

Book mark:

(358)

*J. J. J.*

Copyist.

*J* | **5 Cav.** | **U.S.C.T.**

*Richard Johnson*  
*Plt*, Co. C, 5 Reg't U. S. Col'd Cavalry.

Appears on

**Company Muster Roll**

for *May 7 June*, 186*5*.

Present or absent *Present*

Stoppage, \$ *100* for

Due Gov't, \$ *100* for

Valuation of horse, \$ *100*

Valuation of horse equipments, \$ *100*

Remarks:

-----  
-----  
-----  
-----  
-----  
-----  
-----  
-----  
-----

Book mark:

-----

*J. J. J.*  
Copyist.



S 15 Co 110th  
Richard Johnson  
priv, Co 110th, 5 Reg't U.S. Gen.

Appears on  
**Hospital Muster Roll**

of Nelson U. S. A. General Hospital,  
at Camp Nelson, Ky.,

for date of May 1, 1865.

Attached to hospital:

When....., 186 .

How employed.....

Last paid by Maj. Beecher

to July 28, 1865.

Bounty paid \$ 100; due \$ 100

Present or absent Present

Remarks:.....

Book mark:.....

M. C. Carthy  
(843) Capt

*J* | **5 Cav. | U.S.C.T.**

*Richard Johnson*

*Priv*, Co. C, 5 Reg't U. S. Col'd Cavalry.

Appears on

**Company Muster Roll**

for *Mar. 7 Apr.*, 186*5*.

Present or absent *Absent*

Stoppage, \$ *100* for

Due Gov't, \$ *100* for

Valuation of horse, \$ *100*

Valuation of horse equipments, \$ *100*

Remarks: *In Hospital Camp  
Nelson, Ky.*

Book mark: *100*

*Smith*

*J* | **5 Cav.** | **U.S.C.T.**

*Richard Johnson*  
*Priv*, Co. C, 5 Reg't U. S. Col'd Cavalry.

Appears on

**Company Muster Roll**

for *Jan'y. 7* *Feb'y.*, 186*5*.

Present or absent *Present*

Stoppage, \$ *100* for

Due Gov't, \$ *100* for

Valuation of horse, \$ *100*

Valuation of horse equipments, \$ *100*

Remarks:

-----  
-----  
-----  
-----  
-----  
-----  
-----  
-----  
-----  
-----

Book mark:

-----

*Shull*  
-----  
(358) Copyist.



*f* | **5 Cav. | U.S.C.T.**

*Richard Johnson*

*Pvt*, Co. C, 5 Reg't U. S. Col'd Cavalry.

Appears on

**Company Muster Roll**

for *Nov. & Dec.*, 1864.

Present or absent *Present*

Stoppage, \$ *100* for

Due Gov't, \$ *100* for

Valuation of horse, \$ *100*

Valuation of horse equipments, \$ *100*

Remarks:

Book mark:

*Shull*

(358)

Copyist.

*J* | **5 Cav. | U.S.C.T.**

*Richard Johnson*  
*Priv*, Co. C, 5 Reg't U. S. Col'd Cavalry.

Appears on

**Company Muster Roll**

for *to Oct-31*, 186 *4*.

Present or absent *Present*

Stoppage, \$ *100* for

Due Gov't, \$ *100* for

Valuation of horse, \$ *100*

Valuation of horse equipments, \$ *100*

Remarks:

Book mark:

*Shull*

J | 5 bar U.S.C.T.  
Richard Johnson (Cald)  
Appears with rank of Priv on

**Muster and Descriptive Roll**

of a Detachment of U.S. Substitutes  
Enlisted & Mustered, forwarded

Roll dated  
Lexington, Ky Oct 30, 186 5.  
Where born Kentucky  
Age 18 years; occupation Laborer  
When enlisted Aug 16, 186 4.  
Where enlisted Lexington, Ky  
For what period enlisted 3 years.  
Eyes Blk; hair Blk.  
Complexion Blk; height 5 ft. 8 in.  
When mustered in Aug 16, 186 4.  
Where mustered in Lexington, Ky  
Bounty paid \$ 100; due \$ 100

**Clothing account:**

Last settled \_\_\_\_\_, 186 \_\_\_\_; drawn since \$ 100

Date of first muster Aug 16, 186 4.

Company to which assigned \_\_\_\_\_

Remarks For whom substituted  
Wm J. Pack Enrolled man  
Credited to Scott Co. 7" D. Ky

Book mark: \_\_\_\_\_

(356m) J. H. Harris Copyist.



*J* | **5 Cav.** | **U.S.C.T.**

*Richard Johnson*

*Priv*, Co. *C*, 5 Reg't U. S. Col'd Cavalry.

Appears on

**Company Muster-in and Descriptive Roll**

of the organization named above. Roll dated

*Camp Nelson*, *Ky*, *N. Y.*, *Oct. 24*, 1864.

Where born *Kentucky*

Age *18* y'rs; occupation *Laborer*

When enlisted *Substitute*, 186 .

Where enlisted

For what period enlisted *3* years.

Eyes *Blk.*; hair *Blk.*

Complexion *Blk.*; height *5* ft. *8 1/2* in.

When mustered in *Aug. 16*, 186 .

Where mustered in *Lexington*

Bounty paid \$ *100*; due \$ *100*

Where credited *7<sup>th</sup> Dist. Ky.*

Company to which assigned *C*

Remarks:

*\* Inserted by Townsend Co*

Book mark:

*Shull*

5 bar U.C.T.  
Richard Johnson

Appears with rank of Pvt on

**Muster and Descriptive Roll**

of a Detachment of U. S. Colored  
Troops transferred to U. S. Col's  
ser. at Lexington, Ky. Roll dated  
Louisville, Ky., Aug. 2, 1864.

Where born Ky.

Age 18 years; occupation Laborer

When enlisted Substitute, 186 .

Where enlisted

For what period enlisted 3 years.

Eyes Blue; hair Blue

Complexion Blue; height 5 ft. 8 1/2 in.

When mustered in Aug. 16, 1864.

Where mustered in Lexington

Bounty paid \$ 100; due \$ 100

Clothing account:

Last settled \_\_\_\_\_, 186 ; drawn since \$ 17 55  
100

Date of first muster Aug. 16, 1864.

Company to which assigned

Remarks: Created to 7 Regt. Det.

Ky.

Book mark:

B. J. Stinson

(356m) Copyist.

2 | **5 Cav. | U.S.C.T.**

Richard Johnson

....., Co. C, 5 Reg't U. S. Col'd Cav.

Appears on

**Company Descriptive Book**  
of the organization named above.

**DESCRIPTION.**

Age 18 years; height 5 feet 8 1/2 inches.

Complexion Blk

Eyes Blk; hair Blk

Where born Ky.

Occupation Laborer

**ENLISTMENT.**

When ....., 186 .

Where substitute

By whom .....; term 5 y'rs.

Remarks: .....

.....  
.....  
.....  
.....  
.....  
.....  
.....  
.....  
.....  
.....

Warren



Johnson Richard  
Co E, 5 U. S. Col'd Cav.

Private | Private

CARD NUMBERS

1	5361695	26
2	5361797	27
3	5361889	28
4	5361983	29
5	5362066	30
6	5362147	31
7	5362235	32
8	5362325	33
9	5362411	34
10	5362495	35
11	5362580	36
12	9090234	37
13	43146261	38
14	43154465	39
15	32115724	40
16	40729974	41
17		42
18		43
19		44
20		45
21		46
22		47
23		48
24		49
25		50

Book Mark:

See also

J. | 5 Cav. | U.S.C.T.

*Tomphey Johnson,*  
*Privt., Co. D,* 5 Reg't U. S. Col'd Cavalry.

Appears on **Co. Muster-out Roll**, dated  
*Delaware, Ark., March 16,* 1866.  
Muster-out to date *March 16,* 1866.  
Last paid to *Dec. 31,* 1865.

Clothing account:

Last settled....., 186 ; drawn since \$..... 100

Due soldier \$ *16. 10/100*; due U. S. \$..... 100

Am't for cloth'g in kind or money adv'd \$..... 100

Due U. S. for arms, equipments, &c., \$..... 100

Bounty paid \$ *100. 00/100*; due \$ *100. 00/100*

Remarks:.....

Book mark: *412. 689.*

J | 5 Cav. | U.S.C.T.  
Pompey Johnson  
Priv. Co. D. 5 Reg't U. S. Colored Cav.

Appears on Returns as follows:

June 1865 Col Cook

Book mark :

Hustin



*J.* | **5 Cav.** | **U.S.C.T.**

*Pompey Johnson,*  
*Private,* Co. D, 5 Reg't U. S. Col'd Cavalry.

Appears on

**Company Muster Roll**

for *Jan'y and Febr'y*, 186*6*.

Present or absent *Present.*

Stoppage, \$.....*100* for .....

Due Gov't, \$.....*100* for .....

Valuation of horse, \$.....*100*

Valuation of horse equipments, \$.....*100*

Remarks: *2<sup>d</sup> Installment Bourn-*  
*ty due \$100.00.*

Book mark: .....

(358)

*R. B. Grammer*

Copyist.

**5 Cav. | U.S.C.T.**

*J. Pompey Johnson*  
*Priv.*, Co. D, 5 Reg't U. S. Col'd Cavalry.

Appears on

**Company Muster Roll**

for *Nov. & Dec.*, 1865.

Present or absent *present*

Stoppage, \$ *100* for

Due Gov't, \$ *100* for

Valuation of horse, \$ *100*

Valuation of horse equipments, \$ *100*

Remarks:

Book mark:

*Milliken*

(358)

Copyist.

**5 Cav. U.S.C.T.**

*J*  
*P*  
*Tompey Johnson*  
*Priv.*, Co. D, 5 Reg't U. S. Col'd Cavalry.

Appears on

**Company Muster Roll**

for *Sept. + Oct.*, 1865.

Present or absent *present*

Stoppage, \$ *100* for

Due Gov't, \$ *100* for

Valuation of horse, \$ *100*

Valuation of horse equipments, \$ *100*

Remarks: *Due U.S. for ordnance*  
*\$0.45*

Book mark:

*Milliken*



*J* | **5 Cav.** | **U.S.C.T.**

*Tompey Johnson*  
*Priv.*, Co. D, 5 Reg't U. S. Col'd Cavalry.

Appears on

**Company Muster Roll**

for *July & Aug.*, 186*0*.

Present or absent *present.*

Stoppage, \$ *100* for

Due Gov't, \$ *100* for

Valuation of horse, \$ *100*

Valuation of horse equipments, \$ *100*

Remarks:

-----  
-----  
-----  
-----  
-----  
-----  
-----  
-----

Book mark:

-----

*W. Milliken*  
(358) *W. Milliken* Copyist.

*J* | **5 Cav.** | **U.S.C.T.**

*Pompey Johnson*  
*Priv.*, Co. D, 5 Reg't U. S. Col'd Cavalry.

Appears on

**Company Muster Roll**

for *May + June*, 1865 .

Present or absent *Present*

Stoppage, \$ *100* for

Due Gov't, \$ *100* for

Valuation of horse, \$ *100*

Valuation of horse equipments, \$ *100*

Remarks: *1<sup>st</sup> Instalment Bounty due.*

Book mark: \_\_\_\_\_

*Milliken*

J | **5 Cav. | U.S.C.T.**

*Pompey Johnson*  
*Pvt.*, Co. D, 5 Reg't U. S. Col'd Cavalry.

Appears on

**Company Muster Roll**

for *March & April*, 186*5*.

Present or absent *Present*

Stoppage, \$ *100* for

Due Gov't, \$ *100* for

Valuation of horse, \$ *100*

Valuation of horse equipments, \$ *100*

Remarks: *1st installment of  
Bounty due \$100.*

Book mark:

*Wm H. Scott*



*J* | **5 Cav. | U.S.C.T.**

*Pompey Johnson*  
*Pvt.*, Co. D, 5 Reg't U. S. Col'd Cavalry.

Appears on

**Company Muster Roll**

for *Jan. & Feb.*, 1865.

Present or absent *Present.*

Stoppage, \$ *100* for

Due Gov't, \$ *100* for

Valuation of horse, \$ *100*

Valuation of horse equipments, \$ *100*

Remarks: *1st installment of  
Bounty due \$100.*

Book mark: \_\_\_\_\_

*Wm. H. Scott*

J | **5 Cav. | U.S.C.T.**

*Pompey Johnson*  
-----  
*Pvt.*, Co. D, 5 Reg't U. S. Col'd Cavalry.

Appears on

**Company Muster Roll**

for *Nov. & Dec.*, 1864.

Present or absent *Present.*

Stoppage, \$ *100* for

Due Gov't, \$ *100* for

Valuation of horse, \$ *100*

Valuation of horse equipments, \$ *100*

Remarks: *1<sup>st</sup> & 2<sup>nd</sup> installments  
of Bounty due.*

Book mark: -----

*Wm. B. Scott*

*J* | **5 Cav.** | **U.S.C.T.**

*Pompey Johnson*  
-----  
*Pvt.*, Co. D, 5 Reg't U. S. Col'd Cavalry.

Appears on

**Company Muster Roll**

for *Dated Oct. 31*, 1864.

Present or absent *Present*

Stoppage, \$ *100* for

Due Gov't, \$ *100* for

Valuation of horse, \$ *100*

Valuation of horse equipments, \$ *100*

Remarks: -----  
-----  
-----  
-----  
-----  
-----  
-----  
-----  
-----

Book mark: -----

*Wm. H. Scott*



*J* | **5 Cav.** | **U.S.C.T.**

*Pompey Johnson*  
*Pvt.*, Co. *D*, 5 Reg't U. S. Col'd Cavalry.

Appears on  
**Company Muster-in and Descriptive Roll**  
of the organization named above. Roll dated

*Camp Nelson, N.Y.*, *Oct. 24*, 1864.

Where born *Adair, Ky*

Age *38* y'rs; occupation *Farmer*

When enlisted *Aug. 15*, 1864.

Where enlisted *Lebanon*

For what period enlisted *3* years.

Eyes *Bk*; hair *Bk*

Complexion *Bk*; height *5* ft. *5 1/2* in.

When mustered in *Aug. 27*, 1864.

Where mustered in *Lebanon*

Bounty paid \$ *100*; due \$ *100*

Where credited *4 Dist. Ky*

Company to which assigned

Remarks:

-----  
-----  
-----

Book mark:

-----

*Wm H. Scott*

J | 5 bar | U.S.C.T.  
Pompey Johnson

Appears with rank of Pvt on

**Muster and Descriptive Roll**

of a Detachment of U.S. Colored  
Troops formed for U.S. Col  
Cor. at Lexington, Ky. Roll dated  
Fairfield, Ky., Sept. 7, 1864.

Where born Adair, Ky.

Age 28 years; occupation Farmer

When enlisted Aug. 15, 1864.

Where enlisted Lebanon, Ky.

For what period enlisted 3 years.

Eyes Blue; hair Blue

Complexion Blue; height 5 ft. 5 1/2 in.

When mustered in Aug. 27, 1864.

Where mustered in Lebanon

Bounty paid \$ 100; due \$ 100

Clothing account:

Last settled 1864; drawn since \$ 17 50  
100

Date of first muster Aug. 27, 1864.

Company to which assigned

Remarks: credited to Henry Fitz,  
Ky.

Book mark:

A. J. Dyer

J. | 5 bar | U.S.C.T.

Pompey Johnson

Appears with rank of ..... on

**Muster and Descriptive Roll**

of Detachment of US Colored  
Volunteer Recruits for-  
warded

Roll dated

Lebanon, Ky., Aug 31, 1864

Where born Adair Ky

Age 38 years; occupation farmer

When enlisted Aug 15, 1864

Where enlisted Lebanon Ky

For what period enlisted 3 years.

Eyes Bex; hair Bex

Complexion Bex; height 5 ft. 5 1/2 in.

When mustered in Aug 15, 1864

Where mustered in Lebanon, Ky

Bounty paid \$ 100; due \$ 100

Clothing account:

Last settled ....., 186 ; drawn since \$ 17 50 / 100

Date of first muster Aug 15, 1864

Company to which assigned

Remarks: owner, Jas L. John-

son, Adair Co.

Without consent

4 Long Dist. Ky

Book mark:

(356m)

L. D. Johnson  
Copyist.



*J* | **5 Cav. | U.S.C.T.**  

---

*Samuel Johnson*  

---

*Bl*, Co. *Bl*, 5 Reg't U. S. Col'd Cav.

Appears on  
**Company Descriptive Book**  
of the organization named above.

**DESCRIPTION.**

Age *38* years; height *5* feet *5 1/2* inches.  
Complexion *Black*  
Eyes *Blk*; hair *Blk*  
Where born *Adair Miss.*  
Occupation *farmer*

**ENLISTMENT.**

When *Aug. 15*, 186*4*.  
Where *Lebanon*  
By whom *Capt. Fidler*; term *3* y'rs.

Remarks:  
-----  
-----  
-----  
-----  
-----  
-----  
-----  
-----  
-----

*F. E. Drake*

Johnson Pompey  
Co D, 5 U.S. Col'd Cav.

Private | Private

CARD NUMBERS.

1	5362685	26
2	5362784	27
3	5362885	28
4	5362972	29
5	5363068	30
6	5363156	31
7	5363243	32
8	5363336	33
9	5363423	34
10	5363509	35
11	5363594	36
12	9090314	37
13	43145826	38
14	43146487	39
15	40729973	40
16		41
17		42
18		43
19		44
20		45
21		46
22		47
23		48
24		49
25		50

Book Mark:

See also

J | **5 Cav. U.S.C.T.**

*Oliver Johnson*  
*Pvt*, Co. *A*, 5 Reg't U. S. Col'd Cavalry.

Appears on **Co. Muster-out Roll**, dated  
*Helena Ark* *March 16* 1866.

Muster-out to date *March 16*, 1866.

Last paid to *Dec 31*, 1865.

**Clothing account:**

Last settled....., 186 ; drawn since \$..... 100

Due soldier \$..... 100; due U. S. \$ *3990* / 100

Am't for cloth'g in kind or money adv'd \$..... 100

Due U. S. for arms, equipments, &c., \$ *203* / 100

Bounty paid \$ *100* / 100; due \$ *100* / 100

Remarks: *Due U.S. for Ord*  
*\$2.03*

Book mark : .....

*W. W. Payne*  
(861) Copyist.



*J* | **5 Cav. | U.S.C.T.**

*Owen Johnson*  
*Pvt*, Co. A, 5 Reg't U. S. Col'd Cavalry.

Appears on

**Company Muster Roll**  
for *Jan & Feb*, 186 *6*  
Present or absent *Present*

Stoppage, \$ *100* for

Due Gov't, \$ *100* for

Valuation of horse, \$ *100*

Valuation of horse equipments, \$ *100*

Remarks:

Book mark:

*W. W. Payne*  
(358) Copyist.

*J* | **5 Cav. | U.S.C.T.**

*Quen Johnson*  
*Pvt*, Co. A, 5 Reg't U. S. Col'd Cavalry.

Appears on

**Company Muster Roll**

for *Nov 1865*, 186 **5**

Present or absent *Present*

Stoppage, \$ *100* for

Due Gov't, \$ *52* / *100* for *Ord*

Valuation of horse, \$ *100*

Valuation of horse equipments, \$ *100*

Remarks:

Book mark:

*W. W. Sayre*  
Copyist.

**5 Cav. U.S.C.T.**

*J. W. Johnson*  
\_\_\_\_\_  
*J. W. Johnson*  
\_\_\_\_\_, Co. A, 5 Reg't U. S. Col'd Cavalry.

Appears on

**Company Muster Roll**

for *Dated Dec 31*, 1865.

Present or absent *Present*

Stoppage, \$ \_\_\_\_\_ 100 for \_\_\_\_\_

Due Gov't, \$ \_\_\_\_\_ 100 for \_\_\_\_\_

Valuation of horse, \$ \_\_\_\_\_ 100

Valuation of horse equipments, \$ \_\_\_\_\_ 100

Remarks: \_\_\_\_\_

Book mark: \_\_\_\_\_

*J. W. Johnson*



5 Cav. U.S.C.T.

*J. W. Johnson*  
Co. A, 5 Reg't U.S. Col'd Cavalry.

Appears on

Company Muster Roll

for *J. W. Johnson*, 1865

Present or absent *Present*

Stoppage, \$ 100 for

Due Gov't, \$ 100 for

Valuation of horse, \$ 100

Valuation of horse equipments, \$ 100

Remarks:

Book mark:

*J. W. Johnson*  
Coylist.

5 Cav. U.S.C.T.

*John Johnson*  
Sgt., Co. A, 5 Reg't U. S. Col'd Cavalry.

Appears on

Company Muster Roll

for *May June*, 1865.

Present or absent *Present*

Stoppage, \$ *100* for

Due Gov't, \$ *100* for

Valuation of horse, \$ *100*

Valuation of horse equipments, \$ *100*

Remarks: *Set up attachment  
to muster due \$157.*

Book mark:

(358)

*W. Shaw*  
Copyist.

5 Cav. U.S.C.T.

*John Johnson*  
Rgt., Co. A, 5 Reg't U. S. Col'd Cavalry.

Appears on

Company Muster Roll

for *Mar. 7th*, 1865.

Present or absent *Present*

Stoppage, \$ *100* for

Due Gov't, \$ *100* for

Valuation of horse, \$ *100*

Valuation of horse equipments, \$ *100*

Remarks: *at present  
bonities due \$100.*

Book mark:

(358)

*H. H. H. H.*

Copyist.



*J* | **5 Cav. | U.S.C.T.**

*Owen Johnson*  
*Pr. +*, Co. A, 5 Reg't U.S. Col'd Cavalry.

Appears on

**Company Muster Roll**

for *Jan & Feb.*, 1865.

Present or absent *Present +*

Stoppage, \$ 100 for

Due Gov't, \$ 100 for

Valuation of horse, \$ 100

Valuation of horse equipments, \$ 100

Remarks: *1st Installment  
Bounty due \$100,*

Book mark:

(358)

*O. J. Johnson*  
Copyist.

*A* | **5 Cav.** | **U.S.C.T.**

*Owen Johnson*

*Pvt*, Co. A, 5 Reg't U. S. Col'd Cavalry.

Appears on

**Company Muster Roll**

for *Nov, Dec*, 186*4*.

Present or absent *Present*

Stoppage, \$ *100* for

Due Gov't, \$ *100* for

Valuation of horse, \$ *100*

Valuation of horse equipments, \$ *100*

Remarks: *Due U.S. for  
Ordinance # 1793,  
1st and 2d Installment  
Bonny due.*

Book mark: \_\_\_\_\_

*A. Osterling*

*A* | **5 Cav. | U.S.C.T.**

*Amel Johnson*  
*Pvt*, Co. A, 5 Reg't U.S. Col'd Cavalry.

Appears on

**Company Muster Roll**

for *to Oct, 31*, 186*4*.

Present or absent *Present*,

Stoppage, \$ *100* for

Due Gov't, \$ *100* for

Valuation of horse, \$ *100*

Valuation of horse equipments, \$ *100*

Remarks:

-----  
-----  
-----  
-----  
-----  
-----  
-----  
-----

Book mark:

*Easterling*  
(358) *Easterling* Copyist.



8 | 5 bar 1865

Owen Johnson

Appears with rank of Pvt on

**Muster and Descriptive Roll**

of Detachment of U.S. Colored Troops  
Mustered

Roll dated Louisville Ky, Sept. 13, 1864.

Where born Jefferson Co. Ky

Age 21 years; occupation Laborer

When enlisted Sept. 12, 1864.

Where enlisted Louisville Ky

For what period enlisted 3 years.

Eyes \_\_\_\_\_; hair \_\_\_\_\_

Complexion \_\_\_\_\_; height \_\_\_\_\_ ft. \_\_\_\_\_ in.

When mustered in Sept. 13, 1864.

Where mustered in Louisville Ky

Bounty paid \$ 100; due \$ 100

**Clothing account:**

Last settled \_\_\_\_\_, 186 \_\_\_\_\_; drawn since \$ 100

Date of first muster \_\_\_\_\_, 186 \_\_\_\_\_.

Company to which assigned \_\_\_\_\_

Remarks: credited to Jefferson Co. 5<sup>th</sup> Dist. Ky

Book mark : \_\_\_\_\_

*[Signature]*

*I* | **5 Cav.** | **U.S.C.T.**

*Owen Johnson*

*Bvt*, Co. *A*, 5 Reg't U. S. Col'd Cavalry.

Appears on

**Company Muster-in and Descriptive Roll**

of the organization named above. Roll dated

*Cp. Nelson Ky*, N. Y., *Oct 24*, 1864.

Where born *Jefferson Ky*

Age *20* y'rs; occupation *Laborer*

When enlisted *Sept 12*, 1864.

Where enlisted *Louisville*

For what period enlisted *3* years.

Eyes *Blk*; hair *Blk*

Complexion *Blk*; height *5 ft. 9* in.

When mustered in *Sept 13*, 1864.

Where mustered in *Louisville*

Bounty paid \$ *100*; due \$ *100*

Where credited *to the Dist Kentucky*

Company to which assigned *A*

Remarks:

Book mark:

*Cartwright*

(356d)

Copyist.

*J* | **5 Cav. | U.S.C.T.**  

---

*Judson, Owen*  

---

Co. *A*, 5 Reg't U. S. Col'd Cav.

Appears on  
**Company Descriptive Book**  
of the organization named above.

**DESCRIPTION.**

Age *20* years; height *5* feet *7* inches.  
Complexion *Blk*  
Eyes *Blk*; hair *Blk*  
Where born *Jefferson Ky*  
Occupation *Laborer*

**ENLISTMENT.**

When *Sept 21<sup>st</sup>*, 186 .  
Where *Louisville*  
By whom *Capt. Ham*; term *2* y'rs.

Remarks:  
.....  
.....  
.....  
.....  
.....  
.....  
.....  
.....

*Warren*  
.....  
(383a) Coppist.



5716674 P.O. 90  
5110913 P.O. m ver

*J. H. Mansell & Co*

717  
Johnson Owen

Co A, 5 U. S. Col'd Cav.

Private | Private

CARD NUMBERS.

1	5359652	26
2	5359753	27
3	5359853	28
4	5359950	29
5	5360045	30
6	5360137	31
7	5360226	32
8	5360318	33
9	5360409	34
10	5360497	35
11	5360584	36
12	9190026	37
13	43146692	38
14		39
15		40
16		41
17		42
18		43
19		44
20		45
21		46
22		47
23		48
24		49
25		50

Book Mark:.....

See also.....

**5 Cav. U.S.C.T.**

*J*  
*Levi Johnson*  
*Capt.*, Co. *H*, 5 Reg't U. S. Col'd Cavalry.

Appears on **Co. Muster-out Roll**, dated  
*Delaware Ark*, *Mar 16* 1866.

Muster-out to date *Mar 16*, 1866.

Last paid to *Dec 31* 1865.

**Clothing account:**

Last settled....., 186 ; drawn since \$..... 100

Due soldier \$..... 100; due U. S. \$ *32*<sup>*31*</sup>/<sub>100</sub>

Am't for cloth'g in kind or money adv'd \$..... 100

Due U. S. for arms, equipments, &c., \$..... 100

Bounty paid \$ *100* 100; due \$ *100* 100

Remarks: *Appointed Capt*  
*Aug. 18, 65*

Book mark: .....

*J. A. Stewart*



J | 5 Col'd Cav. | Mass.

L. Johnson

Priv., Co. D, 5 Reg't Mass. Colored Cav.

Appears on Returns as follows:

June 1864. Gain June  
19/64. Point of Rocks,  
Rec'd rec'd from depot.

Aug. & Sept. 1865 - absent on  
detached duty building  
bridges (and A.R. N.  
S.O. 48 - dated Ad. No.  
Leav. Bridges, Aug. 11/65.

Book mark :

(646)

H. B. King

Copyist.

5 Cav. U.S.C.T.

*J*  
*Levi Johnson*

*Capt*, Co. H, 5 Reg't U. S. Col'd Cavalry.

Appears on

**Company Muster Roll**

for *James T. Peby*, 1866.

Present or absent *Present*

Stoppage, \$ *100* for

Due Gov't, \$ *100* for

Valuation of horse, \$ *100*

Valuation of horse equipments, \$ *100*

Remarks:

Book mark:

*J. A. Stewart*  
Copyist.

1865

*J.* | **5 Cav.** | **U.S.C.T.**  
*Levi Johnson*  
*1<sup>st</sup> Corp.*, Co. H, 5 Reg't U. S. Col'd Cavalry.

Appears on

**Company Muster Roll**

for *Nov. & Dec.*, 1865.

Present or absent *Present*

Stoppage, \$ *100* for

Due Gov't, \$ *100* for

Valuation of horse, \$ *100*

Valuation of horse equipments, \$ *100*

Remarks:

Book mark:

(358)

*B. J. C. W. O. L. E.*

Copyist.



*J.* | **5 Cav.** | **U.S.C.T.**

*Levi Johnson*  
1<sup>st</sup> Corp'l, Co. H, 5 Reg't U. S. Col'd Cavalry.

Appears on

**Company Muster Roll**

for *Sept. & Oct.*, 186*5*.

Present or absent *Present.*

Stoppage, \$ 100 for

Due Gov't, \$ 100 for

Valuation of horse, \$ 100

Valuation of horse equipments, \$ 100

Remarks:

Book mark:

(358)

*B. J. Cooke*

Copyist.

J. | **5 Cav.** | **U.S.C.T.**

*Levi Johnson*  
Corpl., Co. H, 5 Reg't U. S. Col'd Cavalry.

Appears on

**Company Muster Roll**

for *July & Aug.*, 1865.

Present or absent *Present.*

Stoppage, \$ *100* for

Due Gov't, \$ *100* for

Valuation of horse, \$ *100*

Valuation of horse equipments, \$ *100*

Remarks: *Promoted by order  
"139" Hd Qrs 5th Cav Augt  
18/1865 from a Private  
to Corpl.*

Book mark:

*B. J. Coyle*

(358)

Copyist.

J. | **5 Cav.** | **U.S.C.T.**

*Levi Johnson*  
Pvt., Co. H, 5 Reg't U. S. Col'd Cavalry.

Appears on

**Company Muster Roll**

for *May & June*, 1865.

Present or absent *Present.*

Stoppage, \$ 100 for

Due Gov't, \$ 100 for

Valuation of horse, \$ 100

Valuation of horse equipments, \$ 100

Remarks: *1<sup>st</sup> Installment Bounty due \$100*

Book mark: \_\_\_\_\_

*B. J. Cooke*

(358)

Copyist.



*J* | **5 Cav. U.S.C.T.**

*Levi Johnson*

*Pat*, Co. H, 5 Reg't U. S. Col'd Cavalry.

Appears on

**Company Muster Roll**

for *Mar & Apr*, 186*5*.

Present or absent *present*

Stoppage, \$ *100* for

Due Gov't, \$ *100* for

Valuation of horse, \$ *100*

Valuation of horse equipments, \$ *100*

Remarks: *1<sup>st</sup> installment of  
Bounty Due \$100*

Book mark: \_\_\_\_\_

*Reynolds*

J | 5 Cav. | U.S.C.T.

Levi Johnson  
Pvt., Co. H, 5 Reg't U. S. Col'd Cavalry.

Appears on

**Company Muster Roll**

for Jan & Feb, 1865.

Present or absent present

Stoppage, \$ 100 for

Due Gov't, \$ 100 for

Valuation of horse, \$ 100

Valuation of horse equipments, \$ 100

Remarks: 1<sup>st</sup> Installment of  
Bounty Due \$100.00

Book mark:

Reynolds

J | **5 Cav.** | **U.S.C.T.**

*Levi Johnson*  
*Pat*, Co. H, 5 Reg't U. S. Col'd Cavalry.

Appears on

**Company Muster Roll**

for *Nov & Dec*, 186*4*.

Present or absent *present*

Stoppage, \$ 100 for

Due Gov't, \$ 100 for

Valuation of horse, \$ 100

Valuation of horse equipments, \$ 100

Remarks: *1<sup>st</sup> and 2<sup>d</sup> Installments*  
*Bounty due*

Book mark: \_\_\_\_\_

*Reynolds*



J | 5 Cav. | U.S.C.T.

Levi Johnson

Pat., Co. H, 5 Reg't U. S. Col'd Cavalry.

Appears on

Company Muster Roll

for from enlistment to Oct 31, 1864.

Present or absent present

Stoppage, \$ 100 for

Due Gov't, \$ 100 for

Valuation of horse, \$ 100

Valuation of horse equipments, \$ 100

Remarks:

Book mark:

Reynolds

*J* | **5 Cav. U.S.C.T.**

*Levy Johnson*  
*Pvt*, Co. *H*, 5 Reg't U. S. Col'd Cavalry.

Appears on

**Company Muster-in and Descriptive Roll**

of the organization named above. Roll dated

*Camp Nelson* <sup>*N.Y.*</sup> *Oct 29*, 1864.

Where born *Woodford Ky*

Age *40* y'rs; occupation *Farmer*

When enlisted *Sept 15*, 1864.

Where enlisted *Camp Nelson Ky*

For what period enlisted *3* years.

Eyes *Black*; hair *Black*

Complexion *Black*; height *5 ft. 9 in.*

When mustered in *Sept 15*, 1864.

Where mustered in *Camp Nelson Ky*

Bounty paid \$ *100*; due \$ *100*

Where credited

Company to which assigned

Remarks: *7<sup>th</sup> Dist Ky*

*x Thomas Dear*

*x Supposed to be name of owner*

*Added May 17. 98. H.A.F.*

Book mark:

*Reynolds*

*J* | **5 Cav. | U.S.C.T.**

*Levi Johnson*  
....., Co. *H*, 5 Reg't U. S. Col'd Cav.

Appears on

**Company Descriptive Book**  
of the organization named above.

**DESCRIPTION.**

Age *42* years; height *5* feet *9* inches.

Complexion *Blk*

Eyes *Blk*; hair *Blk*

Where born *Woodford*

Occupation *Farmer*

**ENLISTMENT.**

When *Sept 15, 1864.*

Where *Camp Nelson*

By whom *W. Randolph*; term *3* y'rs.

Remarks: *Permitted to enlist  
by 1 Reg't Cav 139 Aug 18/65*

(383g)

*A. J. Anderson*

Copist.



*J* | *5 Co* | **U.S.C.T.**  
*Levi Johnson*  
....., Co *5* Reg't U. S. Col'd *Co*

Appears on  
**Company Descriptive Book**  
of the organization named above.

**DESCRIPTION.**

Age *40* years; height *5* feet *9* inches.  
Complexion *Blk*  
Eyes *Blk*; hair *Blk*  
Where born *Woodford Ky*  
Occupation *farmer*

**ENLISTMENT.**

When *Sept, 15*, 186 *4*  
Where *Camp Nelson Ky*  
By whom *H. Randolph* term *3* y'rs.  
Remarks: .....

.....  
.....  
.....  
.....  
.....  
.....  
.....

*F. E. Parks*  
(383g) Copyist.

J. 642349. R<sup>d</sup> And.

S-1041340 Po off

P 1198656 P.O. M. m

R. + P. 496636

J. 2127100 H. K. R. L.

*J. H. Townsend & Co*

716

Johnson Levi

Co. H, 5 U. S. Col'd Cav.

Private

Ensign

CARD NUMBERS.

1	5366814	26
2	5366904	27
3	5367005	28
4	5367096	29
5	5367188	30
6	5367284	31
7	5367312	32
8	5367403	33
9	5367495	34
10	5367585	35
11	5367674	36
12	9090809	37
13	9090901	38
14	40731220	39
15		40
16		41
17		42
18		43
19		44
20		45
21		46
22		47
23		48
24		49
25		50

Book Mark:

See also USCCav



J | **5 Cav.** | **U.S.C.T.**

*John Johnson*  
Sgt, Co. *C*, 5 Reg't U. S. Col'd Cavalry.

Appears on Co. Muster-out Roll, dated  
*Helena Ark, March 16*, 1866.

Muster-out to date *March 16*, 1866.

Last paid to *Dec 31*, 1865.

Clothing account:

Last settled....., 186 ; drawn since \$..... 100

Due soldier \$..... 100; due U. S. \$ *68*<sup>*19*</sup>/<sub>100</sub>

Am't for cloth'g in kind or money adv'd \$..... 100

Due U. S. for arms, equipments, &c., \$..... 100

Bounty paid \$..... 100; due \$..... 100

Remarks: *Due U.S. for one Jashyn*  
*Carbine. Retained as per*  
*Gen Order No 101 War Dpt*  
*\$8, \$ 300 Bounty due as per*  
*Check Book Corroborated by*  
*Descriptive Roll.*

Book mark: *V.50. P.147.69.*

*Rose*

J | 5 Cav. | U.S.C.T.  
John Johnson  
Priv. Co. C, 5 Reg't U. S. Colored Cav.

Appears on Returns as follows:

July 1865, Gann: Assigned to Co.  
as per Reg Order #132 Paris,  
Ky. dated July 27/65

Book mark:

(546)

Huston

Copyist.

J | 5 Cav. | U.S.C.T.

John Johnson  
Pat, Co. C, 5 Reg't U. S. Col'd Cavalry.

Appears on

Company Muster Roll  
for Jan to Feb, 1866

Present or absent Present

Stoppage, \$ 100 for

Due Gov't, \$ 100 for

Valuation of horse, \$ 100

Valuation of horse equipments, \$ 100

Remarks: \$300 Bounty due  
as per Check Book  
Corroborated by  
Descriptive Roll.

Book mark:

Rose

(358)

Copyist.



*J* | **5 Cav. | U.S.C.T.**

*John Johnson*  
*Priv.*, Co. C, 5 Reg't U. S. Col'd Cavalry.

Appears on

**Company Muster Roll**

for *Nov 1869*, 1869.

Present or absent *Present*

Stoppage, \$ *100* for

Due Gov't, \$ *100* for

Valuation of horse, \$ *100*

Valuation of horse equipments, \$ *100*

Remarks: *The 30c. quantity due as per check book corroborated by Descriptive Roll.*

Book mark:

*J. Miller*

*J* | **5 Cav. | U.S.C.T.**

*John Johnson*  
*Pvt.*, Co. C, 5 Reg't U. S. Col'd Cavalry.

Appears on

**Company Muster Roll**

for *Sep + Oct*, 186*5*.

Present or absent *Present*

Stoppage, \$ *100* for

Due Gov't, \$ *100* for

Valuation of horse, \$ *100*

Valuation of horse equipments, \$ *100*

Remarks: *Transferred from 72  
U.S.C. Assigned to Co.  
I per Spect Order No 132  
Reg'd Lt's Dated July  
20/65*

Book mark:

*J. J. J.*  
Copyist.

*J* | **5 Cav.** | **U.S.C.T.**

*John Johnson*  
*Govt.*, Co. C, 5 Reg't U. S. Col'd Cavalry.

Appears on

**Company Muster Roll**

for *July* *Aug*, 186*5*

Present or absent *Present*

Stoppage, \$ *100* for

Due Gov't, \$ *100* for

Valuation of horse, \$ *100*

Valuation of horse equipments, \$ *100*

Remarks: *Transferred from*  
*72 reg't and assigned*  
*to Co per Regtl Order*  
*No 132 dated July 27*  
*1865 at Paris Ky. D 300*  
*Penalty due as per Check*  
*Book corroborated by*  
*Descriptive Roll*

Book mark:

*J. J. J. J.*  
Copyist.



J 5 Cav U.S.C.T.  
John Johnson  
Pvt, Co., 5 Reg't U. S. Col'd Cav

Appears on

**M. and D. Roll of Men Transferred**

to the organization named above,

from

Roll dated July 18, 1865.

When enlisted March 16, 1865.

Period for which enlisted 1 years.

When mustered in March 16, 1865.

Present or absent Not stated

Company to which assigned

Remarks: 1 DO

Deposit under 40305 a 40 \$300

Book mark :

(342)

Abbott

Copyist.

| **5 Cav. | U.S.C.T.**

John Johnson  
....., Co. E, 5 Reg't U. S. Col'd Cav.

Appears on

**Company Descriptive Book**  
of the organization named above.

**DESCRIPTION.**

Age 28 years; height 5 feet 4 inches.

Complexion Blk

Eyes Blk; hair Blk

Where born Richmond, Va.

Occupation Laborer

**ENLISTMENT.**

When May 14 1865

Where Cincinnati, O

By whom Capt. Jones; term 1 y'rs.

Remarks: Assigned as per  
reg. Order 132.

.....  
.....  
.....  
.....  
.....  
.....

715

Johnson John  
Co C, 5 U.S. Col'd Cav.

Private | Private

CARD NUMBERS.

1	5359252	26
2	5362238	27
3	5362328	28
4	5362414	29
5	5362498	30
6	5362583	31
7	9090237	32
8	40729972	33
9		34
10		35
11		36
12		37
13		38
14		39
15		40
16		41
17		42
18		43
19		44
20		45
21		46
22		47
23		48
24		49
25		50

Book Mark:

See also 72<sup>nd</sup> U.S. Col'd Cav.



J. | 5 Cav, | U.S.C.T.

James Johnson  
Capt., Co. 7, 5 Reg't U. S. Col'd Cavalry

Appears on Co. Muster-out Roll, dated  
Havana Ark. March 16, 1866.

Muster-out to date ..... 186 .

Last paid to ..... 186 .

Clothing account:

Last settled ..... 186 ; drawn since \$ ..... 100

Due soldier \$ ..... 100; due U. S. \$ ..... 100

Am't for cloth'g in kind or money adv'd \$ ..... 100

Due U. S. for arms, equipments, &c., \$ ..... 100

Bounty paid \$ ..... 100; due \$ ..... 100

Remarks: Discharged Sept 24.  
65. Genl Hosp Louisville,  
Ky

Book mark : .....

Posaris

J | 5 Cav. | U.S.C.T.

James Johnson

Priv. Co. F, 5 Reg't U. S. Colored Cav.

Appears on Returns as follows:

July 1865, Gain: July 29/65 Paris,  
Ky. Transf'd from the 72<sup>nd</sup>  
Inf't. Col.

July & Aug 1865 Absent sick in  
Genl. Hosp'l. Louisville, Ky.  
Sept 1865 Loss: Sept 24/65 Louis-  
ville, Disch'd. by expiration  
of service at Genl. Hosp'l. Louis-  
ville, Ky.

Book mark:

Hustin

J | 5 Cav. | U.S.C.T.

James Johnson

Pvt, Co. F, 5 Reg't U. S. Col'd Cavalry.

Appears on

Company Muster Roll

for Sept 20th, 1865.

Present or absent

Stoppage, \$ 100 for

Due Gov't, \$ 100 for

Valuation of horse, \$ 100

Valuation of horse equipments, \$ 100

Remarks: Discharged by expiration of service Sept 24, 1865. Never with the Co

No Indent on Det McCall on file

Book mark:

Hart

Copyist.



J | 5 Cav. | U.S.C.T.

James Johnson

Priv., Co. F, 5 Reg't U.S. Col'd Cavalry.

Appears on

Company Muster Roll

for July & Aug, 1865.

Present or absent Absent

Stoppage, \$ 100 for

Due Gov't, \$ 100 for

Valuation of horse, \$ 100

Valuation of horse equipments, \$ 100

Remarks: Assigned to Co from 72  
Co. in Dept by Regt order No. dated  
July 28. Com of Ser transferred  
by Dept order No 127.  
Served in Regt Louisville Ky  
since Feb 18

Book mark:

W. A. C. Copyist.

J | 5 Cav | U.S.C.T.

James Johnson  
Pvt, Co., 5 Reg't U. S. Col'd Cav

Appears on

**M. and D. Roll of Men Transferred**

to the organization named above,

from .....

Roll dated July 18, 1865.

When enlisted ....., 186 .

Period for which enlisted 1 years.

When mustered in Sept 24, 1864.

Present or absent .....

Company to which assigned .....

Remarks: Drafted

Commencement of Service  
Jan 14 1865  
Absent sick since Feb 18 865

Book mark : .....

Abbott  
Copyist.

*J* | **5 Cav. | U.S.C.T.**

*Johnson, James*  
....., Co. *F*, 5 Reg't U. S. Col'd Cav.

Appears on

**Company Descriptive Book**  
of the organization named above.

**DESCRIPTION.**

Age *24* years; height *5* feet *4* inches.

Complexion *Blk*

Eyes *Blk*; hair *Blk*

Where born *Edmundson Ky*

Occupation *laborer*

**ENLISTMENT.**

When ....., 186 .

Where *Drapped*

By whom .....; term *1* y'rs.

Remarks:

*at Owensburg Ky*

.....  
.....  
.....  
.....

*J E Purse*



Johnson James  
Co F, 5 U.S. Col'd Cav.

Private | Private

CARD NUMBERS.

1	5359257	26
2	5365276	27
3	5365420	28
4	5365705	29
5	9090628	30
6	40729971	31
7		32
8		33
9		34
10		35
11		36
12		37
13		38
14		39
15		40
16		41
17		42
18		43
19		44
20		45
21		46
22		47
23		48
24		49
25		50

Book Mark:

See also 72 U.S. Col'd Cav.

J. 5 Cav, U. S. C. T.

Corwin Johnson,  
Priv., Co D, 5 Reg't U. S. Col'd Cavalry.

Appears on Co. Muster-out Roll, dated

Helena, Ark., March 16, 1866.

Muster-out to date \_\_\_\_\_, 186 .

Last paid to *Enlistment*, 186 .

Clothing account:

Last settled \_\_\_\_\_, 186 ; drawn since \$ \_\_\_\_\_ 100

Due soldier \$ \_\_\_\_\_ 100; due U. S. \$ *46.<sup>17</sup>/<sub>100</sub>*

Am't for cloth'g in kind or money adv'd \$ \_\_\_\_\_ 100

Due U. S. for arms, equipments, &c., \$ \_\_\_\_\_ 100

Bounty paid \$ \_\_\_\_\_ 100 due \$ *100.<sup>00</sup>/<sub>100</sub>*

Remarks: *Deserted at Louisville,*

*Ky., July 27/65*

*Transferred from 72 U. S. Col.,  
Inftry. per S. C. 127 Ad. Ord.  
Dir. of Ky. of 1865.*

*Never joined Company.*

Book mark: *1694 C. T. 1881.*

*P. W. Grammer*

J | 5 Cav. | U.S.C.T.  
Irvin Johnson  
Priv. <sup>Unass. v.</sup> Co. D. 5 Reg't U. S. Colored Cav.

Appears on Returns as follows:

July 1865 Gain, July 27/65 Paris Ky.  
Transf. from the 72 US Col  
per R O # 127 Hdqrs Dept of Ky.  
July 1865  
Aug. 1865, Transf. from 72 US Col. As-  
signed to Co D, Aug. 1/65, Coving-  
ton, per R O # 132 July 27/65,  
(Co D) Loss: Deserted. Assigned  
to Co. Never reported.

Book mark:

Austin



J. Flau | U.S.C.T.  
Irvin Johnson  
Priv., Co. D, 5 Reg't U. S. Col'd Cav.

Appears on

**Descriptive List of Deserters**

dated Aug 31, 1865.

Deserted:

When Unknown, 186 .

Where Unknown

Arrested:

When \_\_\_\_\_, 186 .

Where \_\_\_\_\_

Remarks: Transf'd as absent  
without leave from  
72 U.S.C.S.

Book mark: \_\_\_\_\_

Rose

**5 Cav. U.S.C.T.**

*Irvin Johnson*  
*Priv.*, Co. D, 5 Reg't U. S. Col'd Cavalry.

Appears on

**Company Muster Roll**

for *July & Aug*, 1865.

Present or absent

Stoppage, \$ 100 for

Due Gov't, \$ 100 for

Valuation of horse, \$ 100

Valuation of horse equipments, \$ 100

Remarks: *Assigned to lead D p. R.C.,  
132 July 27/65. Never reported  
to lead.*

Book mark:

*Milliken*

J | 5<sup>th</sup> Cav | U.S.C.T.

Irvin Johnson  
Pvt, Co....., 5<sup>th</sup> Reg't U. S. Col'd Cav

Appears on

**M. and D. Roll of Men Transferred**

to the organization named above,

from .....

Roll dated July 18, 1865.

When enlisted Apr 20, 1865.

Period for which enlisted 3 years.

When mustered in Apr 20, 1865.

Present or absent .....

Company to which assigned .....

Remarks: Due US for Ord \$1.77

Absent without leave

Book mark : .....

Abbott



*J* | **5 Cav. | U.S.C.T.**  
*Irvin Johnson*  
....., Co. *B*, 5 Reg't U. S. Col'd Cav.

Appears on

**Company Descriptive Book**  
of the organization named above.

**DESCRIPTION.**

Age *28* years; height *5* feet *10 1/4* inches.

Complexion *Yellow*

Eyes *Blk*; hair *Blk*

Where born *Woodford Ky*

Occupation *farmer*

**ENLISTMENT.**

When *April 20*, 186*5*

Where *Covington*

By whom *Wm Mitchell* term *3* y'rs.

Remarks: *Transferred*  
*from 7<sup>th</sup> U. S. C.*  
*I never joined*  
*this company*  
*Appointed Sergt.*  
*No date Sep 1<sup>st</sup> 1865*

*See on roll*

*X E Parks*

713

Johnson Edwin  
Co D, 5 U. S. Col'd Cav.

Private | Private

CARD NUMBERS.

1	5359253	26
2	5363289	27
3	5359425	28
4	5363648	29
5	9090379	30
6	40729970	31
7		32
8		33
9		34
10		35
11		36
12		37
13		38
14		39
15		40
16		41
17		42
18		43
19		44
20		45
21		46
22		47
23		48
24		49
25		50

Book Mark: 1694 G. P. 1881

See also 72 U.S. Col'd Cav.



UNITED STATES COLORED TROOPS ENLISTMENT.

STATE OF *Kentucky* TOWN OF *Adair* County of *Adair*

I, *Henry Johnson* born in *Adair* in the State of *Kentucky* aged *25* years and by occupation a *farmer* Do HEREBY ACKNOWLEDGE to have volunteered *15* day of *August* 1864

to serve as a Soldier in the Army of the United States of America, for the period of THREE YEARS, unless sooner discharged by proper authority: Do also agree to accept such bounty, pay, rations, and clothing, as are, or may be, established by law for the U. S. colored troops.

And I, *Henry Johnson* do solemnly swear that I will bear true faith and allegiance to the United States of America, and that I will serve them honestly and faithfully against all their enemies or opposers whomsoever; and that I will observe and obey the orders of the President of the United States, and the orders of the officers appointed over me, according to the Rules and Articles of War.

Sworn and subscribed to, at *Lebanon Ky* this *15<sup>th</sup>* day of *August, 1864* *Henry Johnson* his *mark* Before *J. M. Fuller* *Capt & Prov. Mar 40<sup>th</sup> Ky*

I CERTIFY, ON HONOR, That I have carefully examined the above named Volunteer agreeably to the General Regulations of the Army, and that, in my opinion, he is free from all bodily defects and mental infirmity, which would in any way disqualify him from performing the duties of a soldier.

*John C. Maxwell*

EXAMINING SURGEON.

I CERTIFY, ON HONOR, That I have minutely inspected the Volunteer, previously to his enlistment, and that he was entirely sober when enlisted; that, to the best of my judgment and belief, he is of lawful age; and that, in accepting him as duly qualified to perform the duties of an able-bodied soldier, I have strictly observed the regulations which govern the recruiting service. This soldier has *black* eyes, *black* hair, *black* complexion, is *6* feet *—* inches high.

*J. M. Fuller*

*Capt & Prov. Mar. 40<sup>th</sup> Ky.* RECRUITING OFFICER OR AGENT.

Mustered into the United States Service *27<sup>th</sup>* day of *Aug* 1864

*J. M. Fuller*

*Capt & Prov. Mar 40<sup>th</sup> Ky* Mustering Officer

Mustered into the service of the United States, for three years or during the war, from date of enlistment, in Company *—* Regiment of *—* Volunteers, on the *—* day of *—*, 1864, at *—*



This blank will be used for enlistments of United States colored troops. They will be made out in duplicate in all cases—one to accompany the recruiting  
 the superintendent (not the recruiting officer) to the Adjutant General, and one to accompany the accounts of the officer who pays bounty, &c.  
 An enlistment holds to service. A muster-in must, in all cases, precede payment of pay, bounty, pension, &c. A muster-in roll, must in all cases, be filed in  
 and General's Office as evidence of muster-in. The recruiting officer, commissary, or assistant commissary of musters, as the case may be, will countersign both  
 its as having mustered the soldier into the service of the United States before either of them is given to the disbursing officer.

DECLARATION OF RECRUIT.

I, *Henry Johnson* ..... desiring  
 to volunteer as a soldier in the ARMY OF THE UNITED STATES, for the term of *Three Years*,  
 DO DECLARE That I am *25* years and ..... months of age; that I have  
 never been discharged from the United States service on account of disability or by sentence of a  
 court-martial, or by order before the expiration of a term of enlistment; and I know of no  
 impediment to my serving honestly and faithfully as a soldier for three years.

GIVEN at *Lebanon Ky*  
 the *15<sup>th</sup>* day of *August 1864*

Witness *Joseph C. Cull*

*Slave*

*Master's name*  
*James L. Johnson*

*entitled without consent*

*Henry Johnson*  
*mark*  
 Volunteered at *Lebanon Ky*  
 on *15<sup>th</sup> August 1864*  
 by *Wm. G. Miller*  
*Capt. H. V. Brown Quartermaster*  
*Henry Johnson*  
*H. O. By*

No. *Seble one*

Consent of Parent or Guardian in case of a Minor, if a Free Man, or in the case of  
 a Slave, of the Person to whom he owes Service:

I, ..... Do CERTIFY, That I am  
 the .....  
 that the said ..... is ..... years of age; and I  
 do freely give my CONSENT to his volunteering as a SOLDIER in the Army of the United States,  
 for the period of THREE YEARS, under the conditions of the laws of the United States.

GIVEN at .....  
 the ..... day of .....

Johnson, Henry

, Co.

*D*

*5*

Reg't

*USCW*

*1* Inclosures.

Bed Cards .....	Final Statements .....
Burial Records .....	Furloughs or L. of A. ....
Certs. of Dis. for Discharge .....	Med. Certificates .....
C. M. Charges .....	Med. Des. Lists .....
Descriptive Lists .....	Orders .....
Discharge Certificates .....	Pris. of War Record .....
Enlistment Papers <i>1</i> .....	Resignations .....

Other papers relating to—

Admission to Hosp'l .....	Furlough or L. of A. ....
Casualty Sheet .....	Med. Examination .....
Confinement .....	Misc. Information .....
Contracts .....	Pay or Clothing .....
Death or Effects .....	Personal Reports .....
Desertion .....	Rank .....
Discharge from Hosp'l .....	Transfer to Hosp'l .....
Discharge from Service .....	Transfer to V. R. C. ....
Duty .....	Transportation .....

J. | **5 Cav.** | **U.S.C.T.**

*O Henry Johnson,*  
Sergt., Co. *D*, 5 Reg't U. S. Col'd Cavalry.

Appears on **Co. Muster-out Roll**, dated  
*Selema, Ark., March 16,* 186*6*.

Muster-out to date *March 16,* 186*6*.

Last paid to *Dec. 31,* 186*5*.

Clothing account:

Last settled....., 186 ; drawn since \$..... 100

Due soldier \$ *43.<sup>15</sup>* 100; due U. S. \$..... 100

Am't for cloth'g in kind or money adv'd \$..... 100

Due U. S. for arms, equipments, &c., \$..... 100

Bounty paid \$ *100.<sup>00</sup>* 100; due \$ *100.<sup>00</sup>* 100

Remarks: *Appointed Sergt. from*  
*Private Febr. 23, 1866.*

Book mark : .....

*R. S. Dummer*



J | 5 Cav. | U.S.C.T.

Henry Johnson  
Pvt. Bugler } Co. D, 5 Reg't U. S. Colored Cav.  
Sergt.

Appears on Returns as follows:

Jan 1865 Absent sick in Hospital  
Camp Nelson, Ky.

Aug 1865 (Bugler) On duty Hd. Qrs  
Sept 1865 On duty with Regt Band  
Oct 1865 to Jan 1866 (Pvt) On duty,  
Regt. Band  
Feb 1866 (Sergt) On duty in Regt  
Band

Book mark :

Justin

J. | 5 Cav. | U.S.C.T.

*Henry Johnson,*  
Sergt., Co. D, 5 Reg't U. S. Col'd Cavalry.

Appears on

**Company Muster Roll**

for *Jan'y<sup>4</sup> & Febr'y*, 186*e*.

Present or absent *Present.*

Stoppage, \$ *100* for

Due Gov't, \$ *100* for

Valuation of horse, \$ *100*

Valuation of horse equipments, \$ *100*

Remarks: *Promoted from Private*  
*p. R. O. 32 Feb. 23, 186e. On*  
*daily Regt. Band.*  
*2<sup>d</sup> Installment Bounty*  
*due \$ 100.00.*

Book mark:

(358)

*W. D. G.anner*

Copyist.

*J* | **5 Cav. | U.S.C.T.**

*Henry Johnson*  
*Priv.*, Co. D, 5 Reg't U. S. Col'd Cavalry.

Appears on

**Company Muster Roll**

for *Nov. & Dec.*, 1865.

Present or absent *present*

Stoppage, \$ *100* for

Due Gov't, \$ *100* for

Valuation of horse, \$ *100*

Valuation of horse equipments, \$ *100*

Remarks: *Daily duty Reg'l Band*  
*R.O. 125 Aug. 29/65.*

Book mark:

*Miliken*



*J* | **5 Cav.** | **U.S.C.T.**

*Henry Johnson*  
*Priv.*, Co. D, 5 Reg't U. S. Col'd Cavalry.

Appears on

**Company Muster Roll**

for *Sept. & Oct.*, 1865.

Present or absent *present*

Stoppage, \$ *100* for

Due Gov't, \$ *100* for

Valuation of horse, \$ *100*

Valuation of horse equipments, \$ *100*

Remarks: *Due U.S. for camp & Garrison \$6.20. Daily duty Regt. Band.*

Book mark:

*Milliken*

*J* | **5 Cav.** | **U.S.C.T.**  
*Henry Johnson*  
*Bugler*, Co. D, 5 Reg't U. S. Col'd Cavalry.

Appears on

**Company Muster Roll**

for *July & Augt*, 1865.

Present or absent *present.*

Stoppage, \$ *100* for

Due Gov't, \$ *100* for

Valuation of horse, \$ *100*

Valuation of horse equipments, \$ *100*

Remarks:

-----  
-----  
-----  
-----  
-----

Book mark:

*Milliken*  
(358) Copyist.

*A* | **5 Cav.** | **U.S.C.T.**

*Henry Johnson*  
*Bugler*, Co. D, 5 Reg't U. S. Col'd Cavalry.

Appears on

**Company Muster Roll**

for *May + June*, 1865.

Present or absent *Present.*

Stoppage, \$ *100* for

Due Gov't, \$ *100* for

Valuation of horse, \$ *100*

Valuation of horse equipments, \$ *100*

Remarks: *1<sup>st</sup> Instal'n't Bounty due \$100.00.*

Book mark: \_\_\_\_\_

*Williken*



J | **5 Cav. | U.S.C.T.**

*Henry Johnson*  
*Bugler*, Co. D, 5 Reg't U. S. Col'd Cavalry.

Appears on

**Company Muster Roll**

for *March & April*, 186*5*.

Present or absent *Present*

Stoppage, \$ *100* for

Due Gov't, \$ *100* for

Valuation of horse, \$ *100*

Valuation of horse equipments, \$ *100*

Remarks: *1st installment of*  
*Penalty due \$100.*

Book mark: \_\_\_\_\_

*Wm. B. Scott*

*I* | **5 Cav. U.S.C.T.**

*Henry Johnson*

*Pvt.*, Co. D, 5 Reg't U. S. Col'd Cavalry.

Appears on

**Company Muster Roll**

for *Jan. & Feb.*, 186*5*.

Present or absent *Present.*

Stoppage, \$ *100* for

Due Gov't, \$ *100* for

Valuation of horse, \$ *100*

Valuation of horse equipments, \$ *100*

Remarks: *1<sup>st</sup> installment of  
Bounty due \$100. Ap-  
pointed Bugler from  
Private per R.C. 29, 27 Feb.  
65 to date 1<sup>st</sup> Jan. '65.*

Book mark:

*Wm. B. Scott*

(358)

Copyist.

J | **5 Cav.** | **U.S.C.T.**

*Henry Johnson*  
-----  
*Plt.*, Co. D, 5 Reg't U. S. Col'd Cavalry.

Appears on

**Company Muster Roll**

for *Nov. & Dec.*, 1864.

Present or absent *Present.*

Stoppage, \$ *100* for

Due Gov't, \$ *100* for

Valuation of horse, \$ *100*

Valuation of horse equipments, \$ *100*

Remarks: *1<sup>st</sup> & 2<sup>nd</sup> installments  
of Bounty dues.*

Book mark: -----

*Wm. H. Scott*



J | **5 Cav.** | **U.S.C.T.**

Henry Johnson  
Priv., Co. D, 5 Reg't U. S. Col'd Cavalry.

Appears on

**Company Muster Roll**

for Dated Oct. 31, 1864.

Present or absent Present.

Stoppage, \$ 100 for

Due Gov't, \$ 100 for

Valuation of horse, \$ 100

Valuation of horse equipments, \$ 100

Remarks: \_\_\_\_\_

Book mark: \_\_\_\_\_

Wm. B. Scott

**5 Cav. U.S.C.T.**

*J*  
*Henry Johnson*

*Pvt.*, Co. *B*, 5 Reg't U. S. Col'd Cavalry.

Appears on

**Company Muster-in and Descriptive Roll**

of the organization named above. Roll dated  
*Camp Nelson, Ky*, *Oct. 24*, 1864.

Where born *Adair, Ky*

Age *25* y'rs; occupation *Farmer*

When enlisted *Aug. 15*, 1864.

Where enlisted *Lebanon*

For what period enlisted *3* years.

Eyes *Bk*; hair *Bk*

Complexion *Bk*; height *6* ft. *in.*

When mustered in *Aug. 27*, 1864.

Where mustered in *Lebanon*

Bounty paid \$ *100*; due \$ *100*

Where credited *4 Dist. Ky*

Company to which assigned

Remarks:

Book mark:

*Wm. H. Scott*

(356d)

Copyist.

J | 5 bar | U.S.C.T.

Henry Johnson

Appears with rank of Pvt on

**Muster and Descriptive Roll**

of a Detachment of U.S. Colored Troops formed for U.S. service at Lexington, Ky. Roll dated Franklin, Ky., Sept. 7, 1864.

Where born Adair, Ky.

Age 25 years; occupation Farmer

When enlisted Aug. 15, 1864.

Where enlisted Lebanon, Ky.

For what period enlisted 3 years.

Eyes Blue; hair Blue

Complexion Blue; height 6 ft. in.

When mustered in Aug. 27, 1864.

Where mustered in Lebanon

Bounty paid \$ 100; due \$ 100

Clothing account:  
Last settled \_\_\_\_\_, 186 ; drawn since \$ 1750/100

Date of first muster Aug. 27, 1864.

Company to which assigned \_\_\_\_\_

Remarks: Created to Henry J. Johnson  
Ky.

Book mark: \_\_\_\_\_

B. J. D. Danner



J | 5 bar | U.S. Col.

Henry Johnson

Appears with rank of ..... on

**Muster and Descriptive Roll**

of Detachment of US Colored  
Volunteer Recruits for-  
warded Roll dated

Lebanon Ky, Aug 31, 1864.

Where born Adair Ky

Age 25 years; occupation farmer

When enlisted aug 15, 1864.

Where enlisted Lebanon Ky

For what period enlisted 30 years.

Eyes blk; hair blk

Complexion blk; height 6 ft. - in.

When mustered in aug 15, 1864.

Where mustered in Lebanon Ky

Bounty paid \$ 100; due \$ 100

Clothing account:

Last settled ....., 186 ; drawn since \$ 17<sup>50</sup>/<sub>100</sub>

Date of first muster aug 15, 1864.

Company to which assigned .....

Remarks: owner, Jas L Johnson,

Adair Co.

Without consent

4 Long Dist Ky

Book mark: .....

.....

.....

.....

.....

.....

.....

.....

.....

.....

.....

.....

.....

.....

.....

.....

.....

.....

.....

(356m)

L. S. Mason

Copyist.

*J* | **5 Cav. | U.S.C.T.**

*Henry Johnson*

*Co. A*, 5 Reg't U. S. Col'd Cav.

Appears on

**Company Descriptive Book**  
of the organization named above.

**DESCRIPTION.**

Age *25* years; height *6* feet.....inches.

Complexion *Black*

Eyes *Blk*; hair *Blk*

Where born *Adair Ky.*

Occupation *farmer*

**ENLISTMENT.**

When *Aug 15*, 186 *4*.

Where *Lebanon*

By whom *Capt. Siller*; term *3* y'rs.

Remarks: *Appointed*  
*Drum Major*  
*1<sup>st</sup> 1865*

.....  
.....  
.....  
.....  
.....

*F. E. Purke*

0690396 P. M. M.

5727508 P. O. aff

5798057 P. O. aff

A. 3215692 P. O. aff

W. H. M. Co



112

Johnson Henry

Co D, 5 U. S. Col'd Cav.

Private

Sergeant

CARD NUMBERS.

1	5362684	26
2	5362783	27
3	5362884	28
4	5362973	29
5	5363045	30
6	5363132	31
7	5363218	32
8	5363337	33
9	5363424	34
10	5363475	35
11	5363560	36
12	9090313	37
13	43745827	38
14	43146488	39
15	40729969	40
16		41
17		42
18		43
19		44
20		45
21		46
22		47
23		48
24		49
25		50

Book Mark:

See also

*J* | **5 Cav. | U.S.C.T.**

*Harvey Johnson*  
*Plt*, Co. *A*, 5 Reg't U. S. Col'd Cavalry.

Appears on **Co. Muster-out Roll**, dated  
*Helena, Ark* *Mar 16*, 1866.

Muster-out to date *Mar 16*, 1866.

Last paid to *Dec 31*, 1865.

**Clothing account:**

Last settled....., 186 ; drawn since \$..... 100

Due soldier \$ *7* <sup>*59*</sup>/<sub>100</sub>; due U. S. \$..... 100

Am't for cloth'g in kind or money adv'd \$..... 100

Due U. S. for arms, equipments, &c., \$ <sup>*15*</sup>/<sub>100</sub>

Bounty paid \$ *100* 100; due \$ *100* 100

Remarks: *Stop for Ord. 15c*

Book mark: *1176 Co. 79. P. 32. P. 47*

(361)

*J. Stewart*  
Copyist.

5 Cav. U.S.C.T.

J  
Harvey Johnson  
Priv. Co. F, 5 Reg't U. S. Colored Cav.

Appears on Returns as follows:

Nov 1864, Absent sick Genl Hospital  
Camp Nelson Nov 15/64  
Dec 1864 to Feb 1865, apt to June 1865 Ab-  
sent sick in Genl Hospital Camp  
Nelson, Ky. since Oct 9/64.

Book mark :

Austin



*J* | **5 Cav.** | **U.S.C.T.**

*Harvey Johnson*  
*Pvt*, Co. H, 5 Reg't U. S. Col'd Cavalry.

Appears on

**Company Muster Roll**  
for *Jan'y. V. Feby*, 1866.  
Present or absent *Present*

Stoppage, \$ *100* for

Due Gov't, \$ *100* for

Valuation of horse, \$ *100*

Valuation of horse equipments, \$ *100*

Remarks: *Sick in G.S.*

Book mark: \_\_\_\_\_

(358)

*J. A. Stewart*  
Copyist.

*J.* | **5 Cav.** | **U.S.C.T.**  
*Harry Johnson*  
*Pvt.*, Co. H, 5 Reg't U. S. Col'd Cavalry.

Appears on

**Company Muster Roll**

for *Nov. 4<sup>th</sup>*, 1865.

Present or absent *Present.*

Stoppage, \$ 100 for

Due Gov't, \$ 100 for

Valuation of horse, \$ 100

Valuation of horse equipments, \$ 100

Remarks:

Book mark:

(358)

*A. J. Cooke*  
Copyist.

*E.* | **5 Cav.** | **U.S.C.T.**  
*Harry Johnson*  
*Pvt.*, Co. H, 5 Reg't U. S. Col'd Cavalry.

Appears on

**Company Muster Roll**

for *Sept. & Oct.*, 186*5*.

Present or absent *Present.*

Stoppage, \$ 100 for

Due Gov't, \$ 100 for

Valuation of horse, \$ 100

Valuation of horse equipments, \$ 100

Remarks:

Book mark:

(358)

*B. J. Cooke*

Copyist.



*J.* | **5 Cav.** | **U.S.C.T.**

*Henry Johnson*  
*Cvt*, Co H, 5 Reg't U. S. Col'd Cavalry.

Appears on

**Company Muster Roll**

for *July & Aug.*, 1865.

Present or absent *Present.*

Stoppage, \$ 100 for

Due Gov't, \$ 100 for

Valuation of horse, \$ 100

Valuation of horse equipments, \$ 100

Remarks: \_\_\_\_\_

Book mark: \_\_\_\_\_

(358)

*B. J. Cooke*

Copyist.

*J.* | **5 Cav.** | **U.S.C.T.**

*Henry Johnson*  
*Pr*....., Co. H, 5 Reg't U. S. Col'd Cavalry.

Appears on

**Company Muster Roll**

for *May & June*, 1865.

Present or absent *Absent*

Stoppage, \$.....100 for .....

Due Gov't, \$.....100 for .....

Valuation of horse, \$.....100

Valuation of horse equipments, \$.....100

Remarks: *1" Arstallment Bounty  
due \$100. sick and Hosp  
Camp Mconky Oct. 9"  
1864.*

Book mark: .....

(358)

*B. J. Cooke*

Copyist.

*J* | **5 Cav.** | **U.S.C.T.**

*Harvey Johnson*  
*Priv.*, Co. H, 5 Reg't U. S. Col'd Cavalry.

Appears on

**Company Muster Roll**

for *Mar & Apr*, 1865.

Present or absent *Absent*

Stoppage, \$ *100* for

Due Gov't, \$ *100* for

Valuation of horse, \$ *100*

Valuation of horse equipments, \$ *100*

Remarks: *1st installment of*  
*Bounty Due \$100*  
*sick in Camp Nelson*  
*By Oct 9th 1864*

Book mark: \_\_\_\_\_

*Reynolds*  
(358) Copyist.



J | 5 Cav. | U.S.C.T.

Harvey <sup>John</sup> Jackson  
Pot, Co. H, 5 Reg't U. S. Col'd Cavalry.

Appears on

Company Muster Roll

for Jan & Feb, 1865.

Present or absent Absent

Stoppage, \$ 100 for

Due Gov't, \$ 100 for

Valuation of horse, \$ 100

Valuation of horse equipments, \$ 100

Remarks: 1<sup>st</sup> installment of  
Bounty Due \$100,00  
Sick in Hapt Camp  
Nelson Ky Oct 9. 1864

\*Corrected by Demand <sup>(D)</sup> text

Book mark:

Reynolds

(358)

Copyist.

J | 5 Cav. | U.S.C.T.

Harvey <sup>John</sup> ~~Johnson~~  
Pot, Co. H, 5 Reg't U. S. Col'd Cavalry.

Appears on

Company Muster Roll

for Nov & Dec, 1864.

Present or absent Absent

Stoppage, \$ 100 for

Due Gov't, \$ 100 for

Valuation of horse, \$ 100

Valuation of horse equipments, \$ 100

Remarks: 1<sup>st</sup> and 2<sup>d</sup> installment  
Bounty due. Sick in  
Genl Hos Camp Nelson  
since Oct 9<sup>th</sup>

\*Account by Townsend Esq

Book mark:

Reynolds

J | **5 Cav.** | **U.S.C.T.**

Harvey Johnson  
Put, Co. H, 5 Reg't U. S. Col'd Cavalry.

Appears on

**Company Muster Roll**

for from enlistment to Oct 31, 1864.

Present or absent present

Stoppage, \$ 100 for

Due Gov't, \$ 100 for

Valuation of horse, \$ 100

Valuation of horse equipments, \$ 100

Remarks:

Book mark:

Reynolds



J | **5 Cav. | U.S.C.T.**

*Harvey Johnson*  
*Pot*, Co. *H*, 5 Reg't U. S. Col'd Cavalry.

Appears on

**Company Muster-in and Descriptive Roll**

of the organization named above. Roll dated

*Camp Nelson, N. Y. Oct 29*, 1864.

Where born *Woodford Ky*

Age *21* y'rs; occupation *Farmer*

When enlisted *Sept 15*, 1864.

Where enlisted *Camp Nelson Ky*

For what period enlisted *3* years.

Eyes *Black*; hair *Black*

Complexion *Black*; height *5 ft. 9* in.

When mustered in *Sept 15*, 1864.

Where mustered in *Camp Nelson Ky*

Bounty paid \$ *100*; due \$ *100*

Where credited.....

Company to which assigned.....

Remarks: *7th Dist Ky*

*X John Gray*

*X supposed to be name of owner.*

*Added May 17 98. H.A.J.*

Book mark:.....

*Reynolds*

J | **5 Cav. | U.S.C.T.**

Harvey Johnson  
....., Co. D, 5 Reg't U. S. Col'd Cav.

Appears on

**Company Descriptive Book**  
of the organization named above.

**DESCRIPTION.**

Age 21 years; height 5 feet 9 inches.

Complexion Blk

Eyes Blk; hair Blk

Where born Woodford Ky

Occupation Farmer

**ENLISTMENT.**

When Sept 15, 1864.

Where Camp Tieson

By whom J. S. Randolph; term 3 y'rs.

Remarks: .....

.....  
.....  
.....  
.....  
.....  
.....  
.....  
.....

(383g)

A. J. Anderson

Coppist.

*J* | *5 Cav* | **U. S. C. T.**  
*Harvey Johnson*  
....., Co. *H*, 5 Reg't U. S. Col'd *Cav*

Appears on

**Company Descriptive Book**

of the organization named above.

**DESCRIPTION.**

Age *21* years; height *5* feet *9* inches.

Complexion *BLK*

Eyes *BLK*; hair *BLK*

Where born *Woodford Ky*

Occupation *farmer*

**ENLISTMENT.**

When *Sept. 15*, 186 *4*.

Where *Camp Wilson Ky*

By whom *H. Randolph*, term *3* yrs.

Remarks: .....

.....  
.....  
.....  
.....  
.....  
.....  
.....  
.....  
.....  
.....

*J. E. Parks*



S. 14 0 7 1 1 9, P. O. Mexico

J. H. Townsend & Co

711

Johnson Harvey  
Co No , 5 U. S. Col'd Cav.

Private | Private

CARD NUMBERS.

1	5366813	26
2	5366905	27
3	5367004	28
4	5367095	29
5	5367184	30
6	5367283	31
7	5367373	32
8	5367462	33
9	5367557	34
10	5367643	35
11	5367727	36
12	9090807	37
13	9090898	38
14	40729968	39
15		40
16		41
17		42
18		43
19		44
20		45
21		46
22		47
23		48
24		49
25		50

Book Mark: 1176. C.D. 1879

See also

J | **5 Cav. | U.S.C.T.**

*Franklin Johnson*  
Co. *C*, 5 Reg't U. S. Col'd Cavalry.

Appears on **Co. Muster-out Roll**, dated  
*Wesley Ark* *Feb 16*, 1860.  
Muster-out to date *Feb 16*, 1860.  
Last paid to *Dec 31*, 1865.

**Clothing account:**

Last settled....., 186 ; drawn since \$..... 100  
Due soldier \$..... 100; due U. S. \$..... 3 <sup>21</sup>/<sub>100</sub>  
Am't for cloth'g in kind or money adv'd \$..... 100

Due U. S. for arms, equipments, &c., \$..... 100  
Bounty paid \$..... 100; due \$..... 100

Remarks: *Transferred from 72. 21st Co  
for S.O. 27 Hd. In Dep't  
18 July 1865*

Book mark : .....

*E. H. Brown*



J | **5 Cav. U.S.C.T.**  
Franklin Johnson  
Priv. Co. K, 5 Reg't U. S. Colored Cav.

Appears on Returns as follows:

July 1865, Gain July 27/65 Paris  
Ky. by transfer Assigned to Co.  
K, 5 U.S.C. in R.O. 1132

Jan 1866, Absent sick in Hospital  
at Helena, Ark

Book mark:

Huston

(546)

Copyist.

**5 Cav. U.S.C.T.**

*Franklin Johnson*  
*Port*, Co. K, 5 Reg't U. S. Col'd Cav.

Appears on

**Company Muster Roll**

for *Jan Feb*, 186*6*.

Present or absent *Present*

Stoppage, \$ 100 for

Due Gov't, \$ 100 for

Valuation of horse, \$ 100

Valuation of horse equipments, \$ 100

Remarks:

Book mark:

*E. H. Brown*

(358)

Copyist.

*J* | **5 Cav.** | **U.S.C.T.**

*Franklin Johnson*  
*Prof*, Co. K, 5 Reg't U. S. Col'd Cav.

Appears on

**Company Muster Roll**

for *Nov + Dec*, 1865.

Present or absent *Present*

Stoppage, \$ *100* for

Due Gov't, \$ *100* for

Valuation of horse, \$ *100*

Valuation of horse equipments, \$ *100*

Remarks: *Present, Sick in  
Regtl Hospital*

Book mark:

(358)

*J. E. Porter*

Copyist.



J | **5 Cav.** | **U.S.C.T.**

Franklin Johnson  
Co. K, 5 Reg't U. S. Col'd Cav.

Appears on

**Company Muster Roll**

for Sept & Oct, 1862.

Present or absent Present

Stoppage, \$ 100 for

Due Gov't, \$ 100 for

Valuation of horse, \$ 100

Valuation of horse equipments, \$ 100

Remarks: Due U.S. for  
Quar. 14 cts. Due U.S.  
for G. & G. E. 95 cts

Book mark: \_\_\_\_\_

F. E. Porter

(358)

Copyist.

**5 Cav. U.S.C.T.**

*Franklin Johnson*  
Crosby, Co. K, 5 Reg't U. S. Col'd Cav.

Appears on

**Company Muster Roll**

for *July & Aug*, 186*0*.

Present or absent *Present*

Stoppage, \$ *100* for

Due Gov't, \$ *100* for

Valuation of horse, \$ *100*

Valuation of horse equipments, \$ *100*

Remarks: *Assigned to Co "K"*  
*5th U. S. C. Cav per R.O. No*  
*132 July 27, 60*

Book mark:

*F. E. Porter*

*J* | **5 Cav. | U.S.C.T.**

*Franklin Johnson*

....., Co. *K*, 5 Reg't U. S. Col'd Cav.

Appears on

**Company Descriptive Book**  
of the organization named above.

**DESCRIPTION.**

Age *22* years; height *5* feet *6* inches.

Complexion *Black*

Eyes *Blue*; hair *Black*

Where born *Kentucky*

Occupation *Farmer*

**ENLISTMENT.**

When *Intestate*, 186 .

Where .....

By whom .....; term *3* y'rs.

Remarks: *Resigned to Co K for*  
*R.O. No 182 July 27 1865*

.....  
.....  
.....  
.....  
.....

*A J Anderson*

(383g)

Copist.



5<sup>th</sup> Cav | U.S.C.T.

Franklin Johnson

Pvt, Co., 5 Reg't U. S. Col'd Cav

Appears on

**M. and D. Roll of Men Transferred**

to the organization named above,

from

Roll dated July 18, 1865.

When enlisted, 186 .

Period for which enlisted 3 years.

When mustered in Jan 20, 1865.

Present or absent Not Stated

Company to which assigned

Remarks: Substitute

Book mark :

Atton

J 1154516. Porth

A3003110 a w N

A4. 1922421

P.O. ind. Ctl. 587690, 4/7/18 1100

*Wm. H. Wood*

710

Johnson Franklin  
Co K, 5 U. S. Col'd Cav.

Private | Private

CARD NUMBERS.

1	5359258	26
2	5369389	27
3	5369476	28
4	5369562	29
5	5369648	30
6	5369730	31
7	9091128	32
8	40729967	33
9		34
10		35
11		36
12		37
13		38
14		39
15		40
16		41
17		42
18		43
19		44
20		45
21		46
22		47
23		48
24		49
25		50

Book Mark:

See also 72 U.S.C. Inf.



MICROFILM PUBLICATION M1821

COMPILED MILITARY SERVICE RECORDS OF VOLUNTEER UNION SOLDIERS  
WHO SERVED WITH THE UNITED STATES COLORED TROOPS (USCT)

PLEASE NOTE THE FOLLOWING INFORMATION:

Records  
NO ~~RECORD~~ WITH THE NUMBER 709 WAS FOUND WHEN THE RECORDS  
WERE ARRANGED FOR MICROFILMING.

These records are missing

5th CAV USCT

Johnson, Edward L. Co. D Pvt → Cpl

S-1016812 - P.O. Rev.  
S-1016390 - P.O. aff  
D1349692 - P.O. Rd

*A. H. Townsend & Co*

709  
Johnson Edward L

Co D, 5 U. S. Col'd Cav.

Private | Corporal

CARD NUMBERS.

1	5359255	26
2	5363246	27
3	5363332	28
4	5363396	29
5	5363483	30
6	5363568	31
7	9090381	32
8	40729966	33
9		34
10		35
11		36
12		37
13		38
14		39
15		40
16		41
17		42
18		43
19		44
20		45
21		46
22		47
23		48
24		49
25		50

Book Mark:

See also 72 US 6 Inf.



*J* | **5 Cav. | U.S.C.T.**

*Benjamin Johnson*  
\_\_\_\_\_  
*Priv.*, Co. *M.*, 5 Reg't U. S. Col'd Cavalry.

Appears on **Co. Muster-out Roll**, dated  
*Helena Ark*, *Mar 16*, 186*6*.

Muster-out to date \_\_\_\_\_, 186 .

Last paid to \_\_\_\_\_, 186 .  
*Pay due from enlistment*

**Clothing account:**

Last settled \_\_\_\_\_, 186 ; drawn since \$ \_\_\_\_\_ 100

Due soldier \$ \_\_\_\_\_ 100; due U. S. \$ \_\_\_\_\_ 100

Am't for cloth'g in kind or money adv'd \$ \_\_\_\_\_ 100

Due U. S. for arms, equipments, &c., \$ \_\_\_\_\_ 100

Bounty paid \$ \_\_\_\_\_ 100; due \$ \_\_\_\_\_ 100

Remarks: *Missing in Action at*  
*Saltville, Va Oct 2 '64, Slave*  
*Apr. 19 '61*

Book mark : \_\_\_\_\_

\_\_\_\_\_  
*Styer*  
\_\_\_\_\_  
(361) Copyist.

5 Cav. U.S.C.T.

Benjamin Johnson  
Priv. Co. M. 5 Reg't U. S. Colored Cav.

Appears on Returns as follows:

Oct 1864 Loss: Oct. 6/64 Saltville  
Va., missing in action

Book mark:

(546)

J. Hurst

Copyist.

**5 Cav. | U. S. C. T.**

*Benjamin Johnson*  
*Plt.*, Co. M, 5 Reg't U. S. Col'd Cavalry.

Appears on

**Company Muster Roll**

for *to Oct. 31*, 186*4*.

Present or absent *Absent*

Stoppage, \$ *100* for

Due Gov't, \$ *100* for

Valuation of horse, \$ *100*

Valuation of horse equipments, \$ *100*

Remarks: *Missing in action*  
*Oct. 9/64 - Saltville Va.*

*Roll next on which name*  
*appears*

Book mark:

*W. S. Thompson*



J | **5 Cav. | U.S.C.T.**

*Benjamin Johnson*

*Pat.*, Co. *M*, 5 Reg't U. S. Col'd Cavalry.

Appears on

**Company Muster-in and Descriptive Roll**  
of the organization named above. Roll dated

*Camp Nelson, N. Y., Oct 30*, 186*11*.

Where born *Woodford, Ky.*

Age *25* y'rs; occupation *Farmer*

When enlisted *Aug. 17*, 186*4*.

Where enlisted *Camp Nelson, Ky.*

For what period enlisted *2* years.

Eyes *Black*; hair *Black*

Complexion *Black*; height *5* ft. *10* in.

When mustered in *Aug. 17*, 186*11*.

Where mustered in *Camp Nelson, Ky.*

Bounty paid \$ *100*; due \$ *100*

Where credited *4 Dist Ky.*

Company to which assigned

Remarks *\* Miss Fannie Brown*

*\* Supposed to be name of owner.*

*Added May 16. 98. H. J.*

Book mark:

*W. L. Thompson*

*J* | *5*-*Car* | **U.S.C.T.**

*Benjamin Johnson*  
....., Co. *M*, *5*-Reg't U. S. Col'd *Car*

Appears on

**Company Descriptive Book**

of the organization named above.

**DESCRIPTION.**

Age *25*-years; height *5*-feet *10* inches.

Complexion *Black*

Eyes *Blk*; hair *Blk*

Where born *Northon Ky*

Occupation *Farmer*

**ENLISTMENT.**

When *Aug 19, 1864*.

Where *Camp Nelson*

By whom *McKandolph*; term *3* y'rs.

Remarks: *Wiping machine*

(383g)

*A J Anderson*

Copyist.

708

Johnson Benjamin  
Co No. , 5 U. S. Col'd Cav.

Private | Private

CARD NUMBERS.

1	5370857	26
2	5370981	27
3	5371358	28
4	9091291	29
5	40729965	30
6		31
7		32
8		33
9		34
10		35
11		36
12		37
13		38
14		39
15		40
16		41
17		42
18		43
19		44
20		45
21		46
22		47
23		48
24		49
25		50

Book Mark: .....

See also .....



*J* | **5 Cav.** | **U.S.C.T.**

*Alexander Johnson*  
*Pr*, Co. *D*, 5 Reg't U. S. Col'd Cavalry.

Appears on **Co. Muster-out Roll**, dated  
*March 1861*; *March 1861*, 1861.

Muster-out to date *March 1861*, 1861.

Last paid to *Dec 31, 1861*.

**Clothing account:**

Last settled....., 186 ; drawn since \$..... 100

Due soldier \$ *32* <sup>*80*</sup>/<sub>100</sub>; due U. S. \$..... 100

Am't for cloth'g in kind or money adv'd \$..... 100

Due U. S. for arms, equipments, &c., \$ *3* <sup>*19*</sup>/<sub>100</sub>

Bounty paid \$ *100* <sup>*00*</sup>/<sub>100</sub>; due \$ *100* <sup>*00*</sup>/<sub>100</sub>

Remarks: *Home office 19 1861*  
*Due 118 per Ord # 3. 19*

Book mark : .....

(261) *Alexander Johnson* Copyist.

J | **5 Cav. | U.S.C.T.**  
Alexander Johnson  
Priv. Co. D, 5 Reg't U. S. Colored Cav.

Appears on Returns as follows:

Jan to Mar 1865 Absent sick Hosp'l.  
Camp Nelson, Ky

Book mark :

(546)

Justin

Copyist.

*S* | **5 Cav.** | **U.S.C.T.**

*Alexander Johnson*

*R*, Co. B, 5 Reg't U. S. Col'd Cavalry.

Appears on

**Company Muster Roll**

for *Jan 1 - Feb*, 186*6*.

Present or absent *Present*

Stoppage, \$ *100* for

Due Gov't, \$ *100* for

Valuation of horse, \$ *100*

Valuation of horse equipments, \$ *100*

Remarks:

Book mark:

(358)

*Copyist* Copyist.



J. | 5 Cav. | U.S.C.T.

Alexander Johnson

Priv., Co. B, 5 Reg't U. S. Col'd Cavalry.

Appears on

Company Muster Roll

for Nov. & Dec., 1865.

Present or absent present

Stoppage, \$ 100 for

Due Gov't, \$ 100 for

Valuation of horse, \$ 100

Valuation of horse equipments, \$ 100

Remarks:

[Empty lines for remarks]

Book mark:

R. C. Wilson

J. | **5 Cav.** | **U.S.C.T.**

*Alexander Johnson*

*Priv.*, Co. B, 5 Reg't U. S. Col'd Cavalry.

Appears on

**Company Muster Roll**

for *Sept & Oct*, 186*5*.

Present or absent *present*

Stoppage, \$ *100* for

Due Gov't, \$ *100* for

Valuation of horse, \$ *100*

Valuation of horse equipments, \$ *100*

Remarks:

Book mark;

*R. E. Wilson*

*J.* | **5 Cav.** | **U.S.C.T.**

*Alexander Johnson*

*Priv.*, Co. B, 5 Reg't U. S. Col'd Cavalry.

Appears on

**Company Muster Roll**

for *July & Aug.*, 186*5*.

Present or absent *Present*

Stoppage, \$ *100* for

Due Gov't, \$ *100* for

Valuation of horse, \$ *100*

Valuation of horse equipments, \$ *100*

Remarks:

Book mark:

*R. E. Wilson*



J. | 5 Cav. | U.S.C.T.

Alexander Johnson

Priv., Co. B, 5 Reg't U. S. Col'd Cavalry.

Appears on

Company Muster Roll

for May & June, 1865.

Present or absent present

Stoppage, \$ 100 for

Due Gov't, \$ 100 for

Valuation of horse, \$ 100

Valuation of horse equipments, \$ 100

Remarks: Mt. installment  
family due 100

Book mark:

R. E. Wilson

1865

4 | **5 Cav.** | **U.S.C.T.**

Alexander Johnson  
Private, Co. B, 5 Reg't U.S. Col'd Cavalry.

Appears on

**Company Muster Roll**

for Feb 23 to Apr, 1865.

Present or absent Present

Stoppage, \$ 100 for

Due Gov't, \$ 100 for

Valuation of horse, \$ 100

Valuation of horse equipments, \$ 100

Remarks: 1<sup>st</sup> installment  
county due \$100

Book mark: \_\_\_\_\_

Lamb

4 | **5 Cav.** | **U.S.C.T.**

Alexander Johnson  
Private, Co. B, 5 Reg't U. S. Col'd Cavalry.

Appears on

**Company Muster Roll**

for Jan & Feb, 1864.

Present or absent Absent

Stoppage, \$ 100 for

Due Gov't, \$ 100 for

Valuation of horse, \$ 100

Valuation of horse equipments, \$ 100

Remarks: Sick in Gen Hosp  
Camp Nelson, Ky  
1<sup>st</sup> instalment bounty  
\$100 due

Book mark:

(358)

Lamb

Copyist.



J | **5 Cav.** | **U.S.C.T.**

Alexander Johnson  
Private, Co. B, 5 Reg't U.S. Col'd Cavalry.

Appears on

**Company Muster Roll**

for Nov & Dec, 1864.

Present or absent Present

Stoppage, \$ 100 for

Due Gov't, \$ 100 for

Valuation of horse, \$ 100

Valuation of horse equipments, \$ 100

Remarks: 1st & 2nd instal-  
ments bounty due

Book mark: \_\_\_\_\_

Loebl

J | **5 Cav.** | **U.S.C.T.**

Alexander Johnson  
Private, Co. B, 5 Reg't U. S. Col'd Cavalry.

Appears on

**Company Muster Roll**

for Oct 31, 1864.

Present or absent Present

Stoppage, \$ 100 for

Due Gov't, \$ 100 for

Valuation of horse, \$ 100

Valuation of horse equipments, \$ 100

Remarks:

Book mark:

Lauch

*J* | *5 Cav* | **U.S.C.T.**

*Alexander Johnson*  
*Priv., Co B, 5<sup>th</sup> Reg't U. S. Col'd Cav*

Appears on  
**Company Muster-in and Descriptive Roll**  
of the organization named above. Roll dated  
*Camp Nelson Ky Oct 24, 1864.*  
Where born *Fayette Ky*  
Age *29* y'rs; occupation *Farmer*  
When enlisted *Aug 17*, 1864.  
Where enlisted *Camp Nelson*  
For what period enlisted *3* years.  
Eyes *Blue*; hair *Blue*  
Complexion *Blue*; height *5* ft. *9* in.  
When mustered in *Aug 17*, 1864.  
Where mustered in *Camp Nelson*

Bounty paid \$ *100*; due \$ *100*  
Where credited *7 Dist Ky*  
Company to which assigned *B*

Remarks: *Name of owner of*  
*negro - Milton Peak*  
*\* added May 12. 98. by H. J.*

Book mark: \_\_\_\_\_

*Lamb,*



*A* | **5 Cav. | U.S.C.T.**

*Alexander Johnson*

....., Co *B*, 5 Reg't U. S. Col'd Cav.

Appears on

**Company Descriptive Book**  
of the organization named above.

**DESCRIPTION.**

Age *27* years; height *5* feet *7* inches.

Complexion *Blk*

Eyes *Blk*; hair *Blk*

Where born *Shelby Co. Ky*

Occupation *Farmer*

**ENLISTMENT.**

When *Aug 17*, 1864.

Where *Camp Nelson*

By whom *J. Randolph*, term *3* y'rs.

Remarks: .....

.....  
.....  
.....  
.....  
.....  
.....  
.....  
.....  
.....  
.....

*Warren*

S. 1308231 P.O. W. W.  
ROR 41671

S. 1475584 P.O. W. W.

J. J. Burdett Co

107

Johnson Alexander  
Co B, 5 U. S. Col'd Cav.

Private | Private

CARD NUMBERS.

1	5360694	26
2	5360791	27
3	5360879	28
4	5360935	29
5	5361065	30
6	5361151	31
7	5361239	32
8	5361329	33
9	5361412	34
10	5361494	35
11	5361576	36
12	9040132	37
13	40729964	38
14		39
15		40
16		41
17		42
18		43
19		44
20		45
21		46
22		47
23		48
24		49
25		50

Book Mark: .....

See also .....



*J* | **5 Cav. U.S.C.T.**

*Henry Jewett*  
*B. Smith, Co. H., 5 Reg't U. S. Col'd Cavalry.*

Appears on **Co. Muster-out Roll**, dated  
*Bellevue Ark, Mar 16, 1866.*  
Muster-out to date *Mar 16, 1866.*  
Last paid to *Dec 31, 1865.*

**Clothing account:**

Last settled....., 186 . ; drawn since \$..... 100  
Due soldier \$ *13*<sup>*22*</sup>/<sub>100</sub>; due U. S. \$..... 100  
Am't for cloth'g in kind or money adv'd \$..... 100

Due U. S. for arms, equipments, &c., \$ <sup>*55*</sup>/<sub>100</sub>

Bounty paid \$ *100*/<sub>100</sub>; due \$ *100*/<sub>100</sub>

Remarks: *Appeal for Ord. 55*

Book mark : .....

*J. Stewart*  
Copyist.

(361)

**5 Cav. U.S.C.T.**

*Jerry Jewett*

*B. Smith* Co. H, 5 Reg't U. S. Col'd Cavalry.

Appears on

**Company Muster Roll**

for *Jerry Jewett* 186*6*

Present or absent *Present*

Stoppage, \$ *100* for

Due Gov't, \$ *100* for

Valuation of horse, \$ *100*

Valuation of horse equipments, \$ *100*

Remarks:

Book mark:

(358)

*J. A. Stewart*  
Copyist.

J. | **5 Cav. | U.S.C.T.**

*Henry Jewett*  
Blsmith, Co. H, 5 Reg't U. S. Col'd Cavalry.

Appears on

**Company Muster Roll**

for *Nov. & Dec.*, 1865.

Present or absent *Present.*

Stoppage, \$ 100 for

Due Gov't, \$ 100 for

Valuation of horse, \$ 100

Valuation of horse equipments, \$ 100

Remarks:

Book mark:

(358)

*B. J. Cooke*

Copyist.



C. | **5 Cav.** | **U.S.C.T.**

*Henry Jewett*  
-----  
*Almond* Co. H, 5 Reg't U. S. Col'd Cavalry.

Appears on

**Company Muster Roll**

for *Sept. & Oct.*, 1865.

Present or absent *Present.*

Stoppage, \$ 100 for -----

Due Gov't, \$ 100 for -----

Valuation of horse, \$ 100

Valuation of horse equipments, \$ 100

Remarks: -----

Book mark: -----

(358)

*B. J. Cooke*  
-----  
Copyist.

*G.* | **5 Cav.** | **U.S.C.T.**

*Henry Jewett*  
Farmer, Co. H, 5 Reg't U. S. Col'd Cavalry.

Appears on

**Company Muster Roll**

for *July & Aug*, 1865.

Present or absent *Present.*

Stoppage, \$.....100 for .....

Due Gov't, \$.....100 for .....

Valuation of horse, \$.....100

Valuation of horse equipments, \$.....100

Remarks:.....

Book mark:.....

*B. J. Cooke*  
Copyist.

**5 Cav. | U.S.C.T.**

*G.*  
*Henry Jewett*  
*Fair* Co. H, 5 Reg't U. S. Col'd Cavalry.

Appears on

**Company Muster Roll**

for *May & June*, 1865.

Present or absent *Present*

Stoppage, \$ *100* for

Due Gov't, \$ *100* for

Valuation of horse, \$ *100*

Valuation of horse equipments, \$ *100*

Remarks: *"Settlement Bounty due \$700."*

Book mark:

*B. J. Cooke*



J | **5 Cav. | U.S.C.T.**

*Henry Jewett*  
Harris, Co. H, 5 Reg't U. S. Col'd Cavalry.

Appears on  
**Company Muster Roll**  
for *Mar & Apr*, 1865.

Present or absent *present*  
Stoppage, \$ 100 for

Due Gov't, \$ 100 for

Valuation of horse, \$ 100  
Valuation of horse equipments, \$ 100

Remarks: *1<sup>st</sup> installment of  
Bounty Due \$100*

Book mark: \_\_\_\_\_

*Reynolds*  
(358) Copyist.

J | 5 Cav. | U.S.C.T.

Henry Jewell

Bk. Smity Co. H, 5 Reg't U. S. Col'd Cavalry.

Appears on

Company Muster Roll

for Jan'y & Feb'y, 1865.

Present or absent present

Stoppage, \$ 100 for

Due Gov't, \$ 100 for

Valuation of horse, \$ 100

Valuation of horse equipments, \$ 100

Remarks: 1st Installment of  
Bounty Due \$100.00

Book mark:

Reynolds

J | 5 Cav. | U.S.C.T.

Henry Jewell  
Rt. S. Co. H, 5 Reg't U. S. Col'd Cavalry.

Appears on

Company Muster Roll

for Nov 1864, 1864.

Present or absent present

Stoppage, \$ 100 for

Due Gov't, \$ 100 for

Valuation of horse, \$ 100

Valuation of horse equipments, \$ 100

Remarks: 1st and 2nd Installments  
Bounty due.

Book mark:

Reynolds  
(358) Copyist.



J | 5 Cav. | U.S.C.T.

Henry Jewell  
B Smith, Co. H, 5 Reg't U. S. Col'd Cavalry.

Appears on

**Company Muster Roll**

for *from enlistment to Oct 31, 1864*

Present or absent *present*

Stoppage, \$ *100* for

Due Gov't, \$ *100* for

Valuation of horse, \$ *100*

Valuation of horse equipments, \$ *100*

Remarks: *Appointed per  
Regul Order No 12 to date  
October 29<sup>th</sup> 1864*

Book mark:

(358) *Reynolds* Copyist.

**5 Cav. U.S.C.T.**

*J*  
*Henry Jewett*

*Bk Smith Co H*, 5 Reg't U. S. Col'd Cavalry.

Appears on

**Company Muster-in and Descriptive Roll**

of the organization named above. Roll dated

*Camp Nelson Ky*, ~~N.Y.~~, *Oct 29*, 1864.

Where born *Montgomery Ky*

Age *28* y'rs; occupation *Farmer*

When enlisted *Sept 13*, 1864.

Where enlisted *Cp Nelson Ky*

For what period enlisted *3* years.

Eyes *Black*; hair *Black*

Complexion *Black*; height *5 ft. 7 in.*

When mustered in *Sept 15*, 1864.

Where mustered in *Cp Nelson Ky*

Bounty paid \$ *100*; due \$ *100*

Where credited

Company to which assigned

Remarks: *9<sup>th</sup> Dist Ky*

*X Hayden Jewett*

*X Supposed to be same of owner May 17 1865*

*Haj*

Book mark:

*Reynolds*

(356d)

Copyist.

*J* | *5 Cav* | **U.S.C.T.**

*Henry Jewett*  
....., Co *H*, *5* Reg't U. S. Col'd *Cav*

Appears on  
**Company Descriptive Book**  
of the organization named above.

**DESCRIPTION.**

Age *28* years; height *5* feet *7* inches.

Complexion *Blk*

Eyes *Blk*; hair *Blk*

Where born *Montgomery, Ky*

Occupation *farmer*

**ENLISTMENT.**

When *Sep 13*, 186 *7*.

Where *Camp Nelson*

By whom *J. Randolph* term *3* y'rs.

Remarks:  
.....  
.....  
.....  
.....  
.....  
.....  
.....  
.....  
.....

*J. E. Ruck*



D:774530 - P.O. 90  
D.1131249. P.O. 7711  
D.1273974. P.O. 7711

*St. Vincent*

<sup>106</sup>  
Jewett Henry

Co H, 5 U. S. Col'd Cav.

Blacksmith

Blacksmith

CARD NUMBERS.

1	5366746	26
2	5366848	27
3	5366948	28
4	5367042	29
5	5367132	30
6	5367229	31
7	5367318	32
8	5367410	33
9	5367502	34
10	5367592	35
11	5367681	36
12	9898816	37
13		38
14		39
15		40
16		41
17		42
18		43
19		44
20		45
21		46
22		47
23		48
24		49
25		50

Book Mark:

See also

**5 Cav. U.S.C.T.**

*J*  
*Joseph Jewell*  
*Priv*, Co. *D*, 5 Reg't U. S. Col'd Cavalry.

Appears on **Co. Muster-out Roll**, dated  
*Helena, Ark, Mch. 16*, 1866.

Muster-out to date *Mch. 16*, 1866.

Last paid to *Dec. 31*, 1865.

**Clothing account:**

Last settled....., 186 ; drawn since \$..... 100

Due soldier \$..... 100; due U. S. \$ *45*<sup>*57*</sup>/<sub>100</sub>

Am't for cloth'g in kind or money adv'd \$..... 100

Due U. S. for arms, equipments, &c., \$..... 100

Bounty paid \$..... 100; due \$..... 100

Remarks:.....

Book mark: *1869.1882 - 2962.1882.*

*Crewshaw*

(861)

Copyist.



J | 5 Cav. | U.S.C.T.

Joseph Jewell  
Priv. Co. I. 5 Reg't U. S. Colored Cav.

Appears on Returns as follows:

Mar. 1865 Absent detached at  
Hopkinsville, Ky Mar 14"  
Jan + Feb 1866, Co. Cook

Book mark :

(546)

Hustin

Copyist.

*J* | **5 Cav.** | **U.S.C.T.**

*Joseph Jewell*  
*Priv.*, Co. I, 5 Reg't U. S. Col'd Cavalry.

Appears on

**Company Muster Roll**

for *Jan'y. & Feby.*, 1866.

Present or absent *Present*

Stoppage, \$ *100* for

Due Gov't, \$ *100* for

Valuation of horse, \$ *100*

Valuation of horse equipments, \$ *100*

Remarks: *On daily duty as Co. Cook.*

Book mark:

*Crenshaw*

5 Cav. U.S.C.T.

Joseph Jewell

Co. I, 5 Reg't U. S. Col'd Cavalry.

Appears on

Company Muster Roll

for Nov Dec, 1860.

Present or absent Present

Stoppage, \$ 100 for

Due Gov't, \$ 100 for

Valuation of horse, \$ 100

Valuation of horse equipments, \$ 100

Remarks: Due 25 for Copy 1/64

Book mark:

Wess



*J* | **5 Cav.** | **U.S.C.T.**

*Joseph Lowell*  
\_\_\_\_\_  
*For*, Co. *I*, 5 Reg't U. S. Col'd Cavalry.

Appears on

**Company Muster Roll**

for *Sept + Oct*, 186*6*.

Present or absent *Present*

Stoppage, \$ *100* for \_\_\_\_\_

Due Gov't, \$ *100* for \_\_\_\_\_

Valuation of horse, \$ *100*

Valuation of horse equipments, \$ *100*

Remarks: \_\_\_\_\_

\_\_\_\_\_

\_\_\_\_\_

\_\_\_\_\_

\_\_\_\_\_

\_\_\_\_\_

\_\_\_\_\_

\_\_\_\_\_

Book mark: \_\_\_\_\_

\_\_\_\_\_

*Lowell*  
\_\_\_\_\_  
Copyist.

5 Cav. U.S.C.T.

Joseph Jewell

Private, Co. I, 5 Reg't U. S. Col'd Cavalry.

Appears on

Company Muster Roll

for July & Aug, 1865.

Present or absent Present

Stoppage, \$ 100 for

Due Gov't, \$ 100 for

Valuation of horse, \$ 100

Valuation of horse equipments, \$ 100

Remarks:

Book mark:

W. W. W.

(358)

Copyist.

5 Cav. U.S.C.T.

Joseph Sewell

Private, Co. I, 5 Reg't U. S. Col'd Cavalry.

Appears on

Company Muster Roll

for May 1865

Present or absent Present

Stoppage, \$ 100 for

Due Gov't, \$ 100 for

Valuation of horse, \$ 100

Valuation of horse equipments, \$ 100

Remarks: Installment due \$100

Book mark:

Acc'd



J. | **5 Cav.** | **U.S.C.T.**

Joseph Jewell  
Pvt., Co. I, 5 Reg't U. S. Col'd Cavalry.

Appears on

**Company Muster Roll**

for *Mar. + Apr.*, 1865.

Present or absent *Present*

Stoppage, \$ 100 for

Due Gov't, \$ 100 for

Valuation of horse, \$ 100

Valuation of horse equipments, \$ 100

Remarks: *1st installment  
Bounty due.*

Book mark: \_\_\_\_\_

*Philipsen*

*J.* | **5 Cav.** | **U.S.C.T.**

*Joseph Jewell*  
*Pr.*, Co. I, 5 Reg't U. S. Col'd Cavalry.

Appears on

**Company Muster Roll**

for *Jan. & Feb.*, 1865.

Present or absent *Present*

Stoppage, \$ *100* for

Due Gov't, \$ *100* for

Valuation of horse, \$ *100*

Valuation of horse equipments, \$ *100*

Remarks: *1<sup>st</sup> & 2<sup>d</sup> installments  
\$300<sup>x</sup> Bounty due.*

Book mark:

*Philipsen*  
Copyist.

*J.* | **5 Cav.** | **U.S.C.T.**

*Joseph Jewell*  
*Prv.*, Co. I, 5 Reg't U. S. Col'd Cavalry.

Appears on  
**Company Muster Roll**

for *Nov. + Dec.*, 1864.

Present or absent *Present*

Stoppage, \$ *100* for

Due Gov't, \$ *100* for

Valuation of horse, \$ *100*

Valuation of horse equipments, \$ *100*

Remarks: *1<sup>st</sup> + 2<sup>d</sup> installments*  
*Bounty due.*

Book mark:

*Phillipsen*  
Copyist.



J. | **5 Cav.** | **U.S.C.T.**

*Joseph Jewell*

*Priv.*, Co. I, 5 Reg't U. S. Col'd Cavalry.

Appears on

**Company Muster Roll**

for *Organization to Oct. 31*, 1864.

Present or absent *Present*

Stoppage, \$ *100* for

Due Gov't, \$ *100* for

Valuation of horse, \$ *100*

Valuation of horse equipments, \$ *100*

Remarks:

-----  
-----  
-----  
-----  
-----  
-----  
-----  
-----  
-----  
-----

Book mark:

-----

*Philipson*

J | 5 Cav | U.S. Col.

Joseph Jewell

Appears with rank of Private on

**Muster and Descriptive Roll**

of a Detachment of U.S. Col's Recruits  
forwarded for United States Cold  
Troops

Roll dated  
Bowling Green Ky, June 29, 1864.

Where born Barren Co Kentucky

Age 30 years; occupation Farmer

When enlisted June 29, 1864.

Where enlisted Bowling Green

For what period enlisted 3 years.

Eyes Brown; hair Brown

Complexion Yellow; height 5 ft. 6 3/4 in.

When mustered in \_\_\_\_\_, 186 .

Where mustered in \_\_\_\_\_

Bounty paid \$ \_\_\_\_\_ 100; due \$ \_\_\_\_\_ 100

**Clothing account:**

Last settled \_\_\_\_\_, 186 ; drawn since \$ 14 <sup>13</sup>/<sub>100</sub>

Date of ~~first~~ muster into US Ser. June 29, 1864.

Company to which assigned \_\_\_\_\_

Remarks New Recruit - Barren Co  
Ordered Service to John Asher Jewell  
accredited to the 3 Congressmen's  
Dist - of Ky

Book mark: \_\_\_\_\_

L. Murdoch

J. | 5 Cav. | U. S. C. T.  
Joseph Jewell  
Br, Co. I, 5 Reg't U. S. Col'd Cav.

Appears on

**Company Muster-in and Descriptive Roll**  
of the organization named above. Roll dated

Cp. Nelson, Ky., Oct. 31, 1864.

Where born Barron, Ky.

Age 30 y'rs; occupation Farmer

When enlisted June 29, 1864.

Where enlisted Bowling Green

For what period enlisted 3 years.

Eyes Brn; hair Brn

Complexion Yellow; height 5 ft. 6 $\frac{3}{4}$  in.

When mustered in June 29, 1864.

Where mustered in Bowling Green

Bounty paid \$ 100; due \$ 100

Where credited 3<sup>d</sup> dist. Kentucky

Company to which assigned

Remarks:

Enlisted for 108th U. S. C. T.

Transferred to 5th U. S. C. Cavalry

August 12, 1864. per S. O. 192. Head

Quarters Dist. of Ky.

Book mark:

Philipson  
(356d) Copyist.



J | **5 Cav.** | **U.S.C.T.**

Joseph Jewel  
....., Co. D, 5 Reg't U. S. Col'd Cav.

Appears on  
**Company Descriptive Book**  
of the organization named above.

**DESCRIPTION.**

Age 32 years; height 5 feet 6 3/4 inches.  
Complexion Yellow  
Eyes Brown; hair Brown  
Where born Barnes Ky  
Occupation Farmer

**ENLISTMENT.**

When June 29, 1864.  
Where Bow Green  
By whom Capt. Hobson; term 3 y'rs.

Remarks :  
.....  
.....  
.....  
.....  
.....  
.....  
.....  
.....  
.....

(383g) A. J. Anderson Copist.

J | 5 Cav. | 108 | U.S.C.T.

Joseph Jewell  
Co. A, 108 Reg't U. S. Col'd Infantry.

Appears on  
Company Descriptive Book  
of the organization named above.

DESCRIPTION.

Age 30 years; height 5 feet 6 3/4 inches.  
Complexion Yellow  
Eyes Brn; hair Brn.  
Where born Barren Co. Ky  
Occupation Farmer.

ENLISTMENT.

When June 29<sup>th</sup>, 1864.  
Where Bowling Green  
By whom Cap Habson, term 3 y'rs

Remarks:  
.....  
.....  
.....

Enlisted for 108th U. S. C. T.  
Transferred to 5th U. S. C. Cavalry  
unit 12, 1864, per S. O. 192. Head  
Quarters Dist. of Ky.

D. M. Kennedy

105

Juwell Joseph

---

Co B, 5 U. S. Col'd Cav.

Private | Private

CARD NUMBERS.

1	5367820	26
2	5367913	27
3	5368013	28
4	5368106	29
5	5368198	30
6	5368293	31
7	5368384	32
8	5368472	33
9	5368558	34
10	5368645	35
11	5368727	36
12	9090982	37
13	9221620	38
14	43143410	39
15	40729962	40
16		41
17		42
18		43
19		44
20		45
21		46
22		47
23		48
24		49
25		50

Book Mark: .....

See also .....



**5 Cav. U.S.C.T.**

*J*  
*Nicholas Jenkins*  
*Priv*, Co. *C*, 5 Reg't U. S. Col'd Cavalry.

Appears on **Co. Muster-out Roll**, dated

*Helena Ark*, *March*, 186 *6*.

Muster-out to date *March*, 186 *6*.

Last paid to *Dec 31*, 186 *5*.

Clothing account:

Last settled....., 186 ; drawn since \$ *41* <sup>*39*</sup> <sub>*100*</sub>

Due soldier \$.....<sub>100</sub>; due U. S. \$.....<sub>100</sub>

Am't for cloth'g in kind or money adv'd \$.....<sub>100</sub>

Due U. S. for arms, equipments, &c., \$.....<sub>100</sub>

Bounty paid \$.....<sub>100</sub>; due \$.....<sub>100</sub>

Remarks: *Due US for one Jos-*  
*lyn Carbine. Retained as*  
*per Gen Order No 101 War Dpt*  
*\$8. Due US for Ord 53-c*

Book mark : .....

*Rose*

(861)

Copyist.



5 Cav. U.S.C.T.

*J*  
*Nicholas Jenks*  
*Prk.*, Co. C, 5 Reg't U. S. Col'd Cavalry.

Appears on

**Company Muster Roll**

for *Nov. Dec.*, 186*5*.

Present or absent *Present*

Stoppage, \$ *100* for

Due Gov't, \$ *100* for

Valuation of horse, \$ *100*

Valuation of horse equipments, \$ *100*

Remarks: *Spec. W. J. for camp and "Car" Equip. Co. etc.*

Book mark:

*J. J. J.*



*J* | **5 Cav.** | **U.S.C.T.**

*Nicholas Jenks*  
*Pr*, Co. C, 5 Reg't U. S. Col'd Cavalry.

Appears on

**Company Muster Roll**

for *Sep. & Oct.*, 1865.

Present or absent *Present*

Stoppage, \$ 100 for

Due Gov't, \$ 100 for

Valuation of horse, \$ 100

Valuation of horse equipments, \$ 100

Remarks:

Book mark:

(358)

*Linden*  
Copyist.

*J* | **5 Cav. | U.S.C.T.**

*Nicholas Jenks*  
*Priv.*, Co. C, 5 Reg't U. S. Col'd Cavalry.

Appears on

**Company Muster Roll**

for *July & Aug.*, 186 *5*

Present or absent *Present*

Stoppage, \$.....100 for .....

Due Gov't, \$.....100 for .....

Valuation of horse, \$.....100

Valuation of horse equipments, \$.....100

Remarks: .....

.....  
.....  
.....  
.....  
.....  
.....

Book mark: .....

.....  
*J. J. J. J.*  
.....  
Copyist.

*J* | **5 Cav. | U.S.C.T.**

*Nicholas Jenkins*  
*Plt.*, Co. C, 5 Reg't U. S. Col'd Cavalry.

Appears on

**Company Muster Roll**

for *May & June*, 186*5*.

Present or absent *Present*

Stoppage, \$ 100 for

Due Gov't, \$ 100 for

Valuation of horse, \$ 100

Valuation of horse equipments, \$ 100

Remarks:

Book mark:

*J. J. J. J.*



*4* | **5 Cav. | U.S.C.T.**

*Nicholas Jones*

*Priv*, Co. C, 5 Reg't U. S. Col'd Cavalry.

Appears on

**Company Muster Roll**

for *Mar. & Apr.*, 186*5*.

Present or absent *Present*

Stoppage, \$ *100* for

Due Gov't, \$ *100* for

Valuation of horse, \$ *100*

Valuation of horse equipments, \$ *100*

Remarks:

Book mark:

*Shull*

*J* | **5 Cav.** | **U.S.C.T.**

*Nicholas Jenks*

*Pvt*, Co. C, 5 Reg't U. S. Col'd Cavalry.

Appears on

**Company Muster Roll**

for *Jan'y. 1* *Feb'y.*, 186*5*.

Present or absent *Present*

Stoppage, \$ *100* for

Due Gov't, \$ *100* for

Valuation of horse, \$ *100*

Valuation of horse equipments, \$ *100*

Remarks:

-----  
-----  
-----  
-----  
-----  
-----  
-----  
-----

Book mark:

-----

*Shull*

*J* | **5 Cav. | U.S.C.T.**

*Nicholas Leake*

*Pvt*, Co. C, 5 Reg't U. S. Col'd Cavalry.

Appears on

**Company Muster Roll**

for *Nov. 1 Dec.*, 1864.

Present or absent *Present*

Stoppage, \$ *100* for

Due Gov't, \$ *100* for

Valuation of horse, \$ *100*

Valuation of horse equipments, \$ *100*

Remarks:

Book mark:

*Shull*



*J* | **5 Cav.** | **U.S.C.T.**

*Nicholas Jenks*

*Priv*, Co. C, 5 Reg't U. S. Col'd Cavalry.

Appears on

**Company Muster Roll**

for *to Oct. 31*, 186*4*.

Present or absent *Present*

Stoppage, \$ *100* for

Due Gov't, \$ *100* for

Valuation of horse, \$ *100*

Valuation of horse equipments, \$ *100*

Remarks:

Book mark:

*Shull*

J | 5 Cav. | U.S.C.T.

Nick's Jenks

Priv, Co. C, 5 Reg't U. S. Col'd Cavalry.

Appears on

**Company Muster-in and Descriptive Roll**

of the organization named above. Roll dated

Camp Nelson, N.Y., Oct. 24, 1864.

Where born Kentucky

Age 18 y'rs; occupation Laborer

When enlisted Substitute, 186

Where enlisted

For what period enlisted 3 years.

Eyes Blk.; hair Blk.

Complexion Blk.; height 5 ft. 8 1/2 in.

When mustered in Aug. 25, 186

Where mustered in Louisville

Bounty paid \$ 100; due \$ 100

Where credited 5<sup>th</sup> Dist. Ky.

Company to which assigned C

Remarks:

\* Inserted by Duncanson Esq

Book mark:

Shull

J | 5 bar | 2 A.C.T.  
Nichols James

Appears with rank of Pat on

**Muster and Descriptive Roll**

of a Detachment of U.S. Colored  
Troops transferred to U.S. Col'd  
Cor. at Lexington, Ky. Roll dated  
Louisville, Ky., Sept. 2, 1864.

Where born Ky.

Age 18 years; occupation Labourer

When enlisted Substitute, 186 .

Where enlisted

For what period enlisted 3 years.

Eyes Blue; hair Blue

Complexion Blue; height 5 ft. 8 1/2 in.

When mustered in Aug. 25, 1864.

Where mustered in Fournelle

Bounty paid \$ 100; due \$ 100

Clothing account:

Last settled \_\_\_\_\_, 186 ; drawn since \$ 18 19  
100

Date of first muster Aug. 25, 1864.

Company to which assigned

Remarks: Assigned to 5th Regt. Driz.  
Ky.

Book mark:

B. J. Steiner



J | 5 bar USBT  
-----  
Nich Jenkins  
-----  
Appears with rank of Rest on

**Muster and Descriptive Roll**

of a Detachment of men Drafted  
and Mustered into service of US

----- Roll dated  
Louisville Ky, Aug 25 1864

Where born Kentucky  
Age 18 y'rs; occupation Sabrer

**Drafted and mustered in:**

When Aug 25 1864  
Where Louisville Ky  
Enrollment district 5 Dist Ky  
Period 3 years.

Eyes Black; hair Black  
Complexion Black; height 5 ft 8 1/2 in.  
Bounty paid \$ 100; due \$ 100

**Clothing account:**

Last settled \_\_\_\_\_, 186 ; drawn since \$ 100

Date of commencement of service Aug 25 1864

Company to which assigned \_\_\_\_\_

Remarks: Substitute for J. B.  
Smith's anti draft  
Issued clothing unit # 1819

Book mark: \_\_\_\_\_

(356m) J. Jacobson Copyist.



107  
Jenks Nicholas

Co E, 5 U. S. Col'd Cav.

Private

Private

CARD NUMBERS.

1	5361694	26
2	5361796	27
3	5361888	28
4	5361982	29
5	5362065	30
6	5362146	31
7	5362234	32
8	5362324	33
9	5362410	34
10	5362494	35
11	5362579	36
12	9090233	37
13	43146259	38
14	43155112	39
15		40
16		41
17		42
18		43
19		44
20		45
21		46
22		47
23		48
24		49
25		50

Book Mark:

See also



No. 1.

RECORD OF DEATH AND INTERMENT.

Name and number of person interred.....	<i>Wm Jenkins</i>
Number and locality of the grave.....	<i>773</i>
Hospital number of the deceased.....	<i>4778</i>
Regiment, rank and company.....	<i>3<sup>rd</sup> U. S. C. L. Co</i>
Residence before enlistment.....	
Conjugal relation, [and if married the residence of the widow.]	}
Cause of death	}
Age of the deceased.	
Nativity.	
References and remarks.	}
Date of death and burial.	<i>Oct 22/14</i>

Memoranda of effects.

*Drawings on paper Shoes on paper*

Wm Jenkins

3" up to

October 23, 1864,  
Gen'l Hoop: Camp Preleson,  
Ky.



I certify, on honor, that William Jenkins a Private of  
 Captain W. P. Wade Company (D) of the 5<sup>th</sup> Regiment of U. S. Cavalry  
**VOLUNTEERS**, of the State of Kentucky, born in Warren, State  
 of Kentucky, aged 22 years; 5 feet 7 inches high; Dark complexion,  
Dark eyes, Dark hair, and by occupation a Salver, having joined the company on  
 its original organization at Louisville Ky, and enrolled in it at the muster into  
 the service of the United States at Louisville, on the 15 day  
 of Sept., 1864, (or was mustered in service as a recruit, by  
 \_\_\_\_\_, at \_\_\_\_\_, on the \_\_\_\_\_ day of \_\_\_\_\_,  
 186 , or was drafted and mustered into the service of the United States from the \_\_\_\_\_  
 Enrollment District of the State of \_\_\_\_\_, at \_\_\_\_\_,  
 on the \_\_\_\_\_ day of \_\_\_\_\_, 186 ) to serve in the Regiment, for  
 the term of Three years: and having served **HONESTLY** and  
**FAITHFULLY** with his Company in \_\_\_\_\_ to the present date, is now

entitled to a **DISCHARGE** by reason of Died of disease Camp Nelson (Chol. Meph.) Oct. 12<sup>th</sup> 1864

The said William Jenkins was last paid by Paymaster \_\_\_\_\_  
 \_\_\_\_\_ to include the \_\_\_\_\_ day of \_\_\_\_\_, 186 , and has  
 pay due him from Enlistment - Sep 15 - 1864 to the present date; he is entitled to pay and subsistence for  
**TRAVELING** to place of enrollment, and whatever other allowances are authorized to volunteer  
 soldiers, drafted men, or militia, so discharged. He has received from the United States **CLOTHING**  
 amounting to 30  $\frac{80}{100}$  dollars, since the \_\_\_\_\_ day of Enlistment  
 186 , when his clothing account was last settled. He has received from the United States  
 \_\_\_\_\_  $\frac{100}{100}$  dollars advanced **BOUNTY**.

There is to be stopped from him, on account of the State of \_\_\_\_\_, or other  
 authorities, for **CLOTHING**, &c., received on entering service, \_\_\_\_\_  $\frac{100}{100}$  dollars; and  
 for other stoppages, viz: \_\_\_\_\_

\_\_\_\_\_  $\frac{100}{100}$  dollars.

He has been furnished with **TRANSPORTATION** in kind from the place of his discharge to  
 \_\_\_\_\_; and he has been **SUBSISTED** for **TRAVELING** to his  
 place of enrollment, up to the \_\_\_\_\_, 186 .

He is indebted to \_\_\_\_\_, **SUTLER**, \_\_\_\_\_  $\frac{100}{100}$  dollars.

He is indebted to \_\_\_\_\_, **LAUNDRESS**, \_\_\_\_\_  $\frac{100}{100}$  dollars.

Given in Duplicate, at Covington Ky, this 19 day  
 of July, 1865.

David C. Gordon  
1<sup>st</sup> Lt. 5<sup>th</sup> U. S. Cavalry  
 Commanding Company. D



[OFFICE INDORSEMENT.]

War Department,

ADJUTANT GENERAL'S OFFICE,

March 25, 1874,

The death of Sgt William Jenkins, Co. "G", 5<sup>th</sup> Reg't U. S. Colored Cavalry, is reported as follows:—

On Company Muster Roll.

From Oct 31, 1864, not stated, 186

Company Muster-out Roll.

October 12, 1864,

Company Descriptive Book.

186

Company Morning Reports.

186

Soldier's Final Statement.

October 12, 1864,

Soldier's Record of Death and Interment.

186

Soldier's Inventory of Effects.

October 23, 1864,

Soldier's Certificate of Disability for Discharge.

186

Soldier's Individual Muster-out Roll.

186

Regimental Return.

October 1864 not given, 186

186

ADJUTANT GENERAL'S OFFICE.

July 27, 1865

Duplicate with inventory sent 2d Auditor.

FINAL STATEMENT

OF

William Jenkins

5 Reg't of U. S. Cavalry

VOLUNTEERS. 28

NOTE 1.—Two of these certificates (or duplicates) are to be given to each Volunteer Soldier or drafted man who may be discharged previously to the discharge of his company, that he may at once receive from the Paymaster the pay, &c., due him, and the captain or other COMMISSIONED officer commanding the company will certify to the act of the delivery of the duplicate certificates; on these certificates the Soldier is "entitled to" his discharge, and should also present his discharge to the Paymaster to have the payment endorsed on it. The discharge is to be given back to the Soldier by the Paymaster; the latter only retaining as his voucher the duplicate certificates.

NOTE 2.—If the Soldier is entitled to pay for the use of his horse, the Company Commander will certify to that fact on the back of both these final statements, and also to the time he has pay due for having been so mounted on his own horse.

NOTE 3.—When a Soldier is furnished with final statements, his descriptive list, if he has one, should be taken up by the officer who gives the Soldier these statements, and endorsed with a statement to this effect by the officer. This endorsement should exhibit a full statement of the time for which the Soldier was allowed pay on his final statements, the clothing account, and all other charges against him or in his favor, so as to comprise a complete exhibit of his account. It will then be transmitted to the company commander of the Soldier, who will enter all the data necessary to a full understanding of the Soldier's account on the muster roll upon which the Soldier's discharge is reported. The descriptive list will then be destroyed. The object of this is, that the remaining portion of the Soldier's account may be settled upon the receipt of these muster rolls, and the Soldier receive any pay or allowances that may be due him at the time of his discharge, and which may not appear on his final statements from the fact that his descriptive list is incomplete. These accounts for back pay, &c., are settled by the 2d Auditor of the Treasury Department.

NOTE 4.—Charges for loss or injury to ordnance, horse equipments, and other miscellaneous charges, should appear under the heading of "Other Stoppages."

NOTE 5.—Bounty paid by State authorities, and not by the United States, will not be entered on this statement.

NOTE 6.—Amounts due the Sutler and Laundress must be entered on the muster roll on which the discharge, death, desertion, &c., is reported, as well as on the final statement, otherwise the amount cannot be collected from the United States.

NOTE 7.—This blank will be used for deceased volunteers and drafted men, as well as for others.

NOTE 8.—Where a Soldier dies in Hospital or on detached service, his descriptive list, if he has one, should be sent with his final statements, in duplicate, to the Adjutant General, Washington, D. C.



[OFFICE INDORSEMENT.]

War Department,

ADJUTANT GENERAL'S OFFICE,

March 25, 1874,

The death of Sgt William Jenkins, Co. "G", 5<sup>th</sup> Reg't U. S. Colored Cavalry, is reported as follows:—

On Company Muster Roll.

From Reg't to Oct 31, 1864, not stated, 186

Company Muster-out Roll.

October 12, 1864,

Company Descriptive Book.

186

Company Morning Reports.

186

Soldier's Final Statement.

October 12, 1864,

Soldier's Record of Death and Interment.

186

Soldier's Inventory of Effects.

October 23, 1864,

Soldier's Certificate of Disability for Discharge.

186

Soldier's Individual Muster-out Roll.

186

Regimental Return.

For October, 1864, not given, 186

Regimental Quarterly Returns.

186

Regimental Descriptive Book.

186

By Surgeon General.

(S. 45. C. 174) October 23, 1864,

October 23, 1864 is held to be

the correct date, and the Company ~~Roll~~

Roll will be amended accordingly.

*Sumner M. Stewart*  
Asst. Adj. Gen.

Rec'd to 2<sup>nd</sup> Div. May 4 1874

FINAL STATEMENT

OF

*William Jenkins*

5<sup>th</sup> Reg't of *U. S. Caval*

VOLUNTEERS. 23

NOTE 1.—Two of these certificates (or duplicates) are to be given to each Volunteer Soldier or drafted man who may be discharged previously to the discharge of his company, that he may at once receive from the Paymaster the pay, &c., due him, and the captain or other COMMISSIONED officer commanding the company will certify to the act of the delivery of the duplicate certificates; on these certificates the Soldier is "entitled to" his discharge, and should also present his discharge to the Paymaster to have the payment endorsed on it. The discharge is to be given back to the Soldier by the Paymaster; the latter only retaining as his voucher the duplicate certificates.

NOTE 2.—If the Soldier is entitled to pay for the use of his horse, the Company Commander will certify to that fact on the back of both these final statements, and also to the time he has pay due for having been so mounted on his own horse.

NOTE 3.—When a Soldier is furnished with final statements, his descriptive list, if he has one, should be taken up by the officer who gives the Soldier these statements, and endorsed with a statement to this effect by the officer. This endorsement should exhibit a full statement of the time for which the Soldier was allowed pay on his final statements, the clothing account, and all other charges against him or in his favor, so as to comprise a complete exhibit of his account. It will then be transmitted to the company commander of the Soldier, who will enter all the data necessary to a full understanding of the Soldier's account on the muster roll upon which the Soldier's discharge is reported. The descriptive list will then be destroyed. The object of this is, that the remaining portion of the Soldier's account may be settled upon the receipt of these muster rolls, and the Soldier receive any pay or allowances that may be due him at the time of his discharge, and which may not appear on his final statements from the fact that his descriptive list is incomplete. These accounts for back pay, &c., are settled by the 2d Auditor of the Treasury Department.

NOTE 4.—Charges for loss or injury to ordnance, horse equipments, and other miscellaneous charges, should appear under the heading of "Other Stoppages."

NOTE 5.—Bounty paid by State authorities, and not by the United States, will not be entered on this statement.

NOTE 6.—Amounts due the Sutler and Laundress must be entered on the muster roll on which the discharge, death, desertion, &c., is reported, as well as on the final statement, otherwise the amount cannot be collected from the United States.

NOTE 7.—This blank will be used for deceased volunteers and drafted men, as well as for others.

NOTE 8.—Where a Soldier dies in Hospital or on detached service, his descriptive list, if he has one, should be sent with his final statements, in duplicate, to the Adjutant General, Washington, D. C.

Inventory of the effects of Wm Jenkins late  
 a \_\_\_\_\_ of Captain \_\_\_\_\_ Company \_\_\_\_\_ of  
 the 5<sup>th</sup> Regiment of 2<sup>d</sup> Colored Cavalry Volunteers, who was enrolled as  
 a \_\_\_\_\_ at \_\_\_\_\_ in the State of \_\_\_\_\_ on  
 the \_\_\_\_\_ day of \_\_\_\_\_ 186 , and mustered into the service of the United  
 States as \_\_\_\_\_ on the \_\_\_\_\_ day of \_\_\_\_\_ 186 , at \_\_\_\_\_  
 in Company \_\_\_\_\_, \_\_\_\_\_ Regiment of \_\_\_\_\_ Volunteers, to serve \_\_\_\_\_  
 years or during the war; he was born in \_\_\_\_\_ in the State  
 of \_\_\_\_\_; he was \_\_\_\_\_ years of age, \_\_\_\_\_ feet \_\_\_\_\_ inches  
 high, \_\_\_\_\_ complexion, \_\_\_\_\_ eyes, \_\_\_\_\_ hair, and by occupation, when enrolled,  
 \_\_\_\_\_; he died in Conscient Hospital, at  
Camp Nelson Ky on the 25<sup>th</sup> day of October 1864, by  
 reason of Malaria

INVENTORY.					
ARTICLES.	No.	ARTICLES.	No.	ARTICLES.	No.
Hats.....		Pairs trousers.....		Knapsacks.....	
Caps.....	/	Pairs <del>flannel</del> drawers.....	/		
Forage caps.....		Pairs cotton drawers.....			
Great coats.....		Flannel shirts.....			
Uniform coats.....		Cotton shirts.....			
Uniform jackets.....		Pairs boots.....			
Flannel sack coats.....		Pairs shoes.....	/		
Blouses.....		Pairs socks.....			
Stable frocks.....		Blankets.....		MONEY.	
Fatigue overalls.....		Haversacks.....		Specie.....	\$
				Notes.....	\$

I CERTIFY, ON HONOR, that the above inventory comprises all the effects of Wm Jenkins  
Jenkins (Colored), deceased, and that the effects are in the hands  
 of me valued at \$50<sup>00</sup>. No evidence as to disposition  
made of the amount to be disposed of by a Council of Administration.

(~~DUPLICATES~~)

~~SIGNATURE~~ : \_\_\_\_\_

~~Commanding the Company.~~

DATE : \_\_\_\_\_



ARTICLES OF WAR.

ART. 95. When any non-commissioned officer or soldier shall die, or be killed in the service of the United States, the then commanding officer of the troop or company shall, in the presence of two other commissioned officers, take an account of what effects he died possessed of, above his arms and accoutrements, and transmit the same to the office of the Department of War, which said effects are to be accounted for, and paid to the representatives of such deceased non-commissioned officer or soldier. And in case any of the officers, so authorized to take care of the effects of deceased officers and soldiers, should, before they have accounted to their representatives for the same, have occasion to leave the regiment or post, by prepayment or otherwise, they shall, before they be permitted to quit the same, deposit in the hands of the commanding officer, or of the assistant military agent, all the effects of such deceased non-commissioned officers and soldiers, in order that the same may be secured for, and paid to, their respective representatives.

DIRECTIONS.

NOTE 1.—One copy of the inventories of the effects of deceased non-commissioned officers and soldiers, required by the 95th Article of War, will be forwarded to the Adjutant General, by the commander of the company to which the deceased belonged, and a duplicate of the same to the colonel of the regiment. Final statements of pay, clothing, &c., in duplicate, will be sent to the Adjutant General with one copy of the inventory. Both inventory and final statements should be forwarded, as a general rule, through Regimental Headquarters. When a soldier dies at a post or station absent from his company, it will be the duty of his immediate commander to furnish, direct to the Adjutant General, the required inventory and final statements, and, at the same time, to forward to the commanding officer of the company to which the soldier belonged, a report of his death, specifying the date, place, and cause; to what time he was last paid, and the money or other effects in his possession at the time of his decease; which report will be noted on the next muster roll of the company to which the man belonged. Each inventory will be endorsed, "Inventory of the effects of ———, late of company (—) ——— regiment of ———, who died at ———, the ——— day of ———, 186—." If a legal representative receive the effects, it will be stated in the report. If the soldier leave no effects, the fact will be reported on the blank for inventory.

NOTE 2.—Should the effects of a deceased non-commissioned officer or soldier not be administered upon within a short period after his decease, they shall be disposed of by a Council of Administration, under the authority of the commanding officer of the post, and the proceeds deposited with the Paymaster, to the credit of the United States, until they shall be claimed by the legal representatives of the deceased.

NOTE 3.—In all such cases of sales by the Council of Administration, a statement in detail, or account of the proceeds duly certified by the Council and commanding officer, (Form 5.) accompanied by the Paymaster's receipt for the proceeds, will be forwarded by the commanding officer to the Adjutant General. The statement will be endorsed, "Report of the proceeds of the effects of ———, late of company (—) ——— regiment of ———, who died at ———, the ——— day of ———, 186—."

NOTE 4.—The effects in all cases, when called for, should be turned over to the legal representative, without further authority from the Adjutant General. When the effects are turned over to the relatives of the deceased before these inventories are sent to the Adjutant General, their receipts therefor should be attached to the inventories. In all other cases, one copy will be sent with a letter of transmittal direct to the Adjutant General, and a duplicate retained by the officer.

NOTE 5.—Particular care should be taken to take receipts in duplicate from the Paymaster for any funds turned over to him; one copy should be sent direct to the Adjutant General and one retained by the officer.

INVENTORY OF THE EFFECTS

OF

*John Jenkins*

Late of Company \_\_\_\_\_

*5<sup>th</sup>* Reg't of *U. S. Cold Cavalry*

Volunteers, who died at *Camp Stanton Ky*  
on the *23<sup>rd</sup>* day of *October* 1864.

Surgeon General's Office,

RECORD & PENSION BUREAU.

Washington, *24 November 1866.*

The within inventory is a true copy from the records

of *Commodore* Hospital  
*Camp Stanton Ky* on file in

this Office, and contains all the information that can be found.

BY ORDER OF THE SURGEON GENERAL



*J. B. C.*  
Det. Major, Assistant Surgeon, U. S. A.

Inventory of the effects of William Jenkins late  
 a Private of Captain H. J. Wade's Company D of  
 the 5<sup>th</sup> Regiment of W. S. C. Cav Volunteers, who was enrolled as  
 a Private at Louisville in the State of Kentucky on  
 the 13 day of September 1864, and mustered into the service of the United  
 States as a Private on the 15 day of September 1864, at Louisville  
 in Company D, 5<sup>th</sup> Regiment of W. S. C. Cav Volunteers, to serve 3  
 years or during the war; he was born in Henry County in the State  
 of Kentucky; he was 27 years of age, 5 feet 7 inches  
 high, Dark complexion, Dark eyes, Dark hair, and by occupation, when enrolled,  
 a Salver; he died in Genl Hospital, at  
Camp Nelson on the 12 day of October 1864, by  
 reason of (not known)

INVENTORY.					
ARTICLES.	No.	ARTICLES.	No.	ARTICLES.	No.
Hats.....		Pairs trousers.....		Knapsacks.....	
Caps.....		Pairs flannel drawers.....	6		
Forage Caps.....		Pairs cotton drawers.....			
Great coats.....		Flannel shirts.....			
Uniform coats.....		Cotton shirts.....			
Uniform jackets.....		Pairs boots.....			
Flannel sack coats.....		Pairs shoes.....			
Blouses.....		Pairs socks.....		MONEY.	Specie..... \$
Stable frocks.....		Blankets.....			Notes..... \$
Fatigue overalls.....		Haversacks.....			

I CERTIFY, ON HONOR, that the above inventory comprises all the effects of \_\_\_\_\_  
 \_\_\_\_\_, deceased, and that the effects are in the hands  
 of \_\_\_\_\_ at \_\_\_\_\_  
 \_\_\_\_\_ to be disposed of by a Council of Administration.

(DUPLICATES.)

STATION: Covington Ky

DATE: July 19<sup>th</sup> 1866

[A. G. O. No. 100]

David T Gordon  
1<sup>st</sup> Lieut 5<sup>th</sup> W. S. C. Cav  
 Commanding the Company. D



ARTICLES OF WAR.

ART. 95. When any non-commissioned officer or soldier shall die, or be killed in the service of the United States, the then commanding officer of the troop or company shall, in the presence of two other commissioned officers, take an account of what effects he died possessed of, above his arms and accoutrements, and transmit the same to the office of the Department of War, which said effects are to be accounted for, and paid to the representatives of such deceased non-commissioned officer or soldier. And in case any of the officers, so authorized to take care of the effects of deceased officers and soldiers, should, before they have accounted to their representatives for the same, have occasion to leave the regiment or post, by preferment or otherwise, they shall, before they be permitted to quit the same, deposit in the hands of the commanding officer, or of the assistant military agent, all the effects of such deceased non-commissioned officers and soldiers, in order that the same may be secured for, and paid to, their respective representatives.

ARMY REGULATIONS—EDITION OF 1863.

DECEASED SOLDIERS.

Par. 152. Inventories of the effects of deceased non-commissioned officers and soldiers, required by the 95th Article of War, will be forwarded to the Adjutant General, by the commander of the company to which the deceased belonged, and a duplicate of the same to the colonel of the regiment. Final statements of pay, clothing, &c., in duplicate, will be sent to the Adjutant General with one copy of the inventory. When a soldier dies at a post or station absent from his company, it will be the duty of his immediate commander to furnish the required inventory and final statements, and, at the same time, to forward to the commanding officer of the company to which the soldier belonged, a report of his death, specifying the date, place, and cause; to what time he was last paid, and the money or other effects in his possession at the time of his decease; which report will be noted on the next muster roll of the company to which the man belonged. Each inventory will be endorsed, "Inventory of the effects of \_\_\_\_\_, late of company (—) \_\_\_\_\_ regiment of \_\_\_\_\_, who died at \_\_\_\_\_, the \_\_\_\_\_ day of \_\_\_\_\_, 186—." If a legal representative receive the effects, it will be stated in the report. If the soldier leave no effects, the fact will be reported.

Par. 153. Should the effects of a deceased non-commissioned officer or soldier not be administered upon within a short period after his decease, they shall be disposed of by a Council of Administration, under the authority of the commanding officer of the post, and the proceeds deposited with the Paymaster, to the credit of the United States, until they shall be claimed by the legal representatives of the deceased.

Par. 154. In all such cases of sales by the Council of Administration, a statement in detail, or account of the proceeds, duly certified by the Council and commanding officer, accompanied by the Paymaster's receipt for the proceeds, will be forwarded by the commanding officer to the Adjutant General. The statement will be endorsed, "Report of the proceeds of the effects of \_\_\_\_\_, late of company (—) \_\_\_\_\_ regiment of \_\_\_\_\_, who died at \_\_\_\_\_, the \_\_\_\_\_ day of \_\_\_\_\_, 186—."

NOTE 1.—The effects in all cases, when called for, should be turned over to the legal representative, without further authority from the Adjutant General. When the effects are turned over to the relatives of the deceased before these inventories are sent to the Adjutant General, their receipts therefor should be attached to the inventories. In all other cases, one copy will be sent with a letter of transmittal direct to the Adjutant General, and a duplicate retained by the officer.

NOTE 2.—Particular care should be taken to take receipts in duplicate from the Paymaster for any funds turned over to him; one copy should be sent direct to the Adjutant General and one retained by the officer.

INVENTORY OF THE EFFECTS

OF

*William Jenkins*

Late of Company *D*

5<sup>th</sup> Reg't of

*W S Lister*

Volunteers, who died at *Camp Nelson*

on the *12* day of *October* 186*4*





Jenkins, William  
P, Co. 5 Reg't uscc

4 Enclosures.

Bed Cards	Descriptive Lists
Burial Records /	Final Statements /
Certs. of Dis. for Discharge	Furloughs
C. M. Charges	Med. Des. Lists
Med. Certificates	Orders

Other papers relating to—

Admission to Hosp'l	Furlough
Casualty Sheet (Officer's)	Med. Examination
Confinement	Misc. Information
Contracts	Pay or Clothing
Death or Effects 2	Personal Reports
Desertions	Rank
Discharge from Hosp'l	Transfer to Hosp'l
Discharge from Service	Transfer to V. R. C.
Duty	Transportation

*J | 5<sup>th</sup> Cav. U. S. C. I.*

*William Jenkins*  
*, Co. D, 5<sup>th</sup> Reg't U. S. C. Cav.*

**NOTATION.**

Book mark: *S-145-C-I-1874.*

**Record and Pension Office.**

WAR DEPARTMENT.

This book mark refers only to a report from the medical records, made by the Surgeon General to the Adjutant General, relative to the above-named man. As the medical records have since been carded, no transcript of this report is made hereon.

(491)

*W. Allen*

Copyist.

JAN. - 9

5363639

1891 ☆

S. 45 V. 10 C. T. 74.  
Died Oct. 23/64. E. B. V. 10.  
P. 26.



J. | 5 Cav. | U.S.C.T.

*William Jenkin,*  
*Priv., Co. D,* 5 Reg't U. S. Col'd Cavalry.

Appears on **Co. Muster-out Roll**, dated  
*Helena, Ark., March 16,* 186*e.*

Muster-out to date \_\_\_\_\_, 186 .

Last paid to *Enlistment* 186 .

Clothing account:

Last settled \_\_\_\_\_, 186 ; drawn since \$ \_\_\_\_\_ 100

Due soldier \$ \_\_\_\_\_ 100; due U. S. \$ \_\_\_\_\_ 100

Am't for cloth'g in kind or money adv'd \$ \_\_\_\_\_ 100

Due U. S. for arms, equipments, &c., \$ \_\_\_\_\_ 100

Bounty paid \$ \_\_\_\_\_ 100; due \$ *100<sup>00</sup>* 100

Remarks: *Died at Camp Nelson,*  
*Va., Oct. 12/64 of Measles.*  
*Final statements forwarded*  
*Mar. 31, 1865.*

Book mark: *148.192 W. H. D. (over)*

(361)

*R. S. Ganner.*

Copyist.

J | **5 Cav. | U.S.C.T.**  
William Jenkins  
Priv. Co. D. 5 Reg't U. S. Colored Cav.

Appears on Returns as follows:

Oct. 1864 died in Hosp'l, date  
never notified, Camp Nelson,  
Ky

Book mark : .....

(546)

*Austin*

Copyist.

*J* | **5 Cav. | U.S.C.T.**

*William Jenkins*

*Pvt.*, Co. D, 5 Reg't U. S. Col'd Cavalry.

Appears on

**Company Muster Roll**

for *Dated Oct. 31*, 1864.

Present or absent

Stoppage, \$ *100* for

Due Gov't, \$ *100* for

Valuation of horse, \$ *100*

Valuation of horse equipments, \$ *100*

Remarks: *Died at Camp Nelson, Ky of Measles.*

Book mark: *Died Oct. 23, '64 E. B. V. 11.*

*Wm. H. Scott*

(358)

Copyist.

*over*



**5 Cav. U.S.C.T.**

*J*  
*William Jenkins*  
*Pvt.*, Co. *D*, 5 Reg't U. S. Col'd Cavalry.

Appears on

**Company Muster-in and Descriptive Roll**

of the organization named above. Roll dated

*Camp Nelson, Ky.*, *Oct. 24*, 1864.

Where born *Henry, Ky.*

Age *22* y'rs; occupation *Laborer*

When enlisted *Sept. 13*, 1864.

Where enlisted *Louisville*

For what period enlisted *3* years.

Eyes *dk.*; hair *dk.*

Complexion *dk.*; height *5* ft. *7* in.

When mustered in *Sept. 15*, 1864.

Where mustered in *Louisville*

Bounty paid \$ *100*; due \$ *100*

Where credited *5 Dist. Ky.*

Company to which assigned

Remarks:

Book mark:

*Wm. Scott*

(356d)

Copyist.

5600 | 5600 U.S.A.

William Jenkins

Appears with rank of Priv on

**Muster and Descriptive Roll**

of Detachment of U.S. Colored Troops

Mustered for the U.S.A. at Taylor Bles.

Louisville Ky Roll dated

Louisville Ky, Sept. 15, 1864.

Where born Henry Ky

Age 22 years; occupation laborer

When enlisted Sept. 15, 1864.

Where enlisted Louisville Ky

For what period enlisted 3 years.

Eyes Dark; hair Dark

Complexion Dark; height 5 ft. 7 in.

When mustered in Sept. 15, 1864.

Where mustered in Louisville Ky

Bounty paid \$ 100; due \$ 100

Clothing account:

Last settled \_\_\_\_\_, 186 \_\_\_\_\_; drawn since \$ 100

Date of first muster \_\_\_\_\_, 186 \_\_\_\_\_.

Company to which assigned \_\_\_\_\_

Remarks: Credited to Henry Co. 5<sup>th</sup> Dist.

Book mark: \_\_\_\_\_

W. J. Allen





Jenkins William  
Co D, 5 U. S. Col'd Cav.

Private | Private

CARD NUMBERS.

5362683  
5362843  
5363639  
9090312  
S 45-05-1874  
43146771  
40729961

26  
27  
28  
29  
30  
31  
32  
33  
34  
35  
36  
37  
38  
39  
40  
41  
42  
43  
44  
45  
46  
47  
48  
49  
50

Book Mark: S. 45-05-1874

See also

102  
Jefferson Anderson  
Co. A, 5 U. S. Col'd Cav.

Private

CARD NUMBERS.

- |    |    |
|----|----|
| 1  | 26 |
| 2  | 27 |
| 3  | 28 |
| 4  | 29 |
| 5  | 30 |
| 6  | 31 |
| 7  | 32 |
| 8  | 33 |
| 9  | 34 |
| 10 | 35 |
| 11 | 36 |
| 12 | 37 |
| 13 | 38 |
| 14 | 39 |
| 15 | 40 |
| 16 | 41 |
| 17 | 42 |
| 18 | 43 |
| 19 | 44 |
| 20 | 45 |
| 21 | 46 |
| 22 | 47 |
| 23 | 48 |
| 24 | 49 |
| 25 | 50 |

See Anderson Jefferson

Book Mark:

See also

SPECIAL ORDERS, }  
No. 494. }

WAR DEPARTMENT,  
ADJUTANT GENERAL'S OFFICE,  
Washington, September 14th, 1865.

(Extract.)

\* \* \* \* \*

28. The following named officers, having tendered their resignations, are, upon the recommendation of their superior officers, hereby honorably discharged the service of the United States, with condition that they shall receive no final payments, until they have satisfied the Pay Department that they are not indebted to the Government:—

- ✓ 1st Lieutenant *Frederick Jassaud*, 5th U. S. Colored Cavalry.
- ✓ 2d Lieutenant *L. M. Booth*, 5th U. S. Colored Cavalry.
- ✓ 2d Lieutenant *Wilbur A. Reeves*, 113th U. S. Colored Troops.

\* \* \* \* \*

By order of the Secretary of War:

E. D. TOWNSEND,

*Assistant Adjutant General.*

OFFICIAL:

*Assistant Adjutant General.*

*Colonel Foster*

*Camp*



Rec<sup>d</sup> & Noticed Sept. 16. 1865. A.M.  
Prof.

I am in such a position that I cannot refund said money without going home to obtain it, which is in Cleveland Ohio. I have therefore the honor to respectfully request an order for my release, in order that I may return home to secure money to settle said debts. Earliest attention will be most gratefully received.

I have the honor to be  
Very Respectfully  
Yours Att. Servt.  
Frederick Fassand  
Late Lieut. 5<sup>th</sup> Regt  
Cavalry House  
Lexington

To  
Genl. J. C. Davis  
Comd'g Dept. of Ky  
Louisville  
Ky



H. 263. J. N. L. 263

Lexington, Ky. Oct 3/66.

Jassard, Frederick B.  
Late Lt. 5th U. S. C. Cavalry  
Card House, Lexington, Ky.

States that he is under arrest  
for contracting debts from  
enlisted men - and  
requests an order for  
release to enable him  
to settle said debts,

Hd. Qrs. Dept. of Ky.  
Cincinnati, Oct 5/66.

Respectfully referred to  
Genl. Meade - for his  
action.

By Command of  
Genl. J. M. Palmer

J. D. Harlan

Capt & A. A. G.

Lexington Ky  
Oct 3<sup>rd</sup> 1865

Genl. J. M. Davis

Head Qrs. Dept. of Ky.

3  
3  
Sir,

I have  
the honor to address you upon the  
situation in which I am placed, which  
is as follows; I am in arrest at  
Lexington Ky. by Military authority.  
I was late Lt. Lieutenant in the 3<sup>rd</sup>  
U. S. Colored Cavalry, while in  
said Regt I contracted debts among  
the enlisted men, which at the time  
of my discharge I was unable to  
pay, being without money I borrowed  
\$15, / Fifteen Dollars in order to  
defray my expenses home, calcula-  
lating to return to Lexington to  
refund said money, while on my  
way home, I was arrested by  
Military authority; at the same  
time being out of the Service



Frederick Jassand was mustered in as 1st Lieut. 5<sup>th</sup>  
U.S.C. Cavalry Sept 20<sup>th</sup> 1864 On Return of that  
Regt for the month of July 1865 (latest on file) he is  
reported as Commanding Co. 5<sup>th</sup> for R. O. 92, March 31  
1865.

Strength	Com'd	36	
"	Enlisted	1145	P. H.

J. 37. O. L. B. 1865  
Adjutant General's Office.  
Bureau for Colored Troops.  
September 12<sup>th</sup> 1865.

1<sup>st</sup> Lieutenant Fredrick Jassaud,  
5<sup>th</sup> United States Colored Cavalry  
tenders his resignation assigning  
as his reasons therefor, family  
and business affairs demand-  
ing his attention and the close  
of the war.

The acceptance of the resigna-  
tion is recommended by the  
Regimental Commanded "for  
the good of the service."

The Commanding General  
Department of Kentucky,  
referred the resignation to an  
Examining Board, who exam-

ined Lieutenant Jassaud and  
found him "deficient men-  
tally and morally" and therefore  
recommended his muster-out  
of service. - This recommen-  
dation is concurred in by  
Major General Palmer, and it  
is therefore respectfully recom-  
mended that this officer  
be honorably discharged the  
service of the United States  
upon tender of resignation.

F. Jassaud

1<sup>st</sup> Lt. 5<sup>th</sup> U. S. C. Cav.

E. B. 1865, 10 Page 109.

Approved

E. P. Thompson

Asst. Adj. Gen.

A. S. C.

Sept. 1865

Note: Vide Spox  
No 494 of Sept  
14<sup>th</sup> 1865, also appear



To include the 30<sup>th</sup> day of June 1865

to Capt. Genl. U. S. A.  
Washington D. C.

Very Respectfully  
Your Obedt Servt  
Frederick Passand  
1<sup>st</sup> Lieut. 5<sup>th</sup> U. S. Col. Cav.



Camp 5<sup>th</sup> U. S. Col<sup>d</sup> Cavalry  
Lexington Ky Aug<sup>r</sup> 10<sup>th</sup> 1865

Adjutant Gen<sup>l</sup> H. J. A.  
Washington D. C.

Sir

I have the honor herewith to  
tender my resignation as 11<sup>th</sup> Lieutenant 5<sup>th</sup> U. S. Colored  
Cavalry for the following reasons

I have been in the U. S. Service  
for upwards of (11) Four years and it is very essential that I  
should be at home having a family to attend to. Also  
important business transactions which now that the War  
is virtually over need my immediate attention

I certify on  
honor that I am not indebted to the United States  
on any account whatever and that I am not res-  
ponsible for any government property except what  
I am prepared to turn over to the proper officer on  
the acceptance of my resignation and that I was last  
paid by Major Joseph Pool to include the 31<sup>st</sup> day of  
May 1865 and that I sold my accounts to Mr. Beyland  
Agent life insurance Co Lexington Ky  
over

5 Ex 10-410-27 D. Ky. 1865  
Head. Qu. Dept. of Ky.

Louisville, Ky. Aug. 30, '65.

Respectfully forwarded  
to Adjt. Gen. Mil. Div. of  
the Army. Recommendation  
of the Board of Ex-  
aminers approved.

John M. Palmer

6 Maj. Genl. Leardig

Adjt. Genl. Mil. Div. of the Army

Nashville Tenn. Sept 5, '65

Respectfully forwarded to the  
Adjt. Genl. of the Army.

Geo. H. Thomas

Maj. Genl.  
Army



19-DK-101-2-1861  
Camp 54th & 55th  
3<sup>rd</sup> Regt. Ky. Aug 10 1865  
9 2121 5 1585  
Assand. 3  
1<sup>st</sup> Lt 3<sup>rd</sup> Regt. Cal.

Senders his resignation in the  
1<sup>st</sup> Lt 3<sup>rd</sup> Regt. Cal. Last paid  
by my Pol to include 31 months  
and has sold pay account to  
30 June 1865.

Head Quarters 3<sup>rd</sup> Regt. Cal.  
Lexington Kentucky  
August 12 1865

Approved & respectfully  
recommended for the  
good of the service.

Henry McKiddens  
Major 3<sup>rd</sup> Regt. Cal.

Recd at 11 1/2 5. Sch...

Head Quarters 1<sup>st</sup> Div Arty  
Lexington Ky Aug 15 1865

Approved and respectfully  
forwarded  
2  
T. H. Hobbs  
Brig. Genl  
Honidg

3<sup>rd</sup> Regt. Cal. 16<sup>th</sup> 1865

Respectfully returned to  
of 3<sup>rd</sup> Regt. Cal. 16<sup>th</sup> 1865  
board the resignation was  
accepted at the 16<sup>th</sup> 1865  
The board will be passing the  
officer in the 16<sup>th</sup> 1865  
Service desired.

By command  
W. H. Hamilton  
Capt. 1<sup>st</sup> Div. Arty

Recd at 11 1/2 5. Sch...

4 Ad. Ins. Dep<sup>t</sup> of Kentucky  
Office Board of Examiners  
Louisville, Ky, Aug 26/65

Respectfully returned to  
Capt. C. P. Harlow, A.A.S.  
with information that  
the "board" have carefully  
examined Lt. Fred Jassand  
and find <sup>him</sup> deficient mentally  
and morally and  
therefore recommend him  
to be mustered out of the  
U. S. Service.

Chas. G. Patten  
Col. 119<sup>th</sup> Ill. Infy  
Pres<sup>t</sup>. of Board.

Recd at 11 1/2 5. Sch...



Jussand, Frederick  
Co. K 5 Reg't U.S.C.A.

3 Enclosures.

Bed Cards .....	Final Statements .....
Burial Records .....	Furloughs or L. of A. ....
Certs. of Dis. for Discharge .....	Med. Certificates .....
C. M. Charges .....	Med. Des. Lists .....
Descriptive Lists .....	Orders <input checked="" type="checkbox"/> .....
Discharge Certificates .....	Pris. of War Record .....
Enlistment Papers .....	Resignations <input checked="" type="checkbox"/> .....

Other papers relating to—

Admission to Hosp'l .....	Furlough or L. of A. ....
Casualty Sheet .....	Med. Examination .....
Confinement <input checked="" type="checkbox"/> .....	Misc. Information .....
Contracts .....	Pay or Clothing .....
Death or Effects .....	Personal Reports .....
Desertion .....	Rank .....
Discharge from Hosp'l .....	Transfer to Hosp'l .....
Discharge from Service .....	Transfer to V. R. C. ....
Duty .....	Transportation .....

J 1 5600 U.S.A.  
Frederic Jassand  
1 Lt., Co. B., 5 Reg't U.S. 6600

**NOTATION.**

Book mark: 152 - Vol. 14 65. 1879 with  
J - 144 - C. T. - 1864

War Department,

Adjutant General's Office,

Washington, Jan 20, 1879.

Discharged Sep 14 1865,  
S.O. 494 War Department.

C. S. C. C.

JAN. - 9

5361522

☆ 1891 ☆

*L. D. 408 1132, v. 14 C. 79*



*J* | **5 Cav.** | **U.S.C.T.**

*Frederick Jussman*  
*1<sup>st</sup> Lt*, Co. *B*, 5 Reg't U. S. Col'd Cavalry.

Appears on **Co. Muster-out Roll**, dated  
*Helena Ark*, *Mar 16* 186*6*.

Muster-out to date \_\_\_\_\_, 186 .

Last paid to \_\_\_\_\_, 186 .

**Clothing account:**

Last settled \_\_\_\_\_, 186 ; drawn since \$ \_\_\_\_\_ 100

Due soldier \$ \_\_\_\_\_ 100; due U. S. \$ \_\_\_\_\_ 100

Am't for cloth'g in kind or money adv'd \$ \_\_\_\_\_ 100

Due U. S. for arms, equipments, &c., \$ \_\_\_\_\_ 100

Bounty paid \$ \_\_\_\_\_ 100; due \$ \_\_\_\_\_ 100

Remarks: *Was 1<sup>st</sup> Lieut from*  
*Organization of Company Co*  
*Sept 24: 1862 then resigned*  
*Resignation accepted*

Book mark: *Discharged Sept 14/62*

(361) \_\_\_\_\_ Copyist.

JAN. 18

40729960

1899.

† Oct. 1864 (1st Co A, entry cancelled)

5 Cav. U.S.C.T.

Frederick Fassand

Lieut. Col. B. 5 Reg't U. S. Colored Cav.  
Adj't. F.V.S.

Appears on Returns as follows:

Oct 1864 (1 St. Co. A) Present. Ordnance Officer at Camp Nelson Ky.  
From organization to Oct 31 1864 (1 St. Co. B)  
App't. Adj't. of Regt. per Regt Order No. Camp Nelson Ky.  
Oct 1864 to Apr 1865 (Adj't. F.V.S.) Present.  
Transf'd from Co to Reg Staff per R.O. No. 13, dated Oct 31, 64  
May to Aug 1865 (1 St. Co. B) Present.  
On special duty, Comdg. Co. K, 5 U.S.C. Cav. per R.O. No. 92.  
Sept. 1865 Loss: Relieved from duty with the Regt. per R.O. No. 155 his resignation having been accepted by proper authority

June to Aug 1865 (Co Return Co. K) (1 St. Co. -)  
Present. Temporarily assigned to Comdg. Co. K, 5 U.S.C. Cav. per R.O. No. 92, May 31/65

<over>

Book mark:

Austin



J. | 5 Cav. | U.S.C.T.

Fred Jassard

1st Lt., Co. B, 5 Reg't U. S. Col'd Cavalry.

Appears on

Company Muster Roll

for Sept. & Oct., 1865.

Present or absent

Stoppage, \$ 100 for

Due Gov't, \$ 100 for

Valuation of horse, \$ 100

Valuation of horse equipments, \$ 100

Remarks: Resignation accepted  
Sept. 22, 1865. Relieved  
from duty.

Book mark: 152714 C.T. 79. AB. 408

R. E. Wilson

*J.* | **5 Cav.** | **U.S.C.T.**

*Fred Jassard*

*1st Lt.*, Co. B, 5 Reg't U. S. Col'd Cavalry.

Appears on

**Company Muster Roll**

for *July & Aug*, 186*5*.

Present or absent *present*

Stoppage, \$ *100* for

Due Gov't, \$ *100* for

Valuation of horse, \$ *100*

Valuation of horse equipments, \$ *100*

Remarks: *Com'dy Co. 'K' per Reg. ord. 92 - May 31st. 1865*

Book mark: \_\_\_\_\_

*R. E. Wilson*

J. 5 Cav U.S.C.  
J. Jassard  
1st 5" U.S.C. Cav.

**Return**

of the Post of Covington and Newport, Ky.,  
for the month of July, 1865,  
dated Not Dated, 186  ,  
shows the following with regard to the person  
named above :

Post or station .....

Remarks: .....

.....  
.....  
.....  
.....

.....  
.....  
.....  
.....

.....

Book mark: .....

.....

(546) J. R. M. Coach Copyist.



J. | 5 Cav. | U.S.C.T.

Fred Gassard

1st Lt., Co. B, 5 Reg't U. S. Col'd Cavalry.

Appears on

Company Muster Roll

for May 7 June, 1865.

Present or absent present

Stoppage, \$ 100 for

Due Gov't, \$ 100 for

Valuation of horse, \$ 100

Valuation of horse equipments, \$ 100

Remarks: Relieved from duty as Regtl. Adjt. and assigned to Co. "B" 5 U. S. C. Cav. per Regtl. order No. 91, dated May 31, 1865. Temporarily assigned to duty in Co. "K" 5 U. S. C. Cav. per Regtl. order No. 93, dated June 9, 1865.

Book mark:

R. E. Wilson

1860

4 Cav. | **U.S.C.T.**

*Edw. H. Garrison*

Rank *Adj.*, 5<sup>th</sup> Reg't U. S. Col'd *Cav.*

Appears on

**Field and Staff Muster Roll**

for *March & Apr* 186*0*.

Present or absent *Present*

Stoppage, \$ *100* for

Due Gov't, \$ *100* for

Valuation of horse, \$ *100*

Valuation of horse equipments, \$ *100*

Remarks:

Book mark:

*Edw. H. Garrison*

*G. I. Co* | *Co* | **U.S.C.T.**

*Fredrick Jansand*

Rank *Adj.*, *5* Reg't U. S. Col'd *Co*

Appears on a

**Field and Staff Muster-out Roll**

of the organization named above. Roll dated  
*Helena, Ark*, *Mar 16*, 186*6*.

Muster-out to date ..... 186 .

Last paid to ..... 186 .

**Clothing account:**

Last settled....., 186 ; drawn since \$..... 100

Due soldier \$..... 100; due U. S. \$..... 100

Am't for cloth'g in kind or money adv'd \$..... 100

Due U. S. for arms, equipments, &c., \$..... 100

Bounty paid \$..... 100; due \$..... 100

Remarks: *Appointed adjt*  
*Oct 31/64*  
*Relieved from duty and*  
*assigned to Co. B. 31 May*  
*1865*

Book mark: .....

(360)

*E. J. Leman*

Copyist.



Co 15 Cav. U.S.C.T.

Frederick Fassand

Rank Adj, 5 Reg't U. S. Col'd Cav

Appears on

**Field and Staff Muster Roll**

for Jan & Feb 1865

Present or absent Present

Stoppage, \$ 100 for \_\_\_\_\_

Due Gov't, \$ 100 for \_\_\_\_\_

Valuation of horse, \$ 100

Valuation of horse equipments, \$ 100

Remarks: \_\_\_\_\_

Book mark: \_\_\_\_\_

Whitman

5 Cav. | U.S.C.T.

Fredrick Gassard

Rank Adj. S. Reg't U. S. Col'd Cav

Appears on

Field and Staff Muster Roll

for June & Dec 1864.

Present or absent Present

Stoppage, \$ 100 for

Due Gov't, \$ 100 for

Valuation of horse, \$ 100

Valuation of horse equipments, \$ 100

Remarks:

Book mark:

Handwritten signature





4 | **5 Cav.** | **U.S.C.T.**

Frederick Gassard  
1st Lt, Co. B, 5 Reg't U. S. Col'd Cavalry.

Appears on

**Company Muster Roll**

for Oct 31, 1864.

Present or absent Present

Stoppage, \$ 100 for

Due Gov't, \$ 100 for

Valuation of horse, \$ 100

Valuation of horse equipments, \$ 100

Remarks: On Detached  
Service at Camp  
Nelson Ky

Book mark: \_\_\_\_\_

Lamb

JAN. - 9

5359474

☆ 1891 ☆

*Sept 19<sup>th</sup> to Oct 19<sup>th</sup> 1864 Comd'g.  
Company 'B'*

5 Cav. | U.S.C.T.

Fredrick Jassard

Rank Adj't, 5 Reg't U. S. Col'd Cav.

Age years.

Appears on

Field and Staff Muster Roll\*

for to Oct 31, 1864.

Joined for duty and enrolled:

When Aug 9, 1864.

Where Camp Nelson Ky

Period years.

Mustered in:

When Sept 19, 1864.

Where Camp Nelson Ky

Present or absent Present

Stoppage, \$ 100 for

Due Gov't, \$ 100 for

Valuation of horse, \$ 100

Valuation of horse equipments, \$ 100

Remarks: Appointed Adj't per Reg't Ord. No. 13 Oct 31 1864 and transferred to Reg't Staff from Co B. From (over)

\* First current roll. No muster-in roll of Field and Staff on file.

Book mark:

M. J. Jassard



**5 Cav. U.S.C.T.**

*F*  
*Fredrick Jassand*  
*1 Lt*, Co. *B*, 5 Reg't U. S. Col'd Cavalry.

Appears on

**Company Muster-in and Descriptive Roll**  
of the organization named above. Roll dated

*Camp Nelson, N.Y., Oct 24, 1864*

Where born

Age \_\_\_\_\_ y'rs; occupation \_\_\_\_\_

When enlisted \_\_\_\_\_, 186 .

Where enlisted \_\_\_\_\_

For what period enlisted *3* years.

Eyes \_\_\_\_\_; hair \_\_\_\_\_

Complexion \_\_\_\_\_; height \_\_\_\_\_ ft. \_\_\_\_\_ in.

When mustered in \_\_\_\_\_, 186 .

Where mustered in \_\_\_\_\_

Bounty paid \$ 100; due \$ 100

Where credited *Residence Cleve*

*land Ohio*

Company to which assigned *B*

Remarks:

Book mark:

*Lassand*

JAN. - 9

5359177

1891

1864 to rank as first  
Lieut in the 5 Regt.  
U. S. Col. Cavalry from  
the 9 day of August  
1864. Assigned to duty  
with his Company (B)  
Sept. 19. 1864. Enlisted  
men in said comp-  
any were mustered  
in (to the Maximum)  
on or before said date

I | 5 Cav. | U.S.C.T.

Frederick Jassand

1st, Co. B., 5 Reg't U. S. Col'd Cav.

Age 22 years.

Appears on an

**Individual Muster-in Roll**

of the organization named above. Roll dated

Camp Nelson Ky. Sept. 28, 1864.

Muster-in to date Sept. 20  
28, 1864.

Joined for duty and enrolled:

When Sept 19, 1864.

Where Camp Nelson Ky

Period 5 years.

Valuation of horse, \$ 100

Valuation of horse equipments, \$ 100

Remarks: Mustered in upon  
appointment of the Pres-  
ident of the United States  
dated Louisville Ky. Sept. 19  
\*Corrected by H. A. J. Nov. 20/97

Book mark:

I-144-CJ-1864

Sarimer

(336)

Copyist.



J | Scav. | **U.S.C.T.**

Frederick Jassard

1<sup>st</sup> Lt., Co. B, 3 Reg't U. S. Col'd Cavry

Appears on

**Regimental Descriptive Book**

(List of Commissioned Officers)

of the regiment named above.

Rank *1<sup>st</sup> Lieutenant*

Date of appointment..... 186.....

Remarks: *Mustered Sept 19<sup>th</sup> 1864.*  
*at Camp Nelson Ky by*  
*Capt Kinney 18<sup>th</sup> U.S.C.*  
*Appointed Adjutant*  
*per R.O. 13 Oct. 31. 1864.*  
*Relieved from duty*  
*as Adj't and assigned*  
*to Co. B. per R.O. 71 May 31*  
*1865. Discharged per*  
*S.O. 494 War Dept. Washington*  
*D. C. Sept. 14. 65. Rel'd from*  
*duty per R.O. 155 Sep 21. 65.*

*Hearst*

S. 1524610 P O m m  
S 1603676 Aud w D  
P P 534282

Sturtevant Co

101

*Jassaud Frederick*  
**Co B , 5 U. S. Col'd Cav.**

*1<sup>st</sup> Lieutenant* | *1<sup>st</sup> Lieutenant*

**CARD NUMBERS.**

1	5360637	26
2	5359177	27
3	5360734	28
4	5360916	29
5	5359474	30
6	5359480	31
7	5359487	32
8	5359497	33
9	5359571	34
10	5361099	35
11	5361185	36
12	5361356	37
13	5361522	38
14	9435-965	39
15	8-144-07-1864	40
16	42608051	41
17	40729960	42
18		43
19		44
20		45
21		46
22		47
23		48
24		49
25		50

Book Mark: *152.71465.79*  
*8-144-07-1864*

**See also**



RECORD OF DEATH AND INTERMENT.

43

Name and number of person interred.	Franklin Jasper	
Number and locality of the grave .	Range 36 Grave 5	
Hospital number of the deceased .	2017,	
Regiment, rank, and company . . .	5 <sup>th</sup> U.S. Cav, Private Co. "E"	
Residence before enlistment . . .	Virginia, Somerset, Ky,	
Conjugal condition, (and if married, )	Robert Jasper (friend)	Somerset Ky,
B the residence of the widow) .		
2 Cause of death . . . . .	Small Pot,	
Age of the deceased . . . . .	40 yrs	
Nativity . . . . .	Virginia	
References and remarks . . . . .	As per Roll	
Date of death and burial . . . . .	May 5 <sup>th</sup> @ 5 <sup>th</sup>	, 1865.

Duplicates sent to the Adjutant General of the United States Army, and to the Sexton of the Eastern Cemetery.

Memoranda:

- |             |    |                    |
|-------------|----|--------------------|
| Cap         | 1. | Buried with Corpse |
| Overcoat    | 1. | Socks pr           |
| Jacket      | 1. | Drawers "          |
| Trousers    | 1. | Shirts             |
| Shirt       | 1. |                    |
| Drawers     | 1. |                    |
| Boots, prs, | 1. |                    |
| Socks, " ,  | 2. |                    |

Franklin Jasper  
S. U. S. Col & Cav. Priv. C.  
May 5. 65.

Louis. Ky, Eruptive.

HOSPITAL RECORD,

SUBJECT TO THE

ORDER OF THE SURGEON GENERAL

UNITED STATES ARMY.

1



RECORD OF DEATH AND INTERMENT.

Name and number of person interred.	<i>Franklin Jasper</i>
Number and locality of the grave . . .	<i>Range 36 Grave 5</i>
Hospital number of the deceased . . .	<i>2017,</i>
Regiment, rank, and company . . .	<i>5<sup>th</sup> U.S. Cav. Pot. Co. "C"</i>
Residence before enlistment . . .	<i>Somerset, Ky,</i>
Conjugal condition, (and if married, the residence of the widow) . . .	<i>Robert Jasper (father) Somerset Ky,</i>
Cause of death . . . . .	<i>Small Pot,</i>
Age of the deceased . . . . .	<i>40 yrs</i>
Nativity . . . . .	<i>Virginia,</i>
References and remarks . . . . .	<i>No Des Roll</i>
Date of death and burial . . . . .	<i>May 5<sup>th</sup> @ 5</i>

, 1865.

[A duplicate of this Record has been forwarded to the Sexton, and another remains at this Hospital.]

To

SIR:

*Brig. Genl L Thomas  
Adj. Genl U.S.A.*

It becomes my duty to inform you that the person above described died at this Hospital as herein stated; and that it is desired his remains should be interred with the usual military honors.

Respectfully,

*A. C. Brantzenelder*  
Surgeon U. S. Army.

MILITARY HOSPITAL,

*Louisville Empire*

This copy of Record is to be transmitted to the Adjutant General at Washington immediately after the place of burial and the number of the grave have been ascertained and registered. The above notification is to remain attached.



*at the residence of Mrs. G. H. ... July 1865*

*Genl. Win. J. ...*

*Wm. ...*

*Adj. Genl. ...*

COPY OF RECORD

FOR THE

ADJUTANT GENERAL U. S. ARMY

*1399 vol 2 ... 1865*

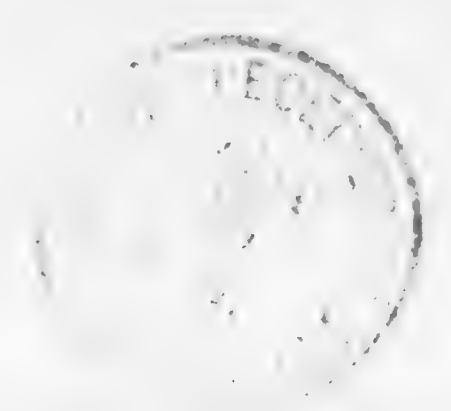

I certify, on honor, that Franklin Jasper a Private of  
 Captain J. N. Schuck's Company (E.) of the 5th Regiment of U.S. C. Cav  
VOLUNTEERS, of the State of \_\_\_\_\_, born in Charlotte, State  
 of Virginia, aged 39 years; 5 feet 11 inches high; BRN complexion,  
BRN eyes, BRN hair, and by occupation a Farmer, having joined the company on  
 its original organization at Camp Nelson Ky, and enrolled in it at the muster into  
 the service of the United States at Camp Nelson Ky, on the Ninth day  
 of September, 1864, (or was mustered in service as a recruit, by \_\_\_\_\_  
 \_\_\_\_\_, at \_\_\_\_\_, on the \_\_\_\_\_ day of \_\_\_\_\_,  
 186\_\_\_\_, or was drafted and mustered into the service of the United States from the \_\_\_\_\_  
 Enrollment District of the State of \_\_\_\_\_, at \_\_\_\_\_,  
 on the \_\_\_\_\_ day of \_\_\_\_\_, 186\_\_\_\_) to serve in the Regiment, for  
 the term of Three Years (3 yrs); and having served HONESTLY and  
 FAITHFULLY with his Company in 5th U.S. C. Cav to the present date, is now  
 entitled to a **DISCHARGE** by reason of Death, Died in Emptive  
General Hospital Louisville Ky May 5th 1865

The said Franklin Jasper was last paid by Paymaster  
May Phelps to include the 28th day of February, 1865, and has  
 pay due him from that time to the present date; he is entitled to pay and subsistence for  
 TRAVELING to place of enrollment, and whatever other allowances are authorized to volunteer  
 soldiers, drafted men, or militia, so discharged. He has received from the United States **CLOTHING**  
 amounting to Fifty- (\$50) 39/100 dollars, since the 9th day of September,  
 1864, when his clothing account was last settled. He has received from the United States  
100 dollars advanced **BOUNTY** 1st Installment Bounty due \$1.00

There is to be stopped from him, on account of the State of \_\_\_\_\_, or other  
 authorities, for **CLOTHING**, &c., received on entering service, Thirty (30) 30/100 dollars; and  
 for other stoppages, viz: \_\_\_\_\_

\_\_\_\_\_ dollars.  
 He has been furnished with TRANSPORTATION in kind from the place of his discharge to \_\_\_\_\_;  
 and he has been SUBSISTED for TRAVELING to his  
 place of enrollment, up to the \_\_\_\_\_, 186\_\_\_\_.

He is indebted to \_\_\_\_\_, **SUTLER**, \_\_\_\_\_ dollars.

He is indebted to \_\_\_\_\_, **LAUNDRESS**, \_\_\_\_\_ dollars.

Given in Duplicate, at Falmouth Kentucky, this 6th day  
 of July, 1865

Jacob L. Schuck  
Capt 5th U.S. C. Cav  
 Commanding Company E



I certify, on honor, that Franklin Jasper a Private of  
 Captain J. H. Schuck's Company (E.) of the 5th Regiment of U.S. Cavalry  
~~VOLUNTEERS~~, of the State of \_\_\_\_\_, born in Charlotte, State  
 of Virginia, aged 39 years; 5 feet 11 inches high; Blk complexion,  
Blk eyes, Blk hair, and by occupation a farmer, having joined the company on  
 its original organization at Camp Nelson Ky, and enrolled in it at the muster into  
 the service of the United States at Camp Nelson Ky, on the  Ninth day  
 of September, 1864, (or was mustered in service as a recruit, by \_\_\_\_\_  
 \_\_\_\_\_, at \_\_\_\_\_, on the \_\_\_\_\_ day of \_\_\_\_\_,  
 186\_\_\_\_, or was drafted and mustered into the service of the United States from the \_\_\_\_\_  
 Enrollment District of the State of \_\_\_\_\_, at \_\_\_\_\_

on the \_\_\_\_\_ day of \_\_\_\_\_, 186\_\_\_\_,) to serve in the Regiment, for  
 the term of Three years (3 yrs); and having served HONESTLY and  
 FAITHFULLY with his Company in 5th U.S. Cavalry to the present date, is now  
 entitled to a **DISCHARGE** by reason of Death, died in Emptive  
General Hospital Louisville Ky. May 5th 1865

The said Franklin Jasper was last paid by Paymaster  
May Phelps to include the 28th day of February, 1865, and has  
 pay due him from that time to the present date; he is entitled to pay and subsistence for  
 TRAVELING to place of enrollment, and whatever other allowances are authorized to volunteer  
 soldiers, drafted men, or militia, so discharged. He has received from the United States **CLOTHING**  
 amounting to Thirty (\$30) 30/100 dollars, since the 9th day of September,  
 1864, when his clothing account was last settled. He has received from the United States  
100 dollars advanced **BOUNTY** 1st Installation Bounty due \$100

There is to be stopped from him, on account of the State of \_\_\_\_\_, or other  
 authorities, for **CLOTHING**, &c., received on entering service, Thirty (30) 30/100 dollars; and  
 for other stoppages, viz: \_\_\_\_\_

\_\_\_\_\_ dollars.

He has been furnished with TRANSPORTATION in kind from the place of his discharge to  
 \_\_\_\_\_; and he has been SUBSISTED for TRAVELING to his  
 place of enrollment, up to the \_\_\_\_\_, 186\_\_\_\_.

He is indebted to \_\_\_\_\_, **SUTLER**, \_\_\_\_\_ dollars.

He is indebted to \_\_\_\_\_, **LAUNDRESS**, \_\_\_\_\_ dollars.

Given in Duplicate, at Falmouth Kentucky, this 6th day  
 of July, 1865

Jacob L Schuck  
Capt 5th U.S. Cav  
 Commanding Company E



Palmyra, N.Y. July 11/1865  
 This soldier has pay due him from the day of Enlistment to the 31<sup>st</sup> day of Dec 1864 & from the 28<sup>th</sup> day of Feb 1865 to the day of his death -  
 (Sgt) J. R. Schuman  
 Capt 5<sup>th</sup> Regt Cav

FINAL STATEMENT

60 "6"  
 OF  
 Franklin Jasper  
 5<sup>th</sup> Reg't of A. J. C. Cav.

VOLUNTEERS.

Enlist July 2, 1865

NOTE 1.—Two of these certificates (or duplicates) are to be given to each Volunteer Soldier or drafted man who may be discharged previously to the discharge of his company, that he may at once receive from the Paymaster the pay, &c., due him, and the captain or other COMMISSIONED officer commanding the company will certify to the act of the delivery of the duplicate certificates; on these certificates the Soldier is "entitled to" his discharge, and should also present his discharge to the Paymaster to have the payment endorsed on it. The discharge is to be given back to the Soldier by the Paymaster; the latter only retaining as his voucher the duplicate certificates.

NOTE 2.—If the Soldier is entitled to pay for the use of his horse, the Company Commander will certify to that fact on the back of both these final statements, and also to the time he has pay due for having been so mounted on his own horse.

NOTE 3.—When a Soldier is furnished with final statements, his descriptive list, if he has one, should be taken up by the officer who gives the Soldier these statements, and endorsed with a statement to this effect by the officer. This endorsement should exhibit a full statement of the time for which the Soldier was allowed pay on his final statements, the clothing account, and all other charges against him or in his favor, so as to comprise a complete exhibit of his account. It will then be transmitted to the company commander of the Soldier, who will enter all the data necessary to a full understanding of the Soldier's account on the muster roll upon which the Soldier's discharge is reported. The descriptive list will then be destroyed. The object of this is, that the remaining portion of the Soldier's account may be settled upon the receipt of these muster rolls, and the Soldier receive any pay or allowances that may be due him at the time of his discharge, and which may not appear on his final statements from the fact that his descriptive list is incomplete. These accounts for back pay, &c., are settled by the 2d Auditor of the Treasury Department.

NOTE 4.—Charges for loss or injury to ordnance, horse equipments, and other miscellaneous charges, should appear under the heading of "Other Stoppages."

NOTE 5.—Bounty paid by State authorities, and not by the United States, will not be entered on this statement.

NOTE 6.—Amounts due the Sutler and Laundress must be entered on the muster roll on which the discharge, death, desertion, &c., is reported, as well as on the final statement, otherwise the amount cannot be collected from the United States.

NOTE 7.—This blank will be used for deceased volunteers and drafted men, as well as for others.

NOTE 8.—Where a Soldier dies in Hospital or on detached service, his descriptive list, if he has one, should be sent with his final statements, in duplicate, to the Adjutant General, Washington, D. C.

[OFFICE INDORSEMENT.]

War Department,

ADJUTANT GENERAL'S OFFICE,

February 25, 1874.

The death of Franklin Jasper,  
Private, Co. C, 5<sup>th</sup> Reg't U. S.  
 Colored Cavalry, is reported as follows:

On Company Muster Roll.	
For <u>February</u> , 1865, <u>May 25</u> , 1865	
Company Muster-out Roll.	
<u>June 1</u> , 1865	1865
Company Descriptive Book.	
	186
Company Morning Reports.	
	186
Soldier's Final Statement.	
<u>June 2</u>	186
Soldier's Record of Death and Interment.	
<u>June 5</u>	186
Soldier's Inventory of Effects.	
	186
Soldier's Certificate of Disability for Discharge.	
	186
Soldier's Individual Muster-out Roll.	
	186
Regimental Return.	
For <u>June</u> , 1865, <u>June 25</u> , 1865	186
Regimental Quarterly Returns.	
	186
Regimental Descriptive Book.	
	186
By Surgeon General.	
( )	186

May 5, 1865, is held to be the correct date, and the Company Muster Roll will be amended accordingly.

Thomas M. Linn  
 Assistant Adjutant General.  
 E.B. 11/3 Sec. letters to 2d Aud.  
 April 2d 1874

ADJUTANT GENERAL'S OFFICE  
 July 27 1865  
 Duplicate with Inventory sent 2d Auditor.

Jasper, Franklin  
P. E., 5 Reg't

2 Enclosures. 3 Items

Bed Cards	Descriptive Lists
Burial Records /	Final Statements /
Certs. of Dis. for Discharge	Furloughs
C. M. Charges	Med. Des. Lists
Med. Certificates	Orders

Other papers relating to—

Admission to Hosp'l	Furlough
Casualty Sheet (Officer's)	Med. Examination
Confinement	Misc. Information
Contracts	Pay or Clothing
Death or Effects /	Personal Reports
Desertions	Rank
Discharge from Hosp'l	Transfer to Hosp'l
Discharge from Service	Transfer to V. R. C.
Duty	Transportation



**5 Cav. U.S.C.T.**

*Franklin Jasper*  
Pvt., Co. B, 5 Reg't U. S. Col'd Cavalry.

Appears on **Co. Muster-out Roll**, dated  
*Wilmington, Ark. March, 1866*.

Muster-out to date \_\_\_\_\_, 186 .

Last paid to *Pay due from enlistment* 186 .

**Clothing account:**

Last settled \_\_\_\_\_, 186 ; drawn since \$ 100

Due soldier \$ 100; due U. S. \$ *17* <sup>10</sup>/<sub>100</sub>

Am't for cloth'g in kind or money adv'd \$ 100

Due U. S. for arms, equipments, &c., \$ 100

Bounty paid \$ 100; due \$ 100

Remarks: *Died at Louisville  
Ky May 5 1865 from  
small Pox (Typhoid),  
his remains forwarded  
July 6 1865*

Book mark: *926 P47.68*

*E. A. Remant*



J | 5 Cav. | U.S.C.T.

Franklin Jasper  
Priv. Co. E, 5 Reg't U. S. Colored Cav.

Appears on Returns as follows:

Jan 1/65 Loss: Jan 25/65 Simpsonville Ky. missing in action near Simpsonville, Ky

Feb 1/65 Gain: Jan 25 Simpsonville Ky. Taken up from missing in action

Feb. to June 1865 Absent sick in Gen. Hosp't. New Albany Ind since Feb 2/65 from wounds rec'd in action Jan 25"

July 1/65 Died May 25/65 Louisville, Ky. Rec'd notice of his death July 6/65

Book mark:

Hustin

*J* | **5 Cav. U.S.C.T.**

*Franklin Jasper*  
*Privt*, Co. E, 5 Reg't U. S. Col'd Cavalry.

Appears on

**Company Muster Roll**

for *July & Aug.*, 1865.

Present or absent.....

Stoppage, \$.....100 for.....

Due Gov't, \$.....100 for.....

Valuation of horse, \$.....100

Valuation of horse equipments, \$.....100

Remarks: *Died of disease at*  
*Hospl. Louisville, Ky.*  
*May 25/65. Received*  
*notice of death July 6/65.*

Book mark: *Died May 5/65*  
*E. B. V. 11. P. 3*

(358)

*Long*  
Copyist.

*J* | **5 Cav.** | **U.S.C.T.**

*Franklin Jasper*  
*Out*, Co. E, 5 Reg't U.S. Col'd Cavalry.

Appears on

**Company Muster Roll**

for *May - June*, 1865.

Present or absent *absent*

Stoppage, \$ *100* for

Due Gov't, \$ *100* for

Valuation of horse, \$ *100*

Valuation of horse equipments, \$ *100*

Remarks: *Absent sick in*  
*Genl. Hosp. New Albany*  
*Ind. since Jan. 25/65.*  
*1<sup>st</sup> Instalment*  
*Bounty due \$100.*

Book mark:

(358)

*F. J. [Signature]*  
Copyist.



*F 5 1865*

*Jasper Franklin*  
*Priv*, Co. *C*, 5<sup>th</sup> Reg't *USC*

Appears on

**Hospital Muster Roll**

of Branch No. 2 Eruptive U. S. A. General Hospital,

at **Louisville, Ky.,**

for *March and April* 1865.

**Attached to hospital :**

When \_\_\_\_\_, 186 .

How employed \_\_\_\_\_

Last paid by Maj. \_\_\_\_\_

to \_\_\_\_\_, 186 .

Bounty paid \$ 100 ; due \$ 100

Present or absent *Present*

Remarks : \_\_\_\_\_

\_\_\_\_\_

\_\_\_\_\_

\_\_\_\_\_

\_\_\_\_\_

\_\_\_\_\_

\_\_\_\_\_

\_\_\_\_\_

Book mark : \_\_\_\_\_

\_\_\_\_\_

*Crosby* Copyist.

9 | **5 Cav. | U.S.C.T.**

Franklin Jasper  
Priv., Co. E, 5 Reg't U. S. Col'd Cavalry.

Appears on

**Company Muster Roll**

for March & April, 1865.

Present or absent Absent

Stoppage, \$ 100 for

Due Gov't, \$ 100 for

Valuation of horse, \$ 100

Valuation of horse equipments, \$ 100

Remarks: Absent sick in  
Hosp. New Orleans Ind. since  
Jan. 25 65.  
First instalment of  
Bounty due.

Book mark:

M. H. ...

Feb 15 Army U.S.C.A.  
Jasper Franklin  
Co. E, 5 Reg't U.S.C.

Appears on

**Hospital Muster Roll**

of Corps d'Afrique U. S. A. General Hospital,

at New Albany, Ind.,

for Jan 1 to Feb 1, 1865.

**Attached to hospital:**

When....., 186 .

How employed.....

Last paid by Maj. ....

to....., 186 .

Bounty paid \$ 100; due \$ 100

Present or absent Present

Remarks : .....

.....

.....

.....

.....

.....

Book mark : .....

.....



9 | **5 Cav. U.S.C.T.**

*Franklin Jasper*  
*Pvt.*, Co. E, 5 Reg't U. S. Col'd Cavalry.

Appears on

**Company Muster Roll**

for *Jan & Feb*, 1865.

Present or absent *Absent*

Stoppage, \$ 100 for

Due Gov't, \$ 100 for

Valuation of horse, \$ 100

Valuation of horse equipments, \$ 100

Remarks: *But Hospital New Albany Ind. since Feb 25 65 from wounds received in action at Simpsonville Ky. Jan 25-65*

Book mark:

*M. Rowland*  
(358) Copyist.

*J* | **5 Cav. | U.S.C.T.**

*Franklin Jasper*  
*Ct.*, Co. E, 5 Reg't U. S. Col'd Cavalry.

Appears on

**Company Muster Roll**

for *Nov. 7 Dec*, 186*4*.

Present or absent *Present*

Stoppage, \$ *100* for

Due Gov't, \$ *100* for

Valuation of horse, \$ *100*

Valuation of horse equipments, \$ *100*

Remarks: *1<sup>st</sup> & 2<sup>nd</sup> instalment  
of Bounty due*

Book mark:

*M. W. Rowland*  
(358) Copyist.

9 | **5 Cav. | U.S.C.T.**

*Franklin Jasper*

*Plt.*, Co. E, 5 Reg't U. S. Col'd Cavalry.

Appears on

**Company Muster Roll**

for *Enlistment to Oct 31*, 1864.

Present or absent *Present*

Stoppage, \$.....100 for .....

Due Gov't, \$.....100 for .....

Valuation of horse, \$.....100

Valuation of horse equipments, \$.....100

Remarks:.....

Book mark:.....

*M. Cowland*



9 | 5 Cav. | U.S.C.T.

Franklin Jasper

Priv., Co. C, 5 Reg't U. S. Col'd Cavalry.

Appears on

**Company Muster-in and Descriptive Roll**

of the organization named above. Roll dated

Camp Nelson, N.H., Oct. 26, 1864.

Where born Charlotte Virginia

Age 34 y'rs; occupation Farmer

When enlisted Sept. 8, 1864.

Where enlisted Cp. Nelson Ky

For what period enlisted 3 years.

Eyes Black; hair Black

Complexion Black; height 5 ft. 11 in.

When mustered in Sept. 9, 1864.

Where mustered in Cp. Nelson Ky

Bounty paid \$ 100; due \$ 100

Where credited

Company to which assigned

Remarks: 8<sup>th</sup> District Kentucky

\* Thomas Jasper

\* Supposed to be name of owner.

Added May 17. 98. H.A.J.

Book mark:

General Notation R. & P. 407 375.

M. Cowland

(356d)

Copyist.

*J* | **5 Cav. | U.S.C.T.**  
*Franklin Jasper*  
....., Co. *E*, 5 Reg't U. S. Col'd Cav.

Appears on

**Company Descriptive Book**  
of the organization named above.

**DESCRIPTION.**

Age *34* years; height *5* feet *11* inches.

Complexion *Black*

Eyes *Blk*; hair *Blk*

Where born *Charlottesville Va*

Occupation *farmer*

**ENLISTMENT.**

When *Sep 8*, 186

Where *Camp Nelson*

By whom *J. B. Randolph* term *3* y'rs.

Remarks: *died of disease*  
*May 25 - 1865*

*J. E. Parks*

100  
Franklin

5 U. S. Col'd Cav.

Private

RD NUMBERS.

12  
16  
18  
24  
24  
2  
4  
4  
36

26  
27  
28  
29  
30  
31  
32  
33  
34  
35  
36  
37  
38  
39  
40  
41  
42  
43  
44  
45  
46  
47  
48  
49  
50

H. S. P. 407375,



# UNITED STATES COLORED TROOPS ENLISTMENT.

STATE OF

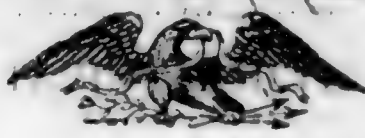

TOWN OF

*Kentucky*  
I, *Samuel Jarris* born in *Marshall co*  
in the State of *Mississippi* aged *Eighteen* years  
and by occupation a *Farmer* Do HEREBY ACKNOWLEDGE to  
have volunteered *Eight* day of *September* 1864

to serve as a **Soldier** in the **Army of the United States of America**, for the  
period of **THREE YEARS**, unless sooner discharged by proper authority: Do  
also agree to accept such bounty, pay, rations, and clothing, as are, or may be,  
established by law for the U. S. colored troops.

And I, *Samuel Jarris*  
do solemnly swear that I will bear true faith and allegiance to the **United States  
of America**, and that I will serve them honestly and faithfully against all their  
enemies or opposers whomsoever; and that I will observe and obey the orders  
of the President of the United States, and the orders of the officers appointed  
over me, according to the Rules and Articles of War.

Sworn and subscribed to, at *Camp Nelson*  
this *8th* day of *Sept 1864* *Samuel Jarris*  
Before *J. C. Randolph* *Drum* *is* *Jarris*  
*Drum* *mark*

I CERTIFY, ON HONOR, That I have carefully examined the above named Volunteer agree-  
ably to the General Regulations of the Army, and that, in my opinion, he is free from all bodily  
defects and mental infirmity, which would in any way disqualify him from performing the  
duties of a soldier.

*P. G. Barrett*  
*Asst Surg & Co*  
EXAMINING SURGEON.

I CERTIFY, ON HONOR, That I have minutely inspected the Volunteer *Samuel Jarris*  
previously to his enlistment, and that he was entirely sober when enlisted; that, to the best of  
my judgment and belief, he is of lawful age; and that, in accepting him as duly qualified to per-  
form the duties of an able-bodied soldier, I have strictly observed the regulations which govern  
the recruiting service. This soldier has *Blue* eyes, *Black* hair, *Black* com-  
plexion, is *five* feet *three* inches high.

*J. C. Randolph*  
*Drum*  
RECRUITING OFFICER OR AGENT.

Mustered into the United States Service.. *Eight* day of *September* 1864.

*N. C. Kinney*  
Mustering Officer.  
*Capt 18 u s Inf*

Mustered into the service of the United States, for three years or during the year, from date of enlistment, in Company  
Regiment of *Volunteers*, on the *8th* day of *September*, 1864 at *Camp Nelson*

*Capt 18 u s Inf*



NOTE 1.—This blank will be used for enlistments of United States colored troops. They will be made out in duplicate in all cases—one to accompany the recruiting return of the superintendent (not the recruiting officer) to the Adjutant General, and one to accompany the accounts of the officer who pays bounty, &c.

NOTE 2.—An enlistment holds to service. A muster-in must, in all cases, precede payment of pay, bounty, pension, &c. A muster-in roll, must in all cases, be filed in the Adjutant General's Office as evidence of muster-in. The mustering officer, commissary, or assistant commissary of musters, as the case may be, will countersign both enlistments as having mustered the soldiers into the service of the United States before either of them is given to the disbursing officer.

DECLARATION OF RECRUIT.

I, Samuel Jarris desiring to volunteer as a soldier in the ARMY OF THE UNITED STATES, for the term of Three Years, DO DECLARE That I am 18 years and ..... months of age; that I have never been discharged from the United States service on account of disability or by sentence of court-martial, or by order before the expiration of a term of enlistment; and I know of no impediment to my serving honestly and faithfully as a soldier for three years.

GIVEN at Cumbe Nelson the 8<sup>th</sup> day of September 1864

Witness: M. S. Palmer

Samuel Jarris  
 By Wm. R. M. Smith  
 Volunteered at Camp Nelson  
Sept 8<sup>th</sup> 1864  
 No. 109  
Samuel Jarris  
Sept 14 1864

Consent of Parent or Guardian in case of a Minor, if a Free Man, or in the case of a Slave, of the Person to whom he owes Service:

I, ..... Do CERTIFY, That I am the ..... that the said ..... is ..... years of age; and I do freely give my CONSENT to his volunteering as a SOLDIER in the Army of the United States, for the period of THREE YEARS, under the conditions of the laws of the United States.

GIVEN at ..... the ..... day of .....

Witness: .....

Jarvis, Samuel -

....., Co. ...., Reg't *U.S.A.*

Enclosures.

Bed Cards .....	Final Statements .....
Burial Records .....	Furloughs or L. of A. ....
Certs. of Dis. for Discharge .....	Med. Certificates .....
C. M. Charges .....	Med. Des. Lists .....
Descriptive Lists .....	Orders .....
Discharge Certificates .....	Pris. of War Record .....
Enlistment Papers <i>2</i> .....	Resignations .....

Other papers relating to—

Admission to Hosp'l .....	Furlough or L. of A. ....
Casualty Sheet .....	Med. Examination .....
Confinement .....	Misc. Information .....
Contracts .....	Pay or Clothing .....
Death or Effects .....	Personal Reports .....
Desertion .....	Rank .....
Discharge from Hosp'l .....	Transfer to Hosp'l .....
Discharge from Service .....	Transfer to V. R. C. ....
Duty .....	Transportation .....



MICROFILM PUBLICATION M 1821

COMPILED MILITARY SERVICE RECORDS  
OF VOLUNTEER UNION SOLDIERS WHO  
SERVED WITH THE USCT (US COLORED TROOPS)  
5TH REGIMENT OF CAVALRY

PERSONAL PAPERS' TARGET SHEET

PLEASE NOTE THE CHECKED INFORMATION ABOUT THE PERSONAL PAPERS IN  
THIS FILE:



NO PERSONAL PAPERS WERE FOUND IN THIS FILE WHEN THE  
RECORDS WERE ARRANGED FOR MICROFILMING.



1 PERSONAL PAPER(S) FOUND IN THIS FILE WHEN THE RECORDS  
WERE ARRANGED FOR MICROFILMING.

J | **5 Cav.** | **U.S.C.T.**

Samuel Jarris

Det., Co. G, 5 Reg't U. S. Col'd Cavalry.

Appears on **Co. Muster-out Roll**, dated  
Helena, Ark. Mch. 16, 1866.

Muster-out to date Mch. 16, 1866.

Last paid to Dec. 31, 1865.

Clothing account:

Last settled....., 186 ; drawn since \$..... 100

Due soldier \$..... 100; due U. S. \$ 40 <sup>57</sup>/<sub>100</sub>

Am't for cloth'g in kind or money adv'd \$..... 100

Due U. S. for arms, equipments, &c., \$..... <sup>53</sup>/<sub>100</sub>

Bounty paid \$ 100 100; due \$ 100 100

Remarks: Slave - due U.S. for Ord.  
\$ <sup>53</sup>/<sub>100</sub>

Book mark : .....

Jarris

5 Cav. U.S.C.T.

Samuel Jarvis  
Priv. Co. G. 5 Reg't U. S. Colored Cav.

Appears on Returns as follows:

Oct. 1864 Loss: Missing in action  
Saltville, Va. Oct. 2/64  
Nov. 1864 Gain Nov. 22, Camp  
Nelson, Returned from miss-  
ing in action  
Nov. 1864 to Jan. 1865 Absent on  
detached service at Camp  
Nelson Ky. Nov. 22/64  
Feb to May 1865 Absent sick in  
Genl Hospital Camp Nelson, Ky.

Book mark :

Hustin



2 | **5 Cav.** | **U.S.C.T.**

*Samuel Jarvis*

*Sgt.*, Co. G, 5 Reg't U. S. Col'd Cavalry.

Appears on

**Company Muster Roll**

for *Quincy & Gehrig*, 1866.

Present or absent *Present*

Stoppage, \$ *100* for

Due Gov't, \$ *100* for

Valuation of horse, \$ *100*

Valuation of horse equipments, \$ *100*

Remarks:

Book mark:

*Tahier*

5 Cav. U.S.C.T.

*Samuel Jarvis*  
Sergeant, Co. G, 5 Reg't U. S. Col'd Cavalry.

Appears on

**Company Muster Roll**

for *March 1865*, 1865.

Present or absent *Present*

Stoppage, \$ *100* for

Due Gov't, \$ *100* for

Valuation of horse, \$ *100*

Valuation of horse equipments, \$ *100*

Remarks:

Book mark:

(358)

*J. Arthur*  
Copyist.

5 Cav. U.S.C.T.

*Samuel Jarvis*

*Samuel*, Co. G, 5 Reg't U. S. Col'd Cavalry.

Appears on

**Company Muster Roll**

for *Sept + Oct.*, 1863.

Present or absent *Present*

Stoppage, \$ *100* for

Due Gov't, \$ *100* for

Valuation of horse, \$ *100*

Valuation of horse equipments, \$ *100*

Remarks:

Book mark:

(358)

*Samuel Jarvis*  
Copyist.



5 Cav. U.S.C.T.

*Samuel Jarvis*

*Sgt.*, Co. G, 5 Reg't U. S. Col'd Cavalry.

Appears on

**Company Muster Roll**

for *July 1st*, 186*5*.

Present or absent *Present*

Stoppage, \$ *100* for

Due Gov't, \$ *100* for

Valuation of horse, \$ *100*

Valuation of horse equipments, \$ *100*

Remarks:

Book mark:

(358)

*J. A. Jones*

Copyist.

5 Cav. U.S.C.T.

*Samuel Jarvis*  
Sgt., Co. G, 5 Reg't U. S. Col'd Cavalry.

Appears on

**Company Muster Roll**

for *May + June*, 1865.

Present or absent *Present*

Stoppage, \$ *100* for

Due Gov't, \$ *100* for

Valuation of horse, \$ *100*

Valuation of horse equipments, \$ *100*

Remarks: *First Installment  
Doubtful \$100*

Book mark: \_\_\_\_\_

*Leah*  
Copyist.

*J. B. Orr West*  
*Samuel Jarris*  
*priv., Co. 5 Reg't 115e Cav*  
Appears on

**Hospital Muster Roll**

of Nelson U. S. A. General Hospital,

at Camp Nelson, Ky.,

for *dated May 1*, 186*5*.

Attached to hospital:

When \_\_\_\_\_, 186 .

How employed \_\_\_\_\_

Last paid by Maj. *Beecher*

to *July 28*, 186*5*.

Bounty paid \$ 100; due \$ 100

Present or absent *Present*

Remarks: \_\_\_\_\_

\_\_\_\_\_  
\_\_\_\_\_  
\_\_\_\_\_  
\_\_\_\_\_  
\_\_\_\_\_

Book mark: \_\_\_\_\_

*M. C. Quality*



*J* | **5 Cav.** | **U.S.C.T.**

*Samuel Jarvis,*  
*Pvt.,* Co. G, 5 Reg't U. S. Col'd Cavalry.

Appears on

**Company Muster Roll**

for *March & April*, 1865.

Present or absent *Absent*

Stoppage, \$ *100* for

Due Gov't, \$ *100* for

Valuation of horse, \$ *100*

Valuation of horse equipments, \$ *100*

Remarks: *Sick in Genl. Hospital, Camp Nelson Ky, 1st instant Bandy \$100.00 due.*

Book mark:

*[Signature]*

(358)

Copyist.

J | **5 Cav. | U.S.C.T.**

*Samuel Jarvis.*  
*Pvt.*, Co. G, 5 Reg't U. S. Col'd Cavalry.

Appears on

**Company Muster Roll**

for *Jan. & Feb.*, 186*5*.

Present or absent *Absent.*

Stoppage, \$ *100* for

Due Gov't, \$ *100* for

Valuation of horse, \$ *100*

Valuation of horse equipments, \$ *100*

Remarks: *Sick in Genl.*  
*Hosptl. Camp Nelson*  
*Ky. 1<sup>st</sup> Instalt*  
*Bounty \$100<sup>00</sup> due.*

Book mark:

(358)

*[Signature]*  
Copyist.

J | 5 Am. U.S.C. 7

Samuel Janis  
Prvt., Co. G, 5 Reg't U.S.C. 7

Appears on

**Hospital Muster Roll**

of Nelson U. S. A. General Hospital,

at Camp Nelson, Ky.,

for June & July, 1865.

Attached to hospital:

When....., 186 .

How employed.....

Last paid by Maj.....

to Pay Sec. Gen. Assistant, 186 .

Bounty paid \$ 100; due \$ 100

Present or absent Present

Remarks:.....

Book mark :.....

M. C. O'Keefe



*J* | **5 Cav. | U.S.C.T.**

*Samuel Jarvis.*

*Priv.*, Co. G, 5 Reg't U. S. Col'd Cavalry.

Appears on

**Company Muster Roll**

for *Nov. + Dec.*, 1864.

Present or absent *Absent*,

Stoppage, \$ *100* for

Due Gov't, \$ *100* for

Valuation of horse, \$ *100*

Valuation of horse equipments, \$ *100*

Remarks: *On detached ser-*  
*vice at Camp Nelson*  
*Ky. Returned from*  
*Missing in Action Nov. 4/64*  
*1st & 2d installments*  
*Penalty dec.*

Book mark: \_\_\_\_\_

(358)

*J. M. [Signature]*

Copyist.

J. | **5 Cav.** | **U.S.C.T.**

*Samuel Jarvis*  
Pvt., Co. G, 5 Reg't U. S. Col'd Cavalry.

Appears on

**Company Muster Roll**

for *Enlt. to Oct. 31, 1864*, 1864.

Present or absent.....

Stoppage, \$.....100 for.....

Due Gov't, \$.....100 for.....

Valuation of horse, \$.....100

Valuation of horse equipments, \$.....100

Remarks:.....

*Missing in action  
Fallville Va. Oct. 2/64*

Book mark:.....

*[Signature]* Copyist.

*J* | **5 Cav.** | **U.S.C.T.**

*Samuel Jarvis*

*Pvt.*, Co. *G*, 5 Reg't U. S. Col'd Cavalry.

Appears on

**Company Muster-in and Descriptive Roll**

of the organization named above. Roll dated

*Camp Nelson Ky, N. Y., Oct. 27, 1864.*

Where born *Marshall Miss.*

Age *18* y'rs; occupation *Farmer.*

When enlisted *Sept. 8*, 1864.

Where enlisted *Camp Nelson Ky.*

For what period enlisted *3* years.

Eyes *Black*; hair *Black*

Complexion *Black*; height *5 ft. 3 in.*

When mustered in *Sept. 8*, 1864.

Where mustered in *Camp Nelson.*

Bounty paid \$ *100*; due \$ *100*

Where credited *To Desol. Ky.*

Company to which assigned

Remarks:

*Free.*

Book mark:

*[Signature]*

(356d)

Copyist.



Q | **5 Cav. | U.S.C.T.**

Samuel Jarvis

....., Co. F, 5 Reg't U. S. Col'd Cav.

Appears on

**Company Descriptive Book**  
of the organization named above.

**DESCRIPTION.**

Age 8 years; height 5 feet 3 inches.

Complexion Black

Eyes Blk; hair Blk

Where born Marshall Miss.

Occupation Farmer

**ENLISTMENT.**

When Sep 8, 186 4.

Where Camp Nelson

By whom A. Randolph term 3 y'rs.

Remarks: Missing in  
action Saltville  
Va Oct. 7<sup>th</sup> 64,  
taken up Nov. 22-  
64,

J. E. Purvis

1196281 P.O. m m  
1304766 P.O. rtd  
R. & P. 504315

Sturges

099  
Jarvis Samuel

Co G, 5 U. S. Col'd Cav.

Private | Private

CARD NUMBERS.

1	5365762	26
2	5365905	27
3	5365959	28
4	5366051	29
5	5366148	30
6	5366240	31
7	5366331	32
8	5366420	33
9	5366505	34
10	5366594	35
11	5366679	36
12	9090687	37
13	32115546	38
14	32115715	39
15	40729957	40
16		41
17		42
18		43
19		44
20		45
21		46
22		47
23		48
24		49
25		50

Book Mark:

See also



March 17 1865  
Hospital Number 10070 Bed 4

Name Louis Farber

Age 20 Nativity Ky

Married ~~Single~~

Residence Lexington Ky

Post Office address of  
wife or nearest relative. Emma Farber

Lexington Ky

Rank Private Co. I Regiment 5th U.S. Cav

When admitted Nov 20 1865

From what source Lexington Ky

**Diagnosis:** (in surgical cases, state explicitly seat and  
character of wound or injury.)

Jefferson G. H.

On what occasion wounded Jeffersonville, Ind.

Date

Nature of missile or weapon

TREATMENT.

[HERE NOTE IMPORTANT COMPLICATIONS AND ALL OPERATIONS.]

---

RESULT AND DATE.

Deserted Nov 24<sup>th</sup> 65-

# UNITED STATES COLORED TROOPS ENLISTMENT.

STATE OF



TOWN OF

I, Ky Lewis Jarboe born in County of Marion  
Marion Co  
in the State of Ky aged 20 years  
and by occupation a Farmer Do HEREBY ACKNOWLEDGE to have  
volunteered this 28 day of June 1864

to serve as a **Soldier** in the **Army of the United States of America**, for  
the period of **THREE YEARS**, unless sooner discharged by proper authority:  
Do also agree to accept such bounty, pay, rations, and clothing, as are, or may be,  
established by law for the U. S. colored troops.

And I, Lewis Jarboe  
do solemnly swear, that I will bear true faith and allegiance to the **United States  
of America**, and that I will serve them honestly and faithfully against all their  
enemies or opposers whomsoever; and that I will observe and obey the orders of  
the President of the United States, and the orders of the officers appointed over  
me, according to the Rules and Articles of War.

Sworn and subscribed to, at Sharon Ky } his  
this 28 day of June 1864 } Lewis Jarboe  
mark

Before Wm Fuller  
Capt + Pro Mar 4<sup>th</sup> Dist Ky

I CERTIFY, ON HONOR, That I have carefully examined the above named Volunteer, agreeably to the  
General Regulations of the Army, and that, in my opinion, he is free from all bodily defects and mental infirmity,  
which would in any way disqualify him from performing the duties of a soldier.

John C. Maxwell

EXAMINING SURGEON.

I CERTIFY, ON HONOR, That I have minutely inspected the Volunteer, Lewis Jarboe  
previously to his enlistment, and that he was entirely sober when enlisted; that, to the best of my judgment and  
belief, he is of lawful age; and that, in accepting him as duly qualified to perform the duties of an able-bodied  
soldier, I have strictly observed the regulations which govern the recruiting service. This soldier has brn  
eyes, blk hair, blk complexion, is 5 feet 6 inches high.

Wm Fuller  
Capt + Pro Mar 4<sup>th</sup> Dist Ky RECRUITING OFFICER OR AGENT.

Mustered into the United States service 29 day of June 1864

Wm Fuller  
Capt + Pro Mar 4<sup>th</sup> Dist Ky Mustering Officer.

Mustered into the service of the United States, for three years or during the war, from date of enlistment, in Company .....  
Regiment of ..... Volunteers, on the ..... day of ..... 186, at .....



NOTE 1.—This blank will be used for enlistments of United States colored troops. They will be made out in duplicate in all cases—one to accompany the recruiting return of the superintendent (not the recruiting officer) to the Adjutant General, and one to accompany the accounts of the officer who pays bounty, &c.

NOTE 2.—An enlistment holds to service. A muster-in, must in all cases, precede payment of pay, bounty, pension, &c. A muster-in roll, must in all cases, be filed in the Adjutant General's Office as evidence of muster-in. The mustering officer, commissary, or assistant commissary of musters, as the case may be, will countersign both enlistments as having mustered the soldier into the service of the United States before either of them is given to the disbursing officer.

DECLARATION OF RECRUIT.

I, Levi Jarboe desiring to volunteer as a soldier in the ARMY OF THE UNITED STATES, for the term of Three Years, DO DECLARE That I am 20 years and ..... months of age; that I have never been discharged from the United States service on account of disability or by sentence of a court-martial, or by order before the expiration of a term of enlistment; and I know of no impediment to my serving honestly and faithfully as a soldier for three years.

GIVEN at Shannon Ky the 28 day of June 1864

Witness:

*Master name  
William Jarboe  
without consent*

*his  
Levi Jarboe  
mark  
By J M Tucker  
28 June 1864  
Volunteered at  
Shannon Ky  
Levi Jarboe  
Richard J. Jarboe*

Consent of Parent or Guardian in case of a Minor, if a Free Man, or in the case of a Slave, of the Person to whom he owes Service:

I, ..... Do CERTIFY, That I am the ..... that the said ..... is ..... years of age; and I do freely give my CONSENT to his volunteering as a SOLDIER in the Army of the United States, for the period of THREE YEARS, under the conditions of the laws of the United States.

GIVEN at ..... the ..... day of .....

Witness:

Jarber, Louis  
Co. I, 5 Reg't U.S. Cav

2 Enclosures.

Bed Cards ..... 1	Descriptive Lists .....
Burial Records .....	Final Statements .....
Certs. of Dis. for Discharge .....	Furloughs .....
C. M. Charges .....	Med. Des. Lists .....
Med. Certificates .....	Orders .....

E. P. 1

Other papers relating to—

Admission to Hosp'l .....	Furlough .....
Casualty Sheet (Officer's) .....	Med. Examination .....
Confinement .....	Misc. Information .....
Contracts .....	Pay or Clothing .....
Death or Effects .....	Personal Reports .....
Desertions .....	Rank .....
Discharge from Hosp'l .....	Transfer to Hosp'l .....
Discharge from Service .....	Transfer to V. R. C. .....
Duty .....	Transportation .....

1884. Discharge certificate furnished by A.S.O April 20, 1888.

Write nothing below this line.



J. | 5<sup>th</sup> Cav. | U.S.C.

Lewis Jarboe

, Co. D., 5<sup>th</sup> Reg't U.S.C. Cav.

**NOTATION.**

Book mark:

2591 B. 1888 with  
541.6.5. 1879.

**War Department,**

Adjutant General's Office,

Washington, April 4<sup>th</sup>, 1888.

"Admitted to Post Hospital  
Lexington, Ky. August 13, 1865,  
with gunshot wound, disposi-  
tion not stated, again admitted  
to same hospital August 21, 1865,  
with gunshot wound right foot  
and sent to general hospital No-  
ember 20, 1865, entered Jefferson  
general hospital Jeffersonville,  
Ind. November 20, 1865 conva-  
lescent and deserted November 24,  
1865. Charge of desertion of  
November 24, 1865, is removed and  
he is discharged to date November  
24, 1865, to complete his military  
record under the provisions of the  
act of Congress approved July 5."

E. P. Conrazier.

(over)

JAN. - 9

5368726

1891 ☆

J. 99. v. of 5" R. C. T. 1868  
V. 97 P. 27, '69

\* Inserted by comparer.

J | **5 Cav. | U.S.C.T.**  
Lewis Jarbor  
Pot., Co. D, 5 Reg't U. S. Col'd Cavalry.

Appears on **Co. Muster-out Roll**, dated  
Helena, Ark., *Feb. 16*, 1866.

Muster-out to date \_\_\_\_\_, 186 .

Last paid to *Oct. 31*, 1865.

Clothing account:

Last settled \_\_\_\_\_, 186 ; drawn since \$ \_\_\_\_\_ 100

Due soldier \$ \_\_\_\_\_ 100; due U. S. \$ \_\_\_\_\_ 100

Am't for cloth'g in kind or money adv'd \$ \_\_\_\_\_ 100

Due U. S. for arms, equipments, &c., \$ \_\_\_\_\_ 100

Bounty paid \$ \_\_\_\_\_ 100; due \$ \_\_\_\_\_ 100

Remarks: *Sick in General Hosp'l.*  
*Jeffersonville, Ind. since*  
*Nov. 20. 1865 - Descriptive*  
*List furnished - No Discharge*  
*given.*

Book mark: *See 25-91-B (E. B.) 88*  
*(over)*

*Cresshaw*



5 Cav. U.S.C.T.

J  
Lewis Jarboe  
Priv. Co. I, 5 Reg't U. S. Colored Cav.

Appears on Returns as follows:

Mar. 1865 Absent on detach<sup>d</sup> serv-  
ice, Cadiz, Ky. Mch. 15/65

Aug & Sept. 1865 Absent sick in Hosp<sup>l</sup>  
Lexington, Ky. since Aug 16/65  
Oct. 1865 to Feb. 1866 Absent sick in  
Gen Hosp<sup>l</sup> Lexington, Ky. since  
Aug. 20/65

Book mark :

(546)

Austin

Copyist.

5 Cav. U.S.C.T.

Lewis Jarber

Priv., Co. I, 5 Reg't U. S. Col'd Cavalry.

Appears on

Company Muster Roll

for Jan'y. & Feby., 1866

Present or absent absent

Stoppage, \$ 100 for

Due Gov't, \$ 100 for

Valuation of horse, \$ 100

Valuation of horse equipments, \$ 100

Remarks: Sick in Hospital  
Lexington Ky. since  
20" Aug, 1865.

Book mark:

Ovenshaw

5 Cav. U.S.C.T.

Lewis Barbae  
Sgt, Co. I, 5 Reg't U. S. Col'd Cavalry.

Appears on

Company Muster Roll

for Nov & Dec, 1865.

Present or absent Absent

Stoppage, \$ 100 for

Due Gov't, \$ 100 for

Valuation of horse, \$ 100

Valuation of horse equipments, \$ 100

Remarks: Due pay for AG, 8/1/64  
Sick in Genl. Hospital  
Leipzig by since  
Aug 20/65

Book mark:

Handwritten signature



**5 Cav. U.S.C.T.**

*Lewis Jarboe*

*1st* Co. I, 5 Reg't U. S. Col'd Cavalry.

Appears on

**Company Muster Roll**

for *Sept + Oct*, 1865.

Present or absent *Absent*

Stoppage, \$ 100 for

Due Gov't, \$ 100 for

Valuation of horse, \$ 100

Valuation of horse equipments, \$ 100

Remarks: *sick in hospital*  
*Springfield Ky since*  
*Aug 20/65*

Book mark:

*W. W. W.*

**5 Cav. U.S.C.T.**

*Lewis Carboe*  
*Pr*

, Co. I, 5 Reg't U. S. Col'd Cavalry.

Appears on

**Company Muster Roll**

for *July & Aug*, 1865.

Present or absent *Absent*

Stoppage, \$ 100 for

Due Gov't, \$ 100 for

Valuation of horse, \$ 100

Valuation of horse equipments, \$ 100

Remarks *Sick in Hospital*  
*Lexington Ky since*  
*Aug 20 65*

Book mark: \_\_\_\_\_

*Wend*

5 Cav. U.S.C.T.

*Louis James*

*1st*, Co. I, 5 Reg't U. S. Col'd Cavalry.

Appears on

Company Muster Roll

for *May 1 June*, 1865.

Present or absent *Present*

Stoppage, \$ 100 for

Due Gov't, \$ 100 for

Valuation of horse, \$ 100

Valuation of horse equipments, \$ 100

Remarks: *Install bounty due \$100-*

-----  
-----  
-----  
-----  
-----  
-----  
-----

Book mark: -----

(358)

*James*  
Copyist.



*J.* **5 Cav. | U.S.C.T.**

*Lewis Jarboe*  
....., Co. I, 5 Reg't U. S. Col'd Cavalry.

Appears on

**Company Muster Roll**

for *Mch. + Apl.*, 1865.

Present or absent *Present*

Stoppage, \$..... 100 for.....

Due Gov't, \$..... 100 for.....

Valuation of horse, \$..... 100

Valuation of horse equipments, \$..... 100

Remarks: *1st installment*  
*Bounty due.*

Book mark: .....

*Philipsen*

5 Cav. U.S.C.T.

*Lewis Garboe*

*For*, Co. I, 5 Reg't U. S. Col'd Cavalry.

Appears on

**Company Muster Roll**

for *Jan. & Feb.*, 1865.

Present or absent *Present*

Stoppage, \$ 100 for

Due Gov't, \$ 100 for

Valuation of horse, \$ 100

Valuation of horse equipments, \$ 100

Remarks: *1<sup>st</sup> & 2<sup>d</sup> installments*  
*\$300<sup>x</sup> Bounty due*

Book mark:

*Philipsen*

J. | **5 Cav.** | **U.S.C.T.**

*Lewis Jarboe*  
Prv. Co. I, 5 Reg't U. S. Col'd Cavalry.

Appears on

**Company Muster Roll**

for *Nov. + Dec.*, 1864.

Present or absent *Present*

Stoppage, \$ *100* for

Due Gov't, \$ *100* for

Valuation of horse, \$ *100*

Valuation of horse equipments, \$ *100*

Remarks: *1st + 2nd installments*  
*Bounty due.*

Book mark:

*Philipsen*



J. | **5 Cav.** | **U.S.C.T.**

Lewis Jarboe

Priv., Co. I, 5 Reg't U. S. Col'd Cavalry.

Appears on

**Company Muster Roll**

for organization to Oct. 31, 1864.

Present or absent Present

Stoppage, \$ 100 for

Due Gov't, \$ 100 for

Valuation of horse, \$ 100

Valuation of horse equipments, \$ 100

Remarks:

Book mark:

Philipsen

*J.* | **5 Cav.** | **U.S.C.T.**

*Lewis Jarboe*

*Priv.*, Co. *D*, 5 Reg't U. S. Col'd Cavalry.

Appears on

**Company Muster-in and Descriptive Roll**

of the organization named above. Roll dated

*Cpt. Nelson*, <sup>*Ky.*</sup> ~~*N.Y.*~~ *Oct. 31*, 1864.

Where born *Marion, Ky.*

Age *20* y'rs; occupation *Farmer*

When enlisted *June 29*, 1864.

Where enlisted *Sebanon*

For what period enlisted *3* years.

Eyes *Brown*; hair *Blk*

Complexion *Blk*; height *5 ft. 6 in.*

When mustered in *June 29*, 1864.

Where mustered in *Sebanon*

Bounty paid \$ *100*; due \$ *100*

Where credited *4<sup>th</sup> Dist. Kentucky.*

Company to which assigned.....

Remarks:

*Enlisted for 108th U.S.C.T,  
Transferred to 5th U.S.C. Cavalry  
August 2, 1864, per S.O. 192, Head  
Quarters List of Ky.*

Book mark: *See 2591-B (E.R.) 88.  
541-CJ-1879*

*Philipsen*

*L<sup>x</sup>* | **5 Cav. | U.S.C.T.**

*Lewis, James*  
....., Co. *D*, 5 Reg't U. S. Col'd Cav.

Appears on

**Company Descriptive Book**  
of the organization named above.

**DESCRIPTION.**

Age *24* years; height *5* feet *6* inches.

Complexion *Black*

Eyes *Brown*; hair *Blk*

Where born *Marion Ky*

Occupation *Farmer*

**ENLISTMENT.**

When *June 29, 1864.*

Where *Lebanon*

By whom *Capt. Fidler*; term *3* y'rs.

Remarks:

*\* Corrected by Williams  
File clerk*



5 bar U.S.C.V.  
Lewis Garboe

Appears with rank of \_\_\_\_\_ on

**Muster and Descriptive Roll**  
of a Detachment of U.S. Col'd Veterans  
recruits forwarded

Roll dated  
Lebanon Ky June 29, 1864.

Where born \_\_\_\_\_

Age 20 years; occupation Farmer

When enlisted June 29, 1864.

Where enlisted Lebanon Ky

For what period enlisted 3 1/2 years.

Eyes Bro; hair Blk

Complexion Blk; height 5 ft. 6 in.

When mustered in \_\_\_\_\_, 186 .

Where mustered in \_\_\_\_\_

Bounty paid \$ \_\_\_\_\_ 100; due \$ \_\_\_\_\_ 100

Clothing account: \_\_\_\_\_

Last settled \_\_\_\_\_, 186 ; drawn since \$ 13 58 100

Date of first muster June 29, 1864.

Company to which assigned \_\_\_\_\_

Remarks Owners name & residence

Wm Garboe, Marion Co

Enlisted without consent of Owner

Enlisted & mustered by Pro. Mar. 4 Dist Ky

Book mark: \_\_\_\_\_

*J.* | *5 Cav.*  
**108** | **U.S.C.T.**  

---

*Louis Jarboe*  

---

*A*, Co. *A*, 108 Reg't U. S. Col'd Infantry.

Appears on  
**Company Descriptive Book**  
of the organization named above.

**DESCRIPTION.**

Age *20* years; height *5* feet *6* inches.  
Complexion *Blk*  
Eyes *Bm*; hair *Blk*  
Where born *Warren Co. Ky.*  
Occupation *Farmer*

**ENLISTMENT.**

When *Jan. 28*, 1864.  
Where *Lebanon*  
By whom *Capt Fidler*, term *3* y'rs  
Remarks:

Enlisted for 108th U. S. C. T.  
Transferred to 5th U. S. C. Cavalry  
August 12, 1864, per S. O. 192. Head  
Quarters Dist. of Ky.

*D. M. Kennedy*  
Copyist.

Rep 354 331.

A 1687611 P.O. ~~St.~~

*Wm. L. ... Co.*



670  
Garboe Lewis

Co *B*, 5 U. S. Col'd Cav.

Private | Private

CARD NUMBERS:

1	5367819	26
2	5367912	27
3	5368012	28
4	5368105	29
5	5368197	30
6	5368292	31
7	5368383	32
8	5368471	33
9	5368557	34
10	5368644	35
11	5368726	36
12	9090981	37
13	9221621	38
14	541-05-1879	39
15	43143415	40
16	40729958	41
17		42
18		43
19		44
20		45
21		46
22		47
23		48
24		49
25		50

Book Mark: 2591 B(EB) 1888

541-05-1879

See also

CASUALTY SHEET.

Name: *James J. ...*  
Rank: *Private* Company: *2* Regiment: *100th*  
Arm: \_\_\_\_\_ State: \_\_\_\_\_  
Nature of Casualty: \_\_\_\_\_

CAUSE OF CASUALTY—(NAME OF DISEASE, &c.)

BY WHOM DISCHARGED.

FROM WHAT SOURCE THIS INFORMATION WAS OBTAINED.

DEGREE OF DISABILITY.

BY WHOM CERTIFIED.

REMARKS.

DATE OF DISCHARGE, DEATH, &c.

PLACE OF DISCHARGE, DEATH, &c.

*[Signature]*  
Clerk.



See letter to 2<sup>nd</sup> Aid. July 2, 1874.

[OFFICE INDORSEMENT.]

War Department,

ADJUTANT GENERAL'S OFFICE,

June 15, 1874,

The death of Pte James  
James, Co. M., 5<sup>th</sup> Reg't U. S.

Colored Cavalry, is reported as follows:

On Company Muster Roll.

For Mar. & April, 1865, <sup>killed in action</sup> during <sup>at Saltville</sup>, 1864,

Company Muster-out Roll.

Lost in action at Saltville, Va., Oct. 2, 1864,

Company Descriptive Book.

Muster Roll, 186

Company Morning Reports,

from Aug. 31, 64, Pursuit factory, 186

Soldier's Final Statement.

, 186

Soldier's Record of Death and Interment.

, 186

Soldier's Inventory of Effects.

, 186

Soldier's Certificate of Disability for Discharge.

, 186

Soldier's Individual Muster-out Roll.

Annual Return of Regt for killed in  
action at Saltville, Va. Dec. 20, 64, 186

Regimental Return.

For , 186 , , 186

Regimental Quarterly Returns.

, 186

Regimental Descriptive Book.

, 186

By Surgeon General.

, 186

(Dec. 20, 1864) is held to be

the correct date, and the Company Muster  
Roll will be amended accordingly.

E. B. 11  
100 *Thoma M. Seward*  
Noted on Reg. R. 69 Assistant Adjutant General

CASUALTY SHEET

No. \_\_\_\_\_

*James*  
\_\_\_\_\_ of Company \_\_\_\_\_  
\_\_\_\_\_ Regiment of \_\_\_\_\_  
State Volunteers.

NATURE OF CASUALTY.

1864



*James, James*

*P*, Co. *M*, **5** Reg **U. S. C. Cav.**

*1* Enclosures.

Bed Cards .....	Descriptive Lists .....
Burial Records .....	Final Statements .....
Certs. of Dis. for Discharge .....	Furloughs .....
C. M. Charges .....	Med. Des. Lists .....
Med. Certificates .....	Orders .....

Other papers relating to—

Admission to Hosp'l .....	Furlough .....
Casualty Sheet ( <del>Officer's</del> ) <i>1</i> .....	Med. Examination .....
Confinement .....	Misc. Information .....
Contracts .....	Pay or Clothing .....
Death or Effects .....	Personal Reports .....
Desertions .....	Rank .....
Discharge from Hosp'l .....	Transfer to Hosp'l .....
Discharge from Service .....	Transfer to V. R. C. .....
Duty .....	Transportation .....

JAN. - 9

5371756

\* 1891 \*

\* A. G. O. Killed in action at  
Saltville, Va. Dec. 20. 64

E. B.  $\frac{11}{100}$

*J* | **5 Cav. | U.S.C.T.**

*James James*

*Pt.*, Co. *M*, 5 Reg't U. S. Col'd Cavalry.

Appears on **Co. Muster-out Roll**, dated  
*Helena Ark*, *Mar 16*, 1866.

Muster-out to date \_\_\_\_\_, 186 .

Last paid to \_\_\_\_\_, 186 .  
*Pay due from enlistment*

Clothing account:

Last settled \_\_\_\_\_, 186 ; drawn since \$ \_\_\_\_\_ 100

Due soldier \$ \_\_\_\_\_ 100; due U. S. \$ \_\_\_\_\_ 100

Am't for cloth'g in kind or money adv'd \$ \_\_\_\_\_ 100

Due U. S. for arms, equipments, &c., \$ \_\_\_\_\_ 100

Bounty paid \$ \_\_\_\_\_ 100; due \$ \_\_\_\_\_ 100

Remarks: *Missing in Action at*  
*Saltrille, Va. Oct. 2. 1864*  
*Apr. 19. 61*

Book mark: *1.169 67. 1877 orders payment*  
*to the heirs of this man. X*

(861)

*Hynd*  
Copyist.  
*(Over)*



J | 5 Cav. | U.S.C.T.

James James  
Pvt., Co. M, 5 Reg't U. S. Colored Cav.

Appears on Returns as follows:

Nov. 1864, Absent at Camp  
Nelson, Ky.

Apr. 1865 Loss: Apr. 7/65 Salt-  
ville Va. Killed in action  
Saltville, Va, 20 Dec '64

Book mark :

(540)

Austin

Copyist.

JAN. - 9

5371238

1891

20, 1864 at Hallville, Va.  
E. B. 100

*J* | **5 Cav. | U.S.C.T.**

*James James*  
*(Priv.)*, Co. M, 5 Reg't U. S. Col'd Cavalry.

Appears on

**Company Muster Roll**

for *Mar. & Apr.*, 1865.

Present or absent.....

Stoppage, \$.....100 for.....

Due Gov't, \$.....100 for.....

Valuation of horse, \$.....100

Valuation of horse equipments, \$.....100

Remarks: *killed in action*  
*during the 4th of July 1865*  
*date unkn. war.*

Book mark: *14th December*

*W. S. Thompson*  
Copyist.

(358)

(5227)



*1* | **5 Cav. | U.S.C.T.**

*James James*  
*Ch. 1*, Co. M, 5 Reg't U. S. Col'd Cavalry.

Appears on

**Company Muster Roll**

for *Jan 10 Feb.*, 1865.

Present or absent *Absent*

Stoppage, \$ *100* for

Due Gov't, \$ *100* for

Valuation of horse, \$ *100*

Valuation of horse equipments, \$ *100*

Remarks: *100 8<sup>th</sup> 9<sup>th</sup> instalments*  
*of bounty due.*  
*At Camp Nelson Ky.*

Book mark:

*H. S. Thompson*

*J* | **5 Cav. | U.S.C.T.**

*James James*  
*Priv.*....., Co. M, 5 Reg't U. S. Col'd Cavalry.

Appears on

**Company Muster Roll**

for *Nov. 8 Dec.*....., 1864.

Present or absent *Absent*.....

Stoppage, \$..... 100 for.....

Due Gov't, \$..... 100 for.....

Valuation of horse, \$..... 100

Valuation of horse equipments, \$..... 100

Remarks: *At Camp Nelson  
Ky. 1st & 2nd  
of bounty due.*

Book mark:.....

*W. D. Simpson*

*A* | **5 Cav. | U.S.C.T.**

*James James*  
....., Co. M, 5 Reg't U. S. Col'd Cavalry.

Appears on

**Company Muster Roll**

for *to Oct. 31* ....., 1864.

Present or absent *Present* .....

Stoppage, \$ ..... 100 for .....

Due Gov't, \$ ..... 100 for .....

Valuation of horse, \$ ..... 100

Valuation of horse equipments, \$ ..... 100

Remarks: .....

Book mark: .....

(358)

*W. S. Thompson*

Copyist.



*J* | **5 Cav. | U.S.C.T.**

*James James*<sup>0+</sup>

*Co. M.*, Co. *M.*, 5 Reg't U. S. Col'd Cavalry.

Appears on

**Company Muster-in and Descriptive Roll**

of the organization named above. Roll dated

*Camp Nelson*, *N.Y.*, *Oct 30*, 186*1*.

Where born *Burrard, Ky.*

Age *21* y'rs; occupation *Farmer*

When enlisted *Aug. 29*, 186*4*.

Where enlisted *Camp Nelson, Ky.*

For what period enlisted *3* years.

Eyes *Black*; hair *Black*

Complexion *Black*; height *5* ft. *6* in.

When mustered in *Aug. 30*, 186*4*.

Where mustered in *Camp Nelson, Ky.*

Bounty paid \$ *100*; due \$ *100*

Where credited *Dist. Ky.*

Company to which assigned

Remarks *\* Henry Walls.*

*\* Supposed to be name of owner. Added May 16, 95.*

*As it appears on roll added May 16, 95, by 1st J.*

Book mark: *W 1798 Ky.*

*W. S. Thompson*

(356d)

Copyist.

J | 5-leaf | **U.S.C.T.**

James James  
C, Co. M, 5 Reg't U. S. Col'd leaf

Appears on

**Company Descriptive Book**

of the organization named above.

**DESCRIPTION.**

Age 21 years; height 5 feet 6 inches.

Complexion Black

Eyes BRN; hair BRN

Where born Germany

Occupation Farmer

**ENLISTMENT.**

When Aug 29, 1864.

Where Camp Nelson

By whom DeLande; term 3 y'rs.

Remarks:

-----  
-----  
-----  
-----  
-----  
-----  
-----  
-----  
-----  
-----

(383g)

A. J. Anderson

Copyist.

697

James James  
Co No, 5 U. S. Col'd Cav.

Private | Private

CARD NUMBERS.

1	5370856	26
2	5370945	27
3	5371045	28
4	5371130	29
5	5371238	30
6	5371756	31
7	9091290	32
8	40729989	33
9		34
10		35
11		36
12		37
13		38
14		39
15		40
16		41
17		42
18		43
19		44
20		45
21		46
22		47
23		48
24		49
25		50

Book Mark: 1.169.65.1877

See also



J | 5 Cav. | U.S.C.T.

Thomas Jackson

Pvt., Co. M, 5 Reg't U. S. Col'd Cavalry.

Appears on Co. Muster-out Roll, dated Helena Ark, Mar 16, 1866.

Muster-out to date \_\_\_\_\_, 186 .

Last paid to \_\_\_\_\_, 186 .  
Pay due from enlistment

Clothing account:

Last settled \_\_\_\_\_, 186 ; drawn since \$ 100

Due soldier \$ 100; due U. S. \$ 100

Am't for cloth'g in kind or money adv'd \$ 100

Due U. S. for arms, equipments, &c., \$ 100

Bounty paid \$ 100; due \$ 100

Remarks: Missing on Return at Saltville Va. Oct. 2. by Sluice  
Apr. 19. 61

Book mark : \_\_\_\_\_

J. H. Jones

5 Cav. U.S.C.T.

Thomas Jackson

Pvt. Co. M, 5 Reg't U. S. Colored Cav.

Appears on Returns as follows:

Oct. 1864 Loss Oct. 6/64 Saltville  
Va. missing in action

Book mark :

(546)

Austen

Copyist.

**5 Cav. | U.S.C.T.**

*Thomas Jackson*

*Plk*, Co. M, 5 Reg't U. S. Col'd Cavalry.

Appears on

**Company Muster Roll**

for *to Oct. 31*, 1864.

Present or absent *Absent*

Stoppage, \$ *100* for

Due Gov't, \$ *100* for

Valuation of horse, \$ *100*

Valuation of horse equipments, \$ *100*

Remarks: *Missing in Action  
Oct. 2/64 - Sackett's Bay*

*All roll next in which name  
appears*

Book mark:

*W. D. Thompson*



**5 Cav. U.S.C.T.**

*J*  
*Thomas Jackson*

*Co. M*, Co. *M*, 5 Reg't U. S. Col'd Cavalry.

Appears on

**Company Muster-in and Descriptive Roll**

of the organization named above. Roll dated

*Camp Nelson, N.Y., Oct 30, 1864.*

Where born *Garrard, Ky.*

Age *18* y'rs; occupation *Farmer*

When enlisted *Aug 29*, 186*4*.

Where enlisted *Camp Nelson, Ky.*

For what period enlisted *3* years.

Eyes *Black*; hair *Black*

Complexion *Black*; height *5* ft. *6* in.

When mustered in *Aug. 29*, 186*4*.

Where mustered in *Camp Nelson, Ky.*

Bounty paid \$ *100*; due \$ *100*

Where credited *8 Dist Ky.*

Company to which assigned

Remarks *\* Mrs Elmira M. Donald*

*\* Supposed to be name of owner.*

*Added May 16, 98. H.A.J.*

Book mark:

*M. S. Thompson*

(356d) Copyist.

9 | 5 leav | **U.S.C.T.**

Thomas Jackson  
Co M, 5 Reg't U. S. Col'd leav

Appears on

**Company Descriptive Book**

of the organization named above.

**DESCRIPTION.**

Age 18 years; height 5 feet 6 inches.

Complexion Black

Eyes BRN; hair BRN

Where born Gerard Ky

Occupation Farmer

**ENLISTMENT.**

When Aug 29, 1864.

Where Camp Nelson

By whom McKandless; term 3 y'rs.

Remarks: Wiping in action Oct  
22/64 Saltville Va

-----  
-----  
-----  
-----  
-----  
-----  
-----  
-----  
-----

A. J. Anderson

696

son Thomas

, 5 U. S. Col'd Cav.

Private

CARD NUMBERS.

55  
50  
61  
89  
56

26

27

28

29

30

31

32

33

34

35

36

37

38

39

40

41

42

43

44

45

46

47

48

49

50



# UNITED STATES COLORED TROOPS ENLISTMENT.

I, Shamasa Jackson born in Kentucky Camp Wilson Martinsburg in the State of K. C. K., aged Twenty one years, and by occupation a Farmer, Do HEREBY ACKNOWLEDGE to have volunteered 15th day of September, 1864, to serve as a Soldier in the Army of the United States of America, for the period of **THREE YEARS**, unless sooner discharged by proper authority: Do also agree to accept such bounty, pay, rations, and clothing, as are, or may be, established by law for the U. S. colored troops.

And I, Shamasa Jackson do solemnly swear that I will bear true faith and allegiance to the United States of America, and that I will serve them honestly and faithfully against all their enemies or opposers whomsoever; and that I will observe and obey the orders of the President of the United States, and the orders of the officers appointed over me, according to the Rules and Articles of War.

Sworn and subscribed to, at Camp Wilson this 15th day of Sept 1864.  
Before J. C. Randolph  
J. C. M.

I CERTIFY, ON HONOR, That I have carefully examined the above named Volunteer agreeably to the General Regulations of the Army, and that, in my opinion, he is free from all bodily defects and mental infirmity, which would in any way disqualify him from performing the duties of a soldier.

P. G. Barrett  
Asst Surg 9th U.S.C. Examining Surgeon.

I CERTIFY, ON HONOR, That I have minutely inspected the Volunteer, Shamasa Jackson previously to his enlistment, and that he was entirely sober when enlisted; that, to the best of my judgment and belief, he is of lawful age; and that, in accepting him as duly qualified to perform the duties of an able-bodied soldier, I have strictly observed the regulations which govern the recruiting service. This soldier has Blue eyes, Black hair, Dark complexion, 5 feet 5 inches high.

J. C. Randolph  
Recruiting Officer or Agent.

Mustered into the United State service 15th day of Sept, 1864.

N. G. Ramsey  
Capt 18th U.S.C. Mustering Officer.

Mustered into the service of the United States, for three years or during the war, from date of enlistment, in Company Canal Regiment of U.S. Colored Volunteers, on the 15th day of September 1864, at Camp Wilson Ky

N. G. Ramsey  
Capt 18th U.S.C.  
Mustering Officer

NOTE 1. This blank will be used for enlistments of United States colored troops. They will be made out in duplicate in all cases—one to accompany the recruiting return of the superintendent (not the recruiting officer) to the Adjutant-General, and one to accompany the accounts of the officer who pays bounty, &c.

NOTE 2. An enlistment holds to service. A muster-in must, in all cases, precede payment of pay, bounty, pension, &c. A muster-in roll must in all cases be filed in the Adjutant-General's Office as evidence of muster-in. The mustering officer, commissary, or assistant commissary of musters, as the case may be, will countersign both enlistments as having mustered the soldiers into the service of the United States before either of them is given to the disbursing officer.

DECLARATION OF RECRUIT.

I, Thomas Jackson, desiring to volunteer as a soldier in the ARMY OF THE UNITED STATES, for the term of Three Years, DO DECLARE that I am 21 years and \_\_\_\_\_ months of age; that I have never been discharged from the United States service on account of disability or by sentence of a court-martial, or by order before the expiration of a term of enlistment; and I know of no impediment to my serving honestly and faithfully as a soldier for three years.

GIVEN at Camp Jackson the 13 day of September 1860

Witness: W. L. Palmer

Thomas Jackson  
Volunteered at Camp Jackson Sept 13, 1860  
By W. L. Palmer  
or W. L. Palmer  
James H. Moore

Consent of Parent or Guardian in case of a Minor, if a Free Man, or in the case of a Slave, of the Person to whom he owes Service:

I, \_\_\_\_\_ Do CERTIFY, That I am the \_\_\_\_\_ that the said \_\_\_\_\_ is \_\_\_\_\_ years of age; and I do freely give my CONSENT to his volunteering as a SOLDIER in the Army of the United States, for the period of THREE YEARS, under the conditions of the laws of the United States.

GIVEN at \_\_\_\_\_ the \_\_\_\_\_ day of \_\_\_\_\_

Witness:



Thomas Jackson

\_\_\_\_\_, Co. \_\_\_\_\_, Reg't \_\_\_\_\_

Enclosures.

Bed Cards	Final Statements
Burial Records	Furloughs or L. of A.
Certs. of Dis. for Discharge	Med. Certificates
C. M. Charges	Med. Des. Lists
Descriptive Lists	Orders
Discharge Certificates	Pris. of War Record
Enlistment Papers	Resignations

Other papers relating to—

Admission to Hosp'l	Furlough or L. of A.
Casualty Sheet	Med. Examination
Confinement	Misc. Information
Contracts	Pay or Clothing
Death or Effects	Personal Reports
Desertion	Rank
Discharge from Hosp'l	Transfer to Hosp'l
Discharge from Service	Transfer to V. R. C.
Duty	Transportation



*J* | **5 Cav.** | **U.S.C.T.**  

---

*Thomas Jackson*  
*Pat*, Co. *H*, 5 Reg't U. S. Col'd Cavalry.

Appears on **Co. Muster-out Roll**, dated  
*Helena Ark March 16* 1866.  
Muster-out to date *Mar. 16*, 1866.  
Last paid to *Dec 31*, 1865.

---

Clothing account:  
Last settled....., 186 ; drawn since \$..... 100  
Due soldier \$..... 100; due U. S. \$ *69* <sup>*47*</sup>/<sub>100</sub>  
Am't for cloth'g in kind or money adv'd \$..... 100

---

Due U. S. for arms, equipments, &c., \$..... 100  
Bounty paid \$ *100* 100; due \$ *100* 100

Remarks: .....

.....

.....

.....

.....

.....

Book mark: *3257. 1880*

---

(361) *J. A. Stewart* Copyist.

J | 5 Cav. | U.S.C.T.

Thomas Jackson  
Priv., Co. I, 5 Reg't U. S. Colored Cav.

Appears on Returns as follows:

Oct. & Nov. 1864, Loss; missing in  
action, Oct. 2/64 Saltville, Va.  
Dec. 1864, Gain; Dec. 14, Camp Nelson  
Returned from missing in ac-  
tion, Saltville, Va., Oct. 2/64,  
Absent on detached service, Camp  
Nelson, since Dec. 14/64.

Feb. 1865, Gain; Feb. 28/65, Camp Nelson,  
Ky. Taken up from missing in  
action, Saltville, Va., Oct. 2/64.

Dec. 1865, Loss; Dec. 1865, Helena,  
Ark. Dropped, having been  
taken up erroneously in Feb. '65.

Nov. 1864, Entry cancelled.

Book mark :

Austin

(646)

Copyist.

Q | 5<sup>th</sup> Cav | **U.S.C.T.**

Thomas Jackson  
Co. H, 5<sup>th</sup> Reg't U. S. Col'd Cav

Appears on

**Company Descriptive Book**

of the organization named above.

**DESCRIPTION.**

Age 21 years; height 5 feet 9 inches.

Complexion Blk

Eyes Blk; hair Blk

Where born Montgomery Ky

Occupation Farmer

**ENLISTMENT.**

When Sep. 15, 1864

Where Camp Nelson Ky

By whom W. Randolph, term 3 yrs.

Remarks: Missing in  
action Saltville Va,  
Oct. 7<sup>th</sup> - 1864, taken  
up, Camp Nelson  
Ky. Nov. 23<sup>rd</sup> - 1864,

W. Randolph  
Coryist.



*J* | **5 Cav.** | **U.S.C.T.**

*Thomas Jackson*  
*Pat*, Co. H, 5 Reg't U. S. Col'd Cavalry.

Appears on

**Company Muster Roll**  
for *Jan'y. & Feb'y*, 1866.  
Present or absent *Present*

Stoppage, \$.....100 for.....

Due Gov't, \$.....100 for.....

Valuation of horse, \$.....100

Valuation of horse equipments, \$.....100

Remarks:.....

Book mark:.....

(358)

*J. Stewart*  
Copyist.

J.

5 Cav. U.S.C.T.

Thomas Jackson

Cvt, Co. H, 5 Reg't U. S. Col'd Cavalry.

Appears on

Company Muster Roll

for Nov. 4<sup>th</sup>, 1865.

Present or absent Present

Stoppage, \$ 100 for

Due Gov't, \$ 100 for

Valuation of horse, \$ 100

Valuation of horse equipments, \$ 100

Remarks:

Book mark:

R. J. Crook

(358)

Copyist.

*J. R.* | **5 Cav.** | **U.S.C.T.**

*Jackson, Thomas*  
*Cvt*, Co. H, 5 Reg't U. S. Col'd Cavalry.

Appears on

**Company Muster Roll**

for *Sept & Oct.*, 1865.

Present or absent *Present*

Stoppage, \$ 100 for

Due Gov't, \$ 100 for

Valuation of horse, \$ 100

Valuation of horse equipments, \$ 100

Remarks:

*\*Corrected by Thomas R. C.*

Book mark:

*R. J. Cooke*



J. | **5 Cav.** | **U.S.C.T.**

*Tom Jackson*

*Serjt*, Co. H, 5 Reg't U. S. Col'd Cavalry.

Appears on

**Company Muster Roll**

for *July & Aug.*, 186*5*.

Present or absent *Present*

Stoppage, \$.....100 for .....

Due Gov't, \$.....100 for .....

Valuation of horse, \$.....100

Valuation of horse equipments, \$.....100

Remarks: *Promoted by order  
"139" Hd Qrs 5 U.S.C. Aug. 18/65  
from a Private to a Serjt.*

Book mark: .....

*B. J. Crooke*

(358)

Copyist.

J. | **5 Cav.** | **U.S.C.T.**  

---

*Thomas Jackson*  
*Cvt*, Co. H, 5 Reg't U. S. Col'd Cavalry.

Appears on

**Company Muster Roll**  
for *May & June*, 1865.  
Present or absent *Present*.

Stoppage, \$ 100 for

Due Gov't, \$ 100 for

Valuation of horse, \$ 100

Valuation of horse equipments, \$ 100

Remarks: *1<sup>st</sup> Installment Bounty*  
*due \$100.*

Book mark: \_\_\_\_\_

(358)

*B. J. Cooke*

Copyist.

J | **5 Cav.** | **U.S.C.T.**

Thomas Jackson

Put, Co. H, 5 Reg't U. S. Col'd Cavalry.

Appears on

**Company Muster Roll**

for Mar & Apr, 1865.

Present or absent present

Stoppage, \$ 100 for

Due Gov't, \$ 100 for

Valuation of horse, \$ 100

Valuation of horse equipments, \$ 100

Remarks: 1<sup>st</sup> installment of  
Bounty Due \$100

Book mark: \_\_\_\_\_

Reynolds



J | 5 Cav. | U.S.C.T.

41  
Thomas Jackson  
Pot, Co. H, 5 Reg't U. S. Col'd Cavalry.

Appears on

**Company Muster Roll**

for Jan & Feb, 1865.

Present or absent present

Stoppage, \$ 100 for

Due Gov't, \$ 100 for

Valuation of horse, \$ 100

Valuation of horse equipments, \$ 100

Remarks: 1st installment of  
Bounty Due \$100.00  
from Missing in action  
Sattville Va Oct 2"  
Jan. 19. 1865

As shown on Roll

Book mark:

Reynolds

J | 5 Cav. | U.S.C.T.

Thomas Jackson

Priv., Co. H, 5 Reg't U. S. Col'd Cavalry.

Appears on

Company Muster Roll

for Nov & Dec, 1864.

Present or absent Absent

Stoppage, \$ 100 for

Due Gov't, \$ 100 for

Valuation of horse, \$ 100

Valuation of horse equipments, \$ 100

Remarks: 1<sup>st</sup> and 2<sup>d</sup> Installments  
Bounty due. On  
detached service  
Camp Nelson since  
Dec 14. Ret. from  
fighting in action  
Dec 14"

Book mark:

Reynolds

J | **5 Cav.** | **U.S.C.T.**

*Thomas Jackson*

*Priv.*, Co. H, 5 Reg't U. S. Col'd Cavalry.

Appears on

**Company Muster Roll**

for *from enlistment to Oct 31, 1864.*

Present or absent *Absent*

Stoppage, \$ *100* for

Due Gov't, \$ *100* for

Valuation of horse, \$ *100*

Valuation of horse equipments, \$ *100*

Remarks: *Missing in Action  
Sattville Va Oct 2<sup>d</sup> 1864*

Book mark:

(358)

*Reynolds*

Copyist.



**5 Cav. U.S.C.T.**

*J*  
*Thomas Jackson*

*Priv*, Co. *H*, 5 Reg't U. S. Col'd Cavalry.

Appears on

**Company Muster-in and Descriptive Roll**

of the organization named above. Roll dated

*Camp Nelson, N.Y., Oct 29, 1864.*

Where born *Montgomery Ky*

Age *21* y'rs; occupation *Farmer*

When enlisted *Sept 15*, 1864.

Where enlisted *Camp Nelson Ky*

For what period enlisted *3* years.

Eyes *Black*; hair *Black*

Complexion *Black*; height *5 ft. 9 in.*

When mustered in *Sept 15*, 1864.

Where mustered in *Camp Nelson Ky*

Bounty paid \$ *100*; due \$ *100*

Where credited

Company to which assigned

Remarks: *9th Dist Ky*

*Leroy Stone.*

*Supposed to be name of owner.*

*Added May 17, 98 H.A.F.*

Book mark:

*Reynolds*

5 Cav. U.S.C.T.

Thomas Jackson  
Co. H, 5 Reg't U. S. Col'd Cav.

Appears on

Company Descriptive Book  
of the organization named above.

DESCRIPTION.

Age 21 years; height 5 feet 7 inches.

Complexion BRN

Eyes BRN; hair BRN

Where born Montgomery

Occupation Farmer

ENLISTMENT.

When Sept 15, 1864.

Where Camp Nelson

By whom C. K. ...; term 3 y'rs.

Remarks: Promoted to Sgt by Regt  
order "139" Aug 18/65

A. J. Anderson

By 61829 P090  
8833514 - P090 Mtd.  
J-1153572 - P.O. MYM  
D 1517428 P090 MYM  
D 1517865 P090 MYM

*St. Vincent Ltd*



Jackson Thomas

Co H, 5 U.S. Col'd Cav.

Private

Private

CARD NUMBERS.

1	5366812	26
2	5366931	27
3	5367001	28
4	5367092	29
5	5367184	30
6	5367280	31
7	5367308	32
8	5367480	33
9	5367550	34
10	5367642	35
11	5367728	36
12	9090806	37
13	9090899	38
14	40729955	39
15		40
16		41
17		42
18		43
19		44
20		45
21		46
22		47
23		48
24		49
25		50

Book Mark:

See also

PROOF OF OWNERSHIP.

STATE OF KENTUCKY,

COUNTY OF

*Woodford*

} SS.

We

*A. L. Childers*

and

*Bro S Minary*

each of lawful

age, and resident citizens of the State and County aforesaid, do certify that

*J W Soyman*

*Sept*

of the State and County aforesaid, was on the

*15th*

day of

186*4*, the lawful owner of the slave named

*Steward Jackson*

referred to and described in the foregoing claim for compensation.

*A. L. Childers*

*John S. Minary*

Sworn to and subscribed before me a

*Notary Public*

for the County of

*Woodford*

State of Kentucky, this the

*8*

day of

*Dec*

186*6*.

*D P Robb*

5 CENT  
STAMP.



PROOF OF LOYALTY.

STATE OF KENTUCKY,

COUNTY OF

*Woodford*

} SS.

We

*W J Steele*

and

*B. Craig*

loyal men and

each of lawful age, and resident citizens of the

of

~~in~~ the State and County aforesaid, upon our oaths declare that we have known

*J W Soyman*

a resident of the State and County aforesaid, since the 4th day of March, 1861, and know that he has firmly and faithfully maintained his or her adherence and allegiance to the Government of the United States, by defending its cause against the Government and forces of the so-called Confederate States of America, in all suitable and practicable ways, and according to his or her ability and opportunity.

*B. Craig*

*W J Steele*

Sworn to and subscribed before me a

*Notary Public*

for the county of

*Woodford*

State of Kentucky, this the

*8*

day of

*Dec*

186*6*.

*D P Robb*

5 CENT  
STAMP.



POWER OF ATTORNEY.

My Post-Office address is *Versailles* County of *Madison* State of Kentucky, and I hereby direct that all communications to me, touching this claim, be sent under cover to \_\_\_\_\_, who is hereby appointed and constituted my true and lawful attorney, to prosecute this claim for me, and who is hereby authorized and empowered to receive and receipt for any award, order, draft, certificate, voucher, warrant, papers or money that may be issued in the adjustment of this claim, or the payment thereof, the same as I might or could do in person were I present and acting for myself, and to file any additional evidence or papers that may be required in the prosecution of this claim.

[WITNESS.]

The owner  
signs here.

Two witnesses to  
owner's signature  
sign here.

50 CENT  
STAMP.



**CERTIFICATE OF AWARD OF THE BOARD OF CLAIMS.**

OFFICE OF THE BOARD OF CLAIMS  
FOR SLAVES ENLISTED OR DRAFTED IN THE SERVICE OF THE U. S. }

....., 186.....  
We hereby certify, that ..... of ..... county, State of Kentucky, having proved, under oath, ..... loyalty to the Constitution and Government of the United States, and established ..... title as to the ownership of ..... , a slave, ..... and mustered at ..... on the ..... day of ..... , 186....., by ..... in the service of the United States, in the ..... Regiment of Colored Troops, Co. ...., the sum of ..... dollars has been awarded to ..... by this Board, subject to the approval of the Secretary of War, as a compensation for the said slave, under the provisions of section 24, Act approved February 24, 1864, and section 2, Act approved July 28, 1866.

....., President of the Board.  
....., Member of the Board.  
....., Member of the Board.

To .....  
Chief of the Bureau for the Organization of Colored Troops, Washington, D. C.

Headquarters Kentucky Volunteers,

Adjutant-General's Office,  
Frankfort, Nov 22, 1866.

I hereby certify, that it appears from the U. S. Muster-Rolls on file in this Office, that Staneard Jackson was enrolled on the 15<sup>th</sup> day of Sept, 1864, at Camp Nelson Ky, by J. C. Randolph, and mustered into the U. S. service on the 15<sup>th</sup> day of Sept, 1864, at Camp Nelson Ky by Capt W. C. Himes to serve three years. Said Staneard Jackson is described as follows: 31 yrs age, Black eyes, Black hair, Black complexion, 5 ft 10 in height. It further appears from said Rolls, that Staneard Jackson owed service to Thornton Twyman and was credited to Woodford County Ky and assigned to Company 'H' 5<sup>th</sup> Regt Colored Cavalry.



In Testimony Whereof, I have hereunto set my hand, and affixed my Official Seal, this 22<sup>nd</sup> day of Nov, 1866.

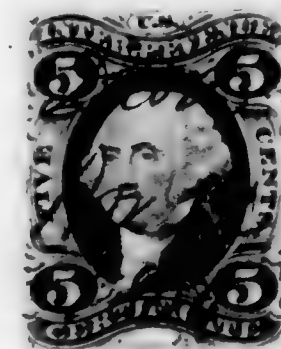

D. D. Lindsey  
Adjutant General Kentucky.

B 404 R 316

**POWER OF ATTORNEY.**

My Post-Office address is Versailles County of Woodford State of Kentucky, and I hereby direct that all communications to me, touching this claim, be sent under cover to ....., who is hereby appointed and constituted my true and lawful attorney, to prosecute this claim for me, and who is hereby authorized and empowered to receive and receipt for any award, order, draft, certificate, voucher, warrant, papers or money that may be issued in the adjustment of this claim, or the payment thereof, the same as I might or could do in person were I present and acting for myself, and to file any additional evidence or papers that may be required in the prosecution of this claim.

[WITNESS.]

The owner signs here. }

50 CENT  
STAMP.

Two witnesses to owner's signature sign here.



No.

CLAIM OF

*J. W. Trueman*

FOR THE COMPENSATION OF SLAVE NAMED

*Stanard Jackson*

I, *J. W. Trueman* a loyal citizen, and a resident of *Versailles*, County of *Woodford*, State of Kentucky, hereby claim compensation, under the provisions of Section 24, act approved February 24, 1864, and section 2, act approved July, 28, 1866, for my slave *Stanard Jackson*, enlisted *15th Sept* 186*4*, at *Camp Nelson*, by *C. Randalph* in the *5th* regiment U. S. Colored Troops, Co. *"H"*; certificate of which enlistment, and a descriptive list, as required, accompany this application. That I did not acquire said slave subsequent to said enlistment, but had a valid title to him at the date of said enlistment, and previous thereto: I having acquired my title to him and my ownership over him as follows, to-wit:

*By purchase from Brothers in 1850*

In proof of my loyalty to the Constitution and Government of the United States, I present the accompanying oath, which I have taken, signed and acknowledged; to be filed with this application, in accordance with requirement of General Orders, No. 329, 1863, War Department, Adjutant General's Office.

*Nov 8*, 186*6*

*J. W. Trueman*

OATH OF ALLEGIANCE.

I, *J. W. Trueman*, the owner and Claimant, do solemnly swear that the foregoing claim is a just and true claim due to me as master and owner of the said slave, and that the facts alleged in said claim in respect to the draft or enlistment (as the case may be) of said slave into the Military service of the United States are true. And I do further swear that I have never joined, or been concerned in, any insurrection or rebellion; that I have never borne arms against the United States; that I have never given any aid, countenance, counsel or encouragement to any person or persons engaged, or whom I had reason to believe were about to engage, in insurrection, rebellion or armed hostility against the United States; that I have neither sought, nor accepted, nor attempted to exercise the functions of any office, civil or military, nor to perform any service whatever, under any authority or pretended authority in hostility to the United States; that I have not yielded a voluntary support to any insurrection, rebellion or pretended government, authority, power or constitution within the United States hostile thereto. And I do further swear that, to the best of my knowledge and ability, I have supported and defended, and will continue to support and defend, the United States against all enemies, foreign and domestic; and that I have supported, defended and obeyed, and will continue to support, defend and obey, the Constitution and laws of the United States; that I will bear true faith and allegiance to the same; and that I take this oath freely, without any mental reservation or purpose of evasion: So help me God.

*J. W. Trueman*

Sworn to and subscribed before me, at *Versailles*, this *8* day of *Nov*, 186*6*

*J. P. Robert P*



War Department,

ADJUTANT GENERAL'S OFFICE,

Washington,

July 28 1867

Respectfully returned to the  
Commission for the State of  
Kentucky, with the informa-  
tion that Stannard Jackson  
was enlisted at Camp Nelson  
Ky. Sept. 15, 1864, and was  
mustered in as Pvt. in Co. "K",  
5<sup>th</sup> U.S. Col. Cav. Sept. 15, 1864,

A. R. Moore

Asst. Adj't General.

W. H. L.

No.

538

APPLICATION OF

J. W. Lippman

OF

Madison Ky

FOR COMPENSATION FOR SLAVE,

Named Stannard Jackson

Enlisted Sep 15 1864

In Com. of 5<sup>th</sup> Regiment,

U. S. COLORED TROOPS.

Received July 10, 1867

Compensation Awarded

....., 186

..... Dollars.

President of Board of Claims.

Claimant's Attorney,

Claimant's Post-office Address,

Versailles Ky



Jackson, Stan  
Pvt, Co. N, ✓ Reg't U.S. 66av

Enclosures.

Bed Cards	Descriptive Lists
Burial Records	Final Statements
Certs. of Dis. for Discharge	Furloughs
C. M. Charges	Med. Des. Lists
Med. Certificates	Orders

Other papers relating to—

Admission to Hosp'l	Furlough
Casualty Sheet (Officer's)	Med. Examination
Confinement	Misc. Information /
Contracts	Pay or Clothing
Death or Effects	Personal Reports
Desertions	Rank
Discharge from Hosp'l	Transfer to Hosp'l
Discharge from Service	Transfer to V. R. C.
Duty	Transportation





*J* | **5 Cav. | U.S.C.T.**

*Samuel Jackson*  
*Prst*, Co *A*, 5 Reg't U. S. Col'd Cavalry.

Appears on **Co. Muster-out Roll**, dated  
*Helena, Ark March 16,* 1866.

Muster-out to date \_\_\_\_\_, 186 .

Last paid to *Pay due from enlistment*, 186 .

**Clothing account:**

Last settled \_\_\_\_\_, 186 ; drawn since \$ \_\_\_\_\_ 100

Due soldier \$ \_\_\_\_\_ 100; due U. S. \$ \_\_\_\_\_ 100

Am't for cloth'g in kind or money adv'd \$ \_\_\_\_\_ 100

Due U. S. for arms, equipments, &c., \$ \_\_\_\_\_ 100

Bounty paid \$ \_\_\_\_\_ 100; due \$ *200* 100

Remarks: *Absent sick in Genl.*  
*Capt. Camp Nelson, Ky. since*  
*Oct. 9. 64,*  
*Des. Roll furnished.*  
*No discharge given.*

Book mark: *A 58. Vol. 7. C. T. 68.*

*J. P. Stewart*  
(361) Copyist.

5 Cav. U.S.C.T.

J  
Stannard Jackson  
Priv. Co. H. 5 Reg't U. S. Colored Cav.

Appears on Returns as follows:

Oct. 1864 to Feb. 1865, Absent sick in  
Genl Hosp. Camp Nelson, Ky  
since Oct. 9/64.

Apr. 1865 to Feb. 1866 Absent sick  
in Genl Hosp. Camp Nel-  
son, Ky. since Oct. 9/64.

Nov. 1864 Entry cancelled.

Book mark :

Justin



*J* | **5 Cav.** | **U.S.C.T.**

*Samuel Jackson*  
*Pvt*, Co. H, 5 Reg't U. S. Col'd Cavalry.

Appears on

**Company Muster Roll**  
for *Jan'y. & Feby*, 1866.  
Present or absent *Absent*

Stoppage, \$ *100* for

Due Gov't, \$ *100* for

Valuation of horse, \$ *100*

Valuation of horse equipments, \$ *100*

Remarks: *Sick in Genl. Hospl.*  
*Camp Wilson, N.Y. since*  
*Oct. 9. 64.*

Book mark: \_\_\_\_\_

(358)

*A. Stewart*  
Copyist.

J. | **5 Cav.** | **U.S.C.T.**  
*Stannard Jackson*  
*Priv*, Co. H, 5 Reg't U. S. Col'd Cavalry.

Appears on

**Company Muster Roll**  
for *Nov. 7 Dec.*, 1865.

Present or absent *Absent.*

Stoppage, \$ *100* for

Due Gov't, \$ *100* for

Valuation of horse, \$ *100*

Valuation of horse equipments, \$ *100*

Remarks: *Sick in Genl Hosp't.*  
*Camp Nelson Ky since*  
*Oct. 9<sup>th</sup> 1864. First In-*  
*stallment Bounty paid \$100*

Book mark:

(358)

*B. J. Cooke*

Copyist.

J. | **5 Cav.** | **U.S.C.T.**

*Stannard Jackson*  
Cvt., Co. H, 5 Reg't U. S. Col'd Cavalry.

Appears on

**Company Muster Roll**

for *Sept. & Oct.*, 1865.

Present or absent *Absent.*

Stoppage, \$ 100 for

Due Gov't, \$ 100 for

Valuation of horse, \$ 100

Valuation of horse equipments, \$ 100

Remarks: *Sick in Genl Hosp  
Camp Nelson Ky since  
Oct. 9<sup>th</sup> 64.*

Book mark: \_\_\_\_\_

(358)

*B J Cooke*

Copyist.



1865

*J. Standard Jackson*  
**5 Cav. U.S.C.T.**  
*Co.*, Co. H, 5 Reg't U. S. Col'd Cavalry.

Appears on

**Company Muster Roll**

for *July & Aug.*, 1865.

Present or absent *Absent.*

Stoppage, \$ 100 for

Due Gov't, \$ 100 for

Valuation of horse, \$ 100

Valuation of horse equipments, \$ 100

Remarks: *Sick in Hospital  
Camp Nelson Ky Oct. 9  
1864.*

Book mark:

(358)

*B. J. Cooke*

Copyist.

*J.* | **5 Cav.** | **U.S.C.T.**

*Stannard Jackson*  
*Pvt.*, Co. H, 5 Reg't U. S. Col'd Cavalry.

Appears on

**Company Muster Roll**

for *May + June*, 1865.

Present or absent *Absent.*

Stoppage, \$ 100 for

Due Gov't, \$ 100 for

Valuation of horse, \$ 100

Valuation of horse equipments, \$ 100

Remarks: *1<sup>st</sup> Installment Bounty  
due \$100. sick and Hoop.  
Camp Nelson Ky Oct  
9th. 1864.*

Book mark : \_\_\_\_\_

(358)

*B J Cooke*

Copyist.

J | **5 Cav.** | **U.S.C.T.**

*Steward Jackson*

*Priv*, Co. H, 5 Reg't U. S. Col'd Cavalry.

Appears on

**Company Muster Roll**

for *Mar & Apr*, 1865.

Present or absent *Absent*

Stoppage, \$ *100* for

Due Gov't, \$ *100* for

Valuation of horse, \$ *100*

Valuation of horse equipments, \$ *100*

Remarks: *1st instalment of  
Bounty Due \$100  
Sick Haspt Camp  
Nelson 14 Oct 9m 1864*

Book mark:

*Reynolds*



J | 5 Cav. | U.S.C.T.

Stannard Jackson

Put, Co. H, 5 Reg't U. S. Col'd Cavalry.

Appears on

**Company Muster Roll**

for Jan & Feb, 1865.

Present or absent Absent

Stoppage, \$ 100 for

Due Gov't, \$ 100 for

Valuation of horse, \$ 100

Valuation of horse equipments, \$ 100

Remarks: 1<sup>st</sup> Installment of  
Bounty Due \$100.00  
Sick in Hospital  
Camp Nelson Ky  
Oct 9. 64

Book mark:

Reynolds

(358)

Copyist.

*J* | **5 Cav.** | **U.S.C.T.**

*Stannard Jackson*

*Pat*, Co. H, 5 Reg't U. S. Col'd Cavalry.

Appears on

**Company Muster Roll**

for *Nov & Dec*, 186 *4*.

Present or absent *Absent*

Stoppage, \$ *100* for

Due Gov't, \$ *100* for

Valuation of horse, \$ *100*

Valuation of horse equipments, \$ *100*

Remarks: *1<sup>st</sup> and 2<sup>d</sup> Installments  
Bounty due. Sick  
in Genl Hrs camp  
Nelson since Oct 9"*

Book mark: \_\_\_\_\_

*Reynolds*

J | **5 Cav.** | **U.S.C.T.**

*Stanward Jackson*  
Pot, Co. H, 5 Reg't U. S. Col'd Cavalry.

Appears on

**Company Muster Roll**

for *from enlistment to Oct 31, 1864.*

Present or absent *Absent*

Stoppage, \$ 100 for

Due Gov't, \$ 100 for

Valuation of horse, \$ 100

Valuation of horse equipments, \$ 100

Remarks: *In Genl Hospital  
Camp Nelson Oct 9<sup>th</sup> 1864*

Book mark:

*Reynolds*



J | **5 Cav.** | **U.S.C.T.**

*Stannard Jackson*

*Pat*, Co. *H*, 5 Reg't U. S. Col'd Cavalry.

Appears on

**Company Muster-in and Descriptive Roll**

of the organization named above. Roll dated

*Camp Nelson Ky*, ~~N.Y.~~ *Oct 29*, 1864.

Where born *Woodford Ky*

Age *31* y'rs; occupation *Farmer*

When enlisted *Sept 15*, 1864.

Where enlisted *Camp Nelson Ky*

For what period enlisted *3* years.

Eyes *Black*; hair *Black*

Complexion *Black*; height *5 ft. 10 in.*

When mustered in *Sept 15*, 1864.

Where mustered in *Camp Nelson Ky*

Bounty paid \$ *100*; due \$ *100*

Where credited

Company to which assigned

Remarks: *7th Dist Ky*  
*Thornton Twinn*

*x* *Supposed to be name of owner.*

*Added May 17. 98. H.A.F.*

Book mark:

*Reynolds*

*J* | *5 Cav* | **U.S.C.T.**

*Samuel Jackson*  
....., Co. *H* *5* Reg't U. S. Col'd *Cav*

Appears on

**Company Descriptive Book**

of the organization named above.

**DESCRIPTION.**

Age *31* years; height *5* feet *10* inches.

Complexion *Blk*

Eyes *Blk*; hair *Blk*

Where born *Woodford Ky*

Occupation *farmer*

**ENLISTMENT.**

When *Sept. 15*, 186 *4*

Where *Camp Nelson Ky*

By whom *H. Randolph*; term *3* y'rs.

Remarks:

.....  
.....  
.....  
.....  
.....  
.....  
.....  
.....  
.....  
.....

*J. E. Rusk*

9 | **5 Cav. | U.S.C.T.**

Stannard Jackson

....., Co. 76, 5 Reg't U. S. Col'd Cav.

Appears on

**Company Descriptive Book**  
of the organization named above.

**DESCRIPTION.**

Age 31 years; height 5 feet 10 inches.

Complexion Blk

Eyes Blk; hair Blk

Where born Woodford Ky

Occupation Farmer

**ENLISTMENT.**

When Sept 15, 1864.

Where Camp Nelson

By whom J. Randolph; term 3 y'rs.

Remarks: .....

.....

.....

.....

.....

.....

.....

.....

A. J. Anderson



694

Jackson Stannard

Co 26, 5 U. S. Col'd Cav.

Private

Private

CARD NUMBERS.

1	5366811	26
2	5366903	27
3	5367003	28
4	5367094	29
5	5367186	30
6	5367282	31
7	5367372	32
8	5367461	33
9	5367549	34
10	5367641	35
11	5367725	36
12	S. 58-CIT. 68.	37
13	9090803-	38
14	9090897	39
15	40729954	40
16		41
17		42
18		43
19		44
20		45
21		46
22		47
23		48
24		49
25		50

Book Mark: S. 58. M. 7. 65. 68

See also

State of Kentucky Mercer County Sec.

I certify that J. W. Caldwell before whom the foregoing application affidavits were made is a Notary Public of Mercer County Ky, duly authorized to administer oaths, and that the above is his genuine signature

Witness my hand and affixed the seal of said County this 12<sup>th</sup> January 1866  
J. W. Caldwell  
Notary Public Mercer County

of

APPLICATION OF

Buckley M. Bowman

OF

Mercer County Ky

FOR COMPENSATION FOR SLAVE.

named Buck Jackson

enlisted April 5<sup>th</sup> 1865,

in Com. 'E', 5<sup>th</sup> Cav<sup>ts</sup> Regiment,

U. S. COLORED TROOPS.

Received \$21, 1867.

Compensation Awarded

, 186

Gallons.

President of Board of Claims.

Claimant's Attorney,

Geo. S. Wilford Jr.

Frankford Ky

Claimant's Post-office Address,

Frankford Ky

Mercer County Ky

FRANKFORT COMMONWEALTH PRINT.



PROOF OF OWNERSHIP.

STATE OF KENTUCKY,

COUNTY OF *mercier*

} SS.

We *D. B. Bowman* and *John Bowman* each of lawful age, and resident citizens of the State and County aforesaid, do certify that *Dudley M. Bowman* of the State and County aforesaid, was on the *5<sup>th</sup>* day of *April* 1865, the lawful owner of the slave named *Dick Jackson*; referred to and described in the foregoing claim for compensation.

*D. B. Bowman*  
*John Bowman*

Sworn to and subscribed before me a *Notary Public* for the County of *mercier* State of Kentucky, this the *12<sup>th</sup>* day of *July* 1867.

*J. M. Cardwell Notary Public*

5 CENT STAMP.

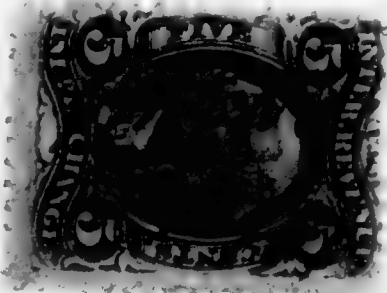

PROOF OF LOYALTY.

STATE OF KENTUCKY,

COUNTY OF *mercier*

} SS.

We *A. G. Kyle* and *Ben Campbell* loyal men and each of lawful age, and resident citizens of the of in the State and County aforesaid, upon our oaths declare that we have known *D. M. Bowman* a resident of the State and County aforesaid, since the 4th day of March, 1861, and know that he has firmly and faithfully maintained his or her adherence and allegiance to the Government of the United States, by defending its cause against the Government and forces of the so-called Confederate States of America, in all suitable and practicable ways, and according to his or her ability and opportunity.

*A. G. Kyle*  
*Ben Campbell*

Sworn to and subscribed before me a *Notary Public* for the county of *mercier* State of Kentucky, this the *12<sup>th</sup>* day of *July* 1867.

*J. M. Cardwell Notary Public*

5 CENT STAMP.

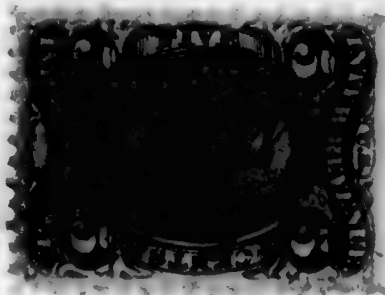

POWER OF ATTORNEY.

My Post-Office address is *Harrodsburg* County of *mercier* State of Kentucky, and I hereby direct that all communications to me, touching this claim, be sent under cover to *Mr. B. Lillard Jr. Frankfort Ky*, who is hereby appointed and constituted my true and lawful attorney, to prosecute this claim for me, and who is hereby authorized and empowered to receive and receipt for any award, order, draft, certificate, voucher, warrant, papers or money that may be issued in the adjustment of this claim, or the payment thereof, the same as I might or could do in person were I present and acting for myself, and to file any additional evidence or papers that may be required in the prosecution of this claim.

[WITNESS.]

The owner signs here.

*D. M. Bowman*

50 CENT STAMP.

*A. G. Kyle*  
*Ben Campbell*

Two witnesses to owner's signature sign here.





CERTIFICATE OF AWARD OF THE BOARD OF CLAIMS.

OFFICE OF THE BOARD OF CLAIMS  
FOR SLAVES ENLISTED OR DRAFTED IN THE SERVICE OF THE U. S.

186

We hereby certify, that \_\_\_\_\_ of \_\_\_\_\_ county, State of Kentucky, having proved, under oath, \_\_\_\_\_ loyalty to the Constitution and Government of the United States, and established \_\_\_\_\_ title as to the ownership of \_\_\_\_\_ a slave, \_\_\_\_\_ and mustered at \_\_\_\_\_ on the \_\_\_\_\_ day of \_\_\_\_\_, 186 \_\_\_\_\_ by \_\_\_\_\_ in the service of the United States, in the \_\_\_\_\_ Regiment of Colored Troops, Co. \_\_\_\_\_ the sum of \_\_\_\_\_ dollars has been awarded to \_\_\_\_\_ by this Board, subject to the approval of the Secretary of War, as a compensation for the said slave, under the provisions of section 24, Act approved February 24, 1864, and section 2, Act approved July 28, 1866.

\_\_\_\_\_  
President of the Board.  
\_\_\_\_\_  
Member of the Board.  
\_\_\_\_\_  
Member of the Board.

To \_\_\_\_\_ Chief of the Bureau for the Organization of Colored Troops, Washington, D. C.

Headquarters Kentucky Volunteers,

Adjutant-General's Office,

Frankfort, Decr \_\_\_\_\_, 1866.

I hereby certify, that it appears from the U. S. Muster- & Rolls on file in this Office, that Dick Jackson was enrolled on the \_\_\_\_\_ day of April, 1865, at Camp Nelson Ky, by J. Farraud, and mustered into the U. S. service on the 17<sup>th</sup> day of April, 1865, at Lexington Ky, by Wm Goodloe, to serve Three years. Said Dick Jackson is described as follows: Age, 27 years; eyes, Black; hair, Black, complexion, Black; height, 5 feet 8 inches. It further appears from said Rolls, that Dick Jackson owed service to Dudley Bowman, was credited to Mercer County, Ky., and was assigned to Co. "C", 5<sup>th</sup> Regiment U. S. Cavalry.

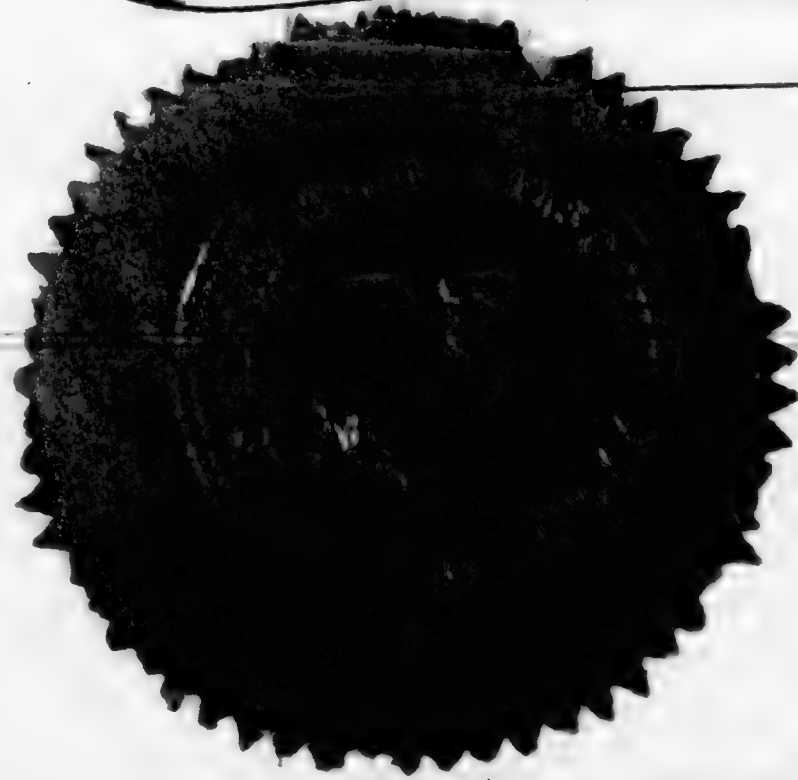

B. 322, R. 788

In Testimony Whereof, I have hereunto set my hand, and affixed my Official Seal, this 18 day of Decr, 1866.

D. Lindsay  
Adjutant General of Kentucky.



STAMP.



POWER OF ATTORNEY.

My Post-Office address is Harrodsburg County of Mercer State of Kentucky, and I hereby direct that all communications to me, touching this claim, be sent under cover to Mrs B. Lillard Fr. Frankfort Ky, who is hereby appointed and constituted my true and lawful attorney, to prosecute this claim for me, and who is hereby authorized and empowered to receive and receipt for any award, order, draft, certificate, voucher, warrant, papers or money that may be issued in the adjustment of this claim, or the payment thereof, the same as I might or could do in person were I present and acting for myself, and to file any additional evidence or papers that may be required in the prosecution of this claim.

[WITNESS.]

The owner signs here.

D. M. Bowman

50 CENT STAMP.

A. H. Kyle  
Ben. Blampfle

Two witnesses to owner's signature sign here.





No.

**C L A I M O F**

*Dudley M. Bowman*

**FOR THE COMPENSATION OF SLAVE NAMED**

*Dick Jackson*

I, *Dudley M. Bowman* a loyal citizen, and a resident of \_\_\_\_\_,  
 County of *Mercer*, State of Kentucky, hereby claim compensation, under  
 the provisions of Section 24, act approved February 24, 1864, and section 2, act approved July, 28,  
 1866, for my slave *Dick Jackson*, enlisted *April 5<sup>th</sup>*  
 1865, at *Camp Nelson Ky*, by *F. Tarrant*  
 in the *Fifth Cav<sup>l</sup>* regiment U. S. Colored Troops, Co. "E"; certificate of  
 which enlistment, and a descriptive list, as required, accompany this application. That I did not ac-  
 quire said slave subsequent to said enlistment, but had a valid title to him at the date of said enlist-  
 ment, and previous thereto: I having acquired my title to him and my ownership over him as fol-  
 lows, to-wit: *By inheritance from my father and*  
*previous to April 5<sup>th</sup> 1865*

In proof of my loyalty to the Constitution and Government of the United States, I present the ac-  
 companying oath, which I have taken, signed and acknowledged; to be filed with this application, in  
 accordance with requirement of General Orders, No. 329, 1863, War Department, Adjutant General's  
 Office.

*14 Jan* . 1867 .

*D. M. Bowman*

**OATH OF ALLEGIANCE.**

I, *Dudley M. Bowman*, the owner and Claimant, do solemnly swear that  
 the foregoing claim is a just and true claim due to me as master and owner of the said slave, and that  
 the facts alleged in said claim in respect to the draft or enlistment (as the case may be) of said slave  
 into the Military service of the United States are true. And I do further swear that I have never  
 joined, or been concerned in, any insurrection or rebellion; that I have never borne arms against the  
 United States; that I have never given any aid, countenance, counsel or encouragement to any person  
 or persons engaged, or whom I had reason to believe were about to engage, in insurrection, rebellion  
 or armed hostility against the United States; that I have neither sought, nor accepted, nor attempted  
 to exercise the functions of any office, civil or military, nor to perform any service whatever, under  
 any authority or pretended authority in hostility to the United States; that I have not yielded a vol-  
 untary support to any insurrection, rebellion or pretended government, authority, power or constitution  
 within the United States hostile thereto. And I do further swear that, to the best of my knowledge  
 and ability, I have supported and defended, and will continue to support and defend, the United  
 States against all enemies, foreign and domestic; and that I have supported, defended and obeyed, and  
 will continue to support, defend and obey, the Constitution and laws of the United States; that I will  
 bear true faith and allegiance to the same; and that I take this oath freely, without any mental reserva-  
 tion or purpose of evasion: So help me God.

*D. M. Bowman*

Sworn to and subscribed before me, at *Harrodsburg*  
 this *12* day of *Jan* . 1867 .

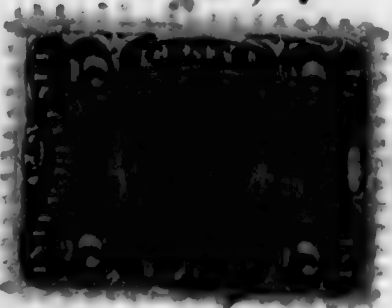

*J. M. Hardwell*  
 Notary Public

War Department,  
ADJUTANT GENERAL'S OFFICE.

Washington, Feb. 8 1867.

Respectfully returned to the  
Commission for the State of  
Kentucky, with the informa-  
tion that Richard Jackson  
was enlisted at Camp Nelson Ky  
April 5 1865, and was  
mustered in as private in Co "E"  
5<sup>th</sup> U.S.C. Cav. April 17, 1865.

19.1223.6

*[Signature]*

Asst. Adj't General.

*State of Kentucky, Mercer County  
I do hereby certify that  
Application of Dudley M. Bowman  
is correct. My Study authorized to ad-  
dress above in this Commission  
Dudley M. Bowman  
My Seal  
J. W. G.*

No. 1223

APPLICATION OF

Dudley M. Bowman

OF

Mercer County Ky

FOR COMPENSATION FOR SLAVE.

Named Dick Jackson

Enlisted April 5<sup>th</sup> 1865,

In Com. "E", 5<sup>th</sup> Cav<sup>l</sup> Regiment,

U. S. COLORED TROOPS.

Received Jan'y 26, 1867.

Compensation Awarded

....., 186.....

..... Dollars.

President of Board of Claims.

Claimant's Attorney,

Mr B. Telford Jr.  
Frankford Ky.

Claimant's Post-office Address,

Harrodsburg  
Mercer County Ky

FRANKFORT COMMONWEALTH PRINT.



Credited to Mercer Co of KY

VOLUNTEER ENLISTMENT.

STATE OF

TOWN OF

Kentucky

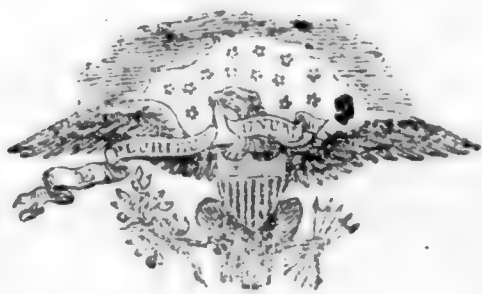

Co of Jessamine

I, Dick Jackson, born in Mercer Co in the State of Kentucky, aged twenty seven years, and by occupation a Laborer, do HEREBY ACKNOWLEDGE to have volunteered this Fifth day of April, 1865, to serve as a Soldier in the Army of the United States of America, for the period of THREE YEARS, unless sooner discharged by proper authority: Do also agree to accept such bounty, pay, rations, and clothing, as are, or may be, established by law for volunteers. And I, Dick Jackson, do solemnly swear, that I will bear true faith and allegiance to the United States of America, and that I will serve them honestly and faithfully against all their enemies or opposers whomsoever; and that I will observe and obey the orders of the President of the United States, and the orders of the officers appointed over me, according to the Rules and Articles of War.

Sworn and subscribed to, at Camp Nelson this 5 day of April, 1865, Dick Jackson mark  
BEFORE J. Cassandine Capt 5th U.S.C. Co.

I CERTIFY, ON HONOR, That I have carefully examined the above-named Volunteer, agreeably to the General Regulations of the Army, and that, in my opinion, he is free from all bodily defects and mental infirmity, which would in any way disqualify him from performing the duties of a soldier.

John Swan  
Capt Surgeon 5th U.S.C. Co.  
EXAMINING SURGEON.

I CERTIFY, ON HONOR, That I have minutely inspected the Volunteer Dick Jackson previously to his enlistment, and that he was entirely sober when enlisted; that, to the best of my judgment and belief, he is of lawful age; and that, in accepting him as duly qualified to perform the duties of an able-bodied soldier, I have strictly observed the Regulations which govern the recruiting service. This soldier has Blk eyes, Blk hair, Blk complexion, is five feet eight 1/2 inches high.

J. Cassandine Capt 5th U.S.C. Co.  
15th Regiment of U.S.C. Volunteers,  
RECRUITING OFFICER.

(A. G. O. No. 74 & 76.)

Certificate for the Signature of the Mustering Officer, Commissary, or Assistant Commissary of Musters, as the case may be.  
Mustered into the service of the United States, for three years or during the war, from date of enlistment, in Co. 15th  
Regiment of U.S.C. Volunteers, on the 19 day of April, 1865, at Depue's Station, Ky.  
and credited to War, (or Sub-district) in the Town of \_\_\_\_\_, in the County of \_\_\_\_\_, in the State of \_\_\_\_\_  
th Congressional District, in the State of \_\_\_\_\_  
Bounty paid at time of Mustering: \_\_\_\_\_  
U. S. Bounty: \_\_\_\_\_  
Local Bounty: \_\_\_\_\_  
William Grant  
Capt 1st Regt Mer of KY  
Mustering Officer

NOTE 1.—This blank will be used for both enlistments and re-enlistments—enlistment of veterans, &c., &c., in the volunteer service. They will be made out in duplicate in all cases—one to accompany the recruiting return of the superintendent (not the recruiting officer) to the Adjutant General, and one to accompany the accounts of the officer who pays bounty, &c. The Regiment and Company in which the soldier last served should be given on the back.

NOTE 2.—An enlistment holds to service. A muster-in must, in all cases, precede payment of pay, bounty, pension, &c. A muster-in roll must, in all cases, be filed in the Adjutant General's Office as evidence of muster-in. The mustering officer, commissary, or assistant commissary of musters, as the case may be, will countersign both enlistments as having mustered the soldier into the service of the United States before either of them is given to the disbursing officer.

DECLARATION OF RECRUIT.

I, Rich Jackson, desiring  
 VOLUNTEER as a Soldier in the Army of the United States, for the term of THREE YEARS,  
 Do Declare, That I am Twenty seven years and \_\_\_\_\_ months  
 of age; that I have never been discharged from the United States service on account of disability or by  
 sentence of a court martial, or by order before the expiration of a term of enlistment; and I know of no  
 impediment to my serving honestly and faithfully as a soldier for three years.

GIVEN at Camp Nelson Ky  
 the 5 day of April 65

Witness:

W Jackson Rich Jackson  
*W Jackson* *Rich Jackson*



Discharged \_\_\_\_\_, 18 \_\_\_\_

Reg't of \_\_\_\_\_

enlistment; last served in Company ( )

5th U.S. Cavalry

Regiment of \_\_\_\_\_

By \_\_\_\_\_

Volunteered at Camp Nelson  
5 April, 1865

No. Rich Jackson

054

CONSENT IN CASE OF MINOR.

I, Abel Gorman (Merce G), Do CERTIFY, That I am  
 the \_\_\_\_\_ of \_\_\_\_\_; that the  
 said \_\_\_\_\_ is \_\_\_\_\_ years of age; and I  
 do hereby freely give my CONSENT to his volunteering as a SOLDIER in the ARMY OF THE UNITED STATES  
 for the period of THREE YEARS.

GIVEN at \_\_\_\_\_  
 the \_\_\_\_\_ day of \_\_\_\_\_

Witness:



Credited to Mercer Co. Ky

VOLUNTEER ENLISTMENT.

STATE OF

TOWN OF

Kentucky

Co of Tennessee

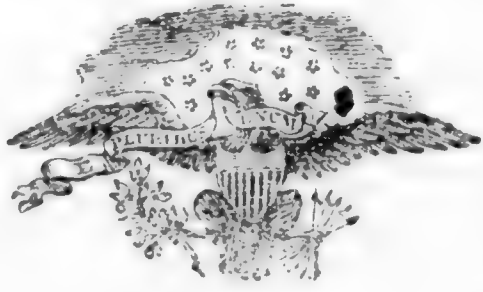

I, Dick Jackson, born in Mercer Co in the State of Kentucky, aged twenty seven years, and by occupation a Laborer, do hereby acknowledge to have volunteered this 5th day of April, 1865, to serve as a Soldier in the Army of the United States of America, for the period of THREE YEARS, unless sooner discharged by proper authority: Do also agree to accept such bounty, pay, rations, and clothing, as are, or may be, established by law for volunteers. And I, Dick Jackson, do solemnly swear, that I will bear true faith and allegiance to the United States of America, and that I will serve them honestly and faithfully against all their enemies or opposers whomsoever; and that I will observe and obey the orders of the President of the United States, and the orders of the officers appointed over me, according to the Rules and Articles of War.

Sworn and subscribed to, at Camp Nelson this 5 day of April, 1865. Dick Jackson

BEFORE J. Fassand, 5th Regt U.S.C. Examining Surgeon

I CERTIFY, ON HONOR, That I have carefully examined the above-named Volunteer, agreeably to the General Regulations of the Army, and that, in my opinion, he is free from all bodily defects and infirmity, which would in any way disqualify him from performing the duties of a soldier.

John Swan, Capt Surgeon 5th Regt U.S.C. Examining Surgeon.

I CERTIFY, ON HONOR, That I have minutely inspected the Volunteer Dick Jackson previously to his enlistment, and that he was entirely sober when enlisted; that, to the best of my judgment and belief, he is of lawful age; and that, in accepting him as duly qualified to perform the duties of an able-bodied soldier, I have strictly observed the Regulations which govern the recruiting service. This soldier has Blue eyes, Blue hair, Blue complexion, is five feet eight 1/2 inches high.

J. Fassand, 5th Regt U.S.C. Recruiting Officer.

Certificate for the Signature of the Mustering Officer, Commissary, or Assistant Commissary of Musters, as the case may be. Mustered into the service of the United States, for three years or during the war, from date of enlistment, in Co. 2nd Regt of W. H. Cade's Volunteers, on the 17 day of April, 1865, at Lexington Ky, and credited to 1st Ward, (or Sub-district,) in the Town of Lexington, in the County of Jefferson, in the State of Kentucky. Bounty paid at time of Mustering: U. S. Bounty, Local Bounty.

William H. ... Capt of 9th Mar 7 of 1865





Jackson Dick

....., Co. ...., 5 Reg't U.S.C. leav.

3 Enclosures.

Bed Cards .....	Final Statements .....
Burial Records .....	Furloughs or L. of A. ....
Certs. of Dis. for Discharge .....	Med. Certificates .....
C. M. Charges .....	Med. Des. Lists .....
Descriptive Lists .....	Orders .....
Discharge Certificates .....	Pris. of War Record .....
Enlistment Papers .....	Resignations .....

Other papers relating to—

Admission to Hosp'l .....	Furlough or L. of A. ....
Casualty Sheet .....	Med. Examination .....
Confinement .....	Misc. Information ✓ .....
Contracts .....	Pay or Clothing .....
Death or Effects .....	Personal Reports .....
Desertion .....	Rank .....
Discharge from Hosp'l .....	Transfer to Hosp'l .....
Discharge from Service .....	Transfer to V. R. C. ....
Duty .....	Transportation .....

**5 Cav. U.S.C.T.**

*Richard Jackson*  
*Priv.*, Co. *B*, 5 Reg't U. S. Col'd Cavalry.

Appears on **Co. Muster-out Roll**, dated  
*Nelena, Ark* *Mar 16*, 186*6*.

Muster-out to date *\* Mar 3*, 186*6*.

Last paid to *Dec 31*, 186*5*.

**Clothing account:**

Last settled....., 186 ; drawn since \$..... 100

Due soldier \$..... 100; due U. S. \$ *26*<sup>*38*</sup>/<sub>100</sub>

Am't for cloth'g in kind or money adv'd \$..... 100

Due U. S. for arms, equipments, &c., \$..... 100

Bounty paid \$ *104*<sup>*XX*</sup>/<sub>100</sub>; due \$..... 100

**Remarks:**

*\* Records on file in 2nd. Auditor's Office show this Co. Mustered Out to take effect Mch, 16th. 1866. and paid to include Mch, 15th. 1866.*

Book mark: *B 1223 Ky.*

*J. L. Leonard*



**5 Cav. U.S.C.T.**

*J*  
*Allick Jackson*  
Priv. Co. *E*, 5 Reg't U. S. Colored Cav.

Appears on Returns as follows:

*Apr. 1865 Gain: Apr. 19 Camp  
Nelson Assigned to Co E, as  
per Regtl Order.*

Book mark:

(546)

*Hustin*

Copyist.

**5 Cav. U.S.C.T.**

*Richard Jackson*  
*Priv*, Co. E, 5 Reg't U.S. Col'd Cavalry.

Appears on

**Company Muster Roll**

for *Jan & Feb*, 186*6*

Present or absent *Present*

Stoppage, \$ *100* for

Due Gov't, \$ *100* for

Valuation of horse, \$ *100*

Valuation of horse equipments, \$ *100*

Remarks:

Book mark:

*J. L. Leonard*  
Copyist.

*J.* | **5 Cav.** | **U.S.C.T.**

*Richard Jackson*  
*Priv*, Co. E, 5 Reg't U. S. Col'd Cavalry.

Appears on

**Company Muster Roll**

for *Nov & Dec.*, 1865.

Present or absent *present*

Stoppage, \$ *100* for

Due Gov't, \$ *100* for

Valuation of horse, \$ *100*

Valuation of horse equipments, \$ *100*

Remarks:

-----  
-----  
-----  
-----  
-----  
-----  
-----

Book mark:

-----  
*Long*  
-----  
Copyist.



*J* | **5 Cav. | U.S.C.T.**

*Richard Jackson*  
*Put* ..... Co. E, 5 Reg't U. S. Col'd Cavalry.

Appears on

**Company Muster Roll**

for *Sept + Oct.* ..... 1865.

Present or absent *present* .....

Stoppage, \$ ..... 100 for .....

Due Gov't, \$ ..... 100 for .....

Valuation of horse, \$ ..... 100

Valuation of horse equipments, \$ ..... 100

Remarks: .....

Book mark: .....

(358)

*Long*  
Copyist.

*J* | **5 Cav. U.S.C.T.**

*Richard Jackson*  
*Priv.*, Co. E, 5 Reg't U. S. Col'd Cavalry.

Appears on

**Company Muster Roll**

for *July & Aug*, 186*5*.

Present or absent *Present*

Stoppage, \$ *100* for

Due Gov't, \$ *100* for

Valuation of horse, \$ *100*

Valuation of horse equipments, \$ *100*

Remarks:

Book mark:

(358)

*Long*  
Copyist.

*J* | **5 Cav. | U.S.C.T.**

*Dick Jackson*  
*Put*, Co. E, 5 Reg't U. S. Col'd Cavalry.

Appears on

**Company Muster Roll**

for *May - June*, 186 *5*.

Present or absent *Present*

Stoppage, \$ *100* for

Due Gov't, \$ *100* for

Valuation of horse, \$ *100*

Valuation of horse equipments, \$ *100*

Remarks: *1<sup>st</sup> Instalment*  
*Bounty due \$100.*

Book mark: \_\_\_\_\_

(358)

*Long*  
Copyist.



9 | **5 Cav. | U.S.C.T.**

Dick Jackson  
Plt., Co. E, 5 Reg't U. S. Col'd Cavalry.

Appears on

**Company Muster Roll**

for Mich. J. April, 1865.

Present or absent Present

Stoppage, \$ 100 for

Due Gov't, \$ 100 for

Valuation of horse, \$ 100

Valuation of horse equipments, \$ 100

Remarks: Five instalments  
of Bounty due

Book mark:

W. B. [Signature]

*J* | *5 Cav* | **U. S. C. T.**  
*Dick Jackson*

Appears with rank of *Pvt* on

**Muster and Descriptive Roll of a Detachment of U. S. Vols. forwarded**

for the *5* Reg't U. S. Col'd *Cav*, Roll dated  
*Lexington Ky, April 17, 1865.*

Where born *Mercer Co. Ky*

Age *27* y'rs; occupation *Laborer*

When enlisted *April 5*, 1865.

Where enlisted *Camp Nelson*

For what period enlisted *3* years.

Eyes *Blk*; hair *Blk*

Complexion *Blk*; height *5 ft. 8 in.*

When mustered in *April 17*, 1865.

Where mustered in *Lexington Ky*

Bounty paid \$ *100*; due \$ *100*

Where credited *Mercer Co. 7 Dist. Ky*

Company to which assigned

Remarks:

Book mark:

*General Notation R. & P. 407875.*

*Valentine*

(339)

Copyist.

*J* | **5 Cav. | U.S.C.T.**  
*Wick Jackson*  
....., Co. *E*, 5 Reg't U. S. Col'd Cav.

Appears on  
**Company Descriptive Book**  
of the organization named above.

**DESCRIPTION.**

Age *27* years; height *5* feet *8* inches.  
Complexion *Black*  
Eyes *Blk*; hair *Blk*  
Where born *Mercer Ky*  
Occupation *Laborer*

**ENLISTMENT.**

When *April 5*, 186*5*.  
Where *Camp Nelson*  
By whom *Fassand*; term *3* y'rs.

Remarks:

.....  
.....  
.....  
*J. E. Parker*  
(383g) Coppist.



P 1362812 P.O. aff  
P 2314500 P.O. aff  
D. 2845278 and wd  
J 2869500 and wd

Sturtevant Co

693

Jackson Richard

Co E, 5 U. S. Col'd Cav.

Private

Private

CARD NUMBERS.

1	5359220	26
2	5364087	27
3	5364175	28
4	5364259	29
5	5364353	30
6	5364438	31
7	5364522	32
8	5364599	33
9	9090460	34
10	40729948	35
11		36
12		37
13		38
14		39
15		40
16		41
17		42
18		43
19		44
20		45
21		46
22		47
23		48
24		49
25		50

Book Mark: General Notation R. & P. 407375,

See also

# UNITED STATES COLORED TROOPS ENLISTMENT.

STATE OF

TOWN OF

*Kentucky* *Camp Nelson*

I, *Moses Jackson* born in *Guyton Co.*  
in the State of *Kentucky* aged *thirteen* years  
and by occupation a *farmer* Do HEREBY ACKNOWLEDGE to  
have volunteered *first* day of *September* 186*4*  
to serve as a **Soldier** in the **Army of the United States of America**, for the  
period of **THREE YEARS**, unless sooner discharged by proper authority: Do  
also agree to accept such bounty, pay, rations, and clothing, as are, or may be,  
established by law for the U. S. colored troops.

And I, *Moses Jackson*  
do solemnly swear that I will bear true faith and allegiance to the **United States**  
**of America**, and that I will serve them honestly and faithfully against all their  
enemies or opposers whomsoever; and that I will observe and obey the orders  
of the President of the United States, and the orders of the officers appointed  
over me, according to the Rules and Articles of War.

Sworn and subscribed to, at *Camp Nelson*  
this *11<sup>th</sup>* day of *Sept. 1864* *Moses Jackson*  
Before *Alexander*

I CERTIFY, ON HONOR, That I have carefully examined the above named Volunteer agree-  
ably to the General Regulations of the Army, and that, in my opinion, he is free from all bodily  
defects and mental infirmity, which would in any way disqualify him from performing the  
duties of a soldier.

*J. G. Barrett*  
Asst Surg 7<sup>th</sup> Col  
EXAMINING SURGEON.

I CERTIFY, ON HONOR, That I have minutely inspected the Volunteer *M. Jackson*  
previously to his enlistment, and that he was entirely sober when enlisted; that, to the best of  
my judgment and belief, he is of lawful age; and that, in accepting him as duly qualified to per-  
form the duties of an able-bodied soldier, I have strictly observed the regulations which govern  
the recruiting service. This soldier has *blue* eyes, *black* hair, *black* com-  
plexion, is *5* feet *10* inches high.

*Alexander*  
2<sup>nd</sup> Lt. P. M.  
RECRUITING OFFICER OR AGENT.

Mustered into the United States Service *11<sup>th</sup>* day of *September* 186*4*

*Alexander*  
Capt 18<sup>th</sup> U.S. Inf  
Mustered Officer

Mustered into the service of the United States for three years or during the war, from date of enlistment, in Company *Company Nelson*  
Regiment of *18<sup>th</sup> U.S. Inf* Volunteers, on the *11<sup>th</sup>* day of *September* 186*4* at *Camp Nelson*

*Alexander*  
Capt 18<sup>th</sup> U.S. Inf  
Mustered Officer



NOTE 1.—This blank will be used for enlistments of United States colored troops. They will be made out in duplicate in all cases—one to accompany the recruiting return of the superintendent (not the recruiting officer) to the Adjutant General, and one to accompany the accounts of the officer who pays bounty, &c.

NOTE 2.—An enlistment holds to service. A muster-in must, in all cases, precede payment of pay, bounty, pension, &c. A muster-in roll, must in all cases, be filed in the Adjutant General's Office as evidence of muster-in. The mustering officer, commissary, or assistant commissary of musters, as the case may be, will countersign both enlistments as having mustered the soldiers into the service of the United States before either of them is given to the disbursing officer.

DECLARATION OF RECRUIT.

I, Moses Jackson desiring to volunteer as a soldier in the ARMY OF THE UNITED STATES, for the term of Three Years, DO DECLARE That I am 19 years and ..... months of age; that I have never been discharged from the United States service on account of disability or by sentence of a court-martial, or by order before the expiration of a term of enlistment; and I know of no impediment to my serving honestly and faithfully as a soldier for three years.

GIVEN at Camp Nelson Ky the 12<sup>th</sup> day of September 1864.

Witness: M. L. Palmer

Moses Jackson  
his mark

By John Jackson  
Volunteered at Camp Nelson Ky  
Sept 18 64  
12  
Mr. Wright Co

Consent of Parent or Guardian in case of a Minor, if a Free Man, or in the case of a Slave, of the Person to whom he owes Service:

I, ..... Do CERTIFY, That I am the ..... that the said ..... is ..... years of age; and I do freely give my CONSENT to his volunteering as a SOLDIER in the Army of the United States, for the period of THREE YEARS, under the conditions of the laws of the United States.

GIVEN at ..... the ..... day of .....

Witness : .....  
(A. G. O. No. 74 & 76.)

# UNITED STATES COLORED TROOPS ENLISTMENT.

STATE OF

TOWN OF

*Kentucky*  
I, *Moses Jackson*, born in  
in the State of *Virginia*, aged *Seventy nine* years,  
and by occupation a *Farmer*, Do HEREBY ACKNOWLEDGE to  
have volunteered *in* the day of *September*, 1864,  
to serve as a Soldier in the Army of the United States of America, for the period of  
**THREE YEARS**, unless sooner discharged by proper authority: Do also agree to  
accept such bounty, pay, rations, and clothing, as are, or may be, established by law for  
the U. S. colored troops.

And I, *Moses Jackson*  
do solemnly swear that I will bear true faith and allegiance to the United States of  
America, and that I will serve them honestly and faithfully against all their enemies  
or opposers whomsoever; and that I will observe and obey the orders of the President  
of the United States, and the orders of the officers appointed over me, according to the  
Rules and Articles of War.

Sworn and subscribed to, at *Camp Nelson*  
this *16<sup>th</sup>* day of *Sept*, 1864. *Moses Jackson*  
Before *J. R. Williams* *2. P.M.*

I CERTIFY, ON HONOR, That I have carefully examined the above named Volunteer agreeably to the General Regula-  
tions of the Army, and that, in my opinion, he is free from all bodily defects and mental infirmity, which would in any  
way disqualify him from performing the duties of a soldier.

*P. G. Barrett*  
Asst Surg 7<sup>th</sup> C. C. T. Examining Surgeon.

I CERTIFY, ON HONOR, That I have minutely inspected the Volunteer, *M. Jackson* previously to  
his enlistment, and that he was entirely sober when enlisted; that, to the best of my judgment and belief, he is of law-  
ful age; and that, in accepting him as duly qualified to perform the duties of an able bodied soldier, he has strictly ob-  
served the regulations which govern the recruiting service. This soldier has *dark* eyes, *dark* hair  
*dark* complexion, *dark* feet *right* inches high.

*J. R. Williams*  
and *J. P. M.*  
Recruiting Officer or Agent.

Mustered into the United State service *18<sup>th</sup>* day of *Sept*, 1864.

*N. C. Finney*  
Capt 18<sup>th</sup> U. S. Mustering Officer.

Mustered into the service of the United States, for three years or during the war, from date of enlistment, in Company  
Regiment of *U. S. Colored Cavalry* Volunteers, on the *16<sup>th</sup>* day of *September* 1864, at *Camp Nelson Ky*  
*N. C. Finney*  
Capt 18<sup>th</sup> U. S. C.



NOTE 1. This blank will be used for enlistments of United States colored troops. They will be made out in duplicate in all cases—one to accompany the recruiting return of the superintendent (not the recruiting officer) to the Adjutant-General, and one to accompany the accounts of the officer who pays bounty, &c.

NOTE 2. An enlistment holds to service. A muster-in must, in all cases, precede payment of pay, bounty, pension, &c. A muster-in roll must in all cases be filed in the Adjutant-General's Office as evidence of muster-in. The mustering officer, commissary, or assistant commissary of musters, as the case may be, will countersign both enlistments as having mustered the soldiers into the service of the United States before either of them is given to the disbursing officer.

DECLARATION OF RECRUIT.

I, Moses Jackson, desiring  
to volunteer as a soldier in the ARMY OF THE UNITED STATES, for the term of Three Years,  
DO DECLARE that I am 29 years and \_\_\_\_\_ months of age; that  
I have never been discharged from the United States service on account of disability or  
by sentence of a court-martial, or by order before the expiration of a term of enlistment;  
and I know of no impediment to my serving honestly and faithfully as a soldier for  
three years.

GIVEN at Camp Nelson  
the 16<sup>th</sup> day of September, 1869

Witness: Leroy Mills

Moses Jackson  
with  
By Wm. H. West  
ser. of rank  
from B. Braxwell  
Volunteered at Camp Nelson  
Sept 16<sup>th</sup>, 1869.  
Wm. H. West  
Sept 16<sup>th</sup>, 1869

Consent of Parent or Guardian in case of a Minor, of a Free Man, or in the case of a Slave,  
of the Person to whom he owes Service:

I, \_\_\_\_\_ Do CERTIFY, That I am  
the \_\_\_\_\_  
that the said \_\_\_\_\_ is \_\_\_\_\_ years of age; and I  
do freely give my CONSENT to his volunteering as a SOLDIER in the Army of the United  
States, for the period of THREE YEARS, under the conditions of the laws of the United  
States.

GIVEN at \_\_\_\_\_  
the \_\_\_\_\_ day of \_\_\_\_\_

Witness: \_\_\_\_\_



NOTE 1. This blank will be used for enlistments of United States colored troops. They will be made out in duplicate in all cases—one to accompany the recruiting return of the superintendent (not the recruiting officer) to the Adjutant-General, and one to accompany the accounts of the officer who pays bounty, &c.

NOTE 2. An enlistment holds to service. A muster-in must, in all cases, precede payment of pay, bounty, pension, &c. A muster-in roll must in all cases be filed in the Adjutant-General's Office as evidence of muster-in. The mustering officer, commissary, or assistant commissary of musters, as the case may be, will countersign both enlistments as having mustered the soldiers into the service of the United States before either of them is given to the disbursing officer.

DECLARATION OF RECRUIT.

I, Moses Jackson, desiring to volunteer as a soldier in the ARMY OF THE UNITED STATES, for the term of Three Years, DO DECLARE that I am 29 years and \_\_\_\_\_ months of age; that I have never been discharged from the United States service on account of disability or by sentence of a court-martial, or by order before the expiration of a term of enlistment; and I know of no impediment to my serving honestly and faithfully as a soldier for three years.

GIVEN at Camb. Nelson the 16<sup>th</sup> day of September, 1869

Witness: Leroy Mills

Moses Jackson  
with By B. Brantwell  
Sept 16<sup>th</sup>, 1869  
Volunteered at Camb. Nelson  
Sept 16<sup>th</sup>, 1869

Consent of Parent or Guardian in case of a Minor, of a Free Man, or in the case of a Slave, of the Person to whom he owes Service:

I, \_\_\_\_\_ Do CERTIFY, That I am the \_\_\_\_\_ that the said \_\_\_\_\_ is \_\_\_\_\_ years of age; and I do freely give my CONSENT to his volunteering as a SOLDIER in the Army of the United States, for the period of THREE YEARS, under the conditions of the laws of the United States.

GIVEN at \_\_\_\_\_ the \_\_\_\_\_ day of \_\_\_\_\_

Witness: \_\_\_\_\_

MICROFILM PUBLICATION M 1821

COMPILED MILITARY SERVICE RECORDS  
OF VOLUNTEER UNION SOLDIERS WHO  
SERVED WITH THE USCT (US COLORED TROOPS)  
5TH REGIMENT OF CAVALRY

PERSONAL PAPERS' TARGET SHEET

PLEASE NOTE THE CHECKED INFORMATION ABOUT THE PERSONAL PAPERS IN  
THIS FILE:

- NO PERSONAL PAPERS WERE FOUND IN THIS FILE WHEN THE  
RECORDS WERE ARRANGED FOR MICROFILMING.
- 2 PERSONAL PAPER(S) FOUND IN THIS FILE WHEN THE RECORDS  
WERE ARRANGED FOR MICROFILMING.

Jackson. Moser

Co. Reg't W.S. 11

3 Enclosures.

Bed Cards .....	Final Statements .....
Burial Records .....	Furloughs or L. of A. ....
Certs. of Dis. for Discharge .....	Med. Certificates .....
C. M. Charges .....	Med. Des. Lists .....
Descriptive Lists .....	Orders .....
Discharge Certificates .....	Pris. of War Record .....
Enlistment Papers <i>31</i> .....	Resignations .....

Other papers relating to—

Admission to Hosp'l .....	Furlough or L. of A. ....
Casualty Sheet .....	Med. Examination .....
Confinement .....	Misc. Information .....
Contracts .....	Pay or Clothing .....
Death or Effects .....	Personal Reports .....
Desertion .....	Rank .....
Discharge from Hosp'l .....	Transfer to Hosp'l .....
Discharge from Service .....	Transfer to V. R. C. ....
Duty .....	Transportation .....



J | **5 Cav. U.S.C.T.**

Moses Jackson  
Park, Co. G, 5 Reg't U. S. Col'd Cavalry.

Appears on **Co. Muster-out Roll**, dated  
Helena, Ark. Mch. 16, 1866.

Muster-out to date Mch. 16, 1866.

Last paid to Dec. 31, 1865.

**Clothing account:**

Last settled....., 186 ; drawn since \$..... 100

Due soldier \$..... 100; due U. S. \$ 57 <sup>05</sup>/<sub>100</sub>

Am't for cloth'g in kind or money adv'd \$..... 100

Due U. S. for arms, equipments, &c., \$..... 100

Bounty paid \$ 100 100; due \$ 100 100

Remarks: None

Book mark: V-238-P. 7-76.

(861)

Taylor

Copyist.

2 | **5 Cav.** | **U.S.C.T.**

Wm. Jackson  
Private, Co. G, 5 Reg't U. S. Col'd Cavalry.

Appears on

**Company Muster Roll**

for Jan'y & Feb'y, 1866.

Present or absent Present.

Stoppage, \$..... 100 for .....

Due Gov't, \$..... 100 for .....

Valuation of horse, \$..... 100

Valuation of horse equipments, \$..... 100

Remarks: .....

Book mark: .....

(358)

Wm. Jackson  
Copyist.

5 Cav. U.S.C.T.

*James Jackson*  
.....  
*James*, Co. G, 5 Reg't U. S. Col'd Cavalry.

Appears on

**Company Muster Roll**

for *Nov. Dec.*, 1863.

Present or absent *Present*

Stoppage, \$.....100 for .....

Due Gov't, \$.....100 for .....

Valuation of horse, \$.....100

Valuation of horse equipments, \$.....100

Remarks: .....

Book mark: .....

(358)

*James*  
.....  
Copyist.



**5 Cav. U.S.C.T.**

*James Jackson*  
....., Co. G, 5 Reg't U. S. Col'd Cavalry.

Appears on

**Company Muster Roll**

for *Sept 1st*....., 1865.

Present or absent *Present*

Stoppage, \$.....100 for .....

Due Gov't, \$.....100 for .....

Valuation of horse, \$.....100

Valuation of horse equipments, \$.....100

Remarks: .....

Book mark: .....

(358)

*James Jackson*  
.....  
Copyist.

**5 Cav. | U.S.C.T.**

*Wm. Jackson*  
.....  
*Bar.*....., Co. G, 5 Reg't U. S. Col'd Cavalry.

Appears on

**Company Muster Roll**

for *July & Aug.*....., 1865.

Present or absent *Present*.....

Stoppage, \$..... 100 for .....

Due Gov't, \$..... 100 for .....

Valuation of horse, \$..... 100

Valuation of horse equipments, \$..... 100

Remarks: .....

Book mark: .....

(358)

*J. G. ...*  
.....  
Copyist.

*J.* | **5 Cav. | U.S.C.T.**

*Moses Jackson*  
*Sgt.*, Co. G, 5 Reg't U. S. Col'd Cavalry.

Appears on

**Company Muster Roll**

for *May & June*, 186*x*.

Present or absent *Present*

Stoppage, \$.....*100* for.....

Due Gov't, \$.....*100* for.....

Valuation of horse, \$.....*100*

Valuation of horse equipments, \$.....*100*

Remarks: *First Installment*  
*Quinty due \$100*

Book mark: .....

(358)

*J. Jackson*  
Copyist.



*J* | **5 Cav. | U.S.C.T.**

*Moses Jackson*  
-----  
*Pvt.*, Co. G, 5 Reg't U. S. Col'd Cavalry.

Appears on

**Company Muster Roll**

for *March & April*, 1865.

Present or absent *present*

Stoppage, \$ *100* for

Due Gov't, \$ *100* for

Valuation of horse, \$ *100*

Valuation of horse equipments, \$ *100*

Remarks: *1st Instalmt*  
*Bounty due \$100*

Book mark: -----

(358)

*[Signature]*  
-----  
Copyist.

*J* | **5 Cav. U.S.C.T.**

*Moses Jackson*  
Pat., Co. G, 5 Reg't U. S. Col'd Cavalry.

Appears on

**Company Muster Roll**

for *Jan. & Feb.*, 186*5*.

Present or absent *present*.

Stoppage, \$ *100* for

Due Gov't, \$ *100* for

Valuation of horse, \$ *100*

Valuation of horse equipments, \$ *100*

Remarks:

*Due U. S. for Ord. of 16<sup>th</sup> 1864  
1<sup>st</sup> Inst. Bount  
\$100<sup>00</sup> due*

Book mark:

(358)

*[Signature]*  
Copyist.

*J.* | **5 Cav. | U.S.C.T.**

*Mease Jackson,*

*Pvt.*, Co. G, 5 Reg't U. S. Col'd Cavalry.

Appears on

**Company Muster Roll**

for *Nov. & Dec.*, 1864.

Present or absent *present*

Stoppage, \$ *100* for

Due Gov't, \$ *100* for

Valuation of horse, \$ *100*

Valuation of horse equipments, \$ *100*

Remarks: *1<sup>st</sup> & 2<sup>d</sup> installment  
Bounty due.*

Book mark:



*f.*

**5 Cav. U.S.C.T.**

*Moses Jackson.*

*Pvt.*, Co. G, 5 Reg't U. S. Col'd Cavalry.

Appears on

**Company Muster Roll**

for *Enll. to Oct. 31., 1864.*

Present or absent *present.*

Stoppage, \$ *100* for

Due Gov't, \$ *100* for

Valuation of horse, \$ *100*

Valuation of horse equipments, \$ *100*

Remarks: *Seck in quarters*

Book mark: \_\_\_\_\_

*[Signature]*

*J* | **5 Cav. U.S.C.T.**

*Moses Jackson*

*Pvt.*, Co. *G*, 5 Reg't U. S. Col'd Cavalry.

Appears on

**Company Muster-in and Descriptive Roll**

of the organization named above. Roll dated

*Camp Nelson*, *Ky.*, *N. Y.*, *Oct. 27*, 1864.

Where born *Hazette Ky.*

Age *17* y'rs; occupation *Furrier*

When enlisted *Sept. 1*, 1864.

Where enlisted *Camp Nelson, Ky.*

For what period enlisted *3* years.

Eyes *Black*; hair *Black*

Complexion *Black*; height *5* ft. *5* in.

When mustered in *Sept. 1*, 1864.

Where mustered in *Cp. Nelson Ky.*

Bounty paid \$ *100*; due \$ *100*

Where credited *7<sup>4</sup> Seat, Ky.*

Company to which assigned

Remarks:

*x Mrs. N. Jackson*

*x Supposed to be name of owner*

*x Added May 17 1848 H. A. J.*

Book mark:

(356d)

*[Signature]*  
Copyist.

Q | **5 Cav. | U.S.C.T.**

Moses Jackson

....., Co. B, 5 Reg't U. S. Col'd Cav.

Appears on

**Company Descriptive Book**  
of the organization named above.

**DESCRIPTION.**

Age 19 years; height 5 feet 5 inches.

Complexion Black

Eyes Black; hair Black

Where born Fayette Ky

Occupation farmer

**ENLISTMENT.**

When Sep 1, 186 4.

Where Camp Nelson

By whom W. Randolph, term 3 y'rs.

Remarks:

.....  
.....  
.....  
.....  
.....  
.....  
.....

W. H. Riker



1217484-0000000  
01751696 Po Red

St. Vincent Co

Jackson Moses  
Co G, 5 U. S. Col'd Cav.

Private | Private

CARD NUMBERS.

5365761	26
5365857	27
5365957	28
5366049	29
5366146	30
5366238	31
5366329	32
5366418	33
5366504	34
5366593	35
5366678	36
9090686	37
	38
	39
	40
	41
	42
	43
	44
	45
	46
	47
	48
	49
	50

Book Mark:

See also:

*J* | **5 Cav. | U.S.C.T.**

*Moses Jackson*

*Pat*, Co. *A*, 5 Reg't U. S. Col'd Cavalry.

Appears on **Co. Muster-out Roll**, dated  
*Helena, Ark, March 16*, 1866.

Muster-out to date ..... , 186 .

Last paid to ..... , 186 .

**Clothing account:**

Last settled....., 186 ; drawn since \$..... 100

Due soldier \$..... 100; due U. S. \$..... 100

Am't for cloth'g in kind or money adv'd \$..... 100

Due U. S. for arms, equipments, &c., \$..... 100

Bounty paid \$..... 100; due \$..... 100

Remarks: *Deserted Nov. 4, 64,*  
*at Lexington, Ky.*

Book mark : .....

(861)

*J. A. Stewart*  
Copyright.



J | **5 Cav. | U.S.C.T.**  
Moses Jackson  
Priv. Co. H. 5 Reg't U. S. Colored Cav.

Appears on Returns as follows:

Nov 1864 Loss; Nov 4, Lexington  
Deserted

Book mark :

(546)

J. Austin

Copyist.

*J* | **5 Cav.** | **U.S.C.T.**

*Moses Jackson*

*Pvt*, Co. H, 5 Reg't U. S. Col'd Cavalry.

Appears on

**Company Muster Roll**

for *Nov & Dec*, 1864.

Present or absent.....

Stoppage, \$.....100 for.....

Due Gov't, \$.....100 for.....

Valuation of horse, \$.....100

Valuation of horse equipments, \$.....100

Remarks: *Deserted Lexington  
Ky Nov 4<sup>th</sup> 1<sup>st</sup> and 2<sup>d</sup>  
Installments Bounty due,  
Due US for Ordnance  
\$25.10*

Book mark:.....

*Reynolds*

J | 5 Cav | U.S.C.T.

Moses Jackson  
Priv., Co. H, 5 Reg't U. S. Col'd Cav.

Appears on

**Descriptive List of Deserters**

dated Nov 30, 1864.

Deserted:

When Nov 4, 1864.

Where Livingston

Arrested:

When \_\_\_\_\_, 186 .

Where \_\_\_\_\_

Remarks:

\_\_\_\_\_  
\_\_\_\_\_  
\_\_\_\_\_  
\_\_\_\_\_  
\_\_\_\_\_

Book mark:

\_\_\_\_\_  
Rose



*J* | **5 Cav. | U.S.C.T.**

*Moses Jackson*

*Pat*, Co. H, 5 Reg't U. S. Col'd Cavalry.

Appears on

**Company Muster Roll**

for *from enlistment to Oct 31*, 1864.

Present or absent *present*

Stoppage, \$ *100* for

Due Gov't, \$ *100* for

Valuation of horse, \$ *100*

Valuation of horse equipments, \$ *100*

Remarks:

Book mark:

*Reynolds*

J | **5 Cav. | U.S.C.T.**

Moses Jackson

Priv., Co. H., 5 Reg't U. S. Col'd Cavalry.

Appears on

**Company Muster-in and Descriptive Roll**

of the organization named above. Roll dated

Camp Nelson, <sup>Ky</sup> ~~N.Y.~~ Oct 29, 1864.

Where born Virginia

Age 29 y'rs; occupation Farmer

When enlisted Sept 16, 1864.

Where enlisted Camp Nelson Ky

For what period enlisted 3 years.

Eyes Black; hair Black

Complexion Black; height 5 ft. 8 in.

When mustered in Sept 16, 1864.

Where mustered in Camp Nelson Ky

Bounty paid \$ 100; due \$ 100

Where credited

Company to which assigned

Remarks: 7th Dist Ky

\* Wm B. Bradwell.

\* Supposed to be name of owner.

Added May 17. 98. H. A. J.

Book mark:

Reynolds

J | **5 Cav. | U.S.C.T.**

James Jackson  
....., Co. 46, 5 Reg't U. S. Col'd Cav.

Appears on  
**Company Descriptive Book**  
of the organization named above.

**DESCRIPTION.**

Age 39 years; height 5 feet 8 inches.

Complexion 12612

Eyes 13612; hair 13612

Where born Virginia

Occupation Farmer

**ENLISTMENT.**

When Sept 14, 1864.

Where Camp Nelson

By whom W. Landwehr; term 3 y'rs.

Remarks: † Died in tent 7600 ft  
Durington Ky

† Remark cancelled by a line  
drawn through it

A. J. Anderson



15<sup>th</sup> Co. U.S.C.T.

Moses Jackson

Co. H. 5<sup>th</sup> Reg't U.S. Col'd Cav

Appears on

**Company Descriptive Book**

of the organization named above.

**DESCRIPTION.**

Age 39 years; height 5 feet 8 inches.

Complexion Blk

Eyes Blk; hair Blk

Where born Virginia

Occupation farmer

**ENLISTMENT.**

When Sept. 16, 1864

Where Camp Nelson N.Y.

By whom H. Randolph, term 3 yrs.

Remarks: deserted

Lexington N.Y.

Nov. 14" - 1864

.....

.....

.....

.....

.....

.....

.....

.....

.....

.....

.....

.....

.....

.....

.....

.....

.....

.....

.....

.....

.....

J. E. Purke

(383g) Copyist.

1775905 P.O. ml

1767093 P.O. ml

Sturtevant Co

Jackson Moses

Co No. , 5 U. S. Col'd Cav.

Private

Private

CARD NUMBERS.

1	5366810	26
2	5366902	27
3	5367027	28
4	5359368	29
5	5367762	30
6	9090812	31
7	9090904	32
8	40729953	33
9		34
10		35
11		36
12		37
13		38
14		39
15		40
16		41
17		42
18		43
19		44
20		45
21		46
22		47
23		48
24		49
25		50

Book Mark: .....

See also .....



PROOF OF OWNERSHIP.

STATE OF KENTUCKY,

COUNTY OF Mercer } SS.

We D. D. Bowman and John Bowman each of lawful age, and resident citizens of the State and County aforesaid, do certify that Hedley M. Bowman of the State and County aforesaid, was on the 5<sup>th</sup> day of April 1865, the lawful owner of the slave named Jordan Jackson referred to and described in the foregoing claim for compensation.

D. D. Bowman

John Bowman

Sworn to and subscribed before me a Notary Public for the County of Mercer State of Kentucky, this the 12<sup>th</sup> day of July 1867.

J. W. Cardwell Notary Public

5 CENT STAMP.



PROOF OF LOYALTY.

STATE OF KENTUCKY,

COUNTY OF Mercer } SS.

We A. G. Kyle and B. B. Campbell loyal men and each of lawful age, and resident citizens of the of in the State and County aforesaid, upon our oaths declare that we have known D. D. Bowman a resident of the State and County aforesaid, since the 4th day of March, 1861, and know that he has firmly and faithfully maintained his or her adherence and allegiance to the Government of the United States, by defending its cause against the Government and forces of the so-called Confederate States of America, in all suitable and practicable ways, and according to his or her ability and opportunity.

A. G. Kyle

Ben Campbell

Sworn to and subscribed before me a Notary Public for the county of Mercer State of Kentucky, this the 17<sup>th</sup> day of July 1867.

J. W. Cardwell Notary Public

5 CENT STAMP.

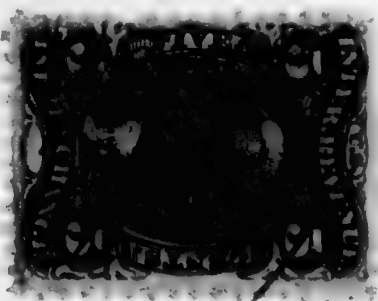

POWER OF ATTORNEY.

My Post-Office address is Harrodsburg County of Mercer State of Kentucky, and I hereby direct that all communications to me, touching this claim, be sent under cover to Lucas Tilford Esq Frankfort Ky, who is hereby appointed and constituted my true and lawful attorney, to prosecute this claim for me, and who is hereby authorized and empowered to receive and receipt for any award, order, draft, certificate, voucher, warrant, papers or money that may be issued in the adjustment of this claim, or the payment thereof, the same as I might or could do in person were I present and acting for myself, and to file any additional evidence or papers that may be required in the prosecution of this claim.

[WITNESS.]

The owner signs here. }

D. D. Bowman

50 CENT STAMP.

A. G. Kyle  
Ben Campbell

Two witnesses to owner's signature sign here. }

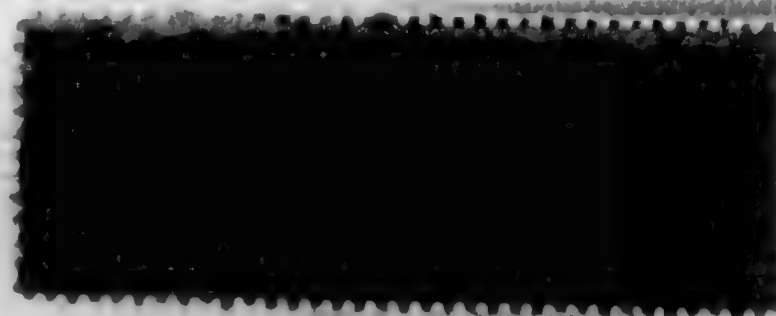



CERTIFICATE OF AWARD OF THE BOARD OF CLAIMS.

OFFICE OF THE BOARD OF CLAIMS  
FOR SLAVES ENLISTED OR DRAFTED IN THE SERVICE OF THE U. S.

186

We hereby certify, that \_\_\_\_\_ of \_\_\_\_\_ county, State of Kentucky, having proved, under oath, \_\_\_\_\_ loyalty to the Constitution and Government of the United States, and established \_\_\_\_\_ title as to the ownership of \_\_\_\_\_ a slave, \_\_\_\_\_ and mustered at \_\_\_\_\_ on the \_\_\_\_\_ day of \_\_\_\_\_, 186 \_\_\_\_\_ by \_\_\_\_\_ in the service of the United States, in the \_\_\_\_\_ Regiment of Colored Troops, Co. \_\_\_\_\_ the sum of \_\_\_\_\_ dollars has been awarded to \_\_\_\_\_ by this Board, subject to the approval of the Secretary of War, as a compensation for the said slave, under the provisions of section 24, Act approved February 24, 1864, and section 2, Act approved July 28, 1866.

\_\_\_\_\_  
President of the Board.  
\_\_\_\_\_  
Member of the Board.  
\_\_\_\_\_  
Member of the Board.

To \_\_\_\_\_  
Chief of the Bureau for the Organization of Colored Troops, Washington, D. C.

Headquarters Kentucky Volunteers,

Adjutant-General's Office,

Frankfort, Decr 18, 1866.

I hereby certify, that it appears from the U. S. Muster-Dr Rolls on file in this Office, that Jordan Jackson was enrolled on the 5<sup>th</sup> day of April, 1865, at Camp Nelson Ky, by J. Farraud and mustered into the U. S. service on the 17<sup>th</sup> day of April, 1865, at Lexington Ky, by Wm Goodloe, to serve Three years. Said Jordan Jackson is described as follows: Age, 22 years; eyes, Black; hair, Black complexion, Black; height, 5 feet 7 inches. It further appears from said Rolls, that Jordan Jackson owed service to Dudley Bowman, was credited to Mercer County, Ky., and was assigned to Co. "C", 5<sup>th</sup> Regiment U. S. Cavalry.

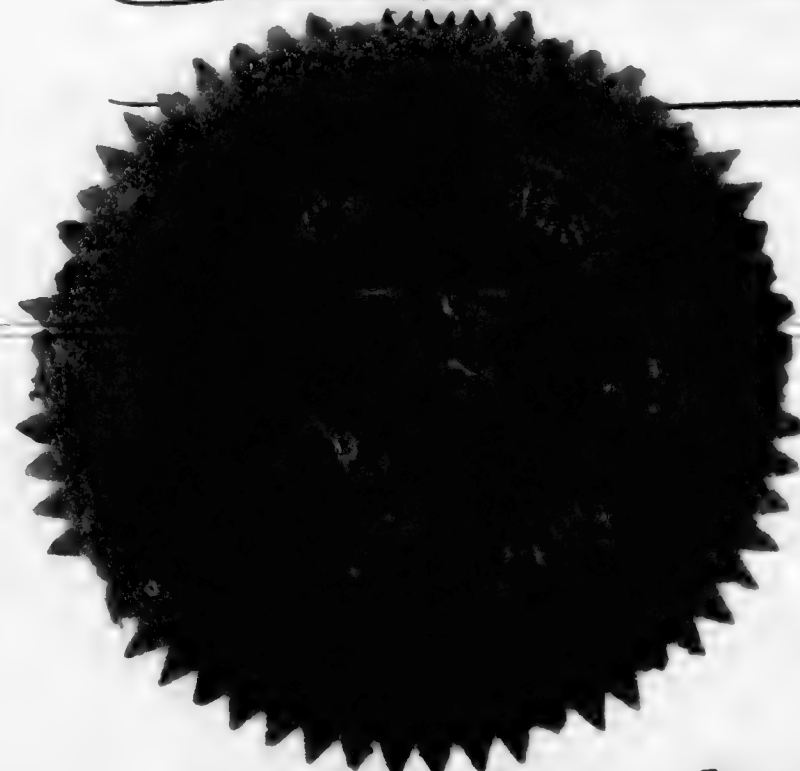

In Testimony Whereof, I have hereunto set my hand, and affixed my Official Seal, this 18 day of Decr, 1866.

*D. W. Lindsey*  
Adjutant-General of Kentucky.

D. 321, R. 888



STAMP.



POWER OF ATTORNEY.

My Post-Office address is Harrodsburg County of Mercer State of Kentucky, and I hereby direct that all communications to me, touching this claim, be sent under cover to Noah Sifford Jr. Frankfort Ky, who is hereby appointed and constituted my true and lawful attorney, to prosecute this claim for me, and who is hereby authorized and empowered to receive and receipt for any award, order, draft, certificate, voucher, warrant, papers or money that may be issued in the adjustment of this claim, or the payment thereof, the same as I might or could do in person were I present and acting for myself, and to file any additional evidence or papers that may be required in the prosecution of this claim.

[WITNESS.]

The owner signs here.

*D. M. Bowman*

50 CENT STAMP.

*Al Ryle*  
*Ben Campbell*

Two witnesses to owner's signature sign here.





No.

CLAIM OF

*Hudley M. Bowman*

FOR THE COMPENSATION OF SLAVE NAMED

*Jordan Jackson*

I, *Hudley M. Bowman* loyal citizen, and a resident of \_\_\_\_\_,  
 County of *Mercer* State of Kentucky, hereby claim compensation, under  
 the provisions of Section 24, act approved February 24, 1864, and section 2, act approved July, 28,  
 1866, for my slave *Jordan Jackson*, enlisted *April 5<sup>th</sup>*  
 1865, at *Camp Nelson*, by *J. Jarrard*  
 in the *Fifth Cav* regiment U. S. Colored Troops, Co. "E"; certificate of  
 which enlistment, and a descriptive list, as required, accompany this application. That I did not ac-  
 quire said slave subsequent to said enlistment, but had a valid title to him at the date of said enlist-  
 ment, and previous thereto: I having acquired my title to him and my ownership over him as fol-  
 lows, to-wit: *By inheritance, from my father and*  
*previous to the April 5<sup>th</sup> 1865*

In proof of my loyalty to the Constitution and Government of the United States, I present the ac-  
 companying oath, which I have taken, signed and acknowledged; to be filed with this application, in  
 accordance with requirement of General Orders, No. 329, 1863, War Department, Adjutant General's  
 Office.

*12 Jan*, 1867.

*H. M. Bowman*

OATH OF ALLEGIANCE.

I, *Hudley M. Bowman*, the owner and Claimant, do solemnly swear that  
 the foregoing claim is a just and true claim due to me as master and owner of the said slave, and that  
 the facts alleged in said claim in respect to the draft or enlistment (as the case may be) of said slave  
 into the Military service of the United States are true. And I do further swear that I have never  
 joined, or been concerned in, any insurrection or rebellion; that I have never borne arms against the  
 United States; that I have never given any aid, countenance, counsel or encouragement to any person  
 or persons engaged, or whom I had reason to believe were about to engage, in insurrection, rebellion  
 or armed hostility against the United States; that I have neither sought, nor accepted, nor attempted  
 to exercise the functions of any office, civil or military, nor to perform any service whatever, under  
 any authority or pretended authority in hostility to the United States; that I have not yielded a vol-  
 untary support to any insurrection, rebellion or pretended government, authority, power or constitution  
 within the United States hostile thereto. And I do further swear that, to the best of my knowledge  
 and ability, I have supported and defended, and will continue to support and defend, the United  
 States against all enemies, foreign and domestic; and that I have supported, defended and obeyed, and  
 will continue to support, defend and obey, the Constitution and laws of the United States; that I will  
 bear true faith and allegiance to the same; and that I take this oath freely, without any mental reserva-  
 tion or purpose of evasion: So help me God.

*H. M. Bowman*

Sworn to and subscribed before me, at *Harrodsburg*,  
 this *12<sup>th</sup>* day of *Jan*, 1867.

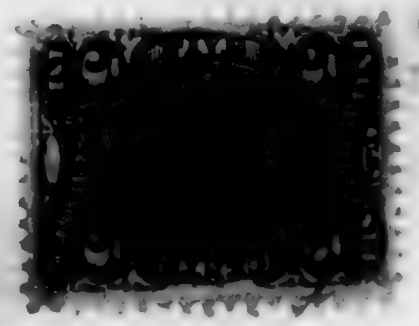

*J. W. Cardwell*  
 Notary Public



War Department,

ADJUTANT GENERAL'S OFFICE,

Washington, Feb 8 1867.

Respectfully returned to the Commission for the State of Kentucky, with the information that Jordan Jackson was enlisted at Camp Nelson Ky April 5 1865, and was mustered in as private in Co "E" 5th U.S. Col. April 5, 1865

Ms. 12 20. 10

J. P. Ramey

Asst. Adj't General.

BAB.

State of Kentucky  
Commission for the State of Kentucky  
Jordan Jackson  
enlisted at Camp Nelson Ky  
April 5 1865  
and was mustered in as private  
in Co "E" 5th U.S. Col.  
April 5, 1865  
1867

No. 1220

APPLICATION OF

Dudley M. Borman

OF

Mercer County Ky

FOR COMPENSATION FOR SLAVE,

Named Jordan Jackson

Enlisted April 5<sup>th</sup> 1865

In Com. "E", 5<sup>th</sup> Col. Regiment,

U. S. COLORED TROOPS.

Received Jan 21, 1867.

Compensation Awarded

....., 186...  
..... Dollars.

President of Board of Claims.

Claimant's Attorney,

Jacob B. Telford Jr.,

Frankfort Ky

Claimant's Post-office Address,

Harrodsburg

Mercer County Ky

FRANKFORT COMMONWEALTH PRINT.



*Credited To Mercer Co 7th Ill*

VOLUNTEER ENLISTMENT.

STATE OF

TOWN OF

*Kentucky*

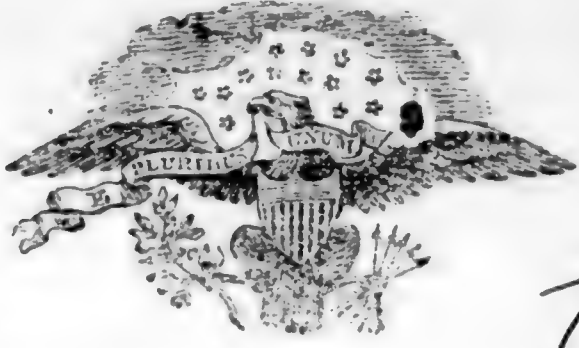

*Town of Dennard*

I, *Jordan Jackson* born in *Mercer Co* in the State of *Kentucky*, aged *twenty two* years, and by occupation a *laborer*, Do HEREBY ACKNOWLEDGE to have volunteered this *7th* day of *Apr*, 1865, to serve as a **Soldier** in the **Army of the United States of America**, for the period of **THREE YEARS**, unless sooner discharged by proper authority: Do also agree to accept such bounty, pay, rations, and clothing, as are, or may be, established by law for volunteers. And I, *Jordan Jackson* do solemnly swear, that I will bear true faith and allegiance to the **United States of America**, and that I will serve them honestly and faithfully against all their enemies or opposers whomsoever; and that I will observe and obey the orders of the President of the United States, and the orders of the officers appointed over me, according to the Rules and Articles of War.

Sworn and subscribed to, at *Camp Nelson* in this *5* day of *Apr*, 1865, *Jordan Jackson* mark  
BEFORE *J. Cassard Lieut 5th U.S. Col.*

I CERTIFY, ON HONOR, That I have carefully examined the above-named Volunteer, agreeably to the General Regulations of the Army, and that, in my opinion, he is free from all bodily defects and mental infirmity, which would in any way disqualify him from performing the duties of a soldier.

*John Swan*  
*Apt. Surgeon 5th U.S. Col.*  
EXAMINING SURGEON

I CERTIFY, ON HONOR, That I have minutely inspected the Volunteer *Jordan Jackson* previously to his enlistment, and that he was entirely sober when enlisted; that, to the best of my judgment and belief, he is of lawful age; and that, in accepting him as duly qualified to perform the duties of an able-bodied soldier, I have strictly observed the Regulations which govern the recruiting service. This soldier has *Blue* eyes, *Black* hair, *White* complexion, is *five* feet *seven* inches high.

*J. Cassard Lieut 5th U.S. Col.*  
Regiment of *U.S. Col.* Volunteers,  
RECRUITING OFFICER.

*William Powell*  
*Capt & Quar Master 7th Ill*  
*Mustering Officer*  
Certificate for the Signature of the Mustering Officer, Commissary, or Assistant Commissary of Mustering, as the case may be.  
Mustered into the service of the United States, for three years or during the war, from date of enlistment, in Co. *3th* Regiment of *Mc Clellan* Volunteers, on the *17* day of *April*, 1865, at *Lexington Ky*, and credited to *Ward* (or Sub-district) in the Town of *Dennard*, in the County of *Dennard*, in the State of *Kentucky*.  
Bounty paid at time of Mustering: *U. S. Bounty*, *Local Bounty*.







Credited To Merce Co, Ky.

VOLUNTEER ENLISTMENT.

STATE OF

TOWN OF

Kentucky Co. of Jessamine

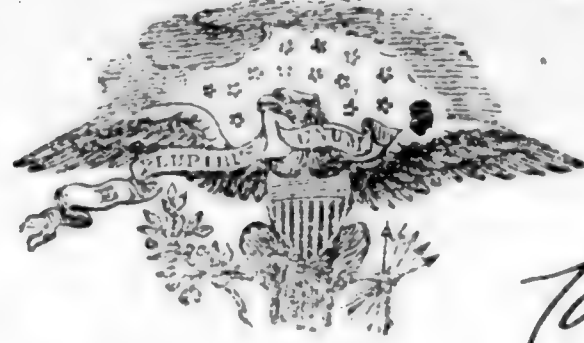

I, Jordan Jackson, born in Merce Co in the State of Kentucky, aged twenty two years, and by occupation a laborer, Do HEREBY ACKNOWLEDGE to have volunteered this Fifth day of April, 1865, to serve as a Soldier in the Army of the United States of America, for the period of THREE YEARS, unless sooner discharged by proper authority: Do also agree to accept such bounty, pay, rations, and clothing, as are, or may be, established by law for volunteers. And I, Jordan Jackson do solemnly swear, that I will bear true faith and allegiance to the United States of America, and that I will serve them honestly and faithfully against all their enemies or opposers whomsoever; and that I will observe and obey the orders of the President of the United States, and the orders of the officers appointed over me, according to the Rules and Articles of War.

Sworn and subscribed to, at Camp Nelson this 5 day of April, 1865, Jordan Jackson his mark BEFORE J. Fassand Lieut 5th U.S.C. Co.

I CERTIFY, ON HONOR, That I have carefully examined the above-named Volunteer, agreeably to the General Regulations of the Army, and that, in my opinion, he is free from all bodily defects and mental infirmity, which would in any way disqualify him from performing the duties of a soldier.

John Swan M.D. Surgeon 5th U.S.C. Co. EXAMINING SURGEON.

I CERTIFY, ON HONOR, That I have minutely inspected the Volunteer Jordan Jackson previously to his enlistment, and that he was entirely sober when enlisted; that, to the best of my judgment and belief, he is of lawful age; and that, in accepting him as duly qualified to perform the duties of an able-bodied soldier, I have strictly observed the Regulations which govern the recruiting service. This soldier has Blue eyes, Blue hair, Blue complexion, is five feet seven inches high.

J. Fassand Lieut 5th U.S.C. Co. Recruits, U.S.C. Co. RECRUITING OFFICER.

(A. G. O. No. 74 & 76.)

Certificate for the Signature of the Mustering Officer, Commissary, or Assistant Commissary of Musters, as the case may be. Mustered into the service of the United States, for three years or during the war from date of enlistment, in Co. of 49th Regt of Volunteers, on the 19 day of April, 1865, at Lexington, Ky. and credited to Ward, (or Sub-district,) in the Town of Jessamine, in the County of Jessamine, in the State of Kentucky. Bounty paid at time of Muster-in: U. S. Bounty, Local Bounty.

William H. ... Capt. ...



NOTE 1.—This blank will be used for both enlistments and re-enlistments—enlistment of veterans, &c., &c., in the volunteer service. They will be made out in duplicate in all cases—one to accompany the recruiting return of the superintendent (not the recruiting officer) to the Adjutant General, and one to accompany the accounts of the officer who pays bounty, &c. The Regiment and Company in which the soldier last served should be given on the back.

NOTE 2.—An enlistment holds to service. A muster-in must, in all cases, precede payment of pay, bounty, pension, &c. A muster-in roll must, in all cases, be filed in the Adjutant General's Office as evidence of muster-in. The mustering officer, commissary, or assistant commissary of musters, as the case may be, will countersign both enlistments as having mustered the soldier into the service of the United States before either of them is given to the disbursing officer.

DECLARATION OF RECRUIT.

I, Jordan Jackson, desiring VOLUNTEER as a Soldier in the Army of the United States, for the term of THREE YEARS, Do Declare, That I am Twenty Two years and \_\_\_\_\_ months of age; that I have never been discharged from the United States service on account of disability or by sentence of a court martial, or by order before the expiration of a term of enlistment; and I know of no impediment to my serving honestly and faithfully as a soldier for three years.

GIVEN at Camp Nelson Va the 5 day of April 65

Witness:

Jackson

Jordan Jackson  
Mark

No. \_\_\_\_\_

Volunteered at

Stamps Intermittent  
Chick Foot, 1863

By

Jordan Jackson  
Regiment of 95th Regt

enlistment; last served in Company ( )

Regt of \_\_\_\_\_

Discharged \_\_\_\_\_

18 .

book

enlistment in Chick Foot, 1863  
Jordan Jackson

CONSENT IN CASE OF MINOR.

I, Aludg Gorman (Merca C), Do CERTIFY, That I am the \_\_\_\_\_ of \_\_\_\_\_; that the said \_\_\_\_\_ is \_\_\_\_\_ years of age; and I do hereby freely give my CONSENT to his volunteering as a SOLDIER in the ARMY OF THE UNITED STATES for the period of THREE YEARS.

GIVEN at \_\_\_\_\_ the \_\_\_\_\_ day of \_\_\_\_\_

Witness:

[Signature]

Jackson, Jordan  
*P. E.*, Co. *5*, Reg't *USlebor.*

*3* Enclosures.

Bed Cards .....	Final Statements .....
Burial Records .....	Furloughs or L. of A. ....
Certs. of Dis. for Discharge .....	Med. Certificates .....
C. M. Charges .....	Med. Des. Lists .....
Descriptive Lists .....	Orders .....
Discharge Certificates .....	Pris. of War Record .....
Enlistment Papers <i>2</i> .....	Resignations .....

Other papers relating to—

Admission to Hosp'l .....	Furlough or L. of A. ....
Casualty Sheet .....	Med. Examination .....
Confinement .....	Misc. Information <i>/</i> .....
Contracts .....	Pay or Clothing .....
Death or Effects .....	Personal Reports .....
Desertion .....	Rank .....
Discharge from Hosp'l .....	Transfer to Hosp'l .....
Discharge from Service .....	Transfer to V. R. C. ....
Duty .....	Transportation .....



**5 Cav. U.S.C.T.**

*Jordan Jackson*  
Cm., Co. B., 5 Reg't U. S. Col'd Cavalry.

Appears on **Co. Muster-out Roll**, dated  
*Wheeler, Ark. Mar 16,* 1866.

Muster-out to date \* *Mar. 3,* 1866.

Last paid to *Dec 31,* 1865.

**Clothing account:**

Last settled....., 186 ; drawn since \$..... 100

Due soldier \$.....100; due U. S. \$ *5*  $\frac{64}{100}$

Am't for cloth'g in kind or money adv'd \$.....100

Due U. S. for arms, equipments, &c., \$..... 100

Bounty paid \$ *100*  $\frac{XX}{100}$ ; due \$..... 100

Remarks:.....

\* Records on file in 2nd. Auditor's Office show this Co. Mustered Out to take effect Mch, 16th. 1866. and paid to include Mch, 15th. 1866.

Book mark: *P 1220 Ky.*

(361)

*J. H. [Signature]*  
Copyist.

J | **5 Cav. | U.S.C.T.**  
Jordan Jackson  
Priv. Co. E, 5 Reg't U. S. Colored Cav.

Appears on Returns as follows:

Apr. 1865, Gain: Apr. 19 Camp  
Nelson, Assigned to Co E  
as per Regt Order.

Book mark :

(546)

Huston

Copyist.

J | **5 Cav.** | **U.S.C.T.**

Jordan Jackson  
Am, Co. E, 5 Reg't U. S. Col'd Cavalry.

Appears on

**Company Muster Roll**

for Jan & Feb, 1866.

Present or absent Present

Stoppage, \$ 100 for

Due Gov't, \$ 100 for

Valuation of horse, \$ 100

Valuation of horse equipments, \$ 100

Remarks:

Book mark:

(358)

M. L. Smart  
Copyist.



*J* | **5 Cav. | U.S.C.T.**

*Jordan Jackson*  
*Pvt*, Co. E, 5 Reg't U. S. Col'd Cavalry.

Appears on

**Company Muster Roll**

for *Nov & Dec*, 1865.

Present or absent *present*

Stoppage, \$ *100* for

Due Gov't, \$ *100* for

Valuation of horse, \$ *100*

Valuation of horse equipments, \$ *100*

Remarks:

Book mark:

(358)

*Long*

Copyist.

*J* | **5 Cav. U.S.C.T.**

*Jordon Jackson*  
*Put*, Co. E, 5 Reg't U.S. Col'd Cavalry.

Appears on

**Company Muster Roll**  
for *Sept. + Oct.*, 1865.

Present or absent *present*

Stoppage, \$ 100 for

Due Gov't, \$ 100 for

Valuation of horse, \$ 100

Valuation of horse equipments, \$ 100

Remarks:

Book mark:

(358)

*Long*

Copyist.

*J* | **5 Cav. | U.S.C.T.**

*Jordan Jackson*  
*Pvt*....., Co. E, 5 Reg't U. S. Col'd Cavalry.

Appears on

**Company Muster Roll**

for *July - Aug.*....., 1865.

Present or absent *present*

Stoppage, \$.....100 for .....

Due Gov't, \$.....100 for .....

Valuation of horse, \$.....100

Valuation of horse equipments, \$.....100

Remarks:.....

.....  
.....  
.....  
.....  
.....

Book mark:.....

.....  
.....  
.....  
.....  
.....

(358)

*Louy*  
Copyist.



2 | 5 Cav. | U.S.C.T.

*Gordon Jackson*  
*Pvt*, Co. E, 5 Reg't U. S. Col'd Cavalry.

Appears on

**Company Muster Roll**

for *May & June*, 1865.

Present or absent *Present*

Stoppage, \$ *100* for

Due Gov't, \$ *100* for

Valuation of horse, \$ *100*

Valuation of horse equipments, \$ *100*

Remarks: *1<sup>st</sup> Instalment*  
*Bounty due \$100.*

Book mark:

(358)

*Long*  
Copyist.

*J* | **5 Cav.** | **U.S.C.T.**

*Gordon Jackson*

*Co.*, Co. E, 5 Reg't U. S. Col'd Cavalry.

Appears on

**Company Muster Roll**

for *March & April*, 1865.

Present or absent *Present*

Stoppage, \$ *100* for

Due Gov't, \$ *100* for

Valuation of horse, \$ *100*

Valuation of horse equipments, \$ *100*

Remarks: *First instalment of Bounty due*

Book mark:

*M. Rowland*

J 5 Cav. U.S.C.T.  
Jordan Jackson  
Appears with rank of Pvt on

**Muster and Descriptive Roll of a Detachment of U. S. Vols. forwarded**

for the 5 Reg't U. S. Col'd Cav. Roll dated  
Lexington Ky, Apr 11, 1865.

Where born Mercer Co., Ky.

Age 22 y'rs; occupation Laborer

When enlisted Apr 5, 1865.

Where enlisted Camp Nelson

For what period enlisted 3 years.

Eyes Blk; hair Blk

Complexion Blk; height 5 ft. 7 in.

When mustered in April 17, 1865.

Where mustered in Lexington Ky

Bounty paid \$ 100; due \$ 100

Where credited Mercer Co. 7 Dist Ky

Company to which assigned

Remarks:

Book mark:

General Notation R. & P. 407875,

Valentine

(339)

Copyist.



1865

*J* | **5 Cav. | U.S.C.T.**

*Gordon Jackson*  
....., Co. *E*, 5 Reg't U. S. Col'd Cav.

Appears on

**Company Descriptive Book**  
of the organization named above.

**DESCRIPTION.**

Age *27* years; height *5* feet *7* inches.

Complexion *Black*

Eyes *BLK*; hair *BLK*

Where born *Mercer Ky*

Occupation *laborer*

**ENLISTMENT.**

When *April 5*, 186 *5*.

Where *Camp Nelson*

By whom *Hassard*, term *3* y'rs.

Remarks:

.....  
.....  
.....  
.....

*F. E. Drake*

*Jackson Jordan*

**Co E , 5 U. S. Col'd Cav.**

*Private* | *Private*

**CARD NUMBERS.**

1	5359219	26
2	5364088	27
3	5364176	28
4	5364260	29
5	5364354	30
6	5364439	31
7	5364523	32
8	5364600	33
9	9090459	34
10	40729952	35
11		36
12		37
13		38
14		39
15		40
16		41
17		42
18		43
19		44
20		45
21		46
22		47
23		48
24		49
25		50

**Book Mark:**

General Notation R. & P. 407375,

**See also**



I certify, on honor, that Henry Jackson, a Private of  
 Captain \_\_\_\_\_ Company (3rd) of the 5th Regiment of U.S. Cavalry  
**VOLUNTEERS**, of the State of Miss. Colored Cavalry, born in Lucret Co State  
 of Kentucky, aged 22 years; 5 feet 9 inches high; Black complexion,  
Black eyes, Black hair, and by occupation a Farmer, who joined for service  
 and was enrolled (see Note 9) on the 29 day of August, 1864, at Camp Nelson  
 by S. C. Randolph, Capt., for the period of Three years, and mustered into  
 the service of the United States on the Thirtieth day of August, 1864 at  
Camp Nelson, by Capt. V. Kimey; and having served  
 HONESTLY and FAITHFULLY with his Company to the present date, is now entitled to a  
**DISCHARGE** by reason of Death

The said Henry Jackson was last paid by Paymaster  
Major Knapp, to include the 31<sup>st</sup> day of October, 1865, and  
 has pay due him from that time to the present date; he is entitled to pay and subsistence for  
**TRAVELING** to place of enrollment, and whatever other allowances are authorized to volunteer  
 soldiers, drafted men, or militia, so discharged. He has received from the United States **CLOTHING**  
 amounting to \$117.69 100 dollars, since the first day of March,  
 1865, when his clothing account was last settled. He has received from the United States  
\$100 100 dollars ~~and~~ **BOUNTY**.

There is to be stopped from him, on account of the State of \_\_\_\_\_, or other  
 authorities, for **CLOTHING**, &c., received on entering service, \_\_\_\_\_ 100 dollars; and  
 for other stoppages, viz: \_\_\_\_\_

\_\_\_\_\_ 100 dollars.  
 He has been furnished with **TRANSPORTATION** in kind from the place of his discharge to  
 \_\_\_\_\_; and he has been **SUBSISTED** for **TRAVELING** to his  
 place of enrollment, up to the \_\_\_\_\_, 186 .

He is indebted to \_\_\_\_\_, **BUTLER**, Five 100 dollars.  
 He is indebted to \_\_\_\_\_, **LAUNDRESS**, Nothing 100 dollars.

Given in Duplicate, at Helena Arkansas, this 26 day  
 of December, 1865.

W. L. Bonham  
5<sup>th</sup> U.S. Cavalry  
2<sup>nd</sup> Lieut Commanding Company.



*Extract from Act of Congress.*

SEC. 12. *And be it further enacted,* That the fees of agents and attorneys for making out and causing to be executed the papers necessary to establish a claim for a pension, bounty, and other allowance before the Pension Office, under this act, shall not exceed the following rates: For making out and causing to be duly executed a declaration by the applicant, with the necessary affidavits, and forwarding the same to the Pension Office, with the requisite correspondence, ten dollars: which sum shall be received by such agent or attorney in full for all services in obtaining such pension, and shall not be demanded or received, in whole or in part, until such pension shall be obtained; and the sixth and seventh sections of an act entitled "An act to grant pensions," approved July [fourteenth,] eighteen hundred and sixty-two, are hereby repealed.

SEC. 13. *And be it further enacted,* That any agent or attorney who shall, directly or indirectly, demand or receive any greater compensation for his services under this act than is prescribed in the preceding section of this act, or who shall contract or agree to prosecute any claim for a pension, bounty, or other allowance under this act, on the condition that he shall receive a per centum upon any portion of the amount of such claim, or who shall wrongfully withhold from a pensioner or other claimant the whole or any part of the pension or claim allowed and due to such pensioner or claimant, shall be deemed guilty of a high misdemeanor, and, upon conviction thereof, shall, for every such offense, be fined not exceeding three hundred dollars, or imprisoned at hard labor not exceeding two years, or both, according to the circumstances and aggravations of the offense.

Approved July 4, 1864.

NOTE 10.—If any soldier is charged a higher fee than that allowed by the above act, he should report the fact and the name of the agent to the Adjutant General, in order that steps may be taken to have the same refunded.

FINAL STATEMENT

100 2/5  
OF 1

*Henry Jackson*

5 Reg't of *U.S. Cavalry*

VOLUNTEERS.

*No. Dec 24 1865*

NOTE 1.—Two of these certificates (or duplicates) are to be given to each Volunteer Soldier or drafted man who may be discharged without being mustered out (Final Statements are never given to men mustered out of service,) that he may at once receive from the Paymaster the pay, &c., due him, and the captain or other COMMISSIONED officer commanding the company will certify to the act of the delivery of the duplicate certificates; with these certificates the Soldier is "entitled to" his discharge and should also present his discharge to the Paymaster to have the payment endorsed on it. The discharge is to be given back to the Soldier by the Paymaster; the latter only retaining as his vouchers the duplicate certificates.

NOTE 2.—If the Soldier is entitled to pay for the use of his horse, the Company Commander will certify to that fact on the back of both these final statements, and also to the time he has pay due for having been so mounted on his own horse.

NOTE 3.—When a Soldier is furnished with final statements, his descriptive list, if he has one, should be taken up by the officer who gives the Soldier these statements, and endorsed with a statement to this effect by the officer. The endorsement should exhibit a full statement of the time for which the Soldier was allowed pay on his final statements, the clothing account, and all other charges against him or in his favor, so as to comprise a complete exhibit of his account. It will then be transmitted to the Company Commander of the Soldier, who will enter all the data necessary to a full understanding of the Soldier's account on the muster roll upon which the Soldier's discharge is reported. The descriptive list will then be destroyed. The object of this is, that the remaining portion of the Soldier's account may be settled upon the receipt of these muster rolls, and the Soldier receive any pay or allowances that may be due him at the time of his discharge, and which may not appear on his last final statements from the fact that his descriptive list is incomplete. These accounts for back pay, &c., are settled by the 2d Auditor of the Treasury Department.

NOTE 4.—Charges for loss or injury to ordnance, horse equipments, and other miscellaneous charges, should appear under the heading of "Other Stoppages."

NOTE 5.—Bounty paid by State authorities, and not by the United States, will not be entered on this statement.

NOTE 6.—Amounts due the Sutler and Laundress must be entered on the muster roll on which the discharge, death, desertion, &c., is reported, as well as on the final statement, otherwise the amount cannot be collected from the United States.

NOTE 7.—This blank will be used for deceased volunteers and drafted men, as well as for others.

NOTE 8.—Where a Soldier dies in Hospital or on detached service, his descriptive list, if he has one, should be sent with his final statements, in duplicate, to the Adjutant General, Washington, D. C.

NOTE 9.—If the soldier is a drafted man or substitute, the space for time, &c., or enrolled, should contain only the word *drafted* or *substitute*, as the case may be. If the Soldier is a "VETERAN," (or RECRUIT,) the words *as a veteran*, (or *recruit*) as the case may be, should be interlined after the words *mustered into the service of the U. S.* A statement of all the installments of *Veteran* or *Recruit Bounty RECEIVED* by the Soldier must be made on the back of each final statement.

ADJUTANT GENERAL'S OFFICE

*Jan 34*  
Discharged

*Discharged*



Inventory of the effects of Henry Jackson late  
 a Private of Captain \_\_\_\_\_ Company M of  
 the 5<sup>th</sup> Regiment of U.S. Cavalry Volunteers, who was enrolled as  
 a Private at Camp Nelson in the State of Kentucky on  
 the 29 day of August 1864, and mustered into the service of the United  
 States as a Private on the 30 day of August 1864, at Camp Nelson  
 in Company M, 5 Regiment of U.S. Cavalry Volunteers, to serve 3 years  
 years or during the war; he was born in Laurel Co in the State  
 of Kentucky; he was 22 years of age, 5 feet 8 inches  
 high, Black complexion, Black eyes, Black hair, and by occupation, when enrolled,  
 a Farmer; he died in Post Hospital, at  
Hellena Arkansas on the 24 day of December 1865, by  
 reason of Small Pox

INVENTORY.					
ARTICLES.	No.	ARTICLES.	No.	ARTICLES.	No.
Hats.....		Pairs trousers.....		Knapsacks.....	
Caps.....		Pairs flannel drawers.....			
Forage caps.....		Pairs cotton drawers.....			
Great coats.....		Flannel shirts.....			
Uniform coats.....		Cotton shirts.....			
Uniform jackets.....		Pairs boots.....			
Flannel sack coats.....		Pairs shoes.....			
Blouses.....		Pairs socks.....			
Stable frocks.....		Blankets.....			
Fatigue overalls.....		Haversacks.....			
	<i>No Effects</i>		<i>No Effects</i>	MONEY.	
				Specie.....	\$
				Notes.....	\$

I CERTIFY, ON HONOR, that the above inventory comprises all the effects of \_\_\_\_\_  
 \_\_\_\_\_, deceased, and that the effects are in the hands  
 of \_\_\_\_\_ at \_\_\_\_\_  
 \_\_\_\_\_ to be disposed of by a Council of Administration.

( DUPLICATES. )

STATION: Hellena Arkansas

DATE: December 30 / 1865

W. S. Barber  
5 U.S. Cavalry  
2<sup>d</sup> Lt Commanding the Company.

ARTICLES OF WAR.

ART. 95. When any non-commissioned officer or soldier shall die, or be killed in the service of the United States, the then commanding officer of the troop or company shall, in the presence of two other commissioned officers, take an account of what effects he died possessed of, above his arms and accoutrements, and transmit the same to the office of the Department of War, which said effects are to be accounted for, and paid to the representatives of such deceased non-commissioned officer or soldier. And in case any of the officers, so authorized to take care of the effects of deceased officers and soldiers, should, before they have accounted to their representatives for the same, have occasion to leave the regiment or post, by preferment or otherwise, they shall, before they be permitted to quit the same, deposit in the hands of the commanding officer, or of the assistant military agent, all the effects of such deceased non-commissioned officers and soldiers, in order that the same may be secured for, and paid to, their respective representatives.

ARMY REGULATIONS—EDITION OF 1861.

DECEASED SOLDIERS.

Par. 152. Inventories of the effects of deceased non-commissioned officers and soldiers, required by the 95th Article of War, will be forwarded to the Adjutant General, by the commander of the company to which the deceased belonged, and a duplicate of the same to the colonel of the regiment. Final statements of pay, clothing, &c., will be sent with the inventories. When a soldier dies at a post or station absent from his company, it will be the duty of his immediate commander to furnish the required inventory, and, at the same time, to forward to the commanding officer of the company to which the soldier belonged, a report of his death, specifying the date, place, and cause; to what time he was last paid, and the money or other effects in his possession at the time of his decease; which report will be noted on the next muster roll of the company to which the man belonged. Each inventory will be endorsed, "Inventory of the effects of \_\_\_\_\_, late of company (—) \_\_\_\_\_ regiment of \_\_\_\_\_, who died at \_\_\_\_\_, the \_\_\_\_\_ day of \_\_\_\_\_, 186—." If a legal representative receive the effects, it will be stated in the report. If the soldier leave no effects, the fact will be reported.

Par. 153. Should the effects of a deceased non-commissioned officer or soldier not be administered upon within a short period after his decease, they shall be disposed of by a Council of Administration, under the authority of the commanding officer of the post, and the proceeds deposited with the Paymaster, to the credit of the United States, until they shall be claimed by the legal representatives of the deceased.

Par. 154. In all such cases of sales by the Council of Administration, a statement in detail, or account of the proceeds, duly certified by the Council and commanding officer, accompanied by the Paymaster's receipt for the proceeds, will be forwarded by the commanding officer to the Adjutant General. The statement will be endorsed, "Report of the proceeds of the effects of \_\_\_\_\_, late of company (—) \_\_\_\_\_ regiment of \_\_\_\_\_, who died at \_\_\_\_\_, the \_\_\_\_\_ day of \_\_\_\_\_, 186—."

NOTE 1.—The effects in all cases, when called for, should be turned over to the legal representative, without further authority from the Adjutant General. When the effects are turned over to the relatives of the deceased before these inventories are sent to the Adjutant General, their receipts therefor should be attached to the inventories. In all other cases, one copy will be sent with a letter of transmittal direct to the Adjutant General, and a duplicate retained by the officer.

NOTE 2.—Particular care should be taken to take receipts in duplicate from the Paymaster for any funds turned over to him; one copy should be sent direct to the Adjutant General and one retained by the officer.

INVENTORY OF THE EFFECTS

OF  
*Henry Jackson*

Late of Company *M.*

*5* Reg't of *11th Reg't*

Volunteers, who died at *1st Reg't*

on the *24* day of *Dec* 186*5*.





Jackson, Henry  
P. Co. M, 5 Regt U.S.C. Cav.

2 Enclosures.

Bed Cards	Descriptive Lists
Burial Records	Final Statements /
Certs. of Dis. for Discharge	Furloughs
C. M. Charges	Med. Des. Lists
Med. Certificates	Orders

Other papers relating to—

Admission to Hosp'l	Furlough
Casualty Sheet (Officer's)	Med. Examination
Confinement	Misc. Information
Contracts	Pay or Clothing
Death or Effects /	Personal Reports
Desertions	Rank
Discharge from Hosp'l	Transfer to Hosp'l
Discharge from Service	Transfer to V. R. C.
Duty	Transportation

*J* | **5 Cav. | U.S.C.T.**

*Henry Jackson*  
*Pvt*, Co. *M*, 5 Reg't U. S. Col'd Cavalry.

Appears on **Co. Muster-out Roll**, dated  
*Helena Ark*, *Mar 16*, 186*6*.

Muster-out to date \_\_\_\_\_, 186 .

Last paid to \_\_\_\_\_, 186 .

**Clothing account:**

Last settled \_\_\_\_\_, 186 ; drawn since \$ \_\_\_\_\_ 100

Due soldier \$ \_\_\_\_\_ 100; due U. S. \$ \_\_\_\_\_ 100

Am't for cloth'g in kind or money adv'd \$ \_\_\_\_\_ 100

Due U. S. for arms, equipments, &c., \$ \_\_\_\_\_ 100

Bounty paid \$ \_\_\_\_\_ 100; due \$ \_\_\_\_\_ 100

Remarks: *Died in Post Hosp at*  
*Helena, Ark Dec. 24, 65, Final*  
*statements forwarded to G. O.*  
*Slave Apt 19 '61*

Book mark: \_\_\_\_\_

J | 5 Cav. | U.S.C.T.  
Henry Jackson  
Privt. Co. M, 5 Reg't U. S. Colored Cav.

Appears on Returns as follows:

Oct. to Dec 1864, Absent on det.  
serv. Oct 11/64, at Nashville  
Tenn.

Jan + Feb 1865, Absent at Camp  
Nelson, Dismounted.

Mar. 1865, Absent det at Camp  
Nelson.

Dec. 1865 Died of small Pox, Dec  
24/65, Helena, Ark.

Book mark :

(546)

Huston

Copyist.



**5 Cav. | U.S.C.T.**

*J*  
*Henry Jackson*

*Mr*, Co. M, 5 Reg't U. S. Col'd Cavalry.

Appears on

**Company Muster Roll**

for *Nov & Dec*, 186*J*.

Present or absent

Stoppage, \$ 100 for

Due Gov't, \$ 100 for

Valuation of horse, \$ 100

Valuation of horse equipments, \$ 100

Remarks: *Died in Post Hospital*  
*Helena Arkansas*  
*December 24 1865 taking*  
*Quarrel, Havesuch and*  
*Leanteen*

Book mark:

(358)

*W. W. C. C.*  
Copyist.

**5 Cav. | U.S.C.T.**

*J*  
*Henry Jackson*

*Pr*, Co. M, 5 Reg't U. S. Col'd Cavalry.

Appears on

**Company Muster Roll**

for *Sept & Oct*, 186*5*.

Present or absent *Present*

Stoppage, \$ 100 for

Due Gov't, \$ 100 for

Valuation of horse, \$ 100

Valuation of horse equipments, \$ 100

Remarks: *Advance 15¢*

Book mark:

*Quincy*

*J* | **5 Cav. | U.S.C.T.**

*Henry Jackson*  
*No.*, Co. M, 5 Reg't U. S. Col'd Cavalry.

Appears on

**Company Muster Roll**

for *July + Aug*, 1865.

Present or absent *Present*

Stoppage, \$ 100 for

Due Gov't, \$ 100 for

Valuation of horse, \$ 100

Valuation of horse equipments, \$ 100

Remarks:

Book mark:

*Quinn*

Copyist.



J | **5 Cav. | U.S.C.T.**

*Henry Jackson*

*Pvt*, Co. M, 5 Reg't U. S. Col'd Cavalry.

Appears on

**Company Muster Roll**

for *May + June*, 1865.

Present or absent *Present*

Stoppage, \$ 100 for

Due Gov't, \$ 100 for

Valuation of horse, \$ 100

Valuation of horse equipments, \$ 100

Remarks: *1<sup>st</sup> Enlistment bounty due \$100.*

-----  
-----  
-----  
-----  
-----  
-----  
-----

Book mark: -----

*Cutus*  
Copyist.

**5 Cav. | U.S.C.T.**

*Henry Jackson*  
....., Co. M, 5 Reg't U. S. Col'd Cavalry.

Appears on

**Company Muster Roll**

for *Mar. & Apr.*, 1865.

Present or absent *Present.*

Stoppage, \$ *100* for .....

Due Gov't, \$ *100* for .....

Valuation of horse, \$ *100*

Valuation of horse equipments, \$ *100*

Remarks: *1st instalment  
bounty due \$100*

Book mark: .....

*M. S. Thompson*  
.....  
Copyist.

5 Cav. | U.S.C.T.

Henry Jackson  
Cvt., Co. M, 5 Reg't U. S. Col'd Cavalry.

Appears on

Company Muster Roll

for Jan. & Feb., 1865.

Present or absent Absent

Stoppage, \$ 100 for

Due Gov't, \$ 100 for

Valuation of horse, \$ 100

Valuation of horse equipments, \$ 100

Remarks: 1st & 2d instalments  
of bounty due.  
On detached service  
Nashville, Tenn. Oct. 4 '64

Book mark:

M. S. Thompson



*J* | **5 Cav. | U.S.C.T.**

*Henry Jackson*  
*Priv.*, Co. M, 5 Reg't U. S. Col'd Cavalry.

Appears on

**Company Muster Roll**

for *Nov. & Dec.*, 1864

Present or absent *Absent*

Stoppage, \$ 100 for

Due Gov't, \$ 100 for

Valuation of horse, \$ 100

Valuation of horse equipments, \$ 100

Remarks: *In detached service*  
*at Nashville Tenn.*  
*Oct. 4, 11 1st & 2d in*  
*statements of bounty due*

Book mark:

*W.S. Thompson*

*J* | **5 Cav. | U.S.C.T.**

*Henry Jackson*  
-----  
*Priv*, Co. M, 5 Reg't U. S. Col'd Cavalry.

Appears on

**Company Muster Roll**

for *to Oct 31*, 1864.

Present or absent *Absent*

Stoppage, \$ *100* for

Due Gov't, \$ *100* for

Valuation of horse, \$ *100*

Valuation of horse equipments, \$ *100*

Remarks: *On detached service  
Nashville, Tenn. Oct. 13/64*

Book mark: -----

*M. S. Thompson*

*A* | **5 Cav.** | **U.S.C.T.**

*Henry Jackson*  
*Priv.*, Co. *M*, 5 Reg't U. S. Col'd Cavalry.

Appears on  
**Company Muster-in and Descriptive Roll**  
of the organization named above. Roll dated

*Camp Nelson*, *N.Y.*, *Oct. 20*, 186*4*.

Where born *Laurel N.Y.*

Age *22* y'rs; occupation *Farmer*

When enlisted *Aug. 29*, 186*4*.

Where enlisted *Camp Nelson N.Y.*

For what period enlisted *3* years.

Eyes *Black*; hair *Black*

Complexion *Black*; height *5* ft. *7* in.

When mustered in *Aug. 29*, 186*4*.

Where mustered in *Camp Nelson N.Y.*

Bounty paid \$ *100*; due \$ *100*

Where credited *Laurel N.Y.*

Company to which assigned

Remarks *\* Levi Jackson*

*\* supposed to be name of owner*

*Added May 16, 98. H.A.J.*

Book mark:

*W.H. Thompson*



J | 5 Co | **U.S.C.T.**

Henry Jackson  
M, 5 Reg't U. S. Col'd Co

Appears on

**Company Descriptive Book**

of the organization named above.

**DESCRIPTION.**

Age 22 years; height 5 feet 9 inches.

Complexion Black

Eyes Blk; hair Blk

Where born Laurel Ky

Occupation Farmer

**ENLISTMENT.**

When Aug 29, 1864.

Where Camp Nelson

By whom McRandolph; term 3 y'rs.

Remarks:

-----  
-----  
-----  
-----  
-----  
-----  
-----  
-----  
-----  
-----

(383g)

A. J. Anderson

Copyist.

S893 901 Yomon.  
D1167054 - Poath

*J. M. ...*

Jackson Henry  
Co etc, 5 U. S. Col'd Cav.

Private | Private

CARD NUMBERS.

1	5370854	26
2	5370944	27
3	5371044	28
4	5371129	29
5	5371215	30
6	5371301	31
7	5371385	32
8	5371472	33
9	5371584	34
10	5371766	35
11	9091288	36
12	40729951	37
13		38
14		39
15		40
16		41
17		42
18		43
19		44
20		45
21		46
22		47
23		48
24		49
25		50

Book Mark:

See also



STATE OF  
COUNTY

Arkansas }  
Phillips } ss.

late 1<sup>st</sup> Lt. & Adj. Gen.

I,

3<sup>rd</sup> Regt

Henry Jackson  
W. J. Calhoun

do solemnly declare on oath, that I have duly accounted for all Public Property, for which I have ever been responsible as an Officer of the Volunteer Forces of the United States; that I have rendered all returns and reports, required by Revised Army Regulations of 1863 and existing orders; that I am not now, on any account whatever, indebted to the General Government except as stated on Muster-out Rolls.

H. W. Jackson

late 1<sup>st</sup> Lt. & Adj. Gen.

Sworn and subscribed before me, at Helena Ark

this 17<sup>th</sup> day of March 1866.

W. F. Morse

Capt & Comdr. Muster  
Dep'ty Adj.

Affidavit of Nonindebtedness to U. S.,

of Henry Jackson

late 1st U. S. Artillery 3rd Reg't

U. S. Soldier on which was

based Certificate of Nonindebtedness  
to U. S.,

Dated March 17th 1866.

1<sup>st</sup> Brig  
Head-Quarters, First Division Department of Ky.

Lexington, Ky., October 26<sup>th</sup> 1865.

**SPECIAL ORDERS,**

No. 19

“EXTRACT”

VI. Lieut Henry Jackson, 5<sup>th</sup> U.S.C. Cav is hereby relieved from duty as A. D. C. at these Hd Qrs and will report without delay to the Commandg Officer of his regiment for duty

By Command of  
Brig Genl Jas. S. Bristow

*J. P. Plummer*

Capt. and A. A. A. G.

Lieut Henry Jackson  
5<sup>th</sup> U.S.C. Cav



1<sup>st</sup> Div 1<sup>st</sup> Pri 1<sup>st</sup> Div  
See by Oct. 26. 1865

Special Order 19

Releasing Lt. H Jackson  
suspect for duty at Pri  
Hd Qs.

1<sup>st</sup> Brig  
Head-Quarters, First Division Department of Ky.

Lexington, Ky., October 18<sup>th</sup> 1865.

SPECIAL ORDERS, }

No. 12-

"EXTRACT"

IV. Lieut Henry Jackson, Act Adj. 5<sup>th</sup> U.S. Col<sup>d</sup> "Car" is hereby detailed as A. D. C. at these Hd Qrs. He will be obeyed and respected accordingly.

Henry Jackson  
5<sup>th</sup> U.S. Col

By Command of Brig. Gen. JAS. S. BRISBIN,

*G. P. Plummer*

Capt. and A. A. A. G.

No 1<sup>st</sup> Div 1<sup>st</sup> Div Dty  
Sex 7th Oct. 18. 1865

Special Order No. 12.

Detail for U. S. Jackson



Louisville Ky.  
May 8<sup>th</sup> 1865.

Special Orders  
No. 33.

Abstract.

VIII \* \* \* The following promotions and assignments to fill original vacancies in U.S. Colored Troops are announced. The enlisted men will be discharged from their present service on being mustered into the colored organization:

5<sup>th</sup> U. S. Colored Cavalry  
Sergt. Major Henry Jackson, to be  
2<sup>nd</sup> Lieutenant.

By order of the Secretary of War  
Official copy } Sig. S. Thomas  
} Sig. J. Bates Dickson, Adjutant General  
Capt. & A. A. G.

Official copy  
S. A. Porter

Co. 125<sup>th</sup> U. S. C. & I.  
Ad. S. U. S. Troops

Special Order. 33

Louisville Ky

May 8. 1865

L. Thomas

Adj. Gen -

Appointment of Sergt May

11<sup>th</sup> Regt 5<sup>th</sup> Inf. C. C. to be

2<sup>nd</sup> Lt. 5<sup>th</sup> Inf. C. C.







NOTE 1.—This blank will be used for both enlistments and reenlistments—enlistment of veterans, &c., &c., in the volunteer service. They will be made out in duplicate in all cases—one to accompany the recruiting return of the superintendent (not the recruiting officer) to the Adjutant General, and one to accompany the accounts of the officer who pays bounty, &c. The Regiment and Company in which the soldier last served should be given on the back.

NOTE 2.—An enlistment holds to service. A muster-in must, in all cases, precede payment of pay, bounty, pension, &c. A muster-in roll must, in all cases, be filed in the Adjutant General's Office as evidence of muster-in. The mustering officer, commissary, or assistant commissary of musters, as the case may be, will countersign both enlistments as having mustered the soldier into the service of the United States before either of them is given to the disbursing officer.

### DECLARATION OF RECRUIT.

I, Henry Jackson, desiring to VOLUNTEER as a Soldier in the Army of the United States, for the term of THREE YEARS, Do Declare, That I am 29 years and \_\_\_\_\_ months of age; that I have never been discharged from the United States service on account of disability or by sentence of a court martial, or by order before the expiration of a term of enlistment; and I know of no impediment to my serving honestly and faithfully as a soldier for three years.

GIVEN at Louisville Kentucky the 8 day of January 1865

Witness:

[Signature] [Signature]

Discharged \_\_\_\_\_, 18\_\_

Reg't of \_\_\_\_\_

enlistment; last served in Company ( )

[Signature]

By Col J. M. Smith  
Cmpd. W. O.

Volunteered at Louisville Ky, 1865

No. One

Henry Jackson

### CONSENT IN CASE OF MINOR.

I, \_\_\_\_\_, Do CERTIFY, That I am the \_\_\_\_\_ of \_\_\_\_\_; that the said \_\_\_\_\_ is \_\_\_\_\_ years of age; and I do hereby freely give my CONSENT to his volunteering as a SOLDIER in the ARMY OF THE UNITED STATES for the period of THREE YEARS.

GIVEN at \_\_\_\_\_ the \_\_\_\_\_ day of \_\_\_\_\_

Witness:

Jackson, Henry  
 Lieut., 5 Regt. U.S.C. Cav.

5 1/2 Enclosures.

Bed Cards .....	Descriptive Lists .....
Burial Reccrds .....	Final Statements .....
Certs. of Dis. for Discharge .....	Furloughs .....
C. M. Charges .....	Med. Des. Lists .....
Med. Certificates .....	Orders ..... 3

*and Paper 1*

Other papers relating to—

Admission to Hosp'l .....	Furlough .....
Casualty Sheet (Officer's) .....	Med. Examination .....
Confinement .....	Misc. Information ..... /
Contracts .....	Pay or Clothing .....
Death or Effects .....	Personal Reports .....
Desertions .....	Rank .....
Discharge from Hosp'l .....	Transfer to Hosp'l .....
Discharge from Service .....	Transfer to V. R. C. .....
Duty .....	Transportation .....

J. 15 Cav. U.S.C.  
Henry Jackson  
1<sup>st</sup> Lt., Co. H, 5 Reg't U.S.C.

**NOTATION.**

Book mark: J. 66 C. J. 1865.

**Record and Pension Office,**

WAR DEPARTMENT,  
Washington, Feb. 4, 1899.

Under the provisions of the act of Congress, approved February 24, 1897, this officer is held and considered by this Department to have been mustered into the service of the United States in the grade of

Lieutenant  
Co. H, 5 Reg't U.S. Colored  
Cavalry

to take effect from Dec. 2, 1865.

vice John N. Hookmorton,  
Resigned.



JAN. - 9

5359572

1891

statement as Seryt major  
it not having been paid.  
Original place of enrollment  
Peru, Ills.

5 Cav | U.S.C.T.

Henry Jackson

Rank Adj, Reg't U. S. Col'd Cav

Appears on a

Field and Staff Muster-out Roll

of the organization named above. Roll dated

Velona Ark March, 1866 .

Muster-out to date Mar 16, 1866 .

Last paid to pay due from muster, 186 .

Clothing account:

Last settled, 186 ; drawn since \$ 100

Due soldier \$ 100; due U. S. \$ 100

Am't for cloth'g in kind or money adv'd \$ 100

Due U. S. for arms, equipments, &c., \$ 100

Bounty paid \$ 100; due \$ 100

Remarks: Seryt Major U.S. Co from Jan 2 '65 to May 13 '65 then appointed 2nd Lt Co A to Oct 31 '65 then Adj to Dec 27. 65. then 1st Lt & Adj to date of muster out \$100. bounty and being first in (over)

Book mark:

J. Leonard

JAN. - 9

5360527

1891

No 190 Hd Qrs 5 U.S. C.C.  
Brown's Barracks Low-  
ville / Ky Nov 24, 65,  
to date Nov 1st 1865



J | 5 Cav | U.S.C.T.

Henry Jackson  
2<sup>d</sup> W. Co. A, 5 Reg't U. S. Col'd Cav

Appears on Co. Muster-out Roll, dated  
Helena Ark Mich 16, 1866.

Muster-out to date \_\_\_\_\_, 186 .

Last paid to \_\_\_\_\_, 186 .

Clothing account:

Last settled \_\_\_\_\_, 186 ; drawn since \$ \_\_\_\_\_ 100

Due soldier \$ \_\_\_\_\_ 100; due U. S. \$ \_\_\_\_\_ 100

Am't for cloth'g in kind or money adv'd \$ \_\_\_\_\_ 100

Due U. S. for arms, equipments, &c., \$ \_\_\_\_\_ 100

Bounty paid \$ \_\_\_\_\_ 100; due \$ \_\_\_\_\_ 100

Remarks: Appointed from  
Lieut. Major 5 U.S.C.  
to 2<sup>d</sup> Lt. May 8, 1865.  
Transferred to Regt's  
Staff & appointed Adjutant  
3<sup>d</sup> U.S.C. as per R.C.

Book mark: \_\_\_\_\_

over

W. Sayre

JAN. 18

40729950

1899.

*Dec. 28/65, Transf. to F. V. S. and  
appointed Regt. Adj. per R.O. 209  
Dec. 28/65*

5 Cav. U.S.C.T.

J  
Henry Jackson

Sgt. Maj. M.C.S.  
2<sup>nd</sup> Lieut. Co. A, 5 Reg't U. S. Colored Cav.  
Adj't, F.V.S.

Appears on Returns as follows:

Feb 1865 Jan: Feb 24/65 Louisville  
Ky. Mustered & assigned  
May 1865 Dischg. May 13/65 Louis-  
ville Ky. by order  
May to July 1865 (2<sup>nd</sup> Lt Co. A) Present.  
On special duty at Regtl Hdqrs.  
5<sup>th</sup> U.S.C. Cav., Paris Ky. as Actg.  
Adj't Mustered & assigned 1<sup>st</sup>  
May, 1865, per R.O. of 31 May '65  
Aug to Oct 1865 Present. Special duty  
as Actg. Adj't. 5<sup>th</sup> U.S. Cav. per  
R.O. of 31 May '65  
Nov. 1865, Transf. to Regtl Staff as  
per R.O. 130, dated Hdqrs. 5<sup>th</sup> U.S.  
C.C. Browns Blks. Nov. 24, 1865  
(Adj't F.V.S.) Present. Appointed  
Adj't. per R.O. 190, to date Nov. 1  
1865 Transf. from Co. A  
Dec. 1865 to Feb. 1866 Present, Mus-  
tered as 2<sup>nd</sup> Lt. Dec. 27/65 Mus-  
tered & assigned to Co. H (over)

Book mark:

Houston



5000 | 5000 | **U.S.C.T.**

*W Jackson*

Rank *Adj.*, *15* Reg't U. S. Col'd *Can*

Appears on

**Field and Staff Muster Roll**

for *Jan 1st* 186*6*.

Present or absent *Present*

Stoppage, \$ *100* for

Due Gov't, \$ *100* for

Valuation of horse, \$ *100*

Valuation of horse equipments, \$ *100*

Remarks:

.....  
.....  
.....  
.....  
.....  
.....  
.....

Book mark:

*W Jackson*

*J 15 Ca* | **U.S.C.T.**

*Henry Jackson*  
Rank *Adj. 5* Reg't U. S. Col'd *Can*

Appears on  
**Field and Staff Muster Roll**  
for *Nov. 4 Dec* 1865.

Present or absent *Present*

Stoppage, \$ *100* for

Due Gov't, \$ *100* for

Valuation of horse, \$ *100*

Valuation of horse equipments, \$ *100*

Remarks: *Appointed to yll. Adj. for R.O. 190, 1 Nov. 1865*

Book mark:

*H. [Signature]*

JAN. - 9

5359176

1891 \*

President to fill  
vacancy caused by  
resignation of 1st  
Lt. J. W. Throcmorton

Received and accepted  
appointment Dec. 27.  
1865

Musters to take effect  
Dec. 28. 1865



J | 5 Cav. | U.S.C.T.

Henry Jackson

1st, Co. H., 5 Reg't U. S. Col'd Cav

Age 30 years.

Appears on an

**Individual Muster-in Roll**

of the organization named above. Roll dated

Helena Ark., Dec. 28, 1865.

Muster-in to date Dec 28, 1865.

Joined for duty and enrolled:

When Dec 28, 1865.

Where Helena Ark

Period 3 years.

Valuation of horse, \$ 100

Valuation of horse equipments, \$ 100

Remarks: Promoted from  
2<sup>nd</sup> Lt. & adjutant 5<sup>th</sup> U. S.  
C. Cav. to 1<sup>st</sup> Lt. Co. H.  
5<sup>th</sup> U. S. Col. Cav. by the

Book mark:

Surmer

U.S.C.T.

*J* | *5* | *Henry Jackson*  
2<sup>nd</sup> *adj.*, Co. *5*, Reg't U. S. Col'd *Cary*

Appears on an

**Individual Muster-out Roll**

of the organization named above. Roll dated

*Holena Ark*, *Dec 27*, 1865.

Muster-out to date *Dec 27*, 1865.

Last paid to *Oct 31*, 1865.

**Clothing account:**

Last settled ..... 186 ; drawn since \$ ..... 100

Due soldier \$ ..... 100; due U. S. \$ ..... 100

Am't for cloth'g in kind or money adv'd \$ ..... 100

Due U. S. for arms, equipments, &c., \$ ..... 100

Bounty paid \$ ..... 100 due \$ ..... 100

**Remarks:**

*Promoted to 1<sup>st</sup> Lt. Co. G. 5<sup>th</sup> U.S.C.  
Cary by appointment from the  
President of the United States bearing  
date Dec 2, 65. Muster to  
take effect 27 Dec. 65*

**Book mark:**

*N. T. Hughes*

(348)

Copyist.

I 15<sup>th</sup> Cav. U.S.C.  
Henry Jackson  
1<sup>st</sup> Lt., Col., 5<sup>th</sup> Reg't U.S. Col'd Cav.

Appears on

**Regimental Descriptive Book**

(List of Commissioned Officers)

of the regiment named above.

Rank 1<sup>st</sup> Lieutenant.

Date of appointment Dec 2, 1865.

Remarks: Mustered by  
H. C. S. Hussey at  
Helena, Ark. Dec. 27, 1865.

Hearst



*J* | **5 Cav. | U.S.C.T.**

*Henry Jackson*  
*2<sup>d</sup> Lt.*, Co. A, 5 Reg't U. S. Col'd Cavalry.

Appears on

**Company Muster Roll**

for *Nov & Dec*, 1865.

Present or absent.....

Stoppage, \$.....100 for .....

Due Gov't, \$.....100 for .....

Valuation of horse, \$.....100

Valuation of horse equipments, \$.....100

Remarks: *Transferred to*  
*Reg't Staff as per*  
*Pl. 190 Dated*  
*Brown Bks Nov 24.*

Book mark: .....

*Wmsayre*  
Copyist.

5 Cav. U.S.C.T.

*J. J. ...*  
*Lieut.*, Co. A, 5 Reg't U. S. Col'd Cavalry.

Appears on

**Company Muster Roll**

for *Dated Oct. 31*, 186*5*.

Present or absent *Absent*

Stoppage, \$ *100* for

Due Gov't, \$ *100* for

Valuation of horse, \$ *100*

Valuation of horse equipments, \$ *100*

Remarks: *M. J. ... duty*  
*Act. Adjt. 5 U.S.C.C.*

Book mark:

*J. J. ...*  
Copyist.

5 Cav. U.S.C.T.

*Henry Jackson*  
2<sup>d</sup> Lieut., Co. A, 5 Reg't U. S. Col'd Cavalry.

Appears on

Company Muster Roll

for *Jul. 1<sup>st</sup> 1867*, 1867.

Present or absent *Present*

Stoppage, \$ *100* for

Due Gov't, \$ *100* for

Valuation of horse, \$ *100*

Valuation of horse equipments, \$ *100*

Remarks: *In special duty at Regt. Hd. Co. to A. Dept.*

Book mark:

(358)

*H. A. [Signature]*  
Copyst.



5 Cav. U.S.C.T.

*J. J. Jackson*

*2nd Lt.*, Co. A, 5 Reg't U. S. Col'd Cavalry.

Appears on

**Company Muster Roll**

for *May & June*, 1865.

Present or absent *Present*

Stoppage, \$ *100* for

Due Gov't, \$ *100* for

Valuation of horse, \$ *100*

Valuation of horse equipments, \$ *100*

Remarks: *On Special duty as a. adjt. per R. O. 91. 31 May 1865.*

Book mark:

*J. J. Jackson*

J | 5 Cav | U.S.C.T.

Henry Jackson

2 St, Co., 5 Reg't U. S. Col'd Cav

Age 30 years.

Appears on an

**Individual Muster-in Roll**

of the organization named above. Roll dated

Louisville Ky, May 17, 1865.

Muster-in to date May 17, 1865.

Joined for duty and enrolled:

When May 14, 1865.

Where Louisville Ky.

Period 3 years.

Valuation of horse, \$ 100

Valuation of horse equipments, \$ 100

Remarks: This muster to take effect from fourteenth day of May 1865.

Book mark:

Sarimer

J | 5 | U.S.C.T.

Henry Jackson  
Sgt Maj Co. ---, 5 Reg't U. S. Col'd Cav'y

Appears on an

**Individual Muster-out Roll**

of the organization named above. Roll dated

Louisville Ky, May 17, 1865.

Muster-out to date May 13, 1865.

Last paid to Feb 28, 1865.

**Clothing account:**

Last settled <sup>never settled</sup> ---, 186 --- ; drawn since \$ --- 100

Due soldier \$ --- 100 ; due U. S. \$ --- 100

Am't for cloth'g in kind or money adv'd \$ --- 100

Due U. S. for arms, equipments, &c., \$ --- 100

Bounty paid \$ --- 100 due \$ 100 <sup>00</sup>/<sub>100</sub>

**Remarks:**

Mustered out by reason of  
promotion to 2<sup>d</sup> Lt in 5<sup>th</sup>  
U.S.C. Cav'y  
This muster to take effect  
May 13/65

**Book mark:**

W. T. Hughes





5 Cav, U.S.C.T.

Henry Jackson

Rank 1st Lt Reg't U. S. Col'd Cav

Appears on

Field and Staff Muster Roll

for March 1865

Present or absent Present

Stoppage, \$ 100 for

Due Gov't, \$ 100 for

Valuation of horse, \$ 100

Valuation of horse equipments, \$ 100

Remarks: First instalment of bounty due \$100.00

Book mark:

W. J. ...

I 15 Cav. | U.S.C.T.

Henry Jackson

Rank Sgt. Major 5 Reg't U. S. Col'd Cav

Appears on

**Field and Staff Muster Roll**

for Jan & Feb 1865.

Present or absent Present

Stoppage, \$ 100 for

Due Gov't, \$ 100 for

Valuation of horse, \$ 100

Valuation of horse equipments, \$ 100

Remarks: First installment  
of bounty due \$100.00  
joined at Camp  
Helson Ky. Jan 65

Book mark:

[Signature]



J | 5 bar. | U.S.C.T.

Henry Jackson

Appears with rank of *Sergr Major* on

**Muster and Descriptive Roll of a Detach-**  
**ment of U. S. Vols. forwarded**

for the *5* Reg't U. S. Col'd *bar*, Roll dated  
*Louisville Ky Feb 24*, 1865.

Where born *England*

Age *29* y'rs; occupation *Farmer*

When enlisted *Jan'y 2*, 1865.

Where enlisted *Louisville Ky*

For what period enlisted *3* years.

Eyes *Blue*; hair *Light*

Complexion *Light*, height *5* ft. *8* in.

When mustered in *Feb 24*, 1865.

Where mustered in *Louisville Ky*

Bounty paid \$ *100*; due \$ *100*

Where credited

Company to which assigned

Remarks: *Mustered as Sergrt*  
*Major of 5<sup>th</sup> U. S. Col'd bar.*

*By order of Secretary of War.*

Book mark: *J 66 - Et 1865*

*Valentine*

S. 135-6378-P.O. mth

R. J. 538678,

D. 1709797 and W.D.

A 1811699 and W.D.

A 1854278 and W.D.

as 1307717

S. 2808954 P.O. mth

*Stannard Co*

Jackson Henry  
Co A, 5 U. S. Col'd Cav.

Serjt Major | Adjutant

CARD NUMBERS.

1	5359204	26
2	5359490	27
3	5359500	28
4	5359309	29
5	5359175	30
6	5360077	31
7	5360165	32
8	5360259	33
9	5360438	34
10	5359308	35
11	5360527	36
12	5359176	37
13	5359540	38
14	5359554	39
15	5359572	40
16	9435-979	41
17	9435-993	42
18	J 66-CT-1865	43
19	40729950	44
20		45
21		46
22		47
23		48
24		49
25		50

Book Mark: J 66-CT-1865.

See also



J. 1 5<sup>th</sup> Cav. 1 U.S. Cav.  
Harrison Jackson  
, Co. G, 5<sup>th</sup> Reg't U.S. Cav.

E.B. 11/239 **NOTATION.**

Book mark: J. 98. 6. J. 1874.

**War Department,**

Adjutant General's Office,

Washington, Dec. 12<sup>th</sup>, 1874.

Missing in action October  
2<sup>nd</sup> 1864.

E. P. Conroy

*J* | **5 Cav.** | **U.S.C.T.**

*Harrison Jackson*  
*Plt., Co. G, 5 Reg't U. S. Col'd Cavalry.*

Appears on **Co. Muster-out Roll**, dated  
*Adena, Ark, Mich. 16, 1866.*

Muster-out to date \_\_\_\_\_, 186 .

Last paid to \_\_\_\_\_, 186 .  
*Pay due from Enlistment*

**Clothing account:**

Last settled \_\_\_\_\_, 186 ; drawn since \$ \_\_\_\_\_ 100

Due soldier \$ \_\_\_\_\_ 100; due U. S. \$ *31* <sup>*24*</sup> / 100

Am't for cloth'g in kind or money adv'd \$ \_\_\_\_\_ 100

Due U. S. for arms, equipments, &c., \$ \_\_\_\_\_ 100

Bounty paid \$ \_\_\_\_\_ 100; due \$ \_\_\_\_\_ 100

Remarks: *Slave - Missing after action*  
*Oct. 2/64, Saltville, Va.*

Book mark: *V. 211 - P. 170 - 74.*

(261) \_\_\_\_\_ *Jabier*  
Copyist.

J | 5 Cav. | U.S.C.T.  
Harrison Jackson  
Priv. Co. G, 5 Reg't U. S. Colored Cav.

Appears on Returns as follows:

Oct 1864 Loss; Missing in ac-  
tion, Saltville, Va, Oct 2/64

Book mark :

(546)

Justin

Copyist.



J. | 5 Cav. | U.S.C.T.  
Harrison Jackson  
Pvt., Co. G, 5 Reg't U. S. Col'd Cavalry.

Appears on

Company Muster Roll

for Full to Oct. 31, 1864.

Present or absent present,

Stoppage, \$ 100 for

Due Gov't, \$ 100 for

Valuation of horse, \$ 100

Valuation of horse equipments, \$ 100

Remarks:

Missing in action Oct. 7/64

Roll next on which name appears

Book mark: J. 98. V. 10. C. T. / 74.  
+ G. B. V. 11 p 239.

*[Signature]*

*J* | **5 Cav. U.S.C.T.**

*Harrison Jackson*

*Priv.*, Co. *G*, 5 Reg't U. S. Col'd Cavalry.

Appears on

**Company Muster-in and Descriptive Roll**

of the organization named above. Roll dated

*Camp Nelson*, *Ky*, *N. Y.*, *Oct. 27*, 1864.

Where born *Fayette Ky.*

Age *32* y'rs; occupation *Farmer*.

When enlisted *Sept. 1*, 1864.

Where enlisted *Camp Nelson Ky.*

For what period enlisted *3* years.

Eyes *Black*; hair *Black*

Complexion *Black*; height *5 ft. 6 in.*

When mustered in *Sept. 1*, 1864.

Where mustered in *Cp. Nelson*.

Bounty paid \$ *100*; due \$ *100*

Where credited *7<sup>th</sup> Cav. Dist.*

Company to which assigned

Remarks:

*x Mrs. N. Jackson*

*x # Supposed to be name of owner.*

*# Added May 17. 98. Had*

Book mark:

(356d)

Copyist.

J | **5 Cav. | U.S.C.T.**

Harrison Jackson

....., Co. E, 5 Reg't U. S. Col'd Cav.

Appears on

**Company Descriptive Book**  
of the organization named above.

**DESCRIPTION.**

Age 35 years; height 5 feet 6 inches.

Complexion Black

Eyes Black; hair Black

Where born Fayette Ky

Occupation farmer

**ENLISTMENT.**

When Sep ....., 186 4.

Where Camp Nelson

By whom Randolph term 3 y'rs.

Remarks: Missing in  
action Saltville  
Ta Oct. 7" 64

F. E. Ricks



687

Jackson Harrison  
Co G, 5 U. S. Col'd Cav.

Private | Private

CARD NUMBERS.

1	5365760	26
2	5365856	27
3	5366716	28
4	9890685	29
5	98-05-1874	30
6	40729949	31
7		32
8		33
9		34
10		35
11		36
12		37
13		38
14		39
15		40
16		41
17		42
18		43
19		44
20		45
21		46
22		47
23		48
24		49
25		50

Book Mark: J. 98. 7. 10. 69. 74

See also

PROOF OF OWNERSHIP.

State of Kentucky,  
County of Woodford } ss.

We, *John S Minary* and *Presley J Rice* each of law-  
ful age, and resident citizens of the State and county aforesaid, do certify that *Sachauel Stone*  
.....of the State and county aforesaid, was on the *6th* day of *Sept*  
186*4*, the lawful owner of the slave named *Jiles Jackson*; referred  
to and described in the foregoing claim for compensation.

*John S Minary*  
*Presley J Rice*  
Notary Public  
Sworn to and subscribed before me a *Woodford* for the county of  
.....State of Kentucky, this the *8* day of *Dec* 186*6*

5 CENT STAMP.



PROOF OF LOYALTY.

State of Kentucky  
County of *Woodford* } ss.

We, *P J Rice* and *John S Minary* loyal men and  
each of lawful age, and resident citizens of the .....  
in the State and county aforesaid, upon our oaths declare that we have known *Sachauel Stone*  
a resident of the State and county aforesaid, since the 4th day of March, 1861, and know that he has firmly  
and faithfully maintained his or her adherence and allegiance to the Government of the United States, by  
defending its cause against the Government and forces of the so called Confederate States of America, in  
all suitable and practicable ways, and according to his or her ability and opportunity.

*John S Minary*  
*Presley J Rice*  
Notary Public  
Sworn to and subscribed before me a *Woodford* for the county of  
.....State of Kentucky, this the ..... day of *Dec* 186*6*

5 CENT STAMP.



POWER OF ATTORNEY.

My Post Office address is ..... County of ..... State of  
Kentucky, and I hereby direct that all communications to me, touching this claim, be sent under cover to  
....., who is hereby appointed and constituted  
my true and lawful attorney, to prosecute this claim for me, and who is hereby authorized and empowered to  
receive and receipt for any award, order, draft, certificate, voucher, warrant, papers or money that may be  
issued in the adjustment of this claim, or the payment thereof, the same as I might or could do in person  
were I present and acting for myself, and to file any additional evidence or papers that may be required in  
the prosecution of this claim.

[WITNESS:]

The owner  
signs here. }

50 CENT  
STAMP.

Two witnesses to  
owner's signature  
sign here. }



Headquarters Kentucky Volunteers,

Adjutant-General's Office,

Frankfort, Nov 9, 1866.

I hereby certify, that it appears from the U. S. Muster-  
Rolls on file in this Office, that **Diles Jackson**  
was enrolled on the 6<sup>th</sup> day of Sept 1864, at  
Camp Nelson Ky by J. C. Randolph,  
and mustered into the U. S. service on the 10<sup>th</sup> day of Sept  
1864, at Camp Nelson Ky, by Capt H. C. Kinney  
to serve Three years. Said **Diles Jackson**  
is described as follows: Eighteen yrs, Black eyes, Black hair,  
Black complexion, 5' 8" height. It further appears from  
said Rolls, that **Diles Jackson** owed  
service to Nat Stone and is  
Credited to Woodford County  
Kentucky and was assigned  
to Company H 5<sup>th</sup> U. S. Cavalry

In Testimony Whereof, I have hereunto set my  
hand, and affixed my Official Seal, this  
9<sup>th</sup> day of Nov, 1866.

*D. W. Lindsey*  
Adjutant General of Kentucky.



B. 406 R 316

ER OF ATTORNEY.

My Post Office address is ..... County of ..... State of  
Kentucky, and I hereby direct that all communications to me, touching this claim, be sent under cover to

....., who is hereby appointed and constituted  
my true and lawful attorney, to prosecute this claim for me, and who is hereby authorized and empowered to  
receive and receipt for any award, order, draft, certificate, voucher, warrant, papers or money that may be  
issued in the adjustment of this claim, or the payment thereof, the same as I might or could do in person  
were I present and acting for myself, and to file any additional evidence or papers that may be required in  
the prosecution of this claim.

[WITNESS:]

The owner  
signs here.

50 CENT  
STAMP.

Two witnesses to  
owner's signature  
sign here.

CERTIFICATE OF AWARD OF THE BOARD OF CLAIMS.

For Slaves Enlisted or Drafted in the Service of the United States.

OFFICE OF THE BOARD OF CLAIMS,

We hereby certify, that....., of....., county, State of Kentucky

having proved, under oath,..... loyalty, to the Constitution and Government of the United States,  
and established..... title as to the ownership of.....

a slave..... and mustered at....., by.....  
on the..... day of..... 186....., in the service of the United States, in the..... Regiment

of Colored Troops, Co..... the sum of..... dollars has been awarded  
to..... by this Board, subject to the approval of the Secretary of War, as a compensation for the said  
slave, under the provisions of Section 24, Act approved February 24, 1864, and Section 2, Act approved July  
28, 1866.

President of the Board.

Member of the Board.

Member of the Board.

Chief of the Bureau for the  
Organization of Colored Troops, Washington D. C.

To.....



No. ....

CLAIM OF

Nathaniel Stone of Woodford County

FOR THE COMPENSATION OF SLAVE NAMED

Nathaniel Stone Giles Jackson

I, Nathaniel Stone, Versailles, Woodford, a loyal citizen, and a resident of ... County of ... State of Kentucky, hereby claim compensation, under the provisions of Section 24, Act approved February 24, 1864, and Section 2, Act approved July 28, 1866 for my slave, Giles Jackson

enlisted Oct. 24, 1864, at Camp Nelson by Randolph in the 5th Regiment U. S. Colored Troops, Co. "H" certificate of which enlistment, and a descriptive list, as required, accompany this application. That I did not acquire said slave subsequent to said enlistment, but had a valid title to him at the date of said enlistment and previous thereto; I having acquired my title to him and my ownership over him as follows, to-wit: Having Purchased him in 1854

In proof of my loyalty to the Constitution and Government of the United States, I present the accompanying oath, which I have taken, signed and acknowledged; to be filed with this application, in accordance with requirement of General Orders, No. 329, 1863, War Department, Adjutant General's Office.

Deer Nathaniel Stone 1866

OATH OF ALLEGIANCE.

Nathaniel Stone, the owner and claimant, do solemnly swear that the

foregoing claim is a just and true claim due to me as master and owner of the said slave, and that the facts alleged in said claim in respect to the draft or enlistment (as the case may be) of said slave into the military service of the United States are true. And I do further swear that I have never joined, or been concerned in, any insurrection or rebellion; that I have never borne arms against the United States; that I have never given any aid, countenance, counsel or encouragement, to any person or persons engaged, or whom I had reason to believe were about to engage, in insurrection, rebellion or armed hostility against the United States; that I have neither sought, nor accepted, nor attempted to exercise the functions of any office, civil or military, nor to perform any service whatever, under any authority, or pretended authority, in hostility to the United States: that I have not yielded a voluntary support to any insurrection, rebellion or pretended government authority, power or constitution within the United States hostile thereto. And I do further swear that, to the best of my knowledge and ability, I have supported and defended, and will continue to support and defend the United States against all enemies, foreign and domestic, and that I have supported, defended and obeyed, and will continue to support, defend and obey, the Constitution and Laws of the United States; that I will bear true faith and allegiance to the same; and that I take this oath freely, without any mental reservation or purpose of evasion: So help me God.

Nathaniel Stone

5 CENT STAMP.

Sworn to and subscribed before me a Notary Public this 8th day of Dec 1866 David P. Robert P

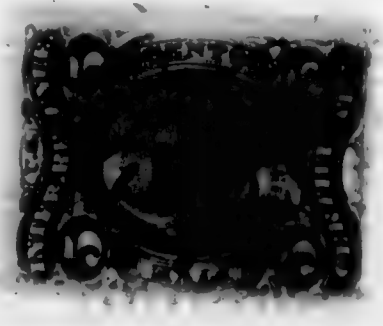

War Department,

ADJUTANT GENERAL'S OFFICE,

Washington, *Jan 29 1867*

*Respectfully returned to the Commission for the State of Kentucky, with the information that Giles Jackson was enlisted at Camp Nelson Ky Sept 6, 1864, and was mustered in as Pvt in Co. "K" 5th U.S.C. Co., Sept. 15, 1864.*

*D. 522 Ky*

*A. F. Rowner*

Asst. Adj't General.

*M. H. H.*

No. *5-22*

APPLICATION OF

*Net Stone*

OF

*Woodford County*

FOR COMPENSATION FOR SLAVE

named *Giles Jackson*

enlisted *Sept 6* 186*4*

in Co. *A* 5<sup>th</sup> Regiment

U. S. Colored Troops.

Received *Jan 10* 186*6*

Compensation awarded

186

Dollars.

President Board of Claims.

Claimant's Attorney,

CLAIMANT'S POST-OFFICE ADDRESS:

*Versailles Ky*

UNION STANDARD PRINT, LEXINGTON, KY.



Jackson, Giles

Rt, Co. H, 5 Reg't U.S. Caval

Enclosures.

Bed Cards	Descriptive Lists
Burial Records	Final Statements
Certs. of Dis. for Discharge	Furloughs
C. M. Charges	Med. Des. Lists
Med. Certificates	Orders

Other papers relating to—

Admission to Hosp'l	Furlough
Casualty Sheet (Officer's)	Med. Examination
Confinement	Misc. Information
Contracts	Pay or Clothing
Death or Effects	Personal Reports
Desertions	Rank
Discharge from Hosp'l	Transfer to Hosp'l
Discharge from Service	Transfer to V. R. C.
Duty	Transportation



*J* | **5 Cav. | U.S.C.T.**

*Giles Jackson*  
*Pat*, Co. *H*, 5 Reg't U. S. Col'd Cavalry.

Appears on **Co. Muster-out Roll**, dated  
*Helena, Ark. Mar. 16*, 1866.

Muster-out to date *Mar 16*, 1866.

Last paid to *Dec 31*, 1865.

**Clothing account:**

Last settled....., 186 ; drawn since \$..... 100

Due soldier \$..... 100; due U. S. \$ *45*<sup>*89*</sup>/<sub>100</sub>

Am't for cloth'g in kind or money adv'd \$..... 100

Due U. S. for arms, equipments, &c., \$..... 100

Bounty paid \$ *100* 100; due \$ *100* 100

Remarks:.....  
.....  
.....  
.....  
.....  
.....

Book mark:.....

*J. P. Stewart*  
Copyist.

**5 Cav. | U.S.C.T.**

*J*  
*Giles Jackson*

*Pat*, Co. H, 5 Reg't U. S. Col'd Cavalry.

Appears on

**Company Muster Roll**

for *Jan'y & Feby*, 1866.

Present or absent *Present*

Stoppage, \$ *100* for

Due Gov't, \$ *100* for

Valuation of horse, \$ *100*

Valuation of horse equipments, \$ *100*

Remarks:

Book mark:

(358)

*J. Stewart*  
Copyist.

J. | **5 Cav.** | **U.S.C.T.**  
*Giles Jackson*  
Cvt., Co. H, 5 Reg't U. S. Col'd Cavalry.

Appears on

**Company Muster Roll**

for *Nov. & Dec.*, 186*5*

Present or absent *Present.*

Stoppage, \$ 100 for

Due Gov't, \$ 100 for

Valuation of horse, \$ 100

Valuation of horse equipments, \$ 100

Remarks:

-----  
-----  
-----  
-----  
-----  
-----  
-----  
-----

Book mark: -----

(358)

*B. J. Cooke*  
Copyist.



J. | **5 Cav.** | **U.S.C.T.**

*Giles Jackson*  
Cvt., Co. H, 5 Reg't U. S. Col'd Cavalry.

Appears on

**Company Muster Roll**

for *Sept. & Oct.*, 1865.

Present or absent *Present.*

Stoppage, \$ 100 for

Due Gov't, \$ 100 for

Valuation of horse, \$ 100

Valuation of horse equipments, \$ 100

Remarks:

Book mark:

(358)

*R. J. Cooke*  
Copyist.

J. | **5 Cav.** | **U.S.C.T.**  
Giles Jackson  
Cvt., Co. H, 5 Reg't U. S. Col'd Cavalry.

Appears on

**Company Muster Roll**

for *July & Aug.*, 1865.

Present or absent *Present.*

Stoppage, \$ 100 for

Due Gov't, \$ 100 for

Valuation of horse, \$ 100

Valuation of horse equipments, \$ 100

Remarks:

Book mark:

(358) *B. J. Coode* Copyist.

J. | **5 Cav.** | **U.S.C.T.**

*Giles Jackson*

*Pvt.*, Co. H, 5 Reg't U. S. Col'd Cavalry.

Appears on

**Company Muster Roll**

for *May & June*, 1865.

Present or absent *Present.*

Stoppage, \$ *100* for

Due Gov't, \$ *100* for

Valuation of horse, \$ *100*

Valuation of horse equipments, \$ *100*

Remarks: *1<sup>st</sup> Installment Bounty due \$100.*

Book mark: \_\_\_\_\_

*B. J. Cooke*

(358)

Copyist.



*J* | **5 Cav.** | **U.S.C.T.**

*Giles Jackson*

*Reg't*, Co. H, 5 Reg't U. S. Col'd Cavalry.

Appears on

**Company Muster Roll**

for *Mar & Apr*, 1865.

Present or absent *present*

Stoppage, \$ *100* for

Due Gov't, \$ *100* for

Valuation of horse, \$ *100*

Valuation of horse equipments, \$ *100*

Remarks: *1st installment of  
Bounty Due \$100*

Book mark: \_\_\_\_\_

(358)

*Reynolds*

Copyist.

J | 5 Cav. | U.S.C.T.

Giles Jackson

Put, Co. H, 5 Reg't U. S. Col'd Cavalry.

Appears on

**Company Muster Roll**

for Jan & Feb, 1865.

Present or absent present

Stoppage, \$ 100 for

Due Gov't, \$ 100 for

Valuation of horse, \$ 100

Valuation of horse equipments, \$ 100

Remarks: 1<sup>st</sup> Installment of  
Bounty Due \$100.00

Book mark:

(358)

Reynolds

Copyist.

*J* | **5 Cav.** | **U.S.C.T.**

*Giles Jackson*

*Pvt.*, Co. H, 5 Reg't U. S. Col'd Cavalry.

Appears on

**Company Muster Roll**

for *Nov & Dec*, 186 *4*.

Present or absent *present*

Stoppage, \$ *100* for

Due Gov't, \$ *100* for

Valuation of horse, \$ *100*

Valuation of horse equipments, \$ *100*

Remarks: *1<sup>st</sup> and 2<sup>d</sup> Installments*

*Bounty due.*

Book mark: \_\_\_\_\_

(358)

*Reynolds*

Copyist.



J | 5 Cav. | U.S.C.T.

Giles Jackson

Pot, Co. H, 5 Reg't U. S. Col'd Cavalry.

Appears on

Company Muster Roll

for *from enlistment to Oct 31, 1864.*

Present or absent *present*

Stoppage, \$ 100 for

Due Gov't, \$ 100 for

Valuation of horse, \$ 100

Valuation of horse equipments, \$ 100

Remarks: *Enrolled Sept 6/64*

Book mark: \_\_\_\_\_

Reynolds

*J* | **5 Cav. | U.S.C.T.**  
*Giles Jackson*

*Put*, Co. *H*, 5 Reg't U. S. Col'd Cavalry.

Appears on

**Company Muster-in and Descriptive Roll**  
of the organization named above. Roll dated

*Camp Nelson, Ky, N. Y., Oct 29, 1864.*

Where born *Woodford Ky*

Age *18* y'rs; occupation *Farmer*

When enlisted *Sept 16*, 1864.

Where enlisted *Camp Nelson Ky*

For what period enlisted *3* years.

Eyes *Black*; hair *Black*

Complexion *Black*; height *5 ft. 8 in.*

When mustered in *Sept 15*, 1864.

Where mustered in *Camp Nelson Ky*

Bounty paid \$ *100*; due \$ *100*

Where credited

Company to which assigned

Remarks: *7th Dist Ky*

*x Nat Stone*

*x supposed to be name of owner.*

*Addea May 17 98. H.A.F.*

Book mark:

*Reynolds*

*J* | *5 Co* | **U.S.C.T.**

*Giles Jackson*

....., Co. *H*, 5 Reg't U. S. Col'd *Co*

Appears on

**Company Descriptive Book**

of the organization named above.

**DESCRIPTION.**

Age *18* years; height *5* feet *8* inches.

Complexion *Blk*

Eyes *Blk*; hair *Blk*

Where born *Woodford Ky*

Occupation *farmer*

**ENLISTMENT.**

When *Sep. 6*, 186 *4*

Where *Camp Nelson Ky*

By whom *J. E. Rusk*, term *3* y'rs.

Remarks:

.....  
.....  
.....  
.....  
.....  
.....  
.....  
.....

*J. E. Rusk*



J | **5 Cav.** | **U.S.C.T.**

Julius Jackson  
....., Co. H, 5 Reg't U. S. Col'd Cav.

Appears on

**Company Descriptive Book**  
of the organization named above.

**DESCRIPTION.**

Age 18 years; height 5 feet 8 inches.

Complexion Blk

Eyes Blk; hair Blk

Where born Windsor Ky

Occupation Farmer

**ENLISTMENT.**

When Sept-6, 1864.

Where Camp T. Wilson

By whom J. S. Randolph; term 3 y'rs.

Remarks: .....

.....  
.....  
.....  
.....  
.....  
.....  
.....  
.....

A. J. Anderson  
(383g) Coppist.

686

Jackson Giles

Co H, 5 U. S. Col'd Cav.

Private | Private

CARD NUMBERS.

1	5366809	26
2	5366901	27
3	5367002	28
4	5367093	29
5	5367185	30
6	5367281	31
7	5367371	32
8	5367460	33
9	5367548	34
10	5367640	35
11	5367729	36
12	9090808	37
13	9090910	38
14		39
15		40
16		41
17		42
18		43
19		44
20		45
21		46
22		47
23		48
24		49
25		50

Book Mark:

See also

J. | **5 Cav. | U.S.C.T.**

*George Jackson*  
Copt., Co. A, 5 Reg't U. S. Col'd Cavalry.

Appears on **Co. Muster-out Roll**, dated  
*Adena Ark* *Feb 16*, 1860.  
Muster-out to date *Feb 15*, 1860.  
Last paid to *Dec 31*, 1860.

**Clothing account:**

Last settled....., 186 ; drawn since \$..... 100  
Due soldier \$..... 100; due U. S. \$ *66* <sup>15</sup>/<sub>100</sub>  
Am't for cloth'g in kind or money adv'd \$..... 100

Due U. S. for arms, equipments, &c., \$..... 100  
Bounty paid \$ *100* 100; due \$ *100* 100

Remarks: *Pat to Jan 6 65 then*  
*1st Sgt to Jan 8 65 then reduced*  
*to the rank of Private Corp Jan*  
*2/66* *11*

Book mark: .....

*E. H. B. ...*



J | 5 Cav. | U.S.C.T.

George Jackson  
Cpl., Co. K, 5 Reg't U. S. Col'd Cav.

Appears on

**Company Muster Roll**

for Jan Feb, 1866

Present or absent Present

Stoppage, \$ 100 for

Due Gov't, \$ 100 for

Valuation of horse, \$ 100

Valuation of horse equipments, \$ 100

Remarks: 2 Instalment bounty due \$ 100. Promoted to Cpl. per R. O. No 1 Jan 3 1866 Helena Ark

Book mark:

E. H. Brown

*J* | **5 Cav. U.S.C.T.**

*George Jackson*  
*Prov*, Co. K, 5 Reg't U. S. Col'd Cav.

Appears on

**Company Muster Roll**

for *Nov + Dec*, 186*0*.

Present or absent *Present*

Stoppage, \$ *100* for

Due Gov't, \$ *100* for

Valuation of horse, \$ *100*

Valuation of horse equipments, \$ *100*

Remarks:

-----  
-----  
-----  
-----  
-----  
-----  
-----

Book mark:

-----

*J. E. Porter*

J | 5 Cav. | U.S.C.T.

George Jackson  
Capt., Co. K, 5 Reg't U. S. Col'd Cav.

Appears on

**Company Muster Roll**

for Sept & Oct, 1860.

Present or absent Present

Stoppage, \$ 100 for

Due Gov't, \$ 100 for

Valuation of horse, \$ 100

Valuation of horse equipments, \$ 100

Remarks: Dec 24 S. for  
Ord. 14 cts Dec 26 S.  
for G. & E. 99 cts. Reduced  
to the ranks from 1st  
Sergh per RO no 150  
issued Nelson Ky  
Sept 8. 1860

Book mark: \_\_\_\_\_

F. E. Porter



J | **5 Cav.** | **U.S.C.T.**

George Jackson  
1 Sgt, Co. K, 5 Reg't U. S. Col'd Cav.

Appears on

**Company Muster Roll**

for July & Aug, 1860.

Present or absent Present

Stoppage, \$ 100 for

Due Gov't, \$ 100 for

Valuation of horse, \$ 100

Valuation of horse equipments, \$ 100

Remarks:

Book mark:

J. E. Porter

**5 Cav. U.S.C.T.**

*George Jackson*

*1 Sgt.*, Co. K, 5 Reg't U. S. Col'd Cav.

Appears on

**Company Muster Roll**

for *May & June*, 1865.

Present or absent *Present*

Stoppage, \$ *100* for

Due Gov't, \$ *100* for

Valuation of horse, \$ *100*

Valuation of horse equipments, \$ *100*

Remarks: *Widder her R.O. No 20  
Jan 1. 1865 First inst all  
month bounty due \$100*

Book mark:

*F. E. Porter*

J | 5 Cav. | U.S.C.T.

George Jackson

1<sup>st</sup> Sgt., Co. K, 5 Reg't U. S. Col'd Cav.

Appears on

Company Muster Roll

for Mar & Apr, 1865.

Present or absent Present

Stoppage, \$ 100 for

Due Gov't, \$ 100 for

Valuation of horse, \$ 100

Valuation of horse equipments, \$ 100

Remarks: App'd per R.O 23 Jan 1<sup>st</sup> 65  
App'd duty Sergt per R.O 12 Oct 31/64  
1<sup>st</sup> installment  
Bondy due \$100

Book mark:

H. Miller



*J* | **5 Cav. U.S.C.T.**

*George Jackson*  
1<sup>st</sup> Sergt, Co. K, 5 Reg't U. S. Col'd Cav.

Appears on

**Company Muster Roll**

for *Jan 8 Feb*, 1865.

Present or absent *Present*

Stoppage, \$ *100* for

Due Gov't, \$ *100* for

Valuation of horse, \$ *100*

Valuation of horse equipments, \$ *100*

Remarks: *Appl'd per Regtl order  
23 to date Jan 1<sup>st</sup> 1865 - 1<sup>st</sup> 82<sup>nd</sup>  
installments \$300 Bount due*

Book mark:

(358)

*H. Miller*

Copyist.

*J* | **5 Cav.** | **U.S.C.T.**

*George Jackson*  
*Pvt*, Co. K, 5 Reg't U. S. Col'd Cav.

Appears on

**Company Muster Roll**

for *Nov 4 Dec*, 1864.

Present or absent *Present*

Stoppage, \$ *100* for

Due Gov't, \$ *100* for

Valuation of horse, \$ *100*

Valuation of horse equipments, \$ *100*

Remarks: *1 "82" installments -  
Security due*

Book mark:

(358)

*H S Miller*  
Copyist.

J | **5 Cav. | U.S.C.T.**

*George Jackson*  
-----  
*Pvt*, Co. K, 5 Reg't U. S. Col'd Cav.

Appears on

**Company Muster Roll**

for *Organization to Oct 31*, 1864 .

Present or absent *Present*

Stoppage, \$ *100* for

Due Gov't, \$ *100* for

Valuation of horse, \$ *100*

Valuation of horse equipments, \$ *100*

Remarks: -----  
-----  
-----  
-----  
-----  
-----  
-----  
-----

Book mark: -----  
-----

(358) *H. S. Miller* Copyist.



**5 Cav. U.S.C.T.**

*J*

*George Jackson*

*Pvt*, Co. *K*, 5 Reg't U. S. Col'd Cavalry.

Appears on

**Company Muster-in and Descriptive Roll**

of the organization named above. Roll dated

*Camp Nelson N. Y. Oct 30*, 1864.

Where born *Bohannon Ky*

Age *20* y'rs; occupation *Laborer*

When enlisted *Aug 27*, 1864.

Where enlisted *Lexington Ky*

For what period enlisted *3* years.

Eyes *Blk*; hair *Blk*

Complexion *Blk*; height *5* ft. *3* in.

When mustered in *Aug 27*, 1864.

Where mustered in *Lexington Ky*

Bounty paid \$ *100*; due \$ *100*

Where credited *7 Dist Ky*

Company to which assigned

Remarks: *True*

Book mark:

*A J Miller*

(356d)

Copyist.

J. | 5 bar | U.S.C.

George Jackson

Appears with rank of Priv on

**Muster and Descriptive Roll**

of a Detachment of U.S. Colored Troops  
forwarded to Camp Nelson by  
Camp of instruction. Roll dated

Lexington Ky, Aug 27, 1864.

Where born Bowdon Co Ky.

Age 20 years; occupation Laborer

When enlisted Aug 27, 1864.

Where enlisted Lexington Ky.

For what period enlisted 3 years.

Eyes Blk; hair Blk

Complexion Blk; height 5 ft. 3 in.

When mustered in \_\_\_\_\_, 186 .

Where mustered in \_\_\_\_\_

Bounty paid \$ \_\_\_\_\_ 100; due \$ \_\_\_\_\_ 100

Clothing account:

Last settled \_\_\_\_\_, 186 ; drawn since \$ \_\_\_\_\_ 100

Date of first muster Aug 27, 1864.

Company to which assigned \_\_\_\_\_

Remarks: Free born Bowdon Co.

to be credited 7 dis. Ky.

\_\_\_\_\_

\_\_\_\_\_

Book mark : \_\_\_\_\_

\_\_\_\_\_

\_\_\_\_\_

\_\_\_\_\_

\_\_\_\_\_

\_\_\_\_\_

\_\_\_\_\_

\_\_\_\_\_

\_\_\_\_\_

\_\_\_\_\_

\_\_\_\_\_

\_\_\_\_\_

\_\_\_\_\_

\_\_\_\_\_

\_\_\_\_\_

\_\_\_\_\_

\_\_\_\_\_

W. M. Potter

J | **5 Cav. | U.S.C.T.**

George Jackson

....., Co. E, 5 Reg't U. S. Col'd Cav.

Appears on

**Company Descriptive Book**  
of the organization named above.

**DESCRIPTION.**

Age 24 years; height 5 feet 3 inches.

Complexion Black

Eyes BRN; hair BLK

Where born Boston City

Occupation Laborer

**ENLISTMENT.**

When ..... Aug 27, 1864.

Where Washington City

By whom Thompson; term 3 y'rs.

Remarks: .....

.....

.....

.....

.....

.....

.....

.....

.....

(383g)

A. J. Anderson

Copist.



S-746074. P O 90  
S-984963 - P.O. mem  
1992628 Proof

*J. H. Mumford*

065  
Jackson George

Co K, 5 U. S. Col'd Cav.

Private | Corporal

CARD NUMBERS.

5368845	26
5368934	27
5369035	28
5369073	29
5369161	30
5369249	31
5369335	32
5369475	33
5369561	34
5369611	35
5369695	36
9091085	37
43145517	38
	39
	40
	41
	42
	43
	44
	45
	46
	47
	48
	49
	50

Book Mark:

See also

*J* | **5 Cav.** | **U.S.C.T.**

*David Jackson*  
*Pvt*, Co. *M*, 5 Reg't U. S. Col'd Cavalry.

Appears on **Co. Muster-out Roll**, dated  
*Helena Ark*, *Mar 16*, 186*6*.

Muster-out to date *Mar 16*, 186*6*.

Last paid to *Dec 31*, 186*5*.

**Clothing account:**

Last settled....., 186 ; drawn since \$..... 100

Due soldier \$..... 100; due U. S. \$ *24* <sup>*48*</sup> / 100

Am't for cloth'g in kind or money adv'd \$..... 100

Due U. S. for arms, equipments, &c., \$..... 100

Bounty paid \$ *100* / 100; due \$ *100* / 100

Remarks: *Slave Apl. 19. 61*

Book mark : .....

(861)

*Hays*  
Copied.



J | 5 Cav. | U.S.C.T.

David Jackson  
Priv. Co. M. 5 Reg't U. S. Colored Cav.

Appears on Returns as follows:

Feb. 1866, On daily duty as Color guard.

Book mark:

Justin

5 Cav. | U.S.C.T.

*David Jackson*

*Pvt*, Co. M, 5 Reg't U. S. Col'd Cavalry.

Appears on

**Company Muster Roll**

for *Jan + Feb*, 1866.

Present or absent *Present*

Stoppage, \$ *100* for

Due Gov't, \$ *100* for

Valuation of horse, \$ *100*

Valuation of horse equipments, \$ *100*

Remarks: *Color Guard Daily duty*

Book mark:

*Hynes*

Copyist.

*J* | **5 Cav. | U.S.C.T.**

*David Jackson*  
*Plt*, Co. M, 5 Reg't U. S. Col'd Cavalry.

Appears on

**Company Muster Roll**

for *Nov & Dec*, 186*5*.

Present or absent *Present*

Stoppage, \$ 100 for

Due Gov't, \$ 100 for

Valuation of horse, \$ 100

Valuation of horse equipments, \$ 100

Remarks:

Book mark:

(358)

*C. W. W.*  
Copyist.



J | 5 Cav. | U.S.C.T.

David Jackson

Plt, Co. M, 5 Reg't U. S. Col'd Cavalry.

Appears on

Company Muster Roll

for Sept & Oct, 1865.

Present or absent Present

Stoppage, \$ 100 for

Due Gov't, \$ 100 for

Valuation of horse, \$ 100

Valuation of horse equipments, \$ 100

Remarks:

Book mark:

(358)

Leuts Copyist.

*J* | **5 Cav. | U.S.C.T.**

*David Jackson*  
*Pr*, Co. M, 5 Reg't U. S. Col'd Cavalry.

Appears on

**Company Muster Roll**

for *July & Aug*, 186*5*.

Present or absent *Present*

Stoppage, \$ *100* for

Due Gov't, \$ *100* for

Valuation of horse, \$ *100*

Valuation of horse equipments, \$ *100*

Remarks:

.....  
.....  
.....  
.....  
.....  
.....  
.....  
.....  
.....  
.....

Book mark:

.....

*Leuts*  
Copyist.

*J* | **5 Cav. | U.S.C.T.**

*David Jackson*  
*Pr*, Co. M, 5 Reg't U. S. Col'd Cavalry.

Appears on

**Company Muster Roll**

for *May & June*, 1865.

Present or absent *Present*

Stoppage, \$ *100* for

Due Gov't, \$ *100* for

Valuation of horse, \$ *100*

Valuation of horse equipments, \$ *100*

Remarks: *Entalment bounty*  
*due 100*

Book mark:

*C. W. ...*  
Copyist.



*J*

**5 Cav. | U.S.C.T.**

*David Jackson*

*Priv.*, Co. M, 5 Reg't U. S. Col'd Cavalry.

Appears on

**Company Muster Roll**

for *Mar. & Apr.*, 186*5*.

Present or absent *Present*

Stoppage, \$ *100* for

Due Gov't, \$ *100* for

Valuation of horse, \$ *100*

Valuation of horse equipments, \$ *100*

Remarks: *1st installment  
bond due \$100*

Book mark: \_\_\_\_\_

*W.S. Thompson*

(358)

Copyist.

*J* | **5 Cav. | U.S.C.T.**

*David Jackson*  
-----  
*Priv.* -----, Co. M, 5 Reg't U. S. Col'd Cavalry.

Appears on

**Company Muster Roll**

for *Jan. & Feb.* -----, 1865.

Present or absent *Present* -----

Stoppage, \$ ----- 100 for -----

Due Gov't, \$ ----- 100 for -----

Valuation of horse, \$ ----- 100

Valuation of horse equipments, \$ ----- 100

Remarks: *1st & 2d instal-*  
*ments of bounty due.*

Book mark: -----

*W. S. Thompson*  
-----  
Copyist.

*A* | **5 Cav. | U.S.C.T.**

*David Jackson*  
....., Co. M, 5 Reg't U. S. Col'd Cavalry.

Appears on

**Company Muster Roll**

for *Nov. 8 Dec.* ....., 186*1*.

Present or absent *Present.*

Stoppage, \$.....*100* for .....

Due Gov't, \$.....*100* for .....

Valuation of horse, \$.....*100*

Valuation of horse equipments, \$.....*100*

Remarks: *1<sup>st</sup> & 2<sup>d</sup> installments  
of bounty due.*

Book mark: .....

*M. S. Thompson*  
(358) Copyist,



*J*

**5 Cav. | U.S.C.T.**

*David Jackson*

*Priv.*, Co. M, 5 Reg't U. S. Col'd Cavalry.

Appears on

**Company Muster Roll**

for *to Oct. 31*, 1864.

Present or absent *Present*

Stoppage, \$ *100* for

Due Gov't, \$ *100* for

Valuation of horse, \$ *100*

Valuation of horse equipments, \$ *100*

Remarks:

.....  
.....  
.....  
.....  
.....  
.....  
.....  
.....

Book mark:

*W.S. Thompson*

(358)

Copyist.

5 Cav. U.S.C.T.

David Jackson

Priv., Co. M, 5 Reg't U. S. Col'd Cavalry.

Appears on

Company Muster-in and Descriptive Roll

of the organization named above. Roll dated

Camp Nelson, N. Y., Oct. 30, 1864.

Where born Bourbon, Ky.

Age 18 y'rs; occupation Farmer

When enlisted Aug. 29, 1864.

Where enlisted Camp Nelson, Ky.

For what period enlisted 3 years.

Eyes Black; hair Black

Complexion Black; height 5 ft. 8 in.

When mustered in Aug. 30, 1864.

Where mustered in Camp Nelson, Ky.

Bounty paid \$ 100; due \$ 100

Where credited 7 Dist. Ky.

Company to which assigned

Remarks: \* Tho. Jones

\* Supposed to be name found

Addea May 16, 98. H. J.

Book mark:

W. H. Thompson

(356d)

Copyist.

J | 5-leaf | **U.S.C.T.**

David Jackson  
Co M, 5-Reg't U. S. Col'd leaf

Appears on

**Company Descriptive Book**

of the organization named above.

**DESCRIPTION.**

Age 18 years; height 5 feet 8 inches.

Complexion Black

Eyes Black; hair Black

Where born Bowling Green Ky

Occupation Farmer

**ENLISTMENT.**

When Aug 29, 1864.

Where Camp Nelson

By whom J. B. Randolph; term 3 y'rs.

Remarks: \_\_\_\_\_

\_\_\_\_\_  
\_\_\_\_\_  
\_\_\_\_\_  
\_\_\_\_\_  
\_\_\_\_\_  
\_\_\_\_\_  
\_\_\_\_\_  
\_\_\_\_\_  
\_\_\_\_\_  
\_\_\_\_\_

(383g)

A. J. Anderson

Copyist.



51050302 Po: mem  
RCP397573-

01917641 POPTM  
01917913 PO aff

1934672 PO aff  
2mHdstone 8/24/23

*Sturtevant Co*

684

Jackson David

Co etc, 5 U. S. Col'd Ca

Private

Private

CARD NUMBERS.

1	5370853	26
2	5370943	27
3	5371043	28
4	5371128	29
5	5371214	30
6	5371300	31
7	5371384	32
8	5371471	33
9	5371556	34
10	5371642	35
11	5371725	36
12	9091287	37
13	40729947	38
14		39
15		40
16		41
17		42
18		43
19		44
20		45
21		46
22		47
23		48
24		49
25		50

Book Mark:

See also

**5 Cav. | U.S.C.T.**

*J*  
*Cupid Jackson*  
*Pat*, Co. *A*, 5 Reg't U. S. Col'd Cavalry.

Appears on **Co. Muster-out Roll**, dated  
*Helena Ark, Mch 16*, 186*6*.  
Muster-out to date *Mch 16*, 186*6*.  
Last paid to *Dec 31*, 186*5*.

**Clothing account:**

Last settled....., 186 ; drawn since \$..... 100

Due soldier \$ *22*<sup>*04*</sup>/<sub>100</sub>; due U. S. \$..... 100

Am't for cloth'g in kind or money adv'd \$..... 100

Due U. S. for arms, equipments, &c., \$..... 100

Bounty paid \$..... 100; due \$..... 100

Remarks:.....

Book mark:.....

*Rose*



J | 5 Cav. | U.S.C.T.

Cupid Jackson  
Pvt., Co. C, 5 Reg't U. S. Colored Cav.

Appears on Returns as follows:

From Organization to Oct 31, 1864 to Nov  
1864. Absent sick & Hspl. Camp  
Nelson.

Book mark :

Justin

(546)

Copyist.

*J* | **5 Cav.** | **U.S.C.T.**

*Cupid Jackson*  
*Put*, Co. C, 5 Reg't U. S. Col'd Cavalry.

Appears on

**Company Muster Roll**  
for *Jan<sup>and</sup> Feb*, 186*6*.  
Present or absent *Present*

Stoppage, \$.....100 for .....

Due Gov't, \$.....100 for .....

Valuation of horse, \$.....100

Valuation of horse equipments, \$.....100

Remarks:.....

Book mark:.....

*Rose*

5 Cav. U.S.C.T.

*J. Cupid Jackson*  
\_\_\_\_\_, Co. C, 5 Reg't U. S. Col'd Cavalry.

Appears on

**Company Muster Roll**

for *Nov. Dec.*, 186*9*.

Present or absent *Present*

Stoppage, \$ *100* for \_\_\_\_\_

Due Gov't, \$ *100* for \_\_\_\_\_

Valuation of horse, \$ *100*

Valuation of horse equipments, \$ *100*

Remarks: *1 yr. 11 mos. for camp and gear. Grip cost.*

Book mark: \_\_\_\_\_

(358)

*J. J. J. J.*  
Copyist.



J | 5 Cav. | U.S.C.T.

*Cupid Jackson*

*Prb*, Co. C, 5 Reg't U. S. Col'd Cavalry.

Appears on

**Company Muster Roll**

for *Sep + Oct*, 186*5*

Present or absent *Present*

Stoppage, \$ 100 for

Due Gov't, \$ 100 for

Valuation of horse, \$ 100

Valuation of horse equipments, \$ 100

Remarks:

-----  
-----  
-----  
-----  
-----  
-----  
-----  
-----  
-----

Book mark:

*Junder*  
Copyist.

*J* | **5 Cav. | U.S.C.T.**

*Lupid Jackson*  
*2<sup>d</sup>*, Co. C, 5 Reg't U. S. Col'd Cavalry.

Appears on

**Company Muster Roll**

for *July Aug*, 186 *5*

Present or absent *Present*

Stoppage, \$ *100* for

Due Gov't, \$ *100* for

Valuation of horse, \$ *100*

Valuation of horse equipments, \$ *100*

Remarks:

-----  
-----  
-----  
-----  
-----  
-----  
-----  
-----  
-----  
-----

Book mark:

(358)

*Linden*  
Copyist.

*J* | **5 Cav.** | **U.S.C.T.**

*Cupid Jackson*  
*Prk.*, Co. C, 5 Reg't U. S. Col'd Cavalry.

Appears on

**Company Muster Roll**

for *May* *June*, 186*9*.

Present or absent *Present*

Stoppage, \$ *100* for

Due Gov't, \$ *100* for

Valuation of horse, \$ *100*

Valuation of horse equipments, \$ *100*

Remarks:

-----  
-----  
-----  
-----  
-----  
-----  
-----  
-----

Book mark:

-----

*J. J. J.*



**5 Cav. | U.S.C.T.**

*Cupid Jackson*

*Priv*, Co. C, 5 Reg't U. S. Col'd Cavalry.

Appears on

**Company Muster Roll**

for *Mar. 7 Apr.*, 186*5*.

Present or absent *Present*

Stoppage, \$ 100 for

Due Gov't, \$ 100 for

Valuation of horse, \$ 100

Valuation of horse equipments, \$ 100

Remarks:

Book mark:

*Shull*

*J* | **5 Cav.** | **U.S.C.T.**

*Cupid Jackson*

*Pris*, Co. C, 5 Reg't U. S. Col'd Cavalry.

Appears on

**Company Muster Roll**

for *Jan'y. & Feby.*, 186*3*.

Present or absent *Present*

Stoppage, \$ 100 for

Due Gov't, \$ 100 for

Valuation of horse, \$ 100

Valuation of horse equipments, \$ 100

Remarks:

Book mark:

*Shue*

*J* | **5 Cav. | U.S.C.T.**

*Cupid Jackson*  
*Priv*, Co. C, 5 Reg't U. S. Col'd Cavalry.

Appears on

**Company Muster Roll**

for *Nov. & Dec.*, 1864.

Present or absent *Present*

Stoppage, \$ *100* for

Due Gov't, \$ *100* for

Valuation of horse, \$ *100*

Valuation of horse equipments, \$ *100*

Remarks:

Book mark:

*Shull*  
(358) Copyist.



*J* | **5 Cav.** | **U.S.C.T.**

*Cupid Jackson*  
*Priv*, Co. C, 5 Reg't U. S. Col'd Cavalry.

Appears on

**Company Muster Roll**

for *to Oct. 31*, 1864.

Present or absent *absent*

Stoppage, \$ *100* for

Due Gov't, \$ *100* for

Valuation of horse, \$ *100*

Valuation of horse equipments, \$ *100*

Remarks: *Hospital, Camp Nelson Ky.*

Book mark:

*Shull*

J | 5 bar 10365  
Cupid Jackson  
Appears with rank of Rec't on

**Muster and Descriptive Roll**  
of a Detachment of new Drafted  
and Mustered into Service of U.S.  
Louisville Ky . Roll dated  
Aug 25 1864

Where born Tenn  
Age 18 y'rs; occupation \_\_\_\_\_

Drafted and mustered in:

When Aug 25, 1864  
Where Louisville Ky  
Enrollment district 5 Dist Ky  
Period 3 years.

Eyes Black; hair Black  
Complexion Black; height 6 ft. 1 in.  
Bounty paid \$ 100; due \$ 100

Clothing account:

Last settled \_\_\_\_\_, 186 ; drawn since \$ 100

Date of commencement of service Aug 25, 1864

Company to which assigned \_\_\_\_\_

Remarks: Substitute for C. W.  
Alexander, Art's draft  
Issued clothing amt \$18.19

Book mark: \_\_\_\_\_

(356m)

Jacobson

Copyist.

J | 5 bar | U.S.C.T.

Leopold Jackson

Appears with rank of 1st on

**Muster and Descriptive Roll**

of a Detachment of U. S. colored  
Troops transferred to U. S. col'd  
cor. at Lexington Ky Roll dated  
Louisville Ky. Sept 2, 1864.

Where born Lebanon

Age 18 years; occupation Labourer

When enlisted Substitute, 186

Where enlisted

For what period enlisted 3 years.

Eyes Blue; hair Blue

Complexion Blue; height 6 ft. 1 in.

When mustered in Aug. 25, 1864.

Where mustered in Louisville

Bounty paid \$ 100; due \$ 100

**Clothing account:**

Last settled \_\_\_\_\_, 186 ; drawn since \$ 18 19/100

Date of first muster Aug. 25, 1864.

Company to which assigned

Remarks: promoted to 5th Regt. Dist.  
Ky.

Book mark:

B. J. D. [Signature]



**5 Cav. U.S.C.T.**

*Cupid Jackson*

*Priv*, Co. *C*, 5 Reg't U. S. Col'd Cavalry.

Appears on

**Company Muster-in and Descriptive Roll**

of the organization named above. Roll dated

*Camp Nelson*, *N.Y.*, *Oct. 24*, 1864.

Where born *Tennessee*

Age *18* y'rs; occupation *Laborer*

When enlisted *\* Substitute*, 186 .

Where enlisted

For what period enlisted *3* years.

Eyes *Blk.*; hair *Blk.*

Complexion *Blk.*; height *6* ft. *1* in.

When mustered in *Aug. 25*, 186 .

Where mustered in *Louisville*

Bounty paid \$ *100*; due \$ *100*

Where credited *5" Dist. Ky.*

Company to which assigned *C*

Remarks:

*\* Inserted by Personal Exp*

Book mark:

*Skull*

**5 Cav. | U.S.C.T.**

*Cupid Jackson*

....., Co. *C*, 5 Reg't U. S. Col'd Cav.

Appears on

**Company Descriptive Book**  
of the organization named above.

**DESCRIPTION.**

Age *18* years; height *6* feet *1* inches.

Complexion *Blk*

Eyes *Blk*; hair *Blk*

Where born *Tenn.*

Occupation *Labourer*

**ENLISTMENT.**

When *substitute*, 186 .

Where .....

By whom .....; term *3* y'rs.

Remarks: .....

.....  
.....  
.....  
.....  
.....  
.....  
.....  
.....

*Hansen*

Jackson Cupid  
Co E, 5 U. S. Col'd Cav.

Private | Private

CARD NUMBERS.

1	5361693	26
2	5361795	27
3	5361887	28
4	5361981	29
5	5362064	30
6	5362145	31
7	5362233	32
8	5362323	33
9	5362409	34
0	5362493	35
1	5362578	36
2	97 90232	37
3	43146258	38
4	43155111	39
15	40729946	40
16		41
17		42
18		43
19		44
20		45
21		46
22		47
23		48
24		49
25		50

Book Mark: .....

See also .....



*J* | **5 Cav. | U.S.C.T.**

*Benjamin Jackson*  
*Pat*, Co. *H*, 5 Reg't U. S. Col'd Cavalry.

Appears on **Co. Muster-out Roll**, dated  
*Selema, Ark Mar. 16*, 1866.  
Muster-out to date *Mar. 16*, 1866.  
Last paid to *Dec. 31*, 1865.

**Clothing account:**

Last settled....., 186 ; drawn since \$..... 100  
Due soldier \$ *7*<sup>*15*</sup>/<sub>100</sub>; due U. S. \$..... 100  
Am't for cloth'g in kind or money adv'd \$..... 100

Due U. S. for arms, equipments, &c., \$..... 100  
Bounty paid \$ *100*..... 100; due \$ *100*..... 100

Remarks:.....  
.....  
.....  
.....  
.....

Book mark:.....

(861) *J. A. Stewart* Copyist.

*J* | **5 Cav. | U.S.C.T.**  
*Benjamin Jackson*  
*2d*, Co. H, 5 Reg't U. S. Col'd Cavalry.

Appears on

**Company Muster Roll**  
for *Jerry V. Tully*, 186*6*.  
Present or absent *Present*

Stoppage, \$.....*100* for .....

Due Gov't, \$.....*100* for .....

Valuation of horse, \$.....*100*

Valuation of horse equipments, \$.....*100*

Remarks:.....

Book mark:.....

(358)

*J. Stewart*  
Copyist.

J. | **5 Cav. | U.S.C.T.**  
*Ben Jackson*  
*Pvt*, Co. H, 5 Reg't U. S. Col'd Cavalry.

Appears on

**Company Muster Roll**  
for *Nov. & Dec.*, 1865.

Present or absent *Present.*

Stoppage, \$ 100 for

Due Gov't, \$ 100 for

Valuation of horse, \$ 100

Valuation of horse equipments, \$ 100

Remarks:

Book mark:

(858)

*B. J. Clark*

Copyist.



J. | **5 Cav.** | **U.S.C.T.**  

---

*Ben Jackson*  
*Pvt.*, Co. H, 5 Reg't U. S. Col'd Cavalry.

Appears on

**Company Muster Roll**  
for *Sept. & Oct.*, 1865.  
Present or absent *Present.*

Stoppage, \$ 100 for \_\_\_\_\_

Due Gov't, \$ 100 for \_\_\_\_\_

Valuation of horse, \$ 100

Valuation of horse equipments, \$ 100

Remarks: \_\_\_\_\_  
\_\_\_\_\_  
\_\_\_\_\_  
\_\_\_\_\_  
\_\_\_\_\_  
\_\_\_\_\_  
\_\_\_\_\_  
\_\_\_\_\_

Book mark: \_\_\_\_\_

(858)

*B. J. Cooke*  
Copyist.

J. | 5 Cav. | U.S.C.T.

Ben Jackson  
Pvt., Co. H, 5 Reg't U. S. Col'd Cavalry.

Appears on

**Company Muster Roll**

for July & Aug., 1865.

Present or absent Present.

Stoppage, \$ 100 for

Due Gov't, \$ 100 for

Valuation of horse, \$ 100

Valuation of horse equipments, \$ 100

Remarks:

-----  
-----  
-----  
-----  
-----  
-----  
-----

Book mark:

*R J Apple*

(358)

Copyist.

J. | 5 Cav. | U.S.C.T.

Ben Jackson  
Pvt., Co. H, 5 Reg't U. S. Col'd Cavalry.

Appears on

Company Muster Roll  
for May & June, 1865.

Present or absent Present.

Stoppage, \$ 100 for

Due Gov't, \$ 100 for

Valuation of horse, \$ 100

Valuation of horse equipments, \$ 100

Remarks: 1<sup>st</sup> Regimental Bounty  
due \$100.

Book mark:

B. J. Cook



*J* | **5 Cav.** | **U.S.C.T.**

*Ben Jackson*

*Pat*, Co. H, 5 Reg't U. S. Col'd Cavalry.

Appears on

**Company Muster Roll**

for *Mar & Apr*, 186*5*.

Present or absent *present*

Stoppage, \$ *100* for

Due Gov't, \$ *100* for

Valuation of horse, \$ *100*

Valuation of horse equipments, \$ *100*

Remarks: *1<sup>st</sup> installment of  
Bounty Due \$100*

Book mark:

(358)

*Reynolds*

Copyist.

J | 5 Cav. | U.S.C.T.

Ben Jackson  
Put, Co. H, 5 Reg't U. S. Col'd Cavalry.

Appears on

Company Muster Roll

for Jan & Feb, 1863.

Present or absent present

Stoppage, \$ 100 for

Due Gov't, \$ 100 for

Valuation of horse, \$ 100

Valuation of horse equipments, \$ 100

Remarks: 1st Installment of  
Bounty Due \$100.00

Book mark:

Reynolds

(358)

Copyist.

J | 5 Cav. | U.S.C.T.

Ben Jackson

Pat., Co. H, 5 Reg't U. S. Col'd Cavalry.

Appears on

Company Muster Roll

for Nov & Dec, 1864.

Present or absent present

Stoppage, \$ 100 for

Due Gov't, \$ 100 for

Valuation of horse, \$ 100

Valuation of horse equipments, \$ 100

Remarks: 1<sup>st</sup> and 2<sup>d</sup> Installments  
Bounty due

Book mark:

Reynolds



*J* | **5 Cav.** | **U.S.C.T.**

*Ben Jackson*

*Priv*, Co. H, 5 Reg't U. S. Col'd Cavalry.

Appears on

**Company Muster Roll**

for *from enlistment to Oct 3/1864*

Present or absent *present*

Stoppage, \$ *100* for

Due Gov't, \$ *100* for

Valuation of horse, \$ *100*

Valuation of horse equipments, \$ *100*

Remarks: *Sick in Quarters*

Book mark:

*Reynolds*

J | 5 Cav. | U.S.C.T.

Ben Jackson

Put, Co. H, 5 Reg't U. S. Col'd Cavalry.

Appears on

**Company Muster-in and Descriptive Roll**

of the organization named above. Roll dated

Camp Nelson Ky, N. Y., Oct 29, 1864.

Where born Anderson Ky

Age 20 y'rs; occupation Farmer

When enlisted Sept 17, 1864.

Where enlisted Camp Nelson Ky

For what period enlisted 3 years.

Eyes Black; hair Black

Complexion Black; height 5 ft. 9 in.

When mustered in Sept 17, 1864.

Where mustered in Camp Nelson Ky

Bounty paid \$ 100; due \$ 100

Where credited

Company to which assigned

Remarks: 4<sup>th</sup> Dist Ky

\* Baton Bush

\* Supposed to be name of owner.

Added May 17, 98. H.A.J.

Book mark:

Reynolds

Q | **5 Cav. | U.S.C.T.**

Ben Jackson  
Co. H, 5 Reg't U. S. Col'd Cav.

Appears on  
**Company Descriptive Book**  
of the organization named above.

**DESCRIPTION.**

Age 24 years; height 5 feet 9 inches.

Complexion Blk

Eyes Blk; hair Blk

Where born Sumner Ky

Occupation Fanner

**ENLISTMENT.**

When Sept 13, 1864.

Where Camp Tice

By whom W. Canale; term 3 y'rs.

Remarks:  
-----  
-----  
-----  
-----  
-----  
-----  
-----  
-----  
-----  
-----

A. J. Anderson  
(383g) Coppist.



*I* | *5 Cav* | **U.S.C.T.**  
*Benjamin Jackson*  
*H 5th* Reg't U.S. Col'd *Cav*

Appears on

**Company Descriptive Book**  
of the organization named above.

**DESCRIPTION.**

Age *20* years; height *5* feet *7* inches.

Complexion *Blk*

Eyes *Blk*; hair *Blk*

Where born *Anderson Ky*

Occupation *farmer*

**ENLISTMENT.**

When *Sep 13*, 186 *4*

Where *Camp Nelson Ky*

By whom *H. Randolph* term *3* y'rs.

Remarks:

-----  
-----  
-----  
-----  
-----  
-----  
-----  
-----  
-----  
-----

*J. E. Parks*

Jackson Benjamin

Co H, 5 U. S. Col'd Cav.

Private

Private

CARD NUMBERS.

1	5366808	26
2	5366900	27
3	5367000	28
4	5367091	29
5	5367183	30
6	5367279	31
7	5367370	32
8	5367459	33
9	5367547	34
10	5367639	35
11	5367732	36
12	9090814	37
13	9090906	38
14		39
15		40
16		41
17		42
18		43
19		44
20		45
21		46
22		47
23		48
24		49
25		50

Book Mark:

See also



UNITED STATES COLORED TROOPS ENLISTMENT.

STATE OF



TOWN OF

*Kentucky* *Camp Nelson*

*Andrew Jackson* born in *Woodford Co*

in the State of *Kentucky* aged *Twenty five* years

and by occupation a *Farmer* Do HEREBY ACKNOWLEDGE TO

have volunteered *Thirteenth* day of *September* 1864

to serve as a Soldier in the Army of the United States of America, for the period of THREE YEARS, unless sooner discharged by proper authority: Do also agree to accept such bounty, pay, rations, and clothing, as are, or may be, established by law for the U. S. colored troops.

And I, *Andrew Jackson*

do solemnly swear that I will bear true faith and allegiance to the United States of America, and that I will serve them honestly and faithfully against all their enemies or opposers whomsoever; and that I will observe and obey the orders of the President of the United States, and the orders of the officers appointed over me, according to the Rules and Articles of War.

Sworn and subscribed to, at *Camp Nelson*  
this *13<sup>th</sup>* day of *Sept* 1864 by *Andrew Jackson*

Before *J. C. Randolph*  
*J. C. Randolph*

I CERTIFY, ON HONOR, That I have carefully examined the above named Volunteer agreeably to the General Regulations of the Army, and that, in my opinion, he is free from all bodily defects and mental infirmity, which would in any way disqualify him from performing the duties of a soldier.

*P. G. Barrett*  
*West, Surg., 7<sup>th</sup> U.S.C.*  
EXAMINING SURGEON.

I CERTIFY, ON HONOR, That I have minutely inspected the Volunteer *Andrew Jackson* previously to his enlistment, and that he was entirely sober when enlisted; that, to the best of my judgment and belief, he is of lawful age; and that, in accepting him, as duly qualified to perform the duties of an able-bodied soldier, I have strictly observed the regulations which govern the recruiting service. This soldier has *blue* eyes, *black* hair, *fair* complexion, is *five* feet *five* inches high.

*J. C. Randolph*  
*J. C. Randolph*  
RECRUITING OFFICER OR AGENT.

Mustered into the United States Service... *15<sup>th</sup>* day of *Sept* 1864

*N. C. McKinney*  
*Capt 18<sup>th</sup> U.S.P.*  
Mustering Officer.

Mustered into the service of the United States, for three years or during the war, from date of enlistment, in Company *...* Regiment of *U.S. Colored Cavalry* Volunteers, on the *15<sup>th</sup>* day of *September* 1864, at *Camp Nelson Ky*

*W. C. Farmer*  
*Mustering Officer*



NOTE 1.—This blank will be used for enlistments of United States colored troops. They will be made out in duplicate in all cases—one to accompany the recruiting return of the superintendent (not the recruiting officer) to the Adjutant General, and one to accompany the accounts of the officer who pays bounty, &c.

NOTE 2.—An enlistment holds to service. A muster-in must, in all cases, precede payment of pay, bounty, pension, &c. A muster-in roll, must in all cases, be filed in the Adjutant General's Office as evidence of muster-in. The mustering officer, commissary, or assistant commissary of musters, as the case may be, will countersign both enlistments as having mustered the soldiers into the service of the United States before either of them is given to the disbursing officer.

DECLARATION OF RECRUIT.

I, Andrew Jackson desiring to volunteer as a soldier in the ARMY OF THE UNITED STATES, for the term of Three Years, DO DECLARE That I am 25 years and ..... months of age; that I have never been discharged from the United States service on account of disability or by sentence of a court-martial, or by order before the expiration of a term of enlistment; and I know of no impediment to my serving honestly and faithfully as a soldier for three years.

GIVEN at Camp Nelson the 14 day of September 1864

Witness: W. L. Palmer

Andrew Jackson  
Volunteered at Camp Nelson  
No. 114  
September 14 1864  
By John S. Phelps  
in presence of John S. Phelps

Consent of Parent or Guardian in case of a Minor, if a Free Man, or in the case of a Slave, of the Person to whom he owes Service:

I, ..... Do CERTIFY, That I am the ..... that the said ..... is ..... years of age; and I do freely give my CONSENT to his volunteering as a SOLDIER in the Army of the United States, for the period of THREE YEARS, under the conditions of the laws of the United States.

GIVEN at ..... the ..... day of .....

Witness: .....

Jackson, Andrew

Co. H, 5 Reg't 25cc

1 Enclosures.

Bed Cards	Final Statements
Burial Records	Furloughs or L. of A.
Certs. of Dis. for Discharge	Med. Certificates
C. M. Charges	Med. Des. Lists
Descriptive Lists	Orders
Discharge Certificates	Pris. of War Record
Enlistment Papers	Resignations

Other papers relating to—

Admission to Hosp'l	Furlough or L. of A.
Casualty Sheet	Med. Examination
Confinement	Misc. Information
Contracts	Pay or Clothing
Death or Effects	Personal Reports
Desertion	Rank
Discharge from Hosp'l	Transfer to Hosp'l
Discharge from Service	Transfer to V. R. C.
Duty	Transportation

*J* | **5 Cav. | U.S.C.T.**

*Andrew Jackson*  
*Prst*, Co. *H*, 5 Reg't U. S. Col'd Cavalry.

Appears on **Co. Muster-out Roll**, dated  
*Helena, Ark Mar 16*, 1866.

Muster-out to date *Mar. 16*, 1866.

Last paid to *Dec. 31*, 1865.

**Clothing account:**

Last settled....., 186 ; drawn since \$..... 100

Due soldier \$ *79*<sup>*45*</sup>/<sub>100</sub>; due U. S. \$..... 100

Am't for cloth'g in kind or money adv'd \$..... 100

Due U. S. for arms, equipments, &c., \$ <sup>*15*</sup>/<sub>100</sub>

Bounty paid \$ *100* 100; due \$ *100* 100

Remarks: *Map. for Ord. 15<sup>c</sup>*

Book mark: .....

*J. Stewart*  
Copied.



J | 5 Cav. | U.S.C.T.

Andrew Jackson  
Priv. Co. H, 5 Reg't U. S. Colored Cav.

Appears on Returns as follows:

Feb 1865 Absent on detach'd duty  
at Lexington since Jan 20/65  
with the Brig Band.

Mar. 1865 Absent detach'd service  
Jan 20/65 Ky. with the Band

Apr to July 1865 Absent on det. duty  
Brig Band, Louisville Ky Jan  
20/65

Aug 1865 to Feb, 1866 On daily duty  
in Regt Band.

Book mark :

Austin

5 Cav. U.S.C.T.

*Andrew Jackson*  
Pat, Co. H, 5 Reg't U. S. Col'd Cavalry.

Appears on

**Company Muster Roll**

for *Jan'y. 1<sup>st</sup> Feby*, 1866.

Present or absent *Present*

Stoppage, \$ 100 for

Due Gov't, \$ 100 for

Valuation of horse, \$ 100

Valuation of horse equipments, \$ 100

Remarks:

Book mark:

(358)

*J. Stewart*  
Copyist.

1865

J. | 5 Cav. | U.S.C.T.  
Andrew Jackson  
Cot., Co. H, 5 Reg't U. S. Col'd Cavalry.

Appears on

Company Muster Roll  
for Nov. 4<sup>th</sup>, 1865.

Present or absent Present.

Stoppage, \$ 100 for

Due Gov't, \$ 100 for

Valuation of horse, \$ 100

Valuation of horse equipments, \$ 100

Remarks: On daily duty  
in Regt Band.

Book mark:

(358)

B. J. Cooke

Copyist.



J. | **5 Cav.** | **U.S.C.T.**  
*Andrew Jackson*  
*Art*, Co. H, 5 Reg't U. S. Col'd Cavalry.

Appears on

**Company Muster Roll**

for *Sept. & Oct.*, 1865.

Present or absent *Present.*

Stoppage, \$ 100 for

Due Gov't, \$ 100 for

Valuation of horse, \$ 100

Valuation of horse equipments, \$ 100

Remarks:

Book mark:

(358)

*B. J. Cooke*

Copyist.

J. | **5 Cav.** | **U.S.C.T.**

*Andrew Jackson*  
*Coy*, Co. H, 5 Reg't U. S. Col'd Cavalry.

Appears on

**Company Muster Roll**

for *July & Aug.*, 1865.

Present or absent *Present*

Stoppage, \$ 100 for

Due Gov't, \$ 100 for

Valuation of horse, \$ 100

Valuation of horse equipments, \$ 100

Remarks:

Book mark:

*B. J. Cooke*

J. | **5 Cav.** | **U.S.C.T.**  
*Andrew Jackson*  
*Prst*, Co. H, 5 Reg't U. S. Col'd Cavalry.

Appears on

**Company Muster Roll**

for *May & June*, 1865.

Present or absent *Absent*.

Stoppage, \$ 100 for

Due Gov't, \$ 100 for

Valuation of horse, \$ 100

Valuation of horse equipments, \$ 100

Remarks: *1<sup>st</sup> Installment Bounty*  
*due \$100. 1<sup>st</sup> Brigade*  
*Band Louisville, Ky Jan.*  
*20<sup>th</sup> 1865.*

Book mark:

(358)

*B. J. Cooke*

Copyist.



J | 5 Cav. | U.S.C.T.

Andrew Jackson  
Put, Co. H, 5 Reg't U. S. Col'd Cavalry.

Appears on

**Company Muster Roll**

for *Mar & Apr*, 1865.

Present or absent *Absent*

Stoppage, \$ 100 for

Due Gov't, \$ 100 for

Valuation of horse, \$ 100

Valuation of horse equipments, \$ 100

Remarks: *1<sup>st</sup> installment of  
Bounty Due \$100  
Detch Louisville Ky  
Brigade Band  
Jan 20<sup>th</sup> 1865*

Book mark:

*Reynolds*

J | 5 Cav. | U.S.C.T.

Andrew Jackson  
Pvt., Co. H, 5 Reg't U. S. Col'd Cavalry.

Appears on

**Company Muster Roll**

for Jan & Feb, 1865.

Present or absent Absent

Stoppage, \$ 100 for

Due Gov't, \$ 100 for

Valuation of horse, \$ 100

Valuation of horse equipments, \$ 100

Remarks: 1<sup>st</sup> Installment of  
Bounty Due \$100.00  
Detached Service  
Lexington Ky in  
Brigade Brass Band  
Jan 20 "1865

Book mark:

Reynolds

J | 5 Cav. | U.S.C.T.

Andrew Jackson  
Pot, Co. H, 5 Reg't U. S. Col'd Cavalry.

Appears on

Company Muster Roll

for Nov & Dec, 1864.

Present or absent present

Stoppage, \$ 100 for

Due Gov't, \$ 100 for

Valuation of horse, \$ 100

Valuation of horse equipments, \$ 100

Remarks: 1<sup>st</sup> and 2<sup>d</sup> Installments  
Bounty due

Book mark:

Reynolds

(358)

Copyist.



J | 5 Cav. | U.S.C.T.

Andrew Jackson

Pat., Co. H, 5 Reg't U. S. Col'd Cavalry.

Appears on

**Company Muster Roll**

for *from enlistment to Oct 31, 1864.*

Present or absent *present*

Stoppage, \$ 100 for

Due Gov't, \$ 100 for

Valuation of horse, \$ 100

Valuation of horse equipments, \$ 100

Remarks:

Book mark:

Reynolds

*J* | **5 Cav. U.S.C.T.**

*Andrew Jackson*

*Put*....., Co. *H*, 5 Reg't U. S. Col'd Cavalry.

Appears on

**Company Muster-in and Descriptive Roll**

of the organization named above. Roll dated

*Camp Nelson, Ky. Oct 29, 1864*

Where born *Woodford Ky*

Age *25* y'rs; occupation *Farmer*

When enlisted *Sept 14*....., 1864.

Where enlisted *Camp Nelson Ky*

For what period enlisted *3* years.

Eyes *Black* ; hair *Black*

Complexion *Black* ; height *5 ft. 3 in.*

When mustered in *Sept 15*....., 1864.

Where mustered in *Camp Nelson Ky*

Bounty paid \$ *100* ; due \$ *100*

Where credited.....

Company to which assigned.....

Remarks: *7<sup>th</sup> Dist Ky*

*x John Lapsley.*

*x Supposed to be name of owner.*

*Added May 17. 98. H.A.J.*

Book mark:.....

*Reynolds*

J | **5 Cav. | U.S.C.T.**

Andrew Jackson

....., Co. H, 5 Reg't U. S. Col'd Cav.

Appears on

**Company Descriptive Book**  
of the organization named above.

**DESCRIPTION.**

Age 25 years; height 5 feet 5 inches.

Complexion 1302

Eyes 1302; hair 1302

Where born North Carolina

Occupation Farmer

**ENLISTMENT.**

When Sept., 1864.

Where Camp Decatur

By whom C. J. Anderson; term 3 y'rs.

Remarks:

.....  
.....  
.....  
.....  
.....

Inserted by company.

A. J. Anderson  
(3830) Coppist.



*J* | *5 Cav* | **U. S. C. T.**

*Andrew Jackson*  
....., Co *H* *5* Reg't U. S. Col'd *Cav*

Appears on

**Company Descriptive Book**

of the organization named above.

**DESCRIPTION.**

Age *25* years; height *5* feet *5* inches.

Complexion *Blk*

Eyes *Blk*; hair *Blk*

Where born *Woodford Ky*

Occupation *farmer*

**ENLISTMENT.**

When *Sep, 14*, 186 *4*.

Where *Camp Nelson Ky*

By whom *H. Randolph*, term *3* y'rs.

Remarks: .....

.....  
.....  
.....  
.....  
.....  
.....  
.....  
.....  
.....  
.....

*F. E. Purke*

S. 778112 P.O. Mon  
S 1360987 - P.O. Mon  
S 2118548 And wd  
A.Y. 1800619

Sturges & Co

Jackson Andrew

Co H, 5 U. S. Col'd Cav.

Private

Private

CARD NUMBERS.

1	5366807	26
2	5366899	27
3	5366999	28
4	5367090	29
5	5367182	30
6	5367278	31
7	5367369	32
8	5367458	33
9	5367546	34
10	5367638	35
11	5367733	36
12	9090816-	37
13	9090907	38
14	40729945	39
15		40
16		41
17		42
18		43
19		44
20		45
21		46
22		47
23		48
24		49
25		50

Book Mark:

See also



*J* | **5 Cav. | U.S.C.T.**

*Andrew Jackson*  
*Pvt*, Co. *D*, 5 Reg't U. S. Col'd Cavalry.

Appears on **Co. Muster-out Roll**, dated  
*October 1st*, *March* 186*6*.

Muster-out to date *March* 186*6*.

Last paid to *Dec 31*, 186*5*.

**Clothing account:**

Last settled....., 186 ; drawn since \$..... 100

Due soldier \$ *6* <sup>*20*</sup>/<sub>100</sub>; due U. S. \$..... 100

Am't for cloth'g in kind or money adv'd \$..... 100

Due U. S. for arms, equipments, &c., \$ *1* <sup>*48*</sup>/<sub>100</sub>

Bounty paid \$ *100* 100; due \$ *100* 100

Remarks: *Stanc exp 19. 1861*

*Due U.S for Ord \$ 1.48*

Book mark : .....

*W. J. ...*  
Copyright.

5 Cav. U.S.C.T.

Andrew Jackson  
Pvt Co. B, 5 Reg't U. S. Colored Cav.

Appears on Returns as follows:

"From organization to Oct 31" to Dec 1864  
Absent wounded at Saltville,  
Va., Oct 2/64, Hospital Ashland, Ky

Apr 1865 Absent det at New Haven,  
Ky.

Oct 1865 Absent detached service  
at Commissary Dept. 5 U.S.C.T.

Book mark :

(546)

Justin

Copyist.

*J* | **5 Cav. | U.S.C.T.**

*Andrew Jackson*  
*Pvt*, Co. B, 5 Reg't U. S. Col'd Cavalry.

Appears on

**Company Muster Roll**

for *Jan. - Feb.*, 186*6*.

Present or absent *Present*

Stoppage, \$ *100* for

Due Gov't, \$ *100* for

Valuation of horse, \$ *100*

Valuation of horse equipments, \$ *100*

Remarks:

Book mark:

*W. J. ...*  
Copyist.



J. | 5 Cav. | U.S.C.T.

Andrew Jackson

Priv., Co. B, 5 Reg't U. S. Col'd Cavalry.

Appears on

Company Muster Roll

for Nov. & Dec., 1865.

Present or absent present

Stoppage, \$ 100 for

Due Gov't, \$ 100 for

Valuation of horse, \$ 100

Valuation of horse equipments, \$ 100

Remarks:

Book mark:

R. G. Wilson

J. | 5 Cav. | U.S.C.T.

Andrew Jackson

Priv., Co. B, 5 Reg't U. S. Col'd Cavalry.

Appears on

**Company Muster Roll**

for Sept. & Oct., 1865.

Present or absent Absent

Stoppage, \$ 100 for

Due Gov't, \$ 100 for

Valuation of horse, \$ 100

Valuation of horse equipments, \$ 100

Remarks: Detach service at the  
Commissary Dept. U. S. C. C., per R. O.  
No. 165.

Book mark:

R. C. Wilson

*J.* | **5 Cav.** | **U.S.C.T.**

*Andrew Jackson*

*Priv.*, Co. B, 5 Reg't U. S. Col'd Cavalry.

Appears on

**Company Muster Roll**

for *July & Aug.*, 186*5*.

Present or absent *Present*

Stoppage, \$ *100* for

Due Gov't, \$ *100* for

Valuation of horse, \$ *100*

Valuation of horse equipments, \$ *100*

Remarks:

Book mark:

*R. G. Wilson*



J. | **5 Cav.** | **U.S.C.T.**

Andrew Jackson

Priv., Co. B, 5 Reg't U. S. Col'd Cavalry.

Appears on

**Company Muster Roll**

for May & June, 1865.

Present or absent present

Stoppage, \$ 100 for

Due Gov't, \$ 100 for

Valuation of horse, \$ 100

Valuation of horse equipments, \$ 100

Remarks: not installment from  
by due \$100

Book mark: \_\_\_\_\_

R. C. Wilson

*J* | **5 Cav.** | **U.S.C.T.**

*x Andrew*  
*Alexander Jackson*  
*Saier*, Co. B, 5 Reg't U. S. Col'd Cavalry.

Appears on

**Company Muster Roll**

for *Feb 23 to April*, 186*5*.

Present or absent *Absent*

Stoppage, \$ *100* for

Due Gov't, \$ *100* for

Valuation of horse, \$ *100*

Valuation of horse equipments, \$ *100*

Remarks: *Detached Service*  
*at New Haven Reg.*  
*1<sup>st</sup> installment bounty*  
*due \$100*

*Reconciled by Townsend & Co*

Book mark:

*Lauch*

J | **5 Cav.** | **U.S.C.T.**

Andrew Jackson  
Priv, Co. B, 5 Reg't U. S. Col'd Cavalry.

Appears on

**Company Muster Roll**

for Jan & Feb, 1867.

Present or absent Present

Stoppage, \$ 100 for

Due Gov't, \$ 100 for

Valuation of horse, \$ 100

Valuation of horse equipments, \$ 100

Remarks: 1<sup>st</sup> installment  
bounty \$100 due

Book mark: \_\_\_\_\_

Lamb



g | **5 Cav.** | **U.S.C.T.**

Andrew Jackson  
Pen, Co. B, 5 Reg't U. S. Col'd Cavalry.

Appears on

**Company Muster Roll**

for Nov & Dec, 1864.

Present or absent Absent

Stoppage, \$ 100 for

Due Gov't, \$ 100 for

Valuation of horse, \$ 100

Valuation of horse equipments, \$ 100

Remarks: Sick in Hospital  
Ashland Ky.  
1st & 2nd installments  
paid here.

Book mark:

Lamb

J | **5 Cav. | U.S.C.T.**

Andrew Jackson  
Paris, Co. B, 5 Reg't U. S. Col'd Cavalry.

Appears on

**Company Muster Roll**

for Oct 31, 1864.

Present or absent Absent

Stoppage, \$ 100 for

Due Gov't, \$ 100 for

Valuation of horse, \$ 100

Valuation of horse equipments, \$ 100

Remarks: Sick in Hospital  
at Ashland Ky

Book mark: \_\_\_\_\_

(358)

Lamb  
Copyist.

J. | <sup>5</sup> 6 Cav. | U.S.C.S.

Andrew Jackson.  
Priv., Co. B, 6 Reg't U.S.C. Cav.

Appears on

**Hospital Muster Roll**

of **Convalescent Camp U. S. A. Hospital,**

at **Camp Nelson, Ky.,**

for Sept. & Oct., 1864.

Attached to hospital:

When Oct. 28, 1864.

How employed Patient.

Last paid by Maj. \_\_\_\_\_

to \_\_\_\_\_, 186 .

Bounty paid \$ 100; due \$ 100

Present or absent Present.

Remarks: \_\_\_\_\_  
\_\_\_\_\_  
\_\_\_\_\_  
\_\_\_\_\_  
\_\_\_\_\_  
\_\_\_\_\_  
\_\_\_\_\_  
\_\_\_\_\_

Book mark: \_\_\_\_\_

Dickerson,



J | 51 Coar | U.S.C.T.

Andrew Jackson  
Pew, Co. B, 51 Reg't U. S. Col'd Coar

Appears on

**Company Muster-in and Descriptive Roll**  
of the organization named above. Roll dated

Camp Nelson Ky Oct 24, 1864.

Where born Fayette Ky

Age 23 y'rs; occupation Farmer

When enlisted Aug 18, 1864:

Where enlisted Camp Nelson

For what period enlisted 3 years.

Eyes Blue; hair Blue

Complexion Blue; height 5 ft. 6 in.

When mustered in Aug 19, 1864.

Where mustered in Camp Nelson

Bounty paid \$ 100; due \$ 100

Where credited 7 Dist Ky

Company to which assigned B

Remarks \* Name of owner of

Negro - James Patrick

\* Added May 12 98 H. J.

Book mark :

Lamb,

*J* | **5 Cav. | U.S.C.T.**  

---

*Andrew Jackson*  
-----, Co. *B*, 5 Reg't U. S. Col'd Cav.

Appears on

**Company Descriptive Book**  
of the organization named above.

**DESCRIPTION.**

Age *23* years; height *5* feet *6* inches.

Complexion *Blk.*

Eyes *Blk.*; hair *Blk.*

Where born *Fayette Co., Ky.*

Occupation *Farmer*

**ENLISTMENT.**

When *Aug. 10*, 186 *4*.

Where *Camp Nelson*

By whom *J. C. Randolph*, term *3* y'rs.

Remarks: -----  
-----  
-----  
-----  
-----  
-----  
-----  
-----  
-----  
-----

*A. A. Hall*

(383g)

*Cornel*  
*Cornel*

S. 1425242 P.O. return  
P 1716975 P.O. aff

St. James Co



Jackson Andrew  
Co B, 5 U. S. Col'd Cav.

Private | Private

CARD NUMBERS.

1	5360692	26
2	5360789	27
3	5360877	28
4	5360973	29
5	5361063	30
6	5361149	31
7	5361237	32
8	5361327	33
9	5361416	34
10	5361492	35
11	5361574	36
12	9090530	37
13	31413061	38
14	40729944	39
15		40
16		41
17		42
18		43
19		44
20		45
21		46
22		47
23		48
24		49
25		50

Book Mark:

See also

J. | 5 Col. Cav. | U.S.  
Aaron Jackson,  
Pvt., Co. F, 5<sup>th</sup> Reg't U.S.C. Cav.

**NOTATION.**

Book mark: J-104 R. C. T. - 1868

War Department,

Record and Pension Division,

Washington, Sept. 19, 1891.

It has this day (Sept. 19, 1891,)

been determined by this Department from evidence furnished by the Second Auditor of the Treasury, that this man was discharged the service February 3, 1865, at Vicksburg, Miss., by reason of surgeon's certificate of disability.

Cancelled  
No notation  
Jesse 24.9 #

J | 5 | Company | unrecd  
Anson Jackson  
Priv., Co. F., 5 Reg't unrecd  
Company

**NOTATION.**

Book mark: J 104 Rb 7 1868

**War Department,**

Record and Pension Division,

Washington, June 24, 1892.

Notation of Sept 19,  
1891 is canceled

It has this day  
(June 24, 1892) been  
determined by this Dept  
that this man was  
admitted to Nelson's  
Camp Nelson Ky.  
October 31, 1864. diag-  
nosis not stated and  
that he was sent to  
Convalescent Camp  
November 14, 1864.

Investigation fails  
to elicit any further  
information relative  
to this soldier

Kelly



**5 Cav. U.S.C.T.**

*Baron Jackson*

*Plt*, Co. *F*, 5 Reg't U. S. Col'd Cavalry.

Appears on **Co. Muster-out Roll**, dated  
*Helena Ark*, *Feb 16*, 186 *6*.

Muster-out to date \_\_\_\_\_, 186 .

Last paid to *Pay due from Enlistment*, 186 .

**Clothing account:**

Last settled \_\_\_\_\_, 186 ; drawn since \$ \_\_\_\_\_ 100

Due soldier \$ \_\_\_\_\_ 100; due U. S. \$ \_\_\_\_\_ 100

Am't for cloth'g in kind or money adv'd \$ \_\_\_\_\_ 100

Due U. S. for arms, equipments, &c., \$ \_\_\_\_\_ 100

Bounty paid \$ \_\_\_\_\_ 100; due \$ \_\_\_\_\_ 100

Remarks: *Absent sick in Genl Hosp*  
*Camp Nelson Ky since Nov 8.*  
*1864, no discharge furnished*

Book mark: *J. 104 Vol 5 R.C. 7 1868*

J

5 Cav. U.S.C.T.

Aaron Jackson  
Priv. Co. F. 5 Reg't U. S. Colored Cav.

Appears on Returns as follows:

Dec 1864 & Jan 1865, Absent sick in  
Hospel Point Burnside Ky.  
Nov. 3/64

Feb to July 1865 Absent sick in Genl.  
Hospel Paducah Ky Dec 3/64

Aug 1865 to Feb 1866 Absent sick in  
Genl Hospel Camp Nelson Ky  
since Nov 2/64

Book mark :

Austin

**5 Cav. U.S.C.T.**

*J*  
*Aaron Jackson*

*Prst*, Co. F, 5 Reg't U. S. Col'd Cavalry.

Appears on

**Company Muster Roll**

for *Jan & Feb*, 186 *6*

Present or absent *Absent*

Stoppage, \$ *100* for

Due Gov't, \$ *100* for

Valuation of horse, \$ *100*

Valuation of horse equipments, \$ *100*

Remarks: *Absent Sick Genl Hosp.*  
*Camp Nelson Tex since Nov*  
*3<sup>d</sup> - 64.*

Book mark:

*J. Davis*



J | 5 Cav. | U.S.C.T.

Aaron Jackson

Priv., Co. F, 5 Reg't U. S. Col'd Cavalry.

Appears on

Company Muster Roll

for Nov & Dec, 1865.

Present or absent absent

Stoppage, \$ 100 for

Due Gov't, \$ 100 for

Valuation of horse, \$ 100

Valuation of horse equipments, \$ 100

Remarks: Sick in Genl Kope  
Camp Nelson Ky since  
Nov 2 - 1864.

Book mark:

J | 5 Cav. | U.S.C.T.

Arum Jackson

Pvt, Co. F, 5 Reg't U. S. Col'd Cavalry.

Appears on

Company Muster Roll

for Sept & Oct, 1865.

Present or absent Absent

Stoppage, \$ 100 for

Due Gov't, \$ 100 for

Valuation of horse, \$ 100

Valuation of horse equipments, \$ 100

Remarks: Sick in Genl Hoptt Riverside  
Point since Oct 3 - 1865

Book mark:

*J* | **5 Cav. | U.S.C.T.**

*Aaron Jackson*

*Pol*, Co. F, 5 Reg't U. S. Col'd Cavalry.

Appears on

**Company Muster Roll**

for *July & Aug*, 186 *5*.

Present or absent *absent*

Stoppage, \$ *100* for

Due Gov't, \$ *100* for

Valuation of horse, \$ *100*

Valuation of horse equipments, \$ *100*

Remarks: *Sick in Genl Keck's Brigade  
Point Ky since Oct 3<sup>rd</sup> 1864*

Book mark: \_\_\_\_\_



J

5 Cav. U.S.C.T.

Aaron Jackson

Pvt, Co. F, 5 Reg't U. S. Col'd Cavalry.

Appears on

Company Muster Roll

for May & June, 1865.

Present or absent Absent

Stoppage, \$ 100 for

Due Gov't, \$ 100 for

Valuation of horse, \$ 100

Valuation of horse equipments, \$ 100

Remarks: 1st installment Bounty due \$ 100-

Sick in Genl West's Camp  
Nelson Ky since Oct 3. 1864

Book mark:

Went

I | 5 Cav. | U.S.C.T.

*Arrow Jackson*

*Paris*, Co. F, 5 Reg't U. S. Col'd Cavalry.

Appears on

**Company Muster Roll**

for *May & Apr*, 1865.

Present or absent *Absent.*

Stoppage, \$ *100* for

Due Gov't, \$ *100* for

Valuation of horse, \$ *100*

Valuation of horse equipments, \$ *100*

Remarks:

*Sick in Genl Hospr  
Camp Nelson Ky since  
Nov 2/64*

*First installment Bounty  
due.*

Book mark:

*Currin*

J | **5 Cav.** | **U.S.C.T.**

Arvon Jackson  
Priv, Co. F, 5 Reg't U. S. Col'd Cavalry.

Appears on

**Company Muster Roll**

for Jan & Feb, 1865.

Present or absent Absent

Stoppage, \$ 100 for

Due Gov't, \$ 100 for

Valuation of horse, \$ 100

Valuation of horse equipments, \$ 100

Remarks:

1 Installment Bounty due.  
Sick in Genl Hoop's Camp  
At son by since Oct 3

Book mark:

Sumner



*J* | *Nov.* | **U.S.C.T**

*Aaron Jackson*

*Pvt*, Co. *F*, *5* Reg't U. S. Col'd *Caivy*.

Appears on

**Company Muster Roll**

for *Nov. & Dec.*, 1864.

Present or absent *Absent*

Stoppage, \$ *100* for

Due Gov't, \$ *100* for

Valuation of horse, \$ *100*

Valuation of horse equipments, \$ *100*

Remarks: *1st Instal't County*  
*due. Sick in Genl.*  
*Hosp. Point Burnside*  
*since Nov. 3.*

Book mark:

(355)

*Fitz*  
Copyist.  
*Compr.*

J. | **5 Cav.** | **U.S.C.T.**

*Aaron Jackson*

*Privt*, Co. F, 5 Reg't U. S. Col'd Cavalry.

Appears on

**Company Muster Roll**

for *to Oct. 31*, 186*4*.

Present or absent *Present.*

Stoppage, \$ *100* for

Due Gov't, \$ *100* for

Valuation of horse, \$ *100*

Valuation of horse equipments, \$ *100*

Remarks:

-----  
-----  
-----  
-----  
-----  
-----  
-----

Book mark:

-----

*Lewis*  
(358) Copyist.

**5 Cav. U.S.C.T.**

*J*  
*Aaron Jackson*

*Priv*, Co. *F*, 5 Reg't U. S. Col'd Cavalry.

Appears on

**Company Muster-in and Descriptive Roll**

of the organization named above. Roll dated

*Sept Nelson Ky*, *N. Y.*, *Oct 29*, 1864.

Where born *Woodford Ky*

Age *18* y'rs; occupation *Farmer*

When enlisted *Sept 23*, 1864.

Where enlisted *Sept Nelson Ky*

For what period enlisted *3* years.

Eyes *Blk*; hair *Blk*

Complexion *Blk*; height *5 ft. 4 in.*

When mustered in *Sept 23*, 1864.

Where mustered in *Sept Nelson*

Bounty paid \$ *100*; due \$ *100*

Where credited *7 Dist Ky*

Company to which assigned *F*

Remarks: *Name of owner of Negro - Samuel Gay*

*\* Added May 12, 98 by H.A.J*

Book mark:

*Currier*



*J* | **5 Cav. | U.S.C.T.**

*Caron Jackson*

....., Co. *A*, 5 Reg't U. S. Col'd Cav.

Appears on

**Company Descriptive Book**  
of the organization named above.

**DESCRIPTION.**

Age *18* years; height *6* feet *4* inches.

Complexion *Black*

Eyes *Black*; hair *Blk*

Where born *Woodford Ky*

Occupation *farmer*

**ENLISTMENT.**

When *Sep 73*, 186 .

Where *Camp Nelson*

By whom *J. Randolph* term *3* y'rs.

Remarks: .....

.....  
.....  
.....  
.....  
.....

*J. E. Parks*

A. 685012 P. M. T. M.

R + P. 335196.

Rep 358757-

A 961081-2. Hand Clk

Rep 384796.

*Wm. W. W.*

617  
Jackson Aaron

Co F, 5 U. S. Col'd Cav.

Private | Private

CARD NUMBERS.

1	5364713	26
2	5364812	27
3	5364914	28
4	5365004	29
5	5365094	30
6	5365185	31
7	5365277	32
8	5365366	33
9	5365454	34
10	5365542	35
11	5365630	36
12	J. -104-R.C.T.-68	37
13	90903-40	38
14	J. -104-R.C.T.-68	39
15	40729943	40
16		41
17		42
18		43
19		44
20		45
21		46
22		47
23		48
24		49
25		50

Book Mark: J. 104. 7d. 5 R.C.T. 1868

See also



J | 5 cav | ref. C.

William Jackson,

, Co. B, 5 Reg't ref. C. Cav.

**NOTATION.**

Book mark: 9649 - B - '88

War Department,

Adjutant General's Office,

Washington, May 25, 1889

Application for certificate in lieu of lost discharge.

One Certificate — furnished.

*G. J.*

*J* | **5 Cav. U.S.C.T.**

*William J. Jackson*  
Pvt., Co. *B*, 5 Reg't U. S. Col'd Cavalry.

Appears on **Co. Muster-out Roll**, dated  
*October 1861*, *Nov 16*, 186*1*.  
Muster-out to date *Nov 16*, 186*1*.  
Last paid to *Dec 31*, 186*1*.

Clothing account:

Last settled....., 186 ; drawn since \$..... 100  
Due soldier \$ *16 69* / 100; due U. S. \$..... 100  
Am't for cloth'g in kind or money adv'd \$..... 100

Due U. S. for arms, equipments, &c., \$..... 100  
Bounty paid \$ *100* / 100; due \$ *100* / 100

Remarks: *None up to 19. 1861*

Book mark: *9649 B 88 410624*

*J. Jackson*

J | 5 Cav. | U.S.C.T.

William Jackman

Priv, Co. D, 5 Reg't U. S. Colored Cav.

Appears on Returns as follows:

Nov & Dec 1864, Absent sick Hoopl,  
Ashland, Ky  
Jan to Nov 1865, Absent sick Hoopl,  
Camp Nelson, Ky.

Book mark: \_\_\_\_\_

Austin

(546)  
72

Copyist.



*H* | **5 Cav.** | **U.S.C.T.**

*William Jackson*  
*Pvt*, Co. B, 5 Reg't U. S. Col'd Cavalry.

Appears on

**Company Muster Roll**

for *Jan & Feb, 1866*

Present or absent *Present*

Stoppage, \$ *100* for

Due Gov't, \$ *100* for

Valuation of horse, \$ *100*

Valuation of horse equipments, \$ *100*

Remarks: *Given in Ch Dis*

Book mark:

(358)

*W. Jackson* Copyist.

J. | **5 Cav.** | **U.S.C.T.**

William Jackson  
Priv., Co. B, 5 Reg't U. S. Col'd Cavalry.

Appears on

**Company Muster Roll**  
for Nov. & Dec., 1865.

Present or absent Present

Stoppage, \$ 100 for

Due Gov't, \$ 100 for

Valuation of horse, \$ 100

Valuation of horse equipments, \$ 100

Remarks: Ack in Co. quarters.

Book mark: \_\_\_\_\_

R. Ewiler

*J.* | **5 Cav. U.S.C.T.**

*William Jackson*

*Priv.*, Co. B, 5 Reg't U. S. Col'd Cavalry.

Appears on

**Company Muster Roll**

for *Sept. & Octo.*, 186*5*.

Present or absent *Absent*

Stoppage, \$ *100* for

Due Gov't, \$ *100* for

Valuation of horse, \$ *100*

Valuation of horse equipments, \$ *100*

Remarks: *Sick in Hosp! Camp Nelson, Ky.*

Book mark: \_\_\_\_\_

*R. E. Wilson*



J | 5-6 | U.S.C.T

William Jackson  
Pvt, Co. D, 5<sup>th</sup> Reg't U.S.C.C

Appears on

**Hospital Muster Roll**

of U. S. A. Post Hospital,

at Camp Nelson, Ky.,

for July & Aug, 1865.

Attached to hospital:

When \_\_\_\_\_, 186 .

How employed \_\_\_\_\_

Last paid by Maj. Bucher  
to Feb 28, 1865.

Bounty paid \$ 100; due \$ 100

Present or absent Present

Remarks: \_\_\_\_\_  
\_\_\_\_\_  
\_\_\_\_\_  
\_\_\_\_\_  
\_\_\_\_\_  
\_\_\_\_\_  
\_\_\_\_\_  
\_\_\_\_\_  
\_\_\_\_\_  
\_\_\_\_\_

Book mark : \_\_\_\_\_

C. L. Parker

*J.* | **5 Cav.** | **U.S.C.T.**

*William Jackson*

*Priv.*, Co. B, 5 Reg't U. S. Col'd Cavalry.

Appears on

**Company Muster Roll**

for *July & Aug.*, 186*5*.

Present or absent *Absent*

Stoppage, \$ *100* for

Due Gov't, \$ *100* for

Valuation of horse, \$ *100*

Valuation of horse equipments, \$ *100*

Remarks: *Sick in Genl Hospital  
Camp Nelson, Ky.*

Book mark:

*R. Cowles*

*J* | **5 Cav. | U.S.C.T.**

*William Jackson*

*Priv.*, Co. B, 5 Reg't U. S. Col'd Cavalry.

Appears on

**Company Muster Roll**

for *May & June*, 186*5*.

Present or absent *Absent*

Stoppage, \$ *100* for

Due Gov't, \$ *100* for

Valuation of horse, \$ *100*

Valuation of horse equipments, \$ *100*

Remarks: *Sick in Hosp'l Camp  
Nelson, Ky. 1st installment  
bounty due \$100-*

Book mark: \_\_\_\_\_

*R. E. Wilson*



*J. S. Co. No. 4*  
*William Jackson* x  
*ser. Co. B, 5 Reg't U.S.C. Cav*

Appears on

**Hospital Muster Roll**

of Nelson U. S. A. General Hospital,

at Camp Nelson, Ky.,

for *admitted May 1*, 1865.

Attached to hospital:

When....., 186 .

How employed.....

Last paid by Maj. *Beecher*

to *July 25*, 1865.

Bounty paid \$ 100; due \$ 100

Present or absent *present*

Remarks:.....  
.....  
.....  
.....  
.....

x *William Jackson in*  
*present column*

Book mark:.....

*M. Cooney*

J. | 5 Co. | U.S.C.T.

William Jackson  
Priv., Co. B., 5 Reg't U.S.C.C.

Appears on

**Hospital Muster Roll**

of Convalescent Camp U. S. A. Hospital,

at Camp Nelson, Ky.,

for March & April., 1865.

Attached to hospital:

When Apr. 1, 1865.

How employed Patient.

Last paid by Maj. Beecher.

to Feb. 28, 1865.

Bounty paid \$ 100; due \$ 100

Present or absent Present.

Remarks: \_\_\_\_\_  
\_\_\_\_\_  
\_\_\_\_\_  
\_\_\_\_\_  
\_\_\_\_\_  
\_\_\_\_\_  
\_\_\_\_\_  
\_\_\_\_\_

Book mark: \_\_\_\_\_  
\_\_\_\_\_

Dickerson

g | **5 Cav.** | **U.S.C.T.**

William Jackman  
Priv, Co. B, 5 Reg't U. S. Col'd Cavalry.

Appears on

**Company Muster Roll**

for Feb 28 1865, 1865.

Present or absent Absent

Stoppage, \$ 100 for

Due Gov't, \$ 100 for

Valuation of horse, \$ 100

Valuation of horse equipments, \$ 100

Remarks: Hospital Camp  
Anderson Ky.

1<sup>st</sup> instalment bounty  
due \$100

Book mark: \_\_\_\_\_

Lamb



J. | 5 Co., U.S.C.P.  
William Jackson,  
Priv., Co. B, 5 Reg't U.S.C.C.

Appears on

**Hospital Muster Roll**

of **Convalescent Camp U. S. A. Hospital,**

at **Camp Nelson, Ky.,**

for Jan. + Feb., 1865.

Attached to hospital:

When Jan 11, 1865.

How employed Patient.

Last paid by Maj. Pay due from Enlistment  
to \_\_\_\_\_, 186 .

Bounty paid \$ 100; due \$ 100

Present or absent Present.

Remarks: \_\_\_\_\_  
\_\_\_\_\_  
\_\_\_\_\_  
\_\_\_\_\_  
\_\_\_\_\_  
\_\_\_\_\_  
\_\_\_\_\_  
\_\_\_\_\_  
\_\_\_\_\_  
\_\_\_\_\_

Book mark: \_\_\_\_\_

Jackson  
(343) Copied.

J | **5 Cav.** | **U.S.C.T.**

William Jackman  
Pvt., Co. B, 5 Reg't U. S. Col'd Cavalry.

Appears on

**Company Muster Roll**

for Jan & Feb, 1865.

Present or absent Absent

Stoppage, \$ 100 for

Due Gov't, \$ 100 for

Valuation of horse, \$ 100

Valuation of horse equipments, \$ 100

Remarks: Sick in Fort Keese  
Camp Nelson Aug  
1<sup>st</sup> instalment bounty  
\$100 due

Book mark: \_\_\_\_\_

Lamb

J. | 5 Cav. U.S.C.P.  
William Jackson,  
Priv., Co. B., 5 Reg't U.S.C.P.

Appears on

**Hospital Muster Roll**

of Convalescent Camp U. S. A. Hospital,

at Camp Nelson, Ky.,

for Nov. & Dec., 1864.

Attached to hospital:

When Dec. 4, 1864.

How employed Patient

Last paid by Maj. \_\_\_\_\_

to \_\_\_\_\_, 186 .

Bounty paid \$ 100; due \$ 100

Present or absent Present

Remarks: \_\_\_\_\_  
\_\_\_\_\_  
\_\_\_\_\_  
\_\_\_\_\_  
\_\_\_\_\_  
\_\_\_\_\_  
\_\_\_\_\_  
\_\_\_\_\_  
\_\_\_\_\_

Book mark: \_\_\_\_\_

Dickerson,



J | **5 Cav.** | **U.S.C.T.**

William Jackson  
Pair, Co. B, 5 Reg't U. S. Col'd Cavalry.

Appears on

**Company Muster Roll**

for Nov & Dec, 1864.

Present or absent Absent

Stoppage, \$ 100 for

Due Gov't, \$ 100 for

Valuation of horse, \$ 100

Valuation of horse equipments, \$ 100

Remarks: Sick in Hospital  
Ashland, Ky.  
1st & 2nd instalments  
 bounty due

Book mark: \_\_\_\_\_

James

J | **5 Cav.** | **U.S.C.T.**

William Jackman  
Pvt, Co. B, 5 Reg't U. S. Col'd Cavalry.

Appears on

**Company Muster Roll**

for Oct 31, 1864.

Present or absent Absent

Stoppage, \$ 100 for

Due Gov't, \$ 100 for

Valuation of horse, \$ 100

Valuation of horse equipments, \$ 100

Remarks: Sick in Hospital  
Ashland Ky

Book mark: \_\_\_\_\_

Laub  
Copyist.

*J* | <sup>5</sup> *Co. C* *U.S.C.T.*  
*Wm. Jackman*  
*Pvt.*, Co. *K*, *6* Reg't *U.S.C.T.*

Appears on

**Hospital Muster Roll**

of **U. S. A. General Hospital,**

at **Ashland, Ky.,**

for *Sept & Oct*, 186*4*.

Attached to hospital:

When *Oct 11*, 186*4*.

How employed *patient*

Last paid by Maj. \_\_\_\_\_

to \_\_\_\_\_, 186 .

Bounty paid \$ 100; due \$ 100

Present or absent *present*

Remarks: *No desert roll*

Book mark : \_\_\_\_\_

(848)

*Joeryn*  
Copyist.



9 | 5 Cav. | U.S.C.T.

William Packman  
Tus., Co. B, 5<sup>th</sup> Reg't U. S. Col'd Cav.

Appears on

Company Muster-in and Descriptive Roll  
of the organization named above. Roll dated

Camp Nelson Key, Oct 24, 1864.

Where born Lincoln Key

Age 21 y'rs; occupation Farmer

When enlisted Aug 19, 1864.

Where enlisted Camp Nelson

For what period enlisted 3 years.

Eyes Brn; hair Brn

Complexion Brn; height 5 ft. 7 in.

When mustered in Aug 19, 1864.

Where mustered in Camp Nelson

Bounty paid \$ 100; due \$ 100

Where credited 7 Dist Key

Company to which assigned B

Remarks: Name of owner of

Acro - William Packman

\* Added May 12, 98 by H. J.

Book mark: 96-57-12-1888

Lamb

*J* | **5 Cav. | U.S.C.T.**  
*William Jackman*  
....., Co. *B*, 5 Reg't U. S. Col'd Cav.

Appears on

**Company Descriptive Book**  
of the organization named above.

**DESCRIPTION.**

Age *21* years; height *5* feet *7* inches.

Complexion *Blk*

Eyes *Blk*; hair *Blk*

Where born *Lincobn Co. Ky*

Occupation *Farmer*

**ENLISTMENT.**

When *Aug 19*, 1864.

Where *Camp McLean*

By whom *A. C. Randolph*; term *3* y'rs.

Remarks:

.....  
.....  
.....  
.....  
.....  
.....  
.....  
.....

*Warren*

02393336 P.O. m m .

St. Vincent Co



*Jackman William*

**Co B., 5 U. S. Col'd Cav.**

*Private*

*Private*

**CARD NUMBERS.**

1	5360693	26
2	5360790	27
3	5360878	28
4	5360974	29
5	5361064	30
6	5361150	31
7	5361238	32
8	5361328	33
9	5361411	34
10	5361493	35
11	5361575	36
12	9090131	37
13	9649-B-1888	38
14	31467309	39
15	31413352	40
16	31413534	41
17	31413605	42
18	32115722	43
19	32116140	44
20	40729942	45
21		46
22		47
23		48
24		49
25		50

Book Mark: *9649 B-1888*

See also

Ward 17 Bed 55

Hospital Number 13-470

Name Troy Segrave

Age 24 Nativity Ky

Married or Single Married

Residence Paris Bourbon Co Ky

Post Office address of wife or nearest relative } Same as residence wife Mariah Page

Rank Corp Co G Regiment 5. S. S. C. Cav

When admitted August 20<sup>th</sup>

From what source Joe Holt

Diagnosis: (in surgical cases state explicitly seat and character of wound or injury.)

Jefferson G. H.

Jeffersonville, Ind.

On what occasion wounded

Date

Nature of missile or weapon

TREATMENT.

[HERE NOTE IMPORTANT COMPLICATIONS AND ALL OPERATIONS.]

---

RESULT AND DATE.

*Returned to Duty  
Sept 14*



Med 17 1209 55

Hospital Number 5470

Name Troy Leggett  
Age 23 Nativity Bourbon Co Ky  
Married or Single Single

Residence Bourbon Co Ky  
Post Office address of } Mariah Page  
wife or nearest relative. } Paris Ky

Rank Priv Co. G Regiment 5th Col Cav

When admitted Apr 14th 1865

From what source of Holt Ind

Diagnosis: (in surgical cases state explicitly seat and character of wound or injury.)

G. W. Free M.D. Louisville

Jefferson G. H.  
Jeffersonville, Ind.

On what occasion wounded Jeffersonville Ky  
Date Feb 1865  
Nature of missile or weapon Pistol ball

TREATMENT.

[HERE NOTE IMPORTANT COMPLICATIONS AND ALL OPERATIONS.]

---

RESULT AND DATE.

Barracks No. 1. Louisville, Ky.  
Septbr. 17. 1868

**NOTE 1.**—This blank will be used for enlistments of United States colored troops. They will be made out in duplicate in all cases—one to accompany the recruiting return of the superintendent (not the recruiting officer) to the Adjutant General, and one to accompany the accounts of the officer who pays bounty, &c.

**NOTE 2.**—An enlistment holds to service. A muster-in must, in all cases, precede payment of pay, bounty, pension, &c. A muster-in roll, must in all cases, be filed in the Adjutant General's Office as evidence of muster-in. The mustering officer, commissary, or assistant commissary of musters, as the case may be, will countersign both enlistments as having mustered the soldiers into the service of the United States before either of them is given to the disbursing officer.

DECLARATION OF RECRUIT.

I, Troy Lagrigo desiring to volunteer as a soldier in the ARMY OF THE UNITED STATES, for the term of Three Years, DO DECLARE That I am 21 years and ..... months of age; that I have never been discharged from the United States service on account of disability or by sentence of a court-martial, or by order before the expiration of a term of enlistment; and I know of no impediment to my serving honestly and faithfully as a soldier for three years.

GIVEN at Camp Nelson the 1st day of September 1864

Witness: M. L. Palmer

Troy Lagrigo  
 By James Lagrigo  
 or Bonston  
 of Bonston  
 Volunteered at Camp Nelson  
Sept 1st 1864  
John W. ...  
 No. ....  
Troy Lagrigo

Consent of Parent or Guardian in case of a Minor, if a Free Man, or in the case of a Slave, of the Person to whom he owes Service:

I, ..... Do CERTIFY, That I am the ..... that the said ..... is ..... years of age; and I do freely give my CONSENT to his volunteering as a SOLDIER in the Army of the United States, for the period of THREE YEARS, under the conditions of the laws of the United States.

GIVEN at ..... the ..... day of .....

Witness: .....



Isgraves, Troy  
Sgt. Co. G,      **5** Reg't **U.S.C. Cav**  
3 Enclosures.

Bed Cards ..... <span style="font-size: 1.5em; font-family: cursive;">2</span> Burial Records ..... Certs. of Dis. for Discharge ..... C. M. Charges ..... Med. Certificates ..... <i>Enlistment Papers</i> ..... <span style="font-size: 1.5em; font-family: cursive;">1</span>	Descriptive Lists ..... Final Statements ..... Furloughs ..... Med. Des. Lists ..... Orders .....
---	---

Other papers relating to—

Admission to Hosp'l ..... Casualty Sheet (Officer's) ..... Confinement ..... Contracts ..... Death or Effects ..... Desertions ..... Discharge from Hosp'l ..... Discharge from Service ..... Duty .....	Furlough ..... Med. Examination ..... Misc. Information ..... Pay or Clothing ..... Personal Reports ..... Rank ..... Transfer to Hosp'l ..... Transfer to V. R. C. .... Transportation .....
--	---

JAN. - 9

5366677

1891

2074. 1898. -  
5830. P.M. 2. 5

*S* | **5 Cav.** | **U.S.C.T.**

*Fray Leggett*  
Pot, Co. *G*, 5 Reg't U. S. Col'd Cavalry.

Appears on **Co. Muster-out Roll**, dated  
*Helena, Ark. Mch. 16*, 1866.

Muster-out to date *Mch. 16*, 1866.

Last paid to *Dec. 31*, 1865.

**Clothing account:**

Last settled....., 186 ; drawn since \$..... 100

Due soldier \$..... 100; due U. S. \$ *33* <sup>*53*</sup>/<sub>100</sub>

Am't for cloth'g in kind or money adv'd \$..... 100

Due U. S. for arms, equipments, &c., \$..... 100

Bounty paid \$ *100* 100; due \$ *100* 100

Remarks: *Slave.*

Book mark: *1274 - Dis - July 8/67*

*over.*

(361)

*Triley*  
Copyist.



U. | 5 Cav. | U.S.C.T.

Troy Segriegg. \*

Pvt., Co. G., 5 Reg't U. S. Colored Cav.

Appears on Returns as follows:

Jan. 1865. Absent on detached service with Lt. Flint, guarding Cook cattle from Camp Nelson to Louisville.

Feb. 1865. Lost, Jan. 25/65, Simpsonville, Ky. Missing in action.

Mar. 1865. Gained, Mar. 2/65, Louisville, Ky. Taken up from missing in action at Simpsonville, Ky., Jan. 25/65.

Mar. to June, 1865. Absent sick in Gen. Hoop, New Albany, Ind.

July 1865. Absent sick in Hoop, Cincinnati, O.

Aug. 1865. Absent sick in Gen. Hoop, New Albany, Ind., since Jan. 25/65.

Sept. 1865. Absent sick in Regt. Hoop, Lexington, Ky., Sept. 19/65.

Dec. 1865. On duty Hdqrs. 5 U. S. C. C.  
\* Name appears also as Troy Segriegg.

Book mark :

*C* | **5 Cav.** | **U.S.C.T.**

*Frank Spring*  
-----  
*Pat.*, Co. G, 5 Reg't U. S. Col'd Cavalry.

Appears on

**Company Muster Roll**

for *Jan'y & Feb'y*, 186*6*.

Present or absent *Present*

Stoppage, \$ *100* for

Due Gov't, \$ *100* for

Valuation of horse, \$ *100*

Valuation of horse equipments, \$ *100*

Remarks: -----  
-----  
-----  
-----  
-----  
-----  
-----  
-----  
-----  
-----

Book mark: -----  
-----

*Spring*

5 Cav. U.S.C.T.

James D. Quinn  
Ser., (Co.) G, 5 Reg't U. S. Col'd Cavalry.

Appears on

**Company Muster Roll**

for Nov - Dec, 1865.

Present or absent Present

Stoppage, \$ 100 for

Due Gov't, \$ 100 for

Valuation of horse, \$ 100

Valuation of horse equipments, \$ 100

Remarks: Discharged by Regt  
Nov 1865

Book mark: \_\_\_\_\_

(358)

James D. Quinn  
Copyist.





S. | **5 Cav.** | **U.S.C.T.**

Tray D. D. D.  
Sgt., Co. G, 5 Reg't U. S. Co'd Cavalry.

Appears on

**Company Muster Roll**

for July - Aug., 1865.

Present or absent Absent

Stoppage, \$ 100 for

Due Gov't, \$ 100 for

Valuation of horse, \$ 100

Valuation of horse equipments, \$ 100

Remarks: Sick, in San  
Francisco New Albany,  
Ind. Dec 21st for  
transportation furnished  
while on furlough Dec 20

Book mark: \_\_\_\_\_

(358)

[Signature]  
Copyist.

I 15-66

Froy Isagrig  
Pvt, Co. G, 5-Reg't Coldhar

Appears on

**Hospital Muster Roll**

of Jefferson U. S. A. General Hospital,

at Jeffersonville, Ind.,

for July, Aug, 1865:

Attached to hospital:

When ....., 186 .

How employed .....

Last paid by Maj. ....

to ....., 186 .

Bounty paid \$ 100; due \$ 100

Present or absent Present

Remarks : .....

.....

.....

.....

Ward 17

.....

Book mark : .....

.....

(348) P. H. Allen Copyist.



S. | **5 Cav.** | **U.S.C.T.**

Tracy Jennings  
Sgt., Co. G, 5 Reg'd U. S. Col'd Cavalry.

Appears on

**Company Muster Roll**

for May + June, 1865.

Present or absent Absent

Stoppage, \$ 100 for

Due Gov't, \$ 100 for

Valuation of horse, \$ 100

Valuation of horse equipments, \$ 100

Remarks: Sick in camp  
Hospital New Albany,  
Ind. First Detachment  
Bounty also \$100

Book mark: \_\_\_\_\_

(358)

J. G. [Signature] Copyist.

I | 5 Cav. | U.S.C.T.

Troy J. J. J. J.  
Pvt., Co. G, 5 Reg't U. S. Col'd Cavalry.

Appears on

**Company Muster Roll**

for March & April, 1865.

Present or absent Absent.

Stoppage, \$ 100 for

Due Gov't, \$ 100 for

Valuation of horse, \$ 100

Valuation of horse equipments, \$ 100

Remarks: Seck in Gen. Hooplt.  
New Albany Ind,  
Taken up from missing  
in action Simpsonville Ky  
Jan. 25/65. March 2/65,  
1st instalment Bounty  
\$100.00 due.

Book mark: \_\_\_\_\_

(358)

*[Signature]*

Copyist.

5 | 1 5 Cav. U.S.A.

George Troy

Priv., Co. G, 5 Reg't U.S.A.

Appears on

**Hospital Muster Roll**

of Corps d'Afrique U. S. A. General Hospital,

at New Albany, Ind.,

for Mar. 4th Apr., 1865 .

**Attached to hospital :**

When \_\_\_\_\_, 186 .

How employed \_\_\_\_\_

Last paid by Maj. \_\_\_\_\_

to Never paid, 186 .

Bounty paid \$ 100 ; due \$ 100

Present or absent Present

Remarks : Paid for Jan. 4th Feb. 65  
by Maj. Phelps

Book mark: \_\_\_\_\_



1 Stacy H. C. C.  
2 1  
George, 2021  
Co. G, 5 Reg't H. C. C.

Appears on

**Hospital Muster Roll**

of Corps d'Afrique U. S. A. General Hospital,

at New Albany, Ind.,

for Sept 8 - 1867, 1867.

Attached to hospital :

When ....., 186 .

How employed .....

Last paid by Maj. ....

to ....., 186 .

Bounty paid \$ 100 ; due \$ 100

Present or absent Present

Remarks : .....

.....  
.....  
.....  
.....  
.....  
.....  
.....  
.....

Book mark : .....

.....

I | **5 Cav.** | **U.S.C.T.**

Troy Isgrigg  
Priv, Co. G, 5 Reg't U. S. Col'd Cavalry.

Appears on

**Company Muster Roll**

for Jan. & Feb, 1865.

Present or absent.....

Stoppage, \$.....100 for.....

Due Gov't, \$.....100 for.....

Valuation of horse, \$.....100

Valuation of horse equipments, \$.....100

Remarks:

Missing in action  
at Simpsonville Ky  
Jan. 25/65.

Book mark:.....

(358)

[Signature]  
Copyist.

I | 5 Cav. | U.S.C.T.

Troy Isgreek.

Priv., Co. G, 5 Reg't U. S. Col'd Cavalry.

Appears on

Company Muster Roll

for Nov. & Dec., 1864.

Present or absent present

Stoppage, \$ 100 for

Due Gov't, \$ 100 for

Valuation of horse, \$ 100

Valuation of horse equipments, \$ 100

Remarks: 1st & 2d mustered.  
Bounty due.

Book mark:

*[Signature]*



*J* | **5 Cav.** | **U.S.C.T.**

*Troy Ingrigg*  
*Pvt.*, Co. G, 5 Reg't U. S. Col'd Cavalry.

Appears on

**Company Muster Roll**

for *Enll. to Oct. 31, 1864*.

Present or absent *present*

Stoppage, \$ *100* for

Due Gov't, \$ *100* for

Valuation of horse, \$ *100*

Valuation of horse equipments, \$ *100*

Remarks:

-----  
-----  
-----  
-----  
-----  
-----

Book mark: -----

*[Signature]*

I | 5 Cav. | U.S.C.T.

Thomas Isgrigg  
Privt, Co. G, 5 Reg't U. S. Col'd Cavalry.

Appears on

Company Muster-in and Descriptive Roll  
of the organization named above. Roll dated

Camp Nelson <sup>Ky</sup>, N. Y., Oct. 23, 1864.

Where born Bourbon <sup>Ky</sup>.

Age 21 y'rs; occupation Farmer.

When enlisted Sept. 1, 1864.

Where enlisted Camp Nelson <sup>Ky</sup>.

For what period enlisted 3 years.

Eyes Black; hair Black

Complexion Black; height 5 ft. 11 in.

When mustered in Sept. 1, 1864.

Where mustered in Camp Nelson

Bounty paid \$ 100; due \$ 100

Where credited 7<sup>th</sup> Dist. <sup>Ky</sup>.

Company to which assigned

Remarks:

X Thomas Isgrigg.

X # Supposed to be name of owner.

# Added May 17. 98. H.A.J.

Book mark:

(356d)

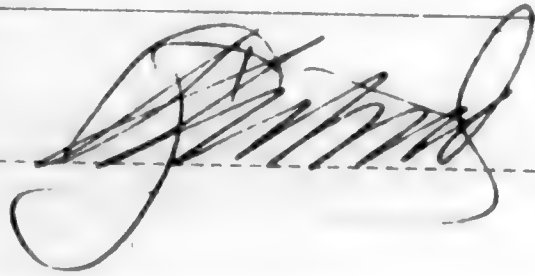

Copyist.

I | **5 Cav.** | **U.S.C.T.**

Tray Legrigg  
Co. H, 5 Reg't U. S. Col'd Cav.

Appears on

**Company Descriptive Book**  
of the organization named above.

**DESCRIPTION.**

Age 21 years; height 5 feet 7 inches.

Complexion Black

Eyes Black; hair Black

Where born Bampan Ky

Occupation Farmer

**ENLISTMENT.**

When Sept 1, 1864.

Where Camp Nelson

By whom W. Randolph, term 3 y'rs.

Remarks: Missing in  
action Sharpshooters  
Reg. Jan. 25-65.  
Taken up Mar. 2-65

J. E. Purke



S-9965-47-P.O. Rt.

N.Y. 1535692

D. 2935017 P.O. Rt.

Mounter

Exp.

*Isgrigg Roy*

*Co G*, **5** U. S. Col'd Cav.

*Private*

*Private*

CARD NUMBERS.

1	5365759	26
2	5365855	27
3	5365956	28
4	5366088	29
5	5366145	30
6	5366237	31
7	5366328	32
8	5366417	33
9	5366503	34
10	5366592	35
11	5366677	36
12	9090684	37
13	32109751	38
14	32109881	39
15	32098974	40
16	40729941	41
17		42
18		43
19		44
20		45
21		46
22		47
23		48
24		49
25		50

Book Mark: .....

See also .....

I | 5<sup>th</sup> Cav. | U.S.C.T.

Simon Ingrame  
prvt, Co. G, 5<sup>th</sup> Reg't U. S. Col'd Cavalry

Appears on Co. Muster-out Roll, dated  
Helena Ark, March 16, 1866.

Muster-out to date March 16, 1866.

Last paid to Dec 31, 1865.

Clothing account:

Last settled \_\_\_\_\_, 186 ; drawn since \$ \_\_\_\_\_ 100

Due soldier \$ \_\_\_\_\_ 100; due U. S. \$ 69 <sup>95</sup>/<sub>100</sub>

Am't for cloth'g in kind or money adv'd \$ \_\_\_\_\_ 100

Due U. S. for arms, equipments, &c., \$ \_\_\_\_\_ 100

Bounty paid \$ 100 100; due \$ 100 100

Remarks: Slave

Book mark : \_\_\_\_\_

(361)

Est. McKees  
Camp Copyist.



V. | 5 Cav. | U.S.C.T.

Simon Ingrame.

Priv., Co. G., 5 Reg't U. S. Colored Cav.

Appears on Returns as follows:

Oct. 1864 to May 1865. Absent sick  
in Gen. Hoop, at Ashland, Ky.,  
since Oct. '64.

Book mark :

(546)

J. Baker  
Copyist.

| **5 Cav.** | **U.S.C.T.**

*Simon Ingram*

*Sgt.*, Co. G, 5 Reg't U. S. Col'd Cavalry.

Appears on

**Company Muster Roll**

for *Jan'y & Feb'y*, 1866.

Present or absent *Present*

Stoppage, \$    100 for   

Due Gov't, \$    100 for   

Valuation of horse, \$    100

Valuation of horse equipments, \$    100

Remarks: *Due U.S. for Ord. 53*

Book mark:   

(358)

*Palmer*

Copyist.

2 | **5 Cav.** | **U.S.C.T.**

Simon [unclear]  
Simy, Co. G, 5 Reg't U. S. Col'd Cavalry.

Appears on

**Company Muster Roll**

for Nov 1 Dec, 1865.

Present or absent Present

Stoppage, \$ 100 for

Due Gov't, \$ 100 for

Valuation of horse, \$ 100

Valuation of horse equipments, \$ 100

Remarks: \_\_\_\_\_  
\_\_\_\_\_  
\_\_\_\_\_  
\_\_\_\_\_  
\_\_\_\_\_  
\_\_\_\_\_  
\_\_\_\_\_  
\_\_\_\_\_

Book mark: \_\_\_\_\_  
\_\_\_\_\_

(358)

[Signature]  
Copyist.



5 Cav. U.S.C.T.

*Simon J. ...*  
*...*, Co. G, 5 Reg't U. S. Col'd Cavalry.

Appears on

**Company Muster Roll**

for *Sept. 1865*, 1865.

Present or absent *Present*

Stoppage, \$ 100 for

Due Gov't, \$ 100 for

Valuation of horse, \$ 100

Valuation of horse equipments, \$ 100

Remarks:

Book mark:

(358)

*...*  
Copyist.

S. | **5 Cav.** | **U.S.C.T.**

Simon Ingram  
S., Co. G, 5 Reg't U. S. Col'd Cavalry.

Appears on

**Company Muster Roll**

for July + Aug, 1865.

Present or absent Present

Stoppage, \$ 100 for

Due Gov't, \$ 100 for

Valuation of horse, \$ 100

Valuation of horse equipments, \$ 100

Remarks: \_\_\_\_\_

Book mark: \_\_\_\_\_

(358)

Simon Ingram  
Copyist.

| **5 Cav.** | **U.S.C.T.**

Simon Dugan  
                    , Co. G, 5 Reg't U. S. Col'd Cavalry.

Appears on

**Company Muster Roll**

for May & June, 1868.

Present or absent Present

Stoppage, \$                      100 for                     

Due Gov't, \$                      100 for                     

Valuation of horse, \$                      100

Valuation of horse equipments, \$                      100

Remarks: First Installment  
 Bounty due \$100

Book mark:                     

(358)

                     Copyist.



I | 5 Cav. | U.S.C.T.

Simon Ingram  
Pvt., Co. G, 5 Reg't U. S. Col'd Cavalry.

Appears on

Company Muster Roll

for March & April, 1865.

Present or absent Absent

Stoppage, \$ 100 for

Due Gov't, \$ 100 for

Valuation of horse, \$ 100

Valuation of horse equipments, \$ 100

Remarks: Seen in Genl.  
Hospital, Ashland Ky.  
1st Instmt. Bond  
\$100<sup>00</sup> due.

Book mark: \_\_\_\_\_

(358)

[Signature]  
Copyist.

I | 5 Cav. | U.S.C.T.

*Simon Ingram*  
Pvt., Co. G, 5 Reg't U. S. Col'd Cavalry.

Appears on

**Company Muster Roll**

for *Jan. & Feb.*, 1865.

Present or absent *Absent*

Stoppage, \$ *100* for

Due Gov't, \$ *100* for

Valuation of horse, \$ *100*

Valuation of horse equipments, \$ *100*

Remarks: *Sick in Gen. Hospital, Ashland Ky.*

Book mark:

(358)

*[Signature]*

Copyist.

I. | 5 Cav. | U.S.C.T.

*Simon Ingrame.*

*Prvt.*, Co. G, 5 Reg't U. S. Col'd Cavalry.

Appears on

**Company Muster Roll**

for *Nov. & Dec.*, 1864.

Present or absent *Absent.*

Stoppage, \$ *100* for

Due Gov't, \$ *100* for

Valuation of horse, \$ *100*

Valuation of horse equipments, \$ *100*

Remarks: *Seek in Genl. Hoop's  
Ashland Ky. since Oct/64  
1<sup>st</sup> & 2<sup>d</sup> int. Bounty due.*

Book mark: \_\_\_\_\_

(358)

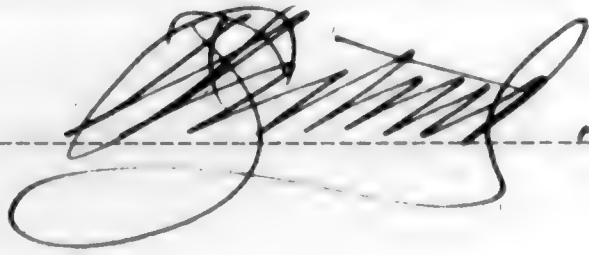

Copyist.



I | 5 Cav. | U.S.C.T.

*Semin Ingram,*  
*Pvt.,* Co. G, 5 Reg't U. S. Col'd Cavalry.

Appears on

**Company Muster Roll**

for *Enll. to Oct. 31,* 1864.

Present or absent *Absent,*

Stoppage, \$ *100* for

Due Gov't, \$ *100* for

Valuation of horse, \$ *100*

Valuation of horse equipments, \$ *100*

Remarks: *In Genl Hospital,*  
*Ashland Ky.*

Book mark: \_\_\_\_\_

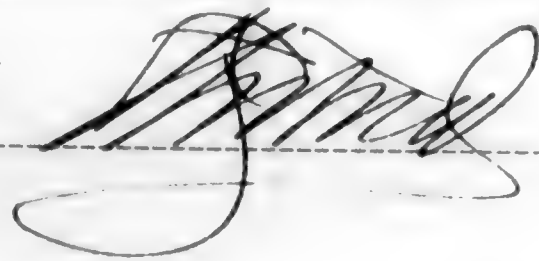

**5 Cav. U.S.C.T.**

*Simon Ingram.*

*Pvt., Co. G, 5 Reg't U. S. Col'd Cavalry.*

Appears on

**Company Muster-in and Descriptive Roll**

of the organization named above. Roll dated

*Camp Nelson, Ky., Oct. 29, 1864.*

Where born *Virginia*

Age *25* y'rs; occupation *Farmer.*

When enlisted *Sept. 8*, 1864.

Where enlisted *Camp Nelson Ky.*

For what period enlisted *3* years.

Eyes *Black*; hair *Black*

Complexion *Black*; height *5 ft. 6 in.*

When mustered in *Sept. 9*, 1864.

Where mustered in *Camp Nelson.*

Bounty paid \$ *100*; due \$ *100*

Where credited *8<sup>th</sup> Dist. Ky.*

Company to which assigned

Remarks:

\* *Samuel Ingram*

\* *Supposed to be name of owner.*

\* *Added May 17. 98. H. J.*

Book mark:

*[Signature]*

2 | **5 Cav.** | **U.S.C.T.**

Lincoln Ingram  
....., Co. G, 5 Reg't U. S. Col'd Cav.

Appears on

**Company Descriptive Book**  
of the organization named above.

**DESCRIPTION.**

Age 25 years; height 5 feet 6 inches.

Complexion Black

Eyes Black; hair Black

Where born Virginia

Occupation Farmer

**ENLISTMENT.**

When Sep 8, 186 4.

Where Camp Nelson

By whom Chas Randolph; term 3 y'rs.

Remarks: .....

.....

.....

.....

.....

.....

.....

.....

.....

.....

.....

.....

.....

.....

.....

J. E. Purke



S. 692316 P.O. '90  
S-959685 2 and

2-19-59 206 P.O. 214100

Imbarten  
Eph,

11/11

*Donarum*  
Co *G*, 5 U. S. Col'd Cav.

*Private*

*Private*

CARD NUMBERS.

1	5365758	26
2	5365854	27
3	5365955	28
4	5366048	29
5	5366144	30
6	5366236	31
7	5366327	32
8	5366416	33
9	5366502	34
10	5366591	35
11	5366676	36
12	9090683	37
13	40729940	38
14		39
15		40
16		41
17		42
18		43
19		44
20		45
21		46
22		47
23		48
24		49
25		50

Book Mark:

See also

*A* | **5 Cav.** | **U.S.C.T.**

*Leroy Hyatt*  
.....  
*Pvt.*, Co. *A*, 5 Reg't U. S. Col'd Cavalry.

Appears on **Co. Muster-out Roll**, dated  
*Helena, Ark* *Mar. 16*, 186*6*.  
Muster-out to date *Mar. 16*, 186*6*.  
Last paid to *Dec. 31*, 186*5*.

**Clothing account:**

Last settled....., 186 ; drawn since \$..... 100

Due soldier \$..... 100; due U. S. \$ *31* <sup>*55*</sup>/<sub>100</sub>

Am't for cloth'g in kind or money adv'd \$..... 100

Due U. S. for arms, equipments, &c., \$..... 100

Bounty paid \$ *100* 100; due \$ *100* 100

Remarks:.....

Book mark:.....

(261)

*J. C. Stewart*  
.....  
Copyist.



|        5 Cav. |        U.S.C.T.

*Leroy Hyette*

*Oct.*, Co. *H.*, 5 Reg't U. S. Colored Cav.

Appears on **Returns** as follows:

*Oct. to Dec 1864. Absent on detached  
service, Point Burnside since  
Oct. 3/64.*

Book mark : .....

(546)

*J. G. Ballou*

Copyist.

*A* | **5 Cav.** | **U.S.C.T.**

*Leroy Hyatt*

*Plt*, Co. H, 5 Reg't U. S. Col'd Cavalry.

Appears on

**Company Muster Roll**

for *Jan'y. 1<sup>st</sup> 1866*, 1866.

Present or absent *Present*

Stoppage, \$ *100* for

Due Gov't, \$ *100* for

Valuation of horse, \$ *100*

Valuation of horse equipments, \$ *100*

Remarks: *Sick in Reg't.  
Hospital.*

Book mark: \_\_\_\_\_

(358)

*J. Stewart*  
Copyist.

*L* | **5 Cav. | U.S.C.T.**

*Leroy Hyatt*  
*Rt*, Co. H, 5 Reg't U. S. Col'd Cavalry.

Appears on

**Company Muster Roll**

for *Nov. 4<sup>th</sup>*, 1865.

Present or absent *Present.*

Stoppage, \$ *100* for

Due Gov't, \$ *100* for

Valuation of horse, \$ *100*

Valuation of horse equipments, \$ *100*

Remarks:

Book mark:

*B. J. Cooke*



*76* | **5 Cav. | U.S.C.T.**

*Leroy Hyatt*  
*Cvt.*, Co. H, 5 Reg't U. S. Col'd Cavalry.

Appears on

**Company Muster Roll**

for *Sept. & Oct.*, 1865.

Present or absent *Present*

Stoppage, \$ *100* for

Due Gov't, \$ *100* for

Valuation of horse, \$ *100*

Valuation of horse equipments, \$ *100*

Remarks:

-----  
-----  
-----  
-----  
-----

Book mark:

*B. J. Cook*  
Copyist.

76 5 Cav. U.S.C.T.

Leroy H. Gatt

Priv., Co. H, 5 Reg't U. S. Col'd Cavalry.

Appears on

Company Muster Roll

for July & Aug., 1865.

Present or absent Present.

Stoppage, \$ 100 for

Due Gov't, \$ 100 for

Valuation of horse, \$ 100

Valuation of horse equipments, \$ 100

Remarks:

Book mark:

B. J. Crook

*76* | **5 Cav. U.S.C.T.**  
*Deroy Lyatt*  
*Priv*, Co. H, 5 Reg't U. S. Col'd Cavalry.

Appears on

**Company Muster Roll**  
for *May & June*, 1865.  
Present or absent *Present.*

Stoppage, \$ *100* for

Due Gov't, \$ *100* for

Valuation of horse, \$ *100*

Valuation of horse equipments, \$ *100*

Remarks: *1<sup>st</sup> Installment Bounty due \$100.*

Book mark: \_\_\_\_\_

(358)

*B. J. Cooke*  
Copyist.



H | **5 Cav.** | **U.S.C.T.**

Leroy Hyatt  
Priv, Co. H, 5 Reg't U. S. Col'd Cavalry.

Appears on

**Company Muster Roll**

for Mar & Apr, 1865.

Present or absent present

Stoppage, \$ 100 for

Due Gov't, \$ 100 for

Valuation of horse, \$ 100

Valuation of horse equipments, \$ 100

Remarks: 1st installment of  
Bounty Due \$100

Book mark: \_\_\_\_\_

(358)

Reynolds

Copyist.

H | **5 Cav.** | **U.S.C.T.**

Leroy Hyatt  
Put, Co. H, 5 Reg't U. S. Col'd Cavalry.

Appears on

**Company Muster Roll**

for Jan & Feb, 1865.

Present or absent present

Stoppage, \$ 100 for

Due Gov't, \$ 100 for

Valuation of horse, \$ 100

Valuation of horse equipments, \$ 100

Remarks: 1<sup>st</sup> Installment of  
Bounty Due \$100.00

Book mark: \_\_\_\_\_

Reynolds

(358)

Copyist.

H | **5 Cav.** | **U.S.C.T.**

Leroy Hyatt

Pat, Co. H, 5 Reg't U. S. Col'd Cavalry.

Appears on

**Company Muster Roll**

for Nov & Dec, 1864.

Present or absent Absent

Stoppage, \$ 100 for

Due Gov't, \$ 100 for

Valuation of horse, \$ 100

Valuation of horse equipments, \$ 100

Remarks: 1<sup>st</sup> and 2<sup>d</sup> Installments  
Bounty due. On  
detached service  
Point Burnside  
since Oct 3<sup>rd</sup>

Book mark: \_\_\_\_\_

Reynolds



H | **5 Cav.** | **U.S.C.T.**

Leroy Hyatt  
Pvt., Co. H, 5 Reg't U. S. Col'd Cavalry.

Appears on

**Company Muster Roll**

for from enlistment to Oct 31, 1864, 1864.

Present or absent Absent

Stoppage, \$ 100 for

Due Gov't, \$ 100 for

Valuation of horse, \$ 100

Valuation of horse equipments, \$ 100

Remarks: Delight service  
Burnside Point Oct  
3 1864

Book mark: \_\_\_\_\_

Reynolds

H | **5 Cav.** | **U.S.C.T.**

Leroy Hyatt

Pat, Co. H, 5 Reg't U. S. Col'd Cavalry.

Appears on

**Company Muster-in and Descriptive Roll**

of the organization named above. Roll dated

Camp Nelson, Ky, Oct 29, 1864.

Where born Missouri

Age 18 y'rs; occupation Farmer

When enlisted Sept 14, 1864.

Where enlisted Camp Nelson Ky

For what period enlisted 3 years.

Eyes Black; hair Black

Complexion Black; height 5 ft. 3 in.

When mustered in Sept 15, 1864.

Where mustered in Camp Nelson Ky

Bounty paid \$ 100; due \$ 100

Where credited

Company to which assigned

Remarks: 8th Dist Ky

\* General Hyatt

\* Supposed to be name of owner

Added May 17/98. H. W. J.

Book mark:

Reynolds

*H 5 Cav* | **U.S.C.T.**

*Henry Lyatt*  
....., Co. *H 5* Reg't U. S. Col'd *Cav*

Appears on

**Company Descriptive Book**

of the organization named above.

**DESCRIPTION.**

Age *18* years; height *5* feet *3* inches.

Complexion *Blk*

Eyes *Blk*; hair *Blk*

Where born *Missouri*

Occupation *farmer*

**ENLISTMENT.**

When *Sep 14*, 186*4*.

Where *Camp Nelson Ky*

By whom *H. Randolph* term *3* y'rs.

Remarks:

.....  
.....  
.....  
.....  
.....  
.....  
.....  
.....  
.....  
.....

*J. E. Purps*



16 | **5 Cav.** | **U.S.C.T.**

Lewis Heyatt  
....., Co. H, 5 Reg't U. S. Col'd Cav.

Appears on

**Company Descriptive Book**  
of the organization named above.

**DESCRIPTION.**

Age 18 years; height 5 feet 3 inches.

Complexion Blk

Eyes Blk; hair Blk

Where born Missouri

Occupation Farmer

**ENLISTMENT.**

When Sept 14, 1864.

Where Lewis & Clark

By whom W. Randolph; term 3 y'rs.

Remarks:  
.....  
.....  
.....  
.....  
.....  
.....  
.....  
.....  
.....

W. Randolph

Hyatt Leroy  
Co No. , 5 U. S. Col'd Cav.

Private | Private

CARD NUMBERS.

1	5366806	26
2	5366898	27
3	5366998	28
4	5367089	29
5	5367180	30
6	5367275	31
7	5367366	32
8	5367455	33
9	5367543	34
10	5367635	35
11	5367719	36
12	9090796	37
12	9090890	38
14	40729929	39
15		40
16		41
17		42
18		43
19		44
20		45
21		46
22		47
23		48
24		49
25		50

Book Mark:

See also







Wm. H. Smith,  
Co. C.

---

Charge and Specification preferred against Private  
George Hiatt Company "E" 5<sup>th</sup> Regiment U. S.  
Colored Cavalry

Charge

Conduct prejudicial to good order and military discipline

Specification

That Private George Hiatt Company "E" 5<sup>th</sup> Regiment  
U. S. Colored Cavalry did interfere with Sergeant Robert  
Creevy Company "E" 5<sup>th</sup> Regiment U. S. Colored Cavalry of the  
said Regt Creevy being in the discharge of his duty, and  
did threaten to strike him with a club and did make use  
of the following words to wit:

"You are a God damn son of a bitch, let him come!"

This at Camp 5<sup>th</sup> Regiment U. S. Colored Cavalry near  
Helena Arkansas on or about the 13<sup>th</sup> day of December 1865

J. W. Freery  
Sgt 1-54<sup>th</sup> U. S. Col  
Comdg Company

Witness

Abner Craig 1<sup>st</sup> Lieutenant Company "E" 5<sup>th</sup> Regiment  
U. S. Colored Cavalry

Charge and Specification  
prepared against  
Private George Hiatt  
Company C. 5<sup>th</sup> Regiment  
1<sup>st</sup> Colonel Cavalry



of 6th Cavalry near Helena Ark  
on or about the 13<sup>th</sup> day of December 1863.

Signed Otto Frey  
(H. S. Frey, Jr.,  
Counsel for the  
Government)

To which Charges and Specifications  
the accused pleaded as follows,

In the Specification <sup>alleged</sup> to be true,  
namely a "Bad Law" <sup>is</sup> "Guilty",  
to the Charge "Guilty".

And the Court having investigated the  
Case and maturely considered the  
evidence adduced, finds the accused  
as follows

Of the Specification "Guilty"

Of the Charge - Guilty,

And the Court does therefore sentence  
him to fifteen days hard labor <sup>in confinement of</sup> and to  
forfeit the dollars pay proper to the  
Government.

Henry M. Hodges,  
Major, Regt. Co. Cav.,  
1st Field Court.

Present

Majr Henry W. Madden, Staff of Col.

Sergeant George Neale Co. Company 1st  
Regiment U.S. Colored Cavalry was then  
called into Court and having heard the  
order appointing the Court read, was  
asked if he had any objection to the  
officer detailed to which he replied  
in the negative.

The accused was then arraigned on the  
following charges and Specification  
to-wit:

Charge:

Conduct prejudicial to good order  
and Military discipline

Specification

That private George Neale Company,  
Co. 1st U.S. Colored Cavalry did interfere  
with Sergeant Robert Curry Company,  
Co. 1st U.S. Colored Cavalry, the  
said Sergeant Curry being in the discharge  
of his duty, and did threaten to strike  
him with a club and did make use  
of the following words to-wit:

You are a God damn son of a bitch hit  
him once

Richard Lamb of 1st Regiment



Case No 2-

Proceedings of a Regimental Court Martial  
Consisting of Major Henry McAdams  
5th U.S. Cav. detailed for that purpose  
in pursuance of section seven Chapter  
201 of Act of July 17th 1862. in virtue  
of the following orders to wit

Head Quarters 3rd U.S. Cav. Co.  
Albany. N.Y. Dec. 7th 1863

Order No 196.

A field court martial is hereby  
ordered to convene at Camp of the 5th U.S. Cav.  
Monday Dec 14th 1863. or as soon thereafter  
as practicable for the trial of such cases as  
may be brought before it.

The following is the detail for the  
Court

Major Henry McAdams 5th U.S. Cav.

By Command of  
Colonel J. H. Carpenter,  
Chief of Regt.

Signed H. Jackson.

H. Adjutant

Albany, N.Y. Dec. 14th 1863  
Camp 5th U.S. Cav.

The Court met pursuant to the above order.



Proceedings of a  
Regt Court Martial  
in the case of private  
George Hyatt - C. C.  
No. 1 of C. C. -

Charge

Conduct indisciplined  
toward order and  
militar discipline

Sentence

Fifteen days hard  
labor in confinement  
& to forfeit ten dollars  
pay proper to the Govern-  
ment.

7-12-63

Respectfully returned  
to the Provost Marshal  
at Fort Mifflin

Respectfully returned  
to the Provost Marshal  
at Fort Mifflin

Respectfully returned  
to the Provost Marshal  
at Fort Mifflin

Hiatt, George

P, Co. E, 5 Reg U.S.C. Cav

3 Enclosures.

Bed Cards

Burial Records

Certs. of Dis. for Discharge

C. M. Charges

Med. Certificates

Descriptive Lists

Final Statements

Furloughs

Med. Des. Lists

Orders

Other papers relating to—

Admission to Hosp'l

Casualty Sheet (Officer's)

Confinement

Contracts

Death or Effects

Desertions

Discharge from Hosp'l

Discharge from Service

Duty

Furlough

Med. Examination

Misc. Information /

Pay or Clothing

Personal Reports

Rank

Transfer to Hosp'l

Transfer to V. R. C.

Transportation

26 | 5 Cav. | U.S.C.T.

George Buatt  
Bvt, Co. E, 5 Reg't U. S. Col'd Cavalry.

Appears on Co. Muster-out Roll, dated  
Helena, Ark, Mar 16, 1866.

Muster-out to date \* Mar 3, 1866.

Last paid to Dec 31, 1865.

Clothing account:

Last settled....., 186 ; drawn since \$..... 100

Due soldier \$ 9 <sup>01</sup>/<sub>100</sub>; due U. S. \$..... 100

Am't for cloth'g in kind or money adv'd \$..... 100

Due U. S. for arms, equipments, &c., \$ <sup>55</sup>/<sub>100</sub>

Bounty paid \$ 100 <sup>XX</sup>/<sub>100</sub>; due \$ 100 <sup>XX</sup>/<sub>100</sub>

Remarks: Due U.S. pay  
Ordman on 15th.

\* Records on file in 2nd. Auditor's  
Office show this Co. Mustered Out  
to take effect Mch, 16th. 1866. and  
paid to include Mch, 15th. 1866.

Book mark : .....

(861)

G. W. Leonard

Copyist.



26 | **5 Cav. | U.S.C.T.**

George Hiatt  
Priv., Co. E, 5 Reg't U. S. Col'd Cavalry.

Appears on

**Company Muster Roll**

for Jan. + Feb., 186 G.

Present or absent Present

Stoppage, \$ 100 for

Due Gov't, \$ 100 for

Valuation of horse, \$ 100

Valuation of horse equipments, \$ 100

Remarks:

Book mark:

(358)

W. J. [Signature]

Copyist.

*H* | **5 Cav.** | **U.S.C.T.**

*George Hiatt*

*Put*, Co. E, 5 Reg't U. S. Col'd Cavalry.

Appears on

**Company Muster Roll**

for *Nov & Dec.*, 1865.

Present or absent *present*

Stoppage, \$ *100* for

Due Gov't, \$ *100* for

Valuation of horse, \$ *100*

Valuation of horse equipments, \$ *100*

Remarks: *Ten dollars pay stopped by sentence of F. O. Court Martial Orders No. 2 dated Dec. 17/65.*

Book mark:

(358)

*Long*

Copyist.

*H* | **5 Cav.** | **U.S.C.T.**

*George Hiatt*  
*Priv.*, Co. E, 5 Reg't U. S. Col'd Cavalry.

Appears on

**Company Muster Roll**

for *Sept + Oct.*, 1865.

Present or absent *present*

Stoppage, \$ *100* for

Due Gov't, \$ *100* for

Valuation of horse, \$ *100*

Valuation of horse equipments, \$ *100*

Remarks: *Reduced from Corp'l.  
to Private per R. O. No.  
147 dated Sept. 5/65.*

Book mark:

(358)

*Long*  
Copyist.



*H* | **5 Cav.** | **U.S.C.T.**

*George Hiatt*  
*Capt*, Co. E, 5 Reg't U. S. Col'd Cavalry.

Appears on

**Company Muster Roll**

for *July & Aug.*, 186 *5*

Present or absent *present*

Stoppage, \$ *100* for

Due Gov't, \$ *100* for

Valuation of horse, \$ *100*

Valuation of horse equipments, \$ *100*

Remarks:

Book mark:

(358)

*Long*

Copyist.

*H* | **5 Cav. | U.S.C.T.**

*George Hiatt*  
Corpl., Co. E, 5 Reg't U. S. Col'd Cavalry.

Appears on

**Company Muster Roll**

for *May - June*, 1865.

Present or absent *Present*

Stoppage, \$ *100* for

Due Gov't, \$ *100* for

Valuation of horse, \$ *100*

Valuation of horse equipments, \$ *100*

Remarks: *1<sup>st</sup> Instalment of  
Bounty due \$100.*

Book mark:

(358)

*Long*  
Copyist.

H | **5 Cav.** | **U.S.C.T.**

George Hunt  
Capt., Co. E, 5 Reg't U. S. Col'd Cavalry.

Appears on

**Company Muster Roll**

for March & Apr, 1865.

Present or absent Present

Stoppage, \$ 100 for

Due Gov't, \$ 100 for

Valuation of horse, \$ 100

Valuation of horse equipments, \$ 100

Remarks: 1<sup>st</sup> instalment  
of Bounty due

Book mark:

(358)

M. Rowland  
Copyist.



H | **5 Cav.** | **U.S.C.T.**

George Hiatt  
Corpl., Co. E, 5 Reg't U. S. Col'd Cavalry.

Appears on

**Company Muster Roll**

for Jan. & Feb., 1865.

Present or absent Present

Stoppage, \$ 100 for

Due Gov't, \$ 100 for

Valuation of horse, \$ 100

Valuation of horse equipments, \$ 100

Remarks: With instrument  
of bounty due \$ 100  
Due H. S. for insurance  
\$ 8.27.

Book mark:

(358)

W. R. Rowland

Copyist.

H | **5 Cav.** | **U.S.C.T.**

*George H. East*  
-----  
*Capt.*, Co. E, 5 Reg't U. S. Col'd Cavalry.

Appears on

**Company Muster Roll**

for *Nov 7 Dec*, 186*1*.

Present or absent *Present*

Stoppage, \$ *100* for

Due Gov't, \$ *100* for

Valuation of horse, \$ *100*

Valuation of horse equipments, \$ *100*

Remarks: *1" & 2" Distain*  
*accidents of 12 months ago*

Book mark: \_\_\_\_\_

(358)

*W. H. Rowland*

Copyist.

*H* | **5 Cav. | U.S.C.T.**

*George Heath*  
.....  
*Capt.*, Co. E, 5 Reg't U. S. Col'd Cavalry.

Appears on

**Company Muster Roll**

for *Enlistment* to *Oct 31*, 1864.

Present or absent *Present*

Stoppage, \$.....100 for .....

Due Gov't, \$.....100 for .....

Valuation of horse, \$.....100

Valuation of horse equipments, \$.....100

Remarks: *Appointed per Regt. Order No. 12, Oct 26-64*

.....  
.....  
.....  
.....  
.....  
.....

Book mark: .....

.....  
.....  
*M. Rowland*  
.....  
**(358)** *Copyist.*



H | 5 Cav. | U.S.C.T.

George Hyatt

Corpl., Co. E, 5 Reg't U. S. Col'd Cavalry.

Appears on

**Company Muster-in and Descriptive Roll**

of the organization named above. Roll dated

Camp Nelson, <sup>Hy</sup> N. Y., Oct. 20, 1864.

Where born Shelly Hy

Age 35 y'rs; occupation Farmer

When enlisted Sept. 7, 1864.

Where enlisted Camp Nelson Hy

For what period enlisted 3 years.

Eyes Black; hair Black

Complexion Black; height 5 ft. 8 in.

When mustered in Sept. 9, 1864.

Where mustered in Camp Nelson Hy.

Bounty paid \$ 100; due \$ 100

Where credited

Company to which assigned

Remarks: 4<sup>th</sup> District Kentucky

\* Meredith Hyatt

\* Supposed to be name of owner

Added May 16, 95. H. A. J.

Book mark:

General Notation N. & P. 407375,

W. R. Coulson

(356d)

Copyist.

*H* | **5 Cav.** | **U.S.C.T.**

*George Hiatt*  
....., Co. *E*, 5 Reg't U. S. Col'd Cav.

Appears on

**Company Descriptive Book**  
of the organization named above.

**DESCRIPTION.**

Age *35* years; height *5* feet *8* inches.

Complexion *Black*

Eyes *BLK*; hair *BLK*

Where born *Shelby Ky*

Occupation *farmer*

**ENLISTMENT.**

When *Sep 9*, 186 *4*

Where *Camp Nelson*

By whom *J. Randolph*, term *3* y'rs.

Remarks:

.....  
.....  
.....  
.....

*J E Parks*

51218943 P.O. M.M.

J. McFall



*Knyatt George*

Co E, 5 U.S. Col'd Cav.

*Corporal* | *Private*

CARD NUMBERS.

1	5363672	26
2	5363773	27
3	5363875	28
4	5363960	29
5	5364051	30
6	5364139	31
7	5364224	32
8	5364350	33
9	5364436	34
10	5364519	35
11	5364596	36
12	9090413	37
13		38
14		39
15		40
16		41
17		42
18		43
19		44
20		45
21		46
22		47
23		48
24		49
25		50

Book Mark:

General Notation R. & P. 407375,

See also

MEMORANDUM FROM PRISONER OF WAR RECORDS.

No. \_\_\_\_\_

(This blank to be used only in the arrangement of said records.)

NAME.	RANK.	ORGANIZATION.				INFORMATION OBTAINED FROM—			
		No. of Reg't.	State.	Arm of Service.	Co.	Records of—	Vol.	Page.	Vol.
<i>Mitchinson Joseph</i>	<i>P</i>	<i>5</i>	<i>U. S. Colored Cav.</i>	<i>"H"</i>					

Captured at \_\_\_\_\_, 186\_\_\_\_, confined at Richmond, Va., \_\_\_\_\_, 186\_\_\_\_.

Admitted to Hospital at \_\_\_\_\_

where he died \_\_\_\_\_, 186\_\_\_\_, of \_\_\_\_\_

Paroled at \_\_\_\_\_, 186\_\_\_\_; reported at Camp Parole, Md., \_\_\_\_\_, 186\_\_\_\_.

*No Record subsequent to Oct 1/64*

*Pens Base Woodward Octo" 29. 83.*

Copied by *CA* *12/17/83*

(Record continued.)

Furloughed \_\_\_\_\_, 186 , for \_\_\_\_\_ days; returned \_\_\_\_\_, 186 ;  
deserted \_\_\_\_\_, 186 ; \_\_\_\_\_

*2 and one to USCT Branch Dec 17 86*

Copied by \_\_\_\_\_

*Adjutant General's Office.*

\_\_\_\_\_, 18

This is accepted as referring to \_\_\_\_\_

Co. \_\_\_\_\_, Reg't \_\_\_\_\_

and records will be corrected accordingly.

*Assistant Adjutant Gen'l.*



**CERTIFICATE OF AWARD OF THE BOARD OF CLAIMS.**

OFFICE OF THE BOARD OF CLAIMS  
FOR SLAVES ENLISTED OR DRAFTED IN THE SERVICE OF THE U. S.

Frankfort Ky  
March 6<sup>th</sup>, 1867

We hereby certify, that *David L. Coleman* of *Dayette* county, State of Kentucky, having proved, under oath, his loyalty to the Constitution and Government of the United States, and established his title as to the ownership of *Joseph Hutchinson*, a slave, enlisted and mustered at *Camp Nelson, Ky* on the *15* day of *Sept*, 1864, by *Capt A. C. Kenney* *3<sup>d</sup>* Regiment of Colored Troops, Co. *A*, the sum of *Three Hundred* dollars has been awarded to \_\_\_\_\_ by this Board, subject to the approval of the Secretary of War, as a compensation for the said slave, under the provisions of section 24, Act approved February 24, 1864, and section 2, Act approved July 28, 1866.

*H. M. Moore* . President of the Board.  
*Geo. W. Blakely* . Member of the Board.  
\_\_\_\_\_ . Member of the Board.

To \_\_\_\_\_  
Chief of the Bureau for the Organization of Colored Troops, Washington, D. C.

**PROOF OF OWNERSHIP.**

STATE OF KENTUCKY,

COUNTY OF *Dayette* } SS.

We *Geo W Sutton* and *H M Moore* each of lawful age, and resident citizens of the State and County aforesaid, do certify that *David L Coleman* a resident of the State and County aforesaid, was on the *15<sup>th</sup>* day of *September* 1864, the lawful owner of the slave named *Joseph Hutchinson* referred to and described in the foregoing claim for compensation.

*Geo W Sutton*  
*H M Moore*

Sworn to and subscribed before me a *Notary Public* for the County of *Dayette* State of Kentucky, this the *15* day of *Dec* 1866.

5 CENT  
STAMP

**PROOF OF LOYALTY.**

STATE OF KENTUCKY,

COUNTY OF *Dayette* } SS.

We *Geo W Sutton* and *H R Houghton* loyal men and each of lawful age, and resident citizens of the County of *Dayette* in the State and County aforesaid, upon our oaths declare that we have known *David L Coleman* a resident of the State and County aforesaid, since the 4th day of March, 1861, and know that he has firmly and faithfully maintained his adherence and allegiance to the Government of the United States, by defending its cause against the Government and forces of the so-called Confederate States of America, in all suitable and practicable ways, and according to his ability and opportunity.

*Geo W Sutton*  
*H R Houghton*

Sworn to and subscribed before me a *Notary Public* for the county of *Dayette* State of Kentucky, this the *15* day of *Dec* 1866.

5 CENT  
STAMP

**POWER OF ATTORNEY.**

My Post-Office address is \_\_\_\_\_ County of \_\_\_\_\_ State of Kentucky, and I hereby direct that all communications to me, touching this claim, be sent under cover to \_\_\_\_\_, who is hereby appointed and constituted my true and lawful attorney, to prosecute this claim for me, and who is hereby authorized and empowered to receive and receipt for any award, order, draft, certificate, voucher, warrant, papers or money that may be issued in the adjustment of this claim, or the payment thereof, the same as I might or could do in person were I present and acting for myself, and to file any additional evidence or papers that may be required in the prosecution of this claim.

[WITNESS.]

The owner  
signs here.

Two witnesses to  
owner's signature  
sign here.

50 CENT  
STAMP



No.

CLAIM OF

David S Coleman

FOR THE COMPENSATION OF SLAVE NAMED

I, *David S Coleman* a loyal citizen, and a resident of ~~Scottsboro~~ *Other*,  
 County of *Myrtle*, State of Kentucky, hereby claim compensation, under  
 the provisions of Section 24, act approved February 24, 1864, and section 2, act approved July, 28,  
 1866, for my slave *Joseph Hutcherson*, enlisted *September 15<sup>th</sup>*  
 1864, at *Camp Nelson*, by *Capt. A. C. Kinney*  
 in the *5<sup>th</sup>* regiment U. S. Colored Troops, Co. *H*; certificate of  
 which enlistment, and a descriptive list, as required, accompany this application. That I did not ac-  
 quire said slave subsequent to said enlistment, but had a valid title to him at the date of said enlist-  
 ment, and previous thereto; I having acquired my title to him and my ownership over him as fol-  
 lows, to-wit: *the said slave Joseph Hutcherson being*  
*born in my possession and continued so*  
*until he enlisted*

In proof of my loyalty to the Constitution and Government of the United States, I present the ac-  
 companying oath, which I have taken, signed and acknowledged; to be filed with this application, in  
 accordance with requirement of General Orders, No. 329, 1863. War Department, Adjutant General's  
 Office.

*15<sup>th</sup> day of Dec* . 186*6*.

*David S Coleman*

I, *David S Coleman* OATH OF ALLEGIANCE.

, the owner and Claimant, do solemnly swear that  
 the foregoing claim is a just and true claim due to me as master and owner of the said slave, and that  
 the facts alleged in said claim in respect to the ~~draft~~ enlistment (as the case may be) of said slave  
 into the Military service of the United States are true. And I do further swear that I have never  
 joined, or been concerned in, any insurrection or rebellion; that I have never borne arms against the  
 United States; that I have never given any aid, countenance, counsel or encouragement to any person  
 or persons engaged, or whom I had reason to believe were about to engage, in insurrection, rebellion  
 or armed hostility against the United States; that I have neither sought, nor accepted, nor attempted  
 to exercise the functions of any office, civil or military, nor to perform any service whatever, under  
 any authority or pretended authority in hostility to the United States; that I have not yielded a vol-  
 untary support to any insurrection, rebellion or pretended government, authority, power or constitution  
 within the United States hostile thereto. And I do further swear that, to the best of my knowledge  
 and ability, I have supported and defended, and will continue to support and defend, the United  
 States against all enemies, foreign and domestic; and that I have supported, defended and obeyed, and  
 will continue to support, defend and obey, the Constitution and laws of the United States; that I will  
 bear true faith and allegiance to the same; and that I take this oath freely, without any mental reserva-  
 tion or purpose of evasion: So help me God.

*David S Coleman*

Sworn to and subscribed before me, at *Lexington*,  
 this *15* day of *Dec*, 186*6*.

*B. J. Davis*  
 Notary Public



No. *942*

APPLICATION OF

*David J. Coleman*

OF

*Fayette County Ky*

FOR COMPENSATION FOR SLAVE,

Named *Joseph Hutchinson*

Enlisted *Sept 15*, 1864,

In Com. *A*, *5<sup>th</sup>* Regiment,

U. S. COLORED TROOPS.

Received *Jan 16<sup>th</sup>*, 1867.

Compensation Awarded

*March 6<sup>th</sup>*, 1867.

*Three Hundred Dollars.*

*N. Moore*

President of Board of Claims.

Claimant's Attorney,

Claimant's Post-office Address,

*Lexington*

*Ky*

FRANKFORT COMMONWEALTH PRINT.



Headquarters Kentucky Volunteers,

Adjutant-General's Office,

Frankfort, Dec<sup>r</sup> 12<sup>th</sup>, 1866.

I hereby certify, that it appears from the U. S. Muster-in  
Rolls on file in this Office, that Jos Hutchinerson  
was enrolled on the 14<sup>th</sup> day of Sept<sup>r</sup>, 1864, at  
Camp Nelson Ky, by J C Randolph,  
and mustered into the U. S. service on the 15<sup>th</sup> day of Sep<sup>t</sup>,  
1864, at Camp Nelson Ky, by Cap<sup>t</sup> N C Kinney,  
to serve three years. Said Jos Hutchinerson  
is described as follows: Age, 24 years; eyes, black; hair, black;  
complexion, black; height, 5 feet 10 inches. It further  
appears from said Rolls, that Joseph Hutchinerson owed service  
to David Coleman, was credited to Fayette  
County, Ky., and was assigned to Co. 'H', 5<sup>th</sup> Regiment  
U. S. C. Cav.

In Testimony Whereof, I have hereunto set my  
hand, and affixed my Official Seal, this  
12<sup>th</sup> day of Dec<sup>r</sup>, 1866.

D. Lindsay  
Adjutant General of Kentucky.

B. 577, R. 316



War Department,

ADJUTANT GENERAL'S OFFICE,

Washington, *Feb'y 5* 1867.

*Respectfully returned to the Commission for the State of Kentucky with the information that Joseph Hutchison was enlisted at Camp Nelson, Ky. Sept. 14<sup>th</sup> 1864 and was mustered in as priv. in Co "H" 5<sup>th</sup> U.S. Cav. Sept. 15<sup>th</sup> 1864.*

*6982.16*

*A. B. V.*

*A. B. V.*

Asst. Adj't General.



Credited to Kayette co. 7. D. 54

# UNITED STATES COLORED TROOPS ENLISTMENT.

STATE OF

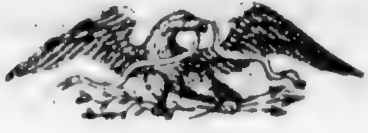

TOWN OF

*Kentucky*

*County of Kayette*

I, *Joseph Hutchison* born in *Kayette co*  
in the State of *Kentucky* aged *Twenty four* years  
and by occupation a *Farmer* Do HEREBY ACKNOWLEDGE TO  
have volunteered *fourteenth* day of *Sept.* 1864

to serve as a **Soldier** in the **Army of the United States of America**, for the  
period of **THREE YEARS**, unless sooner discharged by proper authority: Do  
also agree to accept such bounty, pay, rations, and clothing, as are, or may be,  
established by law for the U. S. colored troops.

And I, *Joseph Hutchison*  
do solemnly swear that I will bear true faith and allegiance to the **United States  
of America**, and that I will serve them honestly and faithfully against all their  
enemies or opposers whomsoever; and that I will observe and obey the orders  
of the President of the United States, and the orders of the officers appointed  
over me, according to the Rules and Articles of War.

Sworn and subscribed to, *Joseph Hutchison*  
this *14* day of *Sept 1864* *Joseph Hutchison*  
Before *Mc Randolph* *Mark*

I CERTIFY, ON HONOR, That I have carefully examined the above named Volunteer agree-  
ably to the General Regulations of the Army, and that, in my opinion, he is free from all bodily  
defects and mental infirmity, which would in any way disqualify him from performing the  
duties of a soldier.

EXAMINING SURGEON.

I CERTIFY, ON HONOR, That I have minutely inspected the Volunteer *Joseph Hutchison*  
previously to his enlistment, and that he was entirely sober when enlisted; and in  
my judgment and belief, he is of lawful age, and that, in accepting him, as duly qualified to per-  
form the duties of an able-bodied soldier, I have strictly observed the regulations which govern  
the recruiting service. This soldier has *well* eyes, *well* hair, *well* com-  
plexion, is *well* feet *well* inches high.

*Mc Randolph*  
RECRUITING OFFICER OR AGENT.

Mustered into the United States Service *14* day of *Sept* 1864

Mustering Officer

..... Mustered into the service of the United States, for three years or during the war, from date of enlistment, in Company .....  
..... Regiment of ..... Volunteers, on the ..... day of ..... 1864, at .....



NOTE 1.—This blank will be used for enlistments of United States colored troops. They will be made out in duplicate in all cases—one to accompany the recruiting return of the superintendent (not the recruiting officer) to the Adjutant General, and one to accompany the accounts of the officer who pays bounty, &c.

NOTE 2.—An enlistment holds to service. A muster-in must, in all cases, precede payment of pay, bounty, pension, &c. A muster-in roll, must in all cases, be filed in the Adjutant General's Office as evidence of muster-in. The mustering officer, commissary, or assistant commissary of musters, as the case may be, will countersign both enlistments as having mustered the soldiers into the service of the United States before either of them is given to the disbursing officer.

DECLARATION OF RECRUIT.

I, Joseph Hutchison ..... desiring to volunteer as a soldier in the ARMY OF THE UNITED STATES, for the term of Three Years, DO DECLARE That I am 24 years and ..... months of age; that I have never been discharged from the United States service on account of disability or by sentence of a court-martial, or by order before the expiration of a term of enlistment; and I know of no impediment to my serving honestly and faithfully as a soldier for three years.

GIVEN at Camp Nelson the 14 day of Sept. 1864

Witness: J. M. G. Kerson

Joseph Hutchison  
 Volunteered at Camp Nelson  
14th Sept 1864  
 By J. P. Kenna  
 No. Joseph Hutchison

Triplicate Copy

Consent of Parent or Guardian in case of a Minor, if a Free Man, or in the case of a Slave, of the Person to whom he owes Service:

I, David Calman Do CERTIFY, That I am the owner of Joseph Hutchison a slave that the said Joseph Hutchison is Twentyfour years of age; and I do freely give my CONSENT to his volunteering as a SOLDIER in the Army of the United States, for the period of THREE YEARS, under the conditions of the laws of the United States.

GIVEN at Camp Nelson the 14th day of September 1864

Witness: D. S. Coleman



# UNITED STATES COLORED TROOPS ENLISTMENT.

STATE OF

TOWN OF

*Kentucky*



*Camp Nelson*

I, *Joseph Hutchison* born in *Gazette Co*  
in the State of *Kentucky* aged *Twenty four* years  
and by occupation a *Farmer* Do HEREBY ACKNOWLEDGE to

have volunteered *fourteenth* day of *September* 1864  
to serve as a **Soldier** in the **Army of the United States of America**, for the  
period of **THREE YEARS**, unless sooner discharged by proper authority: Do  
also agree to accept such bounty, pay, rations, and clothing, as are, or may be,  
established by law for the U. S. colored troops.

And I, *Joseph Hutchison*  
do solemnly swear that I will bear true faith and allegiance to the **United States  
of America**, and that I will serve them honestly and faithfully against all their  
enemies or opposers whomsoever; and that I will observe and obey the orders  
of the President of the United States, and the orders of the officers appointed  
over me, according to the Rules and Articles of War.

Sworn and subscribed to, at *Camp Nelson*  
this *14th* day of *Sept* 1864 *Joseph Hutchison*  
Before *J. C. Randolph*

I CERTIFY, ON HONOR, That I have carefully examined the above named Volunteer agree-  
ably to the General Regulations of the Army, and that, in my opinion, he is free from all bodily  
defects and mental infirmity, which would in any way disqualify him from performing the  
duties of a soldier.

*P. G. Barrett*  
asst. Surg. 4th I. & C.  
EXAMINING SURGEON.

I CERTIFY, ON HONOR, That I have minutely inspected the Volunteer, *Joseph Hutchison*  
previously to his enlistment, and that he was entirely sober when enlisted; that, to the best of  
my judgment and belief, he is of lawful age; and that, in accepting him, as duly qualified to per-  
form the duties of an able-bodied soldier, I have strictly observed the regulations which govern  
the recruiting service. This soldier has *five* eyes, *five* hair, *five* com-  
plexion, is *five* feet *ten* inches high.

*J. C. Randolph*  
RECRUITING OFFICER OR AGENT.

Mustered into the United States Service *15th* day of *Sept* 1864.

*A. C. Kinney*  
Capt 18th U.S. Mustering Officer.

Mustered into the service of the United States, for three years or during the war, from date of enlistment, in Company  
Regiment of *U.S. Colored Cavalry* Volunteers, of the *15th* day of *September* 1864 at *Camp Nelson Ky*

*W. C. Kinney*  
Capt 18th U.S. *Mustering Officer*







Hutchinson Joseph

P, Co. H., 5 Reg't U. S. C. C.

3 Enclosures.

Bed Cards .....	Final Statements .....
Burial Records .....	Furloughs or L. of A. ....
Certs. of Dis. for Discharge .....	Med. Certificates .....
C. M. Charges .....	Med. Des. Lists .....
Descriptive Lists .....	Orders .....
Discharge Certificates .....	Pris. of War Record /
Enlistment Papers /	Resignations .....

Other papers relating to—

Admission to Hosp'l .....	Furlough or L. of A. ....
Casualty Sheet .....	Med. Examination .....
Confinement .....	Misc. Information /
Contracts .....	Pay or Clothing .....
Death or Effects .....	Personal Reports .....
Desertion .....	Rank .....
Discharge from Hosp'l .....	Transfer to Hosp'l .....
Discharge from Service .....	Transfer to V. R. C. ....
Duty .....	Transportation .....

*A* | **5 Cav.** | **U.S.C.T.**

*Joseph Hutchison*  
*Capt.*, Co. *A*, 5 Reg't U. S. Col'd Cavalry.

Appears on **Co. Muster-out Roll**, dated  
*Helena, Ark Mar. 16*, 1866.

Muster-out to date *Mar. 16*, 1866.

Last paid to *Dec. 31*, 1865.

**Clothing account:**

Last settled....., 186 ; drawn since \$..... 100

Due soldier \$..... 100; due U. S. \$ *37* <sup>*82*</sup>/<sub>100</sub>

Am't for cloth'g in kind or money adv'd \$..... 100

Due U. S. for arms, equipments, &c., \$..... 100

Bounty paid \$ *100* 100; due \$ *100* 100

Remarks: *Appointed Capt.*  
*Nov. 4. 65.*

Book mark: *483, 555.*

(861)

*J. R. Stewart*  
Copied.

2 | **5 Cav.** | **U.S.C.T.**

*Joseph Hutchinson*

*Plt.*, Co. *H*, 5 Reg't U. S. Colored Cav.

Appears on **Returns** as follows:

*Oct 1864 Absent missing in action*

*Oct. 2/64 Saltville, Va*

*Nov 1864 Absent, missing in action*

*Oct. 2/64 Saltville, Va*

*Dec 1864. Rain Dec 14. Camp Kel-*

*son Returned from missing*

*in action Saltville, Va, Oct*

*2/64. Absent on detached*

*service Camp Nelson river.*

*Dec 14/64*

*May to July 1865. On daily duty,*  
*Co. Cook*

*+ Name appears also as Joseph Hutchinson*  
*+ Entry cancelled.*

Book mark :

(540)

*J. B. Ballou*

Copyist.



*A* | **5 Cav.** | **U.S.C.T.**

*Joseph Buchanan*  
Copt., Co. H, 5 Reg't U. S. Col'd Cavalry.

Appears on

**Company Muster Roll**

for *Jerry T. Gibby*, 1866.

Present or absent *Present*

Stoppage, \$.....100 for.....

Due Gov't, \$.....100 for.....

Valuation of horse, \$.....100

Valuation of horse equipments, \$.....100

Remarks:.....

Book mark:.....

(358)

*J. M. Stewart*  
Copyist.

*N.* | **5 Cav.** | **U.S.C.T.**

*Joseph Robinson*  
*G. Corp.*, Co. H, 5 Reg't U. S. Col'd Cavalry.

Appears on

**Company Muster Roll**

for *Nov. & Dec.*, 1865.

Present or absent *Present*

Stoppage, \$ *100* for

Due Gov't, \$ *100* for

Valuation of horse, \$ *100*

Valuation of horse equipments, \$ *100*

Remarks: *Promoted to Corp'l Per Regt Order No. 179 dated Nov. 4"/1865.*

Book mark: \_\_\_\_\_

(358)

*B. J. Cooke*

Copyist.

76 | 5 Cav. | U.S.C.T.

Joseph Luckison  
Co. H, 5 Reg't U. S. Col'd Cavalry.

Appears on

Company Muster Roll

for Sept. & Oct., 1865

Present or absent Present

Stoppage, \$ 100 for

Due Gov't, \$ 100 for

Valuation of horse, \$ 100

Valuation of horse equipments, \$ 100

Remarks:

[Empty lines for remarks]

Book mark:

R. J. Cooke  
Copyist.



*H* | *5 bar* | **U.S.C.T**

*Joseph Hutchison*  
*Pri*, Co. *H*, *5* Reg't U. S. Col'd *bar*

Appears on

**Company Muster Roll**

for *July & Aug*, 186 *5*

Present or absent *Present*

Stoppage, \$ *100* for

Due Gov't, \$ *100* for

Valuation of horse, \$ *100*

Valuation of horse equipments, \$ *100*

Remarks:

Book mark:

(358)

*Rever*  
*Camp* Copyist.

H | **5 Cav.** | **U.S.C.T.**

Joseph Hutchison  
Priv, Co. H, 5 Reg't U. S. Col'd Cavalry.

Appears on

**Company Muster Roll**

for May & June, 1865.

Present or absent Present

Stoppage, \$ 100 for

Due Gov't, \$ 100 for

Valuation of horse, \$ 100

Valuation of horse equipments, \$ 100

Remarks: 1<sup>st</sup> Installment  
Bounty due \$100.

Book mark:

(358)

Rever  
Copyist.

*H* | **5 Cav.** | **U.S.C.T.**

*Joseph Hutchinson*  
*Pat*, Co. H, 5 Reg't U. S. Col'd Cavalry.

Appears on

**Company Muster Roll**

for *Mar & Apr*, 186*3*.

Present or absent *present*

Stoppage, \$ *100* for

Due Gov't, \$ *100* for

Valuation of horse, \$ *100*

Valuation of horse equipments, \$ *100*

Remarks: *1st installment of*  
*Bonny Due \$100*

Book mark:

(358)

*Reynolds*

Copyist.



H | **5 Cav.** | **U.S.C.T.**

Joseph Hutchison  
Pot, Co. H, 5 Reg't U. S. Col'd Cavalry.

Appears on

**Company Muster Roll**

for Jan & Feb, 1865.

Present or absent present

Stoppage, \$ 100 for

Due Gov't, \$ 100 for

Valuation of horse, \$ 100

Valuation of horse equipments, \$ 100

Remarks: 1<sup>st</sup> Installment of  
Bounty Due \$100.00

Book mark: \_\_\_\_\_

Reynolds

H | **5 Cav.** | **U.S.C.T.**

*Joseph Hutchison*

*Priv.*, Co. H, 5 Reg't U. S. Col'd Cavalry.

Appears on

**Company Muster Roll**

for *Nov + Dec*, 1864

Present or absent *Absent*

Stoppage, \$ *100* for

Due Gov't, \$ *100* for

Valuation of horse, \$ *100*

Valuation of horse equipments, \$ *100*

Remarks: *1 + 2 Inshellments*

*Brandy due on detached  
service camp Nelson since  
Dec 14. Returned from  
missing in action  
Dec 14*

Book mark:

(358)

*Perman*  
*copyist* Copyist.

H | **5 Cav.** | **U.S.C.T.**

Jos Hulchison

Pat, Co. H, 5 Reg't U. S. Col'd Cavalry.

Appears on

**Company Muster Roll**

for from enlistment to Oct 31, 1864.

Present or absent Absent

Stoppage, \$ 100 for

Due Gov't, \$ 100 for

Valuation of horse, \$ 100

Valuation of horse equipments, \$ 100

Remarks: Miping in Action  
Saltville Va. Oct 2<sup>d</sup> 1864

Book mark: \_\_\_\_\_

Reynolds



H 5 Cav | **U.S.C.T.**

*Joseph Hutchison*  
Priv., Co H, 5 Reg't U. S. Col'd Cav

Appears on

**Company Muster-in and Descriptive Roll**  
of the organization named above. Roll dated

*Camp Nelson Ky, Oct 29, 1864.*

Where born *Fayette Ky*

Age *24* y'rs; occupation *Farmer*

When enlisted *Sept 14*, 1864.

Where enlisted *Camp Nelson, Ky*

For what period enlisted *3* years.

Eyes *Black*; hair *Black*

Complexion *Black*; height *5* ft. *10* in.

When mustered in *Sept 15*, 1864.

Where mustered in *Camp Nelson, Ky*

Bounty paid \$ *100*; due \$ *100*

Where credited

Company to which assigned

Remarks: *7 Dist Ky*

\* *David Coleman*

\* *Supposed to be name of owner. Aided May 17/45*

Book mark:

*Reimer*  
*comp*

(356d)

76 | **5 Cav.** | **U.S.C.T.**

Joseph Hutchison  
....., Co. 76, 5 Reg't U. S. Col'd Cav.

Appears on

**Company Descriptive Book**  
of the organization named above.

**DESCRIPTION.**

Age 24 years; height 5 feet 10 inches.

Complexion Rbr.....

Eyes Rbr.....; hair Rbr.....

Where born Fayette Ky.....

Occupation Farmer.....

**ENLISTMENT.**

When ..... Sept-14, 1864 .

Where Camp Nelson.....

By whom J. Randolph; term 3 y'rs.

Remarks: .....

.....  
.....  
.....  
.....  
.....  
.....  
.....  
.....

(383g) A. J. Anderson Coppiet.

*H 5 Co* | **U. S. C. T.**

*Joseph Hutchison*  
....., Co *H*, 5 Reg't U. S. Col'd *Co*

Appears on  
**Company Descriptive Book**  
of the organization named above.

**DESCRIPTION.**

Age *24* years; height *5* feet *70* inches.

Complexion *Blk*

Eyes *Blk*; hair *Blk*

Where born *Dayette Ky*

Occupation *farmer*

**ENLISTMENT.**

When *Sep. 14*, 186 *7*.

Where *Camp Nelson Ky*

By whom *H. Randolph* term *3* y'rs.

Remarks: *Missing in*  
*action Oct. 2<sup>d</sup> 1864*  
*Salpville Va.*  
*Taken up Camp*  
*Nelson Ky. Dec.*  
*14<sup>th</sup> - 1864*

*J. E. Purke*



Wutchison Joseph

*Butchison Joseph*  
Co *H*, 5 U. S. Col'd Cav.

*Private* | *Corporal*

CARD NUMBERS.

1	5366805	26
2	5366930	27
3	5366988	28
4	5367079	29
5	5367168	30
6	5367264	31
7	5367355	32
8	5367444	33
9	5367501	34
10	5367591	35
11	5367678	36
12	9090793-	37
13	9090889	38
14	40729928	39
15		40
16		41
17		42
18		43
19		44
20		45
21		46
22		47
23		48
24		49
25		50

Book Mark: .....

See also .....

STATE OF

*Arkansas*

COUNTY

*Phillip*

} ss.

*I, Richard L. Hutchinson*  
*late 1<sup>st</sup> Lt & R. C. S. 5<sup>th</sup> Regiment U. S. Col & Cavalry*

*Vets., do solemnly declare in oath, that I have duly accounted for all Public Property, for which I have ever been responsible as an Officer of the Volunteer Forces of the United States; that I have rendered all returns and reports, required by Revised Army Regulations of 1863 and existing orders; that I am not now, on any account whatever, indebted to the General Government except as stated on Muster-out Rolls.*

*Richard L. Hutchinson,*  
*1<sup>st</sup> Lt & R. C. S. 5<sup>th</sup> Regt.*

*Sworn and subscribed before me, at* *Wesley Ark.*  
*this 17<sup>th</sup> day of March 1866.*

*W. F. Morse*  
*Capt & Comdr. Muster*  
*Dept. of Arkansas*



Affidavit of Nonindebtedness to U. S.,

of Richard G. Hutchins

late 1<sup>st</sup> Lt. U. S. 3<sup>d</sup> Reg't

U. S. Col'd. Reg't on which was

based Certificate of Nonindebtedness  
to U. S.,

Dated March 17<sup>th</sup> 1866.

Head-Quarters Department of Kentucky,

Louisville Ky. August 19<sup>th</sup> 1865.

Special Orders, }  
No. 135 }

(Extract.)

\* \* \* \* \*  
! Leave of Absence is hereby granted the following named officers, for the number of days set opposite their names:

Lieut R. L. Glutchins & R. C. S  
5<sup>th</sup> U. S. A. Navy for twenty (20) days

\* \* \* \* \*  
The following extracts from Regulations and General Orders, relative to leaves of absence, will be strictly observed:

"When not otherwise specified, leaves of absence will commence the day an officer is relieved from duty at his post, after receiving the order granting him leave.

"At the expiration of his leave, the officer must report in person *with his command*, and *not* at the office from which his leave issued.

"No officer is permitted to visit Washington without special permission from the Secretary of War, which must be stated in the order granting leave of absence.

"If an officer be not able to travel at the expiration of his sick leave, he must report his address to the commander of his post, regiment or corps, and also to the Adjutant General of the Army; and in his first report state the day when his leave of absence commenced. These reports must be repeated every twenty days, and each one must be accompanied by the certificate of a *medical officer of the army*, made in the usual form, and stating that the officer is not able to travel. If there is no army physician in the place where the officer resides, the certificate of a citizen physician, the truth of which must be sworn to before a *civil magistrate*, may be substituted. *Extensions of leave are not granted in orders.*

"Officers absent from duty without leave, or beyond the time of their leaves, will not be allowed to draw pay until a court or commission, which will be ordered on their return to their post or command, shall determine whether there was sufficient cause for their absence. They will accordingly provide themselves with a full description of the nature and cause of their disability, certified by the proper medical authority as required by existing orders and regulations."

"And be it further enacted, that any officer absent from duty with leave, except for sickness or wounds, shall, during his absence, receive half of the pay and allowances prescribed by law, and no more; and any officer absent without leave shall, in addition to the penalties prescribed by law or court-martial, forfeit all pay and allowances during such absence."

"And be it further enacted, that the thirty-first section of an act entitled 'An act for enrolling and calling out the National forces, and for other purposes' approved March third one thousand eight hundred and sixty-three, be, and the same is hereby so amended as that an officer may have, when allowed by order of his proper commander, leave of absence for other cause than sickness and wounds without deduction from his pay or allowances: PROVIDED, that the aggregate of such absence shall not exceed thirty days in any one year."

By command of Major General

*Hand*  
Brewster Sullivan  
Assistant Adjutant General

@ C.  
5<sup>th</sup> U. S. A. Navy. Lieut & Acty  
thru, et, 1022023

Special Order 155

Adm. Serv. Dept. of Hyg.  
Lansdowne St. Aug 19. 65

Leave of absence for Asst  
Surgeon R. L. Hutchins



Head-Quarters First Division, Department of Kentucky,

Lexington, Ky., August 17th, 1865.

**SPECIAL ORDERS,**  
**No. 165.**

"EXTRACT."

On account of the severe illness of his wife, permission is granted to Lieut. A. S. Ketchum, 5th U. S. C. C. to go to Lexington Ky. for forty-eight (48) hours.

By Command of Brig. Gen. E. H. HOBSON,

*A. R. Gentry*  
Captain and Acting Assistant Adjutant General.

Special Order 165

Wd No 1<sup>st</sup> Div Dept of Hy  
Let Hy. Aug 17. 1865

Ordering W Hutchins to  
Carrington Hy

Camp 5<sup>th</sup> U. S. C. Cav.

Lexington Ky. Aug. 14<sup>th</sup> / 45.

Sir!

I have the honor to request a leave  
of absence for (20) twenty days in order to  
visit my Wife at Warsaw, New York, who is  
lying sick & not expected to live.

I have the honor to be,

Very Respectfully,

Your Obedt. Servt.

R. L. Hutchins

1<sup>st</sup> Lieut & A. C. S. 5<sup>th</sup> U. S. C. Cav.

Capt. Wm. H. ...



36-363-2 Accepted <sup>11th</sup> 1865  
Serial 1017, Aug 15th

Hentstuns, N. L.  
Lieut & A. C. S. 5th U.S.C.  
Application for leave of  
absence of twenty days  
to visit his family at  
Warsaw, New York, where his  
Wife is dying at the point  
of death. Very Respectfully,  
N. L. Hentstuns,  
Lieut & A. C. S. 5th U.S.C.

Head Quarters 1st Div of Ky  
Lexington Ky Aug 11th 1865

Respectfully forwarded this  
is a case of extreme neces-  
sity and I would respectfully  
request that the leave be  
granted

W. H. Hobson  
Brig Genl  
Lexington, Ky

Head Quarters  
Lexington Ky  
10 August 1865

Approved and respect-  
fully forwarded

Henry M. Kiddle  
Major Surge  
Comd Regt

5-0

1000

1000

*Nutkins, R. L.*  
*1st Regt, 5th U.S. Cavalry*  
*4 Enclosures.*

Bed Cards .....	Final Statements .....
Burial Records .....	Furloughs or L. of A. ....
Certs. of Dis. for Discharge .....	Med. Certificates .....
C. M. Charges .....	Med. Des. Lists .....
Descriptive Lists .....	Orders ..... <i>2</i>
Discharge Certificates .....	Pris. of War Record .....
Enlistment Papers .....	Resignations .....

Other papers relating to—

Admission to Hosp'l .....	Furlough or L. of A. <i>/</i>
Casualty Sheet .....	Med. Examination .....
Confinement .....	Misc. Information <i>/</i>
Contracts .....	Pay or Clothing .....
Death or Effects .....	Personal Reports .....
Desertion .....	Rank .....
Discharge from Hosp'l .....	Transfer to Hosp'l .....
Discharge from Service .....	Transfer to V. R. C. ....
Duty .....	Transportation .....

*H* | *5 Cav* | **U.S.C.T.**

*Richard L. Hutchins*

Rank *P.C.S.*, *5* Reg't U. S. Col'd *Cav*

Appears on a

**Field and Staff Muster-out Roll**

of the organization named above. Roll dated

*Helena, Ark* *Mar 10*, 186*6* .

Muster-out to date *Mar 11*, 186*6* .

Last paid to *Dec 31*, 186*5* .

**Clothing account:**

Last settled....., 186*6* ; drawn since \$..... *100*

Due soldier \$..... *100*; due U. S. \$..... *100*

Am't for cloth'g in kind or money adv'd \$..... *100*

Due U. S. for arms, equipments, &c., \$..... *100*

Bounty paid \$..... *100*; due \$..... *100*

Remarks: *pt. from 22 Oct 1864*

*to date of muster out.*

*Appointed P.C.S. 17 April 65*

*Appointed from 121 Ohio*

*Vol. Cav. Original place*

*of enrollment, Akron Ohio.*

Book mark: *44675 R + P. Div. '89*

*J. W. Leonard*  
Copyist.



*H* | **5 Cav. | U.S.C.T.**

*R. L. Hutchins*  
*1st Lt., Co. C, 5 Reg't U. S. Col'd Cavalry.*

Appears on **Co. Muster-out Roll**, dated  
*Helena Ariz, Mch 16, 1866.*  
Muster-out to date *+ Mch 16, 1866.*  
Last paid to \_\_\_\_\_, 186 .

**Clothing account:**

Last settled \_\_\_\_\_, 186 ; drawn since \$ \_\_\_\_\_ 100

Due soldier \$ \_\_\_\_\_ 100; due U. S. \$ \_\_\_\_\_ 100

Am't for cloth'g in kind or money adv'd \$ \_\_\_\_\_ 100

Due U. S. for arms, equipments, &c., \$ \_\_\_\_\_ 100

Bounty paid \$ \_\_\_\_\_ 100; due \$ \_\_\_\_\_ 100

Remarks: *Transferred by Reg*  
*Order No 52 Dated April 17*  
*1865 to Reg' Staff as 1st*  
*Clk.*

*\*Cancelled by J. H. McFall Sr.*

Book mark: \_\_\_\_\_

*Rose*

JAN. 18

40729927

1899

June & July 1865. Present. On special  
duty as Acty. C. S. Paris, Ky, per  
S. O. 38, Hdqrs. H. & France, Paris,  
Ky, 30 May 1865.

Aug 1865. Absent with leave per S. O.  
149, D. K. Aug 12/65.

Sept. 1865 to Feb 1866. Present.

H | 5 Cav. | U.S.C.T.

Richard L. Hutchins  
1st  
R. L. S., Co. C., 5 Reg't U. S. Colored Cav.

Appears on **Returns** as follows:

From organization to Oct. 31, 1864

Absent on detached service

Dismounted Camp, Camp Nelson,  
Ky, since Oct. 22/64

Dec 1864 Absent, detached service  
with 3rd Bat. 5th U.S.C. to Det. Co.  
2nd Regt since Nov 7/64 Russell  
ville, Ky

Jan & Feb 1865 Absent, detached,  
& acting Regt Com

March 1865 Present. On special duty  
as A. R. C. S., date of order  
not known

April 1865. Prom. Transf'd by Regt.  
Order No. 52, dated April 17,  
1865 to Regt's Staff as R. L. S.  
(R. L. S.) Present. Transf'd  
from Co. C as per R. O. 52,  
17 April, 1865.

May 1865 Present.

(over)

Book mark :

(546)

J. C. Faller

Copyist.



H | 5 cav. | U.S.C.T.

R. L. Hutchins

Rank Co. S., 5 Reg't U. S. Col'd Cav

Appears on

**Field and Staff Muster Roll**

for Jan & Feb 1866.

Present or absent Present

Stoppage, \$ 100 for

Due Gov't, \$ 100 for

Valuation of horse, \$ 100

Valuation of horse equipments, \$ 100

Remarks:

Book mark:

(357)

W. J. [Signature]

Copyist.

*N* | *5 Cav* | **U.S.C.T.**

*Richard L. Hutchins*

Rank *A.C.S.*, *1* Reg't U. S. Col'd *Cav*

Appears on

**Field and Staff Muster Roll**

for *Nov. & Dec* 186*5*.

Present or absent *Present*

Stoppage, \$ *100* for

Due Gov't, \$ *100* for

Valuation of horse, \$ *100*

Valuation of horse equipments, \$ *100*

Remarks:

Book mark:

*W. J. ...*

Co. 15 Cav. | **U.S.C.T.**

Richard H. Hutchins

Rank Pvt., 5 Reg't U. S. Col'd Cav

Appears on

**Field and Staff Muster Roll**

for Sept. & Oct 1865.

Present or absent Present

Stoppage, \$ 100 for \_\_\_\_\_

Due Gov't, \$ 100 for \_\_\_\_\_

Valuation of horse, \$ 100

Valuation of horse equipments, \$ 100

Remarks: \_\_\_\_\_  
\_\_\_\_\_  
\_\_\_\_\_  
\_\_\_\_\_  
\_\_\_\_\_  
\_\_\_\_\_  
\_\_\_\_\_  
\_\_\_\_\_

Book mark: \_\_\_\_\_

\_\_\_\_\_  
Richard H. Hutchins  
\_\_\_\_\_  
(357) Copyist.



✓ 15000 | **U.S.C.T.**

Richard L. Houghton

Rank 1. Co., 3. Reg't U. S. Col'd Cav

Appears on

**Field and Staff Muster Roll**

for July & Aug 1865.

Present or absent absent

Stoppage, \$ 100 for

Due Gov't, \$ 100 for

Valuation of horse, \$ 100

Valuation of horse equipments, \$ 100

Remarks: absent with leave P.O. 155 d. up Aug 14 1865

Book mark:

J. L. Houghton

16 | 5 Cav. | **U.S.C.T.**

Richard K. Mendenhall

Rank *1st Lt.*, ... 1 Reg't U. S. Col'd *5th Cav.*

Appears on

**Field and Staff Muster Roll**

for *May 1861* 1861.

Present or absent *Present*

Stoppage, \$ *100* for

Due Gov't, \$ *100* for

Valuation of horse, \$ *100*

Valuation of horse equipments, \$ *100*

Remarks:

-----  
-----  
-----  
-----  
-----  
-----  
-----

Book mark:

(857)

*W. H. Keenan*

Copyist.

*Co's Cav.* | **U.S.C.T.**

*Richard L. Houlbourn*

Rank *PCP, 3* Reg't U. S. Col'd *Cav*

Appears on

**Field and Staff Muster Roll**

for *May & Apr* 1865.

Present or absent *Present*

Stoppage, \$ *100* for

Due Gov't, \$ *100* for

Valuation of horse, \$ *100*

Valuation of horse equipments, \$ *100*

Remarks: *1st Cavalry U.S.*  
*Co. A. D. 37 17. 1865*

Book mark:

*Richard L. Houlbourn*



76 | **5 Cav.** | **U.S.C.T.**

R. L. Hutchins

1<sup>st</sup> Lieut, Co. C, 5 Reg't U. S. Col'd Cavalry.

Appears on

**Company Muster Roll**

for Mar. 7 Apr., 1865.

Present or absent

Stoppage, \$ 100 for

Due Gov't, \$ 100 for

Valuation of horse, \$ 100

Valuation of horse equipments, \$ 100

Remarks: Transferred by Reg. Order  
No. 52 dated April 17, 1865  
to Regimental Staff as R.O.S.

Book mark:

*10* | **5 Cav.** | **U.S.C.T.**

*R. L. Hutchins*  
*1<sup>st</sup> Lieut.*, Co. C, 5 Reg't U. S. Col'd Cavalry.

Appears on

**Company Muster Roll**

for *Jany & Sby*, 186*5*.

Present or absent *Absent*

Stoppage, \$ *100* for

Due Gov't, \$ *100* for

Valuation of horse, \$ *100*

Valuation of horse equipments, \$ *100*

Remarks: *On detached service as  
A.R. Commissary per Regt.  
Order No. 23 Pt. 8, 1865*

Book mark:

*Shull*

*26* | **5 Cav.** | **U.S.C.T.**

*Richard L. Hutchins*

*1<sup>st</sup> Lieut.*, Co. C, 5 Reg't U. S. Col'd Cavalry.

Appears on

**Company Muster Roll**

for *Nov. & Dec.*, 186*4*

Present or absent *Absent*

Stoppage, \$ *100* for

Due Gov't, \$ *100* for

Valuation of horse, \$ *100*

Valuation of horse equipments, \$ *100*

Remarks: *Absent on detached service as actg. Regtl. Com. with 3<sup>d</sup> Battalion*

Book mark:

*Shull*

(358)

Copyist.



JAN. - 9

5359174

1891

Oct. 21 1864. To rank  
as a First Lieutenant  
in the 5<sup>th</sup> Regiment U.S.  
Caval. Battery from the  
21st day of October 1864.

Assigned to duty with  
his Company (C.) Octo-  
ber 22 1864. Existing  
men of said Company  
were mustered in (to the  
maximum) on or before  
said date

H | 5 Cav. | **U.S.C.T.**

R S Hutchins

1st, Co. C, 5 Reg't U. S. Col'd Cav.

Age 25 years.

Appears on an

**Individual Muster-in Roll**

of the organization named above. Roll dated

Camp Nelson Ky, Nov. 4, 1864.

Muster-in to date Oct. 22, 1864.

Joined for duty and enrolled:

When Oct. 22, 1864.

Where Camp Nelson Ky

Period 3 years.

Valuation of horse, \$ 100

Valuation of horse equipments, \$ 100

Remarks: Mustered in upon  
appointment of the Pres-  
ident of the United States  
dated Baltimore Md.

Book mark: M/in to date Oct 21/64  
per 8492-US/89

Sarimer

(336)

Copyist.

*26* | **5 Cav.** | **U.S.C.T.**

*R. S. Hutchins*

*1<sup>st</sup> Lieut, Co. C,* 5 Reg't U. S. Col'd Cavalry.

Appears on

**Company Muster-in and Descriptive Roll**

of the organization named above. Roll dated

*Camp Nelson, Ky, Oct. 24,* 1864.

Where born .....

Age ..... y'rs; occupation .....

When enlisted ....., 186 ..

Where enlisted .....

For what period enlisted ..... years.

Eyes .....; hair .....

Complexion .....; height ..... ft. .... in.

When mustered in ....., 186 ..

Where mustered in .....

Bounty paid \$ ..... 100; due \$ ..... 100

Where credited .....

Company to which assigned .....

Remarks : .....

.....

.....

.....

Book mark : .....

*Shull*



H | 5 Cav. | U.S.C.T.

R. L. Hutchins

1<sup>st</sup> Lt., Co. C., 5<sup>th</sup> Reg't U. S. Col'd Cavalry

Appears on

**Regimental Descriptive Book**

(List of Commissioned Officers)

of the regiment named above.

Rank 1<sup>st</sup> Lieutenant

Date of appointment Oct. 21 1864.

Remarks: Mustered Oct. 22, 1864,  
at Camp Nelson Ky  
by Capt N. C. Hinsey  
98<sup>th</sup> U. S. A.

Appointed R. C. S. per  
R. O. 52 Apr 14, 65.

Hearst

S919793-Proof  
R.P. 401197. (New)  
S 1687369 Roman  
J30767741.0.24

J. H. McFall

Stina

114  
1633  
1838  
1932  
2097  
214978  
29509  
29519  
29529  
29542  
29556  
29529  
345715  
33467  
39977

2  
3  
4  
5  
6  
7  
8  
9  
10  
11  
12  
13  
14  
15  
16  
17  
18  
19  
20  
21  
22  
23  
24  
25  
26  
27  
28  
29  
30  
31  
32  
33  
34  
35  
36  
37  
38  
39  
40  
41  
42  
43  
44  
45  
46  
47  
48  
49  
50

8492-75-1889  
1175-A-1889



*W* | **5 Cav.** | **U.S.C.T.**

*Philip Hunter*  
*Priv*, Co. *C*, 5 Reg't U. S. Col'd Cavalry.

Appears on **Co. Muster-out Roll**, dated  
*Delena Ark, March 16, 1866.*

Muster-out to date *March 16, 1866.*

Last paid to *Dec 31, 1865.*

**Clothing account:**

Last settled....., 186 ; drawn since \$..... 100

Due soldier \$..... 100; due U. S. \$ *44* <sup>*24*</sup>/<sub>100</sub>

Am't for cloth'g in kind or money adv'd \$..... 100

Due U. S. for arms, equipments, &c., \$..... 100

Bounty paid \$ *100* 100; due \$ *100* 100

Remarks: *Due US for Ord 454*

Book mark : .....

*Rose*

26 | **5 Cav.** | **U.S.C.T.**

*Philip Hunter*

*Sgt.*, Co. *C*, 5 Reg't U. S. Colored Cav.

Appears on **Returns** as follows:

*Jan 1865. Absent sick in Hosp  
Camp Nelson, Ky.*

Book mark :

(546)

*J. C. Ballou*

Copyist.

*N* | **5 Cav.** | **U.S.C.T.**

*Philip Hunter*  
*Pat*, Co. C, 5 Reg't U. S. Col'd Cavalry.

Appears on

**Company Muster Roll**  
for *Jan to Feb*, 186*6*.  
Present or absent *Present*

Stoppage, \$.....*100* for .....

Due Gov't, \$.....*100* for .....

Valuation of horse, \$.....*100*

Valuation of horse equipments, \$.....*100*

Remarks: .....

Book mark: .....

*Rose*

(358)

Copyist.



5 | **5 Cav.** | **U.S.C.T.**

*Phillip Hunter*

*Private*, Co. C, 5 Reg't U. S. Col'd Cavalry.

Appears on

**Company Muster Roll**

for *Nov. & Dec.*, 186*4*.

Present or absent *Present*

Stoppage, \$ 100 for

Due Gov't, \$ 100 for

Valuation of horse, \$ 100

Valuation of horse equipments, \$ 100

Remarks: *Due U.S. Army  
Camp and Bar Equip  
13<sup>th</sup>*

Book mark:

(358)

*J. J. J. J.*

Copyist.

*H* | **5 Cav.** | **U.S.C.T.**

*Philip Hunter*

*Pr.*, Co. C, 5 Reg't U. S. Col'd Cavalry.

Appears on

**Company Muster Roll**

for *Sep* *to Oct*, 186*5*.

Present or absent *Present*

Stoppage, \$ 100 for

Due Gov't, \$ 100 for

Valuation of horse, \$ 100

Valuation of horse equipments, \$ 100

Remarks:

Book mark:

(358)

*J. J. J. J.*  
Copyist.

H | **5 Cav.** | **U.S.C.T.**

*Philip Hunter*

*Pr.*, Co. C, 5 Reg't U. S. Col'd Cavalry.

Appears on

**Company Muster Roll**

for *Sep* + *Oct*, 1865.

Present or absent *Present*

Stoppage, \$.....100 for .....

Due Gov't, \$.....100 for .....

Valuation of horse, \$.....100

Valuation of horse equipments, \$.....100

Remarks:.....

Book mark:.....

(358)

*J. L. Linder*

Copyist.



*H* | **5 Cav.** | **U.S.C.T.**

*Philip Hunter*

*Pr.*, Co. C, 5 Reg't U. S. Col'd Cavalry.

Appears on

**Company Muster Roll**

for *July + Aug.*, 186 *3*.

Present or absent *Present*

Stoppage, \$ 100 for

Due Gov't, \$ 100 for

Valuation of horse, \$ 100

Valuation of horse equipments, \$ 100

Remarks:

Book mark:

*J. J. J. J.*  
Copyist.

*H* | **5 Cav.** | **U.S.C.T.**

*Phillip Hunter*

*Priv*, Co. C, 5 Reg't U. S. Col'd Cavalry.

Appears on

**Company Muster Roll**

for *May & June*, 186*5*.

Present or absent *Present*

Stoppage, \$ *100* for

Due Gov't, \$ *100* for

Valuation of horse, \$ *100*

Valuation of horse equipments, \$ *100*

Remarks: *First Instalment  
of Bounty due \$100*

Book mark: \_\_\_\_\_

*Linden*

26 | **5 Cav.** | **U.S.C.T.**

*Phillip Hunter*

*Priv*, Co. C, 5 Reg't U. S. Col'd Cavalry.

Appears on

**Company Muster Roll**

for *Mar. 7 Apr.*, 186*3*.

Present or absent *Present*

Stoppage, \$ *100* for

Due Gov't, \$ *100* for

Valuation of horse, \$ *100*

Valuation of horse equipments, \$ *100*

Remarks: *First installment of  
Bounty due \$100*

Book mark:

*Shull*



*H* | **5 Cav.** | **U.S.C.T.**

*Philip Hunter*

*Pris*, Co. C, 5 Reg't U. S. Col'd Cavalry.

Appears on

**Company Muster Roll**

for *Jany. & Feby.*, 186*5*.

Present or absent *Present*

Stoppage, \$ *100* for

Due Gov't, \$ *100* for

Valuation of horse, \$ *100*

Valuation of horse equipments, \$ *100*

Remarks: *First enlistment  
Bounty due \$100*

Book mark:

*Shull*

*No* | **5 Cav.** | **U.S.C.T.**

*Philip Hunter*

*Priv*, Co. C, 5 Reg't U. S. Col'd Cavalry.

Appears on

**Company Muster Roll**

for *Nov. 7 Dec.*, 186 *4*.

Present or absent *Present*

Stoppage, \$ *100* for

Due Gov't, \$ *100* for

Valuation of horse, \$ *100*

Valuation of horse equipments, \$ *100*

Remarks: *First & second instal-  
ments of bounty due Due  
U.S. for Ordinance 17.93*

Book mark:

*Shull*

*76* | **5 Cav.** | **U.S.C.T.**

*Phillip Hunter*

*Pvt*, Co. C, 5 Reg't U. S. Col'd Cavalry.

Appears on

**Company Muster Roll**

for *to Oct. 31*, 186 *4*.

Present or absent *Present*

Stoppage, \$ *100* for

Due Gov't, \$ *100* for

Valuation of horse, \$ *100*

Valuation of horse equipments, \$ *100*

Remarks:

Book mark:

*Shull*



*26* | **5 Cav.** | **U.S.C.T.**

*Philip Hunter*

*Pris*, Co. *C*, 5 Reg't U. S. Col'd Cavalry.

Appears on

**Company Muster-in and Descriptive Roll**

of the organization named above. Roll dated

*Camp Nelson, Ky*, N. Y., *Oct. 24*, 1864.

Where born *Alexm, Ky.*

Age *20* y'rs; occupation *Laborer*

When enlisted *Aug. 27*, 1864.

Where enlisted *Louisville*

For what period enlisted *3* years.

Eyes *Dr.*; hair *Dr.*

Complexion *Yellow*; height *5* ft. *7 1/2* in.

When mustered in *Aug. 30*, 1864.

Where mustered in *Louisville*

Bounty paid \$ *100*; due \$ *100*

Where credited *4" Dist. Ky.*

Company to which assigned *C*

Remarks:

Book mark:

*Shull*

H | 5 bar | U.S.C.T.

Phillip Hunter

Appears with rank of Private on

**Muster and Descriptive Roll**

of a Detachment of U.S. Colored  
Troops transferred to U.S. Colored  
at Lexington, Ky.

Roll dated  
Louisville, Ky., Sept. 2, 1864.

Where born Fulton, Ky.

Age 20 years; occupation Laborer

When enlisted Aug. 27, 1864.

Where enlisted Louisville, Ky.

For what period enlisted 3 years.

Eyes Dark; hair Dark

Complexion Fair; height 5 ft. 7 in.

When mustered in Aug. 30, 1864.

Where mustered in Louisville

Bounty paid \$ 100; due \$ 100

Clothing account:  
Last settled 1864; drawn since \$ 17.55  
100

Date of first muster Aug. 30, 1864.

Company to which assigned

Remarks: transferred to H. C. Bayl. Det.  
Ky.

Book mark:

P. J. Bidwell

A. | 5 bar | 1864

Philipp Hunter

Appears with rank of Pvt on

**Muster and Descriptive Roll**

of Detachment US Colored  
Recruits Mustered for

US Colored Inf. Roll dated  
Louisville Ky Aug 30, 1864.

Where born Nelson Ky

Age 20 years; occupation laborer

When enlisted Aug 27, 1864.

Where enlisted Louisville Ky

For what period enlisted 3 years.

Eyes dark; hair dark

Complexion yellow; height 5 ft. 7 1/2 in.

When mustered in Aug 30, 1864.

Where mustered in Louisville Ky

Bounty paid \$ 100; due \$ 100

**Clothing account:**

Last settled \_\_\_\_\_, 186 ; drawn since \$ 100

Date of first muster \_\_\_\_\_, 186 .

Company to which assigned \_\_\_\_\_

Remarks: lex to Nelson Co  
H. Dist

Book mark : \_\_\_\_\_

(356m)

L. B. Burton  
Copyist.



A | **5 Cav. | U.S.C.T.**

Phillip Hunter

....., Co. C, 5 Reg't U. S. Col'd Cav.

Appears on

**Company Descriptive Book**  
of the organization named above.

**DESCRIPTION.**

Age 20 years; height 5 feet, 7 1/2 inches.

Complexion Yellow

Eyes Dark; hair Dark

Where born Madison Co., Ky.

Occupation Laborer

**ENLISTMENT.**

When Aug 27, 1864.

Where Louisville

By whom Capt. Hunter; term 3 y'rs.

Remarks: .....

.....  
.....  
.....  
.....  
.....  
.....  
.....  
.....  
.....

Hunter

Hunter Philip

Co E, 5 U. S. Col'd Cav.

Private - Private

CARD NUMBERS.

1	5361692	26
2	5361794	27
3	5361886	28
4	5361980	29
5	5362063	30
6	5362144	31
7	5362231	32
8	5362321	33
9	5362407	34
10	5362492	35
11	5362577	36
12	9090232	37
13	43145687	38
14	43146244	39
15	40729926	40
16		41
17		42
18		43
19		44
20		45
21		46
22		47
23		48
24		49
25		50

Book Mark:

See also

76 | 5-leaf | **U.S.C.T.**

Joseph Hunter  
, Co M, 5-Reg't U. S. Col'd leaf

Appears on

**Company Descriptive Book**

of the organization named above.

**DESCRIPTION.**

Age 19 years; height 5 feet 6 inches.

Complexion Black

Eyes BRN; hair BRN

Where born Jepson Ky

Occupation Farmer

**ENLISTMENT.**

When Aug 29, 1864.

Where Camp Nelson

By whom McKanderson; term 3 y'rs.

Remarks:

-----  
-----  
-----  
-----  
-----  
-----  
-----  
-----  
-----  
-----

A. J. Anderson  
(383g) Copyist.



H | 5 Cav. | U.S.C.T.

Joseph Hunter  
Priv., Co. M, 5 Reg't U. S. Colored Cav.

Appears on **Returns** as follows:

Oct. to Dec 1864 Absent on de-  
tached service at Nash-  
ville, Tenn, Oct. 4/64  
Jan. & Feb 1865 Absent at camp  
Nelson, Dismounted.  
Mar 1865 Absent det. at camp  
Nelson

Book mark : \_\_\_\_\_

(540)

J. C. Ballou  
Copyist.

*H* | **5 Cav.** | **U.S.C.T.**

*Joseph Hunter*  
*Prvt*, Co. *M*, 5 Reg't U. S. Col'd Cavalry.

Appears on **Co. Muster-out Roll**, dated  
*Helena Ark*, *Mar 16*, 186*6*.  
Muster-out to date *Mar 16*, 186*6*.  
Last paid to *Dec 31*, 186*5*.

**Clothing account:**

Last settled....., 186 ; drawn since \$..... 100

Due soldier \$..... 100; due U. S. \$ *114* <sup>*08*</sup>/<sub>100</sub>

Am't for cloth'g in kind or money adv'd \$..... 100

Due U. S. for arms, equipments, &c., \$..... <sup>*65*</sup>/<sub>100</sub>

Bounty paid \$..... 100; due \$..... 100

Remarks: *Slave Apr. 19 '61*

Book mark : .....

*H* | **5 Cav. | U.S.C.T.**

*Joseph Hunter*

*Pr*, Co. M, 5 Reg't U. S. Col'd Cavalry.

Appears on

**Company Muster Roll**

for *Jan + Feb*, 186*6*.

Present or absent *Present*

Stoppage, \$ *100* for

Due Gov't, \$ *100* for

Valuation of horse, \$ *100*

Valuation of horse equipments, \$ *100*

Remarks:

Book mark:

*Hyne*

Copyist.



*A1* | **5 Cav. | U.S.C.T.**

*Joseph Hunter*

*NW*, Co. M, 5 Reg't U. S. Col'd Cavalry.

Appears on

**Company Muster Roll**

for *Nov & Dec*, 1865.

Present or absent *Present*

Stoppage, \$ *100* for

Due Gov't, \$ *100* for

Valuation of horse, \$ *100*

Valuation of horse equipments, \$ *100*

Remarks:

Book mark:

(358)

*C. W. W.*  
Copyist.

*A* | **5 Cav. | U.S.C.T.**

*Joseph Hunter*  
*M*, Co. M, 5 Reg't U. S. Col'd Cavalry.

Appears on

**Company Muster Roll**

for *Sept & Oct*, 186*5*.

Present or absent *Present*

Stoppage, \$ *100* for

Due Gov't, \$ *100* for

Valuation of horse, \$ *100*

Valuation of horse equipments, \$ *100*

Remarks: *Due 61 for Camp & Garrison # 155. Advance # 257*

Book mark:

*Leuis*  
Copyist.

*A* | **5 Cav. | U.S.C.T.**

*Joseph Hunter*  
*Mr*, Co. M, 5 Reg't U. S. Col'd Cavalry.

Appears on

**Company Muster Roll**

for *July & Aug*, 186*5*.

Present or absent *Present*

Stoppage, \$ *100* for

Due Gov't, \$ *100* for

Valuation of horse, \$ *100*

Valuation of horse equipments, \$ *100*

Remarks:

Book mark:

*Curtis*



*H* | **5 Cav. | U.S.C.T.**

*Joseph Hunter*  
*Pr.*

....., Co. M, 5 Reg't U. S. Col'd Cavalry.

Appears on

**Company Muster Roll**

for *May & June*, 1865.

Present or absent *Present*

Stoppage, \$.....100 for .....

Due Gov't, \$.....100 for .....

Valuation of horse, \$.....100

Valuation of horse equipments, \$.....100

Remarks: *1<sup>st</sup> Entalment bounty*  
*due \$100.*

Book mark: .....

(358)

*Cutter*  
Copyist.

H | 5 Cav. | U.S.C.T.

Joseph Hunter  
Capt., Co. M, 5 Reg't U. S. Col'd Cavalry.

Appears on

**Company Muster Roll**

for Mar. & Apr., 1867.

Present or absent Present

Stoppage, \$ 100 for

Due Gov't, \$ 100 for

Valuation of horse, \$ 100

Valuation of horse equipments, \$ 100

Remarks: 1st installment  
monthly due \$100

Book mark:

M. Thompson

H

**5 Cav. | U.S.C.T.**

*Joseph Hunter*

*Pvt.*, Co. M, 5 Reg't U. S. Col'd Cavalry.

Appears on

**Company Muster Roll**

for *Jan 1st*, 186*5*.

Present or absent *Absent*

Stoppage, \$ *100* for

Due Gov't, \$ *100* for

Valuation of horse, \$ *100*

Valuation of horse equipments, \$ *100*

Remarks: *1st instalment of bounty due. In detached service at Nashville Tenn. Oct 4/64*

Book mark:

*H. S. Chapman*



4

**5 Cav. | U. S. C. T.**

*Joseph Hunter*

*Pr.*, Co. M, 5 Reg't U. S. Col'd Cavalry.

Appears on

**Company Muster Roll**

for *Nov 9 1864*, 1864.

Present or absent *Absent*

Stoppage, \$ *100* for

Due Gov't, \$ *100* for

Valuation of horse, \$ *100*

Valuation of horse equipments, \$ *100*

Remarks: *(On detached service at Nashville Tenn. Oct 4 64. 1<sup>st</sup> & 2<sup>d</sup> months of bounty due.*

Book mark: \_\_\_\_\_

*W. S. Thompson*

(358)

Copyist.

H | **5 Cav.** | **U.S.C.T.**

Joseph Hunter  
Private, Co. M, 5 Reg't U. S. Col'd Cavalry.

Appears on

**Company Muster Roll**

for to Oct. 31, 1864.

Present or absent Absent

Stoppage, \$ 100 for

Due Gov't, \$ 100 for

Valuation of horse, \$ 100

Valuation of horse equipments, \$ 100

Remarks: On detached service  
Nashville, Tenn., Oct. 15/64

Book mark: \_\_\_\_\_

M. S. Thompson

A | 5 Cav. | U.S.C.T.

Joseph Hunter  
Co. M, 5 Reg't U. S. Col'd Cavalry.

Appears on

Company Muster-in and Descriptive Roll  
of the organization named above. Roll dated

Camp Nelson, <sup>Ky.</sup> N. Y., Oct. 30, 1864.

Where born Jessamine, Ky.

Age 19 y'rs; occupation Farmer

When enlisted Aug. 29, 1864.

Where enlisted Camp Nelson, Ky.

For what period enlisted 3 years.

Eyes Black; hair Black

Complexion Black; height 5 ft. 6 in.

When mustered in Aug. 29, 1864.

Where mustered in Camp Nelson, Ky.

Bounty paid \$ 100; due \$ 100

Where credited 7 Dist. Ky.

Company to which assigned

Remarks: \* Wm Hunter.

\* Supposed to be name of owner.

Added May 16. 98. H. A. J.

Book mark:

W. S. Thompson



070  
unter Joseph

No. 5 U. S. Col'd Cav.

Private

Private

CARD NUMBERS.

70852	26
70942	27
71042	28
71127	29
71213	30
71299	31
71383	32
71470	33
71555	34
71640	35
71724	36
71286	37
729924	38
	39
	40
	41
	42
	43
	44
	45
	46
	47
	48
	49
	50

h:  
0

I certify, on honor, that John Hunter, a Private of  
 Captain G.E. Goddard Company (m) of the 5<sup>th</sup> Regiment of U.S. Col. Cav  
**VOLUNTEERS**, of the State of Kentucky, born in Harrison Co., State  
 of Kentucky, aged 45 years; 5 feet 7 inches high; blk complexion,  
blk eyes, blk hair, and by occupation a Farmer, who joined for service  
 and was enrolled (see Note 9) on the 29<sup>th</sup> day of August, 1864, at Camp Nelson Ky  
 by J.C. Randolph, for the period of Three years, and mustered into  
 the service of the United States on the 30<sup>th</sup> day of August, 1864, at  
Camp Nelson Ky, by Capt W.C. Kinney; and having served  
 HONESTLY and FAITHFULLY with his Company to the present date, is now entitled to a  
**DISCHARGE** by reason of death

The said John Hunter ~~was~~ <sup>has</sup> last paid by Paymaster  
 pay due from Enlistment to include the \_\_\_\_\_ day of \_\_\_\_\_, 1864, and  
 has pay due him from that time to the present date; he is entitled to pay and subsistence for  
**TRAVELING** to place of enrollment, and whatever other allowances are authorized to volunteer  
 soldiers, drafted men, or militia, so discharged. He has received from the United States **CLOTHING**  
 amounting to Thirty  $\frac{70}{100}$  dollars, since the \_\_\_\_\_ day of Enlistment,  
 1864, when his clothing account was last settled. He has received from the United States  
 \_\_\_\_\_  $\frac{100}{100}$  dollars advanced **BOUNTY**.

There is to be stopped from him, on account of the State of \_\_\_\_\_, or other  
 authorities, for **CLOTHING, &c.**, received on entering service, \_\_\_\_\_  $\frac{100}{100}$  dollars; and  
 for other stoppages, viz: \_\_\_\_\_  
 \_\_\_\_\_  $\frac{100}{100}$  dollars.  
 He has been furnished with **TRANSPORTATION** in kind from the place of his discharge to  
 \_\_\_\_\_; and he has been **SUBSISTED** for **TRAVELING** to his  
 place of enrollment, up to the \_\_\_\_\_, 1864.

He is indebted to \_\_\_\_\_, **SUTLER**, \_\_\_\_\_  $\frac{100}{100}$  dollars.

He is indebted to \_\_\_\_\_, **LAUNDRESS**, \_\_\_\_\_  $\frac{100}{100}$  dollars.

Given in Duplicate, at Paris Ky, this 18<sup>th</sup> day  
 of July, 1865.

G.E. Goddard  
Capt 5<sup>th</sup> U.S. Col. Cav.  
 Commanding Company.

Recd at 2:18 PM  
 July 18 1865



Extract from Act of Congress.

SEC. 12. And be it further enacted, That the fees of agents and attorneys for making out and causing to be executed the papers necessary to establish a claim for a pension, bounty, and other allowance before the Pension Office, under this act, shall not exceed the following rates: For making out and causing to be duly executed a declaration by the applicant, with the necessary affidavits, and forwarding the same to the Pension Office, with the requisite correspondence, ten dollars; which sum shall be received by such agent or attorney in full for all services in obtaining such pension, and shall not be demanded or received, in whole or in part, until such pension shall be obtained; and the sixth and seventh sections of an act entitled "An act to grant pensions," approved July [fourteenth,] eighteen hundred and sixty-two, are hereby repealed.

SEC. 13. And be it further enacted, That any agent or attorney who shall, directly or indirectly, demand or receive any greater compensation for his services under this act than is prescribed in the preceding section of this act, or who shall contract or agree to prosecute any claim for a pension, bounty, or other allowance under this act, on the condition that he shall receive a per centum upon any portion of the amount of such claim, or who shall wrongfully withhold from a pensioner or other claimant the whole or any part of the pension or claim allowed and due to such pensioner or claimant, shall be deemed guilty of a high misdemeanor, and, upon conviction thereof, shall, for every such offense, be fined not exceeding three hundred dollars, or imprisoned at hard labor not exceeding two years, or both, according to the circumstances and aggravations of the offense.

Approved July 4, 1834.

NOTE 10.—If any soldier is charged a higher fee than that allowed by the above act, he should report the fact and the name of the agent to the Adjutant General, in order that steps may be taken to have the same refunded.

FINAL STATEMENT

60 1/2  
 Priv John Hunter  
 5<sup>th</sup> Reg't of U. S. Cav.

VOLUNTEERS.

NOTE 1.—Two of these certificates (or duplicates) are to be given to each Volunteer Soldier or drafted man who may be discharged without being mustered out (Final Statements are never given to men mustered out of service) that he may at once receive from the Paymaster the pay, &c. due him, and the captain or other COMMISSIONED officer commanding the company will certify to the act of the delivery of the duplicate certificates; with these certificates the Soldier is "entitled to" his discharge, and should also present his discharge to the Paymaster to have the payment endorsed on it. The discharge is to be given back to the Soldier by the Paymaster; the latter only retaining as his vouchers the duplicate certificates.

NOTE 2.—If the Soldier is entitled to pay for the use of his horse, the Company Commander will certify to that fact on the back of both these final statements, and also to the time he has pay due for having been so mounted on his own horse.

NOTE 3.—When a Soldier is furnished with final statements, his descriptive list, if he has one, should be taken up by the officer who gives the Soldier these statements, and endorsed with a statement to this effect by the officer. The endorsement should exhibit a full statement of the time for which the Soldier was allowed pay on his final statements, the clothing account, and all other charges against him or in his favor, so as to comprise a complete exhibit of his account. It will then be transmitted to the Company Commander of the Soldier, who will enter all the data necessary to a full understanding of the Soldier's account on the muster roll upon which the Soldier's discharge is reported. The descriptive list will then be destroyed. The object of this is, that the remaining portion of the Soldier's account may be settled upon the receipt of these muster rolls, and the Soldier receive any pay or allowances that may be due him at the time of his discharge, and which may not appear on his last final statements from the fact that his descriptive list is incomplete. These accounts for back pay, &c., are settled by the 2d Auditor of the Treasury Department.

NOTE 4.—Charges for loss or injury to ordnance, horse equipments, and other miscellaneous charges, should appear under the heading of "Other Stoppages."

NOTE 5.—Bounty paid by State authorities, and not by the United States, will not be entered on this statement.

NOTE 6.—Amounts due the Sutler and Laundress must be entered on the muster roll on which the discharge, death, desertion, &c., is reported, as well as on the final statement, otherwise the amount cannot be collected from the United States.

NOTE 7.—This blank will be used for deceased volunteers and drafted men, as well as for others.

NOTE 8.—Where a Soldier dies in Hospital or on detached service, his descriptive list, if he has one, should be sent with his final statements, in duplicate, to the Adjutant General, Washington, D. C.

NOTE 9.—If the soldier is a drafted man or substitute, the space for time, &c., of enrolled, should contain only the word *drafted* or *substitute*, as the case may be. If the Soldier is a "VETERAN," (or RECRUIT,) the words as a *veteran*, (or *recruit*;) as the case may be, should be interlined after the words *mustered into the service of the U. S.* A statement of all the installments of *Veteran* or *Recruit* Bounty RECEIVED by the Soldier must be made on the back of each final statement.

See letter to 2<sup>d</sup> and July 2, 1864

[OFFICE INDORSEMENT.]

War Department,

ADJUTANT GENERAL'S OFFICE,

June 15, 1864

The death of John Hunter  
 Private, Co. 11, 5<sup>th</sup> Reg't U. S.

Colored Cavalry, is reported as follows:—

On Company Muster Roll.

Foramoy, Col. 1864, <sup>Reg't U. S. Col. 1864</sup> 1864

Company Muster-out Roll.

Regimental Return, 1864

Company Descriptive Book.

186

Company Morning Reports.

186

Soldier's Final Statement.

1864

Soldier's Record of Death and Interment.

186

Soldier's Inventory of Effects.

186

Soldier's Certificate of Disability for Discharge.

186

Soldier's Individual Muster-out Roll.

186

Regimental Return.

For Col. 1864, <sup>Reg't U. S. Col. 1864</sup> 1864

Regimental Quarterly Returns, 4<sup>th</sup> Q. 1864

Killed in action at Harpersburg, Oct 21, 1864

Regimental Descriptive Book.

186

By Surgeon General.

186

Oct 21, 1864 is held to be

the correct date, and the Company Muster

Roll will be amended accordingly. E. B. 1/100

Thoma M. Freund

Noted on Reg. R. 64

Asst. Adj. Gen.

ADJUTANT GENERAL'S OFFICE.

July 19, 1864

Duplicate with Inventory sent 2d Auditor.



Extract from Act of Congress.

SEC. 12. And be it further enacted, That the fees of agents and attorneys for making out and causing to be executed the papers necessary to establish a claim for a pension, bounty, and other allowance before the Pension Office, under this act, shall not exceed the following rates: For making out and causing to be duly executed a declaration by the applicant with the necessary affidavits, and forwarding the same to the Pension Office, with the requisite correspondence, ten dollars; which sum shall be received by such agent or attorney in full for all services in obtaining such pension, and shall not be demanded or received, in whole or in part, until such pension shall be obtained; and the sixth and seventh sections of an act entitled "An act to grant pensions," approved July [fourteenth,] eighteen hundred and sixty-two, are hereby repealed.

SEC. 13. And be it further enacted, That any agent or attorney who shall, directly or indirectly, demand or receive any greater compensation for his services under this act than is prescribed in the preceding section of this act, or who shall contract or agree to prosecute any claim for a pension, bounty, or other allowance under this act, on the condition that he shall receive a per centum upon any portion of the amount of such claim, or who shall wrongfully withhold from a pensioner or other claimant the whole or any part of the pension or claim allowed and due to such pensioner or claimant, shall be deemed guilty of a high misdemeanor, and, upon conviction thereof, shall, for every such offense, be fined not exceeding three hundred dollars, or imprisoned at hard labor not exceeding two years, or both, according to the circumstances and aggravations of the offense.

Approved July 4, 1864.

NOTE 10.—If any soldier is charged a higher fee than that allowed by the above act, he should report the fact and the name of the agent to the Adjutant General, in order that steps may be taken to have the same refunded.

FINAL STATEMENT

60 1/2  
 Priv John Hunter  
 5<sup>th</sup> Reg't of U. S. Col.

VOLUNTEERS.

NOTE 1.—Two of these certificates (or duplicates) are to be given to each Volunteer Soldier or drafted man who may be discharged without being mustered out (Final Statements are never given to men mustered out of service) that he may at once receive from the Paymaster the pay, &c. due him, and the captain or other COMMISSIONED officer commanding the company will certify to the act of the delivery of the duplicate certificates; with these certificates the Soldier is "entitled to" his discharge, and should also present his discharge to the Paymaster to have the payment endorsed on it. The discharge is to be given back to the Soldier by the Paymaster; the latter only retaining as his vouchers the duplicate certificates.

NOTE 2.—If the Soldier is entitled to pay for the use of his horse, the Company Commander will certify to that fact on the back of both these final statements, and also to the time he has pay due for having been mounted on his own horse.

NOTE 3.—When a Soldier is furnished with final statements, his descriptive list, if he has one, should be taken up by the officer who gives the Soldier these statements, and endorsed with a statement to this effect by the officer. The endorsement should exhibit a full statement of the time for which the Soldier was allowed pay on his final statements, the clothing account, and all other charges against him or in his favor, so as to comprise a complete exhibit of his account. It will then be transmitted to the Company Commander of the Soldier, who will enter all the data necessary to a full understanding of the Soldier's account on the muster roll upon which the Soldier's discharge is reported. The descriptive list will then be destroyed. The object of this is, that the remaining portion of the Soldier's account may be settled upon the receipt of these muster rolls, and the Soldier receive any pay or allowances that may be due him at the time of his discharge, and which may not appear on his last final statements from the fact that his descriptive list is incomplete. These accounts for back pay, &c., are settled by the 2d Auditor of the Treasury Department.

NOTE 4.—Charges for loss or injury to ordnance, horse equipments, and other miscellaneous charges, should appear under the heading of "Other Stoppages."

NOTE 5.—Bounty paid by State authorities, and not by the United States, will not be entered on this statement.

NOTE 6.—Amounts due the Sutler and Laundress must be entered on the muster roll on which the discharge, death, desertion, &c., is reported, as well as on the final statement, otherwise the amount cannot be collected from the United States.

NOTE 7.—This blank will be used for deceased volunteers and drafted men, as well as for others.

NOTE 8.—Where a Soldier dies in Hospital or on detached service, his descriptive list, if he has one, should be sent with his final statements, in duplicate, to the Adjutant General, Washington, D. C.

NOTE 9.—If the soldier is a drafted man or substitute, the space for time, &c., of enrolled, should contain only the word *drafted* or *substitute*, as the case may be. If the Soldier is a "VETERAN," (or RECRUIT,) the words as a *veteran*, (or *recruit*;) as the case may be, should be interlined after the words *mustered into the service of the U. S.* A statement of all the installments of *Veteran* or *Recruit* Bounty RECEIVED by the Soldier must be made on the back of each final statement.

See letter to 2<sup>d</sup> and July 2, 1864

[OFFICE INDORSEMENT.]

War Department,

ADJUTANT GENERAL'S OFFICE,

June 15, 1864

The death of John Hunter  
 Private, Co. M, 5<sup>th</sup> Reg't U. S.

Colored Company, is reported as follows:—

On Company Muster Roll.

For amount, 1864, 1864

Company Muster-out Roll.

Regimental Return, 1864

Company Descriptive Book.

186

Company Morning Reports.

186

Soldier's Final Statement.

1864

Soldier's Record of Death and Interment.

186

Soldier's Inventory of Effects.

186

Soldier's Certificate of Disability for Discharge.

186

Soldier's Individual Muster-out Roll.

186

Regimental Return.

For 1864, 1864

Regimental Quarterly Returns, 4<sup>th</sup> Q. 1864

Killed in action at Harpersburg, Oct 21, 1864

Regimental Descriptive Book.

186

By Surgeon General.

186

Oct 21, 1864 is held to be

the correct date, and the Company Muster

Roll will be amended accordingly. E. B. 1/100

Thoma M. S. [Signature]

Noted on Reg. R. 64

Asst. Adj. Gen.

ADJUTANT GENERAL'S OFFICE.

July 19, 1864

Duplicate with Inventory sent 2d Auditor.



PROOF OF OWNERSHIP.

State of Kentucky,

County of Harrison } ss.

We, A. D. Lyle ..... and W. W. Bradley ..... each of lawful age, and resident citizens of the State and county aforesaid, do certify that J. Newton Smith ..... of the State and county aforesaid, was on the 29 ..... day of August ..... 1864, the lawful owner of the slave named John A. Hunter .....; referred to and described in the foregoing claim for compensation.

A. D. Lyle  
W. W. Bradley

Sworn to and subscribed before me a County Judge ..... for the county of Harrison ..... State of Kentucky, this the 20 ..... day of November 1866

J. R. Curry J. H. C.



PROOF OF LOYALTY.

State of Kentucky,

County of Harrison } ss.

We, A. D. Lyle ..... and W. W. Bradley ..... each of lawful age, and resident citizens of the ..... of ..... in the State and county aforesaid, upon our oaths declare that we have known J. N. Smith ..... a resident of the State and county aforesaid, since the 4th day of March, 1861, and know that he has firmly and faithfully maintained his or her adherence and allegiance to the Government of the United States, by defending its cause against the Government and forces of the so-called Confederate States of America, in all suitable and practicable ways, and according to his or her ability and opportunity.

A. D. Lyle  
W. W. Bradley

Sworn to and subscribed before me a County Judge ..... for the county of Harrison 14 ..... State of Kentucky, this the 20 ..... day of Nov ..... 1866

J. R. Curry J. H. C.





Cavalry  
Head-Quarters U. S. Colored Troops,

Lexington, Ky. March 6<sup>th</sup> 1865.

I certify on Honor, that John Hunter, a colored man belonging to John M. Smith of Harrison Co. Ky. was enlisted on the 29<sup>th</sup> day of August 1864 at Camp Nelson, Ky. by J. H. Randolph, Dep. Pro. Mar. and mustered into the U. S. Service August 30<sup>th</sup> 1864 at Camp Nelson, Ky. by Capt. N. C. Sweeney, 18<sup>th</sup> U. S. Inf., Mustering Officer and that said John Hunter was assigned to Co. No. 5<sup>th</sup> U. S. Col. Cav.

*F. Hoats*  
Lieut. Col. 6<sup>th</sup> U. S. Col. Cav.  
S. O. U. S. Col. Cav.

*49 1864*

Sworn to and subscribed before me a County Judge for the county of Harrison 1<sup>st</sup> State of Kentucky, this the 20 day of Mar 1865  
J. R. Gump J. R. Gump



CERTIFICATE OF AWARD OF THE BOARD OF CLAIMS.

OFFICE OF THE BOARD OF CLAIMS,  
For Slaves Enlisted or Drafted in the Service of the United States.

We hereby certify, that ..... 186.....  
..... county, State of....., of  
having proved, under oath, ..... loyalty, to the Constitution and Government of the United States,  
and established ..... title as to the ownership of.....  
a slave enlisted or drafted (as the case may be) and mustered at.....  
on the..... day of..... 186....., by.....  
....., in the service of the United States, in the..... Regiment  
of Colored Troops, Co..... the sum of..... dollars has been awarded  
to..... by this Board, subject to the approval of the Secretary of War, as a compensation for the said  
slave, under the provisions of Section 24, Act approved February 24, 1864, and Section 2, Act approved July  
29, 1866.

President of the Board.  
Member of the Board.  
Member of the Board.

To.....  
Chief of the Bureau for the  
Organization of Colored Troops, Washington D. C.



CLAIM FOR COMPENSATION FOR ENLISTED SLAVE.

No. -----

I, J. Newton Smith, a loyal citizen, and a resident of ... County of Harrison ... State of Kentucky, hereby claim compensation, under the provisions of Section 24, Act approved February 24, 1864, and Section 2, Act approved July 28, 1866, for my slave John ... enlisted 29 Aug 1864 at Camp Nelson, by J. B. Randolph D. Pro in the 5th Regiment U. S. Colored Troops, Cav Co. M certificate of which enlistment, and a descriptive list, as required, accompany this application I raised said slave

In proof of my loyalty to the Constitution and Government of the United States, I present the accompanying oath, which I have taken, signed and acknowledged; to be filed with this application, in accordance with requirement of General Orders, No. 329, 1863, War Department, Adjutant General's Office.

And I do hereby constitute and appoint, with full power of substitution and revocation, W. W. Shible of Guthrie Ky

my true and lawful Attorney to prosecute this claim for me and in my name to receive and receipt for all orders or certificates that may be issued in payment thereof.

J. Newton Smith

Nov 20th, 1866

OATH OF ALLEGIANCE.

I, J. Newton Smith, the owner and claimant, do solemnly swear that the

foregoing claim is a just and true claim due to me as master and owner of the said slave, and that the facts alleged in said claim in respect to the draft or enlistment (as the case may be) of said slave into the military service of the United States are true. And I do further swear that I have never joined, or been concerned in, any insurrection or rebellion; that I have never borne arms against the United States; that I have never given any aid, countenance, counsel or encouragement, to any person or persons engaged, or whom I had reason to believe were about to engage, in insurrection, rebellion or armed hostility against the United States; that I have neither sought, nor accepted, nor attempted to exercise the functions of any office, civil or military, nor to perform any service whatever, under any authority, or pretended authority, in hostility to the United States: that I have not yielded a voluntary support to any insurrection, rebellion or pretended government authority, power or constitution within the United States hostile thereto. And I do further swear that, to the best of my knowledge and ability, I have supported and defended, and will continue to support and defend the United States against all enemies, foreign and domestic, and that I have supported, defended and obeyed, and will continue to support, defend and obey, the Constitution and Laws of the United States; that I will bear true faith and allegiance to the same; and that I take this oath freely, without any mental reservation or purpose of evasion: So help me God.

J. Newton Smith

Sworn to and subscribed before me and the above power of attorney acknowledged at

Harrison Co. Ky this 20 day of November 1866

J. P. Burns J. H. C.



ENDORSEMENT.

No. 2098

APPLICATION OF

J. Newton Smith

OF

Harrison Co 14

for compensation for service of slave,

John Hunter

enlisted 29 August 1864

in Co. M 5th Regiment

U. S. Colored troops Cavalry

Received July 28 1867

Compensation awarded

186

Dollars.

President Board of Claims.

P. O. ADDRESS OF CLAIMANT

Ben's Station  
Harrison Co 14  
Presented by W. W. Sproule  
Cynthiana 14

War Department,

ADJUTANT GENERAL'S OFFICE,

Washington, April 8 1867.

Respectfully returned to the  
Commission for the State of  
Ky., with the informa-

tion that John Hunter  
was enlisted at Camp Nelson Ky.  
Aug. 29. 1864, and was  
mustered in as Pvt in Co. "M"  
5th U. S. Colored Aug 30/64.

J. S. Seward

Asst. Adj't General.



# UNITED STATES COLORED TROOPS ENLISTMENT.

STATE OF

TOWN OF

*Kentucky*



*Camp Nelson*

I, *John Hunter* born in *Harrison Co*

in the State of *Kentucky* aged *Forty five* years

and by occupation a *Farmer* Do HEREBY ACKNOWLEDGE to

have volunteered *Twenty ninth* day of *August* 186*4*

to serve as a **Soldier** in the **Army of the United States of America**, for the period of **THREE YEARS**, unless sooner discharged by proper authority: Do also agree to accept such bounty, pay, rations, and clothing, as are, or may be, established by law for the U. S. colored troops.

And I, *John Hunter*

do solemnly swear that I will bear true faith and allegiance to the **United States of America**, and that I will serve them honestly and faithfully against all their enemies or opposers whomsoever; and that I will observe and obey the orders of the President of the United States, and the orders of the officers appointed over me, according to the Rules and Articles of War.

Sworn and subscribed to, at *Camp Nelson*

this *29<sup>th</sup>* day of *Aug 1864* *John Hunter* <sup>his</sup> mark

Before *J. S. Randolph* <sub>D.P.M.</sub>

I CERTIFY, ON HONOR, That I have carefully examined the above named Volunteer agreeably to the General Regulations of the Army, and that, in my opinion, he is free from all bodily defects and mental infirmity, which would in any way disqualify him from performing the duties of a soldier.

*R. G. Bowers*  
Capt *Lucy J. J. J.*  
EXAMINING SURGEON.

I CERTIFY, ON HONOR, That I have minutely inspected the Volunteer *J. Hunter* previously to his enlistment, and that he was entirely sober when enlisted, that, to the best of my judgment and belief, he is of lawful age, and that, in accepting him as duly qualified to perform the duties of an able-bodied soldier, I have strictly observed the regulations which govern the recruiting service. This soldier has *Blk* eyes, *Blk* hair, *Blk* complexion, is *five* feet *seven* inches high.

*J. S. Randolph*  
and *D. P. M.*  
RECRUITING OFFICER OR AGENT.

Mustered into the United States Service *30<sup>th</sup>* day of *August* 186*4*.

*N. O. Kimey*  
Capt *18<sup>th</sup> US Col*

Mustered into the service of the United States, for three years or during the war, from date of enlistment, in Company *Cavalry* Regiment of *Volunteers*, on the *30<sup>th</sup>* day of *August* 186*4* at *Camp Nelson*

*N. O. Kimey*  
Capt *18<sup>th</sup> US Col*  
*Major*



**NOTE 1.**—This blank will be used for enlistments of United States colored troops. They will be made out in duplicate in all cases—one to accompany the recruiting return of the superintendent (not the recruiting officer) to the Adjutant General, and one to accompany the accounts of the officer who pays bounty, &c.

**NOTE 2.**—An enlistment holds to service. A muster-in must, in all cases, precede payment of pay, bounty, pension, &c. A muster-in roll, must in all cases, be filed in the Adjutant General's Office as evidence of muster-in. The mustering officer, commissary, or assistant commissary of musters, as the case may be, will countersign both enlistments as having mustered the soldiers into the service of the United States before either of them is given to the disbursing officer.

**DECLARATION OF RECRUIT.**

I, John Hunter, desiring to volunteer as a soldier in the ARMY OF THE UNITED STATES, for the term of Three Years, DO DECLARE That I am 45 years and ..... months of age; that I have never been discharged from the United States service on account of disability or by sentence of a court-martial, or by order before the expiration of a term of enlistment; and I know of no impediment to my serving honestly and faithfully as a soldier for three years.

GIVEN at Camp Nelson the 29<sup>th</sup> day of August 1864

Witness: J. C. Strook

John Hunter  
 mark  
 By John W. Smith  
 Volunteered at Camp Nelson  
Aug 29 1864  
John W. Smith  
 or Assistant Surgeon

John Hunter  
658  
1173

Consent of Parent or Guardian in case of a Minor, if a Free Man, or in the case of a Slave, of the Person to whom he owes Service:

I, ..... Do CERTIFY, That I am the ..... that the said ..... is ..... years of age; and I do freely give my CONSENT to his volunteering as a SOLDIER in the Army of the United States, for the period of THREE YEARS, under the conditions of the laws of the United States.

GIVEN at ..... the ..... day of .....

Witness: .....

Hunter John

P, Co M,

5 Reg U.S.C. Cav.

5

**Enclosures.**

Bed Cards .....

Burial Records .....

Certs. of Dis. for Discharge .....

C. M. Charges .....

Med. Certificates .....

Descriptive Lists .....

Final Statements / .....

Furloughs .....

Med. Des. Lists .....

Orders .....

**Other papers relating to—**

Admission to Hosp'l .....

Casualty Sheet (Officer's) .....

Confinement .....

Contracts .....

Death or Effects .....

Desertions .....

Discharge from Hosp'l .....

Discharge from Service .....

Duty .....

Furlough .....

Med. Examination .....

Misc. Information .....

Pay or Clothing .....

Personal Reports .....

Rank .....

Transfer to Hosp'l .....

Transfer to V. R. C. ....

Transportation .....

26 | 5 Cav. | U.S.C.T.

*John Hunter*  
P.M., Co. M, 5 Reg't U. S. Col'd Cavalry.

Appears on Co. Muster-out Roll, dated  
*Helena Ark, Mar 16*, 186*6*.

Muster-out to date \_\_\_\_\_, 186 .

Last paid to \_\_\_\_\_, 186 .

Clothing account:

Last settled \_\_\_\_\_, 186 ; drawn since \$ \_\_\_\_\_ 100

Due soldier \$ \_\_\_\_\_ 100; due U. S. \$ \_\_\_\_\_ 100

Am't for cloth'g in kind or money adv'd \$ \_\_\_\_\_ 100

Due U. S. for arms, equipments, &c., \$ \_\_\_\_\_ 100

Bounty paid \$ \_\_\_\_\_ 100; due \$ \_\_\_\_\_ 100

Remarks: *Killed in Action at*  
*Harrodsburg, Ky Oct. 2 64*  
*I leave Apr. 19. 61*

Book mark: *V. 211 P. 36. 74. Oct 21 61*  
*11*  
*100*

(861)

*Hunter*  
Pr. Comm.

Copyist.



76 | **5 Cav.** | **U.S.C.T.**

*John Hunter*  
-----  
*Priv.*, Co. *A*, 5 Reg't U. S. Colored Cav.

Appears on **Returns** as follows:

*Oct. 1864* *Done* *Oct. 6/64* *Harrods-*  
*burg, Ky. Called at*  
*Harrodsburg, Ky. Sept. 21/64*

Book mark : .....

*J. C. Ballou*  
-----  
(546) Caryist.

H | 5 Cav. | U.S.C.T.

*John Hunter*  
*Priv.*, Co. M, 5 Reg't U. S. Col'd Cavalry.

Appears on

**Company Muster Roll**

for *to Oct. 31*, 186*1*.

Present or absent

Stoppage, \$ 100 for

Due Gov't, \$ 100 for

Valuation of horse, \$ 100

Valuation of horse equipments, \$ 100

Remarks: *Killed at Mansfield*  
*Msy. Oct. 6, 1861*

Book mark: *Vol. 21<sup>st</sup> 245. 10.*

(358)

*John Hunter*

Copyist.

4 | 5 Cav. | U.S.C.T.

John Hunter

Co. M, 5 Reg't U. S. Col'd Cavalry.

Appears on

Company Muster-in and Descriptive Roll of the organization named above. Roll dated Camp Nelson, N.Y., Oct 30, 1864.

Where born Harrison, Ky.

Age 45 y'rs; occupation Farmer

When enlisted Aug. 29, 1864.

Where enlisted Camp Nelson, Ky.

For what period enlisted 3 years.

Eyes Black; hair Black

Complexion Black; height 5 ft. 7 in.

When mustered in Aug. 30, 1864.

Where mustered in Camp Nelson, Ky.

Bounty paid \$ 100; due \$ 100

Where credited 7 Dist. Ky.

Company to which assigned

Remarks: \* John Smith

\* Supposed to be name of owner

Added May 16. 98. H. A. J.

Book mark: G. 2098 Ky

H. S. Thompson

(356d)

Copyist.



26 | 5 years | **U.S.C.T.**

John Neunter  
Com, 5 Reg't U. S. Col'd leav

Appears on

**Company Descriptive Book**

of the organization named above.

**DESCRIPTION.**

Age 45 years; height 5 feet 7 inches.

Complexion Black

Eyes Blk; hair Blk

Where born Harrison Ky

Occupation Farmer

**ENLISTMENT.**

When Aug 29, 1864.

Where Camp Nelson

By whom J. C. Campbell term 3 y'rs.

Remarks: Killed in action

-----  
-----  
-----  
-----  
-----  
-----  
-----  
-----

A. J. Anderson  
(383g) Copyist.

1869

Hunter John

Co No, 5 U. S. Col'd Cav.

Private | Private

CARD NUMBERS.

1	5370851	26
2	5370990	27
3	5371752	28
4	9091285	29
5	40729923	30
6		31
7		32
8		33
9		34
10		35
11		36
12		37
13		38
14		39
15		40
16		41
17		42
18		43
19		44
20		45
21		46
22		47
23		48
24		49
25		50

Book Mark:

EB  $\frac{11}{100}$

See also







*Extract from Act of Congress.*

SEC. 12. *And be it further enacted,* That the fees of agents and attorneys for making out and causing to be executed the papers necessary to establish a claim for a pension, bounty, and other allowance before the Pension Office, under this act, shall not exceed the following rates: For making out and causing to be duly executed a declaration by the applicant, with the necessary affidavits, and forwarding the same to the Pension Office, with the requisite correspondence, ten dollars; which sum shall be received by such agent or attorney in full for all services in obtaining such pension, and shall not be demanded or received, in whole or in part, until such pension shall be obtained; and the sixth and seventh sections of an act entitled "An act to grant pensions," approved July [fourteenth,] eighteen hundred and sixty-two; are hereby repealed.

SEC. 13. *And be it further enacted,* That any agent or attorney who shall, directly or indirectly, demand or receive any greater compensation for his services under this act than is prescribed in the preceding section of this act, or who shall contract or agree to prosecute any claim for a pension, bounty, or other allowance under this act, on the condition that he shall receive a per centum upon any portion of the amount of such claim, or who shall wrongfully withhold from a pensioner or other claimant the whole or any part of the pension or claim allowed and due to such pensioner or claimant, shall be deemed guilty of a high misdemeanor, and, upon conviction thereof, shall, for every such offense, be fined not exceeding three hundred dollars, or imprisoned at hard labor not exceeding two years, or both, according to the circumstances and aggravations of the offense.

Approved July 4, 1864.

NOTE 10.—If any soldier is charged a higher fee than that allowed by the above act, he should report the fact and the name of the agent to the Adjutant General, in order that steps may be taken to have the same refunded.

ADJUTANT GENERAL'S OFFICE.

March 16<sup>th</sup> 1865.

Duplicate with Inventory sent 2d Auditor.

FINAL STATEMENT

100 "6"

OF

John Hunter

5<sup>th</sup> Reg't of W. J. C. Co.

VOLUNTEERS.

NOTE 1.—Two of these certificates (or duplicates) are to be given to each Volunteer Soldier or drafted man who may be discharged without being mustered out (Final Statements are never given to men mustered out of service,) that he may at once receive from the Paymaster the pay, &c., due him, and the captain or other COMMISSIONED officer commanding the company will certify to the act of the delivery of the duplicate certificates; with these certificates the Soldier is "entitled to" his discharge and should also present his discharge to the Paymaster to have the payment endorsed on it. The discharge is to be given back to the Soldier by the Paymaster; the latter only retaining as his vouchers the duplicate certificates.

NOTE 2.—If the Soldier is entitled to pay for the use of his horse, the Company Commander will certify to that fact on the back of both these final statements, and also to the time he has pay due for having been so mounted on his own horse.

NOTE 3.—When a Soldier is furnished with final statements, his descriptive list, if he has one, should be taken up by the officer who gives the Soldier these statements, and endorsed with a statement to this effect by the officer. The endorsement should exhibit a full statement of the time for which the Soldier was allowed pay on his final statements, the clothing account, and all other charges against him or in his favor, so as to comprise a complete exhibit of his account. It will then be transmitted to the Company Commander of the Soldier, who will enter all the data necessary to a full understanding of the Soldier's account on the muster roll upon which the Soldier's discharge is reported. The descriptive list will then be destroyed. The object of this is, that the remaining portion of the Soldier's account may be settled upon the receipt of these muster rolls, and the Soldier receive any pay or allowances that may be due him at the time of his discharge, and which may not appear on his last final statements from the fact that his descriptive list is incomplete. These accounts for back pay, &c., are settled by the 2d Auditor of the Treasury Department.

NOTE 4.—Charges for loss or injury to ordnance, horse equipments, and other miscellaneous charges, should appear under the heading of "Other Stoppages."

NOTE 5.—Bounty paid by State authorities, and not by the United States, will not be entered on this statement.

NOTE 6.—Amounts due the Sutler and Laundress must be entered on the muster roll on which the discharge, death, desertion, &c., is reported, as well as on the final statement, otherwise the amount cannot be collected from the United States.

NOTE 7.—This blank will be used for deceased volunteers and drafted men, as well as for others.

NOTE 8.—Where a Soldier dies in Hospital or on detached service, his descriptive list, if he has one, should be sent with his final statements, in duplicate, to the Adjutant General, Washington, D. C.

NOTE 9.—If the soldier is a drafted man or substitute, the space for time, &c., of enrolled, should contain only the word *drafted* or *substitute*, as the case may be. If the Soldier is a "VETERAN," (or RECRUIT,) the words *as a veteran*, (or *recruit*) as the case may be, should be interlined after the words *mustered into the service of the U. S.* A statement of all the installments of *Veteran* or *Recruit* Bounty RECEIVED by the Soldier must be made on the back of each final statement.



# UNITED STATES COLORED TROOPS ENLISTMENT.

STATE OF

TOWN OF

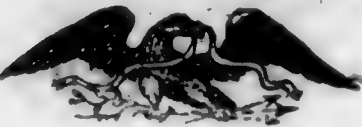
*Kentucky*  *Louisville Ky*

I, *John Hunter* born in *Nelson Co*  
in the State of *Kentucky* aged *Thirty nine* years  
and by occupation a *Labourer* Do HEREBY ACKNOWLEDGE to

have volunteered *30<sup>th</sup>* day of *Aug* 186 *4*

to serve as a **Soldier** in the **Army of the United States of America**, for the period of **THREE YEARS**, unless sooner discharged by proper authority: Do also agree to accept such bounty, pay, rations, and clothing, as are, or may be, established by law for the U. S. colored troops.

And I, *John Hunter*  
do solemnly swear that I will bear true faith and allegiance to the **United States of America**, and that I will serve them honestly and faithfully against all their enemies or opposers whomsoever; and that I will observe and obey the orders of the President of the United States, and the orders of the officers appointed over me, according to the Rules and Articles of War.

Sworn and subscribed to, at *Louisville Ky*

this *30<sup>th</sup>* day of *Aug 1864* *John Hunter*  
Before *Capt C. Hearn* *mark*

I CERTIFY, ON HONOR, that I have carefully examined the above named Volunteer agreeably to the General Regulations of the Army, and that, in my opinion, he is free from all bodily defects and mental infirmity, which would in any way disqualify him from performing the duties of a soldier.

*J. Cummins* *h d*

EXAMINING SURGEON.

I CERTIFY, ON HONOR, That I have minutely inspected the Volunteer, *John Hunter* previously to his enlistment, and that he was entirely sober when enlisted; that, to the best of my judgment and belief, he is of lawful age; and that, in accepting him as duly qualified to perform the duties of an able-bodied soldier, I have strictly observed the regulations which govern the recruiting service. This soldier has *Black* eyes, *Black* hair, *Black* complexion, is *5* feet *8 1/2* inches high.

*Capt C. Hearn* *Capt*  
*12<sup>th</sup> Ky Inf*  
RECRUITING OFFICER OR AGENT.

Mustered into the United States Service *12<sup>th</sup> Ky Inf* DAY OF *Aug* 186 *4*

*Capt*  
Mustering Officer.

Mustered into the service of the United States, for three years or during the war, from date of enlistment, in Company  
Regiment of  
Volunteers, on the  
day of  
186, at



NOTE 1.—This blank will be used for enlistments of United States colored troops. They will be made out in duplicate in all cases—one to accompany the recruiting return of the superintendent (not the recruiting officer) to the Adjutant General, and one to accompany the accounts of the officer who pays bounty, &c.

NOTE 2.—An enlistment holds to service. A muster-in must, in all cases, precede payment of pay, bounty, pension, &c. A muster-in roll, must in all cases, be filed in the Adjutant General's Office as evidence of muster-in. The mustering officer, commissary, or assistant commissary of musters, as the case may be, will countersign both enlistments as having mustered the soldiers into the service of the United States before either of them is given to the disbursing officer.

DECLARATION OF RECRUIT.

I, John Hunter ..... desiring to volunteer as a soldier in the ARMY OF THE UNITED STATES, for the term of Three Years, DO DECLARE That I am 39 years and ..... months of age; that I have never been discharged from the United States service on account of disability or by sentence of a court-martial, or by order before the expiration of a term of enlistment; and I know of no impediment to my serving honestly and faithfully as a soldier for three years.

GIVEN at Louisville Ky the 30<sup>th</sup> day of Aug 1864

Witness: G. W. States

John Hunter

1710 1864

Volunteered at Louisville Ky  
By John Hunter  
1864  
19<sup>th</sup> Aug

No. John Hunter

171

Consent of Parent or Guardian in case of a Minor, if a Free Man, or in the case of a Slave, of the Person to whom he owes Service:

I, ..... Do CERTIFY, That I am the ..... that the said ..... is ..... years of age; and I do freely give my CONSENT to his volunteering as a SOLDIER in the Army of the United States, for the period of THREE YEARS, under the conditions of the laws of the United States.

GIVEN at ..... the ..... day of .....

Witness: .....



Hunter, John

P, Co. C, 5 Reg U.S.C. Cav.

W Enclosures.

Bed Cards	Descriptive Lists
Burial Records	Final Statements
Certs. of Dis. for Discharge	Furloughs
C. M. Charges	Med. Des. Lists
Med. Certificates	Orders
Enlistment paper	

Other papers relating to—

Admission to Hosp'l	Furlough
Casualty Sheet (Officer's)	Med. Examination
Confinement	Misc. Information
Contracts	Pay or Clothing
Death or Effects	Personal Reports
Desertions	Rank
Discharge from Hosp'l	Transfer to Hosp'l
Discharge from Service	Transfer to V. R. C.
Duty	Transportation

*H* | **5 Cav. U.S.C.T.**

*John Hunter*  
-----  
*Put*, Co. *C*, 5 Reg't U. S. Col'd Cavalry.

Appears on **Co. Muster-out Roll**, dated  
*Helena Arto Mich 16*, 1866.

Muster-out to date \_\_\_\_\_, 186 .

Last paid to \_\_\_\_\_, 186 .  
*Pay due from enlistment*

Clothing account:

Last settled \_\_\_\_\_, 186 ; drawn since \$ \_\_\_\_\_ 100

Due soldier \$ \_\_\_\_\_ 100; due U. S. \$ \_\_\_\_\_ 100

Am't for cloth'g in kind or money adv'd \$ \_\_\_\_\_ 100

Due U. S. for arms, equipments, &c., \$ \_\_\_\_\_ 100

Bounty paid \$ \_\_\_\_\_ 100; due \$ \_\_\_\_\_ 100

Remarks: *Killed in Action*  
*Oct 2, 1864, Saltville, Va.*  
*Dec 3, 1864, Final*  
*Statements furnished.*

Book mark: *124.661. V.214. P.12.74.*

*Rose*

| **5 Cav.** | **U.S.C.T.**

*John Hunter*  
*Pvt.*, Co. *C*, 5 Reg't U. S. Colored Cav.

Appears on **Returns** as follows:

*From organization to Oct. 31, 1864*  
*born Oct. 2/64 Saltville,*  
*Va. Killed in fight.*

Book mark : .....

(540)

*J. C. Ballou*

Copyist.



76 | 5 Cav. | U.S.C.T.

*John Hunter*

*Priv*, Co. C, 5 Reg't U. S. Col'd Cavalry.

Appears on

**Company Muster Roll**

for *to Oct. 31*, 186*4*.

Present or absent *Absent*

Stoppage, \$ *100* for

Due Gov't, \$ *100* for

Valuation of horse, \$ *100*

Valuation of horse equipments, \$ *100*

Remarks: *Killed at the Battle of  
Saltville, Va. Oct. 2, 1864*

Book mark:

*Shull*

*H* | **5 Cav. | U.S.C.T.**

*John Hunter*

*Pris*, Co. *C*, 5 Reg't U. S. Col'd Cavalry.

Appears on

**Company Muster-in and Descriptive Roll**

of the organization named above. Roll dated

*Camp Nelson*, *N.Y.*, *Oct. 24*, 1864.

Where born *Nelson, Ky.*

Age *39* y'rs; occupation *Laborer*

When enlisted *Aug. 30*, 1864.

Where enlisted *Louisville*

For what period enlisted *3* years.

Eyes *Dr.*; hair *Dr.*

Complexion *Dr.*; height *5* ft. *8 1/2* in.

When mustered in *Sept. 1*, 1864.

Where mustered in *Louisville*

Bounty paid \$ *100*; due \$ *100*

Where credited *4" Dist. Ky.*

Company to which assigned *C*

Remarks:

-----

-----

-----

-----

Book mark:

-----

*Shull*

14 | 5 bar | U.S.C.T.

John Hunter

Appears with rank of 2nd on

**Muster and Descriptive Roll**

of a Detachment of U.S. Colored Troops transferred to U.S. Colored Cav. at Lexington Ky. Roll dated Louisville Ky. Sept. 2, 1864.

Where born Melrose Ky.

Age 29 years; occupation Laborer

When enlisted Aug. 30, 1864.

Where enlisted Louisville Ky.

For what period enlisted 3 years.

Eyes brn; hair brn

Complexion brn; height 5 ft. 8 1/2 in.

When mustered in Sept. 1, 1864.

Where mustered in Louisville

Bounty paid \$ 100; due \$ 100

Clothing account:  
Last settled \_\_\_\_\_, 186 ; drawn since \$ 17 55/<sub>100</sub>

Date of first muster Sept. 1, 1864.

Company to which assigned \_\_\_\_\_

Remarks: transferred to 4th Regt. Dist. Ky.

Book mark: \_\_\_\_\_

A. J. S. Jones



14 | **5 Cav. | U.S.C.T.**

John C. Gunter  
....., Co. C, 5 Reg't U. S. Col'd Cav.

Appears on  
**Company Descriptive Book**  
of the organization named above.

**DESCRIPTION.**

Age 39 years; height 5 feet 8 2 inches.  
Complexion Dark  
Eyes Dark; hair Dark  
Where born Wilson Co., Ky.  
Occupation Farmer

**ENLISTMENT.**

When Aug. 30, 1864.  
Where Lansville

By whom Capt. F. H. ...; term 3 y'rs.

Remarks: Killed. See receipt

.....  
.....  
.....  
.....  
.....  
.....  
.....  
.....

Hansen

Hunter John

Co E, 5 U. S. Col'd Cav.

Private

Private

CARD NUMBERS.

1	5361691	26
2	5361793	27
3	5362616	28
4	9090231	29
5	43146251	30
6	40729922	31
7		32
8		33
9		34
10		35
11		36
12		37
13		38
14		39
15		40
16		41
17		42
18		43
19		44
20		45
21		46
22		47
23		48
24		49
25		50

Book Mark:

See also

March 16 ✓ Bed 6  
Hospital Number 16007.

Name George Hunter

Age 22 Nativity Ky

~~Married~~ Single

Residence Woodford Co Ky

Post Office address of wife or nearest relative. Aaron Serce Versailles Ky

Rank Priv Co. H Regiment 5th Sear 5th S C Co

When admitted Nov-17<sup>th</sup> 65

From what source Lawrenceville Ky

Diagnosis: (in surgical cases, state explicitly seat and character of wound or injury.)

Haemorrhysis

Jefferson G. H.

On what occasion wounded Jeffersonville, Ind.

Date

Nature of missile or weapon

July 190



TREATMENT.

[HERE NOTE IMPORTANT COMPLICATIONS AND ALL OPERATIONS.]

RESULT AND DATE..

Barracks No 1. Louisville, Ky.  
Decbr. 14. 1865.

# UNITED STATES COLORED TROOPS ENLISTMENT.

STATE OF

TOWN OF

*Kentucky*  
 I, *George Hunter*, born in *Camp Wilson Woodford Co*,  
 in the State of *Kentucky*, aged *Twenty two* years,  
 and by occupation a *Farmer*, Do HEREBY ACKNOWLEDGE to  
 have volunteered *Fifteenth* day of *September*, 1864,  
 to serve as a Soldier in the Army of the United States of America, for the period of  
**THREE YEARS**, unless sooner discharged by proper authority: Do also agree to  
 accept such bounty, pay, rations, and clothing, as are, or may be, established by law for  
 the U. S. colored troops.

And I, *George Hunter*  
 do solemnly swear that I will bear true faith and allegiance to the **United States of  
 America**, and that I will serve them honestly and faithfully against all their enemies  
 or opposers whomsoever; and that I will observe and obey the orders of the President  
 of the United States, and the orders of the officers appointed over me, according to the  
 Rules and Articles of War.

Sworn and subscribed to, at *Camp Wilson*  
 this *15<sup>th</sup>* day of *Sept* 1864,  
 Before *J. C. Randolph* *Geo. Hunter*  
*J. P. M.*

I CERTIFY, ON HONOR, That I have carefully examined the above named Volunteer agreeably to the General Regula-  
 tions of the Army, and that, in my opinion, he is free from all bodily defects and mental infirmity, which would in any  
 way disqualify him from performing the duties of a soldier.

*J. G. Barrett*  
*Asst Surg & Corp* Examining Surgeon.

I CERTIFY, ON HONOR, That I have minutely inspected the Volunteer, *G. Hunter*, previously to  
 his enlistment, and that he was entirely sober when enlisted; that, to the best of my judgment and belief, he is of law-  
 ful age; and that, in accepting him as duly qualified to perform the duties of an able bodied soldier, I have strictly ob-  
 served the regulations which govern the recruiting service. This soldier has *Both* eyes, *Both* hair,  
*Dark* complexion, is *five* feet *six* inches high.

*J. C. Randolph*  
*Recruiting Officer or Agent.*

Mustered into the United State service *15<sup>th</sup>* day of *Sept*, 1864.

*N. O. Timney*  
*Capt 18<sup>th</sup> U.S. I.* Mustering Officer.

Mustered into the service of the United States, for three years or during the war, from date of enlistment, in Company  
 Regiment of *U.S. Colored Cavalry* Volunteers, on the  
*15<sup>th</sup>* day of *September* 1864, at *Camp Wilson Ky*

*N. O. Timney*  
*Capt 18<sup>th</sup> U.S. I.*

*Trusts Officers*



NOTE 1. This blank will be used for enlistments of United States colored troops. They will be made out in duplicate in all cases—one to accompany the recruiting return of the superintendent (not the recruiting officer) to the Adjutant-General, and one to accompany the accounts of the officer who pays bounty, &c.

NOTE 2. An enlistment holds to service. A muster-in must, in all cases, precede payment of pay, bounty, pension, &c. A muster-in roll must in all cases be filed in the Adjutant-General's Office as evidence of muster-in. The mustering officer, commissary, or assistant commissary of musters, as the case may be, will countersign both enlistments as having mustered the soldiers into the service of the United States before either of them is given to the disbursing officer.

### DECLARATION OF RECRUIT.

I, George Hunter, desiring to volunteer as a soldier in the ARMY OF THE UNITED STATES, for the term of Three Years, DO DECLARE that I am 22 years and \_\_\_\_\_ months of age; that I have never been discharged from the United States service on account of disability or by sentence of a court-martial, or by order before the expiration of a term of enlistment; and I know of no impediment to my serving honestly and faithfully as a soldier for three years.

GIVEN at Camp Nelson the 15 day of September 1864

Witness: Leroy Smith

51122  
George Hunter  
1864

George Hunter  
By J. W. Randolph  
or Woodford Co  
C. D. Smith  
Volunteered at Camp Nelson  
Sept 15, 1864  
No. 1154  
Sept 16/64

Consent of Parent or Guardian in case of a Minor, of a Free Man, or in the case of a Slave, of the Person to whom he owes Service:

I, \_\_\_\_\_ Do CERTIFY, That I am the \_\_\_\_\_ that the said \_\_\_\_\_ is \_\_\_\_\_ years of age; and I do freely give my CONSENT to his volunteering as a SOLDIER in the Army of the United States, for the period of THREE YEARS, under the conditions of the laws of the United States.

GIVEN at \_\_\_\_\_ the \_\_\_\_\_ day of \_\_\_\_\_

Witness: \_\_\_\_\_



Hunter, George  
I, Co. H, 5 Reg't 1st Caval

2 Enclosures.

Bed Cards /  
Burial Records  
Certs. of Dis. for Discharge  
C. M. Charges  
Med. Certificates

Descriptive Lists  
Final Statements  
Furloughs  
Med. Des. Lists  
Orders

*E.P. 1*

Other papers relating to—

Admission to Hosp'l  
Casualty Sheet (Officer's)  
Confinement  
Contracts  
Death or Effects  
Desertions  
Discharge from Hosp'l  
Discharge from Service  
Duty

Furlough  
Med. Examination  
Misc. Information  
Pay or Clothing  
Personal Reports  
Rank  
Transfer to Hosp'l  
Transfer to V. R. C.  
Transportation

*A* | **5 Cav.** | **U.S.C.T.**

*George Hunter*  
*Pat*, Co. *A*, 5 Reg't U. S. Col'd Cavalry.

Appears on **Co. Muster-out Roll**, dated  
*Helena, Ark March 16*, 1866.

Muster-out to date *Mar. 16*, 1866.

Last paid to *Dec 31*, 1865.

**Clothing account:**

Last settled....., 186 ; drawn since \$..... 100

Due soldier \$ *74*<sup>*66*</sup>/<sub>100</sub>; due U. S. \$..... 100

Am't for cloth'g in kind or money adv'd \$..... 100

Due U. S. for arms, equipments, &c., \$..... <sup>*55*</sup>/<sub>100</sub>

Bounty paid \$ *100*/<sub>100</sub>; due \$ *100*/<sub>100</sub>

Remarks: *Stop for Orduce. 55c*

Book mark : .....

(861)

*J. M. Stewart*  
Copyist.

| **5 Cav.** | **U.S.C.T.**

*George Hunter*

*Pvt.*, Co. *H*, 5 Reg't U. S. Colored Cav.

Appears on **Returns** as follows:

*Oct to Dec 1864. Absent on de-*  
*tached service, Point Burn-*  
*side since Oct. 3/64*

*July to Nov 1865. Absent sick on*  
*Gen. Mospitt's Covington Regt,*  
*since July 5/65.*

Book mark : \_\_\_\_\_

(546)

*J. L. Ballou*

Copyist.



*A* | **5 Cav.** | **U.S.C.T.**

*George Hunter*  
*Pat*, Co. H, 5 Reg't U. S. Col'd Cavalry.

Appears on

**Company Muster Roll**  
for *Jany. 1 Feby*, 186*6*.  
Present or absent *Present*

Stoppage, \$.....100 for .....

Due Gov't, \$.....100 for .....

Valuation of horse, \$.....100

Valuation of horse equipments, \$.....100

Remarks:.....

Book mark:.....

(358)

*J. A. Stewart*  
Copyist.

*76* **5 Cav. U.S.C.T.**  
*George Hunter*  
*Cvt*, Co. H, 5 Reg't U. S. Col'd Cavalry.

Appears on

**Company Muster Roll**  
for *Nov. & Dec.*, 186*5*.

Present or absent *Present*

Stoppage, \$ *100* for

Due Gov't, \$ *100* for

Valuation of horse, \$ *100*

Valuation of horse equipments, \$ *100*

Remarks: *First Installment  
Bounty Due \$100.*

Book mark:

*B. J. Cooke*  
Copyist.

76 | 5 Cav. | U.S.C.T.

George Hunter  
Pr., Co. H, 5 Reg't U. S. Col'd Cavalry.

Appears on

**Company Muster Roll**

for Sept. & Oct., 1865.

Present or absent Absent.

Stoppage, \$ 100 for

Due Gov't, \$ 100 for

Valuation of horse, \$ 100

Valuation of horse equipments, \$ 100

Remarks: Sick in Genl Hosp  
Covington, Ky since  
July 6<sup>th</sup> 1865.

Book mark:

(358)

B J Cooke  
Copyist.



A. 1 5 Cav U.S.C.

George Hunter  
Pvt., Co. H, 5 Reg't U.S.C. Cav.

Appears on

**Hospital Muster Roll**

of U. S. A. Post Hospital,

at Covington, Ky.,

for Sept Oct, 1865.

Attached to hospital :

When July 5, 1865.

How employed Patient

Last paid by Maj. \_\_\_\_\_

to \_\_\_\_\_, 1865.

Bounty paid \$ 100; due \$ 100

Present or absent Present

Remarks: \_\_\_\_\_

Book mark: \_\_\_\_\_

Ransom  
Copyist.

76 | 5 Cav. | U.S.C.T.

George Hunter  
Priv., Co. H, 5 Reg't U. S. Col'd Cavalry.

Appears on

Company Muster Roll

for July & Aug., 1865.

Present or absent Absent.

Stoppage, \$ 100 for

Due Gov't, \$ 100 for

Valuation of horse, \$ 100

Valuation of horse equipments, \$ 100

Remarks: Sick in Hospital  
Corvinton July 5" 1865.

Book mark:

(358)

B. J. Cooke

Copyist.

76 | 5 Cav. | U.S.C.T.

*George Hunter*  
Co. H, 5 Reg't U. S. Col'd Cavalry.

Appears on

**Company Muster Roll**

for *May & June*, 1865.

Present or absent *Present.*

Stoppage, \$ 100 for

Due Gov't, \$ 100 for

Valuation of horse, \$ 100

Valuation of horse equipments, \$ 100

Remarks: *1<sup>st</sup> Installment Bounty due \$100.*

Book mark: \_\_\_\_\_

(358)

*B. J. Cook*

Copyist.



H | **5 Cav.** | **U.S.C.T.**

George Hunter  
Privt., Co. H, 5 Reg't U. S. Col'd Cavalry.

Appears on

**Company Muster Roll**

for Mar & Apr, 1865.

Present or absent present

Stoppage, \$ 100 for

Due Gov't, \$ 100 for

Valuation of horse, \$ 100

Valuation of horse equipments, \$ 100

Remarks: 1<sup>st</sup> installment of  
Bounty Due \$100

Book mark: \_\_\_\_\_

(358)

Reynolds

Copyist.

H | **5 Cav.** | **U.S.C.T.**

George Hunter  
Put, Co. H, 5 Reg't U. S. Col'd Cavalry.

Appears on

**Company Muster Roll**

for Jan & Feby, 1865.

Present or absent present

Stoppage, \$.....100 for .....

Due Gov't, \$.....100 for .....

Valuation of horse, \$.....100

Valuation of horse equipments, \$.....100

Remarks: 1<sup>st</sup> Installment of  
Bounty Due \$100.00

Book mark: .....

(358)

Reynolds

Copyist.

71 | **5 Cav.** | **U.S.C.T.**

George Hunter

Pat, Co. H, 5 Reg't U. S. Col'd Cavalry.

Appears on

**Company Muster Roll**

for Nov & Dec, 1864.

Present or absent Absent

Stoppage, \$ 100 for

Due Gov't, \$ 100 for

Valuation of horse, \$ 100

Valuation of horse equipments, \$ 100

Remarks: 1<sup>st</sup> and 2<sup>d</sup> Installments  
Bounty due. On  
Detached service  
Point Burnside  
since Oct 3"

Book mark: \_\_\_\_\_

(358)

Reynolds

Copyist.



*H* | **5 Cav.** | **U.S.C.T.**

*George Hunter*  
*Pot*, Co. H, 5 Reg't U. S. Col'd Cavalry.

Appears on

**Company Muster Roll**

for *from enlistment to Oct 31, 1864.*

Present or absent *Absent*

Stoppage, \$ *100* for

Due Gov't, \$ *100* for

Valuation of horse, \$ *100*

Valuation of horse equipments, \$ *100*

Remarks: *Detcht Service*  
*Burnside Point*  
*Oct 3 1864*

Book mark:

*Reynolds*

*H* | **5 Cav.** | **U.S.C.T.**

*George Hunter*

*Pvt*, Co *H*, 5 Reg't U. S. Col'd Cavalry.

Appears on

**Company Muster-in and Descriptive Roll**

of the organization named above. Roll dated

*Camp Nelson, Ky*, *Oct 29*, 1864.

Where born *Woodford Ky*

Age *22* y'rs; occupation *Farmer*

When enlisted *Sept 15*, 1864.

Where enlisted *Camp Nelson Ky*

For what period enlisted *3* years.

Eyes *Black*; hair *Black*

Complexion *Black*; height *5 ft. 6 in.*

When mustered in *Sept 15*, 1864.

Where mustered in *Camp Nelson Ky*

Bounty paid \$ *100*; due \$ *100*

Where credited

Company to which assigned

Remarks: *7th Dist Ky*

\* *C. O. Smith*

\* *Supposed to be name of owner.*

*Adena May 17. 1878. H. J.*

Book mark:

*Reynolds*

76 | **5 Cav.** | **U.S.C.T.**

George Hunter

Co. 76, 5 Reg't U. S. Col'd Cav.

Appears on

**Company Descriptive Book**  
of the organization named above.

**DESCRIPTION.**

Age 22 years; height 5 feet 6 inches.

Complexion Rose

Eyes Rose; hair Rose

Where born Stratford, Ky

Occupation Farmer

**ENLISTMENT.**

When Sept 15, 1864.

Where Camp Nelson

By whom J. Anderson; term 3 y'rs.

Remarks:  
-----  
-----  
-----  
-----  
-----  
-----  
-----  
-----  
-----  
-----

J. Anderson



*H* 5 Cav | **U. S. C. T.**

*George Hunter*

*H* 5 Reg't U. S. Col'd Cav

Appears on

**Company Descriptive Book**

of the organization named above.

**DESCRIPTION.**

Age *27* years; height *5* feet *6* inches.

Complexion *Black*

Eyes *Blk*; hair *Blk*

Where born *Woodford Ky*

Occupation *farmer*

**ENLISTMENT.**

When *Sep 15*, 186 *7*.

Where *Camp Nelson Ky*

By whom *H. Randolph*; term *3* yrs.

Remarks: .....

.....  
.....  
.....  
.....  
.....  
.....  
.....  
.....  
.....  
.....

*A. E. Parks*

Hunter George

Co H, 5 U. S. Col'd Cav.

Private

Private

CARD NUMBERS.

1	5366804	26
2	5366897	27
3	5366997	28
4	5367088	29
5	5367178	30
6	5367274	31
7	5367365	32
8	5367454	33
9	5367542	34
10	5367634	35
11	5367714	36
12	9090788	37
13	9090882	38
14	31415330	39
15	40729921	40
16		41
17		42
18		43
19		44
20		45
21		46
22		47
23		48
24		49
25		50

Book Mark:

See also

Adjutant General's Office,

COLORED TROOPS BRANCH,

Jan'y 21, 1871

Vol. C. T., 187

Wanted in case of *Qued Hunter* Pvt., Co. *A*,  
5 Reg't *U. S. C. Cav.* information relative  
to cause of death. *M. R. & W. Jan & July 1865*  
*reports him "killed in Hospital Covington Ky,*  
*Jan'y 24 - 1865. x x x"*

Respectfully,

*H. A. Woodward*  
Chief Clerk.

*J. J. Dalton*

Adjutant General's Office,

Record Room

Jan'y 25, 1871

Vol. C. T., 187

Reply in case of *Qued Hunter*, Co. *D*,  
5 Reg't *U. S. C. Cav.*  
Reg't. Description book and Co. Description book show

*Dead in Genl. Hospital (Covington) Jan'y 24 '65 -*  
*(Cause of death not given)*  
*Final Statements forwarded to A.G.O.*  
*Co. Mg. Rep. book does not cover case.*

*K.C.F.*

*M.F.*



Creed Hunter  
Co. "K"

---

I certify, on honor, that Creed Hunter, Private of  
 Captain N. P. Wades Company (D) of the 3<sup>rd</sup> Regiment of W. C. Cav  
**VOLUNTEERS**, of the State of \_\_\_\_\_, born in Adair, State  
 of Kentucky, aged 26 years; 5 feet 10 inches high; Black complexion,  
Black eyes, Black hair, and by occupation a Laborer, having joined the company on  
 its original organization at Selawon Ky, and enrolled in it at the muster into  
 the service of the United States at Selawon Ky, on the 27<sup>th</sup> day  
 of August, 1864, (or was mustered in service as a recruit, by \_\_\_\_\_  
 \_\_\_\_\_, at \_\_\_\_\_, on the \_\_\_\_\_ day of \_\_\_\_\_,  
 186 , or was drafted and mustered into the service of the United States from the \_\_\_\_\_  
 Enrollment District of the State of \_\_\_\_\_, at \_\_\_\_\_,  
 on the \_\_\_\_\_ day of \_\_\_\_\_, 186 ;) to serve in the Regiment, for  
 the term of Three Years; and having served **HONESTLY** and  
**FAITHFULLY** with his Company in The Field, to the present date, is now  
 entitled to a **DISCHARGE** by reason of \_\_\_\_\_

The said Private Creed Hunter was last paid by Paymaster  
Pay due from \_\_\_\_\_ to include the \_\_\_\_\_ day of Aug 15, 1864, and has  
 pay due him from that time to the present date; he is entitled to pay and subsistence for  
**TRAVELING** to place of enrollment, and whatever other allowances are authorized to volunteer  
 soldiers, drafted men, or militia, so discharged. He has received from the United States **CLOTHING**  
 amounting to Sixty nine  $\frac{85}{100}$  dollars, since the \_\_\_\_\_ day of enlistment,  
 186 , when his clothing account was last settled. He has received from the United States  
 \_\_\_\_\_  $\frac{100}{100}$  dollars advanced **BOUNTY**. \$300.00 Bounty due

There is to be stopped from him, on account of the State of \_\_\_\_\_, or other  
 authorities, for **CLOTHING**, &c., received on entering service, \_\_\_\_\_  $\frac{100}{100}$  dollars; and  
 for other stoppages, viz: \_\_\_\_\_

\_\_\_\_\_  $\frac{100}{100}$  dollars.  
 He has been furnished with **TRANSPORTATION** in kind from the place of his discharge to  
 \_\_\_\_\_; and he has been **SUBSISTED** for **TRAVELING** to his  
 place of enrollment, up to the \_\_\_\_\_, 186 .

He is indebted to \_\_\_\_\_, **SUTLER**, \_\_\_\_\_  $\frac{100}{100}$  dollars.  
 He is indebted to \_\_\_\_\_, **LAUNDRESS**, \_\_\_\_\_  $\frac{100}{100}$  dollars.

Given in Duplicate, at Demopolis Ky, this 16 day  
 of May, 1865.

David G. Gordon  
1<sup>st</sup> Lieut 5<sup>th</sup> W. C. Cav  
 Commanding Company. D



425  
A. G. O. June 17, 1865  
Pro. of C of acc. + 2 m. acc.  
for \$11.25. sent 2d Auditor

FINAL STATEMENT

60 29  
OF

Priv. Creed Hunter

5<sup>th</sup> Reg't of U. S. Cavalry

VOLUNTEERS.

Disch. June 20, 1865.

NOTE 1.—Two of these certificates (or duplicates) are to be given to each Volunteer Soldier or drafted man who may be discharged previously to the discharge of his company, that he may at once receive from the Paymaster the pay, &c., due him, and the captain or other COMMISSIONED officer commanding the company will certify to the act of the delivery of the duplicate certificates; on these certificates the Soldier is "entitled to" his discharge, and should also present his discharge to the Paymaster to have the payment endorsed on it. The discharge is to be given back to the Soldier by the Paymaster; the latter only retaining as his voucher the duplicate certificates.

NOTE 2.—If the Soldier is entitled to pay for the use of his horse, the Company Commander will certify to that fact on the back of both these final statements, and also to the time he has pay due for having been so mounted on his own horse.

NOTE 3.—When a Soldier is furnished with final statements, his descriptive list, if he has one, should be taken up by the officer who gives the Soldier these statements, and endorsed with a statement to this effect by the officer. This endorsement should exhibit a full statement of the time for which the Soldier was allowed pay on his final statements, the clothing account, and all other charges against him or in his favor, so as to comprise a complete exhibit of his account. It will then be transmitted to the company commander of the Soldier, who will enter all the data necessary to a full understanding of the Soldier's account on the muster roll upon which the Soldier's discharge is reported. The descriptive list will then be destroyed. The object of this is, that the remaining portion of the Soldier's account may be settled upon the receipt of these muster rolls, and the Soldier receive any pay or allowances that may be due him at the time of his discharge, and which may not appear on his final statements from the fact that his descriptive list is incomplete. These accounts for back pay, &c., are settled by the 2d Auditor of the Treasury Department.

NOTE 4.—Charges for loss or injury to ordnance, horse equipments, and other miscellaneous charges, should appear under the heading of "Other Stoppage."

NOTE 5.—Bounty paid by State authorities, and not by the United States, will not be entered on this statement.

NOTE 6.—Amounts due the Sutler and Laundress must be entered on the muster roll on which the discharge, death, desertion, &c., is reported, as well as on the final statement, otherwise the amount cannot be collected from the United States.

NOTE 7.—This blank will be used for deceased volunteers and drafted men, as well as for others.

NOTE 8.—Where a Soldier dies in Hospital or on detached service, his descriptive list, if he has one, should be sent with his final statements, in duplicate, to the Adjutant General, Washington, D. C.

ADJUTANT GENERAL'S OFFICE.

May 20<sup>th</sup> 1865.

Duplicate with Inventory sent 2d Auditor.



*Hunter, Creed*

*P*, Co. *D*, **5** Reg. **U.S.C. Cav.**

**2** Enclosures.

Bed Cards	Descriptive Lists
Burial Records	Final Statements /
Certs. of Dis. for Discharge	Furloughs
C. M. Charges	Med. Des. Lists
Med. Certificates	Orders

Other papers relating to—

Admission to Hosp'l	Furlough
Casualty Sheet (Officer's)	Med. Examination
Confinement	Misc. Information /
Contracts	Pay or Clothing
Death or Effects	Personal Reports
Desertions	Rank
Discharge from Hosp'l	Transfer to Hosp'l
Discharge from Service	Transfer to V. R. C.
Duty	Transportation

*N.* | **5 Cav.** | **U.S.C.T.**

*Creed Hunter*  
*Priv.*, Co *D*, 5 Reg't U. S. Col'd Cavalry.

Appears on **Co. Muster-out Roll**, dated

*Helena, Ark., March 16,* 1866 .

Muster-out to date \_\_\_\_\_, 186 .

Last paid to *Enlistment*, 186 .

Clothing account:

Last settled \_\_\_\_\_, 186 ; drawn since \$ \_\_\_\_\_ 100

Due soldier \$ \_\_\_\_\_ 100; due U. S. \$ \_\_\_\_\_ 100

Am't for cloth'g in kind or money adv'd \$ \_\_\_\_\_ 100

Due U. S. for arms, equipments, &c., \$ \_\_\_\_\_ 100

Bounty paid \$ \_\_\_\_\_ 100; due \$ *100<sup>00</sup>* 100

Remarks: *Died at Covington, Ky.,*  
*Jan'y 24/65.*

*Final statements forwarded*  
*Mar 31, 1865*

Book mark: *21642<sup>2</sup> and Jan 21/67 Rf.*  
*P.V. 87. 64.69.*

(861)

*M. Grauer*

Copyist.

2 | **5 Cav.** | **U.S.C.T.**

*Creed Hunter*

*Pt.*, Co. *D*, 5 Reg't U. S. Colored Cav.

Appears on **Returns** as follows:

*Jan 1865 Absent sick in Hospital  
Covington, Ky*

*Feb 1865. Arr: Jan 24/65. Cov-  
ington, Died in Gen Hospital.  
Notification not rec'd till  
Feb*

Book mark :

(546)

*J. C. Ballou*

Copyist.



26 | 5 Cav. | U.S.C.T.

*Breed Hunter*

*Rob.*, Co. D, 5 Reg't U. S. Col'd Cavalry.

Appears on

**Company Muster Roll**

for *Jan. & Feb.*, 1865.

Present or absent

Stoppage, \$ 100 for

Due Gov't, \$ 100 for

Valuation of horse, \$ 100

Valuation of horse equipments, \$ 100

Remarks: *Died in Hospital  
Garrison, Ky Jan. 24,  
'65. First installment  
of Bounty due \$100.*

Book mark: *2164. 3<sup>d</sup> bid. Jan. 10, '67.*

*Wm. Scott*

26 | **5 Cav.** | **U.S.C.T.**

Breed Hunter

Priv., Co. D, 5 Reg't U. S. Col'd Cavalry.

Appears on

**Company Muster Roll**

for Nov & Dec, 1864.

Present or absent Present

Stoppage, \$ 100 for

Due Gov't, \$ 100 for

Valuation of horse, \$ 100

Valuation of horse equipments, \$ 100

Remarks: 1" & 2" installments  
of Bounty due.

Book mark: \_\_\_\_\_

Wm. H. Scott

*96* | **5 Cav.** | **U.S.C.T.**

*Breed Hunter*

*Robt.*, Co. D, 5 Reg't U. S. Col'd Cavalry.

Appears on

**Company Muster Roll**

for *Dated Oct. 31*, 1864.

Present or absent *Present.*

Stoppage, \$ *100* for

Due Gov't, \$ *100* for

Valuation of horse, \$ *100*

Valuation of horse equipments, \$ *100*

Remarks:

Book mark:

*Wm. H. Scott*



14 | 5 bar | U.S.C.T.

Greene Hunter

Appears with rank of Pvt on

**Muster and Descriptive Roll**

of a Detachment of U.S. Colored  
Troops formed for U.S. Col  
serv. at Lexington, Ky. Roll dated  
Trinidad, Ky., Sept. 7, 1864.

Where born Adair, Ky.

Age 26 years; occupation Farmer

When enlisted Aug. 15, 1864.

Where enlisted Lebanon, Ky.

For what period enlisted 3 years.

Eyes Blue; hair Black

Complexion Black; height 5 ft. 10 in.

When mustered in Aug. 27, 1864.

Where mustered in Lebanon

Bounty paid \$ 100; due \$ 100

Clothing account:  
Last settled \_\_\_\_\_, 1864; drawn since \$ 17 50/100

Date of first muster Aug. 27, 1864.

Company to which assigned \_\_\_\_\_

Remarks: transferred to Henry Fine  
Ky.

Book mark: \_\_\_\_\_

(356m) B. J. D. D. D. D. Copyist.

A | 5 bar | US 67

Leveed Hunter

Appears with rank of \_\_\_\_\_ on \_\_\_\_\_

**Muster and Descriptive Roll**

of Detachment of U.S. Colored  
Volunteer Recruits for -  
warded \_\_\_\_\_

Roll dated  
Lebanon Ky Aug 31, 1864

Where born Adair Ky

Age 26 years; occupation farmer

When enlisted Aug 15, 1864

Where enlisted Lebanon Ky

For what period enlisted 3 years.

Eyes Blk; hair Blk

Complexion Blk; height 5 ft. 10 in.

When mustered in Aug 15, 1864

Where mustered in Lebanon Ky

Bounty paid \$ 100; due \$ 100

**Clothing account:**

Last settled \_\_\_\_\_, 1864; drawn since \$ 17.50/100

Date of first muster Aug 27, 1864

Company to which assigned \_\_\_\_\_

Remarks: Ben Hunter, owner,  
Adair Co.

Without consent  
4 Long list Ky

Book mark: \_\_\_\_\_

(356m)

U. D. Harrison Copyist.

16 | **5 Cav.** | **U.S.C.T.**

Great Hunter

....., Co. 10, 5 Reg't U. S. Col'd Cav.

Appears on

**Company Descriptive Book**  
of the organization named above.

**DESCRIPTION.**

Age 26 years; height 5 feet 10 inches.

Complexion Black

Eyes Blk; hair Blk

Where born Adair Ky.

Occupation Sabanner

**ENLISTMENT.**

When Aug 15, 1864.

Where Lebanon

By whom Capt. Fidler, term 3 y'rs.

Remarks: Killed in Genl.  
Hospital Covington  
Kent, Jan, 24 "1865  
final statements  
forwarded to A.G.S.  
May 17 "1865, Feb.  
20 "

J. E. Parks



26 | 5 Cav. | U.S.C.T.

Creed Hunter

Pvt., Co. H, 5 Reg't U. S. Col'd Cavalry.

Appears on

**Company Muster-in and Descriptive Roll**

of the organization named above. Roll dated

Camp Nelson, N. Y., Oct. 24, 1864.

Where born Adams, Ky

Age 26 y'rs; occupation Farmer

When enlisted Aug. 15, 1864.

Where enlisted Lebanon

For what period enlisted 3 years.

Eyes Br; hair Br

Complexion Br; height 5 ft. 10 in.

When mustered in Aug 24, 1864.

Where mustered in Lebanon

Bounty paid \$ 100; due \$ 100

Where credited 4 Dist Ky

Company to which assigned

Remarks:

Book mark:

Wm H Scott

29. 201. 6-3-31  
22.

J. H. McFall

666

Hunter Creed

Co D, 5 U. S. Col'd Cav.

Private | Private

CARD NUMBERS.

1	5362682	26
2	5362782	27
3	5362883	28
4	5363018	29
5	5363638	30
6	9090311	31
7	43145820	32
8	43146485	33
9	40729920	34
10		35
11		36
12		37
13		38
14		39
15		40
16		41
17		42
18		43
19		44
20		45
21		46
22		47
23		48
24		49
25		50

Book Mark:

See also



# UNITED STATES COLORED TROOPS ENLISTMENT.

STATE OF *Kentucky*  TOWN OF *Adair*  
 I, *Charles Hunter* born in *Adair*  
 in the State of *Kentucky* aged *18* years  
 and by occupation a *farmer* Do HEREBY ACKNOWLEDGE to  
 have volunteered *15<sup>th</sup>* day of *August* 186*4*  
 to serve as a **Soldier** in the **Army of the United States of America**, for the  
 period of **THREE YEARS**, unless sooner discharged by proper authority: Do  
 also agree to accept such bounty, pay, rations, and clothing, as are, or may be,  
 established by law for the U. S. colored troops.

And I, *Charles Hunter*  
 do solemnly swear that I will bear true faith and allegiance to the **United States  
 of America**, and that I will serve them honestly and faithfully against all their  
 enemies or opposers whomsoever: and that I will observe and obey the orders  
 of the President of the United States, and the orders of the officers appointed  
 over me, according to the Rules and Articles of War.

Sworn and subscribed to, at *Lebanon Ky*  
 this *15<sup>th</sup>* day of *August 1864* *Charles Hunter*  
 Before *Wm. H. Hule* *his mark*  
*Capt A Provo Mar 4<sup>th</sup> Dist Ky*

I CERTIFY, ON HONOR, That I have carefully examined the above named Volunteer agree-  
 ably to the General Regulations of the Army, and that, in my opinion, he is free from all bodily  
 defects and mental infirmity, which would in any way disqualify him from performing the  
 duties of a soldier.

*John C. Maxwell*

EXAMINING SURGEON.

I CERTIFY, ON HONOR, That I have minutely inspected the Volunteer,.....  
 previously to his enlistment, and that he was entirely sober when enlisted; that, to the best of  
 my judgment and belief, he is of lawful age; and that, in accepting him as duly qualified to per-  
 form the duties of an able-bodied soldier, I have strictly observed the regulations which govern  
 the recruiting service. This soldier has *17<sup>2</sup>* eyes, *Black* hair, *Cape* com-  
 plexion, is *6* feet *1* inches high.

*Wm. Hule*  
*Capt A Provo Mar 4<sup>th</sup> Dist Ky* RECRUITING OFFICER OR AGENT.

Mustered into the United States Service... *27<sup>th</sup>* day of *August* 186*4*

*Wm. Hule*  
*Capt A Provo Mar 4<sup>th</sup> Dist Ky* Mustering Officer

Mustered into the service of the United States, for three years or during the war, from date of enlistment, in Company .....  
 Regiment of ..... Volunteers, on the ..... day of ..... 186, at .....



RE 1.—This blank will be used for enlistments of United States colored troops. They will be made out in duplicate in all cases—one to accompany the recruiting  
 in of the superintendent (not the recruiting officer) to the Adjutant General, and one to accompany the accounts of the officer who pays bounty, &c.  
 RE 2.—An enlistment holds to service. A muster-in must, in all cases, precede payment of pay, bounty, pension, &c. A muster-in roll, must in all cases, be filed in  
 Adjutant General's Office as evidence of muster-in. The mustering officer, commissary, or assistant commissary of musters, as the case may be, will countersign both  
 musters as having mustered the soldiers into the service of the United States before either of them is given to the disbursing officer.

DECLARATION OF RECRUIT.

I, Charles Hunter desiring  
 to volunteer as a soldier in the ARMY OF THE UNITED STATES, for the term of Three Years,  
 DO DECLARE That I am 18 years and        months of age; that I have  
 never been discharged from the United States service on account of disability or by sentence of a  
 court-martial, or by order before the expiration of a term of enlistment; and I know of no  
 impediment to my serving honestly and faithfully as a soldier for three years.

GIVEN at Seaboard Ky  
 the 15<sup>th</sup> day of August 1864

Witness: Ed Dell

Slave  
 Muster Name  
Joe Hunter

enlisted without consent.

Chas<sup>l</sup> Hunter  
 mark  
Am Shuler  
Charles Hunter  
 Volunteered at Seaboard Ky  
August 15. 1864  
 No.        of              

Consent of Parent or Guardian in case of a Minor, if a Free Man, or in the case of  
 a Slave, of the Person to whom he owes Service:

I,        Do CERTIFY, That I am  
 the         
 that the said        is        years of age; and I  
 do freely give my CONSENT to his volunteering as a SOLDIER in the Army of the United States,  
 for the period of THREE YEARS, under the conditions of the laws of the United States.

GIVEN at         
 the        day of       

Witness:

153

*Hunter* *Charles*  
 \_\_\_\_\_, Co. \_\_\_\_\_, Reg't *U.S.*

**Enclosures.**

Bed Cards .....	Final Statements .....
Burial Records .....	Furloughs or L. of A. ....
Certs. of Dis. for Discharge .....	Med. Certificates .....
C. M. Charges .....	Med. Des. Lists .....
Descriptive Lists .....	Orders .....
Discharge Certificates .....	Pris. of War Record .....
Enlistment Papers .....	Resignations .....

Other papers relating to—

Admission to Hosp'l .....	Furlough or L. of A. ....
Casualty Sheet .....	Med. Examination .....
Confinement .....	Misc. Information .....
Contracts .....	Pay or Clothing .....
Death or Effects .....	Personal Reports .....
Desertion .....	Rank .....
Discharge from Hosp'l .....	Transfer to Hosp'l .....
Discharge from Service .....	Transfer to V. R. C. ....
Duty .....	Transportation .....



*N.* | **5 Cav.** | **U.S.C.T.**

*Charles Hunter,*

*Priv.*, Co. *D.*, 5 Reg't U. S. Col'd Cavalry.

Appears on **Co. Muster-out Roll**, dated

*Helena, Ark., March 16,* 186*6.*

Muster-out to date *March 16,* 186*6.*

Last paid to *Dec. 31,* 186*5.*

Clothing account:

Last settled....., 186 ; drawn since \$.....  $\frac{100}{100}$

Due soldier \$.....  $\frac{100}{100}$ ; due U. S. \$ *30.*  $\frac{46}{100}$

Am't for cloth'g in kind or money adv'd \$.....  $\frac{100}{100}$

Due U. S. for arms, equipments, &c., \$.....  $\frac{100}{100}$

Bounty paid \$ *100.*  $\frac{00}{100}$ ; due \$ *100.*  $\frac{00}{100}$

Remarks:.....

Book mark :.....

*R. E. Spangler*

76 | **5 Cav.** | **U.S.C.T.**

*Charles Hunter*

*Private*, Co. *D*, 5 Reg't U. S. Colored Cav.

Appears on **Returns** as follows:

*Oct. 1864 to Jan 1865. Absent  
sick in Hospital Camp  
Vicksburg, Ky. date not known.*

Book mark : .....

(546)

*J. C. Ballou*

Copyist.

*D.* | **5 Cav.** | **U.S.C.T.**

*Charles Hunter,*

*Siv.*, Co. D, 5 Reg't U. S. Col'd Cavalry.

Appears on

**Company Muster Roll**

for *Jan'y<sup>4<sup>th</sup></sup> Feb'y*, 186*e*.

Present or absent *Present.*

Stoppage, \$ *100* for

Due Gov't, \$ *100* for

Valuation of horse, \$ *100*

Valuation of horse equipments, \$ *100*

Remarks: *2<sup>d</sup> Installment Bounty  
due \$ 100.00.*

Book mark:

*M. Grauer*



*H* | **5 Cav.** | **U.S.C.T.**

*Charles Hunter*

*Priv.*, Co. D, 5 Reg't U. S. Col'd Cavalry.

Appears on

**Company Muster Roll**

for *Nov & Dec.*, 1865.

Present or absent *present*

Stoppage, \$ *100* for

Due Gov't, \$ *100* for

Valuation of horse, \$ *100*

Valuation of horse equipments, \$ *100*

Remarks: *Due U. S. for ordnance  
\$0.30.*

Book mark:

*Milliken*

*He* | **5 Cav.** | **U.S.C.T.**

*Charles Hunter*

*Priv.*, Co. D, 5 Reg't U. S. Col'd Cavalry.

Appears on

**Company Muster Roll**

for *Sept. & Oct.*, 186*5*.

Present or absent *present*

Stoppage, \$ *100* for

Due Gov't, \$ *100* for

Valuation of horse, \$ *100*

Valuation of horse equipments, \$ *100*

Remarks: *Due U.S. for Camp  
& Garrison #620.*

Book mark: \_\_\_\_\_

*W. Miller*

*He* | **5 Cav.** | **U.S.C.T.**

*Charles Hunter*  
*Prior*, Co. D, 5 Reg't U. S. Col'd Cavalry.

Appears on

**Company Muster Roll**

for *July + Aug.*, 1865.

Present or absent *present.*

Stoppage, \$ 100 for

Due Gov't, \$ 100 for

Valuation of horse, \$ 100

Valuation of horse equipments, \$ 100

Remarks:

-----  
-----  
-----  
-----  
-----  
-----

Book mark: -----

*Milliken*



*H* | **5 Cav.** | **U.S.C.T.**

*Charles Hunter*  
*Priv.*, Co. D, 5 Reg't U. S. Col'd Cavalry.

Appears on

**Company Muster Roll**

for *May + June*, 1865.

Present or absent *Present*

Stoppage, \$ *100* for

Due Gov't, \$ *100* for

Valuation of horse, \$ *100*

Valuation of horse equipments, \$ *100*

Remarks: *1st Instalmt Bountly due*

Book mark:

(358)

*Williker*

Copyist.

96 | 5 Cav. | U.S.C.T.

Charles Hunter

Pol., Co. D, 5 Reg't U. S. Col'd Cavalry.

Appears on

**Company Muster Roll**

for *March & April*, 1865.

Present or absent *Present*

Stoppage, \$ *100* for

Due Gov't, \$ *100* for

Valuation of horse, \$ *100*

Valuation of horse equipments, \$ *100*

Remarks: *1st installment of  
Bounty due \$100.  
Stoppage. One Joslyn  
carbine lost carelessly.*

Book mark:

*Wm. B. Scott*

(358)

Copyist.

26 | 5 Cav. | U.S.C.T.

Charles Hunter

Pvt., Co. D, 5 Reg't U. S. Col'd Cavalry.

Appears on

**Company Muster Roll**

for Jan. & Feb., 1865.

Present or absent Present.

Stoppage, \$ 100 for

Due Gov't, \$ 100 for

Valuation of horse, \$ 100

Valuation of horse equipments, \$ 100

Remarks: 1<sup>st</sup> installment of  
Bounty due \$100

Book mark:

Wm. B. Scott



26 | 5 Cav. | U.S.C.T.

Charles Hunter

Pl., Co. D, 5 Reg't U. S. Col'd Cavalry.

Appears on

**Company Muster Roll**

for Nov. & Dec., 1864.

Present or absent Absent.

Stoppage, \$ 100 for

Due Gov't, \$ 100 for

Valuation of horse, \$ 100

Valuation of horse equipments, \$ 100

Remarks: Sick in Hospital,  
Camp Nelson, Ky. 1864  
installments of Bounty due.

Book mark:

Wm. B. Scott

*96* | **5 Cav.** | **U.S.C.T.**

*Charles Hunter*

*Pvt.*, Co. D, 5 Reg't U. S. Col'd Cavalry.

Appears on

**Company Muster Roll**

for *Dated Oct. 31*, 186 *4*.

Present or absent *Absent*

Stoppage, \$ *100* for

Due Gov't, \$ *100* for

Valuation of horse, \$ *100*

Valuation of horse equipments, \$ *100*

Remarks: *Sick in Hospital,  
Camp Nelson, Ky.*

Book mark:

*Wm. S. Scott*

H. | 5 bar | U.S. P.

Charles Hunter

Appears with rank of \_\_\_\_\_ on

**Muster and Descriptive Roll**

of Detachment of us colored  
Volunteer Recruits for -  
warded Roll dated

Lebanon, Ky, Aug 31, 1864.

Where born Adair Ky

Age 18 years; occupation farmer

When enlisted aug 15, 1864.

Where enlisted Lebanon Ky

For what period enlisted 3 years.

Eyes Bro; hair Blk

Complexion cop.; height 5 ft 10 in.

When mustered in aug 15, 1864.

Where mustered in Lebanon Ky

Bounty paid \$ 100; due \$ 100

**Clothing account:**

Last settled \_\_\_\_\_, 1864; drawn since \$ 17 <sup>50</sup>/<sub>100</sub>

Date of first muster aug 27, 1864.

Company to which assigned \_\_\_\_\_

Remarks: Owner, Joe Hunter,

Adair Co.

Without consent

4 Cong Dist, Ky

Book mark: \_\_\_\_\_



N | 5 bar | U.S.C.T.

Charles Hunter

Appears with rank of Pvt on

**Muster and Descriptive Roll**

of a Detachment of U.S. Colored  
Troops forwarded for U.S. Colia  
car. at Lexington, Ky. Roll dated  
Louisville, Ky. Sept. 7, 1864.

Where born Adair, Ky.

Age 18 years; occupation Farmer

When enlisted Aug. 15, 1864.

Where enlisted Lebanon, Ky.

For what period enlisted 1 years.

Eyes Brown; hair Black

Complexion Copper; height 5 ft. 10 in.

When mustered in Aug. 27, 1864.

Where mustered in Lebanon

Bounty paid \$ 100; due \$ 100

Clothing account:

Last settled 1864; drawn since \$ 17.50  
100

Date of first muster Aug. 27, 1864.

Company to which assigned

Remarks: credited to 4 cong. Sec.

Ky.

Book mark:

O. J. Hunter

26 | 5 Cav. | U.S.C.T.

Charles Hunter

Pvt., Co. A, 5 Reg't U. S. Col'd Cavalry.

Appears on

**Company Muster-in and Descriptive Roll**

of the organization named above. Roll dated

Camp Nelson, N.Y., Oct. 24, 1864.

Where born Adair, Ky.

Age 18 y'rs; occupation Farmer

When enlisted Aug. 15, 1864.

Where enlisted Lebanon

For what period enlisted 3 years.

Eyes Brn; hair Bk

Complexion Copper; height 5 ft. 10 in.

When mustered in Aug. 27, 1864.

Where mustered in Lebanon

Bounty paid \$ 100; due \$ 100

Where credited 4 Dist. Ky.

Company to which assigned

Remarks:

Book mark:

Wm H. Scott

*H* | **5 Cav.** | **U.S.C.T.**

*Charles Hunter*  
....., Co. *H*, 5 Reg't U. S. Col'd Cav.

Appears on

**Company Descriptive Book**  
of the organization named above.

**DESCRIPTION.**

Age *18* years; height *5* feet *10* inches.

Complexion *Copper*

Eyes *Brown*; hair *Black*

Where born *Adair Ky.*

Occupation *Saddler*

**ENLISTMENT.**

When *Aug 15*, 186 *4*.

Where *Salem*

By whom *Capt. Adler*; term *3* y'rs.

Remarks: .....

.....

.....

.....

.....

.....

.....

*J. E. Purke*



S 1096420 - P O mmm  
S - 2114996 P.O. aff

JH McFall dx

Hunter Charles

Co D, 5 U. S. Col'd Cav.

Private

Private

CARD NUMBERS.

1	5362681	26
2	5362781	27
3	5362882	28
4	5362971	29
5	5363067	30
6	5363155	31
7	5363242	32
8	5363328	33
9	5363416	34
10	5363503	35
11	5363589	36
12	9090310	37
13	43145822	38
14	43146486	39
15	40729919	40
16		41
17		42
18		43
19		44
20		45
21		46
22		47
23		48
24		49
25		50

Book Mark:

See also



# UNITED STATES COLORED TROOPS ENLISTMENT.

STATE OF

TOWN OF

*Kentucky*



*Louisville*

I, *Abraham Hunter* born in *Shuman Co*

in the State of *Kentucky* aged *24* years

and by occupation a *Laborer* Do HEREBY ACKNOWLEDGE TO

have volunteered *26* day of *Aug* 186 *4*

to serve as a **Soldier** in the **Army of the United States of America**, for the period of **THREE YEARS**, unless sooner discharged by proper authority: Do also agree to accept such bounty, pay, rations, and clothing, as are, or may be, established by law for the U. S. colored troops.

And I, *Abraham Hunter*

do solemnly swear that I will bear true faith and allegiance to the **United States of America**, and that I will serve them honestly and faithfully against all their enemies or opposers whomsoever; and that I will observe and obey the orders of the President of the United States, and the orders of the officers appointed over me, according to the Rules and Articles of War.

Sworn and subscribed to, at *Louisville Ky*

this *26<sup>th</sup>* day of *Aug 1864*

Before *Capt C. C. Ham*

I CERTIFY, ON HONOR, That I have carefully examined the above named Volunteer agreeably to the General Regulations of the Army, and that, in my opinion, he is free from all bodily defects and mental infirmity, which would in any way disqualify him from performing the duties of a soldier.

*J. Cummings*

EXAMINING SURGEON.

I CERTIFY, ON HONOR, That I have minutely inspected the Volunteer *A. Hunter* previously to his enlistment, and that he was entirely sober when enlisted; that, to the best of my judgment and belief, he is of lawful age; and that, in accepting him, as duly qualified to perform the duties of an able-bodied soldier, I have strictly observed the regulations which govern the recruiting service. This soldier has *Dark* eyes, *Dark* hair, *Dark* complexion, is *5* feet *7/2* inches high.

*C. C. Ham*

*12<sup>th</sup> of Aug* RECRUITING OFFICER OR AGENT.

Mustered into the United States Service..... day of *Aug* 186 *4*

Name of owner  
*Abraham Hunter*

*C. C. Ham*  
Mustered Officer.

Mustered into the service of the United States, for three years or during the war, from date of enlistment, in Company .....  
Regiment of ..... Volunteers, on the ..... day of ..... 186, at .....



NOTE 1.—This blank will be used for enlistments of United States colored troops. They will be made out in duplicate in all cases, one to accompany the recruiting return of the superintendent (not the recruiting officer) to the Adjutant General, and one to accompany the accounts of the officer who pays bounty, &c.

NOTE 2.—An enlistment holds to service. A muster-in must, in all cases, precede payment of pay, bounty, pension, &c. A muster-in roll, must in all cases, be filed in the Adjutant General's Office as evidence of muster-in. The mustering officer, commissary, or assistant commissary of musters, as the case may be, will countersign both enlistments as having mustered the soldiers into the service of the United States before either of them is given to the disbursing officer.

DECLARATION OF RECRUIT.

I, Abraham Carter desiring to volunteer as a soldier in the ARMY OF THE UNITED STATES, for the term of Three Years, DO DECLARE That I am 24 years and ..... months of age; that I have never been discharged from the United States service on account of disability or by sentence of a court-martial, or by order before the expiration of a term of enlistment; and I know of no impediment to my serving honestly and faithfully as a soldier for three years.

GIVEN at Laurinville Pa the 29 day of Aug 1864

Witness: [Signature]

Abraham Carter  
No. 107  
Volunteered at Laurinville Pa  
Aug 26 1864  
By Capt G. P. [Signature]  
5th M.D.C. Corps  
Quintana and Twenty Four

Consent of Parent or Guardian in case of a Minor, if a Free Man, or in the case of a Slave, of the Person to whom he owes Service:

I, ..... Do CERTIFY, That I am the ..... that the said ..... is ..... years of age; and I do freely give my CONSENT to his volunteering as a SOLDIER in the Army of the United States, for the period of THREE YEARS, under the conditions of the laws of the United States.

GIVEN at ..... the ..... day of .....

Witness: .....

Hunter Asalom

....., Co. ...., 5 Reg't U.S.C.

**Enclosures.**

Bed Cards .....	Final Statements .....
Burial Records .....	Furloughs or L. of A. ....
Certs. of Dis. for Discharge .....	Med. Certificates .....
C. M. Charges .....	Med. Des. Lists .....
Descriptive Lists .....	Orders .....
Discharge Certificates .....	Pris. of War Record .....
Enlistment Papers .....	Resignations .....

**Other papers relating to—**

Admission to Hosp'l .....	Furlough or L. of A. ....
Casualty Sheet .....	Med. Examination .....
Confinement .....	Misc. Information .....
Contracts .....	Pay or Clothing .....
Death or Effects .....	Personal Reports .....
Desertion .....	Rank .....
Discharge from Hosp'l .....	Transfer to Hosp'l .....
Discharge from Service .....	Transfer to V. R. C. ....
Duty .....	Transportation .....

*N* | **5 Cav.** | **U.S.C.T.**

*Absalom Hunter*

*Put*, Co. *C*, 5 Reg't U. S. Col'd Cavalry.

Appears on **Co. Muster-out Roll**, dated

*Helena Ark*, *March*, 186 *6*.

Muster-out to date *March*, 186 *6*.

Last paid to *Dec 31*, 186 *5*.

Clothing account:

Last settled....., 186 ; drawn since \$..... 100

Due soldier \$..... 100; due U. S. \$ *68*<sup>*94*</sup> 100

Am't for cloth'g in kind or money adv'd \$..... 100

Due U. S. for arms, equipments, &c., \$..... 100

Bounty paid \$ *100* 100; due \$ *100* 100

Remarks:.....

Book mark:.....

*Rose*





*N* | **5 Cav.** | **U.S.C.T.**

*Absalom Hunter*  
*Pat*, Co. C, 5 Reg't U. S. Col'd Cavalry.

Appears on

**Company Muster Roll**  
for *Jan and Feb*, 186*6*.

Present or absent *Present*

Stoppage, \$ *100* for

Due Gov't, \$ *100* for

Valuation of horse, \$ *100*

Valuation of horse equipments, \$ *100*

Remarks:

-----  
-----  
-----  
-----  
-----  
-----  
-----

Book mark:

-----

*Rose*

*G* | **5 Cav.** | **U.S.C.T.**

*Abraham Hunte,*

*Private*, Co. C, 5 Reg't U. S. Col'd Cavalry.

Appears on

**Company Muster Roll**

for *Nov 4 Dec*, 186*4*.

Present or absent *Present*

Stoppage, \$ *100* for

Due Gov't, \$ *100* for

Valuation of horse, \$ *100*

Valuation of horse equipments, \$ *100*

Remarks: *See list of*

*camp and gear*  
*#133*

Book mark:

*J. J. Jorden*  
Copyist.



*A* | **5 Cav.** | **U.S.C.T.**

*Abraham Hunter*

*Plt.*, Co. C, 5 Reg't U. S. Col'd Cavalry.

Appears on

**Company Muster Roll**

for *Sep.* ~~*Oct.*~~, 186 *5*

Present or absent *Present*

Stoppage, \$ 100 for

Due Gov't, \$ 100 for

Valuation of horse, \$ 100

Valuation of horse equipments, \$ 100

Remarks:

Book mark:

(358)

*Linden*

Copyist.

*H* | **5 Cav.** | **U.S.C.T.**

*Abraham Hunter*

*Priv.*, Co. C, 5 Reg't U. S. Col'd Cavalry.

Appears on

**Company Muster Roll**

for *July + Aug*, 186 *5*.

Present or absent *Present*

Stoppage, \$ *100* for

Due Gov't, \$ *100* for

Valuation of horse, \$ *100*

Valuation of horse equipments, \$ *100*

Remarks:

Book mark:

(358)

*Grider*  
Copyist.

*A* | **5 Cav.** | **U.S.C.T.**

*Abraham Hunter*  
*Pvt.*, Co. C, 5 Reg't U. S. Col'd Cavalry.

Appears on

**Company Muster Roll**

for *May & June*, 1865.

Present or absent *Present*

Stoppage, \$ *100* for

Due Gov't, \$ *100* for

Valuation of horse, \$ *100*

Valuation of horse equipments, \$ *100*

Remarks: *First Instalment  
of Bounty worth 100*

Book mark:

*Linder*



10 | **5 Cav. | U.S.C.T.**

*Abraham Hunter*

*Pris*, Co. C, 5 Reg't U. S. Col'd Cavalry.

Appears on

**Company Muster Roll**

for *Nov. 1 Apr.*, 1863.

Present or absent *Present*

Stoppage, \$ 100 for

Due Gov't, \$ 100 for

Valuation of horse, \$ 100

Valuation of horse equipments, \$ 100

Remarks: *First mistalances of  
Bondy due \$100*

Book mark:

*Shull*

76 | 5 Cav. | U.S.C.T.

*Absalom Hunter*

*Pris*, Co. C, 5 Reg't U. S. Col'd Cavalry.

Appears on

**Company Muster Roll**

for *Jan'y. + Feb'y.*, 186*5*.

Present or absent *Present*

Stoppage, \$ 100 for

Due Gov't, \$ 100 for

Valuation of horse, \$ 100

Valuation of horse equipments, \$ 100

Remarks: *First instalment -  
Bounty due \$100*

Book mark :

*Shull*

*H* | **5 Cav. | U.S.C.T.**

*William Hunter*

*Pris*, Co. C, 5 Reg't U. S. Col'd Cavalry.

Appears on

**Company Muster Roll**

for *Nov. 7 Dec.*, 186*4*.

Present or absent *absent*

Stoppage, \$ *100* for

Due Gov't, \$ *100* for

Valuation of horse, \$ *100*

Valuation of horse equipments, \$ *100*

Remarks: *Sick in Hospital, Knoxville Tenn. First & second statements of bounty due*

Book mark:

*Shull*



*76* | **5 Cav.** | **U.S.C.T.**

*Abraham Hunter*

*Pvt*, Co. C, 5 Reg't U. S. Col'd Cavalry.

Appears on

**Company Muster Roll**

for *to Oct. 31*, 186 *4*.

Present or absent *Present*

Stoppage, \$ *100* for

Due Gov't, \$ *100* for

Valuation of horse, \$ *100*

Valuation of horse equipments, \$ *100*

Remarks:

Book mark:

*Shull*

*H* | **5 Cav.** | **U.S.C.T.**

*Abraham Hunter*

*Priv*, Co. *C*, 5 Reg't U. S. Col'd Cavalry.

Appears on

**Company Muster-in and Descriptive Roll**  
of the organization named above. Roll dated

*Camp Nelson, Ky*, *N. Y.*, *Oct. 24*, 186 *4*.

Where born *Nelson, Ky.*

Age *24* y'rs; occupation *Laborer*

When enlisted *Aug. 26*, 186 .

Where enlisted *Louisville*

For what period enlisted *3* years.

Eyes *Bl.*; hair *Bl.*

Complexion *Bl.*; height *5* ft. *9 1/2* in.

When mustered in *Aug. 30*, 186 .

Where mustered in *Louisville*

Bounty paid \$ *100*; due \$ *100*

Where credited *4<sup>th</sup> Dist. Ky.*

Company to which assigned *C*

Remarks:

.....  
.....  
.....

Book mark:

.....

*Shull*

(356d)

Copyist.

N | 5 bar | 40.7

Abraham Hunter

Appears with rank of Pvt on

**Muster and Descriptive Roll**

of a Detachment of U. S. Colored  
Troops Transferred to U. S. Col  
Co. at Lexington. Ky. Roll dated

Louisville. Ky., Sept. 2, 1864.

Where born Nelson. Ky.

Age 24 years; occupation Laborer

When enlisted Aug. 24, 1864.

Where enlisted Louisville. Ky.

For what period enlisted 3 years.

Eyes Dark; hair Dark

Complexion Dark; height 5 ft. 9/2 in.

When mustered in Aug. 30, 1864.

Where mustered in Louisville

Bounty paid \$ 100; due \$ 100

**Clothing account:**

Last settled \_\_\_\_\_, 186 \_\_\_\_\_; drawn since \$ 17.55  
100

Date of first muster Aug. 30, 1864.

Company to which assigned \_\_\_\_\_

Remarks: Credited to H. Bugh  
Det. Ky.

Book mark: \_\_\_\_\_

A. J. Small



A. | 560 | USCT.

Abraham Hunter

Appears with rank of Priv on

**Muster and Descriptive Roll**

of Attachment US Colored  
Recruits mustered for US  
Colored Inf.

Roll dated Louisville Ky, Aug 30 1864

Where born Nelson Ky

Age 24 years; occupation laborer

When enlisted Aug 26, 1864

Where enlisted Louisville Ky

For what period enlisted 3 years.

Eyes dark; hair dark

Complexion dark; height 5 ft. 9 1/2 in.

When mustered in Aug 30, 1864

Where mustered in Louisville Ky

Bounty paid \$ 100; due \$ 100

Clothing account:

Last settled \_\_\_\_\_, 1864; drawn since \$ 100

Date of first muster \_\_\_\_\_, 1864

Company to which assigned \_\_\_\_\_

Remarks: ser to Nelson Co  
4 list

Book mark: \_\_\_\_\_

(356m)

L. D. Purdon  
Copyist.

29 | 5 Cav. | U.S.C.T.

Abraham Hunter

Co. C, 5 Reg't U. S. Col'd Cav.

Appears on

Company Descriptive Book  
of the organization named above.

DESCRIPTION.

Age 24 years; height 5 feet 9 1/2 inches.

Complexion *dark*

Eyes *dark*; hair *dark*

Where born *Meigs Co. Ky.*

Occupation *laborer*

ENLISTMENT.

When *Aug. 26*, 1864.

Where *Lansville*

By whom *Capt. Ham.*; term *3* y'rs.

Remarks:

.....  
.....  
.....  
.....  
.....  
.....  
.....  
.....

*Ham*

Post 573539  
A 1887451 H.L.O.  
S. 2065919 Po. Intern  
S 2866566 And w d

J. H. McFall Jr



*Assalton*  
*Hunter Absalom*

**Co C, 5 U. S. Col'd Cav.**

*Private* | *Private*

**CARD NUMBERS.**

1	5361686	26
2	5361792	27
3	5361885	28
4	5361979	29
5	53620612	30
6	5362143	31
7	5362230	32
8	5362320	33
9	5362406	34
10	5362491	35
11	5362576	36
12	9090230	37
12	43145686	38
14	43146243	39
15	40729918	40
16		41
17		42
18		43
19		44
20		45
21		46
22		47
23		48
24		49
25		50

Book Mark: \_\_\_\_\_

See also \_\_\_\_\_

Adjutant General's Office,

COLORED TROOPS BRANCH,

August 11, 1877

Vol. C. T., 187

Wanted in case of \_\_\_\_\_, Co. \_\_\_\_\_,

Reg't \_\_\_\_\_  
absent without leave, \_\_\_\_\_  
\_\_\_\_\_

Respectfully,

W. A. Woodward

Chief Clerk.

P. J. Dalton

Adjutant General's Office,

, 1877

Vol. C. T., 187

Reply in case of \_\_\_\_\_, Co. \_\_\_\_\_,

Reg't \_\_\_\_\_

Co. Morning Report Book repts Aug 21st Geo Humphrey from absent  
in Hospital to present for duty,  
Co. and Regt Records furnish no record of absence either, leave  
or return therefrom, or any evidence of trial.

3007

George Humphrey  
Co. C.



\_\_\_\_\_

\_\_\_\_\_

---

*Humphrey, Geo.*  
 \_\_\_\_\_, Co. *C*, \_\_\_\_\_ Reg't *150th*

----- / **Enclosures.**

Bed Cards .....	Final Statements .....
Burial Records .....	Furloughs or L. of A. ....
Certs. of Dis. for Discharge .....	Med. Certificates .....
C. M. Charges .....	Med. Des. Lists .....
Descriptive Lists .....	Orders .....
Discharge Certificates .....	Pris. of War Record .....
Enlistment Papers .....	Resignations .....

**Other papers relating to—**

Admission to Hosp'l .....	Furlough or L. of A. ....
Casualty Sheet .....	Med. Examination .....
Confinement .....	Misc. Information / .....
Contracts .....	Pay or Clothing .....
Death or Effects .....	Personal Reports .....
Desertion .....	Rank .....
Discharge from Hosp'l .....	Transfer to Hosp'l .....
Discharge from Service .....	Transfer to V. R. C. ....
Duty .....	Transportation .....
.....	.....

*W* | **5 Cav. U.S.C.T.**

*George Humphrey*  
Corpl., Co. *C*, 5 Reg't U. S. Col'd Cavalry.

Appears on **Co. Muster-out Roll**, dated  
*Helena Ark, March 16,* 1866.

Muster-out to date *March 16,* 1866.

Last paid to *Dec 31,* 1865.

**Clothing account:**

Last settled....., 186 ; drawn since \$..... 100

Due soldier \$..... 100; due U. S. \$ *37* <sup>77</sup>/<sub>100</sub>

Am't for cloth'g in kind or money adv'd \$..... 100

Due U. S. for arms, equipments, &c., \$..... 100

Bounty paid \$ *100* 100; due \$ *100* 100

Remarks: *Put from organization*  
*until Sep 1 1865 when made Corpl.*

Book mark : .....

*Rose*

76 | **5 Cav.** | **U.S.C.T.**

George Humphrey  
Pvt., Co. C, 5 Reg't U. S. Colored Cav.

Appears on **Returns** as follows:

From organization to Oct. 31, 1864.

Absent sick Hospital Camp  
Nelson.

Nov. 1864 Absent sick Hospital  
Camp Nelson.

July 1865. Absent sick Hospital  
Paris, Ky.

Aug 1865 Absent at Louisville,  
Ky on 24 hours leave

Book mark : \_\_\_\_\_

(546)

J. G. Ballou  
Copyist.



*H* | **5 Cav. | U.S.C.T.**

*George Humphrey*  
*Cop*, Co. C, 5 Reg't U. S. Col'd Cavalry.

Appears on

**Company Muster Roll**  
for *Jan<sup>mo</sup> Feb*, 186*6*.  
Present or absent *Present*

Stoppage, \$ *100* for

Due Gov't, \$ *100* for

Valuation of horse, \$ *100*

Valuation of horse equipments, \$ *100*

Remarks: *Sick in Quarters!*

Book mark: \_\_\_\_\_

*Rose*

*91* | **5 Cav.** | **U.S.C.T.**

*George Humphrey*  
*Cpl.*, Co. C, 5 Reg't U. S. Cold Cavalry.

Appears on

**Company Muster Roll**

for *Nov. 4 Dec.*, 186*5*.

Present or absent *Present*

Stoppage, \$ *100* for

Due Gov't, \$ *100* for

Valuation of horse, \$ *100*

Valuation of horse equipments, \$ *100*

Remarks: *Sick in Quarters*

Book mark: \_\_\_\_\_

*Linden*

*H* | **5 Cav. U.S.C.T.**

*George Humphrey*  
*Capt.*, Co. C, 5 Reg't U. S. Cold Cavalry.

Appears on

**Company Muster Roll**

for *Sep. & Oct.*, 186*5*.

Present or absent *Present*

Stoppage, \$.....100 for .....

Due Gov't, \$.....100 for .....

Valuation of horse, \$.....100

Valuation of horse equipments, \$.....100

Remarks: *Made Capt.*  
*Sep 1<sup>st</sup> / 65*

Book mark: .....

*Luider*  
Copyist.



*H* | **5 Cav.** | **U.S.C.T.**

*George Humphrey*  
*Priv.*, Co. C, 5 Reg't U. S. Col'd Cavalry.

Appears on

**Company Muster Roll**

for *July & Aug*, 186*5*.

Present or absent *Absent*

Stoppage, \$ *100* for

Due Gov't, \$ *100* for

Valuation of horse, \$ *100*

Valuation of horse equipments, \$ *100*

Remarks: *Absent without*

*leave*

Book mark: \_\_\_\_\_

*Linden*  
Copyist.

*H* | **5 Cav.** | **U.S.C.T.**

*George Humphrey*  
*G.H.*, Co. C, 5 Reg't U. S. Cold Cavalry.

Appears on

**Company Muster Roll**

for *May & June*, 186*3*.

Present or absent *Present*

Stoppage, \$ *100* for

Due Gov't, \$ *100* for

Valuation of horse, \$ *100*

Valuation of horse equipments, \$ *100*

Remarks: *First Instalment of Bounty due \$100*

Book mark: \_\_\_\_\_

*J. Miller*

*76* | **5 Cav. | U.S.C.T.**

*George Humphrey*

*Priv*, Co. C, 5 Reg't U. S. Col'd Cavalry.

Appears on

**Company Muster Roll**

for *Mar. 7 Apr.*, 186 *5*.

Present or absent *Present*

Stoppage, \$ *100* for

Due Gov't, \$ *100* for

Valuation of horse, \$ *100*

Valuation of horse equipments, \$ *100*

Remarks: *First instalment of  
Bounty due \$100*

Book mark:

*Shull*



*76* | **5 Cav.** | **U.S.C.T.**

*George Humphrey*  
*Priv*, Co. C, 5 Reg't U. S. Col'd Cavalry.

Appears on

**Company Muster Roll**

for *Jan'y. & Feby.*, 186*5*.

Present or absent *Present*

Stoppage, \$ *100* for

Due Gov't, \$ *100* for

Valuation of horse, \$ *100*

Valuation of horse equipments, \$ *100*

Remarks: *First instalment -  
Bounty due \$100*

Book mark:

*Shull*

*H* | **5 Cav.** | **U.S.C.T.**

*George Humphrey*  
*Priv*, Co. C, 5 Reg't U. S. Col'd Cavalry.

Appears on

**Company Muster Roll**

for *Nov. & Dec.*, 1864.

Present or absent *Present*

Stoppage, \$ *100* for

Due Gov't, \$ *100* for

Valuation of horse, \$ *100*

Valuation of horse equipments, \$ *100*

Remarks: *First & Second instalments bounty due*

Book mark:

*Shaw*

H. | 5 Cav. | U.S.C.S.

George Humphrey.  
Priv., Co. \_\_\_\_\_, 5 Reg't U.S.C.S.

Appears on

**Hospital Muster Roll**

of Convalescent Camp U. S. A. Hospital,

at Camp Nelson, Ky.,

for Nov. & Dec., 1864.

Attached to hospital:

When Dec. 22, 1864.

How employed Patient.

Last paid by Maj. \_\_\_\_\_

to \_\_\_\_\_, 186 .

Bounty paid \$ 100; due \$ 100

Present or absent Present.

Remarks: \_\_\_\_\_

\_\_\_\_\_  
\_\_\_\_\_  
\_\_\_\_\_  
\_\_\_\_\_  
\_\_\_\_\_  
\_\_\_\_\_  
\_\_\_\_\_  
\_\_\_\_\_

Book mark: \_\_\_\_\_

\_\_\_\_\_  
Dickerson,



*Ho* | **5 Cav.** | **U.S.C.T.**

*George Humphrey*  
*Priv*, Co. C, 5 Reg't U. S. Col'd Cavalry.

Appears on

**Company Muster Roll**

for *to Oct. 31*, 186*4*.

Present or absent *Absent*

Stoppage, \$ *100* for

Due Gov't, \$ *100* for

Valuation of horse, \$ *100*

Valuation of horse equipments, \$ *100*

Remarks: *Hospital, Camp Nelson, Ky.*

Book mark:

*Shull*  
Copyist.

26 | 5 Cav. | U.S.C.T.

George Humphrey  
Priv, Co. C, 5 Reg't U. S. Col'd Cavalry.

Appears on

**Company Muster-in and Descriptive Roll**  
of the organization named above. Roll dated

Camp Nelson, <sup>Ky</sup> N.Y., Oct. 24, 1864.

Where born Nelson, Ky.

Age 23 y'rs; occupation Laborer

When enlisted Aug. 27, 186 .

Where enlisted Louisville

For what period enlisted 3 years.

Eyes <sup>Dr.</sup> Dr. ; hair <sup>Dr.</sup> Dr.

Complexion <sup>Dr.</sup> Dr. ; height 5 ft. 8 in.

When mustered in Aug. 30, 186 .

Where mustered in Louisville

Bounty paid \$ 100 ; due \$ 100

Where credited 4<sup>th</sup> Dist. Ky.

Company to which assigned C

Remarks :

Book mark :

Shill

14 | 5 bar | U.S.C.T.

George Humphrey

Appears with rank of Pvt on

**Muster and Descriptive Roll**

of a Detachment of U.S. colored  
Troops transferred to U.S. colored  
ser. at Lexington, Ky. Roll dated  
Louisville, Ky. Sept. 2, 1864.

Where born Melrose, Ky.

Age 23 years; occupation Labourer

When enlisted Aug. 27, 1864.

Where enlisted Louisville, Ky.

For what period enlisted 3 years.

Eyes brn; hair brn

Complexion brn; height 5 ft. 8 in.

When mustered in Aug. 30, 1864.

Where mustered in Louisville, Ky.

Bounty paid \$ 100; due \$ 100

**Clothing account:**

Last settled 1864; drawn since \$ 17.55/100

Date of first muster Aug. 30, 1864.

Company to which assigned

Remarks: transferred to 4th Regt. Dist

Ky.

Book mark:

A. J. Russell



5 bar

H. | U.S. lat.

George Humphrey

Appears with rank of Priv. on

**Muster and Descriptive Roll**

of Detachment US Colored  
Recruits mustered for US  
Colored Inf.

Roll dated

Louisville Ky, Aug 30, 1864

Where born Nelson Ky

Age 23 years; occupation laborer

When enlisted Aug 27, 1864

Where enlisted Louisville Ky

For what period enlisted 3 years.

Eyes dark; hair dark

Complexion dark; height 5 ft. 8 in.

When mustered in Aug 30, 1864

Where mustered in Louisville Ky

Bounty paid \$ 100; due \$ 100

Clothing account:

Last settled, 186 ; drawn since \$ 100

Date of first muster, 186 .

Company to which assigned

Remarks: let to Nelson Co

H. list

Book mark:

L. G. Barton

*c 9* | **5 Cav. | U.S.C.T.**

*George Humphrey*  
....., Co. *C*, 5 Reg't U. S. Col'd Cav.

Appears on  
**Company Descriptive Book**  
of the organization named above.

**DESCRIPTION.**

Age *23* years; height *5* feet *8* inches.

Complexion *dark*

Eyes *dark*; hair *dark*

Where born *Bellevue Co. Ky.*

Occupation *Laborer*

**ENLISTMENT.**

When *Aug. 27*, 186*4*.

Where *Lewisville*

By whom *Capt. Hunt*; term *3* y'rs.

Remarks: *Made Capt. See*  
*7420*

.....  
.....  
.....  
.....  
.....  
.....

*Harrison*

1997052. Postd

J. McFall



*Humphrey George*

**Co C, 5 U. S. Col'd Cav.**

*Private*

*Corporal*

**CARD NUMBERS.**

1	5361690	26
2	5361791	27
3	5361884	28
4	5361978	29
5	5362061	30
6	5362142	31
7	5362229	32
8	5362284	33
9	5362373	34
10	5362457	35
11	5362541	36
12	9090229	37
13	43145689	38
14	43146246	39
15	31413347	40
16	40729917	41
17		42
18		43
19		44
20		45
21		46
22		47
23		48
24		49
25		50

Book Mark: \_\_\_\_\_

See also \_\_\_\_\_

662

Hultz James  
Co K, 5 U. S. Col'd Cav.

Private | Private

CARD NUMBERS.

1	26
2	27
3 See Hulse	28 James
4	29
5	30
6	31
7	32
8	33
9	34
10	35
11	36
12	37
12	38
14	39
15	40
16	41
17	42
18	43
19	44
20	45
21	46
22	47
23	48
24	49
25	50

Book Mark:

See also



PROOF OF OWNERSHIP.

KENTUCKY, } SS.  
Clark }  
David J Snowden and Joseph Stewart each of lawful  
and resident citizens of the State and County aforesaid, do certify that Mrs Mary  
Hulse of the State and County aforesaid, was on the Seventh day of  
October 1864, the lawful owner of the slave named James Hulse  
referred to and described in the foregoing claim for compensation.

David J Snowden  
Joseph Stewart

Sworn to and subscribed before me a Justice of the Peace for the County of  
Clark State of Kentucky, this the 17th day of January 1867.  
H Lowy pec



PROOF OF LOYALTY.

STATE OF KENTUCKY, } SS.  
COUNTY OF Clark }  
We David J Snowden and Joseph Stewart loyal men and  
each of lawful age, and resident citizens of the County of Clark  
in the State and County aforesaid, upon our oaths declare that we have known Mary Hulse  
a resident of the State and County aforesaid, since the 4th day of March, 1861, and know that she has  
firmly and faithfully maintained his or her adherence and allegiance to the Government of the United  
States, by defending its cause against the Government and forces of the so-called Confederate States  
of America, in all suitable and practicable ways, and according to his or her ability and opportunity.

David J Snowden  
Joseph Stewart

Sworn to and subscribed before me a Justice of the Peace for the county of  
Clark State of Kentucky, this the 17th day of January 1867.  
H Lowy pec



POWER OF ATTORNEY.

My Post-Office address is Kiddville County of Clark State of  
Kentucky, and I hereby direct that all communications to me, touching this claim, be sent under cover  
to Wm A Snowden of Kiddville Kentucky, who is hereby appointed and consti-  
tuted my true and lawful attorney, to prosecute this claim for me, and who is hereby authorized and  
empowered to receive and receipt for any award, order, draft, certificate, voucher, warrant, papers or  
money that may be issued in the adjustment of this claim, or the payment thereof, the same as I  
might or could do in person were I present and acting for myself, and to file any additional evidence  
or papers that may be required in the prosecution of this claim.

[WITNESS.]

The owner  
signs here. }

Mary Hulse  
mark

David J Snowden }  
Joseph Stewart }

Two witnesses to  
owner's signature  
sign here.

50 CENT  
STAMP.



**CERTIFICATE OF AWARD OF THE BOARD OF CLAIMS.**

OFFICE OF THE BOARD OF CLAIMS  
FOR SLAVES ENLISTED OR DRAFTED IN THE SERVICE OF THE U. S.

We hereby certify, that \_\_\_\_\_ of \_\_\_\_\_ county, State of Kentucky, having proved, under oath, \_\_\_\_\_ loyalty to the Constitution and Government of the United States, and established \_\_\_\_\_ title as to the ownership of \_\_\_\_\_, a slave, \_\_\_\_\_ and mustered at \_\_\_\_\_ on the \_\_\_\_\_ day of \_\_\_\_\_, 186\_\_\_\_, by \_\_\_\_\_ in the service of the United States, in the \_\_\_\_\_ Regiment of Colored Troops, Co. \_\_\_\_\_, the sum of \_\_\_\_\_ dollars has been awarded to \_\_\_\_\_ by this Board, subject to the approval of the Secretary of War, as a compensation for the said slave, under the provisions of section 24, Act approved February 24, 1864, and section 2, Act approved July 28, 1866.

\_\_\_\_\_, President of the Board.  
\_\_\_\_\_, Member of the Board.  
\_\_\_\_\_, Member of the Board.

To \_\_\_\_\_  
Chief of the Bureau for the Organization of Colored Troops, Washington, D. C.

Headquarters Kentucky Volunteers,

Adjutant-General's Office,

Frankfort, Dec. 18th, 1866.

I hereby certify, that it appears from the U. S. Muster-Rolls on file in this Office, that James Hulse was enrolled on the 7th day of October, 1864, at Lexington Ky, by Thos. H. Moore, and mustered into the U. S. service on the 7th day of October, 1864, at Lexington Ky, by Thos. H. Moore to serve Three years. Said James Hulse is described as follows: Age, 21 years; eyes, Black; hair, Black; complexion, Black; height, 5 feet 6 inches. It further appears from said Rolls, that James Hulse owed service to Mary Hulse, was credited to Clarke County, Ky., and was assigned to Co. "B", Fifth Regiment U. S. C. Cavalry.

In Testimony Whereof, I have hereunto set my hand, and affixed my Official Seal, this 18th day of December, 1866.

*D. Lindsay*  
Adjutant-General of Kentucky.

15.360 R. 423

**POWER OF ATTORNEY.**

My Post-Office address is *Widdville* County of *Clark* State of Kentucky, and I hereby direct that all communications to me, touching this claim, be sent under cover to *Wm A Snowden of Widdville Kentucky*, who is hereby appointed and constituted my true and lawful attorney, to prosecute this claim for me, and who is hereby authorized and empowered to receive and receipt for any award, order, draft, certificate, voucher, warrant, papers or money that may be issued in the adjustment of this claim, or the payment thereof, the same as I might or could do in person were I present and acting for myself, and to file any additional evidence or papers that may be required in the prosecution of this claim.

[WITNESS.]

The owner signs here.

*Mary Hulse*  
mark

50 CENT STAMP.

*Wm A Snowden*  
*Joseph Stewart*

Two witnesses to owner's signature sign here.



No.

CLAIM OF

Mrs. Mary Hulse

FOR THE COMPENSATION OF SLAVE NAMED

I, *Mary Hulse* a loyal citizen, and a resident of *Kiddie*, County of *Clark*, State of Kentucky, hereby claim compensation, under the provisions of Section 24, act approved February 24, 1864, and ~~section 2~~ act approved July, 28, 1866, for my slave *James Hulse*, enlisted *October 7<sup>th</sup>* 1864, at *Leighton Kentucky*, by *Thos H. Moore* in the *5<sup>th</sup>* regiment U. S. Colored Troops, Co. "D"; certificate of

which enlistment, and a descriptive list, as required, accompany this application. That I did not acquire said slave subsequent to said enlistment, but had a valid title to him at the date of said enlistment, and previous thereto: I having acquired my title to him and my ownership over him as follows, to-wit: *That said James Hulse was born her property. She having previously owned his mother that he remained uninteruptedly in her possession until the day of enlistment that she claims no bounty for the services of said slave but relinquishes all her right to bounty under act of July 25, 1866*

In proof of my loyalty to the Constitution and Government of the United States, I present the accompanying oath, which I have taken, signed and acknowledged; to be filed with this application, in accordance with requirement of General Orders, No. 329, 1863, War Department, Adjutant General's Office.

*January*, 1867. *Mary Hulse*

OATH OF ALLEGIANCE.

I, *Mary Hulse*, the owner and Claimant, do solemnly swear that the foregoing claim is a just and true claim due to me as master and owner of the said slave, and that the facts alleged in said claim in respect to the draft or enlistment (as the case may be) of said slave into the Military service of the United States are true. And I do further swear that I have never joined, or been concerned in, any insurrection or rebellion; that I have never borne arms against the United States; that I have never given any aid, countenance, counsel or encouragement to any person or persons engaged, or whom I had reason to believe were about to engage, in insurrection, rebellion or armed hostility against the United States; that I have neither sought, nor accepted, nor attempted to exercise the functions of any office, civil or military, nor to perform any service whatever, under any authority or pretended authority in hostility to the United States; that I have not yielded a voluntary support to any insurrection, rebellion or pretended government, authority, power or constitution within the United States hostile thereto. And I do further swear that, to the best of my knowledge and ability, I have supported and defended, and will continue to support and defend, the United States against all enemies, foreign and domestic; and that I have supported, defended and obeyed, and will continue to support, defend and obey, the Constitution and laws of the United States; that I will bear true faith and allegiance to the same; and that I take this oath freely, without any mental reservation or purpose of evasion: So help me God.

*Mary Hulse*  
mark

Sworn to and subscribed before me, at this *17<sup>th</sup>* day of *January*, 1867.



*W. Lowry*  
*Clark County Kentucky*

War Department,

ADJUTANT GENERAL'S OFFICE,

Washington, April 9, 1867.

Respectfully returned to the  
Commission for the State of

Ky., with the information  
that James House  
was enlisted at Lexington Ky  
Oct. 7, 1864, and was  
mustered in as Pvt. in Co. "K"  
5<sup>th</sup> U. S. Colored Regt. Oct 7/64.

16. 2087 Ky

J. W. Safford  
Asst. Adj't General.

No. 2087

APPLICATION OF

Mrs. Mary House

OF

Wildville Kentucky

FOR COMPENSATION FOR SLAVE.

Named James House

enlisted October 7<sup>th</sup> 1864,

in Com. "K", fifth Regiment,

U. S. COLORED TROOPS.

Received July 28, 1867

Compensation Awarded

186  
Dollars.

President of Board of Claims.

Claimant's Attorney,

Wm W Snowden,  
Wildville Ky.

Claimant's Post-office Address,

Wildville Clark Co  
Kentucky

FRANKFORT COMMONWEALTH PRINT.



TREATMENT.

[HERE NOTE IMPORTANT COMPLICATIONS AND ALL OPERATIONS.]

Returned to duty  
Feb. 24. / 05-

---

RESULT AND DATE.

Hospital Number 318

Name James North

Age 18 Nativity Kentucky

Married or Single Single

Residence Clark County

Post Office address of  
wife or nearest relative.

Rank Private Co. 10<sup>th</sup> Regiment S. M. G. Co.

When admitted January 12<sup>th</sup> 1865

From what source Field

**Diagnosis:** (in surgical cases, state explicitly seat and  
character of wound or injury.)

Applied to

Branch B.-G. H.  
Bowling Green, Ky.

On what occasion wounded

Date

Nature of missile or weapon

TREATMENT.

[HERE NOTE IMPORTANT COMPLICATIONS AND ALL OPERATIONS.]

---

RESULT AND DATE.

Placed in duty 4. 10/64



Hospital Number 278

Name James Smith

Age 19 Nativity Kentucky

Married or Single Single

Residence Smith, Ky.

Post Office address of }  
wife or nearest relative. }

Rank Private Co. M Regiment 24th

When admitted September 14, 1864

From what source Union

Diagnosis: (in surgical cases, state explicitly seat and character of wound or injury.)

Amputation,

Branch B.-G. H.  
Bowling Green, Ky.

On what occasion wounded .....

Date .....

Nature of missile or weapon .....

15

1st Ind.

*[Handwritten signature]*  
LBR 3

War Dept., A.G.O., Oct. 13, 1915--To the Governor, National ~~Military~~ Home,  
Danville, Vermilion County, Illinois.

The records of this office show that James Hulse, Company K, 5th U. S. Colored  
Cavalry, was mustered into service March 7, 1864, and was honorably discharged  
March 16, 1866, as a private.

*[Handwritten signature]*  
The Adjutant General.

4 L

(Attach this end.)

Statement of Service Reference Slip.

Wulfe, James  
(Name.)  
Capt 5th Cal Cav  
(Rank and organization.)

Request for military record of the above-named by applicant whose name and address are shown by attached carbon copy of answer.

M.I. Mch 7. 64 as  
Pvt.

<sup>mt co</sup>  
M.O. Mch 16. 1866 as  
Pvt

1140  
10-13-15

Johnson  
M.I.



*Kelly, James*  
*P, Co. R, 5 Reg't Mass Cav*

*4* Enclosures.

Bed Cards	<i>2</i>	Descriptive Lists
Burial Records		Final Statements
Certs. of Dis. for Discharge		Furloughs
C. M. Charges		Med. Des. Lists
Med. Certificates		Orders

Other papers relating to—

Admission to Hosp'l	Furlough
Casualty Sheet (Officer's)	Med. Examination
Confinement	Misc. Information
Contracts	Pay or Clothing
Death or Effects	Personal Reports
Desertions	Rank
Discharge from Hosp'l	Transfer to Hosp'l
Discharge from Service	Transfer to V. R. C.
Duty	Transportation

*SS 1*

*5* | **5 Cav.** | **U.S.C.T.**

*James O'Neal*  
*Pat*, Co. *K*, 5 Reg't U. S. Col'd Cavalry.

Appears on **Co. Muster-out Roll**, dated  
*Indiana Ark*, *July 16*, 186*6*.  
Muster-out to date *Nov 16*, 186*6*.  
Last paid to *Dec 31*, 186*5*.

**Clothing account:**

Last settled....., 186 ; drawn since \$..... 100  
Due soldier \$..... 100; due U. S. \$ *37* <sup>*20*</sup> / 100  
Am't for cloth'g in kind or money adv'd \$..... 100

Due U. S. for arms, equipments, &c., \$..... 100  
Bounty paid \$ *100* 100; due \$..... 100

Remarks:.....  
.....  
.....  
.....  
.....  
.....

Book mark: *2087 Ky*

*E. H. B. ...*

H | **5 Cav.** | **U.S.C.T.**

*James Huber*  
-----  
*Priv.*, Co. *K*, 5 Reg't U. S. Colored Cav.

Appears on **Returns** as follows:

*Jan 7 Feb 18 65 Absent sick in*  
*5th Mo Bowling Green, Ky*  
*Jan 7/65.*

Book mark :  
-----  
-----

(546)

*J. L. Brewer*  
-----  
Coryist.



*A* | **5 Cav.** | **U.S.C.T.**

*James Hulce*  
*Cpt*, Co. K, 5 Reg't U. S. Col'd Cav.

Appears on

**Company Muster Roll**

for *Jan Feb*, 1866.

Present or absent *Present*

Stoppage, \$ *100* for

Due Gov't, \$ *100* for

Valuation of horse, \$ *100*

Valuation of horse equipments, \$ *100*

Remarks:

-----  
-----  
-----  
-----  
-----  
-----  
-----

Book mark:

*E. H. Brown*  
Copyist.

H

5 Cav.

U.S.C.T.

James Hulse  
Prov, Co. K, 5 Reg't U. S. Col'd Cav.

Appears on

**Company Muster Roll**

for Nov + Dec, 1865.

Present or absent Present

Stoppage, \$ 100 for

Due Gov't, \$ 100 for

Valuation of horse, \$ 100

Valuation of horse equipments, \$ 100

Remarks: Due U.S for Ord  
277 For B + G E 95-

Book mark:

J. E. Porter

26 | **5 Cav.** | **U.S.C.T.**

James Hulse  
Corp, Co. K, 5 Reg't U. S. Col'd Cav.

Appears on

**Company Muster Roll**

for Sept & Oct, 1867.

Present or absent Present

Stoppage, \$ 100 for

Due Gov't, \$ 100 for

Valuation of horse, \$ 100

Valuation of horse equipments, \$ 100

Remarks: Due U.S. for  
Co. G. Co. 95 cts Due  
U.S. for Ard 50 cts

Book mark: \_\_\_\_\_

J. E. Porter

(358)

Copyist.



*H* | **5 Cav.** | **U.S.C.T.**

*James Haultz*  
*Prov*, Co. K, 5 Reg't U. S. Col'd Cav.

Appears on

**Company Muster Roll**

for *July & Aug*, 186*5*.

Present or absent *Present*

Stoppage, \$ *100* for

Due Gov't, \$ *100* for

Valuation of horse, \$ *100*

Valuation of horse equipments, \$ *100*

Remarks:

Book mark:

*F. E. Porter*

(358)

Copyist.

*H* | **5 Cav.** | **U.S.C.T.**

*James Hulse*  
-----  
*Prof*, Co. K, 5 Reg't U. S. Col'd Cav.

Appears on

**Company Muster Roll**

for *May & June*, 186 *5*.

Present or absent *Present*

Stoppage, \$ *100* for

Due Gov't, \$ *100* for

Valuation of horse, \$ *100*

Valuation of horse equipments, \$ *100*

Remarks: *First installment  
county due \$100*

Book mark: -----

*J. E. Porter*  
-----  
Copyist.

*A* | *5 cav* | **U.S.C.T**

*James Hultz*  
*Pvt., Co. K, 5 Reg't U. S. Col'd Cav*

Appears on

**Company Muster Roll**

for *Mar & Apr*, 1865.

Present or absent *Present*

Stoppage, \$ *100* for

Due Gov't, \$ *100* for

Valuation of horse, \$ *100*

Valuation of horse equipments, \$ *100*

Remarks: *1st installment of  
Bounty due \$100*

Book mark:

(358)

*H S Miller*

Copyist.



H | **5 Cav.** | **U.S.C.T.**

James Hulse  
Pvt., Co. K, 5 Reg't U. S. Col'd Cav.

Appears on

**Company Muster Roll**

for Jan & Feb, 1865.

Present or absent Absent

Stoppage, \$ 100 for

Due Gov't, \$ 100 for

Valuation of horse, \$ 100

Valuation of horse equipments, \$ 100

Remarks: In Gen Hospit - Bowling  
Green Ky Jan 2<sup>nd</sup> 1865  
1<sup>st</sup> & 2<sup>nd</sup> installments \$300  
Bounty due

Book mark: \_\_\_\_\_

(358) H. S. Miller Copyist.

H | **5 Cav.** | **U.S.C.T.**

James Hulse  
Pvt, Co. K, 5 Reg't U. S. Col'd Cav.

Appears on

**Company Muster Roll**

for Nov & Dec, 1864.

Present or absent Present

Stoppage, \$ 100 for

Due Gov't, \$ 100 for

Valuation of horse, \$ 100

Valuation of horse equipments, \$ 100

Remarks: 1" & 2" installments  
Bounty due

Book mark: \_\_\_\_\_

H S Miller

A | **5 Cav.** | **U.S.C.T.**

James Hulse  
Pvt., Co. K, 5 Reg't U. S. Col'd Cav.

Appears on

**Company Muster Roll**

for Organization to Oct 31, 1864.

Present or absent Present

Stoppage, \$ 100 for

Due Gov't, \$ 100 for

Valuation of horse, \$ 100

Valuation of horse equipments, \$ 100

Remarks:

-----  
-----  
-----  
-----  
-----  
-----  
-----

Book mark: -----

A. S. Miller  
(358) Copyist.



H. | 5 bar | USLTS,

James Hulse  
Appears with rank of Priv. on

**Muster and Descriptive Roll**

of Detachment of USL. Vols.  
forwarded Camp Nelson, Ky.

Roll dated  
Lexington, Ky, Oct. 7, 1864.

Where born Lebanon Ky

Age 21 years; occupation Sabotier

When enlisted Oct. 7, 186 .

Where enlisted Lexington, Ky

For what period enlisted 3 years.

Eyes Blue; hair Blue

Complexion Blue; height 5 ft. 6 in.

When mustered in \_\_\_\_\_, 186 .

Where mustered in \_\_\_\_\_

Bounty paid \$ \_\_\_\_\_ 100; due \$ \_\_\_\_\_ 100

**Clothing account:**

Last settled \_\_\_\_\_, 186 ; drawn since \$ \_\_\_\_\_ 100

Date of first muster Oct. 7, 1864.

Company to which assigned \_\_\_\_\_

Remarks: To be credited to  
Blank Co. 7th Dist. Ky

Book mark: \_\_\_\_\_

C. J. Hamill

(356m)

Copyist.

H | **5 Cav.** | **U.S.C.T.**

James Hulst  
Pvt, Co. K, 5 Reg't U. S. Col'd Cavalry.

Appears on

**Company Muster-in and Descriptive Roll**  
of the organization named above. Roll dated

Camp Nelson Ky, N. Y. Oct 30, 1864.

Where born Clark Ky

Age 21 y'rs; occupation Laborer

When enlisted Oct 7, 1864.

Where enlisted Lexington Ky

For what period enlisted 3 years.

Eyes Blk; hair Blk

Complexion Blk; height 5 ft. 6 in.

When mustered in Oct 7, 1864.

Where mustered in Lexington

Bounty paid \$ 100; due \$ 100

Where credited 7 Dist Ky

Company to which assigned \_\_\_\_\_

Remarks: \_\_\_\_\_

\_\_\_\_\_

\_\_\_\_\_

\_\_\_\_\_

Book mark: H. 2087. Ky.

H S Miller

(356d)

Copyist.

76 | **5 Cav. | U.S.C.T.**

James Hulse  
....., Co. D, 5 Reg't U. S. Col'd Cav.

Appears on

**Company Descriptive Book**  
of the organization named above.

**DESCRIPTION.**

Age 24 years; height 5 feet 6 inches.

Complexion Black

Eyes Blue; hair Black

Where born Charlotte Co. Va.

Occupation Laborer

**ENLISTMENT.**

When Oct-7, 1864.

Where Lexington Va.

By whom H. H. H.; term 3 y'rs.

Remarks: .....

.....  
.....  
.....  
.....  
.....  
.....  
.....  
.....

A. J. Anderson



A. 1173666 P.O. m m  
A. 1425333 P.O. Ass.  
D 2304521 and WJ

A. 1670901

A. 10-13-15 m m

8-6-33-1-1

S.S. Ills. S.S. Home.

5-1-31  
2

J. H. McLaughlin

Hulse James

Co 76, 5 U. S. Col'd Cav.

Private

Private

CARD NUMBERS.

1	5368844	26
2	5368933	27
3	5369034	28
4	5369121	29
5	5369209	30
6	5369296	31
7	5369385	32
8	5369473	33
9	5369558	34
10	5369645	35
11	5369729	36
12	9091084	37
13	43148228	38
14	40729916	39
15		40
16		41
17		42
18		43
19		44
20		45
21		46
22		47
23		48
24		49
25		50

Book Mark:

See also

Hulse



**NATIONAL ARCHIVES MICROFILM PUBLICATIONS**

Microfilm Publication M1817

COMPILED MILITARY SERVICE RECORDS OF VOLUNTEER UNION  
SOLDIERS WHO SERVED WITH THE UNITED STATES COLORED  
TROOPS: 1st Through 5th United States Colored Cavalry, 5th Massachusetts  
Cavalry (Colored), 6th United States Colored Cavalry

Roll 68

5th United States Colored Cavalry

Hulse, James - Keller, Ephraim

**NATIONAL ARCHIVES AND RECORDS ADMINISTRATION**

NATIONAL ARCHIVES MICROFILM PUBLICATIONS

**Roll**    **Description**

- 73    Shrewsbury, Joseph - Stone, John
- 74    Stone, Lewis - Trye, Benjamin
- 75    Trueheart, Samuel - Williams, James
- 76    Williams, Jerry - Yowell, Joseph

**5th Massachusetts Cavalry (Colored)**

- 77    Abbey, David - Biers, William
- 78    Billings, Jeremiah - Burgess, Williams
- 79    Burnett, Lewis - Cook, Joseph T.
- 80    Cooper, Isaac - Dunmore, William
- 81    Durbin, Stephen - Furman, Seneca A.
- 82    Gadson, James - Gurley, Joseph L.
- 83    Guy, James - Hill, John W.
- 84    Hill, Richard - Johns, Thomas H.
- 85    Johnson, Aaron - Lambert, William
- 86    Lancaster, James - Mason, John
- 87    Mason, John H. - Nelson, Philip
- 88    Nelson, Preston - Preston, Thomas
- 89    Price, Adam - Sampson, George P.
- 90    Sanborn, Madison - Stringer, William
- 91    Strother, Frank - Vance, William H.
- 92    Van Hoesen, Charles - Wilkinson, Simon
- 93    Williams, Abram H. - Young, Thomas

**6th United States Colored Cavalry**

- 94    Abbot, John - Birch, James
- 95    Bivins, Gabriel - Buckner, George
- 96    Buckner, Henderson - Compton, James
- 97    Cook, Benjamin - Ellis, William
- 98    Ellis, Wyatt - Godley, Isaac
- 99    Gooch, Alexander - Herston, Abraham
- 100    Heywood, John R. - Johnson, Jackson
- 101    Johnson, James M. - Marshall, Lyman
- 102    Marshall, William - Neihardt, Isaac D.
- 103    Nelson, Joseph - Redd, Tiney
- 104    Redway, Hamilton K. - Sebree, Bob Woodcock
- 105    Sebree, Crittenden - Sumpter, John
- 106    Sutherland, Williams - Washington, Charles
- 107    Washington, George - Wren (no first name)

<u>Roll</u>	<u>Description</u>
35	Cammel, Austin - Cooper, Stephen
36	Coran, Joseph - Erving, Tilson
37	Erwin, Anderson - Gool, George
38	Gordon, Alfred - Haskins, Jasper
39	Hawkins, Frank - Jackson, Harvey
40	Jackson, Henry - Kembro, Abraham
41	Kenedy, Lemuel - Lott, Judge
42	Lott, Matton - Mitchell, Berry
43	Mitchell, George - Pettis, Edmond
44	Pettis, George - Roberson, Jefferson
45	Roberson, Wallace - Simpson, Levi
46	Sims, Anderson - Taylor, Phillip
47	Taylor, Richard - Washington, Isaac
48	Washington, Oscar - Williams, Mitchel
49	Williams, Moses - Young, Mathew

**4th United States Colored Cavalry**

50	Abraham, Randall - Blanchan, William
51	Blanchard, Moses - Clark, Moses
52	Clark, Theodore - Ellars, James
53	Ellars, John - Heath, Culbert
54	Henderson, George - Johnson, Henderson
55	Johnson, Henry - Mayberry, Nelson
56	Macomory, John - Oliver, Celestine
57	Olsten, Alexander - Robinson, William
58	Robinson, William E. - Thomas, Stephen
59	Thomas, William - Williams, Horace
60	Williams, Isaac - Zulia, Francois

**5th United States Colored Cavalry**

61	Abel, Fletcher - Biggs, Randall
62	Birch, Benjamin - Burly, Frank
63	Burly, James - Coffman, James D.
64	Coke, Samuel - Dudley, John
65	Duke, John - Givens, Peter
66	Glen, John - Harriden, Edmund
67	Harrigan, Harden - Hughes, Thomas
68	Hulse, James - Keller, Ephraim
69	Kelley, Franklin - Matthews, Benjamin
70	Maupin, Preston - Murry, Ned
71	Murtney, Morton - Ray, John
72	Ray, Thomas - Sherrod, William



ROLL LIST

**Roll**    **Description**

**1st United States Colored Cavalry**

- 1    Akess, Alexander - Bom, John H.
- 2    Bomer, James - Cartwright, John
- 3    Casey, Thomas - Davenport, John J.
- 4    Davis, Augustus - Floyd, George
- 5    Fly, Benjamin - Griffin, Oliver
- 6    Griffin, Quinton - Holstead, Peter
- 7    Holt, George - Jones, Herbert
- 8    Jones, Howell - Macoy, Peter
- 9    Madry, Andrew - Mosley, Jacob
- 10   Moss, James - Polk, James
- 11   Pollard, Sipio - Sales, William
- 12   Sample, Abram (Abraham) - Smith, Ives
- 13   Smith, James - Times, Nelson
- 14   Tines, Archer - Wheldon, Charles M.
- 15   Whitby, Joseph - Wilson, Isaac
- 16   Wilson, James - Zoe (no first name)

**2d United States Colored Cavalry**

- 17   Abbot, John - Bell, Charles
- 18   Bell, Henry - Burns, Richard
- 19   Burroughs, George L. - Cotton, Samuel
- 20   Coues, Alexander - Duncan, Levi
- 21   Dunkins, Ezikiah James - Gardner, Richard
- 22   Garris, Henry - Harrison, Thomas
- 23   Harrison, William - Humphries, David
- 24   Hunter, Francis - Jones, Robert
- 25   Jones, Robert F. - Martin, Robert (Martin)
- 26   Martin, Thaddeus or Martin, Thaddeus W. - Osborne, Henry S.
- 27   Oulden, Jacob - Prior, Edward or Edmund
- 28   Proctor, David - Sawyer, Wilson
- 29   Scabber, Charles - Stanley, William
- 30   Stanley, Wright or Right - Upshear, Neverson
- 31   Upshear, Samuel - Whites, Joe
- 32   Whites, Silas - Zodrick, Isaiah A. or Isaiah

**3d United States Colored Cavalry**

- 33   Aaron, John - Black, David
- 34   Black, Richard - Cameron, Wyatt

Other record groups having information pertaining to the USCT include Records of the Bureau of Refugees, Freedmen, and Abandoned Lands (RG 105); Records of the Provost Marshal General's Bureau (Civil War) (RG 110); Records of the Accounting Officers of the Department of the Treasury (RG 217); and Records of U.S. Army Continental Commands, 1821-1920 (RG 393).



NATIONAL ARCHIVES MICROFILM PUBLICATIONS

reproduced as Microfilm Publication M1659, *Records of the Fifty-fourth Massachusetts Infantry Regiment (Colored), 1863-1865*.

The "record of events" cards include information copied from the unit's muster rolls and returns. They show the stations of the field and staff and those of the various companies of the regiment at the time the muster roll or return was prepared and sometimes mention battles, skirmishes, or other activities in which the regiment participated. The cards have been reproduced as Microfilm Publication M594 *Compiled Records Showing Service of Military Units in Volunteer Union Organizations*.

Record Group 94 also includes a card index for the USCT, reproduced as Microfilm Publication M589, *Index to Compiled Military Service Records of Volunteer Union Soldiers Who Served with U.S. Colored Troops*, which may be used to locate the regiment of USCT personnel. An index card gives the name of the soldier and his rank, as well as the unit in which he served; sometimes there is a cross-reference to his service in other units or organizations. The National Archives is continually producing microfilm publications of volunteer Union compiled military service records. A complete listing of finished publications can be found in the National Archives' *Microfilm Resources for Research: A Comprehensive Catalog* which is available online at <http://www.nara.gov>.

The Records of the Colored Troops Division, within RG 94, include division correspondence and records relating to recruiting, the appointment of officers, and the slave or free status of individuals; and a compilation of historical extracts and official papers concerning the military service of African Americans from the colonial period through the Civil War entitled *The Negro in the Military Service of the United States 1639-1886*. This compilation is reproduced as Microfilm Publication M858. The Records of the Bounty and Claims Division, also in RG 94, include correspondence of the division and records relating to bounties and claims paid to loyal owners of slaves by the Slave Claims Commissions of Delaware, Kentucky, Maryland, Missouri, Tennessee and West Virginia.

If an application for a pension was made, the pension application case file may be among the Records of the Veterans Administration (RG 15). Indexes to the pension applications have been reproduced as Microfilm Publication T288, *General Index to Pension Files, 1861-1934*, and T289, *Organizational Index to Pension Files of Veterans Who Served Between 1861 and 1900*.

If a soldier or officer was tried before a general court-martial or if an individual or his unit was the subject of a court of inquiry or military commission, transcripts of the proceedings may be among the Records of the Office of the Judge Advocate General (Army) (RG 153). The registers to the proceedings have been reproduced as Microfilm Publication M1105, *Registers of the Records of the Proceedings of the U.S. Army General Courts-Martial, 1809-1890*.



1865 when it was ordered to the Department of Arkansas. The unit was mustered out on April 15, 1866. Compiled casualty figures are not available.

### Records Description

Compiled service records consist of a jacket-envelope for each soldier, labeled with his name, rank, unit, and card numbers. The compilation of service records of Union soldiers began in 1890 under the direction of Col. Fred C. Ainsworth, head of the Record and Pension Office of the Adjutant General's Office, Department of War. Information from muster rolls, regimental returns, descriptive books, and other records was copied verbatim onto cards. A separate card was prepared each time an individual name appeared on a document. These cards were numbered on the back, and these numbers were entered onto the outside jacket containing the cards. The carded information was verified by a separated operation of comparison; great care was taken to ensure that the cards were accurate.

A typical jacket contains card abstracts of entries found in original records relating to the soldier and original documents relating solely to that soldier. Examples of the latter include enlistment papers, substitute certificates, casualty sheets, death reports, prisoner-of-war memorandums, and correspondence. Unique to the records of the USCT are deeds of manumission, oaths of allegiance, proof of ownership, certificates of monetary award, and bills of sale. These items appear most frequently in units recruited in the border states of Kentucky, Missouri, and Maryland. These states remained in the Union but were slave states. Jackets and cards include a section labeled "bookmark" which was reserved for cross-references to other records relating to the individual or his unit. The service records are arranged by arm of service, thereunder numerically by regiment or independent battalion or company and thereunder alphabetically by name of the soldier. Records for officers are interfiled alphabetically by name with the records of enlisted men. If an individual served in more than one unit, which was typical for USCT officers, there will be a separate service record for each unit in which he served.

### Related Records

Among the records of the Adjutant General's Office in the National Archives are many of the original records that were abstracted or "carded" by the Record and Pension Office. These include the individual unit's muster rolls, returns and descriptive books. Other series in RG 94 that contain information relating to volunteer Union soldiers who served with the USCT include carded records relating to Union staff officers, carded medical records of volunteer Union soldiers, unbound and bound regimental records and "record of events" cards. The regimental records of the 54th Massachusetts Infantry (Colored) have been



**4th United States Colored Cavalry**

Organized on September 12, 1863, as the 1st Corps d'Afrique Cavalry, this regiment was redesignated the 4th United States Colored Cavalry on April 4, 1864. From its organization until August 1864, it was attached to the Defenses of New Orleans, Department of the Gulf. On August 8, 1864, the 4th was ordered to Baton Rouge, LA, District of Port Hudson, and remained on duty at that post until July 1865 when it was transferred to the Department of Mississippi. It performed duties at various points in that department until it was mustered out on March 20, 1866. Compiled casualty figures are not available.

**5th United States Colored Cavalry**

This regiment was organized at Camp Nelson, KY, on October 24, 1864, and attached to the 1st Division, District of Kentucky, Department of Ohio. December 10-29, 1864, it participated in Stoneman's Raid into southwestern Virginia, including the capture of Saltville and the destruction of saltworks on December 20-21. In February 1865 the regiment was transferred to the Military District and Department of Kentucky until December of that year when it was ordered to the Department of Arkansas. During the latter period the unit performed mostly garrison duty. The regiment was mustered out March 20, 1866. Losses included 35 killed in action and 152 dead from disease and other causes.

**5th Massachusetts Cavalry (Colored)**

This regiment was organized at Camp Meigs, Reedville, MA, in the spring of 1864, and sent to Washington, DC, in May of that year. On May 13 the regiment moved to City Point, VA, where it was attached to the 18th Army Corps. Until June 16 it functioned as an infantry unit and participated in the siege of Petersburg. On June 30 it was moved to Point Lookout, MD, to guard prisoners of war. In July 1864 the regiment, still at Point Lookout, became part of the 22d Army Corps. It was transferred to the 25th Army Corps in March 1865 and ordered to the field near Richmond and Petersburg. In June the regiment was ordered to the Department of Texas where it was assigned duty at Clarksville until October 31, 1865, when it was mustered out. Losses included 7 men killed in action and 116 dead from disease and other causes.

**6th United States Colored Cavalry**

This regiment was organized at Camp Nelson, KY, on October 24, 1864, and attached to the 1st Division, District of Kentucky, Department of Ohio. December 10-29, 1864, it participated in Stoneman's Raid, including the destruction of the lead mines in southwestern Virginia. At the end of December the regiment returned to Camp Nelson and in February 1865 was transferred to the Military District and Department of Kentucky. It remained there until December



**1st United States Colored Cavalry**

This regiment was organized at Camp Hamilton, VA, on December 22, 1863, and assigned to duty in the Department of Virginia and North Carolina. The 1st participated in Gen. Benjamin F. Butler's operations on the south side of the James River and against Petersburg and Richmond, May 4-28, 1864. These included the capture of Bermuda Hundred and City Point, VA, on May 5, and events leading up to and including the siege of Petersburg. In August 1864 it was transferred to the defenses of Portsmouth, District of Eastern Virginia. On June 10, 1865, the 1st sailed from City Point, VA, to Texas where it was assigned duty on the Rio Grande and various other areas of the state. The unit was mustered out on February 4, 1866. Compiled casualty figures are not available.

**2d United States Colored Cavalry**

This regiment was organized at Fort Monroe, VA, on December 22, 1863, and assigned to duty in the Department of Virginia and North Carolina. The 2d participated in Gen. Benjamin F. Butler's operations on the south side of the James River and against Petersburg and Richmond, May 4-28, 1864. These included the capture of Bermuda Hundred and City Point, VA, on May 5, and events leading up to and including the siege of Petersburg. In February 1865 it was transferred to Norfolk, District of Eastern Virginia. On June 10, 1865, the 2d sailed from City Point, VA, to Texas where it was assigned duty on the Rio Grande and various other areas of the state. The unit was mustered out on February 12, 1866. Losses included 19 killed in action and 161 dead from disease and other causes.

**3d United States Colored Cavalry**

Organized at Vicksburg, MS, on October 9, 1863, as the 1st Mississippi Cavalry (African Descent), this regiment was redesignated the 3d U.S. Colored Cavalry on March 11, 1864. From its organization until March 1864, the unit was attached to the District of Northeast Louisiana and from January to March 1864 participated in operations up the Yazoo River and the occupation of Yazoo City. The regiment was then transferred to the District of Vicksburg, Department of Tennessee, where it remained until December 1864. That month the unit moved to Memphis, TN, and from December 21, 1864, to January 5, 1865, participated in Gen. Benjamin Grierson's raid to destroy the Mobile & Ohio Railroad. The 3d remained on duty in Memphis and the District of West Tennessee and took part in the expedition from Memphis to Brownsville, MS, April 23-26, 1865. On April 29 the regiment returned to Vicksburg and operated around Natchez in search of fugitive Confederate President Jefferson Davis. The unit remained in the District of West Tennessee and Department of Mississippi until January 26, 1866, when it was mustered out. Losses included 37 killed in action and 367 dead from disease and other causes.



free and contraband African Americans. Thomas was given broad authority. He was to explain the administration's policy regarding African American soldiers and recruit volunteers to raise and command them. Stanton wanted all officers of such units to be white, but that policy was softened to allow African American surgeons and chaplains. By the end of the war, in addition to the chaplains and surgeons, there were some 87 African-American officers. Thomas's endeavor was very successful, and on May 22, 1863, the Bureau of Colored Troops was established to coordinate and organize regiments from all parts of the country. Created under War Department General Order No. 143, the bureau was responsible for handling "all matters relating to the organization of Colored Troops." The bureau was directly under the Adjutant General's Office and its procedures and rules were specific and strict. All African American regiments were now to be designated United States Colored Troops (USCT). At this time there were some African American regiments with state names and a few regiments in the Department of the Gulf designated as Corps d'Afrique. All these were ultimately assimilated into the USCT, even though some of the regiments, such as the 5th Massachusetts, retained their state designations.

To facilitate recruiting in the states of Maryland, Missouri, Tennessee, and eventually Kentucky, the War Department issued General Order No. 329 on October 3, 1863. Section 6 of the order stated that if any citizen should offer his or her slave for enlistment into the military service, that person would, "if such slave be accepted, receive from the recruiting officer a certificate thereof, and become entitled to compensation for the service or labor of said slave, not exceeding the sum of three hundred dollars, upon filing a valid deed of manumission and of release, and making satisfactory proof of title." For this reason, some records of manumission are contained in the compiled service records reproduced in this publication.

The USCT fought in 39 major engagements and over 400 lesser ones. Sixteen African American soldiers received Medals of Honor. As it was in other units, the death toll from disease was very high in the USCT. Deaths from disease and battle totaled 37,000. The last regiment of the USCT was mustered out of Federal service in December 1867.

Important sources for information about African American units in the Civil War are the War Department's *The War of the Rebellion: A Compilation of the Official Records of the Union and Confederate Armies* (Washington, DC: 1880-1901; reprinted Harrisburg, 1971 and 1985) and the Navy Department's *The War of the Rebellion; A Compilation of the Official Records of the Union and Confederate Navies* (Washington, DC: 1874-1922; reprinted Harrisburg, 1971 and 1985). These multivolume works contains reports of operations and other official correspondence.



## INTRODUCTION

On the 107 rolls of this microfilm publication, M1817, are reproduced the compiled military service records of volunteer Union soldiers belonging to the 1st through 5th United States Colored Cavalry, the 5th Massachusetts Cavalry (Colored), and the 6th United States Colored Cavalry. While the 5th Massachusetts did retain its state designation, these units were all part of the United States Colored Troops (USCT). The USCT included 7 numbered cavalry regiments; 14 numbered artillery regiments; 144 numbered infantry regiments; plus Brigade Bands Nos. 1 & 2 (Corps d'Afrique and US Colored Troops); Powell's Regiment Colored Infantry; Southard's Company Colored Infantry; Quartermaster Detachment; Pioneer Corps, 1st Division, 16th Army Corps; Unassigned Company A Colored Infantry and Unassigned USCT. The records reproduced are part of the Records of the Adjutant General's Office, 1780's-1917, Record Group (RG) 94.

## Background

### United States Colored Troops

Since the time of the American Revolution, African Americans have volunteered to serve their country in time of war. The Civil War was no exception. Official sanction was the difficulty. In the fall of 1862 there were four Union regiments of African Americans raised in New Orleans, LA: the 1st, 2d, and 3d Louisiana Native Guard, and the 1st Louisiana Heavy Artillery (African Descent). The 1st South Carolina Infantry (African Descent) was not officially organized until January 1863; however, three companies of the regiment were on coastal expeditions as early as November 1862. Similarly, the 1st Kansas Colored Infantry was not mustered into Federal service until January 1863, even though the regiment had already participated in the action at Island Mound, MO, on October 27, 1862. These early unofficial regiments received little Federal support, but they showed the strength of the African American soldier's desire to fight for freedom.

The first official authorization to employ African Americans in Federal service was the Second Confiscation and Militia Act of July 17, 1862. This act allowed President Abraham Lincoln to receive into the military or naval service persons of African descent and gave him permission to use them for any purpose "he may judge best for the public welfare." However, the President did not authorize use of African Americans until issuance of the Emancipation Proclamation on January 1, 1863.

In late January 1863, Gov. John Andrew of Massachusetts received permission to raise a regiment of African American soldiers. The pace of organizing additional regiments was very slow. In March Secretary of War Edwin M. Stanton sent Gen. Lorenzo Thomas to the lower Mississippi Valley to recruit

M1817

COMPILED MILITARY SERVICE RECORDS OF  
VOLUNTEER UNION SOLDIERS WHO SERVED WITH THE  
UNITED STATES COLORED TROOPS:  
1st Through 5th United States Colored Cavalry  
5th Massachusetts Cavalry (Colored)  
6th United States Colored Cavalry

Introduction by Michael E. Pilgrim

Records prepared for microfilming by members of  
the Civil War Conservation Corps

Budge Weidman, Project Director

Pat Alfredson	Naomi Glass	Dave Murray
Phyllis Altrogge	Sue Goward*	Ray Puzio
Kenneth Ashton	Bert Greenstein	Bill Schneider
Sue Barnard*	Anne Greenwood	Sylvia Scott
Dee Benson	Jim Harris	Lynn Shearouse
Ann N. Brown	Walter Hayden	Mary Stack-Dunne
Robert Budway	Mary Hayden	Ben Stearns
MaryAnn Castellana*	Pat Ikonen	Bill Stormer*
Mary Lou Cole	Dick Ives	Pat Sullivan
Marjory Cooper	Sarah Jaffe	Gorman Tidball*
Giovanni Croce	Barbara Kemp	Cathy Tinston
B. H. Custer	Bev Manypenny	John Toole
Bob Denney	Frank Masterson	Maryellen Toole
Richard Dow	Joe Mazur	Milt Weatherhead
Yvette Fallin	Sarah McDougall	C. Lois Young
	Ben Miles	

Team leaders are indicated by the asterisk.

National Archives and Records Administration  
1997



MICROCOPY

1944

RESEARCH



National Archives at College Park



8601 Adelphi Road College Park MD 20740-6001

Rebecca Sullivan

Z3

OPERATOR

CAMERA

September 11, 1997

10

DATE FILMED

REDUCTION RATIO

03510107

FILM EMULSION NUMBER

M1817

08

PROJECT NUMBER

ROLL NUMBER

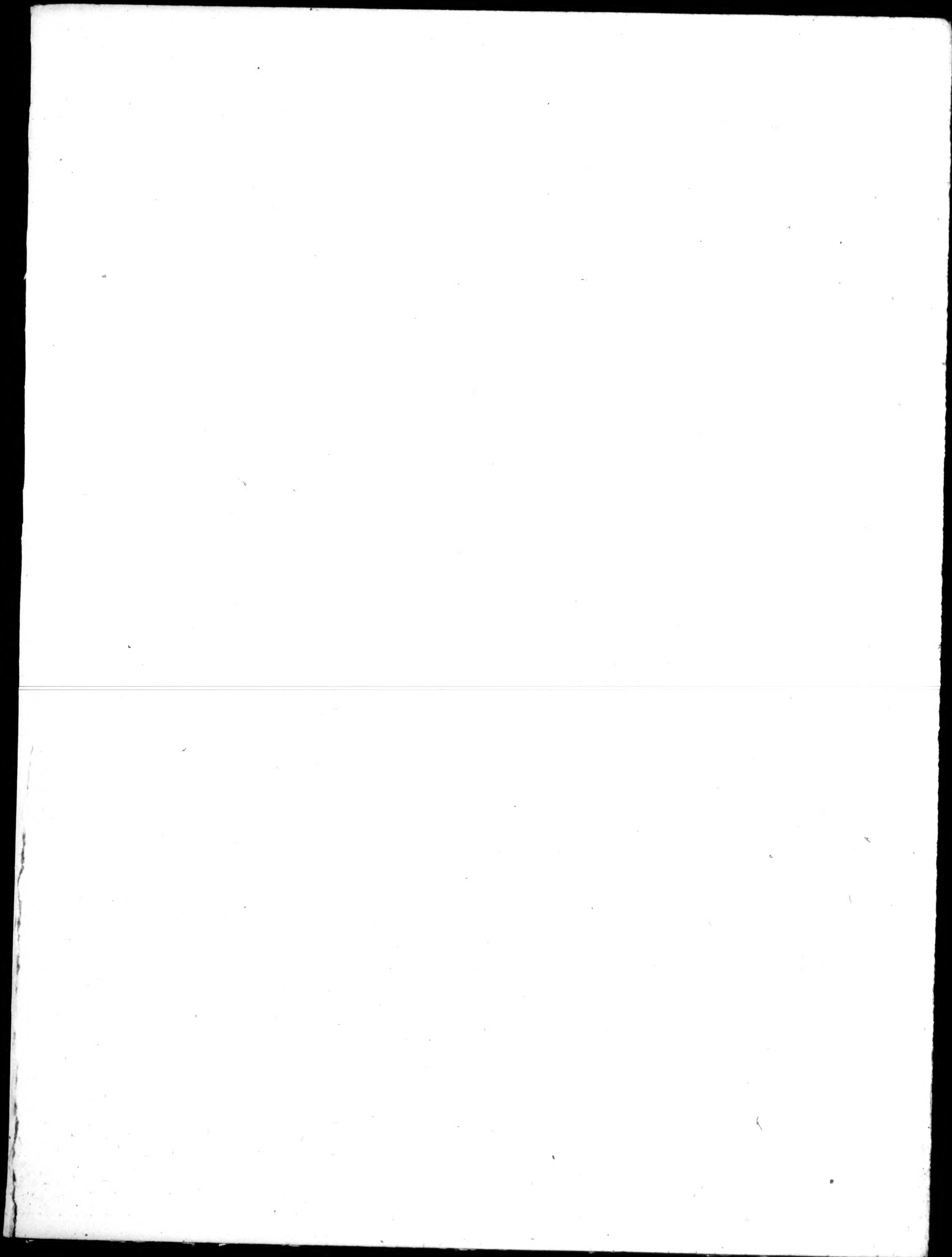



# IMAGE EVALUATION TEST TARGET (QA-3)

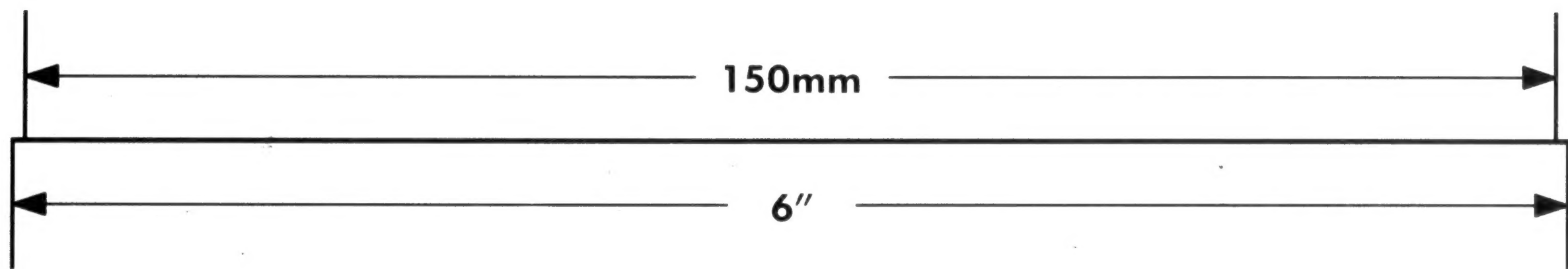
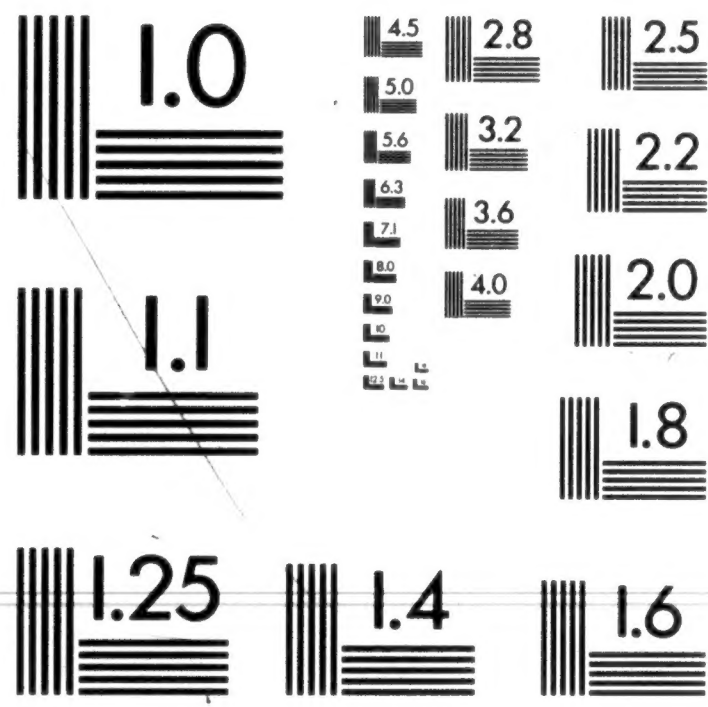
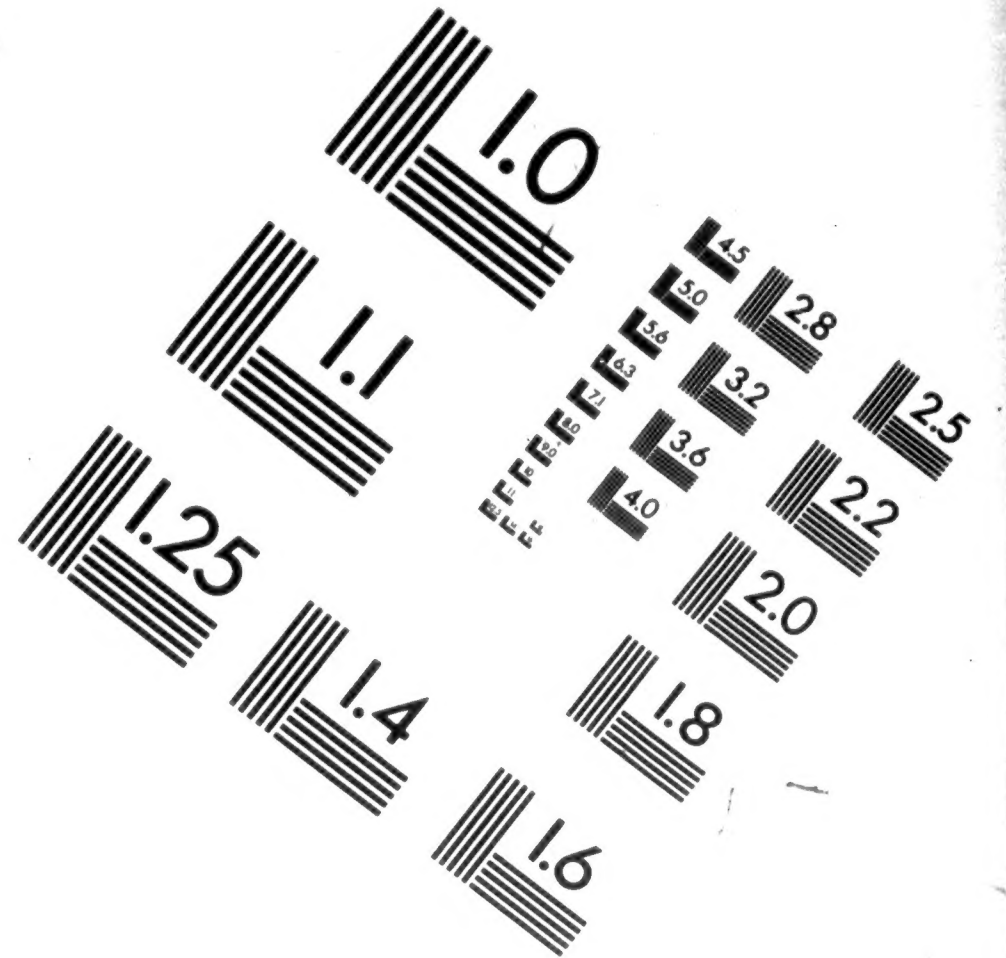
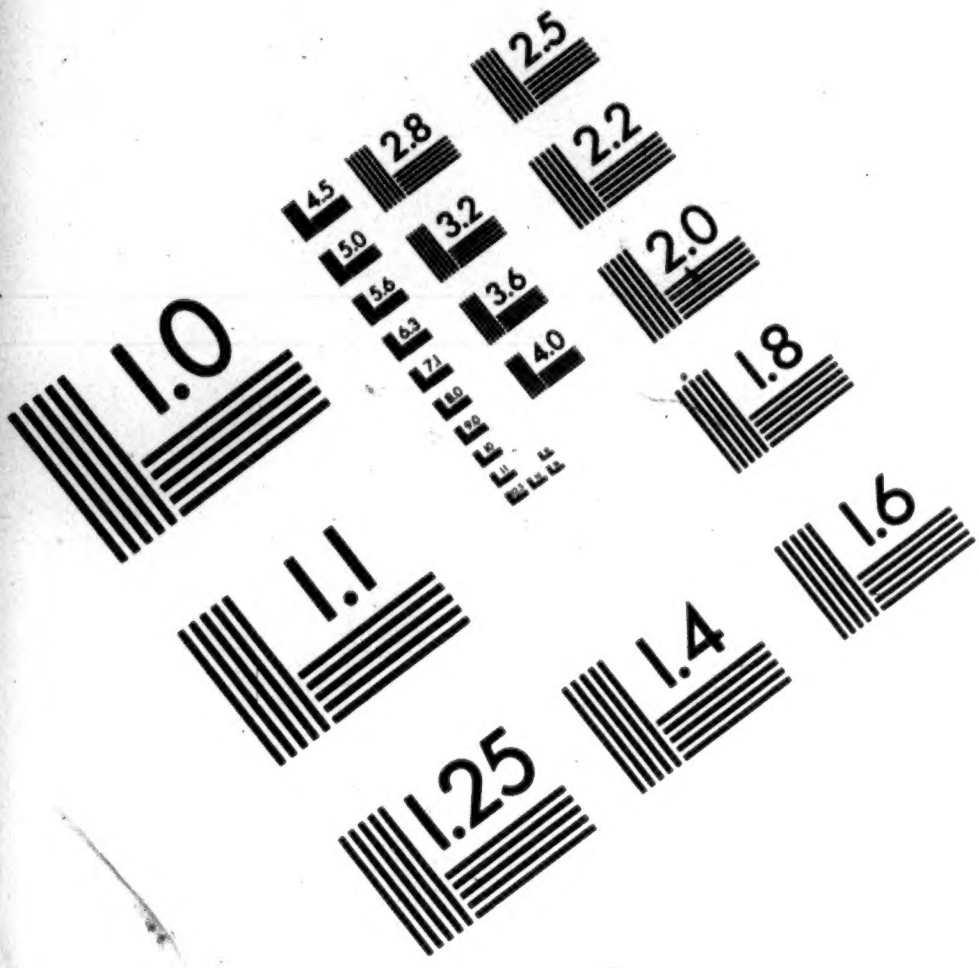

**APPLIED IMAGE, Inc**  
 1653 East Main Street  
 Rochester, NY 14609 USA  
 Phone: 716/482-0300  
 Fax: 716/288-5989

© 1993, Applied Image, Inc., All Rights Reserved

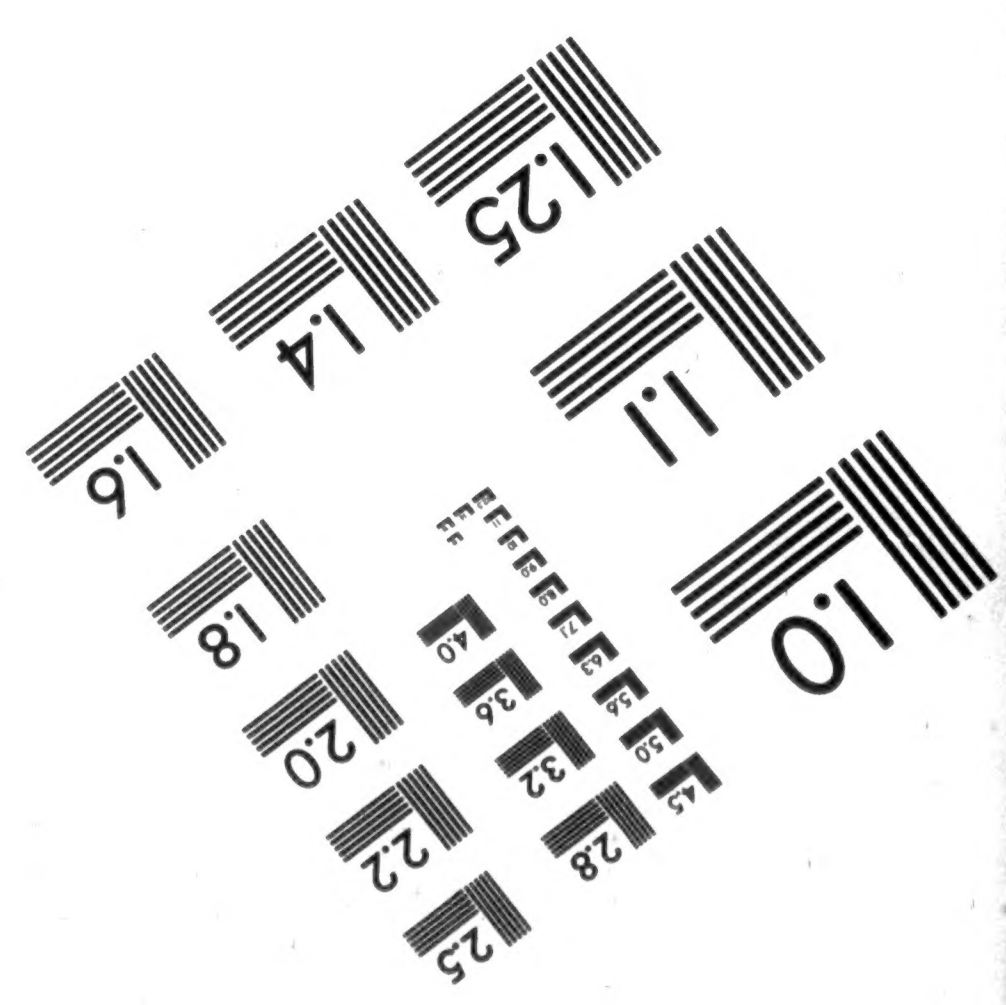
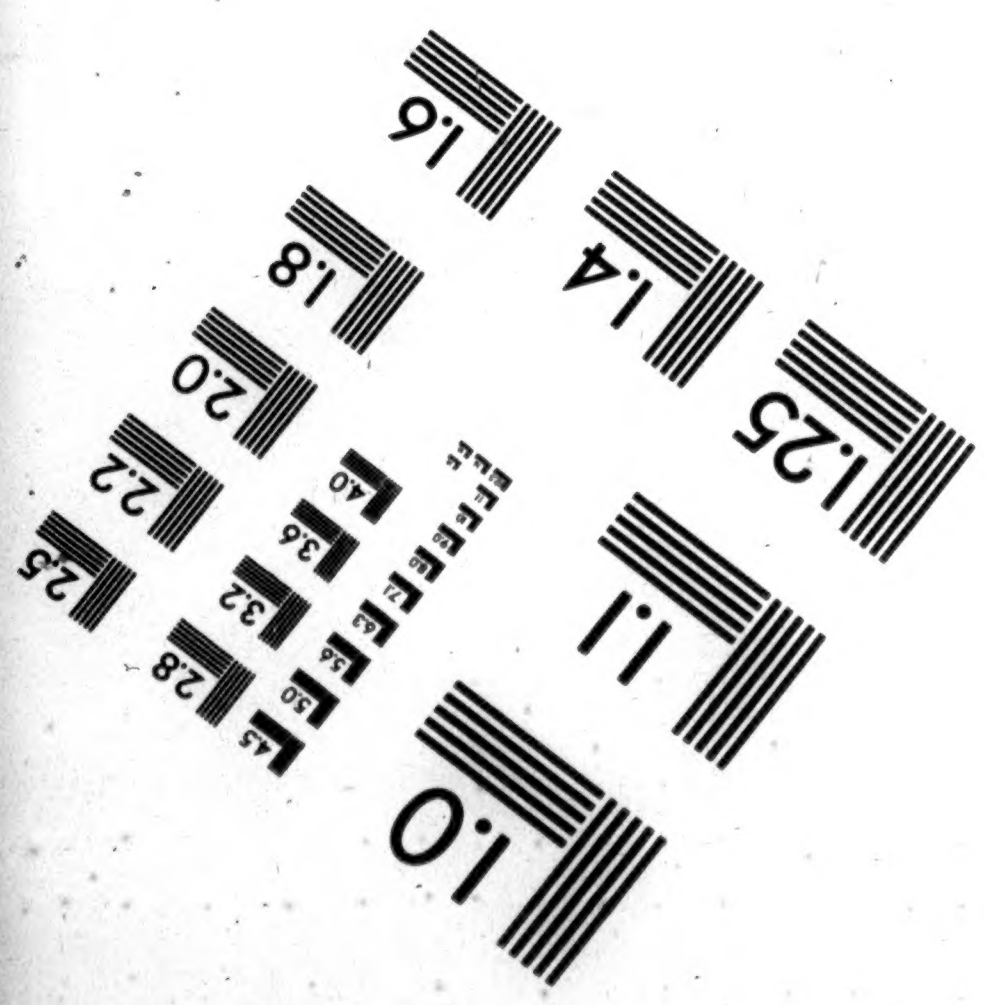



**NATIONAL  
ARCHIVES  
MICROFILM  
PUBLICATIONS**