

**NATIONAL
ARCHIVES
MICROFILM
PUBLICATION**

IMAGE EVALUATION TEST TARGET (QA-3)

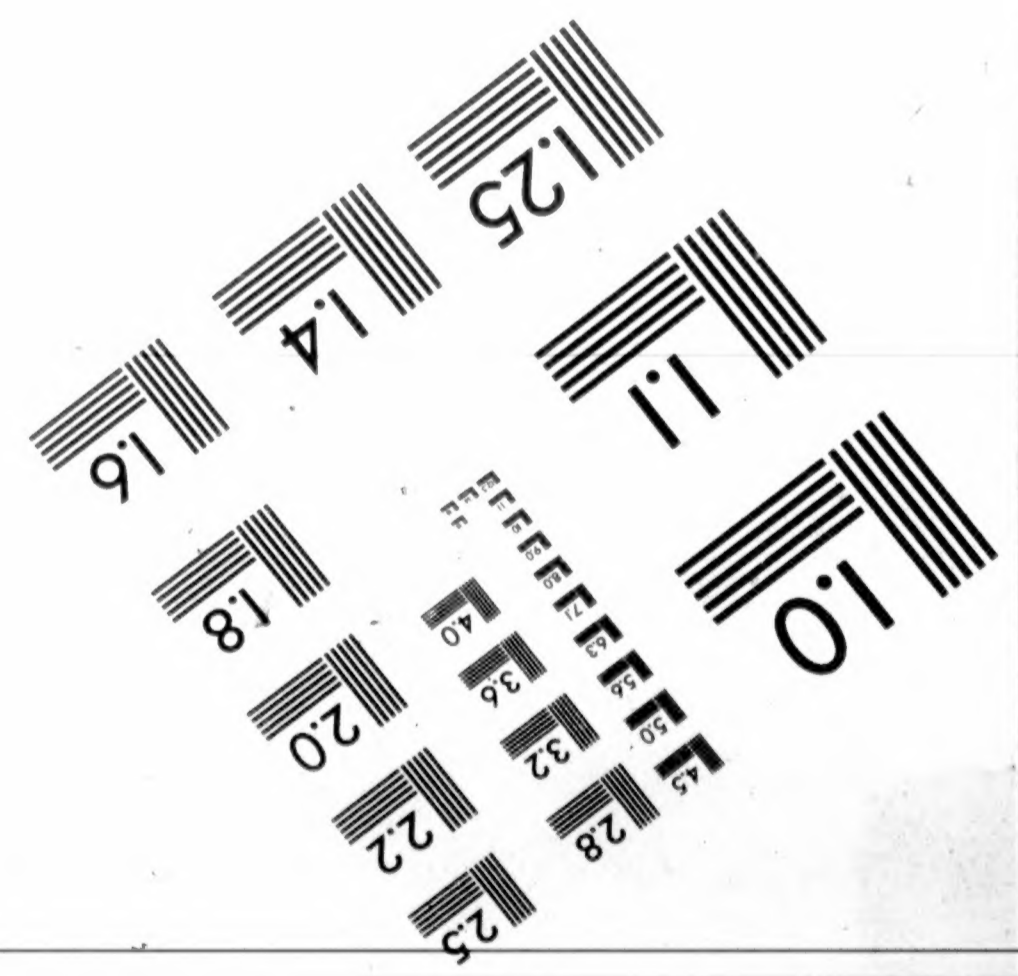
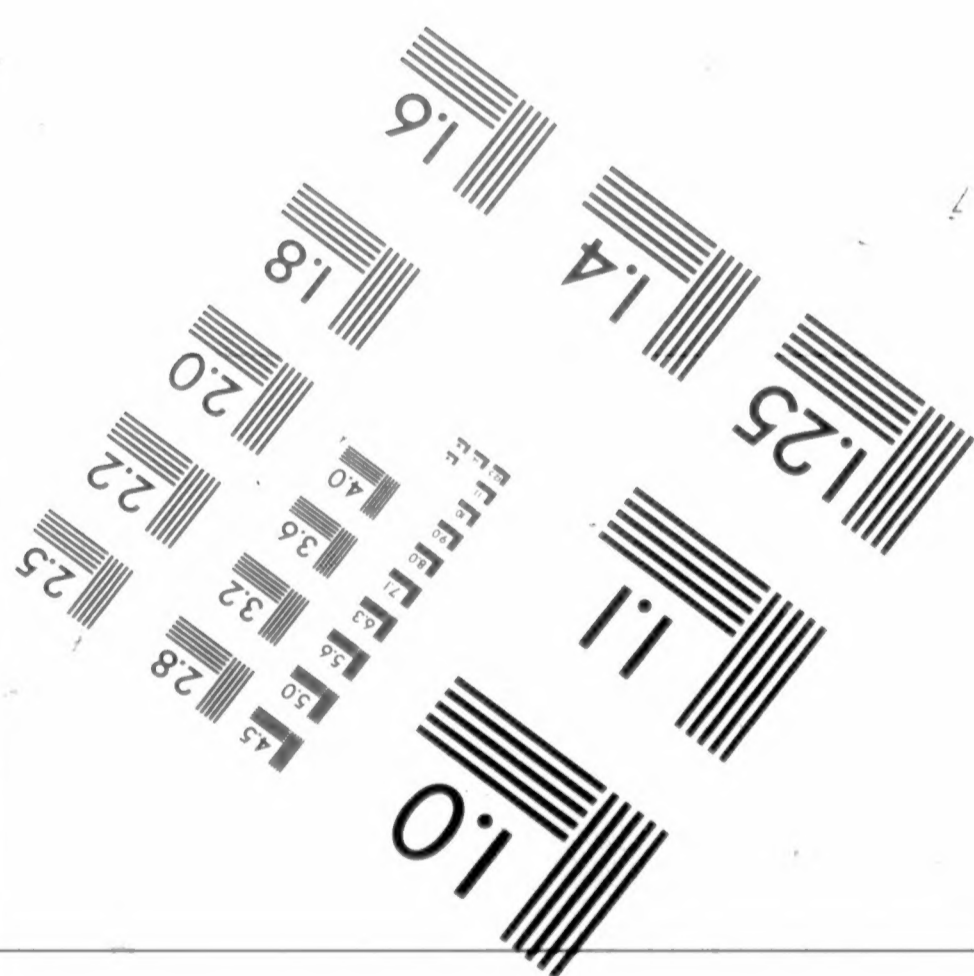
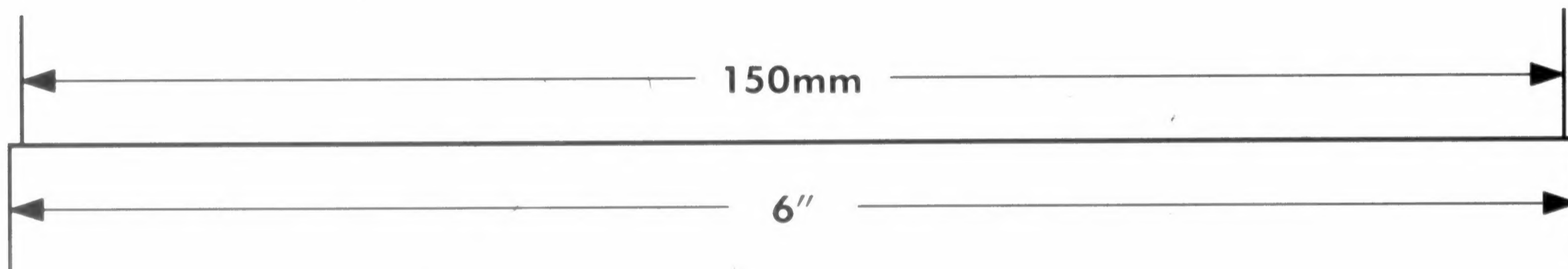
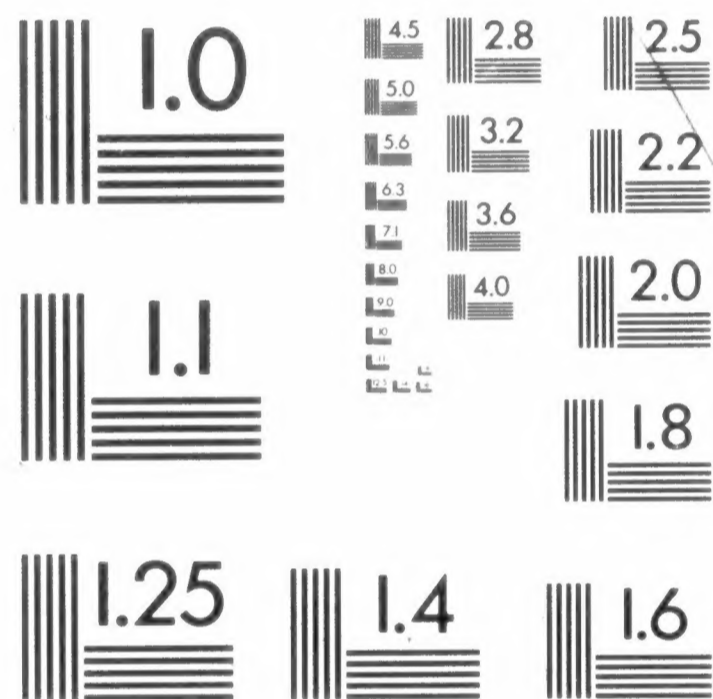
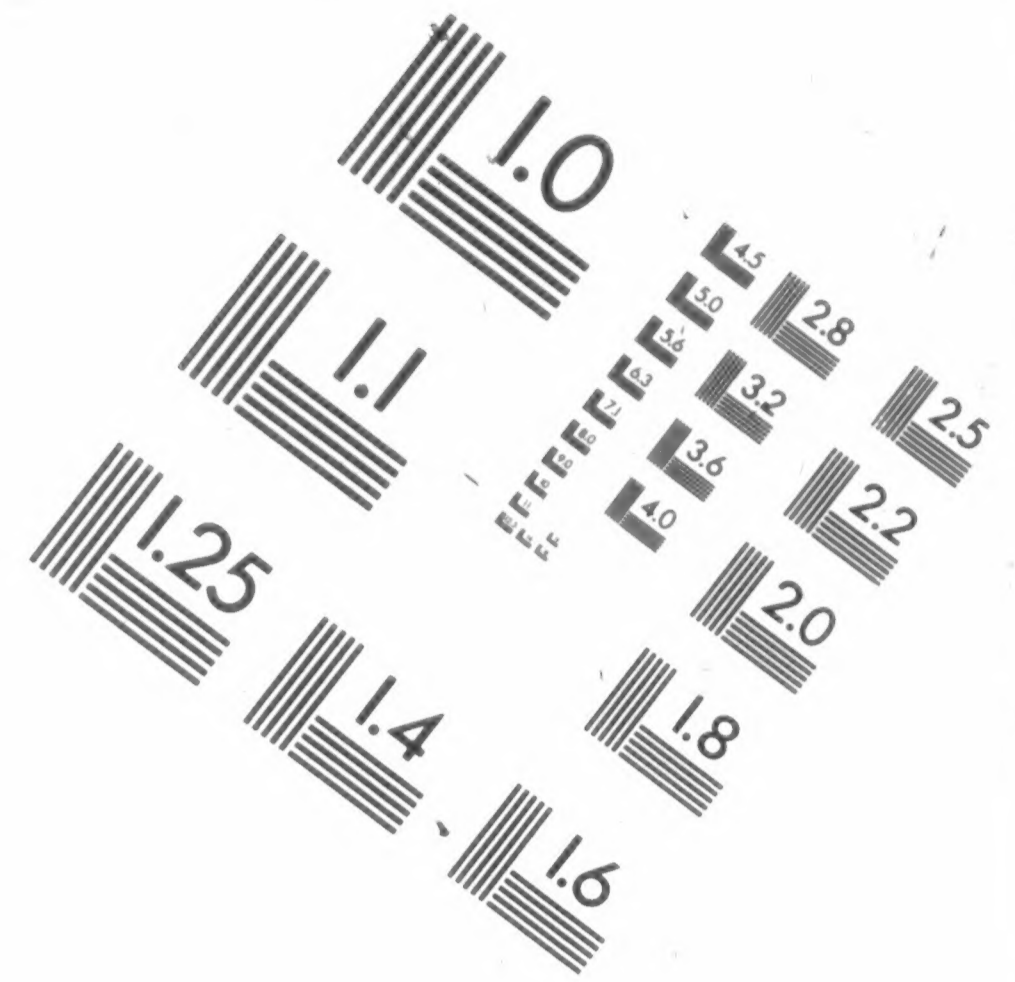
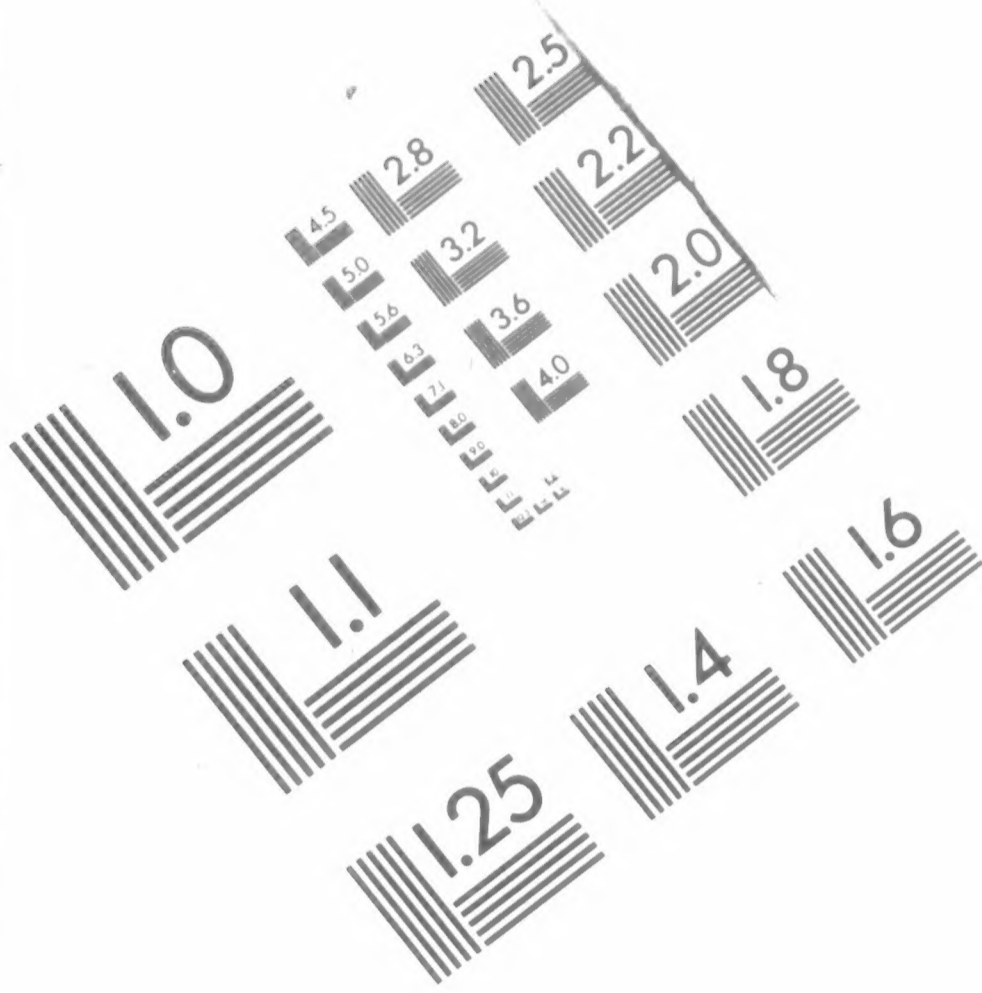

APPLIED IMAGE, Inc
1653 East Main Street
Rochester, NY 14609 USA
Phone: 716/482-0300
Fax: 716/288-5989

© 1993, Applied Image, Inc., All Rights Reserved

VW

National Archives at College Park



8601 Adelphi Road College Park MD 20740-6001

V W A R E

OPERATOR

CAMERA

9-23-97

Z-4

DATE FILMED

REDUCTION RATIO

03510107

10X

FILM EMULSION NUMBER

M1817

72

PROJECT NUMBER

ROLL NUMBER

MICROCOPY

1817

ROLL

72

M1817

COMPILED MILITARY SERVICE RECORDS OF
VOLUNTEER UNION SOLDIERS WHO SERVED WITH THE
UNITED STATES COLORED TROOPS:

1st Through 5th United States Colored Cavalry

5th Massachusetts Cavalry (Colored)

6th United States Colored Cavalry

Introduction by Michael E. Pilgrim

Records prepared for microfilming by members of
the Civil War Conservation Corps

Budge Weidman, Project Director

Pat Alfredson	Naomi Glass	Dave Murray
Phyllis Altrogge	Sue Goward*	Ray Puzio
Kenneth Ashton	Bert Greenstein	Bill Schneider
Sue Barnard*	Anne Greenwood	Sylvia Scott
Dee Benson	Jim Harris	Lynn Shearouse
Ann N. Brown	Walter Hayden	Mary Stack-Dunne
Robert Budway	Mary Hayden	Ben Stearns
MaryAnn Castellana*	Pat Ikonen	Bill Stormer*
Mary Lou Cole	Dick Ives	Pat Sullivan
Marjory Cooper	Sarah Jaffe	Gorman Tidball*
Giovanni Croce	Barbara Kemp	Cathy Tinston
B. H. Custer	Bev Manypenny	John Toole
Bob Denney	Frank Masterson	Maryellen Toole
Richard Dow	Joe Mazur	Milt Weatherhead
Yvette Fallin	Sarah McDougall	C. Lois Young
	Ben Miles	

Team leaders are indicated by the asterisk.

National Archives and Records Administration
1997

INTRODUCTION

On the 107 rolls of this microfilm publication, M1817, are reproduced the compiled military service records of volunteer Union soldiers belonging to the 1st through 5th United States Colored Cavalry, the 5th Massachusetts Cavalry (Colored), and the 6th United States Colored Cavalry. While the 5th Massachusetts did retain its state designation, these units were all part of the United States Colored Troops (USCT). The USCT included 7 numbered cavalry regiments; 14 numbered artillery regiments; 144 numbered infantry regiments; plus Brigade Bands Nos. 1 & 2 (Corps d'Afrique and US Colored Troops); Powell's Regiment Colored Infantry; Southard's Company Colored Infantry; Quartermaster Detachment; Pioneer Corps, 1st Division, 16th Army Corps; Unassigned Company A Colored Infantry and Unassigned USCT. The records reproduced are part of the Records of the Adjutant General's Office, 1780's-1917, Record Group (RG) 94.

Background

United States Colored Troops

Since the time of the American Revolution, African Americans have volunteered to serve their country in time of war. The Civil War was no exception. Official sanction was the difficulty. In the fall of 1862 there were four Union regiments of African Americans raised in New Orleans, LA: the 1st, 2d, and 3d Louisiana Native Guard, and the 1st Louisiana Heavy Artillery (African Descent). The 1st South Carolina Infantry (African Descent) was not officially organized until January 1863; however, three companies of the regiment were on coastal expeditions as early as November 1862. Similarly, the 1st Kansas Colored Infantry was not mustered into Federal service until January 1863, even though the regiment had already participated in the action at Island Mound, MO, on October 27, 1862. These early unofficial regiments received little Federal support, but they showed the strength of the African American soldier's desire to fight for freedom.

The first official authorization to employ African Americans in Federal service was the Second Confiscation and Militia Act of July 17, 1862. This act allowed President Abraham Lincoln to receive into the military or naval service persons of African descent and gave him permission to use them for any purpose "he may judge best for the public welfare." However, the President did not authorize use of African Americans until issuance of the Emancipation Proclamation on January 1, 1863.

In late January 1863, Gov. John Andrew of Massachusetts received permission to raise a regiment of African American soldiers. The pace of organizing additional regiments was very slow. In March Secretary of War Edwin M. Stanton sent Gen. Lorenzo Thomas to the lower Mississippi Valley to recruit

free and contraband African Americans. Thomas was given broad authority. He was to explain the administration's policy regarding African American soldiers and recruit volunteers to raise and command them. Stanton wanted all officers of such units to be white, but that policy was softened to allow African American surgeons and chaplains. By the end of the war, in addition to the chaplains and surgeons, there were some 87 African-American officers. Thomas's endeavor was very successful, and on May 22, 1863, the Bureau of Colored Troops was established to coordinate and organize regiments from all parts of the country. Created under War Department General Order No. 143, the bureau was responsible for handling "all matters relating to the organization of Colored Troops." The bureau was directly under the Adjutant General's Office and its procedures and rules were specific and strict. All African American regiments were now to be designated United States Colored Troops (USCT). At this time there were some African American regiments with state names and a few regiments in the Department of the Gulf designated as Corps d'Afrique. All these were ultimately assimilated into the USCT, even though some of the regiments, such as the 5th Massachusetts, retained their state designations.

To facilitate recruiting in the states of Maryland, Missouri, Tennessee, and eventually Kentucky, the War Department issued General Order No. 329 on October 3, 1863. Section 6 of the order stated that if any citizen should offer his or her slave for enlistment into the military service, that person would, "if such slave be accepted, receive from the recruiting officer a certificate thereof, and become entitled to compensation for the service or labor of said slave, not exceeding the sum of three hundred dollars, upon filing a valid deed of manumission and of release, and making satisfactory proof of title." For this reason, some records of manumission are contained in the compiled service records reproduced in this publication.

The USCT fought in 39 major engagements and over 400 lesser ones. Sixteen African American soldiers received Medals of Honor. As it was in other units, the death toll from disease was very high in the USCT. Deaths from disease and battle totaled 37,000. The last regiment of the USCT was mustered out of Federal service in December 1867.

Important sources for information about African American units in the Civil War are the War Department's *The War of the Rebellion: A Compilation of the Official Records of the Union and Confederate Armies* (Washington, DC: 1880-1901; reprinted Harrisburg, 1971 and 1985) and the Navy Department's *The War of the Rebellion; A Compilation of the Official Records of the Union and Confederate Navies* (Washington, DC: 1874-1922; reprinted Harrisburg, 1971 and 1985). These multivolume works contains reports of operations and other official correspondence.

1st United States Colored Cavalry

This regiment was organized at Camp Hamilton, VA, on December 22, 1863, and assigned to duty in the Department of Virginia and North Carolina. The 1st participated in Gen. Benjamin F. Butler's operations on the south side of the James River and against Petersburg and Richmond, May 4-28, 1864. These included the capture of Bermuda Hundred and City Point, VA, on May 5, and events leading up to and including the siege of Petersburg. In August 1864 it was transferred to the defenses of Portsmouth, District of Eastern Virginia. On June 10, 1865, the 1st sailed from City Point, VA, to Texas where it was assigned duty on the Rio Grande and various other areas of the state. The unit was mustered out on February 4, 1866. Compiled casualty figures are not available.

2d United States Colored Cavalry

This regiment was organized at Fort Monroe, VA, on December 22, 1863, and assigned to duty in the Department of Virginia and North Carolina. The 2d participated in Gen. Benjamin F. Butler's operations on the south side of the James River and against Petersburg and Richmond, May 4-28, 1864. These included the capture of Bermuda Hundred and City Point, VA, on May 5, and events leading up to and including the siege of Petersburg. In February 1865 it was transferred to Norfolk, District of Eastern Virginia. On June 10, 1865, the 2d sailed from City Point, VA, to Texas where it was assigned duty on the Rio Grande and various other areas of the state. The unit was mustered out on February 12, 1866. Losses included 19 killed in action and 161 dead from disease and other causes.

3d United States Colored Cavalry

Organized at Vicksburg, MS, on October 9, 1863, as the 1st Mississippi Cavalry (African Descent), this regiment was redesignated the 3d U.S. Colored Cavalry on March 11, 1864. From its organization until March 1864, the unit was attached to the District of Northeast Louisiana and from January to March 1864 participated in operations up the Yazoo River and the occupation of Yazoo City. The regiment was then transferred to the District of Vicksburg, Department of Tennessee, where it remained until December 1864. That month the unit moved to Memphis, TN, and from December 21, 1864, to January 5, 1865, participated in Gen. Benjamin Grierson's raid to destroy the Mobile & Ohio Railroad. The 3d remained on duty in Memphis and the District of West Tennessee and took part in the expedition from Memphis to Brownsville, MS, April 23-26, 1865. On April 29 the regiment returned to Vicksburg and operated around Natchez in search of fugitive Confederate President Jefferson Davis. The unit remained in the District of West Tennessee and Department of Mississippi until January 26, 1866, when it was mustered out. Losses included 37 killed in action and 367 dead from disease and other causes.

4th United States Colored Cavalry

Organized on September 12, 1863, as the 1st Corps d'Afrique Cavalry, this regiment was redesignated the 4th United States Colored Cavalry on April 4, 1864. From its organization until August 1864, it was attached to the Defenses of New Orleans, Department of the Gulf. On August 8, 1864, the 4th was ordered to Baton Rouge, LA, District of Port Hudson, and remained on duty at that post until July 1865 when it was transferred to the Department of Mississippi. It performed duties at various points in that department until it was mustered out on March 20, 1866. Compiled casualty figures are not available.

5th United States Colored Cavalry

This regiment was organized at Camp Nelson, KY, on October 24, 1864, and attached to the 1st Division, District of Kentucky, Department of Ohio. December 10-29, 1864, it participated in Stoneman's Raid into southwestern Virginia, including the capture of Saltville and the destruction of saltworks on December 20-21. In February 1865 the regiment was transferred to the Military District and Department of Kentucky until December of that year when it was ordered to the Department of Arkansas. During the latter period the unit performed mostly garrison duty. The regiment was mustered out March 20, 1866. Losses included 35 killed in action and 152 dead from disease and other causes.

5th Massachusetts Cavalry (Colored)

This regiment was organized at Camp Meigs, Reedville, MA, in the spring of 1864, and sent to Washington, DC, in May of that year. On May 13 the regiment moved to City Point, VA, where it was attached to the 18th Army Corps. Until June 16 it functioned as an infantry unit and participated in the siege of Petersburg. On June 30 it was moved to Point Lookout, MD, to guard prisoners of war. In July 1864 the regiment, still at Point Lookout, became part of the 22d Army Corps. It was transferred to the 25th Army Corps in March 1865 and ordered to the field near Richmond and Petersburg. In June the regiment was ordered to the Department of Texas where it was assigned duty at Clarksville until October 31, 1865, when it was mustered out. Losses included 7 men killed in action and 116 dead from disease and other causes.

6th United States Colored Cavalry

This regiment was organized at Camp Nelson, KY, on October 24, 1864, and attached to the 1st Division, District of Kentucky, Department of Ohio. December 10-29, 1864, it participated in Stoneman's Raid, including the destruction of the lead mines in southwestern Virginia. At the end of December the regiment returned to Camp Nelson and in February 1865 was transferred to the Military District and Department of Kentucky. It remained there until December

1865 when it was ordered to the Department of Arkansas. The unit was mustered out on April 15, 1866. Compiled casualty figures are not available.

Records Description

Compiled service records consist of a jacket-envelope for each soldier, labeled with his name, rank, unit, and card numbers. The compilation of service records of Union soldiers began in 1890 under the direction of Col. Fred C. Ainsworth, head of the Record and Pension Office of the Adjutant General's Office, Department of War. Information from muster rolls, regimental returns, descriptive books, and other records was copied verbatim onto cards. A separate card was prepared each time an individual name appeared on a document. These cards were numbered on the back, and these numbers were entered onto the outside jacket containing the cards. The carded information was verified by a separated operation of comparison; great care was taken to ensure that the cards were accurate.

A typical jacket contains card abstracts of entries found in original records relating to the soldier and original documents relating solely to that soldier. Examples of the latter include enlistment papers, substitute certificates, casualty sheets, death reports, prisoner-of-war memorandums, and correspondence. Unique to the records of the USCT are deeds of manumission, oaths of allegiance, proof of ownership, certificates of monetary award, and bills of sale. These items appear most frequently in units recruited in the border states of Kentucky, Missouri, and Maryland. These states remained in the Union but were slave states. Jackets and cards include a section labeled "bookmark" which was reserved for cross-references to other records relating to the individual or his unit. The service records are arranged by arm of service, thereunder numerically by regiment or independent battalion or company and thereunder alphabetically by name of the soldier. Records for officers are interfiled alphabetically by name with the records of enlisted men. If an individual served in more than one unit, which was typical for USCT officers, there will be a separate service record for each unit in which he served.

Related Records

Among the records of the Adjutant General's Office in the National Archives are many of the original records that were abstracted or "carded" by the Record and Pension Office. These include the individual unit's muster rolls, returns and descriptive books. Other series in RG 94 that contain information relating to volunteer Union soldiers who served with the USCT include carded records relating to Union staff officers, carded medical records of volunteer Union soldiers, unbound and bound regimental records and "record of events" cards. The regimental records of the 54th Massachusetts Infantry (Colored) have been

NATIONAL ARCHIVES MICROFILM PUBLICATIONS

reproduced as Microfilm Publication M1659, *Records of the Fifty-fourth Massachusetts Infantry Regiment (Colored), 1863-1865*.

The "record of events" cards include information copied from the unit's muster rolls and returns. They show the stations of the field and staff and those of the various companies of the regiment at the time the muster roll or return was prepared and sometimes mention battles, skirmishes, or other activities in which the regiment participated. The cards have been reproduced as Microfilm Publication M594 *Compiled Records Showing Service of Military Units in Volunteer Union Organizations*.

Record Group 94 also includes a card index for the USCT, reproduced as Microfilm Publication M589, *Index to Compiled Military Service Records of Volunteer Union Soldiers Who Served with U.S. Colored Troops*, which may be used to locate the regiment of USCT personnel. An index card gives the name of the soldier and his rank, as well as the unit in which he served; sometimes there is a cross-reference to his service in other units or organizations. The National Archives is continually producing microfilm publications of volunteer Union compiled military service records. A complete listing of finished publications can be found in the National Archives' *Microfilm Resources for Research: A Comprehensive Catalog* which is available online at <http://www.nara.gov>.

The Records of the Colored Troops Division, within RG 94, include division correspondence and records relating to recruiting, the appointment of officers, and the slave or free status of individuals; and a compilation of historical extracts and official papers concerning the military service of African Americans from the colonial period through the Civil War entitled *The Negro in the Military Service of the United States 1639-1886*. This compilation is reproduced as Microfilm Publication M858. The Records of the Bounty and Claims Division, also in RG 94, include correspondence of the division and records relating to bounties and claims paid to loyal owners of slaves by the Slave Claims Commissions of Delaware, Kentucky, Maryland, Missouri, Tennessee and West Virginia.

If an application for a pension was made, the pension application case file may be among the Records of the Veterans Administration (RG 15). Indexes to the pension applications have been reproduced as Microfilm Publication T288, *General Index to Pension Files, 1861-1934*, and T289, *Organizational Index to Pension Files of Veterans Who Served Between 1861 and 1900*.

If a soldier or officer was tried before a general court-martial or if an individual or his unit was the subject of a court of inquiry or military commission, transcripts of the proceedings may be among the Records of the Office of the Judge Advocate General (Army) (RG 153). The registers to the proceedings have been reproduced as Microfilm Publication M1105, *Registers of the Records of the Proceedings of the U.S. Army General Courts-Martial, 1809-1890*.

NATIONAL ARCHIVES MICROFILM PUBLICATIONS

Other record groups having information pertaining to the USCT include Records of the Bureau of Refugees, Freedmen, and Abandoned Lands (RG 105); Records of the Provost Marshal General's Bureau (Civil War) (RG 110); Records of the Accounting Officers of the Department of the Treasury (RG 217); and Records of U.S. Army Continental Commands, 1821-1920 (RG 393).

ROLL LIST

Roll Description

1st United States Colored Cavalry

- 1 Akess, Alexander - Bom, John H.
- 2 Bomer, James - Cartwright, John
- 3 Casey, Thomas - Davenport, John J.
- 4 Davis, Augustus - Floyd, George
- 5 Fly, Benjamin - Griffin, Oliver
- 6 Griffin, Quinton - Holstead, Peter
- 7 Holt, George - Jones, Herbert
- 8 Jones, Howell - Macoy, Peter
- 9 Madry, Andrew - Mosley, Jacob
- 10 Moss, James - Polk, James
- 11 Pollard, Sipio - Sales, William
- 12 Sample, Abram (Abraham) - Smith, Ives
- 13 Smith, James - Times, Nelson
- 14 Tines, Archer - Wheldon, Charles M.
- 15 Whitby, Joseph - Wilson, Isaac
- 16 Wilson, James - Zoe (no first name)

2d United States Colored Cavalry

- 17 Abbot, John - Bell, Charles
- 18 Bell, Henry - Burns, Richard
- 19 Burroughs, George L. - Cotton, Samuel
- 20 Coues, Alexander - Duncan, Levi
- 21 Dunkins, Ezekiah James - Gardner, Richard
- 22 Garris, Henry - Harrison, Thomas
- 23 Harrison, William - Humphries, David
- 24 Hunter, Francis - Jones, Robert
- 25 Jones, Robert F. - Martin, Robert (Martin)
- 26 Martin, Thaddeus or Martin, Thaddeus W. - Osborne, Henry S.
- 27 Oulden, Jacob - Prior, Edward or Edmund
- 28 Proctor, David - Sawyer, Wilson
- 29 Scabber, Charles - Stanley, William
- 30 Stanley, Wright or Right - Upshear, Neverson
- 31 Upshear, Samuel - Whites, Joe
- 32 Whites, Silas - Zodrick, Isaiah A. or Isaiah

3d United States Colored Cavalry

- 33 Aaron, John - Black, David
- 34 Black, Richard - Cameron, Wyatt

NATIONAL ARCHIVES MICROFILM PUBLICATIONS

<u>Roll</u>	<u>Description</u>
35	Cammel, Austin - Cooper, Stephen
36	Coran, Joseph - Erving, Tilson
37	Erwin, Anderson - Gool, George
38	Gordon, Alfred - Haskins, Jasper
39	Hawkins, Frank - Jackson, Harvey
40	Jackson, Henry - Kembro, Abraham
41	Kenedy, Lemuel - Lott, Judge
42	Lott, Matton - Mitchell, Berry
43	Mitchell, George - Pettis, Edmond
44	Pettis, George - Roberson, Jefferson
45	Roberson, Wallace - Simpson, Levi
46	Sims, Anderson - Taylor, Phillip
47	Taylor, Richard - Washington, Isaac
48	Washington, Oscar - Williams, Mitchel
49	Williams, Moses - Young, Mathew

4th United States Colored Cavalry

50	Abraham, Randall - Blanchan, William
51	Blanchard, Moses - Clark, Moses
52	Clark, Theodore - Ellars, James
53	Ellars, John - Heath, Culbert
54	Henderson, George - Johnson, Henderson
55	Johnson, Henry - Mayberry, Nelson
56	Macomory, John - Oliver, Celestine
57	Olsten, Alexander - Robinson, William
58	Robinson, William E. - Thomas, Stephen
59	Thomas, William - Williams, Horace
60	Williams, Isaac - Zulia, Francois

5th United States Colored Cavalry

61	Abel, Fletcher - Biggs, Randall
62	Birch, Benjamin - Burly, Frank
63	Burly, James - Coffman, James D.
64	Coke, Samuel - Dudley, John
65	Duke, John - Givens, Peter
66	Glen, John - Harriden, Edmund
67	Harrigan, Harden - Hughes, Thomas
68	Hulse, James - Keller, Ephraim
69	Kelley, Franklin - Matthews, Benjamin
70	Maupin, Preston - Murry, Ned
71	Murtney, Morton - Ray, John
72	Ray, Thomas - Sherrod, William

NATIONAL ARCHIVES MICROFILM PUBLICATIONS

Roll **Description**

- 73 Shrewsbury, Joseph - Stone, John
- 74 Stone, Lewis - Trye, Benjamin
- 75 Trueheart, Samuel - Williams, James
- 76 Williams, Jerry - Yowell, Joseph

5th Massachusetts Cavalry (Colored)

- 77 Abbey, David - Biers, William
- 78 Billings, Jeremiah - Burgess, Williams
- 79 Burnett, Lewis - Cook, Joseph T.
- 80 Cooper, Isaac - Dunmore, William
- 81 Durbin, Stephen - Furman, Seneca A.
- 82 Gadson, James - Gurley, Joseph L.
- 83 Guy, James - Hill, John W.
- 84 Hill, Richard - Johns, Thomas H.
- 85 Johnson, Aaron - Lambert, William
- 86 Lancaster, James - Mason, John
- 87 Mason, John H. - Nelson, Philip
- 88 Nelson, Preston - Preston, Thomas
- 89 Price, Adam - Sampson, George P.
- 90 Sanborn, Madison - Stringer, William
- 91 Strother, Frank - Vance, William H.
- 92 Van Hoesen, Charles - Wilkinson, Simon
- 93 Williams, Abram H. - Young, Thomas

6th United States Colored Cavalry

- 94 Abbot, John - Birch, James
- 95 Bivins, Gabriel - Buckner, George
- 96 Buckner, Henderson - Compton, James
- 97 Cook, Benjamin - Ellis, William
- 98 Ellis, Wyatt - Godley, Isaac
- 99 Gooch, Alexander - Herston, Abraham
- 100 Heywood, John R. - Johnson, Jackson
- 101 Johnson, James M. - Marshall, Lyman
- 102 Marshall, William - Neihardt, Isaac D.
- 103 Nelson, Joseph - Redd, Tiney
- 104 Redway, Hamilton K. - Sebree, Bob Woodcock
- 105 Sebree, Crittenden - Sumpter, John
- 106 Sutherland, Williams - Washington, Charles
- 107 Washington, George - Wren (no first name)

NATIONAL ARCHIVES MICROFILM PUBLICAT

Microfilm Publication M1817

PILED MILITARY SERVICE RECORDS OF VOLUNTEER UNIC
DIERS WHO SERVED WITH THE UNITED STATES COLORED
OPS: 1st Through 5th United States Colored Cavalry, 5th Massachu
ry (Colored), 6th United States Colored Cavalry

72

United States Colored Cavalry

Ray, Thomas - Sherrod, William

NATIONAL ARCHIVES AND RECORDS ADMINISTRATIO

NATIONAL ARCHIVES MICROFILM PUBLICATIONS

Microfilm Publication M1817

COMPILED MILITARY SERVICE RECORDS OF VOLUNTEER UNION
SOLDIERS WHO SERVED WITH THE UNITED STATES COLORED
TROOPS: 1st Through 5th United States Colored Cavalry, 5th Massachusetts
Cavalry (Colored), 6th United States Colored Cavalry

Roll 72

5th United States Colored Cavalry

Ray, Thomas - Sherrod, William

NATIONAL ARCHIVES AND RECORDS ADMINISTRATION

1059
Ray Thomas

Co D, 5 U. S. Col'd Cav.

Private Private

CARD NUMBERS.

1	5362706	26
2	5362801	27
3	5362900	28
4	5362988	29
5	5363046	30
6	5363133	31
7	5363219	32
8	5363349	33
9	5363435	34
10	5363519	35
11	5363605	36
12	9090335	37
13	43145846	38
14	43146501	39
15		40
16		41
17		42
18		43
19		44
20		45
21		46
22		47
23		48
24		49
25		50

Book Mark:

See also

A 5 Cav. U.S.C.T.

Thomas Gray
Co. A, 5 Reg't U. S. Col'd Cav.

Appears on

Company Descriptive Book
of the organization named above.

DESCRIPTION.

Age *18* years; height *5* feet *11* inches.

Complexion *Black*

Eyes *Black*; hair *Black*

Where born *Merion N.Y.*

Occupation *farmer*

ENLISTMENT.

When *Aug 15*, 186*4*.

Where *Lebanon N.Y.*

By whom *Capt. Hiddle*, term *3* y'rs.

Remarks: *Appointed Bugler*
March 25 - 1865

L. E. Park

R

5 bar

USCT.

Tom Ray

Appears with rank of _____ on _____

Muster and Descriptive Roll

of Detachment of U.S. Colored
Volunteer Recruits for
warded Roll dated

Lebanon Ky, Aug 31, 1864.

Where born Marion Ky

Age 18 years; occupation farmer

When enlisted Aug 15, 186

Where enlisted Lebanon Ky

For what period enlisted 3 years.

Eyes BRN; hair BRN

Complexion Cop; height 5 ft. 5 in.

When mustered in Aug 15, 186

Where mustered in Lebanon Ky

Bounty paid \$ 100; due \$ 100

Clothing account:

Last settled _____, 186 ; drawn since \$ 17.50/100

Date of first muster Aug 27, 1864.

Company to which assigned _____

Remarks Owner, Addison
Taylor, Marion Co.
Without consent
4 Long Rich Ky

Book mark: _____

U.S. Marion

(356m)

Copyist.

R | 5 bars | U.S.O.T.

Tom Ray

Appears with rank of Pvt on

Muster and Descriptive Roll

of a Detachment of U. S. colored
Troops formed for U. S. service

ser. at Lexington, Ky. Roll dated
Franklin, Ky., Sept. 7, 1864.

Where born Lebanon, Ky.

Age 18 years; occupation Farmer

When enlisted Aug. 15, 1864.

Where enlisted Lebanon

For what period enlisted 3 years.

Eyes Blue; hair Blue

Complexion Blue; height 5 ft. 11 in.

When mustered in Aug. 27, 1864.

Where mustered in Lebanon

Bounty paid \$ 100; due \$ 100

Clothing account:

Last settled _____, 186 ; drawn since \$ 17.50
100

Date of first muster Aug. 27, 1864.

Company to which assigned _____

Remarks: promoted to 4 cong. dist.
Ky.

Book mark: _____

D. J. O'Brien

(356m)

Copyist.

P 5 Cav. U.S.C.T.

Tom Ray

Vol, Co. *D*, 5 Reg't U. S. Col'd Cavalry.

Appears on

Company Muster-in and Descriptive Roll

of the organization named above. Roll dated

Camp Nelson, N. Y., Oct. 24, 1864.

Where born *Marion, Ky.*

Age *18* y'rs; occupation *Farmer*

When enlisted *Aug. 15*, 1864.

Where enlisted *Lebanon*

For what period enlisted *3* years.

Eyes *Bl*; hair *Bl*

Complexion *Bl*; height *5* ft. *11* in.

When mustered in *Sept. 27*, 1864.

Where mustered in *Lebanon*

Bounty paid \$ *100*; due \$ *100*

Where credited *4 Dist. Ky.*

Company to which assigned

Remarks:

Book mark:

Wm H. Scott

(356d)

Copyist.

R

5 Cav. U.S.C.T.

Tom Ray

Plt., Co. D, 5 Reg't U. S. Col'd Cavalry.

Appears on

Company Muster Roll

for Dated Oct. 31, 1864.

Present or absent Present

Stoppage, \$ 100 for

Due Gov't, \$ 100 for

Valuation of horse, \$ 100

Valuation of horse equipments, \$ 100

Remarks:

Book mark:

Wm. H. Scott

(358)

Copyist.

R

5 Cav. U.S.C.T.

Tom Ray

Pvt., Co. D, 5 Reg't U. S. Col'd Cavalry.

Appears on

Company Muster Roll

for Nov. & Dec., 1864.

Present or absent Present

Stoppage, \$ 100 for

Due Gov't, \$ 100 for

Valuation of horse, \$ 100

Valuation of horse equipments, \$ 100

Remarks: Due U. S. for Ord-
nance \$ 17.93. 1st & 2^d in-
stallments of Bounty
due.

Book mark:

Wm. Scott

(358)

Copyist.

R | 5 Cav. | U.S.C.T.

Tommy Ray

Pvt., Co. D, 5 Reg't U.S. Col'd Cavalry.

Appears on

Company Muster Roll

for Jan. & Feb., 1865.

Present or absent Present

Stoppage, \$ 100 for

Due Gov't, \$ 100 for

Valuation of horse, \$ 100

Valuation of horse equipments, \$ 100

Remarks: 1st installment of
Bounty due \$100.

Book mark:

Wm. H. Scott

(358)

Copyist.

R | 5 Cav. | U.S.C.T.

Thomas Ray

Bufoer, Co. D, 5 Reg't U. S. Col'd Cavalry.

Appears on

Company Muster Roll

for March & April, 1865.

Present or absent Present.

Stoppage, \$ 100 for

Due Gov't, \$ 100 for

Valuation of horse, \$ 100

Valuation of horse equipments, \$ 100

Remarks: 1st installment of
County dues \$ 100

Book mark:

Wm. H. Scott

R

5 Cav. U.S.C.T.

Thomas Ray

Private, Co. D, 5 Reg't U. S. Col'd Cavalry.

Appears on

Company Muster Roll

for *May & June*, 1865.

Present or absent *present*

Stoppage, \$ *100* for

Due Gov't, \$ *100* for

Valuation of horse, \$ *100*

Valuation of horse equipments, \$ *100*

Remarks: *1st Installm't Bounty due \$100.00*

Book mark :

Milliken

(358)

Copyist.

R

5 Cav. U.S.C.T.

Thomas Day

Bugler, Co. D, 5 Reg't U.S. Col'd Cavalry.

Appears on

Company Muster Roll

for July & Aug't, 1865.

Present or absent present.

Stoppage, \$ 100 for

Due Gov't, \$ 100 for

Valuation of horse, \$ 100

Valuation of horse equipments, \$ 100

Remarks:

Book mark:

Milliken

(358)

Copyist.

R

5 Cav.

U.S.C.T.

Thomas Lutz

Private, Co. D, 5 Reg't U.S. Col'd Cavalry.

Appears on

Company Muster Roll

for Sept. & Oct., 1865.

Present or absent present

Stoppage, \$ 100 for

Due Gov't, \$ 100 for

Valuation of horse, \$ 100

Valuation of horse equipments, \$ 100

Remarks: Due U.S. for camp + Garrison \$ 0.65

Book mark:

Williken

(358)

Copyist.

L

5 Cav. U.S.C.T.

Thomas Ray

Private, Co. D, 5 Reg't U. S. Col'd Cavalry.

Appears on

Company Muster Roll

for *Nov. & Dec.*, 1865.

Present or absent *Present*

Stoppage, \$ *100* for

Due Gov't, \$ *100* for

Valuation of horse, \$ *100*

Valuation of horse equipments, \$ *100*

Remarks:

Book mark: -----

W. Miliken

(358) Copyist.

R

5 Cav.

U.S.C.T.

Thomas Ray,

Priv., Co. D, 5 Reg't U. S. Col'd Cavalry.

Appears on

Company Muster Roll

for *Jan'y 4th Feby*, 186*6*.

Present or absent *Present.*

Stoppage, \$ *100* for

Due Gov't, \$ *100* for

Valuation of horse, \$ *100*

Valuation of horse equipments, \$ *100*

Remarks: *2^d Installment Barm-ty due \$100.00.*

Book mark:

R. Grauner

(358)

Copyist.

R. | 5 Cav. | U.S.C.T.

Thomas Ray,

Priv., Co. *G*, 5 Reg't U. S. Col'd Cavalry.

Appears on Co. Muster-out Roll, dated

Helena, Ark., March 16, 186*6*.

Muster-out to date *March 16,* 186*6*.

Last paid to *Dec. 31,* 186*5*.

Clothing account:

Last settled....., 186 ; drawn since \$..... 100

Due soldier \$..... 100; due U. S. \$ *28. 67* / 100

Am't for cloth'g in kind or money adv'd \$..... 100

Due U. S. for arms, equipments, &c., \$..... 100

Bounty paid \$ *100. 00* / 100; due \$ *100. 00* / 100

Remarks:.....

Book mark:.....

M. Brunner

(361)

Copyist.

Ray, Tom

, Co. 20, 5 Regt. U.S.C. Cav.

2 Enclosures.

Bed Cards	Descriptive Lists
Burial Records	Final Statements
Certs. of Dis. for Discharge	Furloughs
C. M. Charges	Med. Des. Lists
Med. Certificates	Orders

3rd Apr 1

Other papers relating to—

Admission to Hosp'l	Furlough
Casualty Sheet (Officer's)	Med. Examination
Confinement	Misc. Information /
Contracts	Pay or Clothing
Death or Effects	Personal Reports
Desertions	Rank
Discharge from Hosp'l	Transfer to Hosp'l
Discharge from Service	Transfer to V. R. C.
Duty	Transportation

Mr. Gibson;

From "Rendz. records"
Please report, as to
receipt & disposition of Tom
Ray, Co. D. 5th ^{U.S. Army} ~~Mass.~~ Cavalry
Colored - see report herewith.

He was mustered in
by Capt. Fidler, Pro. Mar.
Lebanon, Ky. 4th Dist

His Master's name was
Addison Taylor, Marion Co.

Respectfully
W. Anderson

C. S. D.) per J. S.
May 4. 86)

W. Anderson:

He was recd at
Ky. Rendz. Sept. 1st /84, sent to
Col. B. B. Smith Lexington Ky. Sept
8th /84, who receipted for the
detachment Sept 8th /84. No
later record found. Sent. Man.
signed to rest.

C. S. D.)
June 3. 86.)

Respy.
W. Anderson

RE 1.—This blank will be used for enlistments of United States colored troops. They will be made out in duplicate in all cases—one to accompany the recruiting officer, and one to accompany the accounts of the officer who pays bounty, &c.
 RE 2.—An enlistment holds to service. A muster-in must, in all cases, precede payment of pay, bounty, pension, &c. A muster-in roll, must in all cases, be filed in the Adjutant General's Office as evidence of muster-in. The mustering officer, commissary, or assistant commissary of musters, as the case may be, will countersign both documents as having mustered the soldiers into the service of the United States before either of them is given to the disbursing officer.

DECLARATION OF RECRUIT.

I, Tom Ray desiring to volunteer as a soldier in the ARMY OF THE UNITED STATES, for the term of Three Years, DO DECLARE That I am 18 years and 0 months of age; that, I have never been discharged from the United States service on account of disability or by sentence of a court-martial, or by order before the expiration of a term of enlistment; and I know of no impediment to my serving honestly and faithfully as a soldier for three years.

GIVEN at Letanor Ky the 15th day of August 1864.

Witness: Joe Odell

his
Tom & Ray
mark

Slave
Mustered from
Adelisa Taylor
entire without consent

Volunteered at Letanor Ky
August 15 1864
 By Wm Miller
Capt & Quartermaster
4th Dist Ky

Consent of Parent or Guardian in case of a Minor, if a Free Man, or in the case of a Slave, of the Person to whom he owes Service:

I, Do CERTIFY, That I am the that the said is years of age; and I do freely give my CONSENT to his volunteering as a SOLDIER in the Army of the United States, for the period of THREE YEARS, under the conditions of the Laws of the United States.

GIVEN at the day of

Witness:

UNITED STATES COLORED TROOPS ENLISTMENT.

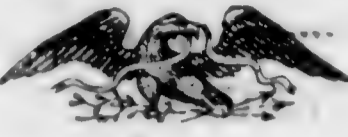
STATE OF *Kentucky*  ~~TOWN OF~~ *County of Marion*

I, *Tom Ray* born in *Marion*
in the State of *Kentucky* aged *18* years

and by occupation a *farmer* Do HEREBY ACKNOWLEDGE to
have volunteered *15th* day of *August* 1864

to serve as a **Soldier** in the **Army of the United States of America**, for the
period of **THREE YEARS**, unless sooner discharged by proper authority: Do
also agree to accept such bounty, pay, rations, and clothing, as are, or may be,
established by law for the U. S. colored troops.

And I, *Tom Ray*
do solemnly swear that I will bear true faith and allegiance to the **United States
of America**, and that I will serve them honestly and faithfully against all their
enemies or opposers whomsoever; and that I will observe and obey the orders
of the President of the United States, and the orders of the officers appointed
over me, according to the Rules and Articles of War.

Sworn and subscribed to, at *Lebanon Ky*
this *15th* day of *August 1864* *Tom Ray*

Before *W. M. Heiler*
Capt & Prov. Mar. 4th Dist. Ky *Mark*

I CERTIFY, ON HONOR, That I have carefully examined the above named Volunteer agree-
ably to the General Regulations of the Army, and that, in my opinion, he is free from all bodily
defects and mental infirmity, which would in any way disqualify him from performing the
duties of a soldier.

John C. Maxwell

EXAMINING SURGEON.

I CERTIFY, ON HONOR, That I have minutely inspected the Volunteer *Tom Ray*
previously to his enlistment, and that he was entirely sober when enlisted; that, to the best of
my judgment and belief, he is of lawful age; and that, in accepting him as duly qualified to per-
form the duties of an able-bodied soldier, I have strictly observed the regulations which govern
the recruiting service. This soldier has *black* eyes, *black* hair, *Cop* com-
plexion, is *5.* feet *5.* inches high.

W. M. Heiler

Capt & Prov. Mar. 4th Dist. Ky RECRUITING OFFICER OR AGENT.

Mustered into the United States Service *27th* day of *Aug* 1864

W. M. Heiler

Capt & Prov. Mar. 4th Dist. Ky Mustering Officer

Mustered into the service of the United States, for three years or during the war, from date of enlistment, in Company
Regiment of
Volunteers, on the
day of
1864, at

1060

Redeout, Charles

Co M, 5 U. S. Col'd Cav.

Private

CARD NUMBERS.

1	26
See Redeout, Charles	27
2	28
3	29
4	30
5	31
6	32
7	33
8	34
9	35
10	36
11	37
12	38
13	39
14	40
15	41
16	42
17	43
18	44
19	45
20	46
21	47
22	48
23	49
24	50
25	

Book Mark:

See also

Redman Anthony

Co A, 5 U. S. Col'd Cav.

Private Corporal

CARD NUMBERS.

1	5359669	26
2	5359769	27
3	5359869	28
4	5359966	29
5	5360057	30
6	5360149	31
7	5360179	32
8	5360271	33
9	5360360	34
10	5360449	35
11	5360537	36
12	9090045	37
13	43146395	38
14	31413555	39
15	40730241	40
16		41
17		42
18		43
19		44
20		45
21		46
22		47
23		48
24		49
25		50

Book Mark:

See also

K | 5 Cav. | U.S.C.T.

Anthony Redman

....., Co. *A*, 5 Reg't U. S. Col'd Cav.

Appears on

Company Descriptive Book
of the organization named above.

DESCRIPTION.

Age *27* years; height *5* feet *1 1/2* inches.

Complexion *Blk*

Eyes *Blk*; hair *Blk*

Where born *Taylor Co Ky*

Occupation *Farmer*

ENLISTMENT.

When *Sept. 5*....., 186 .

Where *Lebanon*

By whom *Capt. Fiddler* term *3* y'rs.

Remarks:

.....
.....
.....
.....
.....
.....
.....
.....
.....

Warren

R

5600

U.S.C.T.

Anthony Redman

Appears with rank of _____ on

Muster and Descriptive Roll

of a Detachment of U. S. colored
Volunteer Recruits formed

Roll dated

Lebanon Ky., Sept. 5, 1864.

Where born Taylor Ky.

Age 24 years; occupation Farmer

When enlisted Sept. 5, 1864.

Where enlisted Lebanon Ky.

For what period enlisted 3 years.

Eyes Blue; hair Black

Complexion Copr; height 5 ft. 6 in.

When mustered in Sept. 5, 1864.

Where mustered in Lebanon

Bounty paid \$ 100; due \$ 100

Clothing account:

Last settled _____, 1864; drawn since \$ 17 ⁵⁰/₁₀₀

Date of first muster Sept. 5, 1864.

Company to which assigned _____

Remarks: Master - George R. Redman -

Taylor Co. Ky. Without comment

Book mark: _____

(356m)

B. J. D. D. D.

Copyist.

A

5 Cav. U.S.C.T.

Porter, Benjamin

Pvt, Co. *A*, 5 Reg't U. S. Col'd Cavalry.

Appears on

Company Muster-in and Descriptive Roll
of the organization named above. Roll dated

Cpt. Nelson, N. Y., Oct. 24, 1864.

Where born *Wagoner Ky.*

Age *20* y'rs; occupation *Furrier*

When enlisted *Sept. 5*, 1864.

Where enlisted *Sebanon*

For what period enlisted *3* years.

Eyes *Blk*; hair *Blk*

Complexion *Blk*; height *5* ft. *1 1/2* in.

When mustered in *Sept. 5*, 1864.

Where mustered in *Sebanon*

Bounty paid \$ *100*; due \$ *100*

Where credited *4th Dist. Kentucky*

Company to which assigned *A*

Remarks:
.....
.....
.....

Book mark:

Castling

(356d)

Copyist.

2 | 5 Cav. | U.S.C.T.

Anthony Pedman
Co., Co. A, 5 Reg't U. S. Col'd Cavalry.

Appears on

Company Muster Roll

for *Oct 31*, 186*4*.

Present or absent *Present*,

Stoppage, \$ *100* for

Due Gov't, \$ *100* for

Valuation of horse, \$ *100*

Valuation of horse equipments, \$ *100*

Remarks:
.....
.....
.....
.....
.....
.....
.....
.....
.....
.....

Book mark:

(358) *Anthony Pedman* Copyist.

R

5 Cav.

U.S.C.T.

Anthony Redman

Priv., Co. A, 5 Reg't U. S. Col'd Cavalry.

Appears on

Company Muster Roll

for Nov, & Dec, 1864.

Present or absent

Stoppage, \$ 100 for

Due Gov't, \$ 100 for

Valuation of horse, \$ 100

Valuation of horse equipments, \$ 100

Remarks: In Hospital at
Camp Nelson, Ky.
Due W. S. for Ord. \$17.93,
1st and 2d installment
Bounty due.

Book mark:

Custerling

(358)

Copyist.

R | **5 Cav. | U.S.C.T.**

Anthony Redman
Capt, Co. A, 5 Reg't U. S. Col'd Cavalry.

Appears on

Company Muster Roll

for *Jan & Feb*, 186*5*.

Present or absent *Absent**

Stoppage, \$ *100* for

Due Gov't, \$ *100* for

Valuation of horse, \$ *100*

Valuation of horse equipments, \$ *100*

Remarks: *In Genl. Hosp**,
Camp Nelson Ky.
1st Installation
Bounty due \$100.

Book mark:

Quarterling
358) *Quarterling* Copyist.

R. | 5 Cav. | U.S.C.P.

Anthony Redman.

Sgt., Co. A., 5 Reg't U.S.C.C.

Appears on

Hospital Muster Roll

of Convalescent Camp U. S. A. Hospital,

at Camp Nelson, Ky.,

for Jan + Feb., 1865.

Attached to hospital:

When Jan 10, 1865.

How employed Patient -

Last paid by Maj. Pay due from Enlistment.
to _____, 1865.

Bounty paid \$ 100; due \$ 100

Present or absent Present.

Remarks: _____

Book mark: _____

Gickerson.

R

5 Cav. U.S.C.T.

Anthony Redman

Plt., Co. A, 5 Reg't U.S. Col'd Cavalry.

Appears on

Company Muster Roll

for *W.M. D. Galt*, 1865.

Present or absent *Present*

Stoppage, \$ *100* for

Due Gov't, \$ *100* for

Valuation of horse, \$ *100*

Valuation of horse equipments, \$ *100*

Remarks: *1st installment
bounty due \$ 75.*

Book mark:

Anthony Redman

(358)

Copyist.

5 Cav. U.S.C.T.

R

John Thomas

Co. A, 5 Reg't U. S. Col'd Cavalry.

Appears on

Company Muster Roll

for *May 1865*, 186*5*.

Present or absent *Present*

Stoppage, \$ *100* for

Due Gov't, \$ *100* for

Valuation of horse, \$ *100*

Valuation of horse equipments, \$ *100*

Remarks: *Present Dec 5 59*

Book mark:

John Thomas
Copyist.

P

5 Cav. U.S.C.T.

Anthony Redman
Sgt.; Co. A, 5 Reg't U.S. Col'd Cavalry.

Appears on

Company Muster Roll

for 22nd Aug. 1865.

Present or absent Present

Stoppage, \$ 100 for

Due Gov't, \$ 100 for

Valuation of horse, \$ 100

Valuation of horse equipments, \$ 100

Remarks: Promoted as
Sgt. Co. A, 5 Reg't
Col'd Cavalry 65

Book mark:

Anthony
Copyist.

(358)

Q

5 Cav. U.S.C.T.

Anthony Redman
Copt., Co. A, 5 Reg't U. S. Col'd Cavalry.

Appears on

Company Muster Roll

for *Roll of Feb. 31*, 1865.

Present or absent *Present*

Stoppage, \$ 100 for

Due Gov't, \$ 100 for

Valuation of horse, \$ 100

Valuation of horse equipments, \$ 100

Remarks:
.....
.....
.....
.....
.....
.....
.....
.....
.....
.....

Book mark:

Anthony Redman
Coptist.

(358)

R

5 Cav. U.S.C.T.

Anthony Redman
Cope, Co. A, 5 Reg't U. S. Col'd Cavalry.

Appears on

Company Muster Roll

for Nov & Dec, 1865.

Present or absent Present

Stoppage, \$ 100 for

Due Gov't, \$ 52 / 100 for Ord

Valuation of horse, \$ 100

Valuation of horse equipments, \$ 100

Remarks:

Book mark:

W. M. Sayre
Copyist.

(358)

R

5 Cav. U.S.C.T.

Anthony Redman
Cople, Co. A, 5 Reg't U. S. Col'd Cavalry.

Appears on

Company Muster Roll

for Jan & Feb, 1866.

Present or absent Present

Stoppage, \$ 100 for

Due Gov't, \$ 100 for

Valuation of horse, \$ 100

Valuation of horse equipments, \$ 100

Remarks:

Book mark:

M. W. Payne
Copyist.

(358)

R

5 Cav. U.S.C.T.

Anthony Redman

Priv., Co. B, 5 Reg't U. S. Colored Cav.

Appears on Returns as follows:

Dec. 1864 to Mar. 1865. —
Absent sick in
Gen. Hosp. Camp
Weldon Ky

Book mark :

(546)

E. Thomson

Copyist.

R | 5 Cav. | U.S.C.T.

Anthony Redman
Corpl, Co. A, 5 Reg't U. S. Col'd Cavalry.

Appears on Co. Muster-out Roll, dated
Helena Ark, Mch 16, 1866.

Muster-out to date Mch 16, 1866.

Last paid to Dec 31, 1865.

Clothing account:

Last settled _____, 186 ; drawn since \$ _____ 100

Due soldier \$ _____ 100; due U. S. \$ _____ / ⁶¹ 100

Am't for cloth'g in kind or money adv'd \$ _____ 100

Due U. S. for arms, equipments, &c., \$ _____ ⁹⁰ 100

Bounty paid \$ ¹⁰⁰ 100; due \$ ¹⁰⁰ 100

Remarks Priv. from enroll-
ment to July 5. 65, then
Corpl, due U.S. for
Ord. 90 cts

Book mark: 468938 + 2536.1863

(361)

W. W. Payne

Copyist.

Redman, Anthony

....., Co.....,

Reg't

1st Co.

..... / Enclosures.

Bed Cards	Final Statements
Burial Records	Furloughs or L. of A
Certs. of Dis. for Discharge	Med. Certificates
C. M. Charges	Med. Des. Lists
Descriptive Lists	Orders
Discharge Certificates	Pris. of War Record
Enlistment Papers	Resignations

Other papers relating to—

Admission to Hosp'l	Furlough or L. of A
Casualty Sheet	Med. Examination
Confinement	Misc. Information
Contracts	Pay or Clothing
Death or Effects	Personal Reports
Desertion	Rank
Discharge from Hosp'l	Transfer to Hosp'l
Discharge from Service	Transfer to V. R. C.
Duty	Transportation

DECLARATION OF RECRUIT.

I, Anthony Redman desiring to volunteer as a soldier in the ARMY OF THE UNITED STATES, for the term of Three Years, DO DECLARE That I am 24 years and months of age; that I have never been discharged from the United States service on account of disability or by sentence of a court-martial, or by order before the expiration of a term of enlistment; and I know of no impediment to my serving honestly and faithfully as a soldier for three years.

GIVEN at Schenen N.Y. the 5th day of Sept 1864

Witness:

Thos B Bann

Anthony Redman
Mark

Charles A. Davis
Samuel Redman
Substantive without amount

Volunteered at Schenen N.Y.
Sept 5th 1864
By Comdr J. M. Stillie
Co 9th Regt 44th Div N.Y.

No. Henry Hunt 53
1864

Consent of Parent or Guardian in case of a Minor, if a Free Man, or in the case of a Slave, of the Person to whom he owes Service:

I, Do CERTIFY, That I am the that the said is years of age; and I do freely give my CONSENT to his volunteering as a SOLDIER in the Army of the United States, for the period of THREE YEARS, under the conditions of the laws of the United States.

GIVEN at the day of

Witness:

NOTE 1.—This blank will be used for enlistments of United States colored troops. They will be made out in duplicate in all cases—one to accompany the recruiting return of the superintendent (not the recruiting officer) to the Adjutant General, and one to accompany the accounts of the officer who pays bounty, &c.
NOTE 2.—An enlistment holds to service. A muster-in must, in all cases, precede payment of pay, bounty, pension, &c. A muster-in roll, must in all cases, be filed in the Adjutant General's Office as evidence of muster-in. The mustering officer, commissary, or assistant commissary of musters, as the case may be, will countersign both enlistments as having mustered the soldiers into the service of the United States before either of them is given to the disbursing officer.

UNITED STATES COLORED TROOPS ENLISTMENT.

STATE OF

TOWN OR



Ky

County of Taylor

I, *Anthony Redman* born in *Taylor Co*

in the State of *Ky* aged *24* years

and by occupation a *farmer* Do HEREBY ACKNOWLEDGE to

have volunteered *5th* day of *Sept* 186*4*

to serve as a Soldier in the Army of the United States of America, for the period of THREE YEARS, unless sooner discharged by proper authority: Do also agree to accept such bounty, pay, rations, and clothing, as are, or may be, established by law for the U. S. colored troops.

And I, *Anthony Redman*

do solemnly swear that I will bear true faith and allegiance to the United States of America, and that I will serve them honestly and faithfully against all their enemies or opposers whomsoever: and that I will observe and obey the orders of the President of the United States, and the orders of the officers appointed over me, according to the Rules and Articles of War.

Sworn and subscribed to, at *Letaman Ky*

this *5th* day of *Sept* 186*4* *Anthony Redman*

Before *J. M. Hillier* *Mark*

I CERTIFY, ON HONOR, That I have carefully examined the above named Volunteer agreeably to the General Regulations of the Army, and that, in my opinion, he is free from all bodily defects and mental infirmity, which would in any way disqualify him from performing the duties of a soldier.

John C. Maxwell

EXAMINING SURGEON.

I CERTIFY, ON HONOR, That I have minutely inspected the Volunteer, *Anthony Redman* previously to his enlistment, and that he was entirely sober when enlisted; that, to the best of my judgment and belief, he is of lawful age; and that, in accepting him as duly qualified to perform the duties of an able-bodied soldier, I have carefully observed the regulations which govern the recruiting service. This soldier has *dark* eyes, *dark* hair, *dark* complexion, is *5* feet *10* inches high.

J. M. Hillier
Capt & Pro M in 4th Dist Ky RECRUITING OFFICER OR AGENT.

Mustered into the United States Service *5th* day of *Sept* 186*4*

J. M. Hillier
Capt & Pro M in 4th Dist Ky Mustering Officer

Mustered into the service of the United States, for three years or during the war, from date of enlistment, in Company *Volunteers, on the* *1864* at *Regiment of* *day of*

1062
Redman & Peterson

Co A, 5 U. S. Col'd Cav.

Private | Sergeant

CARD NUMBERS.

1	5359590	26
2	53596921	27
3	5359794	28
4	5359894	29
5	5359989	30
6	5360082	31
7	5360170	32
8	5360260	33
9	5360422	34
10	5360451	35
11	5360534	36
12	9090046	37
13	43146396	38
14		39
15		40
16		41
17		42
18		43
19		44
20		45
21		46
22		47
23		48
24		49
25		50

Book Mark:

See also

R | 5 Cav. | U.S.C.T.

Walter Redman

Co. *A*, 5 Reg't U. S. Col'd Cav.

Appears on

Company Descriptive Book

of the organization named above.

DESCRIPTION.

Age *23* years; height *5* feet *9* inches.

Complexion *Blk*

Eyes *Blk*; hair *Blk*

Where born *Taylor Co Ky*

Occupation *Farmer*

ENLISTMENT.

When *Sept. 5*, 186 .

Where *Shannon*

By whom *Capt Fiddles*, term *3* y'rs.

Remarks:

r

W. Redman

R

5 bar

U.S.C.

Tilton Redman

Appears with rank of _____ on

Muster and Descriptive Roll

of a Detachment of U.S. Colored
Volunteer Cavalry, founded

Roll dated

Lebanon, Ky., Sept. 5, 1864.

Where born Taylor, Ky.

Age 23 years; occupation Farmer

When enlisted Sept. 5, 1864.

Where enlisted Lebanon, Ky.

For what period enlisted 3 years.

Eyes Black; hair Black

Complexion Black; height 5 ft. 1/2 in.

When mustered in Sept. 5, 1864.

Where mustered in Lebanon

Bounty paid \$ 100; due \$ 100

Clothing account:

Last settled _____, 1864; drawn since \$ 7 50/100

Date of first muster Sept. 5, 1864.

Company to which assigned _____

Remarks: Master - George W. Redman,

Taylor, Ky. without consent

Book mark: _____

B. J. D. D. D. D. D.

(356m)

Copyist.

R

5 Cav.

U.S.C.T.

John Redman

Co. A, 5 Reg't U. S. Col'd Cavalry.

Appears on

Company Muster-in and Descriptive Roll
of the organization named above. Roll dated

Sept. 24, N. Y., *Oct. 24*, 1864.

Where born *Madison Ky.*

Age *23* y'rs; occupation *Farmer*

When enlisted *Sept. 5*, 1864.

Where enlisted *Seaman*

For what period enlisted *3* years.

Eyes *Blue*; hair *Black*

Complexion *Blue*; height *5 ft. 9* in.

When mustered in *Sept. 5*, 1864.

Where mustered in *Seaman*

Bounty paid \$ *100*; due \$ *100*

Where credited *8th Dist Kentucky*

Company to which assigned *A*

Remarks:

Book mark:

E. A. King

(356d)

Copyist.

R

5 Cav. | U.S.C.T.

Florian Redman
Compt., Co. A, 5 Reg't U. S. Col'd Cavalry.

Appears on

Company Muster Roll

for *to Oct. 31*, 186*4*.

Present or absent *Present*.

Stoppage, \$ *100* for

Due Gov't, \$ *100* for

Valuation of horse, \$ *100*

Valuation of horse equipments, \$ *100*

Remarks:

Book mark: -----

(358)

E. Stebbins
Copyist.

R

5 Cav. U.S.C.T.

Gleaton Redman

Corpl., Co. A, 5 Reg't U. S. Col'd Cavalry.

Appears on

Company Muster Roll

for *Nov. & Dec.*, 1864.

Present or absent *Present*,

Stoppage, \$ *100* for

Due Gov't, \$ *100* for

Valuation of horse, \$ *100*

Valuation of horse equipments, \$ *100*

Remarks: *1st and 2^d Installment
Bounty due.*

Book mark: _____

Pasteling
Copyist.

(358)

R

5 Cav. U.S.C.T.

Fulton Redman

Sergeant, Co. A, 5 Reg't U.S. Col'd Cavalry.

Appears on

Company Muster Roll

for Jan & Feb, 1865.

Present or absent Present

Stoppage, \$ 100 for

Due Gov't, \$ 100 for

Valuation of horse, \$ 100

Valuation of horse equipments, \$ 100

Remarks: 1st Installment
Bounty due \$100.

Book mark:

(358)

Castling Copyist.

R

5 Cav. U.S.C.T.

Fallon Redman

Serjt, Co. A, 5 Reg't U. S. Col'd Cavalry.

Appears on

Company Muster Roll

for *Feb. 1st*, 1865.

Present or absent *Present*

Stoppage, \$ *100* for

Due Gov't, \$ *100* for

Valuation of horse, \$ *100*

Valuation of horse equipments, \$ *100*

Remarks: *Let receipt for
Society due 9th*

Book mark:

Fallon

(358)

Copyist.

R

5 Cav. U.S.C.T.

Talton Redman

Serjt, Co. A, 5 Reg't U.S. Col'd Cavalry.

Appears on

Company Muster Roll

for May & June, 1865.

Present or absent Present

Stoppage, \$ 100 for

Due Gov't, \$ 100 for

Valuation of horse, \$ 100

Valuation of horse equipments, \$ 100

Remarks: It is installment
bond due \$15.

Book mark:

J. M. Way

(358)

Copyist.

5 Cav. U.S.C.T.

Talton Redman
Supt, Co. A, 5 Reg't U. S. Col'd Cavalry.

Appears on

Company Muster Roll

for *Sept. 1865*, 1865.

Present or absent *Present*

Stoppage, \$ 100 for

Due Gov't, \$ 100 for

Valuation of horse, \$ 100

Valuation of horse equipments, \$ 100

Remarks:

Book mark:

J. A. Hawley

(358)

Copyist.

R

5 Cav. U.S.C.T.

Talbot Robinson

1st Supt, Co. A, 5 Reg't U. S. Col'd Cavalry.

Appears on

Company Muster Roll

for *dated Oct. 31* 1865.

Present or absent *Present*

Stoppage, \$ *100* for

Due Gov't, \$ *100* for

Valuation of horse, \$ *100*

Valuation of horse equipments, \$ *100*

Remarks: *Appointed 1st Supt
from Supt. Dec. 1865 - ad. per R. O.
165 par VI*

Book mark:

(358)

H. H. H. H.
Copyist.

R

5 Cav.

U.S.C.T.

Talton Redman

Pvt, Co. A, 5 Reg't U.S. Col'd Cavalry.

Appears on

Company Muster Roll

for Nov & Dec, 1865.

Present or absent Present

Stoppage, \$ 100 for

Due Gov't, \$ 100 for

Valuation of horse, \$ 100

Valuation of horse equipments, \$ 100

Remarks: Reduced to the ranks from 1st Sgt as per R.O. No 181 Date Nov 17 1865

Book mark:

M. Wayne

(358)

Copyist.

R

5 Cav. U.S.C.T.

Salton Redman
Corp, Co. A, 5 Reg't U.S. Col'd Cavalry.

Appears on

Company Muster Roll

for Jan & Feb, 1866

Present or absent Present

Stoppage, \$ 100 for

Due Gov't, \$ 100 for

Valuation of horse, \$ 100

Valuation of horse equipments, \$ 100

Remarks: Appointed Cor-
poral per O.C., No.
13 Hd Tro: 5" U.S.
C.C. date Jan 25
1866

Book mark:

M. W. Payne
Copyist.

(358)

R

5 Cav. U.S.C.T.

Zalton Redman
Sergt A, Co. A, 5 Reg't U. S. Col'd Cavalry.

Appears on Co. Muster-out Roll, dated

Helena Ark March 16, 1866.

Muster-out to date

March 16, 1866.

Last paid to

Dec 31, 1865.

Clothing account:

Last settled....., 186 ; drawn since \$.....100

Due soldier \$.....100; due U. S. \$ 16 ⁴⁹/₁₀₀

Am't for cloth'g in kind or money adv'd \$.....100

Due U. S. for arms, equipments, &c., \$.....90/₁₀₀

Bounty paid \$ 100/₁₀₀; due \$ 100/₁₀₀

Remarks: Corpl from Org of Co.
to Feb 13.65, then Sergt. to
Oct. 7, 65 then 1st Sergt to
17 Nov. 65. then reduced to
rank, then Priv until Jan
25.66. then Corpl to March

Book mark :

over

W. W. Payne

(361)

Copyist.

JAN. - 9

5360534

1891

1st 1866. New Sergeant
Due U.S. for Ord. 40cts

Redman, Nelson

....., Co., Reg't *M.C.G.*

Enclosures.

Bed Cards	Final Statements
Burial Records	Furloughs or L. of A.
Certs. of Dis. for Discharge	Med. Certificates
C. M. Charges	Med. Des. Lists
Descriptive Lists	Orders
Discharge Certificates	Pris. of War Record
Enlistment Papers	Resignations

Other papers relating to—

Admission to Hosp'l	Furlough or L. of A.
Casualty Sheet	Med. Examination
Confinement	Misc. Information
Contracts	Pay or Clothing
Death or Effects	Personal Reports
Desertion	Rank
Discharge from Hosp'l	Transfer to Hosp'l
Discharge from Service	Transfer to V. R. C.
Duty	Transportation
.....

RE 1.—This blank will be used for enlistments of United States colored troops. They will be made out in duplicate in all cases—one to accompany the recruiting
 n of the superintendent (not the recruiting officer) to the Adjutant General, and one to accompany the accounts of the officer who pays bounty, &c.
 RE 2.—An enlistment holds to service. A muster-in must, in all cases, precede payment of pay, bounty, pension, &c. A muster-in roll, must in all cases, be filed in
 Adjutant General's Office as evidence of muster-in. The mustering officer, commissary, or a sistant commissary of musters, as the case may be, will countersign both
 iments as having mustered the soldiers into the service of the United States before either of them is given to the disbursing officer.

DECLARATION OF RECRUIT.

I, Zeleton Redman desiring
 to volunteer as a soldier in the ARMY OF THE UNITED STATES, for the term of Three Years,
 DO DECLARE That I am 23 years and months of age; that I have
 never been discharged from the United States service on account of disability or by sentence of a
 court-martial, or by order before the expiration of a term of enlistment; and I know of no
 impediment to my serving honestly and faithfully as a soldier for three years.

GIVEN at Lebanon Ky
 the 5th day of Sept 1864

Witness: Geo B Brown

*Me volun in name
 Geo B Redman
 without consent*

Zeleton Redman
 Volunteered at Lebanon Ky
 No. 104
 By Geo B Brown
1864

Consent of Parent or Guardian in case of a Minor, if a Free Man, or in the case of
 a Slave, of the Person to whom he owes Service:

I, Do CERTIFY, That I am
 the
 that the said is years of age; and I
 do freely give my CONSENT to his volunteering as a SOLDIER in the Army of the United States,
 for the period of THREE YEARS, under the conditions of the laws of the United States.

GIVEN at
 the day of

Witness:

UNITED STATES COLORED TROOPS ENLISTMENT.

STATE OF

Ky

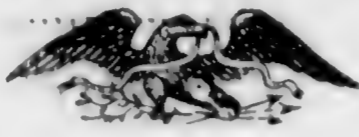

TOWN OF

County of Taylor

I, *Teleton Redman* born in *Taylor Co*

in the State of *Ky* aged *23* years

and by occupation a *farmer* Do HEREBY ACKNOWLEDGE to

have volunteered *5th* day of *Sept* 186*4*

to serve as a **Soldier** in the **Army of the United States of America**, for the period of **THREE YEARS**, unless sooner discharged by proper authority: Do also agree to accept such bounty, pay, rations, and clothing, as are, or may be, established by law for the U. S. colored troops.

And I, *Teleton Redman*

do solemnly swear that I will bear true faith and allegiance to the **United States of America**, and that I will serve them honestly and faithfully against all their enemies or opposers whomsoever; and that I will observe and obey the orders of the President of the United States, and the orders of the officers appointed over me, according to the Rules and Articles of War.

Sworn and subscribed to, at *Sebanu Ky* this *5th* day of *Sept 1864* *Teleton Redman* *mark*

Before *M Foster*
Capt 2nd Reg 170th Mus 4th Dist Ky

I CERTIFY, ON HONOR, That I have carefully examined the above named Volunteer agreeably to the General Regulations of the Army, and that, in my opinion, he is free from all bodily defects and mental infirmity, which would in any way disqualify him from performing the duties of a soldier.

John C. Maxwell

EXAMINING SURGEON.

I CERTIFY, ON HONOR, That I have minutely inspected the Volunteer, *Teleton Redman* previously to his enlistment, and that he was entirely sober when enlisted; that, to the best of my judgment and belief, he is of lawful age; and that, in accepting him as duly qualified to perform the duties of an able-bodied soldier, I have strictly observed the regulations which govern the recruiting service. This soldier has *blue* eyes, *black* hair, *black* complexion, is *5* feet *10* inches high.

M Foster
Capt 2nd Reg 170th Mus 4th Dist Ky RECRUITING OFFICER OR AGENT.

Mustered into the United States Service *5th* day of *Sept* 186*4*

M Foster

Capt 2nd Reg 170th Mus 4th Dist Ky Mustering Officer

..... Mustered into the service of the United States, for three years or during the war, from date of enlistment, in Company
Regiment of Volunteers, on the day of 186, at

Nedman Nelson

Co a, **5 U. S. Col'd Cav.**

Private | *Private*

CARD NUMBERS.

1	5359670	26
2	5359770	27
3	5359870	28
4	5359967	29
5	5360058	30
6	5360150	31
7	5360238	32
8	5360330	33
9	5360421	34
10	5360509	35
11	5360596	36
12	90900HH	37
13	43146394	38
14	40730242	39
15		40
16		41
17		42
18		43
19		44
20		45
21		46
22		47
23		48
24		49
25		50

Book Mark:

See also

R | **5 Cav.** | **U.S.C.T.**

William Redmon

....., Co. *A*, 5 Reg't U. S. Col'd Cav.

Appears on

Company Descriptive Book
of the organization named above.

DESCRIPTION.

Age *20* years; height *5* feet *6* inches.

Complexion *Copper*

Eyes *Blk*; hair *Blk*

Where born *Taylor Co Ky*

Occupation *Farmer*

ENLISTMENT.

When *Sept 5*, 186 .

Where *Lebanon*

By whom *Capt. Fiddler*; term *3* y'rs.

Remarks:

.....
.....
.....
.....
.....
.....
.....
.....
.....

W. Redmon

R

5 Cav.

U.S.C.T.

Nelson Redman

Prvt, Co. A, 5 Reg't U. S. Col'd Cavalry.

Appears on

Company Muster-in and Descriptive Roll

of the organization named above. Roll dated

Ep. Nelson Ky, N. Y., Oct. 24, 1864.

Where born Taylor Ky.

Age 20 y'rs; occupation Farmer.

When enlisted Sept, 5, 1864.

Where enlisted Lebanon

For what period enlisted 3 years.

Eyes Blue; hair Blue

Complexion Copper; height 5 ft. 6 in.

When mustered in Sept, 5, 1864.

Where mustered in Lebanon

Bounty paid \$ 100; due \$ 100

Where credited 4th Dist, Kentucky

Company to which assigned A.

Remarks:

Book mark:

Easterling

(356d)

Copyist.

R | 5 Cav. | U.S.C.T.

Nelson Pedman

Capt, Co. A, 5 Reg't U. S. Col'd Cavalry.

Appears on

Company Muster Roll

for *to Oct. 31*, 186*4*.

Present or absent *Absent*,

Stoppage, \$ *100* for

Due Gov't, \$ *100* for

Valuation of horse, \$ *100*

Valuation of horse equipments, \$ *100*

Remarks: *Sick in Hospital
at Camp Nelson
Ky.*

Book mark:

Casterlong

(358)

Copyist.

R

5 Cav.

U.S.C.T.

Nelson Redman

Cpt, Co. A, 5 Reg't U.S. Col'd Cavalry.

Appears on

Company Muster Roll

for *Nov. & Dec.*, 1864.

Present or absent *Present*

Stoppage, \$ *100* for

Due Gov't, \$ *100* for

Valuation of horse, \$ *100*

Valuation of horse equipments, \$ *100*

Remarks: *1st and 2^d Installment*

Bounty due

Book mark: _____

(358)

Easterling

Copyist.

R

5 Cav. U.S.C.T.

Melton Redman

Priv, Co. A, 5 Reg't U. S. Col'd Cavalry.

Appears on

Company Muster Roll

for *Jan & Feb*, 1865

Present or absent *Present*

Stoppage, \$ *100* for

Due Gov't, \$ *100* for

Valuation of horse, \$ *100*

Valuation of horse equipments, \$ *100*

Remarks: *part of stallment
Barn is by tree \$100*

Book mark:

W. A. ...

(358)

Copyist.

R

5 Cav. U.S.C.T.

Nelson Redman

Pvt., Co. A, 5 Reg't U. S. Col'd Cavalry.

Appears on

Company Muster Roll

for *Wm. J. Opl.*, 1865.

Present or absent *Present*

Stoppage, \$ 100 for

Due Gov't, \$ 100 for

Valuation of horse, \$ 100

Valuation of horse equipments, \$ 100

Remarks: *1st installment
bounty due \$105.*

Book mark:

J. M. [Signature]

(358)

Copyist.

R

5 Cav. U.S.C.T.

William Redman

Co. A, Co. A, 5 Reg't U. S. Col'd Cavalry.

Appears on

Company Muster Roll

for *May 1865*, 1865.

Present or absent *Present*

Stoppage, \$ *100* for

Due Gov't, \$ *100* for

Valuation of horse, \$ *100*

Valuation of horse equipments, \$ *100*

Remarks: *Wm Redman
bounty due \$150.*

Book mark:

J. M. [Signature]

(358)

Copyist.

R

5 Cav. U.S.C.T.

William Redwood

Plt., Co. A, 5 Reg't U. S. Col'd Cavalry.

Appears on

Company Muster Roll

for *Sept. & Oct.* 186*5*

Present or absent *Present*

Stoppage, \$ *100* for

Due Gov't, \$ *100* for

Valuation of horse, \$ *100*

Valuation of horse equipments, \$ *100*

Remarks:
.....
.....
.....
.....
.....
.....
.....
.....
.....
.....

Book mark:

W. Redwood
Cpyrist.

(358)

5 Cav. U.S.C.T.

R
Wilson Redman
Sgt., Co. A, 5 Reg't U. S. Col'd Cavalry.

Appears on

Company Muster Roll

for *Sept 3*, 186*5*.

Present or absent

Present

Stoppage, \$ 100 for

Due Gov't, \$ 100 for

Valuation of horse, \$ 100

Valuation of horse equipments, \$ 100

Remarks:

Book mark:

J. M. [Signature]

(358)

Copyist.

R

5 Cav. U.S.C.T.

Anderson Redman

Pvt., Co. A, 5 Reg't U. S. Col'd Cavalry.

Appears on

Company Muster Roll

for Nov 1865

Present or absent Present

Stoppage, \$ 100 for

Due Gov't, \$ 52/100 for Ard

Valuation of horse, \$ 100

Valuation of horse equipments, \$ 100

Remarks:

Book mark:

W. Mayre

(358)

Copyist.

R

5 Cav. U.S.C.T.

Nelson Redman

Pvt., Co. A, 5 Reg't U. S. Col'd Cavalry.

Appears on

Company Muster Roll

for Jan & Feb, 1866

Present or absent Present

Stoppage, \$ 100 for

Due Gov't, \$ 100 for

Valuation of horse, \$ 100

Valuation of horse equipments, \$ 100

Remarks:

Book mark:

W. W. Payne

(358)

Copist.

Q. | **5 Cav.** | **U.S.C.T.**

Abelvin Redman

Priv., Co. B, 5 Reg't U. S. Colored Cav.

Appears on **Returns** as follows:

Oct. & Nov. 1864. - Absent sick
in Hosp. at Camp
Weldon Ky.

Book mark :

(546)

E. Thenton

Copyist.

R

5 Cav. U.S.C.T.

Nelson Redman

Pvt, Co. A, 5 Reg't U. S. Col'd Cavalry.

Appears on Co. Muster-out Roll, dated

Helena Ark, Mch 16, 1866.

Muster-out to date Mch 16, 1866.

Last paid to Dec 31, 1865.

Clothing account:

Last settled, 186 ; drawn since \$ 100

Due soldier \$ 100; due U. S. \$ 22 81 / 100

Am't for cloth'g in kind or money adv'd \$ 100

Due U. S. for arms, equipments, &c., \$ 2 03 / 100

Bounty paid \$ 100 / 100; due \$ 100 / 100

Remarks: Due U.S. for Ord

\$2.03

Book mark: 450.503

W. W. Sayre

(361)

Copyist.

Redman, Melvin

, Co. ,

Reg't

MSOY

Enclosures.

Bed Cards	Final Statements
Burial Records	Furloughs or L. of A
Certs. of Dis. for Discharge	Med. Certificates
C. M. Charges	Med. Des. Lists
Descriptive Lists	Orders
Discharge Certificates	Pris. of War Record
Enlistment Papers	Resignations

Other papers relating to—

Admission to Hosp'l	Furlough or L. of A
Casualty Sheet	Med. Examination
Confinement	Misc. Information
Contracts	Pay or Clothing
Death or Effects	Personal Reports
Desertion	Rank
Discharge from Hosp'l	Transfer to Hosp'l
Discharge from Service	Transfer to V. R. C.
Duty	Transportation

NOTE 1.—This blank will be used for enlistments of United States colored troops. They will be made out in duplicate in all cases—one to accompany the recruit to the recruiting officer, and one to accompany the accounts of the officer who pays bounty, &c.

NOTE 2.—An enlistment holds to service. A muster-in must, in all cases, precede payment of pay, bounty, pension, &c. A muster-in roll, must in all cases, be filed in the Adjutant General's Office as evidence of muster-in. The mustering officer, commissary, or assistant commissary of musters, in the case may be, will countersign both enlistments as having mustered the soldiers into the service of the United States before either of them is given to the disbursing officer.

DECLARATION OF RECRUIT.

I, Melvin Redman desiring to volunteer as a soldier in the ARMY OF THE UNITED STATES, for the term of *Three Years*, DO DECLARE That I am 20 years and months of age; that I have never been discharged from the United States service on account of disability or by sentence of a court-martial, or by order before the expiration of a term of enlistment; and I know of no impediment to my serving honestly and faithfully as a soldier for three years.

GIVEN at Saratoga NY the 5th day of September 1864

Witness: Geo B Brown

*Muster name
George Redman
Quoted without comment*

Melvin Redman
 Volunteered at Saratoga NY
 No. 444
 By Robert A. M. Fisher
Adj. Gen. H. A. Wood
 1864

Consent of Parent or Guardian in case of a Minor, if a Free Man, or in the case of a Slave, of the Person to whom he owes Service:

I, Do CERTIFY, That I am the that the said is years of age; and I do freely give my CONSENT to his volunteering as a SOLDIER in the Army of the United States, for the period of THREE YEARS, under the conditions of the laws of the United States.

GIVEN at the day of

Witness:

UNITED STATES COLORED TROOPS ENLISTMENT.

STATE OF

TOWN OF

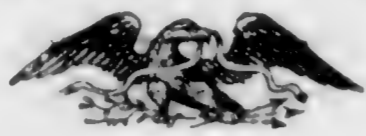

I, Melvin Redman born in County of Taylor
Ky in the State of Ky aged 30 years
 and by occupation a farmer Do HEREBY ACKNOWLEDGE to
 have volunteered 5th day of Sept 1864

to serve as a **Soldier** in the **Army of the United States of America**, for the
 period of **THREE YEARS**, unless sooner discharged by proper authority: Do
 also agree to accept such bounty, pay, rations, and clothing, as are, or may be,
 established by law for the U. S. colored troops.

And I, Melvin Redman
 do solemnly swear that I will bear true faith and allegiance to the **United States**
of America, and that I will serve them honestly and faithfully against all their
 enemies or opposers whomsoever; and that I will observe and obey the orders
 of the President of the United States, and the orders of the officers appointed
 over me, according to the Rules and Articles of War.

Sworn and subscribed to, at Seton Ky
 this 5th day of Sept 1864 Melvin Redman
 Before W. Hunter his
Capt 4th Reg Mar 4th Dist Ky mark

I CERTIFY, ON HONOR, That I have carefully examined the above named Volunteer agree-
 ably to the General Regulations of the Army, and that, in my opinion, he is free from all bodily
 defects and mental infirmity, which would in any way disqualify him from performing the
 duties of a soldier.

John C. Maxwell

EXAMINING SURGEON.

I CERTIFY, ON HONOR, That I have minutely inspected the Volunteer, Melvin Redman
 previously to his enlistment, and that he was entirely sober when enlisted; that, to the best of
 my judgment and belief, he is of lawful age; and that, in accepting him as duly qualified to per-
 form the duties of an able-bodied soldier, I have strictly observed the regulations which govern
 the recruiting service. This soldier has blue eyes, black hair, dark com-
 plexion, is 5 feet 10 inches high.

W. Hunter
Capt 4th Reg Mar 4th Dist Ky RECRUITING OFFICER OR AGENT.

Mustered into the United States Service 5th day of Sept 1864

W. Hunter
Capt 4th Reg Mar 4th Dist Ky Mustering Officer

Mustered into the service of the United States, for three years or during the war, from date of enlistment, in Company 1 Regiment of Volunteers, on the 5th day of Sept, 1864, at Seton Ky

1064

Reed Austin

Co L, 5 U. S. Col'd Cav.

Private Private

CARD NUMBERS.

1	5359268	26
2	5370405	27
3	5370490	28
4	5370581	29
5	5370653	30
6	5370724	31
7	9091194	32
8	32116358	33
9	32232783	34
10	32233060	35
11	40730243	36
12		37
13		38
14		39
15		40
16		41
17		42
18		43
19		44
20		45
21		46
22		47
23		48
24		49
25		50

Book Mark:

See also 72 M.S.C.I.

R

5 Cav. | U.S.C.T.

Austin Reed

, Co. *E*, 5 Reg't U. S. Col'd Cav.

Appears on

Company Descriptive Book

of the organization named above.

DESCRIPTION.

Age *18* years; height *5* feet *1/2* inches.

Complexion *BRN*

Eyes *BRN*; hair *BRN*

Where born *Kentucky*

Occupation *Laborer*

ENLISTMENT.

When *Substituted*, 186 .

Where *9 Dist Ky*

By whom ; term *3* y'rs.

Remarks:

A. J. Anderson

(383g)

Coppist.

R | 5 Cav | U.S.C.T.

Austin Reed

Pvt, Co....., 5 Reg't U. S. Col'd Cav

Appears on

M. and D. Roll of Men Transferred

to the organization named above,

x from
Camp Nelson, July 18, 1865.
Roll dated

When enlisted 186 .

Period for which enlisted 3 years.

When mustered in Dec 22, 1864.

Present or absent Not Stated

Company to which assigned.....

Remarks: 9 Dty Substitute

x Inserted by J.B. Powell, Ex

Book mark :

Abbott

(342)

Copyist.

2 | 5 Cav. | U.S.C.T.

Austin Reed

2d, Co. L, 5 Reg't U. S. Col'd Cavalry.

Appears on

Company Muster Roll

for *July & Aug*, 186*5*.

Present or absent *Present*

Stoppage, \$ 100 for

Due Gov't, \$ 100 for

Valuation of horse, \$ 100

Valuation of horse equipments, \$ 100

Remarks: *Sick in Regt's Hospital*

Book mark:

Reed

R | 5 Cav. | U.S.C.T.

Austin Reed

Capt., Co. L, 5 Reg't U. S. Col'd Cavalry.

Appears on

Company Muster Roll

for Sep & Oct, 1865.

Present or absent Absent

Stoppage, \$ 100 for

Due Gov't, \$ 100 for

Valuation of horse, \$ 100

Valuation of horse equipments, \$ 100

Remarks: Kept sick in
Det. Dept. Tex. Ky.

Book mark:

Reed

(358)

Copyist.

R | 56 | U.S.C.T

Austin Reed

Pvt, Co. L, 5th Reg't U.S.C.C.

Appears on

Hospital Muster Roll

of U. S. A. Post Hospital,

at Camp Nelson, Ky.,

for Sept & Oct, 1865.

Attached to hospital:

When, 186 .

How employed

Last paid by Maj.

to, 186 .

Bounty paid \$ 100; due \$ 100

Present or absent Present

Remarks:

Book mark:

C. L. Parker

(343)

Copyist.

R | 5 Cav. | U.S.C.T.

Austin Reed

Prof, Co. L, 5 Reg't U.S. Col'd Cavalry.

Appears on

Company Muster Roll

for *10th Dec*, 1865.

Present or absent *Absent*

Stoppage, \$ *100* for

Due Gov't, \$ *100* for

Valuation of horse, \$ *100*

Valuation of horse equipments, \$ *100*

Remarks: *Absent sick in Camp Nelson, Ky.*

Book mark:

Reed

(358)

Copyist.

R | 5 Car | U.S.C.T.

Austain Reed

Priv, Co. 20, 5 Reg't U.S. Col. Cav

Appears on

Hospital Muster Roll

of Marine U. S. A. General Hospital,

at St. Louis, Mo.,

for Nov & Dec, 1865.

Attached to hospital:

When Dec 21, 1865.

How employed Patient

Last paid by Maj.

to, 186 .

Bounty paid \$ 100; due \$ 100

Present or absent Present

Remarks:

Book mark:

Spalten

R | 5 Cav. | U.S.C.T.

Walter Reed

Tat, Co. L, 5 Reg't U. S. Col'd Cavalry.

Appears on

Company Muster Roll

for Jan. & Feb., 1866.

Present or absent Present

Stoppage, \$ 100 for

Due Gov't, \$ 100 for

Valuation of horse, \$ 100

Valuation of horse equipments, \$ 100

Remarks: Sick in Quarters

Book mark:

A. J. Taylor

(358)

Copyist.

22 | 5 Car | U.S.C.T.

Austin Reed

Pvt, Co. L, 5 Reg't U.S.C. Car

Appears on

Hospital Muster Roll

of Marine U. S. A. General Hospital,

at St. Louis, Mo.,

for Jan & Feb, 1866.

Attached to hospital:

When _____, 186 .

How employed _____

Last paid by Maj. _____

to _____, 186 .

Bounty paid \$ 100; due \$ 100

Present or absent _____

Remarks: Returned to duty
Jan. 11. 66.

Book mark: _____

J. J. [Signature]

(843)

Copyist.

R

5 Cav.

U.S.C.T.

Justin Reed

Priv., Co. F, 5 Reg't U. S. Colored Cav.

Appears on Returns as follows:

July 1865. - Sick July 27
65 Paris Ky. Transf
to Co.

Sept. 1865. - Absent sick
in P. H. since Sept. 14
65

Oct. 1865. - Absent sick in
Post Hosp. Tex. Ky

Nov. & Dec. 1865. - Absent sick
ind. Hosp. Camp Nelson
since Sept. 14/65

Book mark :

(546)

E. Thomson

Copyist.

R | 5600 | U.S.C.T.

Musten Reed

Priv, Co. *L*, *5* Reg't U. S. Col'd *Cavalry*

Appears on **Co. Muster-out Roll**, dated
Helena, Ark. Mar. 16, 1866.

Muster-out to date *Mar. 16*, 1866.

Last paid to *Dec. 31*, 1865.

Clothing account:

Last settled _____, 186 ; drawn since \$ _____ 100

Due soldier \$ *27*^{*67*}/₁₀₀; due U. S. \$ _____ 100

Am't for cloth'g in kind or money adv'd \$ _____ 100

Due U. S. for arms, equipments, &c., \$ _____ 100

Bounty paid \$ _____ 100; due \$ _____ 100

Remarks: *Slave. Transfd.*
from 72^d U.S.C. I per S.O.
No. 127 Par. 3. Ad. gvis.
Dept. of Ky July 18th 1865.

Book mark:

C. T. Taylor

(361)

Copyist.

Reed, Austin

P, Co. L, 5 Reg't 115th Caval

2 Enclosures.

Bed Cards	2	Descriptive Lists
Burial Records		Final Statements
Certs. of Dis. for Discharge		Furloughs
C. M. Charges		Med. Des. Lists
Med. Certificates		Orders

Other papers relating to—

Admission to Hosp'l	Furlough
Casualty Sheet (Officer's)	Med. Examination
Confinement	Misc. Information
Contracts	Pay or Clothing
Death or Effects	Personal Reports
Desertions	Rank
Discharge from Hosp'l	Transfer to Hosp'l
Discharge from Service	Transfer to V. R. C.
Duty	Transportation

ward 19
Hospital Number Bed 48
16115

Name Auston Reed

Age 19 Nativity Ky

~~Married~~ or Single

Residence Mount Sterling Ky

Post Office address of } to aunt
wife or nearest relative. } Patsey Burns
Mount Sterling

Rank Troop Co. 2 Regiment 5 Cav. 61

When admitted Nov 8 1865

From what source Camp Nelson Ky

Diagnosis: (in surgical cases, state explicitly seat and character of wound or injury.)

Diarrhoea

48

Jefferson G. H.

On what occasion wounded Jeffersonville, Ind.

Date

Nature of missile or weapon

TREATMENT.

[HERE NOTE IMPORTANT COMPLICATIONS AND ALL OPERATIONS.]

RESULT AND DATE.

referred to St. Louis Mo. Dec. 20 1857

Hospital Number **4499** 60 { ~~77~~ ⁶

Name *Austair Reed*

Age *18* Nativity *Ky*

Married or Single *Single*

Residence *Monst. sumner Co Ky*

Post Office address of } *Jacob Reed*
wife or nearest relative, } *Same as her*

Rank *Priv. Co. I* Regiment *5th US Cav*

When admitted *20th 7th 1864*

From what source *Jefferson ^{Gen. Hays} Ind*

Diagnosis:—(In surgical cases state explicitly seat and character of wound or injury.)

Convalescent

On what occasion wounded **Marine G. H.**

Date **St. Louis, Mo.**

Nature of missile or weapon

TREATMENT.

[HERE NOTE IMPORTANT COMPLICATIONS AND ALL OPERATIONS.]

Young ref

RESULT AND DATE.

*Returned to duty
Jan. 11. 66*

1065

Reed, Garrett,

Co K, 5 U. S. Col'd Cav.

Private

CARD NUMBERS.

1	See Reed,	26	Garrett
2		27	
3		28	
4		29	
5		30	
6		31	
7		32	
8		33	
9		34	
10		35	
11		36	
12		37	
13		38	
14		39	
15		40	
16		41	
17		42	
18		43	
19		44	
20		45	
21		46	
22		47	
23		48	
		49	
		50	

Book Mark:

See also

Reed James L
Co *A*, 5 U. S. Col'd Cav.

1st Lt Lieutenant *1st Lt* Lieutenant

CARD NUMBERS.

1	5359185	26
2	5365242	27
3	5365332	28
4	5365422	29
5	5365511	30
6	5365601	31
7	9435978	32
8	40730244	33
9		34
10		35
11		36
12		37
13		38
14		39
15		40
16		41
17		42
18		43
19		44
20		45
21		46
22		47
23		48
24		49
25		50

Book Mark:

See also *120 U.S.C.P.*

R 15. Cav. U.S.C.A.

James L Reed

1st Lt., Co. F, 5th Reg't U.S. Col'd Cav.

Appears on

Regimental Descriptive Book

(List of Commissioned Officers)

of the regiment named above.

Rank 1st Lieutenant

Date of appointment June 6, 1865.

Remarks: Enrolled at

Louisville Ky by the
President June 19, 1865.

3 years.

Mustered June 19, 1865 at
Louisville by Capt
Simon Snyder.

Heard

James L. Reed

1st, Co. 7, 5 Reg't U. S. Col'd

Age 28 years.

Appears on an

Individual Muster-in Roll

of the organization named above. Roll dated

Louisville Ky, Aug 11, 1865.

Muster-in to date June 17, 1865.

Joined for duty and enrolled:

When June 17, 1865.

Where Louisville Ky.

Period 3 years.

Valuation of horse, \$ 100

Valuation of horse equipments, \$ 100

Remarks: This muster to date from June 17, 65. Affidavit filed & forwarded to A.S. Wash-

Book mark:

Sarauer

JAN. - 9

5359185

1891

ington D.C.

Mustered as 2 Lieut
120th U. S. C. I. U. S.
Aug 11/65 to date from
June 16 1865 in order
to be mustered in as
1 Lieut Co. F 5. U. S.
C. C. U.

R

5 Cav.

U.S.C.T.

James L Reed

1st Lieut, Co. F, 5 Reg't U. S. Col'd Cavalry.

Appears on

Company Muster Roll

for July & Aug, 1865.

Present or absent absent

Stoppage, \$ 100 for

Due Gov't, \$ 100 for

Valuation of horse, \$ 100

Valuation of horse equipments, \$ 100

Remarks: Assigned to Co by Regt order no dated June 17. 65. on special duty with Band

Book mark:

Hart Copyist.

R

5 Cav.

U.S.C.T.

James L Reed

1st Lieut, Co. F, 5 Reg't U. S. Col'd Cavalry.

Appears on

Company Muster Roll

for Sept & Oct, 1865.

Present or absent Absent

Stoppage, \$ 100 for

Due Gov't, \$ 100 for

Valuation of horse, \$ 100

Valuation of horse equipments, \$ 100

Remarks: on special duty with Regt Band and date & no of order unknown

Book mark:

Mark

(358)

Copyist.

R | 5 Cav. | U.S.C.T.

James L Reed

1st Lt, Co. F, 5 Reg't U. S. Col'd Cavalry.

Appears on

Company Muster Roll

for Nov 2 Dec, 1865.

Present or absent Present

Stoppage, \$ 100 for

Due Gov't, \$ 100 for

Valuation of horse, \$ 100

Valuation of horse equipments, \$ 100

Remarks: Daily duty with Regimental Band by Regt over No

Book mark:

Wash

(358)

Copyist.

R

5 Cav. U.S.C.T.

James S. Reed

Lieut, Co. F, 5 Reg't U. S. Col'd Cavalry.

Appears on

Company Muster Roll

for Jan & Feb, 1866

Present or absent Absent

Stoppage, \$ 100 for

Due Gov't, \$ 100 for

Valuation of horse, \$ 100

Valuation of horse equipments, \$ 100

Remarks: On leave absence, per S. O. No 24 Hd Qrs Dept Ark L. Rock Feb 9. 1866

Book mark:

J. W. Davis

(358)

Copyist.

R

5 Cav.

U.S.C.T.

James L. Reed

1st Co. F., 5 Reg't U. S. Colored Cav.

Appears on Returns as follows:

Aug. to Dec. 1865. - Present
daily duty in charge
of Regt. Band.

Jan. 1866. - Present

Feb. 1866. - Absent on
leave of absence.

* name appears also as James B.
Reed.

Book mark :

E. Thornton

(546)

Copyist.

R

5 Cav. U.S.C.T.

James S. Reed

1st Lieut, Co. F, 5 Reg't U. S. Col'd Cavalry.

Appears on Co. Muster-out Roll, dated Helena, Ark, Mch 16, 1866.

Muster-out to date Mch 16, 1866.

Last paid to Not Known, 1866.

Clothing account:

Last settled, 1866; drawn since \$ 100

Due soldier \$ 100; due U. S. \$ 100

Am't for cloth'g in kind or money adv'd \$ 100

Due U. S. for arms, equipments, &c., \$ 100

Bounty paid \$ 100; due \$ 100

Remarks: Aft from civil life. Resignation accepted per S.O. No 72 dated War Dept U.S. Wash- ington D.C. Feb 16. 1866

Book mark: P.M.G. 8431 Jan 14/67

J.W. Davis

(361)

Copyist.

Reed James L

1st Lt, Co. F, 5 Reg't U. S. C. Cav.

7

Enclosures.

Bed Cards	Final Statements
Burial Records	Furloughs or L. of A.
Certs. of Dis. for Discharge	Med. Certificates /
C. M. Charges	Med. Des. Lists
Descriptive Lists	Orders 5
Discharge Certificates	Pris. of War Record
Enlistment Papers	Resignations 2

Other papers relating to—

Admission to Hosp'l	Furlough or L. of A. /
Casualty Sheet	Med. Examination
Confinement	Misc. Information
Contracts	Pay or Clothing
Death or Effects	Personal Reports
Desertion	Rank
Discharge from Hosp'l	Transfer to Hosp'l
Discharge from Service	Transfer to V. R. C.
Duty	Transportation

Head Quarters 1st Div. 1st Div. Dept of Ky
Lex Ky. Nov. 6. 1865

Special Order 29

Orders S. Reed to proceed to
Louisville Ky.

First Brigade
Head-Quarters, First Division Department of Ky.

Lexington, Ky., November 6th 1865.

SPECIAL ORDERS, }

No. 29.

"EXTRACT"

11th 1st Lieut James L. Reed
5th U. S. Col. Cary will proceed without
delay to Louisville Ky on business connected
with these Head Quarters, and return
The D. M. Dept will furnish
the necessary transportation

By Command of Brig Gen. J. T. Wade

Maj. H. M. Kildor
Company 5th U. S. C. Co.
Camp

J. Campbell Wade
Capt. and A. A. A. G.

Camp 5th U.S. Col. Cav.
Helena, Ark.
R. D. C. T. R. P. 1866.
James L. Reed.
1st Lieut. 5th U.S. Col. Cav.

Send his resignation on account
of ill health and enclose Surgeon's
certificate of disability
Jan 22 1866

~~With R. B. 1336~~
Headquarters 5th U.S. Col. Cav.
Helena, Ark.
Jan. 18. 1866.

Approved and respectfully
forwarded.
L. J. Thompson
Cvt. 5th U.S. Col. Cav.
Comdr.

~~With R. B. 1336~~
Reed also Feb. 13. 1866

Jan 23 1866
Headquarters
St. Francis River District
Helena Ark Jan 20 1866

Respectfully forwarded
Approved:
M. B. R. 1336
Commanding

Approved
R. B. 1336
J. E. Smith
Brig. St. Col. Surgeon U.S.A.
Med. Director Dept. of Ark.
H. D. B.
Jan 29 1866

Headquarters Dep't of Ark.,
Little Rock, Ark. Jan 29 1866.
Respectfully forwarded
Approved:
J. J. Reynolds
Major General Commanding.

Headquarters
St. Francis River District
Helena Ark
Respectfully forwarded
to the Adjutant
General of the Army.
Approved:
M. B. R. 1336
Commanding
By
J. J. Reynolds
Major General
U.S. Army
In absence of the General

Note: Name Spor.
No 72 of Feb 16,
1866. as office

Camp 5th U.S. Col Cavalry
Helena Arkansas January 18th 1866

Adjutant General
U.S. Army
Washington D.C.

Sir

I have the honor herewith to
tender my resignation as 1st Lieut of
Co "4" 5th U.S. Colored Cavalry on account
of general ill health incapacitating me
from service and respectfully request that
it may be immediately accepted.

I certify on honor that I am not
indebted to the United States on any account
whatever and that I am prepared to turn
over the property in my hands at any time.

I am very Respectfully your obedient
Servant,

James S. Reed
1st Lieut Co 5th U.S. Cav

Camp 5 reg bat cavalry
Helena Ark Feb 3. 1866

Recd L.S.
1/2 Lt Col S. S. S. Co
No 29 & 29

Application for inventory
camp ledger in order to visit
Hastings Michigan
E.B.L.

Head 130 5 reg Cavalry
Helena Ark
Feb 4. 1866

Respectfully forwarded
approved
L. J. Carpenter
Col S. S. Co
Comd

No. 29. part Feb 4. 66

H^d Q^r St Francis R Dist
Helena Ark. Feb 3rd 1866

Respectfully returned
for answer as to the num-
ber of officers on duty with
the Company.

By Command of
Col Albert B. S. Co
M. C. Jaynes
1st Regt Cavalry

Head 130 5 reg Cavalry
Helena Ark
5 Feb. 1866

Respectfully returned to
Lt Jacques Abale 1st Regt St
Francis River Dist with the
information that Capt. S. Gray
is on duty with Co F S. S. Co
L. J. Carpenter
Col S. S. Co
Comd

Ex 20 57 St Francis R Dist 1866

Headquarters
St Francis River Dist
Helena Ark Feb 6/66

Respectfully forwarded
Approved for Company

Capt.
A. B. S. Co
Col. S. S. Co
Commanding.

Enter & return file

Jan 5. 0. 29. 66 One
Feb 9. 66

Know

Camp 5th U.S.C. Cavalry
Helena Arkansas "Feb" 3rd 1866

Adjutant Genl
Department of Ark

Sir

I have the honor to request
that I may be granted a leave of absence
for ⁽²⁰⁾ twenty days in order that I may
visit my home at Hastings Michigan

I am Sir Very Respectfully
Your Obedient Servant

James S Reed
1st Supt Co "4" 3rd U.S.C.

Office Surgeon in Chief
H^Q of Genl. Francis B. Liss
Havana Aug^r 19th 60

Approved, on a per-
sonal examination.

D. A. L. Torrey
Surgeon & Regt.
Surgeon in Chief.

C 45 C of P 5/24/88.

X

James S. Reed 1st Lieut
of Company H of the 5th Regiment U.S. Colored
Cavalry, having applied for a certificate
on which to ground an application to resign
I do hereby certify that I have carefully
examined this Officer, and find him suffering
from General Debility, consequent upon an attack
of typho-malarial fever, of several weeks duration.
And in consequence thereof he is in my opinion
unfit for duty. I further declare my belief that
he will not be able to resume his duties for many
days to come, and that in my opinion a change
of climate is absolutely necessary, if not to
preserve life, to prevent permanent disability.

Dated at Camp 5th U.S.C. Helena Arkansas

This 18th day of January 1866.

C. W. Bowen
Surgeon 5th U.S.C. Camp

Head Quarters of West
Lute Rock Ark

Feb. 9. 1886

Special Order No 29

Leave of absence for 1st
Lt J L Reed. Surgeon

SPECIAL ORDERS

No. 29.

HEADQUARTERS,
DEPARTMENT OF ARKANSAS,
Little Rock, Ark., Feb. 9th, 1865.

[EXTRACT.]

1. Leave of absence for twenty (20) days, to go beyond the limits of the Department, is hereby granted 1st Lieutenant **JAMES L. REED**, 5th U. S. Colored Cavalry.

* * * * *

By command of Major General J. J. REYNOLDS:

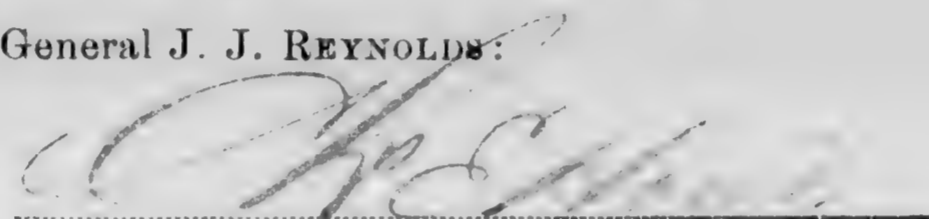

Captain, Assistant Adjutant General.

*Copy of order
5th U.S. Colored Cavalry*

Reed, Geo. L.
1st Lt. 5th U.S.C. Cav.

C

Reg. 25. 1866

SPECIAL ORDERS,
No. 72.

WAR DEPARTMENT,
ADJUTANT GENERAL'S OFFICE,
Washington, February 16th, 1866.

(Extract.)

* * * * *

3. 1st Lieutenant *James L. Reed*, 5th U. S. Colored Cavalry, having tendered his resignation, is hereby honorably discharged the service of the United States, on account of physical disability, with condition that he shall receive no final payments, until he has satisfied the Pay Department that he is not indebted to the Government.

* * * * *

By order of the Secretary of War :

E. D. TOWNSEND,
Assistant Adjutant General.

OFFICIAL :

Assistant Adjutant General.

Colonel Foster

SPECIAL ORDERS, } WAR DEPARTMENT,
No. 72. } ADJUTANT GENERAL'S OFFICE,
Washington, February 16th, 1866.

(Extract.)

* * * * *

3. 1st Lieutenant *James L. Reed*, 5th U. S. Colored Cavalry, having tendered his resignation, is hereby honorably discharged the service of the United States, on account of physical disability, with condition that he shall receive no final payments, until he has satisfied the Pay Department that he is not indebted to the Government.

* * * * *

By order of the Secretary of War :

E. D. TOWNSEND,

Assistant Adjutant General.

OFFICIAL:

Assistant Adjutant General.

General B...

James L. Reed

Lt. Col. 7, 5 U.S. C. Cor

Headquarters Fifth U. S. Colored Cavalry,

Helena Mont. Mas 5 1866.

ORDER }
NO. 38 }

EXTRACT.

III. The resignation of 1st Lt James S Reed Co T
5th U.S. Col Cav having been accepted and
his discharge ordered by S. O. No 72 Was Dept
d. G. O. Washington D. C dated Feb. 16. 1866
He is hereby relieved from duty with his
Regiment.

By command of

Col E H Taylor

A. Combs
Co T

H Jackson

Lieut. & Adjutant.

Reid Joseph
Co. D, 5 U. S. Col'd Cav.

Private | *Private*

CARD NUMBERS.

1	5362707	26
2	5362802	27
3	5362901	28
4	5363019	29
5	5363642	30
6	9090336	31
7	43146322	32
8	43146503	33
9	31413361	34
10	40730246	35
11		36
12		37
13		38
14		39
15		40
16		41
17		42
18		43
19		44
20		45
21		46
22		47
23		48
24		49
25		50

Book Mark:

See also

R | 5 Cav. | U.S.C.T.

Joseph Reid

, Co. D, 5 Reg't U. S. Col'd Cav.

Appears on

Company Descriptive Book
of the organization named above.

DESCRIPTION.

Age 35 years; height 5 feet 9 inches.

Complexion Black

Eyes Black; hair Black

Where born Nelson, Ky.

Occupation Laborer

ENLISTMENT.

When Sept. 3, 1864.

Where Louisville, Ky.

By whom Capt. Nomack term 3 y'rs.

Remarks: Died Gen. Hosp.

Camp Nelson

Jan. 31, 65. Final

statements forwarded

to A.S.O. Mar. 31, 65

A. A. Hall

(3830)

~~Captain~~
Comp.

R

5600

U.S.C.T.

Jos. Reed

Appears with rank of Rec't on

Muster and Descriptive Roll

of a detachment of U. S. colored
Troops. mustered

Roll dated

Louisville, Ky., Sept. 3, 1864.

Where born Jefferson, Ky.

Age 35 years; occupation Farmer

When enlisted Sept. 3, 1864.

Where enlisted Louisville, Ky.

For what period enlisted 3 years.

Eyes Blue; hair Black

Complexion Black; height 5 ft. 9 in.

When mustered in Sept. 3, 1864.

Where mustered in Louisville, Ky.

Bounty paid \$ 100; due \$ 100

Clothing account:

Last settled _____, 186 ; drawn since \$ 100

Date of first muster Sept. 3, 1864.

Company to which assigned _____

Remarks: S. Dist Ky.

Book mark: _____

A. J. D. Dinsell

(356m)

Copyist.

R

5 bar

U.S.C.T.

Joseph Reed

Appears with rank of Pvt on

Muster and Descriptive Roll

of a Detachment of U. S. Colored
Troop formed for U. S. serv
car. at Lexington. Ky.

Roll dated

Louisville. Ky. Sept. 7, 1864.

Where born Nelson. Ky.

Age 25 years; occupation Labourer

When enlisted Sept. 3, 1864.

Where enlisted Louisville

For what period enlisted 3 years.

Eyes Blue; hair Blue

Complexion Blue; height 5 ft. 9 in.

When mustered in Sept. 3, 1864.

Where mustered in Louisville

Bounty paid \$ 100; due \$ 100

Clothing account:

Last settled 186; drawn since \$ 17.50
100

Date of first muster Sept. 3, 1864.

Company to which assigned

Remarks: transferred to 5 Comp. Dist.

Ky.

Book mark: -----

D. J. Stinson

(356m)

Copyist.

R | 5 Cav. | U.S.C.T.

Joseph Reid

Pr., Co. H, 5 Reg't U. S. Col'd Cavalry.

Appears on

Company Muster-in and Descriptive Roll

of the organization named above. Roll dated

Camp Nelson, ^{Ky.} N. Y., Oct. 24, 1864.

Where born Nelson, Ky

Age 35 y'rs; occupation Laborer

When enlisted Sept. 13, 1864.

Where enlisted Louisville

For what period enlisted 3 years.

Eyes Br; hair Br

Complexion Br; height 5 ft. 9 in.

When mustered in Sept. 3, 1864.

Where mustered in Louisville

Bounty paid \$ 100; due \$ 100

Where credited 5 Dist. Ky.

Company to which assigned

Remarks:

Book mark:

Wm. Scott

(356d)

Copyist.

R

5 Cav. U.S.C.T.

Joseph Reid

Priv., Co. D, 5 Reg't U. S. Col'd Cavalry.

Appears on

Company Muster Roll

for *Quoted Oct 31*, 1864.

Present or absent *Present.*

Stoppage, \$ *100* for

Due Gov't, \$ *100* for

Valuation of horse, \$ *100*

Valuation of horse equipments, \$ *100*

Remarks:

Book mark: -----

Wm. H. Scott

(358)

Copyist.

R | 5 Cav. | U.S.C.T.

Joseph Reid

Priv., Co. D, 5 Reg't U. S. Col'd Cavalry.

Appears on

Company Muster Roll

for Nov. & Dec., 1864.

Present or absent Present

Stoppage, \$ 100 for

Due Gov't, \$ 100 for

Valuation of horse, \$ 100

Valuation of horse equipments, \$ 100

Remarks: 1st & 2nd installments of Bounty due

Book mark:

Wm. H. Scott

(358)

Copyist.

R | 5 Cav. | U.S.C.T.

Joseph Red.

Serjeant, Co. C, 5 Reg't U.S.C.T.

appears on

Hospital Muster Roll

of Convalescent Camp U. S. A. Hospital,

at Camp Nelson, Ky.,

for Nov. & Dec., 1864.

Attached to hospital:

When Nov. 30, 1864.

How employed Patient

Last paid by Maj.

....., 186 .

Bounty paid \$ 100; due \$ 100

Present or absent Present.

Remarks:

Book mark:

Dickerson,

(343)

Copyist.

R

5 Cav. U.S.C.T.

Joseph Reid

Co. D, 5 Reg't U. S. Col'd Cavalry.

Appears on

Company Muster Roll

for Jan. & Feb., 1865.

Present or absent

Stoppage, \$ 100 for

Due Gov't, \$ 100 for

Valuation of horse, \$ 100

Valuation of horse equipments, \$ 100

Remarks: Died in Hospital, Camp Nelson, Ky. Jan. 31, '65. First installment of Bounty due \$100.

Book mark: 155834 Feb. 3, '64
9013 20 April 25/68

Wm. B. Scott

(358)

Copyist.

Q

5 Cav.

U.S.C.T.

Joseph Reid

Pvt., Co. D, 5 Reg't U. S. Colored Cav.

Appears on Returns as follows:

Feb. 1865, - from Jan. 31/65
Camp Nelson, died
in Regt. Hosp. No. 1
ficial on not rec
bill Feb.

Book mark :

E. Thornton

(548)

Copyist.

R. | 5 Cav. | U.S.C.T.

Joseph Reid,
Private, Co. D, 5 Reg't U. S. Col'd Cavalry.

Appears on Co. Muster-out Roll, dated
Helena, Ark., March 16, 1866.

Muster-out to date 186 .

Last paid to *Enlistment,* 186 .

Clothing account:

Last settled 186 ; drawn since \$ 100

Due soldier \$ 100; due U. S. \$ 100

Am't for cloth'g in kind or money adv'd \$ 100

Due U. S. for arms, equipments, &c., \$ 100

Bounty paid \$ 100; due \$ *100.⁰⁰*

Remarks: *Died at Camp Nelson,*
Va., Jan'y 31/65.

Final statements forwarded
March 31, 1865.

Book mark: *155834 Feb. 3/68.*

9013. 20. Apr. 20/68.

R. B. Granger.

Reed Joseph
P. Co. D., 5 Reg't U. S. Cavalry

3 Enclosures.

Bed Cards	Final Statements
Burial Records	Furloughs or L. of A.
Certs. of Dis. for Discharge	Med. Certificates
C. M. Charges	Med. Des. Lists
Descriptive Lists	Orders
Discharge Certificates	Pris. of War Record
Enlistment Papers	Resignations

Other papers relating to—

Admission to Hosp'l	Furlough or L. of A.
Casualty Sheet	Med. Examination
Confinement	Misc. Information
Contracts	Pay or Clothing
Death or Effects	Personal Reports
Desertion	Rank
Discharge from Hosp'l	Transfer to Hosp'l
Discharge from Service	Transfer to V. R. C.
Duty	Transportation

Co "D"
FINAL STATEMENT

OF

Priv Joseph Reid
Private Reg't of U. S. Cavalry

VOLUNTEERS.

NOTE 1.—Two of these certificates (or duplicates) are to be given to each Volunteer Soldier or drafted man who may be discharged previously to the discharge of his company, that he may at once receive from the Paymaster the pay, &c., due him, and the captain or other COMMISSIONED officer commanding the company will certify to the act of the delivery of the duplicate certificates; on these certificates the Soldier is "entitled to" his discharge, and should also present his discharge to the Paymaster to have the payment endorsed on it. The discharge is to be given back to the Soldier by the Paymaster; the latter only retaining as his voucher the duplicate certificates.

NOTE 2.—If the Soldier is entitled to pay for the use of his horse, the Company Commander will certify to that fact on the back of both these final statements, and also to the time he has pay due for having been so mounted on his own horse.

NOTE 3.—When a Soldier is furnished with final statements, his descriptive list, if he has one, should be taken up by the officer who gives the Soldier these statements, and endorsed with a statement to this effect by the officer. This endorsement should exhibit a full statement of the time for which the Soldier was allowed pay on his final statements, the clothing account, and all other charges against him or in his favor, so as to comprise a complete exhibit of his account. It will then be transmitted to the company commander of the Soldier, who will enter all the data necessary to a full understanding of the Soldier's account on the muster roll upon which the Soldier's discharge is reported. The descriptive list will then be destroyed. The object of this is, that the remaining portion of the Soldier's account may be settled upon the receipt of these muster rolls, and the Soldier receive any pay or allowances that may be due him at the time of his discharge, and which may not appear on his final statements from the fact that his descriptive list is incomplete. These accounts for back pay, &c., are settled by the 2d Auditor of the Treasury Department.

NOTE 4.—Charges for loss or injury to ordnance, horse equipments, and other miscellaneous charges, should appear under the heading of "Other Stoppages."

NOTE 5.—Bounty paid by State authorities, and not by the United States, will not be entered on this statement.

NOTE 6.—Amounts due the Sattler and Laundress must be entered on the muster roll on which the discharge, death, desertion, &c., is reported, as well as on the final statement, otherwise the amount cannot be collected from the United States.

NOTE 7.—This blank will be used for deceased volunteers and drafted men, as well as for others.

NOTE 8.—Where a Soldier dies in Hospital or on detached service, his descriptive list, if he has one, should be sent with his final statements, in duplicate, to the Adjutant General, Washington, D. C.

ADJUTANT GENERAL'S OFFICE.

June 2^d 1865.

Duplicate with Inventory sent 2d Auditor.

I certify, on honor, that Joseph Reid a Private of
 Captain N. P. Wade's Company (A) of the 5th Regiment of W. Va.
VOLUNTEERS, of the State of _____, born in Nelson, State
 of Kentucky, aged 35 years; 5 feet 9 inches high; Black complexion,
Black eyes, Black hair, and by occupation a Farmer, having joined the company on
 its original organization at Louisville Ky, and enrolled in it at the muster into
 the service of the United States at Louisville Ky, on the Third day
 of September, 1864, (or was mustered in service as a recruit, by _____
 _____, at _____, on the _____ day of _____,
 186 , or was drafted and mustered into the service of the United States from the _____
 Enrollment District of the State of _____, at _____,
 on the _____ day of _____, 186), to serve in the Regiment, for
 the term of Three Years: and having served **HONESTLY** and
FAITHFULLY with his Company in _____ to the present date, is now
 entitled to a **DISCHARGE** by reason of _____

(Due July 31, 1865 per muster roll)
 The said Private Joseph Reid was last paid by Paymaster
Pay due from Government 3 day of September, 1864, and has
 pay due him from that time to the present date; he is entitled to pay and subsistence for
TRAVELING to place of enrollment, and whatever other allowances are authorized to volunteer
 soldiers, drafted men, or militia, so discharged. He has received from the United States **CLOTHING**
 amounting to Thirty $\frac{00}{100}$ dollars, since the 3 day of September,
 1864, when his clothing account was last settled. He has received from the United States
 $\frac{00}{100}$ dollars advanced **BOUNTY**. \$300.00 Bounty due

There is to be stopped from him, on account of the State of _____, or other
 authorities, for **CLOTHING**, &c., received on entering service, _____ $\frac{00}{100}$ dollars; and
 for other stoppages, viz: _____

_____ $\frac{00}{100}$ dollars.
 He has been furnished with **TRANSPORTATION** in kind from the place of his discharge to
 _____; and he has been **SUBSISTED** for **TRAVELING** to his
 place of enrollment, up to the _____, 186 .

He is indebted to _____, **SUTLER**, _____ $\frac{00}{100}$ dollars.
 He is indebted to _____, **LAUNDRESS**, _____ $\frac{00}{100}$ dollars.

Given in Duplicate, at Camp Nelson Ky, this 31 day
 of March, 1864.

David G. Gordon
Private 5th W. Va.
 Commanding Company.

Joseph Reed
Co. 5th Regt. U.S.C.,
Died Jan 31st 1865.
Gen'l Hosp: Camp Nelson, Ky.

RECORD OF DEATH AND INTERMENT.

Name and number of person interred	Joseph Reid
Number and locality of the grave	929
Hospital number of the deceased	6114
Regiment, rank and company	Re Co. 6 th U.S. Inf.
Residence before enlistment	
Conjugal relation. (and if married the residence of the widow.)	
Cause of death	Small Pox
Age of the deceased.	
Nativity.	
References and remarks.	
Date of death and burial.	January 31 st 1865

Possessed no Effects

Expended with
burial

- (1) His Pants
- (1) His Socks
- (1) Coat
- (1) Shirt

Joseph Keel
Co. A.

Adjutant General's Office,

COLORED TROOPS BRANCH,

1871

Vol. C. T., 187

Wanted in case of _____, Co. _____,

Reg't _____
_____ 4 Feb. 1855, up to his
_____ 27 1855

Respectfully,

R. A. Woodward

Chief Clerk.

J. H. Dalton

Adjutant General's Office,

Record Room

Jan'y. 25, 1871

Vol. C. T., 187

Reply in case of _____, Co. _____,

5 Reg't U. S. C. Cav.

Reg't. & Co. Descriptive books show _____ in
Gen. Hospital Camp Nelson, Ky. Jan'y. 31 '71
(Cause of death not given) Final statements from _____
Co. Morning Rep. book does not cover date

Mf.

1068

Rennick, Jack

Co L, 5 U. S. Col'd Cav.

Private

CARD NUMBERS.

1	26
2	27
3	28
4	29
5	30
6	31
7	32
8	33
9	34
10	35
11	36
12	37
13	38
14	39
15	40
16	41
17	42
18	43
19	44
20	45
21	46
22	47
23	48
24	49
25	50

See Rennick, Jack

Book Mark:

See also

1004

Henry Alexander

Co *A*, 5 U. S. Col'd Cav.

Private

Corporal

CARD NUMBERS.

1	5364743	26
2	5364837	27
3	5364937	28
4	5365029	29
5	5365118	30
6	5365170	31
7	5365259	32
8	5365349	33
9	5365437	34
10	5365526	35
11	5365616	36
12	9090580	37
13		38
14		39
15		40
16		41
17		42
18		43
19		44
20		45
21		46
22		47
23		48
24		49
25		50

Book Mark:

See also

R | 5 Cav. | U.S.C.T.

Alexander Janix

Co. *F*, 5 Reg't U. S. Col'd Cav.

Appears on

Company Descriptive Book
of the organization named above.

DESCRIPTION.

Age *23* years; height *6* feet, *3* inches.

Complexion *Black*

Eyes *Black*; hair *Black*

Where born *Franklin Ky*

Occupation *farmer*

ENLISTMENT.

When *Sep 16*, 186 .

Where *Camp Nelson*

By whom *J. Randolph* term *3* y'rs.

Remarks:

J. E. Purke

R

5 Cav. U.S.C.T.

Alexander Remick

Priv, Co. F, 5 Reg't U. S. Col'd Cavalry.

Appears on

Company Muster-in and Descriptive Roll

of the organization named above. Roll dated

Sept Nelson, N.Y., Oct 29, 1864.

Where born Franklin Ky

Age 23 y'rs; occupation Farmer

When enlisted Sept 16, 1864.

Where enlisted Sept Nelson

For what period enlisted 3 years.

Eyes Blk; hair Blk

Complexion Blk; height 6 ft. 3 in.

When mustered in Sept 16, 1864.

Where mustered in Sept Nelson

Bounty paid \$100; due \$100

Where credited 7 Dist Ky

Company to which assigned F

Remarks: Name of owner of Negro - John Church

* added may 31 98 CMA

Book mark:

Remick

(356d)

Copyist.

R | 5 Cav. | U.S.C.T.

Alexander Romer

Privat, Co. F, 5 Reg't U. S. Col'd Cavalry.

Appears on

Company Muster Roll

for to Oct 31, 1864.

Present or absent Present

Stoppage, \$ 100 for

Due Gov't, \$ 100 for

Valuation of horse, \$ 100

Valuation of horse equipments, \$ 100

Remarks:

Book mark:

(358)

Romer

Copyist.

R | **5 Cav. | U.S.C.T.**

Alexander Paris.

Privt, Co. F, 5 Reg't U. S. Col'd Cavalry.

Appears on

Company Muster Roll

for *Nov & Dec*, 1864.

Present or absent *Present.*

Stoppage, \$ *100* for

Due Gov't, \$ *100* for

Valuation of horse, \$ *100*

Valuation of horse equipments, \$ *100*

Remarks:

*1st 2 Installment Bounty
due.*

Book mark:

Cumey

(358)

Copyist.

R

5 Cav. U.S.C.T.

Alexander Panix

Privt, Co. F, 5 Reg't U. S. Col'd Cavalry.

Appears on

Company Muster Roll

for Jan & Feb, 1865.

Present or absent Present.

Stoppage, \$ 100 for

Due Gov't, \$ 100 for

Valuation of horse, \$ 100

Valuation of horse equipments, \$ 100

Remarks:

1 Installment Bounty \$100 due

Book mark:

Panix

(358)

Copyist.

R

5 Cav. U.S.C.T.

Alexander Rennie

Privt, Co. F, 5 Reg't U. S. Col'd Cavalry.

Appears on

Company Muster Roll

for May & April, 186 5

Present or absent Present

Stoppage, \$ 100 for

Due Gov't, \$ 100 for

Valuation of horse, \$ 100

Valuation of horse equipments, \$ 100

Remarks:

First installment of
Bounty due

Book mark:

Rennie

(358)

Copyist.

R

5 Cav.

U.S.C.T.

Alexander Rannix

Capt, Co. F, 5 Reg't U. S. Col'd Cavalry.

Appears on

Company Muster Roll

for May 2 June, 1865.

Present or absent Present

Stoppage, \$ 100 for

Due Gov't, \$ 100 for

Valuation of horse, \$ 100

Valuation of horse equipments, \$ 100

Remarks: 1st Instalment Bounty
due \$ 100.

Provided by Regt order No
106 June 20-1865

Book mark:

Hart

Copyist.

(358)

R

5 Cav. U.S.C.T.

Alexander Renix

Capt, Co. F, 5 Reg't U. S. Col'd Cavalry.

Appears on

Company Muster Roll

for July & Aug, 1865.

Present or absent Present

Stoppage, \$ 100 for

Due Gov't, \$ 100 for

Valuation of horse, \$ 100

Valuation of horse equipments, \$ 100

Remarks:

Book mark:

Mark

(358)

Copyist.

R

5 Cav.

U.S.C.T.

Alexander Renix

Capt, Co. F, 5 Reg't U. S. Col'd Cavalry.

Appears on

Company Muster Roll

for Sept & Oct, 1865.

Present or absent Present

Stoppage, \$ 100 for

Due Gov't, \$ 100 for

Valuation of horse, \$ 100

Valuation of horse equipments, \$ 100

Remarks:

Book mark:

W. W. W.

(358)

Copyist.

R

5 Cav.

U.S.C.T.

Alexander Renix

Coyl, Co. F, 5 Reg't U. S. Col'd Cavalry.

Appears on

Company Muster Roll

for Nov & Dec, 1865.

Present or absent Present

Stoppage, \$ 100 for

Due Gov't, \$ 100 for

Valuation of horse, \$ 100

Valuation of horse equipments, \$ 100

Remarks:

Book mark:

Wark

(358)

Copyist.

R

5 Cav. U.S.C.T.

Alexander Renix

Corpl, Co. F, 5 Reg't U.S. Col'd Cavalry.

Appears on

Company Muster Roll

for Jan & Feb, 1866

Present or absent Present

Stoppage, \$ 100 for

Due Gov't, \$ 100 for

Valuation of horse, \$ 100

Valuation of horse equipments, \$ 100

Remarks:

Book mark:

A. W. Davis

(358)

Copyist.

R

5 Cav. U.S.C.T.

Alexander Renix

Corpl, Co. F, 5 Reg't U. S. Col'd Cavalry.

Appears on Co. Muster-out Roll, dated

Helena Ark Mch 16, 1866.

Muster-out to date

Mch 16, 1866.

Last paid to

Dec 31, 1865.

Clothing account:

Last settled _____, 186 ; drawn since \$ _____ 100

Due soldier \$ _____ 100; due U. S. \$ 22 ⁷⁹/₁₀₀

Am't for cloth'g in kind or money adv'd \$ _____ 100

Due U. S. for arms, equipments, &c., \$ _____ 100

Bounty paid \$ 100 ¹⁰⁰/₁₀₀; due \$ 100 ¹⁰⁰/₁₀₀

Remarks:

June 20. 65

Book mark:

V 222 P 96.75

(361)

J W Davis

Copyist.

101
Remick Gaek

Co L, 5 U. S. Col'd Cav.

Private Private

CARD NUMBERS.

1	5369844	26
2	5369939	27
3	5370032	28
4	5370134	29
5	5370224	30
6	5370314	31
7	5370400	32
8	5370485	33
9	5370586	34
10	5370657	35
11	5370728	36
12	9091192	37
13	43148136	38
14	43154549	39
15	32111770	40
16	32111900	41
17	31405252	42
18	34450699	43
19	40730247	44
20		45
21		46
22		47
23		48
24		49
25		50

Book Mark:

See also

S. 916385 2" Auto.
S. 919297 2" Auto. Ret.
RHP 797154

J. B. Dowd
Exr

R | **5 Cav. | U.S.C.T.**

Jack Lemrick

, Co. *L*, 5 Reg't U. S. Col'd Cav.

Appears on

Company Descriptive Book
of the organization named above.

DESCRIPTION.

Age *8* years; height *5* feet *11* inches.

Complexion *Black*

Eyes *Blue*; hair *Blue*

Where born *Barton Ky*

Occupation *Laborer*

ENLISTMENT.

When *Substitute*, 186 .

Where *7 Dist Ky*

By whom _____; term *3* y'rs.

Remarks:

A. J. ...

(383g)

Copist.

R

5 bar

U.S.A.

Jack Kemnick

Appears with rank of Pvt on

Muster and Descriptive Roll

of Ketchum of the beloved
Troops forwarded

Roll dated

Louisville, Ky. Oct. 4, 1864.

Where born West Ky

Age 18 years; occupation Laborer

When enlisted _____, 186 .

Where enlisted _____

For what period enlisted 3 years.

Eyes Black; hair Black

Complexion Black; height 2 ft. 11 in.

When mustered in Sept. 28, 1864.

Where mustered in Lexington

Bounty paid \$ 100; due \$ 100

Clothing account:

Last settled _____, 186 ; drawn since \$ 17⁵⁰ 100

Date of first muster Sept. 26, 1864.

Company to which assigned _____

Remarks: Credited to 9"

Long West Ky.

Substitute

Book mark: _____

M. M. J. J. J. J.

(356m)

Copyist.

R

5 bar

U.S. Co.

Zach Rennick (Cold)

Appears with rank of Priv on

Muster and Descriptive Roll

of a Detachment of U.S. Substitutes
Enlisted & Mustered, forwarded

Roll dated

Lexington, Ky, Oct 30, 1865.

Where born Kentucky

Age 18 years; occupation Laborer

When enlisted Sept 26, 1864.

Where enlisted Lexington, Ky.

For what period enlisted 3 years.

Eyes Gray; hair Blk

Complexion Dark; height 5 ft. 11 in.

When mustered in Sept 26, 1864.

Where mustered in Lexington, Ky.

Bounty paid \$ 100; due \$ 100

Clothing account:

Last settled _____, 186 ; drawn since \$ 100

Date of first muster Sept 26, 1864.

Company to which assigned _____

Remarks For whom substituted

W. C. Rennick Drafted man

credited to Bourbon Co. 7th D. Ky.

Book mark : _____

J. W. Morris

(356m)

Copyist.

R

5 Cav. U.S.C.T.

Lack Pennick

Pvt, Co. C, 5 Reg't U. S. Col'd Cavalry.

Appears on

Company Muster-in and Descriptive Roll

of the organization named above. Roll dated

Camp Nelson, Ky Oct 30, 1864.

Where born Kentucky

Age 18 y'rs; occupation Sabon

When enlisted, 186 .

Where enlisted

For what period enlisted 3 years.

Eyes Black; hair Black

Complexion Black; height 5 ft. 11 in.

When mustered in Sept 26, 1864.

Where mustered in Lexington

Bounty paid \$ 100; due \$ 100

Where credited 7th Dist Ky

Company to which assigned

Remarks:

Substitute

Book mark:

Bradley

R | 5 Cav | USCI

Zachariah Kemp
Priv, Co. C, 5 Reg't USCI Cav

Appears on

Hospital Muster Roll

of **U. S. A. General Hospital,**
(Branch B—Colored.)

at **Bowling Green, Ky.,**

for Sept & Oct, 1864.

Attached to hospital :

When Oct 29, 1864.

How employed Patient

Last paid by Maj. _____

to _____, 186 .

Bounty paid \$ 100; due \$ 100

Present or absent Present

Remarks: _____

Book mark: _____

J. L. Linnear

R | 5 Cav. | U.S.C.T.

Zack Remick
Cor, Co. L, 5 Reg't U. S. Col'd Cavalry.

Appears on

Company Muster Roll

for dated Oct 31, 1864

Present or absent Absent

Stoppage, \$ 100 for

Due Gov't, \$ 100 for

Valuation of horse, \$ 100

Valuation of horse equipments, \$ 100

Remarks: On det serv
Nashville Tenn
Oct 15/64

Book mark:

Bull

(358)

Copyist.

R

5 Cav.

U.S.C.T.

Zack Remick
Cor

Co. L, 5 Reg't U. S. Col'd Cavalry.

Appears on

Company Muster Roll

for Nov & Dec, 1864

Present or absent Present

Stoppage, \$ 100 for

Due Gov't, \$ 100 for

Valuation of horse, \$ 100

Valuation of horse equipments, \$ 100

Remarks: Left in Gene
Hosp at Bowling
Green Ky. when
on the way to Nash-
ville Tenn. reported
for duty Nov 10. 1864

Book mark:

Brades

R | *5 Cav* | *U.S.C.*

Zachariah Kenye
Priv, Co. *C*, *5* Reg't *U.S.Cav*

Appears on

Hospital Muster Roll

of **U. S. A. General Hospital,**
(Branch B—Colored.)

at **Bowling Green, Ky.,**

for *Nov & Dec*, 186*4*.

Attached to hospital:

When....., 186 .

How employed.....

Last paid by Maj.....

to....., 186 .

Bounty paid \$ 100; due \$ 100

Present or absent.....

Remarks: *Returned to duty*
November 17. 64

Book mark :.....

(343)

Shuman

Copyist.

R

5 Cav. U.S.C.T.

Jack Remick
Co. L, 5 Reg't U. S. Col'd Cavalry.

Appears on

Company, Muster Roll

for *Jan'y & Feb'y*, 1865.

Present or absent *Absent*

Stoppage, \$ 100 for

Due Gov't, \$ 100 for

Valuation of horse, \$ 100

Valuation of horse equipments, \$ 100

Remarks: *In Owl Hoop
Bowling Green Ky
since July 1/65
Due 11 \$ for Owl-
mance \$125*

Book mark:

Redde

R

5 Cav.

U.S.C.T.

Zack Remick
Pr

, Co. L, 5 Reg't U.S. Col'd Cavalry.

Appears on

Company Muster Roll

for

March 1865

1865

Present or absent

Present

Stoppage, \$

100 for

Due Gov't, \$

100 for

Valuation of horse, \$

100

Valuation of horse equipments, \$

100

Remarks:

Book mark:

Prick

(358)

Copyist.

R | 5th Cav. | U.S. 65

Jack Runnix
Priv. Co. L. 5th Regt. U.S. 66.

Appears on

Muster Roll

of Convalescent Barracks, Bowling Green, Ky.,

for March & April, 1865.

Station Bowling Green, Ky.

Clothing account:

Last settled _____, 186 ; drawn since \$ 100

Present or absent _____

Remarks Sent to Regt. April 16/65
By order Post Comdt.

Book mark: _____

(520)

J. Jones

Copyist.

C | **5 Cav. | U.S.C.T.**

Jack Remmick

A, Co. L, 5 Reg't U. S. Col'd Cavalry.

Appears on

Company Muster Roll

for *May & June*, 1865.

Present or absent *Present*

Stoppage, \$ 100 for

Due Gov't, \$ 100 for

Valuation of horse, \$ 100

Valuation of horse equipments, \$ 100

Remarks:

Book mark:

Remmick

R | 5 Cav. | U.S.C.T.

Zack - Kammick

Prof, Co. L, 5 Reg't U. S. Col'd Cavalry.

Appears on

Company Muster Roll

for *July & Aug., 1865.*

Present or absent *Present*

Stoppage, \$ 100 for

Due Gov't, \$ 100 for

Valuation of horse, \$ 100

Valuation of horse equipments, \$ 100

Remarks:

Book mark:

Recharter

10

5 Cav. U.S.C.T.

Zack Pennick

1st, Co. L, 5 Reg't U. S. Col'd Cavalry.

Appears on

Company Muster Roll

for *Sept*, 186*5*

Present or absent *Present*

Stoppage, \$ 100 for

Due Gov't, \$ 100 for

Valuation of horse, \$ 100

Valuation of horse equipments, \$ 100

Remarks:

Book mark:

W. S. Deater

(358)

Copyist.

C | **5 Cav. | U.S.C.T.**

Zack Remmick

Plt, Co. L, 5 Reg't U. S. Col'd Cavalry.

Appears on

Company Muster Roll

for *Mr. Rice*, 186*5*.

Present or absent *Present*

Stoppage, \$ 100 for

Due Gov't, \$ 100 for

Valuation of horse, \$ 100

Valuation of horse equipments, \$ 100

Remarks:

Book mark:

(358)

W. L. ...

Copyist.

R | 5 Cav. | U.S.C.T.

Jack Remick
Capt., Co. 2, 5 Reg't U.S.C. Cav.

Appears on

Hospital Muster Roll

of U.S.A. Hospt. Conval. Bks.,

at Bowling Green, Ky.,

for Jan & Feb, 1865.

Attached to hospital:

When _____, 186 .

How employed _____

Last paid by Maj. _____

to *Never Paid*, 186 .

Bounty paid \$ 100; due \$ 100

Present or absent *Present*

Remarks: _____

Book mark: _____

Ward

R

5 Cav. | U.S.C.T.

Jack Remmick

1st, Co. L, 5 Reg't U. S. Col'd Cavalry.

Appears on

Company Muster Roll

for *Jan. 7 Feb.*, 186*6*.

Present or absent *Present*

Stoppage, \$ 100 for

Due Gov't, \$ 100 for

Valuation of horse, \$ 100

Valuation of horse equipments, \$ 100

Remarks:

Book mark:

O. P. Taylor

(358)

Copyist.

R | 5 Cav. | U.S.C.T.

Jack Pennick

, Co. G, 5 Reg't U. S. Colored Cav.

Appears on Returns as follows:

Oct. 1864, - Absent det. serv.
Nashville Tenn

Jan. to March 1865, - Absent
d. serv. at Bowling Green
Ky. since Jan. 1/65

* Name appears also as
Jack Pennick

Book mark :

E. Thorton

(546)

Copyist.

B | 56w | U.S.C.T.

Jack Remmick

1st, Co. L, 5 Reg't U. S. Col'd Cavalry

Appears on Co. Muster-out Roll, dated Helena, Ark, Mar. 16, 1866.

Muster-out to date Mar. 16, 1866.

Last paid to Dec. 31, 1865.

Clothing account:

Last settled 186 ; drawn since \$ 100

Due soldier \$ 100; due U. S. \$ 57 ⁴⁹/₁₀₀

Am't for cloth'g in kind or money adv'd \$ 100

Due U. S. for arms, equipments, &c., \$ ⁵⁵/₁₀₀

Bounty paid \$ 100; due \$ 100

Remarks: Slave. Due U. S. for Ord. 55 cts.

Book mark:

A. P. Taylor

(361)

Copyist.

Rennick, Zachariah

....., Co., *5th* Reg't *U. S. C.*

4 Enclosures.

Bed Cards <i>2</i>	Final Statements
Burial Records	Furloughs or L. of A.
Certs. of Dis. for Discharge	Med. Certificates
C. M. Charges	Med. Des. Lists
Descriptive Lists	Orders
Discharge Certificates	Pris. of War Record
Enlistment Papers <i>2</i>	Resignations

Other papers relating to—

Admission to Hosp'l	Furlough or L. of A.
Casualty Sheet	Med. Examination
Confinement	Misc. Information
Contracts	Pay or Clothing
Death or Effects	Personal Reports
Desertion	Rank
Discharge from Hosp'l	Transfer to Hosp'l
Discharge from Service	Transfer to V. R. C.
Duty	Transportation
.....

26 154

No.

Zachariah Remick
(Col)

Enlisted at Lexington Ky

As Substitute for

Wm H Remick

On the 26 day of Sept, 1864

By

J. H. Moore

Wm H Remick

J. J. Lewis

Board of Enrollment,

7th Dist. of Kentucky

SUBSTITUTE
VOLUNTEER ENLISTMENT.

STATE OF

TOWN OF

Kentucky



Lexington

I, *Zachariah Rennie (Ltd)* born in the State
of *Kentucky*, aged *Eighteen* years, and by
occupation a *Sabotier* Do HEREBY ACKNOWLEDGE to have agreed with
William A Rennie, Esq., of *Bourbon County*
Kentucky

to become his **SUBSTITUTE** in the Military Service, for a sufficient consideration paid and
delivered to me, on the *twenty sixth* day of *September*, 1864,
and having thus agreed with said *William A Rennie*, I DO HEREBY
ACKNOWLEDGE to have enlisted this *twenty sixth* day of *Sept*,
1864, to serve as a **Soldier** in the **Army of the United States of America**, for the period
of **THREE YEARS**, unless sooner discharged by proper authority: I do also agree to accept such
bounty, pay, rations, and clothing, as are, or may be, established by law for soldiers. And I do
solemnly swear that I will bear true and faithful allegiance to the **United States of America**;
that I will serve them honestly and faithfully against all their enemies or opposers whomsoever;
and that I will observe and obey the orders of the President of the United States, and the orders
of the Officers appointed over me, according to the Rules and Articles of War.

SWORN and subscribed to, at *Lexington Ky*
this *26* day of *Sept* 1864
BEFORE *J. H. Moore*
Capt. & Pro. Mar.
7 Dist. Ky.

Zachariah Rennie
mark

We certify, on honor, That we have carefully examined the above-named Volunteer Substitute
agreeably to the Regulations, and that, in our opinion, he is free from all bodily defects and mental infirmity
which would in any way disqualify him from performing the duties of a soldier; that he was entirely sober
when enlisted; that he is of lawful age, (not under 18 years;) and that, in accepting him as duly qualified to
perform the duties of an able-bodied soldier, and as a Substitute in lieu of *Wm A Rennie*
Rennie, drafted in *Bourbon Co Kentucky*
Sept 22, 1864 we have strictly observed the Regulations which govern
in such cases. This soldier has *BR* eyes, *BR* hair, *BR* complexion; is *five* feet *11*
inches high.

J. H. Moore
Provost Marshal.

J. J. Moore
Commissioner of Board.
J. J. Moore
Surgeon of Board.

Board of Enrollment of *7* Dist. of *Kentucky*

DECLARATION OF SUBSTITUTE.

I, Zachariah Rennie (C'd) desiring to ENLIST
in the Army of the United States, for THREE YEARS, **Do declare**, That I am
Eighteen years and _____ months of age; that I have
never been discharged from the United States service on account of disability or by sentence of
a court martial; and I know of no impediment to my serving honestly and faithfully as a soldier
for three years.

GIVEN at Lexington Kentucky
the 26 day of Sept 1864.

WITNESS:

Gott Miller

Zachariah ^{his} Rennie
mark

K

15X

No. 76

Zachariah Rennick (Co)

Enlisted at Lexington Ky

As Substitute for

Wm H. Rennick

On the 26 day of Sept, 1864.

By

Geo W Moore

Witness

A. J. Gano

Board of Enrollment,

7th Dist. of Kentucky

SUBSTITUTE
VOLUNTEER ENLISTMENT.

STATE OF

TOWN OF

Kentucky

Sevington



I, *Zachariah Rennie* (C.O.) born in the State
of *Kentucky*, aged *Eighteen* years, and by
occupation a *Laborer* Do HEREBY ACKNOWLEDGE to have agreed with
William H. Rennie, Esq., of *Bourbon County*
Kentucky

to become his **SUBSTITUTE** in the Military Service, for a sufficient consideration paid and
delivered to me, on the *twenty sixth* day of *September*, 1864;
and having thus agreed with said *William H. Rennie*, I DO HEREBY
ACKNOWLEDGE to have enlisted this *twenty sixth* day of *September*
1864, to serve as a **Soldier** in the **Army of the United States of America**, for the period
of **THREE YEARS**, unless sooner discharged by proper authority: I do also agree to accept such
bounty, pay, rations, and clothing, as are, or may be, established by law for soldiers. And I do
solemnly swear that I will bear true and faithful allegiance to the **United States of America**;
that I will serve them honestly and faithfully against all their enemies or opposers whomsoever;
and that I will observe and obey the orders of the President of the United States, and the orders
of the Officers appointed over me, according to the Rules and Articles of War.

SWORN and subscribed to, at *Sevington Ky*
this *26* day of *September* 1864
BEFORE *Geo H Moore*
Capt. & Pro. Mar.
7 Dist. Ky.

Zachariah H. Rennie
mark

We certify, on honor, That we have carefully examined the above-named Volunteer Substitute
agreeably to the Regulations, and that, in our opinion, he is free from all bodily defects and mental infirmity
which would in any way disqualify him from performing the duties of a soldier; that he was entirely sober
when enlisted; that he is of lawful age, (not under 18 years;) and that, in accepting him as duly qualified to
perform the duties of an able-bodied soldier, and as a Substitute in lieu of *William H*
Rennie, drafted in *Bourbon County Ky*
Sept 22, 1864, we have strictly observed the Regulations which govern
in such cases. This soldier has *Black* eyes, *Blk* hair, *Blk* complexion; is *five* feet *11*
inches high.

Geo H Moore

Provost Marshal.

Calvin Brown

Commissioner of Board.

J. J. Moore

Surgeon of Board.

Board of Enrollment of *7* Dist. of *Kentucky*

DECLARATION OF SUBSTITUTE.

I, Zachariah Rennie (Col) desiring to ENLIST
in the Army of the United States, for THREE YEARS, **Do declare**, That I am
Eighteen years and _____ months of age; that I have
never been discharged from the United States service on account of disability or by sentence of
a court martial; and I know of no impediment to my serving honestly and faithfully as a soldier
for three years.

GIVEN at Berington Kentucky
the 26 day of Sept 1864.

WITNESS:

Geoff. Miller

Zachariah Rennie
mark

Hospital Number 222.....

Name Zach. Perry.....

Age 28 Nativity Kentucky.....

Married or Single. Single.....

Residence Bourbon Co. Kentucky.....

Post Office address of }
wife or nearest relative. }

Rank Private Co. C Regiment 5th U.S. C.....

When admitted Oct. 29/64. Order of Co. Comdr.....

From what source Field.....

Diagnosis: (in surgical cases state explicitly seat and
character of wound or injury.)

Musler

Branch B - G. H.
Bowling Green, Ky.

On what occasion wounded.....

Date.....

Nature of missile or weapon.....

TREATMENT.

[HERE NOTE IMPORTANT COMPLICATIONS AND ALL OPERATIONS.]

Faint handwritten notes, possibly including "SUMMER 64" and "H. P. O. on 11/15".

RESULT AND DATE.

Returned to duty Nov. 17/64.

Hospital Number 435

Name Jack Rummel

Age 20 Nativity Pa

Married or Single Single

Residence Bowling Green, Ky

Post Office address of
wife or nearest relative. Wm Rummel, Clinton
ville, Bourbon Co Ky

Rank 1st Co L 5 Regiment 11th Cav

When admitted Mar 18 65

From what source Field

Diagnosis: (in surgical cases, state explicitly seat and character of wound or injury.)

Epistaxis

Branch B.-G. H.
Bowling Green, Ky.

On what occasion wounded _____

Date _____

Nature of missile or weapon _____

TREATMENT.

[HERE NOTE IMPORTANT COMPLICATIONS AND ALL OPERATIONS.]

RESULT AND DATE.

Returned to duty
March 24th / 08

Rice Robert

Co E., 5 U. S. Col'd Cav.

Private | *Private*

CARD NUMBERS.

5363732	26
5363861	27
5364668	28
9090482	29
857-03-1874	30
40730248	31
	32
	33
	34
	35
	36
	37
	38
	39
	40
	41
	42
	43
	44
	45
	46
	47
	48
	49
	50

Book Mark *A. E. P. > K, 857-03-74*
General Notation N. & P. 407375.

See also

A | **5 Cav. | U.S.C.T.**

Robert Rice

, Co. *E*, 5 Reg't U. S. Col'd Cav.

Appears on

Company Descriptive Book
of the organization named above.

DESCRIPTION.

Age *25* years; height *5* feet *5* inches.

Complexion *Black*

Eyes *Blk*; hair *Blk*

Where born *Shelby Ky*

Occupation *farmer*

ENLISTMENT.

When *Sep 9*, 186*4*.

Where *Camp Nelson*

By whom *J. B. Randolph*, term *3* y'rs.

Remarks: *died of disease*
Oct. 10 " 1864

J. E. Parks

17

5 Cav. U.S.C.T.

Robert Rice

Co. C, 5 Reg't U. S. Col'd Cavalry.

Appears on

Company Muster-in and Descriptive Roll

of the organization named above. Roll dated

Camp Nelson, N. Y., Sept 26, 1864.

Where born *Shelby Ky*

Age 25 y'rs; occupation *Farmer*

When enlisted *Sept 9*, 1864.

Where enlisted *Cp. Nelson Ky*

For what period enlisted *3* years.

Eyes *Black*; hair *Black*

Complexion *Black*; height *5* ft. *5* in.

When mustered in *Sept 9*, 1864.

Where mustered in *Cp. Nelson Ky*

Bounty paid \$ *100*; due \$ *100*

Where credited

Company to which assigned

Remarks: *7 District Kentucky*

X Tolly Rice.

X Supposed to be name of owner.

Added May 17. 98. H.A.F.

Book mark: *\$ 57-07-1874*

General Notation R. & P. 407875,

A. Rowland

(356d)

Copyist.

R

5 Cav. U.S.C.T.

Robert L. Rice

Rice, Co. E, 5 Reg't U. S. Col'd Cavalry.

Appears on

Company Muster Roll

for *Enlistment to Oct 31*, 1864.

Present or absent

Stoppage, \$ 100 for

Due Gov't, \$ 100 for

Valuation of horse, \$ 100

Valuation of horse equipments, \$ 100

Remarks: *Died in Genl. Hos-
pital*

Book mark: *Died Oct. 19/64 (over)*

(358)

M. Rowland

Copyist.

JAN. - 9

5363861

* 1891 *

Book Mark:

*EBV. 1 P 38 & S. 57
V. 10. C. 2 74*

R

5 Cav. | U.S.C.T.

Robert Rice

Priv., Co. E, 5 Reg't U. S. Colored Cav.

Appears on Returns as follows:

Oct. 1864, - Lost: Died
in Gen. Hospital
Oct. 1/64

Book mark :

E. Thornton

(546)

Copyist.

R

5 Cav. U.S.C.T.

Robert Reed

Priv., Co. E, 5 Reg't U. S. Col'd Cavalry.

Appears on Co. Muster-out Roll, dated Helena Ark, May 11, 1861.

Muster-out to date _____, 186 .

Last paid to _____ 186 .
Pay due from subs & mch.

Clothing account:

Last settled _____, 186 ; drawn since \$ _____ 100

Due soldier \$ $\frac{400}{100}$; due U. S. \$ _____ 100

Am't for cloth'g in kind or money adv'd \$ _____ 100

Due U. S. for arms, equipments, &c., \$ _____ 100

Bounty paid \$ _____ 100; due \$ _____ 100

Remarks: Died at Camp Nelson, Ky, October 19, 1864 of Pneumonia. Final statements forwarded February 17, 1865.

Book mark: P. 4 1242, 68; 2169
7157.73

J. B. [Signature]

R 5th Cav. U.S.C.S.

Robert Rice

, Co. E, 5th Reg't U.S.C. Cav.

NOTATION.

Book mark: *S-57-C-J-1874.*

Record and Pension Office.

WAR DEPARTMENT.

This book mark refers only to a report from the medical records, made by the Surgeon General to the Adjutant General, relative to the above-named man. As the medical records have since been carded, no transcript of this report is made hereon.

(491)

W. Allen
Copyist.

Rice Robert

P, Co. E, 5 Reg't 26. S. C. Cav

Enclosures.

Bed Cards	Final Statements
Burial Records	Furloughs or L. of A.
Certs. of Dis. for Discharge	Med. Certificates
C. M. Charges	Med. Des. Lists
Descriptive Lists	Orders
Discharge Certificates	Pris. of War Record
Enlistment Papers	Resignations

Other papers relating to—

Admission to Hosp'l	Furlough or L. of A.
Casualty Sheet	Med. Examination
Confinement	Misc. Information
Contracts	Pay or Clothing
Death or Effects	Personal Reports
Desertion	Rank
Discharge from Hosp'l	Transfer to Hosp'l
Discharge from Service	Transfer to V. R. C.
Duty	Transportation

Robert Rice
Co 5th U.S. Col. Cav.

Died Oct 19, 1864

Gen'l Hosp. Camp Nelson
Ky.

Robert Luci
3-4 U. S. L. C.
Paid Oct 19/64

✓

✓

RECORD OF DEATH AND INTERMENT

Name and number of person interred.....	<i>Robert Rice</i>
Number and locality of the grave.....	<i>767</i>
Hospital number of the deceased.....	<i>4899</i>
Regiment, rank and company.....	<i>5th U. S. Cav. Dr</i>
Residence before enlistment.....	
Conjugal relation, [and if married the residence of the widow.]	}
Cause of death	
Age of the deceased.	
Nativity.	
References and remarks.	}
Date of death and burial.	

Memoranda of effects.

No effects

Complete

CASUALTY SHEET

No. _____

Robert Rice

Cold Reef of Company _____

Regiment of _____

Unassigned

State Volunteers.

NATURE OF CASUALTY.

Killed, Oct. 19, 1864

v

for signature

Robert Rice
Major General Col'd

Sept 12/65

W. M. Appraisal
value of Effects.

Am't 2,500 " Sent
2 " Auditor

to

Genl Wm H. Hopt
Camp Nelson Ky

CASUALTY SHEET.

Name: Robt Rice
Rank: Cold Recruit Company: _____ Regiment: _____
Arm: _____ State: _____
Nature of Casualty: _____

Death

USE OF CASUALTY—(NAME OF DISEASE, &c.)

Pneumonia

DEGREE OF DISABILITY.

BY WHOM CERTIFIED.

J. J. Woodward
A. S. A.

DATE OF DISCHARGE, DEATH, &c.

Oct. 14, 1864

PLACE OF DISCHARGE, DEATH, &c.

BY WHOM DISCHARGED.

FROM WHAT SOURCE THIS INFORMATION WAS
OBTAINED.

Inv. of effects

REMARKS.

Inv. of effects sent
2^d Auditor Nov. 6, 1864

J. J.

Clerk.

2 f.s. & in ret'd for cor date
of death May 16, 1865,

CASUALTY SHEET

No. _____
Robert Rice

_____ of Company *E*
5" Regiment of *U. S. C.*

State Volunteers.

NATURE OF CASUALTY.

INVENTORY OF THE EFFECTS

OF

Robert Rice

Late of Company *E.*

5 Reg't of *the S C C*

Volunteers, who died at *Camp Nelson Ky*

on the *19* day of *October* 1864.

Inventory of the effects of Robert Rice late
 a Private of Captain Jacob K Schuck's Company E of
 the 5 Regiment of U.S. Col. Leav Volunteers, who was enrolled as
 a Recruit at Camp Nelson in the State of Kentucky on
 the 9th day of September 1864, and mustered into the service of the United
 States as a Private on the 9th day of September 1864, at Camp Nelson
 in Company E, 5 Regiment of U.S. Col. Leav Volunteers, to serve 3
 years or during the war; he was born in Shelby County in the State
 of Kentucky; he was 25 years of age, 5 feet 5 inches
 high, Blk complexion, Blk eyes, Blk hair, and by occupation, when enrolled,
 a Tanner; he died in Nelson Gen Hospital, at
Camp Nelson Ky on the 19th day of October 1864, by
 reason of Pneumonia

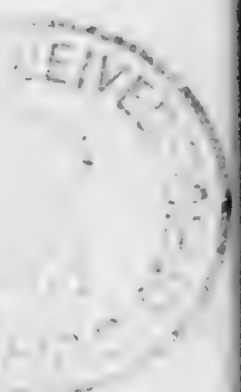

INVENTORY.					
ARTICLES.	No.	ARTICLES.	No.	ARTICLES.	No.
Hats.....	<i>No Effects</i>	Pairs trousers.....	<i>No Effects</i>	Knapsacks.....	<i>No Effects</i>
Caps.....		Pairs flannel drawers.....			
Forage Caps.....		Pairs cotton drawers.....			
Great coats.....		Flannel shirts.....			
Uniform coats.....		Cotton shirts.....			
Uniform jackets.....		Pairs boots.....			
Flannel sack coats.....		Pairs shoes.....			
Blouses.....		Pairs socks.....			
Stable frocks.....		Blankets.....			
Fatigue overalls.....		Haversacks.....			
				MONEY.	
				Specie.....	\$
				Notes.....	\$

I CERTIFY, ON HONOR, that the above inventory comprises all the effects of Private
Robert Rice, deceased, and that the effects are in the hands
 of _____ at _____
 _____ to be disposed of by a Council of Administration.

(DUPLICATES.)

Augustus Flint
Lieutenant
 Commanding the Company.

STATION: Salvage Co Ky

DATE: May 24 1865

E. B., S. G. O.

Surgeon General's Office,

Record and Pension Bureau,

Nov 5th 1866

Respectfully returned, with Inventory of Effects enclosed, in case of the within named man. *Robt Rice. Col. Recruit.*

No evidence on file from which Final Statements can be prepared.

He appears on the Hope Register of Nelson's Hope Camp Nelson Ky. as "Priv. Co. — 5" U. S. Army."

By Order of the Surgeon General:

J. J. Woodward
Major and Surgeon
No. 50
Vol. 4.
Wm

WAR DEPARTMENT,

ADJUTANT GENERAL'S OFFICE,

WASHINGTON, *Oct 9*, 1866.

SIR:

Final Statements in the cases of deceased soldiers are required to be sent to the Adjutant General's Office in duplicate, with one copy of the Inventory of Effects. The Descriptive List should also be sent to this Office in cases where the soldier was absent from his Company at the time of his death. Where there were no effects, it should be so stated on a blank Inventory, properly signed.

Certificates of Disability should be sent in duplicate. Special care should be taken that the date of discharge and signature of the discharging officer should be affixed.

No of the Final Statement's *No* Inventory, has been received in the case of *Robt. Rice*, of Co. *Col. Rec't*, Regiment of *Unadj'd* Volunteers, whose papers were forwarded to this Office. You will please forward the missing papers without delay.

I have the honor to be, sir,

Very respectfully,

Your obedient servant,

E. S. Hazard

Assistant Adjutant General.
(110)

COMMANDING OFFICER

W. Woodward A. J. G. A.

*Died in U.S. Hospital Camp Nelson Ky
date & cause of death unknown*

D. J. C.

FINAL STATEMENT

No 100
Robert Rice
5 Reg't of the 1st Col

VOLUNTEERS.

NOTE 1.—Two of these certificates (or duplicates) are to be given to each Volunteer Soldier or drafted man who may be discharged previously to the discharge of his company, that he may at once receive from the Paymaster the pay, &c., due him, and the captain or other COMMISSIONED officer commanding the company will certify to the act of the delivery of the duplicate certificates; on these certificates the Soldier is "entitled to" his discharge, and should also present his discharge to the Paymaster to have the payment endorsed on it. The discharge is to be given back to the Soldier by the Paymaster; the latter only retaining as his voucher the duplicate certificates.

NOTE 2.—If the Soldier is entitled to pay for the use of his horse, the Company Commander will certify to that fact on the back of both these final statements, and also to the time he has pay due for having been so mounted on his own horse.

NOTE 3.—When a Soldier is furnished with final statements, his descriptive list, if he has one, should be taken up by the officer who gives the Soldier these statements, and endorsed with a statement to this effect by the officer. This endorsement should exhibit a full statement of the time for which the Soldier was allowed pay on his final statements, the clothing account, and all other charges against him or in his favor, so as to comprise a complete exhibit of his account. It will then be transmitted to the company commander of the Soldier, who will enter all the data necessary to a full understanding of the Soldier's account on the muster roll upon which the Soldier's discharge is reported. The descriptive list will then be destroyed. The object of this is, that the remaining portion of the Soldier's account may be settled upon the receipt of these muster rolls, and the Soldier receive any pay or allowances that may be due him at the time of his discharge, and which may not appear on his final statements from the fact that his descriptive list is incomplete. These accounts for back pay, &c., are settled by the 2d Auditor of the Treasury Department.

NOTE 4.—Charges for loss or injury to ordnance, horse equipments, and other miscellaneous charges, should appear under the heading of "Other Stoppages."

NOTE 5.—Bounty paid by State authorities, and not by the United States, will not be entered on this statement.

NOTE 6.—Amounts due the Sutler and Laundress must be entered on the muster roll on which the discharge, death, desertion, &c., is reported, as well as on the final statement, otherwise the amount cannot be collected from the United States.

NOTE 7.—This blank will be used for deceased volunteers and drafted men, as well as for others.

NOTE 8.—Where a Soldier dies in Hospital or on detached service, his descriptive list, if he has one, should be sent with his final statements, in duplicate, to the Adjutant General, Washington, D. C.

[OFFICE INDORSEMENT.]

War Department,

ADJUTANT GENERAL'S OFFICE,

May 5, 1874

The Company of Volunteers,
Col. C., 5 Reg't U. S.
Colored, is reported as follows:
On Company Muster Roll.
Formed Oct 19, 1861, no. 1111, 186
Company Muster-out Roll.
Oct 19, 186
Company Descriptive Book.
Oct 19, 186
Company Morning Reports.
Oct 19, 186
Soldier's Final Statement.
Oct 19, 186
Soldier's Record of Death and Interment.
Oct 19, 186
Soldier's Inventory of Effects.
Oct 19, 186
Soldier's Certificate of Disability for Discharge.
Oct 19, 186
Soldier's Individual Muster-out Roll.
Oct 19, 186
Regimental Return.
For Oct 19, 1861, Oct 19, 186
Regimental Quarterly Returns.
Oct 19, 186
Regimental Descriptive Book.
Oct 19, 186

By Surgeon General.
Oct 19, 186
Oct 19, 186 is held to be
the correct date, and the Company Muster
Roll will be amended accordingly.
See Order to 2nd Auditor, D. C.
James M. [Signature]
Noted on Reg. Roll Oct 19
Assistant Adjutant General.

W.D. for Co. 105
no. of spec. sent
Auditor
C.

ADJUTANT GENERAL'S OFFICE.
May 31 1874
Duplicate with Inventory sent 2d Auditor.

I certify, on honor, that Robert Rice a Private of
Captain J. E. Schuck's Company (C) of the 5 Regiment of the 56th Iowa
VOLUNTEERS, of the State of _____, born in Shelby Co, State
of Kentucky, aged 25 years; 5 feet 5 inches high Blk complexion,
Blk eyes, Blk hair, and by occupation a Farmer, having joined the company on
its original organization at Camp Nelson Ky, and enrolled in it at the muster into
the service of the United States at Camp Nelson Ky, on the 9th day
of September, 1864 (or was mustered in service as a recruit, by Captain
H. C. Keiser, at Camp Nelson, on the 9th day of September,
1864, or was drafted and mustered into the service of the United States from the _____
Enrollment District of the State of _____, at _____,
on the _____ day of _____, 186) to serve in the Regiment, for
the term of Three Years; and having served HONESTLY and
FAITHFULLY with his Company in 5th the 56th Iowa to the present date, is now
entitled to a **DISCHARGE** by reason of Death — Died in
General Hospital Camp Nelson Ky Oct 19th 1864

The said Robert Rice has pay due from enlistment
was last paid by Paymaster
_____ to include the _____ day of _____, 186 , and has
pay due him from that time to the present date; he is entitled to pay and subsistence for
TRAVELING to place of enrollment, and whatever other allowances are authorized to volunteer
soldiers, drafted men, or militia, so discharged. He has received from the United States **CLOTHING**
amounting to 37 ⁷⁹ 100 dollars, since the 9th day of September,
1864, when his clothing account was last settled. He has received from the United States
100 ~~dollars advanced~~ **BOUNTY**. due (\$300) three hundred dollars

There is to be stopped from him, on account of the State of _____, or other
authorities, for **CLOTHING**, &c., received on entering service, _____ 100 dollars; and
for other stoppages, viz: _____

_____ 100 dollars.
He has been furnished with TRANSPORTATION in kind from the place of his discharge to
_____ ; and he has been SUBSISTED for TRAVELING to his
place of enrollment, up to the _____, 186 .

He is indebted to _____, **SUTLER**, _____ 100 dollars.

He is indebted to _____, **LAUNDRESS**, _____ 100 dollars.

Given in Duplicate, at Salisbury Ky, this 24th day
of May, 1865.

Augustus J. Hunt
Lieutenant

Commanding Company

1842
Rice William

Co E, 5 U. S. Col'd Cav.

Private | Corporal

CARD NUMBERS.

1	5363733	26
2	5363825	27
3	5363927	28
4	5363995	29
5	5364102	30
6	5364145	31
7	5364229	32
8	5364322	33
9	5364408	34
10	5364491	35
11	5364570	36
12	9090487	37
13		38
14		39
15		40
16		41
17		42
18		43
19		44
20		45
21		46
22		47
23		48
24		49
25		50

Book Mark:

General William H. B. 407875

See also

Q | **5 Cav.** | **U.S.C.T.**

William Rice

....., Co. E, 5 Reg't U. S. Col'd Cav.

Appears on

Company Descriptive Book
of the organization named above.

DESCRIPTION.

Age 41 years; height 5 feet 11 inches.

Complexion Black

Eyes Blk; hair Blk

Where born Shelby Ky

Occupation farmer

ENLISTMENT.

When Sep 9, 1864.

Where Camp Nelson

By whom W. Randolph term 3 y'rs.

Remarks:

W E Purke

(383g)

Copist.

B | 5 Cav. | U.S.C.T.

William Rice

Cpl., Co. B, 5 Reg't U. S. Col'd Cavalry.

Appears on

Company Muster-in and Descriptive Roll

of the organization named above. Roll dated

Camp Nelson, ^{Ky} N. Y., Oct 26, 1864.

Where born ^{Ky} Shelby

Age 21 y'rs; occupation ^{Ky} Farmer

When enlisted ^{Ky} Sept. 9, 1864.

Where enlisted ^{Ky} Cp. Nelson

For what period enlisted 3 years.

Eyes ^{Ky} Black; hair ^{Ky} Black

Complexion ^{Ky} Black; height 5 ft. 11 in.

When mustered in ^{Ky} Sept. 9, 1864.

Where mustered in ^{Ky} Cp. Nelson

Bounty paid \$ 100; due \$ 100

Where credited

Company to which assigned

Remarks: ^{Ky} District Kentucky

^{Ky} Mrs Mary Rice.

^{Ky} Supposed to be name of owner.

^{Ky} Added May 17. 98. H. A. J.

Book mark:

General Notation N. & T. 507370.

Leff Rowland

(356d)

Copyist.

R

5 Cav. | U.S.C.T.

William Rice

Cvt., Co. E, 5 Reg't U. S. Col'd Cavalry.

Appears on

Company Muster Roll

for *Enlistment to Oct 31*, 1864.

Present or absent *Present*

Stoppage, \$ *100* for

Due Gov't, \$ *100* for

Valuation of horse, \$ *100*

Valuation of horse equipments, \$ *100*

Remarks: *Sick in Quarters*

Book mark:

S. W. Rowland

(358)

Copyist.

R | **5 Cav.** | **U.S.C.T.**

William Riel

Cpt., Co. E, 5 Reg't U.S. Col'd Cavalry.

Appears on

Company Muster Roll

for *Nov, & Dec.*, 1864.

Present or absent *Present*

Stoppage, \$ *100* for

Due Gov't, \$ *100* for

Valuation of horse, \$ *100*

Valuation of horse equipments, \$ *100*

Remarks: *1st and 2^d instalments
of Bounties due*

Book mark:

Alb Rowland

(358)

Copyist.

192

5 Cav.

U.S.C.T.

William Rice

Capt.

Co. E, 5 Reg't U. S. Col'd Cavalry.

Appears on

Company Muster Roll

for Jan 1st 1865.

Present or absent Present

Stoppage, \$ 100 for

Due Gov't, \$ 100 for

Valuation of horse, \$ 100

Valuation of horse equipments, \$ 100

Remarks: First instalment of 12 months due \$ 100 Due U.S. for Ordnance \$ 4.47

Book mark:

M. R. Rowland

(358)

Copyist.

n^o

5 Cav.

U.S.C.T.

William Dyer

Co. E, 5 Reg't U. S. Col'd Cavalry.

Appears on

Company Muster Roll

for *March, April*, 1865.

Present or absent *Present*

Stoppage, \$ 100 for

Due Gov't, \$ 100 for

Valuation of horse, \$ 100

Valuation of horse equipments, \$ 100

Remarks: *First installment
of Bounties due*

Book mark:

W. Dyer

(358)

Copyist.

R

5 Cav. U.S.C.T.

William Rice

Corpl, Co. E, 5 Reg't U. S. Col'd Cavalry.

Appears on

Company Muster Roll

for May - June, 1865.

Present or absent present.

Stoppage, \$ 100 for

Due Gov't, \$ 100 for

Valuation of horse, \$ 100

Valuation of horse equipments, \$ 100

Remarks: 1st Instalment of Bounty due \$100.

Appointed Corpl. from Private May 1/65 per Regtl. Order No. 96.

Book mark:

Long

(358)

Copyist.

R

5 Cav. U.S.C.T.

William Rice

Corpl, Co. E, 5 Reg't U. S. Col'd Cavalry.

Appears on

Company Muster Roll

for July & Aug., 1865.

Present or absent present

Stoppage, \$ 100 for

Due Gov't, \$ 100 for

Valuation of horse, \$ 100

Valuation of horse equipments, \$ 100

Remarks:

Book mark:

Long

(358)

Copyist.

R

5 Cav. | U.S.C.T.

William Rice

Corpl., Co. E, 5 Reg't U. S. Col'd Cavalry.

Appears on

Company Muster Roll

for *Sept & Oct*, 1863.

Present or absent *Present*

Stoppage, \$ 100 for

Due Gov't, \$ 100 for

Valuation of horse, \$ 100

Valuation of horse equipments, \$ 100

Remarks:

Book mark:

Long

(358)

Copyist.

R | **5 Cav. | U.S.C.T.**

William Rice

Corpl., Co. E, 5 Reg't U.S. Col'd Cavalry.

Appears on

Company Muster Roll

for *Nov & Dec.*, 1865.

Present or absent *present*

Stoppage, \$ *100* for

Due Gov't, \$ *100* for

Valuation of horse, \$ *100*

Valuation of horse equipments, \$ *100*

Remarks:

Book mark:

(358)

Long

Copyist.

A

5 Cav. U.S.C.T.

William Rice

Corp., Co. E, 5 Reg't U.S. Col'd Cavalry.

Appears on

Company Muster Roll

for Jan & Feb, 1865.

Present or absent Present

Stoppage, \$ 100 for

Due Gov't, \$ 100 for

Valuation of horse, \$ 100

Valuation of horse equipments, \$ 100

Remarks:

[Blank lines for remarks]

Book mark:

[Signature] Copyist.

(358)

R

5 Cav. U.S.C.T.

William Rice

Corp, Co. E, 5 Reg't U. S. Col'd Cavalry.

Appears on Co. Muster-out Roll, dated Helena, Ark., Mar 16, 1866.

Muster-out to date * Mar 3, 1866.

Last paid to Dec 31, 1865.

Clothing account:

Last settled _____, 1866 ; drawn since \$ _____ 100

Due soldier \$ _____ 100 ; due U. S. \$ 38 ³⁷/₁₀₀

Am't for cloth'g in kind or money adv'd \$ _____ 100

Due U. S. for arms, equipments, &c., \$ _____ 100

Bounty paid \$ 100 ^{xx}/₁₀₀ ; due \$ 100 ^{xx}/₁₀₀

Remarks: Private from Org. of Co. to June 6/65 then Corp.

* Records on file in 2nd. Auditor's Office show this Co. Mustered Out to take effect Mch, 16th. 1866. and paid to include Mch, 15th. 1866.

Book mark: 1509 1879 497 139

J. L. Remond Copyist.

(861)

1015
Richard Charles

Co E, 5 U. S. Col'd Cav.

Private

Private

CARD NUMBERS.

1	5359269	26
2	5364274	27
3	5364393	28
4	5359434	29
5	5364674	30
6	9090486	31
7	40730249	32
8		33
9		34
10		35
11		36
12		37
13		38
14		39
15		40
16		41
17		42
18		43
19		44
20		45
21		46
22		47
23		48
24		49
25		50

Book Mark:

General Notation R. & P. 407875

See also 72 U.S.C.A.

A | **5 Cav.** | **U.S.C.T.**

Charles Richards
....., Co. *E*, 5 Reg't U. S. Col'd Cav.

Appears on

Company Descriptive Book
of the organization named above.

DESCRIPTION.

Age *27* years; height *5* feet *7* inches.

Complexion *Black*

Eyes *Blk*; hair *Blk*

Where born *Harding Ky*

Occupation *farmer*

ENLISTMENT.

When *drapped*, 186 .

Where

By whom; term *1* y'rs.

Remarks: *Reserped*

F. E. Pucke

(383g)

Copist.

R 5 Car | U.S.C.T.

Charles Richards

Pvt, Co., 5 Reg't U. S. Col'd Car

Appears on

M. and D. Roll of Men Transferred

to the organization named above,

from

Camp Nelson, Ky July 18

Roll dated , 1865.

When enlisted , 186 .

Period for which enlisted / years.

When mustered in Sept 26 , 1864 .

Present or absent

Company to which assigned

Remarks: Drafted

Paid expenses for Apprehension
as deserter \$30.00
Absent sick since Mch 23 1865

*Inserted by J B Doud Ex

Book mark :

General Notation N. & P. 40737

Abbott

(342)

Copyist.

R | 5 Cav. | U.S.C.T.

Charles Richard

Private, Co. E, 5 Reg't U. S. Col'd Cavalry.

Appears on

Company Muster Roll

for July & Aug., 1865.

Present or absent absent

Stoppage, \$ 100 for

Due Gov't, \$ 100 for

Valuation of horse, \$ 100

Valuation of horse equipments, \$ 100

Remarks: Rec'd by transfer from 72 Co. I. per R.O. No. 127 dated D. of Ky. July 18/65.

Assigned to Co. per R.O. No. 32 dated July 27/65.

Absent sick in Hospl. Covington, Ky. since March 27/65.

Book mark:

Long

(358)

Copyist.

R

5 Cav. U.S.C.T.

Charles Richards

Private, Co. E, 5 Reg't U.S. Col'd Cavalry.

Appears on

Company Muster Roll

for Sept & Oct., 1865.

Present or absent

Stoppage, \$ 100 for

Due Gov't, \$ 100 for

Valuation of horse, \$ 100

Valuation of horse equipments, \$ 100

Remarks: Deserted.

This man was transferred from the 42nd U.S.C.I. but never reported.

Book mark:

Long

(358)

Copyist.

11
R. 5 Cav | U.S.C.T.

Charles Richards
Priv., Co. E, 5 Reg't U. S. Col'd Cav

Appears on

Descriptive List of Deserters

dated Oct 31, 1865.

Deserted:

When Unknown, 1865.

Where Hospl Covington Ky

Arrested:

When _____, 1865.

Where _____

Remarks:

This man was transferred from 72 U.S. Col'd sick in Hospl, but has been discharged therefrom & has not reported.

Book mark: _____

Rose

R

5 Cav. U.S.C.T.

Charles Richards

Pvt., Co. E, 5 Reg't U. S. Colored Cav.

Appears on Returns as follows:

July 1865. - Laid July 27
Paris Ky. Transf.
to Co. E as per Reg't.
Order No. 132

~ Absent sick in Covington

Ky. since Mch. 27/65

Aug. & Sept. 1865. - Absent
sick in Hosp. Covington
Ky. since Mch. 19
'65 from disease.

Oct. 1865. - Absent; Deserted
Transferred from 72
U.S. Col. but had not
been reported.

Book mark :

E. Thornton

(546)

Copyist.

186

5 Cav. | U.S.C.T.

Charles Richards

Private, Co. B, 5 Reg't U. S. Col'd Cavalry.

Appears on Co. Muster-out Roll, dated Helena, Ark. Mar 16, 1866.

Muster-out to date _____, 1866.

Last paid to Pay due from muster in. 1866.

Clothing account:

Last settled _____, 1866; drawn since \$ 100

Due soldier \$ 45 ⁵⁰/₁₀₀; due U. S. \$ 100

Am't for cloth'g in kind or money adv'd \$ 100

Due U. S. for arms, equipments, &c., \$ 100

Bounty paid \$ 100; due \$ 100

Remarks: (See sheet)

This man was transferred from 72 U.S.C.T. but never reported

Book mark: _____

(361)

J. W. [Signature]

Copyist.

1074
Richard Levi

Co L, 5 U. S. Col'd Cav.

Private | Private

CARD NUMBERS.

1	5369845	26
2	5369940	27
3	5370033	28
4	5370088	29
5	5370179	30
6	5370265	31
7	5370404	32
8	5370489	33
9	5370580	34
10	5370652	35
11	5370723	36
12	9091140	37
13	43154481	38
14	43148138	39
15	40730250	40
16		41
17		42
18		43
19		44
20		45
21		46
22		47
23		48
24		49
25		50

Book Mark:

See also

S 711429 - P 90
S. 1422595, P.O. M...
P.O. misc 1099585. 6/16/2015

J. B. Dowd
Ex

R | **5 Cav. | U.S.C.T.**

Levi Richards

....., Co. *L*, 5 Reg't U. S. Col'd Cav.

Appears on

Company Descriptive Book
of the organization named above.

DESCRIPTION.

Age *18* years; height *5* feet *8* inches.

Complexion *Blk*

Eyes *Blk*; hair *Blk*

Where born *Virginia*

Occupation *Laborer*

ENLISTMENT.

When *Substitute*, 186 .

Where *7 Dist Ky*

By whom; term *3* y'rs.

Remarks:

.....
.....
.....
.....
.....
.....
.....
.....
.....

A J Anderson
(383a) Coppist.

5 Cav

Levi Richards

Appears with rank of Priv on

Muster and Descriptive Roll

of Detachment of U.S. Colored
troops, forwarded

Roll dated Louisville, Ky. Oct. 4, 1864.

Where born Virginia

Age 18 years; occupation Laborer

When enlisted _____, 186

Where enlisted _____

For what period enlisted 3 years.

Eyes Black; hair Black

Complexion Black; height 5 ft. 8 in.

When mustered in Sept. 3, 1864.

Where mustered in Lexington

Bounty paid \$ 100; due \$ 100

Clothing account:

Last settled _____, 186 ; drawn since \$ 17⁵⁰100

Date of first muster Sept. 3, 1864.

Company to which assigned _____

Remarks: Credited to 7"
Long Dist. Ky
Substitute

Book mark: _____

(356m)

W. W. Spelman
Copyist.

R | 5 bar | U.S.G.T.

Levi Richards (Col)

Appears with rank of *Priv* on

Muster and Descriptive Roll

of a Detachment of U.S. Substitutes
Enlisted & Mustered, Forwarded

Roll dated
Lexington, Ky Oct 30, 1865.

Where born *Kentucky*

Age *18* years; occupation *laborer*

When enlisted *Sept 3*, 1864.

Where enlisted *Lexington, Ky.*

For what period enlisted *3* years.

Eyes *Blk*; hair *Blk*

Complexion *Blk*; height *5 ft. 8* in.

When mustered in *Sept 3*, 1864.

Where mustered in *Lexington, Ky.*

Bounty paid \$ *100*; due \$ *100*

Clothing account:

Last settled _____, 186 ; drawn since \$ *100*

Date of first muster *Sept 3*, 1864.

Company to which assigned _____

Remarks *For whom substituted
Horace Walker Enrolled man
Credited to Woodford Co. 7 "D. Ky.*

Book mark : _____

(356m)

J. W. Morris

Copyist.

R

5 Cav. U.S.C.T.

Levi Richards

Priv., Co. R, 5 Reg't U. S. Col'd Cavalry.

Appears on

Company Muster-in and Descriptive Roll

of the organization named above. Roll dated
Camp Nelson, N.Y., Oct 30, 1864

Where born Virginia

Age 18 y'rs; occupation Labourer

When enlisted, 1864

Where enlisted

For what period enlisted 3 years.

Eyes Black; hair Black

Complexion Black; height 5 ft. 8 in.

When mustered in Sept 3, 1864

Where mustered in Lexington

Bounty paid \$100; due \$100

Where credited 7th Dist Ky

Company to which assigned

Remarks: Substitute

Book mark:

Bradley

(356d)

Copyist.

R

5 Cav.

U.S.C.T.

Lev Richard

For

Co. L, 5 Reg't U. S. Col'd Cavalry.

Appears on

Company Muster Roll

for dated Oct 31, 1864

Present or absent Absent

Stoppage, \$ 100 for

Due Gov't, \$ 100 for

Valuation of horse, \$ 100

Valuation of horse equipments, \$ 100

Remarks: On det serv
Nashville Tenn
Oct 15/64

Book mark:

Bridges

(358)

Copyist.

R

5 Cav.

U.S.C.T.

Levi Richards

Priv

Co. L, 5 Reg't U. S. Col'd Cavalry.

Appears on

Company Muster Roll

for Nov & Dec, 1864

Present or absent Absent

Stoppage, \$ 100 for

Due Gov't, \$ 100 for

Valuation of horse, \$ 100

Valuation of horse equipments, \$ 100

Remarks: Under Order
Nashville Tenn
Oct 15/64

Book mark:

Bradley

(358)

Copyist.

R | 5 Cav. | U.S.C.T.

Levi Richards

Opl, Co. L, 5 Reg't U. S. Col'd Cavalry.

Appears on

Company Muster Roll

for January & Feb'y, 1865

Present or absent Absent

Stoppage, \$ 100 for

Due Gov't, \$ 100 for

Valuation of horse, \$ 100

Valuation of horse equipments, \$ 100

Remarks: Appointed by Order
No 26. dated Camp Nel-
son. Feb'y 13 1865 to
rank from Jan'y 1
1865. In dismount-
ed Camp Camp
Nelson

Book mark:

Bridle

(358)

Copyist.

R | 5 Cav. | U.S.C.T.

Levi Richards

Opel, Co. L, 5 Reg't U. S. Col'd Cavalry.

Appears on

Company Muster Roll

for *Mar 1865*, 1865.

Present or absent *Present*

Stoppage, \$ 100 for

Due Gov't, \$ 100 for

Valuation of horse, \$ 100

Valuation of horse equipments, \$ 100

Remarks:

Book mark:

Brick

(358)

Copyist.

R | 5 Cav. | U.S.C.T.

Levi Richards

Sgt., Co. L, 5 Reg't U. S. Col'd Cavalry.

Appears on

Company Muster Roll

for *May June*, 18*65*.

Present or absent *Present*

Stoppage, \$ *100* for

Due Gov't, \$ *100* for

Valuation of horse, \$ *100*

Valuation of horse equipments, \$ *100*

Remarks: *Reported from*

Comp. Ser R. O. No. 70
Dated May 4/65

Book mark:

Proctor

18

5 Cav. U.S.C.T.

Lori Richards

1st Lt., Co. L, 5 Reg't U. S. Col'd Cavalry.

Appears on

Company Muster Roll

for July & Aug, 1865.

Present or absent Present

Stoppage, \$ 100 for

Due Gov't, \$ 100 for

Valuation of horse, \$ 100

Valuation of horse equipments, \$ 100

Remarks: Reduced to the rank of 1st Lt. per Reg't. Order No. 129 Aug 29, 1865

Book mark:

Richard

R

5 Cav. U.S.C.T.

Lewis Richards

Sgt, Co. L, 5 Reg't U. S. Col'd Cavalry.

Appears on

Company Muster Roll

for *Sept & Oct*, 1865.

Present or absent *Present*

Stoppage, \$ *100* for

Due Gov't, \$ *100* for

Valuation of horse, \$ *100*

Valuation of horse equipments, \$ *100*

Remarks: *Reduced to the rank of
Sergt. Augt. 29. 65 per
R.O. No 129*

Book mark:

Rechner

(358)

Copyist.

R | **5 Cav.** | **U.S.C.T.**

Levi Richards

Co., Co. L, 5 Reg't U. S. Col'd Cavalry.

Appears on

Company Muster Roll

for *Mr. Miller*, 1865.

Present or absent *Present*

Stoppage, \$ 100 for

Due Gov't, \$ 100 for

Valuation of horse, \$ 100

Valuation of horse equipments, \$ 100

Remarks:

Book mark: -----

Rocheater

R | **5 Cav. | U.S.C.T.**

Levi Richards

Pl, Co. L, 5 Reg't U. S. Col'd Cavalry.

Appears on

Company Muster Roll
for *Jan. & Feb.*, 186*6*.

Present or absent *Present*

Stoppage, \$ *100* for

Due Gov't, \$ *100* for

Valuation of horse, \$ *100*

Valuation of horse equipments, \$ *100*

Remarks: *In Camp in Regt's
Guard House.*

Book mark:

C. G. Taylor

(358)

Copyist.

9

5 Cav.

U.S.C.T.

Levi Richards

Corp, Co. F, 5 Reg't U. S. Colored Cav.

Appears on Returns as follows:

Oct. to Dec, 1864, - Absent
on det. serv. Nashville
Tenn. Oct. 15/64

Jan. 1865, - Absent in dis-
mounted Camp Camp
Nelson Ky.

Feb. 1865, - (Corp.) - Absent
in dismounted Camp
Camp Nelson Ky.

Mar. 1865, - On daily duty
as Guard at Regt.
Hq. Drs.

Book mark :

(546)

E. Thomson

Copyist.

R | 5 Cav. | U.S.C.T.

Levi Richards

Priv, Co. L, 5 Reg't U. S. Col'd Cavalry

Appears on Co. Muster-out Roll, dated
Helena, Ark, Mar. 16, 1866.

Muster-out to date Mar. 16, 1866.

Last paid to Dec. 31, 1865.

Clothing account:

Last settled _____, 1866 ; drawn since \$ _____ 100

Due soldier \$ _____ 100; due U. S. \$ _____ 6 ⁶⁶/₁₀₀

Am't for cloth'g in kind or money adv'd \$ _____ 100

Due U. S. for arms, equipments, &c., \$ _____ 100

Bounty paid \$ _____ 100; due \$ _____ 100

Remarks: Slave Was Priv. from
enrollment to Feb. 13th, 65, then
Corpl. to May 11th, 65 then
Sergt. to Augt. 29th, 65
Then Private.

Book mark: _____

O. J. Taylor

(361)

Copyist.

Statement of Service Reference Slip.

Office Pension

Claim No. 1099585

Levi Richards

(Name.)

L, Co L, 5 Reg't US Cold Cav.

To med see June 5, 1916

For history

no med per eps

Johnson
J.H. Jr.

No addl. med.
records found.
✓ 5 cards ret'd.

Statement furnished June 6, 1916

J. J. F. J.

Richards, Levi

Sgt, Co. L,

5

Regt

U.S.C. Cav.

Enclosures.

Bed Cards	Descriptive Lists
Burial Records	Final Statements
Certs. of Dis. for Discharge	Furloughs
C. M. Charges	Med. Des. Lists
Med. Certificates	Orders

Other papers relating to—

Admission to Hosp'l	Furlough
Casualty Sheet (Officer's)	Med. Examination
Confinement	Misc. Information
Contracts	Pay or Clothing
Death or Effects	Personal Reports
Desertions	Rank
Discharge from Hosp'l	Transfer to Hosp'l
Discharge from Service	Transfer to V. R. C.
Duty	Transportation

SSRS 7

Head Qu 5th Inf Col Cav
Camp Nelson Ky. 29 Aug. 1865

Order No. 145

Extract

11 Upon the representations of his Company Com-
mander Sergt. Levi Richards Co L. 5th Inf-CV
is hereby reduced to the ranks for repeated
violation of orders To take effect
from this date

By order of
Wm. H. Miller
Major Comd
W. H. Miller
Lt Col

Richardson Jones
Co *K*, 5 U. S. Col'd Cav.

Sergeant Sergeant
CARD NUMBERS.

1	5368784	26
2	5368884	27
3	5368985	28
4	5369076	29
5	5369166	30
6	5369253	31
7	5369339	32
8	5369426	33
9	5369593	34
10	5359447	35
11	5369780	36
12	4090104	37
13	43145505	38
14	40730251	39
15		40
16		41
17		42
18		43
19		44
20		45
21		46
22		47
23		48
24		49
25		50

Book Mark:

See also

E | 5 Cav. | U.S.C.T.

John Richardson
....., Co. *K*, 5 Reg't U. S. Col'd Cav.

Appears on

Company Descriptive Book
of the organization named above.

DESCRIPTION.

Age *25* years; height *5* feet *9* inches.

Complexion *Black*

Eyes *Black*; hair *Black*

Where born *Fayette Co Ky*

Occupation *Laborer*

ENLISTMENT.

When *Aug 27*, 1864.

Where *Lexington Ky*

By whom *J. H. Moore*; term *3* y'rs.

Remarks:

.....
.....
.....
.....
.....
.....
.....
.....

A. J. Anderson
Coppist.

29

5 bar

MS. C. 1

John Richardson

Appears with rank of Pvt. on

Muster and Descriptive Roll

of U.S. Detachment of U.S. Colored Vols.
forwarded to Camp Nelson Ky.

Camp of instruction Roll dated
Lexington Ky, Aug 27, 1864.

Where born Fayette Co. Ky.

Age 25 years; occupation Labourer

When enlisted Aug. 27, 1864.

Where enlisted Lexington Ky.

For what period enlisted 3 years.

Eyes Blk; hair Blk

Complexion Blk; height 5 ft. 9 in.

When mustered in _____, 186 .

Where mustered in _____

Bounty paid \$ _____ 100; due \$ _____ 100

Clothing account:

Last settled _____, 186 ; drawn since \$ _____ 100

Date of first muster Aug. 27, 1864.

Company to which assigned _____

Remarks: Former William Richardson
Fayette Co to be credited 7 Dec
1864

Book mark : _____

W. M. Potter

(356m)

Copyist.

A

5 Cav.

U.S.C.T.

John Richardson

Serjt, Co. *H*, 5 Reg't U. S. Col'd Cavalry.

Appears on

Company Muster-in and Descriptive Roll

of the organization named above. Roll dated

Camp Nelson Ky, N. Y., Oct 30, 1864.

Where born *Fayette Ky*

Age *23* y'rs; occupation *Laborer*

When enlisted *Aug 27, 1864.*

Where enlisted *Lexington Ky*

For what period enlisted *3* years.

Eyes *Blk*; hair *Blk*

Complexion *Copper*; height *5* ft. *9* in.

When mustered in *Aug 27, 1864.*

Where mustered in *Lexington Ky*

Bounty paid \$ *100*; due \$ *100*

Where credited *7 Dist Ky*

Company to which assigned

Remarks: *William Richardson*

x Supposed to be name of owner

Book mark:

A. P. Miller

(356d)

Copyist.

R

5 Cav.

U.S.C.T.

John Richardson

Sergt, Co. K, 5 Reg't U. S. Col'd Cav.

Appears on

Company Muster Roll

for Organization to Oct 31, 1864.

Present or absent Present

Stoppage, \$ 100 for

Due Gov't, \$ 100 for

Valuation of horse, \$ 100

Valuation of horse equipments, \$ 100

Remarks: App'd per Regtl Order
No 12 to date Oct 30 1864

Book mark:

(358)

H. S. Miller

Copyist.

R

5 Cav.

U.S.C.T.

John Richardson

Sergt, Co. K, 5 Reg't U. S. Col'd Cav.

Appears on

Company Muster Roll

for *Nov & Dec*, 1864.

Present or absent *Present*

Stoppage, \$ *100* for

Due Gov't, \$ *100* for

Valuation of horse, \$ *100*

Valuation of horse equipments, \$ *100*

Remarks: *Appt'd per Regtl order*
no 12 to date Oct 30 1864
1"02" Installments' Bounty due

Book mark: _____

H S Miller

(358)

Copyist.

R

5 Cav.

U.S.C.T.

John Richardson
Sergt., Co. K, 5 Reg't U. S. Col'd Cav.

Appears on

Company Muster Roll

for *Jan 1 Feb*, 1865.

Present or absent *Present*

Stoppage, \$ *100* for

Due Gov't, \$ *100* for

Valuation of horse, \$ *100*

Valuation of horse equipments, \$ *100*

Remarks: *1 "42" installments \$300*
Bounty due

Book mark:

H S Miller

(358)

Copyist.

R

5 Cav.

U.S.C.T.

John Richardson

Serjt, Co. K, 5 Reg't U. S. Col'd Cav.

Appears on

Company Muster Roll

for Mar & Apr, 1865.

Present or absent Present

Stoppage, \$ 100 for

Due Gov't, \$ 100 for

Valuation of horse, \$ 100

Valuation of horse equipments, \$ 100

Remarks: Appt'd per R.O. 12
Oct 31/64 1st installment
Bounty due \$100

Book mark:

H. S. Miller

(358)

Copyist.

R

5 Cav.

U.S.C.T.

John Richardson
Sergeant, Co. K, 5 Reg't U. S. Col'd Cav.

Appears on

Company Muster Roll

for May & June, 1861.

Present or absent Present

Stoppage, \$ 100 for

Due Gov't, \$ 100 for

Valuation of horse, \$ 100

Valuation of horse equipments, \$ 100

Remarks: app'd per R.O. No 12
Oct 31. 1864. First install-
ment bounty due \$100

Book mark:

J. E. Porter

(358)

Copyist.

R

5 Cav. U.S.C.T.

John Richardson

Sgt., Co. K, 5 Reg't U. S. Col'd Cav.

Appears on

Company Muster Roll

for July & Aug, 1865.

Present or absent absent

Stoppage, \$ 100 for

Due Gov't, \$ 100 for

Valuation of horse, \$ 100

Valuation of horse equipments, \$ 100

Remarks: Absent in confinement Mil Prison Lexington Ky

Book mark:

J. E. Porter

(358)

Copyist.

R

5 Cav.

U.S.C.T.

John Richardson

Co. K, 5 Reg't U. S. Col'd Cav.

Appears on

Company Muster Roll

for Sept & Oct, 1867.

Present or absent Absent

Stoppage, \$ 100 for

Due Gov't, \$ 100 for

Valuation of horse, \$ 100

Valuation of horse equipments, \$ 100

Remarks: Due U. S. for
to & G. E. H. 1. 63. Absent
in confinement at
Det. Reg

Book mark:

J. E. Porter

(358)

Copyist.

R

5 Cav. U.S.C.T.

John Richardson
Sergeant, Co. K, 5 Reg't U. S. Col'd Cav.

Appears on

Company Muster Roll

for Nov & Dec, 1865.

Present or absent

Stoppage, \$ 100 for

Due Gov't, \$ 100 for

Valuation of horse, \$ 100

Valuation of horse equipments, \$ 100

Remarks: Deserted Nov 25.
1865 Louisville, Ky
1st Installment Bounty
due \$100

Book mark:

J. E. Porter

(358)

Copyist.

RC

U.S.C.T.

John Richardson
Serg't, Co. K, 5 Reg't U. S. Col'd Cav

Appears on

Descriptive List of Deserters

dated Nov 30, 1865.

Deserted:

When Nov 25, 1865.

Where Louisville Ky

Arrested:

When _____, 186 .

Where _____

Remarks:

Book mark:

Rose

(351)

Copyist.

R

5 Cav.

U.S.C.T.

John Richardson
Sgt., Co. K, 5 Reg't U. S. Colored Cav.

Appears on Returns as follows:

July to Oct. 1865 - Absent
in arrest in confine-
ment Mil. Prison
Lexington Ky. Charges
preferred.

Nov. 1865 - Dec. Nov. 25/65 -
Louisville Ky. De-
serted.

Book mark :

(546)

E. J. Thornton

Copyist.

R

5 Cav. U.S.C.T.

John Richardson

Sgt., Co. K, 5 Reg't U. S. Col'd Cavalry.

Appears on Co. Muster-out Roll, dated Helena Ark, Feb 16, 1866.

Muster-out to date, 1866.

Last paid to Pay due from enlistment, 1866.

Clothing account:

Last settled, 1866; drawn since \$100

Due soldier \$100; due U. S. \$21 26/100

Am't for cloth'g in kind or money adv'd \$100

Due U. S. for arms, equipments, &c., \$100

Bounty paid \$100; due \$100 100

Remarks: Deserted at Louisville Ky for 25/65

Book mark:

E. M. Brown

(361)

Copyist.

Richardson John

Sgt, Co. K, 5 Reg't U.S.C. Cav.

4 Enclosures.

Bed Cards	Final Statements
Burial Records	Furloughs or L. of A.
Certs. of Dis. for Discharge	Med. Certificates
C. M. Charges 3	Med. Des. Lists
Descriptive Lists	Orders
Discharge Certificates	Pris. of War Record
Enlistment Papers	Resignations

Other papers relating to—

Admission to Hosp'l	Furlough or L. of A.
Casualty Sheet	Med. Examination
Confinement	Misc. Information /
Contracts	Pay or Clothing
Death or Effects	Personal Reports
Desertion	Rank
Discharge from Hosp'l	Transfer to Hosp'l
Discharge from Service	Transfer to V. R. C.
Duty	Transportation

A-178-K.K-Vol-2-1865

Military Prison No. 3

Lexington, Ky. Aug 27th/65

Richardson, Sergt. John

Co. K. 5th U.S.C. Cav.

States that he has been arrested on suspicion of cutting down one of the Boys that was tied up. & states that he is clear of it. and requests an Investigation in his case, has been b. fined nearly 2 months waiting for charges &c

Head Quarters Dept of Ky
Louisville Sept 5th 1865

Respectfully referred to the commanding officer 1st Division, Dept of Kentucky
By command of
Major General Palmer

W. A. Geil
A. A. Geil

Head Quarters 1st Div Dept of Ky
Lexington Ky
Sept 7th 1865

Respectfully referred to Lieut
Col A. Coates Comdr of Fort Lexington
Ky for action

In command of

Col. J. H. Burhove
W. R. Foster
Capt. Regt. A. A. G.

Head Quarters 1st Div Dept of Ky
Office Prov. Marshal
Lexington Ky. Sept. 13/65.

Respectfully returned to
Capt. W. R. Foster A. A. G.
with information that the
within named man was
arrested July 7/65. at Covington
Ky. by Lieut. J. J. J. charged
with desertion no charges
have passed through this
office against him.
W. H. P. Ponce
Capt. Regt. A. A. G.

R. B. C. Vol. A, O. J. A. Hds. Dept.
of Ky. Nov 10 1865.

Index No. 7

CHARGES AND SPECIFICATIONS
PREFERRED AGAINST

John Richardson
Sergeant of Co. "K"
8th Regt. of U.S. Cavalry
Vol.

Headquarters Department of Kentucky,
Louisville, Ky. Nov 8th 1865.

To be tried by a General Court-Martial.

By order of Maj. Gen. Palmer

William H. Coyl
Judge Advocate,
Department of Kentucky.

Charges and Specifications preferred against
John Richardson Sergeant - Co K^o 5th Regt. Colored
Cavalry.

Charge 1st Beginning a Mutiny.

Specification: In this, that - he, John Richardson,
Sergeant of Company K^o 5th U. S. Colored Cavalry,
did begin a mutiny which occurred at Covington, Ky.,
on or about the 5th day of July 1865, by inciting and
causing several of the enlisted men of his company and
regiment to assemble together for the purpose of
resisting the lawful orders and authority of their
superior officer, and did cause said enlisted men
to load their guns, and did with the aid and
assistance of said enlisted men release one John
Gay Bugler of said company and regiment,
from punishment to which he had been subjected
by proper authority.

Charge 2^d: - Mutiny.

Specification: - In this, that - he, John
Richardson, Sergeant of company, K^o 5th U. S.
Colored Cavalry, did lead a party of enlisted men
and release by force one John Gay Bugler, Co K^o
5th U. S. Colored Cavalry from punishment to which
he had been subjected by proper authority, with loaded
guns to the intimidation of the Officer commanding
the company. This at Covington Ky, on or about the
5th day of July, 1865.

William H. Coyle
Judge Adv. Dept. of Ky.

Witnesses

1st Lt D. G. Gordon, 5th U.S. Cavalry
2^d Lt G. B. Taylor " " " "
1st Supt. Paddy Brent Co. H. 5th U.S. Cavalry
Bugler John Gay " " " " " "

Charges and Specifications
preferred against
Serge John Richardson
Co H. 5th Inf C Cal

Charges and Specifications preferred against Sergt.
John Richardson Co H 5th Inf Col Cav

Charge 1st Inciting Mutiny

Specification 1st In this that he the said John Richardson
Sergt Co H 5th Inf Col Cav did incite the men of "H" Co
5th Inf Col Cav to mutiny against the officer in command
of said Company and did relieve by force one
John Gay Bugler H Co 5th Inf Col Cav from punishment
This at Covington Ky on the 7th day of July 1865

Specification 2nd In this that he the said John
Richardson Sergt. Co H 5th Inf Col Cav did wilfully and
with malice aforethought incite the enlisted men of
"H" Co 5th Inf Col Cav to load their guns and go with
loaded guns and relieve one John Gay Bugler "H" Co
5th Inf Col Cav from punishment This at Covington
Ky on the 7th day of July 1865

Charge 2nd Mutiny

Specification In this that he ~~the said~~ John Richardson
Sergt Co H 5th Inf Col Cav did ~~wilfully and with malice~~
~~aforethought~~ lead a party of enlisted men and
relieve by force one John Gay Bugler "H" Co
5th Inf Col Cav from ^{punishment to which he had been subjected by proper} ~~the~~ with loaded
guns, ~~and~~ to the intimidation of the Officer
Commanding the Company. This at Covington

By on the Fifth day of July 1865

Witnesses

1st Lt. D. G. Gordon 5th U. S. C. A.

2nd Lt. G. B. Taylor 5th U. S. C. A.

1st Sergt. Paddy Brent Co. H. 5th U. S. C. A.

Private John Gay Co. H. 5th U. S. C. A.

Charges and Specifications
Preferred against Sergt
John Richardson Co H
5th Inf^y Cav

Charges and Specifications prepared against
Sergt John Richardson Co H. 5th U^s Col Cas

Charge 1st Inciting Mutiny

Specification 1st In this that he the said John Richardson Sergt. Co H. 5th U^s Col Cas did incite the men of "H" Company 5th U^s Col Cas to mutiny against the officer in command of the said Company and did relieve by force one John Gay Bugler Co H. 5th U^s Col Cas from punishment This at Covington Ky on the fifth day of July 1865.

Specification 2nd In this that he the said John Richardson Sergt. Co H. 5th U^s Col Cas did wilfully and with malice aforethought incite the enlisted men of H Co 5th U^s C Cas to load their guns and go with loaded guns and relieve one John Gay Bugler Co H. 5th U^s C Cas from punishment This at Covington Ky on the fifth day of July 1865.

Charge 2nd Mutiny

Specification 1st In this that he the said John Richardson Sergt. Co H. 5th U^s Col Cas did with malice aforethought lead a party of enlisted men and release by force one John Gay

Bugler Co H 5th Regt of Cav from punishment
this with loaded guns and to the intimidation
of the Officer Commanding the Company
This at Covington Key on the Fifth day
of July 1865-

Henry P. Kiddle
Major General

Witnesses

James S. Elliott late Capt 5th Regt of Cav
Fred Jarsand late 1st Lt 5th Regt of Cav
1st Lt D. G. Gordon 5th Regt of Cav
2nd Lt G. B. Taylor 5th Regt of Cav
Paddy Brent 1st Sergt Co H 5th Regt of Cav
John Gay Bugler 5th Regt of Cav

Richmond Crossley

Co K, 5 U. S. Col'd Cav.

Private | Private

CARD NUMBERS.

1	5368862	26
2	5368950	27
3	5369051	28
4	5369138	29
5	5369226	30
6	5369313	31
7	5369401	32
8	5369487	33
9	5369572	34
10	5369657	35
11	5369738	36
12	9091105	37
13	43145492	38
14		39
15		40
16		41
17		42
18		43
19		44
20		45
21		46
22		47
23		48
24		49
25		50

Book Mark:

See also

E | 5 Cav. | U.S.C.T.

Ernest Richmond

, Co. *K*, 5 Reg't U. S. Col'd Cav.

Appears on

Company Descriptive Book

of the organization named above.

DESCRIPTION.

Age *28* years; height *5* feet *8* inches.

Complexion *Black*

Eyes *Blue*; hair *Black*

Where born *Martin Co. N.C.*

Occupation *Farmer*

ENLISTMENT.

When *Aug 26, 1864.*

Where *London Ky*

By whom *Capt. R. Hays* term *3* y'rs.

Remarks:

A. J. Anderson

(383g)

Copist.

19 | 5 bar | U.S. C.

Crossley, Richmond

Appears with rank of Priv. on

Muster and Descriptive Roll

of a Detachment of U.S. Colored
Recruits forwarded

Roll dated
London Ky., Aug 26, 1864.

Where born Martin N. Carolina

Age 38 years; occupation Farmer

When enlisted Aug 22, 1864.

Where enlisted London Ky.

For what period enlisted 3 years.

Eyes Black; hair Black

Complexion Black; height 5 ft. 8 in.

When mustered in Aug 26, 1864.

Where mustered in London Ky.

Bounty paid \$ 100; due \$ 100

Clothing account:

Last settled _____, 186 ; drawn since \$ 100

Date of first muster Aug 22, 1864.

Company to which assigned _____

Remarks: Credited to Jackson Co.
S. Dist Ky. owner John
Richmond Scott Co Va.
Contraband.

Book mark: _____

(356m)

W. W. Potter

Copyist.

R

5 Cav.

U.S.C.T.

Crossley Richmond

Pot, Co. K, 5 Reg't U. S. Col'd Cavalry.

Appears on

Company Muster-in and Descriptive Roll

of the organization named above. Roll dated

Camp Nelson Ky, N. Y., Oct 30, 1864.

Where born *Marion North Carolina*

Age 38 y'rs; occupation *Tanner*

When enlisted *Aug 28*, 1864.

Where enlisted *Soudon*

For what period enlisted *3* years.

Eyes *Blk*; hair *Blk*

Complexion *Blk*; height *5* ft. *8* in.

When mustered in *Aug 26*, 1864.

Where mustered in *Soudon*

Bounty paid \$ *100*; due \$ *100*

Where credited *Dist Ky*

Company to which assigned

Remarks: ** John Richmond*

X Supposed to be name of owner

Book mark:

H. S. Miller

(356d)

Copyist.

R

5 Cav.

U.S.C.T.

Crosby Richmond
Pvt, Co. K, 5 Reg't U. S. Col'd Cav.

Appears on

Company Muster Roll

for *Organization to Oct 31*, 1864.

Present or absent *Present*

Stoppage, \$ *100* for

Due Gov't, \$ *100* for

Valuation of horse, \$ *100*

Valuation of horse equipments, \$ *100*

Remarks:

Book mark : -----

(358)

H. J. Miller

Copyist.

B

5 Cav.

U.S.C.T.

Crosley Richmond

Pvt., Co. K, 5 Reg't U. S. Col'd Cav.

Appears on

Company Muster Roll

for *Nov & Dec*, 1864.

Present or absent *Present*

Stoppage, \$ 100 for

Due Gov't, \$ 100 for

Valuation of horse, \$ 100

Valuation of horse equipments, \$ 100

Remarks: *1st & 2nd installment*

Bounty due

Book mark:

H. S. Miller

(358)

Copyist.

A

5 Cav. U.S.C.T.

Crosby Richmond
Priv, Co. K, 5 Reg't U. S. Col'd Cav.

Appears on

Company Muster Roll

for *Jan & Feb*, 1865.

Present or absent *Present*

Stoppage, \$ *100* for

Due Gov't, \$ *100* for

Valuation of horse, \$ *100*

Valuation of horse equipments, \$ *100*

Remarks: *1 "82" installments*
\$300 Bounty due

Book mark:

H O Miller

(358)

Copyist.

R 5 Cav U.S.C.T

Crostley Richmond
Pot, Co K, 5 Reg't U. S. Col'd Cav

Appears on

Company Muster Roll

for Mar & Apr, 1865.

Present or absent Present

Stoppage, \$ 100 for

Due Gov't, \$ 100 for

Valuation of horse, \$ 100

Valuation of horse equipments, \$ 100

Remarks: 1st installment of
Bounty due \$100

Book mark:

H. S. Miller

(358)

Copyist.

R

5 Cav.

U.S.C.T.

Crestley Richmond

Prof, Co. K, 5 Reg't U. S. Col'd Cav.

Appears on

Company Muster Roll

for May & June, 1865.

Present or absent Present

Stoppage, \$ 100 for

Due Gov't, \$ 100 for

Valuation of horse, \$ 100

Valuation of horse equipments, \$ 100

Remarks First installment bounty due \$100

Book mark:

F. E. Porter

(358)

Copyist.

C

5 Cav. U.S.C.T.

Croftley Richmond

Prof, Co. K, 5 Reg't U. S. Col'd Cav.

Appears on

Company Muster Roll

for July & Aug, 1865.

Present or absent Present

Stoppage, \$ 100 for

Due Gov't, \$ 100 for

Valuation of horse, \$ 100

Valuation of horse equipments, \$ 100

Remarks:

Book mark:

F. E. Porter

(358)

Copyist.

G

5 Cav. U.S.C.T.

Crosby Richmond

Co. K, 5 Reg't U. S. Col'd Cav.

Appears on

Company Muster Roll

for Sept & Oct, 1865.

Present or absent Present

Stoppage, \$ 100 for

Due Gov't, \$ 100 for

Valuation of horse, \$ 100

Valuation of horse equipments, \$ 100

Remarks: Due U. S. for
C + G. E. 03 cts

Book mark:

F. E. Porter

(358)

Copyist.

R

5 Cav. U.S.C.T.

Crosley Richmond

Prof, Co. K, 5 Reg't U. S. Col'd Cav.

Appears on

Company Muster Roll

for Nov & Dec, 1865.

Present or absent Present

Stoppage, \$ 100 for

Due Gov't, \$ 100 for

Valuation of horse, \$ 100

Valuation of horse equipments, \$ 100

Remarks: Due U.S. for Co
G.E. 65

Book mark:

F. E. Porter

Q

5 Cav.

U.S.C.T.

Crosby

Richmond

Prt., Co. K, 5 Reg't U. S. Col'd Cav.

Appears on

Company Muster Roll

for Jan Feb, 1866.

Present or absent Present

Stoppage, \$ 100 for

Due Gov't, \$ 100 for

Valuation of horse, \$ 100

Valuation of horse equipments, \$ 100

Remarks: 2^d Instalment bounty due \$100

Book mark:

E. H. Brown

Q | **5 Cav. | U.S.C.T.**

Gentry, Richmond
Co. K, 5 Reg't U. S. Col'd Cavalry.

Appears on **Co. Muster-out Roll**, dated
Feb 16, 1860.
Muster-out to date Feb 16, 1860.
Last paid to Dec 31, 1865.

Clothing account:

Last settled....., 186 ; drawn since \$..... 100
Due soldier \$..... 100; due U. S. \$..... 8 ¹⁹ 100
Am't for cloth'g in kind or money adv'd \$..... 100

Due U. S. for arms, equipments, &c., \$..... 100

Bounty paid \$ 100; due \$ 100

Remarks:.....
.....
.....
.....
.....

Book mark: P. 37 P. 166. 76, 253. 1879

E. H. Brown
(261) Copyist.

1011
Richmond Joseph

Co G, 5 U. S. Col'd Cav.

Private | Private

CARD NUMBERS.

1	5365781	26
2	5365875	27
3	5365975	28
4	5366062	29
5	5366160	30
6	5366251	31
7	5366343	32
8	5366432	33
9	5366518	34
10	5366606	35
11	5366691	36
12	9090706	37
13	40730282	38
14		39
15		40
16		41
17		42
18		43
19		44
20		45
21		46
22		47
23		48
24		49
25		50

Book Mark:

See also

9 | 5 Cav. | U.S.C.T.

Joseph Richmond

....., Co. H, 5 Reg't U. S. Col'd Cav.

Appears on

Company Descriptive Book
of the organization named above.

DESCRIPTION.

Age 18 years; height 5 feet 6 inches.

Complexion Black

Eyes Blk; hair Blk

Where born Bayle Ky

Occupation farmer

ENLISTMENT.

When Sept 8, 186 +

Where Camp Nelson

By whom J. Randolph, term 3 y'rs.

Remarks:

.....

.....

.....

.....

.....

.....

.....

.....

.....

.....

.....

.....

.....

.....

.....

.....

.....

.....

.....

.....

.....

.....

.....

.....

.....

.....

.....

.....

.....

.....

.....

.....

.....

.....

.....

.....

.....

.....

.....

.....

.....

.....

.....

.....

.....

.....

J. E. Purke

R,

5 Cav.

U.S.C.T.

Joseph Richmond

Priv., Co., 5 Reg't U. S. Col'd Cavalry.

Appears on

Company Muster-in and Descriptive Roll

of the organization named above. Roll dated

Camp Nelson Ky, N. Y., Oct. 29, 1864.

Where born Boyle Ky.

Age 18 y'rs; occupation Farmer.

When enlisted Sept, 8, 1864.

Where enlisted Camp Nelson Ky.

For what period enlisted 3 years.

Eyes Black; hair Black

Complexion Black; height 5 ft. 6 in.

When mustered in Sept, 8, 1864.

Where mustered in Camp Nelson Ky.

Bounty paid \$ 100; due \$ 100

Where credited 7th Dist. Ky.

Company to which assigned

Remarks:

X Mrs. Mary T. Taylor.

X # Supposed to be name of owner.

Added May 17, 98. H. K. J.

Book mark:

(356d)

Copyist.

Joseph Richmond.
Priv., Co. G, 5 Reg't U. S. Col'd Cavalry.

Appears on

Company Muster Roll

for *Enll. to Oct. 31*, 1864.

Present or absent *Absent.*

Stoppage, \$ *100* for

Due Gov't, \$ *100* for

Valuation of horse, \$ *100*

Valuation of horse equipments, \$ *100*

Remarks: *On detail service
Burnside Point Ky. -
Oct. 14/64*

Book mark: _____

(358)

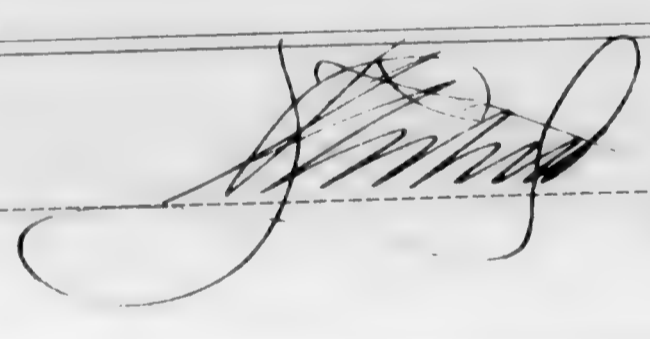

Copyist.

R

5 Cav.

U.S.C.T.

Joseph Richmond

Pvt., Co. G, 5 Reg't U. S. Col'd Cavalry.

Appears on

Company Muster Roll

for Nov. & Dec., 1864.

Present or absent Absent.

Stoppage, \$ 100 for

Due Gov't, \$ 100 for

Valuation of horse, \$ 100

Valuation of horse equipments, \$ 100

Remarks: On detached service at Point Burnside Ky. P. & 2nd installments Bounty due.

Book mark:

(358)

[Signature]

Copyist.

R,

5 Cav.

U.S.C.T.

Joseph Richmond

Pvt., Co. G, 5 Reg't U. S. Col'd Cavalry.

Appears on

Company Muster Roll

for Jan. 1st 1865.

Present or absent Present,

Stoppage, \$ 100 for

Due Gov't, \$ 100 for

Valuation of horse, \$ 100

Valuation of horse equipments, \$ 100

Remarks:

See U. S. for Ord. 25th 1st installment Bounty \$100.00 due.

Book mark:

[Signature]

(358)

Copyist.

R. | 5 Cav. | U.S.C.T.

Joseph Redman
Pvt., Co. G, 5 Reg't U. S. Col'd Cavalry.

Appears on

Company Muster Roll

for Dec. & Apl., 1865.

Present or absent Present

Stoppage, \$ 100 for

Due Gov't, \$ 100 for

Valuation of horse, \$ 100

Valuation of horse equipments, \$ 100

Remarks: 1st Instated.
Duty \$100 due.

Book mark: *

(358)

W. M. [Signature]
Copyist.

5 Cav. U.S.C.T.

Joseph Richmond
Sgt., Co. G, 5 Reg't U. S. Col'd Cavalry.

Appears on

Company Muster Roll

for May 1st 1865.

Present or absent Present

Stoppage, \$ 100 for

Due Gov't, \$ 100 for

Valuation of horse, \$ 100

Valuation of horse equipments, \$ 100

Remarks: First Installment
Payable due \$100

Book mark:

(358)

[Signature]

Copyist.

S.

5 Cav. U.S.C.T.

Joseph Richmond
Sgt., Co. G, 5 Reg't U. S. Col'd Cavalry.

Appears on

Company Muster Roll

for *July - Aug.*, 1865.

Present or absent *Absent*

Stoppage, \$ 100 for

Due Gov't, \$ 100 for

Valuation of horse, \$ 100

Valuation of horse equipments, \$ 100

Remarks: *In confinement*
Military Prison,
Leavenworth, since
Aug. 13, 65

Book mark:

(358)

Leavenworth
Copyist.

Q. | **5 Cav.** | **U.S.C.T.**

Joseph G. Gachman
Sgt., Co. G, 5 Reg't U. S. Col'd Cavalry.

Appears on

Company Muster Roll

for *Sept 1st*, 186*3*.

Present or absent *Present*

Stoppage, \$ 100 for

Due Gov't, \$ 100 for

Valuation of horse, \$ 100

Valuation of horse equipments, \$ 100

Remarks: *Det Military Prison at Georgetown, D.C.*

Book mark: _____

(358)

G. Gachman Copyist.

J. J.

5 Cav. U.S.C.T.

Joseph J. Richmond
Co. G, 5 Reg't U. S. Col'd Cavalry.

Appears on

Company Muster Roll

for *Nov 1865*, 1865.

Present or absent *Present*

Stoppage, \$ *100* for

Due Gov't, \$ *100* for

Valuation of horse, \$ *100*

Valuation of horse equipments, \$ *100*

Remarks: *Not installed
family due to*

Book mark:

(358)

J. J. Richmond
Copyist.

F

5 Cav.

U.S.C.T.

Joseph Richmond

Priv., Co. G, 5 Reg't U. S. Col'd Cavalry.

Appears on

Company Muster Roll

for *Jan'y & Feb'y*, 1866.

Present or absent *Present*

Stoppage, \$ *100* for

Due Gov't, \$ *100* for

Valuation of horse, \$ *100*

Valuation of horse equipments, \$ *100*

Remarks: *Due U.S. for ord. \$ $\frac{53}{100}$*

Book mark: _____

Fuller

(358)

Copyist.

R

5 Cav. U.S.C.T.

Joseph Richmond
Private, Co. G, 5 Reg't U. S. Colored Cav.

Appears on Returns as follows:

Oct. to Dec. 1864. - Absent on
det. serv. at Burnside
Point Oct. 11/64.

Aug. to Oct. 1865. - Absent
in mil. Prison Alex-
ington Ky. since
Aug. 13/65

Book mark :

(546)

G. Thomson

Copyist.

E

5 Cav.

U.S.C.T.

Joseph Richmond

Det., Co. *E*, 5 Reg't U. S. Col'd Cavalry.

Appears on **Co. Muster-out Roll**, dated

Ark. Meh. 16, 1866.

Muster-out to date

Meh. 16 1866.

Last paid to

Dec. 31, 1865.

Clothing account:

Last settled....., 186 ; drawn since \$..... 100

Due soldier \$..... 100; due U. S. \$ *54* ^{*27*}/₁₀₀

Am't for cloth'g in kind or money adv'd \$..... 100

Due U. S. for arms, equipments, &c., \$..... ^{*53*}/₁₀₀

Bounty paid \$ *100* 100; due \$ *100* 100

Remarks: *Slave - 1000 U.S. for Ordnance*
*ance: \$ ^{*53*}/₁₀₀*

Book mark: *498, 814*

P. H. C. C.

(361)

Copyist.

Richmond Joseph

P, Co. G, 5 Reg't U. S. Caval

Enclosures.

Bed Cards	Final Statements
Burial Records	Furloughs or L. of A.
Certs. of Dis. for Discharge	Med. Certificates
C. M. Charges	Med. Des. Lists
Descriptive Lists	Orders
Discharge Certificates	Pris. of War Record
Enlistment Papers	Resignations

Other papers relating to—

Admission to Hosp'l	Furlough or L. of A.
Casualty Sheet	Med. Examination
Confinement	Misc. Information
Contracts	Pay or Clothing
Death or Effects	Personal Reports
Desertion	Rank
Discharge from Hosp'l	Transfer to Hosp'l
Discharge from Service	Transfer to V. R. C.
Duty	Transportation

Joseph Kestelman
100 G

Adjutant General's Office,

COLORED TROOPS BRANCH,

March 21, 1871

Vol. C. T., 187

Wanted in case of

3 Reg't

James Richmond, Co. G,
1st Col. Col., in uniform relative to
said volume re 1st Reg't Col. Aug. 1865 re 1st Reg't
1st Col. Col. in uniform re 1st Reg't Col. Aug. 1865 re 1st Reg't

Respectfully,

C. A. Woodward
Chief Clerk.

J. H. Halton

Adjutant General's Office,

Record Room

March 31, 1871

Vol. C. T., 187

Reply in case of

5 Reg't

1st Joseph Richmond, Co. G,
U.S. C. Cav.

Co. Morning Rep. book shows Aug. 13 '65 in Conf. at
Lexington Ky. - Nov. 5 '65 Released from conf. at Lexington
Records of Gen. Mar. Gen. Dept. Dist. Ky. show: Joel Richmond Pvt. of Co. I
5 USC. confined at Lexington Ky. Aug. 14 '65. - Charges, disposition
re not given. No evidence relative to charges, trial &c.
There are no Registers of Prisoners of Lexington Ky. for '65 on file.

M.F.

Richmond Wallace

Co K, 5 U. S. Col'd Cav.

Private | *Private*

CARD NUMBERS.

1	5368863	26
2	5368951	27
3	5369052	28
4	5369130	29
5	5369227	30
6	5369314	31
7	5369402	32
8	5369488	33
9	5369573	34
10	5369658	35
11	5369739	36
12	4091106	37
13	43145491	38
14	40730252	39
15		40
16		41
17		42
18		43
19		44
20		45
21		46
22		47
23		48
24		49
25		50

Book Mark:

See also

R | 5 Cav. | U.S.C.T.

Wallace Richmond

, Co. *K*, 5 Reg't U. S. Col'd Cav.

Appears on

Company Descriptive Book
of the organization named above.

DESCRIPTION.

Age *20* years; height *5* feet *6* inches.

Complexion *Black*

Eyes *Blue*; hair *Black*

Where born *Wise Co Va*

Occupation *Farmer*

ENLISTMENT.

When *Aug 26, 1864.*

Where *Louisa Ky*

By whom *Capt Hays*; term *3* y'rs.

Remarks:

(383g)

A J Anderson

Coppist.

19. |

5 bar

U.S.A.

Wallace Richmond

Appears with rank of Pvt on

Muster and Descriptive Roll

of a Detachment of U.S. Colored
Recruits forwarded

Roll dated
Landon Ky, Aug 26, 1864.

Where born Misc Co Va

Age 20 years; occupation Farmer

When enlisted Aug. 22, 1864.

Where enlisted Landon Ky

For what period enlisted 3 years.

Eyes Black; hair Black

Complexion Black; height 5 ft. 6 in.

When mustered in Aug. 26, 1864.

Where mustered in Landon Ky

Bounty paid \$ 100; due \$ 100

Clothing account:

Last settled _____, 186 ; drawn since \$ 100

Date of first muster Aug. 22, 1864.

Company to which assigned _____

Remarks: Credited to Laurel Co. &

Sgt. My. owner John

Richmond Scott Co Va

Contraband

Book mark : _____

W. Potter

(356m)

Copyist.

B

5 Cav.

U.S.C.T.

Wallace Richmond

Pvt., Co. 17, 5 Reg't U. S. Col'd Cavalry.

Appears on

Company Muster-in and Descriptive Roll

of the organization named above. Roll dated

Camp Nelson Ky, N.Y., Oct 30, 1864.

Where born Wife Virginia

Age 20 y'rs; occupation Farmer

When enlisted Aug 22, 1864.

Where enlisted London

For what period enlisted 3 years.

Eyes Blk; hair Blk

Complexion Blk; height 5 ft. 6 in.

When mustered in Aug 26, 1864.

Where mustered in London

Bounty paid \$ 100; due \$ 100

Where credited 8 Dist Ky

Company to which assigned

Remarks: * John Richmond

*Supposed to be name of owner

Book mark:

H Miller

(356d)

Copyist.

R | **5 Cav.** | **U.S.C.T.**

Wallace Richmond

Pvt., Co. K, 5 Reg't U. S. Col'd Cav.

Appears on

Company Muster Roll

for *Organization to Oct 31, 1864.*

Present or absent *Present*

Stoppage, \$ *100* for

Due Gov't, \$ *100* for

Valuation of horse, \$ *100*

Valuation of horse equipments, \$ *100*

Remarks:

Book mark:

H. S. Miller

(358)

Copyist.

A | **5 Cav.** | **U.S.C.T.**

Mallice Richmond

Pvt, Co. K, 5 Reg't U. S. Col'd Cav.

Appears on

Company Muster Roll

for *Nov & Dec*, 1864.

Present or absent *Present*

Stoppage, \$ *100* for

Due Gov't, \$ *100* for

Valuation of horse, \$ *100*

Valuation of horse equipments, \$ *100*

Remarks: *1" & 2" instalments*
Bounty due

Book mark:

H S Miller

(358)

Copyist.

R

5 Cav.

U.S.C.T.

Wallace Richmond

Pvt, Co. K, 5 Reg't U. S. Col'd Cav.

Appears on

Company Muster Roll

for *Jan & Feb*, 186*5*.

Present or absent *Present*

Stoppage, \$ *100* for

Due Gov't, \$ *100* for

Valuation of horse, \$ *100*

Valuation of horse equipments, \$ *100*

Remarks: *1" & 2" installments -
\$200 Bounty due*

Book mark:

H. J. Miller

(358)

Copyist.

A 5 Cav U.S.C.T

Wallace Richmond
Pvt, Co. H, 5 Reg't U. S. Col'd Cav

Appears on

Company Muster Roll

for Mar & Apr, 1865.

Present or absent Present

Stoppage, \$ 100 for

Due Gov't, \$ 100 for

Valuation of horse, \$ 100

Valuation of horse equipments, \$ 100

Remarks: 1st installment of
Bounty due \$100

Book mark:

H Miller

(358)

Copyist.

R

5 Cav.

U.S.C.T.

Wallace Richmond

Prof, Co. K, 5 Reg't U. S. Col'd Cav.

Appears on

Company Muster Roll

for May & June, 1865.

Present or absent Present

Stoppage, \$ 100 for

Due Gov't, \$ 100 for

Valuation of horse, \$ 100

Valuation of horse equipments, \$ 100

Remarks: First installment bounty due \$100

Book mark:

J. E. Porter

(358)

Copyist.

R

5 Cav.

U.S.C.T.

Wallace Richmond

Prov, Co. K, 5 Reg't U. S. Col'd Cav.

Appears on

Company Muster Roll

for July & Aug, 1865.

Present or absent Present

Stoppage, \$ 100 for

Due Gov't, \$ 100 for

Valuation of horse, \$ 100

Valuation of horse equipments, \$ 100

Remarks:

Book mark:

J. E. Porter

(358)

Copyist.

(A)

5 Cav.

U.S.C.T.

Wallace Richmond

Prov., Co. K, 5 Reg't U. S. Col'd Cav.

Appears on

Company Muster Roll

for *Sept & Oct*, 186*5*.

Present or absent *Present*

Stoppage, \$ *100* for

Due Gov't, \$ *100* for

Valuation of horse, \$ *100*

Valuation of horse equipments, \$ *100*

Remarks: *Daily duty at Reg't I. M. Dept*

Book mark:

J. E. Porter

(358)

Copyist.

R

5 Cav.

U.S.C.T.

Wallace Richmond

Prov, Co. K, 5 Reg't U. S. Col'd Cav.

Appears on

Company Muster Roll

for Nov & Dec, 1860.

Present or absent Present

Stoppage, \$ 100 for

Due Gov't, \$ 100 for

Valuation of horse, \$ 100

Valuation of horse equipments, \$ 100

Remarks: Due U.S for Ord
60. Present sick in
Regil Hospital

Book mark:

J. E. Porter

(358)

Copyist.

R

5 Cav. U.S.C.T.

Wallace Richmond

Capt., Co. K, 5 Reg't U. S. Col'd Cav.

Appears on

Company Muster Roll

for Jan Feb, 1866.

Present or absent Present

Stoppage, \$ 100 for

Due Gov't, \$ 100 for

Valuation of horse, \$ 100

Valuation of horse equipments, \$ 100

Remarks: 2^d instalment bounty due \$100.

Book mark:

E. N. Brown

(358)

Copyist.

R | 5 Cav. | U.S.C.T.

Wallace Richmond

Pvt., Co. K, 5 Reg't U. S. Colored Cav.

Appears on Returns as follows:

Sept. & Oct. 1865. - On daily
duty as teamster
at Reg't. I. M. Dept

Jan. 1866. - Absent sick
in Hosp. at Helena
Ark.

Book mark :

(546)

E. J. Thomson

Copist.

R | **5 Cav.** | **U.S.C.T.**

Wallace Richmond
Cs, Co. K, 5 Reg't U. S. Col'd Cavalry.

Appears on **Co. Muster-out Roll**, dated
Valencia Ark, Mich 16, 1866.
Muster-out to date Mich 16, 1866.
Last paid to Dec 31, 1865.

Clothing account:

Last settled....., 186 ; drawn since \$..... 100

Due soldier \$..... 100; due U. S. \$ 20 ⁶⁴/₁₀₀

Am't for cloth'g in kind or money adv'd \$..... 100

Due U. S. for arms, equipments, &c., \$..... 100

Bounty paid \$ 100 100; due \$ 100 100

Remarks:

Book mark:

E. H. Brown.

Co

50

Printed

BOARD NUMBERS

1	5359262	26
2	537405	27
3	5371491	28
4	5371575	29
5	5371668	30
6	5371744	31
7	9091335	32
8	R64-CJ-1874	33
9	40730240	34
10		35
11		36
12		37
13		38
14		39
15		40
16		41
17		42
18		43
19		44
20		45
21		46
22		47
23		48
24		49
25		50

Book Mark: 5187-B-88

R 64-CJ-1874

See also 72 M.S.C. Inf.

22 | 5-600 | U.S.C.T.

Charles Redmont
Comd, 5th Reg't U. S. Col'd Cav

Appears on

Company Descriptive Book

of the organization named above.

DESCRIPTION.

Age 28 years; height 5 feet 8 inches.

Complexion Dark

Eyes Blue; hair Black

Where born Passes Ohio

Occupation Clerk

ENLISTMENT.

When Feb 11, 1865.

Where Columbus Oh

By whom Capt. Nesbit; term 1 yr.

Remarks:

A. J. Anderson

(3837)

Copyist.

R | 5th Cav | U.S.C.T.

Charles Rideout

Pvt, Co. 5th Reg't U. S. Col'd ^{Leav}

Appears on

M. and D. Roll of Men Transferred

to the organization named above,

from ⁷ Camp Nelson, Ky, July 18, 1865.

Roll dated

When enlisted Feb 11, 1865.

Period for which enlisted 1 years.

When mustered in Feb 11, 1865.

Present or absent Not Stated

Company to which assigned

Remarks: 7 D Q

*Inserted by J. S. Dowd, Ex

Book mark: R. 64. Q. 5 - 1874

Abbon

(342)

Copyist.

R

5 Cav. | U.S.C.T.

Charles Ridout

M- Co. M, 5 Reg't U. S. Col'd Cavalry.

Appears on

Company Muster Roll

for July & Aug, 1865.

Present or absent Present

Stoppage, \$ 100 for

Due Gov't, \$ 100 for

Valuation of horse, \$ 100

Valuation of horse equipments, \$ 100

Remarks: Transferred from 72 U.S.C. I. in accordance with S.O. No 132 D.K. date July 27th 1865

Book mark:

(358)

C. W. C. Copyist.

R

5 Cav. | U.S.C.T.

Charles Redmont

M-, Co. M, 5 Reg't U. S. Col'd Cavalry.

Appears on

Company Muster Roll

for *Sept & Oct*, 186*5*.

Present or absent *Present*

Stoppage, \$ *100* for

Due Gov't, \$ *100* for

Valuation of horse, \$ *100*

Valuation of horse equipments, \$ *100*

Remarks: *Due US for Capt
Mansie # 1.55.
Advance # 5.76*

Book mark:

W. W. [Signature]
Copyist.

R

5 Cav. | U.S.C.T.

Charles Ridant

No. , Co. M, 5 Reg't U. S. Col'd Cavalry.

Appears on

Company Muster Roll

for Nov & Dec, 1865.

Present or absent Present

Stoppage, \$ 100 for

Due Gov't, \$ 100 for

Valuation of horse, \$ 100

Valuation of horse equipments, \$ 100

Remarks:

Book mark:

Leuty
Copyist.

(358)

R

5 Cav. | U.S.C.T.

Charles Redout

Pvt, Co. M, 5 Reg't U. S. Col'd Cavalry.

Appears on

Company Muster Roll

for Jan + Feb, 1866.

Present or absent

Stoppage, \$ 100 for

Due Gov't, \$ 100 for

Valuation of horse, \$ 100

Valuation of horse equipments, \$ 100

Remarks: Discharged at Helena,
Ark Feb 11. 66 per expiration
of service

Book mark:

Hynes

(358)

Copyist.

P

5 Cav. U.S.C.T.

Charles Rideout

Priv., Col. M., 5 Reg't U. S. Colored Cav.

Appears on Returns as follows:

July 1865. - Paid July 27
'65 Paris Ky. Travel
to M Co. per P.O.
No. 132 July 27/65

Feb. 1866. - Adv Feb. 11
Helena Ark. Disch
expiration of ser-
vice.

Book mark :

E. Thornton

(546)

Copyist.

R

5 Cav.

U.S.C.T.

Charles Rideout

Plt, Co. M, 5 Reg't U. S. Col'd Cavalry.

Appears on Co. Muster-out Roll, dated

Helena Ark, Mar 16, 1866.

Muster-out to date

Mar 16, 1866.

Last paid to

Dec. 31, 1865.

Clothing account:

Last settled....., 186 ; drawn since \$..... 100

Due soldier \$ 17 ⁹⁸/₁₀₀; due U. S. \$..... 100

Am't for cloth'g in kind or money adv'd \$..... 100

Due U. S. for arms, equipments, &c., \$..... 100

Bounty paid \$..... 100; due \$ 100 100

Remarks: Transferred from 72nd U S C Inf to 5 U S C Cav. per S O. 117 dated Hd Qrs. Opt. Ky July 27, '65. Assigned to Co per Reg O. 132, '65. Free Apr. 19, '61

Book mark: 5187. B-'88

(861)

J. Lyons

Copyist.

R | 5th Cav | U.S.C.S.

Charles Rideout

, Co. M, 5th Reg't U.S.C. Cav.

NOTATION.

Book mark: 5187-B-1888. with
R-64. Co. J-1874.

War Department,

Adjutant General's Office,

Washington. June 20, 1888.

Application for certificate in lieu of lost discharge.

one Certificate furnished.

(476)

W. J. Allen

Copist.

Hidgely Co.

Co. L, 5 U. S. Col'd Cav.

Private | *Private*

CARD NUMBERS.

1	5369846	26
2	5369941	27
3	5370034	28
4	5370135	29
5	5370182	30
6	5370317	31
7	5370403	32
8	5370488	33
9	5370583	34
10	5370655	35
11	5370726	36
12	9091195	37
13	43148134	38
14	40730253	39
15		40
16		41
17		42
18		43
19		44
20		45
21		46
22		47
23		48
24		49
25		50

Book Mark:

See also

D 1348207 - P.O. Man
S-1675812 - P.O. Aff

D 1788051 P.O. aff

D. 2847407 And wd

S-2894729 " "

P.O. on 4 in Gy. 988501

4/12/17 EAC

2. 111 - Hdr aff - 4/12/17 use

J.B. Donald
Exp

R | **5 Cav. | U.S.C.T.**

Ed Ridgely

, Co. *L*, 5 Reg't U. S. Col'd Cav.

Appears on

Company Descriptive Book
of the organization named above.

DESCRIPTION.

Age *18* years; height *5* feet *7* inches.

Complexion *Copper*

Eyes *Blu*; hair *Blu*

Where born *Kentucky*

Occupation *Laborer*

ENLISTMENT.

When *Substitute*, 186 .

Where *7 Dist Ky*

By whom; term *3* y'rs.

Remarks:

A. J. Anderson

(383g)

Copist.

5 bar U.S.A.

Ed. Ridgely

Appears with rank of P.D. on

Muster and Descriptive Roll

of Detachment of U.S. Colored
Troops, forwarded

Roll dated

Louisville, Ky., Oct. 4, 1864.

Where born Kentucky

Age 18 years; occupation Lighter

When enlisted , 186 .

Where enlisted

For what period enlisted 3 years.

Eyes Blue; hair Black

Complexion Copper; height 5 ft. 7 in.

When mustered in Sept. 21, 1864.

Where mustered in Lexington

Bounty paid \$ 100; due \$ 100

Clothing account:

Last settled , 186 ; drawn since \$ 17⁵⁰ 100

Date of first muster Sept. 21, 1864.

Company to which assigned

Remarks: Credited to 7 long

hair Ky.

Substitute

Book mark:

(356m)

W. M. Jackson

Copyist.

R

5 Cav. U.S.C.T.

Ed Ridgeli

Pvt, Co. D, 5 Reg't U. S. Col'd Cavalry.

Appears on

Company Muster-in and Descriptive Roll

of the organization named above. Roll dated

Camp Nelson, Ky, Oct 30, 1864.

Where born Kentucky

Age 18 y'rs; occupation Laborer

When enlisted, 186 .

Where enlisted

For what period enlisted 3 years.

Eyes Black; hair Black

Complexion Copper; height 5 ft. 7 in.

When mustered in Sept 21, 186 .

Where mustered in Lexington

Bounty paid \$ 100; due \$ 100

Where credited 7 Dist Ky

Company to which assigned

Remarks:

Substitute

Book mark:

Brade

(356d)

Copyist.

R

5 Cav. U.S.C.T.

Ed Riggely
Pr

Co. L, 5 Reg't U. S. Col'd Cavalry.

Appears on

Company Muster Roll

for dated Oct 31, 1864

Present or absent Absent

Stoppage, \$ 100 for

Due Gov't, \$ 100 for

Valuation of horse, \$ 100

Valuation of horse equipments, \$ 100

Remarks: On det serv
Washville Tenn
Oct 15/64

~

Book mark:

Bruder

(358)

Copyist.

R | 5 Cav. | U.S.C.T.

Ed Riggley

Por, Co. L, 5 Reg't U. S. Col'd Cavalry.

Appears on

Company Muster Roll

for Nov & Dec, 186

Present or absent Absent

Stoppage, \$ 100 for

Due Gov't, \$ 100 for

Valuation of horse, \$ 100

Valuation of horse equipments, \$ 100

Remarks: Quid det Serv
Nashville Tenn
Oct 15/64.

Book mark:

Bradley

(358)

Copyist.

R

5 Cav. U.S.C.T.

Ed Riggely

Pat, Co. L, 5 Reg't U. S. Col'd Cavalry.

Appears on

Company Muster Roll

for Jany & Fley, 1865.

Present or absent Absent

Stoppage, \$ 100 for

Due Gov't, \$ 100 for

Valuation of horse, \$ 100

Valuation of horse equipments, \$ 100

Remarks Indismounted
Camp Camp Nelson
Ky

Book mark:

B. W. W.

(358)

Copyist.

R | 5 Cav. | U.S.C.T.

Ed Reggsley

Cpl, Co. L, 5 Reg't U.S. Col'd Cavalry.

Appears on

Company Muster Roll

for *Muster Roll*, 1865.

Present or absent *Present*

Stoppage, \$ 100 for

Due Gov't, \$ 100 for

Valuation of horse, \$ 100

Valuation of horse equipments, \$ 100

Remarks *Appt to Corp
per RO no 46
dated Camp
Mexico Apr 1/65
left to rank
from Apr 1/65*

Book mark:

B. B. B.

R. | **5 Cav. | U.S.C.T.**

Ed. Ridgway

Rt., Co. L, 5 Reg't U. S. Col'd Cavalry.

Appears on

Company Muster Roll

for *May & June, 1865.*

Present or absent *Present*

Stoppage, \$ *100* for

Due Gov't, \$ *100* for

Valuation of horse, \$ *100*

Valuation of horse equipments, \$ *100*

Remarks: *Reappointed Corp'l.
Per R.O. No. 46
Apr. 6. 65 to rank
From April 1. 1865.
Reduced to the
ranks per R.O. No. 70
May 4. 65*

Book mark:

Proctor

P

5 Cav. | U.S.C.T.

Ed. Ridgely

Pvt, Co. L, 5 Reg't U. S. Col'd Cavalry.

Appears on

Company Muster Roll

for *July & Aug*, 1865.

Present or absent *Present*

Stoppage, \$ 100 for

Due Gov't, \$ 100 for

Valuation of horse, \$ 100

Valuation of horse equipments, \$ 100

Remarks:

Book mark: _____

Rocheater

(358)

Copyist.

10

5 Cav. | U.S.C.T.

Ed. Ridgely
Prvt, Co. L, 5 Reg't U. S. Col'd Cavalry.

Appears on

Company Muster Roll

for *Sept & Oct*, 1865.

Present or absent *Present*

Stoppage, \$ *100* for

Due Gov't, \$ *100* for

Valuation of horse, \$ *100*

Valuation of horse equipments, \$ *100*

Remarks: *In daily duty as
Company Cook*

Book mark:

Pro Master

R | **5 Cav.** | **U.S.C.T.**

E. Ridgely
Rt, Co. L, 5 Reg't U.S. Col'd Cavalry.

Appears on

Company Muster Roll

for *W. Mc*, 186*2*.

Present or absent *Present*

Stoppage, \$ *100* for

Due Gov't, \$ *100* for

Valuation of horse, \$ *100*

Valuation of horse equipments, \$ *100*

Remarks: *Indaily duty as
Company cook*

Book mark:

(358)

Rockester

Copyist.

R

5 Cav. U.S.C.T.

Ed. Redgely

Pl, Co. L, 5 Reg't U.S. Col'd Cavalry.

Appears on

Company Muster Roll

for *Jan, Feb.*, 186*t.*

Present or absent *Present*

Stoppage, \$ *100* for

Due Gov't, \$ *100* for

Valuation of horse, \$ *100*

Valuation of horse equipments, \$ *100*

Remarks: *On daily duty as Company Clerk.*

Book mark:

O. P. Taylor

(358)

Copyist.

R

5 Cav. U.S.C.T.

Ed Ridgely

Pvt., Co. F, 5 Reg't U. S. Colored Cav.

Appears on Returns as follows:

Oct. to Dec. 1864. - Absent
on det. serv. Wash -
ville Penn. Oct 15/64

Jan. & Feb. 1865. - Absent
in Dismounted Camp
Camp Nelson Ky.

Oct. 1865. - On daily duty
Co. Cook.

Dec. 1865 to Feb. 1866. - On
duty Co. Cook.

* name appears also as Ed
Riggely.

Book mark :

E. J. Thomson

(546)

Copist.

R | 5600 - U.S.C.T.

Ed Ridgely

Priv, Co. L., 5 Reg't U. S. Col'd Cavalry

Appears on Co. Muster-out Roll, dated Helena, Ark, Mar. 16, 1866.

Muster-out to date Mar. 16, 1866.

Last paid to Dec. 31, 1865.

Clothing account:

Last settled _____, 1866 ; drawn since \$ 100

Due soldier \$ 31 ¹¹/₁₀₀; due U. S. \$ 100

Am't for cloth'g in kind or money adv'd \$ 100

Due U. S. for arms, equipments, &c., \$ 100

Bounty paid \$ 100; due \$ 100

Remarks: Slave. Was Priv. to April 1st, 65 Then Corp'l. to May 4th. Then Private.

Book mark :

O. T. Taylor

(361)

Copyist.

Bridges Edmund
Co. *L*, 5 Reg't US Cavalry

~~4~~ Enclosures.

Bed Cards	Final Statements
Burial Records	Furloughs or L. of A.
Certs. of Dis. for Discharge	Med. Certificates
C. M. Charges	Med. Des. Lists
Descriptive Lists	Orders
Discharge Certificates	Pris. of War Record
Enlistment Papers <i>2</i>	Resignations

Other papers relating to—

Admission to Hosp'l	Furlough or L. of A.
Casualty Sheet	Med. Examination
Confinement	Misc. Information
Contracts	Pay or Clothing
Death or Effects	Personal Reports
Desertion	Rank
Discharge from Hosp'l	Transfer to Hosp'l
Discharge from Service	Transfer to V. R. C.
Duty	Transportation
<i>Receipts 1</i>	

Statement of Service Reference Slip.

Office Pension

Claim No. ex. 988501

Ed Ridgely
(Name.)

, Co. I, 5 Reg't U.S.C. Army

To Med Div. April 12, 1917

For med rec,

no med p.p.

11-30

Johnson
7. EOC

add

No medical record found

✓ 4 cds ret'd

Statement furnished

Apr. 12, 1917

D. J. M.

B

No. 23

Edmund Bridges (Cad)

Enlisted at Lexington Ky.

As Substitute for

George M Parkley

On the 21st day of Sept, 1864.

By

Geo H Moon

Alonso Brown

E. J. Gano

Board of Enrollment,

7 Dist. of Kentucky

SUBSTITUTE
VOLUNTEER ENLISTMENT.

STATE OF

Kentucky



TOWN OF

Lexington

I, *Edmund Bridgy (Coed)* born in the State
of *Kentucky*, aged *Eighteen* years, and by
occupation a *Labourer*

Do HEREBY ACKNOWLEDGE to have agreed with
George M Parkley, Esq., of *Jessamine County*
State of Kentucky

to become his **SUBSTITUTE** in the Military Service, for a sufficient consideration paid and
delivered to me, on the *twenty first* day of *September*, 186*4*,
and having thus agreed with said *Geo M Parkley*, I DO HEREBY
ACKNOWLEDGE to have enlisted this *twenty first* day of *September*,
186*4*, to serve as a **Soldier** in the **Army of the United States of America**, for the period
of **THREE YEARS**, unless sooner discharged by proper authority: I do also agree to accept such
bounty, pay, rations, and clothing, as are, or may be, established by law for soldiers. And I do
solemnly swear that I will bear true and faithful allegiance to the **United States of America**;
that I will serve them honestly and faithfully against all their enemies or opposers whomsoever;
and that I will observe and obey the orders of the President of the United States, and the orders
of the Officers appointed over me, according to the Rules and Articles of War.

SWORN and subscribed to, at *Lexington Ky*
this *21st* day of *Sept*, 186*4*

BEFORE *Thos H Moore*
Capt & Pro Marshal
of Dist Ky

Edmund Bridgy
mark

We certify, on honor, That we have carefully examined the above-named Volunteer Substitute
agreeably to the Regulations, and that, in our opinion, he is free from all bodily defects and mental infirmity
which would in any way disqualify him from performing the duties of a soldier; that he was entirely sober
when enlisted; that he is of lawful age, (not under 18 years;) and that, in accepting him as duly qualified to
perform the duties of an able-bodied soldier, and as a Substitute in lieu of *George M*
Parkley drafted in *Jessamine County, State of Kentucky*
Sept 20th, 186*4*, we have strictly observed the Regulations which govern
in such cases. This soldier has *Black* eyes, *Blade* hair, *Light* complexion; is *Five* feet
inches high.

Thos H Moore
Provost Marshal.

Alanda Brown
Commissioner of Board.

J. J. Hans
Surgeon of Board.

Board of Enrollment of *4th* Dist. of *Kentucky*

DECLARATION OF SUBSTITUTE.

I, Edmund Bridges (Col) desiring to ENLIST
in the Army of the United States, for THREE YEARS, **Do declare**, That I am
Eighteen years and _____ months of age; that I have
never been discharged from the United States service on account of disability or by sentence of
a court martial; and I know of no impediment to my serving honestly and faithfully as a soldier
for three years.

GIVEN at Springtown N.Y.
the 21st day of September 1864

WITNESS:

Geo W Miller

Edmund Bridges
mark

Br² 31
No. 31

Edmund Bridges (Act)

Enlisted at Lexington Ky

As Substitute for

George W Parkley

On the 21st day of Sep^r, 1864.

By

Thos H. Mober

Oliver Brown

L. J. Gano

Board of Enrollment,

7 Dist. of Kentucky

1st 11th 5. U. C. C.

SUBSTITUTE VOLUNTEER ENLISTMENT.

STATE OF

Kentucky

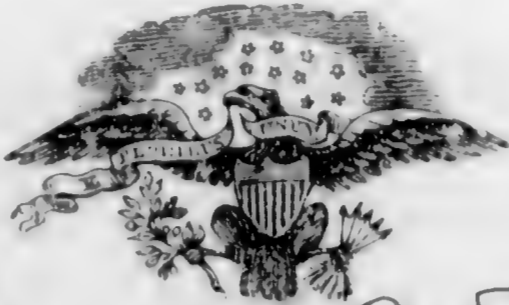

TOWN OF

Lexington

I, *Edmund Bridges* born in the State of *Kentucky*, aged *Eighteen* years, and by occupation a *Laborer*

Do HEREBY ACKNOWLEDGE to have agreed with *George M Barkley*, Esq., of *Jessamine County* State of *Kentucky*

to become his **SUBSTITUTE** in the Military Service, for a sufficient consideration paid and delivered to me, on the *twenty first* day of *September*, 186*4*;

and having thus agreed with said *George M Barkley*, I DO HEREBY ACKNOWLEDGE to have enlisted this *twenty first* day of *September*

186*4* to serve as a **Soldier** in the **Army of the United States of America**, for the period of **THREE YEARS**, unless sooner discharged by proper authority: I do also agree to accept such bounty, pay, rations, and clothing, as are, or may be, established by law for soldiers. And I do solemnly swear that I will bear true and faithful allegiance to the **United States of America**; that I will serve them honestly and faithfully against all their enemies or opposers whomsoever; and that I will observe and obey the orders of the President of the United States, and the orders of the Officers appointed over me, according to the Rules and Articles of War.

SWORN and subscribed to, at *Lexington Ky*

this *21st* day of *Sept*, 186*4*

BEFORE

John H Moore
Cap and Prov. Marshal
7. Dist Ky

Edmund Bridges
mark.

We certify, on honor, That we have carefully examined the above-named Volunteer Substitute agreeably to the Regulations, and that, in our opinion, he is free from all bodily defects and mental infirmity which would in any way disqualify him from performing the duties of a soldier; that he was entirely sober when enlisted; that he is of lawful age, (not under 18 years;) and that, in accepting him as duly qualified to perform the duties of an able-bodied soldier, and as a Substitute in lieu of *George M Barkley* Ky. Sept 20th, drafted in *Jessamine County* State of *Ky*, 186*4*, we have strictly observed the Regulations which govern in such cases. This soldier has *Black* eyes, *Black* hair, *Light* complexion; is *Five* feet *7* inches high.

John H Moore

Provost Marshal.

William Brown

Commissioner of Board.

L. J. Gano

Surgeon of Board.

Board of Enrollment of *7* Dist. of *Kentucky*

DECLARATION OF SUBSTITUTE.

I, Edmund Bridges (Col) desiring to ENLIST
in the Army of the United States, for THREE YEARS, **Do declare**, That I am
Eighteen years and months of age; that I have
never been discharged from the United States service on account of disability or by sentence of
a court martial; and I know of no impediment to my serving honestly and faithfully as a soldier
for three years.

GIVEN at Lexington Ky
the 21st day of September 1864

WITNESS:

Geoff Miller

Edmund Bridges
mark

Ned Garrett

Co K, 5 U. S. Col'd Cav.

Private Private

CARD NUMBERS.

1	5368864	26
2	5368979	27
3	5369229	28
4	5369316	29
5	5369404	30
6	5369490	31
7	5369575	32
8	5369660	33
9	5369741	34
10	9091107	35
11	43148274	36
12	40730245	37
13		38
14		39
15		40
16		41
17		42
18		43
19		44
20		45
21		46
22		47
23		48
24		49
25		50

Book Mark:

See also

R | 5 Cav. | U.S.C.T.

Garnett Reed

, Co. *K*, 5 Reg't U. S. Col'd Cav.

Appears on

Company Descriptive Book
of the organization named above.

DESCRIPTION.

Age *47* years; height *5* feet *8* inches.

Complexion *Mullatto*

Eyes *Blu*; hair *Blk*

Where born *Clark Co Ky*

Occupation *Labourer*

ENLISTMENT.

When *Oct 9*, 1864.

Where *Lexington*

By whom *J.H. Mum*; term *3* y'rs.

Remarks: *Missing in action*
Saltville Va Oct 27/64
Taken up from missing
in action April 17/64
Camp Nelson Ky.

A.J. Anderson

(3830)

Copist.

R

5 Cav. U.S.C.T.

Garrett Reed

Pvt., Co. H, 5 Reg't U. S. Col'd Cavalry.

Appears on

Company Muster-in and Descriptive Roll

of the organization named above. Roll dated

Camp Nelson Ky, N. Y., Oct. 30, 1864.

Where born Clark Ky

Age 47 y'rs; occupation Laborer

When enlisted Oct 7, 1864.

Where enlisted Lexington

For what period enlisted 3 years.

Eyes Blk; hair Blk

Complexion Mulatto; height 5 ft. 8 in.

When mustered in Oct 7, 1864.

Where mustered in Lexington

Bounty paid \$ 100; due \$ 100

Where credited 7 Dist Ky

Company to which assigned

Remarks:

Book mark:

A. S. Miller

(356d)

Copyist.

R. | 5 bar | U.S. 5

Garnett Ried

Appears with rank of Priv. on

Muster and Descriptive Roll

of Detachment of U.S. Col'd Vols.
forwarded to Genl. Rendezvous,
Camp Nelson, Ky. Roll dated
Lexington, Ky, Oct. 7, 1864.

Where born Clark Miss.

Age 47 years; occupation Laborer

When enlisted Oct. 7, 1864.

Where enlisted Lexington, Ky

For what period enlisted 3 years.

Eyes Blk; hair Blk

Complexion mul; height 5 ft. 8 in.

When mustered in _____, 1864.

Where mustered in _____

Bounty paid \$ 100; due \$ 100

Clothing account:
Last settled _____, 1864; drawn since \$ 100

Date of first muster Oct. 7, 1864.

Company to which assigned _____

Remarks: To be credited to
Franklin Co. 7 Dis. Ky

Book mark: _____

G. J. Harris

(356m)

Copyist.

R | 5 Cav. | U.S.C.T.

Garrett Kied

Pvt., Co. K, 5 Reg't U. S. Col'd Cav.

Appears on

Company Muster Roll

for *Organization to Oct 31*, 1864.

Present or absent

Stoppage, \$ 100 for

Due Gov't, \$ 100 for

Valuation of horse, \$ 100

Valuation of horse equipments, \$ 100

Remarks: *Missing in action*
Saltville Va Oct 2 1864

Roll book + Apr 65, next on
which name appears.

Book mark:

H S Miller

(358)

Copyist.

A

5 Cav

U.S.C.T

Garrett Reed

Pvt, Co. K, 5 Reg't U. S. Col'd Cav

Appears on

Company Muster Roll

for Mar & Apr, 1865.

Present or absent Present

Stoppage, \$ 100 for

Due Gov't, \$ 100 for

Valuation of horse, \$ 100

Valuation of horse equipments, \$ 100

Remarks: 1st installment of
Bounty due \$100
Taken up ^{26. April, 65} from missing in
action Oct 2/64.

*As it appears on roll.

Book mark:

H. S. Miller

(358)

Copyist.

R

5 Cav. U.S.C.T.

Garrett Ried

Prov, Co. K, 5 Reg't U. S. Col'd Cav.

Appears on

Company Muster Roll

for May & June, 1865.

Present or absent Present

Stoppage, \$ 100 for

Due Gov't, \$ 100 for

Valuation of horse, \$ 100

Valuation of horse equipments, \$ 100

Remarks: First installment
county due \$100

Book mark:

J. E. Porter

(358)

Copyist.

2

5 Cav.

U.S.C.T.

Garrett Ried

Prof, Co. K, 5 Reg't U. S. Col'd Cav.

Appears on

Company Muster Roll

for July & Aug, 1863.

Present or absent Present

Stoppage, \$ 100 for

Due Gov't, \$ 100 for

Valuation of horse, \$ 100

Valuation of horse equipments, \$ 100

Remarks:

Book mark:

J. E. Porter

(358)

Copyist.

A

5 Cav.

U.S.C.T.

Garrett Ried

Co. K, 5 Reg't U. S. Col'd Cav.

Appears on

Company Muster Roll

for Sept & Oct, 1865.

Present or absent Present

Stoppage, \$ 100 for

Due Gov't, \$ 100 for

Valuation of horse, \$ 100

Valuation of horse equipments, \$ 100

Remarks:

Book mark:

F. E. Porter

(358)

Copyist.

R

5 Cav.

U.S.C.T.

Garrett Reed

Prov, Co. K, 5 Reg't U. S. Col'd Cav.

Appears on

Company Muster Roll

for Nov & Dec, 1860.

Present or absent Present

Stoppage, \$ 100 for

Due Gov't, \$ 100 for

Valuation of horse, \$ 100

Valuation of horse equipments, \$ 100

Remarks:

Book mark:

J. E. Porter

(358)

Copyist.

Q

5 Cav. U.S.C.T.

Garratt Reid

Private, Co. K, 5 Reg't U. S. Col'd Cav.

Appears on

Company Muster Roll

for Jan Feb, 1866.

Present or absent Present

Stoppage, \$ 100 for

Due Gov't, \$ 100 for

Valuation of horse, \$ 100

Valuation of horse equipments, \$ 100

Remarks: 2 instalment bounty due \$ 100.

Book mark:

E. H. Brown

5 (358)

Copyist.

9

5 Cav.

U.S.C.T.

Harrett Reede

Priv., Co. K 5 Reg't U. S. Colored Cav.

Appears on Returns as follows:

Oct. 1864, - Lost Oct. 2, 64
Saltville Va. missing
in action.

Apr. 1865, - Main; Returned
from missing in
action Saltville Va.
2 Oct- 64

X name appears also as
Harrett Reid.

Book mark :

E. Thornton

(548)

Copyist.

R

5 Cav. U.S.C.T.

Garrett Reed

Priv, Co. *K*, 5 Reg't U. S. Col'd Cavalry.

Appears on Co. Muster-out Roll, dated

Helena Ark, *March 16*, 1866.

Muster-out to date *March 16*, 1866.

Last paid to *Dec 21*, 1865.

Clothing account:

Last settled....., 186 ; drawn since \$..... 100

Due soldier \$ *27* ^{*68*}/₁₀₀; due U. S. \$..... 100

Am't for cloth'g in kind or money adv'd \$..... 100

Due U. S. for arms, equipments, &c., \$..... 100

Bounty paid \$ *100* 100; due \$ *100* 100

Remarks:.....

Book mark:.....

E. H. Brown

Reid Garrett

P, Co. K 5 Reg't U. S. C. C.

Enclosures.

Bed Cards	Final Statements
Burial Records	Furloughs or L. of A
Certs. of Dis. for Discharge	Med. Certificates
C. M. Charges	Med. Des. Lists
Descriptive Lists	Orders
Discharge Certificates	Pris. of War Record /
Enlistment Papers	Resignations

Other papers relating to—

Admission to Hosp'l	Furlough or L. of A
Casualty Sheet	Med. Examination
Confinement	Misc. Information
Contracts	Pay or Clothing
Death or Effects	Personal Reports
Desertion	Rank
Discharge from Hosp'l	Transfer to Hosp'l
Discharge from Service	Transfer to V. R. C.
Duty	Transportation

MEMORANDUM FROM PRISONER OF WAR RECORDS.

No. _____

(This blank to be used only in the arrangement of said records.)

INFORMATION OBTAINED FROM—

NAME.	RANK.	ORGANIZATION.				INFORMATION OBTAINED FROM—				
		No. of Reg't.	State.	Arm of Service.	Co.	Records of—	Vol.	Page.	Vol.	Page.
Reid Garrett	D	5	U.S.	6th	K					

Captured at _____, 186 ; brought from _____, and confined at Richmond, Va., _____, 186

No record subsequent to Oct 1 1864

Admitted to Hospital at _____, 186 ; treated for _____

Where he died _____, 186 ; of _____

Paroled at _____, 186 ; reported at _____, 186

Pen base 686433 Rec. A.C. Mar 15/89. Ret'd (then from) May 6/89 JWP. 4, 26-89

Wesley Jack

Co *K*, 5 U. S. Col'd Cav.

Private | *Private*

CARD NUMBERS.

5368865	26
5368952	27
5369053	28
5369140	29
5369228	30
5369315	31
5369403	32
5369489	33
5369574	34
5369659	35
5369740	36
9091108	37
43148266	38
40730254	39
	40
	41
	42
	43
	44
	45
	46
	47
	48
	49
	50

Book Mark:

See also

RVP 790085
y

J. B. Donald
Exr

U

X

K | **5 Cav.** | **U.S.C.T.**

Jack Risk
....., Co. *K*, 5 Reg't U. S. Col'd Cav.

Appears on

Company Descriptive Book
of the organization named above.

DESCRIPTION.

Age *36* years; height *5* feet *5* inches.

Complexion *black*

Eyes *blk*; hair *blk*

Where born *Clark Co, Ky.*

Occupation *Laborer*

ENLISTMENT.

When *Oct. 7*, 1864.

Where *Lexington Ky.*

By whom *T. H. Moore*; term *3* y'rs.

Remarks:

.....
.....
.....
.....
.....
.....
.....
.....

(383g)

A. A. Hall
~~Captain~~
Comdr

R.

5 bar

U.S.A.

Jack Risk

Appears with rank of Pvt. on

Muster and Descriptive Roll

of Detachment of U.S. Col. 5th
forwarded Camp Nelson, Ky

Roll dated
Lexington, Ky, Oct. 7, 1864.

Where born Clark, Ky

Age 36 years; occupation Labourer

When enlisted Oct. 7, 186 .

Where enlisted Lexington, Ky

For what period enlisted 3 years.

Eyes Blk.; hair Blk.

Complexion Blk.; height 6 ft. 5 in.

When mustered in _____, 186 .

Where mustered in _____

Bounty paid \$ 100; due \$ 100

Clothing account:

Last settled _____, 186 ; drawn since \$ 100

Date of first muster Oct. 7, 1864.

Company to which assigned _____

Remarks: To be credited to
Clark Co. 9th Dist. Ky.

Book mark: _____

H. J. Hamie

(356m)

Copyist.

R

5 Cav.

U.S.C.T.

Jack Risk

Pvt, Co. *K*, 5 Reg't U. S. Col'd Cavalry.

Appears on

Company Muster-in and Descriptive Roll

of the organization named above. Roll dated

Camp Nelson, *N. Y.*, *Oct 30*, 1864.

Where born *Clark Ky*

Age *36* y'rs; occupation *Laborer*

When enlisted *Oct 7*, 1864.

Where enlisted *Lexington*

For what period enlisted *3* years.

Eyes *Blk*; hair *Blk*

Complexion *Blk*; height *5 ft. 5 in.*

When mustered in *Oct 7*, 1864.

Where mustered in *Lexington*

Bounty paid \$ *100*; due \$ *100*

Where credited *7 Dist Ky*

Company to which assigned

Remarks:

.....
.....
.....

Book mark:

H. S. Miller

(356d)

Copyist.

B | **5 Cav. U.S.C.T.**

Jack Risk
Pvt, Co. K, 5 Reg't U. S. Col'd Cav.

Appears on

Company Muster Roll

for *Organization to Oct 31*, 1864.

Present or absent *Absent*

Stoppage, \$ *100* for

Due Gov't, \$ *100* for

Valuation of horse, \$ *100*

Valuation of horse equipments, \$ *100*

Remarks: *In Genl Hospt-Camp
Nelson Ky Oct 5/64*

Book mark:

(358)

H. S. Miller

Copyist.

A

5 Cav.

U.S.C.T.

Jack Risk

Plt, Co. K, 5 Reg't U. S. Col'd Cav.

Appears on

Company Muster Roll

for *Nov & Dec*, 1864.

Present or absent *Absent*

Stoppage, \$ *100* for

Due Gov't, \$ *100* for

Valuation of horse, \$ *100*

Valuation of horse equipments, \$ *100*

Remarks: *In Genl Hospit Camp
Nelson Ky Oct 5 / 1864
1" & 2" installments Borne by
due*

Book mark:

D. S. Miller

(358)

Copyist.

Jack Risk

Pvt., Co. K, 5 Reg't U. S. Col'd Cav.

Appears on

Company Muster Roll

for Jan & Feb, 1865.

Present or absent Absent

Stoppage, \$ 100 for

Due Gov't, \$ 100 for

Valuation of horse, \$ 100

Valuation of horse equipments, \$ 100

Remarks: In Gen Hospt - Camp Nelson Ky Oct 5, 1864
1" & 2" installments \$300
Bounty due

Book mark:

H J Miller

(358)

Copyist.

R 5 Cav | **U.S.C.T**

Jack Risk

Pvt, Co. *H*, 5 Reg't U. S. Col'd *Cav*

Appears on

Company Muster Roll

for *Mar & Apr*, 186*5*.

Present or absent *Present*

Stoppage, \$ *100* for

Due Gov't, \$ *100* for

Valuation of horse, \$ *100*

Valuation of horse equipments, \$ *100*

Remarks: *1st installment of
Bounty due \$100*

Book mark:

H. Miller

(358)

Copyist.

Jack Risk
Prof., Co. K, 5 Reg't U. S. Col'd Cav.

Appears on

Company Muster Roll

for May & June, 1863.

Present or absent Present

Stoppage, \$ 100 for

Due Gov't, \$ 100 for

Valuation of horse, \$ 100

Valuation of horse equipments, \$ 100

Remarks: First installment
bounty due \$100

Book mark:

J. E. Porter

R

5 Cav.

U.S.C.T.

Jack Risk

Prov, Co. K, 5 Reg't U. S. Col'd Cav.

Appears on

Company Muster Roll

for July & Aug, 1865.

Present or absent Present

Stoppage, \$ 100 for

Due Gov't, \$ 100 for

Valuation of horse, \$ 100

Valuation of horse equipments, \$ 100

Remarks:

Book mark:

F. E. Porter

(358)

Copyist.

R

5 Cav.

U.S.C.T.

Jack Risk

Prof, Co. K, 5 Reg't U. S. Col'd Cav.

Appears on

Company Muster Roll

for Sept & Oct, 1865.

Present or absent Present

Stoppage, \$ 100 for

Due Gov't, \$ 100 for

Valuation of horse, \$ 100

Valuation of horse equipments, \$ 100

Remarks: Due U.S. for
6 & 9. E. 6. 64, Due U.S.
for Ord 69 cts

Book mark:

J. E. Porter

(358)

Copyist.

Q

5 Cav.

U.S.C.T.

Jack Risk

Prov, Co. K, 5 Reg't U. S. Col'd Cav.

Appears on

Company Muster Roll

for Nov + Dec, 1861.

Present or absent Present

Stoppage, \$ 100 for

Due Gov't, \$ 100 for

Valuation of horse, \$ 100

Valuation of horse equipments, \$ 100

Remarks: Due U. S for Ord
30 For G + G.E 310

Book mark:

J. E. Porter

(358)

Copyist.

Q

5 Cav. U.S.C.T.

Jack Risk

Cot, Co. K, 5 Reg't U. S. Col'd Cav.

Appears on

Company Muster Roll

for Jan Feb, 1866.

Present or absent Present

Stoppage, \$ 100 for

Due Gov't, \$ 100 for

Valuation of horse, \$ 100

Valuation of horse equipments, \$ 100

Remarks:

[Empty lines for remarks]

Book mark:

E. H. Brown

(358)

Copyist.

Jack Pisk

Priv., Co. K, 5 Reg't U. S. Colored Cav.

Appears on Returns as follows:

Oct. 1864 to Feb. 1865. - Absent
sick in hosp. Camp
Wilson Ky Oct. 5/64

Jan. 1866. - On daily duty
Madison Ark.

Book mark :

(540)

E. Thornton

Copyist.

Q

5 Cav. U.S.C.T.

Jack Rush

Capt., Co. K, 5 Reg't U. S. Col'd Cavalry.

Appears on Co. Muster-out Roll, dated

Feb 16, 1866.

Muster-out to date

Mar 6, 1866.

Last paid to

Dec 31, 1865.

Clothing account:

Last settled, 186 ; drawn since \$ 100

Due soldier \$ 100; due U. S. \$ 31 ⁰⁷/₁₀₀

Am't for cloth'g in kind or money adv'd \$ 100

Due U. S. for arms, equipments, &c., \$ 100

Bounty paid \$ 100 ⁰⁰/₁₀₀; due \$ 100

Remarks:

Book mark:

E. V. Brown

Risk, Jack

....., Co.

Reg't U. S. C. J.

/ Enclosures.

Bed Cards	Final Statements
Burial Records	Furloughs or L. of A.
Certs. of Dis. for Discharge	Med. Certificates
C. M. Charges	Med. Des. Lists
Descriptive Lists	Orders
Discharge Certificates	Pris. of War Record
Enlistment Papers /	Resignations

Other papers relating to—

Admission to Hosp'l	Furlough or L. of A.
Casualty Sheet	Med. Examination
Confinement	Misc. Information
Contracts	Pay or Clothing
Death or Effects	Personal Reports
Desertion	Rank
Discharge from Hosp'l	Transfer to Hosp'l
Discharge from Service	Transfer to V. R. C.
Duty	Transportation
.....

NOTE 1.—This blank will be used for enlistments of United States colored troops. They will be made out in duplicate in all cases—one to accompany the recruiting return of the superintendent (not the recruiting officer) to the Adjutant General, and one to accompany the accounts of the officer who pays bounty, &c.

NOTE 2.—An enlistment holds to service. A muster-in must, in all cases, precede payment of pay, bounty, pension, &c. A muster-in roll, must in all cases, be filed in the Adjutant General's Office as evidence of muster-in. The mustering officer, commissary, or assistant commissary of musters, as the case may be, will countersign both enlistments as having mustered the soldiers into the service of the United States before either of them is given to the disbursing officer.

DECLARATION OF RECRUIT.

I, Jack Risk desiring to volunteer as a soldier in the ARMY OF THE UNITED STATES, for the term of Three Years, DO DECLARE That I am thirty six years and months of age; that I have never been discharged from the United States service on account of disability or by sentence of a court-martial, or by order before the expiration of a term of enlistment; and I know of no impediment to my serving honestly and faithfully as a soldier for three years.

GIVEN at Lexington Ky the 9 day of Oct 1864

Witness: B. F. June

Jack Risk
mark

Volunteered at Lexington Ky.
Oct. 7 1864
Thos M. Moore, Jr. M.
Thos. Kirtley.
Jack Risk
No. 1005 - Service Co

Consent of Parent or Guardian in case of a Minor, if a Free Man, or in the case of a Slave, of the Person to whom he owes Service:

I, Joseph Risk of Clark Co Do CERTIFY, That I am the owner of Jack Risk a Slave that the said Jack Risk is thirty six years of age; and I do freely give my CONSENT to his volunteering as a SOLDIER in the Army of the United States, for the period of THREE YEARS, under the conditions of the laws of the United States.

GIVEN at Lexington Kentucky the 9th day of October 1864

Witness:

UNITED STATES COLORED TROOPS ENLISTMENT.

STATE OF

TOWN OF

Kentucky

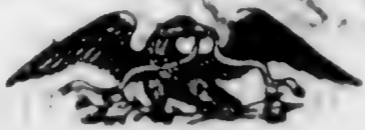

Lexington

I, Jack Risk born in Clarke Co,

in the State of Kentucky aged thirty six years

and by occupation a Laborer Do HEREBY ACKNOWLEDGE to

have volunteered Seventh day of October 1864

to serve as a Soldier in the Army of the United States of America, for the period of THREE YEARS, unless sooner discharged by proper authority: Do also agree to accept such bounty, pay, rations, and clothing, as are, or may be, established by law for the U. S. colored troops.

And I, Jack Risk

do solemnly swear that I will bear true faith and allegiance to the United States of America, and that I will serve them honestly and faithfully against all their enemies or opposers whomsoever; and that I will observe and obey the orders of the President of the United States, and the orders of the officers appointed over me, according to the Rules and Articles of War.

Sworn and subscribed to, at Lexington Ky

this 7th day of Oct 1864 before John A. Murn

Capt and Pro Mar 7 64. Jack Risk MK

J. J. Gann

EXAMINING SURGEON.

I CERTIFY, ON HONOR, That I have minutely inspected the Volunteer, Jack Risk previously to his enlistment, and that he was entirely sober when enlisted; that, to the best of my judgment and belief, he is of lawful age; and that, in accepting him as duly qualified to perform the duties of an able-bodied soldier, I have strictly observed the regulations which govern the recruiting service. This soldier has five eyes, five hair, five complexion, is five feet five inches high.

John A. Murn Capt and Pro Mar 7 64. RECRUITING OFFICER OR AGENT.

Mustered into the United States Service day of 1864

Mustering Officer.

Mustered into the service of the United States, for three years or during the war, from date of enlistment, in Company ... Regiment of ... Volunteers, on the ... day of ... 1864, at ...

Robert Elisha

Co *E*, 5 U. S. Col'd Cav.

Private *Boyles*

CARD NUMBERS.

1	5359211	26
2	5364101	27
3	5364187	28
4	5364232	29
5	5364325	30
6	5364412	31
7	5364495	32
8	5364572	33
9	9090483	34
10	40730256	35
11		36
12		37
13		38
14		39
15		40
16		41
17		42
18		43
19		44
20		45
21		46
22		47
23		48
24		49
25		50

Book Mark: General Notation N. & P. 407375.

See also

A

5 Cav. U.S.C.T.

Elisha Roberts

Co. *E*, 5 Reg't U. S. Col'd Cav.

Appears on

Company Descriptive Book
of the organization named above.

DESCRIPTION.

Age *18* years; height *5* feet *8* inches.

Complexion *Copper*

Eyes *Blk*; hair *Blk*

Where born *Adair Ky*

Occupation *farmer*

ENLISTMENT.

When *Mar 7*, 186*5*.

Where *Camp Nelson*

By whom *Hassard*; term *3* y'rs.

Remarks:

J E Russ

(383g)

Copist.

R 5 Cav U.S.C.T.

Elisha Robert

Appears with rank of Pvt on

Muster and Descriptive Roll of a Detachment of U. S. Vols. forwarded

for the 5 Reg't U. S. Col'd Cav, Roll dated

Lexington Ky, Mar 23 1865.

Where born Adair Co. Ky

Age 18 y'rs; occupation Farmer

When enlisted March 7, 1865.

Where enlisted Camp Nelson Ky

For what period enlisted 3 years.

Eyes Blk; hair Blk

Complexion Copr; height 5 ft. 8 in.

When mustered in March 23, 1865.

Where mustered in Lexington Ky

Bounty paid \$ 100; due \$ 100

Where credited Boyle Co. Dist Ky

Company to which assigned

Remarks:

Book mark:

General Notation B. & P. 40727L

Valentine

(339)

Copyist.

R

5 Cav. U.S.C.T.

Elisha Roberts

Capt., Co. E, 5 Reg't U. S. Col'd Cavalry.

Appears on

Company Muster Roll

for March & April, 1865.

Present or absent Present

Stoppage, \$ 100 for

Due Gov't, \$ 100 for

Valuation of horse, \$ 100

Valuation of horse equipments, \$ 100

Remarks: First instalment of Bounty due

Book mark:

W. H. [Signature]

R

5 Cav. U.S.C.T.

Elisha Roberts

Pvt, Co. E, 5 Reg't U. S. Col'd Cavalry.

Appears on

Company Muster Roll

for May June, 1865.

Present or absent present

Stoppage, \$ 100 for

Due Gov't, \$ 100 for

Valuation of horse, \$ 100

Valuation of horse equipments, \$ 100

Remarks: 1st Instalment
Bounty due \$100.

Book mark:

Long

(358)

Copyist.

R | 5 Cav. | U.S.C.T.

Elisha Roberts

Bugler, Co. E, 5 Reg't U. S. Col'd Cavalry.

Appears on

Company Muster Roll

for July - Aug., 1865.

Present or absent present

Stoppage, \$ 100 for

Due Gov't, \$ 100 for

Valuation of horse, \$ 100

Valuation of horse equipments, \$ 100

Remarks: Appointed Bugler from Private Aug. 1st '65 per R. O. No. 136

Book mark:

(358)

Long

Copyist.

R | 5 Cav. | U.S.C.T.

Elisha Roberts

Bugler, Co. E, 5 Reg't U.S. Col'd Cavalry.

Appears on

Company Muster Roll

for *Sept & Oct*, 1865.

Present or absent *present*

Stoppage, \$ 100 for

Due Gov't, \$ 100 for

Valuation of horse, \$ 100

Valuation of horse equipments, \$ 100

Remarks:

Book mark:

(358)

Long

Copyist.

R | 5 Cav. | U.S.C.T.

Elisha Roberts

Bugler, Co. E, 5 Reg't U.S. Col'd Cavalry.

Appears on

Company Muster Roll

for Nov & Dec, 1865.

Present or absent present

Stoppage, \$ 100 for

Due Gov't, \$ 100 for

Valuation of horse, \$ 100

Valuation of horse equipments, \$ 100

Remarks:

Book mark:

Long

(358)

Copyist.

R

5 Cav. U.S.C.T.

Elisha Roberts

Regler, Co. E, 5 Reg't U. S. Col'd Cavalry.

Appears on

Company Muster Roll

for Jan + Feb, 1866.

Present or absent Present

Stoppage, \$ 100 for

Due Gov't, \$ 100 for

Valuation of horse, \$ 100

Valuation of horse equipments, \$ 100

Remarks:

Book mark:

(358)

W. H. ...

Copyist.

Q | 5 Cav. | U.S.C.T.

Elish Roberts

Co. E, 5 Reg't U. S. Colored Cav.

Appears on Returns as follows:

March 1865, - Gain: Assigned
to Co. E March 28
65.

Book mark :

(546)

E. J. Hunter

Copyist.

2

5 Cav. U.S.C.T.

Elisha Roberts

Bugler, Co. *B*, 5 Reg't U. S. Col'd Cavalry.

Appears on Co. Muster-out Roll, dated *Helena Ark. Mar 16, 1866 .*

Muster-out to date * *Mar 3, 1866 .*

Last paid to *Dec 31, 1865 .*

Clothing account:

Last settled....., 186 ; drawn since \$..... 100

Due soldier \$..... 100; due U. S. \$ *27 ⁶⁵ / 100*

Am't for cloth'g in kind or money adv'd \$..... 100

Due U. S. for arms, equipments, &c., \$..... 100

Bounty paid \$ *100 ^{xx} / 100*; due \$..... 100

Remarks: *Was Paroled to Aug 5/65 thru Bugler*

* **Records on file in 2nd. Auditors Office show this Co. Mustered Out to take effect Mch, 16th. 1866. and paid to include Mch, 15th. 1866.**

Book mark :

(361)

J. J. Leonard

Copyist.

Robert, Elisha

, Co. _____,

5th Reg't U.S.C. Cav.

2 Enclosures.

Bed Cards	Final Statements
Burial Records	Furloughs or L. of A.
Certs. of Dis. for Discharge	Med. Certificates
C. M. Charges	Med. Des. Lists
Descriptive Lists	Orders
Discharge Certificates	Pris. of War Record
Enlistment Papers 2	Resignations

Other papers relating to—

Admission to Hosp'l	Furlough or L. of A.
Casualty Sheet	Med. Examination
Confinement	Misc. Information
Contracts	Pay or Clothing
Death or Effects	Personal Reports
Desertion	Rank
Discharge from Hosp'l	Transfer to Hosp'l
Discharge from Service	Transfer to V. R. C.
Duty	Transportation

NOTE 1.—This blank will be used for both enlistments and re-enlistments—enlistment of veterans, &c., &c., in the volunteer service. They will be made out in duplicate in all cases—one to accompany the recruiting return of the superintendent (not the recruiting officer) to the Adjutant General, and one to accompany the accounts of the officer who pays bounty, &c. The Regiment and Company in which the soldier last served should be given on the back.

NOTE 2.—An enlistment holds to service. A muster-in must, in all cases, precede payment of pay, bounty, pension, &c. A muster-in roll must, in all cases, be filed in the Adjutant General's Office as evidence of muster-in. The mustering officer, commissary, or assistant commissary of musters, as the case may be, will countersign both enlistments as having mustered the soldier into the service of the United States before either of them is given to the disbursing officer.

DECLARATION OF RECRUIT.

I, Elisha Robert, desiring to VOLUNTEER as a Soldier in the Army of the United States, for the term of THREE YEARS, Do Declare, That I am 18 years and _____ months of age; that I have never been discharged from the United States service on account of disability or by sentence of a court martial, or by order before the expiration of a term of enlistment; and I know of no impediment to my serving honestly and faithfully as a soldier for three years.

GIVEN at Camp Nelson Ky the 7 day of March 1865

Witness:

H Jackson
Elisha Robert
mark

Elisha Robert
No. 21
Volunteered at Camp Nelson
March 7th, 1865
By J. J. Hancock
5th Regiment of USCC
enlistment; last served in Company ()
5th Regt of 11th Ky Inf
Discharged _____, 1865

CONSENT IN CASE OF MINOR.

I, Mr Tarkenton (Boyle City), Do CERTIFY, That I am the _____ of _____; that the said _____ is _____ years of age; and I do hereby freely give my CONSENT to his volunteering as a SOLDIER in the ARMY OF THE UNITED STATES for the period of THREE YEARS.

GIVEN at _____ the _____ day of _____

Witness:

Credited to Boyle Co 7 5th.

VOLUNTEER ENLISTMENT.

STATE OF

TOWN OF

Kentucky



Co of Jessamine

I, Elisha Robert, born in Adair Co, in the State of Kentucky, aged 18 years, and by occupation a Farmer, Do HEREBY ACKNOWLEDGE to have volunteered this seventh day of March, 1865, to serve as a Soldier in the Army of the United States of America, for the period of THREE YEARS, unless sooner discharged by proper authority: Do also agree to accept such bounty, pay, rations, and clothing as are, or may be, established by law for volunteers. And I, Elisha Robert, do solemnly swear, that I will bear true faith and allegiance to the United States of America, and that I will serve them honestly and faithfully against all their enemies or opposers whomsoever; and that I will observe and obey the orders of the President of the United States, and the orders of the officers appointed over me, according to the Rules and Articles of War.

Sworn and subscribed to, at Camp Nelson this 7 day of Mar, 1865, BEFORE H. Garrison, 5th U.S.C. Cav., Elisha Robert

I CERTIFY, ON HONOR, That I have carefully examined the above-named Volunteer, agreeably to the General Regulations of the Army, and that, in my opinion, he is free from all bodily defects and mental infirmity, which would in any way disqualify him from performing the duties of a soldier.

Herman J. Smith, Asst Surg, 5th U.S.C. Cav., EXAMINING SURGEON.

I CERTIFY, ON HONOR, That I have minutely inspected the Volunteer Elisha Robert previously to his enlistment, and that he was entirely sober when enlisted; that, to the best of my judgment and belief, he is of lawful age; and that, in accepting him as duly qualified to perform the duties of an able-bodied soldier, I have strictly observed the Regulations which govern the recruiting service. This soldier has blue eyes, blue hair, Copper complexion, is five feet eight inches high.

H. Garrison, 5th U.S.C. Cav., Regiment of U.S.C. Cav. Volunteers, RECRUITING OFFICER.

(A. G. O. No. 74 & 76.)

Mustered into the service of the United States, for three years or during the war, from date of enlistment, in Company K, 23rd Regiment of U.S.C. Volunteers, on the 23 day of March, 1865, at Lexington, Ky.

Call on Mr. ...

NOTE 1.—This blank will be used for both enlistments and re-enlistments—enlistment of veterans, &c., &c., in the volunteer service. They will be made out in duplicate in all cases—one to accompany the recruiting return of the superintendent (not the recruiting officer) to the Adjutant General, and one to accompany the accounts of the officer who pays bounty, &c. The Regiment and Company in which the soldier last served should be given on the back.

NOTE 2.—An enlistment holds to service. A muster-in must, in all cases, precede payment of pay, bounty, pension, &c. A muster-in roll must, in all cases, be filed in the Adjutant General's Office as evidence of muster-in. The mustering officer, commissary, or assistant commissary of musters, as the case may be, will countersign both enlistments as having mustered the soldier into the service of the United States before either of them is given to the disbursing officer.

DECLARATION OF RECRUIT.

I, Eliza Robert, desiring to VOLUNTEER as a Soldier in the Army of the United States, for the term of THREE YEARS, Do Declare, That I am 18 years and _____ months of age; that I have never been discharged from the United States service on account of disability or by sentence of a court martial, or by order before the expiration of a term of enlistment; and I know of no impediment to my serving honestly and faithfully as a soldier for three years.

GIVEN at Camp Nelson Ky the _____ day of March, 1865

Witness: W. H. [Signature] Eliza Robert
mark



Volunteered at Camp Nelson
March 7th, 1865,
 By W. H. [Signature]
 for 5th Regiment of WS CE
 Discharged _____, 18 ____
 Reg't of _____
 enlistment; last served in Company () _____

Eliza Roberts

No. _____

CONSENT IN CASE OF MINOR.

I, Mr Parkerslow (Doyle Co Ky), DO CERTIFY, That I am _____ of _____; that the said _____ is _____ years of age; and I do hereby freely give my CONSENT to his volunteering as a SOLDIER in the ARMY OF THE UNITED STATES for the period of THREE YEARS.

GIVEN at _____ the _____ day of _____

Witness: _____

Credited To Doyle Co 7 574.

VOLUNTEER ENLISTMENT.

STATE OF

TOWN OF

Kentucky

Co of Jessamine



I, *Elisha Robert*, born in *Adair Co.*, in the State of *Kentucky*, aged *18* years, and by occupation a *Farmer*, Do HEREBY ACKNOWLEDGE to have volunteered this *Seventh* day of *March*, 1865, to serve as a **Soldier** in the **Army of the United States of America**, for the period of **THREE YEARS**, unless sooner discharged by proper authority: Do also agree to accept such bounty, pay, rations, and clothing, as are, or may be, established by law for volunteers. And I, *Elisha Robert*, do solemnly swear, that I will bear true faith and allegiance to the **United States of America**, and that I will serve them honestly and faithfully against all their enemies or opposers whomsoever; and that I will observe and obey the orders of the President of the United States, and the orders of the officers appointed over me, according to the Rules and Articles of War.

Sworn and subscribed to, at *Camp Nelson Ky* this *7* day of *Apr*, 1865, BEFORE *J. F. Sanderson* *5th A.S.C. Gen*

I CERTIFY, ON HONOR, That I have carefully examined the above-named Volunteer, agreeably to the General Regulations of the Army, and that, in my opinion, he is free from all bodily defects and mental infirmity, which would in any way disqualify him from performing the duties of a soldier.

Samuel J. Smith
Asst Surg. 5th U.S. C. B.
EXAMINING SURGEON.

I CERTIFY, ON HONOR, That I have minutely inspected the Volunteer *Elisha Robert* previously to his enlistment, and that he was entirely sober when enlisted; that, to the best of my judgment and belief, he is of lawful age; and that, in accepting him as duly qualified to perform the duties of an able-bodied soldier, I have strictly observed the Regulations which govern the recruiting service. This soldier has *Blue* eyes, *Blk* hair, *Complexion*, is *five* feet *Eight* inches high.

J. F. Sanderson
Regiment of *U.S. Cavalry* Volunteers,
RECRUITING OFFICER.

(A. G. O. No. 74 & 76.)

Mastered into the service of the United States, for three years or during the war, from date of enlistment, in Company *A* of *5th A.S.C.* Regiment of *U.S. Cavalry* Volunteers, on the *23* day of *March* 1865, at *Jessamine Ky*

John W. Moore
Capt. 5th U.S. Cav
Mastering Officer

Roberts Benjamin

Co *D*, 5 U. S. Col'd Cav.

Private | *Private*

CARD NUMBERS.

1	5362708	26
2	5362803	27
3	5362933	28
4	5363259	29
5	5363351	30
6	5363437	31
7	5363545	32
8	5363657	33
9	9090037	34
10	43146775	35
11	40730255	36
12		37
13		38
14		39
15		40
16		41
17		42
18		43
19		44
20		45
21		46
22		47
23		48
24		49
25		50

Book Mark:

See also

R

5 Cav. | U.S.C.T.

Benjamin Roberts

Co. *W*, 5 Reg't U. S. Col'd Cav.

Appears on

Company Descriptive Book
of the organization named above.

DESCRIPTION.

Age *27* years; height *5* feet *6* inches.

Complexion *dark*

Eyes *dark*; hair *dark*

Where born *Henry Ky*

Occupation *laborer*

ENLISTMENT.

When *Sep 13*, 186*4*.

Where *Louisville Ky.*

By whom *Capt Ham*; term *3* y'rs.

Remarks: *Missing in ac-*
tion Dec. 20" 1864,
Marion Va, returned
Aug. 9" 1865, discharged
on Surgeon's certificate
of disability Feb. 17"
1866

J E Parks

Q

5 bar

U.S.A.

Benjamin Roberts

Appears with rank of Pvt on

Muster and Descriptive Roll

of Detachment of U.S. Colored Recruits

Mustered for the U.S.A. at Taylor Bks.

Louisville Ky Roll dated

Louisville Ky, Sept. 15, 1864.

Where born Henry Ky

Age 27 years; occupation Labourer

When enlisted Sept. 13, 1864.

Where enlisted Louisville Ky

For what period enlisted 3 years.

Eyes Dark; hair Dark

Complexion Dark; height 5 ft. 6 in.

When mustered in Sept. 15, 1864.

Where mustered in Louisville Ky

Bounty paid \$ 100; due \$ 100

Clothing account:

Last settled, 186 ; drawn since \$ 100

Date of first muster, 186 .

Company to which assigned

Remarks: Credited in pay for 5 Dist.

Book mark:

Robert

(356m)

Copyist.

R

5 Cav.

U.S.C.T.

Benjamin Robert

Co. N, 5 Reg't U. S. Col'd Cavalry.

Appears on

Company Muster-in and Descriptive Roll

of the organization named above. Roll dated

Camp Nelson, N.Y., Oct. 5th, 1864.

Where born Henry, Ky

Age 27 y'rs; occupation Laborer

When enlisted Aug. 13, 1864.

Where enlisted Louisville

For what period enlisted 3 years.

Eyes Br; hair Br

Complexion Br; height 5 ft. 6 in.

When mustered in Sept. 5, 1864.

Where mustered in Lebanon

Bounty paid \$ 100; due \$ 100

Where credited 5 Dist. Ky.

Company to which assigned

Remarks:

Book mark:

Wm. H. Scott

(356d)

Copyist.

R

5 Cav. U.S.C.T.

Benjamin Roberts

Priv., Co. D, 5 Reg't U.S. Col'd Cavalry.

Appears on

Company Muster Roll

for dated Oct. 31, 1864.

Present or absent Present

Stoppage, \$ 100 for

Due Gov't, \$ 100 for

Valuation of horse, \$ 100

Valuation of horse equipments, \$ 100

Remarks:

Book mark:

Wm H Scott

(358)

Copyist.

R

5 Cav.

U.S.C.T.

Benjamin Roberts

Co. D, 5 Reg't U. S. Col'd Cavalry.

Appears on

Company Muster Roll

for Nov & Dec, 1864.

Present or absent Absent

Stoppage, \$ 100 for

Due Gov't, \$ 100 for

Valuation of horse, \$ 100

Valuation of horse equipments, \$ 100

Remarks: Missing in action
Marion, Va. Dec. 20, '64
1 & 2 installments of
Bounty due.

Roll July & Aug. 65, next
on which name appears.

Book mark:

Wm. Scott

R

5 Cav. U.S.C.T.

Benjamin Roberts

Private, Co. D, 5 Reg't U. S. Col'd Cavalry.

Appears on

Company Muster Roll

for July & Aug., 1865.

Present or absent present

Stoppage, \$ 100 for

Due Gov't, \$ 100 for

Valuation of horse, \$ 100

Valuation of horse equipments, \$ 100

Remarks: Missing in action
Marion Va. Dec. 20th 1865;
returned to Co. Aug. 9th 1865.

Book mark:

Williken

(358)

Copyist.

A

5 Cav.

U.S.C.T.

Benjamin Roberts

Priv., Co. D, 5 Reg't U. S. Col'd Cavalry.

Appears on

Company Muster Roll

for *Sept. & Oct.*, 1865.

Present or absent *present*

Stoppage, \$ *100* for

Due Gov't, \$ *100* for

Valuation of horse, \$ *100*

Valuation of horse equipments, \$ *100*

Remarks:

Book mark:

Willeken

(358)

Copyist.

R

5 Cav. U.S.C.T.

Benjamin Roberts

Priv., Co. D, 5 Reg't U. S. Col'd Cavalry.

Appears on

Company Muster Roll

for *Nov. & Dec.*, 186*3*.

Present or absent *present.*

Stoppage, \$ *100* for

Due Gov't, \$ *100* for

Valuation of horse, \$ *100*

Valuation of horse equipments, \$ *100*

Remarks: *Sick in quarters.*

Book mark:

Milliken

(358)

Copyist.

R.

5 Cav.

U.S.C.T.

Benjamin Roberts,
Private, Co. D, 5 Reg't U. S. Col'd Cavalry.

Appears on

Company Muster Roll

for *Jan'y⁴ & Febr'y*, 186*6*.

Present or absent

Stoppage, \$ 100 for

Due Gov't, \$ 100 for

Valuation of horse, \$ 100

Valuation of horse equipments, \$ 100

Remarks: *Discharged on Surg.*

Certificate of disability.

Discharge & final statements

given Feb. 13, 1864.

Due John Parson, Suter,

\$ 10.00.

Book mark: *Discharged Feb 12 1866 E. P.*

v. 9 P. 4381

R. S. Brauner

(358)

Copyist.

Q

5 Cav.

U.S.C.T.

Benjamin Roberts

Pvt., Co. D., 5 Reg't U. S. Colored Cav.

Appears on Returns as follows:

Dec. 1864. - Adv. Dec. 20/64
Marion Va. Missing
in action.

Aug. 1865. - Adv. Aug. 9/65
Dixington. Dropped
as missing in action
Dec. roll of '64

Feb. 1866. - Adv. Feb. 13
Helena Ark. Disch.
on Surg. Cert. of
disability.

Book mark :

(546)

E. J. Thorton

Copyist.

R. | 5 Car. | U. S. C. T.

Benjamin Roberts,
Priv. Co. D, 5 Reg't U. S. Col'd Cary.

Appears on Co. Muster-out Roll, dated

Helena, Ark., March 16, 1866.

Muster-out to date _____, 186 .

Last paid to Oct. 31, 1865.

Clothing account:

Last settled _____, 186 ; drawn since \$ _____ 100

Due soldier \$ _____ 100; due U. S. \$ _____ 100

Am't for cloth'g in kind or money adv'd \$ _____ 100

Due U. S. for arms, equipments, &c., \$ _____ 100

Bounty paid \$ 100.⁰⁰ due \$ _____ 100

Remarks: Discharged at Helena,
Ark., Feb. 12/66 on Surg.
Certificate of disability.

Book mark: P. V. 21 P. 79. 71.

P. 225 P. 41. 76.

R. S. Drimmer.

Roberts, Benjamin

, Co. *D*, 5 Reg't U.S.C. C&V

5 Enclosures.

Bed Cards	Descriptive Lists
Burial Records	Final Statements
Certs. of Dis. for Discharge <i>1</i>	Furloughs
C. M. Charges	Med. Des. Lists
Med. Certificates	Orders <i>2</i>

P. of W. slip. 1

Other papers relating to—

Admission to Hosp'l	Furlough
Casualty Sheet (Officer's)	Med. Examination
Confinement	Misc. Information <i>1</i>
Contracts	Pay or Clothing
Death or Effects	Personal Reports
Desertions	Rank
Discharge from Hosp'l	Transfer to Hosp'l
Discharge from Service	Transfer to V. R. C.
Duty	Transportation

MEMORANDUM FROM PRISONER OF WAR RECORDS.

No. 4

(This blank to be used only in the arrangement of said records.)

INFORMATION OBTAINED FROM—

NAME.	RANK.	ORGANIZATION.				Records of—	Vol.	Page.	Vol.	Page.
		No. of Reg't.	State.	Arm' of Service.	Co.					
<i>Roberts Ben.</i>	<i>P</i>	<i>5</i>	<i>U.S.</i>	<i>C.T. I.</i>	<i>Miss Roll</i>	<i>622</i>				

Captured at _____, 186 ; brought from _____, and
 confined at Richmond, Va., 186 ,
Appears on report from Marion Hospital (Rebel) dated Dec. 25/64 as belong-
 Admitted to Hospital at *Wm*, 186 ; treated for *Amanda Roberts of Henry*.
 Where he died *Wm. Wounded*, 186 ; of *in back, flesh wound.*
 Paroled at _____, 186 ; reported at _____, 186 .
No later record.

(Record continued.)

Furloughed _____, 186 , for _____ days; returned _____, 186 ;
deserted _____, 186 ;

Adjutant General's Office,

18 .

This is accepted as referring to _____

Co. _____, _____ Reg't _____

and records will be corrected accordingly.

Assistant Adjutant Gen'l.

*Wmd Aug. case. 5-3-1889 Rec. apl. April 27. 89
Ret'd (Ten years) May 7. 89.*

3--287

Copied by *W.L.*

Wound for Capt. [unclear]
Knoxville Tenn Aug 2/65

P. B. M. D. T. 1863

Col. B. H. [unclear]

Major W. A. Guel

States that B Roberts
Co H 5th Cav was
wounded in Virginia
in Dec last and has
just come in - sent
to Nashville to be free
to his regiment

SO No 43 part Aug 5/65

Head-Quarters Department of Tennessee,

Knoxville, Tenn., Aug 2 1865.

General:

The bearer of this,
Ben Roberts, belongs to Co D. 5th
U.S.C. Cav. - Was wounded in
Virginia in Dec last & has just
come in here. We don't know where
his regt is and have sent him to
Nashville to be forwarded to his
regt.

Very Respectfully
B. H. Dalk
Major

Brig Gen J. G. Parkhurst
Pro War Gen Mil Div Tenn

Special Order 43

Hd Qrs Military Div of the Tennessee
Nashville Tenn

Aug. 5. 1865

Ordering Pri B. Roberts Co
D. 5th Inf C to report to
his Regiment

Recd. H. S. - 5. 50

HEAD-QUARTERS MILITARY DIVISION OF THE TENNESSEE,

Nashville, Tenn., August 5 1865.

SPECIAL ORDERS, }

No. 43 }

[EXTRACT.]

1 Gen Roberts Company 13 5th U.S. Cold Cavalry is hereby ordered to report to Major General J. W. Palmer Comdg. Dept Ky to be sent to his regiment. Quarter Master W. H. Deist will furnish transportation.

BY COMMAND OF MAJOR GENERAL THOMAS:

Comdg. Officer

5th U. S. Cold Cavalry

Henry H. Critt.
Assistant Adjutant General.

Ben Roberts

5th U.S. Col^d Cav

Bill

with the 4th U.S. Col^d Cav
at Fort Huachuca

Recd. M. J. 9-15-

HEAD-QUARTERS MILITARY DIVISION OF THE TENNESSEE,

Nashville, Tenn., August 5, 1865.

SPECIAL ORDERS,

No. 43

[EXTRACT.]

1 Ben Roberts Company D 5 Wf Col's Cav
is hereby ordered to report to Maj Genl.
J. M. Palmer Comd'g Dept of Ky to be sent
to his regiment Quarters masters Dept will
furnish transportation

S-C-144-1-

BY COMMAND OF MAJOR GENERAL THOMAS:

Maj Genl J. M. Palmer
Comd'g

Henry R. Witt
Assistant Adjutant General.

Adjutant General's Office
Oct 4th 1871.

Muster Roll of Company "D",
5th U. S. C. Cavalry, for Jan'y and
Feb'y, 1866. reports date of dis-
charge of Private Benjamin
Roberts as Feb'y 13th 1866.

Muster out Roll of Company and
a Surgeons Certificate of Disability
of the soldier, give date of dis-
charge as Feb'y 12th 1866.

The latter date (Feb'y twelfth,
1866.) is held to be correct and
the Company Muster Roll above
cited, will be amended accord-
ingly.

Thomas M. Vincent

Asst. Adj. Genl.

1871
1870
1869
1868
1867
1866

In letter of
Oct 6th 1871 to
General

... the same manner to the regimental, post, or detachment
commander, who will, if the discharge is authorized by the endorse-
ment of the proper authority, sign the soldier's discharge, and the
last certificate on this paper; see that the soldier is furnished with
the proper final statements in duplicate, and forward BOTH of these
certificates to the Adjutant General, U. S. Army, at
Washington, D. C. they will not, under any circumstances, be given
to the hands of the soldier.

July 24th 1866

Duplicate sent to Pension Office.

1866
R 4711 B No

CERTIFICATE OF DISABILITY FOR DISCHARGE

IN THE CASE OF

Benjamin Roberts
a Private Co. "D"
Fifth Regt of U. S. Cavalry

Head in 541 CC

Helena Ark 14 Jan 66

Respectfully forwarded

L. M. Vincent

Colonel U. S. Cavalry

Headqrs Department of Arkansas,
Little Rock, Ark. Jan'y 31st 1866

To be Discharged.

By command of.

Major Genl. G. J. Reynolds,

Capt. G. J. Reynolds

Received (A. G. Office) 186

Enmo Ref

Office Surg in Chief
St. R. District
Helena Ark Jan 23rd 66

Respectfully forwarded
Approved on a per-
sonal examination

D. A. Ladd
Surg 56th U. S. C.
Surg in Chief

Jan 26th 1866
Hqrs. Ft. Snelling, Minn
Helena Ark Jan 24th 1866

Respectfully forwarded
Approved

Wm. Denton
Ed. 56th U. S. C.
Commanding

Approved
R. B. 1337
J. R. Smith

Brig. Genl. Col. & Surgeon, U. S. A.
Med. Director, Dept. of Ark

M. D. C.
Jan'y 31/66.

ARMY OF THE UNITED STATES.

CERTIFICATE

OF DISABILITY FOR DISCHARGE.

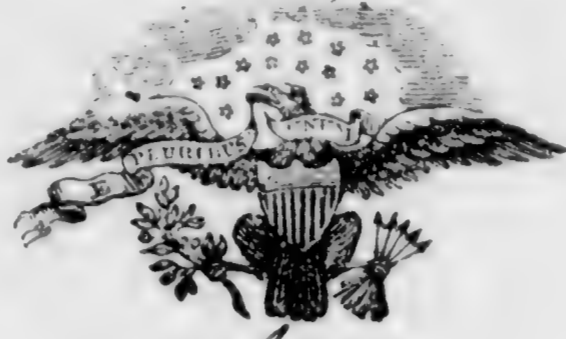

Private Benjamin Roberts, of Captain Henry P. Wade's Company, (D) of the Fifth Regiment of the United States Col. Cavalry was enlisted by Capt. Ham of the _____ Regiment of _____ at Louisville, Kentucky on the 13th day of September, 1864 to serve Three years; he was born in Henry in the State of Kentucky, is Twenty seven years of age, five feet six inches high, dark complexion, dark eyes, dark hair, and by occupation when enlisted a Laborer. During the last two months said soldier has been unfit for duty 60 days. He was in the Battle of Mansfield, Va. Dec. 20th 1864, and was wounded - while in the line of duty - by a ball which entered at the breast, passing out through the upper part of left hip bone. He was taken prisoner by the rebels after the battle. He rejoined his Company Aug 9th 1865, since which time he has been unfit for duty. Helena Ark.

DATE: Dec. 22nd 1865.

David G. Gordon
1st Lieut 5th U.S. Cav.
Commanding Company. *DG*

I CERTIFY, that I have carefully examined the said Benjamin Roberts of Captain Wade's Company, and find him incapable of performing the duties of a soldier because of † a gunshot wound recd while in the line of duty. The ball entered the superior part of the ilium, and passed forward and upward, came out at the 7th rib, about two inches from its attachment to the sternum. The wound in the ilium has been constantly opened, discharging pus and has rendered him unfit for duty since the injury. Present disability 3/4.

Hermon J. Smith
Assistant Surgeon, in charge
5th U.S. C. C.

DISCHARGED, this Twelfth day of February, 1866, at Helena Arkansas

L. Spruill

Commanding the Reg't.

The Soldier desires to be addressed at

Town Newcastle County Henry State Kentucky

* See Note 1 on the back of this. † See Note 2 on the back of this.

Roberts Isaac

Co A, 5 U. S. Col'd Cav.

Private | Private

CARD NUMBERS.

1	5359671	26
2	5359771	27
3	5359883	28
4	5360613	29
5	9090047	30
6	43146606	31
7	40730257	32
8		33
9		34
10		35
11		36
12		37
13		38
14		39
15		40
16		41
17		42
18		43
19		44
20		45
21		46
22		47
23		48
24		49
25		50

Book Mark:

See also

R | **5 Cav. | U.S.C.T.**

Isaac Roberts

, Co. *R*, 5 Reg't U. S. Col'd Cav.

Appears on

Company Descriptive Book
of the organization named above.

DESCRIPTION.

Age *23* years; height *5* feet *5* inches.

Complexion *Dark*

Eyes *Dark*; hair *Dark*

Where born *Shelby Co Ky*

Occupation *Labourer*

ENLISTMENT.

When *Sept. 8*, 186 .

Where *Louisville*

By whom *Capt. Ham*; term *3* y'rs.

Remarks: *died Nov. 1st 64*

Warren

R | 5 bar | U.S.C.T.

Isaac Roberts

Appears with rank of 1st on

Muster and Descriptive Roll

of a Detachment of U. S. Colored
Recruits mustered for U. S. Colored

at Taylor Sts. Louisville, Ky. Roll dated
Louisville, Ky., Sept. 9, 1864.

Where born Shelby, Ky.

Age 23 years; occupation Laborer

When enlisted Sept. 8, 1864.

Where enlisted Louisville, Ky.

For what period enlisted 3 years.

Eyes Dark; hair Dark

Complexion Dark; height 5 ft. 5 in.

When mustered in Sept. 9, 1864.

Where mustered in Louisville, Ky.

Bounty paid \$ 100; due \$ 100

Clothing account:
Last settled _____, 186 ; drawn since \$ 100

Date of first muster _____, 186 .

Company to which assigned _____

Remarks: for Shelby Co 4 Dist

Book mark : _____

(356m)

A. J. O. Russell

Copyist.

R | **5 Cav.** | **U.S.C.T.**

Isaac Roberts

Priv, Co. A, 5 Reg't U. S. Col'd Cavalry.

Appears on

Company Muster-in and Descriptive Rpl

of the organization named above. Roll dated

Sept 24, N. Y., 1864.

Where born Shelby Ky.

Age 23 y'rs; occupation laborer

When enlisted Sept 8, 1864.

Where enlisted Unionville

For what period enlisted 3 years.

Eyes br; hair br

Complexion br; height 5 ft. 5 in.

When mustered in Sept 1, 1864.

Where mustered in Unionville

Bounty paid \$ 100; due \$ 100

Where credited 4th Dist, Kentucky

Company to which assigned 1

Remarks:

Book mark:-----

(356d)

Isaac Roberts
Copyist.

R | **5 Cav. | U.S.C.T.**

Isaac Roberts

Pvt, Co. A, 5 Reg't U.S. Col'd Cavalry.

Appears on

Company Muster Roll

for *Oct 31*, 1864.

Present or absent *Absent*

Stoppage, \$ *100* for

Due Gov't, \$ *100* for

Valuation of horse, \$ *100*

Valuation of horse equipments, \$ *100*

Remarks: *Sick in Hospital
at Camp Nelson
Ky.*

Book mark: *Isaac Roberts*

(358)

Bastelsing
Copyist.

R | **5 Cav. | U.S.C.T.**

Isaac Roberts

Priv, Co. A, 5 Reg't U.S. Col'd Cavalry.

Appears on

Company Muster Roll

for *Nov. & Dec.*, 1864.

Present or absent

Stoppage, \$ 100 for

Due Gov't, \$ 100 for

Valuation of horse, \$ 100

Valuation of horse equipments, \$ 100

Remarks: *Died in Hospital
at Camp Nelson Ky.
Nov. 1." 1864*

Book mark:

(358)

Easterling

Copyist.

R

5 Cav.

U.S.C.T.

Isaac Roberts

Prs, Co. H, 5 Reg't U. S. Colored Cav.

Appears on Returns as follows:

Oct. & Nov. 1864. - Absent
 Sick in Hosp. at
 Camp Nelson Ky.
 Dec. 1864. - Arr Nov. 1864
 Camp Nelson. Died
 in U. S. Gen. Hosp.
 Camp Nelson Ky.

Book mark :

(540)

E. Thornton

Copyist.

R

5 Cav. U.S.C.T.

Isaac Roberts

Pvt, Co. A, 5 Reg't U. S. Col'd Cavalry.

Appears on Co. Muster-out Roll, dated
New York Feb 16, 1866.

Muster-out to date _____, 1866 .

Last paid to pay due from 1866 .
enlistment

Clothing account:

Last settled _____, 1866 ; drawn since \$ _____ 100

Due soldier \$ _____ 100 ; due U. S. \$ _____ 100

Am't for cloth'g in kind or money adv'd \$ _____ 100

Due U. S. for arms, equipments, &c., \$ _____ 100

Bounty paid \$ _____ 100 ; due \$ _____ 100

Remarks: Died Cp Nelson Ky
Nov 1st, 1864 Disease
unknown. Final
statements forwarded
Dec 31, 1864

Book mark: 150.785

(361)

W. W. Sayre
Copyist.

Roberts, Isaac

P, Co. 26, 5 Reg't USCC

2 Enclosures. (3 Items)

Bed Cards	Descriptive Lists
Burial Records /	Final Statements /
Certs. of Dis. for Discharge	Furloughs
C. M. Charges	Med. Des. Lists
Med. Certificates	Orders

Other papers relating to—

Admission to Hosp'l	Furlough
Casualty Sheet (Officer's)	Med. Examination
Confinement	Misc. Information
Contracts	Pay or Clothing
Death or Effects /	Personal Reports
Desertions	Rank
Discharge from Hosp'l	Transfer to Hosp'l
Discharge from Service	Transfer to V. R. C.
Duty	Transportation

Isaac Roberts
Co. H. 5th U. S. C. Co.
November 1. 1864.
Genl Hosp: Camp Nelson,
Ky.

RECORD OF DEATH AND INTERMENT

Name and number of person interred: *Isaac Roberts*
 Number and locality of the grave. *795*
 Hospital number of the deceased. *1783*
 Regiment, rank and company. *5th Colored. Cav. Dist Co. H*
 Residence before enlistment
 Conjugal relation, (and if married, the residence of the widow.)
 Cause of death. *Measles*
 Age of the deceased.
 Nativity.
 References and remarks. }
 Date of death and burial. *Nov 1st / 64*

Memoranda of effects.

Boots. pr. 1
Cap 1
Haversack 1
Expenses with Corpse 1
Shirt 1
Uniform Jacket 1
Goggles 1
Drawers 1
Stockings pr 1

Extract from Act of Congress.

SEC. 12. *And be it further enacted*, That the fees of agents and attorneys for making out and causing to be executed the papers necessary to establish a claim for a pension, bounty, and other allowance before the Pension Office, under this act, shall not exceed the following rates: For making out and causing to be duly executed a declaration by the applicant, with the necessary affidavits, and forwarding the same to the Pension Office, with the requisite correspondence, ten dollars: which sum shall be received by such agent or attorney in full for all services in obtaining such pension, and shall not be demanded or received, in whole or in part, until such pension shall be obtained; and the sixth and seventh sections of an act entitled "An act to grant pensions," approved July [fourteenth,] eighteen hundred and sixty-two, are hereby repealed.

SEC. 13. *And be it further enacted*, That any agent or attorney who shall, directly or indirectly, demand or receive any greater compensation for his services under this act than is prescribed in the preceding section of this act, or who shall contract or agree to prosecute any claim for a pension, bounty, or other allowance under this act, on the condition that he shall receive a per centum upon any portion of the amount of such claim, or who shall wrongfully withhold from a pensioner or other claimant the whole or any part of the pension or claim allowed and due to such pensioner or claimant, shall be deemed guilty of a high misdemeanor, and, upon conviction thereof, shall, for every such offense, be fined not exceeding three hundred dollars, or imprisoned at hard labor not exceeding two years, or both, according to the circumstances and aggravations of the offense.

Approved July 4, 1864.

NOTE 10.—If any soldier is charged a higher fee than that allowed by the above act, he should report the fact and the name of the agent to the Adjutant General, in order that steps may be taken to have the same refunded.

ADJUTANT GENERAL'S OFFICE

Jan 15th 1865.

Duplicate with Inventory sent 2d Auditor.

FINAL STATEMENT

60 H
OF
Francis Roberts

5th
Reg't of U.S. Cavalry

VOLUNTEERS.

NOTE 1.—Two of these certificates (or duplicates) are to be given to each Volunteer Soldier or drafted man who may be discharged without being mustered out (Final Statements are never given to men mustered out of service,) that he may at once receive from the Paymaster the pay, &c., due him, and the captain or other COMMISSIONED officer commanding the company will certify to the act of the delivery of the duplicate certificates; with these certificates the Soldier is "entitled to" his discharge, and should also present his discharge to the Paymaster to have the payment endorsed on it. The discharge is to be given back to the Soldier by the Paymaster; the latter only retaining as his vouchers the duplicate certificates.

NOTE 2.—If the Soldier is entitled to pay for the use of his horse, the Company Commander will certify to that fact on the back of both these final statements, and also to the time he has pay due for having been so mounted on his own horse.

NOTE 3.—When a Soldier is furnished with final statements, his descriptive list, if he has one, should be taken up by the officer who gives the Soldier these statements, and endorsed with a statement to this effect by the officer. The endorsement should exhibit a full statement of the time for which the Soldier was allowed pay on his final statements, the clothing account, and all other charges against him or in his favor, so as to comprise a complete exhibit of his account. It will then be transmitted to the Company Commander of the Soldier, who will enter all the data necessary to a full understanding of the Soldier's account on the muster roll upon which the Soldier's discharge is reported. The descriptive list will then be destroyed. The object of this is, that the remaining portion of the Soldier's account may be settled upon the receipt of these muster rolls, and the Soldier receive any pay or allowances that may be due him at the time of his discharge, and which may not appear on his last final statements from the fact that his descriptive list is incomplete. These accounts for back pay, &c., are settled by the 2d Auditor of the Treasury Department.

NOTE 4.—Charges for loss or injury to ordnance, horse equipments, and other miscellaneous charges, should appear under the heading of "Other Stoppages."

NOTE 5.—Bounty paid by State authorities, and not by the United States, will not be entered on this statement.

NOTE 6.—Amounts due the Sutler and Laundress must be entered on the muster roll on which the discharge, death, desertion, &c., is reported, as well as on the final statement, otherwise the amount cannot be collected from the United States.

NOTE 7.—This blank will be used for deceased volunteers and drafted men, as well as for others.

NOTE 8.—Where a Soldier dies in Hospital or on detached service, his descriptive list, if he has one, should be sent with his final statements, in duplicate, to the Adjutant General, Washington, D. C.

NOTE 9.—If the soldier is a drafted man or substitute, the space for time, &c., of enrolled, should contain only the word *drafted* or *substitute*, as the case may be. If the Soldier is a "VETERAN," (or RECRUIT) the words *as a veteran*, (or *recruit*.) as the case may be, should be interlined after the words *mustered into the service of the U. S.* A statement of all the installments of *Veteran* or *Recruit* Bounty RECEIVED by the Soldier must be made on the back of each final statement.

I certify, on honor, that Isaac Roberts, a Private of
 Captain J. W. Anderson's Company (A) of the fifth Regiment of U. S. Cavalry
VOLUNTEERS, of the State of _____, born in Shelby Co, State
 of Kentucky, aged 23 years; 5 feet 5 inches high; Black complexion,
Blk eyes, Blk hair, and by occupation a Laborer, who joined for service
 and was enrolled (see Note 9) on the Eighth day of Sept, 1864, at Louisville
 by Capt. Warr, for the period of three years, and mustered into
 the service of the United States on the ninth day of September, 1864, at
Louisville, by Capt Smith; and having served
 HONESTLY and FAITHFULLY with his Company to the present date, is now entitled to a
DISCHARGE by reason of Death in U. S. Genl Hospt at
Camp Nelson "Ky" Nov 1st 1864 Disease not "Known"
 The said Isaac Roberts has pay ^{due from date of} was last paid by Paymaster
Enlistment, to include the _____ day of _____, 186 , and
 has pay due him from that time to the present date; he is entitled to pay and subsistence for
TRAVELING to place of enrollment, and whatever other allowances are authorized to volunteer
 soldiers, drafted men, or militia, so discharged. He has received from the United States **CLOTHING**
 amounting to Seventy ⁵⁰/₁₀₀ dollars, since the Eighth day of September,
 1864, when his clothing account was last settled. He has received from the United States
 _____ ¹⁰⁰/₁₀₀ dollars advanced **BOUNTY**.

There is to be stopped from him, on account of the State of _____, or other
 authorities, for **CLOTHING, &c.**, received on entering service, _____ ¹⁰⁰/₁₀₀ dollars; and
 for other stoppages, viz: _____

_____ ¹⁰⁰/₁₀₀ dollars.
 He has been furnished with **TRANSPORTATION** in kind from the place of his discharge to
 _____; and he has been **SUBSISTED** for **TRAVELING** to his
 place of enrollment, up to the _____, 186 .

He is indebted to _____, **SUTLER**, _____ ¹⁰⁰/₁₀₀ dollars.

He is indebted to _____, **LAUNDRESS**, _____ ¹⁰⁰/₁₀₀ dollars.

Given in Duplicate, at Camp Nelson "Ky", this 31st day
 of December, 1864.

John W. Anderson
Capt. Co. A.
 Commanding Company.

Robertson Cyrus
Co I, 5 U. S. Col'd Cav.

1st Lieutenant / 1st Lieutenant

CARD NUMBERS.

1	5359187	26
2	5367966	27
3	5368059	28
4	5368153	29
5	5368246	30
6	5368338	31
7	5368427	32
8	5368514	33
9	5368601	34
10	5368683	35
11	9435968	36
12	4480-B-1889	37
13	40730258	38
14		39
15		40
16		41
17		42
18		43
19		44
20		45
21		46
22		47
23		48
24		49
25		50

Book Mark: 4480-B-1889

See also 11 Mich. Cav.

R.P. 352015 (R-Number)

S-780027-2 And

R.P. 352015 (Rem.)

1187408 2 and 2nd

81178385 and w. d.

R.P. 784509

Q.Y. 1435947

J. B. Doud
Ex

R 15th Cav. | U.S.C.T.

C. Robertson

1st Lt., Co. *D*, 3rd Reg't U. S. Col'd *Cav.*

Appears on

Regimental Descriptive Book

(List of Commissioned Officers)

of the regiment named above.

Rank *1st Lieutenant*

Date of appointment *Oct. 21* 186*4*.

Remarks: *Mustered Nov. 24, 1864,*
at Camp Nelson Ky
by Capt. N. C. Kinney
for U. S. A.

Hearst

R | O Car. | U.S.C.T.

Cyrus Robertson

1 Lt., Co. I, 5 Reg't U. S. Col'd Car.

Age 23 years.

Appears on an

Individual Muster-in Roll

of the organization named above. Roll dated

Camp Nelson Ky, Nov. 24, 1864.

Muster-in to date Nov 24, 1864.

Joined for duty and enrolled:

When Nov. 23, 1864.

Where Camp Nelson Ky.

Period 3 years.

Valuation of horse, \$ 100

Valuation of horse equipments, \$ 100

Remarks: Mustered in upon appointment of the President of the United States, dates Baltimore

Book mark: 4480-B-1889

Sarimer

JAN. - 9

5359187

1891*

(Wm.) Oct. 21 1864

to rank as a First
Lieut in the 6 Regt.
U. S. Cav. Cavalry from
the 21 day of October
1864.

Assigned to duty with
his Company (I) Nov.
24 1864

Enlisted men of said
company were mustered in
(to the Minimum) on
or before said date

R.

5 Cav.

U.S.C.T.

Cyrus Robertson

1st Lt., Co. I, 5 Reg't U. S. Col'd Cavalry.

Appears on

Company Muster Roll

for Nov. + Dec., 1864.

Present or absent Present

Stoppage, \$ 100 for

Due Gov't, \$ 100 for

Valuation of horse, \$ 100

Valuation of horse equipments, \$ 100

Remarks: Mustered and assigned
Nov. 25", 1864.

Book mark:

Philipson

(358)

Copyist.

R

5 Cav. U.S.C.T.

Cyrus Robertson

1st Lt., Co. I, 5 Reg't U. S. Col'd Cavalry.

Appears on

Company Muster Roll

for Jan. & Feb., 1865.

Present or absent Not stated.

Stoppage, \$ 100 for

Due Gov't, \$ 100 for

Valuation of horse, \$ 100

Valuation of horse equipments, \$ 100

Remarks: Mustered and assigned Nov. 24, 1864.

Book mark:

Phillipsen

(358)

Copyist.

R

5 Cav. U.S.C.T.

Cyrus R. Robertson

1st Lt., Co. I, 5 Reg't U. S. Col'd Cavalry.

Appears on

Company Muster Roll

for Mch. & Apl., 1865.

Present or absent Present

Stoppage, \$ 100 for

Due Gov't, \$ 100 for

Valuation of horse, \$ 100

Valuation of horse equipments, \$ 100

Remarks: Commanding Co.

Book mark:

Philipson

(358)

Copyist.

R

5 Cav.

U.S.C.T.

Cyrus Robertson

1st Lt., Co. I, 5 Reg't U. S. Col'd Cavalry.

Appears on

Company Muster Roll

for *May & June*, 1865.

Present or absent *Present*

Stoppage, \$ *100* for

Due Gov't, \$ *100* for

Valuation of horse, \$ *100*

Valuation of horse equipments, \$ *100*

Remarks:

Book mark:

Robertson

(358)

Copyist.

R | **5 Cav.** | **U.S.C.T.**

Ernest Robertson

1st Lt, Co. I, 5 Reg't U. S. Col'd Cavalry.

Appears on

Company Muster Roll

for *July & Aug*, 1865.

Present or absent *Present*

Stoppage, \$ 100 for

Due Gov't, \$ 100 for

Valuation of horse, \$ 100

Valuation of horse equipments, \$ 100

Remarks: *Pay due for increase in valuation to April 30 1865.*

Pay due for Command of Company from Nov 30 1864 to June 30 65

Book mark:

Alvio

R

5 Cav. U.S.C.T.

Cyrus Robertson

1st Lt, Co. I, 5 Reg't U. S. Col'd Cavalry.

Appears on

Company Muster Roll

for *Sept Dec*, 186*5*.

Present or absent *Present*

Stoppage, \$ *100* for

Due Gov't, \$ *100* for

Valuation of horse, \$ *100*

Valuation of horse equipments, \$ *100*

Remarks: *Pay due for*

*Command of Co from
1st Dec 1864 to 6 July
1865. & from Aug 20/65
to Oct 31/65. Not paid
for increase on rations
to Apr 30/65*

Book mark: *100*

Allen

E

5 Cav. U.S.C.T.

Cyrus Robinson

1st Lt, Co. I, 5 Reg't U. S. Col'd Cavalry.

Appears on

Company Muster Roll

for *Nov 1860*, 1860.

Present or absent *Present*

Stoppage, \$ *100* for

Due Gov't, \$ *100* for

Valuation of horse, \$ *100*

Valuation of horse equipments, \$ *100*

Remarks: *\$20.00 due for
responsibility in
Command of Co.*

Book mark:

Deed

R

5 Cav.

U.S.C.T.

Cyrus Robertson

1st Lieut, Co. I, 5 Reg't U. S. Col'd Cavalry.

Appears on

Company Muster Roll

for Jan'y. & Feby., 1866.

Present or absent Present

Stoppage, \$ 100 for

Due Gov't, \$ 100 for

Valuation of horse, \$ 100

Valuation of horse equipments, \$ 100

Remarks: Pay due for responsibility in command of Co. for the months of Dec. 1864 Jan'y. Feby. Mch. & Apl. '65, \$50⁰⁰ For the months of Nov. & Dec. 1865 & Jan'y. & Feby. 1866 - \$40⁰⁰

Book mark:

Cresham

Q

5 Cav.

U.S.C.T.

Cyrus Robertson

127, Co. E, 5 Reg't U. S. Colored Cav.

Appears on Returns as follows:

Nov 1864. - Gain: mustered
& assigned Nov. 25/64

Dec. 1864 to Feb. 1865. - Present
Signs Return as Comdg.
Co.

March & April 1865. - Present
May to Dec. 1865. - Present
Signs Return as
Comdg. Co.

Jan. 1866. - Absent with
leave.

Feb. 1866. - Present. Signs
Return as Comdg.
Co.

Book mark :

E. Thornton

(548)

Copyist.

R

5 Cav. U.S.C.T.

Cyrus Robertson

1st Lieut, Co. D, 5 Reg't U. S. Col'd Cavalry.

Appears on Co. Muster-out Roll, dated

Helena, Ark, Mch. 16, 1866.

Muster-out to date

Mch. 16, 1866.

Last paid to

Nov. 30, 1865.

Clothing account:

Last settled....., 186 ; drawn since \$..... 100

Due soldier \$..... 100; due U. S. \$..... 100

Am't for cloth'g in kind or money adv'd \$..... 100

Due U. S. for arms, equipments, &c., \$..... 100

Bounty paid \$..... 100; due \$..... 100

Remarks: Promoted from Sergt. 11th

Mich. Cav. to 1st Lt. 5th U.S.C.

Cav. - Orig'l. place of En-
rollment, Hillsdale, Mich.

Due for responsibility in
Command of the Company.

Book mark: 4480. B. A. G. O. (V. E. B.) - 89

Crenshaw

JAN. - 9

5368633

1891

for the months of Dec. '64.
Jan'y. Feby. Mar. & Apl. '65.
\$50⁰⁰ - Nov. & Dec. '65 and
Jan'y. & Feby. '66. \$40⁰⁰ -
Stop for rations furnished
in kind \$15.53.

R 5 Cav U.S.C. & 1

Myrus Robertson

at-
Lieut. Co. I, 5 Reg't U.S.C. Cav.

NOTATION.

Book mark: 4480 B. 1889

War Department,

Record and Pension Division,

Washington, August 8, 1889.

See also No. 211st Mich.
Cav. and No. 2, 8th Mich.
Cav.

F. Dunn

Robertson, Cyrus

1 Lt., Co.

5

Reg

U.S.C. Cav.

7

Enclosures.

Bed Cards

✓

Descriptive Lists

Burial Records

Final Statements

Certs. of Dis. for Discharge

Furloughs

C. M. Charges

Med. Des. Lists

Med. Certificates

Orders

z

Other papers relating to—

Admission to Hosp'l

Furlough

Casualty Sheet (Officer's)

Med. Examination

Confinement

Misc. Information

Contracts

Pay or Clothing

Death or Effects

Personal Reports

Desertions

Rank

Discharge from Hosp'l

Transfer to Hosp'l

Discharge from Service

Transfer to V. R. C.

Duty

Transportation

Hospital Number 625

Name Lewis Robertson

Age 23 Nativity Michigan

Married or Single Single

Residence Hillsdale Hillsdale Mich

Post Office address of } John L. Robertson
wife or nearest relative. }

Rank Lieut Co. Regiment 6th U.S. Cavalry

When admitted September 22nd 1864

From what source Regiment

Diagnosis: (in surgical cases state explicitly seat and character of wound or injury.)

Fever

Branch A-G. H.
Bowling Green, Ky.

On what occasion wounded.....

Date.....

Nature of missile or weapon.....

112.00

TREATMENT.

[HERE NOTE IMPORTANT COMPLICATIONS AND ALL OPERATIONS.]

RESULT AND DATE.

Returned to duty
Oct 17/01

Hospital Number 712

Name Leyous Robertson

Age 23 Nativity Michigan

Married or Single Single

Residence Hillsdale, Hillsdale Co. Mich

Post Office address of } John C. Robertson
wife or nearest relative. }

Rank 2 Lt Co. _____ Regiment 62nd Infantry

When admitted Nov 7th 1864

From what source Field

Diagnosis: (in surgical cases state explicitly seat and character of wound or injury.)

Dysentery

Branch A-G. H.

Bowling Green, Ky.

On what occasion wounded _____

Date _____

Nature of missile or weapon _____

Head Qu Quarters
Helena Ark. 29 Dec 65
R. 39 (Inf) DA. 1865

Robertson. C
1st Lt Co I Sufce

G. O. # 5. par 1
Request a leave of absence
for (20) twenty days with
leave to apply for an
extension of 10 days.

States he has not had a
leave since he has been
with his Regt

Head Qu Sufce
Helena Ark Dec 30. 65

Approved and respectfully
forwarded

L. H. Hays
Colonel Sufce
Comd Regt

1865
Respectfully forwarded
approved

J. H. Bristin
Major Genl W S Vol
Commanding

64 Regt 16th P. F. A. 1865
H. C. P. R. Dist.
Helena Ark Jan 26 1866

Respectfully for
warded approved

E. A. Carr
Bt. Maj. Gen
Commanding

Co'd Qu "I" Co 52nd Inf 66
Helena Ark Dec 29/65

Sir

I have the honor herewith to request a leave of absence for (20) twenty days (with permission of an extension of (10) ten days) to visit my home in Hillsdale - Hillsdale County Michigan

I certify upon honor that I have had no leave of absence since joining the Regiment for more than (48) forty eight hours - Lieut Jacob Herck is on duty with the Co and I see no reason why my services cannot be spared

Very Respectfully

Your Obedt Serv^t

To

Charles E Howe

Cyrus Robinson

Adj^t Gen^l Dept Ark

1st Lieut Cosupce

Little Rock

Arkansas

Wm Dept of Arkansas
Little Rock Ark
Jan 9. 1866

Special Order No 5

Leave of absence for 1st Lt
Robertson.

SPECIAL ORDERS }
No. 5.

HEADQUARTERS,
DEPARTMENT OF ARKANSAS,
Little Rock, Ark., Jan., 9th, 1866.

[EXTRACT.]

1. Leave of absence for twenty (20) days, to proceed beyond the limits of this Department, with permission to apply to Headquarters Military Division of the Mississippi for an extension of ten (10) days, is hereby granted the following officers :

1st Lieutenant Cyrus Robertson, 5th U. S. Colored Cavalry.

* * * * *

By command of Major General J. J. REYNOLDS :

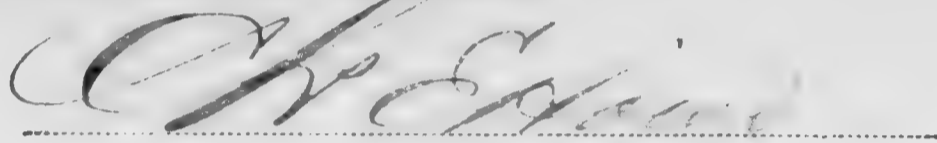

Captain, Assistant Adjutant General.

C. H. Egan
5th U. S. Colored Cavalry

H. G. Brown 1866.

Chicago Ill
July. 22. 1866.

Robertson, Cyrus.
1st Lieut 5th U.S. C.O.

Requests ten days' extension
to leave of absence.

I. O. No 13 par B

Recd Wm. M. Army 24/66

Chicago Ill. 22nd Jan 1866 -
Assist. Adj. Gen.
Military Div. Mississippi.

Sir.

I have the honor to request
an extension of ten (10) days to a leave
of absence for twenty (20) days
granted me by special order No. (37)
dated Hd. Qs. Dept. Ark. 9th January
1866 permission having been granted
in said order to ask such an
extension

"address"

Hillsdale
Mich.

Very Respectfully
Yours Obedt. Servant
Cyrus Robertson
1st Lieut. 5th U.S.C.

Major Genl Div of the
Mississippi

St Louis Mo. February 26. 66.

Special Order No 13

Extends the leave of absence
of 1st Lt C Robertson Surge
Ten days

Head Quarters Military Division of the Mississippi,

St. Louis, Mo., January 26th 1866

Special Orders, }
No. 13 }

EXTRACT.

x
3 The leave of absence
for twenty days granted Lt. Col.
Cyrus Robertson 5th U. S. Colored Cavalry
per S. O. No 5, of date January 9th
1866, from Headquarters Department
of Arkansas, is upon the recommendation
of the Department's Commander extended
ten days.

BY ORDER OF MAJOR GENERAL W. T. SHERMAN:

ASSISTANT ADJUTANT GENERAL.

To Comdg Officer
5th U. S. Col'd Cav
Dept of Arkansas, Little Rock

E. Francis R. Dyer

Affidavit of Nonindebtedness to U. S.,

of *Cyrus Albertson*

late *1st* *Co.* *3rd* Reg't

U. S. Army on which was

based Certificate of Nonindebtedness

to U. S.,

Dated *March 17th* 1866.

STATE OF
COUNTY

Alhambra
Phillips } ss.

Cyrus Robertson
late 1st Lt. Co. I. 3rd Regiment U. S. Col. & Cal. Vols.

I do solemnly declare on oath, that I have duly accounted for all Public Property, for which I have ever been responsible as an Officer of the Volunteer Forces of the United States; that I have rendered all returns and reports, required by Revised Army Regulations of 1863 and existing orders; that I am not now, on any account whatever, indebted to the General Government except as stated on Muster-out Rolls.

Cyrus Robertson
late 1st Lieut. Co. I. 3rd Regt.

Sworn and subscribed before me, at *Wetmore Ark*
this *17th* day of *March* 1866.

W. F. Morse
Capt. & Comdg. Muster
Capt. of Arkansas

10010
Robertson Edward

Co B, 5 U. S. Col'd Cav.

Private | Private

CARD NUMBERS.

1	26
2	27
3	28
4	29
5	30
6	31
7	32
8	33
9	34
10	35
11	36
12	37
13	38
14	39
15	40
16	41
17	42
18	43
19	44
20	45
21	46
22	47
23	48
24	49
25	50

Book Mark:

See also

Robins William

Co *L*, 5 U. S. Col'd Cav.

Private Corporal

CARD NUMBERS.

5369847	26
5369942	27
5370035	28
5370135	29
5370225	30
5370271	31
5370355	32
5370452	33
5370609	34
5359449	35
5370790	36
9091197	37
43148135	38
43147183	39
AG 1554885	40
40730259	41
	42
	43
	44
	45
	46
	47
	48
	49
	50

Book Mark: *AG 1554885*

See also

D. 2850499 Pomeroy
1554885

S. W. E. News, Wash. D. C. 3/19/30
A. P. S.

J. B. Dowd
Ex

R

5 Cav. U.S.C.T.

William Rabins

Co. *L*, 5 Reg't U. S. Col'd Cav.

Appears on

Company Descriptive Book

of the organization named above.

DESCRIPTION.

Age *27* years; height *5* feet *10* inches.

Complexion *Dark*

Eyes *Dark*; hair *Dark*

Where born *Henry Ky*

Occupation *Labourer*

ENLISTMENT.

When *Sept 24, 186*

Where *Lansville Ky*

By whom *Capt Smith*; term *3* y'rs.

Remarks: *Disch'd Nov 26"/65*

A J Anderson

(383g)

Copist.

R

5 Cav. U.S.C.T.

William Robbins

Pvt, Co. L, 5 Reg't U. S. Col'd Cavalry.

Appears on

Company Muster-in and Descriptive Roll

of the organization named above. Roll dated

Camp Nelson, Ky, Oct 20, 1864.

Where born Henry Ky

Age 27 y'rs; occupation Rubber

When enlisted Sept 24, 1864.

Where enlisted Louisville

For what period enlisted 3 years.

Eyes BR; hair BR

Complexion BR; height 5 ft. 10 in.

When mustered in Sept 24, 1864.

Where mustered in Louisville

Bounty paid \$ 100; due \$ 100

Where credited 5 Dist Ky

Company to which assigned

Remarks:

Book mark:

Braden

(356d)

Copyist.

R | 5600 | U.S.G.T

William Robbins

Appears with rank of Pr on

Muster and Descriptive Roll

of Detachment of U.S. Colored Troops

Mustered for U.S.G.T. at Taylor Bks

Louisville Ky. Roll dated

Louisville Ky., Sept 24, 1864.

Where born Keokuk Ky

Age 27 years; occupation laborer

When enlisted Sept 24, 1864.

Where enlisted Louisville

For what period enlisted 3 years.

Eyes Dark; hair Dark

Complexion Dark; height - ft. - in.

When mustered in Sept 24, 1864.

Where mustered in Louisville Ky

Bounty paid \$ 100; due \$ 100

Clothing account:

Last settled -, 1864; drawn since \$ 100

Date of first muster -, 1864.

Company to which assigned -

Remarks: Healthy - Heavy Co. 5th Dist

-

Book mark: AG 1554885

-

(356m)

W. Robbins

Copyist.

R. | 5 bar | U.S.S.

William Robins

Appears with rank of Sgt on

Muster and Descriptive Roll

of Detachment of U.S. Colored Troops forwarded

Roll dated

Squirrville Ky, Oct 24, 1864

Where born Henry Ky

Age 27 years; occupation Boxer

When enlisted Sept 24, 1864

Where enlisted Louisville Ky

For what period enlisted 3 years.

Eyes Dark; hair Dark

Complexion Dark; height 5 ft. 10 in.

When mustered in Sept 24, 1864

Where mustered in Louisville

Bounty paid \$ 100; due \$ 100

Clothing account:

Last settled _____, 186 ⁵⁰; drawn since \$ 17-100

Date of first muster Sept 24, 1864

Company to which assigned _____

Remarks: Credited to 4"

Henry Kirk Ky

Book mark: _____

(356m)

M. M. Jackson

Copyist.

R

5 Cav.

U.S.C.T.

William Robbins

Pvt., Co. L, 5 Reg't U. S. Col'd Cavalry.

Appears on

Company Muster Roll

for *Dated Oct 31*, 186*4*

Present or absent *Absent*

Stoppage, \$ *100* for

Due Gov't, \$ *100* for

Valuation of horse, \$ *100*

Valuation of horse equipments, \$ *100*

Remarks: *Audit serv
Nashville Tenn
Oct 15/64*

Book mark:

Brady

R

5 Cav.

U.S.C.T.

William Robbins

Pvt

Co. L, 5 Reg't U. S. Col'd Cavalry.

Appears on

Company Muster Roll

for Nov & Dec, 1864

Present or absent Absent

Stoppage, \$ 100 for

Due Gov't, \$ 100 for

Valuation of horse, \$ 100

Valuation of horse equipments, \$ 100

Remarks: Under zero
mustered June
Oct 16 / Sep. 1 + 2
Install. of Bounty
due

Book mark:

Bradley

(358)

Copyist.

R | 5 Cav. | U.S.C.T.

William Robins
Sgt, Co. L, 5 Reg't U. S. Col'd Cav.

Appears on

Company Muster Roll

for Jan 1 Feb, 1865.

Present or absent Absent

Stoppage, \$ 100 for

Due Gov't, \$ 100 for

Valuation of horse, \$ 100

Valuation of horse equipments, \$ 100

Remarks: In dismounted
Camp, Camp Nelson, Ky.
1 & 2 installments bounty
due.

Book mark:

W. D. Doid

(358)

Exr Copyist

R

5 Cav. U.S.C.T.

William Robins

For, Co. L, 5 Reg't U.S. Col'd Cavalry.

Appears on

Company Muster Roll

for *Mut & Ape*, 1865

Present or absent *Present*

Stoppage, \$ 100 for

Due Gov't, \$ 100 for

Valuation of horse, \$ 100

Valuation of horse equipments, \$ 100

Remarks: *1st Install of
Bounty due \$100*

Book mark:

Proctor

(358)

Copyist.

R | 5 Cav. | U.S.C.T.

William Robins
Copt, Co. L, 5 Reg't U.S. Col'd Cavalry.

Appears on

Company Muster Roll

for *May & June*, 1865.

Present or absent *Present*

Stoppage, \$ *100* for

Due Gov't, \$ *100* for

Valuation of horse, \$ *100*

Valuation of horse equipments, \$ *100*

Remarks: *1st. Instalment*

Compt. due \$100.
Appointed Copt. for
Oct. 70 dated May
7. 1865

Book mark:

Robins

102

5 Cav.

U.S.C.T.

William Robins
Corpl, Co. L, 5 Reg't U.S. Col'd Cavalry.

Appears on

Company Muster Roll

for

July 5th Aug. 1865

Present or absent

Present

Stoppage, \$

100 for

Due Gov't, \$

100 for

Valuation of horse, \$

100

Valuation of horse equipments, \$

100

Remarks:

Book mark:

Robins

(358)

Copyist.

C | **5 Cav.** | **U.S.C.T.**

William Robins
Compl., Co. L, 5 Reg't U. S. Col'd Cavalry.

Appears on

Company Muster Roll

for *Sept & Oct*, 1865.

Present or absent *Present*

Stoppage, \$ 100 for

Due Gov't, \$ 100 for

Valuation of horse, \$ 100

Valuation of horse equipments, \$ 100

Remarks:

Book mark:

Rochester

(358)

Copyist.

RB | *Flau* | **U.S.C.T.**

William Robins
Corp, Co. *L*, *5* Reg't U. S. Col'd *Cav*

Appears on

Descriptive List of Deserters

dated *Nov 30*, 186*5*.

Deserted:

When *Nov 26*, 186*5*.

Where *Louisville Ky*

Arrested:

When _____, 186 .

Where _____

Remarks: _____

Book mark: _____

Rose

(351)

Copyist.

C | **5 Cav. | U.S.C.T.**

William Robins
Capt, Co. L, 5 Reg't U.S. Col'd Cavalry.

Appears on

Company Muster Roll

for *Nov Dec*, 1865.

Present or absent

Stoppage, \$ 100 for

Due Gov't, \$ 100 for

Valuation of horse, \$ 100

Valuation of horse equipments, \$ 100

Remarks: *Deserted at*
Louisville Ky. Nov.
26th 1865 Due U.S.
for ord. 55cts. for
C.C. & G. Equipage
\$4.70

Book mark:

Pro Master

(358)

Copyist.

R | 5 Cav. | U.S.C.T.

William Robins

Corp, Co. F, 5 Reg't U. S. Colored Cav.

Appears on Returns as follows:

Oct. 10 Dec. 1864, - Absent on
det. serv. Nashville
Tenn. Oct. 15/64

Jan. & Feb. 1865, - Absent
in Dismounted Camp
Camp Nelson Ky.

March 1865, - On daily duty
as Guard at Regt.
Ho. Dep.

Nov. 1865, - (Corp.) - Adv.
Nov. 26/65 Louisville
Ky. Deserted.

Book mark:

E. Thornton

(548)

Copyist.

R | 5600 | U.S.C.T.

William Robins
Capt, Co. L, 5 Reg't U. S. Col'd Cavalry

Appears on Co. Muster-out Roll, dated
Helena, Ariz, Mar. 16, 1866.

Muster-out to date _____, 186 .

Last paid to Oct. 31, 1865 .

Clothing account:

Last settled _____, 186 ; drawn since \$ _____ 100

Due soldier \$ _____ 100; due U. S. \$ $3\frac{65}{100}$

Am't for cloth'g in kind or money adv'd \$ _____ 100

Due U. S. for arms, equipments, &c., \$ _____ 100

Bounty paid \$ $1\frac{50}{100}$ 100; due \$ _____ 100

Remarks: Deserted Nov. 26, 65
at Louisville Ky.

Book mark : _____

O. P. Taylor

(361)

Copyist.

R | 5 | U.S.C.V.

William Robbins
Corpl., Co. I, 5 Reg't U.S.C.V.

NOTATION.

Book mark: A. G. 1554885

The Adjutant General's Office,

WAR DEPARTMENT,

Washington, Aug. 25, 1909.

The charge of desertion of November
26, 1865,

against this man *is* removed and he is discharged
to date *November 26*, 1865, under the pro-
visions of the act of Congress, approved March 2, 1889.

Discharge certificate ~~issued~~ ^{prepared} by War Department
August 25, 1909, and filed.

W. W. Gibson

(A. G. O. 246)

Copyist.

Robbins *Wm*

....., Co., Reg't *U. S. C. J.*

/ **Enclosures.**

Bed Cards	Final Statements
Burial Records	Furloughs or L. of A.
Certs. of Dis. for Discharge	Med. Certificates
C. M. Charges	Med. Des. Lists
Descriptive Lists	Orders
Discharge Certificates	Pris. of War Record
Enlistment Papers <i>/</i>	Resignations

Other papers relating to—

Admission to Hosp'l	Furlough or L. of A.
Casualty Sheet	Med. Examination
Confinement	Misc. Information
Contracts	Pay or Clothing
Death or Effects	Personal Reports
Desertion	Rank
Discharge from Hosp'l	Transfer to Hosp'l
Discharge from Service	Transfer to V. R. C.
Duty	Transportation
.....

DECLARATION OF RECRUIT.

I, *William Robbins*..... desiring to volunteer as a soldier in the ARMY OF THE UNITED STATES, for the term of *Three Years*, DO DECLARE That I am *27* years and months of age; that I have never been discharged from the United States service on account of disability or by sentence of a court-martial, or by order before the expiration of a term of enlistment; and I know of no impediment to my serving honestly and faithfully as a soldier for three years.

GIVEN at *Missile Ky* the *24* day of *Sept* 18*64*

Witness:

George M Hanley

NOTE 1.—This blank will be used for enlistments of United States colored troops. They will be made out in duplicate in all cases—one to accompany the recruiting return of the superintendent (not the recruiting officer) to the Adjutant General, and one to accompany the accounts of the officer who pays bounty, &c.

NOTE 2.—An enlistment holds to service. A muster-in must, in all cases, precede payment of pay, bounty, pension, &c. A muster-in roll, must in all cases, be filed in the Adjutant General's Office as evidence of muster-in. The mustering officer, commissary, or assistant commissary of musters, as the case may be, will countersign both enlistments as having mustered the soldiers into the service of the United States before either of them is given to the disbursing officer.

Consent of Parent or Guardian in case of a Minor, if a Free Man, or in the case of a Slave, of the Person to whom he owes Service:

I, Do CERTIFY, That I am the that the said is years of age; and I do freely give my CONSENT to his volunteering as a SOLDIER in the Army of the United States, for the period of **THREE YEARS**, under the conditions of the laws of the United States.

GIVEN at the day of

Witness:

(A. G. O. No. 74 & 76.)

Volunteered at
Sept 24 1864
By Lt Smith Corp
Price a poor soldier, never been in
William Robbins
No. 311

UNITED STATES COLORED TROOPS ENLISTMENT.

STATE OF

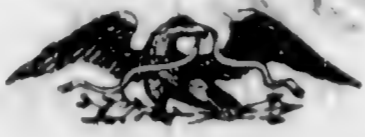

TOWN OF

Kentucky
I, *William Robbins* born in *Hamburg*
in the State of *Kentucky* aged *27* years
and by occupation *laborer* Do HEREBY ACKNOWLEDGE to
have volunteered *24th* day of *Sept* 186*4*

to serve as a **Soldier** in the **Army of the United States of America**, for the period of **THREE YEARS**, unless sooner discharged by proper authority: Do also agree to accept such bounty, pay, rations, and clothing, as are, or may be, established by law for the U. S. colored troops.

And I, *William Robbins*
do solemnly swear that I will bear true faith and allegiance to the **United States of America**, and that I will serve them honestly and faithfully against all their enemies or opposers whomsoever; and that I will observe and obey the orders of the President of the United States, and the orders of the officers appointed over me, according to the Rules and Articles of War.

Sworn and subscribed to, at *Louisville*
this *24th* day of *Sept* *William Robbins*
Before *[Signature]* *Wm Robbins*

I CERTIFY, ON HONOR, That I have carefully examined the above named Volunteer agreeably to the General Regulations of the Army, and that, in my opinion, he is free from all bodily defects and mental infirmity, which would in any way disqualify him from performing the duties of a soldier.

W. H. McConnell
U. S. Surgeon
EXAMINING SURGEON.

I CERTIFY, ON HONOR, That I have minutely inspected the Volunteer..... previously to his enlistment, and that he was entirely sober when enlisted; that, to the best of my judgment and belief, he is of lawful age; and that, in accepting him, as duly qualified to perform the duties of an able-bodied soldier, I have strictly observed the regulations which govern the recruiting service. This soldier has *Dark* eyes, *Dark* hair, *Dark* complexion, is *5* feet *10* inches high.

12th Sept
RECRUITING OFFICER OR AGENT.

Mustered into the United States Service.....day of186 .

Abraham Robbins

Mustering Officer.

Mustered into the service of the United States, for three years or during the war, from date of enlistment, in Company
Regiment of Volunteers, on the day of 186 , at

Robbins of H. Co. 1st Regt. Colored Troops

1087
Robinson Albert

Co M, 5 U. S. Col'd Cav.

Private Private

CARD NUMBERS.

1	5370878	26
2	5370992	27
3	5359363	28
4	5371061	29
5	5359371	30
6	5371145	31
7	5371232	32
8	5371318	33
9	5371406	34
10	5371492	35
11	5371576	36
12	5371661	37
13	5371745	38
14	9091315	39
15	31785575	40
16	40730260	41
17		42
18		43
19		44
20		45
21		46
22		47
23		48
24		49
25		50

Book Mark:

See also

R | *5-leaf* | **U.S.C.T.**

Almont Robinson

, Co. *M*, *5*-Reg't U. S. Col'd *leaf*

Appears on

Company Descriptive Book

of the organization named above.

DESCRIPTION.

Age *32* years; height *5* feet *5* in.

Complexion *Black*

Eyes *Blue*; hair *Black*

Where born *Nicholas Ky*

Occupation *Farmer*

ENLISTMENT.

When *Aug 29, 1864*.

Where *Camp Nelson*

By whom *H. Randolph*; term *3* y'rs.

Remarks: *Returned to duty
Nov. 1864.*

**Inserted by comparison.*

A. J. Anderson

(383g)

Copyist.

R | S car | U.S.C.T.

Albert Robinson

Co. M, Reg't U. S. Col'd car

Appears on

Company Muster-in and Descriptive Roll
of the organization named above. Roll dated

Camp Nelson Ky, Oct 30, 1864.

Where born Nicholas, Ky

Age 30 y'rs; occupation Farmer

When enlisted Aug. 29, 1864.

Where enlisted Camp Nelson, Ky.

For what period enlisted 3 years.

Eyes Black; hair Black

Complexion Black; height 5 ft. 3 in.

When mustered in Aug. 30, 1864.

Where mustered in Camp Nelson, Ky.

Bounty paid \$ 100; due \$ 100

Where credited 7 Dist Ky.

Company to which assigned

Remarks: * Samson Stone

* supposed to be name of owner.

Added May 18. 98. H.A.J.

Book mark:

W. S. Thompson

56?

R 16 Coy USCA
Alfred Robinson
Priv, Co. C, 16 Regt US Col. Cav.

Appears on

Descriptive List of Deserters

of Miss. of Ky.

dated Sept, 1864.

Age 31 years; eyes *Blk*; hair *Blk*

Complexion *Blk*; height, 5 ft. 7 in.

Where born *Nicholas, Ky.*

Occupation

Residence when enlisted

Deserted:

When *Sept 27*, 1864.

Where *Mt. Sterling, Ky.*

Remarks:

Endorsement on list shows that the men named therein were received at

*Off. Pra Marshal
Lex. Ky., Sept. 26, 1864.*

Book mark:

G. Taylor

(526)

Copyist.

R | 5 Cav. | U.S.C.T.

Albert Robinson
Prvt., Co. M, 5 Reg't U. S. Col'd Cavalry.

Appears on

Company Muster Roll

for *to Oct. 31*, 186*7*.

Present or absent

Stoppage, \$ 100 for

Due Gov't, \$ 100 for

Valuation of horse, \$ 100

Valuation of horse equipments, \$ 100

Remarks: *Deserted Oct. 1st / 64*
while on the Saelville
Expedition

Book mark:

M. S. Thompson

(358)

Copyist.

7B | 5 Cav | U.S.C.T.

Albert Robinson

Priv., Co. M, 5 Reg't U. S. Col'd Cav.

Appears on

Descriptive List of Deserters

dated Oct 31, 1864.

Deserted:

When Oct, 1864.

Where Unknown

Arrested:

When _____, 186 .

Where _____

Remarks : _____

Book mark : _____

J. Rose

(351)

Copyist.

R. | **5 Cav. | U. S. C. T.**

Albert Robinson
Priv., Co. M, 5 Reg't U. S. Col'd Cavalry.

Appears on

Company Muster Roll

for *Nov. & Dec*, 1864.

Present or absent *Absent*

Stoppage, \$ *100* for

Due Gov't, \$ *100* for

Valuation of horse, \$ *100*

Valuation of horse equipments, \$ *100*

Remarks: *Returned from Louisville to Camp Nelson Ky. 1st & 2d instalments of bounty due.*

Book mark:

W. S. Thompson

(358)

Copyist.

R. B. Swan | U.S.C.T.

Albert Robinson

Priv, Co. *M*, 5 Reg't U. S. Col'd *Cal.*

Appears on

Descriptive List of Deserters

dated *Nov 30*, 1864.

Deserted:

When _____, 186 .

Where _____

Arrested:

When _____, 186 .

Where _____

Remarks: *Taken up Nov 3
at Camp Nelson.*

*This man was re-
ported as deserter errone-
ously, he having been
absent sick.*

Book mark: _____

Rose

Copyist.

2

5 Cav. | U.S.C.T.

Albert Roberson

(Pvt.), Co. M, 5 Reg't U. S. Col'd Cavalry.

Appears on

Company Muster Roll

for Jan 1st, 1863.

Present or absent Absent

Stoppage, \$ 100 for

Due Gov't, \$ 100 for

Valuation of horse, \$ 100

Valuation of horse equipments, \$ 100

Remarks: 1st & 2d installments
of bounty due.
Returned from Louisville
to Camp Nelson, Ky.

Book mark: _____

M. H. Thompson

(358)

Copyist.

A

5 Cav. | U. S. C. T.

Albert Robinson

Co. M, Co. M, 5 Reg't U. S. Col'd Cavalry.

Appears on

Company Muster Roll

for *Mar. 9*, 186*4*.

Present or absent *Present*

Stoppage, \$ *100* for

Due Gov't, \$ *100* for

Valuation of horse, \$ *100*

Valuation of horse equipments, \$ *100*

Remarks: *1st installment
bonus due \$100*

Book mark:

W. S. Thompson

(358)

Copyist.

R

5 Cav. U.S.C.T.

Albert Robinson

No. Co. M, 5 Reg't U. S. Col'd Cavalry.

Appears on

Company Muster Roll

for May & June, 1865.

Present or absent Absent

Stoppage, \$ 100 for

Due Gov't, \$ 100 for

Valuation of horse, \$ 100

Valuation of horse equipments, \$ 100

Remarks: Daily duty Rept Hd
2d. as per Rept. Order
No.

Book mark:

(358)

C. W. [Signature]
Copyist.

R

5 Cav. | U. S. C. T.

Albert Robinson

Private, Co. M, 5 Reg't U. S. Col'd Cavalry.

Appears on

Company Muster Roll

for July & Aug, 1865.

Present or absent Present

Stoppage, \$ 100 for

Due Gov't, \$ 100 for

Valuation of horse, \$ 100

Valuation of horse equipments, \$ 100

Remarks: On daily duty with Regt -
2 M. Sept

Book mark:

(358)

C. W. T. S.
Copyist.

R

5 Cav. U.S.C.T.

Albert Robinson

Private, Co. M, 5 Reg't U. S. Col'd Cavalry.

Appears on

Company Muster Roll

for Sept & Oct, 1865.

Present or absent Present

Stoppage, \$ 100 for

Due Gov't, \$ 100 for

Valuation of horse, \$ 100

Valuation of horse equipments, \$ 100

Remarks: Due US for Camp & Garrison \$ 1.55

Book mark:

(358)

Leiter Copyist.

R

5 Cav. | U.S.C.T.

Albert Robinson

111, Co. M, 5 Reg't U. S. Col'd Cavalry.

Appears on

Company Muster Roll

for Nov & Dec, 1865.

Present or absent Present

Stoppage, \$ 100 for

Due Gov't, \$ 100 for

Valuation of horse, \$ 100

Valuation of horse equipments, \$ 100

Remarks:

Book mark:

(358)

Copyist.

R

5 Cav.

U.S.C.T.

Albert Robinson

Priv., Co. M, 5 Reg't U. S. Colored Cav.

Appears on Returns as follows:

Oct. 1864, - Over Oct. 1/64

Mt. Sterling Ky. Deserted
on the road to the

Nov. 1864, - Gained Nov. 2/64

Camp Nelson Ky. Re-
joined from desertion.

Absent. Returned from
Louisville Ky. to Camp
Nelson Ky.

Dec. 1864 to Mch. 1865, - Absent
at Camp Nelson dis-
mounted.

Apr. 1865, - Absent driving ambu-
lance.

May 1865, - Absent detached
Regt. Hosp. Dept.

June 1865 to Feb. 1866, - On
duty in R. 2. M. Dept.

Regt. Quar. No. 86 Reg. Ar.

5 U.S. Col. Cav. May 23/65 (over)

Book mark:

E. Thornton

(546)

Copyist.

JAN. 18

40730260

1899.

x name appears also as
Albert Robertson,
Alfred Robinson

R

5 Cav. | U.S.C.T.

Albert Robinson

Plt, Co. M, 5 Reg't U. S. Col'd Cavalry.

Appears on

Company Muster Roll

for Jan + Feb, 1866.

Present or absent Present

Stoppage, \$ 100 for

Due Gov't, \$ 100 for

Valuation of horse, \$ 100

Valuation of horse equipments, \$ 100

Remarks: On daily duty in R 2 M Sept

Book mark:

Stygn

Copyist.

(358)

R

5 Cav. U.S.C.T.

Albert Robinson

Pvt., Co. M, 5 Reg't U. S. Col'd Cavalry.

Appears on Co. Muster-out Roll, dated

Helena, Ark, Mar 16, 1866.

Muster-out to date Mar 16, 1866.

Last paid to Dec 31, 1865.

Clothing account:

Last settled....., 186 ; drawn since \$ 100

Due soldier \$ 9 ⁶³/₁₀₀; due U. S. \$ 100

Am't for cloth'g in kind or money adv'd \$ 100

Due U. S. for arms, equipments, &c., \$ 100

Bounty paid \$ 100 100; due \$ 100 100

Remarks: Slave April 19. 61

Book mark:

(361)

[Signature]

Copyist.

Robinson Alfred

P, Co. M, 5 Reg't U. S. C. Cav

Enclosures.

Bed Cards	Final Statements
Burial Records	Furloughs or L. of A.
Certs. of Dis. for Discharge	Med. Certificates
C. M. Charges	Med. Des. Lists
Descriptive Lists	Orders
Discharge Certificates	Pris. of War Record
Enlistment Papers	Resignations

Other papers relating to—

Admission to Hosp'l	Furlough or L. of A.
Casualty Sheet	Med. Examination
Confinement	Misc. Information
Contracts	Pay or Clothing
Death or Effects	Personal Reports
Desertion	Rank
Discharge from Hosp'l	Transfer to Hosp'l
Discharge from Service	Transfer to V. R. C.
Duty	Transportation

Alfred Robinson
Co. M.

Adjutant General's Office,

COLORED TROOPS BRANCH

Vol. _____ C. T., 187

In case of _____
Reg't _____

Respectfully,

to A. Woodson
P. H.

Adjutant General's Office,

Division of Records & _____

June _____

Vol. _____ C. T., 187

In case of Albert Robinson
Reg't U. S. Col'd Cav.

Co D Co's BK - Deserted on March in Va Oct
Nov 3, 1864 at Camp Nelson. He
was reported as a deserter, having

Co D Co's BK - Deserted at Lexington
Returned to duty Nov 1864.

His rights prior to Dec 1864 on file
No record of trial.

1014
Robinson Benjamin

Co C, 5 U. S. Col'd Cav.

Private Private

CARD NUMBERS.

1	5361717	26
2	5361819	27
3	5361907	28
4	5361938	29
5	5362021	30
6	5362105	31
7	5362187	32
8	5362276	33
9	5362365	34
10	5362512	35
11	5362597	36
12	9090260	37
13	43145322	38
14	43146283	39
15	40730261	40
16		41
17		42
18		43
19		44
20		45
21		46
22		47
23		48
24		49
25		50

Book Mark:

See also

B | **5 Cav. | U.S.C.T.**

Benjamin Robinson
Co. *C*, 5 Reg't U. S. Col'd Cav.

Appears on

Company Descriptive Book
of the organization named above.

DESCRIPTION.

Age *20* years; height *5* feet *11 1/2* inches.

Complexion *Blk*

Eyes *Blk*; hair *Blk*

Where born *Jackson Ala.*

Occupation *Laborer*

ENLISTMENT.

When *Aug. 10*, 1864.

Where *Louisiana*

By whom *Capt. Hamack*; term *3* y'rs.

Remarks: *Made Sergeant*
See M.C.O.

Robinson

R | 5 bar | U.S.C.T.

Ben Robinson

Appears with rank of Pvt on

Muster and Descriptive Roll

of a Detachment of U.S. Colored Troops transferred to U.S. Colored

Regt. at Lexington, Ky. Roll dated Louisville, Ky., Sept. 2, 1864.

Where born Jackson, Ala.

Age 30 years; occupation Laborer

When enlisted Aug. 10, 1864.

Where enlisted Louisville, Ky.

For what period enlisted 1 years.

Eyes Blue; hair Blue

Complexion Blue; height 5 ft. 11 1/2 in.

When mustered in Aug. 10, 1864.

Where mustered in Louisville

Bounty paid \$ 100; due \$ 100

Clothing account:

Last settled _____, 1864; drawn since \$ 17.55 100

Date of first muster Aug. 10, 1864.

Company to which assigned _____

Remarks: Created to 5th Colored Regt.

Ky.

Book mark: _____

A. J. Wessell

R

5 Cav.

U.S.C.T.

Ben Robinson

Pvt, Co. C, 5 Reg't U. S. Col'd Cavalry.

Appears on

Company Muster-in and Descriptive Roll

of the organization named above. Roll dated

Camp Nelson, ^{Ky} N. Y., Oct. 24, 1864.

Where born Jackson, Alabama

Age 30 y'rs; occupation Laborer

When enlisted Aug. 10, 1864.

Where enlisted Louisville

For what period enlisted 3 years.

Eyes Blk; hair Blk

Complexion Blk; height 5 ft. 4 1/2 in.

When mustered in Aug. 10, 1864.

Where mustered in Louisville

Bounty paid \$ 100; due \$ 100

Where credited 5th Dist. Ky.

Company to which assigned C

Remarks:

Book mark:

Shull

(356d)

Copyist.

N. | 5 bar | U.S. CT

Ben Robinson

Appears with rank of Act. on

Muster and Descriptive Roll

of a Detachment of U.S. Colored
Troops Mustered

Roll dated

Louisville Ky, Aug 10, 1864.

Where born Jackson Alabama

Age 30 years; occupation Laborer

When enlisted Aug 10, 1864.

Where enlisted Louisville Ky.

For what period enlisted 3 years.

Eyes Black; hair Black

Complexion Black; height 5 ft. 4 1/2 in.

When mustered in Aug 10, 1864.

Where mustered in Louisville Ky

Bounty paid \$ 100; due \$ 100

Clothing account:

Last settled _____, 186 ; drawn since \$ 100

Date of first muster Aug 10, 1864.

Company to which assigned _____

Remarks: 5 Comp. Dist Ky.

Book mark: _____

Wm Potter

(356m)

Copyist.

R

5 Cav.

U.S.C.T.

Benjamin Robinson

Priv, Co. C, 5 Reg't U. S. Col'd Cavalry.

Appears on

Company Muster Roll

for *to Oct. 31*, 1864.

Present or absent *Absent*

Stoppage, \$ *100* for

Due Gov't, \$ *100* for

Valuation of horse, \$ *100*

Valuation of horse equipments, \$ *100*

Remarks: *Wounded in the Battle of Saltville Va. Oct. 2, 1864. In Hospital*

Book mark:

Shull

(358)

Copyist.

R

5 Cav.

U.S.C.T.

Benjamin Roberson

Priv, Co. C, 5 Reg't U. S. Col'd Cavalry.

Appears on

Company Muster Roll

for *Nov. & Dec.*, 1864.

Present or absent *Present*

Stoppage, \$ *100* for

Due Gov't, \$ *100* for

Valuation of horse, \$ *100*

Valuation of horse equipments, \$ *100*

Remarks: *First & second instalments of bounty due*

Book mark:

Shull

(358)

Copyist.

R

5 Cav.

U.S.C.T.

Benjamin Robinson

Serjt, Co. C, 5 Reg't U. S. Col'd Cavalry.

Appears on

Company Muster Roll

for *Jan'y. & Feb'y*, 1865.

Present or absent *Present*

Stoppage, \$ *100* for

Due Gov't, \$ *100* for

Valuation of horse, \$ *100*

Valuation of horse equipments, \$ *100*

Remarks: *First misstatement of bounty due \$100 Appointed Serjt. per Regtl. Order No. 27 to rank from Jan. 1, 1864*

Book mark:

Shull

R | **5 Cav.** | **U.S.C.T.**

Benjamin Robinson
Sgt., Co. C, 5 Reg't U. S. Col'd Cavalry.

Appears on

Company Muster Roll

for *Mar. 1 1863*, 186*3*.

Present or absent *Present*

Stoppage, \$ 100 for

Due Gov't, \$ 100 for

Valuation of horse, \$ 100

Valuation of horse equipments, \$ 100

Remarks: *First installment of
Bounty due \$100*

Book mark:

(358)

Shull

Copyist.

R

5 Cav.

U.S.C.T.

Benjamin Robinson

Igt., Co. C, 5 Reg't U. S. Col'd Cavalry.

Appears on

Company Muster Roll

for May & June, 1865.

Present or absent Present

Stoppage, \$ 100 for

Due Gov't, \$ 100 for

Valuation of horse, \$ 100

Valuation of horse equipments, \$ 100

Remarks: First Instalment of Bounty due \$100

Book mark:

(358)

J. Linder

Copyist.

R

5 Cav.

U.S.C.T.

Benjamin Robinson

Sgt., Co. C, 5 Reg't U. S. Col'd Cavalry.

Appears on

Company Muster Roll

for July & Aug., 1865.

Present or absent Present

Stoppage, \$ 100 for

Due Gov't, \$ 100 for

Valuation of horse, \$ 100

Valuation of horse equipments, \$ 100

Remarks:

Book mark:

(358)

J. J. J. J.

Copyist.

R

5 Cav. U.S.C.T.

Benjamin Robinson

Lt., Co. C, 5 Reg't U. S. Col'd Cavalry.

Appears on

Company Muster Roll

for Sep 4th, 1865.

Present or absent Present

Stoppage, \$ 100 for

Due Gov't, \$ 100 for

Valuation of horse, \$ 100

Valuation of horse equipments, \$ 100

Remarks:

Book mark:

(358)

J. J. J. J.

Copyist.

R

5 Cav. U.S.C.T.

Benjamin Robinson

Lt, Co. C, 5 Reg't U. S. Col'd Cavalry.

Appears on

Company Muster Roll

for Nov. 4th Dec., 1865.

Present or absent Present

Stoppage, \$ 100 for

Due Gov't, \$ 100 for

Valuation of horse, \$ 100

Valuation of horse equipments, \$ 100

Remarks: See list for Camp and Gar Equip #132

Book mark:

J. J. J. J.

(358)

Copyist.

R

5 Cav. U.S.C.T.

Benjamin Robinson
Put, Co. C, 5 Reg't U. S. Col'd Cavalry.

Appears on

Company Muster Roll

for Jan^{mo} Feb, 1866.

Present or absent Present

Stoppage, \$ 100 for

Due Gov't, \$ 100 for

Valuation of horse, \$ 100

Valuation of horse equipments, \$ 100

Remarks: Reduced to the
Ranks from Sgt as per
Reg Order No 31 dated
Feb 18, 1866 to take effect
Feb 17th, 1866.

Book mark:

Rose

(358)

Copyist.

Q

5 Cav. U.S.C.T.

Benjamin Robinson

Sgt, Co. B, 5 Reg't U. S. Colored Cav.

Sgt

Appears on Returns as follows:

From organization to Oct. 31-1864-
Absent on acct. Sgt.
at Saltville Battle Hosp.
on field.

Nov. 1864. - Absent sick wounded
at Saltville Hosp.
on Field.

Feb. 1865. - (Sgt) - Feb. 22. 65
Camp Nelson Ky.
Appointed per Regt.
Order No. 27

Feb. 1866. - Feb. 19, 66 Helena
Ark. Reduced to
Ranks as per Regt. Order
No. 31

Book mark:

(548)

E. Thorton

Copyist.

R

5 Cav. U.S.C.T.

Benjamin Robinson
Priv, Co. *C*, 5 Reg't U. S. Col'd Cavalry.

Appears on **Co. Muster-out Roll**, dated

Helena Ark, *March 16*, 1866.

Muster-out to date *March 16*, 1866.

Last paid to *Dec 31*, 1865.

Clothing account:

Last settled....., 186 ; drawn since \$..... 100

Due soldier \$..... 100; due U. S. \$ *32* ^{*65*}/₁₀₀

Am't for cloth'g in kind or money adv'd \$..... 100

Due U. S. for arms, equipments, &c., \$..... 100

Bounty paid \$ *100* ^{*100*}/₁₀₀; due \$ *100* ^{*100*}/₁₀₀

Remarks: *Private from organi-*
zation of Company until
Feb 27, 1865 when made Sgt.
Sgt until Feb 14, 1866
when reduced to ranks.

Book mark :

Rose

Robinson Charles

Co 6, 5 U. S. Col'd Cav.

Private | *Private*

CARD NUMBERS.

1	5361716	26
2	5361818	27
3	5361906	28
4	5362014	29
5	5362630	30
6	9090259	31
7	43145448	32
8	43146282	33
9	40730262	34
10		35
11		36
12		37
13		38
14		39
15		40
16		41
17		42
18		43
19		44
20		45
21		46
22		47
23		48
24		49
25		50

Book Mark:

See also

R | 5 Cav. | U.S.C.T.

Charles Robertson

Co. E, 5 Reg't U. S. Col'd Cav.

Appears on

Company Descriptive Book

of the organization named above.

DESCRIPTION.

Age 21 years; height 5 feet 8 inches.

Complexion 3/4 R

Eyes Blk; hair Blk

Where born Spencer Co., Ky.

Occupation Farmer

ENLISTMENT.

When Aug. 22, 1864.

Where Louisville

By whom Capt. T. Vanack, term 3 y'rs.

Remarks: died - see over the

Thacker

11 | 5 bar | M.S.C.T.

Chas Robinson

Appears with rank of Recr on

Muster and Descriptive Roll

of a Detachment of U.S. Colored Troops Mustered

Roll dated Louisville Ky, Aug 22, 1864.

Where born Spencer Ky

Age 21 years; occupation Laborer

When enlisted Aug. 22, 1864.

Where enlisted Louisville Ky

For what period enlisted 3 years.

Eyes Black; hair Black

Complexion Black; height 5 ft. 8 in.

When mustered in Aug. 22, 1864.

Where mustered in Louisville Ky

Bounty paid \$ 100; due \$ 100

Clothing account:

Last settled _____, 186 ; drawn since \$ 100

Date of first muster Aug. 22, 1864.

Company to which assigned _____

Remarks: 5th Cong. Dist Ky.

Book mark : _____

W. W. Potter

(356m)

Copyist.

R

5 bar

U.S.C.T.

Chas Roberson

Appears with rank of 1st on

Muster and Descriptive Roll

of a Detachment of U.S. colored Troops transferred to U.S. col'd cav. Lexington, Ky.

Roll dated

Louisville, Ky., Sept. 2, 1864.

Where born Spencer, Ky.

Age 21 years; occupation Laborer

When enlisted Aug. 22, 1864.

Where enlisted Franklin, Ky.

For what period enlisted 3 years.

Eyes Blue; hair Blue

Complexion Blue; height 5 ft. 8 in.

When mustered in Aug. 22, 1864.

Where mustered in Louisville

Bounty paid \$ 100; due \$ 100

Clothing account:

Last settled, 186 ; drawn since \$ 17.55 / 100

Date of first muster Aug. 22, 1864.

Company to which assigned

Remarks: transferred to 5th Regt. Inf.

Ky.

Book mark:

B. J. Turner

(356m)

Copyist.

R

5 Cav.

U.S.C.T.

Charles Robinson

Co. C, 5 Reg't U. S. Col'd Cavalry.

Appears on

Company Muster-in and Descriptive Roll

of the organization named above. Roll dated

Marysville, Ky, Oct. 24, 1864.

Where born Spencer, Ky

Age 21 y'rs; occupation Laborer

When enlisted Aug. 22, 1864.

Where enlisted Louisville

For what period enlisted 3 years.

Eyes Blk; hair Blk.

Complexion Blk; height 5 ft. 8 in.

When mustered in Aug. 22, 1864.

Where mustered in Louisville

Bounty paid \$100; due \$100

Where credited 5th Dist. Ky.

Company to which assigned C

Remarks:

Book mark:

Shull

(356d)

Copyist.

R

5 Cav. U.S.C.T.

Charles Roberson

Priv, Co. C, 5 Reg't U. S. Col'd Cavalry.

Appears on

Company Muster Roll

for *to Oct. 31*, 1864.

Present or absent *Present*

Stoppage, \$ *100* for

Due Gov't, \$ *100* for

Valuation of horse, \$ *100*

Valuation of horse equipments, \$ *100*

Remarks:

Book mark:

Still

(358)

Copyist.

Charles Roberson

Priv, Co. C, 5 Reg't U. S. Col'd Cavalry.

Appears on

Company Muster Roll

for *Nov. 7 Dec.*, 1864.

Present or absent *Present*

Stoppage, \$ *100* for

Due Gov't, \$ *100* for

Valuation of horse, \$ *100*

Valuation of horse equipments, \$ *100*

Remarks: *First & Second installments of bounty due U.S. for Ord-nanced 17.93*

Book mark:

Shull

R

5 Cav. U.S.C.T.

Charles Robinson

Pvt., Co. C, 5 Reg't U. S. Col'd Cavalry.

Appears on

Company Muster Roll

for Jan'y. & Feby., 1865.

Present or absent

Stoppage, \$ 100 for

Due Gov't, \$ 100 for

Valuation of horse, \$ 100

Valuation of horse equipments, \$ 100

Remarks: Died Feb. 23, 1865 -
in Gen. Hosp. Camp Nelson,
Ky. First instalment
Bounty due \$100

Book mark:

Shull

Q

5 Cav.

U.S.C.T.

Charles Robinson

Qry, Co. B, 5 Reg't U. S. Colored Cav.

Appears on Returns as follows:

Feb. 16. 51. - Arr Feb. 23/65
Camp Nelson Ky.
Died in Genl.
Hosp.

Book mark:

E. J. Thornton

(548)

Copyist.

RC | **5 Cav. | U.S.C.T.**

Charles Robinson
Priv, Co. *C*, 5 Reg't U. S. Col'd Cavalry.

Appears on **Co. Muster-out Roll**, dated
Helena Ark, Mch 16, 1866.

Muster-out to date _____, 186 .

Last paid to _____, 186 .

Pay due from enlistment

Clothing account:

Last settled _____, 186 ; drawn since \$ _____ 100

Due soldier \$ _____ 100; due U. S. \$ _____ 100

Am't for cloth'g in kind or money adv'd \$ _____ 100

Due U. S. for arms, equipments, &c., \$ _____ 100

Bounty paid \$ _____ 100; due \$ _____ 100

Remarks: *Died Feb 23, 1865,*
Camp Nelson, Ky, of
Dysentary.
Feb 28, 1865, Final
Statements forwarded.

Book mark: _____

Rose

(361)

Copyist.

Robinson, Charles

P, Co. B, 5 Reg't USCC

2 Enclosures (3 Items)

Bed Cards	Descriptive Lists
Burial Records	Final Statements
Certs. of Dis. for Discharge	Furloughs
C. M. Charges	Med. Des. Lists
Med. Certificates	Orders

Other papers relating to—

Admission to Hosp'l	Furlough
Casualty Sheet (Officer's)	Med. Examination
Confinement	Misc. Information
Contracts	Pay or Clothing
Death or Effects	Personal Reports
Desertions	Rank
Discharge from Hosp'l	Transfer to Hosp'l
Discharge from Service	Transfer to V. R. C.
Duty	Transportation

Charles Robinson
Priv. Co. 3rd U.S.C.
Died Feb 23rd 1866
Genl Hosp. Camp. Nelson.

✓

✓

RECORD OF DEATH AND INTERMENT.

Name and number of person interred	Charles Robinson
Number and locality of the grave	989
Hospital number of the deceased	6266
Regiment, rank and company	1st Co. 63rd U.S.C.
Residence before enlistment	
Conjugal relation (and if married the residence of the widow.)	
Cause of death	Dysentery acute
Age of the deceased.	
Nativity.	
References and remarks.	
Date of death and burial.	February 23 ^d 1865

- (1) Cap
- (1) Over Coat
- (1) P's Drawers
- (1) P's Boots
- (1) Blanket
- (1) Canteen

- Expended with
- Corp 21
- (1) Jacket
- (1) P's Trousers
- (1) Shirt
- (1) P's Stockings

Inventory of Effects
forward from Hospital
First instalment
Bounty due \$100
B. J. Robinson
1st Conn'dg Co

W.C.C. 100
100
100

FINAL STATEMENT

Geo "K"

Charles Robinson

5th Reg't of U.S Col Cav

VOLUNTEERS.

NOTE 1.—Two of these certificates (or duplicate) are to be given to each Volunteer Soldier or drafted man who may be discharged without being mustered out (Final Statements are never given to men mustered out of service,) that he may at once receive from the Paymaster the pay, &c., due him, and the captain or other COMMISSIONED officer commanding the company will certify to the act of the delivery of the duplicate certificates; with these certificates the Soldier is "entitled to" his discharge, and should also present his discharge to the Paymaster to have the payment endorsed on it. The discharge is to be given back to the Soldier by the Paymaster; the latter only retaining as his vouchers the duplicate certificates.

NOTE 2.—If the Soldier is entitled to pay for the use of his horse, the Company Commander will certify to that fact on the back of both these final statements, and also to the time he has pay due for having been so mounted on his own horse.

NOTE 3.—When a Soldier is furnished with final statements, his descriptive list, if he has one, should be taken up by the officer who gives the Soldier these statements, and endorsed with a statement to this effect by the officer. The endorsement should exhibit a full statement of the time for which the Soldier was allowed pay on his final statements, the clothing account, and all other charges against him or in his favor, so as to comprise a complete exhibit of his account. It will then be transmitted to the Company Commander of the Soldier, who will enter all the data necessary to a full understanding of the Soldier's account on the muster roll upon which the Soldier's discharge is reported. The descriptive list will then be destroyed. The object of this is, that the remaining portion of the Soldier's account may be settled upon the receipt of these muster rolls, and the Soldier receive any pay or allowances that may be due him at the time of his discharge, and which may not appear on his last final statements from the fact that his descriptive list is incomplete. These accounts for back pay, &c., are settled by the 2d Auditor of the Treasury Department.

NOTE 4.—Charges for loss or injury to ordnance, horse equipments, and other miscellaneous charges, should appear under the heading of "Other Stoppages."

NOTE 5.—Bounty paid by State authorities, and not by the United States, will not be entered on this statement.

NOTE 6.—Amounts due the Sutler and Laundress must be entered on the muster roll on which the discharge, death, desertion, &c., is reported, as well as on the final statement, otherwise the amount cannot be collected from the United States.

NOTE 7.—This blank will be used for deceased volunteers and drafted men, as well as for others.

NOTE 8.—Where a Soldier dies in Hospital or on detached service, his descriptive list, if he has one, should be sent with his final statements, in duplicate, to the Adjutant General, Washington, D. C.

NOTE 9.—If the soldier is a drafted man or substitute, the space for time, &c., of enrolled, should contain only the word *drafted* or *substitute*, as the case may be. If the Soldier is a "VETERAN," (or RECRUIT,) the words *as a veteran*, (or *recruit*) as the case may be, should be interlined after the words *mustered into the service of the U. S.* A statement of all the installments of *Veteran* or *Recruit* Bounty, RECEIVED by the Soldier must be made on the back of each final statement.

ADJUTANT GENERAL'S OFFICE.

11th 15th 1865.

Duplicate with Inventory sent 2d Auditor.

I certify, on honor, that Charles Robinson, a Private of
Captain D. C. Stone Company (C) of the 5th Regiment of U. S. Colored
VOLUNTEERS, of the State of _____, born in Hot Springs State
of Kentucky, aged 21 years; 5 feet 8 inches high; Black complexion,
Black eyes, Black hair, and by occupation a Seaman, who joined for service
and was enrolled (see Note 9) on the 22nd day of August, 1864, at Louisville Ky
by Capt Wornack, for the period of Three years, and mustered into
the service of the United States on the 22nd day of August, 1864, at
Louisville Ky, by Capt Wornack; and having served
HONESTLY and FAITHFULLY with his Company to the present date, is now entitled to a
DISCHARGE by reason of Death caused by Dysentery Acute
on the 23rd day of February 1865 in Gen. Hoptt Camp Nelson Ky

The said Charles Robinson has pay ~~was last paid by Paymaster~~
~~due from enlistment~~ to include the _____ day of _____, 186____, and
~~has pay due him from that time to the present date; he is entitled to pay and subsistence for~~
TRAVELING to place of enrollment, and whatever other allowances are authorized to volunteer-
soldiers, drafted men, or militia, so discharged. He has received from the United States **CLOTHING**
amounting to Fifty One $\frac{9}{100}$ dollars, since the _____ day of enlistment.
186____, when his clothing account was last settled. He has received from the United States
~~Fifty One $\frac{9}{100}$ dollars advanced **BOONTY**. First instalment Bounty One \$100~~

~~There is to be stopped from him, on account of the State of _____, or other~~
~~authorities, for **CLOTHING**, &c., received on entering service, _____ $\frac{100}{100}$ dollars; and~~
for other stoppages, viz: Ordinance \$17.93

_____ $\frac{100}{100}$ dollars.
He has been furnished with **TRANSPORTATION** in kind from the place of his discharge to
_____; and he has been **SUBSISTED** for **TRAVELING** to his
place of enrollment, up to the _____, 186____.

~~He is indebted to _____, **SUTLER**, _____ $\frac{100}{100}$ dollars.~~

~~He is indebted to _____, **LAUNDRESS**, _____ $\frac{100}{100}$ dollars.~~

Given in Duplicate, at Camp Nelson Ky, this 23rd day
of February, 1865.

C. J. Robinson

Lieut

Commanding Company

Robinson Edward

Co B, 5 U. S. Col'd Cav.

Private Private

CARD NUMBERS.

1	5360719	26
2	5360816	27
3	5360904	28
4	5360998	29
5	5361087	30
6	5361173	31
7	5361260	32
8	5361347	33
9	5361431	34
10	5361514	35
11	5361596	36
12	9090159	37
13		38
14		39
15		40
16		41
17		42
18		43
19		44
20		45
21		46
22		47
23		48
24		49
25		50

Book Mark:

See also:

R | 5 Cav. | U.S.C.T.

Edward Robertson

Co. B, 5 Reg't U. S. Col'd Cav.

Appears on

Company Descriptive Book
of the organization named above.

DESCRIPTION.

Age 27 years; height 5 feet 11 inches.

Complexion Blk

Eyes Blk; hair Blk

Where born Maryland Co. Ky.

Occupation Farmer

ENLISTMENT.

When Aug. 12, 1864.

Where Camp Nelson

By whom J. C. Randolph, term 3 y'rs.

Remarks:

R | 1st Cav | U.S.C.T.

Edward Robinson

1st Cav, Co: B, 1st Reg't U. S. Col'd Cav

Appears on

Company Muster-in and Descriptive Roll
of the organization named above. Roll dated

Camp Nelson Ky Oct 24, 1864.

Where born Woodford Ky

Age 27 y'rs; occupation Farmer

When enlisted Aug 12, 1864.

Where enlisted Cp Nelson

For what period enlisted 3 years.

Eyes Brk; hair Brk

Complexion Brk; height 5' 11 in.

When mustered in Aug 12, 1864.

Where mustered in Cp Nelson

Bounty paid \$ 100; due \$ 100

Where credited 7th Dist Ky

Company to which assigned B

Remarks: * Name of owner of

Negro - William Gibson

* Added May 13 48 by H. J.

Book mark :

Lamb

R | **5 Cav.** | **U.S.C.T.**

Edward Robinson

Priv, Co. B, 5 Reg't U. S. Col'd Cavalry.

Appears on

Company Muster Roll

for Oct 31, 1864

Present or absent Present

Stoppage, \$ 100 for

Due Gov't, \$ 100 for

Valuation of horse, \$ 100

Valuation of horse equipments, \$ 100

Remarks:

Book mark: -----

Lamb

(358)

Copyist.

R | 5 Cav. | U.S.C.T.

Edward Robertson

Private, Co. B, 5 Reg't U. S. Col'd Cavalry.

Appears on

Company Muster Roll

for Nov & Dec, 1864.

Present or absent Present

Stoppage, \$ 100 for

Due Gov't, \$ 100 for

Valuation of horse, \$ 100

Valuation of horse equipments, \$ 100

Remarks: 1st & 2nd instalment, County dues, Due el. r., for Ooduaue \$0.55

Book mark:

Lamb

(358)

Copyist.

R

5 Cav.

U.S.C.T.

Edward Robertson

Private, Co. B, 5 Reg't U. S. Col'd Cavalry.

Appears on

Company Muster Roll

for Jan & Feb, 1865.

Present or absent Absent

Stoppage, \$ 100 for

Due Gov't, \$ 100 for

Valuation of horse, \$ 100

Valuation of horse equipments, \$ 100

Remarks: Sick in Fort Hays
Camp Nelson, Ky
1st instalment bounty
\$100 due

Book mark:

Lamb

(358)

Copyist.

R

5 Cav.

U.S.C.T.

Edward Robertson

Private, Co. B, 5 Reg't U. S. Col'd Cavalry.

Appears on

Company Muster Roll

for Feb. 25 to Apr. 1862

Present or absent Absent

Stoppage, \$ 100 for

Due Gov't, \$ 100 for

Valuation of horse, \$ 100

Valuation of horse equipments, \$ 100

Remarks: Detach service at New Haven Key 1st instalment to bounty due \$100

Book mark:

Lauch

(358)

Copyist.

R | 5 Cav. | U.S.C.T.

Edward Robertson

Pvt., Co. B, 5 Reg't U. S. Col'd Cavalry.

Appears on

Company Muster Roll

for *May & June*, 186*5*.

Present or absent *present*

Stoppage, \$ *100* for

Due Gov't, \$ *100* for

Valuation of horse, \$ *100*

Valuation of horse equipments, \$ *100*

Remarks: *1st installment bounty due \$100 -*

Book mark:

R. E. Wilson

(358)

Copyist.

R | **5 Cav.** | **U.S.C.T.**

Edward Robertson

Priv., Co. B, 5 Reg't U. S. Col'd Cavalry.

Appears on

Company Muster Roll

for *July & Aug.*, 186*5*.

Present or absent *present*

Stoppage, \$ *100* for

Due Gov't, \$ *100* for

Valuation of horse, \$ *100*

Valuation of horse equipments, \$ *100*

Remarks:

Book mark:

R. E. Wilson

(358)

Copyist.

R | 5 Cav. | U.S.C.T.

Edward Robertson

Priv., Co. B, 5 Reg't U. S. Col'd Cavalry.

Appears on

Company Muster Roll

for Sept & Oct., 1865.

Present or absent Absent

Stoppage, \$ 100 for

Due Gov't, \$ 100 for

Valuation of horse, \$ 100

Valuation of horse equipments, \$ 100

Remarks: Detach service at Loudon, Ky per O. Order No. 167 from H^d Q^rters Camp Nelson

Book mark:

R. C. Wilson

R | **5 Cav.** | **U.S.C.T.**

Edward Robertson

Pris, Co. B, 5 Reg't U. S. Col'd Cavalry.

Appears on

Company Muster Roll

for Nov. & Dec., 1865.

Present or absent present

Stoppage, \$ 100 for

Due Gov't, \$ 100 for

Valuation of horse, \$ 100

Valuation of horse equipments, \$ 100

Remarks:

Book mark:

R. E. Wilson

(358)

Copyist.

W | **5 Cav.** | **U.S.C.T.**

Edward Robertson

Pvt, Co. B, 5 Reg't U. S. Col'd Cavalry.

Appears on

Company Muster Roll

for *Jan 1st*, 186*6*

Present or absent *Present*

Stoppage, \$ *100* for

Due Gov't, \$ *100* for

Valuation of horse, \$ *100*

Valuation of horse equipments, \$ *100*

Remarks:

Book mark:

(358)

copyist

Copyist.

K | 5 Cav. | U.S.C.T.

Edward Peterson

B, Co. *D*, 5 Reg't U. S. Col'd Cavalry.

Appears on Co. Muster-out Roll, dated
October 1861, *1861*

Muster-out to date *Nov 1861*

Last paid to *Dec 31, 1861*

Clothing account:

Last settled _____, 186 ; drawn since \$ _____ 100

Due soldier \$ *9*^{*49*} 100; due U. S. \$ _____ 100

Am't for cloth'g in kind or money adv'd \$ _____ 100

Due U. S. for arms, equipments, &c., \$ *2*^{*83*} 100

Bounty paid \$ *100* 100; due \$ *100* 100

Remarks: *Stare up to 19. 1861*

Due 28 per Cent \$ 2.83

Book mark: *V 191 P 14. 74*

W. J. ...

1093
Robinson Edward

Co E, 5 U. S. Col'd Cav.

Private Private

CARD NUMBERS.

1	5359215	26
2	5364103	27
3	5364188	28
4	5364272	29
5	5364365	30
6	5364449	31
7	5364532	32
8	5364611	33
9	9090484	34
10	31413557	35
11	40730264	36
12	40730263	37
13		38
14		39
15		40
16		41
17		42
18		43
19		44
20		45
21		46
22		47
23		48
24		49
25		50

Book Mark:.....

General Notation R. & P. 401375.

See also.....

Q | **5 Cav.** | **U.S.C.T.**

Edward Robinson

....., Co. *E*, 5 Reg't U. S. Col'd Cav.

Appears on

Company Descriptive Book
of the organization named above.

DESCRIPTION.

Age *18* years; height *5* feet *5* inches.

Complexion *Black*

Eyes *Blk*; hair *Blk*

Where born *Fayette Ky*

Occupation *laborer*

ENLISTMENT.

When *April 3*, 1865.

Where *Camp Nelson*

By whom *Hessand*, term *3* y'rs.

Remarks:

.....
.....
.....
.....
.....
.....
.....
.....
.....
.....

A. W. Hall

(383g)

*Copist.
Camp*

R. | 5 Co. | U.S.C.T.

Edward Robinson

Appears with rank of Pvt on

Muster and Descriptive Roll of a Detachment of U. S. Vols. forwarded

for the 5 Reg't U. S. Col'd Co., Roll dated
Lexington Ky, Apr 17, 1865.

Where born Fayette Co. Ky

Age 18 y'rs; occupation Laborer

When enlisted Apr 5th, 1865.

Where enlisted Camp Nelson

For what period enlisted 3 years.

Eyes Blk; hair Blk

Complexion Blk; height 5 ft. 5 in.

When mustered in April 17, 1865.

Where mustered in Lexington Ky

Bounty paid \$ 100; due \$ 100

Where credited Fayette Co. 7 Dist Ky

Company to which assigned

Remarks:

Book mark:

General Notation R. G. P. 407375.

Talentone

(339)

Copyist.

R. | 5 Cav. | U.S.C.P.

Fred Robinson,
Priv, Co. B, 5 Reg't U.S.C.C.

Appears on

Hospital Muster Roll

of **Convalescent Camp U. S. A. Hospital,**

at **Camp Nelson, Ky.,**

for Jan & Feb., 1865.

Attached to hospital:

When Feb. 22, 1865.

How employed Patient.

Last paid by Maj. _____

to _____, 186 .

Bounty paid \$ 100; due \$ 100

Present or absent Present.

Remarks: _____

Book mark: _____

Dickerson,

(343)

Copyist.

R

5 Cav. U.S.C.T.

Edward Robinson

Capt., Co. E, 5 Reg't U. S. Col'd Cavalry.

Appears on

Company Muster Roll

for March & April, 1865.

Present or absent Present

Stoppage, \$ 100 for

Due Gov't, \$ 100 for

Valuation of horse, \$ 100

Valuation of horse equipments, \$ 100

Remarks: First installment of Bounty, due

Book mark:

M. W. Cowan

(358)

Copyist.

R

5 Cav. U.S.C.T.

Edward Robinson

Priv., Co. E, 5 Reg't U. S. Col'd Cavalry.

Appears on

Company Muster Roll

for May June, 1865.

Present or absent present

Stoppage, \$ 100 for

Due Gov't, \$ 100 for

Valuation of horse, \$ 100

Valuation of horse equipments, \$ 100

Remarks: 1st Instalment
Bounty due \$100.

Book mark:

Long

(358)

Copyist.

R

5 Cav. U.S.C.T.

Edward Robinson

Pvt, Co. E, 5 Reg't U. S. Col'd Cavalry.

Appears on

Company Muster Roll

for July & Aug., 1865.

Present or absent present

Stoppage, \$ 100 for

Due Gov't, \$ 100 for

Valuation of horse, \$ 100

Valuation of horse equipments, \$ 100

Remarks:

Book mark:

Long

(358)

Copyist.

R

5 Cav. U.S.C.T.

Edward Robinson

Priv., Co. E, 5 Reg't U. S. Col'd Cavalry.

Appears on

Company Muster Roll

for Sept + Oct, 1865.

Present or absent Present

Stoppage, \$ 100 for

Due Gov't, \$ 100 for

Valuation of horse, \$ 100

Valuation of horse equipments, \$ 100

Remarks:

Book mark:

Long

(358)

Copyist.

P

5 Cav. U.S.C.T.

Edward Robinson
Priv., Co. E, 5 Reg't U.S. Col'd Cavalry.

Appears on

Company Muster Roll

for *Nov + Dec*, 1865.

Present or absent *present*

Stoppage, \$ 100 for

Due Gov't, \$ 100 for

Valuation of horse, \$ 100

Valuation of horse equipments, \$ 100

Remarks:

Book mark:

(358)

P. Long
Copyist.

A

5 Cav. U.S.C.T.

Edward Robinson

Priv, Co. E, 5 Reg't U. S. Col'd Cavalry.

Appears on

Company Muster Roll

for Jan & Feb, 1866.

Present or absent Present

Stoppage, \$ 100 for

Due Gov't, \$ 100 for

Valuation of horse, \$ 100

Valuation of horse equipments, \$ 100

Remarks:

Book mark:

(358)

J. M. Leonard

Copyist.

R

5 Cav. U.S.C.T.

Edward Robinson

Pvt., Co. B, 5 Reg't U. S. Colored Cav.

Appears on Returns as follows:

Jan. to March 1865. - Absent
Sick Hosp. Camp
Weldon Ky.

Apr. 1865. - Absent det.
at New Haven
Ky.

Oct. 1865. - Absent detached
Service London Ky.

x name appears also as
Edward Robertson

Book mark:

E. Thornton

(546)

Copyist.

R

5 Cav. U.S.C.T.

Edwin Robinson

Pvt., Co. E, 5 Reg't U. S. Colored Cav.

Appears on Returns as follows:

Apr. 1865. - Gave Apr. 19
lamp Nelson, who
signed to Co E
as per Regt. order.

Book mark:

(546)

E. J. Thornton

Copyist.

R

5 Cav. | U.S.C.T.

Edward Robinson

Priv., Co. E, 5 Reg't U. S. Col'd Cavalry.

Appears on Co. Muster-out Roll, dated
Wheeler, Ark., Mar 16, 1866.

Muster-out to date * Mar. 3, 1866.

Last paid to Dec 31, 1865.

Clothing account:

Last settled....., 186 ; drawn since \$..... 100

Due soldier \$..... 100; due U. S. \$..... 100 ³²

Am't for cloth'g in kind or money adv'd \$..... 100

Due U. S. for arms, equipments, &c., \$..... 100

Bounty paid \$..... 100^{xx}; due \$..... 100

Remarks:

* Records on file in 2nd. Auditor's Office show this Co. Mustered Out to take effect Mch, 16th. 1866. and paid to include Mch, 15th. 1866.

Book mark:

J. L. Demaris

(361)

Copyist.

Robinson, Edward

, Co.

5th Reg't & S. C. Cav.

Enclosures.

Bed Cards	Final Statements
Burial Records	Furloughs or L. of A.
Certs. of Dis. for Discharge	Med. Certificates
C. M. Charges	Med. Des. Lists
Descriptive Lists	Orders
Discharge Certificates	Pris. of War Record
Enlistment Papers	Resignations

Other papers relating to—

Admission to Hosp'l	Furlough or L. of A.
Casualty Sheet	Med. Examination
Confinement	Misc. Information
Contracts	Pay or Clothing
Death or Effects	Personal Reports
Desertion	Rank
Discharge from Hosp'l	Transfer to Hosp'l
Discharge from Service	Transfer to V. R. C.
Duty	Transportation

NOTE 1.—This blank will be used for both enlistments and re-enlistments—enlistment of veterans, &c., &c., in the volunteer service. They will be made out in duplicate in all cases—one to accompany the recruiting return of the superintendent (not the recruiting officer) to the Adjutant General, and one to accompany the accounts of the officer who pays bounty, &c. The Regiment and Company in which the soldier last served should be given on the back.

NOTE 2.—An enlistment holds to service. A muster-in must, in all cases, precede payment of pay, bounty, pension, &c. A muster-in roll must, in all cases, be filed in the Adjutant General's Office as evidence of muster-in. The mustering officer, commissary, or assistant commissary of musters, as the case may be, will countersign both enlistments as having mustered the soldier into the service of the United States before either of them is given to the disbursing officer.

DECLARATION OF RECRUIT.

I, Edward Robinson, desiring VOLUNTEER as a Soldier in the Army of the United States, for the term of THREE YEARS, Do Declare, That I am eighteen years and _____ months of age; that I have never been discharged from the United States service on account of disability or by sentence of a court martial, or by order before the expiration of a term of enlistment; and I know of no impediment to my serving honestly and faithfully as a soldier for three years.

GIVEN at Camp Nelson Ky the 3 day of April 85

Witness:

W. Johnson

Edward Robinson
mark

(Signature)

Discharged _____, 18 _____.

Reg't of _____

enlistment; last served in Company ()

Regiment of 1st Cavalry

By 3rd class and

Volunteered at Camp Nelson Ky 3rd April, 1865.

No. 56

Edward Robinson (Vol)
March 24 1865

CONSENT IN CASE OF MINOR.

I, Robert J. Meckmudge (Agent), Do CERTIFY, That I am the _____ of _____; that the said _____ is _____ years of age; and I do hereby freely give my CONSENT to his volunteering as a SOLDIER in the ARMY OF THE UNITED STATES for the period of THREE YEARS.

GIVEN at _____ the _____ day of _____

Witness:

Credited to Fayette Co. Ky

VOLUNTEER ENLISTMENT.

STATE OF

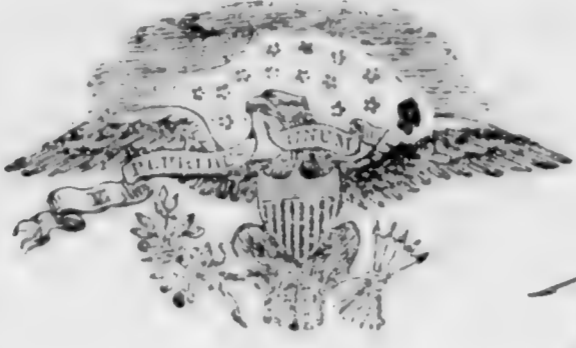

TOWN OF

Kentucky

of Jessamine

I, Edward Robinson born in Fayette Co, in the State of Kentucky, aged fifteen years, and by occupation a laborer, Do HEREBY ACKNOWLEDGE to have volunteered this third day of April, 1865, to serve as a Soldier in the Army of the United States of America, for the period of THREE YEARS, unless sooner discharged by proper authority: Do also agree to accept such bounty, pay, rations, and clothing, as are, or may be, established by law for volunteers. And I, Edward Robinson do solemnly swear, that I will bear true faith and allegiance to the United States of America, and that I will serve them honestly and faithfully against all their enemies or opposers whomsoever; and that I will observe and obey the orders of the President of the United States, and the orders of the officers appointed over me, according to the Rules and Articles of War.

Sworn and subscribed to, at

Camp Nelson, April, 1865

this 3 day of

BEFORE

J. Fassand Lieut Col 5th U.S.C.

Edward Robinson mark

I CERTIFY, ON HONOR, That I have carefully examined the above-named Volunteer, agreeably to the General Regulations of the Army, and that, in my opinion, he is free from all bodily defects and mental infirmity, which would in any way disqualify him from performing the duties of a soldier.

John Swan Capt Surgeon 5th U.S.C. Examining Surgeon.

I CERTIFY, ON HONOR, That I have minutely inspected the Volunteer Edward Robinson previously to his enlistment, and that he was entirely sober when enlisted; that, to the best of my judgment and belief, he is of lawful age; and that, in accepting him as duly qualified to perform the duties of an able-bodied soldier, I have strictly observed the Regulations which govern the recruiting service. This soldier has Blue eyes, Blue hair, Fair complexion, is five feet five inches high.

J. Fassand Lieut Col 5th U.S.C. Recruiting Officer.

Certificate for the Signature of the Mustering Officer, Commissary, or Assistant Commissary of Musters, as the case may be. Mustered into the service of the United States, for three years or during the war, from date of enlistment, in Co. of the 1st day of April, 1865, at Jessamine Ky. Regiment of MS Cavalry Volunteers, on the 17th day of April, 1865, at Jessamine Ky. and credited to Ward, (or Sub-district) in the Town of in the County of th Congressional District, in the State of U. S. Bounty, Local Bounty, Bounty paid at time of Muster-in: William Hoattle Capt The Majesty's Mustering Officer

NOTE 1.—This blank will be used for both enlistments and re-enlistments—enlistment of veterans, &c., &c., in the volunteer service. They will be made out in duplicate in all cases—one to accompany the recruiting return of the superintendent (not the recruiting officer) to the Adjutant General, and one to accompany the accounts of the officer who pays bounty, &c. The Regiment and Company in which the soldier last served should be given on the back.

NOTE 2.—An enlistment holds to service. A muster-in must, in all cases, precede payment of pay, bounty, pension, &c. A muster-in roll must, in all cases, be filed in the Adjutant General's Office as evidence of muster-in. The mustering officer, commissary, or assistant commissary of musters, as the case may be, will countersign both enlistments as having mustered the soldier into the service of the United States before either of them is given to the disbursing officer.

DECLARATION OF RECRUIT.

I, Edward Robinson, desiring VOLUNTEER as a Soldier in the Army of the United States, for the term of THREE YEARS, Do Declare, That I am eighteen years and _____ months of age; that I have never been discharged from the United States service on account of disability or by sentence of a court martial, or by order before the expiration of a term of enlistment; and I know of no impediment to my serving honestly and faithfully as a soldier for three years.

GIVEN at Camp Nelson Ky the 3 day of April 1865

Witness:

[Signature]

Edward Robinson
mark

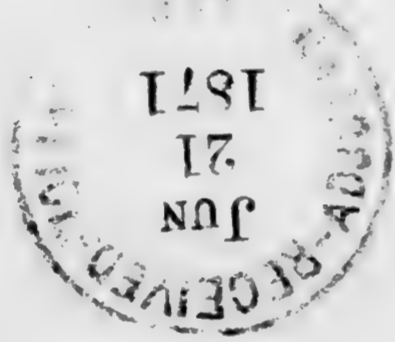

Discharged _____, 18__

Regt of _____

enlistment; last served in Company ()

Regiment of _____

By _____

3 April, 1865

Volunteered at

Camp Nelson

No. _____

Edward Robinson

CONSENT IN CASE OF MINOR.

I, Roll J. Prockmidge Ogelle Ky, Do CERTIFY, That I am the _____ of _____; that the said _____ is _____ years of age; and I do hereby freely give my CONSENT to his volunteering as a SOLDIER in the ARMY OF THE UNITED STATES for the period of THREE YEARS.

GIVEN at _____ the _____ day of _____

Witness:

Credited To Fayette Co & Ky.

VOLUNTEER ENLISTMENT.

STATE OF

TOWN OF

Kentucky

C. of Jessamine



I, Edward Robinson, born in Fayette Co in the State of Kentucky, aged eighteen years, and by occupation a Laborer, Do HEREBY ACKNOWLEDGE to have volunteered this Third day of April, 1865, to serve as a Soldier in the Army of the United States of America, for the period of THREE YEARS, unless sooner discharged by proper authority: Do also agree to accept such bounty, pay, rations, and clothing, as are, or may be, established by law for volunteers. And I, Edward Robinson, do solemnly swear, that I will bear true faith and allegiance to the United States of America, and that I will serve them honestly and faithfully against all their enemies or opposers whomsoever; and that I will observe and obey the orders of the President of the United States, and the orders of the officers appointed over me, according to the Rules and Articles of War.

Sworn and subscribed to, at Camp Nelson, his day of April, 1865, Edward Robinson mark BEFORE J. Fassaud Lieut Adjut 5th U.S.C. Co.

I CERTIFY, ON HONOR, That I have carefully examined the above-named Volunteer, agreeably to the General Regulations of the Army, and that, in my opinion, he is free from all bodily defects and mental infirmity, which would in any way disqualify him from performing the duties of a soldier.

John Swan Asst Surgeon 5th U.S.C. Co. EXAMINING SURGEON.

I CERTIFY, ON HONOR, That I have minutely inspected the Volunteer Edward Robinson previously to his enlistment, and that he was entirely sober when enlisted; that, to the best of my judgment and belief, he is of lawful age; and that, in accepting him as duly qualified to perform the duties of an able-bodied soldier, I have strictly observed the Regulations which govern the recruiting service. This soldier has Blue eyes, Blue hair, Fair complexion, is five feet seven inches high.

J. Fassaud Lieut Adjut 5th U.S.C. Co. REGIMENT OF U.S.C. VOLUNTEERS, RECRUITING OFFICER.

(A. G. O. No. 74 & 76.)

Certificate for the Signature of the Mustering Officer, Commissary, or Assistant Commissary of Musters, as the case may be. Mustered into the service of the United States, for three years or during the war, from date of enlistment, in Co. 1st day of April, 1865, at Lexington Ky. Regiment of 49th Army Volunteers, on the 19th day of April, 1865, in the County of Jessamine, in the State of Kentucky. Bounties paid at time of Muster-in: U. S. Bounty, Local Bounty. William H. Applebe Col 49th Army 20th Regt

Robinson John

Co D, 5 U. S. Col'd Cav.

Private Private

CARD NUMBERS.

1	5362709	26
2	5362804	27
3	5362902	28
4	5362987	29
5	5363082	30
6	5363169	31
7	5363258	32
8	5363348	33
9	5363434	34
10	5363518	35
11	5363604	36
12	9090338	37
13	43146397	38
14		39
15		40
16		41
17		42
18		43
19		44
20		45
21		46
22		47
23		48
24		49
25		50

Book Mark:

See also

REP 468107

1957675 P.O. ~~Ans~~

D. 2259334 P.O. ~~aff~~

J. B. Donald
Exp

R | **5 Cav.** | **U.S.C.T.**

John Robinson
....., Co. *10*, 5 Reg't U. S. Col'd Cav.

Appears on

Company Descriptive Book
of the organization named above.

DESCRIPTION.

Age *18* years; height *5* feet *6 1/2* inches.

Complexion *Copper*

Eyes *Black*; hair *Black*

Where born *Nelson Ky.*

Occupation *farmer*

ENLISTMENT.

When *Sep 5*....., 186 *4*.

Where *Lebanon*

By whom *Capt Fidler*; term *3* y'rs.

Remarks:

.....
.....
.....
.....
.....

F E Purke

(383g)

Copist.

R. | **5 Cav.** | **U.S.C.T.**

John Robinson

Regt., Co. *10*, 5 Reg't U. S. Col'd Cavalry.

Appears on

Company Muster-in and Descriptive Roll

of the organization named above. Roll dated

Camp Nelson, N.Y., Oct. 24, 1864.

Where born *Nelson, Ky.*

Age *18* y'rs; occupation *Farmer*

When enlisted *Aug. 13*, 1864.

Where enlisted *Lebanon*

For what period enlisted *3* years.

Eyes *Bl.*; hair *Bl.*

Complexion *Copper*; height *5 ft. 6 1/2 in.*

When mustered in *Aug. 26*, 1864.

Where mustered in *Lexington*

Bounty paid \$ *100*; due \$ *100*

Where credited *4 Dist. Ky.*

Company to which assigned

Remarks:

Book mark:

Wm. H. Scott

R | 5 bar | U.S.C.T.

John Robinson

Appears with rank of on

Muster and Descriptive Roll

of a Detachment of U.S. Colored
Volunteer Recruits formed

Lebanon, Ky., Sept. 5, 1864. Roll dated

Where born Nelson, Ky.

Age 18 years; occupation Farmer

When enlisted Sept. 5, 1864.

Where enlisted Lebanon, Ky.

For what period enlisted 1 years.

Eyes Blue; hair Black

Complexion Blue; height 5 ft. 9 in.

When mustered in Sept. 5, 1864.

Where mustered in Lebanon

Bounty paid \$ 100; due \$ 100

Clothing account:

Last settled, 1864; drawn since \$ 17.50/100

Date of first muster Sept. 5, 1864.

Company to which assigned

Remarks: Master - Nelson Robinson.
Nelson, Ky. Nitrate account

Book mark:

B. J. Bussell

(356m)

Copyist.

R

5 Cav. U.S.C.T.

John Robinson

Priv., Co. D, 5 Reg't U. S. Col'd Cavalry.

Appears on

Company Muster Roll

for Dated Oct. 31, 1864.

Present or absent Present.

Stoppage, \$ 100 for

Due Gov't, \$ 100 for

Valuation of horse, \$ 100

Valuation of horse equipments, \$ 100

Remarks:

Book mark:

Wm. H. Scott

(358)

Copyist.

R | **5 Cav.** | **U.S.C.T.**

John Robinson

Priv., Co. D, 5 Reg't U. S. Col'd Cavalry.

Appears on

Company Muster Roll

for *Nov. & Dec.*, 1864.

Present or absent *Present*

Stoppage, \$ *100* for

Due Gov't, \$ *100* for

Valuation of horse, \$ *100*

Valuation of horse equipments, \$ *100*

Remarks: *Due U. S. for Ord.
nances \$1493. 1" & 2"
installments of Bounties
due.*

Book mark:

Wm. H. Scott

(358)

Copyist.

R | **5 Cav. | U.S.C.T.**

John Robinson

Priv., Co. D, 5 Reg't U. S. Col'd Cavalry.

Appears on

Company Muster Roll

for *Jan. & Feb.*, 1865.

Present or absent *Present*

Stoppage, \$ *100* for

Due Gov't, \$ *100* for

Valuation of horse, \$ *100*

Valuation of horse equipments, \$ *100*

Remarks: *1st installment of
Bounty due \$100.*

Book mark :

Wm H Scott

(358)

Copyist.

R | **5 Cav. | U.S.C.T.**

John Robinson
Pvt., Co. D, 5 Reg't U. S. Col'd Cavalry.

Appears on

Company Muster Roll

for *March & April*, 1865.

Present or absent *Present.*

Stoppage, \$ *100* for

Due Gov't, \$ *100* for

Valuation of horse, \$ *100*

Valuation of horse equipments, \$ *100*

Remarks: *1st installment of
Bounty due \$100.*

Book mark:

Wm. H. Scott

(358)

Copyist.

R

5 Cav. U.S.C.T.

John Robinson

Private, Co. D, 5 Reg't U. S. Col'd Cavalry.

Appears on

Company Muster Roll

for May & June, 1865

Present or absent Present

Stoppage, \$ 100 for

Due Gov't, \$ 100 for

Valuation of horse, \$ 100

Valuation of horse equipments, \$ 100

Remarks: 1st Instalment Bounty due \$100.00.

Book mark:

Williker

R

5 Cav. U.S.C.T.

John Robinson

Priv., Co. D, 5 Reg't U. S. Col'd Cavalry.

Appears on

Company Muster Roll

for July & Aug., 1865.

Present or absent present

Stoppage, \$ 100 for

Due Gov't, \$ 100 for

Valuation of horse, \$ 100

Valuation of horse equipments, \$ 100

Remarks:

Book mark:

Milliken

(358)

Copyist.

R

5 Cav. U.S.C.T.

John Robinson
Private, Co. D, 5 Reg't U. S. Col'd Cavalry.

Appears on

Company Muster Roll

for Sept. & Oct., 1865.

Present or absent present

Stoppage, \$ 100 for

Due Gov't, \$ 100 for

Valuation of horse, \$ 100

Valuation of horse equipments, \$ 100

Remarks: Due U.S. for ordnance \$0.30.

Book mark:

Williken

(358)

Copyist.

R

5 Cav. U.S.C.T.

John Robinson
Priv., Co. D, 5 Reg't U. S. Col'd Cavalry.

Appears on

Company Muster Roll

for *Nov. & Dec.*, 1865.

Present or absent *present.*

Stoppage, \$ *100* for

Due Gov't, \$ *100* for

Valuation of horse, \$ *100*

Valuation of horse equipments, \$ *100*

Remarks:

Book mark:

Milliken

(358)

Copyist.

R. | 5 Cav. | U.S.C.T.

John Robinson,

Private, Co. D, 5 Reg't U. S. Col'd Cavalry.

Appears on

Company Muster Roll

for *Jan'y^{4th} Febr'y*, 186 *6*.

Present or absent *Present.*

Stoppage, \$ *100* for

Due Gov't, \$ *100* for

Valuation of horse, \$ *100*

Valuation of horse equipments, \$ *100*

Remarks:

Book mark:

(358)

R. Grauer

Copyist.

R. | **5 Cav.** | **U.S.C.T.**

John Robinson,
Private, Co *D*, 5 Reg't U. S. Col'd Cavalry.

Appears on **Co. Muster-out Roll**, dated
Delmar, Ark., March 16, 186*6*.
Muster-out to date *March 16,* 186*6*.
Last paid to *Dec. 31,* 186*5*.

Clothing account:

Last settled....., 186 ; drawn since \$..... 100
Due soldier \$..... 100; due U. S. \$ *17*^{*27*}/₁₀₀
Am't for cloth'g in kind or money adv'd \$..... 100

Due U. S. for arms, equipments, &c., \$..... 100
Bounty paid \$ *100*^{*00*}/₁₀₀; due \$ *100*^{*00*}/₁₀₀

Remarks:.....
.....
.....
.....
.....
.....

Book mark: *3233.1878.*

(361)

R. E. G. G. G. G.
Copyist.

Robinson John

....., Co....., Reg't.....

..... / Enclosures.

Bed Cards.....	Final Statements.....
Burial Records.....	Furloughs or L. of A.....
Certs. of Dis. for Discharge.....	Med. Certificates.....
C. M. Charges.....	Med. Des. Lists.....
Descriptive Lists.....	Orders.....
Discharge Certificates.....	Pris. of War Record.....
Enlistment Papers..... /	Resignations.....

Other papers relating to—

Admission to Hosp'l.....	Furlough or L. of A.....
Casualty Sheet.....	Med. Examination.....
Confinement.....	Misc. Information.....
Contracts.....	Pay or Clothing.....
Death or Effects.....	Personal Reports.....
Desertion.....	Rank.....
Discharge from Hosp'l.....	Transfer to Hosp'l.....
Discharge from Service.....	Transfer to V. R. C.....
Duty.....	Transportation.....

NOTE 1.—This blank will be used for enlistments of United States colored troops. They will be made out in duplicate in all cases—one to accompany the recruiting return of the superintendent (not the recruiting officer) to the Adjutant General, and one to accompany the accounts of the officer who pays bounty, &c.

NOTE 2.—An enlistment holds to service. A muster-in must, in all cases, precede payment of pay, bounty, pension, &c. A muster-in roll, must in all cases, be filed in the Adjutant General's Office as evidence of muster-in. The mustering officer, commissary, or assistant commissary of musters, as the case may be, will countersign both enlistments as having mustered the soldiers into the service of the United States before either of them is given to the disbursing officer.

DECLARATION OF RECRUIT.

I, John Robinson desiring to volunteer as a soldier in the ARMY OF THE UNITED STATES, for the term of Three Years, DO DECLARE That I am 18 years and months of age; that I have never been discharged from the United States service on account of disability or by sentence of a court-martial, or by order before the expiration of a term of enlistment; and I know of no impediment to my serving honestly and faithfully as a soldier for three years.

GIVEN at Litham Ky the 5th day of Sept 1864

Witness: Geo B Brown

John Robinson
Volunteered at Litham Ky
Sept 5th 1864
By Geo B Brown
Asst Commr 1st Div 1st Ky

Proves name
Widens Robinson
Auth'd to receive amount

Consent of Parent or Guardian in case of a Minor, if a Free Man, or in the case of a Slave, of the Person to whom he owes Service:

I, Do CERTIFY, That I am the that the said is years of age; and I do freely give my CONSENT to his volunteering as a SOLDIER in the Army of the United States, for the period of THREE YEARS, under the conditions of the laws of the United States.

GIVEN at the day of

Witness:

NOTE 1.—This blank will be used for enlistments of United States colored troops. They will be made out in duplicate in all cases—one to accompany the recruiting return of the superintendent (not the recruiting officer) to the Adjutant General, and one to accompany the accounts of the officer who pays bounty, &c.

NOTE 2.—An enlistment holds to service. A muster-in must, in all cases, precede payment of pay, bounty, pension, &c. A muster-in roll, must in all cases, be filed in the Adjutant General's Office as evidence of muster-in. The mustering officer, commissary, or assistant commissary of masters, as the case may be, will countersign both enlistments as having mustered the soldiers into the service of the United States before either of them is given to the disbursing officer.

DECLARATION OF RECRUIT.

I, John Robinson desiring to volunteer as a soldier in the ARMY OF THE UNITED STATES, for the term of Three Years, DO DECLARE That I am 18 years and months of age; that I have never been discharged from the United States service on account of disability or by sentence of a court-martial, or by order before the expiration of a term of enlistment; and I know of no impediment to my serving honestly and faithfully as a soldier for three years.

GIVEN at Shannon Ky the 5th day of Sept 1864

Witness: Geo B Brown

John Robinson
 By Geo B Brown
 Volunteered at Shannon Ky
Sept 5th 1864
 No. Sept 5th 1864
Geo B Brown

Proves name
John Robinson
Quinted within amount

Consent of Parent or Guardian in case of a Minor, if a Free Man, or in the case of a Slave, of the Person to whom he owes Service:

I, Do CERTIFY, That I am the that the said is years of age; and I do freely give my CONSENT to his volunteering as a SOLDIER in the Army of the United States, for the period of THREE YEARS, under the conditions of the laws of the United States.

GIVEN at the day of

Witness:
 (A. G. O. No. 74 & 76.)

UNITED STATES COLORED TROOPS ENLISTMENT.

STATE OF



TOWN OF

Ky

County of Nelson

I, *John Robinson*

born in *Nelson Co*

in the State of *Ky* aged *18* years

and by occupation a *farmer* Do HEREBY ACKNOWLEDGE TO

have volunteered *5th* day of *Sept* 186*4*

to serve as a **Soldier** in the **Army of the United States of America**, for the period of **THREE YEARS**, unless sooner discharged by proper authority: Do also agree to accept such bounty, pay, rations, and clothing, as are, or may be, established by law for the U. S. colored, troops.

And I, *John Robinson*

do solemnly swear that I will bear true faith and allegiance to the **United States of America**, and that I will serve them honestly and faithfully against all their enemies or opposers whomsoever; and that I will observe and obey the orders of the President of the United States, and the orders of the officers appointed over me, according to the Rules and Articles of War.

Sworn and subscribed to, at *Seban Ky*

this *5th* day of *Sept 1864* *John Robinson*

Before *Wm Gidder*
Capt & Pro Mar 4th Dist Ky

I CERTIFY, ON HONOR, That I have carefully examined the above named Volunteer agreeably to the General Regulations of the Army, and that, in my opinion, he is free from all bodily defects and mental infirmity, which would in any way disqualify him from performing the duties of a soldier.

John C. Maxwell

EXAMINING SURGEON.

I CERTIFY, ON HONOR, That I have minutely inspected the Volunteer, *John Robinson* previously to his enlistment, and that he was entirely sober when enlisted; that, to the best of my judgment and belief, he is of lawful age; and that, in accepting him as duly qualified to perform the duties of an able-bodied soldier, I have strictly observed the regulations which govern the recruiting service. This soldier has *blue* eyes, *dark* hair, *fair* complexion, is *5* feet *10* inches high.

Wm Gidder

Capt & Pro Mar 4th Dist Ky RECRUITING OFFICER OR AGENT.

Mustered into the United States Service *5th* day of *Sept* 186*4*

Wm Gidder

Capt & Pro Mar 4th Dist Ky Mustering Officer

Mustered into the service of the United States, for three years or during the war, from date of enlistment, in Company _____ Regiment of _____ Volunteers, on the _____ day of _____ 186*4* at _____

1895
Robinson Samuel

Co *F*, 5 U. S. Col'd Cav.

Private | Private

CARD NUMBERS.

1	5364744	26
2	5364877	27
3	5365691	28
4	9090574	29
5	40730265	30
6		31
7		32
8		33
9		34
10		35
11		36
12		37
13		38
14		39
15		40
16		41
17		42
18		43
19		44
20		45
21		46
22		47
23		48
24		49
25		50

Book Mark:

See also

Q

5 Cav. | U.S.C.T.

Samuel Robinson

Co. *X*, 5 Reg't U. S. Col'd Cav.

Appears on

Company Descriptive Book

of the organization named above.

DESCRIPTION.

Age *19* years; height *5* feet *10* inches.

Complexion *Black*

Eyes *BK*; hair *BK*

Where born *Clark Ky*

Occupation *farmer*

ENLISTMENT.

When *Sep 13*, 186 .

Where *Camp Nelson*

By whom *J. S. Gualpha* term *3* y'rs.

Remarks:

J. E. Pines

N

5 Cav.

U.S.C.T.

Samuel Robinson

Priv, Co. F, 5 Reg't U. S. Col'd Cavalry.

Appears on

Company Muster-in and Descriptive Roll

of the organization named above. Roll dated

Camp Nelson, N.Y., Oct 29, 1864.

Where born Blk Ky

Age 17 y'rs; occupation Farmer

When enlisted Sept 13, 1864.

Where enlisted Camp Nelson

For what period enlisted 3 years.

Eyes Blk; hair Blk

Complexion Blk; height 5 ft. 10 in.

When mustered in Sept 14, 1864.

Where mustered in Camp Nelson

Bounty paid \$ 100; due \$ 100

Where credited T. D. 1st Ky

Company to which assigned F

Remarks: Named owner of Negro - Thomas Robinson

* added 5/3/98 ena

Book mark:

Sumner

R

5 Cav. U.S.C.T.

Samuel Robinson

Priv, Co. F, 5 Reg't U. S. Col'd Cavalry.

Appears on

Company Muster Roll

for to Oct 31, 1864.

Present or absent Absent.

Stoppage, \$ 100 for

Due Gov't, \$ 100 for

Valuation of horse, \$ 100

Valuation of horse equipments, \$ 100

Remarks:

Missing in action at
Slaterville Va Oct 2, 1864.

Co. M, roll next on which
name appears

Book mark:

Currier

(358)

Copyist.

Q

5 Cav. U.S.C.T.

Samuel Robinson

Priv., Co. F, 5 Reg't U. S. Colored Cav.

Appears on Returns as follows:

Oct. 1864, - Priv.; missing
in action Oct. 2/64
Saltville Va.

Book mark:

E. Thomson

(548)

Copyist.

R | 5 Cav. | U.S.C.T.

Samuel Robinson
Pt. Co. 7, 5 Reg't U. S. Col'd Cavalry

Appears on Co. Muster-out Roll, dated
Helena, Ark. Nov 16, 1866.

Muster-out to date _____, 1866 .

Last paid to _____, 1866 .

Clothing account:

Last settled _____, 1866 ; drawn since \$ _____ 100

Due soldier \$ _____ 100; due U. S. \$ _____ 100

Am't for cloth'g in kind or money adv'd \$ _____ 100

Due U. S. for arms, equipments, &c., \$ _____ 100

Bounty paid \$ _____ 100; due \$ _____ 100

Remarks: *Missing in action*
Oct 2. 64 Saltrille, Virginia

Book mark: _____

(361)

J. W. Davis

Copyist.

Robinson Sydney J.

Co Lt, 5 U. S. Col'd Cav.

1st Lieutenant Captain

CARD NUMBERS.

1	5359184	26
2	5369974	27
3	5370075	28
4	5370167	29
5	5370258	30
6	5370345	31
7	5370445	32
8	5370540	33
9	5370678	34
10	5370683	35
11	5359317	36
12	5359186	37
13	5369595	38
14	5369677	39
15	9090488	40
16	9435971	41
17	9435999	42
18	40730283	43
19		44
20		45
21		46
22		47
23		48
24		49
25		50

Book Mark:

See also *14 Ill. Cav.*

A | **5 Cav.** | **U.S.C.T.**

William Robinson

....., Co. *E*, 5 Reg't U. S. Col'd Cav.

Appears on

Company Descriptive Book
of the organization named above.

DESCRIPTION.

Age *24* years; height *5* feet *5* inches.

Complexion *Black*

Eyes *Blk*; hair *Blk*

Where born *Bath Ky*

Occupation *farmer*

ENLISTMENT.

When *Sep 9*, 186 *4*.

Where *Camp Nelson*

By whom *J. G. P. R.*, term *3* y'rs.

Remarks:

.....

.....

.....

.....

.....

.....

.....

.....

.....

.....

.....

.....

.....

.....

.....

.....

.....

.....

.....

.....

.....

.....

.....

.....

.....

(383g)

Copist.

J. G. P. R.

K 15 Cav | U.S.C.T.

Sidney J Robinson

1st Lt, Co. L, 5 Reg't U. S. Col'd Cav

Appears on

Regimental Descriptive Book

(List of Commissioned Officers)

of the regiment named above.

Rank 1st Lieutenant

Date of appointment Dec 14 1864

Remarks: Mustered Dec 15 1864 at Camp Nelson Ky. by Capt Nimrey

Promoted to Capt. Mustered Out 27 Dec 65.

A. Smith
Compt.

R 15 Cav. U.S.A.

Sidney J. Robinson

Capt, Co. K, 5th Reg't U.S. Col'd Cavalry

Appears on

Regimental Descriptive Book

(List of Commissioned Officers)

of the regiment named above.

Rank *Captain*

Date of appointment *Dec 2*, 1865.

Remarks: *Mustered by
H. C. S. Hussey, Helena
Ark. Dec. 28, 1865.*

Hearst

R | S | U.S.C.T.

Sydney J Robinson

1st, Co. I, 9 Reg't U. S. Col'd Cay

Age 20 years.

Appears on an

Individual Muster-in Roll

of the organization named above. Roll dated

Camp Nelson Ky Dec 30, 1864.

Muster-in to date Dec 14, 1864.

Joined for duty and enrolled :

When Dec 14, 1864.

Where Camp Nelson Ky

Period 3 years.

Valuation of horse, \$ 100

Valuation of horse equipments, \$ 100

Remarks: Mustered in upon appointment of the President of the United States: dated

Book mark:

Sarmer

(336)

Copyist.

JAN. - 9

5359184

1891

Louisville Ky Dec.
14. 1864 to rank as
1 Lieutenant in the
5 U. S. Cold. Cav. from
the date of his muster
into service

Assigned to duty
with his company
(L) Dec. 14. 1864.

Enlisted men of said
company were mustered
in to the minimum
on or before said
date

7

R

5 Cav.

U.S.C.T.

Sidney J. Robinson

1st Lt, Co. L, 5 Reg't U. S. Col'd Cavalry.

Appears on

Company Muster Roll

for Nov Dec, 1864

Present or absent Absent

Stoppage, \$ 100 for

Due Gov't, \$ 100 for

Valuation of horse, \$ 100

Valuation of horse equipments, \$ 100

Remarks: Mustered & as -
Signed Dec 14th 1864
On duty with detach-
ment Camp Nelson
Ky

Book mark:

Brade

(358)

Copyist.

R

5 Cav.

U.S.C.T.

Sidney J. Robinson

1st Lt, Co. L, 5 Reg't U.S. Col'd Cavalry.

Appears on

Company Muster Roll

for

Jan'y & Feby

1865

Present or absent

Absent

Stoppage, \$

100 for

Due Gov't, \$

100 for

Valuation of horse, \$

100

Valuation of horse equipments, \$

100

Remarks:

Mustered & assigned the 14th Feb On duty with Detch Camp Nelson

Book mark:

Brick

(358)

Copyist.

R

5 Cav. U.S.C.T.

Sydney J. Robinson

10th Lt., Co. L, 5 Reg't U. S. Col'd Cavalry.

Appears on

Company Muster Roll

for March 1865, 1865

Present or absent Present

Stoppage, \$ 100 for

Due Gov't, \$ 100 for

Valuation of horse, \$ 100

Valuation of horse equipments, \$ 100

Remarks: Comdy. Co C.
5th US C. C. from Feb
3rd 1865 to April 22nd 1865
inclusion. Relieved
+ assigned to duty
with Co B. Same Regt
per R.O. No 59. dated
Camp Nelson Apr 27/65

Book mark:

Biddle

(358)

Copyist.

R

5 Cav. | U.S.C.T.

Sydney T. Robinson

22, Co. L, 5 Reg't U. S. Col'd Cavalry.

Appears on

Company Muster Roll

for *May & June, 1865.*

Present or absent *Present*

Stoppage, \$ *100* for

Due Gov't, \$ *100* for

Valuation of horse, \$ *100*

Valuation of horse equipments, \$ *100*

Remarks: *Commanding Co. C
5th U.S.C.C. from
Feb. 3. 65 to April
22. 65 including*

Book mark:

Procter

(358)

Copyist.

192 | 5 Cav. | U.S.C.T.

Sydney T. Robinson
Private Co. L, 5 Reg't U. S. Col'd Cavalry.

Appears on

Company Muster Roll

for *July & Aug, 1865.*

Present or absent *Present*

Stoppage, \$ 100 for

Due Gov't, \$ 100 for

Valuation of horse, \$ 100

Valuation of horse equipments, \$ 100

Remarks:

Book mark: -----

Robester

P | 5 Cav. | U.S.C.T.

S. T. Robinson

Plat, Co. L, 5 Reg't U. S. Col'd Cavalry.

Appears on

Company Muster Roll

for *Sept & Oct*, 1865.

Present or absent *Absent*

Stoppage, \$ *100* for

Due Gov't, \$ *100* for

Valuation of horse, \$ *100*

Valuation of horse equipments, \$ *100*

Remarks: *On Det. & Services
Comdg. Comp. K, 5th U.S.
C. & I. Co., Sept 23^d
65 ser R. O. No. 152*

Book mark:

Robinson

(358)

Copyist.

R | **5 Cav.** | **U.S.C.T.**

A. T. Robinson

1247, Co. L, 5 Reg't U. S. Col'd Cavalry.

Appears on

Company Muster Roll

for *C. W. Rice*, 1865.

Present or absent *Absent*

Stoppage, \$ 100 for

Due Gov't, \$ 100 for

Valuation of horse, \$ 100

Valuation of horse equipments, \$ 100

Remarks: *In Special duty
Comdg. Co K 5th
U.S.C. since Sept.
23rd 65 per R.O. No.
157*

Book mark:

Recorder

18

5

U.S.C.T.

Sydney T. Robinson
1st, Co. G, 5 Reg't U. S. Col'd Cav'y

Appears on an

Individual Muster-out Roll

of the organization named above. Roll dated

Atlanta Ga, Dec 28, 1865.

Muster-out to date Dec 27, 1865.

Last paid to Oct 31, 1865.

Clothing account:

Last settled _____, 186 ; drawn since \$ 100

Due soldier \$ 100; due U. S. \$ 100

Am't for cloth'g in kind or money adv'd \$ 100

Due U. S. for arms, equipments, &c., \$ 100

Bounty paid \$ 100 due \$ 100

Remarks: Promoted to Captain
Co. K 5 U.S.C. by Appointment
from the President of the U.S.
bearing date Dec 2, 1865
Muster out to take effect
Dec 27, 1865

Book mark:

M. J. Hughes

(348)

Copyist.

R | 5 Cav. U.S.C.T.

Sydney T. Robinson

Capt, Co. H, 5 Reg't U. S. Col'd Cav

Age 26 years.

Appears on an

Individual Muster-in Roll

of the organization named above. Roll dated

Helena Ark, Dec. 28, 1865.

Muster-in to date Dec 28, 1865.

Joined for duty and enrolled :

When Dec. 28, 1865 .

Where Helena Ark

Period 3 years.

Valuation of horse, \$ 100

Valuation of horse equipments, \$ 100

Remarks : Promoted from
1st Lt. Co. L. 5 U.S. C. Co.
to Captain Co. H. 5 U.S.
C. Co. to fill an original

Book mark :

Sarimer

(336)

Copyist.

JAN. - 9

5359186

* 1891 *

vacancy.

*Received and accepted
appointment Dec. 27, 1865*

*Mustered to take
effect Dec. 28, 1865*

R

5 Cav.

U.S.C.T.

D. D. Robinson

Capt., Co. K, 5 Reg't U. S. Col'd Cav.

Appears on

Company Muster Roll

for *Jan Feb*, 186*5*.

Present or absent *Present*.

Stoppage, \$ *100* for

Due Gov't, \$ *100* for

Valuation of horse, \$ *100*

Valuation of horse equipments, \$ *100*

Remarks: *Assigned to Co K per R.O. No 208 Helena Ark Dec 27, 65. Responsibility money due for the command of Co K during the month of Dec. 1865*

Book mark:

E. H. Brown

(358)

Copyist.

B

5 Cav. | U.S.C.T.

Sidney T. Robinson
Plt. Co. L, 5 Reg't U.S. Col'd Cavalry.

Appears on

Company Muster Roll

for *Jan. & Feb.*, 186*6*.

Present or absent

Stoppage, \$ 100 for

Due Gov't, \$ 100 for

Valuation of horse, \$ 100

Valuation of horse equipments, \$ 100

Remarks: *Transferred: - As signed to Company K as Captain per R.O. No 208 Exp. 11 Dec. 27th, 1865.*

Book mark:

O. N. Taylor

(358)

Copyist.

R

5 Cav.

U.S.C.T.

Sidney T. Robinson

1 Lt., Co. L, 5 Reg't U. S. Colored Cav.
Capt " K

Appears on Returns as follows:

Dec. 1864 & Jan. 1865. - Absent on duty
with Det. Camp Nelson Ky.
mustered and assigned Dec 14
'64

Feb. 1865. - Absent on duty with
Detch. Camp Nelson Ky.

(Co. b) - Present temporarily as-
signed to Co. Feb. 3. 65

Signs Return as Comdg. Co.

March 1865. - (Co. L) - Present Comdg.
Co. b.

(Co. b) - Present. Temporarily assigned
to command of Co. b per Regt.
order No. 18 dated Camp Nelson
Ky. Feb. 9/65

Signs Return.

Apr. to Aug. 1865. - Present

Sept. to Dec. 1865. - On detached
Comdg. Co. K per O. No. 157
since Sept. 23/65 (over)

Book mark :

E. Thornton

(546)

Copyist.

JAN. 18

40730283

1899.

(Co. K) Present. Temporarily assigned to the command of Co. K per R.O. No. 156 dated Lexington Ky. Sept. 23 '65. Signs Return as Comdg. the Co.

Jan. 1866. - (Co L) - Absent. Promoted & assigned to Co. K as Capt. per R.O. No. 208 Ex. 11 Dec. 27/65

(Capt. Co. K) - Present assigned to K Co. per R.O. No. 208 Helena Ark Dec. 27 '65

Feb. 1866. - Present

R

5 Cav.

U.S.C.T.

Stanley T. Robinson

Quar., Co. L, 5 Reg't U. S. Col'd Cavalry.

Appears on Co. Muster-out Roll, dated

Helena Ark, March 1866.

Muster-out to date _____, 186 .

Last paid to _____, 1865.

Clothing account:

Last settled _____, 186 ; drawn since \$ _____ 100

Due soldier \$ _____ 100; due U. S. \$ _____ 100

Am't for cloth'g in kind or money adv'd \$ _____ 100

Due U. S. for arms, equipments, &c., \$ _____ 100

Bounty paid \$ _____ 100; due \$ _____ 100

Remarks: Was Seryt Co L^{*146}

Ill Cav, Rec'd accepted
appointment Dec 14/64
Promoted to Capt of
Co K 5th U.S.C. Dec 28
1865

Book mark: _____

* Corrected 5-27-1903 Austin

Merritt

(361)

Copyist
Comp

R

5 Cav. U.S.C.T.

Sidney A. Robinson

Capt., Co. K, 5 Reg't U. S. Col'd Cavalry.

Appears on Co. Muster-out Roll, dated

Helena Ark Mar 18, 1866.

Muster-out to date Mar 16, 1866.

Last paid to Dec 27, 1865.

Clothing account:

Last settled, 186 ; drawn since \$ 100

Due soldier \$ 100; due U. S. \$ 100

Am't for cloth'g in kind or money adv'd \$ 100

Due U. S. for arms, equipments, &c., \$ 100

Bounty paid \$ 100; due \$ 100

Remarks: Was 1st Lieut. Co. L from Dec 15, 64 to Dec 27, 65. Then Capt. to date. Muster out originally appointed from Sgt. 14 Ills Cav. Original place of enrollment Tennessee & Perry Co. Ills. Pay due for commanding Co. since Oct. 31, 65.

Book mark:

E. H. Brown.

Robinson S. J.

2d Lt, Capt
Co.

5 Reg't U. S. C. Cav.

5 Enclosures.

Bed Cards	Final Statements
Burial Records	Furloughs or L. of A.
Certs. of Dis. for Discharge	Med. Certificates
C. M. Charges	Med. Des. Lists
Descriptive Lists	Orders 2
Discharge Certificates	Pris. of War Record
Enlistment Papers	Resignations

Other papers relating to—

Admission to Hosp'l	Furlough or L. of A.
Casualty Sheet	Med. Examination
Confinement	Misc. Information /
Contracts	Pay or Clothing
Death or Effects	Personal Reports
Desertion	Rank
Discharge from Hosp'l	Transfer to Hosp'l
Discharge from Service /	Transfer to V. R. C.
Duty /	Transportation

67-3. A. M. Nesbitt 1865.

68-b. A. M. Nesbitt 1865.

69-5. A. M. Nesbitt 1865.

70-7. M. A. Nesbitt 1865.

Camp Nelson Ky
December 30th 1864

I certify that I have this
day mustered Sydney T Robinson
as 1st Lieut in the 5th US Colored
Cavalry to date from fifteenth
day of December 1864

C. C. Hume

Capt 18th Regt

Must. Officer

C. L. Dr. to W. C. Carver
Camp Nelson, Ky Jan. 17, 1865.

Robinson, L. C.
1st Lt. Co. B. 5th U.S.

R. Y. Moore

Applies for discharge as
S. M. Sergt. 14th Ill. Inf. Co. in
having been mustered in
as an officer.

Very Respectfully

J. Q. 20. Jan 17
Camp Nelson, Ky

R. Y. Moore

Col. G. M. Smith, Dist. of Ky
Office, Asst. Com. of Muster,
Lexington, Ky Jan. 20, 65.

Respectfully forwarded to
Capt. J. Bates Dickrow, A. S. G.
with recommendation that
the applicant be discharged
& late in 1864, the day
previous to his muster in
as an officer.

J. C. Henderson
1st Lt. Co. B. 5th U.S.

69-5. A. C. No. (A. S. G.) 1865.

Head Qrs 5th U S Cavalry

Camp Nelson Ky Jan 17th 1865

J. C. Henderson
Majr, A. C. M.

Sir

The following is a brief
Sketch of my military History, On the 30th day
of Sept 1862 I enlisted in the 14th Illinois Vol
Cavalry, On the organization of the Regt Jan 7th 1863
was mustered into Co "L" of Said Regt and ap-
pointed 2nd duty Sergt, was promoted to 1st duty
Sergt about the first of March 1863 and to Commis-
sary Sergt about the 1st of June 1863, and to L. M.
Sergt, about the 1st of May 1864 in which capacity I
served until my muster as an Officer, was in Skirmish
at Celina Tenn April 20th 1863 in battle at Buf-
fingtons Island Ohio July 19th 1863 in battle at King-
port Tenn Sept 1863 in Battle at Blountville Tenn
Sept 1863 in Battle at Raytown Tenn Oct 1863 in
Battle at Blountville Tenn Oct 1863, in Skirmish
at Bristol Va Oct 1863 in Battle at Walkers
Ford Clinch River Tenn Dec 19th 1863, in Skirmish at

Powder Spring Gap Clinch Mountains Tenn Dec
1863 in Battle at Beans Station Tenn Dec 1863
in battle at Mossy Creek Tenn Dec 26th 1863 in
Skirmish near Kenesaw Mountains Ga July 3rd
1864, in Skirmish at Moores Bridge Chattahoochee
River Ga July 10th 1864, in Battle at Macon Ga
July 30th 1864 in Battle at Sunshine Church Ga
July 31st 1864, On the 11th of Oct 1864 I was
detached from Co. B. 14th Ill Vol Cav by
Special Order { No 31 } dated 16th Qrs Mil Dist Ky
Lexington Ky Oct 11th 1864, Since which time
I have been on duty at this place as I was
ordered here immediately, In consequence of the
loss of Co Records it is impossible to give the
exact dates of ^{some of} the above mentioned Battles
and Skirmishes

Very Respectfully
Your Obt Servt
S T Robinson

1st Lt. Co. B. 5th U.S. Cav

Head Qrs 5th of Col Cav

Lexington Ky 23 Sept. 1865

Order No. 157

Extract

11 St. J. J. Robinson Co & 5th of Col Cav is hereby
relieved from duty with his Company and
will assume command of Co "H" same
Regiment

By order of
Wm Hilder
Maj Comd
Huckion
S. M. adg

Head Qrs 5th Inf Col Cav

Helena. Ark. Dec. 27. 1865.

Order No. 208

Extract

11 Capt E. J. Robinson 5th U.S. Cavalry hereby
assigned to Company H. 5th Inf Col Cav

* * * * *

L. Humphreys

Colonel 5th Inf Col Cav

Comd'g Regt

Affidavit of Nonindebtedness to U. S.,

of Sidney H. Robinson

late Capt. Co. H. 5th Reg't

U. S. Col. 1st on which was

based Certificate of Nonindebtedness
to U. S.,

Dated March 17th 1866.

STATE OF Delaware
COUNTY Phillips } ss.

I, Sidney F. Robinson
late Capt Co "K" 5th Regiment U. S. C. Caly
Volts., do solemnly declare on oath, that I have duly accounted for all Public
Property for which I have ever been responsible as an Officer of the Volunteer
Forces of the United States: that I have rendered all returns and reports, re-
quired by Revised Army Regulations of 1863 and existing orders: that
I am not now, on any account whatever, indebted to the General Government
except as stated on Muster-out Rolls.

S. F. Robinson
late Capt 5th Regt. C.

Sworn and subscribed before me, at Meriden N.H.
this 17 day of March 1866.

W. F. Morse
Capt & Comdr Muster
Dep't of N. Hampshire

1091
Robinson William

Co E, 5 U. S. Col'd Cav.

Private Private

CARD NUMBERS.

1	5363734	26
2	5363853	27
3	5363996	28
4	5364100	29
5	5364137	30
6	5364221	31
7	5364315	32
8	5364401	33
9	536448	
10	5364610	35
11	40730266	36
12		37
13		38
14		39
15		40
16		41
17		42
18		43
19		44
20		45
21		46
22		47
23		48
24		49
25		50

Book Mark:

General Notation R. & P. 407375,

See also

R

5 Cav.

U.S.C.T.

William Robinson

Co. E, 5 Reg't U. S. Col'd Cavalry.

Appears on

Company Muster-in and Descriptive Roll

of the organization named above. Roll dated

Camp Nelson, N. Y., Oct 26, 1864.

Where born Bath Ky

Age 24 y'rs; occupation Farmer

When enlisted Sept. 9, 1864.

Where enlisted Cp. Nelson Ky

For what period enlisted 3 years.

Eyes Black; hair Black

Complexion Black; height 5 ft. 5 in.

When mustered in Sept. 9, 1864.

Where mustered in Cp. Nelson Ky

Bounty paid \$ 100; due \$ 100

Where credited

Company to which assigned

Remarks: 2^d District Kentucky

* Robert Marshal

* Supposed to be name of owner

added my 1875 era

Book mark:

Manual Number N. S. 11 807375.

H. W. [Signature]

(356d)

Copyist.

R

5 Cav. U.S.C.T.

William Robinson

Pvt., Co. E, 5 Reg't U.S. Col'd Cavalry.

Appears on

Company Muster Roll

for Enlistment to Oct. 31, 1864.

Present or absent

Stoppage, \$ 100 for

Due Gov't, \$ 100 for

Valuation of horse, \$ 100

Valuation of horse equipments, \$ 100

Remarks: Missing at the Battle of Saltville Va. Oct. 2nd 1864

All Jan & Feb. 65 next on which name appears

Book mark:

M. W. Rowland

(358)

Copyist.

R

5 Cav. U.S.C.T.

William Robinson

Pr, Co. E, 5 Reg't U. S. Col'd Cavalry.

Appears on

Company Muster Roll

for *Jan. 9 Feb.*, 1865.

Present or absent *Present*

Stoppage, \$ *100* for

Due Gov't, \$ *100* for

Valuation of horse, \$ *100*

Valuation of horse equipments, \$ *100*

Remarks: *First instalment of Bounties due \$ 100 Due U.S. for Advance \$ 3.00. Taken up from Missing in action 2^d Oct 64*

Book mark:

W. Rowland

(358)

Copyist.

William Robinson

Co. E, 5 Reg't U. S. Col'd Cavalry.

Appears on

Company Muster Roll

for *March 1865*, 186*5*.

Present or absent *Present*

Stoppage, \$ 100 for

Due Gov't, \$ 100 for

Valuation of horse, \$ 100

Valuation of horse equipments, \$ 100

Remarks: *First installment of bounty due*

Book mark:

Wm. Robinson
Copyist.

R | 5 Cav. | U.S.C.T.

William Robinson
Sgt., Co. E, 5 Reg't U. S. Col'd Cavalry.

Appears on

Company Muster Roll

for May & June, 1865.

Present or absent Present

Stoppage, \$ 100 for

Due Gov't, \$ 100 for

Valuation of horse, \$ 100

Valuation of horse equipments, \$ 100

Remarks: 1st Instalment of
Bounty due \$100.
Appointed Sgt.
from Priv. May 1/65
per Regtl. Order No. 16.

Book mark:

(358)

Long
Copyist.

R

5 Cav.

U.S.C.T.

William Robinson
Sgt., Co. E, 5 Reg't U.S. Col'd Cavalry.

Appears on

Company Muster Roll

for July-Aug., 1865.

Present or absent present

Stoppage, \$ 100 for

Due Gov't, \$ 100 for

Valuation of horse, \$ 100

Valuation of horse equipments, \$ 100

Remarks:

Book mark:

Long

Copyist.

(358)

R

5 Cav. U.S.C.T.

William Robinson

Sgt., Co. E, 5 Reg't U.S. Col'd Cavalry.

Appears on

Company Muster Roll

for Sept & Oct., 1865.

Present or absent present

Stoppage, \$ 100 for

Due Gov't, \$ 100 for

Valuation of horse, \$ 100

Valuation of horse equipments, \$ 100

Remarks:

Book mark:

Long

(358)

Copyist.

R

5 Cav. U.S.C.T.

William Robinson

Sgt., Co. E, 5 Reg't U. S. Col'd Cavalry.

Appears on

Company Muster Roll

for Nov + Dec, 1865.

Present or absent Present

Stoppage, \$ 100 for

Due Gov't, \$ 100 for

Valuation of horse, \$ 100

Valuation of horse equipments, \$ 100

Remarks:

Book mark:

Long

(358)

Copyist.

R

5 Cav. U.S.C.T.

William Robinson

Sgt., Co. E, 5 Reg't U.S. Col'd Cavalry.

Appears on

Company Muster Roll

for Jan. & Feb., 1866.

Present or absent Present

Stoppage, \$ 100 for

Due Gov't, \$ 100 for

Valuation of horse, \$ 100

Valuation of horse equipments, \$ 100

Remarks:

Book mark:

J. M. Bernard

R | **5 Cav. | U.S.C.T.**

William Robinson

Priv, Co. *E*, 5 Reg't U. S. Colored Cav.

Appears on **Returns** as follows :

*Oct. 1864, - Priv: Missing
at the battle of Saltville
Va. Oct. 2/64*

Book mark : _____

E. L. Thomson

(548)

Copyist.

A

5 Cav. U.S.C.T.

William Robinson

Private, Co. E, 5 Reg't U. S. Col'd Cavalry

Appears on Co. Muster-out Roll, dated Helena Ark, Mar 16, 1866.

Muster-out to date * Mar 3, 1866.

Last paid to Dec 31, 1865.

* Records on file in 2nd. Auditors

Office show this Co. Mustered Out Clothing account: to take effect Mch, 16th. 1866. and last settled 1866 drawn since \$ 100.00 to include Mch, 15th. 1866.

Due soldier \$ 100; due U. S. \$ 10 07/100

Am't for cloth'g in kind or money adv'd \$ 100

Due U. S. for arms, equipments, &c., \$ 3 0/100

Bounty paid \$ 100 00/100; due \$ 100 00/100

Remarks: Private from Org of Co. to May 1/65 then sent to Mar 6/66 then returned to camp. Due U.S. for Ordnance 3000

Book mark: 302 670

W. Leonard

(861)

Copyist.

Robinson William

P, Co. E, 5 Reg. U. S. G. C.

2 Enclosures.

Bed Cards	Final Statements
Burial Records	Furloughs or L. of A.
Certs. of Dis. for Discharge	Med. Certificates
C. M. Charges	Med. Des. Lists
Descriptive Lists	Orders
Discharge Certificates	Pris. of War Record
Enlistment Papers	Resignations

Other papers relating to—

Admission to Hosp'l	Furlough or L. of A.
Casualty Sheet	Med. Examination
Confinement	Misc. Information
Contracts	Pay or Clothing
Death or Effects	Personal Reports
Desertion	Rank
Discharge from Hosp'l	Transfer to Hosp'l
Discharge from Service	Transfer to V. R. C.
Duty	Transportation

MEMORANDUM FROM PRISONER OF WAR RECORDS.

No. _____

(This blank to be used only in the arrangement of said records.)

INFORMATION OBTAINED FROM—

NAME.	RANK.	ORGANIZATION.				Records of—			
		No. of Reg't.	State.	Arm of Service.	Co.	Vol.	Page.	Vol.	Page.
<i>Robinson William P.</i>		<i>5</i>	<i>USC</i>	<i>Corp</i>	<i>E</i>				

Captured at _____, 186 ; brought from _____, and confined at Richmond, Va., _____, 186 , _____

Admitted to Hospital at _____, 186 ; treated for _____

Where he died _____, 186 ; of _____

Paroled at _____, 186 ; reported at _____, 186 .

Grand case # 183. 410 Rand P. Div. Released 4. 17. 90

NOTE 1.—This blank will be used for enlistments of United States colored troops. They will be made out in duplicate in all cases—one to accompany the recruiting return of the superintendent (not the recruiting officer) to the Adjutant General, and one to accompany the accounts of the officer who pays bounty, &c.

NOTE 2.—An enlistment holds to service. A muster-in must, in all cases, precede payment of pay, bounty, pension, &c. A muster-in roll, must in all cases, be filed in the Adjutant General's Office as evidence of muster-in. The mustering officer, commissary, or assistant commissary of musters, as the case may be, will countersign both enlistments as having mustered the soldiers into the service of the United States before either of them is given to the disbursing officer.

DECLARATION OF RECRUIT

I, William Johnson desiring to volunteer as a soldier in the ARMY OF THE UNITED STATES, for the term of Three Years, DO DECLARE That I am 24 years and months of age; that I have never been discharged from the United States service on account of disability or by sentence of a court-martial, or by order before the expiration of a term of enlistment; and I know of no impediment to my serving honestly and faithfully as a soldier for three years.

GIVEN at Camp Nelson the 9 day of Sept 1864

Witness: John Dickerson

William Johnson
 By Wm Johnson

Mr. Robinson
Robert Starbuck

Volunteered at Camp Nelson
Sept 9 1864
Wm Johnson
or Fayette Col

No. 1000
Wm Johnson
See Serial & Register

Consent of Parent or Guardian in case of a Minor, if a Free Man, or in the case of a Slave, of the Person to whom he owes Service:

I, Do CERTIFY, That I am the that the said is years of age; and I do freely give my CONSENT to his volunteering as a SOLDIER in the Army of the United States, for the period of THREE YEARS, under the conditions of the laws of the United States.

GIVEN at the day of

Witness:

UNITED STATES COLORED TROOPS ENLISTMENT.

STATE OF

TOWN OF

Kentucky *Camp Nelson*

I, *William Robinson* born in *Bath co*

in the State of *Kentucky* aged *twenty four* years

and by occupation a *Farmer* Do HEREBY ACKNOWLEDGE to

have volunteered *11th* day of *September* 1864

to serve as a **Soldier** in the **Army of the United States of America**, for the period of **THREE YEARS**, unless sooner discharged by proper authority: Do also agree to accept such bounty, pay, rations, and clothing, as are, or may be, established by law for the U. S. colored troops.

And I, *William Robinson*

do solemnly swear that I will bear true faith and allegiance to the **United States of America**, and that I will serve them honestly and faithfully against all their enemies or opposers whomsoever; and that I will observe and obey the orders of the President of the United States, and the orders of the officers appointed over me, according to the Rules and Articles of War.

Sworn and subscribed to, at *Camp Nelson*
this *9th* day of *Sept 1864* *William Robinson*
John Randolph
Before *J. Randolph*

I CERTIFY, ON HONOR, That I have carefully examined the above named Volunteer agreeably to the General Regulations of the Army, and that, in my opinion, he is free from all bodily defects and mental infirmity, which would in any way disqualify him from performing the duties of a soldier.

P. G. Barrett
ass't Surgt. Gen.
EXAMINING SURGEON.

I CERTIFY, ON HONOR, That I have minutely inspected the Volunteer, *W. Robinson* previously to his enlistment, and that he was entirely sober when enlisted; that, to the best of my judgment and belief, he is of lawful age, and that, in accepting him as duly qualified to perform the duties of an able-bodied soldier, I have strictly observed the regulations which govern the recruiting service. This soldier has *5 1/2* eyes, *5 1/2* hair, *5 1/2* complexion, is *5 1/2* feet *5 1/2* inches high.

J. Randolph
RECRUITING OFFICER OR AGENT.

Mustered into the United States Service. *11th* day of *September* 1864.

N. C. Munney
Mustering Officer.

Mustered into the service of the United States, for three years or during the war, from date of enlistment, in Company *Co. B* of *1st* Regiment of *Miss. Colored* Volunteers, on the *11th* day of *September* 1864, at *Camp Nelson*.

W. Robinson
N. C. Munney
Co. B

Rodgers Ande

Co A, 5 U.S. Col'd Cav.

Private | Private

CARD NUMBERS.

1	5364746	26
2	5364839	27
3	5364939	28
4	5365029	29
5	5365120	30
6	5365209	31
7	5365300	32
8	5365389	33
9	5365478	34
10	5365566	35
11	5365656	36
12	9090577	37
13	40730269	38
14		39
15		40
16		41
17		42
18		43
19		44
20		45
21		46
22		47
23		48
24		49
25		50

Book Mark:

See also

Rep 359708.
S 1073348 P1 aff
S, 10. 9/8 345 P1 mmr P11
S 2852550 a u d w d
A 3278418 P1 P1

J. B. Dond
Exr

R

5 Cav.

U.S.C.T.

Ande Rodgers

Pvt, Co. F, 5 Reg't U. S. Col'd Cavalry.

Appears on

Company Muster-in and Descriptive Roll

of the organization named above. Roll dated

Sept Nelson, N. Y., Oct 29, 1864.

Where born Boyle Ky

Age 18 y'rs; occupation Farmer

When enlisted Sept 14, 1864.

Where enlisted Sept Nelson

For what period enlisted 3 years.

Eyes Blk; hair Blk

Complexion Blk; height 5 ft. 4 in.

When mustered in Sept 14, 1864.

Where mustered in Sept. Nelson

Bounty paid \$ 100; due \$ 100

Where credited 4 Dec 1 Ky

Company to which assigned F

Remarks: Name of owner of Negro - Wm Rodgers

Entered Army 3/48 CORU

Book mark:

Sumner

R

5 Cav. | U.S.C.T.

Ande Rodgers

Privt, Co. F, 5 Reg't U. S. Col'd Cavalry.

Appears on

Company Muster Roll

for *to Oct 31*, 186*4*.

Present or absent *Present*

Stoppage, \$ *100* for

Due Gov't, \$ *100* for

Valuation of horse, \$ *100*

Valuation of horse equipments, \$ *100*

Remarks:

Book mark:

Schur

(358)

Copyist.

R

5 Cav. U.S.C.T.

Ande Rodgers

Pvt

, Co. F, 5 Reg't U. S. Col'd Cavalry.

Appears on

Company Muster Roll

for Nov & Dec, 1864.

Present or absent Absent.

Stoppage, \$ 100 for

Due Gov't, \$ 100 for

Valuation of horse, \$ 100

Valuation of horse equipments, \$ 100

Remarks:

172 Installments Bounty due.

Sick in Genl Hospital

Camp Nelson Ky. since

Nov 2/64

Book mark:

Sumner

R

5 Cav. U.S.C.T.

Andy Rodgers

Privt, Co. F, 5 Reg't U. S. Col'd Cavalry.

Appears on

Company Muster Roll

for *Jan & Feb*, 186*5*.

Present or absent *Absent*.

Stoppage, \$ *100* for

Due Gov't, \$ *100* for

Valuation of horse, \$ *100*

Valuation of horse equipments, \$ *100*

Remarks:

*1 Installment Bounty \$100 due
Sick in Genl Hospt Camp
Alson since Nov 2/64*

Book mark:

Cummins

(358)

Copyist.

A

5 Cav. | U.S.C.T.

Andy Rogers
Private, Co. F, 5 Reg't U. S. Col'd Cavalry.

Appears on

Company Muster Roll

for *Mar & Apr*, 186 *5*.

Present or absent *Present.*

Stoppage, \$ *100* for

Due Gov't, \$ *100* for

Valuation of horse, \$ *100*

Valuation of horse equipments, \$ *100*

Remarks:

First installment Bounty due

Book mark:

Sumner

(358)

Copyist.

R

5 Cav.

U.S.C.T.

Andy Rogers

Pos

, Co. F, 5 Reg't U. S. Col'd Cavalry.

Appears on

Company Muster Roll

for May & June, 1865.

Present or absent Present

Stoppage, \$ 100 for

Due Gov't, \$ 100 for

Valuation of horse, \$ 100

Valuation of horse equipments, \$ 100

Remarks: 1st Instalment Bounty due \$ 100.

Book mark:

Wark

(358)

Copyist.

R | 5 Cav. | U.S.C.T.

Andy Rogers

Prs, Co. F, 5 Reg't U. S. Col'd Cavalry.

Appears on

Company Muster Roll

for July & Aug, 1865.

Present or absent Present

Stoppage, \$ 100 for

Due Gov't, \$ 100 for

Valuation of horse, \$ 100

Valuation of horse equipments, \$ 100

Remarks:

Book mark:

Mark

(358)

Copyist.

R

5 Cav.

U.S.C.T.

Andy Rogers

Pvt, Co. F, 5 Reg't U. S. Col'd Cavalry.

Appears on

Company Muster Roll

for Sept 20th, 1865.

Present or absent Present

Stoppage, \$ 100 for

Due Gov't, \$ 100 for

Valuation of horse, \$ 100

Valuation of horse equipments, \$ 100

Remarks:

Book mark:

Wash

(358)

Copyist.

R | 5 Cav. | U.S.C.T.

May Rogers

Pol, Co. F, 5 Reg't U. S. Col'd Cavalry.

Appears on

Company Muster Roll

for *Nov & Dec*, 1865.

Present or absent *Present*

Stoppage, \$ *100* for

Due Gov't, \$ *100* for

Valuation of horse, \$ *100*

Valuation of horse equipments, \$ *100*

Remarks:

Book mark:

(358)

Hark

Copyist.

R

5 Cav. U.S.C.T.

Andy Rogers

Prs

, Co. F, 5 Reg't U. S. Col'd Cavalry.

Appears on

Company Muster Roll

for Jan & Feb, 1866

Present or absent Present

Stoppage, \$ 100 for

Due Gov't, \$ 100 for

Valuation of horse, \$ 100

Valuation of horse equipments, \$ 100

Remarks:

Book mark:

J. W. D. Jones

(358)

Copyist.

R | 5 Cav. | U.S.C.T.

Andy Rogers
Priv., Co. F, 5 Reg't U. S. Colored Cav.

Appears on Returns as follows:

Oct. 1864. - On picket duty
Oct. 26/64 Camp Nelson
Ky.

Dec. 1864 to March, 1865. - Absent
sent sick in Gen. Hosp.
Camp Nelson Ky.
Nov. 2/64.

Apr. to July 1865. - On duty
Co. Cook.

Nov. 1865. - On duty Brig.
Hooqrs.

Book mark :

(546)

E. J. Thomson

Copyist.

R

5 Cav. U.S.C.T.

Andy Rogers
Pvt, Co. F, 5 Reg't U. S. Col'd Cavalry.

Appears on Co. Muster-out Roll, dated
Helena Ark Mch 16, 1866.

Muster-out to date Mch 16, 1866.

Last paid to Dec 31, 1865.

Clothing account:

Last settled _____, 186 ; drawn since \$ _____ 100

Due soldier \$ _____ 100; due U. S. \$ 48 ⁶⁰/₁₀₀

Am't for cloth'g in kind or money adv'd \$ _____ 100

Due U. S. for arms, equipments, &c., \$ _____ 100

Bounty paid \$ 100 100; due \$ 100 100

Remarks: _____

Book mark: 427.424

(361)

JW Davis

Copyist.

R | 5 Cav. | U.S.C.T.

Andy Rodgers
Co. *F*, 5 Reg't U. S. Col'd Cav.

Appears on

Company Descriptive Book
of the organization named above.

DESCRIPTION.

Age *18* years; height *5* feet *4* inches.

Complexion *Black*

Eyes *Bk*; hair *Bk*

Where born *Boyle Ky*

Occupation *farmer*

ENLISTMENT.

When *Sep 14*, 186 .

Where *Camp Nelson*

By whom *G. G. Rudolph* term *3* y'rs.

Remarks:

F. E. K. R. S.

Rodgers Andy

, Co. _____,

Reg't _____

U.S.A.

Enclosures.

Bed Cards	Final Statements
Burial Records	Furloughs or L. of A
Certs. of Dis. for Discharge	Med. Certificates
C. M. Charges	Med. Des. Lists
Descriptive Lists	Orders
Discharge Certificates	Pris. of War Record
Enlistment Papers	Resignations

Other papers relating to—

Admission to Hosp'l	Furlough or L. of A
Casualty Sheet	Med. Examination
Confinement	Misc. Information
Contracts	Pay or Clothing
Death or Effects	Personal Reports
Desertion	Rank
Discharge from Hosp'l	Transfer to Hosp'l
Discharge from Service	Transfer to V. R. C.
Duty	Transportation

DECLARATION OF RECRUIT.

I, Andy Rodgers desiring to volunteer as a soldier in the ARMY OF THE UNITED STATES, for the term of Three Years, DO DECLARE That I am 19 years and months of age; that I have never been discharged from the United States service on account of disability or by sentence of court-martial, or by order before the expiration of a term of enlistment; and I know of no impediment to my serving honestly and faithfully as a soldier for three years.

GIVEN at Camp Nelson Ky. the 14 day of September 1864

Witness: J. M. Bond

Andy Rodgers
Volunteered at Camp Nelson Ky.
Sept 14 1864
Wm. Bond
Washington
William Rodgers

Consent of Parent or Guardian in case of a Minor, if a Free Man, or in the case of a Slave, of the Person to whom he owes Service:

I, Do CERTIFY, That I am the that the said is years of age; and I do freely give my CONSENT to his volunteering as a SOLDIER in the Army of the United States, for the period of THREE YEARS, under the conditions of the laws of the United States.

GIVEN at the day of

Witness: J. M. Bond
(A. G. O. No. 74 & 76.)

NOTE 1.—This blank will be used for enlistments of United States colored troops. They will be made out in duplicate in all cases—one to accompany the recruiting return of the superintendent (not the recruiting officer) to the Adjutant General, and one to accompany the accounts of the officer who pays bounty, &c.

NOTE 2.—An enlistment holds to service. A muster-in must, in all cases, precede payment of pay, bounty, pension, &c. A muster-in roll, must in all cases, be filed in the Adjutant General's Office as evidence of muster-in. The mustering officer, commissary, or assistant commissary of musters, as the case may be, will countersign both enlistments as having mustered the soldiers into the service of the United States before either of them is given to the disbursing officer.

UNITED STATES COLORED TROOPS ENLISTMENT.

STATE OF

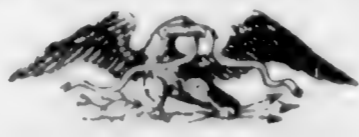

TOWN OF

Kentucky

Camp Nelson

I, *Andy Rodgers* born in *Boyle Co*

in the State of *Kentucky* aged *Eighteen* years

and by occupation a *Farmer* Do HEREBY ACKNOWLEDGE to

have volunteered *fourteenth* day of *September* 1864

to serve as a **Soldier** in the **Army of the United States of America**, for the

period of **THREE YEARS**, unless sooner discharged by proper authority: Do

also agree to accept such bounty, pay, rations, and clothing, as are, or may be,

established by law for the U. S. colored troops.

And I, *Andy Rodgers*

do solemnly swear that I will bear true faith and allegiance to the **United States**

of America, and that I will serve them honestly and faithfully against all their

enemies or opposers whomsoever; and that I will observe and obey the orders

of the President of the United States, and the orders of the officers appointed

over me, according to the Rules and Articles of War.

Sworn and subscribed to, at *Camp Nelson*

this *14* day of *Sept* 1864 *Andy Rodgers*

Before *J. C. ...*

I CERTIFY ON HONOR. That I have carefully examined the above named Volunteer agreeably to the General Regulations of the Army, and that, in my opinion, he is free from all bodily defects and mental infirmity, which would in any way disqualify him from performing the duties of a soldier.

P. G. Barrett
asst surg 7th C. O. C
EXAMINING SURGEON.

I CERTIFY, ON HONOR, That I have minutely inspected the Volunteer, *Andy Rodgers* previously to his enlistment, and that he was entirely sober when enlisted; that, to the best of my judgment and belief, he is of lawful age; and that, in accepting him, as duly qualified to perform the duties of an able-bodied soldier, I have strictly observed the regulations which govern the recruiting service. This soldier has *dark* eyes, *dark* hair, *dark* complexion, is *five* feet *four* inches high.

J. C. ...
and *J. P. ...*
RECRUITING OFFICER OR AGENT.

Mustered into the United States Service *14* day of *Sept* 1864

A. C. Kinney
Capt 18th U. S. I
Mustering Officer.

Mustering Officer

Mustered into the service of the United States, for three years or during the war, from date of enlistment, in Company *...* Regiment of *U. S. Colored Volunteers*, on the *14th* day of *September*, 1864 at *Camp Nelson Ky*

104
Rodgers Marshal

Co F, 5 U. S. Col'd Cav.

Private | *Private*

CARD NUMBERS.

1	5364745	26
2	5364838	27
3	5364938	28
4	5365028	29
5	5365119	30
6	5365208	31
7	5365299	32
8	5365388	33
9	5365479	34
10	5365567	35
11	5365654	36
12	9090575	37
13		38
14		39
15		40
16		41
17		42
18		43
19		44
20		45
21		46
22		47
23		48
24		49
25		50

Book Mark:

See also

A | 5 Cav. | U.S.C.T.

Marshal Rodgers

....., Co. *X*, 5 Reg't U. S. Col'd Cav.

Appears on

Company Descriptive Book
of the organization named above.

DESCRIPTION.

Age *25* years; height *5* feet *8* inches.

Complexion *Black*

Eyes *Bk*; hair *Bk*

Where born *Montgomery Ky*

Occupation *farmer*

ENLISTMENT.

When *Sep 23*....., 186 .

Where *Camp Nelson*

By whom *J. Randolph*, term *3* y'rs.

Remarks:

.....

.....

.....

.....

.....

.....

.....

J. E. Pusey

R

5 Cav.

U.S.C.T.

Mueshat Rodgers

Priv, Co. F, 5 Reg't U. S. Col'd Cavalry.

Appears on

Company Muster-in and Descriptive Roll

of the organization named above. Roll dated

Sept Nelson, N. Y., Oct 27, 1864

Where born Montgomery Ky

Age 25 y'rs; occupation Farmer

When enlisted Sept 23, 1864

Where enlisted Sept Nelson

For what period enlisted 3 years.

Eyes Blk; hair Blk

Complexion Blk; height 5 ft. 8 in.

When mustered in Sept 23, 1864

Where mustered in Sept Nelson

Bounty paid \$100; due \$100

Where credited 9 D in Ky

Company to which assigned F

Remarks: Name of owner of Negro - Geo. Rodgers

* Added May 13/45 Cua

Book mark:

Currier

R

5 Cav. U.S.C.T.

Marshal Rodgers

Priv, Co. F, 5 Reg't U. S. Col'd Cavalry.

Appears on

Company Muster Roll

for to Oct 31, 1864

Present or absent Present

Stoppage, \$ 100 for

Due Gov't, \$ 100 for

Valuation of horse, \$ 100

Valuation of horse equipments, \$ 100

Remarks:

Book mark:

Sumner

(358)

Copyist.

A

5 Cav. U.S.C.T.

Marshall, Rodgers

Pvt, Co. F, 5 Reg't U. S. Col'd Cavalry.

Appears on

Company Muster Roll

for Nov & Dec, 1864.

Present or absent Present.

Stoppage, \$ 100 for

Due Gov't, \$ 100 for

Valuation of horse, \$ 100

Valuation of horse equipments, \$ 100

Remarks:

1st 2 Installment Bounty due.

Book mark:

Gunnis

(358)

Copyist.

R | 5 Cav. | U.S.C.T.

Marshal Rodgers

Privt

, Co. F, 5 Reg't U. S. Col'd Cavalry.

Appears on

Company Muster Roll

for *Jan & Feb*, 186*5*.

Present or absent *Present*

Stoppage, \$ *100* for

Due Gov't, \$ *100* for

Valuation of horse, \$ *100*

Valuation of horse equipments, \$ *100*

Remarks:

1. Installment of bounty \$400 due

Book mark:

Curran

(358)

Copyist.

W

5 Cav. U.S.C.T.

Marshal Rogers

Parr, Co. F, 5 Reg't U. S. Col'd Cavalry.

Appears on

Company Muster Roll

for *Mar 7 Apr*, 186*5*.

Present or absent *Present*

Stoppage, \$ *100* for

Due Gov't, \$ *100* for

Valuation of horse, \$ *100*

Valuation of horse equipments, \$ *100*

Remarks:

First installment Bounty due

Book mark:

Sumner

(358)

Copyist.

R

5 Cav.

U.S.C.T.

Marchal Rogers

Pvt

, Co. F, 5 Reg't U. S. Col'd Cavalry.

Appears on

Company Muster Roll

for May & June, 1865

Present or absent Present

Stoppage, \$ 100 for

Due Gov't, \$ 100 for

Valuation of horse, \$ 100

Valuation of horse equipments, \$ 100

Remarks: 1st Instalment Brevety due \$100.

Book mark:

Hart

(358)

Copyist.

R | 5 Cav. | U.S.C.T.

Marshal Rogers

Pvt., Co. F, 5 Reg't U.S. Col'd Cavalry.

Appears on

Company Muster Roll

for July & Aug, 1865.

Present or absent Present

Stoppage, \$ 100 for

Due Gov't, \$ 100 for

Valuation of horse, \$ 100

Valuation of horse equipments, \$ 100

Remarks:

Book mark:

W. C. ...

Copyist.

Marshal Rogers

Priv, Co. F, 5 Reg't U. S. Col'd Cavalry.

Appears on

Company Muster Roll

for Sept & Oct, 1865.

Present or absent Present

Stoppage, \$ 100 for

Due Gov't, \$ 100 for

Valuation of horse, \$ 100

Valuation of horse equipments, \$ 100

Remarks:

Book mark:

Wark Copyist.

R

5 Cav.

U.S.C.T.

Marshal Rogers

Pvt, Co. F, 5 Reg't U. S. Col'd Cavalry.

Appears on

Company Muster Roll

for Nov & Dec, 1865.

Present or absent Present

Stoppage, \$ 100 for

Due Gov't, \$ 100 for

Valuation of horse, \$ 100

Valuation of horse equipments, \$ 100

Remarks:

Book mark:

Hark

(358)

Copyist.

R | 5 Cav. | U.S.C.T.

Marshal Rogers

Pvt, Co. F, 5 Reg't U. S. Col'd Cavalry.

Appears on

Company Muster Roll

for Jan & Feb, 1866

Present or absent Present

Stoppage, \$ 100 for

Due Gov't, \$ 100 for

Valuation of horse, \$ 100

Valuation of horse equipments, \$ 100

Remarks:

Book mark:

(358)

J. W. Davis

Copyist.

R

5 Cav. U.S.C.T.

Marshal Rogers

Pvt, Co. F, 5 Reg't U. S. Col'd Cavalry.

Appears on Co. Muster-out Roll, dated Helena Ark. Mar 16, 1866.

Muster-out to date Mar 16, 1866.

Last paid to Dec 31, 1865.

Clothing account:

Last settled , 186 ; drawn since \$ 100

Due soldier \$ 19 ⁷⁷/₁₀₀; due U. S. \$ 100

Am't for cloth'g in kind or money adv'd \$ 100

Due U. S. for arms, equipments, &c., \$ 100

Bounty paid \$ 100 ⁰⁰/₁₀₀; due \$ 100

Remarks:

Book mark: V219. P102. 75

(361)

J. W. Davis

Copyist.

¹¹⁰⁰
Rodgers Samuel

Co D, 5 U. S. Col'd Cav.

Private Sergeant

CARD NUMBERS.

1	5362710	26
2	5362751	27
3	5362853	28
4	5362951	29
5	5363044	30
6	5363128	31
7	5363209	32
8	5363298	33
9	5363386	34
10	5363472	35
11	5363557	36
12	9090339	37
13		38
14		39
15		40
16		41
17		42
18		43
19		44
20		45
21		46
22		47
23		48
24		49
25		50

Book Mark:

See also

R

5 Cav. | U.S.C.T.

Samuel Rogers

Co. D, 5 Reg't U. S. Col'd Cav.

Appears on

Company Descriptive Book
of the organization named above.

DESCRIPTION.

Age 18 years; height 5 feet 8 inches.

Complexion Copper

Eyes Black, hair Black

Where born Ky

Occupation Laborer

ENLISTMENT.

When _____, 186 .

Where Substitute

By whom _____; term 3 y'rs.

Remarks: Appointed Corp'l
Oct. 24, 1864.
Promoted Serg't
July 1, 1865.

A. A. Hall

(383g)

~~Capt.~~
Camp.

R | **5 Cav.** | **U.S.C.T.**

Sam Rodgers

Plt., Co. *W*, 5 Reg't U. S. Col'd Cavalry.

Appears on

Company Muster-in and Descriptive Roll

of the organization named above. Roll dated

Camp Nelson, N. Y., Oct 24, 1864.

Where born *Kentucky*

Age *18* y'rs; occupation *Labourer*

When enlisted _____, 186 .

Where enlisted _____

For what period enlisted *3* years.

Eyes *Brn*; hair *Brn*

Complexion *Copper*; height *5* ft. *8* in.

When mustered in *Sept. 14, 1864.*

Where mustered in *Louisville*

Bounty paid \$ *100*; due \$ *100*

Where credited *7 Dist. Ky.*

Company to which assigned _____

Remarks: _____

Book mark: _____

Wm H. Scott

(356d)

Copyist.

R | **5 Cav.** | **U.S.C.T.**

Samm Rodgers

Corporal, Co. D, 5 Reg't U. S. Col'd Cavalry.

Appears on

Company Muster Roll

for *Dated Oct. 31*, 186*4*.

Present or absent *Present*.

Stoppage, \$ *100* for _____

Due Gov't, \$ *100* for _____

Valuation of horse, \$ *100*

Valuation of horse equipments, \$ *100*

Remarks: _____

(Substitute)

Book mark : _____

Wm H. Scott

R | 5 Cav. | U.S.C.T.

Sam Rogers

Corp, Co. D, 5 Reg't U. S. Col'd Cavalry.

Appears on

Company Muster Roll

for *Nov. & Dec.*, 1864.

Present or absent *Present*

Stoppage, \$ *100* for

Due Gov't, \$ *100* for

Valuation of horse, \$ *100*

Valuation of horse equipments, \$ *100*

Remarks: *Due U. S. for Ord-
nance \$ 17.93.*

Book mark :

Wm H. Scott

R,

5 Cav.

U.S.C.T.

Sam Rogers

Corps, Co. D, 5 Reg't U. S. Col'd Cavalry.

Appears on

Company Muster Roll

for *Jan. & Feb.*, 1865.

Present or absent *Present*

Stoppage, \$ *100* for

Due Gov't, \$ *100* for

Valuation of horse, \$ *100*

Valuation of horse equipments, \$ *100*

Remarks: ** 1st installment of
Bounty due \$100.*

** As on Roll.*

Book mark:

Wm. H. Scott

(358)

Copyist.

R

5 Cav. U.S.C.T.

Samuel Rodgers

Corp., Co. D, 5 Reg't U. S. Col'd Cavalry.

Appears on

Company Muster Roll

for March & April, 1865.

Present or absent Present

Stoppage, \$ 100 for

Due Gov't, \$ 100 for

Valuation of horse, \$ 100

Valuation of horse equipments, \$ 100

Remarks:

Book mark:

Wm H Scott

(358)

Copyist.

A

5 Cav. U.S.C.T.

Samuel Rodgers

Corpl, Co. D, 5 Reg't U. S. Col'd Cavalry.

Appears on

Company Muster Roll

for *May + June*, 1865.

Present or absent *Present*

Stoppage, \$ *100* for

Due Gov't, \$ *100* for

Valuation of horse, \$ *100*

Valuation of horse equipments, \$ *100*

Remarks:

Book mark:

W. Milliken

(358)

Copyist.

R

5 Cav. U.S.C.T.

Samuel Rodgers

Serjt, Co. D, 5 Reg't U. S. Col'd Cavalry.

Appears on

Company Muster Roll

for *July + Aug.*, 1865.

Present or absent *present.*

Stoppage, \$ *100* for

Due Gov't, \$ *100* for

Valuation of horse, \$ *100*

Valuation of horse equipments, \$ *100*

Remarks:

Book mark:

Milliken

(358)

Copyist.

R

5 Cav. | U.S.C.T.

Samuel Rodgers

Serg't, Co. D, 5 Reg't U. S. Col'd Cavalry.

Appears on

Company Muster Roll

for *Sept. & Oct.*, 1865.

Present or absent *present*

Stoppage, \$ *100* for

Due Gov't, \$ *100* for

Valuation of horse, \$ *100*

Valuation of horse equipments, \$ *100*

Remarks: *Promit'd from Corp'l to
Serg't July 1st p R.O. 119. Due U.S.
for Ordnance \$0.30. Due U.S. for camp
& Garrison \$4.90.*

Book mark:

Milliken

(358)

Copyist.

R

5 Cav.

U.S.C.T.

Samuel Rodgers

Sergeant, Co. D, 5 Reg't U. S. Col'd Cavalry.

Appears on

Company Muster Roll

for *Nov. & Dec.*, 1865.

Present or absent *present*

Stoppage, \$ *100* for

Due Gov't, \$ *100* for

Valuation of horse, \$ *100*.

Valuation of horse equipments, \$ *100*

Remarks:

Book mark:

Williken

(358)

Copyist.

R.

5 Cav. U.S.C.T.

Samuel Rodgers,

Serjt., Co. D, 5 Reg't U. S. Col'd Cavalry.

Appears on

Company Muster Roll

for *Jan'y and Febr'y*, 1866.

Present or absent *Present.*

Stoppage, \$ 100 for

Due Gov't, \$ 100 for

Valuation of horse, \$ 100

Valuation of horse equipments, \$ 100

Remarks:

Book mark: -----

R. D. Dranner

(358)

Copyist.

R. | 5 Cav. | U.S.C.T.

Samuel Rodgers,
Serg't., Co. *D*, 5 Reg't U. S. Col'd Cavalry.

Appears on Co. Muster-out Roll, dated

Selma, Ark., March 16, 186*6*.

Muster-out to date *March 16,* 186*6*.

Last paid to *Dec. 31,* 186*5*.

Clothing account:

Last settled....., 186 ; drawn since \$..... 100

Due soldier \$..... 100; due U. S. \$ *37.*^{*57*}/₁₀₀

Am't for cloth'g in kind or money adv'd \$..... 100

Due U. S. for arms, equipments, &c., \$..... 100

Bounty paid \$..... 100; due \$..... 100

Remarks: *Corporal from organiza-*
tion till promoted to Sgt.
July 1, 1865.

Book mark:

(861)

J. W. Danner

Copyist.

1101
Russell Henry

Co G, 5 U. S. Col'd Cav.

Sergeant | Corporal

CARD NUMBERS.

1	5359235	26
2	5366290	27
3	5366379	28
4	5366538	29
5	5366729	30
6	5359318	31
7	9090731	32
8	40730267	33
9		34
10		35
11		36
12		37
13		38
14		39
15		40
16		41
17		42
18		43
19		44
20		45
21		46
22		47
23		48
24		49
25		50

Book Mark:

See also 72 U.S.C. I.

S. 2392053 P.O. m m

M. A. 976565

S. 2474373 And. W.D.

M. A. 1055025

J. Donald
Ext

R | **5 Cav. | U.S.C.T.**

Henry Cadwell
....., Co. *H*, 5 Reg't U. S. Col'd Cav.

Appears on

Company Descriptive Book
of the organization named above.

DESCRIPTION.

Age *19* years; height *5* feet *6* inches.

Complexion *Black*

Eyes *Blk*; hair *Blk*

Where born *Georgia*

Occupation *farmer*

ENLISTMENT.

When, 186 .

Where *Substitute*

By whom; term *1* y'rs.

Remarks: *Discharged*
Dec 19th expiration
of term of service
assigned to Co per
G.O. no 137 taken
Paris by July 27th
1865

T. E. Puck

R 5 Cav U.S.C.T.

Henry Rodesell
Sergt, Co., 5 Reg't U. S. Col'd Cav

Appears on

M. and D. Roll of Men Transferred

to the organization named above,

*from
Camp Nelson, Ky, July 18, 1865.
Roll dated

When enlisted, 186

Period for which enlisted 1 years.

When mustered in Dec 10, 1864.

Present or absent Not stated

Company to which assigned

Remarks: Aft Corpse Jan 28 - 1865
Aftd Serqt June 15 1865
10 D.C.
Sub for Lawrence Brown drafted

*Inserted by J.B. Powell: Ex

Book mark :

Atorn

R

Henry Russell

Company, Co. G, 5 Reg't U. S. Col'd Cavalry.

Appears on

Company Muster Roll

for July 1st, 1865.

Present or absent Present

Stoppage, \$ 100 for

Due Gov't, \$ 100 for

Valuation of horse, \$ 100

Valuation of horse equipments, \$ 100

Remarks: Reduced by transfer from 72nd S. Inf. U.S. No. 29, dated Feb. 2nd. Dept. of Ky., Louisville, Ky. July 1st, 65. Assigned to Company for B. Co. 182, dated Paris, Ky. July 1st, 65. Reduced from Sergt.

Book mark:

(over)

L. A. ...

JAN. -9

5366290

☆ 1891 ☆

*Per P. O. No. 139,
dated Aug. 16, 1885*

R.

5 Cav.

U.S.C.T.

Henry Goodsell
Sergeant, Co. G, 5 Reg't U. S. Col'd Cavalry.

Appears on

Company Muster Roll

for Sept 1st, 1865.

Present or absent Present

Stoppage, \$ 100 for

Due Gov't, \$ 100 for

Valuation of horse, \$ 100

Valuation of horse equipments, \$ 100

Remarks: Assigned to Co. G, Co. D. No. 132. Reduced from Sergeant to rank, per R.O. 134, Aug 16, 1865 and promoted to Corporal per R.O. 139, Aug 16, 1865.

Book mark:

(358)

James

Copyist.

5 Cav. U.S.C.T.

Wm. H. ...
Co. G, 5 Reg't U. S. Col'd Cavalry.

Appears on

Company Muster Roll

for *Nov 1 Dec.*, 1865.

Present or absent

Stoppage, \$ 100 for

Due Gov't, \$ 100 for

Valuation of horse, \$ 100

Valuation of horse equipments, \$ 100

Remarks: *Discharged
expiration term of
service at Helena,
Ark, Dec 19, 1865*

Book mark:

(358)

[Signature]
Copyist.

R

5 Cav. U.S.C.T.

Henry Roddell

^{upassg}
Sgt, Co. G, 5 Reg't U. S. Colored Cav.
corp

Appears on Returns as follows:

July 1865. - Gain July 27/65
Paris Ky. Transf. from
the 72 U.S. C. Inf. per
D.O. 127 Hqs. Dep't.
of Ky. 18 July '65

Aug. 1865. - Arr Aug. 1
'65 Lexington, Assigned
to Co. G per R.O. 132
27 July '65

(Co G.) Gain Aug. 1. 65
Lexington, Transf. from
72 C. I. per D.O. no. 127
dated Louisville Ky.
July 18/65. Aseq. to
Co. G per R.O. no. 132 dated
July 27/65.

Dec. 1865. - (Corp.) - Arr Dec. 19
Helena Ark. Disch. expi-
ration of term of service.

Book mark:

E. Thornton

(548)

Copyist.

R

5 Cav.

U.S.C.T.

Henry Rodsell

Capt., Co. *G*, 5 Reg't U. S. Col'd Cavalry.

Appears on **Co. Muster-out Roll**, dated

Helena, Ark. Mch. 16, 1866.

Muster-out to date _____, 186 .

Last paid to *Oct. 31*, 1865.

Clothing account:

Last settled _____, 186 ; drawn since \$ _____ 100

Due soldier \$ *3* ^{*10*}/₁₀₀; due U. S. \$ _____ 100

Am't for cloth'g in kind or money adv'd \$ _____ 100

Due U. S. for arms, equipments, &c., \$ _____ 100

Bounty paid \$ _____ 100; due \$ _____ 100

Remarks: *Free - Discharged Dec. 19/63*

*Helena, Ark. on acct. of expira=
tion of term of service, Trans=
ferred from 72nd U.S.C. per S.O.
No. 127 - par. 3 - Hd. Qrs. receipt of
Ky. 18 July, 1865.*

Book mark: _____

T. Davis

(361)

Copyist.

Henry Rodwell
Capt, Co. *G*, *5* Reg't U. S. Col'd *Carry*

Appears on an

Individual Muster-out Roll

of the organization named above. Roll dated

Helena Ark, *Dec 19*, 186 *5*.

Muster-out to date *Dec 19*, 186 *5*.

Last paid to *Oct. 31*, 186 *5*.

Clothing account:

Last settled ^{*never settled*} *^*, 186 ; drawn since \$ *70* ^{*80*} _{*100*}

Due soldier \$ *100*; due U. S. \$ *100*

Am't for cloth'g in kind or money adv'd \$ *100*

Due U. S. for arms, equipments, &c., \$ *100*

Bounty paid \$ *100* due \$ *100*

Remarks: *This man was transferred from 72 USC.I. as High per S.O. 127 per 3rd Gen Dept of War 18th July 1865. He was reduced to the ranks per R.O. 139 18th Aug 1865 and appointed (over)*

Book mark: _____

M. G. Hughes

JAN. - 9

5359318

1891 *

Corpl per R.O. 139 18th Aug
1865.

Mustered out under
provisions of War Dept
Circular No 41 of
1864 - to take effect
Dec 19, 1865

Roe Shady

Co *F*, 5 U. S. Col'd Cav.

Private Private

CARD NUMBERS.

1	5364747	26
2	5364840	27
3	5364940	28
4	5365030	29
5	5365121	30
6	5365210	31
7	5365301	32
8	5365390	33
9	5365480	34
10	5365568	35
11	5365655	36
12	9090576	
13	40730268	
14		39
15		40
16		41
17		42
18		43
19		44
20		45
21		46
22		47
23		48
24		49
25		50

Book Mark:

R. 15. C. J. 1868.

See also

R | **5 Cav.** | **U.S.C.T.**

Shade Gae

....., Co. *F*, 5 Reg't U. S. Col'd Cav.

Appears on

Company Descriptive Book

of the organization named above.

DESCRIPTION.

Age *21* years; height *5* feet *11* inches.

Complexion *Black*

Eyes *BR*; hair *BR*

Where born *Hancock Tenn.*

Occupation *farmer*

ENLISTMENT.

When *Sep 23*, 186 .

Where *Camp Nelson*

By whom *A. B. Randolph* term *3* y'rs.

Remarks:

.....

.....

.....

.....

.....

.....

.....

F. E. Purse

(383a)

Copist.

R

5 Cav.

U.S.C.T.

Shady Cove

Pratt, Co. F, 5 Reg't U. S. Col'd Cavalry.

Appears on

Company Muster-in and Descriptive Roll

of the organization named above. Roll dated

Sept Nelson, N. Y., Oct 27, 1864

Where born Hancock Maine

Age 21 y'rs; occupation Farmer

When enlisted Sept 23, 1864.

Where enlisted Sept Nelson

For what period enlisted 3 years.

Eyes Blk; hair Blk

Complexion Blk; height 5 ft. 11 in.

When mustered in Sept 23, 1864.

Where mustered in Sept Nelson

Bounty paid \$ 100; due \$ 100

Where credited Dist N. Y.

Company to which assigned F.

Remarks: True

* added may 1864 C. N. A.

Book mark:

Lummer

R 5 Cav. U.S.C.T

Shade Rae

Det, Co. F, 5 Reg't U. S. Col'd Cav.

Appears on

Company Muster Roll

for dated Oct. 21, 1864.

Present or absent Present

Stoppage, \$ 100 for

Due Gov't, \$ 100 for

Valuation of horse, \$ 100

Valuation of horse equipments, \$ 100

Remarks:

Book mark:

(358)

Fitz Copyist
Hampson

10 | 5 Cav. | U.S.C.T.

Shady Row

Present, Co. F, 5 Reg't U. S. Col'd Cavalry.

Appears on

Company Muster Roll

for *Nov & Dec*, 186*4*.

Present or absent *Present*

Stoppage, \$ *100* for

Due Gov't, \$ *100* for

Valuation of horse, \$ *100*

Valuation of horse equipments, \$ *100*

Remarks:

1st Installment Bounty due

Book mark: *See Dec 18/64 at Report of the
2d U.S. Gen'l A. of Pneumonia C B Vol 11 P 19.*

Lewis

(358)

Copyist.

R

5 Cav.

U.S.C.T.

Shade Row

Pvt

Co. F, 5 Reg't U. S. Col'd Cavalry.

Appears on

Company Muster Roll

for

Jan & Feb

, 1865.

Present or absent

Not stated

Stoppage, \$

100 for

Due Gov't, \$

100 for

Valuation of horse, \$

100

Valuation of horse equipments, \$

100

Remarks:

1 Installment Bounty \$100 due

Book mark:

Russier

(358)

Copyist.

A

5 Cav. U.S.C.T.

Shade Roe

Private, Co. F, 5 Reg't U.S. Col'd Cavalry.

Appears on

Company Muster Roll

for May & Apr, 1865.

Present or absent Absent.

Stoppage, \$ 100 for

Due Gov't, \$ 100 for

Valuation of horse, \$ 100

Valuation of horse equipments, \$ 100

Remarks:

Sick in Guit Hospital
at Camp Nelson Ky
since Nov 12, 1864.

First installment Bounty
due

Book mark:

Currier

R | 5 Cav. | U.S.C.T.

Shade Rae

Pvt, Co. F, 5 Reg't U. S. Col'd Cavalry.

Appears on

Company Muster Roll

for May & June, 1865.

Present or absent absent

Stoppage, \$ 100 for

Due Gov't, \$ 100 for

Valuation of horse, \$ 100

Valuation of horse equipments, \$ 100

Remarks: 1st Instalment Bounty
due \$ 100.

Seek in Genl Hopt's Pack
Reg since Nov 11-64.

Book mark:

Wark

(358)

Copyist.

R | 5 Cav. | U.S.C.T.

Shade Rae

Cor, Co. F, 5 Reg't U.S. Col'd Cavalry.

Appears on

Company Muster Roll

for July & Aug, 1865.

Present or absent absent

Stoppage, \$ 100 for

Due Gov't, \$ 100 for

Valuation of horse, \$ 100

Valuation of horse equipments, \$ 100

Remarks: Sick in Genl Hospital
Paducah Ky since Nov-11-1865

Book mark:

Mark
Copyist.

R

5 Cav.

U.S.C.T.

Shade Rae

Pvt, Co. F, 5 Reg't U. S. Col'd Cavalry.

Appears on

Company Muster Roll

for Sept & Oct, 1865.

Present or absent absent

Stoppage, \$ 100 for

Due Gov't, \$ 100 for

Valuation of horse, \$ 100

Valuation of horse equipments, \$ 100

Remarks: Sick in Genl Hoapt Paducah Ky since Nov 11th 1864

Book mark:

Hart

(358)

Copyist,

R

5 Cav.

U.S.C.T.

Shade Roe

Pvt, Co. F, 5 Reg't U. S. Col'd Cavalry.

Appears on

Company Muster Roll

for Nov a Dec, 1865.

Present or absent absent

Stoppage, \$ 100 for

Due Gov't, \$ 100 for

Valuation of horse, \$ 100

Valuation of horse equipments, \$ 100

Remarks: Sick in Genl Keph
Pamela Ky since Nov
11-1864.

Book mark:

Wark

(358)

Copyist.

R

5 Cav. U.S.C.T.

Shade Roe

Pol, Co. F, 5 Reg't U. S. Col'd Cavalry.

Appears on

Company Muster Roll

for Jan & Feb, 1866

Present or absent Absent

Stoppage, \$ 100 for

Due Gov't, \$ 100 for

Valuation of horse, \$ 100

Valuation of horse equipments, \$ 100

Remarks: Sick in Genl Hosp Paducah Ky since Nov 11. 1864

Book mark:

Gosdavis

(358)

Copyist.

P

5 Cav. U.S.C.T.

Shade Roe

P, Co. *V*, 5 Reg't U. S. Colored Cav.

Appears on Returns as follows:

Feb. to July 1861 - Absent
sick in Gen. Hosp. Camp
Nelson Ky - date not
known.

Aug. 1865 to Feb. 1866. - Absent
sick Gen. Hosp.
Paducah Ky. Since
Nov. 11 - 61

Book mark:

L Thornton

(548)

Copyist.

R

5 Cav. U.S.C.T.

Shade Roe

Pvt, Co. F, 5 Reg't U. S. Col'd Cavalry.

Appears on Co. Muster-out Roll, dated Helena Ark, Feb 16, 1866.

Muster-out to date _____, 1866 .

Last paid to Pay due from enrollment, 1866 .

Clothing account:

Last settled _____, 1866 ; drawn since \$ _____ 100

Due soldier \$ _____ 100; due U. S. \$ _____ 100

Am't for cloth'g in kind or money adv'd \$ _____ 100

Due U. S. for arms, equipments, &c., \$ _____ 100

Bounty paid \$ _____ 100; due \$ _____ 100

Remarks: absent sick in Genl Hosp Paducah since Nov 1. 1864
no discharged furnished

Book mark: V214. P59. 74. R15-bol 7, (over)

(361)

J. W. Davis

Copyist.

JAN. - 9

5365655

1891 *

*P. J. 1868. Dind Dec 18/64
ENB. V. 11. P. 19.*

Roe, Shade

P, Co. A, 5 Reg U.S.C. Cav.

3 Enclosures.

Bed Cards	Descriptive Lists
Burial Records	Final Statements
Certs. of Dis. for Discharge	Furloughs
C. M. Charges	Med. Des. Lists
Med. Certificates	Orders

Other papers relating to—

Admission to Hosp'l	Furlough
Casualty Sheet (Officer's) /	Med. Examination
Confinement	Misc. Information 2
Contracts	Pay or Clothing
Death or Effects	Personal Reports
Desertions	Rank
Discharge from Hosp'l	Transfer to Hosp'l
Discharge from Service	Transfer to V. R. C.
Duty	Transportation

War Department,

ADJUTANT GENERAL'S OFFICE,

March 9, 1874,

The record of *Shade Road*
Private, Co. *F*, 5th Reg't U. S.

Colored *Corp*, is reported as follows:

On Company Muster Roll.
For *March*, 186*2*, *March 1862*, 186
Company Muster-out Roll, *March 1862*, 186
March 1862, *March 1862*, 186
Company Descriptive Book.

March 1862, 186
March 1862, 186

March 1862, 186
Soldier's Final Statement.

March 1862, 186
Soldier's Record of Death and Interment.

March 1862, 186
Soldier's Inventory of Effects.

March 1862, 186
Soldier's Certificate of Disability for Discharge.

March 1862, 186
Soldier's Individual Muster-out Roll.

March 1862, 186
Regimental Return.

For *March 1862*, 186
Regimental Quarterly Returns.

March 1862, 186
Regimental Descriptive Book.

March 1862, 186
By Surgeon General.

(*March 1862*) *March 1862*, 186
March 1862, 186

March 1862, 186 is held to be
the correct date, and the Company ~~Muster~~
Rolls will be amended accordingly.

Thomas D. ...
E. B. *11/19* *Noted* *see letter to 2d and*
16.11 Assistant Adjutant General
April 20 1874

CASUALTY SHEET

Complete
No. *Shade Road*
Private of Company *F*
5th
Regiment of *U.S. Col.*

State Volunteers.

NATURE OF CASUALTY.

Died Dec 18th 1864

CASUALTY SHEET.

Name: *Shade Rael*
Rank: *Private* Company: *1st F^a* Regiment: *5th*
Arm: *U.S. Cavalry* State: _____
Nature of Casualty: *Death*

CAUSE OF CASUALTY—(NAME OF DISEASE, &C.)

Pneumonia

BY WHOM DISCHARGED.

FROM WHAT SOURCE THIS INFORMATION WAS OBTAINED.

R. S. Dally & Co. 1868.

DEGREE OF DISABILITY.

BY WHOM CERTIFIED.

L. G. Woodward
Asst Surg. U.S.A.

DATE OF DISCHARGE, DEATH, &C.

Dec 18th 1864

REMARKS.

PLACE OF DISCHARGE, DEATH, &C.

Regt'l Hqs. 8th U.S. Cavalry
Probably at Paducah, Ky.) *Wm J. Powers,*

Clerk.

R. of A. Vol. 16, No. 3015

Washington D.C.

July 22^d 1868

Shode Rod

Priv C 3, 5th U.S. Cavalry

Report in case of from
Surgeon General's Office

Notes

Return

R. OF A.
No. 3015
VOL. 16

Surgeon General's Office,

Record and Pension Division,

July 22^d, 1868.

Respectfully returned to the Adjutant General, U. S. Army, with certificate from records filed in this Office enclosed, in case of the soldier described within.

BY ORDER OF THE SURGEON GENERAL:

J. J. Woodward
Bvt. Lt. Col. and Asst. Surgeon, U. S. A.
(69)

R. of A., Vol. 16 No. 3015

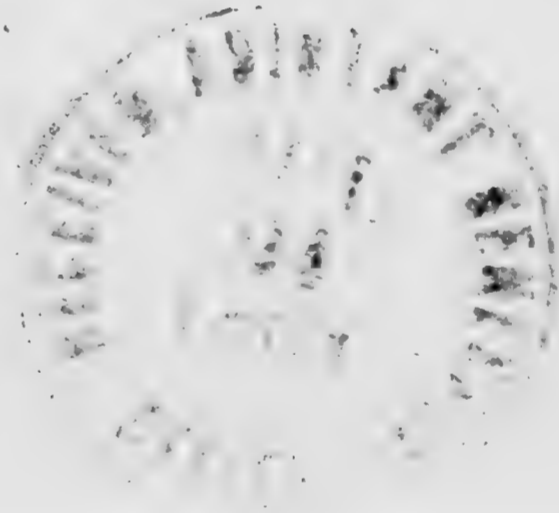

Adjutant General's Office,

Washington, July 7th, 1868.

Surgeon General, U. S. Army,

Washington, D. C.

General.

I have the honor to request that this office be furnished such information as can be obtained from the records of your office in regard to the final disposition made of
Private Shade Row
Company "F", 5th U. S. Colored Cavalry
who is reported on the muster-out roll of his Company "Absent sick in Hospital at Paducah, Ky. since Nov 1st 1864. No Discharge furnished."

If evidence of death is found, please furnish final papers if possible.

I have the honor to be,

Very respectfully,

Your obedient servant,

Thomas M. Vincent

Assistant Adjutant General.

W.S.P.

Pension Number.....

R. of..... A., Vol. *16*, No. *313*

WAR DEPARTMENT,
Surgeon General's Office,

RECORD AND PENSION DIVISION,

Washington, D. C., *July 22*, 186*3*.

[CERTIFICATE FROM RECORDS.]

It appears, from the records filed in this Office, that.....

..... Co....., Reg't..... Vol.....

was admitted to..... Hospital,.....

....., 186*3*, from..... for treatment for.....

It also appears, as reported by..... Surgeon.....

..... that....., Co. *34*,

5 Reg't *W. S. Col.* Vol. *100*, *disch. December 15, 1861*, at

Hosp. of the 8th U. S. Regt. of Pennsylvania.

Remarks: *All final papers can be furnished by this office within*

400.

BY ORDER OF THE SURGEON GENERAL:

J. Woodward

Brev. Lieut. Col. and Asst. Surgeon, U. S. Army.

(64)

(NOTE. This certificate should not be detached from the accompanying papers.)

1103

Rogers, Andy.

Co *A*, 5 U. S. Col'd Cav.

Private

CARD NUMBERS.

1	26
<i>See Rodgers</i>	<i>Andy.</i>
3	28
4	29
5	30
6	31
7	32
8	33
9	34
10	35
11	36
12	37
13	38
14	39
15	40
16	41
17	42
18	43
19	44
20	45
21	46
22	47
23	48
24	49
25	50

Book Mark:

See also

1104

Rogers, Marshal

Co *A*, 5 U. S. Col'd Cav.

Private

CARD NUMBERS.

1	26
2	27
3	28
4	29
5	30
6	31
7	32
8	33
9	34
10	35
11	36
12	37
13	38
14	39
15	40
16	41
17	42
18	43
19	44
20	45
21	46
22	47
23	48
24	49
25	50

See Rogers, Marshal

Book Mark:

See also

1105

Rogers, Sam

Co D, 5 U.S. Col'd Cav.

Corporal

CARD NUMBERS.

1	26
<i>See Rodgers, Samuel</i>	
3	28
4	29
5	30
6	31
7	32
8	33
9	34
10	35
11	36
12	37
12	38
14	39
15	40
16	41
17	42
18	43
19	44
20	45
21	46
22	47
23	48
24	49
25	50

Book Mark:

See also

1106
Rollins George

Co K, 5 U. S. Col'd Cav.

Sergeant Sergeant

CARD NUMBERS.

1	5368783	26
2	5368883	27
3	5368984	28
4	5369075	29
5	5369163	30
6	5369251	31
7	5369337	32
8	5369424	33
9	5369513	34
10	5369599	35
11	5369683	36
12	9090103	37
13	43145518	38
14	40730270	39
15		40
16		41
17		42
18		43
19		44
20		45
21		46
22		47
23		48
24		49
25		50

Book Mark:

See also

R | **5 Cav. | U.S.C.T.**

George Rollins

, Co. *K*, 5 Reg't U. S. Col'd Cav.

Appears on

Company Descriptive Book
of the organization named above.

DESCRIPTION.

Age *33* years; height *5* feet *6* inches.

Complexion *Black*

Eyes *BRN*; hair *BRN*

Where born *Lexington Ky*

Occupation *Laborer*

ENLISTMENT.

When *Aug 27*, 1864

Where *Lexington Ky*

By whom *J. H. Moore*; term *3* y'rs.

Remarks:

A. J. Anderson

(383g)

Copist.

R | 5 bar | U.S.C.

George Rollins

Appears with rank of Private on

Muster and Descriptive Roll

of a Detachment of U.S. Colored Vols
forwarded to Camp Nelson Ky.
Camp of Instruction. Roll dated
Lexington Ky, Aug 27, 1864.

Where born Scott Co Ky.

Age 33 years; occupation Laborer

When enlisted Aug 27, 1864.

Where enlisted Lexington Ky

For what period enlisted 3 years.

Eyes Blk; hair Blk

Complexion Blk; height 5 ft. 6 in.

When mustered in _____, 186 .

Where mustered in _____

Bounty paid \$ _____ 100; due \$ _____ 100

Clothing account:

Last settled _____, 186 ; drawn since \$ _____ 100

Date of first muster Aug 27, 1864.

Company to which assigned _____

Remarks: Owner James Rollins
Scott Co. to be credited 7 dis
Ky

Book mark: _____

W.M. Potter

(356m)

Copyist.

R

5 Cav.

U.S.C.T.

George Rollins

1st Searg't, Co. K, 5 Reg't U. S. Col'd Cavalry.

Appears on

Company Muster-in and Descriptive Roll

of the organization named above. Roll dated

Camp Nelson Ky, N. Y., Oct 30, 1864.

Where born Scott Ky

Age 33 y'rs; occupation Laborer

When enlisted Aug 27, 1864.

Where enlisted Lexington Ky

For what period enlisted 3 years.

Eyes Blk; hair Blk

Complexion Blk; height 5 ft. 6 in.

When mustered in Aug 27, 1864.

Where mustered in Lexington Ky

Bounty paid \$ 100; due \$ 100

Where credited 7th Dist Ky

Company to which assigned

Remarks: James Rollins

X Supposed to be name of owner

Book mark: R. 2070. Ky

H. S. Miller

(356d)

Copyist.

R

5 Cav.

U.S.C.T.

George Rollins

1st Spt, Co. K, 5 Reg't U. S. Col'd Cav.

Appears on

Company Muster Roll

for Organization of Co. to Oct 31, 1864.

Present or absent Present

Stoppage, \$ 100 for

Due Gov't, \$ 100 for

Valuation of horse, \$ 100

Valuation of horse equipments, \$ 100

Remarks: App'd per Reg'tl Order No 12 to date Oct 30, 1864

Book mark:

H S Miller

(358)

Copyist.

R

5 Cav.

U.S.C.T.

George Rollins

1st Sergt, Co. K, 5 Reg't U. S. Col'd Cav.

Appears on

Company Muster Roll

for *Novth Dec*, 1864.

Present or absent *Present*

Stoppage, \$ *100* for

Due Gov't, \$ *100* for

Valuation of horse, \$ *100*

Valuation of horse equipments, \$ *100*

Remarks: *Apptd per Regtl order
No 12 to date Oct 30/1864
1st & 2nd installments Bounty
due*

Book mark:

H S Miller

(358)

Copyist.

George Rollins

Com Sgt, Co. K, 5 Reg't U. S. Col'd Cav.

Appears on

Company Muster Roll

for *Jan & Feb*, 1865.

Present or absent *Present*

Stoppage, \$ *100* for

Due Gov't, \$ *100* for

Valuation of horse, \$ *100*

Valuation of horse equipments, \$ *100*

Remarks: *Apptd per Regtl order
23 to date Jan 1/65 1" & 2"
installments - \$300 Bounty due.*

Book mark:

H Miller

R

5 Cav.

U.S.C.T.

George Rollins

Com Sgt, Co. K, 5 Reg't U. S. Col'd Cav.

Appears on

Company Muster Roll

for Mar & Apr, 1865.

Present or absent Present

Stoppage, \$ 100 for

Due Gov't, \$ 100 for

Valuation of horse, \$ 100

Valuation of horse equipments, \$ 100

Remarks: Adept per R.O. 23 Jan 1/65. Reduced from 1st Sergt per R.O. 23 Jan 1/65 - First installment Bounty due \$100

Book mark:

H Miller

(358)

Copyist.

R | **5 Cav.** | **U.S.C.T.**

George Rollins

Com Sgt Co. K, 5 Reg't U. S. Col'd Cav.

Appears on

Company Muster Roll

for May & June, 1866.

Present or absent Present

Stoppage, \$ 100 for

Due Gov't, \$ 100 for

Valuation of horse, \$ 100

Valuation of horse equipments, \$ 100

Remarks: App'd per R O No 23
Jan. 1. 1866 First install-
ment bounty due \$100

Book mark: _____

J. E. Potter

(358)

Copyist.

R.

5 Cav.

U.S.C.T.

George Robbins

Com. Sgt. Co. K, 5 Reg't U. S. Col'd Cav.

Appears on

Company Muster Roll

for July & Aug., 1865.

Present or absent Present

Stoppage, \$ 100 for

Due Gov't, \$ 100 for

Valuation of horse, \$ 100

Valuation of horse equipments, \$ 100

Remarks:

Book mark:

J. E. Porter

(358)

Copyist.

A

5 Cav.

U.S.C.T.

George Rollins
Sergt, Co. K, 5 Reg't U. S. Col'd Cav.

Appears on

Company Muster Roll

for *Sept & Oct*, 186*4*.

Present or absent *Present*

Stoppage, \$ *100* for

Due Gov't, \$ *100* for

Valuation of horse, \$ *100*

Valuation of horse equipments, \$ *100*

Remarks: *Disch'd for*
Co. G, E 5, 1864

Book-mark:

J. E. ...

9

5 Cav.

U.S.C.T.

George Collins

Co. K, 5 Reg't U. S. Col'd Cav.

Appears on

Company Muster Roll

for Nov & Dec, 1865.

Present or absent Present

Stoppage, \$ 100 for

Due Gov't, \$ 100 for

Valuation of horse, \$ 100

Valuation of horse equipments, \$ 100

Remarks: Due M. S. for
E. B. 45

Book mark:

T. E. Parker

(358)

Copyist.

R

5 Cav.

U.S.C.T.

George Rollins

Sgt, Co. K, 5 Reg't U. S. Col'd Cav.

Appears on

Company Muster Roll

for *Jan Feb*, 186*6*.

Present or absent *Present*

Stoppage, \$ *100* for

Due Gov't, \$ *100* for

Valuation of horse, \$ *100*

Valuation of horse equipments, \$ *100*

Remarks: *2^d Instalment bounty due \$100*

Book mark:

E. H. Brown

(358)

Copyist.

P

5 Cav. | U.S.C.T.

George Rollins
Sergeant, Co. K, 5 Reg't U. S. Colored Cav.

Appears on **Returns** as follows:

Jan. 1866. - On daily duty
as commissary. Sergeant
at Helena for
rations.

Book mark :

(546)

E. Thornton

Copyist.

R

5 Cav. U.S.C.T.

George Rollins

Co. K, 5 Reg't U. S. Col'd Cavalry.

Appears on Co. Muster-out Roll, dated

Sept 6, 1866

Muster-out to date

Nov 6, 1866

Last paid to

Dec 31, 1865

Clothing account:

Last settled, 186 ; drawn since \$ 100

Due soldier \$ 100; due U. S. \$ 15.90 / 100

Am't for cloth'g in kind or money adv'd \$ 100

Due U. S. for arms, equipments, &c., \$ 100

Bounty paid \$ 100.00; due \$ 100.00

Remarks: Absent from private Oct. 20/64 reduced to Fgh Jan 4/65

Book mark: R. 2070 Ky

E. H. Bean

Rollins, Geo

Capt, Co. K, 5 Reg't US Caval

Enclosures.

Bed Cards	Descriptive Lists
Burial Records	Final Statements
Certs. of Dis. for Discharge	Furloughs
C. M. Charges	Med. Des. Lists
Med. Certificates	Orders

Other papers relating to—

Admission to Hosp'l	Furlough
Casualty Sheet (Officer's)	Med. Examination
Confinement	Misc. Information
Contracts	Pay or Clothing
Death or Effects	Personal Reports
Desertions	Rank
Discharge from Hosp'l	Transfer to Hosp'l
Discharge from Service	Transfer to V. R. C.
Duty	Transportation

War Department,

ADJUTANT GENERAL'S OFFICE,

Washington, April 9 1867.

Respectfully returned to the
Commission for the State of
Ky.

with the informa-
tion that George Rollins

was enlisted at Lexington Ky.
Aug 27. 1864, and was

mustered in as Bergh. in Co. K
5th U. S. Col. Cav. Aug 27/64.

J. W. Hazard

Asst. Adj't General.

J.B.

No. 2070

APPLICATION OF

James Rawlins

OF

Scott Co. Ky

FOR COMPENSATION FOR SLAVE,

Named George Rollins

Enlisted Aug 27 1864

In Com. K, 5th Regiment,

U. S. COLORED TROOPS.

Received Feb 28, 1867

Compensation Awarded

, 186

Dollars.

President of Board of Claims.

Claimant's Attorney,

Robinson & Gaus

Claimant's Post-office Address,

Georgetown
Ky

FRANKFORD COMMONWEALTH PRINT.

No. 11

CLAIM OF

James Rawlins

FOR THE COMPENSATION OF SLAVE NAMED

Geo Rollins

I, *James Rawlins* a loyal citizen, and a resident of *the* County of *Scott* State of Kentucky, hereby claim compensation, under the provisions of Section 24, act approved February 24, 1864, and section 2, act approved July, 28, 1866, for my slave *Geo Rollins*, enlisted *August 27th*, 1864, at *Lexington Ky*, by *Wm A Moore* in the *5th* regiment U. S. Colored Troops, Co. *K*; certificate of which enlistment, and a descriptive list, as required, accompany this application. That I did not acquire said slave subsequent to said enlistment, but had a valid title to him at the date of said enlistment, and previous thereto: I having acquired my title to him and my ownership over him as follows, to-wit: *My purchase*

In proof of my loyalty to the Constitution and Government of the United States, I present the accompanying oath, which I have taken, signed and acknowledged; to be filed with this application, in accordance with requirement of General Orders, No. 329, 1863, War Department, Adjutant General's Office.

J. Rawlins

186

OATH OF ALLEGIANCE.

I, *James Rawlins*, the owner and Claimant, do solemnly swear that the foregoing claim is a just and true claim due to me as master and owner of the said slave, and that the facts alleged in said claim in respect to the draft or enlistment (as the case may be) of said slave into the Military service of the United States are true. And I do further swear that I have never joined, or been concerned in, any insurrection or rebellion; that I have never borne arms against the United States; that I have never given any aid, countenance, counsel or encouragement to any person or persons engaged, or whom I had reason to believe were about to engage, in insurrection, rebellion or armed hostility against the United States; that I have neither sought, nor accepted, nor attempted to exercise the functions of any office, civil or military, nor to perform any service whatever, under any authority or pretended authority in hostility to the United States; that I have not yielded a voluntary support to any insurrection, rebellion or pretended government, authority, power or constitution within the United States hostile thereto. And I do further swear that, to the best of my knowledge and ability, I have supported and defended, and will continue to support and defend, the United States against all enemies, foreign and domestic; and that I have supported, defended and obeyed, and will continue to support, defend and obey, the Constitution and laws of the United States; that I will bear true faith and allegiance to the same; and that I take this oath freely, without any mental reservation or purpose of evasion: So help me God.

J. Rawlins

Sworn to and subscribed before me, at *Lexington*, this *19* day of *January*, 186*7*.

W. A. Moore
A. P. S. C.

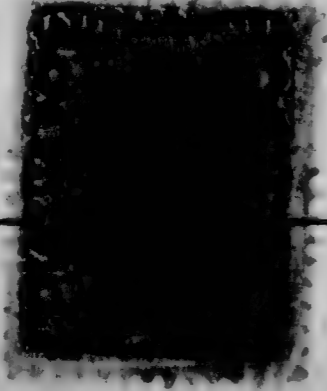

Headquarters Kentucky Volunteers,

Adjutant-General's Office,

Frankfort, Dec 12, 1866.

I hereby certify, that it appears from the U. S. Muster-Daw
Rolls on file in this Office, that Geo Rollins
was enrolled, on the 27, day of August, 1864, at
Lexington Ky, by Thos. H. Moore
and mustered into the U. S. service on the 27, day of August
1864, at Lexington Ky, by Thos. H. Moore
to serve Three, years. Said Geo Rollins
is described as follows: Age, 33 years; eyes, Black, hair, Black
complexion, Black height, 5 feet 6 inches. It further
appears from said Rolls, that Geo Rollins owed service
to James Rollins, was credited to Scott
County, Ky., and was assigned to Co. K., 5th Regiment
W. S. Cav

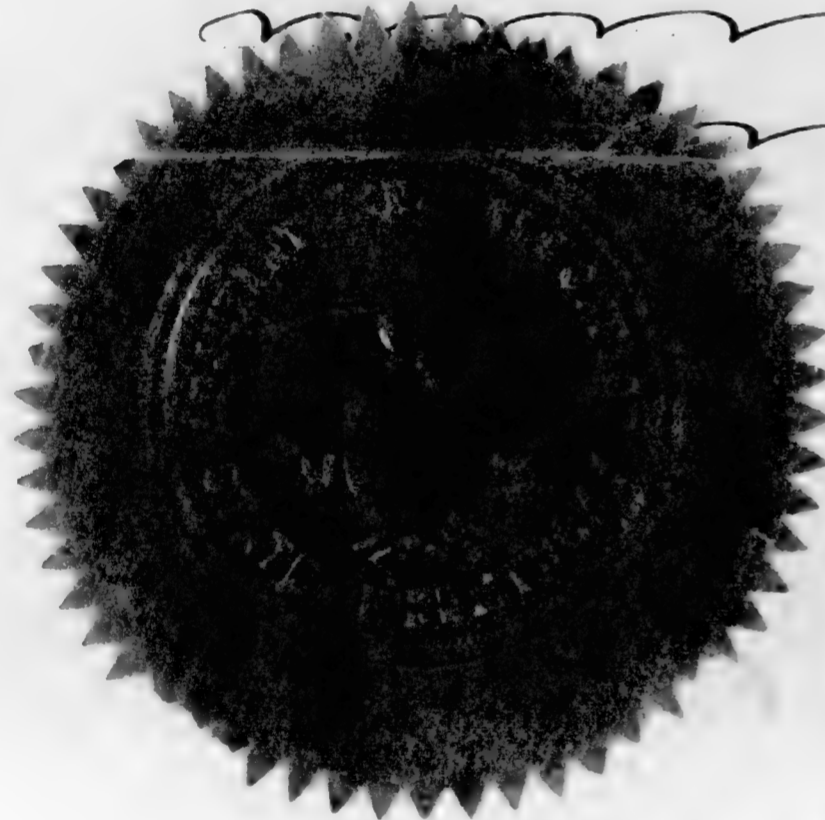

In Testimony Whereof, I have hereunto set my
hand, and affixed my Official Seal, this
12, day of Dec, 1866.



D. D. Lindsay
Adjutant General of Kentucky.

B. 154, R. 257,



POWER OF ATTORNEY.

My Post-Office address is Wayne Town County of Scott State of
Kentucky, and I hereby direct that all communications to me, touching this claim, be sent under cover
to Gas Robert & J. S. Gaud, who is hereby appointed and consti-
tuted my true and lawful attorney, to prosecute this claim for me, and who is hereby authorized and
empowered to receive and receipt for any award, order, draft, certificate, voucher, warrant, papers or
money that may be issued in the adjustment of this claim, or the payment thereof, the same as I
might or could do in person were I present and acting for myself, and to file any additional evidence
or papers that may be required in the prosecution of this claim.

[WITNESS.]

The owner
signs here.

A. Rawlins

50 CENT
STAMP.

J. N. Himmell
S. C. Barlow

Two witnesses to
owner's signature
sign here.

PROOF OF OWNERSHIP.

KENTUCKY, } SS.
OF Scott
We J. N. Finnell and W. C. Barlow each of lawful age, and resident citizens of the State and County aforesaid, do certify that James Rawlin of the State and County aforesaid, was on the 27th day of August 1864, the lawful owner of the slave named Gus Rollan; referred to and described in the foregoing claim for compensation.

J. N. Finnell
W. C. Barlow

Sworn to and subscribed before me a Notary Public for the County of Scott State of Kentucky, this the 19th day of Jan^y 1867.

G. M. Cleave & P. S. C.



PROOF OF LOYALTY.

STATE OF KENTUCKY, } SS.
COUNTY OF Scott
We J. N. Finnell and W. C. Barlow loyal men and each of lawful age, and resident citizens of the of in the State and County aforesaid, upon our oaths declare that we have known James Rawlin a resident of the State and County aforesaid, since the 4th day of March, 1861, and know that he has firmly and faithfully maintained his or her adherence and allegiance to the Government of the United States, by defending its cause against the Government and forces of the so-called Confederate States of America, in all suitable and practicable ways, and according to his or her ability and opportunity.

J. N. Finnell
W. C. Barlow

Sworn to and subscribed before me a Notary Public for the county of Scott State of Kentucky, this the 19 day of Jan^y 1867.

G. M. Cleave & P. S. C.



POWER OF ATTORNEY.

My Post-Office address is George Town County of Scott State of Kentucky, and I hereby direct that all communications to me, touching this claim, be sent under cover to Jas Robert & J. S. Gano, who is hereby appointed and constituted my true and lawful attorney, to prosecute this claim for me, and who is hereby authorized and empowered to receive and receipt for any award, order, draft, certificate, voucher, warrant, papers or money that may be issued in the adjustment of this claim, or the payment thereof, the same as I might or could do in person were I present and acting for myself, and to file any additional evidence or papers that may be required in the prosecution of this claim.

[WITNESS.]

The owner signs here.

J. N. Rawlin

50 CENT STAMP.

J. N. Finnell
W. C. Barlow

Two witnesses to owner's signature sign here.

Roney Joseph

Co *6*, 5 U. S. Col'd Cav.

Corporal | *Private*

CARD NUMBERS.

1	5361741	26
2	5361844	27
3	5361939	28
4	5362022	29
5	5362165	30
6	5362254	31
7	5362342	32
8	5362427	33
9	5362513	34
10	5362598	35
11	9090261	36
12	43145451	37
13	43146284	38
14	40730271	39
15		40
16		41
17		42
18		43
19		44
20		45
21		46
22		47
23		48
24		49
25		50

Book Mark:

See also

R | 5 Cav. | U.S.C.T.

Joseph Rosney

Co. C, 5 Reg't U. S. Col'd Cav.

Appears on

Company Descriptive Book
of the organization named above.

DESCRIPTION.

Age 21 years; height 5 feet 8 1/2 inches.

Complexion Copper

Eyes Blk; hair Blk

Where born Oldham Co., Ky.

Occupation Laborer

ENLISTMENT.

When Aug. 22, 1864.

Where Louisville

By whom Capt. Hancock; term 3 y'rs.

Remarks: Made Sargent

See No. 1

Harris

R | 5600 | M.S.C.

Joe Honey
Appears with rank of Recd. on

Muster and Descriptive Roll

of a Detachment of M.D. Colored Troops Mustered

Roll dated Louisville Ky, Aug 22, 1864.

Where born Oldham Ky.

Age 21 years; occupation Laborer

When enlisted Aug 22, 1864.

Where enlisted Louisville Ky

For what period enlisted 3 years.

Eyes Black; hair Black

Complexion Black; height 5 ft. 8 1/2 in.

When mustered in Aug. 22, 1864.

Where mustered in Louisville Ky.

Bounty paid \$ 100; due \$ 100

Clothing account:

Last settled _____, 186 ; drawn since \$ 100

Date of first muster Aug. 22, 1864.

Company to which assigned _____

Remarks: 5th Cong Dist Ky.

Book mark : _____

W. Potter

(356m)

Copyist.

R

5 bar

U.S.C.T.

Geo. Roney

Appears with rank of Pvt on

• Muster and Descriptive Roll

of a Detachment of U.S. Colored
Troops Transferred to U.S. Colored
Cav. at Lexington, Ky. Roll dated
Louisville, Ky., Sept 2, 1864.

Where born Alabama, Ky

Age 21 years; occupation Labourer

When enlisted Aug. 22, 1864.

Where enlisted Louisville, Ky.

For what period enlisted 3 years.

Eyes Blue; hair Blue

Complexion Blue; height 5 ft. 8 1/2 in.

When mustered in Aug. 22, 1864.

Where mustered in Louisville

Bounty paid \$ 100; due \$ 100

Clothing account:

Last settled _____, 186 ; drawn since \$ 17 5/100

Date of first muster Aug. 22, 1864.

Company to which assigned _____

Remarks: Created to 5 beryl. Sgt.
Ky.

Book mark: _____

B. J. Steiner

(356m)

Copyist.

R | 5 Cav. | U.S.C.T.

Joseph Rony
Capt, Co. C, 5 Reg't U. S. Col'd Cavalry.

Appears on

Company Muster Roll

for to Oct. 31, 1864.

Present or absent Present

Stoppage, \$ 100 for

Due Gov't, \$ 100 for

Valuation of horse, \$ 100

Valuation of horse equipments, \$ 100

Remarks:

(Enrolled Aug. 22/64,
at Louisville, 10/14/64
& Mustered in Aug. 22/64,
at Louisville, Ky. for
4 yrs.)

Book mark:

Shull

(358)

Copyist.

47

5 Cav. U.S.C.T.

Joseph Roney
Coptel, Co. C, 5 Reg't U. S. Col'd Cavalry.

Appears on

Company Muster Roll

for Nov. & Dec., 1864

Present or absent Present

Stoppage, \$ 100 for

Due Gov't, \$ 100 for

Valuation of horse, \$ 100

Valuation of horse equipments, \$ 100

Remarks: First & second instal-
ments of bounty due Due
U.S. for Ord. 11/1/3

Book mark:

Shull

(358)

Copyist.

R

5 Cav. U.S.C.T.

Joseph Roney
Sergt., Co. C, 5 Reg't U. S. Col'd Cavalry.

Appears on

Company Muster Roll

for Jan'y. & Feby. 1865.

Present or absent Present

Stoppage, \$ 100 for

Due Gov't, \$ 100 for

Valuation of horse, \$ 100

Valuation of horse equipments, \$ 100

Remarks: First instatement of bounty due \$100 Promoted from Corp. to Sergt. per Regt. Order No. 27 to rank from Jan. 1, 1864

Book mark:

Shull

(358)

Copyist.

Joseph Roney

Serret, Co. C, 5 Reg't U. S. Col'd Cavalry.

Appears on

Company Muster Roll

for *Mar. & Apr.*, 1865.

Present or absent *Present*

Stoppage, \$ *100* for

Due Gov't, \$ *100* for

Valuation of horse, \$ *100*

Valuation of horse equipments, \$ *100*

Remarks: *First installment of
Bounty due \$100*

Book mark:

J. R.

R

5 Cav. U.S.C.T.

Joseph Roney
Sgt., Co. C, 5 Reg't U. S. Col'd Cavalry.

Appears on

Company Muster Roll

for *May & June*, 186*3*.

Present or absent *Present*

Stoppage, \$ *100* for

Due Gov't, \$ *100* for

Valuation of horse, \$ *100*

Valuation of horse equipments, \$ *100*

Remarks: *Reduced to Rank
from Sgt May 25/65
as per Reg' Order.
First installment of
County due \$100*

Book mark:

(358)

J. J. J. J.
Copyist.

X

R

5 Cav.

U.S.C.T.

Joseph R. ...
Priv., Co. C, 5 Reg't U. S. Col'd Cavalry.

Appears on

Company Muster Roll

for July & Aug., 1862

Present or absent Present

Stoppage, \$ 100 for

Due Gov't, \$ 100 for

Valuation of horse, \$ 100

Valuation of horse equipments, \$ 100

Remarks:

Book mark:

(358)

Linder

Copyist.

R | 5 Cav. | U.S.C.T.

Joseph Roney
Priv., Co. C, 5 Reg't U. S. Col'd Cavalry.

Appears on

Company Muster Roll

for Sep. & Oct., 1865.

Present or absent Present

Stoppage, \$ 100 for

Due Gov't, \$ 100 for

Valuation of horse, \$ 100

Valuation of horse equipments, \$ 100

Remarks:

Book mark:

(358)

Linden
Copyist.

R

5 Cav. U.S.C.T.

Joseph Roney

Private, Co. C, 5 Reg't U. S. Col'd Cavalry.

Appears on

Company Muster Roll

for Nov & Dec, 1865.

Present or absent Present

Stoppage, \$ 100 for

Due Gov't, \$ 100 for

Valuation of horse, \$ 100

Valuation of horse equipments, \$ 100

Remarks: Due pay for Camp and Gar Equip 13.25

Book mark:

(358)

J. J. J. J. J.

Copyist.

JR

5 Cav.

U.S.C.T.

Joseph Roney
Put, Co. C, 5 Reg't U. S. Col'd Cavalry.

Appears on

Company Muster Roll

for

Jan Mo Feli, 186 *6*

Present or absent

Present

Stoppage, \$

100 for

Due Gov't, \$

100 for

Valuation of horse, \$

100

Valuation of horse equipments, \$

100

Remarks:

Book mark:

Rose

(358)

Copyist.

Joseph Roney
Sgt., Co. C, 5 Reg't U. S. Colored Cav.

Appears on Returns as follows:

Feb. 1865. - Feb. 22/65
Camp Wilson Ky.
Appointed per Reg.
Order no. 27

May 1865. - May 29, 65
Cynthiana Ky. Reduced
to the rank of priv.
order no. 88 Hqs. D. S.
5 U.S. C. Cav. dated May
25. 65

Book mark :

RB

5 Cav.

U.S.C.T.

Joseph Roney
Sgt, Co. C, 5 Reg't U. S. Cavalry.

Appears on Co. Muster-out Roll, dated

Helena Ark, Mar 16, 1866.

Muster-out to date Mar 16, 1866.

Last paid to Dec 31, 1865.

Clothing account:

Last settled....., 186 ; drawn since \$..... 100

Due soldier \$..... 100; due U. S. \$ 137 53 100

Am't for cloth'g in kind or money adv'd \$..... 100

Due U. S. for arms, equipments, &c., \$..... 100

Bounty paid \$ 100 100; due \$ 100 100

Remarks:.....

(Age 21.)

Book mark:.....

J. Rose

(261)

Copyist.

Roney, Joseph

, Co. , Reg't U. S. C. 7

2 Enclosures.

Bed Cards	Final Statements
Burial Records	Furloughs or L. of A.
Certs. of Dis. for Discharge	Med. Certificates
C. M. Charges	Med. Des. Lists
Descriptive Lists	Orders
Discharge Certificates	Pris. of War Record
Enlistment Papers 2	Resignations

Other papers relating to—

Admission to Hosp'l	Furlough or L. of A.
Casualty Sheet	Med. Examination
Confinement	Misc. Information
Contracts	Pay or Clothing
Death or Effects	Personal Reports
Desertion	Rank
Discharge from Hosp'l	Transfer to Hosp'l
Discharge from Service	Transfer to V. R. C.
Duty	Transportation

NOTE 1.—This blank will be used for enlistments of United States colored troops. They will be made out in duplicate in all cases—one to accompany the recruiting return of the superintendent (not the recruiting officer) to the Adjutant General, and one to accompany the accounts of the officer who pays bounty, &c.

NOTE 2.—An enlistment holds to service. A muster-in must, in all cases, precede payment of pay, bounty, pension, &c. A muster-in roll, must in all cases, be filed in the Adjutant General's Office as evidence of muster-in. The mustering officer, commissary, or assistant commissary of musters, as the case may be, will countersign both enlistments as having mustered the soldiers into the service of the United States before either of them is given to the disbursing officer.

DECLARATION OF RECRUIT.

I, James Remy desiring to volunteer as a soldier in the ARMY OF THE UNITED STATES, for the term of Three Years, DO DECLARE That I am 21 years and _____ months of age; that I have never been discharged from the United States service on account of disability or by sentence of a court-martial, or by order before the expiration of a term of enlistment; and I know of no impediment to my serving honestly and faithfully as a soldier for three years.

GIVEN at Lansville Ky the 22 day of August 1864

Witness: E. J. Coleman

James Remy his mark

By Wm. M. ...
Volunteered at Lansville Ky
Class No. ...
Aug 1 22 1864
Capt ...
5th West Ky

Consent of Parent or Guardian in case of a Minor, if a Free Man, or in the case of a Slave, of the Person to whom he owes Service:

I, _____ Do CERTIFY, That I am the _____ that the said _____ is _____ years of age; and I do freely give my CONSENT to his volunteering as a SOLDIER in the Army of the United States, for the period of THREE YEARS, under the conditions of the laws of the United States.

GIVEN at _____ the _____ day of _____

Witness: _____

UNITED STATES COLORED TROOPS ENLISTMENT.

STATE OF

TOWN OF

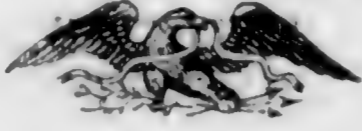

Kentucky

Louisville

I, *Joe Roney* born in *Alabama*

in the State of *Kentucky* aged *21* years

and by occupation a *laborer* Do HEREBY ACKNOWLEDGE TO

have volunteered *27* day of *August* 186*4*

to serve as a **Soldier** in the **Army of the United States of America**, for the period of **THREE YEARS**, unless sooner discharged by proper authority: Do also agree to accept such bounty, pay, rations, and clothing, as are, or may be, established by law for the U. S. colored troops.

And I, *Joe Roney*

do solemnly swear that I will bear true faith and allegiance to the **United States of America**, and that I will serve them honestly and faithfully against all their enemies or opposers whomsoever; and that I will observe and obey the orders of the President of the United States, and the orders of the officers appointed over me, according to the Rules and Articles of War.

Sworn and subscribed to, at *Louisville Ky* this *27* day of *August* 186*4*

Before *J. M. Murch* *mark*
Capt & Prov Mar 5 Dist Ky

I CERTIFY, ON HONOR, That I have carefully examined the above named Volunteer agreeably to the General Regulations of the Army, and that, in my opinion, he is free from all bodily defects and mental infirmity, which would in any way disqualify him from performing the duties of a soldier.

J. S. Bell

EXAMINING SURGEON, *5 Dist Ky*

I CERTIFY, ON HONOR, That I have minutely inspected the Volunteer, *Joe Roney* previously to his enlistment, and that he was entirely sober when enlisted; that, to the best of my judgment and belief, he is of lawful age; and that, in accepting him as duly qualified to perform the duties of an able-bodied soldier, I have strictly observed the regulations which govern the recruiting service. This soldier has *black* eyes, *black* hair, *black* complexion, is *5* feet *8 1/2* inches high.

J. M. Murch

Capt & Prov Mar 5 RECRUITING OFFICER OR AGENT.

Mustered into the United States Service *27* day of *Aug* 186*4*

J. M. Murch

Capt & Prov Mar 5 Mustering Officer
5 Dist

Mustered into the service of the United States, for three years or during the war, from date of enlistment, in Company _____ Regiment of _____ Volunteers, on the _____ day of _____, 186*4*, at _____

NOTE 1.—This blank will be used for enlistments of United States colored troops. They will be made out in duplicate in all cases—one to accompany the recruiting return of the superintendent (not the recruiting officer) to the Adjutant General, and one to accompany the accounts of the officer who pays bounty, &c.

NOTE 2.—An enlistment holds to service. A muster-in must, in all cases, precede payment of pay, bounty, pension, &c. A muster-in roll, must in all cases, be filed in the Adjutant General's Office as evidence of muster-in. The mustering officer, commissary, or assistant commissary of musters, as the case may be, will countersign both enlistments as having mustered the soldiers into the service of the United States before either of them is given to the disbursing officer.

DECLARATION OF RECRUIT.

I, James Remy desiring to volunteer as a soldier in the ARMY OF THE UNITED STATES, for the term of Three Years, DO DECLARE That I am 21 years and _____ months of age; that I have never been discharged from the United States service on account of disability or by sentence of a court-martial, or by order before the expiration of a term of enlistment; and I know of no impediment to my serving honestly and faithfully as a soldier for three years.

GIVEN at Louisville Ky the 21 day of August 1864

Witness: E. Lehman

James Remy
mark

No. James Remy
Volunteered at Louisville Ky
Aug 1 22 1864
Wm Munnick
Capt & For Gen
of Louisville Ky

Consent of Parent or Guardian in case of a Minor, if a Free Man, or in the case of a Slave, of the Person to whom he owes Service:

I, _____ Do CERTIFY, That I am the _____ that the said _____ is _____ years of age; and I do freely give my CONSENT to his volunteering as a SOLDIER in the Army of the United States, for the period of THREE YEARS, under the conditions of the laws of the United States.

GIVEN at _____ the _____ day of _____

Witness:

1101
Rooster, Andrew

Co M, 5 U. S. Col'd Cav.

Private

Carrier

CARD NUMBERS.

1	5370879	26
2	5370961	27
3	5371062	28
4	5371091	29
5	5371174	30
6	5371261	31
7	5371346	32
8	5371432	33
9	5371520	34
10	5371607	35
11	5371688	36
12	9091316	37
13	40730276	
14		
15		40
16		41
17		42
18		43
19		44
20		45
21		46
22		47
23		48
24		49
25		50

Book Mark:

See also

S1296278. P.O. man
A2643074 PoRtd
S.S. 273. 4/1/29. ch

J. J. Donald
Ex

OR | *5-leaf* | **U.S.C.T.**

Andrew Ranker

Com, *5* Reg't U. S. Col'd *leaf*

Appears on

Company Descriptive Book

of the organization named above.

DESCRIPTION.

Age *21* years ; height *5* feet *7* inches.

Complexion *Black*

Eyes *BRN* ; hair *BRN*

Where born *Clark Ky*

Occupation *Farmer*

ENLISTMENT.

When *Aug 29, 1864*.

Where *Camp Nelson*

By whom *H. Randolph* ; term *3* y'rs.

Remarks:

A. J. Anderson

(383g)

Copyist.

Reuben Rucker
Co. *M*, 5 Reg't U. S. Col'd *Cav.*

Appears on

Company Muster-in and Descriptive Roll
of the organization named above. Roll dated

Camp Nelson, Ky., *Oct 30*, 1864.

Where born *Clark, Ky.*

Age *21* y'rs; occupation *Farmer*

When enlisted *Aug. 29*, 1864.

Where enlisted *Camp Nelson, Ky.*

For what period enlisted *3* years.

Eyes *Black*; hair *Black*

Complexion *Black*; height *5* ft. *7* in.

When mustered in *Aug. 24*, 1864.

Where mustered in *Camp Nelson, Ky.*

Bounty paid \$ *100*; due \$ *100*

Where credited *7 Dist. Ky.*

Company to which assigned

Remarks: *X* *Reuben Rucker.*

X *Supposed to be name of owner.*

Added May 18. 98. H.A.J.

Book mark:

W.S. Thompson

19

5 Cav. | U.S.C.T.

Andrew Barber

Co. M, Co. M, 5 Reg't U. S. Col'd Cavalry.

Appears on

Company Muster Roll

for *to Oct. 31*, 186*4*.

Present or absent *Present*

Stoppage, \$ *100* for

Due Gov't, \$ *100* for

Valuation of horse, \$ *100*

Valuation of horse equipments, \$ *100*

Remarks:

Book mark:

M. S. Thompson

(358)

Copyist.

R

5 Cav. U.S.C.T.

Andrew Rooker

Plt., Co. M, 5 Reg't U. S. Col'd Cavalry.

Appears on

Company Muster Roll

for Nov. & Dec., 1864.

Present or absent Present

Stoppage, \$ 100 for

Due Gov't, \$ 100 for

Valuation of horse, \$ 100

Valuation of horse equipments, \$ 100

Remarks: 1st & 2nd installments of bounty due.

Book mark:

W. S. Thompson

(358)

Copyist.

R.

5 Cav. | U.S.C.T.

Andrew Parker

Bar, Co. M, 5 Reg't U. S. Col'd Cavalry.

Appears on

Company Muster Roll

for *Jan 10 Feb*, 186*3*.

Present or absent *Present*

Stoppage, \$ *100* for

Due Gov't, \$ *100* for

Valuation of horse, \$ *100*

Valuation of horse equipments, \$ *100*

Remarks: *Appointed by Regt. order No. 19 to date Jan. 1/65 pay to 2 months of bounty due*

Book mark:

A. S. Thompson

(358)

Copyist.

R

5 Cav. | U. S. C. T.

Andrew Rooper

Farrier, Co. M, 5 Reg't U. S. Col'd Cavalry.

Appears on

Company Muster Roll

for *Mar. & Apr.*, 186*5*.

Present or absent *Present.*

Stoppage, \$ *100* for

Due Gov't, \$ *100* for

Valuation of horse, \$ *100*

Valuation of horse equipments, \$ *100*

Remarks: *1st in statement, bounty
due \$100 deposited
per Regtl. order No. 19 to
date Jan. 1st / 65*

Book mark:

W. S. Thompson

(358)

Copyist.

R

5 Cav. U.S.C.T.

Andrew Rooker
Fauquier, Co. M, 5 Reg't U. S. Col'd Cavalry.

Appears on

Company Muster Roll

for May & June, 1865.

Present or absent Present

Stoppage, \$ 100 for

Due Gov't, \$ 100 for

Valuation of horse, \$ 100

Valuation of horse equipments, \$ 100

Remarks: *1st Enticement bounty due \$100.*

Book mark:

Leuts

Copyist.

(358)

R

5 Cav. | U.S.C.T.

Andrew Rooker

Favier, Co. M, 5 Reg't U. S. Col'd Cavalry.

Appears on

Company Muster Roll

for July + Aug, 1865.

Present or absent Present

Stoppage, \$ 100 for

Due Gov't, \$ 100 for

Valuation of horse, \$ 100

Valuation of horse equipments, \$ 100

Remarks:

Book mark:

C. W. [Signature]
Copyist.

(358)

B

5 Cav. | U.S.C.T.

Andrew Parker

Furrier, Co. M, 5 Reg't U. S. Col'd Cavalry.

Appears on

Company Muster Roll

for *Sept & Oct*, 186*5*.

Present or absent *Present*

Stoppage, \$ *100* for

Due Gov't, \$ *100* for

Valuation of horse, \$ *100*

Valuation of horse equipments, \$ *100*

Remarks: *Due US for Camp & Garrison # 153*

Filled with Parker, Andrew

Book mark:

C. W. [Signature]
Copyist.

R

5 Cav. | U.S.C.T.

Andrew Rooker

Fancier, Co. M, 5 Reg't U. S. Col'd Cavalry.

Appears on

Company Muster Roll

for Nov & Dec, 1865.

Present or absent Present

Stoppage, \$ 100 for

Due Gov't, \$ 100 for

Valuation of horse, \$ 100

Valuation of horse equipments, \$ 100

Remarks:

Book mark:

Quits

(358)

Copyist.

R

5 Cav. | U.S.C.T.

Andrew Rooker

Farrier, Co. M, 5 Reg't U. S. Col'd Cavalry.

Appears on

Company Muster Roll

for Jan & Feb, 1866.

Present or absent Present

Stoppage, \$ 100 for

Due Gov't, \$ 100 for

Valuation of horse, \$ 100

Valuation of horse equipments, \$ 100

Remarks:

Book mark:

Hynes Copyist.

(358)

R | 5 Cav. | U.S.C.T.

Andrew Rucker *

Pvt., Co. M, 5 Reg't U. S. Colored Cav.

Appears on Returns as follows:

July 1865 On duty detailed
for duty with R. Q. M. Dept.

Aug 1865 On duty in Q. M. Dept

*Name appears also as
Andrew Rooker

Book mark :

Hottel

(546)

Copyist.

R

5 Cav.

U.S.C.T.

Andrew Rooker

Farrier, Co. *M*, 5 Reg't U. S. Col'd Cavalry.

Appears on Co. Muster-out Roll, dated

Helena Ark, *Mar 16*, 1866.

Muster-out to date *Mar 16*, 1866.

Last paid to *Dec 31*, 1865.

Clothing account:

Last settled....., 186 ; drawn since \$..... 100

Due soldier \$..... 100; due U. S. \$ *24* ^{*59*}/_{*100*}

Am't for cloth'g in kind or money adv'd \$..... 100

Due U. S. for arms, equipments, &c., \$..... 100

Bounty paid \$ *100* 100; due \$ *100* 100

Remarks: *Appointed Farrier Per R.O.*
19 Feb. 4 '65 to date Jan 1 '65
Slave apt. 19 '61

Book mark:

(361)

Styer
Copyist.

Roster ¹¹⁰¹ *Nelia*

Co *L*, 5 U. S. Col'd Cav.

Private | *Private*

CARD NUMBERS.

1	5359266	26
2	5378441	27
3	5359420	28
4	5370792	29
5	9091192	30
6	40730273	31
7		32
8		33
9		34
10		35
11		36
12		37
13		38
14		39
15		40
16		41
17		42
18		43
19		44
20		45
21		46
22		47
23		48
24		49
25		50

Book Mark:

See also *72 W.C.P.*

R | **5 Cav. | U.S.C.T.**

Nelia Roster

....., Co. L, 5 Reg't U. S. Col'd Cav.

Appears on

Company Descriptive Book
of the organization named above.

DESCRIPTION.

Age 19 years; height 5 feet 8 inches.

Complexion blk

Eyes blk; hair dk

Where born Bowling Co., Ky.

Occupation Laborer

ENLISTMENT.

When May 30, 1865

Where Paris Ky.

By whom Capt. Jeffries; term 3 y'rs.

Remarks: Dischgd July
29, 65

.....
.....
.....
.....
.....

A. A. Hall

(383a)

~~Compt~~
comp

12

5 Cav. | U.S.C.T.

John A. Coester

....., Co. L, 5 Reg't U. S. Col'd Cavalry.

Appears on

Company Muster Roll

for *July & Aug*, 1865.

Present or absent

Stoppage, \$.....100 for

Due Gov't, \$.....100 for

Valuation of horse, \$.....100

Valuation of horse equipments, \$.....100

Remarks: *Transf'd from 72 U.S.C.T.*

per A.O. No. 427 Ad. Ins.

Dept. of Ky. July 18th 65

Assigned to Co. per A.O. No.

132 Dated July 18th 65

Transf'd as absent with-

out leave and dropped at

ones as a deserter

Book mark:

Coester

(358)

Copyist.

R | 5th Cav | U.S.C.T.

Nolin Roster

Co., Co., 5th Reg't U. S. Col'd Cav

Appears on

M. and D. Roll of Men Transferred

to the organization named above,

from *Frank Nelson*, Roll dated *16 July 18*, 1865.

When enlisted *May 30*, 1865.

Period for which enlisted *3* years.

When mustered in *June 5*, 1865.

Present or absent *Not Stated*

Company to which assigned

Remarks: *7th Det*

Inserted by J.B. Doid. Exp

Book mark :

Abbott

RC | 5 Cau | U.S.C.T.

Melia Roster
Priv, Co. L, 5 Reg't U. S. Col'd Cau

Appears on

Descriptive List of Deserters

dated July 31, 1865.

Deserted:

When July 29, 1865.

Where Unknown

Arrested:

When _____, 186 .

Where _____

Remarks: _____

Book mark: _____

Rose

(351)

Copyist.

R | 5 Cav. | U.S.C.T.

Nelia Foster

Priv., Co. F, 5 Reg't U. S. Colored Cav.

Appears on Returns as follows:

July 1865: - Present July 27/65
Paris Ky. Transf. to
Co.

Deserted July 29/65
Paris Ky. Transf. as
absent without leave.

* name appears also as Nelia
Foster

Book mark :

E. A. Thornton

(546)

Copist.

R | 5 bars. | **U.S.C.T.**

Melia Roster

Priv. Co. *S*, 5 Reg't U. S. Col'd Cavalry

Appears on **Co. Muster-out Roll**, dated
Alabama, Ark. March, 1866 .

Muster-out to date _____, 186 .

Last paid to *Never Paid*, 186 .

Clothing account:

Last settled _____, 186 ; drawn since \$ _____ 100

Due soldier \$ _____ 100; due U. S. \$ *1980* 100

Am't for cloth'g in kind or money adv'd \$ _____ 100

Due U. S. for arms, equipments, &c., \$ _____ 100

Bounty paid \$ _____ 100; due \$ _____ 100

Remarks: *Deserted July 29, 65.*
place unknown, Transfd.
from 72^d U.S.C., I per S.C. No.
127. Par. 3. Hd. qrs. Spr. Ky.
July 18th 65, as absent
without leave.

Book mark : _____

O. J. Taylor

(361)

Copyist.

Rowlett Anthony

Co I, 5 U. S. Col'd Cav.

Sergeant Sergeant

CARD NUMBERS.

1	5367774	26
2	5367872	27
3	5367971	28
4	5368066	29
5	5368244	30
6	5368766	31
7	4090938	32
8	9221649	33
9	43143115	34
10	40730274	35
11		36
12		37
13		38
14		39
15		40
16		41
17		42
18		43
19		44
20		45
21		46
22		47
23		48
24		49
25		50

Book Mark:

See also

B | *5 Cav*
108 | **U.S.C.T.**

Anthony Rowlet

CS, Co. *CS*, 108 Reg't U. S. Col'd Infantry.

Appears on

Company Descriptive Book

of the organization named above.

DESCRIPTION.

Age *26* years; height *5* feet *7* inches.

Complexion *Yellow*

Eyes *Bru*; hair *Blk*

Where born *Wort Co. Ky*

Occupation *Farmer*

ENLISTMENT.

When *June 27th*, 186*4*.

Where *Bowling Green*

By whom *Cap Holson*, term *3* y'rs

Remarks:

Enlisted for 100th U.S.C.T.

Transferred to 5th U.S.C. Cavalry

August 2, 1864, per S.O. 192, Head

Quarters Dist of Ky.

D. M. Kennedy

(383a)

Copyist.

12 | **5 Cav. | U.S.C.T.**

Anthony Rawlett

Co. *2*, 5 Reg't U. S. Col'd Cav.

Appears on

Company Descriptive Book

of the organization named above.

DESCRIPTION.

Age *26* years; height *5* feet *7* inches.

Complexion *Yellow*

Eyes *Brown*; hair *Blk*

Where born *Heart Ky*

Occupation *Farmer*

ENLISTMENT.

When *June 27*, 186*4*.

Where *Bowling Green*

By whom *Capt. Hobson*; term *3* y'rs.

Remarks:

A. J. Anderson

(383g)

Copist.

R.

5 Cav. U.S.C.T.

Anthony Rowlett

Serjt., Co. F, 5 Reg't U. S. Col'd Cavalry.

Appears on

Company Muster-in and Descriptive Roll

of the organization named above. Roll dated

Cp. Nelson, ^{Ky.} ~~N.Y.~~, Oct. 31, 1864.

Where born Hart, Ky.

Age 26 y'rs; occupation Farmer

When enlisted June 27, 1864.

Where enlisted Bowling Green

For what period enlisted 3 years.

Eyes Brown; hair Black

Complexion Yellow; height 5 ft. 7 in.

When mustered in June 27, 1864.

Where mustered in Bowling Green

Bounty paid \$ 100; due \$ 100

Where credited 3^d Dist. Kentucky.

Company to which assigned

Remarks: Enlisted for 108th U.S.C.T.
Transferred to 5th U.S.C. Cavalry
August 2, 1864, per S.O. 192. Head
Quarters Dist. of Ky.

Book mark:

Philipson

(356d)

Copyist.

5 car

R

U.S.C.T.

Anthony Rowlett

Appears with rank of Private on

Muster and Descriptive Roll

of a Detachment of U.S. Colored
Recruits forwarded for United
States Colored Troop. Roll dated

Bowling Green Ky, June 27, 1864.

Where born Hart Kentucky

Age 26 years; occupation Farmer

When enlisted June 27, 1864.

Where enlisted Bowling Green

For what period enlisted 3 years.

Eyes Dk Brown; hair Blk

Complexion Yellow; height 5 ft. 7 in.

When mustered in _____, 186 .

Where mustered in _____

Bounty paid \$ 100; due \$ 100

Clothing account:

Last settled _____, 186 ; drawn since \$ 14 ¹³/₁₀₀

Date of first muster into U.S. service June 27, 1864.

Company to which assigned _____

Remarks New Recruit Hart Co

Owed service to Geo W. Rowlett

Book mark: _____

R. Munday

(356m)

Copyist.

R. | **5 Cav.** | **U.S.C.T.**

Anthony Rawlett

Serg^t, Co. *I*, 5 Reg't U. S. Col'd Cavalry.

Appears on

Company Muster Roll

for *Organization to Oct. 31, 1864.*

Present or absent *Present*

Stoppage, \$ *100* for *1*

Due Gov't, \$ *100* for

Valuation of horse, \$ *100*

Valuation of horse equipments, \$ *100*

Remarks: *Appointed per
Regt. Order No. 12 to date
October 30, 1864.*

Book mark:

Philipsen

(358)

Copyist.

R. | 5 Cav. | U.S.C.T.

Anthony Rawlett
Serg't., Co. I, 5 Reg't U. S. Col'd Cavalry.

Appears on

Company Muster Roll

for Nov. + Dec., 1864.

Present or absent Absent

Stoppage, \$ 100 for

Due Gov't, \$ 100 for

Valuation of horse, \$ 100

Valuation of horse equipments, \$ 100

Remarks: 1st + 2^d installments
Bounty due. Sick in
Hospital Camp Nelson,
Ky., Nov. 4/64.

Book mark:

Philipsen

(358)

Copyist.

R | **5 Cav.** | **U.S.C.T.**

Anthony Rowlett

Serg^t, Co. *I*, 5 Reg't U. S. Col'd Cavalry.

Appears on

Company Muster Roll

for *Jan. & Feb.*, 186*5*.

Present or absent *Present*

Stoppage, \$ *100* for

Due Gov't, \$ *100* for

Valuation of horse, \$ *100*

Valuation of horse equipments, \$ *100*

Remarks: *In Gen's Hospital
Camp Nelson, Ky,
since Nov. 4th 1864.
*Appointed per Regtl. order
No. 12 Dated Oct. 30/64*

**Inserted by comparison*

Book mark:

Philipson

(358)

Copyist.

R. | **5 Cav.** | **U.S.C.T.**

Anthony Rowlett

Sergt., Co. I, 5 Reg't U. S. Col'd Cavalry.

Appears on

Company Muster Roll

for *March & April*, 1865.

Present or absent

Stoppage, \$ 100 for

Due Gov't, \$ 100 for

Valuation of horse, \$ 100

Valuation of horse equipments, \$ 100

Remarks: *Died in Genl
Hosp^l Camp Nelson,
Ky., Nov. 13th, 1864.*

*First installment of
county due \$ 100^x*

Book mark: *153.163*

Philipsen

Q

5 Cav.

U.S.C.T.

Anthony Rowlett

Sgt., Co. F, 5 Reg't U. S. Colored Cav.

Appears on Returns as follows:

Nov. 1864. to Jan. 1865; - Absent
sick in Gen. Hoop. Camp
Nelson Ky. Since
Nov. 4/64.

Feb. 1865. (Sgt.) - x Absent
sick in Gen. Hoop.
Camp Nelson Ky.
Nov. 4/64

Mich. 1865. - Dec. 18/64
Camp Nelson Ky.
Died of disease at
Nelson Gen. Hoop.

Name canceled

Book mark :

E. Thornton

(546)

Copyist.

R | **5 Cav. | U.S.C.T.**

Anthony Rowlett
Sergt., Co. *D*, 5 Reg't U. S. Col'd Cavalry.

Appears on **Co. Muster-out Roll**, dated
Helena, Ark. Mch. 16, 1866.

Muster-out to date _____, 186 .

Last paid to _____, 186 .

Clothing account:

Last settled _____, 186 ; drawn since \$ _____ 100

Due soldier \$ _____ 100; due U. S. \$ *9* ⁰⁰/₁₀₀

Am't for cloth'g in kind or money adv'd \$ _____ 100

Due U. S. for arms, equipments, &c., \$ _____ 100

Bounty paid \$ _____ 100; due \$ _____ 100

Remarks: *Died Nov. 18, 1864, Camp
Nelson, Ky., acute Bronchitis.
Sergt. from organization of
Company.*

Book mark: *153. 163.*

Crenshaw

Rowley, A.

, Co.

5 Reg't usce

2 Enclosures. 3 items

Bed Cards	Descriptive Lists
Burial Records /	Final Statements /
Certs. of Dis. for Discharge	Furloughs
C. M. Charges	Med. Des. Lists
Med. Certificates	Orders

Other papers relating to—

Admission to Hosp'l	Furlough
Casualty Sheet (Officer's)	Med. Examination
Confinement	Misc. Information
Contracts	Pay or Clothing
Death or Effects /	Personal Reports
Desertions	Rank
Discharge from Hosp'l	Transfer to Hosp'l
Discharge from Service	Transfer to V. R. C.
Duty	Transportation

Adj. Gen. Sept. 1865
M. M. Abraham
Adj. Gen. 2d Auditor

FINAL STATEMENT

No 2
 OF

Anthony Rouletts
 Fifth Reg't of U. S. C. Cav.

VOLUNTEERS.

NOTE 1.—Two of these certificates (or duplicates) are to be given to each Volunteer Soldier or drafted man who may be discharged without being mustered out (Final Statements are never given to men mustered out of service,) that he may at once receive from the Paymaster the pay, &c., due him, and the captain or other COMMISSIONED officer commanding the company will certify to the act of the delivery of the duplicate certificates; with these certificates the Soldier is "entitled to" his discharge, and should also present his discharge to the Paymaster to have the payment endorsed on it. The discharge is to be given back to the Soldier by the Paymaster; the latter only retaining as his vouchers the duplicate certificates.

NOTE 2.—If the Soldier is entitled to pay for the use of his horse, the Company Commander will certify to that fact on the back of both these final statements, and also to the time he has pay due for having been so mounted on his own horse.

NOTE 3.—When a Soldier is furnished with final statements, his descriptive list, if he has one, should be taken up by the officer who gives the Soldier these statements, and endorsed with a statement to this effect by the officer. The endorsement should exhibit a full statement of the time for which the Soldier was allowed pay on his final statements, the clothing account, and all other charges against him or in his favor, so as to comprise a complete exhibit of his account. It will then be transmitted to the Company Commander of the Soldier, who will enter all the data necessary to a full understanding of the Soldier's account on the muster roll upon which the Soldier's discharge is reported. The descriptive list will then be destroyed. The object of this is, that the remaining portion of the Soldier's account may be settled upon the receipt of these muster rolls, and the Soldier receive any pay or allowances that may be due him at the time of his discharge, and which may not appear on his last final statements from the fact that his descriptive list is incomplete. These accounts for back pay, &c., are settled by the 2d Auditor of the Treasury Department.

NOTE 4.—Charges for loss or injury to ordnance, horse equipments, and other miscellaneous charges, should appear under the heading of "Other Stoppages."

NOTE 5.—Bounty paid by State authorities, and not by the United States, will not be entered on this statement.

NOTE 6.—Amounts due the Sutler and Laundress must be entered on the muster roll on which the discharge, death, desertion, &c., is reported, as well as on the final statement, otherwise the amount cannot be collected from the United States.

NOTE 7.—This blank will be used for deceased volunteers and drafted men, as well as for others.

NOTE 8.—Where a Soldier dies in Hospital or on detached service, his descriptive list, if he has one, should be sent with his final statements, in duplicate, to the Adjutant General, Washington, D. C.

NOTE 9.—If the soldier is a drafted man or substitute, the space for time, &c., of enrolled, should contain only the word *drafted* or *substitute*, as the case may be. If the Soldier is a "VETERAN," (or RECRUIT,) the words *as a veteran*, (or *recruit*) as the case may be, should be interlined after the words *mustered into the service of the U. S.* A statement of all the installments of *Veteran* or *Recruit* Bounty RECEIVED by the Soldier must be made on the back of each final statement.

ADJUTANT GENERAL'S OFFICE
July 26 1865
 Duplicate with Inventory sent 2d Auditor.

I certify, on honor, that Anthony Renlett, a Sergeant of
 Captain J. M. Burch Company (2^d) of the 5th Regiment of U. S. Col. Cav
VOLUNTEERS, of the State of Kentucky, born in Kent. Co., State
 of Kentucky, aged 26 years; 5 feet 7 inches high; yellow complexion,
Blue eyes, Black hair, and by occupation a Farmer, who joined for service
 and was enrolled (see Note 9) on the 27th day of June, 1864, at Bowling Green Ky
 by Capt. Nelson, for the period of Three years, and mustered into
 the service of the United States on the 27th day of June, 1864, at
Bowling Green, by Capt. Nelson; and having served
 HONESTLY and FAITHFULLY with his Company to the present date, is now entitled to a
DISCHARGE by reason of Death - cause not known
he died on the 12th Nov. 1864 at Camp Nelson Ky

The said Anthony Renlett has ~~paid~~ was last paid by Paymaster
from Enrollment, to include the 27th day of June, 1864, and
 has pay due him from that time to the present date; he is entitled to pay and subsistence for
TRAVELING to place of enrollment, and whatever other allowances are authorized to volunteer
 soldiers, drafted men, or militia, so discharged. He has received from the United States **CLOTHING**
 amounting to Sixty Dollars ³⁷/₁₀₀ dollars, since the 27th day of June
 1864, ~~when~~ his clothing account was ~~last~~ ^{never} settled. He has received from the United States
~~100~~ ^X 100 dollars advanced **BOUNTY**.

There is to be stopped from him, on account of the State of X, or other
 authorities, for **CLOTHING, &c.**, received on entering service, X 100 dollars; and
 for other stoppages, viz: X

X 100 dollars.
 He has been furnished with **TRANSPORTATION** in kind from the place of his discharge to
X; and he has been **SUBSISTED** for **TRAVELING** to his
 place of enrollment, up to the X, 186 .

He is indebted to X, **SUTLER**, X 100 dollars.

He is indebted to X, **LAUNDRESS**, X 100 dollars.

Given in Duplicate, at Paris Ky, this 10th day
 of July, 1865.

Thomas A. Burch
Capt. Co. 5th U. S. Col. Cav.
 Commanding Company.

A. Powell &

5th U.S. C.C.

Died November 18, 1864,

Leit Hosp: Camp Nelson, Ky.

RECORD OF DEATH AND INTERMENT

Name and number of person interred *A Rowlet*
 Number and locality of the grave *823*
 Hospital number of the deceased *5113*
 Regiment, rank and company *5th U.S.C.*
 Residence before enlistment
 Conjugal relation, (and if married, the residence of the widow.)
 Cause of death. *Acute Bronchitis*
 Age of the deceased.
 Nativity.
 References and remarks.
 Date of death and burial. *Nov 18/64*

Memoranda of effects.

Blanket 1
Over coat 1
Drawers 2
Boots 1
Cap 1
Socks 1
Ruler 1

Expended with Cooper
Shirt 2
Pants 1
Jackets 1

Rawlett William

Co I, 5 U. S. Col'd Cav.

Corporal Sergeant

CARD NUMBERS.

1	5367785	26
2	5367883	27
3	5367984	28
4	5368076	29
5	5368168	30
6	5368260	31
7	5368352	32
8	5368440	33
9	5368523	34
10	5368610	35
11	5368692	36
12	9090949	37
13	9221647	38
14	43143253	39
15		40
16		41
17		42
18		43
19		44
20		45
21		46
22		47
23		48
24		49
25		50

Book Mark:

See also

B

5 Cav

108

U.S.C.T.

William Rowlett

Co. A, 108 Reg't U. S. Col'd Infantry.

Appears on

Company Descriptive Book

of the organization named above.

DESCRIPTION.

Age 22 years; height 5 feet 3 inches.

Complexion Light

Eyes Light; hair Light

Where born Hart Co. Ky.

Occupation Farmer

ENLISTMENT.

When June 28, 1864

Where Louisville

By whom Cap Smith, term 3 y'rs

Remarks:

Enlisted for 108th U.S.C.T.

Transferred to 5th U.S.C. Cavalry

Sept 12, 1864. par. SIC. 102. Head

Quarters Dist of Ky.

Wm Kennedy

(383a)

Copist.

R | 5 Cav. | U.S.C.T.

William Parlet

, Co. I, 5 Reg't U. S. Col'd Cav.

Appears on

Company Descriptive Book
of the organization named above.

DESCRIPTION.

Age 29 years; height 5 feet 3 inches.

Complexion Light

Eyes Light; hair Light

Where born Hart, Ky.

Occupation Farmer

ENLISTMENT.

When June 28, 1864.

Where Lebanon

By whom Capt. Fidler; term 3 y'rs.

Remarks:

A. A. Hall

(383g)

Captist.
Comp.

R | 5 bar U.S.C.T

William Rowlet

Appears with rank of Priv. on

Muster and Descriptive Roll

of a Detachment of U.S. Colored
Recruits mustered by Capt. G. H.
Smith

Roll dated
Louisville Ky June 28, 1864.

Where born Hart Co Kentucky

Age 22 years; occupation farm hand

When enlisted June 28, 1864.

Where enlisted Louisville Ky

For what period enlisted 3 years.

Eyes Light; hair Light

Complexion Light; height 5 ft. 3 in.

When mustered in _____, 186 .

Where mustered in _____

Bounty paid \$ _____ 100; due \$ _____ 100

Clothing account:

Last settled _____, 186 ; drawn since \$ _____ 100

Date of first muster _____, 186 .

Company to which assigned _____

Remarks: Accredited to Jefferson
County 5th District W. Ky

Book mark: _____

(356m)

L. Murdoch

Copyist.

R. | **5 Cav.** | **U.S.C.T.**

William Rowlett

Corpl, Co. *I*, 5 Reg't U. S. Col'd Cavalry.

Appears on

Company Muster-in and Descriptive Roll
of the organization named above. Roll dated

Cp. Nelson, ~~N.Y.~~ ^{Ky.} *Oct. 31*, 1864.

Where born *Hart, Ky.*

Age *22* y'rs; occupation *Farm hand*

When enlisted *June 28*, 1864.

Where enlisted *Louisville*

For what period enlisted *3* years.

Eyes *Light*; hair *Light*

Complexion *Light*; height *5* ft. *3* in.

When mustered in *June 28*, 1864.

Where mustered in *Louisville*

Bounty paid \$ *100*; due \$ *100*

Where credited *5th Dist. Kentucky*

Company to which assigned

Remarks:

Enlisted for 108th U.S.C.T.
Transferred to 5th U.S.C. Cavalry
August 12, 1864. per S.C. 192. Head
Quarters Dist. of Ky.

Book mark:

Philipson

(356d)

Copyist.

R. | 5 Cav. | U.S.C.T.

William Rowlett

Capt., Co. I, 5 Reg't U. S. Col'd Cavalry.

Appears on

Company Muster Roll

for Organization to Oct. 31, 1864.

Present or absent Present

Stoppage, \$ 100 for

Due Gov't, \$ 100 for

Valuation of horse, \$ 100

Valuation of horse equipments, \$ 100

Remarks: appointed per Regt. order No. 12 to date October 30, 1864.

Book mark:

Philipson

(358)

Copyist.

R. | 5 Cav. | U.S.C.T.

William Rowlett

Corp^l, Co. I, 5 Reg't U. S. Col'd Cavalry.

Appears on

Company Muster Roll

for *Nov. & Dec.*, 1864.

Present or absent *Present*

Stoppage, \$ 100 for

Due Gov't, \$ 100 for

Valuation of horse, \$ 100

Valuation of horse equipments, \$ 100

Remarks: *1st & 2^d installments*
Bounty due.

Book mark: _____

Philipson

(358)

Copyist.

R | 5 Cav. | U.S.C.T.

William Rowlett

Coop^d, Co. I, 5 Reg't U. S. Col'd Cavalry.

Appears on

Company Muster Roll

for Jan. & Feb., 1865.

Present or absent Present

Stoppage, \$ 100 for

Due Gov't, \$ 100 for

Valuation of horse, \$ 100

Valuation of horse equipments, \$ 100

Remarks: Appointed per Regt^d Order No. 12, dated October 30th, 1864. 1st + 2^d installments \$300⁺ Bounty due.

Book mark:

Philipson

(358)

Copyist.

R | **5 Cav. | U.S.C.T.**

William Rowlett

Corp., Co. I, 5 Reg't U. S. Col'd Cavalry.

Appears on

Company Muster Roll

for *Mar. + Apl.*, 1865.

Present or absent *Present*

Stoppage, \$ *100* for

Due Gov't, \$ *100* for

Valuation of horse, \$ *100*

Valuation of horse equipments, \$ *100*

Remarks: *1st installment*

*Bounty due. appointed
per Regt Order No. 12,
dated Oct. 30/64.*

Book mark:

Philipsen

(358)

Copyist.

P

5 Cav.

U.S.C.T.

William Lowell

Cope, Co. I, 5 Reg't U. S. Col'd Cavalry.

Appears on

Company Muster Roll

for *May & June*, 186*0*.

Present or absent *Present*

Stoppage, \$ *100* for

Due Gov't, \$ *100* for

Valuation of horse, \$ *100*

Valuation of horse equipments, \$ *100*

Remarks: *Installment of \$100
App'td Cope per Reg't order
Nov. 12 date Oct. 30/60*

Book mark:

all

R

5 Cav.

U.S.C.T.

William Bowlett

Compl, Co. I, 5 Reg't U. S. Col'd Cavalry.

Appears on

Company Muster Roll

for *July & Aug*, 1865.

Present or absent *Present*

Stoppage, \$ *100* for

Due Gov't, \$ *100* for

Valuation of horse, \$ *100*

Valuation of horse equipments, \$ *100*

Remarks:

Book mark: -----

(358)

W. Bowlett

Copyist.

R

5 Cav.

U.S.C.T.

William Bowlett

Capt, Co. I, 5 Reg't U. S. Col'd Cavalry.

Appears on

Company Muster Roll

for *Sept & Oct*, 186*5*

Present or absent *Present*

Stoppage, \$ *100* for

Due Gov't, \$ *100* for

Valuation of horse, \$ *100*

Valuation of horse equipments, \$ *100*

Remarks:

Book mark: *T*

Deus

(358)

Copyist.

R

5 Cav.

U.S.C.T.

William Rowlett

Sgt, Co. I, 5 Reg't U. S. Col'd Cavalry.

Appears on

Company Muster Roll

for *Nov & Dec*, 1865.

Present or absent: *Present*

Stoppage, \$ *100* for

Due Gov't, \$ *100* for

Valuation of horse, \$ *100*

Valuation of horse equipments, \$ *100*

Remarks: *Due \$1.69 for C.T.G.*

*Promoted to Sgt from Corporal
per Regt order no. 207
Dec 26/65*

Book mark:

Allen

R

5 Cav. U.S.C.T.

William Rowlett

Sergt., Co. I, 5 Reg't U. S. Col'd Cavalry.

Appears on

Company Muster Roll

for Jan'y. & Feby., 1866.

Present or absent Present

Stoppage, \$ 100 for

Due Gov't, \$ 100 for

Valuation of horse, \$ 100

Valuation of horse equipments, \$ 100

Remarks:

[Empty lines for remarks]

Book mark:

Cresshaw

(358)

Copyist.

R

5 Cav. U.S.C.T.

William Rowlett

Sergt., Co. D, 5 Reg't U. S. Col'd Cavalry.

Appears on Co. Muster-out Roll, dated Helena, Ark, March 16, 1866.

Muster-out to date March 16, 1866.

Last paid to Dec. 31, 1865.

Clothing account:

Last settled, 186 ; drawn since \$ 100

Due soldier \$ 10 ²⁰/₁₀₀; due U. S. \$ 100

Am't for cloth'g in kind or money adv'd \$ 100

Due U. S. for arms, equipments, &c., \$ 1 ²⁵/₁₀₀

Bounty paid \$ 100; due \$ 100

Remarks: Corp'l. from organization of Co. to Dec. 25, 1865 - then Sergt.

Due U.S. for Ord. 1.25.

Book mark: V172. P252.73.

Orenshaw

(861)

Copyist.

Rucker Alfred

Co D, 5 U. S. Col'd Cav.

Corporal Sergeant

CARD NUMBERS.

1	5367784	26
2	5367882	27
3	5367982	28
4	5368075	29
5	5368167	30
6	5368259	31
7	5368351	32
8	5368439	33
9	5368522	34
10	5368609	35
11	5368691	36
12	9090949	37
13	9221646	38
14	43143789	39
15	40730275	40
16		41
17		42
18		43
19		44
20		45
21		46
22		47
23		48
24		49
25		50

Book Mark:

See also

R | *5 Cav.*
108 | **U.S.C.T.**

Alfred Rucker

....., Co. *A*, 108 Reg't U. S. Col'd Infantry.

Appears on

Company Descriptive Book

of the organization named above.

DESCRIPTION.

Age *23* years; height *5* feet *7* inches.

Complexion *Dark*

Eyes *Dark*; hair *Dark*

Where born *Nelson Co. Ky*

Occupation *Farmer*

ENLISTMENT.

When *June 29*, 186*4*

Where *Louisville*

By whom *Cap. Smith*, term *3* y'rs

Remarks:

Enlisted for 100th U.S.C.T.
Transferred to 5th U.S.C. Cavalry
August 12, 1864, per S.O. 192. Head
Quarters 1st of Ky.

D. M. Kennedy
(383a) *Copyist.*

18 | **5 Cav. | U.S.C.T.**

Alfred Rucker

, Co. *I*, 5 Reg't U. S. Col'd Cav.

Appears on

Company Descriptive Book
of the organization named above.

DESCRIPTION.

Age *23* years; height *5* feet *7* inches.

Complexion *Dark*

Eyes *Dark*; hair *Dark*

Where born *Nelson Ky*

Occupation *Farmer*

ENLISTMENT.

When *July 2*, 1864.

Where *Lonsville*

By whom *Capt Smith*; term *3* y'rs.

Remarks:

A J Anderson

(3830)

Copist.

R | 5 bar U.S.C.S.

Alford Rucker
Pot

Appears with rank of _____ on

Muster and Descriptive Roll

of Detachment of U.S. Colored
Recruits mustered

Roll dated
Louisville Ky, July 2, 1864.

Where born Nelson Co. Kentucky

Age 23 years; occupation Farmer

When enlisted June 29, 1864.

Where enlisted Louisville Ky

For what period enlisted 3 years.

Eyes Dark; hair Dark

Complexion Dark; height 5 ft. 7 in.

When mustered in July 2, 1864.

Where mustered in Louisville

Bounty paid \$ 100; due \$ 100

Clothing account:

Last settled _____, 186 ; drawn since \$ 100

Date of first muster _____, 186 .

Company to which assigned

Remarks: Accredited to Jef-
ferson County & 50th Reg.
Dist. N. Ky.

Book mark : _____

(356m) J. W. Wilkinson Copyist.

R. | 5 Cav. | U.S.C.T.

Alfred Rucker
Corpl, Co. I, 5 Reg't U. S. Col'd Cavalry.

Appears on

Company Muster-in and Descriptive Roll

of the organization named above. Roll dated

Sept. Nelson, ^{Ky.} ~~N.Y.~~, Oct. 31, 1864.

Where born Nelson, Ky.

Age 23 y'rs; occupation Farmer

When enlisted June 29, 1864.

Where enlisted Louisville

For what period enlisted 3 years.

Eyes DK; hair DK

Complexion DK; height 5 ft. 7 in.

When mustered in June 29, 1864.

Where mustered in Louisville

Bounty paid \$100; due \$100

Where credited 5th Dist. Kentucky

Company to which assigned

Remarks:

Enlisted for 108th U.S.C.T.
Transferred to 5th U.S.C. Cavalry
August 2, 1864. per S. C. 192, Head
Quarters Dist. of Ky.

Book mark:

Philipson

(356d)

Copyist.

R. | 5 Cav. | U.S.C.T.

Alfred Rucker

Corpl, Co. I, 5 Reg't U. S. Col'd Cavalry.

Appears on

Company Muster Roll

for Organization to Oct. 31, 1864.

Present or absent Present

Stoppage, \$ 100 for

Due Gov't, \$ 100 for

Valuation of horse, \$ 100

Valuation of horse equipments, \$ 100

Remarks: Appointed per Regt. Order No. 12 to date October 30, 1864.

Book mark:

Philipson

(358)

Copyist.

R. | 5 Cav. | U.S.C.T.

Alfred Rucker

Corpl, Co, I, 5 Reg't U. S. Col'd Cavalry.

Appears on

Company Muster Roll

for *Nov. + Dec.*, 1864.

Present or absent *Present*

Stoppage, \$ *100* for

Due Gov't, \$ *100* for

Valuation of horse, \$ *100*

Valuation of horse equipments, \$ *100*

Remarks: *1st + 2^d installments*

Bounty due.

Book mark:

Philipsen

(358)

Copyist.

R. | 5 Cav. | U.S.C.T.

Alfred Rucker

Corp^t, Co. I, 5 Reg't U. S. Col'd Cavalry.

Appears on

Company Muster Roll

for Jan. + Feb., 1865.

Present or absent Present

Stoppage, \$ 100 for

Due Gov't, \$ 100 for

Valuation of horse, \$ 100

Valuation of horse equipments, \$ 100

Remarks: appointed per Regt order No. 12, dated October 30th, 1864.

1st + 2^d installments \$300⁺

Bounty due.

Book mark:

Philipson

(358)

Copyist.

R. | **5 Cav.** | **U.S.C.T.**

Alfred Rucker

Corp., Co. I, 5 Reg't U. S. Col'd Cavalry.

Appears on

Company Muster Roll

for *Mch. + Apl.*, 186*5*.

Present or absent *Present*

Stoppage, \$ *100* for

Due Gov't, \$ *100* for

Valuation of horse, \$ *100*

Valuation of horse equipments, \$ *100*

Remarks: *1st installment*
Bounty due. Appointed
per Regt. Order No. 12,
dated Oct. 30"/64.

Book mark: _____

(358)

Philipsen
Copyist.

P

5 Cav. | U.S.C.T.

Alfred Tucker

Capt, Co. I, 5 Reg't U. S. Col'd Cavalry.

Appears on

Company Muster Roll

for *May June*, 1865.

Present or absent *Present*

Stoppage, \$ 100 for

Due Gov't, \$ 100 for

Valuation of horse, \$ 100

Valuation of horse equipments, \$ 100

Remarks: *Install bounty due per
App't. Capt per Reg't man
no. 12 date Oct 12 date
Oct 30/65*

Book mark:

Alfred Tucker

B | **5 Cav.** | **U.S.C.T.**

Alfred Tucker
Capt, Co. I, 5 Reg't U. S. Col'd Cavalry.

Appears on

Company Muster Roll

for *July 1865*, 1865.

Present or absent *Present*

Stoppage, \$ *100* for

Due Gov't, \$ *100* for

Valuation of horse, \$ *100*

Valuation of horse equipments, \$ *100*

Remarks: _____

Book mark: _____

W.C.C.
Copyist.

R

5 Cav.

U.S.C.T.

Alvin Fisher

Co. I, Co. I, 5 Reg't U. S. Col'd Cavalry.

Appears on

Company Muster Roll

for *Sept + Oct*, 186*5*.

Present or absent *Present*

Stoppage, \$ *100* for

Due Gov't, \$ *100* for

Valuation of horse, \$ *100*

Valuation of horse equipments, \$ *100*

Remarks:

Book mark: -----

(358)

Alvin Fisher

Copyist.

P

5 Cav. U.S.C.T.

Alfred Tucker

Sgt, Co. I, 5 Reg't U. S. Col'd Cavalry.

Appears on

Company Muster Roll

for *Nov & Dec*, 1865.

Present or absent *Present*

Stoppage, \$ *100* for

Due Gov't, \$ *100* for

Valuation of horse, \$ *100*

Valuation of horse equipments, \$ *100*

Remarks *Quar. for C & G. \$.69*
Promoted to sergt. from
Corpe per Regt order no.
207 dated Dec 26/65

Book mark:

Deers

(358)

Copyist.

R

5 Cav.

U.S.C.T.

Alfred Rucker

Sergt., Co. I, 5 Reg't U. S. Col'd Cavalry.

Appears on

Company Muster Roll

for Jan'y. & Feb'y., 1866.

Present or absent Present

Stoppage, \$ 100 for

Due Gov't, \$ 100 for

Valuation of horse, \$ 100

Valuation of horse equipments, \$ 100

Remarks:

Book mark:

Orenshaw

(358)

Copyist.

R

5 Cav. U.S.C.T.

Wm. Rucker

Co. I, 5 Reg't U. S. Colored Cav.

Appears on Returns as follows:

March 1865 - Absent
det-^h at Hopkinsville
Ky. March 14

Book mark :

(546)

E. Thomson

Copyist.

R

5 Cav. U.S.C.T.

Alfred Rucker

Sergt., Co. D, 5 Reg't U. S. Col'd Cavalry.

Appears on Co. Muster-out Roll, dated Helena, Ark., Mch. 16, 1866.

Muster-out to date Mch. 16, 1866.

Last paid to Dec. 31, 1865.

Clothing account:

Last settled....., 186 ; drawn since \$ 100

Due soldier \$ 16 09 / 100; due U. S. \$ 100

Am't for cloth'g in-kind or money adv'd \$ 100

Due U. S. for arms, equipments, &c., \$ 59 / 100

Bounty paid \$ 100; due \$ 100

Remarks: Compl. from organization of Co. to Dec. 25, 1865. then Sergt. Due U.S. for Ord. 599.

Book mark: P.M.G. 4669. 31 May - 4759 / 1 (Cover)

Cresshaw

(861)

Copyright.

JAN. - 9

5368691

1891 *

May. 25/66 = v. 166. P. 137. 73.
P. 2439. Ky.

Rucker, Alford

, Co. 9, 5 Reg't U. S. C. Cav

2 Enclosures.

Bed Cards	Final Statements
Burial Records	Furloughs or L. of A
Certs. of Dis. for Discharge	Med. Certificates
C. M. Charges	Med. Des. Lists
Descriptive Lists	Orders
Discharge Certificates	Pris. of War Record
Enlistment Papers	Resignations

Other papers relating to—

Admission to Hosp'l	Furlough or L. of A
Casualty Sheet	Med. Examination
Confinement	Misc. Information
Contracts	Pay or Clothing
Death or Effects	Personal Reports
Desertion	Rank
Discharge from Hosp'l	Transfer to Hosp'l
Discharge from Service	Transfer to V. R. C.
Duty	Transportation
	Slave claim

NOTE 1.—This blank will be used for both enlistments and re-enlistments—enlistment of veterans, &c., &c., in the volunteer service. They will be made out in duplicate in all cases—one to accompany the recruiting return of the superintendent (not the recruiting officer) to the Adjutant General, and one to accompany the accounts of the officer who pays bounty, &c. The Regiment and Company in which the soldier last served should be given on the back.

NOTE 2.—An enlistment book to service. A muster-in must, in all cases, precede payment of pay, bounty, pension, &c. A muster-in roll must, in all cases, be filed in the Adjutant General's Office as evidence of muster-in. The mustering officer, commissary, or assistant commissary of musters, as the case may be, will countersign both enlistments as having mustered the soldier into the service of the United States before either of them is given to the disbursing officer.

DECLARATION OF RECRUIT.

I, Alford Rucker desiring to VOLUNTEER as a Soldier in the Army of the United States, for the term of THREE YEARS, Do Declare, That I am 23 years and _____ months of age; that I have never been discharged from the United States service on account of disability or by sentence of a court martial, or by order before the expiration of a term of enlistment; and I know of no impediment to my serving honestly and faithfully as a soldier for three years.

GIVEN at Louisville Ky the 29 day of June 1864

Witness: A. L. Gorman Alford Rucker

R-11

enlistment; last served in Company ()
Reg't of _____
Discharged _____ 18 _____

By A. H. Smith
Regiment of 23rd

Volunteered at Louisville Ky June 29 1864.

Alford Rucker
No. 1016
1016

CONSENT IN CASE OF MINOR.

I, _____ Do CERTIFY, That I am the _____ of _____; that the said _____ is _____ years of age; and I do hereby freely give my CONSENT to his volunteering as a SOLDIER in the ARMY OF THE UNITED STATES for the period of THREE YEARS.

GIVEN at _____ the _____ day of _____

Witness: _____

Colored
VOLUNTEER ENLISTMENT.

STATE OF

TOWN OF

Kentucky



Louisville

I, *Alford Tucker* born in *Jackson Co*
in the State of *Kentucky* aged *23* years,
and by occupation a *Farmer* Do HEREBY ACKNOWLEDGE to have
volunteered this *twenty ninth* day of *June* 1864,
to serve as a **Soldier** in the **Army of the United States of America**, for
the period of **THREE YEARS**, unless sooner discharged by proper authority:
Do also agree to accept such bounty, pay, rations, and clothing, as are, or may be,
established by law for volunteers. And I, *Alford Tucker* do
solemnly swear, that I will bear true faith and allegiance to the **United States
of America**, and that I will serve them honestly and faithfully against all
their enemies or opposers whomsoever; and that I will observe and obey the
orders of the President of the United States, and the orders of the officers
appointed over me, according to the Rules and Articles of War.

Sworn and subscribed to, at *Louisville*
this *29* day of *June* 1864
BEFORE *Capt J. Smith*
W. B. C.

I CERTIFY, ON HONOR, That I have carefully examined the above-named Volunteer, agreeably
to the General Regulations of the Army, and that, in my opinion, he is free from all bodily defects and
mental infirmity, which would in any way disqualify him from performing the duties of a soldier.

a. a. Surg. J. M. Trice
EXAMINING SURGEON.

I CERTIFY, ON HONOR, That I have minutely inspected the Volunteer, *Alford Tucker*
previously to his enlistment, and that he was entirely sober when enlisted; that, to the best of my
judgment and belief, he is of lawful age: and that, in accepting him as duly qualified to perform the
duties of an able-bodied soldier, I have strictly observed the Regulations which govern the recruiting
service. This soldier has *dark* eyes, *light* hair, *dark* complexion, is *5*
feet *7* inches high.

J. T. Smith
Capt *W. B. C.*
Regiment of *Volunteers,*
RECRUITING OFFICER.

(A. G. O. No. 74 & 76.)

Daniel Polk

Mustered into the service of the United States, for three years or during the war, from date of enlistment, in Company _____
 Regiment of _____
 Volunteers, on the *29* day of *June* 1864

J. T. Smith
W. B. C.
W. B. C.

War Department,

ADJUTANT GENERAL'S OFFICE,

Washington, April 12 1867.

Respectfully returned to the Commission for the State of Kentucky, with the information that Alfred Rucker was enlisted at Louisville Ky June 29, 1864 and was mustered in as private in Co "F" 5th U.S. Col. July 2, 1864.

P. 2439. Ky.

J. C. Maggard

Asst. Adj't General.

BAB

No. 2439

APPLICATION OF

Daniel Polk

OF

Shelby Co. Kentucky

FOR COMPENSATION FOR SLAVE,

Named Alfred Rucker

Enlisted at Louisville Ky July 2 1864,

In Com. "F" 5th Col. Regiment,

U. S. COLORED TROOPS.

Received March 28, 1867

Compensation Awarded

....., 186...

..... Dollars.

President of Board of Claims.

Claimant's Attorney,

M. C. Taylor

Shelbyville Ky.

Claimant's Post-office Address,

Shelbyville - Shelby Co

Kentucky

No.

CLAIM OF

Daniel Polk

FOR THE COMPENSATION OF SLAVE NAMED

I, Daniel Polk, Alfred Rucker

a loyal citizen, and a resident of ... County of Shelby, State of Kentucky, hereby claim compensation, under the provisions of Section 24, act approved February 24, 1864, and section 2, act approved July, 28, 1866, for my slave Alfred Rucker, enlisted July 2, 1864, at Louisville Ky, by Capt Smith in the ... regiment U. S. Colored Troops, Co. ...; certificate of ... That I did not ac-

Headquarters Kentucky Volunteers,

Adjutant-General's Office,

Frankfort, Feby 27 1867.

I hereby certify, that it appears from the U. S. Muster-Freedman's Rolls on file in this Office, that Alfred Rucker was enrolled on the ... day of ... 1864, at ... by ... and mustered into the U. S. service on the 2. day of July 1864, at Louisville Ky by Capt Smith to serve Three years. Said Alfred Rucker is described as follows: Age, ... years; eyes, ...; hair, ... complexion, ... height, ... feet ... inches. It further appears from said Rolls that Alfred Rucker owed service to Daniel Pope, was credited to Nelson County, Ky., and was assigned to Co. "D" 5 Regiment U. S. Cavalry

In Testimony Whereof, I have hereunto set my hands, and affixed my Official Seal, this 27 day of Feby, 1867.

D. Lindsey Adjutant-General of Kentucky.

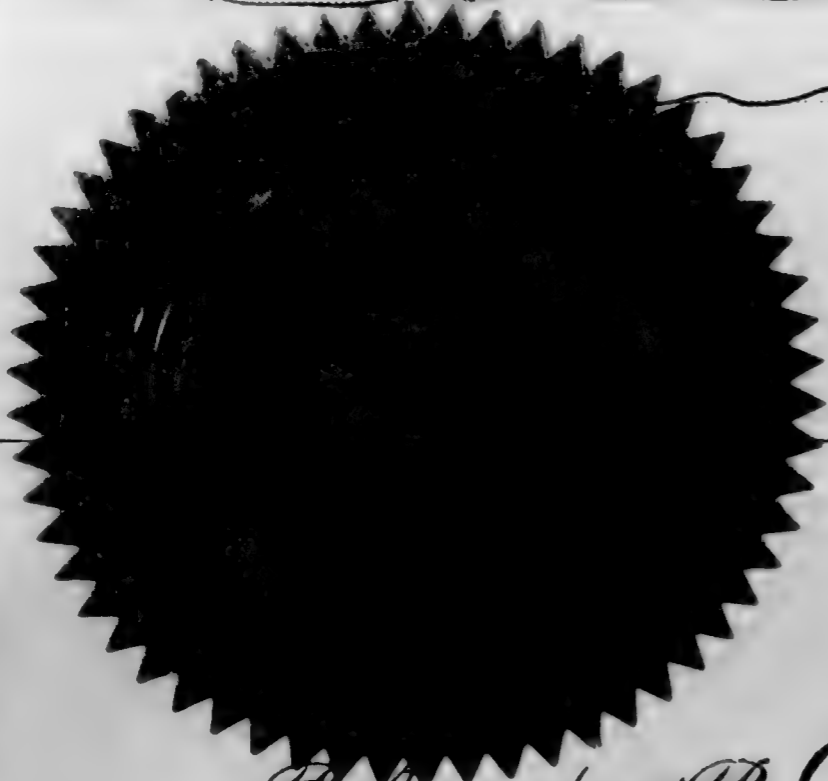

D. J. Freedman R. C. D. Cur

No.

CLAIM OF
Daniel Potk

FOR THE COMPENSATION OF SLAVE NAMED

I, *Alfred Rucker*
Daniel Potk a loyal citizen, and a resident of _____,
County of *Shelby*, State of Kentucky, hereby claim compensation, under
the provisions of Section 24, act approved February 24, 1864, and section 2, act approved July, 28,
1866, for my slave *Alfred Rucker*, enlisted *July 2*
1864, at *Louisville Ky*, by *Capt Smith*
in the _____ regiment U. S. Colored Troops, Co. *I*; certificate of

which enlistment, and a descriptive list, as required, accompany this application. That I did not ac-
quire said slave subsequent to said enlistment, but had a valid title to him at the date of said enlist-
ment, and previous thereto: I having acquired my title to him and my ownership over him as fol-
lows, to-wit: *I purchased said Alfred in the year*
1853 & held him in my possession as my prop-
erty until he entered in the U S Army.

In proof of my loyalty to the Constitution and Government of the United States, I present the ac-
companying oath, which I have taken, signed and acknowledged; to be filed with this application, in
accordance with requirement of General Orders, No. 329, 1863, War Department, Adjutant General's
Office.

Feb 23 186*7* *Daniel Potk*

OATH OF ALLEGIANCE.
I, *Daniel Potk*, the owner and Claimant, do solemnly swear that
the foregoing claim is a just and true claim due to me as master and owner of the said slave, and that
the facts alleged in said claim in respect to the draft or enlistment (as the case may be) of said slave
into the Military service of the United States are true. And I do further swear that I have never
joined, or been concerned in, any insurrection or rebellion; that I have never borne arms against the
United States; that I have never given any aid, countenance, counsel or encouragement to any person
or persons engaged, or whom I had reason to believe were about to engage, in insurrection, rebellion
or armed hostility against the United States; that I have neither sought, nor accepted, nor attempted
to exercise the functions of any office, civil or military, nor to perform any service whatever, under
any authority or pretended authority in hostility to the United States; that I have not yielded a vol-
untary support to any insurrection, rebellion or pretended government, authority, power or constitution
within the United States hostile thereto. And I do further swear that, to the best of my knowledge
and ability, I have supported and defended, and will continue to support and defend, the United
States against all enemies, foreign and domestic; and that I have supported, defended and obeyed, and
will continue to support, defend and obey, the Constitution and laws of the United States; that I will
bear true faith and allegiance to the same; and that I take this oath freely, without any mental reserva-
tion or purpose of evasion: So help me God.

Daniel Potk

Sworn to and subscribed before me, at *Shelbyville*,
this *23^d* day of *February*, 186*7*.



STAMP.

John E. Courale M.D.
for Shelby Co Kentucky

1113
Rucker Andrew

Co M, 5 U. S. Col'd Cav.

Private | Garrison

CARD NUMBERS.

1	26
2	27
3	28
4	29
5	30
6	31
7	32
8	33
9	34
10	35
11	36
12	37
13	38
14	39
15	40
16	41
17	42
18	43
19	44
20	45
21	46
22	47
23	48
24	49
25	50

Book Mark:

See also

Rucker Benjamin

Co *L*, 5 U. S. Col'd Cav.

Private | *Private*

CARD NUMBERS.

1	5369848	26
2	5369943	27
3	5370036	28
4	5370089	29
5	5370180	30
6	5370316	31
7	5370402	32
8	5370487	33
9	5370582	34
10	5370654	35
11	5370725	36
12	9091198	37
13	43147036	38
14	43148137	39
15	40730277	40
16		41
17		42
18		43
19		44
20		45
21		46
22		47
23		48
24		49
25		50

Book Mark:

See also

R | 5th Cav | **U.S.C.T.**

Benjamin Rusler
, Co. D, 5th Reg't U. S. Col'd Cav

Appears on

Company Descriptive Book

of the organization named above.

DESCRIPTION.

Age 25 years; height 5 feet 8 inches.

Complexion Dark

Eyes Dark; hair Dark

Where born Shelby Ky

Occupation Laborer

ENLISTMENT.

When Sept 21, 1864.

Where Lansdown Ky

By whom Capt. Ham; term 3 y'rs.

Remarks:

(383g) A. J. Anderson Copyist.

R | 560 N.S. 65.

Benjamin Rucker

Appears with rank of Priv on

Muster and Descriptive Roll

of Detachment of U.S. Colored Recruits
Mustered for U.S. 65. at Taylor's Bluffs
Louisville Ky. Roll dated

Louisville Ky., Sept. 23, 1864.

Where born Shelby Ky

Age 25 years; occupation Labourer

When enlisted Sept. 21, 1864.

Where enlisted Louisville Ky

For what period enlisted 3 years.

Eyes Dark; hair Dark

Complexion Dark; height 5 ft. 8 in.

When mustered in Sept. 23, 1864.

Where mustered in Louisville

Bounty paid \$ 100; due \$ 100

Clothing account:

Last settled _____, 186 ; drawn since \$ 100

Date of first muster _____, 186 .

Company to which assigned _____

Remarks: Credited to Shelby Co. 4th Dist

Book mark: _____

[Signature]

R | 5 bar | U.S.A.

Benjamin Tucker
Appears with rank of Pol on

Muster and Descriptive Roll

of Detachment of 1st Colored
Troops, forwarded

Roll dated
Louisville, Ky, Oct. 4, 1864.

Where born Shelby, Ky

Age 25 years; occupation Farmer

When enlisted Sept. 21, 1864

Where enlisted Louisville, Ky

For what period enlisted 3 years.

Eyes Dark; hair Dark

Complexion Dark; height 5 ft. 8 in.

When mustered in Sept. 23, 1864.

Where mustered in Louisville

Bounty paid \$ 100; due \$ 100

Clothing account:

Last settled 186; drawn since \$ 17⁵⁰/100

Date of first muster Sept. 23, 1864

Company to which assigned

Remarks: Credited to 4"
Long Dist. Ky.

Book mark:

(356m)

W. H. Tucker

Copyist.

R

5 Cav.

U.S.C.T.

Benjamin Rucker

Por Co. L, 5 Reg't U. S. Col'd Cavalry.

Appears on

Company Muster-in and Descriptive Roll

of the organization named above. Roll dated

Camp Nelson, ~~NY~~ ^{Ky}, Oct 30, 1864.

Where born Shelby, Ky

Age 25 y'rs; occupation Suburban

When enlisted Sept 21, 1864

Where enlisted Louisville

For what period enlisted 3 years.

Eyes Br; hair Br

Complexion Br; height 5 ft. 8 in.

When mustered in Sept 23, 1864.

Where mustered in Louisville

Bounty paid \$ 100; due \$ 100

Where credited 5th Dist Ky

Company to which assigned

Remarks:

Book mark:

Bradley

(356d)

Copyist.

R | 5 Cav. | U.S.C.T. |

Benjamin Tucker

Pop, Co. L, 5 Reg't U. S. Col'd Cavalry.

Appears on

Company Muster Roll

for dated Oct 31, 1864

Present or absent Absent

Stoppage, \$ 100 for

Due Gov't, \$ 100 for

Valuation of horse, \$ 100

Valuation of horse equipments, \$ 100

Remarks: On det serv
Nashville Tenn
Oct 15/64

Book mark:

Budd

(358)

Copyist.

R

5 Cav.

U.S.C.T.

Benjamin Tucker

Par, Co. L, 5 Reg't U.S. Col'd Cavalry.

Appears on

Company Muster Roll

for Nov & Dec, 1864

Present or absent Absent

Stoppage, \$ 100 for

Due Gov't, \$ 100 for

Valuation of horse, \$ 100

Valuation of horse equipments, \$ 100

Remarks: On det serv
Nashville Tenn
Oct 15/64. 1st
install. Bondy
due

Book mark:

Bradley

(358)

Copyist.

A

5 Cav. U.S.C.T.

Benjamin Tucker

Cpl., Co. L, 5 Reg't U. S. Col'd Cavalry.

Appears on

Company Muster Roll

for June 5 Feby, 1865.

Present or absent Absent

Stoppage, \$ 100 for

Due Gov't, \$ 100 for

Valuation of horse, \$ 100

Valuation of horse equipments, \$ 100

Remarks: Appointed by Order No 26. dated Camp Nelson Feby 13. 1865 to rank from June 1/65 102 installments of Bounty due. In dismounted Camp Camp Nelson Ky

Book mark:

Biddle

(358)

Copyist.

R

5 Cav. U.S.C.T.

Ben Tucker

Cpl

Co. L, 5 Reg't U.S. Col'd Cavalry.

Appears on

Company Muster Roll

for *Mar 1865*, 1865

Present or absent *Present*

Stoppage, \$ 100 for

Due Gov't, \$ 100 for

Valuation of horse, \$ 100

Valuation of horse equipments, \$ 100

Remarks: *1st Install
of 3 months due
\$100*

Book mark:

[Signature]

(358)

Copyist.

R | 5 Cav. | U.S.C.T.

Dominic Tucker
Cpt, Co. L, 5 Reg't U. S. Col'd Cavalry.

Appears on

Company Muster Roll

for *May & June*, 1865.

Present or absent *Present*

Stoppage, \$ *100* for

Due Gov't, \$ *100* for

Valuation of horse, \$ *100*

Valuation of horse equipments, \$ *100*

Remarks: *1st Installment*
Bounty due \$100.
Reduced from Corp.
Per R.O. No. 88
Dated May 25. 1865

Book mark:

Tucker

W

5 Cav. | U.S.C.T.

Benj. Tucker

Qr, Co. L, 5 Reg't U. S. Col'd Cavalry.

Appears on

Company Muster Roll

for *July + Aug*, 1865.

Present or absent *Present*

Stoppage, \$ *100* for

Due Gov't, \$ *100* for

Valuation of horse, \$ *100*

Valuation of horse equipments, \$ *100*

Remarks: *In daily duty as
Co. Cook*

Book mark:

Rechner

R | **5 Cav.** | **U.S.C.T.**

Benjamin Rucker

2d, Co. L, 5 Reg't U. S. Col'd Cavalry.

Appears on

Company Muster Roll

for *Sept Oct*, 1865.

Present or absent *Present*

Stoppage, \$ 100 for

Due Gov't, \$ 100 for

Valuation of horse, \$ 100

Valuation of horse equipments, \$ 100

Remarks:

Book mark:

(358)

Rucker

Copyist.

R

5 Cav. | U.S.C.T.

Benjamin Rucker

2nd, Co. L, 5 Reg't U. S. Col'd Cavalry.

Appears on

Company Muster Roll

for *W. M. Lee*, 1865.

Present or absent *Present*

Stoppage, \$ 100 for

Due Gov't, \$ 100 for

Valuation of horse, \$ 100

Valuation of horse equipments, \$ 100

Remarks: *Due U.S. for dis-
charge 30 cts*

Book mark:

Rucker

(358)

Copyist.

R | 5 Cav. | U.S.C.T.

Benjamin Rucker

Private, Co. L, 5 Reg't U. S. Col'd Cavalry.

Appears on

Company Muster Roll

for Jan. 7 Feb, 1866.

Present or absent Present

Stoppage, \$ 100 for

Due Gov't, \$ 100 for

Valuation of horse, \$ 100

Valuation of horse equipments, \$ 100

Remarks:

Book mark:

A. P. Taylor

(358)

Copyist.

Benjamin Pucker

Pvt, Co. F, 5 Reg't U. S. Colored Cav.
corp

Appears on Returns as follows:

Oct to Dec. 1864. - Absent on
det. serv. Nashville
Tenn. Oct. 15/64.

Jan. & Feb. 1865. - Absent in
dismounted Camp
Camp Nelson Ky.

Apr. 1865. - (corp) - On daily
duty in charge of
Guard at P No qrs.

June to Sept. 1865. - (Pvt.) -
On daily duty as
Co. Cook.

Book mark :

E. J. Thornton

(545)

Copyist.

R 15 Cav. U.S.C.T.

Benjamin Rucker

Priv, Co. C, 5 Reg't U. S. Col'd Cavalry

Appears on Co. Muster-out Roll, dated
Spartan, Ark, Mar. 16, 1866.

Muster-out to date Mar. 16, 1866.

Last paid to Dec. 31, 1865.

Clothing account:

Last settled _____, 186 ; drawn since \$ 100

Due soldier \$ 100; due U. S. \$ 4 ³⁶/₁₀₀

Am't for cloth'g in kind or money adv'd \$ 100

Due U. S. for arms, equipments, &c., \$ ⁴⁰/₁₀₀

Bounty paid \$ 100 ¹⁰⁰/₁₀₀; due \$ 100

Remarks: Slave. Was Priv. to
Feb. 13th, 65 then Corp'l to
May 25th 65, then Private
Due U. S. for Ord. 40cts.

Book mark: V. 01. P. 117. 69. - E. B. 70. 547

O. T. Taylor

(361)

Copyist.

Rucker, Benjamin

, Co. L ,

5 Reg't *Misc*

/ Inclosures.

Bed Cards	Final Statements
Burial Records	Furloughs or L. of A.
Certs. of Dis. for Discharge	Med. Certificates
C. M. Charges	Med. Des. Lists
Descriptive Lists	Orders
Discharge Certificates	Pris. of War Record
Enlistment Papers	Resignations

Other papers relating to—

Admission to Hosp'l	Furlough or L. of A.
Casualty Sheet	Med. Examination
Confinement	Misc. Information
Contracts	Pay or Clothing
Death or Effects	Personal Reports
Desertion	Rank
Discharge from Hosp'l	Transfer to Hosp'l
Discharge from Service	Transfer to V. R. C.
Duty	Transportation

NOTE 1.—This blank will be used for enlistments of United States colored troops. They will be made out in duplicate in all cases—one to accompany the recruiting return of the superintendent (not the recruiting officer) to the Adjutant General, and one to accompany the accounts of the officer who pays bounty, &c.

NOTE 2.—An enlistment holds to service. A muster-in must, in all cases, precede payment of pay, bounty, pension, &c. A muster-in roll, must in all cases, be filed in the Adjutant General's Office as evidence of muster-in. The mustering officer, commissary, or assistant commissary of musters, as the case may be, will countersign both enlistments as having mustered the soldiers into the service of the United States before either of them is given to the disbursing officer.

DECLARATION OF RECRUIT

I, Benjamin B. Bunch, desiring to volunteer as a soldier in the ARMY OF THE UNITED STATES, for the term of Three Years, DO DECLARE That I am 25 years and — months of age; that I have never been discharged from the United States service on account of disability or by sentence of a court-martial, or by order before the expiration of a term of enlistment; and I know of no impediment to my serving honestly and faithfully as a soldier for three years.

GIVEN at Louisville the 21st day of Sept 1864

Witness:

G. W. Stotes

Benjamin B. Bunch

By

Volunteered at

Sept 21 1864
at Louisville

1275

Consent of Parent or Guardian in case of a Minor, if a Free Man, or in the case of a Slave, of the Person to whom he owes Service:

I, Do CERTIFY, That I am the that the said is years of age; and I do freely give my CONSENT to his volunteering as a SOLDIER in the Army of the United States, for the period of THREE YEARS, under the conditions of the laws of the United States.

GIVEN at the day of

Witness:

Russ Martin

Co L, 5 U. S. Col'd Cav.

Private Private

CARD NUMBERS.

1	26
<i>See Martin,</i>	<i>Russ.</i>
3	28
4	29
5	30
6	31
7	32
8	33
9	34
10	35
11	36
12	37
13	38
14	39
15	40
16	41
17	42
18	43
19	44
20	45
21	46
22	47
23	48
24	49
25	50

Book Mark:

See also

1110
Russell James

Co *D*, 5 U. S. Col'd Cav.

Private | Sergeant

CARD NUMBERS.

1	5362711	26
2	5362805	27
3	5362903	28
4	5363021	29
5	5363658	30
6	5359979	31
7	5360609	32
8	9090062	33
9	9090340	34
10	143145102	35
11	40730279	36
12		37
13		38
14		39
15		40
16		41
17		42
18		43
19		44
20		45
21		46
22		47
23		48
24		49
25		50

Book Mark:

See also

R

5 Cav. U.S.C.T.

James Russell

Co. *10*, 5 Reg't U. S. Col'd Cav.

Appears on

Company Descriptive Book
of the organization named above.

DESCRIPTION.

Age *23* years; height *5* feet *4* inches.

Complexion *Copper*

Eyes *Black*; hair *Black*

Where born *South Carolina*

Occupation *Laborer*

ENLISTMENT.

When *Sep 14*, 186*4*.

Where *Louisville*

By whom *Capt Morgan*; term *3* y'rs.

Remarks: *Transferred to*
Co "A" Feb. 8
1865 per Reg't. order
no 23.

J E Parks

(383g)

Copist.

J. | **5 Cav. | U.S.C.T.**

Russell James

....., Co. *A*, 5 Reg't U. S. Col'd Cav.

Appears on

Company Descriptive Book

of the organization named above.

DESCRIPTION.

Age *23* years; height *5* feet *4* inches.

Complexion *Blk*

Eyes *Blk*; hair *Blk*

Where born *S. Carolina*

Occupation *Labourer*

ENLISTMENT.

When *Sept 14*, 186 .

Where *Louisville*

By whom *Capt Morgan*, term *3* y'rs.

Remarks: *Died Feb. 23/65*

Wasson

A | 5 bar | U.S.A.

James Russell

Appears with rank of Rec't on

Muster and Descriptive Roll

of a Detachment of U.S. Colored Troops
Mustered by Capt. G. W. Monack

5th Dist. Ky. Roll dated
Louisville Ky., Sept 14, 1864.

Where born South Carolina

Age 23 years; occupation laborer

When enlisted Sept 14, 1864.

Where enlisted Louisville Ky.

For what period enlisted 3 years.

Eyes black; hair black

Complexion black; height 5 ft. 4 in.

When mustered in Sept 14, 1864.

Where mustered in Louisville Ky.

Bounty paid \$ 100; due \$ 100

Clothing account:

Last settled _____, 186 ; drawn since \$ 100

Date of first muster Sept 14, 1864.

Company to which assigned _____

Remarks: 5th Dist. Ky.

Book mark: _____

J. E. James

(356m)

Copyist.

R

5 Cav. U.S.C.T.

James Russell

Priv., Co. D, 5 Reg't U. S. Col'd Cavalry.

Appears on

Company Muster-in and Descriptive Roll

of the organization named above. Roll dated

Camp Lebanon, N.Y., Oct. 24, 1864.

Where born South Carolina

Age 23 y'rs; occupation Laborer

When enlisted Sept. 14, 1864.

Where enlisted Louisville

For what period enlisted 3 years.

Eyes Br; hair Br

Complexion Br; height 5 ft. 4 in.

When mustered in Aug. 27, 1864.

Where mustered in Lebanon

Bounty paid \$100; due \$100

Where credited 5 Dist. Ky.

Company to which assigned

Remarks:

Book mark:

Wm H. Scott

(356d)

Copyist.

R

5 Cav. U.S.C.T.

James Russell

Plt., Co. D, 5 Reg't U. S. Col'd Cavalry.

Appears on

Company Muster Roll

for Dated Oct. 31, 1864.

Present or absent Present.

Stoppage, \$ 100 for

Due Gov't, \$ 100 for

Valuation of horse, \$ 100

Valuation of horse equipments, \$ 100

Remarks:

Book mark:

Wm H Scott

(358)

Copyist.

R

5 Cav. U.S.C.T.

James Russell

Plt, Co. D, 5 Reg't U. S. Col'd Cavalry.

Appears on

Company Muster Roll

for *Nov. & Dec.*, 186*4*.

Present or absent *Present*

Stoppage, \$ *100* for

Due Gov't, \$ *100* for

Valuation of horse, \$ *100*

Valuation of horse equipments, \$ *100*

Remarks: *1" & 2" installments of Bounty dues*

Book mark:

Wm. H. Scott

(358)

Copyist.

R

5 Cav. U.S.C.T.

James Russell

Priv., Co. D, 5 Reg't U. S. Col'd Cavalry.

Appears on

Company Muster Roll

for Jan & Feb., 1865.

Present or absent

Stoppage, \$ 100 for

Due Gov't, \$ 100 for

Valuation of horse, \$ 100

Valuation of horse equipments, \$ 100

Remarks: Transferred to Co. A. 5th U.S.C. per R.O. 23 8 Feb. '65. First installment of Bounty due \$100

Book mark:

Wm B Scott

R

5 Cav. U.S.C.T.

James Russell
Sergeant, Co. A, 5 Reg't U.S. Col'd Cavalry.

Appears on

Company Muster Roll

for Jan. 9th 1865

Present or absent

Stoppage, \$ 100 for

Due Gov't, \$ 100 for

Valuation of horse, \$ 100

Valuation of horse equipments, \$ 100

Remarks: Transferred from
Co. "D" to Co. "A" as per
R.O. No. 23, Feb. 7, 1865.
Died in Genl. Hosp't,
Camp Nelson Ky.
Feb. 24, 1865.

Book mark: Died Feb. 23/65. C.B. N. 10
P. 522.

Easterling

(358)

Copyist.

Q | 5 Cav. | U.S.C.T.

James Russell

Sgt., Co. D, 5 Reg't U. S. Colored Cav.

Appears on Returns as follows:

Feb. 1865 - Arr. Feb. 8/65
Camp Nelson. Transf.
to Co. A per P.O. 23

Feb 8/65

(Co. A) Arr. Feb. 7/65
Camp Nelson. Transf.
from Co. D to Co. A
5 U.S. Cav.

Arr. Feb. 23/65 Camp
Nelson. Died in Camp
Nelson Gen. Hosp.

Book mark :

(540)

E. J. Thomson

Copyist.

R

5 Cav. U.S.C.T.

James Russell
Sergt, Co. A, 5 Reg't U. S. Col'd Cavalry.

Appears on Co. Muster-out Roll, dated
Helena Ark Feb 16, 1866

Muster-out to date _____, 1866 .

Last paid to Pay due from, 1866 .
enlistment

Clothing account:

Last settled _____, 1866 ; drawn since \$ _____ 100

Due soldier \$ _____ 100 ; due U. S. \$ _____ 100

Am't for cloth'g in kind or money adv'd \$ _____ 100

Due U. S. for arms, equipments, &c., \$ _____ 100

Bounty paid \$ _____ 100 ; due \$ _____ 100

Remarks: Deid Cp Nelson Ky,
Feb 23. 1865 - Small pox.
Final statements for-
warded Feb. 26. 1865

Book mark: 117874.

W. Sayre

(361)

Copyist.

N. | 5 Cav. | U. S. C. T.

James Russell,
Pvt., Co. D., 5 Reg't U. S. Col'd Cav.

Appears on Co. Muster-out Roll, dated

Helena, Ark., March 16, 1864.

Muster-out to date _____, 186 .

Last paid to *Enlistment*, 186 .

Clothing account:

Last settled _____, 186 ; drawn since \$ _____ 100

Due soldier \$ _____ 100; due U. S. \$ _____ 100

Am't for cloth'g in kind or money adv'd \$ _____ 100

Due U. S. for arms, equipments, &c., \$ _____ 100

Bounty paid \$ _____ 100 due \$ *100.* ⁰⁰/₁₀₀

Remarks: *Transferred by Regl. Order No. 23 to Company "H.", Feb. 8/65.*

Book mark : _____

(361)

R. D. Sawyer

Copyist.

Russell, James
P, Co. A, Regt 1st Caval

2 Enclosures.

Bed Cards	Descriptive Lists
Burial Records /	Final Statements /
Certs. of Dis. for Discharge	Furloughs
C. M. Charges	Med. Des. Lists
Med. Certificates	Orders

Other papers relating to—

Admission to Hosp'l	Furlough
Casualty Sheet (Officer's)	Med. Examination
Confinement	Misc. Information
Contracts	Pay or Clothing
Death or Effects	Personal Reports
Desertions	Rank
Discharge from Hosp'l	Transfer to Hosp'l
Discharge from Service	Transfer to V. R. C.
Duty	Transportation

War Department,

ADJUTANT GENERAL'S OFFICE,

December 2, 1873

The death of Sgt James Russell, Co. A, 5th Reg't U. S. Colored Cavalry, is reported as follows:—

On Company Muster Roll.
 For Jan'y and Feb'y, 1865, Feb'y 24, 1865
 Company Muster-out Roll.
 February 23, 1865.
 Company Descriptive Book.
 February 23, 1865
 Company Morning Reports.
 February 23, 1865.
 Soldier's Final Statement.
 February 23, 1865.
 Soldier's Record of Death and Interment.

, 186
 Soldier's Inventory of Effects.
 , 186
 Soldier's Certificate of Disability for Discharge.

, 186
 Soldier's Individual Muster-out Roll.

, 186
 Regimental Return.
 For , 186 , , 186
 Regimental Quarterly Returns.

, 186
 Regimental Descriptive Book.

, 186
 By Surgeon General.

() , 186
 February 23, 1865, is held to be
 the correct date, and the Company Muster
 Roll will be amended accordingly.

Thoma M. Stewart
 E. B. 10
 522
 Asst. Adj. Gen.
 Selected & Aud. Dec. 10, 1873

Co A
 FINAL STATEMENT

OF
James Russell
5th Reg't of U. S. Cavalry

1
 VOLUNTEERS.

NOTE 1.—Two of these certificates (or duplicates) are to be given to each Volunteer Soldier or drafted man who may be discharged without being mustered out (Final Statements are never given to men mustered out of service,) that he may at once receive from the Paymaster the pay, &c., due him, and the captain or other COMMISSIONED officer commanding the company will certify to the act of the delivery of the duplicate certificates; with these certificates the Soldier is "entitled to" his discharge and should also present his discharge to the Paymaster to have the payment endorsed on it. The discharge is to be given back to the Soldier by the Paymaster; the latter only retaining as his vouchers the duplicate certificates.

NOTE 2.—If the Soldier is entitled to pay for the use of his horse, the Company Commander will certify to that fact on the back of both these final statements, and also to the time he has pay due for having been so mounted on his own horse.

NOTE 3.—When a Soldier is furnished with final statements, his descriptive list, if he has one, should be taken up by the officer who gives the Soldier these statements, and endorsed with a statement to this effect by the officer. The endorsement should exhibit a full statement of the time for which the Soldier was allowed pay on his final statements, the clothing account, and all other charges against him or in his favor, so as to comprise a complete exhibit of his account. It will then be transmitted to the Company Commander of the Soldier, who will enter all the data necessary to a full understanding of the Soldier's account on the muster roll upon which the Soldier's discharge is reported. The descriptive list will then be destroyed. The object of this is, that the remaining portion of the Soldier's account may be settled upon the receipt of these muster rolls, and the Soldier receive any pay or allowances that may be due him at the time of his discharge, and which may not appear on his last final statements from the fact that his descriptive list is incomplete. These accounts for back pay, &c., are settled by the 2d Auditor of the Treasury Department.

NOTE 4.—Charges for loss or injury to ordnance, horse equipments, and other miscellaneous charges, should appear under the heading of "Other Stoppages."

NOTE 5.—Bounty paid by State authorities, and not by the United States, will not be entered on this statement.

NOTE 6.—Amounts due the Suttler and Laundress must be entered on the muster roll on which the discharge, death, desertion, &c., is reported, as well as on the final statement, otherwise the amount cannot be collected from the United States.

NOTE 7.—This blank will be used for deceased volunteers and drafted men, as well as for others.

NOTE 8.—Where a Soldier dies in Hospital or on detached service, his descriptive list, if he has one, should be sent with his final statements, in duplicate, to the Adjutant General, Washington, D. C.

NOTE 9.—If the soldier is a drafted man or substitute, the space for time, &c., of enrolled, should contain only the word *drafted or substitute*, as the case may be. If the Soldier is a "VETERAN," (or RECRUIT,) the words as a *veteran*, (or *recruit*,) as the case may be, should be interlined after the words *mustered into the service of the U. S.* A statement of all the installments of *Veteran or Recruit Bounty RECEIVED* by the Soldier, must be made on the back of each final statement.

I certify, on honor, that James Russell, a Serjeant of
 Captain J. W. Anderson Company (A) of the 5th Regiment of U. S. C.
VOLUNTEERS, of the State of _____, born in S. Carolina, State
 of _____, aged 23 years; 5 feet 4 inches high; Blk complexion,
Blk eyes, Blk hair, and by occupation a Laborer, who joined for service
 and was enrolled (see Note 9) on the 14th day of Sept, 1864, at Louiseville
 by Capt Mornack, for the period of _____ years, and mustered into
 the service of the United States on the 14th day of September, 1864, at
Louiseville, by Capt Mornack; and having served
 HONESTLY and FAITHFULLY with his Company to the present date, is now entitled to a
DISCHARGE by reason of Death

The said James Russell was last paid by Paymaster
 _____, to include the _____ day of _____, 1864, and
 has pay due him from that time to the present date; he is entitled to pay and subsistence for
TRAVELING to place of enrollment, and whatever other allowances are authorized to volunteer
 soldiers, drafted men, or militia, so discharged. He has received from the United States **CLOTHING**
 amounting to \$40.³⁰/₁₀₀ dollars, since the 14th day of September,
 1864, when his clothing account was last settled. He has received from the United States
 _____ 100 dollars advanced **BOUNTY**.

There is to be stopped from him, on account of the State of _____, or other
 authorities, for **CLOTHING**, &c., received on entering service, _____ 100 dollars; and
 for other stoppages, viz: _____

_____ 100 dollars.
 He has been furnished with **TRANSPORTATION** in kind from the place of his discharge to
 _____, and he has been **SUBSISTED** for **TRAVELING** to his
 place of enrollment up to the _____

(Ad. Ac. July 23/65)
 See Mr. [unclear]

[Faint, mostly illegible handwriting]

July 23/65
 Paid [unclear]

[unclear]
 [unclear]

James Russell
Pr Col. 5th U.S.C. C.
February 23. 1865.
Kent Hosp. Camp Nelson, Ky.

RECORD OF DEATH AND INTERMENT.

Name and number of person interred . . .
 Number and locality of the grave . . .
 Hospital number of the deceased . . .
 Regiment, rank and company . . .
 Residence before enlistment . . .
 Conjugal relation. (and if married the residence of the widow.)
 Cause of death
 Age of the deceased.
 Nativity.
 References and remarks.
 Date of death and burial.

James Russell
9517
6222
Regt Co A's U.S.A.
 }
Small Pox
 }
February 23^d 1866

~~He possessed no effects~~
 (1) One coat
 (1) Pair Pants
 (1) Shirt Money \$18.83
 (1) Hat
 (2) Pair Boots
 (1) Jacket
 (1) Uniform coat
 (1) Pair Drawers

Received by the

Russell Jesse

B, 5 U. S. Col'd Cav

Private | Private

CARD NUMBERS.

5360720	26
5360817	27
5360920	28
5361627	29
4090160	30
40730278	31
	32
	33
	34
	35
	36
	37
	38
	39
	40
	41
	42
	43
	44
	45
	46
	47
	48
	49
	50

Mark:

also

R | 5 Cav. | U.S.C.T.

Jesse Russell

, Co. B, 5 Reg't U. S. Col'd Cav.

Appears on

Company Descriptive Book
of the organization named above.

DESCRIPTION.

Age 17 years; height 2 feet 5 inches.

Complexion Blk

Eyes Blk; hair Blk

Where born Bourbon Co Ky.

Occupation Laborer

ENLISTMENT.

When Aug. 20, 1864.

Where Lexington Ky.

By whom Capt Moore; term 3 y'rs.

Remarks: Wounded in Crossing
Clinch River Va. Dec.
24 1864 final statements
forwarded

R | I'low | U.S.C.T.

Jesse Russell

Co. B, 1st Reg't U. S. Col'd Cav

Appears on

Company Muster-in and Descriptive Roll
of the organization named above. Roll dated

Camp Nelson Ky, Oct 24, 1864.

Where born Bowbrow Ky

Age 19 y'rs; occupation Laborer

When enlisted Aug 17, 1864.

Where enlisted Lexington

For what period enlisted 3 years.

Eyes Brn; hair Brn

Complexion Brn; height 5' 5" in.

When mustered in Aug 20, 1864.

Where mustered in Lexington

Bounty paid \$ 100; due \$ 100

Where credited 7 Dist Ky

Company to which assigned B

Remarks * Name of owner of

Negro - James Russell

* Acq'd Mar, 13. 98. by H. J.

Book mark :

Lauch

R | **5 Cav.** | **U.S.C.T.**

Jesse Russell

Present, Co. B, 5 Reg't U. S. Col'd Cavalry.

Appears on

Company Muster Roll

for Oct 31, 1864.

Present or absent Present

Stoppage, \$ 100 for

Due Gov't, \$ 100 for

Valuation of horse, \$ 100

Valuation of horse equipments, \$ 100

Remarks:

Book mark: -----

Laub

R | 5 Cav. | U.S.C.T.

Jessie Russell
Bent, Co. B, 5 Reg't U. S. Col'd Cavalry.

Appears on

Company Muster Roll

for Nov & Dec, 1864.

Present or absent

Stoppage, \$ 100 for

Due Gov't, \$ 100 for

Valuation of horse, \$ 100

Valuation of horse equipments, \$ 100

Remarks: Drowned in crossing
Church River 24 Dec
1864
at & 2" instalments
bounty due

Book mark:

Lamb

R | 5 Cav. | U.S.C.T.

Jessie Russell
Co. *D*, 5 Reg't U. S. Colored Cav.

Appears on Returns as follows:

Dec. 1864 - *Dec. 24/64*
Marion Va, Drowned
in crossing Clinch
River Va.

Book mark :

(546)

G. Thorton

Copyist.

R

5 Cav. U.S.C.T.

Jesse Russell

Private, Co. D, 5 Reg't U. S. Col'd Cavalry.

Appears on Co. Muster-out Roll, dated

Helena Ark, Mar 16, 1864.

Muster-out to date _____, 186 .

Last paid to *Rec'd for Enrolment*, 186 .

Clothing account:

Last settled _____, 186 ; drawn since \$ _____ 100

Due soldier \$ _____ 100; due U. S. \$ *44* ²⁰ 100

Am't for cloth'g in kind or money adv'd \$ _____ 100

Due U. S. for arms, equipments, &c., \$ _____ 100

Bounty paid \$ _____ 100; due \$ _____ 100

Remarks: *Died Dec 24 '64, Clinch River Va, Drowning. Drowned in crossing Clinch River Va. Final statements forwarded.*

Slane Apr 19, 1861

Book mark: *V. 221. P. 42. 75*

(361)

Jesse Russell

Copyist.

Russell, Jessie
P, Co. B, 5 Regt U.S.C. Cav.

2 Enclosures.

Bed Cards	Descriptive Lists
Burial Records	Final Statements /
Certs. of Dis. for Discharge	Furloughs
C. M. Charges	Med. Des. Lists
Med. Certificates	Orders

Other papers relating to—

Admission to Hosp'l	Furlough
Casualty Sheet (Officer's)	Med. Examination
Confinement	Misc. Information
Contracts	Pay or Clothing
Death or Effects /	Personal Reports
Desertions	Rank
Discharge from Hosp'l	Transfer to Hosp'l
Discharge from Service	Transfer to V. R. C.
Duty	Transportation

V FINAL STATEMENT

Co B
OF

James Russell
5th Regt of U.S. Cavalry

VOLUNTEERS.

Company 24th 11th Mo.

NOTE 1.—Two of these certificates (or duplicates) are to be given to each Volunteer Soldier or drafted man who may be discharged without being mustered out (Final Statements are never given to men mustered out of service.) that he may at once receive from the Paymaster the pay, &c., due him, and the captain or other COMMISSIONED officer commanding the company will certify to the act of the delivery of the duplicate certificates; with these certificates the Soldier is "entitled to" his discharge, and should also present his discharge to the Paymaster to have the payment endorsed on it. The discharge is to be given back to the Soldier by the Paymaster; the latter only retaining as his vouchers the duplicate certificates.

NOTE 2.—If the Soldier is entitled to pay for the use of his horse, the Company Commander will certify to that fact on the back of both these final statements, and also to the time he has pay due for having been mounted on his own horse.

NOTE 3.—When a Soldier is furnished with final statements, his descriptive list, if he has one, should be taken up by the officer who gives the Soldier these statements, and endorsed with a statement to this effect by the officer. The endorsement should exhibit a full statement of the time for which the Soldier was allowed pay on his final statements, the clothing, account, and all other charges against him or in his favor, so as to comprise a complete exhibit of his account. It will then be transmitted to the Company Commander of the Soldier, who will enter all the data necessary to a full understanding of the Soldier's account on the muster roll upon which the Soldier's discharge is reported. The descriptive list will then be destroyed. The object of this is, that the remaining portion of the Soldier's account may be settled upon the receipt of these muster rolls, and the Soldier receive any pay or allowances that may be due him at the time of his discharge, and which may not appear on his last final statements from the fact that his descriptive list is incomplete. These accounts for back pay, &c., are settled by the 2d Auditor of the Treasury Department.

NOTE 4.—Charges for loss or injury to ordnance, horse equipments, and other miscellaneous charges, should appear under the heading of "Other Stoppages."

NOTE 5.—Bounty paid by State authorities, and not by the United States, will not be entered on this statement.

NOTE 6.—Amounts due the Sutler and Laundress must be entered on the muster roll on which the discharge, death, desertion, &c., is reported, as well as on the final statement, otherwise the amount cannot be collected from the United States.

NOTE 7.—This blank will be used for deceased volunteers and drafted men, as well as for others.

NOTE 8.—Where a Soldier dies in Hospital or on detached service, his descriptive list, if he has one, should be sent with his final statements, in duplicate, to the Adjutant General, Washington, D. C.

NOTE 9.—If the soldier is a drafted man or substitute, the space for time, &c., or enrolled, should contain only the word *drafted* or *substitute*, as the case may be. If the Soldier is a "VETERAN," (or RECRUIT,) the words *as a veteran*, (or *recruit*) as the case may be, should be interlined after the words *mustered into the service of the U. S.* A statement of all the installments of *Veteran* or *Recruit Bounty* RECEIVED by the Soldier must be made on the back of each final statement.

ADJUTANT GENERAL'S OFFICE.

Mar 3rd 1865.

Duplicate with Inventory sent 2d Auditor,

I certify, on honor, that Jessie Russell, a Private of
 Captain Chas. J. Green Company (B) of the 5th Regiment of U.S. Cavalry
VOLUNTEERS, of the State of _____, born in Bourban Co., State
 of Kentucky, aged 19 years; 5 feet 5 inches high; Black complexion,
Black eyes, Black hair, and by occupation a Laborer, who joined for service
 and was enrolled (see Note 9) on the 17th day of August, 1864, at Lexington Ky
 by Capt. Moore, P. M., for the period of Three years, and mustered into
 the service of the United States on the 20th day of August, 1864 at
Lexington Ky, by Capt. Moore P. M.; and having served
 HONESTLY and FAITHFULLY with his Company to the present date, is now entitled to a
DISCHARGE by reason of Death He was drowned
crossing Church River Dec 24th 1864
 The said Jessie Russell was last paid by Paymaster
enlistment, to include the _____ day of _____, 186____, and
 has pay due him from that time to the 24th Dec 1864 present date; he is entitled to pay and subsistence for
TRAVELING to place of enrollment, and whatever other allowances are authorized to volunteer
 soldiers, drafted men, or militia, so discharged. He has received from the United States **CLOTHING**
 amounting to Fifty seven⁷⁵ dollars, since the 20 day of August
 1864 when his clothing account was last settled. He has received from the United States
 _____ dollars advanced **BOUNTY**.

There is to be stopped from him, on account of the State of _____, or other
 authorities, for **CLOTHING**, &c., received on entering service, _____ dollars; and
 for other stoppages, viz: _____

_____ dollars.
 He has been furnished with **TRANSPORTATION** in kind from the place of his discharge to
 _____; and he has been **SUBSISTED** for **TRAVELING** to his
 place of enrollment, up to the _____, 186____.

He is indebted to _____, **SUTLER**, _____ dollars.

He is indebted to _____, **LAUNDRESS**, _____ dollars.

Given in Duplicate, at In the field, this 31st day
 of December, 1864.

Chas. J. Green
Captain
 Commanding Company

INVENTORY OF THE EFFECTS

OF

Jesse Russell

Late of Company B

5 Reg't of U.S. Cavalry

Volunteers, who ~~died~~ ^{was} at Drowned

on the 24 day of December 1864



Inventory of the effects of Jesse Russell late
 a Private of Captain Chas. J. Green Company B of
 the 5th Regiment of U.S. Cavalry Volunteers, who was enrolled as
 a Private at Lickingtown in the State of Kentucky on
 the 17 day of August 1864, and mustered into the service of the United
 States as a Private on the 20th day of August 1864, at Lickingtown Ky
 in Company B, 5 Regiment of U.S. Cavalry Volunteers, to serve Three
 years or during the war; he was born in Bourbon County in the State
 of Kentucky; he was 19 years of age, 5 feet 5 inches
 high, Black complexion, Black eyes, Black hair, and by occupation, when enrolled,
 a Laborer; he ~~died in~~ was drowned in ~~the~~
crossing Clinch River on the 24 day of December 1864, by
 reason of

INVENTORY.						
ARTICLES.	No.	ARTICLES.	No.	ARTICLES.	No.	
Hats.....	No Effects	Pairs trousers.....	No Effects	Knapsacks.....		
Caps.....		Pairs flannel drawers.....				
Forage caps.....		Pairs cotton drawers.....				
Great coats.....		Flannel shirts.....				
Uniform coats.....		Cotton shirts.....				
Uniform jackets.....		Pairs boots.....				
Flannel sack coats.....		Pairs shoes.....				
Blouses.....		Pairs socks.....				
Stable frocks.....		Blankets.....				
Fatigue overalls.....		Haversacks.....				
				MONEY.	Specie.....	\$
					Notes.....	\$

I CERTIFY, ON HONOR, that the above inventory comprises all the effects of Jesse Russell, deceased, and that the effects are in the hands of X X X X X at X X X to be disposed of by a Council of Administration.

(DUPLICATES.)

Chas. J. Green
Captain
 Commanding the Company.

STATION: In the field

DATE: December 31st 1864

1110
Russell Pius

Co D, 5 U. S. Col'd Cav.

Private Private

CARD NUMBERS.

1	5362712	26
2	5362807	27
3	5362904	28
4	5362989	29
5	5363084	30
6	5363171	31
7	5363260	32
8	5363350	33
9	5363436	34
10	5363528	35
11	5363606	36
12	9090341	37
13	43145848	38
14	43146502	39
15	40730280	40
16		41
17		42
18		43
19		44
20		45
21		46
22		47
23		48
24		49
25		50

Book Mark: ~~3209 C. A. & G.~~

See also

Rep 378370-

S. 1201672 P.O. W. W. W.

R+P 418921-

S-1778693 P.O. OH

J. B. Powell
Exp

R

5 Cav. | U.S.C.T.

Wins Russell

Co. *40*, 5 Reg't U. S. Col'd Cav.

Appears on

Company Descriptive Book

of the organization named above.

DESCRIPTION.

Age *24* years; height *5* feet *5* inches.

Complexion *Copper*

Eyes *Black*; hair *Black*

Where born *Same N.Y.*

Occupation *farmer*

ENLISTMENT.

When *Aug 15*, 186*4*.

Where *Latham*

By whom *Capt Fidler*, term *3* y'rs.

Remarks:

F E Purke

P | 5 bar | US 67.

Pius Russell

Appears with rank of _____ on

Muster and Descriptive Roll

of Detachment of US Colored
Volunteer Recruits for-
warded

Roll dated
Lebanon, Ky, Aug 31, 1864.

Where born Larue Ky

Age 24 years; occupation farmer

When enlisted Aug 15, 186 .

Where enlisted Lebanon Ky

For what period enlisted 3 years.

Eyes Blk ; hair Blk

Complexion Blk ; height 5 ft. 5 in.

When mustered in Aug 15, 186 .

Where mustered in Lebanon Ky

Bounty paid \$ 100; due \$ 100

Clothing account:

Last settled _____, 186 ; drawn since \$ 17 ⁵⁰/₁₀₀

Date of first muster Aug 27, 186 4.

Company to which assigned _____

Remarks: Owner, Mary
Russell, Larue Co
Without consent
4 Cong Dist, Ky

Book mark: _____

(356m)

G. B. Barton Copyist.

R

5 bar

U.S.C.T.

Pius Russell.

Appears with rank of Pvt on

Muster and Descriptive Roll

of a Detachment of U. S. Colored
Troops formed for U. S. Colored
serv. at Lexington, Ky. Roll dated

Louisville, Ky., Sep. 7, 1864.

Where born Larue, Ky

Age 24 years; occupation Farmer

When enlisted Aug. 15, 1864.

Where enlisted Lebanon.

For what period enlisted 3 years.

Eyes Blue; hair Blue

Complexion Blue; height 5 ft. 5 in.

When mustered in Aug. 27, 1864.

Where mustered in Lebanon

Bounty paid \$ 100; due \$ 100

Clothing account:

Last settled _____, 186 ; drawn since \$ 17⁵⁰/₁₀₀

Date of first muster Aug. 27, 1864.

Company to which assigned _____

Remarks: Created to 4 Cong. Dist.
Ky.

Book mark: _____

P. J. Russell

(356m)

Copyist.

R | 5 Cav. | U.S.C.T.

Pais Russell

Co. A, Co. *A*, 5 Reg't U. S. Col'd Cavalry.

Appears on

Company Muster-in and Descriptive Roll

of the organization named above. Roll dated

Camp Nelson, Ky, N.Y., *Oct. 24*, 1864.

Where born *Larue, Ky*

Age *24* y'rs; occupation *Farmer*

When enlisted *Aug. 15*, 1864.

Where enlisted *Lebanon*

For what period enlisted *3* years.

Eyes *Bk*; hair *Bk*

Complexion *Bk*; height *5* ft. *5* in.

When mustered in *Aug. 10*, 1864.

Where mustered in *Greenupburg*

Bounty paid \$ *100*; due \$ *100*

Where credited *4 Dist. Ky*

Company to which assigned

Remarks:

Book mark:

Wm H Scott

(356d)

Copyist.

R | 5 Cav. | U.S.C.T.

James Russell

Priv., Co. D, 5 Reg't U. S. Col'd Cavalry.

Appears on

Company Muster Roll

for *Dated Oct. 31*, 186*4*.

Present or absent *Absent*

Stoppage, \$ *100* for

Due Gov't, \$ *100* for

Valuation of horse, \$ *100*

Valuation of horse equipments, \$ *100*

Remarks: *Sick - Camp Nelson Ky.*

Book mark:

Wm. H. Scott

(358)

Copyist.

R

5 Cav. U.S.C.T.

Peter Raper

Priv., Co. D, 5 Reg't U. S. Col'd Cavalry.

Appears on

Company Muster Roll

for Nov. & Dec., 1864.

Present or absent Absent

Stoppage, \$ 100 for

Due Gov't, \$ 100 for

Valuation of horse, \$ 100

Valuation of horse equipments, \$ 100

Remarks: Sick in Hospital, Camp Nelson, Ky. 1 & 2 installments of Bounty due.

Book mark:

Wm. H. Scott

R | **5 Cav. | U.S.C.T.**

Chris Raper

Pvt, Co. D, 5 Reg't U. S. Col'd Cavalry.

Appears on

Company Muster Roll

for *Jan. + Feb.*, 186*5*.

Present or absent *Present.*

Stoppage, \$ *100* for

Due Gov't, \$ *100* for

Valuation of horse, \$ *100*

Valuation of horse equipments, \$ *100*

Remarks: *1st installment of
Bounty due \$100.*

Book mark:

Wm. H. Scott

(358)

Copyist.

R | 5 Cav. | U.S.C.T.

Pius Raper

Pol, Co. D, 5 Reg't U. S. Col'd Cavalry.

Appears on

Company Muster Roll

for *March & April*, 1865.

Present or absent *Present.*

Stoppage, \$ *100* for

Due Gov't, \$ *100* for

Valuation of horse, \$ *100*

Valuation of horse equipments, \$ *100*

Remarks: *1st installment of
Bounty due \$100.*

Book mark:

Wm. H. Scott

(358)

Copyist.

R 5 Cav. U.S.C.T.

Pius Raper

Priv., Co. D, 5 Reg't U. S. Col'd Cavalry.

Appears on

Company Muster Roll

for *May & June*, 1865.

Present or absent *Present*

Stoppage, \$ *100* for

Due Gov't, \$ *100* for

Valuation of horse, \$ *100*

Valuation of horse equipments, \$ *100*

Remarks: *1st Installment Bounties due \$100.00.*

Book mark:

Milliken

(358)

Copyist.

R

5 Cav. U.S.C.T.

Luis Raper

Priv., Co. D, 5 Reg't U. S. Col'd Cavalry.

Appears on

Company Muster Roll

for July & Aug., 1865.

Present or absent present

Stoppage, \$ 100 for

Due Gov't, \$ 100 for

Valuation of horse, \$ 100

Valuation of horse equipments, \$ 100

Remarks:

Book mark:

Williken

(358)

Copyist.

A

5 Cav. U.S.C.T.

Leis Raper

Priv., Co. D, 5 Reg't U. S. Col'd Cavalry.

Appears on

Company Muster Roll

for *Sept. & Oct.*, 186*5*.

Present or absent *present*

Stoppage, \$ *100* for

Due Gov't, \$ *100* for

Valuation of horse, \$ *100*

Valuation of horse equipments, \$ *100*

Remarks: *Due U.S. for camp & Garrison \$0.65.*

Book mark:

Williken

(358)

Copyist.

R

5 Cav. U.S.C.T.

J. Raper

Priv., Co. D, 5 Reg't U. S. Col'd Cavalry.

Appears on

Company Muster Roll

for *Nov. & Dec.*, 1865.

Present or absent *present.*

Stoppage, \$ *100* for

Due Gov't, \$ *100* for

Valuation of horse, \$ *100*

Valuation of horse equipments, \$ *100*

Remarks:

Book mark:

Milliken

(358)

Copyist.

R. | 5 Cav. | U.S.C.T.

Time Raper

Private, Co. D, 5 Reg't U. S. Col'd Cavalry.

Appears on

Company Muster Roll

for *Jan'ynd Feb'y*, 186*6*.

Present or absent *Present.*

Stoppage, \$ *100* for

Due Gov't, \$ *100* for

Valuation of horse, \$ *100*

Valuation of horse equipments, \$ *100*

Remarks: *2^d Installment Boun-*
ty due \$ 100.00.

Book mark:

(358)

W. D. ...

Copyist.

R | 5 Cav. | U.S.C.T.

Pius Russell *

Bot, Co. D, 5 Reg't U. S. Colored Cav.

Appears on Returns as follows:

Oct to Dec 1864 Absent sick
in Hosp. Camp Nelson,
Ky date not known

March to May 1865. On duty
Co. C 6th

* Name appears also as
Pius Raper

Book mark :

Storrell

(546)

Copyist.

R. | 5 Cav. | U.S.C.T.

Russell
Tim Russell,

Emt., Co. *L*, 5 Reg't U. S. Col'd Cavalry.

Appears on Co. Muster-out Roll, dated

Selma, Ark., March 16, 1866.

Muster-out to date *March 16,* 1866.

Last paid to *Dec. 31,* 1865.

Clothing account:

Last settled....., 186 ; drawn since \$..... 100

Due soldier \$ *23.93* / 100; due U. S. \$..... 100

Am't for cloth'g in kind or money adv'd \$..... 100

Due U. S. for arms, equipments, &c., \$..... 100

Bounty paid \$ *100.00* / 100; due \$ *100.00* / 100

Remarks:

**Corrected by J.B. Durd. Esq.*

Book mark: *3209 C.T. / 186**

**Cancelled Bookmark does not refer to this man: July 9/95. HoJ*

N.B. Dummer

Russell Piers

, Co.

Reg't

W S C T

Enclosures.

Bed Cards	Final Statements
Burial Records	Furloughs or L. of A
Certs. of Dis. for Discharge	Med. Certificates
C. M. Charges	Med. Des. Lists
Descriptive Lists	Orders
Discharge Certificates	Pris. of War Record
Enlistment Papers	Resignations

Other papers relating to—

Admission to Hosp'l	Furlough or L. of A
Casualty Sheet	Med. Examination
Confinement	Misc. Information
Contracts	Pay or Clothing
Death or Effects	Personal Reports
Desertion	Rank
Discharge from Hosp'l	Transfer to Hosp'l
Discharge from Service	Transfer to V. R. C.
Duty	Transportation

NOTE 1.—This blank will be used for enlistments of United States colored troops. They will be made out in duplicate in all cases—one to accompany the recruiting turn of the superintendent (not the recruiting officer) to the Adjutant General, and one to accompany the accounts of the officer who pays bounty, &c.

NOTE 2.—An enlistment holds to service. A muster-in must, in all cases, precede payment of pay, bounty, pension, &c. A muster-in roll, must in all cases, be filed in the Adjutant General's Office as evidence of muster-in. The mustering officer, commissary, or assistant commissary of musters, as the case may be, will countersign both musters as having mustered the soldiers into the service of the United States before either of them is given to the disbursing officer.

DECLARATION OF RECRUIT.

I, *Pius Ruppel* desiring to volunteer as a soldier in the ARMY OF THE UNITED STATES, for the term of *Three Years*, DO DECLARE That I am *24* years and months of age; that I have never been discharged from the United States service on account of disability or by sentence of a court-martial, or by order before the expiration of a term of enlistment; and I know of no impediment to my serving honestly and faithfully as a soldier for three years.

GIVEN at *Lebanon Ky* the *15th* day of *August 1864*

Witness: *J. A. Adell*

Pius Ruppel
mark

B^y

Volunteered at *Lebanon Ky*

August 15th 1864

Wm. Miller
Capt. 15th Regt. Ind. Inf.

John Ruppel

No. *541*
Smith's Co. 9th

Slave
Muster Name - *Mary Ruppel*

Enl without consent

Consent of Parent or Guardian in case of a Minor, if a Free Man, or ~~in case of~~ a Slave, of the Person to whom he owes Service:

I, Do CERTIFY, That I am the that the said is years of age; and I do freely give my CONSENT to his volunteering as a SOLDIER in the Army of the United States, for the period of THREE YEARS, under the conditions of the laws of the United States.

GIVEN at the day of

Witness:

UNITED STATES COLORED TROOPS ENLISTMENT.

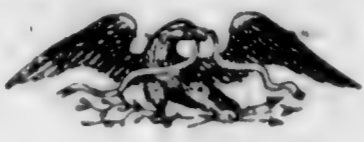
STATE OF *Kentucky*  TOWN OF *Lurie* County of *Lurie*
 I, *Pius Pusep* born in *Lurie*
 in the State of *Kentucky* aged *24* years
 and by occupation a *farmer* Do HEREBY ACKNOWLEDGE to
 have volunteered *15th* day of *August* 1864
 to serve as a **Soldier** in the **Army of the United States of America**, for the
 period of **THREE YEARS**, unless sooner discharged by proper authority: Do
 also agree to accept such bounty, pay, rations, and clothing, as are, or may be,
 established by law for the U. S. colored troops.

And I, *Pius Pusep*
 do solemnly swear that I will bear true faith and allegiance to the **United States
 of America**, and that I will serve them honestly and faithfully against all their
 enemies or opposers whomsoever; and that I will observe and obey the orders
 of the President of the United States, and the orders of the officers appointed
 over me, according to the Rules and Articles of War.

Sworn and subscribed to, at *Lebanon Ky*
 this *15th* day of *August* 1864 *Pius Pusep*
 Before *Wm Hedley* *Enoch*
Capt & Prov Mar 4th Dist Ky

I CERTIFY, ON HONOR, That I have carefully examined the above named Volunteer agree-
 ably to the General Regulations of the Army, and that, in my opinion, he is free from all bodily
 defects and mental infirmity, which would in any way disqualify him from performing the
 duties of a **soldier**.

John C. Maxwell

EXAMINING SURGEON.

I CERTIFY, ON HONOR, That I have minutely inspected the Volunteer *Pius Pusep*
 previously to his enlistment, and that he was entirely sober when enlisted; that, to the best of
 my judgment and belief, he is of lawful age; and that, in accepting him as duly qualified to per-
 form the duties of an able-bodied soldier, I have strictly observed the regulations which govern
 the recruiting service. This soldier has *black* eyes, *black* hair, *black* com-
 plexion, is *5* feet *5* inches high.

Wm Hedley

Capt & Prov Mar 4th Ky RECRUITING OFFICER OR AGENT.

Mustered into the United States Service *27th* day of *Aug*, 1864

Wm Hedley

Capt & Prov Mar 4th Ky Mustering Officer

Mustered into the service of the United States, for three years or during the war, from date of enlistment, in Company _____
 Regiment of _____ Volunteers, on the _____ day of _____, 1864, at _____

Russell Robert

Co A, 5 U. S. Col'd Cav.

Private | Private

CARD NUMBERS.

1	5364748	26
2	5364841	27
3	5364941	28
4	5365031	29
5	5365122	30
6	5365211	31
7	5365302	32
8	5365391	33
9	5365481	34
10	5365569	35
11	5365658	36
12	9090579	37
13		38
14		39
15		40
16		41
17		42
18		43
19		44
20		45
21		46
22		47
23		48
24		49
25		50

Book Mark:

See also

A | **5 Cav.** | **U.S.C.T.**

Robert Russell

Co. *L*, 5 Reg't U. S. Col'd Cav.

Appears on

Company Descriptive Book

of the organization named above.

DESCRIPTION.

Age *27* years; height *5* feet *6* inches.

Complexion *Black*

Eyes *Black*; hair *Black*

Where born *Woodford Ky*

Occupation *farmer*

ENLISTMENT.

When *Sep 15*, 186 .

Where *Camp Nelson*

By whom *J. Randolph*; term *3* y'rs.

Remarks:

J. E. Purdie

R

5 Cav.

U.S.C.T.

Robert Russell

Priv, Co. F, 5 Reg't U. S. Col'd Cavalry.

Appears on

Company Muster-in and Descriptive Roll

of the organization named above. Roll dated

Sept Nelson, N. Y., Oct 29, 1864.

Where born Woodford Ky

Age 27 y'rs; occupation Farmer

When enlisted Sept 15, 1864.

Where enlisted Sept Nelson

For what period enlisted 3 years.

Eyes Blk; hair Blk

Complexion Blk; height 5 ft. 6 in.

When mustered in Sept 15, 1864.

Where mustered in Sept Nelson

Bounty paid \$ 100; due \$ 100

Where credited 7 Dist Ky

Company to which assigned F.

Remarks: Name of owner of Negro - Wm Bush

* Added May 13/78 C.A.R.

Book mark: B 1777 Ky

Sumner

R

5 Cav. | U.S.C.T.

Robert Russell

Pvt, Co. F, 5 Reg't U. S. Col'd Cavalry.

Appears on

Company Muster Roll

for *to Oct 31*, 186 *4*.

Present or absent *Present*

Stoppage, \$ *100* for

Due Gov't, \$ *100* for

Valuation of horse, \$ *100*

Valuation of horse equipments, \$ *100*

Remarks:

Book mark: -----

(358)

Currier

Copyist.

R | 5 Cav. | U.S.C.T

Robert Russell

Regt, Co. F, 5 Reg't U. S. Col'd Cavalry

Appears on

Company Muster Roll

for Nov. 8 Dec., 1864.

Present or absent Present

Stoppage, \$ 100 for

Due Gov't, \$ 100 for

Valuation of horse, \$ 100

Valuation of horse equipments, \$ 100

Remarks: 1 & 2 Install, bounty due.

Book mark:

(358)

Fitz Copyist. Cooper

A

5 Cav. U.S.C.T.

Robert Russell

Privt

Co. F, 5 Reg't U. S. Col'd Cavalry.

Appears on

Company Muster Roll

for Jan & Feb, 1865.

Present or absent Present.

Stoppage, \$ 100 for

Due Gov't, \$ 100 for

Valuation of horse, \$ 100

Valuation of horse equipments, \$ 100

Remarks:

1st allment Bounty \$100 due

Book mark:

Currin

(358)

Copyist.

A

5 Cav. U.S.C.T.

Robert Russell

Private, Co. F, 5 Reg't U. S. Col'd Cavalry.

Appears on

Company Muster Roll

for May & Apr, 1865

Present or absent Present

Stoppage, \$ 100 for

Due Gov't, \$ 100 for

Valuation of horse, \$ 100

Valuation of horse equipments, \$ 100

Remarks:

First installment of
Bounty due

Book mark:

Russell

(858)

Copyist.

R | 5 Cav. | U.S.C.T.

Robert Russell

Pvt., Co. F, 5 Reg't U.S. Col'd Cavalry.

Appears on

Company Muster Roll

for May & June, 1865.

Present or absent Present

Stoppage, \$ 100 for

Due Gov't, \$ 100 for

Valuation of horse, \$ 100

Valuation of horse equipments, \$ 100

Remarks: 1st Instalment Bounty
due \$ 100.

Book mark:

(358)

Wark
Copyist.

R | 5 Cav. | U.S.C.T.

Robert Russell

Pvt, Co. F, 5 Reg't U.S. Col'd Cavalry.

Appears on

Company Muster Roll

for July & Aug, 1865.

Present or absent Present

Stoppage, \$ 100 for

Due Gov't, \$ 100 for

Valuation of horse, \$ 100

Valuation of horse equipments, \$ 100

Remarks:

Book mark:

Mark Copyist.

R

5 Cav. U.S.C.T.

Robert Russell

Pvt, Co. F, 5 Reg't U.S. Col'd Cavalry.

Appears on

Company Muster Roll

for Sept 20th, 1865.

Present or absent Present

Stoppage, \$ 100 for

Due Gov't, \$ 100 for

Valuation of horse, \$ 100

Valuation of horse equipments, \$ 100

Remarks:

Book mark:

Hark

Copyist.

(358)

R

5 Cav. U.S.C.T.

Robert Russell

Pvt, Co. F, 5 Reg't U. S. Col'd Cavalry.

Appears on

Company Muster Roll

for Nov & Dec, 1865.

Present or absent Present

Stoppage, \$ 100 for

Due Gov't, \$ 100 for

Valuation of horse, \$ 100

Valuation of horse equipments, \$ 100

Remarks:

Book mark:

Hart

Copyist.

(358)

R

5 Cav. U.S.C.T.

Robert L Russell

Priv, Co. F, 5 Reg't U. S. Col'd Cavalry.

Appears on

Company Muster Roll

for Jan & Feb, 1866

Present or absent Present

Stoppage, \$ 100 for

Due Gov't, \$ 100 for

Valuation of horse, \$ 100

Valuation of horse equipments, \$ 100

Remarks:

Book mark:

(358)

G. W. Davis

Copyist.

R | 5 Cav. | U.S.C.T.

Robert Russell

Priv., Co. F, 5 Reg't U. S. Col'd Cavalry.

Appears on Co. Muster-out Roll, dated Helena Ark, Feb 16, 1866.

Muster-out to date Feb 16, 1866.

Last paid to Dec 31, 1865.

Clothing account:

Last settled _____, 1866 ; drawn since \$ _____ 100

Due soldier \$ 39 ⁶⁰/₁₀₀; due U. S. \$ _____ 100

Am't for cloth'g in kind or money adv'd \$ _____ 100

Due U. S. for arms, equipments, &c., \$ _____ 100

Bounty paid \$ 100 ⁰⁰/₁₀₀; due \$ 100 ⁰⁰/₁₀₀

Remarks: _____

Book mark: B 1799 Reg

W. J. Davis

(361)

Copyist.

Russell Robt

P-5, Co. 7

5 Reg't US 66

2 Enclosures.

Bed Cards	Descriptive Lists
Burial Records	Final Statements
Certs. of Dis. for Discharge	Furloughs
C. M. Charges	Med. Des. Lists
Med. Certificates	Orders

E. P.

Other papers relating to—

Admission to Hosp'l	Furlough
Casualty Sheet (Officer's)	Med. Examination
Confinement	Misc. Information /
Contracts	Pay or Clothing
Death or Effects	Personal Reports
Desertions	Rank
Discharge from Hosp'l	Transfer to Hosp'l
Discharge from Service	Transfer to V. R. C.
Duty	Transportation

E.P. filed 1/7/09 WCB

NOTE 1. This blank will be used for enlistments of United States colored troops. They will be made out in duplicate in all cases—one to accompany the recruiting return of the superintendent (not the recruiting officer) to the Adjutant-General, and one to accompany the accounts of the officer who pays bounty, &c.

NOTE 2. An enlistment holds to service. A muster-in must, in all cases, precede payment of pay, bounty, pension, &c. A muster-in roll must in all cases be filed in the Adjutant-General's Office as evidence of muster-in. The mustering officer, commissary, or assistant commissary of musters, as the case may be, will countersign both enlistments as having mustered the soldiers into the service of the United States before either of them is given to the disbursing officer.

DECLARATION OF RECRUIT.

I, Robert Russell, desiring
to volunteer as a soldier in the ARMY OF THE UNITED STATES, for the term of Three years,
DO DECLARE that I am 37 years and _____ months of age; that
I have never been discharged from the United States service on account of disability or
by sentence of a court-martial, or by order before the expiration of a term of enlistment;
and I know of no impediment to my serving honestly and faithfully as a soldier for
three years.

GIVEN at Camp Nelson Ky
the 15th day of September 1864

Witness: J. C. Stock

Robert Russell
mark

By

Wm. H. Davis
Volunteered at Camp Nelson
Sept 15, 1864

Both
the
No. 1000

Consent of Parent or Guardian in case of a Minor, if a Free Man, or in the case of a Slave,
of the Person to whom he owes Service:

I, _____ Do CERTIFY, That I am
the _____
that the said _____ is _____ years of age; and I
do freely give my CONSENT to his volunteering as a SOLDIER in the Army of the United
States, for the period of THREE YEARS, under the conditions of the laws of the United
States.

GIVEN at _____
the _____ day of _____

Witness: _____

UNITED STATES COLORED TROOPS ENLISTMENT.

Mustered into the service of the United States, for three years or during the war, from date of enlistment, in Company

STATE OF

TOWN OF

Kentucky
 I, *Robert Russell*, born in *Woodford Co*,
 in the State of *Kentucky*, aged *Twenty seven* years,
 and by occupation a *Farmer*, Do HEREBY ACKNOWLEDGE to
 have volunteered *Fifteenth* day of *September* 1864,
 to serve as a Soldier in the Army of the United States of America, for the period of
THREE YEARS, unless sooner discharged by proper authority: Do also agree to
 accept such bounty, pay, rations, and clothing, as are, or may be, established by law for
 the U. S. colored troops.

And I, *Robert Russell*
 do solemnly swear that I will bear true faith and allegiance to the United States of
 America, and that I will serve them honestly and faithfully against all their enemies
 or opposers whomsoever; and that I will observe and obey the orders of the President
 of the United States, and the orders of the officers appointed over me, according to the
 Rules and Articles of War.

Sworn and subscribed to, at *Camp Nelson*
 this *15th* day of *Sept* 1864, *Robert Russell*
 Before *J. C. Randolph* *mark*
J. C. M.

I CERTIFY, ON HONOR, That I have carefully examined the above named Volunteer agreeably to the General Regula-
 tions of the Army, and that, in my opinion, he is free from all bodily defects and mental infirmity, which would in any
 way disqualify him from performing the duties of a soldier.

P. G. Barrett
Examining Surgeon.

I CERTIFY, ON HONOR, That I have minutely inspected the Volunteer, *Robert Russell* previously to
 his enlistment, and that he was entirely sober when enlisted; that, to the best of my judgment and belief, he is of law-
 ful age; and that, in accepting him as duly qualified to perform the duties of an able-bodied soldier, I have strictly ob-
 served the regulations which govern the recruiting service. This soldier has *Blue* eyes, *Black* hair,
Dark complexion, is *Five* feet *Eight* inches high.

J. C. Randolph
Recruiting Officer or Agent.

Mustered into the United State service *15* day of *Sept*, 1864.

W. C. Kinney
Mustering Officer.

Regiment of *U S Colored Cavalry* Volunteers, on the *15th* day of *September* 1864, at *Camp Nelson*

W. C. Kinney
Capt 18th U S C

Mustering Officer

War Department,

ADJUTANT GENERAL'S OFFICE,

Washington, April 8th 1867.

Respectfully returned to the
Commission for the State of
Ky.

with the informa-
tion that Robert Russell

was enlisted at Camp Nelson Ky.
Sept. 15. 1864. and was

mustered in as Pvt. in Co. F
5th U. S. Colored Reg. Sept. 15/64.

Wm. Hayward

Asst. Adj't General.

J.B.

ENDORSEMENT.

No. 1799

APPLICATION OF

William Bush

Jessamine OF
Duyette County Ky

For Compensation for Service of Slave,

Robert Russell

Enlisted _____, 186 ,

In *F* Co., *5th Col* Regiment

U. S. Colored Troops.

Received *July 16*, 186 *7*.

Compensation Awarded

, 186 ,

Dollars.

President Board of Claims.

P. O. ADDRESS OF CLAIMANT:

Hanley

Jessamine Co

B & Bruce & Co

Atty General

POWER OF ATTORNEY.

My Post-office address is _____, County of _____, State of Kentucky, and I hereby direct that all communications to me, touching this claim, be sent under cover to _____, who is hereby appointed and constituted my true and lawful attorney, to prosecute this claim for me, and who is hereby authorized and empowered to receive and receipt for any award, order, draft, certificate, voucher, warrant, papers, or money that may be issued in the adjustment of this claim, or the payment thereof, the same as I might or could do in person were I present and acting for myself, and to file any additional evidence or papers that may be required in the prosecution of this claim.

[WITNESS.]

The owner signs here.

William Bush

Two witnesses to owner's signature sign here.

C. B. Howard

R. G. Bush



oath, which I have taken, signed and acknowledged, to be filed with this application, in accordance with requirement of General Orders No. 329, 1863, War Department, Adjutant General's Office.

He was a slave for life
William Bush

December 3rd 1866.

Oath of Allegiance.

I, *William Bush*, the owner and claimant, do solemnly swear

that the foregoing claim is a just and true claim due to me as master and owner of the said slave, and that the facts alleged in said claim in respect to the draft or enlistment [as the case may be] of said slave into the military service of the United States are true. And I do further swear, that I have never joined, or been concerned in, any insurrection or rebellion; that I have never borne arms against the United States; that I have never given any aid, countenance, counsel, or encouragement to any person or persons engaged, or whom I had reason to believe were about to engage, in insurrection, rebellion, or armed hostility against the United States; that I have neither sought nor accepted, nor attempted to exercise the functions of any office, civil or military, nor to perform any service whatever, under any authority, or pretended authority, in hostility to the United States; that I have not yielded a voluntary support to any insurrection, rebellion, or pretended government, authority, power, or constitution within the United States, hostile thereto. And I do further swear, that, to the best of my knowledge and ability, I have supported and defended, and will continue to support and defend, the United States, against all enemies, foreign and domestic; and that I have supported, defended, and obeyed, and will continue to support, defend, and obey, the Constitution and laws of the United States; that I will bear true faith and allegiance to the same; and that I take this oath freely, without any mental reservation or purpose of evasion: So help me God.

William Bush



Sworn to and subscribed before me, a *Notary Public*,
this *3* day of *Dec*, 1866.

J. G. Duran
Notary Public

Claim for Compensation for Enlisted Slave.

No.
I, *William Bush*, a loyal citizen, and a resident
of *Nawley*, County of *Jessamine*, State of *Kentucky*,
hereby claim compensation, under the provisions of section 24, Act approved February 24, 1864, and section 2, Act
approved July 28, 1866, for my slave *Rob or Robert Russell*,
enlisted _____, 186____, at _____, by _____,
in the *5th Cavalry* Regiment U. S. Colored
Troops, Co. *F*; certificate of which enlistment, and a descriptive list, as required, accompany this application.

In proof of my loyalty to the Constitution and Government of the United States, I present the accompanying
oath, which I have taken, signed and acknowledged, to be filed with this application, in accordance with requirement
of General Orders No. 329, 1863, War Department, Adjutant General's Office.

December 3rd, 186*6*.

He was a slave for life
William Bush

Oath of Allegiance.

I, *William Bush*, the owner and claimant, do solemnly swear
that the foregoing claim is a just and true claim due to me as master and owner of the said slave, and that the facts
alleged in said claim in respect to the draft or enlistment [as the case may be] of said slave into the military service of the
United States are true. And I do further swear, that I have never joined, or been concerned in, any insurrection or rebellion;
that I have never borne arms against the United States; that I have never given any aid, countenance, counsel, or encouragement
to any person or persons engaged, or whom I had reason to believe were about to engage, in insurrection, rebellion, or
armed hostility against the United States; that I have neither sought nor accepted, nor attempted to exercise the functions
of any office, civil or military, nor to perform any service whatever, under any authority, or pretended authority, in
hostility to the United States; that I have not yielded a voluntary support to any insurrection, rebellion, or pretended
government, authority, power, or constitution within the United States, hostile thereto. And I do further swear, that, to
the best of my knowledge and ability, I have supported and defended, and will continue to support and defend, the
United States, against all enemies, foreign and domestic; and that I have supported, defended, and obeyed, and will continue to
support, defend, and obey, the Constitution and laws of the United States; that I will bear true faith and allegiance to the
same; and that I take this oath freely, without any mental reservation or purpose of evasion: So help me God.

William Bush



Sworn to and subscribed before me, a *Notary Public*,
this *3* day of *Dec*, 186*6*.

J. G. Harrison
Notary Public

Proof of Ownership.

State of Kentucky, }
COUNTY OF Hayette } SS.

WE, John Kearney and J. E. Hamaby, each
of lawful age, and resident citizens of the State and County aforesaid, do certify that William
Rush, of the State and County aforesaid, was, on the 1st day
of January, 1860, the lawful owner of the slave named Robt Russell,
referred to and described in the foregoing claim for compensation.

John Kearney
J. E. Hamaby

Sworn to and subscribed before me, a Notary Public for the County of
, State of Kentucky, this the 3 day of Decr, 1866.

J. P. Davidson
Notary Public



Proof of Loyalty.

State of Kentucky, }
COUNTY OF Hayette } SS.

WE, John Kearney and J. E. Hamaby, loyal
men, and each of lawful age, and resident citizens of the County of Hayette,
in the State and County aforesaid, upon our oaths declare that we have known William Rush of
Assurance Co, a resident of the State and County aforesaid, since the 4th day of March, 1861, and
know that he has firmly and faithfully maintained his adherence and allegiance to the Government of the
United States, by defending its cause against the Government and forces of the so-called Confederate States of
America, in all suitable and practicable ways, and according to his ability and opportunity.

J. E. Hamaby
John Kearney

Sworn to and subscribed before me, a Notary Public for the County of
, State of Kentucky, this the 3 day of Decr, 1866.

J. P. Davidson
Notary Public

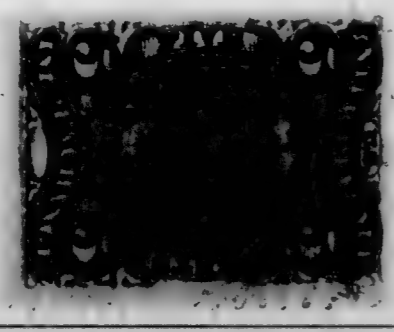

Russell William

Co I, 5 U. S. Col'd Cav.

Private Private

CARD NUMBERS.

1	5367842	26
2	5367933	27
3	5368033	28
4	5368126	29
5	5368218	30
6	5368311	31
7	5368402	32
8	5368490	33
9	5368574	34
10	5368661	35
11	5368743	36
12	4001003	37
13	9221648	38
14	43143174	39
15	40730281	40
16		41
17		42
18		43
19		44
20		45
21		46
22		47
23		48
24		49
25		50

Book Mark:

See also

R | *5 Cav.*
108 | **U.S.C.T.**

William Russel

Co. *A*, 108 Reg't U. S. Col'd Infantry.

Appears on

Company Descriptive Book

of the organization named above.

DESCRIPTION.

Age *20* years; height *5* feet *6* inches.

Complexion *Copper*

Eyes *Bru*; hair *Blk*

Where born *Taylor Co. Ky*

Occupation *Farmer*

ENLISTMENT.

When *June 28*, 186*4*.

Where *Lebanon*

By whom *Capt Fidler*, term *3* y'rs

Remarks:

Enlisted for 108th U. S. C. T.

Transferred to 5th U. S. C. Cavalry

August 12, 1864, per S. C. 192. Head

Quarters East of Ky.

D. M. Kennedy

(383a)

Comyist.

R

5 Cav. | U.S.C.T.

William Russell

, Co. *D*, 5 Reg't U. S. Col'd Cav.

Appears on

Company Descriptive Book

of the organization named above.

DESCRIPTION.

Age *21* years; height *5* feet *6* inches.

Complexion *Copper*

Eyes *Brown*; hair *Black*

Where born *Caylor Ky*

Occupation *Farmer*

ENLISTMENT.

When *June 28, 1864.*

Where *Lebanon*

By whom *Capt. Fidler*; term *3* y'rs.

Remarks:

R. J. Anderson

(383g)

Copist.

R | 5600 U.S.C.T.

William Russel

Appears with rank of _____ on

Muster and Descriptive Roll

of a Detachment of U.S. Cold Vol
recruits forwarded

Roll dated
Lebanon Ky, June 28, 1864.

Where born Taylor Co Ky

Age 20 years; occupation Farmer

When enlisted June 28, 1864.

Where enlisted Lebanon Ky

For what period enlisted 3 years.

Eyes Bro; hair Blk

Complexion Cop; height 5 ft. 6 in.

When mustered in _____, 186 .

Where mustered in _____

Bounty paid \$ 100; due \$ 100

Clothing account:

Last settled _____, 186 ; drawn since \$ 13.58 / 100

Date of first muster June 28, 1864.

Company to which assigned _____

Remarks Owners name and Residence
Augusta Russell, Taylor Co
Enlisted without consent of owner
4th Dist Ky

Book mark: _____

(356m)

L. Murchy
Copyist.

R. 5 Cav. U. S. C. T.

William Russell

Priv., Co. I, 5 Reg't U. S. Col'd Cav.

Appears on

Company Muster-in and Descriptive Roll
of the organization named above. Roll dated

Cp. Nelson, Ky., Oct. 31, 1864.

Where born

Taylor, Kentucky

Age

20 y'rs; occupation

Farmer

When enlisted

June 28, 1864.

Where enlisted

Sebanon

For what period enlisted

3 years.

Eyes

Brown; hair

Black.

Complexion

Copper; height

5 ft. 6 in.

When mustered in

June 28, 1864.

Where mustered in

Sebanon

Bounty paid \$

100; due \$

100

Where credited

4th Dist. Kentucky

Company to which assigned

Remarks:

Enlisted for 106th U. S. C. T.

Transferred to

5th U. S. C. Cavalry

August 2, 1864.

p. r. S. O. 152. Head

Quarters

Dist of Ky.

Book mark:

Philipsen

(356d)

Copyist.

R. | 5 Cav. | U.S.C.T.

William Russell

Pr, Co. I, 5 Reg't U. S. Col'd Cavalry.

Appears on

Company Muster Roll

for Organization to Oct. 31, 1864.

Present or absent Present

Stoppage, \$ 100 for

Due Gov't, \$ 100 for

Valuation of horse, \$ 100

Valuation of horse equipments, \$ 100

Remarks:

Book mark:

Philipson

(358)

Copyist.

R.

5 Cav.

U.S.C.T.

William Russell

Prv., Co. I, 5 Reg't U. S. Col'd Cavalry.

Appears on

Company Muster Roll

for Nov. & Dec., 1864.

Present or absent Present

Stoppage, \$ 100 for

Due Gov't, \$ 100 for

Valuation of horse, \$ 100

Valuation of horse equipments, \$ 100

Remarks: 1st & 2^d installments
Bounty due.

Book mark:

Philipsen

(358)

Copyist.

R.

5 Cav.

U.S.C.T.

William Russell

Prv., Co. I, 5 Reg't U. S. Col'd Cavalry.

Appears on

Company Muster Roll

for Jan. & Feb., 1865.

Present or absent Present

Stoppage, \$ 100 for

Due Gov't, \$ 100 for

Valuation of horse, \$ 100

Valuation of horse equipments, \$ 100

Remarks: 1st + 2^d installments \$300⁺ Bounty due.

Book mark:

Philipson

(358)

Copyist.

R. | 5 Cav. | U.S.C.T.

William Russell

Priv., Co. I, 5 Reg't U. S. Col'd Cavalry.

Appears on

Company Muster Roll

for *Mch. + April*, 1865.

Present or absent *Present*

Stoppage, \$ 100 for

Due Gov't, \$ 100 for

Valuation of horse, \$ 100

Valuation of horse equipments, \$ 100

Remarks: *1st installment
Bounty due.*

Book mark:

Philipson

(358)

Copyist.

F | **5 Cav.** | **U.S.C.T.**

William Russell

Pr, Co. I, 5 Reg't U. S. Col'd Cavalry.

Appears on

Company Muster Roll

for *May & June*, 186*5*.

Present or absent *Present*

Stoppage, \$ *100* for

Due Gov't, \$ *100* for

Valuation of horse, \$ *100*

Valuation of horse equipments, \$ *100*

Remarks: *Install. point due*
\$100.

Book mark: _____

R

5 Cav. U.S.C.T.

William Russell

Pr, Co. I, 5 Reg't U. S. Col'd Cavalry.

Appears on

Company Muster Roll

for *July & Aug*, 1865.

Present or absent *Present*

Stoppage, \$ 100 for

Due Gov't, \$ 100 for

Valuation of horse, \$ 100

Valuation of horse equipments, \$ 100

Remarks:

Book mark:

W. Russell

(358)

Copyist.

E | **5 Cav. | U.S.C.T.**

William Russell

Co. I, Co. I, 5 Reg't U. S. Col'd Cavalry.

Appears on

Company Muster Roll

for *Sept to Oct*, 186*5*.

Present or absent *Present*

Stoppage, \$ *100* for

Due Gov't, \$ *100* for

Valuation of horse, \$ *100*

Valuation of horse equipments, \$ *100*

Remarks:

Book mark:

W. Russell

(358)

Copyist.

R

5 Cav. | U.S.C.T.

William Russell

Sgt, Co. I, 5 Reg't U. S. Col'd Cavalry.

Appears on

Company Muster Roll

for *Nov + Dec*, 186*5*.

Present or absent *Present*

Stoppage, \$ *100* for

Due Gov't, \$ *100* for

Valuation of horse, \$ *100*

Valuation of horse equipments, \$ *100*

Remarks: *Det'd for Co. G, 64*

Detained in Co. I. Dept per
P.O. no. 202

Book mark:

Devo

R

5 Cav.

U.S.C.T.

William Russell

Priv., Co. I, 5 Reg't U. S. Col'd Cavalry.

Appears on

Company Muster Roll

for Jan'y. & Feby., 1866.

Present or absent Present

Stoppage, \$ 100 for

Due Gov't, \$ 100 for

Valuation of horse, \$ 100

Valuation of horse equipments, \$ 100

Remarks: On daily duty in
Com. Dept. per R.O. No. 202.

Book mark:

Crenshaw

(358)

Copyist.

R | 5 Cav. | U.S.C.T.

William Russell

Priv, Co. I, 5 Reg't U. S. Colored Cav.

Appears on Returns as follows:

March 1865 - Absent detach^d
at Hopkinsville Ky
March 14th

Dec. 1865 to Feb 1866 On duty
detailed in C. S. Dept.

Book mark :

(548)

E. Thornton

Copist.

R | **5 Cav.** | **U.S.C.T.**

William Russell
Pvt, Co. *D*, 5 Reg't U. S. Col'd Cavalry.

Appears on **Co. Muster-out Roll**, dated
Helena, Ark. Mch. 16, 1866.

Muster-out to date *Mch. 16*, 1866.

Last paid to *Dec. 31*, 1865.

Clothing account:

Last settled....., 186 ; drawn since \$..... 100

Due soldier \$..... 100; due U. S. \$ *35* ^{*15*}/₁₀₀

Am't for cloth'g in kind or money adv'd \$..... 100

Due U. S. for arms, equipments, &c., \$..... 100

Bounty paid \$..... 100; due \$..... 100

Remarks:.....

Book mark: *P. R. 1, P. 27, 68-V 110, P. 165-69.*

Crenshaw

(861)

Copyist.

1171
Sallie Jesse

Co E, 5 U. S. Col'd Cav.

Private | Private

CARD NUMBERS.

1	5363735	26
2	5363826	27
3	5363928	28
4	5363997	29
5	5364104	30
6	5364189	31
7	5364275	32
8	5364366	33
9	5364450	34
10	5364533	35
11	5364612	36
12	9090489	37
13		38
14		39
15		40
16		41
17		42
18		43
19		44
20		45
21		46
22		47
23		48
24		49
25		50

Book Mark: General Notation R. & D. 407375,

See also

S. 583712. 2^d. And.
S 730525, 2^d and Ridd,
Anonymous letter to
Am. Soc. 4/26/23

H. Smith IX

D | **5 Cav.** | **U.S.C.T.**

Jessie Sallie
....., Co. *E*, 5 Reg't U. S. Col'd Cav.

Appears on

Company Descriptive Book
of the organization named above.

DESCRIPTION.

Age *30* years; height *5* feet *6* inches.

Complexion *Black*

Eyes *Blk*; hair *Blk*

Where born *S. Carolina*

Occupation *farmer*

ENLISTMENT.

When *Sep 8*, 186 *4*.

Where *Camp Nelson*

By whom *J. B. Randolph*, term *3* y'rs.

Remarks:

.....

.....

.....

.....

.....

.....

.....

.....

.....

.....

.....

.....

.....

.....

.....

.....

.....

.....

.....

.....

.....

.....

.....

.....

J. E. Burke

S | **5 Cav.** | **U.S.C.T.**

Jesse Sallie

C, Co. *E*, 5 Reg't U. S. Col'd Cavalry.

Appears on

Company Muster-in and Descriptive Roll

of the organization named above. Roll dated

Camp Nelson, N. Y., Oct. 26, 1864.

Where born *South Carolina*

Age *36* y'rs; occupation *Farmer*

When enlisted *Sept. 8*, 1864.

Where enlisted *Cp. Nelson N.Y.*

For what period enlisted *3* years.

Eyes *Black*; hair *Black*

Complexion *Black*; height *5* ft. *6* in.

When mustered in *Sept. 2*, 1864.

Where mustered in *Cp. Nelson N.Y.*

Bounty paid \$ *100*; due \$ *100*

Where credited

Company to which assigned

Remarks: *8th District Kentucky*

* *Martin Sallie*

* *Supposed to be name of owner*

added May 18/98. C.M.A.

Book mark:

General Notation: N. & V. 407370.

M. Rowland

(356d)

Copyist.

S | **5 Cav. | U.S.C.T.**

Jesse Sallie

Pvt., Co. E, 5 Reg't U. S. Col'd Cavalry.

Appears on

Company Muster Roll

for *Enlistment to Oct 31*, 1864.

Present or absent *Present*

Stoppage, \$ *100* for

Due Gov't, \$ *100* for

Valuation of horse, \$ *100*

Valuation of horse equipments, \$ *100*

Remarks:

Book mark:

(358)

M. J. Cowland

Copyist.

S | **5 Cav.** | **U.S.C.T.**

Jesse Lallie

Pvt.

Co. E, 5 Reg't U. S. Col'd Cavalry.

Appears on

Company Muster Roll

for *Nov, & Dec*, 1864.

Present or absent *Present*

Stoppage, \$ *100* for

Due Gov't, \$ *100* for

Valuation of horse, \$ *100*

Valuation of horse equipments, \$ *100*

Remarks: *"94" instrument
of 20 cents due*

Book mark:

(358)

A. W. Woodard

Copyist.

S

5 Cav.

U.S.C.T.

Jessie Hallie

Wm.

Co. E, 5 Reg't U. S. Col'd Cavalry.

Appears on

Company Muster Roll

for *Jan 9*, 186*5*.

Present or absent *Present*

Stoppage, \$ *100* for

Due Gov't, \$ *100* for

Valuation of horse, \$ *100*

Valuation of horse equipments, \$ *100*

Remarks: *1st instalment*

of Bounty due \$100

Due Gov't for Ordnance \$4.57

Book mark:

W. Rowland

(358)

Copyist.

S | **5 Cav.** | **U.S.C.T.**

Alvin Sallis

Sallis, Co. E, 5 Reg't U. S. Col'd Cavalry.

Appears on

Company Muster Roll

for *March & April*, 1865.

Present or absent *Present*

Stoppage, \$ *100* for

Due Gov't, \$ *100* for

Valuation of horse, \$ *100*

Valuation of horse equipments, \$ *100*

Remarks: *First installment
of Bounty due*

Book mark:

(358)

W. J. England

Copyist.

S | 5 Cav. | U.S.C.T.

Jessie Sallie
Put, Co. E, 5 Reg't U. S. Col'd Cavalry.

Appears on

Company Muster Roll

for May June, 1865.

Present or absent present

Stoppage, \$ 100 for

Due Gov't, \$ 100 for

Valuation of horse, \$ 100

Valuation of horse equipments, \$ 100

Remarks: 1st Instalment
Bounty due \$100.

Book mark:

(358)

Copyist.

S

5 Cav.

U.S.C.T.

Jessie Sallie

Priv., Co. E, 5 Reg't U.S. Col'd Cavalry.

Appears on

Company Muster Roll

for July & Aug., 1865.

Present or absent present

Stoppage, \$ 100 for

Due Gov't, \$ 100 for

Valuation of horse, \$ 100

Valuation of horse equipments, \$ 100

Remarks:

Book mark:

Long

(358)

Copyist.

S

5 Cav.

U.S.C.T.

Jessie Sallie

Put., Co. E, 5 Reg't U.S. Col'd Cavalry.

Appears on

Company Muster Roll

for Sept. & Oct., 1865.

Present or absent present

Stoppage, \$ 100 for

Due Gov't, \$ 100 for

Valuation of horse, \$ 100

Valuation of horse equipments, \$ 100

Remarks:

Book mark:

Long

(358)

Copyist.

S. | 5 Cav. | U.S.C.T.

Jessie D'artie
Private, Co. E, 5 Reg't U. S. Col'd Cavalry.

Appears on

Company Muster Roll

for Nov & Dec, 1865.

Present or absent Present

Stoppage, \$ 100 for

Due Gov't, \$ 100 for

Valuation of horse, \$ 100

Valuation of horse equipments, \$ 100

Remarks:

Book mark:

Long Copyist.

(358)

J

5 Cav. U.S.C.T.

James Dallas
Wain

, Co. E, 5 Reg't U.S. Col'd Cavalry.

Appears on

Company Muster Roll

for *Jan. 1st*, 186 *6*.

Present or absent *Present*

Stoppage, \$ *100* for

Due Gov't, \$ *100* for

Valuation of horse, \$ *100*

Valuation of horse equipments, \$ *100*

Remarks:

Book mark:

J. Wain

(358)

Copyist.

5 Cav. U.S.C.T.

James Gallie

Co. E, 5 Reg't U. S. Col'd Cavalry.

Appears on Co. Muster-out Roll, dated

Velona, Ark. Mar. 16, 1866.

Muster-out to date * *Mar 3*, 1866.

Last paid to *Dec 31*, 1865.

Clothing account:

Last settled....., 186 ; drawn since \$..... 100

Due soldier \$..... 100; due U. S. \$..... $4 \frac{17}{100}$

Am't for cloth'g in kind or money adv'd \$..... 100

Due U. S. for arms, equipments, &c., \$..... $\frac{25}{100}$

Bounty paid \$..... $100 \frac{xx}{100}$; due \$..... $100 \frac{xy}{100}$

Remarks: *Due U.S. for*
Ordinance 25 cts

* Records on file in 2nd. Auditor's Office show this Co. Mustered Out to take effect Mch, 16th. 1866. and paid to include Mch, 15th. 1866.

Book mark:

J. C. Leonard

(361)

Copyist.

1122

Samuel, Isaac

Co C, 5 U. S. Col'd Cav.

Private

Private

CARD NUMBERS.

1	5361718	26
2	5361820	27
3	5361908	28
4	5361998	29
5	5362082	30
6	5362166	31
7	5362255	32
8	5362343	33
9	5362428	34
10	5362514	35
11	5362599	36
12	9090262	37
13	43145732	38
14	43146290	39
15	40730284	40
16		41
17		42
18		43
19		44
20		45
21		46
22		47
23		48
24		49
25		50

Book Mark:.....

See also.....

5 Cav. | U.S.C.T.

Isaac Samuels

Co. *E*, 5 Reg't U. S. Col'd Cav.

Appears on

Company Descriptive Book

of the organization named above.

DESCRIPTION.

Age *26* years; height *5* feet *5 1/2* inches.

Complexion *Dark*

Eyes *Dark*; hair *Dark*

Where born *Nelson Co., Ky.*

Occupation *Laborer*

ENLISTMENT.

When *Aug. 27*, 1864.

Where *Louisville*

By whom *Capt. Ham*; term *3* y'rs.

Remarks:

W. Ham

(383g)

Copist.

S | 5 bar | USCT.

Isaac Samuels

Appears with rank of Private on

Muster and Descriptive Roll

of Detachment US Colored
Recruits mustered for

US Colored Inf, Roll dated
Louisville Ky, Aug 30, 1864.

Where born Nelson Ky

Age 26 years; occupation laborer

When enlisted Aug 27, 1864.

Where enlisted Louisville Ky

For what period enlisted 3 years.

Eyes dark; hair dark

Complexion dark; height 5 ft. 5 1/2 in.

When mustered in Aug 30, 1864.

Where mustered in Louisville Ky

Bounty paid \$ 100; due \$ 100

Clothing account:

Last settled _____, 186 ; drawn since \$ 100

Date of first muster _____, 186 .

Company to which assigned _____

Remarks: Cr. to Nelson co
4 list

Book mark : _____

L. S. Burton
Copyist.

(356m)

S | 5 bar | *U.S.C.T.*

Isaac Samuels

Appears with rank of *Pvt* on

Muster and Descriptive Roll

of *a Detachment of U.S. Colored*
Troops transferred to U.S. Colored
Co. at Lexington Ky. Roll dated

Louisville Ky., *Sept. 2*, 1864.

Where born *Nelson Ky.*

Age *26* years; occupation *Laborer*

When enlisted *Aug. 27*, 1864.

Where enlisted *Louisville Ky.*

For what period enlisted *1* years.

Eyes *Dark*; hair *Dark*

Complexion *Dark*; height *5* ft. *5 1/2* in.

When mustered in *Aug. 30*, 1864.

Where mustered in *Louisville*

Bounty paid \$ *100*; due \$ *100*

Clothing account:

Last settled _____, 1864; drawn since \$ *17 55*/₁₀₀

Date of first muster *Aug. 30*, 1864.

Company to which assigned _____

Remarks: *transferred to 4th Regt. Inf.*

Ky.

Book mark: _____

B. J. Stinson

(356m)

Copyist.

Leaac Samuels

Priv, Co. *C*, 5 Reg't U. S. Col'd Cavalry.

Appears on

Company Muster-in and Descriptive Roll

of the organization named above. Roll dated

Camp Nelson, Ky, N. Y., *Oct. 24*, 1864.

Where born *Nelson, Ky*

Age *26* y'rs; occupation *Laborer*

When enlisted *Aug. 27*, 1864.

Where enlisted *Louisville*

For what period enlisted *3* years.

Eyes *Dr.*; hair *Dr.*

Complexion *Dr.*; height *5* ft. *5* in.

When mustered in *Aug. 30*, 1864.

Where mustered in *Louisville*

Bounty paid \$ *100*; due \$ *100*

Where credited *4th Dist. Ky.*

Company to which assigned *C*

Remarks:

Book mark: *(+ 1416 Ky.*

(+) Roll Form

Shull

(356d)

Inserted by compe.

Copyist.

S | 5 Cav. | U.S.C.T.

Isaac Samuels

Priv, Co. C, 5 Reg't U. S. Col'd Cavalry.

Appears on

Company Muster Roll

for *to Oct. 31*, 1864.

Present or absent *Absent*

Stoppage, \$ *100* for

Due Gov't, \$ *100* for

Valuation of horse, \$ *100*

Valuation of horse equipments, \$ *100*

Remarks: *Wounded at the Battle
of Saltville, Va. Oct. 2, 1864
In Hospital*

Book mark:

Shull

(358)

Copyist.

J

5 Cav. U.S.C.T.

Isaac Samuels

Pvt, Co. C, 5 Reg't U. S. Col'd Cavalry.

Appears on

Company Muster Roll

for *Nov. & Dec.*, 1864.

Present or absent *Present-*

Stoppage, \$ *100* for

Due Gov't, \$ *100* for

Valuation of horse, \$ *100*

Valuation of horse equipments, \$ *100*

Remarks: *First & second instalments of bounty due*

Book mark:

Shull

(358)

Copyist.

S

5 Cav.

U.S.C.T.

Isaac Samuels

Pm, Co. C, 5 Reg't U. S. Col'd Cavalry.

Appears on

Company Muster Roll

for *Jan'y. & Feby.*, 186*5*.

Present or absent *Present*

Stoppage, \$ *100* for

Due Gov't, \$ *100* for

Valuation of horse, \$ *100*

Valuation of horse equipments, \$ *100*

Remarks: *First visitment
Bounty due \$100*

Book mark:

Shull

(358)

Copyist.

Samuel Samuels

Prin, Co. C, 5 Reg't U. S. Col'd Cavalry.

Appears on

Company Muster Roll

for *Mar. & Apr.*, 186*5*.

Present or absent *Present*

Stoppage, \$ *100* for

Due Gov't, \$ *100* for

Valuation of horse, \$ *100*

Valuation of horse equipments, \$ *100*

Remarks: *First installment of
Bounty due \$100*

Book mark:

Shull

I | **5 Cav. | U.S.C.T.**

Isaac Samuels

Priv., Co. C, 5 Reg't U. S. Col'd Cavalry.

Appears on

Company Muster Roll

for *May & June*, 186 *5*

Present or absent *Present*

Stoppage, \$ *100* for

Due Gov't, \$ *100* for

Valuation of horse, \$ *100*

Valuation of horse equipments, \$ *100*

Remarks: *First Instalment of Bounty due \$100*

Book mark :

(358)

Linder

Copyist.

I | **5 Cav. | U.S.C.T.**

Isaac Samuels
Plt., Co. C, 5 Reg't U. S. Col'd Cavalry.

Appears on

Company Muster Roll

for *July & Aug.*, 186*5*.

Present or absent *Present*

Stoppage, \$ *100* for

Due Gov't, \$ *100* for

Valuation of horse, \$ *100*

Valuation of horse equipments, \$ *100*

Remarks:

Book mark: -----

(358)

Grider
Copyist.

S | **5 Cav. U.S.C.T.**

Isaac Samuel

Priv., Co. C, 5 Reg't U. S. Col'd Cavalry.

Appears on

Company Muster Roll

for *Sep + Oct*, 186*5*.

Present or absent *Present*

Stoppage, \$ *100* for

Due Gov't, \$ *100* for

Valuation of horse, \$ *100*

Valuation of horse equipments, \$ *100*

Remarks:

Book mark:

(358)

J. Under

Copyist.

S

5 Cav.

U.S.C.T.

Isaac Samuels

Pat, Co. C, 5 Reg't U. S. Col'd Cavalry.

Appears on

Company Muster Roll

for *Jan^{mo} Feb*, 186 *6*

Present or absent *Present*

Stoppage, \$ *100* for

Due Gov't, \$ *100* for

Valuation of horse, \$ *100*

Valuation of horse equipments, \$ *100*

Remarks:

Book mark:

Rose

I | **5 Cav. | U.S.C.T.**

Isaac Samuel

Private, Co. C, 5 Reg't U. S. Col'd Cavalry.

Appears on

Company Muster Roll

for *Nov Dec*, 1865.

Present or absent *Present*

Stoppage, \$.....100 for

Due Gov't, \$.....100 for

Valuation of horse, \$.....100

Valuation of horse equipments, \$.....100

Remarks:

Book mark:

(358)

Luider

Copyist.

S | 5 Cav. | U.S.C.T.

Isaac Samuels

Pvt, Co. C, 5 Reg't U. S. Colored Cav.

Appears on Returns as follows:

Oct. 1864, Absent sick wounded
at the Battle of Saltville,
Hospl unknown.

Nov. 1864, Absent sick Hospl Camp
Nelson.

Sept. & Oct. 1865, Regtl teamster.

Book mark:

L. B. Bowman

(546)

Copyist.

S

5 Cav. U.S.C.T.

Isaac Samuels

Put, Co. *C*, 5 Reg't U. S. Col'd Cavalry.

Appears on **Co. Muster-out Roll**, dated *Helena Ark*, *March 16*, 186*6*.

Muster-out to date *March 16*, 186*6*.

Last paid to *Dec 31*, 186*5*.

Clothing account:

Last settled....., 186 ; drawn since \$..... $\overline{100}$

Due soldier \$ *15⁵⁶* $\overline{100}$; due U. S. \$..... $\overline{100}$

Am't for cloth'g in kind or money adv'd \$..... $\overline{100}$

Due U. S. for arms, equipments, &c., \$..... $\overline{100}$

Bounty paid \$ *100* $\overline{100}$; due \$ *100* $\overline{100}$

Remarks:.....

Book mark: *S. 2416 Ky*

2780. 1880

Rose

MICROFILM PUBLICATION M.1821

COMPILED MILITARY SERVICE RECORDS
OF VOLUNTEER UNION SOLDIERS WHO
SERVED WITH THE USCT (US COLORED TROOPS)
5TH REGIMENT OF CAVALRY

PERSONAL PAPERS' TARGET SHEET

PLEASE NOTE THE CHECKED INFORMATION ABOUT THE PERSONAL PAPERS IN
THIS FILE:

- NO PERSONAL PAPERS WERE FOUND IN THIS FILE WHEN THE
RECORDS WERE ARRANGED FOR MICROFILMING.
- 2 PERSONAL PAPER(S) FOUND IN THIS FILE WHEN THE RECORDS
WERE ARRANGED FOR MICROFILMING.

Samuel, Isaac

R Co, 5 Reg't US 66

1 Enclosures.

Bed Cards	Descriptive Lists
Burial Records	Final Statements
Certs. of Dis. for Discharge	Furloughs
C. M. Charges	Med. Des. Lists
Med. Certificates	Orders

Other papers relating to—

Admission to Hosp'l	Furlough
Casualty Sheet (Officer's)	Med. Examination
Confinement	Misc. Information
Contracts	Pay or Clothing
Death or Effects	Personal Reports
Desertions	Rank
Discharge from Hosp'l	Transfer to Hosp'l
Discharge from Service	Transfer to V. R. C.
Duty	Transportation

NOTE 1.—This blank will be used for enlistments of United States colored troops. They will be made out in duplicate in all cases—one to accompany the recruiting return of the superintendent (not the recruiting officer) to the Adjutant General, and one to accompany the accounts of the officer who pays bounty, &c.

NOTE 2.—An enlistment holds to service. A muster-in must, in all cases, precede payment of pay, bounty, pension, &c. A muster-in roll, must in all cases, be filed in the Adjutant General's Office as evidence of muster-in. The mustering officer, commissary, or assistant commissary of musters, as the case may be, will countersign both enlistments as having mustered the soldiers into the service of the United States before either of them is given to the disbursing officer.

DECLARATION OF RECRUIT.

I, Isaac Samuels..... desiring to volunteer as a soldier in the ARMY OF THE UNITED STATES, for the term of Three Years, DO DECLARE That I am.....28..... years and months of age; that I have never been discharged from the United States service on account of disability or by sentence of a court-martial, or by order before the expiration of a term of enlistment; and I know of no impediment to my serving honestly and faithfully as a soldier for three years.

GIVEN at Louisville Ky..... the 27 day of Aug 1864

Witness: L. L. Hamner

Isaac Samuels
No.
Volunteered at Louisville Ky
By Adj. G. L. Hamner
1203

Two hundred and eleven

Consent of Parent or Guardian in case of a Minor, if a Free Man, or in the case of a Slave, of the Person to whom he owes Service:

I, Do CERTIFY, That I am the that the said..... is..... years of age; and I do freely give my CONSENT to his volunteering as a SOLDIER in the Army of the United States, for the period of THREE YEARS, under the conditions of the laws of the United States.

GIVEN at the day of

Witness:

UNITED STATES COLORED TROOPS ENLISTMENT.

STATE OF

TOWN OF

Kentucky

Lancaster

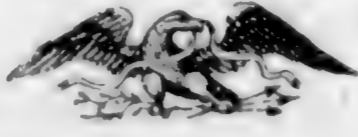

I, *Isaac Samuels* born in *Delaware*

in the State of *Kentucky* aged *26* years

and by occupation a *Fabrician* Do HEREBY ACKNOWLEDGE TO

have volunteered *24* day of *April* 1864

to serve as a **Soldier** in the **Army of the United States of America**, for the

period of **THREE YEARS**, unless sooner discharged by proper authority: Do

also agree to accept such bounty, pay, rations, and clothing, as are, or may be,

established by law for the U. S. colored troops.

And I, *Isaac Samuels*

do solemnly swear that I will bear true faith and allegiance to the **United States**

of America, and that I will serve them honestly and faithfully against all their

enemies or opposers whomsoever; and that I will observe and obey the orders

of the President of the United States, and the orders of the officers appointed

over me, according to the Rules and Articles of War.

Sworn and subscribed to, at *Lancaster*

this *24* day of *April* 1864

Before *Capt. W. H. ...*

I CERTIFY, ON HONOR, That I have carefully examined the above named Volunteer agreeably to the General Regulations of the Army, and that, in my opinion, he is free from all bodily defects and mental infirmity, which would in any way disqualify him from performing the duties of a soldier.

D. Grimes M.D.

EXAMINING SURGEON.

I CERTIFY, ON HONOR, That I have minutely inspected the Volunteer *Isaac Samuels* previously to his enlistment, and that he was entirely sober when enlisted; that, to the best of my judgment and belief, he is of lawful age; and that, in accepting him as duly qualified to perform the duties of an able-bodied soldier, I have strictly observed the regulations which govern the recruiting service. This soldier has *Dark* eyes, *Dark* hair, *Dark* complexion, is *5* feet *3-3/4* inches high.

W. H. ... Capt
12th Ky Infy RECRUITING OFFICER OR AGENT.

Mustered into the United States Service *30th Aug* day of *Aug* 1864.

Isaac Samuels

W. H. ... Capt
Mustering Officer.

Mustered into the service of the United States, for three years or during the war, from date of enlistment, in Company ...
Regiment of ... Volunteers, on the ... day of ... 1864, at ...

War Department,

ADJUTANT GENERAL'S OFFICE,

Washington, April 12 1867.

Respectfully returned to the Commission for the State of Kentucky, with the information that Isaac Samuels was enlisted at Louisville Ky August 27 1864 and was mustered in as private in Co "C" 5th U.S. Col. Aug 30 1864.

J. W. Hazard

Asst. Adj't General.

BAR

No. 2416

APPLICATION OF

Mrs Rachel Samuels

OF

Sayers Depot Ky

FOR COMPENSATION FOR SLAVE,

Named Isaac Samuels

Enlisted August 27 1864

In Com. C, 5th Col. Regiment,

U. S. COLORED TROOPS.

Received _____, 186...

Compensation Awarded

_____, 186...

Dollars.

President of Board of Claims.

Claimant's Attorney,

Claimant's Post-office Address,

Sayers Depot
Nelson County

FRANKFORT COMMONWEALTH PRINT.

Co. C 5th Cav

UNITED STATES COLORED TROOPS ENLISTMENT.

STATE OF

TOWN OF

Kentucky

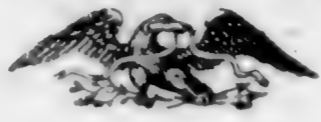

Louisville

I, *Isaac Samuels* born in *Nelson*

in the State of *Kentucky* aged *26* years

and by occupation a *Labourer* Do HEREBY ACKNOWLEDGE TO

have volunteered *27th* day of *August* 186*4*

to serve as a **Soldier** in the **Army of the United States of America**, for the

period of **THREE YEARS**, unless sooner discharged by proper authority: Do

also agree to accept such bounty, pay, rations, and clothing, as are, or may be,

established by law for the U. S. colored troops.

And I, *Isaac Samuels*

do solemnly swear that I will bear true faith and allegiance to the **United States**

of America, and that I will serve them honestly and faithfully against all their

enemies or opposers whomsoever; and that I will observe and obey the orders

of the President of the United States, and the orders of the officers appointed

over me, according to the Rules and Articles of War.

Sworn and subscribed to, at *Louisville, Ky.*

this *27th* day of *Aug. 1864* (signed) *Isaac Samuels*

Before *E. C. Neam, Capt. 12th Regt.*

I CERTIFY, ON HONOR, That I have carefully examined the above named Volunteer agreeably to the General Regulations of the Army, and that, in my opinion, he is free from all bodily defects and mental infirmity, which would in any way disqualify him from performing the duties of a soldier.

(signed) *D. Cummings*
EXAMINING SURGEON.

I CERTIFY, ON HONOR, That I have minutely inspected the Volunteer, *I. Samuels*, previously to his enlistment, and that he was entirely sober when enlisted; that, to the best of my judgment and belief, he is of lawful age; and that, in accepting him, as duly qualified to perform the duties of an able-bodied soldier, I have strictly observed the regulations which govern the recruiting service. This soldier has *dark* eyes, *dark* hair, *dark* complexion, is *5^{ft} 7ⁱⁿ* feet *3ⁱⁿ* inches high.

(signed) *E. C. Neam, Capt.*
12th Regt. P.V.
RECRUITING OFFICER OR AGENT.

Mustered into the United States Service *30th* day of *Aug.* 186*4*.

(signed) *J. H. Smith, Capt.*
MUSTERING OFFICER.

Mustered into the service of the United States, for three years or during the war, from date of enlistment, in Company *Co. C 5th Cav* Regiment of *Volunteers, on the* *27th* day of *Aug.* 186*4*, at *Louisville, Ky.*

Isaac Samuels
E. C. Neam
D. Cummings

untary support to any insurrection, rebellion or pretended government, authority, power or constitution within the United States hostile thereto. And I do further swear that, to the best of my knowledge and ability, I have supported and defended, and will continue to support and defend, the United States against all enemies, foreign and domestic; and that I have supported, defended and obeyed, and will continue to support, defend and obey, the Constitution and laws of the United States; that I will bear true faith and allegiance to the same; and that I take this oath freely, without any mental reservation or purpose of evasion: So help me God.

Rachel Samuels

Sworn to and subscribed before me, at *Lagers Depot*,
this *21st* day of *March*, 186*7*.

R. H. Horrell, J. P. N. C.



DECLARATION OF RECRUIT.

I, Lease Amuels desiring to volunteer as a soldier in the ARMY OF THE UNITED STATES, for the term of Three Years, DO DECLARE That I am 26 years and months of age; that I have never been discharged from the United States service on account of disability or by sentence of a court-martial, or by order before the expiration of a term of enlistment; and I know of no impediment to my serving honestly and faithfully as a soldier for three years.

GIVEN at Louisville, Kentucky the 27 day of August, 1862

Witness:

(signed) Lease Amuels

NOTE 1.—This blank will be used for enlistments of United States colored troops. They will be made out in duplicate in all cases—one to accompany the recruiting return of the superintendent (not the recruiting officer) to the Adjutant General, and one to accompany the accounts of the officer who pays bounty, &c.

NOTE 2.—An enlistment holds to service. A muster-in must, in all cases, precede payment of pay, bounty, pension, &c. A muster-in roll, must in all cases, be filed in the Adjutant General's Office as evidence of muster-in. The mustering officer, commissary, or assistant commissary of musters, as the case may be, will countersign both enlistments as having mustered the soldiers into the service of the United States before either of them is given to the disbursing officer.

By

Volunteered at

No.

18

Consent of Parent or Guardian in case of a Minor, if a Free Man, or in the case of a Slave, of the Person to whom he owes Service:

I, Do CERTIFY, That I am the that the said is years of age; and I do freely give my CONSENT to his volunteering as a SOLDIER in the Army of the United States, for the period of THREE YEARS, under the conditions of the laws of the United States.

GIVEN at

the day of

Witness:

Mrs Rachel. Samuels

FOR THE COMPENSATION OF SLAVE NAMED

Isaac Samuels

I, *Mrs Rachel Samuels* a loyal citizen, and a resident of *Sayers Depot*,
 County of *Nelson*, State of Kentucky, hereby claim compensation, under
 the provisions of Section 24, act approved February 24, 1864, and section 2, act approved Ju'y, 28,
 1866, for my slave *Isaac Samuels*, enlisted *27th day August*,
 1864, at *Louisville*, by *C. C. Ham*
 in the *5th Cav* regiment U. S. Colored Troops, Co. *C*; certificate of
 which enlistment, and a descriptive list, as required, accompany this application. That I did not ac-
 quire said slave subsequent to said enlistment, but had a valid title to him at the date of said enlist-
 ment, and previous thereto; I having acquired my title to him and my ownership over him as fol-
 lows, to-wit: *inherited him*

In proof of my loyalty to the Constitution and Government of the United States, I present the ac-
 companying oath, which I have taken, signed and acknowledged; to be filed with this application, in
 accordance with requirement of General Orders, No. 329, 1863, War Department, Adjutant General's
 Office.

March 21, 1867.

Rachel Samuels

OATH OF ALLEGIANCE.

I, *Rachel Samuels*, the owner and Claimant, do solemnly swear that
 the foregoing claim is a just and true claim due to me as master and owner of the said slave, and that
 the facts alleged in said claim in respect to the draft or enlistment (as the case may be) of said slave
 into the Military service of the United States are true. And I do further swear that I have never
 joined, or been concerned in, any insurrection or rebellion; that I have never borne arms against the
 United States; that I have never given any aid, countenance, counsel or encouragement to any person
 or persons engaged, or whom I had reason to believe were about to engage, in insurrection, rebellion
 or armed hostility against the United States; that I have neither sought, nor accepted, nor attempted
 to exercise the functions of any office, civil or military, nor to perform any service whatever, under
 any authority or pretended authority in hostility to the United States; that I have not yielded a vol-
 untary support to any insurrection, rebellion or pretended government, authority, power or constitution
 within the United States hostile thereto. And I do further swear that, to the best of my knowledge
 and ability, I have supported and defended, and will continue to support and defend, the United
 States against all enemies, foreign and domestic; and that I have supported, defended and obeyed, and
 will continue to support, defend and obey, the Constitution and laws of the United States; that I will
 bear true faith and allegiance to the same; and that I take this oath freely, without any mental reserva-
 tion or purpose of evasion: So help me God.

Rachel Samuels

Sworn to and subscribed before me, at *Sayers Depot*,
 this *21st* day of *March*, 1867.

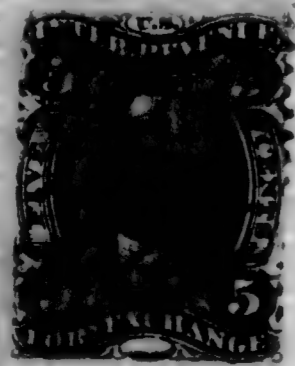

R. H. Horrell J. P. N. C.

PROOF OF OWNERSHIP.

STATE OF KENTUCKY,

COUNTY OF *Nelson*

} SS.

We *Alexander Sayers* and *John H. Wisheart* each of lawful age, and resident citizens of the State and County aforesaid, do certify that *Mr Rachel Samuels* of the State and County aforesaid, was on the *27th* day of *August* 186*4*, the lawful owner of the slave named *Isaac Samuels*; referred to and described in the foregoing claim for compensation.

Hese? Sayers
John H. Wisheart

Sworn to and subscribed before me a *Justice of the Peace* for the County of *Nelson* State of Kentucky, this the *21st* day of *March* 186*7*.

R. E. Horrell J.P.



PROOF OF LOYALTY.

STATE OF KENTUCKY,

COUNTY OF *Nelson*

} SS.

We *Alexander Sayers* and *John H. Wisheart* loyal men and each of lawful age, and resident citizens of the *Sayers Settlement* of *Sayers Settlement* in the State and County aforesaid, upon our oaths declare that we have known *Mr Rachel Samuels* a resident of the State and County aforesaid, since the 4th day of March, 1861, and know that he has firmly and faithfully maintained his or her adherence and allegiance to the Government of the United States, by defending its cause against the Government and forces of the so-called Confederate States of America, in all suitable and practicable ways, and according to his or her ability, and opportunity.

Alexander Sayers
John H. Wisheart

Sworn to and subscribed before me a *Justice of the Peace* for the county of *Nelson* State of Kentucky, this the *21* day of *March* 186*7*.

R. E. Horrell J.P.



POWER OF ATTORNEY.

My Post-Office address is _____ County of _____ State of Kentucky, and I hereby direct that all communications to me, touching this claim, be sent under cover to _____, who is hereby appointed and constituted my true and lawful attorney, to prosecute this claim for me, and who is hereby authorized and empowered to receive and receipt for any award, order, draft, certificate, voucher, warrant, papers or money that may be issued in the adjustment of this claim, or the payment thereof, the same as I might or could do in person were I present and acting for myself, and to file any additional evidence or papers that may be required in the prosecution of this claim.

[WITNESS.]

The owner signs here. }

Two witnesses to owner's signature sign here. }

50 CENT STAMP.

1123

Samuel Pius

Co. C, 5 U. S. Col'd Cav.

Private Engler

CARD NUMBERS.

1	5361719	26
2	5361821	27
3	5361909	28
4	5361999	29
5	5362031	30
6	5362112	31
7	5362195	32
8	5362291	33
9	5362379	34
10	5362464	35
11	5362547	36
12	9090263	37
13	43146288	38
14	43145727	39
15	40730285	40
16		41
17		42
18		43
19		44
20		45
21		46
22		47
23		48
24		49
25		50

Book Mark:

See also

es | 5 Cav. | U.S.C.T.

Charles Samuel

....., Co. *C*, 5 Reg't U. S. Col'd Cav.

Appears on

Company Descriptive Book
of the organization named above.

DESCRIPTION.

Age *20* years; height *5* feet *7* inches.

Complexion *Wk*

Eyes *Wk*; hair *Wk*

Where born *Nelson Co., Ky.*

Occupation *Laborer*

ENLISTMENT.

When *Aug. 27*, 186*4*.

Where *Louisville*

By whom *Capt F. Ham*; term *3* y'rs.

Remarks:

.....
.....
.....
.....
.....
.....
.....
.....

Ham

S | **5 Cav. | U.S.C.T.**

Pius Samuels

P, Co. *C*, 5 Reg't U. S. Col'd Cavalry.

Appears on

Company Muster-in and Descriptive Roll

of the organization named above. Roll dated

Camp Nelson, *Ky*, *N. Y.*, *Oct. 24*, 1864.

Where born *Nelson. Ky*

Age *19* y'rs; occupation *Laborer*

When enlisted *Aug. 27*, 1864.

Where enlisted *Louisville*

For what period enlisted *3* years.

Eyes *Bl.*; hair *Bl.*

Complexion *Bl.*; height *5* ft. *7/2* in.

When mustered in *Aug. 30*, 1864.

Where mustered in *Louisville*

Bounty paid \$ *100*; due \$ *100*

Where credited *4th Dist. Ky.*

Company to which assigned *C.*

Remarks:

Book mark:

Shull

S | 5 bar | U.S.C.

Pius Samuel

Appears with rank of Pvt on

Muster and Descriptive Roll

of a Detachment of U. S. Colored
Troop Transferred to U. S. Colored
Co. at Lexington, Ky. Roll dated
Louisville, Ky., Sept. 2, 1864.

Where born Felton, Ky.

Age 19 years; occupation Labourer

When enlisted Aug. 27, 1864.

Where enlisted Louisville, Ky.

For what period enlisted 3 years.

Eyes brn; hair brn

Complexion brn; height 5 ft. 7 1/2 in.

When mustered in Aug. 30, 1864.

Where mustered in Louisville

Bounty paid \$ 100; due \$ 100

Clothing account:
Last settled _____, 1864; drawn since \$ 17 55 / 100

Date of first muster Aug. 30, 1864.

Company to which assigned _____

Remarks: credited to 4 bond. list,
Ky.

Book mark: _____

B. J. O'Sullivan

S 1 5600 1864

Pias Samuels

Appears with rank of Private on

Muster and Descriptive Roll

of Detachment US Colored
Recruits mustered for us.

Colored Inf Roll dated
Louisville Ky, Aug 30, 1864.

Where born Nelson Co Ky

Age 19 years; occupation laborer

When enlisted Aug 27, 1864.

Where enlisted Louisville Ky

For what period enlisted 3 years.

Eyes dark; hair dark

Complexion dark; height 5 ft 7 1/2 in.

When mustered in Aug 30, 1864.

Where mustered in Louisville Ky

Bounty paid \$ 100; due \$ 100

Clothing account:

Last settled _____, 186 ; drawn since \$ 100

Date of first muster _____, 186 .

Company to which assigned _____

Remarks: lex to Nelson Co
H. Dist

Book mark : _____

(356m)

L. D. Barton
Copyist.

J | **5 Cav. | U.S.C.T.**

Pais Samuels

Pais, Co. C, 5 Reg't U. S. Col'd Cavalry.

Appears on

Company Muster Roll

for *to Oct. 31*, 186*4*.

Present or absent *Present*

Stoppage, \$ *100* for

Due Gov't, \$ *100* for

Valuation of horse, \$ *100*

Valuation of horse equipments, \$ *100*

Remarks:

Book mark:

Shull

(358)

Copyist.

S

5 Cav.

U.S.C.T.

Pius Samuels

Pius, Co. C, 5 Reg't U. S. Col'd Cavalry.

Appears on

Company Muster Roll

for *Nov. & Dec.*, 1864.

Present or absent *Present*

Stoppage, \$ *100* for

Due Gov't, \$ *100* for

Valuation of horse, \$ *100*

Valuation of horse equipments, \$ *100*

Remarks: *First & Second installments of bounty due*

Book mark:

Small

(358)

Copyist.

S | **5 Cav. | U.S.C.T.**

Pais Samuels

Pais, Co. C, 5 Reg't U. S. Col'd Cavalry.

Appears on

Company Muster Roll

for *Jan'y. & Feby.*, 186*5*.

Present or absent *Present*

Stoppage, \$ *100* for

Due Gov't, \$ *100* for

Valuation of horse, \$ *100*

Valuation of horse equipments, \$ *100*

Remarks: *First instalment
Bounty due \$100*

Book mark: _____

Shull

(358)

Copyist.

J | **5 Cav.** | **U.S.C.T.**

Benjamin

Bugler, Co. C, 5 Reg't U. S. Col'd Cavalry.

Appears on

Company Muster Roll

for *Mar. 7 Apr.*, 186*5*.

Present or absent *Present*

Stoppage, \$ *100* for

Due Gov't, \$ *100* for

Valuation of horse, \$ *100*

Valuation of horse equipments, \$ *100*

Remarks: *First installment of
Bounty due \$100*

Book mark:

Shull

(358)

Copyist.

S | **5 Cav.** | **U.S.C.T.**

Lewis Samuels

Ingler, Co. C, 5 Reg't U. S. Col'd Cavalry.

Appears on

Company Muster Roll

for *May & June*, 1865.

Present or absent *Present*

Stoppage, \$ *100* for

Due Gov't, \$ *100* for

Valuation of horse, \$ *100*

Valuation of horse equipments, \$ *100*

Remarks: *First Instalment of Bounty due \$100*

Book mark:

(358)

Ingler
Copyist.

S | **5 Cav. | U.S.C.T.**

Guis Samuels

Pumpkin, Co. C, 5 Reg't U. S. Col'd Cavalry.

Appears on

Company Muster Roll

for *July* & *Aug.*, 186 *5*

Present or absent *Present*

Stoppage, \$.....*100* for

Due Gov't, \$.....*100* for

Valuation of horse, \$.....*100*

Valuation of horse equipments, \$.....*100*

Remarks:

Book mark:

(358)

J. Miller
Copyist.

S

5 Cav. U.S.C.T.

Pius Samuel

Quyer, Co. C, 5 Reg't U. S. Col'd Cavalry.

Appears on

Company Muster Roll

for *Sep* *to Oct*, 186*5*.

Present or absent *Present*

Stoppage, \$ 100 for

Due Gov't, \$ 100 for

Valuation of horse, \$ 100

Valuation of horse equipments, \$ 100

Remarks: *Reg'd Band*

Book mark:

Linden

S | **5 Cav. | U.S.C.T.**

Guise Samuels

Dugley, Co. C, 5 Reg't U. S. Col'd Cavalry.

Appears on

Company Muster Roll

for *Nov Dec*, 186*5*.

Present or absent *Present*

Stoppage, \$ *100* for

Due Gov't, \$ *100* for

Valuation of horse, \$ *100*

Valuation of horse equipments, \$ *100*

Remarks: *In Daily Duty with Reg't Band*

Book mark:

Linden

(358)

Copyist.

S

5 Cav.

U.S.C.T.

Pius Samuels

Bugler, Co. C, 5 Reg't U. S. Col'd Cavalry.

Appears on

Company Muster Roll

for *Jan^{mo} Feb*, 186*6*

Present or absent *Present*

Stoppage, \$ *100* for

Due Gov't, \$ *100* for

Valuation of horse, \$ *100*

Valuation of horse equipments, \$ *100*

Remarks: *On daily duty with Reg Band*

Book mark:

Rose

(358)

Copyist.

S

5 Cav.

U.S.C.T.

Pius Samuels

Pot
Bugler, Co. *C*, 5 Reg't U. S. Colored Cav.

Appears on Returns as follows:

Aug. 1865, (Pot) Detailed for Regtl Band.

Sept. 1865, (Bugler) Detailed for Regtl Band.

Oct. 1865, Bugler Regtl Band.

Nov. 1865 to Jan'y 1866, Detailed with Regtl Band.

Book mark:

L. B. Bowman

(546)

Copyist.

S

5 Cav.

U.S.C.T.

Pius Samuel

Bugler Co. *C.*, 5 Reg't U. S. Col'd Cavalry.

Appears on **Co. Muster-out Roll**, dated

Helena Ark, Mch 16, 1866.

Muster-out to date

Mch 16, 1866.

Last paid to

Dec 31, 1865.

Clothing account:

Last settled....., 186 ; drawn since \$.....¹⁰⁰

Due soldier \$ *22*^{*75*}/₁₀₀; due U. S. \$.....¹⁰⁰

Am't for cloth'g in kind or money adv'd \$.....¹⁰⁰

Due U. S. for arms, equipments, &c., \$.....¹⁰⁰

Bounty paid \$ *100*¹⁰⁰; due \$ *100*¹⁰⁰

Remarks: *Put from organization of the Company until Apl 22 1865 when made Bugler.*

Book mark: *418226*

Roe

Samuel Pias

....., Co.

5 Reg't *U.S. Army*

Enclosures.

Bed Cards	Final Statements
Burial Records	Furloughs or L. of A.
Certs. of Dis. for Discharge	Med. Certificates
C. M. Charges	Med. Des. Lists
Descriptive Lists	Orders
Discharge Certificates	Pris. of War Record
Enlistment Papers	Resignations

Other papers relating to—

Admission to Hosp'l	Furlough or L. of A.
Casualty Sheet	Med. Examination
Confinement	Misc. Information
Contracts	Pay or Clothing
Death or Effects	Personal Reports
Desertion	Rank
Discharge from Hosp'l	Transfer to Hosp'l
Discharge from Service	Transfer to V. R. C.
Duty	Transportation

Filed Mar. 16, 1903

NOTE 1.—This blank will be used for enlistments of United States colored troops. They will be made out in duplicate in all cases—one to accompany the recruiting return of the superintendent (not the recruiting officer) to the Adjutant General, and one to accompany the accounts of the officer who pays bounty, &c.

NOTE 2.—An enlistment holds to service. A muster-in must, in all cases, precede payment of pay, bounty, pension, &c. A muster-in roll, must in all cases, be filed in the Adjutant General's Office as evidence of muster-in. The mustering officer, commissary, or assistant commissary of musters, as the case may be, will countersign both enlistments as having mustered the soldiers into the service of the United States before either of them is given to the disbursing officer.

DECLARATION OF RECRUIT.

I, Pas Samuels desiring to volunteer as a soldier in the ARMY OF THE UNITED STATES, for the term of Three Years, DO DECLARE That I am 19 years and months of age; that I have never been discharged from the United States service on account of disability or by sentence of a court-martial, or by order before the expiration of a term of enlistment; and I know of no impediment to my serving honestly and faithfully as a soldier for three years.

GIVEN at Louisville Ky the 27th day of August 1864

Witness: Col. Ham

Pas Samuels

Volunteered at Louisville Ky
By Capt. C. C. Ham
18th Sep 1864

Five hundred and fifty
Pas Samuels

Consent of Parent or Guardian in case of a Minor, if a Free Man, or in the case of a Slave, of the Person to whom he owes Service:

I, Do CERTIFY, That I am the

that the said, is years of age; and I do freely give my CONSENT to his volunteering as a SOLDIER in the Army of the United States, for the period of THREE YEARS, under the conditions of the laws of the United States.

GIVEN at the day of

Witness:

UNITED STATES COLORED TROOPS ENLISTMENT.

STATE OF

TOWN OF

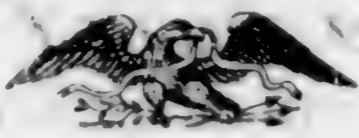

Ky *Louisville*

I, *Pias Samuel* born in *Nelson Co*
in the State of *Ky* aged *nineteen* years

and by occupation a *Laborer* Do HEREBY ACKNOWLEDGE to
have volunteered *27th* day of *Aug* 186*4*

to serve as a **Soldier** in the **Army of the United States of America**, for the
period of **THREE YEARS**, unless sooner discharged by proper authority: Do
also agree to accept such bounty, pay, rations, and clothing, as are, or may be,
established by law for the U. S. colored troops.

And I, *Pias Samuel*
do solemnly swear that I will bear true faith and allegiance to the **United States
of America**, and that I will serve them honestly and faithfully against all their
enemies or opposers whomsoever; and that I will observe and obey the orders
of the President of the United States, and the orders of the officers appointed
over me, according to the Rules and Articles of War.

Sworn and subscribed to, at *Louisville*
this *27th* day of *Aug* 186*4*.
Before *Capt. Wm. H. ...* *Pias Samuel*

I CERTIFY, ON HONOR, That I have carefully examined the above named Volunteer agree-
ably to the General Regulations of the Army, and that, in my opinion, he is free from all bodily
defects and mental infirmity, which would in any way disqualify him from performing the
duties of a soldier.

D. ...

EXAMINING SURGEON.

I CERTIFY, ON HONOR, That I have minutely inspected the Volunteer *P. Samuel*
previously to his enlistment, and that he was entirely sober when enlisted; that, to the best of
my judgment and belief, he is of lawful age; and that, in accepting him as duly qualified to per-
form the duties of an able-bodied soldier, I have strictly observed the regulations which govern
the recruiting service. This soldier has *Dark* eyes, *Dark* hair, *Yellow* com-
plexion, is *4 1/2* feet *4 1/2* inches high.

Wm. H. ... *Capt*
12th Ky Infy
RECRUITING OFFICER OR AGENT.

Mustered into the United States Service *27th* day of *Aug* 186*4*

Willson Samuel *W. H. ...* *Capt*
Mustering Officer.

Mustered into the service of the United States, for three years or during the war, from date of enlistment, in Company ...
Regiment of ... Volunteers, on the ... day of ... 1864, at ...

1124

Samuel Poyan

Co. C., 5 U. S. Col'd Cav.

Private Corporal

CARD NUMBERS.

1	5361720	26
2	5361822	27
3	5361910	28
4	5362000	29
5	5362083	30
6	5362167	31
7	5362256	32
8	5362287	33
9	5362375	34
10	5362459	35
11	5362543	36
12	9590264	37
13	43146289	38
14	43145729	39
15	40730286	40
16		41
17		42
18		43
19		44
20		45
21		46
22		47
23		48
24		49
25		50

Book Mark:

See also

S | **5 Cav. | U.S.C.T.**

Rowan Jewells

....., Co. *C*, 5 Reg't U. S. Col'd Cav.

Appears on

Company Descriptive Book
of the organization named above.

DESCRIPTION.

Age *28* years; height *5* feet *6 1/2* inches.

Complexion *dark*

Eyes *dark*; hair *dark*

Where born *Kelso Co., Ky.*

Occupation *Laborer*

ENLISTMENT.

When *Aug. 27*....., 186*4*.

Where *Louisville*

By whom *Capt. Ham.*; term *3*.....y'rs.

Remarks: *Made Sargent. See*

N.C.O.

Harrison

S | **5 Cav. U.S.C.T.**

Rover Samuels

Priv, Co. *C*, 5 Reg't U. S. Col'd Cavalry.

Appears on

Company Muster-in and Descriptive Roll
of the organization named above. Roll dated

Camp Nelson, Ky, *N. Y.*, *Oct. 24*, 1864.

Where born *Nelson, Ky.*

Age *28* y'rs; occupation *Laborer*

When enlisted *Aug. 27*, 1864.

Where enlisted *Lansville*

For what period enlisted *3* years.

Eyes *Bl.*; hair *Bl.*

Complexion *Bl.*; height *5 ft. 6 1/2 in.*

When mustered in *Aug. 30*, 1864.

Where mustered in *Lansville*

Bounty paid \$ *100*; due \$ *100*

Where credited *4" Dist. Ky.*

Company to which assigned *C*

Remarks:

Book mark: *S - 2415 Ky.*

Still

(356d) *x inserted by com. pr.* Copyist.

S | 5 bar | USCT

Rover Samuels

Appears with rank of Private on

Muster and Descriptive Roll

of detachment US colored
Recruits mustered for US
colored Inf Roll dated

Louisville Ky, Aug 30, 1864.

Where born Nelson Co Ky

Age 28 years; occupation laborer

When enlisted Aug 27, 1864

Where enlisted Louisville Ky

For what period enlisted 3 years.

Eyes dark; hair dark

Complexion dark; height 5 ft. 6 1/2 in.

When mustered in Aug 30, 1864

Where mustered in Louisville Ky

Bounty paid \$ 100; due \$ 100

Clothing account:

Last settled _____, 186 ; drawn since \$ 100

Date of first muster _____, 186 .

Company to which assigned _____

Remarks: lex to Nelson Co
H list

Book mark : _____

(356m)

L. D. Burton

Copyist.

S | 5 bar | U.S.C.T.

Rowen Samuel

Appears with rank of Pvt on

Muster and Descriptive Roll

of a Detachment of U.S. Colored Troops transferred to U.S. Civil

Cor. at Lexington, Ky Roll dated
Louisville, Ky. Sept. 2, 1864.

Where born Felton, Ky.

Age 28 years; occupation Labourer

When enlisted Aug. 27, 1864.

Where enlisted Louisville, Ky.

For what period enlisted 3 years.

Eyes brn; hair brn

Complexion brn; height 5 ft. 6 1/2 in.

When mustered in Aug. 30, 1864.

Where mustered in Louisville

Bounty paid \$ 100; due \$ 100

Clothing account:

Last settled _____, 1864; drawn since \$ 17 55/100

Date of first muster Aug. 30, 1864.

Company to which assigned _____

Remarks: transferred to 46th Regt. Inf.

Ky.

Book mark: _____

B. J. Tinsell

(356m)

Copyist.

Rowan Samuel

Priv, Co. C, 5 Reg't U. S. Col'd Cavalry.

Appears on

Company Muster Roll

for *to Oct. 31*, 1864.

Present or absent *Present*

Stoppage, \$ *100* for

Due Gov't, \$ *100* for

Valuation of horse, \$ *100*

Valuation of horse equipments, \$ *100*

Remarks:

Book mark:

Shull

(358)

Copyist.

S | **5 Cav.** | **U.S.C.T.**

Rowan Samuels

Pvt, Co. C, 5 Reg't U. S. Col'd Cavalry.

Appears on

Company Muster Roll

for *Nov. & Dec.*, 1864.

Present or absent *Present*

Stoppage, \$ *100* for

Due Gov't, \$ *100* for

Valuation of horse, \$ *100*

Valuation of horse equipments, \$ *100*

Remarks: *First & Second instal-
ments of bounty due. Due
U.S. for Ordnance 17.93*

Book mark:

Shull

(358)

Copyist.

Rowen Samuels

Pris, Co. C, 5 Reg't U. S. Col'd Cavalry.

Appears on

Company Muster Roll

for *Jan'y. & Feb'y.*, 186*5*.

Present or absent *Present*

Stoppage, \$ *100* for

Due Gov't, \$ *100* for

Valuation of horse, \$ *100*

Valuation of horse equipments, \$ *100*

Remarks: *First enlistment -
Bounty due \$100*

Book mark:

Shull

Rowan Samuels

Pris, Co. C, 5 Reg't U. S. Col'd Cavalry.

Appears on

Company Muster Roll

for *Mar. 7 1865*, 186*5*.

Present or absent *Present*

Stoppage, \$ *100* for

Due Gov't, \$ *100* for

Valuation of horse, \$ *100*

Valuation of horse equipments, \$ *100*

Remarks: *First instalment of
Bounty due \$100*

Book mark :

Small

S

5 Cav. | U.S.C.T.

Rowan Samuels

Private, Co. C, 5 Reg't U. S. Col'd Cavalry.

Appears on

Company Muster Roll

for *May & June*, 186*5*.

Present or absent *Present*

Stoppage, \$ 100 for

Due Gov't, \$ 100 for

Valuation of horse, \$ 100

Valuation of horse equipments, \$ 100

Remarks: *First Instalment of Bounty due #101*

Book mark: _____

(358)

J. Vidler
Copyist.

S

5 Cav. U.S.C.T.

Rowan Samuels

Priv., Co. C, 5 Reg't U. S. Col'd Cavalry.

Appears on

Company Muster Roll

for *July & Aug*, 186 *2*

Present or absent *Present*

Stoppage, \$ 100 for

Due Gov't, \$ 100 for

Valuation of horse, \$ 100

Valuation of horse equipments, \$ 100

Remarks:

Book mark:

(358)

J. Linden
Copyist.

J

5 Cav. U.S.C.T.

Roman Samuels

Cpl., Co. C, 5 Reg't U. S. Col'd Cavalry.

Appears on

Company Muster Roll

for *Sep. 7* to *Oct*, 1865.

Present or absent *Present*

Stoppage, \$ 100 for

Due Gov't, \$ 100 for

Valuation of horse, \$ 100

Valuation of horse equipments, \$ 100

Remarks: *Made Cpl*
Oct. 21 / 65

Book mark:

(358)

Luciden

Copyist.

S

5 Cav. U.S.C.T.

Roman Samuel

Cpl., Co. C, 5 Reg't U. S. Col'd Cavalry.

Appears on

Company Muster Roll

for *Nov to Dec*, 186*5*.

Present or absent *Present*

Stoppage, \$ *100* for

Due Gov't, \$ *100* for

Valuation of horse, \$ *100*

Valuation of horse equipments, \$ *100*

Remarks: *Due m. for Camp and Gar Equip. 04^{cts}*

Book mark:

Leader

S

5 Cav.

U.S.C.T.

Rowan Samuels

Corp, Co. C, 5 Reg't U. S. Col'd Cavalry.

Appears on

Company Muster Roll

for *Jan and Feb*, 186 *6*.

Present or absent *Present*

Stoppage, \$ *100* for

Due Gov't, \$ *100* for

Valuation of horse, \$ *100*

Valuation of horse equipments, \$ *100*

Remarks:

Book mark:

Rose

(358)

Copyist.

S | 5 Cav. | U.S.C.T.

Rowan Samuels

Pvt., Co. C, 5 Reg't U. S. Colored Cav.

Appears on Returns as follows:

Sept. 1865, Absent on furlough
Sept. 26/65 Lebanon, Ky.
Ten days.

Book mark:

L. B. Bowman

(546)

Copyist.

S

5 Cav. U.S.C.T.

Rowan Samuels

Corp., Co. C., 5 Reg't U. S. Col'd Cavalry.

Appears on Co. Muster-out Roll, dated

Helena Ark, Mch 16, 1866.

Muster-out to date

Mch 16, 1866.

Last paid to

Dec 31, 1865.

Clothing account:

Last settled....., 186 ; drawn since \$..... 100

Due soldier \$..... 100; due U. S. \$ 18 ¹⁹/₁₀₀

Am't for cloth'g in kind or money adv'd \$..... 100

Due U. S. for arms, equipments, &c., \$..... 100

Bounty paid \$ 100 ¹⁰⁰/₁₀₀; due \$ 100 ¹⁰⁰/₁₀₀

Remarks: Put from organiza-
tion until Oct 21, 1865 when
made Corp

Book mark: S. 2415 Hy

Rose

Samuel Bowen

Co. C

5 Reg't U.S.C.

2 Enclosures.

Bed Cards	Final Statements
Burial Records	Furloughs or L. of A
Certs. of Dis. for Discharge	Med. Certificates
C. M. Charges	Med. Des. Lists
Descriptive Lists	Orders /
Discharge Certificates	Pris. of War Record
Enlistment Papers /	Resignations

Other papers relating to—

Admission to Hosp'l	Furlough or L. of A
Casualty Sheet	Med. Examination
Confinement	Misc. Information
Contracts	Pay or Clothing
Death or Effects	Personal Reports
Desertion	Rank
Discharge from Hosp'l	Transfer to Hosp'l
Discharge from Service	Transfer to V. R. C.
Duty	Transportation
	How Claimed /

War Department,

ADJUTANT GENERAL'S OFFICE,

Washington, April 12 1867.

Respectfully returned to the Commission for the State of Kentucky, with the information that Rowin Samuels was enlisted at Louisville Ky August 27 1864 and was mustered in as private in Co "C" 5th U.S.C.T. Aug 30 1864.

2415-84

J. W. Hazard

Asst. Adj't General.

BAR

No. 2415-

APPLICATION OF

J. W. Samuels

OF

Sayers Depot &

FOR COMPENSATION FOR SLAVE,

Named Rowin Samuels

Enlisted August 27 1864,

In Com. C, 5th U.S.C.T. Regiment,

U. S. COLORED TROOPS.

Received _____, 186...

Compensation Awarded

_____, 186...

Dollars.

President of Board of Claims.

Claimant's Attorney,

Claimant's Post-office Address,

Sayers Depot

Nelson Co Ky

Co. C 5th reg

UNITED STATES COLORED TROOPS ENLISTMENT.

STATE OF

TOWN OF

Kentucky  *Louisville*
I, *Rowen Samuels* born in *Nelson, Ky.*

in the State of *Kentucky* aged *28* years

and by occupation a *Laborer* Do HEREBY ACKNOWLEDGE TO

have volunteered *27th* day of *August* 186*4*

to serve as a **Soldier** in the **Army of the United States of America**, for the period of **THREE YEARS**, unless sooner discharged by proper authority: Do also agree to accept such bounty, pay, rations, and clothing, as are, or may be, established by law for the U. S. colored troops.

And I, *Rowen Samuels* do solemnly swear that I will bear true faith and allegiance to the **United States of America**, and that I will serve them honestly and faithfully against all their enemies or opposers whomsoever; and that I will observe and obey the orders of the President of the United States, and the orders of the officers appointed over me, according to the Rules and Articles of War.

Sworn and subscribed to, at *Louisville, Ky.*
this *27th* day of *Aug. 1864* (signed) *Rowen Samuels*
Before *C. C. Hawn, Capt. 12th Ky. Inf.*

I CERTIFY, ON HONOR, That I have carefully examined the above named Volunteer agreeably to the General Regulations of the Army, and that, in my opinion, he is free from all bodily defects and mental infirmity, which would in any way disqualify him from performing the duties of a soldier.

(signed) *D. Cummings*
D. Cummings
EXAMINING SURGEON.

I CERTIFY, ON HONOR, That I have minutely inspected the Volunteer *R. Samuels* previously to his enlistment, and that he was entirely sober when enlisted; that, to the best of my judgment and belief, he is of lawful age; and that, in accepting him as duly qualified to perform the duties of an able-bodied soldier, I have strictly observed the regulations which govern the recruiting service. This soldier has *dark eyes, dark hair, dark complexion,* is *5* feet *6 1/2* inches high.

(signed) *C. C. Hawn, Capt.*
C. C. Hawn, Capt.
RECRUITING OFFICER OR AGENT.

Mustered into the United States Service *30th* day of *Aug.* 186*4*

(signed) *J. M. Smith, Capt.*
J. M. Smith
Mustering Officer

untary support to any insurrection, rebellion or pretended government, authority, power or constitution within the United States hostile thereto. And I do further swear that, to the best of my knowledge and ability, I have supported and defended, and will continue to support and defend, the United States against all enemies, foreign and domestic; and that I have supported, defended and obeyed, and will continue to support, defend and obey, the Constitution and laws of the United States; that I will bear true faith and allegiance to the same; and that I take this oath freely, without any mental reservation or purpose of evasion: So help me God.

R. W. Samuels

Sworn to and subscribed before me, at *Lafayette Depot,*
this *21* day of *March*, 186*7*.

5 CENT,
STAMP.

B. H. Horrell J. P. N. C.

Mustered into the service of the United States, for three years or during the war, from date of enlistment, in Company _____ Regiment of _____ Volunteers, on the _____ day of _____, 1864, at _____

Rowen Samuels
D. Cummings
C. C. Hawn
J. M. Smith

NOTE 1.—This blank will be used for enlistments of United States colored troops. They will be made out in duplicate in all cases—one to accompany the recruiting officer who pays bounty, &c. A muster-in roll, must in all cases, be filed in the Adjutant General's Office as evidence of muster-in. The mustering officer, commissary, or assistant commissary of musters, as the case may be, will countersign both enlistments as having mustered the soldiers into the service of the United States before either of them is given to the disbursing officer.

DECLARATION OF Rover Samuels
 I, Rover Samuels do hereby
 to volunteer as a soldier in the ARMY OF THE UNITED STATES, for the term of Three Years
 DO DECLARE That I am 28 years and months of age; that I have
 never been discharged from the United States service on account of disability or by sentence of a
 court-martial, or by order before the expiration of a term of enlistment; and I know of no
 impediment to my serving honestly and faithfully, as a soldier for three years.

GIVEN at Lowville, New York,
 the 27 day of August, 1864

Witness:

(signed Rover Samuels)

Billed
 Volunteered at
 No.
 18 ..

Consent of Parent or Guardian in case of a Minor, if a Free Man, or in the case of a Slave, of the Person to whom he owes Service:

I, Do CERTIFY, That I am
 the
 that the said is years of age; and I
 do freely give my CONSENT to his volunteering as a SOLDIER in the Army of the United States,
 for the period of THREE YEARS, under the conditions of the laws of the United States.

GIVEN at
 the day of

Witness:

CLAIM OF

J. W. Samuels

FOR THE COMPENSATION OF SLAVE NAMED

Rowen Samuels

I, *J. W. Samuels* a loyal citizen, and a resident of *Sayers Depot*
 County of *Nelson*, State of Kentucky, hereby claim compensation, under
 the provisions of Section 24, act approved February 24, 1864, and section 2, act approved July, 28,
 1866, for my slave *Rowen Samuels*, enlisted *27th day August,*
 1864, at *Louisville*, by *C. C. Hoam*
 in the *5th Cav* regiment U. S. Colored Troops, Co. *C*; certificate of
 which enlistment, and a descriptive list, as required, accompany this application. That I did not ac-
 quire said slave subsequent to said enlistment, but had a valid title to him at the date of said enlist-
 ment, and previous thereto: I having acquired my title to him and my ownership over him as fol-
 lows, to-wit: *Born Mine*

In proof of my loyalty to the Constitution and Government of the United States, I present the ac-
 companying oath, which I have taken, signed and acknowledged; to be filed with this application, in
 accordance with requirement of General Orders, No. 329, 1863, War Department, Adjutant General's
 Office.

March 21st, 1867.

J. W. Samuels

OATH OF ALLEGIANCE.

I, *J. W. Samuels*, the owner and Claimant, do solemnly swear that
 the foregoing claim is a just and true claim due to me as master and owner of the said slave, and that
 the facts alleged in said claim in respect to the draft or enlistment (as the case may be) of said slave
 into the Military service of the United States are true. And I do further swear that I have never
 joined, or been concerned in, any insurrection or rebellion; that I have never borne arms against the
 United States; that I have never given any aid, countenance, counsel or encouragement to any person
 or persons engaged, or whom I had reason to believe were about to engage, in insurrection, rebellion
 or armed hostility against the United States; that I have neither sought, nor accepted, nor attempted
 to exercise the functions of any office, civil or military, nor to perform any service whatever, under
 any authority or pretended authority in hostility to the United States; that I have not yielded a vol-
 untary support to any insurrection, rebellion or pretended government, authority, power or constitution
 within the United States hostile thereto. And I do further swear that, to the best of my knowledge
 and ability, I have supported and defended, and will continue to support and defend, the United
 States against all enemies, foreign and domestic; and that I have supported, defended and obeyed, and
 will continue to support, defend and obey, the Constitution and laws of the United States; that I will
 bear true faith and allegiance to the same; and that I take this oath freely, without any mental reserva-
 tion or purpose of evasion: So help me God.

J. W. Samuels

Sworn to and subscribed before me, at *Sayers Depot,*
 this *21* day of *March*, 1867.

5 CENT,
 STAMP.

B. C. Horrell J. P. N. C.

PROOF OF OWNERSHIP.

STATE OF KENTUCKY,

COUNTY OF *Nelson* } SS.

We *Alexander Sayers* and *John H. Wisheart* each of lawful age, and resident citizens of the State and County aforesaid, do certify that *T. W. Samuels* of the State and County aforesaid, was on the *27th* day of *August* 186*7*, the lawful owner of the slave named *Rosen: Samuels*; referred to and described in the foregoing claim for compensation.

Alexander Sayers
John H. Wisheart

Sworn to and subscribed before me a *Justice of the Peace* for the County of *Nelson* State of Kentucky, this the *21st* day of *March* 1867.

R. E. Horrell J. P. N. C.



PROOF OF LOYALTY.

STATE OF KENTUCKY,

COUNTY OF *Nelson* } SS.

We *Alexander Sayers* and *John H. Wisheart* loyal men and each of lawful age, and resident citizens of the *Sayers* of *Sayers* in the State and County aforesaid, upon our oaths declare that we have known *T. W. Samuels* a resident of the State and County aforesaid, since the 4th day of March, 1861, and know that he has firmly and faithfully maintained his or her adherence and allegiance to the Government of the United States, by defending its cause against the Government and forces of the so-called Confederate States of America, in all suitable and practicable ways, and according to his or her ability and opportunity.

Alexander Sayers
John H. Wisheart

Sworn to and subscribed before me a *Justice of the Peace* for the county of *Nelson* State of Kentucky, this the *21st* day of *March* 1867.

R. E. Horrell J. P. N. C.



POWER OF ATTORNEY.

My Post-Office address is _____ County of _____ State of Kentucky, and I hereby direct that all communications to me, touching this claim, be sent under cover to _____, who is hereby appointed and constituted my true and lawful attorney, to prosecute this claim for me, and who is hereby authorized and empowered to receive and receipt for any award, order, draft, certificate, voucher, warrant, papers or money that may be issued in the adjustment of this claim, or the payment thereof, the same as I might or could do in person were I present and acting for myself, and to file any additional evidence or papers that may be required in the prosecution of this claim.

[WITNESS.]

The owner signs here. }

Two witnesses to owner's signature sign here. }

50 CENT STAMP.

NOTE 1.—This blank will be used for enlistments of United States colored troops. They will be made out in duplicate in all cases—one to accompany the recruiting return of the superintendent (not the recruiting officer) to the Adjutant General, and one to accompany the accounts of the officer who pays bounty, &c.

NOTE 2.—An enlistment holds to service. A muster-in must, in all cases, precede payment of pay, bounty, pension, &c. A muster-in roll, must in all cases, be filed in the Adjutant General's Office as evidence of muster-in. The mustering officer, commissary, or assistant commissary of musters, as the case may be, will countersign both enlistments as having mustered the soldiers into the service of the United States before either of them is given to the disbursing officer.

DECLARATION OF RECRUIT.

I, Rowen Samuel desiring to volunteer as a soldier in the ARMY OF THE UNITED STATES, for the term of Three Years, DO DECLARE That I am 28 years and months of age; that I have never been discharged from the United States service on account of disability or by sentence of a court-martial, or by order before the expiration of a term of enlistment; and I know of no impediment to my serving honestly and faithfully as a soldier for three years.

GIVEN at Louisville Ky the 27th day of Aug 1864

Witness: C. Coffey

Rowen Samuel

Volunteered at Louisville Ky
Aug 29th 1864
By Capt C. Coffey
15th Regt

Rowen Samuel
15th Regt

Consent of Parent or Guardian in case of a Minor, if a Free Man, or in the case of a Slave, of the Person to whom he owes Service:

I, Do CERTIFY, That I am the that the said is years of age; and I do freely give my CONSENT to his volunteering as a SOLDIER in the Army of the United States, for the period of THREE YEARS, under the conditions of the laws of the United States.

GIVEN at the day of

Witness:

UNITED STATES COLORED TROOPS ENLISTMENT.

STATE OF

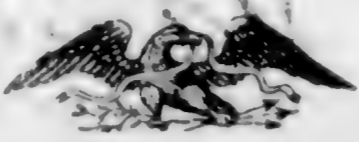

TOWN OF

Ky *Louisville*

I, *Rowen Samuel* born in *Nelson Co*
in the State of *Ky* aged *Twenty Eight* years
and by occupation a *Laborer* Do HEREBY ACKNOWLEDGE to
have volunteered *27th* day of *August* 1864

to serve as a **Soldier** in the **Army of the United States of America**, for the
period of **THREE YEARS**, unless sooner discharged by proper authority: Do
also agree to accept such bounty, pay, rations, and clothing, as are, or may be,
established by law for the U. S. colored troops.

And I, *Rowen Samuel*
do solemnly swear that I will bear true faith and allegiance to the **United States
of America**, and that I will serve them honestly and faithfully against all their
enemies or opposers whomsoever; and that I will observe and obey the orders
of the President of the United States, and the orders of the officers appointed
over me, according to the Rules and Articles of War.

Sworn and subscribed to, at *Louisville*
this *27th* day of *Aug 1864*. *Rowen Samuel*
Before *Capt. Lele Ham* *12th Ky Inf*

I CERTIFY, ON HONOR, That I have carefully examined the above named Volunteer agree-
ably to the General Regulations of the Army, and that, in my opinion, he is free from all bodily
defects and mental infirmity, which would in any way disqualify him from performing the
duties of a soldier.

D. G. ...

EXAMINING SURGEON.

I CERTIFY, ON HONOR, That I have minutely inspected the Volunteer *Rowen Samuel*
previously to his enlistment, and that he was entirely sober when enlisted; that, to the best of
my judgment and belief, he is of lawful age; and that, in accepting him, as duly qualified to per-
form the duties of an able-bodied soldier, I have strictly observed the regulations which govern
the recruiting service. This soldier has *Dark* eyes, *Dark* hair, *Dark* com-
plexion, is *5 1/2* feet *6 1/4* inches high.

Lele Ham *Capt*
12th Ky Inf
RECRUITING OFFICER OR AGENT.

Mustered into the United States Service, *27th* day of *Aug* 1864

Taylor Samuel
W. C.
Mustering Officer.

..... Mustered into the service of the United States, for three years or during the war, from date of enlistment, in Company
..... Regiment of Volunteers, on the day of 1864, at

Rec'd Oct. 24th / 15 of guard
in Henry's a police Com-
-mission, and Duce camp any day
before.

James Powell
St. E. Hill G.

R. Sumner

Comp C 5th Regt.

Head Qu 5th Inf C Cav

Camp Brebin Ky

24 October 1865

Order No. 174

Extract

* * *
1 Coapt R. Samuels & 1 man Co C. 5th C Cav
will take charge of a prisoner and will
proceed to Lexington Ky where he will turn
him over to Lt Powell Regt Mar Gen 1st
Regt 1st Div Dept of Ky He will then return
with the least practicable delay

By order of

Wm Hader

Major Comd

to Coapt R. Samuels Stuckson

Co C 5th Cav Lt Powell

1125

Sanders, George

Co M, 5 U. S. Col'd Cav.

Sergeant Sergeant

CARD NUMBERS.

1	5370796	26
2	5370896	27
3	5370998	28
4	5371079	29
5	5371161	30
6	5371247	31
7	5371331	32
8	5371417	33
9	5371504	34
10	5371593	35
11	5371675	36
12	9091318	37
13	40730287	38
14		39
15		40
16		41
17		42
18		43
19		44
20		45
21		46
22		47
23		48
24		49
25		50

Book Mark:

See also

S-2198527 Acad. U.S.
S-2201878 RO WTM
RHP 701666

H. Street &

S | *5 Cav* | **U.S.C.T.**

George Anderson

, *Co M*, *5* Reg't U. S. Col'd *Cav*

Appears on

Company Descriptive Book

of the organization named above.

DESCRIPTION.

Age *26* years; height *5* feet *9* inches.

Complexion *Black*

Eyes *Black*; hair *Black*

Where born *Fayette Ky*

Occupation *Farmer*

ENLISTMENT.

When *Aug 29, 1864*.

Where *Camp Nelson*

By whom *McRannick*; term *3* y'rs.

Remarks:

A. J. Anderson

(383g)

Copyist.

S

5 Cav.

U.S.C.T.

George Sanders

Ser^{gt}, Co. M., 5 Reg't U. S. Col'd Cavalry.

Appears on

Company Muster-in and Descriptive Roll

of the organization named above. Roll dated

Camp Nelson, Ky, N. Y., Oct 30, 1861.

Where born Fayette, Ky

Age 26 y'rs; occupation Farmer

When enlisted Aug 29, 1861.

Where enlisted Camp Nelson, Ky

For what period enlisted 3 years.

Eyes Black; hair Black

Complexion Black; height 5 ft. 9 in.

When mustered in Aug 30, 1861.

Where mustered in Camp Nelson, Ky.

Bounty paid \$ 100; due \$ 100

Where credited 1/2 de Diet, Ky

Company to which assigned

Remarks: ^x John Payne

x Supposed to be name of owner.

Added May 18, 48. H.A.J.

Book mark:

W.S. Thompson

(356d)

Copyist.

S

5 Cav. | U.S.C.T.

George Sanders

Serjt, Co. M, 5 Reg't U. S. Col'd Cavalry.

Appears on

Company Muster Roll

for *to Oct 31*, 186*4*.

Present or absent *Present*

Stoppage, \$ *100* for

Due Gov't, \$ *100* for

Valuation of horse, \$ *100*

Valuation of horse equipments, \$ *100*

Remarks: *Approved per Regt Orders No 12 to date Oct 30, 1864*

Book mark:

W.S. Thompson

(358)

Copyist.

5 Cav. | U.S.C.T.

George Saunders

Sergt, Co. M, 5 Reg't U. S. Col'd Cavalry.

Appears on

Company Muster Roll

for *Nov. 7, 1864*, 186*4*.

Present or absent *Present*

Stoppage, \$ *100* for

Due Gov't, \$ *100* for

Valuation of horse, \$ *100*

Valuation of horse equipments, \$ *100*

Remarks: *Appointed per Reg'tl. Order No. 19. to date Oct. 30, 1864 first & second instalments of bounty due*

Book mark:

W. S. Thompson

(358)

Copyist.

S

5 Cav. | U. S. C. T.

George Sanders

Sergeant, Co. M, 5 Reg't U. S. Col'd Cavalry.

Appears on

Company Muster Roll

for *Jan. 7 Feb.*, 186*5*.

Present or absent *Present.*

Stoppage, \$ *100* for

Due Gov't, \$ *100* for

Valuation of horse, \$ *100*

Valuation of horse equipments, \$ *100*

Remarks: *Appointed per Reg't order No. 12 to date Oct. 3. 1864. 1st. of 2^d in statements of bounty due*

Book mark:

M. S. Thompson

(358)

Copyist.

8

5 Cav. | U. S. C. T.

George Sanders

Sergh., Co. M, 5 Reg't U. S. Col'd Cavalry.

Appears on

Company Muster Roll

for *Mar & Apr.*, 186*4*.

Present or absent *Present*

Stoppage, \$ *100* for

Due Gov't, \$ *100* for

Valuation of horse, \$ *100*

Valuation of horse equipments, \$ *100*

Remarks: *1st installment bounty
due 7/10 appointed per
Reg't order No. 13, to date
Oct. 3/64*

Book mark:

W. S. Thompson

(358)

Copyist.

S

5 Cav. | U.S.C.T.

George Sanders
Sgt, Co. M, 5 Reg't U. S. Col'd Cavalry.

Appears on

Company Muster Roll

for *May June*, 1865.

Present or absent *Present*

Stoppage, \$ *100* for

Due Gov't, \$ *100* for

Valuation of horse, \$ *100*

Valuation of horse equipments, \$ *100*

Remarks: *1st Enlistment bounty*
due \$100.

Book mark:

C. W. ...

Copyist.

(358)

S

5 Cav. | U.S.C.T.

George Sanders

Sept., Co. M, 5 Reg't U. S. Col'd Cavalry.

Appears on

Company Muster Roll

for *July & Aug*, 186*5*.

Present or absent *Present*

Stoppage, \$ *100* for

Due Gov't, \$ *100* for

Valuation of horse, \$ *100*

Valuation of horse equipments, \$ *100*

Remarks:

Book mark:

Quinn

(358)

Copyist.

S

5 Cav. | U.S.C.T.

George Sanders

Sept., Co. M, 5 Reg't U. S. Col'd Cavalry.

Appears on

Company Muster Roll

for *Sept & Oct*, 186*5*.

Present or absent *Present*

Stoppage, \$ 100 for

Due Gov't, \$ 100 for

Valuation of horse, \$ 100

Valuation of horse equipments, \$ 100

Remarks:

Book mark:

Curry

Copyist.

S

5 Cav. U.S.C.T.

George Saunders

Seyb, Co. M, 5 Reg't U. S. Col'd Cavalry.

Appears on

Company Muster Roll

for Nov & Dec, 1865.

Present or absent Present

Stoppage, \$ 100 for

Due Gov't, \$ 100 for

Valuation of horse, \$ 100

Valuation of horse equipments, \$ 100

Remarks On duty in Reg't
2nd Reg't as Wagon Master

Book mark:

Copyist.

S | **5 Cav. | U.S.C.T.**

George Sanders

S'gt, Co. M, 5 Reg't U. S. Col'd Cavalry.

Appears on

Company Muster Roll

for *Jan & Feb*, 186*6*.

Present or absent *Present*

Stoppage, \$ *100* for

Due Gov't, \$ *100* for

Valuation of horse, \$ *100*

Valuation of horse equipments, \$ *100*

Remarks: *On duty in R. 2 M. Sept*

Book mark: *5101*

(358)

Hynes
Copyist.

S | **5 Cav. U.S.C.T.**

George Sanders

Serqt, Co. *M*, 5 Reg't U. S. Colored Cav.

Appears on Returns as follows:

Feb'y 1865, Wagon Master.

*Oct. 1865 to Jan'y 1866, On duty in
L. M. Dept.*

*Feb'y 1866, On daily duty in R.
L. M. Dept.*

Book mark:

L. B. Bowman

(546)

Copyist.

S

5 Cav.

U.S.C.T.

George Sanders

Sgt, Co. M, 5 Reg't U. S. Col'd Cavalry.

Appears on Co. Muster-out Roll, dated

Helena Ark, Mar 16, 1866.

Muster-out to date

Mar 16, 1866.

Last paid to

Dec. 31, 1865.

Clothing account:

Last settled....., 186 ; drawn since \$..... 100

Due soldier \$..... 100; due U. S. \$ 18 ⁸¹/₁₀₀

Am't for cloth'g in kind or money adv'd \$..... 100

Due U. S. for arms, equipments, &c., \$..... 100

Bounty paid \$ 100 100; due \$ 100 100

Remarks: Adept Sgt Per R.O. 12

Par 12 Oct. 30. 64 Slave Affiq
1864

Book mark: 5373 P.M.G. June 2/66

(361)

Stamps

Copyist.

Sanders, George,

, Co. M, 5 Reg't 42nd Inf.

1 ~~5~~ Enclosures.

Bed Cards	Final Statements
Burial Records	Furloughs or L. of A.
Certs. of Dis. for Discharge	Med. Certificates
C. M. Charges	Med. Des. Lists
Descriptive Lists	Orders
Discharge Certificates	Pris. of War Record
Enlistment Papers / 5	Resignations

Other papers relating to—

Admission to Hosp'l	Furlough or L. of A.
Casualty Sheet	Med. Examination 7
Confinement	Misc. Information
Contracts	Pay or Clothing
Death or Effects	Personal Reports
Desertion	Rank
Discharge from Hosp'l	Transfer to Hosp'l
Discharge from Service	Transfer to V. R. C.
Duty	Transportation

NOTE 1.—This blank will be used for enlistments of United States colored troops. They will be made out in duplicate in all cases—one to accompany the recruiting return of the superintendent (not the recruiting officer) to the Adjutant General, and one to accompany the accounts of the officer who pays bounty, &c.

NOTE 2.—An enlistment holds to service. A muster-in must, in all cases, precede payment of pay, bounty, pension, &c. A muster-in roll, must in all cases, be filed in the Adjutant General's Office as evidence of muster-in. The mustering officer, commissary, or assistant commissary of musters, as the case may be, will countersign both enlistments as having mustered the soldiers into the service of the United States before either of them is given to the disbursing officer.

DECLARATION OF RECRUIT.

I, George J. Sanders desiring to volunteer as a soldier in the ARMY OF THE UNITED STATES, for the term of *Three Years*, DO DECLARE That I am 26 years and months of age; that I have never been discharged from the United States service on account of disability or by sentence of a court-martial, or by order before the expiration of a term of enlistment; and I know of no impediment to my serving honestly and faithfully as a soldier for three years.

GIVEN at Camp Nelson the 29 day of August 1864

Witness: J. C. Stock

George J. Sanders
 No. 100
 Volunteered at Camp Nelson
Aug 29 1864
 By Wm. H. Randolph
or Thos. W. Birney
John Payne

Consent of Parent or Guardian in case of a Minor, if a Free Man, or in the case of a Slave, of the Person to whom he owes Service:

I, Do CERTIFY, That I am the that the said is years of age; and I do freely give my CONSENT to his volunteering as a SOLDIER in the Army of the United States, for the period of THREE YEARS, under the conditions of the laws of the United States.

GIVEN at the day of

Witness:

UNITED STATES COLORED TROOPS ENLISTMENT.

STATE OF

TOWN OF



Kentucky
I, *George Sanders* born in *Camp Nelson Fayette Co*
in the State of *Kentucky* aged *Twenty six* years
and by occupation a *Farmer* Do HEREBY ACKNOWLEDGE to

have volunteered *Twenty sixth* day of *August* 1864
to serve as a **Soldier** in the **Army of the United States of America**, for the
period of **THREE YEARS**, unless sooner discharged by proper authority: Do
also agree to accept such bounty, pay, rations, and clothing, as are, or may be,
established by law for the U. S. colored troops.

And I, *George Sanders*
do solemnly swear that I will bear true faith and allegiance to the **United States
of America**, and that I will serve them honestly and faithfully against all their
enemies or opposers whomsoever; and that I will observe and obey the orders
of the President of the United States, and the orders of the officers appointed
over me, according to the Rules and Articles of War.

Sworn and subscribed to, at *Camp Nelson*
this *29th* day of *August* 1864. *George Sanders*
Before *J. L. Randolph* *H. P. M.*

I CERTIFY, ON HONOR, That I have carefully examined the above named Volunteer agree-
ably to the General Regulations of the Army, and that, in my opinion, he is free from all bodily
defects and mental infirmity, which would in any way disqualify him from performing the
duties of a soldier.

P. G. Bennett
Capt Surg 7th Cav
EXAMINING SURGEON.

I CERTIFY, ON HONOR, That I have minutely inspected the Volunteer, *G. Sanders*
previously to his enlistment, and that he was entirely sober when enlisted; that, to the best of
my judgment and belief, he is of lawful age; and that, in accepting him as duly qualified to per-
form the duties of an able-bodied soldier, I have strictly observed the regulations which govern
the recruiting service. This soldier has *blue* eyes, *black* hair, *dark* complexion, is *five* feet *nine* inches high.

J. L. Randolph
H. P. M.
RECRUITING OFFICER OR AGENT.

Mustered into the United States Service *30th* day of *August* 1864

N. C. Timney
Capt 18th Inf
Mustering Officer

W. C. Timney
Capt 18th Inf
Adj. Gen.

Mustered into the service of the United States, for three years or during the war, from date of enlistment, in Company
Regiment of *1st Colored* Volunteers, on the *30th* day of *August* 1864 at *Camp Nelson*

1126

Sanders Jacob

Co L, 5 U. S. Col'd Cav.

Private

Private

CARD NUMBERS.

1	26
2	27
3	28
4	29
5	30
6	31
7	32
8	33
9	34
10	35
11	36
12	37
13	38
14	39
15	40
16	41
17	42
18	43
19	44
20	45
21	46
22	47
23	48
24	49
25	50

See Sanders Jacob

Book Mark:

See also

1127 Luther
Luster
Sanders, Luster

Co A, 5 U.S. Col'd Cav.

Private Private

CARD NUMBERS.

1	5359672	26
2	5359772	27
3	5359871	28
4	5360616	29
5	9090053	30
6	43146399	31
7	40730289	32
8		33
9		34
10		35
11		36
12		37
13		38
14		39
15		40
16		41
17		42
18		43
19		44
20		45
21		46
22		47
23		48
24		49
25		50

Book Mark:

See also

S | 5 Cav. | U.S.C.T.

Leicester Sanders

, Co. A, 5 Reg't U. S. Col'd Cav.

Appears on

Company Descriptive Book
of the organization named above.

DESCRIPTION.

Age 20 years; height 5 feet 7 inches.

Complexion Blk

Eyes Blk; hair Blk

Where born Taylor Co Ky

Occupation Farmer

ENLISTMENT.

When Sept 5, 186 .

Where Lebanon

By whom Capt Fiddler, term 3 y'rs.

Remarks: Died Dec 10/64

Warr

S | 56av | U.S.C.T.

Leather Saunders

Appears with rank of _____ on

Muster and Descriptive Roll

of a Detachment of U.S. colored
Mustered Accounts provided

Roll dated
Lebanon, Ky., Sept. 5, 1864.

Where born Taylor, Ky.

Age 20 years; occupation Farmer

When enlisted Sept. 5, 1864.

Where enlisted Lebanon, Ky.

For what period enlisted 3 years.

Eyes Blue; hair Black

Complexion Blue; height 5 ft. 9 in.

When mustered in Sept. 5, 1864.

Where mustered in Lebanon

Bounty paid \$ 100; due \$ 100

Clothing account:
Last settled _____, 1864; drawn since \$ 17 ⁵⁰/₁₀₀

Date of first muster Sept. 5, 1864.

Company to which assigned _____

Remarks: Master Pleasant Saunders.

Taylor, Co. Ky. With me current.

Book mark: _____

(356m)

D. J. D. D. D.

Copyist.

5 Cav. U.S.C.T.

Eustace Sanders

Co. A, 5 Reg't U. S. Col'd Cavalry.

Appears on

Company Muster-in and Descriptive Roll

of the organization named above. Roll dated

Ch. Nelson Ky, N. Y., Oct. 24, 1864.

Where born *Madison Kentucky*

Age *20* y'rs; occupation *Farmer*

When enlisted *Sept. 5*, 1864.

Where enlisted *Lebanon*

For what period enlisted *3* years.

Eyes *Blk*; hair *Blk*

Complexion *Blk*; height *5* ft. *7* in.

When mustered in *Sept. 5*, 1864.

Where mustered in *Lebanon*

Bounty paid \$ *100*; due \$ *100*

Where credited *4th Dist. Kentucky*

Company to which assigned *A*

Remarks:

Book mark:

Basterling

(356d)

Copyist.

S

5 Cav. | U.S.C.T.

Euster Sanders

Pvt, Co. A, 5 Reg't U. S. Col'd Cavalry.

Appears on

Company Muster Roll

for *8 Oct, 31*, 1864.

Present or absent *Present*

Stoppage, \$ *100* for

Due Gov't, \$ *100* for

Valuation of horse, \$ *100*

Valuation of horse equipments, \$ *100*

Remarks:
.....
.....
.....
.....
.....
.....
.....
.....
.....
.....

Book mark:

O. A. Sanders

(358)

Copyist.

S

5 Cav.

U.S.C.T.

Luster Sanders

Priv, Co. A, 5 Reg't U. S. Col'd Cavalry.

Appears on

Company Muster Roll

for *Nov, & Dec*, 186 *4*

Present or absent

Stoppage, \$ 100 for

Due Gov't, \$ 100 for

Valuation of horse, \$ 100

Valuation of horse equipments, \$ 100

Remarks: *died in Hospital
at Camp Nelson Ky,
Dec 10th 1864,
1st and 2^d Installment
Bounty due.*

Book mark:

(358)

Basterling

Copyist.

S

5 Cav.

U.S.C.T.

Luther Sanders

Pvt., Co. A, 5 Reg't U. S. Colored Cav.

Appears on Returns as follows:

Nov. 1864, Absent sick in Hospl
Camp Nelson, Ky.

Dec. 1864, Loss: Dec. 10/64, Camp
Nelson. Died in U.S. Genl
Hospl Camp Nelson, Ky.

Book mark:

L. B. Bowman

(546)

Copyist.

S

5 Cav. U.S.C.T.

Luther Sanders

Pvt, Co. A, 5 Reg't U. S. Col'd Cavalry.

Appears on Co. Muster-out Roll, dated

Helena Ark Mich 16 1866.

Muster-out to date _____, 186 .

Last paid to Pay due from 186 .
enlistment

Clothing account:

Last settled _____, 186 ; drawn since \$ _____ 100

Due soldier \$ _____ 100 ; due U. S. \$ _____ 100

Am't for cloth'g in kind or money adv'd \$ _____ 100

Due U. S. for arms, equipments, &c., \$ _____ 100

Bounty paid \$ _____ 100 ; due \$ _____ 100

Remarks: Died Cp Nelson Ky

Dec 18, 1864. Disease

unknown. Final

Statements forwarded

Dec 31, 1864.

Book mark: V. 17. P. 433. 70-369. 1879

Over

W. W. Sayre

(361)

Copyst.

JAN. - 9

5360616

1891

*See Dec 10/64 C.B. Vol 9.
P. 150*

Sanders, Luther

P. Co. A, 5 Reg't 11th Cav

3 Enclosures.

Bed Cards	Descriptive Lists
Burial Records /	Final Statements /
Certs. of Dis. for Discharge	Furloughs
C. M. Charges	Med. Des. Lists
Med. Certificates	Orders

Other papers relating to—

Admission to Hosp'l	Furlough
Casualty Sheet (Officer's)	Med. Examination
Confinement	Misc. Information
Contracts	Pay or Clothing
Death or Effects /	Personal Reports
Desertions	Rank
Discharge from Hosp'l	Transfer to Hosp'l
Discharge from Service	Transfer to V. R. C.
Duty	Transportation

Suther Sanders
In: Co A. J. W. S. L. S.
Died Dec^r 10. 1864
Genl Hoop: Camp Nelson Ky

1864

1864

1864

1864

1864

RECORD OF DEATH AND INTERMENT.

Name and number of person interred.....	Luther Sanders
Number and locality of the grave.....	857
Hospital number of the deceased.....	3575
Regiment, rank and company.....	3 rd W. S. L. C. Inf. Co. A.
Residence before enlistment.....	
Conjugal relation, (and if married the residence of the widow).....	Single
Cause of death.....	Pleurisy,
Age of the deceased.....	
Nativity	
References and remarks.....	
Date of death and burial.....	Dec 10 th / 64

Duplicates sent

Memoranda:

- 1. Blanket,
- 1. G. Coat.
- 1. Poncho
- 1. pr Drawers
- 1. Shirt
- 1. Boots,

Expended with corpse
 One Shirt,
 " pr Pants
 " Coat,
 " pr Sock.

INVENTORY OF THE EFFECTS

OF

Private Luther Sanders

Late of Company A

5th Reg't of 21st U. S. Col'd Troop

Volunteers, who died at Camp Nelson, Ky

on the 10th day of December 1864.

Surgeon General's Office,

RECORD & PENSION BUREAU,

Washington, October 30th 1866

The within Inventory is a true copy from the records

of Nelson General Hospital

Camp Nelson, Ky on file in

this Office, and contains all the information in the case that
can be found.

BY ORDER OF THE SURGEON GENERAL:

J. H. Woodward
Major, Assistant Surgeon, U. S. A.
A. C. C.

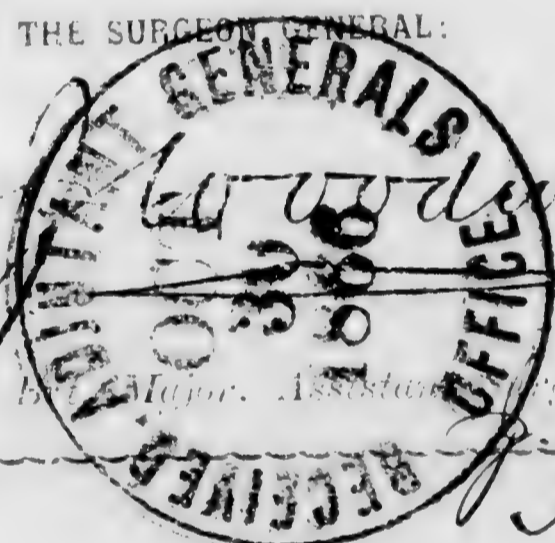

Inventory of the effects of Luther Sanders late
 a Private of Captain _____ Company A of
 the 5th Regiment of 21st Gold Troop Volunteers, who was enrolled as
 a _____ at _____ in the State of _____ on
 the _____ day of _____ 186 , and mustered into the service of the United
 States as _____ on the _____ day of _____ 186 , at _____
 in Company _____, _____ Regiment of _____ Volunteers, to serve _____
 years or during the war; he was born in _____ in the State
 of _____; he was _____ years of age, _____ feet _____ inches
 high, _____ complexion, _____ eyes, _____ hair, and by occupation, when enrolled,
 a _____; he died in Nelson General Hospital at
Camp Nelson Ky on the 10th day of December 1864, by
 reason of Pleurisy

INVENTORY.					
ARTICLES.	No.	ARTICLES.	No.	ARTICLES.	No.
Hats.....		Pairs trowsers.....		Knapsacks.....	
Caps.....		Pairs flannel drawers.....	/	<u>Poncho</u>	/
Forage caps.....		Pairs cotton drawers.....			
Great coats.....	/	Flannel shirts.....	/		
Uniform coats.....		Cotton shirts.....			
Uniform jackets.....		Pairs boots.....	/		
Flannel sack coats.....		Pairs shoes.....			
Blouses.....		Pairs socks.....			
Stable frocks.....		Blankets.....	/	MONEY.	
Fatigue overalls.....		Haversacks.....		Specie.....	\$
				Notes.....	\$

I CERTIFY, ON HONOR, that the above inventory comprises all the effects of Private
Luther Sanders, deceased, and that the effects are in the hands
 of 2nd Lt. E. W. Rostieau at Camp Nelson Ky A. G. M. June 7th 1865 to be disposed of by a Council of Administration.

(DUPLICATES.)

STATION : _____

Commanding the Company.

DATE : _____

Extract from Act of Congress.

SEC. 12. And be it further enacted, That the fees of agents and attorneys for making out and causing to be executed the papers necessary to establish a claim for a pension, bounty, and other allowance before the Pension Office, under this act, shall not exceed the following rates: For making out and causing to be duly executed a declaration by the applicant, with the necessary affidavits, and forwarding the same to the Pension Office, with the requisite correspondence, ten dollars: which sum shall be received by such agent or attorney in full for all services in obtaining such pension, and shall not be demanded or received, in whole or in part, until such pension shall be obtained; and the sixth and seventh sections of an act entitled "An act to grant pensions," approved July [fourteenth,] eighteen hundred and sixty-two, are hereby repealed.

SEC. 13. And be it further enacted, That any agent or attorney who shall, directly or indirectly, demand or receive any greater compensation for his services under this act than is prescribed in the preceding section of this act, or who shall contract or agree to prosecute any claim for a pension, bounty, or other allowance under this act, on the condition that he shall receive a per centum upon any portion of the amount of such claim, or who shall wrongfully withhold from a pensioner or other claimant the whole or any part of the pension or claim allowed and due to such pensioner or claimant, shall be deemed guilty of a high misdemeanor, and, upon conviction thereof, shall, for every such offense, be fined not exceeding three hundred dollars, or imprisoned at hard labor not exceeding two years, or both, according to the circumstances and aggravations of the offense.

Approved July 4, 1864.

NOTE 10.—If any soldier is charged a higher fee than that allowed by the above act, he should report the fact and the name of the agent to the Adjutant General, in order that steps may be taken to have the same refunded.

ADJUTANT GENERAL'S OFFICE.

July 21 1865

Duplicate with Inventory sent 2d Auditor.

FINAL STATEMENT

60 A
OF
Luther Sanders

3rd Reg't of U. S. Cavalry

VOLUNTEERS.

NOTE 1.—Two of these certificates (or duplicates) are to be given to each Volunteer Soldier or drafted man who may be discharged without being mustered out (Final Statements are never given to men mustered out of service,) that he may at once receive from the Paymaster the pay, &c., due him, and the captain or other COMMISSIONED officer commanding the company will certify to the act of the delivery of the duplicate certificates; with these certificates the Soldier is "entitled to" his discharge, and should also present his discharge to the Paymaster to have the payment endorsed on it. The discharge is to be given back to the Soldier by the Paymaster; the latter only retaining as his vouchers the duplicate certificates.

NOTE 2.—If the Soldier is entitled to pay for the use of his horse, the Company Commander will certify to that fact on the back of both these final statements, and also to the time he has pay due for having been so mounted on his own horse.

NOTE 3.—When a Soldier is furnished with final statements, his descriptive list, if he has one, should be taken up by the officer who gives the Soldier these statements, and endorsed with a statement to this effect by the officer. The endorsement should exhibit a full statement of the time for which the Soldier was allowed pay on his final statements, the clothing account, and all other charges against him or in his favor, so as to comprise a complete exhibit of his account. It will then be transmitted to the Company Commander of the Soldier, who will enter all the data necessary to a full understanding of the Soldier's account on the muster roll upon which the Soldier's discharge is reported. The descriptive list will then be destroyed. The object of this is, that the remaining portion of the Soldier's account may be settled upon the receipt of these muster rolls, and the Soldier receive any pay or allowances that may be due him at the time of his discharge, and which may not appear on his last final statements from the fact that his descriptive list is incomplete. These accounts for back pay, &c., are settled by the 2d Auditor of the Treasury Department.

NOTE 4.—Charges for loss or injury to ordnance, horse equipments, and other miscellaneous charges, should appear under the heading of "Other Stoppages."

NOTE 5.—Bounty paid by State authorities, and not by the United States, will not be entered on this statement.

NOTE 6.—Amounts due the Sutler and Laundress must be entered on the muster roll on which the discharge, death, desertion, &c., is reported, as well as on the final statement, otherwise the amount cannot be collected from the United States.

NOTE 7.—This blank will be used for deceased volunteers and drafted men, as well as for others.

NOTE 8.—Where a Soldier dies in Hospital or on detached service, his descriptive list, if he has one, should be sent with his final statements, in duplicate, to the Adjutant General, Washington, D. C.

NOTE 9.—If the soldier is a drafted man or substitute, the space for time, &c., or enrolled, should contain only the word *drafted* or *substitute*, as the case may be. If the Soldier is a "VETERAN," (OR RECRUIT,) the words *as a veteran*, (or *recruit*.) as the case may be, should be interlined after the words *mustered into the service of the U. S.* A statement of all the installments of *Veteran* or *Recruit* Bounty RECEIVED by the Soldier must be made on the back of each final statement.

Adjutant General's Office
Washington, D. C., Sept. 6, 1870.

§ 13 vol 9, P. 150
The Muster Out Roll of Company "A" 5th U. S. Colored Cavalry reports the death of Private Luther Sanders December 18, 1864.

The Muster Roll of the Company for November and December 1864, and the Final Statement of the soldier report date of death December 10th 1864.

The latter date (December tenth 1864) is held to be correct and the Muster Out Roll will be amended accordingly.

J. A. Archibone
Major U. S. Army,
Subj. Bureau Col. Troops.

Edw. J. M.

In return
Sept 8. 1870
2nd Army



I certify, on honor, that Luther Sanders, a Private of
Captain P. W. Anderson Company (A) of the fifth Regiment of U.S. Cavalry
VOLUNTEERS, of the State of _____, born in Saylor Co, State
of Kentucky, aged 20 years; 5 feet 7 inches high; Dark complexion,
Blue eyes, Blk hair, and by occupation a Laborer, who joined for service
and was enrolled (see Note 9) on the 5th day of Sept, 1864 at Sebanon
by Capt Fielder, for the period of three years, and mustered into
the service of the United States on the 5th day of September, 1864, at
Sebanon, by Capt Fielder; and having served
HONESTLY and FAITHFULLY with his Company to the present date, is now entitled to a
DISCHARGE by reason of Death in U.S. Genl Hospit at camp
Nelson "Ky" Dec 10th 1864 Disease not known

The said Luther Sanders has pay due from date of
Enlistment, to include the _____ day of _____, 186 , and
has pay due him from that time to the present date; he is entitled to pay and subsistence for
TRAVELING to place of enrollment, and whatever other allowances are authorized to volunteer
soldiers, drafted men, or militia, so discharged. He has received from the United States **CLOTHING**
amounting to twenty nine $\frac{63}{100}$ dollars, since the 5th day of September,
1864, when his clothing account was last settled. He has received from the United States
 $\frac{ }{100}$ dollars advanced **BOUNTY**.

There is to be stopped from him, on account of the State of _____, or other
authorities, for **CLOTHING**, &c., received on entering service, _____ $\frac{ }{100}$ dollars; and
for other stoppages, viz: _____
_____ $\frac{ }{100}$ dollars.

He has been furnished with **TRANSPORTATION** in kind from the place of his discharge to
_____; and he has been **SUBSISTED** for **TRAVELING** to his
place of enrollment, up to the _____, 186 .

He is indebted to _____, **SUTLER**, _____ $\frac{ }{100}$ dollars.
He is indebted to _____, **LAUNDRESS**, _____ $\frac{ }{100}$ dollars.

Given in Duplicate, at Camp Nelson "Ky", this 31st day
of December, 1864

John W. Anderson
Capt Co. A
Commanding Company.

Sanders, William

Co L, 5 U. S. Col'd Cav.

Private | Private

CARD NUMBERS.

1	5369849	26
2	5369944	27
3	5370037	28
4	5370136	29
5	5370226	30
6	5370318	31
7	5370406	32
8	5370531	33
9	5359347	34
10	5370778	35
11	90-21199	36
12	43147420	37
13	43148152	38
14	40730290	39
15		40
16		41
17		42
18		43
19		44
20		45
21		46
22		47
23		48
24		49
25		50

Book Mark:

See also

S | 5-leaf | **U.S.C.T.**

William Sanders

Co. L, 5-Reg't U. S. Col'd leaf

Appears on

Company Descriptive Book

of the organization named above.

DESCRIPTION.

Age 18 years; height 5- feet 10 inches.

Complexion Copper

Eyes Blue; hair Blue

Where born Kentucky

Occupation Farmer

ENLISTMENT.

When Substitute, 1866

Where 6 Dist Ky

By whom _____; term 1-yr.

Remarks: Rec'd Sept 27"/65

A. J. Anderson

(383g)

Copyist.

S

5 Cav

U.S.C.T.

William Sanders

Appears with rank of _____ on

Muster and Descriptive Roll

of Detachment U.S. Negro
Substitutes forwarded

_____ Roll dated
Covington Ky, Sept. 27, 1864.

Where born Kentucky

Age 18 years; occupation Farmer

When enlisted Sept 27, 1864.

Where enlisted Covington Ky

For what period enlisted 1 years.

Eyes Blk; hair Blk

Complexion Copper; height 5 ft. 10 in.

When mustered in Sept 27, 1864.

Where mustered in Covington Ky

Bounty paid \$ 100; due \$ 100

Clothing account:

Last settled _____, 186 ; drawn since \$ 12 ²⁰/₁₀₀

Date of first muster Sept 27, 1864.

Company to which assigned _____

Remarks: Credited to Cavalry Co.
S. D. E. C. D. Ky

Book mark : _____

A. C. Black

(356m)

Copyist.

D. | 5 bar | U.S.A.

William Sanders

Appears with rank of Sgt on

Muster and Descriptive Roll

of Detachment of 1st Colored Troops, forwarded

Roll dated

Louisville Ky., Oct. 4, 1864.

Where born Kentucky

Age 18 years; occupation Farmer

When enlisted _____, 186 .

Where enlisted _____

For what period enlisted _____ years.

Eyes Black; hair Black

Complexion Copper; height 5 ft. 10 in.

When mustered in Sept. 27, 1864.

Where mustered in Louisville

Bounty paid \$ 100; due \$ 100

Clothing account:

Last settled _____, 186 ; drawn since \$ 12²⁰/₁₀₀

Date of first muster Sept. 27, 1864.

Company to which assigned _____

Remarks: Credited to Co. 1st Ky. Inf. (substitute)

Book mark: _____

(356m)

W. W. Spector

Copyist.

D

5 Cav.

U.S.C.T.

William Sanders

Priv, Co. R, 5 Reg't U. S. Col'd Cavalry.

Appears on

Company Muster-in and Descriptive Roll

of the organization named above. Roll dated

Camp Nelson, Ky, Oct 30, 1864.

Where born Kentucky

Age 18 y'rs; occupation Farmer

When enlisted, 186 .

Where enlisted

For what period enlisted 1 years.

Eyes Black; hair Black

Complexion Copper; height 5 ft. 10 in.

When mustered in Sept 27, 186 .

Where mustered in Covington

Bounty paid \$ 100; due \$ 100

Where credited 6" Dist. Ky.

Company to which assigned

Remarks:

Substitute

Book mark:

Bradley

(356d)

Copyist.

S | 5 Cav. | U.S.C.T.

William Sanders
Pot, Co. L, 5 Reg't U. S. Col'd Cavalry.

Appears on

Company Muster Roll
for dated Oct 31, 1864

Present or absent Absent

Stoppage, \$ 100 for

Due Gov't, \$ 100 for

Valuation of horse, \$ 100

Valuation of horse equipments, \$ 100

Remarks: Under Gun
Nashville Tenn
Oct. 15/64

Book mark:

B. Sanders

(358)

Copyist.

S

5 Cav. U.S.C.T.

William Sanders

Pop, Co. L, 5 Reg't U.S. Col'd Cavalry.

Appears on

Company Muster Roll

for Nov & Dec, 1864.

Present or absent Absent

Stoppage, \$ 100 for

Due Gov't, \$ 100 for

Valuation of horse, \$ 100

Valuation of horse equipments, \$ 100

Remarks: Under our
muster roll since
Oct 15/64

Book mark:

Biddle

S | 5 Cav. | U.S.C.T.

William Sanders

Private, Co. L, 5 Reg't U. S. Col'd Cavalry.

Appears on

Company Muster Roll

for January & February, 1865

Present or absent Absent

Stoppage, \$ 100 for

Due Gov't, \$ 100 for

Valuation of horse, \$ 100

Valuation of horse equipments, \$ 100

Remarks: Indismounted

Camp Camp Nelson
Ky. 1 & 2 instale
of Bounty due

Book mark:

Biddle

(358)

Copyist.

S | **5 Cav. | U.S.C.T.**

William Sanders

Por, Co. L, 5 Reg't U. S. Col'd Cavalry.

Appears on

Company Muster Roll

for *March*, 1865

Present or absent *Present*

Stoppage, \$ 100 for

Due Gov't, \$ 100 for

Valuation of horse, \$ 100

Valuation of horse equipments, \$ 100

Remarks:

Book mark:

B. D. D.

(358)

Copyist.

S | **5 Cav.** | **U.S.C.T.** |

William Saunders
Sgt, Co. L, 5 Reg't U. S. Col'd Cavalry.

Appears on

Company Muster Roll

for *May & June*, 1865.

Present or absent *Present*

Stoppage, \$ 100 for

Due Gov't, \$ 100 for

Valuation of horse, \$ 100

Valuation of horse equipments, \$ 100

Remarks:

Book mark:

W. P. Foster

(358)

Copyist.

S | **5 Cav. | U.S.C.T.**

William Sanders
(Sgt), Co. L, 5 Reg't U. S. Col'd Cavalry.

Appears on

Company Muster Roll

for *July & Aug*, 18*65*.

Present or absent *Present*

Stoppage, \$ *100* for

Due Gov't, \$ *100* for

Valuation of horse, \$ *100*

Valuation of horse equipments, \$ *100*

Remarks: *Due U. S. for this*
40 cts -

Book mark :

W. Sanders

(358)

Copyist.

S | **5 Cav. | U.S.C.T.**

William Sanders
Pvt, Co. L, 5 Reg't U. S. Col'd Cavalry.

Appears on

Company Muster Roll

for *Sept & Oct*, 18*65*.

Present or absent

Stoppage, \$ 100 for

Due Gov't, \$ 100 for

Valuation of horse, \$ 100

Valuation of horse equipments, \$ 100

Remarks: *Mustered out of
Service for expiration
of term*

Book mark: *Discharged Sep 28/65
E. B. U. P. 79*

Reedster

S

5 Cav.

U.S.C.T.

William Sanders

Priv., Co. L., 5 Reg't U. S. Colored Cav.

Appears on Returns as follows:

Oct. to Dec. 1864, Absent on detached
service Nashville, Tenn.

Oct. 15/64.

Jan'y + Feby 1865, Absent in dis-
mounted camp, camp
Nelson, Ky.

July 1865, Absent in conf't at
Lexington, Ky.

Sept. 1865, Loss; Sept. 27/65, Lex.,
Ky. Dischgd Expiration
of service.

Book mark:

L. B. Bowman

(546)

Copyist.

A | *3rd Cav* | **U.S.C.T.**

William Sanders

(1st), Co. E, 3rd Reg't U. S. Col'd Cav

Appears on a

Detachment Muster-out Roll

of the organization named above. Roll dated

Lexington Ky Sept 25, 1865.

Muster-out to date *Sept 25, 1865*

Last paid to *Feb 25, 1865*

Clothing account:

Last settled....., 186 ; drawn since \$.....¹⁰⁰

Due soldier \$ *31* ^{*57*}/₁₀₀; due U. S. \$.....¹⁰⁰

Am't for cloth'g in kind or money adv'd \$.....¹⁰⁰

Due U. S. for arms, equipments, &c., \$.....¹⁰⁰

Bounty paid \$.....¹⁰⁰; due \$.....¹⁰⁰

Remarks: *Mustered out by*

reason of expiration
of term of service
& substitute

Discharge furnished

Book mark:

(349)

J. H. Anderson

Copyist.

S | *5 Cav.* | **U.S.C.T.**

William Saunders

C, Co. *D*, *5* Reg't U. S. Col'd *Cavalry*

Appears on **Co. Muster-out Roll**, dated
Delaware, Ark, Mar. 16, 1866.

Muster-out to date _____, 186 .

Last paid to *Feb. 28*, 1865.

Clothing account:

Last settled _____, 186 ; drawn since \$ _____ 100

Due soldier \$ *21* ^{*15*}/₁₀₀; due U. S. \$ _____ 100

Am't for cloth'g in kind or money adv'd \$ _____ 100

Due U. S. for arms, equipments, &c., \$ _____ 100

Bounty paid \$ _____ 100; due \$ _____ 100

Remarks: *Discharged Sep. 27*
65, at Lexington Ky. Must-
ered out for Expiration of
Service.

Book mark: *Discharged Sept. 28*
(over)

(361)

A. D. Taylor
Copyist.

Saunders, William

S, Co. *L.*

5

Regt

U.S.C. Cav.

2

Enclosures.

Bed Cards	Descriptive Lists
Burial Records	Final Statements
Certs. of Dis. for Discharge	Furloughs
C. M. Charges	Med. Des. Lists
Med. Certificates	Orders

Other papers relating to—

Admission to Hosp'l	Furlough
Casualty Sheet (Officer's)	Med. Examination
Confinement	Misc. Information
Contracts	Pay or Clothing
Death or Effects	Personal Reports
Desertions	Rank
Discharge from Hosp'l	Transfer to Hosp'l
Discharge from Service	Transfer to V. R. C.
Duty	Transportation

45-

No. _____

Wm Sanders

Enlisted at *Orange Ky*

As Substitute for

Silas Gey

On the *21st* day of *Sept*, 186*4*.

By

Henry H. Mitchell

E. A. May

E. J. Buckner

Board of Enrollment,

Dist. of *Kentucky*

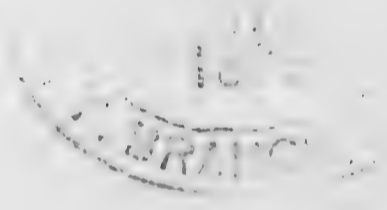

Credited to Carroll

Co. 1st Regt. Dist. Ky.

(No. 40.)

SUBSTITUTE VOLUNTEER ENLISTMENT.

STATE OF

TOWN OF



Kentucky *Carroll*

I, *Wm Sanders* born in the State
of *Kentucky*, aged *18* years, and by
occupation a *Farmer*. Do HEREBY ACKNOWLEDGE to have agreed with
Silas Gex, Esq., of *Carroll Co. Ky.*

to become his **SUBSTITUTE** in the Military Service, for a sufficient consideration paid and
delivered to me, on the *27th* day of *Sept.*, 186*4*
and having thus agreed with said *Silas Gex* I DO HEREBY
ACKNOWLEDGE to have enlisted this *27th* day of *Sept.*
186*4* to serve as a **Soldier** in the **Army of the United States of America**, for the period
of ~~THREE YEARS~~ *one*, unless sooner discharged by proper authority: I do also agree to accept such
bounty, pay, rations, and clothing, as are, or may be, established by law for soldiers. And I do
solemnly swear that I will bear true and faithful allegiance to the **United States of America**;
that I will serve them honestly and faithfully against all their enemies or opposers whomsoever;
and that I will observe and obey the orders of the President of the United States, and the orders
of the Officers appointed over me, according to the Rules and Articles of War.

SWORN and subscribed to, at *Carroll Ky.*
this *27* day of *Sept.*, 186*4*

BEFORE *Wm Sanders*
Maj Henry A Mitchell

We certify, on honor, That we have carefully examined the above-named Volunteer Substitute
agreeably to the Regulations, and that, in our opinion, he is free from all bodily defects and mental infirmity
which would in any way disqualify him from performing the duties of a soldier; that he was entirely sober
when enlisted; that he is of lawful age, (not under 18 years;) and that, in accepting him as duly qualified to
perform the duties of an able-bodied soldier, and as a Substitute in lieu of *Silas Gex*
Sept. 27 1864 drafted in *Carroll Co. 1st Regt. Dist. Ky.*
186*4*, we have strictly observed the Regulations which govern
in such cases. This soldier has *black* eyes, *black* hair, *fair* complexion; is *5* feet *10*
inches high.

Henry A Mitchell
Provost Marshal.

R. A. Atthey
Commissioner of Board.

E. J. Robinson
Surgeon of Board.

Board of Enrollment of *Carroll* Dist. of *Kentucky*

DECLARATION OF SUBSTITUTE.

I, Wm Sanders desiring to ENLIST
in the Army of the United States, for ~~THREE YEARS~~ ^{one} **Do declare**, That I am
18 1/2 years and _____ months of age; that I have
never been discharged from the United States service on account of disability or by sentence of
a court martial; and I know of no impediment to my serving honestly and faithfully as a soldier
for three years.

GIVEN at _____
the 27 day of Sept 1865

WITNESS:

A. A. Taylor

Wm Sanders
Mark

Charges & Specifications
preferred against the
Sauders Pri Co b. 5th Feb

Charge and Specification preferred against private
William Saunders of Company L, 5th U.S. Cavalry.

Charge

Sleeping on Post.

Specification.

In this that the private William
Saunders of Company L, 5th Regt. U.S. Cavalry
being duly posted as a sentry was found asleep
on his post between the hours of (11) eleven and
(12) twelve o'clock, when visited by the officers
of the day. This at Camp of Det 5th U.S. Cavalry
near Cairo Ky- on the night of June 2^d 1865

Michael Conroy
capt 5th U.S. Cavalry.

Witnesses

Sgt. West Miller Company K, 5th U.S. Cavalry.
Priv. George Spahr " " " " " "

Charge and Specification preferred against
William Saunders, of Company L, 5th Regt. Col. Cav.

Charge

(Sleeping on Post.)

Specification.

On this that he Priv. William Saunders
of Company L, 5th Regt. Col. Cav. being duly
posted as a sentry, was found a sleep on his post
between the hours of (11) eleven and (12) twelve o'clock
on when visited by the Officer of the day—

This at Camp of Det 5th Regt. Cavalry near
Paris Ky. on the night of June 2^d. 1865.

Michael Conroy
Capt 5th Regt. Col. Cav.

Witnesses

Corpl - West Miller Company K, 5th Regt. Col. Cav.
Priv. George Spahr " " " " " "

Sanders Wm.

....., Co., Reg't *U.S.A.T*

Enclosures.

- | | |
|------------------------------------|----------------------------|
| Bed Cards | Final Statements |
| Burial Records | Furloughs or L. of A. |
| Certs. of Dis. for Discharge | Med. Certificates |
| C. M. Charges | Med. Des. Lists |
| Descriptive Lists | Orders |
| Discharge Certificates | Pris. of War Record |
| Enlistment Papers | Resignations |

Other papers relating to—

- | | |
|------------------------------|---------------------------|
| Admission to Hosp'l | Furlough or L. of A. |
| Casualty Sheet | Med. Examination |
| Confinement | Misc. Information |
| Contracts | Pay or Clothing |
| Death or Effects | Personal Reports |
| Desertion | Rank |
| Discharge from Hosp'l | Transfer to Hosp'l |
| Discharge from Service | Transfer to V. R. C. |
| Duty | Transportation |
| | |

William Sumner

1852

Adjutant General's Office,

COLORED TROOPS BRANCH,

May 22, 1874

Vol. C. T., 187

Wanted in case of William Saunders, 2nd, Co. A,

3 Reg't

R.R. for July 1864, about him "in confinement" Lexington Ky, date not known"

Respectfully,

R. A. Woodward
Chief Clerk.)
P. H.

Adjutant General's Office,

, 187

Vol. C. T., 187

Reply in case of _____, Co. _____,

Reg't

It appears from records on file that charges were preferred against Saunders for sleeping on post. No record of trial. Records of Lexington, Ky. not on file.

R. R. D. H. W.
5.29.74, P. H. W.

1129

Samuel Jacob

Co L, 5 U. S. Col'd Cav.

Private

Private

CARD NUMBERS.

1	5359275	26
2	5370408	27
3	5370537	28
4	5370759	29
5	9091202	30
6	40730288	31
7		32
8		33
9		34
10		35
11		36
12		37
13		38
14		39
15		40
16		41
17		42
18		43
19		44
20		45
21		46
22		47
23		48
24		49
25		50

Book Mark:

See also 72 U S C Inf

Hls. regl. 4-7-40-264

H. Sturt &

S 15-Car | **U.S.C.T.**

Jacob Sanders

, Co. L, 5-Reg't U. S. Col'd Car

Appears on

Company Descriptive Book

of the organization named above.

DESCRIPTION.

Age 26 years; height 5 feet 1/2 inches.

Complexion Blk

Eyes Waxy; hair Red

Where born Russell Co., Va

Occupation Laborer

ENLISTMENT.

When Substitute, 186 .

Where 4th Dist Ky

By whom _____; term 3 y'rs.

Remarks: Died Sept 30th / 65

A. J. Anderson

(383g)

Copyist.

S 5 Cav | U.S.C.T.

Jacob Sanders

Pvt, Co., 5 Reg't U. S. Col'd Cav

Appears on

M. and D. Roll of Men Transferred

to the organization named above,

from

Roll dated July 18, 1865.

When enlisted, 186 .

Period for which enlisted 3 years.

When mustered in Jan 12, 1865.

Present or absent Not Stated

Company to which assigned

Remarks: 14 D.C.

Sub for Solomon Christian (drafted)
Deposit under 40305 A40 \$380

Book mark :

Abbott

(342)

Copyist.

J | **5 Cav.** | **U.S.C.T.**

Jacob Sanders
Pvt, Co. L, 5 Reg't U. S. Col'd Cavalry.

Appears on

Company Muster Roll

for *July & Aug*, 1865.

Present or absent *Present*

Stoppage, \$ *100* for

Due Gov't, \$ *100* for

Valuation of horse, \$ *100*

Valuation of horse equipments, \$ *100*

Remarks *Transferred from 72 U.S. C.T. per G.O. No. 127 Hd Qrs Dept of Ky. July 18. 65 Assigned to Co per R.O. 132 July 27. 65. Due Soldier for like Int. dep't under G.O. No. 300 & G.O. No. 111 Sept. Dec 27. 64 \$ 380.00*

Book mark:

Rochester

(358)

Copyist.

S | 5 Cav. | U.S.C.T.

Jacob Sanders
Capt, Co. L, 5 Reg't U. S. Col'd Cavalry.

Appears on

Company Muster Roll

for *Sept & Oct*, 1865.

Present or absent

Stoppage, \$ 100 for

Due Gov't, \$ 100 for

Valuation of horse, \$ 100

Valuation of horse equipments, \$ 100

Remarks: *Died in R. N.*

Sept 30. 65

*Due Soldier for like
amt. - Sep & under G.O.
712300 War Dept. A.
G.O. Dec 27th 64
\$ 380.*

Book mark:

R. Dexter

Jacob Sanders

Pvt., Co. L., 5 Reg't U. S. Colored Cav.

Appears on Returns as follows:

July 1865, Gain: July 27/65, Paris, Ky. Transfd to Co. Absent sick Camp Nelson, Ky.

Sept. 1865, Absent sick in Regtl Hospl since Sept. 22/65.

Oct. 1865, Loss: Sept. 30, Camp Brisbin. Died of Disease in Regtl Hospl.

Book mark:

L. B. Bowman

(546)

Copyist.

S | *5 Cav.* | **U.S.C.T.**

Jacob Saunders
Pr., Co. *L*, *5* Reg't U. S. Col'd *Cavalry*

Appears on **Co. Muster-out Roll**, dated
Helena Ark Mar. 14, 186*6* .
Muster-out to date _____, 186 .
Last paid to *Never Paid*, 186 .

Clothing account:

Last settled _____, 186 ; drawn since \$ _____ $\overline{100}$
Due soldier \$ *11* $\frac{67}{100}$; due U. S. \$ _____ $\overline{100}$
Am't for cloth'g in kind or money adv'd \$ _____ $\overline{100}$

Due U. S. for arms, equipments, &c., \$ _____ $\overline{100}$
Bounty paid \$ _____ $\overline{100}$; due \$ _____ $\overline{100}$

Remarks: *Leid at Lexington Ky*
Sept. 30th 65 Disease Disar-
rhua. Transfd from 72^d U.S. Col
per S.O. 127, Par. 3. Hd. qrs. Sept. Ky
July 18th 1865. Final statements
forwarded.

Book mark: *V. 153 P. 62. 73. -*

A. T. Taylor

(361)

Copyist.

Sanders, Jacob

P, Co. L, 5 Regt. U. S. C. Cav.

3 Enclosures.

Bed Cards	Descriptive Lists
Burial Records	Final Statements
Certs. of Dis. for Discharge	Furloughs
C. M. Charges	Med. Des. Lists
Med. Certificates	Orders

Other papers relating to—

Admission to Hosp'l	Furlough
Casualty Sheet (Officer's)	Med. Examination
Confinement	Misc. Information
Contracts	Pay or Clothing
Death or Effects	Personal Reports
Desertions	Rank
Discharge from Hosp'l	Transfer to Hosp'l
Discharge from Service	Transfer to V. R. C.
Duty	Transportation

INVENTORY OF THE EFFECTS

OF

Jacob Sanders

Late of Company *D*

5th Reg't of *W.C.*

Volunteers, who died at *Hosp^l at Long. Is.*

on the *30th* day of *Sept* 186 *5*.



Inventory of the effects of Jacob Sanders late
 a Private of Captain Michael Conroy Company L of
 the 5th Regiment of U. S. Col^d Cav. Volunteers, who was enrolled as
 a substitute at _____ in the State of _____ on
 the _____ day of _____ 1865, and mustered into the service of the United
 States as a Recruit on the 12th day of January 1865, at Urbana, Mo.
 in Company L, 5th Regiment of U. S. C. Volunteers, to serve 13
 years or during the war; he was born in Russell County in the State
 of Virginia; he was 26 years of age, 5 feet 7 1/2 inches
 high, Blk complexion, Blk eyes, wooly hair, and by occupation, when enrolled,
 a Laborer; he died in Regt Hospital, at
Near Lexington, Ky. on the 30th day of Sept 1865, by
 reason of Chronic Diarrhea,

INVENTORY.						
ARTICLES.	No.	ARTICLES.	No.	ARTICLES.	No.	
Hats.....	}	Pairs trousers.....	}	Knapsacks.....		
Caps.....		Pairs flannel drawers.....		}	<u>Soldiers check</u>	
Forage caps.....		Pairs cotton drawers.....			<u>Book - 1</u>	
Great coats.....		Flannel shirts.....			<u>for \$380 deposited</u>	
Uniform coats.....		Cotton shirts.....			<u>with 100 Walcott papers</u>	
Uniform jackets.....		Pairs boots.....				
Flannel sack coats.....		Pairs shoes.....				
Blouses.....		Pairs socks.....				
Stable frocks.....		Blankets.....				
Fatigue overalls.....		Haversacks.....				
					Money.	
				Specie.....	\$	
				<u>Cheque Book</u>	<u>380</u>	
				<u>Notes</u>		

I CERTIFY, ON HONOR, that the above inventory comprises all the effects of Private
Jacob Sanders, deceased, and that the Cheque Book is effects are in the hands
of forwarded herewith at _____
 _____ to be disposed of by a Council of Administration.

(DUPLICATES.)

STATION: Helena Ark
 DATE: Dec 19th 1865

Michael Conroy
Capt 5th U. S. C.
 Commanding the Company.

Extract from Act of Congress.

SEC. 12. And be it further enacted, That the fees of agents and attorneys for making out and causing to be executed the papers necessary to establish a claim for a pension, bounty, and other allowance before the Pension Office, under this act, shall not exceed the following rates: For making out and causing to be duly executed a declaration by the applicant, with the necessary affidavits, and forwarding the same to the Pension Office, with the requisite correspondence, ten dollars: which sum shall be received by such agent or attorney in full for all services in obtaining such pension, and shall not be demanded or received, in whole or in part, until such pension shall be obtained; and the sixth and seventh sections of an act entitled "An act to grant pensions," approved July [fourteenth,] eighteen hundred and sixty-two, are hereby repealed.

SEC. 13. And be it further enacted, That any agent or attorney who shall, directly or indirectly, demand or receive any greater compensation for his services under this act than is prescribed in the preceding section of this act, or who shall contract or agree to prosecute any claim for a pension, bounty, or other allowance under this act, on the condition that he shall receive a per centum upon any portion of the amount of such claim, or who shall wrongfully withhold from a pensioner or other claimant the whole or any part of the pension or claim allowed and due to such pensioner or claimant, shall be deemed guilty of a high misdemeanor, and, upon conviction thereof, shall, for every such offense, be fined not exceeding three hundred dollars, or imprisoned at hard labor not exceeding two years, or both, according to the circumstances and aggravations of the offense.

Approved July 4, 1834.

NOTE 10.—If any soldier is charged a higher fee than that allowed by the above act, he should report the fact and the name of the agent to the Adjutant General, in order that steps may be taken to have the same refunded.

Handwritten notes:
Adj. Gen. Dec 27 1861
Office 1000 ...
Adjutant General's Office
Washington D.C.

ADJUTANT GENERAL'S OFFICE
Dec 27 1861
Duplicate with Inventory sent to A. G. O.

FINAL STATEMENT

60 "2"
Jacob Sanders
Co. 5th Reg't of Inf. C. S.

VOLUNTEERS.

NOTE 1.—Two of these certificates (or duplicates) are to be given to each Volunteer Soldier or drafted man who may be discharged without being mustered out (Final Statements are never given to men mustered out of service) that he may at once receive from the Paymaster the pay, &c., due him, and the captain or other COMMISSIONED officer commanding the company will certify to the act of the delivery of the duplicate certificates; with these certificates the Soldier is "entitled to" his discharge, and should also present his discharge to the Paymaster to have the payment endorsed on it. The discharge is to be given back to the Soldier by the Paymaster; the latter only retaining as his vouchers the duplicate certificates.

NOTE 2.—If the Soldier is entitled to pay for the use of his horse, the Company Commander will certify to that fact on the back of both these final statements, and also to the time he has pay due for having been so mounted on his own horse.

NOTE 3.—When a Soldier is furnished with final statements, his descriptive list, if he has one, should be taken up by the officer who gives the Soldier these statements, and endorsed with a statement to this effect by the officer. The endorsement should exhibit a full statement of the time for which the Soldier was allowed pay on his final statements, the clothing account, and all other charges against him or in his favor, so as to comprise a complete exhibit of his account. It will then be transmitted to the Company Commander of the Soldier, who will enter all the data necessary to a full understanding of the Soldier's account on the muster roll upon which the Soldier's discharge is reported. The descriptive list will then be destroyed. The object of this is, that the remaining portion of the Soldier's account may be settled upon the receipt of these muster rolls, and the Soldier receive any pay or allowances that may be due him at the time of his discharge, and which may not appear on his last final statements from the fact that his descriptive list is incomplete. These accounts for back pay, &c., are settled by the 2d Auditor of the Treasury Department.

NOTE 4.—Charges for loss or injury to ordnance, horse equipments, and other miscellaneous charges, should appear under the heading of "Other Stoppages."

NOTE 5.—Bounty paid by State authorities, and not by the United States, will not be entered on this statement.

NOTE 6.—Amounts due the Sutler and Laundress must be entered on the muster roll on which the discharge, death, desertion, &c., is reported, as well as on the final statement, otherwise the amount cannot be collected from the United States.

NOTE 7.—This blank will be used for deceased volunteers and drafted men, as well as for others.

NOTE 8.—Where a Soldier dies in Hospital or on detached service, his descriptive list, if he has one, should be sent with his final statements, in duplicate, to the Adjutant General, Washington, D. C.

NOTE 9.—If the soldier is a drafted man or substitute, the space for time, &c., of enrolled, should contain only the word *drafted* or *substitute*, as the case may be. If the Soldier is a "VETERAN," (or RECRUIT,) the words *as a veteran*, (or *recruit*;) as the case may be, should be interlined after the words *mustered into the service of the U. S.* A statement of all the installments of Veteran or Recruit Bounty RECEIVED by the Soldier must be made on the back of each final statement.

I certify, on honor, that Jacob Sanders, a Private of
 Captain Michl Conroy Company (L) of the 5th Regiment of Infantry
VOLUNTEERS, of the State of _____, born in Russell Co, State
 of Virginia aged 25 years; 5 feet 7 1/2 inches high; Black complexion,
Black eyes, wooly hair, and by occupation a Sabrer, who joined for service
 and was enrolled (see Note 9) on the 4 day of Feb, 1865, at Stittuts
 by _____, for the period of _____ years, and mustered into
 the service of the United States on the 12th day of January, 1865, at
Urban, by 4th Dist Ohio; and having served
 HONESTLY and FAITHFULLY with his Company to the present date, is now entitled to a
DISCHARGE by reason of Death from chronic
Brain fever in Regt Hospital on 30th Sept 1865

The said Jacob Sanders was last paid by Paymaster
Never Paid, to include the _____ day of _____, 1865, and
 has pay due him from enrollment ~~that time~~ to the present date; he is entitled to pay and subsistence for
TRAVELING to place of enrollment, and whatever other allowances are authorized to volunteer
 soldiers, drafted men, or militia, so discharged. He has received from the United States **CLOTHING**
 amounting to \$41 - 33/100 dollars, since the 12th day of January,
 1865, when his clothing account was last settled. He has received from the United States
 _____ 100 dollars advanced **BOUNTY**.

There is to be stopped from him, on account of the State of _____, or other
 authorities, for **CLOTHING, &c.**, received on entering service, _____ 100 dollars; and
 for other stoppages, viz: _____

_____ 100 dollars.
 He has been furnished with **TRANSPORTATION** in kind from the place of his discharge to
 _____; and he has been **SUBSISTED** for **TRAVELING** to his
 place of enrollment, up to the _____, 1865.

He is indebted to _____, **SUTLER**, _____ 100 dollars.
 He is indebted to _____, **LAUNDRESS**, _____ 100 dollars.

Given in Duplicate, at Atlanta Ark, this 19th day
 of Dec, 1865.

Michael Conroy
Capt Col 5th Inf
 Commanding Company.

Report of the Death
of
Jacob Saunders.
5, W. S. Cary



Head, Line, Mail, Dept. 5th U.S. C.C.
Camp near Lexington Ky.
October 2^d 1865

Captain Cooney
Comdg Co 2^d 5th U.S. C.C.

Sir

I have the honor
to inform you that Jacob Saunders of your
Company died at this Hospital on the 30th day
of September 1865 of chronic Diarrhoea

G. M. Bowen
Surgeon 5th U.S. C.C.
James J. Lawrence
Hosp'l Steward U.S.A.

130
Scales William

Co A ^{4th} Regt. S. 5 U. S. Col'd Cav.

Guyler Chief Bugler

CARD NUMBERS.

1	5-3595-91	26
2	5-35-9693	27
3	5-35-9795	28
4	5-35-9899	29
5	5-35-9997	30
6	5-36-5590	31
7	5-36-0172	32
8	5-36-0346	33
9	5-35-9533	34
10	5-35-9547	35
11	5-35-9561	36
12	5-36-0635	37
13	5-35-9580	38
14	9090056	39
15	43145107	40
16	40730291	41
17		42
18		43
19		44
20		45
21		46
22		47
23		48
24		49
25		50

Book Mark:

See also

D | 5 Cav. | U.S.C.T.

William Seales

....., Co. *A*, 5 Reg't U. S. Col'd Cav.

Appears on

Company Descriptive Book
of the organization named above.

DESCRIPTION.

Age *22* years; height *5* feet, *0* inches.

Complexion *Blk*

Eyes *Blk*; hair *Blk*

Where born *Williamson Tenn.*

Occupation *Laborer*

ENLISTMENT.

When *Sept. 14*....., 186 .

Where *Louisville*

By whom *Capt. Morgan*, term *3* y'rs.

Remarks:

.....

.....

.....

.....

.....

.....

.....

.....

.....

.....

.....

.....

.....

.....

.....

.....

.....

.....

.....

.....

.....

.....

.....

.....

.....

.....

.....

.....

.....

.....

.....

.....

.....

.....

.....

.....

.....

.....

.....

.....

.....

.....

D | **5 Cav.** | **U.S.C.T.**

William Sealers

Bglr., Co. *A*, 5 Reg't U. S. Col'd Cavalry.

Appears on

Company Muster-in and Descriptive Roll
of the organization named above. Roll dated

Sp. Nelsonky, N. Y., Oct. 24, 1864.

Where born *Williamson Penna.*

Age *26* y'rs; occupation *Labourer*.

When enlisted *Sept 14*, 1864.

Where enlisted *Louisville*

For what period enlisted *3* years.

Eyes *Blk*; hair *Blk*

Complexion *Blk*; height *5 ft. 10* in.

When mustered in *Sept. 14*, 1864.

Where mustered in *Louisville*

Bounty paid \$ *100*; due \$ *100*

Where credited *4th Dist. Kentucky*

Company to which assigned *A*.

Remarks:
.....
.....
.....

Book mark:

Eustaling

(356d)

Copyist.

\$ 1 5 bar 1864

Wm Scates

Appears with rank of Rec't on

Muster and Descriptive Roll

of a Detachment of U.S. Colored Troops.
Mustered by Capt G W Tomack

5th Dist Ky Roll dated
Louisville Ky, Sept 14, 1864

Where born Williamson Tenn

Age 26 years; occupation laborer

When enlisted Sept 14, 1864.

Where enlisted Louisville Ky

For what period enlisted 2 years.

Eyes black; hair black

Complexion black; height 5 ft. 10 in.

When mustered in Sept 14, 1864.

Where mustered in Louisville Ky

Bounty paid \$ 100; due \$ 100

Clothing account:

Last settled _____, 186 ; drawn since \$ 100

Date of first muster Sept 14, 1864.

Company to which assigned _____

Remarks: 5th Dist. Ky

Book mark : _____

(356m)

W. J. James

Copyist.

S

5 Cav.

U.S.C.T.

William Seales

Bugler, Co. A, 5 Reg't U. S. Col'd Cavalry.

Appears on

Company Muster Roll

for *To Oct. 31*, 186*4*.

Present or absent *Present*

Stoppage, \$ *100* for

Due Gov't, \$ *100* for

Valuation of horse, \$ *100*

Valuation of horse equipments, \$ *100*

Remarks:

.....
.....
.....
.....
.....
.....
.....
.....

Book mark:

(358)

E. A. Sealing
Copyist.

William Seales

Byler, Co. A, 5 Reg't U. S. Col'd Cavalry.

Appears on

Company Muster Roll

for *Nov. & Dec.*, 1864.

Present or absent *Present*,

Stoppage, \$ *100* for

Due Gov't, \$ *100* for

Valuation of horse, \$ *100*

Valuation of horse equipments, \$ *100*

Remarks: *Due U.S. for Ordinance \$17.93. Paid 2d installment Bounty due.*

Book mark: _____

(358)

Castellina
Copyist.

S

5 Cav. | U.S.C.T.

William V. Leake

Reg't, Co. A, 5 Reg't U.S. Col'd Cavalry.

Appears on

Company Muster Roll

for *Jan 20 1865*, 1865.

Present or absent *Present*

Stoppage, \$ *100* for

Due Gov't, \$ *100* for

Valuation of horse, \$ *100*

Valuation of horse equipments, \$ *100*

Remarks: *1st Installment
Community due \$100.*

Book mark: _____

W. V. Leake

(358)

Copyist.

5 Cav. U.S.C.T.

William C. Cole

Capt., Co. A, 5 Reg't U. S. Col'd Cavalry.

Appears on

Company Muster Roll

for M. J. [unclear], 186 [unclear]

Present or absent Present

Stoppage, \$ 100 for

Due Gov't, \$ 100 for

Valuation of horse, \$ 100

Valuation of horse equipments, \$ 100

Remarks: [unclear] amount due \$150.

Book mark:

[Signature]

(358)

Copyist.

L | **5 Cav. | U.S.C.T.**

Wm. Seales

Bugler, Co. A, 5 Reg't U. S. Col'd Cavalry.

Appears on

Company Muster Roll

for *May 1862*, 1862

Present or absent *Present*

Stoppage, \$ *100* for

Due Gov't, \$ *100* for

Valuation of horse, \$ *100*

Valuation of horse equipments, \$ *100*

Remarks: *Act. chief bugler
at Regt. HdQs.
Bornty due \$50.*

Book mark: _____

W. H. H. H.

(358)

Copyist.

10

5 Cav. U.S.C.T.

William Deane

Serjt., Co. A, 5 Reg't U. S. Col'd Cavalry.

Appears on

Company Muster Roll

for Sept 1865, 1865

Present or absent Present

Stoppage, \$ 100 for

Due Gov't, \$ 100 for

Valuation of horse, \$ 100

Valuation of horse equipments, \$ 100

Remarks: Permitted from
competer as per R.O.
to date in
Cavalry, 1865.

Book mark:

W. Deane

(358)

Coyist.

William Deales

Rank *Capt* Reg't U. S. Col'd *Car*

Appears on

Field and Staff Muster Roll

for *Sept 1 1865* 1865.

Present or absent *Present*

Stoppage, \$ *100* for

Due Gov't, \$ *100* for

Valuation of horse, \$ *100*

Valuation of horse equipments, \$ *100*

Remarks: *Promoted from
Leigh Co. A. 5th US CC
per R. O. 161, October 1865*

Book mark:

W. Deales

5 Cav. U.S.C.T.

William Deane

Serjt; Co. A, 5 Reg't U. S. Col'd Cavalry.

Appears on

Company Muster Roll

for *dated Oct. 3*, 1869.

Present or absent

Stoppage, \$ 100 for

Due Gov't, \$ 100 for

Valuation of horse, \$ 100

Valuation of horse equipments, \$ 100

Remarks: *Appointed to
Wool Com Staff
of U.S. C.C. as per
R.O. No. 6, P 111*

Book mark:

Palmer
Copyist.

1 | 5th Cav. | U.S.C.T.

William Swales

Rank Capt, 5 Reg't U. S. Col'd Cav

Appears on

Field and Staff Muster Roll

for Nov. & Dec. 1865.

Present or absent Present

Stoppage, \$ 100 for

Due Gov't, \$ 100 for

Valuation of horse, \$ 100

Valuation of horse equipments, \$ 100

Remarks:

Book mark:

(357)

J. H. [Signature]

Copyist.

W. Bennett

Rank *Capt*, *1* Reg't U. S. Col'd *61st*

Appears on

Field and Staff Muster Roll

for *Jan & Feb* 186*6*

Present or absent *Present*

Stoppage, \$ *100* for

Due Gov't, \$ *100* for

Valuation of horse, \$ *100*

Valuation of horse equipments, \$ *100*

Remarks: *Second installment
Duty done \$100.00*

Book mark:

W. Bennett

S

5 Cav. U.S.C.T.

William Seales

Chief Bugler Co. A, 5 Reg't U. S. Colored Cav.

Appears on Returns as follows:

May 1865 absent without leave.

June 1865, Acting Chief Bugler at
Regt Hdqrs.

Aug. + Sept. 1865, actg Chief
Bugler.

Oct. 1865, Loss: Oct. 1, Camp Brisbane,
Va. Apt. Chief Trumpeter in
Regt Non Com Staff 10
for R. P. 101, 52 for 12.

(Chief Bugler) Gain: Oct. 1/65,
Camp Brisbane. Transf'd
from Co. A.

Book mark:

L. B. Bowman

(546)

Copyist.

A | 5 Cav | **U.S.C.T.**

William Seal

Rank Ch. Buy, 5 Reg't U. S. Col'd Cav

Appears on a

Field and Staff Muster-out Roll

of the organization named above. Roll dated

Helena, Ark Mar 16, 1866.

Muster-out to date Mar 16, 1866.

Last paid to Dec 31, 1865.

Clothing account:

Last settled....., 186 ; drawn since \$..... 100

Due soldier \$..... 100; due U. S. \$..... 62/100

Am't for cloth'g in kind or money adv'd \$..... 100

Due U. S. for arms, equipments, &c., \$..... 100

Bounty paid \$..... 100^{xx}; due \$..... 100^{xx}

Remarks: Private from enlistment
to July 5, 65 then Serg
Co A. to Sept 30, 65 then
Chief Buyer. Slave

Book mark: 4424 1880

S

5 Cav. U.S.C.T.

William Scoles

Sergt, Co. A, 5 Reg't U. S. Col'd Cavalry

Appears on Co. Muster-out Roll, dated

Helena Ark, March 16, 1866.

Muster-out to date _____, 186 .

Last paid to June 30, 1865.

Clothing account:

Last settled _____, 186 ; drawn since \$ _____ 100

Due soldier \$ _____ 100; due U. S. \$ 2 93 / 100

Am't for cloth'g in kind or money adv'd \$ _____ 100

Due U. S. for arms, equipments, &c., \$ _____ 100

Bounty paid \$ _____ 100; due \$ _____ 100

Remarks: Transferred to Regt Staff as Chief Bugler per HQ No 161, Hd Qrs 5th U.S. CC Oct 1, 1865 Cp Bristol Ky. Prt. from enrollment to July 5, 1865. then Sergt.

Book mark : _____

W. W. Sayre

(361)

Copyist.

1157

Schuck Jacob K
Co C, 5 U. S. Col'd Cav.

Captain | Captain

CARD NUMBERS.

1	26
2	27
3	28
4	29
5	30
6	31
7	32
8	33
9	34
10	35
11	36
12	37
12	38
14	39
15	40
16	41
17	42
18	43
19	44
20	45
21	46
22	47
23	48
24	49
25	50

See Schuck J. K.

Book Mark:

See also

1132

Scott Alexander

Co M, 5 U. S. Col'd Cav.

Private | Private

CARD NUMBERS.

1	5370880	26
2	5370962	27
3	5371064	28
4	5371146	29
5	5371233	30
6	5371319	31
7	5371407	32
8	5371493	33
9	5371577	34
10	5371662	35
11	5371746	36
12	9041319	37
13		38
14		39
15		40
16		41
17		42
18		43
19		44
20		45
21		46
22		47
23		48
24		49
25		50

Book Mark:

See also

A. J. Anderson | U.S.C.T.

A. J. Anderson

, Co: *M*, 5th Reg't U. S. Col'd *Car*

Appears on

Company Descriptive Book

of the organization named above.

DESCRIPTION.

Age *32* years; height *5* feet *8* inches.

Complexion *Black*

Eyes *BRN*; hair *BRN*

Where born *Scout Ky*

Occupation *Farmer*

ENLISTMENT.

When *Aug 29* 1864.

Where *Camp Nelson*

By whom *McKandolph*, term *3* y'rs.

Remarks:

A. J. Anderson

(383g)

Copyist.

23

5 Cav

U.S.C.T.

Alexander Scott

Priv., Co. M, 5 Reg't U. S. Col'd Cav

Appears on

Company Muster-in and Descriptive Roll

of the organization named above. Roll dated

Camp Nelson, Ky, Oct 30, 1864.

Where born Scott, Ky.

Age 32 y'rs; occupation Farmer

When enlisted Aug. 29, 1864.

Where enlisted Camp Nelson, Ky.

For what period enlisted 3 years.

Eyes Black; hair Black

Complexion Black; height 5 ft. 8 in.

When mustered in Aug. 30, 1864.

Where mustered in Camp Nelson, Ky.

Bounty paid \$ 100; due \$ 100

Where credited 7 Dist. Ky.

Company to which assigned

Remarks: ~~Beran Wood~~

~~Supposed to be name of owner.~~

Added May 18. 98. N.A.J.

Book mark:

W.S. Thompson

(356d)

Copyst.

C. J.

5 Cav. | U.S.C.T.

Alexander Scott

174, Co. M, 5 Reg't U.S. Col'd Cavalry.

Appears on

Company Muster Roll

for *to Oct. 31*, 186*1*.

Present or absent *Present*

Stoppage, \$ *100* for

Due Gov't, \$ *100* for

Valuation of horse, \$ *100*

Valuation of horse equipments, \$ *100*

Remarks:

Book mark: -----

(358)

W. S. Thompson

Copyist.

L

5 Cav. U.S.C.T.

Alexander Scott

Prvt., Co. M, 5 Reg't U. S. Col'd Cavalry.

Appears on

Company Muster Roll

for *Nov. & Dec.*, 1864.

Present or absent *Present*

Stoppage, \$ *100* for

Due Gov't, \$ *100* for

Valuation of horse, \$ *100*

Valuation of horse equipments, \$ *100*

Remarks: *1st & 2^d installment*

of bounty due.

Book mark:

M. S. Thompson

(358)

Copyist.

8

5 Cav. | U.S.C.T.

Alexander Scott

Priv., Co. M, 5 Reg't U. S. Col'd Cavalry.

Appears on

Company Muster Roll

for Jan. & Feb., 1863.

Present or absent Present.

Stoppage, \$ 100 for

Due Gov't, \$ 100 for

Valuation of horse, \$ 100

Valuation of horse equipments, \$ 100

Remarks: 1st & 2d installments of bounty due.

Book mark:

M. S. Thompson

(358)

Copyist.

08

5 Cav. | U.S.C.T.

Alexander Scott

Capt., Co. M, 5 Reg't U. S. Col'd Cavalry.

Appears on

Company Muster Roll

for *Mar. & Apr.*, 186*3*.

Present or absent *Present.*

Stoppage, \$ *100* for

Due Gov't, \$ *100* for

Valuation of horse, \$ *100*

Valuation of horse equipments, \$ *100*

Remarks: *1st installment
bounty due 7 100*

Book mark:

W. S. Thompson

(358)

Copyist.

S

5 Cav. | U.S.C.T.

Alexander Scott

Pr, Co. M, 5 Reg't U. S. Col'd Cavalry.

Appears on

Company Muster Roll

for *May & June*, 1865.

Present or absent *Present*

Stoppage, \$ *100* for

Due Gov't, \$ *100* for

Valuation of horse, \$ *100*

Valuation of horse equipments, \$ *100*

Remarks: *1st Entertainment County
Due \$100.*

Book mark:

Cutter

Copyist.

(358)

S

5 Cav. | U. S. C. T.

Alexander Scott

Plt, Co. M, 5 Reg't U. S. Col'd Cavalry.

Appears on

Company Muster Roll

for *July + Aug*, 1865.

Present or absent *Present*

Stoppage, \$ *100* for

Due Gov't, \$ *100* for

Valuation of horse, \$ *100*

Valuation of horse equipments, \$ *100*

Remarks:

Book mark:

Scott
Copyist.

(358)

S

5 Cav. | U. S. C. T.

Alexander Scott

Mr, Co. M, 5 Reg't U. S. Col'd Cavalry.

Appears on

Company Muster Roll

for *Sept & Oct*, 1865.

Present or absent *Present*

Stoppage, \$ *100* for

Due Gov't, \$ *100* for

Valuation of horse, \$ *100*

Valuation of horse equipments, \$ *100*

Remarks: *Dwells for Capt
Gammie # 153*

Book mark:

W. W. W.

(358)

Copyist.

S

5 Cav. | U.S.C.T.

Alexander Scott

Pvt, Co. M, 5 Reg't U. S. Col'd Cavalry.

Appears on

Company Muster Roll

for Jan & Feb, 1866.

Present or absent Present

Stoppage, \$ 100 for

Due Gov't, \$ 100 for

Valuation of horse, \$ 100

Valuation of horse equipments, \$ 100

Remarks:

[Dashed lines for remarks]

Book mark:

[Signature]

(358)

Copyist.

S

5 Cav.

U.S.C.T.

Alexander Scott

Pvt, Co M, 5 Reg't U. S. Col'd Cavalry.

Appears on Co. Muster-out Roll, dated

Helena Ark, Mar 16, 1866.

Muster-out to date

Mar 16, 1866.

Last paid to

Dec. 31, 1865.

Clothing account:

Last settled....., 186 ; drawn since \$..... 100

Due soldier \$..... 100; due U. S. \$ 19 87/100

Am't for cloth'g in kind or money adv'd \$..... 100

Due U. S. for arms, equipments, &c., \$..... 100

Bounty paid \$ 100 100; due \$ 100 100

Remarks: Slave Apr 19. 61

Book mark:

269/84

(361)

Styes

Copyist.

Scott, Alexander

Co. M

5

Reg't NSCCar

1 Enclosures.

Bed Cards	Final Statements
Burial Records	Furloughs or L. of A.
Certs. of Dis. for Discharge	Med. Certificates
C. M. Charges	Med. Des. Lists
Descriptive Lists	Orders
Discharge Certificates	Pris. of War Record
Enlistment Papers	Resignations

Other papers relating to—

Admission to Hosp'l	Furlough or L. of A.
Casualty Sheet	Med. Examination
Confinement	Misc. Information
Contracts	Pay or Clothing
Death or Effects	Personal Reports
Desertion	Rank
Discharge from Hosp'l	Transfer to Hosp'l
Discharge from Service	Transfer to V. R. C.
Duty	Transportation

DECLARATION OF RECRUIT.

I, Alexander Scott desiring to volunteer as a soldier in the ARMY OF THE UNITED STATES, for the term of Three Years, DO DECLARE That I am 22 years and months of age; that I have never been discharged from the United States service on account of disability or by sentence of a court-martial, or by order before the expiration of a term of enlistment; and I know of no impediment to my serving honestly and faithfully as a soldier for three years.

GIVEN at Camp Nelson the 29th day of August 1864

Witness: J. C. Strook

Alexander Scott
mark

By William Wood
Wm. Y. Wood
Wm. Y. Wood
Volunteered at Camp Nelson
Aug 29 1864
No. Alexander Scott
The Hundred & Thirty Seven

Consent of Parent or Guardian in case of a Minor, if a Free Man, or in the case of a Slave, of the Person to whom he owes Service:

I, Do CERTIFY, That I am the that the said is years of age; and I do freely give my CONSENT to his volunteering as a SOLDIER in the Army of the United States, for the period of THREE YEARS, under the conditions of the laws of the United States.

GIVEN at the day of

Witness:

NOTE 1.—This blank will be used for enlistments of United States colored troops. They will be made out in duplicate in all cases—one to accompany the recruiting return of the superintendent (not the recruiting officer) to the Adjutant General, and one to accompany the accounts of the officer who pays bounty, &c.
NOTE 2.—An enlistment holds to service. A muster-in-must, in all cases, precede payment of pay, bounty, pension, &c. A muster-in roll, must in all cases, be filed in the Adjutant General's Office as evidence of muster-in. The mustering officer, commissary, or assistant commissary of musters, as the case may be, will countersign both enlistments as having mustered the soldiers into the service of the United States before either of them is given to the disbursing officer.

UNITED STATES COLORED TROOPS ENLISTMENT.

STATE OF

TOWN OF

Kentucky

Camp Nelson

I, *Alexander Scott* born in *Scott Co*

in the State of *Kentucky* aged *Twenty Two* years

and by occupation a *Farmer* Do HEREBY ACKNOWLEDGE TO

have volunteered *Twenty ninth* day of *August* 186*4*

to serve as a **Soldier** in the **Army of the United States of America**, for the

period of **THREE YEARS**, unless sooner discharged by proper authority: Do

also agree to accept such bounty, pay, rations, and clothing, as are, or may be,

established by law for the U. S. colored troops.

And I, *Alexander Scott*

do solemnly swear that I will bear true faith and allegiance to the **United States**

of America, and that I will serve them honestly and faithfully against all their

enemies or opposers whomsoever; and that I will observe and obey the orders

of the President of the United States, and the orders of the officers appointed

over me, according to the Rules and Articles of War.

Sworn and subscribed to, at *Camp Nelson*

this *29th* day of *Aug 1864* *Alexander Scott* his

Before *Alexander Scott* mark

I CERTIFY, ON HONOR, That I have carefully examined the above named Volunteer agree-
ably to the General Regulations of the Army, and that, in my opinion, he is free from all bodily
defects and mental infirmity, which would in any way disqualify him from performing the
duties of a soldier.

J. G. Barrett
Asst Surg 7th Regt
EXAMINING SURGEON.

I CERTIFY, ON HONOR, That I have minutely inspected the Volunteer, *A. Scott*
previously to his enlistment, and that he was entirely sober when enlisted; that, to the best of
my judgment and belief, he is of lawful age; and that, in accepting him as duly qualified to per-
form the duties of an able-bodied soldier, I have strictly observed the regulations which govern
the recruiting service. This soldier has *blue* eyes, *blue* hair, *blue* complexion, is *five* feet *eight* inches high.

Alexander Scott
D. P. M.
RECRUITING OFFICER OR AGENT.

Mustered into the United States Service.....*30* day of *August* 186*4*

N. C. Grimes
Capt 18th US Inf
Mustering Officer

Mustering Officer

N. C. Grimes
Capt 18th US Inf

Mustered into the service of the United States, for three years or during the war, from date of enlistment, in Company
Regiment of *Volunteers*, on the *30th* day of *August* 186*4* at *Camp Nelson*

Scott H. H. H.

Co *M*, 5 U. S. Col'd Cav.

Private | *Private*

CARD NUMBERS.

1	5370881	26
2	5370963	27
3	5371063	28
4	5371147	29
5	5371765	30
6	9091325	31
7	8126-05-1874	32
8	40730292	33
9		34
10		35
11		36
12		37
13		38
14		39
15		40
16		41
17		42
18		43
19		44
20		45
21		46
22		47
23		48
24		49
25		50

Book Mark: *8126-05-1874*

See also

5 | *5* *Car* | **U.S.C.T.**

Alfred Scott

, *Co M*, *5* Reg't U. S. Col'd *Car*

Appears on

Company Descriptive Book

of the organization named above.

DESCRIPTION.

Age *21* years; height *5* feet *4* inches.

Complexion *Black*

Eyes *BR*; hair, *BR*

Where born *Scott Ky*

Occupation *Farmer*

ENLISTMENT.

When *Aug 29*, 1864.

Where *Camp Nelson*

By whom *McKananeph*; term *3* y'rs.

Remarks: *Dis at US Gr Hosp*
Camp Nelson Ky
14 Oct 1864.

(383g)

A. J. Anderson

Copyist.

Alfred Scott

Co. M, 5 Reg't U. S. Col'd Cav.

Appears on

Company Muster-in and Descriptive Roll
of the organization named above. Roll dated
Camp Nelson, Ky, Oct 30, 1864.

Where born *Scott, Ky.*

Age *21* y'rs; occupation *Farmer*

When enlisted *Aug. 29*, 1864.

Where enlisted *Camp Nelson, Ky.*

For what period enlisted *3* years.

Eyes *Black*; hair *Black*

Complexion *Black*; height *5* ft. *4* in.

When mustered in *Aug 31*, 1864.

Where mustered in *Camp Nelson, Ky.*

Bounty paid \$ *100*; due \$ *100*

Where credited *7 Dist. Ky.*

Company to which assigned

Remarks: *J. C. Beatty*

x Supposed to be name of owner,

Added May 18, 98. H.A.F.

Book mark: *B-111 Ky.*

S 126-05-1874

W. S. Thompson

28

5 Cav. | U. S. C. T.

Alfred Scott
.....
Priv......, Co. M, 5 Reg't U. S. Col'd Cavalry.

Appears on

Company Muster Roll

for *to Oct. 31*....., 186*1*/.

Present or absent *Present.*.....

Stoppage, \$.....100 for

Due Gov't, \$.....100 for

Valuation of horse, \$.....100

Valuation of horse equipments, \$.....100

Remarks:.....

Book mark:.....

M. S. Thompson
.....

(358)

Copyist.

S

5 Cav. | U.S.C.T.

Alfred Scott
Prv., Co. M, 5 Reg't U. S. Col'd Cavalry.

Appears on

Company Muster Roll

for Nov. 8 Dec., 1864.

Present or absent Absent

Stoppage, \$ 100 for

Due Gov't, \$ 100 for

Valuation of horse, \$ 100

Valuation of horse equipments, \$ 100

Remarks: Sick at camp
Nelson, Ky.
pay of 3 instalments
of bounty due

Book mark:

M. S. Thompson

(358)

Copyist.

8

5 Cav. | U.S.C.T.

Wm. Scott

(Bvt.), Co. M, 5 Reg't U. S. Col'd Cavalry.

Appears on

Company Muster Roll

for *Jan & Feb.*, 1865.

Present or absent

Stoppage, \$ 100 for

Due Gov't, \$ 100 for

Valuation of horse, \$ 100

Valuation of horse equipments, \$ 100

Remarks: *1st & 2d instalments of bounty due. Sack at Camp Nelson Ky.*

Book mark: *Died Oct. 14/64 E.B. 7. 11. 4' 12.5*

M. S. Thompson

(358)

Copyist.

(over)

S | 5 Cav. | U.S.C.T.

Alfred Scott

Priv, Co. M, 5 Reg't U. S. Colored Cav.

Appears on Returns as follows:

Nov. 1864, Absent sick in Drs.
Camp Nelson, Ky.

Dec. 1864 to Mch 1865, Absent sick
at Camp Nelson, Ky.

Book mark :

L. B. Bowman

(546)

Copyist.

S | 5 Cav. | U.S.C.T.

Alfred Scott

Pvt., Co. M., 5 Reg't U. S. Col'd Cavalry.

Appears on Co. Muster-out Roll, dated
Helena Ark, Mar 16, 1866.

Muster-out to date _____, 186 .

Last paid to _____, 186 .

Clothing account:

Last settled _____, 186 ; drawn since \$ _____ 100

Due soldier \$ _____ 100; due U. S. \$ _____ 100

Am't for cloth'g in kind or money adv'd \$ _____ 100

Due U. S. for arms, equipments, &c., \$ _____ 100

Bounty paid \$ _____ 100; due \$ _____ 100

Remarks: died in Genl Hospital
Camp Nelson, Ky Oct. 14. 64
Slave Apr 19. 61

Book mark: S. 126. 2. 10. C. 2. 74

(361)

Styus

Copyied.

S. 1 5th Cav. U.S.C.

Alfred Scott

, Co. No. , 5th Reg't U.S.C.

NOTATION.

Book mark:

EB 11/125

S. 126.6-2.1874.

Record and Pension Office,

WAR DEPARTMENT.

This book mark refers only to a report from the medical records, made by the Surgeon General to the Adjutant General, relative to the above-named man. As the medical records have since been carded, no transcript of this report is made hereon.

E. P. Vanauzer.

(491)

Copyist.

Scott Alfred

P, Co. M, 5 Reg't 26. S. C. Cav.

8 Enclosures.

Bed Cards	Final Statements
Burial Records /	Furloughs or L. of A
Certs. of Dis. for Discharge	Med. Certificates
C. M. Charges	Med. Des. Lists
Descriptive Lists	Orders
Discharge Certificates	Pris. of War Record
Enlistment Papers	Resignations

Other papers relating to—

Admission to Hosp'l	Furlough or L. of A
Casualty Sheet 3	Med. Examination
Confinement	Misc. Information /
Contracts	Pay or Clothing
Death or Effects 2	Personal Reports
Desertion	Rank
Discharge from Hosp'l	Transfer to Hosp'l
Discharge from Service	Transfer to V. R. C.
Duty	Transportation

1

War Department,

ADJUTANT GENERAL'S OFFICE,

Washington, Feb 8 1867.

Respectfully returned to the Commission for the State of Kentucky, with the information that Alfred Scott was enlisted at Camp Nelson, August 29 1864 and was mustered in as private in Co. M. 5th U.S.C.T. Aug. 30. 1864.

61171 B

H. R. Moore

Asst. Adj't General.

H.A.B.

No. 1171

APPLICATION OF

Joseph B. Beatty

OF

Scott County Ky

FOR COMPENSATION FOR SLAVE,

Named Amos Scott

Enlisted Jan 31 1864,

In Com. W, 5th Regiment,

U. S. COLORED TROOPS.

Received Jan 19, 1867

Compensation Awarded

186

Dollars.

President of Board of Claims.

Claimant's Attorney,

Robinson & Gano

Claimant's Post-office Address,

Frankfort Ky

FRANKFORT COMMONWEALTH PRINT.

Headquarters Kentucky Volunteers,

Adjutant-General's Office,

Frankfort, Dec 7, 1866.

I hereby certify, that it appears from the U. S. Muster-Dr
Rolls on file in this Office, that Alfred Scott
was enrolled on the 29 day of August, 1864, at
Camp Nelson Ky., by J. C. Randolph,
and mustered into the U. S. service on the 30 day of August
1864, at Camp Nelson Ky., by Capt. H. C. Kinney
to serve Three years. Said Alfred Scott
is described as follows: Twenty One age, Black eyes, Black hair,
Black complexion, 5' 4" height. It further appears from
said Rolls, that Alfred Scott owed
service to J. C. Beatty and
is Credited to Scott County
Kentucky and was assigned
to Company No 5 Caval Colored



In Testimony Whereof, I have hereunto set my
hand, and affixed my Official Seal, this
7 day of Dec 1866.



D. W. Lindsey
Adjutant General of Kentucky.

B. 207. B. 264

any authority or pretended authority in hostility to the United States; that I have not yielded a vol-
untary support to any insurrection, rebellion or pretended government, authority, power or constitution
within the United States hostile thereto. And I do further swear that, to the best of my knowledge
and ability, I have supported and defended, and will continue to support and defend, the United
States against all enemies, foreign and domestic; and that I have supported, defended and obeyed, and
will continue to support, defend and obey, the Constitution and laws of the United States; that I will
bear true faith and allegiance to the same; and that I take this oath freely, without any mental reserva-
tion or purpose of evasion: So help me God.

Sworn to and subscribed before me, at

this 24 day of Dec 1866.

A. B. Beatty
Georgetown Ky.

Goard Spears
Notary Public for Scott Co Ky



CLAIM OF

Joseph B. Beatty

FOR THE COMPENSATION OF SLAVE NAMED

Alfred Scott

I, Joseph B. Beatty, a loyal citizen, and a resident of the County of Scott, State of Kentucky, hereby claim compensation, under the provisions of Section 24, act approved February 24, 1864, and section 2, act approved July, 28, 1866, for my slave Alfred Scott, enlisted August 30th, 1864, at Camp Nelson Ky, by Capt McHenry in the 5th regiment U. S. Colored Troops, Co. M; certificate of which enlistment, and a descriptive list, as required, accompany this application. That I did not acquire said slave subsequent to said enlistment, but had a valid title to him at the date of said enlistment, and previous thereto: I having acquired my title to him and my ownership over him as follows, to-wit: by being born my slave.

In proof of my loyalty to the Constitution and Government of the United States, I present the accompanying oath, which I have taken, signed and acknowledged; to be filed with this application, in accordance with requirement of General Orders, No. 329, 1863, War Department, Adjutant General's Office.

J. B. Beatty

, 186...

OATH OF ALLEGIANCE.

I, Joseph B. Beatty, the owner and Claimant, do solemnly swear that the foregoing claim is a just and true claim due to me as master and owner of the said slave, and that the facts alleged in said claim in respect to the draft or enlistment (as the case may be) of said slave into the Military service of the United States are true. And I do further swear that I have never joined, or been concerned in, any insurrection or rebellion; that I have never borne arms against the United States; that I have never given any aid, countenance, counsel or encouragement to any person or persons engaged, or whom I had reason to believe were about to engage, in insurrection, rebellion or armed hostility against the United States; that I have neither sought, nor accepted, nor attempted to exercise the functions of any office, civil or military, nor to perform any service whatever, under any authority or pretended authority in hostility to the United States; that I have not yielded a voluntary support to any insurrection, rebellion or pretended government, authority, power or constitution within the United States hostile thereto. And I do further swear that, to the best of my knowledge and ability, I have supported and defended, and will continue to support and defend, the United States against all enemies, foreign and domestic; and that I have supported, defended and obeyed, and will continue to support, defend and obey, the Constitution and laws of the United States; that I will bear true faith and allegiance to the same; and that I take this oath freely, without any mental reservation or purpose of evasion: So help me God.

J. B. Beatty

Sworn to and subscribed before me, at Georgetown Ky, this 24 day of Dec, 1864.

David Spencer, Notary Public for Scott Co Ky



PROOF OF OWNERSHIP.

STATE OF KENTUCKY,

COUNTY OF *Scott* } SS.

We *J. G. Miller* and *J. L. Sinclair* each of lawful age, and resident citizens of the State and County aforesaid, do certify that *Joseph B. Beatty* of the State and County aforesaid, was on the *30* day of *August* 186*4*. the lawful owner of the slave named *Alfred Scott*; referred to and described in the foregoing claim for compensation.

Sworn to and subscribed before me a *Helen Tuller* for the County of *Scott* State of Kentucky, this the *24* day of *Dec* 186*6*.
J. L. Sinclair
J. G. Miller
Helen Tuller

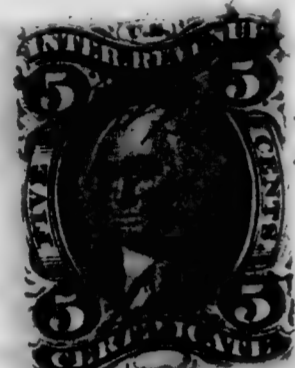

PROOF OF LOYALTY.

STATE OF KENTUCKY,

COUNTY OF *Scott* } SS.

We *J. L. Sinclair* and *J. G. Miller* loyal men and each of lawful age, and resident citizens of the of in the State and County aforesaid, upon our oaths declare that we have known *Joseph B. Beatty* a resident of the State and County aforesaid, since the 4th day of March, 1861, and know that he has firmly and faithfully maintained his or her adherence and allegiance to the Government of the United States, by defending its cause against the Government and forces of the so-called Confederate States of America, in all suitable and practicable ways, and according to his or her ability and opportunity.

Sworn to and subscribed before me a *Helen Tuller* for the county of *Scott* State of Kentucky, this the *24* day of *Dec* 186*6*.
J. L. Sinclair
J. G. Miller
Helen Tuller



POWER OF ATTORNEY.

My Post-Office address is _____ County of _____ State of Kentucky, and I hereby direct that all communications to me, touching this claim, be sent under cover to _____, who is hereby appointed and constituted my true and lawful attorney, to prosecute this claim for me, and who is hereby authorized and empowered to receive and receipt for any award, order, draft, certificate, voucher, warrant, papers or _____ that may be issued in the adjustment of this claim, or the payment thereof, the same as I could do in person were I present and acting for myself, and to file any additional evidence that may be required in the prosecution of this claim.

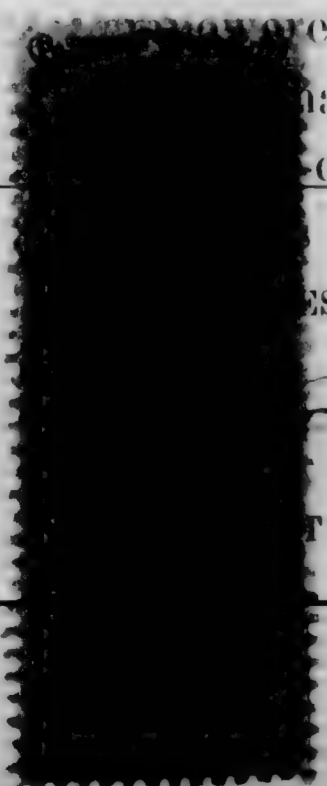

ESS.] } The owner signs here. } *J. B. Beatty*
} Two witnesses to owner's signature sign here. }
J. L. Sinclair
J. G. Miller

Alfred Scott

5" Uf 6 W

October 14th 1864,

Genl Hosp: Camp Delany

RECORD OF DEATH AND INTERMENT.

Name and number of person interred	Alfred Scott
Number and locality of the grave	763
Hospital number of the deceased.	4735
Regiment, rank and company.	5 th U. S. Col. Ia
Residence before enlistment.	
Conjugal relation, [and if married the residence of the widow.]	}
Cause of death	
Age of the deceased.	} Dysentery
Nativity.	
References and remarks.	} (Oct 14/00)
Date of death and burial.	

Memoranda of effects.

Coats wrapper, cap, out, all blankets
 Co. provided with cap, uniform coat, pants
 stockings,

INVENTORY OF THE EFFECTS

OF

Priv. Alfred Scott

Late of Company _____

5 Reg't of U. S. C. C.

Volunteers, who died at Camp Nelson Ky
on the 14 day of October 1864.

Surgeon General's Office,

RECORD & PENSION BUREAU,

Washington, Nov. 5th 1866

The within Inventory is a true copy from the records
of Nelson General Hospital
Camp Nelson Ky on file in
this Office, and contains all the information in the case that
can be found.

BY ORDER OF THE SURGEON GENERAL:

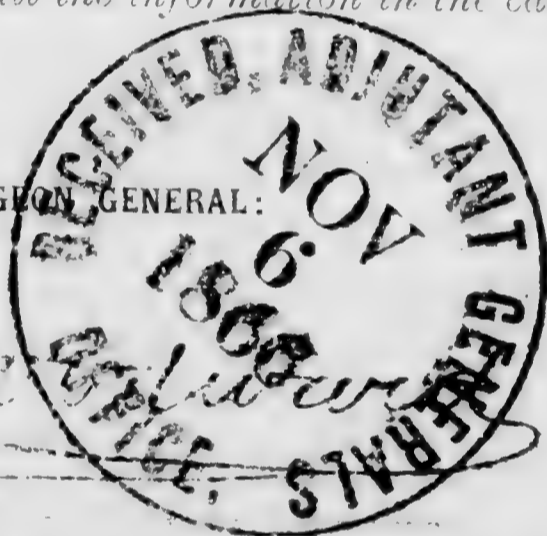

[Handwritten signature]

Bvt. Major, Assistant Surgeon, U. S. A.

J. R. D.

or be
icer of
sioned
ve his
e De-
paid to
oidier.
ffects
ated to
ent or
tted to
of the
sioned
ad paid

nd non-
f War,
of the
ame to
c., in
of the
ded, as
er dies
y of his
the re-
orward
onged,
at time
at the
er roll
will be
mpany

ated in
rted on

icer or
eace,
er the
eds de-
il they

ation, a
by the
aymas-
anding
y (Re-
186-

turned
the Ad-
s of the
al, their
r cases,
djutant

uplicate
should
icer.

Inventory of the effects of Alfred Scott late
 a Private of Captain _____ Company _____ of
 the 5 Regiment of 22 S. I. C. Volunteers, who was enrolled as
 a _____ at _____ in the State of _____ on
 the _____ day of _____ 186 , and mustered into the service of the United
 States as a _____ on the _____ day of _____ 186 , at _____
 in Company _____, _____ Regiment of _____ Volunteers, to serve _____
 years or during the war; he was born in _____ in the State
 of _____; he was _____ years of age, _____ feet _____ inches
 high, _____ complexion, _____ eyes, _____ hair, and by occupation, when enrolled,
 a _____; he died in Nelson General Hospital, at
Camp Nelson, Ky on the 14 day of October 1864, by
 reason of Dysentery.

INVENTORY.					
ARTICLES.	No.	ARTICLES.	No.	ARTICLES.	No.
Hats.....		Pairs trousers.....		Knapsacks.....	
Caps.....	/	Pairs flannel drawers.....		<u>oil Blanket</u>	/
Forage caps.....		Pairs cotton drawers.....			
Great coats.....		Flannel shirts.....			
Uniform coats.....		Cotton shirts.....			
Uniform jackets.....		Pairs boots.....	/		
Flannel sack coats.....		Pairs shoes.....			
Blouses.....		Pairs socks.....			
Stable frocks.....		Blankets.....			
Fatigue overalls.....		Haversacks.....			
				MONEY.	
				Specie.....	\$
				Notes.....	\$

I CERTIFY, ON HONOR, that the above inventory comprises all the effects of Alfred Scott, deceased, and that the effects are in the hands
of one appraised at \$1.75 by Capt E. B. R. Resteigne
A. I. M. to be disposed of by a Council of Administration.

(DUPLICATES.)

STATION : _____

 Commanding the Company.

DATE : _____

Inventory

*of the effects of Alfred
Scott*

*late of Co. A. 3rd Regiment
U. S. G. C. who died
at Anson General
Hospital Oct 14th*

A. S.

U. S. Army General Hospital,

Oct 14th, 1864.

Commanding Officer — Company, 'M'
5th Regt. U. S. C. Cav

I have to inform you
that Alfred Scott of your Company, died
in this hospital on the 14th day of Oct 1864
of Dysentery Acute

~~I inclose his descriptive list, with pay and clothing account,~~
~~and inventory of his effects.~~

Very respectfully yours, &c.,

Surgeon U. S. V

In charge of General Hospital.

Miss. files

CASUALTY SHEET

No.

Alfred Scott,

of Company

5 Regiment of U.S.C.C.

State Volunteers.

NATURE OF CASUALTY.

Died Oct. 11th 1864.

CASUALTY SHEET.

Name: *Alfred Scott*

Rank:

Company:

Regiment:

Arm:

State:

Nature of Casualty:

Death

CAUSE OF CASUALTY—(NAME OF DISEASE, &C.)

BY WHOM DISCHARGED.

Acute Dysentery,

FROM WHAT SOURCE THIS INFORMATION WAS OBTAINED.

DEGREE OF DISABILITY.

Inv. of effects

BY WHOM CERTIFIED.

J. J. Woodward,
A. S. U. S. A.

REMARKS.

DATE OF DISCHARGE, DEATH, &C.

Oct. 14th 1864

This man never belonged to 5th U. S. C. Cav. as reported from hospital. see G. 518 Vol. 3. R. C. I. 1865, Inv of effects sent 2^d Auditor, Jan. 3^o 1866.

PLACE OF DISCHARGE, DEATH, &C.

General Hospital
Camp Nelson, Ky.

James Beckwith,
Clerk.

CASUALTY SHEET

No. _____

William Scott
Private of Company *M*
2 Regiment of *1st Regt*
State Volunteers.

NATURE OF CASUALTY.

See Serial 116/64

[OFFICE INDORSEMENT.]

War Department,

ADJUTANT GENERAL'S OFFICE,

July 17th, 1874

The *report* of *William Scott*
Private, Co. *M*, *5* Reg't U. S.

Colored *Company*, is reported as follows:—
On Company Muster Roll.

For *Jan 1, 1864*, *admitted*, 186
Company Muster-out Roll.

William Scott (at *Co. M*) 186
Company Descriptive Book.

....., 186
Company Morning Reports.

....., 186
Soldier's Final Statement.

....., 186
Soldier's Record of Death and Interment.

....., 186
Soldier's Inventory of Effects.

....., 186
Soldier's Certificate of Disability for Discharge.

....., 186
Soldier's Individual Muster-out Roll.

....., 186
Regimental Return.

For *Jan 1, 1864*, *admitted*, 186
Regimental Quarterly Returns.

....., 186
Regimental Descriptive Book.

....., 186
By Surgeon General.

(S. 126 V. 10 6 2/4) *October 14th*, 1864

October 14th, 1864 is held to be
the correct date, and the Company Muster

Roll will be amended accordingly.
Noted H.M.
Noted R.C.G.

J.P. Martin
Asst. Adj. Gen.

E 13 *Rec'd letter to Second Adm.*
125 *Aug 10th 1874.*

CASUALTY SHEET.

Name: *Cyrus Scott*

Rank: *Private* Company: *D* Regiment: *1st Regt*

Arm: _____ State: _____

Nature of Casualty: *death*

CAUSE OF CASUALTY—(NAME OF DISEASE, &c.)

BY WHOM DISCHARGED.

DEGREE OF DISABILITY.

FROM WHAT SOURCE THIS INFORMATION WAS OBTAINED.

1st Regt

BY WHOM CERTIFIED.

REMARKS.

DATE OF ~~DISCHARGE~~, DEATH, &c.

October 1st 1864

PLACE OF DISCHARGE, DEATH, &c.

Fort Fisher, N. C.

E. C. Jones,
Clerk.

Complete
CASUALTY SHEET

No. _____

Alfred Scott

Col. Rec. of Company _____

_____ Regiment of *Unattached*

State Volunteers.

NATURE OF CASUALTY.

Acc.

for deposit
Alfred Scott
Capt. Reel
Manassasville

Cap. A. Scott 12/15

A. A. M. Appraised
value of effects. Cont.
\$1,250 Sent 2^d Cont.

100

H.

Done in the Great Hospital
Camp Nelson Ky.

Sumner's account

E. B., S. G. O.

Surgeon General's Office,

Record and Pension Bureau,

Nov. 5: 1866.

Respectfully returned. The records of

Nelson. Genl Hospital

Camp Nelson. N.Y.

on file in this Office, furnish no evidence con-
cerning the within named man. (Alfred

Scott. Col. Recruit.)

An Inventory enclosed in
the case of Alfred Scott.
Col. 5. U. S. C. C. No
Evidence on file from
which Final Statements
or an Inventory can be
prepared.

By Order of the Surgeon General:

J. R. D.

Major and Assistant Surgeon, U. S. A.

J. R. D.

1866
48
4.

WAR DEPARTMENT,

ADJUTANT GENERAL'S OFFICE,

WASHINGTON,

Oct 9th, 1866

SIR:

Final Statements in the cases of deceased soldiers are required to be sent to the Adjutant General's Office in duplicate, with one copy of the Inventory of Effects. The Descriptive List should also be sent to this Office in cases where the soldier was absent from his Company at the time of his death. Where there were no effects, it should be so stated on a blank Inventory, properly signed.

Certificates of Disability should be sent in duplicate. Special care should be taken that the date of discharge and signature of the discharging officer should be affixed.

No. of the Final Statement & No. Inventory, has been received in the case of Alfred Scott, of Co. Col. R. I. Regiment of Unattached Volunteers, whose papers were forwarded to this Office. You will please forward the missing papers without delay.

I have the honor to be, sir,

Very respectfully,

Your obedient servant,

W. H. Hazard

Assistant Adjutant General.

(110)

~~COMMANDING OFFICER~~

J. Woodward A. J. A.

*Died in U.S. Hospital. Camp Nelson
date & cause of death unknown.*

R. B. C.

Scott Cain

Co *G*, 5 U. S. Col'd Cav.

Private | *Private*

CARD NUMBERS.

1	5365782	26
2	5365876	27
3	5365976	28
4	5366063	29
5	5366161	30
6	5366252	31
7	5366344	32
8	5366433	33
9	5366519	34
10	5366607	35
11	5366692	36
12	9040705	37
13	8-59-07-1868	38
14	40730294	39
15		40
16		41
17		42
18		43
19		44
20		45
21		46
22		47
23		48
24		49
25		50

Book Mark: *8-59-07-1868*

See also

S

5 Cav. U.S.C.T.

Wm Scott

....., Co. *4*, 5 Reg't U. S. Col'd Cav.

Appears on

Company Descriptive Book
of the organization named above.

DESCRIPTION.

Age *27* years; height *5* feet *6* inches.

Complexion *Black*

Eyes *Blk*; hair *Blk*

Where born *Wayne Ky*

Occupation *farmer*

ENLISTMENT.

When *Sep 8*, 186*4*.

Where *Camp Nelson*

By whom *H. Randolph*, term *3* y'rs.

Remarks:

.....

.....

.....

.....

.....

.....

.....

.....

.....

.....

.....

.....

.....

.....

.....

.....

.....

.....

.....

.....

.....

.....

.....

.....

.....

.....

.....

.....

.....

.....

.....

.....

.....

.....

.....

.....

.....

.....

.....

.....

.....

.....

.....

.....

.....

.....

F. E. P. H. K.

S. 5. Cav. U.S.C.T.

Sam Scott

Priv., Co. G, 5 Reg't U. S. Col'd Cavalry.

Appears on

Company Muster-in and Descriptive Roll

of the organization named above. Roll dated

Camp Nelson Ky, N. Y., Oct. 27, 1864.

Where born Wayne Ky.

Age 22 y'rs; occupation Farmer.

When enlisted Sept. 8, 1864.

Where enlisted Camp Nelson Ky.

For what period enlisted 3 years.

Eyes Black; hair Black.

Complexion Black; height 5 ft. 6 in.

When mustered in Sept. 9, 1864.

Where mustered in Camp Nelson

Bounty paid \$ 100; due \$ 100

Where credited 8th Dist Ky

Company to which assigned

Remarks:

* Thomas Scott,

* Supposed to be name of owner.

* Added May 18. 45. S. J.

Book mark:

[Signature]

S. 5 Cav. | U.S.C.T.

Sam Scott.

Prvt., Co. G, 5 Reg't U. S. Col'd Cavalry.

Appears on

Company Muster Roll

for *Enll. to Oct. 31.*, 1864.

Present or absent *Absent.*

Stoppage, \$ *100* for

Due Gov't, \$ *100* for

Valuation of horse, \$ *100*

Valuation of horse equipments, \$ *100*

Remarks: *In Genl. Hospital,
Ashland Ky.*

Book mark: _____

(358)

J. M. [Signature]

Copyist.

S. | **5 Cav.** | **U.S.C.T.**

Sam Scott,

Pvt., Co. G, 5 Reg't U. S. Col'd Cavalry.

Appears on

Company Muster Roll

for *Nov. & Dec.*, 1864.

Present or absent *Absent*

Stoppage, \$ *100* for

Due Gov't, \$ *100* for

Valuation of horse, \$ *100*

Valuation of horse equipments, \$ *100*

Remarks: *In Genl. Hospital
at Ashland Ky.
1st & 2^d Inst'tment Penity
due.*

Book mark: _____

(358)

[Signature]

Copyist.

S. 5 Cav. U.S.C.T.

Levin Scott

Pvt., Co. G, 5 Reg't U. S. Col'd Cavalry.

Appears on

Company Muster Roll

for Jan. & Feb., 1865.

Present or absent Absent

Stoppage, \$ 100 for

Due Gov't, \$ 100 for

Valuation of horse, \$ 100

Valuation of horse equipments, \$ 100

Remarks:

Sick in Gen. Hosptl,
Ashland Ky.
1st Instnl. Berenty
\$1000 due

Book mark:

Handwritten signature

(358)

Copyist.

S. | **5 Cav.** | **U.S.C.T.**

Leam Scott,

Priv., Co. G, 5 Reg't U. S. Col'd Cavalry.

Appears on

Company Muster Roll

for *March, & April,* 1865.

Present or absent *Absent*

Stoppage, \$ *100* for

Due Gov't, \$ *100* for

Valuation of horse, \$ *100*

Valuation of horse equipments, \$ *100*

Remarks: *Sick in Genl. Hospital, Ashland Ky. 1st Instnt Bounty \$100.⁰⁰ due.*

Book mark: _____

(358)

[Signature]

Copyist.

2. 5 Cav. U.S.C.T.

John Scott

Co. G, 5 Reg't U. S. Col'd Cavalry.

Appears on

Company Muster Roll

for May + June, 1865.

Present or absent Absent

Stoppage, \$ 100 for

Due Gov't, \$ 100 for

Valuation of horse, \$ 100

Valuation of horse equipments, \$ 100

Remarks: Sick in service
Hospital Ashland Ky
First Hospital
Duty due \$100

Book mark:

(358)

Signature Copyist.

Wain Scott
_____, Co. G, 5 Reg't U. S. Col'd Cavalry.

Appears on

Company Muster Roll

for *July - Aug*, 1865.

Present or absent *Present*

Stoppage, \$ _____ 100 for _____

Due Gov't, \$ _____ 100 for _____

Valuation of horse, \$ _____ 100

Valuation of horse equipments, \$ _____ 100

Remarks: *Sick in service*
Wagon Accident,
Aug

Book mark: _____

[Signature] Copyist.

2. | **5 Cav.** | **U.S.C.T.**

James G. Salt

Salt, Co. G, 5 Reg't U. S. Col'd Cavalry.

Appears on

Company Muster Roll

for *Sept 1st Oct*, 1865.

Present or absent *Absent*

Stoppage, \$ 100 for

Due Gov't, \$ 100 for

Valuation of horse, \$ 100

Valuation of horse equipments, \$ 100

Remarks: *See Serial No 107
at Adelund, Ky.*

Book mark: _____

(358)

James G. Salt

Copyist.

Frederick Scott

S., Co. G, 5 Reg't U. S. Col'd Cavalry.

Appears on

Company Muster Roll

for Nov + Dec, 1865.

Present or absent Absent

Stoppage, \$ 100 for

Due Gov't, \$ 100 for

Valuation of horse, \$ 100

Valuation of horse equipments, \$ 100

Remarks: Lieut. Fredrick Scott
Wagoner, 1st Regt. Cal. Cav.
since Oct. 1865
1st Regiment Cal. Cav.
due \$100

Book mark: _____

(358)

Frederick Scott
Copyist.

21 | 5 Cav. | U.S.C.T.

Ernie Scott

Feb., Co. G, 5 Reg't U. S. Col'd Cavalry.

Appears on

Company Muster Roll

for *Jan'y & Feb'y*, 1866.

Present or absent *Absent*

Stoppage, \$ *100* for

Due Gov't, \$ *100* for

Valuation of horse, \$ *100*

Valuation of horse equipments, \$ *100*

Remarks: *Sick in Genl. Hospital
Ashland, Ky. since Oct, 1864.
1st installment bounty due \$100.*

Book mark: _____

E. J. Carter

(358)

Copyist.

S

5 Cav. U.S.C.T.

Cain Scott

Pvt, Co. G, 5 Reg't U. S. Colored Cav.

Appears on Returns as follows:

Oct. 1864 to Feby 1866, Absent sick
in Genl Hoapl at Ashland,
Ky. since Oct. 9/64.

Book mark :

L. B. Bowman

(546)

Copyist.

Wain Scott

Priv., Co. *G*, 5 Reg't U. S. Col'd Cavalry.

Appears on Co. Muster-out Roll, dated
Helena, Ark, Mch. 16, 1866.

Muster-out to date _____, 186 .

Last paid to _____, 186 .
Pay due from Enlistment

Clothing account:

Last settled _____, 186 ; drawn since \$ _____ 100

Due soldier \$ _____ 100; due U. S. \$ *10* ⁶⁵/₁₀₀

Am't for cloth'g in kind or money adv'd \$ _____ 100

Due U. S. for arms, equipments, &c., \$ _____ 100

Bounty paid \$ *None* 100; due \$ *100* 100

Remarks: *Slave - absent sick*
in Genl. Hospt. Ashland,
Ky. since Oct. 1864. Descrip-
tive list furnished. No
discharge furnished.

Book mark: *A 59-2106. J-6. P-1868.*

Scott

JAN. - 9

5366692

☆ 1891 ☆

251465/80 - 1256-6. J. 1881.

S | 5th Cav. | U.S.C.S.

Cain Scott

, Co. G, 5th Reg't U.S.C. Cav.

NOTATION.

Book mark: S-59-C-S-1868.

Record and Pension Office,

WAR DEPARTMENT.

This book mark refers only to a report from the medical records, made by the Surgeon General to the Adjutant General, relative to the above-named man. As the medical records have since been carded, no transcript of this report is made hereon.

(491)

M. Allen

Copyist.

1135

Scott David

Co D, 5 U. S. Col'd Cav.

Private Private

CARD NUMBERS.

1	5362713	26
2	5362806	27
3	5362905	28
4	5362990	29
5	5363114	30
6	5363643	31
7	4090342	32
8	43145321	33
9	40730295	34
10		35
11		36
12		37
13		38
14		39
15		40
16		41
17		42
18		43
19		44
20		45
21		46
22		47
23		48
24		49
25		50

Book Mark:

See also

S

5 Cav. U.S.C.T.

David Scott

Co. D, 5 Reg't U. S. Col'd Cav.

Appears on

Company Descriptive Book
of the organization named above.

DESCRIPTION.

Age *18* years; height *5* feet *4* inches.

Complexion *Copper*

Eyes *Black*; hair *Black*

Where born *Carter Ny*

Occupation *farmer*

ENLISTMENT.

When *Aug 10*, 186 *4*

Where *Greensburg*

By whom *Capt Grier*; term *3* y'rs.

Remarks: *Died Genl. Hos-*
pital Lexington
Ny Nov. 14 1864
final statements
forwarded to
W.S. Mar. 31 1865

J E Park

S | 5 bar W. E.

David Scott

Appears with rank of Priv. on

Muster and Descriptive Roll

of a Detachment of U.S. Colored
Recruits forwarded

Roll dated
Greensburg Ky, Aug 10, 1864.

Where born Carter Co Ky.

Age 18 years; occupation Farmer

When enlisted Aug. 10, 1864.

Where enlisted Greensburg Ky.

For what period enlisted 3 years.

Eyes Black; hair Black

Complexion Black; height 5 ft. 4 in.

When mustered in _____, 186 .

Where mustered in _____

Bounty paid \$ _____ 100; due \$ _____ 100

Clothing account:

Last settled _____, 186 ; drawn since \$ _____ 100

Date of first muster Aug 10, 1864.

Company to which assigned _____

Remarks: Credited to Greenv Co.

9. Dist of Ky.

Book mark : _____

W. E. Potter

(356m)

Copyist.

S | 5 Cav. | U.S.C.T.

David Scott

Pvt., Co. B, 5 Reg't U. S. Col'd Cavalry.

Appears on

Company Muster-in and Descriptive Roll

of the organization named above. Roll dated

Camp Nelson, Ky., Oct. 24, 1864.

Where born Barter, Ky.

Age 18 y'rs; occupation Farmer

When enlisted Aug. 16, 1864.

Where enlisted Greenupburg

For what period enlisted 3 years.

Eyes Bl.; hair Bl.

Complexion Bl.; height 5 ft. 4 in.

When mustered in Sept. 2, 1864.

Where mustered in Louisville

Bounty paid \$ 100; due \$ 100

Where credited 9 Dist. Ky.

Company to which assigned

Remarks:

Book mark:

David Scott

(356d)

Copyist.

S **5 Cav. U.S.C.T.**

David Scott

Plt., Co. D, 5 Reg't U. S. Col'd Cavalry.

Appears on

Company Muster Roll

for *Month Oct. 31*, 186*4*.

Present or absent *Absent*

Stoppage, \$ *100* for

Due Gov't, \$ *100* for

Valuation of horse, \$ *100*

Valuation of horse equipments, \$ *100*

Remarks: *Sick in Hospital,
Lexington, Ky.*

Book mark:

Wm. H. Scott

(358)

Copyist.

S

5 Cav. U.S.C.T.

David Scott

Pvt, Co. D, 5 Reg't U. S. Col'd Cavalry.

Appears on

Company Muster Roll

for *Nov. & Dec.*, 186*4*.

Present or absent *Absent*

Stoppage, \$ *100* for

Due Gov't, \$ *100* for

Valuation of horse, \$ *100*

Valuation of horse equipments, \$ *100*

Remarks: *Sick in Hospital,
Lexington, Ky. 1'42" install-
ments of Bounty due.*

Book mark:

David Scott

(358)

Copyist.

S | **5 Cav. U.S.C.T.**

David Scott

Priv., Co. D, 5 Reg't U. S. Col'd Cavalry.

Appears on

Company Muster Roll

for *Jan. & Feb.*, 1865.

Present or absent *Absent.*

Stoppage, \$ *100* for

Due Gov't, \$ *100* for

Valuation of horse, \$ *100*

Valuation of horse equipments, \$ *100*

Remarks: *Sick in Hospital
Lexington, Ky. First in-
stallment of Bounty
due \$100.*

Book mark:

M. H. Scott

S

5 Cav. U.S.C.T.

David Scott

Priv., Co. D, 5 Reg't U. S. Col'd Cavalry.

Appears on

Company Muster Roll

for March & April, 1865.

Present or absent

Stoppage, \$ 100 for

Due Gov't, \$ 100 for

Valuation of horse, \$ 100

Valuation of horse equipments, \$ 100

Remarks: 1st installment of
Bounty due \$ 100.
Died of Disease Lexington
Gen'l Hospital, Nov.
14, '64. Notification rec'd
March 13, '65.

Book mark:

David Scott

(358)

Copyist.

S | 5 Cav. | U.S.C.T.

David Scott

Pot, Co. D, 5 Reg't U. S. Colored Cav.

Appears on Returns as follows:

Oct. 1864 to Feby 1865; Absent sick
in Hospl Lexington, Ky.
Mch 1865; Loss: Nov. 14/64, Lexington,
Ky. Died of Disease. Recd
notice of his death Mch
13/65.

Book mark:

L. B. Bowman

(546)

Copyist.

S. | 5 Cav. | U.S.C.T.

David Scott,

Private, Co. *A*, 5 Reg't U. S. Col'd Cavalry.

Appears on Co. Muster-out Roll, dated

Helena, Ark., March 16, 186*6.*

Muster-out to date _____, 186 .

Last paid to *Enlistment* 186 .

Clothing account:

Last settled _____, 186 ; drawn since \$ _____ ¹⁰⁰

Due soldier \$ _____ ¹⁰⁰; due U. S. \$ _____ ¹⁰⁰

Am't for cloth'g in kind or money adv'd \$ _____ ¹⁰⁰

Due U. S. for arms, equipments, &c., \$ _____ ¹⁰⁰

Bounty paid \$ _____ ¹⁰⁰; due \$ *100.⁰⁰* ¹⁰⁰

Remarks: *Died at Lexington, Va.,*

Nov. 14/64 of Typhoid Fever.

Final statements forwarded

March 31, 1865.

Book mark: _____

R. D. Gawner.

(361)

Copyist.

Scott, David

P, Co. D,

5

Reg't

U. S. C. Cav

Enclosures.

Bed Cards	Descriptive Lists
Burial Records	Final Statements /
Certs. of Dis. for Discharge	Furloughs
C. M. Charges	Med. Des. Lists
Med. Certificates	Orders

Other papers relating to—

Admission to Hosp'l	Furlough
Casualty Sheet (Officer's)	Med. Examination
Confinement	Misc. Information
Contracts	Pay or Clothing
Death or Effects	Personal Reports
Desertions	Rank
Discharge from Hosp'l	Transfer to Hosp'l
Discharge from Service	Transfer to V. R. C.
Duty	Transportation

Inv. sent for to Mrs. [unclear] Jan 3, 66

FINAL STATEMENT

S. 48, Vol. 2, R. C. 3, 11th Regt. N. Y. Inf.
Also pay 23, 1864

P. [unclear]
Pvt David Scott
Fifth Reg't of U. S. Cav.

VOLUNTEERS.

Died Nov 14th 1864

NOTE 1.—Two of these certificates (or duplicates) are to be given to each Volunteer Soldier or drafted man who may be discharged previously to the discharge of his company, that he may at once receive from the Paymaster the pay, &c., due him, and the captain or other COMMISSIONED officer commanding the company will certify to the act of the delivery of the duplicate certificates; on these certificates the Soldier is "entitled to" his discharge, and should also present his discharge to the Paymaster to have the payment endorsed on it. The discharge is to be given back to the Soldier by the Paymaster; the latter only retaining as his voucher the duplicate certificates.

NOTE 2.—If the Soldier is entitled to pay for the use of his horse, the Company Commander will certify to that fact on the back of both these final statements, and also to the time he has pay due for having been so mounted on his own horse.

NOTE 3.—When a Soldier is furnished with final statements, his descriptive list, if he has one, should be taken up by the officer who gives the Soldier these statements, and endorsed with a statement to this effect by the officer. This endorsement should exhibit a full statement of the time for which the Soldier was allowed pay on his final statements, the clothing account, and all other charges against him or in his favor, so as to comprise a complete exhibit of his account. It will then be transmitted to the company commander of the Soldier, who will enter all the data necessary to a full understanding of the Soldier's account on the muster roll upon which the Soldier's discharge is reported. The descriptive list will then be destroyed. The object of this is, that the remaining portion of the Soldier's account may be settled upon the receipt of these muster rolls, and the Soldier receive any pay or allowances that may be due him at the time of his discharge, and which may not appear on his final statements from the fact that his descriptive list is incomplete. These accounts for back pay, &c., are settled by the 2d Auditor of the Treasury Department.

NOTE 4.—Charges for loss or injury to ordnance, horse equipments, and other miscellaneous charges, should appear under the heading of "Other Stoppages."

NOTE 5.—Bounty paid by State authorities, and not by the United States, will not be entered on this statement.

NOTE 6.—Amounts due the Sutler and Landress must be entered on the muster roll on which the discharge, death, desertion, &c., is reported, as well as on the final statement, otherwise the amount cannot be collected from the United States.

NOTE 7.—This blank will be used for deceased volunteers, and drafted men, as well as for others.

NOTE 8.—Where a Soldier dies in Hospital or on detached service, his descriptive list, if he has one, should be sent with his final statements, in duplicate, to the Adjutant General, Washington, D. C.

See effects cannot be
claimed from company
see [unclear]

23.

Advt [unclear] 1864
[unclear] [unclear]
[unclear] [unclear]
[unclear] [unclear]
[unclear] [unclear]

APPROVED JOHN [unclear]
Apr 4th 1864
[unclear]

I certify, on honor, that David Scott a Private of
 Captain H. P. Hades Company (10) of the Fifth Regiment of W. C. Cav.
VOLUNTEERS, of the State of _____, born in Leicester, State
 of Kentucky, aged 18 years; 5 feet 4 inches high; Black complexion,
Blackeyes, Black hair, and by occupation a Farmer, having joined the company on
 its original organization at Greensburg Ky, and enrolled in it at the muster into
 the service of the United States at Greensburg Ky, on the 10th day
 of August, 1864, (or was mustered in service as a recruit, by _____
 _____, at _____, on the _____ day of _____,
 186 , or was drafted and mustered into the service of the United States from the _____
 Enrollment District of the State of _____, at _____,
 on the _____ day of _____, 186 ,) to serve in the Regiment, for
 the term of Three Years: and having served **HONESTLY** and
FAITHFULLY with his Company in _____ to the present date, is now
 entitled to a **DISCHARGE** by reason of _____

The said Private David Scott was last paid by Paymaster
May due from Enlistment ~~to include the~~ 10th day of August, 1864, and has
 pay due him from that time to the present date; he is entitled to pay and subsistence for
TRAVELING to place of enrollment, and whatever other allowances are authorized to volunteer
 soldiers, drafted men, or militia, so discharged. He has received from the United States **CLOTHING**
 amounting to Thirty $\frac{00}{100}$ dollars, since the 10th day of August,
 1864, when his clothing account was last settled. He has received from the United States
00 $\frac{00}{100}$ dollars advanced **BOUNTY**. \$300.00 County due

There is to be stopped from him, on account of the State of _____, or other
 authorities, for **CLOTHING**, &c., received on entering service, _____ $\frac{00}{100}$ dollars; and
 for other stoppages, viz: _____

_____ $\frac{00}{100}$ dollars.
 He has been furnished with **TRANSPORTATION** in kind from the place of his discharge to
 _____; and he has been **SUBSISTED** for **TRAVELING** to his
 place of enrollment, up to the _____, 186 .

He is indebted to _____, **SUTLER**, _____ $\frac{00}{100}$ dollars.
 He is indebted to _____, **LAUNDRESS**, _____ $\frac{00}{100}$ dollars.

Given in Duplicate, at Camp Nelson Ky, this 31 day
 of March, 1865.

David G. Gordon
1st Lieut 5th Regt
 Commanding Company.

1136
Scott Elijah

Co. A, 5 U. S. Col'd Cav.

Private | Private

CARD NUMBERS.

1	5359673	26
2	5359773	27
3	5359872	28
4	5359968	29
5	5360059	30
6	5360151	31
7	5360239	32
8	5360331	33
9	5360423	34
10	5360510	35
11	5360597	36
12	9090069	37
13	43146623	38
14	40730296	39
15		40
16		41
17		42
18		43
19		44
20		45
21		46
22		47
23		48
24		49
25		50

Book Mark:

See also

S | 5 Cav. | U.S.C.T.

Elijah Scott

Co. A, 5 Reg't U. S. Col'd Cav.

Appears on

Company Descriptive Book

of the organization named above.

DESCRIPTION.

Age 18 years; height 5 feet 8 inches.

Complexion blk.

Eyes blk.; hair blk.

Where born Shelby Co. Ky.

Occupation Laborer.

ENLISTMENT.

When Sept. 9, 1865.

Where Louisville Ky.

By whom Capt. Haw, term 3 y'rs.

Remarks:

A. A. Hall

(383g)

Captain
Camp.

S | 5 bar | U.S.C.T.

Elijah Scott

Appears with rank of Pvt on

Muster and Descriptive Roll

of a Detachment of U. S. Colored
Recruits mustered

Roll dated
Louisville, Ky., Sept. 9, 1864.

Where born Tenn

Age 18 years; occupation laborer

When enlisted Sept. 9, 1864.

Where enlisted Louisville, Ky

For what period enlisted 3 years.

Eyes dark; hair dark

Complexion dark; height 5 ft. 8 in.

When mustered in Sept. 9, 1864.

Where mustered in Louisville, Ky

Bounty paid \$ 100; due \$ 100

Clothing account:
Last settled _____, 1864; drawn since \$ 100

Date of first muster _____, 1864.

Company to which assigned _____

Remarks: Seneca Co. 24 Dist. N.Y.

Book mark: _____

B. B. Dussell

(356m) Copyist.

Elijah Scott

Priv, Co. *A*, 5 Reg't U. S. Col'd Cavalry.

Appears on

Company Muster-in and Descriptive Roll

of the organization named above. Roll dated

Ch. Nelson, N. Y., *Oct. 24*, 1864.

Where born *Kennerly*

Age *8* y'rs; occupation *laborer*

When enlisted *Sept. 9*, 1864.

Where enlisted *Louisville*

For what period enlisted *3* years.

Eyes *dk*; hair *dk*

Complexion *dk*; height *5* ft. *8* in.

When mustered in *Sept. 9*, 1864.

Where mustered in *Louisville*

Bounty paid \$ *100*; due \$ *100*

Where credited *5th Dist. Kentucky*

Company to which assigned *A*

Remarks:

Book mark:

Castulain

(356d)

Copyist.

J | **5 Cav. | U.S.C.T.**

Elijah Scott

Cpt, Co. A, 5 Reg't U. S. Col'd Cavalry.

Appears on

Company Muster Roll

for *to Oct. 31*, 186 *4*

Present or absent *Absent*,

Stoppage, \$ *100* for

Due Gov't, \$ *100* for

Valuation of horse, \$ *100*

Valuation of horse equipments, \$ *100*

Remarks: *Sick in Hospital
at Camp Nelson
Ky.*

Book mark: _____

(358)

Castling
Copyist.

Elijah Scott

Priv, Co. A, 5 Reg't U. S. Col'd Cavalry.

Appears on

Company Muster Roll

for *Nov & Dec*, 1864.

Present or absent *Present*

Stoppage, \$ *100* for

Due Gov't, \$ *100* for

Valuation of horse, \$ *100*

Valuation of horse equipments, \$ *100*

Remarks: *1st and 2^d Installment
Bounty due.*

Book mark:

*D
Castelling*

(358)

Copyist.

S | **5 Cav. | U.S.C.T.**

William Scott

Pvt, Co. A, 5 Reg't U. S. Col'd Cavalry.

Appears on

Company Muster Roll

for *Jan. & Feb.*, 1865..

Present or absent *Present*,

Stoppage, \$ *100* for

Due Gov't, \$ *100* for

Valuation of horse, \$ *100*

Valuation of horse equipments, \$ *100*

Remarks: *1st Installment -
Bounty due \$100.*

Book mark:

Castling

(358)

Copyist.

5 Cav. U.S.C.T.

Elijah Scott

Plt., Co. A, 5 Reg't U.S. Col'd Cavalry.

Appears on

Company Muster Roll

for M.A. [unclear], 1865.

Present or absent Present

Stoppage, \$ 100 for

Due Gov't, \$ 100 for

Valuation of horse, \$ 100

Valuation of horse equipments, \$ 100

Remarks: 1st installment bounty due \$ 75.

Book mark:

J. M. [unclear]

(358)

Copyist.

a | **5 Cav. U.S.C.T.**

Oliver Scott

Reck, Co. A, 5 Reg't U.S. Col'd Cavalry.

Appears on

Company Muster Roll

for *May & June*, 1863-

Present or absent *Present*

Stoppage, \$ *100* for

Due Gov't, \$ *100* for

Valuation of horse, \$ *100*

Valuation of horse equipments, \$ *100*

Remarks: *At installment
County due \$ 50.*

Book mark:

W. W. W.

(358)

Compt.

A

5 Cav. U.S.C.T.

Elijah Scott

Plt, Co. A, 5 Reg't U. S. Col'd Cavalry

Appears on

Company Muster Roll

for *Jul. & Aug.* 1865:

Present or absent *Present*

Stoppage, \$ *100* for

Due Gov't, \$ *100* for

Valuation of horse, \$ *100*

Valuation of horse equipments, \$ *100*

Remarks:

Book mark:

J. H. [Signature]
Copyist.

(358)

S

5 Cav. U.S.C.T.

Elijah Scott

Plt, Co. A, 5 Reg't U. S. Col'd Cavalry.

Appears on

Company Muster Roll

for *Roll Pt. 3'*, 1865.

Present or absent *Present*

Stoppage, \$ 100 for

Due Gov't, \$ 100 for

Valuation of horse, \$ 100

Valuation of horse equipments, \$ 100

Remarks:

Book mark:

J. H. Lawley
Cpyist.

(358)

S

5 Cav. U.S.C.T.

Elijah Scott

Pvt, Co. A, 5 Reg't U.S. Col'd Cavalry.

Appears on

Company Muster Roll

for Nov 20th, 1865

Present or absent Present

Stoppage, \$ 100 for

Due Gov't, \$ 30 ¹²/₁₀₀ for Ord

Valuation of horse, \$ 100

Valuation of horse equipments, \$ 100

Remarks:

Book mark:

W. W. Sayre

(358)

Copyist.

S | **5 Cav. U.S.C.T.**

Elijah Scott

Private, Co. A, 5 Reg't U.S. Col'd Cavalry.

Appears on

Company Muster Roll

for *Jan & Feb*, 186*6*

Present or absent *Present*

Stoppage, \$ *100* for

Due Gov't, \$ *100* for

Valuation of horse, \$ *100*

Valuation of horse equipments, \$ *100*

Remarks:

Book mark:

W. W. Sayre

(358)

Copyist.

S | 5 Cav. | U.S.C.T.

Elijah Scott

Priv., Co. *A*, 5 Reg't U. S. Colored Cav.

Appears on Returns as follows:

*Oct. & Nov. 1864, Absent sick
in Hospl at Camp
Nelson, Ky.*

Book mark :

L. B. Bowman

(546)

Copyist.

S

5 Cav. U.S.C.T.

Elijah Scott
Pvt, Co. A, 5 Reg't U. S. Col'd Cavalry.

Appears on Co. Muster-out Roll, dated

Helena Ark March 16, 1866.

Muster-out to date

March 16, 1866.

Last paid to

Dec 31, 1865.

Clothing account:

Last settled....., 186 ; drawn since \$..... 100

Due soldier \$..... 100; due U. S. \$ 58¹⁸ 100

Am't for cloth'g in kind or money adv'd \$..... 100

Due U. S. for arms, equipments, &c., \$..... 60 100

Bounty paid \$ 100 100; due \$ 100 100

Remarks: Due U.S. for Ord
60 cts

Book mark :

W. W. Sayre

(361)

Copyist.

Scott Graham

Co E, 5 U. S. Col'd Cav.

Private Private

CARD NUMBERS.

<i>5363736</i>	26
<i>5363827</i>	27
<i>5363929</i>	28
<i>5363998</i>	29
<i>5364105</i>	30
<i>5364212</i>	31
<i>5364681</i>	32
<i>4090490</i>	33
<i>40730297</i>	34
	35
	36
	37
	38
	39
	40
	41
	42
	43
	44
	45
	46
	47
	48
	49
	50

Book Mark: General Notation N. & P. 407375,

See also

D. | **5 Cav.** | **U.S.C.T.**

Ephraim Scott
....., Co. *E*, 5 Reg't U. S. Col'd Cav.

Appears on
Company Descriptive Book
of the organization named above.

DESCRIPTION.

Age *34* years; height *5* feet *8* inches.

Complexion *Black*

Eyes *Blk*; hair *Blk*

Where born *Franklin Ky*

Occupation *farmer*

ENLISTMENT.

When *Sep 13*, 186*4*.

Where *Camp Nelson*

By whom *W. G. Randolph* term *3* y'rs.

Remarks: *discharged*
surg. cert. Disability
June 20th - 1865

J. E. Purke

(383g)

Copist.

D

5 Cav.

U.S.C.T.

Ephraim Scott

Plt., Co. *C*, 5 Reg't U. S. Col'd Cavalry.

Appears on

Company Muster-in and Descriptive Roll

of the organization named above. Roll dated

Camp Nelson, N.Y., Oct. 26, 1864.

Where born *Franklin Ky*

Age *39* y'rs; occupation *Farmer*

When enlisted *Sept. 13*, 1864.

Where enlisted *Cp. Nelson Ky*

For what period enlisted *3* years.

Eyes *Black*; hair *Black*

Complexion *Black*; height *5 ft. 8 in.*

When mustered in *Sept. 13*, 1864.

Where mustered in *Cp. Nelson Ky*

Bounty paid \$ *100*; due \$ *100*

Where credited

Company to which assigned

Remarks: *7 District Kentucky*

Stephen Black

** Supposed to be name of owner*

Added May 18/98 CVA

Book mark *See List of Dis 400 S. C.*

General Notation N. C. 407375

H. W. Rowland

(356d)

Copyist.

S | **5 Cav. | U.S.C.T.**

Ephraim Scott
S, Co. E, 5 Reg't U. S. Col'd Cavalry.

Appears on

Company Muster Roll

for *Enlistment to Oct. 31, 1864*.

Present or absent *Present*

Stoppage, \$ *100* for

Due Gov't, \$ *100* for

Valuation of horse, \$ *100*

Valuation of horse equipments, \$ *100*

Remarks:

Book mark : -----

(358) *A. W. Rowland* Copyist.

S | **5 Cav.** | **U.S.C.T.**

Ephraim Scott

Cvt., Co. E, 5 Reg't U. S. Col'd Cavalry.

Appears on

Company Muster Roll

for *Nov, & Dec,*, 1864.

Present or absent *Absent*

Stoppage, \$ *100* for

Due Gov't, \$ *100* for

Valuation of horse, \$ *100*

Valuation of horse equipments, \$ *100*

Remarks: *On detached ser-*
vice, Camp Nelson Ky.
Nov. 2nd 1864. 1st & 2nd in-
statement of Bounty due

Book mark:

M. R. Cowling

J | **5 Cav.** | **U.S.C.T.**

Ephraim Scott

Plt., Co. E, 5 Reg't U. S. Col'd Cavalry.

Appears on

Company Muster Roll

for *Jan, 7 Feb*, 1865.

Present or absent *Present*

Stoppage, \$ *100* for

Due Gov't, \$ *100* for

Valuation of horse, \$ *100*

Valuation of horse equipments, \$ *100*

Remarks: *First instalment of Bounty due \$100. Due U.S. for Ordnance \$ 6.30*

Book mark:

W. Rowland

(358)

Copyist.

S | **5 Cav.** | **U.S.C.T.**

Edmund Scott

C. A., Co. E, 5 Reg't U. S. Col'd Cavalry.

Appears on

Company Muster Roll

for *March & April*, 186*5*.

Present or absent *Present*

Stoppage, \$ *100* for

Due Gov't, \$ *100* for

Valuation of horse, \$ *100*

Valuation of horse equipments, \$ *100*

Remarks: *First installment
of Bounty due.*

Book mark:

A. W. [Signature]

(358)

Copyist.

S | 5 Cav. | U.S.C.T.

Ephraim Scott

Private, Co. E, 5 Reg't U. S. Col'd Cavalry.

Appears on

Company Muster Roll

for May & June, 1865.

Present or absent

Stoppage, \$ 100 for

Due Gov't, \$ 100 for

Valuation of horse, \$ 100

Valuation of horse equipments, \$ 100

Remarks: Discharged -
Surgeons Certificate of
Disability June 20/65.

Book mark: Discharged June 23/65
E.B. V. 10 p 440

(358)

Long
Copyist.

S | **5 Cav.** | **U.S.C.T.**

Ephraim Scott

Pvt, Co. *E*, 5 Reg't U. S. Colored Cav.

Appears on Returns as follows:

*Nov. 1864, absent on detached service
Camp Nelson, Ky.*

Nov. 2/64.

*Dec. 1864, Absent detached service
Camp Nelson, Ky. Oct. 2/64.*

*June 1865, Loss: June 20/65, Fal-
mouth, Ky. Dischgd Surg's
cert. disability.*

Book mark :

L. B. Bowman

(546)

Copyist.

5 Cav. U.S.C.T.

William Scott
Co. B, 5 Reg't U. S. Col'd Cavalry.

Appears on Co. Muster-out Roll, dated
Adena O. H., March 11, 1864.

Muster-out to date _____, 186 .

Last paid to Feb 20, 1865.

Clothing account:

Last settled _____, 186 ; drawn since \$ _____ 100

Due soldier \$ 32 ³⁴/₁₀₀; due U. S. \$ _____ 100

Am't for cloth'g in kind or money adv'd \$ _____ 100

Due U. S. for arms, equipments, &c., \$ _____ 100

Bounty paid \$ _____ 100; due \$ _____ 100

Remarks: Discharged at
Salmon Creek Ky. June
20 1864 Surgeon's Cer-
tificate of disability

Book mark: 460 S.C. 678/84; 7/63 P. 214. 73;
Discharge June 23/64 E.B.V. P. 440

(361)

J. M. [Signature]

Copyist.

Scott, Ephraim

P, Co. E, 5 Regt U. S. C. Cav.

3 Enclosures.

Bed Cards	Descriptive Lists
Burial Records	Final Statements
Certs. of Dis. for Discharge /	Furloughs
C. M. Charges	Med. Des. Lists
Med. Certificates	Orders

Other papers relating to—

Admission to Hosp'l	Furlough
Casualty Sheet (Officer's)	Med. Examination
Confinement	Misc. Information
Contracts	Pay or Clothing
Death or Effects	Personal Reports
Desertions	Rank
Discharge from Hosp'l	Transfer to Hosp'l
Discharge from Service	Transfer to V. R. C.
Duty	Transportation /

War Department
Adjutant General's Office
August 4th 1873 -

The Muster-Roll of Co. E.
5th W.S.C. Cav. for May & June 1865
and the Muster-Roll gives June
20th 1865 as the date of discharge of
Private Ephraim Scott

The Surgeon's certificate of
disability, however, gives June 23rd
1865 as the date of discharge

The latter date - (June 23rd - 1865)
is held to be correct, and the Co. Rolls
cited will be amended accordingly -

Thomas M. Stewart
Assistant Adjutant General
dated 8/11

Letter to 2^d Lt. Aug. 9th 1873.

July 1. 1873
Duplicate sent the Pension Office.

1865 10
CERTIFICATE OF DISABILITY FOR DISCHARGE,

869 IN THE CASE OF
Ephraim Scott
a Private Co. E
5th Reg't of W.S.C. Cav

Head Quarters
5th W.S.C. Cav.
Paris Ky. 6 June 1865

Approved and respectfully
forwarded

J. J. Munst...
Lt. Col 5th W.S.C. Cav
Commanding

Received (A. G. Office), 1865

En on O'Refles

Head Qrs. Med. Dept.,
7th Div. Dept. Ky.
Lexington Ky. June 8th 1865

Respectfully forwarded
approved

Wm. M. Lewis Surg. U.S.A.
Chief Surg. 7th Div. Dept. Ky.

Adjt. 7th Div. Dept. Ky.
Lex Ky June 8th 1865

Approved and respy
forwarded.

C. W. Keoburn
Surg Genl Comdg.

Recd 571-6

Head Quarters of 14th
Louisville 14th June 1865
Do be discharged

Command of
Paul J. Palmer
of
of
of

THE UNITED STATES

CERTIFICATE

DISABILITY

FOR DISCHARGE



Dep. Surg. Gen.
Approved
Col. Med. Director
Capt. of Regt.

Private Abraham Best of Captain J. H. ...
Company, (Co.) of the 5th Regiment of United States
was enlisted by J. L. Randolph of
the 5th Regiment of ... at Camp Nelson Ky
on the Sixteenth day of September 1864, to serve Three years; he was born
in Franklin Ky in the State of Kentucky is Thirty-nine
years of age, Five feet Eight inches high, Black complexion, Black eyes,
Black hair, and by occupation when enlisted a Farmer During the last two

months said soldier has been unfit for duty 60 days* from the effects of
Rheumatic Pains which to my knowledge has kept him from
duty more or less During the time he has been with his company
"and this man states" that he was affected with the same
disease prior to entering the Service

STATION: Chalmers Ky
DATE: June 3rd 1865

William ...
Lieut-5th U.S. Cav
Commanding Company.

I CERTIFY, that I have carefully examined the said Abraham Best of
Captain J. H. ... Company, and find him incapable of performing the duties of a soldier
because of Chronic Rheumatism and Old Age. The States that he is
39 years Old, but in my opinion he is at least ten years older. He
has been under treatment most of the time for the last three months
he is better at times, but is wholly unfit for duty during damp changeable
weather. He is not a proper subject for the Land Army Service and I do not think
a proper subject for the Veteran Reserve Corps.

W. B. ... Surgeon. U.S.A.

DISCHARGED, this Twenty-third day of June 1865, at Paris
Kentucky

Henry M. ...
May 5th 1865
Commanding the Reg't.

The soldier desires to be addressed at
Town Frankfort County Franklin State Kentucky

* See Note 1 on the back of this. † See Note 2 on the back of this.

July 5th 1865.

Name, Ephraim Scott

Regiment, Co "E" 5th U.S.C.A

From Cincinnati, O., to

Falmouth Ky

Duty, Discharged

Not paid

War Department,
ADJUTANT GENERAL'S OFFICE.

Washington, *Sept 17* 1867.

Respectfully returned to the
Commission for the State of
Kentucky, with the informa-
tion that Ephraim Scott
was enlisted at *Camp Nelson*
Ky. Sept 13, 1864 and was
mustered in as Pvt. in Co. "E"
5th U.S.C. Cav. Sept 13, 1864
13400

J. R. Moore

Asst. Adj't General.

W. A. H.

ENDORSEMENT.

No. *13400*

APPLICATION OF

Stephen Black

OF

Frankfort Kentucky

For Compensation for Service of Slave,

Ephraim Scott

Enlisted *Sept 13th*, 1864

In "E" Co., *5th* Regiment

U. S. Colored ~~Troops~~ *Cavalry*

Received *Dec 27th*, 1866.

Compensation Awarded

, 186 ,

Dollars.

President Board of Claims.

P. O. ADDRESS OF CLAIMANT:

Frankfort

Kentucky

Alfred Hensley Atty

Claim for Compensation for Enlisted Slave.

I, Stephen Black, a loyal citizen, and a resident of Franklin, County of Franklin, State of Kentucky, hereby claim compensation, under the provisions of section 24, Act approved February 24, 1864, and section 2, Act approved July 28, 1866, for my slave Ephraim Scott, enlisted Sept 13th, 1864, at Camp Nelson Ky, by J C Randolph, in the Fifth Regiment U. S. Colored Cavalry "E" Troops, Co. "E"; certificate of which enlistment, and a descriptive list, as required, accompany this application. That I did not acquire said slave subsequent to said enlistment, but had a valid title to him at the date of said enlistment, and previous thereto, I having acquired my title to him and my ownership over him as follows, to-wit:

Inherited the negro

In proof of my loyalty to the Constitution and Government of the United States, I present the accompanying oath, which I have taken, signed and acknowledged, to be filed with this application, in accordance with requirement of General Orders No. 329, 1863, War Department, Adjutant General's Office.

Frankfort Ky, December 17th, 1866.

S. Black

Oath of Allegiance.

I, Stephen Black, the owner and claimant, do solemnly swear that the foregoing claim is a just and true claim due to me as master and owner of the said slave, and that the facts alleged in said claim in respect to the draft or enlistment [as the case may be] of said slave into the military service of the United States are true. And I do further swear, that I have never joined, or been concerned in, any insurrection or rebellion; that I have never borne arms against the United States; that I have never given any aid, countenance, counsel, or encouragement to any person or persons engaged, or whom I had reason to believe were about to engage, in insurrection, rebellion, or armed hostility against the United States; that I have neither sought nor accepted, nor attempted to exercise the functions of any office, civil or military, nor to perform any service whatever, under any authority, or pretended authority, in hostility to the United States; that I have not yielded a voluntary support to any insurrection, rebellion, or pretended government, authority, power, or constitution within the United States, hostile thereto. And I do further swear, that, to the best of my knowledge and ability, I have supported and defended, and will continue to support and defend, the United States, against all enemies, foreign and domestic; and that I have supported, defended, and obeyed, and will continue to support, defend, and obey, the Constitution and laws of the United States; that I will bear true faith and allegiance to the same; and that I take this oath freely, without any mental reservation or purpose of evasion: So help me God.

S. Black

[5 Cent Stamp.]

Sworn to and subscribed before me, at Frankfort Ky, this 17th day of December, 1866.

John P. Lindsay, Notary Public



CERTIFICATE OF AWARD OF THE BOARD OF CLAIMS.

Office of the Board of Claims,
For Slaves Enlisted or Drafted in the Service of the United States,

....., 186
....., of
WE HEREBY CERTIFY, That
....., having proved under
County, State of
oath, loyalty to the Constitution and Government of the United States, and established
title as to the ownership of , a slave, enlisted or drafted
[as the case may be] and mustered at on the day
of , 186 , by , in the service
of the United States, in the Regiment Colored Troops, Company , the sum
of dollars has been awarded to by this Board, subject to the
approval of the Secretary of War, as a compensation for the said slave, under the provisions of section 24, Act
approved February 24, 1864, and section 2, Act approved July 28, 1866.

....., *President of the Board.*
....., *Member of the Board.*
....., *Member of the Board.*

To ,
Chief of the Bureau for the Organization of Colored Troops,
Washington, D. C.

POWER OF ATTORNEY.

My Post-office address is *Frankfort* , County of *Franklin* , State
of Kentucky, and I hereby direct that all communications to me, touching this claim, be sent under cover to
Alfred Hensley Frankfort Ky , who is hereby appointed and constituted my
true and lawful attorney, to prosecute this claim for me, and who is hereby authorized and empowered to receive and
receipt for any award, order, draft, certificate, voucher, warrant, papers, or money that may be issued in the adjustment
of this claim, or the payment thereof, the same as I might or could do in person were I present and acting for myself,
and to file any additional evidence or papers that may be required in the prosecution of this claim.

[WITNESS.]

[5 Cent Stamp.]

D. W. Lindsay
Mrs. B. Dillard

The owner
signs here.

S. Black

Two witnesses to owner's
signature sign

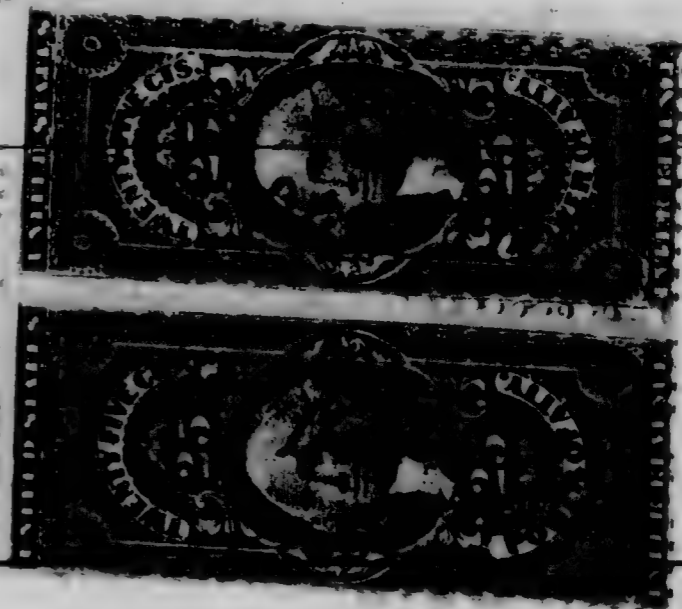

Headquarters Kentucky Volunteers,

Adjutant-General's Office,

Frankfort, Dec 7, 1866.

I hereby certify, that it appears from the U. S. Muster Rolls on file in this Office, that Ephraim Scott was enrolled on the 13. day of September, 1864, at Camp Nelson Ky. by D. B. Randolph and mustered into the U. S. service on the 13. day of September 1864, at Camp Nelson Ky. by Capt. W. C. Kinney, to serve three years. Said Ephraim Scott is described as follows: 39. years age, Black eyes, Black hair, Black complexion, 5ft 8in height. It further appears from said Rolls, that Ephraim Scott owed service to Stephen Black and is credited to Franklin County Kentucky and was assigned to Company C 5th Regiment U. S. Cavalry

In Testimony Whereof, I have hereunto set my hand, and affixed my Official Seal, this

7. day of Dec, 1866

D. W. Lindsay
Adjutant General of Kentucky.

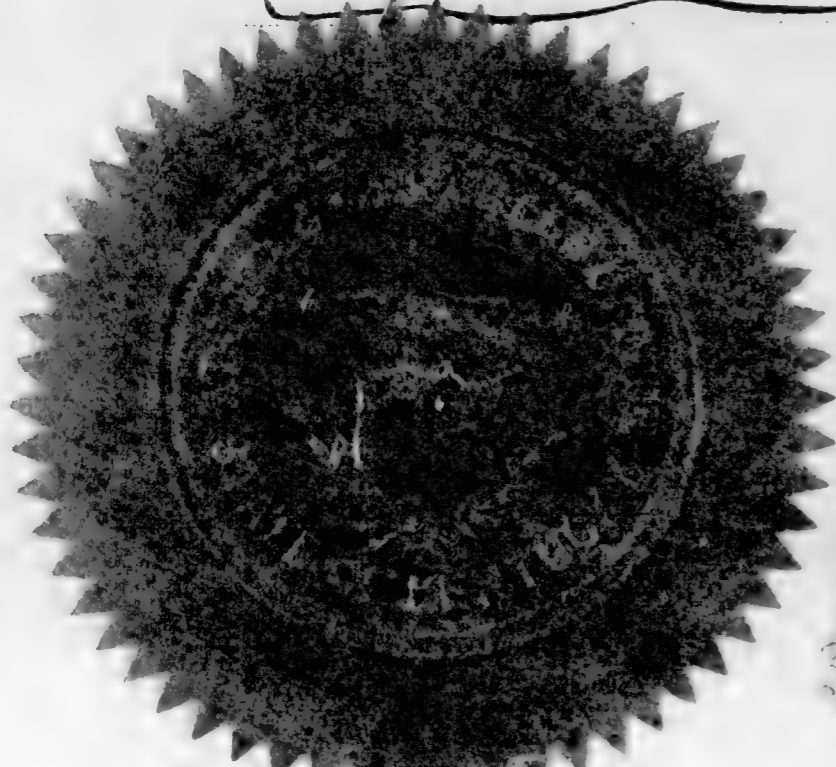

1310 K 612

America, in all suitable and practicable ways, and according to

Wm A. Games

D. W. Lindsay

Notary Public

for the County of

Franklin

, State of Kentucky, this the 17th day of December, 1866.

John D. Lindsay

Notary Public



Proof of Ownership.

State of Kentucky,
COUNTY OF Franklin } SS.

WE, Thomas Dougherty and B. F. Jones, each of lawful age, and resident citizens of the State and County aforesaid, do certify that Stephen Black, of the State and County aforesaid, was, on the 13th day of Sept, 1864, the lawful owner of the slave named Ephriam Scott, referred to and described in the foregoing claim for compensation.

Thos Dougherty

B F Jones

Sworn to and subscribed before me, a Notary Public for the County of Franklin, State of Kentucky, this the 17th day of December, 1866.

John B Lindsey
Notary Public



Proof of Loyalty.

State of Kentucky,
COUNTY OF Franklin } SS.

WE, Wm A Gains and D. W. Lindsey, loyal men, and each of lawful age, and resident citizens of the City of Frankfort, in the State and County aforesaid, upon our oaths declare that we have known Stephen Black, a resident of the State and County aforesaid, since the 4th day of March, 1861, and know that he has firmly and faithfully maintained his adherence and allegiance to the Government of the United States, by defending its cause against the Government and forces of the so-called Confederate States of America, in all suitable and practicable ways, and according to his ability and opportunity.

Wm A Gains

D W Lindsey

Sworn to and subscribed before me, a Notary Public for the County of Franklin, State of Kentucky, this the 17th day of December, 1866.

John B Lindsey
Notary Public



1150
Scott George

Co L, 5 U. S. Col'd Cav.

Private | Private

CARD NUMBERS.

1	5369850	26
2	5369945	27
3	5370038	28
4	5370137	29
5	5370184	30
6	5370276	31
7	5370419	32
8	5370533	33
9	53709350	34
10	5370780	35
11	9091202	36
12	43148140	37
13	43155212	38
14	40730299	39
15		40
16		41
17		42
18		43
19		44
20		45
21		46
22		47
23		48
24		49
25		50

Book Mark:

See also

S. 1543

01976683

AM. 18423

2

S | 5th Cav | **U.S.C.T.**

George Scott

, Co. L, 5th Reg't U. S. Col'd Cav

Appears on

Company Descriptive Book

of the organization named above.

DESCRIPTION.

Age 18 years; height 5 feet 10 inches.

Complexion Yellow

Eyes Blue; hair Black

Where born Kentucky

Occupation Laborer

ENLISTMENT.

When Substituted, 1865

Where 5th Dist Ky

By whom _____; term 1 yr.

Remarks: Disch^d Oct. 1 / 65

*As it appears on Book

A. J. Anderson

(383g)

Copyist.

S | 5 bar W. H. H.

Geo Scott

Appears with rank of Rec't on

Muster and Descriptive Roll

of A Detachment of Men Drafted
and Mustered into Service of U.S.

Roll dated
Louisville Ky, Oct 1, 1864

Where born Kentucky

Age 18 y'rs; occupation Laborer

Drafted and mustered in:

When Oct 1, 1864

Where Louisville Ky

Enrollment district 5 Dist Ky

Period 1 years.

Eyes Blk; hair Blk

Complexion Yellow; height 5 ft 10 in.

Bounty paid \$ 100; due \$ 100

Clothing account:

Last settled _____, 186 _____; drawn since \$ 100

Date of commencement of service Oct 1, 1864.

Company to which assigned _____

Remarks: Sub for J. Moore

Drtd Sept 22/64

Assd clothing to amt \$19.50

Book mark: _____

(356m)

J Jacobson
Copyist.

5 bar

U.S.A.

George Scott

Appears with rank of Private on

Muster and Descriptive Roll

of Detachment of U.S. Colored Troops, forwarded

Roll dated

Louisville, Ky., Oct. 4, 1864.

Where born Kentucky

Age 18 years; occupation Boxer

When enlisted _____, 186 .

Where enlisted _____

For what period enlisted _____ years.

Eyes Black; hair Black

Complexion Yellow; height 5 ft. 10 in.

When mustered in Oct. 1, 1864

Where mustered in Louisville

Bounty paid \$ 100; due \$ 100

Clothing account:

Last settled _____, 186 ; drawn since \$ 14⁵⁰ 100

Date of first muster Oct. 1, 1864.

Company to which assigned _____

Remarks: Credited to 5 long
Dist. Ky.
Substitute

Book mark: _____

(356m)

M. M. [Signature]

Copyist.

6

5 Cav.

U.S.C.T.

George Scott

Pat, Co. D, 5 Reg't U. S. Col'd Cavalry.

Appears on

Company Muster-in and Descriptive Roll

of the organization named above. Roll dated

Camp Nelson, Ky., Oct 30, 1864.

Where born Kentucky

Age 18 y'rs; occupation Laborer

When enlisted, 186 .

Where enlisted

For what period enlisted 1 years.

Eyes Black; hair Black

Complexion yellow; height 5 ft. 10 in.

When mustered in Oct 1, 1864.

Where mustered in Louisville

Bounty paid \$ 100; due \$ 100

Where credited 5" Dist Ky

Company to which assigned

Remarks:

Substitute

Book mark:

Brady

(356d)

Copyist.

S

5 Cav.

U.S.C.T.

George Scott
Pvt

Co. L, 5 Reg't U. S. Col'd Cavalry.

Appears on

Company Muster Roll

for dated Oct 31, 1864

Present or absent Absent

Stoppage, \$ 100 for

Due Gov't, \$ 100 for

Valuation of horse, \$ 100

Valuation of horse equipments, \$ 100

Remarks: On det Serv
Mustville Tenn
Oct 15/64

Book mark:

Badder

(358)

Copyist.

S

5 Cav.

U.S.C.T.

George Scott
Pot, Co. L, 5 Reg't U. S. Col'd Cavalry.

Appears on

Company Muster Roll

for

Nov Dec, 1864

Present or absent

Absent

Stoppage, \$

100 for

Due Gov't, \$

100 for

Valuation of horse, \$

100

Valuation of horse equipments, \$

100

Remarks

On des des
Washington June
Oct 15/64

Book mark:

Bradley

(358)

Copyist.

S

5 Cav.

U.S.C.T.

George Scott
Pop

Co. L, 5 Reg't U.S. Col'd Cavalry.

Appears on

Company Muster Roll

for

June Feb, 1865

Present or absent

Absent

Stoppage, \$

100 for

Due Gov't, \$

100 for

Valuation of horse, \$

100

Valuation of horse equipments, \$

100

Remarks:

Indis mounted
Camp Camp Mass
Reg

Book mark:

Prsdw

S | 5 Cav. | U.S.C.T.

George Scott
Trumpeter, Co. L, 5 Reg't U. S. Col'd Cavalry.

Appears on

Company Muster Roll

for *March 1865*, 1865.

Present or absent *Present*

Stoppage, \$ *100* for

Due Gov't, \$ *100* for

Valuation of horse, \$ *100*

Valuation of horse equipments, \$ *100*

Remarks: *App'td Trumpeter
per RO No 41 dated
Camp Nelson Ky
Mar 25/65*

Book mark:

Prader

(358)

Copyist.

S

5 Cav.

U.S.C.T.

Lang Scott
Dugler, Co. L, 5 Reg't U. S. Col'd Cavalry.

Appears on

Company Muster Roll

for *May June*, 18*65*.

Present or absent *Present*

Stoppage, \$ *100* for

Due Gov't, \$ *100* for

Valuation of horse, \$ *100*

Valuation of horse equipments, \$ *100*

Remarks: *Appointed Trumpeter*
per R.O. No. 41
Dated Mar 25/65

Book mark:

Proctor

S | **5 Cav. | U.S.C.T.**

George Scott

Plt, Co. L, 5 Reg't U.S. Col'd Cavalry.

Appears on

Company Muster Roll

for *July & Aug*, 1865.

Present or absent *Present*

Stoppage, \$ 100 for

Due Gov't, \$ 100 for

Valuation of horse, \$ 100

Valuation of horse equipments, \$ 100

Remarks: *Reduced to the rank
from Bugler per R.O.
No 137 Aug 12, 1865*

Book mark :

Boester

S | **5 Cav. | U.S.C.T.**

George Scott
G.H., Co. L, 5 Reg't U. S. Col'd Cavalry.

Appears on

Company Muster Roll

for *Sept Oct*, 18*65*.

Present or absent

Stoppage, \$ 100 for

Due Gov't, \$ 100 for

Valuation of horse, \$ 100

Valuation of horse equipments, \$ 100

Remarks: *Mustered out of service for expiration of Term*

Book mark: *Discharged Oct 2/65*
E.B. U. I. P. 205

Provester

8 | 5-car | U.S.C.T.

George Scott
Pvt., Co. L, 5-Reg't U. S. Col'd Car

Appears on a

Detachment Muster-out Roll

of the organization named above. Roll dated

Lexington Ky Oct 2, 1865.

Muster-out to date Oct 2, 1865.

Last paid to June 30, 1865.

Clothing account:

Last settled....., 186 ; drawn since \$.....100

Due soldier \$.....100; due U. S. \$.....100

Am't for cloth'g in kind or money adv'd \$.....100

Due U. S. for arms, equipments, &c., \$.....100

Bounty paid \$.....100; due \$ 25 ⁵⁰/₁₀₀

Remarks: Mustered out by
reason of expiration
of term of service
Substitute
Discharge furnished

Book mark:

(349)

J. H. Anderson
Copyist.

S | 5 Cav. | U.S.C.T.

George Scott

Pot, Co. L, 5 Reg't U. S. Colored Cav.

Appears on Returns as follows:

Oct To Dec, 1864, Absent on detached
service Nashville, Tenn.

Oct. 15/64.

Jan'y + Feby 1865, Absent in dis-
mounted camp, Camp
Nelson, Ky.

Oct. 1865, Loss: Oct. 1, Lex., Ky.
Dischgd Expiration of ser-
vice.

Book mark :

L. B. Bowman

(546)

Copyist.

A | *5 bars* | **U.S.C.T.**

George Scott
Pr, Co. *D*, *5* Reg't U. S. Col'd *Cavalry*

Appears on **Co. Muster-out Roll**, dated
Helena, Ark, *Mar. 16*, 1866.

Muster-out to date _____, 186__.

Last paid to *June 30*, 1865.

Clothing account:

Last settled _____, 186__ ; drawn since \$ _____ $\overline{100}$

Due soldier \$ *14* $\frac{07}{100}$; due U. S. \$ _____ $\overline{100}$

Am't for cloth'g in kind or money adv'd \$ _____ $\overline{100}$

Due U. S. for arms, equipments, &c., \$ _____ $\overline{100}$

Bounty paid \$ _____ $\overline{100}$; due \$ _____ $\overline{100}$

Remarks: *Discharged Oct. 1st, 65, at Lexington Ky. Mustered out for expiration of service.*

Book mark: *Discharged Oct. 2/65 (over)*

(361)

O. T. Taylor

Copyist.

JAN. - 9

5370780

1891

x E. B. V. 11, P. 205.

Scott, George

P, Co. L

5

Reg't *Wacey*

2 Enclosures.

Bed Cards	Final Statements
Burial Records	Furloughs or L. of A.
Certs. of Dis. for Discharge	Med. Certificates
C. M. Charges	Med. Des. Lists
Descriptive Lists	Orders
Discharge Certificates	Pris. of War Record
Enlistment Papers	Resignations

Other papers relating to—

Admission to Hosp'l	Furlough or L. of A.
Casualty Sheet	Med. Examination
Confinement	Misc. Information
Contracts	Pay or Clothing
Death or Effects	Personal Reports
Desertion	Rank
Discharge from Hosp'l	Transfer to Hosp'l
Discharge from Service	Transfer to V. R. C.
Duty	Transportation

28

No. 391

George Scott

Enlisted at Louisville Ky

AS SUBSTITUTE FOR

Jackson Moore

On the 1 day of Oct 1864

BY

G. W. Hornack Pres

W. R. Hamer Comd

J. D. Bell Surgeon

Board of Enrollment.

5 Dist. of Ky



(No. 40.)

SUBSTITUTE VOLUNTEER ENLISTMENT.

STATE OF

TOWN OF

Kentucky
I, *Gory Scott*



Louisa

born in the State of

Kentucky aged *18* years, and by occupation a

laborer

, Do I HEREBY ACKNOWLEDGE to have agreed with

Jackson Moore, Esq., of *Louisa Henry*
County Ky

to become his SUBSTITUTE in the Military Service, for a sufficient consideration paid and delivered to me, on the *1st* day of *Oct* 186*4*; and having thus agreed

with said *Jackson Moore*, I DO HEREBY ACKNOWLEDGE to have enlisted this *1st* day of *Oct* 186*4*, to serve as a

SOLDIER in the Army of the United States of America, for the period of ~~THREE~~ *THREE* YEARS, unless sooner discharged by proper authority: I do also agree to accept such bounty, pay, rations, and clothing, as are, or may be, established by law for ~~soldiers~~ *soldiers*. And I do solemnly swear that I will bear true and faithful allegiance to the United States of America; and that I will serve them honestly and faithfully against all their enemies or opposers whomsoever; and that I will observe and obey the orders of the President of the United States, and the orders of the Officers appointed over me, according to the Rules and Articles of War.

Sworn and subscribed to at *Louisa Ky*
this *1* day of *Oct* 186*4*
before *R. M. Munnach*
Capt & Prov. Mar. 5th Dist

Gory Scott
18

[Signature]

We Certify on Honor, That we have carefully examined the above-named Volunteer Substitute agreeably to the Regulations, and that, in our opinion, he is free from all bodily defects and mental infirmity which would in any way disqualify him from performing the duties of a soldier; that he was entirely sober when enlisted; that he is of lawful age, (not under 18 years;) and that in accepting him as duly qualified to perform the duties of an able-bodied soldier, and as a Substitute in lieu of

Jackson Moore of Henry County Ky drafted in *5th Dist Ky*
Sept 20 186*4*, we have strictly observed the Regulations which govern in such cases. This soldier has *2* eyes, *dark* hair, *paler* complexion; is *5* feet *10* inches high.

R. M. Munnach
Provost Marshal

Will R. Hervey
Commissioner of Board.

[Signature]
Surgeon of Board.

Board of Enrollment of *5th* Dist. of *Ky*

DECLARATION OF SUBSTITUE.

I, George Scott
desiring to ENLIST in the Army of the United States, for ~~THREE~~^{one} YEARS, Do declare, That I am
18 years and months of age; that I have
never been discharged from the United States service on account of disability or by sentence of a court
martial; and I know of no impediment to my serving honestly and faithfully as a soldier for ~~three~~^{one} years.

GIVEN AT Louisville Ky
the 1 day of Oct 1861

WITNESS :

C. C. Little

George W. Scott
mark

28

No. 391

George Scott

Enlisted at Louisville Ky

AS SUBSTITUTE FOR

Jackson Moore

On the 1 day of Oct 1864

BY

G. W. Howack Best

W. R. Hervey Com^d

J. J. Bell Surgeon

Board of Enrollment.

5 Dist. of Ky

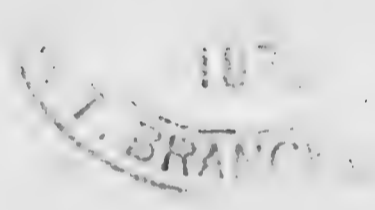

SUBSTITUTE VOLUNTEER ENLISTMENT.

STATE OF

TOWN OF

Kentucky



Louisville

I, *George Scott* born in the State of *Kentucky* aged *18* years, and by occupation a *laborer*

, Do HEREBY ACKNOWLEDGE to have agreed with *Jackson Moore*, Esq., of *Henry*

County Ky

to become his SUBSTITUTE in the Military Service, for a sufficient consideration paid and delivered to me, on the *1st* day of *Oct* 186*4*; and having thus agreed with said *Jackson Moore*, I DO HEREBY ACKNOWLEDGE to have

enlisted this *1st* day of *Oct* 186*4*, to serve as a SOLDIER in the Army of the United States of America, for the period of **THREE YEARS**, unless sooner discharged by proper authority: I do also agree to accept such bounty, pay, rations, and clothing, as are, or may be, established by law for *enlisted men*. And I do solemnly swear that I will bear true and faithful allegiance to the United States of America; and that I will serve them honestly and faithfully against all their enemies or opposers whomsoever; and that I will observe and obey the orders of the President of the United States, and the orders of the Officers appointed over me, according to the Rules and Articles of War.

Sworn and subscribed to at *Louisville Ky* this *1* day of *Oct* 186*4*, before *J. M. Moore* *George Scott* *Capt Wm. M. ...*

[Signature]

We Certify on Honor, That we have carefully examined the above-named Volunteer Substitute agreeably to the Regulations, and that, in our opinion, he is free from all bodily defects and mental infirmity which would in any way disqualify him from performing the duties of a soldier; that he was entirely sober when enlisted; that he is of lawful age, (not under 18 years;) and that in accepting him as duly qualified to perform the duties of an able-bodied soldier, and as a Substitute in lieu of

Jackson Moore of Henry Co Ky drafted in *5 Dec 1864* *Sept 22* 186*4* we have strictly observed the Regulations which govern in such cases. This soldier has *blue* eyes, *black* hair, *yellow* complexion; is *5* feet *1* inches high.

J. M. Moore
Provost Marshal

Will R. Hervey
Commissioner of Board.

E. S. Bell
Surgeon of Board.

Board of Enrollment of *5* Dist. of *10*

DECLARATION OF SUBSTITUE.

I, George Scott
desiring to ENLIST in the Army of the United States, for ^{one} THREE YEARS, Do declare, That I am
18 years and months of age; that I have
never been discharged from the United States service on account of disability or by sentence of a court
martial; and I know of no impediment to my serving honestly and faithfully as a soldier for ^{one} ~~three~~ years.

GIVEN AT Seneca Falls
the 1 day of Oct 1864

WITNESS:

C. E. Settle

George Scott
his mark

1137

Scott Henderson

Co D, 5 U. S. Col'd Cav.

Private Private

CARD NUMBERS.

5362714	26
5362808	27
5362906	28
5362991	29
5363085	30
5363172	31
5363261	32
5363352	33
5363439	34
5363522	35
5363608	36
9040342	37
D-57-07-1868	38
43146505	39
43155138	40
31785311	41
40730298	42
	43
	44
	45
	46
	47
	48
	49
	50

Book Mark: D-57-07-1868

See also

S

5 Cav. | U.S.C.T.

Henderson Scott

Co. *11*, 5 Reg't U. S. Col'd Cav.

Appears on

Company Descriptive Book

of the organization named above.

DESCRIPTION.

Age *18* years; height *5* feet *7* inches.

Complexion *Copper*

Eyes *Black*; hair *Black*

Where born *Queen City*

Occupation *laborer*

ENLISTMENT.

When _____, 186 .

Where *Substitute*

By whom _____; term *3* y'rs.

Remarks: _____

X E Parks

(383g)

Copist.

S | 5 bar USGT

Henderson Scott

Appears with rank of Rec't on

Muster and Descriptive Roll

of a Detachment of men Drafted
and mustered into service US

Roll dated
Louisville Ky, Sept 2, 1864.

Where born Owen Ky

Age 18 y'rs; occupation Saborer

Drafted and mustered in:

When Sept 2, 1864.

Where Louisville Ky

Enrollment district 5 Dist Ky

Period 3 years.

Eyes Black; hair Black

Complexion Black; height 5 ft. 7 in.

Bounty paid \$ 100; due \$ 100

Clothing account:

Last settled _____, 186 ; drawn since \$ 100

Date of commencement of service Sept 2, 1864.

Company to which assigned _____

Remarks: Substitute for Simeon

Wilson Anti Draft

Issued clothing amt \$ 19⁵⁷

Book mark: _____

(356m)

Jacobson

Copyist.

S | 5 Cav | U.S.A.

Henderson Scott

Appears with rank of Pvt on

Muster and Descriptive Roll

of a Detachment of U.S. Colored Troops forwarded for U.S. Col. Ser. at Lexington, Ky.

Roll dated Louisville, Ky., Sept. 7, 1864.

Where born Ipswich, Ky.

Age 18 years; occupation Laborer

When enlisted Substitute, 1864.

Where enlisted _____

For what period enlisted 3 years.

Eyes Blue; hair Red

Complexion Red; height 5 ft. 7 in.

When mustered in Sept. 2, 1864.

Where mustered in Louisville

Bounty paid \$ 100; due \$ 100

Clothing account:

Last settled _____, 1864; drawn since \$ 19.57/100

Date of first muster Sept. 2, 1864.

Company to which assigned _____

Remarks: Credited to 5. Dist. Ky.

Book mark: _____

(356m)

A. J. C. Dunbar

Copyist.

S | 5 Cav. | U.S.C.T.

Henderson Scott

Priv., Co. D, 5 Reg't U. S. Col'd Cavalry.

Appears on

Company Muster-in and Descriptive Roll

of the organization named above. Roll dated

Camp Nelson, N.Y., Oct. 24, 1864.

Where born Owens, Ky

Age 18 y'rs; occupation Laborer

When enlisted, 186 .

Where enlisted

For what period enlisted 3 years.

Eyes BK; hair BK

Complexion BK; height 5 ft. 7 in.

When mustered in Sept. 15, 1864.

Where mustered in Louisville

Bounty paid \$ 100; due \$ 100

Where credited 5 Dist. Ky

Company to which assigned

Remarks:

Book mark: S-57-07-1866

Wm H Scott

(356d)

Copyist.

S | 5 Cav. | U.S.C.T.

Anderson Scott

Priv., Co. D, 5 Reg't U. S. Col'd Cavalry.

Appears on

Company Muster Roll

for Dated Oct. 31, 1864.

Present or absent Absent

Stoppage, \$ 100 for

Due Gov't, \$ 100 for

Valuation of horse, \$ 100

Valuation of horse equipments, \$ 100

Remarks: Sick - Camp Nelson, Ky.

Book mark:

Wm. H. Scott

(358)

Copyist.

S

5 Cav. | U.S.C.T.

Henderson Scott

Priv., Co. D, 5 Reg't U. S. Col'd Cavalry.

Appears on

Company Muster Roll

for *Nov. + Dec.*, 1864.

Present or absent *Absent*

Stoppage, \$ *100* for

Due Gov't, \$ *100* for

Valuation of horse, \$ *100*

Valuation of horse equipments, \$ *100*

Remarks: *Sick in Hospital,
Camp Nelson, Ky.*

Book mark :

M. H. Scott

(358)

Copyist.

5
S 1 6 Cav U.S.

Henderson Scott

Priv., Co. H, 6 Reg't U.S. Col. Cav

Appears on

Descriptive List of Deserters Arrested.

List dated July 9, 1865, and signed
by Provost Marshal, District of Kentucky.

Deserted:

When Dec., 1864.

Where Camp Nelson Ky

Arrested:

When July 7, 1865.

Where Owen Co Ky

Remarks: Arrested by H. F.

Swope Reward \$30. paid

acknowledges

to have enlisted as Substitute

for Jim Wilson of Owen

Co Ky, and to have (over)

Endorsement on list shows that the men named

therein were received at Hd Qrs Post Comdr

Covington Ky, July 9, 1865.

Reynolds

(516)

Copyist.

APR. 21.

31785311

1894.

Deserted from
his Regt. 6"
W. Col Cav

S | 5 Cav. | U.S.C.T.

Handerson Scott

Plt., Co. D, 5 Reg't U. S. Col'd Cavalry.

Appears on

Company Muster Roll

for *Jan. & Feb.*, 186*5*.

Present or absent *Absent*

Stoppage, \$ *100* for

Due Gov't, \$ *100* for

Valuation of horse, \$ *100*

Valuation of horse equipments, \$ *100*

Remarks: ** Sick in Hospital
Camp Nelson, Ky. First
instalment of Bounty
due \$100.*

** Remarks cancelled, as
shown on Roll.*

Book mark: *100*

M. H. Scott

S

5 Cav.

U.S.C.T.

Henderson Scott

Pol., Co. D, 5 Reg't U. S. Col'd Cavalry.

Appears on

Company Muster Roll

for March & April, 1865.

Present or absent. Absent.

Stoppage, \$ 100 for

Due Gov't, \$ 100 for

Valuation of horse, \$ 100

Valuation of horse equipments, \$ 100

Remarks: In Hospital, Camp Nelson, Ky.

Book mark:

M. H. Scott

S | **5 Cav. U.S.C.T.**

Henderson Scott

Priv., Co. D, 5 Reg't U. S. Col'd Cavalry.

Appears on

Company Muster Roll

for *May + June*, 1865.

Present or absent *absent*

Stoppage, \$ *100* for

Due Gov't, \$ *100* for

Valuation of horse, \$ *100*

Valuation of horse equipments, \$ *100*

Remarks: *In Hospital, Camp
Nelson Ky.*

Book mark:

Milliken

(358)

Copyist.

J

5 Cav. U.S.C.T.

Henderson Scott

Private, Co. D, 5 Reg't U. S. Col'd Cavalry.

Appears on

Company Muster Roll

for July & Aug., 1863.

Present or absent absent

Stoppage, \$ 100 for

Due Gov't, \$ 100 for

Valuation of horse, \$ 100

Valuation of horse equipments, \$ 100

Remarks: In Hospital, Camp Nelson Ky.

Book mark:

Milliken

(358)

Copyist.

J

5 Cav. U.S.C.T.

Henderson Scott

Priv., Co. D, 5 Reg't U. S. Col'd Cavalry.

Appears on

Company Muster Roll

for *Sept. & Oct.*, 1865.

Present or absent *Absent*

Stoppage, \$ *100* for

Due Gov't, \$ *100* for

Valuation of horse, \$ *100*

Valuation of horse equipments, \$ *100*

Remarks: *In Hospital leave
Nelson Ky.*

Book mark:

Milliken

(358)

Copyist.

S | **5 Cav.** | **U.S.C.T.**

Henderson Scott

Private, Co. D, 5 Reg't U. S. Col'd Cavalry.

Appears on

Company Muster Roll

for *Nov, & Dec.*, 1865.

Present or absent *absent*

Stoppage, \$ *100* for

Due Gov't, \$ *100* for

Valuation of horse, \$ *100*

Valuation of horse equipments, \$ *100*

Remarks: *Absent sick - Hospl
Camp Nelson Ky.*

Book mark:

Milliken

S. | 5 Cav. | U.S.C.T.

Henderson Scott,
Priv., Co. D, 5 Reg't U. S. Col'd Cavalry.

Appears on

Company Muster Roll

for *Jan'y 4th Feb'y*, 186*e*.

Present or absent *Absent.*

Stoppage, \$ 100 for

Due Gov't, \$ 100 for

Valuation of horse, \$ 100

Valuation of horse equipments, \$ 100

Remarks: *Sick in Hosp'tl. Camp,*
Nelson, Ky.

Book mark:

(358)

W. Brauner
Copyist.

S

5 Cav. U.S.C.T.

Henderson Scott

Post, Co. D, 5 Reg't U. S. Colored Cav.

Appears on Returns as follows:

Oct. to Dec. 1864, Absent sick in
Hospl Camp Nelson, Ky.

Feb'y to Aug. 1865, Absent sick in
Hospl Camp Nelson, Ky.

Sept. 1865, Absent sick in Post-
Hospl Camp Nelson, Ky.

Oct. 1865 To Feb'y 1866, Absent sick
in Hospl Camp Nelson, Ky.

Book mark :

L. B. Bowman

(546)

Copyist.

S.

5 Cav.

U.S.C.T.

Henderson Scott,

Priv., Co. D., 5 Reg't U. S. Col'd Cavalry.

Appears on **Co. Muster-out Roll**, dated

Helena, Ark., March 16, 1866.

Muster-out to date. *March 16,* 1866.

Last paid to *Enlistment,* 1866.

Clothing account:

Last settled....., 1866 ; drawn since \$..... 100

Due soldier \$ *66.45* / 100; due U. S. \$..... 100

Am't for cloth'g in kind or money adv'd \$..... 100

Due U. S. for arms, equipments, &c., \$..... 100

Bounty paid \$..... 100; due \$..... 100

Remarks: *Absent sick in Dept. Camp*

Nelson, Ky., since October 1864.

No discharge given.

Book mark: *S 57 V 7 C. T. 1868.*

M. Grauer

(361)

Copyright.

S 5th Cav U.S.C. I

Henderson Scott

, Co. D, 5th Reg't U.S.C. Cav.

NOTATION.

Book mark: S. 57-C-I-1868

Record and Pension Office,

WAR DEPARTMENT.

This book mark refers only to a report from the medical records, made by the Surgeon General to the Adjutant General, relative to the above-named man. As the medical records have since been carded, no transcript of this report is made hereon.

W. Allen

(491)

Copyist.

1140
Scott King

Co M, 5 U. S. CoPd Cav.

Private | Private

CARD NUMBERS.

1	5370882	26
2	5370987	27
3	5371759	28
4	9091020	29
5	40730300	30
6		31
7		32
8		33
9		34
10		35
11		36
12		37
13		38
14		39
15		40
16		41
17		42
18		43
19		44
20		45
21		46
22		47
23		48
24		49
25		50

Book Mark:

See also

S. L. Carter | U.S.C.T.

King Scott

, Co. *H*, *5* Reg't U. S. Col'd *Cav*

Appears on

Company Descriptive Book

of the organization named above.

DESCRIPTION.

Age *22* years ; height *5* feet *8* inches.

Complexion *Black*

Eyes *Blk* ; hair *Blk*

Where born *Scott Ky*

Occupation *Farmer*

ENLISTMENT.

When *Aug 29*, 1864.

Where *Camp Nelson*

By whom *McRandolph* ; term *3* y'rs.

Remarks: *Wiping in action*

A. J. Anderson

(3837)

Copyist.

S | 5 Car

U.S.C.T.

Scott

Co. M, 5 Reg't U. S. Col'd

Appears on

Company Muster-in and Descriptive Roll of the organization named above. Roll dated

Camp Nelson, Ky, Oct 30, 1864.

Where born Scott, Ky.

Age 22 y'rs; occupation Farmer

When enlisted Aug. 29, 1864.

Where enlisted Camp Nelson, Ky.

For what period enlisted 3 years.

Eyes Black; hair Black

Complexion Black; height 5 ft. 8 in.

When mustered in Aug. 30, 1864.

Where mustered in Camp Nelson, Ky.

Bounty paid \$ 100; due \$ 100

Where credited Dist

Company to which assigned

Remarks: Stephen Thompson

x Supposed to be name of owner.

Added May 18, 48 H.A.J.

Book mark:

M. S. Thompson

(356d)

Copyist.

at

5 Cav. | U.S.C.T.

King Scott

Co. M, 5 Reg't U. S. Col'd Cavalry.

Appears on

Company Muster Roll

for Oct. 31, 1864.

Present or absent Absent

Stoppage, \$ 100 for

Due Gov't, \$ 100 for

Valuation of horse, \$ 100

Valuation of horse equipments, \$ 100

Remarks: Missing in Action
Oct. 2/64 Sacketville, Va.

Book mark:

M. S. Thompson

(358)

Copyist.

King Scott

Pvt., Co. M, 5 Reg't U. S. Colored Cav.,

Appears on Returns as follows:

Oct. 1864, Loss; Oct. 6/64, Saltville, Va. Missing in action.

Book mark:

L. B. Bowman

(546)

Copyist.

S | 5 Cav. | U.S.C.T.

King Scott

Plt, Co. *M*, 5 Reg't U. S. Col'd Cavalry.

Appears on Co. Muster-out Roll, dated
Helena, Ark, *Mar 16*, 186*6*.

Muster-out to date _____, 186 .

Last paid to _____, 186 .

Pay due from enlistment

Clothing account:

Last settled _____, 186 ; drawn since \$ _____ 100

Due soldier \$ _____ 100; due U. S. \$ _____ 100

Am't for cloth'g in kind or money adv'd \$ _____ 100

Due U. S. for arms, equipments, &c., \$ _____ 100

Bounty paid \$ _____ 100; due \$ _____ 100

Remarks: *Missing in Action at*
Saltsville, Va Oct 2: '64 Slave
Apr. 19 '61

Book mark: _____

(361)

Hynes

Copyist.

Scott King

P, Co. M., 5 Reg't U. S. G. C.

Enclosures.

Bed Cards	Final Statements
Burial Records	Furloughs or L. of A
Certs. of Dis. for Discharge	Med. Certificates
C. M. Charges	Med. Des. Lists
Descriptive Lists	Orders
Discharge Certificates	Pris. of War Record
Enlistment Papers	Resignations

Other papers relating to—

Admission to Hosp'l	Furlough or L. of A
Casualty Sheet	Med. Examination
Confinement	Misc. Information
Contracts	Pay or Clothing
Death or Effects	Personal Reports
Desertion	Rank
Discharge from Hosp'l	Transfer to Hosp'l
Discharge from Service	Transfer to V. R. C.
Duty	Transportation

MEMORANDUM FROM PRISONER OF WAR RECORDS.

No. _____

(This blank to be used only in the arrangement of said records.)

INFORMATION OBTAINED FROM—

NAME.	RANK.	ORGANIZATION.				Records of—	Vol.	Page.	Vol.	Page.
		No. of Reg't.	State.	Arm of Service.	Co.					
<i>Scott King</i>	<i>P</i>	<i>5</i>	<i>U. S. C. Cav. In</i>							

Captured at _____, 186 ; brought from _____, and confined at Richmond, Va., _____, 186 ,

Admitted to Hospital at _____, 186 ; treated for _____

Where he died _____, 186 ; of _____

Paroled at _____, 186 ; reported at _____, 186 .

No record sub. to Oct. 1-64

(Record continued.)

Furloughed _____, 186 , for _____ days; returned _____, 186 ;
deserted _____, 186 ;

2 And. Case Reed abo Sept 4.87 returned May 1.880

Copied by *H. H. W. 4-26-88*

Adjutant General's Office,

, 18

This is accepted as referring to _____

Co. _____, Reg't, _____

and records will be corrected accordingly.

Assistant Adjutant Gen'l.

Scott Lawery

Co M, 5 U. S. Col'd Cav.

Private | *Private*

CARD NUMBERS.

1	5370883	26
2	5370988	27
3	5371760	28
4	9091321	29
5	40730302	30
6		31
7		32
8		33
9		34
10		35
11		36
12		37
13		38
14		39
15		40
16		41
17		42
18		43
19		44
20		45
21		46
22		47
23		48
24		49
25		50

Book Mark:

See also

21 | 5 | car | **U.S.C.T.**

Frederic Scott

Co. M, 5th Reg't U. S. Col'd car

Appears on

Company Descriptive Book

of the organization named above.

DESCRIPTION.

Age 21 years; height 5 feet 9 inches.

Complexion Black

Eyes BRN; hair BRN

Where born Baunton Ky

Occupation Farmer

ENLISTMENT.

When Aug 29, 1864.

Where Camp Nelson

By whom Holland; term 3 y'rs.

Remarks: Wiping in action

(383g)

A. J. Anderson

Copyist.

S | 3 Cav. | U.S.C.T.

Lourey Scott

Co. M, 3 Reg't U. S. Col'd Cav

Appears on

Company Muster-in and Descriptive Roll
of the organization named above. Roll dated

Camp Nelson Ky, Oct 30, 1861.

Where born Boone Co. Ky.

Age 21 y'rs; occupation Farmer.

When enlisted Aug. 29, 1861.

Where enlisted Camp Nelson, Ky.

For what period enlisted 3 years.

Eyes Black; hair Black

Complexion Black; height 5 ft. 9 in.

When mustered in Aug. 29, 1861.

Where mustered in Camp Nelson, Ky.

Bounty paid \$ 100; due \$ 100

Where credited 7 Dist. Ky.

Company to which assigned

Remarks: Lewis Cunningham

x Supposed to be name of owner

Added May 18. 98. H. A. J.

Book mark: h. 1714, Ky

M. S. Thompson

(356d)

Copyist.

28

5 Cav. | U.S.C.T.

Lowery Scott

(B. 1.), Co. M, 5 Reg't U. S. Col'd Cavalry.

Appears on

Company Muster Roll

for *to 11 Feb. 51*, 186*11*.

Present or absent *Absent*

Stoppage, \$ *100* for

Due Gov't, \$ *100* for

Valuation of horse, \$ *100*

Valuation of horse equipments, \$ *100*

Remarks: *Missing in Action
Oct. 2/64 Battle of...*

Book mark:

M. S. Thompson

(358)

Copyist.

S | **5 Cav.** | **U.S.C.T.**

Lovery Scott

Priv, Co. *M*, 5 Reg't U. S. Colored Cav.

Appears on **Returns** as follows:

Oct. 1864, Loss: Oct. 6/64, Saltville, Va. Missing in action.

Book mark :

L. B. Bowman

(546)

Copyist.

S | 5 Cav. | U.S.C.T.

Louise Scott

Pvt., Co. M., 5 Reg't U. S. Col'd Cavalry.

Appears on Co. Muster-out Roll, dated
Hebera, Ark Mar 16, 1866.

Muster-out to date _____, 186 .

Last paid to _____, 186 .
Pay due from enlistment

Clothing account:

Last settled _____, 186 ; drawn since \$ _____ 100

Due soldier \$ _____ 100; due U. S. \$ _____ 100

Am't for cloth'g in kind or money adv'd \$ _____ 100

Due U. S. for arms, equipments, &c., \$ _____ 100

Bounty paid \$ _____ 100; due \$ _____ 100

Remarks: Missing in Action at
Saltrille, Va, Oct. 2, '64
Slave
Apr. 19 '61

Book mark: U. 220 P. 121.75

(361)

Styan

Copyist.

Scott Lowery

P, Co. M, 5 Reg't US 66

Enclosures.

Bed Cards	Descriptive Lists
Burial Records	Final Statements
Certs. of Dis. for Discharge	Furloughs
C. M. Charges	Med. Des. Lists
Med. Certificates	Orders

Other papers relating to—

Admission to Hosp'l	Furlough
Casualty Sheet (Officer's)	Med. Examination
Confinement	Misc. Information
Contracts	Pay or Clothing
Death or Effects	Personal Reports
Desertions	Rank
Discharge from Hosp'l	Transfer to Hosp'l
Discharge from Service	Transfer to V. R. C.
Duty	Transportation

MICROFILM PUBLICATION M 1821

COMPILED MILITARY SERVICE RECORDS
OF VOLUNTEER UNION SOLDIERS WHO
SERVED WITH THE USCT (US COLORED TROOPS)
5TH REGIMENT OF CAVALRY

PERSONAL PAPERS' TARGET SHEET

PLEASE NOTE THE CHECKED INFORMATION ABOUT THE PERSONAL PAPERS IN
THIS FILE:

- NO PERSONAL PAPERS WERE FOUND IN THIS FILE WHEN THE
RECORDS WERE ARRANGED FOR MICROFILMING.
- 2 PERSONAL PAPER(S) FOUND IN THIS FILE WHEN THE RECORDS
WERE ARRANGED FOR MICROFILMING.

War Department,

ADJUTANT GENERAL'S OFFICE.

Washington, April 11th 1867.

Respectfully returned to the
Commission for the State of
Ky., with the informa-
tion that Lerroy Scott
was enlisted at Camp Nelson Ky.
Aug 29 1864, and was
mustered in as Pvt. in Co. "M"
5th U.S. Col. Inf. Aug 29/64.

H 17/16

J. W. Hazard

J. W.

Asst. Adj't General.

ENDORSEMENT.

No. 17151

APPLICATION OF

M^{rs}. Louisa A. Kinnighan

OF

Paris Bourbon City Ky

For Compensation for Service of Slave,

Lerroy Scott

Enlisted *29 Aug*, 1864,

In Co., "*M*" *17* Regiment

U. S. Colored Troops.

Received _____, 186 .

Compensation Awarded

_____, 186 ,

Dollars.

President Board of Claims.

P. O. ADDRESS OF CLAIMANT:

Care of Noah Spence Esq

Paris Ky

Headquarters Kentucky Volunteers,

Adjutant-General's Office,

Frankfort, Dec 14, 1866.

I hereby certify, that it appears from the U. S. Muster-
Rolls on file in this Office, that Lavery Scott
was enrolled on the 29th day of August, 1864, at
Camp Nelson Ky by J. Randolph,
and mustered into the U. S. service on the 29th day of August,
1864, at Camp Nelson Ky by Capt H. O. Kinney
to serve Three years. Said Lavery Scott
is described as follows: Age, 21 years; eyes, Black; hair, Black,
complexion, Black; height, 5 feet 9 inches. It further
appears from said Rolls, that Lavery Scott owed service
to Miss Cunningham, was credited to Bourbon
County, Ky., and was assigned to Co. M, 5th Lt Regiment
U. S. C. Cary

In Testimony Whereof, I have hereunto set my
hand, and affixed my Official Seal, this
14 day of Dec, 1866.

D. W. Lindsay
Adjutant General of Kentucky.

B. 253, R. 264

United States, against all enemies, foreign and domestic; and that I have supported, defended, and obeyed, and will continue to
support, defend, and obey, the Constitution and laws of the United States; that I will bear true faith and allegiance to the
same; and that I take this oath freely, without any mental reservation or purpose of evasion: So help me God.

Louisa A. Keeningham

[5 Cent Stamp.]

Sworn to and subscribed before me, at Augusta, Georgia,
this 26th day of December, 1866.

David Noath

Clerk City Court Augusta, Georgia,
a Court of Record.

Claim for Compensation for Enlisted Slave.

I, Louisa A. Keenine Ham, a loyal citizen, and a resident of Paris, County of Boonville, State of Kentucky hereby claim compensation, under the provisions of section 24, Act approved February 24, 1864, and section 2, Act approved July 28, 1866, for my slave Larry Scott, enlisted 29th August, 1864, at Camp Nelson Kentucky, by Capt Randolph S. Milner in service by Capt F. W. Kinney, in the Fifth Regiment U. S. Colored Troops, Co. M; certificate of which enlistment, and a descriptive list, as required, accompany this application. That I did not acquire said slave subsequent to said enlistment, but had a valid title to him at the date of said enlistment, and previous thereto, I having acquired my title to him and my ownership over him as follows, to-wit:

Said Larry Scott was born my slave I having inherited him from my mother from the mother's estate his Grand Mother also being the slave of my mother & I having ownership over him up to the day of his joining the Army

In proof of my loyalty to the Constitution and Government of the United States, I present the accompanying oath, which I have taken, signed and acknowledged, to be filed with this application, in accordance with requirement of General Orders No. 329, 1863, War Department, Adjutant General's Office.

Augusta, Georgia, December 26th, 1866. Louisa A. Keenine Ham

Oath of Allegiance.

I, Louisa A. Keenine Ham, the owner and claimant, do solemnly swear that the foregoing claim is a just and true claim due to me as ~~master~~ ^{mistress} and owner of the said slave, and that the facts alleged in said claim in respect to the draft or enlistment [as the case may be] of said slave into the military service of the United States are true. And I do further swear, that I have never joined, or been concerned in, any insurrection or rebellion; that I have never borne arms against the United States; that I have never given any aid, countenance, counsel, or encouragement to any person or persons engaged, or whom I had reason to believe were about to engage, in insurrection, rebellion, or armed hostility against the United States; that I have neither sought nor accepted, nor attempted to exercise the functions of any office, civil or military, nor to perform any service whatever, under any authority, or pretended authority, in hostility to the United States; that I have not yielded a voluntary support to any insurrection, rebellion, or pretended government, authority, power, or constitution within the United States, hostile thereto. And I do further swear, that, to the best of my knowledge and ability, I have supported and defended, and will continue to support and defend, the United States, against all enemies, foreign and domestic; and that I have supported, defended, and obeyed, and will continue to support, defend, and obey, the Constitution and laws of the United States; that I will bear true faith and allegiance to the same; and that I take this oath freely, without any mental reservation or purpose of evasion: So help me God.

Louisa A. Keenine Ham

[5 Cent Stamp.]

Sworn to and subscribed before me, at Augusta, Georgia, }
this 26th day of December, 1866. }

David Noath

Clerk City Court Augusta, Georgia,
a Court of Record.



Proof of Ownership.

State of Kentucky, }
COUNTY OF Kentucky } SS.

WE, Noah Spears and W. W. Massie, each of lawful age, and resident citizens of the State and County aforesaid, do certify that Louisa A. Kainingsham, of the State and County aforesaid, was, on the 29th day of August, 1864, the lawful owner of the slave named Lorry Scott, referred to and described in the foregoing claim for compensation. I was the owner of the said Lorry Scott from the time of the beginning of the late rebellion till the time of his enlistment Noah Spears
W. W. Massie

Sworn to and subscribed before me, a Notary Public for the County of Douglas, State of Kentucky, this the 2nd day of January, 1867.



[5 Cent Stamp.]

W. W. Massie
Notary Public

Proof of Loyalty.

State of Kentucky, }
COUNTY OF Douglas } SS.

WE, Noah Spears and W. W. Massie, loyal men, and each of lawful age, and resident citizens of the City of Paris, in the State and County aforesaid, upon our oaths declare that we have known Mrs Louisa A. Kainingsham, a resident of the State and County aforesaid, since the 4th day of March, 1861, and know that she has firmly and faithfully maintained her adherence and allegiance to the Government of the United States, by defending its cause against the Government and forces of the so-called Confederate States of America, in all suitable and practicable ways, and according to her ability and opportunity.

Noah Spears
W. W. Massie

Sworn to and subscribed before me, a Notary Public for the County of Douglas, State of Kentucky, this the 2nd day of January, 1867.



[5 Cent Stamp.]

W. W. Massie
Notary Public

1142
Scott Seth

Co E, 5 U. S. Col'd Cav.

Private Private

CARD NUMBERS.

1	5363737	26
2	5363828	27
3	5363930	28
4	5363999	29
5	5364106	30
6	5364190	31
7	5364276	32
8	5364367	33
9	5364451	34
10	5364534	35
11	5364613	36
12	9090495	37
13		38
14		39
15		40
16		41
17		42
18		43
19		44
20		45
21		46
22		47
23		48
24		49
25		50

Book Mark: General Notation R. & P. 407875.

See also

S-651868 - 20 Aug 1

S-1112692 - 20 Nov

S-2051631 P.O. Nov

P.P. 657333

S-2790211 Aug 2

P.O. Nov. 967419 - 6-11-11 - 17

H. Street &c

S | **5 Cav. | U.S.C.T.**

Sepp Scott

....., Co. *E*, 5 Reg't U. S. Col'd Cav.

Appears on

Company Descriptive Book
of the organization named above.

DESCRIPTION.

Age *20* years; height *5* feet *8* inches.

Complexion *Black*

Eyes *Blk*; hair *Blk*

Where born *Scott Tenn*

Occupation *farmer*

ENLISTMENT.

When *Sep 8*, 186 *7*

Where *Camp Nelson*

By whom *J. B. Randolph*, term *3* y'rs.

Remarks:

.....
.....
.....
.....
.....

A. E. Fuhrer

D | **5 Cav. U.S.C.T.**

Seth Scott

C. Co. E., 5 Reg't U. S. Col'd Cavalry.

Appears on

Company Muster-in and Descriptive Roll

of the organization named above. Roll dated

Camp Nelson, N. Y., Sept 20, 1864.

Where born *Scott, Tenn.*

Age *20* y'rs; occupation *Farmer*

When enlisted *Sept 8*, 1864.

Where enlisted *Camp Nelson, N. Y.*

For what period enlisted *3* years.

Eyes *Black*; hair *Black*

Complexion *Black*; height *5 ft. 8 in.*

When mustered in *Sept 9*, 1864.

Where mustered in *Camp Nelson, N. Y.*

Bounty paid \$ *100*; due \$ *100*

Where credited

Company to which assigned

Remarks: *8th District Kentucky*

** Thomas Scott*

** supposed to be name of owner*

Added May 1878 C. & A.

Book mark:

W. H. R. Co. N. Y. 1878

(356d)

A. W. Ross

Copyist.

S | **5 Cav. | U.S.C.T.**

Seth Scott

Priv, Co. E, 5 Reg't U. S. Col'd Cavalry.

Appears on

Company Muster Roll

for *Enlistment to Oct. 31, 1864.*

Present or absent *Present*

Stoppage, \$ *100* for

Due Gov't, \$ *100* for

Valuation of horse, \$ *100*

Valuation of horse equipments, \$ *100*

Remarks:

Book mark:

(358)

M. R. [Signature]

Copyist.

S

5 Cav.

U.S.C.T.

Seth Scott

Cpt., Co. E, 5 Reg't U.S. Col'd Cavalry.

Appears on

Company Muster Roll

for Nov. & Dec., 1864.

Present or absent Present

Stoppage, \$ 100 for

Due Gov't, \$ 100 for

Valuation of horse, \$ 100

Valuation of horse equipments, \$ 100

Remarks: "1 & 2" instalments
of Bounty, &c

Book mark:

A. W. [Signature]

(358)

Copyist.

S

5 Cav.

U.S.C.T.

Seth Scott

Private

Co. E, 5 Reg't U. S. Col'd Cavalry.

Appears on

Company Muster Roll

for *Jan. 1st Feb. 2nd*, 1865.

Present or absent *Present*

Stoppage, \$ *100* for

Due Gov't, \$ *100* for

Valuation of horse, \$ *100*

Valuation of horse equipments, \$ *100*

Remarks: *First instalment of Bounties due \$100. Due H. S. for Ordnance \$36.02*

Book mark:

M. W. Cowling

(358)

Copyist.

S

5 Cav. | U.S.C.T.

John Scott

Co. E, 5 Reg't U. S. Col'd Cavalry.

Appears on

Company Muster Roll

for *John Scott*, 1860.

Present or absent *Present*

Stoppage, \$ 100 for

Due Gov't, \$ 100 for

Valuation of horse, \$ 100

Valuation of horse equipments, \$ 100

Remarks: *First installment
of Bounty due*

Book mark:

A. W. England

(358)

Copyist.

S

5 Cav.

U.S.C.T.

Sith Scott

Priv., Co. E, 5 Reg't U. S. Col'd Cavalry.

Appears on

Company Muster Roll

for May & June, 1865.

Present or absent Present

Stoppage, \$ 100 for

Due Gov't, \$ 100 for

Valuation of horse, \$ 100

Valuation of horse equipments, \$ 100

Remarks: 1st Instalment
Bounty due \$100.

Book mark:

Long

Copyist.

(358)

S

5 Cav. U.S.C.T.

Seth Scott

Priv., Co. E, 5 Reg't U. S. Col'd Cavalry.

Appears on

Company Muster Roll

for July & Aug., 1865

Present or absent present

Stoppage, \$ 100 for

Due Gov't, \$ 100 for

Valuation of horse, \$ 100

Valuation of horse equipments, \$ 100

Remarks:

Book mark:

Long

(358)

Copyist.

S

5 Cav. U.S.C.T.

Seth Scott

Put, Co. E, 5 Reg't U.S. Col'd Cavalry.

Appears on

Company Muster Roll

for Sept. & Oct., 1865.

Present or absent present

Stoppage, \$ 100 for

Due Gov't, \$ 100 for

Valuation of horse, \$ 100

Valuation of horse equipments, \$ 100

Remarks:

Book mark:

Long

(358)

Copyist.

S

5 Cav.

U.S.C.T.

Seth Scott

Put, Co. E, 5 Reg't U. S. Col'd Cavalry.

Appears on

Company Muster Roll

for Nov & Dec, 1865.

Present or absent present

Stoppage, \$ 100 for

Due Gov't, \$ 100 for

Valuation of horse, \$ 100

Valuation of horse equipments, \$ 100

Remarks:

Book mark:

Long

(358)

Copyist.

5 Cav. U.S.C.T.

John Scott

Co. E, 5 Reg't U. S. Col'd Cavalry.

Appears on

Company Muster Roll

for Jan & Feb, 1866.

Present or absent Present

Stoppage, \$ 100 for

Due Gov't, \$ 100 for

Valuation of horse, \$ 100

Valuation of horse equipments, \$ 100

Remarks:

Book mark:

(358)

Handwritten signature

Copyist.

5 Cav. U.S.C.T.

John B. Pratt

Co. C, 5 Reg't U. S. Col'd Cavalry.

Appears on Co. Muster-out Roll, dated *Wilmington, N.C., March 11*, 1866.

Muster-out to date * *Mar. 3*, 1866.

Last paid to *Sept 1*, 1866.

Clothing account:

Last settled _____, 1866 ; drawn since \$ _____ ¹⁰⁰

Due soldier \$ _____ ¹⁰⁰; due U. S. \$ _____ ^{10 19} ₁₀₀

Am't for cloth'g in kind or money adv'd \$ _____ ¹⁰⁰

Due U. S. for arms, equipments, &c., \$ _____ ⁵⁵ ₁₀₀

Bounty paid \$ *160* ^{XX} ₁₀₀; due \$ *160* ^{XX} ₁₀₀

Remarks: *Discharged for
Insufficient 5508*

* **Records on file in 2nd. Auditors
Office show this Co. Mustered Out
to take effect Mch, 16th. 1866. and
paid to include Mch, 15th. 1866.**

Book mark: _____

(861)

J. H. [Signature]

Copyist.

Seth Seth

....., Co., Reg't *5th USCT*

Enclosures.

Bed Cards	Final Statements
Burial Records	Furloughs or L. of A.
Certs. of Dis. for Discharge	Med. Certificates
C. M. Charges	Med. Des. Lists
Descriptive Lists	Orders
Discharge Certificates	Pris. of War Record
Enlistment Papers)	Resignations

Other papers relating to—

Admission to Hosp'l	Furlough or L. of A.
Casualty Sheet	Med. Examination
Confinement	Misc. Information
Contracts	Pay or Clothing
Death or Effects	Personal Reports
Desertion	Rank
Discharge from Hosp'l	Transfer to Hosp'l
Discharge from Service	Transfer to V. R. C.
Duty	Transportation
<i>SS. Ray 2/1/11</i>

MICROFILM PUBLICATION M 1821

COMPILED MILITARY SERVICE RECORDS
OF VOLUNTEER UNION SOLDIERS WHO
SERVED WITH THE USCT (US COLORED TROOPS)
5TH REGIMENT OF CAVALRY

PERSONAL PAPERS' TARGET SHEET

PLEASE NOTE THE CHECKED INFORMATION ABOUT THE PERSONAL PAPERS IN
THIS FILE:

- NO PERSONAL PAPERS WERE FOUND IN THIS FILE WHEN THE
RECORDS WERE ARRANGED FOR MICROFILMING.
- 2 PERSONAL PAPER(S) FOUND IN THIS FILE WHEN THE RECORDS
WERE ARRANGED FOR MICROFILMING.

NOTE 1.—This blank will be used for enlistments of United States colored troops. They will be made out in duplicate in all cases—one to accompany the recruiting return of the superintendent (not the recruiting officer) to the Adjutant General, and one to accompany the accounts of the officer who pays bounty, &c.

NOTE 2.—An enlistment holds to service. A muster-in must, in all cases, precede payment of pay, bounty, pension, &c. A muster-in roll, must in all cases, be filed in the Adjutant General's Office as evidence of muster-in. The mustering officer, commissary, or assistant commissary of musters, as the case may be, will countersign both enlistments as having mustered the soldiers into the service of the United States before either of them is given to the disbursing officer.

DECLARATION OF RECRUIT.

UNITED STATES COLORED TROOPS

I, Leth Scott desiring to volunteer as a soldier in the ARMY OF THE UNITED STATES, for the term of Three Years, DO DECLARE That I am 22 years and months of age; that I have never been discharged from the United States service on account of disability or by sentence of a court-martial, or by order before the expiration of a term of enlistment; and I know of no impediment to my serving honestly and faithfully as a soldier for three years.

GIVEN at Camp Nelson Ky the 6th day of September 1864

Witness: J. C. Strock

his
mark
Volunteered at Camp Nelson
Sept 6th 1864
J. C. Strock
or Wayne Co Ky
Thomas Dent
S. H. C. Co

Leth Scott
Adjutant General's Office

Consent of Parent or Guardian in case of a Minor, if a Free Man, or in the case of a Slave, of the Person to whom he owes Service:

I, Do CERTIFY, That I am the that the said is years of age; and I do freely give my CONSENT to his volunteering as a SOLDIER in the Army of the United States, for the period of THREE YEARS, under the conditions of the laws of the United States.

GIVEN at the day of

Witness:
(A. G. O. No. 74 & 76.)

UNITED STATES COLORED TROOPS ENLISTMENT.

STATE OF

TOWN OF

Kentucky  *Camp Nelson*

I, *Seth Scott* born in *Scott Co*

in the State of *Tennessee* aged *Twenty* years

and by occupation a *Farmer* Do HEREBY ACKNOWLEDGE to

have volunteered *Eighth* day of *September* 186*4*

to serve as a **Soldier** in the **Army of the United States of America**, for the

period of **THREE YEARS**, unless sooner discharged by proper authority: Do

also agree to accept such bounty, pay, rations, and clothing, as are, or may be,

established by law for the U. S. colored troops.

And I, *Seth Scott*

do solemnly swear that I will bear true faith and allegiance to the **United States**

of America, and that I will serve them honestly and faithfully against all their

enemies or opposers whomsoever; and that I will observe and obey the orders

of the President of the United States, and the orders of the officers appointed

over me, according to the Rules and Articles of War.

Sworn and subscribed to, at *Camp Nelson*

this *18th* day of *Sept 1864* *Seth Scott*

Before *J. C. Randolph* *mark*

I CERTIFY, ON HONOR, That I have carefully examined the above named Volunteer agree-

ably to the General Regulations of the Army, and that, in my opinion, he is free from all bodily

defects and mental infirmity, which would in any way disqualify him from performing the

duties of a soldier.

P. G. Barrett
Asst Surg 7th Co
EXAMINING SURGEON.

I CERTIFY, ON HONOR, That I have minutely inspected the Volunteer, *S. Scott*

previously to his enlistment, and that he was entirely sober when enlisted; that, to the best of

my judgment and belief, he is of lawful age; and that, in accepting him as duly qualified to per-

form the duties of an able-bodied soldier, I have strictly observed the regulations which govern

the recruiting service. This soldier has *Blue* eyes, *Black* hair, *Black* complexion, is *Five* feet *Eight* inches high.

J. C. Randolph
and *J. P. M.*
RECRUITING OFFICER OR AGENT.

Mustered into the United States Service *Ninth* day of *September* 186*4*.

W. C. Kinney
Capt US Inf
Mustering Officer.

..... Mustered into the service of the United States for three years or during the war, from date of enlistment, in Company
..... Regiment of *Mississippi* Volunteers, on the *Ninth* day of *September* 186*4* at *Camp Nelson*

W. C. Kinney
Mustering Officer

Statement of Service Reference Slip.

Office Pension

Claim No. Of. 767419

Seth Scott
(Name.)

, Co. E , 5 Reg't U.S.C. Cav.

Mil. St. fur^d

To Med. Sec. Div. 6-11, 1917

For med. record,

No med. p. p. Johnson 7.
per Ek.

Statement furnished 6-12-, 1917

J. J. F. S.

1143
Scott Tom

Co K, 5 U.S. Col'd Cav.

Private | Private

CARD NUMBERS.

1	5368866	26
2	5368953	27
3	5369054	28
4	5369145	29
5	5369230	30
6	5369317	31
7	5369405	32
8	5369491	33
9	5369576	34
10	5369661	35
11	5369742	36
12	9091109	37
13	43145515	38
14		39
15		40
16		41
17		42
18		43
19		44
20		45
21		46
22		47
23		48
24		49
25		50

Book Mark:

See also

1 | **5 Cav. | U.S.C.T.**

Tom Scott

Co. *K*, 5 Reg't U. S. Col'd Cav.

Appears on

Company Descriptive Book
of the organization named above.

DESCRIPTION.

Age *7* years; height *5* feet *3* inches.

Complexion *Black*

Eyes *Blu*; hair *Blu*

Where born *Bourbon Co Ky*

Occupation *Laborer*

ENLISTMENT.

When *Aug 27, 1864.*

Where *Lexington Ky*

By whom *W. M. M.*; term *3* y'rs.

Remarks:

A. J. Anderson

(383g)

Copist.

S

5 Cav. U.S.C.T.

Tom Scott

Pvt, Co. *K*, 5 Reg't U. S. Col'd Cavalry.

Appears on

Company Muster-in and Descriptive Roll

of the organization named above. Roll dated

Camp Nelson Ky, N. Y., Oct 30, 1864.

Where born *Bourbon Ky*

Age *19* y'rs; occupation *Laborer*

When enlisted *Aug 27, 1864.*

Where enlisted *Lexington*

For what period enlisted *3* years.

Eyes *Blk*; hair *Blk*

Complexion *Blk*; height *5 ft. 3 in.*

When mustered in *Aug 27, 1864.*

Where mustered in *Lexington*

Bounty paid \$ *100*; due \$ *100*

Where credited *7 Dist Ky*

Company to which assigned

Remarks: ** James Scott*

** Supposed to be name of owner*

Book mark:

H. Miller

(356d)

Copyist.

S 1 5 Cas W.C.T

Tom Scott

Appears with rank of Private on

Muster and Descriptive Roll

of a Detachment of W. Colored Troops
forwarded to Camp Nelson Ky
Camp of instruction. Roll dated
Lexington Ky, Aug 27, 1864.

Where born Bourbon Co Ky.

Age 19 years; occupation Laborer

When enlisted Aug 27, 1864.

Where enlisted Lexington Ky.

For what period enlisted 3 years.

Eyes Blk; hair Blk

Complexion Blk; height 5 ft. 3 in.

When mustered in , 186 .

Where mustered in

Bounty paid \$ 100; due \$ 100

Clothing account:

Last settled , 186 ; drawn since \$ 100

Date of first muster Aug 27, 1864.

Company to which assigned

Remarks: owner James Scott
Bourbon Co. to be credited 75¢
by.

Book mark :

W. W. Potter

(356m)

Copyist.

S | **5 Cav.** | **U.S.C.T.**

Tom Scott

Privt, Co. K, 5 Reg't U. S. Col'd Cav.

Appears on

Company Muster Roll

for *Organization to Oct 31*, 1864.

Present or absent *Present*

Stoppage, \$ *100* for

Due Gov't, \$ *100* for

Valuation of horse, \$ *100*

Valuation of horse equipments, \$ *100*

Remarks:

Book mark:

(358)

H. S. Miller

Copyist.

S

5 Cav.

U.S.C.T.

Tom Scott

Plt, Co. K, 5 Reg't U. S. Col'd Cav.

Appears on

Company Muster Roll

for *Nov & Dec*, 1864.

Present or absent *Present*

Stoppage, \$ *100* for

Due Gov't, \$ *100* for

Valuation of horse, \$ *100*

Valuation of horse equipments, \$ *100*

Remarks: *1" & 2" installments*
Bounty due

Book mark:

H. S. Miller

(358)

Copyist.

S | **5 Cav. U.S.C.T.**

Tom Scott

Pvt-, Co. K, 5 Reg't U. S. Col'd Cav.

Appears on

Company Muster Roll

for *Jan & Feb*, 1865.

Present or absent *Present*

Stoppage, \$ *100* for

Due Gov't, \$ *100* for

Valuation of horse, \$ *100*

Valuation of horse equipments, \$ *100*

Remarks: *1" & 2" installments -
\$300 Bounty due*

Book mark:

H. Miller

(358)

Copyist.

S | *5 Cav* | **U.S.C.T**

Tom Scott

Pvt, Co. K, 5 Reg't U. S. Col'd Cav

Appears on

Company Muster Roll

for *Mar & Apr*, 186*5*.

Present or absent *Present*

Stoppage, \$ *100* for

Due Gov't, \$ *100* for

Valuation of horse, \$ *100*

Valuation of horse equipments, \$ *100*

Remarks: *1st installment of
Bounty due \$100*

Book mark:

H. S. Miller

(358)

Copyist.

S

5 Cav. U.S.C.T.

Tom Scott

Cross, Co. K, 5 Reg't U. S. Col'd Cav.

Appears on

Company Muster Roll

for *May & June*, 1865.

Present or absent *Present*

Stoppage, \$ 100 for

Due Gov't, \$ 100 for

Valuation of horse, \$ 100

Valuation of horse equipments, \$ 100

Remarks: *First installment
bounty due \$100*

Book mark:

J. E. Porter

(358)

Copyist.

S

5 Cav.

U.S.C.T.

Tom Scott

Prov, Co. K, 5 Reg't U. S. Col'd Cav.

Appears on

Company Muster Roll

for July & Aug, 1865.

Present or absent Present

Stoppage, \$ 100 for

Due Gov't, \$ 100 for

Valuation of horse, \$ 100

Valuation of horse equipments, \$ 100

Remarks:

Book mark:

J. E. Porter

(358)

Copyist.

S

5 Cav.

U.S.C.T.

John Scott

Co. K, Co. K, 5 Reg't U. S. Col'd Cav.

Appears on

Company Muster Roll

for *Sept & Oct*, 186*5*.

Present or absent *Present*

Stoppage, \$ *100* for

Due Gov't, \$ *100* for

Valuation of horse, \$ *100*

Valuation of horse equipments, \$ *100*

Remarks: *Due U. S. for
C. & G. Co. 69 cts*

Book mark:

J. E. Porter

(358)

Copyist.

S

5 Cav. U.S.C.T.

Tom Scott

Prov, Co. K, 5 Reg't U. S. Col'd Cav.

Appears on

Company Muster Roll

for *Nov & Dec*, 1860.

Present or absent *Present*

Stoppage, \$ *100* for

Due Gov't, \$ *100* for

Valuation of horse, \$ *100*

Valuation of horse equipments, \$ *100*

Remarks: *Due U.S for 68*
G.E. 95cts

Book mark:

J. E. Porter

(358)

Copyist.

S

5 Cav.

U.S.C.T.

Tom Scott
Cot, Co. K, 5 Reg't U. S. Col'd Cav.

Appears on

Company Muster Roll

for Jan Feb, 1866.

Present or absent Present

Stoppage, \$ 100 for

Due Gov't, \$ 100 for

Valuation of horse, \$ 100

Valuation of horse equipments, \$ 100

Remarks: 2^d instalment bounty
due \$100

Book mark:

E. H. Brown

(358)

Copyist.

D | **5 Cav.** | **U.S.C.T.**

Tom Scott

Co. K, Co. *K*, 5 Reg't U. S. Col'd Cavalry.

Appears on **Co. Muster-out Roll**, dated

Helena Ark, *Mich 16*, 1866.

Muster-out to date

Mich 16, 1866.

Last paid to

Dec 31, 1865.

Clothing account:

Last settled....., 186 ; drawn since \$..... 100

Due soldier \$..... 100; due U. S. \$..... ⁸⁸ 100

Am't for cloth'g in kind or money adv'd \$..... 100

Due U. S. for arms, equipments, &c., \$..... 100

Bounty paid \$ *100* 100; due \$ *100* 100

Remarks:.....

.....

.....

.....

.....

Book mark:.....

E. T. Brown

Scott, Tom

Co. K

J

Reg't USCA

1 Inclosures.

Bed Cards	Final Statements
Burial Records	Furloughs or L. of A.
Certs. of Dis. for Discharge	Med. Certificates
C. M. Charges	Med. Des. Lists
Descriptive Lists	Orders
Discharge Certificates	Pris. of War Record
Enlistment Papers	Resignations

Other papers relating to—

Admission to Hosp'l	Furlough or L. of A.
Casualty Sheet	Med. Examination
Confinement	Misc. Information
Contracts	Pay or Clothing
Death or Effects	Personal Reports
Desertion	Rank
Discharge from Hosp'l	Transfer to Hosp'l
Discharge from Service	Transfer to V. R. C.
Duty	Transportation

Form 1.—This blank will be filled up by the parents of United States colored troops. They will be made out in duplicate in all cases—one to accompany the recruiting arm of the superintendent and the recruiting officer, to the Adjutant General, and one to accompany the accounts of the officer who pays bounty, &c.

Form 2.—An enlistment holds to service. A muster-in must, in all cases, precede payment of pay, bounty, pension, &c. A muster-in roll, must in all cases, be filed in Adjutant General's Office as evidence of muster-in. The recruiting officer, commissary, or assistant commissary of musters, as the case may be, will countersign both statements as having mustered the soldiers into the service of the United States before either of them is given to the disbursing officer.

DECLARATION OF RECRUIT.

I, Tom Scott desiring to volunteer as a soldier in the ARMY OF THE UNITED STATES, for the term of Three Years, DO DECLARE That I am 19 years and months of age; that I have never been discharged from the United States service on account of disability or by sentence of a court-martial, or by order before the expiration of a term of enlistment; and I know of no impediment to my serving honestly and faithfully as a soldier for three years.

GIVEN at Lexington, Kentucky the 27 day of August 1864

Witness: P. D. Brown.

Tom Scott
mark

Volunteered at
Lexington Ky.
Aug. 27 1864
Wm. S. Moore
Capt. S. M. Moore
Majority

Don Scott
No. 1000

Consent of Parent or Guardian in case of a Minor, if a Free Man, or in the case of a Slave, of the Person to whom he owes Service:

I, James Scott of Bourbon Co. Do CERTIFY, That I am the owner of Tom Scott a slave that the said Tom Scott is 19 years of age; and I do freely give my CONSENT to his volunteering as a SOLDIER in the Army of the United States, for the period of THREE YEARS, under the conditions of the laws of the United States.

GIVEN at Lexington Kentucky the 27 day of August 1864

Witness:

UNITED STATES COLORED TROOPS ENLISTMENT.

STATE OF *Kentucky* TOWN OF *Lexington*
I. *Tom Scott* born in *Bourbon County*

in the State of *Kentucky* aged *Nineteen* years
and by occupation a *Laborer* Do HEREBY ACKNOWLEDGE to
have volunteered *2nd* day of *August* 186*4*

to serve as a **Soldier** in the **Army of the United States of America**, for the
period of **THREE YEARS**, unless sooner discharged by proper authority: Do
also agree to accept such bounty, pay, rations, and clothing, as are, or may be,
established by law for the U. S. colored troops.

And I, *Tom Scott*
do solemnly swear that I will bear true faith and allegiance to the **United States
of America**, and that I will serve them honestly and faithfully against all their
enemies or opposers whomsoever: and that I will observe and obey the orders
of the President of the United States, and the orders of the officers appointed
over me, according to the Rules and Articles of War.

Sworn and subscribed to, at *Lexington Ky.* *his*
this *2nd* day of *Aug 1864* *Tom Scott*
Before *J. H. Moore* *mark*
Capt & Pro. Mar. 7 Dist Ky

I CERTIFY, ON HONOR, That I have carefully examined the above named Volunteer agree-
ably to the General Regulations of the Army, and that, in my opinion, he is free from all bodily
defects and mental infirmity, which would in any way disqualify him from performing the
duties of a soldier.

S. J. Hand

EXAMINING SURGEON.

I CERTIFY, ON HONOR, That I have minutely inspected the Volunteer, *Tom Scott*
previously to his enlistment, and that he was entirely sober when enlisted; that, to the best of
my judgment and belief, he is of lawful age; and that, in accepting him as duly qualified to per-
form the duties of an able-bodied soldier, I have strictly observed the regulations which govern
the recruiting service. This soldier has *dark* eyes, *dark* hair, *dark* com-
plexion, is *five* feet *5* inches high.

J. H. Moore
Capt & Pro. Mar. 7 Dist Ky
RECRUITING OFFICER

Mustered into the United States Service.....day of186

Mustering Officer

Mustered into the service of the United States, for three years or during the war, from date of enlistment, in Company
Regiment of Volunteers, on the day of 186, at

1144

Scurry William

Co E, 5 U. S. Col'd Cav.

Private Private

CARD NUMBERS.

1	5389276	26
2	5364287	27
3	5364376	28
4	5364460	29
5	5364572	30
6	5364620	31
7	9090496	32
8	40730301	33
9		34
10		35
11		36
12		37
13		38
14		39
15		40
16		41
17		42
18		43
19		44
20		45
21		46
22		47
23		48
24		49
25		50

Book Mark:

General Notation R. & P. 407375.

See also 72 rec of Scurry William

J

5 Cav.

U.S.C.T.

William Scurry

....., Co. *E*, 5 Reg't U. S. Col'd Cav.

Appears on

Company Descriptive Book
of the organization named above.

DESCRIPTION.

Age *18* years; height *5* feet *4 1/2* inches.

Complexion *Black*

Eyes *Blk*; hair *Blk*

Where born *Franklin O*

Occupation *Laborer*

ENLISTMENT.

When *Mar 31*, 186*5*.

Where *Newark O*

By whom *Capt Simmet*; term *1* y'rs.

Remarks:

.....
.....
.....
.....
.....
.....
.....
.....
.....

F E Parks

(3830)

Copist.

S 5th *lear* | U.S.C.T.

William Scurry

Pvt, Co., 5th Reg't U. S. Col'd *lear*

Appears on

M. and D. Roll of Men Transferred

to the organization named above,

from

Roll dated *July 18*, 1865.

When enlisted *March 30*, 1865.

Period for which enlisted years.

When mustered in *March 30*, 1865.

Present or absent *Not Stated*

Company to which assigned

Remarks: *3 D.O.*

Book mark :

General Hospital, R. & J. 007070.

Abbot

(342)

Copyist.

S

5 Cav.

U.S.C.T.

William Scurry

Private, Co. E, 5 Reg't U. S. Col'd Cavalry.

Appears on

Company Muster Roll

for July & Aug., 1865.

Present or absent present

Stoppage, \$ 100 for

Due Gov't, \$ 100 for

Valuation of horse, \$ 100

Valuation of horse equipments, \$ 100

Remarks: Rec'd by transfer from 72 Co. I. per S.O. No. 127 dated D. of Ky. July 18, '65. Assigned to Co. per R.O. No. 132 dated July 27/65.

Book mark:

Pong

(358)

Copyist.

S | 5 Cav. | U.S.C.T.

William Scurry

Pat, Co. E, 5 Reg't U. S. Col'd Cavalry.

Appears on

Company Muster Roll

for Sept. & Oct., 1865.

Present or absent present

Stoppage, \$ 100 for

Due Gov't, \$ 100 for

Valuation of horse, \$ 100

Valuation of horse equipments, \$ 100

Remarks:

Book mark:

(358)

Long

Copyist.

OS

5 Cav.

U.S.C.T.

William Scurry

Private, Co. E, 5 Reg't U.S. Col'd Cavalry.

Appears on

Company Muster Roll

for Nov & Dec., 1865.

Present or absent present

Stoppage, \$ 100 for

Due Gov't, \$ 100 for

Valuation of horse, \$ 100

Valuation of horse equipments, \$ 100

Remarks: Daily duty R.H.A. as per R.O. No. 205

Book mark:

Lang

(358)

Copyist.

5 Cav. U.S.C.T.

William Bourne

Co. E, 5 Reg't U. S. Col'd Cavalry.

Appears on

Company Muster Roll

for Jan & Feb, 1866

Present or absent Present

Stoppage, \$ 100 for

Due Gov't, \$ 100 for

Valuation of horse, \$ 100

Valuation of horse equipments, \$ 100

Remarks: On daily duty with Regimental Hospital as per R.O. 210, 405 of 1865

Book mark:

W. Bourne

(358)

Copyist.

S | 5 Cav. | U.S.C.T.

William Scurry

Pvt. Co. E, 5 Reg't U. S. Colored Cav.

Appears on Returns as follows:

July 1865, Gain; July 27, Paris, Ky.
Transfd to Co. E, as per
Regtl Order No. 132.

Dec. 1865, Nurse Regtl Hospl
5 U. S. C. Cav.

Jan'y 1866, On daily duty Nurse
Regtl Hospl.

Feb'y 1866, On daily duty Regtl
Hospl.

Book mark :

L. B. Bowman

(546)

Copyist.

S

5 Cav. U.S.C.T.

William Scurry
Gm, Co. *E*, 5 Reg't U. S. Col'd Cavalry.

Appears on **Co. Muster-out Roll**, dated

Delmas Ark *Mar 16*, 186*6*.

Muster-out to date ** Mar 13*, 186*6*.

Last paid to *Dec 31*, 186*5*.

*** Records on file in 2nd. Auditors**

Office show this Co. Mustered Out

to take effect Mch, 16th. 1866. and

paid to include Mch, 15th. 1866.

Last settled *1866* drawn since \$ *100*

Due soldier \$ *11 78* / *100*; due U. S. \$ *100*

Am't for cloth'g in kind or money adv'd \$ *100*

Due U. S. for arms, equipments, &c., \$ *100*

Bounty paid \$ *100*; due \$ *85 66 2/3*

Remarks: *Received by transfer*
from 72 U.S.C.T. as per
S.O. No 177 & filed W.D. Docs,
Sept. 8 July 8 1865

Book mark :

W. Scurry

(361)

Copyist.

1145

Seals, Alexander

Co E, 5 U. S. Col'd Cav.

Private

Private

CARD NUMBERS.

1	5363738	26
2	5363829	27
3	5363931	28
4	5364034	29
5	5364653	30
6	9090498	31
7	40730303	32
8		33
9		34
10		35
11		36
12		37
13		38
14		39
15		40
16		41
17		42
18		43
19		44
20		45
21		46
22		47
23		48
24		49
25		50

Book Mark: General Notation N. & P. 407375,

See also

D

5 Cav. U.S.C.T.

Alexander Seals

Co. E, 5 Reg't U. S. Col'd Cav.

Appears on

Company Descriptive Book
of the organization named above.

DESCRIPTION.

Age 29 years; height 5 feet 7 inches.

Complexion Black

Eyes Blk; hair Blk

Where born Clark Ky

Occupation farmer

ENLISTMENT.

When Sep 9, 1864

Where Camp Nelson

By whom G. G. Randolph term 3 y'rs.

Remarks: Missing in
actions

J. E. Puck

(383g)

Copist.

S

5 Cav.

U.S.C.T.

Alexander Seal

Pvt., Co E, 5 Reg't U. S. Col'd Cavalry.

Appears on

Company Muster-in and Descriptive Roll

of the organization named above. Roll dated

Camp Nelson, N.Y., Sept 26, 1864.

Where born Clark Ky.

Age 29 y'rs; occupation Farmer

When enlisted Sept 9, 1864.

Where enlisted Cp. Nelson Ky

For what period enlisted 3 years.

Eyes Black; hair Black

Complexion Black; height 5 ft. 9 in.

When mustered in Sept 9, 1864.

Where mustered in Cp. Nelson Ky

Bounty paid \$ 100; due \$ 100

Where credited

Company to which assigned

Remarks: 7 District Ky.

* Susan Webb

* Supposed to be name of woman

added May 17/98 CMA

Book mark:

General Hamilton N. & O. 401870.

W. W. Crossland

(356d)

Copyist.

S | **5 Cav. | U.S.C.T.**

Alexander Seals

Pvt., Co. E, 5 Reg't U. S. Col'd Cavalry.

Appears on

Company Muster Roll

for *Enlistment to Oct. 31, 1864.*

Present or absent *Present*

Stoppage, \$ *100* for

Due Gov't, \$ *100* for

Valuation of horse, \$ *100*

Valuation of horse equipments, \$ *100*

Remarks:

Book mark:

(358)

M. Rowland

Copyist.

S | **5 Cav. | U.S.C.T.**

Alexander Seal

Pvt., Co. E, 5 Reg't U. S. Col'd Cavalry.

Appears on

Company Muster Roll

for *Nov. & Dec.*, 1864.

Present or absent *Present*

Stoppage, \$ *100* for

Due Gov't, \$ *100* for

Valuation of horse, \$ *100*

Valuation of horse equipments, \$ *100*

Remarks: *1st and 2^d instalment of Bounty due*

Book mark:

(358)

J. W. Rowland

Copyist.

[Faint handwritten name]
....., Co. E, 5 Reg't U.S. Col'd Cavalry.

Appears on

Company Muster Roll

for *[Handwritten name]*, 186*[Handwritten]*.

Present or absent *[Handwritten]*

Stoppage, \$.....100 for

Due Gov't, \$.....100 for

Valuation of horse, \$.....100

Valuation of horse equipments, \$.....100

Remarks: *[Handwritten]*
[Handwritten]
[Handwritten]
[Handwritten]

Book mark:

[Handwritten signature]

S

5 Cav.

U.S.C.T.

Alexander Seals

Priv. Co. E, 5 Reg't U. S. Colored Cav.

Appears on Returns as follows:

Jan'y 1865, Loss: Jan'y 25/65, Simp-
sonville, Ky. Missing in
action near Simpsonville
Ky.

Book mark :

L. B. Bowman

(546)

Copyist.

D

5 Cav. U.S.C.T.

Alexander Beale

Priv., Co. *E*, 5 Reg't U. S. Col'd Cavalry.

Appears on **Co. Muster-out Roll**, dated *November 20th*, 186*6*.

Muster-out to date _____, 186 .

Last paid to *Pay due from enlistment*, 186 .

Clothing account:

Last settled _____, 186 ; drawn since \$ _____ $\overline{100}$

Due soldier \$ _____ $\overline{100}$; due U. S. \$ _____ $\overline{100}$

Am't for cloth'g in kind or money adv'd \$ _____ $\overline{100}$

Due U. S. for arms, equipments, &c., \$ _____ $\overline{100}$

Bounty paid \$ _____ $\overline{100}$; due \$ _____ $\overline{100}$

Remarks: *Missing in Action at Camp Sumner, Ky. January 25 1865*

Book mark: *P. 32 P. 19. 75; 73. 1882 2666, 1881*

(861)

J. J. Leonard

Copyist.

Seals, Alexander

P, Co. E, 5 Reg't U. S. G. C.

Enclosures.

Bed Cards	Final Statements
Burial Records	Furloughs or L. of A
Certs. of Dis. for Discharge	Med. Certificates
C. M. Charges	Med. Des. Lists
Descriptive Lists	Orders
Discharge Certificates	Pris. of War Record
Enlistment Papers	Resignations

Other papers relating to—

Admission to Hosp'l	Furlough or L. of A
Casualty Sheet	Med. Examination
Confinement	Misc. Information
Contracts	Pay or Clothing
Death or Effects	Personal Reports
Desertion	Rank
Discharge from Hosp'l	Transfer to Hosp'l
Discharge from Service	Transfer to V. R. C.
Duty	Transportation

MEMORANDUM FROM PRISONER OF WAR RECORDS.

No. _____

(This blank to be used only in the arrangement of said records.)

NAME.	RANK.	ORGANIZATION.				INFORMATION OBTAINED FROM—			
		No. of Reg't.	State.	Arm of Service.	Co.	Records of—	Vol.	Page.	Vol.
<i>Seals Alexander P</i>	<i>P</i>	<i>5</i>	<i>U.S.</i>	<i>Coast E.</i>					

Captured at _____, 186____, confined at Richmond, Va., _____, 186____.

Admitted to Hospital at _____

where he died _____, 186____, of _____

Paroled at _____, 186____; reported at Camp Parole, Md., _____, 186____.

*No record subsequent to Jan 24/65
2 and case to Woodward Jan 12 52
Copied by F.S.D.*

1146

Wals, Thomas

Co E, 5 U. S. Col'd Cav.

Private

Private

CARD NUMBERS.

1	5363739	26
2	5363854	27
3	5364281	28
4	5364372	29
5	5364456	30
6	5364538	31
7	5364617	32
8	9090499	33
9	40730305	34
10		35
11		36
12		37
13		38
14		39
15		40
16		41
17		42
18		43
19		44
20		45
21		46
22		47
23		48
24		49
25		50

Book Mark:

General No. 407375.

See also

5-1011922-P.O. M M
S.I.S. 286 6595 a.w.a.
Alf 225 8630
US Va 17/3/32 C.F.P.

A. S. ...

S | 5 Cav. | U.S.C.T.

Thomas Deale

, Co. *E*, 5 Reg't U. S. Col'd Cav.

Appears on

Company Descriptive Book
of the organization named above.

DESCRIPTION.

Age *27* years; height *5* feet *8* inches.

Complexion *Black*

Eyes *Blk*; hair *Blk*

Where born *Clark Ky*

Occupation *farmer*

ENLISTMENT.

When *Sep 9*, 186 *4*

Where *Camp Nelson*

By whom *J. Randolph* term *3* y'rs.

Remarks:

A. E. Puck

S

5 Cav.

U.S.C.T.

Thomas Seals

Cpt., Co. *E*, 5 Reg't U. S. Col'd Cavalry.

Appears on

Company Muster-in and Descriptive Roll

of the organization named above. Roll dated

Camp Nelson, N.Y., Oct 26, 1864.

Where born *Clark Ky*

Age *27* y'rs; occupation *Farmer*

When enlisted *Sept. 9*, 1864.

Where enlisted *Cp. Nelson Ky.*

For what period enlisted *3* years.

Eyes *Black*; hair *Black*

Complexion *Black*; height *5* ft. *8* in.

When mustered in *Sept. 9*, 1864.

Where mustered in *Cp. Nelson Ky*

Bounty paid \$ *100*; due \$ *100*

Where credited

Company to which assigned

Remarks: *7th District Ky.*

Richard Webb

Supposed to be name of owner

and may 1878 end

Book mark:

General Notation R. U. P. 40 (1870)

M. Rowland

(356d)

Copyist.

S | **5 Cav. | U.S.C.T.**

Thomas' Seal

Co. E, Co. E, 5 Reg't U. S. Col'd Cavalry.

Appears on

Company Muster Roll

for *Enlistment to Oct 31*, 1864.

Present or absent.....

Stoppage, \$.....100 for.....

Due Gov't, \$.....100 for.....

Valuation of horse, \$.....100

Valuation of horse equipments, \$.....100

Remarks: *Missing at the
Battle of Gettville Va
Oct 2nd 1864*

Next on Roll July & Aug 1865

Book mark:.....

(358)

J. W. Cowland

Copyist.

S

5 Cav.

U.S.C.T.

Thomas Seals

Private, Co. E, 5 Reg't U. S. Col'd Cavalry.

Appears on

Company Muster Roll

for July & Aug., 1865.

Present or absent Present

Stoppage, \$ 100 for

Due Gov't, \$ 100 for

Valuation of horse, \$ 100

Valuation of horse equipments, \$ 100

Remarks: Returned from missing in action at Saltville, Va. Oct. 2/64.

Book mark:

Long

(358)

Copyist.

S

5 Cav.

U.S.C.T.

Thomas Seals

Priv., Co. E, 5 Reg't U. S. Col'd Cavalry.

Appears on

Company Muster Roll

for Sept & Oct., 1865.

Present or absent present

Stoppage, \$ 100 for

Due Gov't, \$ 100 for

Valuation of horse, \$ 100

Valuation of horse equipments, \$ 100

Remarks:

[Empty lines for remarks]

Book mark:

Long

(358)

Copyist.

S

5 Cav.

U.S.C.T.

Thomas Seals

Put., Co. E, 5 Reg't U. S. Col'd Cavalry.

Appears on

Company Muster Roll

for Nov 20, 1865.

Present or absent present

Stoppage, \$ 100 for

Due Gov't, \$ 100 for

Valuation of horse, \$ 100

Valuation of horse equipments, \$ 100

Remarks:

Book mark:

Long

(358)

Copyist.

5 Cav. U.S.C.T.

Thomas Seal

Imi, Co. E, 5 Reg't U. S. Col'd Cavalry.

Appears on

Company Muster Roll

for Jan & Feb, 1866.

Present or absent Present

Stoppage, \$ 100 for

Due Gov't, \$ 100 for

Valuation of horse, \$ 100

Valuation of horse equipments, \$ 100

Remarks:

Book mark:

W. J. Seal

(358)

Copyist.

S | 5 Cav. | U.S.C.T.

Thomas Seals

Pvt. Co. E, 5 Reg't U. S. Colored Cav.

Appears on Returns as follows:

Oct. 1864, Loss: Missing at the
battle of Saltville, Va.
Oct. 2/64

July 1865, Gain: July 8/65, Paris,
Ky. from missing in
action at Saltville, Va.
Oct. 2/64.

Book mark:

L. B. Bowman

(546)

Copyist.

A

5 Cav. U.S.C.T.

Thomas Seals

Co. E, 5 Reg't U. S. Col'd Cavalry.

Appears on **Co. Muster-out Roll**, dated *March 16*, 1866.

Muster-out to date * *Mar 3*, 1866.

Last paid to *Dec 31*, 1865.

Clothing account:

Last settled....., 186 ; drawn since \$..... $\frac{100}{100}$

Due soldier \$..... $\frac{100}{100}$; due U. S. \$..... $2 \frac{63}{100}$

Am't for cloth'g in kind or money adv'd \$..... $\frac{100}{100}$

Due U. S. for arms, equipments, &c., \$..... $\frac{55}{100}$

Bounty paid \$..... $\frac{100}{100}$; due \$..... $\frac{100}{100}$

Remarks: *See M.S. for Ordnance book*

* **Records on file in 2nd. Auditor's Office show this Co. Mustered Out to take effect Mch, 16th. 1866. and paid to include Mch, 15th. 1866.**

Book mark :

G. W. Leonard

(361)

Copyist.

Seals Thomas

, Co.

Reg't

U S C T

Enclosures.

Bed Cards	Final Statements
Burial Records	Furloughs or L. of A
Certs. of Dis. for Discharge	Med. Certificates
C. M. Charges	Med. Des. Lists
Descriptive Lists	Orders
Discharge Certificates	Pris. of War Record
Enlistment Papers	Resignations

Other papers relating to—

Admission to Hosp'l	Furlough or L. of A
Casualty Sheet	Med. Examination
Confinement	Misc. Information
Contracts	Pay or Clothing
Death or Effects	Personal Reports
Desertion	Rank
Discharge from Hosp'l	Transfer to Hosp'l
Discharge from Service	Transfer to V. R. C.
Duty	Transportation

NOTE 1.—This blank will be used for enlistments of United States colored troops. They will be made out in duplicate in all cases—one to accompany the recruiting return of the superintendent (not the recruiting officer) to the Adjutant General, and one to accompany the accounts of the officer who pays bounty, &c.

NOTE 2.—An enlistment holds to service. A muster-in must, in all cases, precede payment of pay, bounty, pension, &c. A muster-in roll, must in all cases, be filed in the Adjutant General's Office as evidence of muster-in. The mustering officer, commissary, or assistant commissary of musters, as the case may be, will countersign both enlistments as having mustered the soldiers into the service of the United States before either of them is given to the disbursing officer.

DECLARATION OF RECRUIT.

I, Thomas Seal desiring to volunteer as a soldier in the ARMY OF THE UNITED STATES, for the term of Three Years, DO DECLARE That I am 27 years and months of age; that I have never been discharged from the United States service on account of disability or by sentence of a court-martial, or by order before the expiration of a term of enlistment; and I know of no impediment to my serving honestly and faithfully as a soldier for three years.

GIVEN at Camp Nelson Ky the 9 day of September 1864

Witness:

Leroy Kirk

Thomas Seal

Volunteer of Camp Nelson
 No. 1000
Sept 9 1864
Richard Mott
or Blank

Sept 9 1864
Adj. Gen. S. D. ...

Consent of Parent or Guardian in case of a Minor, if a Free Man, or in the case of a Slave, of the Person to whom he owes Service:

I, Do CERTIFY, That I am the that the said is years of age; and I do freely give my CONSENT to his volunteering as a SOLDIER in the Army of the United States, for the period of THREE YEARS, under the conditions of the laws of the United States.

GIVEN at the day of

Witness:

UNITED STATES COLORED TROOPS ENLISTMENT.

STATE OF

TOWN OF

Kentucky

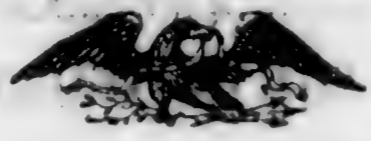

Camp Nelson

I, *Thomas Seale* born in *Clark co*

in the State of *Kentucky* aged *Twenty seven* years

and by occupation a *Farmer* Do HEREBY ACKNOWLEDGE to

have volunteered *Ninth* day of *September* 186*4*

to serve as a **Soldier** in the **Army of the United States of America**, for the period of **THREE YEARS**, unless sooner discharged by proper authority: Do also agree to accept such bounty, pay, rations, and clothing, as are, or may be, established by law for the U. S. colored troops.

And I, *Thomas Seale*

do solemnly swear that I will bear true faith and allegiance to the **United States of America**, and that I will serve them honestly and faithfully against all their enemies or opposers whomsoever; and that I will observe and obey the orders of the President of the United States, and the orders of the officers appointed over me, according to the Rules and Articles of War.

Sworn and subscribed to, at *Camp Nelson*

this *9* day of *Sept* 186*4* *Thomas Seale*

Before *J. C. Randolph* *W. P. M.*

I CERTIFY, ON HONOR, That I have carefully examined the above named Volunteer agreeably to the General Regulations of the Army, and that, in my opinion, he is free from all bodily defects and mental infirmity, which would in any way disqualify him from performing the duties of a soldier.

P. G. Barrett
Asst Surg
EXAMINING SURGEON.

I CERTIFY, ON HONOR, That I have minutely inspected the Volunteer, *Seale* previously to his enlistment, and that he was entirely sober when enlisted; that, to the best of my judgment and belief, he is of lawful age; and that, in accepting him as duly qualified to perform the duties of an able-bodied soldier, I have strictly observed the regulations which govern the recruiting service. This soldier has *blue* eyes, *black* hair, *dark* complexion, is *five* feet *eight* inches high.

J. C. Randolph
and *W. P. M.*
RECRUITING OFFICER OR AGENT.

Mustered into the United States Service *Ninth* day of *September* 186*4*.

N. C. Kinney
Mustering Officer.
Capt 8th Regt

Mustered into the service of the United States, for three years or during the war, from date of enlistment, in Company *Company* Regiment of *Volunteers*, on the *Ninth* day of *September* 186*4* at *Camp Nelson*

N. C. Kinney
Capt 8th Regt
Mustering Officer

Sears, Martin

Co *C*, 5 U. S. Col'd Cav.

Private

Private

CARD NUMBERS.

1	5361721	26
2	5367823	27
3	5361929	28
4	5362618	29
5	9090265	30
6	43145725	31
7	43146286	32
8	40730304	33
9		34
10		35
11		36
12		37
13		38
14		39
15		40
16		41
17		42
18		43
19		44
20		45
21		46
22		47
23		48
24		49
25		50

Book Mark:

See also

Q | 5 Cav. | U.S.C.T.

Martin Seiss

, Co. C, 5 Reg't U. S. Col'd Cav.

Appears on

Company Descriptive Book

of the organization named above.

DESCRIPTION.

Age 23 years; height 5 feet 3/4 inches.

Complexion Dark

Eyes Dark; hair Dark

Where born Wisconsin Co. Ky.

Occupation Laborer

ENLISTMENT.

When Aug. 26, 1864.

Where Louisville

By whom Capt. Ham.; term 3 y'rs.

Remarks: Killed - see death

Hamm

S | 5 Cav MSB T.

Martin Sears

Appears with rank of Private on

Muster and Descriptive Roll

of Detachment US Colored
Recruits Mustered for US

Colored Inf Roll dated
Louisville Ky Aug 30, 1864.

Where born Nelson Co Ky

Age 23 years; occupation laborer

When enlisted Aug 26, 1864.

Where enlisted Louisville Ky

For what period enlisted 3 years.

Eyes dark; hair dark

Complexion dark; height 5 ft. 6 3/4 in.

When mustered in Aug 30, 1864

Where mustered in Louisville Ky

Bounty paid \$ 100; due \$ 100

Clothing account:

Last settled _____, 186 ; drawn since \$ 100

Date of first muster _____, 186 .

Company to which assigned _____

Remarks: lex to Nelson Co
4 list

Book mark : _____

(356m)

L. D. Barton
Copyist.

S | 5 bar | U.S.C.T.

Martin Sears
Pvt

Appears with rank of _____ on

Muster and Descriptive Roll

of a Detachment of U.S. Colored
Troops Transferred to U.S. Col'd
Co. at Lexington. Ky. Roll dated
Louisville. Ky. Sept. 2, 1864.

Where born Nelson. Ky.

Age 23 years; occupation Laborer

When enlisted Aug. 26, 1864.

Where enlisted Louisville

For what period enlisted 3 years.

Eyes Brn; hair Brn

Complexion Brn; height 5 ft. 6 1/2 in.

When mustered in Aug 30, 1864.

Where mustered in Louisville

Bounty paid \$ 100; due \$ 100

Clothing account:

Last settled _____, 186 ; drawn since \$ 17 55/100

Date of first muster Aug. 30, 1864.

Company to which assigned _____

Remarks: transferred to H. Co. Col'd

Ky.

Book mark: _____

B. J. Treaswell

(356m)

Copyist.

S | **5 Cav. U.S.C.T.**

Martin Sears

Fris, Co. *C*, 5 Reg't U. S. Col'd Cavalry.

Appears on

Company Muster-in and Descriptive Roll

of the organization named above. Roll dated

Wm. Nelson, *Ky*, N. Y., *Oct. 24*, 1864.

Where born *Nelson, Ky.*

Age *23* y'rs; occupation *Laborer*

When enlisted *Aug. 26*, 1864.

Where enlisted *Louisville*

For what period enlisted *3* years.

Eyes *Bl.*; hair *Bl.*

Complexion *Bl.*; height *5* ft. *6 3/4* in.

When mustered in *Aug. 30*, 1864.

Where mustered in *Louisville*

Bounty paid \$ *100*; due \$ *100*

Where credited *4th Dist. Ky.*

Company to which assigned *C*

Remarks:

Book mark: *S 2418 Ky.*

Small

(356d)

x *Inserted by compiler.*

Copyist.

Martin Sears

Pvt, Co. C, 5 Reg't U. S. Col'd Cavalry.

Appears on

Company Muster Roll

for *to Oct. 31*, 186*4*.

Present or absent *Absent*

Stoppage, \$ *100* for

Due Gov't, \$ *100* for

Valuation of horse, \$ *100*

Valuation of horse equipments, \$ *100*

Remarks: *Wounded in the Battle of Saltville, Va. Oct. 2, 1864 Hospital on Field*

Book mark :

Shull

S | **5 Cav.** | **U.S.C.T.**

Martin Sears

Priv, Co. C, 5 Reg't U. S. Col'd Cavalry.

Appears on

Company Muster Roll

for *Nov. & Dec.*, 1864.

Present or absent

Stoppage, \$ 100 for

Due Gov't, \$ 100 for

Valuation of horse, \$ 100

Valuation of horse equipments, \$ 100

Remarks: *Killed in action at
Saltrille Va. Dec. 20, 1864
First & Second instalments
of bounty due*

Book mark: *124655 - Apr. 25/64.*

Shull

(358)

Copyist.

S | 5 Cav. | U.S.C.T.

Martin Sears

Pvt. Co. C, 5 Reg't U. S. Colored Cav.

Appears on Returns as follows:

From organization to Oct. 31/64
absent-sick wounded at
the battle of Saltoville
Hospl not known.

Nov. 1864, absent sick Hospl
Camp Nelson.

Dec. 1864, Loss: Dec. 20/64, Salt-
ville, Va. Killed in action.

Book mark:

L. B. Bowman

(546)

Copyist.

S

5 Cav.

U.S.C.T.

Martin Sears

Priv., Co. C, 5 Reg't U. S. Col'd Cavalry.

Appears on Co. Muster-out Roll, dated

Helena Ark, Mar 16, 1866.

Muster-out to date _____, 186 .

Last paid to _____, 186 .

Pay due from enlistment

Clothing account:

Last settled _____, 186 ; drawn since \$ _____ 100

Due soldier \$ _____ 100; due U. S. \$ _____ 100

Am't for cloth'g in kind or money adv'd \$ _____ 100

Due U. S. for arms, equipments, &c., \$ _____ 100

Bounty paid \$ _____ 100; due \$ _____ 100

Remarks: Killed in Action

Dec 20, 1864, Saltville, Va.

Dec 31, 1864. Final

Statements furnished.

Book mark: S. 2418. Hy. 1124.655.

P.V. 28. P. 27. 73

Rose

Sears, Martin

P, Co. C

5 Reg' U. S. C. Cav.

2

Enclosures.

Bed Cards	Descriptive Lists
Burial Records	Final Statements /
Certs. of Dis. for Discharge	Furloughs
C. M. Charges	Med. Des. Lists
Med. Certificates	Orders

Other papers relating to—

Admission to Hosp'l	Furlough
Casualty Sheet (Officer's)	Med. Examination
Confinement	Misc. Information /
Contracts	Pay or Clothing
Death or Effects	Personal Reports
Desertions	Rank
Discharge from Hosp'l	Transfer to Hosp'l
Discharge from Service	Transfer to V. R. C.
Duty	Transportation

War Department,
ADJUTANT GENERAL'S OFFICE,

Washington April 12 1867.

Respectfully returned to the
Commission for the State of
Kentucky, with the informa-
tion that Martin Sears
was enlisted at Louisville Ky
August 26 1864 and was
mustered in as private in Co. C,
5th U.S. Col. Aug. 30 1864.

2418 Ky

A. S. Hayward
Asst. Adj't General.

BARB

No. 21118

APPLICATION OF

Alexander Sayers

OF

Sayers Depot

FOR COMPENSATION FOR SLAVE.

Named Martin Sears

Enlisted August 26 1864

in Co. C, 5th Col. Regiment,

U. S. COLORED TROOPS.

Received March 26th 1867.

Compensation Awarded

....., 186.....

..... Dollars.

.....
President of Board of Claims.

Claimant's Attorney,
.....
.....

Claimant's Post-office Address,

Sayers Depot

Nelson Co Ky

FRANKFORT COMMONWEALTH PRINT.

C. C. 5th Cav

UNITED STATES COLORED TROOPS ENLISTMENT.

STATE OF

TOWN OF

Kentucky

Louisville

I, *Martin Sears* born in *Nelson Co.*

in the State of *Kentucky* aged *23* years

and by occupation a *Laborer* Do HEREBY ACKNOWLEDGE to

have volunteered *26* day of *August* 186*4*

to serve as a **Soldier** in the **Army of the United States of America**, for the period of **THREE YEARS**, unless sooner discharged by proper authority: Do also agree to accept such bounty, pay, rations, and clothing, as are, or may be, established by law for the U. S. colored troop.

And I, *Martin Sears*

do solemnly swear that I will bear true faith and allegiance to the **United States of America**, and that I will serve them honestly and faithfully against all their enemies or opposers whomsoever: and that I will observe and obey the orders of the President of the United States, and the orders of the officers appointed over me, according to the Rules and Articles of War.

Sworn and subscribed to, at *Louisville, Ky*
this *26* day of *Aug 1864* signed, *Martin Sears*
Before *C. C. Ham, Capt 72nd Regt*

I CERTIFY, ON HONOR, That I have carefully examined the above named Volunteer agreeably to the General Regulations of the Army, and that, in my opinion, he is free from all bodily defects and mental infirmity, which would in any way disqualify him from performing the duties of a soldier.

signed, J. Cummings, M.D.
A. C. by U. S. A.
EXAMINING SURGEON.

I CERTIFY, ON HONOR, That I have minutely inspected the Volunteer, *M. Sears*, previously to his enlistment, and that he was entirely sober when enlisted; that, to the best of my judgment and belief, he is of lawful age; and that, in accepting him, as duly qualified to perform the duties of an able-bodied soldier, I have minutely observed the regulations which govern the recruiting service. This soldier has *dark* eyes, *dark* hair, *dark* complexion, is *5* feet *6 3/4* inches high.

signed, C. C. Ham, Capt
12th Regt
RECRUITING OFFICER OR AGENT.

Mustered into the United States Service *30* day of *Aug* 186*4*

signed, G. W. Smith, Capt
V. R. C.
Mustering Officer.

Regiment of Volunteers, on the day of 186 at Company

any authority or pretended authority in hostility to the United States, and I do not give my voluntary support to any insurrection, rebellion or pretended government, authority, power or constitution within the United States hostile thereto. And I do further swear that, to the best of my knowledge and ability, I have supported and defended, and will continue to support and defend, the United States against all enemies, foreign and domestic; and that I have supported, defended and obeyed, and will continue to support, defend and obey, the Constitution and laws of the United States; that I will bear true faith and allegiance to the same; and that I take this oath freely, without any mental reservation or purpose of evasion: So help me God.

Alexander Sagers

Sworn to and subscribed before me, at *Sagers Depot*
this *21* day of *March*, 186*7*.

B. E. Horrell, J. P., Co

C. C. Ham

NOTE 1.—This blank will be used for enlistments of United States colored troops. They will be made out in duplicate in all cases—one to accompany the recruiting return of the superintendent (not the recruiting officer) to the Adjutant General, and one to accompany the accounts of the officer who pays bounty, &c.

NOTE 2.—An enlistment holds to service. A muster-in must, in all cases, precede payment of pay, bounty, pension, &c. A muster-in roll, must in all cases, be filed in the Adjutant General's Office as evidence of muster-in. The mustering officer, commissary, or assistant commissary of musters, as the case may be, will countersign both enlistments as having mustered the soldiers into the service of the United States before either of them is given to the disbursing officer.

DECLARATION OF RECRUIT.

I, Martin Sears, desiring to volunteer as a soldier in the ARMY OF THE UNITED STATES, for the term of Three Years, DO DECLARE That I am 23 years and 0 months of age; that I have never been discharged from the United States service on account of disability or by sentence of a court-martial, or by order before the expiration of a term of enlistment; and I know of no impediment to my serving honestly and faithfully as a soldier for three years.

GIVEN at Cincinnati, Ohio the 26 day of Aug, 1864.

Witness:

(Signed) Martin Sears

Consent of Parent or Guardian in case of a Minor, if a Free Man, or in the case of a Slave, of the Person to whom he owes Service:

I, Martin Sears, Do CERTIFY, That I am the father of the said Martin Sears, that the said Martin Sears is 23 years of age; and I do freely give my CONSENT to his volunteering as a Soldier in the Army of the United States, for the period of THREE YEARS, under the conditions of the laws of the United States.

GIVEN at Cincinnati, Ohio the 26 day of Aug

Witness:

No.

CLAIM OF

Alexander Sayers

FOR THE COMPENSATION OF SLAVE NAMED

Martin Sears

Alexander Sayers a loyal citizen, and a resident of Sayers Depot, County of *Allen*, State of Kentucky, hereby claim compensation, under the provisions of Section 21, act approved February 21, 1861, and section 2, act approved July, 28, 1866, for my slave Martin Sears, enlisted 27 day August, 1864, at Louisville, by C. C. Hoan, in the 11th *Ind* *Inf* *Regt* U. S. Colored Troops, Co. *H*; certificate of which enlistment, and a descriptive list, as required, accompany this application. That I did not acquire said slave subsequent to said enlistment, but had a valid title to him at the date of said enlistment, and previous thereto: I having acquired my title to him and my ownership over him as follows, to-wit: *By owning his Mother and being born mine*

In proof of my loyalty to the Constitution and Government of the United States, I present the accompanying oath, which I have taken, signed and acknowledged; to be filed with this application, in accordance with requirement of General Orders, No. 329, 1863, War Department, Adjutant General's Office.

March 21st 1867. *Alexander Sayers*

OATH OF ALLEGIANCE.

I, *Alexander Sayers*, the owner and Claimant, do solemnly swear that the foregoing claim is a just and true claim due to me as master and owner of the said slave, and that the facts alleged in said claim in respect to the draft or enlistment (as the case may be) of said slave into the Military service of the United States are true. And I do further swear that I have never joined, or been concerned in, any insurrection or rebellion; that I have never borne arms against the United States; that I have never given any aid, countenance, counsel or encouragement to any person or persons engaged, or whom I had reason to believe were about to engage, in insurrection, rebellion or armed hostility against the United States; that I have neither sought, nor accepted, nor attempted to exercise the functions of any office, civil or military, nor to perform any service whatever, under any authority or pretended authority in hostility to the United States; that I have not yielded a voluntary support to any insurrection, rebellion or pretended government, authority, power or constitution within the United States hostile thereto. And I do further swear that, to the best of my knowledge and ability, I have supported and defended, and will continue to support and defend, the United States against all enemies, foreign and domestic; and that I have supported, defended and obeyed, and will continue to support, defend and obey, the Constitution and laws of the United States; that I will bear true faith and allegiance to the same; and that I take this oath freely, without any mental reservation or purpose of evasion: So help me God.

Alexander Sayers

Sworn to and subscribed before me, at *Sayers Depot*,
this 21 day of *March*, 1867.

R. E. Horrell, P. M.

PROOF OF OWNERSHIP.

STATE OF KENTUCKY,

COUNTY OF Nelson } SS.

We Lorenzo England and John H. Wisheart each of lawful age, and resident citizens of the State and County aforesaid, do certify that Alexander Sayers of the State and County aforesaid, was on the 27th day of August 1864, the lawful owner of the slave named Martin Sears; referred to and described in the foregoing claim for compensation.

L. England
John H. Wisheart

Sworn to and subscribed before me a Justice of the Peace for the County of Nelson State of Kentucky, this the 21st day of March 1867.

R. C. Howell J. P. N.C.

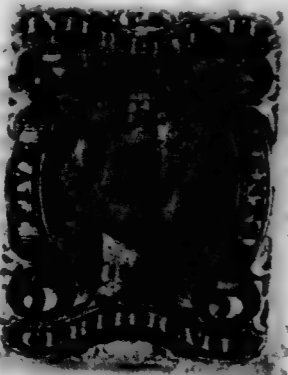

PROOF OF LOYALTY.

STATE OF KENTUCKY,

COUNTY OF Nelson } SS.

We Lorenzo England and John H. Wisheart loyal men and each of lawful age, and resident citizens of the State and County aforesaid, upon our oaths declare that we have known Alexander Sayers a resident of the State and County aforesaid, since the 4th day of March, 1861, and know that he has firmly and faithfully maintained his or her adherence and allegiance to the Government of the United States, by defending its cause against the Government and forces of the so-called Confederate States of America, in all suitable and practicable ways, and according to his or her ability and opportunity.

L. England
John H. Wisheart

Sworn to and subscribed before me a Justice of the Peace for the county of Nelson State of Kentucky, this the 21st day of March 1867.

R. C. Howell J. P. N.C.



POWER OF ATTORNEY.

My Post-Office address is _____ County of _____ State of Kentucky, and I hereby direct that all communications to me, touching this claim, be sent under cover to _____, who is hereby appointed and constituted my true and lawful attorney, to prosecute this claim for me, and who is hereby authorized and empowered to receive and receipt for any award, order, draft, certificate, voucher, warrant, papers or money that may be issued in the adjustment of this claim, or the payment thereof, the same as I might or could do in person were I present and acting for myself, and to file any additional evidence or papers that may be required in the prosecution of this claim.

[WITNESS.]

The owner signs here.

Two witnesses to owner's signature sign here.

50 CENT STAMP.

Extract from Act of Congress.

SEC. 12. *And be it further enacted,* That the fees of agents and attorneys for making out and causing to be executed the papers necessary to establish a claim for a pension, bounty, and other allowance before the Pension Office, under this act, shall not exceed the following rates: For making out and causing to be duly executed a declaration by the applicant, with the necessary affidavits, and forwarding the same to the Pension Office, with the requisite correspondence, ten dollars; which sum shall be received by such agent or attorney in full for all services in obtaining such pension, and shall not be demanded or received, in whole or in part, until such pension shall be obtained; and the sixth and seventh sections of an act entitled "An act to grant pensions," approved July [fourteenth,] eighteen hundred and sixty-two, are hereby repealed.

SEC. 13. *And be it further enacted,* That any agent or attorney who shall, directly or indirectly, demand or receive any greater compensation for his services under this act than is prescribed in the preceding section of this act, or who shall contract or agree to prosecute any claim for a pension, bounty, or other allowance under this act, on the condition that he shall receive a per centum upon any portion of the amount of such claim, or who shall wrongfully withhold from a pensioner or other claimant the whole or any part of the pension or claim allowed and due to such pensioner or claimant, shall be deemed guilty of a high misdemeanor, and, upon conviction thereof, shall, for every such offense, be fined not exceeding three hundred dollars, or imprisoned at hard labor not exceeding two years, or both, according to the circumstances and aggravations of the offense.

Approved July 4, 1864.

NOTE 10.—If any soldier is charged a higher fee than that allowed by the above act, he should report the fact and the name of the agent to the Adjutant General, in order that steps may be taken to have the same refunded.

ADJUTANT GENERAL'S OFFICE.

March 16th 1865.

Duplicate with Inventory sent 2d Auditor.

FINAL STATEMENT

OF

60 000
Martin Sears

5th Reg't of U. S. Cavalry

VOLUNTEERS.

NOTE 1.—Two of these certificates (or duplicates) are to be given to each Volunteer Soldier or drafted man who may be discharged without being mustered out (Final Statements are never given to men mustered out of service, that he may at once receive from the Paymaster the pay, &c., due him, and the captain or other COMMISSIONED officer commanding the company will certify to the act of the delivery of the duplicate certificates; with these certificates the Soldier is "entitled to" his discharge, and should also present his discharge to the Paymaster to have the payment endorsed on it. The discharge is to be given back to the Soldier by the Paymaster; the latter only retaining as his vouchers the duplicate certificates.

NOTE 2.—If the Soldier is entitled to pay for the use of his horse, the Company Commander will certify to that fact on the back of both these final statements, and also to the time he has pay due for having been so mounted on his own horse.

NOTE 3.—When a Soldier is furnished with final statements, his descriptive list, if he has one, should be taken up by the officer who gives the Soldier these statements, and endorsed with a statement to this effect by the officer. The endorsement should exhibit a full statement of the time for which the Soldier was allowed pay on his final statements, the clothing account, and all other charges against him or in his favor, so as to comprise a complete exhibit of his account. It will then be transmitted to the Company Commander of the Soldier, who will enter all the data necessary to a full understanding of the Soldier's account on the muster roll upon which the Soldier's discharge is reported. The descriptive list will then be destroyed. The object of this is, that the remaining portion of the Soldier's account may be settled upon the receipt of these muster rolls, and the Soldier receive any pay or allowances that may be due him at the time of his discharge, and which may not appear on his last final statements from the fact that his descriptive list is incomplete. These accounts for back pay, &c., are settled by the 2d Auditor of the Treasury Department.

NOTE 4.—Charges for loss or injury to ordnance, horse equipments, and other miscellaneous charges, should appear under the heading of "Other Stoppages."

NOTE 5.—Bounty paid by State authorities, and not by the United States, will not be entered on this statement.

NOTE 6.—Amounts due the Sutler and Laundress must be entered on the muster roll on which the discharge, death, desertion, &c., is reported, as well as on the final statement, otherwise the amount cannot be collected from the United States.

NOTE 7.—This blank will be used for deceased volunteers and drafted men, as well as for others.

NOTE 8.—Where a Soldier dies in Hospital or on detached service, his descriptive list, if he has one, should be sent with his final statements, in duplicate, to the Adjutant General, Washington, D. C.

NOTE 9.—If the soldier is a drafted man or substitute, the space for time, &c., of enrolled, should contain only the word *drafted* or *substitute*, as the case may be. If the Soldier is a "VETERAN," (or RECRUIT,) the words *as a veteran*, (or *recruit*;) as the case may be, should be interlined after the words *mustered into the service of the U. S.* A statement of all the installments of *Veteran* or *Recruit* Bounty RECEIVED by the Soldier must be made on the back of each final statement.

I certify, on honor, that Martin Sears, a Private of
Captain D C Stone Company (C) of the 5 Regiment of U. S. Cavalry
VOLUNTEERS, of the State of _____, born in Nelson Ky State
of Kentucky, aged 23 years; 5 feet 6 1/2 inches high; DK complexion,
DK eyes, DK hair, and by occupation a Laborer, who joined for service
and was enrolled (see Note 9) on the 26 day of Aug, 1864, at Louisville Ky
by Capt Stone, for the period of Three years, and mustered into
the service of the United States on the 30 day of August, 1864, at
Louisville Ky, by Capt Smith; and having served
HONESTLY and FAITHFULLY with his Company to the present date, is now entitled to a
DISCHARGE by reason of Death (Killed in action at
Saltville Va - 20 Dec 1864)

The said Martin Sears was last paid by Paymaster
Payee from enlistment, to include the _____ day of _____, 186 , and
has pay due him from that time to the present date; he is entitled to pay and subsistence for
TRAVELING to place of enrollment, and whatever other allowances are authorized to volunteer
soldiers, drafted men, or militia, so discharged. He has received from the United States **CLOTHING**
amounting to Twenty four ⁴⁵/₁₀₀ dollars, since the 26 day of August,
1864 when his clothing account was last settled. He has received from the United States
_____ ^{_____}/₁₀₀ dollars advanced **BOUNTY**. Was instalment of bounty due \$10

There is to be stopped from him, on account of the State of _____, or other
authorities, for **CLOTHING, &c.**, received on entering service, _____ ^{_____}/₁₀₀ dollars; and
for other stoppages, viz: _____

_____ ^{_____}/₁₀₀ dollars.
He has been furnished with **TRANSPORTATION** in kind from the place of his discharge to
_____ ; and he has been **SUBSISTED** for **TRAVELING** to his
place of enrollment, up to the _____, 186 .

He is indebted to _____, **SUTLER**, _____ ^{_____}/₁₀₀ dollars.

He is indebted to _____, **LAUNDRESS**, _____ ^{_____}/₁₀₀ dollars.

Given in Duplicate, at Camp Nelson Ky, this 31 day
of December, 1864.

B T Robinson

1st Lt U S Cavalry

Commanding Company

1140

Jersey Anderson

Co A, 5 U. S. Col'd Cav.

Punnett

Punnett

CARD NUMBERS.

1	5363086	26
2	5363173	27
3	5363262	28
4	5363353	29
5	5363440	30
6	5363523	31
7	5363609	32
8	9090377	33
9	S-55-07-1868	34
10	31415338	35
11	40730306	36
12		37
13		38
14		39
15		40
16		41
17		42
18		43
19		44
20		45
21		46
22		47
23		48
24		49
25		50

Book Mark: *S-55-07-1868*

See also

S

5 Cav. U.S.C.T.

Anderson Jersey

Co. *A*, 5 Reg't U. S. Cav'd Cav.

Appears on

Company Descriptive Book

of the organization named above.

DESCRIPTION.

Age *24* years; height *5* feet *6* inches.

Complexion *Black*

Eyes *Blk*; hair *Blk*

Where born *Tennessee*

Occupation *farmer*

ENLISTMENT.

When *Nov. 24*, 186*4*.

Where *Cumberland Gap*

By whom *Lt Nicolls*, term *3* y'rs.

Remarks: *Transferred*

to Company B

per R. O. No 210

Dec 29" 1865

order revoked

F E Park

S

5 Cav. U.S.C.T.

Anderson Sersey

Priv., Co. D, 5 Reg't U. S. Col'd Cavalry.

Appears on

Company Muster Roll

for March + April, 1865.

Present or absent Present.

Stoppage, \$ 100 for

Due Gov't, \$ 100 for

Valuation of horse, \$ 100

Valuation of horse equipments, \$ 100

Remarks: 1st installment of
Bounty due \$100.

at ...
M. ...
...

Book mark:

Wm H Scott

J

5 Cav.

U.S.C.T.

Anderson Jersey

Privt., Co. D, 5 Reg't U. S. Col'd Cavalry.

Appears on

Company Muster Roll

for *May + June*, 186*5*.

Present or absent *present*

Stoppage, \$ *100* for

Due Gov't, \$ *100* for

Valuation of horse, \$ *100*

Valuation of horse equipments, \$ *100*

Remarks: *1st Instalment Bounty due \$100.00.*

Book mark:

Milliken

(358)

Copyist.

S

5 Cav. U.S.C.T.

Anderson Jersey

Private, Co. D, 5 Reg't U. S. Col'd Cavalry.

Appears on

Company Muster Roll

for *July & Aug.*, 186*5*.

Present or absent *absent*

Stoppage, \$ *100* for

Due Gov't, \$ *100* for

Valuation of horse, \$ *100*

Valuation of horse equipments, \$ *100*

Remarks: *In Hospital, Camp
Nelson Ky.*

Book mark:

Milliken

(358)

Copyist.

S

5 Cav.

U.S.C.T.

Anderson Jersey

Private, Co. D, 5 Reg't U. S. Col'd Cavalry.

Appears on

Company Muster Roll

for Sept. & Oct., 1865.

Present or absent Absent

Stoppage, \$ 100 for

Due Gov't, \$ 100 for

Valuation of horse, \$ 100

Valuation of horse equipments, \$ 100

Remarks: In Hospital Louisville Ky

Book mark:

Williker

(358)

Copyist.

S | 5 | Co | W.S.C.

Anderson Lersey

Priv., Co. H, 5 Reg't W.S.C.

Appears on

Hospital Muster Roll

of **U. S. A. Post Hospital,**

at **Covington, Ky.,**

for Sept Oct, 1865.

Attached to hospital:

When July 17, 1865.

How employed Patient

Last paid by Maj. _____

to _____, 1865.

Bounty paid \$ 100; due \$ 100

Present or absent _____

Remarks: Died Oct 11, 1865

Book mark: _____

Ransom

S

5 Cav.

U.S.C.T.

Anderson Jersey

Private, Co. D, 5 Reg't U. S. Col'd Cavalry.

Appears on

Company Muster Roll

for *Nov. & Dec*, 1865.

Present or absent *absent*

Stoppage, \$ *100* for

Due Gov't, \$ *100* for

Valuation of horse, \$ *100*

Valuation of horse equipments, \$ *100*

Remarks: *Absent sick - Hosp'l
Louisville Ky.*

Book mark:

Milliken

(358)

Copyist.

S.

5 Cav.

U.S.C.T.

Anderson Sensesy,

Private, Co. D, 5 Reg't U. S. Col'd Cavalry.

Appears on

Company Muster Roll

for *Jan'y and Febr'y*, 1866.

Present or absent *Absent*

Stoppage, \$ 100 for

Due Gov't, \$ 100 for

Valuation of horse, \$ 100

Valuation of horse equipments, \$ 100

Remarks *Sick in Hospital. Louisville, Ky.*

1st Installment Bounty due \$100.00.

Book mark :

(358)

R. D. Grammer

Copyist.

Anderson Sersey

Priv. Co. D, 5 Reg't U. S. Colored Cav.

Appears on Returns as follows:

Apl 1865, Gain: Apl 19/65, Camp Nelson. Recruit from depot assigned to Co. per Regt Order No. 54.

July to Sept. 1865, Absent sick in Post Hospl Covington, Ky. Oct. 1865 to Feby 1866, absent sick in Hospl Louisville, Ky.

Book mark:

L. B. Bowman

N. | 5 Cav. | U.S.C.T.

Anderson Sersery,
Priv., Co. D, 5 Reg't U. S. Col'd Cavalry.

Appears on **Co. Muster-out Roll**, dated
Selena, Ark, March 16, 1866.
Muster-out to date *March 16,* 1866.
Last paid to *Enlistment,* 1866.

Clothing account:

Last settled....., 1866 ; drawn since \$..... 100
Due soldier \$ *55.75* / 100 ; due U. S. \$..... 100
Am't for cloth'g in kind or money adv'd \$..... 100

Due U. S. for arms, equipments, &c., \$..... 100
Bounty paid \$..... 100 ; due \$ *100.* / 100

Remarks: *Absent sick in Hospital,*
Louisville, Ky., since July
1865. (No discharge given).

Book mark: *S. 35 Vol. 7. C. T. 1868.*

(361)

R. Drauner.

Copyist.

S 5 Cav U.S.C.S.

Anderson Sersey
, Co. D, 5 Reg't U.S.C. Cav.

NOTATION.

Book mark: *S-55-C-5-1868.*

Record and Pension Office,

WAR DEPARTMENT.

This book mark refers only to a report from the medical records, made by the Surgeon General to the Adjutant General, relative to the above-named man. As the medical records have since been carded, no transcript of this report is made hereon.

(491)

M. Allen
Copyist.

1149

Sharp, Thomas

Co F, 5 U. S. Col'd Cav.

Private

Private

CARD NUMBERS.

1	5364749	26
2	5364842	27
3	5364942	28
4	5365032	29
5	5365123	30
6	5365303	31
7	5365392	32
8	5365482	33
9	5365570	34
10	5365661	35
11	9090587	36
12	40730307	37
13		38
14		39
15		40
16		41
17		42
18		43
19		44
20		45
21		46
22		47
23		48
24		49
25		50

Book Mark:

See also

S | 5 Cav. | U.S.C.T.

Thomas Sharp

, Co. *A*, 5 Reg't U. S. Col'd Cav.

Appears on

Company Descriptive Book

of the organization named above.

DESCRIPTION.

Age *21* years; height *5* feet *9* inches.

Complexion *Black*

Eyes *Black*; hair *Black*

Where born *Mercer Ky*

Occupation *farmer*

ENLISTMENT.

When *Sept 19*, 186 .

Where *Camp Nelson*

By whom *W. Randolph* term *3* y'rs.

Remarks:

.....
.....
.....
.....
.....
.....
.....
.....
.....

W. Randolph

S

5 Cav. U.S.C.T.

Thomas Sharp

Prnr, Co. F, 5 Reg't U. S. Col'd Cavalry.

Appears on

Company Muster-in and Descriptive Roll

of the organization named above. Roll dated

Sept Nelson, N. Y., Oct 29, 1864.

Where born Mercer Ky

Age 21 y'rs; occupation Farmer

When enlisted Sept 19, 1864.

Where enlisted Co Nelson

For what period enlisted 3 years.

Eyes Blk; hair Blk

Complexion Blk; height 5 ft. 7 in.

When mustered in Sept 19, 1864

Where mustered in Co Nelson

Bounty paid \$ 100; due \$ 100

Where credited 7 Dist Ky

Company to which assigned F

Remarks: Name of owner of

Negro - Abr. Clark

* Paid May 13/78 CUA

Book mark:

Summer

S

5 Cav. U.S.C.T.

Thomas Sharp

Private, Co. F, 5 Reg't U. S. Col'd Cavalry.

Appears on

Company Muster Roll

for *to Oct 31* 186 *4*

Present or absent *Present*

Stoppage, \$ *100* for

Due Gov't, \$ *100* for

Valuation of horse, \$ *100*

Valuation of horse equipments, \$ *100*

Remarks:

Book mark:

Sumner

(358)

Copyist.

S

5 Cav. U.S.C.T.

Thomas Sharp

Priv

, Co. F, 5 Reg't U. S. Col'd Cavalry.

Appears on

Company Muster Roll

for *Nov & Dec*, 1864.

Present or absent *Present.*

Stoppage, \$ *100* for

Due Gov't, \$ *100* for

Valuation of horse, \$ *100*

Valuation of horse equipments, \$ *100*

Remarks:

1st Installment Bounty due

Book mark:

Lumir

S | **5 Cav. | U.S.C.T.**

Thomas Sharp

Privt, Co. F, 5 Reg't U. S. Col'd Cavalry.

Appears on

Company Muster Roll

for *Jan 7 Feb*, 186*5*.

Present or absent *Absent.*

Stoppage, \$ *100* for

Due Gov't, \$ *100* for

Valuation of horse, \$ *100*

Valuation of horse equipments, \$ *100*

Remarks:
*1 Installment Bounty \$100 due
Sick in Genl Hqsrs Camp
Alson since Feb 2/65*

Book mark:

Lummer

S | 5 Cav. | U.S.C.T.

Thomas Sharp

Priv., Co. F, 5 Reg't U. S. Col'd Cavalry.

Appears on

Company Muster Roll

for May & Apr, 1865.

Present or absent Absent

Stoppage, \$ 100 for

Due Gov't, \$ 100 for

Valuation of horse, \$ 100

Valuation of horse equipments, \$ 100

Remarks:

Sick in Genl Hooper
Camp Nelson Ky since
Apr 10/65
First installment of
Bounty due

Book mark:

Harmer

S | **5 Cav.** | **U.S.C.T.**

Thomas Sharp

Pvt, Co. F, 5 Reg't U. S. Col'd Cavalry.

Appears on

Company Muster Roll

for July & Aug, 1865.

Present or absent Present

Stoppage, \$ 100 for

Due Gov't, \$ 100 for

Valuation of horse, \$ 100

Valuation of horse equipments, \$ 100

Remarks: Gained from missing
in action July 5 - 1865.

Book mark: _____

(358)

Wark
Copyist.

§

5 Cav.

U.S.C.T.

Thomas Sharp

Prk, Co. F, 5 Reg't U. S. Col'd Cavalry.

Appears on

Company Muster Roll

for Sept 20th, 1865.

Present or absent Present

Stoppage, \$ 100 for

Due Gov't, \$ 100 for

Valuation of horse, \$ 100

Valuation of horse equipments, \$ 100

Remarks:

Book mark:

Sharp

(358)

Copyist.

8

5 Cav. U.S.C.T.

Thomas Sharp

Pvt, Co. F, 5 Reg't U. S. Col'd Cavalry.

Appears on

Company Muster Roll

for Nov & Dec, 1865.

Present or absent Present

Stoppage, \$ 100 for

Due Gov't, \$ 100 for

Valuation of horse, \$ 100

Valuation of horse equipments, \$ 100

Remarks: Error in last Muster Roll: Pay & Bounty due from enlistment to 30th June 65.

Book mark:

Hart

Copyist.

(358)

§

5 Cav. U.S.C.T.

Thomas Sharp

Private, Co. F, 5 Reg't U.S. Col'd Cavalry.

Appears on

Company Muster Roll

for Jan & Feb, 1866

Present or absent Present

Stoppage, \$ 100 for

Due Gov't, \$ 100 for

Valuation of horse, \$ 100

Valuation of horse equipments, \$ 100

Remarks:

Book mark:

G.W. Davis

(358)

Copyist.

J | 5 Cav. | U.S.C.T.

*Thomas Sharp**

Plt, Co. *F*, 5 Reg't U. S. Colored Cav.

Appears on **Returns** as follows:

*Feby to May 1865 Absent sick
in Genl Hosp. Camp
Nelson Ky Feby 2/65*

*Aug 1865. Gained July 15; Townsend
Bridge earned from
missing in action & not
taken up in July
Sept 1865 On duty cook Mil-
itary Prison no. 4, Lex., Ky*

*Name appears also as
Thomas Shoup

Book mark :

Stottrell

(546)

Copyist.

S | **5 Cav. | U.S.C.T.**

Thomas Sharp
Priv, Co. *F*, 5 Reg't U. S. Col'd Cavalry.

Appears on **Co. Muster-out Roll**, dated
Helena Ark *Mar 16*, 186 *6*.

Muster-out to date *Mar 16*, 186 *6*.

Last paid to *Dec 31*, 186 *5*.

Clothing account:

Last settled _____, 186 ; drawn since \$ _____ $\overline{100}$

Due soldier \$ _____ $\overline{100}$; due U. S. \$ *38* $\overline{100}$ ^{*36*}

Am't for cloth'g in kind or money adv'd \$ _____ $\overline{100}$

Due U. S. for arms, equipments, &c., \$ _____ $\overline{100}$

Bounty paid \$ *100* $\overline{100}$; due \$ _____ $\overline{100}$

Remarks: _____

Book mark: _____

(361)

J. W. Davis

Copyist.

Sharp Thomas

I, Co. F, 5 Reg't U. S. C. Cav.

Enclosures.

Bed Cards	Final Statements
Burial Records	Furloughs or L. of A.
Certs. of Dis. for Discharge	Med. Certificates
C. M. Charges	Med. Des. Lists
Descriptive Lists	Orders
Discharge Certificates	Pris. of War Record
Enlistment Papers	Resignations

Other papers relating to—

Admission to Hosp'l	Furlough or L. of A.
Casualty Sheet	Med. Examination
Confinement	Misc. Information
Contracts	Pay or Clothing
Death or Effects	Personal Reports
Desertion	Rank
Discharge from Hosp'l	Transfer to Hosp'l
Discharge from Service	Transfer to V. R. C.
Duty	Transportation

Sharp Thomas

G, Co. F, 5 Reg't U. S. C. Cav.

Enclosures.

Bed Cards	Final Statements
Burial Records	Furloughs or L. of A.
Certs. of Dis. for Discharge	Med. Certificates
C. M. Charges	Med. Des. Lists
Descriptive Lists	Orders
Discharge Certificates	Pris. of War Record
Enlistment Papers	Resignations

Other papers relating to—

Admission to Hosp'l	Furlough or L. of A.
Casualty Sheet	Med. Examination
Confinement	Misc. Information /
Contracts	Pay or Clothing
Death or Effects	Personal Reports
Desertion	Rank
Discharge from Hosp'l	Transfer to Hosp'l
Discharge from Service	Transfer to V. R. C.
Duty	Transportation

Thomas Sheep.
Co. N.

Adjutant General's Office,

COLORED TROOPS BRANCH,

....., 187

Vol. C. T., 187

Wanted in case of, Co. I,

Reg't C. S. C. Co. in action at ...

missing in action; M. R. ...
1865 ... "Missing in action"
July 5th 1865.

Respectfully,

R. A. Woodward

Chief Clerk.

P. J. Harkon

Adjutant General's Office,

....., 187

Vol. C. T., 187

Reply in case of, Co.,

Reg't

Regimental Des. Book reports Thomas Sharp
Co. "H" 5th Col'd Cavalry. Missing in action at Fattville
Va. Oct 2nd 1864. Taken up from missing in action
July 18th 1865.

Reg't morning report book does not cover date.

1130
Sharp, William

Co F, 5 U. S. Col'd Cav.

Private Private

CARD NUMBERS.

1	5364751	26
2	5364878	27
3	5365212	28
4	5365240.	29
5	5365706	30
6	9090583	31
7	40730308	32
8		33
9		34
10		35
11		36
12		37
13		38
14		39
15		40
16		41
17		42
18		43
19		44
20		45
21		46
22		47
23		48
24		49
25		50

Book Mark:

See also

S | 5 Cav. | U.S.C.T.

William Sharp
....., Co. *F*, 5 Reg't U. S. Col'd Cav.

Appears on
Company Descriptive Book
of the organization named above.

DESCRIPTION.

Age *25* years; height *5* feet *3* inches.

Complexion *Black*

Eyes *Black*; hair *Black*

Where born *Upper Miss*

Occupation *Farmer*

ENLISTMENT.

When *Sep 14*, 186 .

Where *Camp Nelson*

By whom *J. H. Randolph* term *3* y'rs.

Remarks:

.....
.....
.....
.....
.....
.....
.....
.....
.....
.....

J. E. Pucke

S | **5 Cav.** | **U.S.C.T.**

William Sharp

Pawi, Co. *F*, 5 Reg't U. S. Col'd Cavalry.

Appears on

Company Muster-in and Descriptive Roll

of the organization named above. Roll dated

Cpt Nelson, ^{*Ky*} N. Y., *Oct 29*, 1864.

Where born *Tipper* *Mississippi*

Age *25* y'rs; occupation *Farmer*

When enlisted *Sept 14*, 1864

Where enlisted *Cpt Nelson*

For what period enlisted *3* years.

Eyes *Blk*; hair *Blk*

Complexion *Blk*; height *5* ft. *9* in.

When mustered in *Sept 14*, 1864.

Where mustered in *Cpt Nelson*

Bounty paid \$ *100*; due \$ *100*

Where credited *7 Dist Ky*

Company to which assigned *F*.

Remarks: *Name of owner of*

Negro - Robert Sharp

** added may 13/98 C.N.A.*

Book mark: -----

Sumner

S | **5 Cav. | U.S.C.T.**

William Sharp

Priv, Co. F, 5 Reg't U. S. Col'd Cavalry.

Appears on

Company Muster Roll

for *to Oct 31*, 186 *4*

Present or absent *Absent*

Stoppage, \$ *100* for

Due Gov't, \$ *100* for

Valuation of horse, \$ *100*

Valuation of horse equipments, \$ *100*

Remarks: *Murphy in action
at Saltville Va Oct 2, 1864*

*I am the
owner of*

Book mark:

Currin

§

5 Cav. U.S.C.T.

William Sharp

Priv, Co. F, 5 Reg't U. S. Col'd Cavalry.

Appears on

Company Muster Roll

for May & June, 1865.

Present or absent Present

Stoppage, \$ 100 for

Due Gov't, \$ 100 for

Valuation of horse, \$ 100

Valuation of horse equipments, \$ 100

Remarks: 1st Instalment Bounty due \$100.

Entire entry canceled by line except remarks

Book mark:

Mark

(358)

Copyist.

S | **5 Cav.** | **U.S.C.T.**

William Sharp

Priv, Co. F, 5 Reg't U. S. Col'd Cavalry.

Appears on

Company Muster Roll

for *May & June*, 1865.

Present or absent

Stoppage, \$ 100 for

Due Gov't, \$ 100 for

Valuation of horse, \$ 100

Valuation of horse equipments, \$ 100

Remarks: *Discharged on Surgeons
Certificate of disability
1st Instalment Bounty due
\$ 100-*

Book mark:

(358)

Hunt
Copyist.

S | 5 Cav. | U.S.C.T.

William Sharp

Priv., Co. F, 5 Reg't U. S. Colored Cav.

Appears on Returns as follows:

Oct. 1864, Loss: Missing in action
Oct. 2/64, Saltville, Va.

Jan'y 1865, Absent sick in Hospl
Camp Nelson, Ky. date
not known

June 1865, Loss: June 28/65, Paris.
Dischg'd on Surg's Certf of
disability

Book mark:

L. D. Bowman

(546)

Copyist.

S 5 Cav, U.S.C.T.

William Sharp
Pvt, Co. F, 5 Reg't U. S. Col'd Cavalry

Appears on Co. Muster-out Roll, dated
Helena Ark, March 16, 1866.

Muster-out to date _____, 186 .

Last paid to _____, 186 .

Clothing account:

Last settled _____, 186 ; drawn since \$ _____ 100

Due soldier \$ _____ 100; due U. S. \$ _____ 100

Am't for cloth'g in kind or money adv'd \$ _____ 100

Due U. S. for arms, equipments, &c., \$ _____ 100

Bounty paid \$ _____ 100; due \$ _____ 100

Remarks: Discharged June 28
1865, Paris, Ky,

Book mark : _____

(361)

W. Davis

Copyist.

Sharp William

P, Co. D, 5 Reg' U. S. C. Cav.

Enclosures.

Bed Cards	Descriptive Lists
Burial Records	Final Statements
Certs. of Dis. for Discharge	Furloughs
C. M. Charges	Med. Des. Lists
Med. Certificates	Orders

Other papers relating to—

Admission to Hosp'l	Furlough
Casualty Sheet (Officer's)	Med. Examination
Confinement	Misc. Information
Contracts	Pay or Clothing
Death or Effects	Personal Reports
Desertions	Rank
Discharge from Hosp'l	Transfer to Hosp'l
Discharge from Service	Transfer to V. R. C.
Duty	Transportation

NOTE 1.

The company commander will here add a statement of all the facts known to him concerning the disease or wound, or cause of disability of the soldier: the time, place, manner, and all the circumstances under which the injury occurred, or disease originated or appeared: the duty, or service, or situation of the soldier at the time the injury was received or disease contracted, stating particularly whether the injury was received or the disease contracted in the line of his duty; and whatever other facts may aid a judgment as to the cause, immediate or remote, of the disability, and the circumstances attending it.

When the facts are not known to the company commander, the certificate of any officer, or affidavit of other person having such knowledge, will be appended—as the surgeon in charge of a hospital, the officer commanding a detachment of recruits, &c., &c.

NOTE 2.

When a probable case for pension, special care must be taken to state the degree of disability—as $\frac{1}{2}$, $\frac{3}{4}$, &c., &c.; to describe particularly the disability, wound, or disease; the extent to which it deprives him of the use of any limb or faculty, or affects his health, strength, activity, constitution, or capacity to labor or earn his subsistence. The surgeon will add, from his knowledge of the facts and circumstances, and from the evidence in the case, his professional opinion of the cause or origin of the disability. In the case of discharges by Medical Inspectors, the last paragraph will state that the "discharge was given by consent of the soldier, after a personal examination, and for disability, the nature, degree, and origin of which are correctly described in the within certificate."

Par. 1260 Regulations, Edit. 1861. Medical officers, in giving certificates of disability, are to take particular care in all cases that have not been under their charge; and especially in epilepsy, convulsions, chronic rheumatism, derangement of the urinary organs, ophthalmia, ulcers, or any obscure disease liable to be feigned or purposely produced; and in no case shall such certificate be given until after sufficient time and examination to detect any attempt at deception.

DIRECTIONS.

This certificate will be made out in duplicate by the soldier's company commander, or other officer commanding the separate detachment to which he belongs, and sent by him to the surgeon who has charge of the hospital where the soldier is sick. The surgeon will then fill out and sign the surgeon's certificate, and forward these papers to the regimental, detachment, or post commander, who will forward them, with his action endorsed thereon, through the proper channel, to his division commander; or, if the troops are not attached to a division, to his corps, department, or other commander or officer to whom the authority to discharge enlisted men may be specially delegated.

These certificates, after having received the action of the highest authority to which they are required to be sent, will be returned through the same channel to the regimental, post, or detachment commander, who will, if the discharge is authorized by the endorsement of the proper authority, sign the soldier's discharge, and the last certificate on this paper; see that the soldier is furnished with the proper final statements in duplicate, and forward BOTH of these certificates direct to the Adjutant General United States Army, at Washington, D. C.; they will not, under any circumstances, be given into the hands of the soldier.

ADJUTANT GENERAL'S OFFICE

July 22. 1865

Duplicate sent the Pension Office.

CERTIFICATE OF DISABILITY FOR DISCHARGE

IN THE CASE OF

1865
867
William Sharp
Private Co. 7
5th Reg't of U.S.C.A.

Head Quarters of C. Cas
Paris Ky. 6 June 1865

Approved and respectfully
forwarded

L. J. Smith
S. Col. 5th Cav
Commanding

Received (A. G. Office) _____, 1865

Enon O. R. Cas

Head Quarters, Dept.
Ky. Div. Dep. Ky.
Lexington Ky June 8th 1865

Respectfully forwarded
approved

Wm. M. New Surgeon U.S.A.
Chief Surg. Ky. Div. Dep. Ky.

Head Quarters, Div. Dept. of Ky.
Lex. Ky. June 8th 1865
Approved and respectfully
forwarded.

E. H. Keegan
Brig. Gen. Comdg.

Head Ins Dept of War
Transmitted by Post Office
To be discharged

Command of
Lieut. Col. Baber
of the 5th Regt. of Ky.

THE UNITED STATES ARMY OF CERTIFICATE OF DISABILITY FOR DISCHARGE.



Approved
of the Secy of War
of the Secy of War
of the Secy of War

~~George~~ William Sharp of Captain Sease
Company, (7) of the Fifth Regiment of United States
was enlisted by J. C. Randolph Provost Marshal
the Regiment of at Camp Nelson Ky
on the fourteenth day of September 1864, to serve Three years; he was born
in Jefferson in the State of Mississippi is Twenty five
years of age, five feet nine inches high, Black complexion, Black eyes,
Black hair, and by occupation when enlisted a Farmer During the last two

months said soldier has been unfit for duty 60 days.* From the effect of a
Thermin. This man states that while on duty at
Burr's side Point Ky. in the month of October 1864 he was ordered
by Lieut Weather to assist in moving a small building and that
as they were ascending a rise of ground he lifted a heavy board at the time a horse

STATION: Townsend Bridge Ky
DATE: June 2nd 1865

Sease
Capt U.S.C.
Commanding Company. 7

I CERTIFY, that I have carefully examined the said William Sharp of
Captain Sease Company, and find him incapable of performing the duties of a soldier
because of Thermin. The Thermin is very severe
and is easily produced. I find it impossible to keep it in place
by any contrivance it can be in his feet. He is therefore disqualified
for the Cavalry service and in my opinion is not a proper subject for
the Veteran Reserve Corps. Degree of disability amounts to one-half.

J. W. Adams
Surgeon. U.S.A.

DISCHARGED, this 28th day of June 1865, at Paris
Kentucky

Newing
Major in Charge
Commanding the Reg't.

The soldier desires to be addressed at
Town Salem County Jefferson State Mississippi

* See Note 1 on the back of this. † See Note 2 on the back of this.

1151

Shelburn, Isaac

Co L, 5 U. S. Col'd Cav.

Private

Private

CARD NUMBERS.

1	5369851	26
2	5369946	27
3	5370039	28
4	5370039	29
5	5370165	30
6	5359385	31
7	5370230	32
8	5359408	33
9	5370322	34
10	5370411	35
11	5370494	36
12	5370588	37
13	5370680	38
14	5370760	39
15	9091203	40
16	43147409	41
17	43148153	42
18	40730309	43
19		44
20		45
21		46
22		47
23		48
24		49
25		50

Book Mark:

See also

S | *5* *lev* | U.S.C.T.

Isaac Shellburne

, Co. *D*, *5* Reg't U. S. Col'd *Car*

Appears on

Company Descriptive Book

of the organization named above.

DESCRIPTION.

Age *8* years; height *5* feet *8* inches.

Complexion *Dark*

Eyes *Dark*; hair *Dark*

Where born *Spencer Ky*

Occupation *Farmer*

ENLISTMENT.

When *Sept-27* 1864.

Where *Louisville Ky*

By whom *Capt Smith*; term *3* y'rs.

Remarks: *Died Jan 14"/66*

A. J. Anderson

(383g)

Copyist.

S. | 5 bar U.S.A.

Isaac Shelburn

Appears with rank of Priv on

Muster and Descriptive Roll

of Det. Co. U.S. C. I. Mustered by Capt

J. H. Smith pursuant to orders

dated Aug. 9, 1864. Roll dated

Louisville, Ky., Sept 27, 1864.

Where born Spencer Co. Ky.

Age 18 years; occupation Farmer

When enlisted Sept 27, 1864

Where enlisted Louisville Ky.

For what period enlisted 3 years.

Eyes Dark; hair Dark

Complexion Dark; height 5 ft. 8 in.

When mustered in Sept 27, 1864.

Where mustered in Louisville.

Bounty paid \$ 100; due \$ 100

Clothing account:

Last settled _____, 1864; drawn since \$ 100

Date of first muster _____, 1864.

Company to which assigned _____

Remarks: Accredited to Spencer Co. 4 Dist.

Book mark: _____

W. L. Potter

(356m)

Copyist.

560

118615

Isaac Shelburne

Appears with rank of 1st on

Muster and Descriptive Roll

of Detachment of 11th Colored
Infantry, forwarded

Roll dated

Springville, Ky, Oct 24, 1864.

Where born Springer, Ky.

Age 18 years; occupation Farmer.

When enlisted Sept. 27, 1864.

Where enlisted Springville, Ky.

For what period enlisted 3 years.

Eyes Dark; hair Dark

Complexion Dark; height 5 ft. 8 in.

When mustered in Sept. 27, 1864.

Where mustered in Springville

Bounty paid \$ 100; due \$ 100

Clothing account:

Last settled 50, 1865; drawn since \$ 11 ⁵⁰ 100

Date of first muster Sept. 27, 1864.

Company to which assigned

Remarks: Credited to 4"

Long. West. Ky.

Book mark:

(356m)

W. H. DeChue

Copyist.

S

5 Cav. U.S.C.T.

Isaac Shelburn

Priv, Co. L, 5 Reg't U. S. Col'd Cavalry.

Appears on

Company Muster-in and Descriptive Roll of the organization named above. Roll dated

Camp Nelson, Ky, Oct 30, 1864

Where born Spencer Ky

Age 18 y'rs; occupation Farmer

When enlisted Sept 27, 1864

Where enlisted Arnisville

For what period enlisted 3 years.

Eyes BK; hair BK

Complexion BK, height 5 ft. 10 in.

When mustered in Sept 27, 1864

Where mustered in Arnisville

Bounty paid \$100, due \$100

Where credited 7th Dist Ky

Company to which assigned

Remarks:

Book mark:

Bruce

(356d)

Copyist.

S | 5 Cav. | U.S.C.T.

Isaac Shelburne

Cor, Co. L, 5 Reg't U. S. Col'd Cavalry.

Appears on

Company Muster Roll

for *date Oct 31*, 186*X*

Present or absent *Absent*

Stoppage, \$ *100* for

Due Gov't, \$ *100* for

Valuation of horse, \$ *100*

Valuation of horse equipments, \$ *100*

Remarks: *In Genl Hosp
Camp Nelson Ky.*

Book mark:

Bridle

(358)

Copyist.

S

5 Cav. U.S.C.T.

Isaac Shelburne

Private, Co. L, 5 Reg't U. S. Col'd Cavalry.

Appears on

Company Muster Roll

for Nov & Dec, 186 X

Present or absent Absent

Stoppage, \$ 100 for

Due Gov't, \$ 100 for

Valuation of horse, \$ 100

Valuation of horse equipments, \$ 100

Remarks: At Camp Nelson Ky. Left in Genl. Hasp. recd notice ordered to report to Co. has failed to do so. 1st 2 misstatement of Bounty Due

Book mark:

Prader

I | *5 Cav* | **U.S.C.T.**

Isaac Shelburn
Priv, Co. *L*, *5* Reg't U. S. Col'd *Cav*

Appears on

Descriptive List of Deserters

dated *Jan 31*, 186 *5*.

Deserted:

When *Unknown*, 186 .

Where *Unknown*

Arrested:

When _____, 186 .

Where _____

Remarks: _____

Book mark: _____

Rose

S | 5 Cav. | U.S.C.T.

Isaac Shelburn

Priv, Co. L, 5 Reg't U.S. Col'd Cavalry.

Appears on

Company Muster Roll

for January, 1865

Present or absent

Stoppage, \$ 100 for

Due Gov't, \$ 100 for

Valuation of horse, \$ 100

Valuation of horse equipments, \$ 100

Remarks: Absent
Reported at last
muster as absent
without leave
have been unable
to learn anything
concerning him

Book mark:

Prader

(358)

Copyist.

I | *Claw* | U.S.C.T.

Isaac Shelburn
Put, Co. *L*, *5* Reg't U. S. Col'd *Cal*

Appears on

Descriptive List of Deserters

dated *March 31*, 186 *5*.

Deserted :

When, 186 .

Where

Arrested :

When, 186 .

Where

Remarks :

Taken up from
Desertion March 31, 1865 at
Camp Nelson. This man
was erroneously dropped as a
deserter, he having been on
detached duty at Camp Nelson Ky.

Book mark :

Rose

(351)

Copyist.

S.

5 Cav.

U.S.C.T.

Isaac Shelburn

Private, Co. L, 5 Reg't U.S. Col'd Cavalry.

Appears on

Company Muster Roll

for March, 1865.

Present or absent Present

Stoppage, \$ 100 for

Due Gov't, \$ 100 for

Valuation of horse, \$ 100

Valuation of horse equipments \$ 100

Remarks: 1st Installment
Due \$100. Erroneously
reported deserted on
last muster he being
in demounted Camp
Det. 5th US C. Camp
Nelson Ky

Book mark:

Biddle

S

5 Cav. | U.S.C.T.

Samuel Selburn

2d, Co. L, 5 Reg't U. S. Col'd Cavalry.

Appears on

Company Muster Roll

for *May & June*, 1865.

Present or absent *Present*

Stoppage, \$ 100 for

Due Gov't, \$ 100 for

Valuation of horse, \$ 100

Valuation of horse equipments, \$ 100

Remarks: *1st. Arrears of Pay due \$100.*

Book mark:

Rocheester

(358)

Copyist.

S | **5 Cav. | U.S.C.T.**

Isaac Shelburn

Plt, Co. L, 5 Reg't U.S. Col'd Cavalry.

Appears on

Company Muster Roll

for *July to Aug*, 1865.

Present or absent *Present*

Stoppage, \$ *100* for

Due Gov't, \$ *100* for

Valuation of horse, \$ *100*

Valuation of horse equipments, \$ *100*

Remarks: *Due to S. for Ord.*
55 cts.

Book mark:

Rockster

(358)

Copyist.

I | **5 Cav. | U.S.C.T.**

Isaac Shelburn

Co. L, Co. L, 5 Reg't U. S. Col'd Cavalry.

Appears on

Company Muster Roll

for *Sept & Oct*, 1885.

Present or absent *Present*

Stoppage, \$ *100* for

Due Gov't, \$ *100* for

Valuation of horse, \$ *100*

Valuation of horse equipments, \$ *100*

Remarks: *Due U. S. Gen-
Ord. 55 cts.*

Book mark:

Recd

S | **5 Cav.** | **U.S.C.T.**

Isaac Shelburn

Pvt, Co. L, 5 Reg't U. S. Col'd Cavalry.

Appears on

Company Muster Roll

for *Nov & Dec*, 1865.

Present or absent *Present*

Stoppage, \$ 100 for

Due Gov't, \$ 100 for

Valuation of horse, \$ 100

Valuation of horse equipments, \$ 100

Remarks:

Book mark: *Isaac Shelburn*

(358)

Isaac Shelburn

Copyist.

S

5 Cav. | U.S.C.T.

Isaac Shelburn

Pr, Co. L, 5 Reg't U.S. Col'd Cavalry.

Appears on

Company Muster Roll

for *Jan. & Feb.*, 186*6*.

Present or absent

Stoppage, \$ 100 for

Due Gov't, \$ 100 for

Valuation of horse, \$ 100

Valuation of horse equipments, \$ 100

Remarks: *Died at Regtl. Hosp. Jan. 16th 66. of acute meningitis.*

Book mark:

C. D. Taylor

(358)

Copyist.

Isaac Shelburne

Pot, Co. L, 5 Reg't U. S. Colored Cav.

Appears on Returns as follows:

Oct. & Nov. 1864, Absent sick Genl
Hospl Camp Nelson, Ky.

Dec. 1864, Absent - Dischgd from
Genl Hospl, Camp Nelson,
Ky. ordered to report to
Comd'g officer failed to report

Jan'y 1865, Loss: Deserted.

Feb'y 1865, Absent in Dismounted
Camp, Camp Nelson, Ky.

Mar 1865, Gain: Erroneously reported
Deserted on last return he
being on det. duty in dis-
mounted camp, Camp
Nelson, Ky.

Jan'y 1866, Loss: Jan'y 16/65, Helena,
Ark. died at Regt Hospl
of Acute Meningitis.

Book mark:

L. B. Bowman

S | *5* *Car* | U.S.C.T.

Isaac Shelburn

Priv, Co. *L*, *5* Reg't U. S. Col'd *Caraboy*

Appears on **Co. Muster-out Roll**, dated *Helena, Ark Mar. 16*, 186*6*.

Muster-out to date _____, 186 .

Last paid to *Oct. 31*, 186*5*.

Clothing account:

Last settled _____, 186 ; drawn since \$ _____ $\overline{100}$

Due soldier \$ _____ $\overline{100}$; due U. S. \$ *39* $\frac{82}{100}$

Am't for cloth'g in kind or money adv'd \$ _____ $\overline{100}$

Due U. S. for arms, equipments, &c., \$ _____ $\overline{100}$

Bounty paid \$ *100* $\overline{100}$; due \$ _____ $\overline{100}$

Remarks: *Died at Helena, Ark. Jan. 16, 66. Disease Acute Meningitis. Final statements forwarded.*

Book mark: *V. 41 P. 41. 69. S. 68. V. 10*
(over)

O. T. Taylor

(361)

Copyist.

JAN. - 9

5370760

☆ 1891 ☆

x C. I. 73. - 2322, 79

Shelburn, Isaac

P, Co. L, 5 Reg' U. S. C. Cav.

3 Enclosures.

Bed Cards	Descriptive Lists
Burial Records	Final Statements /
Certs. of Dis. for Discharge	Furloughs
C. M. Charges	Med. Des. Lists
Med. Certificates	Orders

Other papers relating to—

Admission to Hosp'l	Furlough
Casualty Sheet (Officer's)	Med. Examination
Confinement	Misc. Information
Contracts	Pay or Clothing
Death or Effects 7	Personal Reports
Desertions	Rank
Discharge from Hosp'l	Transfer to Hosp'l
Discharge from Service	Transfer to V. R. C.
Duty	Transportation

Report of the Death
of

Isaac Shelburn

5. 21. 65



Hid. Ins. Med. Dept. 5th U.S.C.C.
Fort Smith Arkansas
January 17th 1866

Secy. Office 5th U.S.C.C.

Sir

I have the honor to
inform you that Pvt. Isaac Shelburn of your
Company died at the Hospital on the 16th day of
January 1866 of Acute Meningitis

Very Respectfully
Your Obedient Servant
G. W. Bowen
Surgeon 5th U.S.C.C.
Dr. James T. Lawless
Hospl. Steward Ad. Ct.

Extract from Act of Congress.

SEC. 12. And be it further enacted, That the fees of agents and attorneys for making out and causing to be executed the papers necessary to establish a claim for a pension, bounty, and other allowance before the Pension Office, under this act, shall not exceed the following rates: For making out and causing to be duly executed a declaration by the applicant, with the necessary affidavits, and forwarding the same to the Pension Office, with the requisite correspondence, ten dollars; which sum shall be received by such agent or attorney in full for all services in obtaining such pension, and shall not be demanded or received, in whole or in part, until such pension shall be obtained; and the sixth and seventh sections of an act entitled "An act to grant pensions," approved July [fourteenth,] eighteen hundred and sixty-two, are hereby repealed.

SEC. 13. And be it further enacted, That any agent or attorney who shall, directly or indirectly, demand or receive any greater compensation for his services under this act than is prescribed in the preceding section of this act, or who shall contract or agree to prosecute any claim for a pension, bounty, or other allowance under this act, on the condition that he shall receive a per centum upon any portion of the amount of such claim, or who shall wrongfully withhold from a pensioner or other claimant the whole or any part of the pension or claim allowed and due to such pensioner or claimant, shall be deemed guilty of a high misdemeanor, and, upon conviction thereof, shall, for every such offense, be fined not exceeding three hundred dollars, or imprisoned at hard labor not exceeding two years, or both, according to the circumstances and aggravations of the offense.

Approved July 4, 1834.

NOTE 10.—If any soldier is charged a higher fee than that allowed by the above act, he should report the fact and the name of the agent to the Adjutant General, in order that steps may be taken to have the same refunded.

FINAL STATEMENT

Co 'G'

Pvt. Isaac Shelburn

Co. 5th Reg't of Inf. Col. 2^d Cav.

VOLUNTEERS.

Jan 16 1864

NOTE 1.—Two of these certificates (or duplicates) are to be given to each Volunteer Soldier or drafted man who may be discharged without being mustered out (Final Statements are never given to men mustered out of service) that he may at once receive from the Paymaster the pay, &c., due him, and the captain or other COMMISSIONED officer commanding the company will certify to the act of the delivery of the duplicate certificates; with these certificates the Soldier is "entitled to" his discharge, and should also present his discharge to the Paymaster to have the payment endorsed on it. The discharge is to be given back to the Soldier by the Paymaster; the latter only retaining as his vouchers the duplicate certificates.

NOTE 2.—If the Soldier is entitled to pay for the use of his horse, the Company Commander will certify to that fact on the back of both these final statements, and also to the time he has pay due for having been so mounted on his own horse.

NOTE 3.—When a Soldier is furnished with final statements, his descriptive list, if he has one, should be taken up by the officer who gives the Soldier these statements, and endorsed with a statement to this effect by the officer. The endorsement should exhibit a full statement of the time for which the Soldier was allowed pay on his final statements, the clothing account, and all other charges against him or in his favor, so as to comprise a complete exhibit of his account. It will then be transmitted to the Company Commander of the Soldier, who will enter all the data necessary to a full understanding of the Soldier's account on the muster roll upon which the Soldier's discharge is reported. The descriptive list will then be destroyed. The object of this is, that the remaining portion of the Soldier's account may be settled upon the receipt of these muster rolls, and the Soldier receive any pay or allowances that may be due him at the time of his discharge, and which may not appear on his last final statements from the fact that his descriptive list is incomplete. These accounts for back pay, &c., are settled by the 2d Auditor of the Treasury Department.

NOTE 4.—Charges for loss or injury to ordnance, horse equipments, and other miscellaneous charges, should appear under the heading of "Other Stoppages."

NOTE 5.—Bounty paid by State authorities, and not by the United States, will not be entered on this statement.

NOTE 6.—Amounts due the Sutler and Laundress must be entered on the muster roll on which the discharge, death, desertion, &c., is reported, as well as on the final statement, otherwise the amount cannot be collected from the United States.

NOTE 7.—This blank will be used for deceased volunteers and drafted men, as well as for others.

NOTE 8.—Where a Soldier dies in Hospital or on detached service, his descriptive list, if he has one, should be sent with his final statements, in duplicate, to the Adjutant General, Washington, D. C.

NOTE 9.—If the soldier is a drafted man or substitute, the space for time, &c., of enrolled, should contain only the word *drafted* or *substitute*, as the case may be. If the Soldier is a "VETERAN," (or RECRUIT,) the words *as a veteran*, (or *recruit*;) as the case may be, should be interlined after the words *mustered into the service of the U. S.* A statement of all the instalments of *Veteran* or *Recruit* Bounty RECEIVED by the Soldier must be made on the back of each final statement.

ADJUTANT GENERAL'S OFFICE

Jan 27 1864

Duplicate of Inventory sent to Adj. Gen.

I certify, on honor, that Isaac Shelburn, a Private of
Captain Michl Conroy's Company (L) of the 5th Regiment of Vol. Inf.,
VOLUNTEERS, of the State of _____, born in Memor co., State
of Kentucky, aged 18 years; 5 feet 8 inches high; Dark complexion,
Dark eyes, Dark hair, and by occupation a Farmer, who joined for service
and was enrolled (see Note 9) on the 27th day of Sept, 1864, at Louisville Ky.
by Capt Smith, for the period of 13 years, and mustered into
the service of the United States on the 27th day of Sept, 1864, at
Louisville Ky. by Capt Smith; and having served
HONESTLY and FAITHFULLY with his Company to the present date, is now entitled to a
DISCHARGE by reason of Death, from acute Meningitis

The said Priv Isaac Shelburn was last paid by Paymaster
Map Knapp, to include the 31st day of October, 1865, and
has pay due him from that time to the present date; he is entitled to pay and subsistence for
TRAVELING to place of enrollment, and whatever other allowances are authorized to volunteer
soldiers, drafted men, or militia, so discharged. He has received from the United States **CLOTHING**
amounting to 98 - $\frac{32}{100}$ dollars, since the 31st day of March,
1865, when his clothing account was last settled. He has received from the United States
100 - $\frac{00}{100}$ dollars advanced **BOUNTY**.

There is to be stopped from him, on account of the State of _____, or other
authorities, for **CLOTHING, &c.**, received on entering service, _____ $\frac{00}{100}$ dollars; and
for other stoppages, viz: _____

_____ $\frac{00}{100}$ dollars.
He has been furnished with **TRANSPORTATION** in kind from the place of his discharge to
_____; and he has been **SUBSISTED** for **TRAVELING** to his
place of enrollment, up to the _____, 186 .

He is indebted to John W. Parsons, **SUTLER**, 12 - $\frac{00}{100}$ dollars.

He is indebted to _____, **LAUNDRESS**, _____ $\frac{00}{100}$ dollars.

Given in Duplicate, at Helena Ark, this 18th day
of January, 1866.

Michael Conroy
Capt Co. 5th Regt.
Commanding Company.

INVENTORY OF THE EFFECTS

OF

Priv. Isaac Shelburn

Late of Company *L*

5th Reg't of *4th Col. Cav.*

Volunteers, who died at *Reg't. Hosp.*

on the *15th* day of *January* 186*6*.



Inventory of the effects of Esac Shulburn late
 a Private of Captain Michael Conroy's Company D. of
 the 5th Regiment of Infantry Volunteers, who was enrolled as
 a Private at Louisville Ky in the State of Kentucky on
 the 27th day of September 1864, and mustered into the service of the United
 States as a Private on the 27th day of Sept 1864, at Louisville Ky.
 in Company D. 5th Regiment of Infantry Volunteers, to serve 3
 years or during the war; he was born in Spencer Co. in the State
 of Kentucky; he was 18 years of age, 5 feet 8 inches
 high, dark complexion, dark eyes, dark hair, and by occupation, when enrolled,
 a Farmer; he died in Regt. Hospital, at
Helena Ark., on the 18th day of January 1866, by
 reason of acute Meningitis.

INVENTORY.					
ARTICLES.	No.	ARTICLES.	No.	ARTICLES.	No.
Hats	}	Pairs trousers	}	Knapsacks	}
Caps		Pairs flannel drawers			
Forage caps		Pairs cotton drawers			
Great coats		Flannel shirts			
Uniform coats		Cotton shirts			
Uniform jackets		Pairs boots			
Flannel sack coats		Pairs shoes			
Blouses		Pairs socks			
Stable frocks		Blankets			
Fatigue overalls		Haversacks			
				MONEY.	
				Specie	\$
				Notes	\$

I CERTIFY, ON HONOR, that the above inventory comprises all the effects of Private
Esac Shulburn, deceased, and that the effects are in the hands
 of _____ at _____
 _____ to be disposed of by a Council of Administration.

(DUPLICATES.)

STATION: Helena Ark

DATE: January 18th 66

[A. G. O. No. 104.]

Michl. Conroy
Capt Co. D. 5th Inf.
 Commanding the Company.

1152
Sheldon, Edward

Co G, 5 U. S. Col'd Cav.

Sergeant Sergeant

CARD NUMBERS.

1	5359236	26
2	5366282	27
3	5366372	28
4	5366462	29
5	5366626	30
6	5359319	31
7	5366728	32
8	9090732	33
9	40730310	34
10		35
11		36
12		37
13		38
14		39
15		40
16		41
17		42
18		43
19		44
20		45
21		46
22		47
23		48
24		49
25		50

Book Mark:

See also 72 Col. ref.

S | 5 Cav. | U.S.C.T.

Edward Sheldon

....., Co. *H*, 5 Reg't U. S. Col'd Cav.

Appears on

Company Descriptive Book
of the organization named above.

DESCRIPTION.

Age *24* years; height *5* feet *4* inches.

Complexion *Muc*

Eyes *Blk*; hair *Blk*

Where born *Alabama*

Occupation *Lawyer*

ENLISTMENT.

When, 186 .

Where *Substitute*

By whom; term *1* y'rs.

Remarks: *Assigned to*
Co per G.O. No 137
Dated Paris Ky
July 27 - 1865, dis-
charged Jan. 11 - 1866
at Helena Ark ex-
piration of term of
service

J E Rucker

S | T Car | U.S.C.T.

Edward Sheldon

Serq[?] Co., 5 Reg't U. S. Col'd Car

Appears on

M. and D. Roll of Men Transferred

to the organization named above,

from

Roll dated July 18, 1865.

When enlisted, 186 .

Period for which enlisted 1 years.

When mustered in Jan 11, 1865.

Present or absent Not Stated

Company to which assigned

Remarks: Deposit under 90 305

Q 90 - \$450

Due US for C+98 \$1.72

Ord 75 ct

substitute

Book mark :

Abbot

(342)

Copyist.

Edward Sheldon

Sgt., Co. G, 5 Reg't U. S. Col'd Cavalry.

Appears on

Company Muster Roll

for *July & Aug.*, 186*5*.

Present or absent *Present*

Stoppage, \$ *100* for

Due Gov't, \$ *100* for

Valuation of horse, \$ *100*

Valuation of horse equipments, \$ *100*

Remarks: *Rec'd by transfer from 2d. Co. D. 5th Cav. No. 129, dated Mo. 2nd. Dept. of Ky., Louisville, Ky. July 17, 1865. Assigned to Company per O.D. No. 132, dated Paris, Ky. July 27, 65*

Book mark:

[Signature] Copyist.

Edward Sheldon

Sgt., Co. G, 5 Reg't U. S. Col'd Cavalry.

Appears on

Company Muster Roll

for *Sept 1865*, 1865.

Present or absent *Present*

Stoppage, \$ *100* for

Due Gov't, \$ *100* for

Valuation of horse, \$ *100*

Valuation of horse equipments, \$ *100*

Remarks: *\$450 dollars
monthly pay, no pay
for Sept, Dec, etc.
retained by Deser
Byrd*

Book mark: _____

Yeater

2 | 5 Cav. | U.S.C.T.

Edward Sheldon

Sgt., Co. G, 5 Reg't U. S. Col'd Cavalry.

Appears on

Company Muster Roll

for November, 1863.

Present or absent Present

Stoppage, \$ 100 for

Due Gov't, \$ 100 for

Valuation of horse, \$ 100

Valuation of horse equipments, \$ 100

Remarks: Due 12 full pay
\$ 120; for 100
\$ 0 75
100

Book mark:

(358)

Guaranteed Copyist.

J

5 Cav.

U.S.C.T.

Edward Sheldon

Sergeant, Co. G, 5 Reg't U. S. Col'd Cavalry.

Appears on

Company Muster Roll

for *Jan'y & Feby*, 1866.

Present or absent

Stoppage, \$ 100 for

Due Gov't, \$ 100 for

Valuation of horse, \$ 100

Valuation of horse equipments, \$ 100

Remarks: *Discharged at Helena, Ark. Jan'y 11/66. expiration of term of service, muster out rolls furnished - Discharge furnished.*

Book mark:

Tabler

(358)

Copyist.

Edward Sheldon

Unassigned

Serjt., Co. G, 5 Reg't U. S. Colored Cav.

Appears on Returns as follows:

July 1865, (Unassigned) Gain: July 27/65,
Paris, Ky. Transfer from the
72 U. S. C. Inf. per S. O. 127
Hdgrs. Dept. of Ky. July 18/65-

Aug. 1865, Loss: Aug. 1/65, Lexington.

Assigned to Co. G, per R. O.
132, July 27/65.

(Co. G) Gain: Aug. 1/65, Lex-
ington. Transfer from 72

C. I. per S. O. No. 127 dated
Louisville, Ky. July 18/65.

Assgd to Co. per R. O. No.
132 dated July 27.

Jan'y 1866, Loss: Jan'y 11/66, Helena,
Ark. Dischg'd expiration of
Term of service.

Book mark:

L. B. Bowman

S

5

U.S.C.T.

Edward Sheldon

Sergt, Co. G, 5 Reg't U. S. Col'd Cav'y

Appears on an

Individual Muster-out Roll

of the organization named above. Roll dated

Melina, Ark, Jan 11, 1866.

Muster-out to date Jan 11, 1866.

Last paid to Oct 31, 1865.

Clothing account:

Last settled ^{never settled} _____, 1866 ; drawn since \$126²⁸/₁₀₀

Due soldier \$ _____ 100 ; due U. S. \$ _____ 100

Am't for cloth'g in kind or money adv'd \$ _____ 100

Due U. S. for arms, equipments, &c., \$ _____ 100

Bounty paid \$ _____ 100 due \$ _____ 100

Remarks: This man was transferred from 72 U.S. C.S. as Sergt per S.O. 127 Par 3 Ad Dir Dept of War 18th July 65. Due U.S. for C & G \$1⁷²/₁₀₀ for Ord No 25¹⁰⁰. - Mustered out under provisions of War Dept. (over)

Book mark: _____

M. T. Hughes

(348)

Copyist.

JAN. - 9

5359319

1891 *

*Circular No 41 of 1864
to take effect 11 Jan 66*

Samuel Sheldon

Park, Co. *G*, 5 Reg't U. S. Col'd Cavalry.

Appears on Co. Muster-out Roll, dated
Helena, Ark. Mch. 16, 1866.

Muster-out to date _____, 186 .

Last paid to *Oct. 31*, 1865 .

Clothing account:

Last settled _____, 186 ; drawn since \$ _____ 100

Due soldier \$ _____ 100; due U. S. \$ *35* ⁸⁸ 100

Am't for cloth'g in kind or money adv'd \$ _____ 100

Due U. S. for arms, equipments, &c., \$ _____ 100

Bounty paid \$ _____ 100; due \$ _____ 100

Remarks: *Free - Discharged June 11, 1866. Helena, Ark, on acct. of expiration of term of service. Transferred from 2d U.S.C. Reg. S.O. No. 127, par. 3, Hd. Qrs. Dept. of Ky, 18th July, 1865.*

Book mark: _____

Taylor

1153

Sheldon, James

Co E, 5 U. S. Col'd Cav.

Private Private

CARD NUMBERS.

1	5359277	26
2	5364286	27
3	5364375	28
4	5364459	29
5	5364541	30
6	5364619	31
7	9090494	32
8	40730311	33
9		34
10		35
11		36
12		37
13		38
14		39
15		40
16		41
17		42
18		43
19		44
20		45
21		46
22		47
23		48
24		49
25		50

Book Mark: General Notation R. & P. 407375,

See also 72 Col. Inf.

S

5 Cav.

U.S.C.T.

James Sheldon

Co. *E*, 5 Reg't U. S. Col'd Cav.

Appears on

Company Descriptive Book

of the organization named above.

DESCRIPTION.

Age *27* years; height *5* feet *8 1/2* inches.

Complexion *Black*

Eyes *Blk*; hair *Blk*

Where born *Charlestown Va*

Occupation *farmer*

ENLISTMENT.

When *Mar 13*, 186 *5*

Where *Cincinnati O*

By whom *Capt Jones*; term *1* y'rs.

Remarks:

.....
.....
.....
.....
.....
.....
.....
.....
.....

J E Parks

(3830)

Copist.

S 5 Cav | U.S.C.T.

James Sheldon

Pvt, Co. 5 Reg't U. S. Col'd Cav

Appears on

M. and D. Roll of Men Transferred

to the organization named above,

from

Roll dated July 18, 1865.

When enlisted March 13, 1865.

Period for which enlisted 1 years.

When mustered in March 30, 1865.

Present or absent Not Stated

Company to which assigned

Remarks: / D Q

Deposit under G.O. 305 a 90 \$100

Book mark :

General Notation N. & P. 407876.

Albion

(342)

Copyist.

S

5 Cav. U.S.C.T.

James Sheldon
Pvt., Co. E, 5 Reg't U. S. Col'd Cavalry.

Appears on

Company Muster Roll

for July & Aug., 1865.

Present or absent present

Stoppage, \$ 100 for

Due Gov't, \$ 100 for

Valuation of horse, \$ 100

Valuation of horse equipments, \$ 100

Remarks: Rec'd. by transfer from
72 Co. I. per S.O. No. 127 dated
D. of Ky. July 18/65.
Assigned to Co.
per R. O. No. 132 dated
July 27/65.

Book mark:

Long

(358)

Copyist.

S

5 Cav.

U.S.C.T.

James Sheldon

Pvt

Co. E, 5 Reg't U. S. Col'd Cavalry.

Appears on

Company Muster Roll

for *Sept & Oct.*, 1865.

Present or absent *Present*

Stoppage, \$ 100 for

Due Gov't, \$ 100 for

Valuation of horse, \$ 100

Valuation of horse equipments, \$ 100

Remarks:

Book mark:

Long

(358)

Copyist.

S | 5 Cav. | U.S.C.T.

James S Sheldon,
Private, Co. E, 5 Reg't U. S. Col'd Cavalry.

Appears on

Company Muster Roll

for Nov & Dec, 1865.

Present or absent present

Stoppage, \$ 100 for

Due Gov't, \$ 100 for

Valuation of horse, \$ 100

Valuation of horse equipments, \$ 100

Remarks: Due soldier as
per Check Book \$100

Book mark:

(358)

Long
Copyist.

A

5 Cav. U.S.C.T.

James Sheldon

Priv, Co. E, 5 Reg't U. S. Col'd Cavalry.

Appears on

Company Muster Roll

for *Jan, & Feb*, 186 *6*.

Present or absent *Present*

Stoppage, \$ *100* for

Due Gov't, \$ *100* for

Valuation of horse, \$ *100*

Valuation of horse equipments, \$ *100*

Remarks:

Book mark:

E. M. Leonard

(358)

Copyist.

5 Cav. U.S.C.T.

James Shields,
B.M., Co. E., 5 Reg't U. S. Col'd Cavalry.

Appears on Co. Muster-out Roll, dated
Victoria, B.C., Mar 16, 1866.

Muster-out to date * Mar 3, 1866.

Last paid to Dec 31, 1866.

* ~~Records on file in 2nd. Auditor's~~

~~Clothing account~~ Office show this Co. Mustered Out
to take effect Mch, 16th, 1866, and
Last settled 1866, drawn since \$ 100
paid to include Mch, 15th, 1866.

Due soldier \$ 100; due U. S. \$ 18 35/100

Am't for cloth'g in kind or money adv'd \$ 100

Due U. S. for arms, equipments, &c., \$ 100

Bounty paid \$ 100; due \$ 100 1/100

Remarks: Received by Transfer
from 72 U.S.C.T. per P.O. No. 127
dated Ad. Gen's Dept. of Ky.
July 8 1865

Book mark :

J. M. Leonard
(361) Copyist.

S | 5 Cav. | U.S.C.T.

James Sheldon
Pot, Co. E, 5 Reg't U. S. Colored Cav.

Appears on Returns as follows:

July 1865, Gain: July 27, Paris,
Ky. Transfd to Co. E, as
per Regtl Order No. 132.
Absent sick in Coving-
ton, Ky.

Book mark:

L. B. Cowman

(546)

Copyist.

1154

Sherrod, William

Co *G*, 5 U. S. Col'd Cav.

Private

Private

CARD NUMBERS.

1	5365783	26
2	5365877	27
3	5365944	28
4	5366064	29
5	5366162	30
6	5366253	31
7	5366345	32
8	5366434	33
9	5366520	34
10	5366608	35
11	5366692	36
12	9090707	37
13		38
14		39
15		40
16		41
17		42
18		43
19		44
20		45
21		46
22		47
23		48
24		49
25		50

Book Mark:

See also

S | **5 Cav. | U.S.C.T.**

William Sherrard

....., Co. *A*, 5 Reg't U. S. Col'd Cav.

Appears on

Company Descriptive Book
of the organization named above.

DESCRIPTION.

Age *18* years; height *5* feet *3* inches.

Complexion *Black*

Eyes *Blk*; hair *Blk*

Where born *Alabama*

Occupation *farmer*

ENLISTMENT.

When *Sept 8*, 186 *4*

Where *Camp Nelson*

By whom *W. Randolph* term *3* y'rs.

Remarks:

.....

.....

.....

.....

.....

.....

.....

F. E. Puck

S | **5 Cav.** | **U.S.C.T.**

William Sherrod

Private, Co. *G*, 5 Reg't U. S. Col'd Cavalry.

Appears on

Company Muster-in and Descriptive Roll

of the organization named above. Roll dated

Camp Nelson Ky. & Oct. 27, 1864.

Where born *Alabama*

Age *18* y'rs; occupation *Farmer*

When enlisted *Sept. 8*, 1864.

Where enlisted *Camp Nelson Ky.*

For what period enlisted *3* years.

Eyes *Black*; hair *Black*

Complexion *Black*; height *5* ft. *3* in.

When mustered in *Sept. 9*, 1864.

Where mustered in *Camp Nelson Ky.*

Bounty paid \$ *100*; due \$ *100*

Where credited *7th Dist. Ky.*

Company to which assigned

Remarks:

Free.

Book mark:

[Signature]

(356d)

Copyist.

S 5 Cav. U.S.C.T.

William Sherwood,

Privt., Co. G, 5 Reg't U. S. Col'd Cavalry.

Appears on

Company Muster Roll

for *Enll. to Oct. 31,* 1864.

Present or absent *Present,*

Stoppage, \$ *100* for

Due Gov't, \$ *100* for

Valuation of horse, \$ *100*

Valuation of horse equipments, \$ *100*

Remarks:

Book mark:

[Signature]

(358)

Copyist.

S | 5 Cav. | U.S.C.T.

William Sherrod,

Pvt., Co. G, 5 Reg't U. S. Col'd Cavalry.

Appears on

Company Muster Roll

for *Nov. + Dec.*, 1864.

Present or absent *present.*

Stoppage, \$ *100* for

Due Gov't, \$ *100* for

Valuation of horse, \$ *100*

Valuation of horse equipments, \$ *100*

Remarks: *1st + 2^d instmt.*
Bounty due.

Book mark: _____

(358)

[Signature]

Copyist.

S. | **5 Cav.** | **U.S.C.T.**

William Sherrod

Priv., Co. G, 5 Reg't U. S. Col'd Cavalry.

Appears on

Company Muster Roll

for *Jan. & Feb.*, 186*5*.

Present or absent *present*.

Stoppage, \$ *100* for

Due Gov't, \$ *100* for

Valuation of horse, \$ *100*

Valuation of horse equipments, \$ *100*

Remarks: *See U. S. Gen Ord*

#179 1st Instant

Bounty \$100⁰⁰ due.

Book mark:

[Signature]

(358)

Copyist.

S. | **5 Cav.** | **U.S.C.T.**

William Sherrod,

Pvt., Co. G, 5 Reg't U. S. Col'd Cavalry.

Appears on

Company Muster Roll

for *March & April*, 1865.

Present or absent *Present*

Stoppage, \$ *100* for

Due Gov't, \$ *100* for

Valuation of horse, \$ *100*

Valuation of horse equipments, \$ *100*

Remarks: *1st Instatement*

Bounty due.

Book mark:

(358)

[Signature]

Copyist.

8.

5 Cav.

U.S.C.T.

William Sherman

Ser., Co. G, 5 Reg't U. S. Col'd Cavalry.

Appears on

Company Muster Roll

for May 1st, 1865

Present or absent Present

Stoppage, \$ 100 for

Due Gov't, \$ 100 for

Valuation of horse, \$ 100

Valuation of horse equipments, \$ 100

Remarks: First Installment Payable due \$100

Book mark:

(358)

Leahue

Copyist.

2

5 Cav.

U.S.C.T.

William Sherrard

Ser., Co. G, 5 Reg't U. S. Col'd Cavalry.

Appears on

Company Muster Roll

for July 1st 1863.

Present or absent Present

Stoppage, \$ 100 for

Due Gov't, \$ 100 for

Valuation of horse, \$ 100

Valuation of horse equipments, \$ 100

Remarks:

Book mark:

(358)

Sherrard

Copyist.

5 Cav. U.S.C.T.

William Sherrard
Sergeant, Co. G, 5 Reg't U. S. Col'd Cavalry.

Appears on

Company Muster Roll

for September, 1864.

Present or absent Present

Stoppage, \$ 100 for

Due Gov't, \$ 100 for

Valuation of horse, \$ 100

Valuation of horse equipments, \$ 100

Remarks:

Book mark:

(358)

Copyist.

2 | **5 Cav.** | **U.S.C.T.**

William Sherrard

San., Co. G, 5 Reg't U. S. Col'd Cavalry.

Appears on

Company Muster Roll

for Nov. Dec., 1863.

Present or absent Present

Stoppage, \$ 100 for

Due Gov't, \$ 100 for

Valuation of horse, \$ 100

Valuation of horse equipments, \$ 100

Remarks:

Book mark:

(358)

W. Sherrard Copyist.

S | 5 Cav. | U.S.C.T.

William Sherrod

Sgt., Co. G, 5 Reg't U. S. Col'd Cavalry.

Appears on

Company Muster Roll

for *Jan'y & Feb'y*, 1866.

Present or absent *Present*

Stoppage, \$ 100 for

Due Gov't, \$ 100 for

Valuation of horse, \$ 100

Valuation of horse equipments, \$ 100

Remarks: *Due up for Ord. ⁵³*

Book mark: _____

Callis

(358)

Copyist.

S | **5 Cav.** | **U.S.C.T.**

William Sherrod

Tark, Co. *4*, 5 Reg't U. S. Col'd Cavalry.

Appears on **Co. Muster-out Roll**, dated
Helena, Ark., *March 16,* 1866.

Muster-out to date *March 16* 1866.

Last paid to *Dec. 31* 1865.

Clothing account:

Last settled....., 186 ; drawn since \$..... 100

Due soldier \$..... 100; due U. S. \$ *38* ⁵³/₁₀₀

Am't for cloth'g in kind or money adv'd \$..... 100

Due U. S. for arms, equipments, &c., \$ ⁵³/₁₀₀

Bounty paid \$ *100* 100; due \$ *100* 100

Remarks: *Slave - Due U.S. for Ordinance*
ance \$ ⁵³/₁₀₀

Book mark:

(861)

Tark

Copyist.

Sherrard William

....., Co.

Reg't *U. S. C. I.*

/ **Enclosures.**

Bed Cards	Final Statements
Burial Records	Furloughs or L. of A.
Certs. of Dis. for Discharge	Med. Certificates
C. M. Charges	Med. Des. Lists
Descriptive Lists	Orders
Discharge Certificates	Pris. of War Record
Enlistment Papers	Resignations

Other papers relating to—

Admission to Hosp'l	Furlough or L. of A.
Casualty Sheet	Med. Examination
Confinement	Misc. Information
Contracts	Pay or Clothing
Death or Effects	Personal Reports
Desertion	Rank
Discharge from Hosp'l	Transfer to Hosp'l
Discharge from Service	Transfer to V. R. C.
Duty	Transportation

NOTE 1.—This blank will be used for enlistments of United States colored troops. They will be made out in duplicate in all cases—one to accompany the recruiting return of the superintendent (not the recruiting officer) to the Adjutant General, and one to accompany the accounts of the officer who pays bounty, &c.

NOTE 2.—An enlistment holds to service. A muster-in must, in all cases, precede payment of pay, bounty, pension, &c. A muster-in roll, must in all cases, be filed in the Adjutant General's Office as evidence of muster-in. The mustering officer, commissary, or assistant commissary of musters, as the case may be, will countersign both enlistments as having mustered the soldiers into the service of the United States before either of them is given to the disbursing officer.

DECLARATION OF RECRUIT.

I, William Sherrod, desiring to volunteer as a soldier in the ARMY OF THE UNITED STATES, for the term of Three Years, DO DECLARE That I am 15 years and months of age; that I have never been discharged from the United States service on account of disability or by sentence of a court-martial, or by order before the expiration of a term of enlistment; and I know of no impediment to my serving honestly and faithfully as a soldier for three years.

GIVEN at Camp Nelson the 8th day of September 1864

Witness: J. C. Strick

William Sherrod
No. 1864
I do hereby certify that the above named William Sherrod is a Volunteer in the Army of the United States for the term of Three Years under the conditions of the laws of the United States.
J. C. Strick
Adjutant General

Consent of Parent or Guardian in case of a Minor, if a Free Man, or in the case of a Slave, of the Person to whom he owes Service:

I, Do CERTIFY, That I am the that the said is years of age; and I do freely give my CONSENT to his volunteering as a SOLDIER in the Army of the United States, for the period of THREE YEARS, under the conditions of the laws of the United States.

GIVEN at the day of

Witness: J. C. Strick

UNITED STATES COLORED TROOPS ENLISTMENT.

STATE OF

TOWN OF

Kentucky

Camp Nelson



I, *William Sherrod* born in

in the State of *Alabama* aged *Eighteen* years

and by occupation a *Farmer* Do HEREBY ACKNOWLEDGE to

have volunteered *Eighth* day of *September* 186*4*

to serve as a **Soldier** in the **Army of the United States of America**, for the

period of **THREE YEARS**, unless sooner discharged by proper authority: Do

also agree to accept such bounty, pay, rations, and clothing, as are, or may be,

established by law for the U. S. colored troops.

And I, *William Sherrod*

do solemnly swear that I will bear true faith and allegiance to the **United States**

of America, and that I will serve them honestly and faithfully against all their

enemies or opposers whomsoever; and that I will observe and obey the orders

of the President of the United States, and the orders of the officers appointed

over me, according to the Rules and Articles of War.

Sworn and subscribed to, at *Camp Nelson*

this *8th* day of *Sept 1864* *William Sherrod*

Before *J. G. Randolph* *mark*

I CERTIFY, ON HONOR, That I have carefully examined the above named Volunteer agreeably to the General Regulations of the Army, and that, in my opinion, he is free from all bodily defects and mental infirmity, which would in any way disqualify him from performing the duties of a soldier.

P. G. Barrett
Asst Surg *7th Co*
EXAMINING SURGEON.

I CERTIFY, ON HONOR, That I have minutely inspected the Volunteer, *W. Sherrod* previously to his enlistment, and that he was entirely sober when enlisted; that, to the best of my judgment and belief, he is of lawful age; and that, in accepting him as duly qualified to perform the duties of an able-bodied soldier, I have strictly observed the regulations which govern the recruiting service. This soldier has *brn* eyes, *brn* hair, *brn* complexion, is *5.2* feet *2.5* inches high.

J. G. Randolph
and *S. P. M*
RECRUITING OFFICER OR AGENT.

Mustered into the United States Service *ninth* day of *September* 186*4*.

N. C. Whinery
Capt US Inf
Mustering Officer.

Mustered into the service of the United States, for three years or during the war, from date of enlistment, in Company *1st* Regiment of *Mounted Cavalry* Volunteers, on the *ninth* day of *September* 186*4*, at *Camp Nelson*

W. Sherrod
N. C. Whinery
Capt US Inf

MICROCOPY

1817

ROLL

72

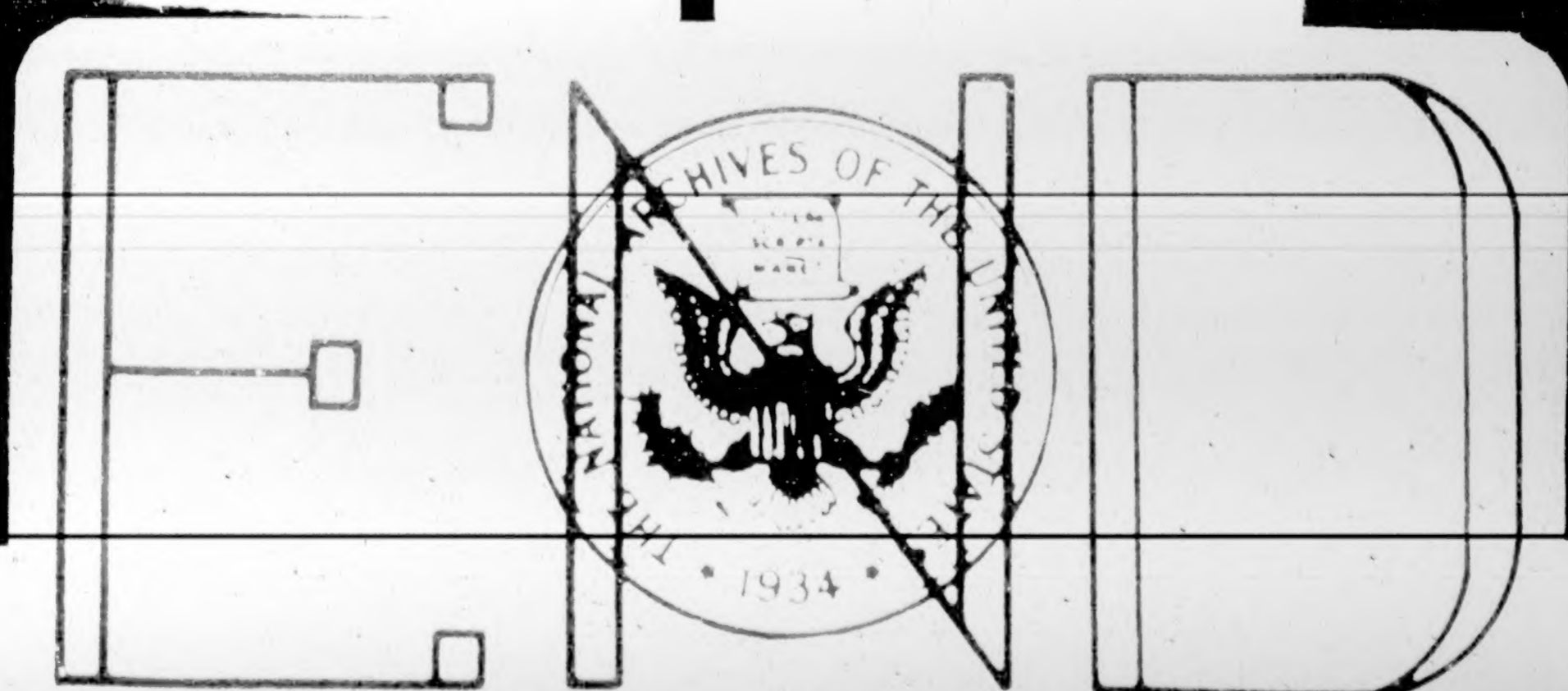
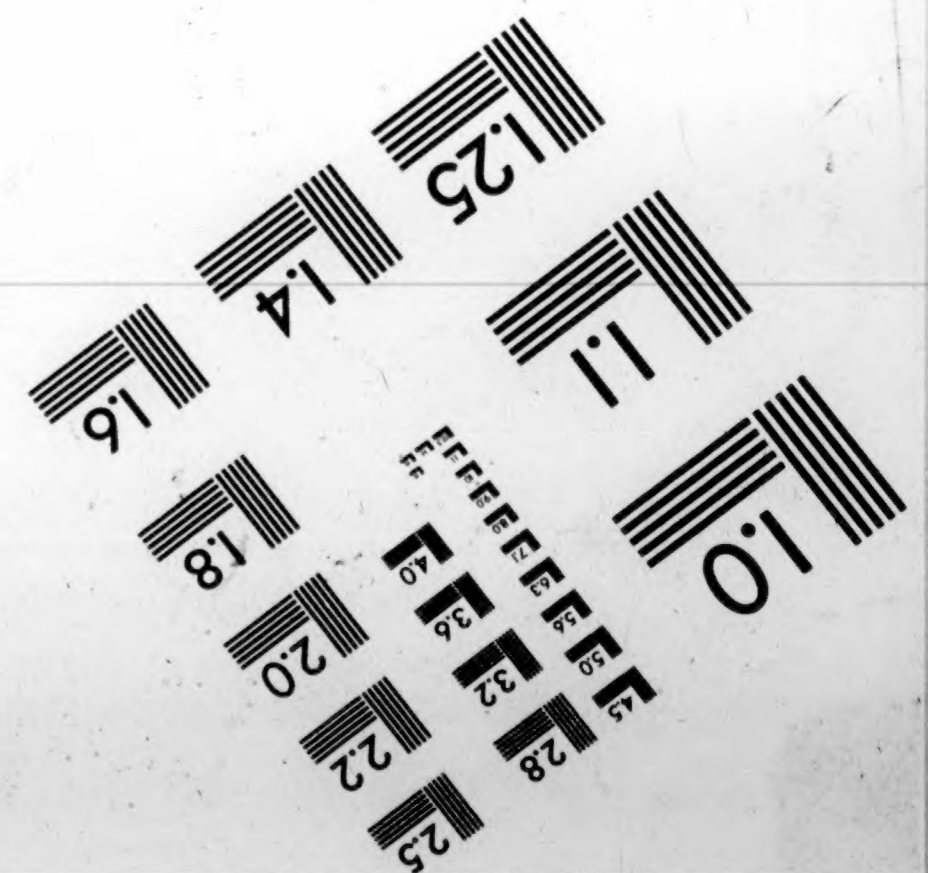
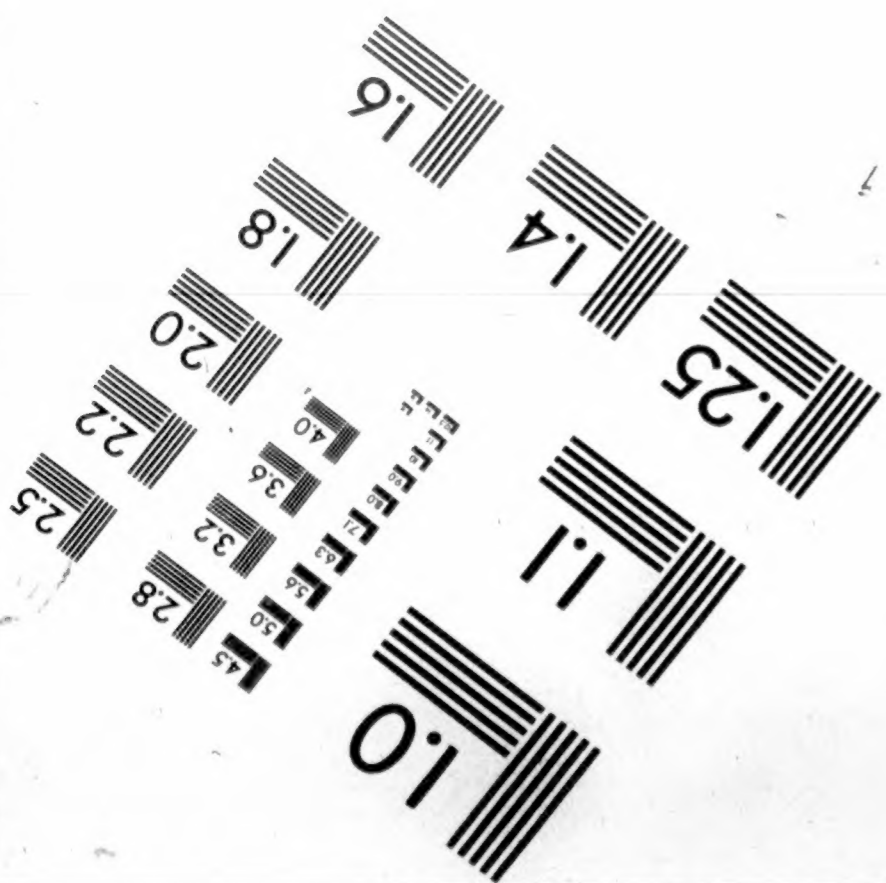
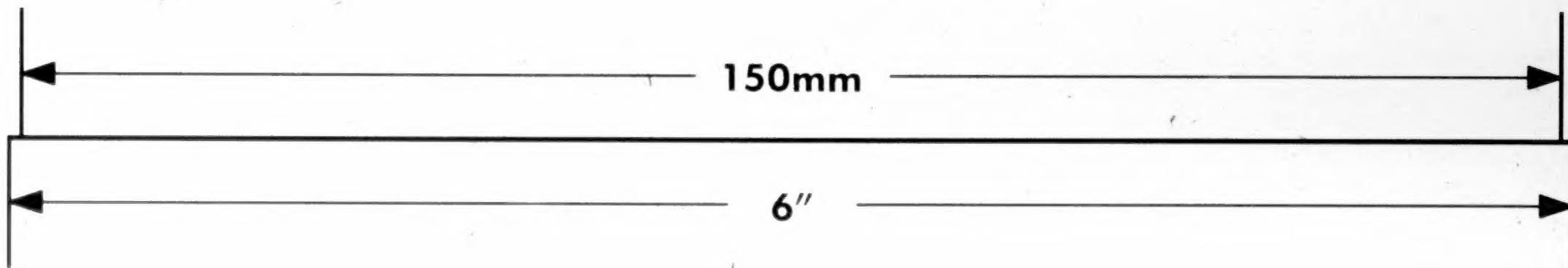
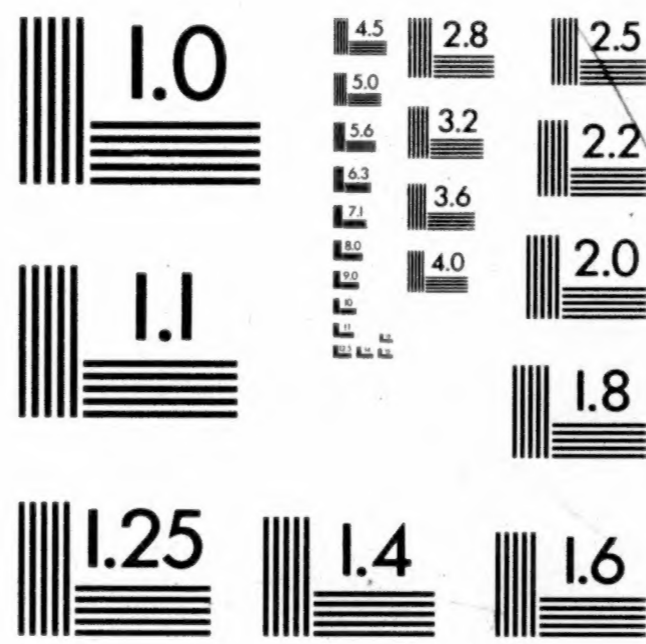
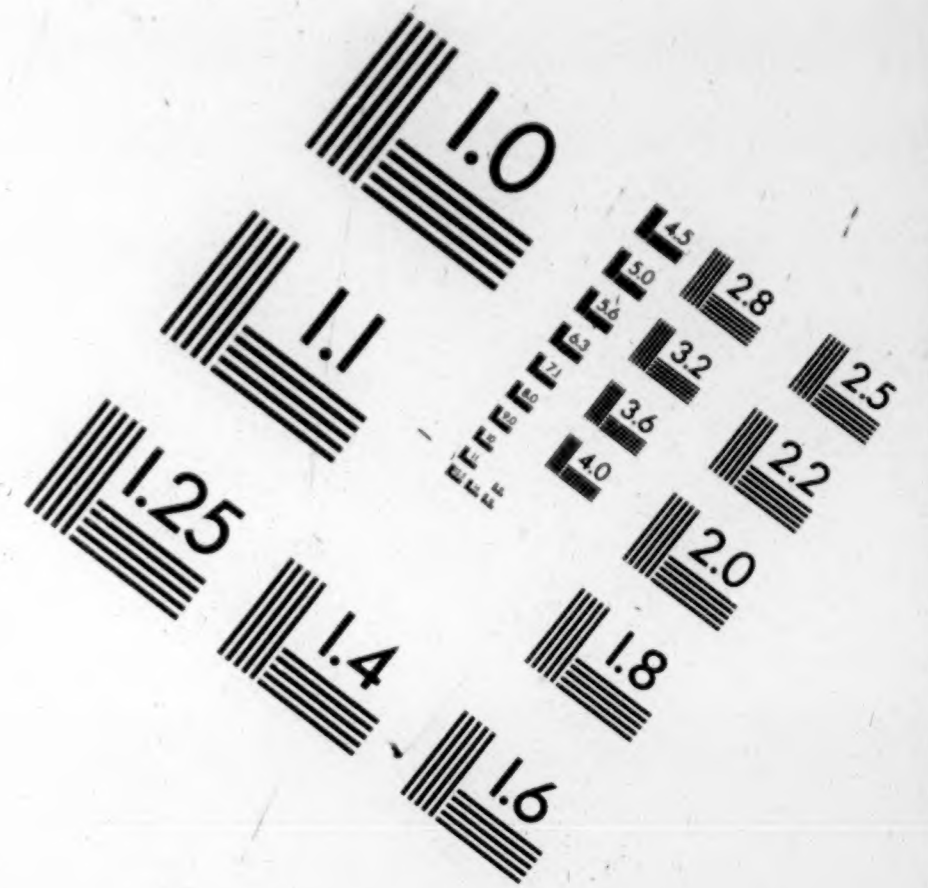
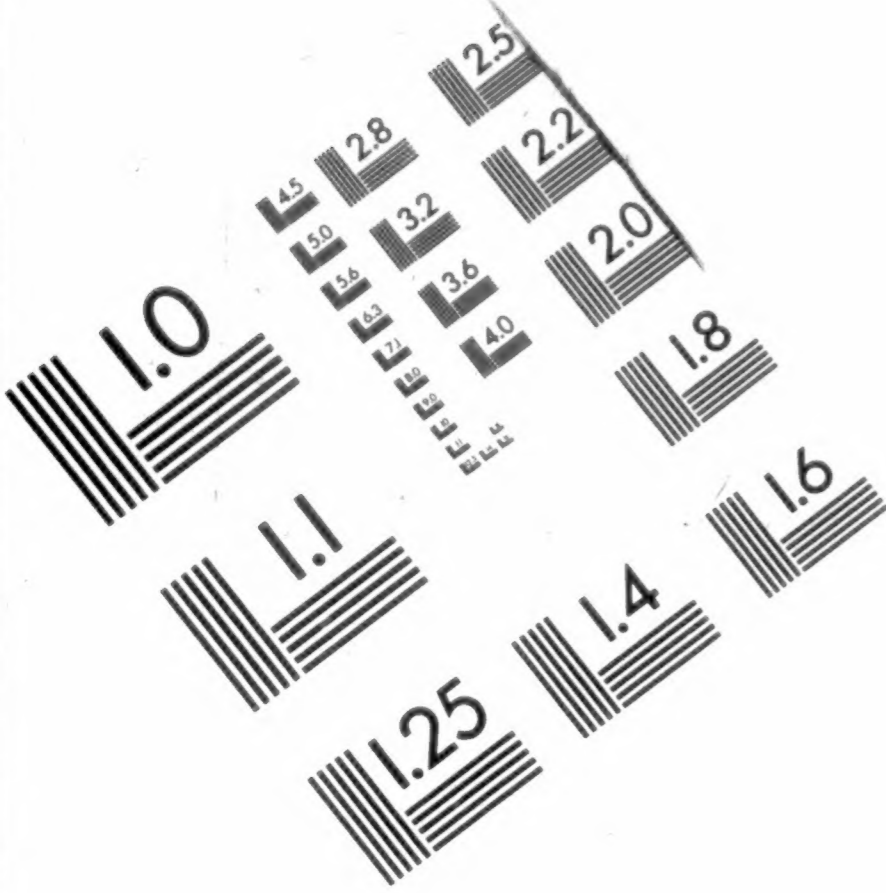

IMAGE EVALUATION TEST TARGET (QA-3)



APPLIED IMAGE, Inc
 1653 East Main Street
 Rochester, NY 14609 USA
 Phone: 716/482-0300
 Fax: 716/288-5989

© 1993, Applied Image, Inc., All Rights Reserved

THE END

PLEASE

REWIND

