

**NATIONAL
ARCHIVES
MICROFILM
PUBLICATION**

IMAGE EVALUATION TEST TARGET (QA-3)

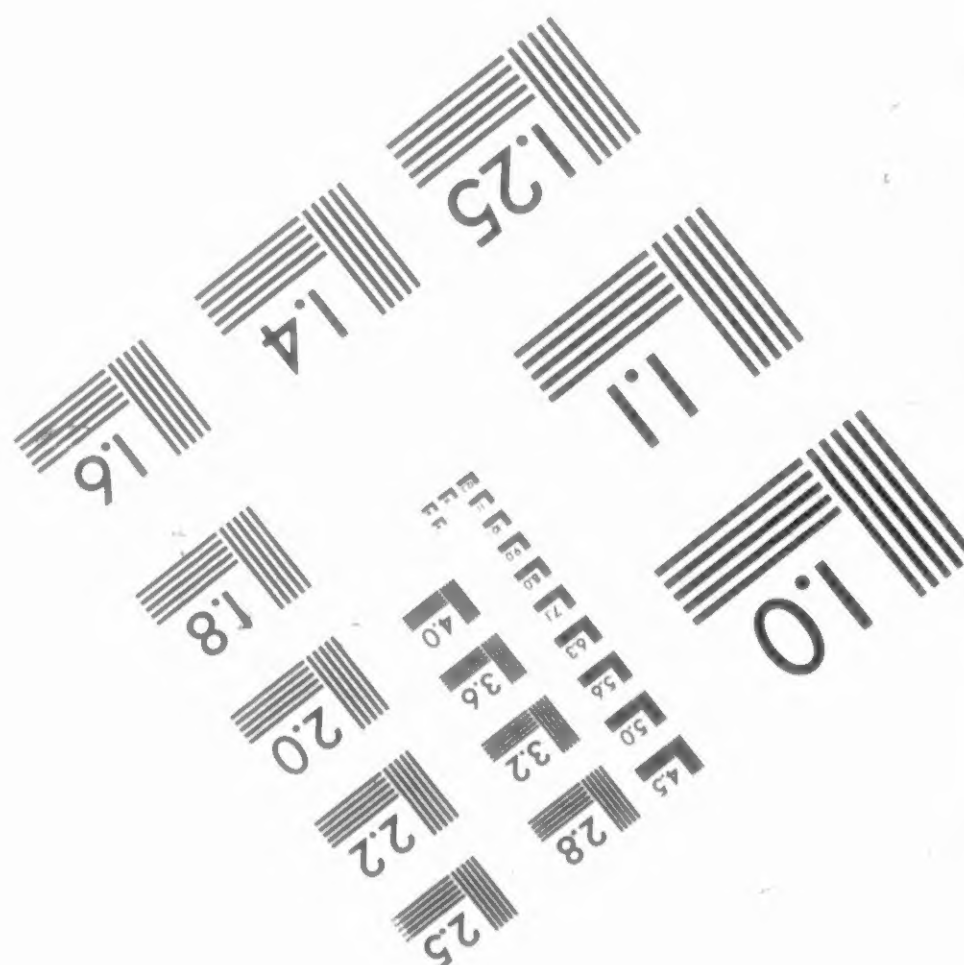
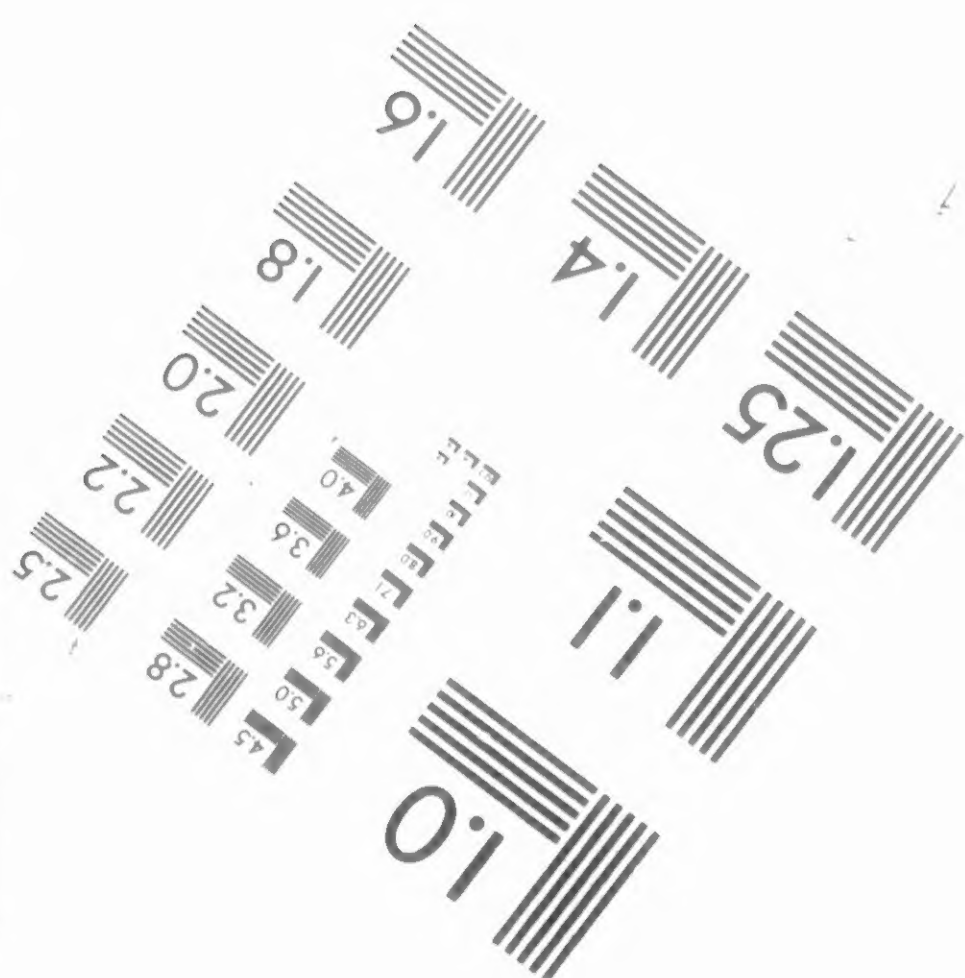
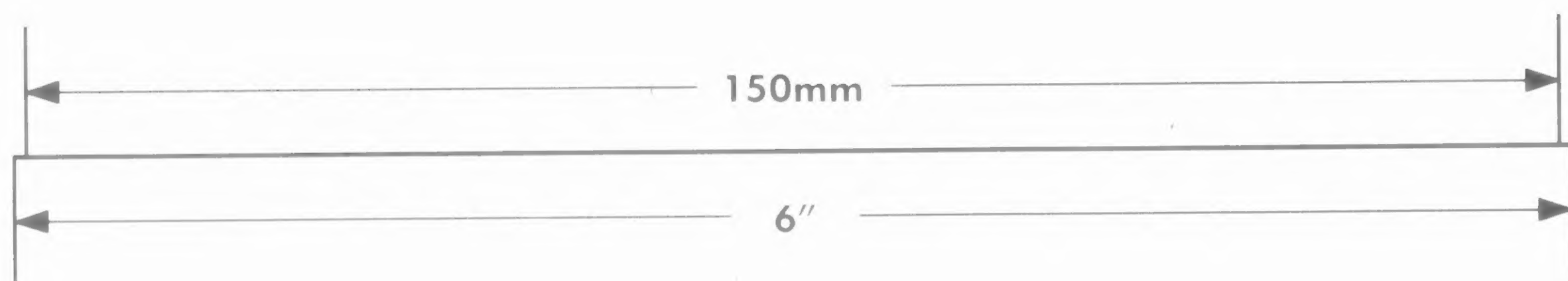
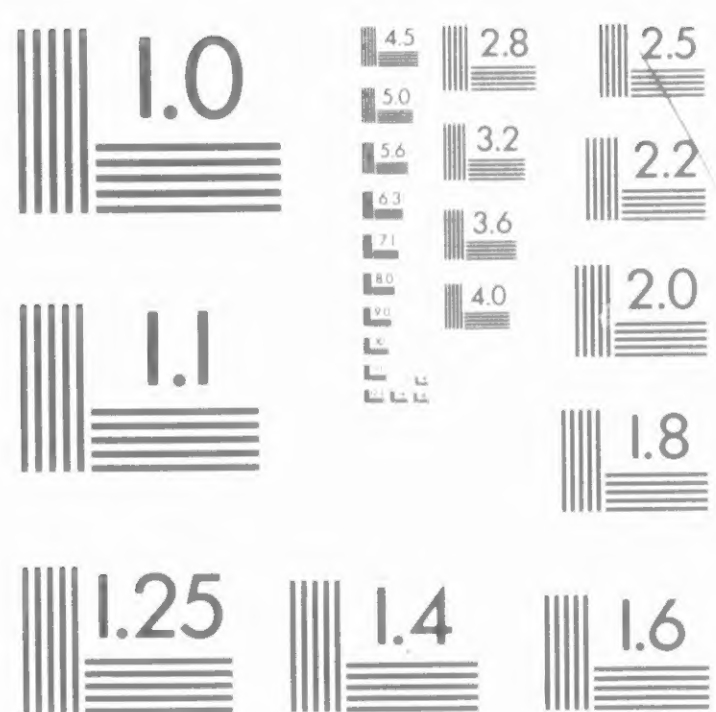
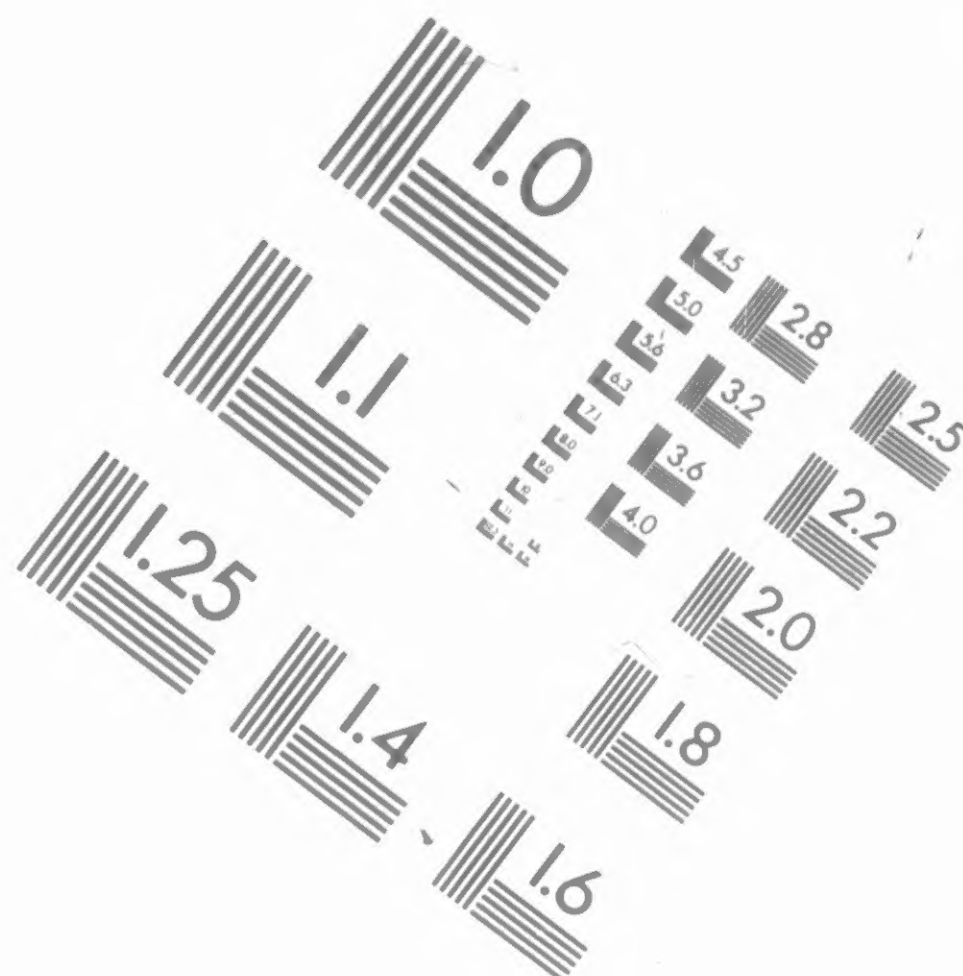
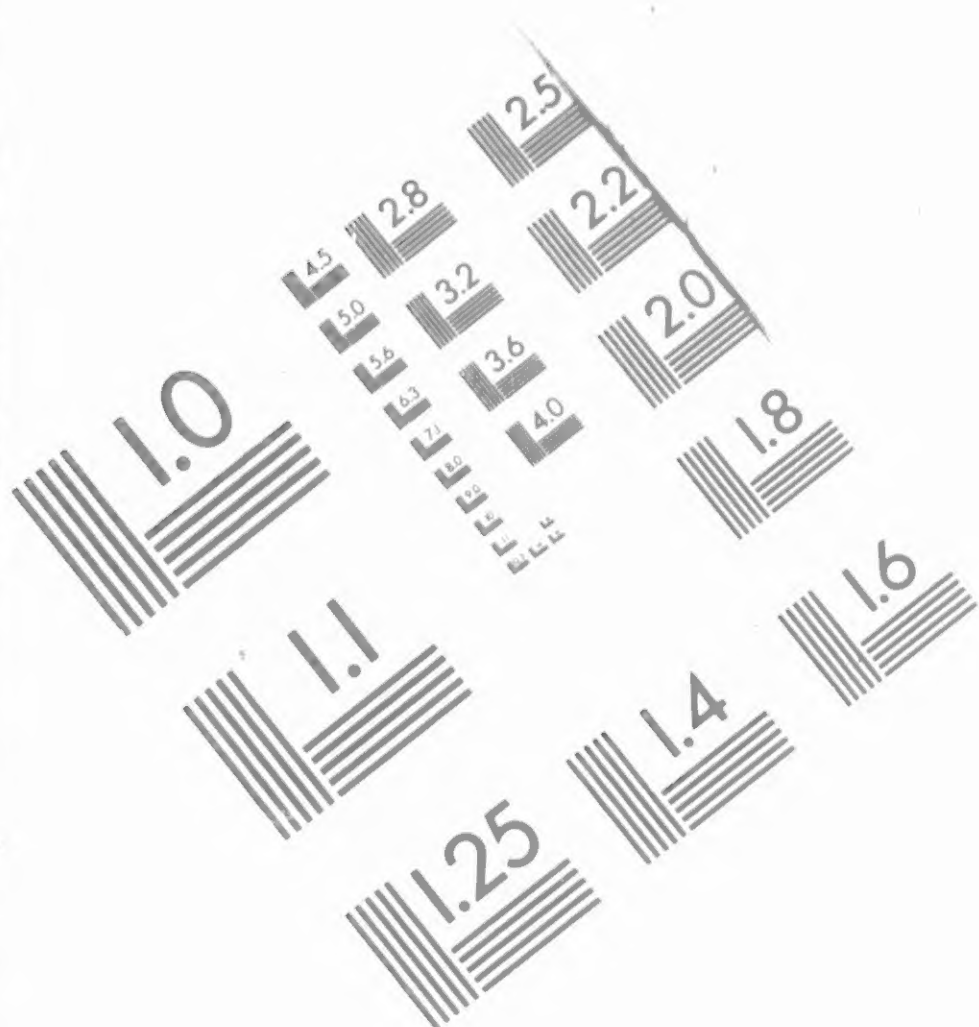

APPLIED IMAGE, Inc
1653 East Main Street
Rochester, NY 14609 USA
Phone: 716/482-0300
Fax: 716/288-5989

© 1993, Applied Image, Inc., All Rights Reserved

VW

National Archives at College Park



8601 Adelphi Road College Park MD 20740-6001

V WARE

OPERATOR

CAMERA

9-30-97

Z-4

DATE FILMED

REDUCTION RATIO

03510107

10X

FILM EMULSION NUMBER

M1817

81

PROJECT NUMBER

ROLL NUMBER

MICROCOPY

1

8

1

7

ROLL

8

1

NATIONAL ARCHIVES MICROFILM PUBLICATIONS

M1817

COMPILED MILITARY SERVICE RECORDS OF
VOLUNTEER UNION SOLDIERS WHO SERVED WITH THE
UNITED STATES COLORED TROOPS:
1st Through 5th United States Colored Cavalry
5th Massachusetts Cavalry (Colored)
6th United States Colored Cavalry

Introduction by Michael E. Pilgrim

Records prepared for microfilming by members of
the Civil War Conservation Corps

Budge Weidman, Project Director

Pat Alfredson	Naomi Glass	Dave Murray
Phyllis Altrogge	Sue Goward*	Ray Puzio
Kenneth Ashton	Bert Greenstein	Bill Schneider
Sue Barnard*	Anne Greenwood	Sylvia Scott
Dee Benson	Jim Harris	Lynn Shearouse
Ann N. Brown	Walter Hayden	Mary Stack-Dunne
Robert Budway	Mary Hayden	Ben Stearns
MaryAnn Castellana*	Pat Ikonen	Bill Stormer*
Mary Lou Cole	Dick Ives	Pat Sullivan
Marjory Cooper	Sarah Jaffe	Gorman Tidball*
Giovanni Croce	Barbara Kemp	Cathy Tinston
B. H. Custer	Bev Manypenny	John Toole
Bob Denney	Frank Masterson	Maryellen Toole
Richard Dow	Joe Mazur	Milt Weatherhead
Yvette Fallin	Sarah McDougall	C. Lois Young
	Ben Miles	

Team leaders are indicated by the asterisk.

National Archives and Records Administration
1997

NATIONAL ARCHIVES MICROFILM PUBLICATIONS

INTRODUCTION

On the 107 rolls of this microfilm publication, M1817, are reproduced the compiled military service records of volunteer Union soldiers belonging to the 1st through 5th United States Colored Cavalry, the 5th Massachusetts Cavalry (Colored), and the 6th United States Colored Cavalry. While the 5th Massachusetts did retain its state designation, these units were all part of the United States Colored Troops (USCT). The USCT included 7 numbered cavalry regiments; 14 numbered artillery regiments; 144 numbered infantry regiments; plus Brigade Bands Nos. 1 & 2 (Corps d'Afrique and US Colored Troops); Powell's Regiment Colored Infantry; Southard's Company Colored Infantry; Quartermaster Detachment; Pioneer Corps, 1st Division, 16th Army Corps; Unassigned Company A Colored Infantry and Unassigned USCT. The records reproduced are part of the Records of the Adjutant General's Office, 1780's-1917, Record Group (RG) 94.

Background

United States Colored Troops

Since the time of the American Revolution, African Americans have volunteered to serve their country in time of war. The Civil War was no exception. Official sanction was the difficulty. In the fall of 1862 there were four Union regiments of African Americans raised in New Orleans, LA: the 1st, 2d, and 3d Louisiana Native Guard, and the 1st Louisiana Heavy Artillery (African Descent). The 1st South Carolina Infantry (African Descent) was not officially organized until January 1863; however, three companies of the regiment were on coastal expeditions as early as November 1862. Similarly, the 1st Kansas Colored Infantry was not mustered into Federal service until January 1863, even though the regiment had already participated in the action at Island Mound, MO, on October 27, 1862. These early unofficial regiments received little Federal support, but they showed the strength of the African American soldier's desire to fight for freedom.

The first official authorization to employ African Americans in Federal service was the Second Confiscation and Militia Act of July 17, 1862. This act allowed President Abraham Lincoln to receive into the military or naval service persons of African descent and gave him permission to use them for any purpose "he may judge best for the public welfare." However, the President did not authorize use of African Americans until issuance of the Emancipation Proclamation on January 1, 1863.

In late January 1863, Gov. John Andrew of Massachusetts received permission to raise a regiment of African American soldiers. The pace of organizing additional regiments was very slow. In March Secretary of War Edwin M. Stanton sent Gen. Lorenzo Thomas to the lower Mississippi Valley to recruit

free and contraband African Americans. Thomas was given broad authority. He was to explain the administration's policy regarding African American soldiers and recruit volunteers to raise and command them. Stanton wanted all officers of such units to be white, but that policy was softened to allow African American surgeons and chaplains. By the end of the war, in addition to the chaplains and surgeons, there were some 87 African-American officers. Thomas's endeavor was very successful, and on May 22, 1863, the Bureau of Colored Troops was established to coordinate and organize regiments from all parts of the country. Created under War Department General Order No. 143, the bureau was responsible for handling "all matters relating to the organization of Colored Troops." The bureau was directly under the Adjutant General's Office and its procedures and rules were specific and strict. All African American regiments were now to be designated United States Colored Troops (USCT). At this time there were some African American regiments with state names and a few regiments in the Department of the Gulf designated as Corps d'Afrique. All these were ultimately assimilated into the USCT, even though some of the regiments, such as the 5th Massachusetts, retained their state designations.

To facilitate recruiting in the states of Maryland, Missouri, Tennessee, and eventually Kentucky, the War Department issued General Order No. 329 on October 3, 1863. Section 6 of the order stated that if any citizen should offer his or her slave for enlistment into the military service, that person would, "if such slave be accepted, receive from the recruiting officer a certificate thereof, and become entitled to compensation for the service or labor of said slave, not exceeding the sum of three hundred dollars, upon filing a valid deed of manumission and of release, and making satisfactory proof of title." For this reason, some records of manumission are contained in the compiled service records reproduced in this publication.

The USCT fought in 39 major engagements and over 400 lesser ones. Sixteen African American soldiers received Medals of Honor. As it was in other units, the death toll from disease was very high in the USCT. Deaths from disease and battle totaled 37,000. The last regiment of the USCT was mustered out of Federal service in December 1867.

Important sources for information about African American units in the Civil War are the War Department's *The War of the Rebellion: A Compilation of the Official Records of the Union and Confederate Armies* (Washington, DC: 1880-1901; reprinted Harrisburg, 1971 and 1985) and the Navy Department's *The War of the Rebellion; A Compilation of the Official Records of the Union and Confederate Navies* (Washington, DC: 1874-1922; reprinted Harrisburg, 1971 and 1985). These multivolume works contains reports of operations and other official correspondence.

1st United States Colored Cavalry

This regiment was organized at Camp Hamilton, VA, on December 22, 1863, and assigned to duty in the Department of Virginia and North Carolina. The 1st participated in Gen. Benjamin F. Butler's operations on the south side of the James River and against Petersburg and Richmond, May 4-28, 1864. These included the capture of Bermuda Hundred and City Point, VA, on May 5, and events leading up to and including the siege of Petersburg. In August 1864 it was transferred to the defenses of Portsmouth, District of Eastern Virginia. On June 10, 1865, the 1st sailed from City Point, VA, to Texas where it was assigned duty on the Rio Grande and various other areas of the state. The unit was mustered out on February 4, 1866. Compiled casualty figures are not available.

2d United States Colored Cavalry

This regiment was organized at Fort Monroe, VA, on December 22, 1863, and assigned to duty in the Department of Virginia and North Carolina. The 2d participated in Gen. Benjamin F. Butler's operations on the south side of the James River and against Petersburg and Richmond, May 4-28, 1864. These included the capture of Bermuda Hundred and City Point, VA, on May 5, and events leading up to and including the siege of Petersburg. In February 1865 it was transferred to Norfolk, District of Eastern Virginia. On June 10, 1865, the 2d sailed from City Point, VA, to Texas where it was assigned duty on the Rio Grande and various other areas of the state. The unit was mustered out on February 12, 1866. Losses included 19 killed in action and 161 dead from disease and other causes.

3d United States Colored Cavalry

Organized at Vicksburg, MS, on October 9, 1863, as the 1st Mississippi Cavalry (African Descent), this regiment was redesignated the 3d U.S. Colored Cavalry on March 11, 1864. From its organization until March 1864, the unit was attached to the District of Northeast Louisiana and from January to March 1864 participated in operations up the Yazoo River and the occupation of Yazoo City. The regiment was then transferred to the District of Vicksburg, Department of Tennessee, where it remained until December 1864. That month the unit moved to Memphis, TN, and from December 21, 1864, to January 5, 1865, participated in Gen. Benjamin Grierson's raid to destroy the Mobile & Ohio Railroad. The 3d remained on duty in Memphis and the District of West Tennessee and took part in the expedition from Memphis to Brownsville, MS, April 23-26, 1865. On April 29 the regiment returned to Vicksburg and operated around Natchez in search of fugitive Confederate President Jefferson Davis. The unit remained in the District of West Tennessee and Department of Mississippi until January 26, 1866, when it was mustered out. Losses included 37 killed in action and 367 dead from disease and other causes.

4th United States Colored Cavalry

Organized on September 12, 1863, as the 1st Corps d'Afrique Cavalry, this regiment was redesignated the 4th United States Colored Cavalry on April 4, 1864. From its organization until August 1864, it was attached to the Defenses of New Orleans, Department of the Gulf. On August 8, 1864, the 4th was ordered to Baton Rouge, LA, District of Port Hudson, and remained on duty at that post until July 1865 when it was transferred to the Department of Mississippi. It performed duties at various points in that department until it was mustered out on March 20, 1866. Compiled casualty figures are not available.

5th United States Colored Cavalry

This regiment was organized at Camp Nelson, KY, on October 24, 1864, and attached to the 1st Division, District of Kentucky, Department of Ohio. December 10-29, 1864, it participated in Stoneman's Raid into southwestern Virginia, including the capture of Saltville and the destruction of saltworks on December 20-21. In February 1865 the regiment was transferred to the Military District and Department of Kentucky until December of that year when it was ordered to the Department of Arkansas. During the latter period the unit performed mostly garrison duty. The regiment was mustered out March 20, 1866. Losses included 35 killed in action and 152 dead from disease and other causes.

5th Massachusetts Cavalry (Colored)

This regiment was organized at Camp Meigs, Reedville, MA, in the spring of 1864, and sent to Washington, DC, in May of that year. On May 13 the regiment moved to City Point, VA, where it was attached to the 18th Army Corps. Until June 16 it functioned as an infantry unit and participated in the siege of Petersburg. On June 30 it was moved to Point Lookout, MD, to guard prisoners of war. In July 1864 the regiment, still at Point Lookout, became part of the 22d Army Corps. It was transferred to the 25th Army Corps in March 1865 and ordered to the field near Richmond and Petersburg. In June the regiment was ordered to the Department of Texas where it was assigned duty at Clarksville until October 31, 1865, when it was mustered out. Losses included 7 men killed in action and 116 dead from disease and other causes.

6th United States Colored Cavalry

This regiment was organized at Camp Nelson, KY, on October 24, 1864, and attached to the 1st Division, District of Kentucky, Department of Ohio. December 10-29, 1864, it participated in Stoneman's Raid, including the destruction of the lead mines in southwestern Virginia. At the end of December the regiment returned to Camp Nelson and in February 1865 was transferred to the Military District and Department of Kentucky. It remained there until December

1865 when it was ordered to the Department of Arkansas. The unit was mustered out on April 15, 1866. Compiled casualty figures are not available.

Records Description

Compiled service records consist of a jacket-envelope for each soldier, labeled with his name, rank, unit, and card numbers. The compilation of service records of Union soldiers began in 1890 under the direction of Col. Fred C. Ainsworth, head of the Record and Pension Office of the Adjutant General's Office, Department of War. Information from muster rolls, regimental returns, descriptive books, and other records was copied verbatim onto cards. A separate card was prepared each time an individual name appeared on a document. These cards were numbered on the back, and these numbers were entered onto the outside jacket containing the cards. The carded information was verified by a separated operation of comparison; great care was taken to ensure that the cards were accurate.

A typical jacket contains card abstracts of entries found in original records relating to the soldier and original documents relating solely to that soldier. Examples of the latter include enlistment papers, substitute certificates, casualty sheets, death reports, prisoner-of-war memorandums, and correspondence. Unique to the records of the USCT are deeds of manumission, oaths of allegiance, proof of ownership, certificates of monetary award, and bills of sale. These items appear most frequently in units recruited in the border states of Kentucky, Missouri, and Maryland. These states remained in the Union but were slave states. Jackets and cards include a section labeled "bookmark" which was reserved for cross-references to other records relating to the individual or his unit. The service records are arranged by arm of service, thereunder numerically by regiment or independent battalion or company and thereunder alphabetically by name of the soldier. Records for officers are interfiled alphabetically by name with the records of enlisted men. If an individual served in more than one unit, which was typical for USCT officers, there will be a separate service record for each unit in which he served.

Related Records

Among the records of the Adjutant General's Office in the National Archives are many of the original records that were abstracted or "carded" by the Record and Pension Office. These include the individual unit's muster rolls, returns and descriptive books. Other series in RG 94 that contain information relating to volunteer Union soldiers who served with the USCT include carded records relating to Union staff officers, carded medical records of volunteer Union soldiers, unbound and bound regimental records and "record of events" cards. The regimental records of the 54th Massachusetts Infantry (Colored) have been

NATIONAL ARCHIVES MICROFILM PUBLICATIONS

reproduced as Microfilm Publication M1659, *Records of the Fifty-fourth Massachusetts Infantry Regiment (Colored), 1863-1865*.

The "record of events" cards include information copied from the unit's muster rolls and returns. They show the stations of the field and staff and those of the various companies of the regiment at the time the muster roll or return was prepared and sometimes mention battles, skirmishes, or other activities in which the regiment participated. The cards have been reproduced as Microfilm Publication M594 *Compiled Records Showing Service of Military Units in Volunteer Union Organizations*.

Record Group 94 also includes a card index for the USCT, reproduced as Microfilm Publication M589, *Index to Compiled Military Service Records of Volunteer Union Soldiers Who Served with U.S. Colored Troops*, which may be used to locate the regiment of USCT personnel. An index card gives the name of the soldier and his rank, as well as the unit in which he served; sometimes there is a cross-reference to his service in other units or organizations. The National Archives is continually producing microfilm publications of volunteer Union compiled military service records. A complete listing of finished publications can be found in the National Archives' *Microfilm Resources for Research: A Comprehensive Catalog* which is available online at <http://www.nara.gov>.

The Records of the Colored Troops Division, within RG 94, include division correspondence and records relating to recruiting, the appointment of officers, and the slave or free status of individuals; and a compilation of historical extracts and official papers concerning the military service of African Americans from the colonial period through the Civil War entitled *The Negro in the Military Service of the United States 1639-1886*. This compilation is reproduced as Microfilm Publication M858. The Records of the Bounty and Claims Division, also in RG 94, include correspondence of the division and records relating to bounties and claims paid to loyal owners of slaves by the Slave Claims Commissions of Delaware, Kentucky, Maryland, Missouri, Tennessee and West Virginia.

If an application for a pension was made, the pension application case file may be among the Records of the Veterans Administration (RG 15). Indexes to the pension applications have been reproduced as Microfilm Publication T288, *General Index to Pension Files, 1861-1934*, and T289, *Organizational Index to Pension Files of Veterans Who Served Between 1861 and 1900*.

If a soldier or officer was tried before a general court-martial or if an individual or his unit was the subject of a court of inquiry or military commission, transcripts of the proceedings may be among the Records of the Office of the Judge Advocate General (Army) (RG 153). The registers to the proceedings have been reproduced as Microfilm Publication M1105, *Registers of the Records of the Proceedings of the U.S. Army General Courts-Martial, 1809-1890*.

NATIONAL ARCHIVES MICROFILM PUBLICATIONS

Other record groups having information pertaining to the USCT include Records of the Bureau of Refugees, Freedmen, and Abandoned Lands (RG 105); Records of the Provost Marshal General's Bureau (Civil War) (RG 110); Records of the Accounting Officers of the Department of the Treasury (RG 217); and Records of U.S. Army Continental Commands, 1821-1920 (RG 393).

ROLL LIST

Roll Description

1st United States Colored Cavalry

- 1 Akess, Alexander - Bom, John H.
- 2 Bomer, James - Cartwright, John
- 3 Casey, Thomas - Davenport, John J.
- 4 Davis, Augustus - Floyd, George
- 5 Fly, Benjamin - Griffin, Oliver
- 6 Griffin, Quinton - Holstead, Peter
- 7 Holt, George - Jones, Herbert
- 8 Jones, Howell - Macoy, Peter
- 9 Madry, Andrew - Mosley, Jacob
- 10 Moss, James - Polk, James
- 11 Pollard, Sipio - Sales, William
- 12 Sample, Abram (Abraham) - Smith, Ives
- 13 Smith, James - Times, Nelson
- 14 Tines, Archer - Wheldon, Charles M.
- 15 Whitby, Joseph - Wilson, Isaac
- 16 Wilson, James - Zoe (no first name)

2d United States Colored Cavalry

- 17 Abbot, John - Bell, Charles
- 18 Bell, Henry - Burns, Richard
- 19 Burroughs, George L. - Cotton, Samuel
- 20 Coues, Alexander - Duncan, Levi
- 21 Dunkins, Ezekiah James - Gardner, Richard
- 22 Garris, Henry - Harrison, Thomas
- 23 Harrison, William - Humphries, David
- 24 Hunter, Francis - Jones, Robert
- 25 Jones, Robert F. - Martin, Robert (Martin)
- 26 Martin, Thaddeus or Martin, Thaddeus W. - Osborne, Henry S.
- 27 Oulden, Jacob - Prior, Edward or Edmund
- 28 Proctor, David - Sawyer, Wilson
- 29 Scabber, Charles - Stanley, William
- 30 Stanley, Wright or Right - Upshear, Neverson
- 31 Upshear, Samuel - Whites, Joe
- 32 Whites, Silas - Zodrick, Isaiah A. or Isaiah

3d United States Colored Cavalry

- 33 Aaron, John - Black, David
- 34 Black, Richard - Cameron, Wyatt

NATIONAL ARCHIVES MICROFILM PUBLICATIONS

Roll	Description
35	Cammel, Austin - Cooper, Stephen
36	Coran, Joseph - Erving, Tilson
37	Erwin, Anderson - Gool, George
38	Gordon, Alfred - Haskins, Jasper
39	Hawkins, Frank - Jackson, Harvey
40	Jackson, Henry - Kembro, Abraham
41	Kenedy, Lemuel - Lott, Judge
42	Lott, Matton - Mitchell, Berry
43	Mitchell, George - Pettis, Edmond
44	Pettis, George - Roberson, Jefferson
45	Roberson, Wallace - Simpson, Levi
46	Sims, Anderson - Taylor, Phillip
47	Taylor, Richard - Washington, Isaac
48	Washington, Oscar - Williams, Mitchel
49	Williams, Moses - Young, Mathew

4th United States Colored Cavalry

50	Abraham, Randall - Blanchan, William
51	Blanchard, Moses - Clark, Moses
52	Clark, Theodore - Ellars, James
53	Ellars, John - Heath, Culbert
54	Henderson, George - Johnson, Henderson
55	Johnson, Henry - Mayberry, Nelson
56	Macomory, John - Oliver, Celestine
57	Olsten, Alexander - Robinson, William
58	Robinson, William E. - Thomas, Stephen
59	Thomas, William - Williams, Horace
60	Williams, Isaac - Zulia, Francois

5th United States Colored Cavalry

61	Abel, Fletcher - Biggs, Randall
62	Birch, Benjamin - Burly, Frank
63	Burly, James - Coffman, James D.
64	Coke, Samuel - Dudley, John
65	Duke, John - Givens, Peter
66	Glen, John - Harriden, Edmund
67	Harrigan, Harden - Hughes, Thomas
68	Hulse, James - Keller, Ephraim
69	Kelley, Franklin - Matthews, Benjamin
70	Maupin, Preston - Murry, Ned
71	Murtney, Morton - Ray, John
72	Ray, Thomas - Sherrod, William

NATIONAL ARCHIVES MICROFILM PUBLICATIONS

Roll **Description**

- 73 Shrewsbury, Joseph - Stone, John
- 74 Stone, Lewis - Trye, Benjamin
- 75 Trueheart, Samuel - Williams, James
- 76 Williams, Jerry - Yowell, Joseph

5th Massachusetts Cavalry (Colored)

- 77 Abbey, David - Biers, William
- 78 Billings, Jeremiah - Burgess, Williams
- 79 Burnett, Lewis - Cook, Joseph T.
- 80 Cooper, Isaac - Dunmore, William
- 81 Durbin, Stephen - Furman, Seneca A.
- 82 Gadson, James - Gurley, Joseph L.
- 83 Guy, James - Hill, John W.
- 84 Hill, Richard - Johns, Thomas H.
- 85 Johnson, Aaron - Lambert, William
- 86 Lancaster, James - Mason, John
- 87 Mason, John H. - Nelson, Philip
- 88 Nelson, Preston - Preston, Thomas
- 89 Price, Adam - Sampson, George P.
- 90 Sanborn, Madison - Stringer, William
- 91 Strother, Frank - Vance, William H.
- 92 Van Hoesen, Charles - Wilkinson, Simon
- 93 Williams, Abram H. - Young, Thomas

6th United States Colored Cavalry

- 94 Abbot, John - Birch, James
- 95 Bivins, Gabriel - Buckner, George
- 96 Buckner, Henderson - Compton, James
- 97 Cook, Benjamin - Ellis, William
- 98 Ellis, Wyatt - Godley, Isaac
- 99 Gooch, Alexander - Herston, Abraham
- 100 Heywood, John R. - Johnson, Jackson
- 101 Johnson, James M. - Marshall, Lyman
- 102 Marshall, William - Neihardt, Isaac D.
- 103 Nelson, Joseph - Redd, Tiney
- 104 Redway, Hamilton K. - Sebree, Bob Woodcock
- 105 Sebree, Crittenden - Sumpter, John
- 106 Sutherland, Williams - Washington, Charles
- 107 Washington, George - Wren (no first name)

NATIONAL ARCHIVES MICROFILM PUBLICATIONS

Microfilm Publication M1817

COMPILED MILITARY SERVICE RECORDS OF VOLUNTEER UNION
SOLDIERS WHO SERVED WITH THE UNITED STATES COLORED
TROOPS: 1st Through 5th United States Colored Cavalry, 5th Massachusetts
Cavalry (Colored), 6th United States Colored Cavalry

Roll 81

5th Massachusetts Cavalry (Colored)

Durbin, Stephen - Furman, Seneca A

NATIONAL ARCHIVES AND RECORDS ADMINISTRATION

270
Durbin, Stephen

Co M, 5 Mass. Cav., (Col'd.)

Private

Private

CARD NUMBERS.

1 5385920
2 5386015
3 5386101
4 5386189
5 5386295
6 5386398
7 5386503
8 5386602
9 5386708
10 5372805
11 5386795
12 4091361
13 4075082
14
15
16
17
18
19
20
21
22
23
24
25

26
27
28
29
30
31
32
33
34
35
36
37
38
39
40
41
42
43
44
45
46
47
48
49
50

Book Mark:

See also



5 Cav. (Col'd.) Mass.

Stephen C. Gardner

, Coz. 4, 5 Reg't Mass. Cav. (Col'd.)

Appears on

Company Descriptive Book

of the organization named above.

DESCRIPTION.

Age *32* years; height *5* feet *3* inches.

Complexion *ruddy*.

Eyes *blue*; hair *black*.

Where born *Wilmington, N. H.*

Occupation *farmer*.

ENLISTMENT.

When *Sept. 1, 1864*.

Where *W. H. Co.*

By whom *W. H. Co.*; term *3* y'rs.

Remarks: *Admitted to membership by
Genl. G. W. Holden, Burlington, N. H.*

W. H. Co. 5th Reg't Mass. Cav. (Col'd.)

A | **5 Col'd Cav.** | **Mass.**

Stephen Durbin
Co. M, 5 Reg't Mass. Col'd Cav.

Appears on

Company Muster-in and Descriptive Roll
of the organization named above. Roll dated
Readville Mass, May 5, 1864.

Where born *Williamspoint Va.*

Age *34* y'rs; occupation *Farmer*

When enlisted *Apr. 30*, 1864.

Where enlisted *Upton Mass*

For what period enlisted *3* years.

Eyes *Blk*; hair *Blk*

Complexion *Blk*; height *5* ft. *8* in.

When mustered in *May 5*, 1864.

Where mustered in *Readville*

Prize money
Bounty paid \$ *2* 100; due \$ *1* 100

Where credited

Company to which assigned

Remarks: *Cred to town of Upton*
Mass. Co. S. Cong. Dist. Mass

Book mark:

Amey

1864

Co. Mst.

A

5 Col'd Cav.

Mass.

Stephen Quartin

Co. M, 5 Reg't Mass. Colored Cavalry.

Appears on

Company Muster Roll

for May 3 to June 30, 1864.

Present or absent. Present

Stoppage, \$ 100 for

Due Gov't, \$ 100 for

Valuation of horse, \$ 100

Valuation of horse equipments, \$ 100

Remarks: # 1 Hospital City
sick to sick

2 shown on Roll.

Book mark:

Quartin

Copyed.

20

5 Col'd Cav. Mass.

Stephen Quirin

Pvt, Co. M, 5 Reg't Mass. Colored Cavalry.

Appears on

Company Muster Roll

for July & Aug., 1864.

Present or absent Present

Stoppage, \$ 100 for

Due Gov't, \$ 100 for

Valuation of horse, \$ 100

Valuation of horse equipments, \$ 100

Remarks:

Book mark:

Army

(358)

(copy)

D | **5 Col'd Cav.** | **Mass.**

Stephen Durbin
Pvt., Co. M, 5 Reg't Mass. Colored Cavalry.

Appears on

Company Muster Roll

for *Sept. & Oct.*, 186*4*.

Present or absent *Present*

Stoppage, \$ 100 for

Due Gov't, \$ 100 for

Valuation of horse, \$ 100

Valuation of horse equipments, \$ 100

Remarks:

Book mark:

C. Williams

(358)

(copied)

Stephen Turbin

Priv, Co. M, 5 Reg't Mass. Colored Cavalry.

Appears on

Company Muster Roll

for *Nov & Dec*, 1864

Present or absent *Present*

Stoppage, \$ 100 for

Due Gov't, \$ 100 for

Valuation of horse, \$ 100

Valuation of horse equipments, \$ 100

Remarks:

Book mark: -----

S. Williams

(378)

Copyist.

21

5 Col'd Cav.

Mass.

Stephen Durbin
Priv., Co. M, 5 Reg't Mass. Colored Cavalry.

Appears on

Company Muster Roll

for *Jan'y & Feb'y*, 1865.

Present or absent *Present.*

Stoppage, \$ 100 for

Due Gov't, \$ 100 for

Valuation of horse, \$ 100

Valuation of horse equipments, \$ 100

Remarks: *Daily duty Com-
pany tailor.*

Book mark:

S. Williams,
Copied.

21

5 Col'd Cav.

Mass.

Stephen Durbin

Priv., Co. M, 5 Reg't Mass. Colored Cavalry.

Appears on

Company Muster Roll

for *March & Apr*, 1865.

Present or absent *Present.*

Stoppage, \$ *100* for

Due Gov't, \$ *6*^{*50*} *100* for *transportation*

Valuation of horse, \$ *100*

Valuation of horse equipments, \$ *100*

Remarks:

Book mark:

C. Williams,

(358)

Copyist.

21

5 Col'd Cav.

Mass.

Stephen Durbin

Priv., Co. M, 5 Reg't Mass. Colored Cavalry.

Appears on

Company Muster Roll

for *May + June*, 1865.

Present or absent *Absent*

Stoppage, \$ *100* for

Due Gov't, \$ *100* for

Valuation of horse, \$ *100*

Valuation of horse equipments, \$ *100*

Remarks: *Detached service*

25 Army Corps Hd Qr.

S.O. 88 May 12, '65

See U.S. for transportation 6.52

Book mark:

C. Williams

(358)

Copyist.

D

5 Col'd Cav.

Mass.

Stephen Durbin

Pr., Co. M, 5 Reg't Mass. Colored Cavalry.

Appears on

Company Muster Roll

for *July & Aug.*, 186*5*.

Present or absent *Absent*

Stoppage, \$.....*100* for.....

Due Gov't, \$.....*100* for.....

Valuation of horse, \$.....*100*

Valuation of horse equipments, \$.....*100*

Remarks:

*Detached service
25th A.C. Hd. Qrs. SO.
88 May 13th 1865.
Due U.S. for transpor-
tation \$6.52.*

Book mark:.....

Hodges

2 | 5 Col'd Cav. | Mass.

Stephen Durbin
Park, Co., 5 Reg't Mass. Col'd Cavalry.

Appears on a

Detachment Muster Roll

of the organization named above

for *Aug 31*, 186*3*

Station *Brown's Santiago, Texas*

Present or absent *Present*

Stoppage, \$ *100* for

Due Gov't, \$ *100* for

Valuation of horse, \$ *100*

Valuation of horse equipments, \$ *100*

Remarks: *On duty as Orderly at Sta.*
208, 2nd Regt 5th Cal. 20th A.C.

Book mark: *208*

D

5 Col'd Cav.

Mass.

Stephen Durbin

Pvt, Co. M, 5 Reg't Mass. Colored Cav.

Appears on Returns as follows:

June 1864 - Absent sick
in Hosptl. City
Point, Va.

July 1864 - Reported from
Hosptl. City Point,
July 2.

Aug. 1864 - On duty to work
on Stables

Oct. 1864 to Feby 1865 - Co. Tailor

May to Sept. 1865 - Absent
detach serv. Orderly
at 25 A. C. Hed. Dis.
S. O. 88 May 12, '65.

appears also as
Stephen Durbin

Book mark:

O. J. Taylor

(546)

Copyist.

A

5 Col'd Cav.

Mass.

Stephen Durbin

Pr, Co. *M*, 5 Reg't Mass. Col'd Cavalry.

Appears on Co. Muster-out Roll, dated

Clarksville Tex, Oct. 31, 1865.

Muster-out to date

Oct. 31, 1865.

Last paid to

Aug 31, 1865.

Clothing account:

Last settled....., 186 ; drawn since \$..... 100

Due soldier \$ *27*⁵³ 100; due U. S. \$..... 100

Am't for cloth'g in kind or money adv'd \$..... 100

Due U. S. for arms, equipments, &c., \$ *11* 100

Bounty paid \$..... 100; due \$ *100* 100

Remarks:

Book mark:

Harley

(261)

Copyist.

391

Durden, Smith

Co F, 5 Mass. Cav., (Col'd.)

Private

Private

CARD NUMBERS.

1	5372193	26
2	5379589	27
3	5379687	28
4	5379797	29
5	5379894	30
6	5380002	31
7	5380102	32
8	5380206	33
9	5380303	34
10	5380399	35
11	5373020	36
12	5373063	37
13	9092049	38
14	34509652	39
15	33238012	40
16	33239286	41
17	40730866	42
18		43
19		44
20		45
21		46
22		47
23		48
24		49
25		50

Book Mark:

See also

Q782494. Pomme
Pp 605/36
MS. 1093286

L. Dalland

D

5 Cav. (Col'd.) | Mass.

Smith Durdan

Co. F, 5 Reg't Mass. Cav. (Col'd.)

Appears on

Company Descriptive Book

of the organization named above.

DESCRIPTION.

Age 23 years; height 5 feet 5 inches.

Complexion Blk

Eyes Blk; hair Blk

Where born Isle of Wight Co. Va.

Occupation Engineer.

ENLISTMENT.

When May 28, 1864.

Where Newton

By whom G.H. Quincey; term 3 y'rs.

Remarks:

Hearn

Q 15 Cav. Mass.

Smith Durden

Appears with rank of _____ on

Muster-in and Descriptive Roll

of a detachment of U. S. Volunteer Recruits for
different regiments of Massachusetts Volunteers.

Roll dated Draft Rendez, Galloups Island,
Boston Harbor, Mass., May 29, 1864,

Where born Ile White Co., Va.

Age 23 years; occupation Engineer

When enlisted May 28, 1864.

Where enlisted Newton, Mass

For what period enlisted 3 years.

Eyes black; hair black

Complexion black; height 5 ft. 5 in.

When mustered in _____, 186 .

Muster-in to date from enlistment, 186 .

Where mustered in _____

Bounty paid \$ 100; due \$ 100

Clothing account:

Last settled \$ _____, 186 ; drawn since \$ 100

Date of first muster _____, 186 .

Regiment to which assigned 5 Cav.

Remarks: Quota of Newton, Middlesex Co.,
7 Cong. Dist.

Book mark: _____

Printed

(356m)

Copyist.

5 Col'd Cav.

Mass.

Smith *Deedam*

Co. F, 5 Reg't Mass. Col'd Cavalry.

Appears on

Company Muster Roll

for *May & June*, 186*4*.

Present or absent *Present*

Stoppage, \$ *100* for

Due Gov't, \$ *100* for

Valuation of horse, \$ *100*

Valuation of horse equipments, \$ *100*

Remarks:

Book mark:

Smith

D

5 Col'd Cav.

Mass.

Smith Durden

Appears with rank of Pri on

Muster and Descriptive Roll of a Detachment of U. S. Vols. forwarded

for the 5 Reg't Mass. Col'd Cavalry. Roll dated

Galloups Island Mass June 13, 1864.

Where born Ile of Wight Co Va

Age 23 y'rs; occupation Engineer

When enlisted May 28, 1864.

Where enlisted Newton Mass

For what period enlisted 3 years.

Eyes Black; hair Black

Complexion Black; height 5 ft. 5 in.

When mustered in May 28, 1864.

Where mustered in Galloups Isld. Mass

Bounty paid \$ 100; due \$ 100

Where credited 7 Cong Dist. Newton, Middle

sex Co
Company to which assigned

Remarks :

Book mark :

Donnelly

(339)

Copyist.

D

5 Col'd Cav.

Mass.

Amick Derdan

Pt, Co. F, 5 Reg't Mass. Col'd Cavalry.

Appears on

Company Muster Roll

for *July & Aug, 1864.*

Present or absent *Present*

Stoppage, \$ *100* for

Due Gov't, \$ *100* for

Valuation of horse, \$ *100*

Valuation of horse equipments, \$ *100*

Remarks:

Book mark:

J A Stewart

(358)

Copyist.

D

5 Col'd Cav.

Mass.

Smith Durdan

Pt, Co. F, 5 Reg't Mass. Col'd Cavalry.

Appears on

Company Muster Roll

for Sept & Oct, 1864.

Present or absent Present

Stoppage, \$ 100 for

Due Gov't, \$ 100 for

Valuation of horse, \$ 100

Valuation of horse equipments, \$ 100

Remarks:

Book mark:

J. H. Stewart

(358)

Copyist.

L

5 Col'd Cav.

Mass.

Smith Derdan

Pt., Co. F, 5 Reg't Mass. Col'd Cavalry.

Appears on

Company Muster Roll

for Nov & Dec, 1864

Present or absent Present

Stoppage, \$ 100 for

Due Gov't, \$ 100 for

Valuation of horse, \$ 100

Valuation of horse equipments, \$ 100

Remarks:

Book mark:

J. H. Stewart

(358)

Copist.

L.

5 Col'd Cav.

Mass.

Smith Derdan

Pt., Co. F, 5 Reg't Mass. Col'd Cavalry.

Appears on

Company Muster Roll

for Jan & Feb, 1865.

Present or absent Present

Stoppage, \$ 100 for

Due Gov't, \$ 100 for

Valuation of horse, \$ 100

Valuation of horse equipments, \$ 100

Remarks: One first Inst
U.S. Bounty

Book mark:

M Stewart,

D

5 Col'd Cav.

Mass.

Smith Derran

Pl., Co. F, 5 Reg't Mass. Col'd Cavalry.

Appears on

Company Muster Roll

for *Mo^oh & Apl*, 186*5*

Present or absent *Present*

Stoppage, \$ *100* for

Due Gov't, \$ *100* for

Valuation of horse, \$ *100*

Valuation of horse equipments, \$ *100*

Remarks: *Due first inst
U.S. Dty 25.00*

Book mark:

H Stewart

10

5 Col'd Cav.

Mass.

Smith Jordan

Pl, Co. F, 5 Reg't Mass. Col'd Cavalry.

Appears on

Company Muster Roll

for *May + June*, 1863.

Present or absent *Absent*

Stoppage, \$ *100* for

Due Gov't, \$ *100* for

Valuation of horse, \$ *100*

Valuation of horse equipments, \$ *100*

Remarks: *Sick U.S.*
Asst Fortress Marshal

Book mark:

(358)

W. J. ...

Copyist,

20 | 5 Cav. (Cold) Mass.

Smith Dordon *

Pvt., Co. F, 5 Reg't Mass. Cav.

Appears on

Hospital Muster Roll

of U. S. A. General Hospital,

at Fort Monroe, Va.,

for *Mayo June*, 1865.

Attached to hospital :

When _____, 186 .

How employed _____

Last paid by Maj. _____

to _____, 186 .

Bounty paid \$ 100 ; due \$ 100

Present or absent *present.*

Remarks : *No Descriptive List.*

4 Dec. 2 Div.

** Smith Dordon in Present Column*

Book mark : _____

Woods

(343)

Copyist.

10

5 Col'd Cav.

Mass.

Smith Jordan

Pt, Co. F, 5 Reg't Mass. Col'd Cavalry.

Appears on

Company Muster Roll

for *July & Aug*, 1863.

Present or absent *Absent*

Stoppage, \$ *100* for

Due Gov't, \$ *100* for

Valuation of horse, \$ *100*

Valuation of horse equipments, \$ *100*

Remarks: *Went at U.S. Genl Hospital Forties
Monsieur since May 5/63*

Book mark:

A. Johnson

(358)

Copyist.

D. 15th Cav (Col'd) Mass.
Smith Dardon
Pvt., Co. E, 5th Reg^t Mass. C. C.

Appears on

Hospital Muster Roll

of **U. S. A. General Hospital,**

at **Fort Monroe, Va.,**

for *July & Aug.*, 186*5*.

Attached to hospital :

When, 186 .

How employed

Last paid by Maj.

to, 186 .

Bounty paid \$ 100; due \$ 100

Present or absent *Present.*

Remarks :

.....
.....
.....
.....
.....
.....
.....
.....
.....
.....

Book mark :

Jane White

D

5 Col'd Cav.

Mass.

Smith Jordan

Pat, Co. *F*, 5 Reg't Mass. Col'd Cavalry.

Appears on a

Detachment Muster-out Roll

of the organization named above. Roll dated

Boston, Mass, *Oct. 31*, 186*5*.

Muster-out to date

Oct. 31, 186*5*.

Last paid to

See .31, 186*4*.

Clothing account:

Last settled....., 186 ; drawn since \$..... ¹⁰⁰

Due soldier \$..... ¹⁰⁰; due U. S. \$..... ¹⁰⁰

Am't for cloth'g in kind or money adv'd \$..... ¹⁰⁰

Due U. S. for arms, equipments, &c., \$..... ¹⁰⁰

Bounty paid \$..... ¹⁰⁰; due \$..... ¹⁰⁰

Remarks: *\$ 25.00 U. S. Bounty*

Paid \$ 75.00 due. Due

Soldier for undrawn

clothing \$ 17.22. Due U.S.

for C. + G. Equipage

\$ 1.00. Due Jas. McDowell
(over)

Book mark:

R. Washington

Copyist.

JAN. - 9

5373020

1891

Letter \$ 10.00. Paid
for May & June 1865.
The above man was absent
sick when Regt was
mustered out.

Discharged by S. O. No. 29
Dept. of Texas, Galveston
dated Texas Sept. 16, 1865.
Mustered out their Regt.

D

5 Col'd Cav.

Mass.

Smith Perdan

Pl, Co F, 5 Reg't Mass. Colored Cav.

Appears on Returns as follows:

June 1864 - June 20, '64
Point of Rocks, Va. Re-
cruit from Depot.

Aug. 1864 - On duty on Stable

May 8 June 1865 - Absent sick at
U. S. Genl. Hosptl. at
since May 20, '65.

July to Sept. 1865 - Absent sick
at U. S. Genl. Hosptl. Fort
Monroe, Va. May 5, '65.

Book mark:

O. J. Taylor.

(546)

Copyist.

10 | **5 Col'd Cav.** | **Mass.**

Smith Perdan

Pl., Co. *F*, 5 Reg't Mass. Col'd Cavalry.

Appears on **Co. Muster-out Roll**, dated *Charlottesville Tex*, *Oct 31*, 186*5*.

Muster-out to date _____, 186 .

Last paid to *Dec 31*, 186*4*.

Clothing account:

Last settled _____, 186 ; drawn since \$ _____ 100

Due soldier \$ *27*^{*58*} 100; due U. S. \$ _____ 100

Am't for cloth'g in kind or money adv'd \$ _____ 100

Due U. S. for arms, equipments, &c., \$ _____ 100

Bounty paid \$ *25* 100; due \$ *73* 100

Remarks: *One U.S. G.O. Regt*
equipt. \$1³⁰. Account
at U.S. Genl. Hosp. Ft.
Monroe Va since
May 5/65. No discharge
permitted

Book mark: _____

J. Johnson

9

5 Col'd Cav.

Mass.

Smith Darden
Pvt, Co F, 5 Reg't Mass. Col'd Cavalry.

Appears on a

List of Discharges furnished by C. M. O. of State,
under the provisions of circular dated A. G. O.,
June 29, 1865.

Discharge furnished , 186 ,

to date from , 186 .

Remarks:

*Discharged by
C/O No 29 Dept
of Texas dated
Sept 16/65.*

Book Mark:

W. H. ...

(360)

Copist.

Arviden, Smith

P. Co. *FP*

5 Reg't Mass. C. Cav

2 Enclosures.

Bed Cards	Final Statements
Burial Records	Furloughs or L. of A.
Certs. of Dis. for Discharge	Med. Certificates
C. M. Charges	Med. Des. Lists
Descriptive Lists	Orders
Discharge Certificates	Pris. of War Record
Enlistment Papers	Resignations

Other papers relating to—

Admission to Hosp'l	Furlough or L. of A.
Casualty Sheet	Med. Examination
Confinement	Misc. Information
Contracts	Pay or Clothing
Death or Effects	Personal Reports
Desertion	Rank
Discharge from Hosp'l	Transfer to Hosp'l
Discharge from Service	Transfer to V. R. C.
Duty	Transportation

NOTE 1.—This blank will be used for both enlistments and re-enlistments—enlistment of veterans, &c., &c., in the volunteer service. They will be made out in duplicate in all cases—one to accompany the recruiting return of the superintendent (not the recruiting officer) to the Adjutant-General, and one to accompany the accounts of the officer who pays bounty, &c. The Regiment and Company in which the soldier last served should be given on the back.

NOTE 2.—An enlistment holds to service. A muster-in must, in all cases, precede payment of pay, bounty, pension, &c. A muster-in roll must, in all cases, be filed in the Adjutant-General's Office as evidence of muster-in. The mustering officer, commissary, or assistant-commissary of musters, as the case may be, will countersign both enlistments as having mustered the soldier into the service of the United States before either of them is given to the disbursing officer.

APRIL 1895. This paper was formerly filed in the Enrollment Div. R. & P. O.

DECLARATION OF RECRUIT.

I, Smith Durdun

desiring

to VOLUNTEER as a Soldier in the Army of the United States, for the term of THREE YEARS, Do Declare, That I am *twenty three* years and _____ months of age; that I have never been discharged from the United States service on account of disability or by sentence of a court-martial, or by order before the expiration of a term of enlistment; and I know of no impediment to my serving honestly and faithfully as a soldier for three years.

GIVEN at *Boston* the *28th* day of *May 1864*

Witness:

John H. Williams

Smith ^{for} *Durdun* _{mark}

Discharged

18

Reg't of

enlistment; last served in Company ()

By

Regiment of

Volunteered at

59th Mass Cav 1864

No.

Smith Durdun

CONSENT IN CASE OF MINOR.

I, _____

Do CERTIFY, That I am

the _____ of _____; that the said _____ is _____ years of age; and I

do hereby freely give my CONSENT to his volunteering as a SOLDIER in the ARMY OF THE UNITED STATES, for the period of THREE YEARS.

GIVEN at _____

the _____ day of _____

Witness:

VOLUNTEER ENLISTMENT.

STATE OF

TOWN OF

Massachusetts

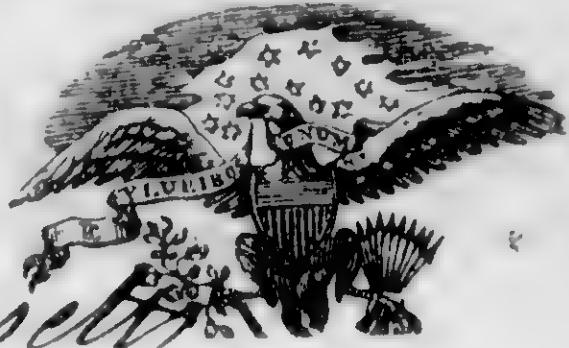

Newton

I, *Smith Durdum* born in *Ile of White Co.* in the State of *Virginia* aged *Twenty three* years, and by occupation a *Engineer* Do HEREBY ACKNOWLEDGE to have volunteered this *Twenty eighth* day of *May* 1864, to serve as a **Soldier** in the Army of the United States of America, for the period of **THREE YEARS**, unless sooner discharged by proper authority: Do also agree to accept such bounty, pay, rations, and clothing, as are, or may be, established by law for volunteers. And I, *Smith Durdum* do solemnly swear, that I will bear true faith and allegiance to the **United States of America**, and that I will serve them honestly and faithfully against all their enemies or opposers whomsoever; and that I will observe and obey the orders of the President of the United States, and the orders of the officers appointed over me, according to the Rules and Articles of War.

Amite
Fifth Mass Cavalry

the
day of
, 186 , at

Mustered into the service of the United States, in Company

Regiment of

Volunteers, on

Sworn and subscribed to, at *Boston* this *Twenty eighth* day of *May* 1864. BEFORE *L. P. Holden* } *Smith + Durdum* ^{his} _{mark} Witness

Justice of the Peace Geo. H. Quincy

I CERTIFY, ON HONOR, That I have carefully examined the above-named Volunteer, agreeably to the General Regulations of the Army, and that, in my opinion, he is free from all bodily defects and mental infirmity, which would in any way disqualify him from performing the duties of a soldier.

P. J. Francis
EXAMINING SURGEON.

Vaccinated

I CERTIFY, ON HONOR, That I have minutely inspected the Volunteer *Smith Durdum* previously to his enlistment, and that he was entirely sober when enlisted; that, to the best of my judgment and belief, he is of lawful age; and that, in accepting him as duly qualified to perform the duties of an able-bodied soldier, I have strictly observed the Regulations which govern the recruiting service. This soldier has *Wh* eyes, *Wh* hair, *Wh* complexion, is *five* feet *five* inches high.

Geo. H. Quincy

Regiment of _____ Volunteers,

U. S. RECRUITING OFFICER
agr

(A. G. O. No. 74 & 75.)
Q 884

CASUALTY SHEET

No.

Smith Oviden

Priv. of Company *E*

5 Regiment of *Mass. Cav.*

State Volunteers. *(Col'd.)*

NATURE OF CASUALTY.

Discharge

Nov. 20/65



CASUALTY SHEET.

Name: *Smith, Oliver*
Rank: *Pvt.* Company: *F* Regiment: *5*
Arm: *Cal.* State: *Mass.*
Nature of Casualty: *Explosion.*

CAUSE OF CASUALTY—(NAME OF DISEASE, &c.)

BY WHOM DISCHARGED.

DEGREE OF DISABILITY.

FROM WHAT SOURCE THIS INFORMATION WAS OBTAINED.

BY WHOM CERTIFIED.

REMARKS.

DATE OF DISCHARGE, DEATH, &c.

June 20/65

PLACE OF DISCHARGE, DEATH, &c.

Massachusetts

Oliver Smith
Clerk.

511

392

Eager, George

Col., 5 Mass. Cav., (Col'd.)

Private

Private

CARD NUMBERS.

1	5352172	26
2	5372267	27
3	5380774	28
4	5380877	29
5	5380975	30
6	5381077	31
7	5381178	32
8	5381280	33
9	5381379	34
10	5381477	35
11	9091993	36
12	34505377	37
12	40730900	38
14		39
15		40
16		41
17		42
18		43
19		44
20		45
21		46
22		47
23		48
24		49
25		50

Book Mark:

See also

E | **5 Cav. (Col'd.)** | **Mass.**

George Eager

....., Co. *D*, 5 Reg't Mass. Cav. (Col'd.)

Appears on

Company Descriptive Book

of the organization named above.

DESCRIPTION.

Age *30* years; height *5* feet *3* inches.

Complexion *Blk*

Eyes *Blk*; hair *Blk*

Where born *Montgomery, N.Y.*

Occupation *Farmer.*

ENLISTMENT.

When *June 16*, 186*4*.

Where *Prince town.*

By whom *Capt. Phalen*; term *3* y'rs.

Remarks: *Mustered June 16-64,
Capt Phalen Galloups Island.*

Hearst

E 1 5 Cal 1 Mass

George Eager

Appears with rank of on

Muster and Descriptive Roll

of a detachment of U. S. Volunteers forwarded from Faneuil Hall, Boston, to Galloup's Island, Boston Harbor, for various regiments Massachusetts Volunteers. Roll dated

Boston Mass, June 10, 1864.

Where born Montgomery N.Y.

Age 30 years; occupation Farmer

When enlisted June 10, 1864

Where enlisted Princeton

For what period enlisted 3 years.

Eyes Blue; hair Blue

Complexion Blue; height 5 ft. 5 in.

When mustered in June 10, 1864

Where mustered in Boston

Bounty paid \$ 100; due \$ 100

Clothing account:

Last settled, 1864; drawn since \$ 100

Date of first muster, 1864

Regiment to which assigned

Remarks: Princeton Worcester Co 9 Dist

Book mark:

(356m)

Sargent

Copyist.

5

5 Col'd Cav.

Mass.

George Gayle

Appears with rank of Private on

Muster and Descriptive Roll of a Detachment of U. S. Vols. forwarded

for the 5 Reg't Mass. Col'd Cavalry. Roll dated
Boston Mass., June 15, 1864.

Where born Montclair N. J.

Age 21 y'rs; occupation Farmer

When enlisted June 16, 1864.

Where enlisted Princetown

For what period enlisted 3 years.

Eyes Black; hair Black

Complexion Dark; height 5 ft. 3 in.

When mustered in June 16, 1864.

Where mustered in Boston

Bounty paid \$ 100; due \$ 100

Where credited Dist. Princetown, Worcester Co.

Company to which assigned

Remarks:

Book mark:

Forsell

E

5 Col'd Cav.

Mass.

George Eager
Pri

Appears with rank of _____ on

Muster and Descriptive Roll of a Detachment of U. S. Vols. forwarded

for the 5 Reg't Mass. Col'd Cavalry. Roll dated

Gallups Isl Mass, July 12, 1864.

Where born Montgomery Ny

Age 30 y'rs; occupation Farmer

When enlisted June 16, 1864

Where enlisted Princeton

For what period enlisted 3 years.

Eyes Black; hair Black

Complexion Black; height 5 ft. 5 in.

When mustered in June 16, 1864.

Where mustered in Boston Mass

Remain
Bounty paid \$ 2 100; due \$ 100

Where credited 9 Coy Dist. Princeton

Worcester Co
Company to which assigned _____

Remarks: _____

Book mark: _____

Dannally

(339)

Copyist.

E

5 Col'd Cav.

Mass.

George Eager

M, Co. G, 5 Reg't Mass. Col'd Cavalry.

Appears on

Company Muster Roll

for *July & Aug*, 186*4*.

Present or absent *Present*

Stoppage, \$ *100* for

Due Gov't, \$ *100* for

Valuation of horse, \$ *100*

Valuation of horse equipments, \$ *100*

Remarks *Enlistment papers not received joined for duty July 15/64.*

Book mark:

Eager

E

5 Col'd Cav.

Mass.

George Eager
Prin, Co. G, 5 Reg't Mass. Col'd Cavalry.

Appears on

Company Muster Roll

for Sept & Oct, 1864

Present or absent Present

Stoppage, \$ 100 for

Due Gov't, \$ 100 for

Valuation of horse, \$ 100

Valuation of horse equipments, \$ 100

Remarks:

Book mark:

Perry

(358)

Copyist.

E

5 Col'd Cav.

Mass.

George Cager

Co. G, 5 Reg't Mass. Col'd Cavalry.

Appears on

Company Muster Roll

for Nov 9 Dec, 1864.

Present or absent Present

Stoppage, \$ 100 for

Due Gov't, \$ 100 for

Valuation of horse, \$ 100

Valuation of horse equipments, \$ 100

Remarks: Due U.S. \$10.00 for advanced pay

Book mark:

Cerry

(358)

Copyist.

E

5 Col'd Cav.

Mass.

George Eager
Priv., Co. G, 5 Reg't Mass. Col'd Cavalry.

Appears on

Company Muster Roll

for Jan. & Feb., 1863.

Present or absent Present

Stoppage, \$ 100 for

Due Gov't, \$ 100 for

Valuation of horse, \$ 100

Valuation of horse equipments, \$ 100

Remarks: Due 1st instal-
ment U.S. Bounty
\$25.00 Due U.S.
for advanced pay
\$10.00 charged on
Nov. & Dec. Rolls.

Book mark:

Perry

(358)

Copyist.

C

5 Col'd Cav.

Mass.

George Cager

Co. G, 5 Reg't Mass. Col'd Cavalry.

Appears on

Company Muster Roll

for March 1st, 1865.

Present or absent Absent

Stoppage, \$ 100 for

Due Gov't, \$ 100 for

Valuation of horse, \$ 100

Valuation of horse equipments, \$ 100

Remarks: Absent sick at

Deep Bottom Va.

since April 3^d, 1865

Due the soldier 1

instalment U. S. Bounty

\$20;

Book mark:

Perry

(358)

Copyist.

E

5 Col'd Cav.

Mass.

George Eager

Prvt, Co. G, 5 Reg't Mass. Col'd Cavalry.

Appears on

Company Muster Roll

for *May & June*, 1865.

Present or absent *Present*

Stoppage, \$ *100* for

Due Gov't, \$ *100* for

Valuation of horse, \$ *100*

Valuation of horse equipments, \$ *100*

Remarks:

Book mark: _____

Perry

6

5 Col'd Cav.

Mass.

George Eager
Priv., Co. G, 5 Reg't Mass. Col'd Cavalry.

Appears on

Company Muster Roll

for July & Aug, 1860.

Present or absent Present

Stoppage, \$ 100 for

Due Gov't, \$ 100 for

Valuation of horse, \$ 100

Valuation of horse equipments, \$ 100

Remarks: Due U.S. for Ordnance lost \$ 43.³²

Book mark:

W. Hear Scott

(358)

Copyist.

E

5 Col'd Cav.

Mass.

George Eager

Pvt, Co. G, 5 Reg't Mass. Colored Cav.

Appears on Returns as follows:

July 1864 - Gained. Recruit
from depot.
Joined Co. July 15.

Apr 1865 - About sick
at Deep Bottom Va
since Apr 3. 65

Book mark:

W. G. Gallade

(546)

Copyist.

E | **5 Col'd Cav.** | **Mass.**

George Eager
Co. G, 5 Reg't Mass. Col'd Cavalry.

Appears on **Co. Muster-out Roll**, dated

Clarksville Oct 31, 186*5*.

Muster-out to date *Oct 31*, 186*6*.

Last paid to *Dec 31*, 186*4*.

Clothing account:

Last settled....., 186 ; drawn since \$..... 100

Due soldier \$..... 100; due U. S. \$ *34 23* 100

Am't for cloth'g in kind or money adv'd \$..... 100

Due U. S. for arms, equipments, &c., \$ *54 32* 100

Bounty paid \$..... 100; due \$ *100* 100

Remarks:

Book mark:

John Scott

(861)

Copyist.

Eager, George

, Co. , 5 Reg't Mass. C.C.

2 Enclosures.

Bed Cards	Final Statements
Burial Records	Furloughs
Certs. of Dis. for Discharge	Med. Certificates
C. M. Charges	Med. Des. Lists
Descriptive Lists	Orders
Discharge Certificates	Pris. of War Record

Other papers relating to—

Admission to Hosp'l	Furlough
Casualty Sheet	Med. Examination
Confinement	Misc. Information
Contracts	Pay or Clothing
Death or Effects	Personal Reports
Desertions	Rank
Discharge from Hosp'l	Transfer to Hosp'l
Discharge from Service	Transfer to V. R. C.
Duty	Transportation

S.P. P

NOTE 1.—This blank will be used for both enlistments and re-enlistments—enlistment of veterans, &c., &c., in the volunteer service. They will be made out in duplicate in all cases—one to accompany the recruiting return of the superintendent (not the recruiting officer) to the Adjutant-General, and one to accompany the accounts of the officer who pays bounty, &c. The Regiment and Company in which the soldier last served should be given on the back.

NOTE 2.—An enlistment holds to service. A muster-in must, in all cases, precede payment of pay, bounty, pension, &c. A muster-in roll must, in all cases, be filed in the Adjutant-General's Office as evidence of muster-in. The mustering officer, commissary, or assistant-commissary of musters, as the case may be, will countersign both enlistments as having mustered the soldier into the service of the United States before either of them is given to the disbursing officer.

M. E. W. Art. Co
No. 21. Boston

DECLARATION OF RECRUIT.

I, *George Eager* desiring to VOLUNTEER as a Soldier in the Army of the United States, for the term of **THREE YEARS**, Do Declare, That I am *Thirty* years and _____ months of age; that I have never been discharged from the United States service on account of disability or by sentence of a court-martial, or by order before the expiration of a term of enlistment; and I know of no impediment to my serving honestly and faithfully as a soldier for three years.

GIVEN at *Boston*
 the *16* day of *June 1864*
 Witness: *D Perkins* *George Eager*
mark

Discharged _____
 18 _____
 Regt of _____
 enlistment; last served in Company () _____

No. _____
George Eager
 Volunteered at *Princeton*
May 15th June 1864
 By *Edw. M. Allen* for
5th Regiment of Mass. Cavalry

CONSENT IN CASE OF MINOR.

I, _____ Do CERTIFY, That I am _____ the _____ of _____ ; that the said _____ is _____ years of age; and I do hereby freely give my CONSENT to his volunteering as a SOLDIER in the ARMY OF THE UNITED STATES, for the period of **THREE YEARS**.

GIVEN at _____ the _____ day of _____
 Witness: _____

Worcester Co. Ninth Dist

VOLUNTEER ENLISTMENT.

STATE OF

Mass

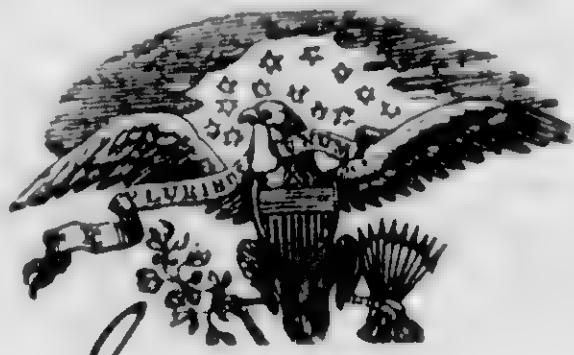

TOWN OF

Princeton

I, George Eager

born in Montgomery aged Thirty years,

in the State of N.Y. and by occupation a Farmer

DO HEREBY ACKNOWLEDGE to have

volunteered this Sixteenth day of June 1864,

to serve as a Soldier in the Army of the United States of America, for the period of THREE YEARS, unless sooner discharged by proper authority: Do also agree to accept such bounty, pay, rations, and clothing, as are, or may be, established by law for volunteers. And I, George Eager do solemnly swear, that I will bear true faith and allegiance to the United States of America, and that I will serve them honestly and faithfully against all their enemies or opposers whomsoever; and that I will observe and obey the orders of the President of the United States, and the orders of the officers appointed over me, according to the Rules and Articles of War.

Sworn and subscribed to, at

W. Dosh }
this 16th day of June 1864 }
BEFORE W. F. Arnold }
m.c.

his mark
George Eager

I CERTIFY, ON HONOR, That I have carefully examined the above-named Volunteer, agreeably to the General Regulations of the Army, and that, in my opinion, he is free from all bodily defects and mental infirmity, which would in any way disqualify him from performing the duties of a soldier.

H. C. Culver.
M.D.

EXAMINING SURGEON.

I CERTIFY, ON HONOR, That I have minutely inspected the Volunteer, George Eager previously to his enlistment, and that he was entirely sober when enlisted; that, to the best of my judgment and belief, he is of lawful age; and that, in accepting him as duly qualified to perform the duties of an able-bodied soldier, I have strictly observed the Regulations which govern the recruiting service.

This soldier has Blue eyes, Blue hair, Blue complexion, is five feet five inches high.

Capt. L. J. ... Regiment of ... Volunteers,
C. A. ...
M.D.

RECRUITING OFFICER.

Mustered into the service of the United States, in Company
the 16 day of June, 1864, at Boston

Company
5th Cav, Regiment of
Mass
Volunteers, on

(A. G. O. No. 74 & 75.)

NOTE 1.—This blank will be used for both enlistments and re-enlistments—enlistment of veterans, &c., &c., in the volunteer service. They will be made out in duplicate in all cases—one to accompany the recruiting return of the superintendent (not the recruiting officer) to the Adjutant-General, and one to accompany the accounts of the officer who pays bounty, &c. The Regiment and Company in which the soldier last served should be given on the back.

NOTE 2.—An enlistment holds to service. A muster-in must, in all cases, precede payment of pay, bounty, pension, &c. A muster-in roll must, in all cases, be filed in the Adjutant-General's Office as evidence of muster-in. The mustering officer, commissary, or assistant-commissary of musters, as the case may be, will countersign both enlistments as having mustered the soldier into the service of the United States before either of them is given to the disbursing officer.

REPORT WAS FORMULATED BY THE ADJUTANT DIV. R. & P. O.

DECLARATION OF RECRUIT.

I, *George Cager* desiring to VOLUNTEER as a Soldier in the Army of the United States, for the term of THREE YEARS, Do Declare, That I am *Thirty* years and _____ months of age; that I have never been discharged from the United States service on account of disability or by sentence of a court-martial, or by order before the expiration of a term of enlistment; and I know of no impediment to my serving honestly and faithfully as a soldier for three years.

GIVEN at *Boston* the *16* day of *June* 1864
 Witness: *L Perkins* *George Cager*
mark

No. *5 New Ber*

Discharged _____ 18____
 Regiment of _____
 enlistment; last served in Company ()
 Volunteered at *Winchester Mass*
16 June 1864
 By *Capt. E. M. Shaheen* from
5th Regiment of Mass. Cavalry

CONSENT IN CASE OF MINOR.

I, _____ Do CERTIFY, That I am _____
 the _____ of _____; that the _____
 said _____ is _____ years of age; and I
 do hereby freely give my CONSENT to his volunteering as a SOLDIER in the ARMY OF THE UNITED STATES,
 for the period of THREE YEARS.

GIVEN at _____ the _____ day of _____
 Witness: _____

(A. G. O. No. 74 & 75.)

Worcester Co North Dist
VOLUNTEER ENLISTMENT.

STATE OF

Mass

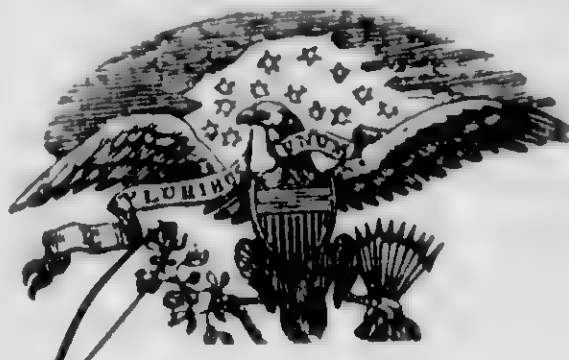

TOWN OF

Princeton

I, *George Cager*

born in *Montgomery*

in the State of

N.Y.

aged *Thirty* years,

and by occupation a

F. Farmer

Do HEREBY ACKNOWLEDGE to have

volunteered this

Eighteenth day of

June

1864,

to serve as a **Soldier** in the Army of the United States of America, for the period of **THREE YEARS**, unless sooner discharged by proper authority: Do also agree to accept such bounty, pay, rations and clothing, as are, or may be, established by law for volunteers. And I, *George Cager* do solemnly swear, that I will bear true faith and allegiance, to the **United States of America**, and that I will serve them honestly and faithfully against all their enemies or opposers whomsoever; and that I will observe and obey the orders of the President of the United States, and the orders of the officers appointed over me, according to the Rules and Articles of War.

Sworn and subscribed to, at

Boston

this

day of

June

1864.

BEFORE

W. F. Arnold
me

his
George + Cager
mark

I CERTIFY, ON HONOR, That I have carefully examined the above-named Volunteer, agreeably to the General Regulations of the Army, and that, in my opinion, he is free from all bodily defects and mental infirmity, which would in any way disqualify him from performing the duties of a soldier.

J. D. Hubert
Wm.

EXAMINING SURGEON.

I CERTIFY, ON HONOR, That I have minutely inspected the Volunteer, previously to his enlistment, and that he was entirely sober when enlisted; that, to the best of my judgment and belief, he is of lawful age; and that, in accepting him as duly qualified to perform the duties of an able-bodied soldier, I have strictly observed the Regulations which govern the recruiting service.

This soldier has *Blue* eyes, *Blue* hair, *Blue* complexion, is *five* feet

five inches high.

Capt. J. A. Mahan
Regiment of Mass. Volunteers,

RECRUITING OFFICER.

(A. G. O. No. 74 & 75.)

Mustered into the service of the United States, in Company
 the *16* day of *June*, 1864, at *Boston*

Colours
5th Cav. Regiment of
Mass
W. F. Arnold
Volunteers, on

397-a

East, George
Co I was Col'd Cau,

CARD NUMBERS.

1	9436058	26
2		27
3		28
4		29
5		30
6		31
7		32
8		33
9		34
10		35
11		36
12		37
13		38
14		39
15		40
16		41
17		42
18		43
19		44
20		45
21		46
22		47
23		48
24		49
25		50

Number of personal papers herein.....

Book Mark:

See also

5th Mass. Cav. Miss.

George East,

Co. 5 Reg't Mass Col'd Cav.

Appears on

Regimental Descriptive Book

of the organization named above.

DESCRIPTION.

Age 39 years; height 5 feet 8 inches.

Complexion Black

Eyes Black; hair Black.

Where born Tenn.

Occupation Gunner.

ENLISTMENT.

When Feb. 11, 1864

Where Springfield,

By whom L. S. Tift; term 3 y'rs.

Remarks: Rejected March 26/64

Tharion

393

Eaton Charles A

Co B, 5 Mass. Cav., (Col'd.)

CARD NUMBERS.

1	26
2	27
3	28
4	29
5	30
6	31
7	32
8	33
9	34
10	35
11	36
12	37
13	38
14	39
15	40
16	41
17	42
18	43
19	44
20	45
21	46
22	47
23	48
24	49
25	50

See Eaton Charles A

Book Mark:

See also

394

Eaton, Charles A.

Co I, 5 Mass. Cav., (Col'd.)

Private

Private

CARD NUMBERS.

1	5374483	26
2	5374579	27
3	5374663	28
4	5374759	29
5	5374863	30
6	5374970	31
7	5375079	32
8	5375243	33
9	5375647	34
10	9092525	35
11	40730899	36
12		37
13		38
14		39
15		40
16		41
17		42
18		43
19		44
20		45
21		46
22		47
23		48
24		49
25		50

Book Mark:

See also

E

5 Cav. (Col'd.) | Mass.

Samuel H. Eaton

Co. B, 5 Reg't Mass. Cav. (Col'd.)

Appears on

Company Descriptive Book

of the organization named above.

DESCRIPTION.

Age 25 years; height 5 feet 7 inches.

Complexion Dark

Eyes Dark; hair Dark

Where born New York

Occupation Laborer

ENLISTMENT.

When June 11, 1864.

Where New York

By whom P. M. Keane; term 3 y'rs.

Remarks: Discharged June 15/65 for
wound of right hand incur for
disability

H. H. Hinds

E

5 Col'd Cav.

Mass.

Charles M. Eaton

Regt., Co. B., 5 Reg't Mass. Col'd Cav.

Appears on

Company Muster-in and Descriptive Roll

of the organization named above. Roll dated

Readville Mass., July 27, 1864.

Where born Glen Cove New York

Age 25 y'rs; occupation Laborer

When enlisted July 4th, 1864.

Where enlisted Lynn

For what period enlisted 3 years.

Eyes Black; hair Black.

Complexion Black; height 5 ft. 7 in.

When mustered in Jan 29, 1864.

Where mustered in

Bounty paid \$ 100; due \$ 100

Where credited

Company to which assigned

Remarks: Sidel

Book mark:

Hoyberger

5

5 Col'd Cav.

Mass.

Charles G. Eaton

Co. B, 5 Reg't Mass. Col'd Cavalry.

Appears on

Company Muster Roll

for *Enlistment to Feb 27, 1864.*

Present or absent *Present*

Stoppage, \$ *100* for

Due Gov't, \$ *100* for

Valuation of horse, \$ *100*

Valuation of horse equipments, \$ *100*

Remarks:

Book mark:

(358)

W. Berger

Copist.

E

5 Col'd Cav.

Mass.

Chas H Eator

Plt, Co. B, 5 Reg't Mass. Col'd Cavalry.

Appears on

Company Muster Roll

for *March & April*, 1864.

Present or absent. *Present*

Stoppage, \$ *100* for

Due Gov't, \$ *100* for

Valuation of horse, \$ *100*

Valuation of horse equipments, \$ *100*

Remarks:

Book mark:

(358)

Hoyt

Copyist.

C

5 Col'd Cav.

Mass.

Charles H. Cutler

P., Co. B, 5 Reg't Mass. Col'd Cavalry.

Appears on

Company Muster Roll

for *May & June*, 1864.

Present or absent *Present*

Stoppage, \$ *100* for

Due Gov't, \$ *100* for

Valuation of horse, \$ *100*

Valuation of horse equipments, \$ *100*

Remarks:

Book mark:

(358)

Hoebinger

Copyist.

E.

5. Col'd Cav.

Mass.

Charles H. Eaton,

Priv., Co. B, 5 Reg't Mass. Col'd Cavalry.

Appears on

Company Muster Roll

for July & Aug., 1864.

Present or absent — Present.

Stoppage, \$ 100 for

Due Gov't, \$ 100 for

Valuation of horse, \$ 100

Valuation of horse equipments, \$ 100

Remarks:

Book mark:

J. M. Brown Copyist.

E.

5 Col'd Cav.

Mass.

Charles H. Eaton,

Priv., Co. B, 5 Reg't Mass. Col'd Cavalry.

Appears on

Company Muster Roll

for Sept. & Oct., 1864.

Present or absent Present.

Stoppage, \$ 100 for

Due Gov't, \$ 100 for

Valuation of horse, \$ 100

Valuation of horse equipments, \$ 100

Remarks: Free on or before Apr. 19/61.

Due U.S. Bounty \$25.00

Book mark:

J. H. Brown,

(358)

Copyist.

E.

5 Col'd Cav.

Mass.

Charles H. Eaton,

Plt., Co. B, 5 Reg't Mass. Col'd Cavalry.

Appears on

Company Muster Roll

for Nov. & Dec., 1864.

Present or absent — Present

Stoppage, \$ 100 for

Due Gov't, \$ 100 for

Valuation of horse, \$ 100

Valuation of horse equipments, \$ 100

Remarks:

Book mark:

M. Brown

Copyist.

E

5 Col'd Cav.

Mass.

Charles H. Eaton

Pvt., Co. B, 5 Reg't Mass. Col'd Cavalry.

Appears on

Company Muster Roll

for Jan'y. & Feby., 1865.

Present or absent

Stoppage, \$ 100 for

Due Gov't, \$ 100 for

Valuation of horse, \$ 100

Valuation of horse equipments, \$ 100

Remarks: Discharged & Final Statements given Jan'y. 13/65 for disability.

Book mark:

J. W. Brown

(358)

Copyist.

E

5 Col'd Cav.

Mass.

Charles Eaton

Pvt, Co. B, 5 Reg't Mass. Colored Cav.

Appears on Returns as follows:

Jan 1865. Loss. Jan 14
Point Lookout

Discharged and
final statement given
on Surgeon Certificate
of disability.

Book mark:

M. Sallade

(546)

Copyist.

E

5 Col'd Cav.

Mass.

Charles H. Eaton

Priv., Co. B, 5 Reg't Mass. Col'd Cavalry.

Appears on Co. Muster-out Roll, dated

Clarksville, Tex, Oct. 31, 1864.

Muster-out to date _____, 1864.

Last paid to _____, Aug. 31, 1864.

Clothing account:

Last settled _____, 1864; drawn since \$ 100

Due soldier \$ 100; due U. S. \$ 100

Am't for cloth'g in kind or money adv'd \$ 100

Due U. S. for arms, equipments, &c., \$ 100

Bounty paid \$ 100; due \$ 100

Remarks: Discharged Jan 13/65;

per order _____ Auger

at Lookout for Disability

Roll Form

Book mark: 20.33.96.75i - C.D.

Scherich

(361)

Copyist.

Eaton Chas H.

P, Co. B,

5

Mass. C. Cav.
Reg't

Enclosures.

Bed Cards

Burial Records

Certs. of Dis. for Discharge

C. M. Charges

Med. Certificates

Descriptive Lists

Final Statements

Furloughs

Med. Des. Lists

Orders

Other papers relating to—

Admission to Hosp'l

Casualty Sheet (Officer's)

Confinement

Contracts

Death or Effects

Desertions

Discharge from Hosp'l

Discharge from Service

Duty

Furlough

Med. Examination

Misc. Information

Pay or Clothing

Personal Reports

Rank

Transfer to Hosp'l

Transfer to V. R. C.

Transportation

NOTE 1.

The company commander will here add a statement of all the facts known to him concerning the disease or wound, or cause of disability of the soldier: the time, place, manner, and all the circumstances under which the injury occurred, or disease originated or appeared: the duty, or service, or situation of the soldier at the time the injury was received or disease contracted, stating particularly whether the injury was received or the disease contracted in the line of his duty; and whatever other facts may aid a judgment as to the cause, immediate or remote, of the disability, and the circumstances attending it.

When the facts are not known to the company commander, the certificate of any officer, or affidavit of other person having such knowledge, will be appended—as the surgeon in charge of a hospital, the officer commanding a detachment of recruits, &c., &c.

NOTE 2.

When a probable case for pension, special care must be taken to state the degree of disability—as $\frac{1}{2}$, $\frac{3}{4}$, &c., &c.; to describe particularly the disability, wound, or disease; the extent to which it deprives him of the use of any limb or faculty, or affects his health, strength, activity, constitution, or capacity to labor or earn his subsistence. The surgeon will add, from his knowledge of the facts and circumstances, and from the evidence in the case, his professional opinion of the cause or origin of the disability. In the case of discharges by Medical Inspectors, the last paragraph will state that the "discharge was given by consent of the soldier, after a personal examination, and for disability, the nature, degree, and origin of which are correctly described in the within certificate."

Par. 1260 Regulations, Edit. 1861.

Medical officers, in giving certificates of disability, are to take particular care in all cases that have not been under their charge; and especially in epilepsy, convulsions, chronic rheumatism, derangement of the urinary organs, ophthalmia, ulcers, or any obscure disease liable to be feigned or purposely produced; and in no case shall such certificate be given until after sufficient time and examination to detect any attempt at deception.

DIRECTIONS.

This certificate will be made out in duplicate by the soldier's company commander, or other officer commanding the separate detachment to which he belongs, and sent by him to the surgeon who has charge of the hospital where the soldier is sick. The surgeon will then fill out and sign the surgeon's certificate, and forward these papers to the regimental, detachment, or post commander, who will forward them, with his action endorsed thereon, through the proper channel, to his division commander; or, if the troops are not attached to a division, to his corps department, or other commander or officer to whom the authority to discharge enlisted men may be specially delegated.

These certificates, after having received the action of the highest authority to which they are required to be sent, will be returned through the same channel to the regimental, post, or detachment commander, who will, if the discharge is authorized by the endorsement of the proper authority, sign the soldier's discharge, and the last certificate on this paper; see that the soldier is furnished with the proper final statements in duplicate, and forward BOTH of these certificates direct to the Adjutant General United States Army, at Washington, D. C.; they will not, under any circumstances, be given into the hands of the soldier.

ADJUTANT GENERAL'S OFFICE

July 4th 1865

Duplicate sent the Pension Office.

1865 3
CERTIFICATE OF DISABILITY FOR DISCHARGE
IN THE CASE OF
Charles H. Coates
a Private of Co. B
Fifth Reg't of Mass
Car. Vols

Office of Surg. in Chief
Pt. Lookout Md refer. 24.64
R.B. 353
Approved
A. H. Dean
Surgeon U.S.A.
Surg. in Chief
St. Mary's Dist.

Received (A. G. Office) 186

Enon. Ref. Cas
Dinty
AT

Headquarters St. Mary's District,
Point Lookout, Md, 26th Dec. 1864

Respectfully forwarded,
approved
Brigadier General Comuz.

HEAD QUARTERS,
DEPARTMENT OF WASHINGTON,
23d Army Corps,
July 4th 1865
TO BE DISCHARGED.
BY COMMAND OF
MAJ. GEN'L C. C. AUGUR.
A. A. G.

ARMY OF THE UNITED STATES
CERTIFICATE
OF DISABILITY FOR DISCHARGE.



Private Charles H. Eaton of Captain Cyrus
C. Emery's Company, (B) of the Fifth Regiment of United States
Mass. Cav Vols was enlisted by J. M. Keol of
the _____ Regiment of _____ at Synn Mass.
on the 4th day of January 1864, to serve 3 years; he was born
in Albion Co in the State of New York is 25
years of age, 5 feet 7 inches high, Dark complexion, Dark eyes,
Dark hair, and by occupation when enlisted a Laborer

During the last two months said soldier has been unfit for duty 60 days.* The soldier was hurt at Point Va. on or about June 6th 1864, while carrying boxes containing ammunition and in the line of his duty, since which time he has not been able to perform the duties of a soldier and in my opinion he never will be able to perform
STATION: Point Lookout Md. the duties of a Cavalry Soldier
DATE: November 19th 1864

Cyrus Emery
Capt 5th Mass Cav
 Commanding Company. B

I CERTIFY, that I have carefully examined the said Charles H. Eaton Private of
 Captain Cyrus Emery's Company, and find him incapable of performing the duties of a soldier
 because of Spinal Hernia caused by an injury received
near about June 6th 1864, while in the discharge of his duty.
Degree of Disability, one third

Ind G. Parker

 _____ Surgeon.

DISCHARGED, this thirtieth day of January 1865, at Point Lookout Maryland.

W. H. Russell
Capt 5th Mass Cav.
 Commanding the Reg't.

The soldier desires to be addressed at
 Town Shenandoah County _____ State N. C.

* See Note 1 on the back of this. † See Note 2 on the back of this.

395

Eddingfield, Frank

Co I, 5 Mass. Cav., (Col'd.)

Private

Private

CARD NUMBERS.

1	5382990	26
2	5383050	27
3	5383148	28
4	5383252	29
5	5383356	30
6	5383459	31
7	5383606	32
8	5383706	33
9	5372987	34
10	9091774	35
11	J140-05-1874	36
12	40730901	37
13	32262339	38
14	40730902	39
15		40
16		41
17		42
18		43
19		44
20		45
21		46
22		47
23		48
24		49
25		50

Book Mark: J140-05-1874

See also

C. **5 Cav. (Col'd.) | Mass.**

Frank Eddingfield.

....., Co. *A*....., 5 Reg't Mass. Cav. (Col'd.)

Appears on

Company Descriptive Book

of the organization named above.

DESCRIPTION.

Age *22* years; height *5* feet *7* inches.

Complexion

Eyes; hair.....

Where born *Georgia.*

Occupation *Tailor.*

ENLISTMENT.

When *June 13*....., 1864.

Where *Boston.*

By whom *Capt. L. Barnes*; term *3* y'rs.

Remarks: *Mustered Capt. L. Barnes.*

Jan. 13 '64. Discharged at Point

Lookout Md. June 9 '65. Descriptive

List given Nov. 26 '65.

H. C. Thomas.

E

5 Col'd Cav.

Mass.

Frank Eddingfield
Priv., Co. I, 5 Reg't Mass Colored Cavalry.

Appears on

Company Muster Roll

for July & Aug, 1864.

Present or absent Present

Stoppage, \$ 100 for

Due Gov't, \$ 100 for

Valuation of horse, \$ 100

Valuation of horse equipments, \$ 100

Remarks: Recruit from Depot
joined Co. at Ft. Lookout, Ma.
July 17th /64 - enlistment
papers not recd.
(enrolled June 13 at Boston
mustered in June 13/64 at
Galloups Hill for 3 years)

Book mark:

W. H. Thompson

(358)

Copyist.

E

5 Col'd Cav.

Mass.

Frank Eddenfield

Priv., Co. I, 5 Reg't Mass. Colored Cavalry.

Appears on

Company Muster Roll

for Sept. & Oct., 1864.

Present or absent Present.

Stoppage, \$ 100 for

Due Gov't, \$ 100 for

Valuation of horse, \$ 100

Valuation of horse equipments, \$ 100

Remarks:

Book mark:

C. F. Thompson

(358)

Copyist.

6

5 Col'd Cav.

Mass.

Frank Eddensfield

, Co. I, 5 Reg't Mass. Colored Cavalry.

Appears on

Company Muster Roll

for Nov. 8 Dec., 1864.

Present or absent Present,

Stoppage, \$ 100 for

Due Gov't, \$ 100 for

Valuation of horse, \$ 100

Valuation of horse equipments, \$ 100

Remarks: Due U. S. for ord. lost \$ 0.08. Rec'd \$ 10.00 advance pay.

Book mark:

C. F. Thompson

(358)

Copyist.

E

5 Col'd Cav.

Mass.

Frank Eddenfield

Ovt., Co. I, 5 Reg't Mass. Colored Cavalry.

Appears on

Company Muster Roll

for Jan. & Feb., 1865.

Present or absent Present.

Stoppage, \$ 100 for

Due Gov't, \$ 100 for

Valuation of horse, \$ 100

Valuation of horse equipments, \$ 100

Remarks: Due 1st installment
U.S. Bounty \$25.00, due
U.S. for ord. lost \$0.08.
Rec'd \$10.00 advance pay.

Book mark:

C. F. Thompson

(358)

Copyist.

E | 5 Cav. | Mass. C.

Frank Eddingfield
Pvt., Co. I., 5-Regt. Mass. C.C.

Appears on

Hospital Muster Roll

of U. S. A. General Hospital,

at Point Lookout, Md.,

for Mar & Apr., 1865.

Attached to hospital:

When, 186 .

How employed

Last paid by Maj. Dodge.

to Dec 31, 1864.

Bounty paid \$ 100; due \$ 100

Present or absent Present.

Remarks:

Ward F.

Book mark:

J. Hasterling
Copyist.

E

5 Col'd Cav.

Mass.

Frank Eddenfield

Priv., Co. I, 5 Reg't Mass. Colored Cavalry.

Appears on

Company Muster Roll

for March 30 Apr., 1865.

Present or absent absent

Stoppage, \$ 100 for

Due Gov't, \$ 100 for

Valuation of horse, \$ 100

Valuation of horse equipments, \$ 100

Remarks: Due 1st installment

U. S. Bounty \$25.00

Absent sick at Point

Lookout since Mar. 27/65

Book mark:

C. F. Thompson

(358)

Copyist.

E

5 Col'd Cav.

Mass.

Frank Eddenfield.

Pvt., Co. I, 5 Reg't Mass. Colored Cavalry.

Appears on

Company Muster Roll

for May & June, 1865.

Present or absent Absent.

Stoppage, \$ 100 for

Due Gov't, \$ 100 for

Valuation of horse, \$ 100

Valuation of horse equipments, \$ 100

Remarks: See 1st installment
U. S. Bounty 25⁰⁰
absent sick at Point
Lookout since Mar. 27
/65.

Book mark:

C. F. Thompson.

(358)

Copyist.

E

5 Col'd Cav.

Mass.

Frank Edenfield

Pat, Co. I, 5 Reg't Mass. Col'd Cavalry.

Appears on a

Detachment Muster-out Roll

of the organization named above. Roll dated

Pt Lookout, Md., June 9, 1865.

Muster-out to date

June 9, 1865.

Last paid to

Dec 31, 1864.

Clothing account:

Last settled Dec 31, 1864; drawn since \$ 100

Due soldier \$ 100; due U. S. \$ 100

Am't for cloth'g in kind or money adv'd \$ 11 ⁰²/₁₀₀

Due U. S. for arms, equipments, &c., \$ 100

Bounty paid \$ 100; due \$ 100

Remarks: Dischs under
G. O. No. 77 War Dept.
May 3, 1865.

Bounty due \$ 25.00

Paid none.

Book mark:

R. Washington

Copyst.

(349)

E

5 Col'd Cav.

Mass.

Frank Eddingfield

Plt, Co. I, 5 Reg't Mass. Colored Cavalry.

Appears on

Company Muster Roll

for

July-Aug

, 1865

Present or absent

Stoppage, \$

100 for

Due Gov't, \$

100 for

Valuation of horse, \$

100

Valuation of horse equipments, \$

100

Remarks:

Discharged at Point Lookout
Md. J. C. 77 June 21 '65 Descriptive
list account of pay & clothing
sent to Staff.

Book mark:

Holcomb

(358)

Copyist.

E

5 Col'd Cav.

Mass.

Frank T. Eddengfield
Pvt., Co. D, 5 Reg't Mass. Colored Cav.

Appears on Returns as follows:

Mch to June 1865,
Absent sick at
Point Lookout since
Mch 27

July 1865 Loss June 9/65
Point Lookout Md
discharged by order
War Dept no 77

His name appears also as
Frank Eddingfield
Frank Edingfield

Book mark :

A. R. Street

(548)

Copyist.

E

5 Col'd Cav.

Mass.

F. Eddington

Priv, Co. C⁹, 5 Reg't Mass. Colored Cav.

Appears on Returns as follows:

July 1864. Gain: Recruit
Pt Lookout Md.
Joined Company July
16. 64.

Aug. 1864. Absent
detached service
Piney Pt.

Book mark:

W. S. Sade

(546)

Copyist.

87 | 5 Col'd Cav. | Mass.

Frank Eddingfield

Prk, Co. J, 5 Reg't Mass. Col'd Cavalry.

Appears on **Co. Muster-out Roll**, dated
Warrville, Texas, Oct 31, 1865.

Muster-out to date _____, 186 .

Last paid to *Dec 31, 1864*.

Clothing account:

Last settled _____, 186 ; drawn since \$ _____ 100

Due soldier \$ *23⁹⁴* 100; due U. S. \$ _____ 100

Am't for cloth'g in kind or money adv'd \$ _____ 100

Due U. S. for arms, equipments, &c., \$ _____ 100

Bounty paid \$ _____ 100; due \$ *100* 100

Remarks: *Discharged June 9/65 at
Point Lookout Md. by order of War.
Dept. dated May 3/65.*

Book mark: *MOR on file J1408 100 J.74.*

Holeman

E. 15. low. (old) / Mass

Frank Eddingfield

, Co. D., 5th Reg't Mass (old) / low.

NOTATION.

Book mark: J. 140. b. J. 1874

War Department,

Adjutant General's Office,

Washington, Nov. 30th, 1874.

Call from

returned with report.

The above book mark was noted on rolls in order to preserve results of search in this case.

E. P. Conaizier

(475)

Copyist.

346

Eddington, William

Co I, 5 Mass. Cav., (Col'd.)

Private

Farrier

CARD NUMBERS.

1	5382679	26
2	5382764	27
3	5382860	28
4	5382941	29
5	5383051	30
6	5383149	31
7	5383234	32
8	5383337	33
9	5383441	34
10	5383542	35
11	5383639	36
12	9091687	37
13	40730903	38
14		39
15		40
16		41
17		42
18		43
19		44
20		45
21		46
22		47
23		48
24		49
25		50

Book Mark:

See also

E. | **5 Cav. (Col'd.)** | **Mass.**

William Edlington.

....., Co. *I*, 5 Reg't Mass. Cav. (Col'd.)

Appears on

Company Descriptive Book
of the organization named above.

DESCRIPTION.

Age *39* years; height *5* feet *8* inches.

Complexion *Light*

Eyes *Brown*; hair *Black*

Where born *Sulphur Va.*

Occupation *Blk Smith.*

ENLISTMENT.

When *Mar. 19th, 1864.*

Where *Waltham.*

By whom *A. O. Swain*; term *3* y'rs.

Remarks:

H. C. Thomas.

E

5 Col'd Cav.

Mass.

William Eddington

Co. I, 5 Reg't Mass. Col'd Cav.

Appears on

Company Muster-in and Descriptive Roll

of the organization named above. Roll dated

Readville Mass, Mch 26, 1864.

Where born Culpeper Co, Va.

Age 39 y'rs; occupation Blacksmith

When enlisted Mch 19, 1864.

Where enlisted Waltham

For what period enlisted 3 years.

Eyes Black; hair Black

Complexion Black; height 5 ft. 8 in.

When mustered in Mch 26, 1864.

Where mustered in

Bounty paid \$ 100; due \$ 100

Where credited 6 Dist, Middlesex

Company to which assigned

Remarks: Residence: Waltham

Book mark:

W.H. Thompson

(356d)

Copyist.

E | **5 Col'd Cav.** | **Mass.**

William Eddington
Priv, Co. I, 5 Reg't Mass. Colored Cavalry.

Appears on

Company Muster Roll

for *Mch 26 to Apl 30*, 1864.

Present or absent *Present*

Stoppage, \$ *100* for

Due Gov't, \$ *100* for

Valuation of horse, \$ *100*

Valuation of horse equipments, \$ *100*

Remarks: _____

Book mark: _____

M. H. Thompson
(358) Copyist.

E

5 Col'd Cav.

Mass.

William Eddington

Co. I, 5 Reg't Mass. Colored Cavalry.

Appears on

Company Muster Roll

for May & June, 1864.

Present or absent Present

Stoppage, \$ 100 for

Due Gov't, \$ 100 for

Valuation of horse, \$ 100

Valuation of horse equipments, \$ 100

Remarks:

Book mark:

W. H. Thompson
Copyist.

E

5 Col'd Cav.

Mass.

William Eddington

Pr, Co. I, 5 Reg't Mass. Colored Cavalry.

Appears on

Company Muster Roll

for *July & Aug*, 186*4*.

Present or absent *Absent*

Stoppage, \$ *100* for

Due Gov't, \$ *100* for

Valuation of horse, \$ *100*

Valuation of horse equipments, \$ *100*

Remarks *Detached Service
Piney Point.*

Book mark:

W. H. Thompson
Copyist.

(358)

6

5 Col'd Cav.

Mass.

William Eddenton

Priv. Co. I, 5 Reg't Mass. Colored Cavalry.

Appears on

Company Muster Roll

for

Sept & Oct, 1864.

Present or absent

Present

Stoppage, \$

100 for

Due Gov't, \$

100 for

Valuation of horse, \$

100

Valuation of horse equipments, \$

100

Remarks:

Book mark:

C. F. Thompson

(358)

Copyist.

E

5 Col'd Cav.

Mass.

William Edenton

Priv., Co. I, 5 Reg't Mass. Colored Cavalry.

Appears on

Company Muster Roll

for Nov. & Dec., 1864.

Present or absent Present.

Stoppage, \$ 100 for

Due Gov't, \$ 100 for

Valuation of horse, \$ 100

Valuation of horse equipments, \$ 100

Remarks:

Book mark:

C. F. Thompson

Copyist.

(358)

E

5 Col'd Cav.

Mass.

William Edenton

Farrier, Co. I, 5 Reg't Mass. Colored Cavalry.

Appears on

Company Muster Roll

for Jan. & Feb., 1865.

Present or absent Present,

Stoppage, \$ 100 for

Due Gov't, \$ 100 for

Valuation of horse, \$ 100

Valuation of horse equipments, \$ 100

Remarks: Dup 1st 2nd 3rd install
means U.S. Bounty \$140.00

Book mark:

C. F. Thompson

(358)

Copyist.

E

5 Col'd Cav.

Mass.

William E Edenton

Famer, Co. I, 5 Reg't Mass. Colored Cavalry.

Appears on

Company Muster Roll

for March & Apr., 1865.

Present or absent Present.

Stoppage, \$ 100 for

Due Gov't, \$ 100 for

Valuation of horse, \$ 100

Valuation of horse equipments, \$ 100

Remarks: Due 1st 2^d 3^d 4th in -
statements U. S. Bounty
\$180.00

Book mark:

C. F. Thompson.

(358)

Copyist.

E

5 Col'd Cav.

Mass.

William Eddentoy

Farmer, Co. I, 5 Reg't Mass. Colored Cavalry.

Appears on

Company Muster Roll

for May & June, 1865.

Present or absent Absent.

Stoppage, \$ 100 for

Due Gov't, \$ 100 for

Valuation of horse, \$ 100

Valuation of horse equipments, \$ 100

Remarks: Due 1st 2^d 3^d 4th install-
ments U.S. Bounty \$180.⁰⁰
on Board Str. Fenobia.

Book mark:

C. F. Thompson

(358)

Copyist.

3

5 Col'd Cav.

Mass.

William Edderton

Farmer, Co. I, 5 Reg't Mass. Colored Cavalry.

Appears on

Company Muster Roll

for July-Aug, 1865.

Present or absent Present

Stoppage, \$ 100 for

Due Gov't, \$ 100 for

Valuation of horse, \$ 100

Valuation of horse equipments, \$ 100

Remarks:

Book mark:

Holcomb

E

5 Col'd Cav.

Mass.

Wm Edington

, Co. C, 5 Reg't Mass. Colored Cav.

Appears on Returns as follows:

June & July 1865. On
duty Fannie

Book mark :

M. Saccade

(546)

Copyist.

E

5 Col'd Cav. | Mass.

William Eddenton

James Co. J, 5 Reg't Mass. Col'd Cavalry.

Appears on Co. Muster-out Roll, dated

Clarksville Texas, Oct 31, 1865.

Muster-out to date

Oct 31, 1865.

Last paid to

Dec 31, 1864.

Clothing account:

Last settled....., 186 ; drawn since \$..... 100

Due soldier \$ 33¹¹/₁₀₀; due U. S. \$..... 100

Am't for cloth'g in kind or money adv'd \$..... 100

Due U. S. for arms, equipments, &c., \$ 11¹¹/₁₀₀

Bounty paid \$..... 100; due \$ 300¹⁰⁰/₁₀₀

Remarks: Mustered out by S.O. No. 2920 Div.

Dept of Texas dated Galveston Texas Sept 10/65
(based on authority from War Dept. dated Sept 8/65
directing the Muster out of colored troops
organized in northern states) their services
being no longer required. Transfer (over)

Book mark:

Hobson

JAN. 10

5383639

1891 *

and subsistence furnished to Boston
mass. Muster out to date Oct 31/65x

397

Ederson, Frank

Co I, 5 Mass. Cav., (Col'd.)

Private

Private

CARD NUMBERS.

1	5372438	26
2	5372494	27
3	5372603	28
4	5374971	29
5	5375081	30
6	5375183	31
7	5375289	32
8	5375443	33
9	5375652	34
10	5372957	35
11	9092528	36
12	40730904	37
13		38
14		39
15		40
16		41
17		42
18		43
19		44
20		45
21		46
22		47
23		48
24		49
25		50

Book Mark:

See also

S. 951626 - P. U. mem
A. G. 1918156
S. 2181160 PO Ret
All 2186172

J. Ballantyne

J. Ballantyne

6

5 Cav. (Col'd.) | Mass.

Frank Ederson

Co. B, 5 Reg't Mass. Cav. (Col'd.)

Appears on

Company Descriptive Book

of the organization named above.

DESCRIPTION.

Age 22 years; height 5 feet 5 inches.

Complexion Black

Eyes Black; hair Black

Where born Stafford Co. Virginia

Occupation Farmer

ENLISTMENT.

When Sept 24, 1864.

Where Boston

By whom Capt. L. Barnes; term 1 y'rs.

Remarks: Rec'd on enlistment at City Point Va. May 24/65 in accordance with orders issued Sept. dated May 2/65

A. Wiley

(3820)

Copist.

E^v

5 Col'd Cav.

Mass.

Frank Edson

Appears with rank of on

Muster and Descriptive Roll of a Detachment of U. S. Vols. forwarded

for the 5 Reg't Mass. Col'd Cavalry. Roll dated

Boston Mass., , 1864.

Where born Stafford Co. Va

Age 22 y'rs; occupation Farmer

When enlisted Sept. 24, 1864.

Where enlisted Boston Mass.

For what period enlisted 1 years.

Eyes blk; hair blk

Complexion blk; height 5 ft. 5 in.

When mustered in Sept 24, 1864.

Where mustered in Boston Mass.

Bounty paid \$ 33 ³³/₁₀₀; due \$ 66 ⁶⁷/₁₀₀

Where credited Ward 1 Springfield Mass

Company to which assigned

Remarks :

Book mark :

M. A. Michaels

(339)

Copyist.

E

5 Col'd Cav.

Mass.

Frank Ederson

Appears with rank of Private on

Muster and Descriptive Roll of a Detachment of U. S. Vols. forwarded

for the 5 Reg't Mass. Col'd Cavalry. Roll dated

Draft Rendezvous, Galloups Island B. H. Mass., Oct. 9, 1864.

Where born Stafford Co. Va.

Age 22 y'rs; occupation Farmer

When enlisted Sept 24, 1864.

Where enlisted Boston

For what period enlisted 1 years.

Eyes black; hair black

Complexion black; height 5 ft. 5 in.

When mustered in Sept. 24, 1864.

Where mustered in Boston

Bounty paid \$ 33 ³³/₁₀₀; due \$ 66 ⁶⁷/₁₀₀

Where credited Springfield Campden Co.

Company to which assigned

Remarks:

Book mark:

M. A. Michael

(339)

Copyist.

E

5 Col'd Cav.

Mass.

Frank Ederson

Appears with rank of *Private* on

Muster and Descriptive Roll of a Detachment of U. S. Vols. forwarded

for the 5 Reg't Mass. Col'd Cavalry. Roll dated

Boston Mass. Sept 24, 1864.

Where born *Stafford Co Va*

Age *22* y'rs; occupation *Farmer*

When enlisted *Sept 24*, 1864.

Where enlisted *Boston Mass.*

For what period enlisted *1* years.

Eyes *black*; hair *black*

Complexion *black*; height *5 ft. 5 in.*

When mustered in *Sept 24*, 1864.

Where mustered in *Boston Mass.*

Bounty paid \$ *3 3* ^{*33*}/_{*100*}; due \$ *6 6* ^{*67*}/_{*100*}

Where credited *City of Springfield Mass*
Ward 1

Company to which assigned

Remarks:

Book mark:

M. A. Michaels

(339)

Copyist.

E.

5 Col'd Cav.

Mass.

Frank Ederson,

Pvt., Co. B, 5 Reg't Mass. Col'd Cavalry.

Appears on

Company Muster Roll

for Sept. & Oct., 1864.

Present or absent Present

Stoppage, \$ 100 for

Due Gov't, \$ 100 for

Valuation of horse, \$ 100

Valuation of horse equipments, \$ 100

Remarks: Joined from Depot
Oct. 26/64.

Book mark:

J. W. Brown

(358)

Copyist.

E.

5 Col'd Cav.

Mass.

Frank Ederson,

Part, Co. B, 5 Reg't Mass. Col'd Cavalry.

Appears on

Company Muster Roll

for Nov. & Dec., 1864.

Present or absent Present.

Stoppage, \$ 100 for

Due Gov't, \$ 100 for

Valuation of horse, \$ 100

Valuation of horse equipments, \$ 100

Remarks: Joined the Co. as a
Recruit - Oct. 28/64.

Book mark:

J. H. Brown

(358)

Copyist.

E.

5 Col'd Cav.

Mass.

Frank Ederson,

Pvt., Co. B, 5 Reg't Mass. Col'd Cavalry.

Appears on

Company Muster Roll

for Jan'y. & Feby., 1865.

Present or absent Present

Stoppage, \$ 100 for

Due Gov't, \$ 100 for

Valuation of horse, \$ 100

Valuation of horse equipments, \$ 100

Remarks: Due U.S. for
Ordinance \$0.67

Book mark:

J. W. Brown
Copyst.

(358)

E. | 5 Col'd Cav. | Mass.

Frank Ederlon,

Part, Co. B, 5 Reg't Mass. Col'd Cavalry.

Appears on

Company Muster Roll

for *March & April*, 1865.

Present or absent *— Present.*

Stoppage, \$ *100* for

Due Gov't, \$ *100* for

Valuation of horse, \$ *100*

Valuation of horse equipments, \$ *100*

Remarks:

Book mark: *Must out at (over.)*

(358)

J. W. Brown
Copist.

JAN. - 9

5375289

★ 1891 ★

City Point, Va., May 24 /65,
Orders A.G.O.

See m-out-Roll on file.

E

5 Col'd Cav.

Mass.

Frank Ederson

Pvt., Co. B, 5 Reg't Mass. Col'd Cavalry.

Appears on

Company Muster Roll

for May & June, 1865.

Present or absent

Stoppage, \$ 100 for

Due Gov't, \$ 100 for

Valuation of horse, \$ 100

Valuation of horse equipments, \$ 100

Remarks: Discharged the service of the U.S. at City Pt. Va. May 24/65. per orders from Sec. of War dated May 8/65.

Book mark:

Scherich

(358)

Copyist.

50

5 Col'd Cav.

Mass.

Frank Ederson

Pvt., Co. B, 5 Reg't Mass. Colored Cav.

Appears on Returns as follows:

Oct. 1864 - Gain - Oct 27, 64
Point Lookout Md.
Recruit from Depot

May 1865 - Loss - May 24/65
Light House Pt. Va.
Discharged by order
Adj. G. Washington May 5,
65

Book mark:

Wm. Sallade

(546)

Copyist.

E

5 Col'd Cav.

Mass.

Frank Ederson

Pat, Co. B, 5 Reg't Mass. Col'd Cavalry.

Appears on a

Detachment Muster-out Roll

of the organization named above. Roll dated

City Point, Va, May 24, 1864.

Muster-out to date May 24, 1864.

Last paid to Dec. 31, 1864.

Clothing account:

Last settled, 186 ; drawn since \$ 100

Due soldier \$ 100; due U. S. \$ 100

Am't for cloth'g in kind or money adv'd \$ 79 ⁹²/₁₀₀

Due U. S. for arms, equipments, &c., \$ 100

Bounty paid \$ 33 ³³/₁₀₀; due \$ 33 ³³/₁₀₀

Remarks: Clothing acct. now

settled. Discharged

under Gen'l O. No. 83

Mar Dept A. G. O.

Washington D. C. May 8th

1864

Book mark:

R. Washington

(349)

Compt.

E

5 Col'd Cav.

Mass.

Frank Ederson

Plt, Co. B, 5 Reg't Mass. Col'd Cavalry.

Appears on Co. Muster-out Roll, dated
Clarksville, Tex., Oct 31, 1865.

Muster-out to date _____, 186 .

Last paid to Dec. 31, 1864 .

Clothing account:

Last settled _____, 186 ; drawn since \$ 100

Due soldier \$ 100; due U. S. \$ 100

Am't for cloth'g in kind or money adv'd \$ 100

Due U. S. for arms, equipments, &c., \$ 100

Bounty paid \$ 100; due \$ 100

Remarks: Discharged May 24/65
by order of Sect. War City
Point, Va. S.O. W.D. May 28/65.

Book mark: _____

Scherich

(861)

Copyist.

Ederson, Frank

, Co. 5th Reg't Mass. C. C.

2 Enclosures.

Bed Cards	Final Statements
Burial Records	Furloughs
Certs. of Dis. for Discharge	Med. Certificates
C. M. Charges	Med. Des. Lists
Descriptive Lists	Orders
Discharge Certificates	Pris. of War Record

Other papers relating to—

Admission to Hosp'l	Furlough
Casualty Sheet	Med. Examination
Confinement	Misc. Information
Contracts	Pay or Clothing
Death or Effects	Personal Reports
Desertions	Rank
Discharge from Hosp'l	Transfer to Hosp'l
Discharge from Service	Transfer to V. R. C.
Duty	Transportation
EP 2	

NOTE 1. — This blank will be used for both enlistments and re-enlistments — enlistment of veterans, &c., &c., in the volunteer service. They will be made out in duplicate in all cases — one to accompany the recruiting return of the superintendent (not the recruiting officer) to the Adjutant-General, and one to accompany the accounts of the officer who pays bounty, &c. The Regiment and Company in which the soldier last served should be given on the back.

NOTE 2. — An enlistment holds to service. A muster-in must, in all cases, precede payment of pay, bounty, pension, &c. A muster-in roll must, in all cases, be filed in the Adjutant-General's Office as evidence of muster-in. The mustering officer, commissary, or assistant-commissary of musters, as the case may be, will countersign both enlistments as having mustered the soldier into the service of the United States before either of them is given to the disbursing officer.

DECLARATION OF RECRUIT.

** Frank Coluson* desiring to VOLUNTEER as a Soldier in the Army of the United States, for the term of ⁰⁷¹⁰ ~~THREE~~ YEARS, Do Declare, That I am *Twenty two* years and — months of age; that I have never been discharged from the United States service on account of disability or by sentence of a court-martial, or by order before the expiration of a term of enlistment; and I know of no impediment to my serving honestly and faithfully as a soldier for three years.

GIVEN at *Hopkin* the *24th* day of *April* 18*64*

Witness: *Geo. Blutz* *Frank Coluson*

Discharged 18 ..
 enlistment; last served in Company ()
 Reg't of ..
 Volunteered at *Hopkin*
 By *Frank Coluson*
 No. *722*

CONSENT IN CASE OF MINOR.

I, _____ of _____ Do CERTIFY, That I am _____; that the _____ years of age; and I do hereby freely give my CONSENT to his volunteering as a SOLDIER in the ARMY OF THE UNITED STATES for the period of THREE YEARS.

GIVEN at _____ the _____ day of _____

Witness: _____

VOLUNTEER ENLISTMENT.

STATE OF

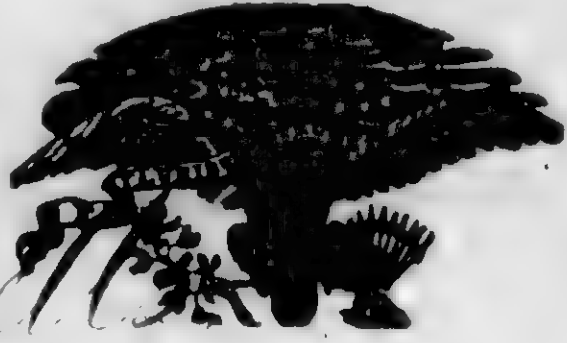

TOWN OF

Cambridge

City of Boston

I, *Thomas C. Swan* born in *Stafford Co*
in the State of *Virginia* aged *Twenty two* years,
and by occupation a *Farmer* Do HEREBY ACKNOWLEDGE to have
volunteered this *Twenty fourth* day of *September* 1864,
to serve as a **Soldier** in the **Army** of the **United States of America**, for the
period of **THREE YEARS**, unless sooner discharged by proper authority: Do also
agree to accept such bounty, pay, rations, and clothing, as are, or may be, estab-
lished by law for volunteers. And I, *Thomas C. Swan* do
solemnly swear that I will bear true faith and allegiance to the **United States**
of America, and that I will serve them honestly and faithfully against all their
enemies or opposers whomsoever; and that I will observe and obey the orders of
the President of the United States, and the orders of the officers appointed over
me, according to the Rules and Articles of War.

Sworn and subscribed to, at *Boston* this *Twenty fourth* day of *September* 1864,
BEFORE *W. L. Barnes* Witness *Thomas C. Swan*

I CERTIFY, ON HONOR, That I have carefully examined the above-named Volunteer, agreeably
to the General Regulations of the Army, and that, in my opinion, he is free from all bodily defects and
mental infirmity, which would in any way disqualify him from performing the duties of a soldier.

John H. Tucker
Surgical Board of Enlistment
John H. Tucker EXAMINING SURGEON.

I CERTIFY, ON HONOR, That I have minutely inspected the Volunteer, *Thomas C. Swan*
previously to his enlistment, and that he was entirely sober when enlisted; that, to the best of my
judgment and belief, he is of lawful age; and that, in accepting him as duly qualified to perform the duties
of an able-bodied soldier, I have strictly observed the Regulations which govern the recruiting service.
This soldier has *Blue* eyes, *Black* hair, *Black* complexion, is *five* feet
five inches high.

W. L. Barnes
Regiment of *21st Massachusetts* Volunteers,
RECRUITING OFFICER.

(A. G. O. No. 74 & 75.)

Mustered into the service of the United States, in Company
the *1st* day of *September*, 1864, at *Boston Mass.*
Admitted to the service of the United States
in the 21st Massachusetts Volunteers

Regiment of *21st* Massachusetts Volunteers, on

W. L. Barnes

NOTE 1. — This blank will be used for both enlistments and re-enlistments — enlistment of veterans, &c., &c., in the volunteer service. They will be made out in duplicate in all cases — one to accompany the recruiting return of the superintendent (not the recruiting officer) to the Adjutant-General, and one to accompany the accounts of the officer who pays bounty, &c. The Regiment and Company in which the soldier last served should be given on the back.

NOTE 2. — An enlistment holds to service. A muster-in must, in all cases, precede payment of pay, bounty, pension, &c. A muster-in roll must, in all cases, be filed in the Adjutant-General's Office as evidence of muster-in. The mustering officer, commissary, or assistant-commissary of musters, as the case may be, will countersign both enlistments as having mustered the soldier into the service of the United States before either of them is given to the disbursing officer.

DECLARATION OF RECRUIT.

X, Frank Ederer desiring to VOLUNTEER as a Soldier in the Army of the United States, for the term of ^{07 1/2} ~~THREE~~ YEARS, months and ~~days~~ ^{07 1/2} months of age; that I have never been discharged from the United States service on account of disability or by sentence of a court-martial, or by order before the expiration of a term of enlistment; and I know of no impediment to my serving honestly and faithfully as a soldier for three years.

GIVEN at *Dartmouth* the *11th* day of *September*

Witness: *Wm. H. ...* *Mont ...*

Discharged *18*
33, 33, 33
30th Jan'y 1861.
N. S.

enlistment; last served in Company ()
Reg't of

Volunteered at *Dartmouth* *1860*
By *Wm. H. ...*
5th Mass. Cav'y
Regiment of *...*

CONSENT IN CASE OF MINOR.

I, _____ Do CERTIFY, That I am _____ of _____; that the _____ years of age; and I do hereby freely give my CONSENT to his volunteering as a SOLDIER in the ARMY OF THE UNITED STATES for the period of THREE YEARS.

GIVEN at _____ the _____ day of _____

Witness :

VOLUNTEER ENLISTMENT.

STATE OF

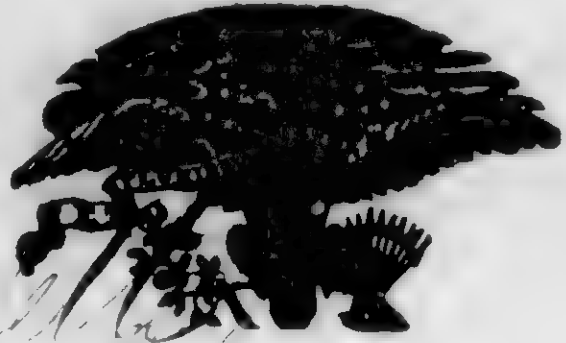

CITY OF ~~TOWN~~ OF

Massachusetts

Salem

I, *Frank Adams* born in *Stoughton* in the State of *Virginia* aged *Twenty Four* years, and by occupation a *Farmer* DO HEREBY ACKNOWLEDGE to have volunteered this *Twenty sixth* day of *September* 1864, to serve as a **Soldier** in the **Army of the United States of America**, for the period of **THREE YEARS**, unless sooner discharged by proper authority: Do also agree to accept such bounty, pay, rations, and clothing, as are, or may be, established by law for volunteers. And I, *Frank Adams* do solemnly swear that I will bear true faith and allegiance to the **United States of America**, and that I will serve them honestly and faithfully against all their enemies or opposers whomsoever; and that I will observe and obey the orders of the President of the United States, and the orders of the officers appointed over me, according to the Rules and Articles of War.

Sworn and subscribed to, at *Salem* this *26th* day of *September* 1864, BEFORE *J. W. DeBarre*

I CERTIFY, ON HONOR, That I have carefully examined the above-named Volunteer, agreeably to the General Regulations of the Army, and that, in my opinion, he is free from all bodily defects and mental infirmity, which would in any way disqualify him from performing the duties of a soldier.

Wm. H. Hunt
Surgeon Major of Engineers
3rd Dist Mass EXAMINING SURGEON.

I CERTIFY, ON HONOR, That I have minutely inspected the Volunteer, *Frank Adams* previously to his enlistment, and that he was entirely sober when enlisted; that, to the best of my judgment and belief, he is of lawful age; and that, in accepting him as duly qualified to perform the duties of an able-bodied soldier, I have strictly observed the Regulations which govern the recruiting service. This soldier has *blue* eyes, *dark* hair, *black* complexion, is *5 1/2* feet *6* inches high.

J. W. DeBarre
Lieut & Surgeon
Regiment of *2nd Mass* Volunteers,
RECRUITING OFFICER.

Mustered into the service of the United States, in Company
the 14th day of September, 1864, at Boston Mass
Frank Adams
11th Mass
1st Regt
Volunteers, on

(A. G. O. No. 74 & 75.)

398

Edlingfield Frank
Co I, 5 Mass. Cav., (Col'd.)

CARD NUMBERS.

1	26
2	27
3	28
4	29
5	See Edlingfield Frank
6	31
7	32
8	33
9	34
10	35
11	36
12	37
13	38
14	39
15	40
16	41
17	42
18	43
19	44
20	45
21	46
22	47
23	48
24	49
25	50

Book Mark:

See also

399

Edward, Alfred

Co D, 5 Mass. Cav., (Col'd.)

Private

Private

CARD NUMBERS.

1	5376911	26
2	5376999	27
3	5377087	28
4	5377177	29
5	5377285	30
6	5377391	31
7	5377491	32
8	5377601	33
9	5377705	34
10	5377801	35
11	5377894	36
12	5377933	37
13	5377990	38
14	9092251	39
15	40730895	40
16		41
17		42
18		43
19		44
20		45
21		46
22		47
23		48
24		49
25		50

Book Mark:

See also

S; 1166424 P.O. m m

Co Lewis Pa. (m) 9/4/13/C-F-51

L Ballantyne

E

5 Cav. (Col'd.) | Mass.

Alfred Edwards

Co. 1, 5 Reg't Mass. Cav. (Col'd.)

Appears on

Company Descriptive Book

of the organization named above.

DESCRIPTION.

Age 24 years; height 5 feet 6 1/2 inches.

Complexion Fair

Eyes Blue; hair Brown

Where born Northampton Mass.

Occupation Farmer

ENLISTMENT.

When June 10, 1864

Where Northampton

By whom J. B. Goddard; term 5 y'rs.

Remarks: Mustered into service
Sept 18 64. at Readville Mass.

Alfred Edwards

E

5 Col'd Cav. | Mass.

Alfred Edward

Co. D, 5 Reg't Mass. Col'd Cav.

Appears on

Company Muster-in and Descriptive Roll

of the organization named above. Roll dated

Readville Mass, July 29, 1864.

Where born *Rockingham Co Va.*

Age *27* y'rs; occupation *Farmer.*

When enlisted *July 5*, 1864.

Where enlisted *Princeton*

For what period enlisted *3* years.

Eyes *BRN*; hair *BRN*

Complexion *BRN*; height *5* ft. *6 1/2* in.

When mustered in *July 29*, 1864.

Where mustered in *Readville Mass*

Bounty paid \$ *100*; due \$ *100*

Where credited *9 Dist Worcester*

Company to which assigned

Remarks:

Book mark:

(356d)

Jarvis
Copyist.

E

5 Col'd Cav.

Mass.

Alfred Edwards

Prvt, Co. D, 5 Reg't Mass. Col'd Cavalry.

Appears on

Company Muster Roll

for *Enlistment to Feb'y 29*, 1864.

Present or absent *Present*

Stoppage, \$ *100* for

Due Gov't, \$ *100* for

Valuation of horse, \$ *100*

Valuation of horse equipments, \$ *100*

Remarks: *Weak.*

Book mark:

Lewis
Copyist.

E

5 Col'd Cav.

Mass.

Alfred Edwards

A-1, Co. D, 5 Reg't Mass. Col'd Cavalry.

Appears on

Company Muster Roll

for *Sept & Oct*, 186*11*.

Present or absent *Present*

Stoppage, \$ *100* for

Due Gov't, \$ *100* for

Valuation of horse, \$ *100*

Valuation of horse equipments, \$ *100*

Remarks:

Book mark:

(358)

J. W. ...
Copyist.

Q

5 Col'd Cav.

Mass.

Alfred Edwards

Dr., Co. D, 5 Reg't Mass. Col'd Cavalry.

Appears on

Company Muster Roll

for *May & June*, 186*4*.

Present or absent *Present*

Stoppage, \$ 100 for

Due Gov't, \$ 100 for

Valuation of horse, \$ 100

Valuation of horse equipments, \$ 100

Remarks:

Book mark:

Barrett

E

5 Col'd Cav.

Mass.

Alfred Edwards

Priv., Co. D, 5 Reg't Mass. Col'd Cavalry.

Appears on

Company Muster Roll

for July & Aug, 1864

Present or absent Present

Stoppage, \$ 100 for

Due Gov't, \$ 100 for

Valuation of horse, \$ 100

Valuation of horse equipments, \$ 100

Remarks:

Book mark:

J. Merchant

(358)

Copyist.

E

5 Col'd Cav.

Mass.

Alfred Edwards

Pvt., Co. D, 5 Reg't Mass. Col'd Cavalry.

Appears on

Company Muster Roll

for Sept & Oct, 1864

Present or absent Present

Stoppage, \$ 100 for

Due Gov't, \$ 100 for

Valuation of horse, \$ 100

Valuation of horse equipments, \$ 100

Remarks:

Book mark:

A. Merchant

(358)

Copyist.

E

5 Col'd Cav.

Mass.

Alfred Edwards

A., Co. D, 5 Reg't Mass. Col'd Cavalry.

Appears on

Company Muster Roll

for Nov, Dec, 1864.

Present or absent Present

Stoppage, \$ 100 for

Due Gov't, \$ 100 for

Valuation of horse, \$ 100

Valuation of horse equipments, \$ 100

Remarks: In Military Stores for Massachusetts & Central Ill.

Book mark:

A. Merchant

(358)

Copyist.

E

5 Col'd Cav.

Mass.

Alfred Edwards

Prin, Co. D, 5 Reg't Mass. Col'd Cavalry.

Appears on

Company Muster Roll

for Jan & Feb, 1865.

Present or absent Present

Stoppage, \$ 100 for

Due Gov't, \$ 100 for

Valuation of horse, \$ 100

Valuation of horse equipments, \$ 100

Remarks: Due 1 2 3 4, Mull's
US Bounty

Book mark:

S. Murchant

Co

5 Col'd Cav.

Mass.

Alfred Edwards

Pr, Co. D, 5 Reg't Mass. Col'd Cavalry.

Appears on

Company Muster Roll

for Mar & Apr, 1865

Present or absent Present

Stoppage, \$ 100 for

Due Gov't, \$ 100 for

Valuation of horse, \$ 100

Valuation of horse equipments, \$ 100

Remarks: Due 1, 2, 3, 4, 1 mo U.S. Bounty

Book mark:

J. Merchant

(358)

Copyist.

E

5 Col'd Cav.

Mass.

Alfred Edward

Pvt, Co. D, 5 Reg't Mass. Col'd Cavalry.

Appears on

Company Muster Roll

for May and June, 1865.

Present or absent Absent

Stoppage, \$ 100 for

Due Gov't, \$ 100 for

Valuation of horse, \$ 100

Valuation of horse equipments, \$ 100

Remarks:

Free before April 19, 1861
Due 1, 2, 3, 4, 5 Mos. U.S.
bonnity. on detached duty
Hd Qrs 125 A.C. City Pt.
May 12/65

Book mark:

House

5

5 Col'd Cav.

Mass.

Alfred Saunders

Sgt., Co., 5 Reg't Mass. Col'd Cavalry.

Appears on a

Detachment Muster Roll

of the organization named above

for *June 30*, 186*5*.

Station *White Ranch, Texas*

Present or absent *Present*

Stoppage, \$ *100* for

Due Gov't, \$ *100* for

Valuation of horse, \$ *100*

Valuation of horse equipments, \$ *100*

Remarks:

Book mark:

Miller

Copyist.

E

5 Col'd Cav.

Mass.

Alfred Edwards

Priv., Co. D, 5 Reg't Mass. Col'd Cavalry.

Appears on

Company Muster Roll

for July and Aug., 1865.

Present or absent Absent

Stoppage, \$ 100 for

Due Gov't, \$ 100 for

Valuation of horse, \$ 100

Valuation of horse equipments, \$ 100

Remarks:

See April 19, 1861
Dec 1 2 3 4 5 in U.S.
Bounty on detached duty
at Hd. Qrs 25 Corps May
12/65

Book mark:

Howse

E

5 Col'd Cav.

Mass.

Alfred Edwards

Priv., Co. D, 5 Reg't Mass. Colored Cav.

Appears on Returns as follows:

May to Sept. 1865.

Absent on detached duty
at Hd. Qrs 25 a. Camp
since May 12, 65.

Book mark:

W. Ballade

(546)

Copyist.

E

5 Col'd Cav.

Mass.

Alfred Edwards

Priv., Co. E, 5 Reg't Mass. Col'd Cavalry.

Appears on Co. Muster-out Roll, dated

Clarksville Texas Oct. 31, 1865.

Muster-out to date Oct 31, 1865.

Last paid to June 30, 1864.

Clothing account:

Last settled....., 186 ; drawn since \$..... 100

Due soldier \$..... 100; due U. S. \$ 8 ⁶⁵/₁₀₀

Am't for cloth'g in kind or money adv'd \$..... 100

Due U. S. for arms, equipments, &c., \$ 11 ⁰⁰/₁₀₀

Bounty paid \$..... 100; due \$ 200 ⁰⁰/₁₀₀

Remarks:

Total money value of
ordnance charged \$ 11.00

Book mark:

House

(861)

Copyist.

400

Edwards, Benjamin

Col 6, 5 Mass. Cav., (Col'd.)

Private

Private

CARD NUMBERS.

1	5 3 7 2 5 8 3	26
2	5 3 7 2 5 3 8	27
3	5 3 7 2 6 3 6	28
4	5 3 7 2 6 1 5	29
5	5 3 7 6 4 5 6	30
6	5 3 7 6 4 9 6	31
7	5 3 7 6 5 9 5	32
8	5 3 7 6 6 9 3	33
9	5 3 7 6 8 6 1	34
10	9 4 3 6 1 8 8	35
11	9 0 9 2 4 9 1	36
12	4 0 7 3 0 9 0 5	37
13		38
14		39
15		40
16		41
17		42
18		43
19		44
20		45
21		46
22		47
23		48
24		49
25		50

Book Mark:

See also:

6
6

5 Cav. (Col'd.) | Mass.

Benjamin Edwards

, Co. 6, 5 Reg't Mass. Cav. (Col'd.)

Appears on

Company Descriptive Book

of the organization named above.

DESCRIPTION.

Age 22 years; height 5 feet 4 inches.

Complexion Colored

Eyes Black ; hair Black

Where born Warren, R Island

Occupation Farmer

ENLISTMENT.

When Dec 6, 1864.

Where Boston

By whom Capt L. Barnes ; term 3 y'rs.

Remarks: Received first installment of
U.S. Bounty \$100. Mustered into U.S.
Service Dec 6/64 by Capt L. Barnes at
Boston, Mass. Died Aug. 28/65 at
New Orleans in Gen Hospital of
Diarrhea

(3830)

M. Fairley

Copyist.

E.

5 Col'd Cav.

Mass.

Benjamin Edwards

Appears with rank of *Private* on

Muster and Descriptive Roll of a Detachment of U. S. Vols. forwarded

for the 5 Reg't Mass. Col'd Cavalry. Roll dated

Boston Mass, Dec. 7, 1864.

Where born *Warren R. I.*

Age *22* y'rs; occupation *Farmer*

When enlisted *Dec. 7*, 1864.

Where enlisted *Boston Mass.*

For what period enlisted *3* years.

Eyes *Blk*; hair *Blk*

Complexion *Colored*; height *5* ft. *4* in.

When mustered in *Dec. 7*, 1864.

Where mustered in *Boston*

Bounty paid \$ *100*; due \$ *100*

Where credited *Town of Franklin Mass.*

Company to which assigned

Remarks:

Book mark:

(339)

M. A. Michaels

Copyist.

E

5 Col'd Cav.

Mass.

~~Benjamin Edwards~~

Appears with rank of ~~Private~~ on

Muster and Descriptive Roll of a Detachment of U. S. Vols. forwarded

for the 5 Reg't Mass. Col'd Cavalry. Roll dated ~~Craft. Rendezvous, Galloups Island, S. H. Mass,~~ Dec 19, 1864.

Where born ~~Warren N. J.~~

Age ~~22~~ y'rs; occupation ~~Tanner~~

When enlisted ~~Dec. 6~~, 1864.

Where enlisted ~~Boston Mass.~~

For what period enlisted ~~3~~ years.

Eyes ~~black~~; hair ~~black~~

Complexion ~~Gold~~; height ~~5 ft. 4~~ in.

When mustered in ~~Dec. 6~~, 1864.

Where mustered in ~~Boston~~

Bounty paid \$ ~~100~~ ¹⁰⁰; due \$ ~~200~~ ¹⁰⁰

Where credited ~~Franklin Norfolk Co~~

Company to which assigned

Remarks: ~~Detained at this Post.~~

~~See also on index card 'Benjamin'~~

Book mark:

M. A. Michaels

E

5 Col'd Cav.

Mass.

Benjamin Edwards

Appears with rank of *Private* (11)

Muster and Descriptive Roll of a Detachment of U. S. Vols. forwarded

for the 5 Reg't Mass. Col'd Cavalry. Roll dated
Draft Rendezvous
Gallups Island Pt Mass, Jan. 3, 1865.

Where born *Warren R. I.*

Age *22* y'rs; occupation *Farmer*

When enlisted *Dec. 6*, 1864.

Where enlisted *Boston Mass.*

For what period enlisted *3* years.

Eyes *black*; hair *black*

Complexion *Gold*; height *5 ft. 4 in.*

When mustered in *Dec. 6*, 1864.

Where mustered in *Boston Mass.*

Bounty paid \$ *100* 100; due \$ *200* 100

Where credited *Franklin Norfolk Co*

Company to which assigned

Remarks: *Detained at this Post*

Entry cancelled except Remarks

Book mark:

M. A. Michaels

(339)

Copyst.

E

5 Col'd Cav.

Mass.

Benjamin Edwards

Appears with rank of *Private* on

Muster and Descriptive Roll of a Detachment of U. S. Vols. forwarded

for the 5 Reg't Mass. Col'd Cavalry. Roll dated
Draft Rendezvous
Galloup Island B. H. Mass Jan 26, 1865.

Where born *Warren R. I.*

Age *22* y'rs; occupation *Farmer*

When enlisted *Dec 6*, 1864.

Where enlisted *Boston Mass.*

For what period enlisted *3* years.

Eyes *black*; hair *black*

Complexion *Gold*; height *5 ft. 4* in.

When mustered in *Dec 6*, 1864.

Where mustered in *Boston Mass.*

Bounty paid \$ *100.00*; due \$ *200.00*

Where credited *Franklin Norfolk Co.*

Company to which assigned

Remarks:

Book mark:

M. A. Michaels

(339)

Copyist.

E

5 Col'd Cav.

Mass.

Benjamin Edwards

Pr, Co. C, 5 Reg't Mass. Col'd Cavalry.

Appears on

Company Muster Roll

for *Jan Feb*, 186*5*.

Present or absent *Present*

Stoppage, \$ *100* for

Due Gov't, \$ *100* for

Valuation of horse, \$ *100*

Valuation of horse equipments, \$ *100*

Remarks:

Book mark:

E. H. Brown

E

5 Col'd Cav.

Mass.

Benjamin Edwards

Port, Co. C, 5 Reg't Mass. Col'd Cavalry.

Appears on

Company Muster Roll

for Mar + April, 1865.

Present or absent Present

Stoppage, \$ 100 for

Due Gov't, \$ 100 for

Valuation of horse, \$ 100

Valuation of horse equipments, \$ 100

Remarks:

Book mark:

E. H. B. Coon.

6

5 Col'd Cav.

Mass.

Benjamin Edwards

Co. C, 5 Reg't Mass. Col'd Cavalry.

Appears on

Company Muster Roll

for May & June, 1865.

Present or absent Present

Stoppage, \$ 100 for

Due Gov't, \$ 100 for

Valuation of horse, \$ 100

Valuation of horse equipments, \$ 100

Remarks:

Book mark:

Abbott

E

5 Col'd Cav.

Mass.

Benjamin Edwards

Private, Co. C, 5 Reg't Mass. Col'd Cavalry.

Appears on

Company Muster Roll

for July & Aug, 1865.

Present or absent Absent

Stoppage, \$.05/100 for Ordnance
for 2 m stores \$6.50

Due Gov't, \$ 100 for

Valuation of horse, \$ 100

Valuation of horse equipments, \$ 100

Remarks: Sick in Stock at Broxton
since July 28/1865

Book mark: Died Aug 28-65. See
fin Stat

Abbott

(358)

Copyist.

E

5 Col'd Cav.

Mass.

Benjamin Edwards

Pvt, Co. C, 5 Reg't Mass. Colored Cav.

Appears on Returns as follows:

Feb. 1865. Enl. Feb. 23. 65

Point Lookout

Recruit from depot

July & Aug. 1865. Absent

sick in Hosp at

Brazos Texas.

Sept. 1865. loss. Aug 28. 65

New Orleans

Died. Rec'd notice

of death Sept. 11. 65.

Book mark:

M. Gallade

(546)

Copyist.

G'

5 Col'd Cav.

Mass.

Benjamin Edwards

Pvt, Co. C, 5 Reg't Mass. Col'd Cavalry.

Appears on Co. Muster-out Roll, dated
Clarkville Texas, Oct 31, 1865.

Muster-out to date _____, 186 .

Last paid to *Never Paid* _____, 186 .

Clothing account:

Last settled _____, 186 ; drawn since \$ _____ 100

Due soldier \$ _____ 100; due U. S. \$ _____ 100

Am't for cloth'g in kind or money adv'd \$ _____ 100

Due U. S. for arms, equipments, &c., \$ _____ 100

Bounty paid \$ _____ 100; due \$ _____ 100

Remarks: *Died Aug 28-65 at New Orleans La in Gen Hospital of Diarrhoea*

Book mark: *15.0, 2 H132*

Abbott

Edwards, Benjamin
P. Co. B., 5 Mass. C. Cav.

6 Enclosures.

Bed Cards	Descriptive Lists
Burial Records /	Final Statements /
Certs. of Dis. for Discharge	Furloughs
C. M. Charges	Med. Des. Lists
Med. Certificates	Orders

Other papers relating to—

Admission to Hosp'l	Furlough
Casualty Sheet (Officer's) /	Med. Examination
Confinement	Misc. Information
Contracts	Pay or Clothing
Death or Effects /	Personal Reports
Desertions	Rank
Discharge from Hosp'l	Transfer to Hosp'l
Discharge from Service	Transfer to V. R. C.
Duty	Transportation
S. P.	2

MICROFILM PUBLICATION M 1822

COMPILED MILITARY SERVICE RECORDS
OF VOLUNTEER UNION SOLDIERS WHO
SERVED WITH THE USCT (US COLORED TROOPS)
5TH MASSACHUSETTS REGIMENT OF CAVALRY

PERSONAL PAPERS' TARGET SHEET

PLEASE NOTE THE CHECKED INFORMATION ABOUT THE PERSONAL PAPERS IN
THIS FILE:

- NO PERSONAL PAPERS WERE FOUND IN THIS FILE WHEN THE
RECORDS WERE ARRANGED FOR MICROFILMING.
- 7 PERSONAL PAPER(S) FOUND IN THIS FILE WHEN THE RECORDS
WERE ARRANGED FOR MICROFILMING.

NOTE 1.—This blank will be used for both enlistments and re-enlistments—enlistment of veterans, &c., &c., in the volunteer service. They will be made out in duplicate in all cases—one to accompany the recruiting return of the superintendent (not the recruiting officer) to the Adjutant-General, and one to accompany the accounts of the officer who pays bounty, &c. The Regiment and Company in which the soldier last served should be given on the back.

NOTE 2.—An enlistment holds to service. A muster-in must, in all cases, precede payment of pay, bounty, pension, &c. A muster-in roll must, in all cases, be filed in the Adjutant-General's Office as evidence of muster-in. The mustering officer, commissary, or assistant-commissary of musters, as the case may be, will countersign both enlistments as having mustered the soldier into the service of the United States before either of them is given to the disbursing officer.

DECLARATION OF RECRUIT.

I, Benjamin Edwards desiring to VOLUNTEER as a Soldier in the Army of the United States, for the term of THREE YEARS, Do Declare, That I am 22 years ~~and~~ months of age; that I have never been discharged from the United States service on account of disability or by sentence of a court-martial, or by order before the expiration of a term of enlistment; and I know of no impediment to my serving honestly and faithfully as a soldier for three years.

GIVEN at Boston Mass- the 6th day of December, 1864

Witness: Benjamin Edwards

No. Benjamin Edwards
 Volunteered at Boston Mass
Dec 7 1864,
 By Wm. Smith
 of 1st Regiment of Mass
 Discharged 18
Wm. Smith
 Reg't of 3rd Mass. Cav
 enlistment; last served in Company ()

CONSENT IN CASE OF MINOR.

I, _____ Do CERTIFY, That I am _____; that the _____ of _____ is _____ years of age; and I do hereby freely give my CONSENT to his volunteering as a SOLDIER in the ARMY OF THE UNITED STATES, for the period of THREE YEARS.

GIVEN at _____ the _____ day of _____

Witness: _____

VOLUNTEER ENLISTMENT.

STATE OF

Massachusetts



CITY OF

Boston

I, Benjamin Edwards born in Warren in the State of Rhode Island aged 22 years, and by occupation a Farmer DO HEREBY ACKNOWLEDGE to have volunteered this 6th day of December 1864, to serve as a Soldier in the Army of the United States of America, for the period of THREE YEARS, unless sooner discharged by proper authority: Do also agree to accept such bounty, pay, rations, and clothing, as are, or may be, established by law for volunteers. And I, Benjamin Edwards do solemnly swear, that I will bear true faith and allegiance to the United States of America, and that I will serve them honestly and faithfully against all their enemies or opposers whomsoever; and that I will observe and obey the orders of the President of the United States, and the orders of the officers appointed over me, according to the Rules and Articles of War.

Sworn and subscribed to, at Boston Mass this 6th day of Dec 1864, BEFORE J. W. L. Barnes Sgt + Purmarro

I CERTIFY, ON HONOR, That I have carefully examined the above-named Volunteer, agreeably to the General Regulations of the Army, and that, in my opinion, he is free from all bodily defects and mental infirmity, which would in any way disqualify him from performing the duties of a soldier.

EXAMINING SURGEON.

I CERTIFY, ON HONOR, That I have minutely inspected the Volunteer, Benjamin Edwards previously to his enlistment, and that he was entirely sober when enlisted; that, to the best of my judgment and belief, he is of lawful age; and that, in accepting him as duly qualified to perform the duties of an able-bodied soldier, I have strictly observed the Regulations which govern the recruiting service. This soldier has Black eyes, Black hair, Dark complexion, is 5 feet 4 inches high.

J. W. L. Barnes Regiment of Massachusetts Volunteers, Recruiting Officer.

(A. G. O. No. 74 & 75.)

the 6th day of December 1864, at Boston Mass Mustered into the service of the United States, in Company "D" 5th Regiment of Cavalry Mass Volunteers, on Accordita to Franklin's 8th

Benjamin Edwards Capt + Purmarro

CASUALTY SHEET

No. _____

Benjamin Edwards.

Priv of Company *C.*

5 Regiment of *Mass. C. C.*

State Volunteers.

NATURE OF CASUALTY.

1st Aug 28th 1865

CASUALTY SHEET.

Name: Benjamin Edwards

Rank: Priv. Company: C Regiment: 5

Arm: Mass. Cav. State:

Nature of Casualty: Death

CAUSE OF CASUALTY—(NAME OF DISEASE, &c.)

BY WHOM DISCHARGED.

DEGREE OF DISABILITY.

FROM WHAT SOURCE THIS INFORMATION WAS OBTAINED.

Roll of Honor
La. Pg. 121

BY WHOM CERTIFIED.

J. M. Moore
Adj. in U.S.A.

REMARKS.

DATE OF DISCHARGE, DEATH, &c.

Aug. 28, 1865

PLACE OF DISCHARGE, DEATH, &c.

Buried
New Orleans

J. P.
Clerk.

Benjamin Edwards
Priv. Co 5. Mass. Cav.
Aug 28. 65.

Corps d'Afrique
New-Orleans.

HOSPITAL RECORD,

SUBJECT TO THE

ORDER OF THE SURGEON GENERAL,

UNITED STATES ARMY.

No. 1.

RECORD OF DEATH AND INTERMENT.

Name and number of person interred, *Benjamin Edwards*
Number and locality of the Grave, -
Hospital number of the deceased, -
Regiment, Rank, and Company, - - *6941
5th Cav Cavalry Private - B*
Residence before enlistment, - - -
Conjugal condition (and if married,)
the residence of the widow,)
Cause of death, - - - - - } *Diarrhoea & Typhoid*
Age of the deceased, - - - - -
Nativity, - - - - -
References, and Remarks, - - - }
Date of death and burial, - - - *August 28th 1865* 186

Duplicates sent to the Adjutant General of the United States Army, and to the Sexton of the Cemetery.

Memoranda:

Copy.

INVENTORY OF THE EFFECTS

OF

(Private) Benjamin Edwards

Late of Company "C"

7th Reg't of Major's Cavalry.

Volunteers, who died at New Orleans, La.

on the 28th day of August 1865.

W. Edwards

Inventory of the effects of *Benjamin Edwards* late
a *Private* of Captain _____ Company "*C*" of
the *5th* Regiment of *Mass Cavalry* Volunteers, who was enrolled as
a _____ at _____ in the State of _____ on
the _____ day of _____ 186 , and mustered into the service of the United
States as a _____ on the _____ day of _____ 186 , at _____
in Company _____, _____ Regiment of _____ Volunteers, to serve _____
years or during the war; he was born in _____ in the State
of _____; he was _____ years of age, _____ feet _____ inches
high, _____ complexion, _____ eyes, _____ hair, and by occupation, when enrolled,
a _____; he died in *Corps d'Afrique U.S. Gen. Hospit.* at
New Orleans La on the *28th* day of *August* 1865, by
reason of *Diarrhea & Fever*.

INVENTORY.					
ARTICLES.	No.	ARTICLES.	No.	ARTICLES.	No.
Hats.....		Pairs trousers.....		Knapsacks.....	
Caps.....		Pairs flannel drawers.....			
Forage caps.....		Pairs cotton drawers.....			
Great coats.....		Flannel shirts.....			
Uniform coats.....		Cotton shirts.....			
Uniform jackets.....		Pairs boots.....			
Flannel sack coats.....		Pairs shoes.....			
Blouses.....		Pairs socks.....			
Stable frocks.....		Blankets.....			
Fatigue overalls.....		Haversacks.....			
				MONEY.	
				Specie.....	\$
				Notes.....	\$

he had no Effects

I CERTIFY, ON HONOR, that the above inventory comprises all the effects of _____
_____, deceased, and that the effects are in the hands
of _____ at _____
_____ to be disposed of by a Council of Administration.

(DUPLICATES.)

STATION: *New Orleans La*

DATE: *August 28th 1865.*

[A. G. O. No. 104.]

surgeon in charge
Commanding the Company.

Corps d'Afrique U.S. Gen Hospit.

Extract from Act of Congress.

SEC. 12. And be it further enacted, That the fees of agents and attorneys for making out and causing to be executed the papers necessary to establish a claim for a pension, bounty, and other allowance before the Pension Office, under this act, shall not exceed the following rates: For making out and causing to be duly executed a declaration by the applicant, with the necessary affidavits, and forwarding the same to the Pension Office, with the requisite correspondence, ten dollars; which sum shall be received by such agent or attorney in full for all services in obtaining such pension, and shall not be demanded or received, in whole or in part, until such pension shall be obtained; and the sixth and seventh sections of an act entitled "An act to grant pensions," approved July [fourteenth,] eighteen hundred and sixty-two, are hereby repealed.

SEC. 13. And be it further enacted, That any agent or attorney who shall, directly or indirectly, demand or receive any greater compensation for his services under this act than is prescribed in the preceding section of this act, or who shall contract or agree to prosecute any claim for a pension, bounty, or other allowance under this act, on the condition that he shall receive a per centum upon any portion of the amount of such claim, or who shall wrongfully withhold from a pensioner or other claimant the whole or any part of the pension or claim allowed and due to such pensioner or claimant, shall be deemed guilty of a high misdemeanor, and, upon conviction thereof, shall, for every such offense, be fined not exceeding three hundred dollars, or imprisoned at hard labor not exceeding two years, or both, according to the circumstances and aggravations of the offense.

Approved July 4, 1864.

NOTE 10.—If any soldier is charged a higher fee than that allowed by the above act, he should report the fact and the name of the agent to the Adjutant General, in order that steps may be taken to have the same refunded.

ADJUTANT GENERAL'S OFFICE

Sept 20 1864

Certificates with Inventory sent 24 Auditor.

FINAL STATEMENT

22

1 of

Frederick Edwards

5th Regt of Mass Cav.

VOLUNTEERS.

NOTE 1.—Two of these certificates (or duplicates) are to be given to each Volunteer Soldier or drafted man who may be discharged without being mustered out, (Final Statements are never given to men mustered out of service) that he may at once receive from the Paymaster the pay, &c. due him, and the captain or other COMMISSIONED officer commanding the company will certify to the act of the delivery of the duplicate certificates; with these certificates the Soldier is "entitled to" his discharge, and should also present his discharge to the Paymaster to have the payment endorsed on it. The discharge is to be given back to the Soldier by the Paymaster; the latter only retaining as his vouchers the duplicate certificates.

NOTE 2.—If the Soldier is entitled to pay for the use of his horse, the Company Commander will certify to that fact on the back of both these final statements, and also to the time he has pay due for having been so mounted on his own horse.

NOTE 3.—When a Soldier is furnished with final statements, his descriptive list, if he has one, should be taken up by the officer who gives the Soldier these statements, and endorsed with a statement to this effect by the officer. The endorsement should exhibit a full statement of the time for which the Soldier was allowed pay on his final statements, the clothing account, and all other charges against him or in his favor, so as to comprise a complete exhibit of his account. It will then be transmitted to the Company Commander of the Soldier, who will enter all the data necessary to a full understanding of the Soldier's account on the muster roll upon which the Soldier's discharge is reported. The descriptive list will then be destroyed. The object of this is, that the remaining portion of the Soldier's account may be settled upon the receipt of these muster rolls, and the Soldier receive any pay or allowances that may be due him at the time of his discharge, and which may not appear on his last final statements from the fact that his descriptive list is incomplete. These accounts for back pay, &c. are settled by the 2d Auditor of the Treasury Department.

NOTE 4.—Charges for loss or injury to ordnance, horse equipments, and other miscellaneous charges, should appear under the heading of "Other Stoppages."

NOTE 5.—Bounty paid by State authorities, and not by the United States, will not be entered on this statement.

NOTE 6.—Amounts due the Sutler and Laundress must be entered on the muster roll on which the discharge, death, desertion, &c., is reported, as well as on the final statement, otherwise the amount cannot be collected from the United States.

NOTE 7.—This blank will be used for deceased volunteers and drafted men, as well as for others.

NOTE 8.—Where a Soldier dies in Hospital or on detached service, his descriptive list, if he has one, should be sent with his final statements, in duplicate, to the Adjutant General, Washington, D. C.

NOTE 9.—If the soldier is a drafted man or substitute, the space for time, &c., of enrolled, should contain only the word drafted or substitute, as the case may be. If the Soldier is a "VETERAN," (or RECRUIT) the words as a veteran, (or recruit,) as the case may be, should be interlined after the words mustered into the service of the U. S. A statement of all the instances of Veteran or Recruit Bounty RECEIVED by the Soldier must be made on the back of each final statement.

Frederick Edwards

I certify, on honor, that Benjamin Edwards, a Private of
Captain M. B. Welch's Company (C) of the 5th Regiment of Mass Inf.
VOLUNTEERS, of the State of Massachusetts, born in Warren, State
of Rhode Island, aged 22 years; 5 feet 4 inches high; Light complexion,
Black eyes, Black hair, and by occupation a Farmer, who joined for service
and was enrolled (see Note 9) on the 6th day of December, 1864, at Boston Mass
by Capt L Barnes, for the period of Three years, and mustered into
the service of the United States on the 6th day of December, 1864, at
Boston Mass, by Capt L Barnes; and having served
HONESTLY and FAITHFULLY with his Company to the present date, is now entitled to a
DISCHARGE by reason of Death. Died in U.S. Gen Hospital at New Orleans
Aug 28th 1865 of Dysentery chronic.

The said Benjamin Edwards was last paid by Paymaster
never paid, to include the _____ day of _____, 186____, and
has pay due him from ^{enrollment} ~~that time~~ to the present date; he is entitled to pay and subsistence for
TRAVELING to place of enrollment, and whatever other allowances are authorized to volunteer
soldiers, drafted men, or militia, so discharged. He has received from the United States **CLOTHING**
amounting to \$85 ¹⁹/₁₀₀ dollars, since the 6th day of December,
1864, when his clothing account was last settled. He has received from the United States
\$100 ⁰⁶/₁₀₀ dollars advanced **BOUNTY**.

There is to be stopped from him, on account of the State of _____, or other
authorities, for **CLOTHING**, &c., received on entering service, _____ ¹⁰⁰/₁₀₀ dollars; and
for other stoppages, viz: For Ord \$105 For 2th Store \$6.50

_____ ¹⁰⁰/₁₀₀ dollars.
He has been furnished with **TRANSPORTATION** in kind from the place of his discharge to
_____ ; and he has been **SUBSISTED** for **TRAVELING** to his
place of enrollment, up to the _____, 186____.

He is indebted to _____, **BUTLER**, _____ ¹⁰⁰/₁₀₀ dollars.

He is indebted to _____, **LAUNDRESS**, _____ ¹⁰⁰/₁₀₀ dollars.

Given in Duplicate, at Clarksville Texas, this 11th day
of September, 1865.

M B Welch

Capt 5th Mass Cav

Commanding Company.

RECORD OF DEATH AND INTERMENT.

Name and number of person interred, *Benjamin Edwards*
 Number and locality of the grave, -
 Hospital number of the deceased, - *6941*
 Regiment, Rank, and Company, - *5th W. Cavalry Private - C*
 Residence before enlistment, - - -
 Conjugal condition (and if married,)
 the residence of the widow,)
 Cause of death, } *Diarrhoea Acute*
 Age of the deceased, - - - - -
 Nativity, - - - - -
 References and Remarks, - - }
 Date of death and burial, - - - *Aug 27th 1865* 186

[A duplicate of this Record has been forwarded to the Sexton, and the other remains at this Hospital.]

To *Adj. Genl. Wm. Henry*
SIR:

It becomes my duty to inform you that the person above described died at this Hospital as herein stated: and that it is desired his remains should be interred with the usual military honors.

Respectfully,

J. E. Pignette
Surgeon U. S. Army.
80th Infantry
in Charge

MILITARY HOSPITAL, *Corps de Sigeur Toulon*
La

This copy of Record is to be transmitted to the Adjutant General at Washington immediately after the place of burial and the number of the grave have been ascertained and registered. The above notification is to remain attached.

NOTE 1.—This blank will be used for both enlistments and re-enlistments—enlistment of veterans, &c., &c., in the volunteer service. They will be made out in duplicate in all cases—one to accompany the recruiting return of the superintendent (not the recruiting officer) to the Adjutant-General, and one to accompany the accounts of the officer who pays bounty, &c. The Regiment and Company in which the soldier last served should be given on the back.

NOTE 2.—An enlistment holds no service. A muster-in must, in all cases, precede payment of pay, bounty, pension, &c. A muster-in roll must, in all cases, be filed in the Adjutant-General's Office as evidence of muster-in. The mustering officer, commissary, or assistant-commissary of musters, as the case may be, will countersign both enlistments as having mustered the soldier into the service of the United States before either of them is given to the disbursing officer.

DECLARATION OF RECRUIT.

I, Benjamin Edwards desiring to VOLUNTEER as a Soldier in the Army of the United States, for the term of THREE YEARS, Do Declare, That I am 22 years and months of age; that I have never been discharged from the United States service on account of disability or by sentence of a court-martial, or by order before the expiration of a term of enlistment; and I know of no impediment to my serving honestly and faithfully as a soldier for three years.

GIVEN at Boston Mass the 6th day of December 1864

Witness: Alfred Wiermouth Benjamin Edwards

135 Mass Ser,

No.

Ben Edwards

Volunteered at Boston Mass

Dec 7 1864,

By Alfred Wiermouth

Regiment of Inf

3rd

enlistment; last served in Company ()

Reg't of

Discharged 18

1st Bantry

Alfred W.

CONSENT IN CASE OF MINOR.

I, Do CERTIFY, That I am ; that the said is years of age; and I do hereby freely give my CONSENT to his volunteering as a SOLDIER in the ARMY OF THE UNITED STATES, for the period of THREE YEARS.

GIVEN at the day of

Witness:

(A. G. O. No. 74 & 75.)

VOLUNTEER ENLISTMENT.

STATE OF

Massachusetts



TOWN OF

Boston

I, Benjamin Edwards born in Warren in the State of Rhode Island aged 22 years, and by occupation a Farmer DO HEREBY ACKNOWLEDGE to have volunteered this 6th day of December 1864, to serve as a Soldier in the Army of the United States of America, for the period of THREE YEARS, unless sooner discharged by proper authority: Do also agree to accept such bounty, pay, rations, and clothing, as are, or may be, established by law for volunteers. And I, Benjamin Edwards do solemnly swear, that I will bear true faith and allegiance to the United States of America, and that I will serve them honestly and faithfully against all their enemies or opposers whomsoever; and that I will observe and obey the orders of the President of the United States, and the orders of the officers appointed over me, according to the Rules and Articles of War.

Sworn and subscribed to, at Boston Mass }
this 6th day of Dec. 1864, }
BEFORE J. M. Liberman }
Colonel and Surgeon }
Benjamin Edwards
Mark

I CERTIFY, ON HONOR, That I have carefully examined the above-named Volunteer, agreeably to the General Regulations of the Army, and that, in my opinion, he is free from all bodily defects and mental infirmity, which would in any way disqualify him from performing the duties of a soldier.

EXAMINING SURGEON.

I CERTIFY, ON HONOR, That I have minutely inspected the Volunteer Benjamin Edwards previously to his enlistment, and that he was entirely sober when enlisted; that, to the best of my judgment and belief, he is of lawful age; and that, in accepting him as duly qualified to perform the duties of an able-bodied soldier, I have strictly observed the Regulations which govern the recruiting service. This soldier has Black eyes, Black hair, Dark complexion, is 5 feet 4 inches high.

J. M. Liberman
Colonel and Surgeon
Volunteers,
RECRUITING OFFICER.

the 6th day of December 1864, at Boston Mass
Accredited to Headquarters 8th
Mustered into the service of the United States, in Company B, 5th Regiment of Cavalry Mass, Volunteers, on

Benjamin Edwards
Captain & Quartermaster
8th Cavalry

(A. G. O. No. 74 & 75.)

14781

400-a

Edwards William

Co., 1st Mass, Col'd Cav.

CARD NUMBERS.

1	9092109	26
2		27
3		28
4		29
5		30
6		31
7		32
8		33
9		34
10		35
11		36
12		37
13		38
14		39
15		40
16		41
17		42
18		43
19		44
20		45
21		46
22		47
23		48
24		49
25		50

Number of personal papers herein.....

Book Mark:

See also

401

Edwards, William

Co E, 5 Mass. Cav., (Col'd.)

Private

Private

CARD NUMBERS.

1	5372085	26
2	5372660	27
3	5378374	28
4	5378483	29
5	5378590	30
6	5378693	31
7	5378799	32
8	5378903	33
9	5379000	34
10	5379162	35
11	5379268	36
12	5372839	37
13	9092170	38
14	34509614	39
15	40730906	40
16		41
17		42
18		43
19		44
20		45
21		46
22		47
23		48
24		49
25		50

Book Mark:

See also

E

5 Cav. (Col'd.) | Mass.

William Edward 1st

Co. E, 5 Reg't Mass. Cav. (Col'd.)

Appears on

Company Descriptive Book

of the organization named above.

DESCRIPTION.

Age 26 years; height 5 feet 8 inches.

Complexion Blk

Eyes Blk; hair Blk

Where born Nicholas Co. Ky.

Occupation Farmer

ENLISTMENT.

When May 27, 1861

Where Boston

By whom L. M. Standish; term Three y'rs.

Remarks: Mustered May 27

Capt. Goodhue Co. E.

Discharged June 22, 1863

Heard

E

5 Col'd Cav.

Mass.

William Edwards

Appears with rank of on

Muster and Descriptive Roll of a Detachment of U. S. Vols. forwarded

for the 5 Reg't Mass. Col'd Cavalry. Roll dated

*Draft Rendezvous
Calloups Island B. Mass., May 28, 1864.*

Where born *Nicholas Co Ky*

Age *20* y'rs; occupation *Farmer*

When enlisted *May 27*, 1864.

Where enlisted *Boston*

For what period enlisted *3* years.

Eyes *dark*; hair *black*

Complexion *dark*; height *5* ft. *8* in.

When mustered in *May 27*, 1864.

Where mustered in *Boston*

Bounty paid \$ *100*; due \$ *100*

Where credited *Boston Wars of Suffolk Co.*

Company to which assigned

Remarks:

.....

.....

Book mark:

M. A. Michaels

(339)

Copyist.

E 15 Cav. Mass.

William Edwards

Appears with rank of _____ on

Muster-in and Descriptive Roll

of a detachment of U. S. Volunteer Recruits for
different regiments of Massachusetts Volunteers.

Roll dated *Craft Kendy, Galloups Island
Boston Harbor, Mass., May 28*, 1864,

Where born *Nicholas Co., Ky.*

Age *26* years; occupation *Farmer.*

When enlisted *May 27, 1864.*

Where enlisted *Boston Mass.*

For what period enlisted *3* years.

Eyes *Dark*; hair *black*

Complexion *dark.*; height *5 ft. 8 in.*

When mustered in _____, 186 .

Muster-in to date *from enlistment*, 186 .

Where mustered in _____

Bounty paid \$ *100*; due \$ *100*

Clothing account:

Last settled \$ _____, 186 ; drawn since \$ *100*

Date of first muster _____, 186 .

Regiment to which assigned *5 Cav.*

Remarks: *Credited to the Quota of Boston,
Ward 9, Suffolk Co. 14 Congl. Dist.*

Book mark: _____

Timberly

(356m)

Copyist.

E

5 Col'd Cav.

Mass.

William Edwards

Pvt, Co. E, 5 Reg't Mass. Col'd Cavalry.

Appears on

Company Muster Roll

for May & June, 1864.

Present or absent Present

Stoppage, \$ 100 for

Due Gov't, \$ 100 for

Valuation of horse, \$ 100

Valuation of horse equipments, \$ 100

Remarks:

Book mark:

[Signature]

Copyist.

(358)

5

5 Col'd Cav.

Mass.

William S. ...

Appears with rank of Private on

Muster and Descriptive Roll of a Detachment of U. S. Vols. forwarded

for the 5 Reg't Mass. Col'd Cavalry. Roll dated ... June 3, 1864.

Where born ... N.Y.

Age 26 y'rs; occupation Farmer

When enlisted May 27, 1864.

Where enlisted Boston Mass

For what period enlisted 3 years.

Eyes Dark; hair Black

Complexion ...; height 5 ft. 8 in.

When mustered in May 27, 1864.

Where mustered in ... Mass

Bounty paid \$ 100; due \$ 100

Where credited ...

Company to which assigned ...

Remarks:

Book mark:

Freese H

E.

5 Col'd Cav.

Mass.

William Edwards.

Priv., Co. E, 5 Reg't Mass. Col'd Cavalry.

Appears on

Company Muster Roll

for July & Aug., 1864.

Present or absent Present

Stoppage, \$ 100 for

Due Gov't, \$ 100 for

Valuation of horse, \$ 100

Valuation of horse equipments, \$ 100

Remarks:

Book mark:

O. J. Clark

(358)

Copyist.

E.

5 Col'd Cav.

Mass.

William Edwards

Priv., Co. E, 5 Reg't Mass. Col'd Cavalry.

Appears on

Company Muster Roll

for Sept Oct, 1864.

Present or absent Present

Stoppage, \$ 100 for

Due Gov't, \$ 100 for

Valuation of horse, \$ 100

Valuation of horse equipments, \$ 100

Remarks:

Book mark:

O. S. Clark

(358)

Copyist.

E.

5 Col'd Cav.

Mass.

William Edwards

Priv., Co. E, 5 Reg't Mass. Col'd Cavalry.

Appears on

Company Muster Roll

for *Nov. 10th Dec.*, 1864.

Present or absent *Present*

Stoppage, \$ *100* for

Due Gov't, \$ *100* for

Valuation of horse, \$ *100*

Valuation of horse equipments, \$ *100*

Remarks:

Book mark:

O. S. Clark

(358)

Copyist.

E.

5 Col'd Cav.

Mass.

William Edwards

Priv, Co. E, 5 Reg't Mass. Col'd Cavalry.

Appears on

Company Muster Roll

for *Jan. & Feb*, 186*5*.

Present or absent *Present*

Stoppage, \$ *100* for

Due Gov't, \$ *100* for

Valuation of horse, \$ *100*

Valuation of horse equipments, \$ *100*

Remarks:

Book mark:

A. Melony

(358)

Copyist.

E.

5 Col'd Cav.

Mass.

William Edwards

Priv., Co. E, 5 Reg't Mass. Col'd Cavalry.

Appears on

Company Muster Roll

for *March & Apr.*, 186*7*.

Present or absent *Present*

Stoppage, \$ *100* for

Due Gov't, \$ *100* for

Valuation of horse, \$ *100*

Valuation of horse equipments, \$ *100*

Remarks:

Book mark:

O. S. Clark

(558)

Copyist.

E

5 Col'd Cav.

Mass.

William Edwards
Cob., Co. E, 5 Reg't Mass. Col'd Cavalry.

Appears on

Company Muster Roll

for *May & June*, 1865.

Present or absent *Absent*

Stoppage, \$ *100* for

Due Gov't, \$ *100* for

Valuation of horse, \$ *100*

Valuation of horse equipments, \$ *100*

Remarks: *Sick in Hospital
Fortress Monroe, Va.
since May 22.*

Book mark: _____

(358)

Downy

Copyist.

2

5 Col'd Cav.

Mass.

William Edwards
Priv. Co. E., 5 Reg't Mass. Col'd Cavalry.

Appears on an

Individual Muster-out Roll

of the organization named above. Roll dated

Fort Monroe Va June 22, 1865.

Muster-out to date

June 22, 1865.

Last paid to

Dec 31, 1864.

Clothing account:

Last settled Dec 31, 1864; drawn since \$ 100

Due soldier \$ 100; due U. S. \$ 100

Am't for cloth'g in kind or money adv'd \$ 100

Due U. S. for arms, equipments, &c., \$ 100

Bounty paid \$ 100 due \$ 125 100

Remarks: Mustered out by
order of War Dept
dated May 31 1865
Patience in U.S. Genl Dept
Fort Monroe Va.

Book mark: V 118 P 258 70. 486.487

Wm Edwards

(348)

Copyist.

E

5 Col'd Cav.

Mass.

William Edwards

Priv. Co. E, 5 Reg't Mass. Col'd Cavalry.

Appears on

Company Muster Roll

for July & Aug, 1865.

Present or absent

Stoppage, \$ 100 for

Due Gov't, \$ 100 for

Valuation of horse, \$ 100

Valuation of horse equipments, \$ 100

Remarks: Mustered out by order War Dept dated May 3/65 on June 22d

Book mark:

Lowry

(358)

Copyist.

E

5 Col'd Cav.

Mass.

William Edwards
Priv., Co. E, 5 Reg't Mass. Colored Cav.

Appears on Returns as follows:

June 1864. Guin. June 5. Co
city Point Va.
Recruit sent from Depot

May 1865. Absent Sick in
Hosp Alexandria Va

June 1865. Absent Sick at
Hampton Gen Hosp.

July 1865. Absent Sick
at Hosp Fort Monroe

Aug. 1865. Ross: June 22
Ft Monroe. Mustered
out by order War Dept
dated May 3. 65.

Book mark:

W. S. S. S. S.

(546)

Copyist.

E

5 Col'd Cav.

Mass.

William Edwards
Sgt, Co. E, 5 Reg't Mass. Col'd Cavalry.

Appears on Co. Muster-out Roll, dated
Clarksville, Tex., Oct. 31, 1865.

Muster-out to date _____, 186 .

Last paid to _____, 186 .

Clothing account:

Last settled _____, 186 ; drawn since \$ _____ 100

Due soldier \$ _____ 100; due U. S. \$ _____ 100

Am't for cloth'g in kind or money adv'd \$ _____ 100

Due U. S. for arms, equipments, &c., \$ _____ 100

Bounty paid \$ _____ 100; due \$ _____ 100

Remarks: Mustered out June 22,
1865 by order War Dept
dated May 3/65.

Book mark: Kel 18: P 258. 71

(861)

Louvy

Copyright.

402
Edwards, William

Co G, 5 Mass. Cav., (Col'd.)

Private

Private

CARD NUMBERS.

1	5380502	26
2	5380603	27
3	5380729	28
4	5381543	29
5	9091917	30
6	40730907	31
7		32
8		33
9		34
10		35
11		36
12		37
13		38
14		39
15		40
16		41
17		42
18		43
19		44
20		45
21		46
22		47
23		48
24		49
25		50

Book Mark:

See also

E

5 Cav. (Col'd.) | Mass.

William Edwards

Co. G, 5 Reg't Mass. Cav. (Col'd.)

Appears on

Company Descriptive Book

of the organization named above.

DESCRIPTION.

Age 21 years; height 5 feet 4 inches.

Complexion Blk

Eyes Blk; hair Blk

Where born Georgetown, D.C.

Occupation Servant.

ENLISTMENT.

When Feb 23, 1864

Where Boston

By whom L. M. Standish term 3 y'rs.

Remarks: Single.

Killed in action June 13, 1864.

Hearst

5 Col'd Cav. | Mass.

William Edwards
Co. _____, 5 Reg't Mass. Col'd Cav.

Appears on

Company Muster-in and Descriptive Roll
of the organization named above. Roll dated
Readville Mass, Mar 4, 1864.

Where born *Georgetown D.C.*

Age *21* y'rs; occupation *Servant*

When enlisted *Feb 23*, 1864.

Where enlisted *Boston Ward 9*

For what period enlisted *3* years.

Eyes *Blk*; hair *Blk*

Complexion *Blk*; height *5* ft. *7* in.

When mustered in *Mar 4*, 1864.

Where mustered in *Readville Mass*

Prem
Bounty paid \$ *2* ¹⁰⁰; due \$ ¹⁰⁰

Where credited *4th Dist. Suffolk*

Company to which assigned _____

Remarks : _____

Book mark : _____

Leger

E

5 Col'd Cav.

Mass.

William Edwards

Pl, Co. G, 5 Reg't Mass. Col'd Cavalry.

Appears on

Company Muster Roll

for *Mar 4 to Apr 30*, 1864.

Present or absent *Present*

Stoppage, \$ *100* for

Due Gov't, \$ *100* for

Valuation of horse, \$ *100*

Valuation of horse equipments, \$ *100*

Remarks:

Book mark:

(358)

W. Edwards

Copyist.

E

5 Col'd Cav.

Mass.

William Edwards

Plt., Co. G, 5 Reg't Mass. Col'd Cavalry.

Appears on

Company Muster Roll

for *May & June*, 186*4*.

Present or absent.....

Stoppage, \$..... *100* for.....

Due Gov't, \$..... *100* for.....

Valuation of horse, \$..... *100*

Valuation of horse equipments, \$..... *100*

Remarks: *Killed in action near Petersburg June 15/64*

Book mark:.....

(358)

Leget

Copyist.

E

5 Col'd Cav.

Mass.

William Edwards
Pt. Co. G, 5 Reg't Mass. Colored Cav.

Appears on Returns as follows:

June 19 by. Loss June 15
/ by near Petersburg
Va. Killed in action

Book mark:

(546)

W. E. Callender

Copyist.

E

5 Col'd Cav.

Mass.

William Edwards

Co. G, 5 Reg't Mass. Col'd Cavalry.

Appears on Co. Muster-out Roll, dated

Charleston S. C. 1863

Muster-out to date _____, 186 .

Last paid to *pay due from mustermut* 186 .

Clothing account:

Last settled _____, 186 ; drawn since \$ _____ 100

Due soldier \$ _____ 100; due U. S. \$ *40* ⁰⁵/₁₀₀

Am't for cloth'g in kind or money adv'd \$ _____ 100

Due U. S. for arms, equipments, &c., \$ _____ 100

Bounty paid \$ _____ 100; due \$ _____ 100

Remarks: *killed in action at Baylows Farm Va June 15. 64*

Book mark : _____

W. H. Scott

Edwards, Jm

P, Co. G.

5

Mass. C. Cav.
Reg't

3

Enclosures.

Bed Cards

Burial Records

Certs. of Dis. for Discharge

C. M. Charges

Med. Certificates

Encl. Pps

Descriptive Lists

Final Statements

Furloughs

Med. Des. Lists

Orders

Other papers relating to—

Admission to Hosp'l

Casualty Sheet (Officer's)

Confinement

Contracts

Death or Effects

Desertions

Discharge from Hosp'l

Discharge from Service

Duty

Furlough

Med. Examination

Misc. Information

Pay or Clothing

Personal Reports

Rank

Transfer to Hosp'l

Transfer to V. R. C.

Transportation

NOTE 1.—This blank will be used for both enlistments and re-enlistments—enlistment of veterans, &c., &c., in the volunteer service. They will be made out in duplicate in all cases—one to accompany the recruiting return of the superintendent (not the recruiting officer) to the Adjutant-General, and one to accompany the accounts of the officer who pays bounty, &c. The Regiment and Company in which the soldier last served should be given on the back.

NOTE 2.—An enlistment holds to service. A muster-in must, in all cases, precede payment of pay, bounty, pension, &c. A muster-in roll must, in all cases, be filed in Adjutant-General's Office as evidence of muster-in. The mustering officer, commissary, or assistant-commissary of musters, as the case may be, will countersign both enlistments as having mustered the soldier into the service of the United States before either of them is given to the disbursing officer.

DECLARATION OF RECRUIT.

I, *William Edwards*

desiring

to VOLUNTEER as a Soldier in the Army of the United States, for the term of THREE YEARS, Do Declare, That I am *twenty six* years and *—* months of age; that I have never been discharged from the United States service on account of disability or by sentence of a court-martial, or by order before the expiration of a term of enlistment; and I know of no impediment to my serving honestly and faithfully as a soldier for three years.

GIVEN at *Boston Mass*

this the *27* day of *May 1864*

Witness:

Saml. Abel *William Edwards*
mark

Discharged

18

Regt of

Enlistment; last served in Company ()

By

Regiment of

18

Volunteered at

Edwards William

No. *5711*

CONSENT IN CASE OF MINOR.

I,

Do CERTIFY, That I am

the

of

; that the

said

is

years of age; and I

do hereby freely give my CONSENT to his volunteering as a SOLDIER in the ARMY OF THE UNITED STATES, for the period of THREE YEARS.

GIVEN at

the

day of

Witness:

VOLUNTEER ENLISTMENT.

STATE OF Massachusetts



City TOWN OF Boston
Ward Nine

the day of

Mustered into the service of the United States, in Company

, 1864, at

Regiment of

Volunteers, on

I, *William Edwards* born in *Nicholas Co*
in the State of *Kentucky* aged *twenty six* years,
and by occupation a *Farmer* DO HEREBY ACKNOWLEDGE to have
volunteered this *Twenty Seventh* day of *May* 1864
to serve as a **Soldier** in the Army of the United States of America, for the
period of **THREE YEARS**, unless sooner discharged by proper authority: Do also
agree to accept such bounty, pay, rations, and, clothing, as are, or may be, estab-
lished by law for volunteers. And I, *William Edwards* do
solemnly swear, that I will bear true faith and allegiance to the **United States**
of **America**, and that I will serve them honestly and faithfully against all their
enemies or opposers whomsoever; and that I will observe and obey the orders of
the President of the United States, and the orders of the officers appointed over
me, according to the Rules and Articles of War.

Sworn and subscribed to, at *Boston*
this *27* day of *May* 1864 } *William Edwards*
BEFORE *me & Miles Standish* } *his*
Justice of Peace } *mark*
Witness } *Samuel Miles Standish*

I CERTIFY, ON HONOR, That I have carefully examined the above-named Volunteer, agreeably
to the General Regulations of the Army, and that, in my opinion, he is free from all bodily defects and
mental infirmity, which would in any way disqualify him from performing the duties of a soldier.

B. J. J. J. J.
EXAMINING SURGEON.

Vaccinated

I CERTIFY, ON HONOR, That I have minutely inspected the Volunteer, *William Edwards*
previously to his enlistment, and that he was entirely sober when enlisted; that, to the best of my
judgment and belief, he is of lawful age; and that, in accepting him as duly qualified to perform the duties
of an able-bodied soldier, I have strictly observed the Regulations which govern the recruiting service.
This soldier has *Dark* eyes, *Black* hair, *Dark* complexion, is *five* feet
Eight inches high.

(A. G. O. No. 74 & 75.) *Samuel Miles Standish* *Regiment of* *Volunteers,*
RECRUITING OFFICER.

6853

34. Man

Witness

16
FINAL STATEMENT

OR

Private James E. Edwards

5th Reg't of Mass Cavalry

VOLUNTEERS.

Head Quarters 5th Reg't

NOTE 1.—Two of these certificates (or duplicates) are to be given to each Volunteer Soldier or drafted man who may be discharged previously to the discharge of his company, that he may at once receive from the Paymaster the pay, &c., due him, and the captain or other COMMISSIONED officer commanding the company will certify to the act of the delivery of the duplicate certificates, on these certificates the Soldier is "entitled to" his discharge, and should also present his discharge to the Paymaster to have the payment endorsed on it. The discharge is to be given back to the Soldier by the Paymaster; the latter only retaining as his voucher the duplicate certificates.

NOTE 2.—If the Soldier is entitled to pay for the use of his horse, the Company Commander will certify to that fact on the back of both these final statements, and also to the time he has pay due for having been so mounted on his own horse.

NOTE 3.—When a Soldier is furnished with final statements, his descriptive list, if he has one, should be taken up by the officer who gives the Soldier these statements, and endorsed with a statement to this effect by the officer. This endorsement should exhibit a full statement of the time for which the Soldier was allowed pay on his final statements, the clothing account, and all other charges against him or in his favor, so as to comprise a complete exhibit of his account. It will then be transmitted to the company commander of the Soldier, who will enter all the data necessary to a full understanding of the Soldier's account on the muster roll upon which the Soldier's discharge is reported. The descriptive list will then be destroyed. The object of this is, that the remaining portion of the Soldier's account may be settled upon the receipt of these muster rolls, and the Soldier receive any pay or allowances that may be due him at the time of his discharge, and which may not appear on his final statements from the fact that his descriptive list is incomplete. These accounts for back pay, &c., are settled by the 2d Auditor of the Treasury Department.

NOTE 4.—Charges for loss or injury to ordnance, horse equipments, and other miscellaneous charges, should appear under the heading of "Other Stoppages."

NOTE 5.—Bounty paid by State authorities, and not by the United States, will not be entered on this statement.

NOTE 6.—Amounts due the Sutler and Laundress must be entered on the muster roll on which the discharge, death, desertion, &c., is reported, as well as on the final statement, otherwise the amount cannot be collected from the United States.

NOTE 7.—This blank will be used for deceased volunteers and drafted men, as well as for others.

NOTE 8.—Where a Soldier dies in Hospital or on detached service, his descriptive list, if he has one, should be sent with his final statements, in duplicate, to the Adjutant General, Washington, D. C.

ADJUTANT GENERAL'S OFFICE.

Aug 17 1864

Duplicate with Inventory sent 2d Auditor.

E. J. [Signature]

I certify, on honor, that William Edwards a Private of
 Captain W. E. M. Clark Company (5) of the 11th Regiment of Mass Cavalry
VOLUNTEERS, of the State of Miss, born in Georgetown, State Dist.
 of Columbia, aged 21 years; 5 feet 7 inches high; Black complexion,
Black eyes, Black hair, and by occupation a Servant, having joined the company on
 its original organization at Reedville, and enrolled in it at the muster into
 the service of the United States at Reedville, on the fourth day
 of March, 1864, (or was mustered in service as a recruit, by
 _____, at _____, on the _____ day of _____,
 1864, or was drafted and mustered into the service of the United States from the _____
 Enrollment District of the State of _____, at _____,
 on the _____ day of _____, 1864,) to serve in the Regiment, for
 the term of three years: and having served **HONESTLY** and
FAITHFULLY with his Company in the U. S. service to the present date, is now
 entitled to a **DISCHARGE** by reason of Killed in action at
Bayard's Farm Va on the 15th June 1864

The said William Edwards was ~~last paid~~ by Paymaster
Never Paid to include the _____ day of _____, 1864, and has
 pay due him from that time to the present date; he is entitled to pay and subsistence for
TRAVELING to place of enrollment, and whatever other allowances are authorized to volunteer
 soldiers, drafted men, or militia, so discharged. He has received from the United States **CLOTHING**
 amounting to \$3 14/₁₀₀ dollars, since the _____ day of _____,
 Feb. 23^d 1864, when his clothing account was last settled. He has received from the United States
 _____ 100 dollars advanced **BOUNTY**.

There is to be stopped from him, on account of the State of _____, or other
 authorities, for **CLOTHING**, &c., received on entering service, _____ 100 dollars; and
 for other stoppages, viz: _____

_____ 100 dollars.
 He has been furnished with **TRANSPORTATION** in kind from the place of his discharge to
 _____; and he has been **SUBSISTED** for **TRAVELING** to his
 place of enrollment, up to the _____, 1864.

He is indebted to _____, **SUTLER**, _____ 100 dollars.

He is indebted to _____, **LAUNDRESS**, _____ 100 dollars.

Given in Duplicate, at City Point Va, this 16th day
 of June, 1864.

W. E. M. Clark

Capt

Commanding Company

Inventories of Effects
of Wm Edwards
at 3rd 5th Mass Ave

Inventary of the effects of William Edwards
a Private of Capt H. E. W. Clarke's Company, 2^d 5th Reg't
Mass Cavalry, Colo. Who was enrolled as a Private
at Boston in the State of Mass. on the 23rd of Feb/64 and mustered
into the Service of the U. S. as a Private on the 4th of March 1864 at Readville,
in Company B, 5th Reg't Mass Cavalry, Colo. & served three years & six months. He was
born in Georgetown, Dist. of Columbia, he was 21 years of age,
5 feet 7 inches high, black complexion, black eyes, black hair, and by occupation
when enrolled a servant. He was killed in action at Baylors Farm Va
on the 15th of June 1864.

I certify on honor that the above inventary comprises all the effects
of Private William Edwards deceased and that the effects of

City Point Va
June 16th 1864

403

Eggleston, William

Co M, 5 Mass. Cav., (Col'd.)

Private

Sergeant.

CARD NUMBERS.

1	5385921	26
2	5385016	27
3	5386102	28
4	5386169	29
5	5386273	30
6	5386373	31
7	5386474	32
8	5386575	33
9	5386678	34
10	5386765	35
11	9091363	36
12		37
13		38
14		39
15		40
16		41
17		42
18		43
19		44
20		45
21		46
22		47
23		48
24		49
25		50

Book Mark:

See also

M. S. 930920
A2393974 - P.O., Phil.
SS, Va.

12-16-31

2

L. Ballou

41

E.

5 Cav. (Col'd.) | Mass.

William Eggleston.

Co. A., 5 Reg't Mass. Cav. (Col'd.)

Appears on

Company Descriptive Book

of the organization named above.

DESCRIPTION.

Age *25* years; height *5* feet *11* inches.

Complexion *Black.*

Eyes *Black*; hair *Black.*

Where born *Martinville Va.*

Occupation *Farmer.*

ENLISTMENT.

When *April 30th, 1864.*

Where *Boston Md. 3.*

By whom *S. A. Denis*; term *3* y'rs.

Remarks: *Mustered May 5th 1864, by
Lieut. D. Madden, Readville Mass.*

H. C. Thomas.

E

5 Col'd Cav.

Mass.

William Eggleston

Pri., Co. M., 5 Reg't Mass. Col'd Cav.

Appears on

Company Muster-in and Descriptive Roll

of the organization named above. Roll dated

Readville Mass, May 5, 1864.

Where born Martinsville Va

Age 25 y'rs; occupation Farmer

When enlisted Apr. 30, 1864.

Where enlisted Boston

For what period enlisted 3 years.

Eyes Blk; hair Blk

Complexion Blk; height 5 ft. 11 in.

When mustered in May 5, 1864.

Where mustered in Readville

Premium
Bounty paid \$ 2 100; due \$ 100

Where credited

Company to which assigned

Remarks: Credited to City of Boston
Ward 3. Suffolk Co. 4. Cong
Dist. Mass.

Book mark:

(356d)

Jenny

Copyist.

E

5 Col'd Cav.

Mass.

William Eggleston

Pri., Co. M, 5 Reg't Mass. Colored Cavalry.

Appears on

Company Muster Roll

for May 5 to June 30, 1864.

Present or absent Present

Stoppage, \$ 100 for

Due Gov't, \$ 100 for

Valuation of horse, \$ 100

Valuation of horse equipments, \$ 100

Remarks:

Book mark:

Avery

(358)

Copyist.

E

5 Col'd Cav.

Mass.

William Eggleston

Pri, Co. M, 5 Reg't Mass. Colored Cavalry.

Appears on

Company Muster Roll

for July & Aug, 1864.

Present or absent Present

Stoppage, \$ 100 for

Due Gov't, \$ 100 for

Valuation of horse, \$ 100

Valuation of horse equipments, \$ 100

Remarks:

Book mark:

(358)

Army

Copyist.

B

5 Col'd Cav.

Mass.

William Eggleston

Corp'l, Co. M, 5 Reg't Mass. Colored Cavalry.

Appears on

Company Muster Roll

for *Sept. + Oct.*, 1864.

Present or absent *Present*

Stoppage, \$ *100* for

Due Gov't, \$ *100* for

Valuation of horse, \$ *100*

Valuation of horse equipments, \$ *100*

Remarks: *Promoted to Corp.*
by S.O. No. 173, Oct. 13, '64.

Book mark:

E. Williams

6

5 Col'd Cav.

Mass.

Williams Eggleston

Capt., Co. M, 5 Reg't Mass. Colored Cavalry.

Appears on

Company Muster Roll

for *Nov^y & Dec*, 1864.

Present or absent *Present*

Stoppage, \$ *100* for

Due Gov't, \$ *100* for

Valuation of horse, \$ *100*

Valuation of horse equipments, \$ *100*

Remarks: *Promoted to Corp.*
by S.O. No. 173 Oct. 13, '64

Book mark:

L. Williams

(358)

Copyist.

B

5 Col'd Cav.

Mass.

William Eggleston

Corpl, Co. M, 5 Reg't Mass. Colored Cavalry.

Appears on

Company Muster Roll

for *Jan, & Feb*, 1865.

Present or absent *Present*.

Stoppage, \$ *100* for

Due Gov't, \$ *100* for

Valuation of horse, \$ *100*

Valuation of horse equipments, \$ *100*

Remarks: *Promoted to Corp'l
by S.O. No. 173. Oct, 13, '64*

Book mark:

W. Williams,

(358)

Copyist.

C

5 Col'd Cav.

Mass.

William Eggleston
Corpl, Co. M, 5 Reg't Mass. Colored Cavalry.

Appears on

Company Muster Roll

for *Mar, & Apr, 1865.*

Present or absent *Present*

Stoppage, \$ *100* for

Due Gov't, \$ *100* for

Valuation of horse, \$ *100*

Valuation of horse equipments, \$ *100*

Remarks:

Book mark:

C. Williams

(358)

Copyist.

E

5 Col'd Cav.

Mass.

William Eggleston,
Corpl, Co. M, 5 Reg't Mass. Colored Cavalry.

Appears on

Company Muster Roll

for *May + June*, 186*5*.

Present or absent *Present*

Stoppage, \$ *100* for

Due Gov't, \$ *100* for

Valuation of horse, \$ *100*

Valuation of horse equipments, \$ *100*

Remarks:

Book mark:

W. Williams

(358)

Copyist.

E

5 Col'd Cav.

Mass.

William Eggleston

Coplc, Co. M, 5 Reg't Mass. Colored Cavalry.

Appears on

Company Muster Roll

for

July & Aug., 1863.

Present or absent

Present

Stoppage, \$

100 for

Due Gov't, \$

100 for

Valuation of horse, \$

100

Valuation of horse equipments, \$

100

Remarks:

Book mark:

Hodges

(358)

Copyist.

E

5 Col'd Cav.

Mass.

William Eggleston

Serjt, Co. M, 5 Reg't Mass. Col'd Cavalry.

Appears on Co. Muster-out Roll, dated

Clarksville Tex, Oct. 31, 1865.

Muster-out to date

Oct. 31, 1865.

Last paid to

Dec. 31, 1864.

Clothing account:

Last settled....., 186 ; drawn since \$..... 100

Due soldier \$ 11 ⁴³/₁₀₀; due U. S. \$..... 100

Am't for cloth'g in kind or money adv'd \$..... 100

Due U. S. for arms, equipments, &c., \$ 0 ⁶⁸/₁₀₀

Bounty paid \$..... 100; due \$ 100 ¹⁰⁰/₁₀₀

Remarks:

Promoted Serjt.
from Corp'l S.O. 139
Sept. 9th 1865.

Book mark :

Hodges

(261)

Copyist.

Olebeck, William

Co A, 5 Mass. Cav., (Col'd.)

Private

Private

CARD NUMBERS.

1	5373282	26
2	5373367	27
3	53734570	28
4	5373542	29
5	5373661	30
6	5373771	31
7	5373871	32
8	5373982	33
9	5374085	34
10	5374186	35
11	5374333	36
12	5372996	37
13	5374425	38
14	9092641	39
15	40730908	40
16		41
17		42
18		43
19		44
20		45
21		46
22		47
23		48
24		49
25		50

Book Mark:

See also

E

5 Cav. (Col'd.) | Mass.

Wm. E. Ebbesen

, Co. F, 5 Reg't Mass. Cav. (Col'd.)

Appears on

Company Descriptive Book

of the organization named above.

DESCRIPTION.

Age 20 years; height 5 feet 1 3/4 inches.

Complexion light

Eyes black; hair black

Where born Quincy, Mass.

Occupation writer

ENLISTMENT.

When Dec 29, 1863.

Where Boston

By whom S. Ebbesen; term 3 y'rs.

Remarks: Discharged out of the service at Fort Sumner, Texas 2) 1865

Wm. E. Ebbesen

(383g)

Copyist.

6

5 Col'd Cav. | Mass.

William Colebeck
Sgt., Co. A., 5 Reg't Mass. Col'd Cav.

Appears on

Company Muster-in and Descriptive Roll
of the organization named above. Roll dated

Readville, Jan. 9, 1864.

Where born Buffalo N.Y.

Age 20 y'rs; occupation Farmer

When enlisted Dec. 29, 1863.

Where enlisted Newton

For what period enlisted Three years.

Eyes Black, hair Black

Complexion Black, height 5 ft. 1 1/4 in.

When mustered in Jan. 9th, 1864.

Where mustered in

Bounty paid \$ 100; due \$ 100

Where credited

Company to which assigned

Remarks:

Book mark:

G. Ford

(356d)

Copyst.

B.

5 Col'd Cav.

Mass.

William Elbeck

Priv, Co. A, 5 Reg't Mass. Col'd Cavalry.

Appears on

Company Muster Roll

for *Enlistment to Feb 29, 1864.*

Present or absent *Present*

Stoppage, \$ 100 for

Due Gov't, \$ 100 for

Valuation of horse, \$ 100

Valuation of horse equipments, \$ 100

Remarks:

Book mark:

G. F. M.

(358)

Copyist.

E

5 Col'd Cav.

Mass.

William Elebeck
Privt, Co. A, 5 Reg't Mass. Col'd Cavalry.

Appears on

Company Muster Roll

for *Mar & Apr*, 1864.

Present or absent *PRESENT*

Stoppage, \$ *100* for

Due Gov't, \$ *100* for

Valuation of horse, \$ *100*

Valuation of horse equipments, \$ *100*

Remarks:

Book mark:

(358)

G. Fox

Copyist.

E

5 Col'd Cav.

Mass.

William Elebeck

Capt., Co. A, 5 Reg't Mass. Col'd Cavalry.

Appears on

Company Muster Roll

for *May & June*, 186*4*

Present or absent *Present*

Stoppage, \$ *100* for

Due Gov't, \$ *100* for

Valuation of horse, \$ *100*

Valuation of horse equipments, \$ *100*

Remarks:

Book mark:

G. F. M.

(358)

Copyist.

E

5 Col'd Cav.

Mass.

William Cleberk

Cm., Co. A, 5 Reg't Mass. Col'd Cavalry.

Appears on

Company Muster Roll

for *July and Aug.*, 186*4*.

Present or absent *Present.*

Stoppage, \$ *100* for

Due Gov't, \$ *100* for

Valuation of horse, \$ *100*

Valuation of horse equipments, \$ *100*

Remarks: *Free on or before*
Apr. 19, 1861.

Book mark:

A. G. Gilbert

(358)

Copyist.

E

5 Col'd Cav.

Mass.

William Elebeck

Pr., Co. A, 5 Reg't Mass. Col'd Cavalry.

Appears on

Company Muster Roll

for *Sept. and Oct.*, 186*4*.

Present or absent *(Present)*

Stoppage, \$ *100* for

Due Gov't, \$ *100* for

Valuation of horse, \$ *100*

Valuation of horse equipments, \$ *100*

Remarks:

Book mark:

A. O. Gilbert

(358)

Copyist.

E

5 Col'd Cav.

Mass.

William Elebeck

Priv., Co. A, 5 Reg't Mass. Col'd Cavalry.

Appears on

Company Muster Roll

for *Nov. and Dec.*, 1864.

Present or absent *Present.*

Stoppage, \$ *100* for

Due Gov't, \$ *100* for

Valuation of horse, \$ *100*

Valuation of horse equipments, \$ *100*

Remarks:

Book mark:

A. Gilbert

(358)

Copyist.

E

5 Col'd Cav.

Mass.

William Elebak
Pro., Co. A, 5 Reg't Mass. Col'd Cavalry.

Appears on

Company Muster Roll

for *Jan. and Feb.*, 1863.

Present or absent *Present.*

Stoppage, \$ *100* for

Due Gov't, \$ *100* for

Valuation of horse, \$ *100*

Valuation of horse equipments, \$ *100*

Remarks: *Due 2, 3 and 4*
inst. N. S. Bounty
\$120⁰⁰

Book mark:

W. Gilbert

(358)

Copyist.

8

5 Col'd Cav.

Mass.

William Elebeck

Pr., Co. A, 5 Reg't Mass. Col'd Cavalry.

Appears on

Company Muster Roll

for *March and Apr.*, 1865.

Present or absent *Present*

Stoppage, \$ *100* for

Due Gov't, \$ *100* for

Valuation of horse, \$ *100*

Valuation of horse equipments, \$ *100*

Remarks: *Due 2, 3 and 4 inst. N. S. Bounty \$120.00 and \$35.00 on 1 inst.*

Book mark:

H. Gilbert

(358)

Copyist.

E

5 Col'd Cav.

Mass.

William Elebeck

Priv, Co. A, 5 Reg't Mass. Col'd Cavalry.

Appears on

Company Muster Roll

for May & June, 1865.

Present or absent absent

Stoppage, \$ 100 for

Due Gov't, \$ 100 for

Valuation of horse, \$ 100

Valuation of horse equipments, \$ 100

Remarks: Due 2nd, 3rd & 4th Dist
U.S. Bounty #120. For 1st Dist
#35. Absent sick at Ft
Maurice May 21/65

Book mark:

Ballade

E

5 Col'd Cav.

Mass.

William Elebeck

Priv., Co. A, 5 Reg't Mass. Col'd Cavalry.

Appears on

Company Muster Roll

for July & Aug., 1865.

Present or absent

Stoppage, \$ 100 for

Due Gov't, \$ 100 for

Valuation of horse, \$ 100

Valuation of horse equipments, \$ 100

Remarks: Discharged at Ft. Monroe June 21, 1865 per Order War Dept

Book mark:

(358)

Ballade

Copyist.

60

5 Col'd Cav.

Mass.

William Ebebeck

Pvt, Co. A, 5 Reg't Mass. Colored Cav.

Appears on Returns as follows:

May to July 1865. About
sick at Fortress
Mourae since
May 20. 65.

Aug. 1865 - loss. June 21
/65. Ft Mourae
Discharged

Book mark :

Mr. Dillade

(546)

Copyist.

E

5 Col'd Cav.

Mass.

William Ellebeck

Priv., Co. A, 5 Reg't Mass. Col'd Cavalry.

Appears on a

Detachment Muster-out Roll

of the organization named above. Roll dated

Fort Monroe, Va, June 21, 1865.

Muster-out to date

June 21, 1865.

Last paid to

Dec. 31, 1864.

Clothing account:

Last settled Jan'y 1, 1865; drawn since \$ 100

Due soldier \$ 100; due U. S. \$ 100

Am't for cloth'g in kind or money adv'd \$ 91 ⁴⁶/₁₀₀

Due U. S. for arms, equipments, &c., \$ 100

Bounty paid \$ 100; due \$ 27 ⁰⁰/₁₀₀

Remarks: Due U. S. for
Saber and full set
of Saber Equipments.
Mustered out by order of
War Dept, dated May
3rd 1865. Patient in
(over)

Book mark:

R. Washington

JAN. - 9

5372996

1891

U. S. General Hospital
Fort Monroe, Va.

E

5 Col'd Cav.

Mass.

William E. Lebeck

Sgt, Co. A, 5 Reg't Mass. Col'd Cavalry.

Appears on Co. Muster-out Roll, dated

Clarkeville, Texas, Oct 31, 1865.

Muster-out to date _____, 186 .

Last paid to _____, 186 .

Clothing account:

Last settled _____, 186 ; drawn since \$ _____ 100

Due soldier \$ _____ 100; due U. S. \$ _____ 100

Am't for cloth'g in kind or money adv'd \$ _____ 100

Due U. S. for arms, equipments, &c., \$ _____ 100

Bounty paid \$ _____ 100; due \$ _____ 100

Remarks: Discharged at Ft. Moore Va

9.10.77 War department June 21. 65

Book mark: P. M. G. Feb. 5. 66 - C. P.

S. Allard

(861)

Copyist.

405

Oliver Manuel

Co A, 5 Mass. Cav., (Col'd.)

CARD NUMBERS.

1	26
2	27
3	28
4	29
5	30
See Oliver Manuel	
6	31
7	32
8	33
9	34
10	35
11	36
12	37
13	38
14	39
15	40
16	41
17	42
18	43
19	44
20	45
21	46
22	47
23	48
24	49
25	50

Book Mark

See also

406

Elisha, James F.
Col., 5 Mass. Cav., (Col'd.)

Private Corporal

CARD NUMBERS.

1	5375697	26
2	5375789	27
3	5375873	28
4	5375967	29
5	5376076	30
6	5376157	31
7	5376286	32
8	5376392	33
9	5376473	34
10	5376573	35
11	5376674	36
12	5376767	37
13	9092391	38
14	40730895	39
15		40
16		41
17		42
18		43
19		44
20		45
21		46
22		47
23		48
24		49
25		50

Book Mark:

See also

6

5. Cav. (Col'd.) | Mass.

James F. Colishu

, Co. 6, 5 Reg't Mass. Cav. (Col'd.)

Appears on

Company Descriptive Book

of the organization named above.

DESCRIPTION.

Age *30* years; height *5* feet *6* inches.

Complexion *dark*

Eyes *hazel*; hair *black*

Where born *Walden, Mass.*

Occupation *barber*

ENLISTMENT.

When *Jan 4*, 1864.

Where *Boston*

By whom *W. Standish*; term *3* y'rs.

Remarks: *Mustered into Company G,
Jan 29, 1864 at Readville, Mass
by Lt McKibbin*

James F. Colishu

James F. Colishu

E

5 Col'd Cav.

Mass.

James F. Elisha
Priv. Co. C, 5 Reg't Mass. Col'd Cav.

Appears on

Company Muster-in and Descriptive Roll
of the organization named above. Roll dated

Readville, Jan. 29, 1864.

Where born Malden, Mass.

Age 30 y'rs; occupation Barber.

When enlisted Jan. 9, 1864.

Where enlisted Boston, Md. 9.

For what period enlisted 3 years.

Eyes Black; hair Black

Complexion Black; height 5 ft. 6 in.

When mustered in Jan. 29, 1864.

Where mustered in Readville, Mass.

Bounty paid \$ 100; due \$ 100

Where credited 7th Dist. Suffolk

Company to which assigned

Remarks:

Book mark:

Sitter.

E.

5 Col'd Cav.

Mass.

James F. Olisha

Priv., Co. C, 5 Reg't Mass. Col'd Cavalry.

Appears on

Company Muster Roll

for Enlistment to Feb. 29, 1864.

Present or absent Present

Stoppage, \$ 100 for

Due Gov't, \$ 100 for

Valuation of horse, \$ 100

Valuation of horse equipments, \$ 100

Remarks:

Book mark:

Sitter

O.

5 Col'd Cav.

Mass.

James F. Elisha
Priv., Co. C, 5 Reg't Mass. Col'd Cavalry.

Appears on

Company Muster Roll

for Mar. & Apr., 1864.

Present or absent Present

Stoppage, \$ 100 for

Due Gov't, \$ 100 for

Valuation of horse, \$ 100

Valuation of horse equipments, \$ 100

Remarks: Thirty Dollars
due to N. S. for appar-
-tension as a deserter.

Book mark:

Sitter

(358)

Copyist.

E.

5 Col'd Cav.

Mass.

James F. Olisha
Priv, Co. C, 5 Reg't Mass. Col'd Cavalry.

Appears on

Company Muster Roll

for May & June, 1864.

Present or absent Present

Stoppage, \$ 100 for

Due Gov't, \$ 100 for

Valuation of horse, \$ 100

Valuation of horse equipments, \$ 100

Remarks: On daily duty
as Company Cook.
Thirty dollars to be
deducted from his
pay for apprehension
as a deserter.

Book mark:

Sitter

(358)

Copyist.

E

5 Col'd Cav.

Mass.

James F. Elisha
Sgt., Co. C, 5 Reg't Mass. Col'd Cavalry.

Appears on

Company Muster Roll

for July & Aug, 1864.

Present or absent Present

Stoppage, \$ 100 for

Due Gov't, \$ 100 for

Valuation of horse, \$ 100

Valuation of horse equipments, \$ 100

Remarks: Thirty dolls to be deduc-
ted from his pay for apprehension
as a deserter.

Book mark: 100

E. H. Brown

C.

5 Col'd Cav.

Mass.

James A Elisha

Plt., Co. C, 5 Reg't Mass. Col'd Cavalry.

Appears on

Company Muster Roll

for Sept & Oct, 1864.

Present or absent Present

Stoppage, \$ 100 for

Due Gov't, \$ 100 for

Valuation of horse, \$ 100

Valuation of horse equipments, \$ 100

Remarks: Free on or before April 19 61
and the U.S. Thirty dollars (\$30)

Book mark:

E. H. Brown

E

5 Col'd Cav.

Mass.

James F. Elisha
Capt, Co. C, 5 Reg't Mass. Col'd Cavalry.

Appears on

Company Muster Roll

for Nov Dec, 1864.

Present or absent Present

Stoppage, \$ 100 for

Due Gov't, \$ 100 for

Valuation of horse, \$ 100

Valuation of horse equipments, \$ 100

Remarks: Due \$30 for 2 M.
stoves \$0.40
Free on or before April 19 61

Book mark:

E. H. Brown

8

5 Col'd Cav.

Mass.

James F. Elisha
Co., Co. C, 5 Reg't Mass. Col'd Cavalry.

Appears on

Company Muster Roll

for Jan Feb, 1865.

Present or absent Present

Stoppage, \$ 100 for

Due Gov't, \$ 100 for

Valuation of horse, \$ 100

Valuation of horse equipments, \$ 100

Remarks: Due W 530.

Due 1st + met W bounty \$1.00.

Book mark:

E. H. Brown

E

5 Col'd Cav.

Mass.

James F. Elisha
Capt., Co. C, 5 Reg't Mass. Col'd Cavalry.

Appears on

Company Muster Roll

for March, 1865.

Present or absent Present

Stoppage, \$ 100 for

Due Gov't, \$ 100 for

Valuation of horse, \$ 100

Valuation of horse equipments, \$ 100

Remarks: Due of 1st month of bounty
due 2^d 3^d 4th month of bounty \$ 1.20.
due of for Car. Ord. \$ 2.25

Book mark:

E. H. Brown

6

5 Col'd Cav.

Mass.

James F Elisha

Capt, Co. C, 5 Reg't Mass. Col'd Cavalry.

Appears on

Company Muster Roll

for May & June, 1865.

Present or absent Present

Stoppage, \$ 2 ²⁵/₁₀₀ for Gro Stores

for 2 M Stores 45 cts

Due Gov't, \$ 100 for

Valuation of horse, \$ 100

Valuation of horse equipments, \$ 100

Remarks: Free before April 17 1861

Due of 1st Dist US Bounty \$35⁰⁰

Due 2-3-4 Dist US Bounty \$120⁰⁰

Book mark:

Abbott

(358)

Copyist.

E

5 Col'd Cav.

Mass.

James F Elisha

5 Corp'l, Co. C, 5 Reg't Mass. Col'd Cavalry.

Appears on

Company Muster Roll

for July & Aug, 1865.

Present or absent Present

Stoppage, \$ 2 ²⁵/₁₀₀ for Ord Stores
for 2 M Stores \$1.10

Due Gov't, \$ 100 for

Valuation of horse, \$ 100

Valuation of horse equipments, \$ 100

Remarks: Free before April 19 1861
On detached service SO 40
3 Div 25 a b July 26 - 65

Book mark:

Albott

E

5 Col'd Cav.

Mass.

James F. Elisha

Pvt, Co. G, 5 Reg't Mass. Colored Cav.
Corp

Appears on Returns as follows:

Apr & May 1864. Detailed
to cook

July to Sept. 1865 (Corp)
Absent at Hd. Hqs. 3 Div.
3 Brig, 25 a.c. by S.O.
No. 40 July 26. 65.

Book mark:

M. Bellade

(546)

Copyist.

C

5 Col'd Cav. Mass.

James F Elisha

Cope, Co. C, 5 Reg't Mass. Col'd Cavalry.

Appears on Co. Muster-out Roll, dated Clarksville Texas, Oct 31, 1865.

Muster-out to date Oct 31, 1865.

Last paid to Dec 31, 1864.

Clothing account:

Last settled....., 186 ; drawn since \$ 100

Due soldier \$ 100; due U. S. \$ 100 ³⁹

Am't for cloth'g in kind or money adv'd \$ 100

Due U. S. for arms, equipments, &c., \$ 2 ²⁵/₁₀₀

Bounty paid \$ 25 ¹⁰⁰/₁₀₀; due \$ 275 ¹⁰⁰/₁₀₀

Remarks: Due U S for C + G \$ 1.10

Promoted Corporal by SO No 37 dated March 8 1865

Book mark: 120 P 9870

Abbott

(861)

Copyist.

406-a

Olisha, Joseph

Co , J. W. S. Co'l'd Care,

CARD NUMBERS.

1	9436023	26
2		27
3		28
4		29
5		30
6		31
7		32
8		33
9		34
10		35
11		36
12		37
13		38
14		39
15		40
16		41
17		42
18		43
19		44
20		45
21		46
22		47
23		48
24		49
25		50

Number of personal papers herein.....

Book Mark:

See also

E. 5 Cav. Mass.
Col'd.

Joseph Elisha,

Co. *5* Reg't *Mass Col'd Cav.*

Appears on

Regimental Descriptive Book

of the organization named above.

DESCRIPTION.

Age *22* years; height *5* feet *4 1/2* inches.

Complexion *Black.*

Eyes *Hazel*; hair *Black.*

Where born *Cambridge Port, Mass.*

Occupation *Seaman.*

ENLISTMENT.

When *January 9*, 186*4*

Where *Boston N. 9.*

By whom *A. M. Standish*; term *3* y'rs.

Remarks: *Rejected January,*
29/64.

Haris

#07

Elisha, Joseph A.
Co 6, 5 Mass. Cav., (Col'd.)

Private

Private

CARD NUMBERS.

1	5372626	26
2	5372632	27
3	5376455	28
4	5376497	29
5	5376596	30
6	5376692	31
7	5376788	32
8	9436200	33
9	9092490	34
10	40730896	35
11		36
12		37
13		38
14		39
15		40
16		41
17		42
18		43
19		44
20		45
21		46
22		47
23		48
24		49
25		50

Book Mark:

See also

6 | **5 Cav. (Col'd.)** | **Mass.**

Joseph W. Elisha
... , Co. *6* ..., 5 Reg't Mass. Cav. (Col'd.)

Appears on

Company Descriptive Book

of the organization named above.

DESCRIPTION.

Age *23* years; height *5* feet *5* inches.

Complexion *Testered*

Eyes *Black* ; hair *Black*

Where born *Boston Mass*

Occupation *Barber*

ENLISTMENT.

When *Jan 3* , 186*5*.

Where *Boston*

By whom *Capt L Barnes* ; term *1* y'rs.

Remarks: *Received first installment
of U. S. Bounty # 33³³ Mustered
into U. S. service Jan 3/65 by Capt
L Barnes at Boston, Mass*

F. W. Wadley

(383g)

Copist.

E. 5th Cav. Mass.

Joseph Blaska,

Co. 5 Reg't Mass Col'd Cav.

Appears on

Regimental Descriptive Book

of the organization named above.

DESCRIPTION.

Age 23 years; height 5 feet 5 inches.

Complexion *Cold.*

Eyes *Blue*; hair *Black*

Where born *Boston, Mass.*

Occupation *Barber.*

ENLISTMENT.

When *Jan. 3*, 1865.

Where *Boston,*

By whom *Capt. Barnes*; term *1* y'rs.

Remarks: *Mustered Jan. 3 /*
Jan. 2. 1865.

Barnes

E

5 Col'd Cav.

Mass.

Joseph E. Lisha

Appears with rank of *Private* on

Muster and Descriptive Roll of a Detachment of U. S. Vols. forwarded

for the 5 Reg't Mass. Col'd Cavalry. Roll dated *Draft Rendezvous*
Gallops Island B. H. Mass. Jan. 26, 1865.

Where born *Boston Mass.*

Age *23* y'rs; occupation *Barber*

When enlisted *Jan. 3*, 1865.

Where enlisted *Boston Mass.*

For what period enlisted *1* years.

Eyes *black*; hair *black*

Complexion *Gold*; height *5* ft. *5* in.

When mustered in *Jan. 3*, 1865.

Where mustered in *Boston Mass.*

Bounty paid \$ *33* ^{*33*}/_{*100*}; due \$ *66* ^{*67*}/_{*100*}

Where credited *Oakham Worcester Co.*

Company to which assigned

Remarks:

Book mark:

M. A. Michaels

(339)

Copyist.

Co.

5 Col'd Cav.

Mass.

Joseph Elisha

Appears with rank of Private on

Muster and Descriptive Roll of a Detachment of U. S. Vols. forwarded

for the 5 Reg't Mass. Col'd Cavalry. Roll dated

Boston Mass Jan. 3, 1865.

Where born Boston Mass.

Age 23 y'rs; occupation Barber

When enlisted Jan. 3, 1865.

Where enlisted Boston Mass.

For what period enlisted 1 years.

Eyes Blk; hair Blk

Complexion Colored; height 5 ft. 5 in.

When mustered in Jan. 3, 1865.

Where mustered in Boston

Bounty paid \$ 33 ³³/₁₀₀; due \$ 66 ⁶⁷/₁₀₀

Where credited Town of Cohasset Mass.

Company to which assigned

Remarks:

Book mark:

M. A. Michael

Q

5 Col'd Cav.

Mass.

Joseph W Elisha
Capt, Co. C, 5 Reg't Mass. Col'd Cavalry.

Appears on

Company Muster Roll

for Jan Feb, 1865.

Present or absent Present

Stoppage, \$ 100 for

Due Gov't, \$ 100 for

Valuation of horse, \$ 100

Valuation of horse equipments, \$ 100

Remarks:

Book mark:

E. H. Brown

(358)

Copyist.

E

5 Col'd Cav.

Mass.

Joseph W Elisha
Capt., Co. C, 5 Reg't Mass. Col'd Cavalry.

Appears on

Company Muster Roll

for Mar & Apr, 1865.

Present or absent Present

Stoppage, \$ 100 for

Due Gov't, \$ 100 for

Valuation of horse, \$ 100

Valuation of horse equipments, \$ 100

Remarks:

Book mark:

E H Brown

(358)

Copyist.

E

5 Col'd Cav.

Mass.

Joseph H Elisha

Put, Co. C, 5 Reg't Mass. Col'd Cavalry.

Appears on

Company Muster Roll

for May & June, 1865.

Present or absent Present

Stoppage, \$ 100 for

Due Gov't, \$ 100 for

Valuation of horse, \$ 100

Valuation of horse equipments, \$ 100

Remarks:

Book mark:

Abbott

E

5 Col'd Cav.

Mass.

Joseph H Elisha

Pvt

, Co. C, 5 Reg't Mass. Col'd Cavalry.

Appears on

Company Muster Roll

for

July & Aug, 1865.

Present or absent

Present

Stoppage, \$

100 for

Due Gov't, \$

100 for

Valuation of horse, \$

100

Valuation of horse equipments, \$

100

Remarks:

On detached service at
Brazos SO No 40 July 26. 1865

Book mark:

Abbott

(358)

Copyist.

E

5 Col'd Cav.

Mass.

Joseph H. Elisha
Priv., Co. K, 5 Reg't Mass. Colored Cav.

Appears on Returns as follows:

Feb. 1865 - Jan. Feb. 23. 65
Point Hookout
Recruit from depot

July to Sept. 1865. Absent
at Hd. Qrs. Cav. Brig
3 Div. 3 Brig 25 a. C
by S. O. No. 40. July 26. 65

Book mark:

W. Gallade

(546)

Copyist.

6

5 Col'd Cav.

Mass.

Joseph H Elisha

Co. C, 5 Reg't Mass. Col'd Cavalry.

Appears on Co. Muster-out Roll, dated
Clarksville Texas, Oct 31, 1865.

Muster-out to date Oct 31, 1865.

Last paid to Dec 31, 1864.

Clothing account:

Last settled....., 186 ; drawn since \$..... 100

Due soldier \$ 14 ³²/₁₀₀; due U. S. \$..... 100

Am't for cloth'g in kind or money adv'd \$..... 100

Due U. S. for arms, equipments, &c., \$ ⁸/₁₀₀

Bounty paid \$ 33 ³³/₁₀₀; due \$ 33 ³³/₁₀₀

Remarks:

Book mark:

Abbott

(361)

Copyist.

Elisha, Joseph,

, Co. , 5th Reg't Mass. C.C.

2 Enclosures.

Bed Cards	Final Statements
Burial Records	Furloughs
Certs. of Dis. for Discharge	Med. Certificates
C. M. Charges	Med. Des. Lists
Descriptive Lists	Orders
Discharge Certificates	Pris. of War Record

Other papers relating to—

Admission to Hosp'l	Furlough
Casualty Sheet	Med. Examination
Confinement	Misc. Information
Contracts	Pay or Clothing
Death or Effects	Personal Reports
Desertions	Rank
Discharge from Hosp'l	Transfer to Hosp'l
Discharge from Service	Transfer to V. R. C.
Duty	Transportation

V.P.

2

NOTE 1. — This blank will be used for both enlistments and re-enlistments — enlistment of veterans, &c., &c., in the volunteer service. They will be made out in duplicate in all cases — one to accompany the recruiting return of the superintendent (not the recruiting officer) to the Adjutant-General, and one to accompany the accounts of the officer who pays bounty, &c. The Regiment and Company in which the soldier last served should be given on the back.

NOTE 2. — An enlistment holds to service. A muster-in must, in all cases, precede payment of pay, bounty, pension, &c. A muster-in roll must, in all cases, be filed in the Adjutant-General's Office as evidence of muster-in. The mustering officer, commissary, or assistant-commissary of musters, as the case may be, will countersign both enlistments as having mustered the soldier into the service of the United States before either of them is given to the disbursing officer.

ORDER WAS FORMED BY
ADJUTANT DIV. R. S. P. O.

DECLARATION OF RECRUIT.

I, *Joseph Eliska* desiring to VOLUNTEER as a Soldier in the Army of the United States, for the term of ~~THREE YEARS~~ ^{one} months Do Declare, That I am *Twenty three* years and _____ months of age; that I have never been discharged from the United States service on account of disability or by sentence of a court-martial, or by order before the expiration of a term of enlistment; and I know of no impediment to my serving honestly and faithfully as a soldier for ~~three years~~ ^{one}

GIVEN at *Worcester, Mass.*
the *5th* day of *January 1865*

Witness:

John H. Collins *Joseph Eliska*

No. *5- New born*

Volunteered at *Worcester Mass*

By *Joseph Eliska* *January 3rd 1865*
Dr *Regiment of Cavalry*

enlistment; last served in Company ()

Reg't of

Discharged

18

83. 33 Battery 2nd H. I.

CONSENT IN CASE OF MINOR.

I, _____ Do CERTIFY, That I am _____; that the _____ of _____; that the _____ is _____ years of age; and I do hereby freely give my CONSENT to his volunteering as a SOLDIER in the ARMY OF THE UNITED STATES for the period of THREE YEARS.

GIVEN at _____
the _____ day of _____

Witness:

VOLUNTEER ENLISTMENT.

STATE OF



TOWN OF

Massachusetts,

I, *Joseph Elisha* born in *Boston*
in the State of *Massachusetts* aged *Twenty three* years,
and by occupation a *Barber* DO HEREBY ACKNOWLEDGE to have
volunteered this *Third* day of *January* 186*5*,
to serve as a **Soldier** in the Army of the United States of America, for the
period of **THREE YEARS**, unless sooner discharged by proper authority: Do also
agree to accept such bounty, pay, rations, and clothing, as are, or may be, estab-
lished by law for volunteers. And I, *Joseph Elisha* do
solemnly swear, that I will bear true faith and allegiance to the **United States**
of America, and that I will serve them honestly and faithfully against all their
enemies or opposers whomsoever; and that I will observe and obey the orders of
the President of the United States, and the orders of the officers appointed over
me, according to the Rules and Articles of War.

Sworn and subscribed to, at

this

day of

January 186*5*,
Joseph Elisha
Barber

BEFORE

I CERTIFY, ON HONOR, That I have carefully examined the above-named Volunteer, agreeably
to the General Regulations of the Army, and that, in my opinion, he is free from all bodily defects and
mental infirmity, which would in any way disqualify him from performing the duties of a soldier.

Dr. A. M. ...

EXAMINING SURGEON.

I CERTIFY, ON HONOR, That I have minutely inspected the Volunteer, *Joseph Elisha*
previously to his enlistment, and that he was entirely sober when enlisted; that, to the best of my
judgment and belief, he is of lawful age; and that, in accepting him as duly qualified to perform the duties
of an able-bodied soldier, I have strictly observed the Regulations which govern the recruiting service.

This soldier has *Blue* eyes, *Black* hair, *Color* complexion, is *Five* feet
5 inches high.

J. M. ...
Regiment of *Provincetown* (Volunteers).
Dist. *Mass.*

RECRUITING OFFICER.

(A. G. O. No. 74 & 75.)

the

day of

January

186*5*, at

Provincetown

Mass.

Regiment of *Provincetown* Mass Volunteers, OR

Mustered into the service of the United States, in Company

1st Regiment of *Provincetown* Mass Volunteers, OR

8th

Capt. ...

First Lieut. ...

1504

NOTE 1. — This blank will be used for both enlistments and re-enlistments — enlistment of veterans, &c., &c., in the volunteer service. They will be made out in duplicate in all cases — one to accompany the recruiting return of the superintendent (not the recruiting officer) to the Adjutant-General, and one to accompany the accounts of the officer who pays bounty, &c. The Regiment and Company in which the soldier last served should be given on the back.

NOTE 2. — An enlistment holds to service. A muster-in must, in all cases, precede payment of pay, bounty, pension, &c. A muster-in roll must, in all cases, be filed in the Adjutant-General's Office as evidence of muster-in. The mustering officer, commissary, or assistant-commissary of musters, as the case may be, will countersign both enlistments as having mustered the soldier into the service of the United States before either of them is given to the disbursing officer.

DECLARATION OF RECRUIT.

I, *Joseph Elina* desiring to VOLUNTEER as a Soldier in the Army of the United States, for the term of ~~THREE YEARS~~ ^{one} ~~THREE~~ YEARS, Do Declare, That I am *Twenty three* years and _____ months of age; that I have never been discharged from the United States service on account of disability or by sentence of a court-martial, or by order before the expiration of a term of enlistment; and I know of no impediment to my serving honestly and faithfully as a soldier for *three* years.

GIVEN at *Boston, Mass* the *3* day of *June* 18*65*

Witness: *A. Collins* *Joseph Elina*

No. _____
Joseph Elina
 Volunteered at *Herber Mass*
Mass 18*65*,
 By *Capt W. L. Barnes*
 Regiment of *Mass*
 Discharged _____ 18____
 enlistment; last served in Company ()
 Regt of _____

CONSENT IN CASE OF MINOR.

I, _____ Do CERTIFY, That I am _____; that the _____ of _____ is _____ years of age; and I do hereby freely give my CONSENT to his volunteering as a SOLDIER in the ARMY OF THE UNITED STATES for the period of THREE YEARS.

GIVEN at _____ the _____ day of _____

Witness: _____

VOLUNTEER ENLISTMENT.

STATE OF



TOWN OF

Massachusetts

I, Joseph Elisha born in Boston in the State of Mass aged Twenty three years, and by occupation a Bookbinder Do HEREBY ACKNOWLEDGE to have volunteered this Thir day of June 1863, to serve as a Soldier in the Army of the United States of America, for the period of THREE YEARS, unless sooner discharged by proper authority: Do also agree to accept such bounty, pay, rations, and clothing, as are, or may be, established by law for volunteers. And I, Joseph Elisha do solemnly swear, that I will bear true faith and allegiance to the United States of America, and that I will serve them honestly and faithfully against all their enemies or opposers whomsoever; and that I will observe and obey the orders of the President of the United States, and the orders of the officers appointed over me, according to the Rules and Articles of War.

Sworn and subscribed to, at Boston, this 3 day of June 1863, before me, W. L. Parson, Captain & Prov. Marshal 3rd Dist. Mass.

I CERTIFY, ON HONOR, That I have carefully examined the above-named Volunteer, agreeably to the General Regulations of the Army, and that, in my opinion, he is free from all bodily defects and mental infirmity, which would in any way disqualify him from performing the duties of a soldier.

Wm. H. Smith, Surgeon General of the Army, Examining Surgeon.

I CERTIFY, ON HONOR, That I have minutely inspected the Volunteer, previously to his enlistment, and that he was entirely sober when enlisted; that, to the best of my judgment and belief, he is of lawful age; and that, in accepting him as duly qualified to perform the duties of an able-bodied soldier, I have strictly observed the Regulations which govern the recruiting service. This soldier has Blue eyes, Black hair, Color complexion, is Five feet 3 inches high.

W. L. Parson, Captain, Regiment of Cavalry, 3rd District, Mass., Recruiting Officer.

(A. G. O. No. 74 & 75.)

the 3 day of June, 1863, at Boston, Mass. Mustered into the service of the United States, in Company for one year, 1st Regiment of Cavalry, Mass. Volunteers, on 1st June 1863. Wm. H. Smith, Surgeon General of the Army. W. L. Parson, Captain, 3rd Dist. Mass.

408

Elliott, John E.

Co D, 5 Mass. Cav., (Col'd.)

Private

Corporal

CARD NUMBERS.

1	5376909	26
2	5377001	27
3	5377088	28
4	5377178	29
5	5377280	30
6	5377390	31
7	5377492	32
8	5377602	33
9	5377706	34
10	5377802	35
11	5377875	36
12	5377950	37
13	9092279	38
14	40730910	39
15		40
16		41
17		42
18		43
19		44
20		45
21		46
22		47
23		48
24		49
25		50

Book Mark:

See also:

E | **5 Cav. (Col'd.)** | **Mass.**

John E. Elliott

Co. *A*, 5 Reg't Mass. Cav. (Col'd.)

Appears on

Company Descriptive Book

of the organization named above.

DESCRIPTION.

Age *20* years; height *5* feet *6* inches.

Complexion *white*

Eyes *blue*; hair *black*

Where born *New Bedford, Mass.*

Occupation *Farmer*

ENLISTMENT.

When *Aug 8*, 186*1*.

Where *New Bedford*

By whom *W. H. ...*; term *1* y'rs.

Remarks: *Member of Co. A,*

5th Regt Mass Cav. (Col'd.)
New Bedford, Mass.

John E. Elliott

E

5 Col'd Cav. | Mass.

John E. Elliott

Co. D, 5 Reg't Mass. Col'd Cav.

Appears on

Company Muster-in and Descriptive Roll

of the organization named above. Roll dated

Readville Mass, Jan 29, 1864.

Where born Newbern N.C.

Age 20 y'rs; occupation Farmer

When enlisted Dec 9, 1863.

Where enlisted Warren

For what period enlisted 3 years.

Eyes Blue; hair Blue

Complexion Blue; height 5 ft. 6 in.

When mustered in Jan 29, 1864.

Where mustered in Readville Mass

Bounty paid \$ 100; due \$ 100

Where credited 8000 Worcester

Company to which assigned

Remarks:

Book mark:

(356d)

Jurvis
Copyist.

E

5 Col'd Cav.

Mass.

John E. Elliott

John E. Elliott, Co. D, 5 Reg't Mass. Col'd Cavalry.

Appears on

Company Muster Roll

for *Enlistment to July 24*, 1864.

Present or absent *Present*

Stoppage, \$ *100* for

Due Gov't, \$ *100* for

Valuation of horse, \$ *100*

Valuation of horse equipments, \$ *100*

Remarks: *Detained as Orderly*

Book mark:

Lewis

(358)

Copyist.

E

5 Col'd Cav.

Mass.

Wm E. Elliott

Wm, Co. D, 5 Reg't Mass. Col'd Cavalry.

Appears on

Company Muster Roll

for *Sept & Oct*, 1864.

Present or absent *Present*

Stoppage, \$ 100 for

Due Gov't, \$ 100 for

Valuation of horse, \$ 100

Valuation of horse equipments, \$ 100

Remarks:

Book mark:

Lewis
Copyist.

E

5 Col'd Cav.

Mass.

John C. Elliott

Plt, Co. D, 5 Reg't Mass. Col'd Cavalry.

Appears on

Company Muster Roll

for *May & June*, 186*4*.

Present or absent *Present*

Stoppage, \$ *100* for

Due Gov't, \$ *100* for

Valuation of horse, \$ *100*

Valuation of horse equipments, \$ *100*

Remarks:

Book mark:

Lewis
Copyist.

E

5 Col'd Cav.

Mass.

John E. Elliott
Prs, Co. D, 5 Reg't Mass. Col'd Cavalry.

Appears on

Company Muster Roll

for July & Aug, 1864.

Present or absent Present

Stoppage, \$ 100 for

Due Gov't, \$ 100 for

Valuation of horse, \$ 100

Valuation of horse equipments, \$ 100

Remarks:

Book mark: -----

J. Merchant

E

5 Col'd Cav.

Mass.

John E. Elliott

Co. D, 5 Reg't Mass. Col'd Cavalry.

Appears on

Company Muster Roll

for Sept & Oct, 1864

Present or absent Present

Stoppage, \$ 100 for

Due Gov't, \$ 100 for

Valuation of horse, \$ 100

Valuation of horse equipments, \$ 100

Remarks:

Book mark:

A. Albrecht

(358)

Copyist.

Q

5 Col'd Cav.

Mass.

John E. Elliott

Pl'd, Co. D, 5 Reg't Mass. Col'd Cavalry.

Appears on

Company Muster Roll

for Am & Dec, 1864.

Present or absent Present

Stoppage, \$ 100 for

Due Gov't, \$ 100 for

Valuation of horse, \$ 100

Valuation of horse equipments, \$ 100

Remarks: In M. Stores for Household & Canteen 95

Book mark:

A. Merchant

(358)

Copyist.

E

5 Col'd Cav.

Mass.

John E. Elliott

Plat., Co. D, 5 Reg't Mass. Col'd Cavalry.

Appears on

Company Muster Roll

for Jan'y Febr, 1865

Present or absent Present

Stoppage, \$ 100 for

Due Gov't, \$ 100 for

Valuation of horse, \$ 100

Valuation of horse equipments, \$ 100

Remarks: Due 1, 2, 3, 4 Instal'ts
US Bounty

Book mark:

A. Merchant

(358)

Copyist.

E

5 Col'd Cav.

Mass.

John E. Elliott

Co. D, 5 Reg't Mass. Col'd Cavalry.

Appears on

Company Muster Roll

for *Month of April*, 186 *S.*

Present or absent *Present*

Stoppage, \$ *100* for

Due Gov't, \$ *100* for

Valuation of horse, \$ *100*

Valuation of horse equipments, \$ *100*

Remarks: *Due 1, 2, 3, 4, Ins US, Bonus*

Book mark:

S. Merchant

(358)

Copyist.

E

5 Col'd Cav.

Mass.

John E. Elliott

Port, Co. D, 5 Reg't Mass. Col'd Cavalry.

Appears on

Company Muster Roll

for May and June, 1865

Present or absent Present

Stoppage, \$ 100 for

Due Gov't, \$ 100 for

Valuation of horse, \$ 100

Valuation of horse equipments, \$ 100

Remarks:

Free before April 19, 1861
Que 1, 2, 3, 4, 5. Ins. U.S.
County

Book mark:

House

E

5 Col'd Cav.

Mass.

John E. Elliott
Capt, Co. D, 5 Reg't Mass. Col'd Cavalry.

Appears on

Company Muster Roll

for July and Aug, 1865.

Present or absent Present

Stoppage, \$ 100 for

Due Gov't, \$ 100 for

Valuation of horse, \$ 100

Valuation of horse equipments, \$ 100

Remarks:

Free April 19 1861
Rue 1 2 3 4 5 Ans. U.S.
County, from Capt.
August 6 vice John
P. ...

Book mark:

House

E

5 Col'd Cav.

Mass.

John Elliotts

Capt, Co. D, 5 Reg't Mass. Colored Cav.

Appears on Returns as follows:

July 1865 - June 10. 65

Clarksville T.

Promoted Capt vice

Tabbs promoted Serjt

June 10.

Book mark:

Mr. Gallade

(546)

Copyist.

E

5 Col'd Cav.

Mass.

James E. Elliott

Supt, Co. E, 5 Reg't Mass. Col'd Cavalry.

Appears on Co. Muster-out Roll, dated
Clarksville Texas, Oct 31, 1865.

Muster-out to date Oct 31, 1865.

Last paid to Dec 31, 1864.

Clothing account:

Last settled....., 186 ; drawn since \$ 100

Due soldier \$ 100; due U. S. \$ 00/100

Am't for cloth'g in kind or money adv'd \$ 100

Due U. S. for arms, equipments, &c., \$ 11 00/100

Bounty paid \$ 100; due \$ 100 00/100

Remarks:

Total money value of ad-
vance charged \$ 11.00
Promoted Sergeant U. S. O. 120
Regt. Hd. Quarters 1st Ill
Promoted Sgt.

Book mark:

House

409
Elsey, John

Co F, 5 Mass. Cav., (Col'd.)

Private | *Private*

CARD NUMBERS.

1	5379322	26
2	5379407	27
3	5379503	28
4	5379593	29
5	5379693	30
6	5379802	31
7	5379899	32
8	5380006	33
9	5380106	34
10	5380209	35
11	5380306	36
12	5380402	37
13	9092050	38
14	40730911	39
15		40
16		41
17		42
18		43
19		44
20		45
21		46
22		47
23		48
24		49
25		50

Book Mark:

See also

E

5 Cav. (Col'd.) | Mass.

John Ellsey

, Co. F, 5 Reg't Mass. Cav. (Col'd.)

Appears on

Company Descriptive Book

of the organization named above.

DESCRIPTION.

Age 30 years; height 5 feet 4 1/2 inches.

Complexion dark

Eyes dark; hair dark

Where born Roehingham, Va.

Occupation Farmer.

ENLISTMENT.

When Feb 5, 1864.

Where Boston

By whom L.M. Standish; term 3 y'rs.

Remarks:

Hearn

John Ellsey

Co. 4, 5 Reg't Mass. Col'd Cav.

Appears on

Company Muster-in and Descriptive Roll

of the organization named above. Roll dated

Readville, Mass., Feb. 22, 1864.

Where born Rockingham, Va.

Age 30 y'rs; occupation Farmer

When enlisted Feb. 22, 1864.

Where enlisted Readville, Md.

For what period enlisted 3 years.

Eyes Blue; hair Black

Complexion Fair; height 5 ft. 1/2 in.

When mustered in Feb. 22, 1864.

Where mustered in

Bounty paid \$ 100; due \$ 100

Where credited Readville, Mass.

Company to which assigned

Remarks:

Book mark:

John Ellsey

E

5 Col'd Cav.

Mass.

John Ellsey

Priv., Co. F, 5 Reg't Mass. Col'd Cavalry.

Appears on

Company Muster Roll

for *Enlistment to Feb. 27*, 1864.

Present or absent

Present

Stoppage, \$

100 for

Due Gov't, \$

100 for

Valuation of horse, \$

100

Valuation of horse equipments, \$

100

Remarks:

Book mark:

(358)

W. H. [Signature]

Copyist.

E

5 Col'd Cav.

Mass.

Wm. S. ...

..., Co. F, 5 Reg't Mass. Col'd Cavalry.

Appears on

Company Muster Roll

for *July & Aug.*, 186*4*.

Present or absent *Present*

Stoppage, \$ *100* for

Due Gov't, \$ *100* for

Valuation of horse, \$ *100*

Valuation of horse equipments, \$ *100*

Remarks:

Book mark:

Wm. S. ...

5

5 Col'd Cav.

Mass.

Ed. Ellsey

Co. F, 5 Reg't Mass. Col'd Cavalry.

Appears on

Company Muster Roll

for March & June, 1864.

Present or absent Present

Stoppage, \$ 100 for

Due Gov't, \$ 100 for

Valuation of horse, \$ 100

Valuation of horse equipments, \$ 100

Remarks: examined to cert.
A. S. Muller

Book mark:

(Handwritten signature)

E

5 Col'd Cav.

Mass.

John Ellesy^x

H, Co. F, 5 Reg't Mass. Col'd Cavalry.

Appears on

Company Muster Roll

for

July & Aug, 1864.

Present or absent

Present

Stoppage, \$

100 for

Due Gov't, \$

100 for

Valuation of horse, \$

100

Valuation of horse equipments, \$

100

Remarks:

Ret'd to Co.

Sept 1/64 formerly
serv'd to Lt. Mallory

^x

In Col. Pres. name appears as

"John Ellesey"

Book mark:

J. H. Stewart

(358)

Copyist.

E

5 Col'd Cav.

Mass.

John Ellesy

Pt., Co. F, 5 Reg't Mass. Col'd Cavalry.

Appears on

Company Muster Roll

for *Sept & Oct*, 1864.

Present or absent *Present*

Stoppage, \$ 100 for

Due Gov't, \$ 100 for

Valuation of horse, \$ 100

Valuation of horse equipments, \$ 100

Remarks:

Book mark:

J. H. Stewart

(358)

Copyist.

E

5 Col'd Cav.

Mass.

John W. Elsey
Pt., Co. F, 5 Reg't Mass. Col'd Cavalry.

Appears on

Company Muster Roll

for Nov & Dec, 1864.

Present or absent Present

Stoppage, \$ 100 for

Due Gov't, \$ 100 for

Valuation of horse, \$ 100

Valuation of horse equipments, \$ 100

Remarks:

Book mark:

J. H. Stewart

(358)

Copyist.

E^d

5 Col'd Cav.

Mass.

John Ellsey
Pt, Co. F, 5 Reg't Mass. Col'd Cavalry.

Appears on

Company Muster Roll

for Jan & Feb, 1863.

Present or absent Present

Stoppage, \$ 100 for

Due Gov't, \$ 100 for

Valuation of horse, \$ 100

Valuation of horse equipments, \$ 100

Remarks: One first four
last U.S. Bty

Book mark:

J. Stewart

(358)

Copyist.

E

5 Col'd Cav.

Mass.

John Ellesey
Pl, Co. F, 5 Reg't Mass. Col'd Cavalry.

Appears on

Company Muster Roll

for Mch & apr, 1863.

Present or absent Present

Stoppage, \$ 100 for

Due Gov't, \$ 100 for

Valuation of horse, \$ 100

Valuation of horse equipments, \$ 100

Remarks: Due first four
inst U.S. Pay 100.00

Book mark:

J. Stewart

(358)

Copyist.

E

5 Col'd Cav.

Mass.

John Ellsey

, Co. F, 5 Reg't Mass. Col'd Cavalry.

Appears on

Company Muster Roll

for *May 1864*, 1864

Present or absent

Present

Stoppage, \$ *100* for

Due Gov't, \$ *100* for

Valuation of horse, \$ *100*

Valuation of horse equipments, \$ *100*

Remarks:

Book mark:

J. H. Johnson

(358)

Copyist.

E

5 Col'd Cav.

Mass.

John Ellsey

J.P., Co. F, 5 Reg't Mass. Col'd Cavalry.

Appears on

Company Muster Roll

for *July & Aug*, 186*5*.

Present or absent *Present*

Stoppage, \$ *100* for

Due Gov't, \$ *100* for

Valuation of horse, \$ *100*

Valuation of horse equipments, \$ *100*

Remarks:

Book mark:

(358)

John Ellsey

Copyist.

6
60

5 Col'd Cav.

Mass.

John Ellsey

Priv., Co. F, 5 Reg't Mass. Colored Cav.

Appears on Returns as follows:

June 1864. On duty
servant

July 1864. On duty
servant to 1st Lieut.

Sept. 1865. Absent on
detailed service

Hd. qrs. 25 a. c. Sept
13. S. O. 76.

Book mark :

W. D. D. D.

(546)

Copyist.

E | **5 Col'd Cav.** | **Mass.**

John Ellsey
Co. *F*, 5 Reg't Mass. Col'd Cavalry.

Appears on **Co. Muster-out Roll**, dated
Wassville Tex, Oct 31, 1863,
Muster-out to date *Oct 31, 1863*,
Last paid to *Dec 31, 1864*.

Clothing account:

Last settled....., 186 ; drawn since \$..... 100
Due soldier \$ *19*³² 100; due U. S. \$..... 100
Am't for cloth'g in kind or money adv'd \$..... 100

Due U. S. for arms, equipments, &c., \$ *11* 100
Bounty paid \$..... 100; due \$ *200* 100

Remarks: *Account of pay for
Equip. 11 00*

Book mark :

(861)

J. V. Johnson
Copyist.

410

Olivia William

Co A, 5 Mass. Cav., (Col'd.)

CARD NUMBERS.

1		26	
2		27	
3		28	
4		29	
5	See Elroyd	30	William
6		31	
7		32	
8		33	
9		34	
10		35	
11		36	
12		37	
13		38	
14		39	
15		40	
16		41	
17		42	
18		43	
19		44	
20		45	
21		46	
22		47	
23		48	
24		49	
25		50	

Book Mark:

See also:

411

Elroyd, William
Co D, 5 Mass. Cav., (Col'd.)

Private | Private

CARD NUMBERS.

1	5372667	26
2	5372093	27
3	5377180	28
4	5377288	29
5	5377393	30
6	5377470	31
7	5377573	32
8	5377673	33
9	5377804	34
10	5377895	35
11	5377991	36
12	9092282	37
12	34509621	38
14	40730897	39
15		40
16		41
17		42
18		43
19		44
20		45
21		46
22		47
23		48
24		49
25		50

Book Mark:

See also

5 Cav. (Col'd.) | Mass.

William Clويد

Co. I, 5 Reg't Mass. Cav. (Col'd.)

Appears on

Company Descriptive Book

of the organization named above.

DESCRIPTION.

Age *21* years; height *5* feet *7* inches.

Complexion *Blk*

Eyes *Blk*; hair *Blk*

Where born *Roxbury Co. Ma.*

Occupation *Fireman*

ENLISTMENT.

When *May 21*, 186*1*

Where *Boston*

By whom *L. M. Sturges*; term *2* y'rs.

Remarks:

E 15 Cav. | Mass.

William Eloyd.

Appears with rank of on

Muster-in and Descriptive Roll

of a detachment of U. S. Volunteer Recruits for
different regiments of Massachusetts Volunteers.

Roll dated *Draft Rendez. Galloups Island,
Boston Harbor, Mass., May 28, 1864,*

Where born *Rock-bridge Co., Va.*

Age *21* years; occupation *Farmer.*

When enlisted *May 27, 1864.*

Where enlisted *Boston, Mass*

For what period enlisted *3* years.

Eyes *Dark*; hair *black*

Complexion *Dark.*; height *5 ft. 7 in.*

When mustered in, 186 .

Muster-in to date *from enlistment,*, 186 .

Where mustered in

Bounty paid \$ *100*; due \$ *100*

Clothing account:

Last settled \$, 186 ; drawn since \$ *100*

Date of first muster, 186 .

Regiment to which assigned *5 Cav.*

Remarks *credited to the Quota of Boston
Ward 9, Suffolk Co., 14 Congl. Dist.*

Book mark:

Printed copy

(356m)

Copyist.

E

5 Col'd Cav.

Mass.

William Elvord

Appears with rank of on

Muster and Descriptive Roll of a Detachment of U. S. Vols. forwarded

for the 5 Reg't Mass. Col'd Cavalry. Roll dated
Draft rendezvous
Gallup Island N.H. Mass, May 28, 1864.

Where born *Rockbridge Co Va*

Age *21* y'rs; occupation *Farmer*

When enlisted *May 27*, 1864.

Where enlisted *Boston*

For what period enlisted *3* years.

Eyes *dark*; hair *black*

Complexion *dark*; height *5 ft. 7 in.*

When mustered in *May 27*, 1864.

Where mustered in *Boston*

Bounty paid \$ *100*; due \$ *100*

Where credited *Boston Ward 9 Suffolk Co.*

Company to which assigned

Remarks:

Book mark:

M. A. Michaels

(339)

Copyist.

William W. Wray

Appears with rank of *Private* on

Muster and Descriptive Roll of a Detachment of U. S. Vols. forwarded

for the 5 Reg't Mass. Col'd Cavalry. Roll dated *Galloups Island Mass, June 13, 1864.*

Where born *Lockbridge Va*

Age *21* y'rs; occupation *Farmer*

When enlisted *May 27*, 1864.

Where enlisted *Boston Mass*

For what period enlisted *5* years.

Eyes *Dark*; hair *Black*

Complexion *Dark*; height *5* ft. *7* in.

When mustered in *May 27*, 1864.

Where mustered in *Galloups Island Mass*

Bounty paid \$ *100*; due \$ *100*

Where credited *4 Cong. Dist. Boston Ward 9 Suffolk Co.*

Company to which assigned

Remarks :

Book mark :

(2) Wray

5

5 Col'd Cav.

Mass.

William Clouid

Plt, Co. D, 5 Reg't Mass. Col'd Cavalry.

Appears on

Company Muster Roll

for May & June, 1864

Present or absent Present

Stoppage, \$ 100 for

Due Gov't, \$ 100 for

Valuation of horse, \$ 100

Valuation of horse equipments, \$ 100

Remarks:

[Empty lines for remarks]

Book mark:

(358)

[Signature]

Copyist.

E

5 Col'd Cav.

Mass.

William Elwood

Co. D, 5 Reg't Mass. Col'd Cavalry.

Appears on

Company Muster Roll

for July & Aug, 1864

Present or absent Present

Stoppage, \$ 100 for

Due Gov't, \$ 100 for

Valuation of horse, \$ 100

Valuation of horse equipments, \$ 100

Remarks:

Book mark:

J. Merchant

(358)

Copyist.

E

5 Col'd Cav.

Mass.

William Uwood

Private, Co. D, 5 Reg't Mass. Col'd Cavalry.

Appears on

Company Muster Roll

for Sept & Oct, 1864.

Present or absent Present

Stoppage, \$ 100 for

Due Gov't, \$ 100 for

Valuation of horse, \$ 100

Valuation of horse equipments, \$ 100

Remarks:

[Empty lines for remarks]

Book mark:

J. M. Mendenhall

(358)

Copyist.

E

5 Col'd Cav.

Mass.

William Elwood

6 Cap, Co. D, 5 Reg't Mass. Col'd Cavalry.

Appears on

Company Muster Roll

for July Dec, 1864

Present or absent Present

Stoppage, \$ 100 for

Due Gov't, \$ 100 for

Valuation of horse, \$ 100

Valuation of horse equipments, \$ 100

Remarks: Promoted by special order to date from Nov 1st G.O. No 192
Dr. M. Stores for Hancock & Co. Curteen 75

Book mark:

J. Marchant

6

5 Col'd Cav.

Mass.

William Elvira

4 Corp, Co. D, 5 Reg't Mass. Col'd Cavalry.

Appears on

Company Muster Roll

for Jan & Feb, 1865

Present or absent Present

Stoppage, \$ 100 for

Due Gov't, \$ 100 for

Valuation of horse, \$ 100

Valuation of horse equipments, \$ 100

Remarks: Free 1st Instal & US, Bounty

Book mark:

S. Merchant

(358)

Copyist.

60

5 Col'd Cav.

Mass.

William Throia

2^d Corp, Co. D, 5 Reg't Mass. Col'd Cavalry.

Appears on

Company Muster Roll

for March & April, 1865.

Present or absent absent

Stoppage, \$ 100 for

Due Gov't, \$ 100 for

Valuation of horse, \$ 100

Valuation of horse equipments, \$ 100

Remarks: Left sick in Rich-
mond Va, Apr 1, 65

Book mark:

A. Merchant

(358)

Copyist.

E

5 Col'd Cav.

Mass.

William Elwood

Pvt, Co. D, 5 Reg't Mass. Col'd Cavalry.

Appears on

Company Muster Roll

for *May and June*, 1865.

Present or absent *Present*

Stoppage, \$ 100 for

Due Gov't, \$ 100 for

Valuation of horse, \$ 100

Valuation of horse equipments, \$ 100

Remarks:

.....
.....
.....
.....
.....
.....
.....
.....

Book mark:

.....

House

E

5 Col'd Cav.

Mass.

William Elwood

Pvt., Co. D, 5 Reg't Mass. Col'd Cavalry.

Appears on

Company Muster Roll

for July and Aug., 1865.

Present or absent Present

Stoppage, \$ 100 for

Due Gov't, \$ 100 for

Valuation of horse, \$ 100

Valuation of horse equipments, \$ 100

Remarks:

Step value of one May-
nard Carbine \$ 30.⁰⁰
1 Carbine sling 95 Cts
Brush cup & 35

Book mark:

House

E

5 Col'd Cav.

Mass.

* Wm Elovie

Port, Co. D, 5 Reg't Mass. Colored Cav.
Corp

Appears on Returns as follows:

June 1864. Gained June 19 by
Point of Rocks.
Recruit rec'd from Depot.

Aug. 1864. On duty
building stables

Apr 1865 (Corp) absent
sick at Pt. Lookout
Md. Dec 25.

* Name appears as
W. Elliot

Book mark:

M. Gallade

(546)

Copyist.

E

5 Col'd Cav.

Mass.

William Elin

Priv., Co. E, 5 Reg't Mass. Col'd Cavalry.

Appears on Co. Muster-out Roll, dated

Clarksville Texas Oct 31, 1865.

Muster-out to date Oct. 31, 1865.

Last paid to Dec 31, 1864.

Clothing account:

Last settled....., 186 ; drawn since \$..... 100

Due soldier \$..... 100; due U. S. \$ 2 14 / 100

Am't for cloth'g in kind or money adv'd \$..... 100

Due U. S. for arms, equipments, &c., \$ 2 25 / 100

Bounty paid \$..... 100; due \$ 100 00 / 100

Remarks:

Total money value of advance charged \$ 42.75
Stop value of one Moryan
Carbine lost Carbine
Sling and pouch & cone

Book mark:

Howe

(over)

Elroyed, William

....., Co. *5* Reg't *Mass Cav*

1 Inclosures.

Bed Cards	Final Statements.....
Burial Records.....	Furloughs or L. of A
Certs. of Dis. for Disch	Med. Certificates
C. M. Charges.....	Med. Des. Lists.....
Descriptive Lists	Orders
Discharge Certificates.....	Pris. of War Record.....
Enlistment Papers.....	Resignations.....

Other papers relating to—

Admission to Hosp'l.....	Furlough or L. of A
Casualty Sheet.....	Med. Examination
Confinement.....	Misc. Information
Contracts	Pay or Clothing
Death or Effects	Personal Reports.....
Desertion	Rank
Discharge from Hosp'l.....	Transfer to Hosp'l.....
Discharge from Service.....	Transfer to V. R. C.
Duty	Transportation.....

NOTE 1.—This blank will be used for both enlistments and re-enlistments—enlistment of veterans, &c., &c., in the volunteer service. They will be made cut in duplicate in all cases—one to accompany the recruiting return of the superintendent (not the recruiting officer) to the Adjutant-General, and one to accompany the accounts of the officer who pays bounty, &c. The Regiment and Company in which the soldier last served should be given on the back.

NOTE 2.—An enlistment holds to service. A muster-in must, in all cases, precede payment of pay, bounty, pension, &c. A muster-in roll must, in all cases, be filed in Adjutant-General's Office as evidence of muster-in. The mustering officer, commissary, or assistant-commissary of musters, as the case may be, will countersign both enlistments as having mustered the soldier into the service of the United States before either of them is given to the disbursing officer.

DECLARATION OF RECRUIT.—

William Eloyd desiring
 to VOLUNTEER as a Soldier in the Army of the United States, for the term of THREE YEARS,
 Do Declare, That I am *twenty one* years and _____ months
 of age; that I have never been discharged from the United States service on account of disability or by
 sentence of a court-martial, or by order before the expiration of a term of enlistment; and I know of no
 impediment to my serving honestly and faithfully as a soldier for three years.

GIVEN at *Boston Mass*
 this the *27* day of *May 1864*

Witness: *W. Sprague* *William Eloyd*
mark

Discharged _____ 18 _____
 Regiment of _____
 enlistment; last served in Company () _____
 By _____ 18 _____
 Volunteered at *Beverly Mass*
 No. *5th Mass Cav*

CONSENT IN CASE OF MINOR.

I, _____ Do CERTIFY, That I am
 the _____ of _____ ; that the
 said _____ is _____ years of age; and I
 do hereby freely give my CONSENT to his volunteering as a SOLDIER in the ARMY OF THE UNITED STATES,
 for the period of THREE YEARS.

GIVEN at _____
 the _____ day of _____

Witness: _____

412

Oly Dempsy

Co *D*, 5 Mass. Cav., (Col'd.)

Private

Private

CARD NUMBERS.

1	5374482	26
2	5374581	27
3	5374665	28
4	5374762	29
5	5374864	30
6	5374972	31
7	5375080	32
8	5375185	33
9	5375290	34
10	5375389	35
11	5375491	36
12	5375586	37
13	9092527	38
14		39
15		40
16		41
17		42
18		43
19		44
20		45
21		46
22		47
23		48
24		49
25		50

Book Mark:

See also

6

5 Cav. (Col'd.) | Mass.

Dempsey Coly

Co. B, 5 Reg't Mass. Cav. (Col'd.)

Appears on

Company Descriptive Book

of the organization named above.

DESCRIPTION.

Age 35 years; height 5 feet 6 inches.

Complexion Colored

Eyes Blue; hair Black

Where born Suffolk Virginia

Occupation Farmer

ENLISTMENT.

When Jan 11, 1864.

Where Lawrence

By whom H. Wood; term 3 y'rs.

Remarks:

[Empty lines for remarks]

Tierley

(3830)

Compt.

5

5 Col'd Cav. | Mass.

Amos Fry

Co. *A*, 5 Reg't Mass. Col'd Cav.

Appears on

Company Muster-in and Descriptive Roll
of the organization named above. Roll dated

Readville Mass., July 29, 1864.

Where born *Stafford Virginia*

Age *35* y'rs; occupation *Farmer*

When enlisted *Jan 4th*, 1864.

Where enlisted *Marlboro*

For what period enlisted *3* years.

Eyes *Black*; hair *Black*.

Complexion *Black*; height *5 ft. 6* in.

When mustered in *Jan 27*, 1864.

Where mustered in

Bounty paid \$ *100*; due \$ *100*

Where credited

Company to which assigned

Remarks: *Middlesex*

Book mark:

Angberger

(356d)

Copyist.

E

5 Col'd Cav.

Mass.

Sam'l Lee

C. Co., Co. B, 5 Reg't Mass. Col'd Cavalry.

Appears on

Company Muster Roll

for *Enlistment to Feb 27*, 1864.

Present or absent *Present*

Stoppage, \$ *100* for

Due Gov't, \$ *100* for

Valuation of horse, \$ *100*

Valuation of horse equipments, \$ *100*

Remarks:

Book mark:

Fairbank

(358)

Copyist.

E
O

5 Col'd Cav.

Mass.

Dempsey Ely

Pl., Co. B, 5 Reg't Mass. Col'd Cavalry.

Appears on

Company Muster Roll

for *March & April*, 1864.

Present or absent *Present*

Stoppage, \$ *100* for

Due Gov't, \$ *100* for

Valuation of horse, \$ *100*

Valuation of horse equipments, \$ *100*

Remarks:

Book mark:

(358)

Hayberger

Copyist.

S
W

5 Col'd Cav.

Mass.

Dempsey Ely

P., Co. B, 5 Reg't Mass. Col'd Cavalry.

Appears on

Company Muster Roll

for *May & June*, 1864.

Present or absent *Present*

Stoppage, \$ *100* for

Due Gov't, \$ *100* for

Valuation of horse, \$ *100*

Valuation of horse equipments, \$ *100*

Remarks:

Book mark:

(358)

Hayberger

Copyist.

E.

5 Col'd Cav.

Mass.

Dempsey Ely

Priv., Co. B, 5 Reg't Mass. Col'd Cavalry.

Appears on

Company Muster Roll

for July & Aug., 1864.

Present or absent Present.

Stoppage, \$ 100 for

Due Gov't, \$ 100 for

Valuation of horse, \$ 100

Valuation of horse equipments, \$ 100

Remarks:

Book mark:

(358)

A. W. Brown

Copist.

E.

5 Col'd Cav.

Mass.

Dempsey Ely,

Priv., Co. B, 5 Reg't Mass. Col'd Cavalry.

Appears on

Company Muster Roll

for Sept. & Oct., 1864.

Present or absent — Present.

Stoppage, \$ 100 for

Due Gov't, \$ 100 for

Valuation of horse, \$ 100

Valuation of horse equipments, \$ 100

Remarks: Free an or before Apr. 19/61.

Due U.S. Bounty \$25.00

Due U.S. for one Bayonet \$2.50

Book mark:

J. W. Brown, Copyist.

(358)

E.

5 Col'd Cav.

Mass.

Dempsey Ely,

Priv., Co. B, 5 Reg't Mass. Col'd Cavalry.

Appears on

Company Muster Roll

for Mar. & Dec., 1864.

Present or absent Present.

Stoppage, \$ 100 for

Due Gov't, \$ 100 for

Valuation of horse, \$ 100

Valuation of horse equipments, \$ 100

Remarks: Due U.S. Ordnance
cost \$ 21.75

Book mark:

W. W. Brown
Copyist.

E.

5 Col'd Cav.

Mass.

Dempsey Ely,
Pvt., Co. B, 5 Reg't Mass. Col'd Cavalry.

Appears on

Company Muster Roll

for *Jan'y. & Feby*, 1865.

Present or absent *Present*

Stoppage, \$ *100* for

Due Gov't, \$ *100* for

Valuation of horse, \$ *100*

Valuation of horse equipments, \$ *100*

Remarks: *Due the soldier*

1st - 2nd - 3rd & 4th Instants.

U.S. Bounty.

Due U.S. for ordnance

\$ 21.75.

Book mark:

J. W. Brown

(358)

Copyist.

E.

5 Col'd Cav.

Mass.

Dempsey Ely,
Pvt, Co. B, 5 Reg't Mass. Col'd Cavalry.

Appears on

Company Muster Roll

for *March & April*, 1865.

Present or absent — *Present.*

Stoppage, \$ *100* for

Due Gov't, \$ *100* for

Valuation of horse, \$ *100*

Valuation of horse equipments, \$ *100*

Remarks:

Book mark:

A W Brown

(358)

Copyist.

E

5 Col'd Cav.

Mass.

Henry Ely

Plt, Co. B, 5 Reg't Mass. Col'd Cavalry.

Appears on

Company Muster Roll

for *May & June*, 186*5*.

Present or absent *Present*

Stoppage, \$ *100* for

Due Gov't, \$ *100* for

Valuation of horse, \$ *100*

Valuation of horse equipments, \$ *100*

Remarks:

Book mark:

Scheseich

(358)

Copyist.

E

5 Col'd Cav.

Mass.

Henry Ely

Co., Co. B, 5 Reg't Mass. Col'd Cavalry.

Appears on

Company Muster Roll

for *July & Aug.*, 186*5*:

Present or absent *Present*

Stoppage, \$ *100* for

Due Gov't, \$ *100* for

Valuation of horse, \$ *100*

Valuation of horse equipments, \$ *100*

Remarks:

✓

Book mark:

Scherich

(358)

Copyist.

E

5 Col'd Cav.

Mass.

Hempsey Ely

Co. B, 5 Reg't Mass. Col'd Cavalry.

Appears on Co. Muster-out Roll, dated

Clarksville, Va., Oct. 31, 1863.

Muster-out to date _____, 186 .

Last paid to *Dec. 31, 1864.*

Clothing account:

Last settled _____, 186 ; drawn since \$ _____ 100

Due soldier \$ *9* ^{*84*} / 100; due U. S. \$ _____ 100

Am't for cloth'g in kind or money adv'd \$ _____ 100

Due U. S. for arms, equipments, &c., \$ _____ 100

Bounty paid \$ *25* ^{*00*} / 100; due \$ *25* ^{*00*} / 100

Remarks: *Absent sick since died. Final statements sent to A.G.O.*

Book mark: *V. 215, P. 40.13; died Oct. 9/65 over*

Scherich

JAN. - 9

5375586

☆ 1681 ☆

of Typho malaria fever
E.B. V. 10 P 548

Wempsey, Eli
R, Co. *B.*, **5** Mass. C. Cav.
Reg't

2 Enclosures.

Bed Cards	Descriptive Lists
Burial Records	Final Statements /
Certs. of Dis. for Discharge	Furloughs
C. M. Charges	Med. Des. Lists
Med. Certificates	Orders

Other papers relating to—

Admission to Hosp'l <i>Pr</i>	Furlough
Casualty Sheet (Officer's) <i>Pr</i> /	Med. Examination
Confinement	Misc. Information
Contracts	Pay or Clothing
Death or Effects	Personal Reports
Desertions	Rank
Discharge from Hosp'l	Transfer to Hosp'l
Discharge from Service	Transfer to V. R. C.
Duty	Transportation

Report sent for to M D D only
Any ~~other~~ ¹⁶
CASUALTY SHEET

No. _____
Eli Dempsey
Priv. of Company _____
Ist Regiment of Mass. Cav.
State Volunteers.

NATURE OF CASUALTY.

Died Oct. 9, 1865.

See Dempsey Ely

Eli Dempsey Ely

CASUALTY SHEET.

Name: Eli Dempsey
Rank: Priv Company: D Regiment: 5th
Arm: Cavalry State: Mass
Nature of Casualty: Death

CAUSE OF CASUALTY—(NAME OF DISEASE, &c.)

Typhoid Mal. fever

BY WHOM DISCHARGED.

FROM WHAT SOURCE THIS INFORMATION WAS OBTAINED.

Roll of Honor Pg 23
Dugan

DEGREE OF DISABILITY.

BY WHOM CERTIFIED.

Jas M. Moore
A. G. M.

REMARKS.

DATE OF DISCHARGE, DEATH, &c.

Oct. 9, 1865

PLACE OF DISCHARGE, DEATH, &c.

Pragos Santiago Texas

James H. Smith
Clerk.

Very low vital
Says Santiago says
March 20th 1867

respectfully returned with
the submission that the
by Leary & Co. 5 mph
Coral, was admitted to
the hospital with typhus
malaria fever Sept. 28th
1865 and died Oct. 5th 1865.
no facts no description
no true account

A. L. Norris, 1867

in charge
with

of Asst. Surg. H. 2. 1867
no use

The above papers
cannot be furnished on
procurement of the Officer

APR 18 1867
GENERAL
Bot Brig. Gen. and Surg. U. S. A., Medical Director.

Head Quarters Sub Dist R. G.
Office Chief Med. Officer
Providence Mass 26th

Respectfully returned to the
Chief Med. Officer Dist of
Texas, with reference to
previous endorsement
5 mass. 10 miles
Capt & Asst. Surg. H. 2.
Chief Med. Officer

P. B. no. 30 P. D. No 266. P. 135.

Headquarters Dist. of Texas
Office of Chief Med. Officer
Galveston Tex April 8 1867
Respectfully returned to Asst. Surg.
Gen. Thos. A. M. Perkins, Surg. Major
Med. Dir. & Med. Dist. with reference
to foregoing endorsement &
George Taylor
Asst. Lt. Col. & Surgeon
Chief Med. Officer

WAR DEPARTMENT,

ADJUTANT GENERAL'S OFFICE,

WASHINGTON, *Aug. 22^d, 1866*

SIR:

Final Statements in the cases of deceased soldiers are required to be sent to the Adjutant General's Office in duplicate, with one copy of the Inventory of Effects. The Descriptive List should also be sent to this Office in cases where the soldier was absent from his Company at the time of his death. Where there were no effects, it should be so stated on a blank Inventory, properly signed.

Certificates of Disability should be sent in duplicate. Special care should be taken that the date of discharge and signature of the discharging officer should be affixed.

John of the Final Statement *Inventory*, has been received in the case of *Priv. Chas. Simpson*, of Co. *B*, *5th* Regiment of *Mass. Cav.*, Volunteers, whose papers were forwarded to this Office. You will please forward the missing papers without delay.

I have the honor to be, sir,

Very respectfully,

Your obedient servant,

Geo. Hayward

Assistant Adjutant General.

(110)

~~COMMANDING OFFICER~~

Medical Director Capt. Gull.

I would prefer to be furnished, please give date place and cause of death, if possible,

H.

Extract from Act of Congress.

SEC. 12. And be it further enacted, That the fees of agents and attorneys for making out and causing to be executed the papers necessary to establish a claim for a pension, bounty, and other allowance before the Pension Office, under this act, shall not exceed the following rates: For making out and causing to be duly executed a declaration by the applicant, with the necessary affidavits, and forwarding the same to the Pension Office, with the requisite correspondence, ten dollars: which sum shall be received by such agent or attorney in full for all services in obtaining such pension, and shall not be demanded or received, in whole or in part, until such pension shall be obtained; and the sixth and seventh sections of an act entitled "An act to grant pensions," approved July [fourteenth,] eighteen hundred and sixty-two, are hereby repealed.

SEC. 13. And be it further enacted, That any agent or attorney who shall, directly or indirectly, demand or receive any greater compensation for his services under this act than is prescribed in the preceding section of this act, or who shall contract or agree to prosecute any claim for a pension, bounty, or other allowance under this act, on the condition that he shall receive a per centum upon any portion of the amount of such claim, or who shall wrongfully withhold from a pensioner or other claimant the whole or any part of the pension or claim allowed and due to such pensioner or claimant, shall be deemed guilty of a high misdemeanor, and, upon conviction thereof, shall, for every such offense, be fined not exceeding three hundred dollars, or imprisoned at hard labor not exceeding two years, or both, according to the circumstances and aggravations of the offense.

Approved July 4, 1864.

NOTE 10.—If any soldier is charged a higher fee than that allowed by the above act, he should report the fact and the name of the agent to the Adjutant General, in order that steps may be taken to have the same refunded.

ADJUTANT GENERAL'S OFFICE.

Oct 24th 1866

Duplicate with Inventory sent 2d Auditor.

28
FINAL STATEMENT.

OF

Hempsey Chas
5 Reg't of Mass Cav

VOLUNTEERS.

Died Oct 9th 1865

NOTE 1.—Two of these certificates (or duplicates) are to be given to each Volunteer Soldier or drafted man who may be discharged without being mustered out (Final Statements are never given to men mustered out of service) that he may at once receive from the Paymaster the pay, &c. due to him, and the captain or other COMMISSIONED officer commanding the company will certify to the act of the delivery of the duplicate certificates; with these certificates the Soldier is "entitled to" his discharge and should also present his discharge to the Paymaster to have the payment endorsed on it. The discharge is to be given back to the Soldier by the Paymaster; the latter only retaining as his vouchers the duplicate certificates.

NOTE 2.—If the Soldier is entitled to pay for the use of his horse, the Company Commander will certify to that fact on the back of both these final statements, and also to the time he has pay due for having been so mounted on his own horse.

NOTE 3.—When a Soldier is furnished with final statements, his descriptive list, if he has one, should be taken up by the officer who gives the Soldier these statements, and endorsed with a statement to this effect by the officer. The endorsement should exhibit a full statement of the time for which the Soldier was allowed pay on his final statements, the clothing account, and all other charges against him or in his favor, so as to comprise a complete exhibit of his account. It will then be transmitted to the Company Commander of the Soldier, who will enter all the data necessary to a full understanding of the Soldier's account on the muster roll upon which the Soldier's discharge is reported. The descriptive list will then be destroyed. The object of this is, that the remaining portion of the Soldier's account may be settled upon the receipt of these muster rolls, and the Soldier receive any pay or allowances that may be due him at the time of his discharge, and which may not appear on his last final statements from the fact that his descriptive list is incomplete. These accounts for back pay, &c., are settled by the 2d Auditor of the Treasury Department.

NOTE 4.—Charges for loss or injury to ordnance, horse equipments, and other miscellaneous charges, should appear under the heading of "Other Stoppages."

NOTE 5.—Bounty paid by State authorities, and not by the United States, will not be entered on this statement.

NOTE 6.—Amounts due the Sutler and Laundress must be entered on the muster roll on which the discharge, death, desertion, &c., is reported, as well as on the final statement, otherwise the amount cannot be collected from the United States.

NOTE 7.—This blank will be used for deceased volunteers and drafted men, as well as for others.

NOTE 8.—Where a Soldier dies in Hospital or on detached service, his descriptive list, if he has one, should be sent with his final statements, in duplicate, to the Adjutant General, Washington, D. C.

NOTE 9.—If the soldier is a drafted man or substitute, the space for time, &c., of enrolled, should contain only the word *drafted* or *substitute*, as the case may be. If the Soldier is a "VETERAN," (or RECRUIT,) the words as a *veteran*, (or *recruit*.) as the case may be, should be interlined after the words *mustered into the service of the U. S.* A statement of all the installments of *Veteran* or *Recruit* *Bounty* RECEIVED by the Soldier must be made on the back of each final statement.

Case of Hempsey Chas

[OFFICE INDORSEMENT.]

War Department,

ADJUTANT GENERAL'S OFFICE,

December 15, 1873

The death of Hempsey Chas
5 Reg't U. S.
Colored Cavalry, is reported as follows:—

	On Company Muster Roll.	
For	186	186
"	Company Muster-out Roll.	186
"	Howdout's and Gode's "Muster-out Roll,"	186
	Company Descriptive Book.	186
	Company Morning Reports.	186
	Soldier's Final Statement.	186
	Soldier's Record of Death and Interment.	186
	Soldier's Inventory of Effects.	186
	Soldier's Certificate of Disability for Discharge.	186
	Soldier's Individual Muster-out Roll.	186
	Regimental Return.	186
For	186	186
	Regimental Quarterly Returns.	186
	Regimental Descriptive Book.	186

By Surgeon General.

Oct 9, 1865, is held to be

the correct date, and the Company Muster-out Roll will be amended accordingly.

Thoma M. Grew

Asst. Adj. Gen.
Noted Rec Letter to 2d Aud.
10/11/74

I certify, on honor, that Sempsey Ely, a Private of
Company (B) of the 5th Regiment of Mass Cavalry
Volunteers, of the State of Mass, born in Suffolk Co State
of Virginia, aged 35 years; 5 feet 6 inches high; Black complexion,
Black eyes, Black hair, and by occupation a Farmer, who joined for service
and was enrolled (see Note 9) on the fourth day of January, 1864, at Mailbox
by W. H. Wood, for the period of three years, and mustered into
the service of the United States on the 29th day of January, 1864, at
Radville, by Lt McKibben; and having served

HONESTLY and **FAITHFULLY** with his Company to the present date, is now entitled to a
DISCHARGE by reason of Death, Died at Post Hospital
Brazos Santiago Texas, Oct 9th 1865.

The said Private Sempsey Ely was last paid by Paymaster
Maj Dodge, to include the 31st day of Dec, 1864, and
has pay due him from that time to the present date; he is entitled to pay and subsistence for
TRAVELING to place of enrollment, and whatever other allowances are authorized to volunteer
soldiers, drafted men, or militia, so discharged. He has received from the United States **CLOTHING**
amounting to Ninety nine $\frac{03}{100}$ dollars, since the last day of settlement,
June 20th 1864, when his clothing account was last settled. He has received from the United States
\$25 $\frac{00}{100}$ dollars advanced **BOUNTY**. One Soldier's \$195 $\frac{00}{100}$ bounty
unpaid

There is to be stopped from him, on account of the State of _____, or other
authorities, for **CLOTHING**, &c., received on entering service, _____ dollars; and
for other stoppages, viz: _____

Three on or before Apr 1st 1861 _____ dollars.
He has been furnished with **TRANSPORTATION** in kind from the place of his discharge to
_____; and he has been **Subsisted** for **Traveling** to his
place of enrollment, up to the _____, 186 _____.

He is indebted to _____, **Sutler**, _____ dollars.

He is indebted to _____, **Laundress**, _____ dollars.

Given in Duplicate, at U.S. War Dept. Washington D.C., this 23rd day
of October, 1866,

Ed. Saggard
Apt. Adj. Gen. Regt.
Commanding Company.

B.B.C.

^{4/3}
Ely, John S.

Co D, 5 Mass. Cav., (Col'd.)

Private

Private

CARD NUMBERS.

1	5374481	26
2	5374580	27
3	5374664	28
4	5374760	29
5	5374863	30
6	5375031	31
7	5375642	32
8	9092526	33
9	32259196	34
10	40730912	35
11		36
12		37
13		38
14		39
15		40
16		41
17		42
18		43
19		44
20		45
21		46
22		47
23		48
24		49
25		50

Book Mark:

See also

6
6

5 Cav. (Col'd.)

Mass.

John S. Ely
Co. B, 5 Reg't Mass. Cav. (Col'd.)

Appears on

Company Descriptive Book

of the organization named above.

DESCRIPTION.

Age 22 years; height 5 feet 10 inches.

Complexion Dark

Eyes Black; hair Black

Where born Boston, Mass

Occupation Teamster

ENLISTMENT.

When Jan 4, 1864.

Where Charleston

By whom H. L. Sands; term 3 y'rs.

Remarks: Discharged Oct 11/64 by
order of Major Gen. Deque for
insubordination

H. L. Sands

E

5 Col'd Cav.

Mass.

John J. ...

John J., Co. *B*, 5 Reg't Mass. Col'd Cav.

Appears on

Company Muster-in and Descriptive Roll
of the organization named above. Roll dated

Readville Mass, July 29 1864.

Where born *Boston Mass.*

Age *22* y'rs; occupation *Teamster*

When enlisted *June 4th*, 1864.

Where enlisted *Marbletown*

For what period enlisted *3* years.

Eyes *Black*; hair *Black*.

Complexion *Black*; height *5 ft. 10 in.*

When mustered in *Jan 29*, 1864.

Where mustered in

Bounty paid \$ *100*; due \$ *100*

Where credited

Company to which assigned

Remarks: *Middlesex*

Book mark:

Aglerger

(356d)

Copyist.

E

5 Col'd Cav.

Mass.

John T Ely

Ely, Co. B, 5 Reg't Mass. Col'd Cavalry.

Appears on

Company Muster Roll

for *Enlistment to Feb 27*, 1864

Present or absent *Present*

Stoppage, \$ *100* for

Due Gov't, \$ *100* for

Valuation of horse, \$ *100*

Valuation of horse equipments, \$ *100*

Remarks:

Book mark:

F. W. Singer

(358)

Copyist.

6

5 Col'd Cav.

Mass.

John T. Ely

Pvt., Co. B, 5 Reg't Mass. Col'd Cavalry.

Appears on

Company Muster Roll

for March & April, 1864.

Present or absent Present

Stoppage, \$ 100 for

Due Gov't, \$ 100 for

Valuation of horse, \$ 100

Valuation of horse equipments, \$ 100

Remarks: in Daily Duty as
Stable orderly since
April 23rd '64

Book mark:

(358)

Hoybarger

Copyist.

5

5 Col'd Cav.

Mass.

John T Ely

A., Co. B, 5 Reg't Mass. Col'd Cavalry.

Appears on

Company Muster Roll

for May & June, 1864.

Present or absent Absent

Stoppage, \$ 100 for

Due Gov't, \$ 100 for

Valuation of horse, \$ 100

Valuation of horse equipments, \$ 100

Remarks: Sick at City Point Va since June 15. /64

Book mark:

(358)

Hoyerger

Copyist.

E 156 Cav. Mass

John J. Ovi

Priv., Co. B, 5 Reg't Mass. Cav.

Appears on

Hospital Muster Roll

of U. S. A. General Hospital,

at Point Lookout, Md.,

for *July & Aug*, 186*4*.

Attached to hospital:

When _____, 186 .

How employed _____

Last paid by Maj. _____

to _____, 186 .

Bounty paid \$ 100; due \$ 100

Present or absent *Present*

Remarks: _____

Ward - A

Book mark: _____

Tough

(843)

Copyist.

E.

5 Col'd Cav.

Mass.

John T. Ely,

Priv., Co. B, 5 Reg't Mass. Col'd Cavalry.

Appears on

Company Muster Roll

for July & Aug., 1864

Present or absent — Absent

Stoppage, \$ 100 for

Due Gov't, \$ 100 for

Valuation of horse, \$ 100

Valuation of horse equipments, \$ 100

Remarks: Sick in Genl. Hosp. at Point Lookout, Md.

Book mark:

A. P. Brown,

(358)

Copyist.

E.

5 Col'd Cav.

Mass.

John T. Ely,

Priv., Co. B, 5 Reg't Mass. Col'd Cavalry.

Appears on

Company Muster Roll

for Sept. & Oct., 1864.

Present or absent

Stoppage, \$ 100 for

Due Gov't, \$ 100 for

Valuation of horse, \$ 100

Valuation of horse equipments, \$ 100

Remarks: Discharged by reason of disability at Pt Lookout, Md., by order of Maj. Gen. Augur. Final statements given.

Book mark:

J. W. Brown

(358)

Copyist.

519

5 Col'd Cav.

Mass.

John T. Ely
1st, Co. B, 5 Reg't Mass. Colored Cav.

Appears on Returns as follows:

Apr 1864. On duty
Stable orderly

June 1864. Absent sick
at City Point Va.

Oct. 1864. Down Oct 5
Point Hookout Md.
Discharged by order
Maj Gen. Auger
for disability.

Book mark:

Mc. Sallade

(546)

Copyist.

E

5 Col'd Cav.

Mass.

John T. Ely
Pot, Co. B, 5 Reg't Mass. Col'd Cavalry.

Appears on Co. Muster-out Roll, dated
Clarkeville, Texas, Oct. 31, 1863.

Muster-out to date _____, 186 .

Last paid to *Feb. 29, 1864.*

Clothing account:

Last settled _____, 186 ; drawn since \$ _____ 100 .

Due soldier \$ _____ 100; due U. S. \$ _____ 100

Am't for cloth'g in kind or money adv'd \$ _____ 100

Due U. S. for arms, equipments, &c., \$ _____ 100

Bounty paid \$ _____ 100; due \$ _____ 100

Remarks: *Discharged Oct. 4/64*
per order Auger Pt.
Lookout for Disability.

Roll No.

Book mark: *C.D.*

Scherich

Ely. John T.
P. Co. B., **5** **Mass. C. Cav.**
 Reg't

1 - **Enclosures.**

Bed Cards	Descriptive Lists
Burial Records	Final Statements
Certs. of Dis. for Discharge	Furloughs
C. M. Charges	Med. Des. Lists
Med. Certificates	Orders

Other papers relating to—

Admission to Hosp'l	Furlough
Casualty Sheet (Officer's)	Med. Examination
Confinement	Misc. Information
Contracts	Pay or Clothing
Death or Effects	Personal Reports
Desertions	Rank
Discharge from Hosp'l	Transfer to Hosp'l
Discharge from Service	Transfer to V. R. C.
Duty	Transportation
.....

NOTE 1.

The company commander will here add a statement of all the facts known to him concerning the disease or wound, or cause of disability of the soldier: the time, place, manner, and all the circumstances under which the injury occurred, or disease originated or appeared: the duty, or service, or situation of the soldier at the time the injury was received or disease contracted, stating particularly whether the injury was received or the disease contracted in the line of his duty; and whatever other facts may aid a judgment as to the cause, immediate or remote, of the disability, and the circumstances attending it.

When the facts are not known to the company commander, the certificate of any officer, or affidavit of other person having such knowledge, will be appended—as the surgeon in charge of a hospital, the officer commanding a detachment of recruits, &c., &c.

NOTE 2.

When a probable case for pension, special care must be taken to state the degree of disability—as $\frac{1}{2}$, $\frac{1}{3}$, &c., &c.; to describe particularly the disability, wound, or disease; the extent to which it deprives him of the use of any limb or faculty, or affects his health, strength, activity, constitution, or capacity to labor or earn his subsistence. The surgeon will add, from his knowledge of the facts and circumstances, and from the evidence in the case, his professional opinion of the cause or origin of the disability. In the case of discharges by Medical Inspectors, the last paragraph will state that the "discharge was given by consent of the soldier, after a personal examination, and for disability, the nature, degree, and origin of which are correctly described in the within certificate."

Par. 1260 Regulations, Edit. 1861.

Medical officers, in giving certificates of disability, are to take particular care in all cases that have not been under their charge; and especially in epilepsy, convulsions, chronic rheumatism, derangement of the urinary organs, ophthalmia, ulcers, or any obscure disease liable to be feigned or purposely produced; and in no case shall such certificate be given until after sufficient time and examination to detect any attempt at deception.

DIRECTIONS.

This certificate will be made out in duplicate by the soldier's company commander, or other officer commanding the separate detachment to which he belongs, and sent by him to the surgeon who has charge of the hospital, or the surgeon in charge of the hospital, who will fill out and sign the surgeon's certificate, and forward these papers to the regimental, detachment, or company commander. He will forward them, with his action endorsed thereon, through the proper channel, to his division commander, or if they are not attached to a division, to his corps department, or other commander or officer to whom the authority to discharge enlisted men may be specially delegated.

These certificates, after having received the action of the highest authority to which they are required to be sent, will be returned through the same channel to the regimental, post, or detachment commander, or will, if the discharge is authorized by the command of the proper authority, sign the soldier's discharge, and the last certificate on this paper; see that the soldier is furnished with the proper final statement in proper and correct form of these certificates direct to the Adjutant-General's Office, at Washington, D. C.; they will not, under any circumstances, be given into the hand of the soldier.

BY ADJUTANT GENERAL
MAJ. GENL. G. M. BENTON

W. R. Smith
and
W. R. Smith

1864

13

1864

CERTIFICATE OF DISABILITY FOR DISCHARGE
IN THE CASE OF

John T. Egan
a *Private* of *Co. B*
Fifth Reg't of *Mass. Vol. Cav.*

Approved and respectfully forwarded.

C. F. Delaney
Lt. Colonel
Comd'g 5th Mass Cav.

Respectfully forwarded to the Medical Director of the Dist.

Respectfully forwarded to the Medical Director of the Dist.

By command of
Reg't Genl J. Barnes
C. F. Delaney
Lt. Colonel

Received (A. G. Office) _____, 1864



E. P. ...

Med Dir Office
St Marks Dist
Print Lookout
Sept 23/64

Respectfully forwarded Approved

A. H. ...
Dir. U.S.A
Med. Director

Respectfully forwarded

Respectfully forwarded

J. Barnes
Reg't Genl

HEADQUARTERS DEPARTMENT OF WASHINGTON,

22d Army Corps, Sept 24 1864.

Respectfully referred to Surgeon R. O. ABBOTT, Medical Director.

BY COMMAND OF MAJOR GENERAL AUGER.

A. H. ...
Ass't. Adj't. General

ARMY OF THE UNITED STATES.

CERTIFICATE

OF DISABILITY FOR DISCHARGE.

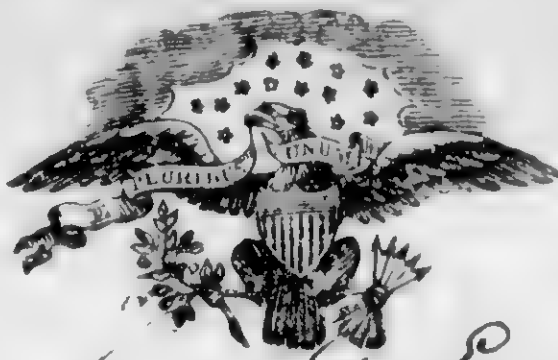

Private John J Ely of Captain Cross
C. Emery's Company; (B) of the 5th Regiment of United States
Infantry was enlisted by H. A. Sands of
the _____ Regiment of _____ at Charlestown Mass
on the fourth day of January 1864, to serve three years; he was born
in Boston in the State of Mass is twenty five
years of age, 5 feet 10 inches high, dark complexion, dark eyes,
dark hair, and by occupation when enlisted a Teacher. During the last two
months said soldier has been unfit for duty 60 days.* and since the
day of enlistment he has had fits which
caused him to be unfit for duty, from
his own statement, and it is my belief that
he had them previous to his enlistment

STATION: Fort Lookout Md
DATE: Sept 2 1864

Cross C Emery
Adj 5th Mass Cav
Commanding Company B

I CERTIFY, that I have carefully examined the said John J Ely of
Captain C. C. Emery's Company, and find him incapable of performing the duties of a soldier
because of Epilepsy. I have reason to believe the disease
unquestioned that he was so affected with said disease
before entry into service. I consider him, by reason
of this affection, unfit for military duty.

W. G. Parkman
1864 Surgeon.
In cliq

DISCHARGED, this fourth day of October 1864 at
Fort Lookout Md.

H. C. Hassell
Col 5th Mass Cavalry
Commanding the Reg't.

The soldier desires to be addressed at
Town _____ County _____ State _____

* See Note 1 on the back of this. † See Note 2 on the back of this.

414

Emery, Cyrus S.

Co. D, 5 Mass. Cav., (Col'd.)

Captain

Captain

CARD NUMBERS.

1	5374459	26
2	5374544	27
3	5374629	28
4	5374716	29
5	5374821	30
6	5374924	31
7	5375034	32
8	5375141	33
9	5375246	34
10	5375347	35
11	5375449	36
12	5377952	37
13	5372840	38
14	5373041	39
15	5375632	40
16	9436220	41
17	42889239	42
18	42889266	43
19	42889285	44
20	42889309	45
21	42889329	46
22	42889352	47
23	40730913	48
24		49
25		50

Book Mark:

See also

E. ^{5th Cav} (Col'd) Mass.

Cyrus C. Emery

Capt., Co. , 5th Reg't ^{Mass} Col'd ^{Cav}

Appears on

Regimental Descriptive Book

(List of Commissioned Officers)

of the regiment named above.

Rank *Captain*

Date of appointment *Jan. 18*, 186 *4*.

Remarks: *Mustered in
service Feb 8/64,*

Tharri

E

5 Col'd Cav.

Mass.

Cyrus L Emery

Capt., Co. B, 5 Reg't Mass. Col'd Cav.

Appears on

Company Muster-in and Descriptive Roll
of the organization named above. Roll dated

Readville Mass, Jan 29, 1864.

Where born

Age *23* y'rs; occupation

When enlisted *July 18*, 1864.

Where enlisted

Boston

For what period enlisted *3* years.

Eyes; hair

Complexion; height *5* ft. *10* in.

When mustered in *Jan 27*, 1864

Where mustered in

Bounty paid \$ *100*; due \$ *100*

Where credited

Company to which assigned

Remarks:

Book mark:

(356d)

Hayberger

Copyist.

E

5 Col'd Cav.

Mass.

Cyrus C Emery
Capt., Co. B, 5 Reg't Mass. Col'd Cavalry.

Appears on

Company Muster Roll

for *Enlistment to Feb 29, 1864.*

Present or absent *Present*

Stoppage, \$ *100* for

Due Gov't, \$ *100* for

Valuation of horse, \$ *100*

Valuation of horse equipments, \$ *100*

Remarks:

Book mark: *100*

Emery

E

5 Col'd Cav.

Mass.

Cyrus C Emery

Capt., Co. B, 5 Reg't Mass. Col'd Cavalry.

Appears on

Company Muster Roll

for *Mar & April*, 1864.

Present or absent *Present*

Stoppage, \$ *100* for

Due Gov't, \$ *100* for

Valuation of horse, \$ *100*

Valuation of horse equipments, \$ *100*

Remarks:

Book mark:

Hogberger

(358)

Copyist.

E
O

5 Col'd Cav.

Mass.

Cyrus C. Emery

Capt., Co. B, 5 Reg't Mass. Col'd Cavalry.

Appears on

Company Muster Roll

for *May & June*, 1864.

Present or absent *Present*

Stoppage, \$ *100* for

Due Gov't, \$ *100* for

Valuation of horse, \$ *100*

Valuation of horse equipments, \$ *100*

Remarks:

Book mark:

(358)

Frederick

Copyist.

E.

5 Col'd Cav.

Mass.

Cyrus C. Emery

Capt, Co. B, 5 Reg't Mass. Col'd Cavalry.

Appears on

Company Muster Roll

for July & Aug., 1864.

Present or absent Present

Stoppage, \$ 100 for

Due Gov't, \$ 100 for

Valuation of horse, \$ 100

Valuation of horse equipments, \$ 100

Remarks:

Book mark:

J. M. Brown Copyist.

(358)

E.

5 Col'd Cav.

Mass.

Lyons C. Emery,

Capt., Co. B, 5 Reg't Mass. Col'd Cavalry.

Appears on

Company Muster Roll

for Sept. & Oct., 1864.

Present or absent - Present.

Stoppage, \$ 100 for

Due Gov't, \$ 100 for

Valuation of horse, \$ 100

Valuation of horse equipments, \$ 100

Remarks:

Book mark:

J. M. Brown

(358)

Copyist.

E.

5 Col'd Cav.

Mass.

Cyrus C. Emery,

Capt., Co. B, 5 Reg't Mass. Col'd Cavalry.

Appears on

Company Muster Roll

for Nov. & Dec., 1864.

Present or absent — Present.

Stoppage, \$ 100 for

Due Gov't, \$ 100 for

Valuation of horse, \$ 100

Valuation of horse equipments, \$ 100

Remarks:

Book mark:

J. M. Brown

(358)

Copyist.

E.

5 Col'd Cav.

Mass.

Cyrus C. Emery,

Capt., Co. B, 5 Reg't Mass. Col'd Cavalry.

Appears on

Company Muster Roll

for Jan'y. & Feby., 1865.

Present or absent — Present.

Stoppage, \$ 100 for

Due Gov't, \$ 100 for

Valuation of horse, \$ 100

Valuation of horse equipments, \$ 100

Remarks:

Book mark:

J. W. Brown

(358)

Copyist.

E.

5 Col'd Cav.

Mass.

Cyrus C. Emery,

Capt., Co. B, 5 Reg't Mass. Col'd Cavalry.

Appears on

Company Muster Roll

for March & April, 1865.

Present or absent - Absent.

Stoppage, \$ 100 for

Due Gov't, \$ 100 for

Valuation of horse, \$ 100

Valuation of horse equipments, \$ 100

Remarks: Absent on sick leave since April 15th 1865

Book mark:

(358)

J. M. Brown
Copyst.

E O | 5 Cav | Mass.

L. C. Emery

Captain

5 Mass. Cav

Return

of the 25th Army Corps,

for the month of *May*, 1865,

dated *In the field, Texas*

July 25, 1865,

shows the following with regard to the officer
named above:

Post or station *Camp Lincoln, Va*

Remarks: *Gain*

Acting Provost Marshal.

Detained by S.O. 137, 25 A.C.

May 21.

Book mark:

J. M. Couch

(546)

Copyst.

E

5 Col'd Cav.

Mass.

Wynus C. Emery

Capt., Co. B, 5 Reg't Mass. Col'd Cavalry.

Appears on

Company Muster Roll

for May & June, 1865.

Present or absent Absent

Stoppage, \$ 100 for

Due Gov't, \$ 100 for

Valuation of horse, \$ 100

Valuation of horse equipments, \$ 100

Remarks: Absent on detached service at Corps Hd. Qrs. as B. Co. M. Co. since May 22/65 - Per S. O. No. 74 dated May 20/65. Due for Comdg. Co. for the months of Jan, Feb & Mar. \$30.00.

Book mark:

Scherich

E | 5 Coar Mass

C. C. Emery
Capt. 5th Mass. Coar.

Return

of the 25th Army Corps,

for the month of June, 1865,
dated In the field Texas

Aug. 28, 1865,
shows the following with regard to the officer
named above:

Post or station Brazos Santiago Texas.

Remarks: Attached Staff
Acting Provost Marshal

Book mark: _____

(546)

J. R. M. Coar

Copyist.

E | 5 Cav Mass

L. C. Emery

Capt. 5 Mass. Cav

Return

of the 25th Army Corps,

for the month of July, 1865,

dated In the field Texas

Sept, 1865,

shows the following with regard to the officer
named above:

Post or station In the field Texas

Remarks: Attached Staff

Provost Marshal

Book mark: _____

(548)

J. R. M. Coe

Copyist.

E

5 Col'd Cav.

Mass.

Nyrus C. Emery

Capt, Co. B, 5 Reg't Mass. Col'd Cavalry.

Appears on

Company Muster Roll

for *July & Aug.*, 186*5*:

Present or absent *Present*

Stoppage, \$ *100* for

Due Gov't, \$ *100* for

Valuation of horse, \$ *100*

Valuation of horse equipments, \$ *100*

Remarks: *Amt. due for Comdg. Co. for Jan. Debt & Md. \$30. Absent and detached. Review at Hd. Qrs. 25 A.C. as A.P.M. since May 22/65. Per S.O. no. 74 dated May 20/65.*

Book mark:

Scherich

E | 5 Cav Mass

C. L. Emery

Captain 5 Mass. Co. Cav.

Return

of the 25th Army Corps,

for the month of Aug, 1865,

dated In the field Texas

Sept 15, 1865,

shows the following with regard to the officer
named above:

Post or station In the field Texas

Remarks: Attached Staff

Provost Marshal. Absent
per S. O. 15. Ad. Ins Dept
of Texas Aug. 30/65.

Book mark: _____

(546)

J. M. Couch

Copyist.

E | 5 Coar Mass.

L. C. Emory
Capt. 5 Mass. Co. Car

Return

of the 25th Army Corps,

for the month of Sept, 1865,

dated In the field Texas

Nov. 1, 1865,

shows the following with regard to the officer
named above:

Post or station In the field Texas.

Remarks: Attached Staff
Prov. Marshal. Absent
per S.O. 15 C. S. H. L. Dept.
of Texas.

Book mark:

(546)

J. R. M. Lovach

Copyist.

E 15 Cav Mass.

L. C. Emery
Capt. 5 Mass. Cav.

Return

of the 25th Army Corps,

for the month of Oct, 1865,

dated In the field Texas
Nov 15, 1865,

shows the following with regard to the officer
named above:

Post or station _____

Remarks: Loss

Relieved per G.O. 63. C. S. H. L.
25. A. C.

Book mark: _____

(546)

J. M. Couch

Copyist.

8

5 Col'd Cav.

Mass.

Cyrus C. Emery

Capt, Co. B, 5 Reg't Mass. Colored Cav.

Appears on Returns as follows:

Jan 1864 to Mar 1865.
Present.

Apr 1865. Absent Sick at
Roxbury Mass.

May to Aug 1865. Absent
on det service at
Gen Hd. No. 25 a. c.

S. O. no. 137 Hd. No 25 a. c.
since May 21 65

Sept. 1865. Transferred to Co D
per S. O. 139 Hd. No 5 Mass Cav.

(Co. D) since. Transferred from
Co. B. to Co. D. by S. O. 139 Regt'd

Hd. No. Sept. 9 65. Absent
on leave of absence of 20 days

granted Aug 30. and
Extended to Sept. 30. 65.

Book mark:

W. Saccade

(546)

Copyist.

30

5 Col'd Cav.

Mass.

Ciprus C. Pineroy

Capt. Co., 5 Reg't Mass. Col'd Cavalry.

Appears on an

Individual Muster-out Roll

of the organization named above. Roll dated

Boston Mass, Dec 23, 1865.

Muster-out to date *Oct 31*, 1865.

Last paid to *Aug 31*, 1865.

Clothing account:

Last settled 186 ; drawn since \$..... 100

Due soldier \$..... 100; due U. S. \$..... 100

Am't for cloth'g in kind or money adv'd \$..... 100

Due U. S. for arms, equipments, &c., \$..... 100

Bounty paid \$..... 100 due \$..... 100

Remarks: *Claims pay for commencing Co B 5 Co for months of Jan Feb Mar April to May 21/65. Went on sick leave when Regiment was (over)*

Book mark:

[Signature]

JAN. - 9

5372840

* 1891 *

Amusements and amuse-
field reported to be
at Boston and has
been on duty with it
up to date of final
payment and discharge

This officer was
authorized to remain
in the State till the
arrival of his Regiment
by Chief M. O. of Mass.

Discharged by A. D.

Nov 29 Dept of Texas
instructed to be left
to go to 5th Regiment
his regiment. The
government having
no further occasion
for his services.

3

5 Col'd Cav.

Mass.

Cyrus C Emery

Capt, Co., 5 Reg't Mass. Col'd Cavalry.

Appears on a

List of Discharges furnished by C. M. O. of State,
under the provisions of circular dated A. G. O.,
June 29, 1865.

Discharge furnished , 186 ,

to date from , 186 .

Remarks: Discharged
by SO #29, Ad
Lrs Dept of Texas
Sept 10/65.

Book Mark:

Edward

(360)

Comd't.

E

5 Col'd Cav.

Mass.

Cyrus W. Emery

Capt, Co. *B*, 5 Reg't Mass. Col'd Cavalry.

Appears on **Co. Muster-out Roll**, dated

Clarksville, Tex., Oct 31, 1865

Muster-out to date _____, 186 .

Last paid to _____, 186 .

Clothing account:

Last settled _____, 186 ; drawn since \$ _____ 100

Due soldier \$ _____ 100 ; due U. S. \$ _____ 100

Am't for cloth'g in kind or money adv'd \$ _____ 100

Due U. S. for arms, equipments, &c., \$ _____ 100

Bounty paid \$ _____ 100 ; due \$ _____ 100

Remarks: *Transferred to Co. C*
per R.S.O. 139 Sept. 9/65.

Book mark : _____

Scherich

(361)

Copyist.

E

5 Col'd Cav.

Mass.

Cyrus C. Emery

Capt, Co. D, 5 Reg't Mass. Col'd Cavalry.

Appears on Co. Muster-out Roll, dated

Clarksville Texas, Oct. 31, 1865.

Muster-out to date Oct. 31, 1865.

Last paid to Aug. 31, 1865.

Clothing account:

Last settled....., 186 ; drawn since \$..... 100

Due soldier \$..... 100; due U. S. \$..... 100

Am't for cloth'g in kind or money adv'd \$..... 100

Due U. S. for arms, equipments, &c., \$..... 100

Bounty paid \$..... 100; due \$..... 100

Remarks: Transferred from Co. B

to Co. D. 20. 1865 Reg't Ha

Quarters dated Sept. 19, 1865

A visit on leave of absence

granted Sept. 1 for 20 days

extended by order of Genl

Book mark: 1.31; C.P. 78

[am]

Horn

JAN. - 9

5377952

* 1891 *

Shuridan to Oct. 1/65
extended till the 20/ of Oct-
ber, 65

Emery, Cyrus C.
 Capt. Co., 5th Reg't Mass. C. Cav.

9 Enclosures.

Bed Cards	Final Statements
Burial Records	Furloughs or L. of A. ..
Certs. of Dis. for Discharge	Med. Certificates 3 2
C. M. Charges	Med. Des. Lists
Descriptive Lists	Orders /
Discharge Certificates	Pris. of War Record
Enlistment Papers	Resignations

Other papers relating to—

Admission to Hosp'l	Furlough or L. of A. 3
Casualty Sheet	Med. Examination
Confinement	Misc. Information /
Contracts	Pay or Clothing
Death or Effects	Personal Reports
Desertion	Rank
Discharge from Hosp'l	Transfer to Hosp'l
Discharge from Service	Transfer to V. R. C.
Duty	Transportation

Capt. Cyrus Emery

5th. Mass. Cav.

Aug. 12th, 1864

Demer's charges made
against him at Det
Hd. Qrs.

Point Lookout Md
August 12th 1864

Sir

I have just been informed by Major Weld Com^d the Regt of certain charges which have been made against me at your Head Quarters, I would beg leave to submit to you the following statement.

While in command of my Company on Picket complaints were made to me by citizens of the vicinity; that my men went by there Houses and through there corn fields trampling the Corn down and that they wished I would have it stopped. I tried to catch some of them while away and for that purpose I rode out to the Corn Field which was just in rear of my Reserve and riding up to a House where

where the door was open. I saw two Soldiers sitting at the table. I asked them if they had permission to be absent from Camp one of them a Serjt said he had and showed me a pass, which was nearly out I then asked the other one if he had permission, and he said no. I told him to start for Camp. I then asked for a match to light a cigar, and as soon as the men started along the lane I followed them turning off on the other road as soon as I passed the gate. I have never been to the house since; nor did I know who lived there before; knowing that enlisted men of this Reg. have made threats in regard to me for the strictness with which I endeavor to do my duty; I believe this to be the cause for these charges against me. of which I am totally innocent I would beg leave to see the General.

as soon as he is at liberty if he will
please to grant me the favor.

Very Respectfully your Obedient Servant

Brig. Gen. J. Barnes

Cyrus C. Emery

Camp Point Lookout Md.

Capt 5th Mass. Cavalry

Through C. O. 5th Mass. Cav.

1 Cyrus C. Emery was mustered in a Capt, 3rd Regt.
Mass. Col'd Cavalry January 29, 1864. On Return
of that Regt for the month of April 1865, he is
reported - present for duty.

Strength - Comm'd A J
Enlisted 1155

W. S.

Logan C. Emery, Captain, 5th Mass Regt. having
applied for a certificate on which to ground an
application for leave of absence, I do hereby certify that
I have carefully examined this Officer & find ^{him} suffering
from Inguinal Hernia & in consequence thereof he is
in my opinion unfit for duty.

I do not entertain any belief that he will be able to
resume his duties in a less period than twenty (20)
days. His disability is affecting him so much that
an operation is deemed advisable & he wishes to proceed
forthwith for that purpose.

F. G. Parker

Surgeon, 5th Mass Regt.

Petersburg, Va.
April 7th 1865

~~E. G. (1864) Vol. 2, 1865~~
Ad. Dir. 5th Mass. Cav.
Petersburg, Va.
April 8th 1865

E. G. Vol 2 Page 95. 1865.
Ad. Dir. U. S. H. Petersburg Va.
April 8th 1865.

Cyrus E. Emery
Capt. 5th Mass. Cav.

Respectfully forwarded
Approved & recommended
Geo. S. Hartwell
Maj. Genl. Commandy

Cyrus E. Emery
Capt. Co. "B" 5th Mass. Cav.
Petersburg Va 1865.

Requests leave of ab-
sence for twenty (20)
days to visit Boston,
Mass. - based on Surg-
en's Certificate of dis-
ability.

One Enclosure

Respectfully forwarded,
Approved:
C. J. Adams for
Col. Leavitt 5th Mass. Cav.

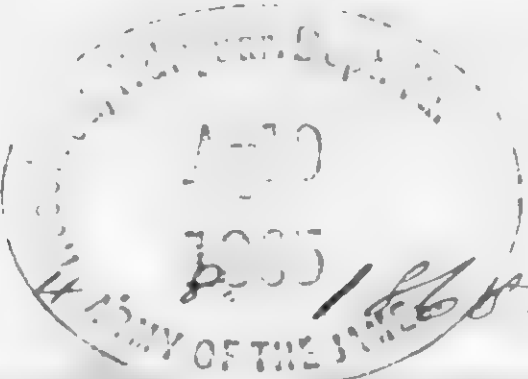
Recd.  APR 8 1865
HEADQUARTERS OF THE ARMY

Petersburg, Va. April 7th 1865

Lieut. D. H. Chamberlain
Adj^t 5th Regt. Cav.

Sir

I have the honor
to request a leave of absence for twenty
(20) days, to visit Boston Mass. based
on the accompanying Surgeons Certif-
-icate.

Very respectfully

Your obedient servant
Ogden C. Emery
Cap^t 5th Regt. Cav.

C. 14. 119 L.M.B. 1865

Roxbury, Mass.

May 4th 1865

Capt. Cyrus C. Emery
3rd Mass. Cav.

Surgeon's Certificate

[Faint signature]

Recd U.S.O. May 8. 1865

Capt. Cyrus C. Emery

Co. B of the 51st

Regiment Map Vol Cav

having applied for a certificate on which to ground an application

for leave of absence, I do hereby certify that I have carefully examined this officer and find that* he is an

invalid & suffering from varicella of the left Hermetid
card. I think the period of recovery is not remote
Date of original leave of absence April 15th 1865

And that in consequence thereof, he is, in my opinion, unfit for duty. I further declare my belief that he

will not be able to resume his duties in a less period than *Twenty* days, from May 4th 1865
and is unable to travel without incurring the risk of permanent disability.

Dated at *Roxbury Mass.* this *fourth* day of *May* 1865



Seen & subscribed to before me before me William Swan

* Here the nature of the disease, wound, or disability, is to be fully stated, and the period during which the officer has suffered under its effects.

† Here state, candidly and explicitly, the opinion as to the period which will probably elapse before the officer will be able to resume his duties. Where there is no reason to expect a recovery, or when the prospect of a recovery is distant and uncertain, it must be so stated.

[This certificate to be made out in triplicate.]

Page - 113
L. R. "E" 113.

Vol "A" - E 23, M & C 1865

New Orleans, La.

Sept. 4, 1865

Emercy, Cyrus C.

Capt. 5th Mass. Cav. & P. M. 25ac.

Applies for an
extension of twenty (20)
days to his leave of
absence, gives reasons

(granted.)

New Orleans La
September 4th 1865

Major George Lee
A. A. Gen

Sir

I have the honor to request an extension of twenty (20) days to the leave of absence granted in Special Order No 13 Hd. Qrs. Department of Texas August 30th 1865 and extended in Special Order No 43 Hd. Qrs. Military Division of the Gulf. September 4th 1865 for ten (10) days.

My reasons for asking for the extension is the length of time I have been delayed in coming here and the length of time it will take to go to Boston Mass. and return to my command.

(over)

Very respectfully

Your obedient servant

Cyrus C. Emery

Capt. 5th Mass Cav

and Prov. Mar 25th A. C.

Address

Rayburn
Mass.

Vol. 2 - E 5 - M. C. - 1875

New Orleans La.
Sept. 4th 1865

Emerg. C. C.
Captain
5th Mass Cav

Requests ten days
extension of his leave
of absence

(Granted.)

New Orleans La
September 4th 1865

Sir

I have the honor to request
an extension of ten (10) days to
leave of absence granted by S. O. No
15. Hd. Qrs. Dept of Texas dated Aug 30th
1865. for twenty (20) days

Very respectfully

Your obedient Serv^t

Asst Adj^t Gen
Military Div Gulf

Cyrus C. Emery
Capt 5th Mass Cav.
and Prov. Marshal 25th Me. I.

C. E. Emery
Capt. 5th Mass. Cav.

Head Quarters, Military Division of the Gulf.
Palmetto Bay, Sept. 4th 1865.

Special Orders.

No. 143.

Contracts.

* * *
The leave of absence for twenty days granted
to Captain Cyrus E. Emery, 3rd Mass. Cav.,
volunteer, in Special Orders
No. 15, Head Quarters, Department of Texas
August 30th, 1865, is hereby extended ten days.
* * *

By Command of Major General J. B. Sheridan
George, Secy.

Assistant Adjutant General

Copy sent
to

Official
Richard A. Kent
Lieut. Col. 6th U.S. Cav.

Copy sent
C. P. 5.

E. 26. W. L. A. P. 1868.

Boston, Mass.

October 17th 1863.

Emery Lyman Esq.
Capt. 5th Mass. Cav.

Surgeon's Certificate

Recd at 0 Oct 20. 13

Captain Cyrus E Emery

Co. of the 5th

Regiment *Mass Cavalry* having applied for a certificate on which to ground an application

for leave of absence, I do hereby certify that I have carefully examined this officer, and find that

he is *invaded in Roxbury Mass. Suffering from the effects of* *malaria fever, since the 1st of September 1865. incurred* *in the line of his duty. Period of recovery not known.*

And that, in consequence thereof, he is, in my opinion, unfit for duty. I further declare my belief that he

will not be able to resume his duties in a less period than *Twenty* days, *from Oct 20/65*

and is unable to travel without incurring the risk of permanent disability.

Dated at *Roxbury*, this *17th* day of *October* 1865

A. M. M. Larn *Wm Dale A.S. U.S.A.*

* Here the nature of the disease, wound, or disability, is to be fully stated, and the period during which the officer has suffered under its effects.

† Here state, candidly and explicitly, the opinion as to the period which will probably elapse before the officer will be able to resume his duties. Where there is no reason to expect a recovery, or when the prospect of a recovery is distant and uncertain, it must be so stated.

[This certificate to be made out in triplicate.]

415

Engles, Charles

Co., 5 Mass. Cav., (Col'd.)

Private

CARD NUMBERS.

1	5372282	26
2		27
3		28
4		29
5		30
6		31
7		32
8		33
9		34
10		35
11		36
12		37
13		38
14		39
15		40
16		41
17		42
18		43
19		44
20		45
21		46
22		47
23		48
24		49
25		50

Book Mark:

See also 35 Mass Inf

E

5 Col'd Cav.

Mass.

Charles Engles

Pri

Appears with rank of on

Muster and Descriptive Roll of a Detachment of U. S. Vols. forwarded

for the 5 Reg't Mass. Col'd Cavalry. Roll dated

Boston Mass July 1-28, 1864.

Where born Havana

Age 20 y'rs; occupation Cigar maker

When enlisted July 21, 1864.

Where enlisted No. Hampshire

For what period enlisted 3 years.

Eyes Black; hair Black

Complexion Dark; height 5 ft. 5 in.

When mustered in July 21, 1864.

Where mustered in Boston

Bounty paid \$ 100 100; due \$ 200 100

Where credited 9 dist. No Hampshire

Hampshire Co
Company to which assigned

Remarks: Transferred from 5 Mass

Cav to 35 Mass Inf by order

of Gen. Andrews July 29, 64

Entire entry cancelled except remarks

Book mark:

Somnelly

Enole, James

Co 6, 5 Mass. Cav., (Col'd.)

Private

Private

CARD NUMBERS.

1	5375696	26
2	5375787	27
3	5375872	28
4	5375968	29
5	5376077	30
6	5376178	31
7	5376287	32
8	5376393	33
9	5376498	34
10	5376597	35
11	5376694	36
12	5376789	37
13	9092390	38
14	40730914	39
15		40
16		41
17		42
18		43
19		44
20		45
21		46
22		47
23		48
24		49
25		50

Book Mark:

See also

6

5 Cav. (Col'd.)

James Enols

, Co. C, 5 Reg't Mass.

Appears on

Company Descriptive B

of the organization named above.

DESCRIPTION.

Age 37 years; height 5 feet

Complexion *Swart*

Eyes *Black*; hair *Blk*

Where born *Albany*

Occupation *Farmer*

ENLISTMENT.

When *May*

Where *Albany*

By whom *S. H. ...*; to

Remarks: *Mustered into Com
May 29, 1864 at Acadia
by A. McKittin*

60352

416

Enos, James

Co 6, 5 Mass. Cav., (Col'd.)

Private

Private

CARD NUMBERS.

1	5375696	26
2	5375787	27
3	5375872	28
4	5375968	29
5	5376077	30
6	5376178	31
7	5376287	32
8	5376393	33
9	5376498	34
10	5376597	35
11	5376694	36
12	5376789	37
13	9092390	38
14	40730914	39
15		40
16		41
17		42
18		43
19		44
20		45
21		46
22		47
23		48
24		49
25		50

Book Mark:

See also

6

5 Cav. (Col'd.) | Mass.

James Enols

, Co. C, 5 Reg't Mass. Cav. (Col'd.)

Appears on

Company Descriptive Book

of the organization named above.

DESCRIPTION.

Age 27 years; height 5 feet 3 inches.

Complexion Fair

Eyes Blue; hair Black

Where born Maryland

Occupation Farmer

ENLISTMENT.

When May 1, 1864

Where Union

By whom J. Enols; term 3 y'rs.

Remarks: Mustered into Company C May 29, 1864 at Andover Mass by J. McKittin

600522

E.

5 Col'd Cav.

Mass.

James Enols.
Priv., Co. "E", 5 Reg't Mass. Col'd Cav.

Appears on

Company Muster-in and Descriptive Roll

of the organization named above. Roll dated

Readville, Jan. 29, 1864.

Where born Maryland.

Age 37 y'rs; occupation Laborer.

When enlisted Jan. 9, 1864.

Where enlisted Boston.

For what period enlisted 3 years.

Eyes Black; hair Black

Complexion Black; height 5 ft. 3 in.

When mustered in Jan. 29, 1864.

Where mustered in Readville, Mass.

Bounty paid \$ 100; due \$ 100

Where credited 2^d Dist. Bristol.

Company to which assigned

Remarks:

Book mark:

Sitter

(356d)

Copyist.

O

5 Col'd Cav.

Mass.

James O'Connell

Priv., Co. C, 5 Reg't Mass. Col'd Cavalry.

Appears on

Company Muster Roll

for Enlistment to Feb. 29, 1864.

Present or absent Present

Stoppage, \$ 100 for

Due Gov't, \$ 100 for

Valuation of horse, \$ 100

Valuation of horse equipments, \$ 100

Remarks: Sick in Hospital
- at

Book mark:

S. Allen

O.

5 Col'd Cav.

Mass.

James Emole
Priv., Co. C, 5 Reg't Mass. Col'd Cavalry.

Appears on

Company Muster Roll

for Mar. & Apr., 1864.

Present or absent Present

Stoppage, \$ 100 for

Due Gov't, \$ 100 for

Valuation of horse, \$ 100

Valuation of horse equipments, \$ 100

Remarks:

Book mark:

Siller

3

5 Col'd Cav.

Mass.

James O'Connell

Co. C, 5 Reg't Mass. Col'd Cavalry.

Appears on

Company Muster Roll

for May & June, 1864

Present or absent Present

Stoppage, \$ 100 for

Due Gov't, \$ 100 for

Valuation of horse, \$ 100

Valuation of horse equipments, \$ 100

Remarks:

Book mark:

Sitter

50

5 Col'd Cav.

Mass.

James Ennals

Co. C, 5 Reg't Mass. Col'd Cavalry.

Appears on

Company Muster Roll

for July & Aug, 1864.

Present or absent Present

Stoppage, \$ 100 for

Due Gov't, \$ 100 for

Valuation of horse, \$ 100

Valuation of horse equipments, \$ 100

Remarks:

Book mark:

E. H. Brown

(358)

Copyist.



E

5 Col'd Cav.

Mass.

James Earnold
Cot, Co. C, 5 Reg't Mass. Col'd Cavalry.

Appears on

Company Muster Roll

for *Sept & Oct*, 1867.

Present or absent *Present*

Stoppage, \$ *100* for

Due Gov't, \$ *100* for

Valuation of horse, \$ *100*

Valuation of horse equipments, \$ *100*

Remarks: *Rec'd on or before Ad 1, 1861*

Book mark:

E. H. Brown

E.

5 Col'd Cav.

Mass.

James E. Carrol
Capt

, Co. C, 5 Reg't Mass. Col'd Cavalry.

Appears on

Company Muster Roll

for Nov & Dec, 1864.

Present or absent

Stoppage, \$ 100 for

Due Gov't, \$ 100 for

Valuation of horse, \$ 100

Valuation of horse equipments, \$ 100

Remarks: Due self for Inf. Ord.
\$0.39 for L.M. stamp \$0.80
see memo before Aug 17 64

Book mark:

E. H. Brown

(358)

Copyst.

E

5 Col'd Cav.

Mass.

James Ginnole

Co. C, 5 Reg't Mass. Col'd Cavalry.

Appears on

Company Muster Roll

for Jan & Feb, 1865.

Present or absent Present

Stoppage, \$ 100 for

Due Gov't, \$ 100 for

Valuation of horse, \$ 100

Valuation of horse equipments, \$ 100

Remarks: Paid 1st & 2nd of
Security \$ 100.

Book mark:

E. H. Brown

E

5 Col'd Cav.

Mass.

James Ennole

Co. C, 5 Reg't Mass. Col'd Cavalry.

Appears on

Company Muster Roll

for March 1865, 1865.

Present or absent Present

Stoppage, \$ 100 for

Due Gov't, \$ 100 for

Valuation of horse, \$ 100

Valuation of horse equipments, \$ 100

Remarks: Early duty in a field
Due at the ...
Due to ...

Book mark:

E. N. Ennole

(358)

(copy)

6

5 Col'd Cav.

Mass.

James Ennis

2-1, Co. C, 5 Reg't Mass. Col'd Cavalry.

Appears on

Company Muster Roll

for ... Jan & June, 1865.

Present or absent ... Absent

Stoppage, \$ 100 for

Due Gov't, \$ 100 for

Valuation of horse, \$ 100

Valuation of horse equipments, \$ 100

Remarks: Free since April 9 '65
Due 1.500 due US Bounty \$35.00
Due 2.304 due US Bounty \$20.00
Daily duty 2. M. Dept
on board transport

Book mark:

Abbon
Copied.

6

5 Col'd Cav.

Mass.

James Ennals

Private

Co. C, 5 Reg't Mass. Col'd Cavalry.

Appears on

Company Muster Roll

for July & Aug 1865

Present or absent. Present

Stoppage, \$ 43 53 100 for Evance

Due Gov't, \$ 100 for

Valuation of horse, \$ 100

Valuation of horse equipments, \$ 100

Remarks: Free before April 1861

Book mark:

Ennals

(18)

1865

5 | 2014 08 | 2014

Received of _____
the sum of _____

Appraised by **Refused** in full

Book mark: _____

(544)

Copy 1st

50

2011

Account

James Smith

To the Hon. Secy of the Treasury

Amount	By	To	Balance
	St. Margaret's	100.00	100.00
	Wentworth	50.00	50.00
	East	25.00	25.00

Clothing account

East	100.00	
Wentworth	50.00	
St. Margaret's	25.00	
Balance		175.00

Balance

Book mark:

21/11/11

(501)

[Faint, illegible handwritten text at the top of the page]

Number

Regimental Descriptive Book

of the *[illegible]* *[illegible]*

RECEPTION

[Faint, illegible handwritten text under the 'RECEPTION' section]

ENLISTMENT

[Faint, illegible handwritten text under the 'ENLISTMENT' section]

[Small illegible text at the bottom left]

[Small illegible text at the bottom right]

Green, Manuel

Co. D, 5 Mass. Cav., (Col'd.)

Private

Private

CARD NUMBERS.

<i>5377 4910</i>	5
<i>5377 5221</i>	7
<i>5377 5222</i>	8
<i>5377 5229</i>	9
<i>5377 5237</i>	0
<i>5377 5242</i>	1
<i>5377 5243</i>	2
<i>5377 5243</i>	3
<i>5377 5247</i>	4
<i>5377 5249</i>	5
<i>5377 5255</i>	6
<i>5377 5239</i>	7
<i>5377 5244</i>	8
<i>9292 5244</i>	9
<i>5377 5245</i>	0
	1
	2
	3
	4
	5
	6
	7
	8
	9
	0
	1
	2
	3
	4
	5
	6
	7
	8
	9
	0

Read Next

See also

6

5 Cav. (Col'd.) Mass.

Manual record

5 Reg't Mass Cav. (Col'd.)

Appears on

Company Descriptive Book

of the organization named above.

DESCRIPTION.

Age - years; height - feet - inches.

Complexion -

Eyes -

Where born -

Occupation -

ENLISTMENT.

When - 186

Where -

By whom - yrs.

Remarks:

No.

Copies.

5

8

5 Col'd Cav. | Mass.

Namuel Erva

A, Co. _____, 5 Reg't Mass. Col'd Cav.

Appears on

Company Muster-in and Descriptive Roll

of the organization named above. Roll dated

Readville Mass, July 29, 1864.

Where born *Stanton Co Missouri*

Age *25* y'rs; occupation *Seaman*

When enlisted *July 11*, 1864.

Where enlisted *Garthmouth*

For what period enlisted *3* years.

Eyes *Blk*; hair *Blk*

Complexion *Blk*; height *5* ft. *1* in.

When mustered in *July 29*, 1864.

Where mustered in *Readville Mass*

Bounty paid \$ *100*; due \$ *100*

Where credited *1st Dist Boston*

Company to which assigned _____

Remarks: _____

Book mark: _____

5 Cold Cav.

Mumuel G.

Dr, Co. D, 5 Reg't Mass.

Appears on

Company Muster

for *Outfitment to*

Present or absent. *Present*

Stoppage, \$ 100 for

Due Gov't, \$ 100 for

Valuation of horse, \$ 1

Valuation of horse equipments,

Remarks:

Book mark:

417

Orera, Manuel

Co D, 5 Mass. Cav., (Col'd.)

Private

Private

CARD NUMBERS.

1 5376910
2 53770021
3 5377089
4 5377179
5 5377287
6 5377395
7 5377493
8 5377603
9 5377707
10 5377939
11 5377803
12 5378039
13 5372841
14 9092280
15 40730915
16
17
18
19
20
21
22
23
24
25

26
27
28
29
30
31
32
33
34
35
36
37
38
39
40
41
42
43
44
45
46
47
48
49
50

Book Mark:

See also

E

5 Cav. (Col'd.) | Mass.

Mannual Ereda

, Co. D, 5 Reg't Mass. Cav. (Col'd.)

Appears on

Company Descriptive Book

of the organization named above.

DESCRIPTION.

Age 25 years; height 5 feet 1 inches.

Complexion blk.

Eyes blk; hair blk

Where born Santa Cruz, Mexico

Occupation Seaman

ENLISTMENT.

When Jan 11, 186

Where Dartmouth

By whom J. Sherman; term 3 y'rs.

Remarks: Mustered Co. D, Jan 29, 1864 at Readville, Md. Mustered out the service of the U.S. Army 11 1/2. at Petersburg, Va. 26. 71.

Heard

E

5 Col'd Cav.

Mass.

Mamel Erwa

Priv, Co., 5 Reg't Mass. Col'd Cav.

Appears on

Company Muster-in and Descriptive Roll

of the organization named above. Roll dated

Readville Mass, July 29, 1864.

Where born *Saxton Co Missouri*

Age *25* y'rs; occupation *Seaman*

When enlisted *July 11*, 1864.

Where enlisted *Dartmouth*

For what period enlisted *3* years.

Eyes *BRN*; hair *BRN*

Complexion *BRN*; height *5* ft. *1* in.

When mustered in *July 29*, 1864.

Where mustered in *Readville Mass*

Bounty paid \$ *100*; due \$ *100*

Where credited *1st Bristol*

Company to which assigned

Remarks :

Book mark :

Lewis

(356d)

Copyist.

E

5 Col'd Cav.

Mass.

Mimmel Orna

Priv, Co. D, 5 Reg't Mass. Col'd Cavalry.

Appears on

Company Muster Roll

for *Enlistment to Feb 29*, 1864.

Present or absent *Present*

Stoppage, \$ *100* for

Due Gov't, \$ *100* for

Valuation of horse, \$ *100*

Valuation of horse equipments, \$ *100*

Remarks:

Book mark:

(358)

Lewis
Copyist.

5

5 Col'd Cav.

Mass.

Emanuel Eric

Det, Co. D, 5 Reg't Mass. Col'd Cavalry.

Appears on

Company Muster Roll

for *Sept & Oct*, 1864.

Present or absent *Present*

Stoppage, \$ 100 for

Due Gov't, \$ 100 for

Valuation of horse, \$ 100

Valuation of horse equipments, \$ 100

Remarks:

Book mark:

(358)

[Signature]

Copyist.

E

5 Col'd Cav.

Mass.

Manuel Orma

AM, Co. D, 5 Reg't Mass. Col'd Cavalry.

Appears on

Company Muster Roll

for *May 7 June*, 186*4*.

Present or absent *Present*

Stoppage, \$ *100* for

Due Gov't, \$ *100* for

Valuation of horse, \$ *100*

Valuation of horse equipments, \$ *100*

Remarks:

Book mark:

(358)

Lewis

Copyist.

E

5 Col'd Cav.

Mass.

Manuel Eira

Plt, Co. D, 5 Reg't Mass. Col'd Cavalry.

Appears on

Company Muster Roll

for July & Aug, 1864.

Present or absent Present

Stoppage, \$ 100 for

Due Gov't, \$ 100 for

Valuation of horse, \$ 100

Valuation of horse equipments, \$ 100

Remarks:

Book mark:

A. Merchant

(358)

Copyist.

E

5 Col'd Cav.

Mass.

Mmanuel Erva

Prs, Co. D, 5 Reg't Mass. Col'd Cavalry.

Appears on

Company Muster Roll

for Sept & Oct, 1864.

Present or absent Present

Stoppage, \$ 100 for

Due Gov't, \$ 100 for

Valuation of horse, \$ 100

Valuation of horse equipments, \$ 100

Remarks:

Book mark:

J. Merchant

(358)

Copyist.

E

5 Col'd Cav.

Mass.

Manuel Ervira

Prin, Co. D, 5 Reg't Mass. Col'd Cavalry.

Appears on

Company Muster Roll

for (Nov & Dec, 1864

Present or absent Present

Stoppage, \$ 100 for

Due Gov't, \$ 100 for

Valuation of horse, \$ 100

Valuation of horse equipments, \$ 100

Remarks: In Muster for Haversack & canteen (95)

Book mark:

A. Albrecht

(358)

Copyist.

4

Co
Cp

5 Col'd Cav.

Mass.

Manuel Evers

Private, Co. D, 5 Reg't Mass. Col'd Cavalry.

Appears on

Company Muster Roll

for Jan & Feb, 1865

Present or absent Present

Stoppage, \$ 100 for

Due Gov't, \$ 100 for

Valuation of horse, \$ 100

Valuation of horse equipments, \$ 100

Remarks: Dec 1 2 3 4, Intt?
MS, Bount

Book mark:

S. Merchant

(358)

Copyist.

20

5 Col'd Cav.

Mass.

Mamel Erere

Priv., Co. D, 5 Reg't Mass. Col'd Cavalry.

Appears on

Company Muster Roll

for ... War & Appl, 186 2.

Present or absent Present

Stoppage, \$ 100 for

Due Gov't, \$ 100 for

Valuation of horse, \$ 100

Valuation of horse equipments, \$ 100

Remarks: Ill. 1, 2, 3, 4, In U.S.,
Bount,

Book mark: 2

J. Merchant

Q

5 Col'd Cav.

Mass.

Mamel Erida

Prnt, Co. D, 5 Reg't Mass. Col'd Cavalry.

Appears on

Company Muster Roll

for May and June, 1865.

Present or absent Absent

Stoppage, \$ 100 for

Due Gov't, \$ 100 for

Valuation of horse, \$ 100

Valuation of horse equipments, \$ 100

Remarks:

Free before April 19, 1861
Due 1 2 3 4 5 Mo. U. S.
Bounty sent to Hospital
L. House Pt. Va May 25/65

Book mark:

House

E

5 Col'd Cav.

Mass.

Mamel Elria

Pvt., Co. D, 5 Reg't Mass. Col'd Cavalry.

Appears on

Company Muster Roll

for July and Aug., 1865.

Present or absent

Stoppage, \$ 100 for

Due Gov't, \$ 100 for

Valuation of horse, \$ 100

Valuation of horse equipments, \$ 100

Remarks:

Mustered out of service
June 17/65 under special
O. 77 War Dept. Adjt Genl
Off. dated May 3/65

Book mark:

House

E

5 Col'd Cav.

Mass.

Manuel E rider

Part, Co. 2, 5 Reg't Mass. Colored Cav.

Appears on Returns as follows:

May 1865. Absent sick in
Hosp at Petersburg

June & July 1865 Absent
left sick in Hosp
at Petersburg Va.
June 12.

Aug. 1865. Abs. June 17. 1865
Fortress Mowbray
Mustered out of Service
under G.O. 77

Same as name also as
Manuel E rider

Book mark:

Mr. Ballade

(546)

Copyist.

E

5 Col'd Cav. Mass.

Mammel Euse

Det., Co. E, 5 Reg't Mass. Col'd Cavalry.

Appears on Co. Muster-out Roll, dated Clarksville Texas Oct. 31, 1865.

Muster-out to date _____, 186 .

Last paid to _____, 186 .

Clothing account:

Last settled _____, 186 ; drawn since \$ _____ 100

Due soldier \$ _____ 100; due U. S. \$ _____ 100

Am't for cloth'g in kind or money adv'd \$ _____ 100

Due U. S. for arms, equipments, &c., \$ _____ 100

Bounty paid \$ _____ 100; due \$ _____ 100

Remarks: _____

Mustered out of service June 12, 1865 at Petersburg Va under G. O. 77

Book mark: _____

House

(361)

Copyist.

8

5 Col'd Cav.

Mass.

Samuel Birra

Co. D, 5 Reg't Mass. Col'd Cavalry.

Appears on an

Individual Muster-out Roll

of the organization named above. Roll dated

Norfolk Va June 17, 1865.

Muster-out to date June 17, 1865.

Last paid to Dec 31, 1864.

Clothing account:

Last settled Dec 31, 1864; drawn since \$ 65 / 100

Due soldier \$ 100; due U. S. \$ 100

Am't for cloth'g in kind or money adv'd \$ 100

Due U. S. for arms, equipments, &c., \$ 100

Bounty paid \$ 100 due \$ 100

Remarks: Discharged from
service of U.S. Gen. Hooker
at Fort Mifflin Va by order
of the War Dept. dated May 3/65
Due 1st, 2nd, 3rd & 4th Installment
of U.S. Bounty.

Book mark:

Samuel Birra

417-a

Erkson, Thomas
Co., J. W. & Co'd Cau

CARD NUMBERS.

1	9436052	26
2		27
3		28
4		29
5		30
6		31
7		32
8		33
9		34
10		35
11		36
12		37
13		38
14		39
15		40
16		41
17		42
18		43
19		44
20		45
21		46
22		47
23		48
24		49
25		50

Number of personal papers herein.....

Book Mark:

See also

C. 5 Cav. Mas.
(Col'd)

Thomas E. Keon,

Co., 5 Reg't Mas Col'd Cav.

Appears on

Regimental Descriptive Book

of the organization named above.

DESCRIPTION.

Age 35 years; height 5 feet 6 inches.

Complexion Black

Eyes Black; hair Black

Where born Parkville, Md.

Occupation Teamster,

ENLISTMENT.

When Feb. 10, 1864

Where Boston Md. Co.

By whom S. Davis; term 3 y'rs.

Remarks: Exp'd Feb. 15/64

Harvi

418

Erwin Manuel

Co *A*, 5 Mass. Cav., (Col'd.)

CARD NUMBERS.

1	26
2	27
3	28
4	29
5 <i>See Erwin Manuel</i>	30
6	31
7	32
8	33
9	34
10	35
11	36
12	37
13	38
14	39
15	40
16	41
17	42
18	43
19	44
20	45
21	46
22	47
23	48
24	49
25	50

Book Mark

See also

419

Essex, Andrew

Co K, 5 Mass. Cav., (Col'd.)

Private

Private

CARD NUMBERS.

1	5372582	26
2	5372638	27
3	5384344	28
4	5384446	29
5	5384610	30
6	5384796	31
7	9091666	32
8	4436118	33
9	Stu-1646-65	34
10	32262322	35
11	40730916	36
12		37
13		38
14		39
15		40
16		41
17		42
18		43
19		44
20		45
21		46
22		47
23		48
24		49
25		50

Book Mark: Stu-1646-1865.

See also

E. 5-Car. (Child) Mues.

Andrew Green,

....., Co....., *5* Reg't *New Col'd Car.*

Appears on

Regimental Descriptive Book

of the organization named above.

DESCRIPTION.

Age *20* years; height *5* feet *11* inches.

Complexion *Black,*

Eyes *Black*; hair *Black*

Where born *Ohio.*

Occupation *Farmer.*

ENLISTMENT.

When *Dec. 20*....., 186*4*.

Where *Boston,*

By whom *apt. Howe*; term *3* y'rs.

Remarks: *Mustered by*

Cap L. Howe, Dec. 20/

64.

.....

.....

.....

.....

.....

.....

.....

.....

.....

.....

.....

.....

.....

.....

.....

.....

.....

.....

.....

.....

.....

E. | **5 Cav. (Col'd.)** | **Mass.**

Andrew Essex.

....., Co. *K*....., 5 Reg't Mass. Cav. (Col'd.)

Appears on

Company Descriptive Book

of the organization named above.

DESCRIPTION.

Age *20* years; height *5* feet *11* inches.

Complexion *Dark.*

Eyes *Blue*; hair *Dark.*

Where born *Ohio.*

Occupation *Farmer.*

ENLISTMENT.

When *Dec 20*....., 186*4*.

Where *Boston.*

By whom *W. G. Howe*.....; term *3*..... y'rs.

Remarks: *Pd. \$100.00 G. S. Bounty*

Dec. 20th 64. due \$200.00

Discharged: May 31st 1865. for

disability Hammond Genl. Hosp.

Ph. Lockport illd. by order of G.

Sutton, Surgeon in Charge.

H. C. Thomas.

E

5 Col'd Cav.

Mass.

Andrew Essex

Appears with rank of _____ on

Muster and Descriptive Roll of a Detachment of U. S. Vols. forwarded

for the 5 Reg't Mass. Col'd Cavalry. Roll dated

Boston Mass. Dec. 20, 1864.

Where born *Ohio.*

Age *20* y'rs; occupation *Farmer*

When enlisted *Dec. 20*, 1864.

Where enlisted *Boston Mass.*

For what period enlisted *3* years.

Eyes *Black*; hair *Dark*

Complexion *Dark*; height *5 ft. 10 in.*

When mustered in *Dec. 20*, 1864.

Where mustered in *Boston*

Bounty paid \$ *100* ¹⁰⁰; due \$ *200* ¹⁰⁰

Where credited *Richmond Mass.*

Company to which assigned _____

Remarks: _____

Book mark: *Sta - 1646 - 1865.*

M. A. Michaels

(339)

Copyist.

E

5 Col'd Cav.

Mass.

Andrew Essex

Appears with rank of *Private* on

Muster and Descriptive Roll of a Detachment of U. S. Vols. forwarded

for the 5 Reg't Mass. Col'd Cavalry. Roll dated *Draft Rendezvous Galloups Island N. H. Mass. Jan 3, 1865.*

Where born *Ohio*

Age *20* y'rs; occupation *Farmer*

When enlisted *Dec. 20*, 1864.

Where enlisted *Boston Mass.*

For what period enlisted *3* years.

Eyes *blue*; hair *dark*

Complexion *dark*; height *5* ft. *11* in.

When mustered in *Dec. 20*, 1864.

Where mustered in *Boston Mass.*

Bounty paid \$ *100* 00; due \$ *200* 00

Where credited *Richmond Berkshire Co*

Company to which assigned

Remarks:

Book mark:

M. A. Michaels

3

5 Col'd Cav.

Mass.

Andrew Essex

Priv., Co. K, 5 Reg't Mass. Col'd Cavalry.

Appears on

Company Muster Roll

for Jan 5 Feb, 1865.

Present or absent Present

Stoppage, \$ 100 for

Due Gov't, \$ 100 for

Valuation of horse, \$ 100

Valuation of horse equipments, \$ 100

Remarks: Recruit from Depot

Book mark:

Edmondson

(358)

Copyist.

62

5 Col'd Cav.

Mass.

Andrew Biscoe

Priv., Co. K, 5 Reg't Mass. Col'd Cavalry.

Appears on

Company Muster Roll

for Mar & Apr, 1861.

Present or absent Absent

Stoppage, \$ 100 for

Due Gov't, \$ 100 for

Valuation of horse, \$ 100

Valuation of horse equipments, \$ 100

Remarks: Absent in Hospital at Point Lookout Md.

Book mark:

Edmondson

E. J. Carr. | Mass. C.

Andrew Essex
Priv., Co. K, 5 Reg't Mass. C.

Appears on

Hospital Muster Roll

of **U. S. A. General Hospital,**

at **Point Lookout, Md.,**

for Mar 7 apr., 1865.

Attached to hospital:

When, 186 .

How employed

Last paid by Maj. Dodge

to Dec 31, 186 4.

Bounty paid \$ 100; due \$ 100

Present or absent Present

Remarks:

Ward F.

Book mark:

(348)

F. H. Hesterling Copyist.

C

5 Col'd Cav.

Mass.

Andrew Barney

Priv, Co. K, 5 Reg't Mass. Col'd Cavalry.

Appears on

Company Muster Roll

for May & June, 1865.

Present or absent

Stoppage, \$ 100 for

Due Gov't, \$ 100 for

Valuation of horse, \$ 100

Valuation of horse equipments, \$ 100

Remarks: Discharged for disability May 31/65 at Point Lookout Md by order of Surgeon in Charge

Book mark:

Edw Anderson

Copyist.

(358)

E

5 Col'd Cav.

Mass.

Andrew Essey

Pvt, Co. A, 5 Reg't Mass. Colored Cav.

Appears on Returns as follows:

Jan 1865. Join Jan 23.
Pt Lookout Md.
Recruit from Depot

March to May 1865. Absent
sick in Hosp. at
Pt Lookout Md
since March 27, 65.

June 1865. rose May 17
Pt Lookout Md.
Discharged for disability
by order Surgeon in
charge.

Book mark:

W. S. Salis

(546)

Copyist.

E

5 Col'd Cav.

Mass.

Audun Essick

Pot, Co. *K*, 5 Reg't Mass. Col'd Cavalry.

Appears on **Co. Muster-out Roll**, dated
Clarksville Texas, Oct. 31, 1865.

Muster-out to date _____, 186 .

Last paid to *Dec. 31, 1864*.

Clothing account:

Last settled _____, 186 ; drawn since \$ _____ 100

Due soldier \$ _____ 100; due U. S. \$ *7* ^{*38*}/₁₀₀

Am't for cloth'g in kind or money adv'd \$ _____ 100

Due U. S. for arms, equipments, &c., \$ _____ 100

Bounty paid \$ *100* ^{*00*}/₁₀₀; due \$ *200* ^{*00*}/₁₀₀

Remarks: *Discharged May 31st, 1865
at Pt. Lookout Md. for disability.*

Book mark: *V 36, P 30/69 C D*

Galligan

(361)

Copyist.

E - 5th Col^d Cav. Mass

Andrew Essex

, Co. K, 5th Reg't Mass Col. Cav

NOTATION.

Book mark: *Stu - 1646 - 1865*

War Department,

Adjutant General's Office,

Washington, *June 10*, 1865.

Discharged on Surgeon's Certificate
of Disability, *May 31* 1865 .

(438)

W. J. Allen

Copyist.

Essex Andrew

P. Co. 16,

5

Mass. C. Cav.
Reg't

3 Enclosures.

Bed Cards	Descriptive Lists
Burial Records	Final Statements
Certs. of Dis. for Discharge/	Furloughs
C. M. Charges	Med. Des. Lists
Med. Certificates	Orders

Other papers relating to—

Admission to Hosp'l	Furlough
Casualty Sheet (Officer's)	Med. Examination
Confinement	Misc. Information
Contracts	Pay or Clothing
Death or Effects	Personal Reports
Desertions	Rank
Discharge from Hosp'l	Transfer to Hosp'l
Discharge from Service	Transfer to V. R. C.
Duty	Transportation

E. P.

2

DECLARATION OF RECRUIT.

I, Andrew Essex desiring to VOLUNTEER as a Soldier in the Army of the United States, for the term of THREE YEARS, Do Declare, That I am Twenty years and _____ months of age; that I have never been discharged from the United States service on account of disability or by sentence of a court-martial, or by order before the expiration of a term of enlistment; and I know of no impediment to my serving honestly and faithfully as a soldier for three years.

GIVEN at City of Boston the 20th day of December 1888

Witness: S. C. Chase Wm. H. [unclear]

No. 115

Volunteered at City of Boston

By W. H. Stone for 5th Regiment of Mass Cavalry

enlistment; last served in Company ()

Reg't of

Discharged 18

[Signature]

APR 1893. THIS PAPER WAS FORMERLY FILED IN THE ENROLLMENT DIV. R. & P. O.

CONSENT IN CASE OF MINOR.

I, _____ Do CERTIFY, That I am _____; that the _____ of _____ is _____ years of age; and I do hereby freely give my consent to his volunteering as a SOLDIER in the ARMY OF THE UNITED STATES for the period of THREE YEARS.

GIVEN at _____ the _____ day of _____

Witness: _____

(A. G. O. No. 74 & 75)

NOTE 1. — This blank will be used for both enlistments and re-enlistments — enlistment of veterans, &c., &c., in the volunteer service. They will be made out in duplicate in all cases — one to accompany the recruiting return of the superintendent (not the recruiting officer) to the Adjutant-General, and one to accompany the accounts of the officer who pays bounty, &c. The Regiment and Company in which the soldier last served should be given on the back.

NOTE 2. — An enlistment holds to service. A muster-in must, in all cases, precede payment of pay, bounty, pension, &c. A muster-in roll must, in all cases, be filed in the Adjutant-General's Office as evidence of muster-in. The mustering officer, commissary, or assistant-commissary of musters, as the case may be, will countersign both enlistments as having mustered the soldier into the service of the United States before either of them is given to the disbursing officer.

VOLUNTEER ENLISTMENT.

STATE OF

TOWN OF

Massachusetts City of Boston



I, Andrew Essex born in Ohio in the State of aged twenty years, and by occupation a Farmer Do HEREBY ACKNOWLEDGE to have volunteered this 20th day of December 1864, to serve as a Soldier in the Army of the United States of America, for the THREE YEARS, unless sooner discharged by proper authority: Do also accept such bounty, pay, rations, and clothing, as are, or may be, established for volunteers. And I, Andrew Essex do solemnly swear, that I will bear true faith and allegiance to the United States of America, and that I will serve them honestly and faithfully against all their enemies or opposers whomsoever; and that I will observe and obey the orders of the President of the United States, and the orders of the officers appointed over me, according to the Rules and Articles of War.

Sworn and subscribed to, at Boston this 20th day of Dec 1864 BEFORE A. Plemer J.P.

I CERTIFY, ON HONOR, That I have carefully examined the above-named Volunteer, agreeably to the General Regulations of the Army, and that, in my opinion, he is free from all bodily defects and mental infirmity, which would in any way disqualify him from performing the duties of a soldier.

H. V. Burdett

EXAMINING SURGEON.

I CERTIFY, ON HONOR, That I have minutely inspected the Volunteer, Andrew Essex previously to his enlistment, and that he was entirely sober when enlisted; that, to the best of my judgment and belief, he is of lawful age; and that, in accepting him as duly qualified to perform the duties of an able-bodied soldier, I have strictly observed the Regulations which govern the recruiting service. This soldier has Blue eyes, dark hair, dark complexion, is Five feet six inches high.

W. G. Howe Capt 1st Regt Mass Volunteers

RECRUITING OFFICER.

Vertical handwritten notes on the right side of the page, including 'Mustered into the service of the United States, in Company', 'the 20th day of December, 1864, at Boston', 'and accepted to the 1st Regt Mass Volunteers', 'of the 1st Mass Dis', 'Regiment of Mass Volunteers, on', and 'W. G. Howe'.

NOTE 1. — This blank will be used for both enlistments and re-enlistments — enlistment of veterans, &c., &c., in the volunteer service. They will be made out in duplicate in all cases — one to accompany the recruiting return of the superintendent (not the recruiting officer) to the Adjutant-General, and one to accompany the accounts of the officer who pays bounty, &c. The Regiment and Company in which the soldier last served should be given on the back.

NOTE 2. — An enlistment holds to service. A muster-in must, in all cases, precede payment of pay, bounty, pension, &c. A muster-in roll must, in all cases, be filed in the Adjutant-General's Office as evidence of muster-in. The mustering officer, commissary, or assistant-commissary of musters, as the case may be, will countersign both enlistments as having mustered the soldier into the service of the United States before either of them is given to the disbursing officer.

DECLARATION OF RECRUIT.

I, Andrew Edder desiring to VOLUNTEER as a Soldier in the Army of the United States, for the term of THREE YEARS, Do Declare, That I am 21 years and 0 months of age; that I have never been discharged from the United States service on account of disability or by sentence of a court-martial, or by order before the expiration of a term of enlistment; and I know of no impediment to my serving honestly and faithfully as a soldier for three years.

GIVEN at Boston the 20th day of December 1864

Witness: C. J. Chase Andrew Edder

No.

Volunteered at Boston

December 20 1864

By W. L. Stone

5th Regiment of Mass Cavalry

enlistment; last served in Company ()

Reg't of

Discharged

1st Bounty Paid

CONSENT IN CASE OF MINOR.

I, _____ Do CERTIFY, That I am _____ the _____ of _____; that the said _____ is _____ years of age; and I do hereby freely give my CONSENT to his volunteering as a SOLDIER in the ARMY OF THE UNITED STATES for the period of THREE YEARS.

GIVEN at _____ the _____ day of _____

Witness: _____

VOLUNTEER ENLISTMENT.

STATE OF



TOWN OF

Massachusetts

City of Boston

I, *William Foster* born in *Ohio* in the State of *Ohio* aged *Twenty* years, and by occupation a *Farmer* Do HEREBY ACKNOWLEDGE to have volunteered this *10th* day of *December* 1864, to serve as a Soldier in the Army of the United States of America, for the period of **THREE YEARS**, unless sooner discharged by proper authority: Do also agree to accept such bounty, pay, rations, and clothing, as are, or may be, established by law for volunteers. And I, *William Foster* do solemnly swear, that I will bear true faith and allegiance to the **United States of America**, and that I will serve them honestly and faithfully against all their enemies or opposers whomsoever; and that I will observe and obey the orders of the President of the United States, and the orders of the officers appointed over me, according to the Rules and Articles of War.

Sworn and subscribed to, at *Boston* this *10th* day of *December* 1864, BEFORE *Wm. Foster*

I CERTIFY, ON HONOR, That I have carefully examined the above-named Volunteer, agreeably to the General Regulations of the Army, and that, in my opinion, he is free from all bodily defects and mental infirmity, which would in any way disqualify him from performing the duties of a soldier.

H. W. Bowditch

EXAMINING SURGEON.

I CERTIFY, ON HONOR, That I have minutely inspected the Volunteer, *William Foster* previously to his enlistment, and that he was entirely sober when enlisted; that, to the best of my judgment and belief, he is of lawful age; and that, in accepting him as duly qualified to perform the duties of an able-bodied soldier, I have strictly observed the Regulations which govern the recruiting service. This soldier has *Blue* eyes, *Dark* hair, *Fair* complexion, is *5' 10"* feet *10"* inches high.

W. G. Payne
Capt & Prov. Mar
Regiment of *1st Mass* Volunteers,

RECRUITING OFFICER.

(A. G. O. No. 74 & 75.)

Mustered into the service of the United States, in Company *A* the *10th* day of *December*, 1864, at *Boston* *Mass*
of *1st Mass* *Volunteers*
Regiment of *1st Mass* *Volunteers*, on
Wm. Foster
1st Mass
4th Mass Dist

NOTE 1.

The company commander will here add a statement of all the facts known to him concerning the disease, wound, or cause of disability of the soldier; the time, place, manner, and all the circumstances under which the injury occurred, or disease originated or appeared; the duty, or service, or situation of the soldier at the time the injury was received or disease contracted, stating particularly whether the injury was received or the disease contracted in the line of his duty; and whatever other facts may aid a judgment as to the cause, immediate or remote, of the disability, and the circumstances attending it.

When the facts are not known to the company commander, the certificate of any officer, or affidavit of other person having such knowledge, will be appended—as the surgeon in charge of a hospital, the officer commanding a detachment of recruits, &c., &c.

NOTE 2.

When a probable case for pension, special care must be taken to state the degree of disability—as $\frac{1}{2}$, $\frac{1}{3}$, &c., &c.; to describe particularly the disability, wound, or disease; the extent to which it deprives him of the use of any limb or faculty, or affects his health, strength, activity, constitution, or capacity to labor or earn his subsistence. The surgeon will add, from his knowledge of the facts and circumstances, and from the evidence in the case, his professional opinion of the cause or origin of the disability. In the case of discharges by Medical Inspectors, the last paragraph will state that the "discharge was given by consent of the soldier, after a personal examination, and for disability, the nature, degree, and origin of which are correctly described in the within certificate."

Par. 1260 Regulations, Edit. 1861.

Medical officers, in giving certificates of disability, are to take particular care in all cases that have not been under their charge; and especially in epilepsy, convulsions, chronic rheumatism, derangement of the urinary organs, ophthalmia, ulcers, or any obscure disease liable to be feined or purposely produced; and in no case shall such certificate be given until after sufficient time and examination to detect any attempt at deception.

DIRECTIONS.

This certificate will be made out in duplicate by the soldier's company commander, or other officer commanding the separate detachment to which he belongs and sent by him to the surgeon who has charge of the hospital where the soldier is sick. The surgeon will then fill out and sign the surgeon's certificate, and forward these papers to the regimental, detachment, or post commander, who will forward them, with his action endorsed thereon, through the proper channel, to his division commander; or, if the troops are not attached to a division, to his corps, department, or other commander or officer to whom the authority to discharge enlisted men may be specially delegated.

These certificates, after having received the action of the highest authority to which they are required to be sent, will be returned through the same channel to the regimental, post, or detachment commander, who will, if the discharge is authorized by the endorsement, forward the original certificate, and the last copy of the surgeon's certificate, to the Adjutant General, with the proper final statements in duplicate, and forward 100 of these certificates direct to the Adjutant General, United States Army, at Washington, D. C.; they will not be returned to the hands of the soldier.

Duplicate sent the Pension Office.

1865
6
CERTIFICATE OF DISABILITY FOR DISCHARGE

IN THE CASE OF

Andrew Ersey
a Private Co. K

5th Reg't of Mass. Inf.

R. P. Akh...
S... ..

HEAD QUARTERS,
DEPARTMENT OF WASHINGTON,
23d Army Corps,

May 29 1865

TO BE DISCHARGED.

BY COMMAND OF

MAJ. GEN'L C. C. AUGER

A. M. Smith

Received (A. G. Office)

135

Ersey Ref Cas

420

Evans, William

Co I; 5 Mass. Cav., (Col'd.)

Private

Private

CARD NUMBERS.

1	5382680	26
2	5382765	27
3	5382861	28
4	5382942	29
5	5383052	30
6	5383150	31
7	5383253	32
8	5383357	33
9	5383460	34
10	5383556	35
11	5383653	36
12	9091698	37
13	32533654	38
14	31548242	39
15	31548600	40
16	34573240	41
17	40730917	42
18		43
19		44
20		45
21		46
22		47
23		48
24		49
25		50

Book Mark: *1*

See also

E. | **5 Cav. (Col'd.)** | **Mass.**

William Evans.

....., Co. *I*, 5 Reg't Mass. Cav. (Col'd.)

Appears on

Company Descriptive Book
of the organization named above.

DESCRIPTION.

Age *19* years; height *5* feet *8½* inches.

Complexion *Brown*

Eyes *Brown*; hair *Black.*

Where born *New Orleans La.*

Occupation *Laborer.*

ENLISTMENT.

When *Mar. 19th*, 186*4*.

Where *Roxbury.*

By whom *A. O. Swain*; term *3* y'rs.

Remarks:

H. C. Thomas.

(383g)

Copyist.

E

5 Col'd Cav.

Mass.

William Evans

Priv., Co. I, 5 Reg't Mass. Col'd Cav.

Appears on

Company Muster-in and Descriptive Roll

of the organization named above. Roll dated

Readville, Mass, Mch 26, 1864

Where born New Orleans, La.

Age 19 y'rs; occupation Laborer

When enlisted Mch 19, 1864.

Where enlisted Roxbury

For what period enlisted 3 years.

Eyes Black; hair Black

Complexion Black; height 5 ft. 8 1/2 in.

When mustered in Mch 26, 1864.

Where mustered in

Bounty paid \$ 100; due \$ 100

Where credited 3^d Dist. Norfolk

Company to which assigned

Remarks: Residence: Roxbury

Book mark:

W. H. Thompson

(356d)

Copyist.

E

5 Col'd Cav.

Mass.

William Evans

Priv, Co. I, 5 Reg't Mass. Colored Cavalry.

Appears on

Company Muster Roll

for *Mch 26 to Apr 30*, 1864.

Present or absent *Present*

Stoppage, \$ *100* for

Due Gov't, \$ *100* for

Valuation of horse, \$ *100*

Valuation of horse equipments, \$ *100*

Remarks:

Book mark:

W. H. Thompson

(358)

Copyist.

E | *5 Cold Car* | *Mass*

William Evans
Pvt, Co. I, 5 Reg Mass C. Car.

Appears on

Hospital Muster Roll

of **Balfour U. S. A. General Hospital,**

at **Portsmouth, Va.,**

for *May & June, 1864*

Attached to hospital:

When, 186 .

How employed

Last paid by Maj.

to, 186 .

Bounty paid \$ *100*; due \$ *100*

Present or absent *Present*

Remarks:

Book mark:

W. D. Sayre

(243)

Copyist.

E

5 Col'd Cav.

Mass.

William Evans

Plt, Co. I, 5 Reg't Mass. Colored Cavalry.

Appears on

Company Muster Roll

for May & June, 1864.

Present or absent Present

Stoppage, \$ 100 for

Due Gov't, \$ 100 for

Valuation of horse, \$ 100

Valuation of horse equipments, \$ 100

Remarks:

Book mark:

W. H. Thompson Copyist.

(358)

E 1 5 Cav 1 Mass

Miss Evans

Art, Co. 4, 2 Reg't Mass Cav

Appears on

Hospital Muster Roll

of Ward U. S. A. General Hospital,

at Newark, N. J.,

for Sept & Oct, 1864.

Attached to hospital:

When Sept 1, 1864.

How employed

Last paid by Maj.

to _____, 1864.

Bounty paid \$ 100; due \$ 100

Present or absent Present

Remarks: Pay due for Sept & Aug 1864

2 ward

Book mark :

Edwards
Copyist.

E

5 Col'd Cav.

Mass.

William Evans

Pvt, Co. I, 5 Reg't Mass. Colored Cavalry.

Appears on

Company Muster Roll

for July & Aug, 1864.

Present or absent Absent

Stoppage, \$ 100 for

Due Gov't, \$ 100 for

Valuation of horse, \$ 100

Valuation of horse equipments, \$ 100

Remarks: Paid by Maj. R. Walker for May & June: \$32.00 Sick Portsmouth, Va.

Book mark:

W. H. Thompson

Copyist.

(358)

E | 5 Cav. | Mass.

William Evans

Art Co. I, 5 Regt. Mass Cav.

Appears on

Muster Roll

of detached soldiers at Fort Wood, Bedloe's Island,
New York Harbor,

for Sept. + Oct., 1864.

Station Fort Wood, N. Y. H.

Clothing account:

Last settled _____, 186 ; drawn since \$ _____ 100

Present or absent Present

Remarks: No descriptive list.

Book mark : _____

Wm. L. ...

E 15 bar. USC. 7

William Evans

Pi, Co. D, 5 Reg't ¹¹⁴³⁸ U.S. Cav

Appears on

Hospital Muster Roll

of Ward U. S. A. General Hospital,

at Newark, N. J.,

for Sept & Oct, 1864.

Attached to hospital:

When July 21, 1864.

How employed

Last paid by Maj. Newell

to July & Aug., 1864.

Bounty paid \$ 100; due \$ 100

Present or absent

Remarks:

Returned to duty Oct. 24
1864

Book mark :

Owsley

(343)

Copyist.

E

5 Col'd Cav.

Mass.

William Evans,

Priv, Co. I, 5 Reg't Mass. Colored Cavalry.

Appears on

Company Muster Roll

for

Sept. & Oct, 1864.

Present or absent

Absent

Stoppage, \$

100 for

Due Gov't, \$

100 for

Valuation of horse, \$

100

Valuation of horse equipments, \$

100

Remarks:

Absent sick at Newark, N.J., since June 15. Paid by Maj. R. Walker for May & June \$32.00

Book mark:

C. F. Thompson

(358)

Copyist.

2

5 Col'd Cav.

Mass.

William Evans

Pvt, Co. I, 5 Reg't Mass. Colored Cavalry.

Appears on

Company Muster Roll

for Nov. & Dec., 1864.

Present or absent Present.

Stoppage, \$ 100 for

Due Gov't, \$ 100 for

Valuation of horse, \$ 100

Valuation of horse equipments, \$ 100

Remarks: Paid by Maj. R. Walker for May & June \$32.00

Book mark:

C. F. Thompson

(358)

Copyist.

E

5 Col'd Cav.

Mass.

William Evans,

Pvt, Co. I, 5 Reg't Mass. Colored Cavalry.

Appears on

Company Muster Roll

for Jan. & Feb, 1865.

Present or absent Present

Stoppage, \$ 100 for

Due Gov't, \$ 100 for

Valuation of horse, \$ 100

Valuation of horse equipments, \$ 100

Remarks: Sep 1st 20th install-
ments U.S. Bounty \$44.⁰⁰
Paid by Maj. R. Walker
for May & June \$32.⁰⁰

Book mark:

C. F. Thompson

(358)

Copyist.

C

5 Col'd Cav.

Mass.

William Evans,

Pvt., Co. I, 5 Reg't Mass. Colored Cavalry.

Appears on

Company Muster Roll

for *Wch. 8 apr.*, 1865.

Present or absent *Present,*

Stoppage, \$ *100* for

Due Gov't, \$ *100* for

Valuation of horse, \$ *100*

Valuation of horse equipments, \$ *100*

Remarks: *Due 1st 2^d 3^d 4th in -
statements U. S. Bounty
\$180.00*

Book mark:

C. F. Thompson

(358)

Copyist.

E

5 Col'd Cav.

Mass.

William Evans,
Pvt., Co. I, 5 Reg't Mass. Colored Cavalry.

Appears on

Company Muster Roll

for May & June, 1865.

Present or absent Present

Stoppage, \$ 100 for

Due Gov't, \$ 100 for

Valuation of horse, \$ 100

Valuation of horse equipments, \$ 100

Remarks: Due 1/20th install-
ments U.S. Bounty \$0.00

Book mark:

(358)

C. F. Thompson

Copyist.

E

5 Col'd Cav.

Mass.

William Evans

Cpt., Co. I, 5 Reg't Mass. Colored Cavalry.

Appears on

Company Muster Roll

for July Aug, 1865

Present or absent Present

Stoppage, \$ 100 for

Due Gov't, \$ 100 for

Valuation of horse, \$ 100

Valuation of horse equipments, \$ 100

Remarks:

Book mark:

Halcomb

E

5 Col'd Cav.

Mass.

William Evans

Priv., Co. C, 5 Reg't Mass. Colored Cav.

Appears on Returns as follows:

July 1864. About sick
Fort Monroe June 20, 64

Aug. 1864. About sick
at Portsmouth Va

Sept 1864 About sick
since June 30, 64.

Oct 1864. About sick
since June 15, 64
at Newark N.J.

Book mark:

W. Sallade

(546)

Copyist.

E

5 Col'd Cav.

Mass.

William Evans

Co. D, 5 Reg't Mass. Col'd Cavalry.

Appears on Co. Muster-out Roll, dated

Clarksville Texas, Oct 31, 1865.

Muster-out to date

Oct 31, 1865.

Last paid to

Dec 31, 1864.

Clothing account:

Last settled....., 186 ; drawn since \$..... 100

Due soldier \$..... 100; due U. S. \$ 49 ⁸⁰/₁₀₀

Am't for cloth'g in kind or money adv'd \$..... 100

Due U. S. for arms, equipments, &c., \$ 11 ⁰⁰/₁₀₀

Bounty paid \$..... 100; due \$ 300 100

Remarks: Mustered out by P.O. no 29

Ad. Ord Dept of Texas dated Galveston Texas Sept 16/65 based on authority from War Dept. dated Sep 8/65 directing the muster out of colored troops organized in Northern States, their services being (over)

Book mark: C.P.

Holecomb

JAN. 10

5383653

1891

no longer required, Transfer
and subsistence furnished
to Boston Mass. Muster out
to date Oct 31/65.

Evans William

Co. D, 5 Reg't Mass. Cav.

Enclosures.

Bed Cards	Final Statements
Burial Records	Furloughs or L. of A.
Certs. of Dis. for Discharge	Med. Certificates
C. M. Charges	Med. Des. Lists
Descriptive Lists	Orders
Discharge Certificates	Pris. of War Record
Enlistment Papers	Resignations

Other papers relating to—

Admission to Hosp'l	Furlough or L. of A.
Casualty Sheet	Med. Examination
Confinement	Misc. Information
Contracts	Pay or Clothing
Death or Effects	Personal Reports
Desertion	Rank
Discharge from Hosp'l	Transfer to Hosp'l
Discharge from Service	Transfer to V. R. C.
Duty	Transportation

3 1/2

CASUALTY SHEET
OF WOUNDED.



Wm Evans

Company I

5 Regiment of Mass Col^d Cont

Volunteers, at the battle of

Disease

see inside

W. J. no. 100
Noted
H.M.

CASUALTY SHEET.

Name, *Wm Evans*
Rank, _____, Company *I*, Regiment, *5*
Arm, *Cav*, State, *Mass Col^d*
Place of casualty, _____
Nature of casualty, *Arrived July 21 Ward Hos*
Chance
Date of casualty, _____

FROM WHAT SOURCE THIS INFORMATION WAS OBTAINED.

Report of Killed, Wounded, and Missing of the _____ Regiment,
Brigade, _____ Division, _____ Corps, dated _____
Has Reg of Eng vol rel ass: Book 4 page 195

W North

Aug 10 1885

Clerk.

Et N d S

420-a

Everson, Howard

Co., S. W. S., Col'd Can

CARD NUMBERS.

1	9436126	26
2		27
3		28
4		29
5		30
6		31
7		32
8		33
9		34
10		35
11		36
12		37
13		38
14		39
15		40
16		41
17		42
18		43
19		44
20		45
21		46
22		47
23		48
24		49
25		50

Number of personal papers herein.....

Book Mark: _____

See also _____

E. | 5 Cav. | Mass.
Co. | Col'd.

Howard Emerson,

....., Co....., *5* Reg't *Mass* Col'd *Cav.*

Appears on

Regimental Descriptive Book

of the organization named above.

DESCRIPTION.

Age *21* years; height *5* feet *6* inches.

Complexion *Black*

Eyes *Black*; hair *Black*

Where born *Sandwich Isl.*

Occupation *Seaman.*

ENLISTMENT.

When *April 19*, 186 .

Where *Roxbury.*

By whom *Sam'l. F. Felt*, term *3* y'rs.

Remarks: *Rejoined April*
22, 1864.

Harvin.

421

Evira Manuel

Co *D*, 5 Mass. Cav., (Col'd.)

CARD NUMBERS.

1	26
2	27
3	28
4	29
5	30
6	31
7	32
8	33
9	34
10	35
11	36
12	37
13	38
14	39
15	40
16	41
17	42
18	43
19	44
20	45
21	46
22	47
23	48
24	49
25	50

See Evira Manuel

Book Mark

See also

422

Airfax, Miles

Co *D*, 5 Mass. Cav., (Col'd.)

Private

Corporal

CARD NUMBERS.

1 *5382681*

26

2 *5382766*

27

3 *5382843*

28

4 *5382924*

29

5 *5383029*

30

6 *5383125*

31

7 *5383225*

32

8 *5383329*

33

9 *5383432*

34

10 *5383533*

35

11 *5383630*

36

12 *9091689*

37

13 *40730922*

38

14

39

15

40

16

41

17

42

18

43

19

44

20

45

21

46

22

47

23

48

24

49

25

50

Book Mark: *932. 1880.*

See also

J.

5 Cav. (Col'd.) | Mass.

Miles Fairfax.

....., Co. *I*, 5 Reg't Mass. Cav. (Col'd.)

Appears on

Company Descriptive Book

of the organization named above.

DESCRIPTION.

Age *19* years; height *5* feet *9½* inches.

Complexion *Brown*

Eyes *Brown*; hair *Brown*

Where born *Fairfax Co. Va.*

Occupation *Farmer.*

ENLISTMENT.

When *Mar. 14th*, 186*4*.

Where *Roxbury.*

By whom *A. C. Swain*; term *3* y'rs.

Remarks:

A. C. Swain.

(3830)

Copyist.

F

5 Col'd Cav.

Mass.

Miles Fairfax

Co. I, 5 Reg't Mass. Col'd Cav.

Appears on

Company Muster-in and Descriptive Roll
of the organization named above. Roll dated

Readville Mass. Mch 26 1864.

Where born *Fauquier Co. Va.*

Age *19* y'rs; occupation *Farmer*

When enlisted *Mch 14*, 1864.

Where enlisted *Roxbury*

For what period enlisted *3* years.

Eyes *Black*; hair *Black*

Complexion *Black*; height *5 ft. 9 1/2 in.*

When mustered in *Mch 26*, 1864.

Where mustered in *Readville. Mass.*

Bounty paid \$ *100*; due \$ *100*

Where credited *3^d Dist. Norfolk*

Company to which assigned

Remarks: *Residence: Roxbury*

** Inserted by Jordan; Ex*

Book mark:

W. H. Thompson

(356d)

Copyist.

J

5 Col'd Cav.

Mass.

Miles Fairfax

Pvt, Co. I, 5 Reg't Mass. Colored Cavalry.

Appears on

Company Muster Roll

for *Mch 26 to Apr 30*, 1864.

Present or absent *Present*

Stoppage, \$ *100* for

Due Gov't, \$ *100* for

Valuation of horse, \$ *100*

Valuation of horse equipments, \$ *100*

Remarks:

Book mark:

W H Thompson
Copyist.

Ji

5 Col'd Cav.

Mass.

Miles Fairfax

Corpl, Co. I, 5 Reg't Mass. Colored Cavalry.

Appears on

Company Muster Roll

for *May & June*, 1864.

Present or absent *Present*

Stoppage, \$ *100* for

Due Gov't, \$ *100* for

Valuation of horse, \$ *100*

Valuation of horse equipments, \$ *100*

Remarks:

Book mark:

(358)

W. H. Thompson
Copyist.

F

5 Col'd Cav.

Mass.

Miles Fairfax
Co. I, 5 Reg't Mass. Colored Cavalry.

Appears on

Company Muster Roll

for *July-Aug*, 1864.

Present or absent. *Absent*

Stoppage, \$ *100* for

Due Gov't, \$ *100* for

Valuation of horse, \$ *100*

Valuation of horse equipments, \$ *100*

Remarks: *Detached Service*
Piney Point

Book mark:

W. H. Thompson

(358)

Copyist.

4

5 Col'd Cav.

Mass.

Wiles Fairfax

Capt., Co. I, 5 Reg't Mass. Colored Cavalry.

Appears on

Company Muster Roll

for *Sept. & Oct.*, 1864.

Present or absent *Present,*

Stoppage, \$ *100* for

Due Gov't, \$ *100* for

Valuation of horse, \$ *100*

Valuation of horse equipments, \$ *100*

Remarks:

Book mark:

C. F. Thompson.

(358)

Copyist.

7

5 Col'd Cav.

Mass.

Miles Fairfax

Capt., Co. I, 5 Reg't Mass. Colored Cavalry.

Appears on

Company Muster Roll

for *Nov, 8 Dec,* 186*4.*

Present or absent *Present.*

Stoppage, \$ *100* for

Due Gov't, \$ *100* for

Valuation of horse, \$ *100*

Valuation of horse equipments, \$ *100*

Remarks:

Book mark:

C. F. Thompson
Copyist.

(358)

4

5 Col'd Cav.

Mass.

Jules Fairfax

Capt., Co. I, 5 Reg't Mass. Colored Cavalry.

Appears on

Company Muster Roll

for *Jan. & Feb.*, 1865.

Present or absent *Present*

Stoppage, \$ *100* for

Due Gov't, \$ *100* for

Valuation of horse, \$ *100*

Valuation of horse equipments, \$ *100*

Remarks: *Due 1st 2^d 3^d install-
ments U.S. Bounty #170.*

Book mark:

C. F. Thompson

(358)

Copyist.

7

5 Col'd Cav.

Mass.

Wiles Fairfax

Capt., Co. I, 5 Reg't Mass. Colored Cavalry.

Appears on

Company Muster Roll

for 1st & 2^d Apr., 1865.

Present or absent Present

Stoppage, \$ 100 for

Due Gov't, \$ 100 for

Valuation of horse, \$ 100

Valuation of horse equipments, \$ 100

Remarks: See 1st 2^d 3^d 4th in -
statements U.S. Bounty
\$188.00

Book mark:

C. F. Thompson

(358)

Copyist.

4

5 Col'd Cav.

Mass.

Wiles Fairfax

Capt., Co. I, 5 Reg't Mass. Colored Cavalry.

Appears on

Company Muster Roll

for *May & June*, 1865.

Present or absent *Present*

Stoppage, \$ *100* for

Due Gov't, \$ *100* for

Valuation of horse, \$ *100*

Valuation of horse equipments, \$ *100*

Remarks: *due 1st 2^d 3^d 4th installments U.S. Bounty \$80.00*

Book mark:

C. F. Thompson

(358)

Copyist.

Jr

5 Col'd Cav.

Mass.

Miles Fairfax

Corpl, Co. I, 5 Reg't Mass. Colored Cavalry.

Appears on

Company Muster Roll

for *July & Aug*, 186

Present or absent *Present*

Stoppage, \$ *100* for

Due Gov't, \$ *100* for

Valuation of horse, \$ *100*

Valuation of horse equipments, \$ *100*

Remarks:

Book mark:

Lalcombe

J

5 Col'd Cav.

Mass.

Miles Fairfax

Co. I, 5 Reg't Mass. Colored Cav.

Appears on **Returns** as follows:

*Aug. 1864 - Absent, detached
service, Piney Pt.*

Book mark:

A. T. Taylor

(546)

Copyist.

F | 5 Col'd Cav. | Mass.

Miles Fairfar

Cavalry, Co. D, 5 Reg't Mass. Col'd Cavalry.

Appears on Co. Muster-out Roll, dated
Clarksville Texas, Oct 31, 1865.

Muster-out to date Oct 3, 1865.

Last paid to Dec 31, 1864.

Clothing account:

Last settled....., 186 ; drawn since \$..... 100

Due soldier \$..... 100; due U. S. \$..... 53/100

Am't for cloth'g in kind or money adv'd \$..... 100

Due U. S. for arms, equipments, &c., \$..... 100

Bounty paid \$..... 100; due \$ 300 100

Remarks: Mustered out by G.O. No. 21

Ho. Sec Dept. of Texas dated Galveston
Texas Sept 16/65 based on authority from
War & Spt. Dept. Sept 8/65 directing the
muster out of colored troops organized in
Northern States (their services being done)

Book mark: 2056 Reg. 2066 - 99, 1850

Holcomb

(861)

Copyist.

JAN. 10

5383630

1891

no longer required. Transport
& subsistence furnished to
Boston Mass. Muster out to
date Oct 31/65.

423

Fanteroy, Simon

Co I, 5 Mass. Cav., (Col'd.)

Private

Private

CARD NUMBERS.

1	5372263
2	5372174
3	5382991
4	5383053
6	5383151
6	5383254
7	5383358
8	5383461
9	5383557
10	5383654
11	9091770
12	34505392
13	40730938
14	
15	
16	
17	
18	
19	
20	
21	
22	
23	
24	
25	

26	
27	
28	
29	
30	
31	
32	
33	
34	
35	
36	
37	
38	
39	
40	
41	
42	
43	
44	
45	
46	
47	
48	
49	
50	

Book Mark:

See also

F

5 Cav. (Col'd.) | Mass.

Simon Forderoy.

Co. I, 5 Reg't Mass. Cav. (Col'd.)

Appears on

Company Descriptive Book

of the organization named above.

DESCRIPTION.

Age *19* years; height *6* feet *1* inches.

Complexion *Blk.*

Eyes *Blk.*; hair *Blk.*

Where born *Virginia*

Occupation *Farmer*

ENLISTMENT.

When *June 16th*, 1864.

Where *Holyoke*

By whom *Capt. Grafton*; term *3* y'rs.

Remarks: *Mustered June 16th 64. Capt. Grafton.*

H. C. Thomas

7

5 Col'd Cav.

Mass.

Simon Fanteroy

Appears with rank of Pri on

Muster and Descriptive Roll of a Detachment of U. S. Vols. forwarded

for the 5 Reg't Mass. Col'd Cavalry. Roll dated

Galloupo Sold Mass, July 12, 1864.

Where born Virginia

Age 19 y'rs; occupation Farmer

When enlisted June 16, 1864.

Where enlisted Holyoke

For what period enlisted 3 years.

Eyes Black; hair Black

Complexion Black; height 6 ft. 1 in.

When mustered in June 16, 1864.

Where mustered in Boston Mass

Pension
Bounty paid \$ 2 100; due \$ 100

Where credited 10 Cong Dist. Holyoke

Hampden Co
Company to which assigned

Remarks:

Book mark:

Donnelly

F | 5 Cav | Mass

Simon Fauleroy

Appears with rank of _____ on _____

Muster and Descriptive Roll

of a detachment of U. S. Volunteers forwarded from Faneuil Hall, Boston, to Galloup's Island, Boston Harbor, for various regiments Massachusetts Volunteers. Roll dated

Boston Mass, June 10, 1864.

Where born _____ Virginia _____

Age 19 years; occupation Farmer

When enlisted June 10, 1864

Where enlisted Holyoke

For what period enlisted 3 years.

Eyes Blue; hair Black

Complexion Blue; height 6 ft. 1 in.

When mustered in June 10, 1864

Where mustered in Boston

Bounty paid \$ 100; due \$ 100

Clothing account:
Last settled _____, 1864; drawn since \$ 100

Date of first muster _____, 1864

Regiment to which assigned 5 Cav

Remarks: Holyoke Hampden Co 10 Regt

Book mark: _____

(856m)

Sargent

Copyist

2
7

5 Col'd Cav.

Mass.

Simon Tauteroy

Appears with rank of Private on

Muster and Descriptive Roll of a Detachment of U. S. Vols. forwarded

for the 5 Reg't Mass. Col'd Cavalry. Roll dated Boston Mass., June 18, 1864.

Where born Virginia

Age 19 y'rs; occupation Farmer

When enlisted June 16, 1864.

Where enlisted Holyoke

For what period enlisted 3 years.

Eyes Dark; hair Dark

Complexion Dark; height 6 ft. 1 in.

When mustered in June 16, 1864.

Where mustered in Boston

Bounty paid \$ 100; due \$ 100

Where credited S. Dist. Holyoke Hampden Co.

Company to which assigned _____

Remarks: _____

Book mark: _____

Fossett

F

5 Col'd Cav.

Mass.

Simon Fonderoy
Pvt, Co. I, 5 Reg't Mass. Colored Cavalry.

Appears on

Company Muster Roll

for *July & Aug*, 186*4*.

Present or absent *Present*

Stoppage, \$ *100* for

Due Gov't, \$ *100* for

Valuation of horse, \$ *100*

Valuation of horse equipments, \$ *100*

Remarks: *Permit from corp*

Joined Co at Pt Lookout
and July 17/64 - enlistment
papers not Recd.

Book mark:

W H Thompson

(358)

Copyist.

4

5 Col'd Cav.

Mass.

Simon Fonderoy

Privt., Co. I, 5 Reg't Mass. Colored Cavalry.

Appears on

Company Muster Roll

for

Sept. & Oct., 1864.

Present or absent

Present

Stoppage, \$

100 for

Due Gov't, \$

100 for

Valuation of horse, \$

100

Valuation of horse equipments, \$

100

Remarks:

Book mark:

C. F. Thompson

(358)

Copyist.

7

5 Col'd Cav.

Mass.

Simon Fonderoy,

Priv., Co. I, 5 Reg't Mass. Colored Cavalry.

Appears on

Company Muster Roll

for Nov. & Dec., 1864.

Present or absent Present,

Stoppage, \$ 100 for

Due Gov't, \$ 100 for

Valuation of horse, \$ 100

Valuation of horse equipments, \$ 100

Remarks: Due U. S. for ord, lost \$0.30 rec'd \$10.00 advance pay.

Book mark:

C. F. Thompson,

(358)

Copyist.

F

5 Col'd Cav.

Mass.

Simon Funderoy

Pvt, Co. I, 5 Reg't Mass. Colored Cavalry.

Appears on

Company Muster Roll

for Jan. & Feb., 1865.

Present or absent Present

Stoppage, \$ 100 for

Due Gov't, \$ 100 for

Valuation of horse, \$ 100

Valuation of horse equipments, \$ 100

Remarks: Dup 1st installment
U.S. Bounty \$25.⁰⁰
Dup U.S. for ord. lost \$30
Rec'd \$10.⁰⁰ advance pay.

Book mark:

C. F. Thompson

(358)

Copyist.

7

5 Col'd Cav.

Mass.

Simon Fonderoy

Pat., Co. I, 5 Reg't Mass. Colored Cavalry.

Appears on

Company Muster Roll

for *W. H. Daper*, 1865.

Present or absent *Present.*

Stoppage, \$ *100* for

Due Gov't, \$ *100* for

Valuation of horse, \$ *100*

Valuation of horse equipments, \$ *100*

Remarks: *Due 1st installment*

U. S. Bounty \$25.00

Book mark:

(358)

C. F. Thompson
Copyist.

7

5 Col'd Cav.

Mass.

Simon Fonderoy

Priv., Co. I, 5 Reg't Mass. Colored Cavalry.

Appears on

Company Muster Roll

for May & June, 1865.

Present or absent Present.

Stoppage, \$ 100 for

Due Gov't, \$ 100 for

Valuation of horse, \$ 100

Valuation of horse equipments, \$ 100

Remarks: See "Installation"
U. S. Bounty \$ 25.00

Book mark:

C. F. Thompson

Copyist.

(358)

7

5 Col'd Cav.

Mass.

Simon Fonderoy

Pvt., Co. I, 5 Reg't Mass. Colored Cavalry.

Appears on

Company Muster Roll

for July & Aug, 1865.

Present or absent Present

Stoppage, \$ 100 for

Due Gov't, \$ 100 for

Valuation of horse, \$ 100

Valuation of horse equipments, \$ 100

Remarks:

Book mark:

Hale

(358)

Copyist.

F

5 Col'd Cav.

Mass.

S. F. Underoy

Plt., Co. *D*, 5 Reg't Mass. Colored Cav.

Appears on **Returns** as follows:

*July 1864 - Recruit Plt.
Bookout, Md. joined
Company July 16, '64.*

Book mark:

O. J. Underoy

(546)

Copyist.

5

5 Col'd Cav.

Mass.

Simon Fonderoy

Capt., Co.

5 Reg't Mass. Col'd Cavalry.

Appears on Co. Muster-out Roll, dated

Clarksville Texas, Oct 3, 1865.

Muster-out to date Oct 31, 1865.

Last paid to Dec 31, 1864.

Clothing account:

Last settled, 186 ; drawn since \$ 100

Due soldier \$ 7 32 / 100; due U. S. \$ 100

Am't for cloth'g in kind or money adv'd \$ 100

Due U. S. for arms, equipments, &c., \$ 100

Bounty paid \$ 100; due \$ 100 100

Remarks: Mustered out by S.O. no 29

W. An. Dept of Texas dated Galveston Texas Sept 16/65 (based on authority from War Dept. dated Sep 8/65 directing the muster out of colored troops organized in northern Texas)

Book mark:

W. Leach

(361)

Copyist.

JAN. 10

5383654

1891

States, their services being no
longer required + Transport &
subsistence furnished to Boston
Mass. Muster out to date Oct 31/65.

Fanteroy, Simon

, Co.

5 Reg't Mass. C. C.

Enclosures.

Bed Cards	Final Statements
Burial Records	Furloughs
Certs. of Dis. for Discharge	Med. Certificates
C. M. Charges	Med. Des. Lists
Descriptive Lists	Orders
Discharge Certificates	Pris. of War Record

Other papers relating to—

Admission to Hosp'l	Furlough
Casualty Sheet	Med. Examination
Confinement	Misc. Information
Contracts	Pay or Clothing
Death or Effects	Personal Reports
Desertions	Rank
Discharge from Hosp'l	Transfer to Hosp'l
Discharge from Service	Transfer to V. R. C.
Duty	Transportation

S. P.

R

NOTE 1.—This blank will be used for both enlistments and re-enlistments—enlistment of veterans, &c., &c., in the volunteer service. They will be made out in duplicate in all cases—one to accompany the recruiting return of the superintendent (not the recruiting officer) to the Adjutant-General, and one to accompany the accounts of the officer who pays bounty, &c. The Regiment and Company in which the soldier last served should be given on the back.

NOTE 2.—An enlistment holds to service. A muster-in must, in all cases, precede payment of pay, bounty, pension, &c. A muster-in roll must, in all cases, be filed in the Adjutant-General's Office as evidence of muster-in. The mustering officer, commissary, or assistant-commissary of musters, as the case may be, will countersign both enlistments as having mustered the soldier into the service of the United States before either of them is given to the disbursing officer.

DECLARATION OF RECRUIT.

I, *Simon Hunteroy* desiring to VOLUNTEER as a Soldier in the Army of the United States, for the term of THREE YEARS, Do Declare, That I am *nineteen* years and _____ months of age; that I have never been discharged from the United States service on account of disability or by sentence of a court-martial, or by order before the expiration of a term of enlistment; and I know of no impediment to my serving honestly and faithfully as a soldier for three years.

GIVEN at *Boston Mass* the *16* day of *June* *1864*

Witness: *Nathl Perkins* *Simon Hunteroy*
mark

Discharged _____ 18 _____
Regt of _____
enlistment; last served in Company ()

By *Simon Hunteroy*
16th Mass 1864,
5th Regiment of Mass Cavalry

No. *52*

CONSENT IN CASE OF MINOR.

I, _____ Do CERTIFY, That I am _____ the _____ of _____; that the said _____ is _____ years of age; and I do hereby freely give my CONSENT to his volunteering as a SOLDIER in the ARMY OF THE UNITED STATES, for the period of THREE YEARS.

GIVEN at _____ the _____ day of _____

Witness: _____

Hamden Co 10 Dist
VOLUNTEER ENLISTMENT.

STATE OF

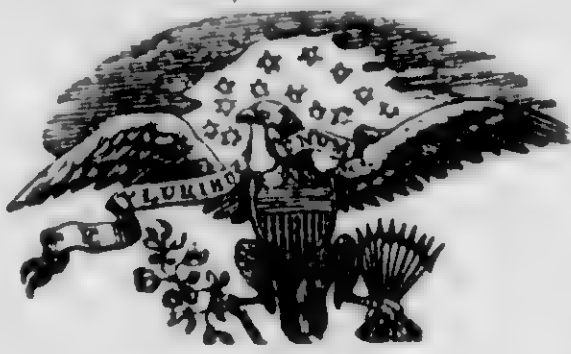

TOWN OF

Mass

Holyoke

I, *Simon Fantasy* born in *Virginia*
 in the State of _____ aged *nineten* years,
 and by occupation a *Farmer* DO HEREBY ACKNOWLEDGE to have
 volunteered this *sixteenth* day of *June* 1864,
 to serve as a Soldier in the Army of the United States of America, for the
 period of **THREE YEARS**, unless sooner discharged by proper authority: Do also
 agree to accept such bounty, pay, rations, and clothing, as are, or may be, estab-
 lished by law for volunteers. And I, *Simon Fantasy* do
 solemnly swear, that I will bear true faith and allegiance to the **United States**
of America, and that I will serve them honestly and faithfully against all their
 enemies or opposers whomsoever; and that I will observe and obey the orders of
 the President of the United States, and the orders of the officers appointed over
 me, according to the Rules and Articles of War.

Sworn and subscribed to, at

Boston Mass

this

10th day of June 1864

BEFORE

F. Arnold
ma

Simon Fantasy
mark

I CERTIFY, ON HONOR, That I have carefully examined the above-named Volunteer, agreeably
 to the General Regulations of the Army, and that, in my opinion, he is free from all bodily defects and
 mental infirmity, which would in any way disqualify him from performing the duties of a soldier.

J. P. Haines
Phys.

EXAMINING SURGEON.

I CERTIFY, ON HONOR, That I have minutely inspected the Volunteer, *Simon Fantasy*
 previously to his enlistment, and that he was entirely sober when enlisted; that, to the best of my
 judgment and belief, he is of lawful age; and that, in accepting him as duly qualified to perform the duties
 of an able-bodied soldier, I have strictly observed the Regulations which govern the recruiting service.
 This soldier has *black* eyes, *black* hair, *black* complexion, is *five* feet
one inches high.

Wm. P. ...
Regiment of _____ Volunteers,

RECRUITING OFFICER.

(A. G. O. No. 74 & 75.)

the 16 day of

June

, 1864, at

Boston Mass

Mustered into the service of the United States, in Company

, 5th Regiment of

Mass

Volunteers, on

Colored

Wm. P. ...
1864

NOTE 1.—This blank will be used for both enlistments and re-enlistments—enlistment of veterans, &c., &c., in the volunteer service. They will be made out in duplicate in all cases—one to accompany the recruiting return of the superintendent (not the recruiting officer) to the Adjutant-General, and one to accompany the accounts of the officer who pays bounty, &c. The Regiment and Company in which the soldier last served should be given on the back.

NOTE 2.—An enlistment holds to service. A muster-in must, in all cases, precede payment of pay, bounty, pension, &c. A muster-in roll must, in all cases, be filed in the Adjutant-General's Office as evidence of muster-in. The mustering officer, commissary, or assistant-commissary of musters, as the case may be, will countersign both enlistments as having mustered the soldier into the service of the United States before either of them is given to the disbursing officer.

DECLARATION OF RECRUIT.

I, *Simon Fanteroy* desiring to VOLUNTEER as a Soldier in the Army of the United States for the term of THREE YEARS, Do Declare, That I am *Nineteen* years and _____ months of age; that I have never been discharged from the United States service on account of disability or by sentence of a court-martial, or by order before the expiration of a term of enlistment; and I know of no impediment to my serving honestly and faithfully as a soldier for three years.

GIVEN at *Goshen Mass* the *16* day of *June* 1864

Witness:

Nathan Perkins *Simon X Fanteroy*
Mark

Discharged

18

Reg't of

enlistment; last served in Company ()

Simon Fanteroy
 Volunteered at *Goshen Mass*
16th June 1864,
 By *Capt. G. A. Stone* for
5th Regiment of Mass Cavalry

No.

5th Mass. Cav
Card

CONSENT IN CASE OF MINOR.

I, _____ Do CERTIFY, That I am _____ the _____ of _____; that the said _____ is _____ years of age; and I do hereby freely give my CONSENT to his volunteering as a SOLDIER in the ARMY OF THE UNITED STATES, for the period of THREE YEARS.

GIVEN at _____ the _____ day of _____

Witness:

Wampden Co - Tenth Dist
VOLUNTEER ENLISTMENT.

STATE OF

Mass

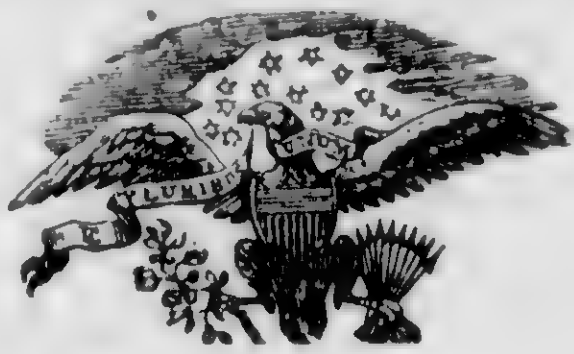

TOWN OF

Keolyok

I, *Simon Fanteroy* born in *Virginia*
in the State of _____ aged *nineteen* years,

and by occupation a *Farmer* DO HEREBY ACKNOWLEDGE to have

volunteered this *Fifteenth* day of *June* 186*4*,

to serve as a **Soldier** in the Army of the United States of America, for the period of **THREE YEARS**, unless sooner discharged by proper authority: Do also agree to accept such bounty, pay, rations, and clothing, as are, or may be established by law for volunteers. And I, *Simon Fanteroy* do solemnly swear, that I will bear true faith and allegiance to the **United States of America**, and that I will serve them honestly and faithfully against all their enemies or opposers whomsoever; and that I will observe and obey the orders of the President of the United States, and the orders of the officers appointed over me, according to the Rules and Articles of War.

Sworn and subscribed to, at

this

Boston
16 day of *June* 186*4*
BEFORE *W. F. Arnold*
no.

his
Simon x Fanteroy
mark

I CERTIFY, ON HONOR, That I have carefully examined the above-named Volunteer, agreeably to the General Regulations of the Army, and that, in my opinion, he is free from all bodily defects and mental infirmity, which would in any way disqualify him from performing the duties of a soldier.

W. F. Arnold
no.

EXAMINING SURGEON.

I CERTIFY, ON HONOR, That I have minutely inspected the Volunteer, *Simon Fanteroy* previously to his enlistment, and that he was entirely sober when enlisted; that, to the best of my judgment and belief, he is of lawful age; and that, in accepting him as duly qualified to perform the duties of an able-bodied soldier, I have strictly observed the Regulations which govern the recruiting service.

This soldier has *Black* eyes, *Black* hair, *Black* complexion, is *Six* feet *one* inches high.

W. F. Arnold
Regiment of *Mass* Volunteers,
RECRUITING OFFICER.

(A. G. O. No. 74 & 75.)

Mustered into the service of the United States, in Company

the *16* day of *June*, 186*4*, at

5th Regiment of *Mass*

Volunteers, on

Colonel

Simon Fanteroy
16th June 1864

424

Ford, Nathaniel P.

Co M, 5 Mass. Cav., (Col'd.)

Private

Corporal

CARD NUMBERS.

1	26
2	27
3	28
4	29
5	30
6	31
7	32
8	33
9	34
10	35
11	36
12	37
13	38
14	39
15	40
16	41
17	42
18	43
19	44
20	45
21	46
22	47
23	48
24	49
25	50

Ser Ford, Nathaniel P.

Book Mark:

See also

425

Farmer Thomas

Co L, 5 Mass. Cav., (Col'd.)

Private

Private

CARD NUMBERS.

1	26
2	27
3	28
4	29
5	30
6	31
7	32
8	33
9	34
10	35
11	36
12	37
13	38
14	39
15	40
16	41
17	42
18	43
19	44
20	45
21	46
22	47
23	48
24	49
25	50

See Former.

Thomas

Book Mark:

See also

426

Farnsworth, George P.

Col., 5 Mass. Cav., (Col'd.)

2nd Lieutenant 2nd Lieutenant

CARD NUMBERS.

1	5375678	26
2	5371910	27
3	5375763	28
4	5375848	29
5	5375933	30
6	5376139	31
7	5376142	32
8	5376252	33
9	5376357	34
10	5376460	35
11	5376653	36
12	5376838	37
13	9436244	38
14	301-05-1879	39
15	40730921	40
16		41
17		42
18		43
19		44
20		45
21		46
22		47
23		48
24		49
25		50

Book Mark: 301 65. 79 + LB $\frac{12}{447}$

See also

R. + P. 507415

H. Jordan
ex

5 Cav. Mass.
(Col'd)

George B. Farnsworth,
Lat. Co., 5 Reg't Mass Col'd Cav.

Appears on

Regimental Descriptive Book

(List of Commissioned Officers)

of the regiment named above.

Rank *Lieutenant.*

Date of appointment *Dec 17*, 186*4*.

Remarks: *Mustered in*
service Dec. 19/64.

Tharin

J

5 Col'd Cav.

Mass.

Geo. B. Farnsworth,

2^d St., Co....., 5 Reg't Mass. Col'd Cavalry.

Age *35* years.

Appears on an

Individual Muster-in Roll

of the organization named above. Roll dated

Boston, Mass., Dec. 19, 186*3.*

Muster-in to date *Dec. 19,* 186*3.*

Joined for duty and enrolled :

When *Dec. 19,* 186

Where *Boston*

Period *3* years.

Valuation of horse, \$ 100

Valuation of horse equipments, \$ 100

Remarks : *Mustered into the U.S. Service in accordance with Genl. Order No. 75 dated War Dept. A.S.D. Washington City, D.C. July 8, 1862, to aid in the organization of the Regiment.*

Book mark :

P. Pool,

27

5 Col'd Cav. | Mass.

George B. Farnsworth.

2^d Lt. Co. B, 5 Reg't Mass. Col'd Cav.

Appears on

Company Muster-in and Descriptive Roll

of the organization named above. Roll dated

Readville, Jan. 29, 1864.

Where born

Age 35 y'rs; occupation

When enlisted Dec. 17, 1863.

Where enlisted Boston

For what period enlisted 3 years.

Eyes; hair

Complexion; height ft. in.

When mustered in Jan. 29, 1864.

Where mustered in Readville, Mass.

Bounty paid \$ 100; due \$ 100

Where credited 3^d Dist. Suffolk

Company to which assigned

Remarks: Mustered by Lt. McLibben 4th Comp. Dec. 19, 1863.

Book mark:

Sitter.

F

5 Col'd Cav.

Mass.

George B. Farnsworth

2^d Lieut, Co. C, 5 Reg't Mass. Col'd Cavalry.

Appears on

Company Muster Roll

for Enlistment to Feb. 29, 1864.

Present or absent Present

Stoppage, \$ 100 for

Due Gov't, \$ 100 for

Valuation of horse, \$ 100

Valuation of horse equipments, \$ 100

Remarks: Mustered into
service under Genl
Order No. 75 dated
July 8, 1862 War Dept.
A. G. O. Washington,
D. C.

Book mark:

Sitter

F

5 Col'd Cav.

Mass.

George B. Farnsworth.

2^d Lt., Co. C, 5 Reg't Mass. Col'd Cavalry.

Appears on

Company Muster Roll

for *Mar. & Apr.*, 1864.

Present or absent *Present.*

Stoppage, \$ *100* for

Due Gov't, \$ *100* for

Valuation of horse, \$ *100*

Valuation of horse equipments, \$ *100*

Remarks:

Book mark:

Sitter.

(358)

Copyist.

57

5 Col'd Cav.

Mass.

George B. Farnsworth

2^d Lt., Co. C, 5 Reg't Mass. Col'd Cavalry.

Appears on

Company Muster Roll

for *May & June*, 186*4*.

Present or absent *Present*

Stoppage, \$ *100* for

Due Gov't, \$ *100* for

Valuation of horse, \$ *100*

Valuation of horse equipments, \$ *100*

Remarks:

Book mark:

Sitter

5

5 Col'd Cav.

Mass.

George B Farnsworth

2nd, Co. C, 5 Reg't Mass. Col'd Cavalry.

Appears on

Company Muster Roll

for July + Aug, 1864.

Present or absent Present

Stoppage, \$ 100 for

Due Gov't, \$ 100 for

Valuation of horse, \$ 100

Valuation of horse equipments, \$ 100

Remarks:

Book mark:

E. H. Brown

G

5 Col'd Cav.

Mass.

George B Farnsworth

2 Lt, Co. C, 5 Reg't Mass. Col'd Cavalry.

Appears on

Company Muster Roll

for *Sept & Oct*, 186*4*.

Present or absent *Present*

Stoppage, \$ *100* for

Due Gov't, \$ *100* for

Valuation of horse, \$ *100*

Valuation of horse equipments, \$ *100*

Remarks:

Book mark:

E. H. Brown

F

5 Col'd Cav.

Mass.

George O Farnsworth
2d Lt, Co. C, 5 Reg't Mass. Col'd Cavalry.

Appears on

Company Master Roll

for *Nov & Dec*, 186*4*.

Present or absent *Present*

Stoppage, \$ *100* for

Due Gov't, \$ *100* for

Valuation of horse, \$ *100*

Valuation of horse equipments, \$ *100*

Remarks:

Book mark:

E. H. Brown

(358)

Copyist.

G

5 Col'd Cav.

Mass.

George O Pansworth

2 Lt, Co. C, 5 Reg't Mass. Col'd Cavalry.

Appears on

Company Muster Roll

for Jan Feb, 1865.

Present or absent Absent

Stoppage, \$ 100 for

Due Gov't, \$ 100 for

Valuation of horse, \$ 100

Valuation of horse equipments, \$ 100

Remarks: Absent with leave from 9th to 19th of Feb since then absent sick

Book mark:

E. H. Brown

D

5 Col'd Cav.

Mass.

George O Farnsworth

2 Lt., Co. C, 5 Reg't Mass. Col'd Cavalry.

Appears on

Company Muster Roll

for *Mar - Apr*, 1865.

Present or absent *Present*

Stoppage, \$ *100* for

Due Gov't, \$ *100* for

Valuation of horse, \$ *100*

Valuation of horse equipments, \$ *100*

Remarks: *Absent with leave from 9 to 19 Feb. Absent sick from 19 Feb to 11 Mar.*

Book mark:

E. H. Brown

7

5 Col'd Cav.

Mass.

Geo B Farnsworth

2 Lieut, Co. C, 5 Reg't Mass. Col'd Cavalry.

Appears on

Company Muster Roll

for May & June, 1865.

Present or absent

Stoppage, \$ 100 for

Due Gov't, \$ 100 for

Valuation of horse, \$ 100

Valuation of horse equipments, \$ 100

Remarks: Discharged at Light House Point Va May 2 1865 by SO 81 Dept of Va

Book mark:

Abbott

(358)

Copist.

F

5 Col'd Cav.

Mass.

George B. Farnsworth
Lieut., Co. C, 5 Reg't Mass. Colored Cav.

Appears on Returns as follows:

February 1864 to January 1865. Present
February 1865. Absent
March & April 1865. Present
May 1865. Discharged by S.O.
81, Dept. of Va., May 2, 66.

Book mark:

O. J. Taylor

(546)

Copyist.

F

5 Col'd Cav.

Mass.

George B Farnsworth

Lieut, Co. B, 5 Reg't Mass. Col'd Cavalry.

Appears on Co. Muster-out Roll, dated
Clarkville Texas, Oct 31, 1865.

Muster-out to date _____, 186 .

Last paid to _____, 186 .

Clothing account:

Last settled _____, 186 ; drawn since \$ _____ 100

Due soldier \$ _____ 100; due U. S. \$ _____ 100

Am't for cloth'g in kind or money adv'd \$ _____ 100

Due U. S. for arms, equipments, &c., \$ _____ 100

Bounty paid \$ _____ 100; due \$ _____ 100

Remarks: Discharged by SO No 81

Had 2rs Dept Va dated May 2.65

Book mark: 301-67-79 240.
(over)

Abbot

JAN. - 9

5376838

1891

Discharged by SO No 120 Hd 2rs
Dept of Virginia May 3 - 65
on Resignation tendered for
personal reasons L B $\frac{12}{447}$

F. 1 5th Cav (old) Mass.

George B. Farnsworth

, Co. B, 5 Reg't Mass (old) Cav.

NOTATION.

LB 12/447

Book mark:

301. 6. J. 1879.

War Department,

Adjutant General's Office,

Washington, Feby. 7th, 1879.

"Discharged by S.O. No. 120
Hed. Ins. Dept. of Virginia May
3rd 1865, on resignation tend-
ered for personal reasons."

E. P. Conner.

(438)

Copyist.

Farnsworth, George B.

2^d Lt., Co.

5th

Reg.

Mass. Cav.

5

Enclosures.

Bed Cards	Final Statements
Burial Records	Furloughs or L. of A.
Certs. of Dis. for Discharge	Med. Certificates
C. M. Charges	Med. Des. Lists 2
Descriptive Lists	Orders
Discharge Certificates	Pris. of War Record
Enlistment Papers	Resignations

Other papers relating to—

Admission to Hosp'l	Furlough or L. of A.
Casualty Sheet	Med. Examination
Confinement	Misc. Information
Contracts	Pay or Clothing
Death or Effects	Personal Reports
Desertion	Rank
Discharge from Hosp'l	Transfer to Hosp'l
Discharge from Service	Transfer to V. R. C.
Duty	Transportation

4 36 1865

Boston Map

July 16th 1865

Farnsworth Geo. B.
Lt. 5th Map Camp.

Surgeon Certif.

Recd A.S.P. July 18th 1865

S^t George B. Farnsworth

Co. 6 of the 5th

Regiment *Mass Cavalry* - having applied for a certificate on which to ground an application

for leave of absence, I do hereby certify that I have carefully examined this officer and find that* *he is*
invalided in Roxbury Mass. suffering from Acute
Bronchitis since Feb. 13. 1865 - Also debility consequent
upon Chronic Diarrhoea of long standing -

Period of recovery not remote -

And that in consequence thereof, he is, in my opinion, unfit for duty. I further declare my belief that he
will not be able to resume his duties in a less period than † *Ten* days, *from Feb. 19/65*
and is unable to travel without incurring the risk of permanent disability.

Dated at

Boston, this *16th* day of *February 1865*

Approved

A. M. M. Larn

Wm Wall a. a. s. g. c.

Surgeon 24th
Regt 1st Mass Cav

* Here the nature of the disease, wound, or disability, is to be fully stated, and the period during which the officer has suffered under its effects.

† Here state, candidly and explicitly, the opinion as to the period which will probably elapse before the officer will be able to resume his duties. Where there is no reason to expect a recovery, or when the prospect of a recovery is distant and uncertain, it must be so stated.

[This certificate to be made out in triplicate.]

Pl. 46. 1865.

Boston Mass

Feb'y 25th 1865.

Farnsworth, Gro. B.

Li. 5th Mass. Car'y.

Surgery's Cont'y.

Pre. A.S.O. Feb'y 27th 1865.

Original ...
Special Orders
1865

St. George B. Farnsworth

Co. B of the 5th

Regiment Mass Cavalry

having applied for a certificate on which to ground an application

for leave of absence, I do hereby certify that I have carefully examined this officer and find that* he is
invalided in Roxbury Mass. suffering from debility
consequent upon Chronic Diarrhea of long standing from
which he has been rapidly losing life within a day or
two when he had a renewal of his disease - Rest is requisite.
Period of recovery not reported -

And that in consequence thereof, he is, in my opinion, unfit for duty. I further declare my belief that he
will not be able to resume his duties in a less period than One days, from Feb 29/65
and is unable to travel without incurring the risk of permanent disability.

Dated at

Boston, this 25th day of February 1865

Approved

J. M. Warren

J. M. Wall A. A. S. F. A.

Surgeon
Medical Director

* Here the nature of the disease, wound, or disability, is to be fully stated, and the period during which the officer has suffered under its effects.

† Here state, candidly and explicitly, the opinion as to the period which will probably elapse before the officer will be able to resume his duties. Where there is no reason to expect a recovery, or when the prospect of a recovery is distant and uncertain, it must be so stated.

[This certificate to be made out in triplicate.]

Sto. Mass. Cav.
2, 28, 1865.

Geo. B. Farnsworth
Lieut. 5th Mass. Cav.

W. H. M.
Major Genl.

Reports the extension
of St. Farnsworth's Law

Head Quarters,

5th REGT, MASS. CAVALRY.

February 28th 1865.

Point Look out Md.

Capt. G. W. New

A. A. A. G.

Co.

I have the honor to inform you that
Lieut. Geo. W. Newcomb's leave of absence has again
been extended on Surgeon's Certificate of disability for
one month.

Very truly
Yours

Wm. A. R. S.

Wm. A. R. S.

Major, Cavalry, 5th Mass. Cav.

105 (21) 1052. 45
Head Quarters
5th Mass. Cav.

P. 14. W. H. P. 1865

L. A. F. 30 Petersburg 1865.
Farnsworth, Geo. B.

2nd Lieut. 5th Mass. Cav.

Resigns his Commission as 2nd Lieut. 5th Mass. Cav. and requests a discharge from the service, for reasons assigned.

Respectfully forwarded (Approved): The circumstances under which this officer has remained in the service during the last six months have been such as to render his discharge, whenever he saw fit to request it a mere matter of justice to himself.

Charles B. Adams for
Col. Lemuel 5th Mass. Cav.

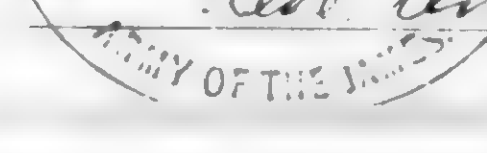

Ad. Gen. W. S. Force
E. B. 1153 Petersburg 1865.
Petersburg Va. May 2/65

Respectfully forwarded
Approved

Wm. A. Burtch
Maj. Gen. Comd'g

Ad. Gen. Dept. of War
Station: Richmond Va.
Special Orders: No. 120. # 4.
Date: May 2, 1865.

Respectfully forwarded to the Adjutant General of the Army.

C. O. C. O. A

Maj. Gen.
Comd'g

Recd W. H. P. 1865

Camp of the 11th Regt. Me. Inf.
near Washington, D.C. 1862

J. S. Chamberlain, Major
11th Regt. Me. Inf.

Received the honor to be
subscribed to the notice, and was glad to receive
the commission from the Hon. Secy of War, and
under the recommendation of my Commissioned
Individual in the 11th Regt. Me. Inf. I hereby
and in request as herewith enclosed from
the Military Service of the United States.

Very respectfully,
J. S. Chamberlain
Major, 11th Regt. Me. Inf.

Copy

Major Dept. of Virginia,
County of the James,
Richmond, Va., May 8, 1865.

Special Order

No. 125

(Extract)

The following named officers having tendered their resignations are hereby honorably discharged the Service of the United States, with condition that they shall receive no final payment until they have satisfied the Pay Department that they are not indebted to the Government:

2d Lt. G. D. Farnsworth,

5th Mass. Cavalry.

By command of Maj. Gen. Ord.

(Signed) Edw. Smith,
a. a. c.

Net
3/2/79

Private Property

CARD NUMBERS.

5-372205	26
5-378428	27
5-378485	28
5-378591	29
5-378694	30
5-378850	31
5-378904	32
5-379006	33
5-379103	34
10 5-373075	35
11 5-373073	36
12 5-379204	37
12 909219H	38
14 33238554	39
15 33239372	40
16 40730927	41
17	42
18	43
19	44
20	45
21	46
22	47
23	
24	49
25	50

Book Mark:

See also

F

5 Cav. (Col'd.) | Mass.

Moses Farnan

Co. E, 5 Reg't Mass. Cav. (Col'd.)

Appears on

Company Descriptive Book

of the organization named above.

DESCRIPTION.

Age 44 years; height 5 feet 1 inches.

Complexion Blk

Eyes Blk; hair Blk

Where born Culpeper Virginia

Occupation Laborer

ENLISTMENT.

When June 4, 1864.

Where Washington D.C.

By whom Capt. Putnam; term Three yrs.

Remarks: Substitute for Marshall Biggs, Sumner Mass.

H. A. S. C.

7

5 Col'd Cav.

Mass.

Moses Farver

Pri

Appears with rank of on

Muster and Descriptive Roll of a Detachment of U. S. Vols. forwarded

for the 5 Reg't Mass. Col'd Cavalry. Roll dated

Washington DC, June 6, 1864

Where born Culpepper Va

Age 44 y'rs; occupation Laborer

When enlisted June 6, 1864

Where enlisted Washington DC

For what period enlisted 3 years.

Eyes Black; hair Black

Complexion Black; height 5 ft. 7 in.

When mustered in June 10, 1864

Where mustered in Washington DC

Bounty paid \$ 100; due \$ 100

Where credited

Company to which assigned

Remarks: Accepted as substitute for Marshall Briggs, 2 Cong Dist. Taunton Mass

Book mark:

Corrected by made 6/14/65

Donnelly

A

5 Col'd Cav.

Mass.

Wassas Ferrer

Privt., Co. E, 5 Reg't Mass. Col'd Cavalry.

Appears on

Company Muster Roll

for *May June*, 186*4*.

Present or absent

Stoppage, \$ *100* for

Due Gov't, \$ *100* for

Valuation of horse, \$ *100*

Valuation of horse equipments, \$ *100*

Remarks: *Recruit,
Muster & descriptive rolls
never been received,*

Book mark:

[Signature]

Copyist.

F

5 Col'd Cav.

Mass.

Moses Farer

Pvt, Co. E, 5 Reg't Mass. Col'd Cavalry.

Appears on

Company Muster Roll

for *July & Aug.*, 1864.

Present or absent *Not stated*

Stoppage, \$ 100 for

Due Gov't, \$ 100 for

Valuation of horse, \$ 100

Valuation of horse equipments, \$ 100

Remarks: *Musten and
Descriptive Roll
never recd.*

Book mark:

O. J. Clark

(358)

Copyist.

F

5 Col'd Cav.

Mass.

Moses Ferrar

Priv, Co. E, 5 Reg't Mass. Col'd Cavalry.

Appears on

Company Muster Roll

for *Sept & Oct*, 186*4*.

Present or absent *Present*

Stoppage, \$ *100* for

Due Gov't, \$ *100* for

Valuation of horse, \$ *100*

Valuation of horse equipments, \$ *100*

Remarks:

Book mark:

A. C. Clark

(358)

Copyist.

J.

5 Col'd Cav.

Mass.

Alfred Ferraro

Prvt., Co. E, 5 Reg't Mass. Col'd Cavalry.

Appears on

Company Muster Roll

for *Nov. Dec.*, 186*4*.

Present or absent *Present*

Stoppage, \$ *100* for

Due Gov't, \$ *100* for

Valuation of horse, \$ *100*

Valuation of horse equipments, \$ *100*

Remarks:

Book mark:

O. J. Keenan

(358)

Copyist.

F

5 Col'd Cav.

Mass.

Moses Ferrar

Prof, Co. E, 5 Reg't Mass. Col'd Cavalry.

Appears on

Company Muster Roll

for *Jan. & Feb.*, 1865.

Present or absent *Present*

Stoppage, \$ *100* for

Due Gov't, \$ *100* for

Valuation of horse, \$ *100*

Valuation of horse equipments, \$ *100*

Remarks: *Stop one curry comb and brush .87 ct*

Book mark:

M. Clark

(358)

Copyist.

F

5 Col'd Cav.

Mass.

Moses Ferrar

Priv., Co. E, 5 Reg't Mass. Col'd Cavalry.

Appears on

Company Muster Roll

for *Jan. & Feb.*, 1865.

Present or absent *Present*

Stoppage, \$ *100* for

Due Gov't, \$ *100* for

Valuation of horse, \$ *100*

Valuation of horse equipments, \$ *100*

Remarks: *Stop one curry
comb and brush
.87 ct*

Book mark:

M. Clark

F

5 Col'd Cav.

Mass.

Moses Ferrar

Cot, Co. E, 5 Reg't Mass. Col'd Cavalry.

Appears on

Company Muster Roll

for March & Apr., 1865.

Present or absent Absent

Stoppage, \$ 100 for

Due Gov't, \$ 87/100 for Ord. lost

Valuation of horse, \$ 100

Valuation of horse equipments, \$ 100

Remarks: Sick in hospital
Petersburgh Va.

Book mark:

O. S. Clark

(358)

Copyist.

T 15 Cav. (Col.) Mass

Moses Therarer

Pvt., Co. E, 5 Reg't Mass. Cav.

Appears on

Hospital Muster Roll

of U. S. A. General Hospital,

at Fort Monroe, Va.,

for May & June, 1865.

Attached to hospital :

When _____, 186 .

How employed _____

Last paid by Maj. _____

to _____, 186 .

Bounty paid \$ 100; due \$ 100

Present or absent present

Remarks : No Descriptive List.

Contraband Sec.

Book mark : _____

Woody

(343)

Copyist.

F

5 Col'd Cav.

Mass.

Moses Ferrar

Co. E, Co. E, 5 Reg't Mass. Col'd Cavalry.

Appears on

Company Muster Roll

for *May June*, 1865.

Present or absent *Absent*

Stoppage, \$ *100* for

Due Gov't, \$ *100* for

Valuation of horse, \$ *100*

Valuation of horse equipments, \$ *100*

Remarks: *Sick in Hospital
Fortress Monroe, Va. since
May 22.*

Book mark:

Ferrar

(358)

Copyist.

F 15th May (old) Mass.
Moses Tanner
Det., Co. E., 5th Reg't Mass. C. C.

Appears on

Hospital Muster Roll

of U. S. A. General Hospital,

at Fort Monroe, Va.,

for July 7 Aug., 1865

Attached to hospital :

When, 186 .

How employed

Last paid by Maj.

to, 186 .

Bounty paid \$ 100 ; due \$ 100

Present or absent Present

Remarks :

Book mark :

(343)

J. White

Copyist.

F

5 Col'd Cav.

Mass.

Moses Ferrar

Priv., Co. E, 5 Reg't Mass. Col'd Cavalry.

Appears on

Company Muster Roll

for July & Aug, 1865.

Present or absent. Absent

Stoppage, \$ 100 for

Due Gov't, \$ 100 for ⁸⁷ ~~100~~ for *advance last*

Valuation of horse, \$ 100

Valuation of horse equipments, \$ 100

Remarks: Sick in Hospital
Fort Monroe, Va. May 22/65

Book mark:

Lorony

(358)

Copyist.

7

5 Col'd Cav.

Mass.

Moses Farrar

Pat., Co. E., 5 Reg't Mass. Col'd Cavalry.

Appears on a

Detachment Muster-out Roll

of the organization named above. Roll dated

Boston, Mass., Oct. 31, 1865.

Muster-out to date Oct. 31, 1865.

Last paid to Dec. 31, 1864.

Clothing account:

Last settled....., 186 ; drawn since \$..... 100

Due soldier \$..... 100; due U. S. \$..... 100

Am't for cloth'g in kind or money adv'd \$..... 100

Due U. S. for arms, equipments, &c., \$..... 100

Bounty paid \$..... 100; due \$..... 100

Remarks: Substitute No

Bounty paid; drew
2 months pay for May
& June 1865; at Fortess
Mourou. Due U. S.
for clothing overdrawn
(over)

Book mark:

R. Washington

(349)

Copyist.

JAN. - 9

5373013

★ 1891 ★

\$ 11.06. Absent sick in
Hospital when Regiment
was mustered out.

Discharged by S. O.
No. 29 Dept. of Texas
Galveston Texas Sept.
16 1865 - mustering the
Regt out of U. S. Service.

F | 5 Col'd Cav. | Mass.

Moses Ferrar

Pl., Co. E, 5 Reg't Mass. Colored Cav.

Appears on Returns as follows:

June 1864 - June 3, '64, City Point
Va. Recruit rec'd from Depot.

July 1864 - Co. Cook.

April 1865 - Absent sick in
Hosptl. Petersburg, Va.

May 1865 - Absent sick in Hosptl
Alexandria, Va.

June 1865 - Absent sick, at
Hampton Genl. Hosptl.

July to Sept. 1865 - Absent sick
at Hosptl, Fort Monroe, Va.

Book mark:

O. J. Taylor.

(546)

Copyist.

J

5 Col'd Cav.

Mass.

Moses Ferrar

Det., Co. *E*, 5 Reg't Mass. Col'd Cavalry.

Appears on **Co. Muster-out Roll**, dated

Clarksville, Tex., Oct 21, 1865.

Muster-out to date _____, 186 .

Last paid to _____, 186 .

Clothing account:

Last settled _____, 186 ; drawn since \$ _____ 100

Due soldier \$ *26²³* 100; due U. S. \$ _____ 100

Am't for cloth'g in kind or money adv'd \$ _____ 100

Due U. S. for arms, equipments, &c., \$ _____ 100

Bounty paid \$ _____ 100; due \$ *100⁰⁰*

Remarks: *Sick in hospital*

*at Fortress Monroe since
May 22/65.*

*No presentiluce Substitute
in discharge furnished.*

Book mark: *M. C. Roll on file*

Lowry

(861)

Copyist.

F

5 Col'd Cav.

Mass.

Moses Ferris

Pol. Co. B, 5 Reg't Mass. Col'd Cavalry.

Appears on a

List of Discharges furnished by C. M. O. of State,
under the provisions of circular dated A. G. O.,
June 29, 1865.

Discharge furnished , 186 ,

to date from , 186 .

Remarks:

*Discharged by
G. O. No 29 Dept of
Texas dated
Sept 10/65*

Book Mark:

E. Howard

(360)

Copyist.

Ferrar, Moses

P, Co. E,

5

Mass. C. Cav.

Reg't

3

Enclosures.

See Ferrar

Bed Cards

Descriptive Lists

Burial Records

Final Statements

Certs. of Dis. for Discharge

Furloughs

C. M. Charges

Med. Des. Lists

Med. Certificates

Orders

Other papers relating to—

Admission to Hosp'l

Furlough

Casualty Sheet (Officer's) /

Med. Examination

Confinement

Misc. Information

Contracts

Pay or Clothing

Death or Effects

Personal Reports

Desertions

Rank

Discharge from Hosp'l

Transfer to Hosp'l

Discharge from Service

Transfer to V. R. C.

Duty

Transportation

EO E

5 Mass. Cav.

No. 11

Wade Parker

Enlisted at Washington DC

As Substitute for

Marshall Bergis

On the 6 day of June, 1864.

By

J. C. Putnam

F. H. Blackford

John R. Keasby

Board of Enrollment,

Dist. of Columbia

April 1895. This paper was formerly
filed in the Enrollment B. & P. O.

SUBSTITUTE

VOLUNTEER ENLISTMENT.

Dist. of
STATE OF

incorporated to
TOWN OF

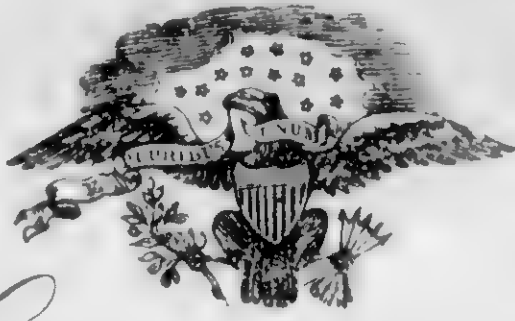

Columbia

Sumner Mass

I, *Moses Farmer* born in the State
of *Virginia*, aged *44* years, and by
occupation a *Leatherer*

DO HEREBY ACKNOWLEDGE to have agreed with,

Marshall Briggs, Esq., of *2^d Cong dist of*
Mass, Town of Sumner

to become his **SUBSTITUTE** in the Military Service, for a sufficient consideration paid and
delivered to me, on the *1st* day of *June*, 1864;

and having thus agreed with said *Marshall Briggs*, I DO HEREBY
ACKNOWLEDGE to have enlisted this *1st* day of *June*,

1864, to serve as a **Soldier** in the **Army of the United States of America**, for the period
of **THREE YEARS**, unless sooner discharged by proper authority: I do also agree to accept such
bounty, pay, rations, and clothing, as are, or may be, established by law for soldiers. And I do
solemnly swear that I will bear true and faithful allegiance to the **United States of America**;
that I will serve them honestly and faithfully against all their enemies or opposers whomsoever;
and that I will observe and obey the orders of the President of the United States, and the orders
of the Officers appointed over me, according to the Rules and Articles of War.

SWORN and subscribed to, at *Washington*

this *1st* day of *June*, 1864

Moses his
Farmer
mark

BEFORE *J. P. Putnam*
Captain Actg. Provost Marshal

5th Mass Colored Cavalry

We certify, on honor, That we have carefully examined the above-named Volunteer Substitute
agreeably to the Regulations, and that, in our opinion, he is free from all bodily defects and mental infirmity
which would in any way disqualify him from performing the duties of a soldier; that he was entirely sober
when enlisted; that he is of lawful age, (not under 18 years;) and that, in accepting him as duly qualified to
perform the duties of an able-bodied soldier, and as a Substitute in lieu of *Marshall Briggs*
of *Sumner Mass*, drafted in *2^d Cong dist State of Mass*
Town of Sumner, 1864, we have strictly observed the Regulations which govern
in such cases. This soldier has *Blue* eyes, *Blk* hair, *Blk* complexion; is *5* feet *7*
inches high.

J. P. Putnam
Captain Actg. Provost Marshal. *oe*

Francis W. Blackford
Commissioner of Board.

J. B. Keane
Surgeon of Board.

Board of Enrollment of _____ Dist. of *Columbia*

DECLARATION OF SUBSTITUTE.

I, Moses T. Farmer desiring to ENLIST
in the **Army of the United States**, for **THREE YEARS**, **Do declare**, That I am
44 years and — months of age; that I have
never been discharged from the United States service on account of disability or by sentence of
a court martial; and I know of no impediment to my serving honestly and faithfully as a soldier
for three years.

GIVEN at Washington DC
the 1st day of June 1864

WITNESS:

Lois Ball

Moses T. Farmer
his
mark

2
1864

No. 13

Moses Turner

Enlisted at Washington DC

As Substitute for

Marshall Baggis

On the 6th day of June, 1864

5th Mass^B Co. Cav.

J. C. Putnam

F. W. Blackford

John Strabury

Board of Enrollment,

Dist. of Columbia

SUBSTITUTE

VOLUNTEER ENLISTMENT.

Draft
STATE OF

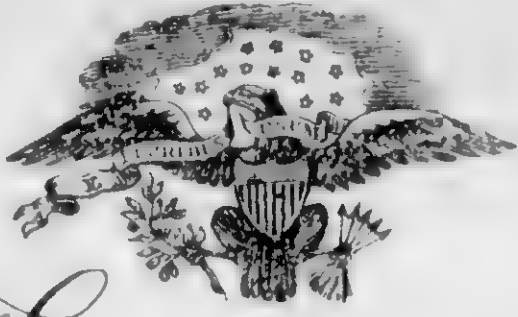

Accredited to
TOWN OF

Columbia

Town of Mass.

I, *Moses F. Pinner* born in the State
of *Virginia*, aged *44* years, and by
occupation a *Bookkeeper*
Montpelier, Virginia, Esq., of *2^d Dist. of Mass*
Town of Columbia

to become his **SUBSTITUTE** in the Military Service, for a sufficient consideration paid and delivered to me, on the *14th* day of *June*, 1864, and having thus agreed with said *Montpelier, Virginia*, I DO HEREBY ACKNOWLEDGE to have enlisted this *14th* day of *June* 1864, to serve as a **Soldier** in the **Army of the United States of America**, for the period of **THREE YEARS**, unless sooner discharged by proper authority: I do also agree to accept such bounty, pay, rations, and clothing, as are, or may be, established by law for soldiers. And I do solemnly swear that I will bear true and faithful allegiance to the **United States of America**; that I will serve them honestly and faithfully against all their enemies or opposers whomsoever; and that I will observe and obey the orders of the President of the United States, and the orders of the Officers appointed over me, according to the Rules and Articles of War.

SWORN and subscribed to, at *Washington*
this *14th* day of *June* 1864 *Moses F. Pinner*
BEFORE *J. P. Putnam* *his*
Contracting Provost Marshal *sworn*

5th Mass Colored Cavalry

We certify, on honor, That we have carefully examined the above-named Volunteer Substitute agreeably to the Regulations, and that, in our opinion, he is free from all bodily defects and mental infirmity which would in any way disqualify him from performing the duties of a soldier; that he was entirely sober when enlisted; that he is of lawful age, (not under 18 years;) and that, in accepting him as duly qualified to perform the duties of an able-bodied soldier, and as a Substitute in lieu of *Montpelier, Virginia* of *Town of Columbia, Mass.* drafted in *2^d Cong. Dist. State of Mass* *Town of Columbia*, 1864, we have strictly observed the Regulations which govern in such cases. This soldier has *Blue* eyes, *Black* hair, *Black* complexion; is *5* feet *7* inches high.

J. P. Putnam
Contracting Provost Marshal. *dc*
Francis W. Blackford
Commissioner of Board.
J. P. Hearsey
Surgeon of Board.

Board of Enrollment of *—* Dist. of *Columbia*

DECLARATION OF SUBSTITUTE.

I, Moses Hammer desiring to ENLIST
in the **Army of the United States**, for **THREE YEARS**, **Do declare**, That I am
27 years and _____ months of age; that I have
never been discharged from the United States service on account of disability or by sentence of
a court martial; and I know of no impediment to my serving honestly and faithfully as a soldier
for three years.

GIVEN at Washington - DC
the 1st day of June

WITNESS:

A. B. Bae

Moses Hammer
his
mark

CASUALTY SHEET

No.

Moses Fryer
Pvt. of Company *E*
5 Regiment of *Mass. Cav.*
State Volunteers (*Col'd.*)

NATURE OF CASUALTY.

Discharge
Nov. 20/65.



CASUALTY SHEET.

Name: *Amos Hoyer*

Rank: *Private* Company: *E* Regiment: *5*

Arm: *Co.* State: *Ind.*

Nature of Casualty: *Exchange*

CAUSE OF CASUALTY—(NAME OF DISEASE, &c.)

BY WHOM DISCHARGED.

FROM WHAT SOURCE THIS INFORMATION WAS OBTAINED.

DEGREE OF DISABILITY.

*Roll 11, Dr. Record.
Roll 1st.*

BY WHOM CERTIFIED.

REMARKS.

DATE OF DISCHARGE, DEATH, &c.

Nov. 20/65

PLACE OF DISCHARGE, DEATH, &c.

Gallup's Army Camp

[Signature]
Clerk.

677

Harrell George

Co F, 5 Mass. Cav., (Col'd.)

Private Private

CARD NUMBERS.

1	5372209	26
2	5372156	27
3	5379594	28
4	5379754	29
5	5380266	30
6	9092060	31
7	34505222	32
8	40730924	33
9		34
10		35
11		36
12		37
12		38
14		39
15		40
16		41
17		42
18		43
19		44
20		45
21		46
22		47
23		48
24		49
25		50

Book Mark:

See also

F

5 Cav. (Col'd.)

Mass.

George Farrell

F, Co. *F*, 5 Reg't Mass. Cav. (Col'd.)

Appears on

Company Descriptive Book

of the organization named above.

DESCRIPTION.

Age *21* years; height *5* feet *5 1/2* inches.

Complexion *dark*

Eyes *blk*; hair *blk*

Where born *Charles Co. Maryland.*

Occupation *Laborer.*

ENLISTMENT.

When *June 8*, 1864.

Where *Spencer.*

By whom *D. Hill.*; term *3* y'rs.

Remarks: *Died in Genl Hospital
Point Lookout Md.
July 29. 1864 at 4 P. M.
of Chronic Diarrhoea.*

Hearst

F

5 Cav. (Col'd.) | Mass.

George Farrell

....., Co. *F*, 5 Reg't Mass. Cav. (Col'd.)

Appears on

Company Descriptive Book

of the organization named above.

DESCRIPTION.

Age *21* years; height *5* feet *5½* inches.

Complexion *dark*

Eyes *blk*; hair *blk*

Where born *Charles Co. Maryland.*

Occupation *Laborer.*

ENLISTMENT.

When *June 8*, 1864.

Where *Spencer.*

By whom *D. Hill.*; term *3* y'rs.

Remarks: *Died in Genl Hosp'tl
Point Lookout Md.
July 29. 1864 at 4 P.M.
of Chronic Diarrhoea.*

Hearst

F | 5 Cav. Mass.
George Farrell

Appears with rank of _____ on _____

Muster and Descriptive Roll

of a detachment of U. S. Volunteers forwarded from Faneuil Hall, Boston, to Galloup's Island, Boston Harbor, for various regiments Massachusetts Volunteers. Roll dated

Boston, Mass. June 8, 1864

Where born Charles Co. Md.

Age 21 years; occupation Laborer

When enlisted June 8, 1864

Where enlisted Spencer

For what period enlisted 3 years.

Eyes black hair black

Complexion dark height 5 ft. 5 1/2 in.

When mustered in June 8, 1864

Where mustered in Boston

Bounty paid \$ 100; due \$ 100

Clothing account:

Last settled _____, 1864; drawn since \$ 100

Date of first muster _____, 1864

Regiment to which assigned 5 Cav.

Remarks:

8 Cong. Dist Spencer, Worcester Co.

Book mark: _____

Austin

F

5 Col'd Cav.

Mass.

George Farrell
Pri

Appears with rank of on

Muster and Descriptive Roll of a Detachment of U. S. Vols. forwarded

for the 5 Reg't Mass. Col'd Cavalry. Roll dated

Boston Mass June 6-11, 1864.

Where born Charles Co Md

Age 21 y'rs; occupation Laborer

When enlisted June 8, 1864.

Where enlisted Spencer

For what period enlisted 3 years.

Eyes Black, hair Black

Complexion Dark; height 5 ft. 5 1/2 in.

When mustered in June 8, 1864.

Where mustered in Boston

Bounty paid \$ 100; due \$ 100

Where credited 8 Dist Spencer

Company to which assigned Worcester Co

Remarks :

Book mark :

Donnelly

(339)

Copyist.

2
57

5 Col'd Cav.

Mass.

George F. Wall

Appears with rank of Private on

Muster and Descriptive Roll of a Detachment of U. S. Vols. forwarded

for the 5 Reg't Mass. Col'd Cavalry. Roll dated

September 23, 1864.

Where born Cheshire Co. N.H.

Age 21 y'rs; occupation Labourer

When enlisted June 8, 1864.

Where enlisted Lowell Mass.

For what period enlisted 3 years.

Eyes Blue; hair Blue

Complexion Blue; height 5 ft. 5 1/2 in.

When mustered in June 8, 1864.

Where mustered in Boston

Bounty paid \$ 100; due \$ 100

Where credited Eng. Dist. Sherman Thayer Co.

Company to which assigned

Remarks:

Book mark:

F. Wall

5 Col'd Cav.

Mass.

George ...

..., Co. F, 5 Reg't Mass. Col'd Cavalry.

Appears on

Company Muster Roll

for *May & June*, 186*1*.

Present or absent *Present*

Stoppage, \$ *100* for

Due Gov't, \$ *100* for

Valuation of horse, \$ *100*

Valuation of horse equipments, \$ *100*

Remarks:

Book mark:

George ...

F

5 Col'd Cav.

Mass.

George Farrell
Pt (Co. F, 5 Reg't Mass. Col'd Cavalry.

Appears on

Company Muster Roll

for July & Aug, 1864.

Present or absent

Stoppage, \$ 100 for

Due Gov't, \$ 100 for

Valuation of horse, \$ 100

Valuation of horse equipments, \$ 100

Remarks: Died in G. Hospl
Point Fortout July 29/64
of Chronic diarrhoea

Book mark:

J. H. Stewart

(358)

Copyist.

G | **5 Col'd Cav.** | **Mass.**

George Farrell

Pr, Co. *F*, 5 Reg't Mass. Colored Cav.

Appears on **Returns** as follows:

June 1864. June 20, '64.
Point of Rocks, Va.
Recruit from depot.
July 1864. Died July 19,
1864, Point Lookout
Md. of chronic di-
arrhoea in General
Hospital.

Book mark:

O. J. Taylor

(546)

Copyist.

F

5 Col'd Cav.

Mass.

George Farrel
Co. F, 5 Reg't Mass. Col'd Cavalry.

Appears on **Co. Muster-out Roll**, dated

Charterville Tex, Oct 31, 1865

Muster-out to date 186 .

Last paid to 186 .

Clothing account:

Last settled 186 ; drawn since \$ 100

Due soldier \$ 100; due U. S. \$ 100

Am't for cloth'g in kind or money adv'd \$ 100

Due U. S. for arms, equipments, &c., \$ 100

Bounty paid \$ 100; due \$ 100

Remarks: *Went in Genl Hoop*
Point to allow Md.
July 29/64 of Chronia
de a ...

Book mark: *163. T. 210/69. V. 102. P. 35/69*

J. J. Johnson

9-1
P. V 32
JA

5380466
P. 195, 76

★ 1681 ★

F S. V107. P. 67.70

Farrell, Geo.

P, Co. F.,

5

Mass. C. Cav.
Reg't

~~4~~

Enclosures.

Bed Cards
Burial Records
Certs. of Dis. for Discharge
C. M. Charges
Med. Certificates

Descriptive Lists
Final Statements 2
Furloughs
Med. Des. Lists
Orders

Other papers relating to—

Admission to Hosp'l
Casualty Sheet (Officer's)
Confinement
Contracts
Death or Effects
Desertions
Discharge from Hosp'l
Discharge from Service
Duty

Furlough
Med. Examination
Misc. Information
Pay or Clothing
Personal Reports
Rank
Transfer to Hosp'l
Transfer to V. R. C.
Transportation

C. P.

2

NOTE 1.—This blank will be used for both enlistments and re-enlistments—enlistment of veterans, &c., &c., in the volunteer service. They will be made out in duplicate in all cases—one to accompany the recruiting return of the superintendent (not the recruiting officer) to the Adjutant General, and one to accompany the accounts of the officer who pays bounty, &c. The Regiment and Company in which the soldier last served should be given on the back.

NOTE 2.—An enlistment holds to service. A muster-in must, in all cases, precede payment of pay, bounty, pension, &c. A muster-in roll must, in all cases, be filed in the Adjutant General's Office as evidence of muster-in. The mustering officer, commissary, or assistant commissary of musters, as the case may be, will countersign both enlistments as having mustered the soldier into the service of the United States before either of them is given to the disbursing officer.

DECLARATION OF RECRUIT.

I, George Farrell desiring to VOLUNTEER as a Soldier in the Army of the United States, for the term of THREE YEARS, Do Declare, That I am twenty one years and _____ months of age; that I have never been discharged from the United States service on account of disability or by sentence of a court martial, or by order before the expiration of a term of enlistment; and I know of no impediment to my serving honestly and faithfully as a soldier for three years.

GIVEN at Boston the 8th day of June 1864

Witness: Jonathan Hill George + Farrell
make

No. _____

George Farrell
Volunteered at Sharon Mass
25 June 1864,
By Jonathan Hill per
5th Regiment of Mass Cavalry
_____ enlistment; last served in Company ()
Regt of _____
Discharged _____ 18 .

CONSENT IN CASE OF MINOR.

I, _____ Do CERTIFY, That I am the _____ of _____; that the said _____ is _____ years of age; and I do hereby freely give my CONSENT to his volunteering as a SOLDIER in the ARMY OF THE UNITED STATES for the period of THREE YEARS.

GIVEN at _____ the _____ day of _____

Witness: _____

VOLUNTEER ENLISTMENT.

STATE OF

Massachusetts

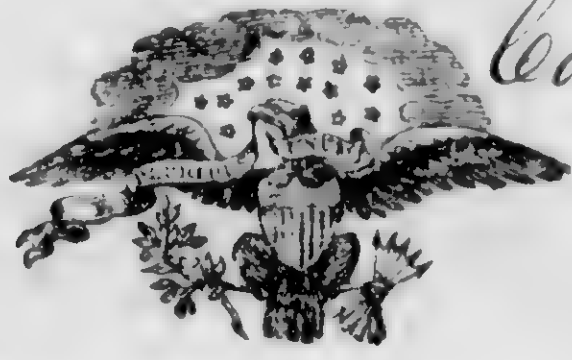

County of Worcester 8th Cong Dist
TOWN OF

Spencer

I, George Farrell born in Charles Co
in the State of Maryland aged Twenty one years,
and by occupation a Sailor Do HEREBY ACKNOWLEDGE to have
volunteered this Eight day of June 1864
to serve as a **Soldier** in the **Army of the United States of America**, for
the period of **THREE YEARS**, unless sooner discharged by proper authority:
Do also agree to accept such bounty, pay, rations, and clothing, as are, or may be,
established by law for volunteers. And I, George Farrell do
solemnly swear, that I will bear true faith and allegiance to the **United States
of America**, and that I will serve them honestly and faithfully against all
their enemies or opposers whomsoever; and that I will observe and obey the
orders of the President of the United States, and the orders of the officers
appointed over me, according to the Rules and Articles of War.

Sworn and subscribed to, at Spencer Mass
this 8 day of June 1864 } George + Farrell
BEFORE W. Norton } his
Mr. Norton } mark

I CERTIFY, ON HONOR, That I have carefully examined the above-named Volunteer, agreeably
to the General Regulations of the Army, and that, in my opinion, he is free from all bodily defects and
mental infirmity, which would in any way disqualify him from performing the duties of a soldier.

W. Norton
Witness Luther Hill
EXAMINING SURGEON.

I CERTIFY, ON HONOR, That I have minutely inspected the Volunteer, George Farrell
previously to his enlistment, and that he was entirely sober when enlisted; that, to the best of my
judgment and belief, he is of lawful age; and that, in accepting him as duly qualified to perform the
duties of an able-bodied soldier, I have strictly observed the Regulations which govern the recruiting
service. This soldier has Black eyes, Black hair, Black complexion, is Five
feet five 1/2 inches high.

Luther Hill Chm Select
Regiment of _____ Volunteers,
RECRUITING OFFICER.

(A. G. O. No. 74 & 76.)

5-72
Mustered into the service of the United States, for three years or during the war, from date of enlistment, in Company _____
Regiment of Mass Cavalry Volunteers, on the 8 day of June, 1864 at Spencer Mass
(Norton)
W. Norton
W. Norton
W. Norton

NOTE 1.—This blank will be used for both enlistments and re-enlistments—enlistment of veterans, &c., &c., in the volunteer service. They will be made out in duplicate in all cases—one to accompany the recruiting return of the superintendent (not the recruiting officer) to the Adjutant General, and one to accompany the accounts of the officer who pays bounty, &c. The Regiment and Company in which the soldier last served should be given on the back.

NOTE 2.—An enlistment holds to service. A muster-in must, in all cases, precede payment of pay, bounty, pension, &c. A muster-in roll must, in all cases, be filed in the Adjutant General's Office as evidence of muster-in. The mustering officer, commissary, or assistant commissary of musters, as the case may be, will countersign both enlistments as having mustered the soldier into the service of the United States before either of them is given to the disbursing officer.

THIS PAPER WAS FORMERLY
 IN THE POSSESSION OF THE
 ENLISTMENT DIV. R. & P. O.

DECLARATION OF RECRUIT.

I, George Farwell desiring
 to VOLUNTEER as a Soldier in the Army of the United States, for the term of THREE YEARS,
 Do Declare, That I am twenty one years and _____ months
 of age; that I have never been discharged from the United States service on account of disability or
 by sentence of a court martial, or by order before the expiration of a term of enlistment; and I know
 of no impediment to my serving honestly and faithfully as a soldier for three years.

GIVEN at Boston
 the 8th day of June 1864

Witness: Lotter Hill George + Farwell
 mark

No. 5th Mass. Cav.
Call
George Farwell
 Volunteered at General Hall
8th June 1864,
 By Lotter Hill
3rd Regiment of Mass. Cav.
5th Mass. Cav.
 _____ enlistment; last served in Company ()
 _____ Regt of _____
 Discharged _____ 18 _____

CONSENT IN CASE OF MINOR.

I, _____ Do CERTIFY, That I am
 the _____ of _____; that the
 said _____ is _____ years of age; and I
 do hereby freely give my CONSENT to his volunteering as a SOLDIER in the ARMY OF THE UNITED
 STATES for the period of THREE YEARS.

GIVEN at _____
 the _____ day of _____

Witness: _____

VOLUNTEER ENLISTMENT.

STATE OF

Massachusetts



County of Worcester 8th Cong District
TOWN OF

Sunder

I, *George Farrell* born in *Charles County*
in the State of *Maryland* aged *Twenty one* years,
and by occupation a *Seaman* Do HEREBY ACKNOWLEDGE to have
volunteered this *Eighth* day of *May June* 1864,
to serve as a **Soldier** in the **Army of the United States of America**, for
the period of **THREE YEARS**, unless sooner discharged by proper authority:
Do also agree to accept such bounty, pay, rations, and clothing, as are, or may be,
established by law for volunteers. And I, *George Farrell* do
solemnly swear, that I will bear true faith and allegiance to the **United States**
of America, and that I will serve them honestly and faithfully against all
their enemies or opposers whomsoever; and that I will observe and obey the
orders of the President of the United States, and the orders of the officers
appointed over me, according to the Rules and Articles of War.

Sworn and subscribed to, at *Boston Mass*
this *9th* day of *June* 1864 } *George Farrell*
BEFORE *Worshipful* } *mark*

W

Witness Luther Hill

I CERTIFY, ON HONOR, That I have carefully examined the above-named Volunteer, agreeably
to the General Regulations of the Army, and that, in my opinion, he is free from all bodily defects and
mental infirmity, which would in any way disqualify him from performing the duties of a soldier.

D. F. Harlow
W

EXAMINING SURGEON.

I CERTIFY, ON HONOR, That I have minutely inspected the Volunteer, *George Farrell*
previously to his enlistment, and that he was entirely sober when enlisted; that, to the best of my
judgment and belief, he is of lawful age; and that, in accepting him as duly qualified to perform the
duties of an able-bodied soldier, I have strictly observed the Regulations which govern the recruiting
service. This soldier has *black* eyes, *black* hair, *Dark* complexion, is *Five*
feet *Five 1/2* inches high.

Luther Hill *Chm*

Regiment of _____ Volunteers,
RECRUITING OFFICER.

(A. G. O. No. 74 & 76.)

Mustered into the service of the United States, for three years or during the war, from date of enlistment, in Company
5th Regiment of *Mass Cavalry* Volunteers, on the *8th* day of *June*, 1864 at *Boston Mass*
(Colwell)
Worshipful
Capital
W
Select

U.S. Army July 5 1864
 W. J. S. Mendenhall
 P. O. of Adams & Co. 700
 New York 30
 1000 Street

FINAL STATEMENT

OF

George Farrell

5th Reg't of Mass Cavalry

VOLUNTEERS.

Disch. July 29 1864

NOTE 1.—Two of these certificates (or duplicates) are to be given to each Volunteer Soldier or drafted man who may be discharged previously to the discharge of his company, that he may at once receive from the Paymaster the pay, &c., due him, and the captain or other COMMISSIONED officer commanding the company will certify to the act of the delivery of the duplicate certificates; on these certificates the Soldier is "entitled to" his discharge, and should also present his discharge to the Paymaster to have the payment endorsed on it. The discharge is to be given back to the Soldier by the Paymaster; the latter only retaining as his voucher the duplicate certificates.

NOTE 2.—If the Soldier is entitled to pay for the use of his horse, the Company Commander will certify to that fact on the back of both these final statements, and also to the time he has pay due for having been so mounted on his own horse.

NOTE 3.—When a Soldier is furnished with final statements, his descriptive list, if he has one, should be taken up by the officer who gives the Soldier these statements, and endorsed with a statement to this effect by the officer. This endorsement should exhibit a full statement of the time for which the Soldier was allowed pay on his final statements, the clothing account, and all other charges against him or in his favor, so as to comprise a complete exhibit of his account. It will then be transmitted to the company commander of the Soldier, who will enter all the data necessary to a full understanding of the Soldier's account on the muster roll upon which the Soldier's discharge is reported. The descriptive list will then be destroyed. The object of this is, that the remaining portion of the Soldier's account may be settled upon the receipt of these muster rolls, and the Soldier receive any pay or allowances that may be due him at the time of his discharge, and which may not appear on his final statements from the fact that his descriptive list is incomplete. These accounts for back pay, &c., are settled by the 2d Auditor of the Treasury Department.

NOTE 4.—Charges for loss or injury to ordnance, horse equipments, and other miscellaneous charges, should appear under the heading of "Other Stoppages."

NOTE 5.—Bounty paid by State authorities, and not by the United States, will not be entered on this statement.

NOTE 6.—Amounts due the Sutler and Laundress must be entered on the muster roll on which the discharge, death, desertion, &c., is reported, as well as on the final statement, otherwise the amount cannot be collected from the United States.

NOTE 7.—This blank will be used for deceased volunteers and drafted men, as well as for others.

NOTE 8.—Where a Soldier dies in Hospital or on detached service, his descriptive list, if he has one, should be sent with his final statements, in duplicate, to the Adjutant General, Washington, D. C.

ADJUTANT GENERAL'S OFFICE.

July 17 1864

Duplicates with Inventory sent 2d Auditor.

I certify, on honor, that George Farrell a private of
 Captain C. P. Bonditete's Company (F) of the Fifth Regiment of Cavalry
VOLUNTEERS, of the State of Massachusetts, born in Charles Co., State
 of Maryland, aged 21 years; 5 feet 5½ inches high; dark complexion,
black eyes, black hair, and by occupation a laborer, having joined the company on
 its original organization at _____, and enrolled in it at the muster into
 the service of the United States at _____, on the _____ day
 of _____, 1864, (or was mustered in service as a recruit, by Capt. W. D.
Norton, at Boston Mass., on the eight day of June,
 1864, or was drafted and mustered into the service of the United States from the _____
 Enrollment District of the State of _____, at _____,
 on the _____ day of _____, 1864,) to serve in the Regiment, for
 the term of three years unless sooner discharged: and having served **HONESTLY** and
FAITHFULLY with his Company in the field & in camp to the present date, is now
 entitled to a **DISCHARGE** by reason of death. Died in General hos-
pital Point Lookout Md. July 29th 1864 of chronic diarrhoea.

The said George Farrell was last paid by Paymaster
 _____ to include the _____ day of _____, 1864, and has
 pay due him from the date of his enlistment June 8th 1864 to the present date; he is entitled to pay and subsistence for
TRAVELING to place of enrollment, and whatever other allowances are authorized to volunteer
 soldiers, drafted men, or militia, so discharged. He has received from the United States **CLOTHING**
 amounting to Twenty $\frac{x}{100}$ dollars, since the 30th day of June,
 1864, when his clothing account was last settled. He has received from the United States
 _____ $\frac{x}{100}$ dollars advanced **BOUNTY**.

There is to be stopped from him, on account of the State of _____, or other
 authorities, for **CLOTHING**, &c., received on entering service, twenty-two $\frac{28}{100}$ dollars; and
 for other stoppages, viz: _____

_____ dollars.
 He has been furnished with **TRANSPORTATION** in kind from the place of his discharge to
 _____; and he has been **SUBSISTED** for **TRAVELING** to his
 place of enrollment, up to the _____, 1864.

He is indebted to _____, **SUTLER**, _____ dollars.

He is indebted to _____, **LAUNDRESS**, _____ dollars.

No inventory of effects has been recd.

Given in Duplicate, at Point Lookout Md., this 31st day
 of July, 1864.

Charles P. Bonditete

Captain

Commanding Company.

FINAL STATEMENT.

743051 M2 (1055)

OF

Prof George Surrall
Co F 3 Reg't of Mass Col'd Cav

VOLUNTEERS.

NOTE 1.—Two of these certificates (or duplicates) are to be given to each Volunteer Soldier or drafted man who may be discharged without being mustered out (Final Statements are never given to men mustered out of service) that he may at once receive from the Paymaster the pay, &c., due to him, and the captain or other COMMISSIONED officer commanding the company will certify to the act of the delivery of the duplicate certificates; with these certificates the Soldier is "entitled to" his discharge, and should also present his discharge to the Paymaster to have the payment endorsed on it. The discharge is to be given back to the Soldier by the Paymaster; the latter only retaining as his vouchers the duplicate certificates.

NOTE 2.—If the Soldier is entitled to pay for the use of his horse, the Company Commander will certify to that fact on the back of both these final statements, and also to the time he has pay due for having been so mounted on his own horse.

NOTE 3.—When a Soldier is furnished with final statements, his descriptive list, if he has one, should be taken up by the officer who gives the Soldier these statements, and endorsed with a statement to this effect by the officer. The endorsement should exhibit a full statement of the time for which the Soldier was allowed pay on his final statements, the clothing account, and all other charges against him or in his favor, so as to comprise a complete exhibit of his account. It will then be transmitted to the Company Commander of the Soldier, who will enter all the data necessary to a full understanding of the Soldier's account on the muster roll upon which the Soldier's discharge is reported. The descriptive list will then be destroyed. The object of this is, that the remaining portion of the Soldier's account may be settled upon the receipt of these muster rolls, and the Soldier receive any pay or allowances that may be due him at the time of his discharge, and which may not appear on his last final statements from the fact that his descriptive list is incomplete. These accounts for back pay, &c., are settled by the 2d Auditor of the Treasury Department.

NOTE 4.—Charges for loss or injury to ordnance, horse equipments, and other miscellaneous charges, should appear under the heading of "Other Stoppages."

NOTE 5.—Bounty paid by State authorities, and not by the United States, will not be entered on this statement.

NOTE 6.—Amounts due the Sutler and Laundress must be entered on the muster roll on which the discharge, death, desertion, &c., is reported, as well as on the final statement, otherwise the amount cannot be collected from the United States.

NOTE 7.—This blank will be used for deceased volunteers and drafted men, as well as for others.

NOTE 8.—Where a Soldier dies in Hospital or on detached service, his descriptive list, if he has one, should be sent with his final statements, in duplicate, to the Adjutant General, Washington, D. C.

NOTE 9.—If the soldier is a drafted man or substitute, the space for time, &c., of enrolled, should contain only the word *drafted* or *substitute*, as the case may be. If the Soldier is a "VETERAN," (or RECRUIT,) the words *as a veteran*, (or *recruit*.) as the case may be, should be interlined after the words *mustered into the service of the U. S.* A statement of all the installments of *Veteran or Recruit Bounty RECEIVED* by the Soldier must be made on the back of each final statement.

Admitted to 2nd Land Hoop Co. 1st Regt. July 26, 1864. Died July 29, 1864.
Died July 29, 1864.
No record of holding of his Hoop Co. in this Office

I certify, on honor, that George Farrell, a Piratical of
Captain _____ Company H of the 3 Regiment of Mass. Col. Can
Volunteers, of the State of _____, born in _____ State
of _____, aged _____ years; _____ feet _____ inches high; _____ complexion,
_____ eyes, _____ hair, and by occupation a _____ who joined for service
and was enrolled (see Note 9) on the _____ day of _____, 186 _____, at _____
by _____, for the period of _____ years, and mustered into
the service of the United States on the _____ day of _____, 186 _____, at _____
by _____; and having served

HONESTLY and **FAITHFULLY** with his Company to the present date, is now entitled to a
DISCHARGE by reason of Death

The said Pat George Farrell was last paid by Paymaster
_____ to include the _____ day of _____, 186 _____, and
has pay due him from that time to the present date; he is entitled to pay and subsistence for
TRAVELING to place of enrollment, and whatever other allowances are authorized to volunteer
soldiers, drafted men, or militia, so discharged. He has received from the United States **CLOTHING**
amounting to _____ dollars, since the _____ day of _____,
186 _____, when his clothing account was last settled. He has received from the United States
_____ dollars advanced **BOUNTY**.

There is to be stopped from him, on account of the State of _____, or other
authorities, for **CLOTHING**, &c., received on entering service, _____ dollars; and
for other stoppages, viz: _____

No Descriptive List of this man on file in this office
_____ dollars.

He has been furnished with **TRANSPORTATION** in kind from the place of his discharge to
_____ ; and he has been **Subsisted** for **Traveling** to his
place of enrollment, up to the _____, 186 _____.

He is indebted to _____, **Sutler**, _____ dollars.

He is indebted to _____, **Laundress**, _____ dollars.

Given in Duplicate, at Med. Director's Office, this 29 day
of December 1865.
Washington D.C.

R. S. [Signature]
Pat. Co. Surgeon
Commanding Company.
Med. Director
Dept of Wash.

429

Foster, Charles

Co M, 5 Mass. Cav., (Col'd.)

Private

Private

CARD NUMBERS.

1	28
2	29
3	30
4	31
5	32
6	33
7	34
8	35
9	36
10	37
11	38
12	39
13	40
14	41
15	42
16	43
17	44
18	45
19	46
20	47
21	48
22	49
23	50
24	
25	

See Foster, Charles.

Book Mark:

See also

430

Fatal Charles C

Co G A, 5 Mass. Cav., (Col'd.)

Private Private

CARD NUMBERS.

1	5380505	26
2	5380648	27
3	5379470	28
4	5379557	29
5	5379655	30
6	5379764	31
7	5379902	32
8	5380011	33
9	5380160	34
10	5381539	35
11	5380468	36
12	9091920	37
13	9092051	38
14	40730925	39
15		40
16		41
17		42
18		43
19		44
20		45
21		46
22		47
23		48
24		49
25		50

Book Mark: EBV. 11 P. 476, 100. 709,

See also

F

5 Cav. (Col'd.) | Mass.

Charles C Fatah

....., Co. *G*....., 5 Reg't Mass. Cav. (Col'd.)

Appears on

Company Descriptive Book

of the organization named above.

DESCRIPTION.

Age *23* years; height *5* feet *10* inches.

Complexion *Blk*

Eyes *Blk* ; hair *Blk*

Where born *Boston Mass*

Occupation *Porter.*

ENLISTMENT.

When *Feb 24*, 186*4*.

Where *Cambridge*

By whom *J. Stevens* ; term *3* y'rs.

Remarks: *Transferred to Company*
F.

Hearst

F | **5 Cav. (Col'd.)** | **Mass.**

Charles C. Fatah

F, Co. *F*, 5 Reg't Mass. Cav. (Col'd.)

Appears on

Company Descriptive Book

of the organization named above.

DESCRIPTION.

Age *25* years; height *5* feet *10* inches.

Complexion *blk*

Eyes *blk*; hair *blk*

Where born *Boston Mass.*

Occupation *Porter.*

ENLISTMENT.

When *Feb 27*, 1864.

Where *Cambridge*

By whom *J. Stevens*; term *3* y'rs.

Remarks: *Transferred to Co.*

H. Levil order No. 13. Mch. 4, 1864,

Died at Reg'tl Hopt. Mch 14, 65,

Final Statement made Mch 16 65,

Hearn

D

5 Col'd Cav. | Mass.

Charles G. Fatale

B, Co. *G*, 5 Reg't Mass. Col'd Cav.

Appears on

Company Muster-in and Descriptive Roll

of the organization named above. Roll dated

Readville Mass March, 1864.

Where born *Boston Mass.*

Age *25* y'rs; occupation *Printer*

When enlisted *Oct 27*, 1864.

Where enlisted *Cambridge*

For what period enlisted *3* years.

Eyes *Blk*; hair *Blk*

Complexion *Blk*; height *5* ft *10* in.

When mustered in *March*, 1864.

Where mustered in *Readville Mass.*

Bounty paid \$ *2* ^{*00*}/_{*100*}; due \$ ^{*00*}/_{*100*}

Where credited *4th Dist Middlesex*

Company to which assigned

Remarks:

Book mark:

Leyer

Q1

5 Col'd Cav.

Mass.

Charles C. Fatale

Pvt, Co. G, 5 Reg't Mass. Col'd Cavalry.

Appears on

Company Muster Roll

for *Mar 4 to Apr 30*, 1864.

Present or absent

Stoppage, \$ 100 for

Due Gov't, \$ 100 for

Valuation of horse, \$ 100

Valuation of horse equipments, \$ 100

Remarks:

*Transferred to Co
H by Genl Regt Order No
13 dated Mar 4, 1864.*

Book mark:

Leger

(358)

Copyist.

5 Col'd Cav.

Mass.

Charles D. Butler

Co. F, Co. F, 5 Reg't Mass. Col'd Cavalry.

Appears on

Company Muster Roll

for *1861*, 186*1*.

Present or absent *Present*

Stoppage, \$ *100* for

Due Gov't, \$ *100* for

Valuation of horse, \$ *100*

Valuation of horse equipments, \$ *100*

Remarks: *Transferred from
Co. E, 5th Reg't Mass. Col'd Cavalry
Nov. 11, 1861, to Co. F, 5th Reg't
Mass. Col'd Cavalry*

Book mark:

W. J. Taylor

5 Col'd Cav.

Mass.

William C. Putnam

Wm. C., Co. F, 5 Reg't Mass. Col'd Cavalry.

Appears on

Company Muster Roll

for *May & June*, 186*4*.

Present or absent *Present*.

Stoppage, \$ *100* for

Due Gov't, \$ *100* for

Valuation of horse, \$ *100*

Valuation of horse equipments, \$ *100*

Remarks: *Transferred from Co. G, 5th Reg't Mass. Col'd Cavalry, 1864. Co. F, 5th Reg't Mass. Col'd Cavalry, 1864. Co. F, 5th Reg't Mass. Col'd Cavalry, 1864. Co. F, 5th Reg't Mass. Col'd Cavalry, 1864.*

Book mark:

Wm. C. Putnam

J

5 Col'd Cav.

Mass.

Charles C. Fatale

2nd Sgt, Co. F, 5 Reg't Mass. Col'd Cavalry.

Appears on

Company Muster Roll

for *July & Aug*, 1864.

Present or absent *Present*

Stoppage, \$ *100* for

Due Gov't, \$ *100* for

Valuation of horse, \$ *100*

Valuation of horse equipments, \$ *100*

Remarks: *Trans. from Co G,*
G.O. 13 app'd Mch
4/64 G.O. 13 Mch 4
64 2, M. S. for Co
F

Book mark:

M Stewart

(358)

Copyist.

F

5 Col'd Cav.

Mass.

Charles C. Fatal

Serjt, Co. F, 5 Reg't Mass. Col'd Cavalry.

Appears on

Company Muster Roll

for *Sept 10 Oct*, 1864.

Present or absent *Present*

Stoppage, \$ *100* for

Due Gov't, \$ *100* for

Valuation of horse, \$ *100*

Valuation of horse equipments, \$ *100*

Remarks:

Book mark:

J. H. Stewart

(358)

Copyist.

F

5 Col'd Cav.

Mass.

Charles C. Fatah

Pt, Co. F, 5 Reg't Mass. Col'd Cavalry.

Appears on

Company Muster Roll

for Nov & Dec, 1864.

Present or absent Present

Stoppage, \$ 100 for

Due Gov't, \$ 100 for

Valuation of horse, \$ 100

Valuation of horse equipments, \$ 100

Remarks: Reduced from Sergeant
D. O. 220 Dec
13, 1864

Book mark:

J. H. Stewart

(358)

Copyist.

J

5 Col'd Cav.

Mass.

Charles C. Fatal

Pt, Co. F, 5 Reg't Mass. Col'd Cavalry.

Appears on

Company Muster Roll

for *Jan & Feb*, 1865

Present or absent *Present*

Stoppage, \$ *100* for

Due Gov't, \$ *100* for

Valuation of horse, \$ *100*

Valuation of horse equipments, \$ *100*

Remarks: *Reduced from
sergt to ranks
Dec 13, 1864
due first four Inst
U. S. Bounty*

Book mark:

J. N. Stewart

(358)

Copyist.

JH | 5 Col'd Cav. | Mass.

Charles C. Fatale
Pt., Co. F, 5 Reg't Mass. Col'd Cavalry.

Appears on

Company Muster Roll

for *March & April, 1865.*

Present or absent.....

Stoppage, \$ 100 for.....

Due Gov't, \$ 100 for.....

Valuation of horse, \$ 100

Valuation of horse equipments, \$ 100

Remarks: *Died at U.S.
regtl Hospl
March 15th Point
Lookout Md.*

Book mark: *Died March 14/65 EPV III P. 476*

JH Stewart
(858) Copyist.

F | **5 Col'd Cav.** | **Mass.**

C. C. Fatah

Ort., Co. *F*, 5 Reg't Mass. Colored Cav.

Appears on **Returns** as follows:

*March: 1865. Mch. 15, Point
Lookout, Died at Reg't
Hospital.*

Book mark :

O. J. Taylor.

(546)

Copyist.

F | **5 Col'd Cav.** | **Mass.**

Charles Fatah

F, Co. *F*, 5 Reg't Mass. Col'd Cavalry.

Appears on **Co. Muster-out Roll**, dated
Warrenton Tex, Oct 31, 1865 .

Muster-out to date _____, 186 .

Last paid to *Aug 31*, 186 4 .

Clothing account:

Last settled _____, 186 ; drawn since \$ _____ 100

Due soldier \$ _____ 100 ; due U. S. \$ _____ 100

Am't for cloth'g in kind or money adv'd \$ _____ 100

Due U. S. for arms, equipments, &c., \$ _____ 100

Bounty paid \$ _____ 100 ; due \$ _____ 100

Remarks: *Died in Reg't
Hosp Point L... about
Mo. March 14/65 of
Consumption*

Book mark: *100709.*

J. J. Johnson
(361) Copied.

J | **5 Col'd Cav. | Mass.**

Charles C. Futral
Pr., Co. *J*, 5 Reg't Mass. Col'd Cavalry.

Appears on **Co. Muster-out Roll**, dated
Chauvillee, Vt., Dec 31, 186*5*.

Muster-out to date 186 .

Last paid to 186 .

Clothing account:

Last settled 186 ; drawn since \$ 100

Due soldier \$ 100; due U. S. \$ 100

Am't for cloth'g in kind or money adv'd \$ 100

Due U. S. for arms, equipments, &c., \$ 100

Bounty paid \$ 100; due \$ 100

Remarks: *Transferred to*
Company F per G.O.
No 13 dated Va Ar
5th Mass Cav March
64

Book mark :

Wm Scott

Fatal, Charles C.

P. F., Co.

5 Reg't

Mass. C. Co.

5 Enclosures.

Bed Cards	Final Statements 2
Burial Records	Furloughs or L. of A.
Certs. of Dis. for Discharge	Med. Certificates
C. M. Charges	Med. Des. Lists
Descriptive Lists	Orders
Discharge Certificates	Pris. of War Record
Enlistment Papers	Resignations

Other papers relating to—

Admission to Hosp'l	Furlough or L. of A.
Casualty Sheet /	Med. Examination
Confinement	Misc. Information
Contracts	Pay or Clothing
Death or Effects 2	Personal Reports
Desertion	Rank
Discharge from Hosp'l	Transfer to Hosp'l
Discharge from Service	Transfer to V. R. C.
Duty	Transportation

MICROFILM PUBLICATION M 1822

✓ COMPILED MILITARY SERVICE RECORDS
OF VOLUNTEER UNION SOLDIERS WHO
SERVED WITH THE USCT (US COLORED TROOPS)
5TH MASSACHUSETTS REGIMENT OF CAVALRY

PERSONAL PAPERS' TARGET SHEET

PLEASE NOTE THE CHECKED INFORMATION ABOUT THE PERSONAL PAPERS IN
THIS FILE:

NO PERSONAL PAPERS WERE FOUND IN THIS FILE WHEN THE
RECORDS WERE ARRANGED FOR MICROFILMING.

4 PERSONAL PAPER(S) FOUND IN THIS FILE WHEN THE RECORDS
WERE ARRANGED FOR MICROFILMING.

War Department,

ADJUTANT GENERAL'S OFFICE,

Oct. 28, 1875.

The 1st of Mass. of Col. F. S. Co., 5th Reg't U.S. Colored Mass. Cav., is reported as follows:

- On Company Muster Roll, March 15, 1865
- For March 15, 1865, March 15, 1865
- Company Muster-out Roll, March 15, 1865
- Company Descriptive Book, 186
- Company Morning Reports, 186
- Soldier's Final Statement, March 15, 1865
- Soldier's Record of Death and Interment, 186
- Soldier's Inventory of Effects, 186
- Soldier's Certificate of Disability for Discharge, 186
- Soldier's Individual Muster-out Roll, 186
- Regimental Return, 186
- Regimental Quarterly Returns, 186
- Regimental Descriptive Book, 186
- By Surgeon General, 186

March 15, 1865, is held to be the correct date, and the Company Muster Roll will be amended accordingly.

Thomas M. Guent
S.B. 476
Assistant Adjutant General.

1st Lt. H.H. See letter to 2d Adj. Dec. 3, 1875

FINAL STATEMENT 2511

OF

Private Charles G. Fatale

5th Reg't of Mass. Col. Cav.

VOLUNTEERS.

NOTE 1.—Two of these certificates (or duplicates) are to be given to each Volunteer Soldier or drafted man who may be discharged without being mustered out. (Final Statements are never given to men mustered out of service) that he may at once receive from the Paymaster the pay, &c., due him, and the captain or other COMMISSIONED officer commanding the company will certify to the net of the delivery of the duplicate certificates; with these certificates the Soldier is "entitled to" his discharge, and should also present his discharge to the Paymaster to have the payment endorsed on it. The discharge is to be given back to the Soldier by the Paymaster; the latter only retaining as his vouchers the duplicate certificates.

NOTE 2.—If the Soldier is entitled to pay for the use of his horse, the Company Commander will certify to that fact on the back of both these final statements, and also to the time he has pay due for having been so mounted on his own horse.

NOTE 3.—When a Soldier is furnished with final statements, his descriptive list, if he has one, should be taken up by the officer who gives the Soldier these statements, and endorsed with a statement to this effect by the officer. The endorsement should exhibit a full statement of the time for which the Soldier was allowed pay on his final statements, the clothing account, and all other charges against him or in his favor, so as to comprise a complete exhibit of his account. It will then be transmitted to the Company Commander of the Soldier, who will enter all the data necessary to a full understanding of the Soldier's account on the muster roll upon which the Soldier's discharge is reported. The descriptive list will then be destroyed. The object of this is, that the remaining portion of the Soldier's account may be settled upon the receipt of these muster rolls, and the Soldier receive any pay or allowances that may be due him at the time of his discharge, and which may not appear on his last final statements from the fact that his descriptive list is incomplete. These accounts for back pay, &c., are settled by the 2d Auditor of the Treasury Department.

NOTE 4.—Charges for loss or injury to ordnance, horse equipments, and other miscellaneous charges, should appear under the heading of "Other Stoppages."

NOTE 5.—Bounty paid by State authorities, and not by the United States, will not be entered on this statement.

NOTE 6.—Amounts due the Sutler and Laundress must be entered on the muster roll on which the discharge, death, desertion, &c., is reported, as well as on the final statement, otherwise the amount cannot be collected from the United States.

NOTE 7.—This blank will be used for deceased volunteers and drafted men, as well as for others.

NOTE 8.—Where a Soldier dies in Hospital or on detached service, his descriptive list, if he has one, should be sent with his final statements, in duplicate, to the Adjutant General, Washington, D. C.

NOTE 9.—If the soldier is a drafted man or substitute, the space for time, &c., of enrolled, should contain only the word drafted or substitute, as the case may be. If the Soldier is a "VETERAN," (or RECRUIT,) the words as a veteran, (or recruit), as the case may be, should be interlined after the words mustered into the service of the U. S. A statement of all the installments of Veteran or Recruit Bounty RECEIVED by the Soldier must be made on the back of each final statement.

I certify, on honor, that Charles G. Fatale, a Private of
 Captain Charles E. Allan's Company (C) of the 5th Regiment of Cavalry
VOLUNTEERS, of the State of Massachusetts, born in Boston, State
 of Massachusetts, aged 25 years; 5 feet 10 inches high; Black complexion,
Black eyes, Black hair, and by occupation a Porter, who joined for service
 and was enrolled (see Note 9) on the 27th day of February, 1864, at Cambridge Mass
 by J. Stevens, for the period of three years, and mustered into
 the service of the United States on the 4th day of March, 1864, at
Boston Mass, by Sgt. O. Fisher 8th U.S. Inf'ty; and having served
 HONESTLY and FAITHFULLY with his Company to the present date, is now entitled to a
DISCHARGE by reason of Death. Died at Regimental Hoop^{ts} of Congestive
fever. March 14th 1865.

The said Charles G. Fatale was last paid by Paymaster
Maj. Dodge, to include the 31st day of August, 1864, and
 has pay due him from that time to the present date; he is entitled to pay and subsistence for
TRAVELING to place of enrollment, and whatever other allowances are authorized to volunteer
 soldiers, drafted men, or militia, so discharged. He has received from the United States **CLOTHING**
 amounting to \$ 38. ⁵⁰/₁₀₀ dollars, since the 30th day of June,
 1864, when his clothing account was last settled. He has received from the United States
100 dollars advanced **BOUNTY**.

There is to be stopped from him, on account of the State of _____, or other
 authorities, for **CLOTHING, &c.**, received on entering service, _____ 100 dollars; and
 for other stoppages, viz: _____

_____ 100 dollars.

He has been furnished with **TRANSPORTATION** in kind from the place of his discharge to
 _____; and he has been **SUBSISTED** for **TRAVELING** to his
 place of enrollment, up to the _____, 1864.

He is indebted to _____, **SUTLER**, _____ 100 dollars.

He is indebted to _____, **LAUNDRESS**, _____ 100 dollars.

Given in Duplicate, at Clarksville, Texas, this 4th day
 of September, 1865.

Charles E. Allan

Capt. 5th Mass. Cavalry
 Commanding Company. F

Received from Serg't Jan. 27, 1865.

FINAL STATEMENT

OF

Charles E. Fatah

5th Reg't of Mass Cavalry.

VOLUNTEERS.

NOTE 1.—Two of these certificates (or duplicates) are to be given to each Volunteer Soldier or drafted man who may be discharged without being mustered out (Final Statements are never given to men mustered out of service,) that he may at once receive from the Paymaster the pay, &c., due him, and the captain or other COMMISSIONED officer commanding the company will certify to the act of the delivery of the duplicate certificates; with these certificates the Soldier is "entitled to" his discharge, and should also present his discharge to the Paymaster to have the payment endorsed on it. The discharge is to be given back to the Soldier by the Paymaster; the latter only retaining as his vouchers the duplicate certificates.

NOTE 2.—If the Soldier is entitled to pay for the use of his horse, the Company Commander will certify to that fact on the back of both these final statements, and also to the time he has pay due for having been so mounted on his own horse.

NOTE 3.—When a Soldier is furnished with final statements, his descriptive list, if he has one, should be taken up by the officer who gives the Soldier these statements, and endorsed with a statement to this effect by the officer. The endorsement should exhibit a full statement of the time for which the Soldier was allowed pay on his final statements, the clothing account, and all other charges against him or in his favor, so as to comprise a complete exhibit of his account. It will then be transmitted to the Company Commander of the Soldier, who will enter all the data necessary to a full understanding of the Soldier's account on the muster roll upon which the Soldier's discharge is reported. The descriptive list will then be destroyed. The object of this is, that the remaining portion of the Soldier's account may be settled upon the receipt of these muster rolls, and the Soldier receive any pay or allowances that may be due him at the time of his discharge, and which may not appear on his last final statements from the fact that his descriptive list is incomplete. These accounts for back pay, &c., are settled by the 2d Auditor of the Treasury Department.

NOTE 4.—Charges for loss or injury to ordnance, horse equipments, and other miscellaneous charges, should appear under the heading of "Other Stoppages."

NOTE 5.—Bounty paid by State authorities, and not by the United States, will not be entered on this statement.

NOTE 6.—Amounts due the Sutler and Laundress must be entered on the muster roll on which the discharge, death, desertion, &c., is reported, as well as on the final statement, otherwise the amount cannot be collected from the United States.

NOTE 7.—This blank will be used for deceased volunteers and drafted men, as well as for others.

NOTE 8.—Where a Soldier dies in Hospital or on detached service, his descriptive list, if he has one, should be sent with his final statements, in duplicate, to the Adjutant General, Washington, D. C.

NOTE 9.—If the soldier is a drafted man or substitute, the space for time, &c., of enrolled, should contain only the word *drafted* or *substitute*, as the case may be. If the Soldier is a "VETERAN," (or RECRUIT,) the words *as a veteran*, (or *recruit*,) as the case may be, should be interlined after the words *mustered into the service of the U. S.* A statement of all the installments of *Veteran* or *Recruit Bounty RECEIVED* by the Soldier must be made on the back of each final statement.

4
6, 503, Vol 3, R. 115*

I certify, on honor, that Charles C. Fatal, a Private of
Captain Chas. Allen's Company (F) of the 5th Regiment of Cavalry
VOLUNTEERS, of the State of Massachusetts, born in Boston, State
of Mass, aged 25 years; 5 feet 10 inches high; Black complexion,
Black eyes, Black hair, and by occupation a Porter, who joined for service
and was enrolled (see Note 9) on the 27th day of February, 1864, at Cambridge Mass.
by J. J. Stevens, for the period of Three years, and mustered into
the service of the United States on the 4th day of March, 1864, at
Boston Mass., by Lieut O. Fisher; and having served
HONESTLY and FAITHFULLY with his Company to the present date, is now entitled to a
~~DISCHARGE~~ by reason of died March 14th 1865. in Regt's Hospital
at Point Lookout. Md. of Consumption.

The said Charles C. Fatal was last paid by Paymaster
May Dodge, to include the 31st day of August, 1864, and
has pay due him from that time to the 14th March 1865. date of his death.
present date; he is entitled to pay and subsistence for
TRAVELING to place of enrollment, and whatever other allowances are authorized to volunteer
soldiers, drafted men, or militia, so discharged. He has received from the United States **CLOTHING**
amounting to Seventy seven ²⁵/₁₀₀ dollars, since the 27th day of February
1864, when his clothing account was last settled. He has received from the United States
100 dollars advanced **BOUNTY**.

There is to be stopped from him, on account of the State of _____, or other
authorities, for **CLOTHING**, &c., received on entering service, _____ ¹⁰⁰/₁₀₀ dollars; and
for other stoppages, viz: _____

_____ ¹⁰⁰/₁₀₀ dollars
He has been furnished with **TRANSPORTATION** in kind from the place of his discharge to
_____; and he has been **SUBSISTED** for **TRAVELING** to his
place of enrollment, up to the _____, 186—.

He is indebted to _____, **SUTLER**, _____ ¹⁰⁰/₁₀₀ dollars.

He is indebted to _____, **LAUNDRESS**, _____ ¹⁰⁰/₁₀₀ dollars.

Given in Duplicate, at Boston Massachusetts, this 12th day
of December, 1865.

J. M. Fernald
Bot. Col. Regt.
Chief Mustering Officer.
Commanding Company

INVENTORY OF THE EFFECTS

OF

Charles C. Fernald

Late of Company "F"

5th Reg't of Mass Cavalry.

Volunteers, who died at *Point Lookout*
Md.

on the 14th day of *March* 1865.

6.505, 2d 3. R. E. 1865

Inventory of the effects of Charles F. Fataat late
 a Private of Captain Charles C. Allen Company "F" of
 the 5th Regiment of Mass Cavalry Volunteers, who was enrolled as
 a Recruit at Cambridge in the State of Massachusetts on
 the 27th day of February 1864, and mustered into the service of the United
 States as a Recruit on the 14th day of March 1864, at Boston, Mass.
 in Company "F" 5th Regiment of Mass Cavalry Volunteers, to serve 3
 years or during the war; he was born in Boston in the State
 of Massachusetts; he was 25 years of age, 5 feet 10 inches
 high, Black complexion, Blue eyes, Black hair, and by occupation, when enrolled,
 a Porter; he died in Regimental Hospital, at
Point Lookout Md. on the 14th day of March 1865, by
 reason of Consumption.

INVENTORY.					
ARTICLES.	No.	ARTICLES.	No.	ARTICLES.	No.
Hats.....		Pairs trousers.....		Knapsacks.....	
Caps.....		Pairs flannel drawers.....			
Forage caps.....		Pairs cotton drawers.....			
Great coats.....		Flannel shirts.....			
Uniform coats.....		Cotton shirts.....			
Uniform jackets.....		Pairs boots.....			
Flannel sack coats.....		Pairs shoes.....			
Blouses.....		Pairs socks.....			
Stable frocks.....		Blankets.....			
Fatigue overalls.....		Haversacks.....			
				MONEY.	
				Specie.....	\$.....
				Notes.....	\$.....

I CERTIFY, ON HONOR, that the above inventory comprises all the effects, of ^{as far as is known} Private
Charles F. Fataat, deceased, and that the effects are in the hands
 of _____ at _____
 _____ to be disposed of by a Council of Administration.

(DUPLICATES.)

STATION: Boston, Mass.

DATE: December 12th 1865.

[A. G. O. No. 104.]

P. W. G. F. Fataat
Bot. Col. U.S.A.
 Commanding the Company.
 Chief Mustering Officer.

2 fs. & Inv. sent for to Chy. M.D. 21 Jan. 1865

CASUALTY SHEET

No.

Charles C. Pahal

Private of Company F.

5th Regiment of Mass. Cavalry

State Volunteers.

NATURE OF CASUALTY.

Wounded March 11th 1865.

CASUALTY SHEET.

Name: Charles C. Takal.
Rank: Private Company: F Regiment: 5th
Arm: Cavalry State: Mass.
Nature of Casualty: Death.

CAUSE OF CASUALTY—(NAME OF DISEASE, &C.)

BY WHOM DISCHARGED.

DEGREE OF DISABILITY.

FROM WHAT SOURCE THIS INFORMATION WAS OBTAINED.

BY WHOM CERTIFIED.

Qw. 1 Return Dec'd Soldier,
1st Gp 1865.

Col. Charles F. Adams
Comdr Regt.

REMARKS.

DATE OF DISCHARGE, DEATH, &C.

March 14th 1865.

PLACE OF DISCHARGE, DEATH, &C.

Pt. Look Out Md.

[Handwritten signature]

A. J. Ball
Clerk.

431

William Martin

Co *H*, 5 Mass. Cav., (Col'd.)

Corporal | *Corporal*

CARD NUMBERS.

1	<i>3372719</i>	26
2		27
3		28
4		29
5		30
6		31
7		32
8		33
9		34
10		35
11		36
12		37
13		38
14		39
15		40
16		41
17		42
18		43
19		44
20		45
21		46
22		47
23		48
24		49
25		50

Book Mark: _____

See also _____

5 | 5 Col'd Cav. | Mass.

Martin Bellam
Corp., Co. *N*, 5 Reg't Mass. Col'd Cavalry.

Appears on a

Detachment Muster Roll

of the organization named above

for *April 30*, 186*7*.

Station *College Green Barracks,*

Present or absent *Present*

Stoppage, \$ *100* for

Due Gov't, \$ *100* for

Valuation of horse, \$ *100*

Valuation of horse equipments, \$ *100*

Remarks: *Enrollment to muster
in not shown.*

*Name not born on Rolls Co.
N.*

Book mark: *2000000*

Tables

431-a

Felstend Samuel
Co. J. W. S. Col'd Cav.

CARD NUMBERS.

1	9436024	26
2		27
3		28
4		29
5		30
6		31
7		32
8		33
9		34
10		35
11		36
12		37
13		38
14		39
15		40
16		41
17		42
18		43
19		44
20		45
21		46
22		47
23		48
24		49
25		50

Number of personal papers herein.....

Book Mark:

See also

5 Car. (Col'd) Mass.
Samuel Felsted,
Co. 5 Reg't Mass Col'd Car.

Appears on

Regimental Descriptive Book

of the organization named above.

DESCRIPTION.

Age 38 years; height 5 feet 7 1/2 inches.

Complexion Black

Eyes Black; hair woolly

Where born Boston, Mass.

Occupation Laborer.

ENLISTMENT.

When Jan'y 7 1864

Where Boston, Md. 5

By whom O'Norris; term 3 y'rs.

Remarks: Respected March 12, 1864.

[Signature]

452

Felton Isaac

Co G, 5 Mass. Cav., (Col'd.)

Private Private

CARD NUMBERS.

1	5-3-8-15-7-4	26
2	5-3-8-16-0-5	27
3	5-3-8-16-9-0	28
4	5-3-8-17-7-0	29
5	5-3-8-18-7-9	30
6	5-3-8-19-7-7	31
7	5-3-8-10-7-9	32
8	5-3-8-11-8-0	33
9	5-3-8-12-8-2	34
10	5-3-8-13-8-1	35
11	5-3-8-14-7-9	36
12	9091919	37
13	40730926	38
14		39
15		40
16		41
17		42
18		43
19		44
20		45
21		46
22		47
23		48
24		49
25		50

Book Mark: 493. 786.

See also

J

5 Cav. (Col'd.) | Mass.

Isaac Felton

....., Co. *G*....., 5 Reg't Mass. Cav. (Col'd.)

Appears on

Company Descriptive Book

of the organization named above.

DESCRIPTION.

Age *27* years; height *5* feet *6* inches.

Complexion *Blk*

Eyes *Blk*; hair *Blk*

Where born *Cummins Co. N.C.*

Occupation *Farmer*

ENLISTMENT.

When *Feb 25*, 1864.

Where *Boston*.

By whom *A. O. Swain*, term *3* y'rs.

Remarks: *Single*.

Hearst

W

5 Col'd Cav. | Mass.

Francis Pelton

W, Co. *G*, 5 Reg't Mass. Col'd Cav.

Appears on

Company Muster-in and Descriptive Roll

of the organization named above. Roll dated

Readville Mass. Mar 4, 1864.

Where born *Cummings Co, N.C.*

Age *27* y'rs; occupation *Farmer*

When enlisted *Feb 25*, 1864.

Where enlisted *Boston*

For what period enlisted *3* years.

Eyes *Blk*; hair *Blk*

Complexion *Blk*; height *5 ft. 6* in.

When mustered in *Mar 4*, 1864.

Where mustered in *Readville Mass*

Bounty paid \$ *2* ¹⁰⁰; due \$ *100*

Where credited *3rd Dist Bristol*

Company to which assigned

Remarks:

Book mark:

Leger

J

5 Col'd Cav.

Mass.

Isaac Helton

Pr, Co. G, 5 Reg't Mass. Col'd Cavalry.

Appears on

Company Muster Roll

for *Mar 4 to Apr 30*, 1864.

Present or absent *Present*

Stoppage, \$ *100* for

Due Gov't, \$ *100* for

Valuation of horse, \$ *100*

Valuation of horse equipments, \$ *100*

Remarks:

Book mark:

Leger

(358)

Copyist.

M

5 Col'd Cav.

Mass.

Isaac Felton

Pl, Co. G, 5 Reg't Mass. Col'd Cavalry.

Appears on

Company Muster Roll

for *May & June, 1864*

Present or absent *Present*

Stoppage, \$ *100* for

Due Gov't, \$ *100* for

Valuation of horse, \$ *100*

Valuation of horse equipments, \$ *100*

Remarks:

Book mark: -----

(358)

L. G. 25

Copyist.

PH

5 Col'd Cav.

Mass.

Isaac Pelton

Pl, Co. G, 5 Reg't Mass. Col'd Cavalry.

Appears on

Company Muster Roll

for *July & Aug*, 186*4*.

Present or absent *Present*

Stoppage, \$ *100* for

Due Gov't, \$ *100* for

Valuation of horse, \$ *100*

Valuation of horse equipments, \$ *100*

Remarks: *Daily duty as
Cook for school master
per the order No 131 dated
July 13/64.*

Book mark:

L. J. [Signature]

(358)

Copyist.

(77)
71

5 Col'd Cav.

Mass.

Isaac Felton

Private, Co. G, 5 Reg't Mass. Col'd Cavalry.

Appears on

Company Muster Roll

for Sept. & Oct., 1864.

Present or absent Present

Stoppage, \$ 100 for

Due Gov't, \$ 100 for

Valuation of horse, \$ 100

Valuation of horse equipments, \$ 100

Remarks: Stop one hour -
back and one Can-
teen.

Book mark:

C. Perry

(358)

Copyist.

187
7

5 Col'd Cav.

Mass.

Isaac Felton

Co. G, 5 Reg't Mass. Col'd Cavalry.

Appears on

Company Muster Roll

for Nov. & Dec., 1864.

Present or absent Present

Stoppage, \$ 100 for

Due Gov't, \$ 100 for

Valuation of horse, \$ 100

Valuation of horse equipments, \$ 100

Remarks: Due U.S. for harness sack & canteen \$1.07 charged on Sept & Oct. Rolls.

Book mark:

Cerry

(358)

Copyist.

27
F.

5 Col'd Cav.

Mass.

Isaac Felton

Private, Co. G, 5 Reg't Mass. Col'd Cavalry.

Appears on

Company Muster Roll

for Jan & Feb, 1865.

Present or absent Present

Stoppage, \$ 100 for

Due Gov't, \$ 100 for

Valuation of horse, \$ 100

Valuation of horse equipments, \$ 100

Remarks: Due 1st, 2^d, 3^d & 4th instalments U. S. Bounty \$180. Due U. S. for haversack & canteen \$107 charged on Sept. & Oct. rolls

Book mark:

Perry

(358)

Copyist.

F

5 Col'd Cav.

Mass.

Isaac Felton

Co., Co. G, 5 Reg't Mass. Col'd Cavalry.

Appears on

Company Muster Roll

for *March 7th 1863*, 1863.

Present or absent *Present*

Stoppage, \$ *100* for

Due Gov't, \$ *100* for

Valuation of horse, \$ *100*

Valuation of horse equipments, \$ *100*

Remarks: *Due the soldier
4 instalments U.S.
Bounty \$180.*

Book mark: _____

(358)

Cerry

Copyist.

07
F

5 Col'd Cav.

Mass.

Francis Felton
Pr., Co. G, 5 Reg't Mass. Col'd Cavalry.

Appears on

Company Muster Roll

for *May & June*, 1865.

Present or absent *Present*

Stoppage, \$ *100* for

Due Gov't, \$ *100* for

Valuation of horse, \$ *100*

Valuation of horse equipments, \$ *100*

Remarks:

Book mark:

Perry

(358)

Copyist.

I

5 Col'd Cav.

Mass.

Isaac Tilton
Private, Co. G, 5 Reg't Mass. Col'd Cavalry.

Appears on

Company Muster Roll

for *July & Aug*, 186*5*.

Present or absent *Present*

Stoppage, \$ *100* for

Due Gov't, \$ *100* for

Valuation of horse, \$ *100*

Valuation of horse equipments, \$ *100*

Remarks: *Detached at work on Mil RR. per S.O. No 114 dated July 28/65*

Book mark:

W. H. Scott

(358)

Copyist.

F

5 Col'd Cav.

Mass.

Isaac Felton

M., Co. G, 5 Reg't Mass. Colored Cav.

Appears on Returns as follows:

July & Aug. 1864 - On daily
duty as cook for
Schoolmaster per S.O.
No. 131, July 18, '64

July to Sept. 1865 - Absent, de-
tached, service to work on
U. S. Military R.R. per S.O.
No. 40, dated Hd. Qu. 3
Brig. 3 Div. 25 A.C. July
28, '65.

Book mark:

P. S. Taylor

(546)

Copyist.

F

5 Col'd Cav.

Mass.

Isaac Felton

Priv, Co. *G*, 5 Reg't Mass. Col'd Cavalry.

Appears on Co. Muster-out Roll, dated

Clarksville Tex, Oct 31, 186*6*

Muster-out to date

Oct 31, 186*6*

Last paid to

Dec 31, 186*4*

Clothing account:

Last settled....., 186 ; drawn since \$..... 100

Due soldier \$..... 100; due U. S. \$ *21* ^{*45*} 100

Am't for cloth'g in kind or money adv'd \$..... 100

Due U. S. for arms, equipments, &c., \$ *11* 100

Bounty paid \$..... 100; due \$ *211* 100

Remarks:

Book mark: *493, 786*

W. H. Scott

(361)

Copyist.

433

Ferguson Charles J.

Co., 5 Mass. Cav., (Col'd.)

Private Private

CARD NUMBERS.

1	5372478	26
2	5372504	27
3	5372607	28
4		29
5		30
6		31
7		32
8		33
9		34
10		35
11		36
12		37
13		38
14		39
15		40
16		41
17		42
18		43
19		44
20		45
21		46
22		47
23		48
24		49
25		50

Book Mark: _____

See also _____

F

5 Col'd Cav.

Mass.

Charles F. Ferguson

Appears with rank of *Private* on

Muster and Descriptive Roll of a Detachment of U. S. Vols. forwarded

for the 5 Reg't Mass. Col'd Cavalry. Roll dated

Boston Mass. Oct 10, 1864.

Where born *Virginia*

Age *31* y'rs; occupation *Cook*

When enlisted *Oct 10*, 1864.

Where enlisted *Boston Mass*

For what period enlisted *3* years.

Eyes *Hazel*; hair *Black*

Complexion *Colored*; height *5 ft. 5 in.*

When mustered in *Oct 10*, 1864.

Where mustered in *Boston*

Bounty paid \$ *100*; due \$ *100*

Where credited *City of Roxbury Mass*

Company to which assigned

Remarks: *Name not taken*

upon muster Roll of

Regt.

Book mark:

(339)

M. A. Michaels

Copyist.

F

5 Col'd Cav.

Mass.

Charles J. Ferguson

Appears with rank of _____ on

Muster and Descriptive Roll of a Detachment of U. S. Vols. forwarded

for the 5 Reg't Mass. Col'd Cavalry. Roll dated

Boston Mass., _____, 186*4*.

Where born *Va*

Age *34* y'rs; occupation *Cook*

When enlisted *Oct 10*, 186*4*.

Where enlisted *Boston Mass.*

For what period enlisted *3* years.

Eyes *Hazel*; hair *Blk*

Complexion *Col.*; height *5 ft. 5 in.*

When mustered in *Oct. 10*, 186*4*.

Where mustered in *Boston Mass.*

Bounty paid \$ *100*; due \$ *100*

Where credited *Roxbury Mass.*

Company to which assigned _____

Remarks: _____

Book mark: _____

M. A. Michael

F

5 Col'd Cav.

Mass.

Charles F. Ferguson

Appears with rank of Private on

Muster and Descriptive Roll of a Detachment of U. S. Vols. forwarded

for the 5 Reg't Mass. Col'd Cavalry. Roll dated ^{Draft Rendezvous} Galloups Island B. Mass, Nov. 12, 1864.

Where born Na

Age 34 y'rs; occupation Cook

When enlisted Oct 10, 1864.

Where enlisted Boston Mass

For what period enlisted 3 years.

Eyes hazel; hair black

Complexion Gold; height 5 ft. 5 in.

When mustered in Oct 10, 1864.

Where mustered in Boston

Bounty paid \$ 100; due \$ 100

Where credited Roxbury Norfolk Co

Company to which assigned

Remarks: Discharged for physical disability Oct 27

* Entire entry cancelled except Remarks

Book mark:

M. A. Michaels

Ferguson Chas F

P, Co., 5 Reg't Mass Cav

3 Enclosures.

Bed Cards	Final Statements
Burial Records	Furloughs or L. of A
Certs. of Dis. for Discharge	Med. Certificates
C. M. Charges	Med. Des. Lists
Descriptive Lists	Orders
Discharge Certificates	Pris. of War Record
Enlistment Papers	Resignations

Other papers relating to—

Admission to Hosp'l	Furlough or L. of A
Casualty Sheet	Med. Examination
Confinement	Misc. Information
Contracts	Pay or Clothing
Death or Effects	Personal Reports
Desertion	Rank
Discharge from Hosp'l	Transfer to Hosp'l
Discharge from Service	Transfer to V. R. C.
Duty	Transportation

NOTE 1.—This blank will be used for both enlistments and re-enlistments—enlistment of veterans, &c., &c., in the volunteer service. They will be made out in duplicate in all cases—one to accompany the recruiting return of the superintendent (not the recruiting officer) to the Adjutant General, and one to accompany the accounts of the officer who pays bounty, &c. The Regiment and Company in which the soldier last served should be given on the back.

NOTE 2.—An enlistment holds to service. A muster-in must, in all cases, precede payment of pay, bounty, pension, &c. A muster-in roll must, in all cases, be filed in the Adjutant General's Office as evidence of muster-in. The mustering officer, commissary, or assistant commissary of musters, as the case may be, will countersign both enlistments as having mustered the soldier into the service of the United States before either of them is given to the disbursing officer.

DECLARATION OF RECRUIT.

I, *Charles T. Ferguson*, desiring to VOLUNTEER as a Soldier in the Army of the United States, for the term of THREE YEARS, Do Declare, That I am *thirty four* years and _____ months of age; that I have never been discharged from the United States service on account of disability or by sentence of a court martial, or by order before the expiration of a term of enlistment; and I know of no impediment to my serving honestly and faithfully as a soldier for three years.

GIVEN at *Boston*, *Mass.* the *10th* day of *Oct.*

Witness:

George Ray

Charles T. Ferguson

Discharged _____, 18 _____

Reg't of _____

enlistment; last served in Company (_____)

By *Capt J. D. S. Jones*
3rd Regt of Iron Shod

Volunteered at *Boston Mass*

Oct 10, 18*64*.

No. _____

Charles T. Ferguson

5 Mass Cav

CONSENT IN CASE OF MINOR.

I, _____, Do CERTIFY, That I am _____ of _____; that the said _____ is _____ years of age; and I do hereby freely give my CONSENT to his volunteering as a SOLDIER in the ARMY OF THE UNITED STATES for the period of THREE YEARS.

GIVEN at _____ the _____ day of _____

Witness:

VOLUNTEER ENLISTMENT.

STATE OF

TOWN OF

Massachusetts

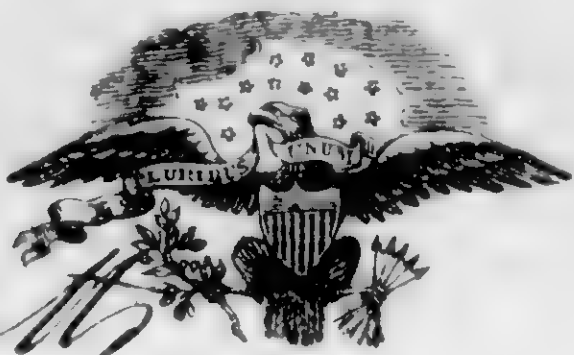

City of Boston

I, *Charles T. Ferguson* born in *Virginia* in the State of _____, aged *Thirty four* years, and by occupation a *Cook*, Do HEREBY ACKNOWLEDGE to have volunteered this *Tenth* day of *October*, 1864, to serve as a **Soldier** in the **Army of the United States of America**, for the period of **THREE YEARS**, unless sooner discharged by proper authority: Do also agree to accept such bounty, pay, rations, and clothing, as are, or may be, established by law for volunteers. And I, *Charles T. Ferguson* do solemnly swear, that I will bear true faith and allegiance to the **United States of America**, and that I will serve them honestly and faithfully against all their enemies or opposers whomsoever; and that I will observe and obey the orders of the President of the United States, and the orders of the officers appointed over me, according to the Rules and Articles of War.

Sworn and subscribed to, at *Boston* this *10* day of *Oct*, 1864, } *Charles T. Ferguson*
BEFORE *J. W. Pierce*
Capt. 4th Mass. Inf.

I CERTIFY, ON HONOR, That I have carefully examined the above-named Volunteer, agreeably to the General Regulations of the Army, and that, in my opinion, he is free from all bodily defects and mental infirmity, which would in any way disqualify him from performing the duties of a soldier.

Wm. H. Smith

Examined and found fit for service
EXAMINING SURGEON.
Wm. H. Smith

I CERTIFY, ON HONOR, That I have minutely inspected the Volunteer *Charles T. Ferguson* previously to his enlistment, and that he was entirely sober when enlisted; that, to the best of my judgment and belief, he is of lawful age; and that, in accepting him as duly qualified to perform the duties of an able-bodied soldier, I have strictly observed the Regulations which govern the recruiting service. This soldier has *hazel* eyes, *black* hair, *colored* complexion, is *five* feet *five* inches high

Wm. H. Smith
Capt. 4th Mass. Inf.
REGUITING OFFICER.

(A. G. O. No. 74 & 75.)

13746

Mustered into the service of the United States, for three years or during the war, from date of enlistment, in Company _____ Regiment of _____ Volunteers, on the _____ day of _____ 1864, at _____
Charles T. Ferguson
3rd Mass. Inf.

NOTE 1.—This blank will be used for both enlistments and re-enlistments—enlistment of veterans, &c., &c., in the volunteer service. They will be made out in duplicate in all cases—one to accompany the recruiting return of the superintendent (not the recruiting officer) to the Adjutant General, and one to accompany the accounts of the officer who pays bounty, &c. The Regiment and Company in which the soldier last served should be given on the back.

NOTE 2.—An enlistment holds to service. A muster-in must, in all cases, precede payment of pay, bounty, pension, &c. A muster-in roll must, in all cases, be filed in the Adjutant General's Office as evidence of muster-in. The mustering officer, commissary, or assistant commissary of musters, as the case may be, will countersign both enlistments as having mustered the soldier into the service of the United States before either of them is given to the disbursing officer.

DECLARATION OF RECRUIT.

I, *Charles T. Ferguson*, desiring to VOLUNTEER as a Soldier in the Army of the United States, for the term of THREE YEARS, Do Declare, That I am *thirty four* years and _____ months of age; that I have never been discharged from the United States service on account of disability or by sentence of a court martial, or by order before the expiration of a term of enlistment; and I know of no impediment to my serving honestly and faithfully as a soldier for three years.

GIVEN at *Waltham* the *10th* day of *Oct*

Witness: *George R. [unclear]* *Charles T. Ferguson*

No. *Charles T. Ferguson*
 Volunteered at *Waltham Mass*
Oct 10 18*64*
 By *Capt J. M. Davis*
 1st Regiment of *Mass*
3rd Inf Mass
5th Mass Cav
 enlistment; last served in company ()
 Regt of _____
 Discharged _____, 18 _____

CONSENT IN CASE OF MINOR.

I, _____, Do CERTIFY, That I am the _____ of _____; that the said _____ is _____ years of age; and I do hereby freely give my CONSENT to his volunteering as a SOLDIER in the ARMY OF THE UNITED STATES for the period of THREE YEARS.

GIVEN at _____ the _____ day of _____

Witness: _____

VOLUNTEER ENLISTMENT.

STATE OF

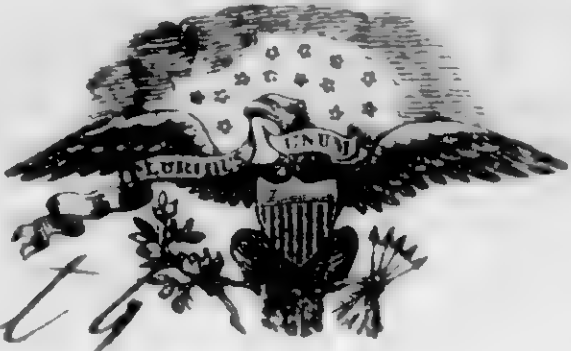

TOWN OF

Massachusetts

City of Boston

I, *Charles F. Ferguson* born in *Virginia*, in the State of _____, aged *thirty four* years, and by occupation a *Cook*, Do HEREBY ACKNOWLEDGE to have volunteered this *Tenth* day of *October*, 1864, to serve as a **Soldier** in the **Army of the United States of America**, for the period of **THREE YEARS**, unless sooner discharged by proper authority: Do also agree to accept such bounty, pay, rations, and clothing, as are, or may be, established by law for volunteers. And I, *Charles F. Ferguson*, do solemnly swear, that I will bear true faith and allegiance to the **United States of America**, and that I will serve them honestly and faithfully against all their enemies or opposers whomsoever; and that I will observe and obey the orders of the President of the United States, and the orders of the officers appointed over me, according to the Rules and Articles of War.

Sworn and subscribed to, at *Boston* }
this *10th* day of *Oct*, 1864, } *Charles F. Ferguson*
BEFORE *Capt. J. W. Marshall*
3rd Dist. Mass.

I CERTIFY, ON HONOR, That I have carefully examined the above-named Volunteer, agreeably to the General Regulations of the Army, and that, in my opinion, he is free from all bodily defects and mental infirmity, which would in any way disqualify him from performing the duties of a soldier.

Os. H. Tuttle

EXAMINING SURGEON.

Bond Enrolment 3rd Dist. Mass.

I CERTIFY, ON HONOR, That I have minutely inspected the Volunteer *Charles F. Ferguson* previously to his enlistment, and that he was entirely sober when enlisted; that, to the best of my judgment and belief, he is of lawful age; and that, in accepting him as duly qualified to perform the duties of an able-bodied soldier, I have strictly observed the Regulations which govern the recruiting service. This soldier has *hazel* eyes, *Black* hair, *Caucasian* complexion, is *five* feet *five* inches high

J. W. Marshall
Capt. - 4th
Regiment of W. Mass. Volunteers,
3rd Dist. Mass. RECRUITING OFFICER.

(A. G. O. No. 74 & 76.)

Mustered into the service of the United States, for three years or during the war, from date of enlistment, in Company
5th Regiment of *Charles F. Ferguson* Volunteers, on the *10th* day of *October*, 1864, at *Boston*
Charles F. Ferguson
3rd Dist. Mass.
Os. H. Tuttle
J. W. Marshall
Capt. - 4th
Regiment of W. Mass. Volunteers,
3rd Dist. Mass.

174

J. B. & Co. 15

CERTIFICATE OF DISABILITY FOR DISCHARGE

IN THE CASE OF

Charles F. Ferguson

a *Private* Co. _____

5th Reg't of *Cavalry*

Mass. Vols

HEADQUARTERS DEPARTMENT OF THE EAST.

NEW YORK CITY, Oct. 24th, 1864.

To be discharged without pay or allowances. Rejected by a Board of Inspection, in accordance with Circular 67, A. G. O., Aug. 26, 1864.

BY COMMAND OF MAJOR GENERAL DIX:

Wilson Parrott

Capt. and A. D. C., A. A. A. G.

Adjutant General's Office,

Nov 5 1864

Duplicate sent the Pension Office



Received (A. G. Office) _____, 186 .

Ernest O. Phelps

ARMY OF THE UNITED STATES.

CERTIFICATE

OF DISABILITY FOR DISCHARGE.

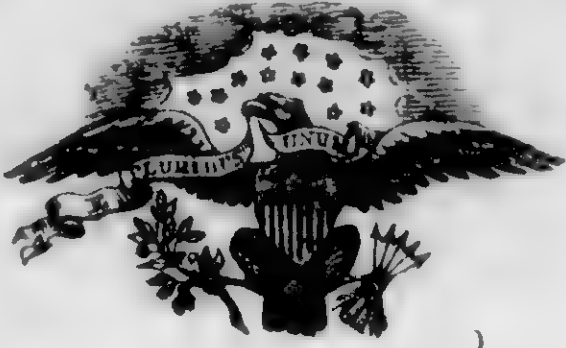

Private *Charles F. Ferguson*, of Captain *Cavalry*
 Company, () of the *5th* Regiment of the United States
Mass. Vols. was enlisted by *J. W. Barnes Capt & Prov. Marshal* of
 the *3rd* Regiment of *Air Mass* at *Boston Mass*
 on the *10th* day of *October*, 186*4* to serve *Three* years; he was born
 in *Virginia* in the State of *Virginia*, is *thirty four*
 years of age, *five* feet *five* inches high, *cloud* complexion, *shred* eyes,
black hair, and by occupation when enlisted a *Cook*. During the last two
 months said soldier has been unfit for duty *_____* days.*

STATION: *Capt. Henderson's Hospital and Boston Har.*
 DATE: *October 21 1864 Mass.*

J. M. Anderson
Col. 13th Regt V.C.
 Commanding ~~Company~~ *Regt*

I CERTIFY, that I have carefully examined the said *Charles F. Ferguson*
 of Captain *5th Cav. Cavalry* Company, and find him incapable of performing the duties of a
 soldier because of *Rheumatic diathesis, asthma, and*
general debility.

unfit for D. R. O.
S. J. Barrow
U.S.A. Surgeon.

DISCHARGED, this *10th* day of *October*, 186*4*, at *Capt. Henderson's*
Gallup's Plaza, B. H. Mass.
J. M. Anderson
Col 13th V.C.
 Commanding the ~~Reg't~~ *Reg't*

The Soldier desires to be addressed at
 Town _____ County _____ State _____

* See Note 1 on the back of this. † See Note 2 on the back of this.

434

Herguson John W

Co D, 5 Mass. Cav., (Col'd.)

Private Private

CARD NUMBERS.

1 5372027

26

2 5372072

27

3 5377186

28

4 5377294

29

5 5377399

30

6 5377499

31

7 5377609

32

8 5377712

33

9 5377809

34

10 5377898

35

11 5377994

36

12 9092288

37

13 2592-5-1880

38

14 34509297

39

15 40730964

40

16

41

17

42

18

43

19

44

20

45

21

46

22

47

23

48

24

49

25

50

Book Mark:

2592 b. 1889

See also

5 Cav. (Col'd.) | Mass.

John H. [unclear]

Co. [unclear], 5 Reg't Mass. Cav. (Col'd.)

Appears on

Company Descriptive Book

of the organization named above.

DESCRIPTION.

Age *20* years; height *5* feet *10* inches.

Complexion *Ruddy*

Eyes *Blue*; hair *Dark*

Where born *Massachusetts*

Occupation *Farmer*

ENLISTMENT.

When *May 1*, 186*1*

Where *Worcester*

By whom *W. [unclear]*; term *1* y'rs.

Remarks: *Mustard mark on forehead*

F. | 5 Cav. | Mass.

John H. Furgerson

Appears with rank of _____ on

Muster-in and Descriptive Roll

of a detachment of U. S. Volunteer Recruits for
different regiments of Massachusetts Volunteers.

Roll dated Draft Randy Galloups

Island. B.H. Mass., May 24, 1864,

Where born Alexandria. Va.

Age 20 years; occupation Laborer.

When enlisted May 21, 1864.

Where enlisted Newton. Mass.

For what period enlisted 3 years.

Eyes Dark.; hair Dark.

Complexion Dark.; height 5 ft. 5 in.

When mustered in _____, 186 .

Muster-in to date from enlistment, 186 .

Where mustered in _____

Bounty paid \$ 100; due \$ 100

Clothing account:

Last settled \$ _____, 186 ; drawn since \$ 100

Date of first muster _____, 186 .

Regiment to which assigned 5 Cav.

Remarks: Quota of Newton
Meddley Co. 7 Cong. Dist.

Book mark: _____

Park

(356m)

Copyist.

17

F

5 Col'd Cav.

Mass.

* John T. Ferguson

Appears with rank of Private on

Muster and Descriptive Roll of a Detachment of U. S. Vols. forwarded

for the 5 Reg't Mass. Col'd Cavalry. Roll dated
Draft Enclosure Sullivan's
Island B. V. Mass., May 31, 1864.

Where born Alexandria Va.

Age 20 y'rs; occupation Farmer

When enlisted May 21, 1864.

Where enlisted Newton Mass.

For what period enlisted 3 years.

Eyes Dark; hair Dark

Complexion Dark; height 5 ft. 5 in.

When mustered in May 21, 1864.

Where mustered in Gallatin Island B. V. Mass

Bounty paid \$ 100; due \$ 100

Where credited 7th Dist Newton Middlesex Co. Mass.

Company to which assigned

Remarks: Retained at this Post. Not
paid State Bounty.

* Retention cancelled by name.

Book mark: 25 1864

J
Forsett

2
5

5 Col'd Cav.

Mass.

Samuel Ferguson

Appears with rank of *Private* on

Muster and Descriptive Roll of a Detachment of U. S. Vols. forwarded

for the 5 Reg't Mass. Col'd Cavalry. Roll dated *Worcester Mass, June 5, 1864.*

Where born *Worcester Ma.*

Age *20* y'rs; occupation *Farmer*

When enlisted *May 21*, 1864.

Where enlisted *Worcester*

For what period enlisted *3* years.

Eyes *Blue*; hair *Black*

Complexion *Rose*; height *5* ft. *5* in.

When mustered in *May 21*, 1864.

Where mustered in *Worcester Mass.*

Bounty paid \$ *100*; due \$ *100*

Where credited *Worcester Mass.*

Company to which assigned

Remarks:

Book mark:

G. H. H.

57

5 Col'd Cav.

Mass.

John H. Ferguson

Pr, Co. D, 5 Reg't Mass. Col'd Cavalry.

Appears on

Company Muster Roll

for *May + June*, 1864.

Present or absent *Present*

Stoppage, \$ *100* for

Due Gov't, \$ *100* for

Valuation of horse, \$ *100*

Valuation of horse equipments, \$ *100*

Remarks:

Book mark: *2592-C-1889.*

(358)

Ferguson
Copyist.

F

5 Col'd Cav.

Mass.

John M. Fergerson

Plt, Co. D, 5 Reg't Mass. Col'd Cavalry.

Appears on

Company Muster Roll

for *July & Aug*, 186 *4*

Present or absent *Present*

Stoppage, \$ *100* for

Due Gov't, \$ *100* for

Valuation of horse, \$ *100*

Valuation of horse equipments, \$ *100*

Remarks:

Book mark:

S. Merchant

(358)

Copyist.

71

5 Col'd Cav.

Mass.

John M. Ferguson

Pr, Co. D, 5 Reg't Mass. Col'd Cavalry.

Appears on

Company Muster Roll

for Sept & Oct, 1864

Present or absent Present

Stoppage, \$ 100 for

Due Gov't, \$ 100 for

Valuation of horse, \$ 100

Valuation of horse equipments, \$ 100

Remarks:

Book mark:

J. Merchant

(358)

Copyist.

J

5 Col'd Cav.

Mass.

John W. Ferguson

Plt., Co. D, 5 Reg't Mass. Col'd Cavalry.

Appears on

Company Muster Roll

for *Am & Dec*, 186*4*

Present or absent *Present*

Stoppage, \$ *100* for

Due Gov't, \$ *100* for

Valuation of horse, \$ *100*

Valuation of horse equipments, \$ *100*

Remarks: *In M. Stores for Household
& (Anten) (S)*

Book mark:

A. Merchant

(358)

Copyist.

Jr

5 Col'd Cav.

Mass.

John M. Ferguson

Pvt, Co. D, 5 Reg't Mass. Col'd Cavalry.

Appears on

Company Muster Roll

for *Jan & Feb*, 1865.

Present or absent *Present*

Stoppage, \$ *100* for

Due Gov't, \$ *100* for

Valuation of horse, \$ *100*

Valuation of horse equipments, \$ *100*

Remarks: *See 1st Instalⁿ U.S.,
Bounty*

Book mark:

A. Merchant

(358)

Copyist.

07

5 Col'd Cav.

Mass.

John M. Ferguson

Prin, Co. D, 5 Reg't Mass. Col'd Cavalry.

Appears on

Company Muster Roll

for *Messrs* *Capt*, 1865.

Present or absent *Present*

Stoppage, \$ *100* for

Due Gov't, \$ *100* for

Valuation of horse, \$ *100*

Valuation of horse equipments, \$ *100*

Remarks: *Due 1st Ins U.S.*
Count,

Book mark:

A. Merchants

(358)

Copyist.

F

5 Col'd Cav.

Mass.

John W. Ferguson

Co. D, Co. D, 5 Reg't Mass. Col'd Cavalry.

Appears on

Company Muster Roll

for *May and June*, 1865.

Present or absent *present*

Stoppage, \$ *100* for

Due Gov't, \$ *100* for

Valuation of horse, \$ *100*

Valuation of horse equipments, \$ *100*

Remarks:

Book mark:

House

J | **5 Col'd Cav.** | **Mass.**

John W. Ferguson

Priv, Co. D, 5 Reg't Mass. Col'd Cavalry.

Appears on

Company Muster Roll

for *July and Aug.*, 1865.

Present or absent *Present*

Stoppage, \$ *100* for

Due Gov't, \$ *100* for

Valuation of horse, \$ *100*

Valuation of horse equipments, \$ *100*

Remarks:

Book mark: -----

House

F

5 Col'd Cav.

Mass.

J. M. Ferguson

Or, Co. *D*, 5 Reg't Mass. Colored Cav.

Appears on **Returns** as follows:

*June 1864 - June 19, '64, Point
of Rocks, Recruit rec'd
from Depot.*

Book mark:

O. J. Taylor

(546)

Copyist.

F

5 Col'd Cav.

Mass.

John Ferguson

Pvt., Co. C, 5 Reg't Mass. Col'd Cavalry.

Appears on Co. Muster-out Roll, dated

Clarksville Texas, Oct 31, 1865.

Muster-out to date Oct. 31, 1865.

Last paid to Dec 31, 1864.

Clothing account:

Last settled....., 186 ; drawn since \$ 100

Due soldier \$ 100; due U. S. \$ 27 ²⁰/₁₀₀

Am't for cloth'g in kind or money adv'd \$ 100

Due U. S. for arms, equipments, &c., \$ 11 ⁰⁰/₁₀₀

Bounty paid \$ 100; due \$ 100 ⁰⁰/₁₀₀

Remarks:

Total money value of
advance charged \$ 11.00.

Book mark: 192.P152.24

House

(361)

Copyist.

JAN. 19

5377994

1891

2592 c-1889

F. | 5th Cold | Mass.
| " | Car. |

John W. Ferguson

, Co. A, 5th Reg't Mass. Cold
Car.

NOTATION.

Book mark: 2592. C. 1889

War Department,

Adjutant General's Office,

Washington, May 11., 1889.

Application for certificate in lieu of lost discharge.

One Certificate furnished.

Muzzey

Copyist.

Ferguson John Jr.

Co.

5

Reg't

Mass Cav

2

Inclosures.

Bed Cards	Final Statements
Burial Records	Furloughs or L. of A
Certs. of Dis. for Disch	Med. Certificates
C. M. Charges	Med. Des. Lists
Descriptive Lists	Orders
Discharge Certificates	Pris. of War Record
Enlistment Papers <i>2</i>	Resignations

Other papers relating to—

Admission to Hosp'l	Furlough or L. of A
Casualty Sheet	Med. Examination
Confinement	Misc. Information
Contracts	Pay or Clothing
Death or Effects	Personal Reports
Desertion	Rank
Discharge from Hosp'l	Transfer to Hosp'l
Discharge from Service	Transfer to V. R. C.
Duty	Transportation

NOTE 1.—This blank will be used for both enlistments and re-enlistments—enlistment of veterans, &c., &c., in the volunteer service. They will be made out in duplicate in all cases—one to accompany the recruiting return of the superintendent (not the recruiting officer) to the Adjutant-General, and one to accompany the accounts of the officer who pays bounty, &c. The Regiment and Company in which the soldier last served should be given on the back.

NOTE 2.—An enlistment holds to service. A muster-in must, in all cases, precede payment of pay, bounty, pension, &c. A muster-in roll must, in all cases, be filed in the Adjutant-General's Office as evidence of muster-in. The mustering officer, commissary, or assistant-commissary of musters, as the case may be, will countersign both enlistments as having mustered the soldier into the service of the United States before either of them is given to the disbursing officer.

DEPARTMENT OF THE ARMY
 OFFICE OF THE ADJUTANT-GENERAL
 DIVISION OF RECRUITING
 WASHINGTON, D. C.

DECLARATION OF RECRUIT.

I, *John W Ferguson* desiring to VOLUNTEER as a Soldier in the Army of the United States, for the term of THREE YEARS, Do Declare, That I am *Twenty* years and _____ months of age; that I have never been discharged from the United States service on account of disability or by sentence of a court-martial, or by order before the expiration of a term of enlistment; and I know of no impediment to my serving honestly and faithfully as a soldier for three years.

GIVEN at *Boston* the *21st* day of *May 1864*

Witness: *John H Williams* *John W Ferguson*
 mark

Discharged

18

Reg't of

enlistment; last served in Company ()

Regiment of

By

18

Volunteered at

5th Mass Cav

No.

5th Mass Cav

CONSENT IN CASE OF MINOR.

I, _____ Do CERTIFY, That I am _____ the _____ of _____; that the said _____ is _____ years of age; and I do hereby freely give my CONSENT to his volunteering as a SOLDIER in the ARMY OF THE UNITED STATES, for the period of THREE YEARS.

GIVEN at _____ the _____ day of _____

Witness:

VOLUNTEER ENLISTMENT.

STATE OF



TOWN OF

Massachusetts

Newton

I, *John W Ferguson* born in *Alexandria*
 in the State of *Virginia* aged *Twenty* years,
 and by occupation a *Laborer* DO HEREBY ACKNOWLEDGE to have
 volunteered this *Twenty first* day of *May* 186*4*,
 to serve as a **Soldier** in the Army of the United States of America, for the
 period of **THREE YEARS**, unless sooner discharged by proper authority: Do also
 agree to accept such bounty, pay, rations and clothing as are, or may be, estab-
 lished by law for volunteers. And I, *John W Ferguson* do
 solemnly swear, that I will bear true faith and allegiance to the **United States**
of America, and that I will serve them honestly and faithfully against all their
 enemies or opposers whomsoever; and that I will observe and obey the orders of
 the President of the United States, and the orders of the officers appointed over
 me, according to the Rules and Articles of War.

Sworn and subscribed to, at *Boston*
 this *Twenty first* day of *May* 186*4*.
 BEFORE *John W Ferguson*
Justice of the Peace *Geo. H. Quincy U.S. Asst*

I CERTIFY, ON HONOR, That I have carefully examined the above-named Volunteer, agreeably
 to the General Regulations of the Army, and that, in my opinion, he is free from all bodily defects and
 mental infirmity, which would in any way disqualify him from performing the duties of a soldier.

Geo. H. Quincy
 EXAMINING SURGEON.

Vaccinated
 I CERTIFY, ON HONOR, That I have minutely inspected the Volunteer, *John W Ferguson*
 previously to his enlistment, and that he was entirely sober when enlisted, that, to the best of my
 judgment and belief, he is of lawful age; and that, in accepting him as duly qualified to perform the duties
 of an able-bodied soldier, I have strictly observed the Regulations which govern the recruiting service
 This soldier has *dark* eyes, *dark* hair, *dark* complexion, is *five* feet
five inches high.

Geo. H. Quincy
 Regiment of *U.S.* Volunteers,
 RECRUITING OFFICER.

(A. G. O. No. 74 & 75.)

the day of , 186 , at Mustered into the service of the United States, in Company

Regiment of

Volunteers, on

1st Mass Cavalry

NOTE 1.—This blank will be used for both enlistments and re-enlistments—enlistment of veterans, &c., &c., in the volunteer service. They will be made cut in duplicate in all cases—one to accompany the recruiting return of the superintendent (not the recruiting officer) to the Adjutant-General, and one to accompany the accounts of the officer who pays bounty, &c. The Regiment and Company in which the soldier last served should be given on the back.

NOTE 2.—An enlistment holds to service. A muster-in must, in all cases, precede payment of pay, bounty, pension, &c. A muster-in roll must, in all cases, be filed in the Adjutant-General's Office as evidence of muster-in. The mustering officer, commissary, or assistant-commissary of musters, as the case may be, will countersign both enlistments as having mustered the soldier into the service of the United States before either of them is given to the disbursing officer.

ADJUTANT-GENERAL'S OFFICE
WASHINGTON, D. C.

DECLARATION OF RECRUIT.

I, *John W Ferguson* desiring to VOLUNTEER as a Soldier in the Army of the United States, for the term of **THREE YEARS**, Do Declare, That I am *Twenty* years and _____ months of age; that I have never been discharged from the United States service on account of disability or by sentence of a court-martial, or by order before the expiration of a term of enlistment; and I know of no impediment to my serving honestly and faithfully as a soldier for three years.

GIVEN at *Boston* the *21st* day of *May 1864*

Witness: *John H Williams* *John W Ferguson*

Discharged _____ 18 _____

enlistment; last served in Company ()
Reg't of _____

By _____
Regiment of _____

Volunteered at _____ 18 _____

No. *51 Mass Cav*

CONSENT IN CASE OF MINOR.

I, _____ Do CERTIFY, That I am _____ the _____ of _____; that the said _____ is _____ years of age; and I do hereby freely give my CONSENT to his volunteering as a SOLDIER in the ARMY OF THE UNITED STATES, for the period of **THREE YEARS**.

GIVEN at _____ the _____ day of _____

Witness: _____

(A. G. O. No. 74 & 75.)

VOLUNTEER ENLISTMENT.

STATE OF

TOWN OF

Massachusetts

Newton

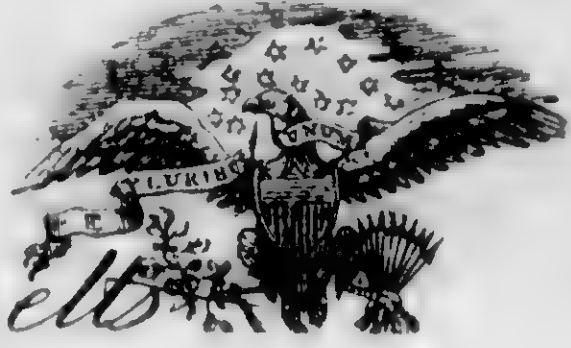

I, *John W Ferguson* born in *Alexandria*
 in the State of *Virginia* aged *Twenty* years,
 and by occupation a *Laborer* Do HEREBY ACKNOWLEDGE to have
 volunteered this *Twenty first* day of *May* 1864,
 to serve as a **Soldier** in the Army of the United States of America, for the
 period of **THREE YEARS**, unless sooner discharged by proper authority: Do also
 agree to accept such bounty, pay, rations, and clothing, as are, or may be, estab-
 lished by law for volunteers. And I, *John W Ferguson* do
 solemnly swear, that I will bear true faith and allegiance to the **United States**
of America, and that I will serve them honestly and faithfully against all their
 enemies or opposers whomsoever; and that I will observe and obey the orders of
 the President of the United States, and the orders of the officers appointed over
 me, according to the Rules and Articles of War.

Mustered into the service of the United States, in Company
day of
, 1864, at

Sworn and subscribed to, at *Boston*
 this *Twenty first* day of *May* 1864.
 BEFORE *D. Mazon*
Justice of the Peace
John W Ferguson
Witness
Geo H Quincy U.S. Asst

I CERTIFY, ON HONOR, That I have carefully examined the above-named Volunteer, agreeably
 to the General Regulations of the Army, and that, in my opinion, he is free from all bodily defects and
 mental infirmity, which would in any way disqualify him from performing the duties of a soldier.

B. J. Jeffries
 EXAMINING SURGEON.

Vaccinated

I CERTIFY, ON HONOR, That I have minutely inspected the Volunteer, *John W Ferguson*
 previously to his enlistment, and that he was entirely sober when enlisted; that, to the best of my
 judgment and belief, he is of lawful age; and that, in accepting him as duly qualified to perform the duties
 of an able-bodied soldier, I have strictly observed the Regulations which govern the recruiting service
 This soldier has *dark* eyes, *dark* hair, *dark* complexion, is *five* feet
five inches high.

Geo. H. Quincy

Regiment of Volunteers,

U.S. RECRUITING OFFICER.

asst

(A. G. O. No. 74 & 75.)

6671

Regiment of

Volunteers, on

5th Mass. Cavalry

435

Ferman, Seneca A
Co E, 5 Mass. Cav., (Col'd.)

Private

Private

CARD NUMBERS.

1		26	
2		27	
3	<i>See Ferman</i>	28	<i>Seneca A.</i>
4		29	
5		30	
6		31	
7		32	
8		33	
9		34	
10		35	
11		36	
12		37	
13		38	
14		39	
15		40	
16		41	
17		42	
18		43	
19		44	
20		45	
21		46	
22		47	
23		48	
24		49	
25		50	

Book Mark: _____

See also _____

Ferris Moses

Co E, 5 Mass. Cav., (Col'd.)

Private

Private

CARD NUMBERS.

- 1
- 2
- 3
- 4
- 5
- 6
- 7
- 8
- 9
- 10
- 11
- 12
- 13
- 14
- 15
- 16
- 17
- 18
- 19
- 20
- 21
- 22
- 23
- 24
- 25

- 26
- 27
- 28
- 29
- 30
- 31
- 32
- 33
- 34
- 35
- 36
- 37
- 38
- 39
- 40
- 41
- 42
- 43
- 44
- 45
- 46
- 47
- 48
- 49
- 50

See Ferris

Moses

Book Mark:

See also

437

Gields Augustus

Co A, 5 Mass. Cav., (Col'd.)

Private | *Private*

CARD NUMBERS.

1	5373284	26
2	5373369	27
3	5373452	28
4	5373544	29
5	5373663	30
6	5373773	31
7	5373873	32
8	5373984	33
9	5374087	34
10	5374188	35
11	5374284	36
12	5374374	37
13	9092643	38
14	40730928	39
15		40
16		41
17		42
18		43
19		44
20		45
21		46
22		47
23		48
24		49
25		50

Book Mark:

See also

7

5 Cav. (Col'd.) | Mass.

Augustus Fields

....., Co. *E*, 5 Reg't Mass. Cav. (Col'd.)

Appears on

Company Descriptive Book

of the organization named above.

DESCRIPTION.

Age *19* years; height *5* feet *8* inches.

Complexion *black*

Eyes *black*; hair *black*

Where born *Pittsfield, Mass*

Occupation *Laborer*

ENLISTMENT.

When *Dec 17*, 186*3*.

Where *Pittsfield*

By whom *J. G. Hunt*; term *3* y'rs.

Remarks:

(3830)

J. T. Woolley

Copyst.

J

5 Col'd Cav.

Mass.

Augustus Fields

Q^{rt}, Co. A, 5 Reg't Mass. Col'd Cav.

Appears on

Company Muster-in and Descriptive Roll

of the organization named above. Roll dated

Readville Jan. 9, 1864.

Where born Pittsfield Mass

Age 19 y'rs; occupation Labourer

When enlisted Dec. 17th, 1863.

Where enlisted Pittsfield

For what period enlisted Three years.

Eyes Black; hair Black

Complexion Black; height 5' ft. 8 in.

When mustered in Jan. 9th, 1864.

Where mustered in Readville

Bounty paid \$ 100; due \$ 100

Where credited

Company to which assigned

Remarks:

+ Inserted by Jordan Ex

Book mark:

G. F. W.

F

5 Col'd Cav.

Mass.

Augustus Field
Opt, Co. A, 5 Reg't Mass. Col'd Cavalry.

Appears on

Company Muster Roll

for *Enlistment to Feb. 29, 1864*

Present or absent *Present*

Stoppage, \$ *100* for

Due Gov't, \$ *100* for

Valuation of horse, \$ *100*

Valuation of horse equipments, \$ *100*

Remarks: *On daily duty*
at Post #4 - Vera Cruz
Jan 30th 1864

Book mark:

G. H. J.

(358)

Copyist.

4

5 Col'd Cav.

Mass.

Augustus Fields
Priv, Co. A, 5 Reg't Mass. Col'd Cavalry.

Appears on

Company Muster Roll

for *Mar & Apr*, 186*4*

Present or absent *Present*

Stoppage, \$ *100* for

Due Gov't, \$ *100* for

Valuation of horse, \$ *100*

Valuation of horse equipments, \$ *100*

Remarks: _____

Book mark: _____

(358)

G. Fox
Copyist.

F

5 Col'd Cav.

Mass.

Augustus Fields
Privt, Co. A, 5 Reg't Mass. Col'd Cavalry.

Appears on

Company Muster Roll

for *May & June*, 1864.

Present or absent *Present*

Stoppage, \$ 100 for

Due Gov't, \$ 100 for

Valuation of horse, \$ 100

Valuation of horse equipments, \$ 100

Remarks:

Book mark:

G. F. M.

J

5 Col'd Cav.

Mass.

Augustus Fields
Private, Co. A, 5 Reg't Mass. Col'd Cavalry.

Appears on

Company Muster Roll

for July and Aug., 1864.

Present or absent. Present

Stoppage, \$ 100 for

Due Gov't, \$ 100 for

Valuation of horse, \$ 100

Valuation of horse equipments, \$ 100

Remarks: Free on or before
Apr. 19, 1861.

Book mark:

H. C. Gillett

J

5 Col'd Cav.

Mass.

Augustus Fields

Cvt., Co. A, 5 Reg't Mass. Col'd Cavalry.

Appears on

Company Muster Roll

for *Sept. and Oct.*, 186*4*.

Present or absent *Present.*

Stoppage, \$ *100* for

Due Gov't, \$ *100* for

Valuation of horse, \$ *100*

Valuation of horse equipments, \$ *100*

Remarks:

Book mark:

M. O. Gilbert

(358)

Copyist.

J

5 Col'd Cav.

Mass.

Augustus Fields

Pvt., Co. A, 5 Reg't Mass. Col'd Cavalry.

Appears on

Company Muster Roll

for *Nov. and Dec.*, 186*4*.

Present or absent *Present.*

Stoppage, \$ *100* for

Due Gov't, \$ *100* for

Valuation of horse, \$ *100*

Valuation of horse equipments, \$ *100*

Remarks: *Stop one pr. Saddle bags \$5.50*

Book mark:

M. O. Gilliat

(358)

Copyist.

F

5 Col'd Cav.

Mass.

Augustus Childs

Priv., Co. A, 5 Reg't Mass. Col'd Cavalry.

Appears on

Company Muster Roll

for *Jan. 1st to Feb. 1st*, 1865.

Present or absent *Present.*

Stoppage, \$ *3*^{*50*}/_{*100*} for *Ord.*

Due Gov't, \$ *100* for

Valuation of horse, \$ *100*

Valuation of horse equipments, \$ *100*

Remarks:

Book mark:

H. O. Gilbert

J

5 Col'd Cav.

Mass.

Augustus Fields
Co. A, 5 Reg't Mass. Col'd Cavalry.

Appears on

Company Muster Roll

for *March and Apr.*, 1865

Present or absent. *Present.*

Stoppage, \$ *100* for

Due Gov't, \$ *100* for

Valuation of horse, \$ *100*

Valuation of horse equipments, \$ *100*

Remarks:

Book mark:

M. O. Gillbert

(358)

Copyist.

F

5 Col'd Cav.

Mass.

Augustus Fields

Pl, Co. A, 5 Reg't Mass. Col'd Cavalry.

Appears on

Company Muster Roll

for *May + June*, 1865.

Present or absent *absent*

Stoppage, \$ *100* for

Due Gov't, \$ *100* for

Valuation of horse, \$ *100*

Valuation of horse equipments, \$ *100*

Remarks: *Absent on tranchent
June 29. 1865*

Book mark: *2*

Sallede

F

5 Col'd Cav.

Mass.

Augustus Fields

Sgt, Co. A, 5 Reg't Mass. Col'd Cavalry.

Appears on

Company Muster Roll

for *July + Aug*, 186 *5*.

Present or absent *Present*

Stoppage, \$ *100* for

Due Gov't, \$ *100* for

Valuation of horse, \$ *100*

Valuation of horse equipments, \$ *100*

Remarks:

Book mark:

Sallade

(358)

Copyist.

F

5 Col'd Cav.

Mass.

A. Fields

Pr., Co. *A*, 5 Reg't Mass. Colored Cav.

Appears on Returns as follows:

*June 1865. Absent as Guard
on Transport since
June 29.*

Book mark:

O. T. Taylor

(546)

Copyist.

7

5 Col'd Cav. Mass.

Augustus Fields

Privat, Co. A, 5 Reg't Mass. Col'd Cavalry.

Appears on Co. Muster-out Roll, dated

Clarksville, Texas, Oct 31, 1865.

Muster-out to date Oct 31, 1865.

Last paid to Dec 31, 1864.

Clothing account:

Last settled....., 186 ; drawn since \$ 100

Due soldier \$ 6²⁶ 100; due U. S. \$ 100

Am't for cloth'g in kind or money adv'd \$ 100

Due U. S. for arms, equipments, &c., \$ 11 100

* Bounty paid \$ 25 100; due \$ 75 100

Remarks: * Free Apr. 9, 1861

Book mark:

Ballade

(861)

Copyist.

Fields Charles H.

Co B, 5 Mass. Cav., (Col'd.)

Private Private

CARD NUMBERS.

1	5374484	26
2	5374582	27
3	5874666	28
4	5374761	29
5	5374865	30
6	5374973	31
7	5375082	32
8	5375186	33
9	5375291	34
10	5375390	35
11	5375492	36
12	5375587	37
13	9592529	38
14	40730930	39
15		40
16		41
17		42
18		43
19		44
20		45
21		46
22		47
23		48
24		49
25		50

Book Mark:

See also

7

5 Cav. (Col'd.) | Mass.

Charles H. Field

Co. B, 5 Reg't Mass. Cav. (Col'd.)

Appears on

Company Descriptive Book

of the organization named above.

DESCRIPTION.

Age 39 years; height 5 feet 8 3/4 inches.

Complexion Brown

Eyes Black; hair Black

Where born Newbury Mass.

Occupation Laborer

ENLISTMENT.

When Dec 28, 1863.

Where Newbury

By whom J. H. Wallcut; term 3 y'rs.

Remarks:

Field

(383a)

Copyist.

F

5 Col'd Cav.

Mass.

Charles M. Field

Bt, Co. *B*, 5 Reg't Mass. Col'd Cav.

Appears on

Company Muster-in and Descriptive Roll
of the organization named above. Roll dated

Readville Mass, Jan'y 29, 1864.

Where born *Newbury Mass.*

Age *37* y'rs; occupation *Laborer*

When enlisted *Dec 28th*, 1863.

Where enlisted *Essex*

For what period enlisted *3* years.

Eyes *Black*; hair *Black*.

Complexion *Black*; height *5 ft. 8³/₄ in.*

When mustered in *Jan 29*, 1864.

Where mustered in *Readville Mass.*

Bounty paid \$ *100*; due \$ *100*

Where credited

Company to which assigned

Remarks: *Essex*

Inspected by Jordan Ex

Book mark:

Hayberger

J

5 Col'd Cav.

Mass.

Charles E. Finley

A., Co. B, 5 Reg't Mass. Col'd Cavalry.

Appears on

Company Muster Roll

for *Enlistment to Feb 29*, 1864.

Present or absent *Present*

Stoppage, \$ *100* for

Due Gov't, \$ *100* for

Valuation of horse, \$ *100*

Valuation of horse equipments, \$ *100*

Remarks: *On 'Daily Duty' attached to Regt. - Band per Sp. order - No 27 dated 2nd Apr. 5th Mass. Cav. Lexdville Mass. - Feb 24 '64*

Book mark:

Finley

(358)

Copist.

F

5 Col'd Cav.

Mass.

Chas H Fields

Pt., Co. B, 5 Reg't Mass. Col'd Cavalry.

Appears on

Company Muster Roll

for *March & April*, 1864.

Present or absent *Present*

Stoppage, \$ *100* for

Due Gov't, \$ *100* for

Valuation of horse, \$ *100*

Valuation of horse equipments, \$ *100*

Remarks: *on Daily Duty
attached to Reg. Band for
S. O. 12th dated 26th p. 5th
Mass. Cav. T. 24 64*

Book mark:

(358)

Fryberger

Copyist.

F

5 Col'd Cav.

Mass.

Charles H. Fields

Pvt., Co. B, 5 Reg't Mass. Col'd Cavalry.

Appears on

Company Muster Roll

for *May & June*, 1864.

Present or absent *Present*

Stoppage, \$ *100* for

Due Gov't, \$ *100* for

Valuation of horse, \$ *100*

Valuation of horse equipments, \$ *100*

Remarks: *On Daily Duty
Attached to Reg. Band
per S.O. No 37 dated 4th Apr.
Ms Cav. Feb 24 '64*

Book mark:

(358)

Hyberger

Copyist.

F.

5 Col'd Cav.

Mass.

Charles H. Fields,

Priv., Co. B, 5 Reg't Mass. Col'd Cavalry.

Appears on

Company Muster Roll

for July & Aug., 1864.

Present or absent Present

Stoppage, \$ 100 for

Due Gov't, \$ 100 for

Valuation of horse, \$ 100

Valuation of horse equipments, \$ 100

Remarks: On Daily Duty attached to Reg. Band per S.O. No. 37 dated H. Q. 5th Mass. Cav. Feb. 24. 64.

Book mark:

(358)

J. W. Brown Copyist.

F.

5 Col'd Cav.

Mass.

Charles H. Fields,

Pvt., Co. B, 5 Reg't Mass. Col'd Cavalry.

Appears on

Company Muster Roll

for Sept. & Oct., 1864

Present or absent Present

Stoppage, \$ 100 for

Due Gov't, \$ 100 for

Valuation of horse, \$ 100

Valuation of horse equipments, \$ 100

Remarks: On Daily Duty attached to Reg. Band per S.O. No. 37 dated Feb. 24. 64 Free on or before Apr. 19/61 Due U.S. Bounty \$ 25.00

Book mark:

W. Brown

(358)

Copyist.

F.

5 Col'd Cav.

Mass.

Charles H. Fields,

Priv., Co. B, 5 Reg't Mass. Col'd Cavalry.

Appears on

Company Muster Roll

for *Nov. & Dec.*, 186*4*.

Present or absent *Present.*

Stoppage, \$ *100* for

Due Gov't, \$ *100* for

Valuation of horse, \$ *100*

Valuation of horse equipments, \$ *100*

Remarks: *on Daily Duty
attached to Reg. Band
per S.O. No. 37 Feb. 24/64.*

Book mark:

H. W. Brown

(358)

Copyist.

F.

5 Col'd Cav.

Mass.

Charles H. Fields,

Privat, Co. B, 5 Reg't Mass. Col'd Cavalry.

Appears on

Company Muster Roll

for *Jan'y. & Feby.*, 1865.

Present or absent *— Present.*

Stoppage, \$ *100* for

Due Gov't, \$ *100* for

Valuation of horse, \$ *100*

Valuation of horse equipments, \$ *100*

Remarks: *Due the Soldier*

1st - 2nd - 3rd & 4th - Instructions.

U.S. Bounty.

*On Daily Duty attached
to Regt. Band.*

Book mark:

A. W. Brown

(358)

Copyist.

4. | **5 Col'd Cav.** | **Mass.**

Charles H. Fields,

Priv, Co. B, 5 Reg't Mass. Col'd Cavalry.

Appears on

Company Muster Roll

for *March & April*, 1865.

Present or absent *— Present.*

Stoppage, \$ *100* for

Due Gov't, \$ *100* for

Valuation of horse, \$ *100*

Valuation of horse equipments, \$ *100*

Remarks: *On Daily Duty
attached to Reg. Band.*

Book mark: *114*

(358)

M. Brown
Copyist.

F

5 Col'd Cav.

Mass.

Charles H. Fields

Plt., Co. B, 5 Reg't Mass. Col'd Cavalry.

Appears on

Company Muster Roll

for *May & June*, 1865.

Present or absent *Present*

Stoppage, \$ *100* for

Due Gov't, \$ *100* for

Valuation of horse, \$ *100*

Valuation of horse equipments, \$ *100*

Remarks *On Daily Duty attached to Reg. Band.*

Book mark:

Schisch

G

5 Col'd Cav.

Mass.

Charles H. Fields

Priv, Co. B, 5 Reg't Mass. Col'd Cavalry.

Appears on

Company Muster Roll

for *July & Aug.*, 186*5*.

Present or absent *Present*

Stoppage, \$ *100* for

Due Gov't, \$ *100* for

Valuation of horse, \$ *100*

Valuation of horse equipments, \$ *100*

Remarks: *On daily duty in Regt Band*

Book mark:

Schlesick

F

5 Col'd Cav.

Mass.

Fields

Post, Co. *B*, 5 Reg't Mass. Colored Cav.

Appears on **Returns** as follows:

*February 1864 to Sept. 1865 - On
duty attached to
Regt. Band.*

Book mark:

O. J. Taylor

(546)

Copyist.

F

5 Col'd Cav.

Mass.

Charles H. Field

Plt., Co. *B*, 5 Reg't Mass. Col'd Cavalry.

Appears on **Co. Muster-out Roll**, dated

Clarksville, Tex., Oct. 31, 1865.

Muster-out to date

Oct. 31, 1865.

Last paid to

Dec 31, 1864.

Clothing account:

Last settled....., 186 ; drawn since \$..... 100

Due soldier \$ *3*^{*13*}..... 100; due U. S. \$..... 100

Am't for cloth'g in kind or money adv'd \$..... 100

Due U. S. for arms, equipments, &c., \$ *8*^{*00*}..... 100

Bounty paid \$ *25*^{*00*}..... 100; due \$ *275*^{*00*}..... 100

Remarks:

Book mark:

Scherich

439

Fields John

Co B, 5 Mass. Cav., (Col'd.)

Private Corporal

CARD NUMBERS.

1	5375701	26
2	5375792	27
3	5375875	28
4	5375969	29
5	5376078	30
6	5376179	31
7	5376289	32
8	5376394	33
9	5376499	34
10	5376598	35
11	5376695	36
12	5376772	37
13	1092395	38
14	40730931	39
15		40
16		41
17		42
18		43
19		44
20		45
21		46
22		47
23		48
24		49
25		50

Book Mark: _____

See also _____

7

5 Cav. (Col'd.) | Mass.

John ...

, Co. 1st, 5 Reg't Mass. Cav. (Col'd.)

Appears on

Company Descriptive Book

of the organization named above.

DESCRIPTION.

Age *21* years; height *5* feet *4* inches.

Complexion *dark*

Eyes *black*; hair *black*

Where born *Detroit, Michigan*

Occupation *Messenger*

ENLISTMENT.

When *Jan 7*, 186*4*.

Where *Dishburg*

By whom *Bartlett. Andrew*; term *3* y'rs.

Remarks: *Mustered into Company 6
Jan 29th 1864 at Readville, Mass
by Lt McKibbin*

(383g)

...
Copyist.

F

5 Col'd Cav.

Mass.

John Fields
Priv., Co. *B*, 5 Reg't Mass. Col'd Cav.

Appears on

Company Muster-in and Descriptive Roll
of the organization named above. Roll dated
Readville, *Jan. 29*, 1864.

Where born *Detroit, Mich.*

Age *44* y'rs; occupation *Mariner.*

When enlisted *Jan. 7*, 1864.

Where enlisted *Fishers*

For what period enlisted *3* years.

Eyes *Black*; hair *Black*

Complexion *Black*; height *5* ft. *4* in.

When mustered in *Jan. 29*, 1864.

Where mustered in *Readville, Mass.*

Bounty paid \$ *100*; due \$ *100*

Where credited *1st Dist. Dubuque.*

Company to which assigned _____

Remarks: _____

Book mark: _____

Sitter.

(354d) Copyist.

F.

5 Col'd Cav.

Mass.

John Fields

Priv., Co. C, 5 Reg't Mass. Col'd Cavalry.

Appears on

Company Muster Roll

for *Enlistment to Feb 29, 1864.*

Present or absent *Absent*

Stoppage, \$ *100* for

Due Gov't, \$ *100* for

Valuation of horse, \$ *100*

Valuation of horse equipments, \$ *100*

Remarks: *Absent without leave since Feb. 26th*

Book mark:

Sitter

(358)

Copyist.

F.

5 Col'd Cav.

Mass.

John Fields,

Priv, Co. C, 5 Reg't Mass. Col'd Cavalry.

Appears on

Company Muster Roll

for *Mar. & Apr.*, 1864.

Present or absent *Present.*

Stoppage, \$ *100* for

Due Gov't, \$ *100* for

Valuation of horse, \$ *100*

Valuation of horse equipments, \$ *100*

Remarks: *Thirty Dollars due U. S. for apprehension as a deserter.*

Book mark:

Sitter,

(358)

Copyist.

F.

5 Col'd Cav.

Mass.

John Fields

Sr.
Pr., Co. C, 5 Reg't Mass. Col'd Cavalry.

Appears on

Company Muster Roll

for *May & June*, 1864.

Present or absent *Present*

Stoppage, \$ *100* for

Due Gov't, \$ *100* for

Valuation of horse, \$ *100*

Valuation of horse equipments, \$ *100*

Remarks: *On daily duty
as Company cook*

Book mark:

Sitter

(358)

Copyist.

G

5 Col'd Cav.

Mass.

John Fields
Pvt., Co. C, 5 Reg't Mass. Col'd Cavalry.

Appears on

Company Muster Roll

for *July & Aug*, 1864.

Present or absent *Present*

Stoppage, \$ *100* for

Due Gov't, \$ *100* for

Valuation of horse, \$ *100*

Valuation of horse equipments, \$ *100*

Remarks: *Thirty dolls to be deducted from his pay for apprehension as a deserter*

Book mark:

E H Barron

A

5 Col'd Cav.

Mass.

John Fields
Capt.

, Co. C, 5 Reg't Mass. Col'd Cavalry.

Appears on

Company Muster Roll

for Sept. & Oct., 1864.

Present or absent Present

Stoppage, \$ 100 for

Due Gov't, \$ 100 for

Valuation of horse, \$ 100

Valuation of horse equipments, \$ 100

Remarks: Due the U.S. thirty dollars (\$30) Free on or before Oct. 19, 61

Book mark:

E. H. Brown

F

5 Col'd Cav.

Mass.

John Fields

Pvt., Co. C, 5 Reg't Mass. Col'd Cavalry.

Appears on

Company Muster Roll

for *Nov Dec*, 1864.

Present or absent *Present*

Stoppage, \$ *100* for

Due Gov't, \$ *100* for

Valuation of horse, \$ *100*

Valuation of horse equipments, \$ *100*

Remarks: *Due Wf \$20 for M. stores \$0.45
Free on or before April 9, 61*

Book mark:

E. H. Barron

F

5 Col'd Cav.

Mass.

John Fields
Prt, Co. C, 5 Reg't Mass. Col'd Cavalry.

Appears on

Company Muster Roll

for *Jan Feb*, 186*5*.

Present or absent *Present*

Stoppage, \$ *100* for

Due Gov't, \$ *100* for

Valuation of horse, \$ *100*

Valuation of horse equipments, \$ *100*

Remarks: *Due W. \$ 30. Due*
1st 4 inst. W. Bounty \$ 1.00.

Book mark:

E. H. Brown

A

5 Col'd Cav.

Mass.

John Fields
Prvt

, Co. C, 5 Reg't Mass. Col'd Cavalry.

Appears on

Company Muster Roll

for *Mar & Apr*, 1865.

Present or absent *Present*

Stoppage, \$ *100* for

Due Gov't, \$ *100* for

Valuation of horse, \$ *100*

Valuation of horse equipments, \$ *100*

Remarks: *Daily duty in 2^d M. Dept.*
Due of the 1st inst. U.S. bounty \$35.
Due 2^d & 3^d & 4th inst. U.S. bounty \$120.

Book mark:

E. H. Brown

J

5 Col'd Cav.

Mass.

John Fields

Pvt

Co. C, 5 Reg't Mass. Col'd Cavalry.

Appears on

Company Muster Roll

for

May & June, 1865.

Present or absent

Absent

Stoppage, \$

100 for

Due Gov't, \$

100 for

Valuation of horse, \$

100

Valuation of horse equipments, \$

100

Remarks:

Free before April 19 1861

Due of 1st Dist US Bounty \$35⁰⁰

Due 2-3 & 4 Dist US Bounty \$120⁰⁰

Daily duty in 2^d M Dept on

board Transport

Book mark:

Abbott

(358)

Copyist.

7

5 Col'd Cav.

Mass.

John P. Fields

Pvt, Co. C, 5 Reg't Mass. Col'd Cavalry.

Appears on

Company Muster Roll

for July & Aug, 1865.

Present or absent Present

Stoppage, \$ 100 for

Due Gov't, \$ 100 for

Valuation of horse, \$ 100

Valuation of horse equipments, \$ 100

Remarks: Free before April 19 1861

Book mark:

Abbott

(358)

Copyst.

7

5 Col'd Cav.

Mass.

J. P. John Fields

Pvt, Co. C, 5 Reg't Mass. Col'd Cavalry.

Appears on

Company Muster Roll

for *July & Aug*, 1865.

Present or absent. *Present*

Stoppage, \$ *100* for

Due Gov't, \$ *100* for

Valuation of horse, \$ *100*

Valuation of horse equipments, \$ *100*

Remarks: *Free before April 19 1861*

Book mark:

A. E. Brown

Copyist.

J | **5 Col'd Cav.** |

Mass.

John Fields

Prvt., Co. C, 5 Reg't Mass. Colored Cav.

Appears on **Returns** as follows:

*Febry 1864 - Absent without
leave*

*March 1864 - On duty, detail-
ed as Co. Cook.*

June 1864 - Co. Cook.

*March to May 1865 - On
daily duty in Q. M. S.
Dept.*

*June 1865 - On extra duty
in Q. M. S. Dept.*

Book mark:

C. J. Taylor

(546)

Copyist.

J

5 Col'd Cav.

Mass.

John Fields

Corpl, Co. *6*, 5 Reg't Mass. Col'd Cavalry.

Appears on **Co. Muster-out Roll**, dated
Clarksville Texas, Oct 31, 186*5*.

Muster-out to date *Oct 31*, 186*5*.

Last paid to *Dec 31*, 186*4*.

Clothing account:

Last settled....., 186 ; drawn since \$..... 100

Due soldier \$ *7*^{*84*}/₁₀₀; due U. S. \$..... 100

Am't for cloth'g in kind or money adv'd \$..... 100

Due U. S. for arms, equipments, &c., \$ *11*/₁₀₀

Bounty paid \$ *25*/₁₀₀; due \$ *275*/₁₀₀

Remarks: *Promoted to Corpl by SO*
No 148 dated Sept 12 1865

Book mark :

Abbott

Fields, John

P, Co.

5

Reg't *Mar. C. Cav.*

Enclosures.

Bed Cards	Final Statements
Burial Records	Furloughs or L. of A
Certs. of Dis. for Discharge	Med. Certificates
C. M. Charges	Med. Des. Lists
Descriptive Lists	Orders
Discharge Certificates	Pris. of War Record
Enlistment Papers	Resignations

Other papers relating to—

Admission to Hosp'l	Furlough or L. of A
Casualty Sheet	Med. Examination
Confinement	Misc. Information
Contracts	Pay or Clothing
Death or Effects	Personal Reports
Desertion	Rank
Discharge from Hosp'l	Transfer to Hosp'l
Discharge from Service	Transfer to V. R. C.
Duty	Transportation

No. 60

John Fields

Enlisted at Sausville Wis

As Substitute for

C. Ackley

On the 13th day of Oct., 1864.
Regt. 5th Reg. Mass. Cav. Co

By

Capt. S. J. M. Putnam

S. B. Caswell

C. R. Head

Board of Enrollment,

2d Dist. of Wis conscrip
credited to Pacific Column
Co. 2d Dist Wis

S. J. M. Putnam
Capt. & Pro
2d Dist

SUBSTITUTE
VOLUNTEER ENLISTMENT.

STATE OF

City
TOWN OF

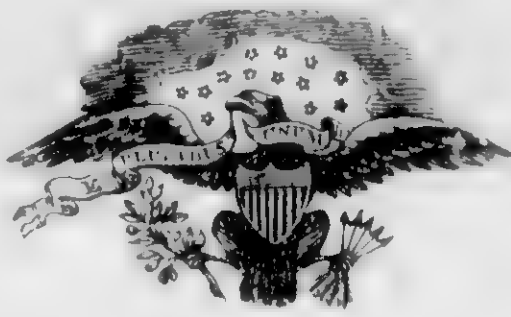

Miss cousin

Lanesville

I, *John Fields* born in the State
of *Tennessee*, aged *Eighteen* years, and by
occupation a *Farmer*

Do HEREBY ACKNOWLEDGE to have agreed with
C. Ackley, Esq., of *Pacific*

Columbia Co. 2d Dist. Miss

to become his **SUBSTITUTE** in the Military Service, for a sufficient consideration paid and
delivered to me, on the *Thirteenth* day of *October*, 1864;
and having thus agreed with said *C. Ackley*, I DO HEREBY
ACKNOWLEDGE to have enlisted this *Thirteenth* day of *October*,
1864, to serve as a **Soldier** in the **Army of the United States of America**, for the period
of ~~THREE YEARS~~ ^{*One*}, unless sooner discharged by proper authority: I do also agree to accept such
bounty, pay, rations, and clothing, as are, or may be, established by law for soldiers. And I do
solemnly swear that I will bear true and faithful allegiance to the **United States of America**;
that I will serve them honestly and faithfully against all their enemies or opposers whomsoever;
and that I will observe and obey the orders of the President of the United States, and the orders
of the Officers appointed over me, according to the Rules and Articles of War.

SWORN and subscribed to, at *Lanesville*

this *13th* day of *October*, 1864

BEFORE

S. J. M. Putnam

Capt and Prov. Marshal

John X Fields
mark

Witness S. Gussmore

We certify, on honor, That we have carefully examined the above-named Volunteer Substitute
agreeably to the Regulations, and that, in our opinion, he is free from all bodily defects and mental infirmity
which would in any way disqualify him from performing the duties of a soldier; that he was entirely sober
when enlisted; that he is of lawful age, (not under 18 years;) and that, in accepting him as duly qualified to
perform the duties of an able-bodied soldier, and as a Substitute in lieu of *C. Ackley*

Lanesville Miss, drafted in *September 21st*, 1864 we have strictly observed the Regulations which govern
in such cases. This soldier has *black* eyes, *black* hair, *black* complexion; is *5* feet *5 1/2*
inches high.

S. J. M. Putnam
Capt & Provost Marshal.

A. B. Caswell
Commissioner of Board.

C. R. Mead
Surgeon of Board.

Board of Enrollment of *2d* Dist. of *Miss cousin*.

DECLARATION OF SUBSTITUTE.

I, John Fields One desiring to ENLIST
in the Army of the United States, for ~~THREE YEARS~~, **Do declare**, That I am
Eighteen years and _____ months of age; that I have
never been discharged from the United States service on account of disability or by sentence of
a court martial; and I know of no impediment to my serving honestly and faithfully as a soldier
for ~~three~~ one years.

GIVEN at Sauesville Wis
the 13 day of October 1864

WITNESS:

A. Devenore John his X Fields
mark

S J M Putnam
13 Oct 1864
Sauesville Wis

440

Finley James

Co K, 5 Mass. Cav., (Col'd.)

Private Private

CARD NUMBERS.

1	5381589	26
2	5381680	27
3	5381768	28
4	5381861	29
5	5381965	30
6	5382069	31
7	5382174	32
8	5382274	33
9	5382373	34
10	5382469	35
11	5382566	36
12	9091805	37
12	40730932	38
14		39
15		40
16		41
17		42
18		43
19		44
20		45
21		46
22		47
23		48
24		49
25		50

Book Mark:

See also

J.

5 Cav. (Col'd.)

Mass.

James Finley.

, Co. *H.*, 5 Reg't Mass. Cav. (Col'd.)

Appears on

Company Descriptive Book

of the organization named above.

DESCRIPTION.

Age *21* years; height *5* feet *9* inches.

Complexion *Black.*

Eyes *Black*; hair *Black.*

Where born *Illinois.*

Occupation *Farmer*

ENLISTMENT.

When *Mar. 4*, 1864.

Where *Chesterfield*

By whom *Luke Lyman*; term *3* y'rs.

Remarks: *Murdered in at Readville*

Mar. 12'64.

H. C. Thomas.

(383g)

Copyist.

J

5 Col'd Cav.

Mass.

James Finley

Pvt, Co. *H*, 5 Reg't Mass. Col'd Cav.

Appears on

Company Muster-in and Descriptive Roll

of the organization named above. Roll dated

Readeville, Mass, Mar 12, 1864.

Where born

Illinois

Age *21* y'rs; occupation

Farmer

When enlisted

Mar. 4, 1864.

Where enlisted

Chesterfield

For what period enlisted

3, years.

Eyes *Black*; hair

Black

Complexion *Black*; height

5 ft. 9 in.

When mustered in

Mar. 12, 1864.

Where mustered in

Readeville Mass.

Bounty paid \$

100

; due \$

100

Where credited

G. B. St. Hampton

Company to which assigned

Remarks:

Inserted by Jordan Co.

Book mark:

J. M. Wall

(356d)

Copyist.

J

5 Col'd Cav.

Mass.

James Finley

Pvt, Co. H, 5 Reg't Mass. Col'd Cavalry.

Appears on

Company Muster Roll

for *Mar 12 to Apr 30* 186*4*

Present or absent *Present*

Stoppage, \$ *100* for

Due Gov't, \$ *100* for

Valuation of horse, \$ *100*

Valuation of horse equipments, \$ *100*

Remarks:

Book mark:

J. M. Malt

(358)

Copyist.

A

5 Col'd Cav.

Mass.

James Finley

Pvt, Co. H, 5 Reg't Mass. Col'd Cavalry.

Appears on

Company Muster Roll

for *May & June*, 186*4*

Present or absent *Present*

Stoppage, \$ *100* for

Due Gov't, \$ *100* for

Valuation of horse, \$ *100*

Valuation of horse equipments, \$ *100*

Remarks:

Book mark:

J. Wall

(358)

Copyist.

J

5 Col'd Cav.

Mass.

James Finley

Pvt, Co. H, 5 Reg't Mass. Col'd Cavalry.

Appears on

Company Muster Roll

for *July & Aug*, 186*4*.

Present or absent *Present*

Stoppage, \$ *100* for

Due Gov't, \$ *100* for

Valuation of horse, \$ *100*

Valuation of horse equipments, \$ *100*

Remarks:

Book mark:

J. M. Wall

(358)

Copyist.

P

5 Col'd Cav.

Mass.

James Finley
Pat, Co. H, 5 Reg't Mass. Col'd Cavalry.

Appears on

Company Muster Roll

for Sept & Oct, 1864.

Present or absent Present

Stoppage, \$ 0 ⁰⁴/₁₀₀ for one cross
sable letter & number.

Due Gov't, \$ 100 for

Valuation of horse, \$ 100

Valuation of horse equipments, \$ 100

Remarks:

Book mark:

C. M. Clark

(358)

Copyist.

P

5 Col'd Cav.

Mass.

James Finley
Pat, Co. II, 5 Reg't Mass. Col'd Cavalry.

Appears on

Company Muster Roll

for *Nov & Dec*, 186*4*

Present or absent *Present*

Stoppage, \$ *100* for

Due Gov't, \$ *100* for

Valuation of horse, \$ *100*

Valuation of horse equipments, \$ *100*

Remarks: *Stop one sur-
cingle, car. box plate
& belt & gun sling.
In confinement.*

Book mark:

C. W. Clark

(358)

Copyist.

F

5 Col'd Cav.

Mass.

James Finley
Put, Co. H, 5 Reg't Mass. Col'd Cavalry.

Appears on

Company Muster Roll

for Jan + Feb, 1865.

Present or absent Present

Stoppage, \$ 100 for

Due Gov't, \$ 100 for

Valuation of horse, \$ 100

Valuation of horse equipments, \$ 100

Remarks: Stop one sur-
cingle, car. box belt +
plate + gun sling (con-
finement) Due 1st, 2d, 3d
+ 4th installments U. S.
bounty.

Book mark:

B M Clark

P

5 Col'd Cav.

Mass.

James Pinley
Pat, Co. II, 5 Reg't Mass. Col'd Cavalry.

Appears on

Company Muster Roll

for *March & April*, 1865.

Present or absent *Present.*

Stoppage, \$ *100* for

Due Gov't, \$ *100* for

Valuation of horse, \$ *100*

Valuation of horse equipments, \$ *100*

Remarks: *Due 1st, 2d, 3d & 4th installments U.S. bounty*

Book mark:

C M Clarke

(358)

Copyist.

7

5 Col'd Cav.

Mass.

James Finley
Pat, Co. H, 5 Reg't Mass. Col'd Cavalry.

Appears on

Company Muster Roll

for May & June, 1865.

Present or absent Present

Stoppage, \$ 100 for

Due Gov't, \$ 100 for

Valuation of horse, \$ 100

Valuation of horse equipments, \$ 100

Remarks: 1st, 2d, 3d & 4th install-
ment U. S. bounty due-
Free on or before April
19, 1861.

Book mark:

L. M. Clark

(358)

Copyist.

F

5 Col'd Cav.

Mass.

Amos Finley

Priv., Co. H, 5 Reg't Mass. Col'd Cavalry.

Appears on

Company Muster Roll

for *July & Aug.*, 186*5*.

Present or absent *present*

Stoppage, \$ *100* for

Due Gov't, \$ *100* for

Valuation of horse, \$ *100*

Valuation of horse equipments, \$ *100*

Remarks: *See on or before Apr. 19. 1861.*

Book mark:

Records

(358)

Copyist.

J

5 Col'd Cav.

Mass.

James Finley

Co. H, 5 Reg't Mass. Colored Cav.

Appears on Returns as follows:

*March 1865 - Absent in
Confinement at Ft.
Leokout, Md since Mar. 29.*

*July 1865 - Absent Fatigue at
Prazos July 27*

*Aug. 1865 - Absent, det. serv. at
Prazos since July 27.*

*Sept. 1865 - Absent, working
on R.R. at Prazos.*

Book mark :

O. J. Taylor

(546)

Copyist.

74

5 Col'd Cav.

Mass.

James Finley

Priv., Co. *A*, 5 Reg't Mass. Col'd Cavalry.

Appears on **Co. Muster-out Roll**, dated
Blacksville, Miss., Octo. 31, 1865.

Muster-out to date *Octo 31*, 1865.

Last paid to *Dec. 31*, 1864.

Clothing account:

Last settled....., 186 ; drawn since \$..... 100

Due soldier \$ *24*^{*83*}/₁₀₀; due U. S. \$..... 100

Am't for cloth'g in kind or money adv'd \$..... 100

Due U. S. for arms, equipments, &c., \$ *11*^{*00*}/₁₀₀

Bounty paid \$..... 100; due \$ *300*^{*00*}/₁₀₀

Remarks: *Free on or before*

April 7. 1861

Book mark:

R. E. Wilson

(861)

Copyist.

Fisher, David C.

Col, 5 Mass. Cav., (Col'd.)

Private

Private

CARD NUMBERS.

1 5375703
 2 5375794
 3 5375877
 4 5375970
 5 5376079
 6 5376188
 7 5376288
 8 5376395
 9 5376500
 10 5376599
 11 5376696
 12 5372796
 13 5376790
 14 9092397
 15 40730945
 16
 17
 18
 19
 20
 21
 22
 23
 24
 25

26
 27
 28
 29
 30
 31
 32
 33
 34
 35
 36
 37
 38
 39
 40
 41
 42
 43
 44
 45
 46
 47
 48
 49
 50

Book Mark:

See also

7

5 Cav. (Col'd.) | Mass.

David G. Fisher

, Co. 6, 5 Reg't Mass. Cav. (Col'd.)

Appears on

Company Descriptive Book

of the organization named above.

DESCRIPTION.

Age - 41 years; height 5 feet 8 inches.

Complexion *fair*

Eyes *blue*; hair *black*

Where born *Leicester, Mass*

Occupation *farmer*

ENLISTMENT.

When *Jan 27*, 1864.

Where *Boston*

By whom *Samuel Davis*; term 3 y'rs.

Remarks: *Mustered into company G
Jan 29, 1864 at Northville Mass by
St McKibbin*

W. Friday

(3830)

Copyist.

F

5 Col'd Cav.

Mass.

David C. Fisher

Priv, Co. *"C"*, 5 Reg't Mass. Col'd Cav.

Appears on

Company Muster-in and Descriptive Roll
of the organization named above. Roll dated

Readville *Jan. 29, 1864.*

Where born *Carisle, Penn'a.*

Age *24* y'rs; occupation *Farmer.*

When enlisted *Jan. 27, 1864.*

Where enlisted *Boston Md. 6*

For what period enlisted *3* years.

Eyes *Black*; hair *Black*

Complexion *Black*; height *5* ft. *8* in.

When mustered in *Jan. 29, 1864.*

Where mustered in *Readville, Mass.*

Bounty paid \$ *100*; due \$ *100*

Where credited *4th Dist Suffolk.*

Company to which assigned

Remarks:

Book mark:

Butler

(356d)

Copyist.

F

5 Col'd Cav.

Mass.

David C. Fisher

Co. C, 5 Reg't Mass. Col'd Cavalry.

Appears on

Company Muster Roll

for Enlistment to Feb. 29, 1864.

Present or absent Present

Stoppage, \$ 100 for

Due Gov't, \$ 100 for

Valuation of horse, \$ 100

Valuation of horse equipments, \$ 100

Remarks: Detailed for Bands, Special Order No. 28.

Book mark:

Sitter

F

5 Col'd Cav.

Mass.

David C. Fisher

Pvt., Co. C, 5 Reg't Mass. Col'd Cavalry.

Appears on

Company Muster Roll

for *Mar. & Apr.*, 1864.

Present or absent *Present*

Stoppage, \$ *100* for

Due Gov't, \$ *100* for

Valuation of horse, \$ *100*

Valuation of horse equipments, \$ *100*

Remarks:

Book mark:

Sitter

(358)

Copyist.

F

5 Col'd Cav.

Mass.

David G. Fisher

Priv., Co. C, 5 Reg't Mass. Col'd Cavalry.

Appears on

Company Muster Roll

for May & June, 1864.

Present or absent Present

Stoppage, \$ 100 for

Due Gov't, \$ 100 for

Valuation of horse, \$ 100

Valuation of horse equipments, \$ 100

Remarks: Detailed for
Barracks & Special
Orders No. 25.

Book mark:

Sitter

D

5 Col'd Cav.

Mass.

David C. Fisher

Pat, Co. C, 5 Reg't Mass. Col'd Cavalry.

Appears on

Company Muster Roll

for *July & Aug*, 1864.

Present or absent *Present*

Stoppage, \$ *100* for

Due Gov't, \$ *100* for

Valuation of horse, \$ *100*

Valuation of horse equipments, \$ *100*

Remarks: *Relieved from Band by
S.O. No. 137*

Book mark:

E. H. Brown

D

5 Col'd Cav.

Mass.

David C. Fisher

Capt., Co. C, 5 Reg't Mass. Col'd Cavalry.

Appears on

Company Muster Roll

for Sept. & Oct., 1864.

Present or absent Present

Stoppage, \$ 100 for

Due Gov't, \$ 100 for

Valuation of horse, \$ 100

Valuation of horse equipments, \$ 100

Remarks: Free on or before Oct 19 61

Book mark:

E. H. Brown

F

5 Col'd Cav.

Mass.

David C Fisher

Pat, Co. C, 5 Reg't Mass. Col'd Cavalry.

Appears on

Company Muster Roll

for *Nov & Dec*, 1864.

Present or absent *Present*

Stoppage, \$ *100* for

Due Gov't, \$ *100* for

Valuation of horse, \$ *100*

Valuation of horse equipments, \$ *100*

Remarks: *Due U.S. for Inf
Ord. \$0.40 for 2 M stores & 88
free on or before Aug 19, 61*

Book mark:

E. N. Brown

D

5 Col'd Cav.

Mass.

David C. Fisher

Pr, Co. C, 5 Reg't Mass. Col'd Cavalry.

Appears on

Company Muster Roll

for *Jan Feb*, 1865.

Present or absent *Present*

Stoppage, \$ *100* for

Due Gov't, \$ *100* for

Valuation of horse, \$ *100*

Valuation of horse equipments, \$ *100*

Remarks: *Due 1st 4 inst of
bounty \$180.*

Book mark:

E. N. Brown

2

5 Col'd Cav.

Mass.

David C Fisher

Co. C, 5 Reg't Mass. Col'd Cavalry.

Appears on

Company Muster Roll

for March April, 1865.

Present or absent Present

Stoppage, \$ 100 for

Due Gov't, \$ 100 for

Valuation of horse, \$ 100

Valuation of horse equipments, \$ 100

Remarks: Due Wf for Car Ord. \$2.25
Due of inst Wf bounty \$35.
Due & 304 inst Wf bounty \$120.

Book mark:

E. H. Beorn

F

5 Col'd Cav.

Mass.

David C Fisher

Pvt

, Co. C, 5 Reg't Mass. Col'd Cavalry.

Appears on

Company Muster Roll

for

May & June, 1865.

Present or absent

Absent

Stoppage, \$

2 $\frac{25}{100}$ for

Ord Stores;

for 2 M. Stores 85cts

Due Gov't, \$

100 for

Valuation of horse, \$

100

Valuation of horse equipments, \$

100

Remarks:

Free before April 19, 1861

Due 1/85 Dist US Bounty \$35.00

Due 2-3+4 Dist US Bounty \$120.00

Detached Service at Hd 2rs

25 A. C. by SO No. 88 dated

May 12 1865

Book mark:

Abbott

7

5 Col'd Cav.

Mass.

David C Fisher

Pvt, Co. C, 5 Reg't Mass. Col'd Cavalry.

Appears on

Company Muster Roll

for July & Aug, 1865.

Present or absent Absent

Stoppage, \$ 2 ²⁵/₁₀₀ for Ordnance
for 2 m stores 85 cts

Due Gov't, \$ 100 for

Valuation of horse, \$ 100

Valuation of horse equipments, \$ 100

Remarks: On detached service No
2 vs 25 a b by SO No 88
May 12 - 1865
Free before April 19 1861

Book mark:

Albion

D. C. Fisher

Sgt., Co., 5 Reg't Mass. Col'd Cavalry.

Appears on a

Detachment Muster Roll

of the organization named above

for *Aug 31*, 1865.

Station *Paragon, Antelope, Texas*

Present or absent *Present*

Stoppage, \$ *100* for

Due Gov't, \$ *100* for

Valuation of horse, \$ *100*

Valuation of horse equipments, \$ *100*

Remarks: *Nothing rec'd settled up
to Dec. 31/64. Stab for Ordnance
\$2.25, Stab for 2. 411. Stares
\$0.35.*

Book mark :

F

5 Col'd Cav.

Mass.

David C. Fisher
Capt. Muscin Co. C, 5 Reg't Mass. Colored Cav.

Appears on Returns as follows:

Febry to April 1864 - On duty
in Regtl. Band.
May & June 1864 - (Muscin) On
duty in Regtl. Band.
July 1864 - On daily duty
in the Band (Capt.)

May & June 1865 - Absent at Corps
Hd. Qrs. with Orderlies.
July to Sept. 1865 - Absent
at Hd. Qrs. 25th B. by
S.O. No. 88 since May
12, 65.

Book mark:

O. J. Taylor

(546)

Copyist.

7

5 Col'd Cav.

Mass.

David C Fisher

Pvt, Co. C, 5 Reg't Mass. Col'd Cavalry.

Appears on Co. Muster-out Roll, dated Clarksville Texas, Oct 31, 1865.

Muster-out to date Oct 31, 1865.

Last paid to June 30, 1865.

Clothing account:

Last settled, 186 ; drawn since \$ 100

Due soldier \$ 100; due U. S. \$ 17 62/100

Am't for cloth'g in kind or money adv'd \$ 100

Due U. S. for arms, equipments, &c., \$ 11 100

Bounty paid \$ 25 100; due \$ 275 100

Remarks: due US for 68 & 8 85 cts

Book mark:

Abbott

(361)

Copyist.

442

Fisher George A.

Co E, 5 Mass. Cav., (Col'd.)

Lieutenant / Lieutenant

CARD NUMBERS.

1	5371919	26
2	5378082	27
3	5378167	28
4	5378252	29
5	5378338	30
6	5378445	31
7	5372844	32
8	5371920	33
9	5376141	34
10	5376251	35
11	5376356	36
12	5376459	37
13	5376560	38
14	5376752	39
15	5379279	40
16	5376837	41
17	9436247	42
18	40730933	43
19		44
20		45
21		46
22		47
23		48
24		49
25		50

Book Mark:

See also

5 | 5 Cav. | Mass
(Col'd)
George A. Fisher,
2nd Co., 5 Reg't Mass Col'd Cav

Appears on

Regimental Descriptive Book

(List of Commissioned Officers)

of the regiment named above.

Rank *Lieutenant*

Date of appointment *Dec. 29, 1864*

Remarks *Mustered in service, Jan. 9/64.*

Harris

G

5 Col'd Cav.

Mass.

George A. Fisher

2^d Lt., Co., 5 Reg't Mass. Col'd Cavalry.

Age 23 years.

Appears on an

Individual Muster-in Roll

of the organization named above. Roll dated

Boston, Mass, Jan. 9, 1864.

Muster-in to date

Jan. 9, 1864.

Joined for duty and enrolled:

When

Dec. 29, 1863.

Where

Boston.

Period

3 years.

Valuation of horse, \$ 100

Valuation of horse equipments, \$ 100

Remarks:

Mustered into the U.S. Service in accordance with Genl. Order No. 75 dated A.G.O. Washington D.C. July 8, 1864. to aid in the organization of this Regiment.

Book mark:

P' Pool

JH

5 Col'd Cav.

Mass.

George A. Fisher
2^d Lieut, Co. E, 5 Reg't Mass. Col'd Cav.

Appears on

Company Muster-in and Descriptive Roll

of the organization named above. Roll dated

Readville, Mass., Feb'y 10, 1864.

Where born

Age 23 y'rs; occupation

When enlisted Dec 29, 1863.

Where enlisted Cambridge

For what period enlisted 3 years.

Eyes; hair

Complexion; height ft. in.

When mustered in Feb'y 10, 1864.

Where mustered in

Bounty paid \$ 100; due \$ 100

Where credited Dist. Middlesex

Company to which assigned

Remarks: Mustered by Lt. Madden,
Jan'y 9, 1864, No. 75

Book mark:

Norman

(356d)

Copyist.

JH

5 Col'd Cav.

Mass.

George A. Fisher
2^d Lt., Co. E, 5 Reg't Mass. Col'd Cavalry.

Appears on

Company Muster Roll

for *Enlistment to 29 Feb'y, 1864.*

Present or absent...

present

Stoppage, \$..... 100 for

Due Gov't, \$..... 100 for

Valuation of horse, \$..... 100

Valuation of horse equipments, \$..... 100

Remarks:

*Mustered by Lt.
Madden, Jan'y 9. 64.
G. A. F.*

Book mark:

JH

5 Col'd Cav.

Mass.

George A Fisher

229, Co. E, 5 Reg't Mass. Col'd Cavalry.

Appears on

Company Muster Roll

for *March 1st*, 186*4*.

Present or absent *present*

Stoppage, \$ 100 for

Due Gov't, \$ 100 for

Valuation of horse, \$ 100

Valuation of horse equipments, \$ 100

Remarks:

Book mark:

[Signature]

(358)

Copyist.

F

5 Col'd Cav.

Mass.

George A. Fisher

2^d Lt., Co. E, 5 Reg't Mass. Col'd Cavalry.

Appears on

Company Muster Roll

for *May & June*, 186*4*.

Present or absent... *Present*

Stoppage, \$..... 100 for

Due Gov't, \$..... 100 for

Valuation of horse, \$..... 100

Valuation of horse equipments, \$..... 100

Remarks:

Book mark:

[Signature]

Copyist.

(358)

F

5 Col'd Cav.

Mass.

George A. Fisher

2^d Lieut, Co. E, 5 Reg't Mass. Col'd Cavalry.

Appears on

Company Muster Roll

for July + Aug, 1864.

Present or absent Present

Stoppage, \$ 100 for

Due Gov't, \$ 100 for

Valuation of horse, \$ 100

Valuation of horse equipments, \$ 100

Remarks: Sick in Hos. from July 3rd to August 2nd 1864

Book mark:

O. J. Clark

(358)

Copyist.

9

5 Col'd Cav.

Mass.

George Fisher

2^d Lt., Co., 5 Reg't Mass. Col'd Cavalry.

Appears on an

Individual Muster-out Roll

of the organization named above. Roll dated

11 Feb - 27, 1864

Muster-out to date *Apr 17, 1864*

Last paid to _____, 186 .

Clothing account:

Last settled _____, 186 ; drawn since \$ _____ 100

Due soldier \$ _____ 100; due U. S. \$ _____ 100

Am't for cloth'g in kind or money adv'd \$ _____ 100

Due U. S. for arms, equipments, &c., \$ _____ 100

Bounty paid \$ _____ 100 due \$ _____ 100

Remarks *Mustered out by reason of promotion Vice John Anderson promoted to Captain*

Book mark: _____

[Signature]

(348)

Copyist.

G

5 Col'd Cav.

Mass.

George A. Fisher
1st., Co. C, 5 Reg't Mass. Col'd Cavalry.

Age 24 years.

Appears on an

Individual Muster-in Roll

of the organization named above. Roll dated

Pt. Lookout, Md., Sept. 27, 1864.

Muster-in to date Sept. 18, 1864.

Joined for duty and enrolled:

When Sept. 18, 1864.

Where Pt. Lookout, Md.

Period 3 years.

Valuation of horse, \$ 100

Valuation of horse equipments, \$ 100

Remarks: This muster to date Sept. 18, 1864, Mustered as 1st Lt. by reason of promotion Vice John Anderson promoted. Residence: Mattiphar, Mass. Cong. Dist. not known.
Book mark: 21-40

P. Pool

A

5 Col'd Cav.

Mass.

George Fisher

1st Lt., Co. C, 5 Reg't Mass. Col'd Cavalry.

Appears on

Company Muster Roll

for Sept + Oct, 1864.

Present or absent Present

Stoppage, \$ 100 for

Due Gov't, \$ 100 for

Valuation of horse, \$ 100

Valuation of horse equipments, \$ 100

Remarks: Promoted 1st Lt and transferred to Co. C. Reg't G.O. No 54 dated Sept 64

Book mark:

E. H. Bann

A

5 Col'd Cav.

Mass.

George A Fisher

1st Lt, Co. C, 5 Reg't Mass. Col'd Cavalry.

Appears on

Company Muster Roll

for *Nov & Dec*, 1864.

Present or absent *Present*

Stoppage, \$ *100* for

Due Gov't, \$ *100* for

Valuation of horse, \$ *100*

Valuation of horse equipments, \$ *100*

Remarks:

Book mark:

E. H. Brown

(358)

Copyist.

A

5 Col'd Cav.

Mass.

George A Fisher

1st Lt, Co. C, 5 Reg't Mass. Col'd Cavalry.

Appears on

Company Muster Roll

for *Jan Feb*, 1865.

Present or absent *Present*

Stoppage, \$ *100* for

Due Gov't, \$ *100* for

Valuation of horse, \$ *100*

Valuation of horse equipments, \$ *100*

Remarks:

Book mark:

E. T. Brown

(358)

Copyist.

5 Col'd Cav. | Mass.

George A. Fisher

1st Lt., Co. C, 5 Reg't Mass. Col'd Cavalry.

Appears on

Company Muster Roll

for War r. July, 1865.

Present or absent Present

Stoppage, \$ 100 for

Due Gov't, \$ 100 for

Valuation of horse, \$ 100

Valuation of horse equipments, \$ 100

Remarks:

Book mark:

E. A. B. [Signature]

F

5 Col'd Cav.

Mass.

George A Fisher

Present, Co. C, 5 Reg't Mass. Col'd Cavalry.

Appears on

Company Muster Roll

for May & June, 1865.

Present or absent Present

Stoppage, \$ 100 for

Due Gov't, \$ 100 for

Valuation of horse, \$ 100

Valuation of horse equipments, \$ 100

Remarks:

Book mark:

U6602

F

5 Col'd Cav.

Mass.

George A Fisher

Lieut, Co. C, 5 Reg't Mass. Col'd Cavalry.

Appears on

Company Muster Roll

for July & Aug, 1865.

Present or absent

Stoppage, \$ 100 for

Due Gov't, \$ 100 for

Valuation of horse, \$ 100

Valuation of horse equipments, \$ 100

Remarks: Discharged by SO No 329
War Dept A 40 Washington
D.C. June 24 1865

Book mark:

Abbott

F

5 Col'd Cav.

Mass.

George A. Fisher

2d Lieut. Co. E

1st Lieut., Co. C, 5 Reg't Mass. Colored Cav.

Appears on Returns as follows:

May & June 1864 - Present.

*July 1864 - Present sick in
Post Hospital since July 3, '64*

*Aug. 1864 - Present spec. duty
Comdg. Co. H.*

*Sept. 1864 (1st Co. C.) Present,
Promoted from 2d Lt. & transfd
from Co. E by order No. dated
Sept. 18, '64.*

Oct. 1864 to June 1865 - Present

*July 1865 - Disch'd by S.O.
No. 329, War Dept. A. G. O.
Washington, D. C., June 24,
85*

Book mark:

O. J. Taylor

(546)

Copyist.

F

5 Col'd Cav.

Mass.

George A Fisher

Lieut, Co. B, 5 Reg't Mass. Col'd Cavalry.

Appears on Co. Muster-out Roll, dated
Clarksville Texas, Oct 31, 1865.

Muster-out to date 186 .

Last paid to 186 .

Clothing account:

Last settled....., 186 ; drawn since \$..... 100

Due soldier \$..... 100; due U. S. \$..... 100

Am't for cloth'g in kind or money adv'd \$..... 100

Due U. S. for arms, equipments, &c., \$..... 100

Bounty paid \$..... 100; due \$..... 100

Remarks: Discharged by SO No 329
War Dept A 90 Washington Dc
dated June 14 1865

Book mark :

Abbot

D

5 Col'd Cav.

Mass.

George A. Fisher
D. Co. *E*, 5 Reg't Mass. Col'd Cavalry.

Appears on **Co. Muster-out Roll**, dated
Clarksville, Tex., Oct 31, 1865.

Muster-out to date 186 .

Last paid to 186 .

Clothing account:

Last settled....., 186 ; drawn since \$..... 100

Due soldier \$..... 100; due U. S. \$..... 100

Am't for cloth'g in kind or money adv'd \$..... 100

Due U. S. for arms, equipments, &c., \$..... 100

Bounty paid \$..... 100; due \$..... 100

Remarks: *Promoted 1st Lt and
assigned to Co. 'C.'*

Book mark :

(861)

L. W. ...

Copyright.

Fisher, G. A.

1st St. Co., 5th Reg't Mass. Cav.

5~~3~~ Enclosures.

Bed Cards	Final Statements ..
Burial Records	Furloughs or L. of A.
Certs. of Dis. for Discharge	Med. Certificates
C. M. Charges	Med. Des. Lists
Descriptive Lists	Orders /
Discharge Certificates	Pris. of War Record
Enlistment Papers	Resignations /

Other papers relating to—

Admission to Hosp'l	Furlough or L. of A. /
Casualty Sheet	Med. Examination
Confinement	Misc. Information 2
Contracts	Pay or Clothing
Death or Effects	Personal Reports
Desertion	Rank
Discharge from Hosp'l	Transfer to Hosp'l
Discharge from Service	Transfer to V. R. C.
Duty	Transportation

2)

1001 C. S. U. N.

M. 2197, ² U. C. (N. 105)

Camp of 5th Lt. Mass. Cav

City Point Va. June 8th 1865.

John A. Andrew,

Gov. of Mass.

Sir,

I have been informed that the officers of Colored State organizations who wish to leave the service will now be allowed to do so. Having made one unsuccessful attempt, I have been advised to write to you and ask what steps must be taken to that end. At the time the regiment was organized, I was a member of the Junior Class (Class of '65) of Harvard College. I left my studies at that time because I thought every young man was needed in the army. Now that the war is over I wish to return home to complete my studies that I may be able to take a profession. I have a widowed mother living, and a young sister, and it is

my duty to put myself in a position to give them
comfort and support, knowing your interest in
the student as well as your unequalled kindness
to the soldier, I have presumed to address you
hoping you will inform and pardon

Your obt. servant,

Geo. A. Fisher, 1st Lieut 5th Mass. Cav.

M. 2197 (1865) 1865
Boston, Mass. 1865
June 14, 1865.

Massachusetts State
Hon. J. A. Andrews
Gov

Encloses applications
of 1st Lt. G. A. Fisher
5th Mass. Cav. and
J. S. Wheat, Capt.
5th Mass. Cav. for
discharge from service.

Hopes the papers
may be regarded
as resignations and
accepted.

[Faint handwritten notes]

M.A. 375. A. 117. 1865.
Adj. Gen's. Office,
June 21, 1865.

Respectfully submit-
ted to Lieut. General
W. S. Grant, Command-
ing Armies of the
United States, with
the recommendation
that 1st Lieut. G. A.
Fisher, 5th Mass. Cav.
(Colonel) be honorably
discharged the service
of the United States.

The other officer men-
tioned in this commu-
nication has been pre-
viously discharged in
order from this office.

L. W. Foster

A. A. Genl. Vols.
Approved
By command of Lt. Gen. Grant
Geo Hamilton

Handy recd
June 22. 65. Brig Genl. Staff

Note: Lieut Fisher
discharged by Sp
No. 329 of June
24 1865. a. g. off

Commonwealth of Massachusetts.

Executive Department.

Boston June 14th. 1865.

Hon. E. M. Stanton.

Sec^y of War.

Sir:

I inclose two letters
received by me, respectively from

Capt. J. L. Wheat, 5th Mass. Vol. Cavalry.

First Lieut. George A. Fisher, " " " " "

The subject to which they relate being one out
of my control, viz: the desire of these officers
to withdraw from the service, I am only able
to forward them with the expression of a
hope that it may be found compatible
with the interest of the service to regard
the papers as resignations, and to

accept such resignations.

I have the honor to be

Your obedient servant,

A handwritten signature in cursive script, appearing to read "Charles Sumner". The signature is fluid and elegant, with a long, sweeping underline that extends to the right.

Governor of Massachusetts.

James S. Wheat Capt 5th Mass. Col'd Cavalry
was honorably discharged - Spc Ord 209, W.D., June 16/1865

George A Fisher was mustered in as 2d Lieut January
9th and was 1st Lieut. Sept. 15, 1864 of the 5th Regt ~~W.D.~~
Col'd Cavalry. On Return of that Regt for the month
of May 1865 he is reported present for duty. W.D.

1st Lt. G. A. Fisher.

(Mass. Cav. (Col'd))

SPECIAL ORDERS, }
No. 329. }

WAR DEPARTMENT.
ADJUTANT GENERAL'S OFFICE,
Washington, June 24th, 1865.

(Extract.)

* * * * *

51. The following named officers, having tendered their resignations, are, upon the recommendation of their superior officers, hereby honorably discharged the service of the United States, with condition that they shall receive no final payments, until they have satisfied the Pay Department that they are not indebted to the Government:—

✓ 1st Lieutenant *George A. Fisher*, 5th Massachusetts Cavalry, (Colored.)

* * * * *

By order of the Secretary of War:

E. D. TOWNSEND,
Assistant Adjutant General.

OFFICIAL:

Assistant Adjutant General.

(C. Fisher)

u

SPECIAL ORDERS, }
No. 329. }

WAR DEPARTMENT.
ADJUTANT GENERAL'S OFFICE,
Washington, June 24th, 1865.

(Extract.)

* * * * *

51. The following named officers, having tendered their resignations, are, upon the recommendation of their superior officers, hereby honorably discharged the service of the United States, with condition that they shall receive no final payments, until they have satisfied the Pay Department that they are not indebted to the Government:—

1st Lieutenant *George A. Fisher*, 5th Massachusetts Cavalry, (Colored.)

* * * * *

By order of the Secretary of War :

E. D. TOWNSEND,

Assistant Adjutant General.

OFFICIAL



Assistant Adjutant General.



443

Fisher George T.

Co 6, 5 Mass. Cav., (Col'd.)

Private Private

CARD NUMBERS.

1	5375700	26
2	5375766	27
3	5375851	28
4	5375937	29
5	5376043	30
6	5376146	31
7	5376256	32
8	5376362	33
9	5376462	34
10	5376565	35
11	5376699	36
12	5376792	37
13	5377843	38
14	9092394	39
15	F-17-054871	40
16	33236766	41
17	33030412	42
18	40730934	43
19		44
20		45
21		46
22		47
23		48
24		49
25		50

Book Mark: F. 17 Vol. 9 C.T. 1871.

See also

7

5 Cav. (Col'd.) | Mass.

George F. Fisher

, Co. G, 5 Reg't Mass. Cav. (Col'd.)

Appears on

Company Descriptive Book

of the organization named above.

DESCRIPTION.

Age 39 years; height 5 feet 11 inches.

Complexion *fair*

Eyes *blue*; hair *black*

Where born *Washington, D.C.*

Occupation *merchant*

ENLISTMENT.

When *May 7*, 1864.

Where *Wilmington*

By whom *W. Fisher*; term *3* y'rs.

Remarks: *Mustered into company G, May 29, 1864 at Readville, Mass by Lt. W. Fisher*

Fisher

(383g)

Copyist.

7

5 Col'd Cav.

Mass.

George S. Fisher
Priv., Co. C, 5 Reg't Mass. Col'd Cav.

Appears on

Company Muster-in and Descriptive Roll
of the organization named above. Roll dated

Readville Jan. 29, 1864.

Where born Framingham, D.C.

Age 39 y'rs; occupation Butcher

When enlisted Jan. 5, 1864.

Where enlisted Mansfield

For what period enlisted 3 years.

Eyes Black; hair Black

Complexion Black; height 5 ft. 10 in.

When mustered in Jan. 29, 1864.

Where mustered in Readville, Mass.

Bounty paid \$ 100; due \$ 100

Where credited 2^d Dist. Plymouth

Company to which assigned

Remarks:

Book mark:

Sitler

F

5 Col'd Cav.

Mass.

George T. Fisher

Serjt, Co. C, 5 Reg't Mass. Col'd Cavalry.

Appears on

Company Muster Roll

for Enlistment to Feb. 29, 1864.

Present or absent Present

Stoppage, \$ 100 for

Due Gov't, \$ 100 for

Valuation of horse, \$ 100

Valuation of horse equipments, \$ 100

Remarks: Appointed by Special Order No. 10

Book mark:

Sitter

F

5 Col'd Cav.

Mass.

George T. Fisher

Serjt, Co. C, 5 Reg't Mass. Col'd Cavalry.

Appears on

Company Muster Roll

for Mar. & Apr., 1864.

Present or absent Present

Stoppage, \$ 100 for

Due Gov't, \$ 100 for

Valuation of horse, \$ 100

Valuation of horse equipments, \$ 100

Remarks:

Book mark:

Sitter

54

5 Col'd Cav.

Mass.

George T. Fisher.

Serj't, Co. C, 5 Reg't Mass. Col'd Cavalry.

Appears on

Company Muster Roll

for Mar & June, 1864.

Present or absent Present

Stoppage, \$ 100 for

Due Gov't, \$ 100 for

Valuation of horse, \$ 100

Valuation of horse equipments, \$ 100

Remarks: Absent by General Order No. 10 dated March 24, 1864.

Book mark:

Sutton

D

5 Col'd Cav.

Mass.

George D Fisher

Sgt., Co. C, 5 Reg't Mass. Col'd Cavalry.

Appears on

Company Muster Roll

for *July + Aug*, 186*4*.

Present or absent *Present*

Stoppage, \$ *100* for

Due Gov't, \$ *100* for

Valuation of horse, \$ *100*

Valuation of horse equipments, \$ *100*

Remarks: *Abandoned by G O No
19 Mar 1864*

Book mark:

E H Barron

F

5 Col'd Cav.

Mass.

George A Fisher

Sgt., Co. C, 5 Reg't Mass. Col'd Cavalry.

Appears on

Company Muster Roll

for *Sept & Oct*, 186*4*.

Present or absent *Present*

Stoppage, \$ *100* for

Due Gov't, \$ *100* for

Valuation of horse, \$ *100*

Valuation of horse equipments, \$ *100*

Remarks: *Appointed by G.O. No 19 dated Mar 24, 64. Free on or before Aug 19, 61.*

Book mark:

E. H. Brown

2

5 Col'd Cav.

Mass.

George A Fisher

Sgt., Co. C, 5 Reg't Mass. Col'd Cavalry.

Appears on

Company Muster Roll

for Nov & Dec, 1864.

Present or absent Present

Stoppage, \$ 100 for

Due Gov't, \$ 100 for

Valuation of horse, \$ 100

Valuation of horse equipments, \$ 100

Remarks: Appointed by G.O. dated Mar 24 64 see on or before Ad. 196

Book mark:

E. H. Brown

G.

5 Col'd Cav.

Mass.

George A. Fisher

Sgt., Co. C, 5 Reg't Mass. Col'd Cavalry.

Appears on

Company Muster Roll

for Jan & Feb, 1865.

Present or absent Present

Stoppage, \$ 100 for

Due Gov't, \$ 100 for

Valuation of horse, \$ 100

Valuation of horse equipments, \$ 100

Remarks: Absent, by G.O. 19 dated Mar 27/64. Due 1st Hunt & bounty \$180.

Book mark:

E. H. Brown.

A

5 Col'd Cav.

Mass.

George A Fisher

Sgt, Co. C, 5 Reg't Mass. Col'd Cavalry.

Appears on

Company Muster Roll

for *March & April*, 1865.

Present or absent *Present*

Stoppage, \$ *100* for

Due Gov't, \$ *100* for

Valuation of horse, \$ *100*

Valuation of horse equipments, \$ *100*

Remarks: *Due of 1st month of bounty \$35. Due 2 3 & 4 months of bounty \$120.*

Book mark:

E. N. Bacon

A | *5* *Car* | *Mass*

George D. Fisher
Sgt, *Co. C*, *5* *Regt* *Mass* *Car*

Appears on

Hospital Muster Roll

of **U. S. A. General Hospital,**

at **Fort Monroe, Va.,**

for *May & June*, 186*5*

Attached to hospital :

When _____, 186 .

How employed _____

Last paid by Maj. _____

to _____, 186 .

Bounty paid \$ 100 ; due \$ 100

Present or absent *Present*

Remarks *No descriptive list.*

15 Ward 1 Division

Book mark : _____

C. W. Allen

(843)

Copyist.

F

5 Col'd Cav.

Mass.

George J Fisher

Sergt, Co. C, 5 Reg't Mass. Col'd Cavalry.

Appears on

Company Muster Roll

for May & June, 1865.

Present or absent Absent

Stoppage, \$ - $\frac{60}{100}$ for Ord Stores

Due Gov't, \$ 100 for

Valuation of horse, \$ 100

Valuation of horse equipments, \$ 100

Remarks: Free before April 19 1861

Absent Sick at Fortress

Monroe Va since June 15 - 65

Due of 1st Dist US Bounty \$ 35.00

Due 2-3+4 Dist US Bounty \$ 20.00

Due US for Transportation \$ 23.50

Book mark:

Abbott

F

5 Col'd Cav.

Mass.

George F Fisher

Pvt, Co. C, 5 Reg't Mass. Col'd Cavalry.

Appears on

Company Muster Roll

for July & Aug, 1865.

Present or absent

Absent

Stoppage, \$

11 ⁴⁰/₁₀₀ for Q M Stores

Due Gov't, \$

100 for

Valuation of horse, \$

100

Valuation of horse equipments, \$

100

Remarks:

Reduced from Sergt SO

109 July 10 '865

Due US for Transportation \$9.40

Sick at Fortress Monroe.

Free before April 19 1861

Book mark:

P.M.G. Co Dec 29/65

Absent

F | 56, Cav, Mass

* George J. Fisher

Pvt, Co. G, 5 Reg't Mass 6, Cav.

Appears on

Hospital Muster Roll

of DeCamp U. S. A. General Hospital,

at David's Island, New York Harbor,

for Sept & Oct, 1865.

Attached to hospital:

When Sept 30, 1865.

How employed Patient

Last paid by Maj. Dodge
to Dec 31, 1864.

Bounty paid \$ 100 ; due \$ 100

Present or absent Present

Remarks: Reduced from Srgt
S.O. 109 July 10-65 for
Trans \$19 $\frac{40}{100}$

Pavilion No 11

x' ...
is George J. Fisher

Book mark:

Rosenblum

F

5 Col'd Cav.

Mass.

George J Fisher

Pvt, Co. C, 5 Reg't Mass. Col'd Cavalry.

Appears on Co. Muster-out Roll, dated
Clarksville Texas, Oct 31, 1865.

Muster-out to date _____, 186 .

Last paid to Dec 31, 1864 .

Clothing account:

Last settled _____, 186 ; drawn since \$ 100

Due soldier \$ 19 ⁴⁴/₁₀₀; due U. S. \$ 100

Am't for cloth'g in kind or money adv'd \$ 100

Due U. S. for arms, equipments, &c., \$ ⁶⁰/₁₀₀

Bounty paid \$ 25 ⁰⁰/₁₀₀; due \$ 275 ⁰⁰/₁₀₀

Remarks: Due US for Cr & G \$ 11.40

Reduced to the Ranks from Sergt
by SO 109 dated July 9, 1865

Due US for Transp 9.40

Paid by Maj Pulsifer for the
May & June 1865 \$ 32.00

Book mark: F. 17 Vol 9 67 1871

and No R on file

Abbott

F

5 Col'd Cav.

Mass.

George T. Fisher

Tert
Plt, Co. *C*, 5 Reg't Mass. Colored Cav.

Appears on Returns as follows:

May 1865 - Absent on furlough.

June 1865 - Absent sick at Fortress Monroe.

July to Sept. 1865 - (Plt) Absent sick at Fortress Monroe.

Book mark:

O. J. Taylor

(546)

Copyist.

F

5 Col'd Cav.

Mass.

George T. Fisher

Sergeant
Co. C, 5 Reg't Mass. Colored Cav.

Appears on Returns as follows:

May 1865 - Absent on furlough.

June 1865 - Absent sick at Fortress Monroe.

July to Sept. 1865 - (Pvt) Absent sick at Fortress Monroe.

Book mark:

O. J. Taylor

(546)

Copyist.

7

5 Col'd Cav.

Mass.

George C. Fisher

Co. C, 5 Reg't Mass. Col'd Cavalry.

Appears on an

Individual Muster-out Roll

of the organization named above. Roll dated

New York City, Nov 17, 1865.

Muster-out to date Nov 17, 1865.

Last paid to Dec 31, 1864.

Clothing account:

Last settled 186 ; drawn since \$ 100

Due soldier \$ 100; due U. S. \$ 100

Am't for cloth'g in kind or money adv'd \$ 100

Due U. S. for arms, equipments, &c., \$ 100

Bounty paid \$ 100 due \$ 100

Remarks: Mustered out -

under telegraphic

Order from War Dept

May 4 1865 on postal

descriptive list

from A. G. Nov 14/65

Book mark: F 17 Vol 9 CT (over)

George C. Fisher

J, 5 ear cold, Mass.

George J Fisher

, Co. C, 5 Reg't Mass cold serv.

NOTATION

Book mark: ~~Reg-465-1865 with~~
J, 17 25 1871

War Department,

Adjutant General's Office,

Washington, Jan 27, 1871.

Call from

returned with report.

The above book mark was noted on rolls in order to
preserve results of search in this case.

(475) F. E. Schellings Copyist.

Fisher, George, P.

P, Co. C, 5 Mass. C. Cav.
Reg't

~~2~~ Enclosures.

Bed Cards	Descriptive Lists
Burial Records	Final Statements
Certs. of Dis. for Discharge	Furloughs
C. M. Charges	Med. Des. Lists
Med. Certificates	Orders

Other papers relating to—

Admission to Hosp'l	Furlough
Casualty Sheet (Officer's)	Med. Examination
Confinement	Misc. Information
Contracts	Pay or Clothing
Death or Effects	Personal Reports
Desertions	Rank
Discharge from Hosp'l	Transfer to Hosp'l
Discharge from Service	Transfer to V. R. C.
Duty	Transportation

MICROFILM PUBLICATION M 1822

COMPILED MILITARY SERVICE RECORDS
OF VOLUNTEER UNION SOLDIERS WHO
SERVED WITH THE USCT (US COLORED TROOPS)
5TH MASSACHUSETTS REGIMENT OF CAVALRY

PERSONAL PAPERS' TARGET SHEET

PLEASE NOTE THE CHECKED INFORMATION ABOUT THE PERSONAL PAPERS IN
THIS FILE:

- NO PERSONAL PAPERS WERE FOUND IN THIS FILE WHEN THE
RECORDS WERE ARRANGED FOR MICROFILMING.
- 5 PERSONAL PAPER(S) FOUND IN THIS FILE WHEN THE RECORDS
WERE ARRANGED FOR MICROFILMING.

VOLUNTEER DESCRIPTIVE LIST and Account of Pay and Clothing of *Geo. T. Fisher Co. Co. 3rd Mass Cav*

No.	NAMES.	RANK.	DESCRIPTION.				WHERE BORN.		OCCUPATION.	ENROLLED OR ENLISTED. (For Drafted Men, see note 10.)			MUSTERED IN. (For Drafted Men, see note 10.)				LAST PAID.		BOUNTY.		CLOTHING ACCOUNT.	
			Years of age.	Eyes.	Hair.	Complexion.	Feet.	In.		State or Kingdom.	Town or county.	When.	Where. (Town and State.)	By whom.	When.	Where. (Town and State.)	By whom. (In the case of drafted men, from what enrollment district.)	Period.	By paymaster.	To what time.	Paid \$ (See note 2).	Due \$ (See note 2).
1	<i>Geo. T. Fisher</i>	<i>Pvt</i>	<i>39</i>	<i>Blue</i>	<i>Blue</i>	<i>Blue</i>	<i>5</i>	<i>10</i>	<i>Washington, D.C.</i>	<i>Bookkeeper</i>	<i>Mass</i>	<i>Jan 29</i>	<i>Concord, Mass</i>	<i>Whitcomb</i>	<i>30/60</i>	<i>May 1864</i>	<i>Dec 31/64</i>	<i>87.85</i>	<i>11</i>	<i>Dec 31/64</i>	<i>28.79</i>	

REMARKS.

8.60⁰⁰ Paid by Maj. Fisher for Months May & June 1864
811.40 Sick in Hospital at New Orleans La since July 8th 65
819.40 Returned to Rank from Sick by S.O. No 109 dated July 9th 65
Supposed to have been discharged - Descriptive List furnished when sent to Hospital

This is a true and correct transcript of the original record of the Provost Marshal General's Office with the records received from the Chief Muster Officer of Massachusetts.

NOTES.

- The amount of any extra pay for which the soldier may be mustered, ex. gr. as Acting Hospital Steward, as Saddler, &c., and which may be still due him, must be carefully noted.
- In the column headed "BOUNTY PAID," must be entered the whole amount actually paid him; in that of "BOUNTY DUE," the whole amount yet due him. Bounty paid by State authorities, and not by the United States, will not be entered on this statement.
- Stoppages for loss or damage done to arms, or other public property, must be noted, and the articles, and particular damage to each, specified. When stoppages are due, under sentence of a Court Martial, a transcript of the same must be entered here; and the amount already stopped must be carefully stated.
- In every case of desertion, the date, and that of delivery, or apprehension, must be given, together with a correct transcript of the order of sentence or pardon.
- A careful statement of the man's CLOTHING ACCOUNT must be made, to date, and the amount DUE TO, or FROM him must be precisely stated.
- Should the man have been engaged in any action or skirmish, it must be mentioned, together with date and place. A full and particular mention will be made of any wounds he may have received in action, or other injury, whilst in the line of his duty.
- If the soldier is entitled to pay for the use of his horse, the company commander will certify to that fact on this list, and also to the time he has been so mounted on his own horse.
- When a soldier is taken up by the officer who gives the soldier these statements, and this endorsement, the soldier was charged against him or in his favor, so as to comprise a full statement of his account. It will then be transmitted to the Provost Marshal of the soldier, who will enter all the data necessary for the discharge of the soldier's account on the muster roll upon which the soldier's discharge is reported. The descriptive list will then be destroyed. The object of this is, that the remaining portion of the soldier's account, and the amount due him, may be settled upon the receipt of these muster rolls, and the soldier receive any pay or allowances that may be due him at the time of his discharge, and which may not appear on his final statement. These accounts are settled by the 2d Auditor of the Treasury Dept. in Hospital or on detached service; his descriptive list, if he has one, should be sent with his final statements, in duplicate, to the Adjutant General, Washington, D. C.
- Men drafted will be considered as mustered in from the date of their draft, and will be mustered for pay on the usual rolls for Volunteers. Their pay commences on the day they report for duty under their summons from the Provost Marshal, which date should be noted on the first Muster Roll, under the heading of "Remarks." On the same line as the soldier's name, under the heading "Joined for Duty and Enrolled—Commencement of First Payment by Time," will be written the word *drafted*, or *substitute*, as the case may be; and under the heading "When Mustered in," will be given the date when the soldier was drafted, or, if a substitute, when enlisted, (substitutes, under the Enrollment Act, are mustered in by enlistment.) under "Where Mustered in," will be given the place from which drafted, (or if a substitute, where enlisted.) under the heading "By whom Mustered in," will be given the No. of the Enrollment District from which he was drafted, and the State to which it belongs, thus: *4th D. Mass.* (meaning 4th Enrollment District, State of Massachusetts.) Or if a substitute, the name of the officer enlisting him. (When enlisted by Board of Enrollment, the name of the Provost Marshal of the Enrollment District.)
- A separate descriptive list should, as a general rule, be given for each man.
- Descriptive lists must, in all cases, be signed by COMMISSIONED OFFICERS; not by enlisted men acting as such.

I CERTIFY that the above is a correct transcript from the Records of *Geo. T. Fisher Co. Co. 3rd Mass Cav*

STATION: *Galena Island*
 DATE: *Spencer Mass 22 Oct 1865*
J. B. Welch
 341 Commanding the Company.

Office Chief Commissary of Musters,

DEPARTMENT OF THE EAST,

NEW YORK CITY, *November 17th* 1865.

I have to report that *Private*

George J. Fisher

Co. C. 5th Reg't *Mass. Cav.*

Robt

is this day mustered out of the United States service, in compliance with telegraphic instructions from War Department of May 3d, 1865.

Very respectfully,

Your obedient servant,

WILSON BARSTOW,

*Brevet Major and A. D. C.,
Chief Commissary of Musters.*

To the Chief Mustering Officer, State of

Mass

CASUALTY SHEET

No.

George J Fisher

Private of Company *C*

5 Regiment of *Mass Cav*

State Volunteers.

NATURE OF CASUALTY.

Killed Nov 17 1865

CASUALTY SHEET.

Name: *George P Fisher*
Rank: *Priv* Company: *C.* Regiment: *5*
Arm: *bar* State: *Mass*
Nature of Casualty: *Disch*

CAUSE OF CASUALTY—(NAME OF DISEASE, &c.)

BY WHOM DISCHARGED.

DEGREE OF DISABILITY.

FROM WHAT SOURCE THIS INFORMATION WAS OBTAINED.

BY WHOM CERTIFIED.

*Roll 18 Mason Messp
Recs Mass 1865.*

REMARKS.

W E Townsend

"G.O.W.S. May 4. 1865"

A A Surg M.A.

DATE OF DISCHARGE, DEATH, &c.

Nov. 17 1865

PLACE OF DISCHARGE, DEATH, &c.

Boston Mass

Sydney

Clerk.

at

De Camp General Hospital, U. S. A.,

DAVIDS' ISLAND, NEW YORK HARBOR.

November 5th 1865

Account of Pay and Clothing of *Private*
George S. Fisher, *5th* Regiment
2nd Mass. Col. Inf., Co. *C*, while at this Hospital.

Admitted into Hospital, October 1st 1865.

Paid by

For the Months of

Quarantined October 31st 1865; not
paid in this Hospital.

Transferred to N.Y. for
muster out.

November 4th 1865

To amount of Clothing drawn,

\$ 23 ³⁵/₁₀₀

I certify that the above is a correct transcript from
the records of this Hospital.

Wm. H. H. H.

Asst Surgeon, U. S. Army,
In Charge of Hospital.

War Department.

Adjutant General's Office.

Washington, November 11, 1865.

Sir:

In reply to your letter requesting a Descriptive List of "George F. Fisher" a Private in Company "C", Fifth Regiment Mass. Cav. Volunteers, I have the honor to furnish the following "Descriptive List" obtained from the records of this Office: which, from the want of the necessary data, (which is in the possession of the Company Commander,) is only "partial."

NAME, RANK AND REGIMENT, DESCRIPTION, &c.

"George Fisher" a Private in Company "C", Fifth Regiment of Mass. Cav. Volunteers, is 39 years of age; but no further "description" can be obtained from the files of this Office.

He was enrolled on the 7th day of January, 1864, at the town of Mansfield in the State of Mass., by W. B. Bates, and mustered into the service of the United States on the 29th day of January, 1864, at the town of Camp Meigs in the State of Mass., by Lieut McKibbe, to serve for the period of three years, or "during the war."

ACCOUNT OF PAY

It is stated on the Muster Rolls of his Company for the months of July & Aug. 1865, (latest on file) that he was last paid by Paymaster Major Dodge on the 31st day of December, 1864. Due the soldier \$35- of 1st Installment, and due 2nd 3rd 4th & 5th Installments of Wf Bounty, \$195,00

ACCOUNT OF CLOTHING.

The files of this Office furnish no account of clothing; it must be obtained, if obtained at all, from his Company Commander.

REMARKS.

On the Muster Roll of his Co for July & Aug 1865, he is reported "Absent sick at Forts Monroe" And the following remarks appear against his name "Reduced from Sergt I. O. 109 July 10th 65" Due U.S. for Transportation \$19,40, for I. M. Stores \$11,40 Due before April 19th 1861. The name of "Geo F Fisher" does not appear on the Rolls of Co "C" 5th Reg Cavalry respectively.

Your obedient servant.

W. H. Hazard

Assistant Adjutant General. Vol 6

(7)

Paul Quirk

1st Lieut Regt

16th Regt of East

This "Partial Descriptive List" is given in order that the soldier may be discharged at once, without waiting for a descriptive list from his company commander; and, having been used by the proper officer to make out the soldier's final statements, should be endorsed with a statement to that effect by this officer. This endorsement should exhibit a full statement of the time for which the soldier was allowed pay on his final statements, the clothing account, and all other charges against him or in his favor, so as to comprise a complete exhibit of his account. It will then be transmitted to the company commander of the soldier, who will enter all the data necessary to a full understanding of the soldier's account on the muster roll upon which the soldier's discharge is reported. This list will then be destroyed. The object of this is, that the remaining portion of the soldier's account may be settled upon the receipt of these muster rolls, and the soldier receive any pay or allowances that may be due him at the time of his discharge, and which may not appear on his final statements from the fact that this list is incomplete or "partial."

Fisher J. Davenport

Co Bk, 5 Mass. Cav., (Col'd.)

2nd Lieutenant 1st Lieutenant

CARD NUMBERS.

1	5371911	26
2	5374461	27
3	5374576	28
4	5381565	29
5	5374713	30
6	5372842	31
7	5381651	32
8	5381738	33
9	5381822	34
10	5381928	35
11	5382034	36
12	5382139	37
13	5382239	38
14	5382434	39
15	5375636	40
16	5382617	41
17	9436238	42
18	40730920	43
19		44
20		45
21		46
22		47
23		48
24		49
25		50

Book Mark: _____

See also _____

F

5 Col'd Cav.

Mass.

J. Davenport Fisher,

2 Lieut, Co., 5 Reg't Mass. Col'd Cavalry.

Age *31* years.

Appears on an

Individual Muster-in Roll

of the organization named above. Roll dated

Boston, Mass., Dec. 19, 1863.

Muster-in to date

Dec. 19, 1863.

Joined for duty and enrolled:

When

Dec. 18, 1863.

Where

Boston, Mass.

Period

3 years.

Valuation of horse, \$

100

Valuation of horse equipments, \$

100

Remarks:

Mustered in accordance with Genl. Order No. 75, dated War Dept. A. G. O. Washington City, D. C. July 8, 1862, to aid in the organization of the Regiment.

Book mark:

J. Pool,

(348)

Copyist.

F | **5 Col'd Cav.** | **Mass.**

A *Davenport Fisher*
95, Co. *B*, 5 Reg't Mass. Col'd Cav.

Appears on

Company Muster-in and Descriptive Roll
of the organization named above. Roll dated
Readville Mass, July 29 1864.

Where born

Age *31* y'rs; occupation

When enlisted *Dec 18*, 186*3*.

Where enlisted *Boston Mass.*

For what period enlisted *3* years.

Eyes.....; hair.....

Complexion.....; height.....ft.....in.

When mustered in....., 186 ..

Where mustered in

Bounty paid \$.....¹⁰⁰; due \$.....¹⁰⁰

Where credited

Company to which assigned

Remarks :

.....

Book mark :

Hoyberger
(356d) Copyist.

Davenport Fisher

504, Co. B, 5 Reg't Mass. Col'd Cavalry.

Appears on

Company Muster Roll

for *Enlistment to Feb-27, 1864.*

Present or absent *Present*

Stoppage, \$ *100* for

Due Gov't, \$ *100* for

Valuation of horse, \$ *100*

Valuation of horse equipments, \$ *100*

Remarks: *Mustered into U.S. Service under G.O. No. 75*

Book mark:

Foy Birnie

A

5 Col'd Cav.

Mass.

Davenport Fisher
227, Co., 5 Reg't Mass. Col'd Cavalry.

Appears on an

Individual Muster-out Roll

of the organization named above. Roll dated

Boston Mass. March 12, 1864.

Muster-out to date

March 12, 1864.

Last paid to

....., 186 .

Clothing account:

Last settled, 186 ; drawn since \$..... 100

Due soldier \$..... 100; due U. S. \$..... 100

Am't for cloth'g in kind or money adv'd \$..... 100

Due U. S. for arms, equipments, &c., \$..... 100

Bounty paid \$..... 100 due \$..... 100

Remarks: *Mustered out as
2^d Lieut. by reason
of promotion to
1st Lt. in the same
regiment.*

Book mark:

[Signature]

(348)

Copyist.

I | 5 Col'd Cav. | Mass.

Davenport Fisher

1 Lt., Co. A, 5 Reg't Mass. Col'd Cav.

Appears on

Company Muster-in and Descriptive Roll
of the organization named above. Roll dated
Readville, Mass, Mar 12, 1864.

Where born *Not stated*

Age *31* y'rs; occupation *Not stated*

When enlisted *Dec, 18*, 186*3*

Where enlisted *Boston, Mass*

For what period enlisted *3* years.

Eyes.....; hair.....

Complexion.....; height.....ft. in.

When mustered in *Mar 12*, 186*4*

Where mustered in

Bounty paid \$.....100; due \$.....100

Where credited

Company to which assigned

Remarks: *Mustered into the service
of the United States March 12/64
by Lieut. M^r Kilburn,*

Book mark:

2281584

J. M. Vall

F

5 Col'd Cav.

Mass.

Davenport Fisher

F. H., Co. B, 5 Reg't Mass. Col'd Cavalry.

Appears on

Company Muster Roll

for *March & April*, 1864.

Present or absent

Stoppage, \$ *100* for

Due Gov't, \$ *100* for

Valuation of horse, \$ *100*

Valuation of horse equipments, \$ *100*

Remarks: *Transferred*

promoted to 1st Lt. and

transferred to 2nd Co. on

Mar. 10. 64

Book mark:

(358)

Hoylenger

Copyist.

J

5 Col'd Cav.

Mass.

Davenport Fiskes

1st Lt., Co. H, 5 Reg't Mass. Col'd Cavalry.

Appears on

Company Muster Roll

for *from* *March 12 to April 30*, 1864.

Present or absent *Present.*

Stoppage, \$ *100* for

Due Gov't, \$ *100* for

Valuation of horse, \$ *100*

Valuation of horse equipments, \$ *100*

Remarks: *Joined by assignment*

as 1st Lieut March 12/64
Promoted from 2nd Lieut Co. B.
Same Regiment.

Book mark: *9251020*

J M Hall

(358)

Copyist.

F

5 Col'd Cav.

Mass.

Davenport Fisher

(G.), Co. H, 5 Reg't Mass. Col'd Cavalry.

Appears on

Company Muster Roll

for *May & June*, 1864.

Present or absent *Present*

Stoppage, \$ *100* for

Due Gov't, \$ *100* for

Valuation of horse, \$ *100*

Valuation of horse equipments, \$ *100*

Remarks:

Book mark:

J. M. Wall

(358)

Copyist.

F

5 Col'd Cav.

Mass.

Davenport Fisher

1st, Co. H, 5 Reg't Mass. Col'd Cavalry.

Appears on

Company Muster Roll

for *July & Aug.*, 186 *4*

Present or absent *absent*

Stoppage, \$ *100* for

Due Gov't, \$ *100* for

Valuation of horse, \$ *100*

Valuation of horse equipments, \$ *100*

Remarks: *On leave of absence from Aug 9 to Aug. 19; on sick leave from Aug. 19 to Sept 3rd*

Book mark:

J. N. Hall

(358)

Copyist.

F

5 Col'd Cav.

Mass.

Davenport Fisher

1st Lieut, Co. H, 5 Reg't Mass. Col'd Cavalry.

Appears on

Company Muster Roll

for *Sept & Oct*, 1864.

Present or absent *Present.*

Stoppage, \$ *100* for

Due Gov't, \$ *100* for

Valuation of horse, \$ *100*

Valuation of horse equipments, \$ *100*

Remarks:

Book mark:

C. A. Clark

(358)

Copyist.

Q

5 Col'd Cav.

Mass.

Davenport Fisher

1st Lt, Co. H, 5 Reg't Mass. Col'd Cavalry.

Appears on

Company Muster Roll

for *Nov. & Dec.*, 186 *4*.

Present or absent *Present*

Stoppage, \$ *5* $\overline{100}$ for

Due Gov't, \$ $\overline{100}$ for

Valuation of horse, \$ $\overline{100}$

Valuation of horse equipments, \$ $\overline{100}$

Remarks:

Book mark:

C. H. Clark

358)

Copyist.

71

5 Col'd Cav.

Mass.

Davenport Fisher

1st Lt, Co. H, 5 Reg't Mass. Col'd Cavalry.

Appears on

Company Muster Roll

for Jan & Feb, 1865

Present or absent Present

Stoppage, \$ 100 for

Due Gov't, \$ 100 for

Valuation of horse, \$ 100

Valuation of horse equipments, \$ 100

Remarks:

Book mark:

C. H. Clark

(358)

Copyst.

7

5 Col'd Cav.

Mass.

Davenport Fisher

1st Lt, Co. H, 5 Reg't Mass. Col'd Cavalry.

Appears on

Company Muster Roll

for March & April, 1865.

Present or absent Present

Stoppage, \$ 100 for

Due Gov't, \$ 100 for

Valuation of horse, \$ 100

Valuation of horse equipments, \$ 100

Remarks:

Book mark:

C. M. Clark

(358)

Copyist.

77

5 Col'd Cav.

Mass.

Davenport Fisher

1st Lt Co. II, 5 Reg't Mass. Col'd Cavalry.

Appears on

Company Muster Roll

for May & June, 1865.

Present or absent

Stoppage, \$ 100 for

Due Gov't, \$ 100 for

Valuation of horse, \$ 100

Valuation of horse equipments, \$ 100

Remarks: Honorably discharged by S O 140, Hd Quarters Dept Va, Richmond, May 24 1865.

Book mark:

C. H. Clark

(358)

Copyist.

F

5 Col'd Cav.

Mass.

Davenport Fisher

1st Lt., Co. *H*, 5 Reg't Mass. Col'd Cavalry.

Appears on **Co. Muster-out Roll**, dated *Clarksville, Tex.*, *Oct. 31*, 186*5*.

Muster-out to date _____, 186 .

Last paid to *Dec 31*, 186*4*.

Clothing account:

Last settled _____, 186 ; drawn since \$ _____ 100

Due soldier \$ _____ 100; due U. S. \$ _____ 100

Am't for cloth'g in kind or money adv'd \$ _____ 100

Due U. S. for arms, equipments, &c., \$ _____ 100

Bounty paid \$ _____ 100; due \$ _____ 100

Remarks: *Honorably discharged*
S.O. 141 Ad. Gens. Dept. of Va. Rich-
mond, May 24th 1865.

Book mark: _____

R. C. ...

(861)

Copyist.

D

| 5 Col'd Cav. | Mass.

J Davenport Fisher

2nd Lieut Co B

1st Lieut, Co. ~~H~~, 5 Reg't Mass. Colored Cav.

Appears on Returns as follows:

Jan & Feb 1864 - Present
March 1864 Transfd to Co. H. pr.
S. O. No. 69.

May & July 1864 (1st Co. H.) Present
Aug 1864 Absent on special sick
leave, since Aug. 19, '64.

Sept. & Oct. 1864 - Present.

Nov. 1864 - Present Comdg. Co.

Dec. 1864 to Feb. 1865. Present.

March 1865 Present Comdg. Co.

April 1865. Present.

May 1865 - May 24. Honorably dis-
charged G. O. 140 Hd. Qrs,
Dept. Virginia, May 24, '65.

Book mark:

O. J. Taylor.

(546)

Copyist.

F

5 Col'd Cav.

Mass.

Davenport Fisher

2nd, Co. *B*, 5 Reg't Mass. Col'd Cavalry.

Appears on **Co. Muster-out Roll**, dated

Clarksville, Tex., (Co: B), 1865.

Muster-out to date _____, 186 .

Last paid to _____, 186 .

Clothing account:

Last settled _____, 186 ; drawn since \$ _____ 100

Due soldier \$ _____ 100; due U. S. \$ _____ 100

Am't for cloth'g in kind or money adv'd \$ _____ 100

Due U. S. for arms, equipments, &c., \$ _____ 100

Bounty paid \$ _____ 100; due \$ _____ 100

Remarks: *Transferred to Co, A, by
promotion Dec 19/63. pr
S.O. 450*

Book mark: _____

Scherich

(861)

Copyist.

Fisher D.

Lit, Co., 5 Reg't Mass. Cavalry

Medical Certificate

(File mark *Avery*, 1864.)

Cannot be found in Medical Certificate File.

Investigation shows that the papers were disposed of as indicated below:

Returned for com. Aug. 27 / 64

Filed with

Fisher, Ravenport

1st St. Co., 5th Reg't Mass. C. Cav.

6 Enclosures.

Bed Cards	Final Statements
Burial Records	Furloughs or L. of A. ..
Certs. of Dis. for Discharge	Med. Certificates 2
C. M. Charges	Med. Des. Lists
Descriptive Lists	Orders
Discharge Certificates	Pris. of War Record
Enlistment Papers	Resignations /

Other papers relating to—

Admission to Hosp'l	Furlough or L. of A. /
Casualty Sheet	Med. Examination
Confinement	Misc. Information
Contracts	Pay or Clothing ..
Death or Effects	Personal Reports
Desertion	Rank ..
Discharge from Hosp'l	Transfer to Hosp'l ..
Discharge from Service	Transfer to V. R. C. ...
Duty /	Transportation ..

MICROFILM PUBLICATION M 1822

COMPILED MILITARY SERVICE RECORDS
OF VOLUNTEER UNION SOLDIERS WHO
SERVED WITH THE USCT (US COLORED TROOPS)
5TH MASSACHUSETTS REGIMENT OF CAVALRY

PERSONAL PAPERS' TARGET SHEET

PLEASE NOTE THE CHECKED INFORMATION ABOUT THE PERSONAL PAPERS IN
THIS FILE:



NO PERSONAL PAPERS WERE FOUND IN THIS FILE WHEN THE
RECORDS WERE ARRANGED FOR MICROFILMING.



5 PERSONAL PAPER(S) FOUND IN THIS FILE WHEN THE RECORDS
WERE ARRANGED FOR MICROFILMING.

Adj. Dir. 5th Mass. Cavalry
St. Louis Mo July 5th /64

Adj. Dir.
Adj. Comd^g 5th Mass Cavalry

Requests permission for Lieut. Fisher
to visit Washington on regimental business

Head Quarters 3rd Mass. Cavalry, 101st.
Point Lookout Md. July 5th, 1864

Sir

I have the honor to make
application for permission to send
Lt. Davenport Fisher ^{at} ~~in~~ ^{by} ~~the~~ ^{the} ~~way~~ ^{way} to Washington
for the purpose of ~~seeing~~ ^{seeing} ~~the~~ ^{the} ~~disposal~~ ^{disposal}
of certain Regimental property left on
shore in that City. He will require
to be there at ~~least~~ ^{least} ~~two~~ ^{two} ~~days~~ ^{days}

~~Very respectfully~~

~~Very truly~~

~~Yours~~

W. R. F. Andrews

Major General

A. A. A. Genl.

Dept. of St. Marys

Point Lookout, Md.

Admitt

1350

1864

7. 2. 3. Aug. 1864

L. D. Fisher
5th Mass Cav

med Cert for Exp
Fund

Fisher

manuscript book

Manuscript book

Sir: Davenport Fisher

Co. *A* of the 5th

Regiment *Mass Cavalry* having applied for a certificate on which to ground an application

for leave of absence, I do hereby certify that I have carefully examined this officer and find that* *he is*
invalided in Boston suffering from debility
consequent upon chronic diarrhoea and dyspepsia

And that in consequence thereof, he is, in my opinion, unfit for duty. I further declare my belief that he
will not be able to resume his duties in a less period than † *Twenty* days, *from Aug 19/64*
and is unable to travel without incurring the risk of permanent disability.

Dated at

Boston, this *19th* day of *August 1864*

Approved:

A. M. Warren
Surgeon U.S.A.

Wm R. Hooker M.D.

* Here the nature of the disease, wound, or disability, is to be fully stated, and the period during which the officer has suffered under its effects.

† Here state, candidly and explicitly, the opinion as to the period which will probably elapse before the officer will be able to resume his duties. Where there is no reason to expect a recovery, or when the prospect of a recovery is distant and uncertain, it must be so stated.

[This certificate to be made out in triplicate.]

Camp 5th Mass Cavalry
Sintookout Rd
Feb 20th 1865

Fisher is absent
1st Lieut. 5th Mass Cav.

Wants to have a horse
for the unit (40 horses for
the unit) in Washington
D.C. on inspection
of the business.

Wants to have a horse
for the unit (40 horses for
the unit) in Washington
D.C. on inspection
of the business.

Wants to have a horse
for the unit (40 horses for
the unit) in Washington
D.C. on inspection
of the business.

Gen. M. J. Fisher
1st Lieut. 5th Mass Cav.

Wants to have a horse
for the unit (40 horses for
the unit) in Washington
D.C. on inspection
of the business.

Davenport Fisher
Lieut. 5th Mass Cav.

Gen. M. J. Fisher
1st Lieut. 5th Mass Cav.

appd

Camp of 5th Man. Cavalry
Feb 28th 1865

Lt James I Newell

Adjutant 5th Man. Cavalry
Lieutenant.

I have the honor
to request a leave of absence for forty eight hours
for the purpose of visiting Washington D.C on important
private business.

Very respectfully

Your obedt. servant

Samuel Fisher

1st Lt 5th Man. Cav

JS

5126 (or) 7012, 1865
Hil Lie, 5th Mass Regt
23 Light Artillery, Va.
May 15th 1865
#1215 (or) 1865

Fisher Davanport
1st Lieut. 5th Mass Regt

Under the resignation
of his Commission
as 1st Lieut. 5th
Mass Regt. on account
of physical disability.

Respectfully for-
warded.

Approved.
Charles B. DeLancey
Col. Comdr. 5th Mass

Recd at ...

Head Quarters Department of Virginia.

ARMY OF THE JAMES,

Richmond, Va. May 2 1865.

Station: - In the Field. Richmond Va

Special Orders No. 140 Par. 3

Date: May 24 1865.

Respectfully forwarded to the Adjutant General of
the Army.

W. L. ...
Maj. Gen. ...
W. L. ...
A. A. ...

Field Troop 38th U.S.
May 19th 1865

This officer was
examined and his
discharge is recom-
mended on account
of disease.

By ...
John ...
May 4 1865

Adjutant General's Office,
25th Army Corps,
Camp Lincoln, Va. May 10th 1865
G. 93 5 ...
Respectfully ...
and attention in-
vited to endorsement of
Medical Ex. Board.

E. P. ...
Surgeon, U.S.A.
Act. Medical Director.

Co. 20th Army Corp.
Camp Lincoln Va.
May 23rd 1865

Respectfully forwarded
Approved

G. ...
Major General Commanding

Camp 5th Mass. Cavalry,
In the Field, near City Point, Va.
May 13th 1865

Colonel:

I have the honor herewith to tender
my resignation as 1st Lieutenant in the 5th Regt.
Massachusetts Cavalry, on account of disability
from deafness, to an extent to render me
unfit for the duties of my station.

I certify that I am not indebted to the United States
on any account whatever, and that I am not
responsible for any Government property whatever, and
that I was last paid by Major Dodge to include the
31st day of December, 1864

Very respectfully,

Your obedient servant

Davenport Fisher

1st Lieut 5th Mass. Cav

Brevet Col. C. W. Smith

A. A. S. Department of Virginia

Lieut. Havensport Fisher of the 5th Regt Mass Cav.
Having applied for a certificate on which to ground
an application for discharge, I do hereby certify that I
have carefully examined this officer and find him
unable to perform the duties of his position on accou^{nt}
of Deafness, which has been gradually increasing
for the past year. I have no reason to expect a
recovery while he remains in the service.

F. G. Parker
Surgeon 5th Mass Cavalry

443

Fisher John

Co B, 5 Mass. Cav., (Col'd.)

Private Private

CARD NUMBERS.

1	5375699	26
2	5375797	27
3	5375874	28
4	5375977	29
5	5376080	30
6	5376181	31
7	5376290	32
8	5376396	33
9	5376501	34
10	5376600	35
11	5376697	36
12	5376791	37
13	9092393	38
14		39
15		40
16		41
17		42
18		43
19		44
20		45
21		46
22		47
23		48
24		49
25		50

Book Mark:

See also

7

5 Cav. (Col'd.) | Mass.

John Fisher

, Co. *C*, 5 Reg't Mass. Cav. (Col'd.)

Appears on

Company Descriptive Book

of the organization named above.

DESCRIPTION.

Age *20* years; height *5* feet *9* inches.

Complexion *Colored*

Eyes *Black*; hair *Black*

Where born *Cent Co. Delaware*

Occupation *Farmer*

ENLISTMENT.

When *June 5*, 186*4*.

Where *Cent Co. Delaware*

By whom *Dr. W. Goddard*; term *3* y'rs.

Remarks: *Mustered into Company C,
of Aug. 29. 1864 at Readville Mass
by Lt. Col. Kibbin*

F. H. [unclear]

(3830)

Copyist.

F.

5 Col'd Cav.

Mass.

John Fisher.

Priv. Co. C, 5 Reg't Mass. Col'd Cav.

Appears on

Company Muster-in and Descriptive Roll

of the organization named above. Roll dated

Readville Jan. 29, 1864.

Where born Kent Co. Del.

Age 20 y'rs; occupation Farmer.

When enlisted Jan. 5, 1864.

Where enlisted Boston Md.

For what period enlisted 3 years.

Eyes Black; hair Black

Complexion Black; height 5 ft. 9 in.

When mustered in Jan. 29, 1864.

Where mustered in Readville, Mass.

Bounty paid \$ 100; due \$ 100

Where credited 4th Dist. Suffolk.

Company to which assigned

Remarks:

Book mark:

Sitter.

F.

5 Col'd Cav.

Mass.

John Fisher.

Priv., Co. C, 5 Reg't Mass. Col'd Cavalry.

Appears on

Company Muster Roll

for Enlistment to Feb. 29, 1864.

Present or absent Present.

Stoppage, \$ 100 for

Due Gov't, \$ 100 for

Valuation of horse, \$ 100

Valuation of horse equipments, \$ 100

Remarks:

Book mark:

Silver.

(358)

Copyist.

5

5 Col'd Cav.

Mass.

John Fisher

Priv, Co. C, 5 Reg't Mass. Col'd Cavalry.

Appears on

Company Muster Roll

for Mar. & Apr., 1864

Present or absent Present

Stoppage, \$ 100 for

Due Gov't, \$ 100 for

Valuation of horse, \$ 100

Valuation of horse equipments, \$ 100

Remarks:

Book mark:

Sitter

F

5 Col'd Cav.

Mass.

John Fisher

Mr, Co. C, 5 Reg't Mass. Col'd Cavalry.

Appears on

Company Muster Roll

for May & June, 1864.

Present or absent Present

Stoppage, \$ 100 for

Due Gov't, \$ 100 for

Valuation of horse, \$ 100

Valuation of horse equipments, \$ 100

Remarks:

Book mark:

Sitten

D

5 Col'd Cav.

Mass.

John Fisher
Capt, Co. C, 5 Reg't Mass. Col'd Cavalry.

Appears on

Company Muster Roll

for *July & Aug*, 186*4*.

Present or absent *Present*

Stoppage, \$ *100* for

Due Gov't, \$ *100* for

Valuation of horse, \$ *100*

Valuation of horse equipments, \$ *100*

Remarks:

Book mark:

E H Brown

5

5 Col'd Cav.

Mass.

John Fisher
Sgt., Co. C, 5 Reg't Mass. Col'd Cavalry.

Appears on

Company Muster Roll

for Sept & Oct, 1864.

Present or absent Present

Stoppage, \$ 100 for

Due Gov't, \$ 100 for

Valuation of horse, \$ 100

Valuation of horse equipments, \$ 100

Remarks: see on or before April 19, 61

Book mark:

E. H. Brown

F

5 Col'd Cav.

Mass.

John Fisher
Capt, Co. C, 5 Reg't Mass. Col'd Cavalry.

Appears on

Company Muster Roll

for *Nov & Dec*, 1864.

Present or absent *Present*

Stoppage, \$ *100* for

Due Gov't, \$ *100* for

Valuation of horse, \$ *100*

Valuation of horse equipments, \$ *100*

Remarks: *Due U.S. for Inf Ord*
\$0.39 for Car Ord \$0.67 for
2 M. shoes \$0.85
Free on or before Ad. 1901

Book mark:

E. H. Brown

G.

5 Col'd Cav.

Mass.

*John
Port*

Fisher

Co. C, 5 Reg't Mass. Col'd Cavalry.

Appears on

Company Muster Roll

for *Jan Feb*, 1865.

Present or absent *Present*

Stoppage, \$ *100* for

Due Gov't, \$ *100* for

Valuation of horse, \$ *100*

Valuation of horse equipments, \$ *100*

Remarks: *Disch'd 1st + inst of
bounty \$180.*

Book mark:

E. H. Brown

D

5 Col'd Cav.

Mass.

John Fisher
Cpt, Co. C, 5 Reg't Mass. Col'd Cavalry.

Appears on

Company Muster Roll

for *Mar & Apr*, 1865.

Present or absent *Present*

Stoppage, \$ *100* for

Due Gov't, \$ *100* for

Valuation of horse, \$ *100*

Valuation of horse equipments, \$ *100*

Remarks: *Due Uf for 2 M Stores \$0.45*
Car Ord. \$0.57 Due of the, at inst
Uf bounty \$35. Due 2 3 & 4 inst
Uf bounty \$120

Book mark:

E. H. Brown

(358)

Copyist.

F

5 Col'd Cav.

Mass.

John Fisher

Pr

Co. C, 5 Reg't Mass. Col'd Cavalry.

Appears on

Company Muster Roll

for *May & June*, 1865.

Present or absent *Present*

Stoppage, \$ *—* $\frac{87}{100}$ for *Ord Stores;*
for Q. M. Stores 45 cts

Due Gov't, \$ *100* for

Valuation of horse, \$ *100*

Valuation of horse equipments, \$ *100*

Remarks: *Free before April 19, 1861*
Due of 1st Dist US Bounty \$3500
Due 2-3-4 Dist US Bounty \$2000

Book mark:

Albon

Copyist.

7

5 Col'd Cav.

Mass.

John Fisher

Pvt

, Co. C, 5 Reg't Mass. Col'd Cavalry.

Appears on

Company Muster Roll

for

July & Aug, 1865.

Present or absent.

Present

Stoppage, \$

- $\frac{87}{100}$

for Ordnance

for Qm Stores \$140

Due Gov't, \$

100 for

Valuation of horse, \$

100

Valuation of horse equipments, \$

100

Remarks:

Free before June 19 1861

Book mark:

Abbott

F

5 Col'd Cav.

Mass.

John Fisher

Pvt, Co. *B*, 5 Reg't Mass. Col'd Cavalry.

Appears on **Co. Muster-out Roll**, dated *Clarksville Texas, Oct 31, 1865*.

Muster-out to date *Oct 31, 1865*.

Last paid to *Dec 31, 1864*.

Clothing account:

Last settled....., 186 ; drawn since \$..... 100

Due soldier \$.....100; due U. S. \$ *64* ³⁴/₁₀₀

Am't for cloth'g in kind or money adv'd \$.....100

Due U. S. for arms, equipments, &c., \$ - ⁸⁷/₁₀₀

Bounty paid \$ *25* ⁻/₁₀₀; due \$ *275* ⁻/₁₀₀

Remarks: *Due US for Cr & C \$40*

Book mark :

Abbott

(361)

Copyist.

446

Fitch Charles A

Co *A*, 5 Mass. Cav., (Col'd.)

Private *Private*

CARD NUMBERS.

1	5379324	26	
2	5379409	27	
3	5379504	28	
4	5379595	29	
5	5379693	30	
6	5379803	31	
7	5379898	32	
8	5380008	33	
9	5380108	34	
10	5380211	35	
11	5380308	36	
12	5380404	37	
13	9092052	38	
14		39	
15		40	
16		41	
17		42	
18		43	
19		44	
20		45	
21		46	
22		47	
23		48	
24		49	
25		50	

Book Mark: _____

See also _____

F

5 Cav. (Col'd.) | Mass.

Charles A. Fitch

Co. *F*, 5 Reg't Mass. Cav. (Col'd.)

Appears on

Company Descriptive Book

of the organization named above.

DESCRIPTION.

Age *27* years; height *5* feet *9* inches.

Complexion *dark*

Eyes *brown*; hair *black*

Where born *Hartford Conn.*

Occupation *Seaman,*

ENLISTMENT.

When *Feb 6*, 186*4*.

Where *Weston*

By whom *J. S. Newell*; term *3* y'rs.

Remarks:

Heass

44

5 Col'd Cav.

Mass.

Charles A. Fitch

Co. B, 5 Reg't Mass. Col'd Cav.

Appears on

Company Muster-in and Descriptive Roll

of the organization named above. Roll dated

Readville, Mass., Dec. 22, 1864.

Where born Hartford, Conn.

Age 27 y'rs; occupation Seaman

When enlisted Feb. 6, 1864.

Where enlisted Readville

For what period enlisted 3 years.

Eyes Black; hair Black

Complexion Black; height 5 ft. 4 in.

When mustered in Feb. 22, 1864.

Where mustered in Readville Mass.

Bounty paid \$ 100; due \$ 100

Where credited Dist. Middlesex

Company to which assigned

Remarks:

Inserted by Jordan Cox

Filed with Fitch, Charles A.

Book mark:

J. E. Fitch

(356d)

Copyist.

4

5 Col'd Cav.

Mass.

Charles A. Fitch

Co., Co. F, 5 Reg't Mass. Col'd Cavalry.

Appears on

Company Muster Roll

for *Enlistment to Feb. 29, 1864.*

Present or absent *Present*

Stoppage, \$ *100* for

Due Gov't, \$ *100* for

Valuation of horse, \$ *100*

Valuation of horse equipments, \$ *100*

Remarks:

Book mark:

G. E. H. [Signature]

(358)

Copyist.

5 Col'd Cav.

Mass.

10/11/11, 11/11/11, 12/11/11

10/11/11, Co. F, 5 Reg't Mass. Col'd Cavalry.

Appears on

Company Muster Roll

for *11/11/11*, *11/11/11*, 186*11*.

Present or absent *Present*

Stoppage, \$ *100* for

Due Gov't, \$ *100* for

Valuation of horse, \$ *100*

Valuation of horse equipments, \$ *100*

Remarks:

Book mark:

(358)

5/11/11

Copyist.

5 Col'd Cav.

Mass.

Charles D. Fitch

Co. F, 5 Reg't Mass. Col'd Cavalry.

Appears on

Company Muster Roll

for *May & June*, 1864.

Present or absent *(Present)*

Stoppage, \$ *100* for

Due Gov't, \$ *100* for

Valuation of horse, \$ *100*

Valuation of horse equipments, \$ *100*

Remarks:

Book mark:

G. D. Fitch

F

5 Col'd Cav.

Mass.

Charles A. Fitch

Pt

, Co. F, 5 Reg't Mass. Col'd Cavalry.

Appears on

Company Muster Roll

for

July & Aug, 1864.

Present or absent

Present

Stoppage, \$

100 for

Due Gov't, \$

100 for

Valuation of horse, \$

100

Valuation of horse equipments, \$

100

Remarks:

Stop one Haversack

Book mark:

J Stewart

(358)

Copyst.

F

5 Col'd Cav.

Mass.

Charles A. Fitch

Pt, Co. F, 5 Reg't Mass. Col'd Cavalry.

Appears on

Company Muster Roll

for *Sept & Oct*, 1864.

Present or absent *Present*

Stoppage, \$ *100* for

Due Gov't, \$ *100* for

Valuation of horse, \$ *100*

Valuation of horse equipments, \$ *100*

Remarks:

Book mark:

M Stewart

(358)

Copyist.

F

5 Col'd Cav.

Mass.

Charles A. Fitch

Pt., Co. F, 5 Reg't Mass. Col'd Cavalry.

Appears on

Company Muster Roll

for Nov & Dec, 1864.

Present or absent Present

Stoppage, \$ 100 for

Due Gov't, \$ 100 for

Valuation of horse, \$ 100

Valuation of horse equipments, \$ 100

Remarks: Due U.S. Gov
one (1) set Inf. equipments
complete 4.39 (1) bayonet

Book mark:

JH Stewart

(358)

Copyist.

F

5 Col'd Cav.

Mass.

Charles A. Fitch

Pt., Co. F, 5 Reg't Mass. Col'd Cavalry.

Appears on

Company Muster Roll

for *Jan & Feb*, 1865.

Present or absent *Present*

Stoppage, \$ *100* for

Due Gov't, \$ *100* for

Valuation of horse, \$ *100*

Valuation of horse equipments, \$ *100*

Remarks: *Due U.S. Gov*
One "1" set Inf equip
Complete One "1"
Bayonet \$6.57
Due first pay. must
U.S. Bounty

Book mark:

J. Stewart

(358)

Copyist

S

5 Col'd Cav.

Mass.

Charles A. Fitch

P1, Co. F, 5 Reg't Mass. Col'd Cavalry.

Appears on

Company Muster Roll

for *March & April*, 1865.

Present or absent. *Present*

Stoppage, \$ *100* for

Due Gov't, \$ *100* for

Valuation of horse, \$ *100*

Valuation of horse equipments, \$ *100*

Remarks: *Due first four
inst. U.S. Bty 180.00*

Book mark:

W Stewart

(868)

Copyist.

F

5 Col'd Cav.

Mass.

Charles A Fitch

PT, Co. F, 5 Reg't Mass. Col'd Cavalry.

Appears on

Company Muster Roll

for *May & June*, 186*8*

Present or absent *Present*

Stoppage, \$ *100* for

Due Gov't, \$ *100* for

Valuation of horse, \$ *100*

Valuation of horse equipments, \$ *100*

Remarks: *Due US for
or advance \$49.42*

Book mark:

L. V. Johnson

(358)

Copyist.

F.

5 Col'd Cav.

Mass.

Charles A. Fitch

Pt., Co. F, 5 Reg't Mass. Col'd Cavalry.

Appears on

Company Muster Roll

for *July & Aug*, 186*3*.

Present or absent *Present*

Stoppage, \$ *100* for

Due Gov't, \$ *100* for

Valuation of horse, \$ *100*

Valuation of horse equipments, \$ *100*

Remarks:

Book mark:

T. J. Johnson

(358)

Copyist.

J | **5 Col'd Cav.** | **Mass.**

Charles A. Fitch

A, Co. *F*, 5 Reg't Mass. Col'd Cavalry.

Appears on **Co. Muster-out Roll**, dated

Charlestown, Tex, (Oct 3, 1863)

Muster-out to date

(Oct 3, 1863)

Last paid to

Dec 31, 1861

Clothing account:

Last settled....., 186 ; drawn since \$..... 100

Due soldier \$..... 100; due U. S. \$ *58* ^{*93*}/₁₀₀

Am't for cloth'g in kind or money adv'd \$..... 100

Due U. S. for arms, equipments, &c., \$ *100* ^{*93*}/₁₀₀

Bounty paid \$..... 100; due \$ *300* 100

Remarks: *Rec'd 100 for 1/2
equip. & 100*

Book mark :

(861)

J. A. Johnson

Copyist.

Fitz Charles A

Co F, 5 Mass. Cav., (Col'd.)

Private Private

CARD NUMBERS.

1	
2	
3	<i>Seritch, Charles A.</i>
4	
5	
6	
7	
8	
9	
10	
11	
12	
13	
14	
15	
16	
17	
18	
19	
20	
21	
22	
23	
24	
25	

26
27
29
30
31
32
33
34
35
36
37
38
39
40
41
42
43
44
45
46
47
48
49
50

Book Mark:

See also

Fitzgerald, Robert E.

Co *F*, 5 Mass. Cav., (Col'd.)

Private

Private

CARD NUMBERS.

1 *5379328*

2 *5379413*

3 *5379505*

4 *5379596*

5 *5379694*

6 *5378555*

7 *5379957*

8 *5380449*

9 *9092053*

10 *40730935*

11

12

13

14

15

16

17

18

19

20

21

22

23

24

25

26

27

28

29

30

31

32

33

34

35

36

37

38

39

40

41

42

43

44

45

46

47

48

49

50

Book Mark:

E.B. V. 11 P. 28.

See also

Miss K. Stone 4/30/34 W.F.H.
ag 20, (5-23-38) E.R.
SS to Pauli Murray, 5012 Just St., N.E.,
Washington, D.C. 4-17-46 W.F.H.

A. Jordan
E.R.

F

5 Cav. (Col'd.) | Mass.

Robert G. Fitzgerald

....., Co. *F*, 5 Reg't Mass. Cav. (Col'd.)

Appears on

Company Descriptive Book

of the organization named above.

DESCRIPTION.

Age *23* years; height *5* feet *6* inches.

Complexion *Cold*

Eyes *Hazel*; hair *black*

Where born *Newcastle Co. Del.*

Occupation *Seaman.*

ENLISTMENT.

When *Jan 15*, 1864.

Where *Boston.*

By whom *D. Davies*; term *3* y'rs.

Remarks: *Mother & two sisters
Discharged. Date unknown*

Hearn

J 5 Col'd Cav. | **Mass.**

Walter Fitzgerald
Co. *4*, 5 Reg't Mass. Col'd Cav.

Appears on

Company Muster-in and Descriptive Roll
of the organization named above. Roll dated

New Bedford, Mass., Feb. 22, 1864.

Where born *New Bedford, Mass.*

Age *23* y'rs; occupation *Seaman*

When enlisted *Jan. 13*, 1864.

Where enlisted *Boston St. 6*

For what period enlisted *3* years.

Eyes *black*; hair *black*

Complexion *black*; height *5* ft. *6* in.

When mustered in *Feb. 22*, 1864.

Where mustered in *Reading, Mass.*

Bounty paid \$ *100*; due \$ *100*

Where credited *11th Dist. Suffolk*

Company to which assigned

Remarks:

** Inserted by Jordan Cox*

Book mark:

(356d)

W. C. Taylor
Copyist.

5 Col'd Cav.

Mass.

Robert M. Fitzgerald

Plt., Co. F, 5 Reg't Mass. Col'd Cavalry.

Appears on

Company Muster Roll

for *Existence to Feb. 29, 1864.*

Present or absent

Present.

Stoppage, \$ 100 for

Due Gov't, \$ 100 for

Valuation of horse, \$ 100

Valuation of horse equipments, \$ 100

Remarks:

Company clerk

Book mark:

(358)

Robert M. Fitzgerald

Copyist.

11.

5 Col'd Cav.

Mass.

Robert S. Fitzgerald

Co. F, Co. F, 5 Reg't Mass. Col'd Cavalry.

Appears on

Company Muster Roll

for *March & Apr.*, 186*4*.

Present or absent *Present*

Stoppage, \$ *100* for

Due Gov't, \$ *100* for

Valuation of horse, \$ *100*

Valuation of horse equipments, \$ *100*

Remarks: *Company Clerk*

Book mark:

(358)

[Signature]

Copyist.

4 | 5 Col'd Cav. | Mass.

Robert S. Fitzgerald

Co. F, 5 Reg't Mass. Col'd Cavalry.

Appears on

Company Muster Roll

for March & June, 1864.

Present or absent Present

Stoppage, \$ 100 for

Due Gov't, \$ 100 for

Valuation of horse, \$ 100

Valuation of horse equipments, \$ 100

Remarks:

Book mark:

Copy

F

5 Col'd Cav.

Mass.

Robt. G. Fitzgerald^x

Pt., Co. F, 5 Reg't Mass. Col'd Cavalry.

Appears on

Company Muster Roll

for July & Aug, 1864.

Present or absent Present

Stoppage, \$ 100 for

Due Gov't, \$ 100 for

Valuation of horse, \$ 100

Valuation of horse equipments, \$ 100

Remarks:

^x In Col. Pres. name appears as "Robt. G. Fitzgerald"

Book mark:

J. W. Stewart

(358)

Copyist.

F

5 Col'd Cav.

Mass.

Robt. G. Fitzgerald

Pt, Co. F, 5 Reg't Mass. Col'd Cavalry.

Appears on

Company Muster Roll

for *Sept & Oct*, 1864.

Present or absent

Stoppage, \$ 100 for

Due Gov't, \$ 100 for

Valuation of horse, \$ 100

Valuation of horse equipments, \$ 100

Remarks: *Discharged*

Book mark: *Disch'd Oct 4/64 E.B.V. 11. P. 28*

(358)

J. N. Stewart

Copyist.

51

5 Col'd Cav.

Mass.

Robert G. Fitzgerald

Pt, Co. F, 5 Reg't Mass. Col'd Cavalry.

Appears on

Company Muster Roll

for *Nov & Dec*, 1864.

Present or absent.....

Stoppage, \$.....100 for.....

Due Gov't, \$.....100 for.....

Valuation of horse, \$.....100

Valuation of horse equipments, \$.....100

Remarks: *Disch'd Oct 15, 1864.*

Book mark: *Disch'd Oct 4/64 E.B.V. p. 28*

J. H. Stewart

(358)

Copist.

F | **5 Col'd Cav.** | **Mass.**

Robert G. Fitzgerald
Pr., Co. *F*, 5 Reg't Mass. Colored Cav.

Appears on **Returns** as follows:

April 1864 - Company Clerk.
May 1864 - Ordinance Clerk to
Court Martial G.O. #30
Dept. Hd. Qrs.

July 1864 - Absent sick.

Oct. 1864 - Oct. 5, '64 Pr.
Lookout discharged for
disability.

Book mark:

(546)

O. J. Taylor

Copyist.

F | **5 Col'd Cav.** | **Mass.**

Robert J. Fitzgerald
Pl., Co. *F*, 5 Reg't Mass. Col'd Cavalry.

Appears on **Co. Muster-out Roll**, dated
Plattsburgh Tex, Oct 31, 1864.

Muster-out to date 186 .
Last paid to 186 .

Clothing account:

Last settled....., 186 ; drawn since \$..... 100
Due soldier \$..... 100; due U. S. \$..... 100
Am't for cloth'g in kind or money adv'd \$ *6* ^{*73*}/₁₀₀

Due U. S. for arms, equipments, &c., \$ 100

Bounty paid \$ 100; due \$ 100

Remarks: *Discharged on*
Surgeons Certificate of
Disability Dec 15/64

Book mark: *433. 278. Discharged*
over

(861)

R. J. Fitzgerald

Copyist.

9-1
N. 5380449

☆ 1891 ☆

Oct 4/74 B. V. 11. P. 2 ✓

Fitzgerald, Robert

P. G., Co. 5 Regt Mass. C. Cav.

Enclosures.

- | | |
|------------------------------|-------------------|
| Bed Cards | Descriptive Lists |
| Burial Records | Final Statements |
| Certs. of Dis. for Discharge | Furloughs |
| C. M. Charges | Med. Des. Lists |
| Med. Certificates | Orders |

Other papers relating to—

- | | |
|----------------------------|----------------------|
| Admission to Hosp'l | Furlough |
| Casualty Sheet (Officer's) | Med. Examination |
| Confinement | Misc. Information |
| Contracts | Pay or Clothing |
| Death or Effects | Personal Reports |
| Desertions | Rank |
| Discharge from Hosp'l | Transfer to Hosp'l |
| Discharge from Service | Transfer to V. R. C. |
| Duty | Transportation |

[OFFICE INDORSEMENT.]
War Department,

ADJUTANT GENERAL'S OFFICE,

March 25, 1874.

The discharge of S. H. Fitzgerald
Private, Co. I, Reg't U. S.
 Colored Mass. Cav., is reported as follows:

On Company Muster Roll.
 For Sept and Oct, 1864, Dis. no date, 1864
 Company Muster-out Roll.

Oct 5, 1864
 Company Descriptive Book.

, 186
 Company Morning Reports.

, 186
 Soldier's Final Statement.

, 186
 Soldier's Record of Death and Interment.

, 186
 Soldier's Inventory of Effects.

, 186
 Soldier's Certificate of Disability for Discharge.

Oct 4, 1864
 Soldier's Individual Muster-out Roll.

, 186
 Regimental Return.

For October, 1864, Oct 5, 1864
 Regimental Quarterly Returns.

, 186
 Regimental Descriptive Book.

, 186
 By Surgeon General.

(Oct 4), 1864, is held to be

the correct date, and the Company Muster

Roll will be amended accordingly.

Thomas M. Sargent

Assistant Adjutant General.

Noted 28. See letter of May 4, 1874.
 to 2^d and
 entered in R

1874
 C 402
 1864
 CERTIFICATE OF DISABILITY FOR DISCHARGE
 IN THE CASE OF
Robert Fitzgerald
 a Private Co. I
Fifth Reg't of Mass. Cav.
Head Quarters 5th Mass. Cav.
Point Lookout Md. Sept 1864

Approved and respectfully forward
 ed

C. B. Alexander for
Lt. Colonel
comdg. 5th Mass. Cav.

Head Quarters 5th Mass. Cav.
Point Lookout Md. Sept 12/64

Respectfully forwarded to the Medical
 Director
By command of Brigadier
James Barr
Adjutant

Received (A. G. Office) _____, 1864



James Barr
Adjutant
Sept 10/64

Med Dir Office
 St Marys Dist
 Pt Lookout Md
 Sep 13/64

Respectfully forwarded approu

A. J. ...
Surgeon U. S. A.
Md. 10/1/64

Head Quarters 5th Mass. Cav.
Sept 13/64

Respectfully forwarded.

J. Barr

Adjutant

Head Quarters Washington
Sept 24/64

Respy. reports Surgeon H.
Med Dir.

By command of

James Barr
Adjutant

ARMY OF THE UNITED STATES.

CERTIFICATE

OF DISABILITY FOR DISCHARGE.

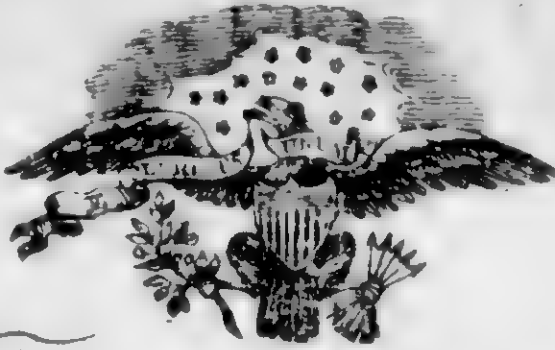

Robert G. Fitzgerald Private of ^{Lieut. Anner T. Mallory} ~~Captain~~ Company, (A) of the Fifth Regiment of ~~United States~~ ^{Mass} Cavalry was enlisted by D. Davies of the _____ Regiment of _____ at Boston on the Fifteenth day of January 1864, to serve Three years; he was born in New Castle County in the State of Delaware is Twenty three years of age, Five feet Six inches high, Colored complexion, hazel eyes, black hair, and by occupation when enlisted a Seaman. During the last two months said soldier has been unfit for duty 60 days.* Said Robert G. Fitzgerald's eyesight is very bad so bad as to preclude him entirely from performing the duties of a soldier caused by some inflammation of the eyes

STATION: Point Lookout Md
 DATE: August 31st 1864

A. T. Mallory
1st Lieut. Col. 4th Regt. Mass
 Commanding Company.

I CERTIFY, that I have carefully examined the said Robert G. Fitzgerald of Captain Mallory's Company, and find him incapable of performing the duties of a soldier because of his eyesight - probably from some inflammation of the eyes is impaired to the extent that he cannot perform his personal or military duties. This in my opinion entirely precludes him from service. He is unfit for service in the Veteran Reserve Corps.

H. Gamwell
 Surgeon. 5th Mass

DISCHARGED, this fourth day of October 1864, at Point Lookout Md

N. T. Russell
Col. 5th Mass. Cavalry
 Commanding the Reg't.

The soldier desires to be addressed at:
 Town _____ County _____ State _____

* See Note 1 on the back of this. † See Note 2 on the back of this.

449

Fleming William

Co M, 5 Mass. Cav., (Col'd.)

Private Private

CARD NUMBERS.

1	5372441	26
2	5372489	27
3	5386193	28
4	5386299	29
5	5386401	30
6	5386506	31
7	5386605	32
8	5372840	33
9	5386751	34
10	5386835	35
11	9091367	36
12	34507680	37
13	40736956	38
14		39
15		40
16		41
17		42
18		43
19		44
20		45
21		46
22		47
23		48
24		49
25		50

Book Mark:

See also

F. 5 Cav. (Col'd.) | Mass.

William Fleming.

Co. *A*, 5 Reg't Mass. Cav. (Col'd.)

Appears on

Company Descriptive Book

of the organization named above.

DESCRIPTION.

Age *18* years; height *5* feet *3* inches.

Complexion *Gold.*

Eyes *Black*; hair *Black*.

Where born *Trinidad, West Indies.*

Occupation *Seaman.*

ENLISTMENT.

When *Sept. 10th, 1864.*

Where *Lowell.*

By whom *G. Clark Jr.*; term *3* y'rs.

Remarks: *Mustered Lieut. W. Kibbore.*

Sept. 10th 64. Bounty paid by Capt.

Dwyer \$100. Due \$200.

Discharged June 25th 1865. Fort Monroe

W. Va.

H. C. Thomas.

382a)

Captist.

F | 5 Cav. | Mass.

William Fleming

Appears with rank of on

Muster and Descriptive Roll

of a detachment of U. S. Volunteers forwarded from Faneuil Hall, Boston, to Galloup's Island, Boston Harbor, for various regiments Massachusetts Volunteers. Roll dated

Boston, Mass, Sept 10, 1864.

Where born Trinidad, W. Indies

Age 18 years; occupation Seaman

When enlisted Sept 10, 1864

Where enlisted Lowell

For what period enlisted 3 years.

Eyes black; hair black

Complexion col'd; height 5 ft. 3 in.

When mustered in Sept. 10, 1864

Where mustered in Boston

Bounty paid \$ 100 ¹⁰⁰; due \$ 200 ¹⁰⁰

Clothing account:

Last settled, 1864; drawn since \$ ¹⁰⁰

Date of first muster, 1864

Regiment to which assigned 5th Cav.

Remarks: 7 Dist. Lowell,

Middlesex Co. Ward 2

.....

Book mark :

.....

T Jones

(356m)

Copyist

F

5 Col'd Cav.

Mass.

William Fleming

Appears with rank of *Private* on

Muster and Descriptive Roll of a Detachment of U. S. Vols. forwarded

for the 5 Reg't Mass. Col'd Cavalry. Roll dated

Boston Mass. Sept 29, 1864.

Where born *Trinidad W. India*

Age *18* y'rs; occupation *Seaman*

When enlisted *Sept. 10*, 1864.

Where enlisted *Lowell*

For what period enlisted *3* years.

Eyes *black*; hair *black*

Complexion *Old*; height *5 ft. 3 in.*

When mustered in *Sept 10*, 1864.

Where mustered in *Boston*

Bounty paid \$ *100* ¹⁰⁰; due \$ *200* ¹⁰⁰

Where credited *Lowell Middlesex Ct Ward 2*

Company to which assigned

Remarks:

Book mark:

M. A. Michaels

(339)

Copyist.

F

5 Col'd Cav.

Mass.

William Fleming

Priv., Co. M, 5 Reg't Mass. Colored Cavalry.

Appears on

Company Muster Roll

for *Sept. & Oct.*, 186*4*

Present or absent. *Present*

Stoppage, \$ *100* for

Due Gov't, \$ *100* for

Valuation of horse, \$ *100*

Valuation of horse equipments, \$ *100*

Remarks: *Recruit from depot.*

Joined Co. Oct. 27, '64.

No enlistment papers received.

Book mark:

L. Williams

F

5 Col'd Cav.

Mass.

William Fleming

Appears with rank of *Private* on

Muster and Descriptive Roll of a Detachment of U. S. Vols. forwarded

for the 5 Reg't Mass. Col'd Cavalry. Roll dated *Draft rendezvous Galloups Island D. H. Mass, Oct 9, 1864.*

Where born *Tindell W. I.*

Age *18* y'rs; occupation *Seaman*

When enlisted *Sept. 10*, 1864.

Where enlisted *Lowell*

For what period enlisted *3* years.

Eyes *black*; hair *black*

Complexion *Color'd*; height *5 ft. 9 in.*

When mustered in *Sept 10*, 1864.

Where mustered in *Boston*

Bounty paid \$ *100 100*; due \$ *200 100*

Where credited *Lowell & 2. Middlesex Co.*

Company to which assigned

Remarks:

Book mark:

M. A. Nichols

(339)

Copyist.

J

5 Col'd Cav.

Mass.

William Fleming

Priv., Co. M, 5 Reg't Mass. Colored Cavalry.

Appears on

Company Muster Roll

for *Nov & Dec*, 186*4*.

Present or absent *Present*

Stoppage, \$ *100* for

Due Gov't, \$ *100* for

Valuation of horse, \$ *100*

Valuation of horse equipments, \$ *100*

Remarks: *Recruit from depot*

Joined Co. Sept, '64

No enlistment papers rec'd

Book mark:

L. Williams

F

5 Col'd Cav.

Mass.

William Fleming
Pvt., Co. M, 5 Reg't Mass. Colored Cavalry.

Appears on

Company Muster Roll

for *Jan, & Feb.,* 186*5.*

Present or absent *Present.*

Stoppage, \$ *100* for

Due Gov't, \$ *100* for

Valuation of horse, \$ *100*

Valuation of horse equipments, \$ *100*

Remarks: *Recruit from depot*

Joined Co. Sept. 27, '64.

Book mark:

L. Williams,

F

5 Col'd Cav.

Mass.

William Fleming

Priv. Co. M, 5 Reg't Mass. Colored Cavalry.

Appears on

Company Muster Roll

for *May & Apr*, 1865.

Present or absent *Present*

Stoppage, \$ *100* for

Due Gov't, \$ *19*^{*25*} *100* for *ordnance*

lost.

Valuation of horse, \$ *100*

Valuation of horse equipments, \$ *100*

Remarks: *Recruit from depot.*

Joined Co. Sept. 27, '64.

Book mark:

G. Williams

(358)

Copyist.

F

5 Col'd Cav.

Mass.

William Fleming

Priv., Co. M, 5 Reg't Mass. Colored Cavalry.

Appears on

Company Muster Roll

for *May & June*, 1865.

Present or absent *Absent*

Stoppage, \$ *100* for

Due Gov't, \$ *100* for

Valuation of horse, \$ *100*

Valuation of horse equipments, \$ *100*

Remarks: *Sick in Hosp. City Point, Va since May 20th '65. Recruit joined Co. Sept. 27th '65. Recd \$19.25 for advance lost.*

Book mark:

L. Williams,

J

5 Col'd Cav.

Mass.

William Fleming

Pr., Co. M, 5 Reg't Mass. Colored Cavalry.

Appears on

Company Muster Roll

for *July & Aug*, 1865.

Present or absent

Stoppage, \$ 100 for

Due Gov't, \$ 100 for

Valuation of horse, \$ 100

Valuation of horse equipments, \$ 100

Remarks:

*Discharged by
order War Department
June 21st 1865 from
Hosp't, Fortress Monroe Va.*

Book mark:

Hodges

(358)

Copyist.

5 Col'd Cav.

Mass.

William Fleming

Pr; Co. M, 5 Reg't Mass. Colored Cav.

Appears on Returns as follows:

Oct. 1864 - Oct. 27 '64 Point
Lookout, Recruit
from Depot.

May & June 1865 - Absent sick
in Hosptl. City Point,
Va. since May 20 '64.
July 1865 - Absent sick at Post
Hosptl Fort Monroe since
May 20, '65.

Aug. 1865 - June 21, '65 Fort
Monroe, by order War
Dept. discharged.

Book mark:

O. J. Taylor

(546)

Copyist.

5 Col'd Cav.

Mass.

William Henry
H. Co. M., 5 Reg't Mass. Col'd Cavalry.

Appears on an

Individual Muster-out Roll

of the organization named above. Roll dated

Fort Monroe Va, June 24, 1864.

Muster-out to date

June 24, 1864.

Last paid to

Dec 31., 1864.

Clothing account:

Last settled *Dec 31, 1864*; drawn since \$.....100

Due soldier \$.....100; due U. S. \$.....100

Am't for cloth'g in kind or money adv'd \$ *28*⁴³/₁₀₀

Due U. S. for arms, equipments, &c., \$.....100

Bounty paid \$ *100* due \$ *200*¹⁰⁰

Remarks: *Due U.S. for ~~uniform~~*

lost \$19.25

*Mustered out by order of the
Dept of the Army May 3/65. Patient
in U.S. Army Hospital Fort
Monroe Va.*

Book mark:

William Henry

J

5 Col'd Cav.

Mass.

William Fleming
Pri, Co. *M*, 5 Reg't Mass. Col'd Cavalry.

Appears on **Co. Muster-out Roll**, dated
Clarksville Tex, Oct. 31, 1865.

Muster-out to date 186 .

Last paid to *Never paid* 186 .

Clothing account:

Last settled 186 ; drawn since \$ 100

Due soldier \$ 100; due U. S. \$ 100

Am't for cloth'g in kind or money adv'd \$ 100

Due U. S. for arms, equipments, &c., \$ 100

Bounty paid \$ 100; due \$ 100

Remarks:

Discharged June 21st, 1865 from Hospt. Fortress Monroe Va. by order War Dept. dated May 3^d, 1865.

Book mark:

Hodges

(261)

Copyist.

Fleming, Wm.

, Co. , 5th Reg't Mass. C.C.

Enclosures.

Bed Cards	Final Statements
Burial Records	Furloughs
Certs. of Dis. for Discharge	Med. Certificates
C. M. Charges	Med. Des. Lists
Descriptive Lists	Orders
Discharge Certificates	Pris. of War Record

Other papers relating to—

Admission to Hosp'l	Furlough
Casualty Sheet	Med. Examination
Confinement	Misc. Information
Contracts	Pay or Clothing
Death or Effects	Personal Reports
Desertions	Rank
Discharge from Hosp'l	Transfer to Hosp'l
Discharge from Service	Transfer to V. R. C.
Duty	Transportation

NOTE 1.—This blank will be used for both enlistments and re-enlistments—enlistment of veterans, &c., &c., in the volunteer service. They will be made out in duplicate in all cases—one to accompany the recruiting return of the superintendent (not the recruiting officer) to the Adjutant-General, and one to accompany the accounts of the officer who pays bounty, &c. The Regiment and Company in which the soldier last served should be given on the back.

NOTE 2.—An enlistment holds to service. A muster-in must, in all cases, precede payment of pay, bounty, pension, &c. A muster-in roll must, in all cases, be filed in the Adjutant-General's Office as evidence of muster-in. The mustering officer, commissary, or assistant-commissary of musters, as the case may be, will countersign both enlistments as having mustered the soldier into the service of the United States before either of them is given to the disbursing officer.

DECLARATION OF RECRUIT.

I, *William H. ...* desiring to VOLUNTEER as a Soldier in the Army of the United States, for the term of THREE YEARS, Do Declare, That I am *21* years and *0* months of age; that I have never been discharged from the United States service on account of disability or by sentence of a court-martial, or by order before the expiration of a term of enlistment; and I know of no impediment to my serving honestly and faithfully as a soldier for three years.

GIVEN at *Washington D.C.* the *10th* day of *Sept*

Witness: *...*

Discharged

18

Reg't of

enlistment; last served in Company ()

By

5th Regiment of *Mass* *Co*

Volunteered at

2nd

1864

No.

...

CONSENT IN CASE OF MINOR.

I, *...* Do CERTIFY, That I am the *...* of *...*; that the said *...* is *...* years of age; and I do hereby freely give my CONSENT to his volunteering as a SOLDIER in the ARMY OF THE UNITED STATES, for the period of THREE YEARS.

GIVEN at *...* the *...* day of *...*

Witness: *...*

VOLUNTEER ENLISTMENT.

STATE OF

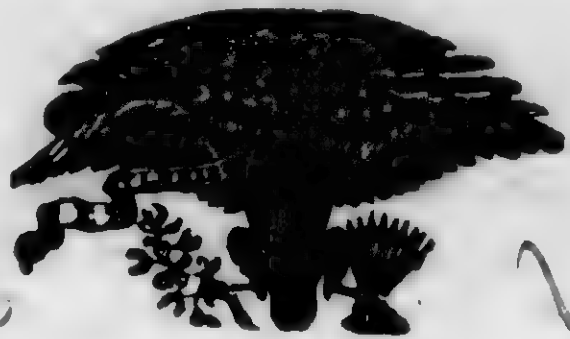

TOWN OF

Connecticut

East Windsor

Mustered into the service of the United States, in Company
the *10* day of *July*, 186*4*, at *East Windsor*

Regiment of

Volunteers, on

I, *William Fleming* born in *Canada*
in the State of *Virginia* aged *21* years,
and by occupation a *Soldier* Do HEREBY ACKNOWLEDGE to have
volunteered this *10* day of *July* 186*4*,
to serve as a **Soldier** in the **Army of the United States of America**, for the
period of **THREE YEARS**, unless sooner discharged by proper authority: Do also
agree to accept such bounty, pay, rations, and clothing, as are, or may be, estab-
lished by law for volunteers. And I, *William Fleming* do
solemnly swear that I will bear true faith and allegiance to the **United States
of America**, and that I will serve them honestly and faithfully against all their
enemies or opposers whomsoever; and that I will observe and obey the orders of
the President of the United States, and the orders of the officers appointed over
me, according to the Rules and Articles of War.

Sworn and subscribed to, at *East Windsor*
this *10* day of *July* 186*4*

BEFORE

Robert P. McKelvey
John D. ...
I CERTIFY, ON HONOR, That I have carefully examined the above-named Volunteer, agreeably
to the General Regulations of the Army, and that, in my opinion, he is free from all bodily defects and
mental infirmity, which would in any way disqualify him from performing the duties of a soldier.

J. A. ...
EXAMINING SURGEON.

I CERTIFY, ON HONOR, That I have minutely inspected the Volunteer,
previously to his enlistment, and that he was entirely sober when enlisted; that, to the best of my
judgment and belief, he is of lawful age; and that, in accepting him as duly qualified to perform the duties
of an able-bodied soldier, I have strictly observed the Regulations which govern the recruiting service.
This soldier has *Blue* eyes, *Dark* hair, *Light* complexion, is *5* feet
6 inches high.

Regiment of *...* Volunteers, *...*
RECRUITING OFFICER.

Robert P. McKelvey
John D. ...

(A. G. O. No. 74 & 75.)

VOLUNTEER ENLISTMENT.

STATE OF

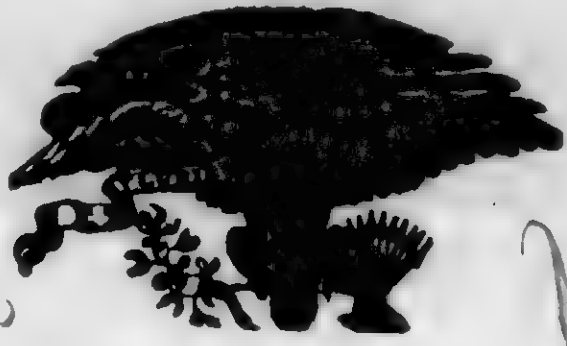

TOWN OF

Massachusetts *Quincy*

I, *William Thomas* born in *Canada*
in the ~~State~~ of *Massachusetts* aged *Eighteen* years,
and by occupation a *Farmer* Do HEREBY ACKNOWLEDGE to have
volunteered this *10th* day of *September* 186*4*,
to serve as a **Soldier** in the **Army of the United States of America**, for the
period of **THREE YEARS**, unless sooner discharged by proper authority: Do also
agree to accept such bounty, pay, rations, and clothing, as are, or may be, estab-
lished by law for volunteers. And I, *William Thomas* do
solemnly swear that I will bear true faith and allegiance to the **United States**
of America, and that I will serve them honestly and faithfully against all their
enemies or opposers whomsoever; and that I will observe and obey the orders of
the President of the United States, and the orders of the officers appointed over
me, according to the Rules and Articles of War.

Sworn and subscribed to, at *Quincy*
this *10th* day of *September* 186*4*
BEFORE *Robert McKim*
at 20 1/2 to July
I CERTIFY, ON HONOR, That I have carefully examined the above-named Volunteer, agreeably
to the General Regulations of the Army, and that, in my opinion, he is free from all bodily defects and
mental infirmity, which would in any way disqualify him from performing the duties of a soldier.

J. A. Carlow
EXAMINING SURGEON.

I CERTIFY, ON HONOR, That I have minutely inspected the Volunteer,
previously to his enlistment, and that he was entirely sober when enlisted; that, to the best of my
judgment and belief, he is of lawful age; and that, in accepting him as duly qualified to perform the duties
of an able-bodied soldier, I have strictly observed the Regulations which govern the recruiting service.
This soldier has *blue* eyes, *black* hair, *clear* complexion, is *4 1/2* feet
6 1/2 inches high.

W. C. Carter
Regiment of *1st* Volunteers,
RECRUITING OFFICER.
Adm. Sec. Adams

(A. G. O. No. 74 & 75.)
12673

the *10th* day of *September*, 186*4*, at *Quincy*,
Mustered into the service of the United States, in Company *B*,
Regiment of *1st* Volunteers, on

Robert McKim
at 20 1/2 to July
M. C.

450

Hetcher John

Co A, 5 Mass. Cav., (Col'd.)

Private Private

CARD NUMBERS.

1	5379326	26
2	5379410	27
3	5379508	28
4	5379597	29
5	5379695	30
6	5379804	31
7	5379905	32
8	5380009	33
9	5380109	34
10	5380212	35
11	5380309	36
12	5372846	37
13	5380405	38
14	9092054	39
15	F15-07-1871	40
16	33031157	41
17	40730937	42
18		43
19		44
20		45
21		46
22		47
23		48
24		49
25		50

Book Mark: 265 b. P. 79 - G. C. F.
4876 F15-07-1871

See also

F

5 Cav. (Col'd.) | Mass.

John Fletcher

....., Co. *F*, 5 Reg't Mass. Cav. (Col'd.)

Appears on

Company Descriptive Book

of the organization named above.

DESCRIPTION.

Age *21* years; height *5* feet *6* inches.

Complexion *dark*

Eyes *blk*; hair *blk*

Where born *Hamilton Canada*

Occupation *Farmer*

ENLISTMENT.

When *Feb 2*, 186 *4*

Where *Winchendon*

By whom *G.B. Raymond*; term *3* y'rs.

Remarks:

Heard

5 Col'd Cav. | Mass.

John F. Fletcher

Co. 1st, 5 Reg't Mass. Col'd Cav.

Appears on

Company Muster-in and Descriptive Roll

of the organization named above. Roll dated

Sea Mills, Mass., Feb. 22, 1864.

Where born Hamilton, Canada

Age 21 y'rs; occupation Farmer

When enlisted Feb. 2, 1864.

Where enlisted Sea Mills, Mass.

For what period enlisted 2 years.

Eyes Black; hair Black

Complexion Black; height 5 ft. 6 in.

When mustered in Feb. 2, 1864.

Where mustered in * Padville, Mass.

Bounty paid \$ 100; due \$ 100

Where credited 4 Dist. Massachusetts

Company to which assigned

Remarks:

* Inserted by Jordan Es

Book mark: F 1505 1871

W. C. Tyler

(356d)

Copist.

41

5 Col'd Cav.

Mass.

John Fletcher

Co. F, 5 Reg't Mass. Col'd Cavalry.

Appears on

Company Muster Roll

for Enlistment to Feb. 29, 1864.

Present or absent Present.

Stoppage, \$ 100 for

Due Gov't, \$ 100 for

Valuation of horse, \$ 100

Valuation of horse equipments, \$ 100

Remarks: Bugler

Book mark:

G. C. Taylor

Copyist.

101

5 Col'd Cav.

Mass.

John Fletcher

Co. F, Co. F, 5 Reg't Mass. Col'd Cavalry.

Appears on

Company Muster Roll

for *March & Apr*, 186*4*.

Present or absent *absent*

Stoppage, \$ *100* for

Due Gov't, \$ *100* for

Valuation of horse, \$ *100*

Valuation of horse equipments, \$ *100*

Remarks: *absent without*
leave

Book mark: _____

John Fletcher

5 Col'd Cav.

Mass.

John A. Nichols

Co. F, 5 Reg't Mass. Col'd Cavalry.

Appears on

Company Muster Roll

for *March & April*, 1864.

Present or absent *Present*

Stoppage, \$ *100* for

Due Gov't, \$ *100* for

Valuation of horse, \$ *100*

Valuation of horse equipments, \$ *100*

Remarks:

Book mark:

John A. Nichols

F

5 Col'd Cav.

Mass.

John Fletcher
Pt, Co. F, 5 Reg't Mass. Col'd Cavalry.

Appears on

Company Muster Roll

for *July & Aug*, 1864.

Present or absent *Present*

Stoppage, \$ *100* for

Due Gov't, \$ *100* for

Valuation of horse, \$ *100*

Valuation of horse equipments, \$ *100*

Remarks:

Book mark:

J. Stewart

(358)

Copyist.

F

5 Col'd Cav.

Mass.

John Fletcher

Pt, Co. F, 5 Reg't Mass. Col'd Cavalry.

Appears on

Company Muster Roll

for *Sept + Oct*, 1864.

Present or absent *Present*

Stoppage, \$ *100* for

Due Gov't, \$ *100* for

Valuation of horse, \$ *100*

Valuation of horse equipments, \$ *100*

Remarks:

Book mark:

J. Stewart

(358)

Copyist.

F

5 Col'd Cav.

Mass.

John Fletcher

Pt., Co. F, 5 Reg't Mass. Col'd Cavalry.

Appears on

Company Muster Roll

for Nov & Dec, 1864.

Present or absent Present

Stoppage, \$ 100 for

Due Gov't, \$ 100 for

Valuation of horse, \$ 100

Valuation of horse equipments, \$ 100

Remarks: Due U.S. Gov
one (1) set Inf. equipments
complete 4 39 (1) bayonet

Book mark:

J. H. Stewart

G

5 Col'd Cav.

Mass.

John Fletcher

Pt

, Co. F, 5 Reg't Mass. Col'd Cavalry.

Appears on

Company Muster Roll

for *Jan & Feb*, 186*5*.

Present or absent *Present*

Stoppage, \$ *100* for

Due Gov't, \$ *100* for

Valuation of horse, \$ *100*

Valuation of horse equipments, \$ *100*

Remarks: *Due 1101 Gov*

*One "1" set Inf
equip complete. One
"1" Bayonet \$6.57
Due first four
Inst U.S. Bounty*

Book mark:

J. H. Stewart

(358)

Copyist.

F

5 Col'd Cav.

Mass.

John Fletcher

Pl, Co. F, 5 Reg't Mass. Col'd Cavalry.

Appears on

Company Muster Roll

for *March & April*, 186*5*

Present or absent *Present*

Stoppage, \$ *100* for

Due Gov't, \$ *100* for

Valuation of horse, \$ *100*

Valuation of horse equipments, \$ *100*

Remarks: *Due first four
inst U.S. Pay 100.00*

Book mark:

J. Stewart

(858)

Copyist.

J.

5 Col'd Cav.

Mass.

John Fletcher
Pl., Co. F, 5 Reg't Mass. Col'd Cavalry.

Appears on

Company Muster Roll

for *May June*, 186*2*.

Present or absent *Present*

Stoppage, \$ *100* for

Due Gov't, \$ *100* for

Valuation of horse, \$ *100*

Valuation of horse equipments, \$ *100*

Remarks: *One US for
or advance \$6.57*

Book mark:

L. J. Johnson

(358)

Copyist.

F

5 Col'd Cav.

Mass.

John Fletcher

Pt, Co. F, 5 Reg't Mass. Col'd Cavalry.

Appears on

Company Muster Roll

for *July & Aug*, 1863.

Present or absent *Present*

Stoppage, \$ *100* for

Due Gov't, \$ *100* for

Valuation of horse, \$ *100*

Valuation of horse equipments, \$ *100*

Remarks: *Was not sick
at Brazos U.S. Genl
Hosp since July 24/63*

Book mark:

J. Johnson

(358)

Copyist.

F | 5-l. Cav. | Mass

John Fletcher

Priv., Co. F, 5 Reg't Mass. Cav.

Appears on

Hospital Muster Roll

of DeCamp U. S. A. General Hospital,

at David's Island, New York Harbor,

for Sept & Oct, 1865.

Attached to hospital:

When _____, 186 .

How employed _____

Last paid by Maj. _____

to _____, 186 .

Bounty paid \$ 100 ; due \$ 100

Present or absent _____

Remarks: Mustered out of service October 12-1865

Book mark : _____

Rosenblum

(843)

Copyst.

5 Col'd Cav. | Mass.

John Fletcher

1st Co., 5 Reg't Mass. Col'd Cavalry.

Appears on an

Individual Muster-out Roll

of the organization named above. Roll dated

W. J. City, *Oct 11*, 1865.

Muster-out to date *Oct 11*, 1865.

Last paid to *Dec 31*, 1864.

Clothing account:

Last settled _____, 1865; drawn since \$ _____ 100

Due soldier \$ _____ 100; due U. S., \$ *40* ^{*Since last settlement*} $\frac{23}{100}$

Am't for cloth'g in kind or money adv'd \$ _____ 100

Due U. S. for arms, equipments, &c., \$ _____ 100

Bounty paid \$ _____ 100 due \$ _____ 100

Remarks *Mustered out under*

1st Order War Dept.

Aug 4 1865.

Clothing Not Settled

Dec 31/64

Dis-1019 E. J. 1871

*Corrected 3 23 1903 Austin

JAN-9

5372846

* 1891 *

That the Justice
has due him
\$5000 of bounty
I will for
Advance \$6³⁷

F

5 Col'd Cav.

Mass.

John Fletcher

Pl., Co. F, 5 Reg't Mass. Colored Cav.

Appears on Returns as follows:

April 1864 - Absent without leave

July 1864 - Absent sick

Sept. 1864 - On daily duty
Stables

July to Sept. 1865 - Absent sick
at U.S. Genl. Hooplt., Bra-
gos de Santiago, Texas
July 20, '65.

Book mark:

O. J. Taylor

(546)

Copyist.

F

5 Col'd Cav.

Mass.

John Fletcher
Co. *F*, 5 Reg't Mass. Col'd Cavalry.

Appears on Co. Muster-out Roll, dated

Charleston, Oct 31, 1863.

Muster-out to date _____, 186 .

Last paid to *Dec 31, 1864*.

Clothing account:

Last settled _____, 186 ; drawn since \$ _____ 100

Due soldier \$ _____ 100; due U. S. \$ *32* ^{*72*} 100

Am't for cloth'g in kind or money adv'd \$ _____ 100

Due U. S. for arms, equipments, &c., \$ *6* ^{*57*} 100

Bounty paid \$ _____ 100; due \$ *300* 100

Remarks: *Accidentally lost his equip. \$1³⁰ absent sick at New Orleans. Since Aug 16th 1864 no change furnished*

Book mark: *263 C. I. 790 900*

(over)

J. H. Jones

JAN. - 9

5380405

1891

Mustered out of service
at New York City Oct 11/63
under telegraphic order.
Was kept A. O.
New 4/66)

J | *5th Cav. (Colored) Mass*

John Fletcher

, Co. J, 5th Reg't Mass Cav. (Col'd)

NOTATION.

Book mark: *L. B. 12-440.*
265-C-J-1879. with
F15-CJ-1871

War Department,

Adjutant General's Office,

Washington, *Feb'y 3* .1879 .

Mustered out of service at New
York City October 11. 1865. under
telegraphic order War Dept. A. G. O.
May 4. 1865.

W. Allen

(438)

Copyist.

Fletcher, John

P. Co. F.

5th Reg't Mass. Cav.

2 Enclosures.

Bed Cards	Final Statements
Burial Records	Furloughs or L. of A.
Certs. of Dis. for Discharge	Med. Certificates
C. M. Charges	Med. Des. Lists
Descriptive Lists	Orders
Discharge Certificates	Pris. of War Record
Enlistment Papers	Resignations

Other papers relating to—

Admission to Hosp'l	Furlough or L. of A.
Casualty Sheet /	Med. Examination
Confinement	Misc. Information
Contracts	Pay or Clothing
Death or Effects	Personal Reports
Desertion	Rank
Discharge from Hosp'l	Transfer to Hosp'l
Discharge from Service /	Transfer to V. R. C.
Duty	Transportation

Office Chief Commissary of Musters,

DEPARTMENT OF THE EAST,

NEW YORK CITY,

Oct 11th

1865.

I have to report that.....

Private

John Fletcher

Co F S^t

Reg't.....

Map Co

Abel

..... is this day mustered out of the United States

service, in compliance with telegraphic instructions from War Department of May 3d, 1865.

Very respectfully,

Your obedient servant,

WILSON BARSTOW,

Brevet Major and A. D. C.,

Chief Commissary of Musters.

To the Chief Mustering Officer, State of

Mass

CASUALTY SHEET

No.

1000

Private of Company *1st*

5th Regiment of *Massachusetts*

State Volunteers. *(Vol.)*

NATURE OF CASUALTY.

Wounded
April 19/65



CASUALTY SHEET.

Name: *[Handwritten Name]*

Rank: *[Handwritten Rank]* Company: *[Handwritten Company]* Regiment: *[Handwritten Regiment]*

Arm: *[Handwritten Arm]* State: *[Handwritten State]*

Nature of Casualty: *[Handwritten Nature of Casualty]*

CAUSE OF CASUALTY—(NAME OF DISEASE, &c.)

BY WHOM DISCHARGED.

DEGREE OF DISABILITY.

FROM WHAT SOURCE THIS INFORMATION WAS OBTAINED.

BY WHOM CERTIFIED.

REMARKS.

DATE OF DISCHARGE, DEATH, &c.

PLACE OF DISCHARGE, DEATH, &c.

Clerk.

[Handwritten initials]

451

Fletcher William

Co K, 5 Mass. Cav., (Col'd.)

Private Private

CARD NUMBERS.

1	5372396	26
2	5372294	27
3	5384028	28
4	5384134	29
5	5384238	30
6	5384343	31
7	5384447	32
8	5384550	33
9	5384650	34
10	5384744	35
11	9091640	36
12	34505901	37
13	40730918	38
14		39
15		40
16		41
17		42
18		43
19		44
20		45
21		46
22		47
23		48
24		49
25		50

Book Mark:

See also

\$1657322 P.O. m+m

\$2696225 PO Pitt
P.O. misc of 981519 5/12/67ms

S.S. v. r. }
Tel. " " } 4/13/29.
a.

H. Jordan
a

J | 5 Cav. (Col'd.) | Mass.

William Fletcher,

Co. *K*, 5 Reg't Mass. Cav. (Col'd.)

Appears on

Company Descriptive Book

of the organization named above.

DESCRIPTION.

Age *19* years; height *5* feet *5* inches.

Complexion *Dark.*

Eyes *Black*; hair *Black.*

Where born *Arlington Va.*

Occupation *Laborer.*

ENLISTMENT.

When *July 8th*, 1864.

Where *S. Dowers.*

By whom *A. B. Merrill*; term *3* y'rs.

Remarks: *Single. Residence Lee's Heights
Va. Received \$100. U. S. Bounty. \$200,
due July 1864. Elected \$20. monthly
Bounty from Mass.*

H. C. Thomas.

T. 5 Cav. Mass.

William Fletcher

Appears with rank of _____ on _____

Muster and Descriptive Roll

of a detachment of U. S. Volunteers forwarded from Faneuil Hall, Boston, to Galloup's Island, Boston Harbor, for various regiments Massachusetts Volunteers. Roll dated

Boston Mass. July 8, 1864

Where born Arlington Va.

Age 19 years; occupation laborer

When enlisted July 8, 1864

Where enlisted S. Danvers

For what period enlisted 3 years.

Eyes blk; hair blk

Complexion blk; height 5 ft. 5 in.

When mustered in July 8, 1864

Where mustered in Boston

Bounty paid \$ 100; due \$ 100

Clothing account:

Last settled _____, 1864; drawn since \$ 100

Date of first muster _____, 1864

Regiment to which assigned 5 Cav.

Remarks: South Danvers Co.

5th Co. 5th Dist.

Book mark:

J. S. Baker

(356m)

Copyist.

F

5 Col'd Cav.

Mass.

William Fletcher

Pri

Appears with rank of on

Muster and Descriptive Roll of a Detachment of U. S. Vols. forwarded

for the 5 Reg't Mass. Col'd Cavalry. Roll dated
Boston Mass July 1-18, 1864

Where born Arlington Va

Age 19 y'rs; occupation Laborer

When enlisted July 8, 1864

Where enlisted So Danvers

For what period enlisted 3 years.

Eyes Black; hair Black

Complexion Dark; height 5 ft. 5 in.

When mustered in July 8, 1864

Where mustered in Boston

Bounty paid \$100; due \$100

Where credited 5 dist. So Danvers
Essex Co.

Company to which assigned

Remarks:

Book mark:

Donnelly

F

5 Col'd Cav.

Mass.

William Fletcher
Pri

Appears with rank of on

Muster and Descriptive Roll of a Detachment of U. S. Vols. forwarded

for the 5 Reg't Mass. Col'd Cavalry. Roll dated

Galloups Old Mass, Aug 7, 1864.

Where born Arlington Va

Age 19 y'rs; occupation Labourer

When enlisted July 8, 1864.

Where enlisted So Danvers Mass

For what period enlisted 3 years.

Eyes Black; hair Black

Complexion Dark; height 5 ft. 5 in.

When mustered in July 8, 1864.

Where mustered in Boston Mass

Bounty paid \$ 100; due \$ 100

Where credited

Company to which assigned

Remarks: 5 Coy Dist So Danvers
Essex Co

Book mark:

Donnelly

F

5 Col'd Cav.

Mass.

William Fletcher

M, Co. K, 5 Reg't Mass. Col'd Cavalry.

Appears on

Company Muster Roll

for *July & Aug*, 1864.

Present or absent *Present*

Stoppage, \$ *100* for

Due Gov't, \$ *100* for

Valuation of horse, \$ *100*

Valuation of horse equipments, \$ *100*

Remarks:

Book mark:

(358)

W. B. ...

Copyist.

F

5 Col'd Cav.

Mass.

William Fletcher

Private, Co. K, 5 Reg't Mass. Col'd Cavalry.

Appears on

Company Muster Roll

for Sept 10th, 1864

Present or absent Present

Stoppage, \$ 100 for

Due Gov't, \$ 100 for

Valuation of horse, \$ 100

Valuation of horse equipments, \$ 100

Remarks:

Book mark:

William Fletcher

(358)

Copyist.

of

5 Col'd Cav.

Mass.

William Fletcher

Sers., Co. K, 5 Reg't Mass. Col'd Cavalry.

Appears on

Company Muster Roll

for Nov + Dec, 1864.

Present or absent Present

Stoppage, \$ 100 for

Due Gov't, \$ 100 for

Valuation of horse, \$ 100

Valuation of horse equipments, \$ 100

Remarks:

Book mark:

Samuel

(358)

Copyist.

9

5 Col'd Cav.

Mass.

William Fletcher

Serjeant, Co. K, 5 Reg't Mass. Col'd Cavalry.

Appears on

Company Muster Roll

for Jan & Feb, 1865.

Present or absent Present

Stoppage, \$ 100 for

Due Gov't, \$ 100 for

Valuation of horse, \$ 100

Valuation of horse equipments, \$ 100

Remarks:

Book mark:

[Signature]

(358)

Copyist.

07

5 Col'd Cav.

Mass.

William Fletcher

Priv., Co. K, 5 Reg't Mass. Col'd Cavalry.

Appears on

Company Muster Roll

for Mar 1 Apr, 1865.

Present or absent Present

Stoppage, \$ 100 for

Due Gov't, \$ 100 for

Valuation of horse, \$ 100

Valuation of horse equipments, \$ 100

Remarks:

Book mark:

Edmundson

97

5 Col'd Cav.

Mass.

William Fletcher

Priv., Co. K, 5 Reg't Mass. Col'd Cavalry.

Appears on

Company Muster Roll

for May 1 June, 1865.

Present or absent Present

Stoppage, \$ 100 for

Due Gov't, \$ 100 for

Valuation of horse, \$ 100

Valuation of horse equipments, \$ 100

Remarks:

Book mark: -----

William Fletcher

(358)

Copyist.

F

5 Col'd Cav.

Mass.

William Fletcher

Pot, Co. K, 5 Reg't Mass. Col'd Cavalry.

Appears on

Company Muster Roll

for July & Aug., 1865.

Present or absent Present

Stoppage, \$ 100 for

Due Gov't, \$ 100 for

Valuation of horse, \$ 100

Valuation of horse equipments, \$ 100

Remarks: Detailed at Brazos on R.R. H. 2 3^d Brig. S. O. 40 July 27/65

Book mark:

Galligan

(358)

Copyist.

F | **5 Col'd Cav.** | **Mass.**

William Fletcher
M., Co. K., 5 Reg't Mass. Colored Cav.

Appears on **Returns** as follows:

*Aug. 1864 - Aug. 12, Pt. Lookout
Recruit rec'd from Depot.*

*July 1865 - Absent detailed building
R.R. at Brazos, San. July 27, '65.*

*Aug. 1865 - Absent detailed on R.R.
at Brazos R.O. 40 July 27, '65.*

*Sept. 1865 - Absent detailed on M.
R.R. at Brazos Hd. 2rs. 3.
Brig S.O. # 40, July 27 & S.O.
48, Aug. 10, '65.*

Book mark:

O. S. Taylor

(546)

Copyist.

F | **5 Col'd Cav.** | **Mass.**

William Fletcher

Pvt, Co. *A*, 5 Reg't Mass. Col'd Cavalry.

Appears on **Co. Muster-out Roll**, dated

Clarksville Texas, Oct. 31, 1865.

Muster-out to date

Oct. 31, 1865.

Last paid to

Dec. 31, 1864.

Clothing account:

Last settled....., 186 ; drawn since \$..... 100

Due soldier \$.....100; due U. S. \$ *35*⁵⁷/₁₀₀

Am't for cloth'g in kind or money adv'd \$.....100

Due U. S. for arms, equipments, &c., \$ *11*⁰⁰/₁₀₀

Bounty paid \$ *100*⁰⁰/₁₀₀; due \$ *200*⁰⁰/₁₀₀

Remarks:

Book mark: *U, 74 P 13. 73*

(361)

Galligan

Copyist.

Fletcher, Wm.

, Co. , 5th Reg't Mass. C.C.

~~4~~ Enclosures.

Bed Cards	Final Statements
Burial Records	Furloughs
Certs. of Dis. for Discharge	Med. Certificates
C. M. Charges	Med. Des. Lists
Descriptive Lists	Orders
Discharge Certificates	Pris. of War Record

Other papers relating to—

Admission to Hosp'l	Furlough
Casualty Sheet	Med. Examination
Confinement	Misc. Information
Contracts	Pay or Clothing
Death or Effects	Personal Reports
Desertions	Rank
Discharge from Hosp'l	Transfer to Hosp'l
Discharge from Service	Transfer to V. R. C.
Duty	Transportation
E. P. 2	S. S. 1

MICROFILM PUBLICATION M 1822

COMPILED MILITARY SERVICE RECORDS
OF VOLUNTEER UNION SOLDIERS WHO
SERVED WITH THE USCT (US COLORED TROOPS)
5TH MASSACHUSETTS REGIMENT OF CAVALRY

PERSONAL PAPERS' TARGET SHEET

PLEASE NOTE THE CHECKED INFORMATION ABOUT THE PERSONAL PAPERS IN
THIS FILE:

- NO PERSONAL PAPERS WERE FOUND IN THIS FILE WHEN THE
RECORDS WERE ARRANGED FOR MICROFILMING.

- 3 PERSONAL PAPER(S) FOUND IN THIS FILE WHEN THE RECORDS
WERE ARRANGED FOR MICROFILMING.

Single

Essex Co
Dist 5

VOLUNTEER ENLISTMENT.

STATE OF

TOWN OF

Massachusetts

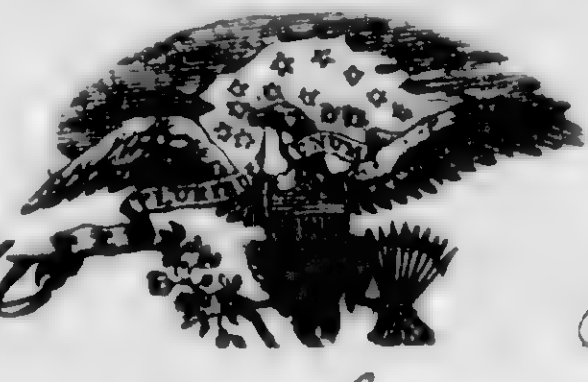

South Danvers

I, *William Fletcher* born in *Arlington*
in the State of *Virginia* aged *Nineteen* years,
and by occupation a *Labourer* DO HEREBY ACKNOWLEDGE to have
volunteered this *Eighth* day of *July* 1864,
to serve as a **Soldier** in the Army of the United States of America, for the
period of **THREE YEARS**, unless sooner discharged by proper authority: Do also
agree to accept such bounty, pay, rations and clothing, as are, or may be, estab-
lished by law for volunteers. And I, *William Fletcher* do
solemnly swear, that I will bear true faith and allegiance to the **United States**
of America, and that I will serve them honestly and faithfully against all their
enemies or opposers whomsoever; and that I will observe and obey the orders of
the President of the United States, and the orders of the officers appointed over
me, according to the Rules and Articles of War.

Sworn and subscribed to, at *Boston*
this *Eighth* day of *July* 1864 of *William F Fletcher*
BEFORE *[Signature]* *mark*

I CERTIFY, ON HONOR, That I have carefully examined the above-named Volunteer, agreeably
to the General Regulations of the Army, and that, in my opinion, he is free from all bodily defects and
mental infirmity, which would in any way disqualify him from performing the duties of a soldier.

J. S. Harker
M.D.
EXAMINING SURGEON.

I CERTIFY, ON HONOR, That I have minutely inspected the Volunteer, *William Fletcher*
previously to his enlistment, and that he was entirely sober when enlisted; that, to the best of my
judgment and belief, he is of lawful age; and that, in accepting him as duly qualified to perform the duties
of an able-bodied soldier, I have strictly observed the Regulations which govern the recruiting service.
This soldier has *Blue* eyes, *Blk* hair, *Dark* complexion, is *5* feet
5 inches high.

A. B. Merrill
Chairman
Regiment of *Volunteers*,
RECRUITING OFFICER.

the *8* day of *July*, 1864, at *Boston*,
Mustered into the service of the United States, in Company *D*,
5th Regiment of *Mass* *Volunteers*, on

NOTE 1.—This blank will be used for both enlistments and re-enlistments—enlistment of veterans, &c., &c., in the volunteer service. They will be made out in duplicate in all cases—one to accompany the recruiting return of the superintendent (not the recruiting officer) to the Adjutant-General, and one to accompany the accounts of the officer who pays bounty, &c. The Regiment and Company in which the soldier last served should be given on the back.

NOTE 2.—An enlistment holds to service. A muster-in must, in all cases, precede payment of pay, bounty, pension, &c. A muster-in roll must, in all cases, be filed in the Adjutant-General's Office as evidence of muster-in. The mustering officer, commissary, or assistant-commissary of musters, as the case may be, will countersign both enlistments as having mustered the soldier into the service of the United States before either of them is given to the disbursing officer.

(A. G. O. No. 74 & 75.)

DECLARATION OF RECRUIT.

I, *William Fletcher* desiring to VOLUNTEER as a Soldier in the Army of the United States, for the term of THREE YEARS, Do Declare, That I am *nineteen* years and _____ months of age; that I have never been discharged from the United States service on account of disability or by sentence of a court-martial, or by order before the expiration of a term of enlistment; and I know of no impediment to my serving honestly and faithfully as a soldier for three years.

GIVEN at *Boston Mass* the *8th* day of *July 1864*

Witness:

W. H. [unclear] *William Fletcher*
mark

Discharged

18

Reg't of

enlistment; last served in Company ()

By

William Fletcher
July 8 1864
C. B. Merrill
Regiment of *Mass. Cav*

Volunteered at

do do

No. *5 Mass. Cav*
(Co. C)

CONSENT IN CASE OF MINOR.

I, _____ Do CERTIFY, That I am _____ the _____ of _____; that the said _____ is _____ years of age; and I do hereby freely give my CONSENT to his volunteering as a SOLDIER in the ARMY OF THE UNITED STATES, for the period of THREE YEARS.

GIVEN at _____ the _____ day of _____

Witness:

Single

Essex Co Dist 5

VOLUNTEER ENLISTMENT.

STATE OF

TOWN OF

Massachusetts



South Duncovers

I, *William J. Foster* born in *Arlington* in the State of *Virginia* aged *Nineteen* years, and by occupation a *Laborer* DO HEREBY ACKNOWLEDGE to have volunteered this *Eighth* day of *July* 1864 to serve as a **Soldier** in the Army of the United States of America, for the period of **THREE YEARS**, unless sooner discharged by proper authority: Do also agree to accept such bounty, pay, rations, and clothing, as are or may be established by law for volunteers. And I, *William Fletcher* do solemnly swear, that I will bear true faith and allegiance to the **United States of America**, and that I will serve them honestly and faithfully against all their enemies or opposers whomsoever; and that I will observe and obey the orders of the President of the United States, and the orders of the officers appointed over me, according to the Rules and Articles of War.

Sworn and subscribed to, at *Boston* this *Eighth* day of *July* 1864 BEFORE *William J. Foster* *mark*

I CERTIFY, ON HONOR, That I have carefully examined the above-named Volunteer, agreeably to the General Regulations of the Army, and that, in my opinion, he is free from all bodily defects and mental infirmity, which would in any way disqualify him from performing the duties of a soldier.

J. S. Nathan
 M.D.
 EXAMINING SURGEON.

I CERTIFY, ON HONOR, That I have minutely inspected the Volunteer, previously to his enlistment, and that he was entirely sober when enlisted; that, to the best of my judgment and belief, he is of lawful age; and that, in accepting him as duly qualified to perform the duties of an able-bodied soldier, I have strictly observed the Regulations which govern the recruiting service. This soldier has *Blk* eyes, *Blk* hair, *Dark* complexion, is *5* feet *5* inches high.

A. B. Merrill
 Chairman *Selection*
 Recruiters *Volunteers*,
 RECRUITING OFFICER.

(A. G. O. No. 74 & 75.)

Mustered into the service of the United States, in Company *B*,
 the *8* day of *July*, 1864, at *Boston*,
 Regiment of *5th* *Mass* Cavalry, *Volunteers*, on

NOTE 1.—This blank will be used for both enlistments and re-enlistments—enlistment of veterans, &c., &c., in the volunteer service. They will be made out in duplicate in all cases—one to accompany the recruiting return of the superintendent (not the recruiting officer) to the Adjutant-General, and one to accompany the accounts of the officer who pays bounty, &c. The Regiment and Company in which the soldier last served should be given on the back.

NOTE 2.—An enlistment holds to service. A muster-in must, in all cases, precede payment of pay, bounty, pension, &c. A muster-in roll must, in all cases, be filed in the Adjutant-General's Office as evidence of muster-in. The mustering officer, commissary, or assistant-commissary of musters, as the case may be, will countersign both enlistments as having mustered the soldier into the service of the United States before either of them is given to the disbursing officer.

W. H. F. [unclear]

DECLARATION OF RECRUIT.

I, *William Fletcher* desiring to VOLUNTEER as a Soldier in the Army of the United States, for the term of THREE YEARS, Do Declare, That I am *21* years and _____ months of age; that I have never been discharged from the United States service on account of disability or by sentence of a court-martial, or by order before the expiration of a term of enlistment; and I know of no impediment to my serving honestly and faithfully as a soldier for three years.

GIVEN at *Boston Mass* the *8th* day of *July 1864*

Witness: *W. H. F. [unclear]* *William Fletcher*
mark

No.

Volunteered at *William Fletcher*
to [unclear]

By *July 8 1864*
W. H. F. [unclear]
1st Regiment of Mass Cav

enlistment; last served in Company ()

Reg't of

Discharged

18

CONSENT IN CASE OF MINOR.

I, _____ Do CERTIFY, That I am _____ of _____; that the said _____ is _____ years of age; and I do hereby freely give my CONSENT to his volunteering as a SOLDIER in the ARMY OF THE UNITED STATES, for the period of THREE YEARS.

GIVEN at _____ the _____ day of _____

Witness:

Statement of Service Reference Slip.

Office Pension

Claim No. 987519

William Fitch

(Name.)

Co. K, 5 Reg't Mass Cav ^{Calif}

To Med Dep. 5/12, 1916

For history

no med for pms

Johnson
M. W.
fa.

No medical record found.

Statement furnished MAY 15 1916 1916

[Signature]

Form No. 447—A. G. O.
Ed. Mar. 22-16—10,000.

452

Hawes Charles

Co D, 5 Mass. Cav., (Col'd.)

Private Private

CARD NUMBERS.

1	5372703	26
2	5377581	27
3	5377611	28
4	5377714	29
5	5377811	30
6	5377899	31
7	5377995	32
8	9092290	33
9		34
10		35
11		36
12		37
13		38
14		39
15		40
16		41
17		42
18		43
19		44
20		45
21		46
22		47
23		48
24		49
25		50

Book Mark:

See also

108497/ P. M. M.

QMG H. L. Stone 4-13-37 C.M.H.

L. Jordan
Ex

24
J

5 Cav. (Col'd.) | Mass.

Charles Flower

....., Co. 3, 5 Reg't Mass. Cav. (Col'd.)

Appears on

Company Descriptive Book

of the organization named above.

DESCRIPTION.

Age 30 years; height 5 feet 4 1/4 inches.

Complexion *fair*

Eyes *blue*; hair *black*

Where born *Long Beach, N.Y.*

Occupation *Student*

ENLISTMENT.

When *Feb*, 1867.

Where *Long Beach, N.Y.*

By whom *.....*; term *1* y'rs.

Remarks: *.....*
.....

F

5 Col'd Cav.

Mass.

Charles Flowers

Appears with rank of Private on

Muster and Descriptive Roll of a Detachment of Drafted Men and Substitutes forwarded

for the 5 Reg't Mass. Colored Cavalry. Roll dated

D.R. Gallups Island, ^{S.N. Mass.} N.Y., Oct. 31, 1864.

Where born Long Island, N.Y.

Age 30 years; occupation Laborer.

Drafted and mustered in:

When Sept. 6, 1864.

Where Concord.

Period 3 years.

Eyes Black; hair Black

Complexion Black; height 5 ft 7/4 in.

Paid bounty and advance pay, \$ 100

Bounty due \$ 100

Where credited _____

Company to which assigned _____

Remarks: Substitute for Emery B. Cobb. Discharged by order of
Book mark: Pro. Mar. Gen.

W.D. Davis

(340)

Copyist.

77

5 Col'd Cav.

Mass.

Charles Flowers

Priv, Co. D, 5 Reg't Mass. Col'd Cavalry.

Appears on

Company Muster Roll

for Am & Dec, 1864.

Present or absent Present

Stoppage, \$ 100 for

Due Gov't, \$ 100 for

Valuation of horse, \$ 100

Valuation of horse equipments, \$ 100

Remarks: No enlistment papers

Book mark:

J. Merchant

(358)

Copyist.

44
71

5 Col'd Cav.

Mass.

Charles Flowers

Rm, Co. D, 5 Reg't Mass. Col'd Cavalry.

Appears on

Company Muster Roll

for *Jan & Feb*, 186 *5*

Present or absent *Present*

Stoppage, \$ *100* for

Due Gov't, \$ *100* for

Valuation of horse, \$ *100*

Valuation of horse equipments, \$ *100*

Remarks: *Due 1st Instal^t U.S.
Bounty*

Book mark: _____

J. Merchant

(358)

Copyist.

J

5 Col'd Cav.

Mass.

Charles Flowers

Pr., Co. D, 5 Reg't Mass. Col'd Cavalry.

Appears on

Company Muster Roll

for *March & April*, 1865.

Present or absent *Present*

Stoppage, \$ *100* for

Due Gov't, \$ *100* for

Valuation of horse, \$ *100*

Valuation of horse equipments, \$ *100*

Remarks: *Due 1st Div U.S. Count,*

Book mark:

J. Merchant

F

5 Col'd Cav.

Mass.

Charles Flowers

Pvt, Co. D, 5 Reg't Mass. Col'd Cavalry.

Appears on

Company Muster Roll

for *May and June*, 1865.

Present or absent *Present*

Stoppage, \$ *100* for

Due Gov't, \$ *100* for

Valuation of horse, \$ *100*

Valuation of horse equipments, \$ *100*

Remarks:

Book mark:

House

(358)

Copyist.

F | **5 Col'd Cav.** | **Mass.**

Charles Flower

for, Co. D, 5 Reg't Mass. Col'd Cavalry.

Appears on

Company Muster Roll

for *July and Aug.*, 1865.

Present or absent *Present*

Stoppage, \$ *100* for

Due Gov't, \$ *100* for

Valuation of horse, \$ *100*

Valuation of horse equipments, \$ *100*

Remarks:

Book mark:

(358)

House

Copyist.

F

5 Col'd Cav. Mass.

Charles Flower

Prvt, Co. *D*, 5 Reg't Mass. Col'd Cavalry.

Appears on **Co. Muster-out Roll**, dated

Clarkville Texas, Oct. 31, 1865.

Muster-out to date

Oct. 31, 1865.

None paid
Last paid to

, 186 .

Clothing account:

Last settled....., 186 ; drawn since \$..... 100

Due soldier \$ *40*^{*80*}/₁₀₀; due U. S. \$..... 100

Am't for cloth'g in kind or money adv'd \$..... 100

Due U. S. for arms, equipments, &c., \$ *11*^{*00*}/₁₀₀

Bounty paid \$..... 100; due \$ *150*^{*00*}/₁₀₀

Remarks:

*Total money value of
advance charged \$11.00*

Book mark:

House

(861)

Copyist.

453

Flowers Madison

Co M, 5 Mass. Cav., (Col'd.)

Private Private

CARD NUMBERS.

1	5385923	26
2	5386018	27
3	5386104	28
4	5386191	29
5	5386298	30
6	5386400	31
7	5386505	32
8	5386604	33
9	5386710	34
10	5386797	35
11	9091365	36
12	40730939	37
13		38
14		39
15		40
16		41
17		42
18		43
19		44
20		45
21		46
22		47
23		48
24		49
25		50

Book Mark: _____

See also _____

F.

5 Cav. (Col'd.) | Mass.

Madison Flowers.

Co. M., 5 Reg't Mass. Cav. (Col'd.)

Appears on

Company Descriptive Book

of the organization named above.

DESCRIPTION.

Age *18* years; height *5* feet *6* inches.

Complexion *Black,*

Eyes *Black*; hair *Black.*

Where born *Roanoke Va.,*

Occupation *Farmer.*

ENLISTMENT.

When *April 30, 1864.*

Where *Boston No. 3.*

By whom *S. A. Derris*; term *3* y'rs.

Remarks: *Mustered May 5, 1864, by*
Lieut. D. Madden, Readville Mass.

H. C. Thomas

383a)

Copist.

F

5 Col'd Cav.

Mass.

Madison Flowers

Pri, Co. *M*, 5 Reg't Mass. Col'd Cav.

Appears on

Company Muster-in and Descriptive Roll
of the organization named above. Roll dated

Readville Mass, May 5, 1864.

Where born *Roanoke Va*

Age *18* y'rs; occupation *Farmer*

When enlisted *Apr. 30*, 1864.

Where enlisted *Boston Mass*

For what period enlisted *3* years.

Eyes *Blk*; hair *Blk*

Complexion *Blk*; height *5 ft. 6* in.

When mustered in *May 5*, 1864.

Where mustered in *Readville*

Premium
Bounty paid \$ *2* 100; due \$ 100

Where credited

Company to which assigned

Remarks: *Cred'td Hd. 3, City of*
Boston Suffolk Co. 4, Cong
Dist. Mass

Book mark:

Avery

(356d)

Copyist.

J

5 Col'd Cav.

Mass.

Madison Flowers

Poi, Co. M, 5 Reg't Mass. Colored Cavalry.

Appears on

Company Muster Roll

for *May 5 to June 30*, 1864.

Present or absent *Present*

Stoppage, \$ *100* for

Due Gov't, \$ *100* for

Valuation of horse, \$ *100*

Valuation of horse equipments, \$ *100*

Remarks:

Book mark:

Avery

(358)

Copyist.

F

5 Col'd Cav.

Mass.

Madison Flowers

Pri, Co. M, 5 Reg't Mass. Colored Cavalry.

Appears on

Company Muster Roll

for *July & Aug*, 1864.

Present or absent *Present*

Stoppage, \$ *100* for

Due Gov't, \$ *100* for

Valuation of horse, \$ *100*

Valuation of horse equipments, \$ *100*

Remarks:

Book mark:

(358)

Swamp

Copyist.

F

5 Col'd Cav.

Mass.

Madison Flowers

Priv., Co. M, 5 Reg't Mass. Colored Cavalry.

Appears on

Company Muster Roll

for *Sept. & Oct.*, 186*4*.

Present or absent *Absent*

Stoppage, \$ *100* for

Due Gov't, \$ *100* for

Valuation of horse, \$ *100*

Valuation of horse equipments, \$ *100*

Remarks: *In confinement
Spit Guard Horse.*

Book mark:

G. Williams,

(358)

Copyist.

F

5 Col'd Cav.

Mass.

Madison Flowers

Priv, Co. M, 5 Reg't Mass. Colored Cavalry.

Appears on

Company Muster Roll

for *Nov. & Dec.*, 186*4*.

Present or absent *Present*

Stoppage, \$ *100* for

Due Gov't, \$ *100* for

Valuation of horse, \$ *100*

Valuation of horse equipments, \$ *100*

Remarks:

Book mark:

C. Williams,

(358)

Copyist.

P

5 Col'd Cav.

Mass.

Madison Flowers

Pvt. Co. M, 5 Reg't Mass. Colored Cavalry.

Appears on

Company Muster Roll

for *Jan, & Feb,* 186*5*

Present or absent *Present.*

Stoppage, \$ *100* for

Due Gov't, \$ *100* for

Valuation of horse, \$ *100*

Valuation of horse equipments, \$ *100*

Remarks:

Book mark:

L. Williams

(358)

Copyist.

J

5 Col'd Cav.

Mass.

Madison Flowers

Priv, Co. M, 5 Reg't Mass. Colored Cavalry.

Appears on

Company Muster Roll

for *May, & Apr., 1865.*

Present or absent *Present*

Stoppage, \$ *100* for

Due Gov't, \$ *100* for

Valuation of horse, \$ *100*

Valuation of horse equipments, \$ *100*

Remarks:

Book mark: -----

G. Williams

F

5 Col'd Cav.

Mass.

Madison Flowers

Priv., Co. M, 5 Reg't Mass. Colored Cavalry.

Appears on

Company Muster Roll

for *May & June*, 1865.

Present or absent *Present*

Stoppage, \$ 100 for

Due Gov't, \$ 100 for

Valuation of horse, \$ 100

Valuation of horse equipments, \$ 100

Remarks:

Book mark:

L. Williams,
Copyst.

J

5 Col'd Cav.

Mass.

Madison Flowers

Pris, Co. M, 5 Reg't Mass. Colored Cavalry.

Appears on

Company Muster Roll

for *July & Aug*, 186*5*.

Present or absent *Present*

Stoppage, \$ *100* for

Due Gov't, \$ *100* for

Valuation of horse, \$ *100*

Valuation of horse equipments, \$ *100*

Remarks:

*Detached Service
S.O. 40 July 26th 1865
work on U.S. M. R.R.*

Book mark:

Hodges

J

5 Col'd Cav.

Mass.

Madison Flowers

Co. M, 5 Reg't Mass. Colored Cav.

Appears on **Returns** as follows:

*July & Aug. 1865 - Absent
detach'd serv. Brazos
Santiago S. O. 40 July
26, '65.*

*Sept. 1865 - Absent detach'd
serv. work on N. O.
M. R. R. S. O. 40 July
26, '65.*

Book mark:

O. J. Taylor

(546)

Copyist.

J

5 Col'd Cav.

Mass.

Madison Flowers

Pr, Co. *M*, 5 Reg't Mass. Col'd Cavalry.

Appears on Co. Muster-out Roll, dated

Clarksville Tex, Oct. 31, 1865.

Muster-out to date

Oct. 31, 1865.

Last paid to

Dec. 31, 1864.

Clothing account:

Last settled....., 186 ; drawn since \$..... 100

Due soldier \$.....100; due U. S. \$ *26* ^{*20*}/₁₀₀

Am't for cloth'g in kind or money adv'd \$.....100

Due U. S. for arms, equipments, &c., \$ *11* ¹⁰⁰/₁₀₀

Bounty paid \$.....100; due \$ *100* ¹⁰⁰/₁₀₀

Remarks:

.....
.....
.....
.....
.....

Book mark:

.....
.....
.....

(861)

Hodges

Copyist.

454

Fogg, John

Co E, 5 Mass. Cav., (Col'd.)

Private

Private

CARD NUMBERS.

1	5-3 f 05-03	26
2	5-3 f 06-04	27
3	5-3 f 06 f 9	28
4	5-3 f 07 7 3-	29
5	5-3 f 0 f 7 f	30
6	5-3 f 09 7 6	31
7	5-3 f 10 7 f	32
8	5-3 f 11 7 9	33
9	5-3 f 12 8 1	34
10	5-3 f 13 f 0	35
11	5-3 f 14 7 f	36
12	9091918	37
13	40730942	38
14		39
15		40
16		41
17		42
18		43
19		44
20		45
21		46
22		47
23		48
24		49
25		50

Book Mark: _____

See also _____

J

5 Cav. (Col'd.)

Mass.

John Fogg

, Co. *G*, 5 Reg't Mass. Cav. (Col'd.)

Appears on

Company Descriptive Book

of the organization named above.

DESCRIPTION.

Age *22* years; height *5* feet *5 1/2* inches.

Complexion *Blk*

Eyes *Blk*; hair *Blk*

Where born *Wilmington Del.*

Occupation *Matress maker.*

ENLISTMENT.

When *Feb 14*, 1864.

Where *Metford*

By whom *J.C. Hatch*; term *3* y'rs.

Remarks: *Married.*

Heam

5 Col'd Cav. | Mass.

F. J. G. J.
John G. J.
Co. _____, 5 Reg't Mass. Col'd Cav.

Appears on

Company Muster-in and Descriptive Roll

of the organization, named above. Roll dated

Readville Mass, Mar 4, 1864.

Where born *Wilmington Del.*

Age *22* y'rs; occupation *Matthres maker*

When enlisted *Feb. 17*, 1864.

Where enlisted *Medford*

For what period enlisted *3* years.

Eyes *Blk*; hair *Blk*

Complexion *Blk*; height *5 ft. 5 1/2 in.*

When mustered in *Mar 4*, 1864.

Where mustered in *Readville Mass*

Bounty paid \$ *2* 100; due \$ *100*

Where credited *6th Dist Middlesex*

Company to which assigned _____

Remarks: _____

Book mark: _____

L. J. G.

(356d)

Copist.

Q

5 Col'd Cav.

Mass.

John Pegg
Sgt., Co. G, 5 Reg't Mass. Col'd Cavalry.

Appears on

Company Muster Roll

for *March to Apr 30*, 1864.

Present or absent *Present*

Stoppage, \$ *100* for

Due Gov't, \$ *100* for

Valuation of horse, \$ *100*

Valuation of horse equipments, \$ *100*

Remarks:

Book mark: -----

L. J. S. S.

Q

5 Col'd Cav.

Mass.

John Pugg
Pr

Co. G, 5 Reg't Mass. Col'd Cavalry.

Appears on

Company Muster Roll

for *March to Apr 30*, 1864.

Present or absent *Present*

Stoppage, \$..... 100 for

Due Gov't, \$..... 100 for

Valuation of horse, \$..... 100

Valuation of horse equipments, \$..... 100

Remarks:

Book mark:

L. J. S. S.

G

5 Col'd Cav.

Mass.

John G. Gage

Co., Co. G, 5 Reg't Mass. Col'd Cavalry.

Appears on

Company Muster Roll

for *May, June, 1864.*

Present or absent *Present*

Stoppage, \$ *100* for

Due Gov't, \$ *100* for

Valuation of horse, \$ *100*

Valuation of horse equipments, \$ *100*

Remarks:

Book mark:

L. G. Gage

(358)

Copyist.

5 Col'd Cav.

Mass.

J
John Fog
Wt

Co. G, 5 Reg't Mass. Col'd Cavalry.

Appears on

Company Muster Roll

for *July, Aug*, 186*4*.

Present or absent *Present*

Stoppage, \$ *100* for

Due Gov't, \$ *100* for

Valuation of horse, \$ *100*

Valuation of horse equipments, \$ *100*

Remarks:

*On daily duty as
Provost guard at the
Prisoners camp since
Aug 16/64.*

Book mark:

(358)

J. Fog
Copyist.

7

5 Col'd Cav.

Mass.

John Fogg

Co. G, 5 Reg't Mass. Col'd Cavalry.

Appears on

Company Muster Roll

for Sept & Oct, 1864.

Present or absent Present

Stoppage, \$ 100 for

Due Gov't, \$ 100 for

Valuation of horse, \$ 100

Valuation of horse equipments, \$ 100

Remarks: Stop one fur r. sack. on daily no Co. Tailor.

Book mark:

Perry

(358)

Copyist.

21
-11

5 Col'd Cav.

Mass.

John Fogg

Co. G, 5 Reg't Mass. Col'd Cavalry.

Appears on

Company Muster Roll

for Nov. & Dec., 1864.

Present or absent Present

Stoppage, \$ 100 for

Due Gov't, \$ 100 for

Valuation of horse, \$ 100

Valuation of horse equipments, \$ 100

Remarks: Due U. S. for haversack. 48 cts charged on Sept & Oct Rollo
On daily duty as Co. Tailor

Book mark:

Perry

(358)

Copyist.

F

5 Col'd Cav.

Mass.

John Fogg
Pri, Co. G, 5 Reg't Mass. Col'd Cavalry.

Appears on

Company Muster Roll

for Jan & Feb, 1865.

Present or absent Present

Stoppage, \$ 100 for

Due Gov't, \$ 100 for

Valuation of horse, \$ 100

Valuation of horse equipments, \$ 100

Remarks: Due 1st, 2d, 3d & 4th instalments U.S. Bounty \$180, due U.S. for Haversack 48cts charged on Sept. & Oct. rolls. Sick in Reg. Hos.

Book mark:

Perry

(358)

Copyist.

27
7

5 Col'd Cav.

Mass.

John Foy
Seri, Co. G, 5 Reg't Mass. Col'd Cavalry.

Appears on

Company Muster Roll

for *Mch. & Apl.*, 1865.

Present or absent *Present*

Stoppage, \$ *100* for

Due Gov't, \$ *100* for

Valuation of horse, \$ *100*

Valuation of horse equipments, \$ *100*

Remarks: *Due the soldier
14 instalments U.S.
Bounty \$180*

Book mark:

Cerry

(358)

Copyist.

77

5 Col'd Cav.

Mass.

John Fogg

Prv, Co. G, 5 Reg't Mass. Col'd Cavalry.

Appears on

Company Muster Roll

for May & June, 1865.

Present or absent

Present

Stoppage, \$ 100 for

Due Gov't, \$ 100 for

Valuation of horse, \$ 100

Valuation of horse equipments, \$ 100

Remarks:

Book mark:

Perry

(358)

Copyist.

J

5 Col'd Cav.

Mass.

John Fogg

Priv., Co. G, 5 Reg't Mass. Col'd Cavalry.

Appears on

Company Muster Roll

for *July & Aug*, 186*5*.

Present or absent *Present*

Stoppage, \$ *100* for

Due Gov't, \$ *100* for

Valuation of horse, \$ *100*

Valuation of horse equipments, \$ *100*

Remarks: *On daily duty
as Company Cook*

Book mark: _____

W. H. Scott

(358)

Copyist.

F | **5 Col'd Cav.** | **Mass.**

John Fogg
Pvt., Co. *A*, 5 Reg't Mass. Colored Cav.

Appears on **Returns** as follows:

Aug. 1864 - On duty Building Stables

Sept. 1864 to Jan'y 1865 - On duty as Co Tailor

July to Sept. 1865 - On duty as Cook, since July 1, 65.

Book mark :

(546)

C. J. Taylor

Copyist.

A

5 Col'd Cav.

Mass.

John Fagg
Priv, Co. G, 5 Reg't Mass. Col'd Cavalry.

Appears on Co. Muster-out Roll, dated

Clarksville, *Sept 31*, 1865

Muster-out to date

Oct 31, 1865

Last paid to

Dec 31, 1864

Clothing account:

Last settled....., 186 ; drawn since \$..... 100

Due soldier \$..... 100; due U. S. \$ *27* ^{*21*}/₁₀₀

Am't for cloth'g in kind or money adv'd \$..... 100

Due U. S. for arms, equipments, &c., \$ *11* ^{*11*}/₁₀₀

Bounty paid \$..... 100; due \$ *200* ^{*00*}/₁₀₀

Remarks:

Book mark:

W. H. Scott

(361)

Copyist.

455

John George W.

Co *A*, 5 Mass. Cav., (Col'd.)

Private

Private

CARD NUMBERS.

1	5-379327	26
2	5-379412	27
3	5-379506	28
4	5-379598	29
5	5-379696	30
6	5-379761	31
7	5-379901	32
8	5-380047	33
9	5-380107	34
10	5-380210	35
11	5-380307	36
12	5-380403	37
13	4092055	38
14	40730943	39
15		40
16		41
17		42
18		43
19		44
20		45
21		46
22		47
23		48
24		49
25		50

Book Mark:

See also

F

5 Cav. (Col'd.) | Mass.

George Washington Folch

, Co. *F*, 5 Reg't Mass. Cav. (Col'd.)

Appears on

Company Descriptive Book

of the organization named above.

DESCRIPTION.

Age *21* years; height *5* feet *8* inches.

Complexion *Gold*

Eyes *Blk*; hair *Blk*

Where born *Martinsburgh, Va.*

Occupation *Laborer.*

ENLISTMENT.

When *Jan 26*, 186*4*

Where *Stoughton*

By whom *J. D. Newell*; term *3* y'rs.

Remarks:

Hearn

(3830)

Copyist.

5 Col'd Cav. | Mass.

George W. Holtz
Co. F, 5 Reg't Mass. Col'd Cav.

Appears on

Company Muster-in and Descriptive Roll
of the organization named above. Roll dated

Radville, Mass., Feb. 22, 1864.

Where born Martinsburg, Va.

Age 22 y'rs; occupation Soldier

When enlisted Jan. 26, 1864.

Where enlisted Radville

For what period enlisted years.

Eyes Black; hair Black

Complexion Black; height 5 ft. 8 in.

When mustered in Feb. 22, 1864.

Where mustered in Radville, Mass.

Bounty paid \$ 100; due \$ 100

Where credited District, Norfolk

Company to which assigned

Remarks:

* Inserted by Jordan C.

Book mark:

Jr

5 Col'd Cav.

Mass.

George H. [unclear]

[unclear], Co. F, 5 Reg't Mass. Col'd Cavalry.

Appears on

Company Muster Roll

for *Estimated to Feb. 29, 1864.*

Present or absent *Present.*

Stoppage, \$ *100* for

Due Gov't, \$ *100* for

Valuation of horse, \$ *100*

Valuation of horse equipments, \$ *100*

Remarks: *Y.O.H.*

Book mark:

(358)

[Signature]

Copyist.

5 Col'd Cav. . | **Mass.**

George W. Smith
....., Co. F, 5 Reg't Mass. Col'd Cavalry.

Appears on

Company Muster Roll

for *March & April*, 186*4*.

Present or absent *Present*

Stoppage, \$..... 100 for

Due Gov't, \$..... 100 for

Valuation of horse, \$..... 100

Valuation of horse equipments, \$..... 100

Remarks: *None*

Book mark:

G. W. Smith
Copyist.

5 Col'd Cav.

Mass.

George H. [unclear]

Co. F, 5 Reg't Mass. Col'd Cavalry.

Appears on

Company Muster Roll

for *March & June*, 1864.

Present or absent *Present*

Stoppage, \$ *100* for

Due Gov't, \$ *100* for

Valuation of horse, \$ *100*

Valuation of horse equipments, \$ *100*

Remarks: *Copy*

Book mark:

[Signature]

F

5 Col'd Cav.

Mass.

George W. Folk

Pt., Co. F, 5 Reg't Mass. Col'd Cavalry.

Appears on

Company Muster Roll

for July & Aug, 1864.

Present or absent Present

Stoppage, \$ 100 for

Due Gov't, \$ 100 for

Valuation of horse, \$ 100

Valuation of horse equipments, \$ 100

Remarks: Cook

Book mark:

W Stewart

(358)

Copyist.

G

5 Col'd Cav.

Mass.

George W. Folk^x

Farriss, Co. F, 5 Reg't Mass. Col'd Cavalry.

Appears on

Company Muster Roll

for *Sept & Oct*, 1864.

Present or absent *Present*

Stoppage, \$ *100* for

Due Gov't, \$ *100* for

Valuation of horse, \$ *100*

Valuation of horse equipments, \$ *100*

Remarks: *App'd Oct 1st 1864*
Co. Farriss

^x
In Col. of Pres name appears
as "George W. Folk"

Book mark:

J. H. Keenan

J

5 Col'd Cav.

Mass.

George W. Folk

Pt, Co. F, 5 Reg't Mass. Col'd Cavalry.

Appears on

Company Muster Roll

for *Nov & Dec*, 1864.

Present or absent. *Present*

Stoppage, \$ *100* for

Due Gov't, \$ *100* for

Valuation of horse, \$ *100*

Valuation of horse equipments, \$ *100*

Remarks:

Book mark:

J. Stewart

(358)

Copyist.

G

5 Col'd Cav.

Mass.

George Lock

Pt, Co. F, 5 Reg't Mass. Col'd Cavalry.

Appears on

Company Muster Roll

for *Jan & Feb*, 186*5*.

Present or absent *Present*

Stoppage, \$ *100* for

Due Gov't, \$ *100* for

Valuation of horse, \$ *100*

Valuation of horse equipments, \$ *100*

Remarks: *One first four
month M.S. Bty*

Book mark:

JH Stewart

(358)

Copyist.

F

5 Col'd Cav.

Mass.

George W. Fock

Pt, Co. F, 5 Reg't Mass. Col'd Cavalry.

Appears on

Company Muster Roll

for *March & April* 1865.

Present or absent *Present*

Stoppage, \$ *100* for

Due Gov't, \$ *100* for

Valuation of horse, \$ *100*

Valuation of horse equipments, \$ *100*

Remarks: *Due first four inst U.S. Bty 180,00*

Book mark:

J. H. Sewant

(858)

Copyist.

F

5 Col'd Cav.

Mass.

George W Foulk

, Co. F, 5 Reg't Mass. Col'd Cavalry.

Appears on

Company Muster Roll

for *May & June*, 186*5*.

Present or absent *Present*

Stoppage, \$ *100* for

Due Gov't, \$ *100* for

Valuation of horse, \$ *100*

Valuation of horse equipments, \$ *100*

Remarks:

Book mark:

J. A. Johnson

(358)

Copyist.

F

5 Col'd Cav.

Mass.

George W Folt

, Co. F, 5 Reg't Mass. Col'd Cavalry.

Appears on

Company Muster Roll

for *July & Aug*, 1863.

Present or absent *Absent*

Stoppage, \$ *100* for

Due Gov't, \$ *100* for

Valuation of horse, \$ *100*

Valuation of horse equipments, \$ *100*

Remarks: *Absent sick at
Brazer's Mt. Genl.
Hosp since Aug 10/63*

Book mark:

J. J. Johnson

(358)

Copyist.

J

5 Col'd Cav.

Mass.

George W. Folk

Q. J., Co *H*, 5 Reg't Mass. Colored Cav.

Appears on Returns as follows:

*March to Aug, 1864. On duty
Cook.*

*Aug & Sept, 1865. Absent sick
at U. S. Genl Hoop's
Brazos de Santiago
Texas. Aug 10,*

Book mark:

O. J. Taylor

(546)

Copyist.

J | **5 Col'd Cav.** | **Mass.**

George W. Folk
J. H. J., Co. *J.*, 5 Reg't Mass. Col'd Cavalry.

Appears on **Co. Muster-out Roll**, dated
Charlestown, Nov, Oct 3, 1864.

Muster-out to date *Oct 31*, 1864.

Last paid to *Dec 31*, 1864.

Clothing account:

Last settled....., 186 ; drawn since \$..... 100

Due soldier \$.....⁵⁶100; due U. S. \$..... 100

Am't for cloth'g in kind or money adv'd \$..... 100

Due U. S. for arms, equipments, &c., \$ *8* 100

Bounty paid \$..... 100; due \$ *300* 100

Remarks: *Rec'd U.S. for part of equip. \$130*

Book mark :

J. H. J.
(861) Copyist.

456

Ford Nathaniel P.

Co M, 5 Mass. Cav., (Col'd.)

Private Corporal

CARD NUMBERS.

1	5-372394	26
2	5-372359	27
3	5-372454	28
4	5-386192	29
5	5-386275	30
6	5-386375	31
7	5-386477	32
8	5-386649	33
9	5-372960	34
10	5-386834	35
11	9091366	36
12	40730944	37
13		38
14		39
15		40
16		41
17		42
18		43
19		44
20		45
21		46
22		47
23		48
24		49
25		50

Book Mark: EBVII. P 167.

See also

F. | **5 Cav. (Col'd.)** | **Mass.**

Nathaniel P. Ward.

....., Co. *A6*, 5 Reg't Mass. Cav. (Col'd.)

Appears on

Company Descriptive Book

of the organization named above.

DESCRIPTION.

Age *19* years; height *5* feet *3 1/2* inches.

Complexion *Black.*

Eyes *Black*; hair *Black.*

Where born *Baltimore Md.*

Occupation *Barber.*

ENLISTMENT.

When *Aug. 31*, 186*4*.

Where *Greennd.*

By whom *Capt. Thompson*; term *1* y'rs.

Remarks: *Mustered by Capt. L. B. Thompson*
Aug. 31 1864. Bounty paid by Capt. Dyer
\$33. Inv. \$67. Discharged by Gen.
Order 83. A.G.O. May 8 1865.

H. C. Thomas.

7

5 Col'd Cav.

Mass.

Nathaniel P. Ford
Pri

Appears with rank of on

Muster and Descriptive Roll of a Detachment of U. S. Vols. forwarded

for the 5 Reg't Mass. Col'd Cavalry. Roll dated

Concord Mass, Aug 31, 1864.

Where born Balto, Md

Age 19 y'rs; occupation Barber

When enlisted Aug 31, 1864.

Where enlisted Concord Mass

For what period enlisted 1 years.

Eyes Black; hair Black

Complexion Black; height 5-5 1/2 in.

When mustered in Aug 31, 1864.

Where mustered in Concord

Bounty paid \$ 33 ³³/₁₀₀; due \$ 66 ⁶⁷/₁₀₀

Where credited 7th Dist, Draent,

Middlesex Co
Company to which assigned

Remarks:

Book mark:

Donnelly

7

5 Col'd Cav.

Mass.

Nathaniel P. Ford

Appears with rank of Pri on

Muster and Descriptive Roll of a Detachment of U. S. Vols. forwarded

for the 5 Reg't Mass. Col'd Cavalry. Roll dated

....., 186 ..

Where born Baltimore Md

Age 19 y'rs; occupation Barber

When enlisted Aug 31, 1864.

Where enlisted Crew Mass

For what period enlisted 3 years.

Eyes Black; hair Black

Complexion Black; height 5 ft. 5 1/2 in.

When mustered in Aug 31, 1864.

Where mustered in Crew

Bounty paid \$ 33 ³³/₁₀₀; due \$ 66 ⁶⁷/₁₀₀

Where credited 7 Dist. Dracut, Middle

sex Co
Company to which assigned

Remarks :

Book mark :

Donnelly

(339)

Copyist.

F

5 Col'd Cav.

Mass.

Nathaniel B Ford

Appears with rank of *Private* on

Muster and Descriptive Roll of a Detachment of U. S. Vols. forwarded

for the 5 Reg't Mass. Col'd Cavalry. Roll dated *Draft Rendezvous Galloups Island B. H. Mass Sept 16, 1864.*

Where born *Baltimore Md*

Age *19* y'rs; occupation *Barber*

When enlisted *Aug. 31*, 1864.

Where enlisted *Concord*

For what period enlisted *1* years.

Eyes *black*; hair *black*

Complexion *black*; height *5 ft. 5 1/2 in.*

When mustered in *Aug. 31*, 1864.

Where mustered in *Concord Mass*

Bounty paid \$ *33 33/100*; due \$ *66 67/100*

Where credited *Dracut Middlesex Co.*

Company to which assigned

Remarks:

Book mark:

M. A. Michaels

(339)

Copyist.

F

5 Col'd Cav.

Mass.

Nathaniel P. Ford

Priv., Co. M, 5 Reg't Mass. Colored Cavalry.

Appears on

Company Muster Roll

for *Sept. & Oct.*, 1864.

Present or absent. *Present*

Stoppage, \$ *100* for

Due Gov't, \$ *100* for

Valuation of horse, \$ *100*

Valuation of horse equipments, \$ *100*

Remarks: *Recruit from depot. Joined Co. Oct 27 '64. No enlistment papers received.*

Book mark:

L. Williams,

F

5 Col'd Cav.

Mass.

Nathaniel P. Ford

Co. M, 5 Reg't Mass. Colored Cavalry.

Appears on

Company Muster Roll

for *Nov, & Dec*, 1864

Present or absent. *Present*

Stoppage, \$ *100* for

Due Gov't, \$ *100* for

Valuation of horse, \$ *100*

Valuation of horse equipments, \$ *100*

Remarks: *Promoted from Private by S.O. No. 226 Dec, 13, 1864 No enlistment papers rec'd.*

Book mark:

L. Williams

F

5 Col'd Cav.

Mass.

Nathaniel P. Ford

Corpl, Co. M, 5 Reg't Mass. Colored Cavalry.

Appears on

Company Muster Roll

for *Jan, & Feb,*, 186*5.*

Present or absent *Present*

Stoppage, \$ *100* for

Due Gov't, \$ *100* for

Valuation of horse, \$ *100*

Valuation of horse equipments, \$ *100*

Remarks: *Promoted to Corp:*
by S.O. No. 225 Dec, 13, 64.

Book mark:

G. Williams,

F

5 Col'd Cav.

Mass.

Nathaniel P. Ford

Corpl, Co. M, 5 Reg't Mass. Colored Cavalry.

Appears on

Company Muster Roll

for *May, & Apr*, 1865.

Present or absent *Present*

Stoppage, \$ *100* for

Due Gov't, \$ *100* for

Valuation of horse, \$ *100*

Valuation of horse equipments, \$ *100*

Remarks: *Promoted to Corpl*
by S.O. 225 Dec, 13 '64.
Mustered out at City
Point, Va May 24, '65 by
order M.G.O. See Muster
out Roll on file.

Book mark:

L. Williams

(358)

Copy.

F

5 Col'd Cav.

Mass.

Nathaniel P. Ford

Corpl, Co. M, 5 Reg't Mass. Colored Cavalry.

Appears on

Company Muster Roll

for *May & June*, 1865.

Present or absent

Stoppage, \$ *100* for

Due Gov't, \$ *100* for

Valuation of horse, \$ *100*

Valuation of horse equipments, \$ *100*

Remarks: *Discharged by*
C.O. No 83 A.C.O. Washing-
ton, D.C. May 8th, 1865

Book mark: *Discharged May 24*
(over)

C. Williams,

(358)

Copyist.

JAN. 10

5386649

★ 1891 ★

'65. EBN 11. P. 167

9 | **5 Col'd Cav.** | **Mass.**

Nathaniel P. Ford

Orn
Cerpl, Co. *M*, 5 Reg't Mass. Colored Cav.

Appears on **Returns** as follows:

*Oct. 1864 - Oct. 27. '64, Point
Lookout, Recruit from
Depot.*

*May 1865 (Cerpl) May 23, '65
City Point, Discharged
by G.O. 83 at G.O. Wash,
D.C. May 8, '65.*

Book mark: _____

(546)

O. J. Taylor

Copyist.

7

5 Col'd Cav.

Mass.

Nathaniel P. Ford

Capt., Co. M, 5 Reg't Mass. Col'd Cavalry.

Appears on a

Detachment Muster-out Roll

of the organization named above. Roll dated

City Point, Va, May 24, 1865.

Muster-out to date May 24, 1865.

Last paid to None Paid, 1865.

Clothing account:

Last settled, 1865; drawn since \$ 100

Due soldier \$ 100; due U. S. \$ 100

Am't for cloth'g in kind or money adv'd \$ 59 ²²/₁₀₀

Due U. S. for arms, equipments, &c., \$ 100

Bounty paid \$ 33 ³³/₁₀₀; due \$ 33 ³³/₁₀₀

Remarks: Clothing acct.

never settled

Book mark:

R. Washington

Copyist.

J

5 Col'd Cav.

Mass.

Nathaniel P. Ford

Copley, Co. *M*, 5 Reg't Mass. Col'd Cavalry.

Appears on Co. Muster-out Roll, dated

Clarksville Tex, Oct. 31, 1865.

Muster-out to date _____, 186 .

Last paid to _____, 186 .

Never paid

Clothing account:

Last settled _____, 186 ; drawn since \$ _____ 100

Due soldier \$ _____ 100; due U. S. \$ _____ 100

Am't for cloth'g in kind or money adv'd \$ _____ 100

Due U. S. for arms, equipments, &c., \$ _____ 100

Bounty paid \$ _____ 100; due \$ _____ 100

Remarks:

Discharged May 23rd
1865 by G.O. no. 83 U.S.O.
Washington D.C. dated
May 8th 1865.

Book mark: *Discharged May 24/65*

(over)

Hodges

(361)

Copyist.

JAN. 10

5386834

☆ 1891 ☆

E. B. V. H. P. 167

Ord, Nathaniel P.

....., Co., *5* Reg't *Mass. C. G.*

2 Enclosures.

Bed Cards	Final Statements
Burial Records	Furloughs
Certs. of Dia. for Discharge	Med. Certificates
C. M. Charges	Med. Des. Lists
Descriptive Lists	Orders
Discharge Certificates	Pris. of War Record

Other papers relating to—

Admission to Hosp'l	Furlough
Casualty Sheet	Med. Examination
Confinement	Misc. Information
Contracts	Pay or Clothing
Death or Effects	Personal Reports
Desertions	Rank
Discharge from Hosp'l	Transfer to Hosp'l
Discharge from Service	Transfer to V. R. C.
Duty	Transportation
<i>E. P.</i>	<i>2</i>

NOTE 1.—This blank will be used for both enlistments and re-enlistments—enlistment of veterans, &c. &c., in the volunteer service. They will be made out in duplicate in all cases—one to accompany the recruiting return of the superintendent (not the recruiting officer) to the Adjutant General, and one to accompany the accounts of the officer who pays bounty, &c. The Regiment and Company in which the soldier last served shall be given on the back.

NOTE 2.—An enlistment book to serve. A muster-in book in all cases, previous payment of pay, bounty, pension, &c. A muster-in roll must, in all cases, be filed in the Adjutant General's Office as evidence of muster-in. The mustering officer, commissary, or assistant commissary of musters, as the case may be, will countersign both enlistments as having mustered the soldier into the service of the United States before either of them is given to the disbursing officer.

APRIL 1895. THIS PAPER WAS FORMERLY FILED IN THE REGIMENTAL DIV. & P. O.

DECLARATION OF RECRUIT.

I, Nathaniel P Ford, desiring one year to VOLUNTEER as a Soldier in the Army of the United States, for the term of THREE YEARS, Do Declare, That I am nineteen years and three months of age; that I have never been discharged from the United States service on account of disability or by sentence of a court martial, or by order before the expiration of a term of enlistment; and I know of no impediment to my serving honestly and faithfully as a soldier for three years one year

GIVEN at Concord Mass the 31 day of August 1864

Witness: William Bowen Nathaniel P Ford mark

5 No. 1222
Nathaniel P Ford
Volunteered at Concord
August 31, 1864

By _____
Regiment of _____
enlistment; last served in Company ()
Reg't of _____
Discharged _____, 18 _____

CONSENT IN CASE OF MINOR.

I, Thomas H. Ford, Do CERTIFY, That I am the father of Nathaniel P Ford; that the said Nathaniel P Ford is nineteen years of age; and I do hereby freely give my CONSENT to his volunteering as a SOLDIER in the ARMY OF THE UNITED STATES for the period of one year ~~THREE YEARS~~.

GIVEN at Lowell Mass the 27 day of August 1864

Witness: Walker Lewis Thomas H Ford

(A. G. O. No. 74 & 76.)

VOLUNTEER ENLISTMENT.

STATE OF

Massachusetts

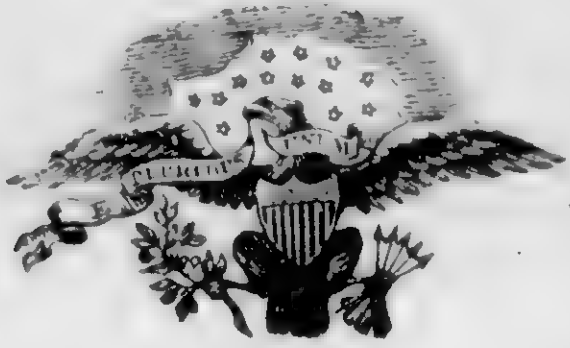

TOWN OF

Dracutt

I, *Nathaniel P. Ford*, born in *Baltimore* in the State of *Maryland*, aged *ninteen* years, and by occupation a *Barber*, Do HEREBY ACKNOWLEDGE to have volunteered this *thirty first* day of *August*, 1864, to serve as a *Soldier* in the Army of the United States of America, for the period of ~~THREE YEARS~~ *one year*, unless sooner discharged by proper authority: Do also agree to accept such bounty, pay, rations, and clothing, as are, or may be, established by law for volunteers. And I, *Nathaniel P. Ford*, do solemnly swear, that I will bear true faith and allegiance to the **United States of America**, and that I will serve them honestly and faithfully against all their enemies or opposers whomsoever; and that I will observe and obey the orders of the President of the United States, and the orders of the officers appointed over me, according to the Rules and Articles of War.

Sworn and subscribed to, at *Concord Mass* } *Nathaniel P Ford*
this *31st* day of *August*, 1864, } *man*
BEFORE

Capt. Prov. Marshal
I CERTIFY, ON HONOR, That I have carefully examined the above-named Volunteer, agreeably to the General Regulations of the Army, and that, in my opinion, he is free from all bodily defects and mental infirmity, which would in any way disqualify him from performing the duties of a soldier.

David P. Fogg
EXAMINING SURGEON.

I CERTIFY, ON HONOR, That I have minutely inspected the Volunteer *Nathaniel P. Ford* previously to his enlistment, and that he was entirely sober when enlisted; that, to the best of my judgment and belief, he is of lawful age; and that, in accepting him as duly qualified to perform the duties of an able-bodied soldier, I have strictly observed the Regulations which govern the recruiting service. This soldier has *Black* eyes, *Black* hair, *Black* complexion, is *five* feet *5 1/2* inches high.

Capt. Prov. Marshal
Regiment of *7th Dist. Mass* Volunteers,
RECRUITING OFFICER.

(A. G. O. No. 74 & 76.)

Mustered into the service of the United States, for ~~three years~~ or during the war, from date of enlistment, in Company *7th Dist. Mass* of the *1st* *Mass* Regiment of *Volunteers*, on the *31* day of *August*, 1864, at *Concord Mass*

Capt. Prov. Marshal
7th Dist. Mass

VOLUNTEER ENLISTMENT.

STATE OF

TOWN OF

Massachusetts

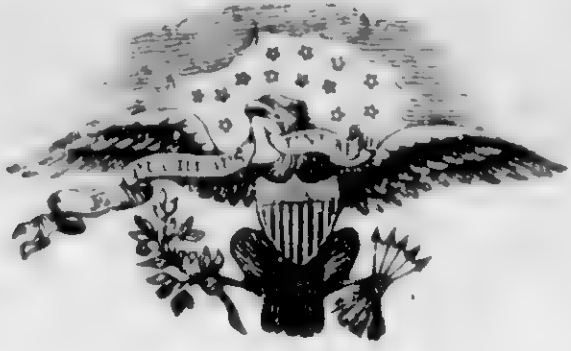

Dorset

Nathaniel P. Ford, born in *Baltimore*
in the State of *Maryland*, aged *ninety* years,
and by occupation a *Barber*, Do HEREBY ACKNOWLEDGE to have
volunteered this *thirty first* day of *August*, 1864,
to serve as a **Soldier** in the **Army of the United States of America**, for
the period of ~~THREE YEARS~~ ^{one year}, unless sooner discharged by proper authority:
Do also agree to accept such bounty, pay, rations, and clothing, as are, or may be,
established by law for volunteers. And I, *Nathaniel P. Ford*, do
solemnly swear, that I will bear true faith and allegiance to the **United States
of America**, and that I will serve them honestly and faithfully against all
their enemies or opposers whomsoever; and that I will observe and obey the
orders of the President of the United States, and the orders of the officers
appointed over me, according to the Rules and Articles of War.

Sworn and subscribed to, at *Concord Mass*
this *31st* day of *August*, 1864, } *Nathaniel P. Ford*
BEFORE *David P. Fogg* } *Examining Surgeon*

Capt. Prov. Marshal
I CERTIFY, ON HONOR, That I have carefully examined the above-named Volunteer, agreeably
to the General Regulations of the Army, and that, in my opinion, he is free from all bodily defects and
mental infirmity, which would in any way disqualify him from performing the duties of a soldier.

David P. Fogg
EXAMINING SURGEON.

I CERTIFY, ON HONOR, That I have minutely inspected the Volunteer *Nathaniel P. Ford*
previously to his enlistment, and that he was entirely sober when enlisted; that, to the best of my
judgment and belief, he is of lawful age; and that, in accepting him as duly qualified to perform the
duties of an able-bodied soldier, I have strictly observed the Regulations which govern the recruiting
service. This soldier has *Black* eyes, *Black* hair, *Black* complexion, is *five*
feet *6 1/2* inches high.

Capt. Prov. Marshal
Regiment of *Volunteers*,
7th Dist. Mass
RECRUITING OFFICER.

(A. G. O. No. 74 & 76.)

Mustered into the service of the United States, for ~~three years~~ ^{one year} or during the war, from date of enlistment, in Company *1st*
of the *1st* Regiment of *Mass* Volunteers, on the *31* day of *August*, 1864, at *Concord Mass*

Capt. Prov. Marshal
7th Dist. Mass

457

Ford Samuel

Co D, 5 Mass. Cav., (Col'd.)

Private Payler

CARD NUMBERS.

1	5376915	26
2	5377013	27
3	5377090	28
4	5377181	29
5	5377289	30
6	5377394	31
7	5377494	32
8	5377604	33
9	5377681	34
10	5377780	35
11	5377876	36
12	5377972	37
13	9092285	38
14	40730946	39
15		40
16		41
17		42
18		43
19		44
20		45
21		46
22		47
23		48
24		49
25		50

Book Mark:

See also

4

5 Cav. (Col'd.) | Mass.

Samuel Foul

Co. L, 5 Reg't Mass. Cav. (Col'd.)

Appears on

Company Descriptive Book

of the organization named above.

DESCRIPTION.

Age 24 years; height 5 feet 4 inches.

Complexion fair

Eyes blue; hair black

Where born Philadelphia Pa.

Occupation Farmer

ENLISTMENT.

When June 22, 1864

Where New York

By whom Samuel Foul; term 3 y'rs.

Remarks: ...

F | **5 Col'd Cav.** | **Mass.**

Samuel Ford

A, Co. *D*, 5 Reg't Mass. Col'd Cav.

Appears on

Company Muster-in and Descriptive Roll
of the organization named above. Roll dated

Readville Mass, July 27, 1864.

Where born *Philadelphia Penn.*

Age *26* y'rs; occupation *Sailor*

When enlisted *July 22*, 1864.

Where enlisted *Dorchester*

For what period enlisted *3* years.

Eyes *BLK*; hair *BLK*

Complexion *BLK*; height *5* ft. *4* in.

When mustered in *July 29*, 1864.

Where mustered in *Readville Mass*

Bounty paid \$ *100*; due \$ *100*

Where credited *4 Dist Norfolk*

Company to which assigned

Remarks:

Book mark:

[Signature]

(356d) *[Signature]* Copyist.

57

5 Col'd Cav.

Mass.

Samuel Ford

Priv, Co. D, 5 Reg't Mass. Col'd Cavalry.

Appears on

Company Muster Roll

for *Enlistment to July 24*, 186*4*.

Present or absent *Present*

Stoppage, \$ *100* for

Due Gov't, \$ *100* for

Valuation of horse, \$ *100*

Valuation of horse equipments, \$ *100*

Remarks:

Book mark:

(358)

[Signature]
Copyist.

57

5 Col'd Cav.

Mass.

Samuel Ford

Co. D, 5 Reg't Mass. Col'd Cavalry.

Appears on

Company Muster Roll

for *Sept 7 1864*, 1864.

Present or absent *Present*

Stoppage, \$ 100 for

Due Gov't, \$ 100 for

Valuation of horse, \$ 100

Valuation of horse equipments, \$ 100

Remarks: *Company Cook*

Book mark:

(358)

[Signature]
Copyist.

67

5 Col'd Cav.

Mass.

Samuel Ford

Private, Co. D, 5 Reg't Mass. Col'd Cavalry.

Appears on

Company Muster Roll

for May & June, 1864.

Present or absent Present

Stoppage, \$ 100 for

Due Gov't, \$ 100 for

Valuation of horse, \$ 100

Valuation of horse equipments, \$ 100

Remarks:

Book mark:

[Signature]

Jr

5 Col'd Cav.

Mass.

Samuel Ford

Pr, Co. D, 5 Reg't Mass. Col'd Cavalry.

Appears on

Company Muster Roll

for *July & Aug*, 186*4*

Present or absent *Present*

Stoppage, \$ *100* for

Due Gov't, \$ *100* for

Valuation of horse, \$ *100*

Valuation of horse equipments, \$ *100*

Remarks: *In confinement
July 18 tried & C. M.,
awaiting sentence*

Book mark:

J. S. Albrecht

(358)

Copyist.

Jr

5 Col'd Cav.

Mass.

Samuel Ford

Pvt, Co. D, 5 Reg't Mass. Col'd Cavalry.

Appears on

Company Muster Roll

for *Sept & Oct*, 186 *4*.

Present or absent *Absent*

Stoppage, \$ *100* for

Due Gov't, \$ *100* for

Valuation of horse, \$ *100*

Valuation of horse equipments, \$ *100*

Remarks: *In confinement
July 18" 64 tried by C.M.
Awaiting sentence*

Book mark:

A. Marchant

(358)

Copyist.

F

5 Col'd Cav.

Mass.

Samuel Ford

Pi, Co. D, 5 Reg't Mass. Col'd Cavalry.

Appears on

Company Muster Roll

for *Nov & Dec*, 186*4*.

Present or absent *Absent*

Stoppage, \$ *100* for

Due Gov't, \$ *100* for

Valuation of horse, \$ *100*

Valuation of horse equipments, \$ *100*

Remarks: *In confinement G.G.H.,
awaiting sentence G.G.H.,
July 18th 64
In Mr. Store for Hammer &
Carter 95*

Book mark:

S. Merchant

(358)

Copyist.

H

5 Col'd Cav.

Mass.

Samuel Ford

Pvt., Co. D, 5 Reg't Mass. Col'd Cavalry.

Appears on

Company Muster Roll

for *Jan & Feb*, 186*5*?

Present or absent *Present*

Stoppage, \$ *100* for

Due Gov't, \$ *100* for

Valuation of horse, \$ *100*

Valuation of horse equipments, \$ *100*

Remarks: *Due 1, 2, 3, 4 months
US Bonus*

Book mark:

J. Merchant

H

5 Col'd Cav.

Mass.

Samuel Hoist

Bugler, Co. D, 5 Reg't Mass. Col'd Cavalry.

Appears on

Company Muster Roll

for May & April, 1865

Present or absent Present

Stoppage, \$ 100 for

Due Gov't, \$ 100 for

Valuation of horse, \$ 100

Valuation of horse equipments, \$ 100

Remarks: Due 1, 2, 3, 4 hrs US
Bount, (had charged G
from 7/1, 18 on roll of Feb 28"

Book mark:

A. Merchant

F

5 Col'd Cav.

Mass.

Samuel Ford

Bagin, Co. D, 5 Reg't Mass. Col'd Cavalry.

Appears on

Company Muster Roll

for *May* *Assess* *June*, 1865.

Present or absent *Present*

Stoppage, \$ *100* for

Due Gov't, \$ *100* for

Valuation of horse, \$ *100*

Valuation of horse equipments, \$ *100*

Remarks: *Full reg't April 19/61*
Reg't 1, 2, 3, 4, 5 and U.S.
Army. Ord. Discharged in
Jan. 28/65 \$1.08

Book mark:

House

F

5 Col'd Cav.

Mass.

Samuel Ford

Bugler, Co. D, 5 Reg't Mass. Col'd Cavalry.

Appears on

Company Muster Roll

for *July and Aug.*, 1865.

Present or absent *Present*

Stoppage, \$ *100* for

Due Gov't, \$ *100* for

Valuation of horse, \$ *100*

Valuation of horse equipments, \$ *100*

Remarks:

*Free April 19, 1861.
Due 1. 2. 3. 4. 5 Ins. U.S.
County. Stop value of one
Remington pistol \$ 16.00
Due for ord. Charged by
order \$ 1.08*

Book mark:

House

(358)

Copyist.

F | **5 Col'd Cav.** | **Mass.**

Samuel Ford

....., Co. *D*, 5 Reg't Mass. Colored Cav.

Appears on **Returns** as follows:

*March 1864. On duty
detailed Cook House.*

Book mark :

(546)

O. J. Taylor
Copyist.

F

5 Col'd Cav.

Mass.

Samuel Ford

Begun, Co. E, 5 Reg't Mass. Col'd Cavalry.

Appears on Co. Muster-out Roll, dated
Clarksville Texas Oct 31, 1865.

Muster-out to date Oct 31, 1865.

Last paid to Dec 31, 1864.

Clothing account:

Last settled....., 186 ; drawn since \$..... 100

Due soldier \$..... 100; due U. S. \$ 58 ⁴⁴/₁₀₀

Am't for cloth'g in kind or money adv'd \$..... 100

Due U. S. for arms, equipments, &c., \$ 19 ⁰⁰/₁₀₀

Bounty paid \$..... 100; due \$ 300 ⁰⁰/₁₀₀

Remarks: Total money value
of advance charged \$19.00
step value of one Remington
pistol 100. Due for advance
charged through error on Dec
64 Rec 1.08.

Book mark :

House

458

Ford William

Co A, 5 Mass. Cav., (Col'd.)

Private | *Private*

CARD NUMBERS.

1	5-379325-	26
2	5-379411	27
3	5-379507	28
4	5-379599	29
5	5-379697	30
6	5-379805-	31
7	5-379958	32
8	5-38045-1	33
9	9092056	34
10	32533670	35
11	32535070	36
12	31548197	37
13	31548800	38
14	33056724	39
15	33058100	40
16	40730948	41
17		42
18		43
19		44
20		45
21		46
22		47
23		48
24		49
25		50

Book Mark:

See also

F

5 Cav. (Col'd.) | Mass.

William Ford

....., Co. *F*, 5 Reg't Mass. Cav. (Col'd.)

Appears on

Company Descriptive Book

of the organization named above.

DESCRIPTION.

Age *32* years; height *5* feet *8* inches.

Complexion *dark*

Eyes *blk*; hair *blk*

Where born *Warrenton, Va.*

Occupation *Laborer.*

ENLISTMENT.

When *Feb 2*, 186*4*.

Where *Winchendon*

By whom *G.B. Raymond*; term *3* y'rs.

Remarks: *Discharged. (Surgical Certificate of Disability) from U.S. Genl Hospital Newark N.J. Nov. 21-64.*

Hearst

A | **5 Col'd Cav. | Mass.**

William Ford
Co. *1st*, 5 Reg't Mass. Col'd Cav.

Appears on

Company Muster-in and Descriptive Roll
of the organization named above. Roll dated
Readville Mass, Feb 22, 1864.

Where born *Warrington Va.*

Age *32* y'rs; occupation *Laborer*

When enlisted *Feb 2*, 1864.

Where enlisted *Warrington*

For what period enlisted *3* years.

Eyes *Black*; hair *Black*

Complexion *Black*; height *5 ft. 8 in.*

When mustered in *Feb 22*, 1864.

Where mustered in *Readville Mass*

Bounty paid \$ *100*; due \$ *100*

Where credited *1st Dist. Worcester*

Company to which assigned

Remarks:

**Inserted by Jordan Co*

Book mark:

F

5 Col'd Cav.

Mass.

William Ford

Co. F, Co. F, 5 Reg't Mass. Col'd Cavalry.

Appears on

Company Muster Roll

for *Enlistment to Feb 24*, 1864.

Present or absent *Present*

Stoppage, \$ *100* for

Due Gov't, \$ *100* for

Valuation of horse, \$ *100*

Valuation of horse equipments, \$ *100*

Remarks:

Book mark:

W. H. [unclear]

5 Col'd Cav.

Mass.

William Bond

William Bond, Co. F, 5 Reg't Mass. Col'd Cavalry.

Appears on

Company Muster Roll

for *March 1st*, 186*1*.

Present or absent *Present*

Stoppage, \$ *100* for

Due Gov't, \$ *100* for

Valuation of horse, \$ *100*

Valuation of horse equipments, \$ *100*

Remarks:

Book mark:

W. C. Bond

5 Col'd Cav.

Mass.

William Wood

Co. F, 5 Reg't Mass. Col'd Cavalry.

Appears on

Company Muster Roll

for *May & June*, 186*4*.

Present or absent *Absent*

Stoppage, \$ *100* for

Due Gov't, \$ *100* for

Valuation of horse, \$ *100*

Valuation of horse equipments, \$ *100*

Remarks: *No descriptive list received, absent such at City Point, Va.*

Book mark:

J. E. Taylor

F | *5th Cold Cav Mass*

William Ford

PM, Co. D, 5th Reg't Mass Cav

Appears on

Hospital Muster Roll

of **Balfour U. S. A. General Hospital,**

at **Portsmouth, Va.,**

for *May & June*, 186*4*

Attached to hospital:

When, 186 .

How employed

Last paid by Maj.

to, 186 .

Bounty paid \$ 100; due \$ 100

Present or absent *Present*

Remarks:

Book mark:

W. W. Payne

(843)

Copyist.

F

5 Col'd Cav.

Mass.

William Ford

Ft., Co. F, 5 Reg't Mass. Col'd Cavalry.

Appears on

Company Muster Roll

for July & Aug, 1864.

Present or absent Absent

Stoppage, \$ 100 for

Due Gov't, \$ 100 for

Valuation of horse, \$ 100

Valuation of horse equipments, \$ 100

Remarks: Absent sick
Market St. G. Hoopl
Newark N. J.

Book mark:

W. H. ...

F 5 Cav. (old) Mass.

William Ford
Pvt, Co. *F*, 5 Reg't Mass. C.

Appears on

Hospital Muster Roll

of **Balfour U. S. A. General Hospital,**

at **Portsmouth, Va.,**

for *July, Aug*, 186*4*.

Attached to hospital:

When _____, 186 .

How employed _____

Last paid by Maj. _____

to _____, 186 .

Bounty paid \$ 100; due \$ 100

Present or absent _____

Remarks: *Transferred North*
July 19/64

Book mark: _____

(843)

Ford
Copyist.

7 | 5 | 1 | Mass

Wm Ford

Co. F, 5 Reg't Mass Cav

Appears on

Hospital Muster Roll

of Ward U. S. A. General Hospital,

at Newark, N. J.,

for July & Aug, 1864.

Attached to hospital:

When July 21, 1864.

How employed

Last paid by Maj. Broadhead
to Feb 29, 1864.

Bounty paid \$ 100; due \$ 100

Present or absent Present

Remarks:

11 Ward

Book mark :

Alb Jones
Copyist.

24

5 Col'd Cav.

Mass.

William Ford

Pt, Co. F, 5 Reg't Mass. Col'd Cavalry.

Appears on

Company Muster Roll

for Sept & Oct, 1864.

Present or absent Absent

Stoppage, \$ 100 for

Due Gov't, \$ 100 for

Valuation of horse, \$ 100

Valuation of horse equipments, \$ 100

Remarks: Absent sick
U.S. Hospital Newark
New Jersey

Book mark:

J. Stewart

4

5^{mas}-ca. U.S.A.

Wm. Ford

Pri., Co. H, 5 Reg't U.S.A.

Appears on

Hospital Muster Roll

of Ward U. S. A. General Hospital,

at Newark, N. J.,

for Sept - Oct, 1864.

Attached to hospital:

When July 21, 1864.

How employed

Last paid by Maj. Newell
to July, Aug., 1864.

Bounty paid \$ 100; due \$ 100

Present or absent

Remarks: Transferred to
Transit Hospital, N. J.
Oct. 27, 1864.

Book mark :

Owsley

J. J. Cav. Mass 97

William Ford

Cvt., Co. G., 5 Reg. Mass, Cav. Col.

Appears on

Hospital Muster Roll

of **Grant U. S. A. General Hospital,**

at **Willet's Point, New York Harbor,**

for Sept - Oct, 1864.

Attached to hospital:

When Oct-27, 1864.

How employed

Last paid by Maj. Newall

to Aug. 31, 1864.

Bounty paid \$ 100; due 100

Present or absent Present

Remarks: Has back pay due from Feb. 29 to June 30/64

Ward 22

Book mark:

Chenich

F | *5* *Mass* | *USG*

William Ford
Pvt, Co. *F*, 5 Reg't *USG*

Appears on

Hospital Muster Roll

of **Grant U. S. A. General Hospital,**

at **Willet's Point, New York Harbor,**

for *Nov & Dec*, 1864.

Attached to hospital:

When *Oct 27*, 1864.

How employed

Last paid by Maj.

to _____, 186 .

Bounty paid \$. . . 100; due . . . 100

Present or absent

Remarks: *Discharged from service November 21, 1864.*

Book mark :

J. A. Fitch

F

5 Col'd Cav.

Mass.

William Ford

Ft, Co. F, 5 Reg't Mass. Col'd Cavalry.

Appears on

Company Muster Roll

for *Nov & Dec*, 1864.

Present or absent

Stoppage, \$ 100 for

Due Gov't, \$ 100 for

Valuation of horse, \$ 100

Valuation of horse equipments, \$ 100

Remarks: *Disch'd from Newark Hosp N.J. Nov 21, 1864 Final statement given*

Book mark:

M. Stewart

(358)

Copyist.

F | 5 Col'd Cav. | Mass.

William Ford

Co. F, 5 Reg't Mass. Colored Cav.

Appears on Returns as follows:

June 1864 - Absent sick at
City Point, Va.

July 1864 - Absent sick out of
the Dept.

Aug & Sept, 1864 - Absent sick
at Fort Sumner, Va.

Oct. & Nov, 1864 - Absent sick
in U.S. Genl. Hospital New
ark N.J. since June
16, '64.

Dec. 1864 - Nov. 21, Newark
N.J. Discharge for disabil-
ity. Notification rec'd Dec
14, '64.

Book mark:

O. J. Taylor.

(546)

Copyist.

J. | **5 Col'd Cav.** | **Mass.**

William Ford

Co. J., 5 Reg't Mass. Col'd Cavalry.

Appears on **Co. Muster-out Roll**, dated
Clarksville, Tenn, Oct 2, 1861.

Muster-out to date _____, 186 .

Last paid to *Feb 29*, 1864 .

Clothing account:

Last settled _____, 186 ; drawn since \$ _____ 100

Due soldier \$ _____ 100; due U. S. \$ _____ 100

Am't for cloth'g in kind or money adv'd \$ _____ 100

Due U. S. for arms, equipments, &c., \$ _____ 100

Bounty paid \$ _____ 100; due \$ _____ 100

Remarks: *Discharged Nov 21/64*
at Genl Hosp Newark
New Jersey for disability

Book mark: _____

(361)

W. Johnson

Copyist.

Ford, Wm

P. Co. J.

5

Mass. C. Cav.
Reg't

4 **Enclosures.**

Bed Cards	Descriptive Lists
Burial Records	Final Statements
Certs. of Dis. for Discharge /	Furloughs
C. M. Charges	Med. Des. Lists
Med. Certificates	Orders

Other papers relating to—

Admission to Hosp'l	Furlough
Casualty Sheet (Officer's) /	Med. Examination
Confinement	Misc. Information
Contracts	Pay or Clothing
Death or Effects	Personal Reports
Desertions	Rank
Discharge from Hosp'l	Transfer to Hosp'l
Discharge from Service	Transfer to V. R. C.
Duty	Transportation

4

CASUALTY SHEET
OF WOUNDED.



Wm Ford

Company

F

5 Regiment of *Mass Cav col^d*

Volunteers, at the battle of

Injury

(see inside)

CASUALTY SHEET.

Name, *Wm Ford*
Rank, _____, Company *F*, Regiment, *5*
Arm, *Car*, State, *Mass Cal*
Place of casualty, _____
Nature of casualty, *Arrived July 21 Ward Has*
Injury to back
Date of casualty, _____

FROM WHAT SOURCE THIS INFORMATION WAS OBTAINED.

Report of Killed, Wounded, and Missing of the _____ Regiment,

Brigade. _____ Division, _____ Corps, dated _____
Has Reg A Eng sol. Rel assⁿ *Book 4 page 210*

W North
Clerk.
Aug 14, 1885

*Et
Ad*

NOTE 1.

The company commander will here add a statement of all the facts known to him concerning the disease or wound, or cause of disability of the soldier; the time, place, manner, and all the circumstances under which the injury occurred, or disease originated or appeared; the duty, or service, or situation of the soldier at the time the injury was received or disease contracted, stating particularly whether the injury was received or the disease contracted in the line of his duty; and whatever other facts may aid a judgment as to the cause, immediate or remote, of the disability, and the circumstances attending it.

When the facts are not known to the company commander, the certificate of any officer, or affidavit of other person having such knowledge, will be appended—as the surgeon in charge of a hospital, the officer commanding a detachment of recruits, &c., &c.

NOTE 2.

When a probable case for pension, special care must be taken to state the degree of disability—as $\frac{1}{2}$, $\frac{1}{4}$, &c., &c.; to describe particularly the disability, wound, or disease; the extent to which it deprives him of the use of any limb or faculty, or affects his health, strength, activity, constitution, or capacity to labor or earn his subsistence. The surgeon will add, from his knowledge of the facts and circumstances, and from the evidence in the case, his professional opinion of the cause or origin of the disability. In the case of discharges by Medical Inspectors, the last paragraph will state that the "discharge was given by consent of the soldier, after a personal examination, and for disability, the nature, degree, and origin of which are correctly described in the within certificate."

Par. 1260 Regulations, Edit. 1861.

Medical officers, in giving certificates of disability, are to take particular care in all cases that have not been under their charge; and especially in epilepsy, convulsions, chronic rheumatism, derangement of the urinary organs, ophthalmia, ulcers, or any obscure disease liable to be feigned or purposely produced; and in no case shall such certificate be given until after sufficient time and examination to detect any attempt at deception.

DIRECTIONS.

This certificate will be made out in duplicate by the soldier's company commander, or other officer commanding the separate detachment to which he belongs, and sent by him to the surgeon who has charge of the hospital where the soldier is sick. The surgeon will then fill out and sign the surgeon's certificate, and forward these papers to the regimental, detachment, or post commander, who will forward them, with his action endorsed thereon, through the proper channel, to his division commander; or, if the troops are not attached to a division, to his corps, department, or other commander or officer to whom the authority to discharge enlisted men may be specially delegated.

These certificates, after having received the action of the highest authority to which they are required to be sent, will be returned through the same channel to the regimental, post, or detachment commander, who will, if the discharge is authorized by the endorsement of the proper authority, sign the soldier's discharge, and the last certificate on this paper; see that the soldier is furnished with the proper final statements in duplicate, and forward BOTH of these certificates direct to the Adjutant General United States Army, at Washington, D. C.; they will not, under any circumstances, be given into the hands of the soldier.

ADJUTANT GENERAL'S OFFICE

1702 1864

Duplicate sent the Pension Office.

CERTIFICATE OF DISABILITY FOR DISCHARGE

IN THE CASE OF

William Ford

a private Co. "F"

5 Reg't of Inf. Col. Cav.

APPROVED

Cell Chouyall

Surgeon, U. S. A.,

Medical Director of the East

HEADQUARTERS DEPARTMENT OF THE EAST,

NEW YORK CITY, Nov 15th. 1864.

To be discharged.

BY COMMAND OF MAJOR GENERAL DIX:

Wilson Boston

Capt. and A. D. C., A. A. A. G.

Received (A. G. Office)

1864

Enrolled in Pension Office

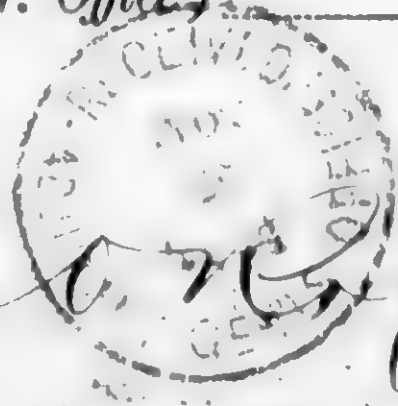

ARMY OF THE UNITED STATES

CERTIFICATE OF DISABILITY FOR DISCHARGE.

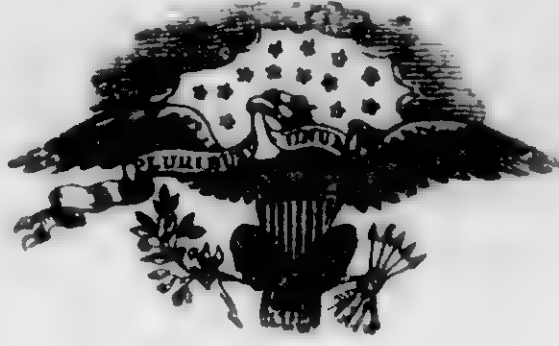

Private William Ford of Captain Charles P Bowditch
P Bowditch Company, ("F") of the Fifth Regiment of United States
Mass. Col. Cav was enlisted by G B Raymond of
 the _____ Regiment of _____ at Wenchen don
 on the second day of February, 1864, to serve three years; he was born
 in Warrenton in the State of Ore, is thirty two
 years of age, five feet eight inches high, dark complexion, black eyes
black hair, and by occupation when enlisted a laborer. During the last two
 months said soldier has been unfit for duty _____ days.*

Medical states that he may well plan to be discharged & contract chronic rheumatism in the hip of his leg, by exposure

STATION: Grant Genl Hosp
 DATE: Nov 15, 1864

A Henry Thurst
per
 Commanding Company. Asst

I CERTIFY, that I have carefully examined the said William Ford of
 Captain Bowditch Company, and find him incapable of performing the duties of a soldier
 because of old age (fifty) & chronic rheumatism cannot
walk upright.

His ability to be

A Henry Thurst
 Surgeon. per

DISCHARGED, this twelfth day of November, 1864, at Grant Genl
Hospital Mills Point N.Y.

A Henry Thurst
per
 Commanding the Regt/Hosp

The Soldier desires to be addressed at

Town Buffalo County _____ State New York

* See Note 1 on the back of this.

† See Note 2 on the back of this.

459

Jr.

Ford William

Co D, 5 Mass. Cav., (Col'd.)

Private | *Private*

CARD NUMBERS.

1	5-376912	26.
2	5-377004	27
3	5-377091	28
4	5-377182	29
5	5-377290	30
6	5-377395	31
7	5-377495	32
8	5-377605	33
9	5-377708	34
10	5-377803	35
11	5-377935	36
12	5-377940	37
13	5-378030	38
14	9092283	39
15	33237675	40
16	33239375	41
17	40730947	42
18		43
19		44
20		45
21		46
22		47
23		48
24		49
25		50

Book Mark: _____

See also _____

J 5 Cav. (Col'd.) | Mass.

William H. Ford

....., Co. *I*, 5 Reg't Mass. Cav. (Col'd.)

Appears on

Company Descriptive Book

of the organization named above.

DESCRIPTION.

Age *28* years; height *5* feet *4* inches.

Complexion *Blk*

Eyes *Blk*; hair *Blk*

Where born *Northwell N.Y.*

Occupation *Hostler.*

ENLISTMENT.

When *June 13*, 186 .

Where *Company's camp*

By whom *A. L. ...*; term *3* y'rs.

Remarks: *Mustered Co. D Jan'y 29, 1864 at Readville Mass.*

Heard

G

5 Col'd Cav.

Mass.

William H. Ford

Bvt, Co. *D*, 5 Reg't Mass. Col'd Cav.

Appears on

Company Muster-in and Descriptive Roll

of the organization named above. Roll dated

Readville Mass, July 29, 1864

Where born *Roswell New York*

Age *20* y'rs; occupation *Wright*

When enlisted *July 13*, 1864.

Where enlisted *Charlestown*

For what period enlisted *3* years.

Eyes *BLU*; hair *BLU*

Complexion *BLU*; height *5* ft. *4* in.

When mustered in *July 29*, 1864.

Where mustered in *Readville Mass*

Bounty paid \$ *100*; due \$ *100*

Where credited *1 Diet Middlesex*

Company to which assigned

Remarks:

Book mark:

J. J. Davis

(356d)

Copyist.

57

5 Col'd Cav.

Mass.

William G. Ford

Private, Co. D, 5 Reg't Mass. Col'd Cavalry.

Appears on

Company Muster Roll

for *Enlistment to Feb 29, 1864.*

Present or absent *Present.*

Stoppage, \$ *100* for

Due Gov't, \$ *100* for

Valuation of horse, \$ *100*

Valuation of horse equipments, \$ *100*

Remarks: *C. R.*

Book mark:

(358)

[Signature]
Copyist.

57

5 Col'd Cav.

Mass.

William E Ford

Pvt, Co. D, 5 Reg't Mass. Col'd Cavalry.

Appears on

Company Muster Roll

for *March & Apr*, 1864.

Present or absent *Absent*

Stoppage, \$ *100* for

Due Gov't, \$ *100* for

Valuation of horse, \$ *100*

Valuation of horse equipments, \$ *100*

Remarks: *Company Cook*
Absent on furlough.

Book mark:

57

5 Col'd Cav.

Mass.

William G. Ford

Dr., Co. D, 5 Reg't Mass. Col'd Cavalry.

Appears on

Company Muster Roll

for May & June, 1864.

Present or absent Present

Stoppage, \$ 100 for

Due Gov't, \$ 100 for

Valuation of horse, \$ 100

Valuation of horse equipments, \$ 100

Remarks: Detach Service at City Point

Book mark:

(358)

James
Copyst.

Jr

5 Col'd Cav.

Mass.

William H. Ford

Prvt, Co. D, 5 Reg't Mass. Col'd Cavalry.

Appears on

Company Muster Roll

for *July & Aug*, 186 *4*

Present or absent *Present*

Stoppage, \$ *100* for

Due Gov't, \$ *100* for

Valuation of horse, \$ *100*

Valuation of horse equipments, \$ *100*

Remarks: *Dial Drill,*
Company cook

Book mark:

J. M. Mearns

(358)

Copyist.

J

5 Col'd Cav.

Mass.

William H. Ford

Pr, Co. D, 5 Reg't Mass. Col'd Cavalry.

Appears on

Company Muster Roll

for *Sept & Oct*, 1864

Present or absent *Present*

Stoppage, \$ *100* for

Due Gov't, \$ *100* for

Valuation of horse, \$ *100*

Valuation of horse equipments, \$ *100*

Remarks: *Company cook*

Book mark:

S. Merchant

(358)

Copyist.

J

5 Col'd Cav.

Mass.

William H. Ford

Pr, Co. D, 5 Reg't Mass. Col'd Cavalry.

Appears on

Company Muster Roll

for *Nov & Dec*, 1864.

Present or absent *Present*

Stoppage, \$ *100* for

Due Gov't, \$ *100* for

Valuation of horse, \$ *100*

Valuation of horse equipments, \$ *100*

Remarks: *In the stores for Harness & Saddle*

Book mark:

W. Albrecht

(358)

Copyist.

Sp

5 Col'd Cav.

Mass.

William C. Ford

Pr, Co. D, 5 Reg't Mass. Col'd Cavalry.

Appears on

Company Muster Roll

for *Jan & Feb*, 1865.

Present or absent *Present*

Stoppage, \$ *100* for

Due Gov't, \$ *100* for

Valuation of horse, \$ *100*

Valuation of horse equipments, \$ *100*

Remarks: *Due 1, 2, 3, 4 Install*
W. Bourn,

Book mark:

J. Merchant

(358)

Copyist.

W

5 Col'd Cav.

Mass.

William H. Ford

Prin, Co. D, 5 Reg't Mass. Col'd Cavalry.

Appears on

Company Muster Roll

for *Nov & Dec*, 1865.

Present or absent *Present*

Stoppage, \$ *100* for

Due Gov't, \$ *100* for

Valuation of horse, \$ *100*

Valuation of horse equipments, \$ *100*

Remarks: *Due 1, 2, 3, 4 Jus U.S.
Bonne*

Book mark:

S. Merchen

(358)

Copyist.

F | **5 Col'd Cav.** | **Mass.**

William Ford

Pr, Co. D, 5 Reg't Mass. Col'd Cavalry.

Appears on

Company Muster Roll

for *May and June*, 1865.

Present or absent *Absent*

Stoppage, \$ *100* for

Due Gov't, \$ *100* for

Valuation of horse, \$ *100*

Valuation of horse equipments, \$ *100*

Remarks:

*Free before April 19, 1861
Coe 1, 2, 3, 4, 5 Ins. U.S.
Wounded. Sent to Hospital
L. House Pt. Va. May 20, 65*

Book mark:

House

(358)

Copyist.

5 | 5 Cav (Col'd) Mass.

William H. Ford*

Prk., Co. D, 5 Reg't Mass. Cav.

Appears on

Hospital Muster Roll

of U. S. A. General Hospital,

at Fort Monroe, Va.,

for May & June, 1865.

Attached to hospital :

When _____, 186 .

How employed _____

Last paid by Maj. Dodge
to Dec. 31, 1864.

Bounty paid \$ 100 ; due \$ 100

Present or absent present

Remarks :

Officers Div.

* William H. Ford in Present Column.

Book mark : _____

Wood

F

5 Col'd Cav.

Mass.

William H. Ford

Pr, Co. D, 5 Reg't Mass. Col'd Cavalry.

Appears on

Company Muster Roll

for July and Aug., 1865.

Present or absent

Stoppage, \$ 100 for

Due Gov't, \$ 100 for

Valuation of horse, \$ 100

Valuation of horse equipments, \$ 100

Remarks:

Crippled by mistake

* Name cancelled by line drawn through it

Book mark:

House

F

5 Col'd Cav.

Mass.

William H. Ford

Pvt, Co. D, 5 Reg't Mass. Col'd Cavalry.

Appears on

Company Muster Roll

for *July and Aug.*, 1865.

Present or absent *Absent*

Stoppage, \$ *100* for

Due Gov't, \$ *100* for

Valuation of horse, \$ *100*

Valuation of horse equipments, \$ *100*

Remarks: *Sent to Hospital at Petersburg Va May 12 since which time have received no notification whether he is in the service or not - Due 1 2 3 4 5 mos U.S. Bounty*

Book mark:

House

F | 5 Col'd Cav. | Mass.

William H. Ford
Pt., Co. D, 5 Reg't Mass. Colored Cav.

Appears on Returns as follows:

March 1864 - On duty, de-
tailed Cook House.

June 1864 - Absent sick in
Hospital.

July to Oct. 1864 - Colcook.

May & June 1865 - Absent sick

July 1865 - Absent left sick
in Hospital at Petersburg,
Va. June 12.

Aug & Sept. 1865 - Absent left
sick in Hospital at

Fortress Monroe, Va.
June 12, '64.

Book mark:

O. T. Taylor

(546)

Copyist.

f

5 Col'd Cav.

Mass.

William Ford

Priv, Co. *Q*, 5 Reg't Mass. Col'd Cavalry.

Appears on **Co. Muster-out Roll**, dated

Clarksville Texas Oct 31, 1865.

Muster-out to date _____, 186 .

Last paid to *Dec 31*, 1864.

Clothing account:

Last settled _____, 186 ; drawn since \$ _____ 100

Due soldier \$ _____ 100; due U. S. \$ _____ 100

Am't for cloth'g in kind or money adv'd \$ _____ 100

Due U. S. for arms, equipments, &c., \$ _____ 100

Bounty paid \$ _____ 100; due \$ *300* ⁰⁰ 100

Remarks: *Sent to Hospital at*

Fort Sumner, Va. May 12

1865 - has descriptive list

No. discharge furnished

Book mark: *U. 144 R 100. 72*

(over)

Home

(361)

Copyist.

JAN. - 9

5378030

1891

F 16 Vol 9 A. J. 1871

Died Oct. 8, 1865 at
Hampton Genl Hosp
St Marks Va. of Typho
Malarial fever & B $\frac{10}{109}$

Ford, Wm H.

P, Co. 10,

5

Reg't Mass. C. Cav.

11 Enclosures.

Bed Cards
Burial Records
Certs. of Dis. for Discharge
C. M. Charges
Med. Certificates

Descriptive Lists
Final Statements
Furloughs
Med. Des. Lists
Orders.....

Other papers relating to—

Admission to Hosp'l
Casualty Sheet (Officer's) 2
Confinement
Contracts
Death or Effects
Desertions
Discharge from Hosp'l
Discharge from Service
Duty

Furlough
Med. Examination
Misc. Information 2
Pay or Clothing
Personal Reports
Rank
Transfer to Hosp'l
Transfer to V. R. C.
Transportation.....

Approved and given in duty June 31. 1872
28

Adj't. General's Office
Washington D.C. June 28th 1872

The Muster Out Roll after '65
5th Mass. Col'd Cavalry, dated
Ocontoville, Tex, Oct. 31st 1865,
reports Private Amos H. Ford
"Sent to Hospital, Fort Monroe Va.
May 12th 1865 - no discharge furnished"

The Surgeon General U.S. Army
reports that the soldier "Died
Oct. 8th 1865, at Hampton Gen'l
Hospital, Fort Monroe, Va. of typhoid
fever."

The last Muster Out Roll will
be amended in accordance with
report from Surg. Gen'l U.S. Army,

Thomas M. Guent
S. B. ¹⁰/₁₆₉ Asst. Adj't General
D.A.

Noted
See letter to you
and of July 5. 1872

CASUALTY SHEET.

No.

William H. Ford

of Company A

5th Regiment of Mass. Cav. Col'd.

State Volunteers.

NATURE OF CASUALTY.

Died Oct. 8th 1865

Edward A. Rice

CASUALTY SHEET.

Name: *William H. Ford*

Rank: _____ Company: *A* Regiment: *5th*

Arm: *Mass, Cav. Colo* State: _____

Nature of Casualty: *Death*

CAUSE OF CASUALTY—(NAME OF DISEASE, &C.)

*Typhoid Malaria
Fever*

BY WHOM DISCHARGED.

FROM WHAT SOURCE THIS INFORMATION WAS
OBTAINED.

*Not official - indirect
from Surgeon General's Office.*

DEGREE OF DISABILITY.

BY WHOM CERTIFIED.

DATE OF DISCHARGE, DEATH, &C.

Oct. 8th 1865

PLACE OF DISCHARGE, DEATH, &C.

*U. S. Genl. Hospital
Fort Monroe, Va.*

REMARKS.

James Beersmith
Clerk.

CASUALTY SHEET

Complete
No. _____

William Ford

Priv of Company *"D"*

5th Regiment of *Mass Cav. (Colt.)*

State Volunteers

NATURE OF CASUALTY.

Died Oct 8, 1865,

CASUALTY SHEET.

Name: *William Ford*
Rank: *Priv* Company: *A* Regiment: *5*
Arm: *Mass Cav. (Col'd)* State: _____
Nature of Casualty: *Death*

CAUSE OF CASUALTY—(NAME OF DISEASE, &C.)

Typho. mal. fever.

BY WHOM DISCHARGED.

FROM WHAT SOURCE THIS INFORMATION WAS OBTAINED.

F. 16. Vol 9. C. 9, 1861.

DEGREE OF DISABILITY.

BY WHOM CERTIFIED.

J. P. Woodward
Asst Surg. U.S.A.

DATE OF DISCHARGE, DEATH, &C.

Oct 8. 1865.

PLACE OF DISCHARGE, DEATH, &C.

Hampton Gen'l Hosp.
Port Monroe. Va.

REMARKS.

Henry Jones

Clerk.

Surgeon General's Office,
Record and Pension Division,

Washington, *JAN 24*, 1867

Respectfully returned to the Adjutant
General, U. S. Army, with report enclosed.

BY ORDER OF THE SURGEON GENERAL:

[Signature]
Bvt. Lt. Col. and Asst. Surgeon, U. S. A.
(80)

F 16. Vol 9. C. 1871

January 24. 1871.

*Dord, William P. The
Lieut. 5th Mass Cavalry,*

*Surgeon General returns
letter of August 19, 1870
from this office, and
reports in case of W.
H. Dord*

*1767
24*

[Faint signature]

[Faint signature]

Rec'd A.G.O. Jan 26, 1871

Adjutant General's Office,

Washington.

April 19th, 1890.

Surgeon General, U. S. Army,

Washington, D. C.

General:

I have the honor to request that this office be furnished such information as can be obtained from the records of your office in regard to the final disposition made of William Ford, late Private Company "D", 5th Mass - Avn., Colored, who is reported on the muster-out roll of his Company "Sent to Hospital, Fort Monroe, Va, May 12th 1865. No Discharge furnished."

If evidence of death or discharge is found. please furnish final papers,

I have the honor to be,

Very respectfully,

Your obedient servant,

Thomas M. Grucant

Assistant Adjutant General.

Hepp
11/10.

WAR DEPARTMENT,

Surgeon General's Office,

RECORD AND PENSION DIVISION,

Washington, D. C. *January 24*, 1870.

[TRANSCRIPT FROM RECORDS.]

It appears from the records filed in this Office, that

W. H. Ford

Private Co *2*, *5* Reg't *Mass.* *6th* Vol. *Cavry*

was admitted to *Hampton Gen'l* Hospital, *Fort Monroe, Va*

May 22, 1865, from *Point of Rocks, Va* for treatment for

Convalescent, and died *Octo. 8. 1865* of *Typho Mal. Fever*.

Hospital records of Point of Rocks furnish no evidence in this case. There are no records in this office from which final papers can be prepared.

By order of the Surgeon General:

[Signature]
Brev. Lieut. Col. and Asst. Surgeon, U. S. Army.

(109)

Vol. *24*

No. *1757*

(NOTE.—This transcript should not be detached from the accompanying papers. If additional information is desired relative to the case, this paper should accompany the application therefor.)

460

Foreman, William

Co A, 5 Mass. Cav., (Col'd.)

Private

Private

CARD NUMBERS.

1	5-372015-	26
2	5-373346	27
3	5-373665-	28
4	5-373776	29
5	5-373875-	30
6	5-373987	31
7	5-374089	32
8	5-374190	33
9	5-374286	34
10	5-374375-	35
11	9092645	36
12	40730919	37
13		38
14		39
15		40
16		41
17		42
18		43
19		44
20		45
21		46
22		47
23		48
24		49
25		50

Book Mark:

See also

5 Cav. (Col'd.) | Mass.

William ...

Co. ..., 5 Reg't Mass. Cav. (Col'd.)

Appears on

Company Descriptive Book

of the organization named above.

DESCRIPTION.

Age *39* years; height *5* feet *10* inches.

Complexion *yellow*

Eyes *brown*; hair *black*

Where born *Montgomery Ala*

Occupation *laborer*

ENLISTMENT.

When *May 11th*, 186*4*.

Where *Cambridge*

By whom *A. S. ...*; term *3* y'rs.

Remarks:

12
F.

5 Col'd Cav.

Mass.

William Foreman

Appears with rank of Private on

Muster and Descriptive Roll of a Detachment of U. S. Vols. forwarded

for the 5 Reg't Mass. Col'd Cavalry. Roll dated Washington D.C., May 13, 1864.

Where born Montgomery Co. Md.

Age 37 y'rs; occupation Laborer

When enlisted May 1, 1864.

Where enlisted Washington D.C.

For what period enlisted 3 years.

Eyes Blue; hair Black

Complexion Yellow; height 5 ft. 0 in.

When mustered in May 1, 1864.

Where mustered in Washington

Bounty paid \$ 100; due \$ 100

Where credited

Company to which assigned

Remarks: To be credited to the quota of Cambridge City, 4th Cav. Dist. Mass.

Book mark:

702208

F

5 Col'd Cav.

Mass.

William Freeman

Priv, Co. A, 5 Reg't Mass. Col'd Cavalry.

Appears on

Company Muster Roll

for *May & June*, 1864.

Present or absent *Present*

Stoppage, \$ 100 for

Due Gov't, \$ 100 for

Valuation of horse, \$ 100

Valuation of horse equipments, \$ 100

Remarks:

Book mark:

G. F. M.

J.

5 Col'd Cav.

Mass.

William Foreman
Pr., Co. A, 5 Reg't Mass. Col'd Cavalry.

Appears on

Company Muster Roll

for *July and Aug.*, 186*4*.

Present or absent *Present*

Stoppage, \$ 100 for

Due Gov't, \$ 100 for

Valuation of horse, \$ 100

Valuation of horse equipments, \$ 100

Remarks: *On daily duty*
as Cook. Present on or
before Apr. 19, 1861.

Book mark:

H. Gilbert

J

5 Col'd Cav.

Mass.

William Torrance

Pr., Co. A, 5 Reg't Mass. Col'd Cavalry.

Appears on

Company Muster Roll

for *Sept. and Oct.*, 1864.

Present or absent *Present.*

Stoppage, \$ *100* for

Due Gov't, \$ *100* for

Valuation of horse, \$ *100*

Valuation of horse equipments, \$ *100*

Remarks: *On daily duty as cook.*

Book mark:

M. C. Gilbert

J

5 Col'd Cav.

Mass.

William Foreman

Pr., Co. A, 5 Reg't Mass. Col'd Cavalry.

Appears on

Company Muster Roll

for *Nov. and Dec.*, 1864.

Present or absent *Present.*

Stoppage, \$ *100* for

Due Gov't, \$ *100* for

Valuation of horse, \$ *100*

Valuation of horse equipments, \$ *100*

Remarks: *Detailed as
Cook.*

Book mark:

M. O. Gilbert

(358)

Copyist.

J.

5 Col'd Cav.

Mass.

William Forman

Pvt., Co. A, 5 Reg't Mass. Col'd Cavalry.

Appears on

Company Muster Roll

for *Jan. and Feb.*, 1865:

Present or absent *Present*

Stoppage, \$ *100* for

Due Gov't, \$ *100* for

Valuation of horse, \$ *100*

Valuation of horse equipments, \$ *100*

Remarks:

Book mark:

L. C. Tuttle

(358)

Copyist.

J.

5 Col'd Cav.

Mass.

William Forman

Priv., Co. A, 5 Reg't Mass. Col'd Cavalry.

Appears on

Company Muster Roll

for *Mich. and Apr.*, 1865.

Present or absent *Absent.*

Stoppage, \$ *100* for

Due Gov't, \$ *100* for

Valuation of horse, \$ *100*

Valuation of horse equipments, \$ *100*

Remarks: *Absent sick at Petersburg, Va. since Apr. 24, 1865.*

Book mark:

M. Gillbert

7

5 Col'd Cav.

Mass.

William Foreman

Priv., Co. A, 5 Reg't Mass. Col'd Cavalry.

Appears on

Company Muster Roll

for May & June, 1865

Present or absent Present

Stoppage, \$ 100 for

Due Gov't, \$ 100 for

Valuation of horse, \$ 100

Valuation of horse equipments, \$ 100

Remarks:

Book mark:

W. L. L. L. L.

17

5 Col'd Cav.

Mass.

William Foreman
Capt., Co. A, 5 Reg't Mass. Col'd Cavalry.

Appears on

Company Muster Roll

for July + Aug, 1865

Present or absent Present

Stoppage, \$ 100 for

Due Gov't, \$ 100 for

Valuation of horse, \$ 100

Valuation of horse equipments, \$ 100

Remarks: Louisa Look

Book mark:

Sallade

F | 5 Col'd Cav. | Mass.

William Foreman

Ort., Co. A, 5 Reg't Mass. Colored Cav.

Appears on Returns as follows:

May 1864 - On duty, Officers Cook

June 1864 - On duty, Servt. to Lt.
Hinckley

July 1864 - On duty Cook, Capt
C. C. Parsons.

Aug 1864 - On duty Offi'

Oct. 1864 to Jan'y 1865 - On duty
Mess Cook.

Feb'y 1865 - On duty Cook.

March 1865 - Co. Cook.

April 1865 - Absent, sick at Peters
burg, Va. since Apr. 24. '65.

May 1865 - On duty Cook.

July to Sept. 1865 - On duty, Co.
Cook.

None appears above - Foreman

Book mark:

O. J. Taylor

(546)

Copyist.

7

5 Col'd Cav.

Mass.

William Foreman
Pvt, Co. A, 5 Reg't Mass. Col'd Cavalry.

Appears on Co. Muster-out Roll, dated
Blacksville Texas Oct 31, 1865.

Muster-out to date Oct 31, 1865.

Last paid to Dec 31, 1864.

Clothing account:

Last settled....., 186 ; drawn since \$ 100

Due soldier \$ 15¹⁵ 100; due U. S. \$ 100

Am't for cloth'g in kind or money adv'd \$ 100

Due U. S. for arms, equipments, &c., \$ 3 100

* Bounty paid \$ 25 100; due \$ 75 100

Remarks: * Free Apr 19. 1861

Book mark :

Sallade

(861)

Copyist.

Foreman, William

Pr, Co., *5th* Reg't *Mass, C, Cav,*

Enclosures.

Bed Cards	Final Statements
Burial Records	Furloughs or L. of A.
Certs. of Dis. for Discharge	Med. Certificates
C. M. Charges	Med. Des. Lists
Descriptive Lists	Orders
Discharge Certificates	Pris. of War Record
Enlistment Papers	Resignations

Other papers relating to—

Admission to Hosp'l	Furlough or L. of A.
Casualty Sheet	Med. Examination
Confinement	Misc. Information
Contracts	Pay or Clothing
Death or Effects	Personal Reports
Desertion	Rank
Discharge from Hosp'l	Transfer to Hosp'l
Discharge from Service	Transfer to V. R. C.
Duty	Transportation

VOLUNTEER ENLISTMENT.

City
STATE OF



To be credited to the
TOWN OF

Washington DC Cambridge 4th Dist of Mass

Mustered into the service of the United States, for three years or during the war, from date of enlistment, in Company
5th Regiment of Mass. Colored Volunteers, on the 11th day of May, 1864, at Washington DC

I, William Foreman born in Montgomery Co in the State of Maryland aged thirty nine years, and by occupation a Laborer Do HEREBY ACKNOWLEDGE to have volunteered this Eleventh day of May 1864 to serve as a Soldier in the Army of the United States of America, for the period of THREE YEARS, unless sooner discharged by proper authority: Do also agree to accept such bounty, pay, rations, and clothing, as are, or may be, established by law for volunteers. And I, William Foreman do solemnly swear, that I will bear true faith and allegiance to the United States of America, and that I will serve them honestly and faithfully against all their enemies or opposers whomsoever; and that I will observe and obey the orders of the President of the United States, and the orders of the officers appointed over me, according to the Rules and Articles of War.

Sworn and subscribed to, at Washington }
this 11th day of May 1864 } William Foreman
BEFORE Henry A. Scheetz }
Capt & Pro Mar DC }
Mark

I CERTIFY, ON HONOR, That I have carefully examined the above-named Volunteer, agreeably to the General Regulations of the Army, and that, in my opinion, he is free from all bodily defects and mental infirmity, which would in any way disqualify him from performing the duties of a soldier.

Job B. Hearsey
Surgeon of Board of Enrolment
EXAMINING SURGEON.

I CERTIFY, ON HONOR, That I have minutely inspected the Volunteer, William Foreman previously to his enlistment, and that he was entirely sober when enlisted; that, to the best of my judgment and belief, he is of lawful age; and that, in accepting him as duly qualified to perform the duties of an able-bodied soldier, I have strictly observed the Regulations which govern the recruiting service. This soldier has brown eyes, black hair, yellow complexion, is 5 feet 10 inches high.

Henry A. Scheetz
Capt & Pro Marshal
Regiment of Pro Marshals
RECRUITING OFFICER.

461

Former, Thomas

CoL, 5 Mass. Cav., (Col'd.)

Private

Private

CARD NUMBERS.

1	5-3 2 4 4 9	26
2	5-3 2 4 9 3 3	27
3	5-3 2 5-0 2 4	28
4	5-3 2 5-1 1 5	29
5	5-3 2 5-2 2 6	30
6	5-3 2 5-3 2 9	31
7	5-3 2 5-4 3 2	32
8	5-3 2 5-5 3 3	33
9	5-3 2 5-6 3 1	34
10	5-3 2 5-7 2 7	35
11	5-3 2 5-8 9 1	36
12	9091 469	37
12	4073 0949	38
14		39
15		40
16		41
17		42
18		43
19		44
20		45
21		46
22		47
23		48
24		49
25		50

Book Mark: _____

See also _____

J

5 Cav. (Col'd.) | Mass.

Thomas Farmer.

....., Co. *F*, 5 Reg't Mass. Cav. (Col'd.)

Appears on

Company Descriptive Book

of the organization named above.

DESCRIPTION.

Age *21* years; height *5* feet *5* inches.

Complexion *Dark.*

Eyes *Dark.*; hair *Dark.*

Where born *Princess Ann Co., Va.*

Occupation *Farmer.*

ENLISTMENT.

When *Apr. 11", 1864.*

Where *West Roxbury.*

By whom *G. F. Wilson*; term *3* y'rs.

Remarks: *Mounted into service at
Needville Mass. Apr. 22/64. by Lieut
McKibben. Died Sept. 30/65 in
Post Hospital at Brazos Santiago
Texas of Anemia.*

T. C. Thomas.

F

5 Col'd Cav.

Mass.

Thomas Former

Put , Co. L , 5 Reg't Mass. Col'd Cav.

Appears on

Company Muster-in and Descriptive Roll

of the organization named above. Roll dated

Readville, Mass., Apr. 22, 1864.

Where born Princess Anne Co., Va

Age 21 y'rs; occupation Farmer

When enlisted Apr. 11, 1864.

Where enlisted West Roxbury

For what period enlisted 3 years.

Eyes Black; hair Black

Complexion Black; height 5 ft. 5 in.

When mustered in Apr. 22, 1864.

Where mustered in Readville Mass

Bounty paid \$ 100; due \$ 100

Where credited 7 Cong. Dist., Mass.

Company to which assigned

Remarks:

+ Mustered by Jordan, Ex

Book mark:

Crenshaw

T

5 Col'd Cav.

Mass.

Thomas Former

Priv, Co. L, 5 Reg't Mass. Col'd Cavalry.

Appears on

Company Muster Roll

for *Apr. 22 to 30*, 186*4*

Present or absent *Present*

Stoppage, \$.....*100* for

Due Gov't, \$.....*100* for

Valuation of horse, \$.....*100*

Valuation of horse equipments, \$.....*100*

Remarks:.....

Book mark:.....

Crenshaw

(358)

Copyist.

F

5 Col'd Cav.

Mass.

Thomas Former

Pvt, Co. L, 5 Reg't Mass. Col'd Cavalry.

Appears on

Company Muster Roll

for *May & June*, 186*4*.

Present or absent *Present*

Stoppage, \$ *100* for

Due Gov't, \$ *100* for

Valuation of horse, \$ *100*

Valuation of horse equipments, \$ *100*

Remarks: *Stop / Canteen.*

Book mark:

Crenshaw

(358)

Copyist.

F

5 Col'd Cav.

Mass.

Thomas Former

Pvt, Co. L, 5 Reg't Mass. Col'd Cavalry.

Appears on

Company Muster Roll

for *July & Aug.*, 186*4*.

Present or absent *Present*

Stoppage, \$ *100* for

Due Gov't, \$ *100* for

Valuation of horse, \$ *100*

Valuation of horse equipments, \$ *100*

Remarks: *Stop one Canteen.*

Book mark:

Cienschaw

(358)

Copyist.

A

5 Col'd Cav.

Mass.

Thomas Farmer

Priv, Co. L, 5 Reg't Mass. Col'd Cavalry.

Appears on

Company Muster Roll

for *Sept + Oct*, 1864.

Present or absent *Present*

Stoppage, \$ *100* for

Due Gov't, \$ *100* for

Valuation of horse, \$ *100*

Valuation of horse equipments, \$ *100*

Remarks:

File with Farmer, Thomas

Book mark:

(358)

J. M. Hance

Copyist.

T

5 Col'd Cav.

Mass.

Thomas Farmer

Pvt, Co. L, 5 Reg't Mass. Col'd Cavalry.

Appears on

Company Muster Roll

for *Nov + Dec*, 1864.

Present or absent *Present*

Stoppage, \$ *100* for

Due Gov't, \$ *100* for

Valuation of horse, \$ *100*

Valuation of horse equipments, \$ *100*

Remarks:

Book mark:

J. M. Hance

(358)

Copyist.

A

5 Col'd Cav.

Mass.

Thomas P. ...

..., Co. L, 5 Reg't Mass. Col'd Cavalry.

Appears on

Company Muster Roll

for *January 1864*, 1864.

Present or absent

Stoppage, \$ *100* for

Due Gov't, \$ *100* for

Valuation of horse, \$ *100*

Valuation of horse equipments, \$ *100*

Remarks:

*See ...
U.S. Cavalry # 25.00*

Book mark:

(358)

J. M. ...

Copyist.

4

5 Col'd Cav.

Mass.

Thomas [unclear]

P., Co. L, 5 Reg't Mass. Col'd Cavalry.

Appears on

Company Muster Roll

for *May 4th 1864*, 1864.

Present or absent *Present*

Stoppage, \$ *100* for

Due Gov't, \$ *100* for

Valuation of horse, \$ *100*

Valuation of horse equipments, \$ *100*

Remarks: *Must be [unclear] of [unclear]*

Book mark:

(358)

J. O. [unclear]

Copyist.

F

5 Col'd Cav.

Mass.

Thomas Warner

Plt, Co. L, 5 Reg't Mass. Col'd Cavalry.

Appears on

Company Muster Roll

for *March June*, 186*6*.

Present or absent *Present*

Stoppage, \$ *100* for

Due Gov't, \$ *100* for

Valuation of horse, \$ *100*

Valuation of horse equipments, \$ *100*

Remarks: *Due for metal work*

2 S. buttons \$28 price before

Apr 19 16

Book mark:

(358)

J. P. Warner

Copyist.

J

5 Col'd Cav.

Mass.

Thomas J. Jorner

Pvt., Co. L, 5 Reg't Mass. Col'd Cavalry.

Appears on

Company Muster Roll

for *July & Aug*, 186*5*.

Present or absent *Present*

Stoppage, \$ *100* for

Due Gov't, \$ *100* for

Valuation of horse, \$ *100*

Valuation of horse equipments, \$ *100*

Remarks: *Free Apr. 19/61*

Book mark:

Combs

F | **5 Col'd Cav.** | **Mass.**

Forma

Q. L., Co *L*, 5 Reg't Mass. Colored Cav.

Appears on **Returns** as follows:

*Sept. 1865 - Absent sick
in Hospital at Brazos.*

Book mark:

(546)

Q. L. Taylor
Copyist.

Farmer, Thomas

P, Co. L, 5 Reg't Mass. C. Cav.

5 Enclosures.

Bed Cards	Final Statements
Burial Records	Furloughs or L. of A.
Certs. of Dis. for Discharge	Med. Certificates
C. M. Charges	Med. Des. Lists
Descriptive Lists	Orders
Discharge Certificates	Pris. of War Record
Enlistment Papers	Resignations

Other papers relating to—

Admission to Hosp'l	Furlough or L. of A.
Casualty Sheet <i>L</i>	Med. Examination
Confinement	Misc. Information <i>3</i>
Contracts	Pay or Clothing
Death or Effects	Personal Reports
Desertion	Rank
Discharge from Hosp'l	Transfer to Hosp'l
Discharge from Service	Transfer to V. R. C.
Duty	Transportation

Ac. No. 14780
24

Complete
CASUALTY SHEET

No. *7*
Thomas James
Private of Company *"I"*
5th Regiment of *Mass Coel*

State Volunteers. *Can*

NATURE OF CASUALTY. *Discharged*
disd Sept 30, 1865

Arthur M. [unclear]

CASUALTY SHEET.

Name: *Thomas Farmer*
Rank: *Private* "G." Company: *5th* Regiment: *mass*
Arm: *bold cavalry* State: _____
Nature of Casualty: *Died.*

CAUSE OF CASUALTY—(NAME OF DISEASE, &c.)

Scouring

DEGREE OF DISABILITY.

BY WHOM CERTIFIED.

J. L. Gilman
capt condg lco

DATE OF DISCHARGE, DEATH, &c.

Sept 30. 1865

PLACE OF DISCHARGE, DEATH, &c.

Post Hosp. Berago Santiago
24th Co.

BY WHOM DISCHARGED.

FROM WHAT SOURCE THIS INFORMATION WAS OBTAINED.

muster out Roll of
Company

REMARKS.

A. S. Miller
Clerk.

If it was sent for Mr. D. Smith
Aug 22. 1866 29

CASUALTY SHEET

Completed
No. _____
Thomas Freeman
Priv of Company I
5th Regiment of Mass. Cav.

State Volunteers.

NATURE OF CASUALTY.

Dec. 1, 1865.

Identical with
Thomas Freeman
and my Mr. D. Smith
P.

Completed by _____

CASUALTY SHEET.

Name: *Thomas Freeman*

Rank: *Priv* Company: *L* Regiment: *5th*

Arm: *Cavalry* State: *Mass*

Nature of Casualty: *Death*

CAUSE OF CASUALTY—(NAME OF DISEASE, &c.)

x x x

DEGREE OF DISABILITY.

BY WHOM CERTIFIED.

J. M. Moore
A. G. M.

DATE OF DISCHARGE, DEATH, &c.

Oct 1, 1865

PLACE OF DISCHARGE, DEATH, &c.

Prasco Santiago Texas.

BY WHOM DISCHARGED.

FROM WHAT SOURCE THIS INFORMATION WAS OBTAINED.

Roll of Honor Pg 23
J. M. Moore

REMARKS.

J. M. Moore
Clerk.

Office Asst Quartermaster
In charge Cemeterial Operations
5th Mility Dist
New Orleans July 1st 1867.

Respectfully returned to Col Pong
Gen J. A. Mc Parlin Med Director
5th Mility Dist. Upon the Records
from Brazos Santiago Tex, on file
in this Office, appears the name
Thomas "Foreman", Priv Co "S"
5th Mass Cav, died at that place
(Brazos) (October 1st 1865)

M. G. Hoopes
Capt. M. S. K. U. S. A.
For Capt Chas Barnard
A. S. M. A. S. Vol

C. 13K +16 No 117

Post Hospital
Brazos Santiago
S M June 24th 1867

Respectfully returned
to Captain J. Cowles &
M. O. J. R. G. with the
information that one
Private Thos Freeman
Co D 5th Mass Cald.
Cavalry died at this
Hospital October 1st
1865

No further records
of C. & Bauer
A. Asst Surg.
U. S. A.



Encl 6230259.
Headquarters, District of Texas.
OFFICE CHIEF MEDICAL OFFICER,
Galveston, Texas, July 9th, 1867.

Respectfully returned
to Medical Director
of 5th Mility Dist with
reference to foregoing
instruments.

Wm. Taylor
Br't Lt. Col., Surgeon U. S. A.
Chief Medical Officer.

WAR DEPARTMENT,

ADJUTANT GENERAL'S OFFICE,

WASHINGTON, *Aug. 25th*, 1866.

SIR:

Final Statements in the cases of deceased soldiers are required to be sent to the Adjutant General's Office in duplicate, with one copy of the Inventory of Effects. The Descriptive List should also be sent to this Office in cases where the soldier was absent from his Company at the time of his death. Where there were no effects, it should be so stated on a blank Inventory, properly signed.

Certificates of Disability should be sent in duplicate. Special care should be taken that the date of discharge and signature of the discharging officer should be affixed.

No. of the Final Statement *of* Inventory, has been received in the case of *Rev. Thomas Sherman*, of Co. *I*, *Ist* Regiment of *Mass. Cav.* Volunteers, whose papers were forwarded to this Office. You will please forward the missing papers without delay.

I have the honor to be, sir,

Very respectfully,

Your obedient servant,

John W. Hayward

Assistant Adjutant General.

(110)

~~COMMANDING OFFICER~~

Medical Director, Capt. Gull,

Original papers cannot be furnished, please give date, place and cause of death, if possible,

13

WAR DEPARTMENT,

ADJUTANT GENERAL'S OFFICE,

WASHINGTON, *July 22.*, 1867

SIR:

Final Statements in the cases of deceased soldiers are required to be sent to the Adjutant General's Office in duplicate, with one copy of the Inventory of Effects. The Descriptive List should also be sent to this Office in cases where the soldier was absent from his Company at the time of his death. Where there were no effects, it should be so stated on a blank Inventory, properly signed.

Certificates of Disability should be sent in duplicate. Special care should be taken that the date of discharge and signature of the discharging officer should be affixed.

No of the Final Statement *for* Inventory, has been received in the case of *Thomas Garner Private*, of Co. *"L"*, *5th* Regiment of *Mass Colored* Volunteers, whose papers were forwarded to this Office. You will please forward the missing papers without delay.

I have the honor to be, sir,

Very respectfully,

Your obedient servant,

Rich. Hazard

Assistant Adjutant General.
(110)

COMMANDING OFFICER

770 *770* *J. J. Woodward* *As Surg U.S.A.*
Surg Genls office

died Sept 30. 1865 at Post Hosp. Brazos Santiago Tex.

H.L.W.

u c r
770

Office Sst Quartermaster
In charge Cemeterial Operations
5th Mil Dist

New Orleans La July 17 1867.

Respectfully returned to But
Brig Genl J. A. Mc Parlin,

Med Director 5th Mil Dist

Records on file at this Office
show that one Thomas Fore-
man, Priv Co E, 5th Mass Cav
died at Brazos Santiago, Tex
October 12th 1865.

W. G. Huges
Capt & Med A. U. S. A.,
for Capt Chas Barnard
A. S. M. U. S. A.

Co. 156 to 117

W. C. C.
Bvt Maj. & Ass't Surgeon U. S. A.,
Chief Med. In charge of office

Head Quarters Sub Dist R. B.
Office Chief Med. Officer
Brownsville, Texas, June 15th 67.
Ely M 23-1-8, - 67
Respectfully returned to the
Chief Med. Officer Dist. of Texas
and attention invited to
foregoing endorsement.

Boyles
Capt & Asst Surg. U. S. A.
Chief Med. Officer

Enc 12-20707. P. 23rd.
Headquarters, District of Texas.

OFFICE CHIEF MEDICAL OFFICER,

Galveston, Texas, July 5th, 1867

Respectfully returned to Medical
Director 5th Mil. District
with reference to foregoing
endorsement.

Wm. Boyles

23rd Col.

Det. Maj. & Asst Surgeon U. S. A.,

Chief Med. In charge of office

Surgeon General's Office,

Record and Pension Division,

5. M. Aug. 17th, 1867.

Respectfully returned to *Asst. Dir.*
Genl. Taggard and attention
invited to preceding endorsements.

*The desired final
papers cannot be
furnished by this
office.*

BY ORDER OF THE SURGEON GENERAL:

J. Woodward

Bvt. Major & Asst. Surgeon, U. S. A.
(38)

24 R. of

No.....

Francis Santiago
May 29th 1867

Respectfully returned to Capt
& Bowles C. M. O. I. D. R. G.
with the information that
one Private Thos Farmer Co
R 5th Mass C. Cav. was ad-
mitted to the ~~hospital~~ Sept
4th 1865 with Scouring and
died October 1st 1865.

No further records
of L L Bauer
A. Asst Surg U.S.A.
In charge.



462

Askey, George A.

Col, **5 Mass. Cav.**, (Col'd.)

Private

Sergeant

CARD NUMBERS.

1	5-371990	26
2	5-375972	27
3	5-376081	28
4	5-376158	29
5	5-376291	30
6	5-376397	31
7	5-376474	32
8	5-376574	33
9	5-376668	34
10	5-376763	35
11	9092399	36
12	40730950	37
13		38
14		39
15		40
16		41
17		42
18		43
19		44
20		45
21		46
22		47
23		48
24		49
25		50

Book Mark: _____

See also _____

7

5 Cav. (Col'd.) | Mass.

George H. Fosley

Co. C, 5 Reg't Mass. Cav. (Col'd.)

Appears on

Company Descriptive Book

of the organization named above.

DESCRIPTION.

Age 21 years; height 5 feet 7 inches.

Complexion rrown

Eyes black; hair black

Where born Washington, D.C.

Occupation Soldier

ENLISTMENT.

When May 12, 1864.

Where Boston, Mass.

By whom H. S. Schuyler; term 3 y'rs.

Remarks: Recruited into U.S. service May 12/64 at Washington D.C. by Capt. Schuyler

(383a)

G. H. Fosley

Copyist.

(7)

5 Col'd Cav.

Mass.

George [unclear]

Appears with rank of Private on

Muster and Descriptive Roll of a Detachment of U. S. Vols. forwarded

for the 5 Reg't Mass. Col'd Cavalry. Roll dated Washington D.C., May 3, 1864.

Where born Washington D.C.

Age 21 y'rs; occupation Miller

When enlisted May 12, 1864.

Where enlisted Washington D.C.

For what period enlisted 3 years.

Eyes Black; hair Black

Complexion Brown; height 5 ft. 7 in.

When mustered in May 12, 1864.

Where mustered in Washington

Bounty paid \$ 100; due \$ 100

Where credited

Company to which assigned

Remarks: To be credited to the Quota of Boston 4th Ward 4 Cong. Dist Mass

Book mark:

[Signature]

71

5 Col'd Cav.

Mass.

George B. Foster

Private, Co. C, 5 Reg't Mass. Col'd Cavalry.

Appears on

Company Muster Roll

for May & June, 1864.

Present or absent Present

Stoppage, \$ 100 for

Due Gov't, \$ 100 for

Valuation of horse, \$ 100

Valuation of horse equipments, \$ 100

Remarks: No account of
muster or clothing
forwarded.

Book mark:

Sitten

G

5 Col'd Cav.

Mass.

George W Foshey

Pr, Co. C, 5 Reg't Mass. Col'd Cavalry.

Appears on

Company Muster Roll

for *July & Aug*, 186*4*.

Present or absent *Present*

Stoppage, \$ *100* for

Due Gov't, \$ *100* for

Valuation of horse, \$ *100*

Valuation of horse equipments, \$ *100*

Remarks:

Book mark:

E H Brown

D

5 Col'd Cav.

Mass.

George W. Foshey
Capt., Co. C, 5 Reg't Mass. Col'd Cavalry.

Appears on

Company Muster Roll

for *Sept. & Oct*, 186*4*.

Present or absent *Present*

Stoppage, \$ *100* for

Due Gov't, \$ *100* for

Valuation of horse, \$ *100*

Valuation of horse equipments, \$ *100*

Remarks: *Appointed by S O No*
182 dated Oct 22/64
Free on or before Apr 19/61

Book mark:

E. H. Brown

(358)

Copyist.

F

5 Col'd Cav.

Mass.

George W. Furkey

Prvt., Co. C, 5 Reg't Mass. Col'd Cavalry.

Appears on

Company Muster Roll

for *Nov Dec*, 1864.

Present or absent *Present*

Stoppage, \$ *100* for

Due Gov't, \$ *100* for

Valuation of horse, \$ *100*

Valuation of horse equipments, \$ *100*

Remarks: *Referred to ranks from
Coh. by S.O. No 235 dated
Nov 15/64 Due U.S. for Car Ord.
\$ 2.85 for 2 M stores \$ 0.85
Free on or before Aug 9 61*

Book mark: *210000*

E. H. Brown

D

5 Col'd Cav.

Mass.

George Foshey
Pvt, Co. C, 5 Reg't Mass. Col'd Cavalry.

Appears on

Company Muster Roll

for *Jan & Feb*, 1865.

Present or absent *Present*

Stoppage, \$ *100* for

Due Gov't, \$ *100* for

Valuation of horse, \$ *100*

Valuation of horse equipments, \$ *100*

Remarks: *Due 1st inst U.S. bounty \$ 25.*

Book mark:

E.H. Brown

5

5 Col'd Cav.

Mass.

George Foshey
Coral., Co. C, 5 Reg't Mass. Col'd Cavalry.

Appears on

Company Muster Roll

for Mar & Apr., 1865.

Present or absent Present

Stoppage, \$ 100 for

Due Gov't, \$ 100 for

Valuation of horse, \$ 100

Valuation of horse equipments, \$ 100

Remarks: Promoted from ranks by
S.O. 62. dated Mar 30/65. Due
Cf. for Car Ord. \$1.04 + 1.16 for 2 M.
stores \$0.45

Book mark:

E. H. B. com.

F

5 Col'd Cav.

Mass.

George Foskey

Capt, Co. C, 5 Reg't Mass. Col'd Cavalry.

Appears on

Company Muster Roll

for May & June, 1865.

Present or absent Present

Stoppage, \$ 4 ¹²/₁₀₀ for Qrd Stores
for Q M Stores \$ 1.30

Due Gov't, \$ 100 for

Valuation of horse, \$ 100

Valuation of horse equipments, \$ 100

Remarks:

Book mark:

Abbott

7

5 Col'd Cav.

Mass.

George Foskey

Serjt, Co. C, 5 Reg't Mass. Col'd Cavalry.

Appears on

Company Muster Roll

for July & Aug, 1865.

Present or absent Present

Stoppage, \$ 4 ¹²/₁₀₀ for Ord Stores;
for 2 M stores \$6.20

Due Gov't, \$ 100 for

Valuation of horse, \$ 100

Valuation of horse equipments, \$ 100

Remarks: Pay due as Corpel from
Mar 1-65 to July 1 1865
Promoted from Corpel by SO
109 to date from July 1, 1865
On detached Service SO 47
3 Brig 3 Div Aug 9 1865

Book mark:

Abbott

(358)

Copyist.

F

5 Col'd Cav.

Mass.

G. H. Foskey

Serj't
Serj't., Co. C, 5 Reg't Mass. Colored Cav.

Appears on Returns as follows:

*June 1864 - June 6, '64, City
Point, Recruit rec'd
from depot.*

*Aug. 1865 - (Serj't) Absent
on detached service
at Cav. Brig. 25 Ab. by S.O.
No. 47, Aug. 9, '65.*

*Sept. 1865 - Absent on det.
service at Cav. Brig.
25 Ab. by S.O. No. 47,
Aug. 9, '65.*

*Name appears also as
George Foskey.*

Book mark:

C. J. Foster

(546)

Copyist.

7

5 Col'd Cav.

Mass.

George N Foster

SerqT, Co. C, 5 Reg't Mass. Col'd Cavalry.

Appears on Co. Muster-out Roll, dated
Clarksville Texas, Oct 31, 1865.

Muster-out to date Oct 31, 1865.

Last paid to Dec 31, 1864.

Clothing account:

Last settled....., 186 ; drawn since \$ 100

Due soldier \$ 100; due U. S. \$ 35 ⁴¹/₁₀₀

Am't for cloth'g in kind or money adv'd \$ 100

Due U. S. for arms, equipments, &c., \$ 16 ¹²/₁₀₀

Bounty paid \$ 100; due \$ 100 ¹⁰⁰/₁₀₀

Remarks: Due us for 6 + 4 8 \$6.20

Promoted to Corpel by SO No 62

March 30-65. Promoted SerqT

by SO 109 dated July 9 1865

Book mark:

Asst

(361)

Copyist.

Toskey, George
 Pr, Co. *5th* Reg't *Mass, C. Cav.*

Enclosures.

Bed Cards	Final Statements
Burial Records	Furloughs or L. of A. ..
Certs. of Dis. for Discharge	Med. Certificates
C. M. Charges	Med. Des. Lists
Descriptive Lists	Orders
Discharge Certificates	Pris. of War Record
Enlistment Papers	Resignations

Other papers relating to—

Admission to Hosp'l	Furlough or L. of A. ..
Casualty Sheet	Med. Examination
Confinement	Misc. Information
Contracts	Pay or Clothing
Death or Effects	Personal Reports
Desertion	Rank
Discharge from Hosp'l	Transfer to Hosp'l
Discharge from Service	Transfer to V. R. C.
Duty	Transportation

NOTE 1.—This blank will be used for both enlistments and re-enlistments—enlistment of veterans, &c., &c., in the volunteer service. They will be made out in duplicate in all cases—one to accompany the recruiting return of the superintendent (not the recruiting officer) to the Adjutant General, and one to accompany the accounts of the officer who pays bounty, &c. The Regiment and Company in which the soldier last served should be given on the back.

NOTE 2.—An enlistment holds to service. A muster-in must, in all cases, precede payment of pay, bounty, pension, &c. A muster-in roll must, in all cases, be filed in the Adjutant General's Office as evidence of muster-in. The mustering officer, commissary, or assistant commissary of musters, as the case may be, will countersign both enlistments as having mustered the soldier into the service of the United States before either of them is given to the disbursing officer.

DECLARATION OF RECRUIT.

I, George Foster desiring to VOLUNTEER as a Soldier in the Army of the United States, for the term of THREE YEARS, Do Declare, That I am twenty one years and two months of age; that I have never been discharged from the United States service on account of disability or by sentence of a court martial, or by order before the expiration of a term of enlistment; and I know of no impediment to my serving honestly and faithfully, as a soldier for three years.

GIVEN at Washington, D. C. the 12th day of May 1864

Witness:

W. Boyden

George Foster
marks

No. 221

George Foster

Enlistment of George Foster

12th May 1864

By Wm. A. Aldrich

Adj. Gen. 1st Regt. Pa. Art.

W. C.

enlistment; last served in Company (—)

Regt of

Discharged 18

J. Mearns, Second Company

CONSENT IN CASE OF MINOR.

I, _____ Do CERTIFY, That I am the _____ of _____; that the said _____ is _____ years of age; and I do hereby freely give my CONSENT to his volunteering as a SOLDIER in the ARMY OF THE UNITED STATES for the period of THREE YEARS.

GIVEN at _____ the _____ day of _____

Witness:

VOLUNTEER ENLISTMENT.

City
STATE OF

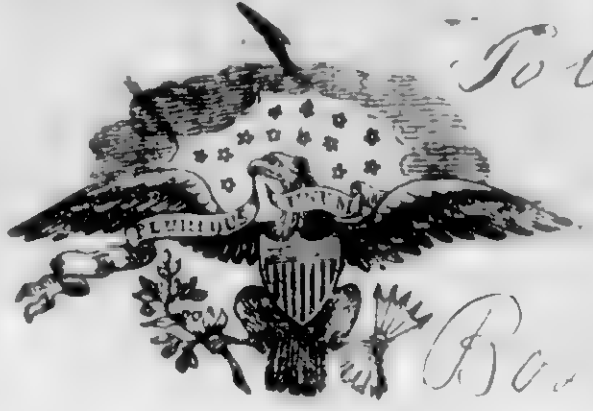

To be credited to the
TOWN OF

Washington

14th Ward
Rd. Co. 4th Dist. Md.

Mustered into the service of the United States, for three years or during the war, from date of enlistment, in Company
of the Regiment of 1st 12th Regiment of Mass Colored Volunteers, on the 12th day of May, 1864, at Washington D.C.

I, George Foskey born in Washington
in the State of Dist. of Col. aged Twentyone years,
and by occupation a laborer Do HEREBY ACKNOWLEDGE to have
volunteered this twelfth day of May 1864
to serve as a **Soldier** in the **Army of the United States of America**, for
the period of **THREE YEARS**, unless sooner discharged by proper authority:
Do also agree to accept such bounty, pay, rations, and clothing, as are, or may be,
established by law for volunteers. And I, George Foskey do
solemnly swear, that I will bear true faith and allegiance to the **United States**
of America, and that I will serve them honestly and faithfully against all
their enemies or opposers whomsoever; and that I will observe and obey the
orders of the President of the United States, and the orders of the officers
appointed over me, according to the Rules and Articles of War.

Sworn and subscribed to, at Washington D.C.
this 12th day of May, 1864, George Foskey
BEFORE Henry A. Sheets mark

Capt. & Prov. M. D. C.
I CERTIFY, ON HONOR, That I have carefully examined the above-named Volunteer, agreeably
to the General Regulations of the Army, and that, in my opinion, he is free from all bodily defects and
mental infirmity, which would in any way disqualify him from performing the duties of a soldier.

John B. Hearsey
Surgeon of the U.S. Army D.C.
EXAMINING SURGEON.

I CERTIFY, ON HONOR, That I have minutely inspected the Volunteer George Foskey
previously to his enlistment, and that he was entirely sober when enlisted; that, to the best of my
judgment and belief, he is of lawful age; and that, in accepting him as duly qualified to perform the
duties of an able-bodied soldier, I have strictly observed the Regulations which govern the recruiting
service. This soldier has Blue eyes, Black hair, Brown complexion, is five
feet seven inches high.

Henry A. Sheets
(appt) 4 Regiment of Prov. Forces D.C.
RECRUITING OFFICER.

Henry A. Sheets
John B. Hearsey

463

Foster, Charles

Co M, 5 Mass. Cav., (Col'd.)

Private

Private

CARD NUMBERS.

1	5-3 f 5-9 2 2	26
2	5-3 f 6 0 1 7	27
3	5-3 f 6 1 0 3	28
4	5-3 f 6 1 9 0	29
5	5-3 f 6 2 9 7	30
6	5-3 f 6 3 9 9	31
7	5-3 f 6 5 0 4	32
8	5-3 f 6 6 0 3	33
9	5-3 f 6 7 0 9	34
10	5-3 f 6 7 9 6	35
11	9091 36 24	36
12	40730951	37
13		38
14		39
15		40
16		41
17		42
18		43
19		44
20		45
21		46
22		47
23		48
24		49
25		50

Book Mark:

See also

F.

5 Cav. (Col'd.) | Mass.

Charles Foster.

....., Co. *M.*, 5 Reg't Mass. Cav. (Col'd.)

Appears on

Company Descriptive Book

of the organization named above.

DESCRIPTION.

Age *18* years; height *5* feet *5* inches.

Complexion *Black.*

Eyes *Black*; hair *Black.*

Where born *Arlington Va.*

Occupation *Laborer.*

ENLISTMENT.

When *April 27, 1864*

Where *Boston No. 10.*

By whom *S. J. Fletcher*; term *3* y'rs.

Remarks: *Mustered May 5th 1864, by
Lieut. D. Madden, Rockwell Mass.*

H. C. Thomas.

3879)

Copist.

F

5 Col'd Cav.

Mass.

Charles Foster

Pri, Co. *M*, 5 Reg't Mass. Col'd Cav.

Appears on

Company Muster-in and Descriptive Roll
of the organization named above. Roll dated

Readville Mass, May 5, 1864.

Where born *Arlington Va.*

Age *18* y'rs; occupation *Labourer*

When enlisted *Apr. 29*, 1864.

Where enlisted *Boston Mass*

For what period enlisted *3* years.

Eyes *Blk*; hair *Blk*

Complexion *Blk*; height *5* ft. *5* in.

When mustered in *May 5*, 1864.

Where mustered in *Readville*

Premium
Bounty paid \$ *2* 100; due \$ *100*

Where credited

Company to which assigned

Remarks: *Cred^{td} to 10. Ward City*
of Boston 3 Cong. Dist. Mass

Book mark:

(356d)

Amey

Copyist.

Ji

5 Col'd Cav.

Mass.

Charles Foster

Pri, Co. M, 5 Reg't Mass. Colored Cavalry.

Appears on

Company Muster Roll

for *May 5 to June 30*, 1864.

Present or absent *Present*

Stoppage, \$ *100* for

Due Gov't, \$ *100* for

Valuation of horse, \$ *100*

Valuation of horse equipments, \$ *100*

Remarks:

Book mark:

(358)

Avery

Copyist.

F

5 Col'd Cav.

Mass.

Charles Foster

Pri., Co. M, 5 Reg't Mass. Colored Cavalry.

Appears on

Company Muster Roll

for *July & Aug*, 1864.

Present or absent *Present*

Stoppage, \$ *100* for

Due Gov't, \$ *100* for

Valuation of horse, \$ *100*

Valuation of horse equipments, \$ *100*

Remarks: *Due U.S. one Can
ten 59¢*

Book mark:

Sweep

(358)

Copyist.

F

5 Col'd Cav.

Mass.

Charles Foster

Pvt., Co. M, 5 Reg't Mass. Colored Cavalry.

Appears on

Company Muster Roll

for *Sept + Oct*, 1864.

Present or absent *Present*

Stoppage, \$ *100* for

Due Gov't, \$ *100* for

Valuation of horse, \$ *100*

Valuation of horse equipments, \$ *100*

Remarks:

Book mark:

C. Williams

(358)

Copyist.

F

5 Col'd Cav.

Mass.

Charles Foster

Pol, Co. M, 5 Reg't Mass. Colored Cavalry.

Appears on

Company Muster Roll

for *Nov & Dec*, 1864.

Present or absent *Present*.

Stoppage, \$ *100* for

Due Gov't, \$ *100* for

Valuation of horse, \$ *100*

Valuation of horse equipments, \$ *100*

Remarks:

Book mark:

C. Williams

F

5 Col'd Cav.

Mass.

Charles Foster

Priv., Co. M, 5 Reg't Mass. Colored Cavalry.

Appears on

Company Muster Roll

for *Jan, & Feb.*, 1865.

Present or absent *Present.*

Stoppage, \$ *100* for

Due Gov't, \$ *2*^{*50*} *100* for *advances*

lost.

Valuation of horse, \$ *100*

Valuation of horse equipments, \$ *100*

Remarks:

Book mark:

C. Williams

(358)

Copyist.

J

5 Col'd Cav.

Mass.

Charles Foster

Priv, Co. M, 5 Reg't Mass. Colored Cavalry.

Appears on

Company Muster Roll

for *May & Apr*, 186*5*.

Present or absent *Present*

Stoppage, \$ *100* for

Due Gov't, \$ *100* for

Valuation of horse, \$ *100*

Valuation of horse equipments, \$ *100*

Remarks:

Book mark:

C. Williams

(358)

Copyist.

5

5 Col'd Cav.

Mass.

Charles Foster

Priv., Co. M, 5 Reg't Mass. Colored Cavalry.

Appears on

Company Muster Roll

for May & June, 1865.

Present or absent Present.

Stoppage, \$ 100 for

Due Gov't, \$ 100 for

Valuation of horse, \$ 100

Valuation of horse equipments, \$ 100

Remarks:

Book mark:

C. Williams

(358)

Copyist.

J

5 Col'd Cav.

Mass.

Charles Foster

Priv., Co. M, 5 Reg't Mass. Colored Cavalry.

Appears on

Company Muster Roll

for *July & Aug.*, 186*2*.

Present or absent *Present*

Stoppage, \$ *100* for

Due Gov't, \$ *100* for

Valuation of horse, \$ *100*

Valuation of horse equipments, \$ *100*

Remarks:

*Detached Service
S.O. 48 Aug. 11th 1862
work on U.S. M. R.R.*

Book mark:

Hodges

(358)

Copyist.

F | **5 Col'd Cav.** | **Mass.**

Charles Foster

Pr, Co *M*, 5 Reg't Mass. Colored Cav.

Appears on **Returns** as follows:

*Aug. 1865. Absent, detach'd
serv. Boca Chica, S.C. 48*

Aug. 10, '65

*Sept. 1865. Absent, detach
serv. on U.S.M.R.R.,
S.C. 48, Aug. 10, '65.*

Book mark:

C. J. Taylor

(546)

Copyist.

J

5 Col'd Cav.

Mass.

Charles Foster

Co. M, 5 Reg't Mass. Col'd Cavalry.

Appears on Co. Muster-out Roll, dated

Clarksville Tex. Oct. 31, 1865.

Muster-out to date

Oct. 31, 1865.

Last paid to

Dec. 31, 1864.

Clothing account:

Last settled....., 186 ; drawn since \$..... 100

Due soldier \$..... 100; due U. S. \$..... *29*^{*92*}/₁₀₀

Am't for cloth'g in kind or money adv'd \$..... 100

Due U. S. for arms, equipments, &c., \$ *11* 100

Bounty paid \$..... 100; due \$ *100* 100

Remarks:

Book mark:

Hodges

(861)

Copyist.

464

Pouderoy, Simon

Co I, 5 Mass. Cav., (Col'd.)

Private

Private

CARD NUMBERS.

1	26
2	27
3	28
4	29
5	30
6	31
7	32
8	33
9	34
10	35
11	36
12	37
13	38
14	39
15	40
16	41
17	42
18	43
19	44
20	45
21	46
22	47
23	48
24	49
25	50

See Pouderoy, Simon.

Book Mark:

See also

465

Foulk, George W

Co F, 5 Mass. Cav., (Col'd.)

Private

Private

CARD NUMBERS.

1	26
2	27
3	28
4	29
5	30
6	31
7	32
8	33
9	34
10	35
11	36
12	37
13	38
14	39
15	40
16	41
17	42
18	43
19	44
20	45
21	46
22	47
23	48
24	49
25	50

Book Mark: /

See also

466

Fouse, Samuel

Co K, 5 Mass. Cav., (Col'd.)

Private | *Corporal.*

CARD NUMBERS.

1		26
2		27
3	<i>See Fouse,</i>	<i>Samuel.</i>
4		29
5		30
6		31
7		32
8		33
9		34
10		35
11		36
12		37
13		38
14		39
15		40
16		41
17		42
18		43
19		44
20		45
21		46
22		47
23		48
24		49
25		50

Book Mark:

See also

467

Fowler, Arthur L. W.

Co 6, 5 Mass. Cav., (Col'd.)

Private

Private

CARD NUMBERS.

1	5-375702	26
2	5-375793	27
3	5-375776	28
4	5-375973	29
5	5-376082	30
6	5-376182	31
7	5-376292	32
8	5-376394	33
9	5-376502	34
10	5-376601	35
11	5-372725	36
12	5-376694	37
13	5-376793	38
14	9090396	39
15	40730952	40
16		41
17		42
18		43
19		44
20		45
21		46
22		47
23		48
24		49
25		50

Book Mark:

See also

\$1063530.00 aff'd

S. 1066918 P. 5 24

R. & P. 517422

55 Maude Jackson, 5746 Arch St.
Philadelphia, Pa. 4/2/41 TEB

55 Carl B. Sillinger Jr., Chief Clerk, 130-138 City
Hall, Philadelphia, Pa., 4/21/41 TEB

D. Jordan
ex

7

5 Cav. (Col'd.) | Mass.

John L. Fowler

, Co. *6*, 5 Reg't Mass. Cav. (Col'd.)

Appears on

Company Descriptive Book

of the organization named above.

DESCRIPTION.

Age *18* years; height *5* feet *3 1/2* inches.

Complexion *Dark*

Eyes *Dark*; hair *Dark*

Where born *Newburyport, Mass.*

Occupation *Lumber*

ENLISTMENT.

When *May*, 1864.

Where *Newburyport*

By whom *Geo. H. Jackson*; term *3* y'rs.

Remarks: *Mustered into Company, Jan 29, 1864 at Readville Mass. by Lt Geo Kibben*

W. H. ...

F

5 Col'd Cav.

Mass.

Arthur L. W. Fowler.

Priv, Co. *C*, 5 Reg't Mass. Col'd Cav.

Appears on

Company Muster-in and Descriptive Roll
of the organization named above. Roll dated

Readville, *Jan. 29*, 1864.

Where born *Newburyport, Mass.*

Age *18* y'rs; occupation *Laborer.*

When enlisted *Jan. 11*, 1864.

Where enlisted *Newburyport.*

For what period enlisted *3* years.

Eyes *Black*; hair *Black*

Complexion *Black*; height *5* ft. *3 1/2* in.

When mustered in *Jan. 29*, 1864.

Where mustered in *Readville, Mass.*

Bounty paid \$ *100*; due \$ *100*

Where credited *5th Dist Essex.*

Company to which assigned _____

Remarks: _____

Book mark: _____

Sitter.

H

5 Col'd Cav.

Mass.

Arthur L. W. Fowler.

Pvt, Co. C, 5 Reg't Mass. Col'd Cavalry.

Appears on

Company Muster Roll

for *Enlistment to Feb. 29, 1864.*

Present or absent *Present.*

Stoppage, \$ *100* for

Due Gov't, \$ *100* for

Valuation of horse, \$ *100*

Valuation of horse equipments, \$ *100*

Remarks:

Book mark:

Sitter.

(358)

Copyist.

F.

5 Col'd Cav.

Mass.

Arthur L. W. Fowler.

Priv., Co. C, 5 Reg't Mass. Col'd Cavalry.

Appears on

Company Muster Roll

for *Mar. & Apr.*, 1864.

Present or absent *Present*

Stoppage, \$ *100* for

Due Gov't, \$ *100* for

Valuation of horse, \$ *100*

Valuation of horse equipments, \$ *100*

Remarks:

Book mark:

Sitter.

(358)

Copyist.

7

5 Col'd Cav.

Mass.

Arthur D. Fowler

Private, Co. C, 5 Reg't Mass. Col'd Cavalry.

Appears on

Company Muster Roll

for May & June, 1864.

Present or absent Present

Stoppage, \$ 100 for

Due Gov't, \$ 100 for

Valuation of horse, \$ 100

Valuation of horse equipments, \$ 100

Remarks:

Book mark:

W. H. Miller

G

5 Col'd Cav.

Mass.

Arthur L W Fowler

Plt, Co. C, 5 Reg't Mass. Col'd Cavalry.

Appears on

Company Muster Roll

for *July & Aug*, 186*7*.

Present or absent *Present*

Stoppage, \$ *100* for

Due Gov't, \$ *100* for

Valuation of horse, \$ *100*

Valuation of horse equipments, \$ *100*

Remarks:

Book mark:

E H Baum

2

5 Col'd Cav.

Mass.

Arthur L W Fowler

Capt., Co. C, 5 Reg't Mass. Col'd Cavalry.

Appears on

Company Muster Roll

for Sept & Oct, 1864.

Present or absent Present

Stoppage, \$ 100 for

Due Gov't, \$ 100 for

Valuation of horse, \$ 100

Valuation of horse equipments, \$ 100

Remarks: Due for Ordnance stores \$0.36
Free on or before April 19, 61

Book mark:

E H Brown

F

5 Col'd Cav.

Mass.

Arthur L. W. Fowler

Plt, Co. C, 5 Reg't Mass. Col'd Cavalry.

Appears on

Company Muster Roll

for *Nov & Dec*, 1864.

Present or absent *Present*

Stoppage, \$ *100* for

Due Gov't, \$ *100* for

Valuation of horse, \$ *100*

Valuation of horse equipments, \$ *100*

Remarks: *Due U.S. for inst. ord.*

\$1.05 for Car. Ord. \$0.87 for 2 M.

stres \$0.40

Free on or before Jul. 1961

Book mark:

C. T. Brown

(358)

Copyist.

F.

5 Col'd Cav.

Mass.

Author *L. W. Fowler*

Pvt., Co. C, 5 Reg't Mass. Col'd Cavalry.

Appears on

Company Muster Roll

for *Jan Feb*, 1865.

Present or absent *Present*

Stoppage, \$ *100* for

Due Gov't, \$ *100* for

Valuation of horse, \$ *100*

Valuation of horse equipments, \$ *100*

Remarks: *Due 1st 4 inst Uf
bounty \$180.*

Book mark:

E. H. Brown

F

5 Col'd Cav.

Mass.

Arthur L. W. Fowler

Prt., Co. C, 5 Reg't Mass. Col'd Cavalry.

Appears on

Company Muster Roll

for Mar & Apr, 1865.

Present or absent Present

Stoppage, \$ 100 for

Due Gov't, \$ 100 for

Valuation of horse, \$ 100

Valuation of horse equipments, \$ 100

Remarks: Due Uf. for Car Ord. \$ 2.85. Due 1st inst. Uf. bounty \$ 35. Due 2 3 inst Uf. bounty \$ 120.

Book mark:

E. H. Brown

F

5 Col'd Cav.

Mass.

Arthur L. W. Fowler

Pvt

Co. C, 5 Reg't Mass. Col'd Cavalry.

Appears on

Company Muster Roll

for

May & June, 1865.

Present or absent

Absent

Stoppage, \$

2 ⁸⁵/₁₀₀ for Ord Stores

Due Gov't, \$

100 for

Valuation of horse, \$

100

Valuation of horse equipments, \$

100

Remarks:

Free before April 19 1861

Due of 5th Inst US Bounty \$35.00

Due 2-3-4 Inst US Bounty \$120.00

Detached Service at Hd Qrs

25 A.B. by SO 88 dated May

12 1865

Book mark:

Abbott

(358)

Copyist.

5 Col'd Cav.

Mass.

Arthur L. G. G. G.
Co. *C*, 5 Reg't Mass. Col'd Cavalry.

Appears on a

Detachment Muster Roll

of the organization named above

for *June 30*, 186*7*

Station *Reg't Santiago, Tex.*

Present or absent *Present*

Stoppage, \$ *100* for

Due Gov't, \$ *100* for

Valuation of horse, \$ *100*

Valuation of horse equipments, \$ *100*

Remarks: *Account book \$20.00
w/ \$103.00. Nothing sold
Dec. 31/67. Amount since \$34.42.*

Book mark:

(344)

Carver

Copyist.

F

5 Col'd Cav.

Mass.

Arthur L W Fowler

Pvt, Co. C, 5 Reg't Mass. Col'd Cavalry.

Appears on

Company Muster Roll

for July & Aug, 1865.

Present or absent Absent

Stoppage, \$ 2 ⁸⁵/₁₀₀ for Ordnance

Due Gov't, \$ 100 for

Valuation of horse, \$ 100

Valuation of horse equipments, \$ 100

Remarks: Free before April 19/86/
In detached service No Drs
25 Ab by 50 88 May 12 1865

Book mark:

Abbott

A

5 Col'd Cav.

Mass.

A. L. M. Fowler

Co. C, 5 Reg't Mass. Colored Cav.

Appears on Returns as follows:

*May & June 1865 - Absent
at Corps Hd. Qrs. with
Ordnance*

*July to Sept. 1865 - Absent
at Hd. Qrs. 25 A.C. by
S.O. No. 88 since May
12, '65.*

Book mark:

O. J. Taylor

(546)

Copyist.

7

5 Col'd Cav.

Mass.

Arthur L W Fowler

Pvt, Co. C, 5 Reg't Mass. Col'd Cavalry.

Appears on Co. Muster-out Roll, dated
Clarksville Texas, Oct 31, 1865.

Muster-out to date Oct 31, 1865.

Last paid to Dec 31, 1864.

Clothing account:

Last settled....., 186 ; drawn since \$ 100

Due soldier \$ 100; due U. S. \$ 27 ³³/₁₀₀

Am't for cloth'g in kind or money adv'd \$ 100

Due U. S. for arms, equipments, &c., \$ 13 ⁸⁵/₁₀₀

Bounty paid \$ 25 ⁻/₁₀₀; due \$ 275 ⁻/₁₀₀

Remarks:

Book mark: P.V. 30 P 212, 74

Abbott

(361)

Copyist.

468

House, Samuel

Co K, 5 Mass. Cav., (Col'd.)

Private

Corporal

CARD NUMBERS.

1	5-38375-2	26
2	5-383838	27
3	5-383917	28
4	5-384097	29
5	5-384816	30
6	9091566	31
7	32533671	32
8	32535506	33
9	40730953	34
10		35
11		36
12		37
13		38
14		39
15		40
16		41
17		42
18		43
19		44
20		45
21		46
22		47
23		48
24		49
25		50

Book Mark:

See also

S. 5 Cav. (Col'd.) | Mass.

Samuel Fouse

Co. *K*, 5 Reg't Mass. Cav. (Col'd.)

Appears on

Company Descriptive Book

of the organization named above.

DESCRIPTION.

Age *27* years; height *5* feet *5* inches.

Complexion *Black*

Eyes *Black*; hair *Black*.

Where born *Alabama*.

Occupation *Miller*.

ENLISTMENT.

When *April 2^d, 186*

Where *Scituate*.

By whom *A. F. Mallory*; term *3* y'rs.

Remarks: *Married, Residence Greenville Ala.*

Appointed Corporal from May 16th 1864.

Ed. Des. 5th Mass. Cav. S. Co. 120. Sent to

Hospital at Portsmouth Va. & died of

Phthisis Pulmonalis July 8th 1864.

*Final Statement papers made out
& sent in A. G. Office.*

H. C. Thomas.

F

5 Col'd Cav.

Mass.

James Howe

Pos, Co. *K*, 5 Reg't Mass. Col'd Cav.

Appears on

Company Muster-in and Descriptive Roll

of the organization named above. Roll dated

Remondie Mass, *April 12*, 1864.

Where born *Ucatama*

Age *27* y'rs; occupation *Miller*

When enlisted *April 20*, 1864.

Where enlisted *Ucatama*

For what period enlisted *3* years.

Eyes *Blue*; hair *Black*

Complexion *Black*; height *5 ft. 5 in.*

When mustered in *April 12*, 1864.

Where mustered in *Remondie Mass*

Bounty paid \$ *100*; due \$ *100*

Where credited *See list Mass*

Company to which assigned

Remarks:

Book mark:

Libanus

4

5 Col'd Cav.

Mass.

Edmund House

Plt, Co. K, 5 Reg't Mass. Col'd Cavalry.

Appears on

Company Muster Roll

for *from April 12 to April 30*, 1867.

Present or absent *Present*

Stoppage, \$ 100 for

Due Gov't, \$ 100 for

Valuation of horse, \$ 100

Valuation of horse equipments, \$ 100

Remarks:

Book mark:

Edmund

14

5 Col'd Cav.

Mass.

+ 1/2 Fouse.

Amuel ~~Smith~~

Cope, Co. K, 5 Reg't Mass. Col'd Cavalry.

Appears on

Company Muster Roll

for March June, 1864.

Present or absent Absent

Stoppage, \$ 100 for

Due Gov't, \$ 100 for

Valuation of horse, \$ 100

Valuation of horse equipments, \$ 100

Remarks: 1/2 paid at Corp's
Mar, 10 on 1/2 on 1/2 Mass
Cor in V. 1/2 on 1/2 absent
since June 15, 64 Sick at
West's Monitor

+ Corrected by Jordan Ex

Book mark:

William

F | Cold Cr. | Mass

Samuel Jones
Corpl. Co. K, 5 Reg't Mass. Cav.

Appears on

Hospital Muster Roll

of Balfour U. S. A. General Hospital,

at Portsmouth, Va.,

for May & June, 1864

Attached to hospital:

When, 186 .

How employed

Last paid by Maj.

to, 186 .

Bounty paid \$ ¹⁰⁰ ; due \$ ¹⁰⁰

Present or absent *Present*

Remarks :

.....
.....
.....
.....
.....
.....

Book mark :

W. W. Payne
Copyist.

S 15 Cav. (Col'd) Mass.

Samuel Fouts

Corpl., Co N., 5 Reg't M. C. C.

Appears on

Hospital Muster Roll

of **Balfour U. S. A. General Hospital,**

at **Portsmouth, Va.,**

for *July & Aug*, 1864.

Attached to hospital:

When, 186 .

How employed

Last paid by Maj.

to, 186 .

Bounty paid \$ 100; due \$ 100

Present or absent

Remarks: *Died July 7/64*

Book mark:

F

5 Col'd Cav.

Mass.

Amice Gorse

Cripe, Co. K, 5 Reg't Mass. Col'd Cavalry.

Appears on

Company Muster Roll

for *July 1864*, 1864.

Present or absent

Stoppage, \$ 100 for

Due Gov't, \$ 100 for

Valuation of horse, \$ 100

Valuation of horse equipments, \$ 100

Remarks: *Appointed Cripe Aug 16/64 18th 5th Mass. Cavalry
S. V. 12th Died at Belfour
Line Horse, July 8, 1864
Final statement sent*

Book mark:

W. W. W.

4

5 Col'd Cav.

Mass.

Samuel Fowse

Capt, Co. K, 5 Reg't Mass. Colored Cav.

Appears on Returns as follows:

May 1864 - Absent May 20,
City Point sick at
Post Hosptl.

June 1864 - Absent sick in
Hosptl. Forbes Monro

July 1864 - July Portsmouth
Died in Hospital.

Book mark:

O. J. Taylor

(546)

Copyist.

F

5 Col'd Cav.

Mass.

Samuel Fowse

Capt, Co. K, 5 Reg't Mass. Col'd Cavalry.

Appears on Co. Muster-out Roll, dated
Clarksville Texas, Oct 31, 1865.

Muster-out to date _____, 186 .

Last paid to Never Paid _____, 186 .

Clothing account:

Last settled _____, 186 ; drawn since \$ _____ 100

Due soldier \$ _____ 100; due U. S. \$ _____ 100

Am't for cloth'g in kind or money adv'd \$ _____ 100

Due U. S. for arms, equipments, &c., \$ _____ 100

Bounty paid \$ _____ 100; due \$ 100 ⁰⁰/₁₀₀

Remarks: Died in Genl Hospt. at
Portsmouth Va. July 8th 1864.

Book mark: F.S.

Galligan

(861)

Copyist.

Sgt. Samuel

Cpl. Co. No. 5 Reg't *Mass 6, Gen*

3

Enclosures.

Bed Cards	Descriptive Lists
Burial Records	Final Statements <i>/</i>
Certs. of Dis. for Discharge	Furloughs
C. M. Charges	Med. Des. Lists
Med. Certificates	Orders

Other papers relating to—

Admission to Hosp'l	Furlough
Casualty Sheet (Officer's)	Med. Examination
Confinement	Misc. Information
Contracts	Pay or Clothing
Death or Effects <i>2</i>	Personal Reports
Desertions	Rank
Discharge from Hosp'l	Transfer to Hosp'l
Discharge from Service	Transfer to V. R. C.
Duty	Transportation

FINAL STATEMENT ¹⁸

OF

Corporal Samuel Fouse

5th Reg't of Cavalry Massachusetts

VOLUNTEERS.

paid July 8th 1864

NOTE 1.—Two of these certificates (or duplicates) are to be given to each Volunteer Soldier or drafted man who may be discharged previously to the discharge of his company, that he may at once receive from the Paymaster the pay, &c., due him, and the captain or other COMMISSIONED officer commanding the company will certify to the act of the delivery of the duplicate certificates; on these certificates the Soldier is "entitled to" his discharge, and should also present his discharge to the Paymaster to have the payment endorsed on it. The discharge is to be given back to the Soldier by the Paymaster; the latter only retaining as his voucher the duplicate certificates.

NOTE 2.—If the Soldier is entitled to pay for the use of his horse, the Company Commander will certify to that fact on the back of both these final statements, and also to the time he has pay due for having been so mounted on his own horse.

NOTE 3.—When a Soldier is furnished with final statements, his descriptive list, if he has one, should be taken up by the officer who gives the Soldier these statements, and endorsed with a statement to this effect by the officer. This endorsement should exhibit a full statement of the time for which the Soldier was allowed pay on his final statements, the clothing account, and all other charges against him or in his favor, so as to comprise a complete exhibit of his account. It will then be transmitted to the company commander of the Soldier, who will enter all the data necessary to a full understanding of the Soldier's account on the muster roll upon which the Soldier's discharge is reported. The descriptive list will then be destroyed. The object of this is, that the remaining portion of the Soldier's account may be settled upon the receipt of these muster rolls, and the Soldier receive any pay or allowances that may be due him at the time of his discharge, and which may not appear on his final statements from the fact that his descriptive list is incomplete. These accounts for back pay, &c., are settled by the 2d Auditor of the Treasury Department.

NOTE 4.—Charges for loss or injury to ordnance, horse equipments, and other miscellaneous charges, should appear under the heading of "Other Stoppages."

NOTE 5.—Bounty paid by State authorities, and not by the United States, will not be entered on this statement.

NOTE 6.—Amounts due the Sutler and Laundress must be entered on the muster roll on which the discharge, death, desertion, &c., is reported, as well as on the final statement, otherwise the amount cannot be collected from the United States.

NOTE 7.—This blank will be used for deceased volunteers and drafted men, as well as for others.

NOTE 8.—Where a Soldier dies in Hospital or on detached service, his descriptive list, if he has one, should be sent with his final statements, in duplicate, to the Adjutant General, Washington, D. C.

ADJUTANT GENERAL'S OFFICE.

July 29th 1864

Duplicate with inventory sent 2d Auditor.

E. ...

I certify, on honor, that Squirel Louse a Corporal of
 Captain L. Higginson's Company (R) of the 5th Regiment of Cavalry
VOLUNTEERS, of the State of Massachusetts, born in _____, State
 of Alabama, aged 27 years; 5 feet 5 inches high; black complexion,
black eyes, black hair, and by occupation a miller, having joined the company on
 its original organization at Camp Meigs Readville Mass, and enrolled in it at the muster into
 the service of the United States at Camp Meigs Readville Mass, on the twelfth day
 of April, 1864, (or was mustered in service as a recruit, by _____
 _____, at _____, on the _____ day of _____,
 186 , or was drafted and mustered into the service of the United States from the _____
 Enrollment District of the State of _____, at _____,
 on the _____ day of _____, 186), to serve in the Regiment, for
 the term of three years: and having served **HONESTLY** and
FAITHFULLY with his Company in the 5th Regt Mass. Cav. to the present date, is now
 entitled to a **DISCHARGE** by reason of Death, caused by disease
contracted in service, on the 8th July 1864.

The said _____ was last paid by Paymaster
was never paid to include the _____ day of _____, 186 , and has
 pay due him from date of enlistment to the present date; he is entitled to pay and subsistence for
TRAVELING to place of enrollment, and whatever other allowances are authorized to volunteer
 soldiers, drafted men, or militia, so discharged. He has received from the United States **CLOTHING**
 amounting to thirty six $\frac{15}{100}$ dollars, since the 2d day of April,
 1864, when his clothing account was last settled. He has received from the United States
 _____ dollars advanced **BOUNTY**.

There is to be stopped from him, on account of the State of _____, or other
 authorities, for **CLOTHING**, &c, received on entering service, _____ dollars; and
 for other stoppages, viz:

_____ dollars.
 He has been furnished with **TRANSPORTATION** in kind from the place of his discharge to
 _____; and he has been **SUBSISTED** for **TRAVELING** to his
 place of enrollment, up to the _____, 186 .

He is indebted to _____, **QUARTER**, _____ dollars.

He is indebted to _____, **LAUNDRESS**, _____ dollars.

Given in Duplicate, at Point Lookout Maryland this 8th day
 of July, 1864.

Samuel L. Higginson
Co. R. 5. Mass. Cav.
Capt. Commanding Company.

INVENTORY OF THE EFFECTS

OF

Corporal Samuel Fowse

Late of Company *K*

5. Reg't of Cavalry Massachusetts

Volunteers, who died at *Portsmouth Va.*

on the *8.* day of *July* 1864.

Inventory of the effects of Samuel Louse late
 a Corporal of Captain Francis L. Higginson's Company K of
 the 5th Regiment of Cavalry Massachusetts Volunteers, who was enrolled as
 a private at De. Scituate in the State of Massachusetts on
 the 24 day of April 1864, and mustered into the service of the United
 States as a private on the 12 day of April 1864, at Readville
 in Company K, 5th Regiment of Cavalry Massachusetts Volunteers, to serve 3
 years or during the war; he was born in _____ in the State
 of Alabama; he was 27 years of age, 5 feet 5 inches
 high, black complexion, black eyes, black hair, and by occupation, when enrolled,
 a Miller; he died in Hospital at
Portsmouth Va. on the 8 day of July 1864, by
 reason of phthisis pulmonalis -

INVENTORY.					
ARTICLES.	No.	ARTICLES.	No.	ARTICLES.	No.
Hats		Pairs trowsers		Knapsacks	
Caps		Pairs flannel drawers		<u>Canteen</u>	<u>1</u>
Forage caps		Pairs cotton drawers			
Great coats		Flannel shirts			
Uniform coats		Cotton shirts			
Uniform jackets		Pairs boots			
Flannel sack coats		Pairs shoes	<u>/</u>		
Blouses		Pairs socks	<u>/</u>		
Stable frocks		Blankets	<u>/</u>		
Fatigue overalls		Haversacks			
				MONEY.	
				Specie	\$
				Notes	\$

I CERTIFY, ~~ON HONOR~~, that the above inventory comprises all the effects of Corporal
Samuel Louse, deceased, and that the effects are in the hands
as per inventory received from Portsmouth Va -
 to be disposed of by a Council of Administration.

(DUPLICATES.)

STATION: Point Lookout Md

DATE: July 8th 1864

[A. G. O. No. 104.]

Francis L. Higginson
Co. K. 5. Mass. Cav.
Capt. Commanding the Company.

Inventory

of the effects of

Wm. H. ...
Samuel Houts

late of Co. *E* 5th Regiment

Wm. C. Clark who died

at Balfour General Hospital, Portsmouth,

Va., *2 July 1864* 1864.

Balfour U. S. Army General Hospital,

Portsmouth, Va. 1864.

Commanding Officer K Company.

5th Regt. Mass Cavalry

I have to inform you that Capt. H

Samuel H. H. H. of your Company, died

in this hospital on Nov. 3rd 1864

of Pneumonia

I inclose his descriptive list, with pay and clothing account, and
inventory of his effects. His Descriptive List has never been filed in the Hosp^y

Very respectfully, yours, &c.,

John L. Russell
1st Lt. U. S. A. & Military Hosp^y

of

Inventory of the effects of *Capt. Samuel Frost*
Company K 5th Regiment. Major G. Carl
who died in Balfour General Hospital, Portsmouth, Va.,

July 8th 1864.

HATS.....		BLANKETS..... <i>green</i>	1
DRESS COATS.....		KNAPSACKS.....	
OVERCOATS.....	1	CANTEENS.....	1
JACKETS.....		HIVERSACKS.....	1
TROUSERS.....		MUSKETS.....	
SHIRTS.....		BAYONETS.....	
DRAWERS.....		CARTRIDGE BOX.....	
BOOTS, prs.....		BELT.....	
SHOES, prs.....	1	MONEY.....	
STOCKINGS.....	1		

469

Francis Benjamin D.

Co 6, 5 Mass. Cav., (Col'd.)

Private

Private

CARD NUMBERS.

1	5-370-698	26
2	5-375-790	27
3	5-375-926	28
4	5-376-862	29
5	9092392	30
6	40730954	31
7		32
8		33
9		34
10		35
11		36
12		37
13		38
14		39
15		40
16		41
17		42
18		43
19		44
20		45
21		46
22		47
23		48
24		49
25		50

Book Mark:

See also

7 5 Cav. (Col'd.) | Mass.

Benjamin D Francis

Co. 6, 5 Reg't Mass. Cav. (Col'd.)

Appears on

Company Descriptive Book

of the organization named above.

DESCRIPTION.

Age 21 years; height 5 feet 9 inches.

Complexion light colored

Eyes hazel; hair black

Where born New York City, N.Y.

Occupation writer

ENLISTMENT.

When Jan 4, 1864.

Where Northam

By whom J. D. Stone; term 3 y'rs.

Remarks: Mistaken into company to
Jan 29 1864 at Readville, Mass
by Lt M. K. Hubber
Died March 20 1864 at Readville,
Mass in Hospital of Diseases of
the Brain

(3830)

Francis
Copist.

F.

5 Col'd Cav.

Mass.

Benjamin D. Francis

Priv., Co. B, 5 Reg't Mass. Col'd Cav.

Appears on

Company Muster-in and Descriptive Roll
of the organization named above. Roll dated

Readville Jan. 29, 1864.

Where born New York, N. Y.

Age 21 y'rs; occupation Porter.

When enlisted Jan. 5, 1864.

Where enlisted Waltham.

For what period enlisted 3 years.

Eyes Black; hair Black.

Complexion Black; height 5 ft. 9 in.

When mustered in Jan. 29, 1864.

Where mustered in Readville, Mass.

Bounty paid \$ 100; due \$ 100

Where credited 6th Dist. Middlesex.

Company to which assigned

Remarks:

Book mark:

Sitter.

F

5 Col'd Cav.

Mass.

Benjamin D. Francis

Priv., Co. C, 5 Reg't Mass. Col'd Cavalry.

Appears on

Company Muster Roll

for *Enlistment to Feb. 29, 1864.*

Present or absent *Present.*

Stoppage, \$ *100* for

Due Gov't, \$ *100* for

Valuation of horse, \$ *100*

Valuation of horse equipments, \$ *100*

Remarks: *Detailed for Band, Special Order No. 28.*

Book mark: _____

Sitter

(358)

Copyist.

F

5 Col'd Cav.

Mass.

Benjamin D. Francis.

....., Co. C, 5 Reg't Mass. Col'd Cavalry.

Appears on

Company Muster Roll

for *May & Apr.*, 1864.

Present or absent.....

Stoppage, \$..... 100 for.....

Due Gov't, \$..... 100 for.....

Valuation of horse, \$..... 100

Valuation of horse equipments, \$..... 100

Remarks: *Never paid.*
Died March 26, 1864.

Book mark:.....

Sitter.

(358)

Copyist.

F | **5 Col'd Cav.** | **Mass.**

Benj' D. Francis
Pr, Co. *B*, 5 Reg't Mass. Colored Cav.

Appears on **Returns** as follows:

Febry 1864 - On duty in
The Band.

March 1864 - Moh. 20, '64
Readville, Mass. En-
listed at Waltham, Mass
Jan. 4, '64.

Died of disease of
Brain.

Book mark: _____

(546)

O. J. Taylor

Copyist.

F

5 Col'd Cav.

Mass.

Benjamin Francis

Priv, Co. *B*, 5 Reg't Mass. Col'd Cavalry.

Appears on **Co. Muster-out Roll**, dated *Clarksville Texas, Oct 31, 1865*.

Muster-out to date _____, 186 .

Last paid to *Never Paid* _____, 186 .

Clothing account:

Last settled _____, 186 ; drawn since \$ _____ 100

Due soldier \$ _____ 100; due U. S. \$ _____ 100

Am't for cloth'g in kind or money adv'd \$ _____ 100

Due U. S. for arms, equipments, &c., \$ _____ 100

Bounty paid \$ _____ 100; due \$ _____ 100

Remarks: *Died March 20-64 at
Readville Mass in Hospital
of Disease of the Brain*

Book mark : _____

Albion

Francis, Bow' D.

P, Co. 6, 5 Mass. C. Cav.

Enclosures.

Bed Cards
Burial Records
Certs. of Dis. for Discharge
C. M. Charges
Med. Certificates

Descriptive Lists
Final Statements /
Furloughs
Med. Des. Lists
Orders

Other papers relating to—

Admission to Hosp'l
Casualty Sheet (Officer's)
Confinement
Contracts
Death or Effects
Desertions
Discharge from Hosp'l
Discharge from Service
Duty

Furlough
Med. Examination
Misc. Information
Pay or Clothing
Personal Reports
Rank
Transfer to Hosp'l
Transfer to V. R. C.
Transportation

FINAL STATEMENT

OF

Benjamin D. Francis
5th Reg't of Mass. Cav

VOLUNTEERS.

Paul Jackson

NOTE 1.—Two of these certificates (or duplicates) are to be given to each Volunteer Soldier or drafted man who may be discharged without being mustered out (Final Statements are never given to men mustered out of service) that he may at once receive from the Paymaster the pay, &c., due him, and the captain or other COMMISSIONED officer commanding the company will certify to the act of the delivery of the duplicate certificates; with these certificates the Soldier is "entitled to" his discharge, and should also present his discharge to the Paymaster to have the payment endorsed on it. The discharge is to be given back to the Soldier by the Paymaster; the latter only retaining as his vouchers the duplicate certificates.

NOTE 2.—If the Soldier is entitled to pay for the use of his horse, the Company Commander will certify to that fact on the back of both these final statements, and also to the time he has pay due for having been so mounted on his own horse.

NOTE 3.—When a Soldier is furnished with final statements, his descriptive list, if he has one, should be taken up by the officer who gives the Soldier these statements, and endorsed with a statement to this effect by the officer. The endorsement should exhibit a full statement of the time for which the Soldier was allowed pay on his final statements, the clothing account, and all other charges against him or in his favor, so as to comprise a complete exhibit of his account. It will then be transmitted to the Company Commander of the Soldier, who will enter all the data necessary to a full understanding of the Soldier's account on the muster roll upon which the Soldier's discharge is reported. The descriptive list will then be destroyed. The object of this is, that the remaining portion of the Soldier's account may be settled upon the receipt of these muster rolls, and the Soldier receive any pay or allowances that may be due him at the time of his discharge, and which may not appear on his last final statements from the fact that his descriptive list is incomplete. These accounts for back pay, &c., are settled by the 2d Auditor of the Treasury Department.

NOTE 4.—Charges for loss or injury to ordnance, horse equipments, and other miscellaneous charges, should appear under the heading of "Other Stoppages."

NOTE 5.—Bounty paid by State authorities, and not by the United States, will not be entered on this statement.

NOTE 6.—Amounts due the Sutler and Laundress must be entered on the muster roll on which the discharge, death, desertion, &c., is reported, as well as on the final statement, otherwise the amount cannot be collected from the United States.

NOTE 7.—This blank will be used for deceased volunteers and drafted men, as well as for others.

NOTE 8.—Where a Soldier dies in Hospital or on detached service, his descriptive list, if he has one, should be sent with his final statements, in duplicate, to the Adjutant General, Washington, D. C.

NOTE 9.—If the soldier is a drafted man or substitute, the space for time, &c., of enrolled, should contain only the word *drafted* or *substitute*, as the case may be. If the Soldier is a "VETERAN" (or RECRUIT,) the words *as a veteran*, (or *recruit*.) as the case may be, should be interlined after the words *mustered into the service*. A full statement of all the installments of *Veteran* or *Recruit* Bounty RECEIVED by the Soldier must be made on the back of each final statement.

ADJUTANT GENERAL'S OFFICE

No. 21

Duplicate with Inventory sent 2d Auditor.



470

Frank, John

Co A, 5 Mass. Cav., (Col'd.)

Private

Corporal

CARD NUMBERS.

1	5-373285-	26
2	5-373370	27
3	5-37345-3	28
4	5-3735-45-	29
5	5-373664	30
6	5-373774	31
7	5-373874	32
8	5-373985-	33
9	5-374088	34
10	5-374189	35
11	5-374285-	36
12	5-374352	37
13	9092-644	38
14		39
15		40
16		41
17		42
18		43
19		44
20		45
21		46
22		47
23		48
24		49
25		50

Book Mark:

See also

7

5 Cav. (Col'd.) | Mass.

Geo. Frank

....., Co. *E*, 5 Reg't Mass. Cav. (Col'd.)

Appears on

Company Descriptive Book

of the organization named above.

DESCRIPTION.

Age *25* years; height *5* feet *6* inches.

Complexion *dark*

Eyes *dark*; hair *dark*

Where born *Worcester, Mass.*

Occupation *Shoemaker*

ENLISTMENT.

When *Dec 26*, 186*5*.

Where *Worcester*

By whom *R. Lopez*; term *3* y'rs.

Remarks: *Promoted Corp. Sept 29 1865*

H. H. [unclear]

(3830)

Copyist.

F

5 Col'd Cav.

Mass.

John Frank
Out, Co. *A*, 5 Reg't Mass. Col'd Cav.

Appears on

Company Muster-in and Descriptive Roll

of the organization named above. Roll dated

Readville Jan 9, 1864.

Where born *Wester Sandwich, Ma*

Age *23* y'rs; occupation *Sailor*

When enlisted *Dec. 16th*, 1863.

Where enlisted *Provincetown*

For what period enlisted *Three* years.

Eyes *Black*; hair *Black*

Complexion *Black*; height *5* ft. *6* in.

When mustered in *Jan. 9th*, 1864.

Where mustered in *Readville*

Bounty paid \$ *100*; due \$ *100*

Where credited

Company to which assigned

Remarks:

Inserted by Jordan Cox

Book mark:

G. F. M.

(356d)

Copyist.

F

5 Col'd Cav.

Mass.

John Frank
But, Co. A, 5 Reg't Mass. Col'd Cavalry.

Appears on

Company Muster Roll

for *Enlistment to Feb 29* 1864.

Present or absent *Present*

Stoppage, \$.....100 for.....

Due Gov't, \$.....100 for.....

Valuation of horse, \$.....100

Valuation of horse equipments, \$.....100

Remarks:.....

.....

.....

.....

.....

.....

.....

.....

Book mark:.....

.....

(358)

G. F. W.

Copyist.

F

5 Col'd Cav.

Mass.

John Frank
Prvt, Co. A, 5 Reg't Mass. Col'd Cavalry.

Appears on

Company Muster Roll

for *Mar & Apr.*, 1864.

Present or absent *Present*

Stoppage, \$ *100* for

Due Gov't, \$ *100* for

Valuation of horse, \$ *100*

Valuation of horse equipments, \$ *100*

Remarks:

Book mark:

G. F. V.

(358)

Copyist.

F

5 Col'd Cav.

Mass.

John Frank
Priv., Co. A, 5 Reg't Mass. Col'd Cavalry.

Appears on

Company Muster Roll

for *May & June*, 1864.

Present or absent *Present*

Stoppage, \$ *100* for

Due Gov't, \$ *100* for

Valuation of horse, \$ *100*

Valuation of horse equipments, \$ *100*

Remarks:

Book mark: -----

G. F. N.

J.

5 Col'd Cav.

Mass.

John Franks

Prv., Co. A, 5 Reg't Mass. Col'd Cavalry.

Appears on

Company Muster Roll

for *July and Aug.*, 1864.

Present or absent *Present.*

Stoppage, \$ *100* for

Due Gov't, \$ *100* for

Valuation of horse, \$ *100*

Valuation of horse equipments, \$ *100*

Remarks: *Free on or before
Apr. 19, 1861.*

Book mark:

M. G. Phillips

(358)

Copyist.

J

5 Col'd Cav.

Mass.

John Franks
Priv.

Co. A, 5 Reg't Mass. Col'd Cavalry.

Appears on

Company Muster Roll

for *Sept. and Oct.*, 1864.

Present or absent *Present.*

Stoppage, \$ *100* for

Due Gov't, \$ *100* for

Valuation of horse, \$ *100*

Valuation of horse equipments, \$ *100*

Remarks: *Stop 1 caudum*
45.

Book mark: _____

M. O. Gilbert

(358)

Copyist.

J.

5 Col'd Cav.

Mass.

John Franks
Priv., Co. A, 5 Reg't Mass. Col'd Cavalry.

Appears on

Company Muster Roll

for *Nov. and Dec.*, 1864.

Present or absent *Present.*

Stoppage, \$ *100* for

Due Gov't, \$ *100* for

Valuation of horse, \$ *100*

Valuation of horse equipments, \$ *100*

Remarks: *Stop over caution*
40¢

Book mark:

M. W. Gilbert,

J.

5 Col'd Cav.

Mass.

John Franks

Co., Co. A, 5 Reg't Mass. Col'd Cavalry.

Appears on

Company Muster Roll

for *Jan. and Feb.*, 1863:

Present or absent *Present.*

Stoppage, \$ *45* for *2 M.*

property.

Due Gov't, \$ *100* for

Valuation of horse, \$ *100*

Valuation of horse equipments, \$ *100*

Remarks: *Due 2, 3 and 4*
inst N. S. Bonny
\$120.00

Book mark:

A. Gilbert

(358)

Copyist.

J

5 Col'd Cav.

Mass.

John Frank

Priv., Co. A, 5 Reg't Mass. Col'd Cavalry.

Appears on

Company Muster Roll

for *March and April*, 1865.

Present or absent *Present.*

Stoppage, \$ *100* for

Due Gov't, \$ *100* for

Valuation of horse, \$ *100*

Valuation of horse equipments, \$ *100*

Remarks: *Due 2, 3 and 4*
inst. M. S. Bounty
\$120.00 and \$35.00 on
1 inst.

Book mark:

M. C. Gilbert

4

5 Col'd Cav.

Mass.

John Franks

Privat, Co. A, 5 Reg't Mass. Col'd Cavalry.

Appears on

Company Muster Roll

for May & June, 1865.

Present or absent Present

Stoppage, \$ 100 for

Due Gov't, \$ 100 for

Valuation of horse, \$ 100

Valuation of horse equipments, \$ 100

Remarks: Due 2^d, 3^d & 4th Inst. U.S. Bounty \$120. & on 1st \$35.

Book mark:

Sallade

(358)

Copyist.

F

5 Col'd Cav.

Mass.

John Franks
Plt, Co. A, 5 Reg't Mass. Col'd Cavalry.

Appears on

Company Muster Roll

for *July & Aug*, 186*5*.

Present or absent *Present*

Stoppage, \$ *100* for

Due Gov't, \$ *100* for

Valuation of horse, \$ *100*

Valuation of horse equipments, \$ *100*

Remarks: *Due 2. 3. 4. 5 Inst 28.*
Bounty #160. On 1st Inst #35.
Free on or before Apr 19. 61

Book mark:

Sallade

(358)

Copyist.

F

5 Col'd Cav.

Mass.

John Frankes

Corp., Co. A, 5 Reg't Mass. Col'd Cavalry.

Appears on Co. Muster-out Roll, dated
Clarkeville, Texas, Oct 31, 1865.

Muster-out to date Oct 31, 1865.

Last paid to Dec 31, 1864.

Clothing account:

Last settled....., 186 ; drawn since \$..... 100

Due soldier \$ 3 92 / 100; due U. S. \$..... 100

Am't for cloth'g in kind or money adv'd \$..... 100

Due U. S. for arms, equipments, &c., \$. / 100

* Bounty paid \$ 25 / 100; due \$ 275 / 100

Remarks: * Free Apr. 19, 1861

Appointed Corporal Feb. 20, 1865

Book mark :

Ballade

(861)

Copyist.

471

Franklin, David

Co D, 5 Mass. Cav., (Col'd.)

Private

Private

CARD NUMBERS.

1	5372460	26
2	5372502	27
3	5377500	28
4	5377610	29
5	5377713	30
6	5377810	31
7	5377950	32
8	5378069	33
9	9092289	34
10	30851865	35
11	30853758	36
12	40730955	37
13		38
14		39
15		40
16		41
17		42
18		43
19		44
20		45
21		46
22		47
23		48
24		49
25		50

Book Mark:

See also

J | **5 Cav. (Col'd.) | Mass.**

David E. Washburn

....., Co. *D*, 5 Reg't Mass. Cav. (Col'd.)

Appears on

Company Descriptive Book

of the organization named above.

DESCRIPTION.

Age *22* years; height *5* feet *7* inches.

Complexion *fair*

Eyes *blue*; hair *dark*

Where born *Boston, Mass.*

Occupation *farmer*

ENLISTMENT.

When *Oct 14*, 1864.

Where *Boston*

By whom *G. H. ...*; term *5* y'rs.

Remarks: *Discharged 11/11/64
for ...
...
...*

Washburn

F

5 Col'd Cav.

Mass.

David Franklin

Appears with rank of _____ on _____

Muster and Descriptive Roll of a Detachment of U. S. Vols. forwarded

for the 5 Reg't Mass. Col'd Cavalry. Roll dated

Boston Mass, Oct 14, 1864.

Where born *Jefferson Co. Va*

Age *22* y'rs; occupation *Waiter*

When enlisted *Oct. 14*, 1864.

Where enlisted *Boston Mass*

For what period enlisted *3* years.

Eyes *Black*; hair *Black*

Complexion *Col*; height *5 ft. 8 in.*

When mustered in *Oct. 14*, 1864.

Where mustered in *Boston Mass*

Bounty paid \$ *100*¹⁰⁰; due \$ *200*¹⁰⁰

Where credited *City of Boston Suffolk Co Mass*

Company to which assigned _____

Remarks: _____

Book mark: _____

M. A. Michaels

Copyist.

DF 5 Col'd Cav. | Mass.

Franklin, David

Appears with rank of *Private* on

Muster and Descriptive Roll of a Detachment of U. S. Vols. forwarded

for the 5. Reg't Mass. Col'd Cavalry. Roll dated
Draft Rendezvous,
Gallinup's Island B. H. Mass, Nov. 12, 1864.

Where born *Jefferson Co. Va*

Age *22* y'rs; occupation *Waiter.*

When enlisted *Oct 14*, 1864.

Where enlisted *Boston Mass*

For what period enlisted *3* years.

Eyes *black*; hair *dark*

Complexion *Gold*; height *5 ft. 8 in.*

When mustered in *Oct 14*, 1864.

Where mustered in *Boston*

Bounty paid \$ *100* ¹⁰⁰; due \$ *200* ¹⁰⁰

Where credited *Boston Suffolk Co.*

Company to which assigned

Remarks:

Book mark:

M. A. Michaels

H

5 Col'd Cav.

Mass.

David Franklin

Pr., Co. D, 5 Reg't Mass. Col'd Cavalry.

Appears on

Company Muster Roll

for *5th Mo & Dec*, 1864

Present or absent *Present*

Stoppage, \$ *100* for

Due Gov't, \$ *100* for

Valuation of horse, \$ *100*

Valuation of horse equipments, \$ *100*

Remarks: *No enlistment papers*

Book mark:

J. M. Merchant

(358)

Copyist.

To

5 Col'd Cav.

Mass.

David Franklin

R., Co. D, 5 Reg't Mass. Col'd Cavalry.

Appears on

Company Muster Roll

for Jan & Feb, 1865

Present or absent Present

Stoppage, \$ 100 for

Due Gov't, \$ 100 for

Valuation of horse, \$ 100

Valuation of horse equipments, \$ 100

Remarks:

Book mark:

A. Merchant

(358)

Copyist.

07

5 Col'd Cav.

Mass.

David Franklin

Private, Co. D, 5 Reg't Mass. Col'd Cavalry.

Appears on

Company Muster Roll

for May 1st 1865

Present or absent Present

Stoppage, \$ 100 for

Due Gov't, \$ 100 for

Valuation of horse, \$ 100

Valuation of horse equipments, \$ 100

Remarks: Due 1st June 1865, Bount,

Book mark:

J. A. Mearns

F

5 Col'd Cav.

Mass.

David Franklin

Priv, Co. D, 5 Reg't Mass. Col'd Cavalry.

Appears on

Company Muster Roll

for *May and June*, 1865.

Present or absent *Absent*

Stoppage, \$ *100* for

Due Gov't, \$ *100* for

Valuation of horse, \$ *100*

Valuation of horse equipments, \$ *100*

Remarks:

*Sent to Hospital at
N. Orleans June 28, 1865*

Book mark:

House

F | *5 Cav (600)* | *Mass*

David Franklin

W, Co *D*, *5* Reg't *Mass C. Cav.*

Appears on

Hospital Muster Roll

of **Corps d'Afrique U. S. A. General Hospital,**

at **New Orleans, La.,**

for *May & June*, 186*5*.

Attached to hospital:

When....., 186 .

How employed.....

Last paid by Maj.

to, 186 .

Bounty paid \$ *100*; due \$ *100*

Present or absent *Present*

Remarks:.....

.....

.....

.....

.....

.....

.....

.....

Book mark:.....

.....

D. Brown

F | 5th Cav (Col'd) | Mass.

David Franklin

Sgt., Co. D, 5th Reg't Mass Cav

Appears on

Hospital Muster Roll

of Corps d'Afrique U. S. A. General Hospital,

at New Orleans, La.,

for July + Aug, 1865.

Attached to hospital:

When _____, 186 .

How employed _____

Last paid by Maj. _____

to _____, 186 .

Bounty paid \$ 100; due \$ 100

Present or absent _____

Remarks: Died July 3/65. -

Book mark: _____

James

(343)

Copyist.

F

5 Col'd Cav.

Mass.

Randa Franklin

Priv, Co. D, 5 Reg't Mass. Col'd Cavalry.

Appears on

Company Muster Roll

for *July and Aug.*, 1865.

Present or absent

Stoppage, \$ 100 for

Due Gov't, \$ 100 for

Valuation of horse, \$ 100

Valuation of horse equipments, \$ 100

Remarks:

*Died in Hospital at
New Orleans on July 3,
1865. final statement
forwarded.*

Book mark:

House

F

5 Col'd Cav.

Mass.

David Franklin
M., Co. D, 5 Reg't Mass. Colored Cav.

Appears on Returns as follows:

Nov. 1864 - Nov. 23, Recruit
from Depot.

June 1865 Absent sick
in Hospt. New Orleans
June 28, '65.

July 1865 - July 3, New
Orleans, La. July 3,
'65.

Book mark :

O. J. Taylor

(546)

Copyist.

f

5 Col'd Cav.

Mass.

Darius Franklin

Prst, Co. *Q*, 5 Reg't Mass. Col'd Cavalry.

Appears on **Co. Muster-out Roll**, dated *Clarksville Texas Oct. 31*, 1865.

Muster-out to date _____, 186 .

Last paid to _____, 186 .

Clothing account:

Last settled _____, 186 ; drawn since \$ _____ 100

Due soldier \$ _____ 100 ; due U. S. \$ _____ 100

Am't for cloth'g in kind or money adv'd \$ _____ 100

Due U. S. for arms, equipments, &c., \$ _____ 100

Bounty paid \$ _____ 100 ; due \$ _____ 100

Remarks:

*Died in Corps Q. Afrique
Hosp't. at New Orleans La
July 3/65*

Book mark:

House

(861)

Copyist.

Franklin David

B, Co. 10,

5

Mass. C. Cav.
Reg't

9

Enclosures.

Bed Cards

Burial Records

Certs. of Dis. for Discharge

C. M. Charges

Med. Certificates

Descriptive Lists

Final Statements

Furloughs

Med. Des. Lists

Orders

Other papers relating to—

Admission to Hosp'l

Casualty Sheet (Officer's) 2

Confinement

Contracts

Death or Effects 3

Desertions

Discharge from Hosp'l

Discharge from Service

Duty

E P 2

Furlough

Med. Examination

Misc. Information 1

Pay or Clothing

Personal Reports

Rank

Transfer to Hosp'l

Transfer to V. R. C.

Transportation

MICROFILM PUBLICATION M 1822

COMPILED MILITARY SERVICE RECORDS
OF VOLUNTEER UNION SOLDIERS WHO
SERVED WITH THE USCT (US COLORED TROOPS)
5TH MASSACHUSETTS REGIMENT OF CAVALRY

PERSONAL PAPERS' TARGET SHEET

PLEASE NOTE THE CHECKED INFORMATION ABOUT THE PERSONAL PAPERS IN
THIS FILE:

- NO PERSONAL PAPERS WERE FOUND IN THIS FILE WHEN THE
RECORDS WERE ARRANGED FOR MICROFILMING.

- 12 PERSONAL PAPER(S) FOUND IN THIS FILE WHEN THE RECORDS
WERE ARRANGED FOR MICROFILMING.

NOTE 1.—This blank will be used for both enlistments and re-enlistments—enlistment of veterans, &c., &c., in the volunteer service. They will be made out in duplicate in all cases—one to accompany the recruiting return of the superintendent (not the recruiting officer) to the Adjutant-General, and one to accompany the accounts of the officer who pays bounty, &c. The Regiment and Company in which the soldier last served should be given on the back.

NOTE 2.—An enlistment holds to service. A muster-in must, in all cases, precede payment of pay, bounty, pension, &c. A muster-in roll must, in all cases, be filed in the Adjutant-General's Office as evidence of muster-in. The mustering officer, commissary, or assistant-commissary of musters, as the case may be, will countersign both enlistments as having mustered the soldier into the service of the United States before either of them is given to the disbursing officer.

DECLARATION OF RECRUIT.

I, *David Franklin* desiring to VOLUNTEER as a Soldier in the Army of the United States, for the term of THREE YEARS, Do Declare, That I am *Twenty two* years and _____ months of age; that I have never been discharged from the United States service on account of disability or by sentence of a court-martial, or by order before the expiration of a term of enlistment; and I know of no impediment to my serving honestly and faithfully as a soldier for three years.

GIVEN at *Boston Mass*
the *14th* day of *October 1864*
Witness: *J. Hosaton* *David Franklin*

By _____
Regiment of _____
Volunteered at *Boston Mass.*
October 14. 1864.
No. _____
David Franklin
Discharged _____
18 _____
Reg't of _____
enlistment; last served in Company () _____

CONSENT IN CASE OF MINOR.

I, _____ Do CERTIFY, That I am _____
the _____ of _____; that the _____
said _____ is _____ years of age; and I
do hereby freely give my CONSENT to his volunteering as a SOLDIER in the ARMY OF THE UNITED STATES,
for the period of THREE YEARS.

GIVEN at _____
the _____ day of _____
Witness: _____

VOLUNTEER ENLISTMENT.

STATE OF

Massachusetts

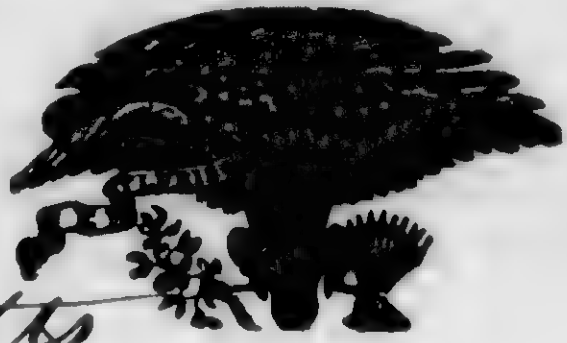

~~CITY~~ TOWN OF

Boston

I, *David Franklin* born in *Jefferson Co*
in the State of *Virginia* aged *Twenty two* years,
and by occupation a *Waiter* Do HEREBY ACKNOWLEDGE to have
volunteered this *Fifteenth* day of *October* 1864,
to serve as a **Soldier** in the **Army of the United States of America**, for the
period of **THREE YEARS**, unless sooner discharged by proper authority: Do also
agree to accept such bounty, pay, rations, and clothing, as are, or may be, estab-
lished by law for volunteers. And I, *David Franklin* do
solemnly swear that I will bear true faith and allegiance to the **United States**
of America, and that I will serve them honestly and faithfully against all their
enemies or opposers whomsoever; and that I will observe and obey the orders of
the President of the United States, and the orders of the officers appointed over
me, according to the Rules and Articles of War.

Sworn and subscribed to, at *Boston*
this *14th* day of *October* 1864, } *David Franklin*
BEFORE *W. J. [Signature]* :

I CERTIFY, ON HONOR, That I have carefully examined the above-named Volunteer, agreeably
to the General Regulations of the Army, and that, in my opinion, he is free from all bodily defects and
mental infirmity, which would in any way disqualify him from performing the duties of a soldier.

H. D. Bowditch
EXAMINING SURGEON.

I CERTIFY, ON HONOR, That I have minutely inspected the Volunteer, *David Franklin*
previously to his enlistment, and that he was entirely sober when enlisted; that, to the best of my
judgment and belief, he is of lawful age; and that, in accepting him as duly qualified to perform the duties
of an able-bodied soldier, I have strictly observed the Regulations which govern the recruiting service.
This soldier has *Blue* eyes, *Dark* hair, *Dark* complexion, is *5* feet
8 inches high.

Ch. [Signature]
RECRUITING OFFICER.

the *14th* day of *October*, 1864, at

Boston *Mass* *5th* Regiment of *Mass Cavalry* Volunteers, on

W. J. [Signature]
Capt. [Signature]
1st Mass Cavalry

(A. G. O. No. 74 & 75.)

NOTE 1. — This blank will be used for both enlistments and re-enlistments — enlistment of veterans, &c., &c., in the volunteer service. They will be made out in duplicate in all cases — one to accompany the recruiting return of the superintendent (not the recruiting officer) to the Adjutant-General, and one to accompany the accounts of the officer who pays bounty, &c. The Regiment and Company in which the soldier last served should be given on the back.

NOTE 2. — An enlistment holds to service. A muster-in must, in all cases, precede payment of pay, bounty, pension, &c. A muster-in roll must, in all cases, be filed in the Adjutant-General's Office as evidence of muster-in. The mustering officer, commissary, or assistant-commissary of musters, as the case may be, will countersign both enlistments as having mustered the soldier into the service of the United States before either of them is given to the disbursing officer.

DECLARATION OF RECRUIT.

I, *David Franklin* desiring to VOLUNTEER as a Soldier in the Army of the United States, for the term of THREE YEARS, Do Declare, That I am *twenty two* years and _____ months of age; that I have never been discharged from the United States service on account of disability or by sentence of a court-martial, or by order before the expiration of a term of enlistment; and I know of no impediment to my serving honestly and faithfully as a soldier for three years.

GIVEN at *Boston Mass* the *14th* day of *October 1864*

Witness: *J. H. Dalton* *David Franklin*

No. *David Franklin*
 Volunteered at *Boston Mass*
October 14 1864,
 By *Major Henry Stowice*
5th Mass. Regiment of
5th Mass. Cavalry

Discharged *29th Oct 1864* 18
 Reg't of *11th Mass. Cavalry*
H. S.

CONSENT IN CASE OF MINOR.

I, _____ Do CERTIFY, That I am _____ of _____; that the said _____ is _____ years of age; and I do hereby freely give my CONSENT to his volunteering as a SOLDIER in the ARMY OF THE UNITED STATES for the period of THREE YEARS.

GIVEN at _____ the _____ day of _____

Witness:

VOLUNTEER ENLISTMENT.

STATE OF

Massachusetts



TOWN OF

Boston

Mustered into the service of the United States, in Company
the *14th* day of *October*, 1864, at *Boston*

I, *David Franklin* born in *Jefferson Co*
in the State of *Virginia* aged *Twenty two* years,
and by occupation a *Wagoner* Do HEREBY ACKNOWLEDGE to have
volunteered this *fourteenth* day of *October* 1864,
to serve as a **Soldier** in the Army of the United States of America, for the
period of **THREE YEARS**, unless sooner discharged by proper authority: Do also
agree to accept such bounty, pay, rations, and clothing, as are, or may be, estab-
lished by law for volunteers. And I, *David Franklin* do
solemnly swear that I will bear true faith and allegiance to the **United States**
of America, and that I will serve them honestly and faithfully against all their
enemies or opposers whomsoever; and that I will observe and obey the orders of
the President of the United States, and the orders of the officers appointed over
me, according to the Rules and Articles of War.

Sworn and subscribed to, at *Boston*
this *14th* day of *October* 1864 of *David Franklin*
BEFORE *W. H. Brown*
Capt. & Prov. Quar. 4th Mass. Dist

I CERTIFY, ON HONOR, That I have carefully examined the above-named Volunteer, agreeably
to the General Regulations of the Army, and that, in my opinion, he is free from all bodily defects and
mental infirmity, which would in any way disqualify him from performing the duties of a soldier.

H. J. Bowditch
EXAMINING SURGEON.

I CERTIFY, ON HONOR, That I have minutely inspected the Volunteer *David Franklin*
previously to his enlistment, and that he was entirely sober when enlisted; that, to the best of my
judgment and belief, he is of lawful age; and that, in accepting him as duly qualified to perform the duties
of an able-bodied soldier, I have strictly observed the Regulations which govern the recruiting service.
This soldier has *Dark* eyes, *Dark* hair, *Dark* complexion, is *5* feet
8 inches high.

O. S. Mearns
Regiment of *Mass* Volunteers,
RECRUITING OFFICER.

(A. G. O. No. 74 & 75.)

W. H. Brown
Capt. & Prov. Quar. 4th Mass. Dist
14th Mass. Dist
Regiment of *Mass* Cavalry Volunteers, on

INVENTORY

OF THE EFFECTS OF

David Franklin

Late of Company "D", 5th Regiment

Mass. Cavalry, who died

at Camp of Agriquer U.S. General

Hospital New Orleans La. July 3rd,

1865.

He had no Descriptive Roll.



Courier's Office U. S. Army General Hospital,
New Orleans La. July 3rd, 1865.

Commanding Officer, "D" Company,
5th Regiment Mass. Cav.

I have to inform you
that David Franklin of your Company died in this
Hospital on 3rd July 1865 of
Typhoid Fever.

I enclose his ~~Descriptive List, with Pay and Clothing Account,~~
and Inventory of his effects.

Very respectfully, yours, &c.,

J. E. Piquette

Surgeon U. S. A.,

In charge of General Hospital

INVENTORY OF THE EFFECTS

OF

Wm. Lewis Franklin

Late of Company "D"

5th Reg't of Mass. Col.

Volunteers, who died at New Orleans, La.

on the 3rd day of July 1865

*Surgeon General's Office
Record and Pension Division
Washington D.C. Jan 24th 1867*

*This Inventory is the
Copy retained with the records
of the Camp & Hospital General
Hospital at New Orleans La;
found in this office, and
contains all information in
the case. Can be found
by the Surgeon General*

John C. Edwards
24
1867
OFFICE.

... die, or be
... officer of
... mmissioned
... above his
... of the De-
... and paid to
... or soldier.
... the effects
... counted to
... giment or
... mitted to
... or of the
... mmissioned
... and paid

... ed officers
... warded to
... which the
... of the regi-
... with the
... t from his
... urnish the
... mmanding
... his death,
... paid, and
... s decease;
... mpany to
... nventory of
... giment of
... If a legal
... t. If the

... officer or
... s decease,
... nder the
... eds depo-
... until they

... tration, a
... d by the
... r's receipt
... er to the
... t of the
...) _____
... 86-."

... rned over
... Adjutant
... f the de-
... ral, their
... her cases,
... Adjutant

... duplicate
... y should
... ficer.

Inventory of the effects of David Franklin late
 a Private of Captain _____ Company "D" of
 the 5th Regiment of Mass. Cav. Volunteers, who was enrolled as
 a _____ at _____ in the State of _____ on
 the _____ day of _____ 186 , and mustered into the service of the United
 States as a _____ on the _____ day of _____ 186 , at _____
 in Company _____, _____ Regiment of _____ Volunteers, to serve _____
 years or during the war; he was born in _____ in the State
 of _____; he was _____ years of age, _____ feet _____ inches
 high, _____ complexion, _____ eyes, _____ hair, and by occupation, when enrolled,
 a _____; he died in Camp of Instruction U.S. Gen. Hosp. at
New Orleans, La. on the 3rd day of July 1865, by
 reason of Typhoid Fever.

INVENTORY.					
ARTICLES.	No.	ARTICLES.	No.	ARTICLES.	No.
Hats		Pairs trousers		Knapsacks	
Caps		Pairs flannel drawers			
Forage caps	8	Pairs cotton drawers			
Great coats		Flannel shirts			
Uniform coats		Cotton shirts			
Uniform jackets		Pairs boots			
Flannel sack coats		Pairs shoes			
Blouses		Pairs socks			
Stable coats		Blankets			
Fatigue overalls		Haversacks			
				MONEY.	
				Specie	\$
				Notes	\$

I CERTIFY, ON HONOR, that the above inventory comprises all the effects of _____
 _____, deceased, and that the effects are in the hands
 of _____ at _____
 _____ to be disposed of by a Council of Administration.

(DUPLICATES.)

STATION: New Orleans, La.

DATE: July 5th 1865

[A. G. O. No. 104.]

 Commanding the Company.

8522. 2188. 1865
18

CASUALTY SHEET

No. _____
Franklin Davis
Private of Company *D*
5th Regiment of *Mass Col*
~~State Volunteers.~~ *Car*

NATURE OF CASUALTY.

Died July 3, 1865

See
David Franklin
W

Franklin Davis

CASUALTY SHEET.

Name: *Franklin Davis*

Rank: *Private "A"* Company: *5th* Regiment: *Mass*

Arm: *10th Cavalry* State: *Mass*

Nature of Casualty: *Death*

CAUSE OF CASUALTY—(NAME OF DISEASE, &C.)

BY WHOM DISCHARGED.

DEGREE OF DISABILITY.

FROM WHAT SOURCE THIS INFORMATION WAS OBTAINED.

BY WHOM CERTIFIED.

Andrew F. Chapman
St. Louis Co.

DATE OF DISCHARGE, DEATH, &C.

July 3, 1865

PLACE OF DISCHARGE, DEATH, &C.

New Orleans La

Mustor Roll of
Co for June 1865
REMARKS.

A. L. Millard
Clerk.

RECORD OF DEATH AND INTERMENT.

Name and number of person interred, *David Franklin*

Number and locality of the grave, -

Hospital number of the deceased, - *6244*

Regiment, Rank, and Company, - - *5 Mass - Cavalry - Private - D*

Residence before enlistment, - - -

Conjugal condition (and if married,)
the residence of the widow,)

Cause of death, } *Typhoid Fever*

Age of the deceased, - - - - -

Nativity, - - - - -

References and Remarks, - - }

Date of death and burial, - - - *July 3rd 1865* 186

[A duplicate of this Record has been forwarded to the Sexton, and the other remains at this Hospital.]

To *Adj. Genl. U.S. Army*
SIR:

It becomes my duty to inform you that the person above described died at this Hospital as herein stated: and that it is desired his remains should be interred with the usual military honors.

Respectfully,

F. E. Reynolds
Surgeon U. S. Army
6 U.S. Infantry
in charge

MILITARY HOSPITAL, *Corps d'Afrique New Orleans.*
Lan

This copy of Record is to be transmitted to the Adjutant General at Washington immediately after the place of burial and the number of the grave have been ascertained and registered. The above notification is to remain attached.

Adm. Serv. Div. (C. Secy. Gen., Div. 13, 56)

Complete
CASUALTY SHEET

No. _____

David Franklin

Priv of Company *A*

5 Regiment of *U.S.C.*

State Volunteers.

NATURE OF CASUALTY.

Died July 3, 1865.

See 5th Mass. bar.
W.

CASUALTY SHEET.

Name: *David Franklin*

Rank: *Priv* Company: *D* Regiment: *5th*

Arm: *U.S. Cavalry* State: _____

Nature of Casualty: *Death*

CAUSE OF CASUALTY—(NAME OF DISEASE, &c.)

BY WHOM DISCHARGED.

DEGREE OF DISABILITY.

FROM WHAT SOURCE THIS INFORMATION WAS OBTAINED.

BY WHOM CERTIFIED.

Roll of Honor
Co. D, Regt. 5th

J. M. Moore
W. M. W. G.

REMARKS.

DATE OF DISCHARGE, DEATH, &c.

July 3, 1865

PLACE OF DISCHARGE, DEATH, &c.

Buried
New Orleans

J. B.

Clerk.

He had no Descriptive List

INVENTORY OF THE EFFECTS

OF
Pvt. David Franklin

Late of Company *G*

5th Reg't of *Mass Cav*

Volunteers, who died at *New Orleans La*

on the *3* day of *July* 186*5*.

Surgeon General's Office,

RECORD & PENSION BUREAU,

Washington, *16 July* 186*5*

The within Inventory is a true copy from the records

of G. A. G. Hospital
New Orleans La, on file in

this Office, and contains all the information in the case that
can be found.

BY ORDER OF THE SURGEON GENERAL:

Bvt. Major, Assistant Surgeon, U. S. A.

le, or be
officer of
mentioned
above his
the De-
paid to
soldier.
e effects
anted to
iment or
anted to
or of the
missioned
and paid

ased non-
e of War,
er of the
e same to
g, &c., in
py of the
arded, as
oldier dies
uty of his
nl, the re-
o forward
belonged,
what time
ion at the
uster roll
y will be
company
of —, —,
s stated in
eported on

officer or
s decease,
under the
ceeds de-
until they

stration, a
ed by the
e Paymas-
mmanding
rsed, "Re-
pany (—)
—, 186—."

be turned
m the Ad-
ves of the
eral, their
ther cases,
Adjutant

a duplicate
opy should
officer.

Copy

Inventory of the effects of David Franklin late
 a private of Captain _____ Company C of
 the 5th Regiment of Mass Cav Volunteers, who was enrolled as
 a _____ at _____ in the State of _____ on
 the _____ day of _____ 186 , and mustered into the service of the United
 States as a _____ on the _____ day of _____ 186- , at _____
 in Company _____ Regiment of _____ Volunteers, to serve _____
 years or during the war; he was born in _____ in the State
 of _____; he was _____ years of age, _____ feet _____ inches
 high, _____ complexion, _____ eyes, _____ hair, and by occupation, when enrolled,
 a _____; he died in Camps d'Aspicure U.S.A. at
New Orleans La on the 3rd day of July 1865, by
 reason of Typhoid Fever.

INVENTORY.

ARTICLES.	No.	ARTICLES.	No.	ARTICLES.	No.
Hats.....		Pairs trousers.....		Knapsacks.....	
Caps.....		Pairs flannel drawers.....			
Forage Caps.....		Pairs cotton drawers.....			
Great coats.....		Flannel shirts.....			
Uniform coats.....		Cotton shirts.....			
Uniform jackets.....		Pairs boots.....			
Flannel sack coats.....		Pairs shoes.....			
Bouses.....		Pairs socks.....			
Sable frocks.....		Blankets.....			
Fatigue overalls.....		Haversacks.....			
				MONEY.	
				Specie.....	\$
				Notes.....	\$

Admitted 90. 30. 1865.

no effects had

I CERTIFY, ON HONOR, that the above inventory comprises all the effects of _____
 deceased, and that the effects are in the hands
 of _____ at _____
 to be disposed of by a Council of Administration.

(DUPLICATES.)

STATION: New Orleans La
 DATE: July 3rd 1865

Commanding the Company.

FINAL STATEMENT

OF

David Franklin

5th Reg't of Mass Cav

VOLUNTEERS.

NOTE 1.—Two of these certificates (or duplicates) are to be given to each Volunteer Soldier or drafted man who may be discharged previously to the discharge of his company, that he may at once receive from the Paymaster the pay, &c., due him, and the captain or other COMMISSIONED officer commanding the company will certify to the act of the delivery of the duplicate certificates; on these certificates the Soldier is "entitled to" his discharge, and should also present his discharge to the Paymaster to have the payment endorsed on it. The discharge is to be given back to the Soldier by the Paymaster; the latter only retaining as his voucher the duplicate certificates.

NOTE 2.—If the Soldier is entitled to pay for the use of his horse, the Company Commander will certify to that fact on the back of both these final statements, and also to the time he has pay due for having been mounted on his own horse.

NOTE 3.—When a Soldier is furnished with final statements, his descriptive list, if he has one, should be taken up by the officer who gives the Soldier these statements, and endorsed with a statement to this effect by the officer. This endorsement should exhibit a full statement of the time for which the Soldier was allowed pay on his final statements, the clothing account, and all other charges against him or in his favor, so as to comprise a complete exhibit of his account. It will then be transmitted to the company commander of the Soldier, who will enter all the data necessary to a full understanding of the Soldier's account on the muster roll upon which the Soldier's discharge is reported. The descriptive list will then be destroyed. The object of this is, that the remaining portion of the Soldier's account may be settled upon the receipt of these muster rolls, and the Soldier receive any pay or allowances that may be due him at the time of his discharge, and which may not appear on his final statements from the fact that his descriptive list is incomplete. These accounts for back pay, &c., are settled by the 2d Auditor of the Treasury Department.

NOTE 4.—Charges for loss or injury to ordnance, horse equipments, and other miscellaneous charges, should appear under the heading of "Other Stoppages."

NOTE 5.—Bounty paid by State authorities, and not by the United States, will not be entered on this statement.

NOTE 6.—Amounts due the Sutler and Laundress must be entered on the muster roll on which the discharge, death, desertion, &c., is reported, as well as on the final statement, otherwise the amount cannot be collected from the United States.

NOTE 7.—This blank will be used for deceased volunteers and drafted men, as well as for others.

NOTE 8.—Where a Soldier dies in Hospital or on detached service, his descriptive list, if he has one, should be sent with his final statements, in duplicate, to the Adjutant General, Washington, D. C.

ADJUTANT GENERAL'S OFFICE
Aug 21 1865
State of Massachusetts, cert 2

I certify, on honor, that David Franklin a Private of
Captain Le Parsons Company (2) of the fifth Regiment of Mass Levee
VOLUNTEERS, of the State of Mass, born in Jefferson Co, State
of Virginia, aged 22 years; 5 feet 8 inches high; Blk complexion,
Blk eyes, Blk hair, and by occupation a Waiter, having joined the company on
its original organization at _____, and enrolled in it at the muster into
the service of the United States at _____, on the _____ day
of _____, 186 _____, (or was mustered in service as a recruit, by Le Parsons
_____, at Boston, on the 14 day of October,
1864, or was drafted and mustered into the service of the United States from the _____
Enrollment District of the State of _____, at _____,
on the _____ day of _____, 186 _____,) to serve in the Regiment, for
the term of _____: and having served **HONESTLY** and
FAITHFULLY with his Company in _____ to the present date, is now
entitled to a **DISCHARGE** by reason of Death.

The said David Franklin was last paid by Paymaster
Major Dodge to include the 31 day of December, 1864, and has
pay due him from that time to the present date; he is entitled to pay and subsistence for
TRAVELING to place of enrollment, and whatever other allowances are authorized to volunteer
soldiers, drafted men, or militia, so discharged. He has received from the United States **CLOTHING**
amounting to 59 46 dollars, since the 31 day of December,
186 _____, when his clothing account was last settled. He has received from the United States
_____ dollars advanced **BOUNTY**.

There is to be stopped from him, on account of the State of _____, or other
authorities, for **CLOTHING**, &c., received on entering service, _____ dollars; and
for other stoppages, viz: _____

_____ dollars.
He has been furnished with **TRANSPORTATION** in kind from the place of his discharge to
_____; and he has been **SUBSISTED** for **TRAVELING** to his
place of enrollment, up to the _____, 186 _____.

He is indebted to _____, **SUTLER**, _____ dollars.

He is indebted to _____, **LAUNDRESS**, _____ dollars.

Given in Duplicate, at Clarksville Texas, this 20 day
of July, 1865.

Andrew J Chapman
Pr. Secy

WAR DEPARTMENT,

ADJUTANT GENERAL'S OFFICE,

WASHINGTON, July 13, 1865.

SIR:

Final Statements in the cases of deceased soldiers are required to be sent to the Adjutant General's Office in duplicate, with one copy of the Inventory of Effects. The Descriptive List should also be sent to this Office in cases where the soldier was absent from his Company at the time of his death. Where there were no effects, it should be so stated on a blank Inventory, properly signed.

Certificates of Disability should be sent in duplicate. Special care should be taken that the date of discharge and signature of the discharging officer should be affixed.

210 of the Final Statement and Inventory, has been received in the case of David Franklin, of Co. A, B Regiment of U.S. Cavalry Volunteers, whose papers were forwarded to this Office. You will please forward the missing papers without delay.

I have the honor to be, sir,

Very respectfully,

Your obedient servant,

Recd July 3, 1865
Bureau of War

J. C. Hazard

Assistant Adjutant General.

(110)

~~COMMANDING OFFICER~~

J. J. Woodward
U.S.A.

afro

Record and Pension Bureau,

Feb'y 13th, 1867.

Respectfully referred to the Medical

Director, Department of the

These papers to be returned with report.

BY ORDER OF THE SURGEON GENERAL:

J. J. Cottrell
Bvt. Maj. and Assistant Surgeon, U. S. A.

Office of Assistant Quartermaster,

New Orleans, La., Feb. 20th 1867.

RESPECTFULLY Returned - no

record of the within & David Franklin Private Co. D. 5th Mass. Cal. died at Camp d'Orgerie Hosp. N. O. July 3rd 1865 and was buried in Monument Cemetery.

E. Strong
Bvt. Lt. Col. & et. 944.

Surgeon General U. S. A.
Washington D. C. The desired papers cannot be furnished or procured by this Office. There is no record of death of the within named in this office, or A. S. G. David Franklin, Private Co. D. 5th Mass. Cal. is reported died at Camp d'Orgerie Gen. Hosp. July 3rd 65 of Typhoid Fever.

T. S. Allen
Bvt Brig. Gen. and Surg. U. S. A., Medical Director.
Records of C. & A. Gen Hospital N. O. La. have been sent to the Surg. Gen. Office

3073

Surgeon General's Office,

Record and Pension Division,

Feb. 28th, 1867.

Respectfully returned to Assistant Adjutant General *J. R. Jaggard*, A. G. O., with an Inventory of Effects enclosed, in case of *Private David Franklin, Co. D, 5th Mass. Cal.* (supposed to be the soldier referred to within).

No evidence on file from which Final Statements can be prepared.



By Order of the Surgeon General:

J. J. Cottrell
Brevet Major and Assistant Surgeon, U. S. Army.

R. of A., Vol. 11 No. 2673

J. R. Jaggard
A. G. O.

WAR DEPARTMENT,

ADJUTANT GENERAL'S OFFICE,

WASHINGTON,

July 22, 1867.

SIR:

Final Statements in the cases of deceased soldiers are required to be sent to the Adjutant General's Office in duplicate, with one copy of the Inventory of Effects. The Descriptive List should also be sent to this Office in cases where the soldier was absent from his Company at the time of his death. Where there were no effects, it should be so stated on a blank Inventory, properly signed.

Certificates of Disability should be sent in duplicate. Special care should be taken that the date of discharge and signature of the discharging officer should be affixed.

No of the Final Statement Or Inventory, has been received in the case of Franklin Davis Private, of Co. "B", 5th Regiment of Mass Col, Cav, Volunteers, whose papers were forwarded to this Office. You will please forward the missing papers without delay.

I have the honor to be, sir,

See [unclear]

Very respectfully,

Your obedient servant,

See [unclear]

See [unclear]

Assistant Adjutant General.

(110)

~~COMMANDING OFFICER~~

J. J. Woodward
a. s. M. G. A.
Surg. Gen. Office

Died July 3, 1865. at New Orleans La.

H. L. M.

472

Frasier, Albert

Co A, 5 Mass. Cav., (Col'd.)

Private

Private

CARD NUMBERS.

1	5-3 f 37 5-3	26
2	5-3 f 3 f 3 9	27
3	5-3 f 3 9 3 3	28
4	5-3 f 4 0 2 9	29
5	5-3 f 4 1 3 3-	30
6	5-3 f 4 2 3 9	31
7	5-3 f 4 3 4 5-	32
8	5-3 f 4 4 4 f	33
9	5-3 f 4 3-5-1	34
10	5-3 f 4 6 5-1	35
11	5-3 f 4 f 2 3	36
12	9 0 9 1 5 6 7	37
13	3 4 3 6 4 4 1 3	38
14	3 0 9 5 3 9 5 3	39
15	4 0 7 3 0 9 5 8	40
		41
		42
		43
		44
		45
		46
		47
		48
		49
		50

Book Mark: *T 46. Vol. 3 R. C. V. 66. 5*
B. V. 10 P. 9

See also

F.

5 Cav. (Col'd.)

Mass.

Albert Frazier.

Co. *K*, 5 Reg't Mass. Cav. (Col'd.)

Appears on

Company Descriptive Book

of the organization named above.

DESCRIPTION.

Age *18* years; height *5* feet *9* inches.

Complexion *Black.*

Eyes *Black*; hair *Black.*

Where born *Sheffield, Sheffield Mass.*

Occupation *Farmer.*

ENLISTMENT.

When *Mar. 29, 1865*

Where *Sheffield.*

By whom *E. E. Callender*; term *3* y'rs.

Remarks: *Single, Residence Sheffield Mass.*

Sent to Hospital, June 14, 1865. Not

reported, dropped Sept. 28, 1865.

H. C. Thomas

359)

Copyist.

4

5 Col'd Cav. | Mass.

William Frazier

Co. B, 5 Reg't Mass. Col'd Cav.

Appears on

Company Muster-in and Descriptive Roll

of the organization named above. Roll dated

Leicester, Mass., April 12, 1864.

Where born Leicester, Mass.

Age 19 y'rs; occupation Farmer

When enlisted May 29, 1864.

Where enlisted Leicester

For what period enlisted 3 years.

Eyes BRN; hair BRN

Complexion BRN; height 5 ft. 9 in.

When mustered in April 12, 1864.

Where mustered in Leicester, Mass.

Bounty paid \$ 100; due \$ 100

Where credited Leicester, Mass.

Company to which assigned

Remarks:

Book mark:

William Frazier

4

5 Col'd Cav.

Mass.

Albert Forzier

Co. K, 5 Reg't Mass. Col'd Cavalry.

Appears on

Company Muster Roll

for the period of April 12th to April 30th, 1864.

Present or absent Present

Stoppage, \$ 100 for

Due Gov't, \$ 100 for

Valuation of horse, \$ 100

Valuation of horse equipments, \$ 100

Remarks:

Book mark:

W. J. ...

112

5 Col'd Cav.

Mass.

Albert Taylor

Co. K, 5 Reg't Mass. Col'd Cavalry.

Appears on

Company Muster Roll

for May Term, 1864.

Present or absent Present

Stoppage, \$ 100 for

Due Gov't, \$ 100 for

Valuation of horse, \$ 100

Valuation of horse equipments, \$ 100

Remarks:

Book mark:

Albert Taylor

F

5 Col'd Cav.

Mass.

Albert Bugier

(P), Co. K, 5 Reg't Mass. Col'd Cavalry.

Appears on

Company Muster Roll

for *July & Aug*, 1864.

Present or absent *Present*

Stoppage, \$ *100* for

Due Gov't, \$ *100* for

Valuation of horse, \$ *100*

Valuation of horse equipments, \$ *100*

Remarks:

Book mark:

Albert

F

5 Col'd Cav.

Mass.

Albert Frazer

Co. K, 5 Reg't Mass. Col'd Cavalry.

Appears on

Company Muster Roll

for Sept 5th 1864, 1864.

Present or absent Present

Stoppage, \$ 100 for

Due Gov't, \$ 100 for

Valuation of horse, \$ 100

Valuation of horse equipments, \$ 100

Remarks:

[Empty lines for remarks]

Book mark:

(358)

[Signature]

Copyist.

7

5 Col'd Cav.

Mass.

Albert Trrazier

3rd, Co. K, 5 Reg't Mass. Col'd Cavalry.

Appears on

Company Muster Roll

for Nov + Dec, 1864.

Present or absent Present

Stoppage, \$ 100 for

Due Gov't, \$ 100 for

Valuation of horse, \$ 100

Valuation of horse equipments, \$ 100

Remarks:

Book mark:

Trrazier

F

5 Col'd Cav.

Mass.

Albert Frasier

Prin, Co. K, 5 Reg't Mass. Col'd Cavalry.

Appears on

Company Muster Roll

for *Jan 1 Feb*, 186*5*.

Present or absent *Present*

Stoppage, \$ *100* for

Due Gov't, \$ *100* for

Valuation of horse, \$ *100*

Valuation of horse equipments, \$ *100*

Remarks:

.....
.....
.....
.....
.....
.....
.....
.....

Book mark:

Out on

9

5 Col'd Cav.

Mass.

Albert Frazier

Prin., Co. K, 5 Reg't Mass. Col'd Cavalry.

Appears on

Company Muster Roll

for Mar 7 Apr, 1865.

Present or absent Present

Stoppage, \$ 100 for

Due Gov't, \$ 100 for

Valuation of horse, \$ 100

Valuation of horse equipments, \$ 100

Remarks:

Book mark:

Edmund

(358)

Copyist.

9

5 Col'd Cav.

Mass.

Albert G. Frasier

Co. K, 5 Reg't Mass. Col'd Cavalry.

Appears on

Company Muster Roll

for May 1865, 1865.

Present or absent Absent

Stoppage, \$ 100 for

Due Gov't, \$ 100 for

Valuation of horse, \$ 100

Valuation of horse equipments, \$ 100

Remarks: Absent sick in
General Hospital since
June 15/65

Book mark:

G. D. ...

(358)

Copyist.

F | 5th Col'd Cav. | Mass.

Albert Frazier
Priv, Co. K, 5th Reg't Mass. C. Cav.

Appears on

Hospital Muster Roll

of McKim's Mansion U. S. A. General Hospital,

at Baltimore, Md.,

for May & June, 1865.

Attached to hospital:

When....., 186 .

How employed

Last paid by Maj.

to, 186 .

Bounty paid \$ 100; due 100

Present or absent Present.

Remarks:

.....

.....

.....

.....

.....

.....

.....

.....

.....

.....

.....

.....

.....

.....

.....

.....

.....

.....

.....

.....

.....

.....

.....

.....

.....

.....

.....

.....

.....

.....

.....

O. H. Underwood

F

5 Col'd Cav.

Mass.

Albert Frazier

Pat, Co. K, 5 Reg't Mass. Col'd Cavalry.

Appears on

Company Muster Roll

for *July & Aug*, 186*5*.

Present or absent *Absent*

Stoppage, \$ *100* for

Due Gov't, \$ *100* for

Valuation of horse, \$ *100*

Valuation of horse equipments, \$ *100*

Remarks: *Absent sick at Norfolk Va. since June 15/65*

Book mark:

Galligan

(358)

Copyist.

F | 56w | Mass

About Frazier

Pvt, Co. K, 5 Reg't Mass Cav

Appears on

Descriptive List of Deserters

from 3 Division, 25 Army Corps,

dated Sept 30, 1865.

Age 25 years; height, 5 feet 6³/4 inches.

Complexion Blk; eyes Blk; hair Blk

Where born Sheffield Co. Mass

Occupation Farmer

When enlisted Mch 29, 1864.

Where enlisted Sheffield Mass

When mustered in Apr 12, 1864.

Where mustered in Readville Mass

For what period mustered in 3 years

Deserted:

When Sept 28, 1865.

Where Brazo Santiago Tex

Remarks: Sent to Hospital at

Petersburg Va. May 5/65

Not heard of since

Dropped as Deserter

Book mark:

Waddington

F | **5 Col'd Cav.** | **Mass.**

Albert Frazier

W., Co. *B*, 5 Reg't Mass. Colored Cav.

Appears on **Returns** as follows:

May 1864 - May 8, '64, Readville, Mass., Left sick in Hospital at Readville, Mass.

June 1864 - June 22, Bermuda Head, returned to duty from Readville, Mass

June & July 1865 - Absent sick in Hospital. June 14, '65, at Fortress Monroe, Va.

Aug. 1865 - Absent sick in Hospital Petersburg, Va. since May 5 - '65

Sept. 1865 - Sept. 28, Brazos, Texas Absent in Hospital Va. since June 14, '65. Not reported Dropped as Deserter.

Book mark :

O. J. Taylor

(546)

Copyist.

F

5 Col'd Cav.

Mass.

Albert Frazier

Pol, Co. K, 5 Reg't Mass. Col'd Cavalry.

Appears on Co. Muster-out Roll, dated
Clarksville Texas Oct. 31, 1865.

Muster-out to date _____, 186 .

Last paid to Dec. 31, 1864.

Clothing account:

Last settled _____, 186 ; drawn since \$ _____ 100

Due soldier \$ 19 ⁶⁶/₁₀₀; due U. S. \$ _____ 100

Am't for cloth'g in kind or money adv'd \$ _____ 100

Due U. S. for arms, equipments, &c., \$ _____ 100

Bounty paid \$ _____ 100; due \$ 300 ⁰⁰/₁₀₀

Remarks: Sent to Hospt at Norfolk
Va. June 14/65. Never heard
of since. Dropped as a
deserter Sept. 28/65.

Book mark: Died July 15, 1865 (over)

Galligan

(861)

Copyist.

See 546 Vol 3 R.C. T./66
V:33. P. 147. 71 F.S.

Charge of desertion removed
Was admitted to McKim's
Hospt June 27/65 and died
July 15/65. Cause of death
Not known.

E. B. V. 10. P. 9

* 1891 *

5384823

JAN. 10

Frazier, Albert

Co. *H.* 5 **Mass. C. Cav.**
Regt

7 Enclosures.

Bed Cards	Descriptive Lists
Burial Records <i>2</i>	Final Statements <i>/</i>
Certs. of Dis. for Discharge	Furloughs
C. M. Charges	Med. Des. Lists
Med. Certificates	Orders

Other papers relating to—

Admission to Hosp'l	Furlough
Casualty Sheet (Officer's)	Med. Examination
Confinement	Misc. Information <i>2</i>
Contracts	Pay or Clothing
Death or Effects <i>/</i>	Personal Reports
Desertions	Rank
Discharge from Hosp'l	Transfer to Hosp'l
Discharge from Service	Transfer to V. R. C.
Duty	Transportation

FINAL STATEMENT

Co "K" 1st Cavalry

OF

Private, West Frasier
Co "K" 1st Cavalry
5th Reg't of Artillery

VOLUNTEERS.

NOTE 1.—Two of these certificates (or duplicates) are to be given to each Volunteer Soldier or drafted man who may be discharged without being mustered out (Final Statements are never given to men mustered out of service.) that he may at once receive from the Paymaster the pay, &c., due him, and the captain or other COMMISSIONED officer commanding the company will certify to the act of the delivery of the duplicate certificates; with these certificates the Soldier is "entitled to" his discharge, and should also present his discharge to the Paymaster to have the payment endorsed on it. The discharge is to be given back to the Soldier by the Paymaster; the latter only retaining as his vouchers the duplicate certificates.

NOTE 2.—If the Soldier is entitled to pay for the use of his horse, the Company Commander will certify to that fact on the back of both these final statements, and also to the time he has pay due for having been so mounted on his own horse.

NOTE 3.—When a Soldier is furnished with final statements, his descriptive list, if he has one, should be taken up by the officer who gives the Soldier these statements, and endorsed with a statement to this effect by the officer. The endorsement should exhibit a full statement of the time for which the Soldier was allowed pay on his final statements, the clothing account, and all other charges against him or in his favor, so as to comprise a complete exhibit of his account. It will then be transmitted to the Company Commander of the Soldier, who will enter all the data necessary to a full understanding of the Soldier's account on the muster roll upon which the Soldier's discharge is reported. The descriptive list will then be destroyed. The object of this is, that the remaining portion of the Soldier's account may be settled upon the receipt of these muster rolls, and the Soldier receive any pay or allowances that may be due him at the time of his discharge, and which may not appear on his last final statements from the fact that his descriptive list is incomplete. These accounts for back pay, &c., are settled by the 2d Auditor of the Treasury Department.

NOTE 4.—Charges for loss or injury to ordnance, horse equipments, and other miscellaneous charges, should appear under the heading of "Other Stoppages."

NOTE 5.—Bounty paid by State authorities, and not by the United States, will not be entered on this statement.

NOTE 6.—Amounts due the Sutler and Laundress must be entered on the muster roll on which the discharge, death, desertion, &c., is reported, as well as on the final statement, otherwise the amount cannot be collected from the United States.

NOTE 7.—This blank will be used for deceased volunteers and drafted men, as well as for officers.

NOTE 8.—Where a Soldier dies in Hospital or on detached service, his descriptive list, if he has one, should be sent with his final statements, in duplicate, to the Adjutant General, Washington, D. C.

NOTE 9.—If the soldier is a drafted man or substitute, the space for time, &c., of enrolled, should contain only the word drafted or substitute, as the case may be. If the Soldier is a "VETERAN," (or RECRUIT) the words as a veteran, (or recruit) as the case may be, should be interlined after the words mustered into the service of the U. S. A statement of all the installments of Veteran or Recruit Bounty RECEIVED by the Soldier must be made on the back of each final statement.

A.G.O.

Deserted from 2nd

Reg't

1st Cavalry

5th Reg't of Artillery

Private, West Frasier

Co "K"

ADJUTANT GENERAL'S OFFICE
July 20 1862
Duplicate to be sent 2d Auditor.

I certify, on honor, that Albert Frazier, a Private of
Captain Higgins Company (K) of the 5th Regiment of W.C. Cavalry
VOLUNTEERS, of the State of _____, born in Sheffield, State
of Mass, aged 21 years; 5 feet 9 inches high; Blk complexion,
Blk eyes, Blk hair, and by occupation a Farmer, who joined for service
and was enrolled (see Note 9) on the 29th day of March, 1864, at Sheffield Mass
by E. Callender, for the period of Three years, and mustered into
the service of the United States on the 12th day of April, 1864, at
Readville Mass, by St. Madden; and having served
HONESTLY and FAITHFULLY with his Company to the present date, is now entitled to a
DISCHARGE by reason of Death from Congestion of Brain
He died at McKim's Mansion Hospital Baltimore Md July 14/65

The said Albert Frazier was last paid by Paymaster
Wm Dodge, to include the 31st day of December, 1864, and
has pay due him from that time to the present date; he is entitled to pay and subsistence for
TRAVELING to place of enrollment, and whatever other allowances are authorized to volunteer
soldiers, drafted men, or militia, so discharged. He has received from the United States **CLOTHING**
amounting to \$ 55 ²⁵/₁₀₀ dollars, since the 30th day of June,
1864, when his clothing account was last settled. He has received from the United States
_____ ¹⁰⁰ dollars advanced **BOUNTY**.

There is to be stopped from him, on account of the State of _____, or other
authorities, for **CLOTHING**, &c., received on entering service, _____ ¹⁰⁰ dollars; and
for other stoppages, viz: _____

_____ ¹⁰⁰ dollars.
He has been furnished with **TRANSPORTATION** in kind from the place of his discharge to
_____, and he has been **SUBSISTED** for **TRAVELING** to his
place of enrollment, up to the _____, 186 .

He is indebted to _____, **SUTLER**, _____ ¹⁰⁰ dollars.

He is indebted to _____, **LAUNDRESS**, _____ ¹⁰⁰ dollars.

Given in Duplicate, at McKim's Hospital Balto Md, this 17th day
of July, 1865 .

W. S. T. M.

Surgeon of Vols

In charge of Hospital **Commanding Company**

I certify, on honor, that Albert Frasier, a Private of
Captain Higgins Company (K) of the 5th Regiment of 14th Cavalry
VOLUNTEERS, of the State of _____, born in Sheffield, State
of Mass, aged 21 years; 5 feet 9 inches high; Blk complexion,
Blk eyes, Blk hair, and by occupation a Farmer, who joined for service
and was enrolled (see Note 9) on the 29th day of March, 1864, at Sheffield Mass
by E. Callender, for the period of Three years, and mustered into
the service of the United States on the 12th day of April, 1864, at
Readville Mass, by St. Madden; and having served
HONESTLY and FAITHFULLY with his Company to the present date, is now entitled to a
DISCHARGE by reason of Death from Congestion of Brain
He died at McKim's Mansion Hospital Baltimore Md July 14/65

The said Albert Frasier was last paid by Paymaster
Max Dodge, to include the 31st day of December, 1864, and
has pay due him from that time to the present date; he is entitled to pay and subsistence for
TRAVELING to place of enrollment, and whatever other allowances are authorized to volunteer
soldiers, drafted men, or militia, so discharged. He has received from the United States **CLOTHING**
amounting to \$ 55 ²³/₁₀₀ dollars, since the 30th day of June,
1864, when his clothing account was last settled. He has received from the United States
_____ ¹⁰⁰ dollars advanced **BOUNTY**.

There is to be stopped from him, on account of the State of _____, or other
authorities, for **CLOTHING**, &c., received on entering service, _____ ¹⁰⁰ dollars; and
for other stoppages, viz: _____

_____ ¹⁰⁰ dollars.
He has been furnished with **TRANSPORTATION** in kind from the place of his discharge to
_____; and he has been **SUBSISTED** for **TRAVELING** to his
place of enrollment, up to the _____, 186 .

He is indebted to _____, **SUTLER**, _____ ¹⁰⁰ dollars.

He is indebted to _____, **LAUNDRESS**, _____ ¹⁰⁰ dollars.

Given in Duplicate, at McKim's Hospital Balto Md, this 17th day
of July, 1865 .

W. S. T. W.

Surgeon of Vols

In charge of Hospital
Commanding Company

Yrs. in regt for \$54.00 Feb 28 1865
Completed 28

CASUALTY SHEET

No. _____
Albert Frazier
Priv of Company K
5th Regiment of Mass Cav.

State Volunteers.

NATURE OF CASUALTY.

Wid July 15th 1865.

Adjutant General's Office
Washington D.C. January 19th 1872
The Muster-out Roll of

Co. "E" 5th Mass. Colored Cavalry, dated Clarksville
Texas, October 31. 1865 reports Private Albert
Frazier "sent to hospital at Norfolk Va
June 14th 1865 - never heard of since. Dropped
as a deserter September 26th 1865."

The Medical Director,
Miss. Military Department, Baltimore,
Md. under date of April 21. 1866. reports
that the above named soldier "was admitted to
W. H. Kim's Hospital June 27th 1865 and
died July 15th 1865 - cause of death not
known."

The charge of desertion will
be removed and the soldier's record will be
amended on the Muster-out Roll, in
accordance with report of Medical Director
Miss. Military Department.

Thoma D. Ingham
S. W. 10th Assistant Adjutant General

11A.
(Bent)
Adm.
Bill.

See letter of January
26 72 to Second Auditor

Execd. 11/10/72

CASUALTY SHEET.

Name: Alfred Frazier
 Rank: Private Company: A Regiment: 5th
 Arm: Mass. Cav. State: _____
 Nature of Casualty: Death

CAUSE OF CASUALTY—(NAME OF DISEASE, &c.)

BY WHOM DISCHARGED.

DEGREE OF DISABILITY.

FROM WHAT SOURCE THIS INFORMATION WAS OBTAINED.
General B. R. C. S. 1866

BY WHOM CERTIFIED.
J. Simpson
Robert S. S. Bell

REMARKS.
 This man was reported on letter as 5th Mass. Cav. but is buried in cemetery of 5th Mass. Cav.
 Taken as evidence of death of man.

DATE OF DISCHARGE, DEATH, &c.
July 15th 1865

PLACE OF DISCHARGE, DEATH, &c.
Dr. McKim's Hospital

Baltimore, Md.

James Beakwith

A. C.

Clerk.

Reported on in office
 July 14, 1865
 Inv. of office sent 2^d and it is
 Aug. 2^d 1866. B.

RECORD OF DEATH AND INTERMENT.

Name and number of person interred.	<i>Albert Frazier</i>
Number and locality of the grave . . .	<i>Laurel Cemetery</i>
Hospital number of the deceased . . .	<i>361</i>
Regiment, rank, and company	<i>5th U.S. Cavalry Private Co K</i>
Residence before enlistment	<i>Sheffield Mass</i>
Conjugal condition, (and if married,)	<i>Single</i>
the residence of the widow)	
Cause of death	<i>Congestion of Brain</i>
Age of the deceased	<i>21 Years</i>
Nativity	<i>Sheffield Mass</i>
References and remarks	<i>P.O address of nearest relative, Morris Frazier, Sheffield Mass</i>
Date of death and burial	
<i>Died July 14th 1865 Burial July 16th 10 O'clock A.M. 1865.</i>	

[A duplicate of this Record has been forwarded to the Sexton, and another remains at this Hospital.]

To

Brig Genl Townsend A.A. M.A.

SIR :

It becomes my duty to inform you that the person above described died at this Hospital as herein stated ; and that it is desired his remains should be interred with the usual military honors.

Respectfully,

[Signature]
Surgeon U. S. Army.

MILITARY HOSPITAL *McKins Mountain Belle Md*

This copy of Record is to be transmitted to the Adjutant General at Washington immediately after the place of burial and the number of the grave have been ascertained and registered. The above notification is to remain attached.

RECORD OF DEATH AND INTERMENT.

✓ Name and number of person interred.	Albert Frazier
Number and locality of the grave . . .	Laurel Cemetery
Hospital number of the deceased . . .	361
Regiment, rank, and company	5 th U.S. Cavalry Private Co "K"
Residence before enlistment	Sheffield Mass
Conjugal condition, (and if married,) the residence of the widow)	Single
Cause of death	Congestion of Brain
Age of the deceased	21 Years
Nativity	Sheffield Mass
References and remarks	P.O. address of nearest relative, Morris Frazier, Sheffield Mass
Date of death and burial	Died July 14 th 1865 Burial July 16 th 10 o'clock AM 1865.

Duplicates sent to the Adjutant General of the United States Army, and to the Sexton of the Cemetery.

Memoranda:

List of Effects
 One (1) Rubber Blanket
 1/2 Shelter Tent
 One (1) P. Pants
 One (1) Blouse
 One (1) P. Shoes

Final Statements and
 Inventory of Effects sent
 to A.S.C. & Co Commander
 July 17th 1865

~~S. 40. vol 3. Part 115 & C.~~

War Department
W 97
Adj't Gen'l's Office
Washington Dec. 12/66

Respectfully referred to the
Medical Director, Depart-
ment of Virginia, Richmond

to be known of the fact and
evidence of death of the
certain named man and
file in his office.

These papers to be
returned

By order of the
Secretary of War
G. S. Suggan
Adj't Gen'l
Washington

a.B.

(1) 100 115
100 115 13-66

On muster out roll of Co H 5 Regt Cav dated Oct 31st /65
Albert Frazier as reported sent to Hqspt Norfolk Va June 14/65, never
heard of since. Reported as a deserter Sept 28/65.

Not found

(90)

(Albert Frasier 5th Mass Cavalry)
Supposed to be dead a Black man

Southfield Mass April 3^d 1866

Adp. General U.S.A.

The Father of Albert Frasier who belonged to the 5th Massachusetts Cavalry has not heard from his son since the 16 of June 1865 (sixty five) he was then sick at Port Smith Virginia ward No 5 — House The name of the House I am unable to read it begins with letter M Have you any record of his death if not where is his Regiment and to whom shall I write. Frasier was a Black Man Will you be so good as to write to

Augustus Sumner

Southfield

Berkshire County

Mass

See J. 58. Vol 3, No 4, 1866

Mo. D. O. Med. Coll. Dept.
Balt. Md. April 21, 1866.
Respectfully returned to the
Adjutant General via Private
Albert Frazier, Co. H. 5th Regt.
Co. Troops was admitted to
Mo. Sims Hospital June
27th 1865 and died July 15th
1865. The cause of death is
not known at this office.
The records of the Mo. Sims
Hospital have been forward-
ed to the Surgeon General's Office.

Simpson
Bvt. Col. & Surgeon U.S.A.
Medical Director

Received Sept 25th 1866
J. S. [Signature]

Medical Director's Office,
 Dept. of the
 Richmond Va. April 13. 1866.
 Respd. Genl. returned.
 It appears from records
 in possession of this
 Office, that the within
 named, Robert Taylor
 was admitted to Surgeon
 and later promoted
 1st Lt. March 20. June
 1865, and transferred
 to Baltimore with
 June 27th 1865.

J. Simons
 1st Lt. Col. of 1st Army
 Medical Director

War Department
 925
 1500.
 Army Surgeon Office
 Washington D.C. 19th
 Robert Taylor returned to
 Medical Director's Office
 Military Department, Dist
 Columbia, attention
 invited to enclosures
 from this Office of the 15th
 inst.

By Order of the
 Secretary of War

 Geo. S. Sargent
 1st Lt. Col. of 1st Army
 15. June 15. 1866.

E. B. S. G. O. 37 143 //

Surgeon General's Office,

Record and Pension Bureau,

April 25 1866

Respectfully returned, with Inventory of Effects enclosed, in case of the within named man.

No evidence on file from which Final Statements can be prepared.

~~John W. ...
Colonel ...
this ...
Merritt~~

By Order of the Surgeon General:

J. G. ...
Brevet Major and Assistant Surgeon U. S. A.
n.f.m.

WAR DEPARTMENT,

ADJUTANT GENERAL'S OFFICE,

WASHINGTON, *April 25*, 1866

SIR:

Final Statements in the cases of deceased soldiers are required to be sent to the Adjutant General's Office in duplicate, with one copy of the Inventory of Effects. The Descriptive List should also be sent to this Office in cases where the soldier was absent from his Company at the time of his death. Where there were no effects, it should be so stated on a blank Inventory, properly signed.

Certificates of Disability should be sent in duplicate. Special care should be taken that the date of discharge and signature of the discharging officer should be affixed.

No. of the Final Statement *0 0 8* Inventory, has been received in the case of *Albert Francis*, of Co. *A*, *5th* Regiment of *Mass, Vol.* Volunteers, whose papers were forwarded to this Office. You will please forward the missing papers without delay.

I have the honor to be, sir,

Very respectfully,

Your obedient servant,

J. H. Hazard

Assistant Adjutant General.
(110)

*Died July 15th 1865
at Baltimore Hospital
(Baltimore Md.)*

~~COMMANDING OFFICER~~

*J. J. Woodward Asst. Surg. U.S.A.,
S. C.*

J. J.

473 James or
" H. J.

Frazier, James W.

Co D, 5 Mass. Cav., (Col'd.)

Private

Private

CARD NUMBERS.

1	5-3776916	26
2	5-3777005	27
3	5-3777092	28
4	5-3777183	29
5	5-3777291	30
6	5-3777396	31
7	5-3777496	32
8	5-3777606	33
9	5-3777709	34
10	5-3777806	35
11	5-3777896	36
12	5-3777992	37
13	9092286	38
14	40730986	39
15		40
16		41
17		42
18		43
19		44
20		45
21		46
22		47
23		48
24		49
25		50

Book Mark:

See also

5 Cav. (Col'd.) | Mass.

James H. Taylor

, Co., 5 Reg't Mass. Cav. (Col'd.)

Appears on

Company Descriptive Book

of the organization named above.

DESCRIPTION.

Age *17* years; height *5* feet *1* inches.

Complexion *Swedish*

Eyes *Blue*; hair *Dark*

Where born *Sweden*

Occupation *Farmer*

ENLISTMENT.

When *June 1*, 186*1*

Where *Sweden*

By whom *Company*; term *5* y'rs.

Remarks: *Mustard soldier*
21. 1864. at head of 4 Reg't

(Signature)

F

5 Col'd Cav.

Mass.

James W. Thrazier

Priv, Co. *D*, 5 Reg't Mass. Col'd Cav.

Appears on

Company Muster-in and Descriptive Roll

of the organization named above. Roll dated

Readville Mass, *July 29*, 1864.

Where born

Zanesville Ohio

Age *19* y'rs; occupation

Laborer

When enlisted

July 21, 1864.

Where enlisted

Boston W. I.

For what period enlisted

3 years.

Eyes

BLU

; hair

BLU

Complexion

BLU

; height

5 ft. *2* in.

When mustered in

July 29, 1864.

Where mustered in

Readville Mass.

Bounty paid \$

100

; due \$

100

Where credited

3 Dist Suffolk

Company to which assigned

Remarks:

Book mark:

Linnis

(356d)

Copyist.

57

5 Col'd Cav.

Mass.

James A. Frazer

Private, Co. D, 5 Reg't Mass. Col'd Cavalry.

Appears on

Company Muster Roll

for Enlistment to July 24, 1864.

Present or absent Present

Stoppage, \$ 100 for

Due Gov't, \$ 100 for

Valuation of horse, \$ 100

Valuation of horse equipments, \$ 100

Remarks: Detained at the Adjutant's Office

Book mark:

(358)

James A. Frazer Copyist.

77

5 Col'd Cav.

Mass.

James H.razier

Sgt, Co. D, 5 Reg't Mass. Col'd Cavalry.

Appears on

Company Muster Roll

for March + April, 1864.

Present or absent Present.

Stoppage, \$ 100 for

Due Gov't, \$ 100 for

Valuation of horse, \$ 100

Valuation of horse equipments, \$ 100

Remarks:

Book mark:

James H.razier

(358)

Copyist.

62

5 Col'd Cav.

Mass.

Simon H. Trayer

711, Co. D, 5 Reg't Mass. Col'd Cavalry.

Appears on

Company Muster Roll

for *May + June*, 1864.

Present or absent *Present*

Stoppage, \$ *100* for

Due Gov't, \$ *100* for

Valuation of horse, \$ *100*

Valuation of horse equipments, \$ *100*

Remarks:

Book mark:

Lewis
Copyist.

H

5 Col'd Cav.

Mass.

James H. Frazer

H, Co. D, 5 Reg't Mass. Col'd Cavalry.

Appears on

Company Muster Roll

for *July & Aug.*, 186 *4*

Present or absent *Present*

Stoppage, \$ *100* for

Due Gov't, \$ *100* for

Valuation of horse, \$ *100*

Valuation of horse equipments, \$ *100*

Remarks: *Detached 2^o New*
Batt. July 5th 1864

Book mark: _____

(358)

S. Merchant

Copyist.

J

5 Col'd Cav.

Mass.

James H. Hrozien
P., Co. D, 5 Reg't Mass. Col'd Cavalry.

Appears on

Company Muster Roll

for *Sept & Oct*, 186*4*

Present or absent *Absent*

Stoppage, \$ *100* for

Due Gov't, \$ *100* for

Valuation of horse, \$ *100*

Valuation of horse equipments, \$ *100*

Remarks: *In confinement at G. B. H.,
awaiting trial by G. C. M.*

Book mark:

J. Mendham

(358)

Copyist.

J

5 Col'd Cav.

Mass.

James H. Frazee

Co. D, 5 Reg't Mass. Col'd Cavalry.

Appears on

Company Muster Roll

for *Am & Dec*, 1864.

Present or absent *Present*

Stoppage, \$ *100* for

Due Gov't, \$ *100* for

Valuation of horse, \$ *100*

Valuation of horse equipments, \$ *100*

Remarks: *Return to Company
(Am & Dec from confine ment)
In the store for Newcomb &
Couten, 95*

Book mark:

S. Merchant

(358)

Copyist.

Jr

5 Col'd Cav.

Mass.

James H. Frazier

Pr, Co. D, 5 Reg't Mass. Col'd Cavalry.

Appears on

Company Muster Roll

for *Jan & Feb*, 1865

Present or absent *Present*

Stoppage, \$ *100* for

Due Gov't, \$ *100* for

Valuation of horse, \$ *100*

Valuation of horse equipments, \$ *100*

Remarks: *All 1, 2, 3, 4 Instal^{ts}
MS Bount*

Book mark:

J. Merchants

No

5 Col'd Cav.

Mass.

James H. Frazier

Priv., Co. D, 5 Reg't Mass. Col'd Cavalry.

Appears on

Company Muster Roll

for *March & April*, 1865.

Present or absent *Present*

Stoppage, \$ *100* for

Due Gov't, \$ *100* for

Valuation of horse, \$ *100*

Valuation of horse equipments, \$ *100*

Remarks: *Due 1, 2, 3, 4, June U.S.,
Bounty,*

Book mark:

J. Merchant

(358)

Copyist.

F

5 Col'd Cav.

Mass.

James H Feazier

Pvt, Co. D, 5 Reg't Mass. Col'd Cavalry.

Appears on

Company Muster Roll

for May and June, 1865.

Present or absent Present

Stoppage, \$ 100 for

Due Gov't, \$ 100 for

Valuation of horse, \$ 100

Valuation of horse equipments, \$ 100

Remarks:

Free before April 19, 1861
Due 1 2 3 4 5 Ind. U.S.
County

Book mark:

House

J

5 Col'd Cav.

Mass.

James Frasure

Priv, Co. D, 5 Reg't Mass. Col'd Cavalry.

Appears on

Company Muster Roll

for *July and Aug.*, 1865.

Present or absent *Absent*

Stoppage, \$ *100* for

Due Gov't, \$ *100* for

Valuation of horse, \$ *100*

Valuation of horse equipments, \$ *100*

Remarks:

*Free April 19, 1861. Que
1 2 3 4 5 Enrolled. Bounty
in compensation in Regt
9. H. since July 29/65.
Step value of one Mognard
Carbine \$ 30.00*

Book mark:

House

J | **5 Col'd Cav.** | **Mass.**

James Frazier
Plt., *Co A*, 5 Reg't Mass. Colored Cav.

Appears on **Returns** as follows:

*Aug. & Sept. 1864 - Absent on
duty at 2 Wis. Battery.*

Book mark:

(546)

O. J. Taylor

Copyist.

F

5 Col'd Cav.

Mass.

James Feazie

Prs, Co. D, 5 Reg't Mass. Col'd Cavalry.

Appears on Co. Muster-out Roll, dated

Clarksville Texas Oct 31, 1865.

Muster-out to date Oct 31, 1865.

Last paid to Dec 31, 1864.

Clothing account:

Last settled....., 186 ; drawn since \$ 100

Due soldier \$ 100; due U. S. \$ 78 ²¹/₁₀₀

Am't for cloth'g in kind or money adv'd \$ 100

Due U. S. for arms, equipments, &c., \$ 33 ⁶⁰/₁₀₀

Bounty paid \$ 100; due \$ 300 ⁶⁰/₁₀₀

Remarks:

Total money value of
advance charged \$ 33.60
Less value of arms & quarant
Carriage

Book mark:

House

474

Frazier, Richard

Co D, 5 Mass. Cav., (Col'd.)

Private

Private

CARD NUMBERS.

1	5-3776913	26
2	5-377006	27
3	5-377093	28
4	5-377184	29
5	5-377292	30
6	5-377397	31
7	5-377497	32
8	5-377607	33
9	5-377710	34
10	5-372847	35
11	5-377807	36
12	5-377941	37
13	5-378040	38
14	9092284	39
15	40730957	40
16		41
17		42
18		43
19		44
20		45
21		46
22		47
23		48
24		49
25		50

Book Mark: E.B.V. 10 P. 310.

See also

F 5 Cav. (Col'd.) | Mass.

Richard Frazier

....., Co *D*, 5 Reg't Mass. Cav. (Col'd.)

Appears on

Company Descriptive Book

of the organization named above.

DESCRIPTION.

Age *40* years; height *5* feet *9* inches.

Complexion *Blk*

Eyes *Blk*; hair *Blk*

Where born *Washington, D.C.*

Occupation *Carpenter*

ENLISTMENT.

When *Jan 14*, 186 .

Where *Sumner*

By whom *W. M. Smith*, term *5* y'rs.

Remarks: *Mustered out of the service of the U.S. Army 21st Regt at Fortrose Sumner on 10/11.*

F

5 Col'd Cav.

Mass.

Richardrazier

Priv, Co. *A*, 5 Reg't Mass. Col'd Cav.

Appears on

Company Muster-in and Descriptive Roll

of the organization named above. Roll dated

Readville Mass, Jan 29, 1864.

Where born *Washington D.C.*

Age *40* y'rs; occupation *Carpenter*

When enlisted *July 14*, 1864.

Where enlisted *Winton*

For what period enlisted *3* years.

Eyes *Blk*; hair *Blk*

Complexion *Blk*; height *5* ft. *7* in.

When mustered in *July 29*, 1864.

Where mustered in *Readville Mass*

Bounty paid \$ *100*; due \$ *100*

Where credited *2 Dent Breast*

Company to which assigned

Remarks:

Book mark:

Lewis

57

5 Col'd Cav.

Mass.

Richard Frazer

Put, Co. D, 5 Reg't Mass. Col'd Cavalry.

Appears on

Company Muster Roll

for Enrollment to July 29, 1864.

Present or absent Present

Stoppage, \$ 100 for

Due Gov't, \$ 100 for

Valuation of horse, \$ 100

Valuation of horse equipments, \$ 100

Remarks:

Book mark:

(358)

James Copyist.

67

5 Col'd Cav.

Mass.

Richardrazier

Priv, Co. D, 5 Reg't Mass. Col'd Cavalry.

Appears on

Company Muster Roll

for *March & April*, 1864.

Present or absent *Present*

Stoppage, \$ 100 for

Due Gov't, \$ 100 for

Valuation of horse, \$ 100

Valuation of horse equipments, \$ 100

Remarks:

Book mark:

(358)

[Signature]
Copyist.

57

5 Col'd Cav.

Mass.

Richard Thayer

Art, Co. D, 5 Reg't Mass. Col'd Cavalry.

Appears on

Company Muster Roll

for May & June, 1864.

Present or absent Present.

Stoppage, \$ 100 for

Due Gov't, \$ 100 for

Valuation of horse, \$ 100

Valuation of horse equipments, \$ 100

Remarks:

[Empty lines for remarks]

Book mark:

[Signature]

Je

5 Col'd Cav.

Mass.

Richard Frazier

Pri, Co. D, 5 Reg't Mass. Col'd Cavalry.

Appears on

Company Muster Roll

for *July & Aug, 1864*

Present or absent *Present*

Stoppage, \$ *100* for

Due Gov't, \$ *100* for

Valuation of horse, \$ *100*

Valuation of horse equipments, \$ *100*

Remarks: *Sail, duty Hospital
Attendant Aug 12/64*

Book mark:

J. Merchant

(358)

Copyist.

H

5 Col'd Cav.

Mass.

Richard Terzian

Priv, Co. D, 5 Reg't Mass. Col'd Cavalry.

Appears on

Company Muster Roll

for *Sept & Oct*, 1864.

Present or absent *Present*

Stoppage, \$..... 100 for

Due Gov't, \$..... 100 for

Valuation of horse, \$..... 100

Valuation of horse equipments, \$..... 100

Remarks: *Sick, sent Hospital
attendant Aug 12, 1864*

Book mark:

S. Mercher

(358)

Copyist.

9
J

5 Col'd Cav.

Mass.

Richard Kragier

Pvt., Co. D, 5 Reg't Mass. Col'd Cavalry.

Appears on

Company Muster Roll

for Am & Dec, 1864

Present or absent Present

Stoppage, \$ 100 for

Due Gov't, \$ 100 for

Valuation of horse, \$ 100

Valuation of horse equipments, \$ 100

Remarks: Return N. Company
Am & Dec from attendant
in Hospital
Dr. Me. Store for Massachusetts
Cavalry 95

Book mark:

V. Alexander

(358)

Copyist.

10

5 Col'd Cav.

Mass.

Richard Magee

Pl., Co. D, 5 Reg't Mass. Col'd Cavalry.

Appears on

Company Muster Roll

for Jan & Feb, 1865.

Present or absent Present

Stoppage, \$ 100 for

Due Gov't, \$ 100 for

Valuation of horse, \$ 100

Valuation of horse equipments, \$ 100

Remarks: Due 1, 2, 3, 4 Instants
MS, Bounty

Book mark:

A. Merchant

(358)

Copyist.

27

5 Col'd Cav.

Mass.

Richard Traylor

Pr., Co. D, 5 Reg't Mass. Col'd Cavalry.

Appears on

Company Muster Roll

for March 8 (copy), 1865.

Present or absent Present

Stoppage, \$ 100 for

Due Gov't, \$ 100 for

Valuation of horse, \$ 100

Valuation of horse equipments, \$ 100

Remarks: Dec 1, 2, 3, 4, No US
Bonus

Book mark:

A. S. Meacham & Co

(358)

Copyist.

F

5 Col'd Cav.

Mass.

Richard Feazure

Pvt., Co. D, 5 Reg't Mass. Col'd Cavalry.

Appears on

Company Muster Roll

for May and June, 1865.

Present or absent Absent

Stoppage, \$ 100 for

Due Gov't, \$ 100 for

Valuation of horse, \$ 100

Valuation of horse equipments, \$ 100

Remarks:

Free before April 19, 1861
Due 1, 2, 3, 4, 5 Mrs. U.S.
bounty sick in Hospital
at City Point - Va 6/65

Book mark:

House

(358)

Copyist.

5 Col'd Cav. Mass.

Richard G. ...
Co. D, 5 Reg't Mass. Col'd Cavalry.

Appears on an

Individual Muster-out Roll

of the organization named above. Roll dated

June 24, 1865.

Muster-out to date June 24, 1865.

Last paid to Dec 31, 1864.

Clothing account:

Last settled Dec 31, 1864; drawn since \$ 100

Due soldier \$ 100; due U. S. \$ 100

Am't for cloth'g in kind or money adv'd \$ 100

Due U. S. for arms, equipments, &c., \$ 100

Bounty paid \$ 100 due \$ 300 100

Remarks: Due U.S. of last settlement of clothing Dec 31, 1864. \$ 300. Said Soldier was free on 19/01 (Mustered out by order)

Book mark:

Richard G. ...

JAN. - 9

5372847

1891 *

Order of War Dept
Dated May 3/65.
Patient in U.S.
Gen'l Hospital,
Fort Monroe, Va.

F

5 Col'd Cav.

Mass.

Richard Trassie

Priv, Co. D, 5 Reg't Mass. Col'd Cavalry.

Appears on

Company Muster Roll

for *July and Aug.*, 1865.

Present or absent

Stoppage, \$ 100 for

Due Gov't, \$ 100 for

Valuation of horse, \$ 100

Valuation of horse equipments, \$ 100

Remarks:

*Mustered out of service
June 24, 65 under S. O.
77 War Dept. A. G. O. dated
May 3 / 65*

Book mark:

House

(358)

Copyist.

G | **5 Col'd Cav.** | **Mass.**

Richard Frazier
Pvt., Co. D, 5 Reg't Mass. Colored Cav.

Appears on **Returns** as follows:

*July 1864 - Absent on duty
at the Stockade*

*Sept. & Oct. 1864 - On duty
Hospital Att.*

*Aug. 1865 - June 17, '65 For-
tress Monroe Mustered
out of service under
G.O. 77.*

*Name appears also as
Frazier.*

Book mark:

O. J. Taylor

(546)

Copyist.

F

5 Col'd Cav.

Mass.

Richard Frasier

Pat, Co. C, 5 Reg't Mass. Col'd Cavalry.

Appears on Co. Muster-out Roll, dated
Clarksville Texas Oct. 31, 1865.

Muster-out to date _____, 186 .

Last paid to _____, 186 .

Clothing account:

Last settled _____, 186 ; drawn since \$ _____ 100

Due soldier \$ _____ 100; due U. S. \$ _____ 100

Am't for cloth'g in kind or money adv'd \$ _____ 100

Due U. S. for arms, equipments, &c., \$ _____ 100

Bounty paid \$ _____ 100; due \$ _____ 100

Remarks:

Discharged out of service June
21, 1865 at Fort Monroe
Va. under G.O. 77

Book mark Discharge June 24/65

(over)

House

JAN. - 9

5378040

1891 *

Q B. N. 10. P 310

475

Freeman Charles

Co., 5 Mass. Cav., (Col'd.)

Private

Private

CARD NUMBERS.

1	5-373054	26
2	5372848	27
3	R.P. 336,266	28
4		29
5		30
6		31
7		32
8		33
9		34
10		35
11		36
12		37
13		38
14		39
15		40
16		41
17		42
18		43
19		44
20		45
21		46
22		47
23		48
24		49
25		50

Book Mark: R.P. 336,266.

See also G. M. S. Col. Inf.

RAP 336 266.

RAP 341 067.

0.720076 2nd am

S. 766 555 2nd and r.e.

S 868 513 P.D.

S 1119 814 - And 110 County

01961552 DO. Ptd

2nd am. History 1/8/33

D. Jordan
ex

Charles Simmons
unassigned
Co., 5 Reg't Mass. Col'd Cavalry.

Appears on an

Individual Muster-out Roll

of the organization named above. Roll dated

Boston Mass, Dec 19, 1865.

Muster-out to date *Oct 31, 1865.*

Last paid to *pay due from Regiment* 186

Clothing account:

Last settled _____, 186 ; drawn since \$ _____ 100

Due soldier \$ _____ 100; due U. S. \$ _____ 100

Am't for cloth'g in kind or money adv'd \$ _____ 100

Due U. S. for arms, equipments, &c., \$ _____ 100

Bounty paid \$ _____ 100 due \$ _____ 100

Remarks: *\$1000 U.S. Bounty paid*
Due Soldier for grubstake
Clothing \$ 422
Paid in Hospital for
the month of May & June 1865
Absent sick (over)

Book mark: *Reg. 236, 266.*

Witnessed

JAN. - 9

5372848

1891

Hospital at Fortness
Monroe when Regiment
was mustered out.

Discharged by
S. O. 29 Dept of
Texas. Admitted
Texas Sept 16/65
Mustering out
via Regiment 1.

Enrolled & mustered in
Jan. 3/65 at Portsmouth.
N.H. for 3 yrs.
Name not taken up on
muster Rolls of Regt.

5 Col'd Cav.

Mass.

Charles Newman
Capt, Co., 5 Reg't Mass. Col'd Cavalry.

Appears on a

List of Discharges furnished by C. M. O. of State,
under the provisions of circular dated A. G. O.,
June 29, 1865.

Discharge furnished 186 ,

to date from 186 .

Remarks: *Discharged by S.O.*
29 Hd Qrs 2 Dept
of Texas Sept 1865

Book Mark :

Steward

(360)

Copyist.

I | 5 Cav. | Mass.

Charles Freeman
Pvt., ~~Mass.~~, 5 Reg't Mass. Cav.

NOTATION.

Book mark: P. P. 336266

Record and Pension Office,

WAR DEPARTMENT,

Washington, Jan. 7, 1897.

Discharge certificate on
file.

A. G. M.

(438)

Copyist.

Freeman, Charles

P, Co., *5* Reg't *Mass. Cav.*

4 Enclosures.

Bed Cards	Final Statements
Burial Records	Furloughs or L. of A.
Certs. of Dis. for Discharge	Med. Certificates
C. M. Charges	Med. Des. Lists <i>/</i>
Descriptive Lists	Orders <i>/</i>
Discharge Certificates	Pris. of War Record
Enlistment Papers	Resignations

Other papers relating to—

Admission to Hosp'l	Furlough or L. of A.
Casualty Sheet	Med. Examination
Confinement	Misc. Information
Contracts	Pay or Clothing
Death or Effects	Personal Reports
Desertion	Rank
Discharge from Hosp'l	Transfer to Hosp'l
Discharge from Service	Transfer to V. R. C.
Duty	Transportation

Col. Freeman

Co -
1st Mass Cav

This paper was found in the files of the Provost
Marshal's Office with the records received
from the Chief Mustering Officer of Massachusetts.

Office A. A. P. M. General ^(M)
Chief M. O. Genl. ^(M) R. S.
Hartford, Conn. Nov. 27th 1885.

Special Order
(No. 101.)

(Extract)

11. Private Charles Freeman Company "A"
5th Regiment Massachusetts Volunteer Infantry, a straggler
having arrived with the 29th Regiment Massachusetts
Infantry and reported at this office for muster out
of service, is hereby ordered to proceed without
delay to Boston, Massachusetts, and report to
the Chief Muster Officer at that place.
The Quartermaster's Department will furnish
the necessary transportation.

By order of
Col. H. C. Gilbert dep. A.

A. A. P. M. General ^(M) R. S.

J. H. Arthur
Quar. Major of Army
Inspector

126 ✓ 126
 MUSTER AND DESCRIPTIVE ROLL of a Detachment of United States Volunteers Mustered into Service and, forwarded by Capt Daniel Hall Co West 1st of Dist A.H. for the Regiment of Volunteers via General Keadygrove stationed at Concord, N.H. pursuant to President's Call for Volunteers dated December 19th 1864

No.	NAMES <small>(The names of the commissioned officers an company, or the detachment to be written at the head of the roll. The names of the privates and the names of those listed in a company to follow in alphabetical order.)</small>	RANK.	WHERE BORN.		AGE.	OCCUPATION.	ENLISTED.				EYES.	HAIR.	COMPLEXION.	HEIGHT. Feet, Inches	MUSTERED INTO SERVICE. <small>(See Note)</small>			LAST PAID.		BOUNTY.		CLOTHING ACCOUNT.		DATE OF FIRST MUSTER.	NAMES. <small>(This column to be filled up by the officer in command of the detachment, or by the commanding officer of the post, when no commissioned officer accompanies it, and to include only the names of those present on the day of arrival at the post or Regiment.)</small>	LETTERS OF COMMISSIONS TO WHICH ASSIGNED.	REMARKS.
			Town, County, or Province.	State, Empire, or Kingdom.			When.	Where. (Town and State)	By whom.	Period.					When.	Where.	By whom.	PAID.	DUE.	DATE OF LAST SETTLEMENT.	TOTAL MONEY VALUE OF CLOTHING DRAWN SINCE LAST SETTLEMENT.						
			When.	Where. (Town and State)			By whom.	Period.	When.	Where.					By whom.	Dolls.	Dolls.	Dolls.	Dolls.								
780	Thuman Charles	Private	St John	New Brunswick	21	Laborer	Jan 3 rd 1865	Blomont, N.H.	Capt Daniel Hall	3 yrs	Black	Black	Black	5 7/8	Jan 3 rd 1865	Blomont, N.H.	Capt Daniel Hall	Pay due from Establishment	100	200	July 3 rd 1865	\$20.00	Thuman Charles	Att.	Credited to East Kingston, a receipt exhibited to company.		

Max Department, Adjutant Genl
 Washington, D.C. September 1865
 True copy for records of West Mass. of the
 furnished for the information of Thomas of Cold Spring
 Thomas M. Sargent
 Adjutant Genl

4-10

Freeman, Noah

Co D, 5 Mass. Cav., (Col'd.)

Private

Private

CARD NUMBERS.

1	5-376914	26
2	5-377007	27
3	5-377094	28
4	5-377185	29
5	5-377293	30
6	5-377394	31
7	5-377494	32
8	5-377604	33
9	5-377711	34
10	5-377804	35
11	5-377897	36
12	5-372797	37
13	5-377993	38
14	9092287	39
15	40730960	40
16		41
17		42
18		43
19		44
20		45
21		46
22		47
23		48
24		49
25		50

Book Mark:

See also

5 Cav. (Col'd.) | Mass.

North ...

..., Co. ..., 5 Reg't Mass. Cav. (Col'd.)

Appears on

Company Descriptive Book

of the organization named above.

DESCRIPTION.

Age *18* years; height *5* feet *5* inches.

Complexion *fair*

Eyes *blue*; hair *brunet*

Where born *Worcester, Mass.*

Occupation *carriage maker*

ENLISTMENT.

When *June 1*, 186 .

Where *Worcester*

By whom *...*; term *3* y'rs.

Remarks: *...*

57

5 Col'd Cav.

Mass.

Noah Freeman

Pvt., Co. D., 5 Reg't Mass. Col'd Cav.

Appears on

Company Muster-in and Descriptive Roll

of the organization named above. Roll dated

Readville Mass, July 29, 1864.

Where born Murfreesboro N.C.

Age 18 y'rs; occupation Shoemaker.

When enlisted July 15, 1864.

Where enlisted Hannover.

For what period enlisted 3 years.

Eyes BLK; hair BLK

Complexion BLK; height 5 ft. 3 1/2 in.

When mustered in July 29, 1864.

Where mustered in Readville Mass

Bounty paid \$ 100; due \$ 100

Where credited 2 Dist Plymouth

Company to which assigned

Remarks:

Book mark:

James

(356d)

Copyist.

57

5 Col'd Cav.

Mass.

Noah Freeman

Private, Co. D, 5 Reg't Mass. Col'd Cavalry.

Appears on

Company Muster Roll

for *Enlistment to July 29*, 186*4*.

Present or absent

Present

Stoppage, \$..... 100 for

Due Gov't, \$..... 100 for

Valuation of horse, \$..... 100

Valuation of horse equipments, \$..... 100

Remarks:

Book mark:

[Signature]

57

5 Col'd Cav.

Mass.

Isaac Freeman

Det., Co. D, 5 Reg't Mass. Col'd Cavalry.

Appears on

Company Muster Roll

for Dec & Jan, 1864.

Present or absent Present

Stoppage, \$ 100 for

Due Gov't, \$ 100 for

Valuation of horse, \$ 100

Valuation of horse equipments, \$ 100

Remarks:

Book mark:

(358)

Copyist.

57

5 Col'd Cav.

Mass.

Joan Freeman

Dr, Co. D, 5 Reg't Mass. Col'd Cavalry.

Appears on

Company Muster Roll

for *May + June*, 1864.

Present or absent *Present*

Stoppage, \$ *100* for

Due Gov't, \$ *100* for

Valuation of horse, \$ *100*

Valuation of horse equipments, \$ *100*

Remarks:

Book mark:

F

5 Col'd Cav.

Mass.

Noah Freeman

Pl, Co. D, 5 Reg't Mass. Col'd Cavalry.

Appears on

Company Muster Roll

for *July & Aug*, 186*4*.

Present or absent *Present*

Stoppage, \$ *100* for

Due Gov't, \$ *100* for

Valuation of horse, \$ *100*

Valuation of horse equipments, \$ *100*

Remarks:

Book mark: *300*

A. M. Mearns

(358)

Copyist.

27

5 Col'd Cav.

Mass.

Asah Freeman

Prin, Co. D, 5 Reg't Mass. Col'd Cavalry.

Appears on

Company Muster Roll

for Sept & Oct, 1864.

Present or absent Present

Stoppage, \$ 100 for

Due Gov't, \$ 100 for

Valuation of horse, \$ 100

Valuation of horse equipments, \$ 100

Remarks:

Book mark:

J. Merchant

(358)

Copyist.

14
H

5 Col'd Cav.

Mass.

Abah Freeman

Plt, Co. D, 5 Reg't Mass. Col'd Cavalry.

Appears on

Company Muster Roll

for Apr & Dec, 1864.

Present or absent Present

Stoppage, \$ 100 for

Due Gov't, \$ 100 for

Valuation of horse, \$ 100

Valuation of horse equipments, \$ 100

Remarks: Dr. M. Stow for Haversuch & Canteen 95

Book mark:

A. Merchant

(358)

Copyist.

F

5 Col'd Cav.

Mass.

Wah Freeman

Pr, Co. D, 5 Reg't Mass. Col'd Cavalry.

Appears on

Company Muster Roll

for *Jan'y Feb*, 1865

Present or absent *Present*

Stoppage, \$ *100* for

Due Gov't, \$ *100* for

Valuation of horse, \$ *100*

Valuation of horse equipments, \$ *100*

Remarks: *Due 1, 2, 3, 4 Instal^{ts}*
U.S. Bounty

Book mark:

S. Merchant

27

5 Col'd Cav.

Mass.

Scoble Freeman

Private, Co. D, 5 Reg't Mass. Col'd Cavalry.

Appears on

Company Muster Roll

for Major (Capt), 1865.

Present or absent Present

Stoppage, \$ 100 for

Due Gov't, \$ 100 for

Valuation of horse, \$ 100

Valuation of horse equipments, \$ 100

Remarks: Due 1, 2, 3, 4, Ins U.S. Bond

Book mark:

S. Merchant

(358)

Copyist.

F

5 Col'd Cav.

Mass.

Noah Freeman

Pvt., Co. D, 5 Reg't Mass. Col'd Cavalry.

Appears on

Company Muster Roll

for May and June, 1865.

Present or absent Absent

Stoppage, \$ 100 for

Due Gov't, \$ 100 for

Valuation of horse, \$ 100

Valuation of horse equipments, \$ 100

Remarks:

Free before April 19, 1861
Que 1, 2, 3, 4, 5, Ins U.S.
Army on detach. duty
Hd. Qrs 25 A.C. City Pt.
May 12/65

Book mark:

House

F

5 Col'd Cav.

Mass.

Noah Freeman

Pr, Co. D, 5 Reg't Mass. Col'd Cavalry.

Appears on

Company Muster Roll

for *July and Aug.*, 1865.

Present or absent *Absent*

Stoppage, \$ 100 for

Due Gov't, \$ 100 for

Valuation of horse, \$ 100

Valuation of horse equipments, \$ 100

Remarks:

*Free April 19, 1861. Dec
1 2 3 4 5 In U.S. County
on detached duty at Hd Qrs
25 Corps since May 12/65*

Book mark:

House

5

5 Col'd Cav.

Mass.

Stark Freeman
Co., Co., 5 Reg't Mass. Col'd Cavalry.

Appears on a

Detachment Muster Roll

of the organization named above

for *Aug 31*, 186*7*.

Station *Argon Santiago, Texas*

Present or absent *Present*

Stoppage, \$ *100* for

Due Gov't, \$ *100* for

Valuation of horse, \$ *100*

Valuation of horse equipments, \$ *100*

Remarks: *Nothing acct settled up
to Dec 31/64. Due 1, 2, 3, 4 x 5"
Instruments of Regt. Account*

Book mark: *36*

F

5 Col'd Cav.

Mass.

Noah Freeman

Co. D, 5 Reg't Mass. Colored Cav.

Appears on Returns as follows:

May to Sept 1865 - absent on
detached duty at Ad. Qrs,
25, A.C. since May 12, '65.

Book mark:

O. T. ...

(546)

Copyist.

F | **5 Col'd Cav. Mass.**

Noah Freeman

Priv, Co. *Q*, 5 Reg't Mass. Col'd Cavalry.

Appears on **Co. Muster-out Roll**, dated *Clarkville Texas Oct 31, 1865.*

Muster-out to date *Oct 31, 1865.*

Last paid to *June 30*, 1864.

Clothing account:

Last settled....., 186 ; drawn since \$..... 100

Due soldier \$..... 100; due U. S. \$ *16* ^{*72*}/₁₀₀

Am't for cloth'g in kind or money adv'd \$..... 100

Due U. S. for arms, equipments, &c., \$ *11* ^{*60*}/₁₀₀

Bounty paid \$..... 100; due \$ *200* ^{*00*}/₁₀₀

Remarks:

*Total money value of
advance charged U.S.*

Book mark:

Howe

477

Freeman, Samuel

Co A, 5 Mass. Cav., (Col'd.)

Private

Private

CARD NUMBERS.

1	5-373243	26
2	5-373364	27
3	5-373451	28
4	5-373543	29
5	5-373662	30
6	5-373772	31
7	5-373872	32
8	5-373983	33
9	5-374086	34
10	5-374187	35
11	5-372997	36
12	5-374334	37
13	5-374426	38
14	9092642	39
15	40730961	40
16		41
17		42
18		43
19		44
20		45
21		46
22		47
23		48
24		49
25		50

Book Mark:

See also

7

5 Cav. (Col'd.) | Mass.

Sam Freeman

, Co. A, 5 Reg't Mass. Cav. (Col'd.)

Appears on

Company Descriptive Book

of the organization named above.

DESCRIPTION.

Age 18 years; height 5 feet 3 inches.

Complexion black

Eyes black; hair black

Where born Southport, Mass.

Occupation Farmer

ENLISTMENT.

When Dec 22, 1863.

Where Southport

By whom J. Ingraham; term 3 y'rs.

Remarks: Mustered out of the service at Fort Monroe Va June 21 1865

(3830)

Freeman

Copyist.

F

5 Col'd Cav. | Mass.

Samuel Freeman
Privt., Co. *A*, 5 Reg't Mass. Col'd Cav.

Appears on

Company Muster-in and Descriptive Roll
of the organization named above. Roll dated

Readville Jan. 9, 1864.

Where born *Amherst Mass*

Age *18* y'rs; occupation *Farmer*

When enlisted *Dec. 22nd*, 1863.

Where enlisted *Amherst*

For what period enlisted *Three* years.

Eyes *Black*, hair *Black*

Complexion *Black*; height *5* ft. *9* in.

When mustered in *Jan 9th*, 1864.

Where mustered in *Readville*

Bounty paid \$ *100*; due \$ *100*

Where credited

Company to which assigned

Remarks:

+ Inserted by Jordan Ex

Book mark:

G. Fry

F

5 Col'd Cav.

Mass.

Samuel Freeman
Privt, Co. A, 5 Reg't Mass. Col'd Cavalry.

Appears on

Company Muster Roll

for *Existence to Feb 29* 1864.

Present or absent *Present*

Stoppage, \$ 100 for

Due Gov't, \$ 100 for

Valuation of horse, \$ 100

Valuation of horse equipments, \$ 100

Remarks:

Book mark:

C. J. [Signature]

F

5 Col'd Cav.

Mass.

Samuel Freeman
Priv, Co. A, 5 Reg't Mass. Col'd Cavalry.

Appears on

Company Muster Roll

for *Mar. & Apr.*, 186 *4*

Present or absent *Present*

Stoppage, \$ *100* for

Due Gov't, \$ *100* for

Valuation of horse, \$ *100*

Valuation of horse equipments, \$ *100*

Remarks: *On daily duty as Bugler*

Book mark:

(358)

G. F. W.
Copyist.

7

5 Col'd Cav.

Mass.

Samuel Freeman

Priv., Co. A, 5 Reg't Mass. Col'd Cavalry.

Appears on

Company Muster Roll

for *May & June*, 186*4*.

Present or absent *Present*

Stoppage, \$.....*100* for

Due Gov't, \$.....*100* for

Valuation of horse, \$.....*100*

Valuation of horse equipments, \$.....*100*

Remarks:

Book mark: *255000*

(358)

G. F. W.

Copyist.

J. | **5 Col'd Cav.** | **Mass.**

Samuel Freeman
Priv., Co. A, 5 Reg't Mass. Col'd Cavalry.

Appears on

Company Muster Roll

for *July and Aug.*, 186*4*.

Present or absent *Present*

Stoppage, \$ *100* for

Due Gov't, \$ *100* for

Valuation of horse, \$ *100*

Valuation of horse equipments, \$ *100*

Remarks: *Free on or before*
Apr. 19, 1861.

Book mark: _____

M. Gilbert,

J

5 Col'd Cav.

Mass.

Samuel Freeman

Pr., Co. A, 5 Reg't Mass. Col'd Cavalry.

Appears on

Company Muster Roll

for *Sept. and Oct.*, 186*4*.

Present or absent *Present.*

Stoppage, \$ *100* for

Due Gov't, \$ *100* for

Valuation of horse, \$ *100*

Valuation of horse equipments, \$ *100*

Remarks: *Stop 1 Haversack*

40

Book mark: " "

H. O. Gilbert

(358)

Copyist.

J

5 Col'd Cav.

Mass.

Samuel Freeman
Priv., Co. A, 5 Reg't Mass. Col'd Cavalry.

Appears on

Company Muster Roll

for Nov. and Dec., 1864.

Present or absent Present.

Stoppage, \$ 100 for

Due Gov't, \$ 100 for

Valuation of horse, \$ 100

Valuation of horse equipments, \$ 100

Remarks: Stop over have
sack 40¢ and one
C Box belt and curry
comb 89¢

Book mark:

M. O. Gilbert,

(358)

Copyist.

J.

5 Col'd Cav.

Mass.

Samuel Freeman
Pvt., Co. A, 5 Reg't Mass. Col'd Cavalry.

Appears on

Company Muster Roll

for *Jan. and Feb.*, 1865.

Present or absent *Present.*

Stoppage, \$ *40* for *Q. M.*
100

property.

Due Gov't, \$ *89* for *Ord.*
100

Valuation of horse, \$ *100*

Valuation of horse equipments, \$ *100*

Remarks: _____

Book mark: _____

M. O. Gilbert

(358)

Copyist.

S.

5 Col'd Cav.

Mass.

Samuel Freeman

Co., Co. A, 5 Reg't Mass. Col'd Cavalry.

Appears on

Company Muster Roll

for *Feb. and Apr.*, 1865:

Present or absent *Present*

Stoppage, \$ *100* for

Due Gov't, \$ *100* for

Valuation of horse, \$ *100*

Valuation of horse equipments, \$ *100*

Remarks:

Book mark:

N. O. Gilbert

F

5 Col'd Cav.

Mass.

Samuel Freeman
1st, Co. A, 5 Reg't Mass. Col'd Cavalry.

Appears on

Company Muster Roll

for *May & June*, 186*5*.

Present or absent: *absent*

Stoppage, \$ *100* for

Due Gov't, \$ *100* for

Valuation of horse, \$ *100*

Valuation of horse equipments, \$ *100*

Remarks: *Absent sick at Ft*
Mourae May 21/65

Book mark:

Salleade

(358)

Copyist.

F

5 Col'd Cav.

Mass.

Samuel Freeman

Pvt, Co. A, 5 Reg't Mass. Col'd Cavalry.

Appears on

Company Muster Roll

for July & Aug, 1865.

Present or absent

Stoppage, \$ 100 for

Due Gov't, \$ 100 for

Valuation of horse, \$ 100

Valuation of horse equipments, \$ 100

Remarks: Discharged at Ft. Monroe June 21. 1865 per order War Dept

Book mark:

(358)

Ballade

Copyist.

F

5 Col'd Cav.

Mass.

Samuel Freeman

Pr., Co. *A*, 5 Reg't Mass. Colored Cav.

Appears on **Returns** as follows:

*April 1865 - Absent at
Petersburg Va. On duty
with Provost Guard.*

*May to July 1865 - Absent sick
at Fortress Monroe, since
May 20 '65.*

*Aug. 1865 - June 21. '65 Ft.
Monroe Disch'd.*

Book mark:

O. J. Taylor

(546)

Copyist.

7

5 Col'd Cav.

Mass.

Samuel Freeman

Pat., Co. A, 5 Reg't Mass. Col'd Cavalry.

Appears on a

Detachment Muster-out Roll

of the organization named above. Roll dated

Fort Monroe, Va, June 21, 1865.

Muster-out to date June 21, 1865.

Last paid to Dec. 31, 1864.

Clothing account:

Last settled....., 186 ; drawn since \$..... 100

Due soldier \$..... 100; due U. S. \$..... 100

Am't for cloth'g in kind or money adv'd \$ 40 ⁸⁸/₁₀₀

Due U. S. for arms, equipments, &c., \$..... 100

Bounty paid \$..... 100; due \$ 75 ⁰⁰/₁₀₀

Remarks: Mustered out
by order of War
Dept - Dated May 3rd
1865 - Patient in U.S.
General Hospital Fort
Monroe, Va.

Book mark:

R. Washington

(349)

Copyist.

F

5 Col'd Cav.

Mass.

Samuel Freeman

Plt, Co. A, 5 Reg't Mass. Col'd Cavalry.

Appears on Co. Muster-out Roll, dated

Clarksville, Texas, Oct. 31, 1865.

Muster-out to date _____, 186 .

Last paid to _____, 186 .

Clothing account:

Last settled _____, 186 ; drawn since \$ _____ 100

Due soldier \$ _____ 100; due U. S. \$ _____ 100

Am't for cloth'g in kind or money adv'd \$ _____ 100

Due U. S. for arms, equipments, &c., \$ _____ 100

Bounty paid \$ _____ 100; due \$ _____ 100

Remarks: Discharged at Ft. Monroe, Va.

G.O. 77th Regt. June 21, 1865

Book mark 4154 P.M. 4, May 15. 66

(over)

Sallade

478

Freeman, William H.

Co B, 5 Mass. Cav., (Col'd.)

Private

Private

CARD NUMBERS.

1	5-374425	26
2	5-374523	27
3	5-374667	28
4	5-374763	29
5	5-374866	30
6	5-374974	31
7	5-375023	32
8	5-375127	33
9	5-375292	34
10	5-375391	35
11	5-375493	36
12	5-375522	37
13	9092530	38
14		39
15		40
16		41
17		42
18		43
19		44
20		45
21		46
22		47
23		48
24		49
25		50

Book Mark:

See also

7 | 5 Cav. (Col'd.) | Mass.

Wm H Freeman

....., Co. *B*....., 5 Reg't Mass. Cav. (Col'd.)

Appears on

Company Descriptive Book

of the organization named above.

DESCRIPTION.

Age *18* years; height *5* feet *6* inches.

Complexion *Dark*

Eyes *Black*; hair *Black*

Where born *Belchertown, Mass*

Occupation *Farmer*

ENLISTMENT.

When *Dec 21*....., 1863.

Where *Belchertown*.....

By whom *S. Merrill*.....; term *3* y'rs.

Remarks:

.....

.....

.....

.....

.....

.....

.....

.....

.....

J. Finley

J 5 Col'd Cav. | **Mass.**

William S. Felman

B, Co. *B*, 5 Reg't Mass. Col'd Cav.

Appears on

Company Muster-in and Descriptive Roll
of the organization named above. Roll dated

Readville Mass. July 29, 1864.

Where born *Belcher town - Mass.*

Age *18* y'rs; occupation *Framer*

When enlisted *Dec 21st*, 1863.

Where enlisted *Belcher town*

For what period enlisted *3* years.

Eyes *Black*; hair *Black*.

Complexion *Black*; height *5 ft. 6 in.*

When mustered in *Jan. 29*, 1864.

Where mustered in *Readville. Mass.*

Bounty paid \$ *100*; due \$ *100*

Where credited

Company to which assigned

Remarks: *Drum Major*

** Inserted by Jordan C. J.*

Book mark:

Hyberger
(356d) Copyist.

J

5 Col'd Cav.

Mass.

Wm L Freeman

Sgt., Co. B, 5 Reg't Mass. Col'd Cavalry.

Appears on

Company Muster Roll

for *Enlistment to Feb 27*, 1864.

Present or absent *Present*

Stoppage, \$ *100* for

Due Gov't, \$ *100* for

Valuation of horse, \$ *100*

Valuation of horse equipments, \$ *100*

Remarks:

Book mark:

Hoyles

(358)

Copyist.

F | 5 Col'd Cav. | Mass.

Wm H Freeman

Pvt., Co. B, 5 Reg't Mass. Col'd Cavalry.

Appears on

Company Muster Roll

for *March & April*, 1864.

Present or absent *Present*

Stoppage, \$ *100* for

Due Gov't, \$ *100* for

Valuation of horse, \$ *100*

Valuation of horse equipments, \$ *100*

Remarks: *Pay for Transportation furnished \$1.81*

Book mark:

Freeman

F | 5 Col'd Cav. | Mass.

W. H. Freeman

A., Co. B, 5 Reg't Mass. Col'd Cavalry.

Appears on

Company Muster Roll

for May & June, 1864.

Present or absent Present

Stoppage, \$ 100 for

Due Gov't, \$ 100 for

Valuation of horse, \$ 100

Valuation of horse equipments, \$ 100

Remarks: To pay for transportation
1. 81

Book mark:

Hamberger

(358)

Copyist.

F.

5 Col'd Cav.

Mass.

William H. Freeman,

Plt, Co. B, 5 Reg't Mass. Col'd Cavalry.

Appears on

Company Muster Roll

for July & Aug., 1864.

Present or absent Present.

Stoppage, \$ 100 for

Due Gov't, \$ 100 for

Valuation of horse, \$ 100

Valuation of horse equipments, \$ 100

Remarks: Due U.S. for Transportation \$ 1.81

Book mark:

H. W. Brown

(358)

Copyist.

F.

5 Col'd Cav.

Mass.

William H. Freeman,

Port, Co. B, 5 Reg't Mass. Col'd Cavalry.

Appears on

Company Muster Roll

for Sept. & Oct., 1864.

Present or absent Present.

Stoppage, \$ 100 for

Due Gov't, \$ 100 for

Valuation of horse, \$ 100

Valuation of horse equipments, \$ 100

Remarks: Free on or before
Apr. 19/61.
Due U.S. Bounty \$25.00

Book mark:

A. W. Brown

(358)

Copyist.

41. | **5 Col'd Cav.** | **Mass.**

Wm H. Freeman,

Privt, Co. B, 5 Reg't Mass. Col'd Cavalry.

Appears on

Company Muster Roll

for Nov. & Dec., 1864.

Present or absent Present.

Stoppage, \$ 100 for

Due Gov't, \$ 100 for

Valuation of horse, \$ 100

Valuation of horse equipments, \$ 100

Remarks: Due U.S. Ordnance
cost - \$ 22.71

Book mark:

(358)

W H Brown
Copyist.

F.

5 Col'd Cav.

Mass.

William H. Freeman,

Priv., Co. B, 5 Reg't Mass. Col'd Cavalry.

Appears on

Company Muster Roll

for Jan'y. & Feby., 1865.

Present or absent Present.

Stoppage, \$ 100 for

Due Gov't, \$ 100 for

Valuation of horse, \$ 100

Valuation of horse equipments, \$ 100

Remarks: Due the Soldier

1st Instnt. U.S. Bounty

\$25.00. Due U.S. \$24.49

Book mark:

H. W. Brown

(358)

Copied.

F. | **5 Col'd Cav.** | **Mass.**

Wm H. Freeman,
Privt, Co. B, 5 Reg't Mass. Col'd Cavalry.

Appears on

Company Muster Roll
for *March & April*, 1865.

Present or absent

Stoppage, \$ *100* for

Due Gov't, \$ *100* for

Valuation of horse, \$ *100*

Valuation of horse equipments, \$ *100*

Remarks:

Book mark: -----

(358)

J. Brown

Copist.

F

5 Col'd Cav.

Mass.

William H. Freeman

Det, Co. B, 5 Reg't Mass. Col'd Cavalry.

Appears on

Company Muster Roll

for *May & June*, 186*5*.

Present or absent *Present*

Stoppage, \$ *100* for

Due Gov't, \$ *100* for

Valuation of horse, \$ *100*

Valuation of horse equipments, \$ *100*

Remarks:

Book mark:

Schmidt

(358)

Copyist.

F

5 Col'd Cav.

Mass.

William H. Freeman

Plt, Co. B, 5 Reg't Mass. Col'd Cavalry.

Appears on

Company Muster Roll

for *July & Aug.*, 186*5*.

Present or absent *Present*

Stoppage, \$ *100* for

Due Gov't, \$ *100* for

Valuation of horse, \$ *100*

Valuation of horse equipments, \$ *100*

Remarks:

Book mark:

Schlesick

(358)

Copyist.

F

5 Col'd Cav.

Mass.

William H. Freeman

Priv, Co. *B*, 5 Reg't Mass. Col'd Cavalry.

Appears on Co. Muster-out Roll, dated

Charleville Tex, Oct 31, 1865.

Muster-out to date

Oct 31, 1865.

Last paid to

Dec 31, 1864.

Clothing account:

Last settled....., 186 ; drawn since \$ 100

Due soldier \$ 100; due U. S. \$ *98* ^{*21*}/₁₀₀

Am't for cloth'g in kind or money adv'd \$ 100

Due U. S. for arms, equipments, &c., \$ 100

Bounty paid \$ *25* ^{*00*}/₁₀₀; due \$ *275* ^{*00*}/₁₀₀

Remarks:

Book mark:

Scherich

(361)

Copyist.

479

Frisbie, David

Co A, 5 Mass. Cav., (Col'd.)

Private

Private

CARD NUMBERS.

1	5-3 f 15-24	26
2	5-3 f 16-79	27
3	5-3 f 17-67	28
4	5-3 f 18-60	29
5	5-3 f 19-64	30
6	5-3 f 20-64	31
7	5-3 f 21-73	32
8	5-3 f 22-73	33
9	5-3 f 23-72	34
10	5-3 f 24-64	35
11	5-3 f 25-65	36
12	9091804	37
13	40730962	38
14		39
15		40
16		41
17		42
18		43
19		44
20		45
21		46
22		47
23		48
24		49
25		50

Book Mark:

See also

F.

5 Cav. (Col'd.) | Mass.

David Frisbie.

Co. H, 5 Reg't Mass. Cav. (Col'd.)

Appears on

Company Descriptive Book

of the organization named above.

DESCRIPTION.

Age *29* years; height *5* feet *8* inches.

Complexion *Dark*

Eyes *Black*; hair... *Black*

Where born *Williamlin Del.*

Occupation *Farmer.*

ENLISTMENT.

When *Mar, 2nd, 186*

Where *Dedham.*

By whom *G. C. Burrill*; term *3* y'rs.

Remarks: *Mustered in at Readville
Mar, 12th 64.*

H. C. Thomas.

(383g)

Copyist.

A

5 Col'd Cav.

Mass.

David Frisbie

Pr., Co. *A*, 5 Reg't Mass. Col'd Cav.

Appears on

Company Muster-in and Descriptive Roll

of the organization named above. Roll dated

Readville Mass, Mar. 12, 1864

Where born *Wilmington Delaware*

Age *29* y'rs; occupation *Farmer*

When enlisted *Mar 2, 1864*

Where enlisted *Dedham*

For what period enlisted *3* years.

Eyes *Black*; hair *Black*

Complexion *Black*; height *5* ft. *8* in.

When mustered in *Mar. 12, 1864*

Where mustered in *Readville Mass.*

Bounty paid \$ *100*; due \$ *100*

Where credited *7 Dist Amherst*

Company to which assigned

Remarks:

** Inserted by Jordan Ex*

Book mark:

J. R. Wall

J

5 Col'd Cav.

Mass.

x Frisbie
David Fisher

Priv., Co. II, 5 Reg't Mass. Col'd Cavalry.

Appears on

Company Muster Roll

for *Mar 12 to Apr 30*, 186*4*

Present or absent *Present*

Stoppage, \$ *100* for

Due Gov't, \$ *100* for

Valuation of horse, \$ *100*

Valuation of horse equipments, \$ *100*

Remarks:

x Corrected by Jordan. Ex

Book mark:

J R Wall

(358)

Copyist.

J

5 Col'd Cav.

Mass.

David Frisbie

Pvt.; Co. H, 5 Reg't Mass. Col'd Cavalry.

Appears on

Company Muster Roll

for *May + June*, 186*4*

Present or absent *absent*

Stoppage, \$ *100* for

Due Gov't, \$ *100* for

Valuation of horse, \$ *100*

Valuation of horse equipments, \$ *100*

Remarks: *detached service*
since June 26 in
Hospl. Deph.

Book mark:

J. Wall

F

5 Col'd Cav.

Mass.

David Frisby

Priv, Co. H, 5 Reg't Mass. Col'd Cavalry.

Appears on

Company Muster Roll

for *July, & Aug.*, 1864

Present or absent *Present*

Stoppage, \$ 100 for

Due Gov't, \$ 100 for

Valuation of horse, \$ 100

Valuation of horse equipments, \$ 100

Remarks:

Book mark:

J. M. Hall
Copyist.

7

5 Col'd Cav.

Mass.

David Prusby

Pat, Co. II, 5 Reg't Mass. Col'd Cavalry.

Appears on

Company Muster Roll

for Sept & Oct, 1864.

Present or absent Present

Stoppage, \$ 0 ⁰⁴/₁₀₀ for one cross
sable letter and number.

Due Gov't, \$ 100 for

Valuation of horse, \$ 100

Valuation of horse equipments, \$ 100

Remarks:

Book mark:

G M Clark

(358)

Copyist.

Q

5 Col'd Cav.

Mass.

David Frisby

Pat, Co. H, 5 Reg't Mass. Col'd Cavalry.

Appears on

Company Muster Roll

for *Nov & Dec*, 1864.

Present or absent *Present*

Stoppage, \$ *100* for

Due Gov't, \$ *100* for

Valuation of horse, \$ *100*

Valuation of horse equipments, \$ *100*

Remarks: *Daily duty
hospital attendant*

Book mark:

C. M. Clark

F

5 Col'd Cav.

Mass.

David Frisby

Put, Co. H, 5 Reg't Mass. Col'd Cavalry.

Appears on

Company Muster Roll

for Jan & Feb, 1865.

Present or absent Present

Stoppage, \$ 100 for

Due Gov't, \$ 100 for

Valuation of horse, \$ 100

Valuation of horse equipments, \$ 100

Remarks: Daily duty
hospital attend duty.
Duty 1st, 2d, 3d & 4th
installment U.S. bounty.

Book mark:

C. H. Clark

(358)

Copyist.

Q

5 Col'd Cav.

Mass.

David Paisley

Put, Co. H, 5 Reg't Mass. Col'd Cavalry.

Appears on

Company Muster Roll

for *March & April*, 1863.

Present or absent *Present*

Stoppage, \$ *100* for

Due Gov't, \$ *100* for

Valuation of horse, \$ *100*

Valuation of horse equipments, \$ *100*

Remarks: *Due 1st, 2d, 3d & 4th installments of U.S. bounty.*

Book mark:

C. M. Clark

(358)

Copyist.

7

5 Col'd Cav.

Mass.

David Frisby

Pat, Co. H, 5 Reg't Mass. Col'd Cavalry.

Appears on

Company Muster Roll

for May & June, 1865.

Present or absent Present

Stoppage, \$ 100 for

Due Gov't, \$ 100 for

Valuation of horse, \$ 100

Valuation of horse equipments, \$ 100

Remarks: 1st, 2d, 3d & 4th install-
ment U.S. Bounty, due
Free on or before April
19, 1861.

Book mark:

C. M. Clark

(358)

Copyist.

David Frisby

Priv., Co. H, 5 Reg't Mass. Col'd Cavalry.

Appears on

Company Muster Roll

for *July & Aug.*, 186*5*.

Present or absent *present*

Stoppage, \$ *100* for

Due Gov't, \$ *100* for

Valuation of horse, \$ *100*

Valuation of horse equipments, \$ *100*

Remarks: *Free on or before Apr. 17. 1861.*

Book mark:

R. Cowles

F | **5 Col'd Cav.** | **Mass.**

David Frisby
M., Co *B*, 5 Reg't Mass. Colored Cav.

Appears on **Returns** as follows:

June to Aug. 1864 - On duty
Hospit. Attendant.

Oct. 1864 to Feby 1865 - On
duty Hospit. Attendant.

Name prescribed as per record
Frisk

Book mark:

O. J. Taylor

(546)

Copyist.

F. | **5 Col'd Cav.** | **Mass.**

David Crosby

Cri., Co. *H*, 5 Reg't Mass. Col'd Cavalry.

Appears on **Co. Muster-out Roll**, dated
Blacksville, Tex., Octo 31, 1865.

Muster-out to date *Octo 31*, 1865.

Last paid to *Dec. 31*, 1864.

Clothing account:

Last settled 186 ; drawn since \$ 100

Due soldier \$ 100; due U. S. \$ *34*^{*32*}/₁₀₀

Am't for cloth'g in kind or money adv'd \$ 100

Due U. S. for arms, equipments, &c., \$ *3*^{*00*}/₁₀₀

Bounty paid \$ 100; due \$ *300*^{*00*}/₁₀₀

Remarks: *Face on or before*

April 14. 1861

Book mark:

R. E. Wilson

(861)

Copyist.

480.

Froman, Alfred

Co E, 5 Mass. Cav., (Col'd.)

Private

Sergeant Major

CARD NUMBERS.

1	5-378109	26
2	5-378194	27
3	5-378255	28
4	5-378339	29
5	5-378446	30
6	5-373132	31
7	5-373148	32
8	5-373165	33
9	5-373184	34
10	5-373200	35
11	5-373217	36
12	5-373233	37
13	5-372172	38
14	140730963	39
15		40
16		41
17		42
18		43
19		44
20		45
21		46
22		47
23		48
24		49
25		50

Book Mark: _____

See also _____

D. 637245 P. 90
S-1468613 and WD
S 1494576 P.O. return

S 1574113 P.O. aff

S 1390069 P.O. aff

S. 1635710 P.O. aff

S. 1636913 P.O. aff

Hastings 10-14-38

[Signature]

H. Jordan
A

F 5 Cav. (Col'd.) | Mass.

Alfred F. Roman
....., Co. *E*....., 5 Reg't Mass. Cav. (Col'd.)

Appears on

Company Descriptive Book

of the organization named above.

DESCRIPTION.

Age *27* years; height *5* feet *11* inches.

Complexion *Blk*

Eyes *Gray*; hair *Blk*

Where born *Spencer Co. Ky*

Occupation *Saddler*

ENLISTMENT.

When *July 3*, 1864.

Where *Boston*

By whom *A. H. [unclear]*; term *Three* yrs.

Remarks: *Munited*

Discharged to Sgt. Major

Sept. 17 1864,

Heard

Jr

5 Col'd Cav. | Mass.

Alfred Froman

Private, Co. C, 5 Reg't Mass. Col'd Cav.

Appears on

Company Muster-in and Descriptive Roll

of the organization named above. Roll dated

Readville, Mass, Feby 10, 1864.

Where born Spencer Co. Kentucky,

Age 27 y'rs; occupation Saddler

When enlisted Feb 3, 1864.

Where enlisted Ward 11. Boston,

For what period enlisted 3 years.

Eyes black; hair black

Complexion black; height 5 ft. 11 1/2 in.

When mustered in Feby 10, 1864.

Where mustered in * Readville, Mass.

Bounty paid \$ 100; due \$ 100

Where credited 3 Qu. Suffolk,

Company to which assigned

Remarks:

* Inserted by Jordan Cox

Book mark:

Froman

F

5 Col'd Cav.

Mass.

Alfred Froman

Private, Co. E, 5 Reg't Mass. Col'd Cavalry.

Appears on

Company Muster Roll

for *Enlistment to 29 Feb'y, 1864.*

Present or absent... *Absent*

Stoppage, \$..... 100 for

Due Gov't, \$..... 100 for

Valuation of horse, \$..... 100

Valuation of horse equipments, \$..... 100

Remarks: *on furlough till
march 12th*

Book mark:

(358)

Froman
Copyist.

JH

5 Col'd Cav.

Mass.

Alfred Froman

Sgt, Co. E, 5 Reg't Mass. Col'd Cavalry.

Appears on

Company Muster Roll

for *Michael*, 1864.

Present or absent. *present*

Stoppage, \$ 100 for

Due Gov't, \$ 100 for

Valuation of horse, \$ 100

Valuation of horse equipments, \$ 100

Remarks:

Book mark:

(358)

Froman

Copyist.

JH

5 Col'd Cav.

Mass.

Alfred Froman

1st Sgt, Co. E, 5 Reg't Mass. Col'd Cavalry.

Appears on

Company Muster Roll

for *May + June*, 186*4*.

Present or absent *present*

Stoppage, \$ *100* for

Due Gov't, \$ *100* for

Valuation of horse, \$ *100*

Valuation of horse equipments, \$ *100*

Remarks: *Promoted from duty
Sergt. to 1st Sergt. June 1. 64*

Book mark:

[Signature]

(358)

Copyist.

F

5 Col'd Cav.

Mass.

Alfred Froman

1st Supt., Co. E, 5 Reg't Mass. Col'd Cavalry.

Appears on

Company Muster Roll

for *July & Aug.*, 1864.

Present or absent *Present*

Stoppage, \$ *100* for

Due Gov't, \$ *100* for

Valuation of horse, \$ *100*

Valuation of horse equipments, \$ *100*

Remarks: *Acting Supt.*

Major Pay due from June 1st as 1st Supt.

Book mark:

O. J. Clark

(358)

Copyist.

7

5 Col'd Cav.

Mass.

Alfred Froman
Sergt Major, 5 Reg't Mass. Colored Cavalry.

Appears on

Field and Staff Muster Roll

for Sept & Oct, 1864

Present or absent Present

Stoppage, \$ 100 for

Due Gov't, \$ 100 for

Valuation of horse, \$ 100

Valuation of horse equipments, \$ 100

Remarks: 1st Sergt Co. E. Promoted
on Non Commissioned Staff
Sept 18/64 G.O. 52.

Book mark:

G.W. Davis
Copyist.

(357)

F | **5 Col'd Cav.** | **Mass.**

Alfred Froman
Sgt Maj, 5 Reg't Mass. Colored Cavalry.

Appears on

Field and Staff Muster Roll

for *Nov & Dec*, 1864.

Present or absent *Present*

Stoppage, \$ *100* for

Due Gov't, \$ *100* for

Valuation of horse, \$ *100*

Valuation of horse equipments, \$ *100*

Remarks:

Book mark:

J W Davis
Copyist.

(357)

F

5 Col'd Cav.

Mass.

Alfred Fournan

Sgt. Maj., 5 Reg't Mass. Colored Cavalry.

Appears on

Field and Staff Muster Roll

for Jan & Feb, 1865

Present or absent Present

Stoppage, \$ 100 for

Due Gov't, \$ 100 for

Valuation of horse, \$ 100

Valuation of horse equipments, \$ 100

Remarks: Due U.S. for transportation \$27.01 - 1st, 2d, 3d + 4th instalments U.S. Bounty due \$180.

Book mark:

W. Davis

F

5 Col'd Cav.

Mass.

Alfred Froman
Sgt. Major, 5 Reg't Mass. Colored Cavalry.

Appears on

Field and Staff Muster Roll

for *March & April*, 1865.

Present or absent *Present*

Stoppage, \$ *100* for

Due Gov't, \$ *100* for

Valuation of horse, \$ *100*

Valuation of horse equipments, \$ *100*

Remarks: *Claims 40¢ per day for use of private horse & equipments since Feby 28/65. 1st 2nd 3rd & 4th installments U.S. County due \$180.*

Book mark:

R. Johnson

(357)

Copyist.

J | **5 Col'd Cav.** | **Mass.**

Alfred Froman
Wgt Maj, 5 Reg't Mass. Colored Cavalry.

Appears on

Field and Staff Muster Roll

for *May & June*, 186*5*.

Present or absent *Present*.

Stoppage. \$ *100* for

Due Gov't, \$ *100* for

Valuation of horse, \$ *100*

Valuation of horse equipments, \$ *100*

Remarks: *Claims 40¢ per*
day since July 28/65,
for use of private
horses & equipments

Book mark:

R. Johnson

Copyist.

(357)

F.

5 Col'd Cav.

Mass.

Alfred Froman

1st May, 5 Reg't Mass. Colored Cavalry.

Appears on

Field and Staff Muster Roll

for *July & Aug.*, 186*5.*

Present or absent *Present.*

Stoppage. \$ *100* for

Due Gov't, \$ *100* for

Valuation of horse, \$ *100*

Valuation of horse equipments, \$ *100*

Remarks: *Claim 40¢ per day for use of private horse & equipments from July 28/65.*

Book mark:

R. Johnson
Copyist.

F | 5 Col'd Cav. | Mass.

A. Froman
Sergeant
Sergeant, Co. E., 5 Reg't Mass. Colored Cav.

Appears on Returns as follows:

May 1864 - On duty in Regt. Band.

July & Aug. 1864 - On duty Act. Sergeant Major.

Sept. 1864 - (1 Sergeant) Sept. 18. 64
A. Lookout, Promoted
Sergeant Major & transferred
to N. C. S. by G.O. 52.

Book mark:

O. J. Taylor

(546)

Copyist.

7

5 Col'd Cav.

Mass.

Alfred Froman

Rank *Sgt Major* 5 Reg't Mass. Colored Cav.

Appears on

Field and Staff Muster-out Roll

of the organization named above. Roll dated

Clarksville, Texas, Oct 31, 1865.

Muster-out to date *Oct 31, 1865.*

Last paid to *Dec 31, 1864.*

Clothing account:

Last settled _____, 186 ; drawn since \$ 100

Due soldier \$ 100; due U. S. \$ *20* ^{*04*}/₁₀₀

Am't for cloth'g in kind or money adv'd \$ 100

Due U. S. for arms, equipments, &c., \$ 100

Bounty paid \$ 100; due \$ *300* ^{*00*}/₁₀₀

Remarks: *Claims back pay 40¢ per day for use of private horse & horse equipments since Feb 28/65 free on or before April 19/64. Appointed Sgt Major per*

Book mark: _____

R. Johnson

Copyist.

JAN. - 9

5373233

★ 1891 ★

NO. 52, Regt Hd Qrs.
Pt. Lookout, Md., Sept
18/64.

Total amount of
ordnance stored \$11-

481

Fry, Alfred

Co I, 5 Mass. Cav., (Col'd.)

Private

Sergeant.

CARD NUMBERS.

1	5-379329	26
2	5-379414	27
3	5-379477	28
4	5-379564	29
5	5-379663	30
6	5-379770	31
7	5-379865	32
8	5-379971	33
9	5-380072	34
10	5-380173	35
11	5-380270	36
12	5-380361	37
13	9092057	38
14	40730940	39
15		40
16		41
17		42
18		43
19		44
20		45
21		46
22		47
23		48
24		49
25		50

Book Mark:

See also

F

5 Cav. (Col'd.) | Mass.

Alfred Fry

....., Co. *F*, 5 Reg't Mass. Cav. (Col'd.)

Appears on

Company Descriptive Book

of the organization named above.

DESCRIPTION.

Age *24* years; height *5* feet *6* inches.

Complexion *Gold*

Eyes *Blk*; hair *Blk*

Where born *E. Greenwich, R. Island,*

Occupation *Sailor.*

ENLISTMENT.

When *Feb 16, 1864.*

Where *Taunton*

By whom *A. Presbury*; term *3* y'rs.

Remarks:

Heard

5 | **5 Col'd Cav.** | **Mass.**

Alfred Taylor
Co. *B*, 5 Reg't Mass. Col'd Cav.

Appears on
Company Muster-in and Descriptive Roll
of the organization named above. Roll dated
Readville, Mass., Feb. 22, 1864.
Where born *East Greenwich, R.I.*
Age *27* y'rs; occupation *Sailor*
When enlisted *Feb. 16, 1864.*
Where enlisted *Readville.*
For what period enlisted *3* years.
Eyes *Black*; hair *Black*
Complexion *Black*; height *5* ft. *6* in.
When mustered in *Feb. 22, 1864.*
Where mustered in *Readville.*
Bounty paid \$ *100*; due \$ *100*
Where credited *2^d Dist. Bristol.*
Company to which assigned
Remarks:

** Inserted by Jordan Cox*

Book mark:

G. Taylor
(356d) Copyist.

5 Col'd Cav.

Mass.

John

John, Co. F, 5 Reg't Mass. Col'd Cavalry.

Appears on

Company Muster Roll

for *William* *10* *April*, 1864.

Present or absent *Present*

Stoppage, \$ *100* for

Due Gov't, \$ *100* for

Valuation of horse, \$ *100*

Valuation of horse equipments, \$ *100*

Remarks:

Book mark:

11

5 Col'd Cav.

Mass.

Alfred May

(Capt), Co. F, 5 Reg't Mass. Col'd Cavalry.

Appears on

Company Muster Roll

for *Nov. & Dec.*, 1864.

Present or absent *Present.*

Stoppage, \$ *100* for

Due Gov't, \$ *100* for

Valuation of horse, \$ *100*

Valuation of horse equipments, \$ *100*

Remarks: *Permanent stable
found*

Book mark:

E. R. Lydon

(358)

Copyist.

5 Col'd Cav.

Mass.

Alfred Dru

Capt., Co. F, 5 Reg't Mass. Col'd Cavalry.

Appears on

Company Muster Roll

for *May & June*, 186*4*.

Present or absent *Present.*

Stoppage, \$ *100* for

Due Gov't, \$ *100* for

Valuation of horse, \$ *100*

Valuation of horse equipments, \$ *100*

Remarks: *ip's mch. 1, 1864*
CO, # 13 mch. 4, 1864.

Book mark:

G. E. Tyler

(358)

Copyist.

F

5 Col'd Cav.

Mass.

Alfred Fry
Cop, Co. F, 5 Reg't Mass, Col'd Cavalry.

Appears on

Company Muster Roll

for *July & Aug*, 186 ⁴/₄

Present or absent *Present*

Stoppage, \$ *100* for

Due Gov't, \$ *100* for

Valuation of horse, \$ *100*

Valuation of horse equipments, \$ *100*

Remarks: *App'd Corp Mch 4/64*
G.O. 13 Mch 4/64

Book mark:

W Stewart

(358)

Copyist.

F

5 Col'd Cav.

Mass.

Alfred Fry

Sergeant, Co. F, 5 Reg't Mass. Col'd Cavalry.

Appears on

Company Muster Roll

for Sept & Oct, 1864

Present or absent Present

Stoppage, \$ 100 for

Due Gov't, \$ 100 for

Valuation of horse, \$ 100

Valuation of horse equipments, \$ 100

Remarks: App'd Sergeant Oct 1st, 1864

Book mark:

J Stewart

(358)

Copyist.

7

5 Col'd Cav.

Mass.

Alfred Fry

Serjeant, Co. F, 5 Reg't Mass Col'd Cavalry.

Appears on

Company Muster Roll

for *Nov & Dec*, 1864.

Present or absent *Present*

Stoppage, \$ *100* for

Due Gov't, \$ *100* for

Valuation of horse, \$ *100*

Valuation of horse equipments, \$ *100*

Remarks:

Book mark:

J. H. Stewart

(358)

Copyist.

F

5 Col'd Cav.

Mass.

Alfred Fry
Sergeant, Co. F, 5 Reg't Mass. Col'd Cavalry.

Appears on

Company Muster Roll

for Jan & Feb, 1865.

Present or absent Present

Stoppage, \$ 100 for

Due Gov't, \$ 100 for

Valuation of horse, \$ 100

Valuation of horse equipments, \$ 100

Remarks: Due first pay
Inst U.S. Pay

Book mark:

J. W. Stewart

(358)

Copyist.

F

5 Col'd Cav.

Mass.

Alfred Fry

Serjeant, Co. F, 5 Reg't Mass. Col'd Cavalry.

Appears on

Company Muster Roll

for *Mch & Apr*, 186 *5*

Present or absent *Present*

Stoppage, \$ *100* for

Due Gov't, \$ *100* for

Valuation of horse, \$ *100*

Valuation of horse equipments, \$ *100*

Remarks: *Due first four
m 27 U.S. Bty # 180.00*

Book mark: *1865*

W Stewart

(558)

Copyist.

F

5 Col'd Cav.

Mass.

Alfred Fry

Serg, Co. F, 5 Reg't Mass. Col'd Cavalry.

Appears on

Company Muster Roll

for *May & June*, 186*2*

Present or absent *Present*

Stoppage, \$ *100* for

Due Gov't, \$ *100* for

Valuation of horse, \$ *100*

Valuation of horse equipments, \$ *100*

Remarks:

Book mark:

W. Johnson

(358)

Copyist.

F

5 Col'd Cav.

Mass.

Alfred Gray

Gray, Co. F, 5 Reg't Mass. Col'd Cavalry.

Appears on

Company Muster Roll

for *July & Aug*, 186*2*.

Present or absent *Present*

Stoppage, \$ *100* for

Due Gov't, \$ *100* for

Valuation of horse, \$ *100*

Valuation of horse equipments, \$ *100*

Remarks:

Book mark:

(358)

A. Johnson

Copyist.

A

5 Col'd Cav.

Mass.

Alfred Fry

, Co. *F*, 5 Reg't Mass. Colored Cav.

Appears on **Returns** as follows:

*Sept. '85 - absent sick at
U. S. Genl Hospital,
Pinaros de Santiago
Sept. 9,*

Book mark : _____

O. J. Taylor

(546)

Copyist.

F

5 Col'd Cav.

Mass.

Alfred Fing

Amy, Co. *F*, 5 Reg't Mass. Col'd Cavalry.

Appears on Co. Muster-out Roll, dated

Channahville Tex Oct 31, 186*5*.

Muster-out to date

Oct 31, 186*5*.

Last paid to

Dec 31, 186*4*.

Clothing account:

Last settled....., 186 ; drawn since \$..... 100

Due soldier \$..... 100; due U. S. \$ *47*^{*72*}/₁₀₀

Am't for cloth'g in kind or money adv'd \$..... 100

Due U. S. for arms, equipments, &c., \$ *11*/₁₀₀

Bounty paid \$..... 100; due \$ *300*/₁₀₀

Remarks: *Due U.S. for C & G.*

Equip. 130

Book mark:

J. V. Johnson

(861)

Copyist.

482

Frye, William

Co *F*, 5 Mass. Cav., (Col'd.)

Private

Private

CARD NUMBERS.

1	5-379323	26
2	5-379408	27
3	5-379509	28
4	5-379600	29
5	5-379698	30
6	5-379806	31
7	5-379903	32
8	5-380010	33
9	5-380110	34
10	5-380213	35
11	5-380310	36
12	5-380406	37
13	9092058	38
14	40730941	39
15		40
16		41
17		42
18		43
19		44
20		45
21		46
22		47
23		48
24		49
25		50

Book Mark:

See also

D. 2342639 *point*
P.Mil. Sc. 1105935-6.16.13 P. 25

A. Jordan
Ex

F

5 Cav. (Col'd.)

Mass.

William Fry

Co. *F*, 5 Reg't Mass. Cav. (Col'd.)

Appears on

Company Descriptive Book

of the organization named above.

DESCRIPTION.

Age *19* years; height *5* feet *2* inches.

Complexion *blk*

Eyes *blk*; hair *blk*

Where born *E. Greenwich Rhode Island,*

Occupation *Sailor.*

ENLISTMENT.

When *Feb 8*, 1864.

Where *Rosbury*

By whom *B. Meridian*; term *3* y'rs.

Remarks:

Hearn

William Taylor

Co. D, 5 Reg't Mass. Col'd Cav.

Appears on

Company Muster-in and Descriptive Roll

of the organization named above. Roll dated

Feb 22, 1864, Mass., 1864.

Where born East Newbury, Mass.

Age 17 y'rs; occupation Sailor

When enlisted Feb 22, 1864.

Where enlisted Newbury, Mass.

For what period enlisted 3 years.

Eyes Black; hair Black

Complexion Black; height 5 ft. 2 in.

When mustered in Feb 22, 1864.

Where mustered in Readville, Mass.

Bounty paid \$ 100; due \$ 100

Where credited 3d Dist, Norfolk

Company to which assigned

Remarks:

Inserted by Jordan Ex

Book mark:

J. Taylor

F

5 Col'd Cav.

Mass.

William Fry

Sgt., Co. F, 5 Reg't Mass. Col'd Cavalry.

Appears on

Company Muster Roll

for *Enlistment to Feb. 29, 1864.*

Present or absent *Present*

Stoppage, \$ *100* for

Due Gov't, \$ *100* for

Valuation of horse, \$ *100*

Valuation of horse equipments, \$ *100*

Remarks:

Book mark:

(358)

J. C. Taylor
Copyist.

5 Col'd Cav.

Mass.

William A. ...

..., Co. F, 5 Reg't Mass. Col'd Cavalry.

Appears on

Company Muster Roll

for *Sept, & Oct*, 186*4*.

Present or absent *Present*

Stoppage, \$ *100* for

Due Gov't, \$ *100* for

Valuation of horse, \$ *100*

Valuation of horse equipments, \$ *100*

Remarks:

Book mark:

Wm. A. ...

7

5 Col'd Cav.

Mass.

....., Co. F, 5 Reg't Mass. Col'd Cavalry.

Appears on

Company Muster Roll

for *Jan & June*, 186*4*.

Present or absent *Present*

Stoppage, \$ *100* for

Due Gov't, \$ *100* for

Valuation of horse, \$ *100*

Valuation of horse equipments, \$ *100*

Remarks:

Book mark:

(358)

W. J. ...

Copyist.

F

5 Col'd Cav.

Mass.

William Foy
Pt., Co. F, 5 Reg't Mass. Col'd Cavalry.

Appears on

Company Muster Roll

for July & Aug, 1864.

Present or absent Present

Stoppage, \$ 100 for

Due Gov't, \$ 100 for

Valuation of horse, \$ 100

Valuation of horse equipments, \$ 100

Remarks:

Book mark:

JH Stewart

(358)

Copyist.

F

5 Col'd Cav.

Mass.

William Fry

Pt, Co. F, 5 Reg't Mass. Col'd Cavalry.

Appears on

Company Muster Roll

for Sept & Oct, 1864.

Present or absent Present

Stoppage, \$ 100 for

Due Gov't, \$ 100 for

Valuation of horse, \$ 100

Valuation of horse equipments, \$ 100

Remarks:

Book mark:

J. Sturman

(358)

Copyist.

F

5 Col'd Cav.

Mass.

William Fry

Pt, Co. F, 5 Reg't Mass. Col'd Cavalry.

Appears on

Company Muster Roll

for *Nov & Dec*, 1864.

Present or absent *Present*

Stoppage, \$ *100* for

Due Gov't, \$ *100* for

Valuation of horse, \$ *100*

Valuation of horse equipments, \$ *100*

Remarks:

Book mark: -----

J. A. Stewart

(358)

Copyist.

7

5 Col'd Cav.

Mass.

William Foy
Pt., Co. F, 5 Reg't Mass. Col'd Cavalry.

Appears on

Company Muster Roll

for Jan & Feb, 1863.

Present or absent Present

Stoppage, \$ 100 for

Due Gov't, \$ 100 for

Valuation of horse, \$ 100

Valuation of horse equipments, \$ 100

Remarks: One first four
Inst Med. Bty

Book mark:

J. H. Stewart

(358)

Copist.

5

5 Col'd Cav.

Mass.

William Fry

Pt, Co. F, 5 Reg't Mass. Col'd Cavalry.

Appears on

Company Muster Roll

for

March & April, 186 *5*

Present or absent

Present

Stoppage, \$

100 for

Due Gov't, \$

100 for

Valuation of horse, \$

100

Valuation of horse equipments, \$

100

Remarks:

*Due first four inst
U.S. Bty 180.00*

Book mark:

W Stewart

(358)

Copyist.

F

5 Col'd Cav.

Mass.

William Fry

H., Co. F, 5 Reg't Mass. Col'd Cavalry.

Appears on

Company Muster Roll

for *May & June*, 1863.

Present or absent *Present*

Stoppage, \$ *100* for

Due Gov't, \$ *100* for

Valuation of horse, \$ *100*

Valuation of horse equipments, \$ *100*

Remarks:

Book mark:

T. Johnson

(358)

Copyist.

J

5 Col'd Cav.

Mass.

William Fry

Pf, Co. F, 5 Reg't Mass. Col'd Cavalry.

Appears on

Company Muster Roll

for *July & Aug*, 186*9*.

Present or absent *Present*

Stoppage, \$ *100* for

Due Gov't, \$ *100* for

Valuation of horse, \$ *100*

Valuation of horse equipments, \$ *100*

Remarks:

Book mark:

A Johnson

(358)

Copyist.

F | **5 Col'd Cav.** |

Mass.

William Fry
Co. F
Sergt., Co. *F*, 5 Reg't Mass. Colored Cav.

Appears on **Returns** as follows:

April 1864 - On duty Per-
manent Stable Guard

April 1865 - (Sergt) Absent on
detached service at
Petersburg April 28, '65.

Book mark: _____

(546)

W. J. Cooper

Copyist.

F | **5 Col'd Cav.** | **Mass.**

William Frey

F, Co. *F*, 5 Reg't Mass. Col'd Cavalry.

Appears on **Co. Muster-out Roll**, dated

Wareham Sep, Oct 31, 1863

Muster-out to date *Oct 31, 1863*

Last paid to *Dec 31, 1864*

Clothing account:

Last settled....., 186 ; drawn since \$..... 100

Due soldier \$..... 100; due U. S. \$ *72* ^{*94*}/₁₀₀

Am't for cloth'g in kind or money adv'd \$..... 100

Due U. S. for arms, equipments, &c., \$ *11* 100

Bounty paid \$..... 100; due \$ *300* 100

Remarks: *Rec'd U.S. for arms & equip. \$130*

Book mark :

J. J. [Signature]
Copyist.

482-a

Fulton, Lewis

Co., 5 W.S. Col'd Car.

CARD NUMBERS.

1	9436077	26
2		27
3		28
4		29
5		30
6		31
7		32
8		33
9		34
10		35
11		36
12		37
13		38
14		39
15		40
16		41
17		42
18		43
19		44
20		45
21		46
22		47
23		48
24		49
25		50

• Number of personal papers herein.....

Book Mark: _____

See also _____

F. Cold, Mass.
Lewis Fulton

Co. 5 Reg't Mass Col'd Cav.

Appears on
Regimental Descriptive Book

of the organization named above.

DESCRIPTION.

Age 43 years; height 5 feet 7 inches.

Complexion Colored

Eyes Black; hair Black

Where born Randolph Co. Ill.

Occupation a laborer.

ENLISTMENT

When March 4, 1864

Where Rehoboth,

By whom A. O. Swain; term 3 y'rs.

Remarks: Rejected March 26/64

Swain

483 or Genica

Furman, Demica A.

Co E, 5 Mass. Cav., (Col'd.)

Private

Private

CARD NUMBERS.

1	5-378110	26
2	5-378195	27
3	5-378281	28
4	5-378375	29
5	5-378484	30
6	5-3785-92	31
7	5-378695	32
8	5-378801	33
9	5-378905	34
10	5-379007	35
11	5-379104	36
12	5-379205	37
13	9092173	38
14	40730965	39
15		40
16		41
17		42
18		43
19		44
20		45
21		46
22		47
23		48
24		49
25		50

Book Mark:

See also

F

5 Cav. (Col'd.) | Mass.

Seneca A. Furman

....., Co. *E*, 5 Reg't Mass. Cav. (Col'd.)

Appears on

Company Descriptive Book

of the organization named above.

DESCRIPTION.

Age *35* years; height *5* feet *7 3/4* inches.

Complexion *Wh*

Eyes *Blk*; hair *Blk*

Where born *Doyleston Penna.*

Occupation *Barber*

ENLISTMENT.

When *Jan 29*, 186*1*.

Where *Boston*

By whom *Attn: No. 100*; term *Three*'rs.

Remarks: *Marr'd.*

.....
.....
.....
.....
.....
.....
.....
.....
.....
.....

Heard

J

5 Col'd Cav.

Mass.

Orneca A. Furman

Private, Co. E, 5 Reg't Mass. Col'd Cav.

Appears on

Company Muster-in and Descriptive Roll

of the organization named above. Roll dated

Readville, Mass, July 10, 1864.

Where born Doylestown, Pennsylvania

Age 35 y'rs; occupation Barber

When enlisted Jan, 27, 1864.

Where enlisted Ward 5, Boston.

For what period enlisted 3 years.

Eyes black; hair black

Complexion black, height 5 ft. 7 3/4 in.

When mustered in July 10, 1864.

Where mustered in Readville, Mass.

Bounty paid \$ 100; due \$ 100

Where credited 4 Dist. Suffolk

Company to which assigned

Remarks:

*Inserted by Jordan Cox

Book mark:

Kuman

J

5 Col'd Cav.

Mass.

Seneca A. Furman

Priv't, Co. E, 5 Reg't Mass. Col'd Cavalry.

Appears on

Company Muster Roll

for *Enlistment to 29 Feb'y*, 186*4*.

Present or absent... *present*

Stoppage, \$... 100 for

Due Gov't, \$... 100 for

Valuation of horse, \$... 100

Valuation of horse equipments, \$... 100

Remarks: *in daily duty as member of Regimental Band per Special Order No. 29.*

Book mark:

(358)

Kennan

Copyist.

F

5 Col'd Cav.

Mass.

Penca A. Furman

Pvt, Co. E, 5 Reg't Mass. Col'd Cavalry.

Appears on

Company Muster Roll

for *March & April*, 186*4*.

Present or absent *Present*

Stoppage, \$ *100* for

Due Gov't, \$ *100* for

Valuation of horse, \$ *100*

Valuation of horse equipments, \$ *100*

Remarks: *Daily Duty,*

Book mark: _____

[Signature]

(358)

Copyist.

JH

5 Col'd Cav.

Mass.

Emmett A. Furman

Private, Co. E, 5 Reg't Mass. Col'd Cavalry.

Appears on

Company Muster Roll

for *May & June*, 1864.

Present or absent *Present*

Stoppage, \$ *100* for

Due Gov't, \$ *100* for

Valuation of horse, \$ *100*

Valuation of horse equipments, \$ *100*

Remarks: *Daily duty as member of Band*

Book mark:

[Signature]
Copyist.

F

5 Col'd Cav.

Mass.

Benca A. Furman

Priv, Co. E, 5 Reg't Mass. Col'd Cavalry.

Appears on

Company Muster Roll

for *July & Aug.*, 1864.

Present or absent *Present*

Stoppage, \$ *100* for

Due Gov't, \$ *100* for

Valuation of horse, \$ *100*

Valuation of horse equipments, \$ *100*

Remarks: *Daily duty as member of Band.*

Book mark:

O. J. Clark

(358)

Copyist.

F

5 Col'd Cav.

Mass.

Ameca H. Furman

Priv., Co. E, 5 Reg't Mass. Col'd Cavalry.

Appears on

Company Muster Roll

for *Sept & Oct.*, 1864.

Present or absent *Present*

Stoppage, \$ *100* for

Due Gov't, \$ *100* for

Valuation of horse, \$ *100*

Valuation of horse equipments, \$ *100*

Remarks: *Daily duty mem-
ber Regt Band.*

Book mark:

A. C. Clark

(358)

Copyist.

J

5 Col'd Cav.

Mass.

Levica A. Furman

Prvt, Co. E, 5 Reg't Mass. Col'd Cavalry.

Appears on

Company Muster Roll

for *Nov. & Dec.*, 1864.

Present or absent *Present*

Stoppage, \$ *100* for

Due Gov't, \$ *100* for

Valuation of horse, \$ *100*

Valuation of horse equipments, \$ *100*

Remarks: *Daily duty, mem-
ber regimental band.*

Book mark:

O. J. Clark

(358)

Copyist.

J

5 Col'd Cav.

Mass.

Benjamin A. Furman

Prvt., Co. E, 5 Reg't Mass. Col'd Cavalry.

Appears on

Company Muster Roll

for *Jan. & Feb.*, 1865.

Present or absent *Present*

Stoppage, \$ *100* for

Due Gov't, \$ *100* for

Valuation of horse, \$ *100*

Valuation of horse equipments, \$ *100*

Remarks: *Daily duty. Regimental band. Due U.S. for transportation to Boston & Mt. #19.40*

Book mark:

M. Slane

(358)

Copyist.

F

5 Col'd Cav.

Mass.

Conica A. Furman

Priv., Co. E, 5 Reg't Mass. Col'd Cavalry.

Appears on

Company Muster Roll

for *March + Apr.*, 1865.

Present or absent *Present*

Stoppage, \$ *100* for

Due Gov't, \$ *100* for

Valuation of horse, \$ *100*

Valuation of horse equipments, \$ *100*

Remarks: *Daily duty Regimental band. Due U.S. for transportation \$19.40*

Book mark:

O. S. Clark

(358)

Copyist.

F

5 Col'd Cav.

Mass.

Amicus A. Ferran
Coh, Co. E, 5 Reg't Mass. Col'd Cavalry.

Appears on

Company Muster Roll

for *May & June*, 1865.

Present or absent *Present*

Stoppage, \$ *100* for

Due Gov't, \$ *100* for

Valuation of horse, \$ *100*

Valuation of horse equipments, \$ *100*

Remarks: *Daily duty Regt bands*

Stop fortrans portation 7940

Book mark:

(358)

Loumy

Copyist.

F

5 Col'd Cav.

Mass.

Cerica A. Furman

Plt, Co. E, 5 Reg't Mass. Col'd Cavalry.

Appears on

Company Muster Roll

for *July & Aug*, 1865.

Present or absent *Present*

Stoppage, \$ *100* for

Due Gov't, \$ *100* for

Valuation of horse, \$ *100*

Valuation of horse equipments, \$ *100*

Remarks: *Daily duty Regt
band*

*Stop for transportation
1741*

Book mark:

Louvy

(358)

Copyist.

F

5 Col'd Cav.

Mass.

C. A. Furman

Mus., Co. *E*, 5 Reg't Mass. Colored Cav.

Appears on Returns as follows:

*May & June 1864 - On duty
Member of the Reg't Band.
July 1864 - On duty, Musician
Sept. to Dec. 1864 - On duty
Member Reg't Band.
Jan'y & Feby 1865 - On duty
Musician.
March 1865 - Absent Musi-
cian.
April to Sept. 1865 - On duty
in Reg't Band.*

Book mark:

C. J. Taylor

(546)

Copyist.

J

5 Col'd Cav.

Mass.

Emica A. Furman

Priv, Co. *E*, 5 Reg't Mass. Col'd Cavalry.

Appears on **Co. Muster-out Roll**, dated *Clarksville, Tex., Oct 31, 1865.*

Muster-out to date *Oct 31, 1865.*

Last paid to *Dec 31, 1864.*

Clothing account:

Last settled....., 186 ; drawn since \$..... 100

Due soldier \$ *35*^{*24*}/₁₀₀; due U. S. \$..... 100

Am't for cloth'g in kind or money adv'd \$..... 100

Due U. S. for arms, equipments, &c., \$ *3*^{*00*}/₁₀₀

Bounty paid \$..... 100; due \$ *300*^{*00*}/₁₀₀

Remarks: *Due U.S. for transportation \$9.40*

Book mark :

Lowry

(861)

Copyist.

MICROCOPY

1817

ROLL

81



IMAGE EVALUATION TEST TARGET (QA-3)

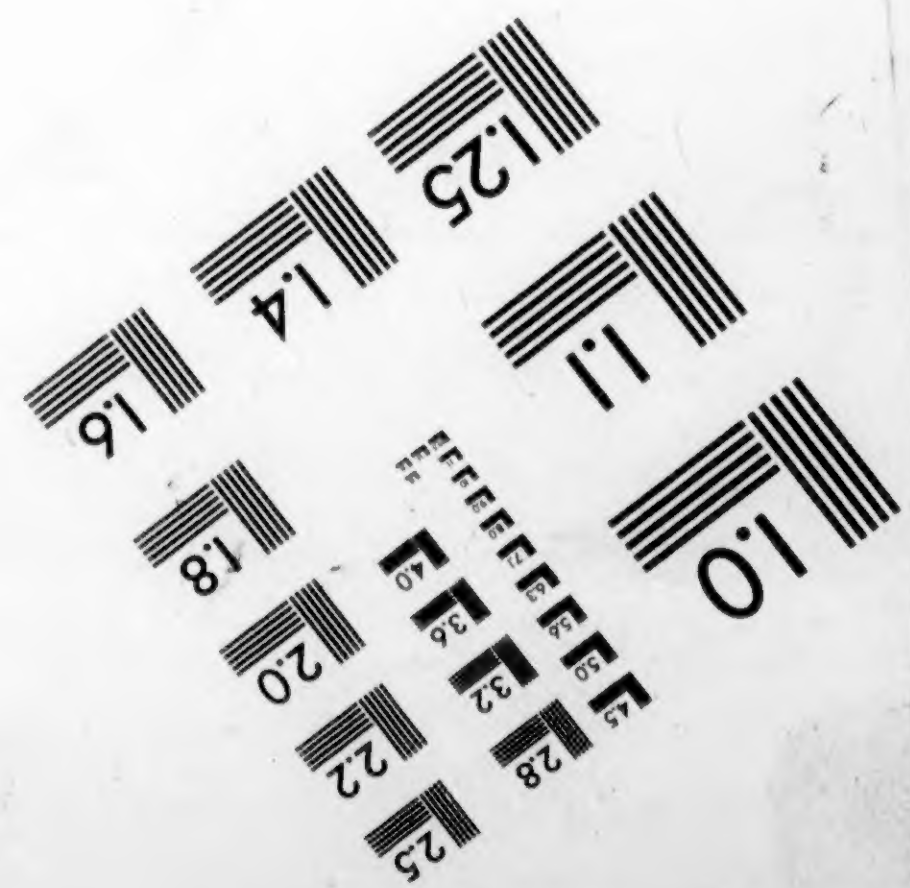
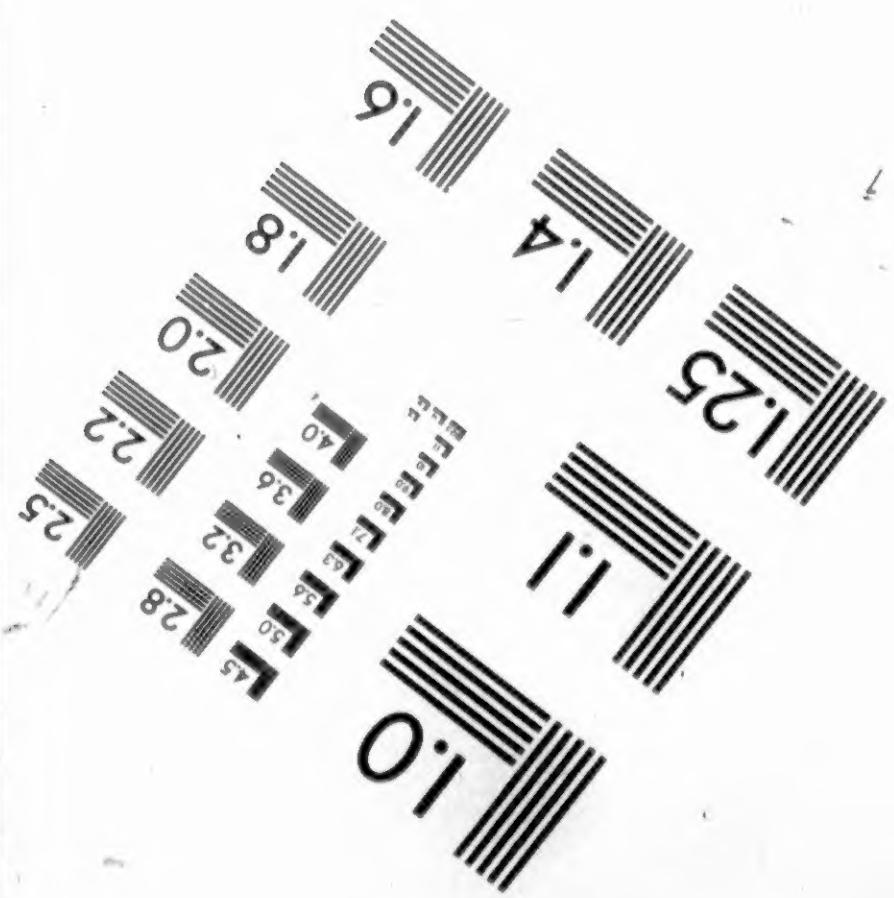
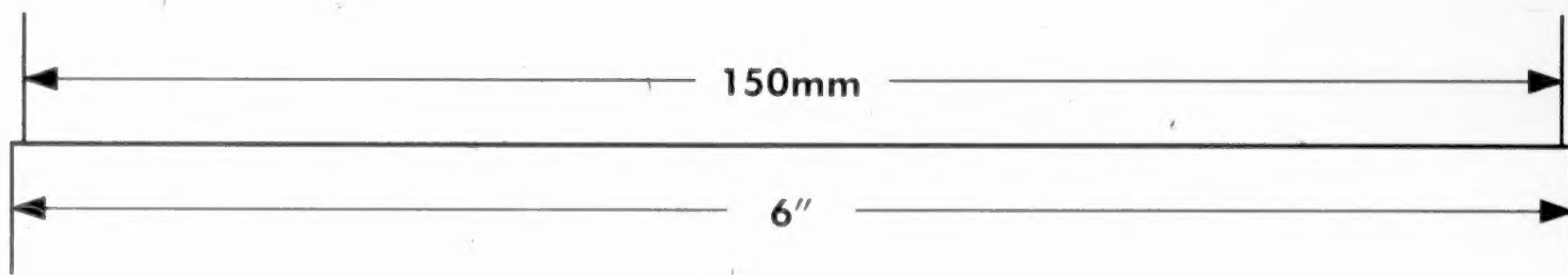
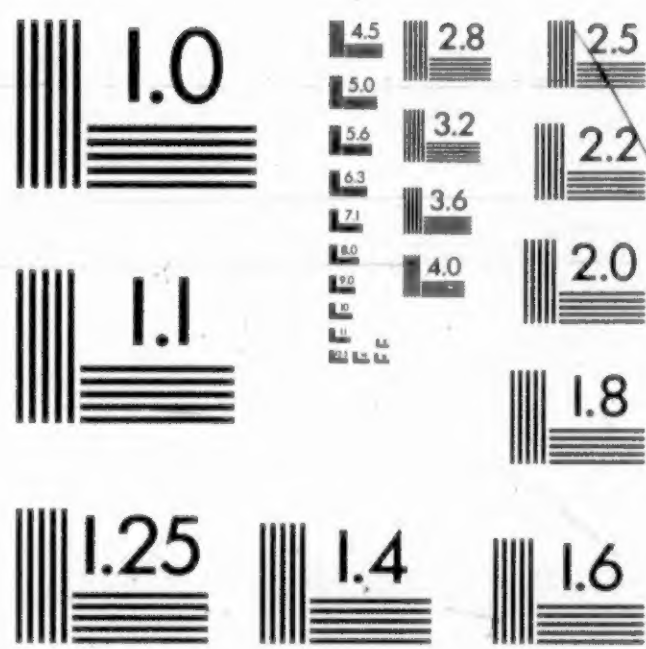
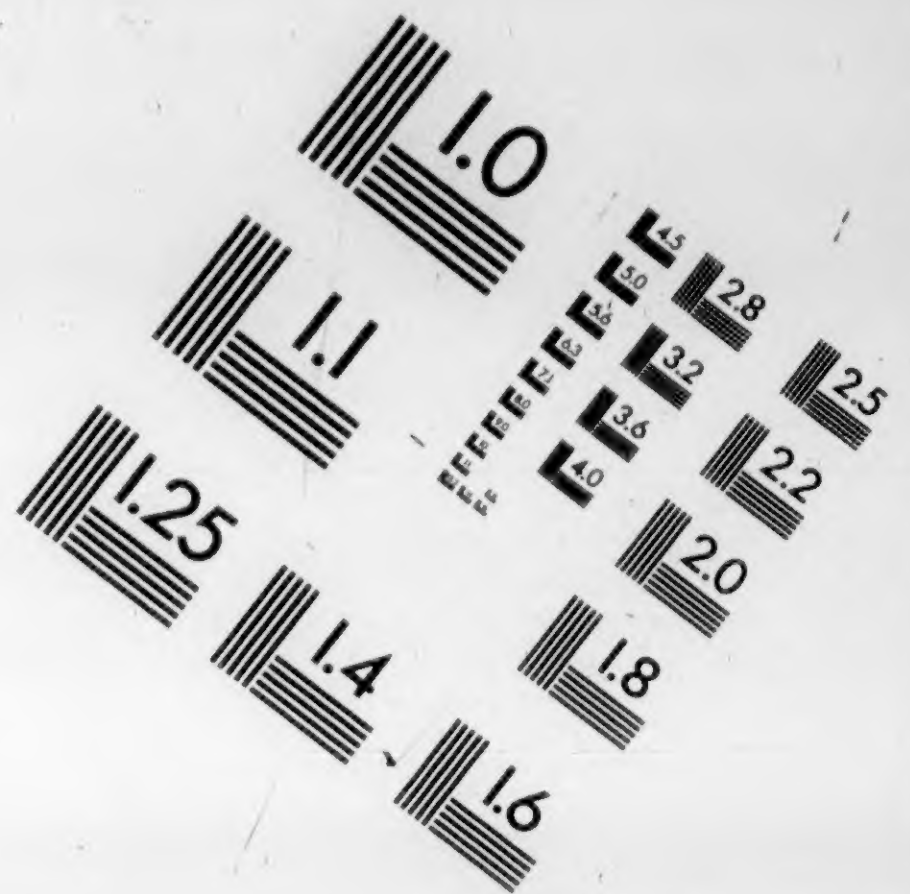
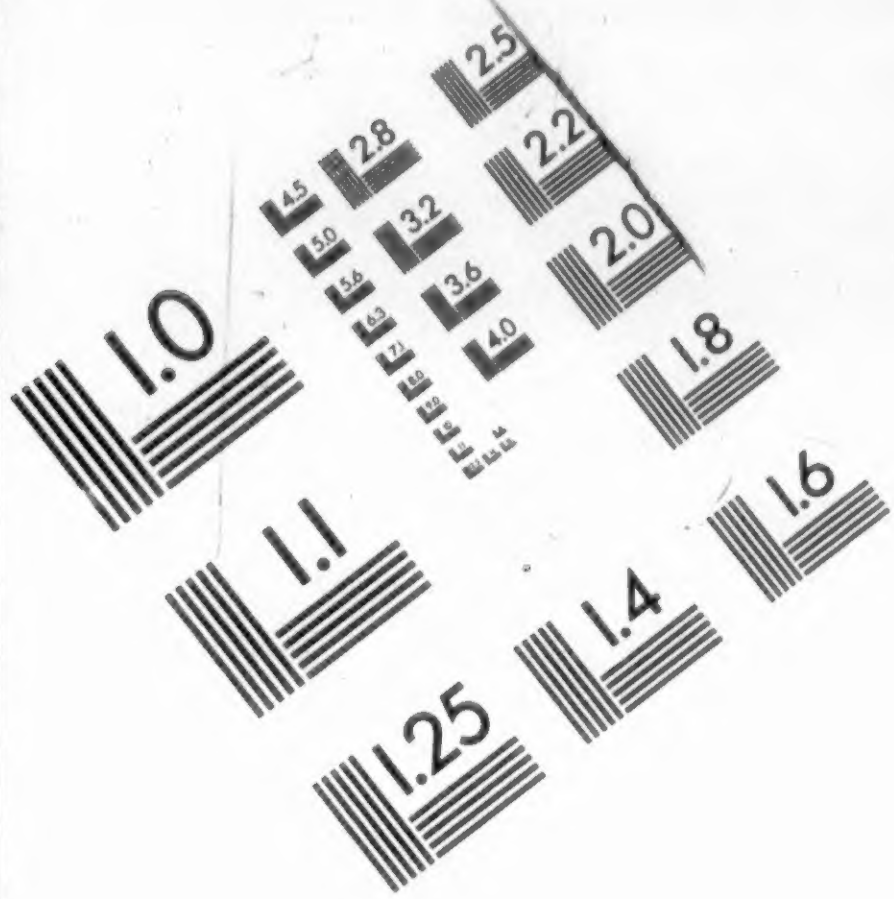

APPLIED IMAGE, Inc
 1653 East Main Street
 Rochester, NY 14609 USA
 Phone: 716/482-0300
 Fax: 716/288-5989

© 1993, Applied Image, Inc., All Rights Reserved

THE END

PLEASE

REWIND