

**NATIONAL
ARCHIVES
MICROFILM
PUBLICATIONS**

IMAGE EVALUATION TEST TARGET (QA-3)

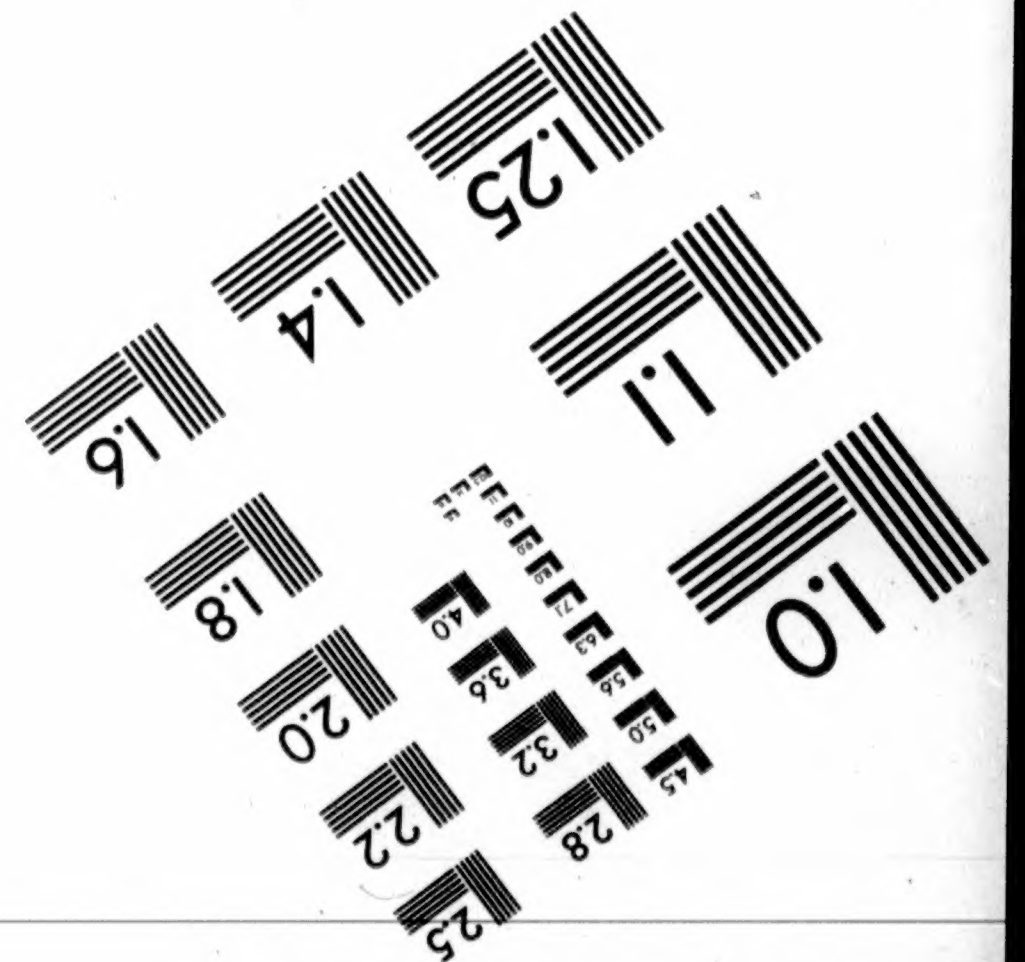
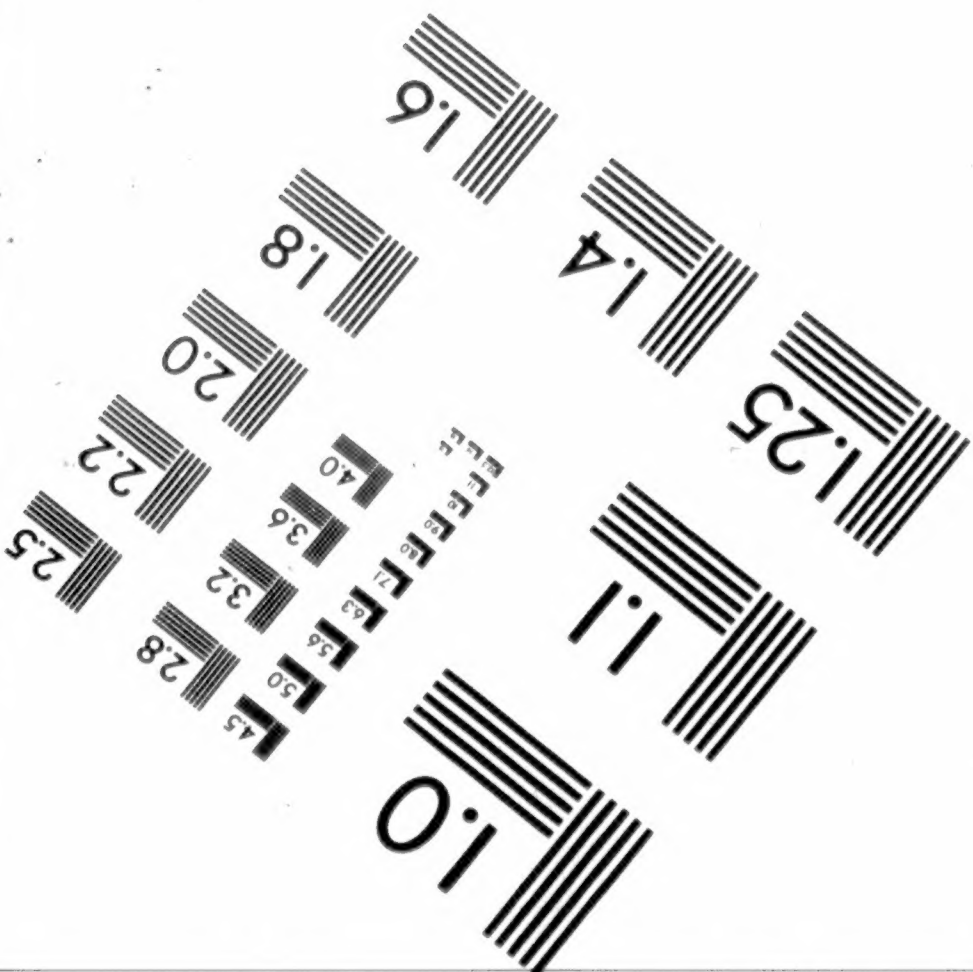
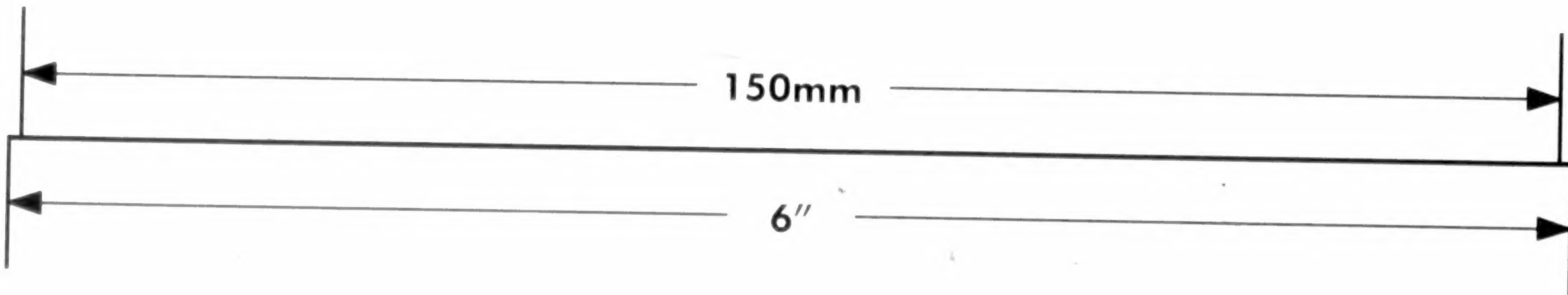
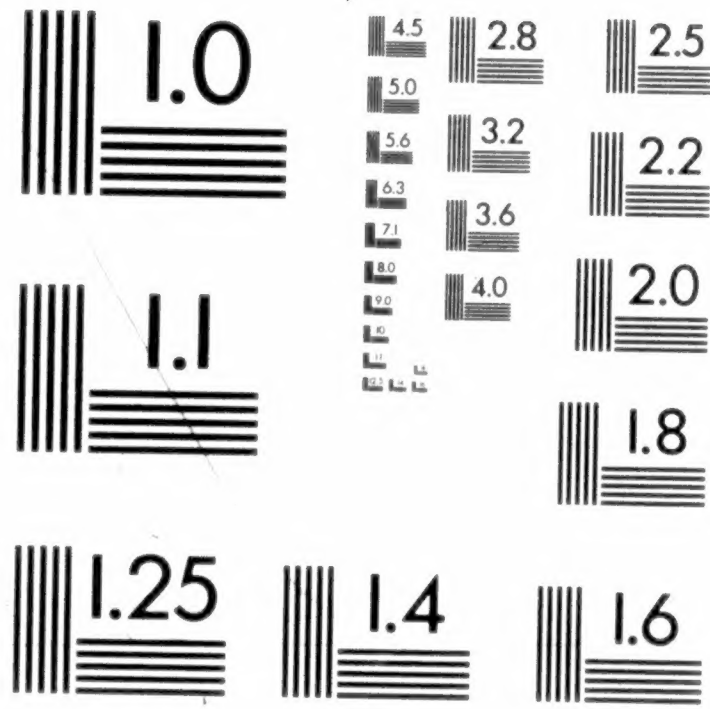
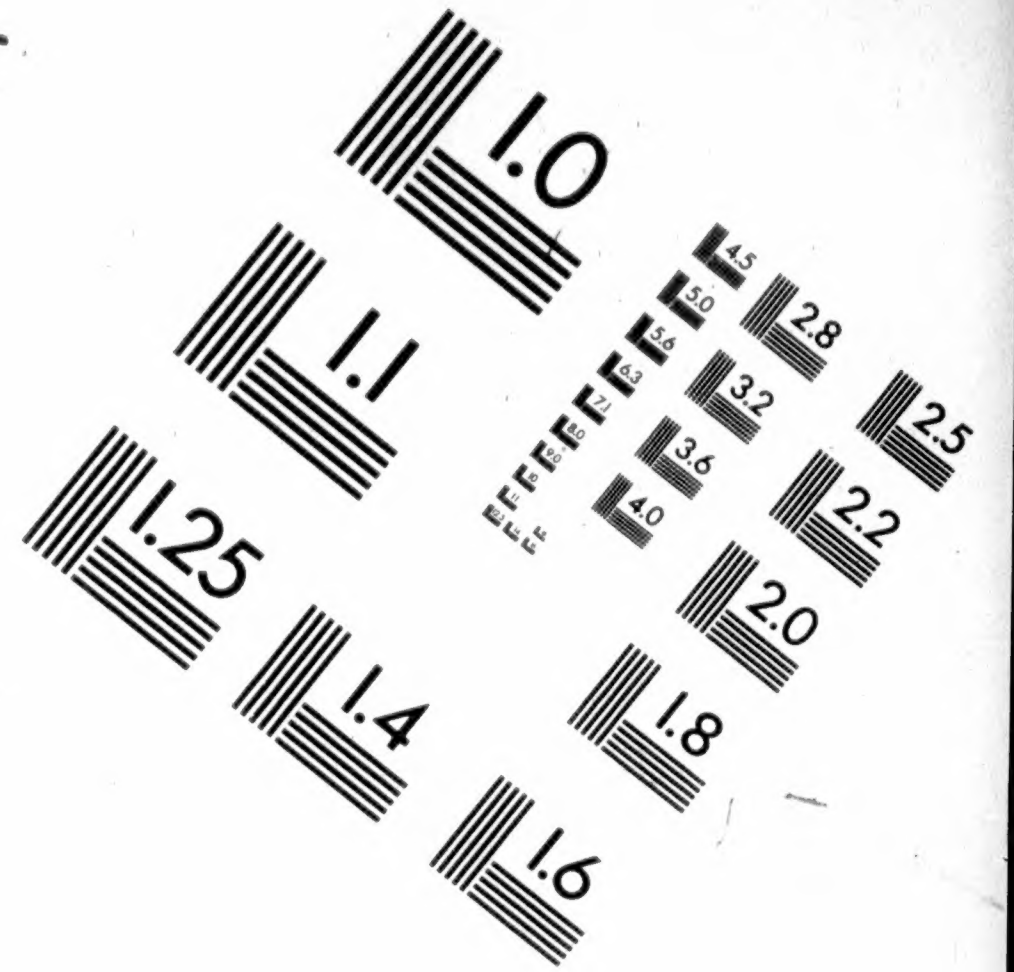
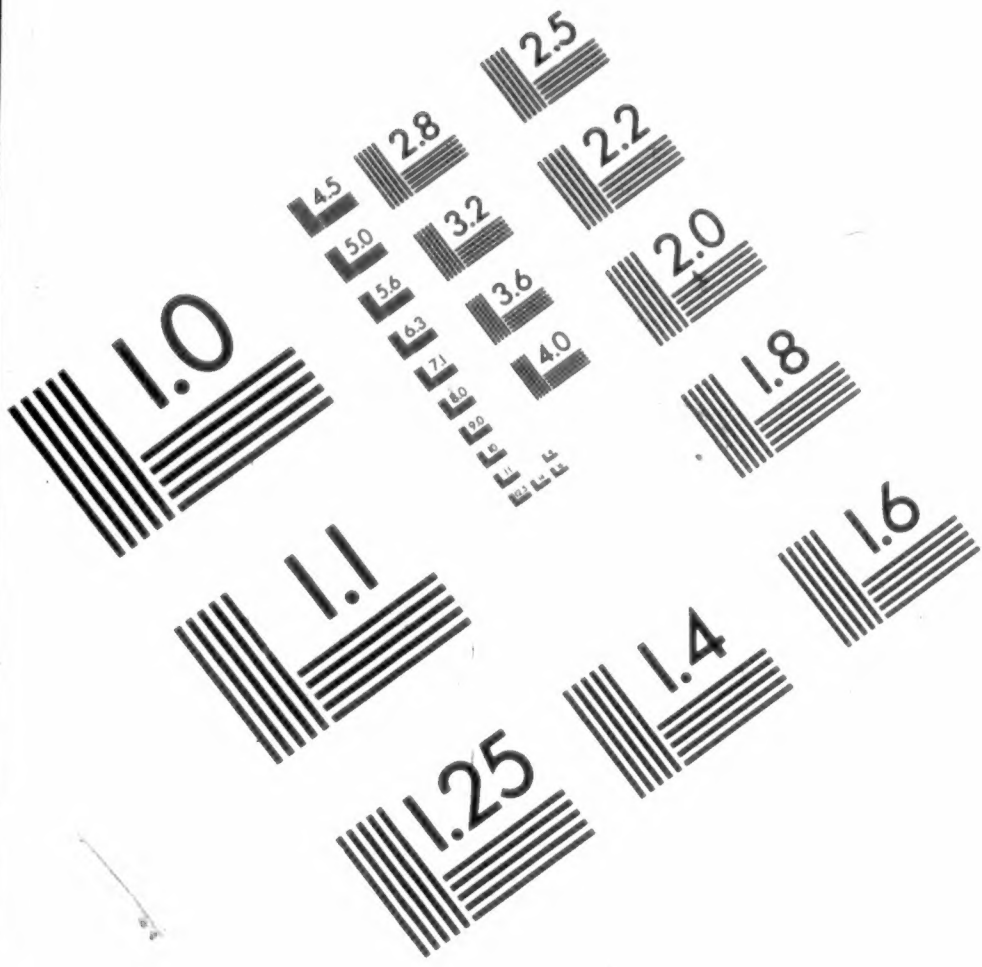

APPLIED IMAGE, Inc
 1653 East Main Street
 Rochester, NY 14609 USA
 Phone: 716/482-0300
 Fax: 716/288-5989

© 1993, Applied Image, Inc., All Rights Reserved

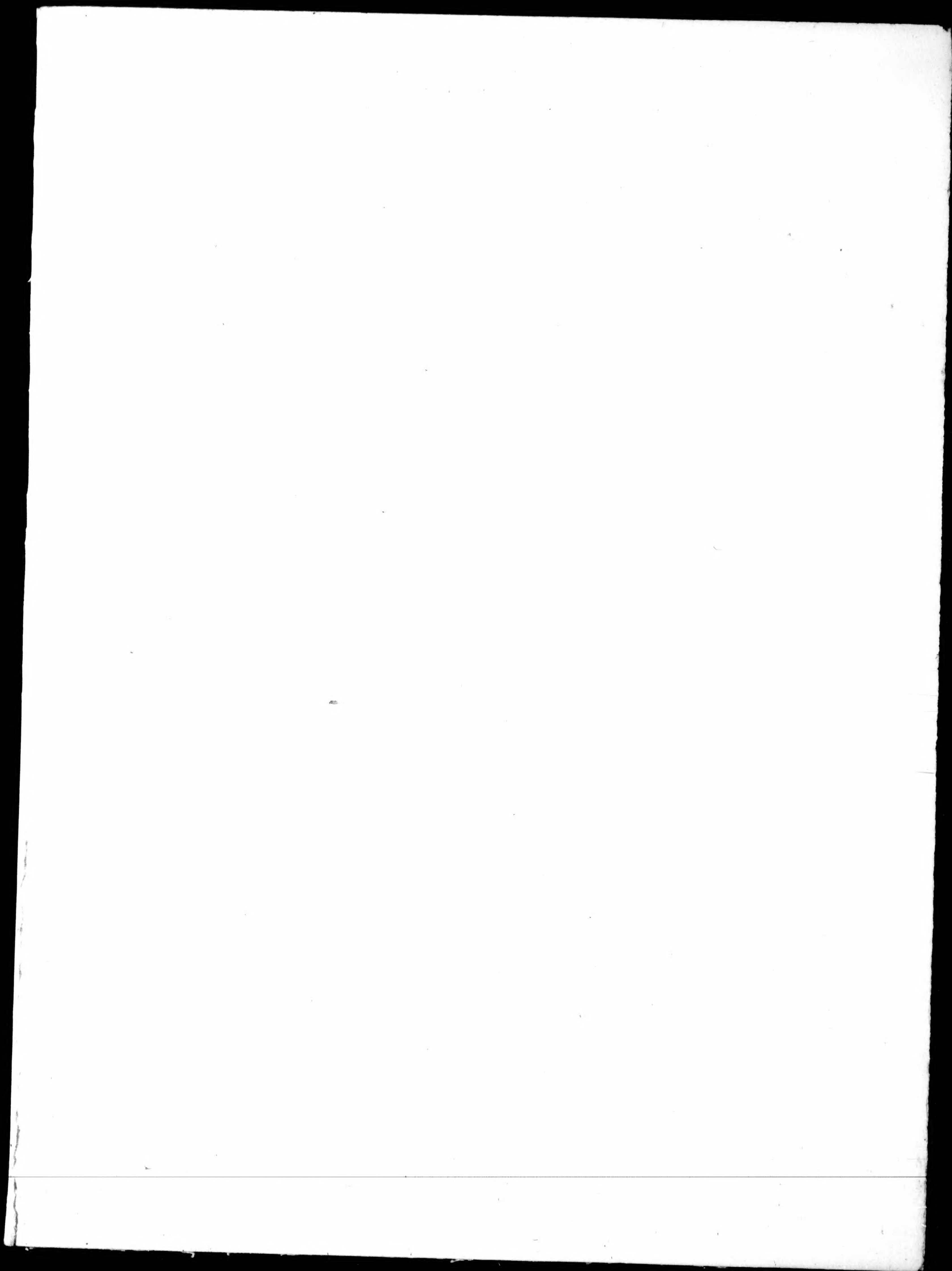

National Archives at College Park



8601 Adelphi Road College Park MD 20740-6001

Rebecca Sullivan Z3

OPERATOR

CAMERA

September 19, 1997 10

DATE FILMED

REDUCTION RATIO

13510107

FILM EMULSION NUMBER

VV 1817 87

PROJECT NUMBER

ROLL NUMBER

NO 11

8

7

MICROCOPY

18

1

7

M1817

COMPILED MILITARY SERVICE RECORDS OF
VOLUNTEER UNION SOLDIERS WHO SERVED WITH THE
UNITED STATES COLORED TROOPS:
1st Through 5th United States Colored Cavalry
5th Massachusetts Cavalry (Colored)
6th United States Colored Cavalry

Introduction by Michael E. Pilgrim

Records prepared for microfilming by members of
the Civil War Conservation Corps

Budge Weidman, Project Director

Pat Alfredson
Phyllis Altrogge
Kenneth Ashton
Sue Barnard*
Dee Benson
Ann N. Brown
Robert Budway
MaryAnn Castellana*
Mary Lou Cole
Marjory Cooper
Giovanni Croce
B. H. Custer
Bob Denney
Richard Dow
Yvette Fallin

Naomi Glass
Sue Goward*
Bert Greenstein
Anne Greenwood
Jim Harris
Walter Hayden
Mary Hayden
Pat Ikonen
Dick Ives
Sarah Jaffe
Barbara Kemp
Bev Manypenny
Frank Masterson
Joe Mazur
Sarah McDougall
Ben Miles

Dave Murray
Ray Puzio
Bill Schneider
Sylvia Scott
Lynn Shearouse
Mary Stack-Dunne
Ben Stearns
Bill Stormer*
Pat Sullivan
Gorman Tidball*
Cathy Tinston
John Toole
Maryellen Toole
Milt Weatherhead
C. Lois Young

Team leaders are indicated by the asterisk.

National Archives and Records Administration
1997

INTRODUCTION

On the 107 rolls of this microfilm publication, M1817, are reproduced the compiled military service records of volunteer Union soldiers belonging to the 1st through 5th United States Colored Cavalry, the 5th Massachusetts Cavalry (Colored), and the 6th United States Colored Cavalry. While the 5th Massachusetts did retain its state designation, these units were all part of the United States Colored Troops (USCT). The USCT included 7 numbered cavalry regiments; 14 numbered artillery regiments; 144 numbered infantry regiments; plus Brigade Bands Nos. 1 & 2 (Corps d'Afrique and US Colored Troops); Powell's Regiment Colored Infantry; Southard's Company Colored Infantry; Quartermaster Detachment; Pioneer Corps, 1st Division, 16th Army Corps; Unassigned Company A Colored Infantry and Unassigned USCT. The records reproduced are part of the Records of the Adjutant General's Office, 1780's-1917, Record Group (RG) 94.

Background

United States Colored Troops

Since the time of the American Revolution, African Americans have volunteered to serve their country in time of war. The Civil War was no exception. Official sanction was the difficulty. In the fall of 1862 there were four Union regiments of African Americans raised in New Orleans, LA: the 1st, 2d, and 3d Louisiana Native Guard, and the 1st Louisiana Heavy Artillery (African Descent). The 1st South Carolina Infantry (African Descent) was not officially organized until January 1863; however, three companies of the regiment were on coastal expeditions as early as November 1862. Similarly, the 1st Kansas Colored Infantry was not mustered into Federal service until January 1863, even though the regiment had already participated in the action at Island Mound, MO, on October 27, 1862. These early unofficial regiments received little Federal support, but they showed the strength of the African American soldier's desire to fight for freedom.

The first official authorization to employ African Americans in Federal service was the Second Confiscation and Militia Act of July 17, 1862. This act allowed President Abraham Lincoln to receive into the military or naval service persons of African descent and gave him permission to use them for any purpose "he may judge best for the public welfare." However, the President did not authorize use of African Americans until issuance of the Emancipation Proclamation on January 1, 1863.

In late January 1863, Gov. John Andrew of Massachusetts received permission to raise a regiment of African American soldiers. The pace of organizing additional regiments was very slow. In March Secretary of War Edwin M. Stanton sent Gen. Lorenzo Thomas to the lower Mississippi Valley to recruit

free and contraband African Americans. Thomas was given broad authority. He was to explain the administration's policy regarding African American soldiers and recruit volunteers to raise and command them. Stanton wanted all officers of such units to be white, but that policy was softened to allow African American surgeons and chaplains. By the end of the war, in addition to the chaplains and surgeons, there were some 87 African-American officers. Thomas's endeavor was very successful, and on May 22, 1863, the Bureau of Colored Troops was established to coordinate and organize regiments from all parts of the country. Created under War Department General Order No. 143, the bureau was responsible for handling "all matters relating to the organization of Colored Troops." The bureau was directly under the Adjutant General's Office and its procedures and rules were specific and strict. All African American regiments were now to be designated United States Colored Troops (USCT). At this time there were some African American regiments with state names and a few regiments in the Department of the Gulf designated as Corps d'Afrique. All these were ultimately assimilated into the USCT, even though some of the regiments, such as the 5th Massachusetts, retained their state designations.

To facilitate recruiting in the states of Maryland, Missouri, Tennessee, and eventually Kentucky, the War Department issued General Order No. 329 on October 3, 1863. Section 6 of the order stated that if any citizen should offer his or her slave for enlistment into the military service, that person would, "if such slave be accepted, receive from the recruiting officer a certificate thereof, and become entitled to compensation for the service or labor of said slave, not exceeding the sum of three hundred dollars, upon filing a valid deed of manumission and of release, and making satisfactory proof of title." For this reason, some records of manumission are contained in the compiled service records reproduced in this publication.

The USCT fought in 39 major engagements and over 400 lesser ones. Sixteen African American soldiers received Medals of Honor. As it was in other units, the death toll from disease was very high in the USCT. Deaths from disease and battle totaled 37,000. The last regiment of the USCT was mustered out of Federal service in December 1867.

Important sources for information about African American units in the Civil War are the War Department's *The War of the Rebellion: A Compilation of the Official Records of the Union and Confederate Armies* (Washington, DC: 1880-1901; reprinted Harrisburg, 1971 and 1985) and the Navy Department's *The War of the Rebellion; A Compilation of the Official Records of the Union and Confederate Navies* (Washington, DC: 1874-1922; reprinted Harrisburg, 1971 and 1985). These multivolume works contains reports of operations and other official correspondence.

1st United States Colored Cavalry

This regiment was organized at Camp Hamilton, VA, on December 22, 1863, and assigned to duty in the Department of Virginia and North Carolina. The 1st participated in Gen. Benjamin F. Butler's operations on the south side of the James River and against Petersburg and Richmond, May 4-28, 1864. These included the capture of Bermuda Hundred and City Point, VA, on May 5, and events leading up to and including the siege of Petersburg. In August 1864 it was transferred to the defenses of Portsmouth, District of Eastern Virginia. On June 10, 1865, the 1st sailed from City Point, VA, to Texas where it was assigned duty on the Rio Grande and various other areas of the state. The unit was mustered out on February 4, 1866. Compiled casualty figures are not available.

2d United States Colored Cavalry

This regiment was organized at Fort Monroe, VA, on December 22, 1863, and assigned to duty in the Department of Virginia and North Carolina. The 2d participated in Gen. Benjamin F. Butler's operations on the south side of the James River and against Petersburg and Richmond, May 4-28, 1864. These included the capture of Bermuda Hundred and City Point, VA, on May 5, and events leading up to and including the siege of Petersburg. In February 1865 it was transferred to Norfolk, District of Eastern Virginia. On June 10, 1865, the 2d sailed from City Point, VA, to Texas where it was assigned duty on the Rio Grande and various other areas of the state. The unit was mustered out on February 12, 1866. Losses included 19 killed in action and 161 dead from disease and other causes.

3d United States Colored Cavalry

Organized at Vicksburg, MS, on October 9, 1863, as the 1st Mississippi Cavalry (African Descent), this regiment was redesignated the 3d U.S. Colored Cavalry on March 11, 1864. From its organization until March 1864, the unit was attached to the District of Northeast Louisiana and from January to March 1864 participated in operations up the Yazoo River and the occupation of Yazoo City. The regiment was then transferred to the District of Vicksburg, Department of Tennessee, where it remained until December 1864. That month the unit moved to Memphis, TN, and from December 21, 1864, to January 5, 1865, participated in Gen. Benjamin Grierson's raid to destroy the Mobile & Ohio Railroad. The 3d remained on duty in Memphis and the District of West Tennessee and took part in the expedition from Memphis to Brownsville, MS, April 23-26, 1865. On April 29 the regiment returned to Vicksburg and operated around Natchez in search of fugitive Confederate President Jefferson Davis. The unit remained in the District of West Tennessee and Department of Mississippi until January 26, 1866, when it was mustered out. Losses included 37 killed in action and 367 dead from disease and other causes.

4th United States Colored Cavalry

Organized on September 12, 1863, as the 1st Corps d'Afrique Cavalry, this regiment was redesignated the 4th United States Colored Cavalry on April 4, 1864. From its organization until August 1864, it was attached to the Defenses of New Orleans, Department of the Gulf. On August 8, 1864, the 4th was ordered to Baton Rouge, LA, District of Port Hudson, and remained on duty at that post until July 1865 when it was transferred to the Department of Mississippi. It performed duties at various points in that department until it was mustered out on March 20, 1866. Compiled casualty figures are not available.

5th United States Colored Cavalry

This regiment was organized at Camp Nelson, KY, on October 24, 1864, and attached to the 1st Division, District of Kentucky, Department of Ohio. December 10-29, 1864, it participated in Stoneman's Raid into southwestern Virginia, including the capture of Saltville and the destruction of saltworks on December 20-21. In February 1865 the regiment was transferred to the Military District and Department of Kentucky until December of that year when it was ordered to the Department of Arkansas. During the latter period the unit performed mostly garrison duty. The regiment was mustered out March 20, 1866. Losses included 35 killed in action and 152 dead from disease and other causes.

5th Massachusetts Cavalry (Colored)

This regiment was organized at Camp Meigs, Reedville, MA, in the spring of 1864, and sent to Washington, DC, in May of that year. On May 13 the regiment moved to City Point, VA, where it was attached to the 18th Army Corps. Until June 16 it functioned as an infantry unit and participated in the siege of Petersburg. On June 30 it was moved to Point Lookout, MD, to guard prisoners of war. In July 1864 the regiment, still at Point Lookout, became part of the 22d Army Corps. It was transferred to the 25th Army Corps in March 1865 and ordered to the field near Richmond and Petersburg. In June the regiment was ordered to the Department of Texas where it was assigned duty at Clarksville until October 31, 1865, when it was mustered out. Losses included 7 men killed in action and 116 dead from disease and other causes.

6th United States Colored Cavalry

This regiment was organized at Camp Nelson, KY, on October 24, 1864, and attached to the 1st Division, District of Kentucky, Department of Ohio. December 10-29, 1864, it participated in Stoneman's Raid, including the destruction of the lead mines in southwestern Virginia. At the end of December the regiment returned to Camp Nelson and in February 1865 was transferred to the Military District and Department of Kentucky. It remained there until December

1865 when it was ordered to the Department of Arkansas. The unit was mustered out on April 15, 1866. Compiled casualty figures are not available.

Records Description

Compiled service records consist of a jacket-envelope for each soldier, labeled with his name, rank, unit, and card numbers. The compilation of service records of Union soldiers began in 1890 under the direction of Col. Fred C. Ainsworth, head of the Record and Pension Office of the Adjutant General's Office, Department of War. Information from muster rolls, regimental returns, descriptive books, and other records was copied verbatim onto cards. A separate card was prepared each time an individual name appeared on a document. These cards were numbered on the back, and these numbers were entered onto the outside jacket containing the cards. The carded information was verified by a separated operation of comparison; great care was taken to ensure that the cards were accurate.

A typical jacket contains card abstracts of entries found in original records relating to the soldier and original documents relating solely to that soldier. Examples of the latter include enlistment papers, substitute certificates, casualty sheets, death reports, prisoner-of-war memorandums, and correspondence. Unique to the records of the USCT are deeds of manumission, oaths of allegiance, proof of ownership, certificates of monetary award, and bills of sale. These items appear most frequently in units recruited in the border states of Kentucky, Missouri, and Maryland. These states remained in the Union but were slave states. Jackets and cards include a section labeled "bookmark" which was reserved for cross-references to other records relating to the individual or his unit. The service records are arranged by arm of service, thereunder numerically by regiment or independent battalion or company and thereunder alphabetically by name of the soldier. Records for officers are interfiled alphabetically by name with the records of enlisted men. If an individual served in more than one unit, which was typical for USCT officers, there will be a separate service record for each unit in which he served.

Related Records

Among the records of the Adjutant General's Office in the National Archives are many of the original records that were abstracted or "carded" by the Record and Pension Office. These include the individual unit's muster rolls, returns and descriptive books. Other series in RG 94 that contain information relating to volunteer Union soldiers who served with the USCT include carded records relating to Union staff officers, carded medical records of volunteer Union soldiers, unbound and bound regimental records and "record of events" cards. The regimental records of the 54th Massachusetts Infantry (Colored) have been

NATIONAL ARCHIVES MICROFILM PUBLICATIONS

reproduced as Microfilm Publication M1659, *Records of the Fifty-fourth Massachusetts Infantry Regiment (Colored), 1863-1865*.

The "record of events" cards include information copied from the unit's muster rolls and returns. They show the stations of the field and staff and those of the various companies of the regiment at the time the muster roll or return was prepared and sometimes mention battles, skirmishes, or other activities in which the regiment participated. The cards have been reproduced as Microfilm Publication M594 *Compiled Records Showing Service of Military Units in Volunteer Union Organizations*.

Record Group 94 also includes a card index for the USCT, reproduced as Microfilm Publication M589, *Index to Compiled Military Service Records of Volunteer Union Soldiers Who Served with U.S. Colored Troops*, which may be used to locate the regiment of USCT personnel. An index card gives the name of the soldier and his rank, as well as the unit in which he served; sometimes there is a cross-reference to his service in other units or organizations. The National Archives is continually producing microfilm publications of volunteer Union compiled military service records. A complete listing of finished publications can be found in the National Archives' *Microfilm Resources for Research: A Comprehensive Catalog* which is available online at <http://www.nara.gov>.

The Records of the Colored Troops Division, within RG 94, include division correspondence and records relating to recruiting, the appointment of officers, and the slave or free status of individuals; and a compilation of historical extracts and official papers concerning the military service of African Americans from the colonial period through the Civil War entitled *The Negro in the Military Service of the United States 1639-1886*. This compilation is reproduced as Microfilm Publication M858. The Records of the Bounty and Claims Division, also in RG 94, include correspondence of the division and records relating to bounties and claims paid to loyal owners of slaves by the Slave Claims Commissions of Delaware, Kentucky, Maryland, Missouri, Tennessee and West Virginia.

If an application for a pension was made, the pension application case file may be among the Records of the Veterans Administration (RG 15). Indexes to the pension applications have been reproduced as Microfilm Publication T288, *General Index to Pension Files, 1861-1934*, and T289, *Organizational Index to Pension Files of Veterans Who Served Between 1861 and 1900*.

If a soldier or officer was tried before a general court-martial or if an individual or his unit was the subject of a court of inquiry or military commission, transcripts of the proceedings may be among the Records of the Office of the Judge Advocate General (Army) (RG 153). The registers to the proceedings have been reproduced as Microfilm Publication M1105, *Registers of the Records of the Proceedings of the U.S. Army General Courts-Martial, 1809-1890*.

NATIONAL ARCHIVES MICROFILM PUBLICATIONS

Other record groups having information pertaining to the USCT include Records of the Bureau of Refugees, Freedmen, and Abandoned Lands (RG 105); Records of the Provost Marshal General's Bureau (Civil War) (RG 110); Records of the Accounting Officers of the Department of the Treasury (RG 217); and Records of U.S. Army Continental Commands, 1821-1920 (RG 393).

NATIONAL ARCHIVES MICROFILM PUBLICATIONS

ROLL LIST

Roll Description

1st United States Colored Cavalry

- 1 Akess, Alexander - Bom, John H.
- 2 Bomer, James - Cartwright, John
- 3 Casey, Thomas - Davenport, John J.
- 4 Davis, Augustus - Floyd, George
- 5 Fly, Benjamin - Griffin, Oliver
- 6 Griffin, Quinton - Holstead, Peter
- 7 Holt, George - Jones, Herbert
- 8 Jones, Howell - Macoy, Peter
- 9 Madry, Andrew - Mosley, Jacob
- 10 Moss, James - Polk, James
- 11 Pollard, Sipio - Sales, William
- 12 Sample, Abram (Abraham) - Smith, Ives
- 13 Smith, James - Times, Nelson
- 14 Tines, Archer - Wheldon, Charles M.
- 15 Whitby, Joseph - Wilson, Isaac
- 16 Wilson, James - Zoe (no first name)

2d United States Colored Cavalry

- 17 Abbot, John - Bell, Charles
- 18 Bell, Henry - Burns, Richard
- 19 Burroughs, George L. - Cotton, Samuel
- 20 Coues, Alexander - Duncan, Levi
- 21 Dunkins, Ezekiah James - Gardner, Richard
- 22 Garris, Henry - Harrison, Thomas
- 23 Harrison, William - Humphries, David
- 24 Hunter, Francis - Jones, Robert
- 25 Jones, Robert F. - Martin, Robert (Martin)
- 26 Martin, Thaddeus or Martin, Thaddeus W. - Osborne, Henry S.
- 27 Oulden, Jacob - Prior, Edward or Edmund
- 28 Proctor, David - Sawyer, Wilson
- 29 Scabber, Charles - Stanley, William
- 30 Stanley, Wright or Right - Upshear, Neverson
- 31 Upshear, Samuel - Whites, Joe
- 32 Whites, Silas - Zodrick, Isaiah A. or Isaiah

3d United States Colored Cavalry

- 33 Aaron, John - Black, David
- 34 Black, Richard - Cameron, Wyatt

NATIONAL ARCHIVES MICROFILM PUBLICATIONS

Roll Description

- 35 Cammel, Austin - Cooper, Stephen
- 36 Coran, Joseph - Erving, Tilson
- 37 Erwin, Anderson - Gool, George
- 38 Gordon, Alfred - Haskins, Jasper
- 39 Hawkins, Frank - Jackson, Harvey
- 40 Jackson, Henry - Kembro, Abraham
- 41 Kenedy, Lemuel - Lott, Judge
- 42 Lott, Matton - Mitchell, Berry
- 43 Mitchell, George - Pettis, Edmond
- 44 Pettis, George - Roberson, Jefferson
- 45 Roberson, Wallace - Simpson, Levi
- 46 Sims, Anderson - Taylor, Phillip
- 47 Taylor, Richard - Washington, Isaac
- 48 Washington, Oscar - Williams, Mitchel
- 49 Williams, Moses - Young, Mathew

4th United States Colored Cavalry

- 50 Abraham, Randall - Blanchan, William
- 51 Blanchard, Moses - Clark, Moses
- 52 Clark, Theodore - Ellars, James
- 53 Ellars, John - Heath, Culbert
- 54 Henderson, George - Johnson, Henderson
- 55 Johnson, Henry - Mayberry, Nelson
- 56 Macomory, John - Oliver, Celestine
- 57 Olsten, Alexander - Robinson, William
- 58 Robinson, William E. - Thomas, Stephen
- 59 Thomas, William - Williams, Horace
- 60 Williams, Isaac - Zulia, Francois

5th United States Colored Cavalry

- 61 Abel, Fletcher - Biggs, Randall
- 62 Birch, Benjamin - Burly, Frank
- 63 Burly, James - Coffman, James D.
- 64 Coke, Samuel - Dudley, John
- 65 Duke, John - Givens, Peter
- 66 Glen, John - Harriden, Edmund
- 67 Harrigan, Harden - Hughes, Thomas
- 68 Hulse, James - Keller, Ephraim
- 69 Kelley, Franklin - Matthews, Benjamin
- 70 Maupin, Preston - Murry, Ned
- 71 Murtney, Morton - Ray, John
- 72 Ray, Thomas - Sherrod, William

NATIONAL ARCHIVES MICROFILM PUBLICATIONS

Roll Description

- 73 Shrewsbury, Joseph - Stone, John
- 74 Stone, Lewis - Trye, Benjamin
- 75 Trueheart, Samuel - Williams, James
- 76 Williams, Jerry - Yowell, Joseph

5th Massachusetts Cavalry (Colored)

- 77 Abbey, David - Biers, William
- 78 Billings, Jeremiah - Burgess, Williams
- 79 Burnett, Lewis - Cook, Joseph T.
- 80 Cooper, Isaac - Dunmore, William
- 81 Durbin, Stephen - Furman, Seneca A.
- 82 Gadson, James - Gurley, Joseph L.
- 83 Guy, James - Hill, John W.
- 84 Hill, Richard - Johns, Thomas H.
- 85 Johnson, Aaron - Lambert, William
- 86 Lancaster, James - Mason, John
- 87 Mason, John H. - Nelson, Philip
- 88 Nelson, Preston - Preston, Thomas
- 89 Price, Adam - Sampson, George P.
- 90 Sanborn, Madison - Stringer, William
- 91 Strother, Frank - Vance, William H.
- 92 Van Hoesen, Charles - Wilkinson, Simon
- 93 Williams, Abram H. - Young, Thomas

6th United States Colored Cavalry

- 94 Abbot, John - Birch, James
- 95 Bivins, Gabriel - Buckner, George
- 96 Buckner, Henderson - Compton, James
- 97 Cook, Benjamin - Ellis, William
- 98 Ellis, Wyatt - Godley, Isaac
- 99 Gooch, Alexander - Herston, Abraham
- 100 Heywood, John R. - Johnson, Jackson
- 101 Johnson, James M. - Marshall, Lyman
- 102 Marshall, William - Neihardt, Isaac D.
- 103 Nelson, Joseph - Redd, Tiney
- 104 Redway, Hamilton K. - Sebree, Bob Woodcock
- 105 Sebree, Crittenden - Sumpter, John
- 106 Sutherland, Williams - Washington, Charles
- 107 Washington, George - Wren (no first name)

NATIONAL ARCHIVES MICROFILM PUBLICATIONS

Microfilm Publication M1817

COMPILED MILITARY SERVICE RECORDS OF VOLUNTEER UNION
SOLDIERS WHO SERVED WITH THE UNITED STATES COLORED
TROOPS: 1st Through 5th United States Colored Cavalry, 5th Massachusetts
Cavalry (Colored), 6th United States Colored Cavalry

Roll 87

5th Massachusetts Cavalry (Colored)

Mason, John H. - Nelson, Philip

967

Mason, John H.
Co. G, 5 Mass. Cav., (Col'd.)

Private | Private

CARD NUMBERS.

1	5381539	26
2	5385628	27
3	5381732	28
4	5381554	29
5	9091954	30
6	40731441	31
7		32
8		33
9		34
10		35
11		36
12		37
13		38
14		39
15		40
16		41
17		42
18		43
19		44
20		45
21		46
22		47
23		48
24		49
25		50

Book Mark:

See also

M | **5 Cav. (Col'd.)** | **Mass.**

John H. Mason

....., Co. *G*....., 5 Reg't Mass. Cav. (Col'd.)

Appears on

Company Descriptive Book
of the organization named above.

DESCRIPTION.

Age *21* years; height *5* feet *6 1/2* inches.

Complexion *Blk*

Eyes *Blk*; hair *Blk*

Where born *St Johns, New Brunswick.*

Occupation *Barber*

ENLISTMENT.

When *Dec 31*, 1863.

Where *Wellsfleet.*

By whom *J. Harris*; term *3* y'rs.

Remarks: *Deserted May 3rd /64.*

Hearst

M | **5 Col'd Cav.** | **Mass.**

John H. Mason
Co. G, 5 Reg't Mass. Col'd Cav.

Appears on
Company Muster-in and Descriptive Roll
of the organization named above. Roll dated

Readville Mass, Mar 4, 1864.

Where born *St Johns New Brunswick*

Age *21* y'rs; occupation *Barber*

When enlisted *Dec 31*, 1863.

Where enlisted *Wellfleet*

For what period enlisted *3* years.

Eyes *Blk*; hair *Blk*

Complexion *Blk*; height *5* ft. *10* in.

When mustered in *Mar 4*, 1864.

Where mustered in *Readville Mass*

Bounty paid \$ *100*; due \$ *100*

Where credited *Dist Barnstable*

Company to which assigned

Remarks:

Book mark:

Lager

M | **5 Col'd Cav.** | **Mass.**

John H. Mason
Pr, Co. G, 5 Reg't Mass. Col'd Cavalry.

Appears on

7 **Company Muster Roll**
for *March to April 30*, 186*4*.

Present or absent *Absent*

Stoppage, \$ *100* for

Due Gov't, \$ *100* for

Valuation of horse, \$ *100*

Valuation of horse equipments, \$ *100*

Remarks: *Attached to Regt
Band by Special order
No 71 dated Feb 22nd
1864.*

Book mark: _____

(358)

Leger

Copyist.

M | **5 Col'd Cav.** | **Mass.**

John H. Mason
Pr, Co. G, 5 Reg't Mass. Col'd Cavalry.

Appears on

Company Muster Roll

for *May/June*, 186*4*.

Present or absent.....

Stoppage, \$.....*100* for.....

Due Gov't, \$.....*100* for.....

Valuation of horse, \$.....*100*

Valuation of horse equipments, \$.....*100*

Remarks: *Deserted May 3/64*

Book mark:.....

Lege

M. | **5 Col'd Cav.** | **Mass.**

John H. Mason
Mus., Co. G, 5 Reg't Mass. Colored Cav.
Pvt.

Appears on **Returns** as follows:

Apr. 1864. Absent without
leave since Apr. 4

May 1864. Loss May 3^d Read-
ville - Deserted. (Pvt.)

Book mark : _____

(646)

J. B. Sittler

Copyist.

M

5 Col'd Cav.

Mass.

John H. Mason
Priv, Co. *G*, 5 Reg't Mass. Col'd Cavalry.

Appears on Co. Muster-out Roll, dated

Charville Tex Oct 31, 186*0*.

Muster-out to date _____, 186 .

Last paid to *Pay from Enrollment*, 186 .

Clothing account:

Last settled _____, 186 ; drawn since \$ _____ 100

Due soldier \$ _____ 100; due U. S. \$ *93 34* / 100

Am't for cloth'g in kind or money adv'd \$ _____ 100

Due U. S. for arms, equipments, &c., \$ _____ 100

Bounty paid \$ _____ 100; due \$ _____ 100

Remarks: *Discharged from Camp*
Meigs Readville Mass
May 3rd 61

Book mark : _____

Mason, Thomas

Co A, 5 Mass. Cav., (Col'd.)

Private Private

CARD NUMBERS.

1	5373316	26
2	5373401	27
3	5373482	28
4	5373585	29
5	5373697	30
6	5373806	31
7	5373907	32
8	5374018	33
9	5374119	34
10	5374215	35
11	5374309	36
12	5374405	37
13	9092685	38
14		39
15		40
16		41
17		42
18		43
19		44
20		45
21		46
22		47
23		48
24		49
25		50

Book Mark:

See also

S679283 Ruff

REP 343878.

S 730034 2 and

S 747120 - 2 and 1/2

over 2319 pounds

Waltham
4

(| **5 Cav. (Col'd.)** | **Mass.**

Thomas Mason

....., Co. F, 5 Reg't Mass. Cav. (Col'd.)

Appears on

Company Descriptive Book

of the organization named above.

DESCRIPTION.

Age 19 years; height 5 feet $\frac{3}{4}$ inches.

Complexion Dark

Eyes Blue; hair Black

Where born Farmington Conn

Occupation Laborer

ENLISTMENT.

When Dec 16, 1863.

Where Road to Boston

By whom H. B. ...; term 3 y'rs.

Remarks:

3830) *H. B. ...*
Coryist.

M | **5 Col'd Cav.** | **Mass.**

Thomas Mason
Priv., Co. *A*, 5 Reg't Mass. Col'd Cav.

Appears on

Company Muster-in and Descriptive Roll
of the organization named above. Roll dated

Readville Jan. 9, 1864.

Where born *Harrisburg Pa*

Age *19* y'rs; occupation *Labourer*

When enlisted *Dec. 16th*, 1863.

Where enlisted *Boston No 1*

For what period enlisted *Three* years.

Eyes *Black*; hair *Black*

Complexion *Black*; height *5* ft. *7 3/4* in.

When mustered in *Jan. 9th*, 1864.

Where mustered in _____

Bounty paid \$ 100; due \$ 100

Where credited _____

Company to which assigned _____

Remarks: _____

Book mark: _____

G. Fox

(356d)

Copyist.

M

5 Col'd Cav.

Mass.

Thomas Mason

Priv, Co. A, 5 Reg't Mass. Col'd Cavalry.

Appears on

Company Muster Roll

for *Enlistment to Feb 29, 1864*

Present or absent *Present*

Stoppage, \$ *100* for

Due Gov't, \$ *100* for

Valuation of horse, \$ *100*

Valuation of horse equipments, \$ *100*

Remarks:

Book mark:

G. F. W.

(358)

Copyist.

M | **5 Col'd Cav.** | **Mass.**

Thomas Mason
Privt, Co. A, 5 Reg't Mass. Col'd Cavalry.

Appears on

Company Muster Roll

for *Mar. 9 Apr.*, 1864.

Present or absent *Present*

Stoppage, \$ *100* for

Due Gov't, \$ *100* for

Valuation of horse, \$ *100*

Valuation of horse equipments, \$ *100*

Remarks:

Book mark:

G. F. M.

M

5 Col'd Cav.

Mass.

Thomas Mason
Priv., Co. A, 5 Reg't Mass. Col'd Cavalry.

Appears on

Company Muster Roll

for *May & June*, 1864.

Present or absent *Present*

Stoppage, \$ 100 for

Due Gov't, \$ 100 for

Valuation of horse, \$ 100

Valuation of horse equipments, \$ 100

Remarks:

Book mark:

G. Fox

M

5 Col'd Cav.

Mass.

Thomas Mason

Priv., Co. A, 5 Reg't Mass. Col'd Cavalry.

Appears on

Company Muster Roll

for *July and Aug.*, 186*4*.

Present or absent *Present.*

Stoppage, \$ *100* for

Due Gov't, \$ *100* for

Valuation of horse, \$ *100*

Valuation of horse equipments, \$ *100*

Remarks:

Book mark:

M. O. Gilbert,

(358)

Copyist.

M | **5 Col'd Cav.** | **Mass.**

Thomas Mason
Priv., Co. A, 5 Reg't Mass. Col'd Cavalry.

Appears on

Company Muster Roll

for *Sept. and Oct.*, 186*4*.

Present or absent *Present.*

Stoppage, \$ *100* for

Due Gov't, \$ *100* for

Valuation of horse, \$ *100*

Valuation of horse equipments, \$ *100*

Remarks: *Stop. 1 caution 4/3.*

Book mark: _____

M. O. Gilbert,

M | **5 Col'd Cav.** | **Mass.**

Thomas Mason
Priv., Co. A, 5 Reg't Mass. Col'd Cavalry.

Appears on

Company Muster Roll

for *Nov. and Dec.*, 1864.

Present or absent *Present.*

Stoppage, \$ *100* for

Due Gov't, \$ *100* for

Valuation of horse, \$ *100*

Valuation of horse equipments, \$ *100*

Remarks: *Stop on caution*
45¢

Book mark:

M. O. Gilbert

M | **5 Col'd Cav.** | **Mass.**

Thomas Mason
Pvt., Co. A, 5 Reg't Mass. Col'd Cavalry.

Appears on

Company Muster Roll

for *Jan. and Feb., 1863*

Present or absent *Present*

Stoppage, \$ $\frac{45}{100}$ for *G.M. Goods.*

Due Gov't, \$ $\frac{100}{100}$ for

Valuation of horse, \$ $\frac{100}{100}$

Valuation of horse equipments, \$ $\frac{100}{100}$

Remarks:

Book mark: -----

H. O. Gilbert

M | **5 Col'd Cav.** | **Mass.**

Thomas Mason
Cpl., Co. A, 5 Reg't Mass. Col'd Cavalry.

Appears on

Company Muster Roll
for *March and Apr.*, 1865.

Present or absent *Present.*

Stoppage, \$ 100 for

Due Gov't, \$ 100 for

Valuation of horse, \$ 100

Valuation of horse equipments, \$ 100

Remarks:

Book mark:

H. O. Gilbert

(358)

Copyist.

M | **5 Col'd Cav.** | **Mass.**

Thomas Mason

Plat, Co. A, 5 Reg't Mass. Col'd Cavalry.

Appears on

Company Muster Roll

for May & June, 1865.

Present or absent Present

Stoppage, \$ 100 for

Due Gov't, \$ 100 for

Valuation of horse, \$ 100

Valuation of horse equipments, \$ 100

Remarks:

Book mark:

(358)

Ballade

Copyist.

M

5 Col'd Cav.

Mass.

Thomas Mason

Pvt., Co. A, 5 Reg't Mass. Col'd Cavalry.

Appears on

Company Muster Roll

for July & Aug, 1865.

Present or absent Present

Stoppage, \$ 100 for

Due Gov't, \$ 100 for

Valuation of horse, \$ 100

Valuation of horse equipments, \$ 100

Remarks:

Book mark:

Dallade

46

5 Col'd Cav.

Mass.

Thomas Mason

1st Lt, Co. A, 5 Reg't Mass. Col'd Cavalry.

Appears on Co. Muster-out Roll, dated
Clarksville, Texas, Oct 31, 1865.

Muster-out to date Oct 31, 1865.

Last paid to Dec 31, 1864.

Clothing account:

Last settled....., 186 ; drawn since \$..... 100

Due soldier \$..... 100; due U. S. \$..... ⁴⁶/₁₀₀

Am't for cloth'g in kind or money adv'd \$..... 100

Due U. S. for arms, equipments, &c., \$ 11 100

Bounty paid \$ 25 100; due \$ 75 100

Remarks: Free Apr. 19, 1861

Book mark: 3628 . 1880

J. Allende

(361)

Copyist.

⁴⁰⁰
Mathew Martin

Co E, 5 Mass. Cav., (Col'd.)

Private

Private

CARD NUMBERS.

1 5372147

26

2 5372139

27

3 5378405

28

4 5378518

29

5 5378626

30

6 5378729

31

7 5378862

32

8 5379273

33

9 9092210

34

10 34505016

35

11 40731368

36

12

37

13

38

14

39

15

40

16

41

17

42

18

43

19

44

20

45

21

46

22

47

23

48

24

49

25

50

Book Mark:

See also

052036197

R. Maccioni
7

M **5 Cav. (Col'd.) | Mass.**

Martin Matthew

E, Co. *E*, 5 Reg't Mass. Cav. (Col'd.)

Appears on

Company Descriptive Book

of the organization named above.

DESCRIPTION.

Age *34* years; height *5* feet *7* inches.

Complexion *Blk*

Eyes *Blk*; hair *Blk*

Where born *Launcester Penna.*

Occupation *Lawyer.*

ENLISTMENT.

When *June 7*, 186 .

Where *Jerksbury*

By whom *J. D. Grafton*; term *three* yrs.

Remarks: *June 7 Co E,
Discharged at Point Lookout
Md. on Jan 17th 1863
by reason of disability.*

Heard

M | *5 Cav.* | *Mass.*

Martin Mathew

Appears with rank of _____ on

Muster-in and Descriptive Roll

of a detachment of U. S. Volunteers forwarded from Faneuil Hall, Boston, to Galloup's Island, Boston Harbor, for various regiments Massachusetts Volunteers. Roll dated

Boston Mass., June 1, 1864.

Where born *LANCASTER Pa.*

Age *34* years; occupation *Lawyer*

When enlisted *June 1, 1864.*

Where enlisted *Tewksbury*

For what period enlisted *3* years.

Eyes *blk*; hair *blk*

Complexion *dk*; height *5 ft. 7 in.*

When mustered in _____, 186 .

Muster-in to date *from enlistment* 186 .

Where mustered in _____

Bounty paid \$ *100*; due \$ *100*

Clothing account:

Last settled _____, 186 ; drawn since \$ *100*

Date of first muster _____, 186 .

Regiment to which assigned *5 Cav.*

Remarks: *6 Dist. Tewksbury Middlesex Co.*

Book mark : _____

(356m)

J. H. Thomas
Copyist.

711 | 5 Col'd Cav. | Mass.

Matthew Matthew

Appears with rank of Private on

Muster and Descriptive Roll of a Detachment of U. S. Vols. forwarded

for the 5 Reg't Mass. Col'd Cavalry. Roll dated
Boston Mass, June 4, 1864.

Where born Lancaster Penn

Age 34 y'rs; occupation Lawyer

When enlisted June 1, 1864.

Where enlisted Carlsbury

For what period enlisted 3 years.

Eyes Black; hair Black

Complexion Dark; height 5 ft. 7 in.

When mustered in _____, 186 .

Where mustered in _____

Bounty paid \$ 100; due \$ 100

Where credited Diet Carlsbury Middlesex Co.

Company to which assigned _____

Remarks: _____

Book mark: _____

(Fossett)

5 Col'd Cav. Mass.

Appears with rank of Private on

Muster and Descriptive Roll of a Detachment of U. S. Vols. forwarded

for the 5 Reg't Mass. Col'd Cavalry. Roll dated
Sunderland Mass June 3, 1864.

Where born Sunderland Mass

Age 27 y'rs; occupation Lawyer

When enlisted June 1, 1864.

Where enlisted Sunderland Mass

For what period enlisted 3 years.

Eyes Blue; hair Blue

Complexion Blue; height 5 ft. 7 in.

When mustered in June 1, 1864.

Where mustered in Boston Mass

Bounty paid \$100; due \$100

Where credited Long Dist Sunderland Middlesex

Company to which assigned

Remarks:

Book mark:

(Hessett)

M | **5 Col'd Cav.** | **Mass.**

Martin Mathews

First, Co. E, 5 Reg't Mass. Col'd Cavalry.

Appears on

Company Muster Roll

for *May & June*, 1864.

Present or absent *present*

Stoppage, \$ *100* for

Due Gov't, \$ *100* for

Valuation of horse, \$ *100*

Valuation of horse equipments, \$ *100*

Remarks: *Daily duty as
Hosp't. Nurse, (Spec. Order 119)*

Book mark: _____

[Signature]
Copyist.

B. | **5 Col'd Cav.** | **Mass.**

Martin Matthews

Priv., Co. E, 5 Reg't Mass. Col'd Cavalry.

Appears on

Company Muster Roll

for *July & Aug.*, 1864.

Present or absent *Present*

Stoppage, \$ *100* for

Due Gov't, \$ *100* for

Valuation of horse, \$ *100*

Valuation of horse equipments, \$ *100*

Remarks: *Daily duty as
Hospital Nurse.
Stop one canteen.*

Book mark:

O. S. Clark

(358)

Copyist.

H. | **5 Col'd Cav.** | **Mass.**

Martin Matthews

Priv., Co. E, 5 Reg't Mass. Col'd Cavalry.

Appears on

Company Muster Roll

for *Sept Oct*, 1864.

Present or absent *Present*

Stoppage, \$ *100* for

Due Gov't, \$ *100* for

Valuation of horse, \$ *100*

Valuation of horse equipments, \$ *100*

Remarks: *Daily duty -
Hospital nurse.*

Book mark:

A. S. Blank

No. | 5 Col'd Cav. | Mass.

Martin Matthews

Priv., Co. E, 5 Reg't Mass. Col'd Cavalry.

Appears on

Company Muster Roll

for *Nov. & Dec.*, 1864.

Present or absent *Present*

Stoppage, \$ *100* for

Due Gov't, \$ *100* for

Valuation of horse, \$ *100*

Valuation of horse equipments, \$ *100*

Remarks: *Daily duty, hos-
pital nurse*

Book mark:

O. S. Clark

H. | **5 Col'd Cav.** | **Mass.**

Martin Matthews

Pvt., Co. E, 5 Reg't Mass. Col'd Cavalry.

Appears on

Company Muster Roll

for *Jan. & Feb.*, 1865-

Present or absent

Stoppage, \$ *100* for

Due Gov't, \$ *100* for

Valuation of horse, \$ *100*

Valuation of horse equipments, \$ *100*

Remarks: *Discharged at
Point Lookout Md
Jan. 29 1865- by order
Maj Genl Auger. Dis-
charges and final state-
ments given*

Book mark: *7862 DMG Aug. 3/66*

A. S. Clark

M. | 5 Col'd Cav. | Mass.

M. Matthews
Pvt, Co. E, 5 Reg't Mass. Colored Cav.

Appears on **Returns** as follows:

June 1864. Gain June 5/64
City Point, Va. Recruit rec'd
from depot.

On duty, Hosp. Dept.

July to Dec. 1864. On duty Hosp.
nurse.

Jan. 1865. Lose Jan. 28/65 Pt.
Lookout, Md. - Disch'd
for disability.

Book mark :

(546)

J. B. Sitter

Copyist.

M | **5 Col'd Cav.** | **Mass.**

Martin Matthews
Co. E, 5 Reg't Mass. Col'd Cavalry.

Appears on **Co. Muster-out Roll**, dated
Clarksville, Tex., Oct 9, 1865.

Muster-out to date _____, 186 .

Last paid to _____, 186 .

Clothing account:

Last settled _____, 186 ; drawn since \$ _____ 100

Due soldier \$ _____ 100; due U. S. \$ _____ 100

Am't for cloth'g in kind or money adv'd \$ _____ 100

Due U. S. for arms, equipments, &c., \$ _____ 100

Bounty paid \$ _____ 100; due \$ _____ 100

Remarks: Discharged Jan. 17,
at Fort Smith, Ark., Md.

Book mark: _____

Matthew Martin

, Co. , 5 Reg't Heavy "C"

2 Enclosures.

Bed Cards	Final Statements
Burial Records	Furloughs or L. of A.
Certs. of Dis. for Discharge	Med. Certificates
C. M. Charges	Med. Des. Lists
Descriptive Lists	Orders
Discharge Certificates	Pris. of War Record
Enlistment Papers 2	Resignations

Other papers relating to—

Admission to Hosp'l	Furlough or L. of A.
Casualty Sheet	Med. Examination
Confinement	Misc. Information
Contracts	Pay or Clothing
Death or Effects	Personal Reports
Desertion	Rank
Discharge from Hosp'l	Transfer to Hosp'l
Discharge from Service	Transfer to V. R. C.
Duty	Transportation

NOTE 1.—This blank will be used for both enlistments and re-enlistments—enlistment of veterans, &c., &c., in the volunteer service. They will be made out in duplicate in all cases—one to accompany the recruiting return of the superintendent (not the recruiting officer) to the Adjutant-General, and one to accompany the accounts of the officer who pays bounty, &c. The Regiment and Company in which the soldier last served should be given on the back.

NOTE 2.—An enlistment holds to service. A muster-in must, in all cases, precede payment of pay, bounty, pension, &c. A muster-in roll must, in all cases, be filed in the Adjutant-General's Office as evidence of muster-in. The mustering officer, commissary, or assistant-commissary of musters, as the case may be, will countersign both enlistments as having mustered the soldier into the service of the United States before either of them is given to the disbursing officer.

APRIL 1895 THIS PAPER WAS FORMERLY
FILED IN THE ENROLLMENT DIV. R. & P. O.

DECLARATION OF RECRUIT.

I, *Martin Mathew* desiring
to VOLUNTEER as a Soldier in the Army of the United States, for the term of THREE YEARS,
Do Declare, That I am *Thirty four* years and _____ months
of age; that I have never been discharged from the United States service on account of disability or by
sentence of a court-martial, or by order before the expiration of a term of enlistment; and I know of no
impediment to my serving honestly and faithfully as a soldier for three years.

GIVEN at *Fort*
the *18th* day of *June* 1864

Witness:

J. W. Corbett *Martin Mathew*

Discharged

Reg't of

enlistment; last served in Company ()

By *John P. Smith*

Regiment of *Mass 2nd Reg*

Volunteered at *Fort Smith Mass*

Martin Mathew

2 Mass. Regt.

CONSENT IN CASE OF MINOR.

I,
the _____ of _____
said _____ is _____ years of age; and I
do hereby freely give my CONSENT to his volunteering as a SOLDIER in the ARMY OF THE UNITED STATES,
for the period of THREE YEARS.

GIVEN at _____
the _____ day of _____

Witness:

VOLUNTEER ENLISTMENT.

STATE OF TOWN OF

Massachusetts Tewkesbury

I, Martin Mathew born in Lancaster in the State of Pennsylvania aged thirty-four years, and by occupation a Sawyer Do HEREBY ACKNOWLEDGE to have volunteered this Fifth day of June 1864, to serve as a Soldier in the Army of the United States of America, for the period of THREE YEARS, unless sooner discharged by proper authority: Do also agree to accept such bounty, pay, rations, and clothing, as are, or may be established by law for volunteers. And I, Martin Mathew do solemnly swear, that I will bear true faith and allegiance to the United States of America, and that I will serve them honestly and faithfully against all their enemies or opposers whomsoever; and that I will observe and obey the orders of the President of the United States, and the orders of the officers appointed over me, according to the Rules and Articles of War.

Sworn and subscribed to, at Boston this 12th day of June 1864 BEFORE [Signature]

I CERTIFY, ON HONOR, That I have carefully examined the above-named Volunteer, agreeably to the General Regulations of the Army, and that, in my opinion, he is free from all bodily defects and mental infirmity, which would in any way disqualify him from performing the duties of a soldier.

[Signature] EXAMINING SURGEON.

Vaccinated

I CERTIFY, ON HONOR, That I have minutely inspected the Volunteer, previously to his enlistment, and that he was entirely sober when enlisted; that, to the best of my judgment and belief, he is of lawful age; and that, in accepting him as duly qualified to perform the duties of an able-bodied soldier, I have strictly observed the Regulations which govern the recruiting service. This soldier has Blue eyes, Black hair, Dark complexion, is Five feet 7 inches high.

[Signature] Regiment of Massachusetts Volunteers,

RECRUITING OFFICER.

(A. G. O. No. 74 & 75.)

the 14th day of June, 1864, at Boston, Mass. Mustered into the service of the United States, in Company 5th Regiment of Massachusetts Volunteers, on

Credited to Tewkesbury and Lancaster

[Handwritten notes and signatures on the right side of the document]

NOTE 1.—This blank will be used for both enlistments and re-enlistments—enlistment of veterans, &c., &c., in the volunteer service. They will be made out in duplicate in all cases—one to accompany the recruiting return of the superintendent (not the recruiting officer) to the Adjutant-General, and one to accompany the accounts of the officer who pays bounty, &c. The Regiment and Company in which the soldier last served should be given on the back.

NOTE 2.—An enlistment holds to service. A muster-in must, in all cases, precede payment of pay, bounty, pension, &c. A muster-in roll must, in all cases, be filed in the Adjutant-General's Office as evidence of muster-in. The mustering officer, commissary, or assistant-commissary of musters, as the case may be, will countersign both enlistments as having mustered the soldier into the service of the United States before either of them is given to the disbursing officer.

DECLARATION OF RECRUIT.

I, *Martin Mathew* desiring to VOLUNTEER as a Soldier in the Army of the United States, for the term of THREE YEARS, Do Declare, That I am *Thirty four* years and _____ months of age; that I have never been discharged from the United States service on account of disability or by sentence of a court-martial, or by order before the expiration of a term of enlistment; and I know of no impediment to my serving honestly and faithfully as a soldier for three years.

GIVEN at *Boston* the *19th* day of *June* 18*64*

Witness: *Jacob Carnish* *Martin Mathew*

Discharged _____
Regt of _____
enlistment; last served in Company () _____

By *Capt. Cooper*
Regiment of _____
Volunteered at *Northampton*
1st June 18*64*

No. *100*

CONSENT IN CASE OF MINOR.

I, _____ Do CERTIFY, That I am _____ the _____ of _____; that the _____ said _____ is _____ years of age; and I do hereby freely give my CONSENT to his volunteering as a SOLDIER in the ARMY OF THE UNITED STATES, for the period of THREE YEARS.

GIVEN at _____ the _____ day of _____

Witness: _____

VOLUNTEER ENLISTMENT.

STATE OF

TOWN OF

Massachusetts

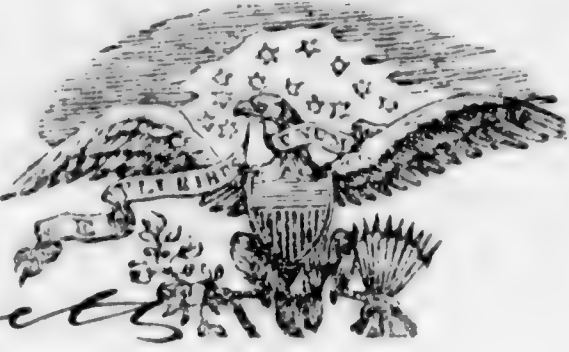

Tewksbury

I, Martin Mathew born in Lancaster in the State of Pennsylvania aged thirty four years, and by occupation a Lawyer Do HEREBY ACKNOWLEDGE to have volunteered this 15th day of June 1864 to serve as a Soldier in the Army of the United States of America, for the period of THREE YEARS, unless sooner discharged by proper authority: Do also agree to accept such bounty, pay, rations, and clothing, as are, or may be established by law for volunteers. And I, Martin Mathew do solemnly swear, that I will bear true faith and allegiance to the United States of America, and that I will serve them honestly and faithfully against all their enemies or opposers whomsoever; and that I will observe and obey the orders of the President of the United States, and the orders of the officers appointed over me, according to the Rules and Articles of War.

Sworn and subscribed to, at Boston this 15th day of June 1864 BEFORE J. H. [Signature]

Martin Mathew

I CERTIFY, ON HONOR, That I have carefully examined the above-named Volunteer, agreeably to the General Regulations of the Army, and that, in my opinion, he is free from all bodily defects and mental infirmity, which would in any way disqualify him from performing the duties of a soldier.

B. Jay Jeffries, EXAMINING SURGEON.

Vaccinated

I CERTIFY, ON HONOR, That I have minutely inspected the Volunteer, previously to his enlistment, and that he was entirely sober when enlisted; that, to the best of my judgment and belief, he is of lawful age; and that, in accepting him as duly qualified to perform the duties of an able-bodied soldier, I have strictly observed the Regulations which govern the recruiting service.

This soldier has dark eyes, black hair, fair complexion, is five feet [blank] inches high.

[Signature] Captain [blank] Regiment of Massachusetts Volunteers, RECRUITING OFFICER.

(A. G. O. No. 74 & 75.)

the 15th day of June, 1864, at

Mustered into the service of the United States, in Company

5th Regiment of

Massachusetts Volunteers, on

[Signature]

Credited to Tewksbury Middlesex & Worcester Counties

[Handwritten notes and signatures]

NOTE 1.

The company commander will here add a statement of all the facts known to him concerning the disease or wound, or cause of disability of the soldier; the time, place, manner, and all the circumstances under which the injury occurred, or disease originated or appeared; the duty, or service, or situation of the soldier at the time the injury was received or disease contracted, stating particularly whether the injury was received or the disease contracted in the line of his duty; and whatever other facts may aid a judgment as to the cause, immediate or remote, of the disability, and the circumstances attending it.

When the facts are not known to the company commander, the certificate of any officer, or affidavit of other person having such knowledge, will be appended—as the surgeon in charge of a hospital, the officer commanding a detachment of recruits, &c., &c.

NOTE 2.

When a probable case for pension, special care must be taken to state the degree of disability—as 1/2, 3/4, &c., &c.; to describe particularly the disability, wound, or disease; the extent of which it deprives him of the use of any limb or faculty, or affects his health, strength, activity, constitution, or capacity to labor or earn his subsistence. The surgeon will add, from his knowledge of the facts and circumstances, and from the evidence in the case, his professional opinion of the cause or origin of the disability. In the case of discharges by Medical Inspectors, the last paragraph will state that the "discharge was given by consent of the soldier, after a personal examination, and for disability, the nature, degree, and origin of which are correctly described in the within certificate."

Par. 1260 Regulations, Edit. 1861.

Medical officers, in giving certificates of disability, are to take particular care in all cases that have not been under their charge; and especially in epilepsy, convulsions, chronic rheumatism, derangement of the urinary organs, ophthalmia, ulcers, or any obscure disease liable to be feigned or purposely produced; and in no case shall such certificate be given until after sufficient time and examination to detect any attempt at deception.

DIRECTIONS.

This certificate will be made out in duplicate by the soldier's company commander, or other officer commanding the separate detachment to which he belongs, and sent by him to the surgeon who has charge of the hospital where the soldier is sick. The surgeon will then fill out and sign the surgeon's certificate, and forward these papers to the regimental, detachment, or post commander, who will forward them, with his action endorsed thereon, through the proper channel, to his division commander; or, if the troops are not attached to a division, to his corps, department, or other commander or officer to whom the authority to discharge enlisted men may be specially delegated.

These certificates, after having received the action of the highest authority to which they are required to be sent, will be returned through the same channel to the regimental, post, or detachment commander, who will, if the discharge is authorized by the endorsement of the proper authority, sign the soldier's discharge, and the last certificate on this paper (see what the soldier is furnished with the proper instructions in duplicate, and forward BOTH of these certificates direct to the Adjutant General United States Army, at Washington, D. C.; they will not, under any circumstances, be given to the hands of the soldier.

Duplicate sent the Pension Office.

M 24. 1863,
No 773 / 1/25 of 1865
M. 12 of 1865 Dept. of War.
CERTIFICATE OF DISABILITY FOR DISCHARGE

IN THE CASE OF

Martin Mathews
Private Co. E Dupel.
1st Regt of Mass. Cav.
Point Lookout Md.
December 24/64.

Approved and respectfully
forwarded

N. C. Abbott
Col. and Surg. U.S. Army

Office Surgeon in Chief
Pt. Lookout Md. Dec. 31. 64

Approved.

A. Heger
Surgeon U.S.A.
Surg. in Chief
Pt. Lookout



Recd at St. Paul 12 31 64
Received at Regd. Off. Dept. Washington
223
E. W. Case

C. B. - 1 - 1/2

Headquarters St. Mary's District,

Point Lookout, Md. January 2^d 1865.

Respectfully forwarded,

Approved J. J. Larned

Brigadier General Comdg.

HEADQUARTERS DEPARTMENT OF WASHINGTON,

22d Army Corps,

Washington, D. C. 1865

Respectfully referred to Surgeon R. O. ABBOTT,
Medical Director.

BY COMMAND OF MAJOR GENERAL AUBUR.

A. Raymond
Ass't Adjt. General.

Handwritten signature and scribbles at the bottom right of the document.

ARMY OF THE UNITED STATES.

CERTIFICATE

OF DISABILITY FOR DISCHARGE.



Martin Matthews a private, of Captain *James S. Wheat* Company, (E) of the *fifth* Regiment of the United States *Mass. Cavalry* was enlisted by *J. D. Gaston* *Regt. Sgt.* of the *5th* Regiment of *Mass. Cavalry*, at *Simsburg, Mass.* on the *seventh* day of *June*, 1864, to serve *three* years; he was born in *Lancaster* in the State of *Pennsylvania*, is *thirty four* years of age, *five* feet *seven* inches high, *Dark* complexion, *Dark* eyes, *Black* hair, and by occupation when enlisted a *sawyer*. During the last two months said soldier has been unfit for duty *60* days.*

Said soldier has done little or no duty since joining the company of reason of having the musket ball head

STATION: *Fort Lockout Md.*
 DATE: *December 13th 1864*

J. G. Parker
1st Lt.
 Commanding Company.

I CERTIFY, that I have carefully examined the said *Martin Matthews, Priv.* of Captain *James S. Wheat* Company, and find him incapable of performing the duties of a soldier because of *an old wound of right hand. the cicatrix preventing motion of the fingers. the hand is painful and is now utterly useless.*
This disability was contracted upon entering the service

F. G. Parker
Asst. Surgeon.
5th Mass. Cav.

DISCHARGED, this *seventh* day of *January*, 186*5*, at *Fort Lockout Md.*

A. S. Wallace
Col. 5th Mass. Cav.
 Commanding the Reg't.

HEAD QUARTERS
DEPARTMENT OF WASHINGTON
22d Army Corps

TO BE DISCHARGED

BY COMMAND OF
MAJ. GENL. C. C. ATGER.

A. A. G.

The Soldier desires to be addressed at
 Town *Wilmington* County *Delaware* State *Del.*
 Note 1 on the back of this. † See Note 2 on the back of this.

[DUPLICATES.]

703-a

Matthews, John
Co., 5th Mass, Col'd Cav.

CARD NUMBERS.

1	9436093	26
2		27
3		28
4		29
5		30
6		31
7		32
8		33
9		34
10		35
11		36
12		37
13		38
14		39
15		40
16		41
17		42
18		43
19		44
20		45
21		46
22		47
23		48
24		49
25		50

Number of personal papers herein.....

Book Mark.....

See also.....

M. Car. Mass.
(Col'd)
John Matthews
....., Co....., 5 Reg' Mass Col'd Car.

Appears on

Regimental Descriptive Book

of the organization named above.

DESCRIPTION.

Age 22 years; height 5 feet 7 inches.

Complexion Black

Eyes Black; hair Black

Where born Providence, R.I.

Occupation Coachman,

ENLISTMENT.

When Mar. 15, 1864.

Where Blackstone,

By whom A. O. Swain; term 3 y'rs.

Remarks: Rejected March
12/64

Swain.

964

Matthews, John S.

Co A, 5 Mass. Cav., (Col'd.)

Private

Private

CARD NUMBERS.

1	5374430	26	
2	5373318	27	
3	5373403	28	
4	5373484	29	
5	5373586	30	
6	5373729	31	
7	9092687	32	
8	40731369	33	
9		34	
10		35	
11		36	
12		37	
13		38	
14		39	
15		40	
16		41	
17		42	
18		43	
19		44	
20		45	
21		46	
22		47	
23		48	
24		49	
25		50	

Book Mark: *Ex B. V. 10. P. 509. 6. 10.*

See also

S1007188 - P.O. rtd
S1241021. P.O. rtd
J. 1367357 P.O. Rtd.
S. 2696426 And. W. 20

R. Waller
4

11 | **5 Cav. (Col'd.)** | **Mass.**

James S. Matthews
....., Co. *X*, 5 Reg't Mass. Cav. (Col'd.)

Appears on

Company Descriptive Book

of the organization named above.

DESCRIPTION.

Age *26* years; height *5* feet *4 1/2* inches.

Complexion *Black*

Eyes *Black*; hair *Black*

Where born *Newapohia Md*

Occupation *laborer*

ENLISTMENT.

When *Dec 17*, 186*3*.

Where *Harrods*

By whom *J. L. ...*; term *3* y'rs.

Remarks: *Discharged June 21st*
1864

Friday

93 | **5 Col'd Cav. | Mass.**

Saml. Mathews
Capt., Co. A, 5 Reg't Mass. Col'd Cav.

Appears on

Company Muster-in and Descriptive Roll
of the organization named above. Roll dated

Readville, Jan 9, 1864.

Where born Annapolis, Md.

Age 26 y'rs; occupation Laborer

When enlisted Dec. 17th, 1863.

Where enlisted Haverhill

For what period enlisted Three years.

Eyes Black, hair Black

Complexion Black; height 5 ft. 4 1/2 in.

When mustered in Jan. 9th, 1864.

Where mustered in _____

Bounty paid \$ 100; due \$ 100

Where credited _____

Company to which assigned _____

Remarks: _____

Book mark: _____

G. F. M.

M

5 Col'd Cav.

Mass.

John Matthews
Capt., Co. A, 5 Reg't Mass. Col'd Cavalry.

Appears on

Company Muster Roll

for *Enlistment to Feb 29, 1864*

Present or absent *Present*

Stoppage, \$ *100* for

Due Gov't, \$ *100* for

Valuation of horse, \$ *100*

Valuation of horse equipments, \$ *100*

Remarks:

.....
.....
.....
.....
.....
.....
.....
.....
.....

Book mark:

(358)

G. F. C.

Copyist.

M | **5 Col'd Cav.** | **Mass.**

John A. Matthews
Prod, Co. A, 5 Reg't Mass. Col'd Cavalry.

Appears on

Company Muster Roll

for *Mar. 9 Apr. 1864*, 1864.

Present or absent *Present*

Stoppage, \$ *100* for

Due Gov't, \$ *100* for

Valuation of horse, \$ *100*

Valuation of horse equipments, \$ *100*

Remarks:

Book mark:

(358)

G. Fox

Copyist.

M

5 Col'd Cav.

Mass.

John L. Matthews
Priv, Co. A, 5 Reg't Mass. Col'd Cavalry.

Appears on

Company Muster Roll

for *May + June*, 1864.

Present or absent *Absent*

Stoppage, \$ 100 for

Due Gov't, \$ 100 for

Valuation of horse, \$ 100

Valuation of horse equipments, \$ 100

Remarks: *In Hospital at
Readville Mass since
May 5/64*

Book mark:

G. F. M.

M | **5 Col'd Cav.** | **Mass.**

John L. Matthews
Priv., Co. A, 5 Reg't Mass. Col'd Cavalry.

Appears on

Company Muster Roll
for *July and Aug.*, 1864.
Present or absent

Stoppage, \$ 100 for

Due Gov't, \$ 100 for

Valuation of horse, \$ 100

Valuation of horse equipments, \$ 100

Remarks: *Date of discharge*
not known!

Book mark: *Discharged June*
10 (over)

H. O. Gilbert,

M. | **5 Col'd Cav.** | **Mass.**

J. L. Matthews*
Priv., Co. A, 5 Reg't Mass. Colored Cav.

Appears on **Returns** as follows: .

May + June 1864. Absent sick
at Readville.

July 1864. Lost June 20/64
Gallipolis - Dischg'd by
order Gen. Dix.

* Name appears also as John
L. Mathers.

Book mark : _____

(548)

J. B. Sittler

Copyist.

M | **5 Col'd Cav.** | **Mass.**

John S. Matthews
Pvt, Co. *A*, 5 Reg't Mass. Col'd Cavalry.

Appears on **Co. Muster-out Roll**, dated
Clarkville, Texas Oct 31, 1865.

Muster-out to date _____, 186 .

Last paid to _____, 186 .

Clothing account:

Last settled _____, 186 ; drawn since \$ _____ 100

Due soldier \$ _____ 100 ; due U. S. \$ _____ 100

Am't for cloth'g in kind or money adv'd \$ _____ 100

Due U. S. for arms, equipments, &c., \$ _____ 100

Bounty paid \$ _____ 100 ; due \$ _____ 100

Remarks: *Discharged at Clarkville, Tex.*
June 20. 1865 by order of Maj
General Augur

Book mark: *Discharged June 26 by S. B. T. 10 P. 500*
(over)

Mathews, John L.
P, Co. A; 5 Regt Mass. C. Cav

2 Enclosures.

Bed Cards	Descriptive Lists
Burial Records	Final Statements
Certs. of Dis. for Discharge	Furloughs
C. M. Charges	Med. Des. Lists
Med. Certificates	Orders

Other papers relating to—

Admission to Hosp'l	Furlough
Casualty Sheet (Officer's)	Med. Examination
Confinement	Misc. Information
Contracts	Pay or Clothing
Death or Effects	Personal Reports
Desertions	Rank
Discharge from Hosp'l	Transfer to Hosp'l
Discharge from Service	Transfer to V. R. C.
Duty	Transportation

[OFFICE INDORSEMENT.]

War Department,

ADJUTANT GENERAL'S OFFICE,

November 22, 1873

The discharge of Private John L. Matthews, Co. A, 5th Reg't U.S. Colored Cavalry, is reported as follows:—

- On Company Muster Roll. For Julyth Aug't, 1864, not given, 186
 - Company Muster-out Roll. June 20, 1864, 186
 - Company Descriptive Book. 186
 - Company Morning Reports. 186
 - Soldier's Final Statement. 186
 - Soldier's Record of Death and Interment. 186
 - Soldier's Inventory of Effects. 186
 - Soldier's Certificate of Disability for Discharge. June 26, 1864, 186
 - Soldier's Individual Muster-out Roll. 186
 - Regimental Return. 186
 - For Regimental Quarterly Returns. 186
 - Regimental Descriptive Book. 186
 - By Surgeon General. 186
- June 26th, 1864, is held to be the correct date, and the Company Muster Roll will be amended accordingly.

Thomas M. Bennett
E.B. 10 See letter to Asst. Adj. Gen.
Noted 509
Dec. 10, 1873.

CERTIFICATE OF DISABILITY FOR DISCHARGE
IN THE CASE OF

33
John L. Matthews
a private Co. A
5th Reg't of Mass. Col. Cav.

Adjutant General's Office,
Aug 2 1864
Duplicate sent in Extension Office

APPROVED

Edw. Bragg
Surgeon, U. S. A.,
Medical Director Dept of the East.

HEADQUARTERS DEPARTMENT OF THE EAST.

NEW-YORK CITY, June 21st, 1864.

To be discharged.

BY COMMAND OF MAJOR GENERAL D. I.

W. S. Johnson
Capt. and A. D. C., A. A. A. G.

Received (A. G. Office) _____, 186 .

Enon O. Rockefeller

John L. Matthews
clothing acct is as follows
one (cavy) over coat
" " dress jacket
" Blouse
" Cap
" " Trowsers
Two " Drawers
" Shirts
one Pr Stockings
" " Boots
" Woolen Bl. M. M.
" Rubber dlt.

ARMY OF THE UNITED STATES

CERTIFICATE

OF DISABILITY  FOR DISCHARGE.

John S. Matthews a private of Captain _____
 _____ Company, (A) of the Fifth Regiment of United States
Mass Vol Corp was enlisted by _____ of
 the _____ Regiment of _____ at Boston Mass
 on the Eighteenth day of December 1863, to serve three years; he was born
 in Sussex Co in the State of Delaware is twenty six
 years of age, five feet 4 1/2 inches high, Black complexion, Black eyes,
Black hair, and by occupation when enlisted a _____ 'During the last two
 months said soldier has been unfit for duty _____ days.*

STATION: Fort Mifflin, Del.
 DATE: June 14/1865

John S. Matthews
 Comd'g Co. 13th Regt Me. Inf.
 Commanding Company.

I CERTIFY, that I have carefully examined the said John S. Matthews private of
 Captain _____ Company, and find him incapable of performing the duties of a soldier
 because of Paralysis of left side, with partial use of
left arm. now of five months duration
He is totally unfit for service.

Calvin G. Fox
 Surgeon. U.S.A.

Handwritten notes:
 June 26 65
 [unclear]
 [unclear]

ARMY OF THE UNITED STATES

CERTIFICATE

OF DISABILITY  FOR DISCHARGE.

John L. Mathews a private of Captain _____
 Company, (*A*) of the *Fifth* Regiment of ~~United States~~
Mass Vol. Corp was enlisted by _____ of
 the _____ Regiment of _____ at *Boston Mass*
 on the *Eighteenth* day of *December* 186*3*, to serve *three* years; he was born
 in *Sussex Co* in the State of *Delaware* is *twenty six*
 years of age, *five* feet *4 1/2* inches high, *Black* complexion, *Black* eyes,
Black hair, and by occupation when enlisted a _____ 'During the last two
 months said soldier has been unfit for duty _____ days.*

STATION: *Fort Mifflin, Philadelphia, Pa.*
 DATE: *June 14 1864*

John J. Marescaux
 Col. 13th Regt. Ill. Inf.
 Commanding Company. 3rd

I CERTIFY, that I have carefully examined the said *John L. Mathews private* of
 Captain _____ Company, and find him incapable of performing the duties of a soldier
 because of † *Paralysis of left side, with partial use of*
left arm. Now of five months duration
He is totally unfit for service.

Calvin G. Faye
 Surgeon. USA

DISCHARGED, this *Twenty Sixth* day of *June* 186*4*, at *Philadelphia, Pa.*
Boston Harbor, Massachusetts

John J. Marescaux
 Col. 13th Regt. Ill. Inf.
 Commanding the Regt. 3rd

The soldier desires to be addressed at
 Town _____ County _____ State _____

* See Note 1 on the back of this. † See Note 2 on the back of this.

CASUALTY SHEET

No:

John L. Matthews

of Company

5 Regiment of *Mass Cav*

State Volunteers.

NATURE OF CASUALTY.

Discharged
June 29 1864.



CASUALTY SHEET.

Name: *John L. Matherus*

Rank: _____ Company: _____ Regiment: *5*

Arm: *Car* State: *Mass*

Nature of Casualty: *Discharged*

CAUSE OF CASUALTY—(NAME OF DISEASE, &c.)

BY WHOM DISCHARGED.

DEGREE OF DISABILITY.

FROM WHAT SOURCE THIS INFORMATION WAS OBTAINED.

*Karl J. H. Traub, Kindez was
Boston Mass*

BY WHOM CERTIFIED.

REMARKS.

DATE OF DISCHARGE, DEATH, &c.

June 29 1864

PLACE OF DISCHARGE, DEATH, &c.

*Gallin's Island
Boston Harbor Mass*

J. G. Sewell
Clerk.

Examined A. J. D.

Mayzeck, John E.
Co A, 5 Mass. Cav., (Col'd.)

Private | Private

CARD NUMBERS.

1	5373374	26
2	5373399	27
3	5373480	28
4	5373613	29
5	5373721	30
6	5374452	31
7	9092682	32
8		33
9		34
10		35
11		36
12		37
13		38
14		39
15		40
16		41
17		42
18		43
19		44
20		45
21		46
22		47
23		48
24		49
25		50

Book Mark: _____

See also _____

M | **5 Cav. (Col'd.)** | **Mass.**

John E. Heggie

....., Co. D., 5 Reg't Mass. Cav. (Col'd.)

Appears on

Company Descriptive Book

of the organization named above.

DESCRIPTION.

Age 31 years; height 5 feet 11 inches.

Complexion light

Eyes blue; hair black

Where born Charleston, S.C.

Occupation Printer

ENLISTMENT.

When Dec 21, 1863.

Where Boston

By whom J. Stone; term 3 y'rs.

Remarks: Discharged April 20 1864

M | **5 Col'd Cav.** | **Mass.**

John E. Maygeek
Cvt, Co. *A*, 5 Reg't Mass. Col'd Cav.

Appears on

Company Muster-in and Descriptive Roll
of the organization named above. Roll dated

Readville Jan 9, 1864.

Where born *Charleston N.C.*

Age *31* y'rs; occupation *Tailor*

When enlisted *Dec. 30th*, 1863.

Where enlisted *Newton*

For what period enlisted *Three* years.

Eyes *Black*; hair *Black*

Complexion *Black*; height *5 ft. 5 1/2 in.*

When mustered in *Jan. 9th*, 1864.

Where mustered in _____

Bounty paid \$ _____ 100; due \$ _____ 100

Where credited _____

Company to which assigned _____

Remarks: _____

Book mark: _____

(356d) *G. F. H.* Copyist.

M

5 Col'd Cav.

Mass.

John E. Wigzell

Priv, Co. A, 5 Reg't Mass. Col'd Cavalry.

Appears on

Company Muster Roll

for *Enlistment to Feb. 29, 1864.*

Present or absent *Present*

Stoppage, \$ *100* for

Due Gov't, \$ *100* for

Valuation of horse, \$ *100*

Valuation of horse equipments, \$ *100*

Remarks: *\$16²⁹ Transportation
furnished by Charles
Kent & others, Toledo, Ohio*

Book mark:

G. J. [Signature]

M | **5 Col'd Cav.** | **Mass.**

John E. Meyer
Capt, Co. A, 5 Reg't Mass. Col'd Cavalry.

Appears on

Company Muster Roll

for *Mar 9 Apr*, 1864.

Present or absent *Not stated*

Stoppage, \$ *100* for

Due Gov't, \$ *100* for

Valuation of horse, \$ *100*

Valuation of horse equipments, \$ *100*

Remarks: *8/6²⁹ Due P. for transportation*

Book mark:

(358)

G. M.

Copyist.

OK

5 Col'd Cav.

Mass.

John E. Wozzick
Sergeant, Co. A, 5 Reg't Mass. Col'd Cavalry.

Appears on

Company Muster Roll

for *May & June*, 1864.

Present or absent

Stoppage, \$ 100 for

Due Gov't, \$ 100 for

Valuation of horse, \$ 100

Valuation of horse equipments, \$ 100

Remarks: *Deserted since April 30, 1864*

Book mark:

G. F. W.

M | 5 Col'd Cav. | Mass.

John E. Mezzeck
Pvt., Co. A, 5 Reg't Mass. Col'd Cavalry.

Appears on

Company Muster Roll

for July and Aug., 1864.

Present or absent

Stoppage, \$ 100 for

Due Gov't, \$ 100 for

Valuation of horse, \$ 100

Valuation of horse equipments, \$ 100

Remarks: Deserted since
Apr. 30, 1864.

Book mark:

M. O. Gilliat

M | **5 Col'd Cav. | Mass.**

John E. Mezzick
1st Lt., Co. A, 5 Reg't Mass. Col'd Cavalry.

Appears on **Co. Muster-out Roll**, dated
Clarksville, Texas, Oct 31, 1865.

Muster-out to date _____, 186 .

Last paid to _____, 186 .

Clothing account:

Last settled _____, 186 ; drawn since \$ _____ 100

Due soldier \$ _____ 100; due U. S. \$ _____ 100

Am't for cloth'g in kind or money adv'd \$ _____ 100

Due U. S. for arms, equipments, &c., \$ _____ 100

Bounty paid \$ _____ 100; due \$ _____ 100

Remarks: *Deserted at Readville*
Mass. Apr 30, 1864

Book mark : _____

(361) *W. L. Vallade* Copyist.

McArthur John

Co H, 5 Mass. Cav. (Col'd.)

Private

Private

CARD NUMBERS.

1	5381610	26
2	5381699	27
3	5381784	28
4	5381881	29
5	5381988	30
6	5382093	31
7	5382197	32
8	5382297	33
9	5382395	34
10	5382526	35
11	5372888	36
12	5382625	37
13	9091826	38
14	32534792	39
15	32536318	40
16	32537296	41
17	32538302	42
18	32539270	43
19	32540227	44
20	40731371	45
21		46
22		47
23		48
24		49
25		50

Book Mark:

See also

A 1189608 P.O. aff
S. 1274757 P.O. aff
S. 1636909 } P.O. aff
S. 1636911 }

A 1664610 P.O. aff

A 1771888 P.O. aff

A 1771980 P.O. aff

A 1771875 P.O. aff

R. Mack -
4

McA. | **5 Cav. (Col'd.)** | **Mass.**

John McArthur.

H., Co. *H.*, 5 Reg't Mass. Cav. (Col'd.)

Appears on

Company Descriptive Book
of the organization named above.

DESCRIPTION.

Age *22* years; height *5* feet *9* inches.

Complexion *Dark.*

Eyes *Black* ; hair *Black.*

Where born *Kinderhook N.Y.*

Occupation *Laborer.*

ENLISTMENT.

When *July, 3rd*, 1864.

Where *Great Barrington.*

By whom *J. M. Seeley* ; term *3* y'rs.

Remarks: *Mustered in at Readville
Mar, 12th 64.*

H. C. Thomas.

Mc | **5 Col'd Cav.** | **Mass.**

John McArthur
Pvt, Co. *A*, 5 Reg't Mass. Col'd Cav.

Appears on

Company Muster-in and Descriptive Roll

of the organization named above. Roll dated

Hadville Mass Mar 12, 1864.

Where born *Rendhook, N.Y.*

Age *22* y'rs; occupation *Laborer.*

When enlisted *Feb. 3,* 186*4.*

Where enlisted *Gr. Barrington*

For what period enlisted *3* years.

Eyes *Black*; hair *Black*

Complexion *Black*; height *5 ft. 9 in.*

When mustered in *Mar. 12,* 186*4.*

Where mustered in

Bounty paid \$ *100*; due \$ *100*

Where credited *10" Dist. Berkshire*

Company to which assigned

Remarks:

Book mark:

J. N. Hall

(356d) Copyist.

Mc | **5 Col'd Cav.** | **Mass.**

John M. Strubury

Priv., Co. H, 5 Reg't Mass. Col'd Cavalry.

Appears on

Company Muster Roll

for *Mar 12 to Apr 30*, 1864.

Present or absent *Present*

Stoppage, \$ *100* for

Due Gov't, \$ *100* for

Valuation of horse, \$ *100*

Valuation of horse equipments, \$ *100*

Remarks:

Book mark:

J. M. Hall

(358)

Copyist.

Mc | **5 Col'd Cav.** | **Mass.**

John McArthur
Priv, Co. H, 5 Reg't Mass. Col'd Cavalry.

Appears on

Company Muster Roll

for May & June, 1864

Present or absent Absent

Stoppage, \$ 100 for

Due Gov't, \$ 100 for

Valuation of horse, \$ 100

Valuation of horse equipments, \$ 100

Remarks: Absent without
leave since June
28th/64

Book mark: _____

J. J. Vall

Mc 5 Col'd Cav. | **Mass.**

John McArthur
Prof., Co. H, 5 Reg't Mass. Col'd Cavalry.

Appears on

Company Muster Roll

for July & Aug., 1864

Present or absent absent

Stoppage, \$ 100 for

Due Gov't, \$ 100 for

Valuation of horse, \$ 100

Valuation of horse equipments, \$ 100

Remarks: absent, sick at
Fortress Monroe since
June 28, 64.

Book mark: _____

(358)

Jon Wall

Copyist.

11 | 5 Cav. (Col'd) Mass.

John Carter
Priv., Co. H, 5 Reg't Mass. (Col'd)

Appears on

Hospital Muster Roll

of **Balfour U. S. A. General Hospital,**

at **Portsmouth, Va.,**

for June 1864, 1864.

Attached to hospital:

When _____, 186 .

How employed _____

Last paid by Maj. _____

to _____, 186 .

Bounty paid \$ 109, due \$ 100

Present or absent Present

Remarks: _____

Book mark: _____

Mc | **5 Col'd Cav.** | **Mass.**

John McArthur
Put, Co. H, 5 Reg't Mass. Col'd Cavalry.

Appears on

Company Muster Roll

for Sept & Oct, 186 4.

Present or absent Absent

Stoppage, \$ 0 ⁰⁴/₁₀₀ for one cross
sabre letter & number.

Due Gov't, \$ 100 for _____

Valuation of horse, \$ 100

Valuation of horse equipments, \$ 100

Remarks: Absent. Sick in
Balfour hospital, Portsmouth
Va. since June 28th. Pd by
May Green for July & Aug. \$32.00.

Book mark: _____

(358)

E. M. Clark

Copyist.

Mc | 5 Cav. (Col'd) | Mass

John McArthur
Priv., Co. H, 5 Reg't Mass C.

Appears on

Hospital Muster Roll

of **Balfour U. S. A. General Hospital,**

at **Portsmouth, Va.,**

for Sept & Oct, 1864

Attached to hospital:

When, 186 .

How employed

Last paid by Maj.

to Pay due from enlistment, 186 .

Bounty paid \$ 100; due \$ 100

Present or absent Present

Remarks: Paid at Bg H by Maj
Green for mos of July & Aug
1864 (\$32.00)

Book mark:

Murray

(343)

Copyist.

M² | **5 Col'd Cav.** | **Mass.**

John McArthur
Pat., Co. H, 5 Reg't Mass. Col'd Cavalry.

Appears on

Company Muster Roll

for *Nov & Dec*, 1864.

Present or absent *Absent.*

Stoppage, \$ *100* for

Due Gov't, \$ *100* for

Valuation of horse, \$ *100*

Valuation of horse equipments, \$ *100*

Remarks: *Absent, sick*
in Balfour Gen
Hospital, Portsmouth,
Va. since July 28th.
Paid for July & Aug.

Book mark: _____

C M Clark

McC 105 Cav. U.S.A.

John McArthur
Co. H, 5 Reg't Mass. Cav.

Appears on

Hospital Muster Roll

of Balfour U. S. A. General Hospital,

at Portsmouth, Va.,

for Nov. & Dec, 1864.

Attached to hospital:

When _____, 1864.

How employed _____

Last paid by Maj. _____

to pay due from Enlistment, 1864.

Bounty paid \$ 100; due \$ 100

Present or absent Present.

Remarks: paid at Hosp. by Maj. Greene
for July & Aug. 1864.

Book mark: _____

(848)

Conterrey

Copyist.

Mc | **5** Col'd Cav. | **Mass.**

John McArthur
Pat, Co. H, 5 Reg't Mass. Col'd Cavalry.

Appears on

Company Muster Roll
for Jan + Feb, 1865
Present or absent Absent

Stoppage, \$ 100 for

Due Gov't, \$ 100 for

Valuation of horse, \$ 100

Valuation of horse equipments, \$ 100

Remarks: Absent, sick
in Balfour, Genl
Hospital, Portsmouth,
Va, since June 28.
Paid for July + Aug.
Due 1st, 2d, 3d + 4th
installments U S bounty.

Book mark: _____

(358)

B U Clark
Copyist.

McC | *5 Cav.* | *U.S.A.*

John McArthur
Priv., Co. *H*, *5* Reg't *Mass. C.*

Appears on

Hospital Muster Roll

of **Balfour U. S. A. General Hospital,**

at **Portsmouth, Va.,**

for *January and February*, 186*5*.

Attached to hospital:

When, 186 .

How employed

Last paid by Maj.

to, 186 .

Bounty paid \$ *100* due \$ *100*

Present or absent *Present*

Remarks:

.....
.....
.....
.....
.....
.....
.....
.....

Book mark:

PAK

(843)

Copyist.

M 5 Col'd Cav. Mass.

John McArthur
Priv, Co. II, 5 Reg't Mass. Col'd Cavalry.

Appears on

Company Muster Roll

for *March & April*, 1865.

Present or absent *Absent*

Stoppage, \$ 100 for

Due Gov't, \$ 100 for

Valuation of horse, \$ 100

Valuation of horse equipments, \$ 100

Remarks: *Absent, sick at Balfour Gen'l hospital, Portsmouth, Va, since June 28, 1864.*

Book mark:

C M Clark

(358)

Copyist.

M. C. *J. Col^d Cav Mass*

John McArthur
Priv, Co. H, 5 Reg't Mass C

Appears on

Hospital Muster Roll

of **Balfour U. S. A. General Hospital,**

at **Portsmouth, Va.,**

for *Mar & Apr, 1865*

Attached to hospital :

When, 186 .

How employed

Last paid by Maj.

to, 186 .

Bounty paid \$ 100 ; due \$ 100

Present or absent *Present*

Remarks :

Book mark :

(843)

Reynolds

Copyist.

16^c | 5 Col'd Cav. | Mass.

John W^c Butcher
Privat, Co. II, 5 Reg't Mass. Col'd Cavalry.

Appears on

Company Muster Roll

for *May & June*, 1865.

Present or absent *Absent*

Stoppage, \$..... 100 for

Due Gov't, \$..... 100 for

Valuation of horse, \$..... 100

Valuation of horse equipments, \$..... 100

Remarks: *1st, 2^d, 3^d & 4th install-
ments U. S. bounty due.
Free on or before April
19, 1861. Absent sick
at Portsmouth, Va.
June 28, 1865.*

Book mark:

C. M. Clark

McLellan, Mass

John McArthur
Pvt., Co. B, 5th Reg't Mass. Cav.

Appears on

Hospital Muster Roll

of **Balfour U. S. A. General Hospital,**

at **Portsmouth, Va.,**

for May & June, 1865

Attached to hospital:

When _____, 186 .

How employed _____

Last paid by Maj. _____

to _____, 186 .

Bounty paid \$ 100; due \$ 100

Present or absent _____

Remarks: Discharged U.S.
Service June 5th 65

Book mark: _____

(343)

B Taylor
Copyist.

M | **5 Col'd Cav.** | **Mass.**

John McArthur

Priv., Co. H, 5 Reg't Mass. Col'd Cavalry.

Appears on

Company Muster Roll

for *July & Aug.*, 186*5*.

Present or absent

Stoppage, \$ 100 for

Due Gov't, \$ 100 for

Valuation of horse, \$ 100

Valuation of horse equipments, \$ 100

Remarks: *discharged at Norfolk Va. June 5th 1865. See order for - W.D. dated May 3rd.*

Book mark:

R. E. Wilson

Mc | 5 Col'd Cav. | Mass.

John McArthur
Pvt., Co. H, 5 Reg't Mass. Colored Cav.

Appears on Returns as follows:

June 1864. Absent without leave
since June 28

July & Aug. 1864. Absent sick
at Fortress Monroe since
June 28"

Sept. 1864. Loss June 28. Ft.
Monroe, dropped by order
of Regt Comdr.

Oct. 1864. Gain Oct. 24 Portsmouth
Va. Taken up from drop-
ped by order Regt Comdr.

Oct. 1864 to July 1865. Absent
sick at Portsmouth, Va.
since June 28/64.

Aug. 1865. Loss June 5 - Nor-
folk, Va. dischg'd per
order of War Dept.
dated May 3"

Book mark :

(546)

J. B. Sittler

Copyist.

Mc | **5** Col'd Cav. | **Mass.**

John McArthur
Prst, Co. *H*, 5 Reg't Mass. Col'd Cavalry.

Appears on an

Individual Muster-out Roll

of the organization named above. Roll dated

Norfolk Va *June 5, 1865.*

Muster-out to date *June 5, 1865.*

Last paid to *Dec 31, 1864.*

Clothing account:

Last settled *June* 186 ; drawn since \$ 100

Due soldier \$ 100; due U. S. \$ 100

Am't for cloth'g in kind or money adv'd \$ *76* ^{*48*} / 100

Due U. S. for arms, equipments, &c., \$ 100

Bounty paid \$ 100 due \$ 100

Remarks: *Discharged*
from Balfour Gen'l
Hospital in Obedienc
to Order from War Dept.
dated May 3 1865.
No account of bounty on descriptive list

Book mark:

[Signature]

Mc | **5 Col'd Cav.** | **Mass.**

John McArthur

Priv., Co. *A*, 5 Reg't Mass. Col'd Cavalry.

Appears on **Co. Muster-out Roll**, dated
Clarksville Tex., *Octo. 31*, 186*5*.

Muster-out to date _____, 186 .

Last paid to. *Never paid*, 186 .

Clothing account:

Last settled _____, 186 ; drawn since \$ _____ 100

Due soldier \$ _____ 100; due U. S. \$ _____ 100

Am't for cloth'g in kind or money adv'd \$ _____ 100

Due U. S. for arms, equipments, &c., \$ _____ 100

Bounty paid \$ _____ 100; due \$ _____ 100

Remarks: *Discharged at Norfolk*
Va. June 5th 1865. Crs. H. D. May 3. 65.

Book mark: *P.M. G. 3444 May 1. 66.*

R. Swiler

901
McClune, George

Co H, 5 Mass. Cav., (Col'd.)

Private (Bugler)

CARD NUMBERS.

1	5381609	26
2	5381698	27
3	5381752	28
4	5381840	29
5	5381945	30
6	5382051	31
7	5382156	32
8	5382257	33
9	5382355	34
10	5382454	35
11	5372886	36
12	5382552	37
12	9091825	38
14	m-21-05-1871	39
15	33031321	40
16	40731370	41
17		42
18		43
19		44
20		45
21		46
22		47
23		48
24		49
25		50

Book Mark: No. 21. v. 9. p. 571 + Ex. v. 11. p. 74.

See also

S-913022 RBMTRM
S-725574 - 250 of Man
Romirel Pl. 930027 7 29 PLS
13
SS. Co Com. Phila. Pa.
6-15-31
SSVB. 6/22/31 CEN.

R. Walker
4

No. 6. | **5 Cav. (Col'd.)** | **Mass.**

George McLane.

....., Co. *H.*, 5 Reg't Mass. Cav. (Col'd.)

Appears on

Company Descriptive Book
of the organization named above.

DESCRIPTION.

Age *18* years; height *5* feet *2* inches.

Complexion *Mulatto.*

Eyes *Black*; hair *Black*

Where born *Philadelphia Pa*

Occupation *Barber.*

ENLISTMENT.

When *Jan'y. 8th*, 1864.

Where *Conway*

By whom *C. Batchelder*; term *3* y'rs.

Remarks: *Mustered in at Readville*
Nov. 12th 64.

H. C. Thomas.

No. | **5 Col'd Cav.** | **Mass.**

George M. Colman

Prf., Co. H; 5 Reg't Mass. Col'd Cav.

Appears on

Company Muster-in and Descriptive Roll
of the organization named above. Roll dated

Readville Mass, Mar 12 1864.

Where born Philadelphia Pa

Age 18 y'rs; occupation Barber.

When enlisted June 8th, 1864.

Where enlisted Conway

For what period enlisted 3 years.

Eyes Black; hair Black.

Complexion Black; height 5 ft. 2 in.

When mustered in Mar 12, 1864.

Where mustered in _____

Bounty paid \$ 100; due \$ 100

Where credited 9th Dist Franklin

Company to which assigned _____

Remarks: _____

Book mark: 2387903

J. M. Wall

(356d)

Copyist.

Mc | **5 Col'd Cav.** | **Mass.**

George M'blaine

Priv., Co. H, 5 Reg't Mass. Col'd Cavalry.

Appears on

Company Muster Roll

for *Mar 12 to Apr 30*, 1864

Present or absent *Present*

Stoppage, \$.....100 for

Due Gov't, \$.....100 for

Valuation of horse, \$.....100

Valuation of horse equipments, \$.....100

Remarks:

Book mark:

(358)

J. M. Hall

Copyist.

Mc | 5 Col'd Cav. | Mass.

George McBlane

Dugby, Co. H, 5 Reg't Mass. Col'd Cavalry.

Appears on

Company Muster Roll

for May & June, 186 4

Present or absent Present

Stoppage, \$ 100 for

Due Gov't, \$ 100 for

Valuation of horse, \$ 100

Valuation of horse equipments, \$ 100

Remarks:

Book mark:

J. M. Wall

Mc | **5 Col'd Cav.** | **Mass.**

George McLane

Bayler, Co. H, 5 Reg't Mass. Col'd Cavalry.

Appears on

Company Muster Roll

for July to Aug., 1864

Present or absent Present

Stoppage, \$ 100 for

Due Gov't, \$ 100 for

Valuation of horse, \$ 100

Valuation of horse equipments, \$ 100

Remarks:

Book mark:

J. M. Hall
Copyist.

M | **5 Col'd Cav.** | **Mass.**

George McBlane
Bayler, Co. H, 5 Reg't Mass. Col'd Cavalry.

Appears on

Company Muster Roll

for Sept & Oct, 1864.

Present or absent Present

Stoppage, \$ 0⁰⁴/₁₀₀ for one cross
saber letter & number.

Due Gov't, \$ 100 for

Valuation of horse, \$ 100

Valuation of horse equipments, \$ 100

Remarks: _____

Book mark: _____

C M Clark
(358) Copyist.

Mc | **5 Col'd Cav.** | **Mass.**

George McBlane
Bugler, Co. H, 5 Reg't Mass. Col'd Cavalry.

Appears on

Company Muster Roll

for *Nov + Dec*, 186*4*.

Present or absent *Present*

Stoppage, \$ *100* for

Due Gov't, \$ *100* for

Valuation of horse, \$ *100*

Valuation of horse equipments, \$ *100*

Remarks:
.....
.....
.....
.....
.....
.....
.....
.....

Book mark:

C M Clark

M | **5 Col'd Cav.** | **Mass.**

George McBlane
Bugler, Co. H, 5 Reg't Mass. Col'd Cavalry.

Appears on

Company Muster Roll

for Jan. & Feb., 1865.

Present or absent Present.

Stoppage, \$ 100 for

Due Gov't, \$ 100 for

Valuation of horse, \$ 100

Valuation of horse equipments, \$ 100

Remarks: Due 1st 2d, 3d &
4th installments U. S
bounty

Book mark: _____

C. M. Clark

No | **5 Col'd Cav.** | **Mass.**

George McElaine

Bugler, Co. H, 5 Reg't Mass. Col'd Cavalry.

Appears on

Company Muster Roll

for *March & April*, 186*5*.

Present or absent *Present*

Stoppage, \$ *100* for

Due Gov't, \$ *100* for

Valuation of horse, \$ *100*

Valuation of horse equipments, \$ *100*

Remarks: *Due 1st, 2d, 3d & 4th installments U. S. bounty.*

Book mark:

C. H. Clark

No. | 5 Col'd Cav. | Mass.

George McLane
Bugler, Co. II, 5 Reg't Mass. Col'd Cavalry.

Appears on

Company Muster Roll

for May & June, 1865.

Present or absent Present

Stoppage, \$..... 100 for

Due Gov't, \$..... 100 for

Valuation of horse, \$..... 100

Valuation of horse equipments, \$..... 100

Remarks: 1st, 2d, 3d & 4th install-
ment U.S. bounty, due.
Free on or before April
1st, 1866.

Book mark:

G. H. Clark

(358)

Copyist.

Mc | **5 Col'd Cav.** | **Mass.**

George M. Come

Buxley, Co. H, 5 Reg't Mass. Col'd Cavalry.

Appears on

Company Muster Roll

for *July & Aug.*, 186*7*.

Present or absent *Absent*

Stoppage, \$ *100* for

Due Gov't, \$ *100* for

Valuation of horse, \$ *100*

Valuation of horse equipments, \$ *100*

Remarks: *Free on or before Apr. 1st 1867. Abs. sick at Providence since Aug. with Due U.S. for Amunice Remington Pistol.*

Book mark:

R. C. ...

Mc | *5th Cav.* | *Mass*

Geo. W. McClane

Pvt, *Co A*, *5th Reg't* *Mass Cav*

Appears on

Hospital Muster Roll

of DeCamp U. S. A. General Hospital,

at David's Island, New York Harbor,

for *Sept & Oct*, 1865.

Attached to hospital:

When _____, 186 .

How employed _____

Last paid by Maj. _____

to _____, 186 .

Bounty paid \$ 100 ; due \$ 100

Present or absent _____

Remarks: *Mustered out of
Service October 10-1865*

Book mark: _____

(348)

Rosenbaum

Copyist.

Mc | **5** Col'd Cav. | **Mass.**

George Mc Clane
Bayler, Co. H., 5 Reg't Mass. Col'd Cavalry.

Appears on an

Individual Muster-out Roll

of the organization named above. Roll dated

N.Y. City *Feb 9*, 1865.

Muster-out to date *Feb 9*, 1865.

Last paid to *Dec 31*, 1864.

Clothing account:

Last settled *Dec 31*, 1864; drawn since \$ *20* ^{*24*}/₁₀₀

Due soldier \$ *100*; due U. S. \$ *100*

Am't for cloth'g in kind or money adv'd \$ *100*

Due U. S. for arms, equipments, &c., \$ *100*

Bounty paid \$ *100* due \$ *100*

Remarks: *Mustered out*
under Tol. Order War
Duple G.O. May 4/65
Des. back state's bounty
paid - Due \$300.00
Due U.S. for re-arming

Book mark: *En M 21 Vol 9 CT 1871*

(348)

Stewart

Copyist.

JAN. - 9

5372886

1891

Patrol # 1495 / 2nd 3rd
& 4th Installment U.S.
Bounty office.

Free on or before
April 19/61.

Mc | **5 Col'd Cav.** | **Mass.**

George McBlane^x
Pvt., Co. H, 5 Reg't Mass. Colored Cav.

Appears on **Returns** as follows:

Aug. & Sept, 1865. Absent sick
at Brazos since Aug. 5

^x Name appears also as
McLain.

Book mark :

(548)

J. B. Dittler

Copyist.

Ms | **5 Col'd Cav.** | **Mass.**

George M. Clime
Bugler, Co. *K*, 5 Reg't Mass. Col'd Cavalry.

Appears on **Co. Muster-out Roll**, dated
Clarksville, Tex., Oct. 31, 1864.

Muster-out to date _____, 186 .

Last paid to *Dec. 31, 1864*.

Clothing account:

Last settled _____, 186 ; drawn since \$ _____ 100

Due soldier \$ *9*²⁰ 100; due U. S. \$ _____ 100

Am't for cloth'g in kind or money adv'd \$ _____ 100

Due U. S. for arms, equipments, &c., \$ _____ 100

Bounty paid \$ _____ 100; due \$ *300* 100

Remarks: *Absent sick at New Or-*
leans, since Aug. 5. 1865. No
discharge furnished. Free
on or before Apr. 19. 1865.

Book mark: *(Dec 21 49 C.F. 1871*
Discharged, Octo. 9. 1865
E.B. V. 11. p 74-

(361)

R. E. Wilson

Copyist.

M 5bold bar Mars
George McClune
, Co. H, 5 Reg't Mass (bold) Cav.

NOTATION.

Book mark: M-21-6.7.1871

Record and Pension Office.

WAR DEPARTMENT.

This book mark refers only to a report from the medical records, made by the Surgeon General to the Adjutant General, relative to the above-named man. As the medical records have since been carded, no transcript of this report is made hereon.

(491)

L. C. Casey
Copyist.

McLane George

Bug, Co. *H*, 5 Reg't *Mass. C.*

3 Enclosures.

Bed Cards	Final Statements
Burial Records	Furloughs or L. of A
Certs. of Dis. for Discharge	Med. Certificates
C. M. Charges	Med. Des. Lists
Descriptive Lists	Orders
Discharge Certificates	Pris. of War Record
Enlistment Papers	Resignations

Other papers relating to—

Admission to Hosp'l	Furlough or L. of A
Casualty Sheet	Med. Examination
Confinement	Misc. Information
Contracts	Pay or Clothing
Death or Effects	Personal Reports
Desertion	Rank
Discharge from Hosp'l	Transfer to Hosp'l
Discharge from Service	Transfer to V. R. C.
Duty	Transportation

Regt. George M^cClave
Co. H. 5th Mass. Cav.

Office Chief Commissary of Musters,

DEPARTMENT OF THE EAST,

NEW YORK CITY, *Oct 10* 1865.

I have to report that

Quaker
George M^r Kelame
Co I, 5th Reg't Mass
Infantry

is this day mustered out of the United States
service, in compliance with telegraphic instructions from War De-
partment of May 3d, 1865.

Very respectfully,

Your obedient servant,

WILSON BARSTOW,

Brevet Major and A. D. C.,

Chief Commissary of Musters.

To the Chief Mustering Officer, State of

Massachusetts

Office Chief Commissary of Musters,

DEPARTMENT OF THE EAST,

NEW YORK CITY, *Oct 10* 1865.

I have to report that.....

Quaker
George M. Clane

Co. I. 5th Mass

Leicester is this day mustered out of the United States

service, in compliance with telegraphic instructions from War Department of May 3d, 1865.

Very respectfully,

Your obedient servant,

WILSON BARSTOW,

Brevet Major and A. D. C.,

Chief Commissary of Musters.

To the Chief Mustering Officer, State of

Massachusetts

[OFFICE INDORSEMENT.]

War Department,

ADJUTANT GENERAL'S OFFICE,

May 16, 1874

The discharge of *George M. Clark*
Private, Co. *H*, 5th Reg't U.S.

Colored *Mass Cav*, is reported as follows:

On Company Muster Roll.

For _____, 186 _____, 186

Company Muster-out Roll. *do!* *Oct 9/5*

Must not be discharged, 186

Company Descriptive Book.

, 186

Company Morning Reports.

, 186

Soldier's Final Statement.

, 186

Soldier's Record of Death and Interment.

, 186

Soldier's Inventory of Effects.

, 186

Soldier's Certificate of Disability for Discharge.

, 186

Soldier's Individual Muster-out Roll.

, 186

Regimental Return.

For _____, 186 _____, 186

Regimental Quarterly Returns.

, 186

Regimental Descriptive Book.

, 186

By Surgeon General.

, 186

Oct 9, 186*2* is held to be
the correct date, and the Company Muster *Out*
Roll will be amended accordingly.

Thoma M. Sweet

Assistant Adjutant General.

EB 11/74. Noted 16.11.

Entered 11/10

CASUALTY SHEET

No.

Company
..... of Company

Regiment of *1st*
State Volunteers. (*2nd*)

NATURE OF CASUALTY.

Wounded
April 10/69



CASUALTY SHEET.

Name: *Amos P. Mayo*

Rank: *Private* Company: *A* Regiment: *5*

Arm: *100* State: *Mass*

Nature of Casualty: *W. (C. 1)*

CAUSE OF CASUALTY—(NAME OF DISEASE, &c.)

BY WHOM DISCHARGED.

FROM WHAT SOURCE THIS INFORMATION WAS OBTAINED.

DEGREE OF DISABILITY.

BY WHOM CERTIFIED.

REMARKS.

DATE OF DISCHARGE, DEATH, &c.

PLACE OF DISCHARGE, DEATH, &c.

Clerk.

Handwritten initials

400
McCoy, James

Co K, 5 Mass. Cav., (Col'd.)

Private

Private

CARD NUMBERS.

1 5372284

26

2 5372354

27

3 5384053

28

4 5384157

29

5 5384260

30

6 5384366

31

7 5384469

32

8 5384571

33

9 5384669

34

10 5384762

35

11 9091648

36

12 34506152

37

13 40731372

38

14

39

15

40

16

41

17

42

18

43

19

44

20

45

21

46

22

47

23

48

24

49

25

50

Book Mark:

See also

McC. **5 Cav. (Col'd.)** | **Mass.**

James McCoy.

....., Co. *K*....., 5 Reg't Mass. Cav. (Col'd.)

Appears on

Company Descriptive Book

of the organization named above.

DESCRIPTION.

Age *20* years; height *5* feet *4* inches.

Complexion *Dark.*

Eyes *Hazel*; hair *Dark.*

Where born *Bristol R.I.*

Occupation *Farmer.*

ENLISTMENT.

When *July 21st, 1864.*

Where *Dorchester.*

By whom *S. Holmes*; term *3* y'rs.

Remarks: *Single. Residence Buckland Del.*

Pd. \$100. U.S. Bounty July 21st 64, due \$200.

H. C. Thomas

(5539)

Copyist.

Mc | **5 Col'd Cav.** | **Mass.**

James Mc Coy

Appears with rank of *Pri* on

Muster and Descriptive Roll of a Detachment of U. S. Vols. forwarded

for the 5 Reg't Mass. Col'd Cavalry. Roll dated

Boston Mass July 18, 1864.

Where born *Bristol R. I.*

Age *20* y'rs; occupation *Farmer*

When enlisted *July 21*, 1864.

Where enlisted *Dorchester*

For what period enlisted *3* years.

Eyes *Hazel*; hair *Dark*

Complexion *Dark*; height *5-4* in.

When mustered in *July 21*, 1864.

Where mustered in *Boston*

Bounty paid \$ *100* ¹⁰⁰; due \$ *200* ¹⁰⁰

Where credited *2 Dist. Dorchester*

Norfolk Co
Company to which assigned

Remarks:

Book mark:

Donnelly

Mc 5 Cav. Mass.
James McBoy.

Appears with rank of _____ on _____

Muster and Descriptive Roll

of a detachment of U. S. Volunteers forwarded from Faneuil Hall, Boston, to Galloup's Island, Boston Harbor, for various regiments Massachusetts Volunteers. Roll dated

Boston, Mass. July 21, 1864.

Where born *Bristol, R. I.*

Age *20* years; occupation *Farmer.*

When enlisted *July 21, 1864.*

Where enlisted *Dorchester*

For what period enlisted *3* years.

Eyes *Hazel*; hair *Dark*

Complexion *Dark*; height *5 ft. 4 in.*

When mustered in *July 21, 1864.*

Where mustered in *Boston*

Bounty paid \$ *100* 100; due \$ *200* 100

Clothing account:
Last settled _____, 1864; drawn since \$ _____ 100

Date of first muster _____, 1864.

Regiment to which assigned *5 Cav.*

Remarks: *Dorchester, Norfolk Co., 2*

Book mark: _____

Pentney
(356m) _____ Copyist.

M | 5 Col'd Cav. | Mass.

James M^e Coy

Appears with rank of *Pri* on

Muster and Descriptive Roll of a Detachment of U. S. Vols. forwarded

for the 5 Reg't Mass. Col'd Cavalry. Roll dated

Gallup, Ind Mass, Aug 7, 1864.

Where born *Bristol R. I.*

Age *20* y'rs; occupation *Farmer*

When enlisted *July 21*, 1864

Where enlisted *Dorchester Mass*

For what period enlisted *3* years.

Eyes *Hazel*; hair *Dark*

Complexion *Dark*; height *5 ft. 4 in.*

When mustered in *July 21*, 1864

Where mustered in *Boston*

Bounty paid \$ *100*/₁₀₀; due \$ *200*/₁₀₀

Where credited

Company to which assigned

Remarks: *2- Dorchester, Norfolk Co.*

Book mark:

Donnelly

Mc | **5 Col'd Cav.** | **Mass.**

James M. Coy
Pvt, Co. K, 5 Reg't Mass. Col'd Cavalry.

Appears on

Company Muster Roll

for *July 1864*, 1864.

Present or absent *Present*

Stoppage, \$ 100 for

Due Gov't, \$ 100 for

Valuation of horse, \$ 100

Valuation of horse equipments, \$ 100

Remarks: *Due list for Cavalry*
057

Book mark: _____

Mc | **5 Col'd Cav.** | **Mass.**

James McCoy

Pris., Co. K, 5 Reg't Mass. Col'd Cavalry.

Appears on

Company Muster Roll

for *Sept & Oct*, 186 *4*

Present or absent *Present*

Stoppage, \$ *100* for

Due Gov't, \$ *100* for

Valuation of horse, \$ *100*

Valuation of horse equipments, \$ *100*

Remarks:

Book mark:

[Signature]

Mc | **5 Col'd Cav.** | **Mass.**

James McCoy
Co. K, 5 Reg't Mass. Col'd Cavalry.

Appears on

Company Muster Roll

for March, 1864.

Present or absent Present

Stoppage, \$ 100 for

Due Gov't, \$ 100 for

Valuation of horse, \$ 100

Valuation of horse equipments, \$ 100

Remarks:

Book mark: _____

Est. J. J. [unclear]
(358) Copyist.

Mc | **5 Col'd Cav.** | **Mass.**

James M. Coy
Priv., Co. K, 5 Reg't Mass. Col'd Cavalry.

Appears on

Company Muster Roll

for Jan & Feb, 1865.

Present or absent Present

Stoppage, \$ 100 for

Due Gov't, \$ 100 for

Valuation of horse, \$ 100

Valuation of horse equipments, \$ 100

Remarks:

Book mark:

(358)

Edmondson

Copyist.

Mc | **5 Col'd Cav.** | **Mass.**

James McCoy

Private, Co. K, 5 Reg't Mass. Col'd Cavalry.

Appears on

Company Muster Roll

for Mar & Apr, 1864.

Present or absent Present

Stoppage, \$ 100 for

Due Gov't, \$ 100 for

Valuation of horse, \$ 100

Valuation of horse equipments, \$ 100

Remarks:

Book mark:

(358)

James McCoy
Copyist.

no | **5 Col'd Cav.** | **Mass.**

James M. Coy
Priv., Co. K, 5 Reg't Mass. Col'd Cavalry.

Appears on

Company Muster Roll

for May of June, 1865.

Present or absent Present

Stoppage, \$ 100 for

Due Gov't, \$ 100 for

Valuation of horse, \$ 100

Valuation of horse equipments, \$ 100

Remarks:

Book mark:

Edmundson

Mc | 5 Col'd Cav. | Mass.

James Mc Coy

Pat, Co. K, 5 Reg't Mass. Col'd Cavalry.

Appears on

Company Muster Roll

for July & Aug., 1865

Present or absent Present

Stoppage, \$ 100 for

Due Gov't, \$ 100 for

Valuation of horse, \$ 100

Valuation of horse equipments, \$ 100

Remarks:

Book mark:

Galligan

M^c | 5 Col'd Cav. | Mass.

James M^cBoyer
Pvt., Co. K, 5 Reg't Mass. Colored Cav.

Appears on Returns as follows:

Aug. 1864. Gain Aug. 12" Pt.
Lookout - Recruit rec'd
from depot.
On daily duty, Fatigue

Book mark :

(546)

J. B. Sittler

Copyist.

Mc | 5 Col'd Cav. | Mass.

James Mc Coy
Capt, Co. K, 5 Reg't Mass. Col'd Cavalry.

Appears on Co. Muster-out Roll, dated
Clarksville Texas, Oct 31, 1865.

Muster-out to date Oct. 31, 1865.

Last paid to Dec. 31, 1864.

Clothing account:

Last settled _____, 186 ; drawn since \$ 100

Due soldier \$ 100; due U. S. \$ 30 ⁶⁷/₁₀₀

Am't for cloth'g in kind or money adv'd \$ 100

Due U. S. for arms, equipments, &c., \$ 11 ⁰⁰/₁₀₀

Bounty paid \$ 100 ⁰⁰/₁₀₀; due \$ 200 ⁰⁰/₁₀₀

Remarks: _____

Book mark: _____

(361)

Galligan

Copyist.

McCoy, James
Pr, Co. _____, Reg't *Mass. C. Cav.*

² Enclosures.

Bed Cards	Final Statements
Burial Records	Furloughs or L. of A.
Certs. of Dis. for Discharge	Med. Certificates
C. M. Charges	Med. Des. Lists
Descriptive Lists	Orders
Discharge Certificates	Pris. of War Record
Enlistment Papers ²	Resignations

Other papers relating to—

Admission to Hosp'l	Furlough or L. of A.
Casualty Sheet	Med. Examination
Confinement	Misc. Information
Contracts	Pay or Clothing
Death or Effects	Personal Reports
Desertion	Rank
Discharge from Hosp'l	Transfer to Hosp'l
Discharge from Service	Transfer to V. R. C.
Duty	Transportation

Norfolk County
VOLUNTEER ENLISTMENT.

STATE OF

TOWN OF

Massachusetts

Dorchester

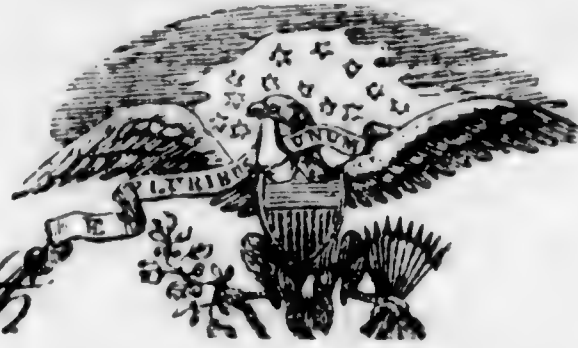

I, *James M Cog* born in *Bristol*
in the State of *Rhode Island* aged *Twenty* years,
and by occupation a *Farmer* DO HEREBY ACKNOWLEDGE to have
volunteered this *twenty first* day of *July* 1864,
to serve as a Soldier in the Army of the United States of America, for the
period of **THREE YEARS**, unless sooner discharged by proper authority: Do also
agree to accept such bounty, pay, rations, and clothing, as are, or may be, estab-
lished by law for volunteers. And I, *James M Cog* do
solemnly swear, that I will bear true faith and allegiance to the **United States**
of America, and that I will serve them honestly and faithfully against all their
enemies or opposers whomsoever; and that I will observe and obey the orders of
the President of the United States, and the orders of the officers appointed over
me, according to the Rules and Articles of War.

Sworn and subscribed to, at *Boston*
this *25* day of *July* 1864,
BEFORE *D. M. [Signature]*

his
James M Cog
Mark

I CERTIFY, ON HONOR, That I have carefully examined the above-named Volunteer, agreeably
to the General Regulations of the Army, and that, in my opinion, he is free from all bodily defects and
mental infirmity, which would in any way disqualify him from performing the duties of a soldier.

J. M. [Signature]
Wm.

EXAMINING SURGEON.

I CERTIFY, ON HONOR, That I have minutely inspected the Volunteer, *James M Cog*
previously to his enlistment, and that he was entirely sober when enlisted; that, to the best of my
judgment and belief, he is of lawful age; and that, in accepting him as duly qualified to perform the duties
of an able-bodied soldier, I have strictly observed the Regulations which govern the recruiting service.
This soldier has *hazel* eyes, *dark* hair, *dark* complexion, is *five* feet
four inches high.

Wm. [Signature]
Company [Signature]
Regiment of *[Signature]* Volunteers,

RECRUITING OFFICER.

(A. G. O. No. 74 & 75.)

Wm. [Signature]

Mustered into the service of the United States, in Company
the *21* day of *July*, 1864, at *Boston*

5 *th*
Regiment of *Mass. Cavalry* Volunteers, on

[Signature]

NOTE 1.—This blank will be used for both enlistments and re-enlistments—enlistment of veterans, &c., &c., in the volunteer service. They will be made out in duplicate in all cases—one to accompany the recruiting return of the superintendent (not the recruiting officer) to the Adjutant-General, and one to accompany the accounts of the officer who pays bounty, &c. The Regiment and Company in which the soldier last served should be given on the back.

NOTE 2.—An enlistment holds to service. A muster-in must, in all cases, precede payment of pay, bounty, pension, &c. A muster-in roll must, in all cases, be filed in the Adjutant-General's Office as evidence of muster-in. The mustering officer, commissary, or assistant-commissary of musters, as the case may be, will countersign both enlistments as having mustered the soldier into the service of the United States before either of them is given to the disbursing officer.

DECLARATION OF RECRUIT.

I, *James M. Coy* desiring to VOLUNTEER as a Soldier in the Army of the United States, for the term of THREE YEARS, Do Declare, That I am *Twenty* years and _____ months of age; that I have never been discharged from the United States service on account of disability or by sentence of a court-martial, or by order before the expiration of a term of enlistment; and I know of no impediment to my serving honestly and faithfully as a soldier for three years.

GIVEN at *Boston* the *21* day of *July*

Witness: *George Roy* *James M. Coy*
Amor

Discharged *100*
100 *18*
1864

enlistment; last served in Company ()

Regt of

By

James M. Coy
Volunteered at *Providence*
July 21 18 *64*
of *Providence*
Regiment of *Providence*

No.

500000

CONSENT IN CASE OF MINOR.

I, _____ Do CERTIFY, That I am _____ the _____ of _____; that the _____ said _____ is _____ years of age; and I do hereby freely give my CONSENT to his volunteering as a SOLDIER in the ARMY OF THE UNITED STATES, for the period of THREE YEARS.

GIVEN at _____ the _____ day of _____

Witness: _____

VOLUNTEER ENLISTMENT.

Norfolk County

STATE OF

TOWN OF

Massachusetts



Dorchester

I, *James M. Coe* born in *Bristol*
in the State of *Rhode Island* aged *Twenty* years,
and by occupation a *Farmer* DO HEREBY ACKNOWLEDGE to have
volunteered this *twenty first* day of *July* 1864,
to serve as a **Soldier** in the Army of the United States of America, for the
period of **THREE YEARS**, unless sooner discharged by proper authority: Do also
agree to accept such bounty, pay, rations, and clothing, as are, or may be, estab-
lished by law for volunteers. And I, *James M. Coe* do
solemnly swear, that I will bear true faith and allegiance to the **United States**
of America, and that I will serve them honestly and faithfully against all their
enemies or opposers whomsoever; and that I will observe and obey the orders of
the President of the United States, and the orders of the officers appointed over
me, according to the Rules and Articles of War.

Sworn and subscribed to, at

this

BEFORE

Boston
21 day of *July* 1864.
D. M. [Signature]

his
James M. Coe
Mark

I CERTIFY, ON HONOR, That I have carefully examined the above-named Volunteer, agreeably
to the General Regulations of the Army, and that, in my opinion, he is free from all bodily defects and
mental infirmity, which would in any way disqualify him from performing the duties of a soldier.

J. M. [Signature]
M.D.

EXAMINING SURGEON.

I CERTIFY, ON HONOR, That I have minutely inspected the Volunteer, *James M. Coe*
previously to his enlistment, and that he was entirely sober when enlisted; that, to the best of my
judgment and belief, he is of lawful age; and that, in accepting him as duly qualified to perform the duties
of an able-bodied soldier, I have strictly observed the Regulations which govern the recruiting service.
This soldier has *hazel* eyes, *dark* hair, *dark* complexion, is *five* feet
four inches high.

(A. G. O. No. 74 & 75.)

James M. Coe
Regiment of [Signature] Volunteers,

RECRUITING OFFICER.

Mustered into the service of the United States, in Company
the *21* day of *July*, 1864, at *Boston*

5th *Regiment of [Signature] Volunteers, on*

[Signature]

101
McDonald, James
Co A, 5 Mass. Cav., (Col'd.)

Private Private

CARD NUMBERS.

1	5382708	26
2	5382793	27
3	5382879	28
4	5382960	29
5	5383110	30
6	5383724	31
7	9091716	32
8	32533828	33
9	32535126	34
10	31547489	35
11	40731374	36
12	40731373	37
13		38
14		39
15		40
16		41
17		42
18		43
19		44
20		45
21		46
22		47
23		48
24		49
25		50

Book Mark:

See also

McD. **5 Cav. (Col'd.) | Mass.**

James William McDonald.

....., Co. *I*, 5 Reg't Mass. Cav. (Col'd.)

Appears on

Company Descriptive Book

of the organization named above.

DESCRIPTION.

Age *19* years; height *5* feet *3* inches.

Complexion *Black.*

Eyes *Brown*; hair *Black.*

Where born *Burkley Co. Pa.*

Occupation *Laborer.*

ENLISTMENT.

When *Mar. 19th, 1864.*

Where *Boston M. C.*

By whom *D. Davies*; term *3* y'rs.

Remarks: *Died at Newark N. J.*
Aug. 18th 1864. Final statements
sent to A.G.O. Aug 1864. received
Aug. 22nd 1865.

H. C. Thomas.

Mc | **5 Col'd Cav.** | **Mass.**

James N McDonald
Priv, Co. *F*, 5 Reg't Mass. Col'd Cav.

Appears on

Company Muster-in and Descriptive Roll
of the organization named above. Roll dated

Readville Mass, Mch 26, 1864.

Where born *Burkley Co, Pa.*

Age *19* y'rs; occupation *Laborer*

When enlisted *Mch 19*, 1864.

Where enlisted *Boston Wd. 6.*

For what period enlisted *3* years.

Eyes *Black*; hair *Black*

Complexion *Black*, height *5* ft. *3* in.

When mustered in *Mch 26*, 1864.

Where mustered in _____

Bounty paid \$ *100*; due \$ *100*

Where credited *4th Dist. Suffolk*

Company to which assigned _____

Remarks: *Residence Boston Wd. 6*

Book mark: _____

W H Thompson

(356d)

Copyist.

Mc | **5 Col'd Cav.** | **Mass.**

James W. McDonald
Priv, Co. I, 5 Reg't Mass. Colored Cavalry.

Appears on

Company Muster Roll

for *McH 26 to Apl 30*, 186*4*.

Present or absent *Present*

Stoppage, \$ *100* for

Due Gov't, \$ *100* for

Valuation of horse, \$ *100*

Valuation of horse equipments, \$ *100*

Remarks:

Book mark:

(358)

W. A. Thompson
Copyist.

No 5 Cold Car. Mass

Jas. M. McDonald
Priv., Co. I, 5 Reg't Mass C. Car

Appears on

Hospital Muster Roll

of Balfour U. S. A. General Hospital,

at Portsmouth, Va.,

for May & June, 1864.

Attached to hospital:

When _____, 186 .

How employed _____

Last paid by Maj. _____

to _____, 186 .

Bounty paid \$ 100; due \$ 100

Present or absent Present

Remarks: _____

Book mark: _____

W. W. Payne
Copyist.

Mc | 5 Col'd Cav. | Mass.

James M. McDaniel
Coy, Co. I, 5 Reg't Mass. Colored Cavalry.

Appears on

Company Muster Roll

for May & June, 1864.

Present or absent Absent

Stoppage, \$ 100 for

Due Gov't, \$ 100 for

Valuation of horse, \$ 100

Valuation of horse equipments, \$ 100

Remarks: Absent sick at Fort
Mourne.

Book mark:

W. H. Thompson
Copyist.

No 15 Cav. (Col.) Mass.

James M Donald
P. A., Co. I., 5 Reg't Mass. Cav.

Appears on

Hospital Muster Roll

of **Balfour U. S. A. General Hospital,**

at **Portsmouth, Va.,**

for *July 1864*, 1864.

Attached to hospital:

When _____, 186 .

How employed _____

Last paid by Maj. _____

to _____, 186 .

Bounty paid \$ 100; due \$ 100

Present or absent _____

Remarks: *Transferred North*

July 1864

Book mark: _____

M 1 5 Cav. Col. Mass

James W. McDaniel
bugler, Co. I., 5 Reg't Mass Cav

Appears on

Hospital Muster Roll

of Ward U. S. A. General Hospital,

at Newark, N. J.,

for July & Aug., 1864.

Attached to hospital:

When July 21, 1864.

How employed

Last paid by Maj.

to unknown, 1864.

Bounty paid \$ 100; due \$ 100

Present or absent

Remarks: dies Aug 13 1864

Book mark :

(848)

Edgson
Copyist.

M | 5 Col'd Cav. | Mass.

James W. McDaniel

Pvt., Co. I, 5 Reg't Mass. Colored Cavalry.

Appears on

Company Muster Roll

for July Aug, 1864.

Present or absent Absent

Stoppage, \$ 100 for

Due Gov't, \$ 100 for

Valuation of horse, \$ 100

Valuation of horse equipments, \$ 100

Remarks: Abs. Sick at Portsmouth Va.

Book mark:

W. J. Simpson Copyist.

Mc | **5 Col'd Cav.** | **Mass.**

James W. McDaniel,
Pvt., Co. I, 5 Reg't Mass. Colored Cavalry.

Appears on

Company Muster Roll

for *Sept. & Oct.*, 186*4*.

Present or absent

Stoppage, \$ 100 for

Due Gov't, \$ 100 for

Valuation of horse, \$ 100

Valuation of horse equipments, \$ 100

Remarks: *Died of diarrhoea*
Aug. 18th at Newark, N.J.

Book mark:

C. F. Thompson

M^c | **5 Col'd Cav.** | **Mass.**

James W. M^c Daniel*
Pvt., Co. I, 5 Reg't Mass. Colored Cav.

Appears on **Returns** as follows:

July 1864, Absent sick, Fort
Monroe June 20/64.

Aug. 1864, Absent sick at
Portsmouth, Va.

* Name appears also as
J. M^c Donald.

Book mark :

(548)

J. B. Sittler

Copyist.

Mc | **5 Col'd Cav.** | **Mass.**

L. M. McDonald

Priv, Co. I, 5 Reg't Mass. Colored Cav.

Appears on **Returns** as follows:

Sept. 1864. Loss Aug. 18"
Newark, New Jersey -
Died Diarrhoea.

Book mark : _____

(648)

J. B. Sittler

Copyist.

M | 5 Col'd Cav. | Mass.

James W McDonald
Pvt, Co. D, 5 Reg't Mass. Col'd Cavalry.

Appears on Co. Muster-out Roll, dated
Blacksville Texas, Oct 31, 1865.

Muster-out to date _____, 186 .

Last paid to never Paid, 186 .

Clothing account:

Last settled _____, 186 ; drawn since \$ _____ 100

Due soldier \$ _____ 100; due U. S. \$ 20¹⁸/₁₀₀

Am't for cloth'g in kind or money adv'd \$ _____ 100

Due U. S. for arms, equipments, &c., \$ _____ 100

Bounty paid \$ _____ 100; due \$ 300/₁₀₀

Remarks: died Aug 18/64 in New York
Final statements sent to A. J. O.
Aug 22/65

Book mark: FS

Kel. [Signature]

McDonald, James H.
Regt Co. D., *B. H. News, Co.*
Reg't

Enclosures.

Bed Cards	Final Statements
Burial Records	Furloughs or L. of A.
Certs. of Dis. for Discharge	Med. Certificates
C. M. Charges	Med. Des. Lists
Descriptive Lists	Orders
Discharge Certificates	Pris. of War Record
Enlistment Papers	Resignations

Other papers relating to—

Admission to Hosp'l	Furlough or L. of A.
Casualty Sheet	Med. Examination
Confinement	Misc. Information
Contracts	Pay or Clothing
Death or Effects	Personal Reports
Desertion	Rank
Discharge from Hosp'l	Transfer to Hosp'l
Discharge from Service	Transfer to V. R. C.
Duty	Transportation

FINAL STATEMENT

^{JOE}
James W. McDonald COI
5th Reg't of Mass. Cavalry

VOLUNTEERS.

NOTE 1.—Two of these certificates (or duplicates) are to be given to each Volunteer Soldier or drafted man who may be discharged previously to the discharge of his company, that he may at once receive from the Paymaster the pay, &c., due him, and the captain or other COMMISSIONED officer commanding the company will certify to the act of the delivery of the duplicate certificates; on these certificates the Soldier is "entitled to" his discharge, and should also present his discharge to the Paymaster to have the payment endorsed on it. The discharge is to be given back to the Soldier by the Paymaster; the latter only retaining as his voucher the duplicate certificates.

NOTE 2.—If the Soldier is entitled to pay for the use of his horse, the Company Commander will certify to that fact on the back of both these final statements, and also to the time he has pay due for having been so mounted on his own horse.

NOTE 3.—When a Soldier is furnished with final statements, his descriptive list, if he has one, should be taken up by the officer who gives the Soldier these statements, and endorsed with a statement to this effect by the officer. This endorsement should exhibit a full statement of the time for which the Soldier was allowed pay on his final statements, the clothing account, and all other charges against him or in his favor, so as to comprise a complete exhibit of his account. It will then be transmitted to the company commander of the Soldier, who will enter all the data necessary to a full understanding of the Soldier's account on the muster roll upon which the Soldier's discharge is reported. The descriptive list will then be destroyed. The object of this is, that the remaining portion of the Soldier's account may be settled upon the receipt of these muster rolls, and the Soldier receive any pay or allowances that may be due him at the time of his discharge, and which may not appear on his final statements from the fact that his descriptive list is incomplete. These accounts for back pay, &c., are settled by the 2d Auditor of the Treasury Department.

NOTE 4.—Charges for loss or injury to ordnance, horse equipments, and other miscellaneous charges, should appear under the heading of "Other Stoppages."

NOTE 5.—Bounty paid by State authorities, and not by the United States, will not be entered on this statement.

NOTE 6.—Amounts due the Sutler and Laundress must be entered on the muster roll on which the discharge, death, desertion, &c., is reported, as well as on the final statement, otherwise the amount cannot be collected from the United States.

NOTE 7.—This blank will be used for deceased volunteers and drafted men, as well as for others.

NOTE 8.—Where a Soldier dies in Hospital or on detached service, his descriptive list, if he has one, should be sent with his final statements; in duplicate, to the Adjutant General, Washington, D. C.

ADJUTANT GENERAL'S OFFICE.
W. G. M.
Duplicate with Inventory sent 2d Auditor.

James W. McDonald

I certify, on honor, that James Well Donald a Private of
 Captain A. Anderson Company (I) of the Fifth Regiment of Cavalry
VOLUNTEERS, of the State of Massachusetts, born in Burkley Co., State
 of Virginia, aged 19 years; 5 feet 3 inches high; Black complexion,
Brown eyes, Black hair, and by occupation a Laborer, having joined the company on
 its original organization at Readville Mass., and enrolled in it at the muster into
 the service of the United States at Readville Mass., on the twenty eighth
 day of March, 1864, (or was mustered in service as a recruit, by
 _____, at _____, on the _____ day of _____,
 186 , or was drafted and mustered into the service of the United States from the _____
 Enrollment District of the State of _____, at _____,
 on the _____ day of _____, 186), to serve in the Regiment, for
 the term of three years; and having served HONESTLY and
 FAITHFULLY with his Company in the field to the present date, is now
 entitled to a **DISCHARGE** by reason of Death at Newark
N. J. Aug 18th 1864 of dysentery

The said James Well Donald was last paid by Paymaster
never paid to include the _____ day of _____, 186 , and has
 pay due him from that time to the present date; he is entitled to pay and subsistence for
 TRAVELING to place of enrollment, and whatever other allowances are authorized to volunteer
 soldiers, drafted men, or militia, so discharged. He has received from the United States **CLOTHING**
 amounting to thirty seven $\frac{68}{100}$ dollars, since the 26th day of March,
 1864, when his clothing account was last settled. He has received from the United States
no $\frac{00}{100}$ dollars advanced **BOUNTY**.

There is to be stopped from him, on account of the State of _____, or other
 authorities, for **CLOTHING**, &c., received on entering service, _____ $\frac{00}{100}$ dollars; and
 for other stoppages, viz: Nothing

no effects _____ $\frac{00}{100}$ dollars.
 He has been furnished with TRANSPORTATION in kind from the place of his discharge to
 _____; and he has been SUBSISTED for TRAVELING to his
 place of enrollment, up to the _____, 186 .

He is indebted to _____, **SUTLER**, _____ $\frac{00}{100}$ dollars.

He is indebted to _____, **LAUNDRESS**, _____ $\frac{00}{100}$ dollars.

Given in Duplicate, at Clarksville Texas, this 22nd day
 of August, 1865.

John B. Anderson
Capt. 5th Mass. Cav.
 Commanding Company I

CASUALTY SHEET

No.

Joseph W. M. Daniels

Drum of Company *D*

5th Regiment of *Mass Col Cav*

State Volunteers.

NATURE OF CASUALTY.

Died Aug 13. 64

CASUALTY SHEET.

Name: *Joseph W. McDavid*

Rank: *Buyler* Company: *D* Regiment: *5*

Arm: *Col Cav* State: *Mass*

Nature of Casualty: *Died*

CAUSE OF CASUALTY—(NAME OF DISEASE, &C.)

BY WHOM DISCHARGED.

DEGREE OF DISABILITY.

FROM WHAT SOURCE THIS INFORMATION WAS OBTAINED.

Roll 29 Wood Hospital N.Y.

BY WHOM CERTIFIED

A.M. Mills

REMARKS.

a a e u e u

DATE OF DISCHARGE, DEATH, &C.

Aug 13. 64

PLACE OF DISCHARGE, DEATH, &C.

Quar 16 N.Y.

Ant Dally
Clerk

H. J. J.

CASUALTY SHEET

+ No. _____
_____ of Company _____

+ _____ Regiment of _____
State Volunteers. Cavry

NATURE OF CASUALTY.

_____ 13th U.S.

+ Jas. W. Mc Donald (colored)
Co. D 5th Map. Cavry
Died at Newark N.J.
Aug 18. 1862

Nov 10/73 J. Bingham & No. 14
Newark records 5 Map Int

CASUALTY SHEET.

Name: Gen. W. M. Lewis
Rank: Pvt. Company: D Regiment: 5
Arm: Inf. State: Ill.
Nature of Casualty: Death

CAUSE OF CASUALTY—(NAME OF DISEASE, &c.)

BY WHOM DISCHARGED.

FROM WHAT SOURCE THIS INFORMATION WAS OBTAINED.

DEGREE OF DISABILITY.

BY WHOM CERTIFIED.

REMARKS.

DATE OF DISCHARGE, DEATH, &c.

PLACE OF DISCHARGE, DEATH, &c.

Clerk.

CASUALTY SHEET
OF WOUNDED.

John W. McDaniel

Private Company *I*

5th Regiment of *Mass Cav (col)*

Volunteers, at the battle of

Chancellorsville

April 30, 1863

CASUALTY SHEET.

Name, *Jas W McDaniel*
Rank, *Private* Company *I*, Regiment, *5*
Arm, *Car*, State, *Mass (col)*
Place of casualty, _____
Nature of casualty, *Wounded July 21 War Hrs*
Incipient Phthisis
Date of casualty, _____

FROM WHAT SOURCE THIS INFORMATION WAS OBTAINED.

Report of Killed, Wounded, and Missing of the _____ Regiment,
_____ Brigade. _____ Division, _____ Corps, dated
Hospital Register New England Soldiers' Relief Association
Book 4, page 417

W North
Dec 8. 1865 Clerk.

*E
N 28*

969-a

McHenry, John
Co., 5th Mass. Col'd Cav.

CARD NUMBERS.

1	9436089	26
2		27
3		28
4		29
5		30
6		31
7		32
8		33
9		34
10		35
11		36
12		37
13		38
14		39
15		40
16		41
17		42
18		43
19		44
20		45
21		46
22		47
23		48
24		49
25		50

Number of personal papers herein.....

Book Mark.....

See also.....

Mc. Car, Mass.
Col'd. Mas.
John McHenry,
Co. 5 Reg't Mass Col'd Car.

Appears on

Regimental Descriptive Book

of the organization named above.

DESCRIPTION.

Age 27 years; height 5 feet 7 inches.
Complexion Black,
Eyes Black; hair Black,
Where born Madison, Indiana
Occupation Laborer.

ENLISTMENT.

When March 12, 1864
Where Rochester,
By whom B. F. Chesley; term 3 y'rs.

Remarks:

Chesley

969-b

McSwane, Henry
Co., J. W. S. Col'd Cav.

CARD NUMBERS.

1	9436081	26
2		27
3		28
4		29
5		30
6		31
7		32
8		33
9		34
10		35
11		36
12		37
13		38
14		39
15		40
16		41
17		42
18		43
19		44
20		45
21		46
22		47
23		48
24		49
25		50

Number of personal papers herein.....

Book Mark:

See also

No. 5 Car. Mass.
Col'd.

Henry McEvane,

....., Co., 5 Reg't Col'd Mass. Cav.

Appears on

Regimental Descriptive Book

of the organization named above.

DESCRIPTION.

Age 27 years; height 5 feet 9 1/2 inches.

Complexion Blk.

Eyes Blk.; hair Blk.

Where born Red River, Ky.

Occupation Farmer.

ENLISTMENT.

When March 9, 1864.

Where Boston, N. H.

By whom G. W. Mesnard; term 3 y'rs.

Remarks: Rejected March
26, 64.

Harvin.

910
McKee, Stephen

Co A, 5 Mass. Cav., (Col'd.)

Private | Private

CARD NUMBERS.

1	5373582	26
2	5373695	27
3	5373805	28
4	5373905	29
5	5374016	30
6	5374117	31
7	5374217	32
8	5374311	33
9	5374401	34
10	5372887	35
11	9092689	36
12	m-28-051871	37
13		38
14		39
15		40
16		41
17		42
18		43
19		44
20		45
21		46
22		47
23		48
24		49
25		50

Book Mark: No. 163: Vol. 5. R. 6. 5. 87 + No. 28. No. 9. 6. 5. 79.
L. B. 12-425.

See also

Mc | 5 Cav. (Col'd.) | Mass.

Stephen Mc Kee

Co. X, 5 Reg't Mass. Cav. (Col'd.)

Appears on

Company Descriptive Book

of the organization named above.

DESCRIPTION.

Age 21 years; height 5 feet 3 inches.

Complexion Dark

Eyes Dark; hair Dark

Where born Inquirer Co Va

Occupation Laborer

ENLISTMENT.

When May 21, 1864.

Where Boston

By whom G. A. Quincy; term 3 y'rs.

Remarks: Paid to include the 31st of October 1864

383a)

Quincy

Copyist.

Mc | **5 Col'd Cav.** | **Mass.**

Stephen McTee
Pvt., Co. A, 5 Reg't Mass. Col'd Cavalry.

Appears on

Company Muster Roll

for *May & June*, 1864.

Present or absent *Present*

Stoppage, \$ *100* for

Due Gov't, \$ *100* for

Valuation of horse, \$ *100*

Valuation of horse equipments, \$ *100*

Remarks: *Enrolled May 21/64 at*
Newton & Mustered in same day
at Washington.

Book mark: _____

G. F. M.
Copyist.

M

5 Col'd Cav.

Mass.

Stephen M Kee
Pr.

Co. A, 5 Reg't Mass. Col'd Cavalry.

Appears on

Company Muster Roll

for July and Aug., 1864.

Present or absent Present

Stoppage, \$ 100 for

Due Gov't, \$ 100 for

Valuation of horse, \$ 100

Valuation of horse equipments, \$ 100

Remarks: Free on or before
Apr. 19, 1861.

Book mark:

M. C. Gilbert

M

5 Col'd Cav.

Mass.

Stephen McKee
Co., Co. A, 5 Reg't Mass. Col'd Cavalry.

Appears on

Company Muster Roll

for *Sept. and Oct.*, 186*4*.

Present or absent *Present.*

Stoppage, \$ *100* for

Due Gov't, \$ *100* for

Valuation of horse, \$ *100*

Valuation of horse equipments, \$ *100*

Remarks: *Stop 1 harness and
scautten .85.*

Book mark: _____

M. O. Gilbert

M

5 Col'd Cav.

Mass.

Stephen McKee
Pvt.

Co. A, 5 Reg't Mass. Col'd Cavalry.

Appears on

Company Muster Roll

for

Nov. and Dec.

1864.

Present or absent

Present.

Stoppage, \$

100 for

Due Gov't, \$

100 for

Valuation of horse, \$

100

Valuation of horse equipments, \$

100

Remarks:

Stop one haversack and canteen 85¢ and one gun sling, one carbine socket 63¢

Book mark:

M. O. Gilbert,

(358)

Copyist.

M | **5 Col'd Cav.** | **Mass.**

Stephen M Kee
Pw., Co. A, 5 Reg't Mass. Col'd Cavalry.

Appears on

Company Muster Roll
for *Jan. and Feb.*, 1865.

Present or absent *Present.*

Stoppage, \$ $\frac{85}{100}$ for *Q.M. Goods.*

Due Gov't, \$ $\frac{63}{100}$ for *Ord.*

Valuation of horse, \$ $\frac{100}{100}$

Valuation of horse equipments, \$ $\frac{100}{100}$

Remarks: _____

Book mark: _____

M. O. Gilbert,

M | **5 Col'd Cav.** | **Mass.**

Stephen McKee
Cvt., Co. A, 5 Reg't Mass. Col'd Cavalry.

Appears on

Company Muster Roll

for *March and Apr.*, 1865.

Present or absent *Present.*

Stoppage, \$ 100 for

Due Gov't, \$ 100 for

Valuation of horse, \$ 100

Valuation of horse equipments, \$ 100

Remarks:

Book mark:

N. O. Gilbert

Mc | **5 Col'd Cav.** | **Mass.**

Stephen Mc Kee
Put, Co. A, 5 Reg't Mass. Col'd Cavalry.

Appears on

Company Muster Roll

for *May & June*, 1865.

Present or absent *Present*

Stoppage, \$ 100 for

Due Gov't, \$ 100 for

Valuation of horse, \$ 100

Valuation of horse equipments, \$ 100

Remarks:

Book mark:

Dallard

Mc | **5 Col'd Cav.** | **Mass.**

Stephen Mc Kee
Plt, Co. A, 5 Reg't Mass. Col'd Cavalry.

Appears on

Company Muster Roll

for July & Aug, 186 5

Present or absent Present

Stoppage, \$ 100 for

Due Gov't, \$ 100 for

Valuation of horse, \$ 100

Valuation of horse equipments, \$ 100

Remarks:

Book mark:

(358)

Dallide

Copyist.

Mc | **5** Col'd Cav. | **Mass.**

Stephen McKee

Co., 5 Reg't Mass. Col'd Cavalry.

Appears on an

Individual Muster-out Roll

of the organization named above. Roll dated

Wash City, *Oct 11*, 1865.

Muster-out to date *Oct 11*, 1865.

Last paid to *Dec 31*, 1864.

Clothing account:

Last settled *Dec 31*, 1864; drawn since \$ 100

Due soldier \$ 100; due U. S. \$ 100

Am't for cloth'g in kind or money adv'd \$ *57* 25 ^{*Since last settlement*} 100

Due U. S. for arms, equipments, &c., \$ 100

Bounty paid \$ 100 due \$ 100

Remarks: *Mustered out under
Tel Order war Dept A.G.O.
May 4/65
No account of
bounty*

Book mark: *428 Vol 9 C.F. 1871*

Stewart
(348) Copyist.

Mc | 5 Col'd Cav. | Mass.

Stephen Mc Kee
Pvt, Co. A., 5 Reg't Mass. Col'd Cavalry.

Appears on Co. Muster-out Roll, dated
Clarkeville, Texas, Oct 31, 1865.

Muster-out to date _____, 186 .

Last paid to Dec 31, 1864.

Clothing account:

Last settled _____, 186 ; drawn since \$ 100

Due soldier \$ 100; due U. S. \$ 10 ⁸⁶/₁₀₀

Am't for cloth'g in kind or money adv'd \$ 100

Due U. S. for arms, equipments, &c., \$ ⁷²/₁₀₀

Bounty paid \$ 25 ¹⁰⁰/₁₀₀; due \$ 75 ¹⁰⁰/₁₀₀

Remarks: Free Apr 19, 1861
Absent sick at N.O. La since
Sept. 22 - 65 no discharge
furnished.

Book mark: Discharge on file see
(copy)

(361)

Ballade

Copyist.

JAN-9

5374401

1891

M. 163 Vol 5. R.C.T. 1867. M. 28
Vol. 9. C. 7. 1871. Mus out roll
on file + 2nd.

235 C. 7. 79. A. O. mustered
out of service Oct. 11. 65 at
New York City under telegraphic
order War Dept. A. O. dated
May 4. 65. S. B. $\frac{12}{425}$

P. M. 4. 6298. Jan 21. 66

M | 5th Cav. (Colored) Mass

Stephen McKee

, Co. A, 5th Reg't Mass Cav. (Col'd)

NOTATION.

Book mark: ^{L. B. 12. 425} 235-C-1879. and
M 16305-67 with M 25-C-1871

War Department,

Adjutant General's Office,

Washington. *Jan'y 29* 1879.

*Mustered out of service October
1. 1865. at New York City under
Telegraphic order War Dept. A. G. O.
dated May 4. 1865.*

McNee, Stephen

P., Co. 3rd, 5 Reg't Mass. Co

2 Enclosures.

Bed Cards	Final Statements
Burial Records	Furloughs or L. of A
Certs. of Dis. for Discharge	Med. Certificates
C. M. Charges	Med. Des. Lists
Descriptive Lists	Orders
Discharge Certificates	Pris. of War Record
Enlistment Papers	Resignations

Other papers relating to—

Admission to Hosp'l	Furlough or L. of A
Casualty Sheet	Med. Examination
Confinement	Misc. Information
Contracts	Pay or Clothing
Death or Effects	Personal Reports
Desertion	Rank
Discharge from Hosp'l	Transfer to Hosp'l
Discharge from Service	Transfer to V. R. C.
Duty	Transportation

Priv. Stephen M^e Kee
Co. A 5th Mass. Cav.

Office Chief Commissary of Musters,

DEPARTMENT OF THE EAST,

NEW YORK CITY, *October 11th* 1865.

I have to report that

Private

Stephen McKee

Co. A, 5th

Reg't

Mass.

Car. Vols

is this day mustered out of the United States

service, in compliance with telegraphic instructions from War Department of May 3d, 1865.

Very respectfully,

Your obedient servant,

WILSON BARSTOW,

Brevet Major and A. D. C.,

Chief Commissary of Musters.

To the Chief Mustering Officer, State of

Mass.

[OFFICE ENDORSEMENT.]

War Department,
ADJUTANT GENERAL'S OFFICE,

....., 187 .

The Discharge of Pvt. Stephen
Mc Kee, Co. A, 5th Reg't U. S.
Colored Mass. Cavalry, is reported as follows:
On Company Muster Roll.

For , 186 , , 186
Company Muster-out Roll. Oct 31 '65

Absent sick at N.O. La since Sept 9th, 1865
no discharge furnished.
Company Descriptive Book.

....., 186
Company Morning Reports.

....., 186
Soldier's Final Statement.

....., 186
Soldier's Record of Death and Interment.

....., 186
Soldier's Inventory of Effects.

....., 186
Soldier's Certificate of Disability for Discharge.

....., 186
Soldier's Individual Muster-out Roll.

October 11, 1865
Regimental Return.

For , 186 , , 186
Regimental Quarterly Returns.

....., 186
Regimental Descriptive Book.

....., 186
By Surgeon General.

(.....) , 186
....., 186 , is held to be
the correct date, and the Company Muster Roll will
be amended accordingly.

Assistant Adjutant General.

971
McKee, Thomas

Co K, 5 Mass. Cav., (Col'd.)

Private

Private

CARD NUMBERS.

1	5383779	26
2	5383865	27
3	5383953	28
4	5384098	29
5	5373088	30
6	5384826	31
7	6534-C-1889	32
8	9091590	33
9		34
10		35
11		36
12		37
13		38
14		39
15		40
16		41
17		42
18		43
19		44
20		45
21		46
22		47
23		48
24		49
25		50

Book Mark: 6534-C-1889.

See also

REP 342320

12/1/1944
4

M. K. 5 Cav. (Col'd.) | Mass.

Thomas McKee

....., Co. *K*, 5 Reg't Mass. Cav. (Col'd.)

Appears on

Company Descriptive Book

of the organization named above.

DESCRIPTION.

Age *23* years; height *5* feet *8½* inches.

Complexion *Black*

Eyes *Black*; hair *Black*

Where born *New Orleans La.*

Occupation *Laborer*

ENLISTMENT.

When *Mar. 22*, 186 ..

Where *Duxbury*

By whom *A. C. Swain*; term *3* y'rs.

Remarks: *Single. Residence New Orleans La. Deserted from camp at Fort Lookout Md. July 1864. Dropped from the rolls Aug. 31 1864.*

H. C. Thomas

MC | **5 Col'd Cav.** | **Mass.**

Thomas McKea
.....
Plt, Co. *B*, 5 Reg't Mass. Col'd Cav.

Appears on

Company Muster-in and Descriptive Roll
of the organization named above. Roll dated
Newville Mass, April, 1867.

Where born *New Orleans, La*

Age *23* y'rs; occupation *laborer*

When enlisted *Mar 22*, 1867.

Where enlisted *Newton*

For what period enlisted *3* years.

Eyes *Blue*; hair *Black*

Complexion *Black*; height *5* ft. *6* in.

When mustered in *April 12*, 1867.

Where mustered in *Newville Mass*

Bounty paid \$ *100*; due \$ *100*

Where credited *Newville Mass*

Company to which assigned

Remarks:

.....

.....

Book mark: *6534-C-89*

.....

W. A. ...

.....

.....

.....

.....

.....

.....

.....

.....

.....

.....

.....

McC | **5 Col'd Cav.** | **Mass.**

Thomas McCree

Co., Co. K, 5 Reg't Mass. Col'd Cavalry.

Appears on

Company Muster Roll

for *the month of August*, 186*1*.

Present or absent *Present*

Stoppage, \$ 100 for

Due Gov't, \$ 100 for

Valuation of horse, \$ 100

Valuation of horse equipments, \$ 100

Remarks: *in confinement*

Book mark:

W. H. ...

Mc | **5 Col'd Cav.** | **Mass.**

Thomas Mc Kee
Pl, Co. K, 5 Reg't Mass. Col'd Cavalry.

Appears on

Company Muster Roll

for May & June, 1864.

Present or absent Present

Stoppage, \$ 100 for

Due Gov't, \$ 100 for

Valuation of horse, \$ 100

Valuation of horse equipments, \$ 100

Remarks: See No in Canton
7.62

Book mark: _____

Libman
Copyist.

Mc | **5 Col'd Cav.** | **Mass.**

Thomas McKee

Pr, Co. K, 5 Reg't Mass. Col'd Cavalry.

Appears on

Company Muster Roll

for July & Aug, 1864.

Present or absent

Stoppage, \$ 100 for

Due Gov't, \$ 100 for

Valuation of horse, \$ 100

Valuation of horse equipments, \$ 100

Remarks: Displaced from
Unit & followed to New York
1864. Due at 1 for Muster
& Equipments \$22.71 for
Canteen & Haversack \$1.07

Book mark:

Albans

M^o Cold Car. Mass.

Thomas McKee

Pvt., Co. K, 5 Reg't Mass. Cold Car.

Appears on

Descriptive List of Deserters

dated Point Lookout Md. Aug. 6, 1864.

Deserted:

When July 5, 1864.

Where Point Lookout.

Arrested:

When _____, 186 .

Where _____

Remarks: _____

Book mark: _____

(351)

60
Cartering

Copyist.

Mc | 5 Col'd Cav. | Mass.

Thomas McKee

Pvt, Co. K, 5 Reg't Mass. Col'd Cavalry.

Appears on Co. Muster-out Roll, dated
Clarksville Texas, Oct. 31, 1865.

Muster-out to date _____, 186 .

Last paid to Never Paid _____, 186 .

Clothing account:

Last settled _____, 186 ; drawn since \$ _____ 100

Due soldier \$ _____ 100; due U. S. \$ _____ 100

Am't for cloth'g in kind or money adv'd \$ _____ 100

Due U. S. for arms, equipments, &c., \$ _____ 100

Bounty paid \$ _____ 100; due \$ 300⁰⁰ 100

Remarks: Deserted from Reg't.
at Pt Lookout Md. July 1st 1864.

Book mark: 6534. C. 89

(361)

Galligan

Copyist.

971-a

McKennon, Miles

Co 5th S. Col'd Cav.

CARD NUMBERS.

1	9436109	26
2		27
3		28
4		29
5		30
6		31
7		32
8		33
9		34
10		35
11		36
12		37
13		38
14		39
15		40
16		41
17		42
18		43
19		44
20		45
21		46
22		47
23		48
24		49
25		50

Number of personal papers herein.....

Book Mark:

See also

Mc. | 5th Cav. | Mass.
| (Col'd.) |
Miss McKennon,
....., Co., 5 Reg't Mass Col'd Cav.

Appears on

Regimental Descriptive Book

of the organization named above.

DESCRIPTION.

Age 19 years; height 5 feet inches.

Complexion Black.

Eyes Black; hair Black.

Where born Vermont, Nova Scotia.

Occupation Barber.

ENLISTMENT.

When Mar. 30, 1864.

Where Boston, Mass.

By whom S. Davis; term 3 y'rs.

Remarks: Rejected April 22, 1864.

Harwin

972

McKenny, William

Co. F, 5 Mass. Cav., (Col'd.)

Private

Private

CARD NUMBERS.

1	5379348	26
2	5379433	27
3	5379551	28
4	5380477	29
5	9092088	30
6	40731376	31
7		32
8		33
9		34
10		35
11		36
12		37
12		38
14		39
15		40
16		41
17		42
18		43
19		44
20		45
21		46
22		47
23		48
24		49
25		50

Book Mark:

See also

Mc | **5 Cav. (Col'd.)** | **Mass.**

William McKimney

....., Co. *F*....., 5 Reg't Mass. Cav. (Col'd.)

Appears on

Company Descriptive Book

of the organization named above.

DESCRIPTION.

Age *34* years; height *5* feet *6 1/4* inches.

Complexion *dark*

Eyes *blk* ; hair *blk*

Where born *France*

Occupation *Tanner*

ENLISTMENT.

When *Jan 20* , 1864.

Where *Boston*

By whom *D. Davies* ; term *3* y'rs.

Remarks: *Deserted on or about*
Mar. 12. 1864.

(383g)

Hearst

Copyist.

77 C | 5 Col'd Cav. | Mass.

William McNamee
Co. F, 5 Reg't Mass. Col'd Cav.

Appears on

Company Muster-in and Descriptive Roll
of the organization named above. Roll dated

Readville, Mass., Dec 2, 1864.

Where born *France*

Age *11* y'rs; occupation *Boys*

When enlisted *June 23*, 1864.

Where enlisted *Boylston, Md.*

For what period enlisted *3* years.

Eyes *Black*; hair *Black*

Complexion *Black*; height *5* ft. *6* in.

When mustered in *Feb. 22*, 1864.

Where mustered in

Bounty paid \$ *100*; due \$ *100*

Where credited *1st Regt. Cavalry*

Company to which assigned

Remarks:

Book mark:

W.C. | **5 Col'd Cav.** | **Mass.**

William W. Kinney
....., Co. F, 5 Reg't Mass. Col'd Cavalry.

Appears on

Company Muster Roll

for *Enlisted to Feb. 27, 1864*.

Present or absent *Absent*

Stoppage, \$..... *100* for

Due Gov't, \$..... *100* for

Valuation of horse, \$..... *100*

Valuation of horse equipments, \$..... *100*

Remarks:

Book mark:

W. J. G.
.....
Copyist.

711 | 5 Col'd Cav. | Mass.

William McKinnon
Co. F, 5 Reg't Mass. Col'd Cavalry.

Appears on

Company Muster Roll

for 1000 & 1000, 1864.

Present or absent

Stoppage, \$ 100 for

Due Gov't, \$ 100 for

Valuation of horse, \$ 100

Valuation of horse equipments, \$ 100

Remarks: Muster roll
Camp Bridge, Ladolite,
March 12, 1864.

Book mark:

M^c | **5 Col'd Cav.** | **Mass.**

William M^c Kinney
Priv, Co. F, 5 Reg't Mass. Colored Cav.

Appears on **Returns** as follows:

Mar. 1864, Absent without
leave.

Apr. 1864. Lose Mar. 12/64
Readville, Mass. - deserted.

Book mark : _____

(546)

J. B. Sittler

Copyist.

972-a

McLane, George
Co., J. W. S. Col'd Cav.

CARD NUMBERS.

1	1436083	26
2		27
3		28
4		29
5		30
6		31
7		32
8		33
9		34
10		35
11		36
12		37
13		38
14		39
15		40
16		41
17		42
18		43
19		44
20		45
21		46
22		47
23		48
24		49
25		50

Number of personal papers herein.....

Book Mark.....

See also.....

No. 5647. Mass.

George McGinnis,

Co. 5, Reg't Col'd Mass. Cav.

Appears on

Regimental Descriptive Book

of the organization named above.

DESCRIPTION.

Age 18 years; height 5 feet 2 inches.

Complexion Mulatto.

Eyes B.R.; hair Black.

Where born Philadelphia Pa.

Occupation Barber.

ENLISTMENT.

When Jan. 7, 1864

Where Concord.

By whom C. Stetson; term 5 y'rs.

Remarks:

.....
.....
.....
.....
.....
.....
.....
.....
.....
.....

.....
.....

973
McKilledge, John

Co A, 5 Mass. Cav., (Col'd.)

Private Private

CARD NUMBERS.

1	5376942	26	
2	5377028	27	
3	5377141	28	
4	5378060	29	
5	9092318	30	
6	40731377	31	
7		32	
8		33	
9		34	
10		35	
11		36	
12		37	
13		38	
14		39	
15		40	
16		41	
17		42	
18		43	
19		44	
20		45	
21		46	
22		47	
23		48	
24		49	
25		50	

Book Mark:

See also

No 5 Cav. (Col'd.) | Mass.

John M. Nelledge

....., Co. *D*, 5 Reg't Mass. Cav. (Col'd.)

Appears on

Company Descriptive Book

of the organization named above.

DESCRIPTION.

Age *40* years; height *5* feet *6* inches.

Complexion *Mulatto*

Eyes *blk*; hair *blk*

Where born *Charlestown, S. C.*

Occupation *Porter*

ENLISTMENT.

When *Jan 24*, 186

Where *Boston, U. S.*

By whom *D. Davis*; term *3* y'rs.

Remarks: *Mustered in Co. D.*

Jan 29, 64, by Lt. McKibbin

Headville Mass.

Discharged from Headville

Mass. Dec 31, 1864.

Heard

Mc | **5 Col'd Cav.** | **Mass.**

John McVeddy

Priv., Co. *D*, 5 Reg't Mass. Col'd Cav.

Appears on

Company Muster-in and Descriptive Roll
of the organization named above. Roll dated

Needville Mass, July 29, 1864.

Where born *Charleston S.C.*

Age *40* y'rs; occupation *Porter*.

When enlisted *July 27*, 1864.

Where enlisted *Boston Md.*

For what period enlisted *3* years.

Eyes *BRN*; hair *BRN*

Complexion *BRN*; height *5* ft. *6* in.

When mustered in *July 29*, 1864.

Where mustered in *Needville Mass*

Bounty paid \$ *100*; due \$ *100*

Where credited *4 Dist Suffolk*

Company to which assigned

Remarks:

Book mark:

(356d)

J. J. J.
Copyist.

100 | **5 Col'd Cav.** | **Mass.**

John M. Milledge
Sgt, Co. D, 5 Reg't Mass. Col'd Cavalry.

Appears on

Company Muster Roll

for *Enlistment in Feb, 29*, 186*4*.

Present or absent *Present*

Stoppage, \$ *100* for

Due Gov't, \$ *100* for

Valuation of horse, \$ *100*

Valuation of horse equipments, \$ *100*

Remarks:

Book mark:

James
Copyist.

Mc | **5 Col'd Cav.** | **Mass.**

John McMillidge

Det., Co. D, 5 Reg't Mass. Col'd Cavalry.

Appears on

Company Muster Roll

for *March & April*, 1864.

Present or absent

Stoppage, \$ 100 for

Due Gov't, \$ 100 for

Valuation of horse, \$ 100

Valuation of horse equipments, \$ 100

Remarks: *Deserted March 8, 1864.*

Book mark:

[Signature]
Copyist.

Mc | **5 Col'd Cav.** | **Mass.**

Imo. Mc Killedge
Pvt, Co. D, 5 Reg't Mass. Colored Cav.

Appears on **Returns** as follows:

Mar. 1864. Loss - Readville
Dropped from Roll as
deserter, Mar. 31/64 by
order.

Book mark : _____

(548)

J. B. Sittler

Copyist.

Mc | **5 Col'd Cav.** | **Mass.**

John McNeillage
Det, Co. *D*, 5 Reg't Mass. Col'd Cavalry.

Appears on **Co. Muster-out Roll**, dated
Clarksville Texas Oct 31, 1865.

Muster-out to date _____, 186 .

Last paid to _____, 186 .

Clothing account:

Last settled _____, 186 ; drawn since \$ _____ 100

Due soldier \$ _____ 100; due U. S. \$ _____ 100

Am't for cloth'g in kind or money adv'd \$ _____ 100

Due U. S. for arms, equipments, &c., \$ _____ 100

Bounty paid \$ _____ 100; due \$ _____ 100

Remarks:

Absent from Co. at
Reading Mass March 31
1864

Book mark: _____

(861)

House

Copyist.

914

McPherson, Samuel

Co F, 5 Mass. Cav., (Col'd.)

Private | Corporal

CARD NUMBERS.

1	5379352	26	
2	5379437	27	
3	5379523	28	
4	5379621	29	
5	5379718	30	
6	5379775	31	
7	5379870	32	
8	5380029	33	
9	5380128	34	
10	5380185	35	
11	5380282	36	
12	5380374	37	
13	9092089	38	
14		39	
15		40	
16		41	
17		42	
18		43	
19		44	
20		45	
21		46	
22		47	
23		48	
24		49	
25		50	

Book Mark:

See also

Mc **5 Cav. (Col'd.) | Mass.**

Samuel McPherson

F, Co. *F*, 5 Reg't Mass. Cav. (Col'd.)

Appears on

Company Descriptive Book

of the organization named above.

DESCRIPTION.

Age *26* years; height *5* feet *8 1/2* inches.

Complexion *Blk*

Eyes *Blk*; hair *Blk*

Where born *Washington Co. Penna.*

Occupation *Farmer*

ENLISTMENT.

When *Feb 16, 1864.*

Where *Boston*

By whom *O. Norcross*; term *3* y'rs.

Remarks: *Appointed Corp'l
May 1, 1865.*

Hearn

1779 | 5 Col'd Cav. | Mass.

Samuel W. Person

Co. 4, 5 Reg't Mass. Col'd Cav.

Appears on
Company Muster-in and Descriptive Roll
of the organization named above. Roll dated
October 10, 1864.

Where born Washington, D.C.

Age 26 y'rs; occupation Farmer

When enlisted Nov 10, 1864.

Where enlisted Boston, Mass.

For what period enlisted 3 years.

Eyes Blue; hair Black

Complexion Black; height 5 ft. 5 in.

When mustered in February, 1865.

Where mustered in

Bounty paid \$ 100; due \$ 100

Where credited 41 1/2 in. Norfolk

Company to which assigned

Remarks:

Book mark:

(356d) *[Signature]* Copyist.

770 | 5 Col'd Cav. | Mass.

Samuel W. Johnson
Co. F, 5 Reg't Mass. Col'd Cavalry.

Appears on

Company Muster Roll

for *Enlistment to Feb 1, 1864.*

Present or absent *Present*

Stoppage, \$ 100 for

Due Gov't, \$ 100 for

Valuation of horse, \$ 100

Valuation of horse equipments, \$ 100

Remarks: *At Post Hospital*

Book mark:

J. E. Dyer
Copyist.

71 2 | **5 Col'd Cav.** | **Mass.**

James W. Garrison
.....
....., Co. F, 5 Reg't Mass. Col'd Cavalry.

Appears on

Company Muster Roll

for *71 2*....., 186*4*.

Present or absent *Present*.....

Stoppage, \$..... 100 for.....

Due Gov't, \$..... 100 for.....

Valuation of horse, \$..... 100

Valuation of horse equipments, \$..... 100

Remarks:.....
.....
.....
.....
.....
.....
.....
.....
.....

Book mark:.....

James W. Garrison
.....
Coryist.

711 | **5 Col'd Cav.** | **Mass.**

James W. (Hazen)
....., Co. F, 5 Reg't Mass. Col'd Cavalry.

Appears on

Company Muster Roll

for *May & June*, 186 ..

Present or absent *Present*

Stoppage, \$..... 100 for

Due Gov't, \$..... 100 for

Valuation of horse, \$..... 100

Valuation of horse equipments, \$..... 100

Remarks:

Book mark:

M^s | 5 Col'd Cav. | Mass.

Samuel M^s Therson
Pt, Co. F, 5 Reg't Mass. Col'd Cavalry.

Appears on

Company Muster Roll

for July & Aug, 1864.

Present or absent Present

Stoppage, \$ 100 for

Due Gov't, \$ 100 for

Valuation of horse, \$ 100

Valuation of horse equipments, \$ 100

Remarks:

Book mark:

J. H. Stewart

M^e | 5 Col'd Cav. | Mass.

Samuel M^e Pherson
Corp, Co. F, 5 Reg't Mass. Col'd Cavalry.

Appears on

Company Muster Roll

for Sept & Oct, 1864

Present or absent Present

Stoppage, \$ 100 for

Due Gov't, \$ 100 for

Valuation of horse, \$ 100

Valuation of horse equipments, \$ 100

Remarks: App'd Corp
Oct 1st, 1864

Book mark:

(358) J. Stewart Copyist.

M^e | **5 Col'd Cav.** | **Mass.**

Samuel M^e Pherson
Corp, Co. F, 5 Reg't Mass. Col'd Cavalry.

Appears on

Company Muster Roll

for *Nov & Dec*, 1864.

Present or absent *Present*

Stoppage, \$ *100* for

Due Gov't, \$ *100* for

Valuation of horse, \$ *100*

Valuation of horse equipments, \$ *100*

Remarks: *App'd Corp Oct*
1st 1864

Book mark: _____

M Stewart

M^{co} | 5 Col'd Cav. | Mass.

Samuel M^{co} Pherson

Pl, Co. F, 5 Reg't Mass. Col'd Cavalry.

Appears on

Company Muster Roll

for Jan & Feb, 1865.

Present or absent Present

Stoppage, \$ 100 for

Due Gov't, \$ 100 for

Valuation of horse, \$ 100

Valuation of horse equipments, \$ 100

Remarks: Reduced from

Co. F to Tanks S.O.

22 Feb 11, 1865

Due first four

Inst U.S. Bty

Book mark:

J. H. Surran

7th | 5 Col'd Cav. | Mass.

Samuel M^r Pherson

Pt., Co. F, 5 Reg't Mass. Col'd Cavalry.

Appears on

Company Muster Roll

for *March & April*, 1865.

Present or absent *Present*

Stoppage, \$ *100* for

Due Gov't, \$ *100* for

Valuation of horse, \$ *100*

Valuation of horse equipments, \$ *100*

Remarks: *Due first four
inst. U.S. Bounty
180.00*

Book mark:

J. Stewart

(358)

Copyist.

No | **5 Col'd Cav.** | **Mass.**

Samuel W. Sherson

Corp, Co. F, 5 Reg't Mass. Col'd Cavalry.

Appears on

Company Muster Roll

for *May & June*, 186*5*.

Present or absent *Present*

Stoppage, \$ *100* for

Due Gov't, \$ *100* for

Valuation of horse, \$ *100*

Valuation of horse equipments, \$ *100*

Remarks: *Appointed
Corp May 1/65*

Book mark:

T. J. Sherson

McC | **5 Col'd Cav.** | **Mass.**

Samuel McPherson
Capt, Co. F, 5 Reg't Mass. Col'd Cavalry.

Appears on

Company Muster Roll

for *July + Aug*, 186*3*.

Present or absent *Present*

Stoppage, \$ *100* for

Due Gov't, \$ *100* for

Valuation of horse, \$ *100*

Valuation of horse equipments, \$ *100*

Remarks: *Appointed*
Capt May 1/63

Book mark:

J. A. Johnson

Me | **5 Col'd Cav. | Mass.**

Samuel M. Therson
Co. *F*, 5 Reg't Mass. Col'd Cavalry.

Appears on **Co. Muster-out Roll**, dated
Chapsville Ia, Oct 31, 1863.

Muster-out to date *Oct 31, 1863*.

Last paid to *Dec 31, 1864*.

Clothing account:

Last settled....., 186 ; drawn since \$..... 100

Due soldier \$..... 100; due U. S. \$..... *71* 100

Am't for cloth'g in kind or money adv'd \$..... 100

Due U. S. for arms, equipments, &c., \$ *11* 100

Bounty paid \$..... 100; due \$ *300* 100

Remarks: *One U.S. Equip. Co. Equip. \$130 Reduced from Co. F to Co. G (1863) No more Reappointed Co. F (May 1865)*

Book mark:

(361)

Therson

Copyist.

974-a

McSpadden, Andrew
Co. S. W. S. Col'd Cav.

CARD NUMBERS.

1	9436186	26
2		27
3		28
4		29
5		30
6		31
7		32
8		33
9		34
10		35
11		36
12		37
13		38
14		39
15		40
16		41
17		42
18		43
19		44
20		45
21		46
22		47
23		48
24		49
25		50

Number of personal papers herein

Book Mark:

See also

No. 5 | Co. | Mass.

Andrew McSpadden,
....., Co....., 5 Reg't Mass Col'd Car.

Appears on

Regimental Descriptive Book

of the organization named above.

DESCRIPTION.

Age 17 years; height 5 feet 7 inches.

Complexion Black

Eyes Black; hair Black

Where born Knoxville, Tenn.

Occupation unknown

ENLISTMENT.

When April 30, 1864

Where Boston 40th

By whom Wm. C. Nash; term 5 y'rs.

Remarks: Resected May 1, 1864

975

Meadows, William P.
Co G, 5 Mass. Cav., (Col'd.)

Private Corporal

CARD NUMBERS.

1	5380546	26
2	5388632	27
3	5380712	28
4	5380806	29
5	5380909	30
6	5381006	31
7	5381109	32
8	5381211	33
9	5381259	34
10	5381359	35
11	5381457	36
12	9091961	37
13		38
14		39
15		40
16		41
17		42
18		43
19		44
20		45
21		46
22		47
23		48
24		49
25		50

Book Mark:

See also:

M

5 Cav. (Col'd.) | Mass.

William R. Meadows

....., Co. *G*, 5 Reg't Mass. Cav. (Col'd.)

Appears on

Company Descriptive Book

of the organization named above.

DESCRIPTION.

Age *22* years; height *5* feet *7* inches.

Complexion *Blk*

Eyes *Blk*; hair *Blk*

Where born *Chambers Co. Ala.*

Occupation *Farmer.*

ENLISTMENT.

When *Feb 27*, 1864.

Where *Boston*

By whom *D. Davies*; term *3* y'rs.

Remarks: *Married.*

Hearn

M | **5 Col'd Cav.** | **Mass.**

William R. Meadows
Rt 1, Co. *G*, 5 Reg't Mass. Col'd Cav.

Appears on
Company Muster-in and Descriptive Roll
of the organization named above. Roll dated
Readville Mass, Mar 4, 1864.

Where born *Chambers Co, Ala*
Age *22* y'rs; occupation *Farmer*

When enlisted *Feb 27*, 1864.

Where enlisted *Boston Ward 6*

For what period enlisted *3* years.

Eyes *Blk*; hair *Blk*

Complexion *Blk*; height *5 ft. 7 in.*

When mustered in *Mar 4*, 1864.

Where mustered in *Readville Mass*

Bounty paid \$ *2* ^{*00*}/_{*100*}; due \$ ^{*00*}/_{*100*}

Where credited *4 Dist Suffolk*

Company to which assigned _____

Remarks: _____

Book mark: _____

Leger

W | **5 Col'd Cav.** | **Mass.**

William R. Meadows
Pvt, Co. G, 5 Reg't Mass. Col'd Cavalry.

Appears on

Company Muster Roll
for *March 30*, 186*4*.

Present or absent *Present*

Stoppage, \$..... *100* for

Due Gov't, \$..... *100* for

Valuation of horse, \$..... *100*

Valuation of horse equipments, \$..... *100*

Remarks:.....
.....
.....
.....
.....
.....
.....
.....
.....
.....

Book mark:.....

.....
L. J. ...
.....
(358) Copyist.

M | **5 Col'd Cav.** | **Mass.**

William B. Meadows
Pr, Co. G, 5 Reg't Mass. Col'd Cavalry.

Appears on

Company Muster Roll

for *May June*, 186*4*.

Present or absent *Present*

Stoppage, \$ *100* for

Due Gov't, \$ *100* for

Valuation of horse, \$ *100*

Valuation of horse equipments, \$ *100*

Remarks: _____

Book mark: _____

Leger
(358) *Leger* Copyist.

W | **5 Col'd Cav.** | **Mass.**

William R. Meadows
Pvt, Co. G, 5 Reg't Mass. Col'd Cavalry.

Appears on

Company Muster Roll

for *July & Aug*, 186*4*.

Present or absent *Present*

Stoppage, \$.....100 for.....

Due Gov't, \$.....100 for.....

Valuation of horse, \$.....100

Valuation of horse equipments, \$.....100

Remarks:.....

Book mark:.....

(358)

Eger

Copyist.

M. | **5** Col'd Cav. | **Mass.**

William R. Meadows
Co., Co. G, 5 Reg't Mass. Col'd Cavalry.

Appears on

Company Muster Roll
for Sept & Oct, 1864.

Present or absent Present

Stoppage, \$ 100 for

Due Gov't, \$ 100 for

Valuation of horse, \$ 100

Valuation of horse equipments, \$ 100

Remarks: _____

Book mark: _____

(358)

Perry

Copyist.

M

5 Col'd Cav.

Mass.

William R. Meadows

Private, Co. G, 5 Reg't Mass. Col'd Cavalry.

Appears on

Company Muster Roll

for Nov. 22^d, 1864.

Present or absent Present

Stoppage, \$ 100 for

Due Gov't, \$ 100 for

Valuation of horse, \$ 100

Valuation of horse equipments, \$ 100

Remarks:

Book mark:

Perry

(358)

Copyist.

716

5 Col'd Cav.

Mass.

Wm R. Meadows

Priv, Co. G, 5 Reg't Mass. Col'd Cavalry.

Appears on

Company Muster Roll

for Jan. & Feb., 1863.

Present or absent Present

Stoppage, \$ 100 for

Due Gov't, \$ 100 for

Valuation of horse, \$ 100

Valuation of horse equipments, \$ 100

Remarks: Due 1st, 2^d, 3^d & 4th installments U. S. Bounty \$180. Due U. S. for waist & plate 46 cts; for bayonet scabbard, 56 cts for bayonet \$2.50. Total \$3.52

Book mark:

Perry

(358)

Copyist.

M | **5 Col'd Cav.** | **Mass.**

Wm R. Meadows

Co. G, 5 Reg't Mass. Col'd Cavalry.

Appears on

Company Muster Roll

for March & April, 1865.

Present or absent Present.

Stoppage, \$ 100 for

Due Gov't, \$ 100 for

Valuation of horse, \$ 100

Valuation of horse equipments, \$ 100

Remarks: Due U. S. for Ord.
#352 charged on Jan.
& Feb. Rolls.

Due the soldier, 4
instalments, U. S.
Bounty \$180.

Book mark: _____

Curry

M. 5 Col'd Cav. | Mass.

William B Meadows
Corpl, Co. G, 5 Reg't Mass. Col'd Cavalry.

Appears on

Company Muster Roll

for May & June, 1865.

Present or absent Present

Stoppage, \$ 100 for

Due Gov't, \$ 100 for

Valuation of horse, \$ 100

Valuation of horse equipments, \$ 100

Remarks: Due U.S. for ord-
nance lost #3,52 chigd
on Jan. & Feb. Rolls
App'd. Corporal.
per R. S. O. No 104.
dated June 11th 1865

Book mark:

Perry

No | **5 Col'd Cav.** | **Mass.**

William R Meadows
Corp, Co. G, 5 Reg't Mass. Col'd Cavalry.

Appears on

Company Muster Roll

for July & Aug, 186 8.

Present or absent Present

Stoppage, \$ 100 for

Due Gov't, \$ 100 for

Valuation of horse, \$ 100

Valuation of horse equipments, \$ 100

Remarks: Due U.S. for Or-
dnance cost, \$250
App'd Corp per S.O.
No. 104. Dated
June 11. 65,

Book mark:

Whear Scott

(358)

Copyist.

M | **5 Col'd Cav.** | **Mass.**

William R. Meadows
Corp, Co. *G*, 5 Reg't Mass. Col'd Cavalry.

Appears on **Co. Muster-out Roll**, dated
Clarksville Tex Oct 31, 186*5*.

Muster-out to date *Oct 31*, 186*5*.

Last paid to *Dec 31*, 186*4*.

Clothing account:

Last settled....., 186 ; drawn since \$..... 100

Due soldier \$..... 100; due U. S. \$..... 100

Am't for cloth'g in kind or money adv'd \$..... 100

Due U. S. for arms, equipments, &c., \$ *3 02* 100

Bounty paid \$..... 100; due \$ *3 11* 100

Remarks: *Appointed Corporal per S.O. No 104 Dated June 11. 65*

Book mark :

(861)

W. H. Scott

Copyist.

976
Medley, Richard T.
Co G, 5 Mass. Cav., (Col'd.)

Private Private

CARD NUMBERS.

1	5372114	26
2	5372247	27
3	5380809	28
4	5380912	29
5	5381010	30
6	5381112	31
7	5381214	32
8	5381315	33
9	5381410	34
10	5372895	35
11	5381508	36
12	9092001	37
	PM-260J-1871	38
14	34505500	39
15	40731379	40
16	40731380	41
17		42
18		43
19		44
20		45
21		46
22		47
23		48
24		49
25		50

Book Mark: 10-26-Vol-9-605-1871.
K.B.-V-10-P-46-65.

See also

M | **5 Cav. (Col'd.) | Mass.**

Richard Thomas Mealey

....., Co. *G*, 5 Reg't Mass. Cav. (Col'd.)

Appears on

Company Descriptive Book

of the organization named above.

DESCRIPTION.

Age *22* years; height *5* feet *7* inches.

Complexion *Blk*

Eyes *Blk* ; hair *Blk*

Where born *Alexandria Va.*

Occupation *Farmer.*

ENLISTMENT.

When *June 22* , 1864.

Where *Savoy.*

By whom *G. H. Quincey* ; term *3* y'rs.

Remarks: *Mustered June 22 64.
at Boston. Capt Goodhue.*

Hearst

M | 5 Cav. | Mass

Richard T. Medley

Appears with rank of _____ on _____

Muster and Descriptive Roll

of a detachment of U. S. Volunteers forwarded from Faneuil Hall, Boston, to Galloup's Island, Boston Harbor, for various regiments Massachusetts Volunteers. Roll dated

Boston Mass, June 22, 1864.

Where born Alexandria Va.

Age 22 years; occupation Farmer

When enlisted June 22, 1864

Where enlisted Savoy

For what period enlisted 3 years.

Eyes Drk; hair Drk

Complexion Drk; height 5 ft. 7 in.

When mustered in June 22, 1864

Where mustered in Boston

Bounty paid \$ 100; due \$ 100

Clothing account:

Last settled _____, 186 _____; drawn since \$ 100

Date of first muster _____, 186 _____

Regiment to which assigned 5th Cav

Remarks: 10 Dist Savoy

Berkshire Co.

Book mark: _____

Murray

(358m)

Copyist

M | **5 Col'd Cav.** | **Mass.**

Richard T. Muelken

Appears with rank of *Private* on

Muster and Descriptive Roll of a Detachment of U. S. Vols. forwarded

for the 5 Reg't Mass. Col'd Cavalry. Roll dated

Boston Mass, *June 28*, 1864.

Where born *Alexandria Va*

Age *22* y'rs; occupation *Farmer*

When enlisted *June 22*, 1864.

Where enlisted *Lynn*

For what period enlisted *3* years.

Eyes *Dark*; hair *Dark*

Complexion *Dark*; height *5-ft. 7* in.

When mustered in *June 22*, 1864.

Where mustered in *Boston*

Bounty paid \$ *100*; due \$ *100*

Where credited *19. Dist & Lynn Garrison*

Company to which assigned

Remarks:

Book mark:

Forrest *X*
Copyist.

M | 5 Col'd Cav. | Mass.

Richard T. Medley

Appears with rank of *Pri* on

Muster and Descriptive Roll of a Detachment of U. S. Vols. forwarded

for the 5 Reg't Mass. Col'd Cavalry. Roll dated
Galloups sold mass, July 12, 1864

Where born *Alexandria Va*

Age *22* y'rs; occupation *Farmer*

When enlisted *June 22*, 1864

Where enlisted *Savoy mass*

For what period enlisted *3* years.

Eyes *Dark*; hair *Dark*

Complexion *Dark*; height *5* ft. *7* in.

When mustered in *June 22*, 1864

Where mustered in *Boston Mass*

Premium
Bounty paid \$ *2* ¹⁰⁰; due \$ ¹⁰⁰

Where credited *10 Cong Dist. Savoy*

Berkshire Co
Company to which assigned

Remarks:

Book mark:

Sonnely

M | **5 Col'd Cav.** | **Mass.**

Thomas Medley

Pvt, Co. G, 5 Reg't Mass. Col'd Cavalry.

Appears on

Company Muster Roll

for *July 4 Aug*, 1864.

Present or absent *Present*

Stoppage, \$ *100* for

Due Gov't, \$ *100* for

Valuation of horse, \$ *100*

Valuation of horse equipments, \$ *100*

Remarks: *Enlistment papers not received joined for duty July 16/64*

Book mark:

L. J. [Signature]

M | 5 Col'd Cav. | Mass.

Thomas Medley
Gru, Co. G, 5 Reg't Mass. Col'd Cavalry.

Appears on

Company Muster Roll
for Sept & Oct, 1864.

Present or absent Present

Stoppage, \$ 100 for

Due Gov't, \$ 100 for

Valuation of horse, \$ 100

Valuation of horse equipments, \$ 100

Remarks: Enlistment papers
not received. Joined
for duty July 10th
1864

Book mark:

(358)

Perry

Copyist.

M. | 5 Col'd Cav. | Mass.

Richard T. Medley
Co. G, 5 Reg't Mass. Col'd Cavalry.

Appears on

Company Muster Roll

for Nov. 9th Dec. 3rd, 1864.

Present or absent Present

Stoppage, \$ 100 for

Due Gov't, \$ 100 for

Valuation of horse, \$ 100

Valuation of horse equipments, \$ 100

Remarks: Due U. S. \$70.00
for advanced pay.
Sick in Reg't Mass.

Book mark:

Perry

M. | 5 Col'd Cav. | Mass.

Richard T. Medley
Prvt, Co. G, 5 Reg't Mass. Col'd Cavalry.

Appears on

Company Muster Roll

for Jan & Feb, 1865.

Present or absent Present

Stoppage, \$ 100 for

Due Gov't, \$ 100 for

Valuation of horse, \$ 100

Valuation of horse equipments, \$ 100

Remarks: Due 1st installment
U.S. Bounty \$25.00.
Sick in Reg't. Adv.
Dur. U.S. \$10.00 advanced
pay charged on Nov. &
Dec. Rolls.

Book mark:

Cerry

M. | **5 Col'd Cav.** | **Mass.**

Richard T. Medley
Pvt., Co. G, 5 Reg't Mass. Col'd Cavalry.

Appears on

Company Muster Roll

for *Mch. 7th*, 1865.

Present or absent *Present*

Stoppage, \$ *100* for

Due Gov't, \$ *100* for

Valuation of horse, \$ *100*

Valuation of horse equipments, \$ *100*

Remarks: *Due the soldier*
1 installment U. S.
Bounty \$25.

Book mark: _____

(358)

Curry
Copyist.

M. **5 Col'd Cav.** | **Mass.**

Richard T. Medley
Prv, Co. G, 5 Reg't Mass. Col'd Cavalry.

Appears on

Company Muster Roll

for *May & June*, 1865.

Present or absent *Present*

Stoppage, \$ *100* for

Due Gov't, \$ *100* for

Valuation of horse, \$ *100*

Valuation of horse equipments, \$ *100*

Remarks:

Book mark:

(358)

Carry
Copyist.

M

5 Col'd Cav.

Mass.

Richard S. Medley
Priv, Co. G, 5 Reg't Mass. Col'd Cavalry.

Appears on

Company Muster Roll

for *July & Aug*, 186*5*.

Present or absent *Absent*

Stoppage, \$ *100* for

Due Gov't, \$ *100* for

Valuation of horse, \$ *100*

Valuation of horse equipments, \$ *100*

Remarks: *Absent sick at*
Prasco Texas since
July 10, 65

Book mark: _____

Wear Scott

M | **5 Col'd Cav.** | **Mass.**

Richard C. Medley
Pvt., Co. *D*, 5 Reg't Mass. Col'd Cavalry.

Appears on an

Individual Muster-out Roll

of the organization named above. Roll dated

New York City, Oct 10, 1865.

Muster-out to date *Oct 10, 1865.*

Last paid to *Dec 31, 1864.*

Clothing account:

Last settled *Dec 31, 1864*; drawn since \$ *15*^{*95*}/_{*100*}

Due soldier \$ *100*; due U. S. \$ *100*

Am't for cloth'g in kind or money adv'd \$ *100*

Due U. S. for arms, equipments, &c., \$ *100*

Bounty paid \$ *100* due \$ *100*

Remarks *Mustered out under
Gen Order War Dept A.G.C
May 4 1865
Descriptive list State
Bounty paid - Due \$ 25.*

Book mark: *Re M. 24 Vol 9 CT 1871.*

(348)

Richard C. Medley

Copyist.

M. | 5 Col'd Cav. | Mass.

Thomas Medley
Pvt., Co. G, 5 Reg't Mass. Colored Cav.

Appears on Returns as follows:

July 1864, Gain - Recruit
from Depot. Joined
Co. July 16"

Book mark :

(546)

J. B. Sittler

Copyist.

M. | 5 Col'd Cav. | Mass.

Richard T. Medley
Priv., Co. G, 5 Reg't Mass. Colored Cav.

Appears on Returns as follows:

Aug. & Sept. 1865, Absent sick
at Brazos Post Hosp.
since Aug. 10/65.

Book mark :

(546)

J. B. Dittler

Copyist.

M | **5 Col'd Cav.** | **Mass.**

Richard T. Medley
Priv, Co. *G*, 5 Reg't Mass. Col'd Cavalry.

Appears on **Co. Muster-out Roll**, dated
Charlottesville Va, Oct 31, 186*5*.

Muster-out to date _____, 186 .

Last paid to *Dec 31*, 186*4*.

Clothing account:

Last settled _____, 186 ; drawn since \$ _____ 100

Due soldier \$ ~~100~~⁶⁹; due U. S. \$ _____ 100

Am't for cloth'g in kind or money adv'd \$ _____ 100

Due U. S. for arms, equipments, &c., \$ _____ 100

Bounty paid \$ _____ 100; due \$ *100* 100

Remarks: *Absent sick at*
New Orleans La since
Aug 10/65. Has Dis
Let. No discharge
furnished

Book mark: *Sec M 26 Vol 9 C 7*
(1000)

W. H. Scott

JAN. 10

5381508

1891 *

1871 Ind mort on
file. 4012, Only May
28.66, Discharged
Oct 10/65 E.B. 2111, 46

*M 15 bar (bnd) Man
Richard J. Medley
Co. G, 5 Reg't Mar bar (bnd)*

NOTATION.

Book mark: *M-26. C. J. 1871*

Record and Pension Office,

WAR DEPARTMENT.

This book mark refers only to a report from the medical records, made by the Surgeon General to the Adjutant General, relative to the above-named man. As the medical records have since been carded, no transcript of this report is made hereon.

(491)

C. C. Coney Copyist.

Medley, Richard J

, Co. G, 5 Regt Mass. Co

✓ \$ Enclosures.

Bed Cards	Final Statements
Burial Records	Furloughs or L. of A
Certs. of Dis. for Discharge	Med. Certificates
C. M. Charges	Med. Des. Lists
Descriptive Lists	Orders
Discharge Certificates	Pris. of War Record
Enlistment Papers 2	Resignations

Other papers relating to—

Admission to Hosp'l	Furlough or L. of A
Casualty Sheet /	Med. Examination
Confinement	Misc. Information
Contracts	Pay or Clothing
Death or Effects	Personal Reports
Desertion	Rank
Discharge from Hosp'l	Transfer to Hosp'l
Discharge from Service /	Transfer to V. R. C.
Duty	Transportation

NOTE 1.—This blank will be used for both enlistments and re-enlistments—enlistment of veterans, &c., &c., in the volunteer service. They will be made out in duplicate in all cases—one to accompany the recruiting return of the superintendent (not the recruiting officer) to the Adjutant-General, and one to accompany the accounts of the officer who pays bounty, &c. The Regiment and Company in which the soldier last served should be given on the back.

NOTE 2.—An enlistment holds to service. A muster-in must, in all cases, precede payment of pay, bounty, pension, &c. A muster-in roll must, in all cases, be filed in the Adjutant-General's Office as evidence of muster-in. The mustering officer, commissary, or assistant-commissary of musters, as the case may be, will countersign both enlistments as having mustered the soldier into the service of the United States before either of them is given to the disbursing officer.

DECLARATION OF RECRUIT.

I, *Richard T Medley* desiring to VOLUNTEER as a Soldier in the Army of the United States, for the term of THREE YEARS, Do Declare, That I am *Twenty two* years and _____ months of age; that I have never been discharged from the United States service on account of disability or by sentence of a court-martial, or by order before the expiration of a term of enlistment; and I know of no impediment to my serving honestly and faithfully as a soldier for three years.

Given at *Boston* the *Twenty second* day of *June 1864*
 Witness: *John H Williams* *Richard T Medley*

Discharged

18

Reg't of

enlistment; last served in Company ()

By *Richard T Medley*
 Volunteered at *Lowry mills*
June 22 18 *64*
 By *S. H. Quincy*
 5th Regiment of *Mass Cav*

No.

CONSENT IN CASE OF MINOR.

I, _____ Do CERTIFY, That I am _____ the _____ of _____; that the _____ said _____ is _____ years of age; and I do hereby freely give my CONSENT to his volunteering as a SOLDIER in the ARMY OF THE UNITED STATES, for the period of THREE YEARS.

GIVEN at _____ the _____ day of _____

Witness:

VOLUNTEER ENLISTMENT.

10th Dist

STATE OF

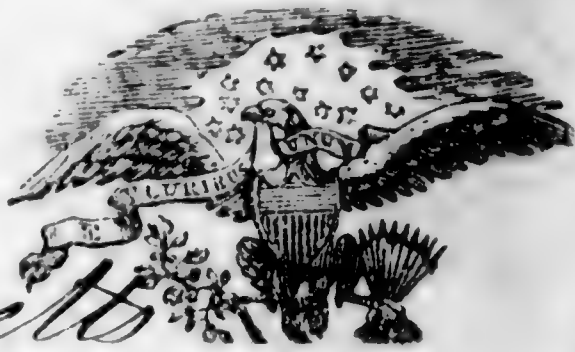

TOWN OF

Savoy

Massachusetts

Berkshire Co

I, Richard T Medley born in Alexandria
 in the State of Virginia aged Twenty two years,
 and by occupation a Farmer DO HEREBY ACKNOWLEDGE to have
 volunteered this Twenty second day of June 1864,
 to serve as a **Soldier** in the Army of the United States of America, for the
 period of **THREE YEARS**, unless sooner discharged by proper authority: Do also
 agree to accept such bounty, pay, rations and clothing, as are, or may be, estab-
 lished by law for volunteers. And I, Richard T Medley do
 solemnly swear, that I will bear true faith and allegiance to the **United States**
of America, and that I will serve them honestly and faithfully against all their
 enemies or opposers whomsoever; and that I will observe and obey the orders of
 the President of the United States, and the orders of the officers appointed over
 me, according to the Rules and Articles of War.

Fifth Mass Cavalry

Sworn and subscribed to, at Boston
 this twenty second day of June 1864
 BEFORE J. M. [unclear]
MC

Richard T Medley
 Witness Mark
Geo. H. Quincy usagt

I CERTIFY, ON HONOR, That I have carefully examined the above-named Volunteer agreeably
 to the General Regulations of the Army, and that, in my opinion, he is free from all bodily defects and
 mental infirmity, which would in any way disqualify him from performing the duties of a soldier.

Vaccinated

P. J. Jeffries
 EXAMINING SURGEON.

I CERTIFY, ON HONOR, That I have minutely inspected the Volunteer Richard T Medley
 previously to his enlistment, and that he was entirely sober when enlisted; that, to the best of my
 judgment and belief, he is of lawful age; and that, in accepting him as duly qualified to perform the duties
 of an able-bodied soldier, I have strictly observed the Regulations which govern the recruiting service.
 This soldier has dark eyes, dark hair, dark complexion, is five feet
seven inches high.

Geo. H. Quincy

Regiment of 10th Dist Volunteers,

u. s. RECRUITING OFFICER
ap

(A. G. O. No. 74 & 75.)

Mustered into the service of the United States, in Company D,
 the 22 day of June, 1864 at Boston Mass
 Regiment of 10th Dist Volunteers, on

A. M. [unclear]
Capt 11 Regt
MC

NOTE 1.—This blank will be used for both enlistments and re-enlistments—enlistment of veterans, &c., &c., in the volunteer service. They will be made out in duplicate in all cases—one to accompany the recruiting return of the superintendent (not the recruiting officer) to the Adjutant-General, and one to accompany the accounts of the officer who pays bounty, &c. The Regiment and Company in which the soldier last served should be given on the back.

NOTE 2.—An enlistment holds to service. A muster-in must, in all cases, precede payment of pay, bounty, pension, &c. A muster-in roll must, in all cases, be filed in the Adjutant-General's Office as evidence of muster-in. The mustering officer, commissary, or assistant-commissary of musters, as the case may be, will countersign both enlistments as having mustered the soldier into the service of the United States before either of them is given to the disbursing officer.

APRIL 1895. THIS PAPER WAS FORMERLY FILED IN THE ENROLLMENT DIV. E. & P. O.

DECLARATION OF RECRUIT.

I, *Richard J Medley* desiring to VOLUNTEER as a Soldier in the Army of the United States, for the term of THREE YEARS, Do Declare, That I am *Twenty two* years and _____ months of age; that I have never been discharged from the United States service on account of disability or by sentence of a court-martial, or by order before the expiration of a term of enlistment; and I know of no impediment to my serving honestly and faithfully as a soldier for three years.

GIVEN at *Boston* the *twenty second* day of *June* 18*64*

Witness: *John A Williams* *Richard J Medley*

Discharged

18

Reg't of

enlistment; last served in Company ()

By *Richard J Medley*
June 25 18*64*
 Regiment of *1st*

John A. Williams

CONSENT IN CASE OF MINOR.

I, _____ Do CERTIFY, That I am _____ the _____ of _____ ; that the said _____ is _____ years of age; and I do hereby freely give my CONSENT to his volunteering as a SOLDIER in the ARMY OF THE UNITED STATES, for the period of THREE YEARS.

GIVEN at _____ the _____ day of _____

Witness: _____

VOLUNTEER ENLISTMENT.

STATE OF

TOWN OF Savoy.

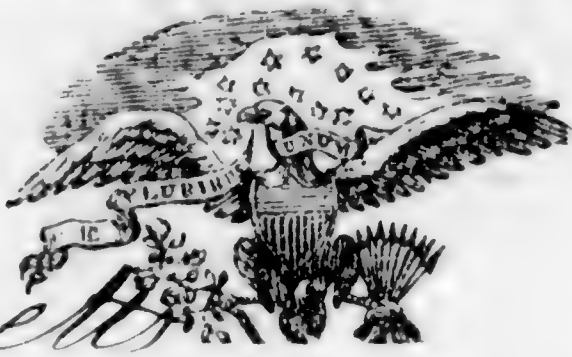

Massachusetts

Berkshire Co.

I, Richard T Medley born in Alexandria
 in the State of Virginia aged Twenty two years,
 and by occupation a Farmer DO HEREBY ACKNOWLEDGE to have
 volunteered this Twenty second day of June 1864,
 to serve as a Soldier in the Army of the United States of America, for the
 period of THREE YEARS, unless sooner discharged by proper authority: Do also
 agree to accept such bounty, pay, rations and clothing, as are, or may be, estab-
 lished by law for volunteers. And I, Richard T Medley do
 solemnly swear, that I will bear true faith and allegiance to the United States
of America, and that I will serve them honestly and faithfully against all their
 enemies or opposers whomsoever; and that I will observe and obey the orders of
 the President of the United States, and the orders of the officers appointed over
 me, according to the Rules and Articles of War.

Fifth Mass. Cavalry

Sworn and subscribed to, at Boston
 this twenty second day of June 1864.
 BEFORE M. Green } Richard T Medley
M. Green } Witness
Geo. H. Quincy, USA

I CERTIFY, ON HONOR, That I have carefully examined the above-named Volunteer, agreeably
 to the General Regulations of the Army, and that, in my opinion, he is free from all bodily defects and
 mental infirmity, which would in any way disqualify him from performing the duties of a soldier.

A. J. J. Jones
 EXAMINING SURGEON.

Vaccinated

I CERTIFY, ON HONOR, That I have minutely inspected the Volunteer, Richard T Medley
 previously to his enlistment, and that he was entirely sober when enlisted; that, to the best of my
 judgment and belief, he is of lawful age; and that, in accepting him as duly qualified to perform the duties
 of an able-bodied soldier, I have strictly observed the Regulations which govern the recruiting service.
 This soldier has dark eyes, dark hair, dark complexion, is five feet
seven inches high.

Geo. H. Quincy

Regiment of _____ Volunteers,

U.S. RECRUITING OFFICER
aght

(A. G. O. No. 74 & 75.)

7467

Mustered into the service of the United States, in Company _____
 the 22 day of June, 1864 at Boston Mass
 Regiment of Mass Cavalry Volunteers, on

M. Green
Witness
aght

Priv. Richard T. Medley
Co. G. 5th Mass Cav.

Office Chief Commissary of Musters,

DEPARTMENT OF THE EAST,

NEW YORK CITY, *April 11* 1865.

I have to report that

Private
Richard S. Medlow
Co G 5th Mass
Car

is this day mustered out of the United States

service, in compliance with telegraphic instructions from War Department of May 3d, 1865.

Very respectfully,

Your obedient servant,

WILSON BARSTOW,

Brevet Major and A. D. C.,

Chief Commissary of Musters.

To the Chief Mustering Officer, State of

Massachusetts

CASUALTY SHEET

No.

John J. ...
..... of Company

.....
Regiment of
State Volunteers. (.....)

NATURE OF CASUALTY.

.....
.....



CASUALTY SHEET.

Name: *Richard ...*

Rank: *Priv.*

Company: *B*

Regiment: *5*

Arm: *...*

State: *...*

Nature of Casualty: *...*

CAUSE OF CASUALTY—(NAME OF DISEASE, &c.)

BY WHOM DISCHARGED.

DEGREE OF DISABILITY.

FROM WHAT SOURCE THIS INFORMATION WAS OBTAINED.

BY WHOM CERTIFIED.

REMARKS.

DATE OF DISCHARGE, DEATH, &c.

PLACE OF DISCHARGE, DEATH, &c.

Clerk.

Handwritten initials

977

Menoken, George S.
Co K, 5 Mass. Cav., (Col'd.)

Private | *Private*

CARD NUMBERS.

1	5383782	26	
2	5383868	27	
3	5383955	28	
4	5384055	29	
5	5384159	30	
6	5384303	31	
7	5384801	32	
8	9091593	33	
9	32533822	34	
10	32535122	35	
11	31548267	36	
12	31548830	37	
13	33056733	38	
14	33058125	39	
15	40731381	40	
16		41	
17		42	
18		43	
19		44	
20		45	
21		46	
22		47	
23		48	
24		49	
25		50	

Book Mark: *1012-12-301 - G.D.*

See also

Prof S. J. ... 9/19/57 ...

Prof ...
4

No. **5 Cav. (Col'd.)** | **Mass.**

George S. Menoken.

....., Co. *K*....., 5 Reg't Mass. Cav. (Col'd.)

Appears on

Company Descriptive Book

of the organization named above.

DESCRIPTION.

Age *39* years; height *5* feet *5½* inches.

Complexion *Colored.*

Eyes *Black*; hair *Black.*

Where born *Philadelphia Pa.*

Occupation *Clergyman.*

ENLISTMENT.

When *Feb. 27*, 186 ..

Where *Boston Wd. 6.*

By whom *D. Davis*; term *3* y'rs.

Remarks: *Discharged, Grant Genl. Hospital Nov. 21 1864.*

H. C. Thomas.

(3559)

Copyist.

No. **5 Cav. (Col'd.) Mass.**

George S. Menoken

....., Co. *K*, 5 Reg't Mass. Cav. (Col'd.)

Appears on

Company Descriptive Book

of the organization named above.

DESCRIPTION.

Age *39* years; height *5* feet *5½* inches.

Complexion *Colored*.

Eyes *Black*; hair *Black*.

Where born *Philadelphia Pa.*

Occupation *Carpenter*.

ENLISTMENT.

When *Feb, 27th, 186*

Where *Boston, Md, 6.*

By whom *D. Davis*; term *3* y'rs.

Remarks: *Discharged, Grant Genl.
Hospital Nov, 21st 1864.*

H. C. Thomas

.....

Co.

M

5 Col'd Cav.

Mass.

George M. ...
Co. 2, 5 Reg't Mass. Col'd Cav.

Appears on

Company Muster-in and Descriptive Roll
of the organization named above. Roll dated

Leicester Mass., April 2, 1867.

Where born Leicester Mass.

Age 27 y'rs; occupation Wagoner

When enlisted 17 March 27, 1864.

Where enlisted Boston June 6

For what period enlisted 5 years.

Eyes BR; hair BR

Complexion BR; height 5 ft. 7 in.

When mustered in April 12, 1864.

Where mustered in Leicester Mass.

Bounty paid \$ 100; due \$ 100

Where credited Leicester Mass.

Company to which assigned

Remarks:

Book mark:

W. H. ...

71 | **5 Col'd Cav.** | **Mass.**

Joseph Minkner
1st, Co. K, 5 Reg't Mass. Col'd Cavalry.

Appears on

Company Muster Roll

for December 1st to Dec 31, 1861.

Present or absent absent

Stoppage, \$ 100 for

Due Gov't, \$ 100 for

Valuation of horse, \$ 100

Valuation of horse equipments, \$ 100

Remarks: absent on furlough
on the purpose of recruiting
the 5th Mass. Col'd Cav.

Book mark: _____

(358)

W. J. ...
Copyist.

M | **5 Col'd Cav.** | **Mass.**

George W. Minaker
(M), Co. K, 5 Reg't Mass. Col'd Cavalry.

Appears on

Company Muster Roll

for *May & June*, 186*4*.

Present or absent *Absent*

Stoppage, \$ *100* for

Due Gov't, \$ *100* for

Valuation of horse, \$ *100*

Valuation of horse equipments, \$ *100*

Remarks: *Went since June 10th 1864 to Fort Mifflin near York, Pa. for transportation. Back to Rochester Mass 2nd July 1864*

Book mark: _____

Libman

M | 5 Cold. Cav. | Mass

George S. Menoken

Pvt, Co. K, 5 Reg't Mass C. Cav.

Appears on

Hospital Muster Roll

of Balfour U. S. A. General Hospital,

at Portsmouth, Va.,

for May & June, 1864.

Attached to hospital:

When _____, 186 .

How employed _____

Last paid by Maj. _____

to _____, 186 .

Bounty paid \$ 100; due \$ 100

Present or absent Present

Remarks: _____

Book mark: _____

(343)

W. W. Dayre
Copyist.

M | **5 Col'd Cav.** | **Mass.**

George A. Menoken

B, Co. K, 5 Reg't Mass. Col'd Cavalry.

Appears on

Company Muster Roll

for *July 9 Aug*, 186*4*.

Present or absent *Absent*

Stoppage, \$ *100* for

Due Gov't, \$ *100* for

Valuation of horse, \$ *100*

Valuation of horse equipments, \$ *100*

Remarks: *(A horse) since June 20
1864 sick in Hospital, due
11. 1 for transportation from
N York to Mass # 372 May
2^o 1864*

Book mark: _____

Uran

M 1 *Col. Cav Mass*
5 *V.S. (19)*

George D. Manca
Pvt., Co. K, 5 Reg't V.S. (19)

Appears on

Hospital Muster Roll

of **Balfour U. S. A. General Hospital,**

at **Portsmouth, Va.,**

for *July 1864*, 186*4*.

Attached to hospital:

When _____, 186 .

How employed _____

Last paid by Maj. _____

to _____, 186 .

Bounty paid \$ 100; due \$ 100

Present or absent _____

Remarks: *Transferred North*
July 19/64

Book mark: _____

(848)

Copyist.

M 1 5 Cav 1 Mass

Geo S. Menoken
Spt, Co. A., 5 Reg't Mass Cav

Appears on

Hospital Muster Roll

of Ward U. S. A. General Hospital,

at Newark, N. J.,

for July & Aug., 1864.

Attached to hospital:

When July 21, 1864.

How employed

Last paid by Maj.

to _____, 186 .

Bounty paid \$ 100; due \$ 100

Present or absent Present

Remarks: No pay due for July & Aug
of

12 Mar

Book mark :

W. C. Brown
Copyist.

m | **5 Col'd Cav.** | **Mass.**

George S. Mansner

Private, Co. K, 5 Reg't Mass. Col'd Cavalry.

Appears on

Company Muster Roll

for Sept + Oct, 1864.

Present or absent Absent

Stoppage, \$ 100 for

Due Gov't, \$ 100 for

Valuation of horse, \$ 100

Valuation of horse equipments, \$ 100

Remarks: Absent since June 20 1864 in Dept of
Mass at Newark N.J

Book mark:

Edmundson

(358)

Copyist.

M 15-6av. 12, S.C.Y.

George S. Menoken
D, Co. K, 5th Reg't U.S. Caval.

Appears on

Hospital Muster Roll

of **Ward U. S. A. General Hospital,**

at **Newark, N. J.,**

for Sept. & Oct, 1864

Attached to hospital:

When July 21, 1864.

How employed

Last paid by Maj. Murvell

to July & Aug., 1864.

Bounty paid \$ 100; due \$ 100

Present or absent

Remarks: Transferred to
Truitt Hospital, N.Y.
Oct. 27, 1864.

Book mark :

Onsley

M 5 Cav. Mass. C. T.

George S. Manakin
Pvt., Co. K., 5 Reg't Mass Cav. Col.

Appears on

Hospital Muster Roll

of Grant U. S. A. General Hospital,

at Willet's Point, New York Harbor,

for Sept. & Oct., 1864.

Attached to hospital:

When Oct. 27, 1864.

How employed

Last paid by Maj. Newall

to Aug. 31, 1864.

Bounty paid \$ 100; due 100

Present or absent Present

Remarks: Was paid for the month
of July & Aug. 1864.
Due ill. for transportation three
two dollars.

Ward 22

Book mark:

Schenck

M | **5 Col'd Cav.** | **Mass.**

George J Menoken

Serjeant, Co. K, 5 Reg't Mass. Col'd Cavalry.

Appears on

Company Muster Roll

for Nov + Dec, 1864.

Present or absent _____

Stoppage, \$ _____ 100 for _____

Due Gov't, \$ _____ 100 for _____

Valuation of horse, \$ _____ 100

Valuation of horse equipments, \$ _____ 100

Remarks: Discharged at
St. York NY Nov 21 1864
Spauld Hospital

Book mark: _____

Edmondson

Ab *cd. car* *mass*
5 *USAT*

George C. Menoken
Plt, Co. *No.* *5* Reg't *U.S.A.*

Appears on

Hospital Muster Roll

of *Grant U. S. A. General Hospital,*

at *Willet's Point, New York Harbor,*

for *Nov 27*, 1864.

Attached to hospital:

When *Oct 27*, 1864.

How employed

Last paid by Maj.

to _____, 186 .

Bounty paid \$ *100*; due *100*

Present or absent

Remarks. *Discharged from*
service November
21, 1864.

Book mark :

L. N. Hitch

M. | 5 Col'd Cav. | Mass.

George S. Menoken
Priv., Co. K, 5 Reg't Mass. Colored Cav.

Appears on Returns as follows:

Apr. 1864. Absent on furlough
for purpose of recruiting
Apr. 18 to May 2

June 1864. June 15 City Point
sick. Sent to Hosp.
Fortress Monroe. Absent.
July to Oct. 1864. Absent sick
in Hosp. since June 20/64.

Nov. 1864. Absent sick in
Newark Hosp. since
June 20/64.

Dec. 1864. Discharged at
Grant Hosp. N. Y. for
disability Nov. 21/64.

Book mark :

(646)

J. B. Sittler.

Copyist.

M | 5 Col'd Cav. | Mass.

George S. Munoken

Priv., Co. K, 5 Reg't Mass. Col'd Cavalry.

Appears on Co. Muster-out Roll, dated
Clarksville Texas, Oct. 31, 1865.

Muster-out to date _____, 186 .

Last paid to Never Paid _____, 186 .

Clothing account:

Last settled _____, 186 ; drawn since \$ _____ 100

Due soldier \$ _____ 100; due U. S. \$ _____ 100

Am't for cloth'g in kind or money adv'd \$ _____ 100

Due U. S. for arms, equipments, &c., \$ _____ 100

Bounty paid \$ _____ 100; due \$ 300 ⁰⁰/₁₀₀

Remarks: Discharged Nov. 21st 1865
at N. Y. for disability.

Book mark Discharged Nov. 21/64 E B ¹²/₂₀₁ G D

(361)

Galligan

Copyist.

Menoken Geo S

P. K., Co. *5* Reg't *Masses*

2 Enclosures.

Bed Cards	Final Statements
Burial Records	Furloughs or L. of A
Certs. of Dis. for Discharge /	Med. Certificates
C. M. Charges	Med. Des. Lists
Descriptive Lists	Orders
Discharge Certificates	Pris. of War Record
Enlistment Papers	Resignations

Other papers relating to—

Admission to Hosp'l	Furlough or L. of A
Casualty Sheet /	Med. Examination
Confinement	Misc. Information
Contracts	Pay or Clothing
Death or Effects	Personal Reports
Desertion	Rank
Discharge from Hosp'l	Transfer to Hosp'l
Discharge from Service	Transfer to V. R. C.
Duty	Transportation

[OFFICE ENDORSEMENT.]

War Department,

ADJUTANT GENERAL'S OFFICE,

April 24th, 1877

The Discharge of Det George
Menoken, Co. K, 5th Reg't S.
Colored Inf. Cal., is reported as follows:

On Company Muster Roll,
For November 21, 1864, November 21, 1864

Company Muster-out Roll.

Company Descriptive Book.

Company Morning Reports.

Soldier's Final Statement.

Soldier's Record of Death and Interment.

Soldier's Inventory of Effects.

Soldier's Certificate of Disability for Discharge.

Soldier's Individual Muster-out Roll.

Regimental Return.

For November 21, 1864,
Regimental Quarterly Returns.

Regimental Descriptive Book.

By Surgeon General.

November 21, 1864, is held to be
the correct date, and the Company Muster-out
Roll will be amended accordingly.

Thomas M. Smeant

Assistant Adjutant General.

Noted 26.11.

Duplicate sent the Pension Office.

1877

32

CERTIFICATE OF DISABILITY FOR DISCHARGE

IN THE CASE OF

George Menoken
a priv Co. "K"
5 Reg't of Mass. Col. Cal.

APPROVED

C. W. Bouquell

Surgeon, U. S. A.,

Medical Director Dept of the East.

HEADQUARTERS DEPARTMENT OF THE EAST.

NEW YORK CITY, Nov 18th. 1864.

To be discharged.

BY COMMAND OF MAJOR GENERAL DIX:

Wilson Parston

Capt. and A. D. C., A. A. A. G.

Received (A. G. Office) _____, 186 .

Enon Adj. Gen.



NOTE 1.

The company commander will here add a statement of all the facts known to him concerning the disease or wound, or cause of disability of the soldier; the time, place, manner, and all the circumstances under which the injury occurred, or disease originated or appeared; the duty, or service, or situation of the soldier at the time the injury was received or disease contracted, stating particularly whether the injury was received or the disease contracted in the line of his duty; and whatever other facts may aid a judgment as to the cause, immediate or remote, of the disability, and the circumstances attending it.

When the facts are not known to the company commander, the certificate of any officer, or affidavit of other person having such knowledge, will be appended—as the surgeon in charge of a hospital, the officer commanding a detachment of recruits, &c., &c.

NOTE 2.

When a probable case for pension, special care must be taken to state the degree of disability—as 1/2, 3/4, &c., &c.; to describe particularly the disability, wound, or disease; the extent to which it deprives him of the use of any limb or faculty, or affects his health, strength, activity, constitution, or capacity to labor or earn his subsistence. The surgeon will add, from his knowledge of the facts and circumstances, and from the evidence in the case, his professional opinion of the cause or origin of the disability. In the case of discharges by Medical Inspectors, the last paragraph will state that the "discharge was given by consent of the soldier, after a personal examination, and for disability, the nature, degree, and origin of which are correctly described in the within certificate."

Par. 1260 Regulations, Edit. 1861.

Medical officers, in giving certificates of disability, are to take particular care in all cases that have not been under their charge; and especially in epilepsy, convulsions, chronic rheumatism, derangement of the urinary organs, ophthalmia, ulcers, or any obscure disease liable to be feigned or purposely produced; and in no case shall such certificate be given until after sufficient time and examination to detect any attempt at deception.

DIRECTIONS.

This certificate will be made out in duplicate by the soldier's company commander, or other officer commanding the separate detachment to which he belongs, and sent by him to the surgeon who has charge of the hospital where the soldier is sick. The surgeon will then fill out and sign the surgeon's certificate, and forward these papers to the regimental, detachment, or post commander, who will forward them, with his action endorsed thereon, through the proper channel, to his division commander; or, if the troops are not attached to a division, to his corps, department, or other commander or officer to whom the authority to discharge enlisted men may be specially delegated.

These certificates, after having received the action of the highest authority to which they are required to be sent, will be returned through the same channel to the regimental, post, or detachment commander, who will, if the discharge is authorized by the endorsement of the proper authority, sign the soldier's discharge, and the last certificate on this paper; see that the soldier is furnished with the proper final statements in duplicate, and forward BOTH of these certificates direct to the Adjutant General United States Army, at Washington, D. C.; they will not, under any circumstances, be given to the soldier.

ADJUTANT GENERAL'S OFFICE

Dec 2 1864

Duplicate sent the Pension Office.

1864
32
CERTIFICATE OF DISABILITY FOR DISCHARGE

IN THE CASE OF

George Menoken
a priv Co. "K"
5 Reg't of Mass. Col. Cer

APPROVED

C. W. Hovey
Surgeon, U. S. A.,
Medical Director Dept of the East

HEADQUARTERS DEPARTMENT OF THE EAST,

New York City, Nov 18th. 1864.

To be discharged.

BY COMMAND OF MAJOR GENERAL DIX:

Wilson Parson

Capt. and A. D. C., A. A. G.

Received (A. G. Office) _____, 186 .

Enon
Adjutant Genl

9

CASUALTY SHEET
OF WOUNDED.



Geo S Menoken

Company K

5 Regiment of Mass Cav (col'd)

Volunteers, at the battle of

Injury

CASUALTY SHEET.

Name, Geo S Menoken
Rank, —, Company K, Regiment, 5
Arm, Car, State, Mass (Col)
Place of casualty, —
Nature of casualty, Arrived July 21 Ward Hospital
Injury to back
Date of casualty, —

FROM WHAT SOURCE THIS INFORMATION WAS OBTAINED.

Report of Killed, Wounded, and Missing of the — Regiment,
— Brigade, — Division, — Corps, dated —
Hospital Register New England Soldiers' Relief Association
Book 4 page 423

W Marshall
Dec 14. 1885 Clerk.

418

470

Meredith Nelson
Co I, 5 Mass. Cav. (Col'd.)

Private | Private

CARD NUMBERS.

1	5382707	26
2	5382792	27
3	5382880	28
4	5382961	29
5	5383080	30
6	5383178	31
7	5383280	32
8	5383382	33
9	5383482	34
10	5383573	35
11	5383670	36
12	9091715-	37
13	40731442	38
14		39
15		40
16		41
17		42
18		43
19		44
20		45
21		46
22		47
23		48
24		49
25		50

Book Mark:

See also

5607-599 - P.O. 91
A1188087 - P.O. 7119 in
RTP 562913

W. Mallin
4

M 5 Cav. (Col'd.) | Mass.

Meridith Nelson.

....., Co. *I*....., 5 Reg't Mass. Cav. (Col'd.)

Appears on

Company Descriptive Book

of the organization named above.

DESCRIPTION.

Age *19* years; height *5* feet *5³/₄* inches.

Complexion *Black.*

Eyes *Black* ; hair *Black.*

Where born *White House Landg, Va.*

Occupation *Farmer.*

ENLISTMENT.

When *Mar. 14th, 186* .

Where *Orleans.*

By whom *A. C. Swain* ; term *3* y'rs.

Remarks:

H. C. Thomas.

M | **5 Col'd Cav.** | **Mass.**

Nelson Mendeth
Pr, Co. *I*, 5 Reg't Mass. Col'd Cav.

Appears on

Company Muster-in and Descriptive Roll
of the organization named above. Roll dated

Readville, Mass, Mch 26, 1864.

Where born *Whitehouse Landing, Va.*

Age *19* y'rs; occupation *Farmer*

When enlisted *Mch 14*, 1864.

Where enlisted *Orleans*

For what period enlisted *3* years.

Eyes *Black*; hair *Black*

Complexion *Black*; height *5 ft. 5 3/4* in.

When mustered in *Mch 26*, 1864.

Where mustered in

Bounty paid \$ *100*; due \$ *100*

Where credited *1st Dist. Barnstable*

Company to which assigned

Remarks: *Residence: Orleans*

Book mark:

(356d)

W. H. Thompson

Copyist.

M | 5 Col'd Cav. | Mass.

Nelson Meridith

Priv., Co. I, 5 Reg't Mass. Colored Cavalry.

Appears on

Company Muster Roll

for *Mch 26 to Apr 30*, 1864.

Present or absent *Present*

Stoppage, \$ *100* for

Due Gov't, \$ *100* for

Valuation of horse, \$ *100*

Valuation of horse equipments, \$ *100*

Remarks:

Book mark:

(358)

W. A. Thompson

Copyist.

M | 5 Col'd Cav. | Mass.

Nelson Meredith

Pvt, Co. I, 5 Reg't Mass. Colored Cavalry.

Appears on

Company Muster Roll

for May & June, 1864.

Present or absent Present

Stoppage, \$ 100 for

Due Gov't, \$ 100 for

Valuation of horse, \$ 100

Valuation of horse equipments, \$ 100

Remarks:

Book mark:

(358)

M. H. Thompson Copyist.

M | 5 Col'd Cav. | Mass.

Nelson Meredith
Sgt, Co. I, 5 Reg't Mass. Colored Cavalry.

Appears on

Company Muster Roll
for July & Aug, 1864
Present or absent Absent

Stoppage, \$ 100 for

Due Gov't, \$ 100 for

Valuation of horse, \$ 100

Valuation of horse equipments, \$ 100

Remarks: Detached Service
At Poney Point

Book mark:

M. H. Thompson
(358) Copyist.

M | **5 Col'd Cav.** | **Mass.**

Nelson Meredith,
Pvt., Co. I, 5 Reg't Mass. Colored Cavalry.

Appears on

Company Muster Roll

for *Sept. & Oct.*, 186*4*.

Present or absent *Present,*

Stoppage, \$ *100* for

Due Gov't, \$ *100* for

Valuation of horse, \$ *100*

Valuation of horse equipments, \$ *100*

Remarks:

Book mark:

(358)

C. F. Thompson,
Copyist.

M | **5 Col'd Cav.** | **Mass.**

Nelson Meredith

Out, Co. I, 5 Reg't Mass. Colored Cavalry.

Appears on

Company Muster Roll

for *Nov. & Dec.*, 186*4*.

Present or absent *Present*,

Stoppage, \$ *100* for

Due Gov't, \$ *100* for

Valuation of horse, \$ *100*

Valuation of horse equipments, \$ *100*

Remarks:

Book mark:

(358)

C. F. Thompson
Copyist.

Me | **5 Col'd Cav.** | **Mass.**

Helson Meredith,

Out, Co. I, 5 Reg't Mass. Colored Cavalry.

Appears on

Company Muster Roll

for *Jan. 8 Feb.*, 186*5*.

Present or absent *Present,*

Stoppage, \$ *100* for

Due Gov't, \$ *100* for

Valuation of horse, \$ *100*

Valuation of horse equipments, \$ *100*

Remarks: *Dep 1st 2^d 3^d install-
ments U.S. Bounty \$140.⁰⁰*

Book mark: _____

(358)

C. F. Thompson,
Copyist.

M

5 Col'd Cav.

Mass.

Nelson Meredith

Pvt., Co. I, 5 Reg't Mass. Colored Cavalry.

Appears on

Company Muster Roll

for *M. C. & Apr.*, 1865.

Present or absent *Present*

Stoppage, \$ *100* for

Due Gov't, \$ *100* for

Valuation of horse, \$ *100*

Valuation of horse equipments, \$ *100*

Remarks: *See 1st 2^d 3^d 4th install
ments U.S. Bounty \$80.00
Company Cook.*

Book mark:

C. F. Thompson

(358)

Copyist.

M | **5 Col'd Cav.** | **Mass.**

Wesley Meredith

Priv., Co. I, 5 Reg't Mass. Colored Cavalry.

Appears on

Company Muster Roll

for May & June, 1865.

Present or absent Present

Stoppage, \$ 100 for

Due Gov't, \$ 100 for

Valuation of horse, \$ 100

Valuation of horse equipments, \$ 100

Remarks: Due 1st 2^d 3^d 4th install-
ments U. S. Bounty \$180.⁰⁰

Book mark: _____

(358)

O. F. Thompson

Copyist.

m | 5 Col'd Cav. | Mass.

Nelson Meredith

Prvt, Co. I, 5 Reg't Mass. Colored Cavalry.

Appears on

Company Muster Roll

for July Aug, 1865.

Present or absent Present

Stoppage, \$ 100 for

Due Gov't, \$ 100 for

Valuation of horse, \$ 100

Valuation of horse equipments, \$ 100

Remarks:

Book mark:

Holeauk

(358)

Copyist.

M. | 5 Col'd Cav. | Mass.

Nelson Meredith
Priv., Co. I, 5 Reg't Mass. Colored Cav.

Appears on Returns as follows:

Aug. 1864. Absent detached
service, Piney Pt.
Nov. 1864 to June 1865. Co. cook.

Book mark :

(546)

J. B. Sittler

Copyist.

M | 5 Col'd Cav. | Mass.

Nelson Meredith
Pvt, Co. J, 5 Reg't Mass. Col'd Cavalry.

Appears on Co. Muster-out Roll, dated
Clarksville Texas, Oct 31, 1865.

Muster-out to date Oct 31, 1865.

Last paid to Dec 31, 1864.

Clothing account:

Last settled....., 186 ; drawn since \$..... 100

Due soldier \$ 12⁸⁷/₁₀₀; due U. S. \$..... 100

Am't for cloth'g in kind or money adv'd \$..... 100

Due U. S. for arms, equipments, &c., \$ 11/100

Bounty paid \$..... 100; due \$ 300/100

Remarks: Mustered out by So. no. 29th Regt
Dept of Tex dated Galveston Texas Sept 16/65
(based on authority from War Dept dated
Sept 8/65 directing the muster out of
Colored men for organized in Northern States)
their services being no longer required (over)

Book mark :

(861)

Holcomb
Copyist.

JAN. 10

5383670

1891 *

Transfers & Subsistence furnished
to Boston Mass. Muster out to
date Oct 31/65.

979

Merritt Alexander
Co K, 5 Mass. Cav., (Col'd.)

~~Private~~ | ~~Private~~

CARD NUMBERS.

1		26
2		27
3		28
4		29
5		30
6	see Merritt Alex	31
7		32
8		33
9		34
10		35
11		36
12		37
13		38
14		39
15		40
16		41
17		42
18		43
19		44
20		45
21		46
22		47
23		48
24		49
25		50

Book Mark:

See also

979-a

Merrill, Edward R.
Co., 5th S. Col'd Cav.
Mass.

CARD NUMBERS.

1	9436229	26
2		27
3		28
4		29
5		30
6		31
7		32
8		33
9		34
10		35
11		36
12		37
13		38
14		39
15		40
16		41
17		42
18		43
19		44
20		45
21		46
22		47
23		48
24		49
25		50

Number of personal papers herein.....

Book Mark:

See also

Worrell E. R.

Cap. Co., 5th Reg't Mass C.C.

2 Enclosures.

Bed Cards	Final Statements
Burial Records	Furloughs or L. of A.
Certs. of Dis. for Discharge	Med. Certificates
C. M. Charges	Med. Des. Lists
Descriptive Lists	Orders
Discharge Certificates	Pris. of War Record
Enlistment Papers	Resignations

Other papers relating to—

Admission to Hosp'l	Furlough or L. of A. /
Casualty Sheet	Med. Examination
Confinement	Misc. Information /
Contracts	Pay or Clothing
Death or Effects	Personal Reports
Desertion	Rank
Discharge from Hosp'l	Transfer to Hosp'l
Discharge from Service	Transfer to V. R. C.
Duty	Transportation

Camp 5th Mass. Cav -
Point Lookout Md. July 3, 1864
1864

E. B. Ed 1 Page 273.
Head. Quarters, Dept of
Washington, 22 a.c.
July 7. 1864.

E. R. Merrill
Capt. 5th Mass. Cav.

Merrill, E. R.
Capt. 5th Mass. Cav.

Respectfully referred to
Brig. Gen. Barnes, Com-
dg Point Lookout.

Application for ^{permission} to visit
Washington D.C. for five
15 days.

By command of
Maj. Gen. August
A. A. G.

Head. Quarters. 3rd U.S. Heavy Arty.
Point Lookout Md. July 3rd 1864

Respectfully forwarded
approved for three (3)
days.
A. S. Graper
Col. 31st U.S. C. Troops
Comdg. District.
E. M.
80

Recd at 99 July 7th

Camp 3rd Mass. Volt. Cav.
Point Lookout. Md.
July 3rd 1864.

Lieut.

I respectfully request per-
mission to visit Washington
City for the purpose of transacting
business pertaining to my Commission.
An absence of five days will
probably be necessary.

Very respectfully,
Your obedient servant

Capt E. H. Merrill
11th Mass Cavalry

To

Lieut. W. F. Anderson.

U. S. A.

St. Mary's District.

HEAD QUARTERS,
FIFTH REGIMENT MASS. CAVALRY.

Post Look out Md. July 9, 1864

I hereby certify that Capt. E. R. Merrill's commission in this regiment has never been mustered into the United States service, nor assigned to any company and has assumed no command or responsibility whatever in the regiment. He has decided to give up his Commission and wishes to proceed north on account of disability arising from an old wound.

Very Respectfully,
J. A. Merrill

H. J. Merrill

Major General

980

Merritt Alexander

Co. **5** Mass. Cav., (Col'd.)

Private

Private

CARD NUMBERS.

1	5383783	26
2	5383869	27
3	5383956	28
4	5384056	29
5	5384160	30
6	5384262	31
7	5384368	32
8	5384471	33
9	5384573	34
10	5384671	35
11	5384764	36
12	9091594	37
13	40731382	38
14		39
15		40
16		41
17		42
18		43
19		44
20		45
21		46
22		47
23		48
24		49
25		50

Book Mark: _____

See also _____

04.1456162

27801216 95mil

2995145 acednd

R. Walker

No. **5 Cav. (Col'd.)** | **Mass.**

Alexander Merritt.

....., Co. *K*....., 5 Reg't Mass. Cav. (Col'd.)

Appears on

Company Descriptive Book

of the organization named above.

DESCRIPTION.

Age *21* years; height *5* feet *6* inches.

Complexion *Dark*.

Eyes *Dark*; hair *Black*.

Where born *Todd Co, Ky.*

Occupation *Farmer*.

ENLISTMENT.

When *April 6th*, 186 ..

Where *Boston Ward 4.*

By whom *L. M. Standish*; term *3* y'rs.

Remarks: *Single. Residence Russellville*
Ky.

H. C. Thomas.

712 | **5 Col'd Cav.** | **Mass.**

Alexander Merritt

Co., Co. K, 5 Reg't Mass. Col'd Cavalry.

Appears on

Company Muster Roll

for from Sept 12th to Sept 30, 1864.

Present or absent (Present)

Stoppage, \$ 100 for

Due Gov't, \$ 100 for

Valuation of horse, \$ 100

Valuation of horse equipments, \$ 100

Remarks:

Book mark: -----

Alexander Merritt

9/12

5 Col'd Cav. | Mass.

Alexander Merritt

No. Co. K, 5 Reg't Mass. Col'd Cav.

Appears on

Company Muster-in and Descriptive Roll
of the organization named above. Roll dated

Andover Mass, April 12, 1864.

Where born Andover, Co. Mass.

Age 21 y'rs; occupation Farmer

When enlisted April 6, 1864.

Where enlisted Boston Mass

For what period enlisted 2 years.

Eyes Blue; hair Black

Complexion Blue; height 5 ft. 5 1/2 in.

When mustered in April 12, 1864.

Where mustered in Andover Mass

Bounty paid \$ 100; due \$ 100

Where credited Andover Mass

Company to which assigned

Remarks:

Book mark:

A. H. Adams

(356d)

Copyist.

712 | 5 Col'd Cav. | Mass.

Alexander Merritt

Co. K, 5 Reg't Mass. Col'd Cavalry.

Appears on

Company Muster Roll

for May 1864, 1864.

Present or absent Present

Stoppage, \$ 100 for

Due Gov't, \$ 100 for

Valuation of horse, \$ 100

Valuation of horse equipments, \$ 100

Remarks:

Book mark:

(358) [Signature] Copyist.

M | **5 Col'd Cav.** | **Mass.**

Alexander Merritt
Pvt, Co. K, 5 Reg't Mass. Col'd Cavalry.

Appears on

Company Muster Roll

for July & Aug, 1864.

Present or absent Present

Stoppage, \$ 100 for

Due Gov't, \$ 100 for

Valuation of horse, \$ 100

Valuation of horse equipments, \$ 100

Remarks: _____

Book mark: _____

(358) W. W. W. Copyist.

M | 5 Col'd Cav. | Mass.

Alexander Merritt

Serjeant, Co. K, 5 Reg't Mass. Col'd Cavalry.

Appears on

Company Muster Roll

for Sept & Oct, 1864.

Present or absent Present

Stoppage, \$100 for

Due Gov't, \$100 for

Valuation of horse, \$100

Valuation of horse equipments, \$100

Remarks:

Book mark:

Remond

M | **5 Col'd Cav.** | **Mass.**

Alexander Merritt

Private, Co. K, 5 Reg't Mass. Col'd Cavalry.

Appears on

Company Muster Roll

for Nov & Dec, 1864.

Present or absent Present

Stoppage, \$ 100 for

Due Gov't, \$ 100 for

Valuation of horse, \$ 100

Valuation of horse equipments, \$ 100

Remarks:

Book mark:

Edmondson

(358)

Copyist.

M | **5 Col'd Cav.** | **Mass.**

Alexander Merritt
Priv., Co. K, 5 Reg't Mass. Col'd Cavalry.

Appears on

Company Muster Roll

for Jan & Feb, 186 5.

Present or absent Present

Stoppage, \$ 100 for

Due Gov't, \$ 100 for

Valuation of horse, \$ 100

Valuation of horse equipments, \$ 100

Remarks: 3 mrs for every
carb. lost \$0.20

Book mark:

Edmondson
Copyist.

M | **5 Col'd Cav.** | **Mass.**

Alexander Merritt

Brig., Co. K, 5 Reg't Mass. Col'd Cavalry.

Appears on

Company Muster Roll

for *Mar & Apr*, 1865.

Present or absent *Present*

Stoppage, \$ *100* for *_____*

Due Gov't, \$ *100* for *_____*

Valuation of horse, \$ *100*

Valuation of horse equipments, \$ *100*

Remarks: *Due MS for money
could not pay 20*

Book mark: _____

(358)

Edmondson

Copyist.

M | **5 Col'd Cav.** | **Mass.**

Andrew Merritt

Brig, Co. K, 5 Reg't Mass. Col'd Cavalry.

Appears on

Company Muster Roll

for May & June, 1865.

Present or absent Present

Stoppage, \$ 100 for

Due Gov't, \$ 100 for

Valuation of horse, \$ 100

Valuation of horse equipments, \$ 100

Remarks: Over his for work
\$.20

Book mark:

Common

M

5 Col'd Cav.

Mass.

Alexander Merritt

Prvt, Co. K, 5 Reg't Mass. Col'd Cavalry.

Appears on

Company Muster Roll

for July & Aug., 1865

Present or absent Present

Stoppage, \$ 100 for

Due Gov't, \$ 100 for

Valuation of horse, \$ 100

Valuation of horse equipments, \$ 100

Remarks: Detailed at Brazos as
Carpenter R. S. O. 135 Aug. 30/65

Book mark: _____

Galligan

(358)

Copyist.

M. | 5 Col'd Cav. | Mass.

A. Merritt

Priv., Co. K, 5 Reg't Mass. Colored Cav.

Appears on Returns as follows:

Aug. & Sept. 1865, Absent de-
tailed at Brazos as
carpenter, Hd. Qrs, 5-
Mass. Cav. S. O. No. 135-
Aug. 30/65.

Book mark :

(646)

J. B. Sittler

Copyist.

711

5 Col'd Cav.

Mass.

Alexander Merritt

Priv., Co. K, 5 Reg't Mass. Col'd Cavalry.

Appears on Co. Muster-out Roll, dated
Clarksville Texas, Oct 31, 1865.

Muster-out to date Oct 31, 1865.

Last paid to Dec 31, 1864.

Clothing account:

Last settled....., 186 ; drawn since \$ 100

Due soldier \$ 100; due U. S. \$ 15 ¹⁵/₁₀₀

Am't for cloth'g in kind or money adv'd \$ 100

Due U. S. for arms, equipments, &c., \$ 11 ⁰⁰/₁₀₀

Bounty paid \$ 100; due \$ 100 ⁰⁰/₁₀₀

Remarks:

Book mark: 6407 2^d a Jan 10/68

Galligan

(861)

Copyist.

980 $\frac{1}{2}$

Mezziek, John E.
Mass.
CoA., 5 U. S. Col'd Cav.

CARD NUMBERS.

1	26
2	27
3	28
4	29
5	30
6	31
7	32
8	33
9	34
10	35
11	36
12	37
13	38
14	39
15	40
16	41
17	42
18	43
19	44
20	45
21	46
22	47
23	48
24	49
25	50

Number of personal papers herein.....

Book Mark:

See also

981

Michael Alfred
Co B, 5 Mass. Cav., (Col'd.)

Private : Private

CARD NUMBERS.

1	5372424	26	
2	5372647	27	
3	5372488	28	
4	5374999	29	
5	5375188	30	
6	5375211	31	
7	5375315	32	
8	5375444	33	
9	5372956	34	
10	5375653	35	
11	9092569	36	
12	40731443	37	
13		38	
14		39	
15		40	
16		41	
17		42	
18		43	
19		44	
20		45	
21		46	
22		47	
23		48	
24		49	
25		50	

Book Mark:

See also

S-660925- 20 90
D 1287268. P.O. name

Alman
4

11 | **5 Cav. (Col'd.)** | **Mass.**

Alfred Michael

....., Co. 3, 5 Reg't Mass. Cav. (Col'd.)

Appears on

Company Descriptive Book

of the organization named above.

DESCRIPTION.

Age 17 years; height 5 feet 5 inches.

Complexion Colored

Eyes black; hair Woolly

Where born Lebanon, Mass.

Occupation Farmer

ENLISTMENT.

When Sept 3, 1864.

Where Springfield

By whom Capt. Woodman; term 1 y'rs.

Remarks: Rec'd on enlistment 9 23 64 in
11th Reg'ty. Discharged at City
Springfield May 24/65 in accordance
with order from War Dept. May 24/65

.....
W. H. H. H. H.
Copyist.

M | **5 Col'd Cav.** | **Mass.**

Alfred Michael

Appears with rank of on

**Muster and Descriptive Roll of a Detach-
ment of U. S. Vols. forwarded**

for the 5 Reg't Mass. Col'd Cavalry. Roll dated

Springfield Mass, Sept 3, 1864.

Where born *Lenox Mass.*

Age *19* y'rs; occupation *Farmer*

When enlisted *Sept 3*, 1864.

Where enlisted *Springfield Mass*

For what period enlisted *1* years.

Eyes *Black*; hair *Wol.*

Complexion *Colored*; height *5 ft. 9 3/4* in.

When mustered in *Sept 3*, 1864.

Where mustered in *Springfield Mass.*

Bounty paid \$ *33* ^{*33*}/_{*100*}; due \$ *66* ^{*67*}/_{*100*}

Where credited

Company to which assigned

Remarks: *Quota of Lenox Berkshire*

Co Mass. Entitled to Bounty

.....

Book mark:

.....

M. A. Michael

(339)

Copyist.

M

5 Col'd Cav.

Mass.

Agred Michael

Appears with rank of _____ on _____

Muster and Descriptive Roll of a Detachment of U. S. Vols. forwarded

for the 5 Reg't Mass. Col'd Cavalry. Roll dated

Springfield Mass, Sept. 3, 1864.

Where born *Lenox Mass*

Age *19* y'rs; occupation *Farmer*

When enlisted *Sept. 3*, 1864.

Where enlisted *Springfield Mass*

For what period enlisted *1* years.

Eyes *black*; hair *Wool*

Complexion *Cold*; height *5* ft *9 3/4* in.

When mustered in *Sept. 3*, 1864.

Where mustered in *Springfield Mass*

Bounty paid \$ *33*^{*33*}/_{*100*}; due \$ *66*^{*67*}/_{*100*}

Where credited *Lenox Berkshire Co Mass*

Company to which assigned _____

Remarks: *Entitled to Bounty*

Book mark: _____

M. A. Michaels

M | **5 Col'd Cav.** | **Mass.**

Alfred Michael

Appears with rank of *Private* on

Muster and Descriptive Roll of a Detachment of U. S. Vols. forwarded

for the 5 Reg't Mass. Col'd Cavalry. Roll dated
Draft Rendezvous
Galloups Island B.H. Mass. Oct. 4, 1864.

Where born *Lenox Mass*

Age *17* y'rs; occupation *Farmer*

When enlisted *Sept. 3*, 1864.

Where enlisted *Springfield*

For what period enlisted *1* years.

Eyes *black*; hair *wooly*

Complexion *Colored*; height *5* ft. *9³/₄* in.

When mustered in *Sept. 5*, 1864.

Where mustered in *Springfield*

Bounty paid \$ *33³³/₁₀₀*; due \$ *66⁶⁷/₁₀₀*

Where credited *Lenox Berkshire Co.*

Company to which assigned

Remarks:

Book mark:

(339)

M. A. Michaels

Copyist.

M. | **5 Col'd Cav.** | **Mass.**

Alfred Michael,
Priv., Co. B, 5 Reg't Mass. Col'd Cavalry.

Appears on

Company Muster Roll
for *Sept. & Oct.*, 186*4*.

Present or absent *Present*

Stoppage, \$ *100* for

Due Gov't, \$ *100* for

Valuation of horse, \$ *100*

Valuation of horse equipments, \$ *100*

Remarks: *Joined from Depot*
Oct. 26/64.
Free on or before Apr. 19/61.

Book mark:

(358)

W. Brown
Copyist.

M. | **5 Col'd Cav.** | **Mass.**

Alfred Michael,
Privt., Co. B, 5 Reg't Mass. Col'd Cavalry.

Appears on

Company Muster Roll

for Nov. & Dec., 1864.

Present or absent Present

Stoppage, \$ 100 for

Due Gov't, \$ 100 for

Valuation of horse, \$ 100

Valuation of horse equipments, \$ 100

Remarks: Due U.S. Ordnance
last \$22.71

Joined the Co. as a
Recruit Oct-28/64.

Book mark: _____

(358)

W. Brown
Copyist.

M. | **5 Col'd Cav.** | **Mass.**

Alfred Michael,
Privt, Co. B, 5 Reg't Mass. Col'd Cavalry.

Appears on

Company Muster Roll

for Jan'y, & Feby., 1865.

Present or absent — Present.

Stoppage, \$ 100 for

Due Gov't, \$ 100 for

Valuation of horse, \$ 100

Valuation of horse equipments, \$ 100

Remarks: Due the U.S.
ordnance lost \$26.88

Book mark: 1

A. W. Brown

(358)

Copist.

M. | **5 Col'd Cav.** | **Mass.**

Alfred Michael,
Priv., Co. B, 5 Reg't Mass. Col'd Cavalry.

Appears on

Company Muster Roll

for *March & April*, 1865.

Present or absent — *Present.*

Stoppage, \$.....100 for.....

Due Gov't, \$.....100 for.....

Valuation of horse, \$.....100

Valuation of horse equipments, \$.....100

Remarks:.....

Book mark: *Mustd out at*
(over.)

(358)

J. M. Brown
Copyist.

JAN. - 9

5375315

1891

City Point, Va., May 24/65,
Orders A.G.O.

See M-out-Roll on file.

M | 5 Col'd Cav. | **Mass.**

Alfred Michael
Priv, Co. *B*, 5 Reg't Mass. Col'd Cavalry.

Appears on a

Detachment Muster-out Roll

of the organization named above. Roll dated

City Point, Va, *May 24*, 186*5*.

Muster-out to date *May 24*, 186*5*.

Last paid to *Dec. 31*, 186*4*.

Clothing account:

Last settled....., 186 ; drawn since \$ 100

Due soldier \$ 100; due U. S. \$ 100

Am't for cloth'g in kind or money adv'd \$ *138*^{*35*} 100

Due U. S. for arms, equipments, &c., \$ 100

Bounty paid \$ *33*^{*23*}/₁₀₀; due \$ *33*^{*33*}/₁₀₀

Remarks: *Clothing acct*
never settled *Discharges*
under Gen'l O. No. 83
War Dept A.G.O.
Washington, A.C. May 8
1865.

Book mark:

R. Washington

M | **5 Col'd Cav.** | **Mass.**

Alfred Michail

Det., Co. B, 5 Reg't Mass. Col'd Cavalry.

Appears on

Company Muster Roll

for May & June, 1865.

Present or absent.....

Stoppage, \$.....100 for.....

Due Gov't, \$.....100 for.....

Valuation of horse, \$.....100

Valuation of horse equipments, \$.....100

Remarks: Discharged the service
of the U.S. at City Pt. Va.
May 24/65, per orders
from Sec. of War dated
May 3/65.

Book mark:.....

Scherich

M. | **5 Col'd Cav.** | **Mass.**

Alfred Michail*
Pvt., Co. B, 5 Reg't Mass. Colored Cav.

Appears on **Returns** as follows:

Oct. 1864. Gain Oct. 27/64
Point Lookout, Md.
Recruit from depot.

May 1865. Loss May 24/65
Light House Pt. Va.
Washington May 3/65
Discharged by order
A. G. O.

* Name appears also as Alfred
Michell.

Book mark :

(546)

J. B. Sittler

Copyist.

M | **5 Col'd Cav.** | **Mass.**

Alfred Michael

Reg't, Co. *B*, 5 Reg't Mass. Col'd Cavalry.

Appears on **Co. Muster-out Roll**, dated
Clarksville, Tex., Oct 31, 1865.

Muster-out to date _____, 186 .

Last paid to *Dec 31*, 1864.

Clothing account:

Last settled _____, 186 ; drawn since \$ _____ 100

Due soldier \$ _____ 100; due U. S. \$ _____ 100

Am't for cloth'g in kind or money adv'd \$ _____ 100

Due U. S. for arms, equipments, &c., \$ _____ 100

Bounty paid \$ _____ 100; due \$ _____ 100

Remarks: *Discharged May 24/65;*
by order Sec'y War Dept
Paint, Va. S.O., U.S., May 13/65.

Book mark: _____

(361)

Scherich

Copyist.

Michael Alfred

....., Co.

Reg't

5th Mass Co

2 Enclosures.

Bed Cards	Final Statements
Burial Records	Furloughs or L. of A
Certs. of Dis. for Discharge	Med. Certificates
C. M. Charges	Med. Des. Lists
Descriptive Lists	Orders
Discharge Certificates	Pris. of War Record
Enlistment Papers 2	Resignations

Other papers relating to—

Admission to Hosp'l	Furlough or L. of A
Casualty Sheet	Med. Examination
Confinement	Misc. Information
Contracts	Pay or Clothing
Death or Effects	Personal Reports
Desertion	Rank
Discharge from Hosp'l	Transfer to Hosp'l
Discharge from Service	Transfer to V. R. C.
Duty	Transportation

Field motion

in enlistments and re-enlistments—enlistment of veterans, &c., &c., in the volunteer service. They will be made out in duplicate
return of the superintendent (not the recruiting officer) to the Adjutant General, and one to accompany the accounts of the officer
pany in which the soldier first served should be given on the back.
A muster-in must, in all cases, precede payment of pay, bounty, pension, &c. A muster-in roll must, in all cases, be filed
muster-in. The mustering officer, commissary, or assistant commissary of musters, as the case may be, will countersign both
e service of the United States before either of them is given to the disbursing officer.

APPROVED AND FILED IN THE ENLISTMENT DIVISION P. O.

DECLARATION OF RECRUIT.

I, Alfred Michail, desiring
to VOLUNTEER as a Soldier in the Army of the United States, for the term of one YEARS,
Do Declare, That I am thirteen years and _____ months
of age; that I have never been discharged from the United States service on account of disability or
by sentence of a court martial, or by order before the expiration of a term of enlistment; and I know of
no impediment to my serving honestly and faithfully as a soldier for three years.

GIVEN at Springfield Mass
the 2nd day of September 1864

Witness: J. K. Hubbard Alfred Michail

enlistment: last served in Company ()
Regt of _____
Discharged _____, 18____
33333 Benny Field

5- Mass ten
No. _____
Alfred Michail
Volunteered at Springfield Mass
September 2nd 1864.
By Alfred Michail
Capt 19th Mass, 10th Regt
Regiment of _____

CONSENT IN CASE OF MINOR.

I, Martha Field Do CERTIFY, That I am the
mother of Alfred Michail; that the
said Alfred Michail is thirteen years of age; and I
do hereby freely give my CONSENT to his volunteering as a SOLDIER in the ARMY OF THE UNITED STATES
for the period of one YEAR.

GIVEN AT Lenox
The 2nd day of Sept 1864, her
Witness: Martha Field
Martha Field
man

VOLUNTEER ENLISTMENT.

STATE OF

Massachusetts

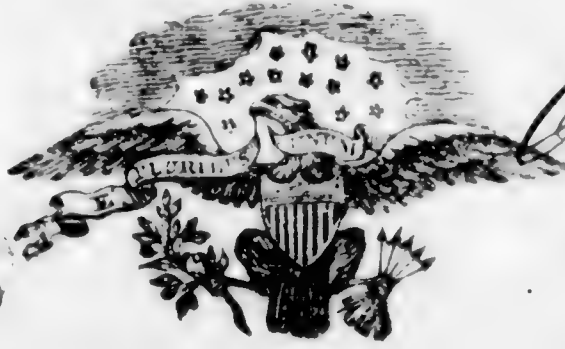

TOWN OF

City of Springfield

I, *Alfred Michael*, born in *Leicester* in the State of *Massachusetts*, aged *Nineteen* years, and by occupation a *Farmer*, Do HEREBY ACKNOWLEDGE to have volunteered this *Third* day of *September*, 1864 to serve as a **Soldier** in the **Army of the United States of America**, for the period of ~~THREE~~ ^{ONE} YEARS, unless sooner discharged by proper authority: Do also agree to accept such bounty, pay, rations, and clothing, as are, or may be, established by law for volunteers. And I, *Alfred Michael*, do solemnly swear, that I will bear true faith and allegiance to the **United States of America**, and that I will serve them honestly and faithfully against all their enemies or opposers whomsoever; and that I will observe and obey the orders of the President of the United States, and the orders of the officers appointed over me, according to the Rules and Articles of War.

Sworn and subscribed to, at

this

Springfield, Mass

this *3rd* day of *September* 1864

Alfred Michael

BEFORE

H. W. Morhouse
Capt & Com. 10th Dist Mass

I CERTIFY, ON HONOR, That I have carefully examined the above-named Volunteer, agreeably to the General Regulations of the Army, and that, in my opinion, he is free from all bodily defects and mental infirmity, which would in any way disqualify him from performing the duties of a soldier.

H. W. Morhouse

EXAMINING SURGEON.

I CERTIFY, ON HONOR, That I have minutely inspected the Volunteer *Alfred Michael* previously to his enlistment, and that he was entirely sober when enlisted; that, to the best of my judgment and belief, he is of lawful age; and that, in accepting him as duly qualified to perform the duties of an able-bodied soldier, I have strictly observed the Regulations which govern the recruiting service. This soldier has *blue* eyes, *blue* hair, *blue* complexion, is *five* feet *9 3/4* inches high.

H. W. Morhouse
Capt & Com. 10th Dist Mass
Regiment of _____ Volunteers,

RECRUITING OFFICER.

(A. G. O. No. 74 & 76.)

12185

5th Co Mustered into the service of the United States, for ~~three~~ ^{one} years or during the war, from date of enlistment, in Company *Cady* Regiment of *Mass* Volunteers, on the *3rd* day of *September* 1864, at *Springfield, Mass*
Quaker Brothers & Barber's Co.
Smithfield & Brantley
H. W. Morhouse
Capt & Com. 10th Dist Mass
W. D. P. P. P.

listments and re-enlistments—enlistment of veterans, &c., &c., in the volunteer service. They will be made out in duplicate of the superintendent (not the recruiting officer) to the Adjutant General, and one to accompany the accounts of the officer in which the soldier has served should be given on the back
 muster-roll, in all cases, precede payment of pay bounty pension, &c. A muster-roll must, in all cases, be filed for it. The mustering officer, commissary, or assistant commissary of musters, as the case may be, will countersign both vice of the United States before either of them is given to the disbursing officer.

DECLARATION OF RECRUIT.

I, Alfred Michael, desiring to VOLUNTEER as a Soldier in the Army of the United States, for the term of THREE YEARS. Do Declare, That I am 17 years and _____ months of age; that I have never been discharged from the United States service on account of disability or by sentence of a court martial, or by order before the expiration of a term of enlistment; and I know of no impediment to my serving honestly and faithfully as a soldier for three years.

GIVEN at Springfield Mass the 3 day of September 1864

Witness:

A. K. Hubbard A. J. [unclear]

#3333
Ernest [unclear]
[unclear]

Discharged _____, 18__

Part of _____

enlistment; last served in Company () _____

5th Mass Cav

Regiment of _____

Alfred Michael
[unclear]

Volunteered at Springfield Mass _____, 1864

Alfred Michael

No. 198
Alfred Michael

CONSENT IN CASE OF MINOR.

I, Martha Field Do CERTIFY, That I am the Mother of Alfred Michael; that the said Alfred is 17 years of age; and I do hereby freely give my CONSENT to his volunteering as a SOLDIER in the ARMY OF THE UNITED STATES for the period of THREE YEARS.

GIVEN AT Lenox
 The 2nd day of September

Witness: H. B. Millington Martha Field

VOLUNTEER ENLISTMENT.

STATE OF

Massachusetts



CITY ~~TOWN~~ OF

Springfield

I, *Alfred Michael*, born in *Leary*
in the State of *Massachusetts*, aged *Nineteen* years,
and by occupation a *Farmer*, Do HEREBY ACKNOWLEDGE to have
volunteered this *Thirtieth* day of *September*, 1864,
to serve as a **Soldier** in the **Army of the United States of America**, for
the period of **THREE YEARS**, unless sooner discharged by proper authority:
Do also agree to accept such bounty, pay, rations, and clothing, as are, or may be,
established by law for volunteers. And I, *Alfred Michael*, do
solemnly swear, that I will bear true faith and allegiance to the **United States
of America**, and that I will serve them honestly and faithfully against all
their enemies or opposers whomsoever; and that I will observe and obey the
orders of the President of the United States, and the orders of the officers
appointed over me, according to the Rules and Articles of War.

Sworn and subscribed to, at

this

Springfield Mass
31 day of *September*

BEFORE

H. M. Merchouse
Capt & Quar. Master, 10th Dist. Mass

I CERTIFY, ON HONOR, That I have carefully examined the above-named Volunteer, agreeably
to the General Regulations of the Army, and that, in my opinion, he is free from all bodily defects and
mental infirmity, which would in any way disqualify him from performing the duties of a soldier.

EXAMINING SURGEON.

I CERTIFY, ON HONOR, That I have minutely inspected the Volunteer *Alfred Michael*
previously to his enlistment, and that he was entirely sober when enlisted; that, to the best of my
judgment and belief, he is of lawful age; and that, in accepting him as duly qualified to perform the
duties of an able-bodied soldier, I have strictly observed the Regulations which govern the recruiting
service. This soldier has *blue* eyes, *blue* hair, *blue* complexion, is *fine*
feet *9 3/4* inches high.

H. M. Merchouse
Capt & Quar. Master, 10th Dist
Regiment of _____ Volunteers,

RECRUITING OFFICER.

Mustered into the service of the United States, for ~~three~~ ²⁴ years or during the war, from date of enlistment, in Company _____
 of the _____ Regiment of *10th Dist. Mass* Volunteers, on the *31* day of *September*, 1864, at *Springfield, Mass*
Alfred Michael
10th Dist. Mass
H. M. Merchouse
Capt & Quar. Master, 10th Dist. Mass

9046

Michael Edward
Co K, 5 Mass. Cav., (Col'd.)

Private Private

CARD NUMBERS.

1	5383778	26
2	5383864	27
3	5383957	28
4	5384057	29
5	5384161	30
6	5384263	31
7	5384369	32
8	5384472	33
9	5384574	34
10	5384672	35
11	5384765	36
12	9091595	37
13	40731384	38
14		39
15		40
16		41
17		42
18		43
19		44
20		45
21		46
22		47
23		48
24		49
25		50

Book Mark:

See also

Private Edm P
Chattus A B 43 USCA

S. 1449773 G.A.R
R. & P. 647211
13063668 P.O. mile
P.O. mile 2,0. 1402 103-3. 15. 30. 79
8/28/30
To Co. Sec with letter &
and chatters - 1/11/27
app. list for 1-31-57

W. W. Walker
4

No. **5 Cav. (Col'd.)** | **Mass.**

Edward Michael.

....., Co. *K*, 5 Reg't Mass. Cav. (Col'd.)

Appears on

Company Descriptive Book

of the organization named above.

DESCRIPTION.

Age *19* years; height *5* feet *6* inches.

Complexion *Black.*

Eyes *Black*; hair *Black.*

Where born *Maine*

Occupation *Farmer.*

ENLISTMENT.

When *April 1st*, 186 .

Where *Boston Wd. 6.*

By whom *D. Davies*; term *3* y'rs.

Remarks: *Single, Residence Belfast Me.*

H. C. Thomas,

(3830)

Copist.

72 | **5 Col'd Cav.** | **Mass.**

William Michael

1st, Co. K, 5 Reg't Mass. Col'd Cavalry.

Appears on

Company Muster Roll

for from April 12th to Cape 98, 1864.

Present or absent Present

Stoppage, \$ 100 for

Due Gov't, \$ 100 for

Valuation of horse, \$ 100

Valuation of horse equipments, \$ 100

Remarks:

Book mark:

(358)

W. M. Michael

Copyist.

7 | **5 Col'd Cav.** | **Mass.**

Edw. M. Nichols
Capt., Co. K, 5 Reg't Mass. Col'd Cavalry.

Appears on

Company Muster Roll

for May & June, 1867.

Present or absent Present

Stoppage, \$ 100 for

Due Gov't, \$ 100 for

Valuation of horse, \$ 100

Valuation of horse equipments, \$ 100

Remarks:

Book mark: _____

Edw. M. Nichols

(358) Copyist.

M | **5 Col'd Cav.** | **Mass.**

Edward Michael

Pos, Co. K, 5 Reg't Mass. Col'd Cavalry.

Appears on

Company Muster Roll

for July & Aug, 1864.

Present or absent Present

Stoppage, \$ 100 for

Due Gov't, \$ 100 for

Valuation of horse, \$ 100

Valuation of horse equipments, \$ 100

Remarks:

Book mark:

Edman

M | **5 Col'd Cav.** | **Mass.**

Edward Michael

Pvt., Co. K, 5 Reg't Mass. Col'd Cavalry.

Appears on

Company Muster Roll

for Sept + Oct, 1864

Present or absent Present

Stoppage, \$ 100 for

Due Gov't, \$ 100 for

Valuation of horse, \$ 100

Valuation of horse equipments, \$ 100

Remarks:

Book mark:

(358)

Merrill

Copyist
Comd.

M | **5 Col'd Cav.** | **Mass.**

Edward Michael

Privt., Co. K, 5 Reg't Mass. Col'd Cavalry.

Appears on

Company Muster Roll

for Nov Dec, 1864.

Present or absent Present

Stoppage, \$ 100 for

Due Gov't, \$ 100 for

Valuation of horse, \$ 100

Valuation of horse equipments, \$ 100

Remarks:

Book mark:

Edward M. Michael

M | **5 Col'd Cav.** | **Mass.**

Edward Michael

Priv., Co. K, 5 Reg't Mass. Col'd Cavalry.

Appears on

Company Muster Roll

for Jan & Feb, 1865.

Present or absent Present

Stoppage, \$ 100 for

Due Gov't, \$ 100 for

Valuation of horse, \$ 100

Valuation of horse equipments, \$ 100

Remarks:

Book mark:

(358)

Edward Michael

Copyist.

EM | **5 Col'd Cav.** | **Mass.**

Edmond Michael

Priv., Co. K, 5 Reg't Mass. Col'd Cavalry.

Appears on

Company Muster Roll

for Mar & Apr, 1865.

Present or absent Present

Stoppage, \$ 100 for

Due Gov't, \$ 100 for

Valuation of horse, \$ 100

Valuation of horse equipments, \$ 100

Remarks: Due MS per sen-
tence 70 @ M \$16.00

Book mark: _____

Edmond

M | **5 Col'd Cav.** | **Mass.**

Edward Michael

Priv., Co. K, 5 Reg't Mass. Col'd Cavalry.

Appears on

Company Muster Roll

for May & June, 1865.

Present or absent Present

Stoppage, \$ 100 for

Due Gov't, \$ 100 for

Valuation of horse, \$ 100

Valuation of horse equipments, \$ 100

Remarks: Due MS per per
June 50 @ 2m \$10

Book mark:

(358)

Edmondson

Copyist.

711 | 5 Col'd Cav. | Mass.

Edward Michael

Pat, Co. K, 5 Reg't Mass. Col'd Cavalry.

Appears on

Company Muster Roll

for July & Aug, 1865.

Present or absent Present

Stoppage, \$ 100 for

Due Gov't, \$ 100 for

Valuation of horse, \$ 100

Valuation of horse equipments, \$ 100

Remarks: Due U.S. per sentence
F. O. C. M. \$16.

Book mark:

(358)

Galligan

Copyist.

M. | **5 Col'd Cav.** | **Mass.**

Edward Michael
Pvt, Co. K, 5 Reg't Mass. Colored Cav.

Appears on **Returns** as follows:

July 1864. July-Point Look-
out detailed as officers
servant.

Aug 1864. Officers servant.

Book mark : _____

(548)

J. B. Sittler

Copyist.

M | 5 Col'd Cav. | Mass.

Edward Michael

Pot, Co. K, 5 Reg't Mass. Col'd Cavalry.

Appears on Co. Muster-out Roll, dated
Clarksville Texas, Oct. 31, 1865.

Muster-out to date Oct. 31, 1865.

Last paid to Dec. 31, 1864.

Clothing account:

Last settled....., 186 ; drawn since \$ 100

Due soldier \$ 100; due U. S. \$ 2 ²⁹/₁₀₀

Am't for cloth'g in kind or money adv'd \$ 100

Due U. S. for arms, equipments, &c., \$ 11 ⁰⁰/₁₀₀

Bounty paid \$ 100; due \$ 100 ⁰⁰/₁₀₀

Remarks: Due U. S. per Sentence
of F. O. C. M. \$16.00

Book mark: V163, P. 40. 73

(361)

Galligan

Copyist.

983

Michael, George
Co A, 5 Mass. Cav., (Col'd.)

Private | Private

CARD NUMBERS.

1	5372371	26
2	5372452	27
3	5373929	28
4	5374015	29
5	5374116	30
6	5374218	31
7	5374312	32
8	5374406	33
9	9092690	34
10	34506832	35
11	40731444	36
12		37
12		38
14		39
15		40
16		41
17		42
18		43
19		44
20		45
21		46
22		47
23		48
24		49
25		50

Book Mark:

See also

M | **5 Cav. (Col'd.)** | **Mass.**

George Michael
....., Co. A, 5 Reg't Mass. Cav. (Col'd.)

Appears on

Company Descriptive Book

of the organization named above.

DESCRIPTION.

Age 35 years; height 5 feet 7 inches.

Complexion black

Eyes black; hair black

Where born St. John's, B.

Occupation sailor

ENLISTMENT.

When Aug 29, 1864.

Where Mass.

By whom Capt. M. Dunn; term 2 y'rs.

Remarks:

.....
.....
.....
.....
.....
.....
.....
.....
.....
.....

(3827)

George Michael
(Copist.)

M | 5 Cav | Mass

George Michael

Appears with rank of _____ on _____

Muster and Descriptive Roll

of a detachment of U. S. Volunteers forwarded from Faneuil Hall, Boston, to Galloup's Island, Boston Harbor, for various regiments Massachusetts Volunteers. Roll dated

Boston Mass Aug 29, 1864.

Where born St John At Brunswick

Age 35 years; occupation Sailor

When enlisted Aug 29, 1864.

Where enlisted Athol

For what period enlisted 2 years.

Eyes dark; hair Blk

Complexion Cold; height 5 ft. 7 in.

When mustered in Aug 29, 1864.

Where mustered in Boston

Bounty paid \$ 100; due \$ 100

Clothing account:

Last settled _____, 186 _____; drawn since \$ 100

Date of first muster _____, 186 _____

Regiment to which assigned 5th Cav

Remarks: Athol Worcester Co 9th Dist

Book mark: _____

[Signature]

(356m)

Copyist.

M

5 Col'd Cav.

Mass.

George Michael

Appears with rank of *Pri* on

Muster and Descriptive Roll of a Detachment of U. S. Vols. forwarded

for the 5 Reg't Mass. Col'd Cavalry. Roll dated

Boston Mass Aug 29, 1864.

Where born *St. Johns New Brunswick*

Age *35* y'rs; occupation *Sailor*

When enlisted *Aug 29*, 186 *4*

Where enlisted *Athol*

For what period enlisted *3* years.

Eyes *Dark*; hair *Black*

Complexion *Cold*; height *5* ft. *7* in.

When mustered in *Aug 29*, 186 *4*.

Where mustered in *Boston*

Bounty paid \$ *100*; due \$ *100*

Where credited *9 Dist, Athol,*

Worcester Co
Company to which assigned

Remarks :

Book mark :

Donnelly

(339)

Copyist.

M | **5 Col'd Cav.** | **Mass.**

George Michael

Appears with rank of *Private* on

Muster and Descriptive Roll of a Detachment of U. S. Vols. forwarded

for the 5 Reg't Mass. Col'd Cavalry. Roll dated *Draft Rendezvous Galloups Island B. H. Mass, Sept 16, 1864.*

Where born *St John N. B.*

Age *35* y'rs; occupation *Sailor*

When enlisted *Aug. 29*, 1864.

Where enlisted *Athol*

For what period enlisted *2* years.

Eyes *dark*; hair *black*

Complexion *Colored*; height *5 ft. 4 in.*

When mustered in *Aug. 29*, 1864.

Where mustered in *Boston Mass.*

Bounty paid \$ *66 ⁶⁶/₁₀₀*; due \$ *133 ³⁴/₁₀₀*

Where credited *Athol Worcester Co*

Company to which assigned

Remarks:

Book mark:

M. A. Michaels
Copyist.

M | **5 Col'd Cav.** | **Mass.**

George Michael
Pvt., Co. A, 5 Reg't Mass. Col'd Cavalry.

Appears on

Company Muster Roll

for *Nov. and Dec.*, 1864.

Present or absent *Present.*

Stoppage, \$ *100* for

Due Gov't, \$ *100* for

Valuation of horse, \$ *100*

Valuation of horse equipments, \$ *100*

Remarks:

Book mark:

A. Gilbert

(358)

Copyist.

M | **5 Col'd Cav.** | **Mass.**

George Michael
Priv., Co. A, 5 Reg't Mass. Col'd Cavalry.

Appears on

Company Muster Roll
for *Jan. and Feb.*, 1865.

Present or absent *Present.*

Stoppage, \$ *100* for

Due Gov't, \$ *100* for

Valuation of horse, \$ *100*

Valuation of horse equipments, \$ *100*

Remarks: *Due that amt. of M. S. Bounty to name scribbling under call of July 18, 1864.*

Book mark: *2*

M. J. Gilbert

(358)

Copyist.

M | **5 Col'd Cav.** | **Mass.**

George Michael
Pr., Co. A, 5 Reg't Mass. Col'd Cavalry.

Appears on

Company Muster Roll

for *Feb. and Apr.*, 1865.

Present or absent *Present*

Stoppage, \$ *100* for

Due Gov't, \$ *100* for

Valuation of horse, \$ *100*

Valuation of horse equipments, \$ *100*

Remarks: *Due that amt. of M. S. Security to men enlisting under call of July 18, 1864.*

Book mark:

M. O. Gilliat

77

5 Col'd Cav.

Mass.

George Michael

Put, Co. A, 5 Reg't Mass. Col'd Cavalry.

Appears on

Company Muster Roll

for May & June, 1865.

Present or absent Present

Stoppage, \$ 100 for

Due Gov't, \$ 100 for

Valuation of horse, \$ 100

Valuation of horse equipments, \$ 100

Remarks: Due that must
County to receive listing
Call July 18, 1865

Book mark:

(358)

Callade

Copyist.

77 | **5 Col'd Cav.** | **Mass.**

George Michael
Plut, Co. A, 5 Reg't Mass. Col'd Cavalry.

Appears on

Company Muster Roll

for July & Aug, 1865.

Present or absent absent

Stoppage, \$ 100 for

Due Gov't, \$ 100 for

Valuation of horse, \$ 100

Valuation of horse equipments, \$ 100

Remarks: Absent sick at Brazos
Due that amt of bounty to men
enlisting und. call July 18, 64

Book mark: 77 5 Col'd Cav. 11

W. A. Caldwell

M. | 5 Col'd Cav. | Mass.

Geo. Michael

Priv., Co. A, 5 Reg't Mass. Colored Cav.

Appears on Returns as follows:

July to Sept. 1865. Absent sick
in Hosp. at Brazos San-
tiago July 8/65.

Book mark :

(646)

J. B. Sittler

Copyist.

M | 5 Col'd Cav. | Mass.

George Michael
Put, Co. A, 5 Reg't Mass. Col'd Cavalry.

Appears on Co. Muster-out Roll, dated
Clarendon, Texas, Oct 31, 1865.

Muster-out to date Oct 31, 1865.

Last paid to Dec 31, 1864.

Clothing account:

Last settled....., 186 ; drawn since \$..... 100

Due soldier \$ 14⁰² 100; due U. S. \$..... 100

Am't for cloth'g in kind or money adv'd \$..... 100

Due U. S. for arms, equipments, &c., \$ 11 100

Bounty paid \$..... 100; due \$ 100 100

Remarks: Free after 19, 1861

Book mark: Dislist on file. See Miss Box

Ballade

Michael George

....., Co., Reg't

2 Enclosures.

Bed Cards	Final Statements
Burial Records	Furloughs or L. of A.
Certs. of Dis. for Discharge	Med. Certificates
C. M. Charges	Med. Des. Lists
Descriptive Lists	Orders
Discharge Certificates	Pris. of War Record
Enlistment Papers <i>2</i>	Resignations

Other papers relating to—

Admission to Hosp'l	Furlough or L. of A.
Casualty Sheet	Med. Examination
Confinement	Misc. Information
Contracts	Pay or Clothing
Death or Effects	Personal Reports
Desertion	Rank
Discharge from Hosp'l	Transfer to Hosp'l
Discharge from Service	Transfer to V. R. C.
Duty	Transportation

11361

VOLUNTEER ENLISTMENT.

STATE OF

TOWN OF

Massachusetts



Athol 9 Dist.

I, *George Michael*, born in *St John*
in the State of *New Brunswick*, aged *Thirty Seven* years,
and by occupation a *Sailor*, Do HEREBY ACKNOWLEDGE to have
volunteered this *Twenty Ninth* day of *August*, 1864,
to serve as a ~~soldier~~ *soldier* in the Army of the United States of America, for
the period of ~~THREE YEARS~~, unless sooner discharged by proper authority:
Do also agree to accept such bounty, pay, rations, and clothing, as are, or may be,
established by law for volunteers. And I, *George Michael*, do
solemnly swear, that I will bear true faith and allegiance to the **United States
of America**, and that I will serve them honestly and faithfully against all
their enemies or opposers whomsoever; and that I will observe and obey the
orders of the President of the United States, and the orders of the officers
appointed over me, according to the Rules and Articles of War.

Sworn and subscribed to, at *Boston*
this *Twenty Ninth* day of *August*, 1864
BEFORE *Wm. M. Allen*

George Michael

Wm. M. Allen
I CERTIFY, ON HONOR, That I have carefully examined the above-named Volunteer, agreeably
to the General Regulations of the Army, and that, in my opinion, he is free from all bodily defects and
mental infirmity, which would in any way disqualify him from performing the duties of a soldier.

J. S. Crawford
EXAMINING SURGEON.

I CERTIFY, ON HONOR, That I have minutely inspected the Volunteer *George Michael*
previously to his enlistment, and that he was entirely sober when enlisted; that, to the best of my
judgment and belief, he is of lawful age; and that, in accepting him as duly qualified to perform the
duties of an able-bodied soldier, I have strictly observed the Regulations which govern the recruiting
service. This soldier has *dark* eyes, *black* hair, *clear* complexion, is *five*
feet *7* inches high.

W. M. Allen
Regiment of *Mass* Volunteers,
RECRUITING OFFICER.

(A. G. O. No. 74 & 76.)

11361

*Mustered into the service of the United States, for ~~three~~ ^{four} years or during the war, from date of enlistment, in Company *B* of *Mass* Regiment of *Mass* Volunteers, on the *29* day of *August*, 1864, at *Boston**

Wm. M. Allen

NOTE 1.—This blank will be used for both enlistments and re-enlistments—enlistment of veterans. &c., &c., in the volunteer service. They will be made out in duplicate in all cases—one to accompany the recruiting return of the superintendent (not the recruiting officer) to the Adjutant General, and one to accompany the accounts of the officer who pays bounty, &c. The Regiment and Company in which the soldier last served should be given on the back.

NOTE 2.—An enlistment holds to service. A muster-in must, in all cases, precede payment of pay, bounty, pension, &c. A muster-in roll must, in all cases, be filed in the Adjutant General's Office as evidence of muster-in. The mustering officer, commissary, or assistant commissary of musters, as the case may be, will countersign both enlistments as having mustered the soldier into the service of the United States before either of them is given to the disbursing officer.

DECLARATION OF RECRUIT.

I, George Michael, desiring to VOLUNTEER as a Soldier in the Army of the United States, for the term of THREE YEARS, Do Declare, That I am Thirty Four years and _____ months of age; that I have never been discharged from the United States service on account of disability or by sentence of a court martial, or by order before the expiration of a term of enlistment; and I know of no impediment to my serving honestly and faithfully as a soldier for three years.

GIVEN at Boston the 29 day of August

Witness:

James Callaway

George Michael
mark

No. _____

George Michael
Volunteered at Waltham

Aug 29, 1864

By Callaway
Regiment of Mass Cavalry

enlistment, last served in Company ()

Reg't of _____

Discharged _____, 18 _____

CONSENT IN CASE OF MINOR.

I, _____, Do CERTIFY, That I am _____ the _____ of _____; that the said _____ is _____ years of age; and I do hereby freely give my CONSENT to his volunteering as a SOLDIER in the ARMY OF THE UNITED STATES for the period of THREE YEARS.

GIVEN at _____ the _____ day of _____

Witness:

VOLUNTEER ENLISTMENT.

214

STATE OF

TOWN OF

Massachusetts

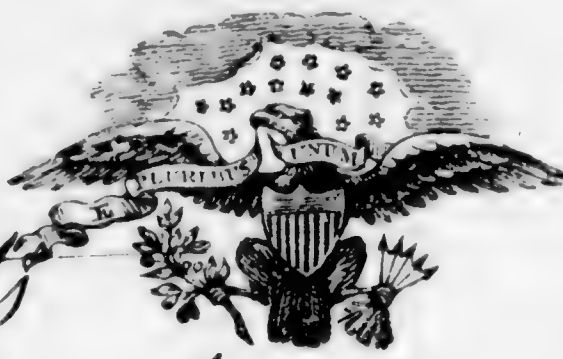

Attol 9 Dist.

I, George Michael, born in St Johns in the State of New Brunswick, aged thirty five years, and by occupation a Sailor, Do HEREBY ACKNOWLEDGE to have volunteered this twenty ninth day of August, 1864, to serve as a Soldier in the Army of the United States of America, for the period of THREE YEARS, unless sooner discharged by proper authority: Do also agree to accept such bounty, pay, rations, and clothing, as are, or may be, established by law for volunteers. And I, George Michael, do solemnly swear, that I will bear true faith and allegiance to the United States of America, and that I will serve them honestly and faithfully against all their enemies or opposers whomsoever; and that I will observe and obey the orders of the President of the United States, and the orders of the officers appointed over me, according to the Rules and Articles of War.

Sworn and subscribed to, at Washon this twenty ninth day of August, 1864, BEFORE W. P. McArthur

George Michael
his mark
James Callaway
Witness

I CERTIFY, ON HONOR, That I have carefully examined the above-named Volunteer, agreeably to the General Regulations of the Army, and that, in my opinion, he is free from all bodily defects and mental infirmity, which would in any way disqualify him from performing the duties of a soldier.

W. P. McArthur
Ma.

EXAMINING SURGEON.

I CERTIFY, ON HONOR, That I have minutely inspected the Volunteer George Michael previously to his enlistment, and that he was entirely sober when enlisted; that, to the best of my judgment and belief, he is of lawful age; and that, in accepting him as duly qualified to perform the duties of an able-bodied soldier, I have strictly observed the Regulations which govern the recruiting service. This soldier has dark eyes, black hair, colored complexion, is five feet seven inches high.

W. P. McArthur
Regiment of Mass Volunteers,

RECRUITING OFFICER.

(A. G. O. No. 74 & 75.)

Registered into the service of the United States, for three years or during the war, from date of enlistment, in Company B of 9th Regiment of Mass Volunteers, on the 29 day of August, 1864, at Washon Ma.

W. P. McArthur
11/11/64

904
Michael, William

Co G, 5 Mass. Cav. (Col'd.)

Private Sergeant

CARD NUMBERS.

1	5-3 8 8 5-4 3	26
2	5-3 8 8 5-7 5-	27
3	5-3 8 8 6 6 1	28
4	5-3 8 8 7 4 2	29
5	5-3 8 8 8 4 5-	30
6	5-3 8 8 9 4 4	31
7	5-3 8 10 4 5	32
8	5-3 8 11 4 7	33
9	5-3 8 12 4 9	34
10	5-3 8 13 4 9	35
11	5-3 8 14 4 7	36
12	9 0 9 1 9 5 7	37
13		38
14		39
15		40
16		41
17		42
18		43
19		44
20		45
21		46
22		47
23		48
24		49
25		50

Book Mark:

See also

51155056 P.O. M. M.

51150748 P.O. aff

51150689 P.O. aff

A2296907 P. aff

Alf Mauer
4

M | **5 Cav. (Col'd.)** | **Mass.**

William Michael

....., Co. *G*, 5 Reg't Mass. Cav. (Col'd.)

Appears on

Company Descriptive Book
of the organization named above.

DESCRIPTION.

Age *25* years; height *5* feet *8* inches.

Complexion *Blk*

Eyes *Blk*; hair *Blk*

Where born *Lennox Mass.*

Occupation *Gardner.*

ENLISTMENT.

When *Feb 20*, 1864.

Where *Linsdale*

By whom *W. J. Carson*; term *3* y'rs.

Remarks: *Married.*

Hearst

W | **5 Col'd Cav.** | **Mass.**

William Nichols

Sgt, Co. *4*, 5 Reg't Mass. Col'd Cav.

Appears on

Company Muster-in and Descriptive Roll
of the organization named above. Roll dated

Roadville Mass, *Mar 4*, 1864.

Where born *Troy Mass*

Age *35* y'rs; occupation *Gardener*

When enlisted *Feb 20*, 1864.

Where enlisted *Hinesdale*

For what period enlisted *3* years.

Eyes *Blk*; hair *Blk*

Complexion *Blk*; height *5 ft. 8 in.*

When mustered in *Mar 4*, 1864.

Where mustered in *Roadville Mass*

Bounty paid \$ *100*; due \$ *100*

Where credited *10 Dist Berkshire*

Company to which assigned _____

Remarks: _____

Book mark: _____

Leves

(356d)

Copyist.

W | **5 Col'd Cav.** | **Mass.**

William Michaels
Serg't, Co. G, 5 Reg't Mass. Col'd Cavalry.

Appears on

Company Muster Roll

for *Mar 4 to Apr 30*, 186*4*.

Present or absent *Present*

Stoppage, \$ *100* for

Due Gov't, \$ *100* for

Valuation of horse, \$ *100*

Valuation of horse equipments, \$ *100*

Remarks: *Appointed Serg't
by Special Regt. order No
477 dated April 28/64
upset to date from March
1864.*

Book mark: _____

Lager

M

5 Col'd Cav.

Mass.

William Michaels

Sergt, Co. G, 5 Reg't Mass. Col'd Cavalry.

Appears on

Company Muster Roll

for *May & June*, 1864.

Present or absent *Present*

Stoppage, \$ *100* for

Due Gov't, \$ *100* for

Valuation of horse, \$ *100*

Valuation of horse equipments, \$ *100*

Remarks: *Appointed Sergt
by Special Regt Order No
47 dated April 28/64
Supt to date from Mar
14/64.*

Book mark:

Lager

711 | **5 Col'd Cav.** | **Mass.**

William Michael
Sergt, Co. G, 5 Reg't Mass. Col'd Cavalry.

Appears on

Company Muster Roll

for July & Aug, 1864.

Present or absent Present

Stoppage, \$ 100 for

Due Gov't, \$ 100 for

Valuation of horse, \$ 100

Valuation of horse equipments, \$ 100

Remarks: App't Sergt by Spe
cial Reg't order no 97
date d Apr 28/64 app't
to date from Mar 4/64
Hope one Contem

Book mark: _____

L. J. J. J.
(358) L. J. J. J. Copyist.

M | 5 Col'd Cav. | Mass.

William Michall

Sgt, Co. G, 5 Reg't Mass. Col'd Cavalry.

Appears on

Company Muster Roll

for Sept. & Oct., 1864.

Present or absent Present

Stoppage, \$ 100 for

Due Gov't, \$ 100 for

Valuation of horse, \$ 100

Valuation of horse equipments, \$ 100

Remarks:

Book mark:

Perry

M. | 5 Col'd Cav. | Mass.

William Michaels
Sgt., Co. G, 5 Reg't Mass. Col'd Cavalry.

Appears on

Company Muster Roll

for Nov. & Dec, 1864

Present or absent Present

Stoppage, \$ 100 for

Due Gov't, \$ 100 for

Valuation of horse, \$ 100

Valuation of horse equipments, \$ 100

Remarks: Due U. S. for
transportation from
Wash to Pittsfield Mass
& Return 16.28.

Book mark:

Perry

(358)

Copyist.

M. | 5 Col'd Cav. | Mass.

Wm Michael
Sgt., Co. G, 5 Reg't Mass. Col'd Cavalry.

Appears on

Company Muster Roll

for Jan. Feb., 1863.

Present or absent Present

Stoppage, \$ 100 for

Due Gov't, \$ 100 for

Valuation of horse, \$ 100

Valuation of horse equipments, \$ 100

Remarks: Due 1st, 2, 3, & 4th
instalments U.S. Bounty
\$180, Due U.S. for
transportation \$16.98
Charged on Nov & Dec.
Rolls. Due U.S. for 1
Gun sling 31 cts.

Book mark:

(358)

Perry

Copyist.

M

5 Col'd Cav.

Mass.

Wm Michaels

Sgt., Co. G, 5 Reg't Mass. Col'd Cavalry.

Appears on

Company Muster Roll

for Mch. & Apl., 1860.

Present or absent Present

Stoppage, \$ 100 for

Due Gov't, \$ 100 for

Valuation of horse, \$ 100

Valuation of horse equipments, \$ 100

Remarks: Due U.S. for ord.
nance 31st charged on
Jan. & Feb. Rolls.

Due the soldier for
rental ments U.S.
(Bounty \$180.

Book mark:

Perry

(358)

Copyist.

M. | 5 Col'd Cav. | Mass.

William Michaels

....., Co. G, 5 Reg't Mass. Col'd Cavalry.

Appears on

Company Muster Roll

for *May & June*, 1865.

Present or absent *Present*

Stoppage, \$ 100 for

Due Gov't, \$ 100 for

Valuation of horse, \$ 100

Valuation of horse equipments, \$ 100

Remarks: *Due U. S. for
ordnance lost 31st
charged on Jan. & Feb.
Rolls.*

Book mark:

Perry

(358)

Copyist.

L.H. | **5 Col'd Cav.** | **Mass.**

William Michaels
Sgt, Co. G, 5 Reg't Mass. Col'd Cavalry.

Appears on

Company Muster Roll

for *July & Aug*, 186*5*.

Present or absent *Present*

Stoppage, \$ *100* for

Due Gov't, \$ *100* for

Valuation of horse, \$ *100*

Valuation of horse equipments, \$ *100*

Remarks: *Due U.S. for*
Ordinance book
31 cents

Book mark: _____

W. H. Scott

(358)

Copyist.

M | **5 Col'd Cav.** | **Mass.**

William Michael
Sgt, Co. *G*, 5 Reg't Mass. Col'd Cavalry.

Appears on **Co. Muster-out Roll**, dated
Clarksville, Oct 31, 186*5*.

Muster-out to date *Oct 31*, 186*5*.

Last paid to *Dec 31*, 186*4*.

Clothing account:

Last settled....., 186 ; drawn since \$..... 100

Due soldier \$ *10* ^{*25*} ₁₀₀; due U. S. \$..... 100

Am't for cloth'g in kind or money adv'd \$..... 100

Due U. S. for arms, equipments, &c., \$ *231* ₁₀₀

Bounty paid \$..... 100; due \$ *300* 100

Remarks:

Book mark:

W. H. Scott
(361) Copyist.

985
Mickey, Ralph

Co I, 5 Mass. Cav. (Col'd.)

Private Sergeant

CARD NUMBERS.

1	5372299	26
2	5372219	27
3	5383007	28
4	5383030	29
5	5383122	30
6	5383222	31
7	5383225	32
8	5383400	33
9	5383531	34
10	5383628	35
11	9091768	36
12	34505739	37
12	40731385	38
14		39
15		40
16		41
17		42
18		43
19		44
20		45
21		46
22		47
23		48
24		49
25		50

Book Mark:

See also

D. 2686905 - And. N, 10

april
7

Me. | **5 Cav. (Col'd.)** | **Mass.**

Ralph Mickey,

....., Co. *I*, 5 Reg't Mass. Cav. (Col'd.)

Appears on

Company Descriptive Book

of the organization named above.

DESCRIPTION.

Age *24* years; height *5* feet *10* inches.

Complexion *Blk.*

Eyes *Blk.*; hair *Blk.*

Where born *Louisiana Va.*

Occupation *Laborer.*

ENLISTMENT.

When *July 1st*, 1864.

Where *Templeton.*

By whom *Capt. Phalen*; term *3* y'rs.

Remarks: *Murdered July 1st 64. Capt. Goodhue, Boston.*

H. C. Thomas,

(383g)

Copyst.

Mo. | 5 Cav. | Mass.

Ralph Mickey

Appears with rank of _____ on _____

Muster and Descriptive Roll

of a detachment of U. S. Volunteers forwarded from Faneuil Hall, Boston, to Galloup's Island, Boston Harbor, for various regiments Massachusetts Volunteers. Roll dated

Boston. Mass. July 1, 1864.

Where born *Louisa Co. Virginia*

Age *24* years; occupation *Laborer.*

When enlisted *July 1, 1864.*

Where enlisted *Templeton*

For what period enlisted *3* years.

Eyes *Blk.*; hair *Blk.*

Complexion *Cal'd*; height *5 ft. 10 in.*

When mustered in *July 1, 1864.*

Where mustered in *Boston*

Bounty paid \$ *100*; due \$ *100*

Clothing account:

Last settled _____, 186 _____; drawn since \$ *100*

Date of first muster _____, 186 _____

Regiment to which assigned *5 Cav.*

Remarks: *Templeton. Worcester Co. 9 Dist.*

Book mark: _____

Park

(358m)

Copyist

M | 5 Col'd Cav. | Mass.

Ralph Mickey

Appears with rank of Pri on

Muster and Descriptive Roll of a Detachment of U. S. Vols. forwarded

for the 5 Reg't Mass. Col'd Cavalry. Roll dated

Galloup's 5th Mass July 12, 1864.

Where born Lerisa Co Va

Age 24 y'rs; occupation Labourer

When enlisted July 1, 1864.

Where enlisted Templeton Mass

For what period enlisted 3 years.

Eyes Black; hair Black

Complexion Colored; height 5 ft. 10 in.

When mustered in July 1, 1864.

Where mustered in Boston Mass

~~Bounty~~ Premium paid \$ 2 100; due \$ 100

Where credited 9 Coy Dist. Templeton

Lowester Co
Company to which assigned

Remarks : _____

Book mark : _____

Donnelly

M | 5 Col'd Cav. | Mass.

Ralph Mickey
Pri

Appears with rank of on

Muster and Descriptive Roll of a Detachment of U. S. Vols. forwarded

for the 5 Reg't Mass. Col'd Cavalry. Roll dated

Boston Mass July 1-28, 1864

Where born Louisa Va

Age 24 y'rs; occupation Laborer

When enlisted July 1, 1864

Where enlisted Templeton

For what period enlisted 3 years.

Eyes Black; hair Black

Complexion Colored; height 5 ft. 10 in.

When mustered in July 1, 1864

Where mustered in Boston

Bounty paid \$ 100; due \$ 100

Where credited 9 Dist. Templeton

Worcester Co
Company to which assigned

Remarks: Premium \$ 2

Book mark :

Dorrelly

M | **5 Col'd Cav.** | **Mass.**

Ralph Mickey
Prs Co. I, 5 Reg't Mass. Colored Cavalry.

Appears on

Company Muster Roll

for *July range*, 186*4*

Present or absent *Present*

Stoppage, \$.....*100* for

Due Gov't, \$.....*100* for

Valuation of horse, \$.....*100*

Valuation of horse equipments, \$.....*100*

Remarks: *Recruit from depot
joined Co. at Pt. Lookout
Md. July 17th/64. Enlistment
papers not Recd.*

Book mark:

W. H. Thompson
Copyist.

M | **5 Col'd Cav.** | **Mass.**

Ralph Mickey
.....
Capt., Co. I, 5 Reg't Mass. Colored Cavalry.
Appears on

Company Muster Roll

for *Sept. & Oct.*, 1864.

Present or absent *Present.*

Stoppage, \$ *100* for

Due Gov't, \$ *100* for

Valuation of horse, \$ *100*

Valuation of horse equipments, \$ *100*

Remarks: *Prom. Capt. Sept. 26*
by Sp. Cr. 156 Hd. 2 rs.
5th Mass. Cav. Sept. 27/64

Book mark:

(358)

C. F. Thompson
Copyist.

M | **5 Col'd Cav.** | **Mass.**

Ralph Mickey,
Sergeant, Co. I, 5 Reg't Mass. Colored Cavalry.
Appears on

Company Muster Roll

for *Nov. & Dec.*, 1864.

Present or absent *Present.*

Stoppage, \$ *100* for

Due Gov't, \$ *100* for

Valuation of horse, \$ *100*

Valuation of horse equipments, \$ *100*

Remarks: *Promoted Sergeant,*
Nov. 1" by S.O., 189 189,
2nd, 5" Mass. Cav. Nov. 1"
from Corp. rec'd \$10.00
ad. pay.

Book mark: _____

(358)

C. F. Thompson
Copyist.

In | **5 Col'd Cav.** | **Mass.**

Ralph Mickey,
Sergt, Co. I, 5 Reg't Mass. Colored Cavalry.

Appears on

Company Muster Roll

for Jan. & Feb., 1865.

Present or absent Present.

Stoppage, \$ 100 for

Due Gov't, \$ 100 for

Valuation of horse, \$ 100

Valuation of horse equipments, \$ 100

Remarks: Due 1st installment
\$25.⁰⁰ Promoted Sergt.
from Corp., nos. 1st by
S. O. 189 Hd. Qrs. 5th Mass.
Cad. Rec'd \$10.⁰⁰ advance
pay.

Book mark: _____

C. F. Thompson,
Copyist.

M | **5 Col'd Cav.** | **Mass.**

Ralph Miskey
Sgt., Co. I, 5 Reg't Mass. Colored Cavalry.

Appears on

Company Muster Roll

for Mch. & Apr., 1865.

Present or absent Present,

Stoppage, \$ 100 for

Due Gov't, \$ 100 for

Valuation of horse, \$ 100

Valuation of horse equipments, \$ 100

Remarks: Due 1st installment
U. S. Bounty \$25.00

Book mark: _____

(358)

C. F. Thompson,
Copyist.

M | **5 Col'd Cav.** | **Mass.**

Ralph Micky
D. Supt., Co. I, 5 Reg't Mass. Colored Cavalry.

Appears on

Company Muster Roll

for *May & June*, 1865.

Present or absent *Present*

Stoppage, \$ *100* for

Due Gov't, \$ *100* for

Valuation of horse, \$ *100*

Valuation of horse equipments, \$ *100*

Remarks: *Due 1st installment*
U.S. Bounty 25.00

Book mark: _____

(358)

C. F. Thompson
Copyist.

M | 5 Col'd Cav. | Mass.

Ralph Mickey

Sgt, Co. I, 5 Reg't Mass. Colored Cavalry.

Appears on

Company Muster Roll

for July & Aug, 1865

Present or absent Present

Stoppage, \$ 100 for

Due Gov't, \$ 100 for

Valuation of horse, \$ 100

Valuation of horse equipments, \$ 100

Remarks:

Book mark:

Felton

Copyist.

(358)

M. | 5 Col'd Cav. | Mass.

R. Mickey
Pvt., Co. D, 5 Reg't Mass. Colored Cav.

Appears on Returns as follows:

July 1864. Gain - Recruit
Pt. Lookout, Md.
Joined Co. July 16/64.

Book mark :

(646)

J. B. Sittler

Copyist.

M | 5 Col'd Cav. | Mass.

Ralph Mickey

Sept, Co. I, 5 Reg't Mass. Col'd Cavalry.

Appears on Co. Muster-out Roll, dated
Blountsville Texas, Oct 31, 1865.

Muster-out to date Oct 31, 1865.

Last paid to Dec 31, 1864.

Clothing account:

Last settled....., 186 ; drawn since \$ 100

Due soldier \$ 100; due U. S. \$ 6 $\frac{2}{100}$

Am't for cloth'g in kind or money adv'd \$ 100

Due U. S. for arms, equipments, &c., \$ 19 $\frac{100}{100}$

Bounty paid \$ 100; due \$ 100

Remarks: Mustered out by S. O. No 29 Hd. Qrs.
Dept. of Texas dated Galveston Texas Sept 16/65
(based on authority from War Dept. dated Sept 8/65
directing the muster out of colored troops
organized in Northern States & their services (over))

Book mark: 32.5 P. M. G. April 19, 1866

(361)

Stalman
Copyist.

JAN. 10

5383628

1891 *

Being no longer required. Transport.
and subsistence furnished to
Boston Mass. Muster out to
date Oct 31/65x

Mickey, Ralph

Pr., Co., 5 Reg't Mass C. Cav.

7 Enclosures.

Bed Cards	Final Statements
Burial Records	Furloughs or L. of A.
Certs. of Dis. for Discharge	Med. Certificates
C. M. Charges	Med. Des. Lists
Descriptive Lists	Orders
Discharge Certificates	Pris. of War Record
Enlistment Papers	Resignations

Other papers relating to—

Admission to Hosp'l	Furlough or L. of A.
Casualty Sheet	Med. Examination
Confinement	Misc. Information
Contracts	Pay or Clothing
Death or Effects	Personal Reports
Desertion	Rank
Discharge from Hosp'l	Transfer to Hosp'l
Discharge from Service	Transfer to V. R. C.
Duty	Transportation

NOTE 1.—This blank will be used for both enlistments and re-enlistments—enlistment of veterans, &c., &c., in the volunteer service. They will be made out in duplicate in all cases—one to accompany the recruiting return of the superintendent (not the recruiting officer) to the Adjutant-General, and one to accompany the accounts of the officer who pays bounty, &c. The Regiment and Company in which the soldier last served should be given on the back.

NOTE 2.—An enlistment holds to service. A muster-in must, in all cases, precede payment of pay, bounty, pension, &c. A muster-in roll must, in all cases, be filed in the Adjutant-General's Office as evidence of muster-in. The mustering officer, commissary, or assistant-commissary of musters, as the case may be, will countersign both enlistments as having mustered the soldier into the service of the United States before either of them is given to the disbursing officer.

DECLARATION OF RECRUIT.

I, *Ralph Miskey* desiring to VOLUNTEER as a Soldier in the Army of the United States, for the term of THREE YEARS, Do Declare, That I (am *Twenty four* years and _____ months of age; that I have never been discharged from the United States service on account of disability or by sentence of a court-martial, or by order before the expiration of a term of enlistment; and I know of no impediment to my serving honestly and faithfully as a soldier for three years.

GIVEN at

the _____ day of _____

Witness:

Boston
July 16-1
J. O. Carruthers *Ralph Miskey*
man

No.

117

Volunteered at

Fempster

Ralph Miskey

By

July 1 1864
Regiment of Irons

enlistment; last served in Company ()

5th Regt of Mass, Cavalry

Discharged

18

CONSENT IN CASE OF MINOR.

I, _____ Do CERTIFY, That I am
the _____ of _____ ; that the
said _____ is _____ years of age; and I
do hereby freely give my CONSENT to his volunteering as a SOLDIER in the ARMY OF THE UNITED STATES,
for the period of THREE YEARS.

GIVEN at

the _____ day of _____

Witness:

Worcester Co. Mass.
VOLUNTEER ENLISTMENT.

STATE OF

Massachusetts

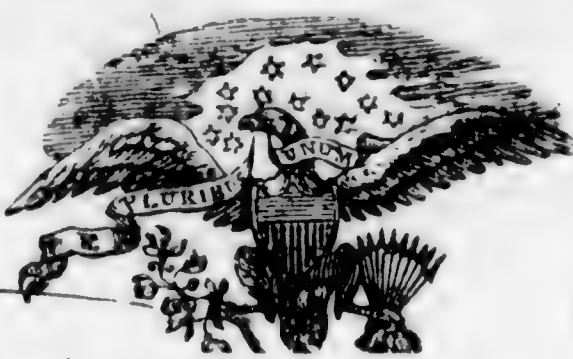

TOWN OF

Templeton

I,

Ralph Micky

born in *Lucia C.*

in the State of *Virginia*

aged *Twenty four* years,

and by occupation a *Laborer*

DO HEREBY ACKNOWLEDGE to have

volunteered this *First* day of *July* 186 *7*

to serve as a **Soldier** in the Army of the United States of America, for the period of **THREE YEARS**, unless sooner discharged by proper authority: Do also agree to accept such bounty, pay, rations, and clothing, as are, or may be, established by law for volunteers. And I, *Ralph Micky* do solemnly swear, that I will bear true faith and allegiance to the **United States of America**, and that I will serve them honestly and faithfully against all their enemies or opposers whomsoever; and that I will observe and obey the orders of the President of the United States, and the orders of the officers appointed over me, according to the Rules and Articles of War.

Sworn and subscribed to, at

this *First* day of *July* 186 *7*

BEFORE

Boston
Q. M. [Signature]

Ralph Micky
man

I CERTIFY, ON HONOR, That I have carefully examined the above-named Volunteer, agreeably to the General Regulations of the Army, and that, in my opinion, he is free from all bodily defects and mental infirmity, which would in any way disqualify him from performing the duties of a soldier.

J. P. Norton
Wm.

EXAMINING SURGEON.

I CERTIFY, ON HONOR, That I have minutely inspected the Volunteer, previously to his enlistment, and that he was entirely sober when enlisted; that, to the best of my judgment and belief, he is of lawful age; and that, in accepting him as duly qualified to perform the duties of an able-bodied soldier, I have strictly observed the Regulations which govern the recruiting service.

This soldier has *Dark* eyes, *Dark* hair, *Colorad* complexion, is *Five* feet *10* inches high.

Capt 2d *Regiment of* *Mass.* *Volunteers,*
Q. M. [Signature]
 RECRUITING OFFICER.

Mustered into the service of the United States, in Company
 the *10th* day of *July*, 186 *7*, at *Boston Mass*
2nd Regiment of *Mass.* *Sanitary* Volunteers, on
Warrior

NOTE 1.—This blank will be used for both enlistments and re-enlistments—enlistment of veterans, &c., &c., in the volunteer service. They will be made out in duplicate in all cases—one to accompany the recruiting return of the superintendent (not the recruiting officer) to the Adjutant-General, and one to accompany the accounts of the officer who pays bounty, &c. The Regiment and Company in which the soldier last served should be given on the back.

NOTE 2.—An enlistment holds to service. A muster-in must, in all cases, precede payment of pay, bounty, pension, &c. A muster-in roll must, in all cases, be filed in the Adjutant-General's Office as evidence of muster-in. The mustering officer, commissary, or assistant-commissary of musters, as the case may be, will countersign both enlistments as having mustered the soldier into the service of the United States before either of them is given to the disbursing officer.

DECLARATION OF RECRUIT.

Ralph Mickey desiring to VOLUNTEER as a Soldier in the Army of the United States, for the term of THREE YEARS, Do Declare, That I am *Twentyfour* years and _____ months of age; that I have never been discharged from the United States service on account of disability or by sentence of a court-martial, or by order before the expiration of a term of enlistment; and I know of no impediment to my serving honestly and faithfully as a soldier for three years.

GIVEN at *Boston* the *1st* day of *July*, 186*4*.

Witness: *J. P. Carruthers* *Ralph Mickey*

5 New Year

By *Ralph Mickey*
Volunteered at *Temple Bar*
July 1 186*4*
Regiment of New Cad

Discharged _____ 18____
24th Mass Bn
18th Mass Bn
enlistment; last served in Company ()
Reg't of _____

CONSENT IN CASE OF MINOR.

I, _____ Do CERTIFY, That I am _____ the _____ of _____; that the said _____ is _____ years of age; and I do hereby freely give my CONSENT to his volunteering as a SOLDIER in the ARMY OF THE UNITED STATES, for the period of THREE YEARS.

GIVEN at _____ the _____ day of _____

Witness: _____

Nonesti Co 9 Dist
VOLUNTEER ENLISTMENT.

STATE OF

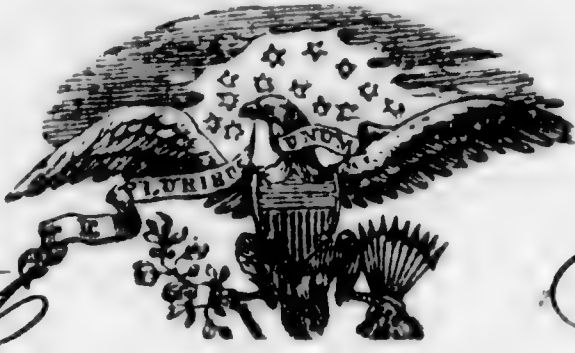

TOWN OF

Massachusetts

Templeton

I, *Ralph Mickey* born in *Lousia Co*
 in the State of *Virginia* aged *Twenty four* years,
 and by occupation a *Labourer* DO HEREBY ACKNOWLEDGE to have
 volunteered this *First* day of *July* 1867,

to serve as a **Soldier** in the Army of the United States of America, for the
 period of **THREE YEARS**, unless sooner discharged by proper authority: Do also
 agree to accept such bounty, pay, rations, and clothing, as are, or may be, estab-
 lished by law for volunteers. And *Ralph Mickey* do
 solemnly swear, that I will bear true faith and allegiance to the **United States**
of America, and that I will serve them honestly and faithfully against all their
 enemies or opposers whomsoever; and that I will observe and obey the orders of
 the President of the United States, and the orders of the officers appointed over
 me, according to the Rules and Articles of War.

Sworn and subscribed to, at *Diston*
 this *First* day of *July* 1867
 BEFORE *J. M. [unclear]*

Ralph Mickey
man

I CERTIFY, ON HONOR, That I have carefully examined the above-named Volunteer, agreeably
 to the General Regulations of the Army, and that, in my opinion, he is free from all bodily defects and
 mental infirmity, which would in any way disqualify him from performing the duties of a soldier.

J. D. Hallow
man

EXAMINING SURGEON.

I CERTIFY, ON HONOR, That I have minutely inspected the Volunteer,
 previously to his enlistment, and that he was entirely sober when enlisted; that, to the best of my
 judgment and belief, he is of lawful age; and that, in accepting him as duly qualified to perform the duties
 of an able-bodied soldier, I have strictly observed the Regulations which govern the recruiting service.

This soldier has *Dark* eyes, *Black* hair, *Color* complexion, is *Five* feet
10 inches high.

Capt L. A. [unclear]
 Regiment of *Mass.* Volunteers,
 RECRUITING OFFICER.

the *1st* day of *July*, 1867, at *Proctor's Store*

Mustered into the service of the United States, in Company

Regiment of *Mass Battery* Volunteers, on

[Handwritten signatures and notes on the right side of the page]

40

Middleton, George

Col., 5 Mass. Cav., (Col'd.)

Private

Private

CARD NUMBERS.

1	5375734	26
2	5375822	27
3	5375900	28
4	5376000	29
5	5376109	30
6	5376208	31
7	5376319	32
8	5376423	33
9	5376528	34
10	5376626	35
11	5376720	36
12	5376813	37
12	5372894	38
14	9092431	39
15	m-19-05-1871	40
16	30852815	41
17	30854240	42
18	33031339	43
19	40731386	44
20		45
21		46
22		47
23		48
24		49
25		50

Book Mark No-19-Vol-9-65-1871 + 243-65-79
L.B.-12-428.

See also

S. 1365-755-Pr. water
S 1498964 POAH.
RHP733555

S 2273116 And W D
S- 2274533- And W D

R. Walker
et

M | **5 Cav. (Col'd.)** | **Mass.**

George Middleton

....., Co. *C*....., 5 Reg't Mass. Cav. (Col'd.)

Appears on

Company Descriptive Book
of the organization named above.

DESCRIPTION.

Age *21* years; height *5* feet *4* inches.

Complexion *Black*

Eyes *Black* ; hair *Black*

Where born *Somersville, N.Y.*

Occupation *Bookster*

ENLISTMENT.

When *Jan 7* , 186*4*.

Where *Uxbridge*

By whom *M. B. Bates* ; term *3* y'rs.

Remarks: *Mustered into company C
Jan 29 1864 at Andover Mass
by Lieut Mc-Kibbin*

W. | **5 Col'd Cav.** | **Mass.**

George Middleton.
Priv., Co. C, 5 Reg't Mass. Col'd Cav.

Appears on

Company Muster-in and Descriptive Roll
of the organization named above. Roll dated

Readville Jan. 29, 1864.

Where born Farmersville, N.Y.

Age 21 y'rs; occupation Hostler

When enlisted Jan. 8, 1864.

Where enlisted Mansfield

For what period enlisted 3 years.

Eyes Black; hair Black

Complexion Black; height 5 ft. 4 in.

When mustered in Jan. 29, 1864.

Where mustered in Readville, Mass.

Bounty paid \$ 100; due \$ 100

Where credited 2^d Dist. Bristol.

Company to which assigned _____

Remarks : _____

Book mark : _____

Sitter.

M. | 5 Col'd Cav. | Mass.

George Middleton
Priv., Co. C, 5 Reg't Mass. Col'd Cavalry.

Appears on

Company Muster Roll

for Enlistment to Feb. 29, 1864.

Present or absent. Present.

Stoppage, \$ 100 for

Due Gov't, \$ 100 for

Valuation of horse, \$ 100

Valuation of horse equipments, \$ 100

Remarks:

Book mark:

Sitter.

M. | **5 Col'd Cav.** | **Mass.**

George Middleton.
Priv., Co. C, 5 Reg't Mass. Col'd Cavalry.

Appears on

Company Muster Roll

for *Mar. & Apr.*, 1864.

Present or absent *Present.*

Stoppage, \$ *100* for

Due Gov't, \$ *100* for

Valuation of horse, \$ *100*

Valuation of horse equipments, \$ *100*

Remarks:

Book mark:

Sitter.

W. | **5** Col'd Cav. | **Mass.**

George Middleboro.

Co. C, Co. C, 5 Reg't Mass. Col'd Cavalry.

Appears on

Company Muster Roll

for *March & June*, 1864.

Present or absent *Present*

Stoppage, \$ *100* for

Due Gov't, \$ *100* for

Valuation of horse, \$ *100*

Valuation of horse equipments, \$ *100*

Remarks:

Book mark:

Sitten.

No. | **5** Col'd Cav. | **Mass.**

George Middleton
Priv, Co. C, 5 Reg't Mass. Col'd Cavalry.

Appears on

Company Muster Roll

for *July & Aug*, 1864.

Present or absent *Present*

Stoppage, \$ *100* for

Due Gov't, \$ *100* for

Valuation of horse, \$ *100*

Valuation of horse equipments, \$ *100*

Remarks:

Book mark:

E. H. Brown

M. | 5 Cav. | U.S.A.

George Middleton
Capt., Co. C, 5 Reg't Mass Cav.

Appears on

Hospital Muster Roll

of Corps d'Afrique U. S. A General Hospital,

at New Orleans, La.,

for July-Aug, 1865.

Attached to hospital:

When _____, 186 .

How employed _____

Last paid by Maj. _____

to _____, 186 .

Bounty paid \$ 100; due \$ 100

Present or absent present

Remarks: _____

Book mark: _____

(843) James _____
Coppist.

M 5 Co (old) Mass.
George Middleton
Priv. Co 5 Reg' Mass Cav

Appears on

Hospital Muster Roll

of Corps d'Afrique U. S. A. General Hospital,

at New Orleans, La.,

for *Sept & Oct*, 1865.

Attached to hospital:

When....., 186 .

How employed.....

Last paid by Maj.

to, 186 .

Bounty paid \$ 100; due \$ 100

Present or absent

Remarks: *Transferred*
Sept 19, 1865.

Book mark: *Steward*

Steward
Cpyist.

(843)

M. | 5 Col'd Cav. | Mass.

George Middleton

Private, Co. C, 5 Reg't Mass. Col'd Cavalry.

Appears on

Company Muster Roll

for *Sept. & Oct.*, 1867.

Present or absent *Present*

Stoppage, \$ *100* for

Due Gov't, \$ *100* for

Valuation of horse, \$ *100*

Valuation of horse equipments, \$ *100*

Remarks: *Free on or before Ad. 19, 61*

Book mark:

E. H. Brown

No | *5th Cav.* | *Mass*

George Middleton
Pvt, Co. *6*, *5* Reg't *Mass Cav*

Appears on

Hospital Muster Roll

of DeCamp U. S. A. General Hospital,

at David's Island, New York Harbor,

for *Sept & Oct*, 1865.

Attached to hospital:

When _____, 186 .

How employed _____

Last paid by Maj. _____

to _____, 186 .

Bounty paid \$ 100 ; due \$ 100

Present or absent _____

Remarks: *Mustered out of*
Service October 24-1865

Book mark: _____

(848)

Rosenbaum
Copyist.

M | **5 Col'd Cav.** | **Mass.**

George Middleton
Pvt, Co. C, 5 Reg't Mass. Col'd Cavalry.

Appears on

Company Muster Roll

for *Nov Dec*, 1864.

Present or absent *Present*

Stoppage, \$ *100* for

Due Gov't, \$ *100* for

Valuation of horse, \$ *100*

Valuation of horse equipments, \$ *100*

Remarks: *Due of for 2 Mjms*
\$2.75
see over before Ad. 9. 61.

Book mark:

E. H. Barron

Mass. | **5 Col'd Cav.** | **Mass.**

George Middleton
Capt., Co. C, 5 Reg't Mass. Col'd Cavalry..

Appears on

Company Muster Roll

for *Jan Feb*, 1865.

Present or absent *Present*

Stoppage, \$ *100* for

Due Gov't, \$ *100* for

Valuation of horse, \$ *100*

Valuation of horse equipments, \$ *100*

Remarks: *Paid at 4 inst of
bounty \$180.*

Book mark:

E H Brown

M | **5 Col'd Cav.** | **Mass.**

George Middleton
Port., Co. C, 5 Reg't Mass. Col'd Cavalry.

Appears on

Company Muster Roll

for *Mar - Apr*, 1865.

Present or absent *Present*

Stoppage, \$ *100* for

Due Gov't, \$ *100* for

Valuation of horse, \$ *100*

Valuation of horse equipments, \$ *100*

Remarks: *Due of the 1st inst - U.S. Bond - \$35.00 - 2 - 3 & 4 inst - U.S. Bond - \$120.00*

Inscribed by Comp.

Book mark:

E. H. Bacon

711 | **5** Col'd Cav. | **Mass.**

George Middleton

Private, Co. C, 5 Reg't Mass. Col'd Cavalry.

Appears on

Company Muster Roll

for May & June, 1865.

Present or absent Present

Stoppage, \$ 100 for

Due Gov't, \$ 100 for

Valuation of horse, \$ 100

Valuation of horse equipments, \$ 100

Remarks: Free before April 19-1861
Due of 1st Dist US Bounty \$35.00
Due 2-3-4 Dist US Bounty \$120.00

Book mark:

Abbott

(358)

Copyist.

M | 5 Col'd Cav. | Mass.

George Middleton

Pvt, Co. C, 5 Reg't Mass. Col'd Cavalry.

Appears on

Company Muster Roll

for July + Aug, 1865.

Present or absent Absent

Stoppage, \$ 1 ⁰⁵/₁₀₀ for Ordnance
for 2 m stores \$6.50

Due Gov't, \$ 100 for

Valuation of horse, \$ 100

Valuation of horse equipments, \$ 100

Remarks: Sick at Brazos Hosp
since July 19 1865
Free before April 19 80

Book mark:

Abbott

M. | 5 Col'd Cav. | Mass.

George Middleton
Pvt., Co. C, 5 Reg't Mass. Colored Cav.

Appears on Returns as follows:

July & Aug. 1865. Absent sick
in Hosp. at Brazos
Texas.

Sept. 1865. Absent sick at
New Orleans.

Book mark :

(548)

J. B. Dittler

Copyist.

M | **5 Col'd Cav.** | **Mass.**

George Middleton
Priv. Co. 5 Reg't Mass. Col'd Cavalry.

Appears on an

Individual Muster-out Roll

of the organization named above. Roll dated

New York City, Oct 23, 1865.

Muster-out to date *Oct 23, 1865.*

Last paid to _____, 186 .

Clothing account:

Last settled _____, 186 ; drawn since \$ _____ 100

Due soldier \$ _____ 100; due U. S. \$ _____ 100

Am't for cloth'g in kind or money adv'd \$ _____ 100

Due U. S. for arms, equipments, &c., \$ _____ 100

Bounty paid \$ _____ 100 due \$ _____ 100

Remarks: *Mustered out under
Gen Order War Dept May
4 1865. To receive
pay from Aug 3/65
and commutation for
transportation to his place*

Book mark: *4 19 Vol 9 C.T. 18-71*

** Corrected by J.H.V. July 15, 1896.*

(348)

A. T. ...
Copyist.

JAN. - 9

5372894

1891

of Enrollment
All other pay and
allowances to be
suspended until
he furnishes proper
evidence for settlement
of the same.

Mustered out on
partial discharge
list from A. S. O.
dated Oct 9 1865.

M | 5 Col'd Cav. | Mass.

George Middleton

Rt, Co. E, 5 Reg't Mass. Col'd Cavalry.

Appears on Co. Muster-out Roll, dated
Clarksville Texas, Oct 31, 1865.

Muster-out to date _____, 186 .

Last paid to _____, 186 .

Clothing account:

Last settled _____, 186 ; drawn since \$ _____ 100

Due soldier \$ _____ ³⁴ 100; due U. S. \$ _____ 100

Am't for cloth'g in kind or money adv'd \$ _____ 100

Due U. S. for arms, equipments, &c., \$ _____ 100

Bounty paid \$ 25 ¹⁰⁰; due \$ 275 ¹⁰⁰

Remarks: Due U.S. for Co. & E \$6.50

Sick in hospital at New Orleans
since July 19 1865

No discharge furnished

Book mark: Res dit on file see Mis Bond
(over)

Abbott

(861)

Copyist.

JAN. - 9

5376813

1891

243. G. J. 79. ago Mustered
out of Service Oct 23, 1865
at New York City under telegraphic
order War Dept dated May
4-65 L B $\frac{12}{428}$

See M 19 Vol 9 G J 1871

Mus Out Roll on file

M 15 (bold) bar 1 Mass
George Middleton
Co. 6, 5 Reg't Mass (bold) la

NOTATION.

L.B. 14/428. 243 - C.T. - 1879. With
Book mark: M - 19 - 6. J. 1871

War Department,

Adjutant General's Office,

Washington, Jan 30, 1879.

Mustered out of Service
Oct 23 1865, at New York
City, under telegraphic order
War Dep. dated May 4/65

(438)

G. C. Barry
Copyist.

Middleton, George
P. Co. 5 Reg't Mass. C.

4 ~~5~~ Enclosures.

Bed Cards	Final Statements
Burial Records	Furloughs or L. of A.
Certs. of Dis. for Discharge	Med. Certificates
C. M. Charges	Med. Des. Lists
Descriptive Lists /	Orders
Discharge Certificates	Pris. of War Record
Enlistment Papers	Resignations

Other papers relating to—

Admission to Hosp'l	Furlough or L. of A.
Casualty Sheet /	Med. Examination
Confinement	Misc. Information /
Contracts	Pay or Clothing
Death or Effects	Personal Reports
Desertion	Rank
Discharge from Hosp'l	Transfer to Hosp'l
Discharge from Service /	Transfer to V. R. C.
Duty	Transportation

Out No. = 1162 (RM)
Priv George Middleton
Co G. 5. Mass Cav

George Middleton
October 1 1865
October 24 1865
N.Y. for Muster out
in this Hospital
Warrenton
Bath, N.Y. Oct 27 1865



War Department,
Adjutant General's Office,

Washington, Oct. 9th 1865

Sir:

In reply to your letter requesting a Descriptive List of George
Widdell a private in Company C 5th
Regiment Mass. Cavalry Volunteers, I have the honor to furnish the
following "Descriptive List," obtained from the records of this Office; which, from the
want of the necessary data, (which is in the possession of the Company Commander,)
is only "partial."

NAME, RANK AND REGIMENT. DESCRIPTION, &c.

George Widdell, a private in Company C
5th Regiment of Mass. Cavalry Volunteers, is 21
years of age; but no further "description" can be obtained from the files of this Office.

He was enrolled on the 5th day of June, 1864,
at the town of Wendell in the State of Maine,
by Wm. H. Kibler, and mustered into the service of the United
States on the 5th day of June, 1864, at the
town of Wendell, in the State of Maine,
by Wm. H. Kibler, to serve for the period of 3 years
or "during the war."

ACCOUNT OF PAY.

It is stated on the Muster Rolls of his Company for the months of
June and July, 1865 that he was last paid by Paymaster
Major Decker to the 31st day of
December, 1864, "Due the soldier \$35.00 1st Installment,
and the 2^d, 3^d, 4th, & 5th of the U.S. Bounty, \$195.00."

ACCOUNT OF CLOTHING.

The files of this Office furnish no account of clothing; it must be obtained, if
obtained at all, from his Company Commander.

REMARKS.

On Muster Roll of his Co. for July August 1865 he is reported:—
"Sick at Hayes Hospital. Free before April 19th 1865.
Dues U.S. for ordnance \$1.05, for S.M. Stores \$6.50."

Very respectfully,

Your obedient servant,

Wm. H. Kibler

Assistant Adjutant General.
(7)

To
Ass't Surg. Warren Webster,
In charge of Camp Gen. Hos.,
David's Point, N. Y. Harbor.

This "Partial Descriptive List" is given in order that the soldier may be discharged at once, without waiting for a descriptive list from his company commander; and, having been used by the proper officer to make out the soldier's final statements, should be endorsed with a statement to that effect by this officer. This endorsement should exhibit a full statement of the time for which the soldier was allowed pay on his final statements, the clothing account, and all other charges against him or in his favor, so as to comprise a complete exhibit of his account. It will then be transmitted to the company commander of the soldier, who will enter all the data necessary to a full understanding of the soldier's account on the muster roll upon which the soldier's discharge is reported. This list will then be destroyed. The object of this is, that the remaining portion of the soldier's account may be settled upon the receipt of these muster rolls, and the soldier receive any pay or allowances that may be due him at the time of his discharge, and which may not appear on his final statements from the fact that this list is incomplete or "partial."

Priv. George Middleton
Co. 6. 5th Mass. Cav.

Office Chief Commissary of Musters,

DEPARTMENT OF THE EAST,

NEW YORK CITY,

1865.

Oct 23

I have to report that

Private
George Middleton
Co C 5th Reg't Mass
Carroll

is this day mustered out of the United States
service, in compliance with telegraphic instructions from War De-
partment of May 3d, 1865.

Very respectfully,

Your obedient servant,

WILSON BARSTOW,

Brevet Major and A. D. C.,
Chief Commissary of Musters.

To the Chief Mustering Officer, State of

Massachusetts

CASUALTY SHEET

No.

Wm. Middleton

..... of Company

..... Regiment of

State Volunteers. *(added)*

NATURE OF CASUALTY.

Wm. Middleton
Capt. 1st Regt.



CASUALTY SHEET.

Name: *Wm. [unclear]*

Rank: *[unclear]* Company: *[unclear]* Regiment: *[unclear]*

Arm: *[unclear]* State: *[unclear]*

Nature of Casualty: *[unclear]*

CAUSE OF CASUALTY—(NAME OF DISEASE, &c.)

BY WHOM DISCHARGED.

FROM WHAT SOURCE THIS INFORMATION WAS OBTAINED.

DEGREE OF DISABILITY.

BY WHOM CERTIFIED.

REMARKS.

DATE OF DISCHARGE, DEATH, &c.

PLACE OF DISCHARGE, DEATH, &c.

Clerk.

[Handwritten initials]

George Middleton
Co. 5th Mass Cav.

Mo. Oct 20 1861
at [unclear]

VOLUNTEER DESCRIPTIVE LIST and Account of Pay and Clothing of

George Middleton Co "C" 5th Mass Cavalry

No.	NAMES.	RANK.	DESCRIPTION.					WHERE BORN.		OCCUPATION.	ENROLLED OR ENLISTED. (For Drafted Men, see note 10.)			MUSTERED IN. (For Drafted Men, see note 10.)				LAST PAID.		BOUNTY.		CLOTHING ACCOUNT.	
			Years of age.	Eyes.	Hair.	Complexion.	HEIGHT. Feet. In.	State or Kingdom.	Town or county.		When.	Where. (Town and State.)	By whom.	When.	Where. (Town and State.)	By whom. (In the case of drafted men, from what enrollment district.)	Period.	By paymaster.	To what time.	Paid \$ (See note 2.)	Due \$ (See note 2.)	Date of last settlement.	Total money value of clothing drawn since last settlement.
	<i>Geo. Middleton</i>		<i>21</i>	<i>Blk</i>	<i>Blk</i>	<i>Blk</i>	<i>5</i>	<i>5</i>	<i>6</i>	<i>Massachusetts</i>	<i>Westerly</i>	<i>Farmer</i>	<i>June 29</i>	<i>Providence</i>	<i>Mass</i>	<i>By paymaster</i>	<i>July 1st</i>	<i>\$25.00</i>	<i>\$25.00</i>	<i>Dec 31 '64</i>	<i>\$37.65</i>		

REMARKS.

See U.S. for Co. M Stores \$6.50) *Sick in Hospital at New Orleans La since July 1st 65*
Discharged & have been discharged (descriptive list sent when sent to Hospital)

This report to be found in the files of the Provost Marshal at the Office of the Chief Muster Officer of Massachusetts.

NOTES.

- The amount of any extra pay for which the soldier may be mustered, *et cetera*, as Acting Hospital Steward, as Saddler, &c., and which may be still due him, must be carefully noted.
- In the column headed "BOUNTY PAID," must be entered the whole amount actually paid him; in that of "BOUNTY DUE," the whole amount yet due him. Bounty paid by State authorities, and not by the United States, will not be entered on this statement.
- Stoppages for loss or damage done to arms, or other public property, must be noted, and the articles, and particular damage to each, specified. When stoppages are due, under sentence of a Court Martial, a transcript of the same must be entered here; and the amount already stopped must be carefully stated.
- In every case of desertion, the date, and that of delivery, or apprehension, must be given, together with a correct transcript of the order of sentence or pardon.
- A careful settlement of the man's CLOTHING ACCOUNT must be made, in date, and the amount DUE TO, or FROM him must be precisely stated.
- Should the man have been engaged in any action, or skirmish, it must be mentioned, together with date and place. A full and particular mention will be made of any wounds he may have received in action, or other injury, whilst in the line of his duty.
- If the soldier is entitled to pay for the use of his horse, the company commander will certify to that fact on this list, and also to the time he has pay due for having been so mounted on his own horse.
- When a soldier is furnished with final statements, his descriptive list, if he has one, should be taken up by the officer who gives the soldier these statements, and endorsed with a statement to this effect by the officer. This endorsement should exhibit a full statement of the time for which the soldier was allowed pay on his final statements, the clothing account, and all other charges against him or in his favor, so as to comprise a complete exhibit of his account. It will then be transmitted to the company commander of the soldier, who will enter all the data necessary to a full understanding of the soldier's account on the muster roll upon which the soldier's discharge is reported. The descriptive list will then be destroyed. The object of this is, that the remaining portion of the soldier's account may be settled upon the receipt of these muster rolls, and the soldier receive any pay or allowances that may be due him at the time of his discharge, and which may not appear on his final statements from the fact that his descriptive list is incomplete. These accounts for back pay, &c., are settled by the 2d Auditor of the Treasury Dept.
- Where a soldier dies in Hospital or on detached service, his descriptive list, if he has one, should be sent with his final statements, in duplicate, to the Adjutant General, Washington, D. C.
- Men drafted will be considered as mustered in from the date of their draft, and will be mustered for pay on the usual rolls for Volunteers. Their pay commences on the day they report for duty under their summons from the Provost Marshal, which date should be noted on same line as the soldier's name, under the heading "Remarks." On the and Enrolled.—Commencement of First Payment by Time." will be written the word *drafted*, or *substitute*, as the case may be; and under the heading "When Mustered in," will be given the date when the soldier was drafted, or, if a substitute, when enlisted, (substitutes, under the Enrollment Act, are mustered in by enlistment.) Under "Where Mustered in," will be given the place from which drafted, (or if a substitute, where enlisted) under the heading "By whom Mustered in," will be and the State to which it belongs, thus: *4th D. Mass.*; meaning 4th Enrollment District, State of Massachusetts.) Or if a substitute, the name of the officer enlisting him. (When enlisted by Board of Enrollment, the name of the Provost Marshal of the Enrollment District.)
- A separate descriptive list should, as a general rule, be given for each man.
- Descriptive lists must, in all cases, be signed by COMMISSIONED officers; not by enlisted men acting as such.

I CERTIFY that the above is a correct transcript from the Records of *Co "C" 5th Mass Cavalry*

STATION: *Galloups Island*
 DATE: *November 22nd 65*
J. B. Welch
Capt Commanding the Company.

986 ~~1~~ a.

Millan John
Co M, 5^{mass} U. S. Col'd Cav.

CARD NUMBERS.

1	26
2	27
3	28
4	29
5	30
6	31
7	32
8	33
9	34
10	35
11	36
12	37
13	38
14	39
15	40
16	41
17	42
18	43
19	44
20	45
21	46
22	47
23	48
24	49
25	50

See Miller John

Number of personal papers herein.....

Book Mark:

See also

986-b

Miller, Charles
Co., I Was, Col'd Can

CARD NUMBERS.

1	9436029	26
2		27
3		28
4		29
5		30
6		31
7		32
8		33
9		34
10		35
11		36
12		37
13		38
14		39
15		40
16		41
17		42
18		43
19		44
20		45
21		46
22		47
23		48
24		49
25		50

Number of personal papers herein.....

Book Mark

See also

M. 5th Cav (Col'd) Mass.

Charles Miller,

....., Co., 5 Reg't Mass Col'd Cav.

Appears on

Regimental Descriptive Book

of the organization named above.

DESCRIPTION.

Age 31 years; height 6 feet 1/4 inches.

Complexion Black,

Eyes Black; hair Black

Where born Philadelphia, Pa.

Occupation Hostler,

ENLISTMENT.

When Jan. 19, 1864.

Where Boston N.H.

By whom J. J. Moll; term 3 y'rs.

Remarks: Rejected January
29, '64.

Harmon

981
Miller, George W.
Co E, 5 Mass. Cav., (Col'd.)

Private

Private

CARD NUMBERS.

1	5378139	26
2	5378224	27
3	5378306	28
4	5378402	29
5	5378515	30
6	5378622	31
7	5378725	32
8	5378830	33
9	5378936	34
10	5379037	35
11	5379132	36
12	5372772	37
13	5379233	38
14	9092215	39
15	4091389	40
16		41
17		42
18		43
19		44
20		45
21		46
22		47
23		48
24		49
25		50

Book Mark:

See also

S. 2087747 Pomona
D 2825789 and rd
D-2994873 - Aud. N. D.
D-2999893 - Aud. N. D.

Walker
at

M | **5 Cav. (Col'd.) | Mass.**

George W. Miller

....., Co. *E*....., 5 Reg't Mass. Cav. (Col'd.)

Appears on

Company Descriptive Book

of the organization named above.

DESCRIPTION.

Age *19* years; height *5* feet *8* inches.

Complexion *Light*

Eyes *Blue* ; hair *Light*

Where born *Virginia*

Occupation *Student*

ENLISTMENT.

When *Jan 30*, 186*4*.

Where *Springfield*

By whom *George W. Miller*; term *Three*'rs.

Remarks:

.....
.....
.....

W. W. ...

M | **5 Col'd Cav.** | **Mass.**

George W. Miller
Pvt, Co. *E*, 5 Reg't Mass. Col'd Cav.

Appears on
Company Muster-in and Descriptive Roll
of the organization named above. Roll dated
Readville, Mass, Feby 10, 1864.

Where born *Virginia*

Age *19* y'rs; occupation *Laborer*

When enlisted *Jan, 30*, 1864.

Where enlisted *Springfield,*

For what period enlisted *3* years.

Eyes *black*; hair *black*

Complexion *black*; height *5 ft. 8* in.

When mustered in *Feby 10*, 1864.

Where mustered in _____

Bounty paid \$ *100*; due \$ *100*

Where credited *10 Dist, Hampden,*

Company to which assigned _____

Remarks: _____

Book mark: _____

M

5 Col'd Cav.

Mass.

George W. Miller
Sgt., Co. E, 5 Reg't Mass. Col'd Cavalry.

Appears on

Company Muster Roll

for *Enlistment to 29 Febr'y*, 1864.

Present or absent *present*

Stoppage, \$ 100 for

Due Gov't, \$ 100 for

Valuation of horse, \$ 100

Valuation of horse equipments, \$ 100

Remarks: *On daily duty as
Col's orderly, pursuant
Order No. 23,*

Book mark:

Norman

(358)

Copyist.

M | **5 Col'd Cav.** | **Mass.**

George W. Miller
Priv., Co. E, 5 Reg't Mass. Col'd Cavalry.

Appears on

Company Muster Roll

for *Micha Aple*, 186*4*

Present or absent *Present*

Stoppage, \$ *100* for

Due Gov't, \$ *100* for

Valuation of horse, \$ *100*

Valuation of horse equipments, \$ *100*

Remarks:

Book mark:

Norman

M | **5** Col'd Cav. | **Mass.**

George W. Miller
Private, Co. E, 5 Reg't Mass. Col'd Cavalry.

Appears on

Company Muster Roll

for *May & June*, 1864.

Present or absent *Present*

Stoppage, \$ 100 for

Due Gov't, \$ 100 for

Valuation of horse, \$ 100

Valuation of horse equipments, \$ 100

Remarks:

Book mark:

(358)

[Signature]
Copyist.

M.

5 Col'd Cav.

Mass.

George W. Miller

Pvt., Co. E, 5 Reg't Mass. Col'd Cavalry.

Appears on

Company Muster Roll

for *July & Aug*, 1864.

Present or absent *Present*

Stoppage, \$ *100* for

Due Gov't, \$ *100* for

Valuation of horse, \$ *100*

Valuation of horse equipments, \$ *100*

Remarks: *Stop one Canton
Haversack*

Book mark:

O. J. Clark

No.

5 Col'd Cav.

Mass.

George W. Miller

Prvt, Co. E, 5 Reg't Mass. Col'd Cavalry.

Appears on

Company Muster Roll

for *Sept & Oct*, 186*4*.

Present or absent *Present*

Stoppage, \$ *100* for

Due Gov't, \$ *100* for

Valuation of horse, \$ *100*

Valuation of horse equipments, \$ *100*

Remarks:

Book mark:

A. S. Clark

No. | **5 Col'd Cav.** | **Mass.**

George W. Miller
Priv., Co. E, 5 Reg't Mass. Col'd Cavalry.

Appears on

Company Muster Roll

for *Nov. Dec.*, 1864.

Present or absent *Present*

Stoppage, \$ *100* for

Due Gov't, \$ *100* for

Valuation of horse, \$ *100*

Valuation of horse equipments, \$ *100*

Remarks: *Stop one haversack*

Book mark:

J. S. Clark
(358) Copyist.

N. | **5 Col'd Cav.** | **Mass.**

George W. Miller
Pvt., Co. E, 5 Reg't Mass. Col'd Cavalry.

Appears on

Company Muster Roll

for *Jan. + Feb.*, 1865.

Present or absent *Present*

Stoppage, \$ *100* for

Due Gov't, \$ *100* for

Valuation of horse, \$ *100*

Valuation of horse equipments, \$ *100*

Remarks: *Stop one haversack 48 ct*

Book mark:

V. S. Clark

(358)

Copyist.

A. | **5 Col'd Cav.** | **Mass.**

George W. Miller

Pvt., Co. E, 5 Reg't Mass. Col'd Cavalry.

Appears on

Company Muster Roll

for *March & Apr.*, 1865.

Present or absent *Present*

Stoppage, \$ *100* for

Due Gov't, \$ *65-*
100 for *copy of*

loss.

Valuation of horse, \$ *100*

Valuation of horse equipments, \$ *100*

Remarks:

Book mark:

A. H. Clark

(358)

Copist.

M | **5 Col'd Cav.** | **Mass.**

George W. Miller
Capt, Co. E, 5 Reg't Mass. Col'd Cavalry.

Appears on

Company Muster Roll

for May & June, 1865.

Present or absent Absent

Stoppage, \$ 100 for

Due Gov't, \$ 100 for

Valuation of horse, \$ 100

Valuation of horse equipments, \$ 100

Remarks: Ordered at 25th Corps
Hd. Qrs since May 12/65
by S. C. to 58
New U. S. C. & G. E.
lost 5/57

Book mark:

(358)

Lacey

Copyist.

M | **5 Col'd Cav.** | **Mass.**

George H. Miller
Priv., Co. E, 5 Reg't Mass. Col'd Cavalry.

Appears on

Company Muster Roll

for July & Aug, 1865.

Present or absent Absent

Stoppage, \$ 100 for

Due Gov't, \$ 100 for

Valuation of horse, \$ 100

Valuation of horse equipments, \$ 100

Remarks: S. S. at Corps Hd. Qrs.
by S. C. M. & since Mar 15/65

Book mark:

Lowry

713 | 5 Col'd Cav. | Mass.

George W. Miller
Part., Co. *E*, 5 Reg't Mass. Col'd Cavalry.

Appears on a

Detachment Muster Roll

of the organization named above

for *Aug 31*, 186*7*.

Station *Winnsville, Texas*.

Present or absent *Present*

Stoppage, \$ *100* for

Due Gov't, \$ *100* for

Valuation of horse, \$ *100*

Valuation of horse equipments, \$ *100*

Remarks: *1 2 3 4 instrument and
by Army Sec.*

Book mark:

Miller

M. | 5 Col'd Cav. | Mass.

George Miller
Pvt., Co. E., 5 Reg't Mass. Colored Cav.

Appears on Returns as follows:

May to Sept. 1865. Absent on
detached service.
Orderly at Corps Hdq.,
Drs.

Book mark :

(648)

J. B. Sittler

Copyist.

711

5 Col'd Cav.

Mass.

George H. Miller
Priv., Co. E, 5 Reg't Mass. Col'd Cavalry.

Appears on Co. Muster-out Roll, dated
Clarksville, Tex., Oct. 31, 1865.

Muster-out to date Oct. 31, 1865.

Last paid to Dec. 31, 1865.

Clothing account:

Last settled _____, 186 ; drawn since \$ 100

Due soldier \$ 14²⁶/₁₀₀; due U. S. \$ 100

Am't for cloth'g in kind or money adv'd \$ 100

Due U. S. for arms, equipments, &c., \$ 2⁸²/₁₀₀

Bounty paid \$ 100; due \$ 30⁰⁰/₁₀₀

Remarks: _____

Book mark: _____

(861)

Lowry

Copyst.

98
Miller, John

Co M, 5 Mass. Cav., (Col'd.)

Private

Private

CARD NUMBERS.

1	5372606	26
2	5372476	27
3	5372474	28
4	5386222	29
5	5386327	30
6	5386427	31
7	5386531	32
8	5386624	33
9	5386730	34
10	5373064	35
11	5372893	36
12	5386815	37
13	9091404	38
14	33237676	39
15	33239813	40
16	40731387	41
17		42
18		43
19		44
20		45
21		46
22		47
23		48
24		49
25		50

Book Mark:

See also

Me. **5 Cav. (Col'd.) | Mass.**

John Millan.

....., Co. *A.*, 5 Reg't Mass. Cav. (Col'd.)

Appears on

Company Descriptive Book

of the organization named above.

DESCRIPTION.

Age *22* years; height *5* feet *7 1/2* inches.

Complexion *Colored.*

Eyes *Black*; hair *Black.*

Where born *Plymouth Canada.*

Occupation *Sailor.*

ENLISTMENT.

When *Oct. 5th*, 186*4*.

Where *Boston.*

By whom *Capt. G. Barnes*; term *2* y'rs.

Remarks: *Enlisted Oct. 5, 64, Boston*
Sgt. G. Barnes, paid \$667.00, Dec
2, 1864

H. C. Thomas.

38a)

Copist.

M | **5 Col'd Cav.** | **Mass.**

John Miller

Appears with rank of _____ on

Muster and Descriptive Roll of a Detachment of U. S. Vols. forwarded

for the 5 Reg't Mass. Col'd Cavalry. Roll dated

Boston Mass., _____, 1864.

Where born *Plymouth Canada*

Age *22* y'rs; occupation *Sailor*

When enlisted *Oct 5*, 1864.

Where enlisted *Boston Mass*

For what period enlisted *2* years.

Eyes *Blk*; hair *Blk*

Complexion *Col.*; height *5 ft. 7 1/2 in.*

When mustered in *Oct 5*, 1864.

Where mustered in *Boston Mass.*

Bounty paid \$ *66* ^{*66*}/₁₀₀; due \$ *133* ^{*34*}/₁₀₀

Where credited *Roxbury Mass*

Company to which assigned _____

Remarks: _____

Book mark: _____

(339)

M. A. Michaels

Copyist.

M

5 Col'd Cav.

Mass.

John Millar

Appears with rank of *Private* on

Muster and Descriptive Roll of a Detachment of U. S. Vols. forwarded

for the 5 Reg't Mass. Col'd Cavalry. Roll dated

Boston Mass. Oct 5, 1864.

Where born *Plymouth Canada*

Age *22* y'rs; occupation *Sailor*

When enlisted *Oct 5*, 1864.

Where enlisted *Boston Mass*

For what period enlisted *2* years.

Eyes *Blk*; hair *Blk*

Complexion *Colored*; height *5 ft. 7 1/2 in.*

When mustered in *Oct 5*, 1864.

Where mustered in *Boston Mass*

Bounty paid \$ *100*; due \$ *100*

Where credited *City of Roxbury Mass.*

Company to which assigned

Remarks:

Book mark:

(339)

M. A. Michael
Copyist.

M | **5 Col'd Cav.** | **Mass.**

John Millard
Appears with rank of *Private* on

Muster and Descriptive Roll of a Detachment of U. S. Vols. forwarded

for the 5 Reg't Mass. Col'd Cavalry. Roll dated
Draft Rendezvous
Yallop's Island R. I. Mass, Oct 20, 1864.

Where born *Plymouth Canada*

Age *22* y'rs; occupation *Sailor*

When enlisted *Oct 5th*, 1864.

Where enlisted *Boston*

For what period enlisted *3* years.

Eyes *black*; hair *black*

Complexion *Gold*; height *5 ft. 7 1/2 in.*

When mustered in *Oct 5th*, 1864.

Where mustered in *Boston Mass*

Bounty paid \$ *66* ^{*66*}/_{*100*}; due \$ *133* ^{*34*}/_{*100*}

Where credited *Roxbury Norfolk Co.*

Company to which assigned

Remarks :

Book mark :

(339)

M. A. Michaels

Copyist.

M | **5 Col'd Cav.** | **Mass.**

John Millan
Plt, Co. M, 5 Reg't Mass. Colored Cavalry.

Appears on

Company Muster Roll
for *Sept. & Oct*, 1864.

Present or absent. *Present*

Stoppage, \$.....*100* for

Due Gov't, \$.....*100* for

Valuation of horse, \$.....*100*

Valuation of horse equipments, \$.....*100*

Remarks: *Recruit from depot.*
Joined Co. Oct., 25, 1864

Book mark:

(358)

S. Williams,
Copyist.

M | **5 Col'd Cav.** | **Mass.**

John Miller
Priv; Co. M, 5 Reg't Mass. Colored Cavalry.

Appears on

Company Muster Roll

for *Nov & Dec*, 186*4*.

Present or absent *Present*

Stoppage, \$ *100* for

Due Gov't, \$ *100* for

Valuation of horse, \$ *100*

Valuation of horse equipments, \$ *100*

Remarks: *Recruit from*
depot. Joined Co. Oct.
25th '64.

Book mark: _____

C. Williams
Copied.

M | **5 Col'd Cav.** | **Mass.**

John Miller
Put, Co. M, 5 Reg't Mass. Colored Cavalry.

Appears on

Company Muster Roll
for *Jan, + Feb,*, 1865.

Present or absent *Present.*

Stoppage, \$ *100* for

Due Gov't, \$ *100* for

Valuation of horse, \$ *100*

Valuation of horse equipments, \$ *100*

Remarks: *Recruit from depot.*
Joined Co. Oct, 25, '64.

Book mark: _____

(358) *C. Williams,* Copyist.

M | **5 Col'd Cav.** | **Mass.**

John Miller
Priv, Co. M, 5 Reg't Mass. Colored Cavalry.

Appears on

Company Muster Roll

for *May + Apr*, 1865.

Present or absent *Present*

Stoppage, \$ *100* for

Due Gov't, \$ *100* for

Valuation of horse, \$ *100*

Valuation of horse equipments, \$ *100*

Remarks:

Book mark:

L. Williams
Copied.

M 1 5 Cavalry Mass.

John Miller
Pvt., Co. M, 5 Reg't Mass Cav.

Appears on

Hospital Muster Roll

of U. S. A. General Hospital,

at Fort Monroe, Va.,

for May & June, 1865.

Attached to hospital :

When _____, 186 .

How employed _____

Last paid by Maj. Dodge
to Dec. 31, 1864.

Bounty paid \$ 100 ; due \$ 100

Present or absent present.

Remarks :

Officers Div.

Book mark :

(343)

Ward,

Copyist.

M | **5 Col'd Cav.** | **Mass.**

John Miller
Priv, Co. M, 5 Reg't Mass. Colored Cavalry.

Appears on

Company Muster Roll

for *May & June*, 186*5*.

Present or absent *Absent*

Stoppage, \$.....*100* for

Due Gov't, \$.....*100* for

Valuation of horse, \$.....*100*

Valuation of horse equipments, \$.....*100*

Remarks: *Lie in Hospital*
Fort Point, Va. since
May 26, 65.

Book mark:

G. Williams

M | 5th Cav. Mass.

John Miller

Pvt., Co. M, 5th Reg. Mass. C. C.

Appears on

Hospital Muster Roll

of U. S. A. General Hospital,

at Fort Monroe, Va.,

for July & Aug, 1865.

Attached to hospital:

When _____, 1865.

How employed _____

Last paid by Maj. Pulifer

to June 30th, 1865.

Bounty paid \$ 100 due \$ 100

Present or absent Present.

Remarks:

Book mark:

(843)

J. White

Copyist.

M | **5 Col'd Cav.** | **Mass.**

John Miller
Pr.; Co. M, 5 Reg't Mass. Colored Cavalry.

Appears on

Company Muster Roll

for *July & Aug.*, 186*5*.

Present or absent *Absent*

Stoppage, \$ *100* for

Due Gov't, \$ *100* for

Valuation of horse, \$ *100*

Valuation of horse equipments, \$ *100*

Remarks: *Absent sick at*
Hosp. Fortress Monroe
Va. since May 20th 1865.

Book mark:

(358)

Hodges
Copyist.

Ch | **5 Col'd Cav.** | **Mass.**

John Miller
P. Co. M., 5 Reg't Mass. Col'd Cavalry.

Appears on a
List of Discharges furnished by C. M. O. of State,
under the provisions of circular dated A. G. O.,
June 29, 1865.

Discharge furnished _____, 186____,
to date from _____, 186____.

Remarks: *Discharged by*
Order No 29 Dept of
War dated
Sept 10/45

Book Mark : _____

Sherrill
(360) *Copyist.*

M | **5 Col'd Cav.** | **Mass.**

John Miller
B Co. M, 5 Reg't Mass. Col'd Cavalry.

Appears on an

Individual Muster-out Roll

of the organization named above. Roll dated

Boston Mass, Nov 24, 1865.

Muster-out to date *Oct 31, 1865.*

Last paid to *June 30, 1865.*

Clothing account:

Last settled 186 ; drawn since \$ 100

Due soldier \$ 100 ; due U. S. \$ 100

Am't for cloth'g in kind or money adv'd \$ 100

Due U. S. for arms, equipments, &c., \$ 100

Bounty paid \$ 100 due \$ 100

Remarks: *U.S. Bounty paid \$66.67*

Due \$66.66

Due Soldier for

clothing not drawn

\$5-33 1/2 Due J. W.

McDonald Suther \$250

Book mark:

JAN. - 9

5372893

1891

Discharged by -
S O No 29 Hd Qr
Dept of Texas dated
Galveston Texas
Sept 16 1865 trusting
his Regt out of service

M. | 5 Col'd Cav. | Mass.

John Millen
Pvt., Co. M, 5 Reg't Mass. Colored Cav.

Appears on Returns as follows:

Oct. 1864. Gained Oct. 25/64
Point Lookout - Recruit
from Depot.

May & June 1865. Absent
sick in Hosp. City
Point Va. May 20/64.

July to Sept. 1865. Absent sick
at Post Hosp. Fortress
Monroe Va. since May
20/65.

Book mark :

(548)

J. B. Sitter

Copyist.

M | **5 Col'd Cav.** | **Mass.**

John Millem
Pr., Co. *M*, 5 Reg't Mass. Col'd Cavalry.

Appears on **Co. Muster-out Roll**, dated
Clarksville Tex. Oct. 31, 1865.

Muster-out to date _____, 186 .
Last paid to *Dec. 31*, 1864.

Clothing account:

Last settled _____, 186 ; drawn since \$ _____ 100

Due soldier \$ *51 41* / 100; due U. S. \$ _____ 100

Am't for cloth'g in kind or money adv'd \$ _____ 100

Due U. S. for arms, equipments, &c., \$ *0 60* / 100

Bounty paid \$ *66 67* / 100; due \$ *66 67* / 100

Remarks:

*Absent sick at
Hospit. Fortress Monroe
Va. since May 20th 1865.
No discharge furnished.*

Book mark: *M.o. Roll on file*

Hodges
Copyist.

Miller, John

P, Co. M, Reg't Heavy C.C.

3 Enclosures.

Bed Cards	Final Statements
Burial Records	Furloughs or L. of A
Certs. of Dis. for Discharge	Med. Certificates
C. M. Charges	Med. Des. Lists
Descriptive Lists	Orders
Discharge Certificates	Pris. of War Record
Enlistment Papers 4	Resignations

Other papers relating to—

Admission to Hosp'l	Furlough or L. of A
Casualty Sheet /	Med. Examination
Confinement	Misc. Information
Contracts	Pay or Clothing
Death or Effects	Personal Reports
Desertion	Rank
Discharge from Hosp'l	Transfer to Hosp'l
Discharge from Service	Transfer to V. R. C.
Duty	Transportation

FORM 40J

CASUALTY SHEET

No.

John Miller
Priv. of Company *"M"*
5 Regiment of *Mass. Cav.*
State Volunteers *Co. 1*

NATURE OF CASUALTY.

Discharged
Nov. 20/65.



CASUALTY SHEET.

Name: *John Miller*

Rank: *Private* Company: *A* Regiment: *5*

Arm: *Inf.* State: *Mass.*

Nature of Casualty: *Discharge*

CAUSE OF CASUALTY—(NAME OF DISEASE, &c.)

BY WHOM DISCHARGED.

DEGREE OF DISABILITY.

FROM WHAT SOURCE THIS INFORMATION WAS OBTAINED.

BY WHOM CERTIFIED.

*Rolls, Dr. Bond.
Hall. Fel.*

REMARKS.

DATE OF DISCHARGE, DEATH, &c.

June 21/65

PLACE OF DISCHARGE, DEATH, &c.

Hallup's Fel, Mass.

Wm. Proctor

Clerk.

67

NOTE 1. — This blank will be used for both enlistments and re-enlistments — enlistment of veterans, &c., &c., in the volunteer service. They will be made out in duplicate in all cases — one to accompany the recruiting return of the superintendent (not the recruiting officer) to the Adjutant-General, and one to accompany the accounts of the officer who pays bounty, &c. The Regiment and Company in which the soldier last served should be given on the back.

NOTE 2. — An enlistment holds to service. A muster-in must, in all cases, precede payment of pay, bounty, pension, &c. A muster-in roll must, in all cases, be filed in the Adjutant-General's Office as evidence of muster-in. The mustering officer, commissary, or assistant-commissary of musters, as the case may be, will countersign both enlistments as having mustered the soldier into the service of the United States before either of them is given to the disbursing officer.

APRIL 1899
FILED IN THE ENROLLMENT DIVISION, P. O.

\$6.66 Bounty
W. S.

DECLARATION OF RECRUIT.

I, *John Miller* desiring to VOLUNTEER as a Soldier in the Army of the United States, for the term of THREE YEARS, Do Declare, That I am *Twenty Two* years and _____ months of age; that I have never been discharged from the United States service on account of disability or by sentence of a court-martial, or by order before the expiration of a term of enlistment; and I know of no impediment to my serving honestly and faithfully as a soldier for three years.

GIVEN at _____ the _____ day of _____

Witness: _____

Discharged _____ 18 _____

Regt of _____

enlistment; last served in Company ()

Volunteered at _____
October 5th 1898,
By Captain _____
3rd Cal. Infantry

No. *571000*

CONSENT IN CASE OF MINOR.

I, _____ Do CERTIFY, That I am _____ of _____; that the said _____ is _____ years of age; and I do hereby freely give my CONSENT to his volunteering as a SOLDIER in the ARMY OF THE UNITED STATES for the period of THREE YEARS.

GIVEN at _____ the _____ day of _____

Witness: _____

VOLUNTEER ENLISTMENT

STATE OF



TOWN OF

Massachusetts

City of Boston

I, *John Miller* born in *Wilmington*
in the State of *Canada* aged *Twenty two* years,
and by occupation a *Printer* DO HEREBY ACKNOWLEDGE to have
volunteered this *11th* day of *October* 186*4*,

to serve as a **Soldier** in the Army of the United States of America, for the
period of **THREE YEARS**, unless sooner discharged by proper authority: Do also
agree to accept such bounty, pay, rations, and clothing, as are, or may be, estab-
lished by law for volunteers. And I, *John Miller* do
solemnly swear, that I will bear true faith and allegiance to the **United States**
of America, and that I will serve them honestly and faithfully against all their
enemies or opposers whomsoever; and that I will observe and obey the orders of
the President of the United States, and the orders of the officers appointed over
me, according to the Rules and Articles of War.

Sworn and subscribed to, at *Wilmington*
this *11th* day of *October* 186*4*
BEFORE *J. W. Le Bump*
Capt & Quartermaster 3rd Cal Mass.

I CERTIFY, ON HONOR, That I have carefully examined the above-named Volunteer, agreeably
to the General Regulations of the Army, and that, in my opinion, he is free from all bodily defects and
mental infirmity, which would in any way disqualify him from performing the duties of a soldier.

John G. Hub
Surgeon General of the Army
EXAMINING SURGEON.

I CERTIFY, ON HONOR, That I have minutely inspected the Volunteer,
previously to his enlistment, and that he was entirely sober when enlisted; that, to the best of my
judgment and belief, he is of lawful age; and that, in accepting him as duly qualified to perform the duties
of an able-bodied soldier, I have strictly observed the Regulations which govern the recruiting service.
This soldier has *blue* eyes, *black* hair, *fair* complexion, is *5' 10"* feet
175 inches high.

J. W. Le Bump
Capt & Quartermaster
Regiment of *3rd Cal Mass* Volunteers,
RECRUITING OFFICER.

(A. G. O. No. 74 & 75.)

the *11th* day of *October* 186*4* at *Wilmington*
Mustered into the service of the United States, in Company

Regiment of *3rd Cal Mass* Volunteers, on

Ceasar de la Cruz
3rd Cal Mass

13705

NOTE 1. — This blank will be used for both enlistments and re-enlistments — enlistment of veterans, &c., &c., in the volunteer service. They will be made out in duplicate in all cases — one to accompany the recruiting return of the superintendent (not the recruiting officer) to the Adjutant-General, and one to accompany the accounts of the officer who pays bounty, &c. The Regiment and Company in which the soldier last served should be given on the back.

NOTE 2. — An enlistment holds to service. A muster-in must, in all cases, precede payment of pay, bounty, pension, &c. A muster-in roll must, in all cases, be filed in the Adjutant-General's Office as evidence of muster-in. The mustering officer, commissary, or assistant-commissary of musters, as the case may be, will countersign both enlistments as having mustered the soldier into the service of the United States before either of them is given to the disbursing officer.

DECLARATION OF RECRUIT.

I, John Miller desiring to VOLUNTEER as a Soldier in the Army of the United States, for the term of THREE YEARS, Do Declare, That I am Twenty two years and _____ months of age; that I have never been discharged from the United States service on account of disability or by sentence of a court-martial, or by order before the expiration of a term of enlistment; and I know of no impediment to my serving honestly and faithfully as a soldier for three years.

GIVEN at Boston Mass the _____ day of _____

Witness: W. H. [unclear]

No. _____
 Volunteered at Boston Mass
Oct-5th 1864,
 By Capt. [unclear]
Regiment of [unclear]
5-15 Co. [unclear]
 Discharged _____ 18 _____
 Reg't of _____
 Disbursed by W. H. [unclear]

CONSENT IN CASE OF MINOR.

I, _____ Do CERTIFY, That I am the _____ of _____; that the said _____ is _____ years of age; and I do hereby freely give my CONSENT to his volunteering as a SOLDIER in the ARMY OF THE UNITED STATES for the period of THREE YEARS.

GIVEN at _____ the _____ day of _____

Witness: _____

VOLUNTEER ENLISTMENT

STATE OF



TOWN OF

Massachusetts

City of Boston

I,

John Millar

born in

Plymouth

in the State of

England

aged

Twenty three years,

and by occupation a

Sailor

DO HEREBY ACKNOWLEDGE to have

volunteered this

Fifth

day of

October

186

to serve as a Soldier in the Army of the United States of America, for the period of THREE YEARS, unless sooner discharged by proper authority: Do also agree to accept such bounty, pay, rations, and clothing, as are, or may be, established by law for volunteers. And I, John Millar do solemnly swear, that I will bear true faith and allegiance to the United States of America, and that I will serve them honestly and faithfully against all their enemies or opposers whomsoever; and that I will observe and obey the orders of the President of the United States, and the orders of the officers appointed over me, according to the Rules and Articles of War.

Sworn and subscribed to, at

this

21st day of

October

186

BEFORE

J. M. Pierce

I CERTIFY, ON HONOR, That I have carefully examined the above-named Volunteer, agreeably to the General Regulations of the Army, and that, in my opinion, he is free from all bodily defects and mental infirmity, which would in any way disqualify him from performing the duties of a soldier.

Wm. H. Ayer

Surgeon General

EXAMINING SURGEON.

I CERTIFY, ON HONOR, That I have minutely inspected the Volunteer, previously to his enlistment, and that he was entirely sober when enlisted; that, to the best of my judgment and belief, he is of lawful age; and that, in accepting him as duly qualified to perform the duties of an able-bodied soldier, I have strictly observed the Regulations which govern the recruiting service.

This soldier has eyes, hair, complexion, is 5 feet 6 inches high.

J. M. Pierce

Capt. Regiment of 3rd Mass. Volunteers,

3rd East Mass

RECRUITING OFFICER.

(A. G. O. No. 74 & 75.)

Accompanied by Roxbury 30th Oct 1864

Mustered into the service of the United States, in Company

Regiment of 3rd Mass. Volunteers, on

Wm. H. Ayer

Miller, John
Co E, 5 Mass. Cav., (Col'd.)

Private | Private

CARD NUMBERS.

1	5378136	26
2	5378221	27
3	5378303	28
4	5378441	29
5	5378546	30
6	5378623	31
7	5378726	32
8	5378831	33
9	5378937	34
10	5379039	35
11	5379133	36
12	5379234	37
13	9092216	38
14	31581665	39
15	31581776	40
16	40731388	41
17		42
18		43
19		44
20		45
21		46
22		47
23		48
24		49
25		50

Bank Mark:

See also

M

5 Cav. (Col'd.) | Mass.

John Miller

Co. E, 5 Reg't Mass. Cav. (Col'd.)

Appears on

Company Descriptive Book

of the organization named above.

DESCRIPTION.

Age 28 years; height 5 feet 8 3/4 inches.

Complexion *Old*

Eyes *Blue*; hair *Black*

Where born *Rand Co. Ill.*

Occupation *Farmer*

ENLISTMENT.

When *Jan 27*, 1864

Where *Boston*

By whom *John Davies*; term *Three* yrs.

Remarks: *Maimed,
Deserted Nov. 30. 1864.*

Heard

M | **5 Col'd Cav.** | **Mass.**

John Miller
Priv, Co. *E*, 5 Reg't Mass. Col'd Cav.

Appears on
Company Muster-in and Descriptive Roll
of the organization named above. Roll dated

Readville, Mass, Feby 10, 1864.

Where born *Kent Co. Delaware*

Age *28* y'rs; occupation *Farmer*

When enlisted *Jan, 29*, 1864.

Where enlisted *Ward 6, Boston,*

For what period enlisted *3* years.

Eyes *black*; hair *black*

Complexion *black*; height *5 ft. 8 3/4 in.*

When mustered in *Feby 10*, 1864.

Where mustered in _____

Bounty paid \$ *100*; due \$ *100*

Where credited *4 Dist, Suffolk,*

Company to which assigned _____

Remarks : _____

Book mark : _____

[Signature]

Mc | **5 Col'd Cav.** | **Mass.**

John Miller

Priv, Co. E, 5 Reg't Mass. Col'd Cavalry.

Appears on

Company Muster Roll

for *Enlistment to 29 Feb'y*, 1864.

Present or absent... *present*

Stoppage, \$..... 100 for

Due Gov't, \$..... 100 for

Valuation of horse, \$..... 100

Valuation of horse equipments, \$..... 100

Remarks:

.....

.....

.....

.....

.....

.....

Book mark:

.....

M | **5** Col'd Cav. | **Mass.**

John Miller
Priv, Co. E, 5 Reg't Mass. Col'd Cavalry.

Appears on

Company Muster Roll

for *Mich & Apl*, 186*4*.

Present or absent *not stated*

Stoppage, \$ *100* for

Due Gov't, \$ *100* for

Valuation of horse, \$ *100*

Valuation of horse equipments, \$ *100*

Remarks:

Book mark: _____

[Signature]
Copyist.

M | **5 Col'd Cav.** | **Mass.**

John Miller
Privt, Co. E, 5 Reg't Mass. Col'd Cavalry.

Appears on

Company Muster Roll

for *May June*, 1864.

Present or absent

Stoppage, \$ 100 for

Due Gov't, \$ 100 for

Valuation of horse, \$ 100

Valuation of horse equipments, \$ 100

Remarks: *Deserted at*
Alexandria, Va. May 11/64,
** To pay for sabre, belt & plate,*

** See on roll)*

Book mark:

M | 5 Cav. | Mass.

John Miller
Priv., Co. E., 5 Reg't Mass. Cav.

Appears on

Hospital Muster Roll

of Camp William Penn U. S. A. Hospital,

at Chelton Hills, Pa.,

for May & June, 1864.

Attached to hospital:

When May 12, 1864.

How employed Convalescent

Last paid by Maj.

to, 186 .

Bounty paid \$ 100; due \$ 100

Present or absent Present

Remarks: To be paid for May & June.

Book mark:

Wilson

(343)

Copyist.

16 | **5 Col'd Cav.** | **Mass.**

John Miller
Prvt., Co. E, 5 Reg't Mass. Col'd Cavalry.

Appears on

Company Muster Roll

for July & Aug., 1864.

Present or absent Present

Stoppage, \$ 100 for

Due Gov't, \$ 100 for

Valuation of horse, \$ 100

Valuation of horse equipments, \$ 100

Remarks: Taken up from
detention. Stop pay for
Saber Belt & plate.
Stop Haversack

Book mark:

C. L. Wood

M. | 5 Cav. | Mass

John Muller

Pvt., Co. E., 5 Reg't Mass. Cav.

Appears on
Hospital Muster Roll

of **Camp William Penn U. S. A. Hospital,**

at **Chelton Hills, Pa.,**

for July & Aug., 186 4.

Attached to hospital :

When _____, 186 .

How employed _____

Last paid by Maj. _____

to _____, 186 .

Bounty paid \$ 100 ; due \$ 100

Present or absent _____

Remarks : Transf'd to his Regt.
Aug 11. by.

Book mark : _____

Wilson

A. | **5 Col'd Cav.** | **Mass.**

John Miller
Cor., Co. E, 5 Reg't Mass. Col'd Cavalry.

Appears on

Company Muster Roll

for *Sept & Oct*, 186*7*.

Present or absent *Present*

Stoppage, \$.....*100* for

Due Gov't, \$.....*100* for

Valuation of horse, \$.....*100*

Valuation of horse equipments, \$.....*100*

Remarks:

Book mark:

O. S. Belant
(358) *O. S. Belant* Copyist.

Mc. | **5 Col'd Cav.** | **Mass.**

John Miller
Priv., Co. E, 5 Reg't Mass. Col'd Cavalry.

Appears on

Company Muster Roll

for Nov. Dec, 1864.

Present or absent Present

Stoppage, \$ 100 for

Due Gov't, \$ 100 for

Valuation of horse, \$ 100

Valuation of horse equipments, \$ 100

Remarks:

Book mark:

J. S. Clark

M. | **5 Col'd Cav.** | **Mass.**

John Miller

Priv., Co. E, 5 Reg't Mass. Col'd Cavalry.

Appears on

Company Muster Roll

for *Jan. & Feb.*, 1865.

Present or absent *Present*

Stoppage, \$ *100* for

Due Gov't, \$ *100* for

Valuation of horse, \$ *100*

Valuation of horse equipments, \$ *100*

Remarks: *Stop one canton.*
45^c

Book mark: -----

A. | **5 Col'd Cav.** | **Mass.**

John Miller

Pr., Co. E, 5 Reg't Mass. Col'd Cavalry.

Appears on

Company Muster Roll

for *Dec. & Apr.*, 1865.

Present or absent *Present*

Stoppage, \$ *100* for

Due Gov't, \$ *1³⁰/₁₀₀* for *lep & g. c.*
lost.

Valuation of horse, \$ *100*

Valuation of horse equipments, \$ *100*

Remarks: -----

Book mark: -----

(358)

O. S. Clark

Copyist.

M | **5 Col'd Cav.** | **Mass.**

John Miller
Capt, Co. E, 5 Reg't Mass. Col'd Cavalry.

Appears on

Company Muster Roll

for *May & June*, 186*5*.

Present or absent *Present*

Stoppage, \$ *100* for

Due Gov't, \$ *100* for

Valuation of horse, \$ *100*

Valuation of horse equipments, \$ *100*

Remarks: *Due U.S. for ord -
nance lost \$2.90*

Book mark:

(358)

Lowry

Copyist.

M | **5 Col'd Cav.** | **Mass.**

John Miller
Pvt., Co. E, 5 Reg't Mass. Col'd Cavalry.

Appears on

Company Muster Roll

for July & Aug, 1865.

Present or absent Present

Stoppage, \$ 100 for

Due Gov't, \$ 100 for

Valuation of horse, \$ 100

Valuation of horse equipments, \$ 100

Remarks: In S.S. at Brazos
per C.C. Brig. Hd. on Aug
29/65.

Book mark: _____

(358)

Lowny

Copyist.

M. | 5 Col'd Cav. | Mass.

J. Miller

Pvt., Co. E, 5 Reg't Mass. Colored Cav.

Appears on Returns as follows:

Aug. & Sept. 1865; Absent
at Brazos.

Book mark :

(546)

J. B. Sittler

Copyist.

M | **5 Col'd Cav. Mass.**

John Miller
Priv, Co. *E*, 5 Reg't Mass. Col'd Cavalry.

Appears on **Co. Muster-out Roll**, dated
Clarksville, Tex., Oct 31, 1865.

Muster-out to date *Oct 31, 1865.*

Last paid to *Dec 31, 1864.*

Clothing account:

Last settled....., 186 ; drawn since \$..... 100

Due soldier \$..... 100; due U. S. \$ *18* ^{*20*}/₁₀₀

Am't for cloth'g in kind or money adv'd \$..... 100

Due U. S. for arms, equipments, &c., \$ *11* ^{*16*}/₁₀₀

Bounty paid \$..... 100; due \$ *30* ^{*00*}/₁₀₀

Remarks:

Book mark:

(361) *Lowry* Copyist.

Willer John

P, Co. E, 5 Regt Mass. C.C.

Enclosures.

Bed Cards	Final Statements
Burial Records	Furloughs or L. of A.
Certs. of Dis. for Discharge	Med. Certificates
C. M. Charges	Med. Des. Lists
Descriptive Lists	Orders
Discharge Certificates	Pris. of War Record
Enlistment Papers	Resignations

Other papers relating to—

Admission to Hosp'l	Furlough or L. of A.
Casualty Sheet	Med. Examination
Confinement	Misc. Information
Contracts	Pay or Clothing
Death or Effects	Personal Reports
Desertion	Rank
Discharge from Hosp'l	Transfer to Hosp'l
Discharge from Service	Transfer to V. R. C.
Duty	Transportation

5th Mass. Cav.

August 14th 1864

E. H. ~~Adams~~ Lieut

Receipt for one man
John Miller

Recd of Mr
Brady one man
John Miller
E. H. Adams
Lieut. 5th Mass. Cav.

Recd of Mrs
Brady one man
John Miller
E. H. Adams
Leut. S. Maples

Received for one man
John Miller

8th Mass Regt
Aug 14th 1862
Leut. S. Maples

5th Mass Cavalry

August 14th 1864

Received Maj. Brady Prov. Marshal
P. L. Lonsious M^{tr}, one man (John
Miller)

E. H. Adams

1st Lieut. C. E.

5th Mass Cavalry

989-a

Miller, John G

Co., S. W. S. Col'd Can.

CARD NUMBERS.

1	9436077	26
2		27
3		28
4		29
5		30
6		31
7		32
8		33
9		34
10		35
11		36
12		37
13		38
14		39
15		40
16		41
17		42
18		43
19		44
20		45
21		46
22		47
23		48
24		49
25		50

Number of personal papers herein.....

Book Mark:

See also

M. *5th Cav* | *Col'd* | *Mass.*
John G Miller
....., Co., *5* Reg't *Mass* Col'd *Cav.*

Appears on

Regimental Descriptive Book

of the organization named above.

DESCRIPTION.

Age *19* years; height *5* feet *2* inches.

Complexion *Colored,*

Eyes *Black*; hair *Black*

Where born *Harrisburg, Pa.*

Occupation *Farmer,*

ENLISTMENT.

When *March 17*, 186*4*

Where *Springfield,*

By whom *S. A. Traft*; term *3* y'rs.

Remarks: *Rejected March 26, 1864*

Tharun

990
Miller, Louis

Co D, 5 Mass. Cav., (Col'd.)

Private

Private

CARD NUMBERS.

1	5376939	26
2	5377029	27
3	5377113	28
4	5377207	29
5	5377315	30
6	5377418	31
7	5377519	32
8	5377659	33
9	5378044	34
10	9092316	35
11	33202943	36
12	33203352	37
13	33203700	38
14	33203812	39
15	40731390	40
16		41
17		42
18		43
19		44
20		45
21		46
22		47
23		48
24		49
25		50

Book Mark: 8B-N-10-P-592.

See also

M 5 Cav. (Col'd.) | Mass.

Lewis Miller

Co. 2, 5 Reg't Mass. Cav. (Col'd.)

Appears on

Company Descriptive Book

of the organization named above.

DESCRIPTION.

Age 29 years; height 5 feet 4 1/2 inches.

Complexion Blk

Eyes Blk; hair Blk

Where born Baltimore Md.

Occupation Farmer

ENLISTMENT.

When Jan 16, 186

Where Mansfield

By whom W.B. Bates; term 3 y'rs.

Remarks: Mustered in Co. 2

Jan 20 by Sgt McKibbin

Newark Mass.

Discharged at Gen Hospital

Nov 12 68 for disability

W. A. [Signature]

M | **5 Col'd Cav.** | **Mass.**

Louis Miller

Priv, Co. *D*, 5 Reg't Mass. Col'd Cav.

Appears on

Company Muster-in and Descriptive Roll
of the organization named above. Roll dated

Readville Mass, July 29, 1864.

Where born *Baltimore Co. Md.*

Age *24* y'rs; occupation *Farmer.*

When enlisted *July 18*, 186*4*.

Where enlisted *Manassas.*

For what period enlisted *3* years.

Eyes *BR*; hair *BR*

Complexion *BR*; height *5* ft. *4 1/2* in.

When mustered in *July 29*, 186*4*.

Where mustered in *Readville Mass*

Bounty paid \$ *100*; due \$ *100*

Where credited *2 Dist Pistol*

Company to which assigned

Remarks:

Book mark:

Jones

A | **5 Col'd Cav.** | **Mass.**

Lewis Miller

Priv, Co. D, 5 Reg't Mass. Col'd Cavalry.

Appears on

Company Muster Roll

for *Enlistment to July 29*, 1864.

Present or absent *Present*

Stoppage, \$ *100* for

Due Gov't, \$ *100* for

Valuation of horse, \$ *100*

Valuation of horse equipments, \$ *100*

Remarks:

Book mark:

J. Amis
Copyist.

M 5 Col'd Cav. | **Mass.**

Lewis Miller

Dr, Co. D, 5 Reg't Mass. Col'd Cavalry.

Appears on

Company Muster Roll

for *Mich & Apr*, 1864.

Present or absent *Present*

Stoppage, \$ *100* for

Due Gov't, \$ *100* for

Valuation of horse, \$ *100*

Valuation of horse equipments, \$ *100*

Remarks:

Book mark:

Jarvis
Copyist.

M | **5 Col'd Cav.** | **Mass.**

Lewis Miller

Pl, Co. D, 5 Reg't Mass. Col'd Cavalry.

Appears on

Company Muster Roll

for *May & June*, 186*4*.

Present or absent *Absent*

Stoppage, \$ 100 for

Due Gov't, \$ 100 for

Valuation of horse, \$ 100

Valuation of horse equipments, \$ 100

Remarks: *Absent Sick in Hospital*

Book mark:

Lewis
Copied.

Al | 5 bar, Mass

Lewis Miller

1st, Co. B, 5 Reg't Mass Col

Appears on

Hospital Muster Roll

of **L'Ouverture U. S. A. General Hospital,**

at **Alexandria, Va.,**

for May & June, 1864.

Attached to hospital :

When June 13, 1864.

How employed _____

Last paid by Maj. _____

to _____, 1864.

Bounty paid \$ 100; due \$ 100

Present or absent Present

Remarks: _____

Book mark: _____

W. H. Wiley Copyist.

M | **5 Col'd Cav.** | **Mass.**

Lewis Miller

Priv, Co. D, 5 Reg't Mass. Col'd Cavalry.

Appears on

Company Muster Roll

for *July & Aug*, 1864.

Present or absent *Absent*

Stoppage, \$ *100* for

Due Gov't, \$ *100* for

Valuation of horse, \$ *100*

Valuation of horse equipments, \$ *100*

Remarks: *Absent left sick in
Hospital Camp Stone Mass Aug 13/64*

Book mark:

(358)

J. Merchant
Copyist.

U | 5 Cav | Mass

Lewis Miller

Port, Co. B, 5 Reg't Mass Cav

Appears on

Hospital Muster Roll

of L'Ouverture U. S. A. General Hospital,

at Alexandria, Va.,

for July & Aug, 1864.

Attached to hospital :

When June 13, 1864.

How employed

Last paid by Maj.

to , 186 .

Bounty paid \$ 100; due \$ 100

Present or absent Present

Remarks: Paid on May & June 64
& has pay due for July & Aug 64

Book mark :

(343)

Finley
Copied.

Mo | **5 Col'd Cav.** | **Mass.**

Lewis Miller

Pr, Co. D, 5 Reg't Mass. Col'd Cavalry.

Appears on

Company Muster Roll

for *Sept, & Oct*, 186*4*

Present or absent *Absent*

Stoppage, \$ *100* for

Due Gov't, \$ *100* for

Valuation of horse, \$ *100*

Valuation of horse equipments, \$ *100*

Remarks: *Left sick at Wash (Wigton) May 13 1864*

Book mark:

J. Merchant

M | 56ar | Mass

Lewis Miller

Plt, Co. B., 5 Reg't Mass Cav

Appears on

Hospital Muster Roll

of L'Ouverture U. S. A. General Hospital,

at Alexandria, Va.,

for Sept & Oct, 1864.

Attached to hospital:

When June 13, 1864.

How employed

Last paid by Maj. G. W. Pennington
to Aug 31, 1864.

Bounty paid \$ 100; due \$ 100

Present or absent Present

Remarks:

Book mark:

Finley

Me | **5 Col'd Cav.** | **Mass.**

Lewis Miller

Mr., Co. D, 5 Reg't Mass. Col'd Cavalry.

Appears on

Company Muster Roll

for *Nov & Dec*, 1864.

Present or absent *Absent*

Stoppage, \$ *100* for

Due Gov't, \$ *100* for

Valuation of horse, \$ *100*

Valuation of horse equipments, \$ *100*

Remarks: *Absent sick at Washington, May 13, 1864*

Book mark:

J. Mendenhall

M | 5 Cav Mass

Lewis Miller

Col, Co. D, 5 Reg't Mass Cav

Appears on

Hospital Muster Roll

of L'Ouverture U. S. A. General Hospital,

at Alexandria, Va.,

for Nov & Dec, 1864.

Attached to hospital :

When June 13, 1864.

How employed _____

Last paid by Maj. Wingard

to Oct 31, 1864

Bounty paid \$ 100; due \$ 100

Present or absent Present

Remarks: _____

Book mark: _____

A. J. Yeager
Copyst.

No. 5 Col'd Cav. | Mass.

Lewis Miller

Prin., Co. D, 5 Reg't Mass. Col'd Cavalry.

Appears on

Company Muster Roll

for Jan & Feb, 1865.

Present or absent

Stoppage, \$ 100 for

Due Gov't, \$ 100 for

Valuation of horse, \$ 100

Valuation of horse equipments, \$ 100

Remarks: Discharged Feb 7, 1865,
Lawrence Hospital, Alex-
andria Va.

Book mark: Discharged (over)

A. Merchant

JAN. - 9

5377659

1891

January 12, 1865 E B W,
10 P. 592

M. | 5 Col'd Cav. | Mass.

Lewis Miller

Priv., Co. D, 5 Reg't Mass. Colored Cav.

Appears on Returns as follows:

May to Dec. 1864. Absent sick
in Hosp. Camp Stoneman
Washington, D.C. May 13,
'64.

Jan. 1865. Absent sick L'ou-
verture Hosp. Alexandria,
May 13/64.

Feb. 1865. Loss Feb. 7 Alexandria
Discharged from Lower-
ture Hosp.

Book mark :

J. B. Sittler

(640)

Copyist.

m | **5 Col'd Cav. Mass.**

Lewis Miller

Pvt, Co. *Q*, 5 Reg't Mass. Col'd Cavalry.

Appears on **Co. Muster-out Roll**, dated *Clarksville Texas Oct:31*, 1865.

Muster-out to date _____, 186 .

Last paid to _____, 186 .

Clothing account:

Last settled _____, 186 ; drawn since \$ _____ 100

Due soldier \$ _____ 100; due U. S. \$ _____ 100

Am't for cloth'g in kind or money adv'd \$ _____ 100

Due U. S. for arms, equipments, &c., \$ _____ 100

Bounty paid \$ _____ 100; due \$ _____ 100

Remarks:

*Discharge at Genl Hospital
Va = 2/65 in Disabil-
ity Va. under G.O. 77*

Book mark: *Discharge January*

House (over)

JAN. - 9

5378044

☆ 1891 ☆

12/65 @ B.V. 10 P 592.

Miller, Lewis

P, Co. R, 5

Reg't ^{Co.} 111 Cal. 2

5

Enclosures.

Bed Cards	Descriptive Lists
Burial Records	Final Statements
Certs. of Dis. for Discharge 2	Furloughs
C. M. Charges	Med. Des. Lists
Med. Certificates	Orders

Other papers relating to—

Admission to Hosp'l	Furlough
Casualty Sheet (Officer's)	Med. Examination
Confinement	Misc. Information
Contracts	Pay or Clothing
Death or Effects	Personal Reports
Desertions	Rank
Discharge from Hosp'l	Transfer to Hosp'l
Discharge from Service 1	Transfer to V. R. C.
Duty	Transportation

Southern
General Hospital, Alexandria, Va.
December 1864....

Lewis Miller
Co. D, 5 Regt. Mass. Cavols

Southern Genl. Branch

Application for *Discharge*
approved.

Action of Board approved.

Discharge forwarded. 12th 1865
Edwin Bennett
Surgeon U. S. Vols. in charge.

[FOR DISCHARGE FOR SICK MAN.]

Querecho

Head-Quarters Third Division U. S. Gen'l Hosp'l.

Alexandria, Va. December 10 1864.

We hereby certify, that we have this day carefully examined
Sick, *Ensign Miller* Co. "D" 5 Regt. *Mass Cav.*
Vols. who was admitted to *General Hospital No. 1 Branch,*
June 13 1864 and find that he is suffering from
Chronic Nephritis of *Eight* months standing, which renders him permanently un-
fit, in our opinion, for military duty. We therefore respectfully re-
commend that he be discharged.

This disease was contracted *since Abstract,*
in the line of duty

He is not in our opinion suitable to enter or re-enlist in the *Vet.*
Res. Corps.

P. O. Address:

Querecho

Yates Co.

N. Y.

Medical Board for
examination of patients
for furlough and discharge.

W. A. Heston

Acty. Asst. Surgeon, U. S. A.

J. Stoddard

Acty. Asst. Surgeon, U. S. A.

E. P. Luce

Acty. Asst. Surgeon, U. S. A.

[OFFICE INDORSEMENT.]

War Department,

ADJUTANT GENERAL'S OFFICE,

February 24, 1874.

The discharge of *Thomas Miller*
Private, Co. *D*, 5th Reg't U. S.
Colored *Infantry*, is reported as follows:—

On Company Muster Roll.

For *Jan 12*, 1865, *Jan 12*, 1865

Company Muster-out Roll.

Jan 12, 1865

Company Descriptive Book.

, 186

Company Morning Reports.

, 186

Soldier's Final Statement.

, 186

Soldier's Record of Death and Interment.

, 186

Soldier's Inventory of Effects.

, 186

Soldier's Certificate of Disability for Discharge.

, 186

Soldier's Individual Muster-out Roll.

, 186

Regimental Return.

For *July*, 1865, *July 7*, 1865

Regimental Quarterly Returns.

, 186

Regimental Descriptive Book.

, 186

By Surgeon General.

, 186

Jan 12, 1865, is held to be
the correct date, and the Company Muster
Roll will be amended accordingly.

Thomas D. Stewart

Asst. Adj. Gen.

912 11
912 592
See letter to 2^d Adv.
Mar. 10 1874

1875
CERTIFICATE OF DISABILITY FOR DISCHARGE

IN THE CASE OF

Thomas Miller

a *Private* Co. *D*

5 Reg't of *Mass. Col.*

RECEIVED
Thomas Miller

HEAD QUARTERS,
DEPARTMENT OF WASHINGTON,
23d Army Corps,

Jan 12 1865
TO BE DISCHARGED.

BY COMMAND OF

MAJ. GENL C. C. AUGER.

A. A. G.

Received (A. G. Office) _____, 186 .



En on drafts

all the facts known to him concerning the time, place, manner, and all the circumstances under which the injury occurred, or disease originated or appeared; the duty, or service, or situation of the soldier at the time the injury was received or disease contracted, stating particularly whether the injury was received or the disease contracted in the line of his duty; and whatever other facts may aid a judgment as to the cause, immediate or remote, of the disability, and the circumstances attending it.

When the facts are not known to the company commander, the certificate of any officer, or affidavit of other person having such knowledge, will be appended—as the surgeon in charge of a hospital, the officer commanding a detachment of recruits, &c., &c.

NOTE 2.

When a probable case for pension, special care must be taken to state the degree of disability—as 1, 2, &c., &c.; to describe particularly the disability, wound, or disease; the extent to which it deprives him of the use of any limb or faculty, or affects his health, strength, activity, constitution, or capacity to labor or earn his subsistence. The surgeon will add, from his knowledge of the facts and circumstances, and from the evidence in the case, his professional opinion of the cause or origin of the disability. In the case of discharges by Medical Inspectors, the last paragraph will state that the "discharge was given by consent of the soldier, after a personal examination, and for disability, the nature, degree, and origin of which are correctly described in the within certificate."

Par. 1260 Regulations, Edit. 1861.

Medical officers, in giving certificates of disability, are to take particular care in all cases that have not been under their charge; and especially in epilepsy, convulsions, chronic rheumatism, derangement of the urinary organs, ophthalmia, ulcers, or any obscure disease liable to be feigned or purposely produced; and in no case shall such certificate be given until after sufficient time and examination to detect any attempt at deception.

DIRECTIONS.

This certificate will be made out in duplicate by the soldier's company commander, or other officer commanding the separate detachment to which he belongs and sent by him to the surgeon who has charge of the hospital where the soldier is sick. The surgeon will then fill out and sign the surgeon's certificate, and forward these papers to the regimental, detachment, or post commander, who will forward them, with his action endorsed thereon, through the proper channel, to his division commander; or, if the troops are not attached to a division, to his corps, department, or other commander or officer to whom the authority to discharge enlisted men may be specially delegated.

These certificates, after having received the action of the highest authority to which they are required to be sent, will be returned through the same channel to the regimental, post, or detachment commander, who will, if the discharge is authorized by the endorsement of the proper authority, sign the soldier's discharge, and the last certificate on this paper; see that the soldier is furnished with the proper final statements in duplicate, and forward BOTH of these certificates direct to the Adjutant General United States Army, at Washington, D. C.; they will not under any circumstances be given into the hands of the soldier.

ADJUTANT GENERAL'S OFFICE

July 4th 1865

Duplicate sent the Pension Office.

1865
CERTIFICATE OF DISABILITY FOR DISCHARGE

IN THE CASE OF

Louis Miller
a *Private* Co. *21st*

5 Reg't of *Mass. Cavalry*

W. B. Smith

HEAD QUARTERS,
DEPARTMENT OF WASHINGTON,
23d Army Corps,

Sam. L. Smith

TO BE DISCHARGED.

BY COMMAND OF

MAJ. GENL C. C. AUGER.

W. B. Smith
A. A. G.

Received (A. G. Office) _____, 1865



En on O.R. Cas

Extract from Act of Congress.

SEC. 12. *And be it further enacted,* That the fees of agents and attorneys for making out and causing to be executed the papers necessary to establish a claim for a pension, bounty, and other allowance before the Pension Office, under this act, shall not exceed the following rates: For making out and causing to be duly executed a declaration by the applicant, with the necessary affidavits, and forwarding the same to the Pension Office, with the requisite correspondence, ten dollars; which sum shall be received by such agent or attorney in full for all services in obtaining such pension, and shall not be demanded or received, in whole or in part, until such pension shall be obtained; and the sixth and seventh sections of an act entitled "An act to grant pensions," approved July [fourteenth,] eighteen hundred and sixty-two, are hereby repealed.

SEC. 13. *And be it further enacted,* That any agent or attorney who shall, directly or indirectly, demand or receive any greater compensation for his services under this act than is prescribed in the preceding section of this act, or who shall contract or agree to prosecute any claim for a pension, bounty, or other allowance under this act, on the condition that he shall receive a per centum upon any portion of the amount of such claim, or who shall wrongfully withhold from a pensioner or other claimant the whole or any part of the pension or claim allowed and due to such pensioner or claimant, shall be deemed guilty of a high misdemeanor, and, upon conviction thereof, shall, for every such offense, be fined not exceeding three hundred dollars, or imprisoned at hard labor not exceeding two years, or both, according to the circumstances and aggravations of the offense.

Approved July 4, 1864.

NOTE 10.—If any soldier is charged a higher fee than that allowed by the above act, he should report the fact and the name of the agent to the Adjutant General, in order that steps may be taken to have the same refunded.

FINAL STATEMENT

Wm. Lewis Kelly
5th Reg't of Mass. Cav.

VOLUNTEERS.

NOTE 1.—Two of these certificates (or duplicates) are to be given to each Volunteer Soldier or drafted man who may be discharged without being mustered out. (Final Statements are never given to men mustered out of service) that he may at once receive from the Paymaster the pay, &c. due him, and the captain or other COMMISSIONED officer commanding the company will certify to the act of the delivery of the duplicate certificates; with these certificates the Soldier is "entitled to" his discharge, and should also present his discharge to the Paymaster to have the payment endorsed on it. The discharge is to be given back to the Soldier by the Paymaster; the latter only retaining as his vouchers the duplicate certificates.

NOTE 2.—If the Soldier is entitled to pay for the use of his horse, the Company Commander will certify to that fact on the back of both these final statements, and also to the time he has pay due for having been so mounted on his own horse.

NOTE 3.—When a Soldier is furnished with final statements, his descriptive list, if he has one, should be taken up by the officer who gives the Soldier these statements, and endorsed with a statement to this effect by the officer. The endorsement should exhibit a full statement of the time for which the Soldier was allowed pay on his final statements, the clothing account, and all other charges against him or in his favor, so as to comprise a complete exhibit of his account. It will then be transmitted to the Company Commander of the Soldier, who will enter all the data necessary to a full understanding of the Soldier's account on the muster roll upon which the Soldier's discharge is reported. The descriptive list will then be destroyed. The object of this is, that the remaining portion of the Soldier's account may be settled upon the receipt of these muster rolls, and the Soldier receive any pay or allowances that may be due him at the time of his discharge, and which may not appear on his last final statements from the fact that his descriptive list is incomplete. These accounts for back pay, &c., are settled by the 2d Auditor of the Treasury Department.

NOTE 4.—Charges for loss or injury to ordnance, horse equipments, and other miscellaneous charges, should appear under the heading of "Other Stoppages."

NOTE 5.—Bounty paid by State authorities, and not by the United States, will not be entered on this statement.

NOTE 6.—Amounts due the Sutler and Laundress must be entered on the muster roll on which the discharge, death, desertion, &c., is reported, as well as on the final statement, otherwise the amount cannot be collected from the United States.

NOTE 7.—This blank will be used for deceased volunteers and drafted men, as well as for others.

NOTE 8.—Where a Soldier dies in Hospital or on detached service, his descriptive list, if he has one, should be sent with his final statements, in duplicate, to the Adjutant General, Washington, D. C.

NOTE 9.—If the soldier is a drafted man or substitute, the space for time, &c., of enrolled, should contain only the word *drafted* or *substitute*, as the case may be. If the Soldier is a "VETERAN," (or RECRUIT,) the words *as a veteran*, (or *recruit*,) as the case may be, should be interlined after the words *mustered into the service of the U. S.* A statement of all the instalments of *Veteran* or *Recruit* Bounty RECEIVED by the Soldier must be made on the back of each final statement.

I certify, on honor, that Lewis Miller, Private of
Captain _____ Company (D) of the 5 Regiment of Ed Cavalry
VOLUNTEERS, of the State of Massachusetts, born in _____, State
of _____, aged 24 years; _____ feet _____ inches high; _____ complexion,
_____ eyes, _____ hair, and by occupation a _____, who joined for service
and was enrolled (see Note 9) on the 10th day of January, 1864, at Marfield Mass
by W B Bates, for the period of Three years, and mustered into
the service of the United States on the 29th day of January, 1864, at
Roadville Mass, by Sent Robert McKibbin; and having served
HONESTLY and FAITHFULLY with his Company to the present date, is now entitled to a
DISCHARGE by reason of Surgeon's certificate of disability
Phthisis pulmonalis

The said Lewis Miller was last paid by Paymaster
Stingard, to include the 31st day of October, 1864, and
has pay due him from that time to the present date; he is entitled to pay and subsistence for
TRAVELING to place of enrollment, and whatever other allowances are authorized to volunteer
soldiers, drafted men, or militia, so discharged. He has received from the United States **CLOTHING**
amounting to Three ³⁴ dollars, since the 14th day of June,
1864, when his clothing account was last settled. He has received from the United States
100 dollars advanced **BOUNTY**.

There is to be stopped from him, on account of the State of _____, or other
authorities, for **CLOTHING**, &c., received on entering service, _____ 100 dollars; and
for other stoppages, viz: _____

_____ 100 dollars.
He has been furnished with **TRANSPORTATION** in kind from the place of his discharge to
_____ ; and he has been **SUBSISTED** for **TRAVELING** to his
place of enrollment, up to the _____, 1864.

He is indebted to _____, **SUTLER**, _____ 100 dollars.

He is indebted to _____, **LAUNDRESS**, _____ 100 dollars.

Given in Duplicate, at Structure Genl Hopt Alexandria, this 12th day
of January, 1865.

Ed Edwin Bentley
Surgeon U. S. Vols

NOTE 1.

The company commander will here add a statement of all the facts known to him concerning the disease or wound, or cause of disability of the soldier; the time, place, manner, and all the circumstances under which the injury occurred, or disease originated or appeared; the duty, or service, or situation of the soldier at the time the injury was received or disease contracted, stating particularly whether the injury was received or the disease contracted in the line of his duty; and whatever other facts may aid a judgment as to the cause, immediate or remote, of the disability, and the circumstances attending it.

When the facts are not known to the company commander, the certificate of any officer, or affidavit of other person having such knowledge, will be appended—as the surgeon in charge of a hospital, the officer commanding a detachment of recruits, &c., &c.

NOTE 2.

When a probable case for pension, special care must be taken to state the degree of disability—as 1/2, 3/4, &c., &c.; to describe particularly the disability, wound, or disease the extent of which it deprives him of the use of any limb or faculty, or affects his health, strength, activity, constitution, or capacity to labor or earn his subsistence. The surgeon will add, from his knowledge of the facts and circumstances, and from the evidence in the case, his professional opinion of the cause or origin of the disability. In the case of discharges by Medical Inspectors, the last paragraph will state that the "discharge was given by consent of the soldier, after a personal examination, and for disability, the nature, degree, and origin of which are correctly described in the within certificate."

Par. 1260 Regulations, Edit. 1861.

Medical officers, in giving certificates of disability, are to take particular care in all cases that have not been under their charge; and especially in epilepsy, convulsions, chronic rheumatism, derangement of the urinary organs, ophthalmia, ulcers, or any obscure disease liable to be feigned or purposely produced; and in no case shall such certificate be given until after sufficient time and examination to detect any attempt at deception.

DIRECTIONS.

This certificate will be made out in duplicate by the soldier's company commander, or other officer commanding the separate detachment to which he belongs, and sent by him to the surgeon who has charge of the hospital where the soldier is sick. The surgeon will then fill out and sign the surgeon's certificate, and forward these papers to the regimental, detachment, or post commander, who will forward them, with his action endorsed thereon, through the proper channel, to his division commander; or, if the troops are not attached to a division, to his corps, department, or other commander or officer to whom the authority to discharge enlisted men may be specially delegated.

These certificates, after having received the action of the highest authority to which they are required to be sent, will be returned through the same channel to the regimental, post, or detachment commander, who will, if the discharge is authorized by the endorsement of the proper authority, sign the soldier's discharge, and the last certificate on this paper; see that the soldier is furnished with the proper final statements in duplicate, and forward BOTH of these certificates direct to the Adjutant General United States Army at Washington, D. C.; they will not, under any circumstances, be given to the hands of the soldier.

Discharged Jan 12th 1862
CERTIFICATE OF DISABILITY FOR DISCHARGE

IN THE CASE OF

Lewis J. Miller
a Private Co. D
1st Mass Reg't of Cavalry

Approved
Wm. R. Abbott

Head Quarters,
Dept. of Washington
12th Army Corps.
To be discharged.
By Command of
Maj. Gen. C. C. Auger:
sd. H. W. Smith,
adly.

Received (A. G. Office) 186

ARMY OF THE UNITED STATES.
CERTIFICATE
OF DISABILITY FOR DISCHARGE.



Priv Lewis Miller of Captain
 Company, (*D*) of the *5th Mass Col* Regiment of the United States
 was enlisted by *W B Bates* of
 the *1st* Regiment of *Mass* at *Shansfield Mass*
 on the *eighteenth* day of *January*, 1864, to serve *three* years; he was born
 in *the State of* *Mass*, is *twenty nine*
 years of age, *5* feet *10* inches high, *fair* complexion, *blue* eyes,
dark hair, and by occupation when enlisted a *farmer*. During the last two
 months said soldier has been unfit for duty *30* days. *He is suffering from*
Phtisis Pulmonalis, and Hemoptysis induced
by exposure since enlistment in line of duty
In my opinion this man will never be fit for any
duty in the military service.

11/17/1864

STATION: *Quartermaster Genl Hosp*
 DATE: *December 10th 1864* (Sg) *W R Fletcher*
a. a. Surg. U.S.A.

Commanding Company
Attending Surg at Lower tier Genl Hosp.

I CERTIFY, that I have carefully examined the said *Priv Lewis Miller*
 of Captain *"D"* Company, and find him incapable of performing the duties of a
 soldier because of *Phtisis Pulmonalis Hemoptysis induced*
by exposure since enlistment in line of duty
Disease permanent (not in path)
Degree of Disability 3/4
Not suit'able to enter or re-enlist in (Genl Hosp)
 (Sgd) *Edwin Bentley* Surgeon. *U.S.A.*

DISCHARGED, this *17th* day of *January*, 1865, at *Lancaster*
General Hospital Alexandria Va.

(Sgd) *Edwin Bentley*
Surg W.S. Vol's in charge
General Hosp's at ea. V.
Commanding the Reg't.

The Soldier desires to be addressed at
 Town *Quincy* County *Wate* State *N.Y.*

TREATMENT.

[HERE NOTE IMPORTANT COMPLICATIONS AND ALL OPERATIONS.]

RESULT AND DATE.

Discharged Jan'y 13. 65

6

Hospital Number 279

Name *Jessie Milley*

Age *31* Nativity *New York*

Married or Single *Married*

Residence *Elmira N.Y.*

Post Office address of wife or nearest relative *Susan Milley*

Elmira N.Y.

Rank *Priv* Co. *B* Regiment *59th Inf*

When admitted *Sept 13-1864*

From what source *Archibald Hays*

Diagnosis: (in surgical cases state explicitly seat and character of wound or injury.)

Right Inguinal Hernia

L'Ouverture G.H.
Alexandria, Va.

On what occasion wounded
Date
Nature of missile or weapon

Miller, Robert

Co L, 5 Mass. Cav., (Col'd.)

Private

Private

CARD NUMBERS.

1 5-384873

2 5-384957

3 5-385084

4 5-385191

5 5-385892

6 9091503

7 40731291

8

9

10

11

12

13

14

15

16

17

18

19

20

21

22

23

24

25

26

27

28

29

30

31

32

33

34

35

36

37

38

39

40

41

42

43

44

45

46

47

48

49

50

Book Mark:

See also

M. | **5 Cav. (Col'd.)** | **Mass.**

Robert Miller.

....., Co. *L.*, 5 Reg't Mass. Cav. (Col'd.)

Appears on

Company Descriptive Book

of the organization named above.

DESCRIPTION.

Age *24* years; height *5* feet *6* inches.

Complexion *Dark.*

Eyes *Black*; hair *Black.*

Where born *Pittsburg Pa.*

Occupation *Farmer.*

ENLISTMENT.

When *Apr. 21st, 186*

Where *Sheffield.*

By whom *G. H. Quincy*; term *3* y'rs.

Remarks: *Mustered into service at
Reedville Mass. Apr. 22/64. by Lieut.
McKibbin. Deserted from the Co.
while on its way through Philadelphia
Pa. May 10th 1864.*

H. C. Thomas.

(3539)

Copyist.

M | **5 Col'd Cav.** | **Mass.**

Robert Miller

Priv., Co. L, 5 Reg't Mass. Col'd Cav.

Appears on

Company Muster-in and Descriptive Roll
of the organization named above. Roll dated

Readville Mass, Apr. 22, 1864.

Where born Pittsburg, Pa.

Age 24 y'rs; occupation labourer

When enlisted Apr. 21, 1864.

Where enlisted Sheffield

For what period enlisted 3 years.

Eyes Black; hair Black

Complexion Black; height 5 ft. 6 in.

When mustered in Apr. 22, 1864.

Where mustered in _____

Bounty paid \$ 100; due \$ 100

Where credited 10th Cong. Dist. Mass.

Company to which assigned _____

Remarks: _____

Book mark: _____

Crenshaw

(356d)

Copyist.

M | **5 Col'd Cav.** | **Mass.**

Robert Miller

Pvt, Co. L, 5 Reg't Mass. Col'd Cavalry.

Appears on

Company Muster Roll

for *Apr. 22 to 30*, 186*4*.

Present or absent *Present*

Stoppage, \$.....*100* for

Due Gov't, \$.....*100* for

Valuation of horse, \$.....*100*

Valuation of horse equipments, \$.....*100*

Remarks:

Book mark:

Creshaw

M | 5 Col'd Cav. | Mass.

Robert Miller
Pvt, Co. L, 5 Reg't Mass. Col'd Cavalry.

Appears on

Company Muster Roll
for May & June, 1864.

Present or absent

Stoppage, \$ 100 for

Due Gov't, \$ 100 for

Valuation of horse, \$ 100

Valuation of horse equipments, \$ 100

Remarks: Deserted at
Phila. Pa., May 10, 1864.

Book mark:

Crenshaw

(358)

Copyist.

M

5 Col'd Cav.

Mass.

Robert Miller

Pvt., Co. L, 5 Reg't Mass. Col'd Cavalry.

Appears on

Company Muster Roll

for July & Aug., 1864.

Present or absent

Stoppage, \$ 100 for

Due Gov't, \$ 100 for

Valuation of horse, \$ 100

Valuation of horse equipments, \$ 100

Remarks: Deserted at Phila. Pa. May 10, 1864.

Book mark:

Crenshaw

(358)

Copyist.

M. | 5 Col'd Cav. | Mass.

Robert Miller

Pvt., Co. L, 5 Reg't Mass. Colored Cav.

Appears on Returns as follows:

May 1864. Absent without leave.

June 1864. Loss - deserted at Phila, Pa. May 10"

Book mark :

(546)

J. B. Sittler

Copyist.

M | **5 Col'd Cav.** | **Mass.**

Robert Miles

Oct, Co. *A*, 5 Reg't Mass. Col'd Cavalry.

Appears on **Co. Muster-out Roll**, dated
October 11th 1863, 186*3*.

Muster-out to date -----, 186 .

Last paid to *none paid* -----, 186 .

Clothing account:

Last settled -----, 186 ; drawn since \$ ----- 100

Due soldier \$ ----- 100; due U. S. \$ ----- 100

Am't for cloth'g in kind or money adv'd \$ ----- 100

Due U. S. for arms, equipments, &c., \$ ----- 100

Bounty paid \$ ----- 100; due \$ ----- 100

Remarks: *Copy to General*
at Philadelphia Pa
for muster-out roll
for 5th Mass Cavalry

Book mark: -----

Copyist

994
Miller, Thomas J.

Co G, 5 Mass. Cav., (Col'd.)

Private

Corporal

CARD NUMBERS.

1	5-380544	26
2	5-380584	27
3	5-380670	28
4	5-380750	29
5	5-380852	30
6	5-380950	31
7	5-381051	32
8	5-381152	33
9	5-381254	34
10	5-381354	35
11	5-381452	36
12	9091959	37
13		38
14		39
15		40
16		41
17		42
18		43
19		44
20		45
21		46
22		47
23		48
24		49
25		50

Book Mark:

See also

J. 1606544 Pomme

A3170795 Pomme

R/walk
4

MB | **5 Cav. (Col'd.)** | **Mass.**

Thomas J. Miller

....., Co. *G*, 5 Reg't Mass. Cav. (Col'd.)

Appears on

Company Descriptive Book

of the organization named above.

DESCRIPTION.

Age *21* years; height *5* feet *6 $\frac{3}{4}$* inches.

Complexion *Blk*

Eyes *Blk*; hair *Blk*

Where born *Baltimore Md.*

Occupation *Ironsmith*

ENLISTMENT.

When *Feb 26*, 1864.

Where *Boston.*

By whom *D. Davies*; term *3* y'rs.

Remarks: *Single.*

Heard

M. | **5 Col'd Cav.** | **Mass.**

Thomas J. Miller

Pvt., Co. *E*, 5 Reg't Mass. Col'd Cav.

Appears on
Company Muster-in and Descriptive Roll
of the organization named above. Roll dated
Readville Mass, Mar 4, 1864.

Where born *Baltimore Md.*

Age *21* y'rs; occupation *Tin Smith*

When enlisted *Feb. 26*, 1864.

Where enlisted *Boston Ward 6*

For what period enlisted *3* years.

Eyes *Blk*; hair *Blk*

Complexion *Blk*; height *5 ft. 6 3/4 in.*

When mustered in *Mar 4*, 1864.

Where mustered in *Readville Mass*

Bounty paid \$ *2* / *100*; due \$ *100*

Where credited *Dist Suffolk*

Company to which assigned _____

Remarks: _____

Book mark: _____

Leger

My | **5 Col'd Cav.** | **Mass.**

Thomas J. Miller
Corp, Co. G, 5 Reg't Mass. Col'd Cavalry.

Appears on

Company Muster Roll
for *March to Apr 30*, 1864

Present or absent *Present*

Stoppage, \$ *100* for

Due Gov't, \$ *100* for

Valuation of horse, \$ *100*

Valuation of horse equipments, \$ *100*

Remarks: *Appointed Corporal*
by Special Regt order No
97 dated April 28, 1864
App'd to Co from Mar
4/64.

Book mark: _____

L. J. ...

M | **5 Col'd Cav.** | **Mass.**

Thomas J Miller
Copl, Co. G, 5 Reg't Mass. Col'd Cavalry.

Appears on

Company Muster Roll

for *May & June*, 186 *4*

Present or absent *Present*

Stoppage, \$ *100* for

Due Gov't, \$ *100* for

Valuation of horse, \$ *100*

Valuation of horse equipments, \$ *100*

Remarks: *Adopted Copl by Special Reg't order no 47 dated April 28/64 Adopt to date from Mar 4/64*

Book mark:

Leger

W | **5 Col'd Cav.** | **Mass.**

Thomas P. Miller
Copl., Co. G, 5 Reg't Mass. Col'd Cavalry.

Appears on

Company Muster Roll

for July & Aug, 1864.

Present or absent Present

Stoppage, \$ 100 for

Due Gov't, \$ 100 for

Valuation of horse, \$ 100

Valuation of horse equipments, \$ 100

Remarks: Appointed Copl
by Special Regt order
No 97 dated Apr 28/64
Appt to date from Mar
4/64. Stop one Haver-
sack & one Canteen

Book mark: _____

(358)

Legg

Copyist.

M. | 5 Col'd Cav. | Mass.

Thomas J. Miller
Corpl, Co. G, 5 Reg't Mass. Col'd Cavalry.

Appears on

Company Muster Roll

for Sept. & Oct., 1864.

Present or absent Present

Stoppage, \$ 100 for

Due Gov't, \$ 100 for

Valuation of horse, \$ 100

Valuation of horse equipments, \$ 100

Remarks:

Book mark:

Perry

M. | 5 Col'd Cav. | Mass.

Thomas J Miller
Corpl, Co. G, 5 Reg't Mass. Col'd Cavalry.

Appears on

Company Muster Roll

for Nov. & Dec., 1864.

Present or absent Present

Stoppage, \$ 100 for

Due Gov't, \$ 100 for

Valuation of horse, \$ 100

Valuation of horse equipments, \$ 100

Remarks:

Book mark:

Perry

M. | 5 Col'd Cav. | Mass.

Thomas J. Miller
Corpl, Co. G, 5 Reg't Mass. Col'd Cavalry.

Appears on

Company Muster Roll

for Jan. & Feb., 1865.

Present or absent Present

Stoppage, \$ 100 for

Due Gov't, \$ 100 for

Valuation of horse, \$ 100

Valuation of horse equipments, \$ 100

Remarks: Due 1, 2, 3, & 4
instalments U. S.
Bounty \$180.

Book mark:

Cerry

(358)

Copyist.

M | **5 Col'd Cav.** | **Mass.**

Thomas J. Miller
Corpl, Co. G, 5 Reg't Mass. Col'd Cavalry.

Appears on

Company Muster Roll

for *Mch & Apl.*, 186*5*.

Present or absent *Present*

Stoppage, \$ *100* for

Due Gov't, \$ *100* for

Valuation of horse, \$ *100*

Valuation of horse equipments, \$ *100*

Remarks: *Due the soldier
four instalments
U.S. Bounty \$180.*

Book mark: _____

(358)

Cerry

Copyist.

M | 5 Col'd Cav. | Mass.

Thomas J. Miller
Corpl, Co. G, 5 Reg't Mass. Col'd Cavalry.

Appears on

Company Muster Roll

for May & June, 1865.

Present or absent Present

Stoppage, \$ 100 for

Due Gov't, \$ 100 for

Valuation of horse, \$ 100

Valuation of horse equipments, \$ 100

Remarks:

Book mark:

(358)

Cerry

Copyist.

No | **5 Col'd Cav.** | **Mass.**

Thomas J. Miller
Capt, Co. G, 5 Reg't Mass. Col'd Cavalry.

Appears on

Company Muster Roll

for *July & August*, 186 *9*.

Present or absent *Present*

Stoppage, \$ *100* for

Due Gov't, \$ *100* for

Valuation of horse, \$ *100*

Valuation of horse equipments, \$ *100*

Remarks:

Book mark:

(358)

Wm J. Scott

Copyist.

M | **5 Col'd Cav.** | **Mass.**

Thomas J. Miller
Cox, Co., 5 Reg't Mass. Col'd Cavalry.

Appears on **Co. Muster-out Roll**, dated
Charlottesville, Oct 31, 1865.

Muster-out to date *Oct 31, 1865.*

Last paid to *Dec 31, 1864.*

Clothing account:

Last settled....., 186 ; drawn since \$ 100

Due soldier \$ 100; due U. S. \$ *47* ^{*08*} 100

Am't for cloth'g in kind or money adv'd \$ 100

Due U. S. for arms, equipments, &c., \$ *//* 100

Bounty paid \$ 100; due \$ *300* 100

Remarks:
.....
.....
.....
.....
.....

Book mark :

W. H. Scott

(361)

Copyist.

993
Mills, Edward

Co A, 5 Mass. Cav., (Col'd.)

Private

Private

CARD NUMBERS.

1 5372572
2 5372562
3 5384300
4 5384379
5 5384473
6 5384611
7 5384802
8 9091662
9 Stw-1503-1865
10 32262328
11 40731392
12
13
14
15
16
17
18
19
20
21
22
23
24
25

26
27
28
29
30
31
32
33
34
35
36
37
38
39
40
41
42
43
44
45
46
47
48
49
50

Book Mark: Stw-1503-1865

See also

No. **5 Cav. (Col'd.)** | **Mass.**

Edward Mills,

....., Co. *K*....., 5 Reg't Mass. Cav. (Col'd.)

Appears on

Company Descriptive Book

of the organization named above.

DESCRIPTION.

Age *24* years; height *5* feet *7* inches.

Complexion *Black*.

Eyes *Black*; hair *Black*.

Where born *N.Y. N.York*.

Occupation *Waiter*.

ENLISTMENT.

When *Dec. 15th*, 1864.

Where *Boston*.

By whom *W. G. Howe*; term *3* y'rs.

Remarks: *Single Residence N.York, N.Y.*

Received \$100. due \$200. U. S. Bounty

Dec. 15th 64. Discharged for disability

at Point Lookout Md. May 17th 1865.

by order of G. Sutton Surgeon U.S.

Genl. Hospl.

H. C. Thomas

M | **5 Col'd Cav.** | **Mass.**

Edward Mills

Appears with rank of *Private* on

Muster and Descriptive Roll of a Detachment of U. S. Vols. forwarded

for the 5 Reg't Mass. Col'd Cavalry. Roll dated

Boston Mass. Dec 15, 1864.

Where born *New York N.Y.*

Age *24* y'rs; occupation *Waiter*

When enlisted *Dec. 15*, 1864.

Where enlisted *Boston Mass.*

For what period enlisted *3* years.

Eyes *blk*; hair *blk*

Complexion *blk*; height *5 ft. 7 in.*

When mustered in *Dec. 15*, 1864.

Where mustered in *Boston*

Bounty paid \$ ~~100~~ ¹⁰⁰; due \$ ~~200~~ ¹⁰⁰

Where credited *Worthington Mass.*

Company to which assigned

Remarks:

**Bounty cancelled*

Book mark: *Stu-1503-1865*

M. A. Michaels

M | **5 Col'd Cav.** | **Mass.**

Edward Mills

Appears with rank of *Private* on

Muster and Descriptive Roll of a Detachment of U. S. Vols. forwarded

for the 5 Reg't Mass. Col'd Cavalry. Roll dated
Draft Rendezvous
Galloups Island N.H. Mass, Dec. 19, 1864.

Where born *New York*

Age *24* y'rs; occupation *Waiter*

When enlisted *Dec. 15*, 1864.

Where enlisted *Boston Mass.*

For what period enlisted *3* years.

Eyes *black*; hair *black*

Complexion *black*; height *5 ft. 7 in.*

When mustered in *Dec. 15*, 1864.

Where mustered in *Boston Mass.*

Bounty paid \$*100*¹⁰⁰; due \$*200*¹⁰⁰

Where credited *Northington Hampshire Co.*

Company to which assigned

Remarks:

Book mark:

M. A. Michaels

M | **5 Col'd Cav.** | **Mass.**

Edward Mills

Priv., Co. K, 5 Reg't Mass. Col'd Cavalry.

Appears on

Company Muster Roll

for Nov & Dec, 1864.

Present or absent Present

Stoppage, \$ 100 for

Due Gov't, \$ 100 for

Valuation of horse, \$ 100

Valuation of horse equipments, \$ 100

Remarks:

Book mark:

Edward Mills

M | **5 Col'd Cav.** | **Mass.**

Edward Mills

Priv., Co. K, 5 Reg't Mass. Col'd Cavalry.

Appears on

Company Muster Roll

for Jan & Feb, 1865.

Present or absent Present

Stoppage, \$ 100 for

Due Gov't, \$ 100 for

Valuation of horse, \$ 100

Valuation of horse equipments, \$ 100

Remarks: Received from
he for

Book mark: _____

Edmondson

M | **5 Col'd Cav.** | **Mass.**

Edward Mills

Priv., Co. K, 5 Reg't Mass. Col'd Cavalry.

Appears on

Company Muster Roll

for Mar 1 65, 1865.

Present or absent Absent

Stoppage, \$ 100 for

Due Gov't, \$ 100 for

Valuation of horse, \$ 100

Valuation of horse equipments, \$ 100

Remarks: Absent in Hospital
at Ft. Monroe Md.

Book mark:

Brownson

M. | 5 Cav. | Mass. C.

Edward Miller
Prvt., Co. K., 5 Reg't Mass. C.

Appears on

Hospital Muster Roll

of **U. S. A. General Hospital,**

at **Point Lookout, Md.,**

for Mar & Apr., 186 5-

Attached to hospital:

When _____, 186 .

How employed _____

Last paid by Maj. Dodge.
to Dec 31, 186 4

Bounty paid \$ 100; due \$ 100

Present or absent Present.

Remarks: _____

Ward F.

Book mark: _____

(848)

B. S. Esterling

Copyist.

M | 5 Col'd Cav. | Mass.

Edward Mills

Priv., Co. K, 5 Reg't Mass. Col'd Cavalry.

Appears on

Company Muster Roll

for May 5 June, 1865.

Present or absent

Stoppage, \$ 100 for

Due Gov't, \$ 100 for

Valuation of horse, \$ 100

Valuation of horse equipments, \$ 100

Remarks: Discharged for disability May 14/65 by order of Surgeon in charge.

Book mark:

[Signature]

M. | 5 Col'd Cav. | Mass.

Edward Mills

Pvt., Co. K, 5 Reg't Mass. Colored Cav.

Appears on **Returns** as follows:

Dec. 1864. Gain Dec. 5/64 Pt.
Lookout, Md. Recruit
from Depot.

Mar. to May 1865. Absent sick
in Hosp. Pt. Lookout
Md. since Mar. 27/65.

June 1865. Loss May 11 Pt.
Lookout Md. Disch'd
for disability by order
of Surgeon in charge.

Book mark :

(648)

J. B. Sittler

Copyist.

711

5 Col'd Cav.

Mass.

Edward Mills

Pvt, Co. K, 5 Reg't Mass. Col'd Cavalry.

Appears on Co. Muster-out Roll, dated
Clarksville Texas, Oct. 31, 1865.

Muster-out to date _____, 186 .

Last paid to Dec. 31, 1864.

Clothing account:

Last settled _____, 186 ; drawn since \$ 100

Due soldier \$ ¹¹100; due U. S. \$ 100

Am't for cloth'g in kind or money adv'd \$ 100

Due U. S. for arms, equipments, &c., \$ 100

Bounty paid \$ 100⁰⁰: due \$ 200⁰⁰

Remarks: Discharged May 19th 1865
at Pt. Lookout Md. for disability

Book mark: G.D.

Galligan

(861)

Copyist.

Mo 5th Col. Cav Mass
Edward Mills
, Co. K, 5th Reg't Mass Col. Cav.

NOTATION.

Book mark: *Stu - 1503 - 1865.*

War Department,

Adjutant General's Office,

Washington, *May 19*, 1865.

Discharged on Surgeon's Certificate
of Disability, *May 17* 1865 .

Mills, Edward

....., Co.

Reg't

5th Reg't "C"

3 Enclosures.

Bed Cards	Final Statements
Burial Records	Furloughs or L. of A
Certs. of Dis. for Discharge /	Med. Certificates
C. M. Charges	Med. Des. Lists
Descriptive Lists	Orders
Discharge Certificates	Pris. of War Record
Enlistment Papers /	Resignations

Other papers relating to—

Admission to Hosp'l	Furlough or L. of A
Casualty Sheet	Med. Examination
Confinement	Misc. Information
Contracts	Pay or Clothing
Death or Effects	Personal Reports
Desertion	Rank
Discharge from Hosp'l	Transfer to Hosp'l
Discharge from Service	Transfer to V. R. C.
Duty	Transportation

Note 1. — This blank will be used for both enlistments and re-enlistments — enlistment of veterans, &c., &c., in the volunteer service. They will be made out in duplicate in all cases — one to accompany the recruiting return of the superintendent (not the recruiting officer) to the Adjutant-General, and one to accompany the accounts of the officer who pays bounty, &c. The Regiment and Company in which the soldier last served should be given on the back.

Note 2. — An enlistment holds to service. A muster-in must, in all cases, precede payment of pay, bounty, pension, &c. A muster-in roll must, in all cases, be filed in the Adjutant-General's Office as evidence of muster-in. The mustering officer, commissary, or assistant-commissary of musters, as the case may be, will countersign both enlistments as having mustered the soldier into the service of the United States before either of them is given to the disbursing officer.

DECLARATION OF RECRUIT.

I, *Edward Miller* desiring to VOLUNTEER as a Soldier in the Army of the United States, for the term of THREE YEARS, Do Declare, That I am *Twenty four* years and _____ months of age; that I have never been discharged from the United States service on account of disability or by sentence of a court-martial, or by order before the expiration of a term of enlistment; and I know of no impediment to my serving honestly and faithfully as a soldier for three years.

GIVEN at *Boston Massachusetts* the *15th* day of *December 1865*

Witness: *J. Downing* *Edward Miller*

No.

Volunteered at *Boston Mass*

Dec 15th 1864,

By *W. H. Stone*

5th Regiment of *Mass Cav.*

enlistment; last served in Company ()

Reg't of

Discharged

18

Mr. Bounty Paid

CONSENT IN CASE OF MINOR.

I, _____ Do CERTIFY, That I am the _____ of _____ ; that the said _____ is _____ years of age; and I do hereby freely give my CONSENT to his volunteering as a SOLDIER in the ARMY OF THE UNITED STATES for the period of THREE YEARS.

GIVEN at _____ the _____ day of _____

Witness:

VOLUNTEER ENLISTMENT.

STATE OF



CITY TOWN OF

Massachusetts

Boston

I, Edward Mills born in New York aged twenty four years, and by occupation a Mailman DO HEREBY ACKNOWLEDGE to have volunteered this 15th day of December, 1864, to serve as a Soldier in the Army of the United States of America, for the period of THREE YEARS, unless sooner discharged by proper authority: Do also agree to accept such bounty, pay, rations, and clothing, as are, or may be, established by law for volunteers. And I, E. Mills do solemnly swear, that I will bear true faith and allegiance to the United States of America, and that I will serve them honestly and faithfully against all their enemies or opposers whomsoever; and that I will observe and obey the orders of the President of the United States, and the orders of the officers appointed over me, according to the Rules and Articles of War.

Sworn and subscribed to, at Boston this 15th day of Dec 1864, BEFORE [Signature] Edward Mills

I CERTIFY, ON HONOR, That I have carefully examined the above-named Volunteer, agreeably to the General Regulations of the Army, and that, in my opinion, he is free from all bodily defects and mental infirmity, which would in any way disqualify him from performing the duties of a soldier.

[Signature: H. J. Brewster]

EXAMINING SURGEON.

I CERTIFY, ON HONOR, That I have minutely inspected the Volunteer, E. Mills previously to his enlistment, and that he was entirely sober when enlisted; that, to the best of my judgment and belief, he is of lawful age; and that, in accepting him as duly qualified to perform the duties of an able-bodied soldier, I have strictly observed the Regulations which govern the recruiting service. This soldier has black eyes, black hair, black complexion, is 5 feet 7 inches high.

[Signature: W. G. Howe] Capt & Prov Mar

RECRUITING OFFICER.

(A. G. O. No. 74 & 75.)

Mustered into the service of the United States, in Company 5th Regiment of Mass Heavy Artillery Volunteers, on the 15th day of December 1864, at Boston Town of Boston 9th District

[Signature: Capt & Prov Mar] 4th Mass Dist

MAR 30

NOTE 1. — This blank will be used for both enlistments and re-enlistments — enlistment of veterans, &c., &c., in the volunteer service. They will be made out in duplicate in all cases — one to accompany the recruiting return of the superintendent (not the recruiting officer) to the Adjutant-General, and one to accompany the accounts of the officer who pays bounty, &c. The Regiment and Company in which the soldier last served should be given on the back.

NOTE 2. — An enlistment holds to service. A muster-in must, in all cases, precede payment of pay, bounty, pension, &c. A muster-in roll must, in all cases, be filed in the Adjutant-General's Office as evidence of muster-in. The mustering officer, commissary, or assistant-commissary of musters, as the case may be, will countersign both enlistments as having mustered the soldier into the service of the United States before either of them is given to the disbursing officer.

DECLARATION OF RECRUIT.

x, Edward Mills desiring to VOLUNTEER as a Soldier in the Army of the United States, for the term of THREE YEARS, Do Declare, That I am *Twenty four* years and months of age; that I have never been discharged from the United States service on account of disability or by sentence of a court-martial, or by order before the expiration of a term of enlistment; and I know of no impediment to my serving honestly and faithfully as a soldier for three years.

GIVEN at *Boston Massachusetts* the *15th* day of *December* 18*64*

Witness:

J P Downing

Edward Mills
(Mark)

No.

Edward Mills

Volunteered at

Boston Mass

Dec 15th 18*64*,

By

W B Howe

1st Regiment of *Mass Cav*

enlistment; last served in Company ()

Reg't of

Discharged

18

CONSENT IN CASE OF MINOR.

I, _____ Do CERTIFY, That I am _____
the _____ of _____; that the _____
said _____ is _____ years of age; and I
do hereby freely give my CONSENT to his volunteering as a SOLDIER in the ARMY OF THE UNITED STATES
for the period of THREE YEARS.

GIVEN at

the _____ day of

Witness:

VOLUNTEER ENLISTMENT.

STATE OF



TOWN OF

Massachusetts

City of Boston

I, *Edward Mills* born in _____
 in the State of *New York* aged *Twenty* years,
 and by occupation a *Writer* DO HEREBY ACKNOWLEDGE to have
 volunteered this *15th* day of *December* 186*4*,
 to serve as a **Soldier** in the Army of the United States of America, for the
 period of **THREE YEARS**, unless sooner discharged by proper authority: Do also
 agree to accept such bounty, pay, rations, and clothing, as are, or may be, estab-
 lished by law for volunteers. And I, *E. Mills* do
 solemnly swear, that I will bear true faith and allegiance to the **United States**
of America, and that I will serve them honestly and faithfully against all their
 enemies or opposers whomsoever; and that I will observe and obey the orders of
 the President of the United States, and the orders of the officers appointed over
 me, according to the Rules and Articles of War.

Sworn and subscribed to, at *Boston*
 this *15* day of *Dec* 186*4*
 BEFORE *Office J.P.* } *Edward Mills*

I CERTIFY, ON HONOR, That I have carefully examined the above-named Volunteer, agreeably
 to the General Regulations of the Army, and that, in my opinion, he is free from all bodily defects and
 mental infirmity, which would in any way disqualify him from performing the duties of a soldier.

W. J. Bennett
 EXAMINING SURGEON.

I CERTIFY, ON HONOR, That I have minutely inspected the Volunteer, *E. Mills*
 previously to his enlistment, and that he was entirely sober when enlisted; that, to the best of my
 judgment and belief, he is of lawful age; and that, in accepting him as duly qualified to perform the duties
 of an able-bodied soldier, I have strictly observed the Regulations which govern the recruiting service.
 This soldier has *blue* eyes, *Black* hair, *Black* complexion, is *5* feet
7 inches high.

W. J. House
 Capt'd Prov Mar
 Regiment of _____ Volunteers,
 RECRUITING OFFICER.

Mustered into the service of the United States, in Company *5th*
 the *15* day of *December* 186*4*, at *Boston*
Town of Northampton by the Soldiers
 Regiment of *5th* Cavalry Volunteers, 11
W. J. House
Capt'd Prov Mar
4th Mass Dist

NOTE 1.

The company commander will here add a statement of all the facts known to him concerning the disease or wound, or cause of disability of the soldier; the time, place, manner, and all the circumstances under which the injury occurred, or disease originated or appeared; the duty, or service, or situation of the soldier at the time the injury was received or disease contracted, stating particularly whether the injury was received or the disease contracted in the line of his duty; and whatever other facts may aid a judgment as to the cause, immediate or remote, of the disability, and the circumstances attending it.

When the facts are not known to the company commander, the certificate of any officer, or affidavit of other person having such knowledge, will be appended—as the surgeon in charge of a hospital, the officer commanding a detachment of recruits, &c., &c.

NOTE 2.

When a probable case for pension, special care must be taken to state the degree of disability—as 1/2, 3/4, &c., &c.; to describe particularly the disability, wound, or disease; the extent to which it deprives him of the use of any limb or faculty, or affects his health, strength, activity, constitution, or capacity to labor or earn his subsistence. The surgeon will add, from his knowledge of the facts and circumstances, and from the evidence in the case, his professional opinion of the cause or origin of the disability. In the case of discharges by Medical Inspectors, the last paragraph will state that the "discharge was given by consent of the soldier, after a personal examination, and for disability, the nature, degree, and origin of which are correctly described in the within certificate."

Par. 1260 Regulations, Edit. 1861.

Medical officers, in giving certificates of disability, are to take particular care in all cases that have not been under their charge; and especially in epilepsy, convulsions, chronic rheumatism, derangement of the urinary organs, ophthalmia, ulcers, or any obscure disease liable to be feigned or purposely produced; and in no case shall such certificate be given until after sufficient time and examination to detect any attempt at deception.

DIRECTIONS.

This certificate will be made out in duplicate by the soldier's company commander, or other officer commanding the separate detachment to which he belongs and sent by him to the surgeon who has charge of the hospital where the soldier is sick. The surgeon will then fill out and sign the surgeon's certificate, and forward these papers to the regimental, detachment, or post commander, who will forward them, with his action endorsed thereon, through the proper channel, to his division commander; or, if the troops are not attached to a division, to his corps, department, or other commander or officer to whom the authority to discharge enlisted men may be specially delegated.

These certificates, after having received the action of the highest authority to which they are required to be sent, will be returned through the same channel to the regimental, post, or detachment commander, who will, if the discharge is authorized by the endorsement of the proper authority, sign the soldier's discharge, and the last certificate on this paper: see that the soldier is furnished with the proper number of copies of duplicate, and forward, upon or through the channel, to the Adjutant General, United States Army, at Washington, D. C.; they will not under any circumstances be given into the hands of the soldier.

Duplicate sent the Pension Office.

CERTIFICATE OF DISABILITY FOR DISCHARGE

IN THE CASE OF

1863 14
Meyers Reg. Dis
Edward Miller

a Private Co. K

5th Reg't of Maine

Edward Miller

MAJOR GENERAL
MAY 1863
DISCHARGED
MAJ GENL G. C. AUGER

A. W. Smith

Received (A. G. Office) 1863

On my O.R. of Co

ARMY OF THE UNITED STATES
CERTIFICATE
OF DISABILITY FOR DISCHARGE.



Private Edward Mills of Captain G. L. Higginson Company, (2d) of the 5th Maine Heavy Artillery Regiment of United States Volunteers was enlisted by W. G. Hoar of the 1st Regiment of _____ at Boston, Mass. on the 15th day of December 1864, to serve 3 years; he was born in _____ City in the State of New York is Twenty-four years of age, _____ feet _____ inches high, Black complexion, Black eyes, Black hair, and by occupation when enlisted a mailer. During the last two months said soldier has been unfit for duty _____ days.*

STATION: U.S. Genl. Hospital
DATE: May 5 1865

G. Sutton
Surgeon U.S.A.
Commanding Company
In Charge

I CERTIFY, that I have carefully examined the said Private Edward Mills of Captain _____ Company, and find him incapable of performing the duties of a soldier because of Paralysis of right leg, from injury received (he states) in battle for Morris Island, S.C. July 4 1864, unfit for the Veteran Reserve Corps Degree of disability three fourths (3/4).

G. Sutton
Surgeon U.S.A.

DISCHARGED, this Seventeenth day of May 1865, at U.S. Army General Hospital, Fort Lookout, Maryland.

G. Sutton
Surgeon U.S.A.
Commanding the Reg't.
In Charge

The soldier desires to be addressed at

Town _____ County _____ State _____

* See Note 1 on the back of this.

† See Note 2 on the back of this.

994
Mills, Lewis J.

Co A, 5 Mass. Cav., (Col'd.)

Private | Private

CARD NUMBERS.

1	5373319	26
2	5373404	27
3	5373485	28
4	5373587	29
5	5373699	30
6	5373809	31
7	5373909	32
8	5374020	33
9	5374121	34
10	5374220	35
11	5374314	36
12	5374403	37
13	9092688	38
14	40731393	39
15	40731394	40
16		41
17		42
18		43
19		44
20		45
21		46
22		47
23		48
24		49
25		50

Book Mark:

See also

11 | **5 Cav. (Col'd.)** | **Mass.**

Lewis F. Wells

Co. A, 5 Reg't Mass. Cav. (Col'd.)

Appears on

Company Descriptive Book

of the organization named above.

DESCRIPTION.

Age 18 years; height 5 feet 6 inches.

Complexion *Col'd*

Eyes *hazel*; hair *dark*

Where born *Nantucket, Mass.*

Occupation *Seaman*

ENLISTMENT.

When *Dec. 24*, 186*3*.

Where *Plymouth*

By whom *A. J. Davis*; term *3* y'rs.

Remarks:

.....
.....
.....
.....
.....
.....
.....
.....
.....

(380)

A. J. Davis
Compt.

M | **5 Col'd Cav.** | **Mass.**

Lewis J. Mills
Privt., Co. A, 5 Reg't Mass. Col'd Cav.

Appears on

Company Muster-in and Descriptive Roll
of the organization named above. Roll dated

Readville Jan. 9, 1864.

Where born Nantucket, Mass

Age 18 y'rs; occupation seaman

When enlisted Dec. 24th, 1863.

Where enlisted Plymouth

For what period enlisted Three years.

Eyes Black, hair Black

Complexion Black; height 5 ft. 6 in.

When mustered in Jan. 9th, 1864.

Where mustered in _____

Bounty paid \$ _____ 100; due \$ _____ 100

Where credited _____

Company to which assigned _____

Remarks: _____

Book mark: _____

(356d) G. Fox Copyist.

311

5 Col'd Cav.

Mass.

Samuel F. Mills
Capt, Co. A, 5 Reg't Mass. Col'd Cavalry.

Appears on

Company Muster Roll

for *Enlistment to Feb 29, 1864*

Present or absent *Present*

Stoppage, \$ *100* for

Due Gov't, \$ *100* for

Valuation of horse, \$ *100*

Valuation of horse equipments, \$ *100*

Remarks: *On daily duty with Major F. Willard since Jan. 30 1864*

Book mark:

G. F. W.

(358)

Copyist.

M | **5 Col'd Cav.** | **Mass.**

Lewis F. Mills
Privt, Co. A, 5 Reg't Mass. Col'd Cavalry.

Appears on

Company Muster Roll

for *Mar. & Apr.*, 1864.

Present or absent *Present*

Stoppage, \$ 100 for

Due Gov't, \$ 100 for

Valuation of horse, \$ 100

Valuation of horse equipments, \$ 100

Remarks: _____

Book mark: _____

G. F. M.

M

5 Col'd Cav.

Mass.

Lewis F. Mills

Pvt., Co. A, 5 Reg't Mass. Col'd Cavalry.

Appears on

Company Muster Roll

for *May + June*, 1864.

Present or absent *Present*

Stoppage, \$ 100 for

Due Gov't, \$ 100 for

Valuation of horse, \$ 100

Valuation of horse equipments, \$ 100

Remarks:

Book mark:

G. F. M.

M | **5 Col'd Cav.** | **Mass.**

Lewis J. Mills

Priv., Co. A, 5 Reg't Mass. Col'd Cavalry.

Appears on

Company Muster Roll

for *July and Aug.*, 1864.

Present or absent *Present.*

Stoppage, \$ *100* for

Due Gov't, \$ *100* for

Valuation of horse, \$ *100*

Valuation of horse equipments, \$ *100*

Remarks: *Detailed as
Order to Command-
ing Officer. Free on
order before Apr. 19, 1864.*

Book mark: _____

H. O. Gilbert

M | **5 Col'd Cav.** | **Mass.**

Lewis J. Mills

Pvt., Co. A, 5 Reg't Mass. Col'd Cavalry.

Appears on

Company Muster Roll

for *Sept. and Oct.*, 186*4*.

Present or absent *Present*

Stoppage, \$ *100* for

Due Gov't, \$ *100* for

Valuation of horse, \$ *100*

Valuation of horse equipments, \$ *100*

Remarks: *Stop 1 harness
1 canton. 83.*

Book mark: _____

M. G. Gilbert

M | 5 Col'd Cav. | Mass.

Lewis J. Mills

Priv., Co. A, 5 Reg't Mass. Col'd Cavalry.

Appears on

Company Muster Roll

for Nov. and Dec., 1864.

Present or absent Present.

Stoppage, \$ 100 for

Due Gov't, \$ 100 for

Valuation of horse, \$ 100

Valuation of horse equipments, \$ 100

Remarks: Stop over haversack and canteen 85c.

Book mark:

M. O. Gilbert,

M | 5 Col'd Cav. | Mass.

Lewis J. Mills
Priv., Co. A, 5 Reg't Mass. Col'd Cavalry.

Appears on

Company Muster Roll
for Jan. and Feb., 1865.

Present or absent Present.

Stoppage, \$ $\frac{85}{100}$ for P. M. Goods.

Due Gov't, \$ 100 for

Valuation of horse, \$ 100

Valuation of horse equipments, \$ 100

Remarks:

Book mark:

M. O. Gilbert

(358)

Copyist.

M | **5 Col'd Cav.** | **Mass.**

Lewis S. Mills
Pr., Co. A, 5 Reg't Mass. Col'd Cavalry.

Appears on

Company Muster Roll

for *Feb. and Apr.*, 1865.

Present or absent *Present.*

Stoppage, \$ *100* for

Due Gov't, \$ *100* for

Valuation of horse, \$ *100*

Valuation of horse equipments, \$ *100*

Remarks: *Due 2, 3 and 4*
inst. M. S. Denny
\$120.00 and \$35.00 on 1
inst.

Book mark:

N. O. Gilbert

716 | 5 Col'd Cav. | Mass.

Lewis F. Mills
Priv., Co. A, 5 Reg't Mass. Col'd Cavalry.

Appears on

Company Muster Roll

for May & June, 1865.

Present or absent Absent

Stoppage, \$ 100 for

Due Gov't, \$ 100 for

Valuation of horse, \$ 100

Valuation of horse equipments, \$ 100

Remarks: Absent on transport
June 29, 1865
June 20, 30 & 4th Just. Bounty
\$120. 10th Just \$35.

Book mark:

(358) W. L. Bellade Copyist.

M

5 Col'd Cav.

Mass.

Lewis F. Mills

Put, Co. A, 5 Reg't Mass. Col'd Cavalry.

Appears on

Company Muster Roll

for July & Aug, 1865.

Present or absent Present

Stoppage, \$ 100 for

Due Gov't, \$ 100 for

Valuation of horse, \$ 100

Valuation of horse equipments, \$ 100

Remarks: Due 2, 3, 4, 5 Dist. of City
Alto. On 1st Dist \$25.
Company Clerk.
Free or before Apr 19. 61

Book mark:

Callade

M. | 5 Col'd Cav. | Mass.

Lewis F. Mills
Priv., Co. A, 5 Reg't Mass. Colored Cav.

Appears on Returns as follows:

June to Aug. 1864. On duty,
servant - Maj. Weld.

June 1865. Absent as guard
on transport since
June 29

Aug. 1865. Co. clerk.

Book mark :

(646)

J. B. Sittler

Copyist.

M. | **5** Col'd Cav. | **Mass.**

Mills

Priv., Co. A, 5 Reg't Mass. Colored Cav.

Appears on **Returns** as follows:

Aug. 1864. On duty, Orderly
at Hd. Qrs.

Book mark :

(548)

J. B. Sittler

Copyist.

46 | 5 Col'd Cav. Mass.

Lewis F. Mills

Priv, Co. A, 5 Reg't Mass. Col'd Cavalry.

Appears on Co. Muster-out Roll, dated
Clarksville Texas, Oct 31, 1865.

Muster-out to date Oct 31, 1865.

Last paid to Dec 31, 1864.

Clothing account:

Last settled....., 186 ; drawn since \$..... 100

Due soldier \$..... 100; due U. S. \$ 50 100

Am't for cloth'g in kind or money adv'd \$..... 100

Due U. S. for arms, equipments, &c., \$ 11 100

* Bounty paid \$ 25 100; due \$ 275 100

Remarks: + Free Apr. 19, 1861

Book mark :

(861)

Ballade

Copyist.

Minch, James

Co A, 5 Mass. Cav., (Col'd.)

Private

Private

CARD NUMBERS.

1	5381614	26
2	5381658	27
3	5381747	28
4	5381832	29
5	5381993	30
6	5382136	31
7	5382624	32
8	9091829	33
9	32533821	34
10	32535125	35
11	31548268	36
12	31548831	37
13	33056712	38
14	33058130	39
15	40731396	40
16		41
17		42
18		43
19		44
20		45
21		46
22		47
23		48
24		49
25		50

Book Mark:

See also

No. **5 Cav. (Col'd.)** | **Mass.**

James Birch.

....., Co. *H.*, 5 Reg't Mass. Cav. (Col'd.)

Appears on

Company Descriptive Book
of the organization named above.

DESCRIPTION.

Age *29* years; height *5* feet *4* inches.

Complexion *Colored.*

Eyes *Black* ; hair *Black.*

Where born *Charleston S.C.*

Occupation *Laborer.*

ENLISTMENT.

When *Feb'y. 25th, 1864.*

Where *Dorchester.*

By whom *B. F. Cherley* ; term *3* y'rs.

Remarks: *Wounded in at Readville
Mar. 12th 64.*

H. C. Thomas.

(3830)

Copyist.

M | 5 Col'd Cav. | Mass.

James Mouch
Pot, Co. N., 5 Reg't Mass. Col'd Cav.

Appears on
Company Muster-in and Descriptive Roll
of the organization named above. Roll dated
Readville, Mass, Mar 12, 1864.

Where born Charleston S C

Age 29 y'rs; occupation Laborer

When enlisted Feb. 25, 1864.

Where enlisted Dedham

For what period enlisted 6 years.

Eyes Black; hair Black

Complexion Black; height 5 ft. 4 in.

When mustered in Mar. 12, 1864.

Where mustered in

Bounty paid \$ 100; due \$ 100

Where credited 7th Dist, Norfolk

Company to which assigned

Remarks:

Book mark:

J. M. Hall

M 5 Col'd Cav. | **Mass.**

James Minch
Capt, Co. H, 5 Reg't Mass. Col'd Cavalry.

Appears on

Company Muster Roll

for *Mar 12 to Apr 30*, 186*4*.

Present or absent *Present*,

Stoppage, \$ *100* for

Due Gov't, \$ *100* for

Valuation of horse, \$ *100*

Valuation of horse equipments, \$ *100*

Remarks: *Appointed Capt
per R.O. No 24 Mch
31st 1864,*

Book mark: *1*

(358)

J. M. Wall
Copyist.

M | **5 Col'd Cav.** | **Mass.**

James Muick
Capt., Co. H, 5 Reg't Mass. Col'd Cavalry.

Appears on

Company Muster Roll

for May & June, 1864

Present or absent absent

Stoppage, \$ 100 for

Due Gov't, \$ 100 for

Valuation of horse, \$ 100

Valuation of horse equipments, \$ 100

Remarks: Absent, sick at
Fortress Monroe since
June 20th/64.

Book mark: _____

J. M. Hall

(358)

Copyist.

M | 5th Cold Cav. | Mass

James Minch
Corp., Co. H, 5th Reg't Mass C. Cav

Appears on

Hospital Muster Roll

of Balfour U. S. A. General Hospital,

at Portsmouth, Va.,

for *May & June*, 1864.

Attached to hospital:

When, 186 .

How employed

Last paid by Maj.

to, 186 .

Bounty paid \$ 100; due \$ 100

Present or absent *Present*

Remarks:

Book mark:

(848)

W. W. Sayre
Copyist.

M **5 Col'd Cav.** | **Mass.**

James Murch
Capt, Co. H, 5 Reg't Mass. Col'd Cavalry.

Appears on

Company Muster Roll

for *July & Aug.*, 186*4*

Present or absent *absent*

Stoppage, \$ *100* for

Due Gov't, \$ *100* for

Valuation of horse, \$ *100*

Valuation of horse equipments, \$ *100*

Remarks: *absent, sick*
at Fortress Monroe
since June 20"/64

Book mark:

J. M. Wall

M 1 5 Cav 1 Mass

James Minch
Capt. Co. H, 5 Reg't Mass Cav
Appears on

Hospital Muster Roll

of **Ward U. S. A. General Hospital,**

at **Newark, N. J.,**

for July & Aug, 1864

Attached to hospital:

When June 21, 1864

How employed

Last paid by Maj.

to _____, 1864

Bounty paid \$ 100; due \$ 100

Present or absent Present

Remarks: No D. L.
Can see on must & card

Book mark :

(348)

W. G. Jones
Copyist.

M 15 Cav. (Col. S.) Mass.

James W. March
Capt., Co. H, 5 Reg't Mass. C.

Appears on

Hospital Muster Roll

of **Balfour U. S. A. General Hospital,**

at **Portsmouth, Va.,**

for *July 1864*, 1864.

Attached to hospital:

When _____, 186 .

How employed _____

Last paid by Maj. _____

to _____, 186 .

Bounty paid \$ 100; due \$ 100

Present or absent _____

Remarks: *Transferred to the*

July 18/64.

Book mark: _____

M

5 Col'd Cav.

Mass.

James Minch
Priv., Co. H, 5 Reg't Mass. Col'd Cavalry.

Appears on

Company Muster Roll

for Sept & Oct, 1864.

Present or absent Absent

Stoppage, \$ 0 ⁶⁴/₁₀₀ for one cross
sabe letter & number.

Due Gov't, \$ 100 for

Valuation of horse, \$ 100

Valuation of horse equipments, \$ 100

Remarks: Absent. Sick in Ward Hospital
Newark, N.J. since June 20. Appointed Capt
R.O., 24, Uch 31, 1864
Reduced from Corporal
per R.O. No. 159, Sept 18.

Book mark:

C. M. Clark

M | 5-bar. | U.S.C.V.

James Minch
Corp., Co. H., 5 ^{Mass} Reg't U.S.Cav.

Appears on

Hospital Muster Roll

of Ward U. S. A. General Hospital,

at Newark, N. J.,

for Sept. - Oct., 1864

Attached to hospital:

When July 21, 1864

How employed

Last paid by Maj. Newell
to July - Aug., 1864.

Bounty paid \$ 100; due \$ 100

Present or absent

Remarks: Transferred to
Transit Hospital N.Y.
Oct. 27, 1864.

Book mark :

Owsley

(848)

Copyist.

M. 5 Cav. Mass. C.T.

James Mirich
Corp., Co. H., 5 Reg't Mass. Cav. Col.

Appears on

Hospital Muster Roll

of Grant U. S. A. General Hospital,

at Willet's Point, New York Harbor,

for Sept. - Oct., 1864.

Attached to hospital:

When Oct. 27, 1864.

How employed

Last paid by Maj.

to _____, 186 .

Bounty paid \$ 100; due 100

Present or absent Present

Remarks: Back pay due from
enlistment offered Corporal
March 31/64. Reduced to the
rank of Sept. 18/64.

Ward 22

Book mark :

Scherich

M | 5 Col'd Cav. | Mass.

James Minch
Pat, Co. H, 5 Reg't Mass. Col'd Cavalry.

Appears on

Company Muster Roll

for Nov & Dec, 1864.

Present or absent

Stoppage, \$ 100 for

Due Gov't, \$ 100 for

Valuation of horse, \$ 100

Valuation of horse equipments, \$ 100

Remarks: Discharged for
physical disability,
from Grant Gen'l
Hosp, Willetts Point,
N.Y.

Book mark:

C H Clark

(358)

Copyist.

No 1 *5* *Willet's*
coll. Cav Ensign

James Minck
Priv., Co. I, 5 Reg't U.S.C.

Appears on
Hospital Muster Roll

of **Grant U. S. A. General Hospital,**

at **Willet's Point, New York Harbor,**

for *Nov & Dec*, 1864.

Attached to hospital:

When *Oct. 27*, 1864.

How employed

Last paid by Maj.

to _____, 186 .

Bounty paid \$ 100; due 100

Present or absent

Remarks: *Discharged from*
service December
15 1864.

Book mark :

L. A. Mitchell
Copyist.

M. | 5 Col'd Cav. | Mass.

James Minch
Corpl., Co. H., 5 Reg't Mass. Colored Cav.
Priv.

Appears on **Returns** as follows:

June to Aug. 1864. Absent sick
at Fortness Monroe since
June 20

Sept. 1864. (Priv.) Lose June 20
Fort Monroe - dropped by
order of Regtl Comdr.

Oct. 1864. Gain Oct. 24 Newark
N. J. Taken up from
dropped by order of
Regtl Comdr. Absent sick
at Newark, N. J. since
June 20.

Nov. 1864. Absent sick at
Newark, N. J. since June
20

Dec. 1864. Lose Dec. 15 New
York - Dischg'd on ac-
count of physical
disability.

Book mark :

(646)

J. B. Sittler

Copyist.

M | 5 Col'd Cav. | Mass.

James Murch
Priv., Co. H., 5 Reg't Mass. Col'd Cavalry.

Appears on Co. Muster-out Roll, dated
Clarksville, Tex, Oct. 31, 1864.

Muster-out to date _____, 186 .

Last paid to Never paid, 186 .

Clothing account:

Last settled _____, 186 ; drawn since \$ 100

Due soldier \$ 100; due U. S. \$ 100

Am't for cloth'g in kind or money adv'd \$ 100

Due U. S. for arms, equipments, &c., \$ 100

Bounty paid \$ 100; due \$ 100

Remarks: Discharged for Physical
Inability at Grant U.S. Gen'l Hosp.
Millet's pt., N.Y. Dec. 15. 64

Book mark: 1648 Dis May 14. 68 - 257 p 145 - 69
G.D.

R. E. Wilson
(861) Copyist.

Munch, Jas

P, Co. *H*,

5

Reg't **Mass. C. Cav**

2 Enclosures.

Bed Cards	Descriptive Lists
Burial Records	Final Statements
Certs. of Dis. for Discharge /	Furloughs
C. M. Charges	Med. Des. Lists
Med. Certificates	Orders

Other papers relating to—

Admission to Hosp'l <i>None</i>	Furlough
Casualty Sheet (Officer's) /	Med. Examination
Confinement	Misc. Information
Contracts	Pay or Clothing
Death or Effects	Personal Reports
Desertions	Rank
Discharge from Hosp'l	Transfer to Hosp'l
Discharge from Service	Transfer to V. R. C. ...
Duty	Transportation

Col's

CASUALTY SHEET
OF WOUNDED.

Jas Minch (Col)

Company *H*

5 Regiment of *Mass Cav*

Volunteers, at the battle of...

Disease

NOTE 1.

The company commander will here add a statement of all the facts known to him concerning the disease or wound, or cause of disability of the soldier; the time, place, manner, and all the circumstances under which the injury occurred, or disease originated or appeared; the duty, or service, or situation of the soldier at the time the injury was received or disease contracted, stating particularly whether the injury was received or the disease contracted in the line of his duty; and whatever other facts may aid a judgment as to the cause, immediate or remote, of the disability, and the circumstances attending it.

When the facts are not known to the company commander, the certificate of any officer, or affidavit of other person having such knowledge, will be appended—as the surgeon in charge of a hospital, the officer commanding a detachment of recruits, &c., &c.

NOTE 2.

When a probable case for pension, special care must be taken to state the degree of disability—as $\frac{1}{2}$, $\frac{1}{4}$, &c., &c.; to describe particularly the disability, wound, or disease: the extent of which it deprives him of the use of any limb or faculty, or affects his health, strength, activity, constitution, or capacity to labor or earn his subsistence. The surgeon will add, from his knowledge of the facts and circumstances, and from the evidence in the case, his professional opinion of the cause or origin of the disability. In the case of discharges by Medical Inspectors, the last paragraph will state that the "discharge was given by consent of the soldier, after a personal examination, and for disability, the nature, degree, and origin of which are correctly described in the within certificate."

Par. 1260 Regulations, Edit. 1861.

Medical officers, in giving certificates of disability, are to take particular care in all cases that have not been under their charge; and especially in epilepsy, convulsions, chronic rheumatism, derangement of the urinary organs, ophthalmia, ulcers, or any obscure disease liable to be feigned or purposely produced; and in no case shall such certificate be given until after sufficient time and examination to detect any attempt at deception.

DIRECTIONS.

This certificate will be made out in duplicate by the soldier's company commander, or other officer commanding the separate detachment to which he belongs, and sent by him to the surgeon who has charge of the hospital where the soldier is sick. The surgeon will then fill out and sign the surgeon's certificate, and forward these papers to the regimental, detachment, or post commander, who will forward them, with his action endorsed thereon, through the proper channel, to his division commander; or, if the troops are not attached to a division, to his corps, department, or other commander or officer to whom the authority to discharge enlisted men may be specially delegated.

These certificates, after having received the action of the highest authority to which they are required to be sent, will be returned through the same channel to the regimental, post, or detachment commander, who will, if the discharge is authorized by the endorsement of the proper authority, sign the soldier's discharge, and the last certificate on this paper; see that the soldier is furnished with a copy of the discharge, and a copy of the certificate, if the discharge is authorized by the endorsement of the proper authority, at Washington, D. C.; they will not, under any circumstances, be given to the hands of the soldier.

ADJUTANT GENERAL'S OFFICE

Duplicate sent the Pension Office.

1864

July 12 of 1864

CERTIFICATE OF DISABILITY FOR DISCHARGE

IN THE CASE OF

James Minch
Private Co. H
Fifth Reg't of Mass Cav

APPROVED

C. W. Bouquell
Surgeon

HEADQUARTERS DEPARTMENT OF THE EAST,

NEW YORK CITY, Dec. 12th, 1864.

To be discharged.

BY COMMAND OF MAJOR GENERAL DIX:

W. L. ...

Capt. and A. D. C., A. A. A. G.

Received (A. G. Office)

Emm ...



ARMY OF THE UNITED STATES.
CERTIFICATE
OF DISABILITY FOR DISCHARGE.

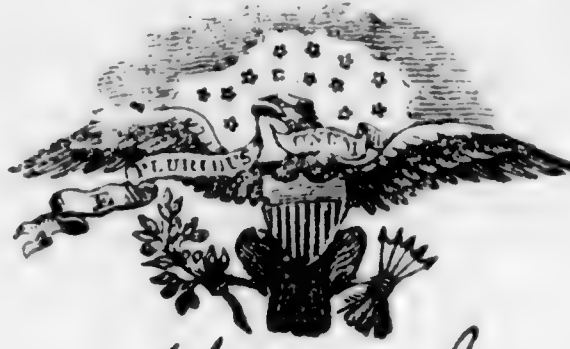

Private James Minch, of Captain Peter J. Rooney Company, (Co.) of the fifth Regiment of the United States Mass Cav was enlisted by B. F. Wheeler of the Regiment of at Dodham on the twenty fifth day of February, 1864 to serve three years; he was born in Charleston in the State of South Carolina, is twenty nine years of age, five feet four inches high, colored complexion, black eyes, black hair, and by occupation when enlisted a laborer. During the last two months said soldier has been unfit for duty days.*

Soldier states that he was injured on the cars between Baltimore & Washington in May 1864

STATION: Grant General Hospital
DATE: Willetts Point NY 14 Dec 8. 1864

W. W. Wood
Surg U. S. Vols
Commanding ~~Company~~ Hosp

I CERTIFY, that I have carefully examined the said James Minch of Captain Rooney Company, and find him incapable of performing the duties of a soldier because of Chronic rheumatism of both limbs, the result of a contusion. They are greatly enlarged with previous maching

Disability is granted
W. W. Wood
Surgeon. Mr

DISCHARGED, this fifteenth day of December, 1864, at Grant General Hospital New York Harbor

W. W. Wood
Surg U. S. Vols
Commanding the Reg't.

The Soldier desires to be addressed at
Town Boston County Suffolk State Mass

* See Note 1 on the back of this. † See Note 2 on the back of this.

Minor, Robert

Co G, 5 Mass. Cav., (Col'd.)

Private

Private

CARD NUMBERS.

1	5372113	26
2	5372248	27
3	5380808	28
4	5380911	29
5	5381008	30
6	5381111	31
7	5381213	32
8	5381314	33
9	5381409	34
10	5381507	35
11	9092000	36
12	34505499	37
13	40731395	38
14		39
15		40
16		41
17		42
18		43
19		44
20		45
21		46
22		47
23		48
24		49
25		50

Book Mark: - No-27 - Vol-9 - 65 - 1871. +

See also

M 5 Cav. (Col'd.) | Mass.

Robert Miner

Co. G, 5 Reg't Mass. Cav. (Col'd.)

Appears on

Company Descriptive Book

of the organization named above.

DESCRIPTION.

Age 20 years; height 5 feet 7 inches.

Complexion Blk

Eyes Blk; hair Blk

Where born Alexandria Va.

Occupation Laborer.

ENLISTMENT.

When June 22, 1864.

Where Hindsdale

By whom G.H. Quincy; term 3 y'rs.

Remarks Mustered June 22 64.

Capt. Goodhue Galloups Island.

Hearst

M | 5 Cav. | Mass
Robert Minor

Appears with rank of _____ on _____

Muster and Descriptive Roll

of a detachment of U. S. Volunteers forwarded from Faneuil Hall, Boston, to Galloup's Island, Boston Harbor, for various regiments Massachusetts Volunteers. Roll dated

Boston Mass, June 22, 1864.

Where born Alexandria Va.

Age 20 years; occupation Laborer

When enlisted June 22, 1864

Where enlisted Hinsdale

For what period enlisted 3 years.

Eyes Dark; hair Dark

Complexion Dark; height 5 ft. 7 in.

When mustered in June 22, 1864

Where mustered in Boston

Bounty paid \$ 100; due \$ 100

Clothing account:

Last settled _____, 1864; drawn since \$ 100

Date of first muster _____, 1864

Regiment to which assigned 5th Cav.

Remarks: 10 Dist Hinsdale

Berkshire Co.

Book mark: _____

(356m)

Murray Copyist.

711 | 5 Col'd Cav. | Mass.

Parker, Wm

Appears with rank of Private on

Muster and Descriptive Roll of a Detachment of U. S. Vols. forwarded

for the 5 Reg't Mass. Col'd Cavalry. Roll dated

June 22, 1864.

Where born Alexandria Va

Age 20 y'rs; occupation Farmer

When enlisted June 22, 1864.

Where enlisted Winchester

For what period enlisted 3 years.

Eyes Blue; hair Black

Complexion Black; height 5 ft. 7 in.

When mustered in June 22, 1864.

Where mustered in Boston

Bounty paid \$ 100; due \$ 100

Where credited Wm. H. H. & Co.

Company to which assigned

Remarks:

Book mark:

Wm. H. H. & Co.

M | 5 Col'd Cav. | Mass.

Robert Minor

Appears with rank of Pri on

Muster and Descriptive Roll of a Detachment of U. S. Vols. forwarded

for the 5 Reg't Mass. Col'd Cavalry. Roll dated

Galloups ~~old Mass~~ July 12, 1864.

Where born Alexandria Va

Age 20 y'rs; occupation Laborer

When enlisted June 22, 1864.

Where enlisted Hinsdale

For what period enlisted 3 years.

Eyes Dark; hair Dark

Complexion Dark; height 5 ft. 7 in.

When mustered in June 22, 1864.

Where mustered in Boston Mass

^{Premium}
Bounty paid \$ 2 ¹⁰⁰; due \$ 100

Where credited 10 Cong Dist. Hinsdale

Perdshaw Co
Company to which assigned

Remarks :
.....
.....

Book mark :

Donnelly

M | **5 Col'd Cav.** | **Mass.**

Robert Minor
PT, Co. G, 5 Reg't Mass. Col'd Cavalry.

Appears on

Company Muster Roll

for *July & Aug*, 1864.

Present or absent *Present*

Stoppage, \$ *100* for

Due Gov't, \$ *100* for

Valuation of horse, \$ *100*

Valuation of horse equipments, \$ *100*

Remarks: *Enlistment papers not received, joined for duty July 16/64.*

Book mark: _____

Leger

M

5 Col'd Cav.

Mass.

Robert Miner

Prn, Co. G, 5 Reg't Mass. Col'd Cavalry.

Appears on

Company Muster Roll

for Sept. & Oct., 1864.

Present or absent Present

Stoppage, \$ 100 for

Due Gov't, \$ 100 for

Valuation of horse, \$ 100

Valuation of horse equipments, \$ 100

Remarks:

Book mark:

Cerry

(358)

Copyist.

M | 5 Col'd Cav. | Mass.

Robert Miner
Pres., Co. G, 5 Reg't Mass. Col'd Cavalry.

Appears on

Company Muster Roll

for Nov & Dec, 1864.

Present or absent Present

Stoppage, \$ 100 for

Due Gov't, \$ 100 for

Valuation of horse, \$ 100

Valuation of horse equipments, \$ 100

Remarks: Due U.S. #10.00
for advanced pay

Book mark:

Cerry

(358)

Copyist.

771 | 5 Col'd Cav. | Mass.

Robert Miner

Priv., Co. G, 5 Reg't Mass. Col'd Cavalry.

Appears on

Company Muster Roll

for Jan. & Feb., 1862.

Present or absent Present

Stoppage, \$ 100 for

Due Gov't, \$ 100 for

Valuation of horse, \$ 100

Valuation of horse equipments, \$ 100

Remarks: Due 1st instalment U.S. Bounty \$25.00. Due U.S. \$10.00 advanced pay, charged on Nov. & Dec. rolls.

Book mark:

Cerry

(358)

Copyist.

116 | 5 Col'd Cav. | Mass.

Robert Miner

Co. G, 5 Reg't Mass. Col'd Cavalry.

Appears on

Company Muster Roll

for *Mich. Tap*, 1863.

Present or absent *Present*

Stoppage, \$ 100 for

Due Gov't, \$ 100 for

Valuation of horse, \$ 100

Valuation of horse equipments, \$ 100

Remarks: *Due the soldier
1 instalment U.S.
Bounty \$25;*

Book mark:

(358)

Curry Copyist.

7M

5 Col'd Cav.

Mass.

Robert Miner
Priv., Co. G, 5 Reg't Mass. Col'd Cavalry.

Appears on

Company Muster Roll

for May & June, 1863.

Present or absent Present

Stoppage, \$ 100 for

Due Gov't, \$ 100 for

Valuation of horse, \$ 100

Valuation of horse equipments, \$ 100

Remarks: Due U.S. for
advance cost \$1.83.

Book mark:

Perry

(358)

Copyist.

M

5 Col'd Cav.

Mass.

Robert Miner

Sir, Co. G, 5 Reg't Mass. Col'd Cavalry.

Appears on

Company Muster Roll

for *July & Aug*, 186*0*.

Present or absent *Present*

Stoppage, \$ *100* for

Due Gov't, \$ *100* for

Valuation of horse, \$ *100*

Valuation of horse equipments, \$ *100*

Remarks: *Due U.S. for Or-*
dinance cost \$ 23
Ret at work on the
R.R. per S.D. No 48
dated Aug 11. 60

Book mark:

Wm Scott

(358)

Copyist.

M. | 5 Col'd Cav. | Mass.

Robert Miner

Pvt., Co. G, 5 Reg't Mass. Colored Cav.

Appears on Returns as follows:

July 1864. Gain - Recruit
from Depot - Joined
Co. July 16"

Aug. & Sept. 1865. Absent
detached at work on
military R. R. per S. O.
no. 48 dated Hd. Qrs.
3^d Brig. 3^d Div. 25 A. C.
Aug. 11/65.

Book mark :

(546)

J. B. Sittler

Copyist.

M | **5 Col'd Cav.** | **Mass.**

Robert Miner
Liv, Co. *G*, 5 Reg't Mass. Col'd Cavalry.

Appears on **Co. Muster-out Roll**, dated
Chickville Tex, Oct 21, 186*0*.

Muster-out to date *Oct 31*, 186*5*.

Last paid to *Dec 31*, 186*4*.

Clothing account:

Last settled....., 186 ; drawn since \$..... 100

Due soldier \$..... 100; due U. S. \$..... *32* 100

Am't for cloth'g in kind or money adv'd \$..... 100

Due U. S. for arms, equipments, &c., \$ *13 23* 100

Bounty paid \$..... 100; due \$ *100* 100

Remarks:.....
.....
.....
.....
.....

Book mark: *See M 27 vol 9*
1231

Wheat Scarf

JAN. 10

5381507

1891

*CP 1871 Ind M.O.R.
in file,*

Mcenion, Robert

....., Co., *5* Reg't *Mass. C. C.*

2 Enclosures.

Bed Cards	Final Statements
Burial Records	Furloughs or L. of A.
Certs. of Dis. for Discharge	Med. Certificates
C. M. Charges	Med. Des. Lists
Descriptive Lists	Orders
Discharge Certificates	Pris. of War Record
Enlistment Papers <i>2</i>	Resignations

Other papers relating to—

Admission to Hosp'l	Furlough or L. of A.
Casualty Sheet	Med. Examination
Confinement	Misc. Information
Contracts	Pay or Clothing
Death or Effects	Personal Reports
Desertion	Rank
Discharge from Hosp'l	Transfer to Hosp'l
Discharge from Service	Transfer to V. R. C.
Duty	Transportation

NOTE 1.—This blank will be used for both enlistments and re-enlistments—enlistment of veterans, &c., &c., in the volunteer service. They will be made out in duplicate in all cases—one to accompany the recruiting return of the superintendent (not the recruiting officer) to the Adjutant-General, and one to accompany the accounts of the officer who pays bounty, &c. The Regiment and Company in which the soldier last served should be given on the back.

NOTE 2.—An enlistment holds to service. A muster-in must, in all cases, precede payment of pay, bounty, pension, &c. A muster-in roll must, in all cases, be filed in the Adjutant-General's Office as evidence of muster-in. The mustering officer, commissary, or assistant-commissary of musters, as the case may be, will countersign both enlistments as having mustered the soldier into the service of the United States before either of them is given to the disbursing officer.

DECLARATION OF RECRUIT.

I, *Robert Minor* desiring to VOLUNTEER as a Soldier in the Army of the United States, for the term of THREE YEARS, Do Declare, That I am *Twenty* years and _____ months of age; that I have never been discharged from the United States service on account of disability or by sentence of a court-martial, or by order before the expiration of a term of enlistment; and I know of no impediment to my serving honestly and faithfully as a soldier for three years.

GIVEN at *Boston*
the *twenty* ^{*seena*} day of *June* 1864

Witness:

John A. Williams

Robert ^{*his*} *Minor*
mark

Discharged

18

Reg't of

enlistment; last served in Company ()

By *John H. Duncanson*
Regiment of *Mass. Cav.*

Volunteered at *Worcester*
June 22 1864

Robert Minor

No.

CONSENT IN CASE OF MINOR.

I, _____ Do CERTIFY, That I am _____ the _____ of _____; that the said _____ is _____ years of age; and I do hereby freely give my CONSENT to his volunteering as a SOLDIER in the ARMY OF THE UNITED STATES, for the period of THREE YEARS.

GIVEN at _____

the _____ day of _____

Witness: _____

VOLUNTEER ENLISTMENT. 10th Dist

STATE OF



TOWN OF Hinsdale

Massachusetts

Berkshire Co.

I, *Robert Minor* born in *Alexandria*
 in the State of *Virginia* aged *Twenty* years,
 and by occupation a *Laborer* DO HEREBY ACKNOWLEDGE to have
 volunteered this *Twenty second* day of *June* 1864,
 to serve as a **Soldier** in the Army of the United States of America, for the
 period of **THREE YEARS**, unless sooner discharged by proper authority: Do also
 agree to accept such bounty, pay, rations and clothing, as are, or may be, estab-
 lished by law for volunteers. And I, *Robert Minor* do
 solemnly swear, that I will bear true faith and allegiance to the **United States**
of America, and that I will serve them honestly and faithfully against all their
 enemies or opposers whomsoever; and that I will observe and obey the orders of
 the President of the United States, and the orders of the officers appointed over
 me, according to the Rules and Articles of War.

Sept 11 Mass Cavalry

Sworn and subscribed to, at *Boston*
 this *twenty second* day of *June* 1864.
 BEFORE *Geo. H. Quincy* } *Robert H. Minor*
Witness } *mark*
Geo. H. Quincy } *U.S. Army*

I CERTIFY, ON HONOR, That I have carefully examined the above-named Volunteer, agreeably
 to the General Regulations of the Army, and that, in my opinion, he is free from all bodily defects and
 mental infirmity, which would in any way disqualify him from performing the duties of a soldier.

Vaccinated
P. Jay Jeffries
 EXAMINING SURGEON.

I CERTIFY, ON HONOR, That I have minutely inspected the Volunteer, *Robert Minor*
 previously to his enlistment, and that he was entirely sober when enlisted; that, to the best of my
 judgment and belief, he is of lawful age; and that, in accepting him as duly qualified to perform the duties
 of an able-bodied soldier, I have strictly observed the Regulations which govern the recruiting service.
 This soldier has *dark* eyes, *dark* hair, *dark* complexion, is *five* feet
seven inches high.

Geo. H. Quincy
 Regiment of _____ Volunteers,
 U.S. RECRUITING OFFICER
agf

(A. G. O. No. 74 & 75.)

Mustered into the service of the United States, in Company
 the *22* day of *June*, 1864, at *Boston*
 Regiment of *Mass Cavalry* Volunteers, on
Sept 11 1864

NOTE 1.—This blank will be used for both enlistments and re-enlistments—enlistment of veterans, &c., &c., in the volunteer service. They will be made out in duplicate in all cases—one to accompany the recruiting return of the superintendent (not the recruiting officer) to the Adjutant-General, and one to accompany the accounts of the officer who pays bounty, &c. The Regiment and Company in which the soldier last served should be given on the back.

NOTE 2.—An enlistment holds to service. A muster-in must, in all cases, precede payment of pay, bounty, pension, &c. A muster-in roll must, in all cases, be filed in the Adjutant-General's Office as evidence of muster-in. The mustering officer, commissary, or assistant-commissary of musters, as the case may be, will countersign both enlistments as having mustered the soldier into the service of the United States before either of them is given to the disbursing officer.

DECLARATION OF RECRUIT.

I, *Robert Minor* desiring to VOLUNTEER as a Soldier in the Army of the United States, for the term of THREE YEARS, Do Declare, That I am *Twenty* years and _____ months of age; that I have never been discharged from the United States service on account of disability or by sentence of a court-martial, or by order before the expiration of a term of enlistment; and I know of no impediment to my serving honestly and faithfully as a soldier for three years.

GIVEN at *Boston* the *twenty second* day of *June* 18*64*

Witness: *John H. Williams* *Robert H. Minor*
mark

APR 1895. THIS PAPER WAS FORMERLY FILED IN THE ENROLLMENT DIV. R. & P. O.

Discharged _____
enlistment; last served in Company ()
Reg't of _____
18 _____

By *J. G. Dunne*
Regiment of *Mass. Cav.*
Volunteered at *Boston Mass*
June 22 18 *64*

No. _____
Robert Minor

CONSENT IN CASE OF MINOR.

I, _____ Do CERTIFY, That I am _____ of _____; that the _____ years of age; and I do hereby freely give my CONSENT to his volunteering as a SOLDIER in the ARMY OF THE UNITED STATES, for the period of THREE YEARS.

GIVEN at _____ the _____ day of _____

Witness: _____

VOLUNTEER ENLISTMENT.

10th Dist.

STATE OF



TOWN OF Hinsdale

Massachusetts

Berkshire Co.

I, **Robert Minor** born in **Alexandria**
 in the State of **Virginia** aged **Twenty** years,
 and by occupation a **Laborer** DO HEREBY ACKNOWLEDGE to have
 volunteered this **Twenty second** day of **June** 1864,
 to serve as a **Soldier** in the Army of the United States of America, for the
 period of **THREE YEARS**, unless sooner discharged by proper authority: Do also
 agree to accept such bounty, pay, rations, and clothing, as are, or may be, estab-
 lished by law for volunteers. And I, **Robert Minor** do
 solemnly swear, that I will bear true faith and allegiance to the **United States**
of America, and that I will serve them honestly and faithfully against all their
 enemies or opposers whomsoever; and that I will observe and obey the orders of
 the President of the United States, and the orders of the officers appointed over
 me, according to the Rules and Articles of War.

Sworn and subscribed to, at **Boston**
 this **Twenty second** day of **June** 1864.
 BEFORE **J. M. ...**

Robert Minor
 Witness **mark**
Geo. H. Quincy U.S. agt

I CERTIFY, ON HONOR, That I have carefully examined the above-named Volunteer, agreeably
 to the General Regulations of the Army, and that, in my opinion, he is free from all bodily defects and
 mental infirmity, which would in any way disqualify him from performing the duties of a soldier.

P. J. Jeffries
 EXAMINING SURGEON.

I CERTIFY, ON HONOR, That I have minutely inspected the Volunteer, **Robert Minor**
 previously to his enlistment, and that he was entirely sober when enlisted; that, to the best of my
 judgment and belief, he is of lawful age; and that, in accepting him as duly qualified to perform the duties
 of an able-bodied soldier, I have strictly observed the Regulations which govern the recruiting service.
 This soldier has **dark** eyes, **dark** hair, **dark** complexion, is **five** feet
seven inches high.

Geo. H. Quincy

Regiment of **U.S.** Volunteers,
 RECRUITING OFFICER
agt

(A. G. O. No. 74 & 75.)

7466

Fifth Mass. Cavalry

Mustered into the service of the United States, in Company
 the 22 day of June, 1864 at ...

Regiment of

Mass. Cavalry, on

J. M. ...

991
Minot, Edward

Co K, 5 Mass. Cav., (Col'd.)

Private | Private

CARD NUMBERS.

1	5-383777	26
2	5-383863	27
3	5-383958	28
4	5-384006	29
5	5-384107	30
6	5-384210	31
7	5-384315	32
8	5-384417	33
9	5-384520	34
10	5-384622	35
11	5-384766	36
12	9091596	37
13	40731397	38
14		39
15		40
16		41
17		42
18		43
19		44
20		45
21		46
22		47
23		48
24		49
25		50

Book Mark:

See also

No. **5 Cav. (Col'd.) Mass.**

Edward Merritt.

....., Co. *K*, 5 Reg't Mass. Cav. (Col'd.)

Appears on

Company Descriptive Book

of the organization named above.

DESCRIPTION.

Age *38* years; height *5* feet *9* inches.

Complexion *Colored*.

Eyes *Black*; hair *Black*.

Where born *Baltimore Md.*

Occupation *Farmer*.

ENLISTMENT.

When *Mar. 29th*, 186*4*.

Where *Boston Md. Co.*

By whom *D. Davies*; term *3* y'rs.

Remarks: *Married. Residence Baltimore*

Md. Appointed Corporal Aug. 1st 1864.

Sergeant Sept. 29th 1864.

H. C. Thomas.

711 | 5 Col'd Cav. | Mass.

Edward Minot

Co. A, 5 Reg't Mass. Col'd Cav.

Appears on
Company Muster-in and Descriptive Roll
of the organization named above. Roll dated
Acadville Mass, April, 1864.

Where born Baltimore Md

Age 38 y'rs; occupation Carpenter

When enlisted May 29, 1864.

Where enlisted Boston Mass

For what period enlisted 3 years.

Eyes Blue; hair Black

Complexion Black; height 5 ft. 11 1/2 in.

When mustered in April 1864.

Where mustered in Providence Mass

Bounty paid \$ 100; due \$ 100

Where credited Providence Mass

Company to which assigned

Remarks:

x corrected by record Sep 29, 1913

Book mark:

W. Minot

M | **5 Col'd Cav.** | **Mass.**

Leona Munt

1st, Co. K, 5 Reg't Mass. Col'd Cavalry.

Appears on

Company Muster Roll

for *from Sept 12 to Sept 20*, 186*4*.

Present or absent *Present*

Stoppage, \$ *100* for

Due Gov't, \$ *100* for

Valuation of horse, \$ *100*

Valuation of horse equipments, \$ *100*

Remarks:

Book mark:

Leona

Mc | **5 Col'd Cav.** | **Mass.**

Edward Minot

M, Co. K, 5 Reg't Mass. Col'd Cavalry.

Appears on

Company Muster Roll

for May 9 June, 1864.

Present or absent (Present)

Stoppage, \$ 100 for

Due Gov't, \$ 100 for

Valuation of horse, \$ 100

Valuation of horse equipments, \$ 100

Remarks:

Book mark: -----

(358) Edwards Copyist.

772 | 5 Col'd Cav. | Mass.

Edward Thibot

Cope, Co. K, 5 Reg't Mass. Col'd Cavalry.

Appears on

Company Muster Roll

for Dec 1864, 1864

Present or absent Present

Stoppage, \$ 100 for

Due Gov't, \$ 100 for

Valuation of horse, \$ 100

Valuation of horse equipments, \$ 100

Remarks: 10th Regiment Cope
Dec 1st 1864. Ad. Dec 1st 1864
Cope, R. D. 144

Book mark:

M | 5 Col'd Cav. | Mass.

Edward Minor

Serjeant, Co. K, 5 Reg't Mass. Col'd Cavalry.

Appears on

Company Muster Roll

for Sept & Oct, 1864

Present or absent Present

Stoppage, \$ 100 for

Due Gov't, \$ 100 for

Valuation of horse, \$ 100

Valuation of horse equipments, \$ 100

Remarks: Promoted from Corporal
to 2nd Lt 5th Mass Cavalry Sept
29/64 Special Order 166

Book mark:

Edmund

(358)

Copyist.

M | 5 Col'd Cav. | Mass.

Edward M. Mott

Serjeant, Co. K, 5 Reg't Mass. Col'd Cavalry.

Appears on

Company Muster Roll

for Nov 1 Dec, 1864

Present or absent Present

Stoppage, \$ 100 for

Due Gov't, \$ 100 for

Valuation of horse, \$ 100

Valuation of horse equipments, \$ 100

Remarks: Promoted from
Corpl Hd 2nd 5th Mass Cav
Sept 29 1864.

Book mark:

(358)

Edmund

Copyist.

M | **5 Col'd Cav.** | **Mass.**

Edward M. Inot

Cap., Co. K, 5 Reg't Mass. Col'd Cavalry.

Appears on

Company Muster Roll

for *Jan & Feb*, 186*5*.

Present or absent *Present*

Stoppage, \$ *100* for

Due Gov't, \$ *100* for

Valuation of horse, \$ *100*

Valuation of horse equipments, \$ *100*

Remarks:

Book mark:

(358)

Edward M. Inot

Copyist.

M | **5 Col'd Cav.** | **Mass.**

Edward M. Mott

sergeant, Co. K, 5 Reg't Mass. Col'd Cavalry.

Appears on

Company Muster Roll

for Mar & Apr, 1865.

Present or absent Present

Stoppage, \$ 100 for

Due Gov't, \$ 100 for

Valuation of horse, \$ 100

Valuation of horse equipments, \$ 100

Remarks: Over his pay
transportation \$2.00

Book mark:

Edmondson

(358)

Copyist.

M | **5 Col'd Cav.** | **Mass.**

Edward Minor

Serq't, Co. K, 5 Reg't Mass. Col'd Cavalry.

Appears on

Company Muster Roll

for May 1 June, 1865.

Present or absent Present

Stoppage, \$ 100 for

Due Gov't, \$ 100 for

Valuation of horse, \$ 100

Valuation of horse equipments, \$ 100

Remarks: Due 1/2 for trans-
portation \$2.00

Book mark:

E. J. Anderson

(358)

Copyist.

M | **5** Col'd Cav. | **Mass.**

Edward Minot

Serjt., Co. K, 5 Reg't Mass. Col'd Cavalry.

Appears on

Company Muster Roll

for July & Aug., 1865

Present or absent Present

Stoppage, \$ 100 for

Due Gov't, \$ 100 for

Valuation of horse, \$ 100

Valuation of horse equipments, \$ 100

Remarks: Due U. S. for transportation
\$2.00. Sick in quarters.

Book mark:

(358)

Galligan

Copyist.

M. | 5 Col'd Cav. | Mass.

Edward Minot
Sergt., Co. K, 5 Reg't Mass. Colored Cav.
Pvt.

Appears on Returns as follows:

Feb. 1865. Absent on furlough
ten (10) days Feb. 28/64

Sept. 1865. (Pvt.) Co. cook.

Book mark :

(546)

J. B. Sittler

Copyist.

M

5 Col'd Cav.

Mass.

Edward Minot

Pat, Co. K, 5 Reg't Mass. Col'd Cavalry.

Appears on Co. Muster-out Roll, dated
Clarksville Texas, Oct. 31, 1865.

Muster-out to date Oct. 31, 1865.

Last paid to Dec. 31, 1864.

Clothing account:

Last settled _____, 186 ; drawn since \$ 100

Due soldier \$ 100; due U. S. \$ 6 ⁵⁹/₁₀₀

Am't for cloth'g in kind or money adv'd \$ 100

Due U. S. for arms, equipments, &c., \$ 3 ⁰⁰/₁₀₀

Bounty paid \$ 100; due \$ 300 ⁰⁰/₁₀₀

Remarks: Pay due as Sergt. until Sept.
22, 1865. R. S. O. 145. Due U. S.
for transportation \$ 2.00.

Book mark: 1955, 1882

Galligan

(361)

Copyist.

Minot

Sgt. Co. K, 5th Reg't Mass C.C.

Enclosures.

Bed Cards	Final Statements
Burial Records	Furloughs or L. of A
Certs. of Dis. for Discharge	Med. Certificates
C. M. Charges	Med. Des. Lists
Descriptive Lists	Orders
Discharge Certificates	Pris. of War Record
Enlistment Papers	Resignations

Other papers relating to—

Admission to Hosp'l	Furlough or L. of A <i>/</i>
Casualty Sheet	Med. Examination
Confinement	Misc. Information
Contracts	Pay or Clothing
Death or Effects	Personal Reports
Desertion	Rank
Discharge from Hosp'l	Transfer to Hosp'l
Discharge from Service	Transfer to V. R. C.
Duty	Transportation

MICROFILM PUBLICATION M 1822

COMPILED MILITARY SERVICE RECORDS
OF VOLUNTEER UNION SOLDIERS WHO
SERVED WITH THE USCT (US COLORED TROOPS)
5TH MASSACHUSETTS REGIMENT OF CAVALRY

PERSONAL PAPERS' TARGET SHEET

PLEASE NOTE THE CHECKED INFORMATION ABOUT THE PERSONAL PAPERS IN
THIS FILE:

- NO PERSONAL PAPERS WERE FOUND IN THIS FILE WHEN THE
RECORDS WERE ARRANGED FOR MICROFILMING.

- 2 PERSONAL PAPER(S) FOUND IN THIS FILE WHEN THE RECORDS
WERE ARRANGED FOR MICROFILMING.

Record and Pension Office,

WAR DEPARTMENT.

The slip hereto attached is a stub from a
"Pass Book", Headquarters Department of
Washington.

No. 233

Name *Adj. Thier*

Reg't *5 Mass (Col.)*

To *P. Lookout Md.*

Voucher

Fort Myer

Date *Mar 11* 1865.

Expires *" 11* 1865.

Sgt. Minor

No. 237 **Head Quarters Department of Washington,**
WASHINGTON, D. C.,
C *March 11th 1865.*

Pass the Bearer *Sgt. Minor, 5th Mass (Col'd) Can*
within the lines of the U. S. Forces to Ft. Lookout, Md.
Reason: to rejoin Regiment.
This Pass will expire March 11th 1865

By Command of MAJOR GENERAL AUGUR:
E. M. Curran Capt., A. Q. M. and A. D. C.

PHILLIPS & SON, Printers & Stationers, Washington, D. C.

997-a

Minter, Jessie
Co., J. W. S. Col'd. Can

CARD NUMBERS.

1	9436049	26
2		27
3		28
4		29
5		30
6		31
7		32
8		33
9		34
10		35
11		36
12		37
13		38
14		39
15		40
16		41
17		42
18		43
19		44
20		45
21		46
22		47
23		48
24		49
25		50

Number of personal papers herein.....

Book Mark.....

See also.....

5th Car. Mass
(Col'd)
Jesse Munter
Co. 5 Reg't Min. Col'd Car.

Appears on

Regimental Descriptive Book

of the organization named above.

DESCRIPTION.

Age 32 years; height 5 feet 6 inches.

Complexion Black,

Eyes Black; hair Black

Where born Mississippi Co Mo

Occupation Farmer.

ENLISTMENT.

When Feb. 11, 1864.

Where Sandwich,

By whom J. C. Hatch; term 3 y'rs.

Remarks: Rejected March
26/64

Harri.

940

Mitchell, Grandison

Co M, 5 Mass. Cav., (Col'd.)

Private

Private

CARD NUMBERS.

1	5385953	26
2	5386042	27
3	5386127	28
4	5386218	29
5	5386324	30
6	5386424	31
7	5386528	32
8	5386621	33
9	5386728	34
10	5386813	35
11	9091399	36
12	40731398	37
13		38
14		39
15		40
16		41
17		42
18		43
19		44
20		45
21		46
22		47
23		48
24		49
25		50

Book Mark:

See also

No. **5 Cav. (Col'd.) | Mass.**

Grandison Mitchell,

....., Co. *A*, 5 Reg't Mass. Cav. (Col'd.)

Appears on

Company Descriptive Book

of the organization named above.

DESCRIPTION.

Age *24* years; height *5* feet *9½* inches.

Complexion *Black.*

Eyes *Black*; hair *Black.*

Where born *Xenia Ohio.*

Occupation *Farmer.*

ENLISTMENT.

When *April 23rd, 1864.*

Where *Boston 11th 4.*

By whom *G. W. Messinger*; term *3* y'rs.

Remarks: *Assured by Lieut. D. Madden*

May 5th 1864. Readville Mass.

H. C. Thomas.

M | **5 Col'd Cav.** | **Mass.**

Grandison Mitchell

Pai, Co. *M*, 5 Reg't Mass. Col'd Cav.

Appears on

Company Muster-in and Descriptive Roll
of the organization named above. Roll dated

Readville Mass, May 5, 1864.

Where born *Yenia O.*

Age *24* y'rs; occupation *Hostler*

When enlisted *Apr. 23*, 1864.

Where enlisted *Boston*

For what period enlisted *3* years.

Eyes *Blk*; hair *Blk*

Complexion *Blk*; height *5 ft. 9 1/2 in.*

When mustered in *May 5*, 1864.

Where mustered in *Readville*

Premium
Bounty paid \$ *2* 100; due \$ 100

Where credited

Company to which assigned

Remarks: *Cred't to 4th Md. Boston*

Suffolk Co. 3^d Cong Dist.
Mass.

Book mark:

Avery

(356d)

Copyist.

M

5 Col'd Cav.

Mass.

Grandison Mitchell

Pri., Co. M, 5 Reg't Mass. Colored Cavalry.

Appears on

Company Muster Roll

for May 5 to June 30, 1864.

Present or absent Present

Stoppage, \$ 100 for

Due Gov't, \$ 100 for

Valuation of horse, \$ 100

Valuation of horse equipments, \$ 100

Remarks:

Book mark:

(358)

Avery

Copyist.

M | **5 Col'd Cav.** | **Mass.**

Grandison Mitchell

Pri., Co. M, 5 Reg't Mass. Colored Cavalry.

Appears on

Company Muster Roll

for *July & Aug*, 1864.

Present or absent *Absent*

Stoppage, \$ *100* for

Due Gov't, \$ *100* for

Valuation of horse, \$ *100*

Valuation of horse equipments, \$ *100*

Remarks: *Servant for Lt. Wilson
at Guil, Barnes Hd, 3rd.*

Book mark: _____

Avery

M. | 5 Col'd Cav. | Mass.

Mitchel, Grandson
Priv., Co. M, 5 Reg't Mass. Colored Cavalry.

Appears on

Company Muster Roll

for *Sept. + Oct*, 1864.

Present or absent *Present.*

Stoppage, \$ *100* for

Due Gov't, \$ *100* for

Valuation of horse, \$ *100*

Valuation of horse equipments, \$ *100*

Remarks:

Book mark:

C. Williams,
Copyst.

M | **5 Col'd Cav.** | **Mass.**

Chandson Mitchell
Plt, Co. M, 5 Reg't Mass. Colored Cavalry.

Appears on

Company Muster Roll

for *Nov, + Dec*, 1864.

Present or absent *Present*

Stoppage, \$ *100* for

Due Gov't, \$ *100* for

Valuation of horse, \$ *100*

Valuation of horse equipments, \$ *100*

Remarks:

Book mark:

C. Williams

M | 5 Col'd Cav. | Mass.

Grandson Mitchell
Pvt, Co. M, 5 Reg't Mass. Colored Cavalry.

Appears on

Company Muster Roll
for Jan, & Feb., 1865.
Present or absent Present

Stoppage, \$ 100 for

Due Gov't, \$ 100 for

Valuation of horse, \$ 100

Valuation of horse equipments, \$ 100

Remarks: Daily duty
R. I. M. Sept.

Book mark:

C. Williams

M | **5 Col'd Cav.** | **Mass.**

Grandson Mitchel
Pvt., Co. M, 5 Reg't Mass. Colored Cavalry.

Appears on

Company Muster Roll

for *May + Apr*, 1865.

Present or absent *Present*

Stoppage, \$ *100* for

Due Gov't, \$ *100* for

Valuation of horse, \$ *100*

Valuation of horse equipments, \$ *100*

Remarks: *Daily duty 2. M.*
Sept.

Book mark:

C. Williams

M | 5 Col'd Cav. | Mass.

Grandson Mitchell

Priv., Co. M, 5 Reg't Mass. Colored Cavalry.

Appears on

Company Muster Roll

for May & June, 1865.

Present or absent Absent

Stoppage, \$ 100 for

Due Gov't, \$ 9⁴⁵/₁₀₀ for ordnance lost.

Valuation of horse, \$ 100

Valuation of horse equipments, \$ 100

Remarks: Guard Q. Quo, Stores on board Transports

Book mark:

C. Williams, Copyist.

M | 5 Col'd Cav. | Mass.

Grandison Mitchell

Pri., Co. M, 5 Reg't Mass. Colored Cavalry.

Appears on

Company Muster Roll

for July & Aug, 1865.

Present or absent Absent

Stoppage, \$ 100 for

Due Gov't, \$ 100 for

Valuation of horse, \$ 100

Valuation of horse equipments, \$ 100

Remarks:

Detached Service
Hd. Sq. Cav. Brigade
S.O. 28 July 11th 1865.
Dues U.S. for 01 cluana
lost \$9.45.

Book mark:

Hodges

M. | 5 Col'd Cav. | Mass.

Grandison Mitchell

Priv., Co. M, 5 Reg't Mass. Colored Cav.

Appears on Returns as follows:

May 1864. Co. cook,
June 1864. Servant,
July to Sept. 1864. Absent,
servant Lieut. Wilson,
Gen Barnes Hd. Qrs.
Feb. to May 1865. On duty,
detailed at R. Q. M. Dept.
June 1865. Absent guard Q. M.
Stores on Transport.

July to Sept. 1865. Absent
detached serv. Brigade Hd.
Qrs. S. O. 28 July '1/65.

Book mark :

(646)

J. B. Sittler

Copyist.

M | **5 Col'd Cav.** | **Mass.**

Grandison Mitchell

Pri., Co. *M*, 5 Reg't Mass. Col'd Cavalry.

Appears on **Co. Muster-out Roll**, dated
Clarksville Tex. Oct. 31, 1865.

Muster-out to date *Oct. 31*, 1865.

Last paid to *Dec. 31*, 1864.

Clothing account:

Last settled....., 186 ; drawn since \$..... 100

Due soldier \$ *30* 100; due U. S. \$..... 100

Am't for cloth'g in kind or money adv'd \$..... 100

Due U. S. for arms, equipments, &c., \$ *13 05* 100

Bounty paid \$..... 100; due \$ *100* 100

Remarks:

Book mark:

Hodges

(361)

Copyist.

999

Mitchell, John

Co A, 5 Mass. Cav., (Col'd.)

Private

Saddler

CARD NUMBERS.

1	5383785	26
2	5383871	27
3	5383959	28
4	5384058	29
5	5384116	30
6	5384220	31
7	5384329	32
8	5384428	33
9	5384531	34
10	5384634	35
11	5384792	36
12	5384729	37
13	9091597	38
14	30852814	39
15	30854423	40
16	40731399	41
17		42
18		43
19		44
20		45
21		46
22		47
23		48
24		49
25		50

Book Mark:

See also

M. **5 Cav. (Col'd.)** **Mass.**

John Mitchell.

....., Co. *K*, 5 Reg't Mass. Cav. (Col'd.)

Appears on

Company Descriptive Book

of the organization named above.

DESCRIPTION.

Age *25* years; height *5* feet *8½* inches.

Complexion *Colored.*

Eyes *Black*; hair *Black.*

Where born *Long Island, N.Y.*

Occupation *Bricklayer.*

ENLISTMENT.

When *April 10, 186*

Where *Boston No. 4.*

By whom *J. L. Higginson*; term *3* y'rs.

Remarks: *Single. Residence Jamaica W. Indies. Appointed Company Saddler Oct. 1864. Discharged at N. Orleans Sept. 26 '65.*

H. C. Thomas.

(S. D.)

Col. just.

M | **5 Col'd Cav.** | **Mass.**

John Mitchell

Co. 4, 5 Reg't Mass. Col'd Cav.

Appears on
Company Muster-in and Descriptive Roll
of the organization named above. Roll dated
Needham Mass, April 12, 1864.

Where born Long Grove, Wis.

Age 25 y'rs; occupation Bricklayer

When enlisted April 10, 1864.

Where enlisted Boston

For what period enlisted 3 years.

Eyes Blue; hair Black

Complexion Black; height 5 ft. 6 in.

When mustered in April 12, 1864.

Where mustered in Needham Mass.

Bounty paid \$ 100; due \$ 100

Where credited Needham Mass.

Company to which assigned _____

Remarks: _____

Book mark: _____

W. W. Adams

711 | **5 Col'd Cav.** | **Mass.**

John Mitchell

711, Co. K, 5 Reg't Mass. Col'd Cavalry.

Appears on

Company Muster Roll

for from Sept 1st to Sept 31, 1861.

Present or absent Present

Stoppage, \$ 100 for

Due Gov't, \$ 100 for

Valuation of horse, \$ 100

Valuation of horse equipments, \$ 100

Remarks: Went in Reg't
Hospital

Book mark:

M | **5 Col'd Cav. ... Mass.**

John Mitchell

M, Co. K, 5 Reg't Mass. Col'd Cavalry.

Appears on

Company Muster Roll

for *May & June*, 186*4*.

Present or absent *Present*

Stoppage, \$ 100 for

Due Gov't, \$ 100 for

Valuation of horse, \$ 100

Valuation of horse equipments, \$ 100

Remarks:

Book mark:

Albans

M | **5 Col'd Cav.** | **Mass.**

John Mitchell
Co, Co. K, 5 Reg't Mass. Col'd Cavalry.

Appears on

Company Muster Roll

for *July & Aug*, 1864.

Present or absent *Present*

Stoppage, \$ 100 for

Due Gov't, \$ 100 for

Valuation of horse, \$ 100

Valuation of horse equipments, \$ 100

Remarks:

Book mark:

Urban
(358) Copyist.

M | **5 Col'd Cav.** | **Mass.**

John Mitchell

Saddler, Co. K, 5 Reg't Mass. Col'd Cavalry.

Appears on

Company Muster Roll

for Sept & Oct, 1864.

Present or absent Present

Stoppage, \$ 100 for

Due Gov't, \$ 100 for

Valuation of horse, \$ 100

Valuation of horse equipments, \$ 100

Remarks:

Book mark:

Edwards

M | **5 Col'd Cav.** | **Mass.**

John Mitchell

Saddler, Co. K, 5 Reg't Mass. Col'd Cavalry.

Appears on

Company Muster Roll

for Nov & Dec, 1864.

Present or absent Present

Stoppage, \$ 100 for

Due Gov't, \$ 100 for

Valuation of horse, \$ 100

Valuation of horse equipments, \$ 100

Remarks: Present as Saddler
since Oct 31 1864

Book mark:

m | **5 Col'd Cav.** | **Mass.**

John Mitchell

Saddler, Co. K, 5 Reg't Mass. Col'd Cavalry.

Appears on

Company Muster Roll

for Jan & Feb, 1865.

Present or absent Present

Stoppage, \$ 100 for

Due Gov't, \$ 100 for

Valuation of horse, \$ 100

Valuation of horse equipments, \$ 100

Remarks: Buy done as Saddler
since Oct 31. 64

Book mark: _____

Samuel

M | **5 Col'd Cav.** | **Mass.**

John Mitchell
Saddlery Co. K, 5 Reg't Mass. Col'd Cavalry.

Appears on

Company Muster Roll

for Mar & Apr, 1865.

Present or absent Present

Stoppage, \$ 100 for

Due Gov't, \$ 100 for

Valuation of horse, \$ 100

Valuation of horse equipments, \$ 100

Remarks:

.....
.....
.....
.....
.....
.....
.....
.....

Book mark:

Edmondson

M | **5 Col'd Cav.** | **Mass.**

John Mitchell

Saddler, Co. K, 5 Reg't Mass. Col'd Cavalry.

Appears on

Company Muster Roll

for May 5 June, 1865.

Present or absent Absent

Stoppage, \$ 100 for

Due Gov't, \$ 100 for

Valuation of horse, \$ 100

Valuation of horse equipments, \$ 100

Remarks: Absent on board
transport

Book mark: _____

Edmondson

M. | 5 cav | U.S.A.

John Mitchell
Saddler, Co. K, 5 Reg't Mass Cavalry

Appears on

Hospital Muster Roll

of Corps d'Afrique U. S. A. General Hospital,

at New Orleans, La.,

for July & Aug, 1865.

Attached to hospital:

When, 1865.

How employed

Last paid by Maj.

to, 1865.

Bounty paid \$ 100; due \$ 100

Present or absent present

Remarks:

Book mark:

J. M. Mitchell

S | 5 Col'd Cav. | Mass.

John Mitchell

Saddler, Co. K, 5 Reg't Mass. Col'd Cavalry.

Appears on

Company Muster Roll

for July & Aug., 1865.

Present or absent absent

Stoppage, \$ 100 for

Due Gov't, \$ 100 for

Valuation of horse, \$ 100

Valuation of horse equipments, \$ 100

Remarks: Absent in Hospt. at
Brazos since July 26/65.

Book mark:

M | 5 Carry Mass
John Mitchell
Saddler, Co K, 5 Reg Mass Carry

Appears on

Hospital Muster Roll

of Corps d'Afrique U. S. A. General Hospital,

at New Orleans, La.,

for Sept 5, 1865.

Attached to hospital:

When _____, 186 .

How employed _____

Last paid by Maj. _____

to _____, 186 .

Bounty paid \$ 100; due \$ 100

Present or absent ...

Remarks: Discharged
Sept 20, 1865

Book mark: _____

Steward

M. | 5 Col'd Cav. | Mass.

John Mitchell
Pvt., Co. K, 5 Reg't Mass. Colored Cav.
Saddler

Appears on Returns as follows:

Sept. 1864. Absent stationed
at Stockade since Sept.
19"

June 1865. Absent detailed on
Q. M. Transport, Ashland
June 28/65.

July & Aug. 1865. (Sadd.) Absent
sick in Hosp. Brazos
Santiago since July
26/65.

Sept. 1865. Absent sick in
Hosp. N. Orleans since
July 26"

Book mark :

(546)

J. B. Sittler

Copyist.

711 | 5 Col'd Cav. | Mass.

John Mitchell

Sadler, Co. *A*, 5 Reg't Mass. Col'd Cavalry.

Appears on **Co. Muster-out Roll**, dated
Clarksville Texas, Oct. 31, 1865.

Muster-out to date _____, 186 .

Last paid to _____, 186 .

Clothing account:

Last settled _____, 186 ; drawn since \$ _____ 100

Due soldier \$ _____ 100; due U. S. \$ _____ 100

Am't for cloth'g in kind or money adv'd \$ _____ 100

Due U. S. for arms, equipments, &c., \$ _____ 100

Bounty paid \$ _____ 100; due \$ _____ 100

Remarks: *Discharged.*

Book mark: *C D*

(361)

Galligan

Copyist.

M

5 Col'd Cav.

Mass.

John Mitchell

Skaddler, Co. K., 5 Reg't Mass. Col'd Cavalry.

Appears on Co. Muster-out Roll, dated
Clarksville Texas, Oct. 31, 1865.

Muster-out to date _____, 186 .

Last paid to Dec. 31, 1864 .

Clothing account:

Last settled _____, 186 ; drawn since \$ _____ 100

Due soldier \$ _____ 100; due U. S. \$ $82 \frac{18}{100}$

Am't for cloth'g in kind or money adv'd \$ _____ 100

Due U. S. for arms, equipments, &c., \$ _____ 100

Bounty paid \$ _____ 100; due \$ $100 \frac{00}{100}$

Remarks: Absent sick in Gen. Hospt. since July 25, 1865 at New Orleans. Discharged at Gen. Hospt. at N. Orleans Sept. 26, 1865. Not paid of until rolls were completed.

Book mark: See List of Dis

Galligan

(861)

Copyist.

Mitchell John

Sudder, Co. Co;

5

Reg't Mass. C. Cav

Enclosures.

Bed Cards	Descriptive Lists
Burial Records	Final Statements
Certs. of Dis. for Discharge	Furloughs
C. M. Charges	Med. Des. Lists
Med. Certificates	Orders

Other papers relating to—

Admission to Hosp'l	Furlough
Casualty Sheet (Officer's)	Med. Examination
Confinement	Misc. Information
Contracts	Pay or Clothing
Death or Effects	Personal Reports
Desertions	Rank
Discharge from Hosp'l	Transfer to Hosp'l
Discharge from Service	Transfer to V. R. C.
Duty	Transportation

MIRN 034
MICROFILM PUBLICATION M 1822

COMPILED MILITARY SERVICE RECORDS
OF VOLUNTEER UNION SOLDIERS WHO
SERVED WITH THE USCT (US COLORED TROOPS)
5TH MASSACHUSETTS REGIMENT OF CAVALRY

PERSONAL PAPERS' TARGET SHEET

PLEASE NOTE THE CHECKED INFORMATION ABOUT THE PERSONAL PAPERS IN
THIS FILE:

- NO PERSONAL PAPERS WERE FOUND IN THIS FILE WHEN THE
RECORDS WERE ARRANGED FOR MICROFILMING.
- 2 PERSONAL PAPER(S) FOUND IN THIS FILE WHEN THE RECORDS
WERE ARRANGED FOR MICROFILMING.

John T. Tull
Saddler Co. K.
3rd Mass. Cav.

Discharged
Sept 28, 1865

Corps d' Afrique U. S. General Hospital.

NEW ORLEANS LA. Sept. 26th 1865.

Sir

I have the honor to inform you that *Edwin Mitchell*
..... a *Saddler* of *K. Company* *5th* Regiment
Mass Cav.
~~U. S. Cavalry~~ was discharged the military service of the U. S. from this hospital this
day on Surgeons Certificate of Disability. Final statements were given him

I have the honor to be very respectfully,

Your most obedient servant,

F. E. Pequet
SURGEON IN CHARGE

To Commanding Officer.

"*K*" Company

5th Regiment U. S. Cav. *Mass Cav.*

NOTE 1.

The company commander will here add a statement of all the facts known to him concerning the disease or wound, or cause of disability of the soldier; the time, place, manner, and all the circumstances under which the injury occurred, or disease originated or appeared; the duty, or service, or situation of the soldier at the time the injury was received or disease contracted, stating particularly whether the injury was received or the disease contracted in the line of his duty; and whatever other facts may aid a judgment as to the cause, immediate or remote, of the disability, and the circumstances attending it.

When the facts are not known to the company commander, the certificate of any officer or affidavit of other person having such knowledge, will be appended—as the surgeon in charge of a hospital, the officer commanding a detachment of recruits, &c., &c.

NOTE 2.

When a probable case for pension, special care must be taken to state the degree of disability—as 1/2, 3/4, &c., &c.; to describe particularly the disability, wound, or disease; the extent of which it deprives him of the use of any limb or faculty, or affects his health, strength, activity, constitution, or capacity to labor or earn his subsistence. The surgeon will add, from his knowledge of the facts and circumstances, and from the evidence in the case, his professional opinion of the cause or origin of the disability. In the case of discharges by Medical Inspectors, the last paragraph will state that the "discharge was given by consent of the soldier, after a personal examination, and for disability, the nature, degree and origin of which are correctly described in the within certificate."

Par. 1260 Regulations, Edit. 1861.

Medical officers, in giving certificates of disability, are to take particular care in all cases that have not been under their charge; and especially in epilepsy, convulsions, chronic rheumatism, derangement of the urinary organs, ophthalmia, ulcers, or any obscure disease liable to be feigned or purposely produced; and in no case shall such certificate be given until after sufficient time and examination to detect any attempt at deception.

DIRECTIONS.

This certificate will be made out in duplicate by the soldier's company commander, or other officer commanding the separate detachment to which he belongs, and sent by him to the surgeon who has charge of the hospital where the soldier is sick. The surgeon will then fill out and sign the surgeon's certificate, and forward these papers to the regimental, detachment, or post commander, who will forward them, with his action endorsed thereon, through the proper channel, to his division commander; or, if the troops are not attached to a division, to his corps, department, or other commander or officer to whom the authority to discharge enlisted men may be specially delegated.

These certificates, after having received the action of the highest authority to which they are required to be sent, will be returned through the same channel to the regimental, post, or detachment commander, who will, if the discharge is authorized by the endorsement of the proper authority, sign the soldier's discharge, and the last certificate on this paper; see that the soldier is furnished with the proper final statements in duplicate, and forward both of these certificates direct to the Adjutant General United States Army, at Washington, D. C.; they will not, under any circumstances, be given into the hands of the soldier.

ADJUTANT GENERAL'S OFFICE

Oct 16 1865

Duplicate sent the Pension Office.

CERTIFICATE OF DISABILITY FOR DISCHARGE

IN THE CASE OF

John Mitchell
a Saddler, Co. K
5th Reg't of Mass Cavalry

CORPS D'AFRIQUE U. S. GENERAL HOSPITAL.

NEW ORLEANS LA Sept 21 1865

Respectfully

Archer Smith
Surgeon, U. S. Army

Hd. Qrs. Dept. of La.
Medical Directors Office
New Orleans, La. Sept 21 1865

Respectfully forwarded to the
Asst. Adjt. Genl. of the Dept.

Approved
S. C. Paulin
13th. Cavalry, Regt. U. S. A.
Medical Director

Received (A. G. Office) 1865

E. W. O'Connell

By order of Major-General E. R. S. Canby:
To be discharged.

New Orleans, La., Sept 22 1865.
Adjutant General's Department of Louisiana.

ARMY OF THE UNITED STATES.

CERTIFICATE

OF DISABILITY



FOR DISCHARGE

John Mitchell (Saddler) of Captain *F. L. Higginson's*
 Company, (*"K"*) of the *fifth* Regiment of the United States
Mass. Cavalry was enlisted by *F. L. Higginson* of
 the *Regiment of* at *Boston Mass.*
 on the *Tenth* day of *April*, 186*4*, to serve *three* years; he was born
 in *Staten Island* in the State of *New York*, is *Twenty*
 years of age, *Five* feet *Eight* inches high, *Colored* complexion, *Black*
 eyes, *Black* hair, and by occupation when enlisted a *Bricklayer*. During the last two
 months said soldier has been unfit for duty *60* days.*

STATION: *Corpsd "Urique" Hd. Quarters, Dept. of La.*
 DATE: *September 12th 1865*

F. E. Piquette
 Surgeon in Charge
 Commanding Company.

I CERTIFY, that I have carefully examined the said *Private John Mitchell*
 of Captain *F. L. Higginson's* Company, and find him incapable of performing the duties of a
 soldier because of *Epilepsy contracted since enlistment*
resulting from injury of head received in line
of duty rendering him unfit for any branch
of the service is entitled to no degree of
disability

J. Jackson
 Adjt. Surg. U.S.A.

DISCHARGED, this *Twenty sixth* day of *September*, 186*5*, at *Corpsd "Urique"*
Hd. Quarters, Dept. of La.

F. E. Piquette
 Surgeon in Charge
 Commanding the Regt.

The Soldier desires to be addressed at

Town.....County.....State.....

* See Note 1 on the back of this.

† See Note 2 on the back of this.

1000

Mitchell, John A.
Co K, 5 Mass. Cav., (Col'd.)

Private

Sergeant

CARD NUMBERS.

1	5383486	26
2	5383872	27
3	5383915	28
4	5384002	29
5	5384105	30
6	5384208	31
7	5384313	32
8	5384413	33
9	5384516	34
10	5384619	35
11	5384714	36
12	9091598	37
13		38
14		39
15		40
16		41
17		42
18		43
19		44
20		45
21		46
22		47
23		48
24		49
25		50

Book Mark:

See also:

A. 659794 P. Rtd
D 1570609 P. Rtd

R. Waller
4

No. | **5 Cav. (Col'd.)** | **Mass.**

John A. Mitchell

....., Co. *K*, 5 Reg't Mass. Cav. (Col'd.)

Appears on

Company Descriptive Book

of the organization named above.

DESCRIPTION.

Age *22* years; height *5* feet *6* inches.

Complexion *Dark*.

Eyes *Dark*; hair *Dark*

Where born *Charlestown Va.*

Occupation *Confectioner*.

ENLISTMENT.

When *April 10*, 186 ..

Where *Boston Wd. 11.*

By whom *H. L. Higginson*; term *3* y'rs.

Remarks: *Single. Residence Milwaukee Wis.*

Appointed Sergeant May 16 '64.

H. C. Thomas

9/12 | **5 Col'd Cav.** | **Mass.**

John W. Mitchell
Co. A, 5 Reg't Mass. Col'd Cav.

Appears on
Company Muster-in and Descriptive Roll
of the organization named above. Roll dated
June 1864, 1864.

Where born Charleston, Va.

Age 22 yrs; occupation Confederate

When enlisted April 10, 1864.

Where enlisted Boston Mass

For what period enlisted 2 years.

Eyes Blue; hair Black

Complexion Black; height 5 ft. 6 1/2 in.

When mustered in April 12, 1864.

Where mustered in Remedice Mass

Bounty paid \$ 100; due \$ 100

Where credited 2nd Reg't Mass

Company to which assigned

Remarks:

Book mark:

W. W. Brown

72 | **5 Col'd Cav.** | **Mass.**

Arthur W Mitchell

Capt, Co. K, 5 Reg't Mass. Col'd Cavalry.

Appears on

Company Muster Roll

for from April 12th to Sept 30, 1864.

Present or absent Present

Stoppage, \$ 100 for

Due Gov't, \$ 100 for

Valuation of horse, \$ 100

Valuation of horse equipments, \$ 100

Remarks:

Book mark: -----

W. H. ...

M | **5 Col'd Cav.** | **Mass.**

Wm A Mitchell

Sgt, Co. K, 5 Reg't Mass. Col'd Cavalry.

Appears on

Company Muster Roll

for May June, 1864.

Present or absent Present

Stoppage, \$ 100 for

Due Gov't, \$ 100 for

Valuation of horse, \$ 100

Valuation of horse equipments, \$ 100

Remarks: appointed to 1st
lieut, 10/04. Co. 1st Regt
Col. 11/20

Book mark:

Wm A Mitchell

M

5 Col'd Cav.

Mass.

Alphon C Mitchell
Co. K, 5 Reg't Mass. Col'd Cavalry.

Appears on

Company Muster Roll

for *Sept 1864*, 186-4.

Present or absent *Present*

Stoppage, \$ 100 for

Due Gov't, \$ 100 for

Valuation of horse, \$ 100

Valuation of horse equipments, \$ 100

Remarks: *Appointed Sep 16*
from 5th Mass
Cavalry

Book mark:

Alphon

m | **5 Col'd Cav.** | **Mass.**

John A. Mitchell
Sergeant, Co. K, 5 Reg't Mass. Col'd Cavalry.

Appears on

Company Muster Roll

for *Sept 5 60*, 186*4*.

Present or absent *Present*

Stoppage, \$ *100* for

Due Gov't, \$ *100* for

Valuation of horse, \$ *100*

Valuation of horse equipments, \$ *100*

Remarks:

Book mark:

Robert A. ...

M | **5 Col'd Cav.** | **Mass.**

John A. Mitchell
Sergeant, Co. K, 5 Reg't Mass. Col'd Cavalry.

Appears on

Company Muster Roll

for Nov & Dec, 186 ↓

Present or absent Present

Stoppage, \$ 100 for

Due Gov't, \$ 100 for

Valuation of horse, \$ 100

Valuation of horse equipments, \$ 100

Remarks:

Book mark:

[Signature]
Copyst.

m | **5 Col'd Cav.** | **Mass.**

John A. Mitchell

Cap, Co. K, 5 Reg't Mass. Col'd Cavalry.

Appears on

Company Muster Roll

for Jan + Feb, 1864.

Present or absent Present

Stoppage, \$ 100 for

Due Gov't, \$ 100 for

Valuation of horse, \$ 100

Valuation of horse equipments, \$ 100

Remarks: _____

Book mark: _____

(358)

Comd on
pyist.

M | **5 Col'd Cav.** | **Mass.**

John A Mitchell
Sergeant, Co. K, 5 Reg't Mass. Col'd Cavalry.

Appears on

Company Muster Roll

for Nov 5 64, 1865.

Present or absent Present

Stoppage, \$ 100 for

Due Gov't, \$ 100 for

Valuation of horse, \$ 100

Valuation of horse equipments, \$ 100

Remarks:

Book mark:

John A Mitchell

m | **5 Col'd Cav.** | **Mass.**

John A Mitchell
Sergeant, Co. K, 5 Reg't Mass. Col'd Cavalry.

Appears on

Company Muster Roll

for May & June, 1865.

Present or absent Present

Stoppage, \$ 100 for

Due Gov't, \$ 100 for

Valuation of horse, \$ 100

Valuation of horse equipments, \$ 100

Remarks:

Book mark:

(358)

Edmond

Copyist.

711

5 Col'd Cav.

Mass.

John A. Mitchell

Serjt., Co. K, 5 Reg't Mass. Col'd Cavalry.

Appears on

Company Muster Roll

for July & Aug, 1865

Present or absent Present

Stoppage, \$ 100 for

Due Gov't, \$ 100 for

Valuation of horse, \$ 100

Valuation of horse equipments, \$ 100

Remarks:

Book mark:

Galligan

(358)

Copyist.

M

5 Col'd Cav.

Mass.

John A. Mitchell

Serg't, Co. *K*, 5 Reg't Mass. Col'd Cavalry.

Appears on **Co. Muster-out Roll**, dated *Clarksville Texas, Oct. 31, 1865*.

Muster-out to date *Oct. 31, 1865*.

Last paid to *Dec. 31, 1864*.

Clothing account:

Last settled....., 186 ; drawn since \$..... 100

Due soldier \$..... 100; due U. S. \$..... *17 74*/₁₀₀

Am't for cloth'g in kind or money adv'd \$..... 100

Due U. S. for arms, equipments, &c., \$..... *3 00*/₁₀₀

Bounty paid \$..... 100; due \$..... *00 00*/₁₀₀

Remarks:

Book mark:

Galligan

(861)

Copyist.

1001
Mitchell, Moses

Co A, 5 Mass. Cav., (Col'd.)

Private

Private

CARD NUMBERS.

1	5381616	26
2	5381703	27
3	5381787	28
4	5381884	29
5	5381991	30
6	5382096	31
7	5382200	32
8	5382300	33
9	5382398	34
10	5382524	35
11	5382892	36
12	5382627	37
13	9091831	38
14	40731400	39
15		40
16		41
17		42
18		43
19		44
20		45
21		46
22		47
23		48
24		49
25		50

Book Mark:

See also

1518374 P 0 21 + 24

Apr 21
4

M. **5 Cav. (Col'd.) | Mass.**

Moses Mitchell.

Co. H., 5 Reg't Mass. Cav. (Col'd.)

Appears on

Company Descriptive Book
of the organization named above.

DESCRIPTION.

Age *19* years; height *5* feet *4* inches.

Complexion *Colored.*

Eyes *Black* ; hair *Black*

Where born *Windsor N.C.*

Occupation *Farmer.*

ENLISTMENT.

When *Feb'y, 24th,* 1864.

Where *Marblefield.*

By whom *D. Stevens* ; term *3* y'rs.

Remarks: *Murdered in at Readville*
Mar, 12th 64.

H. C. Thomas.

M | **5** Col'd Cav. | **Mass.**

Moses Mitchell

Priv., Co. A, 5 Reg't Mass. Col'd Cav.

Appears on

Company Muster-in and Descriptive Roll
of the organization named above. Roll dated

Readville Mass, Mar 12, 1864.

Where born Windsor N.C.

Age 19 y'rs; occupation Farmer

When enlisted Feb 24, 1864

Where enlisted Mansfield

For what period enlisted 3 years.

Eyes Black; hair Black

Complexion Black; height 5 ft. 4 in.

When mustered in Mar 12, 1864

Where mustered in _____

Bounty paid \$ 100; due \$ 100

Where credited 2^d Dist, Plymouth,

Company to which assigned _____

Remarks: _____

Book mark: _____

J. M. Hall

(356d)

Copyist.

M | **5 Col'd Cav.** | **Mass.**

Moses Mitchell

Priv, Co. H, 5 Reg't Mass. Col'd Cavalry.

Appears on

Company Muster Roll

for *Mar 12 to Apr 30*, 186*4*.

Present or absent *Present*

Stoppage, \$ *100* for

Due Gov't, \$ *100* for

Valuation of horse, \$ *100*

Valuation of horse equipments, \$ *100*

Remarks:

Book mark:

J. W. Hall

M | 5 Col'd Cav. | Mass.

Moses Mitchell
Priv., Co. H, 5 Reg't Mass. Col'd Cavalry.

Appears on

Company Muster Roll

for *May & June*, 186*4*

Present or absent *Present*

Stoppage, \$ *100* for

Due Gov't, \$ *100* for

Valuation of horse, \$ *100*

Valuation of horse equipments, \$ *100*

Remarks:

Book mark:

(358)

J. N. Hall

Copyist.

M 5 Col'd Cav. | **Mass.**

Moses Mitchell

Pr, Co. H, 5 Reg't Mass. Col'd Cavalry.

Appears on

Company Muster Roll

for *July & Aug.*, 186*4*

Present or absent *Present*

Stoppage, \$ *100* for

Due Gov't, \$ *100* for

Valuation of horse, \$ *100*

Valuation of horse equipments, \$ *100*

Remarks:

Book mark:

JmWall

(358)

Copyist.

M

5 Col'd Cav.

Mass.

Moses Mitchell

Pat, Co. H, 5 Reg't Mass. Col'd Cavalry.

Appears on

Company Muster Roll

for *Sept + Oct*, 1864

Present or absent *Present*

Stoppage, \$ *0* ^{*04*}/_{*100*} for *one cross*
sube letter and number.

Due Gov't, \$ *100* for

Valuation of horse, \$ *100*

Valuation of horse equipments, \$ *100*

Remarks:

Book mark:

C M Clark

M

5 Col'd Cav.

Mass.

Moses Mitchell

Plt, Co. H, 5 Reg't Mass. Col'd Cavalry.

Appears on

Company Muster Roll

for *Nov + Dec*, 1864.

Present or absent *Present.*

Stoppage, \$ *100* for

Due Gov't, \$ *100* for

Valuation of horse, \$ *100*

Valuation of horse equipments, \$ *100*

Remarks: *Stop one
bayonet + scabbard.*

Book mark:

L M Clark

(358)

Copyist.

M | **5 Col'd Cav.** | **Mass.**

Moses Mitchell

Put, Co. H, 5 Reg't Mass. Col'd Cavalry.

Appears on

Company Muster Roll

for *Jan + Feb*, 1865.

Present or absent *Present*.

Stoppage, \$ *100* for

Due Gov't, \$ *100* for

Valuation of horse, \$ *100*

Valuation of horse equipments, \$ *100*

Remarks: *Stop one bayonet + scabbard. Due 1st, 2d, 3d + 4th installments U. S. bounty.*

Book mark:

C M Clark

(358)

Copyist.

M

5 Col'd Cav.

Mass.

Moses Mitchel

Put, Co. H, 5 Reg't Mass. Col'd Cavalry.

Appears on

Company Muster Roll

for March & April, 1865

Present or absent Present

Stoppage, \$ 100 for

Due Gov't, \$ 100 for

Valuation of horse, \$ 100

Valuation of horse equipments, \$ 100

Remarks: Due 1st, 2d, 3d & 4th installment U. S. County.

Book mark:

C. M. Clark

(358)

Copyist.

M

5 Col'd Cav.

Mass.

Moses Mitchell

Pat, Co. H, 5 Reg't Mass. Col'd Cavalry.

Appears on

Company Muster Roll

for May & June, 1865.

Present or absent Absent

Stoppage, \$ 100 for

Due Gov't, \$ 100 for

Valuation of horse, \$ 100

Valuation of horse equipments, \$ 100

Remarks: 1st 2d, 3d & 4th installment of \$ bounty due. Free on or before April 15, 1861.

Absent sick at City Point, Va.

Book mark:

C. M. Clark

(358)

Copyist.

M 5 Col'd Cav. | **Mass.**

Moses Mitchell

Priv., Co. H, 5 Reg't Mass. Col'd Cavalry.

Appears on

Company Muster Roll

for *July & Aug.*, 186*7*.

Present or absent

Stoppage, \$ *100* for

Due Gov't, \$ *100* for

Valuation of horse, \$ *100*

Valuation of horse equipments, \$ *100*

Remarks: *Discharged at Ft. Warren
Mass. June 21, 1867. per order
from M.D., dated May 31.*

Book mark:

R. E. Wilson

M | **5 Col'd Cav.** | **Mass.**

James Mitchell
Pvt., Co., 5 Reg't Mass. Col'd Cavalry.

Appears on an

Individual Muster-out Roll

of the organization named above. Roll dated

Fort Monroe Va June 21, 1865.

Muster-out to date *June 21, 1865.*

Last paid to *Dec 31, 1864.*

Clothing account:

Last settled, 186 ; drawn since \$ 100

Due soldier \$ 100; due U. S. \$ 100

Am't for cloth'g in kind or money adv'd \$ *35* ⁸⁰/₁₀₀

Due U. S. for arms, equipments, &c., \$ 100

Bounty paid \$ 100 due \$ *all* ¹⁰⁰/₁₀₀

Remarks: *James Mitchell has
all U.S. Bounty here
due which is
allowed to an enlisted
man for three years.
Mustered out
(over)*

Book mark:

James Mitchell

(348)

Copyist.

JAN. - 9

5372892

★ 1891 ★

JAN. - 9

537289

By order of the
War Dept Dated,
May 3/05
Patience H. S.
Gen'l Hospital
Fort Monroe Va.

M | 5 Col'd Cav. | Mass.

Moses Mitchell
Pvt., Co. H, 5 Reg't Mass. Colored Cav.

Appears on Returns as follows:

May 1865. Absent sick May
21"

June 1865. Absent sick, City
Point May 21"

July 1865. Absent sick, Light
House Pt. since May 21"

Aug. 1865. Loss June 21 Ft.
Monroe, Va. disch'd
per order of War Dept.
dated May 3"

Book mark :

(548)

J. B. Sittler

Copyist.

M | **5 Col'd Cav.** | **Mass.**

Moses Mitchell

Civ., Co. *A.*, 5 Reg't Mass. Col'd Cavalry.

Appears on **Co. Muster-out Roll**, dated
Clarksville, Ten., *Oct. 31*, 1865.

Muster-out to date _____, 186 .

Last paid to *Dec. 31*, 186 .

Clothing account:

Last settled _____, 186 ; drawn since \$ _____ 100

Due soldier \$ _____ 100; due U. S. \$ _____ 100

Am't for cloth'g in kind or money adv'd \$ _____ 100

Due U. S. for arms, equipments, &c., \$ _____ 100

Bounty paid \$ _____ 100; due \$ _____ 100

Remarks: *discharged at Ft.*
Monroe, Va June 21, 1865 =
2d. N. D. May 3rd. 1865.

Book mark: _____

R. S. Wilson

1002
Mitchell, Thomas

Co G, 5 Mass. Cav., (Col'd.)

Private

Private

CARD NUMBERS.

1	5380542	26
2	5380631	27
3	5380711	28
4	5380804	29
5	5380908	30
6	5381005	31
7	5381108	32
8	5381210	33
9	5381312	34
10	5381407	35
11	5381505	36
12	9091958	37
13	40731401	38
14		39
15		40
16		41
17		42
18		43
19		44
20		45
21		46
22		47
23		48
24		49
25		50

Book Mark:

See also

S, 10 37214 P. J. M. M.
S, 10 48624 - J. J. M.

A. J. M.
4

M | **5 Cav. (Col'd.)** | **Mass.**

Thomas Mitchell

....., Co. *G*, 5 Reg't Mass. Cav. (Col'd.)

Appears on

Company Descriptive Book
of the organization named above.

DESCRIPTION.

Age *39* years; height *5* feet *4 1/2* inches.

Complexion *Blk*

Eyes *Blk*; hair *Blk*

Where born *Raleigh N. C.*

Occupation *Farmer.*

ENLISTMENT.

When *Feb 25*, 186*9*.

Where *Boston.*

By whom *A.O. Swain*; term *3* y'rs.

Remarks: *Married.*

Hearn

M | **5 Col'd Cav.** | **Mass.**

Thomas Mitchell

Sgt, Co. *Y*, 5 Reg't Mass. Col'd Cav.

Appears on
Company Muster-in and Descriptive Roll
of the organization named above. Roll dated
Randville Mass, Mar 4, 1864.

Where born *Raleigh N.C.*

Age *39* y'rs; occupation *Farmer*

When enlisted *Feb 25*, 1864.

Where enlisted *Boston*

For what period enlisted *3* years.

Eyes *Blk*; hair *Blk*

Complexion *Blk*; height *5 ft. 4 1/2 in.*

When mustered in *Mar 4*, 1864.

Where mustered in *Randville Mass*

Bounty paid \$ *2* 100; due \$ *100*

Where credited *2nd Regt Norfolk*

Company to which assigned

Remarks:

Book mark:

Leger

M. J. | **5 Col'd Cav.** | **Mass.**

Thomas Mitchell
Sgt., Co. G, 5 Reg't Mass. Col'd Cavalry.

Appears on

Company Muster Roll
for *March 30*, 1864.

Present or absent *Present*

Stoppage, \$..... 100 for

Due Gov't, \$..... 100 for

Valuation of horse, \$..... 100

Valuation of horse equipments, \$..... 100

Remarks:.....
.....
.....
.....
.....
.....

Book mark:.....

Legg
.....
.....

May **5 Col'd Cav.** | **Mass.**
Thomas Mitchell
Pvt., Co. G, 5 Reg't Mass. Col'd Cavalry.

Appears on

Company Muster Roll
for *May & June*, 186*4*
Present or absent *Present*

Stoppage, \$.....100 for

Due Gov't, \$.....100 for

Valuation of horse, \$.....100

Valuation of horse equipments, \$.....100

Remarks:

Book mark:

Leger
.....
(358) Copyist.

Wp | **5 Col'd Cav.** | **Mass.**

Thomas Mitchell
Pvt, Co. G, 5 Reg't Mass. Col'd Cavalry.

Appears on
Company Muster Roll
for *July & Aug*, 186*H*.
Present or absent *Present*

Stoppage, \$... 100 for

Due Gov't, \$... 100 for

Valuation of horse, \$... 100

Valuation of horse equipments, \$... 100

Remarks: *Had one Haversack
& one Canteen*

Book mark:

(358) *Legg* Copyist.

M. | 5 Col'd Cav. | Mass.

Thomas Mitchell

Cou, Co. G, 5 Reg't Mass. Col'd Cavalry.

Appears on

Company Muster Roll

for Sept & Oct., 1864.

Present or absent Present

Stoppage, \$ 100 for

Due Gov't, \$ 100 for

Valuation of horse, \$ 100

Valuation of horse equipments, \$ 100

Remarks: On daily duty as Co. Cook

Book mark:

Cerry

(358)

Copyist.

M. | 5 Col'd Cav. | Mass.

Thomas Mitchell

Co. G, 5 Reg't Mass. Col'd Cavalry.

Appears on

Company Muster Roll

for Nov. & Dec., 1864.

Present or absent Present

Stoppage, \$ 100 for

Due Gov't, \$ 100 for

Valuation of horse, \$ 100

Valuation of horse equipments, \$ 100

Remarks: On daily duty
as Co. Cook

Book mark:

Perry

(358)

Copyist.

726

5 Col'd Cav.

Mass.

Thomas Mitchell

Private, Co. G, 5 Reg't Mass. Col'd Cavalry.

Appears on

Company Muster Roll

for Jan. & Feb., 1865.

Present or absent Present

Stoppage, \$ 100 for

Due Gov't, \$ 100 for

Valuation of horse, \$ 100

Valuation of horse equipments, \$ 100

Remarks: Due 1st, 2d, 3d & 4th instalments U. S. Bounty \$180. On daily duty as Co. Cook

Book mark:

Perry

M. | 5 Col'd Cav. | Mass.

Thomas Mitchell
Co., Co. G, 5 Reg't Mass. Col'd Cavalry.

Appears on

Company Muster Roll

for *March 1st*, 1865.

Present or absent *Present*

Stoppage, \$ 100 for

Due Gov't, \$ 100 for

Valuation of horse, \$ 100

Valuation of horse equipments, \$ 100

Remarks: *Due the soldier
4 instalments U.S.
Army 1865*

Book mark:

(358)

Perry Copyist.

M.

5 Col'd Cav.

Mass.

Thomas Mitchell

Priv., Co. G, 5 Reg't Mass. Col'd Cavalry.

Appears on

Company Muster Roll

for May & June, 1863.

Present or absent Present

Stoppage, \$ 100 for

Due Gov't, \$ 100 for

Valuation of horse, \$ 100

Valuation of horse equipments, \$ 100

Remarks:

Book mark:

Cerry

(358) Copyist.

M

5 Col'd Cav.

Mass.

Thomas Mitchell

Priv., Co. G, 5 Reg't Mass. Col'd Cavalry.

Appears on

Company Muster Roll

for July & Aug, 1864

Present or absent Present

Stoppage, \$ 100 for

Due Gov't, \$ 100 for

Valuation of horse, \$ 100

Valuation of horse equipments, \$ 100

Remarks:

Book mark:

W. H. Scott

(358)

Copyist.

M. | 5 Col'd Cav. | Mass.

Thomas Mitchell
Pvt., Co. G, 5 Reg't Mass. Colored Cav.

Appears on Returns as follows:

Aug. 1864. On duty. Help at
Officers mess.

Sept. 1864 to Mar. 1865. Co. cook.

May 1865. Co. cook.

Book mark :

(546)

J. B. Sittler

Copyist.

M | **5 Col'd Cav.** | **Mass.**

Thomas Mitchell

....., Co. *G*, 5 Reg't Mass. Col'd Cavalry.

Appears on **Co. Muster-out Roll**, dated

Charlottesville Sep 31, 186*5*

Muster-out to date ** Oct. 31*, 186*5*.

Last paid to *Dec. 31*, 1864.

Clothing account:

Last settled....., 186 ; drawn since \$..... 100

Due soldier \$ *8 50* 100; due U. S. \$..... 100

Am't for cloth'g in kind or money adv'd \$..... 100

Due U. S. for arms, equipments, &c., \$ *8* 100

Bounty paid \$..... 100; due \$ *300* 100

Remarks:

** Added Aug. 17, 1921.*

203.

Book mark:

W. H. Scott

(861)

Copyist.

4003

Mitchell, William
Co G, 5 Mass. Cav., (Col'd.)

Private | Private

CARD NUMBERS.

1	5380541	26
2	5380630	27
3	5380710	28
4	5380803	29
5	5380904	30
6	5381004	31
7	5381107	32
8	5381209	33
9	5381311	34
10	5381437	35
11	5381550	36
12	9091956	37
13	40731402	38
14		39
15		40
16		41
17		42
18		43
19		44
20		45
21		46
22		47
23		48
24		49
25		50

Book Mark: _____

See also _____

M 5 Cav. (Col'd.) | Mass.

William Mitchell

....., Co. *G*....., 5 Reg't Mass. Cav. (Col'd.)

Appears on

Company Descriptive Book

of the organization named above.

DESCRIPTION.

Age *23* years; height *5* feet *9 1/2* inches.

Complexion *Blk*

Eyes *Blk*; hair *Blk*

Where born *Macon Georgia.*

Occupation *Farmer.*

ENLISTMENT.

When *Feb 25*, 1864.

Where *Boston*

By whom *A. Osburn*; term *3* y'rs.

Remarks: *Single*
Drowned July 22-65.

Hearn

M | **5 Col'd Cav.** | **Mass.**

William Mitchell
Priv Co. *G*, 5 Reg't Mass. Col'd Cav.

Appears on

Company Muster-in and Descriptive Roll
of the organization named above. Roll dated

Readville Mass, Mar 4, 1864.

Where born *Macon, Ga.*

Age *23* y'rs; occupation *Farmer*

When enlisted *Feb 23*, 1864.

Where enlisted *Boston*

For what period enlisted *3* years.

Eyes *Blk*; hair *Blk*

Complexion *Blk*; height *5* ft. *9 1/2* in.

When mustered in *Mar 4*, 1864.

Where mustered in *Readville Mass*

Prem.
Bounty paid \$ *2* 100; due \$ 100

Where credited *Dist Middlesex*

Company to which assigned

Remarks:

Book mark:

Leger

M | **5 Col'd Cav.** | **Mass.**

William Mitchell
Pvt., Co. G, 5 Reg't Mass. Col'd Cavalry.

Appears on

Company Muster Roll
for *March 31*, 186*4*.

Present or absent *Present*

Stoppage, \$ *100* for

Due Gov't, \$ *100* for

Valuation of horse, \$ *100*

Valuation of horse equipments, \$ *100*

Remarks: _____

Book mark: _____

Leggs
(358) *Leggs* Copyist.

M

5 Col'd Cav.

Mass.

William Mitchell
Co't, Co. G, 5 Reg't Mass. Col'd Cavalry.

Appears on

Company Muster Roll

for *May & June*, 186*4*.

Present or absent *Present*

Stoppage, \$ *100* for

Due Gov't, \$ *100* for

Valuation of horse, \$ *100*

Valuation of horse equipments, \$ *100*

Remarks:

Book mark:

L. J. [unclear]

M | **5 Col'd Cav.** | **Mass.**

William Mitchell
Pr, Co. G, 5 Reg't Mass. Col'd Cavalry.

Appears on

Company Muster Roll

for *July & Aug*, 186*4*.

Present or absent *Present*

Stoppage, \$ *100* for

Due Gov't, \$ *100* for

Valuation of horse, \$ *100*

Valuation of horse equipments, \$ *100*

Remarks: *Top one Cavalry*

Book mark:

Leger

(358)

Copyist.

M | **5 Col'd Cav.** | **Mass.**

William Mitchell
....., Co. G, 5 Reg't Mass. Col'd Cavalry.

Appears on

Company Muster Roll

for *Sept & Oct*, 186*4*.

Present or absent *Present*

Stoppage, \$..... *100* for

Due Gov't, \$..... *100* for

Valuation of horse, \$..... *100*

Valuation of horse equipments, \$..... *100*

Remarks:

Book mark:

(358)

Perry

Copyist.

M

5 Col'd Cav.

Mass.

William Mitchell
Pvt., Co. G, 5 Reg't Mass. Col'd Cavalry.

Appears on

Company Muster Roll

for *Nov 7 Dec*, 186*4*.

Present or absent *Present*

Stoppage, \$ *100* for

Due Gov't, \$ *100* for

Valuation of horse, \$ *100*

Valuation of horse equipments, \$ *100*

Remarks:

Book mark: _____

(358)

Perry

Copyist.

M. | 5 Col'd Cav. | Mass.

Wm Mitchell

Priv, Co. G, 5 Reg't Mass. Col'd Cavalry.

Appears on

Company Muster Roll

for Jan & Feb, 1865.

Present or absent Present

Stoppage, \$ 100 for

Due Gov't, \$ 100 for

Valuation of horse, \$ 100

Valuation of horse equipments, \$ 100

Remarks: Due 1st 2d 3d 4th instalments U.S. Bounty \$180, Due U.S. for Prussia belt & plate 46cts, for 2 bayonets \$5.00 Total due U.S. \$5.46

Book mark:

Perry

(358)

Copyist.

M. | 5 Col'd Cav. | Mass.

Wm Mitchell
Private, Co. G, 5 Reg't Mass. Col'd Cavalry.

Appears on

Company Muster Roll

for Mch. Capt., 1865.

Present or absent Present

Stoppage, \$ 100 for

Due Gov't, \$ 100 for

Valuation of horse, \$ 100

Valuation of horse equipments, \$ 100

Remarks: Due U.S. for
Bond \$5.46 charged on
Jan. & Feb. Rolls.
Due the soldier
4 instalments U.S.
Bounty \$180.

Book mark:

Perry

(358)

Copyist.

M. 5 Col'd Cav. | Mass.

William Mitchell
Prv, Co. G, 5 Reg't Mass. Col'd Cavalry.

Appears on

Company Muster Roll

for May & June, 1865.

Present or absent Present

Stoppage, \$ 100 for

Due Gov't, \$ 100 for

Valuation of horse, \$ 100

Valuation of horse equipments, \$ 100

Remarks: Due U.S. for
ordnance lost \$5.46
charged on Jan 8
Feb. Rolls

Book mark:

(358) Perry Copyist.

No

5 Col'd Cav.

Mass.

William Mitchell
Priv, Co. G, 5 Reg't Mass. Col'd Cavalry.

Appears on

Company Muster Roll

for *July & Aug*, 186*6*.

Present or absent

Stoppage, \$ *100* for

Due Gov't, \$ *100* for

Valuation of horse, \$ *100*

Valuation of horse equipments, \$ *100*

Remarks: *Drowned in*
Rio Grande Clark
ville Texas July
22, 66

Book mark:

W. H. Scott

(358)

Copyist.

M. | 5 Col'd Cav. | Mass.

William Mitchell
Pvt., Co. G, 5 Reg't Mass. Colored Cav.

Appears on Returns as follows:

July 1865. Loss July 22/65
Clarkeville, Texas.
Drowned while in
bathing.

Book mark :

(548)

J. B. Sittler

Copyist.

M | **5 Col'd Cav.** | **Mass.**

William Mitchell
Co. G, 5 Reg't Mass. Col'd Cavalry.

Appears on **Co. Muster-out Roll**, dated
Clarksville Tex Oct 31 1861.

Muster-out to date _____, 186 .

Last paid to *Rec'd*, 186 +.

Clothing account:

Last settled _____, 186 ; drawn since \$ _____ 100

Due soldier \$ _____ 100; due U. S. \$ *40* ^{*1/2*} 100

Am't for cloth'g in kind or money adv'd \$ _____ 100

Due U. S. for arms, equipments, &c., \$ _____ 100

Bounty paid \$ _____ 100; due \$ _____ 100

Remarks: *Shot in Rio*
Grande Clarksville
Texas July 22, 65

Book mark: *136.931. H.B.V.*

W. H. Scott

Mitchell Jm

P. Co. 9.

5

Regt Mass. C. Cav

Enclosures.

Bed Cards

Descriptive Lists

Burial Records

Final Statements

Certs. of Dis. for Discharge

Furloughs

C. M. Charges

Med. Des. Lists

Med. Certificates

Orders

Other papers relating to—

Admission to Hosp'l

Furlough

Casualty Sheet (Officer's)

Med. Examination

Confinement

Misc. Information

Contracts

Pay or Clothing

Death or Effects

Personal Reports

Desertions

Rank

Discharge from Hosp'l

Transfer to Hosp'l

Discharge from Service

Transfer to V. R. C.

Duty

Transportation

No sig- 57
FINAL STATEMENT

OF

Private William Mitchell
7th Reg't of Mass. Cav.

VOLUNTEERS.

Co. B. 1st Regt. Mass. Cav.

NOTE 1.—Two of these certificates (or duplicates) are to be given to each Volunteer Soldier or drafted man who may be discharged previously to the discharge of his company, that he may at once receive from the Paymaster the pay, &c., due him, and the captain or other COMMISSIONED officer commanding the company will certify to the act of the delivery of the duplicate certificates; on these certificates the Soldier is "entitled to" his discharge, and should also present his discharge to the Paymaster to have the payment endorsed on it. The discharge is to be given back to the Soldier by the Paymaster; the latter only retaining as his voucher the duplicate certificates.

NOTE 2.—If the Soldier is entitled to pay for the use of his horse, the Company Commander will certify to that fact on the back of both these final statements, and also to the time he has pay due for having been so mounted on his own horse.

NOTE 3.—When a Soldier is furnished with final statements, his descriptive list, if he has one, should be taken up by the officer who gives the Soldier these statements, and endorsed with a statement to this effect by the officer. This endorsement should exhibit a full statement of the time for which the Soldier was allowed pay on his final statements, the clothing account, and all other charges against him or in his favor, so as to comprise a complete exhibit of his account. It will then be transmitted to the company commander of the Soldier, who will enter all the data necessary to a full understanding of the Soldier's account on the muster roll upon which the Soldier's discharge is reported. The descriptive list will then be destroyed. The object of this is, that the remaining portion of the Soldier's account may be settled upon the receipt of these muster rolls, and the Soldier receive any pay or allowances that may be due him at the time of his discharge, and which may not appear on his final statements from the fact that his descriptive list is incomplete. These accounts for back pay, &c., are settled by the 2d Auditor of the Treasury Department.

NOTE 4.—Charges for loss or injury to ordnance, horse equipments, and other miscellaneous charges, should appear under the heading of "Other Stoppages."

NOTE 5.—Bounty paid by State authorities, and not by the United States, will not be entered on this statement.

NOTE 6.—Amounts due the Sutler and Laundress must be entered on the muster roll on which the discharge, death, desertion, &c., is reported, as well as on the final statement, otherwise the amount cannot be collected from the United States.

NOTE 7.—This blank will be used for deceased volunteers and drafted men, as well as for others.

NOTE 8.—Where a Soldier dies in Hospital or on detached service, his descriptive list, if he has one, should be sent with his final statements, in duplicate, to the Adjutant General, Washington, D. C.

[Handwritten signature and circular stamp]

ADJUTANT GENERAL'S OFFICE
Aug 20 1860
Duplicate with Inventory sent 2^d Auditor.

1004

Mole, James J.

Co - , 5 Mass. Cav., (Col'd.)

Private

CARD NUMBERS.

1	5372521	26	
2	5372551	27	
3	9436172	28	
4		29	
5		30	
6		31	
7		32	
8		33	
9		34	
10		35	
11		36	
12		37	
13		38	
14		39	
15		40	
16		41	
17		42	
18		43	
19		44	
20		45	
21		46	
22		47	
23		48	
24		49	
25		50	

Book Mark:

See also

71 | 5 Cav. Mass. | Mass.
James B. Mole,
....., Co., 5 Reg't Col'd

Appears on

Regimental Descriptive Book

of the organization named above.

DESCRIPTION.

Age 26 years; height 5 feet 6 inches.

Complexion Colored

Eyes Green; hair Brown

Where born Baltimore, Md.

Occupation Seaman

ENLISTMENT.

When Apr. 20, 1864.

Where Boston

By whom Capt. James; term 3 y'rs.

Remarks: Mustered Nov. 29/
Capt. in Service, deser-
ted on the way from
Depot.

M | **5 Col'd Cav.** | **Mass.**

James B. Mole

Appears with rank of *Private* on

Muster and Descriptive Roll of a Detachment of U. S. Vols. forwarded

for the 5 Reg't Mass. Col'd Cavalry. Roll dated

Boston Mass. Nov 30, 1864.

Where born *Baltimore Md*

Age *26* y'rs; occupation *Seaman*

When enlisted *Nov. 29, 1864.*

Where enlisted *Boston Mass.*

For what period enlisted *3* years.

Eyes *Grey*; hair *Blk*

Complexion *Colored*; height *5 ft. 6 in.*

When mustered in *Nov. 30, 1864.*

Where mustered in *Boston*

Bounty paid \$ *100* ¹⁰⁰; due \$ *200* ¹⁰⁰

Where credited *Hanover Mass.*

Company to which assigned

Remarks:

Not taken upon Muster rolls of Regt.

Book mark:

M. A. Michael

(339) *Copyist.*

M | **5 Col'd Cav.** | **Mass.**

* James D. Mote

Appears with rank of Private on

Muster and Descriptive Roll of a Detachment of U. S. Vols. forwarded

for the 5 Reg't Mass. Col'd Cavalry. Roll dated Grafton
Grafton Mass., Dec 19, 1864.

Where born Baltimore Md

Age 26 y'rs; occupation Seaman

When enlisted Nov 29, 1864

Where enlisted Boston Mass

For what period enlisted 3 years.

Eyes gray; hair black

Complexion Rose; height 5 ft. 6 in.

When mustered in Nov 29, 1864.

Where mustered in Boston

Bounty paid \$ 100 ¹⁰⁰; due \$ 200 ¹⁰⁰

Where credited Hanover Plymouth Co

Company to which assigned

Remarks: Detained at this Post

Entered only cancelled receipt Remarks

Book mark:

M. A. Michaels
Copyist.

M. M. M. 100

McAleer, James D.

....., Co., Reg't

2 Enclosures.

Bed Cards	Final Statements
Burial Records	Furloughs or L. of A.
Certs. of Dis. for Discharge	Med. Certificates
C. M. Charges	Med. Des. Lists
Descriptive Lists	Orders
Discharge Certificates	Pris. of War Record
Enlistment Papers	Resignations

Other papers relating to—

Admission to Hosp'l	Furlough or L. of A.
Casualty Sheet	Med. Examination
Confinement	Misc. Information
Contracts	Pay or Clothing
Death or Effects	Personal Reports
Desertion	Rank
Discharge from Hosp'l	Transfer to Hosp'l
Discharge from Service	Transfer to V. R. C.
Duty	Transportation

NOTE 1. — This blank will be used for both enlistments and re-enlistments — enlistment of veterans, &c., &c., in the volunteer service. They will be made out in duplicate in all cases — one to accompany the recruiting return of the superintendent (not the recruiting officer) to the Adjutant-General, and one to accompany the accounts of the officer who pays bounty, &c. The Regiment and Company in which the soldier last served should be given on the back.

NOTE 2. — An enlistment holds to service. A must-in must, in all cases, precede payment of pay, bounty, pension, &c. A must-in roll must, in all cases, be filed in the Adjutant-General's Office as evidence of must-in. A mustering officer, commissary, or assistant-commissary of musters, as the case may be, will countersign both enlistments as having mustered the soldier into the service of the United States before either of them is given to the disbursing officer.

APPROVED FOR THE ADJUTANT-GENERAL BY
FILED IN THE ENROLLMENT DIVISION P. O.

DECLARATION OF RECRUIT.

I, *James P Mole* desiring to VOLUNTEER as a Soldier in the Army of the United States, for the term of THREE YEARS, Do Declare, That I am *Twenty Six* years and *0* months of age; that I have never been discharged from the United States service on account of disability or by sentence of a court-martial, or by order before the expiration of a term of enlistment; and I know of no impediment to my serving honestly and faithfully as a soldier for three years.

GIVEN at *Berlin Mass.* the *29* day of *November* 18*64*

Witness: *John H Collins* *James P Mole*
Must

5th Maine
No.

James P Mole

Volunteered at *Berlin Mass*

Nov 20 18*64*,

By *Col J M Alderman*

3rd Regiment of *Maine*

3rd

enlistment; last served in Company ()

Reg't of

Discharged

18

John H Collins
H. C. M.

CONSENT IN CASE OF MINOR.

I, _____ Do CERTIFY, That I am
the _____ of _____ ; that the
said _____ is _____ years of age; and I
do hereby freely give my CONSENT to his volunteering as a SOLDIER in the ARMY OF THE UNITED STATES
for the period of THREE YEARS.

GIVEN at _____
the _____ day of _____

Witness :

VOLUNTEER ENLISTMENT.

STATE OF

TOWN OF

Massachusetts,



I, James B. Mole, born in *Baltimore* in the State of *Maryland* aged *Twenty six* years, and by occupation a *Seaman* Do HEREBY ACKNOWLEDGE to have volunteered this *Twenty ninth* day of *November* 1864, to serve as a **Soldier** in the **Army of the United States of America**, for the period of **THREE YEARS**, unless sooner discharged by proper authority: Do also agree to accept such bounty, pay, rations, and clothing, as are, or may be, established by law for volunteers. And I, *James B. Mole* do solemnly swear that I will bear true faith and allegiance to the **United States of America**, and that I will serve them honestly and faithfully against all their enemies or opposers whomsoever; and that I will observe and obey the orders of the President of the United States, and the orders of the officers appointed over me, according to the Rules and Articles of War.

Sworn and subscribed to, at *Boston, Mass.* this *29* day of *November* 1864 BEFORE *L. M. ...* *James B. Mole* Mark

Cap. J. P. ... I CERTIFY, ON HONOR, That I have carefully examined the above-named Volunteer, agreeably to the General Regulations of the Army, and that, in my opinion, he is free from all bodily defects and mental infirmity, which would in any way disqualify him from performing the duties of a soldier.

Surgeon Board of Enlistment ENAMING SURGEON.

I CERTIFY, ON HONOR, That I have minutely inspected the Volunteer, *J. B. Mole* previously to his enlistment, and that he was entirely sober when enlisted; that, to the best of my judgment and belief, he is of lawful age; and that, in accepting him as duly qualified to perform the duties of an able-bodied soldier, I have strictly observed the Regulations which govern the recruiting service.

This soldier has *Grey* eyes. *Black* hair. *Color* complexion, is *Five* feet *6* inches high.

J. N. ... *Cap. and Prov. Marshal Volunteers,* *3rd Dist. Mass* RECRUITING OFFICER.

(A. G. O. No. 74 & 75.)

Mustered into the service of the United States, in Company *29* day of *November*, 1864, at *Boston Mass* *9* Regiment of Cavalry *Mass* Volunteers, on *...*

14597

MAR 25 1864

NOTE 1. — This blank will be used for both enlistments and re-enlistments — enlistment of veterans, &c., &c., in the volunteer service. They will be made out in duplicate in all cases — one to accompany the recruiting return of the superintendent (not the recruiting officer) to the Adjutant-General, and one to accompany the accounts of the officer who pays bounty, &c. The Regiment and Company in which the soldier last served should be given on the back.

NOTE 2. — An enlistment holds to service. A muster-in must, in all cases, precede payment of pay, bounty, pension, &c. A muster-in roll must, in all cases, be filed in the Adjutant-General's Office as evidence of muster-in. The mustering officer, commissary, or assistant-commissary of musters, as the case may be, will countersign both enlistments as having mustered the soldier into the service of the United States before either of them is given to the disbursing officer.

DECLARATION OF RECRUIT.

I, *James B. Mole* desiring to VOLUNTEER as a Soldier in the Army of the United States, for the term of THREE YEARS, Do Declare, That I am *Twenty six* years and *0* months of age; that I have never been discharged from the United States service on account of disability or by sentence of a court-martial, or by order before the expiration of a term of enlistment; and I know of no impediment to my serving honestly and faithfully as a soldier for three years.

GIVEN at *Boston Mass* the *29* day of *November 1864*

Witness: *John D Collins* *J B Mole*
Mark

No. *James B Mole*
Volunteered at *18*
By *18*
Regiment of *6th Mass. Heavy*
enlistment; last served in Company ()
Reg't of *100th Heavy*
Discharged *18*

CONSENT IN CASE OF MINOR.

I, _____ Do CERTIFY, That I am _____ of _____; that the said _____ is _____ years of age; and I do hereby freely give my CONSENT to his volunteering as a SOLDIER in the ARMY OF THE UNITED STATES for the period of THREE YEARS.

GIVEN at _____ the _____ day of _____

Witness: _____

VOLUNTEER ENLISTMENT.

STATE OF



TOWN OF

Massachusetts.

Weymouth

I, *James B Mole* born in *Baltimore*
in the State of *Maryland* aged *Twenty six* years,
and by occupation a *Seaman* DO HEREBY ACKNOWLEDGE to have
volunteered this *Twenty sixth* day of *November* 1864,
to serve as a **Soldier** in the Army of the United States of America, for the
period of **THREE YEARS**, unless sooner discharged by proper authority: Do also
agree to accept such bounty, pay, rations, and clothing, as are, or may be, estab-
lished by law for volunteers. And I, *James B Mole* do
solemnly swear that I will bear true faith and allegiance to the **United States
of America**, and that I will serve them honestly and faithfully against all their
enemies or opposers whomsoever; and that I will observe and obey the orders of
the President of the United States, and the orders of the officers appointed over
me, according to the Rules and Articles of War.

Sworn and subscribed to, at *Boston, Mass.* this *29* day of *November* 1864,
BEFORE *W. A. Phillips* *Notary*

Capt & Prov. Marshal 3^d Dist Mass.
I CERTIFY, ON HONOR, That I have carefully examined the above-named Volunteer, agreeably
to the General Regulations of the Army, and that, in my opinion, he is free from all bodily defects and
mental infirmity, which would in any way disqualify him from performing the duties of a soldier.

Wm. S. Church
Surgeon Board of Enlistment
3^d Dist Mass. EXAMINING SURGEON.

I CERTIFY, ON HONOR, That I have minutely inspected the Volunteer, *James B Mole*
previously to his enlistment, and that he was entirely sober when enlisted; that, to the best of my
judgment and belief, he is of lawful age; and that, in accepting him as duly qualified to perform the duties
of an able-bodied soldier, I have strictly observed the Regulations which govern the recruiting service.

This soldier has *Grey* eyes, *Black* hair, *Colored* complexion, is *Five* feet
6 inches high.

A. N. L. P. M.
Capt and Prov. Marshal
3^d Dist Mass. RECRUITING OFFICER.

(A. G. O. No. 74 & 75.)

Mustered into the service of the United States, in Company
the *29* day of *November*, 1864, at *Boston Mass*

*Capt & Prov. Marshal
3^d Dist Mass*

3^d
Regiment of Cavalry Mass Volunteers, on

1005

Monroe, Gabriel

Co D, 5 Mass. Cav., (Col'd.)

Private

Private

CARD NUMBERS.

1	5372709	26
2	5377521	27
3	5377628	28
4	5377730	29
5	5377824	30
6	5377912	31
7	5378008	32
8	9092320	33
9	40731404	34
10		35
11		36
12		37
13		38
14		39
15		40
16		41
17		42
18		43
19		44
20		45
21		46
22		47
23		48
24		49
25		50

Book Mark:

See also

M 5 Cav. (Col'd.) | Mass.

Gabriel Monroe

....., Co. *2*, 5 Reg't Mass. Cav. (Col'd.)

Appears on

Company Descriptive Book

of the organization named above.

DESCRIPTION.

Age *21* years; height *5* feet *4* inches.

Complexion *colored*

Eyes *blk*; hair *blk*

Where born *Home Mobile*

Occupation *Porter*

ENLISTMENT.

When *Sept 1*, 1864.

Where *Dunston 2nd Dist*

By whom; term *5* y'rs.

Remarks: *Enrolled man*

.....
.....
.....
.....
.....
.....

Heard

M | 5 Col'd Cav. | **Mass.**

Gabriel Monroe

Appears with rank of Private on

Muster and Descriptive Roll of a Detachment of Drafted Men and Substitutes forwarded

for the 5 Reg't Mass. Colored Cavalry. Roll dated
Dr. Galloups Island, ^{B.N. Mass.} N.Y., Oct. 31, 1864.

Where born St. Louis, Mo.

Age 21 years; occupation porter

Drafted and mustered in:

When Sept. 17, 1864.

Where Fauntun.

Period 3 years.

Eyes Black; hair Black

Complexion Colored; height 5 ft. 7 in.

Paid bounty and advance pay, \$ 100

Bounty due \$ 100

Where credited

Company to which assigned

Remarks: Substitute for enrolled man.

Book mark:

McDaire

Mo | **5 Col'd Cav.** | **Mass.**

Gabriel Monroe

Pr, Co. D, 5 Reg't Mass. Col'd Cavalry.

Appears on

Company Muster Roll

for *Nov & Dec*, 186 *4*.

Present or absent *Present*

Stoppage, \$ *100* for

Due Gov't, \$ *100* for

Valuation of horse, \$ *100*

Valuation of horse equipments, \$ *100*

Remarks: *No Enlistment papers*

Book mark:

D. Merchant
Copyist.

M 5 Col'd Cav. | **Mass.**

Gabriel Monroe

Pr, Co. D, 5 Reg't Mass. Col'd Cavalry.

Appears on

Company Muster Roll

for *Jan & Feb*, 1865.

Present or absent *Present*

Stoppage, \$ *100* for

Due Gov't, \$ *100* for

Valuation of horse, \$ *100*

Valuation of horse equipments, \$ *100*

Remarks: *Due 1st Install
M. Bounty*

Book mark:

S. Merchant

M 5 Col'd Cav. | **Mass.**

Gabriel Monroe

Pvt., Co. D, 5 Reg't Mass. Col'd Cavalry.

Appears on

Company Muster Roll

for *Mar 2 Cpl*, 1865.

Present or absent *Present*

Stoppage, \$ *100* for

Due Gov't, \$ *100* for

Valuation of horse, \$ *100*

Valuation of horse equipments, \$ *100*

Remarks: *Rec'd 1 Incl U.S. Bounty*

Book mark:

J. Marchant

M | **5 Col'd Cav.** | **Mass.**

Gabriel Monroe
Pvt, Co. D, 5 Reg't Mass. Col'd Cavalry.

Appears on

Company Muster Roll

for *May and June*, 1865.

Present or absent *Present*

Stoppage, \$ 100 for

Due Gov't, \$ 100 for

Valuation of horse, \$ 100

Valuation of horse equipments, \$ 100

Remarks:

Book mark:

House

M | **5 Col'd Cav.** | **Mass.**

Samuel Morse

Rt, Co. D, 5 Reg't Mass. Col'd Cavalry.

Appears on

Company Muster Roll

for *July and Aug.*, 1865.

Present or absent *Present.*

Stoppage, \$ *100* for

Due Gov't, \$ *100* for

Valuation of horse, \$ *100*

Valuation of horse equipments, \$ *100*

Remarks:

*In detached duty riding
P.R. at Brazz Damme
L.C. 40 Ho. 2nd Cav. Regt.
July 27/65*

Book mark:

M. | 5 Col'd Cav. | Mass.

Gabriel Monroe

Pvt., Co. 20, 5 Reg't Mass. Colored Cav.

Appears on Returns as follows:

Nov. 1864. Gain Nov. 29"
Recruit from depot.

July 1865. Absent on detach'd
duty since July 27 at
Brazos Santiago.

Aug. & Sept. 1865. Absent on
detach'd duty at Brazos
Santiago S. O. 40 dated
Hd. Qrs. Cav. Brig. July
27/65.

Book mark :

(548)

J. B. Sitter

Copyist.

M | **5 Col'd Cav. Mass.**

Gabriel Thomas
Priv, Co. *C*, 5 Reg't Mass. Col'd Cavalry.

Appears on **Co. Muster-out Roll**, dated
Clarksville Texas, Oct 31, 1865.

Muster-out to date *Oct. 31, 1865.*
Last paid to *over paid*, 186 .

Clothing account:

Last settled....., 186 ; drawn since \$..... 100

Due soldier \$..... 100; due U. S. \$ *23* ^{*3*}/₁₀₀

Am't for cloth'g in kind or money adv'd \$..... 100

Due U. S. for arms, equipments, &c., \$ *11* ^{*00*}/₁₀₀

Bounty paid \$..... 100; due \$ *100* ^{*00*}/₁₀₀

Remarks:

*Total money value of
ordnance charged \$ 11.00*

Book mark:

1089 Harrison

Montgomery, Harris
Co L, 5 Mass. Cav., (Col'd.)

Private

Private

CARD NUMBERS.

1	5384875	26
2	5384958	27
3	5385047	28
4	5385146	29
5	5385254	30
6	5385356	31
7	5385455	32
8	5385555	33
9	5385653	34
10	5385746	35
11	5385840	36
12	9091504	37
13	40731406	38
14		39
15		40
16		41
17		42
18		43
19		44
20		45
21		46
22		47
23		48
24		49
25		50

Book Mark: 1172-85. R & P. - G. O.

See also

O. 2595-614 P. O. Retd

R. Swack
4

16. | **5 Cav. (Col'd.)** | **Mass.**

Harrison Montgomery

....., Co. *L*....., 5 Reg't Mass. Cav. (Col'd.)

Appears on

Company Descriptive Book

of the organization named above.

DESCRIPTION.

Age *18* years; height *5* feet *5* inches.

Complexion *Dark*

Eyes *Black*; hair *Black*

Where born *Louisburg W. Va.*

Occupation *Farmer*

ENLISTMENT.

When *Apr. 6*, 186 ..

Where *Boston, Md. 9.*

By whom *L. M. Standish*; term *3* y'rs.

Remarks: *Mustered into service at
Burlington Mass. Apr. 22/64, by Lieut.
McKibben. Disced Apr. 19/61.*

H. C. Thomas

M | **5 Col'd Cav.** | **Mass.**

Harris Montgomery
Pvt., Co. *L*, 5 Reg't Mass. Col'd Cav.

Appears on

Company Muster-in and Descriptive Roll
of the organization named above. Roll dated
Readville Mass, Apl. 22, 1864.

Where born *Lewisburg, Va.*

Age *18* y'rs; occupation *Farmer*

When enlisted *Apl. 6*, 1864.

Where enlisted *Boston Ward, 9*

For what period enlisted *3* years.

Eyes *Black*; hair *Black*

Complexion *Black*; height *5 ft. 5 in.*

When mustered in *Apl. 22*, 1864.

Where mustered in _____

Bounty paid \$ *100*; due \$ *100*

Where credited *4th Cong. Dist. Mass.*

Company to which assigned _____

Remarks: _____

Book mark: _____

Crenshaw

(356d)

Copyist.

M | **5 Col'd Cav.** | **Mass.**

Harrison Montgomery
Pvt, Co. L, 5 Reg't Mass. Col'd Cavalry.

Appears on

Company Muster Roll

for Apr. 22 to 30, 1864.

Present or absent Present

Stoppage, \$.....100 for.....

Due Gov't, \$.....100 for.....

Valuation of horse, \$.....100

Valuation of horse equipments, \$.....100

Remarks:.....

Book mark:.....

Cresshaw

(358)

Copyist.

M | 5 Col'd Cav. | Mass.

Harrison Montgomery
Pot, Co. L, 5 Reg't Mass. Col'd Cavalry.

Appears on

Company Muster Roll

for May & June, 1864.

Present or absent Present

Stoppage, \$ 100 for

Due Gov't, \$ 100 for

Valuation of horse, \$ 100

Valuation of horse equipments, \$ 100

Remarks:

Book mark:

Creshaw

M | **5 Col'd Cav.** | **Mass.**

Harrison Montgomery
Pvt, Co. L, 5 Reg't Mass. Col'd Cavalry.

Appears on

Company Muster Roll
for July & Aug., 1864.
Present or absent Present

Stoppage, \$.....100 for

Due Gov't, \$.....100 for

Valuation of horse, \$.....100

Valuation of horse equipments, \$.....100

Remarks:

Book mark:

Crenshaw

(358)

Copyist.

M. | **5 Col'd Cav.** | **Mass.**

Harrison Montgomery
Priv, Co. L, 5 Reg't Mass. Col'd Cavalry.

Appears on

Company Muster Roll

for Sept + Oct, 1864.

Present or absent Present

Stoppage, \$ 100 for

Due Gov't, \$ 100 for

Valuation of horse, \$ 100

Valuation of horse equipments, \$ 100

Remarks: Due U.S. for Ordnance
clothes \$ 1.37

Book mark: _____

(358)

J. M. Hance

Copyist.

M. | **5 Col'd Cav.** | **Mass.**

Harrison Montgomery
Priv., Co. L, 5 Reg't Mass. Col'd Cavalry.

Appears on

Company Muster Roll

for *Nov. & Dec.*, 1864.

Present or absent *Present*

Stoppage, \$ *100* for

Due Gov't, \$ *100* for

Valuation of horse, \$ *100*

Valuation of horse equipments, \$ *100*

Remarks *Muster for Ord.*
Stores \$ 1.19

Book mark:

(358)

J. M. Vance

Copyist.

M. | **5 Col'd Cav.** | **Mass.**

Harrison Montgomery
Det., Co. L, 5 Reg't Mass. Col'd Cavalry.

Appears on

Company Muster Roll

for *Jan 1 Feb*, 186*1*.

Present or absent *Present*

Stoppage, \$ *100* for

Due Gov't, \$ *100* for

Valuation of horse, \$ *100*

Valuation of horse equipments, \$ *100*

Remarks: *See 1st installment*
U. S. Cavalry \$ 200.00
See also 2nd installment \$ 100.00

Book mark:

(358)

J. M. H. [Signature]

Copyist.

M

5 Col'd Cav.

Mass.

Harrison Montgomery
Sgt, Co. L, 5 Reg't Mass. Col'd Cavalry.

Appears on

Company Muster Roll

for *Mar & Apr*, 1865.

Present or absent *Present*

Stoppage, \$ *100* for

Due Gov't, \$ *100* for

Valuation of horse, \$ *100*

Valuation of horse equipments, \$ *100*

Remarks: *Recd. & disbursement*
of U. S. Bounty \$ 25.00

Book mark:

(358)

J. W. Vance

Copyist.

M | **5 Col'd Cav.** | **Mass.**

Harrison Montgomery
John, Co. L, 5 Reg't Mass. Col'd Cavalry.

Appears on

Company Muster Roll

for *May & June*, 186*5*.

Present or absent *Present*

Stoppage, \$ *100* for

Due Gov't, \$ *100* for

Valuation of horse, \$ *100*

Valuation of horse equipments, \$ *100*

Remarks: *Due 1st installment*
U.S. bounty \$20. Free
before Aug. 14-61

Book mark:

(358) *J. M. Hance* Copyist.

S | **5 Col'd Cav.** | **Mass.**

William H. ...
... Co. L, 5 Reg't Mass. Col'd Cavalry.

Appears on

Company Muster Roll

for *...*, 186*5*.

Present or absent *Present*

Stoppage, \$ *100* for

Due Gov't, \$ *100* for

Valuation of horse, \$ *100*

Valuation of horse equipments, \$ *100*

Remarks: *...*

Book mark: *...*

...

M. | 5 Col'd Cav. | Mass.

Montgomery
Pvt., Co. L, 5 Reg't Mass. Colored Cav.

Appears on Returns as follows:

Aug. 1865, Absent on Rail
Road by S. O.

Sept. 1865, Absent on Rail
Road near Brazos
by S. O. 48 Aug. 11/65-
Hd. Qrs, Cav. Brig.

Book mark :

(548)

J. B. Sittler

Copyist.

11 | **5 Col'd Cav.** | **Mass.**

James P. [unclear]
Co. *1*, 5 Reg't Mass. Col'd Cavalry.

Appears on **Co. Muster-out Roll**, dated *Sept 13*, 186*5*.

Muster-out to date *Oct 3*, 186*5*.

Last paid to *Nov 3*, 186*4*.

Clothing account:

Last settled....., 186 ; drawn since \$..... 100

Due soldier \$..... 100; due U. S. \$ *19* 100

Am't for cloth'g in kind or money adv'd \$..... 100

Due U. S. for arms, equipments, &c., \$ *11* 100

Bounty paid \$..... 100; due \$ *11* 100

Remarks: *See [unclear]*

Book mark: *11, 2, 85 [unclear]*

1007

Moody, Albert

Co. L, 5 Mass. Cav., (Col'd.)

Private

Private

CARD NUMBERS.

1	5384874	26
2	5384959	27
3	5385848	28
4	5385147	29
5	5385255	30
6	5385357	31
7	5385456	32
8	5385556	33
9	5385654	34
10	5385747	35
11	5385841	36
12	9091505	37
13		38
14		39
15		40
16		41
17		42
18		43
19		44
20		45
21		46
22		47
23		48
24		49
25		50

Book Mark:

See also

S. 817366 P.O. aff
P.O. 195008 P.O. Clinton
A. 2203478 P.O. mail

R. Swack
x

No. **5 Cav. (Col'd.)** | **Mass.**

Albert Moody.

Co. L, 5 Reg't Mass. Cav. (Col'd.)

Appears on

Company Descriptive Book

of the organization named above.

DESCRIPTION.

Age *22* years; height *5* feet *4* inches.

Complexion *Dark.*

Eyes *Black*; hair *Black*

Where born *Isle of White Co, Va.*

Occupation *Fanner.*

ENLISTMENT.

When *April 11, 186*

Where *Roxbury.*

By whom *G. F. Wilson*; term *3* y'rs.

Remarks: *Mustered into Service at
Reedville Mass. Apr. 22/64, by Lieut.
McKibben. Free April 19/61.*

H. C. Thomas

M | 5 Col'd Cav. | Mass.

Albert Moody

Pvt., Co. L, 5 Reg't Mass. Col'd Cav.

Appears on

Company Muster-in and Descriptive Roll

of the organization named above. Roll dated

Leadville Mass, Apl. 22, 1864.

Where born Isle of Wight Co. Va.

Age 22 y'rs; occupation Farmer

When enlisted apl. 11, 1864.

Where enlisted Roxbury

For what period enlisted 3 years.

Eyes Black; hair Black

Complexion Black; height 5 ft. 4 in.

When mustered in apl. 22, 1864.

Where mustered in _____

Bounty paid \$ 100; due \$ 100

Where credited 3 Cong. Dist. Mass.

Company to which assigned _____

Remarks: _____

Book mark: _____

Crewshaw

M | **5 Col'd Cav.** | **Mass.**

Albert Moody
Priv, Co. L, 5 Reg't Mass. Col'd Cavalry.

Appears on

Company Muster Roll

for *Apr. 22 to 30*, 186*4*.

Present or absent *Present*

Stoppage, \$.....*100* for

Due Gov't, \$.....*100* for

Valuation of horse, \$.....*100*

Valuation of horse equipments, \$.....*100*

Remarks:

Book mark:

Crenshaw

M | 5 Col'd Cav. | Mass.

Albert Moody
Pot, Co. L, 5 Reg't Mass. Col'd Cavalry.

Appears on

Company Muster Roll

for *May & June*, 186*4*.

Present or absent *Present*

Stoppage, \$.....100 for

Due Gov't, \$.....100 for

Valuation of horse, \$.....100

Valuation of horse equipments, \$.....100

Remarks:

Book mark:

Cresshaw

M | **5 Col'd Cav.** | **Mass.**

Albert Moody
Pvt., Co. L, 5 Reg't Mass. Col'd Cavalry.

Appears on

Company Muster Roll
for July & Aug., 1864.
Present or absent Present

Stoppage, \$.....100 for

Due Gov't, \$.....100 for

Valuation of horse, \$.....100

Valuation of horse equipments, \$.....100

Remarks:.....
.....
.....
.....
.....
.....
.....
.....
.....

Book mark:.....

Crenshaw

(358)

Copyist.

M. | **5 Col'd Cav.** | **Mass.**

Albert Moody

Priv., Co. L, 5 Reg't Mass. Col'd Cavalry.

Appears on

Company Muster Roll

for Sept & Oct, 1864.

Present or absent Present

Stoppage, \$ 100 for

Due Gov't, \$ 100 for

Valuation of horse, \$ 100

Valuation of horse equipments, \$ 100

Remarks:

Book mark:

(358)

J. M. Hance

Copyist.

M. | **5 Col'd Cav.** | **Mass.**

Albert Moody

Priv., Co. L, 5 Reg't Mass. Col'd Cavalry.

Appears on

Company Muster Roll

for *Nov & Dec*, 186*4*.

Present or absent *Present*

Stoppage, \$ *100* for

Due Gov't, \$ *100* for

Valuation of horse, \$ *100*

Valuation of horse equipments, \$ *100*

Remarks: -----

Book mark: -----

(358) *J. M. Hance* Copyist.

M | **5 Col'd Cav.** | **Mass.**

Alfred M. ...
.....
Sgt., Co. L, 5 Reg't Mass. Col'd Cavalry.

Appears on

Company Muster Roll

for *Jan 4 57*, 186*7*.

Present or absent *Present*

Stoppage, \$ *100* for

Due Gov't, \$ *100* for

Valuation of horse, \$ *100*

Valuation of horse equipments, \$ *100*

Remarks: *Discharge*
W. Co. Cavalry

Book mark:

(358)

J. H. ...

Copyist.

M | **5 Col'd Cav.** | **Mass.**

Albert Mander

Co. L, 5 Reg't Mass. Col'd Cavalry.

Appears on

Company Muster Roll

for *Sept 4th*, 186*4*.

Present or absent *Present*

Stoppage, \$ *100* for

Due Gov't, \$ *100* for

Valuation of horse, \$ *100*

Valuation of horse equipments, \$ *100*

Remarks: *Present*

Book mark:

(358)

J. M. Mander
Copyist.

M. | **5 Col'd Cav.** | **Mass.**

Albert Moody

Pvt., Co. L, 5 Reg't Mass. Col'd Cavalry.

Appears on

Company Muster Roll

for *May + June*, 1865.

Present or absent *Present*

Stoppage, \$ *100* for

Due Gov't, \$ *100* for

Valuation of horse, \$ *100*

Valuation of horse equipments, \$ *100*

Remarks: *Present at muster roll
of S. Co. L, 5 Reg't Mass. Col'd Cavalry
beginning April 14 '65*

Book mark:

J. M. Hance

M | **5 Col'd Cav.** | **Mass.**

Albert Moody

Sgt, Co. L, 5 Reg't Mass. Col'd Cavalry.

Appears on

Company Muster Roll

for July & Aug, 1863.

Present or absent Present

Stoppage, \$ 100 for

Due Gov't, \$ 100 for

Valuation of horse, \$ 100

Valuation of horse equipments, \$ 100

Remarks: Free Aug 2 1863

Book mark: _____

Moody

W | **5 Col'd Cav.** | **Mass.**

John W. ...
....., Co., 5 Reg't Mass. Col'd Cavalry.

Appears on **Co. Muster-out Roll**, dated
Sept 31, 1863, 1863.

Muster-out to date *Sept 31, 1863*, 1863.

Last paid to *Sept 31, 1863*, 1863.

Clothing account:

Last settled....., 186 ; drawn since \$..... 100

Due soldier \$.....³100; due U. S. \$..... 100

Am't for cloth'g in kind or money adv'd \$..... 100

Due U. S. for arms, equipments, &c., \$.....¹⁰⁰100

Bounty paid \$..... 100; due \$.....¹⁰⁰100

Remarks: *Sept 31, 1863*

Book mark :

1008

Moody, Dennis

Co L, 5 Mass. Cav., (Col'd.)

Private

Private

CARD NUMBERS.

1	5372309	26
2	5372337	27
3	5385148	28
4	5385256	29
5	5385358	30
6	5385457	31
7	5385557	32
8	5385655	33
9	5385748	34
10	5385842	35
11	9091506	36
12	34506305	37
13	40731408	38
14		39
15		40
16		41
17		42
18		43
19		44
20		45
21		46
22		47
23		48
24		49
25		50

Book Mark:

See also

M. | **5 Cav. (Col'd.)** | **Mass.**

Dennis Moody.

L., Co. *L.*, 5 Reg't Mass. Cav. (Col'd.)

Appears on

Company Descriptive Book

of the organization named above.

DESCRIPTION.

Age *28* years; height *5* feet *5* inches.

Complexion *Black.*

Eyes *Black*; hair *Dark.*

Where born *Natchez Miss.*

Occupation *Laborer.*

ENLISTMENT.

When *July 28*, 186*4*.

Where *N. Marlboro.*

By whom *W. Walker.*; term *3* y'rs.

Remarks: *Mustered into service by Capt.*

J. M. Goodhue, Boston July 28th 64.

Id, him \$100.00 U.S. Bounty by Capt.

H. Dyer. Due him \$200.00

Free April 19/61.

H. C. Thomas.

M | 5-bav. | Mass

Dennis Moody

Appears with rank of on

Muster and Descriptive Roll

of a detachment of U. S. Volunteers forwarded from Faneuil Hall, Boston, to Galloup's Island, Boston Harbor, for various regiments Massachusetts Volunteers. Roll dated

Boston Mass, July 28, 1864.

Where born Natchez Miss.

Age 28 years; occupation Laborer

When enlisted July 28, 1864.

Where enlisted N. Marlboro

For what period enlisted 3 years.

Eyes blk; hair blk

Complexion drk; height 5 ft. 5 in.

When mustered in July 28, 1864.

Where mustered in Boston

Bounty paid \$ 100⁰⁰/₁₀₀; due \$ 200⁰⁰/₁₀₀

Clothing account:

Last settled, 186 ; drawn since \$ 100

Date of first muster, 186 .

Regiment to which assigned 5-bav.

Remarks: 10 Dist. New Marl-
boro Berkshire Co.

Book mark :

(356m)

J. H. Thomas
Copyist.

M | 5 Col'd Cav. | Mass.

Dennis Moody

Appears with rank of *Pri* on

Muster and Descriptive Roll of a Detachment of U. S. Vols. forwarded

for the 5 Reg't Mass. Col'd Cavalry. Roll dated

Boston Mass July 29, 1864.

Where born *Natchez Miss*

Age *28* y'rs; occupation *Labourer*

When enlisted *July 28*, 1864.

Where enlisted *New Marlboro*

For what period enlisted *3* years.

Eyes *Black*; hair *Black*

Complexion *Dark*; height *5 ft. 5 in.*

When mustered in *July 28*, 1864.

Where mustered in *Boston*

Bounty paid \$ *100*₁₀₀; due \$ *200*₁₀₀

Where credited *10 Dist. New Marlboro*

Berkshire Co
Company to which assigned

Remarks:

Book mark:

Somully

M | 5 Col'd Cav. | Mass.

Dennis Moody
Pvt, Co. L, 5 Reg't Mass. Col'd Cavalry.

Appears on

Company Muster Roll

for July & Aug., 1864.

Present or absent Present

Stoppage, \$ 100 for

Due Gov't, \$ 100 for

Valuation of horse, \$ 100

Valuation of horse equipments, \$ 100

Remarks: Recruit from
Depot joined Aug. 11.
Recd. \$100 bounty.

Book mark:

Cerishaw

M | **5 Col'd Cav.** | **Mass.**

Dennis Moody

Appears with rank of *Pri* on

Muster and Descriptive Roll of a Detachment of U. S. Vols. forwarded

for the 5 Reg't Mass. Col'd Cavalry. Roll dated

Galloups old mass, Aug 7, 1864.

Where born *Natchez Miss*

Age *28* y'rs; occupation *Labourer*

When enlisted *July 28*, 1864.

Where enlisted *New Marlboro Mass*

For what period enlisted *3* years.

Eyes *Black*; hair *Black*

Complexion *Dark*; height *5 ft. 5 in.*

When mustered in *July 28*, 1864.

Where mustered in *Boston Mass*

Bounty paid \$ *100* ₁₀₀; due \$ *200* ₁₀₀

Where credited

Company to which assigned

Remarks: *10 - New Marlboro*

Berkshire Co

Book mark:

Donnelly

M.

5 Col'd Cav.

Mass.

Samuel Moody

Sgt., Co. L, 5 Reg't Mass. Col'd Cavalry.

Appears on

Company Muster Roll

for *Sept & Oct*, 186*4*.

Present or absent *Present*

Stoppage, \$ *100* for

Due Gov't, \$ *100* for

Valuation of horse, \$ *100*

Valuation of horse equipments, \$ *100*

Remarks: *\$ 200 Bounty due*

Book mark:

J. M. Hance

(358)

Copyist.

M | **5 Col'd Cav.** | **Mass.**

Dennis Moody

Plt, Co. L, 5 Reg't Mass. Col'd Cavalry.

Appears on

Company Muster Roll

for *Nov & Dec*, 1864.

Present or absent *Present*

Stoppage, \$ *100* for

Due Gov't, \$ *100* for

Valuation of horse, \$ *100*

Valuation of horse equipments, \$ *100*

Remarks: *\$200 bounty dues*
Due U.S. for Ord Stores \$1.16

Book mark: _____

(358)

J. M. Hance

Copyist.

M. | **5 Col'd Cav.** | **Mass.**

Samuel ...

Pr., Co. L, 5 Reg't Mass. Col'd Cavalry.

Appears on

Company Muster Roll

for *Jan + Feb*, 186*t*.

Present or absent *Present*.

Stoppage, \$ *100* for

Due Gov't, \$ *100* for

Valuation of horse, \$ *100*

Valuation of horse equipments, \$ *100*

Remarks: *See ...*

Book mark: -----

W. H. ...

(358) *W. H. ...* Copyist.

Mo | **5 Col'd Cav.** | **Mass.**

Samuel Moody

Co., Co. L, 5 Reg't Mass. Col'd Cavalry.

Appears on

Company Muster Roll

for *Sept 1864*, 186*4*.

Present or absent *Present*

Stoppage, \$ *100* for

Due Gov't, \$ *100* for

Valuation of horse, \$ *100*

Valuation of horse equipments, \$ *100*

Remarks:

Book mark:

(358)

J. G. ...

Copyist.

M. | **5 Col'd Cav.** | **Mass.**

Dennis Moody

Col., Co. L, 5 Reg't Mass. Col'd Cavalry.

Appears on

Company Muster Roll

for *May & June*, 1865.

Present or absent *Present*

Stoppage, \$.....100 for

Due Gov't, \$.....100 for

Valuation of horse, \$.....100

Valuation of horse equipments, \$.....100

Remarks:-----

Book mark:-----

(358)

J. H. Harris

Copyist.

M | **5 Col'd Cav.** | **Mass.**

Samuel Moody
C, Co. L, 5 Reg't Mass. Col'd Cavalry.

Appears on

Company Muster Roll

for *July & Aug*, 186*3*.

Present or absent *Present*

Stoppage, \$ *100* for

Due Gov't, \$ *100* for

Valuation of horse, \$ *100*

Valuation of horse equipments, \$ *100*

Remarks: *Due U.S. for Gro. Stores \$1.03 + for O & G equipage 75 ct.*

Book mark:

Cover

(358)

Copyist.

M. | 5 Col'd Cav. | Mass.

Dennis Moody
Pvt., Co. L, 5 Reg't Mass. Colored Cav.

Appears on Returns as follows:

Aug. 1864. Gain Aug. 11 Point
Lookout, Md. Recruit
from Depot.

Oct. 1864. On duty in Black-
smith shop.

Book mark :

(546)

J. B. Sittler

Copyist.

J. ... | **5 Col'd Cav.** | **Mass.**

James ...
....., Co. *A*, 5 Reg't Mass. Col'd Cavalry.

Appears on **Co. Muster-out Roll**, dated
September 21, 1863, 186 *3*.
Muster-out to date *July 3, 1863*, 186 *3*.
Last paid to *July 3, 1863*, 186 *3*.

Clothing account:

Last settled....., 186 ; drawn since \$..... 100
Due soldier \$.....100; due U. S. \$..... 100
Am't for cloth'g in kind or money adv'd \$.....100

Due U. S. for arms, equipments, &c., \$..... 100

Bounty paid \$.....100; due \$..... 100

Remarks: *See ...*
...
...

Book mark :

.....
...
.....

Moody, Dennis
Co., No. 5 Reg't Mass. Cav.

2 Enclosures.

Bed Cards	Final Statements
Burial Records	Furloughs or L. of A. ..
Certs. of Dis. for Discharge	Med. Certificates
C. M. Charges	Med. Des. Lists
Descriptive Lists	Orders
Discharge Certificates	Pris. of War Record
Enlistment Papers 2	Resignations

Other papers relating to—

Admission to Hosp'l	Furlough or L. of A.
Casualty Sheet	Med. Examination
Confinement	Misc. Information
Contracts	Pay or Clothing
Death or Effects	Personal Reports
Desertion	Rank
Discharge from Hosp'l	Transfer to Hosp'l
Discharge from Service	Transfer to V. R. C.
Duty	Transportation

NOTE 1.—This blank will be used for both enlistments and re-enlistments—enlistment of veterans, &c., &c., in the volunteer service. They will be made out in duplicate in all cases—one to accompany the recruiting return of the superintendent (not the recruiting officer) to the Adjutant-General, and one to accompany the accounts of the officer who pays bounty, &c. The Regiment and Company in which the soldier last served should be given on the back.

NOTE 2.—An enlistment holds to service. A muster-in must, in all cases, precede payment of pay, bounty, pension, &c. A muster-in roll must, in all cases, be filed in the Adjutant-General's Office as evidence of muster-in. The mustering officer, commissary, or assistant-commissary of musters, as the case may be, will countersign both enlistments as having mustered the soldier into the service of the United States before either of them is given to the disbursing officer.

DECLARATION OF RECRUIT.

I, *Dennis Moody* R. desiring to VOLUNTEER as a Soldier in the Army of the United States, for the term of THREE YEARS, Do Declare, That I am *twenty eight* years and _____ months of age; that I have never been discharged from the United States service on account of disability or by sentence of a court-martial, or by order before the expiration of a term of enlistment; and I know of no impediment to my serving honestly and faithfully as a soldier for three years.

GIVEN at *Boston* the *28* day of *July* 1864

Witness: *Benj. C. Piper* *Dennis Moody*
mark

Discharged *100 Bn*
1864

enlistment; last served in Company ()
 Reg't of

By *Dennis Moody*
 Volunteered at *New Hampshire*
July 27 1864,
1st Regiment of *Concord*
 No. *5 New Hampshire*

CONSENT IN CASE OF MINOR.

I, _____ Do CERTIFY, That I am _____ the _____ of _____; that the said _____ is _____ years of age; and I do hereby freely give my CONSENT to his volunteering as a SOLDIER in the ARMY OF THE UNITED STATES, for the period of THREE YEARS.

GIVEN at _____ the _____ day of _____

Witness:

VOLUNTEER ENLISTMENT.

STATE OF

TOWN OF

Massachusetts



New Marlboro

I, *Dennis Moody* born in *Natchez*
 in the State of *Mississippi* aged *twenty eight* years,
 and by occupation a *Laborer* DO HEREBY ACKNOWLEDGE to have
 volunteered this *twenty eighth* day of *July* 186*4*,
 to serve as a **Soldier** in the **Army of the United States of America**, for the
 period of **THREE YEARS**, unless sooner discharged by proper authority: Do also
 agree to accept such bounty, pay, rations, and clothing, as are, or may be, estab-
 lished by law for volunteers. And I, *Dennis Moody* do
 solemnly swear, that I will bear true faith and allegiance to the **United States**
of America, and that I will serve them honestly and faithfully against all their
 enemies or opposers whomsoever; and that I will observe and obey the orders of
 the President of the United States, and the orders of the officers appointed over
 me, according to the Rules and Articles of War.

Sworn and subscribed to, at *Boston*
 this *28th* day of *July* 186*4* } *Dennis* ^{his} *Moody*
 BEFORE *Geo. W. Chase* } *mark*
D. M. Gordon Capt 11 Regt 4

I CERTIFY, ON HONOR, That I have carefully examined the above-named Volunteer, agreeably
 to the General Regulations of the Army, and that, in my opinion, he is free from all bodily defects and
 mental infirmity, which would in any way disqualify him from performing the duties of a soldier.

A. S. Cochran
 EXAMINING SURGEON.

I CERTIFY, ON HONOR, That I have minutely inspected the Volunteer, *Dennis Moody*
 previously to his enlistment, and that he was entirely sober when enlisted; that, to the best of my
 judgment and belief, he is of lawful age; and that, in accepting him as duly qualified to perform the duties
 of an able-bodied soldier, I have strictly observed the Regulations which govern the recruiting service.
 This soldier has *black* eyes, *black* hair, *dark* complexion, is *five* feet
five inches high.

Warren Walker
 Chairman of Selectmen

Regiment of *of New Marlboro*
 Volunteers,

RECRUITING OFFICER.

(A. G. O. No. 74 & 75.)

the *28th* day of *July*, 186*4*, at *Boston*

Regiment of

Volunteers, on

Dennis Moody
Capt 11 Regt 4
U.S.A.

of the Massachusetts Cavalry now on march

NOTE 1.—This blank will be used for both enlistments and re-enlistments—enlistment of veterans, &c., &c., in the volunteer service. They will be made out in duplicate in all cases—one to accompany the recruiting return of the superintendent (not the recruiting officer) to the Adjutant-General, and one to accompany the accounts of the officer who pays bounty, &c. The Regiment and Company in which the soldier last served should be given on the back.

NOTE 2.—An enlistment holds to service. A muster-in must, in all cases, precede payment of pay, bounty, pension, &c. A muster-in roll must, in all cases, be filed in the Adjutant-General's Office as evidence of muster-in. The mustering officer, commissary, or assistant-commissary of musters, as the case may be, will countersign both enlistments as having mustered the soldier into the service of the United States before either of them is given to the disbursing officer.

DECLARATION OF RECRUIT.

I, *Dennis Moody* desiring to VOLUNTEER as a Soldier in the Army of the United States, for the term of THREE YEARS, Do Declare, That I am *twenty-eight* years and _____ months of age; that I have never been discharged from the United States service on account of disability or by sentence of a court-martial, or by order before the expiration of a term of enlistment; and I know of no impediment to my serving honestly and faithfully as a soldier for three years.

GIVEN at *Boston* the *28th* day of *July* 18*64*

Witness: *Ben C. Piper* *Dennis Moody*
his mark

Discharged

1860

enlistment; last served in Company ()

5th Regt of Mass. Cavalry

18

By

Ben C. Piper
Regiment of Cavalry

Volunteered at

Dennis Moody
Ben C. Piper

No.

6

CONSENT IN CASE OF MINOR.

I, _____ Do CERTIFY, That I am _____ the _____ of _____; that the said _____ is _____ years of age; and I do hereby freely give my CONSENT to his volunteering as a SOLDIER in the ARMY OF THE UNITED STATES, for the period of THREE YEARS.

GIVEN at _____ the _____ day of _____

Witness:

VOLUNTEER ENLISTMENT.

STATE OF

TOWN OF

Massachusetts



New Marlboro

Mustered into the service of the United States, in Company
the 25 day of July . 1864 at Fort Mifflin

I, Dennis Moody born in Natchez
in the State of Mississippi aged twenty-eight years,
and by occupation a Labourer Do HEREBY ACKNOWLEDGE to have
volunteered this twenty eighth day of July 1864,
to serve as a Soldier in the Army of the United States of America, for the
period of THREE YEARS, unless sooner discharged by proper authority: Do also
agree to accept such bounty, pay, rations, and clothing, as are, or may be, estab-
lished by law for volunteers. And I, Dennis Moody do
solemnly swear, that I will bear true faith and allegiance to the United States
of America, and that I will serve them honestly and faithfully against all their
enemies or opposers whomsoever; and that I will observe and obey the orders of
the President of the United States, and the orders of the officers appointed over
me, according to the Rules and Articles of War.

Sworn and subscribed to, at Boston
this 28th day of July 1864 } Dennis Moody
BEFORE me Geo W Chase }
J. M. Woodman, Capt. 11 Regt

I CERTIFY, ON HONOR, That I have carefully examined the above-named Volunteer, agreeably
to the General Regulations of the Army, and that, in my opinion, he is free from all bodily defects and
mental infirmity, which would in any way disqualify him from performing the duties of a soldier.

J. M. Woodman
EXAMINING SURGEON.

I CERTIFY, ON HONOR, That I have minutely inspected the Volunteer, Dennis Moody
previously to his enlistment, and that he was entirely sober when enlisted; that, to the best of my
judgment and belief, he is of lawful age; and that, in accepting him as duly qualified to perform the duties
of an able-bodied soldier, I have strictly observed the Regulations which govern the recruiting service.
This soldier has black eyes, black hair, dark complexion, is five feet
five inches high.

Warren Walker
Chairman of Selectmen
Regiment of Volunteers,
of New Marlboro
RECRUITING OFFICER.

11th Mass Cavalry new recruit

Company
Capt. H. A. Walker

Regiment of
Volunteers, on

Moody, Plumer P.
Co F, 5 Mass. Cav., (Col'd.)

Private | Private

CARD NUMBERS.

1	5379350	26
2	5379435	27
3	5379476	28
4	5379563	29
5	5379661	30
6	5379824	31
7	5379924	32
8	5380037	33
9	5380131	34
10	5380231	35
11	5380352	36
12	5373005	37
13	5380452	38
14	9092090	39
15	40731407	40
16		41
17		42
18		43
19		44
20		45
21		46
22		47
23		48
24		49
25		50

Book Mark:

See also

8-3136102 POKet

Alwalker
4

M | **5 Cav. (Col'd.)** | **Mass.**

Plummer S. Moody

F, Co. *F*, 5 Reg't Mass. Cav. (Col'd.)

Appears on

Company Descriptive Book

of the organization named above.

DESCRIPTION.

Age *21* years; height *5* feet *8* inches.

Complexion *Dark*

Eyes *Blk*; hair *Blk*

Where born *London Co. N. Hampshire*

Occupation *Farmer*

ENLISTMENT.

When *Feb 12*, 186*4*

Where *Cambridge*

By whom *J. Stevens*; term *3* y'rs.

Remarks: *Mustered out of service at Fort Monroe on Surgeons Certificate of Disability June 23 65,*

Hearst

M | **5 Col'd Cav.** | **Mass.**

Sumner P. Moody
....., Co. *(4)*, 5 Reg't Mass. Col'd Cav.

Appears on
Company Muster-in and Descriptive Roll
of the organization named above. Roll dated
Cambridge, Mass., Feb. 22, 1864.

Where born *London Co., Md.*

Age *21* y'rs; occupation *Farmer*

When enlisted *Feb. 12*, 1864.

Where enlisted *Cambridge*

For what period enlisted *13* years.

Eyes *Black*; hair *Black*

Complexion *Black*; height *5* ft. *8* in.

When mustered in *Feb. 22*, 1864.

Where mustered in

Bounty paid \$ *100*; due \$ *100*

Where credited *at Dist. Med. Dep't.*

Company to which assigned

Remarks :

Book mark :

.....
(Signature)
.....

111 | **5 Col'd Cav.** | **Mass.**

Wm. S. Moody
.....
Wm. S. Moody, Co. F, 5 Reg't Mass. Col'd Cavalry.

Appears on

Company Muster Roll

for *Wm. S. Moody to May 1864*, 1864.

Present or absent *Present*

Stoppage, \$..... 100 for

Due Gov't, \$..... 100 for

Valuation of horse, \$..... 100

Valuation of horse equipments, \$..... 100

Remarks:

Book mark:

W. S. Moody

277 | 5 Col'd Cav. | Mass.

Wm. M. Moore
Capt., Co. F, 5 Reg't Mass. Col'd Cavalry.

Appears on

Company Muster Roll

for *Feb. & Apr.*, 1864.

Present or absent *Present.*

Stoppage, \$ *100* for

Due Gov't, \$ *100* for

Valuation of horse, \$ *100*

Valuation of horse equipments, \$ *100*

Remarks: *at Regimental
Hospital*

Book mark:

J. E. Taylor
Copyist.

117 | 5 Col'd Cav. | Mass.

Plummer P. Moody
Copt., Co. F, 5 Reg't Mass. Col'd Cavalry.

Appears on

Company Muster Roll

for May & June, 1864.

Present or absent Absent

Stoppage, \$ 100 for

Due Gov't, \$ 100 for

Valuation of horse, \$ 100

Valuation of horse equipments, \$ 100

Remarks: Left's March, 1, 1864
20, #13 March, 4, 1864, absent
work at (readville) since
May 5, 1864.

Book mark:

G. E. Tyler
Copyist.

'M | 5 Col'd Cav. | Mass.

Plummer P. Moody^x
Corp, Co. F, 5 Reg't Mass. Col'd Cavalry.

Appears on

Company Muster Roll

for July & Aug, 1864.

Present or absent Present

Stoppage, \$ 100 for

Due Gov't, \$ 100 for

Valuation of horse, \$ 100

Valuation of horse equipments, \$ 100

Remarks: App'd Corp Mch
4/64 G.O. 13
Mch 4/64 Ret. to
duty from Hosp
July 29/64

^xIn Col. of Pres. name appears
as "Plummer P. Moody"

Book mark:

J. Stewart
(358) Copyist.

M | 5 Col'd Cav. | Mass.

Plummer P. Moody
Pt, Co. F, 5 Reg't Mass. Col'd Cavalry.

Appears on

Company Muster Roll

for Sept & Oct, 1864.

Present or absent Present

Stoppage, \$ 100 for

Due Gov't, \$ 100 for

Valuation of horse, \$ 100

Valuation of horse equipments, \$ 100

Remarks:

Book mark:

(358)

J. H. Stewart

Copyist.

M | **5 Col'd Cav.** | **Mass.**

Plummer P. Moody
Pt, Co. F, 5 Reg't Mass. Col'd Cavalry.

Appears on

Company Muster Roll

for *Nov & Dec*, 1864.

Present or absent *Present*

Stoppage, \$ *100* for

Due Gov't, \$ *100* for

Valuation of horse, \$ *100*

Valuation of horse equipments, \$ *100*

Remarks: *Due US for*
Ord. one (1) Springfield
rifle and equipments
complete

Book mark: _____

J. W. Seward

W | 5 Col'd Cav. | Mass.

Plummer P. Moody^x
Pt., Co. F, 5 Reg't Mass. Col'd Cavalry.

Appears on

Company Muster Roll

for Jan & Feb, 1865.

Present or absent Present

Stoppage, \$ 100 for

Due Gov't, \$ 100 for

Valuation of horse, \$ 100

Valuation of horse equipments, \$ 100

Remarks: Due U.S. Gov
One Springfield rifle
musket & equipment
complete \$54.39
Due first pay, last
U.S. Bounty
* In Col. Pres name appears
as "Plummer P. Moody"

Book mark:

W. H. Beirall
(358) Copyist.

7W | 5 Col'd Cav. | Mass.

Plumer P. Moody
Pt., Co. F, 5 Reg't Mass. Col'd Cavalry.

Appears on

Company Muster Roll

for *Mo & Apr*, 1865.

Present or absent *Present*

Stoppage, \$ *100* for

Due Gov't, \$ *100* for

Valuation of horse, \$ *100*

Valuation of horse equipments, \$ *100*

Remarks: *Due first pay
inst U.S. Bounty
180,00*

Book mark:

A Stewart
(858) Copyist.

M | **5 Col'd Cav.** | **Mass.**

Samuel J. Moody
Pl, Co. F, 5 Reg't Mass. Col'd Cavalry.

Appears on

Company Muster Roll

for *July & Aug*, 186*5*,

Present or absent

Stoppage, \$ 100 for

Due Gov't, \$ 100 for

Valuation of horse, \$ 100

Valuation of horse equipments, \$ 100

Remarks: *Discharged at Fortress Monroe by order of War Dept.*

Book mark:

J. A. Johnson
(358) Copyist.

M. | 5 Col'd Cav. | Mass.

Plummer P. Moody
Corpl., Co. F, 5 Reg't Mass. Colored Cav.

Appears on Returns as follows:

May 1864, Absent sick,

June 1864, Absent sick at
Readville,

Feb. 1865, Absent on detached
service at Stockade July
18/64.

May 1865, Absent sick at U. S.
Gen. Hosp. at - since
May 20/65.

June 1865, Absent sick,

July 1865, Absent sick at U. S.
Hosp, Fort Monroe, May
20/65.

Aug. 1865, Lose June 23 Fort
Monroe - Dischg'd by
order of War Dept.

Book mark :

(646)

J. B. Sittler

Copyist.

M

5 Col'd Cav.

Mass.

Plumer P. Moody

Co. F, 5 Reg't Mass. Col'd Cavalry.

Appears on a

Detachment Muster-out Roll

of the organization named above. Roll dated

Fort Monroe, Va, June 23, 1864.

Muster-out to date

June 23, 1864.

Last paid to

Dec 31, 1864.

Clothing account:

Last settled Dec 31, 1864; drawn since \$ 100

Due soldier \$ 100; due U. S. \$ 100

Am't for cloth'g in kind or money adv'd \$ 20 40 100

Due U. S. for arms, equipments, &c., \$ 100

Bounty paid \$ 100; due \$ 300 00 100

Remarks:

Plumer P. Moody is indebted to U. S. Gov. for Ordnance 1 Sharpe Carbine (30.00) Carbine sling & sword (\$1.83) 1 Cartridge Box (.875) one (over)

Book mark:

R. Washington

JAN. - 9

5373005

1891

Cap Pouch (4^{cts}) / Light
Cap Sabre belt + felt
Plate (\$9.45-) Total
\$43.25-

Mustered out by order of
War Dept. Dated May
3rd, 1865. Patient in
U. S. Gen'l Hoep't Fort
Monroe, Va.

This Soldier was free
on or before April
19, 1861.

W | **5 Col'd Cav.** | **Mass.**

James J. Moody
A. F., Co. *F.*, 5 Reg't Mass. Col'd Cavalry.

Appears on **Co. Muster-out Roll**, dated
Charlestown, July, Oct 31, 1865.

Muster-out to date _____, 186 .

Last paid to *Dec 31, 1864.*

Clothing account:

Last settled _____, 186 ; drawn since \$ _____ 100

Due soldier \$ _____ 100; due U. S. \$ _____ 100

Am't for cloth'g in kind or money adv'd \$ _____ 100

Due U. S. for arms, equipments, &c., \$ _____ 100

Bounty paid \$ _____ 100; due \$ _____ 100

Remarks: *Discharged June 30/61*
at Dept of War
by order of the Secy
of War

Book mark: *20067*

(861)

J. J. Jones

Copyist.

Moody, Plumer P.

Co. *F*, *5* Reg't *Mass Cold. Cav*

(*CIVIL* *WAR*)
(Philippine Insurrection.)

1 Inclosures.

Bed Cards	Ex. Preliminary to M. O.
Burial Records	Final Statements
Certs. of Dis. for Discharge	Fines
C. M. Charges	Furloughs or L. of A.
Descriptive Lists	Med. Certificates
Descriptive and Assignment Cards	Med. Des. Lists
Discharge Certificates	Orders
Enlistment Papers	Resignations

Other papers relating to—

Admission to Hosp'l	Furlough or L. of A.
Confinement	Med. Examination
Contracts	Misc. Information
Death or Effects	Pay or Clothing
Desertion	Personal Reports
Discharge from Hosp'l <i>/</i>	Rank
Discharge from Service	Transfer to Hosp'l
Duty	Transportation

Surgeon Genl W. J. Dull &
Lieutenant Col Underwood
Respect my kindest regards
to you & Mrs. Underwood
Rainford July 14, 1864

Rainford Is. Hospital
July 19th 1864

Private Plummer, P. Moody, Comp F,
5th Mass. Cav. is this day discharged
from hospital, and will report to
Surgeon Genl. W. J. Dull at the
State House Boston,

Geo. L. Underwood
Capt. and Surgeon, in charge

Newest Market
No. 1. 2.
Boston Aug 19th 1864
Respectfully advanced
to the Mrs. Underwood
N. S. D.
The letter in relation
to order to have
to his announcement
is announced for
transmission
W. J. Dull
in charge

May, 1896. This paper was formerly
filed with the records of the Superin-
tendent of Volunteer Recruiting Service
of Mass., in the Enrolment Div. R. & P. O.

1010
Moore, Aaron J.

Co A, 5 Mass. Cav., (Col'd.)

Private

Sergeant.

CARD NUMBERS.

1	5373317	26
2	5373402	27
3	5373483	28
4	5373584	29
5	5373629	30
6	5373740	31
7	5373839	32
8	5373946	33
9	5374050	34
10	5374154	35
11	5374253	36
12	5374437	37
13	9092686	38
14	30851870	39
15	30852813	40
16	30854344	41
17	40731409	42
18		43
19		44
20		45
21		46
22		47
23		48
24		49
25		50

Book Mark:

See also

11 | **5 Cav. (Col'd.)** | **Mass.**

Harmon J. Moore

....., Co. F, 5 Reg't Mass. Cav. (Col'd.)

Appears on

Company Descriptive Book

of the organization named above.

DESCRIPTION.

Age 22 years; height 5 feet 5 inches.

Complexion black

Eyes black; hair black

Where born Wilmington, Md

Occupation seaman

ENLISTMENT.

When Dec 24, 1863.

Where Wilmington

By whom Company; term 3 y'rs.

Remarks: Appointed sergeant
Sept 1 1864. Died in hospital at
New Orleans La. Sept 17 1865.
Final statement sent by surgeon

W. H. ...
Compt.

M | **5 Col'd Cav.** | **Mass.**

Aaron J. Mott
Pvt., Co. *A*, 5 Reg't Mass. Col'd Cav.

Appears on
Company Muster-in and Descriptive Roll
of the organization named above. Roll dated

Readville Jan 9, 1864.

Where born *Baltimore Md*

Age *32* y'rs; occupation *carman*

When enlisted *Dec. 26th*, 1864.

Where enlisted *Providence*

For what period enlisted *Three* yrs.

Eyes *Black*, hair *Black*

Complexion *Black*, height *5 10* in.

When mustered in *Jan. 9th*, 1864.

Where mustered in

Bounty paid \$ *100*; due \$ *100*

Where credited

Company to which assigned

Remarks:

Book mark:

G. F. M.
(356d) Copyist.

M

5 Col'd Cav.

Mass.

Asa J. Moore

1st, Co. A, 5 Reg't Mass. Col'd Cavalry.

Appears on

Company Muster Roll

for *Enlistment to Feb 29, 1864*

Present or absent *Present*

Stoppage, \$ *100* for

Due Gov't, \$ *100* for

Valuation of horse, \$ *100*

Valuation of horse equipments, \$ *100*

Remarks:

Book mark:

(358)

G. F. R.

Copyist.

M | **5 Col'd Cav.** | **Mass.**

Aaron Moore
Priv, Co. A, 5 Reg't Mass. Col'd Cavalry.

Appears on

Company Muster Roll

for *Mar & Apr.*, 1864.

Present or absent *Present*

Stoppage, \$ 100 for

Due Gov't, \$ 100 for

Valuation of horse, \$ 100

Valuation of horse equipments, \$ 100

Remarks:

Book mark:

(358)

G. F. M.

Copyist.

M | 5 Col'd Cav. | Mass.

Baron J. Moore
Corp., Co. A, 5 Reg't Mass. Col'd Cavalry.

Appears on

Company Muster Roll

for May & June, 1864.

Present or absent Present

Stoppage, \$ 100 for

Due Gov't, \$ 100 for

Valuation of horse, \$ 100

Valuation of horse equipments, \$ 100

Remarks: A. J. Moore
Promoted, Feb. 15, 1864

Book mark:

M

5 Col'd Cav.

Mass.

Charon L. Moore

Corpl., Co. A, 5 Reg't Mass. Col'd Cavalry.

Appears on

Company Muster Roll

for *July and Aug.*, 1864.

Present or absent *Present*

Stoppage, \$ *100* for

Due Gov't, \$ *100* for

Valuation of horse, \$ *100*

Valuation of horse equipments, \$ *100*

Remarks: *Appointed Corpl. Feb. 1, 1864. Present or before Apr. 19, 1864.*

Book mark: _____

H. Gilbert

M

5 Col'd Cav.

Mass.

Aaron J. Moore
Serg't, Co. A 5 Reg't Mass. Col'd Cavalry.

Appears on

Company Muster Roll

for Sept. and Oct., 1864.

Present or absent Present.

Stoppage, \$ 100 for

Due Gov't, \$ 100 for

Valuation of horse, \$ 100

Valuation of horse equipments, \$ 100

Remarks: Appointed Serg't
Sept. 11, 1864.

Book mark:

M. O. Gilbert

M

5 Col'd Cav.

Mass.

Aaron J. Moore
Serg't, Co. A, 5 Reg't Mass. Col'd Cavalry.

Appears on

Company Muster Roll

for *Nov. and Dec.*, 1864.

Present or absent *Present.*

Stoppage, \$ *100* for

Due Gov't, \$ *100* for

Valuation of horse, \$ *100*

Valuation of horse equipments, \$ *100*

Remarks: *Appointed Serg't.*
Sept. 1, 1864.

Book mark: _____

M. O. Gilbert

(358)

Copyist.

M

5 Col'd Cav.

Mass.

Garrett J. Moore
Supt., Co. A, 5 Reg't Mass. Col'd Cavalry.

Appears on

Company Muster Roll

for Jan. and Feb., 1865.

Present or absent Present.

Stoppage, \$ 100 for

Due Gov't, \$ 100 for

Valuation of horse, \$ 100

Valuation of horse equipments, \$ 100

Remarks: Due 2d, 3d and 4th
m. l. M. S. amount \$120.00
1st. Supt. Sept 1, 1864.

Book mark:

A. C. Gilbert

M

5 Col'd Cav.

Mass.

Aaron J. Moore
Sergeant, Co. A, 5 Reg't Mass. Col'd Cavalry.

Appears on

Company Muster Roll

for

March and April, 1865.

Present or absent

Present.

Stoppage, \$

100 for

Due Gov't, \$

100 for

Valuation of horse, \$

100

Valuation of horse equipments, \$

100

Remarks:

Due 2, 3 and 4
inst. M. J. Bonnet
\$20.00 and \$35.00 on
1st inst.

Book mark:

M. O. Gilbert

M

5 Col'd Cav.

Mass.

Aaron G. Moore

Serjt, Co. A, 5 Reg't Mass. Col'd Cavalry.

Appears on

Company Muster Roll

for May & June, 1865.

Present or absent absent

Stoppage, \$ 100 for

Due Gov't, \$ 100 for

Valuation of horse, \$ 100

Valuation of horse equipments, \$ 100

Remarks: Due 25, 35 + 4th U.S. Bounty
\$120.00 Du 1st Inst + 35.
Absent sick Nov. June 29

Book mark:

Sallade

711 | 560 (bold) | 711

Claron J Moore

Pl Co A, 5 Reg't Mass 6 Cav

Appears on

Hospital Muster Roll

of Corps d'Afrique U. S. A. General Hospital,

at New Orleans, La.,

for May & June, 1865.

Attached to hospital:

When, 186 .

How employed

Last paid by Maj.

to, 186 .

Bounty paid \$ 100; due \$ 100

Present or absent Present

Remarks:

Book mark:

Drum

M

5 Col'd Cav.

Mass.

Aaron J. Moore
Serg't, Co. A, 5 Reg't Mass. Col'd Cavalry.

Appears on

Company Muster Roll

for July & Aug, 1865.

Present or absent Absent

Stoppage, \$ 100 for

Due Gov't, \$ 100 for

Valuation of horse, \$ 100

Valuation of horse equipments, \$ 100

Remarks: Due 2, 3, 4, 5 Inst. U.S.
Bty #160. On 1st Inst. #35.
Sick at N. Va. June 29, 65.
Free on or before Apr 19, 61

Book mark:

Dallade

M. | 5 Cav. | U.S.G.I.

Aaron J. Moore

Private, Co. A, 5 Reg't Mass. Cav.

Appears on

Hospital Muster Roll

of Corps d'Afrique U. S. A. General Hospital,

at New Orleans, La.,

for July & Aug, 1865.

Attached to hospital:

When, 186 .

How employed

Last paid by Maj.

to, 186 .

Bounty paid \$ 100; due \$ 100

Present or absent present

Remarks:

Book mark:

J. Moore

M. Shaw (bold) Mass

Aaron J. Moore
Pvt, Co. A, 5 Regt Mass ban

Appears on

Hospital Muster Roll

of **Corps d'Afrique U. S. A. General Hospital,**

at **New Orleans, La.,**

for Sept Oct, 1865.

Attached to hospital:

When _____, 186 .

How employed _____

Last paid by Maj. _____

to _____, 186 .

Bounty paid \$ 100; due \$ 100

Present or absent _____

Remarks: Dead Sept 19

Book mark: _____

W. L. S.

M. | 5 Col'd Cav. | Mass.

Aaron J. Moore
Sergt., Co. A, 5 Reg't Mass. Colored Cav.

Appears on Returns as follows:

June to Aug. 1865. Absent sick
at New Orleans, La.,
since June 29/65.

Sept. 1865. Loss Sept. 19th New
Orleans, La. - Died of
chronic Diarrhoea

Book mark :

(546)

J. B. Sittler

Copyist.

M | **5 Col'd Cav.** | **Mass.**

Aaron J. Moore
Serg't, Co. *A*, 5 Reg't Mass. Col'd Cavalry.

Appears on **Co. Muster-out Roll**, dated
Clarksville, Texas, Oct 31, 1865.

Muster-out to date _____, 186 .

Last paid to _____, 186 .

Clothing account:

Last settled _____, 186 ; drawn since \$ _____ 100

Due soldier \$ _____ 100; due U. S. \$ _____ 100

Am't for cloth'g in kind or money adv'd \$ _____ 100

Due U. S. for arms, equipments, &c., \$ _____ 100

Bounty paid \$ _____ 100; due \$ _____ 100

Remarks: *Died in Hospital at New Orleans, La. Sept. 17, 1864*

Book mark *V. 121, P. 117-71 - P. 117, P. 8-71 - F.S.*

(861)

Sallade

Copyright.

Moore, Aaron J.

Pvt, Co. A, 5 Reg't Mass Cav

5

Enclosures.

Bed Cards	Descriptive Lists
Burial Records	Final Statements 2
Certs. of Dis. for Discharge	Furloughs
C. M. Charges	Med. Des. Lists
Med. Certificates	Orders

Other papers relating to—

Admission to Hosp'l	Furlough
Casualty Sheet (Officer's) ^P 1	Med. Examination
Confinement	Misc. Information
Contracts	Pay or Clothing
Death or Effects 2	Personal Reports
Desertions	Rank
Discharge from Hosp'l	Transfer to Hosp'l
Discharge from Service	Transfer to V. R. C.
Duty	Transportation

Copy

ARTICLES OF WAR.

INVENTORY OF THE EFFECTS

ART. 95. When any non-commissioned officer or soldier shall die, or be killed in the service of the United States, the then commanding officer of the troop or company shall, in the presence of two other commissioned officers, take an account of what effects he died possessed of, above his arms and accoutrements, and transmit the same to the office of the Department of War, which said effects are to be accounted for, and paid to the representatives of such deceased non-commissioned officer or soldier. And in case any of the officers, so authorized to take care of the effects of deceased officers and soldiers, should, before they have accounted to their representatives for the same, have occasion to leave the regiment or post, by preferment or otherwise, they shall, before they be permitted to quit the same, deposit in the hands of the commanding officer, or of the assistant military agent, all the effects of such deceased non-commissioned officers and soldiers, in order that the same may be secured for, and paid to, their respective representatives.

OF

Sergt Aaron J. Moore

Late of Company "A"

5th Reg't of Miss. Cavl

Volunteers, who died at New Orleans

on the 19th day of September 186

ARMY REGULATIONS—EDITION OF 1861.

DECEASED SOLDIERS.

Par. 152. Inventories of the effects of deceased non-commissioned officers and soldiers, required by the 95th Article of War, will be forwarded to the Adjutant General, by the commander of the company to which the deceased belonged, and a duplicate of the same to the colonel of the regiment. Final statements of pay, clothing, &c., will be sent with the inventories. When a soldier dies at a post or station absent from his company, it will be the duty of his immediate commander to furnish the required inventory, and, at the same time, to forward to the commanding officer of the company to which the soldier belonged, a report of his death, specifying the date, place, and cause; to what time he was last paid, and the money or other effects in his possession at the time of his decease; which report will be noted on the next muster roll of the company to which the man belonged. Each inventory will be endorsed, "Inventory of the effects of _____, late of company (—) _____ regiment of _____, who died at _____, the _____ day of _____, 186—." If a legal representative receive the effects, it will be stated in the report. If the soldier leave no effects, the fact will be reported.

Par. 153. Should the effects of a deceased non-commissioned officer or soldier not be administered upon within a short period after his decease, they shall be disposed of by a Council of Administration, under the authority of the commanding officer of the post, and the proceeds deposited with the Paymaster, to the credit of the United States, until they shall be claimed by the legal representatives of the deceased.

Par. 154. In all such cases of sales by the Council of Administration, a statement in detail, or account of the proceeds, duly certified by the Council and commanding officer, accompanied by the Paymaster's receipt for the proceeds, will be forwarded by the commanding officer to the Adjutant General. The statement will be endorsed, "Report of the proceeds of the effects of _____, late of company (—) _____ regiment of _____, who died at _____, the _____ day of _____, 186—."

NOTE 1.—The effects in all cases, when called for, should be turned over to the legal representative, without further authority from the Adjutant General. When the effects are turned over to the relatives of the deceased before these inventories are sent to the Adjutant General, their receipts therefor should be attached to the inventories. In all other cases, one copy will be sent with a letter of transmittal direct to the Adjutant General, and a duplicate retained by the officer.

NOTE 2.—Particular care should be taken to take receipts in duplicate from the Paymaster for any funds turned over to him; one copy should be sent direct to the Adjutant General and one retained by the officer.

Inventory of the effects of Aaron J. Moore late
 a Sergeant of Captain James B. Jewell Company C of
 the 5 Regiment of Mass Cavalry Volunteers, who was enrolled as
 a Private at Provincetown in the State of Mass. on
 the 26 day of December 1863, and mustered into the service of the United
 States as a Private on the 9 day of January 1864 at Readville Mass.
 in Company C, 5 Regiment of Mass Cav. Volunteers, to serve Three
 years or during the war; he was born in Baltimore in the State
 of Maryland; he was 32 years of age, 5 feet 5 inches
 high, Dark complexion, Dark eyes, Dark hair, and by occupation, when enrolled,
 a Seaman; he died in corpsed "Trinities U.S. Gen. Hosp" at
New Orleans La. on the 19 day of September 1865, by
 reason of Diarrhoea chronic

INVENTORY.					
ARTICLES.	No.	ARTICLES.	No.	ARTICLES.	No.
Hats.....		Pairs trousers.....		Knapsacks.....	
Caps.....		Pairs flannel drawers.....			
Forage caps.....		Pairs cotton drawers.....			
Great coats.....		Flannel shirts.....			
Uniform coats.....		Cotton shirts.....			
Uniform jackets.....		Pairs boots.....			
Flannel sack coats.....		Pairs shoes.....			
Blouses.....		Pairs socks.....			
Stable frocks.....		Blankets.....			
Fatigue overalls.....		Haversacks.....			
				MONEY.	
				Specie.....	\$
				Notes.....	\$

He had no Effects

I CERTIFY, ON HONOR, that the above inventory comprises all the effects of _____
 _____, deceased, and that the effects are in the hands
 of _____ at _____
 _____ to be disposed of by a Council of Administration.

(DUPLICATES.)

STATION: New Orleans La.
 DATE: September 19 1865.

 Commanding the Company.

Copy Sept 19 1865
FINAL STATEMENT

OF

Sergt Aaron J. Moore
5th Reg't of Mass Cavalry

VOLUNTEERS.

C. d. A. Hosp

NOTE 1.—Two of these certificates (or duplicates) are to be given to each Volunteer Soldier or drafted man who may be discharged previously to the discharge of his company, that he may at once receive from the Paymaster the pay, &c., due him, and the captain or other COMMISSIONED officer commanding the company will certify to the act of the delivery of the duplicate certificates, on these certificates the Soldier is "entitled to" his discharge, and should also present his discharge to the Paymaster to have the payment endorsed on it. The discharge is to be given back to the Soldier by the Paymaster; the latter only retaining as his voucher the duplicate certificates.

NOTE 2.—If the Soldier is entitled to pay for the use of his horse, the Company Commander will certify to that fact on the back of both these final statements, and also to the time he has pay due for having been so mounted on his own horse.

NOTE 3.—When a Soldier is furnished with final statements, his descriptive list, if he has one, should be taken up by the officer who gives the Soldier these statements, and endorsed with a statement to this effect by the officer. This endorsement should exhibit a full statement of the time for which the Soldier was allowed pay on his final statements, the clothing account, and all other charges against him or in his favor, so as to comprise a complete exhibit of his account. It will then be transmitted to the company commander of the Soldier, who will enter all the data necessary to a full understanding of the Soldier's account on the muster roll upon which the Soldier's discharge is reported. The descriptive list will then be destroyed. The object of this is, that the remaining portion of the Soldier's account may be settled upon the receipt of these muster rolls, and the Soldier receive any pay or allowances that may be due him at the time of his discharge, and which may not appear on his final statements from the fact that his descriptive list is incomplete. These accounts for back pay, &c., are settled by the 2d Auditor of the Treasury Department.

NOTE 4.—Charges for loss or injury to ordnance, horse equipments, and other miscellaneous charges, should appear under the heading of "Other Stoppages."

NOTE 5.—Bounty paid by State authorities, and not by the United States, will not be entered on this statement.

NOTE 6.—Amounts due the Sutler and Laundress must be entered on the muster roll on which the discharge, death, desertion, &c., is reported, as well as on the final statement, otherwise the amount cannot be collected from the United States.

NOTE 7.—This blank will be used for deceased volunteers and drafted men, as well as for others.

NOTE 8.—Where a Soldier dies in Hospital or on detached service, his descriptive list, if he has one, should be sent with his final statements, in duplicate, to the Adjutant General, Washington, D. C.

I certify, on honor, that Aaron J. Moore a Sergt of
 Captain J. S. Newell Company (A) of the 5 " Regiment of Mass Cav.
VOLUNTEERS, of the State of _____, born in Baltimore, State
 of Maryland, aged 32 years; 5 feet 5 inches high; Dark complexion,
Dark eyes, Dark hair, and by occupation a Seaman, having joined the company on
 its original organization at Provincetown Mass, and enrolled in it at the muster into
 the service of the United States at Provincetown Mass, on the 26 " day
 of December, 1863, ~~or~~ ^{and} was mustered in service ~~as a recruit~~, by Lieut.
W. E. Kilbree, at Readville, on the 9 " day of January,
 1864, or was drafted and mustered into the service of the United States from the _____
 Enrollment District of the State of _____, at _____,
 on the _____ day of _____, 186 _____,) to serve in the Regiment, for
 the term of Three Years: and having served **HONESTLY** and
FAITHFULLY with his Company in U.S. Service to the present date, is now
 entitled to a **DISCHARGE** by reason of Suffered from Diarrhoea Chronic
at New Orleans La September 19th 1865.

The said Sergt Aaron J. Moore was last paid by Paymaster
Maj Dodge to include the 31 " day of December, 1864, and has
 pay due him from that time to the present date; he is entitled to pay and subsistence for
TRAVELING to place of enrollment, and whatever other allowances are authorized to volunteer
 soldiers, drafted men, or militia, so discharged. He has received from the United States **CLOTHING**
 amounting to Twenty four $\frac{65}{100}$ dollars, since the 31 " day of December,
 1864, when his clothing account was last settled. He has received from the United States
Twenty five $\frac{100}{100}$ dollars advanced **BOUNTY**.

There is to be stopped from him, on account of the State of _____, or other
 authorities, for **CLOTHING**, &c, received on entering service, _____ $\frac{100}{100}$ dollars; and
 for other stoppages, viz: Free on or before April 19th 1861.

_____ $\frac{100}{100}$ dollars.
 He has been furnished with **TRANSPORTATION** in kind from the place of his discharge to
 _____; and he has been **SUBSISTED** for **TRAVELING** to his
 place of enrollment, up to the _____, 186 _____.

He is indebted to _____, **SUTLER**, _____ $\frac{100}{100}$ dollars.
 He is indebted to _____, **LAUNDRESS**, _____ $\frac{100}{100}$ dollars.

Given in Duplicate, at New Orleans La, this 19th day
 of September, 1865.

Surgeon in Charge
Commanding Company.

MAR 6 1862

58

FINAL STATEMENT

OF

Sergt. *Charles L. Jones*
5th Reg't of *Mass Cavalry*

VOLUNTEERS.

and Sept. 19, 1861

NOTE 1.—Two of these certificates (or duplicates) are to be given to each Volunteer Soldier or drafted man who may be discharged previously to the discharge of his company, that he may at once receive from the Paymaster the pay, &c., due him, and the captain or other COMMISSIONED officer commanding the company will certify to the act of the delivery of the duplicate certificates; on these certificates the Soldier is "entitled to" his discharge, and should also present his discharge to the Paymaster to have the payment endorsed on it. The discharge is to be given back to the Soldier by the Paymaster; the latter only retaining as his voucher the duplicate certificates.

NOTE 2.—If the Soldier is entitled to pay for the use of his horse, the Company Commander will certify to that fact on the back of both these final statements, and also to the time he has pay due for having been so mounted on his own horse.

NOTE 3.—When a Soldier is furnished with final statements, his descriptive list, if he has one, should be taken up by the officer who gives the Soldier these statements, and endorsed with a statement to this effect by the officer. This endorsement should exhibit a full statement of the time for which the Soldier was allowed pay on his final statements, the clothing account, and all other charges against him or in his favor, so as to comprise a complete exhibit of his account. It will then be transmitted to the Company Commander of the Soldier, who will enter all the data necessary to a full understanding of the Soldier's account on the muster roll upon which the Soldier's discharge is reported. The descriptive list will then be destroyed. The object of this is, that the remaining portion of the Soldier's account may be settled upon the receipt of these muster rolls, and the Soldier receive any pay or allowances that may be due him at the time of his discharge, and which may not appear on his final statements from the fact that his descriptive list is incomplete. These accounts for back pay, &c., are settled by the 2d Auditor of the Treasury Department.

NOTE 4.—Charges for loss or injury to ordnance, horse equipments, and other miscellaneous charges, should appear under the heading of "Other Stoppages."

NOTE 5.—Bounty paid by State authorities, and not by the United States, will not be entered on this statement.

NOTE 6.—Amounts due the Sutler and Laundress must be entered on the muster roll on which the discharge, death, desertion, &c., is reported, as well as on the final statement, otherwise the amount cannot be collected from the United States.

NOTE 7.—This blank will be used for deceased volunteers and drafted men, as well as for others.

NOTE 8.—Where a Soldier dies in Hospital or on detached service, his descriptive list, if he has one, should be sent with his final statements, in duplicate, to the Adjutant General, Washington, D. C.

ADJUTANT GENERAL'S OFFICE

100 1861

Duplicate with Inventory sent 2d Auditor.

Charles L. Jones
Sept 19 1861

MARR 573

I certify, on honor, that Aaron J. Moore a Sergt of
 Captain A. S. Newell Company (A) of the 5th Regiment of Mass Cav.
VOLUNTEERS, of the State of _____, born in Baltimore, State
 of Maryland, aged 32 years; 5 feet 5 inches high; Dark complexion,
Dark eyes, Dark hair, and by occupation a Seaman, having joined the company on
 its original organization at Provincetown Mass and enrolled in it at the muster into
 the service of the United States at Provincetown Mass on the 29th day
 of December, 1862, (or was mustered in service as a recruit, by Lieut
M. E. Ribbin, at Beardsville, on the 9th day of January,
 1864, or was drafted and mustered into the service of the United States from the _____
 Enrollment District of the State of _____, at _____,
 on the _____ day of _____, 186) to serve in the Regiment, for
 the term of Three Years: and having served **HONESTLY** and
FAITHFULLY with his Company in U.S. Service to the present date, is now
 entitled to a **DISCHARGE** by reason of Death from Dysentery chronic,
at New Orleans La September 19th 1865.

The said Sergt Aaron J. Moore was last paid by Paymaster
Maj Dodge to include the 31st day of December, 1864, and has
 pay due him from that time to the present date; he is entitled to pay and subsistence for
TRAVELING to place of enrollment, and whatever other allowances are authorized to volunteer
 soldiers, drafted men, or militia, so discharged. He has received from the United States **CLOTHING**
 amounting to Twenty four $\frac{65}{100}$ dollars, since the 31st day of December,
 1864, when his clothing account was last settled. He has received from the United States
Twenty five $\frac{7}{100}$ dollars advanced **BOUNTY**.

There is to be stopped from him, on account of the State of _____, or other
 authorities, for **CLOTHING**; &c., received on entering service, _____ dollars; and
 for other stoppages, viz: Free on or before April 19th 1861.

_____ dollars.
 He has been furnished with **TRANSPORTATION** in kind from the place of his discharge to
 _____; and he has been **SUBSISTED** for **TRAVELING** to his
 place of enrollment, up to the _____, 186 .

He is indebted to _____, **SUTLER**, _____ dollars.

He is indebted to _____, **LAUNDRESS**, _____ dollars.

Given in Duplicate, at New Orleans La, this 19th day
 of September, 1865

F. E. Pyzette
 Surgeon in Charge
 Commanding Company.
 Corps d'Asiique de Gen Hospital.

FORM 514

COPY OF RECORD

FOR THE

ADJUTANT GENERAL, U. S. ARMY.



No. 2.

RECORD OF DEATH AND INTERMENT.

Name and number of person interred,	<i>Varon J. Moore</i>
Number and locality of the Grave,	
Hospital number of the deceased,	<i>6245</i>
Regiment, rank and company,	<i>5 Regt Cavalry - 2nd - 1</i>
Residence before enlistment,	
Conjugal condition, (and if married,	}
The residence of the widow,	
Cause of death,	} <i>Chronic Diarrhea</i>
Age of the deceased,	
Nativity,	
References and remarks,	
Date of death and burial,	<i>September 19th 1864</i>

To *Adj. Gen. (112) Army*

SIR:

It becomes my duty to inform you that the person above described died at this Hospital as herein stated, and that it is desired his remains should be interred with the usual Military honors.

Respectfully,

F. E. Piquette

SURGEON, U. S. ARMY.

*St. Louis, Mo.
in Charge*

MILITARY HOSPITAL, *Camp of Piquette*

CASUALTY SHEET

No. _____

Narron J. Moore
Sergt of Company *A*
5th Regiment of *Mass. Cav.*

State Volunteers.

NATURE OF CASUALTY.

Died Sept. 19, 1865.

CASUALTY SHEET.

Name: *Nathan J. Moore*
Rank: *Serjt.* Company: *A* Regiment: *5*
Arm: *Mass Cav.* State: _____
Nature of Casualty: *Death*

CAUSE OF CASUALTY—(NAME OF DISEASE, &c.)

BY WHOM DISCHARGED.

FROM WHAT SOURCE THIS INFORMATION WAS OBTAINED.

DEGREE OF DISABILITY.

Ref. Hon. Sec.

BY WHOM CERTIFIED.

J. M. Moore
U.S.A.

REMARKS

Pg. 1311

DATE OF DISCHARGE, DEATH, &c.

Febr. 14, 1865
PLACE OF DISCHARGE, DEATH, &c.
10th St. Orleans

J.S.

Clerk.

1011
Moore, Charles

Co L, 5 Mass. Cav., (Col'd.)

Private | Private

CARD NUMBERS.

1	5384876	26
2	5384960	27
3	5385081	28
4	5385187	29
5	5385893	30
6	9091507	31
7	40731410	32
8		33
9		34
10		35
11		36
12		37
13		38
14		39
15		40
16		41
17		42
18		43
19		44
20		45
21		46
22		47
23		48
24		49
25		50

Book Mark:

See also 28th U.S. 65

M. | **5 Cav. (Col'd.)** | **Mass.**

Charles Moore.

....., Co. *L*., 5 Reg't Mass. Cav. (Col'd.)

Appears on

Company Descriptive Book

of the organization named above.

DESCRIPTION.

Age *22* years; height *5* feet *7½* inches.

Complexion *Dark.*

Eyes *Black*; hair *Black.*

Where born *Tennessee.*

Occupation *Boatman.*

ENLISTMENT.

When *Mar. 26,* 186 ..

Where *Medford.*

By whom *A. C. Swain*; term *3* y'rs.

Remarks: *Mustered into service at
Reedville Mass. Apr. 29/64. by Lieut.
McKibben. Arrested as deserter
from the 28th U.S.C.T. at Washington
D.C. May 12th 1864.*

H. C. Thomas.

M | 5 Col'd Cav. | Mass.

Charles Moore

Priv., Co. L, 5 Reg't Mass. Col'd Cav.

Appears on

Company Muster-in and Descriptive Roll
of the organization named above. Roll dated

Readville Mass, Apl. 22, 1864.

Where born Tennessee

Age 22 y'rs; occupation Boatman

When enlisted Mch. 26, 1864.

Where enlisted Medford

For what period enlisted 3 years.

Eyes Black; hair Black

Complexion Black; height 5 ft. 7 1/2 in.

When mustered in Apl. 22, 1864.

Where mustered in

Bounty paid \$ 100; due \$ 100

Where credited 6" Cong. Dist. Mass.

Company to which assigned

Remarks:

Book mark:

Crenshaw

(356d)

Copyist.

M

5 Col'd Cav.

Mass.

Charles Moore

Pvt, Co. L, 5 Reg't Mass. Col'd Cavalry.

Appears on

Company Muster Roll

for Apl. 22 to 30, 1864

Present or absent Present

Stoppage, \$ 100 for

Due Gov't, \$ 100 for

Valuation of horse, \$ 100

Valuation of horse equipments, \$ 100

Remarks: Company Cook

Book mark:

Overshaw

M

5 Col'd Cav.

Mass.

Charles Moore
Pot, Co. L, 5 Reg't Mass. Col'd Cavalry.

Appears on

Company Muster Roll

for May & June, 1864.

Present or absent absent

Stoppage, \$ 100 for

Due Gov't, \$ 100 for

Valuation of horse, \$ 100

Valuation of horse equipments, \$ 100

Remarks: arrested as a deserter from the 28th U.S.C. at Camp Casey Va. about the 12th of May 1864.

Book mark:

Crushaw

M | 5 Col'd Cav. | Mass.

Charles Moore

....., Co. L, 5 Reg't Mass. Col'd Cavalry.

Appears on

Company Muster Roll

for July & Aug., 1864.

Present or absent.....

Stoppage, \$..... 100 for.....

Due Gov't, \$..... 100 for.....

Valuation of horse, \$..... 100

Valuation of horse equipments, \$..... 100

Remarks: Arrested as deserter
from the 28th U.S. C.T. on the
12th of May 1864 at Camp
Casey Va.

Book mark:.....

Crenshaw

(358)

Copyist.

M. | 5 Col'd Cav. | Mass.

Charles Moore

Priv., Co. L, 5 Reg't Mass. Colored Cav.

Appears on Returns as follows:

Apr. 1864, Co. cook.

May 1864, May 12 Camp Casey
arrested by 28 Regt. Col.
U.S. Inf.

Aug. 1865, Absent on Rail Road
by S. O.

Sept. 1865, Absent on Rail
Road near Brazos
by S. O. 48 Aug. 11/65
Hd. Dre. Cav. Brig.

Book mark :

J. B. Sittler

(546)

Copyist.

S. J. [unclear] | **5 Col'd Cav.** | **Mass.**

[Signature]
_____, Co. *[unclear]*, 5 Reg't Mass. Col'd Cavalry.

Appears on **Co. Muster-out Roll**, dated *[unclear]*, 186*5*.

Muster-out to date _____, 186 .

Last paid to *[unclear]* _____, 186 .

Clothing account:

Last settled _____, 186 ; drawn since \$ _____ 100

Due soldier \$ _____ 100; due U. S. \$ _____ 100

Am't for cloth'g in kind or money adv'd \$ _____ 100

Due U. S. for arms, equipments, &c., \$ _____ 100

Bounty paid \$ _____ 100; due \$ _____ 100

Remarks: *[Handwritten notes]*

Book mark: _____

[Signature]

10.11.20

Moore, Cyrus E.
Co., S. W. S. Col'd Can

CARD NUMBERS.

1	9436050	26
2		27
3		28
4		29
5		30
6		31
7		32
8		33
9		34
10		35
11		36
12		37
13		38
14		39
15		40
16		41
17		42
18		43
19		44
20		45
21		46
22		47
23		48
24		49
25		50

Number of personal papers herein.....

Book Mark:

See also

Mass. | 5th Cav. (Col'd) | Mass.

Cyrus E. Moore,
....., Co....., 5 Reg't Mass Col'd Cav.

Appears on

Regimental Descriptive Book

of the organization named above.

DESCRIPTION.

Age 25 years; height 5 feet 5 1/2 inches.

Complexion Black,

Eyes Black; hair Black

Where born Worcester, Mass.

Occupation Bootmaker

ENLISTMENT.

When Feb. 11....., 1864

Where Canton

By whom J. S. Nevill; term 3 y'rs.

Remarks:

.....
.....
.....
.....
.....
.....
.....
.....
.....
.....

Moore

1012
Moore, George H.
Co E, 5 Mass. Cav., (Col'd.)

Private

Private

CARD NUMBERS.

1	5378138	26
2	5328223	27
3	5378305	28
4	5378404	29
5	5378516	30
6	5378625	31
7	5378728	32
8	5378832	33
9	5378938	34
10	5379038	35
11	5379134	36
12	5379235	37
13	9092217	38
14	40731412	39
15		40
16		41
17		42
18		43
19		44
20		45
21		46
22		47
23		48
24		49
25		50

Book Mark:

See also

Ø1257.597. P.O. aff
Ø1257 600 P.O. aff
S. 1346658. P.O. aff
S. 3012296 P.O. aff

R. Swallen
4

M

5 Cav. (Col'd.) | Mass.

George Moore

Co. G, 5 Reg't Mass. Cav. (Col'd.)

Appears on

Company Descriptive Book

of the organization named above.

DESCRIPTION.

Age 23 years; height 5 feet 7 inches.

Complexion *Dark*

Eyes *Blue*; hair *Dark*

Where born *Worcester, Mass.*

Occupation *Merchant*

ENLISTMENT.

When *July 3*, 1864.

Where *Worcester*

By whom *Barthol. Ellis*; term *Three* yrs.

Remarks:

Heard

M 5 Col'd Cav. | **Mass.**

George Moore
Privt, Co. *E*, 5 Reg't Mass. Col'd Cav.

Appears on

Company Muster-in and Descriptive Roll
of the organization named above. Roll dated

Reading Mass, Feby 10, 1864

Where born *Logansport, Indiana,*

Age *3 1/2* y'rs; occupation *Farmer*

When enlisted *Feb, 3*, 1864.

Where enlisted *Winchendon,*

For what period enlisted *3* years.

Eyes *Black*; hair *Black*

Complexion *black*, height *5 ft. 7* in.

When mustered in *Feby 10*, 1864.

Where mustered in

Bounty paid \$ *100*; due \$ *100*

Where credited *90th Mass. Inf.*

Company to which assigned

Remarks :

Book mark :

M | **5 Col'd Cav.** | **Mass.**

George Moore
Priv., Co. E, 5 Reg't Mass. Col'd Cavalry.

Appears on

Company Muster Roll

for *Enlistment to 29 Feb'y*, 1864.

Present or absent

present

Stoppage, \$ 100 for

Due Gov't, \$ 100 for

Valuation of horse, \$ 100

Valuation of horse equipments, \$ 100

Remarks:

Sick in Hospital

Book mark:

(358)

Moore
Copyist.

No | **5 Col'd Cav.** | **Mass.**

George Moore
Privt, Co. E, 5 Reg't Mass. Col'd Cavalry.

Appears on

Company Muster Roll

for *Mich & Apl*, 186*4*.

Present or absent *Present*

Stoppage, \$ *100* for

Due Gov't, \$ *100* for

Valuation of horse, \$ *100*

Valuation of horse equipments, \$ *100*

Remarks:
.....
.....
.....
.....
.....
.....
.....
.....

Book mark:

Norman

M | **5** Col'd Cav. | **Mass.**

George Moore
Private, Co. E, 5 Reg't Mass. Col'd Cavalry.

Appears on

Company Muster Roll

for *May & June*, 186*4*.

Present or absent *present*

Stoppage, \$..... 100 for

Due Gov't, \$..... 100 for

Valuation of horse, \$..... 100

Valuation of horse equipments, \$..... 100

Remarks:

Book mark:

(358)

[Signature]
Copyist.

No. | **5 Col'd Cav.** | **Mass.**

Geo. W. Moore

Pvt., Co. E, 5 Reg't Mass. Col'd Cavalry.

Appears on

Company Muster Roll

for *July + Aug*, 186*4*.

Present or absent *Present*

Stoppage, \$ *100* for

Due Gov't, \$ *100* for

Valuation of horse, \$ *100*

Valuation of horse equipments, \$ *100*

Remarks: *Stop one Car-*
ten.

Book mark:

C. S. Clark

(358)

Copyist.

N. | **5 Col'd Cav.** | **Mass.**

George W. Hoover
Priv, Co. E, 5 Reg't Mass. Col'd Cavalry.

Appears on

Company Muster Roll

for *Sept Oct*, 1864.

Present or absent *Present*

Stoppage, \$ *100* for

Due Gov't, \$ *100* for

Valuation of horse, \$ *100*

Valuation of horse equipments, \$ *100*

Remarks:

Book mark:

(358)

A. S. Clark

Copyist.

No. | **5 Col'd Cav.** | **Mass.**

George W. Moore

Priv., Co. E, 5 Reg't Mass. Col'd Cavalry.

Appears on

Company Muster Roll

for *Nov. Dec.*, 1864.

Present or absent *Present*

Stoppage, \$ *100* for

Due Gov't, \$ *100* for

Valuation of horse, \$ *100*

Valuation of horse equipments, \$ *100*

Remarks: *Stop the carters.*

Book mark: _____

A. J. Leonard

(358)

Copyist.

No. | **5 Col'd Cav.** | **Mass.**

George W. Moore

Cot., Co. E, 5 Reg't Mass. Col'd Cavalry.

Appears on

Company Muster Roll

for *Jan. & Feb.*, 1865.

Present or absent *Present*

Stoppage, \$ *100* for

Due Gov't, \$ *100* for

Valuation of horse, \$ *100*

Valuation of horse equipments, \$ *100*

Remarks: *Stop three can-*
ten \$135-

Book mark: -----

O. S. Clark

No. | **5 Col'd Cav.** | **Mass.**

George W. Moore

Priv., Co. E, 5 Reg't Mass. Col'd Cavalry.

Appears on

Company Muster Roll

for *Nov. & Apr.*, 1865.

Present or absent *Present*

Stoppage, \$ *100* for

Due Gov't, \$ *7⁰² 100* for *sep & Oct.*
lost.

Valuation of horse, \$ *100*

Valuation of horse equipments, \$ *100*

Remarks:

Book mark:

A. S. Clark

M | **5 Col'd Cav.** | **Mass.**

George W. Moore
Pvt, Co. E, 5 Reg't Mass. Col'd Cavalry.

Appears on

Company Muster Roll

for May + June, 1865.

Present or absent Present

Stoppage, \$ 100 for

Due Gov't, \$ 100 for

Valuation of horse, \$ 100

Valuation of horse equipments, \$ 100

Remarks: True U.S. for and
manoe lost 30¢
True U.S. for C. & G. Co.
lost \$2.02

Book mark: _____

Lown

(358)

Copyist.

76 | **5 Col'd Cav.** | **Mass.**

George H. Moore
Privt., Co. E, 5 Reg't Mass. Col'd Cavalry.

Appears on

Company Muster Roll

for July & Aug, 1865.

Present or absent Absent

Stoppage, \$ 100 for

Due Gov't, \$ 100 for

Valuation of horse, \$ 100

Valuation of horse equipments, \$ 100

Remarks: Sick in Hospital
New Orleans, La. since
Aug 16th.

Book mark: _____

(358)

Lewis

Copyist.

M. | **5 Col'd Cav.** | **Mass.**

G. Moore

Pvt., Co. E, 5 Reg't Mass. Colored Cav.

Appears on **Returns** as follows:

July 1865. Absent sick at
Hosp. Brazos Santiago.

Aug. 1865. Absent at New
Orleans.

Book mark : _____

(548)

J. B. Sittler

Copyist.

M | 5 Col'd Cav. | Mass.

George H. Moore
Sgt., Co. E, 5 Reg't Mass. Col'd Cavalry.

Appears on Co. Muster-out Roll, dated
Blacksville, Tex., Oct 21, 1865.

Muster-out to date Oct 21, 1865.

Last paid to Dec 21, 1864.

Clothing account:

Last settled _____, 186 ; drawn since \$ 100

Due soldier \$ 100; due U. S. \$ 23²⁵/₁₀₀

Am't for cloth'g in kind or money adv'd \$ 100

Due U. S. for arms, equipments, &c., \$ 11⁴¹/₁₀₀

Bounty paid \$ 100; due \$ 20⁰⁰/₁₀₀

Remarks:

Book mark: *See list on file. See Mis. Ex.*

(861)

Lowry

Copyist.

Moore, George A.
Co. 5 Mass. Cav., (Col'd.)

Private Dr. Mr. Sergeant.

CARD NUMBERS.

1	53 72579	26
2	53 72422	27
3	53 83208	28
4	53 83281	29
5	53 83383	30
6	53 83424	31
7	53 83525	32
8	53 83622	33
9	9091775	34
10	5438642	35
11	40731411	36
12		37
13		38
14		39
15		40
16		41
17		42
18		43
19		44
20		45
21		46
22		47
23		48
24		49
25		50

Book Mark:

See also

2918156 P.O. 2114

Spencer
41

16. | **5 Cav. (Col'd.)** | **Mass.**

George A. Moore,

Co. I, 5 Reg't Mass. Cav. (Col'd.)

Appears on

Company Descriptive Book

of the organization named above.

DESCRIPTION.

Age *22* years; height *5* feet *5* inches.

Complexion *Swedish*

Eyes *Blue*; hair *Black*

Where born *Worcester Mass.*

Occupation *Barber*

ENLISTMENT.

When *Aug. 18th*, 186*4*.

Where *Vicksburg.*

By whom *E. C. Kinley*; term *3* y'rs.

Remarks: *Mustered in by Lt. Col. Donaldson*
Aug. 20th 64, Vicksburg.

H. C. Thomas,

(353g)

Copist.

W | **5 Col'd Cav.** | **Mass.**

George A. Moore

Appears with rank of *Private* on

Muster and Descriptive Roll of a Detachment of U. S. Vols. forwarded

for the 5 Reg't Mass. Col'd Cavalry. Roll dated

Vicksburg Miss, Sept 1st, 1864.

Where born *Worcester Mass.*

Age *22* y'rs; occupation *Barber*

When enlisted *Aug 18th*, 1864.

Where enlisted *Vicksburg Miss*

For what period enlisted *3* years.

Eyes *Grey*; hair *black*

Complexion *Mulatto*; height *5 ft. 5 in.*

When mustered in *Aug. 20*, 1864.

Where mustered in *Vicksburg Miss*

Bounty paid \$ *none* ¹⁰⁰; due \$ *300* ¹⁰⁰

Where credited

Company to which assigned

Remarks: *The men whose names*

are borne on this Roll are to

be credited on the Quota of the State

of Massachusetts

Book mark:

M. A. Michaels

M 5 Cav. Mass.

George A Moore

Appears with rank of Pvt on

Muster and Descriptive Roll of a Detachment of U. S. Vols. forwarded

for the 5 Reg't ^{Mass. Cavalry (col'd)} Roll dated

Vicksburg Miss, Sept 1, 1864.

Where born Worcester Mass.

Age 22 y'rs; occupation Barber

When enlisted Aug 15, 1864.

Where enlisted Vicksburg, Miss.

For what period enlisted years.

Eyes Gray; hair Black

Complexion Ruddy; height 5 ft. 5 in.

When mustered in Aug 22, 1864.

Where mustered in Vicksburg

Bounty paid \$ 100; due \$ 100

Where credited State of Mass.

Company to which assigned

Remarks: Mustered by Lt. Col. Donnell

for the 5 Mass. Cav. Co.

Stationed at Pursuant

to Genl. Order No 127 dated

Book mark: Memo. of this man filed (over)

not for enrollment of Reg't (over)

Prewitt

JAN. 13

5438642

1891

(Remark continued)

War Dept. A. G. O. Washing-
ton, D. C. July, 9, 1864

(Bookmark continued)

with M. & L. rolls of 5" Mass
Copy.

M | **5 Col'd Cav.** | **Mass.**

George A. Moore

Appears with rank of *Private* on

Muster and Descriptive Roll of a Detachment of U. S. Vols. forwarded

for the 5 Reg't Mass. Col'd Cavalry. Roll dated

Vicksburg Miss, Nov 16, 1864.

Where born *Harrisburg Ky.*

Age *18* y'rs; occupation *Laborer*

When enlisted *Aug. 18*, 1864.

Where enlisted *V. Burg Miss*

For what period enlisted *3* years.

Eyes *Grey*; hair *blk*

Complexion *Mulatto*; height *5 ft. 5 in.*

When mustered in *Aug. 20*, 1864.

Where mustered in *V. Burg Miss.*

Bounty paid \$ *none* $\overline{100}$; due \$ *30.00* $\overline{100}$

Where credited

Company to which assigned

Remarks:

Book mark:

M. A. Michael

(339)

Copyist.

M | **5 Col'd Cav.** | **Mass.**

George A. Moore
Pvt., Co. I, 5 Reg't Mass. Colored Cavalry.

Appears on

Company Muster Roll

for *Nov. & Dec., 1864.*

Present or absent *Present.*

Stoppage, \$ *100* for

Due Gov't, \$ *100* for

Valuation of horse, \$ *100*

Valuation of horse equipments, \$ *100*

Remarks: *Recruit from Depot.*

Book mark: _____

(358)

C. F. Thompson
Copyist.

In | **5 Col'd Cav.** | **Mass.**

George A. Moore
Priv., Co. I, 5 Reg't Mass. Colored Cavalry.

Appears on

Company Muster Roll

for *Jan. & Feb.*, 186*5*.

Present or absent *Present.*

Stoppage, \$ *100* for

Due Gov't, \$ *100* for

Valuation of horse, \$ *100*

Valuation of horse equipments, \$ *100*

Remarks: *Due 1st installment*
U.S. Bounty \$100.00

Book mark: _____

(358)

C. F. Thompson
Copyist.

In | **5 Col'd Cav.** | **Mass.**

George A. Morse
Pvt, Co. I, 5 Reg't Mass. Colored Cavalry.

Appears on

Company Muster Roll

for March & Apr., 1865.

Present or absent Present

Stoppage, \$ 100 for

Due Gov't, \$ 100 for

Valuation of horse, \$ 100

Valuation of horse equipments, \$ 100

Remarks: Due 1st installment
U. S. Bounty #100.00
Company Clerk.

Book mark: _____

(358)

C. F. Thompson
Copyist.

M | **5 Col'd Cav.** | **Mass.**

George A. Moore
2^d Lt. *Sgt.* Co. I, 5 Reg't Mass. Colored Cavalry.
Appears on

Company Muster Roll

for *May & June*, 1865.

Present or absent *Present.*

Stoppage, \$ *100* for

Due Gov't, \$ *100* for

Valuation of horse, \$ *100*

Valuation of horse equipments, \$ *100*

Remarks: *Due 1st installment*
U. S. Bounty 100.⁰⁰
Promoted Sgt. May 1st / 65

Book mark: _____

(358)

C. F. Thompson
Copyist.

m | **5 Col'd Cav.** | **Mass.**

George A. Moore

Q. Sgt., Co. I, 5 Reg't Mass. Colored Cavalry.

Appears on

Company Muster Roll

for *July & Aug*, 186*5*

Present or absent *Present*

Stoppage, \$ *100* for

Due Gov't, \$ *100* for

Valuation of horse, \$ *100*

Valuation of horse equipments, \$ *100*

Remarks: *Promoted Sgt May 1/65 also
112 for loss of one Remington Revolver
\$14.95*

Book mark: _____

Holcomb

M. | 5 Col'd Cav. | Mass.

Geo A. Moore

Priv., Co. I, 5 Reg't Mass. Colored Cav.

Appears on Returns as follows:

Dec. 1864. Gain Dec. 12" Point
Lookout - Recruit from
Depot.

Jan. to Apr. 1865. Co. clerk.

Book mark :

(546)

J. B. Sittler

Copyist.

m | 5 Col'd Cav. | Mass.

George A Moore

Q.M. Sgt. Co. I, 5 Reg't Mass. Col'd Cavalry.

Appears on Co. Muster-out Roll, dated

Charlottesville Tenn, Oct 31, 1865.

Muster-out to date Oct 31, 1865.

Last paid to Dec 31, 1864.

Clothing account:

Last settled....., 186 ; drawn since \$..... 100

Due soldier \$ 3 98¹⁰⁰; due U. S. \$..... 100

Am't for cloth'g in kind or money adv'd \$..... 100

Due U. S. for arms, equipments, &c., \$ 26 ⁵⁰/₁₀₀

Bounty paid \$..... 100; due \$ 100 ¹⁰⁰

Remarks: Promoted Q.M. Sgt.

May 1/65 by S. O. No. 83.

Dated Apr. 30/65, Mustered out by S. O. No. 29 Hd. Qrs. Dept of Texas dated Galveston Texas Sept 16/65 (based on authority from War Dept. (over))

Book mark :

Holecomb

(861)

Copyist.

JAN. 10

5383622

1891

Order of 8/15 directing the
muster out of colored troops organized
in Northern States, their services
being no longer required, Transport
and subsistence furnished to Wash.
Mass. Muster out to date Oct 31/65.

1014

Moore, Isaiah

Co K, 5 Mass. Cav., (Col'd.)

Private

Private

CARD NUMBERS.

1	5383776	26
2	5383862	27
3	5383960	28
4	5384059	29
5	6384162	30
6	5384264	31
7	5384371	32
8	5384474	33
9	5384575	34
10	5384706	35
11	5372969	36
12	5384803	37
13	9091599	38
14	40731413	39
15		40
16		41
17		42
18		43
19		44
20		45
21		46
22		47
23		48
24		49
25		50

Book Mark:

See also

No. 5 Cav. (Col'd.) | Mass.

Isaiah Moore

Co. K, 5 Reg't Mass. Cav. (Col'd.)

Appears on

Company Descriptive Book

of the organization named above.

DESCRIPTION.

Age 29 years; height 5 feet 11½ inches.

Complexion Colored.

Eyes Black; hair Black.

Where born Philadelphia Pa.

Occupation Laborer.

ENLISTMENT.

When May 12th, 1865.

Where Boston Ma.

By whom J. Garret; term 3 y'rs.

Remarks: Singl. Residence Philadelphia
Has Mustered out at Fortress Monroe
Va. June 12th 1865. under G.O. War Dept.
dated May 3rd 1865.

H. C. Thomas

M | **5 Col'd Cav.** | **Mass.**

Saiah Moore

Co. K, 5 Reg't Mass. Col'd Cav.

Appears on

Company Muster-in and Descriptive Roll
of the organization named above. Roll dated

Uxbridge Mass, April, 1864.

Where born *Philadelphia, Penn*

Age *29* y'rs; occupation *laborer*

When enlisted *Mar 11th*, 1864.

Where enlisted *Boston, Mass 6*

For what period enlisted *2* years.

Eyes *Blue*; hair *Black*

Complexion *Black*; height *5* ft. *7/8* in.

When mustered in *April 12*, 1864.

Where mustered in *Uxbridge Mass*

Bounty paid \$ *100*; due \$ *100*

Where credited *Uxbridge Mass*

Company to which assigned

Remarks:

Book mark:

Albany

(356d) Copyist.

111 | **5 Col'd Cav.** | **Mass.**

Wm Moore

1st, Co. K, 5 Reg't Mass. Col'd Cavalry.

Appears on

Company Muster Roll

for Sept 12 to Sept 30, 1867.

Present or absent Present

Stoppage, \$ 100 for

Due Gov't, \$ 100 for

Valuation of horse, \$ 100

Valuation of horse equipments, \$ 100

Remarks:

Book mark:

Wm Moore

M | **5 Col'd Cav.** | **Mass.**

Isiah Moore

B, Co. K, 5 Reg't Mass. Col'd Cavalry.

Appears on

Company Muster Roll

for August 1864, 1864.

Present or absent Present

Stoppage, \$ 100 for

Due Gov't, \$ 100 for

Valuation of horse, \$ 100

Valuation of horse equipments, \$ 100

Remarks:

Book mark: -----

(358) Isiah Moore Copyist.

M | **5 Col'd Cav.** | **Mass.**

Leach Moore

Plt, Co. K, 5 Reg't Mass. Col'd Cavalry.

Appears on

Company Muster Roll

for May & June, 1864.

Present or absent Present

Stoppage, \$ 100 for

Due Gov't, \$ 100 for

Valuation of horse, \$ 100

Valuation of horse equipments, \$ 100

Remarks:

Book mark:

(358)

W. W. W.
Copyist.

m | **5 Col'd Cav.** | **Mass.**

Isaiah Manna

Brig., Co. K, 5 Reg't Mass. Col'd Cavalry.

Appears on

Company Muster Roll

for Sept 10, 1864.

Present or absent Present

Stoppage, \$ 100 for

Due Gov't, \$ 100 for

Valuation of horse, \$ 100

Valuation of horse equipments, \$ 100

Remarks:

Book mark:

Isaiah Manna

M | **5 Col'd Cav.** | **Mass.**

Spaul Moore

Private, Co. K, 5 Reg't Mass. Col'd Cavalry.

Appears on

Company Muster Roll

for Nov - Dec, 1864.

Present or absent Present

Stoppage, \$ 100 for

Due Gov't, \$ 100 for

Valuation of horse, \$ 100

Valuation of horse equipments, \$ 100

Remarks:

Book mark:

Spaul Moore

m | **5 Col'd Cav.** | **Mass.**

Isaiah Moore

Priv., Co. K, 5 Reg't Mass. Col'd Cavalry.

Appears on

Company Muster Roll

for Jan & Feb, 1865.

Present or absent Present

Stoppage, \$ 100 for

Due Gov't, \$ 100 for

Valuation of horse, \$ 100

Valuation of horse equipments, \$ 100

Remarks:

Book mark:

(358)

Isaiah Moore

Copyist.

m | **5 Col'd Cav.** | **Mass.**

Isaiah Morse

Priv., Co. K, 5 Reg't Mass. Col'd Cavalry.

Appears on

Company Muster Roll

for Mar & April, 1865.

Present or absent Present

Stoppage, \$ 100 for

Due Gov't, \$ 100 for

Valuation of horse, \$ 100

Valuation of horse equipments, \$ 100

Remarks:

Book mark:

(358)

B. J. Anderson

Copyist.

70 | **5 Col'd Cav.** | **Mass.**

Isaiah Moore

Priv., Co. K, 5 Reg't Mass. Col'd Cavalry.

Appears on

Company Muster Roll

for May 1 June, 1865.

Present or absent Absent

Stoppage, \$ 100 for

Due Gov't, \$ 100 for

Valuation of horse, \$ 100

Valuation of horse equipments, \$ 100

Remarks: Absent since in
General Hospital since May
21/65

Book mark: _____

P. J. Anderson

711

5 Col'd Cav.

Mass.

Isaiah Moore

Priv., Co. K, 5 Reg't Mass. Col'd Cavalry.

Appears on

Company Muster Roll

for July & Aug., 1865.

Present or absent

Stoppage, \$ 100 for

Due Gov't, \$ 100 for

Valuation of horse, \$ 100

Valuation of horse equipments, \$ 100

Remarks: Discharged June 12th 1865 at Ft. Monroe Va.

Discharged under Gen. O. from War Dept. dated A.G.O. May 3rd 1865.

Book mark:

Galligan

(358)

Copyist.

M. | 5 Col'd Cav. | Mass.

Isaiah Moore

Priv., Co. K, 5 Reg't Mass. Colored Cav.

Appears on Returns as follows:

Aug. 1865. Lose June 12/65 -
Ft. Monroe - Disch'd
under G. O. War Dept.
dated A. G. O. May 3/65.

Book mark :

(546)

J. B. Sittler

Copyist.

M | **5 Col'd Cav.** | **Mass.**

Isiah Moore
Pat, Co. *K*, 5 Reg't Mass. Col'd Cavalry.

Appears on a

Detachment Muster-out Roll

of the organization named above. Roll dated
Fort Monroe, Va, June 12, 1865.

Muster-out to date *June 12, 1865.*

Last paid to *Dec. 31, 1864.*

Clothing account:

Last settled *June 30, 1864*; drawn since \$ 100

Due soldier \$ 100; due U. S. \$ 100

Am't for cloth'g in kind or money adv'd \$ *27* ^{*24*}/_{*100*}

Due U. S. for arms, equipments, &c., \$ 100

Bounty paid \$ 100; due \$ 100

Remarks: *This man has never received any U. S. Bounty. Mustered out by order of War Dept. dated May 3rd 1865. - Patient in U. S. (over)*

Book mark:

R. Washington
(349) Copyist.

JAN. - 9

5372969

1891 *

General Hospital Fort
Monroe, Va.

M

5 Col'd Cav.

Mass.

Isaiah Moore

Pvt, Co. A, 5 Reg't Mass. Col'd Cavalry.

Appears on Co. Muster-out Roll, dated
Clarksville Texas, Oct. 31, 1865.

Muster-out to date _____, 186 .

Last paid to Dec. 31, 1864 .

Clothing account:

Last settled _____, 186 ; drawn since \$ 100

Due soldier \$ 13²⁷/₁₀₀; due U. S. \$ 100

Am't for cloth'g in kind or money adv'd \$ 100

Due U. S. for arms, equipments, &c., \$ 100

Bounty paid \$ 100: due \$ 300⁰⁰/₁₀₀

Remarks: Discharged June 12th 1865
at Fortres Monroe Va, under G.
O. War Dept. May 3^d 1865.

Book mark: _____

Galligan

(861)

Copyist.

1015
Moore, John

Co A, 5 Mass. Cav., (Col'd.)

Private

Private

CARD NUMBERS.

1	5383784	26
2	5383870	27
3	5383961	28
4	5384060	29
5	5384103	30
6	5384265	31
7	5384372	32
8	5384475	33
9	5384576	34
10	5384673	35
11	5384767	36
12	9091600	37
13	40731414	38
14		39
15		40
16		41
17		42
18		43
19		44
20		45
21		46
22		47
23		48
24		49
25		50

Book Mark:

See also

No. **5 Cav. (Col'd.) | Mass.**

John Moore

....., Co. *K*, 5 Reg't Mass. Cav. (Col'd.)

Appears on

Company Descriptive Book

of the organization named above.

DESCRIPTION.

Age *21* years; height *5* feet *6* inches.

Complexion *Black*

Eyes *Black*; hair *Black*

Where born *Westmoreland Pa.*

Occupation *Farmer*

ENLISTMENT.

When *Jan. 11*, 186

Where *Boston Md.*

By whom *L. M. Standish*; term *3* y'rs.

Remarks: *Single, Residence Pittsburg Pa.*

H. C. Thomas

712 | 5 Col'd Cav. | Mass.

Arthur Morse

Co. K, 5 Reg't Mass. Col'd Cav.

Appears on
Company Muster-in and Descriptive Roll
of the organization named above. Roll dated
Pensacola Mass, April 12, 1864.

Where born Hinton, Pa

Age 21 y'rs; occupation Farmer

When enlisted March 11, 1864.

Where enlisted Boston, Mass

For what period enlisted 2 years.

Eyes Blue; hair Black

Complexion Fair; height 5 ft. 6 in.

When mustered in April 12, 1864.

Where mustered in Pensacola Mass

Bounty paid \$ 100; due \$ 100

Where credited 2nd Mass

Company to which assigned

Remarks:

Book mark:

(356d) Copyist.

712 | **5 Col'd Cav.** | **Mass.**

John Wilson

Co., Co. K, 5 Reg't Mass. Col'd Cavalry.

Appears on

Company Muster Roll

for from wife to wife 30, 1867.

Present or absent Present

Stoppage, \$ 100 for

Due Gov't, \$ 100 for

Valuation of horse, \$ 100

Valuation of horse equipments, \$ 100

Remarks:

Book mark:

John Wilson
(358) Copyist.

7
Mr | **5 Col'd Cav.** | **Mass.**

John Moore
Co., Co. K, 5 Reg't Mass. Col'd Cavalry.

Appears on

Company Muster Roll

for May & June, 1865.

Present or absent Present

Stoppage, \$ 100 for

Due Gov't, \$ 100 for

Valuation of horse, \$ 100

Valuation of horse equipments, \$ 100

Remarks:

Book mark:

(358)

W. W. W.

Copyist.

712 | **5 Col'd Cav.** | **Mass.**

John Moore

1st, Co. K, 5 Reg't Mass. Col'd Cavalry.

Appears on

Company Muster Roll

for July & Aug, 1864.

Present or absent Present

Stoppage, \$ 100 for

Due Gov't, \$ 100 for

Valuation of horse, \$ 100

Valuation of horse equipments, \$ 100

Remarks:

Book mark:

C. M.

m | **5 Col'd Cav.** | **Mass.**

John Moore

Priv., Co. K, 5 Reg't Mass. Col'd Cavalry.

Appears on

Company Muster Roll

for Sept & Oct, 1864.

Present or absent Present

Stoppage, \$ 100 for

Due Gov't, \$ 100 for

Valuation of horse, \$ 100

Valuation of horse equipments, \$ 100

Remarks:

Book mark:

Edmund

m | **5 Col'd Cav.** | **Mass.**

John Moore

Priv., Co. K, 5 Reg't Mass. Col'd Cavalry.

Appears on

Company Muster Roll

for Nov & Dec, 1864

Present or absent Present

Stoppage, \$ 100 for

Due Gov't, \$ 100 for

Valuation of horse, \$ 100

Valuation of horse equipments, \$ 100

Remarks:

Book mark:

(358)

Edmond

Copyist.

m | **5 Col'd Cav.** | **Mass.**

John Moore

Private, Co. K, 5 Reg't Mass. Col'd Cavalry.

Appears on

Company Muster Roll

for *Jan 1 Feb*, 1865.

Present or absent *Present*

Stoppage, \$ *100* for

Due Gov't, \$ *100* for

Valuation of horse, \$ *100*

Valuation of horse equipments, \$ *100*

Remarks:

Book mark:

John Moore

m | **5 Col'd Cav.** | **Mass.**

John Moore

Prin., Co. K, 5 Reg't Mass. Col'd Cavalry.

Appears on

Company Muster Roll

for *Mar 5 Apr*, 1865.

Present or absent *Present*

Stoppage, \$ *100* for

Due Gov't, \$ *100* for

Valuation of horse, \$ *100*

Valuation of horse equipments, \$ *100*

Remarks:

Book mark:

Edmondson

70 | **5 Col'd Cav.** | **Mass.**

John Moore

Private, Co. K, 5 Reg't Mass. Col'd Cavalry.

Appears on

Company Muster Roll

for May & June, 1868.

Present or absent Present

Stoppage, \$ 100 for

Due Gov't, \$ 100 for

Valuation of horse, \$ 100

Valuation of horse equipments, \$ 100

Remarks:

Book mark:

P. Anderson
(358) Copyist.

711

5 Col'd Cav.

Mass.

John Moore

Det., Co. K, 5 Reg't Mass. Col'd Cavalry.

Appears on

Company Muster Roll

for July & Aug, 1865

Present or absent Absent

Stoppage, \$ 100 for

Due Gov't, \$ 100 for

Valuation of horse, \$ 100

Valuation of horse equipments, \$ 100

Remarks: Absent in Hospt. at Brazos since July Aug 11, 65

Book mark:

Galligan

(358)

Copyist.

M. | 5 Col'd Cav. | Mass.

John Moore

Priv., Co. K, 5 Reg't Mass. Colored Cav.

Appears on Returns as follows:

Mar. 1865. On duty, Reg'tt
Teamster.

May 1865. Absent sick in
Hosp. Alexandria, Va,
since May 21/65.

June & July 1865. Absent sick
in Hosp. Fortress Mon-
roe since May 21/65.

Aug. 1865. Absent sick in Hosp.
at Brazos since Aug.
11/65.

Book mark :

(548)

J. B. Dittler

Copyist.

M | 5 Col'd Cav. | Mass.

John Moore

(Pot, Co. K, 5 Reg't Mass. Col'd Cavalry.

Appears on Co. Muster-out Roll, dated
Clarksville Texas, Oct. 31, 1865.

Muster-out to date Oct. 31, 1865.

Last paid to Dec. 31, 1864.

Clothing account:

Last settled....., 186 ; drawn since \$..... 100

Due soldier \$..... 100; due U. S. \$..... 9 ²⁶/₁₀₀

Am't for cloth'g in kind or money adv'd \$..... 100

Due U. S. for arms, equipments, &c., \$..... 100

Bounty paid \$..... 100; due \$ 300 ⁰⁰/₁₀₀

Remarks:

Book mark:

(861)

Galligan

Copyist.

1016

Moore, Mills

Co L, 5 Mass. Cav., (Col'd.)

Private

Private

CARD NUMBERS.

1	5384877	26
2	5384961	27
3	5385050	28
4	5385149	29
5	5385257	30
6	5385359	31
7	5385458	32
8	5385558	33
9	5385656	34
10	5385749	35
11	5385843	36
12	9091508	37
12	5385049	38
14		39
15		40
16		41
17		42
18		43
19		44
20		45
21		46
22		47
23		48
24		49
25		50

Card withdrawn and filed in jacket of
Moran, Warner, when it properly belongs.
J.M. Dec 4 95.

Book Mark:

See also

S. 135-8963, P. 2. m. m.

R. J. Walker
4

No. | **5 Cav. (Col'd.)** | **Mass.**

Mells Moore.

....., Co. *L.*, 5 Reg't Mass. Cav. (Col'd.)

Appears on

Company Descriptive Book

of the organization named above.

DESCRIPTION.

Age *25* years; height *5* feet *8 3/4* inches.

Complexion *Dark.*

Eyes *Dark*; hair *Black.*

Where born *Norfolk Va.*

Occupation *Farmer.*

ENLISTMENT.

When *Mar. 23, 186*

Where *Boston, No. 9.*

By whom *L. M. Handich*; term *3* y'rs.

Remarks: *Mustered into service at
Reedville Mass. Apr. 22/64. by Lieut
McKibbin. Free Apr. 19/61.*

H. C. Thomas.

M | 5 Col'd Cav. | Mass.

Mills Moore

Pvt., Co. G, 5 Reg't Mass. Col'd Cav.

Appears on

Company Muster-in and Descriptive Roll
of the organization named above. Roll dated
Readville Mass, Apl. 22, 1864.

Where born Norfolk Co. Va.

Age 25 y'rs; occupation Farmer

When enlisted Mich. 23, 1864.

Where enlisted Boston, Ward 9

For what period enlisted 3 years.

Eyes Black; hair Black

Complexion Black; height 5 ft. 8 3/4 in.

When mustered in Apl. 22, 1864.

Where mustered in

Bounty paid \$ 100; due \$ 100

Where credited 4th Cong. Dist. Mass.

Company to which assigned

Remarks:

Book mark:

Crenshaw

(356d)

Copyist.

M | 5 Col'd Cav. | Mass.

Mills Moore
Priv, Co. L, 5 Reg't Mass. Col'd Cavalry.

Appears on

Company Muster Roll

for Apl. 22 to 30, 1864.

Present or absent Present

Stoppage, \$ 100 for

Due Gov't, \$ 100 for

Valuation of horse, \$ 100

Valuation of horse equipments, \$ 100

Remarks:

Book mark:

Crenshaw

M | 5 Col'd Cav. | Mass.

Mills Moore
Pot, Co. L, 5 Reg't Mass. Col'd Cavalry.

Appears on

Company Muster Roll

for May & June, 1864.

Present or absent Present

Stoppage, \$ 100 for

Due Gov't, \$ 100 for

Valuation of horse, \$ 100

Valuation of horse equipments, \$ 100

Remarks: Stop 1 Canteen

Book mark:

Cienschaw

M | 5 Col'd Cav. | Mass.

Mills Moore
Priv, Co. L, 5 Reg't Mass. Col'd Cavalry.

Appears on

Company Muster Roll
for July & Aug., 1864.
Present or absent Present

Stoppage, \$ 100 for

Due Gov't, \$ 100 for

Valuation of horse, \$ 100

Valuation of horse equipments, \$ 100

Remarks: Stop one canteen.

Book mark:

Crewshaw

(358)

Copyist.

M | **5 Col'd Cav.** | **Mass.**

Mills Moore
Pat, Co. L, 5 Reg't Mass. Col'd Cavalry.

Appears on

Company Muster Roll

for Sept + Oct, 1864.

Present or absent Present

Stoppage, \$ 100 for

Due Gov't, \$ 100 for

Valuation of horse, \$ 100

Valuation of horse equipments, \$ 100

Remarks:

Book mark:

(358)

J. McHance

Copyist.

M | **5 Col'd Cav.** | **Mass.**

Mills Moore

Pvt, Co. L, 5 Reg't Mass. Col'd Cavalry.

Appears on

Company Muster Roll

for *Nov + Dec*, 1864.

Present or absent *Present*

Stoppage, \$ *100* for

Due Gov't, \$ *100* for

Valuation of horse, \$ *100*

Valuation of horse equipments, \$ *100*

Remarks:

Book mark:

(358)

J. M. Hance

Copyist.

M. | **5 Col'd Cav.** | **Mass.**

Mills

Sgt, Co. L, 5 Reg't Mass. Col'd Cavalry.

Appears on

Company Muster Roll

for *Jan 1st to Feb 1st*, 186*4*.

Present or absent *Present*

Stoppage, \$ *100* for

Due Gov't, \$ *100* for

Valuation of horse, \$ *100*

Valuation of horse equipments, \$ *100*

Remarks: *Present 2 of 3rd regt
Statement of horse valued at \$100*

Book mark:

J. F. Deane

M | **5 Col'd Cav.** | **Mass.**

Milburn M. Wood

Co. L, Co. L, 5 Reg't Mass. Col'd Cavalry.

Appears on

Company Muster Roll

for *Mary*, 186*1*.

Present or absent *Present*

Stoppage, \$ *100* for

Due Gov't, \$ *100* for

Valuation of horse, \$ *100*

Valuation of horse equipments, \$ *100*

Remarks: *Present, muster roll
avaluated as per the
15th of 1861 \$ 140.00*

Book mark:

(358)

J. D. Warner

Copyist.

M. | **5 Col'd Cav.** | **Mass.**

Shells Moore

Priv., Co. L, 5 Reg't Mass. Col'd Cavalry.

Appears on

Company Muster Roll

for *March 1861*, 186*1*.

Present or absent *Present*

Stoppage, \$ *100* for

Due Gov't, \$ *100* for

Valuation of horse, \$ *100*

Valuation of horse equipments, \$ *100*

Remarks: *Present in service
of the U.S. Cavalry
\$ 100. Given before April 1861*

Book mark: -----

J. M. Hance
(358) Copyist.

5 Col'd Cav.

Mass.

Wm. J. Brown

Co. I, Co. *I*, 5 Reg't Mass. Col'd Cavalry.

Appears on Co. Muster-out Roll, dated *Oct 31*, 186⁵.

Muster-out to date *Oct 31*, 186⁵.

Last paid to *Dec 31*, 186⁴.

Clothing account:

Last settled....., 186 ; drawn since \$..... 100

Due soldier \$..... 100; due U. S. \$ *43*⁹⁰/₁₀₀

Am't for cloth'g in kind or money adv'd \$..... 100

Due U. S. for arms, equipments, &c., \$ *11*⁰⁰/₁₀₀

Bounty paid \$..... 100; due \$ *300*⁰⁰/₁₀₀

Remarks: *Admitted to service
in the 5th Mass. Col'd Cavalry
at New Bedford, Mass.
Dec 31, 1864*

Book mark:

Wm. J. Brown

1017

Moore, Richard A.

Co D, 5 Mass. Cav., (Col'd.)

Private

Private

CARD NUMBERS.

1	5374513	26
2	5374604	27
3	5374688	28
4	5374791	29
5	5374923	30
6	5375664	31
7	9092567	32
8	40731415	33
9		34
10		35
11		36
12		37
13		38
14		39
15		40
16		41
17		42
18		43
19		44
20		45
21		46
22		47
23		48
24		49
25		50

Book Mark:

See also

11 | **5 Cav. (Col'd.)** | **Mass.**

Richard Henry Moore

Co. B, 5 Reg't Mass. Cav. (Col'd.)

Appears on

Company Descriptive Book

of the organization named above.

DESCRIPTION.

Age 19 years; height 5 feet 3/2 inches.

Complexion Dark

Eyes Black; hair Black

Where born Baltimore, Md

Occupation Laborer

ENLISTMENT.

When Jan 12, 1864.

Where Southwick

By whom S. J. Morrison; term 3 y'rs.

Remarks: Died at Point Lookout
Aug 11, 1864 of Cholera

(383g)

Hindley

Copyist.

M | **5 Col'd Cav.** | **Mass.**

Richard L Moore

Bt., Co. B, 5 Reg't Mass. Col'd Cav.

Appears on

Company Muster-in and Descriptive Roll
of the organization named above. Roll dated

Readville Mass., July 29, 1864.

Where born Baltimore Md.

Age 19 y'rs; occupation Laborer

When enlisted June 20, 1864.

Where enlisted Southwick

For what period enlisted 3 years.

Eyes Black; hair Black

Complexion Black; height 5 ft. 5 1/2 in.

When mustered in _____, 186 .

Where mustered in _____

Bounty paid \$ 100; due \$ 100

Where credited _____

Company to which assigned _____

Remarks: He was here

Book mark: _____

No | **5 Col'd Cav.** | **Mass.**

Richard Horse

Co. B, 5 Reg't Mass. Col'd Cavalry.

Appears on

Company Muster Roll

for *Enlistment to Feb 27, 1864.*

Present or absent *Present*

Stoppage, \$ *100* for

Due Gov't, \$ *100* for

Valuation of horse, \$ *100*

Valuation of horse equipments, \$ *100*

Remarks:

Book mark:

Frederick

No | **5 Col'd Cav.** | **Mass.**

Richard H. Morse

Pt., Co. B, 5 Reg't Mass. Col'd Cavalry.

Appears on

Company Muster Roll

for March & April, 1864.

Present or absent Present

Stoppage, \$ 100 for

Due Gov't, \$ 100 for

Valuation of horse, \$ 100

Valuation of horse equipments, \$ 100

Remarks: _____

Book mark: _____

(358)

H. J. H. H.

Copyist.

16 | **5 Col'd Cav.** | **Mass.**

Richard E Moore

Pl., Co. B, 5 Reg't Mass. Col'd Cavalry.

Appears on

Company Muster Roll

for May & June, 1864.

Present or absent Absent

Stoppage, \$ 100 for

Due Gov't, \$ 100 for

Valuation of horse, \$ 100

Valuation of horse equipments, \$ 100

Remarks: Sick at City Point
since June 20th 64

Book mark: _____

(358) F. L. F. F. F. Copyist.

M. | **5 Col'd Cav.** | **Mass.**

Richard H. Moore,
Privt-, Co. B, 5 Reg't Mass. Col'd Cavalry.

Appears on

Company Muster Roll

for *July & Aug.*, 186*4*.

Present or absent

Stoppage, \$ *100* for

Due Gov't, \$ *100* for

Valuation of horse, \$ *100*

Valuation of horse equipments, \$ *100*

Remarks: *Died in Hammond*
U.S.A. Genl. Hosp., Point
Lookout, Md., Aug. 11. 64 of
Chronic Diarrhea.

Due U.S. for Ordnance
lost \$ 1.99

Book mark:

(358)

J. W. Brown
Copyist.

M. | 5 Col'd Cav. | Mass.

Richard H. Moore
Priv., Co. B, 5 Reg't Mass. Colored Cav.

Appears on Returns as follows:

June 1864. Absent sick at
City Point, Va.

Aug. 1864. Loss Aug. 11/64
Point Lookout, Md. -
Died at Gen. Hosp. Point
Lookout, Md. of Chronic
Diarrhoea.

Book mark :

(646)

J. B. Sittler

Copyist.

M | **5 Col'd Cav.** | **Mass.**

Richard H. Moore

Pvt, Co. *B*, 5 Reg't Mass. Col'd Cavalry.

Appears on **Co. Muster-out Roll**, dated *Clarksville Tex., Oct. 31, 1863*.

Muster-out to date _____, 186 .

Last paid to *Feb. 24, 1864*.

Clothing account:

Last settled _____, 186 ; drawn since \$ _____ 100

Due soldier \$ _____ 100; due U. S. \$ *26* ^{*04*}/_{*100*}

Am't for cloth'g in kind or money adv'd \$ _____ 100

Due U. S. for arms, equipments, &c., \$ _____ 100

Bounty paid \$ _____ 100; due \$ _____ 100

Remarks: *died Aug. 11/64 Pvt. Lookout, Md. Chron's Diarrhoea. Statements sent to Agt.*

Book mark: *J.S.*

Scherich

Moore, Richard H.

P, Co. B,



Reg't 1883, C. Cav

Enclosures.

Bed Cards	Descriptive Lists
Burial Records	Final Statements
Certs. of Dis. for Discharge	Furloughs
C. M. Charges	Med. Des. Lists
Med. Certificates	Orders

Other papers relating to—

Admission to Hosp'l	Furlough
Casualty Sheet (Officer's)	Med. Examination
Confinement	Misc. Information
Contracts	Pay or Clothing
Death or Effects	Personal Reports
Desertions	Rank
Discharge from Hosp'l	Transfer to Hosp'l
Discharge from Service	Transfer to V. R. C.
Duty	Transportation

NARA 973
MICROFILM PUBLICATION M1822

COMPILED MILITARY SERVICE RECORDS
OF VOLUNTEER UNION SOLDIERS WHO
SERVED WITH THE USCT (US COLORED TROOPS)
5TH MASSACHUSETTS REGIMENT OF CAVALRY

PERSONAL PAPERS' TARGET SHEET

PLEASE NOTE THE CHECKED INFORMATION ABOUT THE PERSONAL PAPERS IN
THIS FILE:

- NO PERSONAL PAPERS WERE FOUND IN THIS FILE WHEN THE
RECORDS WERE ARRANGED FOR MICROFILMING.
- 2 PERSONAL PAPER(S) FOUND IN THIS FILE WHEN THE RECORDS
WERE ARRANGED FOR MICROFILMING.

215 2nd St
Hammond US Gen Hospital
Pont Lookout Md August 11th 1864

W. Roger Singula
In charge

Notification of the Death of Private
Richard D. Moore Co B 5th Mass Col Cav

At a Court held at
Hammond Md August 11th 1864



Inventory of the effects of Private Richard H Moore U.S.
5th Mass Cav who died at this Hammond U.S. General
Hospital on the 11th day of August 1864 at 8 o'clock A.M.
of Chronic Diarrhoea =

= Effects =

= None =

S. H. May
Surgeon U.S. Army
In Charge Gen Hospital

Hammond U.S. Gen Hospital
Point Lookout Md Aug 11th 1864

40

FINAL STATEMENT

OF

Private Richard H. Moore

5th Reg't of Mass Cavalry

VOLUNTEERS.

Acad Dec 11 1861

NOTE 1.—Two of these certificates (or duplicates) are to be given to each Volunteer Soldier or drafted man who may be discharged previously to the discharge of his company, that he may at once receive from the Paymaster the pay, &c., due him, and the captain or other COMMISSIONED officer commanding the company will certify to the act of the delivery of the duplicate certificates; on these certificates the Soldier is "entitled to" his discharge, and should also present his discharge to the Paymaster to have the payment endorsed on it. The discharge is to be given back to the Soldier by the Paymaster; the latter only retaining as his voucher the duplicate certificates.

NOTE 2.—If the Soldier is entitled to pay for the use of his horse, the Company Commander will certify to that fact on the back of both these final statements, and also to the time he has pay due for having been so mounted on his own horse.

NOTE 3.—When a Soldier is furnished with final statements, his descriptive list, if he has one, should be taken up by the officer who gives the Soldier these statements, and endorsed with a statement to this effect by the officer. This endorsement should exhibit a full statement of the time for which the Soldier was allowed pay on his final statements, the clothing account, and all other charges against him or in his favor, so as to comprise a complete exhibit of his account. It will then be transmitted to the company commander of the Soldier, who will enter all the data necessary to a full understanding of the Soldier's account on the muster roll upon which the Soldier's discharge is reported. The descriptive list will then be destroyed. The object of this is, that the remaining portion of the Soldier's account may be settled upon the receipt of these muster rolls, and the Soldier receive any pay or allowances that may be due him at the time of his discharge, and which may not appear on his final statements from the fact that his descriptive list is incomplete. These accounts for back pay, &c., are settled by the 2d Auditor of the Treasury Department.

NOTE 4.—Charges for loss or injury to ordnance, horse equipments, and other miscellaneous charges, should appear under the heading of "Other Stoppages."

NOTE 5.—Bounty paid by State authorities, and not by the United States, will not be entered on this statement.

NOTE 6.—Amounts due the Sutler and Laundress must be entered on the muster roll on which the discharge, death, desertion, &c., is reported, as well as on the final statement, otherwise the amount cannot be collected from the United States.

NOTE 7.—This blank will be used for deceased volunteers and drafted men, as well as for others.

NOTE 8.—Where a Soldier dies in Hospital or on detached service, his descriptive list, if he has one, should be sent with his final statements, in duplicate, to the Adjutant General, Washington, D. C.

ADJUTANT GENERAL'S OFFICE.

Aug 31 1861

Duplicate with Inventory sent 2d Auditor.

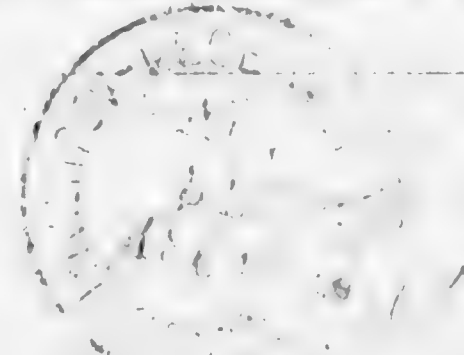

I certify, on honor, that Richard H Moore a Private of
 Captain C. C. Emery's Company (B.) of the Fifth Regiment of Mass Col. d Cavalry
VOLUNTEERS, of the State of Massachusetts, born in Baltimore, State
 of Maryland, aged 19 years; 5 feet 5 1/2 inches high; Dark complexion,
Black eyes, Black hair, and by occupation a Labourer, having joined the company on
 its original organization at Readville Mass, and enrolled in it at the muster into
 the service of the United States at Readville, on the 29th day
 of Jan., 1864, (or was mustered in service as a recruit, by
 _____, at _____, on the _____ day of _____,
 186 _____, or was drafted and mustered into the service of the United States from the _____
 Enrollment District of the State of _____, at _____,
 on the _____ day of _____, 186 _____) to serve in the Regiment, for
 the term of Three Years: and having served **HONESTLY** and
FAITHFULLY with his Company in the field to the present date, is now
 entitled to a **DISCHARGE** by reason of death. Died at General Hospital
Point Lookout Md. Aug. 11th 1864 of Chronic Diarrhea.

The said Richard H Moore was last paid by Paymaster
Maj. Conner to include the 29th day of Feb., 1864, and has
 pay due him from that time to the present date; he is entitled to pay and subsistence for
TRAVELING to place of enrollment, and whatever other allowances are authorized to volunteer
 soldiers, drafted men, or militia, so discharged. He has received from the United States **CLOTHING**
 amounting to Forty five 00 dollars, since the _____ day of enlistment,
 186 _____, when his clothing account was last settled. He has received from the United States
 _____ dollars advanced **BOUNTY**.

There is to be stopped from him, on account of the State of _____, or other
 authorities, for **CLOTHING**, &c., received on entering service, _____ dollars; and
 for other stoppages, viz: One cartridge, one belt, one canteen, one
Belt & Plate, one sandal, one Ball-screw
 _____ 2 35 dollars.

He has been furnished with **TRANSPORTATION** in kind from the place of his discharge to
 _____; and he has been **SUBSISTED** for **TRAVELING** to his
 place of enrollment, up to the _____, 186 _____.

He is indebted to _____, **SUTLER**, _____ dollars.

He is indebted to _____, **LAUNDRESS**, _____ dollars.

Given in Duplicate, at Point Lookout Md, this 12 day
 of Aug., 1864.

Cyrus C Emery
Capt. Co. B. 5th Mass Cavalry
 Commanding Company

1018

Moore, Thomas A.

Co F, 5 Mass. Cav., (Col'd.)

Private

Saddler

CARD NUMBERS.

1	5379349	26
2	5379434	27
3	5379524	28
4	5379622	29
5	5379719	30
6	5379760	31
7	5379860	32
8	5379964	33
9	5380066	34
10	5380167	35
11	5380264	36
12	5380376	37
13	9092091	38
14	40731416	39
15		40
16		41
17		42
18		43
19		44
20		45
21		46
22		47
23		48
24		49
25		50

Book Mark:

See also

1790492 P. C. ...

Wacker
f

M **5 Cav. (Col'd.) | Mass.**

Thomas H Moore

....., Co. *F*....., 5 Reg't Mass. Cav. (Col'd.)

Appears on

Company Descriptive Book

of the organization named above.

DESCRIPTION.

Age *25* years; height *5* feet *6³/₄* inches.

Complexion *dark*

Eyes *blk*; hair *blk*

Where born *Salem Mass*

Occupation *Shoemaker*

ENLISTMENT.

When *Feb 9*, 186*4*.

Where *Salem,*

By whom *S. Wheatland*; term *3* y'rs.

Remarks:

Hearn

117

5 Col'd Cav.

Mass.

Samuel H. Brown

A., Co. F, 5 Reg't Mass. Col'd Cavalry.

Appears on

Company Muster Roll

for *Jan 1st* to *Feb 27*, 1864.

Present or absent *Present*

Stoppage, \$ 100 for

Due Gov't, \$ 100 for

Valuation of horse, \$ 100

Valuation of horse equipments, \$ 100

Remarks:

Book mark:

107 11/27/64

71 | 5 Col'd Cav. | Mass.

Thomas D. Moore

Det., Co. D, 5 Reg't Mass. Col'd Cav.

Appears on

Company Muster-in and Descriptive Roll
of the organization named above. Roll dated

Radcliff, Mass., Dec 22, 1864.

Where born Salem, Mass.

Age 24 y'rs; occupation Shoemaker

When enlisted Dec 9, 1864.

Where enlisted Salem

For what period enlisted 3 years.

Eyes Black; hair Black

Complexion Fair; height 5 ft. 4 in.

When mustered in Dec 22, 1864.

Where mustered in

Bounty paid \$ 100; due \$ 100

Where credited Salem

Company to which assigned

Remarks:

Book mark:

J. H. [Signature]

(356d)

Copyist.

711 | **5 Col'd Cav.** | **Mass.**

James H. Moore

Co. F, 5 Reg't Mass. Col'd Cavalry.

Appears on

Company Muster Roll

for *July 1st*, 186*4*.

Present or absent *present*

Stoppage, \$ *100* for

Due Gov't, \$ *100* for

Valuation of horse, \$ *100*

Valuation of horse equipments, \$ *100*

Remarks:

Book mark:

James H. Moore
Copyist.

77 | **5 Col'd Cav.** | **Mass.**

Wm. M. Wood

Co. F, 5 Reg't Mass. Col'd Cavalry.

Appears on

Company Muster Roll

for *March & June*, 1864.

Present or absent *Present*

Stoppage, \$ *100* for

Due Gov't, \$ *100* for

Valuation of horse, \$ *100*

Valuation of horse equipments, \$ *100*

Remarks: *Went sick to
Camp Hospital, and
was 28, 1864. Got
well again.*

Book mark: _____

M | 5 Col'd Cav. | Mass.

Thomas H. Moore
Pt, Co. F, 5 Reg't Mass. Col'd Cavalry.

Appears on

Company Muster Roll

for July & Aug, 1864.

Present or absent Present

Stoppage, \$ 100 for

Due Gov't, \$ 100 for

Valuation of horse, \$ 100

Valuation of horse equipments, \$ 100

Remarks: Ret'd from Hospl
to duty Aug 3/64
Stop one Haversack

Book mark:

A. Newas

(358)

Copyist.

M | 5 Col'd Cav. | Mass.

Thomas A. Moore
Saddler, Co. F, 5 Reg't Mass. Col'd Cavalry.

Appears on

Company Muster Roll

for Sept & Oct, 1864.

Present or absent Present

Stoppage, \$ 100 for

Due Gov't, \$ 100 for

Valuation of horse, \$ 100

Valuation of horse equipments, \$ 100

Remarks: App'd Co. Saddler
Oct 20/64 S. O. No.
179

Book mark:

J. H. Stewart

(358)

Copyist.

M | **5 Col'd Cav.** | **Mass.**

Thomas A. Moore
Saddler, Co. F, 5 Reg't Mass. Col'd Cavalry.

Appears on

Company Muster Roll

for *Nov & Dec*, 1864.

Present or absent *Present*

Stoppage, \$ *100* for

Due Gov't, \$ *100* for

Valuation of horse, \$ *100*

Valuation of horse equipments, \$ *100*

Remarks: *App'd saddler*
by A.O. 179 Oct 20
1864

Book mark:

J. H. Stewart
(358) *Copist.*

M | 5 Col'd Cav. | Mass.

Thomas A. Moore
Saddler, Co. F, 5 Reg't Mass. Col'd Cavalry.

Appears on

Company Muster Roll
for Jan & Feb, 1865
Present or absent Present

Stoppage, \$ 100 for

Due Gov't, \$ 100 for

Valuation of horse, \$ 100

Valuation of horse equipments, \$ 100

Remarks: App'd saddles
S.O. 119 Oct 20. 1864
Due first four Inst
U.S. Bty

Book mark:

(358)

J. H. Stewart

Copyist.

M | **5 Col'd Cav.** | **Mass.**

Thomas N. Moore

Saddler, Co. F, 5 Reg't Mass. Col'd Cavalry.

Appears on

Company Muster Roll

for *March & April*, 186*5*

Present or absent *Present*

Stoppage, \$ *100* for

Due Gov't, \$ *100* for

Valuation of horse, \$ *100*

Valuation of horse equipments, \$ *100*

Remarks: *Due first four inst U.S. Bty #180.00*

Book mark:

M Stewart

M | **5 Col'd Cav.** | **Mass.**

Thomas A. Moore
Saddler, Co. F, 5 Reg't Mass. Col'd Cavalry.

Appears on

Company Muster Roll

for *May & June*, 186*5*,

Present or absent *Present*

Stoppage, \$ *100* for

Due Gov't, \$ *100* for

Valuation of horse, \$ *100*

Valuation of horse equipments, \$ *100*

Remarks: *Appointed*

Saddler Oct 20/64
J O 179

Book mark:

J. A. Johnson

M | **5 Col'd Cav.** | **Mass.**

Thomas H. Morse
Sad, Co. F, 5 Reg't Mass. Col'd Cavalry.

Appears on

Company Muster Roll

for *July & Aug*, 1863.

Present or absent *Present*

Stoppage, \$ *100* for

Due Gov't, \$ *100* for

Valuation of horse, \$ *100*

Valuation of horse equipments, \$ *100*

Remarks:

Book mark:

J. Johnson

M. | 5 Col'd Cav. | Mass.

Thomas H. Moore

Priv., Co. F, 5 Reg't Mass. Colored Cav.

Appears on Returns as follows:

June 1864, Absent sick in
18th Corps Hosp. Va.

July 1864, Absent sick,

Mar. 1865, Absent without
leave, over time on
furlough 3 days.

Book mark :

(546)

J. B. Sittler

Copyist.

M | **5 Col'd Cav. Mass.**

Thomas H Moore
Sudder, Co. *F*, 5 Reg't Mass. Col'd Cavalry.

Appears on **Co. Muster-out Roll**, dated
Wartsville Tex, *Oct 31*, 186*4*;

Muster-out to date *Oct 31*, 186*4*).

Last paid to *Dec 31*, 186*4*.

Clothing account:

Last settled....., 186 ; drawn since \$..... 100

Due soldier \$ *2*^{*45*}..... 100; due U. S. \$..... 100

Am't for cloth'g in kind or money adv'd \$..... 100

Due U. S. for arms, equipments, &c., \$ *11*..... 100

Bounty paid \$..... 100; due \$ *300*..... 100

Remarks: *Have U.S. for Equip*
Equip. 7.1³²

Book mark :

(361)

L. J. Moore

Copyist.

Moore J. H.

Co. 5 Reg't Mass. C.C.

1 Enclosures.

Bed Cards	Final Statements
Burial Records	Furloughs or L. of A.
Certs. of Dis. for Discharge	Med. Certificates
C. M. Charges	Med. Des. Lists
Descriptive Lists	Orders
Discharge Certificates	Pris. of War Record
Enlistment Papers	Resignations

Other papers relating to—

Admission to Hosp'l	Furlough or L. of A. /
Casualty Sheet	Med. Examination
Confinement	Misc. Information /
Contracts	Pay or Clothing
Death or Effects	Personal Reports
Desertion	Rank
Discharge from Hosp'l	Transfer to Hosp'l
Discharge from Service	Transfer to V. R. C.
Duty	Transportation

MICROFILM PUBLICATION M 1822

COMPILED MILITARY SERVICE RECORDS
OF VOLUNTEER UNION SOLDIERS WHO
SERVED WITH THE USCT (US COLORED TROOPS)
5TH MASSACHUSETTS REGIMENT OF CAVALRY

PERSONAL PAPERS' TARGET SHEET

PLEASE NOTE THE CHECKED INFORMATION ABOUT THE PERSONAL PAPERS IN
THIS FILE:



NO PERSONAL PAPERS WERE FOUND IN THIS FILE WHEN THE
RECORDS WERE ARRANGED FOR MICROFILMING.



2 PERSONAL PAPER(S) FOUND IN THIS FILE WHEN THE RECORDS
WERE ARRANGED FOR MICROFILMING.

S. H. Moore

RECEIVED
MAIL OFFICE
JAN 10 1864

~~No. 347~~

Head Quarters Department of Washington,
WASHINGTON, D. C.,

March 31st 1865

Pass the Bearer

J. H. Moore 5th Mass Cav

within the lines of the U. S. Forces to St. Lookout, Md

Reason: to rejoin Regiment.

This Pass will expire

March 31st 1865

By Command of MAJOR GENERAL AUGUR:

E. H. Camp

Capt., A. Q. M. and A. D. C.

Record and Pension Office,

WAR DEPARTMENT.

The slip hereto attached is a stub from
a "Pass Book", Headquarters Department
of Washington.

No. 347
Name F. H. Moore
Reg't 5 Mass Col Har
To H. F. Frobisher
Voucher
Date Mar 31 1865
Expires ' ' 1865.

5 Mass. Cav. (Co. 1)

Private | Corporal

CARD NUMBERS.

1	5-380538	26
2	5-380627	27
3	5-380709	28
4	5-380805	29
5	5-380854	30
6	5-380951	31
7	5-381053	32
8	5-381154	33
9	5-381256	34
10	5-381356	35
11	5-381454	36
12	9091953	37
12	40731417	38
14		39
15		40
16		41
17		42
18		43
19		44
20		45
21		46
22		47
23		48
24		49
25		50

Book Mark:

See also

S. 2187488 Pomona

By Vaerke
4

M

5 Cav. (Col'd.) | Mass.

Sylvester Moores

G, Co. *G*, 5 Reg't Mass. Cav. (Col'd.)

Appears on

Company Descriptive Book

of the organization named above.

DESCRIPTION.

Age *26* years; height *5* feet *5 1/2* inches.

Complexion *Blk*

Eyes *Blk*; hair *Blk*

Where born *Lanesboro Mass.*

Occupation *Laborer*

ENLISTMENT.

When *Feb 15*, 1864.

Where *Lanesboro*

By whom *J. Tucker*; term *3* y'rs.

Remarks: *Married.*

Hearst

M | **5 Col'd Cav.** | **Mass.**

Septester Moore
B, Co. *G*, 5 Reg't Mass. Col'd Cav.

Appears on

Company Muster-in and Descriptive Roll

of the organization named above. Roll dated

Readville Mass, Mar 4, 1864.

Where born *Jamesboro Mass*

Age *26* y'rs; occupation *Fabrics*

When enlisted *Feb 13*, 1864.

Where enlisted *Jamesboro*

For what period enlisted *3* years.

Eyes *BLK*; hair *BLK*

Complexion *BLK*; height *5 ft. 5 1/2 in.*

When mustered in *Mar 4*, 1864.

Where mustered in *Readville Mass*

Bounty paid \$ *2* ¹⁰⁰; due \$ *100* ¹⁰⁰

Where credited *10 West Berkshire*

Company to which assigned

Remarks:

Book mark:

T. J. G. S.

M | **5 Col'd Cav.** | **Mass.**

Sydney Morris
Private, Co. G, 5 Reg't Mass. Col'd Cavalry.

Appears on

Company Muster Roll
for *March 30*, 1864.

Present or absent *Present*

Stoppage, \$ *100* for

Due Gov't, \$ *100* for

Valuation of horse, \$ *100*

Valuation of horse equipments, \$ *100*

Remarks:

Book mark:

L. J. ...
Copyist.

M | **5 Col'd Cav.** | **Mass.**

Sylvester Woore

Pr, Co. G, 5 Reg't Mass. Col'd Cavalry.

Appears on

Company Muster Roll

for *May 1 June*, 1864.

Present or absent *Absent*

Stoppage, \$..... 100 for

Due Gov't, \$..... 100 for

Valuation of horse, \$..... 100

Valuation of horse equipments, \$..... 100

Remarks: *On detached service at City Point Va since June 20/64.*

Book mark:

Leger

M | **5 Col'd Cav.** | **Mass.**

Sylvester Moores
PT, Co. G, 5 Reg't Mass. Col'd Cavalry.

Appears on

Company Muster Roll

for *July & Aug*, 186*4*.

Present or absent *Present*

Stoppage, \$ *100* for

Due Gov't, \$ *100* for

Valuation of horse, \$ *100*

Valuation of horse equipments, \$ *100*

Remarks: *Daily duty as Co
Cook.*

Book mark: _____

L. J. ...
Copyist.

M

5 Col'd Cav.

Mass.

Sylvester Morris
Corpl, Co. G, 5 Reg't Mass. Col'd Cavalry.

Appears on

Company Muster Roll

for Sept. 7th, 1864.

Present or absent Present

Stoppage, \$ 100 for

Due Gov't, \$ 100 for

Valuation of horse, \$ 100

Valuation of horse equipments, \$ 100

Remarks: Appointed Corpl
by Special Order No.
176 dated Oct. 20th
1864

Book mark:

Perry

M | 5 Col'd Cav. | Mass.

Sylvester Moore
Corpl, Co. G, 5 Reg't Mass. Col'd Cavalry.

Appears on

Company Muster Roll

for Nov & Dec, 1864.

Present or absent Present

Stoppage, \$ 100 for

Due Gov't, \$ 100 for

Valuation of horse, \$ 100

Valuation of horse equipments, \$ 100

Remarks: Appointed Corpl
by S. O. No. 176. dated
Oct. 20. 64

Book mark:

Perry

M

5 Col'd Cav.

Mass.

Sylvester Morris
Copt, Co. G, 5 Reg't Mass. Col'd Cavalry.

Appears on

Company Muster Roll

for Jan 9 Feb, 1865.

Present or absent Present

Stoppage, \$ 100 for

Due Gov't, \$ 100 for

Valuation of horse, \$ 100

Valuation of horse equipments, \$ 100

Remarks: Due 1st, 2nd, 3rd & 4th
instalments U. S.
Bounty \$180. Appointed
corporal per R. P. O.
No. 176, dated Oct. 20,
64

Book mark:

Perry

(358)

Copyist.

M

5 Col'd Cav.

Mass.

Sylvester Moore
Cork Co. G, 5 Reg't Mass. Col'd Cavalry.

Appears on

Company Muster Roll

for Mch. 7 April, 1865.

Present or absent Present

Stoppage, \$ 100 for

Due Gov't, \$ 100 for

Valuation of horse, \$ 100

Valuation of horse equipments, \$ 100

Remarks: Due the soldier
four instalments
U. S. Bounty \$180

Book mark:

Perry

M. | 5 Col'd Cav. | Mass.

Sylvester Moore
Corpl Co. G, 5 Reg't Mass. Col'd Cavalry.

Appears on

Company Muster Roll

for May & June, 1860.

Present or absent Present

Stoppage, \$ 100 for

Due Gov't, \$ 100 for

Valuation of horse, \$ 100

Valuation of horse equipments, \$ 100

Remarks:

Book mark:

Cery

(358)

Copyist.

M

5 Col'd Cav.

Mass.

Elyester Moore
Co. G, 5 Reg't Mass. Col'd Cavalry.

Appears on

Company Muster Roll

for *July & Aug*, 186*4*.

Present or absent *Present*

Stoppage, \$ *100* for

Due Gov't, \$ *100* for

Valuation of horse, \$ *100*

Valuation of horse equipments, \$ *100*

Remarks:

Book mark:

W. H. Scott

(358)

Copyist.

M. | 5 Col'd Cav. | Mass.

Sylvester Moores
Pvt., Co. G, 5 Reg't Mass. Colored Cav.

Appears on Returns as follows:

Mar. 1864. Co. cook,
May 1864. Co. cook,
June 1864. Absent on detached
service at City Point, Va,
July to Sept. 1864. Co. cook.

Book mark :

(548)

J. B. Sittler

Copyist.

M | 5 Col'd Cav. | Mass.

Elyvester Moore
Chp, Co. G, 5 Reg't Mass. Col'd Cavalry.

Appears on Co. Muster-out Roll, dated
Charlottesville, Oct 31, 1865.

Muster-out to date *Oct 31, 1865.*

Last paid to *Dec 31, 1864.*

Clothing account:

Last settled....., 186 ; drawn since \$..... 100

Due soldier \$ *95 83* 100; due U. S. \$..... 100

Am't for cloth'g in kind or money adv'd \$..... 100

Due U. S. for arms, equipments, &c., \$ *3* 100

Bounty paid \$..... 100; due \$ *3 1/4* 100

Remarks:

Book mark: *309, 926/80*

Wm. Scott

1020

Moran, Charles A.

Co., 5 Mass. Cav., (Col'd.)

Private

CARD NUMBERS.

1	5372137	26
2	5372037	27
3	34509339	28
4		29
5		30
6		31
7		32
8		33
9		34
10		35
11		36
12		37
13		38
14		39
15		40
16		41
17		42
18		43
19		44
20		45
21		46
22		47
23		48
24		49
25		50

Book Mark:

See also

M | *5 Cav.* | *Mass.*

Charles H. Moran

Appears with rank of on

Muster-in and Descriptive Roll

of a detachment of U. S. Volunteer Recruits for
different regiments of Massachusetts Volunteers.

Roll dated *Drft Rendz. Galloups*

Isle. Boston Harbor Mass. May 17, 1864,

Where born *Somerset Co. Tenn.*

Age *24* years; occupation *Steward*

When enlisted *May 13, 1864.*

Where enlisted *Roxbury Mass.*

For what period enlisted *3* years.

Eyes *black*; hair *black*

Complexion *black*; height *5 ft. 6 3/4 in.*

When mustered in, 186 .

Muster-in to date *from enlistment,* 186 .

Where mustered in

Bounty paid \$ 100; due \$ 100

Clothing account:

Last settled \$, 186 ; drawn since \$ 100

Date of first muster, 186 .

Regiment to which assigned *5 Cav.*

Remarks: *Credited to the Quota
of 3 cong. Dist. Roxbury
Norfolk*

Book mark:

(356m)

J. H. Thomas
Copist.

711 | 5 Col'd Cav. | Mass.

* Charles E. Moran

Appears with rank of Private on

Muster and Descriptive Roll of a Detachment of U. S. Vols. forwarded

for the 5 Reg't Mass. Col'd Cavalry. Roll dated Galloups Island Mass May 31, 1864.

Where born Somerset Co. Pa

Age 24 y'rs; occupation Stevedore

When enlisted May 13, 1864.

Where enlisted Roxbury Mass

For what period enlisted 3 years.

Eyes Blue; hair Black

Complexion Black; height 5 ft. 6 3/4 in.

When mustered in May 3, 1864.

Where mustered in Galloups Island Mass.

Bounty paid \$100; due \$100

Where credited 3rd Reg't Cavalry Mass

Company to which assigned

Remarks: Retained at the Post. Having made application for transfer to Turry.
* Entire entry cancelled by line.

Book mark:

(G. Green)

711

5 Col'd Cav.

Mass.

Charles C. ...

Appears with rank of Private on

Muster and Descriptive Roll of a Detachment of U. S. Vols. forwarded

for the 5 Reg't Mass. Col'd Cavalry. Roll dated Galloupe Island Mass, June 23, 1864.

Where born Somerset Co. Penn

Age 27 y'rs; occupation Steward

When enlisted May 13, 1864.

Where enlisted Roxbury Mass

For what period enlisted 3 years.

Eyes black; hair Black

Complexion Black; height 5 ft. 6 3/4 in.

When mustered in May 13, 1864.

Where mustered in Galloupe Island Mass

Bounty paid \$ 100; due \$ 100

Where credited

Company to which assigned

Remarks: 2nd Coy. Dist. Quota of

Roxbury Stock Co.

Taken up on Muster rolls of Regt 24

Book mark:

Forrest

Moran, Charles H.

Co. ⁵ 10 CIVIL Reg't Mass. Col'd Cav
(Philippine Insurrection.)

² Inclosures.

Bed Cards	Ex. Preliminary to M. O.
Burial Records	Final Statements
Certs. of Dis. for Discharge	Fines
C. M. Charges	Furloughs or L. of A.
Descriptive Lists	Med. Certificates
Descriptive and Assign- ment Cards }	Med. Des. Lists
Discharge Certificates	Orders
Enlistment Papers ²	Resignations

Other papers relating to—

Admission to Hosp'l	Furlough or L. of A.
Confinement	Med. Examination
Contracts	Misc. Information
Death or Effects	Pay or Clothing
Desertion	Personal Reports
Discharge from Hosp'l	Rank
Discharge from Service	Transfer to Hosp'l
Duty	Transportation

NOTE 1.—This blank will be used for both enlistments and re-enlistments—enlistment of veterans, &c., &c., in the volunteer service. They will be made out in duplicate in all cases—one to accompany the recruiting return of the superintendent (not the recruiting officer) to the Adjutant-General, and one to accompany the accounts of the officer who pays bounty, &c. The Regiment and Company in which the soldier last served should be given on the back.

NOTE 2.—An enlistment holds to service. A muster-in must, in all cases, precede payment of pay, bounty, pension, &c. A muster-in roll must, in all cases, be filed in the Adjutant-General's Office as evidence of muster-in. The mustering officer, commissary, or assistant-commissary of musters, as the case may be, will countersign both enlistments as having mustered the soldier in to the service of the United States before either of them is given to the disbursing officer.

April 1895. This paper was formerly filed in the Enrollment Div. R. & P. O.

DECLARATION OF RECRUIT.

I, *Charles H. Murren* desiring to VOLUNTEER as a Soldier in the Army of the United States, for the term of THREE YEARS, Do Declare, That I am *Twenty-four* years and _____ months of age; that I have never been discharged from the United States service on account of disability or by sentence of a court-martial, or by order before the expiration of a term of enlistment; and I know of no impediment to my serving honestly and faithfully as a soldier for three years.

GIVEN at *Boston Mass,*
the *fifteenth* day of *May 1895*

Witness *Charles S. Mearns* *Charles H. Murren*

Discharged

18

Reg't of

enlistment; last served in Company ()

By

Regiment of

18

Volunteered at

Colon M. Murren

No. *5 Mass Low.*

CONSENT IN CASE OF MINOR.

I, _____ Do CERTIFY, That I am _____ the _____ of _____; that the _____ said _____ is _____ years of age; and I do hereby freely give my CONSENT to his volunteering as a SOLDIER in the ARMY OF THE UNITED STATES, for the period of THREE YEARS.

GIVEN at _____ the _____ day of _____

Witness:

MAY 1864

6429

VOLUNTEER ENLISTMENT.

STATE OF

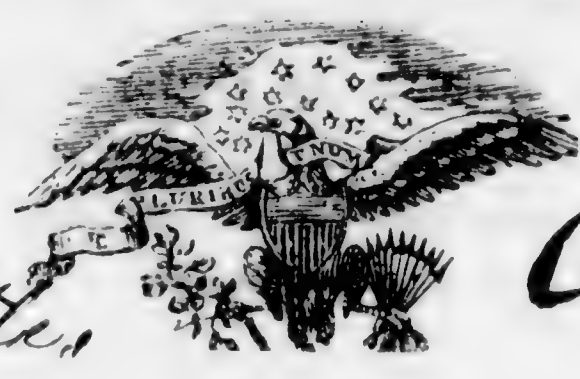

TOWN OF

Massachusetts, *City of Roxbury*

I, *Charles H. Moran* born in *Somerset Co.* in the State of *Pennsylvania* aged *Twenty-four* years, and by occupation a *Steward*. Do HEREBY ACKNOWLEDGE to have volunteered this *Thirteenth* day of *May*, 1864, to serve as a **Soldier** in the **Army of the United States of America**, for the period of **THREE YEARS**, unless sooner discharged by proper authority: Do also agree to accept such bounty, pay, rations, and clothing, as are, or may be, established by law for volunteers. And I, *Charles H. Moran* do solemnly swear, that I will bear true faith and allegiance to the **United States of America**, and that I will serve them honestly and faithfully against all their enemies or opposers whomsoever; and that I will observe and obey the orders of the President of the United States, and the orders of the officers appointed over me, according to the Rules and Articles of War.

Sworn and subscribed to, at *Boston, Mass* this *Thirteenth* day of *May* 1864, *Charles H. Moran* BEFORE *Geo. H. Quincy* Justice of the Peace. *Geo. B. Townsend* Subst.

I CERTIFY, ON HONOR, That I have carefully examined the above-named Volunteer, agreeably to the General Regulations of the Army, and that, in my opinion, he is free from all bodily defects and mental infirmity, which would in any way disqualify him from performing the duties of a soldier.

P. Jay Jeffries
EXAMINING SURGEON.

Vaccinated

I CERTIFY, ON HONOR, That I have minutely inspected the Volunteer, *Charles H. Moran*, previously to his enlistment, and that he was entirely sober when enlisted; that, to the best of my judgment and belief, he is of lawful age; and that, in accepting him as duly qualified to perform the duties of an able-bodied soldier, I have strictly observed the Regulations which govern the recruiting service. This soldier has *Black* eyes, *Black* hair, *Black* complexion, is *five* feet *six 3/4* inches high.

Geo. B. Townsend, Lt. Col.
Fifth Regiment of *Mass. Cav.* Volunteers,
RECRUITING OFFICER.

(A. G. O. No. 74 & 75.)

the day of _____, 1864, at _____ Mustered into the service of the United States, in Company _____

Regiment of _____

Volunteers, on _____

Charles H. Moran - Single.
Charles H. Moran
Geo. H. Quincy

NOTE 1.—This blank will be used for both enlistments and re-enlistments—enlistment of veterans, &c., &c., in the volunteer service. They will be made out in duplicate in all cases—one to accompany the recruiting return of the superintendent (not the recruiting officer) to the Adjutant-General, and one to accompany the accounts of the officer who pays bounty, &c. The Regiment and Company in which the soldier last served should be given on the back.

NOTE 2.—An enlistment holds to service. A muster-in must, in all cases, precede payment of pay, bounty, pension, &c. A muster-in roll must, in all cases, be filed in the Adjutant-General's Office as evidence of muster-in. The mustering officer, commissary, or assistant-commissary of musters, as the case may be, will countersign both enlistments as having mustered the soldier into the service of the United States before either of them is given to the disbursing officer.

APRIL 1895 THIS PAPER WAS FORMERLY
FILED IN THE REGIMENTAL DIV. P. O.

DECLARATION OF RECRUIT.

I, *Charles H. Morrison* desiring to VOLUNTEER as a Soldier in the Army of the United States, for the term of THREE YEARS, Do Declare, That I am *Twenty-four* years and _____ months of age; that I have never been discharged from the United States service on account of disability or by sentence of a court-martial, or by order before the expiration of a term of enlistment; and I know of no impediment to my serving honestly and faithfully as a soldier for three years.

GIVEN at *Boston, Mass.*
the *Twentieth* day of *May* 1864.

Witness: *Charles S. Marten* *Charles H. Morrison*
his

Discharged _____ 18 _____

Reg't of _____
enlistment; last served in Company ()

By _____
Regiment of _____

Volunteered at _____ 18 _____

Charles H. Morrison
5th Mass. Heavy

CONSENT IN CASE OF MINOR.

I, _____ Do CERTIFY, That I am _____
the _____ of _____; that the
said _____ is _____ years of age; and I
do hereby freely give my CONSENT to his volunteering as a SOLDIER in the ARMY OF THE UNITED STATES,
for the period of THREE YEARS.

GIVEN at _____
the _____ day of _____

Witness: _____

VOLUNTEER ENLISTMENT.

STATE OF



OF

Massachusetts

City of Roxbury

the
day of
1864 at
Mustered into the service of the United States, in Company

I, *Charles H. Morann* born in *Somerset Co.*
in the State of *Pennsylvania* aged *Twenty four* years,
and by occupation a *Teacher* DO HEREBY ACKNOWLEDGE to have
volunteered this *Thirteenth* day of *May* 1864,
to serve as a **Soldier** in the Army of the United States of America, for the
period of **THREE YEARS**, unless sooner discharged by proper authority: Do also
agree to accept such bounty, pay, rations, and clothing as are, or may be, estab-
lished by law for volunteers. And I, *Charles H. Morann* do
solemnly swear, that I will bear true faith and allegiance to the **United States**
of **America**, and that I will serve them honestly and faithfully against all their
enemies or opposers whomsoever; and that I will observe and obey the orders of
the President of the United States, and the orders of the officers appointed over
me, according to the Rules and Articles of War.

Sworn and subscribed to, at *Portsmouth, N.H.*
this *Thirteenth* day of *May*, 1864,
BEFORE *C. H. Runcy*
Justice of the Peace.

I CERTIFY, ON HONOR, That I have carefully examined the above-named Volunteer, agreeably
to the General Regulations of the Army, and that, in my opinion, he is free from all bodily defects and
mental infirmity, which would in any way disqualify him from performing the duties of a soldier.

B. Jay Jeffries.
EXAMINING SURGEON.

Vaccinated

I CERTIFY, ON HONOR, That I have minutely inspected the Volunteer, *Charles H. Morann*
previously to his enlistment, and that he was entirely sober when enlisted; that, to the best of my
judgment and belief, he is of lawful age; and that, in accepting him as duly qualified to perform the duties
of an able-bodied soldier, I have strictly observed the Regulations which govern the recruiting service.
This soldier has *Blue* eyes, *Black* hair, *Black* complexion, is *five* feet
six 3/4 inches high.

C. H. Runcy
Fifth Regiment of Mass. Cav. Volunteers,
RECRUITING OFFICER.

Regiment of

Volunteers, on

(A. G. O. No. 74 & 75.)

6429

1020-a

Moran, George E
Co., J. W. S. Col'd Car

CARD NUMBERS.

1	9436066	26
2		27
3		28
4		29
5		30
6		31
7		32
8		33
9		34
10		35
11		36
12		37
13		38
14		39
15		40
16		41
17		42
18		43
19		44
20		45
21		46
22		47
23		48
24		49
25		50

Number of personal papers herein.....

Book Mark:

See also

5th Cav. Mass.
M. (Col'd), Mass.
George E. Moran,
....., Co., 5th Reg't Mass. Col'd Cav.

Appears on

Regimental Descriptive Book

of the organization named above.

DESCRIPTION.

Age 25 years; height 5 feet 6 inches.

Complexion Colored

Eyes Black; hair Blk.

Where born Providence, R.I.

Occupation Bootmaker

ENLISTMENT.

When Feb. 27, 1864

Where Athol, Mass.

By whom B. F. Chesley; term 3 yrs.

Remarks: Rejected, Feb. 28/64

Thompson

1021

Moran, Henry

Co I, 5 Mass. Cav., (Col'd.)

Private

Private

CARD NUMBERS.

1	5372103	26
2	5372258	27
3	5383002	28
4	5383081	29
5	5383179	30
6	5383282	31
7	5383385	32
8	5383483	33
9	5383574	34
10	5383671	35
11	9091773	36
12	34505438	37
13	40731419	38
14		39
15		40
16		41
17		42
18		43
19		44
20		45
21		46
22		47
23		48
24		49
25		50

Book Mark:

See also

51198199 P.O. number
D. 2466409 P.O. Ref.
J. 2565543 - aud w d
D 2995377 aud w d

P. Macken
cf

No. **5 Cav. (Col'd.) Mass.**

Henry Moran.

....., Co. *I*....., 5 Reg't Mass. Cav. (Col'd.)

Appears on

Company Descriptive Book

of the organization named above.

DESCRIPTION.

Age *28* years; height *5* feet *6* inches.

Complexion *Colored*.....

Eyes *Blk.*.....; hair *Blk.*.....

Where born *Oldham Ky.*.....

Occupation *Laborer*.....

ENLISTMENT.

When *June 21st*, 1864.

Where *Charlton*.....

By whom *J. H. Hathaway*; term *3* y'rs.

Remarks:

.....

.....

.....

.....

.....

.....

.....

.....

H. L. Thomas.....

M | 5 Cav | Mass

Henry Mearns

Appears with rank of _____ on _____

Muster and Descriptive Roll

of a detachment of U. S. Volunteers forwarded from Faneuil Hall, Boston, to Galloup's Island, Boston Harbor, for various regiments Massachusetts Volunteers. Roll dated

Boston Mass., June 21, 1864.

Where born Andover Mass.

Age 28 years; occupation laborer

When enlisted June 21, 1864

Where enlisted Charlton

For what period enlisted 3 years.

Eyes blue; hair dark

Complexion fair; height 5 ft. 0 in.

When mustered in June 21, 1864

Where mustered in Boston

Bounty paid \$ 100; due \$ 100

Clothing account:

Last settled _____, 1864; drawn since \$ 100

Date of first muster _____, 1864

Regiment to which assigned 5 Cav

Remarks: Charlton Worcester Co. S. Dist.

Book mark: _____

71 5 Col'd Cav. | Mass.

Henry Hazard

Appears with rank of Private on

Muster and Descriptive Roll of a Detachment of U. S. Vols. forwarded

for the 5 Reg't Mass. Col'd Cavalry. Roll dated

Boston Mass, June 21, 1864.

Where born Andover Ms.

Age 27 y'rs; occupation Farmer

When enlisted June 21, 1864.

Where enlisted Andover

For what period enlisted 5 years.

Eyes Blue; hair Black

Complexion White; height 5 ft. 6 in.

When mustered in June 21, 1864.

Where mustered in Andover

Bounty paid \$ 100; due \$ 100

Where credited Dist. Quarter Master's

Company to which assigned

Remarks:

Book mark:

Finch

(339) Copyist.

M | 5 Col'd Cav. | Mass.

Henry Marand

Appears with rank of *Pri* on

Muster and Descriptive Roll of a Detachment of U. S. Vols. forwarded

for the 5 Reg't Mass. Col'd Cavalry. Roll dated

Galloups 2d Mass July 12, 1864.

Where born *Oldhouse Ky*

Age *28* y'rs; occupation *Laborer*

When enlisted *June 21*, 186 *4*

Where enlisted *Charlton Mass*

For what period enlisted *3* years.

Eyes *Black*; hair *Black*

Complexion *Colored*; height *5 ft. 6* in.

When mustered in *June 21*, 186 *4*.

Where mustered in *Boston Mass*

Premium
Bounty paid \$ *2* ¹⁰⁰; due \$ ¹⁰⁰

Where credited *8 Coy Dist. Charlton*

Worcester Co
Company to which assigned

Remarks:

Book mark:

Donnelly

M | 5 Col'd Cav. | Mass.

Henry Moran
Sgt, Co. I, 5 Reg't Mass. Colored Cavalry.

Appears on

Company Muster Roll

for July & Aug, 1864.

Present or absent Present

Stoppage, \$ 100 for

Due Gov't, \$ 100 for

Valuation of horse, \$ 100

Valuation of horse equipments, \$ 100

Remarks

Recruit from depot
joined Co. at Ft. Lookout
Md. July 17/64 - Enlistment
papers not Recd.
(Enrolled June 21/64 at Charleston
and Mustered in same date at Gallups
Del. for 2 yrs. see Sept & Oct/64 Roll)

Book mark:

(358)

W. H. Thompson
Copyist.

m

5 Col'd Cav.

Mass.

Henry Moran,
Pvt., Co. I, 5 Reg't Mass. Colored Cavalry.

Appears on

Company Muster Roll

for *Sept. 8 Oct,* 1864.

Present or absent *Present,*

Stoppage, \$ *100* for

Due Gov't, \$ *100* for

Valuation of horse, \$ *100*

Valuation of horse equipments, \$ *100*

Remarks:

Book mark: *34*

(358)

C. F. Thompson
Copyist.

M

5 Col'd Cav.

Mass.

Henry Moran,
Priv., Co. I, 5 Reg't Mass. Colored Cavalry.

Appears on

Company Muster Roll

for *Nov. 7 Dec.*, 1864.

Present or absent *Present,*

Stoppage, \$ *100* for

Due Gov't, \$ *100* for

Valuation of horse, \$ *100*

Valuation of horse equipments, \$ *100*

Remarks: *Rec'd 10.⁰⁰ advance pay,*

Book mark: _____

(358)

C. F. Thompson,

Copyist.

M | **5 Col'd Cav.** | **Mass.**

Henry Moran
Pvt., Co. I, 5 Reg't Mass. Colored Cavalry.

Appears on

Company Muster Roll

for Jan. & Feb., 1865.

Present or absent Present,

Stoppage, \$ 100 for

Due Gov't, \$ 100 for

Valuation of horse, \$ 100

Valuation of horse equipments, \$ 100

Remarks: Due 1st installment
U. S. Bounty \$25.⁰⁰
rec'd 10.⁰⁰ advance pay.

Book mark: _____

(358) C. F. Thompson,
Copyist.

M

5 Col'd Cav.

Mass.

Henry Moran

Pvt., Co. I, 5 Reg't Mass. Colored Cavalry.

Appears on

Company Muster Roll

for *Mch. & Apr.*, 1865.

Present or absent *Present.*

Stoppage, \$ *100* for

Due Gov't, \$ *100* for

Valuation of horse, \$ *100*

Valuation of horse equipments, \$ *100*

Remarks: *Due "installment"*
U. S. Bounty \$25.00

Book mark:

C. F. Thompson

(358)

Copyist.

In | **5 Col'd Cav.** | **Mass.**

Henry Moran
Pvt., Co. I, 5 Reg't Mass. Colored Cavalry.

Appears on

Company Muster Roll

for *May & June*, 1865.

Present or absent *Present*.

Stoppage, \$ *100* for

Due Gov't, \$ *100* for

Valuation of horse, \$ *100*

Valuation of horse equipments, \$ *100*

Remarks: *Due 1st installment
U.S. Bounty \$5.00*

Book mark: _____

(358)

C. F. Thompson
Copyist.

M | 5 Col'd Cav. | Mass.

Henry Moran
Pvt, Co. I, 5 Reg't Mass. Colored Cavalry.

Appears on

Company Muster Roll

for July Aug, 1865.

Present or absent Present

Stoppage, \$ 100 for

Due Gov't, \$ 100 for

Valuation of horse, \$ 100

Valuation of horse equipments, \$ 100

Remarks:

Book mark:

Holeman

M, | 5 Col'd Cav. | Mass.

Henry Moran*
Priv., Co. D, 5 Reg't Mass. Colored Cav.

Appears on Returns as follows:

July 1864, Gain - Recruit
Pt. Lookout, Md. joined
Co. July 16/64.

Aug. 1864, On duty building
stables.

Sept. 1864, On extra or daily
duty.

* Name appears also as H.
Morand.

Book mark :

(546)

J. B. Sittler

Copyist.

M | 5 Col'd Cav. | Mass.

Henry Moran
Pvt., Co. D, 5 Reg't Mass. Col'd Cavalry.

Appears on Co. Muster-out Roll, dated
Blacksville Texas, Oct 31, 1865.

Muster-out to date Oct 31, 1865.

Last paid to Dec 31, 1864.

Clothing account:

Last settled....., 186 ; drawn since \$..... 100

Due soldier \$ 40⁰⁸ 100; due U. S. \$..... 100

Am't for cloth'g in kind or money adv'd \$..... 100

Due U. S. for arms, equipments, &c., \$..... 100

Bounty paid \$..... 100; due \$100 100

Remarks: Mustered out by S.O. No. 29 Hd. Qr. Dept. of Texas dated Galveston Texas Sept. 16/65 based on authority from War Dept. dated Sept 25/65, directing the muster out of colored troops organized in northern states; their services (over)

Book mark:

Healants

JAN. 10

5383671

1891

being no longer required. Transport &
Subsistence furnished to Boston Mass.
muster out to date Oct-31/65.

Marand Henry

....., Co.

5 Reg't Mass. I. C.

3 Enclosures.

Bed Cards

Burial Records

Certs. of Dis. for Discharge

C. M. Charges

Descriptive Lists

Discharge Certificates

Enlistment Papers 2

Final Statements

Furloughs or L. of A.

Med. Certificates

Med. Des. Lists

Orders

Pris. of War Record

Resignations

Other papers relating to—

Admission to Hosp'l

Casualty Sheet

Confinement

Contracts

Death or Effects

Desertion

Discharge from Hosp'l

Discharge from Service

Duty

Furlough or L. of A.

Med. Examination

Misc. Information

Pay or Clothing

Personal Reports

Rank

Transfer to Hosp'l

Transfer to V. R. C.

Transportation

MAR 1864

Worcester Co

VOLUNTEER ENLISTMENT. Dist-8

STATE OF

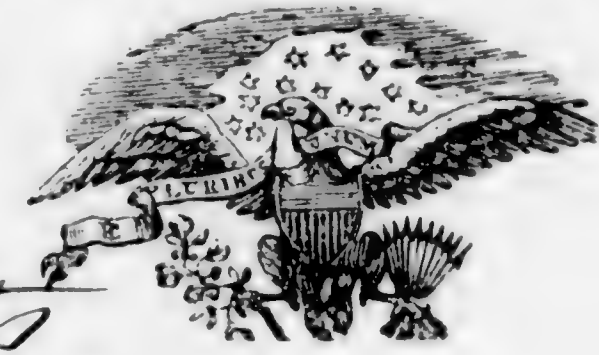

TOWN OF

Massachusetts

Charlton

the 21 day of June, 1864, at Boston

Mustered into the service of the United States, in Company

I, Henry Marand born in Oldham in the State of Kentucky aged Twenty eight years, and by occupation a Laborer Do HEREBY ACKNOWLEDGE to have volunteered this Twenty first day of June 1864 to serve as a Soldier in the Army of the United States of America, for the period of THREE YEARS, unless sooner discharged by proper authority: Do also agree to accept such bounty, pay, rations, and clothing, as are, or may be, established by law for volunteers. And I, Henry Marand do solemnly swear, that I will bear true faith and allegiance to the United States of America, and that I will serve them honestly and faithfully against all their enemies or opposers whomsoever; and that I will observe and obey the orders of the President of the United States, and the orders of the officers appointed over me, according to the Rules and Articles of War.

Sample

Sworn and subscribed to, at Boston this 21st day of June 1864 BEFORE J. M. ... Henry Marand

I CERTIFY, ON HONOR, That I have carefully examined the above-named Volunteer, agreeably to the General Regulations of the Army, and that, in my opinion, he is free from all bodily defects and mental infirmity, which would in any way disqualify him from performing the duties of a soldier.

J. B. ... M.D.

EXAMINING SURGEON.

I CERTIFY, ON HONOR, That I have minutely inspected the Volunteer, Henry Marand previously to his enlistment, and that he was entirely sober when enlisted; that, to the best of my judgment and belief, he is of lawful age; and that, in accepting him as duly qualified to perform the duties of an able-bodied soldier, I have strictly observed the Regulations which govern the recruiting service.

This soldier has Black eyes, Black hair, Copper complexion, is Five feet six inches high.

Regiment of ... Volunteers,

RECRUITING OFFICER.

Joseph W. Hathaway Chairman of Selectmen of Charlton

(A. G. O. No. 74 & 75.)

Vertical handwritten notes on the right side of the page, including 'C. C.', '5th Regiment of Massachusetts Volunteers, on', and 'Enclosed'.

NOTE 1.—This blank will be used for both enlistments and re-enlistments—enlistment of veterans, &c., &c., in the volunteer service. They will be made out in duplicate in all cases—one to accompany the recruiting return of the superintendent (not the recruiting officer) to the Adjutant-General, and one to accompany the accounts of the officer who pays bounty, &c. The Regiment and Company in which the soldier last served should be given on the back.

NOTE 2.—An enlistment holds to service. A muster-in must, in all cases, precede payment of pay, bounty, pension, &c. A muster-in roll must, in all cases, be filed in the Adjutant-General's Office as evidence of muster-in. The mustering officer, commissary, or assistant-commissary of musters, as the case may be, will countersign both enlistments as having mustered the soldier into the service of the United States before either of them is given to the disbursing officer.

APRIL 1895. This paper was formerly filed in the Enrollment Div. P. O.

DECLARATION OF RECRUIT.

Henry Marand desiring to VOLUNTEER as a Soldier in the Army of the United States, for the term of THREE YEARS, Do Declare, That I am *Twenty eight* years and _____ months of age; that I have never been discharged from the United States service on account of disability or by sentence of a court-martial, or by order before the expiration of a term of enlistment; and I know of no impediment to my serving honestly and faithfully as a soldier for three years.

GIVEN at *Boston* the *21st* day of *June 1864*

Witness: *George P. Towle*

Henry his Marand
mark

Discharged _____
Reg't of _____
enlistment; last served in Company () _____

Volunteered at *Worcester*
June 21 1864
By *Smith* Captain
Regiment of *Artillery*

No. _____
W. Hall, Secy

CONSENT IN CASE OF MINOR.

I, _____ Do CERTIFY, That I am _____ the _____ of _____; that the said _____ is _____ years of age; and I do hereby freely give my CONSENT to his volunteering as a SOLDIER in the ARMY OF THE UNITED STATES, for the period of THREE YEARS.

GIVEN at _____ the _____ day of _____

Witness: _____

MAR 7 1864

Worcester Co

VOLUNTEER ENLISTMENT.

List 8

STATE OF

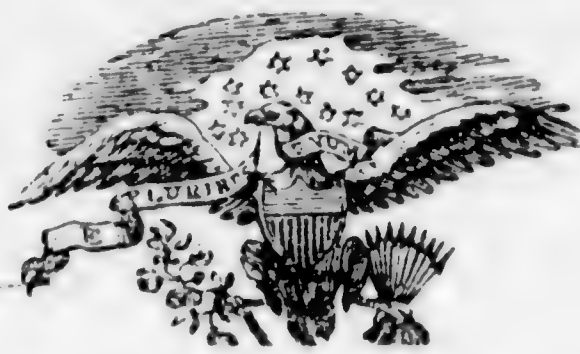

TOWN OF

Massachusetts

Charlton

I, *Henry Marand* born in *Oldham*
 in the State of *Kentucky* aged *Twenty eight* years,
 and by occupation a *Butcher* DO HEREBY ACKNOWLEDGE to have
 volunteered this *Twenty first* day of *June* 1864
 to serve as a Soldier in the Army of the United States of America, for the
 period of **THREE YEARS**, unless sooner discharged by proper authority: Do also
 agree to accept such bounty, pay, rations, and clothing, as are, or may be, estab-
 lished by law for volunteers. And I, *Henry Marand* do
 solemnly swear, that I will bear true faith and allegiance to the **United States**
of America, and that I will serve them honestly and faithfully against all their
 enemies or opposers whomsoever; and that I will observe and obey the orders of
 the President of the United States, and the orders of the officers appointed over
 me, according to the Rules and Articles of War.

Henry

Sworn and subscribed to, at *Boston*
 this *21st* day of *June* 1864 } *Henry Marand*
 BEFORE *J. M. [Signature]* } *maill*

I CERTIFY, ON HONOR, That I have carefully examined the above-named Volunteer, agreeably
 to the General Regulations of the Army, and that, in my opinion, he is free from all bodily defects and
 mental infirmity, which would in any way disqualify him from performing the duties of a soldier.

J. B. [Signature]
Ma.

EXAMINING SURGEON.

I CERTIFY, ON HONOR, That I have minutely inspected the Volunteer, *Henry Marand*
 previously to his enlistment, and that he was entirely sober when enlisted; that, to the best of my
 judgment and belief, he is of lawful age; and that, in accepting him as duly qualified to perform the duties
 of an able-bodied soldier, I have strictly observed the Regulations which govern the recruiting service.

This soldier has *Black* eyes, *Black* hair, *Copper* complexion, is *Five* feet
Six inches high.

Regiment of Volunteers,
 RECRUITING OFFICER.

(A. G. O. No. 74 & 75.)

7408

Joseph H. Hathaway Chairman
of Selectmen of Charlton

Mustered into the service of the United States, in Company
 the *21st* day of *June*, 1864, at *Boston*

10th Regiment of *Massachusetts* *Volunteers*, on
Recruiting

MUSTER AND DESCRIPTIVE ROLL—Continued.

No.	NAME.	RANK.	WHERE BORN.		AGE.	OCCUPATION.	ENLISTED.				EYES.	HAIR.	COMPLEXION.	HEIGHT. Feet. Inches.	MUSTERED INTO SERVICE (See Note 7.)			LAST PAID.		BOUNTY.		CLOTHING ACCOUNT.		DATE OF FIRST MUSTER.	NAME. (This column to be filled up by the officer in command of the detachment, and by the commanding officer of the post whenever necessary, and accompanied by the date and place of all deaths, transfers, discharges, desertions, and apprehensions, to be noted; also any other information which may be necessary for the records of the Adjutant General's Office.)	REMARKS.
			Town, County, or Province.	State, Empire, or Kingdom.			When.	Where. (Town and State).	By whom.	Period.					When.	Where.	By whom.	BY PAYMASTER.	TO WHAT TIME.	PAID.	DUE.	DATE OF LAST SETTLEMENT.	TOTAL MONEY VALUE OF CLOTHING DRAWN SINCE LAST SETTLEMENT.			
																				Dolls.	Dolls.					

RECAPITULATION.		Commissioned Officers.	Sergeants.	Corporals.	Minutemen.	Recruits.	THAT COMMISSIONED OFFICERS.	TOTAL ENLISTED.	AGGREGATE.
PRESENT	For duty.....								
	Sick.....								
	In arrest or confinement.....								
ABSENT	Left sick on the march.....								
	In arrest or confinement.....								
STRENGTH—PRESENT AND ABSENT.....									
ALTERATIONS ON THE MARCH.									
	Discharged.....								
	Transferred.....								
	Died.....								
	Deserted.....								
	Apprehended.....								

I CERTIFY, on honor, that this "Recapitulation," and the "Remarks" set opposite the names of this Detachment of _____ by me, are correct.

STATION: _____

DATE: _____

Commanding the Detachment.

RECORD OF EVENTS WHICH MAY BE USEFUL FOR FUTURE REFERENCE AT THE ADJUTANT GENERAL'S OFFICE.

I CERTIFY, ON HONOR, that this Muster and Descriptive Roll is correct, and that it exhibits the true statement of this Detachment of recruits and that the men have been duly examined and Mustered into Service of the United States for 3 years or during the War from date of enlistment in accordance with Mustering regulations.

STATION: Boston, Mass.

DATE: June 21, 22, 23, 24, 25, 28, 1864.

Capt. J. M. Gardner
Adjutant

This Detachment of recruits has been minutely inspected this 21, 22, 23, 24, 25 day of June 1864, by the undersigned, and the Surgeon of the Regt. agreeably to Regulations; and the recruits are found to be free from all bodily defects and mental infirmities which would in any way disqualify them from performing the duties of a Soldier.

STATION: Boston, Mass.

DATE: June 21, 22, 23, 24, 25, 28, 1864.

Examining Surgeon
Commanding

NOTE 2.—The commanding officer of the Detachment, after stating the results of the inspection, and referring to the report of the Board of Inspectors, should, if he has been found necessary to organize each Board, will add to his certificate such general remarks relative to the appearance, quality, &c., of the recruits, in his judgment, the facts may justify. He will also make out and retain a correct copy of this Muster and Descriptive Roll for the information of company commanders, and forward the original Roll, without delay, to the Adjutant General's Office.

NOTE 3.—Three copies of this Roll cannot be made out, one to be retained by the Adjutant General, and the third to accompany the Company's equipment, and the fifth to be retained by the Adjutant General, and the third to accompany the Company's equipment, and the fifth to be retained by the Adjutant General.

NOTE 4.—Men belonging to different Regiments will not, under any circumstances, be put upon the same Roll.

NOTE 5.—This Roll will be used for musters in Volunteers for old Volunteer Regiments, and for Musters and Descriptive Rolls for both Regulars and Volunteers. When used as Muster-in-Rolls, the mustering officer will add to his certificate that the men have been duly examined in accordance with the Mustering regulations, and distribute the Accusals as required for Muster-in-Rolls.

NOTE 7.—The columns under "Mustered into Service" will be left blank for men enlisted in the Regular Army.

1022

Moran, Warner

Co L, 5 Mass. Cav., (Col'd.)

Private

Private

CARD NUMBERS.

1	5384878	26
2	5384962	27
3	5385150	28
4	5385150	29
5	5385258	30
6	5385360	31
7	5385459	32
8	5385559	33
9	5385657	34
10	5385750	35
11	5385844	36
12	9091509	37
13	5385050	38
14	40731420	39
15		40
16		41
17		42
18		43
19		44
20		45
21		46
22		47
23		48
24		49
25		50

Card withdrawn and filed in packet of
Moon, Mills, where it properly belongs. J.H.V. Dec 12/95.

Book Mark:

See also

REP 364152. A.K.
S. 1265853 Pomeru

R/Mallen
4

No.

5 Cav. (Col'd.)

Mass.

Warner Morem.

G., Co. *G.*, 5 Reg't Mass. Cav. (Col'd.)

Appears on

Company Descriptive Book

of the organization named above.

DESCRIPTION.

Age *35* years; height *5* feet *5* inches.

Complexion *Black.*

Eyes *Black*; hair *Black.*

Where born *King Willm Co. Va.*

Occupation *Teamster.*

ENLISTMENT.

When *April 11*, 186*1*.

Where *Duxbury.*

By whom *G. F. Wilson*; term *3* y'rs.

Remarks: *Mustered into service at
Needville Mass. Apr. 22/61 by Lieut.
McKibben. Free Apr. 19/61.*

H. C. Thomas.

M | 5 Col'd Cav. | Mass.

Warner Moran

Priv., Co. L, 5 Reg't Mass. Col'd Cav.

Appears on

Company Muster-in and Descriptive Roll
of the organization named above. Roll dated

Readville Mass, Apl. 22, 1864.

Where born King Williams Co. Va.

Age 35 y'rs; occupation Teamster

When enlisted April 11, 1864.

Where enlisted Dorchester

For what period enlisted 3 years.

Eyes Black; hair Black

Complexion Black; height 5 ft. 5 in.

When mustered in Apl. 22, 1864.

Where mustered in

Bounty paid \$ 100; due \$ 100

Where credited 2 Cong. Dist. Mass.

Company to which assigned

Remarks:

Book mark:

Crewshaw

(356d)

Copyist.

M | **5 Col'd Cav.** | **Mass.**

Warner Moren
Pvt, Co. L, 5 Reg't Mass. Col'd Cavalry.

Appears on

Company Muster Roll

for *Apr. 22 to 30*, 186*4*.

Present or absent *Present*

Stoppage, \$.....*100* for

Due Gov't, \$.....*100* for

Valuation of horse, \$.....*100*

Valuation of horse equipments, \$.....*100*

Remarks:.....

Book mark:.....

Overshaw

(358)

Copyist.

M | **5 Col'd Cav.** | **Mass.**

Warner Moran
Pvt, Co. L, 5 Reg't Mass. Col'd Cavalry.

Appears on

Company Muster Roll

for *May & June*, 186*4*.

Present or absent *Present*

Stoppage, \$ *100* for

Due Gov't, \$ *100* for

Valuation of horse, \$ *100*

Valuation of horse equipments, \$ *100*

Remarks: *Daily Duty*
Co. Cook.

Book mark:

Crewshaw

(358)

Copyist.

M | **5 Col'd Cav.** | **Mass.**

Warner Moran
Pvt, Co. L, 5 Reg't Mass. Col'd Cavalry.

Appears on

Company Muster Roll
for July & Aug., 1864.
Present or absent Present

Stoppage, \$.....100 for

Due Gov't, \$.....100 for

Valuation of horse, \$.....100

Valuation of horse equipments, \$.....100

Remarks:

Book mark:

Crewshaw

(358)

Copyist.

M. | 5 Col'd Cav. | Mass.

Warner Morant

Priv, Co. L, 5 Reg't Mass. Col'd Cavalry.

Appears on

Company Muster Roll

for Sept + Oct, 1864.

Present or absent Present

Stoppage, \$ 100 for

Due Gov't, \$ 100 for

Valuation of horse, \$ 100

Valuation of horse equipments, \$ 100

Remarks:

Book mark:

(358)

J. M. Vance

Copyist.

M | **5 Col'd Cav.** | **Mass.**

Warner Moran

Sgt, Co. L, 5 Reg't Mass. Col'd Cavalry.

Appears on

Company Muster Roll

for *Nov. & Dec*, 1864.

Present or absent *Present*

Stoppage, \$ *100* for

Due Gov't, \$ *100* for

Valuation of horse, \$ *100*

Valuation of horse equipments, \$ *100*

Remarks: *Due 1/2 of Ord.
Stores 9 cts.*

Book mark:

(358)

J. M. Hance

Copyist.

M. | **5 Col'd Cav.** | **Mass.**

Harner Massey

Sgt., Co. L, 5 Reg't Mass. Col'd Cavalry.

Appears on

Company Muster Roll

for *Jan 1 1864*, 186*4*.

Present or absent *Present*

Stoppage, \$ *100* for

Due Gov't, \$ *100* for

Valuation of horse, \$ *100*

Valuation of horse equipments, \$ *100*

Remarks: *Due 1/1 1864*

His bounty \$ 20.00

Due wife of 1/1 1864

Book mark:

(358)

J. M. H. [Signature]

Copyist.

M | **5 Col'd Cav.** | **Mass.**

Harvey Merrett

Sgt, Co. L, 5 Reg't Mass. Col'd Cavalry.

Appears on

Company Muster Roll

for *March & April*, 186*5*.

Present or absent *Present*

Stoppage, \$ *100* for

Due Gov't, \$ *100* for

Valuation of horse, \$ *100*

Valuation of horse equipments, \$ *100*

Remarks: *Due to maintenance of Upper Bowels &c.*

Book mark:

(358)

J. M. Hance
Copyist.

M | 5 Col'd Cav. | Mass.

Warner Moran

Sgt., Co. L, 5 Reg't Mass. Col'd Cavalry.

Appears on

Company Muster Roll

for May 4 June 1, 1865.

Present or absent Present

Stoppage, \$ 100 for

Due Gov't, \$ 100 for

Valuation of horse, \$ 100

Valuation of horse equipments, \$ 100

Remarks: Due 1st installment
of \$100 on 25th June
Copied Sept 19 61

Book mark:

(358) J. M. Hance Copyist.

M | 5 Cold. Cav. Mass

Walter Moran

Pvt, Co. L, 5 Reg't Mass. Cold. Cav.

Appears on

Company Muster Roll

for July & Aug, 1865.

Present or absent Absent

Stoppage, \$ 1.00 for

Due Gov't, \$ 1.00 for

Remarks: Sick at Buzze since Aug. 12. Recd U.S. for ord. stores 36cts for C. H. E. \$5.85. Free Apr. 19. 61.

Book mark:

E. P. Main

(358)

Comptroller

M. | 5 Col'd Cav. | Mass.

Warner Moran

Priv., Co. L, 5 Reg't Mass. Colored Cav.

Appears on Returns as follows:

May & June 1864. Co. cook.

Aug. & Sept. 1865. Absent sick
in Hosp. at Brazos.

Book mark :

(548)

J. B. Sittler

Copyist.

H | **5 Col'd Cav.** | **Mass.**

William Sherman
Co. A, 5 Reg't Mass. Col'd Cavalry.

Appears on **Co. Muster-out Roll**, dated
Sept 31, 186³.

Muster-out to date *Sept 31*, 186³.

Last paid to *Dec 31*, 186⁴.

Clothing account:

Last settled....., 186 ; drawn since \$..... 100

Due soldier \$ *27*²³ 100; due U. S. \$..... 100

Am't for cloth'g in kind or money adv'd \$..... 100

Due U. S. for arms, equipments, &c., \$ *1100* 100

Bounty paid \$..... 100; due \$ *1000* 100

Remarks: *Wm Sherman*

Co. A 5th Regt Mass Cavalry
mustered out for Co. A
Sept 31 1863
paid to him

Book mark: *V. 115, P. 367, 704 P. 18, P. 8, 71*

* *Invented by compiler.*

[Signature]

1023

Morgan, John C.
Co E, 5 Mass. Cav., (Col'd.)

Private

Private

CARD NUMBERS.

1	5378134	26
2	5378220	27
3	5378331	28
4	5373084	29
5	5379290.	30
6	9092218	31
7		32
8		33
9		34
10		35
11		36
12		37
13		38
14		39
15		40
16		41
17		42
18		43
19		44
20		45
21		46
22		47
23		48
24		49
25		50

Book Mark:

See also

4777 1864
H. 5 Cav. (Col'd.) | Mass.

John C. Morgan
Co. E, 5 Reg't Mass. Cav. (Col'd.)

Appears on
Company Descriptive Book
of the organization named above.

DESCRIPTION.

Age 22 years; height 5 feet 7 inches.
Complexion Blk
Eyes Brown; hair Blk
Where born Lancaster, Penna.
Occupation Bomber.

ENLISTMENT.

When Jan 23, 1864
Where Lancaster
By whom John Kimball; term 3 yrs.
Remarks: Married.
Discharged April 20, 1864.

H. C. C. C.

M | **5 Col'd Cav.** | **Mass.**

John C. Morgan
Privt., Co. *E*, 5 Reg't Mass. Col'd Cav.

Appears on

Company Muster-in and Descriptive Roll
of the organization named above. Roll dated

Seabrook, Mass, Feby 10, 1864.

Where born *Lancaster, Pennsylvania*

Age *32* yrs; occupation *Barber*

When enlisted *Jan 23*, 1864.

Where enlisted *Easton.*

For what period enlisted *3* years.

Eyes *black*; hair *black*

Complexion *black*; height *5 ft 7/2 in.*

When mustered in *Feby 10*, 1864.

Where mustered in

Bounty paid \$ *100*; due \$ *100*

Where credited *West Bristol.*

Company to which assigned

Remarks:

Book mark:

[Signature]

(356d) Copyist.

M

5 Col'd Cav.

Mass.

John C. Morgan

Pvt, Co. E, 5 Reg't Mass. Col'd Cavalry.

Appears on

Company Muster Roll

for *Enlistment to 29 Feby*, 186*4*.

Present or absent... *Absent*

Stoppage, \$..... 100 for

Due Gov't, \$..... 100 for

Valuation of horse, \$..... 100

Valuation of horse equipments, \$..... 100

Remarks: *Absent with
unleave,
Due him a f. pre
mium of 2.00*

Book mark:

Norman

(358)

Copyist.

M 5 Col'd Cav. Mass.

John C. Morgan
Capt, Co. E, 5 Reg't Mass. Col'd Cavalry.

Appears on

Company Muster Roll

for Mich & Apl, 1864

Present or absent

Stoppage, \$ 100 for

Due Gov't, \$ 100 for

Valuation of horse, \$ 100

Valuation of horse equipments, \$ 100

Remarks:

Defective

Book mark:

M | **5 Col'd Cav.** | **Mass.**

John C. Morgan
Lieut., Co. *E*, 5 Reg't Mass. Col'd Cavalry.

Appears on **Co. Muster-out Roll**, dated
Clarksville, Tex., Feb 21, 1865.

Muster-out to date _____, 186 .
Last paid to _____, 186 .

Clothing account:

Last settled _____, 186 ; drawn since \$ _____ 100
Due soldier \$ _____ 100; due U. S. \$ _____ 100
Am't for cloth'g in kind or money adv'd \$ _____ 100

Due U. S. for arms, equipments, &c., \$ _____ 100

Bounty paid \$ _____ 100; due \$ _____ 100

Remarks: *Discharged April 2/64.*

Book mark: _____

(361)

[Signature]
Copyist.

1024

Morgan, Josiah J. P.
Co. G, 5 Mass. Cav., (Col'd.)

Private | Private

CARD NUMBERS.

1	5372630	26
2	5372624	27
3	5381113	28
4	5381215	29
5	5381316	30
6	5381411	31
7	5381509	32
8	9092016	33
9	9436199	34
10	40731421	35
11		36
12		37
13		38
14		39
15		40
16		41
17		42
18		43
19		44
20		45
21		46
22		47
23		48
24		49
25		50

Book Mark:

See also

M

5 Cav. (Col'd.) | Mass.

Josiah J. B. Morgan

Co. G, 5 Reg't Mass. Cav. (Col'd.)

Appears on

Company Descriptive Book

of the organization named above.

DESCRIPTION.

Age 38 years; height 5 feet 9 inches.

Complexion dark

Eyes blue; hair blk.

Where born Baltimore Md.

Occupation Seaman.

ENLISTMENT.

When Jan 2, 1865.

Where Boston

By whom Capt Howe; term 1 y'rs.

Remarks: Mustered by Capt Dyer Jan 2/65 at Boston.

Bounty paid 33.33 due 66.67
Died in post Hospital Brazos Texas
Oct. 6/65. of Chronic Diarrhoea
Final papers furnished.

Heard

11 | 5th | 5th | Mass.

Joseph B. Morgan

....., Co....., 5th Reg't Mass Col'd 5th Cal.

Appears on

Regimental Descriptive Book

of the organization named above.

DESCRIPTION.

Age 38 years; height 5 feet 9 inches.

Complexion Dark

Eyes Blue; hair Black

Where born Baltimore, Md.

Occupation Seaman.

ENLISTMENT.

When Jan. 2, 1865

Where Boston

By whom Capt. [unclear]; term 1 y'rs.

Remarks: Mustered in Jan. 2, 1865
Discharged

[Signature]

M | **5 Col'd Cav.** | **Mass.**

Josiah J. B. Morgan

Appears with rank of _____ on

Muster and Descriptive Roll of a Detachment of U. S. Vols. forwarded

for the 5 Reg't Mass. Col'd Cavalry. Roll dated
Boston Mass. Jan. 21, 1865.

Where born *Baltimore Md.*

Age *38* y'rs; occupation *Seaman*

When enlisted *Jan. 21, 1865.*

Where enlisted *Boston Mass.*

For what period enlisted *1* years.

Eyes *blk*; hair *blk*

Complexion *Dr*; height *5 ft. 9 in.*

When mustered in *Jan. 21, 1865.*

Where mustered in *Boston*

Bounty paid \$ *33 ³³/₁₀₀*; due \$ *66 ⁶⁷/₁₀₀*

Where credited *Dracut Mass.*

Company to which assigned _____

Remarks: _____

Book mark: _____

M. A. Michaels

M | **5 Col'd Cav.** | **Mass.**

Zosiah J. B. Morgan
Pvt., Co. G, 5 Reg't Mass. Col'd Cavalry.

Appears on

Company Muster Roll

for *Jan & Feb*, 1865.

Present or absent *Present*

Stoppage, \$ *100* for

Due Gov't, \$ *100* for

Valuation of horse, \$ *100*

Valuation of horse equipments, \$ *100*

Remarks:

Book mark:

(358)

Perry

Copyist.

M | 5 Col'd Cav. | Mass.

Josiah J. B. Morgan
Co. G, 5 Reg't Mass. Col'd Cavalry.

Appears on

Company Muster Roll

for *March & April*, 1865.

Present or absent *Present*

Stoppage, \$ 100 for

Due Gov't, \$ 100 for

Valuation of horse, \$ 100

Valuation of horse equipments, \$ 100

Remarks:

Book mark:

(358)

Cerry

Copyist.

M

5 Col'd Cav.

Mass.

Josiah J. B. Morgan
Prü, Co. G, 5 Reg't Mass. Col'd Cavalry.

Appears on

Company Muster Roll

for *May & June*, 1865.

Present or absent *Present*

Stoppage, \$ 100 for

Due Gov't, \$ 100 for

Valuation of horse, \$ 100

Valuation of horse equipments, \$ 100

Remarks:

Book mark:

Perry

(358)

Copyist.

M

5 Col'd Cav.

Mass.

Joseph J. Morgan
Priv., Co. G, 5 Reg't Mass. Col'd Cavalry.

Appears on

Company Muster Roll

for *July & Aug*, 186*0*.

Present or absent *Absent*

Stoppage, \$ *100* for

Due Gov't, \$ *100* for

Valuation of horse, \$ *100*

Valuation of horse equipments, \$ *100*

Remarks: *Absent sick at
Brazer's, Mass since
Aug 4th '60*

Book mark: _____

Wm Scott

M. | 5 Col'd Cav. | Mass.

Josiah J. B. Morgan
Pvt., Co. G, 5 Reg't Mass. Colored Cav.

Appears on Returns as follows:

Feb. 1865; Gain Feb. 23/65
Pt. Lookout - Recruit
from Depot.

Aug. & Sept. 1865. Absent sick
at Brazos, Post Hosptl
since Aug. 4/65.

Book mark :

(648)

J. B. Sittler

Copyist.

M

5 Col'd Cav.

Mass.

Josiah J. Morgan
Pri., Co. G, 5 Reg't Mass. Col'd Cavalry.

Appears on Co. Muster-out Roll, dated

Chathamville Tex, Oct 31, 1864.

Muster-out to date _____, 186 .

Last paid to *pay due from Enroll*, 186 .

Clothing account:

Last settled _____, 186 ; drawn since \$ _____ 100

Due soldier \$ *21*²⁰ 100; due U. S. \$ _____ 100

Am't for cloth'g in kind or money adv'd \$ _____ 100

Due U. S. for arms, equipments, &c., \$ _____ 100

Bounty paid \$ *33*³³ 100; due \$ *33*³³ 100

Remarks: *Disin. Tol*

*Hospital Prizes
Texas Cert. No 11
Chronic Diarrhea Recd
Notification after rolls were
made out Final*

Book mark: *In List 177, 258*

(over)

Wm. Scott

(361)

Copyist.

JAN. 10

5381509

1891 ☆

statements forwarded

B.M. Viri. Proj. 71

1188 P 151. 71

Morgan, Josiah B.
Co. G, 5 Reg't Mass'ns

3 Enclosures.

Bed Cards	Final Statements
Burial Records	Furloughs or L. of A
Certs. of Dis. for Discharge	Med. Certificates
C. M. Charges	Med. Des. Lists
Descriptive Lists	Orders
Discharge Certificates	Pris. of War Record
Enlistment Papers	Resignations

Other papers relating to—

Admission to Hosp'l	Furlough or L. of A
Casualty Sheet	Med. Examination
Confinement	Misc. Information
Contracts	Pay or Clothing
Death or Effects	Personal Reports
Desertion	Rank
Discharge from Hosp'l	Transfer to Hosp'l
Discharge from Service	Transfer to V. R. C.
Duty	Transportation

NOTE 1. — This blank will be used for both enlistments and re-enlistments — enlistment of veterans, &c., &c., in the volunteer service. They will be made out in duplicate in all cases — one to accompany the recruiting return of the superintendent (not the recruiting officer) to the Adjutant-General, and one to accompany the accounts of the officer who pays bounty, &c. The Regiment and Company in which the soldier last served should be given on the back.

NOTE 2. — An enlistment holds to service. A muster-in must, in all cases, precede payment of pay, bounty, pension, &c. A muster-in roll must, in all cases, be filed in the Adjutant-General's Office as evidence of muster-in. The mustering officer, commissary, or assistant-commissary of musters, as the case may be, will countersign both enlistments as having mustered the soldier into the service of the United States before either of them is given to the disbursing officer.

DECLARATION OF RECRUIT.

I, Wm. B. Wagner desiring to VOLUNTEER as a Soldier in the Army of the United States, for the term of ~~2~~ 3 YEARS, Do Declare, That I am 27 years and 0 months of age; that I have never been discharged from the United States service on account of disability or by sentence of a court-martial, or by order before the expiration of a term of enlistment; and I know of no impediment to my serving honestly and faithfully as a soldier for 3 years.

GIVEN at 31 the 10th day of April

Witness: Wm. B. Wagner

By W. B. Howell 1885
 In 5th Regiment of Mass. Cav.
 Volunteered at Worcester, Mass.
 No. 1000
 Discharged 18
 Reg't of 5th
 enlistment; last served in Company ()
Wm. B. Wagner
31.5.85

CONSENT IN CASE OF MINOR.

I, _____ Do CERTIFY, That I am _____; that the _____ of _____; that the said _____ is _____ years of age; and I do hereby freely give my CONSENT to his volunteering as a SOLDIER in the ARMY OF THE UNITED STATES for the period of THREE YEARS.

GIVEN at _____ the _____ day of _____

Witness: _____

VOLUNTEER ENLISTMENT.

STATE OF

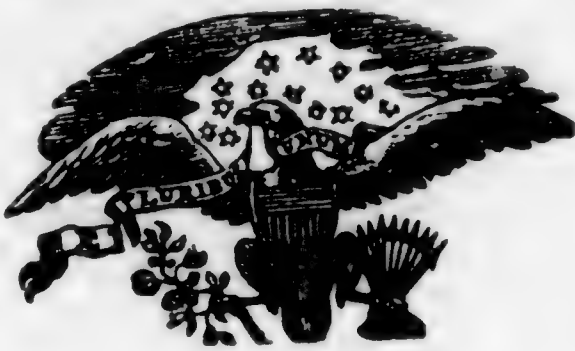

OF

I, *George W. Rice* born in *Georgetown* in the State of *Massachusetts* aged *21* years, and by occupation a *Farmer* DO HEREBY ACKNOWLEDGE to have volunteered this *10th* day of *September* 186*2*, to serve as a **Soldier** in the Army of the United States of America, for the period of ~~1~~ **YEAR**, unless sooner discharged by proper authority: Do also agree to accept such bounty, pay, rations, and clothing, as are, or may be, established by law for volunteers. And I, *George W. Rice* do solemnly swear, that I will bear true faith and allegiance to the **United States of America**, and that I will serve them honestly and faithfully against all their enemies or opposers whomsoever; and that I will observe and obey the orders of the President of the United States, and the orders of the officers appointed over me, according to the Rules and Articles of War.

Sworn and subscribed to, at *Georgetown* this *10th* day of *September* 186*2*, BEFORE *R. F. Rice*

I CERTIFY, ON HONOR, That I have carefully examined the above-named Volunteer, agreeably to the General Regulations of the Army, and that, in my opinion, he is free from all bodily defects and mental infirmity, which would in any way disqualify him from performing the duties of a soldier.

J. O. Boardman

EXAMINING SURGEON.

I CERTIFY, ON HONOR, That I have minutely inspected the Volunteer, *George W. Rice* previously to his enlistment, and that he was entirely sober when enlisted; that, to the best of my judgment and belief, he is of lawful age; and that, in accepting him as duly qualified to perform the duties of an able-bodied soldier, I have strictly observed the Regulations which govern the recruiting service.

This soldier has *Blue* eyes, *Black* hair, *Fair* complexion, is *5* feet *10* inches high.

W. L. Howe
Capt. & Prov. Mgr. 4th Mass. Dist. *Volunteer*

RECRUITING OFFICER.

Mustered into the service of the United States, in Company *1st* the *10th* day of *September*, 186*2*, at *Georgetown*
Regiment of *1st* *Mass. Dist. Volunteers*, on *10th*

March 1895

NOTE 1. — This blank will be used for both enlist and re-enlistments — enlistment of veterans, &c., &c., in the volunteer service. They will be made out in duplicate in all cases — one to accompany the recruiting return of the subndent (not the recruiting officer) to the Adjutant-General, and one to accompany the accounts of the officer who pays bounty, &c. The Regiment and Company in which the last served should be given on the back.

NOTE 2. — An enlistment holds to service. A must, in all cases, precede payment of pay, bounty, pension, &c. A muster-in roll must, in all cases, be filed in the Adjutant-General's Office as evidence of muster-in. Muster officer, commissary, or assistant-commissary of musters, as the case may be, will countersign both enlistments as having mustered the soldier into the service of the United States before either of them is given to the disbursing officer.

DECLARATION OF RECRUIT.

I, *Joseph B. Warren*, desiring to VOLUNTEER as a Soldier in the Army of the United States, for the term of ~~2~~ YEARS, Do Declare, That I am *thirty eight* years and ~~0~~ months of age; that I have never been discharged from the United States service on account of disability or by sentence of a court-martial, or by order before the expiration of a term of enlistment; and I know of no impediment to my serving honestly and faithfully as a soldier for ~~2~~ years.

GIVEN at *Boston* the *10th* day of *March* 1895.

Witness: *C. B. Chase* *Joseph B. Warren*

April 1895. This paper was previously filed in the Enrollment Office, A. P. O.

433 33 Bounty Paid

Discharged *18*

Reg't of

enlistment; last served in Company ()

By

J. B. Warren
Regiment of *Mass Cav*

Volunteered at

No.

CONSENT IN CASE OF MINOR.

I, _____ Do CERTIFY, That I am the _____ of _____; that the said _____ is _____ years of age; and I do hereby freely give my CONSENT to his volunteering as a SOLDIER in the ARMY OF THE UNITED STATES for the period of THREE YEARS.

GIVEN at _____ the _____ day of _____

Witness: _____

NARA 1986

VOLUNTEER ENLISTMENT.

STATE OF



OF

Massachusetts

City of Boston

I, *Frederic B. Madden* born in *Baltimore* in the State of *Maryland* aged *thirty-eight* years, and by occupation a *Seaman* DO HEREBY ACKNOWLEDGE to have volunteered this *second* day of *August* 186*1*, to serve as a Soldier in the Army of the United States of America, for the period of ~~two~~ *YEARS*, unless sooner discharged by proper authority: Do also agree to accept such bounty, pay, rations, and clothing, as are, or may be, established by law for volunteers. And I, *Frederic B. Madden* do solemnly swear, that I will bear true faith and allegiance to the United States of America, and that I will serve them honestly and faithfully against all their enemies or opposers whomsoever; and that I will observe and obey the orders of the President of the United States, and the orders of the officers appointed over me, according to the Rules and Articles of War.

Sworn and subscribed to, at

this *second* day of *August* 186*1*.

BEFORE

Boston
Robert Keyes

I CERTIFY, ON HONOR, That I have carefully examined the above-named Volunteer, agreeably to the General Regulations of the Army, and that, in my opinion, he is free from all bodily defects and mental infirmity, which would in any way disqualify him from performing the duties of a soldier.

EXAMINING SURGEON.

I CERTIFY, ON HONOR, That I have minutely inspected the Volunteer, previously to his enlistment, and that he was entirely sober when enlisted; that, to the best of my judgment and belief, he is of lawful age; and that, in accepting him as duly qualified to perform the duties of an able-bodied soldier, I have strictly observed the Regulations which govern the recruiting service.

This soldier has *blue* eyes, *black* hair, *fair* complexion, is *5* feet *7* inches high.

W. F. Howe
Capt. & Adj. Gen.
4th Mass. Dist.

Volunteers,
RECRUITING OFFICER.

(A. G. O. No. 74 & 75.)

15-91

the *second* day of *August* 186*1*, at *Boston*

Mustered into the service of the United States, in Company *B*

Regiment *1st*

Volunteers, on

Frederic B. Madden
Company B
1st Regt. Mass. Volunteers
Adj. Gen. W. F. Howe

*W. H. Lee 24/11
1862*

FINAL STATEMENT

OF

Joseph B. Morgan
5th Reg't of *Mass Cav*

VOLUNTEERS.

NOTE 1.—Two of these certificates (or duplicates) are to be given to each Volunteer Soldier or drafted man who may be discharged previously to the discharge of his company, that he may at once receive from the Paymaster the pay, &c., due him, and the captain or other COMMISSIONED officer commanding the company will certify to the act of the delivery of the duplicate certificates, on these certificates the Soldier is entitled to his discharge, and should also present his discharge to the Paymaster to have the payment endorsed on it. The discharge is to be given back to the Soldier by the Paymaster; the latter only retaining as his voucher the duplicate certificates.

NOTE 2.—If the Soldier is entitled to pay for the use of his horse, the Company Commander will certify to that fact on the back of both these final statements, and also to the time he has pay due for having been so mounted on his own horse.

NOTE 3.—When a Soldier is furnished with final statements, his descriptive list, if he has one, should be taken up by the officer who gives the Soldier these statements, and endorsed with a statement to this effect by the officer. This endorsement should exhibit a full statement of the time for which the Soldier was allowed pay on his final statements, the clothing account, and all other charges against him or in his favor, so as to comprise a complete exhibit of his account. It will then be transmitted to the company commander of the Soldier, who will enter all the data necessary to a full understanding of the Soldier's account on the muster roll upon which the Soldier's discharge is reported. The descriptive list will then be destroyed. The object of this is, that the remaining portion of the Soldier's account may be settled upon the receipt of these muster rolls, and the Soldier receive any pay or allowances that may be due him at the time of his discharge, and which may not appear on his final statements from the fact that his descriptive list is incomplete. These accounts for back pay, &c., are settled by the 2d Auditor of the Treasury Department.

NOTE 4.—Charges for loss or injury to ordnance, horse equipments, and other miscellaneous charges, should appear under the heading of "Other Stoppages."

NOTE 5.—Bounty paid by State authorities, and not by the United States, will not be entered on this statement.

NOTE 6.—Amounts due the Sutler and Laundress must be entered on the muster roll on which the discharge, death, desertion, &c., is reported, as well as on the final statement, otherwise the amount cannot be collected from the United States.

NOTE 7.—This blank will be used for deceased volunteers and drafted men, as well as for others.

NOTE 8.—Where a Soldier dies in Hospital or on detached service, his descriptive list, if he has one, should be sent with his final statements, in duplicate, to the Adjutant General, Washington, D. C.

ADJUTANT GENERAL'S OFFICE

Nov 3 1862

Duplicate with inventory for 2d Auditor.

Joseph B. Morgan

I certify, on honor, that Joseph J. B. Morgan a Private of
 Captain H. W. Clark Company (9) of the 5th Regiment of Canaloz
VOLUNTEERS, of the State of Massachusetts, born in Baltimore, State
 of Maryland, aged 38 years; 5 feet 9 inches high; dark complexion,
blue eyes, black hair, and by occupation a Seaman, having joined the company on
 its original organization at _____, and enrolled in it at the muster into
 the service of the United States at _____, on the _____ day
 of _____, 186 _____, (or was mustered in service as a recruit, by Capt. Seymour
 _____, at Boston, on the second day of January,
 186 _____; or was drafted and mustered into the service of the United States from the _____
 Enrollment District of the State of _____, at _____,
 on the _____ day of _____, 186 _____,) to serve in the Regiment, for
 the term of one year: and having served **HONESTLY** and
FAITHFULLY with his Company in U. S. Service to the present date, is now
 entitled to a **DISCHARGE** by reason of Death, West Point Hospital Boston
Gen. Case Chronic Pirrhemia, Date October 6th 1865

The said Joseph J. B. Morgan was last paid by Paymaster
Wm. P. D. Smith the _____ day of _____, 186 _____, and has
 pay due him from that time to the present date; he is entitled to pay and subsistence for
TRAVELING to place of enrollment, and whatever other allowances are authorized to volunteer
 soldiers, drafted men, or militia, so discharged. He has received from the United States **CLOTHING**
 amounting to Twenty Six $\frac{26}{100}$ dollars, since the Date of day of Enrollment
 186 _____, when his clothing account was last settled. He has received from the United States
83.33 $\frac{33}{100}$ dollars advanced **BOUNTY**. Due \$ 33.33

There is to be stopped from him, on account of the State of _____, or other
 authorities, for **CLOTHING**, &c., received on entering service, _____ $\frac{100}{100}$ dollars; and
 for other stoppages, viz: _____

_____ $\frac{100}{100}$ dollars.
 He has been furnished with **TRANSPORTATION** in kind from the place of his discharge to
 _____; and he has been **SUBSISTED** for **TRAVELING** to his
 place of enrollment, up to the _____, 186 _____.

He is indebted to _____, **BUTLER**, _____ $\frac{100}{100}$ dollars.

He is indebted to _____, **LAUNDRESS**, _____ $\frac{100}{100}$ dollars.

Given in Duplicate, at Clarksville Texas, this 11th day
 of October, 186 _____.

H. W. Clark

Capt 5th Mass Cav
 Commanding Company

Effect

1023

Morgan, William A.

Co. B, 5 Mass. Cav., (Col'd.)

Private

Private

CARD NUMBERS.

1	5375732	26
2	5375821	27
3	5375929	28
4	5376880	29
5	9092429	30
6	40731422	31
7		32
8		33
9		34
10		35
11		36
12		37
13		38
14		39
15		40
16		41
17		42
18		43
19		44
20		45
21		46
22		47
23		48
24		49
25		50

Book Mark:

See also

M 5 Cav. (Col'd.) | Mass.

William Henry Morgan
Co. C, 5 Reg't Mass. Cav. (Col'd.)

Appears on

Company Descriptive Book
of the organization named above.

DESCRIPTION.

Age 27 years; height 5 feet $\frac{1}{2}$ inches.

Complexion Colored

Eyes Black; hair Black

Where born Cumberland Co. N.C.

Occupation Laborer

ENLISTMENT.

When Jan 8, 1864.

Where Gardner

By whom Lewis S. Gates; term 3 y'rs.

Remarks: Mustered into Company C
Jan 29 1864 at Readville Mass
by Lieut McKibbin
Discharged from Readville Mass
July 24. 1864

W. | **5 Col'd Cav.** | **Mass.**

William H. Morgan.
Co. C, 5 Reg't Mass. Col'd Cav.

Appears on

Company Muster-in and Descriptive Roll
of the organization named above. Roll dated

Wadville, *Jan. 29*, 1864.

Where born *Cumberland Co. Md.*

Age *27* y'rs; occupation *Labourer.*

When enlisted *Jan. 5*, 1864.

Where enlisted *Gardner.*

For what period enlisted *3* years.

Eyes *Black*; hair *Black*

Complexion *Black*; height *5 ft. 6 1/2 in.*

When mustered in *Jan. 29*, 1864.

Where mustered in

Bounty paid \$ *100*; due \$ *100*

Where credited *9th Dist. Worcester.*

Company to which assigned

Remarks:

Book mark:

Sitter.

M. | 5 Col'd Cav. | Mass.

William H. Morgan
Priv., Co. C, 5 Reg't Mass. Col'd Cavalry.

Appears on

Company Muster Roll

for *Enlistment to Feb. 29, 1864.*

Present or absent *Absent.*

Stoppage, \$ *100* for

Due Gov't, \$ *100* for

Valuation of horse, \$ *100*

Valuation of horse equipments, \$ *100*

Remarks: *Absent without leave, since Feb. 25th*

Book mark: _____

Sitter.

Ms. | **5** Col'd Cav. | **Mass.**

William H. Morgan.
Private, Co. C, 5 Reg't Mass. Col'd Cavalry.

Appears on

Company Muster Roll

for *Mar. & Apr.*, 1864.

Present or absent.....

Stoppage, \$..... 100 for.....

Due Gov't, \$..... 100 for.....

Valuation of horse, \$..... 100

Valuation of horse equipments, \$..... 100

Remarks: *Discharged April*
1, 1864. Never paid.

Book mark:.....

Sitter.

M. | 5 Col'd Cav. | Mass.

William H. Morgan
Priv., Co. C, 5 Reg't Mass. Colored Cav.

Appears on Returns as follows:

Feb. & Mar, 1864, Absent
without leave.

Apr. 1864. Lost Apr. 1 Camp
Meigs - Deserted.

Book mark :

(646)

J. B. Sittler

Copyist.

M | 5 Col'd Cav. | Mass.

William Morgan

Pvt, Co. C, 5 Reg't Mass. Col'd Cavalry.

Appears on Co. Muster-out Roll, dated
Clarksville Texas, Oct 31, 1865.

Muster-out to date _____, 186 .

Last paid to _____, 186 .

Clothing account:

Last settled _____, 186 ; drawn since \$ _____ 100

Due soldier \$ _____ 100; due U. S. \$ _____ 100

Am't for cloth'g in kind or money adv'd \$ _____ 100

Due U. S. for arms, equipments, &c., \$ _____ 100

Bounty paid \$ _____ 100; due \$ _____ 100

Remarks: Deserted from Readville
Mass Feb 24-64

Book mark : _____

Abbott

Morris, Henry

Co A, 5 Mass. Cav., (Col'd.)

Private

Private

CARD NUMBERS.

1	5381608	26
2	5381697	27
3	5381783	28
4	5381880	29
5	5381987	30
6	5382092	31
7	5382196	32
8	5382296	33
9	5382394	34
10	5382488	35
11	5382584	36
12	5372891	37
12	9091824	38
14	m-20-07-1871	39
15	33031340	40
16	40731423	41
17		42
18		43
19		44
20		45
21		46
22		47
23		48
24		49
25		50

Book Mark: 653. V. 11. p 74. + Ab-20-Vol 9-65-71

See also

MAR 1957

P.O. 5m 45m. 9/30/31-ars
A.G. 201. 7/31/35-

R/mack
4

No. **5 Cav. (Col'd.)** | **Mass.**

Henry Morris.

....., Co. *H*., 5 Reg't Mass. Cav. (Col'd.)

Appears on

Company Descriptive Book
of the organization named above.

DESCRIPTION.

Age *25* years; height *5* feet *4* inches.

Complexion *Dark.*

Eyes *Dark* ; hair *Black*

Where born *Harrison Co., Va.*

Occupation *Farmer.*

ENLISTMENT.

When *Mar. 4*" , 1864.

Where *Boston, W. 9.*

By whom *L. M. Standish* ; term *3* y'rs.

Remarks: *Murdered in at Readville*
Mar. 12 '64.

H. C. Thomas.

M | **5 Col'd Cav.** | **Mass.**

Henry Morris,
Priv., Co. *H*, 5 Reg't Mass. Col'd Cav.

Appears on

Company Muster-in and Descriptive Roll
of the organization named above. Roll dated
Readville, Mass, Mar. 12, 1864.

Where born *Harrison Co, Va*

Age *25* y'rs; occupation *Farmer.*

When enlisted *Mar 4*, 186*4*.

Where enlisted *Boston, W. Va.*

For what period enlisted *3* years.

Eyes *Black*; hair *Black*

Complexion *Black*; height *5* ft. $\frac{1}{2}$ in.

When mustered in *Mar. 12, 1864.*

Where mustered in

Bounty paid \$ *100*; due \$ *100*

Where credited *4th Dist Suffolk*

Company to which assigned

Remarks:

Book mark:

J. M. Ball

M. | **5 Col'd Cav.** | **Mass.**

Neway Morris
Pvt., Co. H, 5 Reg't Mass. Col'd Cavalry.

Appears on

Company Muster Roll

for Mar 12 to Apr. 30, 1864.

Present or absent Present

Stoppage, \$ 100 for

Due Gov't, \$ 100 for

Valuation of horse, \$ 100

Valuation of horse equipments, \$ 100

Remarks:

Book mark:

(358)

J. N. Wall
Copyist.

M | **5 Col'd Cav.** | **Mass.**

Henry Morris
Priv, Co. H, 5 Reg't Mass. Col'd Cavalry.

Appears on

Company Muster Roll

for *May & June*, 186*4*
Present or absent *Present*

Stoppage, \$.....100 for

Due Gov't, \$.....100 for

Valuation of horse, \$.....100

Valuation of horse equipments, \$.....100

Remarks:

Book mark:

J. W. Wall

M. 5 Col'd Cav. | Mass.

Henry Morris
Pat, Co. H, 5 Reg't Mass. Col'd Cavalry.

Appears on

Company Muster Roll
for July & Aug., 1864.

Present or absent Present

Stoppage, \$ 100 for

Due Gov't, \$ 100 for

Valuation of horse, \$ 100

Valuation of horse equipments, \$ 100

Remarks:

Book mark:

J. M. Hall

11 | 5 Col'd Cav. | Mass.

Henry Morris

Co. H, 5 Reg't Mass. Col'd Cavalry.

Appears on

Company Muster Roll

for Sept & Oct, 1864.

Present or absent Present

Stoppage, \$ 2 ⁰⁴/₁₀₀ for one cross
sable letter & number.

Due Gov't, \$ 100 for

Valuation of horse, \$ 100

Valuation of horse equipments, \$ 100

Remarks:

Book mark:

C. M. Clark

M | **5 Col'd Cav.** | **Mass.**

Henry Morris
Pat, Co. H, 5 Reg't Mass. Col'd Cavalry.

Appears on

Company Muster Roll

for *Nov. & Dec.*, 1864.

Present or absent *Present*.

Stoppage, \$ *100* for

Due Gov't, \$ *100* for

Valuation of horse, \$ *100*

Valuation of horse equipments, \$ *100*

Remarks:

Book mark:

B M Clark

M | **5 Col'd Cav.** | **Mass.**

Henry Morris
Pat, Co. H, 5 Reg't Mass. Col'd Cavalry.

Appears on

Company Muster Roll

for Jan & Feb, 1865.

Present or absent Present

Stoppage, \$ 100 for

Due Gov't, \$ 100 for

Valuation of horse, \$ 100

Valuation of horse equipments, \$ 100

Remarks: Due 1st, 2d, 3d
& 4th installment
U. S bounty

Book mark: _____

C M Clark

H 5 Col'd Cav. | **Mass.**

Henry Morris
Pat, Co. II, 5 Reg't Mass. Col'd Cavalry.

Appears on

Company Muster Roll

for March + April, 1865.

Present or absent Present

Stoppage, \$ 100 for

Due Gov't, \$ 100 for

Valuation of horse, \$ 100

Valuation of horse equipments, \$ 100

Remarks: Due 1st, 2d, 3d +
4th installments U.S.
bounty

Book mark: _____

C M Clark

(358)

Copyist.

M

5 Col'd Cav.

Mass.

Henry Morris

Pat, Co. H, 5 Reg't Mass. Col'd Cavalry.

Appears on

Company Muster Roll

for May & June, 1865.

Present or absent Absent

Stoppage, \$ 100 for

Due Gov't, \$ 100 for

Valuation of horse, \$ 100

Valuation of horse equipments, \$ 100

Remarks: 12th, 2^d, 3^d & 4th installments U. S bounty due. Free on or before April 15, 1861. Guard in Q. M. Transport, June 12, 1865.

Book mark:

C. M. Clark

(358)

Copyist.

M | **5 Col'd Cav.** | **Mass.**

Henry Morris

Priv., Co. H, 5 Reg't Mass. Col'd Cavalry.

Appears on

Company Muster Roll

for *July + Aug.*, 186*1*.

Present or absent *Absent*

Stoppage, \$ *100* for

Due Gov't, \$ *100* for

Valuation of horse, \$ *100*

Valuation of horse equipments, \$ *100*

Remarks: *Fall on or before Apr. 19, 1861. Was sick at Brainerd since Aug. 1861*

Book mark:

P. E. Under

No 156. Cav. Mass.

Henry Morris

Priv., Co. H, 5 Reg't Mass. Cav.

Appears on

Hospital Muster Roll

of DeCamp U. S. A. General Hospital,

at David's Island, New York Harbor,

for *Sept & Oct*, 1865.

Attached to hospital:

When _____, 186 .

How employed _____

Last paid by Maj. _____

to _____, 186 .

Bounty paid \$ 100 ; due \$ 100

Present or absent _____

Remarks: *Mustered out of
Service October 24 1865*

Book mark: _____

Rosenbaum

(343)

Copyist.

M | 5 Col'd Cav. | Mass.

Henry Morris
Priv., Co. H, 5 Reg't Mass. Col'd Cavalry.

Appears on Co. Muster-out Roll, dated
Clarksville, Tex., Oct. 31, 1865.

Muster-out to date _____, 186 .

Last paid to ----- Dec. 31, 186 1/2.

Clothing account:

Last settled _____, 186 ; drawn since \$ _____ 100

Due soldier \$ _____ 100; due U. S. \$ _____ 100

Am't for cloth'g in kind or money adv'd \$ _____ 100

Due U. S. for arms, equipments, &c., \$ _____ 100

Bounty paid \$ _____ 100; due \$ 300 100

Remarks: Abs sick at New Br-
knox, since Aug. 6. 1865.
No discharge furnished.
Free on or before Apr. 19,
1865.

Book mark: 2417 P.M. G. Apr. 16. 1866.
6222

R. E. Wilson

JAN 10

5382584

1891

Book Mark:- Mrs Box Dr.
List on file - Discharg-
ed Octo. 23, 1865-

E.P., V. 11 p. 74. M. O. R on file.

M. | 5 Col'd Cav. | Mass.

Henry Morris

Priv., Co. H, 5 Reg't Mass. Colored Cav.

Appears on Returns as follows:

Sept. 1864. Co. cook.

Mar. to May 1865. On duty,
Regtl. Teamster.

June 1865. Absent guard on
Transport June 12"

July 1865. Absent detach'd serv.
Brig. Hd. Qrs. Clarksville
since July 17"

Aug. & Sept. 1865. Absent sick
at Brazos since Aug. 6"

Book mark :

(548)

J. B. Sittler

Copyist.

Or | **5 Col'd Cav.** | **Mass.**

Ferry Morris
Co. H, 5 Reg't Mass. Col'd Cavalry.

Appears on an

Individual Muster-out Roll

of the organization named above. Roll dated

New York City, Oct-23, 1865.

Muster-out to date *Oct-23, 1865.*

Last paid to _____, 186 .

Clothing account:

Last settled _____, 186 ; drawn since \$ _____ 100

Due soldier \$ _____ 100; due U. S. \$ _____ 100

Am't for cloth'g in kind or money adv'd \$ _____ 100

Due U. S. for arms, equipments, &c., \$ _____ 100

Bounty paid \$ _____ 100 due \$ _____ 100

Remarks: *Mustered out under
Tel. Order from War Dept
A. G. O. May 4 1865. To
receive pay from Aug
31 1865 and commuta-
tion for transportation*

Book mark: *En. M. 20 Vol 9 C. T. 1871*

[Signature]

JAN. - 9

5372891

1891

1

to his place of enrollment. All other pay and allowances to be suspended until he furnishes proper evidence for settlement of the same.

Mustered out on partial Description
List from R. G. O.
dated Oct 9, 1865.

M 5 (bold) Cav Mass
Henry Morris
, Co. H. 5 Regt Mass (bold) Cav

NOTATION.

Book mark : *M - 20 - 612 - 1871*

Record and Pension Office.

WAR DEPARTMENT.

This book mark refers only to a report from the medical records, made by the Surgeon General to the Adjutant General, relative to the above-named man. As the medical records have since been carded, no transcript of this report is made hereon.

(491)

C. C. Carey

Copyist.

Mcarris, Henry
P, Co. *K*, 15th Reg't *Mass. I. C.*

7 *8* Enclosures.

Bed Cards	Final Statements
Burial Records	Furloughs or L. of A.
Certs. of Dis. for Discharge	Med. Certificates
C. M. Charges	Med. Des. Lists
Descriptive Lists	Orders
Discharge Certificates	Pris. of War Record
Enlistment Papers	Resignations

Other papers relating to—

Admission to Hosp'l	Furlough or L. of A.
Casualty Sheet	Med. Examination
Confinement	Misc. Information
Contracts	Pay or Clothing
Death or Effects	Personal Reports
Desertion	Rank
Discharge from Hosp'l	Transfer to Hosp'l
Discharge from Service	Transfer to V. R. C.
Duty	Transportation

2

and.

ADJUTANT GENERAL'S OFFICE,

May 16, 1874

The discharge of Osway Williams
Private, Co. H, 5th Reg't U.S.

Colored Infantry, is reported as follows:

On Company Muster Roll.

For _____, 186 _____, 186

Company Muster-out Roll. *for Co. Oct 23/65*

should not be discharge furnished 186

Company Descriptive Book.

_____, 186

Company Morning Reports.

_____, 186

Soldier's Final Statement.

_____, 186

Soldier's Record of Death and Interment.

_____, 186

Soldier's Inventory of Effects.

_____, 186

Soldier's Certificate of Disability for Discharge.

_____, 186

Soldier's Individual Muster-out Roll.

_____, 186

Regimental Return.

For _____, 186 _____, 186

Regimental Quarterly Returns.

_____, 186

Regimental Descriptive Book.

_____, 186

By Surgeon General.

(_____) _____, 186

Oct 23, 186*5*, is held to be

the correct date, and the Company Muster *out* Roll will be amended accordingly.

Thomas M. Sweet

Assistant Adjutant General.

E.B. 74. Noted. H.M.

CASUALTY SHEET

No.

John J. ...
.....
..... of Company

Regiment of *1st ...*

State Volunteers.

NATURE OF CASUALTY.

...
.....
(...)

NARRATIVE

CASUALTY SHEET.

Name: *James H. ...*

Rank: *Private* Company: *...* Regiment: *...*

Arm: *...* State: *...*

Nature of Casualty: *...*

CAUSE OF CASUALTY—(NAME OF DISEASE, &c.)	BY WHOM DISCHARGED.
DEGREE OF DISABILITY.	FROM WHAT SOURCE THIS INFORMATION WAS OBTAINED.
BY WHOM CERTIFIED.	REMARKS.
DATE OF DISCHARGE, DEATH, &c.	
PLACE OF DISCHARGE, DEATH, &c.	

[Signature]
Clerk.

[Handwritten initials]

Priv. Henry Morris
Co. H. 5th Mass. Cav.

Office Chief Commissary of Musters,

DEPARTMENT OF THE EAST,

NEW YORK CITY, *Oct 23* 1865.

I have to report that

Private
John Harris
Co. 1st Regt Mass
1st

is this day mustered out of the United States

service, in compliance with telegraphic instructions from War Department of May 3d, 1865.

Very respectfully,

Your obedient servant,

WILSON BARSTOW,

Brevet Major and A. D. C.,
Chief Commissary of Musters.

To the Chief Mustering Officer, State of

Massachusetts

End of October 1862
Henry Morris, Private
Co. H. 5 Mass Cav.

Henry Morris
was admitted to the hospital
on October 24 1862
for treatment of
his wound in this hospital

Warren



War Department,
Adjutant General's Office,

Washington, Oct. 7th 1863.

Sir:

In reply to your letter requesting a Descriptive List of Henry Morris, a private in Company H, 13th Regiment Mass. Cavalry Volunteers, I have the honor to furnish the following "Descriptive List," obtained from the records of this Office; which, from the want of the necessary data, (which is in the possession of the Company Commander,) is only "partial."

NAME, RANK AND REGIMENT. DESCRIPTION, &c.

Henry Morris, a private in Company H, 13th Regiment of Mass. Cavalry Volunteers, is 23 years of age; but no further "description" can be obtained from the files of this Office.

He was enrolled on the 4th day of March, 1861, at the town of Boston in the State of Mass. by L. W. ... and mustered into the service of the United States on the 12th day of March, 1861, at the town of Northampton, in the State of Mass. by Wm. ... to serve for the period of 3 years or "during the war."

ACCOUNT OF PAY.

It is stated on the Muster Rolls of his Company for the months of July & August, 1861, that he was last paid by Paymaster James ... to the 31st day of August, 1861. See ... County

ACCOUNT OF CLOTHING.

The files of this Office furnish no account of clothing; it must be obtained, if obtained at all, from his Company Commander.

REMARKS.

See Muster Roll of his Co. for ... reported; Abs. sick at ...

Very respectfully,

Your obedient servant,

[Signature]

Assistant Adjutant General.

To Asst. Surg. Warren ...
...
...

This "Partial Descriptive List" is given in order that the soldier may be discharged at once, without waiting for a descriptive list from his company commander; and, having been used by the proper officer to make out the soldier's final statements, should be endorsed with a statement to that effect by this officer. This endorsement should exhibit a full statement of the time for which the soldier was allowed pay on his final statements, the clothing account, and all other charges against him or in his favor, so as to comprise a complete exhibit of his account. It will then be transmitted to the company commander of the soldier, who will enter all the data necessary to a full understanding of the soldier's account on the muster roll upon which the soldier's discharge is reported. This list will then be destroyed. The object of this is, that the remaining portion of the soldier's account may be settled upon the receipt of these muster rolls, and the soldier receive any pay or allowances that may be due him at the time of his discharge, and which may not appear on his final statements from the fact that this list is incomplete or "partial."

1028

Morris, Lewis

Co E, 5 Mass. Cav., (Col'd.)

Private

Sergeant

CARD NUMBERS.

1	5378140	26
2	5378225	27
3	5378307	28
4	5378353	29
5	5378460	30
6	5378567	31
7	5378670	32
8	5378770	33
9	5378874	34
10	5378976	35
11	5379077	36
12	5379178	37
13	9092219	38
14	40731424	39
15		40
16		41
17		42
18		43
19		44
20		45
21		46
22		47
23		48
24		49
25		50

Book Mark:

See also

M **5 Cav. (Col'd.) | Mass.**

Lewis Mearns

E, Co. *E*, 5 Reg't Mass. Cav. (Col'd.)

Appears on

Company Descriptive Book

of the organization named above.

DESCRIPTION.

Age *24* years; height *5* feet *6* inches.

Complexion *Blt*

Eyes *Blue*; hair *Blt*

Where born *Richmond Va*

Occupation *Messenger*

ENLISTMENT.

When *July 3*, 186*4*.

Where *Boston*.

By whom *A. D. Clapp*; term *Three*'rs.

Remarks:

Mearns

M | **5 Col'd Cav.** | **Mass.**

Lewis Morris
Privt. Co. *E*, 5 Reg't Mass. Col'd Cav.

Appears on

Company Muster-in and Descriptive Roll
of the organization named above. Roll dated

Reading Mass Feb 10, 1864.

Where born *Richmond, Virginia*

Age *25* y'rs; occupation *Mason*

When enlisted *Feb 3*, 1864.

Where enlisted *Ward 11, Boston*

For what period enlisted *3* years.

Eyes *black*; hair *black*

Complexion *black*; height *5 ft. 6 1/2 in.*

When mustered in *Feb 10*, 1864.

Where mustered in

Bounty paid \$ *100*; due \$ *100*

Where credited *Ward 11, Boston*

Company to which assigned

Remarks:

Book mark:

M 5 Col'd Cav. Mass.

Lewis Morris

Quot, Co. E, 5 Reg't Mass. Col'd Cavalry.

Appears on

Company Muster Roll

for *Enlistment to 29 Feb'y, 1864.*

Present or absent *present*

Stoppage, \$ 100 for

Due Gov't, \$ 100 for

Valuation of horse, \$ 100

Valuation of horse equipments, \$ 100

Remarks:

Book mark:

(358)

Thomas
Copyist.

M | **5 Col'd Cav.** | **Mass.**

Lewis Morris

Srnt, Co. E, 5 Reg't Mass. Col'd Cavalry.

Appears on

Company Muster Roll

for *Mich & Ap'l*, 1864.

Present or absent *not stated*

Stoppage, \$ *100* for

Due Gov't, \$ *100* for

Valuation of horse, \$ *100*

Valuation of horse equipments, \$ *100*

Remarks: *Stop Pay \$17.16 Trans-
portation from Detroit
to Boston,*

Book mark: _____

(358)

[Signature]

Copyist.

M | **5** Col'd Cav. | **Mass.**

Lewis Morris

Prpl, Co. E, 5 Reg't Mass. Col'd Cavalry.

Appears on

Company Muster Roll

for *May & June*, 1864.

Present or absent *Present*

Stoppage, \$ _____ 100 for _____

Due Gov't, \$ _____ 100 for _____

Valuation of horse, \$ _____ 100

Valuation of horse equipments, \$ _____ 100

Remarks: *Appointed Corporal June 1. 64.*

Book mark : _____

No.

5 Col'd Cav.

Mass.

Lewis Morris

Capt., Co. E, 5 Reg't Mass. Col'd Cavalry.

Appears on

Company Muster Roll

for *July & Aug.*, 1864.

Present or absent *Present*

Stoppage, \$ *100* for

Due Gov't, \$ *100* for

Valuation of horse, \$ *100*

Valuation of horse equipments, \$ *100*

Remarks: *Appointed Corporal June 1st 1864*

Book mark:

O. S. Clark

~~111~~ No 5 Col'd Cav. Mass.

X Lewis Morris
~~Upper address~~

Capt., Co. E, 5 Reg't Mass. Col'd Cavalry.

Appears on

Company Muster Roll

for Sept Oct, 1864.

Present or absent Present

Stoppage, \$ 100 for

Due Gov't, \$ 100 for

Valuation of horse, \$ 100

Valuation of horse equipments, \$ 100

Remarks:

X corrected by R. J. Walker

Book mark:

A. J. Clark

M | **5 Col'd Cav.** | **Mass.**

Morris, Lewis
Corpl., Co. E, 5 Reg't Mass. Col'd Cavalry.

Appears on

Company Muster Roll

for *Nov. Dec*, 1864.

Present or absent *Absent*

Stoppage, \$ *100* for

Due Gov't, \$ *100* for

Valuation of horse, \$ *100*

Valuation of horse equipments, \$ *100*

Remarks: *Absent on ten days
furlough since Dec. 28. 64.
Stop one Carter.*

Book mark:

O. S. Clark
(358) Copyist.

No.

5 Col'd Cav.

Mass.

Lewis Morris

Sergeant, Co. E, 5 Reg't Mass. Col'd Cavalry.

Appears on

Company Muster Roll

for *Jan. & Feb.*, 1865.

Present or absent *Present*

Stoppage, \$ *100* for

Due Gov't, \$ *100* for

Valuation of horse, \$ *100*

Valuation of horse equipments, \$ *100*

Remarks: *As pointed out by*
General Feb. 1st, 1865. Due
U.S. for transportation
to Detroit Mich & return.
28.04. Stop one Canton 45.

Book mark:

A. Clark

M | **5 Col'd Cav.** | **Mass.**

Morris, Lewis
Sergt, Co. E, 5 Reg't Mass. Col'd Cavalry.

Appears on

Company Muster Roll

for *Sept & Apr.*, 1865.

Present or absent

Stoppage, \$ 100 for

Due Gov't, \$ ⁶⁵100 for *lip & g. b.*
lost.

Valuation of horse, \$ 100

Valuation of horse equipments, \$ 100

Remarks: *Appointed Sergt*
Feb. 1st, 1865 *due U.S.*
for transportation
\$ 28.04

Book mark:

O. S. Clark

M

5 Col'd Cav.

Mass.

Lewis Morris

Sgt., Co. E, 5 Reg't Mass. Col'd Cavalry.

Appears on

Company Muster Roll

for May & June, 1865.

Present or absent Present

Stoppage, \$ 100 for

Due Gov't, \$ 100 for

Valuation of horse, \$ 100

Valuation of horse equipments, \$ 100

Remarks: Pay drawn in Corp'l to Feb 1865.

Due U.S. for transportation \$ 28.14

Due U.S. for C. & G. E. lost 16.9

Book mark:

Lowry

(358)

Copyist.

M | **5 Col'd Cav.** | **Mass.**

Lewis Morris
right, Co. E, 5 Reg't Mass. Col'd Cavalry.

Appears on

Company Muster Roll

for July & Aug, 1865.

Present or absent Present

Stoppage, \$ 100 for

Due Gov't, \$ 100 for

Valuation of horse, \$ 100

Valuation of horse equipments, \$ 100

Remarks: Promoted from
Corpl Feb. 1st 1865
Due U.S. for transportation
\$28.04
Due U.S. for C. & G. Co.
last \$1.20

Book mark: _____

(358) Lewis Copyist.

M. | 5 Col'd Cav. | Mass.

Lewis Morris

....., Co. E, 5 Reg't Mass. Colored Cav.

Appears on **Returns** as follows:

Dec. 1864. Absent on furlough
ten days since Dec. 26,
'64.

Book mark :

(546)

J. B. Sitter

Copyist.

111 | 5 Col'd Cav. Mass.

Lewis Morris
Sgt., Co. E, 5 Reg't Mass. Col'd Cavalry.

Appears on Co. Muster-out Roll, dated
Charlottesville, Va., Oct 21, 1862.

Muster-out to date Oct 21, 1862.

Last paid to Dec 21, 1864.

Clothing account:

Last settled....., 186 ; drawn since \$ 100

Due soldier \$ 100; due U. S. \$ 117⁵/₁₀₀

Am't for cloth'g in kind or money adv'd \$ 100

Due U. S. for arms, equipments, &c., \$ 11⁰⁰/₁₀₀

Bounty paid \$ 100; due \$ 21⁰⁰/₁₀₀

Remarks: Due U.S. for trans-
portation \$ 28.04
Promoted from Corp. Feb
11.65
Due U.S. for G. & B. \$ 11.00

Book mark :

(361) Lewis Copyist.

Morris Louis

P, Co. E, 5 Reg't Mass C.C.

1 Enclosures.

Bed Cards	Final Statements
Burial Records	Furloughs or L. of A.
Certs. of Dis. for Discharge	Med. Certificates
C. M. Charges	Med. Des. Lists
Descriptive Lists	Orders
Discharge Certificates	Pris. of War Record
Enlistment Papers	Resignations

Other papers relating to—

Admission to Hosp'l	Furlough or L. of A. /
Casualty Sheet	Med. Examination
Confinement	Misc. Information
Contracts	Pay or Clothing
Death or Effects	Personal Reports
Desertion	Rank
Discharge from Hosp'l	Transfer to Hosp'l
Discharge from Service	Transfer to V. R. C.
Duty	Transportation

Detroit, May 2nd 1864.

To Sgt. David Harris
Co. C 5th Mass. 104th Regt
~~3rd Michigan~~

At

Note On your 10 days from April 20th 1864
from Regt.

Capt. H. A. Russell

Ordered to Report to Officer Condit

3rd Mass. Co. at Fort Lincoln

Mass. wherever it may be

1028

Morris, Robert A.

Co I, 5 Mass. Cav., (Col'd.)

Private

Sergeant

CARD NUMBERS.

1	5380545	26
2	5380574	27
3	5380660	28
4	3380741	29
5	5380844	30
6	5380942	31
7	5381044	32
8	5381146	33
9	5381248	34
10	5381348	35
11	5381446	36
12	9091960	37
13	40731425	38
14		39
15		40
16		41
17		42
18		43
19		44
20		45
21		46
22		47
23		48
24		49
25		50

Book Mark:

See also

S-988019 - P.O. Nixon
P. 2538524 P O Ret

R. Wallace
4

M 5 Cav. (Col'd.) | Mass.

Robert H. Morris

Co. G, 5 Reg't Mass. Cav. (Col'd.)

Appears on

Company Descriptive Book
of the organization named above.

DESCRIPTION.

Age 24 years; height 6 feet- inches.

Complexion Blk

Eyes Blk; hair Blk

Where born Danville Penna.

Occupation Teamster.

ENLISTMENT.

When Feb 27, 1864.

Where Boston

By whom G.W. Messenger; term 3 y'rs.

Remarks:

Hearn

M | **5 Col'd Cav.** | **Mass.**

Robert H. Morris
Co. G, Co. *G*, 5 Reg't Mass. Col'd Cav.

Appears on

Company Muster-in and Descriptive Roll
of the organization named above. Roll dated
Readville Mass, Mar 4, 1864.

Where born *Danville Penn.*

Age *27* y'rs; occupation *Teamster*

When enlisted *Feb 27*, 1864.

Where enlisted *Boston Ward 4*

For what period enlisted *3* years.

Eyes *Blk*; hair *Blk*

Complexion *Blk*; height *6* ft. *6* in.

When mustered in *Mar 4*, 1864.

Where mustered in *Readville Mass*

Bounty paid \$ *2* ¹⁰⁰; due \$ *100*

Where credited *3rd Dist. Suffolk*

Company to which assigned _____

Remarks: _____

Book mark: _____

Leger

M | **5 Col'd Cav.** | **Mass.**

Robert H. Morris
Serg't, Co. G, 5 Reg't Mass. Col'd Cavalry.

Appears on

Company Muster Roll
for *Mar 4 to Apr 30*, 1864.

Present or absent *Absent*

Stoppage, \$ *100* for

Due Gov't, \$ *100* for

Valuation of horse, \$ *100*

Valuation of horse equipments, \$ *100*

Remarks: *Absent with leave since April 28 1864. Appointed Serg't by Special Regt Order No 97 dated April 28/64 right to date from Mar, 4/64*

Book mark: _____

L. J. G. et

M | **5 Col'd Cav.** | **Mass.**

Robert H. Morris
Serjt, Co. G, 5 Reg't Mass. Col'd Cavalry.

Appears on

Company Muster Roll
for *May to June*, 186*4*.

Present or absent *Present*

Stoppage, \$ *100* for

Due Gov't, \$ *100* for

Valuation of horse, \$ *100*

Valuation of horse equipments, \$ *100*

Remarks: *Appointed Serjt. by*
Special Regt order no 97
dated April 28/64
Appt is date from May 4/64

Book mark: _____

Leger

M | **5 Col'd Cav.** | **Mass.**

Robert H. Morris

Serjt, Co. G, 5 Reg't Mass. Col'd Cavalry.

Appears on

Company Muster Roll

for *July & Aug*, 1864.

Present or absent *Present*

Stoppage, \$ *100* for

Due Gov't, \$ *100* for

Valuation of horse, \$ *100*

Valuation of horse equipments, \$ *100*

Remarks: *App't Serjt by
Special Reg't order no 97
dated Apr 28/64 App't for
date from Mar 4/64 Stop
one Haversack & one Canteen*

Book mark: _____

Leger

(358)

Copyist.

M | **5 Col'd Cav.** | **Mass.**

Robert Morris
Sgt., Co. G, 5 Reg't Mass. Col'd Cavalry.

Appears on

Company Muster Roll
for *Sept & Oct*, 1864.
Present or absent *Present*

Stoppage, \$ *100* for

Due Gov't, \$ *100* for

Valuation of horse, \$ *100*

Valuation of horse equipments, \$ *100*

Remarks:
.....
.....
.....
.....
.....
.....
.....
.....

Book mark:

Perry
(358) *Perry* Copyist.

M

5 Col'd Cav.

Mass.

Robert N. Morris
Sgt., Co. G, 5 Reg't Mass. Col'd Cavalry.

Appears on

Company Muster Roll

for Nov. 7 Dec, 1864

Present or absent Present

Stoppage, \$ 100 for

Due Gov't, \$ 100 for

Valuation of horse, \$ 100

Valuation of horse equipments, \$ 100

Remarks:

Book mark:

Perry

(358)

Copyist.

M | 5 Col'd Cav. | Mass.

Robert H. Morris
Sgt, Co. G, 5 Reg't Mass. Col'd Cavalry.

Appears on

Company Muster Roll

for Jan. & Feb., 1865.

Present or absent Present

Stoppage, \$ 100 for

Due Gov't, \$ 100 for

Valuation of horse, \$ 100

Valuation of horse equipments, \$ 100

Remarks: Due 1st, 2^d, 3^d &
4th instalments U. S.
Bounty #180.

Book mark:

Perry

(358)

Copyist.

M. | 5 Col'd Cav. | Mass.

Robert H. Morris,
Sgt, Co. G, 5 Reg't Mass. Col'd Cavalry.

Appears on

Company Muster Roll

for *Mch. & Apl.*, 1865.

Present or absent *Present*

Stoppage, \$ *100* for

Due Gov't, \$ *100* for

Valuation of horse, \$ *100*

Valuation of horse equipments, \$ *100*

Remarks: *Due the soldier
four instalments
U. S. Bounty \$180.*

Book mark:

Perry

(358)

Copyist.

M. 5 Col'd Cav. | Mass.

Robert N. Morris
Sgt., Co. G, 5 Reg't Mass. Col'd Cavalry.

Appears on

Company Muster Roll

for *May & June*, 186*3*.

Present or absent *Present*

Stoppage, \$ *100* for

Due Gov't, \$ *100* for

Valuation of horse, \$ *100*

Valuation of horse equipments, \$ *100*

Remarks:

Book mark:

(358)

Perry

Copyist.

M | **5 Col'd Cav.** | **Mass.**

Robert H Morris
Sergt, Co. G, 5 Reg't Mass. Col'd Cavalry.

Appears on

Company Muster Roll

for *July & August*, 186*6*

Present or absent *Present*

Stoppage, \$ *100* for

Due Gov't, \$ *100* for

Valuation of horse, \$ *100*

Valuation of horse equipments, \$ *100*

Remarks: *Detached in Pra-
zos Building per
O.D. No 135. dated
Aug 30. 65*

Book mark:

Wear Scott

(358)

Copyist.

M. | 5 Col'd Cav. | Mass.

Robert H. Morris
Sergt., Co. G, 5 Reg't Mass. Colored Cav.

Appears on Returns as follows:

Apr. 1864. Absent with leave
since Apr. 28"

Aug. & Sept. 1865. Absent det.
as carpenter at Brazos
Tex. per S. O. No. 135
dated Hd. Qrs. 5 Mass.
Cav. Aug. 30/65.

Book mark :

(648)

J. B. Sittler

Copyist.

M | **5 Col'd Cav.** | **Mass.**

Robert H Morris
Serg't, Co. *G*, 5 Reg't Mass. Col'd Cavalry.

Appears on **Co. Muster-out Roll**, dated
Clarksville Tex, Oct 31, 1865.

Muster-out to date *Oct 31*, 1865.

Last paid to *Dec 31*, 1864.

Clothing account:

Last settled....., 186 ; drawn since \$..... 100

Due soldier \$.....²³100; due U. S. \$..... 100

Am't for cloth'g in kind or money adv'd \$..... 100

Due U. S. for arms, equipments, &c., \$ *//* 100

Bounty paid \$..... 100; due \$ *300* 100

Remarks:

Book mark:

Wear Scott

1029

Morris, William

Co D, 5 Mass. Cav., (Col'd.)

Private

Private

CARD NUMBERS.

1	5376940	26
2	5377030	27
3	5377114	28
4	5377208	29
5	5377355	30
6	5378061	31
7	9092317	32
8	40751426	33
9		34
10		35
11		36
12		37
13		38
14		39
15		40
16		41
17		42
18		43
19		44
20		45
21		46
22		47
23		48
24		49
25		50

Book Mark:

See also

W **5 Cav. (Col'd.) | Mass.**

William Morris

....., Co. *2*, 5 Reg't Mass. Cav. (Col'd.)

Appears on

Company Descriptive Book

of the organization named above.

DESCRIPTION.

Age *31* years; height *5* feet *7* inches.

Complexion *Blk*

Eyes *Blk*; hair *Blk*

Where born *Montrose Penn*

Occupation *Booker*

ENLISTMENT.

When *Jan 19*, 186

Where *Newtown*

By whom *J. H. Merrill*; term *5* y'rs.

Remarks: *Presented in person
to me by Capt. M. Kelton
Newtown, Pa.*

W. Morris

3820

Copist.

M | **5 Col'd Cav.** | **Mass.**

William Morris

Pr, Co. *D*, 5 Reg't Mass. Col'd Cav.

Appears on

Company Muster-in and Descriptive Roll
of the organization named above. Roll dated

Readville Mass, July 29, 1864.

Where born *Wintone Penn.*

Age *30* y'rs; occupation *Barber.*

When enlisted *July 19*, 1864.

Where enlisted *Wintone*

For what period enlisted *3* years.

Eyes *BLK*; hair *BLK*

Complexion *BLK*; height *5* ft. *9* in.

When mustered in *July 29*, 1864.

Where mustered in *Readville Mass*

Bounty paid \$ *100*; due \$ *100*

Where credited *7 West Middlesex*

Company to which assigned

Remarks:

Book mark:

M | **5 Col'd Cav.** | **Mass.**

William Morris

Priv, Co. D, 5 Reg't Mass. Col'd Cavalry.

Appears on

Company Muster Roll

for *Enlistment to July 29, 1861.*

Present or absent *Present*

Stoppage, \$ *100* for

Due Gov't, \$ *100* for

Valuation of horse, \$ *100*

Valuation of horse equipments, \$ *100*

Remarks:

Book mark:

Lewis
Copyist.

M 5 Col'd Cav. | **Mass.**

William Morris

Priv, Co. D, 5 Reg't Mass. Col'd Cavalry.

Appears on

Company Muster Roll

for *March & April*, 186*4*.

Present or absent *Absent*

Stoppage, \$..... 100 for

Due Gov't, \$..... 100 for

Valuation of horse, \$..... 100

Valuation of horse equipments, \$..... 100

Remarks: *Absent on duty*

Book mark:

James
Copyist.

W **5 Col'd Cav. | Mass.**

William Morris

Pr, Co. D, 5 Reg't Mass. Col'd Cavalry.

Appears on

Company Muster Roll

for *May + June*, 186*4*.

Present or absent *Absent*

Stoppage, \$ *100* for

Due Gov't, \$ *100* for

Valuation of horse, \$ *100*

Valuation of horse equipments, \$ *100*

Remarks: *Absent without leave*

Book mark: _____

J. Morris
Copyist.

Mo | **5 Col'd Cav.** | **Mass.**

William Morris

Pr, Co. D, 5 Reg't Mass. Col'd Cavalry.

Appears on

Company Muster Roll

for *July & Aug*, 186*4*.

Present or absent

Stoppage, \$ *100* for

Due Gov't, \$ *100* for

Valuation of horse, \$ *100*

Valuation of horse equipments, \$ *100*

Remarks: *Deserted May 3/64*

Book mark:

S. Merchant
Copyist.

M. | 5 Col'd Cav. | Mass.

* William Morris

Priv., Co. 20, 5 Reg't Mass. Colored Cav.

Appears on Returns as follows:

May 1864. Absent with
leave from Apr. 16"
to Apr. 25 furlough
extended Readville,
Mass.

June 1864. Absent with leave.

July 1864. Absent without
leave from May 11

Aug. 1864. Lose May 3/64
Readville - Deserted.

* Name appears also as
E. Morris.

Book mark :

(546)

J. B. Sittler

Copyist.

m | **5 Col'd Cav.** | **Mass.**

William Morris

Pvt, Co. *D*, 5 Reg't Mass. Col'd Cavalry.

Appears on **Co. Muster-out Roll**, dated
Clarksville Texas Oct 31, 1865.

Muster-out to date _____, 186 .

Last paid to _____, 186 .

Clothing account:

Last settled _____, 186 ; drawn since \$ _____ 100

Due soldier \$ _____ 100; due U. S. \$ _____ 100

Am't for cloth'g in kind or money adv'd \$ _____ 100

Due U. S. for arms, equipments, &c., \$ _____ 100

Bounty paid \$ _____ 100; due \$ _____ 100

Remarks:

*Deserted from Co. at Read-
ville Mass May 3, 1864*

Book mark:

(861)

House

Copyist.

1030

Morse, James

Co A, 5 Mass. Cav., (Col'd.)

Private

Private

CARD NUMBERS.

1	5383780	26
2	5383866	27
3	5383962	28
4	5384061	29
5	5384164	30
6	5384266	31
7	5384373	32
8	5384476	33
9	5384613	34
10	5384827	35
11	9091601	36
12	40731427	37
13	40731428	38
14	A.S. 201	39
15		40
16		41
17		42
18		43
19		44
20		45
21		46
22		47
23		48
24		49
25		50

Book Mark: A.S. 201

See also

Ag-201 JUL 12 1923 Jm

R. Spruill
X

No. **5 Cav. (Col'd.)** **Mass.**

James Morse

....., Co. *K*....., 5 Reg't Mass. Cav. (Col'd.)

Appears on

Company Descriptive Book

of the organization named above.

DESCRIPTION.

Age *28* years; height *5* feet *8* inches.

Complexion *Black*.

Eyes *Black*; hair *Black*.

Where born *Petersburg Va.*

Occupation *Tobacconist*.

ENLISTMENT.

When *April 1st*, 186*5*.

Where *Roxbury*.

By whom *G. F. Wilson*; term *3* y'rs.

Remarks: *Married, Residence Petersburg*

Va. Deserted at Petersburg, Va.

May 14th 1865. Dropped from Rolls.

H. C. Thomas

(3830)

Copyist.

97
M | 5 Col'd Cav. | Mass.

James Morse
Co. K, 5 Reg't Mass. Col'd Cav.

Appears on
Company Muster-in and Descriptive Roll
of the organization named above. Roll dated
Leicester, Mass., April 12, 1864.

Where born Petersburg Va
Age 28 y'rs; occupation (blacksmith)

When enlisted April 12, 1864.

Where enlisted Company

For what period enlisted 2 years.

Eyes blue; hair black

Complexion black; height 5 ft. 8 1/2 in.

When mustered in April 12, 1864.

Where mustered in Leicester Mass

Bounty paid \$ 100; due \$ 100

Where credited

Company to which assigned

Remarks:

Book mark: A.G. 201

W. H. ...

(356d) Copyist.

M | **5 Col'd Cav.** | **Mass.**

Samuel Morse

1st Lt., Co. K, 5 Reg't Mass. Col'd Cavalry.

Appears on

Company Muster Roll

for *Company "K" 5th Reg't*, 186*7*.

Present or absent *Present*

Stoppage, \$ 100 for

Due Gov't, \$ 100 for

Valuation of horse, \$ 100

Valuation of horse equipments, \$ 100

Remarks: -----

Book mark: -----

72 | **5 Col'd Cav.** | **Mass.**

Quinn Morse
Ch, Co. K, 5 Reg't Mass. Col'd Cavalry.

Appears on

Company Muster Roll

for May 9 June, 1864.

Present or absent Present

Stoppage, \$ 100 for

Due Gov't, \$ 100 for

Valuation of horse, \$ 100

Valuation of horse equipments, \$ 100

Remarks:

Book mark: _____

(358) W. B. Adams Copyist.

M | **5 Col'd Cav.** | **Mass.**

Samuel Morse
Plt, Co. K, 5 Reg't Mass. Col'd Cavalry.

Appears on

Company Muster Roll

for *Aug & Aug*, 1864.

Present or absent *Present*

Stoppage, \$ 100 for

Due Gov't, \$ 100 for

Valuation of horse, \$ 100

Valuation of horse equipments, \$ 100

Remarks:
.....
.....
.....
.....
.....
.....
.....
.....
.....

Book mark:

(358)

W. H. ...

Copyist.

m | **5 Col'd Cav.** | **Mass.**

James Morse

Priv., Co. K, 5 Reg't Mass. Col'd Cavalry.

Appears on

Company Muster Roll

for *Sept 10*, 186*4*.

Present or absent *Present*

Stoppage, \$ *100* for

Due Gov't, \$ *100* for

Valuation of horse, \$ *100*

Valuation of horse equipments, \$ *100*

Remarks:

Book mark:

Edward

M | **5 Col'd Cav.** | **Mass.**

James Mosse

Priv., Co. K, 5 Reg't Mass. Col'd Cavalry.

Appears on

Company Muster Roll

for Nov & Dec, 1864

Present or absent Present

Stoppage, \$ 100 for

Due Gov't, \$ 100 for

Valuation of horse, \$ 100

Valuation of horse equipments, \$ 100

Remarks:

Book mark:

Edmund

m | **5 Col'd Cav.** | **Mass.**

James Mason

Mason, Co. K, 5 Reg't Mass. Col'd Cavalry.

Appears on

Company Muster Roll

for *Jan 1st Feb*, 1865.

Present or absent *Present*

Stoppage, \$ *100* for -----

Due Gov't, \$ *100* for -----

Valuation of horse, \$ *100*

Valuation of horse equipments, \$ *100*

Remarks: -----

Book mark: -----

James Mason

(358) Copyist.

M | **5 Col'd Cav.** | **Mass.**

James Morse

Smith, Co. K, 5 Reg't Mass. Col'd Cavalry.

Appears on

Company Muster Roll

for Mar & Apr, 1865.

Present or absent Present

Stoppage, \$ 100 for

Due Gov't, \$ 100 for

Valuation of horse, \$ 100

Valuation of horse equipments, \$ 100

Remarks:

Book mark:

Edmondson

M | **5 Col'd Cav.** | **Mass.**

James Morse

Priv., Co. K, 5 Reg't Mass. Col'd Cavalry.

Appears on

Company Muster Roll

for May & June, 1865.

Present or absent

Stoppage, \$ 100 for

Due Gov't, \$ 100 for

Valuation of horse, \$ 100

Valuation of horse equipments, \$ 100

Remarks: Presented May 13
'65 at Petersburg, Va
Due us for carbine &
equipts \$32.25 for sabre
& equipts \$9.60 for horse
equipts \$9.76

Book mark:

Edmondson

M. | **5 Col'd Cav.** | **Mass.**

James Moree
Pvt., Co. K, 5 Reg't Mass. Colored Cav.

Appears on **Returns** as follows:

May 1864, Absent sick in
Hosp. Readville, Mass.
May 8.

June 1864. June 22 Bermuda
Hund. Returned to
duty from Readville,
Mass.

Book mark :

(546)

J. B. Sittler

Copyist.

M. | 5 Col'd Cav. | Mass.

Johnes Morse

Priv., Co. K, 5 Reg't Mass. Colored Cav.

Appears on Returns as follows:

May 1865. Loss May 13
Petersburg, Va. - Deserted.

Book mark :

(546)

J. B. Sittler

Copyist.

M

5 Col'd Cav.

Mass.

James Morse
Pvt, Co. K, 5 Reg't Mass. Col'd Cavalry.

Appears on Co. Muster-out Roll, dated
Clarksville Texas, Oct. 31, 1865.

Muster-out to date _____, 186 .

Last paid to Dec. 31, 1864 .

Clothing account:

Last settled _____, 186 ; drawn since \$ _____ 100

Due soldier \$ _____ 100; due U. S. \$ _____ 4 ⁹⁶/₁₀₀

Am't for cloth'g in kind or money adv'd \$ _____ 100

Due U. S. for arms, equipments, &c., \$ _____ 100

Bounty paid \$ _____ 100; due \$ 100 ⁰⁰/₁₀₀

Remarks: Deserted from Regt at
Petersburg Va. May 13th 1865

Book mark : _____

Galligan

Write nothing above this line.

Copy on record card and file the notation recorded below.

Copy made by

Filed July 8, 1923, by *LDJ*.

James Morse

private, Co. K, 5th Reg't Mass Col.
Cav.

NOTATION.

Book mark: AG 201

THE ADJUTANT GENERAL'S OFFICE,
WAR DEPARTMENT,

Washington, July 13, 1923

The charge of desertion of May 13, 1865, standing against this soldier has been removed and he is discharged to date May 13, 1865, under the provisions of the act of Congress approved March 2, 1889.

Discharge certificate prepared by the War Department, July 13, 1923, and filed.

By authority of the Secretary
of War: Robert C. Davis

The Adjutant General.

Form No. 270a—A. G. O.
Ed. Dec. 2-21-500.

By. *C*

1031
Morton George
Co 5, 5 Mass. Cav., (Col'd.)

Private

CARD NUMBERS.

1	26
2	27
3	28
4	29
5	30
6	31
7	32
8	33
9	34
10	35
11	36
12	37
13	38
14	39
15	40
16	41
17	42
18	43
19	44
20	45
21	46
22	47
23	48
24	49
25	50

Book Mark:

See also

10329

Morton, George W.

Co A, 5 Mass. Cav., (Col'd.)

Private

Private

CARD NUMBERS.

1	5381612	26
2	5381701	27
3	5381786	28
4	5381883	29
5	5381990	30
6	5382095	31
7	5382199	32
8	5382299	33
9	5382397	34
10	5382489	35
11	5382585	36
12	9091827	37
13		38
14		39
15		40
16		41
17		42
18		43
19		44
20		45
21		46
22		47
23		48
24		49
25		50

Book Mark: 65-V-11-p-74. + 16-20-v-9-65-71.

See also

No. | **5 Cav. (Col'd.)** | **Mass.**

George W. Morton.

H., Co. *H.*, 5 Reg't Mass. Cav. (Col'd.)

Appears on

Company Descriptive Book
of the organization named above.

DESCRIPTION.

Age *32* years; height *5* feet *4* inches.

Complexion *Colored.*

Eyes *Dark* ; hair *Black.*

Where born *Cecil Co. Md.*

Occupation *Laborer.*

ENLISTMENT.

When *July, 27th*, 186*4*.

Where *Boston, 11th St.*

By whom *D. Davis* ; term *3* y'rs.

Remarks: *Mustered in at Readville
Mass., 12th 64.*

H. C. Thomas.

No. | 5 Col'd Cav. | Mass.

George H. Morton
Priv., Co. K, 5 Reg't Mass. Col'd Cav.

Appears on

Company Muster-in and Descriptive Roll
of the organization named above. Roll dated

Readville Mass, Mar 12, 1864.

Where born Cecile Co. Md.

Age 32 y'rs; occupation Laborer

When enlisted Feb. 27, 1864.

Where enlisted Boston, No 6.

For what period enlisted 3 years.

Eyes Black; hair Black

Complexion Black; height 5 ft. 4 in.

When mustered in Mar 12, 1864.

Where mustered in

Bounty paid \$ 100; due \$ 100

Where credited 4th Dist, Suffolk.

Company to which assigned

Remarks:

Book mark:

J. M. Nail

(356d)

Copyist.

M. | 5 Col'd Cav. | Mass.

George N. Morton

Priv., Co. H, 5 Reg't Mass. Col'd Cavalry.

Appears on

Company Muster Roll

for Mar 12 to Apr. 30, 1864.

Present or absent Present

Stoppage, \$ 100 for

Due Gov't, \$ 100 for

Valuation of horse, \$ 100

Valuation of horse equipments, \$ 100

Remarks:

Book mark:

J. N. Hall

(358)

Copyist.

M | **5 Col'd Cav.** | **Mass.**

George W. Morton
Priv, Co. H, 5 Reg't Mass. Col'd Cavalry.

Appears on

Company Muster Roll

for *May & June*, 186*4*

Present or absent *Present*

Stoppage, \$.....100 for

Due Gov't, \$.....100 for

Valuation of horse, \$.....100

Valuation of horse equipments, \$.....100

Remarks:

Book mark:

J. W. Hall
Copyist.

M 5 Col'd Cav. | **Mass.**

George M. Martin
Priv, Co. H, 5 Reg't Mass. Col'd Cavalry.

Appears on

Company Muster Roll

for *July & Aug*, 186 *4*

Present or absent *Present*

Stoppage, \$ *100* for

Due Gov't, \$ *100* for

Valuation of horse, \$ *100*

Valuation of horse equipments, \$ *100*

Remarks:

Book mark:

J. M. Wall

(358)

Copyist.

M | **5 Col'd Cav.** | **Mass.**

George W Molton
Pat, Co. H, 5 Reg't Mass. Col'd Cavalry.

Appears on

Company Muster Roll

for *Sept & Oct*, 1864.

Present or absent *Present*

Stoppage, \$ *0* ^{*04*}/_{*100*} for *one cross*
sabre letter + number.

Due Gov't, \$ *100* for

Valuation of horse, \$ *100*

Valuation of horse equipments, \$ *100*

Remarks:

Book mark:

C M Clark

M | **5 Col'd Cav.** | **Mass.**

George W Morton
Pat, Co. H, 5 Reg't Mass. Col'd Cavalry.

Appears on

Company Muster Roll

for Nov. + Dec, 1864

Present or absent Present

Stoppage, \$ 100 for

Due Gov't, \$ 100 for

Valuation of horse, \$ 100

Valuation of horse equipments, \$ 100

Remarks:

Book mark:

C. M. Clark

H

5 Col'd Cav.

Mass.

George W Holton
Put, Co. H, 5 Reg't Mass. Col'd Cavalry.

Appears on

Company Muster Roll

for *Jan & Feb*, 1865.

Present or absent *Present*.

Stoppage, \$ *100* for

Due Gov't, \$ *100* for

Valuation of horse, \$ *100*

Valuation of horse equipments, \$ *100*

Remarks: *Due 1st, 2d, 3d & 4th install-
ments U.S bounty.*

Book mark:

C M Clark

(358)

Copyist.

M 5 Col'd Cav. | **Mass.**

George W Morton
Put, Co. II, 5 Reg't Mass. Col'd Cavalry.

Appears on

Company Muster Roll

for March & April, 1865.

Present or absent Present.

Stoppage, \$..... 100 for

Due Gov't, \$..... 100 for

Valuation of horse, \$..... 100

Valuation of horse equipments, \$..... 100

Remarks: Due 1st, 2d 3d &
4th installments U.S.
bounty.

Book mark:

C. H. Clark

(358)

Copyist.

M **5 Col'd Cav.** | **Mass.**

George W Mortons
Put, Co. H, 5 Reg't Mass. Col'd Cavalry.

Appears on

Company Muster Roll

for May + June, 1865.

Present or absent Present

Stoppage, \$..... 100 for

Due Gov't, \$..... 100 for

Valuation of horse, \$..... 100

Valuation of horse equipments, \$..... 100

Remarks: 12th, 2^d, 3^d + 4th install-
ment U.S. bounty, due
Free on or before April
19, 1861.

Book mark:

C. H. Clark

(358)

Copyist.

M | 5 Col'd Cav. | Mass.

George W. Morton

Civi., Co. H, 5 Reg't Mass. Col'd Cavalry.

Appears on

Company Muster Roll

for July & Aug., 1865.

Present or absent present

Stoppage, \$ 100 for

Due Gov't, \$ 100 for

Valuation of horse, \$ 100

Valuation of horse equipments, \$ 100

Remarks: Free on or before Apr. 19. 1861.

Book mark:

R. Lewis

M | 5 Col'd Cav. | Mass.

Geo. W. Morton

Priv., Co. H., 5 Reg't Mass. Col'd Cavalry.

Appears on Co. Muster-out Roll, dated
Clarksville, Tex., Oct. 31, 1865.

Muster-out to date _____, 186 .

Last paid to Dec. 31, 186 11.

Clothing account:

Last settled _____, 186 ; drawn since \$ _____ 100

Due soldier \$ 18 93³ 100; due U. S. \$ _____ 100

Am't for cloth'g in kind or money adv'd \$ _____ 100

Due U. S. for arms, equipments, &c., \$ _____ 100

Bounty paid \$ _____ 100; due \$ 300 100

Remarks: Abs sick at Brazos,
Tex. since Oct. 10, '65. No
discharge furnished.
Free on or before Apr. 19,
1866.

Book mark: 250.397- Died (Oct. 24, '65
10000)

R. E. Wilson

Morton, Geo. W.

P, Co. H, 5 Reg't Mass. C. Cav.

Enclosures.

Bed Cards	Descriptive Lists
Burial Records	Final Statements
Certs. of Dis. for Discharge	Furloughs
C. M. Charges	Med. Des. Lists
Med. Certificates	Orders

Other papers relating to—

Admission to Hosp'l	Furlough
Casualty Sheet (Officer's)	Med. Examination
Confinement	Misc. Information
Contracts	Pay or Clothing
Death or Effects	Personal Reports
Desertions	Rank
Discharge from Hosp'l	Transfer to Hosp'l
Discharge from Service	Transfer to V. R. C.
Duty	Transportation

MICROFILM PUBLICATION M 1822

COMPILED MILITARY SERVICE RECORDS
OF VOLUNTEER UNION SOLDIERS WHO
SERVED WITH THE USCT (US COLORED TROOPS)
5TH MASSACHUSETTS REGIMENT OF CAVALRY

PERSONAL PAPERS' TARGET SHEET

PLEASE NOTE THE CHECKED INFORMATION ABOUT THE PERSONAL PAPERS IN
THIS FILE:

- NO PERSONAL PAPERS WERE FOUND IN THIS FILE WHEN THE
RECORDS WERE ARRANGED FOR MICROFILMING.
- 2 PERSONAL PAPER(S) FOUND IN THIS FILE WHEN THE RECORDS
WERE ARRANGED FOR MICROFILMING.

[OFFICE INDORSEMENT.]

War Department,

ADJUTANT GENERAL'S OFFICE,

May 16, 1874

The death of George W. Horton
Private, Co. 36, 57 Reg't U.S.
Colored Mass Cav., is reported as follows:
On Company Muster Roll.

For _____, 186 _____, 186

Company Muster-out Roll. 1865
about sick, No discharge furnished 186
Company Descriptive Book.

_____, 186

Company Morning Reports.

_____, 186
Soldier's Casualty List
Final Statement.

_____, 186
Soldier's Record of Death and Interment.

_____, 186
Soldier's Inventory of Effects.

_____, 186
Soldier's Certificate of Disability for Discharge.

_____, 186
Soldier's Individual Muster-out Roll.

_____, 186
Regimental Return.

For _____, 186 _____, 186
Regimental Quarterly Returns.

_____, 186
Regimental Descriptive Book.

Says in the Post Office Bureau St. Louis,
Texas report his death in
the hospital Oct 24, 1865
Oct 24, 1866, is held to be

the correct date, and the Company Muster out
Roll will be amended accordingly.

See letter to Bureau of June 9, 1874.

Anna M. Sweet
Assistant Adjutant General.

E13 11
7/14 Aled
Hott.

for ...
CASUALTY SHEET

No. _____

Geo W. Horton
Priv of Company B
S Regiment of Mass Cav.
State Volunteers.

NATURE OF CASUALTY.

Died Oct. 24, 1865

CASUALTY SHEET.

Name: George W. Martin
Rank: Private Company: H Regiment: 5th
Arm: Cavalry State: Mass
Nature of Casualty: Death

CAUSE OF CASUALTY—(NAME OF DISEASE, &c.)

Dysentery

BY WHOM DISCHARGED.

FROM WHAT SOURCE THIS INFORMATION WAS
OBTAINED.

Roll of Honor Pg 23
Index

DEGREE OF DISABILITY.

BY WHOM CERTIFIED.

Jas. M. Moore
A. G. M.

DATE OF DISCHARGE, DEATH, &c.

Oct. 24, 1865

PLACE OF DISCHARGE, DEATH, &c.

Prayer Santiago

REMARKS.

James B. Smith
Clerk.
(170)

Post Hospital
Tragos Carriage
respectfully returns
the information that Lt. Geo.
W. Morton Co. 5th Regt.
Caval. was admitted to
this hospital with Venereal
on 9th 1865 and reported
gone 24 1865.

no other description
but no fine records.

J. Mass
A. L. Norris.

Acting Surgeon
in charge

with no endorsement
of Act. Surg. A. L. Norris
1st Regt. Caval. & Co. 1
The enclosed papers
cannot be furnished or
procured by this office.

L. H. Pullin
Bot Brig. Gen. and Surg. U. S. A., Medical Director.

Head Quarters Sub Dist R. G.
Office Chief Med Officer
Brownsville Mar 26 67

Respectfully returned to the
Chief Med Officer Dist of
Texas with reference to previous
endorsement

E. S. Collier
Capt & Act. Surg. 11th
Chief Med Officer

1865 U. S. M. 272 1156
Head Quarters Dist of Texas
Office of Chief Med Officer
Galveston Tex. April 8 1867
Respectfully returned to Act.
Brig. Gen. Thos. A. M. Parlin
Surgeon Regt. Med. Dir. 5th
District with reference to
foregoing endorsement
Wm. Taylor
Act. Lt. Col's Surgeon
Chief Med Officer

For hospital

Head Quarters Sub Dist R. G.
Office Chief Med Officer
Brownsville Mar 26 '67

Respectfully returned to the
Chief Med Officer Dist of
Texas with reference to previous
endorsement

E. S. Taylor
Capt & Asst Surg. R. G.
Chief Med Officer

Headquarters Department of the Gulf,
5th New Orleans
MEDICAL DIRECTOR'S OFFICE,

New Orleans, La., Apr 1 1867.

RESPECTFULLY

Edw. S. Taylor

Asst. Surg. U. S. A.

reference to endorsement

of Asst. Surg. A. I. Harris

of 20th Feb 67

which is hereby

cancelled & returned to

proper authorities

E. S. Taylor

Asst. Surg. U. S. A.

L. H. Sullivan

Bot Brig. Gen. and Surg. U. S. A., Medical Director.

Apr 1 1867
Head Quarters Dist of Texas
Office of Chief Med Officer
Galveston Tex April 8 1867
Respectfully returned to Det.
Brig Gen. Thos. A. McParlin
Surgeon Regt. Med. Dir. 5th Milit.
District with reference to
foregoing endorsement
E. S. Taylor
Det. Lt. Col. Surgeon
Chief Med Officer

WAR DEPARTMENT,

ADJUTANT GENERAL'S OFFICE,

WASHINGTON, *Aug. 22*, 186*6*

SIR:

Final Statements in the cases of deceased soldiers are required to be sent to the Adjutant General's Office in duplicate, with one copy of the Inventory of Effects. The Descriptive List should also be sent to this Office in cases where the soldier was absent from his Company at the time of his death. Where there were no effects, it should be so stated on a blank Inventory, properly signed.

Certificates of Disability should be sent in duplicate. Special care should be taken that the date of discharge and signature of the discharging officer should be affixed.

Copy of the Final Statement *copy* Inventory, has been received in the case of *P. G. H. Hooten*, of Co. *K*, *S* Regiment of *Mass. Volunteers*, whose papers were forwarded to this Office. You will please forward the missing papers without delay.

I have the honor to be, sir,

Very respectfully,

Your obedient servant,

*Respected Genl
Oct. 24, 1861
Texas.*

Leech

Assistant Adjutant General.

(110)

~~COMMANDING OFFICER~~

Medical Director, Capt. J. H.

If final papers cannot be furnished, please give date, place and cause of death, if possible,

J. H.

MODEL FOR SET OF PAPERS FOR A DECEASED SOLDIER.

FORM 1.—FINAL STATEMENT.

I CERTIFY, ON HONOR, that *John Smith*, a Private of Captain J. Brown's Company, (A.) of the 1st Regiment of Pennsylvania Volunteers, of the State of Pennsylvania, born in Pittsburg, State of Pennsylvania, aged 21 years, 5 feet 10 inches high, light complexion, blue eyes, dark hair, and by occupation a Farmer, having joined the Company on its original organization at Pittsburg, and enrolled in it at the muster into the service of the United States at Pittsburg, on the 1st day of July, 1861, (or was mustered in service as a recruit, by _____, at _____, on the _____ day of _____, 186—, or was drafted and mustered into the service of the United States from the _____ Enrollment District of the State of _____, at _____, on the _____ day of _____, 186—,) to serve in the Regiment for the term of Three Years, and having served *honestly and faithfully* with his Company in the field to the present date, is now entitled to a DISCHARGE by reason of death. Died in Regimental Hospital, Fort Brown, Texas, December 31, 1863, of typhoid fever.

The said John Smith was last paid by Paymaster Major Morse, to include the 31st day of October, 1863, and has pay due him from that time to the present date. He is entitled to pay and subsistence for *traveling* to place of enrollment, and whatever other allowances are authorized to volunteer soldiers, drafted men, or militia, so discharged. He has received from the United States *clothing* amounting to 20.00 dollars, since the 31st day of December, 1862, when his clothing account was last settled. He has received from the United States 25.00 dollars advanced *bounty*.

There is to be stopped from him on account of the State of _____, or other authorities, for *clothing, &c.*, received on entering service, nothing, .00 dollars; and for other stoppages, viz: nothing, .00 dollars. He has been furnished with no *transportation* in kind from the place of his discharge to _____; and he has not been *subsisted for traveling* to his place of enrollment up to the _____, 186—.

He is indebted to _____, Sutler, .00 dollars.

He is indebted to _____, Laundress, .00 dollars.

GIVEN, IN DUPLICATE, at Fort Brown, Texas, this 31st day of December, 1863.

JAMES BROWN,
Captain Co. A, 1st Penn. Vols.,
Commanding Company.

FORM 2.

INVENTORY of the effects of John Smith, late a Private of Captain J. Brown's Company, (A.) of the 1st Regiment of Pennsylvania Volunteers, who was enrolled as a Private at Pittsburg, in the State of Pennsylvania, on the 1st day of July, 1861, and mustered into the service of the United States as a Private on the 1st day of July, 1861, at Pittsburg, in Company A, 1st Regiment of Pennsylvania Volunteers, to serve three years or during the war. He was born in Pittsburg, in the State of Pennsylvania; he was 21 years of age, 5 feet 10 inches high, light complexion, blue eyes, dark hair, and by occupation, when enrolled, a Farmer. He died in Regimental Hospital, at Fort Brown, Texas, on the 31st day of December, 1863, of typhoid fever.

INVENTORY.					
ARTICLES.	No.	ARTICLES.	No.		
Hats.....	1	Pairs trousers.....	1		
Caps.....		Pairs flannel drawers.....			
Forage caps.....		Pairs cotton drawers.....			
Great coats.....		Flannel shirts.....			
Uniform coats.....		Cotton shirts.....			
Uniform jackets.....		Pairs boots.....			
Flannel sack coats.....		Pairs shoes.....			
Blouses.....		Pairs socks.....			
Stable frocks.....		Blankets.....			
Fatigue overalls.....		Haversacks.....			
				Knapsacks.....	
				Watch, silver.....	1
				MONEY.	
		Specie.....	\$4 00		
		Notes.....	\$50 00		

I CERTIFY, ON HONOR, that the above inventory comprises all the effects of Private John Smith, deceased, and that the effects are in the hands of Captain J. Brown, at Fort Brown, Texas, to be disposed of by a Council of Administration, except the money, which has been turned over to Major Wm. C. Morse, Paymaster, U. S. Army, whose receipt is hereto annexed.

STATION: Fort Brown, Texas.

DATE: December 31, 1863.

(Duplicates.)

JAMES BROWN,
Captain Co. A, 1st Penn. Vols.,
Commanding the Company.

*NOTE.—If the effects have been turned over to relatives of deceased, so state on certificate, instead of "in the hands of Captain," &c., and give the names of the persons, and their relation to the deceased person.

FORM 3.—HEIR'S RECEIPT FOR EFFECTS.

RECEIVED of Captain John Brown, Company A, 1st Regiment of Pennsylvania Volunteers, the following effects of Private John Smith, late of Company A, 1st Regiment of Pennsylvania Volunteers, now deceased, which I claim as his wife:
1 great coat, 1 flannel shirt, 1 silver watch, fifty dollars in notes, and two dollars in specie.

MARY SMITH.

FORM 4.—PAYMASTER'S RECEIPT FOR MONEY.

RECEIVED, this 31st day of December, 1863, at Fort Brown, Texas, of Captain James Brown, of Company A, 1st Pennsylvania Volunteers, fifty dollars in Treasury notes and two dollars in specie, the property of the late Private John Smith, of Company A, 1st Pennsylvania Volunteers, who died at Fort Brown, Texas, on the 31st day of December, 1863.

WM. C. MORSE, Paymaster, U. S. A.

FORM 5.—PROCEEDINGS OF A COUNCIL OF ADMINISTRATION.

Convened at Fort Brown, Texas, pursuant to Orders, No. 1, dated Post Headquarters, Fort Brown, Texas, January 2, 1864—consisting of Captain James Keith, Company C, 1st Pennsylvania Volunteers; Captain John Brown, Company D, 1st Pennsylvania Volunteers; and Lieutenant William Roe, Company E, 1st Pennsylvania Volunteers—for the purpose of disposing of the effects of the late John Smith, of Company A, 1st Pennsylvania Volunteers:

The Council found that the effects consisted of the following articles. They were ordered to be sold at auction, which was accordingly done, and the amount set opposite the articles respectively obtained, for which the receipt of the Paymaster is annexed:

AT AUCTION.		
1 shirt brought.....		\$1 00
1 great coat ".....		2 50
1 silver watch ".....		25 00
		\$28 50

JAMES KEITH,
Capt. Co. C, 1st Penn. Vols., President.
WILLIAM ROE,
Lieut. Co. E, 1st Penn. Vols., Resorder.

APPROVED: JOHN SANDERS,
Colonel 1st Penn. Vols.,
Commanding Post.

FORM 6.—PAYMASTER'S RECEIPT.

RECEIVED from Captain John Brown, Company A, 1st Pennsylvania Volunteers, at Fort Brown, Texas, January 10, 1864, twenty-eight dollars and fifty cents, the result of the sale of the effects of the late Private John Smith, of Company A, 1st Pennsylvania Volunteers.

WM. C. MORSE, Paymaster U. S. Army.

ARTICLES OF WAR.

ART. 95. When any non-commissioned officer or soldier shall die, or be killed in the service of the United States, the then commanding officer of the troop or company shall, in the presence of two other commissioned officers, take an account of what effects he died possessed of, above his arms and accoutrements, and transmit the same to the office of the Department of War, which said effects are to be accounted for, and paid to the representatives of such deceased non-commissioned officer or soldier. And in case any of the officers, so authorized to take care of the effects of deceased officers and soldiers, should, before they have accounted to their representatives for the same, have occasion to leave the regiment or post, by preferment or otherwise, they shall, before they be permitted to quit the same, deposit in the hands of the commanding officer, or of the assistant military agent, all the effects of such deceased non-commissioned officers and soldiers, in order that the same may be secured for, and paid to, their respective representatives.

DIRECTIONS.

NOTE 1.—One copy of the inventories of the effects of deceased non-commissioned officers and soldiers, required by the 95th Article of War, will be forwarded to the Adjutant General, by the commander of the company to which the deceased belonged, and a duplicate of the same to the chief of the regiment. Final statements of pay, clothing, &c., in duplicate, will be sent to the Adjutant General with one copy of the inventory. Both inventory and company, if will be the duty of his immediate commander to furnish, direct to the Adjutant General, the required inventory and final statements, and, at the same time, to forward to the commanding officer of the company to which the soldier belonged, a report of his death, specifying the date, place, and cause; to what time he was last paid, and the money or other effects in his possession at the time of his decease; which report will be noted on the next muster roll of the company to which the man belonged. Each inventory will be endorsed "Inventory of the effects of _____, late of company (—) _____ regiment of _____, who died at _____ the _____ day of _____, 186—." If a legal representative receive the effects, it will be stated in the report. If the soldier leave no effects, the fact will be reported on the blank for inventory.

NOTE 2.—Should the effects of a deceased non-commissioned officer or soldier not be administered upon within a short period after his decease, they shall be disposed of by a Council of Administration under the authority of the commanding officer of the post, and the proceeds deposited with the Paymaster, to the credit of the United States, until they shall be claimed by the legal representatives of the deceased. This should be done according to order being sufficient.

NOTE 3.—In all such cases of sales by the Council of Administration, a statement in detail, or account of the proceeds duly certified by the Council and commanding officer, (Form 5.) accompanied by the Paymaster's receipt of the proceeds, will be forwarded by the commanding officer to the Adjutant General. The statement will be endorsed "Report of the proceeds of the effects of _____, late of company (—) _____ regiment of _____, who died at _____ the _____ day of _____, 186—."

NOTE 4.—The effects in all cases, when called for, should be turned over to the legal representative, without further authority from the Adjutant General. When the effects are turned over to the relatives of the deceased before these inventories are sent to the Adjutant General, their receipts therefore should be attached to the inventories. In all other cases, one copy will be sent with a letter of transmittal direct to the Adjutant General, and a duplicate retained by the officer.

NOTE 5.—Particular care should be taken to take receipts in duplicate from the Paymaster for any funds turned over to him; one copy should be sent direct to the Adjutant General, and one retained by the officer.

NOTE 6.—Where a soldier dies in hospital or on detached service, his descriptive list, if he has one, should be sent with his final statements, in duplicate, to the Adjutant General, Washington, D. C.

NOTE 7.—Form 1 will be forwarded in duplicate to the Adjutant General, through Regimental Headquarters, as soon as possible after the death of the soldier, accompanied by one copy of Forms 2 and 3, or 4, as the case may require. A duplicate of the inventory (Form 2) should be retained until the articles are finally disposed of.

NOTE 8.—The papers for each man should be made SEPARATELY for each man, and, when possible, fastened together. This is especially necessary, and must be done in all cases. The papers cannot be properly disposed of at the Adjutant General's Office unless this is done, and must be returned for correction.

NOTE 9.—Where there are no line officers, as for instance, a general hospital without a line officer to command the guard, the Council of Administration may be made up from other commissioned officers, in the same way as prescribed for line officers.

NOTE 10.—Where a soldier dies away from his company or regiment, and the officer having charge of him cannot furnish Final Statements by reason of not being able to obtain a Descriptive List, he should notify the regimental or company commander, (giving him full particulars as to history and description of the man, as far as possible,) whose duty it will then be, in such case, to furnish the necessary papers from the best data he can obtain.

1033
Morton, John

Co A, 5 Mass. Cav., (Col'd.)

Private

Private

CARD NUMBERS.

1	5372682	26
2	5379720	27
3	5379823	28
4	5379922	29
5	5380030	30
6	5380130	31
7	5380230	32
8	5380326	33
9	5380422	34
10	9092092	35
11	40731430	36
12		37
13		38
14		39
15		40
16		41
17		42
18		43
19		44
20		45
21		46
22		47
23		48
24		49
25		50

Book Mark:

See also

S. 1144761 P.O. aff.

S. 1176094 P.O. aff

S. 14 11757. P.O. returned.

Phone 3/18/27 51

Alma
4

M **5 Cav. (Col'd.) | Mass.**

John Moston

F, Co. *F*, 5 Reg't Mass. Cav. (Col'd.)

Appears on

Company Descriptive Book

of the organization named above.

DESCRIPTION.

Age *21* years; height *5* feet *4 1/2* inches.

Complexion *blk*

Eyes *blk*; hair *blk*

Where born *Virginia*

Occupation *Laborer.*

ENLISTMENT.

When *June 2*, 186*4*.

Where *Ellicotts Mills Md.*

By whom *J. W. Blackford* term *3* y'rs.

Remarks:

Hearn

M | **5 Col'd Cav.** **Mass.**

John Moulton

Appears with rank of Private on

Muster and Descriptive Roll of a Detachment of Drafted Men and Substitutes forwarded

for the 5 Reg't Mass. Colored Cavalry. Roll dated Washington, D.C. June 2, 1864.

Where born King William, Va.

Age 21 years; occupation Laborer.

Drafted and mustered in:

When June 2, 1864

Where Washington, D.C.

Period 3 years.

Eyes Black; hair Black

Complexion Black; height 5 ft. 1/2 in.

Paid bounty and advance pay, \$ 100

Bounty due \$ 100

Where credited

Company to which assigned

Remarks: Accepted as substitute for Thos. J. Bourne Ellicott's Mills

Book mark: Md

M. D. ...

M | **5 Col'd Cav.** | **Mass.**

John Morton
Pt, Co. F, 5 Reg't Mass. Col'd Cavalry.

Appears on

Company Muster Roll

for *July & Aug*, 1864

Present or absent *Present*

Stoppage, \$ *100* for

Due Gov't, \$ *100* for

Valuation of horse, \$ *100*

Valuation of horse equipments, \$ *100*

Remarks: *Stop one canteen*

Book mark:

J. Stewart
(358) Copyist.

M | 5 Col'd Cav. | Mass.

John Morton
Pt, Co. F, 5 Reg't Mass. Col'd Cavalry.

Appears on

Company Muster Roll
for Sep 10 Oct, 1864.

Present or absent Present

Stoppage, \$ 100 for

Due Gov't, \$ 100 for

Valuation of horse, \$ 100

Valuation of horse equipments, \$ 100

Remarks:

Book mark:

J. Stewart
(358) Copyist.

M | 5 Col'd Cav. | Mass.

John Morton
Pt, Co. F, 5 Reg't Mass. Col'd Cavalry.

Appears on

Company Muster Roll

for Nov & Dec, 1864.

Present or absent Present

Stoppage, \$ 100 for

Due Gov't, \$ 100 for

Valuation of horse, \$ 100

Valuation of horse equipments, \$ 100

Remarks:

Book mark:

J. H. Stewart

M | 5 Col'd Cav. | Mass.

John Morton
Pl, Co. F, 5 Reg't Mass. Col'd Cavalry.

Appears on

Company Muster Roll

for Jan & Feb, 1865.

Present or absent Present

Stoppage, \$ 100 for

Due Gov't, \$ 100 for

Valuation of horse, \$ 100

Valuation of horse equipments, \$ 100

Remarks: Due first Int
U. S. Bounty

Book mark:

(358)

J. H. Stewart

Copist.

M 5 Col'd Cav. | Mass.

John Morton
Pt., Co. F, 5 Reg't Mass. Col'd Cavalry.

Appears on

Company Muster Roll

for *March & April*, 1865.

Present or absent *Present*

Stoppage, \$ *100* for

Due Gov't, \$ *100* for

Valuation of horse, \$ *100*

Valuation of horse equipments, \$ *100*

Remarks: *Due first inst
M.S. Bounty 25.00*

Book mark:

J. H. Stewart

(858)

Copyist.

M | **5 Col'd Cav.** | **Mass.**

John Norton
_____, Co. F, 5 Reg't Mass. Col'd Cavalry.

Appears on

Company Muster Roll

for *May's term*, 186*2*.

Present or absent *Present*

Stoppage, \$ _____ *100* for _____

Due Gov't, \$ _____ *100* for _____

Valuation of horse, \$ _____ *100*

Valuation of horse equipments, \$ _____ *100*

Remarks: _____

Book mark: _____

J. A. Jones

(358) Copyist.

MA 5 Col'd Cav. | **Mass.**

John Mostow
21, Co. F, 5 Reg't Mass. Col'd Cavalry.

Appears on

Company Muster Roll

for *July 1st Aug*, 186*1*.

Present or absent *Present*

Stoppage, \$ *100* for

Due Gov't, \$ *100* for

Valuation of horse, \$ *100*

Valuation of horse equipments, \$ *100*

Remarks:

Book mark:

J. H. Johnson

M. | 5 Col'd Cav. | Mass.

John Morton
Pvt., Co. F., 5 Reg't Mass. Colored Cav.

Appears on Returns as follows:

July 1864. Gain on or about
July 3/64, Point Lookout
Md. Rect. from Depot.

July to Sept. 1865. Absent sick
at U.S. Gen. Hosp. Brazos
de Santiago, Tex. July 27"

Book mark :

(546)

J. B. Sitter

Copyist.

M. J. ... | **5 Col'd Cav.** | **Mass.**

John ...
..., Co. *D*, 5 Reg't Mass. Col'd Cavalry.

Appears on **Co. Muster-out Roll**, dated
Wassville Tex., Oct 31, 1864.

Muster-out to date *Oct 31, 1864*.

Last paid to *Nov 31, 1864*.

Clothing account:

Last settled....., 186 ; drawn since \$..... 100

Due soldier \$..... 100; due U. S. \$..... ¹⁹100

Am't for cloth'g in kind or money adv'd \$..... 100

Due U. S. for arms, equipments, &c., \$..... 100

Bounty paid \$..... 100; due \$ ~~100~~ 100

Remarks: *One U.S. for 4 1/2*
years & 20

Book mark: *V 184 P 108, 74*

Morton

Moulton, John
Pr., Co. 5 Reg't Mass, C. Cav.

Enclosures.

Bed Cards	Final Statements
Burial Records	Furloughs or L. of A.
Certs. of Dis. for Discharge	Med. Certificates
C. M. Charges	Med. Des. Lists
Descriptive Lists	Orders
Discharge Certificates	Pris. of War Record
Enlistment Papers	Resignations

Other papers relating to—

Admission to Hosp'l	Furlough or L. of A.
Casualty Sheet	Med. Examination
Confinement	Misc. Information
Contracts	Pay or Clothing
Death or Effects	Personal Reports
Desertion	Rank
Discharge from Hosp'l	Transfer to Hosp'l
Discharge from Service	Transfer to V. R. C.
Duty	Transportation

3rd Mass Col'd Co 88

No. 88

John Moulton
Enlisted at Washington D.C.

As Substitute for

Thomas J. Bowser

On the 20th day of June, 1864.

By

Henry A. Scheetz
F. W. Blackford
John P. Krasby

Board of Enrollment,

Dist. of Columbia

A.G.O. Found filed
with U.S. Vols
Nov 18-75

SUBSTITUTE

VOLUNTEER ENLISTMENT.

District
STATE OF

To be credited to the
TOWN OF

Columbia

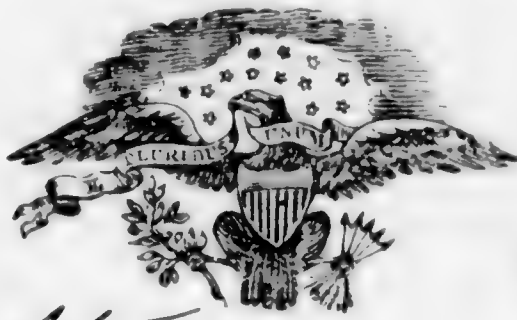

Ellicotts Mills Md.

I, *John Moulton* born in the State
of *Virginia*, aged *twenty one* years, and by
occupation a *labourer*

Do HEREBY ACKNOWLEDGE to have agreed with

Thomas J. Bowie, Esq., of *Ellicotts Mills*
5th Congt Dist, 1st Elector Dist, Maryland

to become his **SUBSTITUTE** in the Military Service, for a sufficient consideration paid and
delivered to me, on the *second* day of *June*, 186*4*;

and having thus agreed with said *Thomas J. Bowie* I DO HEREBY
ACKNOWLEDGE to have enlisted this *second* day of *June*,

186*4*, to serve as a **Soldier** in the **Army of the United States of America**, for the period
of **THREE YEARS**, unless sooner discharged by proper authority: I do also agree to accept such
bounty, pay, rations, and clothing, as are, or may be, established by law for soldiers. And I do
solemnly swear that I will bear true and faithful allegiance to the **United States of America**;
that I will serve them honestly and faithfully against all their enemies or opposers whomsoever;
and that I will observe and obey the orders of the President of the United States, and the orders
of the Officers appointed over me, according to the Rules and Articles of War.

SWORN and subscribed to, at *Washington D.C.*

this *2nd* day of *June*, 186*4*

BEFORE

Henry A. Sheets
Capt & Provost Marshal D.C.

John Moulton
his
mark

We certify, on honor, That we have carefully examined the above-named Volunteer Substitute
agreeably to the Regulations, and that, in our opinion, he is free from all bodily defects and mental infirmity
which would in any way disqualify him from performing the duties of a soldier; that he was entirely sober
when enlisted; that he is of lawful age, (not under 18 years;) and that, in accepting him as duly qualified to
perform the duties of an able-bodied soldier, and as a Substitute in lieu of *Thomas J. Bowie*
who was, drafted in *Ellicotts Mills 5th Congt Dist Md*
May 26th, 186*4*, we have strictly observed the Regulations which govern
in such cases. This soldier has *Black* eyes, *Black* hair, *Black* complexion; is *5* feet *4 1/4*
inches high.

Henry A. Sheets
Capt & Provost Marshal D.C.

Francis H. Blackford
Commissioner of Board.

John B. Neasey
Surgeon of Board.

Board of Enrollment of _____ Dist. of *Columbia*

5th Mass Cavalry

DECLARATION OF SUBSTITUTE.

I, John Moulton desiring to ENLIST
in the Army of the United States, for THREE YEARS, **Do declare**, That I am
thirty one years and _____ months of age; that I have
never been discharged from the United States service on account of disability or by sentence of
a court martial; and I know of no impediment to my serving honestly and faithfully as a soldier
for three years.

GIVEN at Washington DC
the 2nd day of June 1864

WITNESS:

A. Ball John Moulton
his mark



1034

Mortimer, John

Co P, 5 Mass. Cav., (Col'd.)

Private

Private

CARD NUMBERS.

1	53 74 79 2	26
2	53 74 89 2	27
3	53 75 0 0	28
4	53 75 10 7	29
5	53 75 2 1 2	30
6	53 75 3 1 6	31
7	53 75 4 1 5	32
8	53 75 5 1 4	33
9	53 75 6 0 7	34
10	53 75 6 4 6	35
11	90 92 5 6 8	36
12	308528 16	37
13	33030889	38
14	30854241	39
15	40731429	40
16		41
17		42
18		43
19		44
20		45
21		46
22		47
23		48
24		49
25		50

Book Mark: 633.V-10-P-550

See also

RXP 625530

Spaeth
4

M | **5 Cav. (Col'd.)** | **Mass.**

John Mortimer

Co. B, 5 Reg't Mass. Cav. (Col'd.)

Appears on

Company Descriptive Book

of the organization named above.

DESCRIPTION.

Age 20 years; height 5 feet 7 inches.

Complexion Black

Eyes Black; hair Black

Where born Washington, D.C.

Occupation Steamer

ENLISTMENT.

When May 1st, 1861.

Where Cambridge

By whom H. S. Mass; term 2 y'rs.

Remarks:

.....
.....
.....
.....
.....
.....
.....
.....
.....
.....

H. S. Mass

16 | **5 Col'd Cav.** | **Mass.**

Sam'l - Nor - Sim -

Pl, Co. B, 5 Reg't Mass. Col'd Cavalry.

Appears on

Company Muster Roll

for *May & June*, 1864.

Present or absent *Present*

Stoppage, \$ *100* for

Due Gov't, \$ *100* for

Valuation of horse, \$ *100*

Valuation of horse equipments, \$ *100*

Remarks: *Enrolled May 12/64 at Cambridge & Mustered in same day at Washington for 3 yrs*

Book mark:

Ferberger

M. | **5 Col'd Cav.** | **Mass.**

John Mortimer,
Privt, Co. B, 5 Reg't Mass. Col'd Cavalry.

Appears on

Company Muster Roll

for July & Aug., 1864.

Present or absent Present.

Stoppage, \$ 100 for

Due Gov't, \$ 100 for

Valuation of horse, \$ 100

Valuation of horse equipments, \$ 100

Remarks:

Book mark:

(358)

J. W. Brown
Copyst.

M. | **5 Col'd Cav.** | **Mass.**

John Mortimer
Priv, Co. B, 5 Reg't Mass. Col'd Cavalry.

Appears on

Company Muster Roll
for *Sept. & Oct.*, 1864.

Present or absent *Present.*

Stoppage, \$ *100* for

Due Gov't, \$ *100* for

Valuation of horse, \$ *100*

Valuation of horse equipments, \$ *100*

Remarks: *Free on or before*
Apr. 19/61.
Due U.S. Bounty \$ 25.00

Book mark:

J. W. Brown,
(358) *Copyist.*

Ill. | **5 Col'd Cav.** | **Mass.**

John Mortimer,
Sgt., Co. B, 5 Reg't Mass. Col'd Cavalry.

Appears on

Company Muster Roll
for Nov. & Dec., 1864.

Present or absent — Present

Stoppage, \$ 100 for

Due Gov't, \$ 100 for

Valuation of horse, \$ 100

Valuation of horse equipments, \$ 100

Remarks: Due U.S. for Camp
& Car. Equipage \$ 0.85

Book mark: _____

W. Brown

(358)

Copyist.

M. | **5 Col'd Cav.** | **Mass.**

John Martiner,
Priv., Co. B, 5 Reg't Mass. Col'd Cavalry.

Appears on

Company Muster Roll

for *Jan'y. & Feby.*, 1865.

Present or absent *— Present.*

Stoppage, \$ *100* for

Due Gov't, \$ *100* for

Valuation of horse, \$ *100*

Valuation of horse equipments, \$ *100*

Remarks: *Due the Soldier*
1st Instnt. U.S. Bounty
\$25.00. Due U.S. \$1.33

Book mark: _____

W. Brown

(358)

Copyist.

M. | **5 Col'd Cav.** | **Mass.**

John Mortimer,
Pat.; Co. B, 5 Reg't Mass. Col'd Cavalry.

Appears on

Company Muster Roll
for *March & April*, 1865.

Present or absent *- Absent.*

Stoppage, \$ *100* for

Due Gov't, \$ *100* for

Valuation of horse, \$ *100*

Valuation of horse equipments, \$ *100*

Remarks: *I became sick in
Hosp. at Petersburg, Va.,
since Apr. 29/65.*

Book mark:

(358)

J. M. Brown
Copyist.

M | **5 Col'd Cav.** | **Mass.**

John Mortimer
Priv, Co. B, 5 Reg't Mass. Col'd Cavalry.

Appears on

Company Muster Roll

for May & June, 1865:

Present or absent Present

Stoppage, \$ 100 for

Due Gov't, \$ 100 for

Valuation of horse, \$ 100

Valuation of horse equipments, \$ 100

Remarks:

Book mark:

Scherick

M | **5 Col'd Cav.** | **Mass.**

John Martine

Priv., Co. B, 5 Reg't Mass. Col'd Cavalry.

Appears on

Company Muster Roll

for July & Aug., 1865.

Present or absent Absent

Stoppage, \$ 100 for

Due Gov't, \$ 100 for

Valuation of horse, \$ 100

Valuation of horse equipments, \$ 100

Remarks: Absent sick at
Brazoria

Book mark: _____

Scherick

M. | 5 low | U.S.A.

John Mortimer
Capt., Co. B, 5 Reg't Mass Cav.

Appears on

Hospital Muster Roll

of **Corps d'Afrique U. S. A. General Hospital,**

at **New Orleans, La.,**

for July & Aug, 1865.

Attached to hospital:

When _____, 1865.

How employed _____

Last paid by Maj. _____

to _____, 1865.

Bounty paid \$ 100; due \$ 100

Present or absent Present

Remarks: _____

Book mark; _____

Mr 5 Car Old Mass.

John Mortimer
Pvt, Co. B, 5 Reg Mass Cav

Appears on

Hospital Muster Roll

of Corps d'Afrique U. S. A. General Hospital,

at New Orleans, La.

for *Sept & Oct*, 1865.

Attached to hospital:

When _____, 186 .

How employed _____

Last paid by Maj. _____

to _____, 186 .

Bounty paid \$ 100; due \$ 100

Present or absent

Remarks:

Transferred
Sept 19, 1865

Book mark:

(843)

Steward
Cypist.

No 56. Cav. Mass

John Mortimer

Pvt, Co. B, 5 Reg^t Mass Cav^y

Appears on

Hospital Muster Roll

of DeCamp U. S. A. General Hospital,

at David's Island, New York Harbor,

for Sept & Oct, 1865

Attached to hospital:

When, 186 .

How employed

Last paid by Maj.

to, 186 .

Bounty paid \$ 100 ; due \$ 100

Present or absent

Remarks: Discharged from service Oct 21-1865

Book mark:

Rosenbaum
Copyist.

M. | 5 Col'd Cav. | Mass.

John Mortimer

Priv., Co. B, 5 Reg't Mass. Colored Cav.

Appears on Returns as follows:

May 1864. Gain May 18/64
City Point, Va. - Recruit
from Depot.

July to Sept. 1865. Absent sick
at Brazos since July
11/65.

Book mark :

(546)

J. B. Sittler

Copyist.

111 | 5 Collar, ^{Mass.} ~~U.S.C.T.~~

~~John~~ ^{Woodman}
~~Col~~, Co. B, 5^{Mass} Reg't U. S. Col'd Cav.

Appears on **Co. Muster-out Roll**, dated
Warrenton Tex., Oct. 31, 1865.

Muster-out to date _____, 186 .
Last paid to _____, 186 .

Clothing account:

Last settled _____, 186 ; drawn since \$ _____ 100

Due soldier \$ _____ 100; due U. S. \$ _____ 100

Am't for cloth'g in kind or money adv'd \$ _____ 100

Due U. S. for arms, equipments, &c., \$ _____ 100

Bounty paid \$ _____ 100 due \$ _____ 100

Remarks : _____

^X corrected by R. J. Walker

Book mark: C. D. Discharged Oct.
2/16/65 E. B. V. 10, P. 330.

Scherich

M

5 Col'd Cav.

Mass.

John Mortimer
Sgt., Co. B, 5 Reg't Mass. Col'd Cavalry.

Appears on Co. Muster-out Roll, dated
Warrenton, Ore., Oct. 31, 1865.

Muster-out to date _____, 186 .

Last paid to *Dec. 31, 1864.*

Clothing account:

Last settled _____, 186 ; drawn since \$ _____ 100

Due soldier \$ _____ 100; due U. S. \$ *67* ^{*54*} _____ 100

Am't for cloth'g in kind or money adv'd \$ _____ 100

Due U. S. for arms, equipments, &c., \$ _____ 100

Bounty paid \$ *25* ^{*00*} _____ 100; due \$ *75* ^{*00*} _____ 100

Remarks: *Absent sick in Hosp.,
No discharge furnished*

Book mark: *Disch'd, Oct. 24/65. E. B. N. 10. P. 330*

Scherich

Mortimer, John

P, Co. *P*, *5* Reg't *Mass* *Co*

3 Enclosures.

Bed Cards	Final Statements
Burial Records	Furloughs or L. of A
Certs. of Dis. for Discharge /	Med. Certificates
C. M. Charges	Med. Des. Lists
Descriptive Lists	Orders
Discharge Certificates	Pris. of War Record
Enlistment Papers	Resignations

Other papers relating to—

Admission to Hosp'l	Furlough or L. of A
Casualty Sheet /	Med. Examination
Confinement	Misc. Information
Contracts	Pay or Clothing
Death or Effects	Personal Reports
Desertion	Rank
Discharge from Hosp'l	Transfer to Hosp'l
Discharge from Service /	Transfer to V. R. C.
Duty	Transportation

NOTE 1.

The company commander will here add a statement of all the facts known to him concerning the disease or wound or cause of disability of the soldier, the time, place, manner and all the circumstances under which the injury occurred, or disease originated or appeared; the duty or service, or situation of the soldier at the time the injury was received or disease contracted, stating particularly whether the injury was received or the disease contracted in the line of his duty; and whatever other facts may aid a judgment as to the cause, immediate or remote, of the disability, and the circumstances attending it.

When the facts are not known to the company commander, the certificate of any officer, or affidavit of other person having such knowledge, will be appended—as the surgeon in charge of a hospital, the officer commanding a detachment of recruits, &c., &c.

NOTE 2.

When a probable case for pension, special care must be taken to state the degree of disability—as *l. l.*, &c., &c.; to describe particularly the disability, wound, or disease; the extent of which it deprives him of the use of any limb or faculty, or affects his health, strength, activity, constitution, or capacity to labor or earn his subsistence. The surgeon will add, from his knowledge of the facts and circumstances, and from the evidence in the case, his professional opinion of the cause or origin of the disability. In the case of discharges by Medical Inspectors, the last paragraph will state that the "discharge was given by consent of the soldier, after a personal examination, and for disability, the nature, degree, and origin of which are correctly described in the within certificate."

Par. 1260 Regulations, Edit. 1861.

Medical officers, in giving certificates of disability, are to take particular care in all cases that have not been under their charge; and especially in epilepsy, convulsions, chronic rheumatism, derangement of the urinary organs, ophthalmia, ulcers, or any obscure disease liable to be feigned or purposely produced; and in no case shall such certificate be given until after sufficient time and examination to detect any attempt at deception.

DIRECTIONS.

This certificate will be made out in duplicate by the soldier's company commander, or other officer commanding the separate detachment to which he belongs, and sent by him to the surgeon who has charge of the hospital where the soldier is sick. The surgeon will then fill out and sign the surgeon's certificate, and forward these papers to the regimental, detachment, or post commander, who will forward them, with his action endorsed thereon, through the proper channel, to his division commander; or, if the troops are not attached to a division, to his corps, department, or other commander or officer to whom the authority to discharge enlisted men may be specially delegated.

These certificates, after having received the action of the highest authority to which they are required to be sent, will be returned through the same channel to the regimental, post, or detachment commander, who will, if the discharge is authorized by the endorsement of the proper authority, sign the soldier's discharge, and the last certificate on this paper; see that the soldier is furnished with the proper discharge statements in duplicate, and forward BOTH of these to the Adjutant General United States Army, at Washington, D. C.; they will not, under any circumstances, be given into the hands of the soldier.

ADJUTANT GENERAL OFFICE
WASHINGTON, D. C.

Duplicate sent to Pension Office.

493 1115 14
CERTIFICATE OF DISABILITY FOR DISCHARGE

IN THE CASE OF

*John W. Mat...
Private Co. "B"
5 Reg't of Mass. Cav.*

APPROVED

*Wm. H. ...
Surgeon, U. S. A.,
Medical Director Dep't of the East.*

HEADQUARTERS DEPARTMENT OF THE EAST,

NEW YORK CITY, Oct. 15th, 1865.

To be discharged.

BY COMMAND OF MAJOR GENERAL HOOKER:

Wm. L...

Bvt. Maj. and A. D. C., A. A. A. G.

Received (A. G. Office)

186

Enon ...

ARMY OF THE UNITED STATES.
CERTIFICATE
OF DISABILITY FOR DISCHARGE.



Private John Mortimer, of Captain 1st Lieut P. T. Jackson Company, (B.) of the Fifth Mass Regiment of the United States was enlisted by A. A. Sheets of the _____ Regiment of _____ at Cambridge Mass on the twelfth day of May, 1864, to serve three years; he was born in Washington in the State of District Columbia, is _____ years of age, five feet seven inches high, Black complexion, Black eyes, Black hair, and by occupation when enlisted a Seamster. During the last two months said soldier has been unfit for duty 50 days.*

Station: Del Camp Gen Hosp
David's Island N.Y.
DATE: October 7 1865

Warren White
Lieut Major & Asst. Surg. U.S.A.
Commanding Company Hosp

I CERTIFY, that I have carefully examined the said John Mortimer of Captain 1st Lieut P. T. Jackson Company, and find him incapable of performing the duties of a soldier because of Chronic Dumbness, contracted he states, by exposure in the line of duty, Seigneurialis abtete - one scribble.

Sub to recent letter in Warren White's copy
Warren White
Asst. Surgeon. U.S.A.

DISCHARGED, this 11th day of October, 1865, at Del Camp Gen Hosp
David's Island N.Y. Warren White
Brevet Major & Asst Surgeon U.S.A.
Commanding the Reg't. Hosp

The Soldier desires to be addressed at
Town Washington County _____ State D. C.

De Camp General Hospital, U. S. A.,

DAVIDS' ISLAND, NEW YORK HARBOR,

..... 1865.

Sir :

I have to inform you that
..... of Co. B
..... Regiment Volunteers,
has this day been discharged from the Service, on "Surgeon's
Certificate of Disability."

His Descriptive List and Account of Pay and
Clothing received in this Hospital, are enclosed.

I am, Sir, respectfully,
Your obedient servant,

.....
Asst. Surgeon, U. S. Army,
Commanding Hospital.

To Commanding Officer Co.

..... Reg't Vols.

1272

CASUALTY SHEET

No.

100

of Company

Regiment of

1st

State Volunteers.

(Capt.)

NATURE OF CASUALTY.

100
Co. 216's



CASUALTY SHEET.

Name:

John Mortimer

Rank:

Priv.

Company:

B

Regiment:

5

Arm:

Co.

State:

Mass.

Nature of Casualty:

W. P.

CAUSE OF CASUALTY—(NAME OF DISEASE, &c.)

BY WHOM DISCHARGED.

DEGREE OF DISABILITY.

FROM WHAT SOURCE THIS INFORMATION WAS OBTAINED.

BY WHOM CERTIFIED.

W. M. Webster
C. J. A.

DATE OF DISCHARGE, DEATH, &c.

Oct. 21 1865

PLACE OF DISCHARGE, DEATH, &c.

Camp, N. Y. H.

Roll 59, Delcamp
Co., N. Y. H.

REMARKS.

[Signature]

Clerk.

[Handwritten initials]

1034-a

Moses, Antonio
Co., 5 ~~MS~~ Col'd Cav

CARD NUMBERS.

1	9436079	26
2		27
3		28
4		29
5		30
6		31
7		32
8		33
9		34
10		35
11		36
12		37
13		38
14		39
15		40
16		41
17		42
18		43
19		44
20		45
21		46
22		47
23		48
24		49
25		50

Number of personal papers herein

Book Mark

See also

M. Car. Mass.
Col'd
Antonio Moses,
....., Co., *5* Reg't *Mass* Col'd *Car*

Appears on
Regimental Descriptive Book
of the organization named above.

DESCRIPTION.

Age *31* years; height *6* feet *—* inches.
Complexion *Blk.*
Eyes *Blk.*; hair *Blk.*
Where born *Babar Africa.*
Occupation *Sailor.*

ENLISTMENT.

When *March 3*, 186*4*
Where *Brookline,*
By whom *J. E. Smith*; term *3* y'rs.
Remarks: *Rejected March*
26 64

Harmon

1035

Mason, Catron

Co A, 5 Mass. Cav., (Col'd.)

Private

CARD NUMBERS.

1	5381617	26
2	5381704	27
3	5381788	28
4	5381885	29
5	5381992	30
6	5382097	31
7	5382201	32
8	5382301	33
9	5382399	34
10	5382490	35
11	5373049	36
12	5382586	37
12	5372823	38
14	9091832	39
15	40731431	40
16		41
17		42
18		43
19		44
20		45
21		46
22		47
23		48
24		49
25		50

Book Mark: _____

See also _____

No. **5 Cav. (Col'd.)** | **Mass.**

Caban Moses.

....., Co. *H*, 5 Reg't Mass. Cav. (Col'd.)

Appears on

Company Descriptive Book

of the organization named above.

DESCRIPTION.

Age *25* years; height *5* feet *10* inches.

Complexion *Colored.*

Eyes *Black* ; hair *Black.*

Where born *Deson Africa.*

Occupation *Sailor.*

ENLISTMENT.

When *Feb'y, 2nd*, 1864.

Where *Cambridge.*

By whom *J. C. Dawes* ; term *3* y'rs.

Remarks: *Mustered in at Readville
Nov. 13th 64.*

H. C. Thomas.

Mo. | **5 Col'd Cav.** | **Mass.**

Leaton Moses,

Pvt., Co. H., 5 Reg't Mass. Col'd Cav.

Appears on

Company Muster-in and Descriptive Roll
of the organization named above. Roll dated

Readville Mass, Mar 12, 1864.

Where born Deson, Africa,

Age 25 y'rs; occupation Sailor

When enlisted Feb 2, 1864.

Where enlisted Cambridge

For what period enlisted 3 years.

Eyes Black; hair Black

Complexion Black; height 5 ft. 10 in.

When mustered in Mar 12, 1864.

Where mustered in

Bounty paid \$ 100; due \$ 100

Where credited 4th Dist, Middlesex

Company to which assigned

Remarks:

Book mark:

J. W. Hall

M | **5 Col'd Cav.** | **Mass.**

Captain Moses

Priv, Co. H, 5 Reg't Mass. Col'd Cavalry.

Appears on

Company Muster Roll

for *Mar 12 to Apr. 30*, 186 *4*

Present or absent *Present*

Stoppage, \$ *100* for

Due Gov't, \$ *100* for

Valuation of horse, \$ *100*

Valuation of horse equipments, \$ *100*

Remarks:

Book mark:

J M Wall

M | 5 Col'd Cav. | **Mass.**

Leaton Moses,

Priv, Co. H, 5 Reg't Mass. Col'd Cavalry.

Appears on

Company Muster Roll

for *May & June*, 186*4*

Present or absent *Present*

Stoppage, \$ *100* for

Due Gov't, \$ *100* for

Valuation of horse, \$ *100*

Valuation of horse equipments, \$ *100*

Remarks: *Due U.S. \$30 for
apprehension as a
deserter.*

Book mark:

J. N. Wall

M 5 Col'd Cav. | **Mass.**

Leatan Moses,

Pvt, Co. H, 5 Reg't Mass. Col'd Cavalry.

Appears on

Company Muster Roll

for *July & Aug*, 186*4*

Present or absent *Present*

Stoppage, \$ *100* for

Due Gov't, \$ *100* for

Valuation of horse, \$ *100*

Valuation of horse equipments, \$ *100*

Remarks: *Due U.S. \$30 for
apprehension as
deserted*

Book mark:

J. M. Hall

(358)

Copyist.

11 | 5 Col'd Cav. | Mass.

Catan Moses
Capt, Co. H, 5 Reg't Mass. Col'd Cavalry.

Appears on

Company Muster Roll

for Sept + Oct, 1864.

Present or absent Present

Stoppage, \$ 0 ⁰⁰/₁₀₀ for one cross
saber letter + number

Due Gov't, \$ 100 for

Valuation of horse, \$ 100

Valuation of horse equipments, \$ 100

Remarks:

Book mark:

C. M. Clark

M | **5 Col'd Cav.** | **Mass.**

Coaten Moses
Pat, Co. H, 5 Reg't Mass. Col'd Cavalry.

Appears on

Company Muster Roll

for *Nov. & Dec*, 186 *4*.

Present or absent *Present*

Stoppage, \$ *100* for

Due Gov't, \$ *100* for

Valuation of horse, \$ *100*

Valuation of horse equipments, \$ *100*

Remarks: *Due U. S. \$30⁰⁰*

Book mark: _____

(358)

C. M. Clark
Copyist.

M

5 Col'd Cav.

Mass.

Catan Moses

Priv, Co. H, 5 Reg't Mass. Col'd Cavalry.

Appears on

Company Muster Roll

for Jan & Feb, 1865.

Present or absent Present

Stoppage, \$ 100 for

Due Gov't, \$ 100 for

Valuation of horse, \$ 100

Valuation of horse equipments, \$ 100

Remarks: Due U. S. \$ 30.00
Daily duty, company
book Due 1st, 2d, 3d
& 4th installments
U. S. bounty.

Book mark:

C M Clark

M

5 Col'd Cav.

Mass.

Latan Moses

Pat, Co. H, 5 Reg't Mass. Col'd Cavalry.

Appears on

Company Muster Roll

for *March & April*, 1865.

Present or absent *Present.*

Stoppage, \$ *100* for

Due Gov't, \$ *100* for

Valuation of horse, \$ *100*

Valuation of horse equipments, \$ *100*

Remarks: *Due 1st, 2d, 3d
& 4th installment U.S.
bounty.*

Book mark:

C M Blank

M 5 Col'd Cav. Mass.

Caton Moses
Pat, Co. II, 5 Reg't Mass. Col'd Cavalry.

Appears on

Company Muster Roll

for *May & June*, 1865.

Present or absent *+ Present*

Stoppage, \$ *100* for

Due Gov't, \$ *100* for

Valuation of horse, \$ *100*

Valuation of horse equipments, \$ *100*

Remarks: *1st, 2d, 3d & 4th*
installments U. S. bounty.
Free on or before April
19, 1861. Absent sick
at City Point, Va,
May 21, 1861.

+ As shown on Roll.

Book mark:

C. H. Clark

M | **5 Col'd Cav.** | **Mass.**

Estlin Wood

Priv., Co. H, 5 Reg't Mass. Col'd Cavalry.

Appears on

Company Muster Roll

for July & Aug., 1865.

Present or absent present

Stoppage, \$ 100 for

Due Gov't, \$ 100 for

Valuation of horse, \$ 100

Valuation of horse equipments, \$ 100

Remarks: Free on or before Apr. 19. 1866

Book mark: _____

L. Wilson

#1110

5 Col'd Cav.

Mass.

Morgan, Cutler

Reg't, Co. C, 5 Reg't Mass. Col'd Cavalry.

Appears on a

List of Discharges furnished by C. M. O. of State,
under the provisions of circular dated A. G. O.,
June 29, 1865.

Discharge furnished _____, 186 _____,

to date from _____, 186 _____.

Remarks: Disch'd by C. M. O.
#29, Hd Qrs Dept
of Texas Sept
9/65

* Checked by R. Maese

Book Mark: _____

Steward
Copyist.

M. | 5 Col'd Cav. | Mass.

Leatan Moses

Priv., Co. H, 5 Reg't Mass. Colored Cav.

Appears on Returns as follows:

May 1864. Absent detached
Serv. Readville, Hosp.
attndt May 8/64.

Feb. 1865. Co. cook.

Book mark :

(546)

J. B. Sittler

Copyist.

C. No. **5 Col'd Cav. Mass.**

George Carter
H. Co. H., 5 Reg't Mass. Col'd Cavalry.

Appears on an

Individual Muster-out Roll

of the organization named above. Roll dated
Boston Mass, Dec 2, 1865.

Muster-out to date *Feb 3, 1865.*

Last paid to *Dec 31, 1864.*

Clothing account:

Last settled 186 ; drawn since \$ 100

Due soldier \$ 100; due U. S. \$ 100

Am't for cloth'g in kind or money adv'd \$ 100

Due U. S. for arms, equipments, &c., \$ 100

Bounty paid \$ 100 due \$ 100

Remarks: *U.S. Bounty due \$300. Free on or before April 19/61. Due U.S. for overdrawn clothing \$9.55 Due Jno W Mc Donald (over)*

Book mark:

verified by R. Prater
E. H. [unclear]

JAN. - 9

5372823

1891

Butler \$106.00
Rich in Hospital,
at Brazos Island
Texas where he
was mustered out.

Discharged by S.O.
Co 29 Dept. of Texas
Galveston Texas
Sept-16/65 Mustering
out his regiment.

A. B. | **5 Col'd Cav.** | **Mass.**

* *Moses, Captain*
Priv., Co. *H*, 5 Reg't Mass. Col'd Cavalry.

Appears on **Co. Muster-out Roll**, dated
Clarksville, Tex., Oct 31, 186*5*.

Muster-out to date _____, 186 .

Last paid to *Dec. 31*, 186 *4*.

Clothing account:

Last settled _____, 186 ; drawn since \$ _____ 100

*
Due soldier \$ _____ 100; due U. S. \$ *10*^{*31*}/₁₀₀

Am't for cloth'g in kind or money adv'd \$ _____ 100

Due U. S. for arms, equipments, &c., \$ _____ 100

Bounty paid \$ _____ 100; due \$ *300*^{*100*}

Remarks: *Ab. sick at Brazos, Tex.*
since Oct. 16, 1865. No dis-
charge furnished. Free
or before

* *Reviewed by R. Walker*
Book mark: *M.O. in file*

R. Walker

1836
Moses, John

Col, 5 Mass. Cav., (Col'd.)

Private | Private

CARD NUMBERS.

1	5376002	26
2	5376110	27
3	5376209	28
4	5376348	29
5	5376881	30
6	9092469	31
7	40731432	32
8		33
9		34
10		35
11		36
12		37
13		38
14		39
15		40
16		41
17		42
18		43
19		44
20		45
21		46
22		47
23		48
24		49
25		50

Book Mark: _____

See also _____

M **5 Cav. (Col'd.) | Mass.**

John Jones

....., Co. *6*, 5 Reg't Mass. Cav. (Col'd.)

Appears on

Company Descriptive Book
of the organization named above.

DESCRIPTION.

Age *22* years; height *5* feet *6* inches.

Complexion *Black*

Eyes *Black*; hair *Black*

Where born *Laura Leone Africa*

Occupation *Seaman*

ENLISTMENT.

When, 186 ..

Where

By whom ..; term *3* y'rs.

Remarks: *mustered into Co 6.*

*no full descriptive was received
forwarded from Comdr Lookout
Md. Dec 31st 1864*

A. Finley

M. | **5 Col'd Cav.** | **Mass.**

John Moss.

Priv., Co. C, 5 Reg't Mass. Col'd Cavalry.

Appears on

Company Muster Roll

for *May & June*, 1864.

Present or absent *Present*

Stoppage, \$ *100* for

Due Gov't, \$ *100* for

Valuation of horse, \$ *100*

Valuation of horse equipments, \$ *100*

Remarks: *In account of
clothing or musters
forwarded.*

(Enrollment & Muster in not given.)

Book mark:

Sitter.

No. | **5** Col'd Cav. | **Mass.**

John Moses
Capt, Co. C, 5 Reg't Mass. Col'd Cavalry.

Appears on

Company Muster Roll

for *July & Aug*, 186*4*.

Present or absent *Present*

Stoppage, \$ *100* for

Due Gov't, \$ *100* for

Valuation of horse, \$ *100*

Valuation of horse equipments, \$ *100*

Remarks:

Book mark:

E. H. Brown

No. | **5 Col'd Cav.** | **Mass.**

John Moore
Pvt., Co. C, 5 Reg't Mass. Col'd Cavalry.

Appears on

Company Muster Roll

for Sept & Oct, 1864.

Present or absent Present

Stoppage, \$ 100 for

Due Gov't, \$ 100 for

Valuation of horse, \$ 100

Valuation of horse equipments, \$ 100

Remarks: See roll or before Ad. 1861

Book mark:

E. H. Dunn

71 | 5 Col'd Cav. | Mass.

John Moses

, Co. C, 5 Reg't Mass. Col'd Cavalry.

Appears on

Company Muster Roll

for Nov to Dec, 1864.

Present or absent.

Stoppage, \$ 100 for

Due Gov't, \$ 100 for

Valuation of horse, \$ 100

Valuation of horse equipments, \$ 100

Remarks: Dismissed from the rolls never mustered on this date for pay Ord. \$ 2.7 per 2 M. stores \$ 0.1 per Car Ord. \$ 3.0
see on or before April 19 61

Book mark:

E. H. Brown

M. | 5 Col'd Cav. | Mass.

John Moses
Pvt, Co. C, 5 Reg't Mass. Colored Cav.

Appears on Returns as follows:

Dec. 1864. Lost Dec. 23/64
Point Lookout, Md.
Dropped from Roll -
never mustered - worth-
less.

Book mark :

(548)

J. B. Sittler

Copyist.

M

5 Col'd Cav.

Mass.

John Mosco

Pvt, Co. C, 5 Reg't Mass. Col'd Cavalry.

Appears on Co. Muster-out Roll, dated
Clarksville Texas, Oct 31, 1865.

Muster-out to date _____, 186 .

Last paid to _____, 186 .

Clothing account:

Last settled _____, 186 ; drawn since \$ _____ 100

Due soldier \$ _____ 100; due U. S. \$ _____ 100

Am't for cloth'g in kind or money adv'd \$ _____ 100

Due U. S. for arms, equipments, &c., \$ _____ 100

Bounty paid \$ _____ 100; due \$ _____ 100

Remarks: joined the Co May 6-64

Deserted Dec 31-64 at
Point Lookout Md

No descriptive list ever
received of the Soldier

Book mark:

Abbott

1037

Motley, Richard
Co D, 5 Mass. Cav., (Col'd.)

Private | *Private*

CARD NUMBERS.

1	5372537	26
2	5372570	27
3	5372553	28
4	5383315	29
5	5383384	30
6	5383484	31
7	5383575	32
8	5383672	33
9	9091782	34
10	9436173	35
11	40731367	36
12	31792253	37
13		38
14		39
15		40
16		41
17		42
18		43
19		44
20		45
21		46
22		47
23		48
24		49
25		50

Book Mark:

See also

02346459-P.O., Mil.
D. 3120196 P.O. Ret.
P.O. Mym. 1084311. 7/12/17 Her

R. Mack
4

No. **5 Cav. (Col'd.)** | **Mass.**

Richard Motley

....., Co. *I*....., 5 Reg't Mass. Cav. (Col'd.)

Appears on

Company Descriptive Book

of the organization named above.

DESCRIPTION.

Age *23*..... years; height *5*..... feet *4*..... inches.

Complexion *Dark*.....

Eyes *Blue*.....; hair *Black*.....

Where born *Cumberland Va.*.....

Occupation *Barber*.....

ENLISTMENT.

When..... *Dec. 2*"....., 186.....

Where *Boston*.....

By whom *Warner A. Goring*.....; term *3*..... y'rs.

Remarks: *Mustered Capt. Howe Boston*

Dec. 2".....

.....

.....

.....

.....

.....

.....

.....

H. C. Thomas

1st | *5th* | *Mass.*
Reg't | *Car.* | *Col'd*

Richard Mottley,
....., Co....., *5th* Reg't *Mass* Col'd *Car.*

Appears on

Regimental Descriptive Book

of the organization named above.

DESCRIPTION.

Age *28* years; height *5* feet *4* inches.

Complexion *Dark*

Eyes *Blue*; hair *Black*

Where born *Cheshire, N.H.*

Occupation *Carrier,*

ENLISTMENT.

When *Dec. 2*, 1864.

Where *Boston,*

By whom *James Jones*; term *3* y'rs.

Remarks: *Mustered Dec 2 04*
Capt. Jones. All-
sted in the way from
Depot.

Tharun

M | **5 Col'd Cav.** | **Mass.**

Richard Motley

Appears with rank of Private on

**Muster and Descriptive Roll of a Detach-
ment of U. S. Vols. forwarded**

for the 5 Reg't Mass, Col'd Cavalry. Roll dated

Boston Mass, Dec 2, 1864.

Where born Cumberland Va.

Age 23 y'rs; occupation Barber

When enlisted Dec. 2, 1864.

Where enlisted Boston Mass.

For what period enlisted 3 years.

Eyes Blue; hair Dark

Complexion Dark; height 5 ft. 4 in.

When mustered in Dec. 2, 1864.

Where mustered in Boston

Bounty paid \$ 100 ¹⁰⁰; due \$ 200 ¹⁰⁰

Where credited Pepperell Mass.

Company to which assigned _____

Remarks : _____

Book mark : _____

M. A. Nichols

(339)

Copyist.

M | **5 Col'd Cav.** | **Mass.**

Richard Molley

Appears with rank of Private on

Muster and Descriptive Roll of a Detachment of U. S. Vols. forwarded

for the 5 Reg't Mass. Col'd Cavalry. Roll dated

Boston Mass., 186 .

Where born Cumberland Va

Age 23 y'rs; occupation Barber

When enlisted Dec. 2, 1864.

Where enlisted Boston

For what period enlisted 3 years.

Eyes blue ~~ltt~~; hair DK

Complexion lk; height 5 ft. 4 in.

When mustered in Dec 2, 1864.

Where mustered in Boston

Bounty paid \$ 100 ¹⁰⁰; due \$ 200 ¹⁰⁰

Where credited Pepperell Mass.

Company to which assigned _____

Remarks: _____

Book mark: _____

M. A. Michaels

(339)

Copyist.

M | **5 Col'd Cav.** | **Mass.**

Richard Motley

Appears with rank of *Private* on

Muster and Descriptive Roll of a Detachment of U. S. Vols. forwarded

for the 5 Reg't Mass. Col'd Cavalry. Roll dated
Draft Rendezvous
Yallow Island P. H. Mass, Dec 19, 1864.

Where born *Cumberland Va*

Age *23* y'rs; occupation *Barber*

When enlisted *Dec. 2*, 186*4*.

Where enlisted *Boston Mass.*

For what period enlisted *3* years.

Eyes *blue*; hair *dark*

Complexion *dark*; height *5* ft. *4* in.

When mustered in *Dec. 2*, 186*4*.

Where mustered in *Boston*

Bounty paid \$ *100* ¹⁰⁰; due \$ *200* ¹⁰⁰

Where credited *Pepperell Middlesex Co*

Company to which assigned

Remarks:

Book mark:

M. A. Michaels

M | 5 Col. Cav | Mass.

Richard Motley

Priv., Co., 5 Reg't Mass Col

Appears on

Cavalry

Descriptive List of Deserters Arrested.

List dated Dec 28, 1864, and signed by Provost Marshal, 3 District of Maryland.

Deserted:

When _____, 186 .

Where _____

Arrested:

When Dec 28, 1864.

Where Balto

Remarks: Sent to Col Woolley Pro. Mar. & Corps.

States that he enlisted for the 5 Mass. Cav on the 2 Dec. 1864 at Boston Mass rec'd \$600.00 Bounty, was sent (over)

Endorsement on list shows that the men named therein were received at Office Pro. Mar. Baltimore Md., Dec 28, 1864.

M. Spencer

(358e)

C. post.

APR-24.

31792253

1894.

to Gallups Island Boston Harbor, from thence to Washington, D.C. on his way to join his reg't. Deserted the boat at Washington D.C. on the 2nd inst. He was last night arrested at the Philada. Depot in this city in full suit citizens clothes. on his way to Boston at first denied that he belonged to the service.

Reward \$3000 paid.

W | **5 Col'd Cav.** | **Mass.**

Richard Motley,
Priv., Co. I, 5 Reg't Mass. Colored Cavalry.

Appears on

Company Muster Roll

for Jan. & Feb., 1865.

Present or absent Present.

Stoppage, \$ 100 for

Due Gov't, \$ 100 for

Valuation of horse, \$ 100

Valuation of horse equipments, \$ 100

Remarks: Recruit from Depot,
Sentenced by Gen. C. M.
to loss of all pay & allow-
ance now due & \$10.⁰⁰ per
month for one year, and
make good the time lost
by desertion to Dec 19 (1864)
Gen. Ord 82. Hd. Qrs Gen. C.
in Alexandria Va. Jan. 28/65
(over)

Book mark: _____

(358)

C. F. Thompson

Copyist.

JAN. 10

5383315

1891

\$30.00 for apprehension

M | **5 Col'd Cav.** | **Mass.**

Richard Motley,
Pvt., Co. I, 5 Reg't Mass. Colored Cavalry.

Appears on

Company Muster Roll

for *Mch. & Apr.*, 1865.

Present or absent *Present.*

Stoppage, \$ *100* for

Due Gov't, \$ *100* for

Valuation of horse, \$ *100*

Valuation of horse equipments, \$ *100*

Remarks: *Sentenced by Gen. C. M. General, 82 Hd. Qrs. in N. Alexandria Va. to loss of all pay and allowances now due and \$10.00 per month for one year and make good the time lost by detention to Dec. 19/64*

Book mark:

(358)

C. F. Thompson
Copyist.

JAN. 10

5383384

1891

also [#]30.² for apprehension
to forget to read [#]10.² by
sentence of F.C.C. in.

W | **5 Col'd Cav.** | **Mass.**

Richard Motley
Part., Co. I, 5 Reg't Mass. Colored Cavalry.

Appears on

Company Muster Roll

for May & June, 1865.

Present or absent Present,

Stoppage, \$ 100 for

Due Gov't, \$ 100 for

Valuation of horse, \$ 100

Valuation of horse equipments, \$ 100

Remarks: Sentenced by Gen. C. M. to loss of all pay & allowances to Dec. 19/64 & \$10.⁰⁰ per month for 1 year & make good the time lost by desertion to Dec. 19/64 also \$30.⁰⁰ for apprehension & forfeit
over

Book mark: _____

(358)

C. F. Thompson

Copyist.

JAN. 10

5383484

1891

\$10,00 by sentence of F. C.
C. M.

M | 5 Col'd Cav. | Mass.

Richard Motley

Prvt, Co. I, 5 Reg't Mass. Colored Cavalry.

Appears on

Company Muster Roll

for July & Aug, 1865.

Present or absent Present

Stoppage, \$ 100 for

Due Gov't, \$ 100 for

Valuation of horse, \$ 100

Valuation of horse equipments, \$ 100

Remarks: Re-tuned by J.C.M. to loss of all pay & allowances to Dec. 19/64 + \$10 per month for one year & make good the time lost by desertion to Dec 18/64 also \$30 for apprehension and forfeit \$10 by sentence of J.C.M.

Book mark:

Holeman

M. | **5 Col'd Cav.** | **Mass.**

Richard Matley
Pvt., Co. I, 5 Reg't Mass. Colored Cav.

Appears on **Returns** as follows:

Feb. 1865. Gain Feb. 22/65
Pt. Lookout - Recruit
from Depot.

Book mark : _____

(646) J. B. Sittler Copyist.

M | **5 Col'd Cav.** | **Mass.**

Richard Motley
Priv, Co. D, 5 Reg't Mass. Col'd Cavalry.

Appears on **Co. Muster-out Roll**, dated
Clarksville Texas, Oct 31, 1865.

Muster-out to date Oct 31, 1865.

Last paid to _____, 186 ____
Pay due from enrollment

Clothing account:

Last settled _____, 186 ____; drawn since \$ _____ 100

Due soldier \$ 16²⁵ 100; due U. S. \$ _____ 100

Am't for cloth'g in kind or money adv'd \$ _____ 100

Due U. S. for arms, equipments, &c., \$ _____ 100

Bounty paid \$ 100 100; due \$ _____ 100

Remarks: Induced by F. O. C. M. to leave all
pay and allowances to Dec. 9, 64 & \$10
per month for one year and make good the
time lost by desertion to Dec. 9, 64 and
\$20 for apprehension also to forfeit \$100 by
sentence of F. O. C. M. (over)

Book mark: 763 P-3, 73

Holcomb

JAN. 10

5383672

1891

mustered out by S.O. no. 2980. Ors.
Dept of Texas dated Galveston Texas
Sept 16/65 (based on authority from
war Dept. dated Sept 8/65, directing
the muster out of colored troops
organized in Northern States,
their services being no longer required,
Transport & Subsistence furnished to
Boston Mass. muster out to
date Oct 31/65.

Wootley Richard

, Co. J 5 Reg't Msdcc

3 Enclosures.

Bed Cards	Final Statements
Burial Records	Furloughs or L. of A
Certs. of Dis. for Discharge	Med. Certificates
C. M. Charges	Med. Des. Lists
Descriptive Lists	Orders
Discharge Certificates	Pris. of War Record
Enlistment Papers	Resignations

Other papers relating to—

Admission to Hosp'l	Furlough or L. of A
Casualty Sheet	Med. Examination
Confinement	Misc. Information
Contracts	Pay or Clothing
Death or Effects	Personal Reports
Desertion	Rank
Discharge from Hosp'l	Transfer to Hosp'l
Discharge from Service	Transfer to V. R. C.
Duty	Transportation

NOTE 1. — This blank will be used for both enlistments and re-enlistments — enlistment of veterans, &c., &c., in the volunteer service. They will be made out in duplicate in all cases — one to accompany the recruiting return of the superintendent (not the recruiting officer) to the Adjutant-General, and one to accompany the accounts of the officer who pays bounty, &c. The Regiment and Company in which the soldier last served should be given on the back.

NOTE 2. — An enlistment holds to service. A muster-in must, in all cases, precede payment of pay, bounty, pension, &c. A muster-in roll must, in all cases, be filed in the Adjutant-General's Office as evidence of muster-in. The mustering officer, commissary, or assistant-commissary of musters, as the case may be, will countersign both enlistments as having mustered the soldier into the service of the United States before either of them is given to the disbursing officer.

DECLARATION OF RECRUIT.

** Richard Motley* desiring to VOLUNTEER as a Soldier in the Army of the United States, for the term of THREE YEARS, Do Declare, That I am *Twenty three* years and *3* months of age; that I have never been discharged from the United States service on account of disability or by sentence of a court-martial, or by order before the expiration of a term of enlistment; and I know of no impediment to my serving honestly and faithfully as a soldier for three years.

GIVEN at *Boston Mass* the *30th* day of *December* 1864

Witness: *S. M. Blodgett, Richard Motley*

No. *Richard Motley*
 Volunteered at *Boston, Mass.*
December 27th 1864
 By *Capt. W. B. Stone*
 Regiment of *Prov. Marshal*
4th Mass. Dist.
 enlistment; last served in Company ()
 Reg't of
 Discharged *18*
3rd Mass. Cav.
1st Mass. Heavy Art.
No. 10

CONSENT IN CASE OF MINOR.

I, _____ Do CERTIFY, That I am
 the _____ of _____ ; that the
 said _____ is _____ years of age; and I
 do hereby freely give my CONSENT to his volunteering as a SOLDIER in the ARMY OF THE UNITED STATES
 for the period of THREE YEARS.

GIVEN at _____ the _____ day of _____

Witness :

NOTE 1. — This blank will be used for both enlistments and re-enlistments — enlistment of veterans, &c., &c., in the volunteer service. They will be made out in duplicate in all cases — one to accompany the recruiting return of the superintendent (not the recruiting officer) to the Adjutant-General, and one to accompany the accounts of the officer who pays bounty, &c. The Regiment and Company in which the soldier last served should be given on the back.

NOTE 2. — An enlistment holds to service. A muster-in must, in all cases, precede payment of pay, bounty, pension, &c. A muster-in roll must, in all cases, be filed in the Adjutant-General's Office as evidence of muster-in. The mustering officer, commissary, or assistant-commissary of musters, as the case may be, will countersign both enlistments as having mustered the soldier into the service of the United States before either of them is given to the disbursing officer.

DECLARATION OF RECRUIT.

** Richard Molley* desiring to VOLUNTEER as a Soldier in the Army of the United States, for the term of THREE YEARS, Do Declare, That I am *twenty three* years and _____ months of age; that I have never been discharged from the United States service on account of disability or by sentence of a court-martial, or by order before the expiration of a term of enlistment; and I know of no impediment to my serving honestly and faithfully as a soldier for three years.

GIVEN at *Boston Mass*, the *30th* day of *December*, 18*64*

Witness: *S. M. Blodgett, Richard Molley*

Discharged 18 ..

enlistment; last served in Company ()
Reg't of
4th Mass, 52d,
By *Capt. W. G. Oliver*
Brig. Marshal

Volunteered at *Boston Mass*
December 21st 18*64*

No. *5 Mass. Cav*

CONSENT IN CASE OF MINOR.

I, _____ Do CERTIFY, That I am _____ the _____ of _____ ; that the said _____ is _____ years of age; and I do hereby freely give my CONSENT to his volunteering as a SOLDIER in the ARMY OF THE UNITED STATES for the period of THREE YEARS.

GIVEN at _____ the _____ day of _____

Witness: _____

(Married)

VOLUNTEER ENLISTMENT.

STATE OF

TOWN OF

Massachusetts



I, Richard Motley, born in Cumberland in the State of Virginia aged Twenty-three years, and by occupation a Barber Do HEREBY ACKNOWLEDGE to have volunteered this Second day of December 1864, to serve as a Soldier in the Army of the United States of America, for the period of THREE YEARS, unless sooner discharged by proper authority: Do also agree to accept such bounty, pay, rations, and clothing, as are, or may be, established by law for volunteers. And I, Richard Motley do solemnly swear, that I will bear true faith and allegiance to the United States of America, and that I will serve them honestly and faithfully against all their enemies or opposers whomsoever; and that I will observe and obey the orders of the President of the United States, and the orders of the officers appointed over me, according to the Rules and Articles of War.

Sworn and subscribed to, at Boston, this 2nd day of Dec, 1864, before me, Office Justice Peace Capt. S. D. Marshall, 4th Dist. Mass.

I CERTIFY, ON HONOR, That I have carefully examined the above-named Volunteer, agreeably to the General Regulations of the Army, and that, in my opinion, he is free from all bodily defects and mental infirmity, which would in any way disqualify him from performing the duties of a soldier.

H. D. Boydell Surgeon, Board of Enlistment, 4th Dist. Mass. EXAMINING SURGEON.

I CERTIFY, ON HONOR, That I have minutely inspected the Volunteer, Richard Motley, previously to his enlistment, and that he was entirely sober when enlisted; that, to the best of my judgment and belief, he is of lawful age; and that, in accepting him as duly qualified to perform the duties of an able-bodied soldier, I have strictly observed the Regulations which govern the recruiting service. This soldier has Blue eyes, Dark hair, Dark complexion, is Five feet Four inches high.

Regiment of Volunteers, Warner & Spring RECRUITING OFFICER.

(A. G. O. No. 74 & 75.)

Mustered into the service of the United States, in Company the 2nd day of December, 1864, at Boston Mass. 5th Regiment of Warner's Heavy Volunteers, Co. B. 1st Dist. Mass.

5525-

Copy L.S.

Statement
of
Richard Mosley
5th Mass Cooly

55-25

Statement of Richard Mottley
3rd Mass. Coast

Enlisted in Boston Mass on the 2nd
Dec. 1864. Rec^d \$600⁰⁰ bounty for 3rd years
was sent to Washington D.C. on the 19th
Dec 1864. Chined to Point Lookout, on the
way I received permission from my Sgt
to go to get something to eat but did not
return I was arrested in Baltimore Md
by a Detective on the plea after leaving my
Regt's pl^{ts} mob knew the date had Citizen
Clothes on at the time of arrest
I was sent to Fort M^o Henry Md, thence
to France St Mil Brown Alexa Vi

Sgt. Richard Mottley
mark

Witnesses { Isaac Person
2nd Lt 2nd S & T Co
L. A. Carl
1st Lt W. H. B.

1038

Moulton, Charles A.

Col., 5 Mass. Cav., (Col'd.)

Private

Private

CARD NUMBERS.

1	5384879	26
2	5384963	27
3	5385051	28
4	5385152	29
5	5385259	30
6	5385367	31
7	5385460	32
8	5385560	33
9	5385658	34
10	5385751	35
11	5385845	36
12	90915-10	37
13	40731433	38
14		39
15		40
16		41
17		42
18		43
19		44
20		45
21		46
22		47
23		48
24		49
25		50

Book Mark:

See also

D. 634393. P. 6. 9d Retd
S-897199 - P. 6. 7d + 7d (Retd)
J. 2694729 P. 6. 7d

R. Vaeth
4

M. **5 Cav. (Col'd.) | Mass.**

Chas. Henry Moulton.

....., Co. *L.*....., 5 Reg't Mass. Cav. (Col'd.)

Appears on

Company Descriptive Book

of the organization named above.

DESCRIPTION.

Age *27* years; height *5* feet *6* inches.

Complexion *Black.*

Eyes *Black*; hair *Black.*

Where born *Alexandria Va.*

Occupation *Laborer.*

ENLISTMENT.

When *April 15th, 186* .

Where *Dorchester.*

By whom *G. B. Francisworth*; term *3* y'rs.

Remarks: *Mustered into service at
Needville Mass. on Apr. 29/61 by Lieut.
W. Kibben. Dis. Apr. 19/61.*

H. C. Thomas.

M | **5 Col'd Cav.** | **Mass.**

Charles H. Moulton
Priv., Co. L, 5 Reg't Mass. Col'd Cav.

Appears on

Company Muster-in and Descriptive Roll
of the organization named above. Roll dated
Readville Mass, Apl. 22, 1864.

Where born Alexandria Va.

Age 27 y'rs; occupation laborer

When enlisted Apl. 15, 1864.

Where enlisted Dorchester

For what period enlisted 3 years.

Eyes Black; hair Black

Complexion Black; height 5 ft. 6 in.

When mustered in Apl. 22, 1864.

Where mustered in

Bounty paid \$ 100; due \$ 100

Where credited 2nd Cong. Dist. Mass.

Company to which assigned

Remarks:

Book mark:

Cresshaw

(356d)

Copyist.

M | **5 Col'd Cav.** | **Mass.**

Charles A. Moulton
Pvt, Co. L, 5 Reg't Mass. Col'd Cavalry.

Appears on

Company Muster Roll

for *Apr. 22 to 30*, 186*4*.

Present or absent *Present*

Stoppage, \$.....100 for

Due Gov't, \$.....100 for

Valuation of horse, \$.....100

Valuation of horse equipments, \$.....100

Remarks:

Book mark:

Crenshaw

M | 5 Col'd Cav. | Mass.

Chas. A. Moulton
Pvt, Co. L, 5 Reg't Mass. Col'd Cavalry.

Appears on

Company Muster Roll

for *May & June*, 186*4*.

Present or absent *Present*

Stoppage, \$ _____ 100 for _____

Due Gov't, \$ _____ 100 for _____

Valuation of horse, \$ _____ 100

Valuation of horse equipments, \$ _____ 100

Remarks: _____

Book mark: _____

Crenshaw

(358)

Copyist.

1877 1380
M | 5 Col'd Cav. | Mass.

Charles H. Moulton
Pot, Co. L, 5 Reg't Mass. Col'd Cavalry.

Appears on

Company Muster Roll
for July & Aug. 1864.
Present or absent Present

Stoppage, \$ 100 for

Due Gov't, \$ 100 for

Valuation of horse, \$ 100

Valuation of horse equipments, \$ 100

Remarks: Daily Duty
Co. book.

Book mark:

Crenshaw

(358)

Copyist.

M. | 5 Col'd Cav. | Mass.

Charles H. Moulton

Sgt., Co. L, 5 Reg't Mass. Col'd Cavalry.

Appears on

Company Muster Roll

for Sept + Oct, 1864.

Present or absent Present

Stoppage, \$ 100 for

Due Gov't, \$ 100 for

Valuation of horse, \$ 100

Valuation of horse equipments, \$ 100

Remarks: Daily duty B. Co.

Book mark:

(358)

J. M. Hance

Copyist.

M. | 5 Col'd Cav. | Mass.

Charles H. Moulton
Pvt, Co. L, 5 Reg't Mass. Col'd Cavalry.

Appears on

Company Muster Roll

for Nov & Dec, 1864.

Present or absent Present.

Stoppage, \$ 100 for

Due Gov't, \$ 100 for

Valuation of horse, \$ 100

Valuation of horse equipments, \$ 100

Remarks: Daily duty Co. Cook

Book mark:

J. M. Vance
(358) Copyist.

M | **5 Col'd Cav.** | **Mass.**

Charles H. Moulton

Sgt, Co. L, 5 Reg't Mass. Col'd Cavalry.

Appears on

Company Muster Roll

for *Jan + Feb*, 186*4*.

Present or absent *Present*

Stoppage, \$ *100* for

Due Gov't, \$ *100* for

Valuation of horse, \$ *100*

Valuation of horse equipments, \$ *100*

Remarks: *See 1st installment
H. Co. bounty \$ 25.00
Paid by date A. Oct.*

Book mark:

J. M. Vance

M. | **5 Col'd Cav.** | **Mass.**

Charles Moulton

A, Co. L, 5 Reg't Mass. Col'd Cavalry.

Appears on

Company Muster Roll

for *March*, 186*0*.

Present or absent *Present*

Stoppage, \$ *100* for

Due Gov't, \$ *100* for

Valuation of horse, \$ *100*

Valuation of horse equipments, \$ *100*

Remarks *See Moulton's*
Journal
Daily duty

Book mark:

(358)

J. M. Hancock

Copyist.

M. | **5 Col'd Cav.** | **Mass.**

Charles A. Moulton

Sub, Co. L, 5 Reg't Mass. Col'd Cavalry.

Appears on

Company Muster Roll

for *May & June*, 1863.

Present or absent *Present*

Stoppage, \$ 100 for

Due Gov't, \$ 100 for

Valuation of horse, \$ 100

Valuation of horse equipments, \$ 100

Remarks: *Present, 1st installment
of bounty \$25. For
before Apr 19-61 Co. Capt*

Book mark:

(358) *J. M. Hance* Copyist.

[Handwritten] | **5 Col'd Cav.** | **Mass.**

[Handwritten], Co. L, 5 Reg't Mass. Col'd Cavalry.

Appears on

Company Muster Roll

for *[Handwritten]*, 186 *[Handwritten]*.

Present or absent *[Handwritten]*

Stoppage, \$ *[Handwritten]* 100 for *[Handwritten]*

Due Gov't, \$ *[Handwritten]* 100 for *[Handwritten]*

Valuation of horse, \$ *[Handwritten]* 100

Valuation of horse equipments, \$ *[Handwritten]* 100

Remarks: *[Handwritten]*

[Handwritten]

Book mark: *[Handwritten]*

[Handwritten Signature]

M. | 5 Col'd Cav. | Mass.

Lo. Moulton*

Priv., Co. L, 5 Reg't Mass. Colored Cav.

Appears on Returns as follows:

July 1864 to Mar. 1865. Co. cook,

May to Sept. 1865. Co. cook.

* name appears also as Moulton.

Book mark :

(648)

J. B. Sittler

Copyist.

[Signature] | **5 Col'd Cav.** | **Mass.**

[Signature]

[Signature], Co. *[Signature]*, 5 Reg't Mass. Col'd Cavalry.

Appears on **Co. Muster-out Roll**, dated *[Signature]*, 186 *[Signature]*.

Muster-out to date *[Signature]*, 186 *[Signature]*.

Last paid to *[Signature]*, 186 *[Signature]*.

Clothing account:

Last settled....., 186 ; drawn since \$..... 100

Due soldier \$..... 100; due U. S. \$..... 100

Am't for cloth'g in kind or money adv'd \$..... 100

Due U. S. for arms, equipments, &c., \$ *3* ^{*00*}/₁₀₀

Bounty paid \$..... 100; due \$ *2* ^{*00*}/₁₀₀

Remarks: *[Signature]*

Book mark:

[Signature]

1039

Moulton, James A.

Co D, 5 Mass. Cav., (Col'd.)

Private

Private

CARD NUMBERS.

1	5372681	26
2	5377209	27
3	5377316	28
4	5377419	29
5	5377520	30
6	5377627	31
7	5377729	32
8	5372898	33
9	5378043	34
10	9436208	35
11	9092319	36
12	40731434	37
13		38
14		39
15		40
16		41
17		42
18		43
19		44
20		45
21		46
22		47
23		48
24		49
25		50

Book Mark:

See also

51750242 Pomona

R. Walker
x

M 5 Cav. (Col'd.) | Mass.

James Molton

....., Co. *D*, 5 Reg't, Mass. Cav. (Col'd.)

Appears on

Company Descriptive Book

of the organization named above.

DESCRIPTION.

Age years; height feet inches.

Complexion

Eyes ; hair

Where born

Occupation

ENLISTMENT.

When *June 2*, 186 ..

Where *Ellis Mills*

By whom *S. Blackfoot*; term *3* y'rs.

Remarks: *Mustered at Washington June 2/64 by Capt. Street*

Mustered out of the service May 23, 1865, at Alexandria Va. D.C. 71.

Molton

3877)

Copist.

M | **5 Col'd Cav. Mass.**

James Moulton

Appears with rank of Private on

Muster and Descriptive Roll of a Detachment of Drafted Men and Substitutes forwarded

for the 5 Reg't Mass. Colored Cavalry. Roll dated Washington, D.C., June 2, 1864.

Where born Caroline, Pa.

Age 20 years; occupation Laborer.

Drafted and mustered in:

When June 2, 1864.

Where Washington, D.C.

Period 3 years.

Eyes Black; hair Black

Complexion Black; height 5 ft. 9 1/4 in.

Paid bounty and advance pay, \$ 100

Bounty due \$ 100

Where credited

Company to which assigned

Remarks: Accepted as substitute for Wm T. Carr, Ellicott's Mills, Md.

Book mark:

McDaire

(340)

Copyist.

M. | 5th Cal. | Mass.
James Houston
....., Co., 5th Reg't Mass. Col'd

Appears on

Regimental Descriptive Book

of the organization named above.

DESCRIPTION.

Age 20 years; height 5 feet 7 1/2 inches.
Complexion Pink
Eyes Blue; hair Black
Where born Carroll Co. Va.
Occupation Farmer

ENLISTMENT.

When June 2, 1864.
Where Washington
By whom Stuart, term 3 y'rs

Remarks: Accepted as a
substitute for H. C.
Carr, 20th Me. Mil.

James

M 5 Col'd Cav. | **Mass.**

James Mottin

Pvt, Co. D, 5 Reg't Mass. Col'd Cavalry.

Appears on

Company Muster Roll

for *May + June*, 186*4*.

Present or absent *Present*

Stoppage, \$ *100* for

Due Gov't, \$ *100* for

Valuation of horse, \$ *100*

Valuation of horse equipments, \$ *100*

Remarks:

Book mark:

James
Copyist.

M 5 Col'd Cav. | **Mass.**

James Moulton
Pr, Co. D, 5 Reg't Mass. Col'd Cavalry.

Appears on

Company Muster Roll

for *July & Aug*, 186 *4*

Present or absent *Present*

Stoppage, \$ *100* for

Due Gov't, \$ *100* for

Valuation of horse, \$ *100*

Valuation of horse equipments, \$ *100*

Remarks:

Book mark:

J. Merchant

Mass. 5 Col'd Cav. | **Mass.**

James Moulton

Private, Co. D, 5 Reg't Mass. Col'd Cavalry.

Appears on

Company Muster Roll

for *Sept & Oct*, 186*4*

Present or absent *Present*

Stoppage, \$ *100* for

Due Gov't, \$ *100* for

Valuation of horse, \$ *100*

Valuation of horse equipments, \$ *100*

Remarks:

Book mark:

A. Merchant

No. 5 Col'd Cav. | Mass.

James Moulton

Priv., Co. D, 5 Reg't Mass. Col'd Cavalry.

Appears on

Company Muster Roll

for Jan & Dec, 1864

Present or absent Present

Stoppage, \$ 100 for

Due Gov't, \$ 100 for

Valuation of horse, \$ 100

Valuation of horse equipments, \$ 100

Remarks: 2 M. Horses for Harness & Carriage etc

Book mark:

A. M. Moulton

(358)

Copyist.

M 5 Col'd Cav. | **Mass.**

James Moulton

Pr, Co. D, 5 Reg't Mass. Col'd Cavalry.

Appears on

Company Muster Roll

for *Jan & Feb*, 1865

Present or absent *Present*

Stoppage, \$ 100 for

Due Gov't, \$ 100 for

Valuation of horse, \$ 100

Valuation of horse equipments, \$ 100

Remarks: *Due 1st Hospital US,
Bounty,*

Book mark:

A. Merchant

16 5 Col'd Cav. | Mass.

James Aboultou
Pl., Co. D, 5 Reg't Mass. Col'd Cavalry.

Appears on

Company Muster Roll

for *May 1865*, 1865.

Present or absent *Present*

Stoppage, \$ *100* for

Due Gov't, \$ *100* for

Valuation of horse, \$ *100*

Valuation of horse equipments, \$ *100*

Remarks: *See 100 US
Bount,*

Book mark:

S. Aboultou

M | **5 Col'd Cav. Mass.**

James Moulton
Reg't, Co....., 5 Reg't Mass. Col'd Cavalry.

Appears on an

Individual Muster-out Roll

of the organization named above. Roll dated

Petersburg Va, May 23, 1865.

Muster-out to date *July 23, 1865.*

Last paid to *Dec 31, 1864.*

Clothing account:

Last settled *Dec 31, 1864*; drawn since \$ *57* ^{*78*} *100*

Due soldier \$ *100*; due U. S. \$ *100*

Am't for cloth'g in kind or money adv'd \$ *100*

Due U. S. for arms, equipments, &c., \$ *100*

Bounty paid \$ *100* due \$ *100*

Remarks: *Discharged by*
Order of the War De-
partment, dated
May 13 1865. Muster
to date May 23, 1865.

Book mark:

W. T. ...

M. | 5 Col'd Cav. | Mass.

James Moulton
Pvt., Co. D, 5 Reg't Mass. Colored Cav.

Appears on Returns as follows:

May 1865. Loss May 15 Pt.
of Lookout, Md. Disch'd
for disability.

Book mark :

(546)

J. B. Sittler

Copyist.

M

5 Col'd Cav. Mass.

James H. Munton

Priv, Co. *C*, 5 Reg't Mass. Col'd Cavalry.

Appears on **Co. Muster-out Roll**, dated *Clarksville Texas Oct. 31, 1865*.

Muster-out to date _____, 186 .

Last paid to _____, 186 .

Clothing account:

Last settled _____, 186 ; drawn since \$ _____ 100

Due soldier \$ _____ 100; due U. S. \$ _____ 100

Am't for cloth'g in kind or money adv'd \$ _____ 100

Due U. S. for arms, equipments, &c., \$ _____ 100

Bounty paid \$ _____ 100; due \$ _____ 100

Remarks:

*Mustered out of service on
May 23/65 at Alexandria
Va under G. O. 77*

Book mark: _____

Howe

Moulton, James
Co., Co., *5* Reg't *Mass, C. Cav.*

Enclosures.

Bed Cards	Final Statements
Burial Records	Furloughs or L. of A.
Certs. of Dis. for Discharge	Med. Certificates
C. M. Charges	Med. Des. Lists
Descriptive Lists	Orders
Discharge Certificates	Pris. of War Record
Enlistment Papers	Resignations

Other papers relating to—

Admission to Hosp'l	Furlough or L. of A.
Casualty Sheet	Med. Examination
Confinement	Misc. Information
Contracts	Pay or Clothing
Death or Effects	Personal Reports
Desertion	Rank
Discharge from Hosp'l	Transfer to Hosp'l
Discharge from Service	Transfer to V. R. C.
Duty	Transportation

5111th Co 2d Reg - 87

No. 87

James Moulton
Enlisted at Washington D.C.

As Substitute for

Wm T. Carr

On the 2nd day of June, 1864

By

Henry A. Scheetz
Capt 1st Reg U.S. Inf.
F. W. Blackford
John B. Krasby

Board of Enrollment,

— Dist. of Columbia

H. G. C. Found filed
with W. Vols.
in Nov 18-75

SUBSTITUTE

VOLUNTEER ENLISTMENT.

District

NAME OF

Columbia



To be credited to the

TOWN OF

Ellicotts Mills Md

I, James Moulton born in the State of Virginia, aged Twenty years, and by occupation a Laborer

Do HEREBY ACKNOWLEDGE to have agreed with

William T. Carr, Esq., of Ellicotts Mills 5th Congl Dist, Maryland

to become his **SUBSTITUTE** in the Military Service, for a sufficient consideration paid and delivered to me, on the Second day of June, 1864

and having thus agreed with said William T. Carr, I DO HEREBY ACKNOWLEDGE to have enlisted this Second day of June, 1864, to serve as a **Soldier** in the **Army of the United States of America**, for the period of **THREE YEARS**, unless sooner discharged by proper authority: I do also agree to accept such bounty, pay, rations, and clothing, as are, or may be, established by law for soldiers. And I do solemnly swear that I will bear true and faithful allegiance to the **United States of America**; that I will serve them honestly and faithfully against all their enemies or opposers whomsoever; and that I will observe and obey the orders of the President of the United States, and the orders of the Officers appointed over me, according to the Rules and Articles of War.

SWORN and subscribed to, at Washington D.C.

this 2nd day of June, 1864

BEFORE

Amy A. Scheetz
Capt & Provost Marshal D.C.

James Moulton his mark

5th Mass Colored Cavalry

We certify, on honor, That we have carefully examined the above-named Volunteer Substitute agreeably to the Regulations, and that, in our opinion, he is free from all bodily defects and mental infirmity which would in any way disqualify him from performing the duties of a soldier; that he was entirely sober when enlisted; that he is of lawful age, (not under 18 years;) and that, in accepting him as duly qualified to perform the duties of an able-bodied soldier, and as a Substitute in lieu of James Moulton

drafted in Ellicotts Mills 5th Congl Dist Md May 26th, 1864, we have strictly observed the Regulations which govern

in such cases. This soldier has Black eyes, Black hair, Black complexion; is 5 feet 9 1/4 inches high.

Amy A. Scheetz
Capt & Provost Marshal D.C.

Francis M. Blackford
Commissioner of Board.

J. D. Peaslee
Surgeon of Board.

Board of Enrollment of Columbia Dist. of Columbia

DECLARATION OF SUBSTITUTE.

I, James Moulton desiring to ENLIST
in the Army of the United States, for THREE YEARS, **Do declare**, That I am
Twenty years and _____ months of age; that I have
never been discharged from the United States service on account of disability or by sentence of
a court martial; and I know of no impediment to my serving honestly and faithfully as a soldier
for three years.

GIVEN at Washington D.C.
the 2^d day of June 1864

WITNESS:

A. Ball James ^{his} Moulton
mark

1040

Moulton, John

Co., 5 Mass. Cav., (Col'd.)

Private

CARD NUMBERS.

1 See Moulton.

2

3

4

5

6

7

8

9

10

11

12

13

14

15

16

17

18

19

20

21

22

23

24

25

26 John

27

28

29

30

31

32

33

34

35

36

37

38

39

40

41

42

43

44

45

46

47

48

49

50

Book Mark:

See also

1041

Munroe, Charles S.

Co *B*, 5 Mass. Cav., (Col'd.)

Private

Sergeant

CARD NUMBERS.

1	5375735	26
2	5375823	27
3	5375901	28
4	5375945	29
5	5376047	30
6	5376158	31
7	5376259	32
8	5376364	33
9	5376467	34
10	5376567	35
11	5376666	36
12	5376761	37
13	9092432	38
14	40731445	39
15		40
16		41
17		42
18		43
19		44
20		45
21		46
22		47
23		48
24		49
25		50

Book Mark:

See also

S 1500436 P.O. morno
D 2647363 PO-Rita

R. J. M. M. M.
4

11 5 Cav. (Col'd.) | Mass.

Charles J. Lawrence

Co. 6, 5 Reg't Mass. Cav. (Col'd.)

Appears on

Company Descriptive Book
of the organization named above.

DESCRIPTION.

Age 21 years; height 5 feet 6 1/2 inches.

Complexion colored

Eyes black; hair black

Where born Rochester, New York

Occupation seaman

ENLISTMENT.

When Jan 9, 1864.

Where Berkley

By whom W. C. Cabbell; term 3 y'rs.

Remarks: Mustered into Company 6
Jan 24 1864 at Readville, Mass
by Lieut. W. C. Cabbell

W. | **5 Col'd Cav.** | **Mass.**

Charles S. Mumroe.

Priv., Co. C, 5 Reg't Mass. Col'd Cav.

Appears on

Company Muster-in and Descriptive Roll
of the organization named above. Roll dated

Readville Jan. 29, 1864.

Where born Rochester, N. Y.

Age 21 y'rs; occupation Seaman.

When enlisted Jan. 9, 1864.

Where enlisted Berkley

For what period enlisted 3 years.

Eyes Black; hair Black

Complexion Black; height 5 ft. 6 1/2 in.

When mustered in Jan. 29, 1864.

Where mustered in Readville, Mass.

Bounty paid \$ 100; due \$ 100

Where credited 2^d Dist. Bristol.

Company to which assigned _____

Remarks : _____

Book mark : _____

Sitter.

M. | **5** Col'd Cav. | **Mass.**

Charles S. Munroe.

Priv., Co. C, 5 Reg't Mass. Col'd Cavalry.

Appears on

Company Muster Roll

for *Enlistment to Feb. 29, 1864.*

Present or absent *Present.*

Stoppage, \$ *100* for

Due Gov't, \$ *100* for

Valuation of horse, \$ *100*

Valuation of horse equipments, \$ *100*

Remarks: *Detailed to
Head-quarters, Camp
Meigs by Special
Order, No. 11.*

Book mark: _____

Sitter

710. | 5 Col'd Cav. | Mass.

Charles O. Munroe.

Priv., Co. C, 5 Reg't Mass. Col'd Cavalry.

Appears on

Company Muster Roll

for Mar. & Apr., 1864.

Present or absent Present

Stoppage, \$ 100 for

Due Gov't, \$ 100 for

Valuation of horse, \$ 100

Valuation of horse equipments, \$ 100

Remarks:

Book mark:

Sites

M. | **5** Col'd Cav. | **Mass.**

Charles S. Monroe

Cortis, Co. C, 5 Reg't Mass. Col'd Cavalry.

Appears on

Company Muster Roll

for *May & June*, 1864.

Present or absent *Present*

Stoppage, \$ *100* for

Due Gov't, \$ *100* for

Valuation of horse, \$ *100*

Valuation of horse equipments, \$ *100*

Remarks: *Presented to
S. J. Carter, No. 113
Boston, June 2, 1864.*

Book mark: *...*

S. J. Carter

M. | 5 Col'd Cav. | Mass.

Charles S Monroe

Sgt., Co. C, 5 Reg't Mass. Col'd Cavalry.

Appears on

Company Muster Roll

for July & Aug., 1867.

Present or absent Present

Stoppage, \$ 100 for

Due Gov't, \$ 100 for

Valuation of horse, \$ 100

Valuation of horse equipments, \$ 100

Remarks: Absent by S.O. No 128 dated July, 67

Book mark:

E. H. Brown

M | **5 Col'd Cav.** | **Mass.**

Charles S Monroe

Sgt, Co. C, 5 Reg't Mass. Col'd Cavalry.

Appears on

Company Muster Roll

for *Sept & Oct*, 186*4*.

Present or absent *Present*

Stoppage, \$ *100* for

Due Gov't, \$ *100* for

Valuation of horse, \$ *100*

Valuation of horse equipments, \$ *100*

Remarks: *Appointed by S.O. No 128 dated July 1/64 Free on or before Apl. 19/61*

Book mark:

E. H. Brown

M | 5 Col'd Cav. | Mass.

Charles J Munroe

Sgt., Co. C, 5 Reg't Mass. Col'd Cavalry.

Appears on

Company Muster Roll

for Nov 1864, 1864.

Present or absent Present

Stoppage, \$ 100 for

Due Gov't, \$ 100 for

Valuation of horse, \$ 100

Valuation of horse equipments, \$ 100

Remarks: Appointed by S. D. ... 128 dated July 1864 ... for Ord. \$ 0.86 for L. M. Stores \$ 0.80 ... see on or before April 1861

Book mark:

E. T. Brown

N | **5 Col'd Cav.** | **Mass.**

Charles S. Howe
Gt, Co. C, 5 Reg't Mass. Col'd Cavalry.

Appears on

Company Muster Roll

for *Jan Feb*, 1865.

Present or absent *Present*

Stoppage, \$ *100* for

Due Gov't, \$ *100* for

Valuation of horse, \$ *100*

Valuation of horse equipments, \$ *100*

Remarks: *Appointed by S.O. 128 dated July 1, 64 rank 1st 4 inst of bounty \$180.*

Book mark:

E. H. Brown

M | **5 Col'd Cav.** | **Mass.**

Charles J Monroe

Sgt, Co. C, 5 Reg't Mass. Col'd Cavalry.

Appears on

Company Muster Roll

for *War & Aid*, 1865.

Present or absent *Present*

Stoppage, \$ *100* for

Due Gov't, \$ *100* for

Valuation of horse, \$ *100*

Valuation of horse equipments, \$ *100*

Remarks: *Due of the 1st Dist of
W. bounty \$ 35. due 2^d 37
Dist of bounty \$ 120.*

Book mark: _____

E. H. Brown

772 | 5 Col'd Cav. | Mass.

Charles S Munroe

Sergt, Co. C, 5 Reg't Mass. Col'd Cavalry.

Appears on

Company Muster Roll

for May & June, 1865.

Present or absent Present

Stoppage, \$ 15/100 for 2 M Stores

Due Gov't, \$ 100 for

Valuation of horse, \$ 100

Valuation of horse equipments, \$ 100

Remarks: Free before April 19 1861
Due of 1st Dist US Bounty \$ 35.00
Due 2-3+4 Dist US Bounty \$ 20.00

Book mark:

Abbott

M

5 Col'd Cav.

Mass.

Charles S Monroe

Serjt, Co. C, 5 Reg't Mass. Col'd Cavalry.

Appears on

Company Muster Roll

for *July & Aug*, 186 *5*.

Present or absent *Present*

Stoppage, \$ *- 45/100* for *Q M Stores*

Due Gov't, \$ *100* for

Valuation of horse, \$ *100*

Valuation of horse equipments, \$ *100*

Remarks: *Free before April 19 1861*

Book mark:

Abou

M. | **5 Col'd Cav.** | **Mass.**

Charles S. Munroe

Pvt., Co. C, 5 Reg't Mass. Colored Cav.
Sgt.

Appears on **Returns** as follows:

Feb. 1864. On duty, Orderly
at Hd. Qrs.

Mar. 1864. On duty, Orderly
at Hd. Qrs. Camp Meigs.

Apr. 1864. On duty at Hd. Qrs.

Mar. 1865. (Sgt.) On daily duty
as Reg't Color Bearer.

Book mark :

J. B. Sittler

(546)

Copyist.

M | 5 Col'd Cav. Mass.

Charles S Munroe

Serget, Co. C, 5 Reg't Mass. Col'd Cavalry.

Appears on Co. Muster-out Roll, dated
Clarksville Texas, Oct 31, 1865.

Muster-out to date Oct 31, 1865.

Last paid to Dec 31, 1864.

Clothing account:

Last settled....., 186 ; drawn since \$ 100

Due soldier \$ 100; due U. S. \$ 74 ³⁴ 100

Am't for cloth'g in kind or money adv'd \$ 100

Due U. S. for arms, equipments, &c., \$ 11 100

Bounty paid \$ 25 100; due \$ 275 100

Remarks: due US for 6x48 45ct.

Book mark:

Abbot

(861)

Copyist.

1042

Munroe, James

Co B, 5 Mass. Cav., (Col'd.)

Private

Private

CARD NUMBERS.

1	5-380540	26
2	5-380629	27
3	5-380733	28
4	5-381556	29
5	9091993-	30
6	40731405	31
7		32
8		33
9		34
10		35
11		36
12		37
12		38
14		39
15		40
16		41
17		42
18		43
19		44
20		45
21		46
22		47
23		48
24		49
25		50

Book Mark:

See also

M

5 Cav. (Col'd.) | Mass.

James Munroe

Co. G, 5 Reg't Mass. Cav. (Col'd.)

Appears on

Company Descriptive Book

of the organization named above.

DESCRIPTION.

Age 23 years; height 5 feet 6 $\frac{3}{4}$ inches.

Complexion Blk

Eyes Blk; hair Blk

Where born Canada

Occupation Laborer

ENLISTMENT.

When Jan 25, 1864.

Where Boston

By whom D. Davies; term 3 y'rs.

Remarks: Deserted May 12, 1864

Hearn

144 | **5 Col'd Cav.** | **Mass.**

James Monroe
Co. G, 5 Reg't Mass. Col'd Cav.

Appears on
Company Muster-in and Descriptive Roll
of the organization named above. Roll dated
Readville Mass, Mar 4, 1864.

Where born *Canada*

Age *23* y'rs; occupation *Laborer*

When enlisted *Jan 25*, 1864.

Where enlisted *Boston Ward 6*

For what period enlisted *3* years.

Eyes *Blk*; hair *Blk*

Complexion *Blk*; height *5* ft. *6 3/4* in.

When mustered in *Mar 4*, 1864.

Where mustered in *Readville Mass*

Bounty paid \$ *2* 100; due \$ *100*

Where credited *West Suffolk*

Company to which assigned

Remarks:

Book mark:

Leys

W | **5 Col'd Cav.** | **Mass.**

James Monroe
Capt

, Co. G, 5 Reg't Mass. Col'd Cavalry.

Appears on

Company Muster Roll

for *March to Apr 30*, 1864.

Present or absent *Absent*

Stoppage, \$ *100* for

Due Gov't, \$ *100* for

Valuation of horse, \$ *100*

Valuation of horse equipments, \$ *100*

Remarks: *Absent with leave*
since April 25th 1864.

Book mark:

Legat

M | **5 Col'd Cav.** | **Mass.**

James Munroe
Priv, Co. G, 5 Reg't Mass. Col'd Cavalry.

Appears on

Company Muster Roll
for *May & June*, 186*4*.

Present or absent.....

Stoppage, \$.....¹⁰⁰ for.....

Due Gov't, \$.....¹⁰⁰ for.....

Valuation of horse, \$.....¹⁰⁰

Valuation of horse equipments, \$.....¹⁰⁰

Remarks: *Deer to 12/64*

Book mark:.....

L. J. per
(358) Copyist.

M. | 5 Col'd Cav. | Mass.

James Monroe
Pvt., Co. G, 5 Reg't Mass. Colored Cav.

Appears on Returns as follows:

Apr. 1864. Absent with
leave since Apr. 25"

May 1864. Loss May 12"
Readville - Deserted

Book mark :

(546)

J. B. Sittler

Copyist.

M | **5 Col'd Cav.** | **Mass.**

James Monroe
Pri, Co. *G*, 5 Reg't Mass. Col'd Cavalry.

Appears on **Co. Muster-out Roll**, dated
Charlottesville, Oct 31, 1864.

Muster-out to date _____, 186 .

Last paid to *Pay due from Enrollment*, 186 .

Clothing account:

Last settled _____, 186 ; drawn since \$ _____ 100

Due soldier \$ _____ 100; due U. S. \$ *26* ^{*ref*} 100

Am't for cloth'g in kind or money adv'd \$ _____ 100

Due U. S. for arms, equipments, &c., \$ _____ 100

Bounty paid \$ _____ 100; due \$ _____ 100

Remarks: *Deserted from Camp*
Meigs Roadville Mass
May 12, 64

Book mark : _____

W. H. Scott

1043

Murphy, George
Co M, 5 Mass. Cav., (Col'd.)

Private Private

CARD NUMBERS.

1	5385956	26	
2	5386565	27	
3	5386864	28	
4	9091402	29	
5	40731435	30	
6		31	
7		32	
8		33	
9		34	
10		35	
11		36	
12		37	
12		38	
14		39	
15		40	
16		41	
17		42	
18		43	
19		44	
20		45	
21		46	
22		47	
23		48	
24		49	
25		50	

Book Mark: _____

See also

23^d A. J. Lovell Inf.

No. **5 Cav. (Col'd.)** | **Mass.**

George Murphy.

....., Co. *No.*, 5 Reg't Mass. Cav. (Col'd.)

Appears on

Company Descriptive Book

of the organization named above.

DESCRIPTION.

Age *21* years; height *5* feet *5* inches.

Complexion *Black.*

Eyes *Black*; hair *Black.*

Where born *Richmond Va.*

Occupation *Laborer.*

ENLISTMENT.

When *May 6*, 1864.

Where *Upton.*

By whom *G. H. Quincy*; term *3* y'rs.

Remarks: *Apprehended as a deserter from
the 23rd U.S.C. May 11, 1864.*

*Mustered by Lieut. D. Madden May 5th
1864, Readville Mass.*

H. C. Thomas.

529)

Copist.

M | **5 Col'd Cav.** | **Mass.**

George Murphy

Pri, Co. M, 5 Reg't Mass. Col'd Cav.

Appears on

Company Muster-in and Descriptive Roll
of the organization named above. Roll dated

Readville Mass, May 5, 1864.

Where born Richmond Va

Age 21 y'rs; occupation Laborer

When enlisted March 6, 1864.

Where enlisted Upton Mass

For what period enlisted 3 years.

Eyes Blk; hair Blk

Complexion Blk; height 5 ft. 5 in.

When mustered in May 5, 1864.

Where mustered in Readville

Premium
Bounty paid \$ 2 100; due \$ 100

Where credited

Company to which assigned

Remarks: Cred'td to Upton - Noras
ter Co. 8. Cong. Dist. Mass

Book mark:

Avery

(356d)

Copyist.

M | **5 Col'd Cav.** | **Mass.**

George Murphy

Pri, Co. M, 5 Reg't Mass. Col'd Cav.

Appears on

Company Muster-in and Descriptive Roll
of the organization named above. Roll dated

Readville Mass, May 5, 1864.

Where born Richmond Va

Age 21 y'rs; occupation Laborer

When enlisted March 6, 1864.

Where enlisted Upton Mass

For what period enlisted 3 years.

Eyes Blk; hair Blk

Complexion Blk; height 5 ft. 5 in.

When mustered in May 5, 1864.

Where mustered in Readville

Premium
Bounty paid \$ 2 100; due \$ 100

Where credited

Company to which assigned

Remarks: Cred'td to Upton - Horas
ter Co. 8. Cong. Dist. Mass

Book mark:

Avery

(356d)

Copyist.

M | 5 Col'd Cav. | Mass.

George Murphy

Co. M, 5 Reg't Mass. Colored Cavalry.

Appears on

Company Muster Roll

for *May 5 to June 30*, 1864.

Present or absent

Stoppage, \$ 100 for

Due Gov't, \$ 100 for

Valuation of horse, \$ 100

Valuation of horse equipments, \$ 100

Remarks: *Taken as a deserter from the 23. Reg't U. S. Col'd. Troops. May 11. 64.*

Book mark:

(358)

Army

Copyist.

M. | 5 Col'd Cav. | Mass.

George Murphy
Priv., Co. M, 5 Reg't Mass. Colored Cav.

Appears on Returns as follows:

May 1864. Loss May 11/64
Camp Casey. Taken
as a deserter from the
23 Regt. U.S. Col Troops.

Book mark :

(546)

J. B. Sittler

Copyist.

M | **5 Col'd Cav.** | **Mass.**

George Murphy
Pri, Co. *M*, 5 Reg't Mass. Col'd Cavalry.

Appears on **Co. Muster-out Roll**, dated
Clarksville Tex Oct 31, 1865.

Muster-out to date _____, 186 .

Last paid to _____, 186 .
Never paid

Clothing account:

Last settled _____, 186 ; drawn since \$ _____ 100

Due soldier \$ _____ 100; due U. S. \$ _____ 100

Am't for cloth'g in kind or money adv'd \$ _____ 100

Due U. S. for arms, equipments, &c., \$ _____ 100

Bounty paid \$ _____ 100; due \$ _____ 100

Remarks:

*Apprehended as a
Deserter from 23rd
U.S. C.S. May 11 1864.*

Book mark: _____

(361)

Hodges
Copyist.

1044

Murray, Frank

Co A, 5 Mass. Cav., (Col'd.)

Private

Private

CARD NUMBERS.

1	5381611	26
2	5381700	27
3	5381785	28
4	5381882	29
5	5381989	30
6	5382094	31
7	5382198	32
8	5382298	33
9	5382396	34
10	5382525	35
11	5372897	36
12	5382626	37
12	9091826 1/2	38
14	32533836	39
15	32535437	40
16	40731437	41
17		42
18		43
19		44
20		45
21		46
22		47
23		48
24		49
25		50

Book Mark:

See also

No. **5 Cav. (Col'd.) | Mass.**

Frank Murray.

Co. H, 5 Reg't Mass. Cav. (Col'd.)

Appears on

Company Descriptive Book
of the organization named above.

DESCRIPTION.

Age *24* years; height *5* feet *5½* inches.

Complexion *Colored.*

Eyes *Black* ; hair *Black.*

Where born *Mountville Va.*

Occupation *Baker.*

ENLISTMENT.

When *Mar. 2^d*, 1864.

Where *Boston, W. 4.*

By whom *J. C. Hatch* ; term *3* y'rs.

Remarks: *Mustered out at Readville
Dec. 19th 64.*

H. C. Thomas.

M. | **5 Col'd Cav.** | **Mass.**

Francis Murray,
Pvt., Co. *H.*, 5 Reg't Mass. Col'd Cav.

Appears on
Company Muster-in and Descriptive Roll
of the organization named above. Roll dated

Readville Mass, Mar 12, 1864.

Where born *Mountsville, Va.*

Age *24* y'rs; occupation *Baker.*

When enlisted *Nov 2*, 186*4*.

Where enlisted *Boston, Mass.*

For what period enlisted *3* years.

Eyes *Black*; hair *Black*

Complexion *Black*; height *5* ft. *5 1/2* in.

When mustered in *Mar. 12*, 186*4*.

Where mustered in

Bounty paid \$ *100*; due \$ *100*

Where credited *3rd Dist, Suffolk,*

Company to which assigned

Remarks:

Book mark:

J. W. Hall

M. | **5 Col'd Cav.** | **Mass.**

Frank Murry.

Priv., Co. H, 5 Reg't Mass. Col'd Cavalry.

Appears on

Company Muster Roll

for *Mar 12 to Apr. 30*, 1864.

Present or absent *Present*

Stoppage, \$ *100* for

Due Gov't, \$ *100* for

Valuation of horse, \$ *100*

Valuation of horse equipments, \$ *100*

Remarks:

Book mark:

J. M. Wall

M 5 Col'd Cav. | Mass.

Frank Murray,
Pot., Co. H, 5 Reg't Mass. Col'd Cavalry.

Appears on

Company Muster Roll

for May & June, 1864

Present or absent absent

Stoppage, \$ 100 for

Due Gov't, \$ 100 for

Valuation of horse, \$ 100

Valuation of horse equipments, \$ 100

Remarks: Absent, sick
at Fortress Monroe,
since June 20/64.

Book mark:

J M Wall
Copyist.

M 5 Gold Car. Mass

Frank Murray

Pvt., Co. H, 5 Reg't Mass C. Car.

Appears on

Hospital Muster Roll

of Balfour U. S. A. General Hospital,

at Portsmouth, Va.,

for *May & June*, 186*4*

Attached to hospital:

When _____, 186 .

How employed _____

Last paid by Maj. _____

to _____, 186 .

Bounty paid \$ ¹⁰⁰; due \$ ¹⁰⁰

Present or absent *Present*

Remarks: _____

Book mark: _____

W. M. Sayre

M. 15 Cav. (Col.) Mass.

Frank Murray
Pvt., Co. H, 5 Reg't Mass. C.C.

Appears on

Hospital Muster Roll

of Balfour U. S. A. General Hospital,

at Portsmouth, Va.,

for July & Aug., 1864.

Attached to hospital :

When _____, 186 .

How employed _____

Last paid by Maj. _____

to _____, 186 .

Bounty paid \$ 100 ; due \$ 100

Present or absent _____

Remarks : Transferred to Reg't.
Aug. 1/64

Book mark: _____

Cona

A

5 Col'd Cav.

Mass.

Frank Murray,

Priv., Co. II, 5 Reg't Mass. Col'd Cavalry.

Appears on

Company Muster Roll

for *July & Aug.*, 186 *V.*

Present or absent *Present*

Stoppage, \$ *100* for

Due Gov't, \$ *100* for

Valuation of horse, \$ *100*

Valuation of horse equipments, \$ *100*

Remarks:

Book mark:

J. R. Wall

M 5 Col'd Cav. | **Mass.**

Frank Murray

Put, Co. H, 5 Reg't Mass. Col'd Cavalry.

Appears on

Company Muster Roll

for *Sept & Oct*, 1864.

Present or absent *Present*

Stoppage, \$ *0 ⁰⁴/₁₀₀* for *one cross
sabe letter & number*

Due Gov't, \$ *100* for

Valuation of horse, \$ *100*

Valuation of horse equipments, \$ *100*

Remarks:

.....
.....
.....
.....
.....
.....
.....
.....

Book mark:

E. M. Clark

M **5 Col'd Cav.** | **Mass.**

Frank Murray
Pat, Co. H, 5 Reg't Mass. Col'd Cavalry.

Appears on

Company Muster Roll

for *Nov & Dec*, 186*4*.

Present or absent *Present*

Stoppage, \$ *100* for

Due Gov't, \$ *100* for

Valuation of horse, \$ *100*

Valuation of horse equipments, \$ *100*

Remarks:

Book mark:

C M Leach

Me | **5 Col'd Cav.** | **Mass.**

Frank Murray
Put, Co. H, 5 Reg't Mass. Col'd Cavalry.

Appears on

Company Muster Roll

for Jan & Feb, 1865.

Present or absent Present.

Stoppage, \$ 100 for

Due Gov't, \$ 100 for

Valuation of horse, \$ 100

Valuation of horse equipments, \$ 100

Remarks: Daily duty,
Company & Troop.
Due 1st, 2d, 3d &
4th installment U.S.
bounty.

Book mark: _____

C M Clark

M

5 Col'd Cav.

Mass.

Frank Murray
Pat, Co. II, 5 Reg't Mass. Col'd Cavalry.

Appears on

Company Muster Roll

for *March + April*, 1865.

Present or absent *Present*

Stoppage, \$ *100* for

Due Gov't, \$ *100* for

Valuation of horse, \$ *100*

Valuation of horse equipments, \$ *100*

Remarks: *Due 1st, 2d, 3d
+ 4th installments, U.S.
bounty.*

Book mark:

C. M. Clark

(358)

Copyist.

M **5 Col'd Cav.** **Mass.**

Frank Murry
Pat, Co. H, 5 Reg't Mass. Col'd Cavalry.

Appears on

Company Muster Roll

for *May & June*, 1865.

Present or absent *Present*

Stoppage, \$ *100* for

Due Gov't, \$ *100* for

Valuation of horse, \$ *100*

Valuation of horse equipments, \$ *100*

Remarks: *1st, 2d, 3d & 4th*
installment U. S. Bounty
due. Free on or before
April 19, 1861. Absent,
sick at City Point, Va.,
May 21, 1865.

Book mark: _____

C. M. Clark

M | **5 Col'd Cav. Mass.**

Frank Murray
Co., 5 Reg't Mass. Col'd Cavalry.

Appears on an

Individual Muster-out Roll

of the organization named above. Roll dated

Fort Monroe Va June 11, 1865.

Muster-out to date *June 11, 1865.*

Last paid to *Dec 31, 1864.*

Clothing account:

Last settled *Dec 31, 1864*; drawn since \$..... 100

Due soldier \$..... 100; due U. S. \$..... 100

Am't for cloth'g in kind or money adv'd \$ *71* ^{*75*}/₁₀₀

Due U. S. for arms, equipments, &c., \$..... 100

Bounty paid \$..... 100 due \$..... 100

Remarks: *Frank Murray has*
all U. S. bounty due
which is allowed
enrolled men for
three years.

Mustered out by
(over)

Book mark: *477.9.11*

Stewart

JAN. - 9

5372897

1891 *

Order of War Department dated May

3/65

Patient in U.S.
Gen Hospital, Fort
Monroe Va.

M. | **5 Col'd Cav.** | **Mass.**

Frank Murray
Pvt., Co. H, 5 Reg't Mass. Colored Cav.

Appears on **Returns** as follows:

June 1864. Absent sick at
Fortress Monroe since
June 20

Aug. & Sept. 1864. Co. tailor

Jan. to Apr. 1865. Co. tailor
May & June 1865. Absent sick
City Point, May 21/65.

July 1865. Absent sick, Light
House Pt. since May 21

Aug. 1865. Loss June 11 Ft.
Monroe, Va. Dischg'd
per order War Dept.
dated May 3"

Book mark :

J. B. Sittler

(548)

Copyist.

M | 5 Col'd Cav. | Mass.

Frank Murray
Civi., Co. A, 5 Reg't Mass. Col'd Cavalry.

Appears on Co. Muster-out Roll, dated
Clarksville, Tex., Oct. 31, 1865.

Muster-out to date _____, 186 .

Last paid to Dec. 31, 1864.

Clothing account:

Last settled _____, 186 ; drawn since \$ 100

Due soldier \$ 100; due U. S. \$ 100

Am't for cloth'g in kind or money adv'd \$ 100

Due U. S. for arms, equipments, &c., \$ 100

Bounty paid \$ 100; due \$ 100

Remarks: Discharged at Ft. Monroe,
Va. June 1, 1865. Ord. W. D. May 3, 65.

Book mark: _____

R. E. Wilson

1045

Murray, James A.

Co I, 5 Mass. Cav., (Col'd.)

Private

Private

CARD NUMBERS.

1	5372633	26
2	5372627	27
3	5383314	28
4	5383386	29
5	5383485	30
6	5383576	31
7	5383673	32
8	9091781	33
9	9436201	34
10	40731436	35
11		36
12		37
13		38
14		39
15		40
16		41
17		42
18		43
19		44
20		45
21		46
22		47
23		48
24		49
25		50

Book Mark:

See also

711 | 5th Cav. | Mass.
Col'd | Mass.
James A. Murray
....., Co., 5th Reg't Mass Col'd Cav.

Appears on

Regimental Descriptive Book

of the organization named above.

DESCRIPTION.

Age 25 years; height 5 feet 2 inches.
Complexion Olive.
Eyes Black; hair Black
Where born Boston, Mass.
Occupation Porter,

ENLISTMENT.

When Jan. 3, 1865.

Where Boston,

By whom Capt. Brown; term 1 y'rs.

Remarks: Mustered Jan'y 3/
Capt. H. Brown 15

Flanagan

No. **5 Cav. (Col'd.) Mass.**

James A. Murray.

....., Co. *I*....., 5 Reg't Mass. Cav. (Col'd.)

Appears on

Company Descriptive Book

of the organization named above.

DESCRIPTION.

Age *25* years; height *5* feet *2* inches.

Complexion *Gold.*

Eyes *Black*; hair *Black.*

Where born *Boston Mass.*

Occupation *Porter.*

ENLISTMENT.

When *Jan 3*....., 186 ..

Where *Boston.*

By whom *Capt. L. Barnes*; term *1* y'rs.

Remarks: *Enlisted Capt. L. Barnes*

Boston Jan. 3.....

H. C. Thomas.

M | **5 Col'd Cav.** | **Mass.**

James A Murray

Appears with rank of *Private* on

Muster and Descriptive Roll of a Detachment of U. S. Vols. forwarded

for the 5 Reg't Mass. Col'd Cavalry. Roll dated

Boston Mass Jan 3, 1865.

Where born *Boston Mass.*

Age *25* y'rs; occupation *Porter.*

When enlisted *Jan. 3.*, 1865

Where enlisted *Boston Mass.*

For what period enlisted *1* years.

Eyes *blue*; hair *blue*

Complexion *Colored*; height *5* ft. *2* in.

When mustered in *Jan. 3*, 1865.

Where mustered in *Boston*

Bounty paid \$ *33*^{*33*}/_{*100*}; due \$ *66*^{*66*}/_{*100*}

Where credited *Town of Cohasset Mass.*

Company to which assigned _____

Remarks: _____

Book mark: _____

(339) *M. A. Michaels* Copyist.

M | **5** Col'd Cav. | **Mass.**

James A. Murray
Appears with rank of *Private* on

Muster and Descriptive Roll of a Detachment of U. S. Vols. forwarded

for the 5 Reg't Mass. Col'd Cavalry, Roll dated
Draft Rendezvous
Falloups Island, Bk. Mass Jan 16, 1865.

Where born *Boston Mass.*

Age *26* y'rs; occupation *Porter*

When enlisted *Jan. 3*, 1865.

Where enlisted *Boston Mass.*

For what period enlisted *1* years.

Eyes *black*; hair *black*

Complexion *Gold*; height *5* ft. *2* in.

When mustered in *Jan. 3* 1865.

Where mustered in *Boston Mass.*

Bounty paid \$ *33* ^{*33*}/_{*100*}; due \$ *66* ^{*67*}/_{*100*}

Where credited *Cobden Worcester Co.*

Company to which assigned

Remarks:

Book mark:

M. A. Michaels

M

5 Col'd Cav.

Mass.

James A. Murray,
Privt, Co. I, 5 Reg't Mass. Colored Cavalry.

Appears on

Company Muster Roll

for *Jan. 8 Feb.*, 1865.

Present or absent *Present.*

Stoppage, \$ *100* for

Due Gov't, \$ *100* for

Valuation of horse, \$ *100*

Valuation of horse equipments, \$ *100*

Remarks: *Recruit from Depot,*

Book mark: _____

C. F. Thompson
Copyist.

In | **5 Col'd Cav.** | **Mass.**

James A. Murray,
Priv't, Co. I, 5 Reg't Mass. Colored Cavalry.

Appears on

Company Muster Roll

for *In L. & Apr.*, 1865.

Present or absent *Present,*

Stoppage, \$ *100* for

Due Gov't, \$ *100* for

Valuation of horse, \$ *100*

Valuation of horse equipments, \$ *100*

Remarks:

Book mark:

(358)

C. F. Thompson
Copyist.

In | **5 Col'd Cav.** | **Mass.**

James A Murray,
Co. I, 5 Reg't Mass. Colored Cavalry.

Appears on

Company Muster Roll

for *May & June*, 1865.

Present or absent *Present.*

Stoppage, \$ *100* for

Due Gov't, \$ *100* for

Valuation of horse, \$ *100*

Valuation of horse equipments, \$ *100*

Remarks:

Book mark:

(358)

C. F. Thompson
Copyist.

M | 5 Col'd Cav. | Mass.

James A. Murray
Pvt., Co. I, 5 Reg't Mass. Colored Cavalry.

Appears on

Company Muster Roll

for July 1863, 1863.

Present or absent Present

Stoppage, \$ 100 for

Due Gov't, \$ 100 for

Valuation of horse, \$ 100

Valuation of horse equipments, \$ 100

Remarks:

Book mark:

Holecomb

M. | 5 Col'd Cav. | Mass.

Gas Murray
Pvt., Co. I, 5 Reg't Mass. Colored Cav.

Appears on Returns as follows:

Feb. 1865. Gain Feb. 22/65
Pt. Lookout. Recruit
from depot.

Book mark :

(546)

J. B. Sittler

Copyist.

M | 5 Col'd Cav. | Mass.

James A. Murray
Pvt., Co. D, 5 Reg't Mass. Col'd Cavalry.

Appears on Co. Muster-out Roll, dated
Clarksville Texas, Oct 31, 1865.

Muster-out to date Oct 31, 1865.

Last paid to _____, 1865.
Pay due from Enrollment

Clothing account:

Last settled _____, 1865; drawn since \$ 100

Due soldier \$ 28 ⁴³/₁₀₀; due U. S. \$ 100

Am't for cloth'g in kind or money adv'd \$ 100

Due U. S. for arms, equipments, &c., \$ ³⁰/₁₀₀

Bounty paid \$ 22 ³³/₁₀₀; due \$ 22 ³³/₁₀₀

Remarks: Mustered out by SO, No. 29 Hd Quarters Dept of
Texas dated Galveston Texas, Sept 14/65 (based on authority
from War Dept. dated Sept 8/65 directing the
muster out of colored troops organized in
northern states) their services being no longer
required & transport & subsistence furnished to
Cor.

Book mark: _____

Holeman

JAN. 10

5383673

1891

Boston Mass. Master out to
date Oct 31/65x

Murray, James A
Co. K 5 Reg't Mass ce

2 Enclosures.

Bed Cards	Final Statements
Burial Records	Furloughs or L. of A
Certs. of Dis. for Discharge	Med. Certificates
C. M. Charges	Med. Des. Lists
Descriptive Lists	Orders
Discharge Certificates	Pris. of War Record
Enlistment Papers 2	Resignations

Other papers relating to—

Admission to Hosp'l	Furlough or L. of A
Casualty Sheet	Med. Examination
Confinement	Misc. Information
Contracts	Pay or Clothing
Death or Effects	Personal Reports
Desertion	Rank
Discharge from Hosp'l	Transfer to Hosp'l
Discharge from Service	Transfer to V. R. C.
Duty	Transportation

NOTE 1. — This blank will be used for both enlistments and re-enlistments — enlistment of veterans, &c., &c., in the volunteer service. They will be made out in duplicate in all cases — one to accompany the recruiting return of the superintendent (not the recruiting officer) to the Adjutant-General, and one to accompany the accounts of the officer who pays bounty, &c. The Regiment and Company in which the soldier last served should be given on the back.

NOTE 2. — An enlistment holds to service. A muster-in must, in all cases, precede payment of pay, bounty, pension, &c. A muster-in roll must, in all cases, be filed in the Adjutant-General's Office as evidence of muster-in. The mustering officer, commissary, or assistant-commissary of musters, as the case may be, will countersign both enlistments as having mustered the soldier into the service of the United States before either of them is given to the disbursing officer.

DECLARATION OF RECRUIT.

I, *James A. Murray* desiring to VOLUNTEER as a Soldier in the Army of the United States, for the term of THREE YEARS, Do Declare, That I am *Twenty five* years and _____ months of age; that I have never been discharged from the United States service on account of disability or by sentence of a court-martial, or by order before the expiration of a term of enlistment; and I know of no impediment to my serving honestly and faithfully as a soldier for three years.

GIVEN at *Boston, Mass.* the *3* day of *January* 18*65*

Witness: *John H Collins* *James A Murray*

Discharged *1865* 18
 Reg't of *5th Regt Mass Cav*
 enlistment; last served in Company ()
 By *Capt M. L. Brown*
 Volunteered at *1865* 18
 No. _____

CONSENT IN CASE OF MINOR.

I, _____ Do CERTIFY, That I am _____ of _____; that the said _____ is _____ years of age; and I do hereby freely give my CONSENT to his volunteering as a SOLDIER in the ARMY OF THE UNITED STATES for the period of THREE YEARS.

GIVEN at _____ the _____ day of _____

Witness: _____

(Married)

VOLUNTEER ENLISTMENT.

STATE OF



TOWN OF

Massachusetts.

I, James A. Murray born in ... in the State of ... aged ... years, and by occupation a ... DO HEREBY ACKNOWLEDGE to have volunteered this ... day of ... 1865, to serve as a Soldier in the Army of the United States of America, for the period of THREE YEARS, unless sooner discharged by proper authority: Do also agree to accept such bounty, pay, rations, and clothing, as are, or may be, established by law for volunteers. And I, ... do solemnly swear, that I will bear true faith and allegiance to the United States of America, and that I will serve them honestly and faithfully against all their enemies or opposers whomsoever; and that I will observe and obey the orders of the President of the United States, and the orders of the officers appointed over me, according to the Rules and Articles of War.

Sworn and subscribed to, at ... this ... day of ... 1865, James A. Murray BEFORE ...

I CERTIFY, ON HONOR, That I have carefully examined the above-named Volunteer, agreeably to the General Regulations of the Army, and that, in my opinion, he is free from all bodily defects and mental infirmity, which would in any way disqualify him from performing the duties of a soldier.

Pos. In ... Surgeon General of ... 5th Dist. Mass. EXAMINING SURGEON.

I CERTIFY, ON HONOR, That I have minutely inspected the Volunteer, ... previously to his enlistment, and that he was entirely sober when enlisted; that, to the best of my judgment and belief, he is of lawful age; and that, in accepting him as duly qualified to perform the duties of an able-bodied soldier, I have strictly observed the Regulations which govern the recruiting service.

This soldier has ... eyes, ... hair, ... complexion, is ... feet ... inches high.

J. M. LeBaron Regiment of ... Volunteers RECRUITING OFFICER. 5th Dist. Mass.

(A. G. O. No. 74 & 75.)

Mustered into the service of the United States, in Company ... the ... day of ... 1865, at ... Regiment of ... Volunteers, on ...

1895

DECLARATION OF RECRUIT.

I, *James Murray* desiring to VOLUNTEER as a Soldier in the Army of the United States, for the term of THREE YEARS, Do Declare, That I am *23* years and *0* months of age; that I have never been discharged from the United States service on account of disability or by sentence of a court-martial, or by order before the expiration of a term of enlistment; and I know of no impediment to my serving honestly and faithfully as a soldier for three years.

GIVEN at *Boston, Mass* the *3* day of *January* 18*95*

Witness:

John H. Collins *James Murray*

No. *1100*

Volunteered at *101st Regt*

By *Major J. W. St. James*
3rd Regiment of Massachusetts
3rd Lieut. Colonel

enlistment; last served in Company ()

Reg't of

Discharged

18

33rd Battery

APRIL 1895. THIS PAPER WAS FORMERLY FILED IN THE ENROLLMENT OFFICE (A. G. O.)

CONSENT IN CASE OF MINOR.

I, _____ Do CERTIFY, That I am the _____ of _____; that the said _____ is _____ years of age; and I do hereby freely give my CONSENT to his volunteering as a SOLDIER in the ARMY OF THE UNITED STATES for the period of THREE YEARS.

GIVEN at _____ the _____ day of _____

Witness:

NOTE 1. — This blank will be used for both enlistments and re-enlistments — enlistment of veterans, &c., &c., in the volunteer service. They will be made out in duplicate in all cases — one to accompany the recruiting return of the superintendent (not the recruiting officer) to the Adjutant-General, and one to accompany the accounts of the officer who pays bounty, &c. The Regiment and Company in which the soldier last served should be given on the back.
NOTE 2. — An enlistment holds to service. A muster-in must, in all cases, precede payment of pay, bounty, pension, &c. A muster-in roll must, in all cases, be filed in the Adjutant-General's Office as evidence of muster-in. The mustering officer, commissary, or assistant-commissary of musters, as the case may be, will countersign both enlistments as having mustered the soldier into the service of the United States before either of them is given to the disbursing officer.

(6 (ind))

VOLUNTEER ENLISTMENT.

STATE OF



TOWN OF

New Hampshire

I, James Murray, born in ... aged ... years, and by occupation a ... Do HEREBY ACKNOWLEDGE to have volunteered this ... day of ... 1865, to serve as a Soldier in the Army of the United States of America, for the period of THREE YEARS, unless sooner discharged by proper authority: Do also agree to accept such bounty, pay, rations, and clothing, as are, or may be, established by law for volunteers. And I, ... do solemnly swear, that I will bear true faith and allegiance to the United States of America, and that I will serve them honestly and faithfully against all their enemies or opposers whomsoever; and that I will observe and obey the orders of the President of the United States, and the orders of the officers appointed over me, according to the Rules and Articles of War.

Sworn and subscribed to, at ... this ... day of ... 1865, BEFORE ...

I CERTIFY, ON HONOR, That I have carefully examined the above-named Volunteer, agreeably to the General Regulations of the Army, and that, in my opinion, he is free from all bodily defects and mental infirmity, which would in any way disqualify him from performing the duties of a soldier.

Examining Surgeon signature and name

I CERTIFY, ON HONOR, That I have minutely inspected the Volunteer, previously to his enlistment, and that he was entirely sober when enlisted; that, to the best of my judgment and belief, he is of lawful age; and that, in accepting him as duly qualified to perform the duties of an able-bodied soldier, I have strictly observed the Regulations which govern the recruiting service. This soldier has ... eyes, ... hair, ... complexion, is ... feet ... inches high.

Recruiting Officer signature and name

(A. G. O. No. 74 & 75.)

15655

Mustered into the service of the United States, in Company the 3 day of January, 1865, at ...

Regiment of Cavalry, Mass Volunteers, on ...

1046

Murray Shadreck

CoA, 5 Mass. Cav., (Col'd.)

Private

Private

CARD NUMBERS.

1 5373314
 2 5373398
 3 5373479
 4 5373614
 5 5373722
 6 5374453
 7 9092681

26
 27
 28
 29
 30
 31
 32
 33
 34
 35
 36
 37
 38
 39
 40
 41
 42
 43
 44
 45
 46
 47
 48
 49
 50

Book Mark:

See also

101 | **5 Cav. (Col'd.) | Mass.**

Adriek
....., Co. *A*, 5 Reg't Mass. Cav. (Col'd.)

Appears on

Company Descriptive Book

of the organization named above.

DESCRIPTION.

Age *25* years; height *5* feet *4* inches.

Complexion *test?*

Eyes *blue*; hair *black*

Where born *Philadelphia, Penn.*

Occupation *Bookman*

ENLISTMENT.

When *Dec 20*, 1863.

Where *Ward 6 Boston*

By whom *Wm. Hancock*; term *3* y'rs.

Remarks: *Discharged May 6 1864 at
Needham Mass.*

P. A. [unclear]

75 | **5 Col'd Cav.** | **Mass.**

Shadreck Murray
Privt., Co. A, 5 Reg't Mass. Col'd Cav.

Appears on

Company Muster-in and Descriptive Roll
of the organization named above. Roll dated

Readville Jan. 9, 1864.

Where born Philadelphia

Age 25 y'rs; occupation Bookman

When enlisted Dec. 30th, 1863.

Where enlisted Boston No 6

For what period enlisted Three years.

Eyes Black; hair Black

Complexion Black; height 5 ft. 4 in.

When mustered in Jan. 9th, 1864.

Where mustered in _____

Bounty paid \$ _____ 100; due \$ _____ 100

Where credited _____

Company to which assigned _____

Remarks: _____

Book mark: _____

(356d)

G. F. M.

Copyist.

M

5 Col'd Cav.

Mass.

Shadrick Murrae

Priv, Co. A, 5 Reg't Mass. Col'd Cavalry.

Appears on

Company Muster Roll

for *Enlistment to Feb. 29, 1864.*

Present or absent *Present*

Stoppage, \$ *100* for

Due Gov't, \$ *100* for

Valuation of horse, \$ *100*

Valuation of horse equipments, \$ *100*

Remarks:

Book mark:

G. Fox

M | **5 Col'd Cav.** | **Mass.**

Shadrick Murray
Priv, Co. A, 5 Reg't Mass. Col'd Cavalry.

Appears on

Company Muster Roll

for *Mar. & Apr.*, 1864.

Present or absent *Present*

Stoppage, \$ *100* for

Due Gov't, \$ *100* for

Valuation of horse, \$ *100*

Valuation of horse equipments, \$ *100*

Remarks: *Hospital steward*

Book mark: _____

(358)

G. F. M.
Copyist.

M | **5 Col'd Cav.** | **Mass.**

Sadrick Murray
Capt, Co. A, 5 Reg't Mass. Col'd Cavalry.

Appears on

Company Muster Roll

for May & June, 1864.

Present or absent.....

Stoppage, \$.....100 for.....

Due Gov't, \$.....100 for.....

Valuation of horse, \$.....100

Valuation of horse equipments, \$.....100

Remarks: Deserted since
May 7, 1864

Book mark:.....

G. F. N.
Copyist.

M **5 Col'd Cav.** **Mass.**

Shadrack Murray
Pr., Co. A, 5 Reg't Mass. Col'd Cavalry.

Appears on

Company Muster Roll

for *July and Aug.*, 186*4*.

Present or absent *()*

Stoppage, \$ *100* for

Due Gov't, \$ *100* for

Valuation of horse, \$ *100*

Valuation of horse equipments, \$ *100*

Remarks: *Deserter since*
May 7, 1864.

Book mark: _____

A. C. Gilbert

M | **5 Col'd Cav. Mass.**

Shadrick Murray
Priv., Co. *A*, 5 Reg't Mass. Col'd Cavalry.

Appears on **Co. Muster-out Roll**, dated
Clarksville, Texas, Oct 31, 186 *5*.

Muster-out to date _____, 186 .

Last paid to _____, 186 .

Clothing account:

Last settled _____, 186 ; drawn since \$ _____ 100

Due soldier \$ _____ 100; due U. S. \$ _____ 100

Am't for cloth'g in kind or money adv'd \$ _____ 100

Due U. S. for arms, equipments, &c., \$ _____ 100

Bounty paid \$ _____ 100; due \$ _____ 100

Remarks: *Deserted at Baltimore*
Md. Aug 6. 1864

Book mark : _____

(861)

Dallade

Copyist.

1047

Murray, William A.
Co M, 5 Mass. Cav., (Col'd.)

Private | Private

CARD NUMBERS.

1	5372381	26
2	5372431	27
3	5372466	28
4	5386221	29
5	5386326	30
6	5386426	31
7	5386530	32
8	5386623	33
9	5386753	34
10	5372896	35
11	5386839	36
12	9091403	37
13	34506543	38
14	40731438	39
15		40
16		41
17		42
18		43
19		44
20		45
21		46
22		47
23		48
24		49
25		50

Book Mark: _____

See also _____

16 **5 Cav. (Col'd.) | Mass.**

William H. Murray,

....., Co. *16*, 5 Reg't Mass. Cav. (Col'd.)

Appears on

Company Descriptive Book

of the organization named above.

DESCRIPTION.

Age *34* years; height *5* feet *8* inches.

Complexion *Dark*

Eyes *Black*; hair *Black*

Where born *Barbadoes W.I.*

Occupation *Barber*

ENLISTMENT.

When *Aug 17, 1864*

Where *Somerset Mass.*

By whom *B. Edmund & Co.*; term *3* y'rs.

Remarks: *Mustered Aug 18th 1864. It.*
2nd Boston Boston. Paid by Capt. Dwyer
\$100. Due 200. Discharged June 4th
1865. by order War Department.

H. C. Thomas,

M | 5 Cav | Mass

William H. Murray

Appears with rank of _____ on _____

Muster and Descriptive Roll

of a detachment of U. S. Volunteers forwarded from Faneuil Hall, Boston, to Galloup's Island, Boston Harbor, for various regiments Massachusetts Volunteers. Roll dated

Boston, Mass., Aug 16, 1864.

Where born Barbadoes, W. I. Islands.

Age 24 years; occupation Barber.

When enlisted _____ Aug 16, 1864.

Where enlisted Somerset

For what period enlisted 3 years.

Eyes black; hair black

Complexion dark; height 5 ft. 8 in.

When mustered in _____ Aug 16, 1864.

Where mustered in Boston

Bounty paid \$ 100 100; due \$ 200 100

Clothing account:

Last settled _____, 186 _____; drawn since \$ _____ 100

Date of first muster _____, 186 _____

Regiment to which assigned 5 Cav

Remarks: Somerset, Bristol Co.,
2 Lieut.

Book mark: _____

Collings

(356m)

Copyist

M

5 Col'd Cav.

Mass.

William H. Murrey

Appears with rank of *Pri* on

Muster and Descriptive Roll of a Detachment of U. S. Vols. forwarded

for the 5 Reg't Mass. Col'd Cavalry. Roll dated

Boston Mass, *Aug 29*, 1864.

Where born *Barbadoes, W.P. Island*

Age *34* y'rs; occupation *Barber*

When enlisted *Aug 16*, 1864.

Where enlisted *Somerset*

For what period enlisted *3* years.

Eyes *Black*; hair *Black*

Complexion *Dark*; height *5 ft. 8* in.

When mustered in *Aug 16*, 1864.

Where mustered in *Boston*

Bounty paid \$ *100*/₁₀₀; due \$ *200*/₁₀₀

Where credited *2 Det. Somerset,*

Bristol Co
Company to which assigned

Remarks:

Book mark:

Donnelly

(339)

Copyist.

M

5 Col'd Cav. Mass.

William H. Muncoy

Appears with rank of *Private* on

Muster and Descriptive Roll of a Detachment of U. S. Vols. forwarded

for the 5 Reg't Mass. Col'd Cavalry. Roll dated *Draft Rendezvous Galloups Island B# Mass, Sept 3, 1864.*

Where born *Barbadoes W.I.*

Age *34* y'rs; occupation *Barber*

When enlisted *Aug. 17*, 1864.

Where enlisted *Somerset*

For what period enlisted *3* years.

Eyes *black*; hair *black*

Complexion *dark*; height *5 ft. 8 in.*

When mustered in *Aug. 17*, 1864.

Where mustered in *Boston*

Bounty paid \$ *100* ¹⁰⁰; due \$ *200* ¹⁰⁰

Where credited ~~*Somerset*~~ *Bristol Co*

Company to which assigned

Remarks: *Detained at his post*

** Entire entry cancelled except remarks*

Book mark:

M. A. Michaels

(339)

Copyist.

M | **5 Col'd Cav.** | **Mass.**

Wm H. Murray
Priv., Co. M, 5 Reg't Mass. Colored Cavalry.

Appears on

Company Muster Roll

for *Sept & Oct*, 1864.

Present or absent *Present.*

Stoppage, \$ *100* for

Due Gov't, \$ *100* for

Valuation of horse, \$ *100*

Valuation of horse equipments, \$ *100*

Remarks: *Recruit from de-*
pot. Joined Co. Oct.,
25, 1864.

Book mark:

L. Williams

M | 5 Col'd Cav. | Mass.

William H. Murray

Appears with rank of *Private* on

Muster and Descriptive Roll of a Detachment of U. S. Vols. forwarded

for the 5 Reg't Mass. Col'd Cavalry. Roll dated

Draft Rendezvous
Gallops Island Mass Oct 20, 1864.

Where born *Barbadoes W. I.*

Age *34* y'rs; occupation *Barber*

When enlisted *Aug. 17*, 1864.

Where enlisted *Somerset Mass.*

For what period enlisted *3* years.

Eyes *black*; hair *black*

Complexion *dark*; height *5 ft. 8 in.*

When mustered in *Aug. 17*, 1864.

Where mustered in *Boston Mass.*

Bounty paid \$ *100* ¹⁰⁰; due \$ *200* ¹⁰⁰

Where credited *Somerset Bristol Co.*

Company to which assigned

Remarks:

Book mark:

M. A. Michaels

(339)

Copyist.

M | **5 Col'd Cav.** | **Mass.**

William M. Murray
Priv., Co. M, 5 Reg't Mass. Colored Cavalry.

Appears on

Company Muster Roll

for *Nov. & Dec.*, 1864.

Present or absent *Present*

Stoppage, \$ *100* for

Due Gov't, \$ *100* for

Valuation of horse, \$ *100*

Valuation of horse equipments, \$ *100*

Remarks: *Recruit from depot.*
Joined Co. Oct. 25, '64.

Book mark:

G. Williams

M | **5 Col'd Cav.** | **Mass.**

Wm H. Murray

Priv, Co. M, 5 Reg't Mass. Colored Cavalry.

Appears on

Company Muster Roll
for *Jan'y & Feb'y*, 1865.

Present or absent *Present*

Stoppage, \$----- 100 for -----

Due Gov't, \$----- 100 for -----

Valuation of horse, \$----- 100

Valuation of horse equipments, \$----- 100

Remarks: *Recruit from*
depot.

Joined Co. Oct., 25, '64.

Book mark: -----

L. Williams
Copyst.

M | **5 Col'd Cav.** | **Mass.**

William H. Murray
Pol, Co. M, 5 Reg't Mass. Colored Cavalry.

Appears on

Company Muster Roll

for *May & Apr*, 1865.

Present or absent *Present*

Stoppage, \$ *100* for

Due Gov't, \$ *100* for

Valuation of horse, \$ *100*

Valuation of horse equipments, \$ *100*

Remarks:

Book mark:

C. Williams

M | **5 Col'd Cav.** | **Mass.**

William H Murray
Priv, Co. M, 5 Reg't Mass. Colored Cavalry.

Appears on

Company Muster Roll

for *May & June, 1865*

Present or absent *Absent*

Stoppage, \$ *100* for

Due Gov't, \$ *100* for

Valuation of horse, \$ *100*

Valuation of horse equipments, \$ *100*

Remarks: *Sick in Hosp*
City Point, Va since
May 20, '65.

Book mark: _____

C. Williams
Copied.

M | **5 Col'd Cav. Mass.**

William T. Murray
Private, 5 Reg't Mass. Col'd Cavalry.

Appears on an

Individual Muster-out Roll

of the organization named above. Roll dated

Providence, June 4, 1865.

Muster-out to date *June 4, 1865.*

Last paid to *Dec 31, 1864.*

Clothing account:

Last settled *Dec 31, 1864*; drawn since \$..... 100

Due soldier \$..... 100; due U. S. \$..... 100

Am't for cloth'g in kind or money adv'd \$ *17* ^{*85*}/₁₀₀

Due U. S. for arms, equipments, &c., \$..... 100

Bounty paid \$..... 100 due \$..... 100

Remarks: *This Soldier has*
rec'd all the bounty due
him according to Order
from War Dept No 84
Series 65. Mustered
Out by order of com
(over)

Book mark:

W. T. Murray
(348) Copyist.

JAN. - 9

5372896

1891

Ward Dept dated
May 3. 1865.
Patient in
U.S. Gen'l Hospital
Fort Monroe, Va.

M | **5 Col'd Cav.** | **Mass.**

William H. Murray
Pri., Co. M, 5 Reg't Mass. Colored Cavalry.

Appears on

Company Muster Roll

for *July & Aug.*, 186*5*.

Present or absent

Stoppage, \$ *100* for

Due Gov't, \$ *100* for

Valuation of horse, \$ *100*

Valuation of horse equipments, \$ *100*

Remarks:

Discharged by
order War Department
June 4th 1865 from
Hospt. Fortress Monroe Va.

Book mark:

Badger

M. | 5 Col'd Cav. | Mass.

William H. Murray
Pvt., Co. M, 5 Reg't Mass. Colored Cav.

Appears on Returns as follows:

Oct. 1864. Gain Oct. 25/64 Pt.
Lookout. Recruit from
Depot.

May & June 1865. Absent sick in
Hosp. City Point, Va. May
20/65.

July 1865. Absent sick at Post
Hosp. Fort Monroe since
May 20/65.

Aug. 1865. Lost June 4/65 Fort
Monroe by order of
War Dept. - Discharged

Book mark :

(648)

J. B. Sittler

Copyist.

W | **5 Col'd Cav.** | **Mass.**

William H. Murray
Pr., Co. *W*, 5 Reg't Mass. Col'd Cavalry.

Appears on **Co. Muster-out Roll**, dated
Clarksville Tex, Oct 31, 1865.

Muster-out to date _____, 186 .

Last paid to *Dec. 31*, 1864.

Clothing account:

Last settled _____, 186 ; drawn since \$ _____ 100

Due soldier \$ _____ 100; due U. S. \$ _____ 100

Am't for cloth'g in kind or money adv'd \$ _____ 100

Due U. S. for arms, equipments, &c., \$ _____ 100

Bounty paid \$ _____ 100; due \$ _____ 100

Remarks:

Discharged June
4th 1865 from Hospt.
Fortress Monroe Va. by
order War Dept. May 3rd
1865.

Book mark: _____

(361)

Hodges

Copyist.

Murray, John H.

C. M. 5, Co. *Mass ce*, Reg't

7 Enclosures.

Bed Cards	Final Statements
Burial Records	Furloughs or L. of A
Certs. of Dis. for Discharge	Med. Certificates
C. M. Charges	Med. Des. Lists
Descriptive Lists	Orders
Discharge Certificates	Pris. of War Record <i>/</i>
Enlistment Papers <i>2</i>	Resignations

Other papers relating to—

Admission to Hosp'l	Furlough or L. of A
Casualty Sheet	Med. Examination
Confinement	Misc. Information
Contracts	Pay or Clothing
Death or Effects	Personal Reports
Desertion	Rank
Discharge from Hosp'l	Transfer to Hosp'l
Discharge from Service	Transfer to V. R. C.
Duty	Transportation

Note 1.— This blank will be used for both enlistments and re-enlistments — enlistment of veterans, &c., &c., in the volunteer service. They will be made out in duplicate in all cases — one to accompany the recruiting return of the superintendent (not the recruiting officer) to the Adjutant-General, and one to accompany the accounts of the officer who pays bounty, &c. The Regiment and Company in which the soldier last served should be given on the back.

Note 2.— An enlistment holds to service. A muster-in must, in all cases, precede payment of pay, bounty, pension, &c. A muster-in roll must, in all cases, be filed in the Adjutant-General's Office as evidence of muster-in. The mustering officer, commissary, or assistant-commissary of musters, as the case may be, will countersign both enlistments as having mustered the soldier into the service of the United States before either of them is given to the disbursing officer.

(A. G. O. No. 74 & 75)

I, _____ of _____ do hereby give my consent to his volunteering as a Soldier in the Army of the United States for the period of THREE YEARS.

GIVEN at _____ the _____ day of _____

Witness: _____

CONSENT IN CASE OF MINOR

I, _____ of _____ Do certify, That I am the _____ of _____ said _____ is _____ years of age; and I do hereby freely give my consent to his volunteering as a Soldier in the Army of the United States for the period of THREE YEARS.

GIVEN at _____ the _____ day of _____

Witness: _____

DECLARATION OF RECRUIT

I, *William H. Barrett*, desiring to VOLUNTEER as a Soldier in the Army of the United States, for the term of THREE YEARS, Do Declare, That I am *18* years and _____ months of age; that I have never been discharged from the United States service on account of disability or by sentence of a court-martial, or by order before the expiration of a term of enlistment; and I know of no impediment to my serving honestly and faithfully as a soldier for three years.

GIVEN at *London* the _____ day of _____

Witness: _____

No. _____

William H Barrett
 Volunteered at *Amnicet*
August 18 68
 By *H. Edwards & Co*
5th Regiment of Mass. Cav.

() _____
 enlistment; last served in Company _____
 Reg't of _____
 Discharged _____

NOTE 1. — This blank will be used for both enlistments and re-enlistments — enlistment of veterans, &c., &c., in the volunteer service. They will be made out in duplicate in all cases — one to accompany the recruiting return of the superintendent (not the recruiting officer) to the Adjutant-General, and one to accompany the accounts of the officer who pays bounty, &c. The Regiment and Company in which the soldier last served should be given on the back.

NOTE 2. — An enlistment holds to service. A muster-in must, in all cases, precede payment of pay, bounty, pension, &c. A muster-in roll must, in all cases, be filed in the Adjutant-General's Office as evidence of muster-in. The mustering officer, commissary, or assistant-commissary of musters, as the case may be, will countersign both enlistments as having mustered the soldier into the service of the United States before either of them is given to the disbursing officer.

DECLARATION OF RECRUIT.

I, *Wm P. Murray* desiring to VOLUNTEER as a Soldier in the Army of the United States, for the term of THREE YEARS, Do Declare, That I am *Thirty four* years and _____ months of age; that I have never been discharged from the United States service on account of disability or by sentence of a court-martial, or by order before the expiration of a term of enlistment; and I know of no impediment to my serving honestly and faithfully as a soldier for three years.

GIVEN at *Boston* the *16* day of *August* 18*64*

Witness:

H. P. ... *W. C. ...*

No.

William H. Murray
Volunteered at *Barnstable*

August 1864

By *W. C. ...*
5th Regiment of Mass. Cav

enlistment; last served in Company ()

Reg't of

Discharged

18

CONSENT IN CASE OF MINOR.

I, _____ Do CERTIFY, That I am _____ the _____ of _____; that the said _____ is _____ years of age; and I do hereby freely give my CONSENT to his volunteering as a SOLDIER in the ARMY OF THE UNITED STATES for the period of THREE YEARS.

GIVEN at _____ the _____ day of _____

Witness:

VOLUNTEER ENLISTMENT.

STATE OF



TOWN OF

Maine

Sumner

I, *H. H. Murray* born in *Bahamas*
in the State of *W. I. Island* aged *thirty four* years,
and by occupation a *Barber* DO HEREBY ACKNOWLEDGE to have
volunteered this *sixth* day of *Aug* 186*4*

to serve as a Soldier in the Army of the United States of America, for the
period of **THREE YEARS**, unless sooner discharged by proper authority: Do also
agree to accept such bounty, pay, rations, and clothing, as are, or may be, estab-
lished by law for volunteers. And I, *H. H. Murray* do
solemnly swear, that I will bear true faith and allegiance to the **United States
of America**, and that I will serve them honestly and faithfully against all their
enemies or opposers whomsoever; and that I will observe and obey the orders of
the President of the United States, and the orders of the officers appointed over
me, according to the Rules and Articles of War.

Sworn and subscribed to, at

this *sixth* day of *Aug* 186*4*

BEFORE

Wm. H. Murray
2nd Lieut C. M. D. Buff

I CERTIFY, ON HONOR, That I have carefully examined the above-named Volunteer, agreeably
to the General Regulations of the Army, and that, in my opinion, he is free from all bodily defects and
mental infirmity, which would in any way disqualify him from performing the duties of a soldier.

J. P. Mackay
EXAMINING SURGEON.

I CERTIFY, ON HONOR, That I have minutely inspected the Volunteer, *Wm H Murray*
previously to his enlistment, and that he was entirely sober when enlisted; that, to the best of my
judgment and belief, he is of lawful age; and that, in accepting him as duly qualified to perform the duties
of an able-bodied soldier, I have strictly observed the Regulations which govern the recruiting service.
This soldier has *black* eyes, *black* hair, *dark* complexion, is *5* feet
8 inches high.

5 Mass Cavalry
Regiment of *Volunteers*,
RECRUITING OFFICER.

(A. G. O. No. 74 & 75.)

Wm H Murray
2nd Lieut C. M. D. Buff
Wm H Murray

the *6th* day of *August*, 186*4*, at *Sumner* Maine
Mustered into the service of the United States, in Company *...*
Regiment of *...* Volunteers, on

NOTE 1. — This blank will be used for both enlistments and re-enlistments — enlistment of veterans, &c., &c., in the volunteer service. They will be made out in duplicate in all cases — one to accompany the recruiting return of the superintendent (not the recruiting officer) to the Adjutant-General, and one to accompany the accounts of the officer who pays bounty, &c. The Regiment and Company in which the soldier last served should be given on the back.

NOTE 2. — An enlistment holds to service. A muster-in must, in all cases, precede payment of pay, bounty, pension, &c. A muster-in roll must, in all cases, be filed in the Adjutant-General's Office as evidence of muster-in. The mustering officer, commissary, or assistant-commissary of musters, as the case may be, will countersign both enlistments as having mustered the soldier into the service of the United States before either of them is given to the disbursing officer.

APRIL 1895. THE SEVERAL WAR OFFICERS FILED IN THE BUREAU OF THE ADJUTANT-GENERAL.

DECLARATION OF RECRUIT.

I, *H. H. Murray* desiring to VOLUNTEER as a Soldier in the Army of the United States, for the term of THREE YEARS, Do Declare, That I am *Thirty four* years and *—* months of age; that I have never been discharged from the United States service on account of disability or by sentence of a court-martial, or by order before the expiration of a term of enlistment; and I know of no impediment to my serving honestly and faithfully as a soldier for three years.

GIVEN at *Boston, Mass.* the *16* day of *August*, 186*4*.

Witness: *William H. Murray*

No.

Volunteered at *Barnstable*

By *W. Edwards & Co*
5th Regiment of Mass's Cav

enlistment; last served in Company ()

Reg't of

Discharged

18

See Bounty

CONSENT IN CASE OF MINOR.

I, _____ Do CERTIFY, That I am _____ of _____; that the said _____ is _____ years of age; and I do hereby freely give my CONSENT to his volunteering as a SOLDIER in the ARMY OF THE UNITED STATES for the period of THREE YEARS.

GIVEN at _____ the _____ day of _____

Witness:

VOLUNTEER ENLISTMENT.

STATE OF

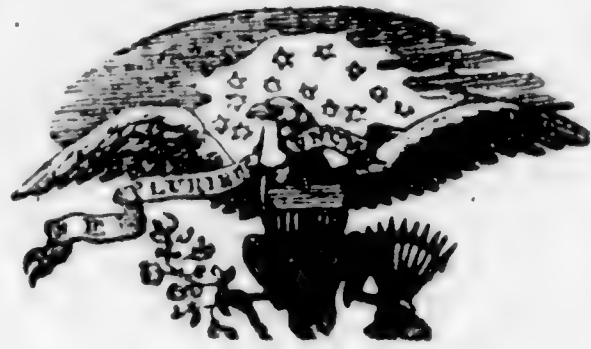

TOWN OF

Mass

Somerset

I, *Wm H. Murray* born in *Baldos* in the State of *N P Island* aged *Thirty four* years, and by occupation a *Barber* DO HEREBY ACKNOWLEDGE to have volunteered this *Seventeenth* day of *August* 1864, to serve as a **Soldier** in the Army of the United States of America, for the period of **THREE YEARS**, unless sooner discharged by proper authority: Do also agree to accept such bounty, pay, rations, and clothing, as are, or may be, established by law for volunteers. And I, *Wm H. Murray* do solemnly swear, that I will bear true faith and allegiance to the **United States of America**, and that I will serve them honestly and faithfully against all their enemies or opposers whomsoever; and that I will observe and obey the orders of the President of the United States, and the orders of the officers appointed over me, according to the Rules and Articles of War.

Sworn and subscribed to, at *Dorchester* this *17th* day of *August* 1864

BEFORE *Wm H. Murray*
2d Lieut. C. M. S. Capt

I CERTIFY, ON HONOR, That I have carefully examined the above-named Volunteer agreeably to the General Regulations of the Army, and that, in my opinion, he is free from all bodily defects and mental infirmity, which would in any way disqualify him from performing the duties of a soldier.

F. S. [Signature]
 EXAMINING SURGEON.

I CERTIFY, ON HONOR, That I have minutely inspected the Volunteer, *Wm H. Murray* previously to his enlistment, and that he was entirely sober when enlisted; that, to the best of my judgment and belief, he is of lawful age; and that, in accepting him as duly qualified to perform the duties of an able-bodied soldier, I have strictly observed the Regulations which govern the recruiting service. This soldier has *Black* eyes, *Black* hair, *Dark* complexion, is *5* feet *8* inches high.

5th Mass Cavalry
 Regiment of *Volunteers*,
 RECRUITING OFFICER.

(A. G. O. No. 74 & 75.)

93476
[Signature]

the *16* day of *August*, 1864, at *Dorchester*
 Mustered into the service of the United States, in Company *of [illegible]* Regiment of *[illegible]*

2d Lieut. C. M. S. Capt
[Signature]

Volunteers, on

1977 1 25

MEMORANDUM FROM PRISONER OF WAR RECORDS.

No. _____

(This blank to be used only in the arrangement of said records.)

NAME.	RANK.	ORGANIZATION.				INFORMATION OBTAINED FROM—				
		No. of Reg't.	State.	Arm of Service.	Co.	Records of—	Vol.	Page.	Vol.	Page.
<i>Murray W. H.</i>	<i>P</i>	<i>5</i>	<i>Mass.</i>	<i>C</i>	<i>16</i>	<i>Medic.</i>	<i>19</i>	<i>100</i>		

Captured at _____, 186 , confined at Richmond, Va., _____, 186 ,

Admitted to Hospital at *Howard-grove Richmond Va. April 1865*
where he died _____, 186 , of _____

Paroled at _____, 186 ; reported at Camp Parole, Md., _____, 186 .

Copied by *C. G. G.*

1048

Myers, Ephraim
Co M. 5 Mass. Cav., (Col'd.)

Private Private

CARD NUMBERS.

1	5385954	26
2	5386543	27
3	5386128	28
4	5386219	29
5	5386325	30
6	5386425	31
7	5386529	32
8	5386622	33
9	5386729	34
10	5386814	35
11	9091400	36
12	40731439	37
13		38
14		39
15		40
16		41
17		42
18		43
19		44
20		45
21		46
22		47
23		48
24		49
25		50

Book Mark:

See also

No. | **5 Cav. (Col'd.)** | **Mass.**

Ephraim Myers

....., Co. *No.*, 5 Reg't Mass. Cav. (Col'd.)

Appears on

Company Descriptive Book

of the organization named above.

DESCRIPTION.

Age *21* years; height *5* feet *7* inches.

Complexion *Black*

Eyes *Black*; hair *Black*

Where born *Wethersville Va.*

Occupation *Farmer*

ENLISTMENT.

When *April 30*, 1864.

Where *Boston No. 3*

By whom *Sgt. Jenks*; term *3* y'rs.

Remarks: *Mustered by Lieut. D. Madden*
May 5th 1864. Wethersville Mass.

H. S. Thomas

M | **5 Col'd Cav.** | **Mass.**

Ephraim Myers

Pri, Co. M, 5 Reg't Mass. Col'd Cav.

Appears on

Company Muster-in and Descriptive Roll
of the organization named above. Roll dated

Readville Mass, May 5, 1864.

Where born Northville Va.

Age 21 y'rs; occupation Farmer

When enlisted Apr. 30, 1864.

Where enlisted Boston

For what period enlisted 3 years.

Eyes Blk; hair Blk

Complexion Blk; height 5 ft. 4 in.

When mustered in May 5, 1864.

Where mustered in Readville

Premium
Bounty paid \$ 2 100; due \$ 100

Where credited

Company to which assigned

Remarks: Cred'td to 3^d Wd. Boston

Suffolk Co. 4 Cong Dist.
Mass

Book mark:

Avery

M | **5 Col'd Cav.** | **Mass.**

Ephraim Myers
Pri., Co. M, 5 Reg't Mass. Colored Cavalry.

Appears on

Company Muster Roll

for *May 5 to June 30*, 1864.

Present or absent *Present*

Stoppage, \$ *100* for

Due Gov't, \$ *100* for

Valuation of horse, \$ *100*

Valuation of horse equipments, \$ *100*

Remarks:

Book mark:

(358)

Avery
Coryist.

Me | **5 Col'd Cav.** | **Mass.**

Ephraim Myers
Pri., Co. M, 5 Reg't Mass. Colored Cavalry.

Appears on

Company Muster Roll

for *July & Aug.*, 1864.

Present or absent *Present*

Stoppage, \$ *100* for

Due Gov't, \$ *100* for

Valuation of horse, \$ *100*

Valuation of horse equipments, \$ *100*

Remarks: *Detached Service
Guard at Stockade.*

Book mark:

(358)

Avery
Copyist.

M | **5 Col'd Cav.** | **Mass.**

Ephraim Myers
Col., Co. M, 5 Reg't Mass. Colored Cavalry.

Appears on

Company Muster Roll

for *Sept. + Oct.*, 186 *4*

Present or absent *Present.*

Stoppage, \$ *100* for

Due Gov't, \$ *100* for

Valuation of horse, \$ *100*

Valuation of horse equipments, \$ *100*

Remarks:

Book mark:

C. Williams,

(358)

Copyist.

M | 5 Col'd Cav. | Mass.

Abraham Myers
Pvt., Co. M, 5 Reg't Mass. Colored Cavalry.

Appears on

Company Muster Roll

for *Nov. & Dec., 1864.*

Present or absent *Present*

Stoppage, \$ *100* for

Due Gov't, \$ *100* for

Valuation of horse, \$ *100*

Valuation of horse equipments, \$ *100*

Remarks:

Book mark:

C. Williams

M | **5 Col'd Cav.** | **Mass.**

Ephraim Myers
Priv., Co. M, 5 Reg't Mass. Colored Cavalry.

Appears on

Company Muster Roll
for *Jan, & Feb.*, 186*5*.
Present or absent *Present*

Stoppage, \$..... 100 for

Due Gov't, \$..... 100 for

Valuation of horse, \$..... 100

Valuation of horse equipments, \$..... 100

Remarks:

Book mark:

L. Williams
Copyright

M | **5 Col'd Cav.** | **Mass.**

Ephraim Meyers
Priv, Co. M, 5 Reg't Mass. Colored Cavalry.

Appears on

Company Muster Roll

for *May & Apr*, 1865.

Present or absent *Present*

Stoppage, \$ *100* for

Due Gov't, \$ *100* for

Valuation of horse, \$ *100*

Valuation of horse equipments, \$ *100*

Remarks:

Book mark:

C. Williams
Copied.

M | 5 Col'd Cav. | Mass.

Ephraim Myers
Priv., Co. M, 5 Reg't Mass. Colored Cavalry.

Appears on

Company Muster Roll

for *May & June*, 1865.

Present or absent *Present*

Stoppage, \$ *100* for

Due Gov't, \$ *100* for

Valuation of horse, \$ *100*

Valuation of horse equipments, \$ *100*

Remarks:

Book mark:

C. Williams,
Copyist.

M | **5 Col'd Cav.** | **Mass.**

Ephraim Myers
Pri., Co. M, 5 Reg't Mass. Colored Cavalry.

Appears on

Company Muster Roll

for *July & Aug.*, 1865.

Present or absent *Absent*

Stoppage, \$ *100* for

Due Gov't, \$ *100* for

Valuation of horse, \$ *100*

Valuation of horse equipments, \$ *100*

Remarks:

Detached Service
S.O. 135 Aug. 30. 1865
at Brasos Santiago.

Book mark:

Hodges

M. | **5 Col'd Cav.** | **Mass.**

Ephriam Myers

Priv., Co. M, 5 Reg't Mass. Colored Cav.

Appears on **Returns** as follows:

July & Aug. 1864. Absent guard
at stockade

Aug. & Sept. 1865. Absent detach'd
serv. Brazos Santiago
S. O. 135 Aug. 29/65.

Book mark :

(546)

J. B. Sittler

Copyist.

M | **5 Col'd Cav.** | **Mass.**

Ephraim Myers
Co. M, Co. *M*, 5 Reg't Mass. Col'd Cavalry.

Appears on **Co. Muster-out Roll**, dated
Clarksville Tex. Oct. 31, 1865.

Muster-out to date *Oct. 31*, 1865.

Last paid to *Dec. 31*, 1864.

Clothing account:

Last settled....., 186 ; drawn since \$..... 100

Due soldier \$..... 100; due U. S. \$ *29*^{*94*}/₁₀₀

Am't for cloth'g in kind or money adv'd \$..... 100

Due U. S. for arms, equipments, &c., \$ *27*^{*20*}/₁₀₀

Bounty paid \$..... 100; due \$ *100*/₁₀₀

Remarks:

Book mark:

Hodges
(861) Copyist.

1049

Myers, Isaac

Co G 5 Mass. Cav., (Col'd.)

Private

Private

CARD NUMBERS.

1	5372674	26
2	5378433	27
3	5378519	28
4	5378627	29
5	5378730	30
6	5378833	31
7	5378939	32
8	5379067	33
9	5379281	34
10	9092211	35
11	40731440	36
12		37
13		38
14		39
15		40
16		41
17		42
18		43
19		44
20		45
21		46
22		47
23		48
24		49
25		50

Book Mark:

See also

M **5 Cav. (Col'd.) | Mass.**

Isaac Myers
....., Co. *E*....., 5 Reg't Mass. Cav. (Col'd.)

Appears on

Company Descriptive Book
of the organization named above.

DESCRIPTION.

Age *23* years; height *5* feet *4* inches.

Complexion *Blk*

Eyes *Brown*; hair *Blk*

Where born *Alexandria Va.*

Occupation *Labourer*

ENLISTMENT.

When *May 31*, 186*4*.

Where *Washington 3^d Dist.*

By whom; term *3* y'rs.

Remarks: *Mustered May 31 64,
by Capt. Putnam,
Substitute for Sgt. Tucker
Boston, Mass.
Died at Field Hospital
25th W. Corp. on May 10 1865.*

Heard

M | **5 Col'd Cav.** **Mass.**

Isaac Myers.

Appears with rank of Private on

Muster and Descriptive Roll of a Detachment of Drafted Men and Substitutes forwarded

for the 5 Reg't Mass. Colored Cavalry. Roll dated Washington, D.C., N.Y., May 31, 1864.

Where born Alexandria, Va.

Age 23 years; occupation Laborer.

Drafted and mustered in:

When May 31, 1864.

Where Washington.

Period 3 years.

Eyes Brown; hair Black

Complexion Black; height 5 ft. 4 in.

Paid bounty and advance pay, \$ 100

Bounty due \$ 100

Where credited _____

Company to which assigned _____

Remarks: Accepted as substitute for Thomas J. Tucker, Boston, Mass.

Book mark: _____

W. C. Davis

M | **5 Col'd Cav.** | **Mass.**

Isaac Myers
Priv, Co. E, 5 Reg't Mass. Col'd Cavalry.

Appears on

Company Muster Roll

for *May & June*, 186*4*.

Present or absent

Stoppage, \$ *100* for

Due Gov't, \$ *100* for

Valuation of horse, \$ *100*

Valuation of horse equipments, \$ *100*

Remarks: *Recruit,*
Muster & Descriptive rolls
now from record

Book mark:

[Signature]

No. | **5 Col'd Cav.** | **Mass.**

Isaac Meyers

Pvt., Co. E, 5 Reg't Mass. Col'd Cavalry.

Appears on

Company Muster Roll

for *July & Aug.*, 1864.

Present or absent *Not stated*

Stoppage, \$ *100* for

Due Gov't, \$ *100* for

Valuation of horse, \$ *100*

Valuation of horse equipments, \$ *100*

Remarks: *Muster Descrip*

Roll now recd.

Stop one horse.

Sack.

Book mark:

D. J. Clark

(358)

Copyist.

B. | **5 Col'd Cav.** | **Mass.**

Isaac Meyers
Cvt, Co. E, 5 Reg't Mass. Col'd Cavalry.

Appears on

Company Muster Roll

for Sept & Oct, 1864.

Present or absent Present

Stoppage, \$ 100 for

Due Gov't, \$ 100 for

Valuation of horse, \$ 100

Valuation of horse equipments, \$ 100

Remarks: Muster and
Descriptive Roll
never received.

Book mark: _____

J. S. Blank

(358)

Copyist.

No. | 5 Col'd Cav. | Mass.

Isaac Meyers

Priv., Co. E, 5 Reg't Mass. Col'd Cavalry.

Appears on

Company Muster Roll

for Nov. & Dec., 1864.

Present or absent Present

Stoppage, \$ 100 for

Due Gov't, \$ 100 for

Valuation of horse, \$ 100

Valuation of horse equipments, \$ 100

Remarks: Muster roll not received.

Book mark:

A. S. Clark

M. | **5 Col'd Cav.** | **Mass.**

Isaac Myers

Prvt., Co. E, 5 Reg't Mass. Col'd Cavalry.

Appears on

Company Muster Roll

for *Jan. & Feb.*, 1865.

Present or absent *Present*

Stoppage, \$ *100* for

Due Gov't, \$ *100* for

Valuation of horse, \$ *100*

Valuation of horse equipments, \$ *100*

Remarks: *Stop one haver-sack 48 ct*

Book mark:

O. S. Cleary

M. | **5 Col'd Cav. Mass.**

Isaac Myers

Priv., Co. E, 5 Reg't Mass. Col'd Cavalry.

Appears on

Company Muster Roll

for *Feb. & Apr.*, 1865.

Present or absent *Present*

Stoppage, \$ *100* for

Due Gov't, \$ *180* for *Exp & G.E.*
lost.

Valuation of horse, \$ *100*

Valuation of horse equipments, \$ *100*

Remarks:

Book mark:

A. S. Clark

M | **5 Col'd Cav.** | **Mass.**

Isaac Myers
Private, Co. E, 5 Reg't Mass. Col'd Cavalry.

Appears on

Company Muster Roll

for May & June, 1865.

Present or absent

Stoppage, \$ 100 for

Due Gov't, \$ 100 for

Valuation of horse, \$ 100

Valuation of horse equipments, \$ 100

Remarks: Died at Field
Hospital 2nd Army
Corps May 12/65.

Book mark:

Loring
(358) Copyist.

M. | 5 Col'd Cav. | Mass.

Isaac Myers
Pvt., Co. E, 5 Reg't Mass. Colored Cav.

Appears on Returns as follows:

June 1864. Gain June 5/64
City Point, Va. Recruit
rec'd from depot.

May 1865. Loss - Died May
16/65. Field Hosp.

Book mark :

(548)

J. B. Sittler

Copyist.

W | **5 Col'd Cav. Mass.**

Isaac Myers
Priv, Co. *E*, 5 Reg't Mass. Col'd Cavalry.

Appears on **Co. Muster-out Roll**, dated
Clarksville Tex., Apr 21, 1865.

Muster-out to date _____, 186 .

Last paid to _____, 186 .

Clothing account:

Last settled _____, 186 ; drawn since \$ _____ 100

Due soldier \$ _____ 100; due U. S. \$ _____ 100

Am't for cloth'g in kind or money adv'd \$ _____ 100

Due U. S. for arms, equipments, &c., \$ _____ 100

Bounty paid \$ _____ 100; due \$ _____ 100

Remarks: *Substitute for*
J. Tucker, Boston Mass.
Died May 10/65 at Field
Hospital 25th St

Book mark: _____

(861)

Lowry

Copyist.

Myers Isaac
J. E. 5 Reg't Mass Co
 , Co. , Reg't *Mass Co*

2 Enclosures.

Bed Cards	Final Statements <i>/</i>
Burial Records	Furloughs or L. of A.
Certs. of Dis. for Discharge	Med. Certificates
C. M. Charges	Med. Des. Lists
Descriptive Lists	Orders
Discharge Certificates	Pris. of War Record
Enlistment Papers <i>/</i>	Resignations

Other papers relating to—

Admission to Hosp'l	Furlough or L. of A.
Casualty Sheet	Med. Examination
Confinement	Misc. Information
Contracts	Pay or Clothing
Death or Effects	Personal Reports
Desertion	Rank
Discharge from Hosp'l	Transfer to Hosp'l
Discharge from Service	Transfer to V. R. C.
Duty	Transportation

FINAL STATEMENT

OF

61
Private Isaac Myers, Co. F
5th Reg't of Massachusetts

VOLUNTEERS.

May 20 1865

NOTE 1.—Two of these certificates (or duplicates) are to be given to each Volunteer Soldier or drafted man who may be discharged previously to the discharge of his company, that he may at once receive from the Paymaster the pay, &c., due him, and the captain or other COMMISSIONED officer commanding the company will certify to the act of the delivery of the duplicate certificates; on these certificates the Soldier is "entitled to" his discharge, and should also present his discharge to the Paymaster to have the payment endorsed on it. The discharge is to be given back to the Soldier by the Paymaster; the latter only retaining as his voucher the duplicate certificates.

NOTE 2.—If the Soldier is entitled to pay for the use of his horse, the Company Commander will certify to that fact on the back of both these final statements, and also to the time he has pay due for having been so mounted on his own horse.

NOTE 3.—When a Soldier is furnished with final statements, his descriptive list, if he has one, should be taken up by the officer who gives the Soldier these statements, and endorsed with a statement to this effect by the officer. This endorsement should exhibit a full statement of the time for which the Soldier was allowed pay on his final statements, the clothing account, and all other charges against him or in his favor, so as to comprise a complete exhibit of his account. It will then be transmitted to the company commander of the Soldier, who will enter all the data necessary to a full understanding of the Soldier's account on the muster roll upon which the Soldier's discharge is reported. The descriptive list will then be destroyed. The object of this is, that the remaining portion of the Soldier's account may be settled upon the receipt of these muster rolls, and the Soldier receive any pay or allowances that may be due him at the time of his discharge, and which may not appear on his final statements from the fact that his descriptive list is incomplete. These accounts for back pay, &c., are settled by the 2d Auditor of the Treasury Department.

NOTE 4.—Charges for loss or injury to ordnance, horse equipments, and other miscellaneous charges, should appear under the heading of "Other Stoppages."

NOTE 5.—Bounty paid by State authorities, and not by the United States, will not be entered on this statement.

NOTE 6.—Amounts due the Sutler and Laundress must be entered on the muster roll on which the discharge, death, desertion, &c., is reported, as well as on the final statement, otherwise the amount cannot be collected from the United States.

NOTE 7.—This blank will be used for deceased volunteers and drafted men, as well as for others.

NOTE 8.—Where a Soldier dies in Hospital or on detached service, his descriptive list, if he has one, should be sent with his final statements, in duplicate, to the Adjutant General, Washington, D. C.

Isaac Myers

ADJUTANT GENERAL'S OFFICE.
May 20 1865
Duplicate with Inventory sent 2d Auditor.

I certify, on honor, that Isaac Myers a Private of
 Captain J. S. Wheat Company (E) of the 5th Regiment of Mass. Col.
VOLUNTEERS, of the State of Massachusetts, born in Alexandria, State
 of Virginia, aged 28 years; 5 feet 4 inches high; Black complexion,
Black eyes, Black hair, and by occupation a Laborer, having joined the company on
 its original organization at _____, and enrolled in it at the muster into
 the service of the United States at _____, on the _____ day
 of _____, 1864, (or was mustered in service as a recruit, by Capt. Putnam
 _____, at Washington D.C., on the 31st day of May,
 1864, or was drafted and mustered into the service of the United States from the
 Enrollment District of the State of _____, at _____,
 on the _____ day of _____, 1864,) to serve in the Regiment, for
 the term of Three Years: and having served **HONESTLY** and
FAITHFULLY with his Company in Virginia to the present date, is now
 entitled to a **DISCHARGE** by reason of Death.

The said Isaac Myers was last paid by Paymaster
M. J. Lodge to include the 31st day of December, 1864, and has
 pay due him from that time to the present date; he is entitled to pay and subsistence for
TRAVELING to place of enrollment, and whatever other allowances are authorized to volunteer
 soldiers, drafted men, or militia, so discharged. He has received from the United States **CLOTHING**
 amounting to \$ 3.10 dollars, since the _____ day of December,
 1864, when his clothing account was last settled. He has received from the United States
No dollars advanced **BOUNTY**. (Substitute for 1st Quarter)

There is to be stopped from him, on account of the State of _____ or other
 authorities, for **CLOTHING**, &c., received on entering service, _____ dollars; and
 for other stoppages, viz: _____

_____ dollars.
 He has been furnished with **TRANSPORTATION** in kind from the place of his discharge to
 _____; and he has been **SUBSISTED** for **TRAVELING** to his
 place of enrollment, up to the _____, 1864.

He is indebted to _____, **SUTLER**, _____ dollars.
 He is indebted to _____, **LAUNDRESS**, _____ dollars.

Given in Duplicate, at New City Point Va., this 4th day
 of May, 1865.

Geo. D. Oliver
1st Lieut Co E 5th Mass Col.
 Commanding Company

5-11-64
C. 99
Am. ...

No. 77

Isaac Meyer's

Enlisted at Washington D.C.

As Substitute for

Thomas J. Tucker

On the 31st day of May, 1864.

By

Henry A. Scheetz
Capt. Pro. Mad. Det. Co.

W. Blackford

Jno S. Spasby

Board of Enrollment,

Dist. of Columbia

of Co. 10th Ind. Inf. with
U.S. Vol., Nov 18-75

SUBSTITUTE

VOLUNTEER ENLISTMENT.

District

STATE OF

To be credited to the

TOWN OF

Columbia

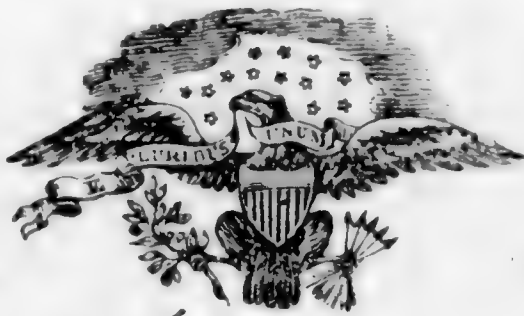

Boston Mass

I, *Isaac Myers* born in the State of *Virginia*, aged *twenty three* years, and by occupation a *Labourer*

Do HEREBY ACKNOWLEDGE to have agreed with *Thomas J. Tucker*, Esq., of *Boston 3rd Congl Dist, 12th Ward, Massachusetts*

to become his **SUBSTITUTE** in the Military Service, for a sufficient consideration paid and delivered to me, on the *thirty first* day of *May*, 186*4*; and having thus agreed with said *Thomas J. Tucker*, I DO HEREBY ACKNOWLEDGE to have enlisted this *thirty first* day of *May*, 186*4*, to serve as a **Soldier** in the **Army of the United States of America**, for the period of **THREE YEARS**, unless sooner discharged by proper authority: I do also agree to accept such bounty, pay, rations, and clothing, as are, or may be, established by law for soldiers. And I do solemnly swear that I will bear true and faithful allegiance to the **United States of America**; that I will serve them honestly and faithfully against all their enemies or opposers whomsoever; and that I will observe and obey the orders of the President of the United States, and the orders of the Officers appointed over me, according to the Rules and Articles of War.

SWORN and subscribed to, at *Washington DC.*

this *31st* day of *May*, 186*4*

BEFORE

Henry A. Scheetz & *Isaac Myers*
Capt & Provost Marshal & C.

5th Mass Colored Cavalry Regiment

We certify, on honor, That we have carefully examined the above-named Volunteer Substitute agreeably to the Regulations, and that, in our opinion, he is free from all bodily defects and mental infirmity which would in any way disqualify him from performing the duties of a soldier; that he was entirely sober when enlisted; that he is of lawful age, (not under 18 years;) and that, in accepting him as duly qualified to perform the duties of an able-bodied soldier, and as a Substitute in lieu of *Thomas J. Tucker* who was drafted in *Boston 3rd Congl Dist Mass* *May 24th*, 186*4*, we have strictly observed the Regulations which govern in such cases. This soldier has *brown* eyes, *black* hair, *black* complexion; is *5* feet *4* inches high.

Henry A. Scheetz
Capt & Provost Marshal & C

Francis W. Blackford
Commissioner of Board.

John B. Peabody
Surgeon of Board.

Board of Enrollment of _____ Dist. of *Columbia*

DECLARATION OF SUBSTITUTE.

I, Isaac Myers desiring to ENLIST in the Army of the United States for THREE YEARS, **Do declare**, That I am Thirty three years and _____ months of age; that I have never been discharged from the United States service on account of disability or by sentence of a court martial; and I know of no impediment to my serving honestly and faithfully as a soldier for three years.

GIVEN at Washington DC
the 31st day of May 1864

WITNESS:

A. O. Ball Isaac Myers

1050

Ayers, Thomas

Co M, 5 Mass. Cav., (Col'd.)

Private | Corporal

CARD NUMBERS.

1	5385-95-5	26
2	5386044	27
3	5386129	28
4	5386220	29
5	5386274	30
6	5386374	31
7	5386475	32
8	5386576	33
9	5386679	34
10	5386767	35
11	9091401	36
12		37
12		38
14		39
15		40
16		41
17		42
18		43
19		44
20		45
21		46
22		47
23		48
24		49
25		50

Book Mark:

See also

A. 625176 P.O. 90

01276719 P.O. 211921

S. 1364363, 2.74. Seal

1417669. P.O. aff

01501333 P.O. aff

092409921

R. J. Walker
4

No. **5 Cav. (Col'd.) | Mass.**

Thomas Myers.

Co. A, 5 Reg't Mass. Cav. (Col'd.)

Appears on

Company Descriptive Book

of the organization named above.

DESCRIPTION.

Age *22* years; height *5* feet *7* inches.

Complexion *Black.*

Eyes *Black*; hair *Black.*

Where born *Charles Co. Md.*

Occupation *Hostler.*

ENLISTMENT.

When *April 30th, 1864.*

Where *Roxbury.*

By whom *G. B. Jamesworth*; term *3* y'rs.

Remarks: *Entered by Serg't G. W. Hadden*

May 5th 1864, Readville Mass.

H. C. Thomas.

M | **5 Col'd Cav.** | **Mass.**

Thomas Myers

Pri, Co. M, 5 Reg't Mass. Col'd Cav.

Appears on

Company Muster-in and Descriptive Roll
of the organization named above. Roll dated

Readville Mass, May 5, 1864.

Where born Charles Co. Md

Age 22 y'rs; occupation Walter

When enlisted Apr. 30, 1864.

Where enlisted Roxbury,

For what period enlisted 3 years.

Eyes Blk; hair Blk

Complexion Blk; height 5 ft. 7 in.

When mustered in May 5, 1864.

Where mustered in Readville

Premium
Bounty paid \$ 2 100; due \$ 100

Where credited

Company to which assigned

Remarks: Cred't to Roxbury
Norfolk Co. 3^d Cong Dist.
Mass.

Book mark:

Avery

M

5 Col'd Cav.

Mass.

Thomas Myers

Priv, Co. M, 5 Reg't Mass. Colored Cavalry.

Appears on

Company Muster Roll

for *May 5 to June 30*, 1864.

Present or absent *Present*

Stoppage, \$ *100* for

Due Gov't, \$ *100* for

Valuation of horse, \$ *100*

Valuation of horse equipments, \$ *100*

Remarks:

Book mark:

Avery

M | **5 Col'd Cav.** | **Mass.**

Thomas Myers

Pri, Co. M, 5 Reg't Mass. Colored Cavalry.

Appears on

Company Muster Roll

for *July & Aug.*, 186*4*.

Present or absent *Present*

Stoppage, \$ *100* for

Due Gov't, \$ *100* for

Valuation of horse, \$ *100*

Valuation of horse equipments, \$ *100*

Remarks: *Due U.S. / Canton 594*

Book mark:

Avery

M | 5 Col'd Cav. | Mass.

Thomas Meyers
Priv., Co. M, 5 Reg't Mass. Colored Cavalry.

Appears on

Company Muster Roll

for Sept, + Oct, 1864.

Present or absent Present.

Stoppage, \$ 100 for

Due Gov't, \$ 100 for

Valuation of horse, \$ 100

Valuation of horse equipments, \$ 100

Remarks:

Book mark:

C. Williams

M | **5 Col'd Cav.** | **Mass.**

Thomas Myers
Co. M, 5 Reg't Mass. Colored Cavalry.

Appears on

Company Muster Roll

for *Nov. & Dec*, 1864.

Present or absent *Present*

Stoppage, \$ *100* for

Due Gov't, \$ *100* for

Valuation of horse, \$ *100*

Valuation of horse equipments, \$ *100*

Remarks: *Promoted from*
Private by S.O No. 226,
Dec. 13, 1864

Book mark:

G. Williams

M | **5 Col'd Cav.** | **Mass.**

Thomas Myers

Corpl, Co. M, 5 Reg't Mass. Colored Cavalry.

Appears on

Company Muster Roll

for *Jan, + Feb*, 1865.

Present or absent *Present*

Stoppage, \$ *100* for

Due Gov't, \$ *100* for

Valuation of horse, \$ *100*

Valuation of horse equipments, \$ *100*

Remarks: *Promoted to Corpl*
by S.O. No. 225 Dec, 13, '64.

Book mark:

L. Williams

(358)

Copyist.

M | **5 Col'd Cav.** | **Mass.**

Thomas Myers

Capt., Co. M, 5 Reg't Mass. Colored Cavalry.

Appears on

Company Muster Roll

for *Mar, & Apr, 1865.*

Present or absent *Present.*

Stoppage, \$ *100* for

Due Gov't, \$ *100* for

Valuation of horse, \$ *100*

Valuation of horse equipments, \$ *100*

Remarks:

Book mark:

C. Williams

M | **5 Col'd Cav.** | **Mass.**

Thomas Myers
Corp, Co. M, 5 Reg't Mass. Colored Cavalry.

Appears on

Company Muster Roll

for *May & June*, 1865.

Present or absent *Present*

Stoppage, \$.....100 for.....

Due Gov't, \$.....100 for.....

Valuation of horse, \$.....100

Valuation of horse equipments, \$.....100

Remarks:.....

Book mark:.....

C. Williams

(358)

Copyist. /

M | **5 Col'd Cav.** | **Mass.**

Thomas Myers

Corpl, Co. M, 5 Reg't Mass. Colored Cavalry.

Appears on

Company Muster Roll

for *July & Aug.*, 186*0*.

Present or absent *Present*

Stoppage, \$ *100* for

Due Gov't, \$ *100* for

Valuation of horse, \$ *100*

Valuation of horse equipments, \$ *100*

Remarks:

Book mark:

Hodges

M | **5 Col'd Cav.** | **Mass.**

Thomas Myers
Cople, Co. *M*, 5 Reg't Mass. Col'd Cavalry.

Appears on **Co. Muster-out Roll**, dated
Clarksville Tex, Oct. 31, 1865.

Muster-out to date *Oct. 31*, 1865.

Last paid to *Dec. 31*, 1864.

Clothing account:

Last settled _____, 186 ; drawn since \$ 100

Due soldier \$ 100; due U. S. \$ *11 64* 100

Am't for cloth'g in kind or money adv'd \$ 100

Due U. S. for arms, equipments, &c., \$ *41* 100

Bounty paid \$ 100; due \$ *100* 100

Remarks:

Book mark: *2286-1880*

(861)

Hodges
Copied.

1050-a

Race, Cammille
Co., 5 ~~W.S.~~ Col'd Cav

CARD NUMBERS.

1	9436208	26
2		27
3		28
4		29
5		30
6		31
7		32
8		33
9		34
10		35
11		36
12		37
13		38
14		39
15		40
16		41
17		42
18		43
19		44
20		45
21		46
22		47
23		48
24		49
25		50

Number of personal papers herein.....

Book Mark.....

See also.....

5th | Car | Mass.
5th | Col'd | Mass.

Amville face

....., Co., Reg't 5th Col'd Car.

Appears on

Regimental Descriptive Book

of the organization named above.

DESCRIPTION.

Age 35 years; height 5 feet 5 inches.

Complexion Colored

Eyes Black; hair Black

Where born Boston, Mass.

Occupation Cook

ENLISTMENT.

When Dec. 3, 186 4

Where Boston

By whom W. H. ...; term 5 y'rs.

Remarks: Mustered also by
Capt. Jones

1051

Taylor Adam

Co B, 5 Mass. Cav. (Col'd.)

Private Private

CARD NUMBERS.

1	26
2	27
3	28
4	29
5	30
6	31
7	32
8	33
9	34
10	35
11	36
12	37
13	38
14	39
15	40
16	41
17	42
18	43
19	44
20	45
21	46
22	47
23	48
24	49
25	50

Taylor Adam

Book Mark:

See also

1052

Narcese. William

Co A, 5 Mass. Cav., (Col'd.)

Private

Private

CARD NUMBERS.

1	5373405	26
2	5373486	27
3	5373588	28
4	5373700	29
5	5373810	30
6	5373910	31
7	5374021	32
8	5374122	33
9	5374221	34
10	5374315	35
11	5374404	36
12	9092691	37
13	5373320	38
14	40731447	39
15		40
16		41
17		42
18		43
19		44
20		45
21		46
22		47
23		48
24		49
25		50

Book Mark:

See also

S- 2206766 - P.O. M & M
D- 2994888 - Aud. W. D.

H. S. Wright

5 Cav. (Col'd.) | Mass.

William Lawrence Jr

....., Co. *D*, 5 Reg't Mass. Cav. (Col'd.)

Appears on

Company Descriptive Book

of the organization named above.

DESCRIPTION.

Age *41* years; height *5* feet *2* inches.

Complexion *African*

Eyes *black*; hair *black*

Where born *Lawrence, Ga.*

Occupation *Farmer*

ENLISTMENT.

When *Dec 24*, 186*3*.

Where *Lawrence*

By whom *W. V. Yates*; term *3* y'rs.

Remarks:
.....
.....
.....
.....
.....
.....
.....
.....
.....
.....

W. V. Yates
Coprinst.

N. 211
* ~~77~~ | 5 Col'd Cav. | Mass.

William ~~Harcech~~
Privt., Co. A, 5 Reg't Mass. Col'd Cav.

Appears on

Company Muster-in and Descriptive Roll
of the organization named above. Roll dated

Readville, Jan. 9, 1864.

Where born Franklin, Va

Age 26 y'rs; occupation Farmer

When enlisted Dec. 24th, 1863.

Where enlisted Franklin, Va

For what period enlisted Three years.

Eyes Black; hair Black

Complexion Black; height 5 ft. 5 1/2 in.

When mustered in Jan. 9th, 1864.

Where mustered in _____

Bounty paid \$ 100; due \$ 100

Where credited _____

Company to which assigned _____

Remarks: _____

~~Not taken up on Muster rolls of Regt~~

Book mark: _____

* Corrected July 20, 1910, P. 85
G. T. H.

31

5 Col'd Cav.

Mass.

William Carrese

Priv, Co. A, 5 Reg't Mass. Col'd Cavalry.

Appears on

Company Muster Roll

for *Enlistment to Feb. 29, 1864.*

Present or absent *Present*

Stoppage, \$ 100 for

Due Gov't, \$ 100 for

Valuation of horse, \$ 100

Valuation of horse equipments, \$ 100

Remarks:

Book mark:

[Signature]

N | **5 Col'd Cav.** | **Mass.**

William Parcell Jr.
Privt, Co. A, 5 Reg't Mass. Col'd Cavalry.

Appears on

Company Muster Roll

for *Mar. & Apr.*, 1864.

Present or absent *Present*

Stoppage, \$ *100* for

Due Gov't, \$ *100* for

Valuation of horse, \$ *100*

Valuation of horse equipments, \$ *100*

Remarks:

Book mark:

(358)

G. F. H.

Copyist.

H | **5 Col'd Cav.** | **Mass.**

William H. H. Jr.
Capt., Co. A, 5 Reg't Mass. Col'd Cavalry.

Appears on

Company Muster Roll

for *May 9 June*, 186*4*.

Present or absent *Present*

Stoppage, \$ *100* for

Due Gov't, \$ *100* for

Valuation of horse, \$ *100*

Valuation of horse equipments, \$ *100*

Remarks:

Book mark:

G. F. M.
Copyist.

N **5 Col'd Cav.** **Mass.**

William Narcisse Jr.
Cw., Co. A, 5 Reg't Mass. Col'd Cavalry.

Appears on

Company Muster Roll

for *July and Aug.*, 1864.

Present or absent *Present.*

Stoppage, \$ *100* for

Due Gov't, \$ *100* for

Valuation of horse, \$ *100*

Valuation of horse equipments, \$ *100*

Remarks: *Free on or before*
Apr. 19, 1861.

Book mark: _____

M. O. Gilbert

N

5 Col'd Cav.

Mass.

William Narcisse Jr.

Pvt., Co. A, 5 Reg't Mass. Col'd Cavalry.

Appears on

Company Muster Roll

for *Sept. and Oct.*, 186*4*.

Present or absent *Present.*

Stoppage, \$ *100* for

Due Gov't, \$ *100* for

Valuation of horse, \$ *100*

Valuation of horse equipments, \$ *100*

Remarks: *Stop 1 Travelsack*
.40

Book mark:

M. O. Gilbert

(358)

Copyist.

N

5 Col'd Cav.

Mass.

William Narcissus
Pr., Co. A, 5 Reg't Mass. Col'd Cavalry.

Appears on

Company Muster Roll

for *Nov. and Dec.*, 1864.

Present or absent *Present*

Stoppage, \$ *100* for

Due Gov't, \$ *100* for

Valuation of horse, \$ *100*

Valuation of horse equipments, \$ *100*

Remarks: *Stop for harness sack 40¢*

Book mark:

M. C. Gilbert

(358)

Copyist.

W

5 Col'd Cav.

Mass.

William Narcisse Jr.
Co., Co. A, 5 Reg't Mass. Col'd Cavalry.

Appears on

Company Muster Roll

for *Jan. and Feb.*, 1865:

Present or absent *Present.*

Stoppage, \$ *40* for *L. M. Goods.*
100 for

Due Gov't, \$ 100 for

Valuation of horse, \$ 100

Valuation of horse equipments, \$ 100

Remarks: *Due 2, 3 and 4*
inst. U.S. Treasury
\$120.00

Book mark:

M. O. Gilman

11 | **5 Col'd Cav.** | **Mass.**

William Narcisse Jr.
Pr., Co. A, 5 Reg't Mass. Col'd Cavalry.

Appears on

Company Muster Roll

for Feb. and Apr., 1865.

Present or absent Present.

Stoppage, \$ 100 for

Due Gov't, \$ 100 for

Valuation of horse, \$ 100

Valuation of horse equipments, \$ 100

Remarks: Dec 2, 3 and 4
in N. J. County
\$120.00 and \$35.00 exp
inc.

Book mark: _____

W. Gilbert

N | **5 Col'd Cav.** | **Mass.**

William Nareuse, Jr.
Pvt, Co. A, 5 Reg't Mass. Col'd Cavalry.

Appears on

Company Muster Roll

for *May & June*, 186*5*.

Present or absent *Present*

Stoppage, \$ *100* for

Due Gov't, \$ *100* for

Valuation of horse, \$ *100*

Valuation of horse equipments, \$ *100*

Remarks: *Due 2^d, 3^d, + 4th Inst*
W. Bounty + 120. + on 1st
Inst + 35.

Book mark:

Callade

N | **5 Col'd Cav.** | **Mass.**

William Nareuse, Jr.
Put, Co. A, 5 Reg't Mass. Col'd Cavalry.

Appears on

Company Muster Roll

for *July & Aug*, 186*5*.

Present or absent *Present*

Stoppage, \$.....*100* for.....

Due Gov't, \$.....*100* for.....

Valuation of horse, \$.....*100*

Valuation of horse equipments, \$.....*100*

Remarks: *Due 2, 3, 4, 5 Inst U.S. Bty #1 Co. 1*
In 1st Inst #35. Detached as laborer
on R.R. at Brazos, S. A. 4 8. Aug 11.
Free on or before 1st 9. 61.

Book mark:

W. Allard
(358) *W. Allard* Copyist.

A. | **5 Col'd Cav.** | **Mass.**

William Marcisse
Pvt., Co. A, 5 Reg't Mass. Colored Cav.

Appears on **Returns** as follows:

Aug. + Sept. 1865. Absent la-
borer on R.R. at Brazos
Santiago.

Book mark :

(648)

J. B. Sittler

Copyist.

W | **5 Col'd Cav. Mass.**

William Narcise Jr.
Pvt, Co. A, 5 Reg't Mass. Col'd Cavalry.

Appears on **Co. Muster-out Roll**, dated
Charlottesville, Texas, Oct 31, 1865.

Muster-out to date *Oct 31, 1865.*

Last paid to *Dec 31 1864.*

Clothing account:

Last settled....., 186 ; drawn since \$..... 100

Due soldier \$..... 100; due U. S. \$ *26* ^{*47*} _{*100*}

Am't for cloth'g in kind or money adv'd \$..... 100

Due U. S. for arms, equipments, &c., \$ *3* 100

x Bounty paid \$ *25* 100; due \$ *275* 100

Remarks: ** Free Apr 19. 1861*

Book mark: *463.766*

(861)

Dallade
Copyist.

1053

Narcise. William Jr.

CoA, 5 Mass. Cav., (Col'd.)

Private

Private

CARD NUMBERS.

1	26
2	27
3	28
4	29
5	30
6	31
7	32
8	33
9	34
10	35
11	36
12	37
13	38
14	39
15	40
16	41
17	42
18	43
19	44
20	45
21	46
22	47
23	48
24	49
25	50

In Narcise 1774

Book Mark:

See also

1054

Nash. Truby

Co M, 5 Mass. Cav., (Col'd.)

Private

Private

CARD NUMBERS.

1	5385957	26
2	5386845	27
3	5386190	28
4	5386328	29
5	5386428	30
6	5386532	31
7	5386626	32
8	5386732	33
9	5386877	34
10	9091406	35
11	33202948	36
12	40731448	37
13		38
14		39
15		40
16		41
17		42
18		43
19		44
20		45
21		46
22		47
23		48
24		49
25		50

Book Mark:

See also

A **5 Cav. (Col'd.) | Mass.**

Timothy Wash.

Co. 16, 5 Reg't Mass. Cav. (Col'd.)

Appears on

Company Descriptive Book

of the organization named above.

DESCRIPTION.

Age *22* years; height *5* feet *5½* inches.

Complexion *Black.*

Eyes *Black*; hair *Black.*

Where born *Richmond Va.*

Occupation *Laborer.*

ENLISTMENT.

When *April 30*, 1864.

Where *Boston No. 3.*

By whom *G. H. Quincy*; term *3* y'rs.

Remarks: *Wounded by Private D. Madden
May 5, 1864, Readville Mass.*

H. C. Thomas.

Copist.

A | **5 Col'd Cav.** | **Mass.**

Truby Nash

Pri., Co. *M.*, 5 Reg't Mass. Col'd Cav.

Appears on

Company Muster-in and Descriptive Roll
of the organization named above. Roll dated

Readville Mass, May 5, 1864.

Where born *Charlestown Va*

Age *21* y'rs; occupation *Laborer*

When enlisted *Apr. 30*, 1864.

Where enlisted *Boston*

For what period enlisted *3* years.

Eyes *Blk*; hair *Blk*

Complexion *Blk*; height *5 ft. 6 1/2 in.*

When mustered in *May 5*, 1864.

Where mustered in *Readville*

Premium *2*
 Bounty paid \$ *2* 100; due \$ *100*

Where credited

Company to which assigned

Remarks: *Credited to 3 Wd. Boston*
Suffolk Co. 4" Cong Dist.
Mass

Book mark:

Avery

(356d)

Copyist.

N 1 5-6-1861 Mass

James Smith

Art. Co. M., 5 Reg't Mass. Cavalry

Appears on

Hospital Muster Roll

of L'Ouverture U. S. A. General Hospital,

at Alexandria, Va.,

for *May & June*, 186*1*.

Attached to hospital :

When *May 4*, 186*1*.

How employed

Last paid by Maj.

to _____, 186*1*.

Bounty paid \$ *100*; due \$ *100*

Present or absent *Present*

Remarks:

Book mark :

Smith
Coyist.

A | **5 Col'd Cav.** | **Mass.**

Pruby Nash

Pri, Co. M, 5 Reg't Mass. Colored Cavalry.

Appears on

Company Muster Roll

for *May 5 to June 30*, 1864.

Present or absent *Absent*

Stoppage, \$ _____ *100* for _____

Due Gov't, \$ _____ *100* for _____

Valuation of horse, \$ _____ *100*

Valuation of horse equipments, \$ _____ *100*

Remarks: *Sick at Hospital
Camp Casey Va.*

Book mark: _____

Avery Copyist.

A | **5 Col'd Cav.** | **Mass.**

Truby Nash

Pri., Co. M, 5 Reg't Mass. Colored Cavalry.

Appears on

Company Muster Roll

for *July & Aug.*, 1864.

Present or absent *Absent*

Stoppage, \$ *100* for

Due Gov't, \$ *100* for

Valuation of horse, \$ *100*

Valuation of horse equipments, \$ *100*

Remarks: *Sick in Hospital
Alexandria Va.*

Book mark: _____

(358)

Avery
Copyst.

N | **5 Col'd Cav.** | **Mass.**

Gruby Wash
Priv, Co. M, 5 Reg't Mass. Colored Cavalry.

Appears on

Company Muster Roll

for *Sept & Oct*, 186*4*

Present or absent *Present*

Stoppage, \$ *100* for

Due Gov't, \$ *100* for

Valuation of horse, \$ *100*

Valuation of horse equipments, \$ *100*

Remarks:

Book mark:

C. Williams
Copied.

(358)

(A) | **5 Col'd Cav.** | **Mass.**

Grady Wash
Put.
Co. M, 5 Reg't Mass. Colored Cavalry.

Appears on

Company Muster Roll

for *Nov. & Dec.*, 1864.

Present or absent *Present*

Stoppage, \$ *100* for

Due Gov't, \$ *100* for

Valuation of horse, \$ *100*

Valuation of horse equipments, \$ *100*

Remarks:

Book mark:

N. | **5 Col'd Cav.** | **Mass.**

Truby Nash.
Priv't, Co. M, 5 Reg't Mass. Colored Cavalry.

Appears on

Company Muster Roll
for *Jan'y & Feb'y*, 186*5*.
Present or absent *Present.*

Stoppage, \$ 100 for

Due Gov't, \$ 100 for

Valuation of horse, \$ 100

Valuation of horse equipments, \$ 100

Remarks:

.....

.....

.....

.....

.....

.....

Book mark:

.....

L. Williams,
(358) Copied.

N | **5 Col'd Cav.** | **Mass.**

Truby Wash
Priv, Co. M, 5 Reg't Mass. Colored Cavalry.

Appears on

Company Muster Roll

for *May & Apr*, 186*5*.

Present or absent *Present*

Stoppage, \$ *100* for

Due Gov't, \$ *100* for

Valuation of horse, \$ *100*

Valuation of horse equipments, \$ *100*

Remarks:

Book mark:

G. Williams

A | **5 Col'd Cav.** | **Mass.**

Truby Wash
Qu't, Co. M, 5 Reg't Mass. Colored Cavalry.

Appears on

Company Muster Roll

for *May & June*, 1865.

Present or absent *Present*

Stoppage, \$ 100 for

Due Gov't, \$ 100 for

Valuation of horse, \$ 100

Valuation of horse equipments, \$ 100

Remarks:

Book mark:

C. Williams
Copyst.

W | **5 Col'd Cav.** | **Mass.**

Truley Nash
Pri., Co. M, 5 Reg't Mass. Colored Cavalry.

Appears on

Company Muster Roll

for *July & Aug.*, 186*J.*

Present or absent *Present*

Stoppage, \$ *100* for

Due Gov't, \$ *100* for

Valuation of horse, \$ *100*

Valuation of horse equipments, \$ *100*

Remarks:

Detached Service
S.O. 40 July 26th 1865
Work on 10th S. W. R.R.

Book mark:

Hodges

A | **5 Col'd Cav.** | **Mass.**

Truby Wash
Pvt, Co. M, 5 Reg't Mass. Colored Cav.

Appears on **Returns** as follows:

May & Sept. 1864. Absent sick
in Hosp. Camp Casey,
Alexa. Va.

July & Aug. 1865. Absent detach'd
serv. Brazos Santiago
S. O. 40 July 26/65.

Sept. 1865. Absent detach'd Serv.
work on U. S. M. R. R.
S. O. 40 July 26/65.

Book mark :

(548)

J. B. Sittler

Copyist.

W | **5 Col'd Cav.** | **Mass.**

Truby Nash

Pr, Co. *M*, 5 Reg't Mass. Col'd Cavalry.

Appears on **Co. Muster-out Roll**, dated
Clarksville Tex. Oct. 31, 186 *5*.

Muster-out to date *Oct. 31*, 186 *5*.

Last paid to *Dec. 31*, 186 *4*.

Clothing account:

Last settled....., 186 ; drawn since \$..... 100

Due soldier \$..... 100; due U. S. \$ *0* ^{*57*} 100

Am't for cloth'g in kind or money adv'd \$..... 100

Due U. S. for arms, equipments, &c., \$ *3* 100

Bounty paid \$..... 100; due \$ *100* 100

Remarks: -----

Book mark: *493.382.*

(861)

Hedges

Copyright.

Truby

Wash. Tobias (Capt)

C. M., 5 Reg't Mass

Enclosures.

Bed Cards	Descriptive Lists
Burial Records	Final Statements
Certs. of Dis. for Discharge	Furloughs
C. M. Charges	Med. Des. Lists
Med. Certificates	Orders

Other papers relating to—

Admission to Hosp'l	Furlough
Casualty Sheet (Officer's)	Med. Examination
Confinement	Misc. Information
Contracts	Pay or Clothing
Death or Effects	Personal Reports
Desertions	Rank
Discharge from Hosp'l	Transfer to Hosp'l
Discharge from Service	Transfer to V. R. C.
Duty	Transportation

TREATMENT.

[HERE NOTE IMPORTANT COMPLICATIONS AND ALL OPERATIONS.]

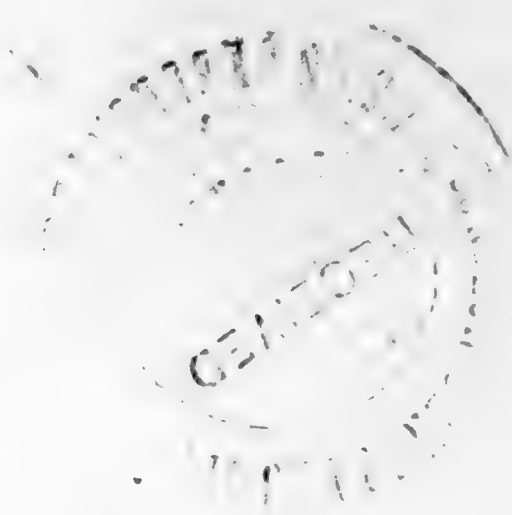

RESULT AND DATE.

Ret'd to Duty 28 July 1864

Hospital Number 156.5

205

Name Tobias Nash (Colored.)

Age 21 yrs. Nativity Ohio

Married or Single Single

Residence Ohio

Post Office address of
wife or nearest relative

Rank Private, Co. D, Regiment 5 Mass.
Cavalry

When admitted May 14th, 1864

From what source from his Regiment

Diagnosis: (in surgical cases state explicitly seat and
character of wound or injury.)

Measles

L'Ouverture G. H.

Alexandria, Va.

On what occasion wounded

Date

Nature of missile or weapon

1055

Nathan. Joseph
Co B, 5 Mass. Cav., (Col'd.)

Private | Private

CARD NUMBERS.

1	5374515	26
2	5374605	27
3	5374689	28
4	5374793	29
5	5374894	30
6	5375001	31
7	5375109	32
8	5375213	33
9	5375317	34
10	5375416	35
11	5375515	36
12	5375609	37
13	9092570	38
14	40731449	39
15		40
16		41
17		42
18		43
19		44
20		45
21		46
22		47
23		48
24		49
25		50

Book Mark: _____

See also _____

N | **5 Cav. (Col'd.)** | **Mass.**

Joseph Nathan

....., Co. A....., 5 Reg't Mass. Cav. (Col'd.)

Appears on

Company Descriptive Book

of the organization named above.

DESCRIPTION.

Age 24 years; height 5 feet 5 1/2 inches.

Complexion Dark

Eyes Black; hair Black

Where born Reading, Mass.

Occupation Carpenter

ENLISTMENT.

When Jan 2....., 1864.

Where Reading

By whom W. W. ...; term 3 y'rs.

Remarks:

.....
.....
.....
.....
.....
.....
.....
.....
.....
.....

5 Col'd Cav. | Mass.

Levi T. T. T.

T. T., Co. *B*, 5 Reg't Mass. Col'd Cav.

Appears on

Company Muster-in and Descriptive Roll

of the organization named above. Roll dated

Reading, Mass., July 29, 1864.

Where born *Reading, Mass.*

Age *24* y'rs; occupation *Laborer*

When enlisted *July 2nd*, 1864.

Where enlisted *Reading*

For what period enlisted *3* years.

Eyes *Black*; hair *Black*.

Complexion *Black*; height *5* ft. *5 1/2* in.

When mustered in *Aug 27*, 1864

Where mustered in

Bounty paid \$ *100*; due \$ *100*

Where credited

Company to which assigned

Remarks: *Middlesex*

Book mark:

H. H. H.

J | **5 Col'd Cav.** | **Mass.**

Joseph Tahan

C.P., Co. B, 5 Reg't Mass. Col'd Cavalry.

Appears on

Company Muster Roll

for *Enlistment to Feb. 27, 1864.*

Present or absent *Present*

Stoppage, \$ *100* for

Due Gov't, \$ *100* for

Valuation of horse, \$ *100*

Valuation of horse equipments, \$ *100*

Remarks: *On Daily Duty attached to Reg't Band per Sp. order - No. 27 dated 24th at 5th Mass Cav. Newville Mass. Feb 24th '64*

Book mark:

Eyerizer

| **5 Col'd Cav.** | **Mass.**

Joseph Northam

Plt., Co. B, 5 Reg't Mass. Col'd Cavalry.

Appears on

Company Muster Roll

for March & April, 1864

Present or absent Absent

Stoppage, \$ 100 for

Due Gov't, \$ 100 for

Valuation of horse, \$ 100

Valuation of horse equipments, \$ 100

Remarks: On duty in
Daily Duty at Hd Qrs
Reg. Bn. per S.O. No 37
dated 22^d 11th - 1864.
Proc. Feb 24, 64

Book mark: _____

(358)

Hoyt

Copyist.

N | **5 Col'd Cav.** | **Mass.**

Joseph Nathan

Pt., Co. B, 5 Reg't Mass. Col'd Cavalry.

Appears on

Company Muster Roll

for *May & June*, 1864.

Present or absent *Present*

Stoppage, \$ *100* for

Due Gov't, \$ *100* for

Valuation of horse, \$ *100*

Valuation of horse equipments, \$ *100*

Remarks: *An Overy Sooty
attached to Reg. Bond
per S. O. No. 37 dated Feb. 24
Mass. Cav. Feb. 24 '64*

Book mark:

Fisher

N. | **5 Col'd Cav.** | **Mass.**

Joseph Nathan,
Priv., Co. B, 5 Reg't Mass. Col'd Cavalry.

Appears on

Company Muster Roll

for July & Aug., 1864.

Present or absent Present.

Stoppage, \$ 100 for

Due Gov't, \$ 100 for

Valuation of horse, \$ 100

Valuation of horse equipments, \$ 100

Remarks: On Daily duty
attached to Reg. Band
per S.O. No. 37 dated H. 2. 5th
Mass Cav. Feb. 24. 64.

Book mark: _____

(358)

J. M. Brown,
Copist.

N. | **5 Col'd Cav.** | **Mass.**

Joseph Nathan,
Pvt, Co. B, 5 Reg't Mass. Col'd Cavalry.

Appears on

Company Muster Roll
for Sept. & Oct., 1864.

Present or absent Present.

Stoppage, \$.....100 for

Due Gov't, \$.....100 for

Valuation of horse, \$.....100

Valuation of horse equipments, \$.....100

Remarks: Free on or before
Apr. 19/61.
Due U.S. Bounty \$25.00

Book mark:

(358) J. W. Brown Copyist.

N. | **5 Col'd Cav.** | **Mass.**

Joseph Nathan,
Sgt., Co. B, 5 Reg't Mass. Col'd Cavalry.

Appears on

Company Muster Roll

for *Nov. & Dec.*, 186*4*.

Present or absent — *Present*

Stoppage, \$.....100 for.....

Due Gov't, \$.....100 for.....

Valuation of horse, \$.....100

Valuation of horse equipments, \$.....100

Remarks: *On Daily Duty*
attached to Reg. Band
in S.C. No. 37 Feb. 24/64.

Book mark:

(358)

W. Brown
Coptist.

N. | **5 Col'd Cav.** | **Mass.**

Joseph Nathan,
Privt, Co. B, 5 Reg't Mass. Col'd Cavalry.

Appears on

Company Muster Roll

for Jan'y. & Feby., 1865.

Present or absent Present

Stoppage, \$ 100 for

Due Gov't, \$ 100 for

Valuation of horse, \$ 100

Valuation of horse equipments, \$ 100

Remarks: Due the Soldier
1st 2nd 3rd & 4th Instants
U.S. Bounty.
On Daily Duty attached
to Regt. Band.
Due U.S. 48 cts

Book mark: _____

L. W. Brown

(358)

Copyist.

N. | 5 Col'd Cav. | Mass.

Joseph Nathan,
Pvt., Co. B, 5 Reg't Mass. Col'd Cavalry.

Appears on

Company Muster Roll
for *March & April*, 1865.

Present or absent — *Present*.

Stoppage, \$ *100* for

Due Gov't, \$ *100* for

Valuation of horse, \$ *100*

Valuation of horse equipments, \$ *100*

Remarks: *On Daily Duty
attached to Reg. Band.*

Book mark: _____

(358)

J. P. Brown
Copyist.

N | **5 Col'd Cav.** | **Mass.**

Joseph Nathan
Priv, Co. B, 5 Reg't Mass. Col'd Cavalry.

Appears on

Company Muster Roll

for May & June, 1865.

Present or absent Present

Stoppage, \$ 100 for

Due Gov't, \$ 100 for

Valuation of horse, \$ 100

Valuation of horse equipments, \$ 100

Remarks: On duty duty
attached to Reg. Band.

Book mark:

Sherick
(358) Copyist.

W | **5 Col'd Cav.** | **Mass.**

Joseph Nathan

Plt, Co. B, 5 Reg't Mass. Col'd Cavalry.

Appears on

Company Muster Roll

for *July & Aug.*, 186*5*:

Present or absent *Present*

Stoppage, \$ *100* for

Due Gov't, \$ *100* for

Valuation of horse, \$ *100*

Valuation of horse equipments, \$ *100*

Remarks: *On duty daily in Regt. Band*

Book mark:

Scherich

A. | **5 Col'd Cav.** | **Mass.**

Nathan

Priv, Co. *B*, 5 Reg't Mass. Colored Cav.

Appears on **Returns** as follows:

*Feb. 1864 to Sept. 1865. On duty at-
tached to Regtl Band.*

Book mark :

(546)

J. B. Sittler

Copyist.

A | **5 Col'd Cav. Mass.**

Joseph Nathan
Pos, Co. *B*, 5 Reg't Mass. Col'd Cavalry.

Appears on **Co. Muster-out Roll**, dated
Clarksville, Tex., Oct. 31, 1865:

Muster-out to date *Oct. 31, 1865*.

Last paid to *Dec. 31, 1864*.

Clothing account:

Last settled....., 186 ; drawn since \$..... 100

Due soldier \$ *29*^{*41*}.....100; due U. S. \$..... 100

Am't for cloth'g in kind or money adv'd \$..... 100

Due U. S. for arms, equipments, &c., \$..... 100

Bounty paid \$ *25*^{*00*}.....100; due \$ *275*^{*00*}..... 100

Remarks:

.....

.....

.....

.....

Book mark:

Scherich

1056

Naylor. Adam
Co C, 5 Mass. Cav., (Col'd.)

Private

Private

CARD NUMBERS.

1	5372054	26
2	5376003	27
3	5376111	28
4	5376211	29
5	5376320	30
6	5376425	31
7	5376530	32
8	5376628	33
9	5376722	34
10	5376815	35
11	9092481	36
12	34509420	37
13	33238016	38
14	30852817	39
15	30854242	40
16	33030909	41
17	40731446	42
18		43
19		44
20		45
21		46
22		47
23		48
24		49
25		50

Book Mark: C. B. v 10 p 565

See also

5 Cav. (Col'd.) | Mass.

Alvin Taylor

Co. C, 5 Reg't Mass. Cav. (Col'd.)

Appears on

Company Descriptive Book
of the organization named above.

DESCRIPTION.

Age *14* years; height *5* feet *8* inches.

Complexion *Dark*

Eyes *Dark*; hair *Dark*

Where born *Hambleton, Virginia*

Occupation *Laborer*

ENLISTMENT.

When *May 14*, 186*4*.

Where *Lexington*

By whom *W. W. ...*; term *3* y'rs.

Remarks: *Enlisted into Co. C, May 14, 1864 at Yellow Tavern Station by Capt. W. W. ...*

N | 5th Cav. | Mass.

x Adam Naylor

Appears with rank of _____ on _____

Muster-in and Descriptive Roll

of a detachment of U. S. Volunteer Recruits for
different regiments of Massachusetts Volunteers.

Roll dated *Sept. 2nd. Galloups*

Sold. B. H. Mass, May 21, 1864,

Where born *Montgomery Co. Md.*

Age *41* years; occupation *Laborer*

When enlisted *May 19, 1864.*

Where enlisted *Lexington Mass.*

For what period enlisted *3* years.

Eyes *black*; hair *black*

Complexion *Colored*; height *5* ft. *8* in.

When mustered in _____, 186 .

Muster-in to date _____, 186 .

Where mustered in _____

Bounty paid \$ *100*; due \$ *100*

Clothing account:

Last settled \$ _____, 186 ; drawn since \$ *100*

Date of first muster _____, 186 .

Regiment to which assigned *5th Cav.*

Remarks: *credited to the quota
of 6 comy Dist. Lexington
Middlesex Co.*

x *Entry cancelled by lead pencil*

Book mark: _____

J. H. Thomas
Copyist.

71 5 Col'd Cav. Mass.

Adam Harris

Appears with rank of Private on

Muster and Descriptive Roll of a Detachment of U. S. Vols. forwarded

for the 5 Reg't Mass. Col'd Cavalry. Roll dated

Galloway Island Mass, May 5th, 1864.

Where born Westbury, Conn.

Age 21 y'rs; occupation Miller

When enlisted May 9, 1864.

Where enlisted Westbury, Conn.

For what period enlisted 3 years.

Eyes Blue; hair Blue

Complexion Good; height 5-ft. 8 in.

When mustered in May 19, 1864.

Where mustered in Galloway Island Mass

Bounty paid \$100; due \$100

Where credited 1st Det. Cavalry, Westbury, Conn.

Company to which assigned

Remarks:

Book mark:

Francis H

W. | **5 Col'd Cav.** | **Mass.**

Adam Taylor

Priv, Co. C, 5 Reg't Mass. Col'd Cavalry.

Appears on

Company Muster Roll

for *May & June*, 1864.

Present or absent *Present*

Stoppage, \$ *100* for

Due Gov't, \$ *100* for

Valuation of horse, \$ *100*

Valuation of horse equipments, \$ *100*

Remarks:

Book mark:

Siller

M 15 Cav (Cold) Mass.

Aaron Mailes
Pvt., Co. G, 5 Reg Mass. Cav.

Appears on

Hospital Muster Roll

of U. S. A. General Hospital,

at Fort Monroe, Va.,

for May & June, 1865.

Attached to hospital :

When, 186 .

How employed

Last paid by Maj.

to, 186 .

Bounty paid \$ 100 ; due \$ 100

Present or absent present

Remarks : No Descriptive List.

4 Dec. 20 iv.

Book mark :

Woods,

(343)

Copyist.

W. | **5 Col'd Cav.** | **Mass.**

Adam Naylor
Co. C, 5 Reg't Mass. Col'd Cavalry.

Appears on

Company Muster Roll

for July & Aug, 1864.

Present or absent Present

Stoppage, \$ 100 for

Due Gov't, \$ 100 for

Valuation of horse, \$ 100

Valuation of horse equipments, \$ 100

Remarks: On daily duty as
Co. Cook

Book mark:

E. H. Barron

71. | 5 bar | U.S.A.

Adam Nailor

priv., Co. B, 5 Reg't Mass. Cav.

Appears on

Hospital Muster Roll

of Corps d'Afrique U. S. A. General Hospital,

at New Orleans, La.,

for July & Aug., 1865.

Attached to hospital:

When _____, 186 .

How employed _____

Last paid by Maj. _____

to _____, 186 .

Bounty paid \$ 100; due \$ 100

Present or absent Present

Remarks: _____

Book mark: _____

W. | **5 Col'd Cav.** | **Mass.**

Adam Taylor
Cpt., Co. C, 5 Reg't Mass. Col'd Cavalry.

Appears on

Company Muster Roll

for Sept & Oct, 1864.

Present or absent Present

Stoppage, \$ 100 for

Due Gov't, \$ 100 for

Valuation of horse, \$ 100

Valuation of horse equipments, \$ 100

Remarks: On daily duty as Co. Cook. Dis. on or before April 19, 61

Book mark:

E. T. Bacon

B | *5 Cav (old) Mass.*

Adam Ingiler
Art, Co. C, 5 Regt Mass Cav

Appears on

Hospital Muster Roll

of *Corps d'Afrique U. S. A. General Hospital,*

at *New Orleans, La.,*

for *Sept & Oct 5*, 186*5*.

Attached to hospital:

When _____, 186 .

How employed _____

Last paid by Maj. _____

to _____, 186 .

Bounty paid \$ 100; due \$ 100

Present or absent _____

Remarks: *Transferred*
Sept 19, 1865

Book mark: _____

Steward
(843) *Copyist.*

N | 5th Cav. | Mass

Adam Naylor
Pvt, Co. C, 5th Reg't Mass Cav.

Appears on

Hospital Muster Roll

of DeCamp U. S. A. General Hospital,

at David's Island, New York Harbor,

for Sept & Oct, 1865.

Attached to hospital:

When, 186 .

How employed

Last paid by Maj.

to, 186 .

Bounty paid \$ 100 ; due \$ 100

Present or absent

Remarks: Discharged from
Service Oct 28 - 1865

Book mark:

Rosenbaum
Copyist.

W | **5 Col'd Cav.** | **Mass.**

Adam Naylor
Priv, Co. C, 5 Reg't Mass. Col'd Cavalry.

Appears on

Company Muster Roll

for *Nov & Dec*, 1864.

Present or absent *Present*

Stoppage, \$ *100* for

Due Gov't, \$ *100* for

Valuation of horse, \$ *100*

Valuation of horse equipments, \$ *100*

Remarks: *Daily duty as Co. Cook*
Due of pay, 2 M stores \$0.48
Free on or before April 9th

Book mark:

E. H. Brown

W | **5 Col'd Cav.** | **Mass.**

Adam Vailor
Cot, Co. C, 5 Reg't Mass. Col'd Cavalry.

Appears on

Company Muster Roll

for *Jan Feb*, 1865.

Present or absent *Present*

Stoppage, \$ *100* for

Due Gov't, \$ *100* for

Valuation of horse, \$ *100*

Valuation of horse equipments, \$ *100*

Remarks: *Daily duty as Co Cook*
Due 1st Dist Ry County 8 25

Book mark:

E. H. B. [unclear]

91 | **5 Col'd Cav.** | **Mass.**

Adam Naylor
Prk, Co. C, 5 Reg't Mass. Col'd Cavalry.

Appears on

Company Muster Roll

for *Mar & Apr*, 1865.

Present or absent.....

Stoppage, \$..... 100 for.....

Due Gov't, \$..... 100 for.....

Valuation of horse, \$..... 100

Valuation of horse equipments, \$..... 100

Remarks: *Due \$ for 2 M.*
Stores \$ 0.85

Book mark:.....

E. H. Brown

7

5 Col'd Cav.

Mass.

Adam Naylor

Pvt, Co. C, 5 Reg't Mass. Col'd Cavalry.

Appears on

Company Muster Roll

for May & June, 1865.

Present or absent Present

Stoppage, \$ 1 ³²/₁₀₀ for Qm stores

Due Gov't, \$ 100 for

Valuation of horse, \$ 100

Valuation of horse equipments, \$ 100

Remarks:

Book mark:

Abbott

72 | 5 Col'd Cav. | Mass.

Adam Nailer

Pvt, Co. C, 5 Reg't Mass. Col'd Cavalry.

Appears on

Company Muster Roll

for July & Aug, 1865.

Present or absent Absent

Stoppage, \$ 100 for

Due Gov't, \$ 100 for

Valuation of horse, \$ 100

Valuation of horse equipments, \$ 100

Remarks: Sick in Hospital at Brazos since July 28 1865

Book mark:

Abbott

A. | **5 Col'd Cav.** | **Mass.**

Adam Naylor
Pvt., Co. C, 5 Reg't Mass. Colored Cav.

Appears on **Returns** as follows:

July 1864 to Mar. 1865. Co. cook,

July & Aug. 1865, Absent sick
in Hosp. at Brazos,
Texas.

Sept. Absent sick at New
Orleans.

Book mark :

(646)

J. B. Sittler

Copyist.

72 | 5 Col'd Cav. Mass.

Adam Naylor

Pvt, Co. E, 5 Reg't Mass. Col'd Cavalry.

Appears on Co. Muster-out Roll, dated
Clarksville Texas, Oct 31, 1865.

Muster-out to date _____, 186 .

Last paid to Dec 31, 1864 .

Clothing account:

Last settled _____, 186 ; drawn since \$ 100

Due soldier \$ 26 ⁵⁸ / 100; due U. S. \$ 100

Am't for cloth'g in kind or money adv'd \$ 100

Due U. S. for arms, equipments, &c., \$ / ¹⁵ / 100

Bounty paid \$ 100; due \$ 100 / 100

Remarks: Due U.S. for 679 & \$7.80

Sick in Hospital at New Orleans

since July 28 1865

No discharge furnished

Book mark: P. V 40 P 15. 77

(Over)

Abbott

JAN. - 9

5376815

1891

3290 Pme, Apr 24-66

See list of Des: See His Box

Discharged Oct 28-65 E.B.

V10 P 565

Naylor Adam

P. Co.

Reg't Mass 22

4 Enclosures.

Bed Cards	Final Statements
Burial Records	Furloughs or L. of A.
Certs. of Dis. for Discharge /	Med. Certificates
C. M. Charges	Med. Des. Lists
Descriptive Lists	Orders
Discharge Certificates	Pris. of War Record
Enlistment Papers 2	Resignations

Other papers relating to—

Admission to Hosp'l	Furlough or L. of A.
Casualty Sheet /	Med. Examination
Confinement	Misc. Information
Contracts	Pay or Clothing
Death or Effects	Personal Reports
Desertion	Rank
Discharge from Hosp'l	Transfer to Hosp'l
Discharge from Service	Transfer to V. R. C.
Duty	Transportation

NOTE 1.—This blank will be used for both enlistments and re-enlistments—enlistment of veterans, &c., &c., in the volunteer service. They will be made out in duplicate in all cases—one to accompany the recruiting return of the superintendent (not the recruiting officer) to the Adjutant-General, and one to accompany the accounts of the officer who pays bounty, &c. The Regiment and Company in which the soldier last served should be given on the back.

NOTE 2.—An enlistment holds to service. A muster-in must, in all cases, precede payment of pay, bounty, pension, &c. A muster-in roll must, in all cases, be filed in the Adjutant-General's Office as evidence of muster-in. The mustering officer, commissary, or assistant-commissary of musters, as the case may be, will countersign both enlistments as having mustered the soldier into the service of the United States before either of them is given to the disbursing officer.

DECLARATION OF RECRUIT.

I, *Adam Taylor* desiring to VOLUNTEER as a Soldier in the Army of the United States, for the term of THREE YEARS, Do Declare, That I am *Forty one* years and _____ months of age; that I have never been discharged from the United States service on account of disability or by sentence of a court-martial, or by order before the expiration of a term of enlistment; and I know of no impediment to my serving honestly and faithfully as a soldier for three years.

GIVEN at *Boston* the *19* day of *May 1864*

Witness: *H. O. Magouer* *Adam X Taylor*
man

FILED IN THE ENROLLMENT DIV. R. & P. O.

Discharged

18

Regt of

enlistment; last served in Company ()

By Regiment of

By

18

Volunteered at

Adam Taylor

No.

5 Maine Co

CONSENT IN CASE OF MINOR.

I, _____ Do CERTIFY, That I am the _____ of _____ ; that the said _____ is _____ years of age; and I do hereby freely give my CONSENT to his volunteering as a SOLDIER in the ARMY OF THE UNITED STATES, for the period of THREE YEARS.

GIVEN at _____ the _____ day of _____

Witness:

VOLUNTEER ENLISTMENT.

STATE OF

TOWN OF

Massachusetts

Lexington

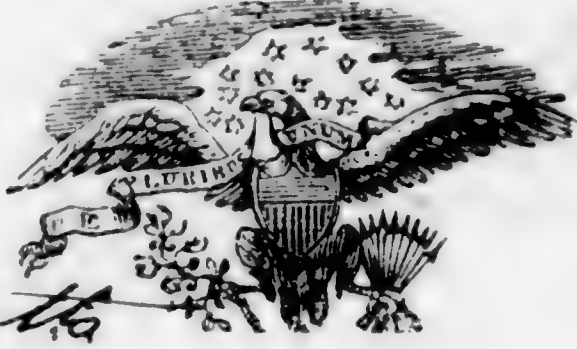

Single 6598

I, *Adam Naylor* born in *Montgomery County* aged *Forty one* years, and by occupation a *Labourer* DO HEREBY ACKNOWLEDGE to have volunteered this *Nineteenth* day of *May* 186*4*, to serve as a **Soldier** in the Army of the United States of America, for the period of **THREE YEARS**, unless sooner discharged by proper authority: Do also agree to accept such bounty, pay, rations, and clothing, as are, or may be, established by law for volunteers. And I, *Adam Naylor* do solemnly swear, that I will bear true faith and allegiance to the **United States of America**, and that I will serve them honestly and faithfully against all their enemies or opposers whomsoever; and that I will observe and obey the orders of the President of the United States, and the orders of the officers appointed over me, according to the Rules and Articles of War.

Sworn and subscribed to, at *Boston* this *19* day of *May* 186*4*.
BEFORE *one W. W. Ballou*
Justice of the Peace

Adam Naylor
mas

I CERTIFY, ON HONOR, That I have carefully examined the above-named Volunteer, agreeably to the General Regulations of the Army, and that, in my opinion, he is free from all bodily defects and mental infirmity, which would in any way disqualify him from performing the duties of a soldier.

W. C. Russell

P. Jay Jeffries
EXAMINING SURGEON.

I CERTIFY, ON HONOR, That I have minutely inspected the Volunteer, *Adam Naylor* previously to his enlistment, and that he was entirely sober when enlisted; that, to the best of my judgment and belief, he is of lawful age; and that, in accepting him as duly qualified to perform the duties of an able-bodied soldier, I have strictly observed the Regulations which govern the recruiting service.

This soldier has *Black* eyes, *Black* hair, *Light* complexion, is *Five* feet *Eight* inches high.

W. C. Russell
June 59 Regiment of *mas* Volunteers,
RECRUITING OFFICER.

the day of , 186 , at

Mustered into the service of the United States, in Company

5th Regiment of *Mass Cavalry* Volunteers, on

NOTE 1.—This blank will be used for both enlistments and re-enlistments—enlistment of veterans, &c., &c., in the volunteer service. They will be made out in duplicate in all cases—one to accompany the recruiting return of the superintendent (not the recruiting officer) to the Adjutant-General, and one to accompany the accounts of the officer who pays bounty, &c. The Regiment and Company in which the soldier last served should be given on the back.

NOTE 2.—An enlistment holds to service. A muster-in must, in all cases, precede payment of pay, bounty, pension, &c. A muster-in roll must, in all cases, be filed in the Adjutant-General's Office as evidence of muster-in. The mustering officer, commissary, or assistant-commissary of musters, as the case may be, will countersign both enlistments as having mustered the soldier into the service of the United States before either of them is given to the disbursing officer.

Filed in the Adjutant-General's Office, P. O.

DECLARATION OF RECRUIT.

I, *Adam Naylor* desiring to VOLUNTEER as a Soldier in the Army of the United States, for the term of THREE YEARS, Do Declare, That I am *Forty-one* years and _____ months of age; that I have never been discharged from the United States service on account of disability or by sentence of a court-martial, or by order before the expiration of a term of enlistment; and I know of no impediment to my serving honestly and faithfully as a soldier for three years.

GIVEN at *Boston* the *19* day of *May* 18*64*

Witness: *A. D. Naylor* *Adam Naylor*
man

Discharged

18

Regt of

enlistment; last served in Company ()

By

Regiment of

18

Volunteered at

Adam Naylor

No. *5* *Nunes Co*

CONSENT IN CASE OF MINOR.

I, _____ Do CERTIFY, That I am the _____ of _____; that the said _____ is _____ years of age; and I do hereby freely give my CONSENT to his volunteering as a SOLDIER in the ARMY OF THE UNITED STATES, for the period of THREE YEARS.

GIVEN at _____ the _____ day of _____

Witness:

VOLUNTEER ENLISTMENT.

STATE OF

TOWN OF

Single

Massachusetts



Lexington

I, *Adam Naylov* born in *Montgomery County*
in the State of *Maryland* aged *Forty one* years,
and by occupation a *Labourer* Do HEREBY ACKNOWLEDGE to have
volunteered this *Nineteenth* day of *May* 186*4*,
to serve as a **Soldier** in the Army of the United States of America, for the
period of **THREE YEARS**, unless sooner discharged by proper authority: Do also
agree to accept such bounty, pay, rations, and clothing, as are, or may be, estab-
lished by law for volunteers. And I, *Adam Naylov* do
solemnly swear, that I will bear true faith and allegiance to the **United States**
of America, and that I will serve them honestly and faithfully against all their
enemies or opposers whomsoever; and that I will observe and obey the orders of
the President of the United States, and the orders of the officers appointed over
me, according to the Rules and Articles of War.

Sworn and subscribed to, at *Boston*
this *17* day of *May* 186*4*.
BEFORE me *W. H. Ballou*
Justice of the Peace

Adam X Naylov
man

I CERTIFY, ON HONOR, That I have carefully examined the above-named Volunteer, agreeably
to the General Regulations of the Army, and that, in my opinion, he is free from all bodily defects and
mental infirmity, which would in any way disqualify him from performing the duties of a soldier.

P. J. Jeffries
EXAMINING SURGEON.

Vaccinated

I CERTIFY, ON HONOR, That I have minutely inspected the Volunteer, *Adam Naylov*
previously to his enlistment, and that he was entirely sober when enlisted; that, to the best of my
judgment and belief, he is of lawful age; and that, in accepting him as duly qualified to perform the duties
of an able-bodied soldier, I have strictly observed the Regulations which govern the recruiting service.
This soldier has *Black* eyes, *Black* hair, *Color* complexion, is *Five* feet
Eight inches high.

Geo. C. Sumner
2nd Regt 59 Regiment of *Mass* Volunteers,
RECRUITING OFFICER.

(A. G. O. No. 74 & 75.)

6598

the day of , 186 , at

Mustered into the service of the United States, in Company

5th Regiment of *Mass Cavalry* Volunteers, on

CASUALTY SHEET

No.

Adam Taylor
Private of Company
5 Regiment of *Mass. Cav.*
State Volunteers. *(Cold.)*

NATURE OF CASUALTY.

Ill.
Oct. 28/65.



CASUALTY SHEET.

Name: *Adam Haysley*
Rank: *Priv.* Company: *Co* Regiment: *5*
Arm: *Co.* State: *Mass.*
Nature of Casualty: *Dis.*

CAUSE OF CASUALTY—(NAME OF DISEASE, &C.)

BY WHOM DISCHARGED.

DEGREE OF DISABILITY.

FROM WHAT SOURCE THIS INFORMATION WAS OBTAINED.

BY WHOM CERTIFIED.

*Roll 54, Adams's
Hospital N. Y. C.*

REMARKS.

*W. Webster
Adm. Surg. U.S.A.*

DATE OF DISCHARGE, DEATH, &C.

Oct. 2, 1865

PLACE OF DISCHARGE, DEATH, &C.

David's Field Hospital

A. W. H.

Clerk.

A. J. D.

[OFFICE INDORSEMENT.]

War Department,

ADJUTANT GENERAL'S OFFICE,

January 12, 1874.

The discharge of Samuel
Smith, Co. C, 5th Reg't U. S.
Colored Infantry, is reported as follows:—

On Company Muster Roll.

For 186 , 186

Company Muster-out Roll. Oct 31/1865

See report *** See discharge 186

Company Descriptive Book.

....., 186

Company Morning Reports.

....., 186

Soldier's Final Statement.

....., 186

Soldier's Record of Death and Interment.

....., 186

Soldier's Inventory of Effects.

....., 186

Soldier's Certificate of Disability for Discharge.

Oct 25th, 1865

Soldier's Individual Muster-out Roll.

....., 186

Regimental Return.

For 186 , 186

Regimental Quarterly Returns.

....., 186

Regimental Descriptive Book.

....., 186

By Surgeon General.

....., 186

Oct 28, 1865, is held to be
the correct date, and the Company Muster-out
Roll will be amended accordingly.

Thomas M. Freeman
E. B. 10
568. Asst. Adj. Gen.

See letter to 2d ind.
Feb 10 1874

CERTIFICATE OF DISABILITY FOR DISCHARGE

IN THE CASE OF

Adam Naylor
a Private Co. "B"

5 Reg't of Mass Cav

APPROVED

M. H. Sloan

Surgeon, U. S. A.,

Medical Director Dep't of the East

HEADQUARTERS DEPARTMENT OF THE EAST,

NEW YORK CITY, Oct. 25th, 1865.

To be discharged.

BY COMMAND OF MAJOR GENERAL HOGGER:

J. W. Taylor

Bvt. Maj. and A. D. C., A. A. A. G.

Received (A. G. Office) 186 .

Em on O'Keefe

NOTE 1.

The company commander will here add a statement of all the facts known to him concerning the disease or wound, or cause of disability of the soldier; the time, place, manner, and all the circumstances under which the injury occurred, or disease originated or appeared; the duty, or service, or situation of the soldier at the time the injury was received or disease contracted, stating particularly whether the injury was received or the disease contracted in the line of his duty; and whatever other facts may aid a judgment as to the cause, immediate or remote, of the disability, and the circumstances attending it.

When the facts are not known to the company commander, the certificate of any officer, or affidavit of other person having such knowledge, will be appended—as the surgeon in charge of a hospital, the officer commanding a detachment of recruits, &c., &c.

NOTE 2.

When a probable case for pension, special care must be taken to state the degree of disability—as 1/2, 3/4, &c., &c.; to describe particularly the disability, wound, or disease; the extent of which it deprives him of the use of any limb or faculty, or affects his health, strength, activity, constitution, or capacity to labor or earn his subsistence. The surgeon will add, from his knowledge of the facts and circumstances, and from the evidence in the case, his professional opinion of the cause or origin of the disability. In the case of discharges by Medical Inspectors, the last paragraph will state that the "discharge was given by consent of the soldier, after a personal examination, and for disability, the nature, degree, and origin of which are correctly described in the within certificate."

Par. 1260 Regulations, Edit. 1861.

Medical officers, in giving certificates of disability, are to take particular care in all cases that have not been under their charge; and especially in epilepsy, convulsions, chronic rheumatism, derangement of the urinary organs, ophthalmia, ulcers, or any obscure disease liable to be feigned or purposely produced; and in no case shall such certificate be given until after sufficient time and examination to detect any attempt at deception.

DIRECTIONS.

This certificate will be made out in duplicate by the soldier's company commander, or other officer commanding the separate detachment to which he belongs, and sent by him to the surgeon who has charge of the hospital where the soldier is sick. The surgeon will then fill out and sign the surgeon's certificate, and forward these papers to the regimental, detachment, or post commander, who will forward them, with his action endorsed thereon, through the proper channel, to his division commander; or, if the troops are not attached to a division, to his corps, department, or other commander or officer to whom the authority to discharge enlisted men may be specially delegated.

These certificates, after having received the action of the highest authority to which they are required to be sent, will be returned through the same channel to the regimental, post, or detachment commander, who will, if the discharge is authorized by the endorsement of the proper authority, sign the soldier's discharge, and the last certificate on this paper; see that the soldier is furnished with the proper final statements in duplicate, and forward BOTH of these certificates direct to the Adjutant General United States Army, at

Washington, D. C.; they will not, under any circumstances, be given into the hands of the soldier.

ADJUTANT GENERAL'S OFFICE

Duplicate sent the Pension Office.

CERTIFICATE OF DISABILITY FOR DISCHARGE

IN THE CASE OF

1143 1865 20
Adam Naylor
a Private Co. "B"

5 Reg't of Mass Cav

APPROVED

M. J. Sloan
Surgeon, U. S. A.,
Medical Director Dep't of the East

HEADQUARTERS DEPARTMENT OF THE EAST.

NEW YORK CITY, Oct. 25th, 1865.

To be discharged.

BY COMMAND OF MAJOR GENERAL HOOKER:

J. W. Taylor
Bvt. Maj. and A. D. C., A. A. A. G.

Received (A. G. Office) _____, 1865

En on Dr. Sloan

ARMY OF THE UNITED STATES
 CERTIFICATE
 OF DISABILITY FOR DISCHARGE.



Private Adam Naylor, of Captain Welsh's
 Company, ("C") of the Fifth Mass Regiment of the United States
Cold Cro was enlisted by G. C. Burwill of
 the Seaboard Regiment of Mass at Seaboard, Mass
 on the Nineteenth day of May, 1864, to serve three years; he was born
 in Montgomery in the State of Maryland, is forty six
 years of age, five feet eight inches high, black complexion, black eyes,
black hair, and by occupation when enlisted a Fence maker. During the last two
 months said soldier has been unfit for duty 60 days.*

He states he was injured in the line of duty in right
arm, near Petersburg Va, by recoil of his musket, June
16-1864

De Camp, Gen Hospital

STATION: David's Island, N.Y.

DATE: October 18, 1865

Warner

Brevet Major & Asst Surg. U.S.A.
 Commanding Company Hospital

I CERTIFY, that I have carefully examined the said Adam Naylor
 of Captain Welsh's Company, and find him incapable of performing the duties of a
 soldier because of contusion of anterior surface of right
arm, by recoil of a musket, causing permanent
lameness.

Disability - one fourth.

Ch. Stonebraker M.D.

Asst Surgeon U.S.A.

DISCHARGED, this Twenty Eighth day of October, 1865, at De Camp, Gen Hospital
David's Island, N.Y. In accordance with orders of War Dept. A.G.O. May 3/65

Warner
Brevet Major & Asst Surg. U.S.A.
 Commanding the Regt. Hospital

The Soldier desires to be addressed at

Town Wellesville County Columbiana State Ohio

* See Note 1 on the back of this. † See Note 2 on the back of this.

Neal Paul

Co D, 5 Mass. Cav., (Col'd.)

Private

Private

CARD NUMBERS.

1	5372075	26
2	5372650	27
3	5377214	28
4	5377320	29
5	5377424	30
6	5377526	31
7	5377633	32
8	5377735	33
9	5377830	34
10	5377943	35
11	5378046	36
12	5378902	37
13	9092324	38
14	34509604	39
15	40731451	40
16		41
17		42
18		43
19		44
20		45
21		46
22		47
23		48
24		49
25		50

Book Mark:

See also:

A **5 Cav. (Col'd.) | Mass.**

Paul Neal

....., Co. *D*, 5 Reg't Mass. Cav. (Col'd.)

Appears on

Company Descriptive Book

of the organization named above.

DESCRIPTION.

Age *41* years; height *5* feet *7 1/2* inches.

Complexion *Blk*

Eyes *Blk*; hair *Blk*

Where born *Bedford Town*

Occupation *Farmer*

ENLISTMENT.

When *May 24*, 186*6*

Where *Boston*

By whom *L. M. Stoddish*; term *3* y'rs.

Remarks: *Mustered at Gallups*
in May 24/64 by Capt
Stoddish, Col'd.
Mustered out of service
June 28 65 at Fortress Monroe
Va. G.O. '11.

Hearst

A 15 Cav, 1 Mass.

Paul Neal.

Appears with rank of _____ on

Muster-in and Descriptive Roll

of a detachment of U. S. Volunteer Recruits for
different regiments of Massachusetts Volunteers.

Roll dated *Draft Rendez, Galloups Island,*
Boston Harbor, Mass, (May 28, 1864,

Where born *Bedford Tenn.*

Age *41* years; occupation *Farmer.*

When enlisted *May 27, 1864.*

Where enlisted *Boston, Mass.*

For what period enlisted *3* years.

Eyes *Dark*; hair *Black*

Complexion *Dark*; height *5 ft 7 1/2 in.*

When mustered in _____, 186 .

Muster-in to date *from enlistment.*, 186 .

Where mustered in _____

Bounty paid \$ *100*; due \$ *100*

Clothing account:

Last settled \$ _____, 186 ; drawn since \$ *100*

Date of first muster _____, 186 .

Regiment to which assigned *5 Cav.*

Remarks *Credited to the Quota of Boston*
(Ward 9, Suffolk Co., 4 Congl. Dist.

Book mark: _____

Printed

N | **5 Col'd Cav.** | **Mass.**

Paul Neal

Appears with rank of on

Muster and Descriptive Roll of a Detachment of U. S. Vols. forwarded

for the 5 Reg't Mass. Col'd Cavalry. Roll dated
Draft Rendezvous
Galloups Island B. Mass., May 28, 1864.

Where born *Bedford Tenn*

Age *41* y'rs; occupation *Farmer*

When enlisted *May 24*, 1864.

Where enlisted *Boston*

For what period enlisted *3* years.

Eyes *dark*; hair *black*

Complexion *dark*; height *5 ft. 7 1/2* in.

When mustered in *May 27*, 1864.

Where mustered in *Boston*

Bounty paid \$ *100*; due \$ *100*

Where credited *Boston Ward 9 Suffolk Co*

Company to which assigned

Remarks:

Book mark:

M. A. Michaels

A 5 Col'd Cav. | **Mass.**

Paul Neal

Dr, Co. D, 5 Reg't Mass. Col'd Cavalry.

Appears on

Company Muster Roll

for *July + June*, 1864.

Present or absent *Present*

Stoppage, \$ 100 for

Due Gov't, \$ 100 for

Valuation of horse, \$ 100

Valuation of horse equipments, \$ 100

Remarks:

Book mark:

(358)

[Signature]
Copyist.

5 Col'd Cav. | Mass.

Appears with rank of *Private* on

Muster and Descriptive Roll of a Detachment of U. S. Vols. forwarded

for the 5 Reg't Mass. Col'd Cavalry. Roll dated

Savannah Ga. Mass., Jan 3, 1864.

Where born *Beaconsfield Mass*

Age *41* y'rs; occupation *Farmer*

When enlisted *May 27*, 1864.

Where enlisted *Beaconsfield Mass*

For what period enlisted *3* years.

Eyes *Dark*; hair *Black*

Complexion *Dark*; height *5 ft. 2 in.*

When mustered in *May 27*, 1864.

Where mustered in *Savannah Ga.*

Bounty paid \$ *100*; due \$ *100*

Where credited *Co. 1st Det Boston Light*

Company to which assigned *Subtrick's*

Remarks:

Book mark:

A | **5 Col'd Cav.** | **Mass.**

Paul Seal

Pr, Co. D, 5 Reg't Mass. Col'd Cavalry.

Appears on

Company Muster Roll

for *July & Aug*, 186 *4*.

Present or absent *Present*

Stoppage, \$ *100* for

Due Gov't, \$ *100* for

Valuation of horse, \$ *100*

Valuation of horse equipments, \$ *100*

Remarks: *Sail, det, company cook*

Book mark:

S. Merchant

A. 5 Col'd Cav. | **Mass.**

Paul Neal

Paul, Co. D, 5 Reg't Mass. Col'd Cavalry.

Appears on

Company Muster Roll

for *Sept & Oct*, 186*1*

Present or absent *Present*

Stoppage, \$ *100* for

Due Gov't, \$ *100* for

Valuation of horse, \$ *100*

Valuation of horse equipments, \$ *100*

Remarks: *Company cook*

Book mark:

(358)

J. Merchant
Copyist.

A | **5 Col'd Cav.** | **Mass.**

Paul Areal

Paul, Co. D, 5 Reg't Mass. Col'd Cavalry.

Appears on

Company Muster Roll

for *Nov & Dec*, 186 *4*

Present or absent *Present*

Stoppage, \$ *100* for

Due Gov't, \$ *100* for

Valuation of horse, \$ *100*

Valuation of horse equipments, \$ *100*

Remarks: *Company Cook*
Dr the Blues for Massachusetts
(written 95)

Book mark:

A. Merchant

(358)

Copyist.

P | **5 Col'd Cav.** | **Mass.**

Paul Neal

Pvt, Co. D, 5 Reg't Mass. Col'd Cavalry.

Appears on

Company Muster Roll

for *Jan'y Term*, 1865.

Present or absent *Present*

Stoppage, \$ *100* for

Due Gov't, \$ *100* for

Valuation of horse, \$ *100*

Valuation of horse equipments, \$ *100*

Remarks: *Due 1st Instate MS.*
Bounts

Book mark: _____

S. Merchant

A 5 Col'd Cav. | **Mass.**

Paul Neal

Pr, Co. D, 5 Reg't Mass. Col'd Cavalry.

Appears on

Company Muster Roll

for *May & Sept*, 186*5*.

Present or absent *Present*

Stoppage, \$ *100* for

Due Gov't, \$ *100* for

Valuation of horse, \$ *100*

Valuation of horse equipments, \$ *100*

Remarks: *Five 1st Regt US,*
Bounty

Book mark:

J. Merchant

72 | **5 Col'd Cav.** | **Mass.**

Paul Neal

Co. D, 5 Reg't Mass. Col'd Cavalry.

Appears on

Company Muster Roll

for May and June, 1865.

Present or absent Absent

Stoppage, \$ 100 for

Due Gov't, \$ 100 for

Valuation of horse, \$ 100

Valuation of horse equipments, \$ 100

Remarks:

Sent to Hospital's House
Pt Va. May 20/65

Book mark:

House

P

5 Col'd Cav. Mass.

Paul Neal

Co. D, 5 Reg't Mass. Col'd Cavalry.

Appears on an

Individual Muster-out Roll

of the organization named above. Roll dated

Fort Monroe, June 28 1865.

Muster-out to date

June 28, 1865.

Last paid to

Dec 31, 1864.

Clothing account:

Last settled *Dec 31, 1864*; drawn since \$..... 100

Due soldier \$..... 100; due U. S. \$..... 100

Am't for cloth'g in kind or money adv'd \$ *34* ^{*32*} / 100

Due U. S. for arms, equipments, &c., \$..... 100

Bounty paid \$..... 100 due \$ *300* / 100

Remarks: *Mustered out by order
War Dept May 3/65 -
Patient in U.S. General
Hospital for the Mounro, Va.*

Book mark:

268.177

Paul Neal

21 5 Col'd Cav. | **Mass.**

Paul Neal

Rt, Co. D, 5 Reg't Mass. Col'd Cavalry.

Appears on

Company Muster Roll

for July and Aug., 186 5.

Present or absent _____

Stoppage, \$ _____ 100 for _____

Due Gov't, \$ _____ 100 for _____

Valuation of horse, \$ _____ 100

Valuation of horse equipments, \$ _____ 100

Remarks: _____
Mustered out of service
June 28/65 under S.O. 77
War Dept. H. G. O. dated May
3 1865

Book mark: _____

Howe
(358) Copyist.

A. | **5 Col'd Cav.** | **Mass.**

Paul Neal

Pvt, Co. 20, 5 Reg't Mass. Colored Cav.

Appears on **Returns** as follows:

June 1864. Gain June 19/64
Point of Rocks - Recruit
rec'd from depot.

June 1864 to Mar. 1865. Co. cook.

Aug. 1865. Loss June 17/65 - For-
tress Monroe - mustered
out of service under G.O.
77.

Book mark :

(648)

J. B. Sittler

Copyist.

n | **5 Col'd Cav. Mass.**

Paul Neal

Det, Co. *Q*, 5 Reg't Mass. Col'd Cavalry.

Appears on **Co. Muster-out Roll**, dated
Clarksville Texas Oct. 31, 1865

Muster-out to date _____, 186 .

Last paid to _____, 186 .

Clothing account:

Last settled _____, 186 ; drawn since \$ _____ 100

Due soldier \$ _____ 100; due U. S. \$ _____ 100

Am't for cloth'g in kind or money adv'd \$ _____ 100

Due U. S. for arms, equipments, &c., \$ _____ 100

Bounty paid \$ _____ 100; due \$ _____ 100

Remarks: _____

*Discharged out of service on
Jan 23/65 at Fort
Monroe Va. under G.O. 77*

Book mark: *368.177*

House

Neal, Paul

Co. D, 5th Reg't Mass. Cold. Car.

(Philippine Insurrection.)

CIVIL WAR
Inclosures.

Bed Cards	Ex. Preliminary to M. O.
Burial Records	Final Statements
Certs. of Dis. for Discharge	Fines
C. M. Charges	Furloughs or L. of A.
Descriptive Lists	Med. Certificates
Descriptive and Assign- ment Cards }	Med. Des. Lists
Discharge Certificates	Orders
Enlistment Papers	Resignations

Other papers relating to—

Admission to Hosp'l	Furlough or L. of A.
Confinement	Med. Examination
Contracts	Misc. Information
Death or Effects	Pay or Clothing
Desertion	Personal Reports
Discharge from Hosp'l	Rank
Discharge from Service	Transfer to Hosp'l
Duty	Transportation

NOTE 1.—This blank will be used for both enlistments and re-enlistments—enlistment of veterans, &c., &c., in the volunteer service. They will be made cut in duplicate in all cases—one to accompany the recruiting return of the superintendent (not the recruiting officer) to the Adjutant-General, and one to accompany the accounts of the officer who pays bounty, &c. The Regiment and Company in which the soldier last served should be given on the back.

NOTE 2.—An enlistment holds to service. A muster-in must, in all cases, precede payment of pay, bounty, pension, &c. A muster-in roll must, in all cases, be filed in the Adjutant-General's Office as evidence of muster-in. The mustering officer, commissary, or assistant-commissary of musters, as the case may be, will countersign both enlistments as having mustered the soldier into the service of the United States before either of them is given to the disbursing officer.

APRIL 1891. THIS PAPER WAS FORMERLY
FILED IN THE ENROLLMENT DIV. P. O.

DECLARATION OF RECRUIT.

I, *Paul Neal* desiring
to VOLUNTEER as a Soldier in the Army of the United States, for the term of THREE YEARS,
Do Declare, That I am *forty one* years and _____ months
of age; that I have never been discharged from the United States service on account of disability or by
sentence of a court-martial, or by order before the expiration of a term of enlistment; and I know of no
impediment to my serving honestly and faithfully as a soldier for three years.

GIVEN at *Boston Mass*
this the *27* day of *May* 18*64*
Witness: *Saml Abell Paul Neal*
Mark

Volunteered at _____ 18____
Paul Neal
By _____
Regiment of _____
Discharged _____ 18____
Regt of _____
enlistment; last served in Company ()

No. *5* _____

CONSENT IN CASE OF MINOR.

I, _____ Do CERTIFY, That I am
the _____ of _____ ; that the
said _____ is _____ years of age; and I
do hereby freely give my CONSENT to his volunteering as a SOLDIER in the ARMY OF THE UNITED STATES,
for the period of THREE YEARS.

GIVEN at _____
the _____ day of _____
Witness: _____

VOLUNTEER ENLISTMENT.

STATE OF Massachusetts

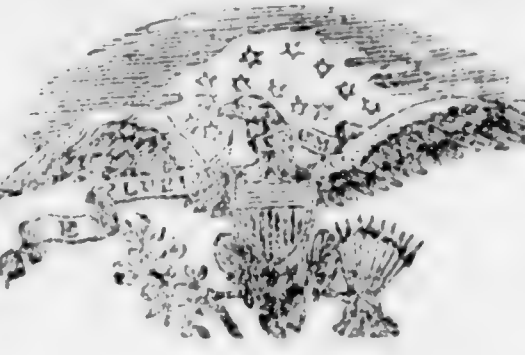

City TOWN OF Boston
Ward Nine

the
day of
1864
at
Mustered into the service of the United States, in Company

I, *Paul Neal* born in *Bedford*
in the State of *Tennessee* aged *forty one* years,
and by occupation a *Farmer* DO HEREBY ACKNOWLEDGE to have
volunteered this *Twenty Seventh* day of *May* 1864
to serve as a *Soldier* in the Army of the United States of America, for the
period of *THREE YEARS*, unless sooner discharged by proper authority: Do also
agree to accept such bounty, pay, rations, and clothing, as are, or may be, estab-
lished by law for volunteers. And I, *Paul Neal* do
solemnly swear, that I will bear true faith and allegiance to the *United States*
of *America*, and that I will serve them honestly and faithfully against all their
enemies or opposers whomsoever; and that I will observe and obey the orders of
the President of the United States, and the orders of the officers appointed over
me, according to the Rules and Articles of War.

Married

Carroll
St. Ann's

Sworn and subscribed to, at *Boston*
this *27* day of *May* 1864 } *Paul Neal*
Before *me & Miles Standish* } *Witness*
Justice of Peace *Samuel Miles Standish*

I CERTIFY, ON HONOR, That I have carefully examined the above-named Volunteer, agreeably
to the General Regulations of the Army, and that, in my opinion, he is free from all bodily defects and
mental infirmity, which would in any way disqualify him from performing the duties of a soldier.

P. J. J. J.
EXAMINING SURGEON.
Paul Neal

Accrued

I CERTIFY, ON HONOR, That I have minutely inspected the Volunteer, *Paul Neal*
previously to his enlistment, and that he was entirely sober when enlisted; that, to the best of my
judgment and belief, he is of lawful age; and that, in accepting him as duly qualified to perform the duties
of an able-bodied soldier, I have strictly observed the Regulations which govern the recruiting service.
This soldier has *Dark* eyes, *Black* hair, *Dark* complexion, is *five* feet
Seven inches high.

(A. G. O. No. 74 & 75.) *Samuel Miles Standish* Regiment of *Volunteers,*
RECRUITING OFFICER.

0843

Regiment of
Volunteers, on

1058

Nelson. Charles P^B
Co H, 5 Mass. Cav., (Col'd.)

Private

Private

CARD NUMBERS.

1	5381618	26
2	5381705	27
3	5381589	28
4	5381887	29
5	5381994	30
6	5382098	31
7	5382202	32
8	5382302	33
9	5382400	34
10	5382491	35
11	5382587	36
12	9091833	37
12	40731452	38
14		39
15		40
16		41
17		42
18		43
19		44
20		45
21		46
22		47
23		48
24		49
25		50

Book Mark:

See also

S 989 715 P...
D. 2442662 P.O. Lett
D 2466653 POKet

Handwritten text, possibly a signature or initials.

N. **5 Cav. (Col'd.) | Mass.**

Charles B. Nelson.

....., Co. *H.*, 5 Reg't Mass. Cav. (Col'd.)

Appears on

Company Descriptive Book
of the organization named above.

DESCRIPTION.

Age *21* years; height *5* feet *5½* inches.

Complexion *Colored.*

Eyes *Dark*; hair *Black.*

Where born *Cecil Co, Md.*

Occupation *Laborer.*

ENLISTMENT.

When *Feb'y, 27* , 1864 .

Where *Boston, M. S.*

By whom *Daniel Davies* ; term *3* y'rs.

Remarks: *Mustered in at Readville*
Mar. 12 '64.

H. C. Thomas.

N. | **5 Col'd Cav.** | **Mass.**

Charles P. Nelson
Priv., Co. *N.*, 5 Reg't Mass. Col'd Cav.

Appears on

Company Muster-in and Descriptive Roll

of the organization named above. Roll dated

Readville Mass, Mar 12, 1864.

Where born *Cecile Co, Md.*

Age *21* y'rs; occupation *Farmer.*

When enlisted *Feb. 27*, 1864.

Where enlisted *Boston, Wd 6.*

For what period enlisted *3.* years.

Eyes *Black.*; hair *Black.*

Complexion *Black*; height *5* ft. *5 1/2* in.

When mustered in *Mar 12*, 1864.

Where mustered in _____

Bounty paid \$ *100*; due \$ *100*

Where credited *4th Dist, Suffolk.*

Company to which assigned _____

Remarks: _____

Book mark: _____

J. M. Hall

A | **5 Col'd Cav.** | **Mass.**

Charles B. Nelson
Priv, Co. H, 5 Reg't Mass. Col'd Cavalry.

Appears on

Company Muster Roll

for *Mar 12 to Apr 30*, 186*4*

Present or absent *Present*

Stoppage, \$ *100* for

Due Gov't, \$ *100* for

Valuation of horse, \$ *100*

Valuation of horse equipments, \$ *100*

Remarks:

Book mark:

J M Hall
(358) *J M Hall* Copyist.

N | **5 Col'd Cav.** | **Mass.**

Charles B. Nelson
Pvt, Co. H, 5 Reg't Mass. Col'd Cavalry.

Appears on

Company Muster Roll

for *May & June, 1864*

Present or absent *Present*

Stoppage, \$.....100 for

Due Gov't, \$.....100 for

Valuation of horse, \$.....100

Valuation of horse equipments, \$.....100

Remarks:

Book mark:

J. M. Wall
Copyist.

N 5 Col'd Cav. | **Mass.**

Charles B. Nelson,

Prvt., Co. II, 5 Reg't Mass. Col'd Cavalry.

Appears on

Company Muster Roll

for *July & Aug*, 186

Present or absent *Present*

Stoppage, \$ *100* for

Due Gov't, \$ *100* for

Valuation of horse, \$ *100*

Valuation of horse equipments, \$ *100*

Remarks:

Book mark:

J. M. Wall

N 5 Col'd Cav. | **Mass.**

Charles B Nelson
Put, Co. H, 5 Reg't Mass. Col'd Cavalry.

Appears on

Company Muster Roll

for *Sept & Oct*, 186*y.*

Present or absent *Present*

Stoppage, \$ *0* ^{*0x*}/_{*100*} for *one cross*
sabre letter & number.

Due Gov't, \$ *100* for

Valuation of horse, \$ *100*

Valuation of horse equipments, \$ *100*

Remarks:
.....
.....
.....
.....
.....
.....
.....

Book mark:

C M Clark

N | **5 Col'd Cav.** | **Mass.**

Charles B Nelson
Pat, Co. H, 5 Reg't Mass. Col'd Cavalry.

Appears on

Company Muster Roll

for *Nov & Dec*, 1864.

Present or absent *Present*

Stoppage, \$ *100* for

Due Gov't, \$ *100* for

Valuation of horse, \$ *100*

Valuation of horse equipments, \$ *100*

Remarks:

Book mark:

(358)

C M Clark
Copyist.

N | **5 Col'd Cav.** | **Mass.**

Charles B Nelson
Pat, Co. H, 5 Reg't Mass. Col'd Cavalry.

Appears on

Company Muster Roll
for *Jan 7 Feb*, 186*4*
Present or absent *Present*

Stoppage, \$ *100* for

Due Gov't, \$ *100* for

Valuation of horse, \$ *100*

Valuation of horse equipments, \$ *100*

Remarks: *Due 1st 2d 3d*
4th installments
U. S bounty.

Book mark: _____

(358)

C. M. Clark
Copyist.

N **5 Col'd Cav. Mass.**

Charles B Nelson
Put, Co. H, 5 Reg't Mass. Col'd Cavalry.

Appears on

Company Muster Roll

for March & April, 1865.

Present or absent Present.

Stoppage, \$ 100 for

Due Gov't, \$ 100 for

Valuation of horse, \$ 100

Valuation of horse equipments, \$ 100

Remarks: Due 1st, 2d, 3d &
4th installment. U.S.
County.

Book mark: _____

(358)

C M Clark
Copyist.

N | **5 Col'd Cav.** | **Mass.**

Charles B Nelson
Pat, Co. II, 5 Reg't Mass. Col'd Cavalry.

Appears on

Company Muster Roll

for *May & June*, 186*5*.

Present or absent *Present*

Stoppage, \$ *100* for

Due Gov't, \$ *100* for

Valuation of horse, \$ *100*

Valuation of horse equipments, \$ *100*

Remarks: *1st, 2d, 3d & 4th install-*
ments U.S. bounty due
Free on or before
April 19, 1865.

Book mark: _____

C M Clark

(358)

Copyist.

2 | **5 Col'd Cav.** | **Mass.**

Charles B. Nelson

Priv., Co. H, 5 Reg't Mass. Col'd Cavalry.

Appears on

Company Muster Roll

for *July & Aug.*, 186*5*.

Present or absent *Present*

Stoppage, \$ *100* for

Due Gov't, \$ *100* for

Valuation of horse, \$ *100*

Valuation of horse equipments, \$ *100*

Remarks: *Full pay for before Apr 19. 1861.*

Book mark: _____

R. S. [Signature]

A. | **5 Col'd Cav.** | **Mass.**

Charles B. Nelson
Pvt., Co. H, 5 Reg't Mass. Colored Cav.

Appears on **Returns** as follows:

July & Aug. 1865. Absent,
detch'd Serv. Fatigue
Brazos since July 27.

Sept. 1865. Absent working
on R.R. at Brazos.

Book mark :

(546)

J. B. Dittler

Copyist.

N | **5 Col'd Cav.** | **Mass.**

Charles B. Nelson
Srs., Co. *A.*, 5 Reg't Mass. Col'd Cavalry.

Appears on **Co. Muster-out Roll**, dated
Clarksville Tex, Oct 31, 186*4*.

Muster-out to date *Oct 31*, 186*4*.

Last paid to *Dec 31*, 186*4*.

Clothing account:

Last settled....., 186 ; drawn since \$..... 100

Due soldier \$..... 100; due U. S. \$..... *31* ^{*10*}/₁₀₀

Am't for cloth'g in kind or money adv'd \$..... 100

Due U. S. for arms, equipments, &c., \$ *3* ⁰⁰/₁₀₀

Bounty paid \$..... 100; due \$ *300* ⁰⁰/₁₀₀

Remarks: *Free on or before April 15, 1864.*

Book mark :

R. E. Wilson

1059

Nelson. Frank

Co M, 5 Mass. Cav., (Col'd.)

Private Saddler

CARD NUMBERS.

1	5385958	26
2	5386046	27
3	5386131	28
4	5386171	29
5	5386278	30
6	5386380	31
7	5386484	32
8	5386582	33
9	5386687	34
10	5386776	35
11	9091407	36
12	40731453	37
13		38
14		39
15		40
16		41
17		42
18		43
19		44
20		45
21		46
22		47
23		48
24		49
25		50

Book Mark: _____

See also _____

A **5 Cav. (Col'd.) | Mass.**

Frank Nelson,

Co. C, 5 Reg't Mass. Cav. (Col'd.)

Appears on

Company Descriptive Book

of the organization named above.

DESCRIPTION.

Age *28* years; height *5* feet *3* inches.

Complexion *Black.*

Eyes *Black*; hair *Black.*

Where born *Crawford Co. Ohio.*

Occupation *Marble cutter.*

ENLISTMENT.

When *April 15th, 1864.*

Where *West Roxbury.*

By whom *Lt. C. Beville*; term *3* y'rs.

Remarks: *Mustered by Lieut. D. Madden.*

May 5th 1864, Readville Mass.

F. C. Thomas.

Copyist.

N | **5 Col'd Cav.** | **Mass.**

Frank Nelson

Pri, Co. *M*, 5 Reg't Mass. Col'd Cav.

Appears on

Company Muster-in and Descriptive Roll
of the organization named above. Roll dated

Readville Mass, May 5, 1864.

Where born *Crawford Co. O.*

Age *28* y'rs; occupation *Marble Cutter*

When enlisted *Apr 15*, 1864.

Where enlisted *West Roxbury*

For what period enlisted *3* years.

Eyes *Blk*; hair *Blk*

Complexion *Blk*; height *5 ft. 3 in.*

When mustered in *May 5*, 1864.

Where mustered in *Readville*

Premium
Bounty paid \$ *2* 100; due \$ 100

Where credited

Company to which assigned

Remarks: *Credited to W. Roxbury*
Suffolk Co. 7 Cong Dist Mass

Book mark:

Avery

(356d)

Copyist.

A | **5 Col'd Cav.** | **Mass.**

Frank Nelson

Pri., Co. M, 5 Reg't Mass. Colored Cavalry.

Appears on

Company Muster Roll

for *May 5 to June 30*, 1864.

Present or absent *Present*

Stoppage, \$.....*100* for

Due Gov't, \$.....*100* for

Valuation of horse, \$.....*100*

Valuation of horse equipments, \$.....*100*

Remarks:.....

Book mark:.....

Army

A | **5 Col'd Cav.** | **Mass.**

Frank Nelson

Pri., Co. M, 5 Reg't Mass. Colored Cavalry.

Appears on

Company Muster Roll

for *July & Aug.*, 1864.

Present or absent *Present*

Stoppage, \$ *100* for

Due Gov't, \$ *100* for

Valuation of horse, \$ *100*

Valuation of horse equipments, \$ *100*

Remarks:

Book mark:

Avery

A | **5 Col'd Cav.** | **Mass.**

Frank Nelson

Sadler Co. M, 5 Reg't Mass. Colored Cavalry.

Appears on

Company Muster Roll

for *Sept. + Oct.*, 1864.

Present or absent *Present*

Stoppage, \$ 100 for

Due Gov't, \$ 100 for

Valuation of horse, \$ 100

Valuation of horse equipments, \$ 100

Remarks:

Book mark:

C. Williams,

N | **5 Col'd Cav.** | **Mass.**

Frank Nelson

Saddler, Co. M, 5 Reg't Mass. Colored Cavalry.

Appears on

Company Muster Roll

for *Nov, + Dec*, 186 *4*

Present or absent *Present*

Stoppage, \$ *100* for

Due Gov't, \$ *100* for

Valuation of horse, \$ *100*

Valuation of horse equipments, \$ *100*

Remarks:

Book mark:

C. Williams

A. | **5 Col'd Cav.** | **Mass.**

Frank Nelson

Saddler, Co. M, 5 Reg't Mass. Colored Cavalry.

Appears on

Company Muster Roll

for *Jan, & Feb, 1865.*

Present or absent *Present*

Stoppage, \$ *100* for

Due Gov't, \$ *3⁹⁸* *100* for *ordnance*

lost.

Valuation of horse, \$ *100*

Valuation of horse equipments, \$ *100*

Remarks:

Book mark:

C. Williams

(358)

Copyist.

N | **5 Col'd Cav.** | **Mass.**

Frank Nelson

Saddled, Co. M, 5 Reg't Mass. Colored Cavalry.

Appears on

Company Muster Roll

for *May & Apr*, 186*5*.

Present or absent *Present.*

Stoppage, \$ *100* for

Due Gov't, \$ *3⁹⁸* *100* for *ordnance*
lost.

Valuation of horse, \$ *100*

Valuation of horse equipments, \$ *100*

Remarks:

Book mark:

L. Williams

A. | **5 Col'd Cav.** | **Mass.**

Frank Nelson
Saddler, Co. M, 5 Reg't Mass. Colored Cavalry.

Appears on

Company Muster Roll

for *May & June*, 1865.

Present or absent *Present*

Stoppage, \$ *100* for

Due Gov't, \$ *398* ₁₀₀ for *ordnance*
lost.

Valuation of horse, \$ *100*

Valuation of horse equipments, \$ *100*

Remarks:

Book mark:

L. Williams,
Copyst.

N | **5 Col'd Cav.** | **Mass.**

Frank Nelson

Saddler, Co. M, 5 Reg't Mass. Colored Cavalry.

Appears on

Company Muster Roll

for *July & Aug.*, 186*5*.

Present or absent *Present*

Stoppage, \$ *100* for

Due Gov't, \$ *100* for

Valuation of horse, \$ *100*

Valuation of horse equipments, \$ *100*

Remarks:

Due U.S. for ordi-
nance lost \$3.98.

Book mark: _____

Hodges

A. | **5 Col'd Cav.** | **Mass.**

Frank Nelson

Priv., Co. M, 5 Reg't Mass. Colored Cav.
Art.

Appears on **Returns** as follows:

May to July 1864. Servant.

Oct. 1864 to June 1865. (Art.)
Co. Saddler.

Book mark :

(546)

J. B. Sittler

Copyist.

N | **5 Col'd Cav.** | **Mass.**

Frank Nelson

Saddler, Co. M, 5 Reg't Mass. Col'd Cavalry.

Appears on **Co. Muster-out Roll**, dated

Clarksville Tex, Oct. 31, 1865.

Muster-out to date *Oct. 31*, 1865.

Last paid to *Dec. 31*, 1864.

Clothing account:

Last settled....., 186 ; drawn since \$..... 100

Due soldier \$.....100; due U. S. \$ *4* ^{*68*}/₁₀₀

Am't for cloth'g in kind or money adv'd \$.....100

Due U. S. for arms, equipments, &c., \$ *3* ^{*98*}/₁₀₀

Bounty paid \$.....100; due \$ *100* 100

Remarks:

Book mark:

Hodges

(361)

Copyist.

1059-a

Nelson, Isaac

Co., 5 W. S. Col'd Can

CARD NUMBERS.

1	9436087	26
2		27
3		28
4		29
5		30
6		31
7		32
8		33
9		34
10		35
11		36
12		37
13		38
14		39
15		40
16		41
17		42
18		43
19		44
20		45
21		46
22		47
23		48
24		49
25		50

Number of personal papers herein.....

Book Mark:

See also

N. | 5th Cav. | Mass. |
(Col'd) |

Jesse Nelson,

....., Co., 5th Reg't Mass Col'd Cav.

Appears on

Regimental Descriptive Book

of the organization named above.

DESCRIPTION.

Age 40 years; height 5 feet 10 inches.

Complexion Black,

Eyes Black; hair Black.

Where born Charleston, S. Carolina

Occupation Laborer.

ENLISTMENT.

When Mar. 12, 1864

Where Boston No 4

By whom J. Foley; term 3 y'rs.

Remarks: Reported March 26/64

Thurston

1060

Nelson. John

Co A, 5 Mass. Cav., (Col'd.)

Private

Private

CARD NUMBERS.

1	5373321	26
2	5373406	27
3	5373487	28
4	5373589	29
5	5373701	30
6	5373811	31
7	5373911	32
8	5374022	33
9	5374143	34
10	5374454	35
11	9092692	36
12	40731466	37
13		38
14		39
15		40
16		41
17		42
18		43
19		44
20		45
21		46
22		47
23		48
24		49
25		50

Book Mark:

See also

A | **5 Cav. (Col'd.)** | **Mass.**

John T. Down

....., Co. *4*, 5 Reg't Mass. Cav. (Col'd.)

Appears on

Company Descriptive Book

of the organization named above.

DESCRIPTION.

Age *18* years; height *5* feet *6* inches.

Complexion *dark*

Eyes *dark*; hair *black*

Where born *Patuxent Md*

Occupation *laborer*

ENLISTMENT.

When *Dec 20*, 186*3*.

Where *Patuxent*

By whom *A. Brown*; term *3* y'rs.

Remarks: *Enlisted in Civil War*
January 22 1864. Dropped
in service March 20 1865

9 | **5 Col'd Cav.** | **Mass.**

John Nelson
Priv., Co. A, 5 Reg't Mass. Col'd Cav.

Appears on

Company Muster-in and Descriptive Roll
of the organization named above. Roll dated

Readville, Jan 9, 1864.

Where born Batavia, N.Y.

Age 18 y'rs; occupation Sabotier

When enlisted Dec. 21st, 1863.

Where enlisted Newton

For what period enlisted Three years.

Eyes Black, hair Black

Complexion Black, height 5 ft. 6 in.

When mustered in Jan. 9th, 1864.

Where mustered in _____

Bounty paid \$ _____ 100; due \$ _____ 100

Where credited _____

Company to which assigned _____

Remarks: _____

Book mark: _____

(356d) G. Ford Copyist.

5 Col'd Cav.

Mass.

John Nelson

Prot, Co. A, 5 Reg't Mass. Col'd Cavalry.

Appears on

Company Muster Roll

for *Enlistment Feb. 29, 1864*

Present or absent *Absent*

Stoppage, \$ *100* for

Due Gov't, \$ *100* for

Valuation of horse, \$ *100*

Valuation of horse equipments, \$ *100*

Remarks: *Delivered to Deputy
U.S. Marshal, Tucker,
Per Gen order Jura, Jan
28/1864*

Book mark:

G. F. M.

31
2

5 Col'd Cav.

Mass.

John Nelson
Capt, Co. A, 5 Reg't Mass. Col'd Cavalry.

Appears on

Company Muster Roll

for *Mar. & Apr.*, 1864

Present or absent *No stated*

Stoppage, \$ *100* for

Due Gov't, \$ *100* for

Valuation of horse, \$ *100*

Valuation of horse equipments, \$ *100*

Remarks: *Capt. Howe's
servant*

Book mark:

G. Fox

H | **5 Col'd Cav.** | **Mass.**

John Nelson

Privt, Co. A, 5 Reg't Mass. Col'd Cavalry.

Appears on

Company Muster Roll

for *May 9 June*, 1864.

Present or absent *Absent*

Stoppage, \$ *100* for

Due Gov't, \$ *100* for

Valuation of horse, \$ *100*

Valuation of horse equipments, \$ *100*

Remarks: *Retained by
Civil Authority*

Book mark: _____

(358)

G. Fry

Copyist.

N

5 Col'd Cav.

Mass.

John Nelson

Priv., Co. A, 5 Reg't Mass. Col'd Cavalry.

Appears on

Company Muster Roll

for *July and Aug.*, 186*4*.

Present or absent *Absent*

Stoppage, \$ *100* for

Due Gov't, \$ *100* for

Valuation of horse, \$ *100*

Valuation of horse equipments, \$ *100*

Remarks: *Retained by civil authorities.*

Book mark: _____

A. O. Gilbert

N

5 Col'd Cav.

Mass.

John Nelson
Pvt., Co. A, 5 Reg't Mass. Col'd Cavalry.

Appears on

Company Muster Roll

for *Sept. and Oct.*, 1864.

Present or absent *Absent.*

Stoppage, \$ *100* for

Due Gov't, \$ *100* for

Valuation of horse, \$ *100*

Valuation of horse equipments, \$ *100*

Remarks: *Retained by civil authority*

Book mark:

M. O. Gilbrub

(358)

Copyist.

71

5 Col'd Cav.

Mass.

John Nelson
Co. A, 5 Reg't Mass. Col'd Cavalry.

Appears on

Company Muster Roll

for *Nov. and Dec.*, 1864.

Present or absent *Absent*

Stoppage, \$ *100* for

Due Gov't, \$ *100* for

Valuation of horse, \$ *100*

Valuation of horse equipments, \$ *100*

Remarks: *Retained by
civil authority.*

Book mark: _____

A. C. Miller,

(358)

Copyist.

N | **5 Col'd Cav.** | **Mass.**

John Nelson
Pr., Co. A, 5 Reg't Mass. Col'd Cavalry.

Appears on

Company Muster Roll

for *Jan. and Feb.*, 186*5*.

Present or absent *Absent.*

Stoppage, \$ *100* for

Due Gov't, \$ *100* for

Valuation of horse, \$ *100*

Valuation of horse equipments, \$ *100*

Remarks: *Days 2, 3 and 4*
inst. N. S. Soule
#186,000 Retained by
civil authority.

Book mark:

N. O. Gillat

71

5 Col'd Cav.

Mass.

John Nelson

Prv., Co. A, 5 Reg't Mass. Col'd Cavalry.

Appears on

Company Muster Roll

for *March and Apr.*, 1865.

Present or absent

Stoppage, \$ 100 for

Due Gov't, \$ 100 for

Valuation of horse, \$ 100

Valuation of horse equipments, \$ 100

Remarks: *Dropped from rolls as deserter
March 27, 1865.*

Book mark:

M. O. Gilbert

(358)

Copyist.

A. | **5 Col'd Cav.** | **Mass.**

John Nelson
Pvt., Co. A, 5 Reg't Mass. Colored Cav.

Appears on **Returns** as follows:

May 1864, Absent, retained
by civil authority at
Albany, N. Y.

June to Dec, 1864, Absent re-
tained by civil authority
since Jan. 28/64

Jan. 1865, Absent retained by
civil authority at Albany.

Feb. 1865, Absent ret'd by civil
authority.

Mar. 1865, Lost Mar. 27/65-
Pt. Lookout Md. drop-
ped as deserter.

Book mark :

(648)

J. B. Sittler

Copyist.

N | 5 Col'd Cav. | Mass.

John Nelson
Plt, Co. A, 5 Reg't Mass. Col'd Cavalry.

Appears on Co. Muster-out Roll, dated
Clarksville, Tenn, Oct 31, 1865.

Muster-out to date _____, 186 .

Last paid to _____, 186 .

Clothing account:

Last settled _____, 186 ; drawn since \$ _____ 100

Due soldier \$ _____ 100; due U. S. \$ _____ 100

Am't for cloth'g in kind or money adv'd \$ _____ 100

Due U. S. for arms, equipments, &c., \$ _____ 100

Bounty paid \$ _____ 100; due \$ _____ 100

Remarks: Deserted at Pt. Lookout
Md. Mar 27, 1865

Book mark: V. 163. P. 41. 73

(361)

J. Allade
Copyist.

1001

Nelson, John

Co L, 5 Mass. Cav., (Col'd.)

Private

Private

CARD NUMBERS.

1	5372367	26
2	5372329	27
3	5385151	28
4	5385260	29
5	5385362	30
6	5385461	31
7	5385561	32
8	5385659	33
9	5385786	34
10	5385899	35
11	9091011	36
12	34506419	37
13	40731454	38
14	A. S. 201	39
15		40
16		41
17		42
18		43
19		44
20		45
21		46
22		47
23		48
24		49
25		50

Book Mark: A. S. 201

See also

1010101010 (7-2-73)

Handwritten signature

et | **5 Cav. (Col'd.) | Mass.**

John Nelson.

....., Co. *L*....., 5 Reg't Mass. Cav. (Col'd.)

Appears on

Company Descriptive Book

of the organization named above.

DESCRIPTION.

Age *35* years; height *5* feet *7* inches.

Complexion *Black.*

Eyes *Black*; hair *Dark.*

Where born *Richmond Va.*

Occupation *Laborer.*

ENLISTMENT.

When *Aug. 3rd, 1864.*

Where *Rockport.*

By whom *C. H. Shaw*; term *3* y'rs.

Remarks: *Enlisted into Service Aug. 3rd 1864. Boston, by Capt. J. M. Goodhue. Received 100 Dollars Bounty from Capt. H. Dwyer, disbursing Officer, due him \$200.00 Deserted from Regt. at Clarksville Texas July 12th 1865. (Last seen in Mexico)*

H. C. Thomas.

N | **5 Col'd Cav.** | **Mass.**

John Nelson
Pvt, Co. L, 5 Reg't Mass. Col'd Cavalry.

Appears on

Company Muster Roll

for *July & Aug.*, 186*4*.

Present or absent *Present*

Stoppage, \$ *100* for

Due Gov't, \$ *100* for

Valuation of horse, \$ *100*

Valuation of horse equipments, \$ *100*

Remarks: *Recruit from Depot joined Aug. 11, Rec'd. \$100 bounty.*

Book mark: _____

Crenshaw

N

5 Col'd Cav.

Mass.

John Nelson

Appears with rank of *Pri* on

Muster and Descriptive Roll of a Detachment of U. S. Vols. forwarded

for the 5 Reg't Mass. Col'd Cavalry. Roll dated

Boston Mass, Aug 3, 1864.

Where born *Richmond Va*

Age *35* y'rs; occupation *Labourer*

When enlisted *Aug 3*, 1864.

Where enlisted *Rockport*

For what period enlisted *3* years.

Eyes *Black*; hair *Black*

Complexion *Skin*; height *5 ft. 7* in.

When mustered in *Aug 3*, 1864.

Where mustered in *Boston*

Bounty paid \$ *100* ¹⁰⁰; due \$ *200* ¹⁰⁰

Where credited *5 Dist. Rockport*

Essey Co
Company to which assigned

Remarks: *Proven to age*

Book mark: *A. G. 201*

Donnelly

At 1 5 Co Mass.

John Nelson

Appears with rank of _____ on _____

Muster and Descriptive Roll

of a detachment of U. S. Volunteers forwarded from Faneuil Hall, Boston, to Galloup's Island, Boston Harbor, for various regiments Massachusetts Volunteers. Roll dated

Boston, Mass., Aug 3, 1864.

Where born Richmond Virginia

Age 35 years; occupation Laborer

When enlisted Aug 3, 1864.

Where enlisted Rockport

For what period enlisted 3 years.

Eyes black hair black

Complexion dark; height 5 ft. 7 in.

When mustered in Aug 3, 1864.

Where mustered in Boston

Bounty paid \$ 100.00; due \$ 200.00

Clothing account:

Last settled _____, 186 _____; drawn since \$ _____ 100

Date of first muster _____, 186 _____

Regiment to which assigned 5 Co

Remarks: Rockport Essex Co,

5 Dist.

no m to age.

Book mark: _____

(356m)

Collings
Copyist.

N

5 Col'd Cav.

Mass.

John Nelson

Appears with rank of *Pri* on

Muster and Descriptive Roll of a Detachment of U. S. Vols. forwarded

for the 5 Reg't Mass. Col'd Cavalry. Roll dated

Galloups held mass, Aug 7, 1864.

Where born *Richmond Va*

Age *35* y'rs; occupation *Laborer*

When enlisted *Aug 3*, 1864.

Where enlisted *Rockport mass*

For what period enlisted *3* years.

Eyes *Black*; hair *Black*

Complexion *Dark*; height *5 ft. 7 in.*

When mustered in *Aug 3*, 1864.

Where mustered in *Boston mass*

Bounty paid \$ *100* ₁₀₀; due \$ *200* ₁₀₀

Where credited

Company to which assigned

Remarks: *5 Cav Dist. Rockport Essex Co.*

Sworn to age

Book mark:

Sonnelly

(339)

Copyist.

N. | **5 Col'd Cav.** | **Mass.**

John Nelson
Prvt, Co. L, 5 Reg't Mass. Col'd Cavalry.

Appears on

Company Muster Roll

for Sept & Oct., 1864.

Present or absent _____

Stoppage, \$ _____ 100 for _____

Due Gov't, \$ _____ 100 for _____

Valuation of horse, \$ _____ 100

Valuation of horse equipments, \$ _____ 100

Remarks: \$200 Bounty due

Book mark: _____

(358)

J. M. Hance

Copyist.

N. | **5 Col'd Cav.** | **Mass.**

John Nelson

Priv., Co. L, 5 Reg't Mass. Col'd Cavalry.

Appears on

Company Muster Roll

for *Nov. & Dec*, 186*4*.

Present or absent *Present*

Stoppage, \$ *100* for

Due Gov't, \$ *100* for

Valuation of horse, \$ *100*

Valuation of horse equipments, \$ *100*

Remarks: *\$ 200 bounty due*

Book mark: -----

(358)

J. M. Hance

Copyist.

Mo. | **5 Col'd Cav.** | **Mass.**

John Nelson
Private, Co. L, 5 Reg't Mass. Col'd Cavalry.

Appears on

Company Muster Roll

for Jan'y & Feb'y, 1864.

Present or absent Present

Stoppage, \$ 100 for

Due Gov't, \$ 100 for

Valuation of horse, \$ 100

Valuation of horse equipments, \$ 100

Remarks:

Book mark : _____

(358)

J. M. Howe

Copyist.

No. | **5 Col'd Cav.** | **Mass.**

John Nelson

_____, Co. L, 5 Reg't Mass. Col'd Cavalry.

Appears on

Company Muster Roll

for *May 1862*, 1862.

Present or absent *Present*

Stoppage, \$ _____ 100 for _____

Due Gov't, \$ _____ 100 for _____

Valuation of horse, \$ _____ 100

Valuation of horse equipments, \$ _____ 100

Remarks: *See V. 2*

(Chapman & Co. 1862)

Book mark: _____

(358)

J. McNamee

Copyist.

K.

5 Col'd Cav.

Mass.

John Nelson
Sgt., Co. L, 5 Reg't Mass. Col'd Cavalry.

Appears on

Company Muster Roll

for *May & June*, 1863.

Present or absent *Present*

Stoppage, \$ *100* for

Due Gov't, \$ *100* for

Valuation of horse, \$ *100*

Valuation of horse equipments, \$ *100*

Remarks: *Due U.S. for clothing \$66.03*

Book mark:

J. M. Vance

5 Col'd Cav.

Mass.

John W. Smith
....., Co. L, 5 Reg't Mass. Col'd Cavalry.

Appears on

Company Muster Roll

for *July 1863*, 186 ³.

Present or absent *Present*

Stoppage, \$ *100* for

Due Gov't, \$ *100* for

Valuation of horse, \$ *100*

Valuation of horse equipments, \$ *100*

Remarks: *Present*

100

100

100

100

100

100

100

100

100

100

100

100

100

100

100

100

A. | **5 Col'd Cav.** | **Mass.**

John Nelson
Pvt., Co. L, 5 Reg't Mass. Colored Cav.

Appears on **Returns** as follows:

Aug. 1864. Gain Aug. 11
Point Lookout, Md.
Recruit from depot.

July 1865. Loss July 12 Clarke-
ville, Ia. Last seen by
Capt. Gilman in Mexico.

Book mark :

(546)

J. B. Sittler

Copyist.

J. M. Wilson | **5 Col'd Cav.** | **Mass.**

J. M. Wilson
Co. *L*, 5 Reg't Mass. Col'd Cavalry.

Appears on **Co. Muster-out Roll**, dated
Sept. 10, 1865, 186⁵.

Muster-out to date _____, 186 .

Last paid to _____, 186¹¹.

Clothing account:

Last settled _____, 186 ; drawn since \$ _____ 100

Due soldier \$ _____ 100; due U. S. \$ _____ 100

Am't for cloth'g in kind or money adv'd \$ _____ 100

Due U. S. for arms, equipments, &c., \$ *37* ²²/₁₀₀

Bounty paid \$ _____ 100; due \$ _____ 100

Remarks: *Discharged 10/14/65,
at Camp Mass. Cavalry
at _____
_____*

Book mark: _____

Write nothing above this line.

Copy on record card and file the notation recorded below.

Copy made by

Filed July 27, 1923, by *JN*

John Nelson

Private L 5th Mass. Cav. Co., Reg't Col.

NOTATION.

Book mark : A.G. 201

THE ADJUTANT GENERAL'S OFFICE,
WAR DEPARTMENT,

Washington, July 19, 1923.

It has this day (....., 1923.)
been determined by this Department from
The charge of desertion of July 12, 1865, against this man has been removed, and he is discharged to date July 12, 1865, under the provisions of the act of Congress approved March 2, 1889.

Discharge certificate prepared by War Department July 19, 1923, and filed.

By authority of the Sec. of War;

Robert O. Davis

Form No. 186a—A. G. O.
Ed. May 23-22—500.

The Adjutant General.
By *C*

Nelson John

....., Co., Reg't

2 Enclosures.

Bed Cards	Final Statements
Burial Records	Furloughs or L. of A
Certs. of Dis. for Discharge	Med. Certificates
C. M. Charges	Med. Des. Lists
Descriptive Lists	Orders
Discharge Certificates	Pris. of War Record
Enlistment Papers	Resignations

Other papers relating to—

Admission to Hosp'l	Furlough or L. of A
Casualty Sheet	Med. Examination
Confinement	Misc. Information
Contracts	Pay or Clothing
Death or Effects	Personal Reports
Desertion	Rank
Discharge from Hosp'l	Transfer to Hosp'l
Discharge from Service	Transfer to V. R. C.
Duty	Transportation

DECLARATION OF RECRUIT

I,

John Nelson

to VOLUNTEER as a Soldier in the Army of the United States, for the
Do Declare That I am *thirty five* years and
of age; that I have never been discharged from the United States' service on
sentence of a court-martial, or by order before the expiration of a term of enl
impediment to my serving honestly and faithfully as a soldier for three years.

GIVEN at

Boston M

the

3rd

day of

August

Witness:

M. Dudley

John T. Marshall

By

L. H. Shaver
5th Regiment of Sharpshooters

enlistment; last served in Company ()

Reg't of

Discharged

18

Noe Bennett

M. N.

April 1391 This document was formerly
filed in the Enrollment Div. B. & P. O.

CONSENT IN CASE OF MINOR

I,

the

of

said

is

do hereby freely give my consent to his volunteering as a SOLDIER in the ARMY
for the period of THREE YEARS.

GIVEN at

the

day of

Witness:

UNTEER ENLISTMENT.

5th Dist

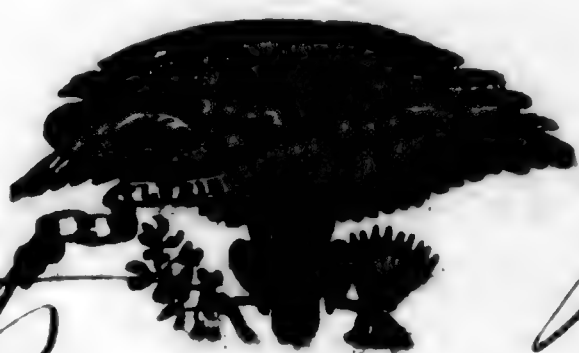

TOWN OF

Rockport.

Nelson
Virginia
laborer

born in

Richmond

aged

Thirty five years,

DO HEREBY ACKNOWLEDGE to have

day of August 1864,

in the Army of the United States of America, for the
R.S., unless sooner discharged by proper authority: Do also
county, pay, rations, and clothing, as are, or may be, estab-
lished. And I, John Nelson do
bear true faith and allegiance to the United States
I will serve them honestly and faithfully against all their
enemies; and that I will observe and obey the orders of
the United States, and the orders of the officers appointed over
me and Articles of War.

Boston
Aug. 1864
W. H. ...
Duffly

John Nelson's
mark

I, That I have carefully examined the above-named Volunteer, agreeably
to the Army, and that, in my opinion, he is free from all bodily defects and
in any way disqualify him from performing the duties of a soldier.

A. P. ...

EXAMINING SURGEON.

I, That I have minutely inspected the Volunteer, John Nelson
and that he was entirely sober when enlisted; that, to the best of my
powerful age; and that, in accepting him as duly qualified to perform the duties
he strictly observed the Regulations which govern the recruiting service.
eyes, black hair, dark complexion, is five feet

Regiment of ... Volunteers,

RECRUITING OFFICER.

Edward H. Shaw

DECLARATION OF RECRUIT

I,

John Nelson

to VOLUNTEER as a Soldier in the Army of the United States, for the
Do Declare, That I am *thirty five* years and _____
of age; that I have never been discharged from the United States service or
sentence of a court-martial, or by order before the expiration of a term of en
impediment to my serving honestly and faithfully as a soldier for three years.

GIVEN at

Boston Ma

the

3rd

day of

August

Witness:

M. Dudley,

John T. ...

By

*E. W. ...
5th Regiment of ...*

enlistment; last served in Company ()

Reg't of

Discharged

18

\$100 ...

CONSENT IN CASE OF MINOR

I,

the

of

said

is

do hereby freely give my CONSENT to his volunteering as a SOLDIER in the ARMY
for the period of THREE YEARS.

GIVEN at

the

day of

Witness:

UNTEER ENLISTMENT.

Essey Co
5th Dist



TOWN OF

Rockport

Nelson
Virginia
laborer

born in Richmond
aged thirty five years,

Do HEREBY ACKNOWLEDGE to have
day of August 1864,

in the Army of the United States of America, for the
ARS, unless sooner discharged by proper authority: Do also
ounty, pay, rations, and clothing, as are or may be, estab-
eers. And I, John Nelson do
ll bear true faith and allegiance to the United States

I will serve them honestly and faithfully against all their
msoever; and that I will observe and obey the orders of
nited States, and the orders of the officers appointed over
les and Articles of War.

Boston
Aug 1864
Brookline
W. C. Cutler

John X Nelson
mark

OR, That I have carefully examined the above-named Volunteer, agreeably
the Army, and that, in my opinion, he is free from all bodily defects and
in any way disqualify him from performing the duties of a soldier.

A. B. Lachar,
M.D.

EXAMINING SURGEON.

NOR, That I have minutely inspected the Volunteer,
and that he was entirely sober when enlisted; that, to the best of my
lawful age; and that, in accepting him as duly qualified to perform the duties
have strictly observed the Regulations which govern the recruiting service.

eyes, black hair dark complexion, is five feet

John Nelson

Regiment of Volunteers,
RECRUITING OFFICER.

Edward H. Shaw

1062

Nelson. Luther

Co D, 5 Mass. Cav., (Col'd.)

Private

Private

CARD NUMBERS.

1	5376943	26
2	5377032	27
3	5377116	28
4	5377211	29
5	5377318	30
6	5377421	31
7	5377523	32
8	5377630	33
9	5377732	34
10	5377827	35
11	5377914	36
12	5378010	37
12	9092322	38
14	40731455	39
15		40
16		41
17		42
18		43
19		44
20		45
21		46
22		47
23		48
24		49
25		50

Book Mark: _____

See also _____

A- **5 Cav. (Col'd.) | Mass.**

Luther Nelson

....., Co. *L*, 5 Reg't Mass. Cav. (Col'd.)

Appears on

Company Descriptive Book

of the organization named above.

DESCRIPTION.

Age *18* years; height *5* feet *7* inches.

Complexion

Eyes; hair

Where born

Occupation

ENLISTMENT.

When, 186 ..

Where

By whom; term *2* y'rs.

Remarks: *Mustered in Co. D,
Jan. 29. 64. by L. McKibbin
Readville Mass,*

Hearst

A | **5 Col'd Cav.** | **Mass.**

Luther Nelson

Priv., Co. *D*, 5 Reg't Mass. Col'd Cav.

Appears on

Company Muster-in and Descriptive Roll
of the organization named above. Roll dated

Readville Mass, July 29, 1864.

Where born *New Bedford Mass.*

Age *18* y'rs; occupation *Farmer.*

When enlisted *July 16*, 1864.

Where enlisted *New Bedford.*

For what period enlisted *3* years.

Eyes *BRN*; hair *BRN*

Complexion *BRN*; height *5* ft. *3 3/4* in.

When mustered in *July 29*, 1864.

Where mustered in *Readville Mass*

Bounty paid \$ *100*; due \$ *100*

Where credited *1st Brit*

Company to which assigned _____

Remarks: _____

Book mark: _____

N 5 Col'd Cav. | **Mass.**

Luther Nelson

Dr, Co. D, 5 Reg't Mass. Col'd Cavalry.

Appears on

Company Muster Roll

for *Enlistment to May 27*, 1864.

Present or absent *present*

Stoppage, \$ _____ 100 for _____

Due Gov't, \$ _____ 100 for _____

Valuation of horse, \$ _____ 100

Valuation of horse equipments, \$ _____ 100

Remarks: *Sick in Hospital*

Book mark: _____

(358)

J. Davis
Copyist.

N | **5 Col'd Cav.** | **Mass.**

Luther Nelson

Priv, Co. D, 5 Reg't Mass. Col'd Cavalry.

Appears on

Company Muster Roll

for *March & Apr*, 186*4*.

Present or absent *Present*

Stoppage, \$ *100* for

Due Gov't, \$ *100* for

Valuation of horse, \$ *100*

Valuation of horse equipments, \$ *100*

Remarks:

Book mark:

(358)

Jamies
Copyist.

5 Col'd Cav. | **Mass.**

Luther Nelson

Sgt, Co. D, 5 Reg't Mass. Col'd Cavalry.

Appears on

Company Muster Roll

for *May + June*, 186*4*.

Present or absent *Absent*

Stoppage, \$ *100* for

Due Gov't, \$ *100* for

Valuation of horse, \$ *100*

Valuation of horse equipments, \$ *100*

Remarks:

Book mark:

Lewis

A | **5 Col'd Cav.** | **Mass.**

Suther Nelson

Pvt, Co. D, 5 Reg't Mass. Col'd Cavalry.

Appears on

Company Muster Roll

for July & Aug, 1864.

Present or absent Present

Stoppage, \$ 100 for

Due Gov't, \$ 100 for

Valuation of horse, \$ 100

Valuation of horse equipments, \$ 100

Remarks: _____

Book mark: _____

S. M. Mearns

Copyist.

A

5 Col'd Cav.

Mass.

Suther Nelson

Prin, Co. D, 5 Reg't Mass. Col'd Cavalry.

Appears on

Company Muster Roll

for Sept & Oct, 1864.

Present or absent Present

Stoppage, \$ 100 for

Due Gov't, \$ 100 for

Valuation of horse, \$ 100

Valuation of horse equipments, \$ 100

Remarks:

Book mark:

J. Merchant

(358)

Copyist.

A 5 Col'd Cav. | **Mass.**

Luther Nelson

Pl, Co. D, 5 Reg't Mass. Col'd Cavalry.

Appears on

Company Muster Roll

for *Jan & Dec*, 1864.

Present or absent *Present*

Stoppage, \$ *100* for

Due Gov't, \$ *100* for

Valuation of horse, \$ *100*

Valuation of horse equipments, \$ *100*

Remarks: *In Muster for Household
& Cavalry 1864*

Book mark :

A. Merchant

(358)

Copyist.

24. | 5 Col'd Cav. | Mass.

Luther Nelson

Pvt., Co. D, 5 Reg't Mass. Col'd Cavalry.

Appears on

Company Muster Roll

for *Jan's Feb*, 1865

Present or absent *Present*

Stoppage, \$ 100 for

Due Gov't, \$ 100 for

Valuation of horse, \$ 100

Valuation of horse equipments, \$ 100

Remarks: *Due 1 2 3, 4 Instat's*
U. S. Bounty

Book mark:

J. Merchant

1 | **5 Col'd Cav.** | **Mass.**

Leather Nelson

Pat, Co. D, 5 Reg't Mass. Col'd Cavalry.

Appears on

Company Muster Roll

for *Wm and Jane*, 1865.

Present or absent *Absent*

Stoppage, \$ 100 for

Due Gov't, \$ 100 for

Valuation of horse, \$ 100

Valuation of horse equipments, \$ 100

Remarks:

*Free before April 19, 1861
See 1, 2, 3, 4, 5 Inv U.S.
Warrant*

Book mark:

House

Lu | **5 Col'd Cav.** | **Mass.**

Luther Nelson

Pvt, Co. D, 5 Reg't Mass. Col'd Cavalry.

Appears on

Company Muster Roll

for July and Aug., 1865.

Present or absent Present

Stoppage, \$ 100 for

Due Gov't, \$ 100 for

Valuation of horse, \$ 100

Valuation of horse equipments, \$ 100

Remarks:

Join April 19, 1861. Due
1 2 3 4 5 One US Bounty
on advance with mission. R.R.
since July 27/65. S. C. 40

Book mark:

None
(358) Copyst.

A. | **5 Col'd Cav.** | **Mass.**

L. Nelson

Priv., Co. D, 5 Reg't Mass. Colored Cav.

Appears on **Returns** as follows:

Aug. & Sept. 1865. Absent on
detached duty as carpenter
at Brazos Santiago since
Aug. 28/65.

Book mark :

(546)

J. B. Sittler

Copyist.

N | **5 Col'd Cav. Mass.**

Luther Nelson

Pvt, Co. *D*, 5 Reg't Mass. Col'd Cavalry.

Appears on **Co. Muster-out Roll**, dated *Clarksville Texas Oct 31, 1865.*

Muster-out to date *Oct 31, 1865.*

Last paid to *Dec 31, 1864.*

Clothing account:

Last settled....., 186 ; drawn since \$ 100

Due soldier \$ 100; due U. S. \$ *2* ^{*55*} ₁₀₀

Am't for cloth'g in kind or money adv'd \$ 100

Due U. S. for arms, equipments, &c., \$ *11* ^{*50*} ₁₀₀

Bounty paid \$ 100; due \$ *30* ^{*00*} ₁₀₀

Remarks:

Total money value of advance charged \$ 11.50

Book mark:

House

Nelson Luther

, Co., 6 Reg't Mass Cavalry

Enclosures.

Bed Cards	Final Statements
Burial Records	Furloughs or L. of A.
Certs. of Dis. for Discharge	Med. Certificates
C. M. Charges	Med. Des. Lists
Descriptive Lists	Orders
Discharge Certificates	Pris. of War Record
Enlistment Papers	Resignations

Other papers relating to—

Admission to Hosp'l	Furlough or L. of A.
Casualty Sheet	Med. Examination
Confinement	Misc. Information /
Contracts	Pay or Clothing
Death or Effects	Personal Reports
Desertion	Rank
Discharge from Hosp'l	Transfer to Hosp'l
Discharge from Service	Transfer to V. R. C.
Duty	Transportation

Sept 6, 65
Letter

1871

Hospital Sept. 5th Miss Co
Sept 18 64

Guards at Stockade

Pass Luther Nelson
through Stockade with covering report
until further orders

Approved

Wm G. Parker

Adj. Surg. in chg.
St. Louis, Mo.

1063

Nelson, Philip

Co K, 5 Mass. Cav., (Col'd.)

Private

Bugler

CARD NUMBERS.

1	5383788	26
2	5383874	27
3	5383963	28
4	5384062	29
5	5384120	30
6	5384224	31
7	5384328	32
8	5384432	33
9	5384536	34
10	5384638	35
11	5384733	36
12	9436117	37
12	9091602	38
14		39
15		40
16		41
17		42
18		43
19		44
20		45
21		46
22		47
23		48
24		49
25		50

Book Mark:

See also

S 1035476 ~~Bo m~~
D. 1629120 ~~Bo m~~

H. L. ~~Bo m~~

77 | 5 Cav. Col'd | Mass.

Philip Wilson,

....., Co....., 5 Reg't Mass Col'd Cav

Appears on

Regimental Descriptive Book

of the organization named above.

DESCRIPTION.

Age 21 years; height 5 feet 5 inches.

Complexion dark.

Eyes dark; hair dark

Where born Baltimore, Md.

Occupation laborer.

ENLISTMENT.

When April 5, 1864.

Where Williamsburg

By whom P. Wilson; term 3 y'rs.

Remarks:

.....
.....
.....
.....
.....
.....
.....
.....
.....
.....

Harvin

K 5 Cav. (Col'd.) | Mass.

Philip Nelson

....., Co. *K*, 5 Reg't Mass. Cav. (Col'd.)

Appears on

Company Descriptive Book

of the organization named above.

DESCRIPTION.

Age *21* years; height *5* feet *5* inches.

Complexion *Dark*

Eyes *Dark*; hair *Dark*

Where born *Baltimore Md.*

Occupation *Laborer*

ENLISTMENT.

When *April 10th*, 186

Where *Williamstown*

By whom *J. H. Higginson*; term *3* y'rs.

Remarks: *Single. Residence Baltimore*

Md. Appointed Bugler Sept. 1864.

.....

.....

.....

.....

.....

.....

.....

.....

.....

.....

.....

.....

.....

.....

.....

.....

.....

.....

H. C. Thomas

A | **5 Col'd Cav.** | **Mass.**

Philip Wilson

Art, Co. D, 5 Reg't Mass. Col'd Cav.

Appears on
Company Muster-in and Descriptive Roll
of the organization named above. Roll dated
Newbridge Mass, April 12, 1864.

Where born Bullington N.H.

Age 26 y'rs; occupation Laborer

When enlisted April 10th, 1864.

Where enlisted Williamstown

For what period enlisted 3 years.

Eyes Blue; hair Blue

Complexion Blue; height 5 ft. 5 in.

When mustered in April 12, 1864.

Where mustered in Newbridge Mass.

Bounty paid \$ 100; due \$ 100

Where credited Newbridge Mass

Company to which assigned _____

Remarks: _____

Book mark: _____

Wilson

(356d) Copyist.

1 | **5 Col'd Cav.** | **Mass.**

Philip Wilson

1st, Co. K, 5 Reg't Mass. Col'd Cavalry.

Appears on

Company Muster Roll

for the 1st time, 186 .

Present or absent Present

Stoppage, \$ 100 for

Due Gov't, \$ 100 for

Valuation of horse, \$ 100

Valuation of horse equipments, \$ 100

Remarks:

Book mark:

Wilson

A | **5 Col'd Cav.** | **Mass.**

Philip Wilson

B, Co. K, 5 Reg't Mass. Col'd Cavalry.

Appears on

Company Muster Roll

for May & June, 1864.

Present or absent Present

Stoppage, \$ 100 for

Due Gov't, \$ 100 for

Valuation of horse, \$ 100

Valuation of horse equipments, \$ 100

Remarks:

Book mark:

5 Col'd Cav. | **Mass.**

Phillip Allen

101, Co. K, 5 Reg't Mass. Col'd Cavalry.

Appears on

Company Muster Roll

for *July & Aug*, 186*7*.

Present or absent *Present*

Stoppage, \$ *100* for

Due Gov't, \$ *100* for

Valuation of horse, \$ *100*

Valuation of horse equipments, \$ *100*

Remarks:

Book mark:

Allen

N | **5 Col'd Cav.** | **Mass.**

Philip Nelson

Reg't, Co. K, 5 Reg't Mass. Col'd Cavalry.

Appears on

Company Muster Roll

for Sept & Oct, 1864.

Present or absent Present

Stoppage, \$ 100 for

Due Gov't, \$ 100 for

Valuation of horse, \$ 100

Valuation of horse equipments, \$ 100

Remarks:

Book mark:

Ed. [unclear]

N | **5 Col'd Cav.** | **Mass.**

Philip Nelson

Reg't, Co. K, 5 Reg't Mass. Col'd Cavalry.

Appears on

Company Muster Roll

for Nov + Dec, 1864.

Present or absent Present

Stoppage, \$ 100 for

Due Gov't, \$ 100 for

Valuation of horse, \$ 100

Valuation of horse equipments, \$ 100

Remarks:

Book mark:

(358)

Philip Nelson

Copyist.

N | **5 Col'd Cav.** | **Mass.**

Philip Nelson

Reg't, Co. K, 5 Reg't Mass. Col'd Cavalry.

Appears on

Company Muster Roll

for Jan 5 Feb, 1865.

Present or absent Present

Stoppage, \$ 100 for

Due Gov't, \$ 100 for

Valuation of horse, \$ 100

Valuation of horse equipments, \$ 100

Remarks:

Book mark:

Edmundson

N | **5 Col'd Cav.** | **Mass.**

Philip Nelson

Company, Co. K, 5 Reg't Mass. Col'd Cavalry.

Appears on

Company Muster Roll

for March & April, 186 5.

Present or absent Present

Stoppage, \$ 100 for

Due Gov't, \$ 100 for

Valuation of horse, \$ 100

Valuation of horse equipments, \$ 100

Remarks:

Book mark:

(358)

Edmondson
Copyist.

N | **5 Col'd Cav.** | **Mass.**

Philip Nelson

Dugan, Co. K, 5 Reg't Mass. Col'd Cavalry.

Appears on

Company Muster Roll

for May 1 June, 1865.

Present or absent Present

Stoppage, \$ 100 for

Due Gov't, \$ 100 for

Valuation of horse, \$ 100

Valuation of horse equipments, \$ 100

Remarks:

Book mark:

(358)

Edmundson

Copyist.

71 | **5 Col'd Cav.** | **Mass.**

Phillip Nelson

Bugler, Co. K, 5 Reg't Mass. Col'd Cavalry.

Appears on

Company Muster Roll

for July & Aug., 186 5.

Present or absent Present

Stoppage, \$ 100 for

Due Gov't, \$ 100 for

Valuation of horse, \$ 100

Valuation of horse equipments, \$ 100

Remarks: Due U. S. for pistol
lost #16. Seen in quarters.

Book mark: _____

Galligan

(358)

Copyist.

W. | 5 Col'd Cav. | Mass.

Phillip Nelson

Bugler, Co. K, 5 Reg't Mass. Col'd Cavalry.

Appears on **Co. Muster-out Roll**, dated
Clarksville Texas, Oct. 31, 1865.

Muster-out to date Oct. 31, 1865.

Last paid to Dec. 31, 1864.

Clothing account:

Last settled....., 186 ; drawn since \$..... 100

Due soldier \$ 26¹¹/₁₀₀; due U. S. \$..... 100

Am't for cloth'g in kind or money adv'd \$..... 100

Due U. S. for arms, equipments, &c., \$ 19⁰⁰/₁₀₀

Bounty paid \$..... 100; due \$ 100⁰⁰/₁₀₀

Remarks:

Book mark: Des list on file see Mrs. Bon

Galligan

NO 11

87

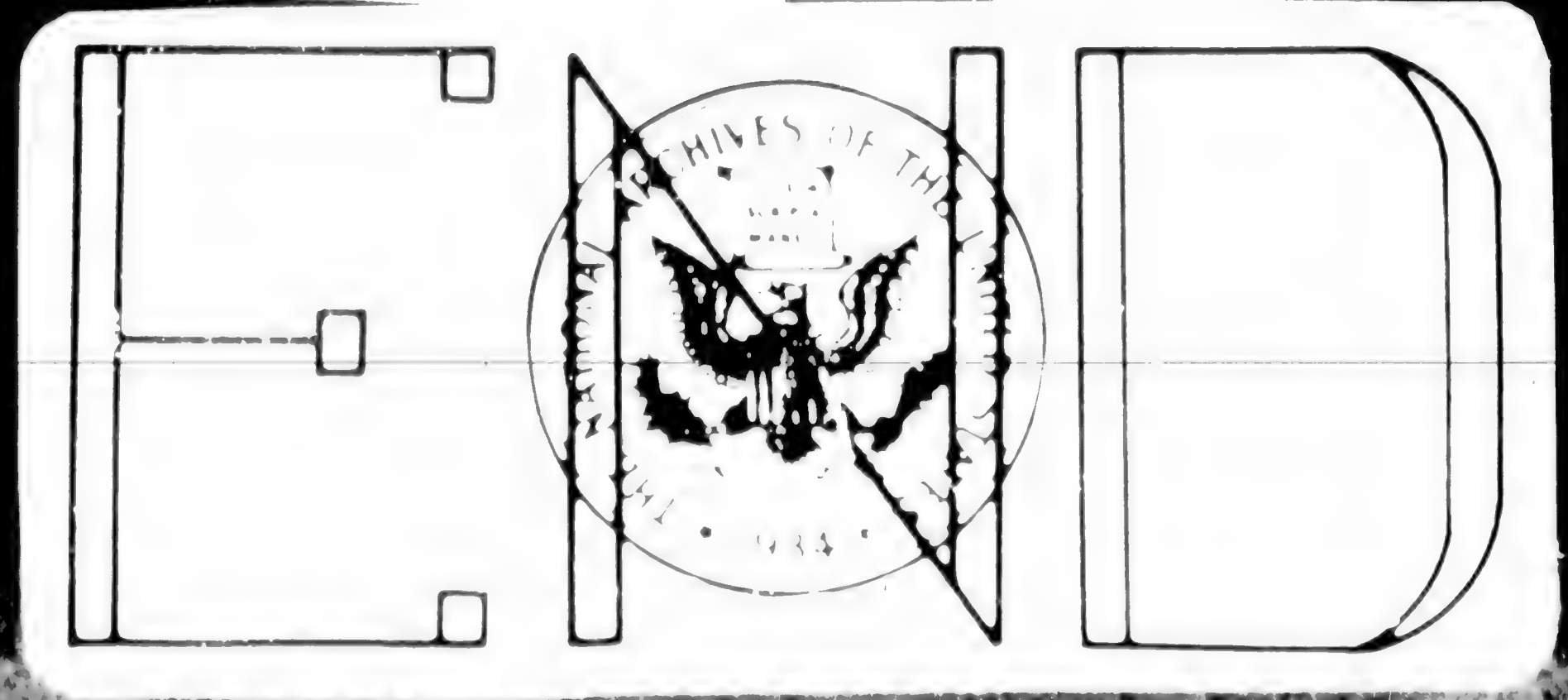

MICROCOPY

18

1

7

IMAGE EVALUATION TEST TARGET (QA-3)

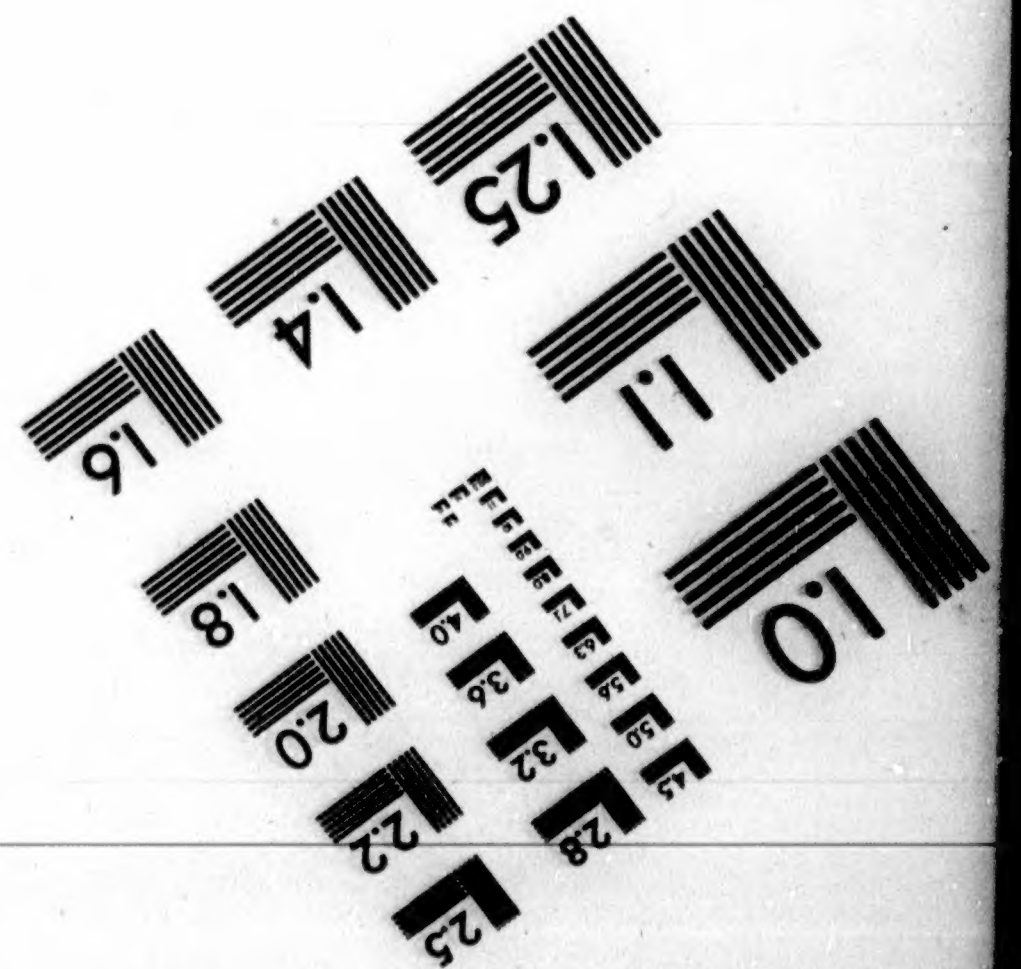
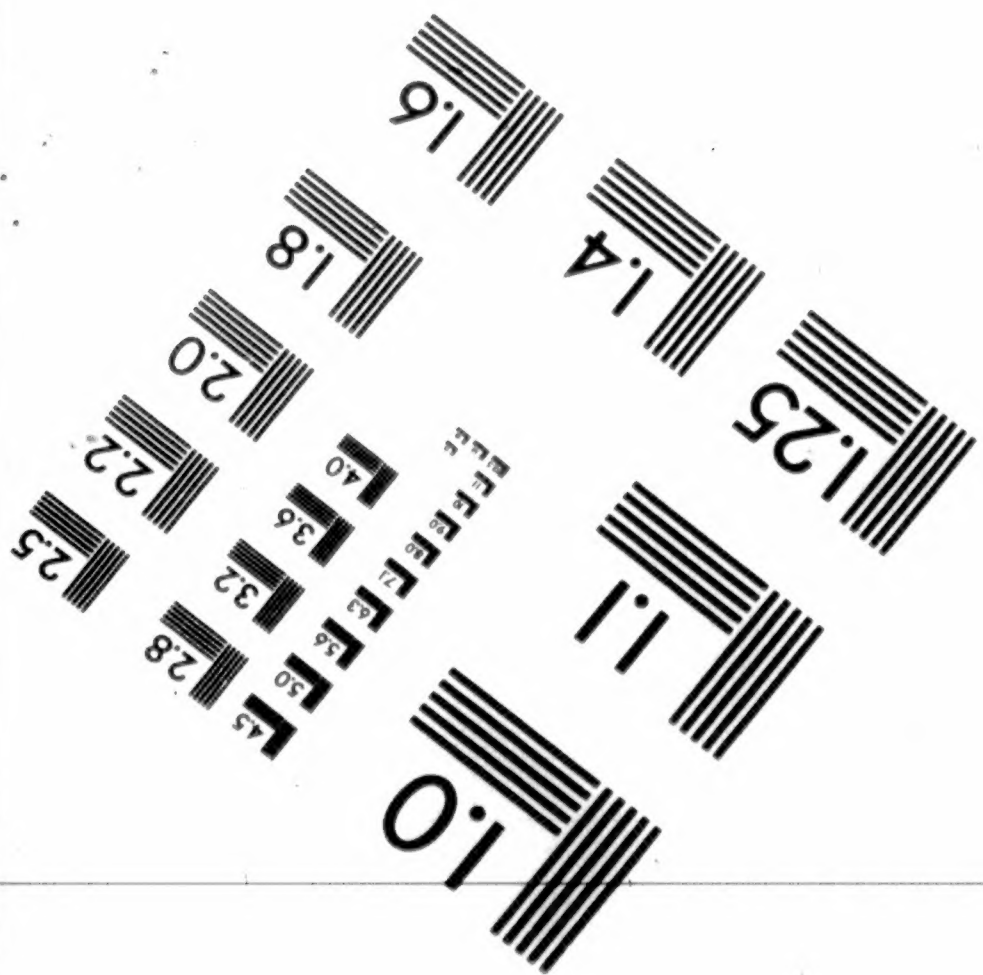
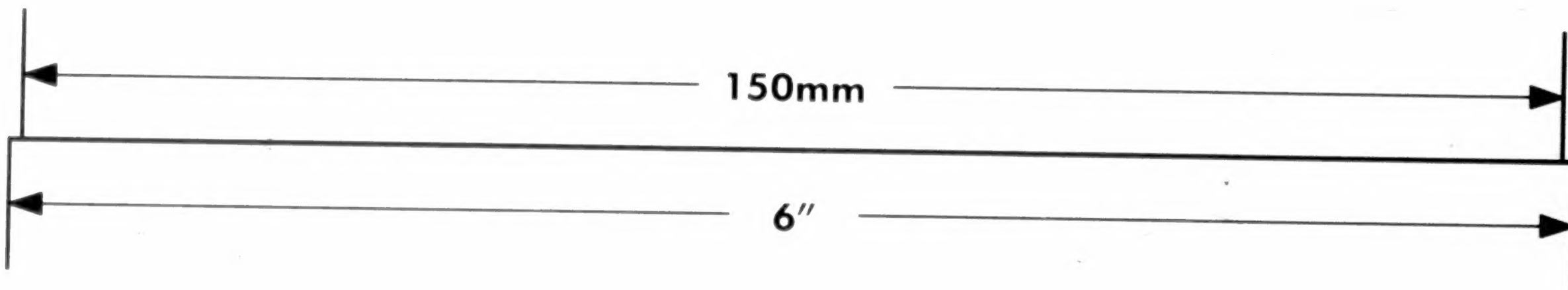
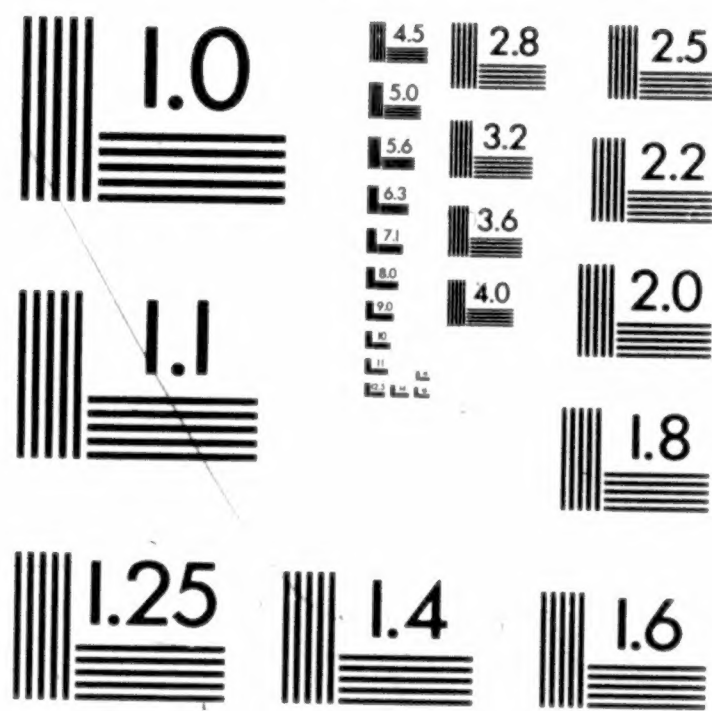
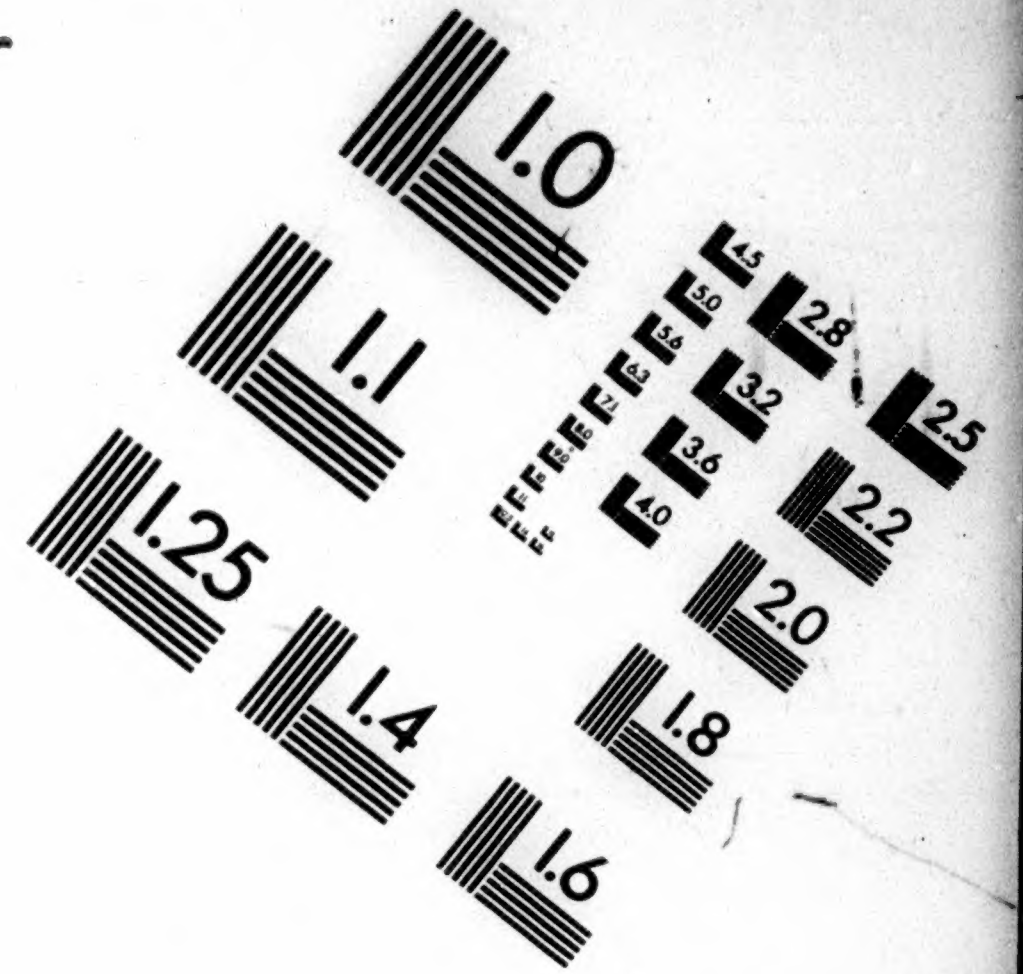
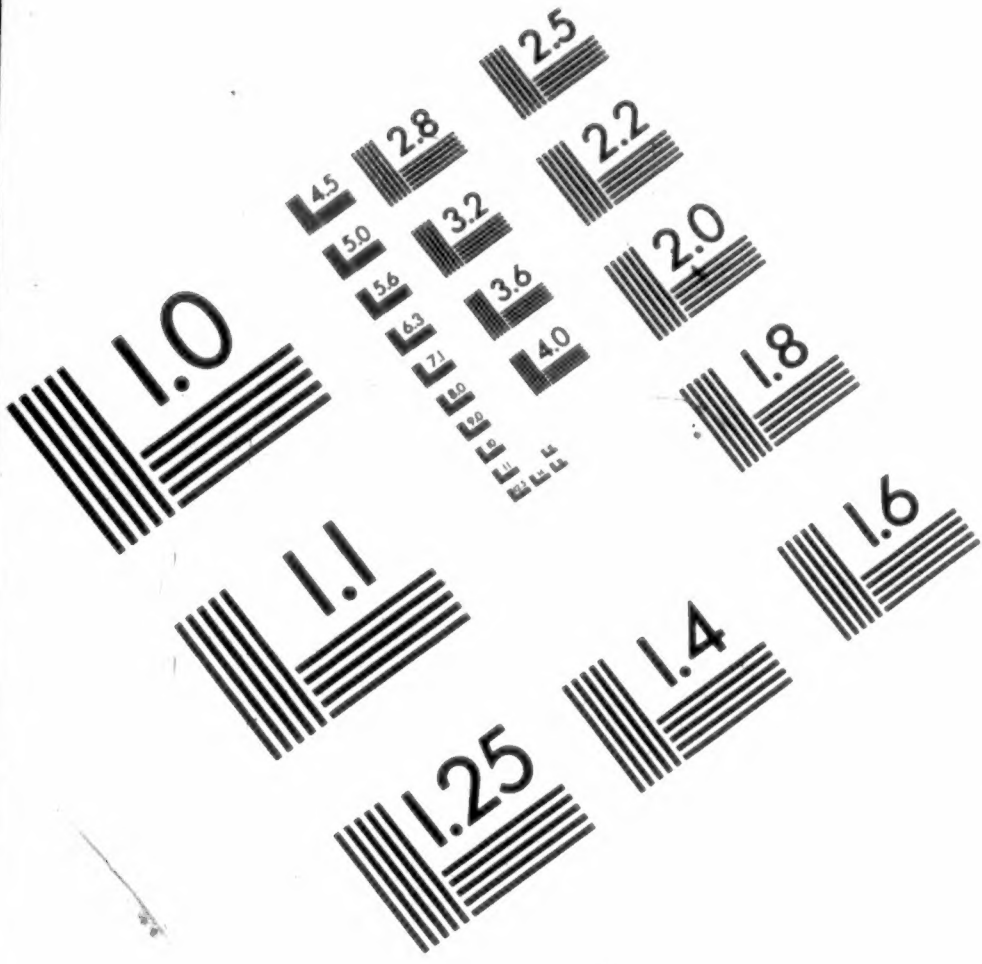

APPLIED IMAGE, Inc
1653 East Main Street
Rochester, NY 14609 USA
Phone: 716/482-0300
Fax: 716/288-5989

© 1993, Applied Image, Inc., All Rights Reserved

END

SE

IND

