

NATIONAL
ARCHIVES
MICROFILM
PUBLICATION

IMAGE EVALUATION TEST TARGET (QA-3)

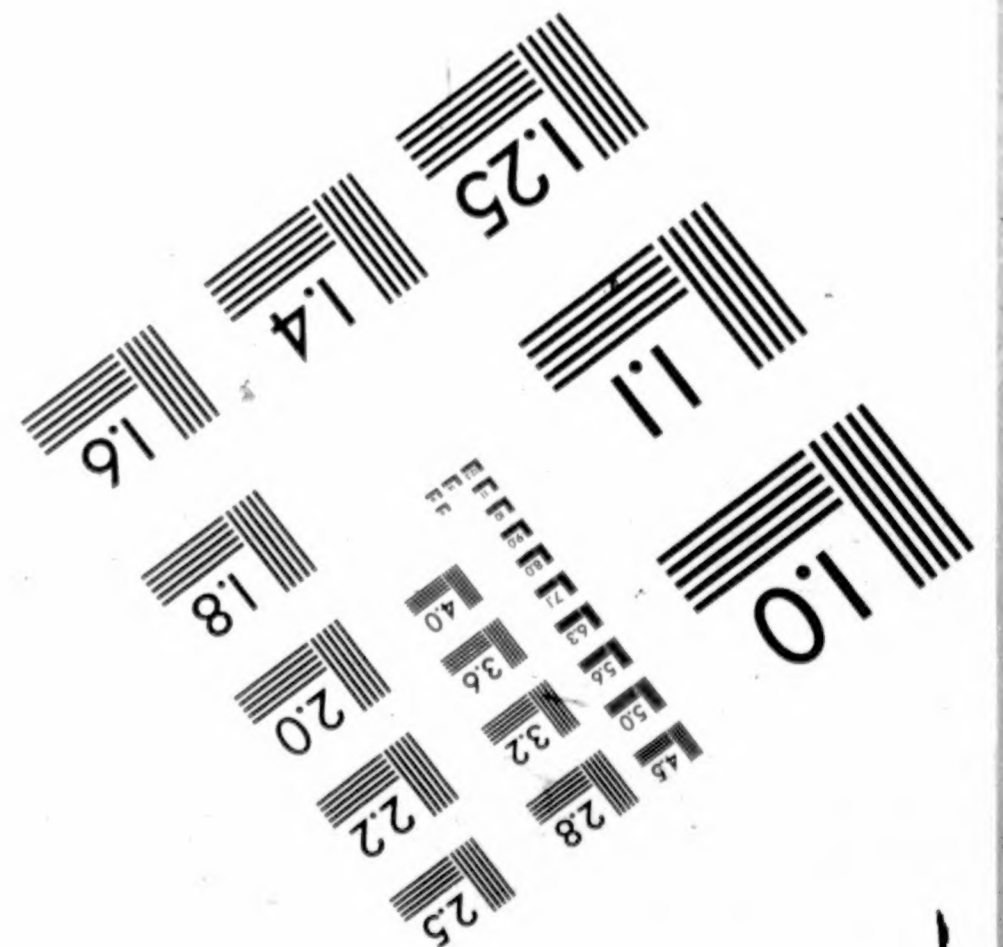
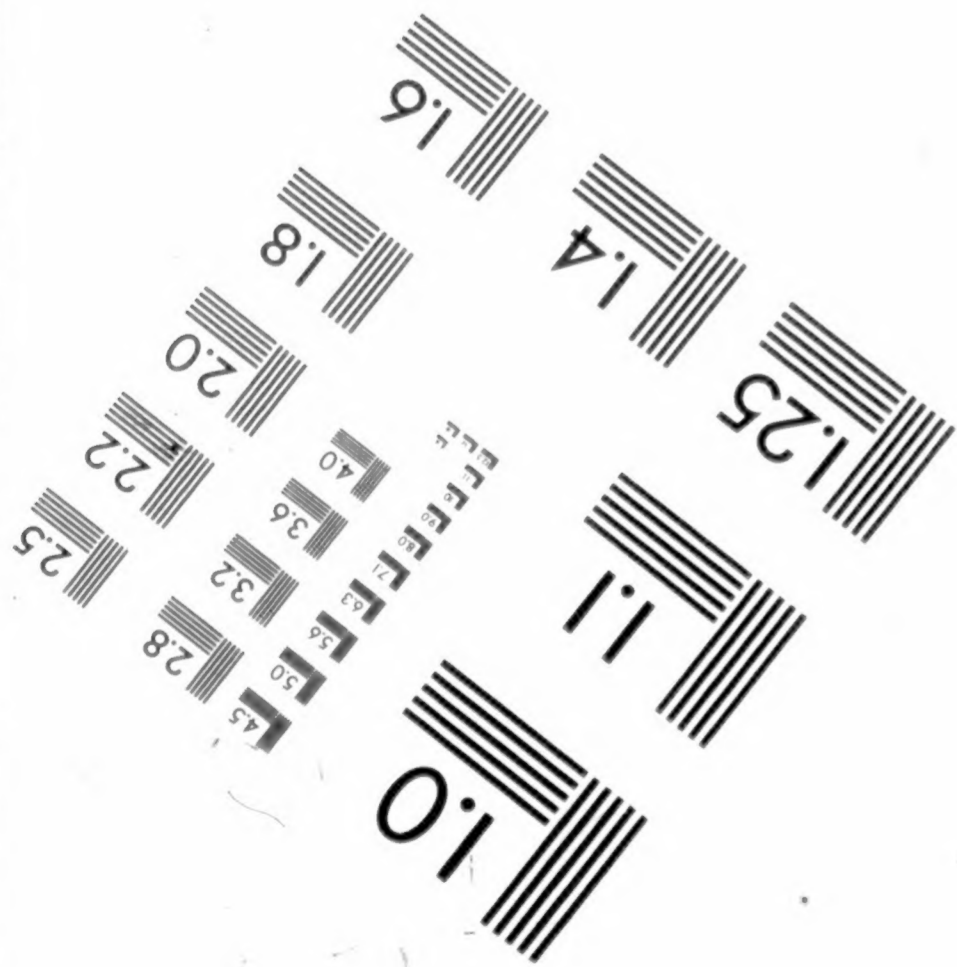
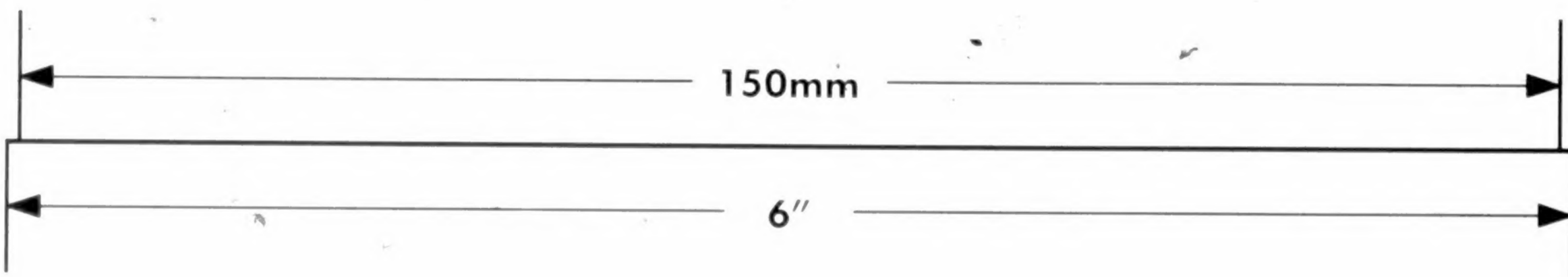
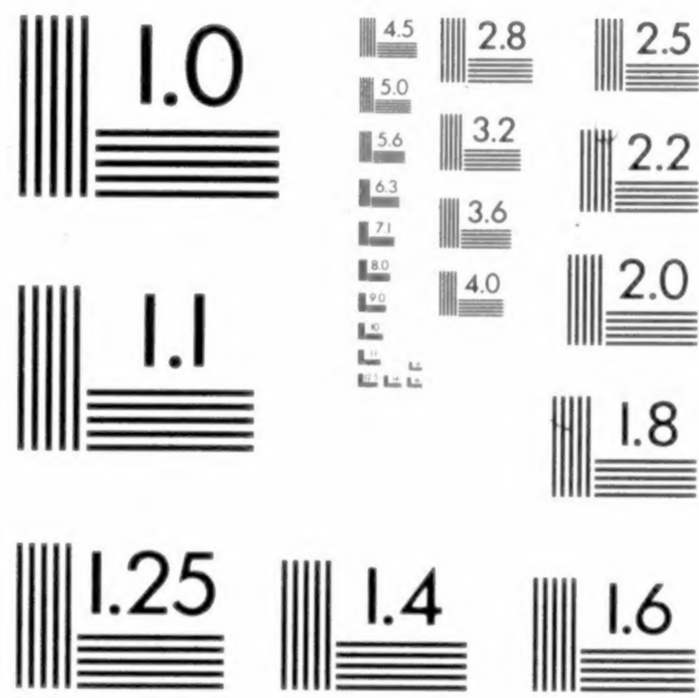
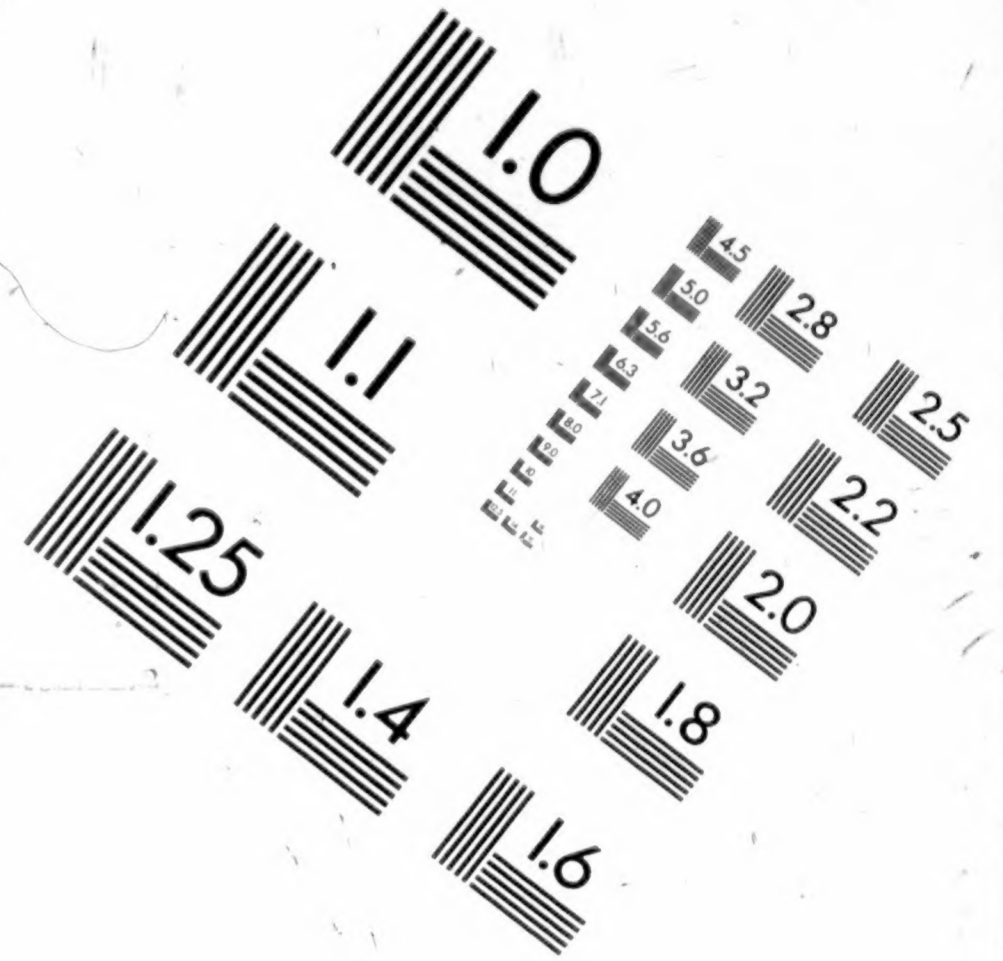
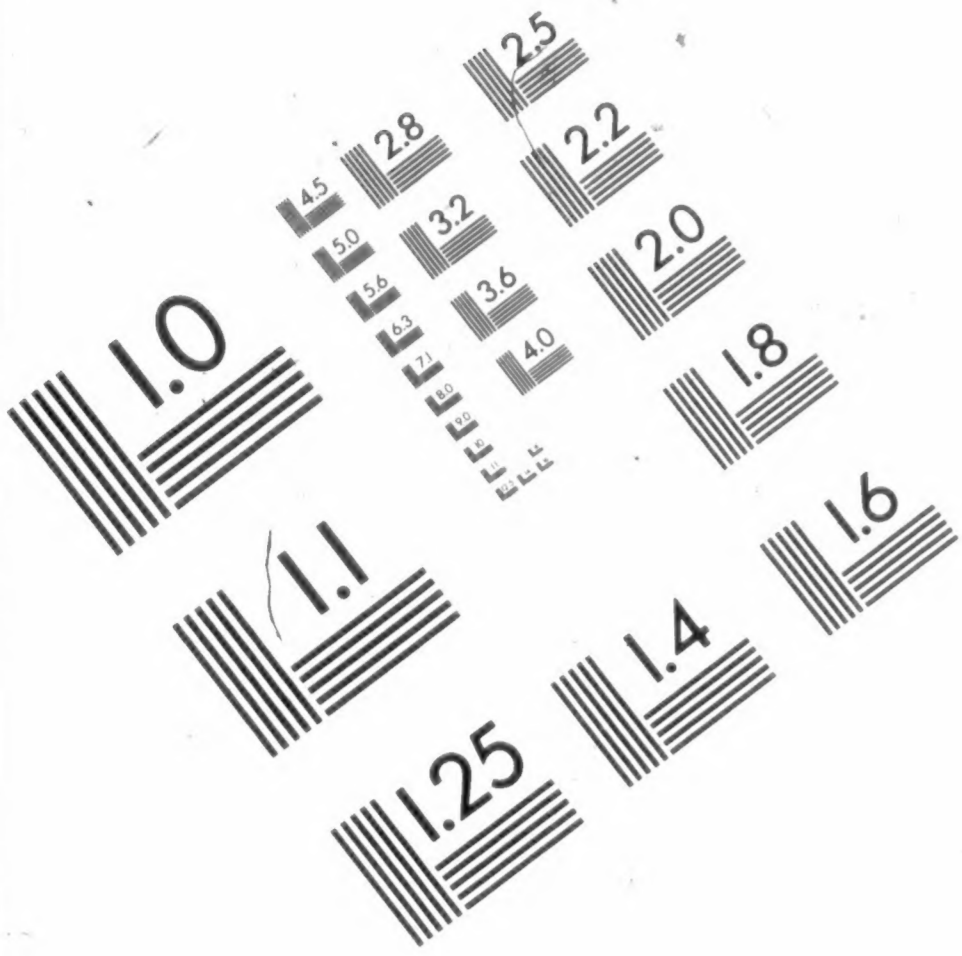

APPLIED IMAGE, Inc
1653 East Main Street
Rochester, NY 14609 USA
Phone: 716/482-0300
Fax: 716/288-5989

© 1993, Applied Image, Inc., All Rights Reserved

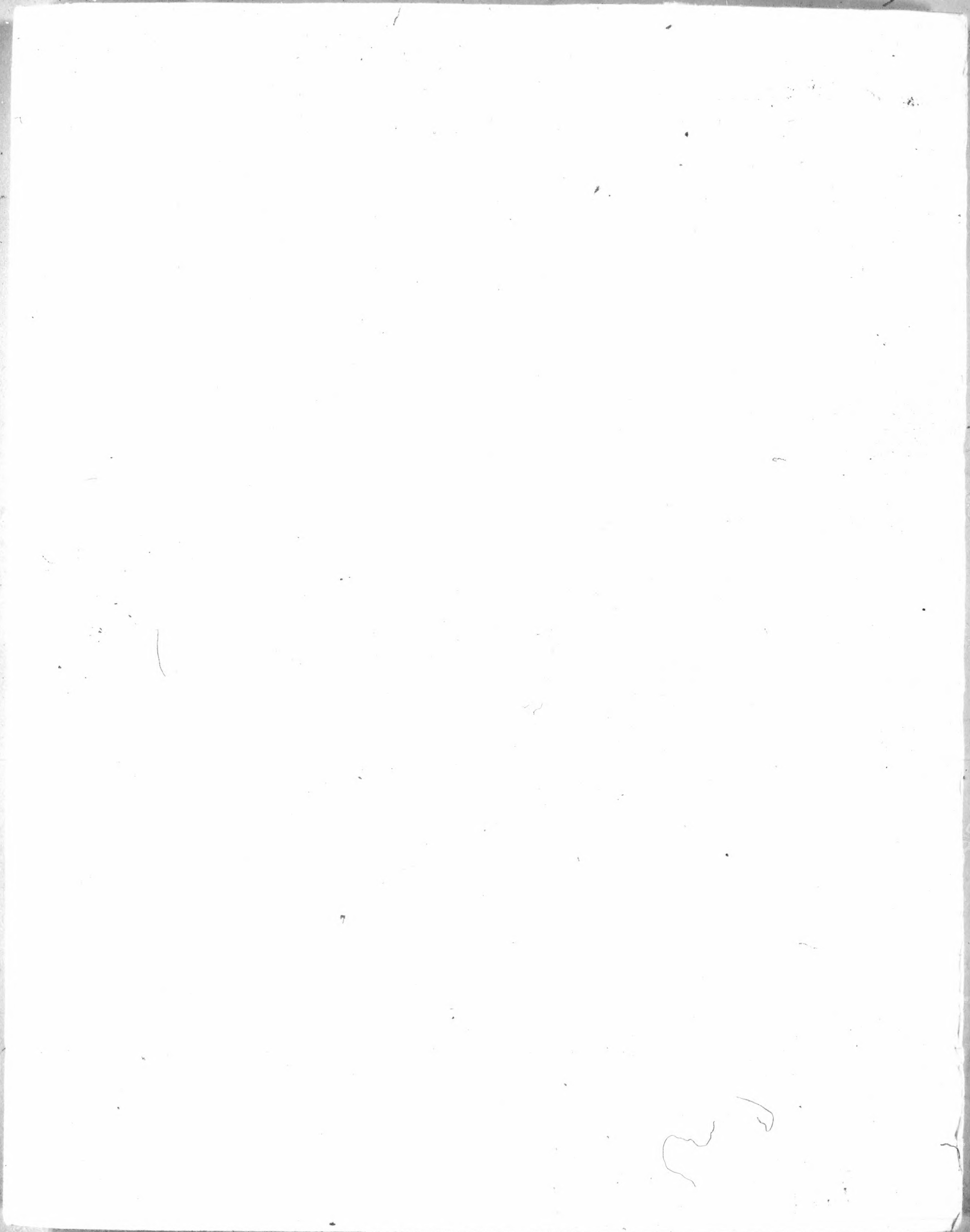

National Archives at College Park



8601 Adelphi Road College Park MD 20740-6001

J PROCTOR

OPERATOR

CAMERA

4-30-99

Z-3

DATE FILMED

REDUCTION RATIO

2461-0576-014-01

10

FILM EMULSION NUMBER

M1820

94

PROJECT NUMBER

ROLL NUMBER

MICROCOPY

1820

ROLL

94

M1820

COMPILED MILITARY SERVICE RECORDS OF
VOLUNTEER UNION SOLDIERS WHO SERVED WITH THE
UNITED STATES COLORED TROOPS:
2d Through 7th Colored Infantry, Including
3d Tennessee Volunteers (African Descent)
6th Louisiana Infantry (African Descent)
7th Louisiana Infantry (African Descent)

Introduction written by Budge Weidman, Project Manager

Records prepared for microfilming by volunteers of
the Civil War Conservation Corps

Pat Alfredson
Phyllis Altrogge
Kenneth Ashton
Sue Barnard*
Rex Bowser
Ann N. Brown
Jerry Brown
Robert Budway
Randy Caldwell
Mary Ann Castellana*
Mary Lou Cole
Giovanni Croce
B. H. Custer
Bob Denney
Earl Dunn
Yvette Fallin
Maria Flesher
Naomi Glass

Sue Goward*
Bert Greenstein
Anne Greenwood
Jim Harris
Walter Hayden
Mary Hayden
Pat Ikonen
Dick Ives
Sarah Jaffe
Barbara Kemp
Bev Manypenny
Frank Masterson
Joe Mazur
Kathleen McCarthy
Catherine McManus
Ben Miles
Dave Murray
Mary Poggioli

Peggy Pratt
Ray Puzio
Sylvia Scott
Lynn Shearouse
Charles Spencer
Mary Stack-Dunne
Ben Stearns
Bill Stormer*
Pat Sullivan
Gorman Tidball*
John Toole
Maryellen Toole
Dean Warner
Melody Warner
Milt Weatherhead
Russ Weidman
Robert Young

Team leaders are indicated by the asterisk.

National Archives and Records Administration
Washington, DC
1999

INTRODUCTION

On the 116 rolls of this microfilm publication, M1820, are reproduced the compiled military service records of volunteer Union soldiers belonging to the 2d through the 7th United States Colored Infantry units, including the 3d Tennessee Volunteers (African Descent) and the 6th and 7th Louisiana Infantries (African Descent). These units were part of the United States Colored Troops (USCT). The USCT included 7 numbered cavalry regiments; 13 numbered artillery regiments plus 1 independent battery; 144 numbered infantry regiments; Brigade Bands Nos. 1 & 2 (Corps d'Afrique and US Colored Troops); Powell's Regiment Colored Infantry; Southard's Company Colored Infantry; Quartermaster Detachment; Pioneer Corps, 1st Division, 16th Army Corps; Pioneer Corps, Cavalry Division, 16th Army Corps; Unassigned Company A Colored Infantry; and Unassigned USCT. There are also miscellaneous service cards arranged alphabetically by surname at the end of the unit records. The records reproduced are part of the Records of the Adjutant General's Office, 1780's-1917, Record Group (RG) 94.

Background

United States Colored Troops

Since the time of the American Revolution, African Americans have volunteered to serve their country in time of war. The Civil War was no exception. Official sanction was the difficulty. In the fall of 1862 there were four Union regiments of African Americans raised in New Orleans, LA: the 1st, 2d, and 3d Louisiana Native Guard, and the 1st Louisiana Heavy Artillery (African Descent). The 1st South Carolina Infantry (African Descent) was not officially organized until January 1863; however, three companies of the regiment were on coastal expeditions as early as November 1862. The 1st Kansas Colored Infantry was not mustered into Federal service until January 1863, even though the regiment had already participated in the action at Island Mound, MO, on October 27, 1862. These early unofficial regiments received little Federal support, but they showed the strength of the African American soldier's desire to fight for freedom.

The first official authorization to employ African Americans in Federal service was the Second Confiscation and Militia Act of July 17, 1862. This act allowed President Abraham Lincoln "to receive [African Americans] into the service of the United States, for the purpose of constructing entrenchments, or performing camp service, or any other labor, or any military or naval service for which they may be found competent." The President did not authorize use of African Americans in combat, however, until issuance of the Emancipation Proclamation on January 1, 1863.

In late January 1863 Governor John Andrew of Massachusetts received permission to raise a regiment of African American soldiers. The pace of organizing additional regiments was very slow. In March Secretary of War Edwin M. Stanton sent Gen. Lorenzo Thomas to the lower Mississippi Valley to recruit free and

contraband African Americans. Thomas was given broad authority. He was to explain the administration's policy regarding African American soldiers and recruit volunteers to raise and command them. Stanton wanted all officers of such units to be white, but that policy was softened to allow African American surgeons and chaplains. By the end of the war, in addition to the chaplains and surgeons, there were 87 African American officers. Thomas's endeavor was very successful, and on May 22, 1863, the Bureau of Colored Troops was established to coordinate and organize regiments from all parts of the country. Created under War Department General Order No. 143, the bureau was responsible for handling "all matters relating to the organization of Colored Troops." The bureau was directly under the Adjutant General's Office and its procedures and rules were specific and strict. All African American regiments were now to be designated United States Colored Troops (USCT). At this time there were some African American regiments with state names and a few regiments in the Department of the Gulf designated as Corps d'Afrique. The Corps d'Afrique units ultimately became numbered regiments in the USCT. The 54th and 55th Massachusetts Infantries (Colored), the 5th Massachusetts Cavalry (Colored), the 29th Connecticut Infantry (Colored), the 6th and 7th Louisiana Infantries (African Descent), the 3d Tennessee Volunteers (African Descent), and the 1st South Carolina Volunteers (Colored) retained their number and state designations.

To facilitate recruiting in the states of Maryland, Missouri, Tennessee, and eventually Kentucky, the War Department issued General Order No. 329 on October 3, 1863. Section 6 of the order stated that if any citizen should offer his or her slave for enlistment into the military service, that person would, "if such slave be accepted, receive from the recruiting officer a certificate thereof, and become entitled to compensation for the service or labor of said slave, not exceeding the sum of three hundred dollars, upon filing a valid deed of manumission and of release, and making satisfactory proof of title." For this reason, some records of manumission are contained in the compiled service records reproduced in this publication.

The USCT fought in 39 major engagements and over 400 lesser ones. Sixteen African American soldiers received the Congressional Medal of Honor. As it was in other units, the death toll from disease was very high in the USCT. Deaths from disease and battle totaled 37,000. The last regiment of the USCT was mustered out of Federal service in December 1867.

Important sources for information about African American units in the Civil War are the War Department's *The War of the Rebellion: A Compilation of the Official Records of the Union and Confederate Armies* (Washington, DC: 1880-1901; reprinted Harrisburg, PA, 1971 and 1985) and the Navy Department's *The War of the Rebellion: A Compilation of the Official Records of the Union and Confederate Navies* (Washington, DC: 1874-1922; reprinted Harrisburg, PA, 1971 and 1985). These multivolume works contain reports of operations and other official correspondence.

2d United States Colored Infantry

This regiment was organized at Arlington, VA, from June 23 to November 11, 1863, to serve 3 years. During its existence, the regiment served in New Orleans, LA, and Ship Island, MI. In 1864 the unit moved to Key West and participated in operations on the west coast of Florida. On February 20, 1865, Companies D and I took part in the attack on Fort Myers, FL. Subsequent service took place in the District of Florida until the regiment was mustered out on January 5, 1866.

3d United States Colored Infantry

This regiment was organized at Camp William Penn, Philadelphia, PA, from August 3 to 10, 1863, to serve 3 years. The regiment participated in the siege of Fort Wagner, SC, and operations against Charleston, SC. In 1864 the unit moved to Jacksonville, FL, and maintained duty in the area until being mustered out October 31, 1865.

3d Tennessee Volunteers (African Descent)

This regiment was organized in the spring of 1864 in Memphis, TN, for the defense of that city. Most of the men were transferred to the 7th United States Colored Heavy Artillery, which was redesignated the 11th United States Colored Infantry (New) on January 23, 1865. There are service records pertaining to the officers and men in the 3d Tennessee Volunteers as well as in the 11th United States Colored Infantry (New).

4th United States Colored Infantry

The regiment was organized at Baltimore, MD, July 15 to September 1, 1863, to serve 3 years. The unit participated in actions in Virginia at Bermuda Hundred, Petersburg, Dutch Gap, and Chaffin's Farm. In North Carolina the regiment took part in the battle and capture of Fort Fisher, Sugar Loaf Hill, and the city of Wilmington. In these actions the regiment sustained losses of 355 officers and men wounded, missing, or killed. The regiment was mustered out of service May 6, 1866.

5th United States Colored Infantry

This regiment was organized at Camp Delaware, OH, from August 6, 1863, to January 15, 1864, to serve 3 years. In Virginia the regiment served at Norfolk and Portsmouth and participated in major battles at Petersburg, Chaffin's Farm, and Fair Oaks. The regiment took part in the capture of Fort Fisher and the city of Wilmington in North Carolina. Its remaining service took place in North Carolina until it was mustered out on September 20, 1865.

6th United States Colored Infantry

This regiment was organized at Camp William Penn, Philadelphia, PA, from July 28 to September 12, 1863, to serve 3 years. The unit participated in battles at Chaffin's Farm, Williamsburg, and Petersburg in Virginia and at Sugar Loaf Hill, NC. During these actions the regiment sustained losses of 237 killed, wounded, or missing. The regiment was mustered out September 20, 1865.

6th Louisiana Infantry (African Descent)

This regiment was organized for 60 days in New Orleans, LA, on July 4, 1863. The unit served at New Orleans and was mustered out August 13, 1863.

7th United States Colored Infantry

This regiment was organized at Baltimore, MD, from September 26 to November 12, 1863, to serve 3 years. The unit served in Virginia, Florida, and South Carolina. It was mustered out of service October 13, 1866.

7th Louisiana Infantry (African Descent)

This regiment was organized for 60 days in New Orleans, LA, on July 10, 1863. It served in New Orleans until it was mustered out on August 6, 1863.

Records Description

Compiled service records consist of a jacket-envelope for each soldier, labeled with his name, rank, unit, and card numbers. The compilation of service records of Union soldiers began in 1890 under the direction of Col. Fred C. Ainsworth, head of the Record and Pension Office of the Adjutant General's Office, Department of War. Information from muster rolls, regimental returns, descriptive books, and other records was copied verbatim onto cards. A separate card was prepared each time an individual name appeared on a document. These cards were numbered on the back, and these numbers were entered onto the outside jacket containing the cards. The carded information was verified by a separated operation of comparison; great care was taken to ensure that the cards were accurate.

A typical jacket contains card abstracts of entries found in original records relating to the soldier and original documents relating solely to that soldier. Examples of the latter include enlistment papers, substitute certificates, casualty sheets, death reports, prisoner-of-war memorandums, and correspondence. Unique to the records of the USCT are deeds of manumission, oaths of allegiance, proof of ownership, certificates of monetary award, and bills of sale. These items appear most frequently in units recruited in the border states of Kentucky, Missouri, and Maryland. These states remained in the Union but were slave states. Jackets and cards include a section labeled "bookmark," which was reserved for cross-references to other records relating to the individual or his unit. The service records are

NATIONAL ARCHIVES MICROFILM PUBLICATIONS

arranged by arm of service, thereunder numerically by regiment or independent battalion or company, and thereunder alphabetically by name of the soldier. Records for officers are interfiled alphabetically by name with the records of enlisted men. If an individual served in more than one unit, which was typical for USCT officers, there will be a separate service record for each unit in which he served.

The unjacketed miscellaneous cards were accumulated by the War Department with the expectation that they would be incorporated in individual compiled service records. This expectation was never fulfilled, however, because either insufficient or contradictory information made it impossible to associate the cards or papers with a particular soldier's service records.

Related Records

Among the records of the Adjutant General's Office in the National Archives are many of the original records that were abstracted or "carded" by the Record and Pension Office. These include the individual unit's muster rolls, returns, and descriptive books. Other series in RG 94 that contain information relating to volunteer Union soldiers who served with the USCT include carded records relating to Union staff officers, carded medical records of volunteer Union soldiers, unbound and bound regimental records and "record of events" cards. The regimental records of the 54th Massachusetts Infantry (Colored) have been reproduced as Microfilm Publication M1659, *Records of the Fifty-fourth Massachusetts Infantry Regiment (Colored), 1863-1865*.

The "record of events" cards include information copied from the unit's muster rolls and returns. They show the stations of the field and staff and the companies of the regiment at the time the muster roll or return was prepared and sometimes mention battles, skirmishes, or other activities in which the regiment participated. The cards have been reproduced as Microfilm Publication M594, *Compiled Records Showing Service of Military Units in Volunteer Union Organizations*.

Record Group 94 also includes a card index for the USCT, reproduced as Microfilm Publication M589, *Index to Compiled Military Service Records of Volunteer Union Soldiers Who Served with U.S. Colored Troops*, which may be used to locate the regiment of a USCT soldier. An index card gives the name of the soldier and his rank, as well as the unit in which he served; sometimes there is a cross-reference to his service in other units or organizations. The National Archives is continually producing microfilm publications of volunteer Union compiled military service records. A complete listing of finished publications can be found in the National Archives *Microfilm Resources for Research: A Comprehensive Catalog*, which is available online at <http://www.nara.gov>.

The records of the Colored Troops Division, within RG 94, include division correspondence and records relating to recruiting, the appointment of officers, and the slave or free status of individuals, as well as a compilation of historical extracts

NATIONAL ARCHIVES MICROFILM PUBLICATIONS

and official papers concerning the military service of African Americans from the colonial period through the Civil War entitled *The Negro in the Military Service of the United States, 1639–1886*. This compilation is reproduced as Microfilm Publication M858. The records of the Bounty and Claims Division, also in RG 94, include correspondence of the division and records relating to bounties and claims paid to loyal owners of slaves by the Slave Claims Commissions of Delaware, Kentucky, Maryland, Missouri, Tennessee, and West Virginia.

If a soldier applied for a pension, the pension application case file may be among the Records of the Veterans Administration (RG 15). Indexes to the pension applications have been reproduced as Microfilm Publications T288, *General Index to Pension Files, 1861–1934*, and T289, *Organizational Index to Pension Files of Veterans Who Served Between 1861 and 1900*.

If a soldier or officer was tried before a general court-martial or if an individual or his unit was the subject of a court of inquiry or military commission, transcripts of those proceedings may be among the Records of the Office of the Judge Advocate General (Army) (RG 153). The registers to the proceedings have been reproduced as Microfilm Publication M1105, *Registers of the Records of the Proceedings of the U.S. Army General Courts-Martial, 1809–1890*.

Other record groups having information pertaining to the USCT include Records of the Bureau of Refugees, Freedmen, and Abandoned Lands (RG 105); Records of the Provost Marshal General's Bureau (Civil War) (RG 110); Records of the Accounting Officers of the Department of the Treasury (RG 217); and Records of U.S. Army Continental Commands, 1821–1920 (RG 393).

Holdings of the National Archives relating to the Civil War are outlined in Kenneth W. Munden and Henry Putnam Beers, *Guide to Federal Archives Relating to the Civil War* (Washington, DC: National Archives, 1962) and Henry Putnam Beers, *Guide to the Archives of the Government of the Confederate States of America* (Washington, DC: National Archives, 1968), which were reprinted as *The Union* (1986) and *The Confederacy* (1986).

ROLL LIST

Roll Description

2d United States Colored Infantry

- 1 Abram, Abraham - Bell, Daniel A.
- 2 Bell, Henry - Brown, Thomas
- 3 Brown, William - Clark, Moses
- 4 Clark, Stephen - Downing, Dennis
- 5 Downs, John - Gavin, Benjamin
- 6 Gibbs, Paton - Haskins, Iverson
- 7 Hasler, William - Jenkins, Charles
- 8 Johnson, Albert - Kratzenberg, Augusta
- 9 Kratzenberg, Charles - Miller, Thomas
- 10 Mills, John Q. - Pettis, Alfred
- 11 Pettis, Frank - Russ, Charles
- 12 Russell, Charles - Spindle, James E.
- 13 Sprague, Benedict - Thoroughgood, Miles E.
- 14 Thornson, Charles H. - West, James
- 15 West, Nimrod - Woodson, William
- 16 Woodward, George G. - Young, William A.

2d United States Colored Infantry Miscellaneous Service Cards

- 16 Ackis, George - Young, Samuel

3d United States Colored Infantry

- 17 Abbot, Charles S. - Bohlen, John
- 18 Bond, Charles - Clemens, William
- 19 Clemmons, Joseph - Fernow, Edward B. F.
- 20 Fields, Alfred - Harmon, William K.
- 21 Harris, George - Jackson, Frederick
- 22 Jackson, George - LaCount, Charles J.
- 23 Ladson, Thomas - Miller, Henry
- 24 Miller, John - Preslin, Stephen
- 25 Preston, Joseph - Shorter, Daniel
- 26 Shorter, John W. - Thompson, George A.
- 27 Thompson, John - Williams, Edward
- 28 Williams, Enoch - Young, William H.

3d United States Colored Infantry Miscellaneous Service Cards

- 29 Abbott, Chas. - Wright, Lorenzo

3d Tennessee Volunteers (African Descent)

30 Ady, George - Young, Samuel

4th United States Colored Infantry

31 Abney, Richard - Bass, James
 32 Batsom, David - Brown, Stephen R.
 33 Brown Uriah - Cherry, Thomas
 34 Chew, Josiah - Davis, Jeremiah
 35 Davis, John H. J. - Ellis, John J.
 36 Emery, Enoch - Gray, James
 37 Grayson, Noble - Hause, William
 38 Hawkins, Alexander - Jackson, John
 39 Jackson, John Daniel - Jones, John
 40 Jones, John Robert - Linthicum, Dennis C.
 41 Linthicum, George L. - Mercer, Benjamin F.
 42 Mickens, Thomas H. - Novel, Charles
 43 Odiorne George G. - Reynolds, S. Walter
 44 Rezin, George F. - Seymour, George W.
 45 Seymour, Thomas - Stockett, Samuel
 46 Stokes, George E. W. - Veal, Charles
 47 Viney, Richard - Willett, James
 48 Williams, Adam - Zimmons, Charles

4th United States Colored Infantry Miscellaneous Service Cards

49 Adams, James O. - Juricks, Jacob
 50 Kane, Chas. - Zook, Gray

5th United States Colored Infantry

51 Adams, John - Black, Edward
 52 Blackburn, Daniel - Brown, James
 53 Brown, J. R. - Coleman, James
 54 Coleman, Thornton - Duckwilder, Clayburn
 55 Dudley, George - Gilson, James
 56 Glasgow, James - Herse, Jerry
 57 Hervit, John - Johnson, Arthur B.
 58 Johnson, Charles - Lett, William
 59 Levis, Hezekiah - McFarland, Allen
 60 McFarland, John - Page, David
 61 Page, Isaiah - Rider, William H.
 62 Ridgeway, John - Sloan, Samuel
 63 Sly, William - Teeters, Charles
 64 Teeters, Henry W. - Walker, William
 65 Walker, Willis - Winters, James

NATIONAL ARCHIVES MICROFILM PUBLICATIONS

66 Winters, Oscar - Zimmerman, Henry

5th United States Colored Infantry Miscellaneous Service Cards

66 Alexander, Arthur - Kyser, Henry

67 Ladd, Andrew - Young, Thomas

6th United States Colored Infantry

68 Abraham, Jacob - Bolier, Abram

69 Boo, David - Carey, Walter

70 Carr, William - Davis, Peter

71 Davis, Robert - Fiderman, William C.

72 Field, Edward - Gustus, John R.

73 Guy, William - Hopkins, James

74 Hosfield, Lewis M. - Johnson, John Henry

75 Johnson, John W. - Lemon, George

76 Lett, Nelson - Miller, John

77 Miller, Lawson L. - Pierce, Alfred B.

78 Pierce, George - Ruff, Jacob

79 Russell, Lloyd - Smith, William H.

80 Snowden, Henry - Van Clief, Emanuel

81 Van Vrankin, William H. - Wilson, Anthony

82 Wilson, Charles - Young, John

6th United States Colored Infantry Miscellaneous Service Cards

82 Abrams, Jacob - Furgerson, Henry

83 Gadsby, John - Young, Richard

6th Louisiana Infantry (African Descent)

84 Aaron, Koff - Chevarre, Ernest

85 Cheveau, Auguste - Guimiase, Julian

86 Gusman, Thomas - Meyer, Wilson

87 Michael, Louis - Sorza, Antoine

88 Span, Octavus - Zenon, Aristide

7th United States Colored Infantry

89 Abraham, John - Bardy, Joseph

90 Bargus, James J. - Bowyer, Littleton

91 Bowzer, Emory - Bundick, Henry

92 Burden, Daniel - Chase, Henry

93 Chase, Isaac - Crawford, George W.

94 Cray, Charles M. - Drummond, William

NATIONAL ARCHIVES MICROFILM PUBLICATIONS

- 95 Dumpson, George - Gale, Joseph
- 96 Gamby, Charles - Griffin, Charles W.
- 97 Griffin, George E. - Hazelton, William
- 98 Hearn, William E. - Jackson, George H.
- 99 Jackson, Henry - Johnson, Samuel
- 100 Johnson, Stephen - Landsell, William
- 101 Lane, William - Melvin, Sime
- 102 Merrill, Lewis - Nichols, Lloyd
- 103 Noonan, William F. - Purnell, James
- 104 Purnell, John H. - Russell, Thomas
- 105 Russum, Alexander - Smith, James R.
- 106 Smith, James W. - Taylor, Daniel
- 107 Taylor, Levin H. - Vaughn, John H.
- 108 Veasey, Edward - Whitman, Moses P.
- 109 Whittica, James - Wright, John Wesley
- 110 Wright, Joseph - Young, Thomas

7th United States Colored Infantry Miscellaneous Service Cards

- 110 Adams, Gilbert - Kutchumber, Jacob
- 111 Landon, Perry H. - Young, Stephen

7th Louisiana Infantry (African Descent)

- 112 Able, Alfred - Colar, Manuel
- 113 Cole, Arnold - Holland, John C.
- 114 Holland, Jules - Myers, Victor
- 115 Narcisse, James - Swails, George A.
- 116 Sylvester, Joseph - Zoodrick, Dick

7th Louisiana Infantry (African Descent) Miscellaneous Service Cards

- 116 Allen, Charles - Whittey, Hiram C.

NATIONAL ARCHIVES MICROFILM PUBLICATIONS

Microfilm Publication M1820

COMPILED MILITARY SERVICE RECORDS OF VOLUNTEER UNION
SOLDIERS WHO SERVED WITH THE UNITED STATES COLORED TROOPS:
2d Through 7th United States Colored Infantry, Including 3d Tennessee Volunteers
(African Descent), 6th Louisiana Infantry (African Descent), 7th Louisiana Infantry
(African Descent)

Roll 94

7th United States Colored Infantry

Cray, Charles M. - Drummond, William

NATIONAL ARCHIVES AND RECORDS ADMINISTRATION

NARA 1

NATIONAL ARCHIVES MICROFILM PUBLICATIONS

Microfilm Publication M1820

COMPILED MILITARY SERVICE RECORDS OF VOLUNTEER UNION
SOLDIERS WHO SERVED WITH THE UNITED STATES COLORED TROOPS:
2d Through 7th United States Colored Infantry, Including 3d Tennessee Volunteers
(African Descent), 6th Louisiana Infantry (African Descent), 7th Louisiana Infantry
(African Descent)

Roll 94

7th United States Colored Infantry

Cray, Charles M. - Drummond, William

NATIONAL ARCHIVES AND RECORDS ADMINISTRATION

Cray ³⁴⁶ Charles W.

Co D., 7 U.S. Col'd Inf.

Private

CARD NUMBERS.

1	26
2	27
3	28
4	29
5	30
6	31
7	32
8	33
9	34
10	35
11	36
12	37
13	38
14	39
15	40
16	41
17	42
18	43
19	44
20	45
21	46
22	47
23	48
24	49
25	50

Book Mark:

See also

347

Crisfield David

Co. 7 U.S. Col'd Inf.

Corporal Private

CARD NUMBERS.

1	6294209	26
2	6294308	27
3	6294408	28
4	6294509	29
5	6294602	30
6	6294696	31
7	6294810	32
8	6294900	33
9	6294995	34
10	6295095	35
11	6295196	36
12	6295296	37
13	6295390	38
14	6295480	39
15	6295570	40
16	6295643	41
17	6295713	42
18	6295787	43
19	6295859	44
20	9066895	45
21		46
22		47
23		48
24		49
25		50

Book Mark:

See also

L. 1659548 Aud. W. R. L.
S. 1702585 - and W. D.

C. 1 7 U.S.C.T.

David Bisfield

Co. E, 7 Reg't U. S. Col'd Inf.

Appears on

Company Descriptive Book

of the organization named above.

DESCRIPTION.

Age 25 years; height 5 feet 5 1/2 inches.

Complexion *Gm.*

Eyes *Blk*; hair *Blk.*

Where born *Somerset, Ma.*

Occupation *Farmer.*

ENLISTMENT.

When *Oct. 22*, 1863.

Where *Somerset, Ma.*

By whom *Ch. W. Binney*; term 3 y'rs.

Remarks: *Mustered in at Camp Stanton, Ma. Nov. 5. 63, by Lt. Col. Haskell.*

Appointed Corp. Dec. 30. 63. Abs. sick Mar. 25. 65. to May. 65.

Reduced to ranks Sept. 21. 64.

H. J. White.

6 | 7 | U.S.C.T.

David Crisfield
Capt, Co. I, 7 Reg't U. S. Col'd Inf

Appears on

Company Muster-in Roll

of the organization named above. Roll dated

Camp Stanton, Charles Co., Md., Nov 5, 1863.

Muster-in to date Nov 5, 1863.

Joined for duty and enrolled:

When Oct 22, 186 .

Where Somerset, Md.

Period 3 years.

Valuation of horse, \$ 100

Valuation of horse equipments, \$ 100

Remarks:

Book mark:

(356)

Adams
Copyist.

C | 7 | U.S.C.T.

David Crisfield
Corp, Co. I, 7 Reg't U. S. Col'd Infantry.

Appears on

Company Muster Roll

for from Nov. 5 to Dec 31, 1863
Present or absent Present

Stoppage, \$ 100 for

Due Gov't, \$ 100 for

Remarks: Enlistment premium
\$2.00 due.

Book mark:

(358)

J B Gage
Copyist.

6

7

U.S.C.T.

David Brisfield
Corp, Co. I, 7 Reg't U. S. Col'd Infantry.

Appears on

Company Muster Roll

for Jan & Feb, 1864

Present or absent Present

Stoppage, \$ 100 for

Due Gov't, \$ 100 for

Remarks: Enlistment premium
\$2.00 due

Book mark:

J.B. Gage

(358)

Copyist.

6 | 7 | U.S.C.T.

David Brisfield
Corp, Co. I, 7 Reg't U. S. Col'd Infantry.

Appears on

Company Muster Roll

for Mch & April, 1864.

Present or absent Present

Stoppage, \$ 100 for

Due Gov't, \$ 100 for

Remarks:

Book mark:

(358)

J. B. Gage
Copyist.

6 | 7 | U.S.C.T.

David Brisfield

Corp, Co. I, 7 Reg't U. S. Col'd Infantry.

Appears on

Company Muster Roll

for May & June, 1864

Present or absent Present

Stoppage, \$ 100 for

Due Gov't, \$ 100 for

Remarks:

Book mark:

(358)

J B Gage

Copyist.

6 | 7 | U.S.C.T.

David Crisfield
Corp, Co. I, 7 Reg't U. S. Col'd Infantry.

Appears on

Company Muster Roll

for July & Aug, 1864.

Present or absent Present

Stoppage, \$ 100 for

Due Gov't, \$ 100 for

Remarks:

Book mark:

(358)

J. G. Gage
Copyst.

6

7

U.S.C.T.

David Crisfield

Priv, Co. I, 7 Reg't U. S. Col'd Infantry.

Appears on

Company Muster Roll

for Sept & Oct, 1864.

Present or absent Present

Stoppage, \$ 100 for

Due Gov't, \$ 100 for

Remarks:

Book mark:

J.B. Gage Copyist.

(358)

C | **7** | **U.S.C.T.**

David Crisfield

Priv, Co. 1, 7 Reg't U. S. Col'd Infantry.

Appears on

Company Muster Roll

for *Nov. & Decr.*, 1864

Present or absent *Present*

Stoppage, \$ *100* for

Due Gov't, \$ *100* for

Remarks:

Book mark:

D. Mahor
Copyist.

C | 7 | U.S.C.T.

David Crisfield
Priv, Co. I, 7 Reg't U. S. Col'd Infantry.

Appears on

Company Muster Roll

for *Jany. + Feby.*, 1865.

Present or absent *Present*

Stoppage, \$ 100 for

Due Gov't, \$ 100 for

Remarks:

Book mark:

D. Maher
Copyist.

C | 7 | U.S.C.T.

David Crisfield
Priv, Co. I, 7 Reg't U. S. Col'd Infantry.

Appears on

Company Muster Roll

for March & April, 1865.

Present or absent absent

Stoppage, \$ 100 for

Due Gov't, \$ 100 for

Remarks:

Absent at Point of Rocks, Va. since
March 25, 1865.

Book mark:

D. Maher
Copyist.

C | **7** | **U.S.C.T.**

David Brisfield

Priv, Co. I, 7 Reg't U. S. Col'd Infantry.

Appears on

Company Muster Roll

for *May + June*, 186 *5*.

Present or absent *Present*

Stoppage, \$..... *100* for

Due Gov't, \$..... *100* for

Remarks:

Book mark:

D. Mahser
Copyist.

C | **7** | **U.S.C.T.**

David Crisfield
Priv, Co. I, 7 Reg't U. S. Col'd Infantry.

Appears on

Company Muster Roll

for *July & Aug.*, 1865.

Present or absent *Present*

Stoppage, \$..... 100 for.....

Due Gov't, \$..... ⁰²100 for *C. & G. Equipage*

" "..... *43⁰⁰ " Ordnance &c.*

Remarks:.....

Book mark:.....

D. Maher
Copyist.

W

7

U.S.C.T.

David Crisfield

Priv., Co. I, 7 Reg't U. S. Col'd Infantry.

Appears on

Company Muster Roll

for Sept. & Oct., 1865.

Present or absent Present

Stoppage, \$ 100 for

Due Gov't, \$ 43 100, for Ordnance, &c.

4 4 44.00 C. & G. Equipage

Remarks:

To forfeit one dollar of Monthly pay by Sentence of F. C. Court

Book mark:

D. Maher Copyist.

(358)

67

7

U.S.C.T.

David Cristfield
Priv, Co. I, 7 Reg't U. S. Col'd Infantry.

Appears on

Company Muster Roll

for Nov. + Decr., 1865.

Present or absent Present

Stoppage, \$ 100 for

Due Gov't, \$ 43/100, for Ordnance, &c.

" " 49. " C & G. Equipage

Remarks:

To forfeit \$1.00. of Monthly pay sentence
of F. A. Court.

Book mark:

D. Maher
Copyist.

6

7

U.S.C.T.

David Brisfield

Private, Co. I, 7 Reg't U. S. Col'd Infantry.

Appears on

Company Muster Roll

for Jan + Feb, 1866.

Present or absent Present.

Stoppage, \$ 100 for

Due Gov't, \$ 100 for

Remarks:

Book mark:

(358)

Sabine Copyist.

20 | 7 | U.S.C.T.

David Winsfield

Part, Co. I, 7 Reg't U. S. Col'd Infantry.

Appears on

Company Muster Roll

for Nov + Apr, 1866.

Present or absent Present.

Stoppage, \$ 100 for

Due Gov't, \$ 26/100 for Ordnance lost.

Remarks:

Book mark:

Sabine Copyist.

6

7

U.S.C.T.

David Brisfield

Private, Co. I, 7 Reg't U. S. Col'd Infantry.

Appears on

Company Muster Roll

for Jan 28 to June 30, 1866.

Present or absent Not stated.

Stoppage, \$ 26 ¹⁰⁰ for ordnance and ordnance stores.

Due Gov't, \$ 100 for

Remarks:

Book mark:

Sabine

Copyist.

(358)

6

7

U.S.C.T.

David Cristfield

Private, Co. I, 7 Reg't U. S. Col'd Infantry.

Appears on

Company Muster Roll

for July - Aug, 1866.

Present or absent Present.

Stoppage, \$ 100 for

Due Gov't, \$ 100 for

Remarks:

Book mark:

Sabine Copyist.

C

7

U.S.C.T.

David Crisfield
Pr. Co. *C*, 7 Reg't U.S. Col'd Infantry.

Appears on **Co. Muster-out Roll**, dated
Indianola, Texas
October 13, 1866.

Muster-out to date *Oct. 13*, 1866.

Last paid to *June 30*, 1866.

Clothing account:

Last settled....., 186 ; drawn since \$ 100
Due soldier \$ *50⁴³*/₁₀₀; due U. S. \$ 100
Am't for cloth'g in kind or money adv'd \$ 100

Due U. S. for arms, equipments, &c., \$ 100

Bounty paid \$ 100; due \$ *100*/₁₀₀

Remarks: *Joined co. at ori-*
ginal organization.
Appointed corp. Dec.
30, '63.
Reduced to ranks, Dec.
21, '64.

Book mark: *100*

Sabine

Crisfield, David

P. I., Co.

7

U. S. C. Inf.

Reg't

Enclosures.

Bed Cards	Descriptive Lists
Burial Records	Final Statements
Certs. of Dis. for Discharge	Furloughs
C. M. Charges	Med. Des. Lists
Med. Certificates	Orders

Other papers relating to—

Admission to Hosp'l	Furlough
Casualty Sheet (Officer's)	Med. Examination
Confinement	Misc. Information
Contracts	Pay or Clothing
Death or Effects	Personal Reports
Desertions	Rank
Discharge from Hosp'l	Transfer to Hosp'l
Discharge from Service	Transfer to V. R. C.
Duty	Transportation

MICROFILM PUBLICATION M 1849

COMPILED MILITARY SERVICE RECORDS
OF VOLUNTEER UNION SOLDIERS WHO SERVED WITH
THE UNITED STATES COLORED TROOPS (USCT)
7TH REGIMENT OF INFANTRY

PERSONAL PAPERS' TARGET SHEET

PLEASE NOTE THE CHECKED INFORMATION ABOUT THE PERSONAL PAPERS IN
THIS FILE:

- NO PERSONAL PAPERS WERE FOUND IN THIS FILE WHEN THE
RECORDS WERE ARRANGED FOR MICROFILMING.
- 4 PERSONAL PAPER(S) FOUND IN THIS FILE WHEN THE RECORDS
WERE ARRANGED FOR MICROFILMING.

1012002
C. 1012002
No. 1693
APPLICATION OF
John W. Cusfield
OF
Somerset County Md.

For Compensation for Service of Slave,

David Cusfield

Enlisted in *Seventh* Regiment

U. S. Colored Troops, Co. *D*

Received, *June 3rd* 1864.

COMPENSATION AWARDED,

October 10th 1865

Three Hundred Dollars.

Thos. Inman
Presid't Bd. Claims

Genl. Wm. C. C. [unclear] 11. 1865.

NARA 29

EVIDENCE OF TITLE.

I, John W. Lewis, of Somerset
County, Md., do solemnly swear that David Crisp
who has been enlisted in the Seventh Regiment, U. S. Colored Troops,
Co. I; is my slave for life; (~~his term of service expiring on~~
~~the~~ day of 186;) and that
I became possessed of him by his birth, ~~in the month~~
~~of~~ about, eighteen hundred and thirty-eight. And I
do further swear that I have not purchased said slave from any person or persons disloyal
to the Government of the United States, with the object of obtaining compensation for
the same; and furthermore, that I have no agency for obtaining compensation for any per-
son or persons but such as, to my knowledge, are loyal citizens of the United States.

John W. Lewis

May 16th

1867

STATE OF MARYLAND,

Somerset County, to wit:

On this *16th* day of *May* in the year 1864,

before me, the subscriber, a Justice of the Peace of the State and County aforesaid, personally appeared *John W. Curfield* and took, signed, and acknowledged the oaths preceding; and further made oath, in due form of law, that all the statements made in this application are, to the best of *his* knowledge and belief, strictly true.

Regiment, U. S. Colored Troops

who has been enlisted in the

(in term of service expiring on

is my slave for

1861

Also personally appeared before me *Sydney L. Long* and

William J. Pittingham, loyal citizens of the United States, residents of

Somerset County, well acquainted with the said *John W. Curfield* &

the said David, and in no manner interested in the prosecution of this

claim, and made oath, in due form of law, that the said *John W. Curfield*

is the owner of the slave *David Curfield*, as a fact of public noto-

riety; that they believe all the statements herein made by *them*, in reference

thereto, are correct, and that *he* is unquestionably loyal to the Government of

the United States. Witness their signatures: 081



Edward F. Owen

Sydney L. Long
W. J. Pittingham
Justice of the Peace

STATE OF MARYLAND,

Somerset County, to wit:

I, *Levin Woolford*, Clerk of the Circuit Court for *Somerset* County, do hereby certify that *Edward F. Duer*,

before whom the foregoing affidavits were made, was, at the time of signing the same, a Justice of the Peace for the County and State aforesaid, duly commissioned and sworn; and that his signature thereto is genuine, and that full faith and credit should be given to his official acts.

Witness my hand and the seal of said Court, this *16* day of

May, A. D. 1864.

Levin Woolford

CLERK.



FOUR

MARYLAND 31
Maryland Somerset County Oct. I hereby certify that the within is
truly Copied from the Original on file and of record in the office of the
Clerk of the Circuit Court for Somerset County - ~ ~

In testimony whereof I hereunto subscribe
my name and affix the seal of the said
Circuit Court this 16th day of May Anno
Domini 1864 Levin Woolford clk



22

DEED OF MANUMISSION AND RELEASE OF SERVICE.

Whereas my slave David Crisfield has enlisted in the service of the United States: now, in consideration thereof, I, J. M. Crisfield, of Somerset county, State of Maryland do hereby, in consideration of said enlistment, manumit, set free, and release the above-named David Crisfield from all service due me; his freedom to commence from the 23^d October 1863, the date of his enlistment as aforesaid in the 7th Regiment of Colored Troops, in the service of the United States.

Witness my hand and seal, this 16th day of May 1864

J. M. Crisfield



Witness:

Edward H. Durr

M. C. Fontaine

Joseph H. Smith

Somerset County,

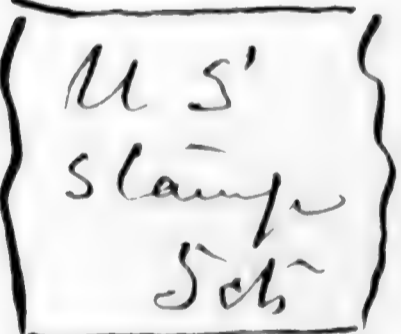

State of Maryland May 16, 1864

Before me appeared this day J. M. Crisfield and acknowledged the above Deed of Manumission and Release of Service to be his free act and deed.

Edward H. Durr J.P.

A.

No. 1693

CLAIMANT'S CERTIFICATE.

I, John W. Crisfield a loyal citizen, and a resident of Somerset, County Severn, State of Maryland, hereby claim compensation, under the provisions of General Orders, No. 329, 1863, for my slave David Crisfield enlisted October 23^d 1863, at Somerset County by Col W. Norney in the Seventh Regiment U. S. Colored Troops, Co. I; certificate of which enlistment, and a descriptive list, as required, accompany this application.

In proof of my loyalty to the Constitution and Government of the United States, I present the accompanying oath, which I have taken, signed, and acknowledged, to be filed with this application, in accordance with requirement of said General Orders.

John W. Crisfield

May 16th 1864.

B.

OATH OF ALLEGIANCE.



I, John W. Brisfield, do solemnly swear that I have never joined, or been concerned in, any insurrection or rebellion; that I have never borne arms against the United States; that I have never given any aid, countenance, counsel, or encouragement to any person or persons engaged, or whom I had reason to believe were about to engage, in insurrection, rebellion, or armed hostility against the United States; that I have neither sought, nor accepted, nor attempted to exercise the functions of any office, civil or military, nor to perform any service whatever, under any authority or pretended authority in hostility to the United States; that I have not yielded a voluntary support to any insurrection, rebellion, or pretended government, authority, power, or constitution within the United States hostile thereto. And I do further swear that, to the best of my knowledge and ability, I have supported and defended, and will continue to support and defend, the United States against all enemies, foreign and domestic; and that I have supported, defended, and obeyed, and will continue to support, defend, and obey, the Constitution and laws of the United States; that I will bear true faith and allegiance to the same; and that I take this oath freely, without any mental reservation or purpose of evasion: So help me God.

J. W. Brisfield

Sworn to and subscribed before me, at Somerus Co
 this 16th day of May 1864. }



Edward S. Owen

Justice of the Peace

C.

I present herewith evidence of my title to the slave David
Cousfield enlisted as aforesaid, and in consideration of the sum of
..... by me received, I hereby covenant and
agree with the United States, that I, my heirs, executors, or assigns, shall never hereafter make
or enforce any claim to the labor or services of said slave; and pledge myself to execute
a valid Deed of Manumission and Release of all my claims to service forever of said
David Cousfield to be filed with the Board of Claims
now in session at Baltimore

Cousfield

May 16th, 1864.

F.

CERTIFICATE OF AWARD OF THE BOARD OF CLAIMS.

No 1022

Office of the Board of Claims
For Slaves Enlisted in the Service of the United States,

Baltimore Md.

October 18th 1863.

\$300-

We hereby certify, that John M. Crisfield, of Somerset county, State of Maryland, having proved, under oath, his loyalty to the Constitution and Government of the United States, and established his title as to the ownership of David Crisfield, a slave enlisted at Somerset Co. Md., on the 23^d day of October, 1863, by Wm. Birney, in the service of the United States, in the 7th Regiment of Colored Troops, Co. I, and having filed a valid Deed of Manumission and Release of Service of said slave, is entitled to the sum of Three Hundred dollars, which has been awarded to him by this Board as a remuneration for all claim to the future labor or service of said slave, under the provision of General Orders, War Department, No. 329, 1863.

Thos. Simmons, President of the Board.

James Jones, Member of the Board.

W. M. [unclear], Member of the Board.

To Ch. C. W. Foster,

Chief of the Bureau for the
Organization of Colored Troops, Washington, D. C.

348

Crockett Albert

Co I, 7 U.S. Col'd Inf.

Private Private

CARD NUMBERS.

1	6294226	26
2	6294325	27
3	6294428	28
4	6294529	29
5	6294624	30
6	6294716	31
7	6294806	32
8	6294899	33
9	6294994	34
10	6295094	35
11	6295195	36
12	6295295	37
13	6295391	38
14	6295479	39
15	6295569	40
16	6295642	41
17	6295712	42
18	6295786	43
19	6295858	44
20	9066898	45
21		46
22		47
23		48
24		49
25		50

Book Mark:

See also

C. 1 7 U.S.C.T.

Albert Crockett

Co. G, 7 Reg't U.S. Col'd Inf.

Appears on

Company Descriptive Book

of the organization named above.

DESCRIPTION.

Age 24 years; height 5 feet 5/2 inches.

Complexion *Sk.*

Eyes *Blk*; hair *Blk.*

Where born *Somerset, Md.*

Occupation *Farmer.*

ENLISTMENT.

When *Oct. 22*, 1863.

Where *Somerset, Md.*

By whom *Wm. B. King*; term 3 y'rs.

Remarks: *Mustered in at Camp Stanton, Md. Nov. 5. 63 by Lt. Col. Haskell.*

A. Miller

Copyist.

C | 7 | U.S.C.T.

Albert Crockett

Priv., Co. I, 7 Reg't U. S. Col'd Inf.

Age 24 years.

Appears on

Company Muster-in Roll

of the organization named above. Roll dated
Camp Stanton
Charles Co., Md., Nov. 5, 1863.

Muster-in to date Nov. 5, 1863

Joined for duty and enrolled:

When Oct. 22, 1863

Where Somerset, Md

Period 3 years.

Remarks:

Book mark:

J. B. Yager

61

7

U.S.C.T.

Albert Crockett

Private, Co. I, 7 Reg't U. S. Col'd Infantry.

Appears on

Company Muster Roll

for from Nov. 5 to Dec. 31, 1863.

Present or absent Present

Stoppage, \$ 100 for

Due Gov't, \$ 100 for

Remarks: Enlistment premium \$2.00 due

Book mark:

J.B. Gage

Copyist.

(358)

61 7 U.S.C.T.

Albert Crockett
Priv., Co. I, 7 Reg't U. S. Col'd Infantry.

Appears on

Company Muster Roll

for Jan & Feb, 1864.

Present or absent Present

Stoppage, \$ 100 for

Due Gov't, \$ 100 for

Remarks: Enlistment premium
\$2.00 due

Book mark:

(358)

J. B. Gage Copyist.

6 | 7 | U.S.C.T.

Albert Crockett

Pvt, Co. I, 7 Reg't U. S. Col'd Infantry.

Appears on

Company Muster Roll

for Mch & Apr, 1864.

Present or absent Present

Stoppage, \$ 100 for

Due Gov't, \$ 100 for

Remarks:

Book mark:

(358)

J. B. Gage Copyist.

6 |

7

U.S.C.T.

Albert Crockett

Pvt, Co. I, 7 Reg't U. S. Col'd Infantry.

Appears on

Company Muster Roll

for *May & June*, 1864.

Present or absent *Present*

Stoppage, \$ *100* for

Due Gov't, \$ *100* for

Remarks:

Book mark:

(358)

J. B. Yage
Copyist.

6 | 7 | U.S.C.T.

Albert Crockett

Pvt, Co. I, 7 Reg't U. S. Col'd Infantry.

Appears on

Company Muster Roll

for July & Aug, 1864.

Present or absent Present

Stoppage, \$ 100 for

Due Gov't, \$ 100 for

Remarks:

Book mark:

(358)

J.B. Gage

Copyst.

6

7

U.S.C.T.

Albert Crockett

Priv, Co. I, 7 Reg't U. S. Col'd Infantry.

Appears on

Company Muster Roll

for Sept & Oct, 1864

Present or absent Present

Stoppage, \$ 100 for

Due Gov't, \$ 100 for

Remarks:

Book mark:

J. B. Gage

Copyist.

(358)

6

7

U.S.C.T.

Albert Crockett

Priv, Co. 1, 7 Reg't U. S. Col'd Infantry.

Appears on

Company Muster Roll

for *Nov. & Decr*, 1864.

Present or absent *Present*

Stoppage, \$ *100* for

Due Gov't, \$ *100* for

Remarks:

Book mark:

D. Mahser

(358)

Copyist.

6 | 7 | U.S.C.T.

Albert Crockett

Priv, Co. 1, 7 Reg't U. S. Col'd Infantry.

Appears on

Company Muster Roll

for *Jan'y. + Feby.*, 1865.

Present or absent *Present*

Stoppage, \$ _____ 100 for _____

Due Gov't, \$ _____ 100 for _____

Remarks: _____

Book mark: _____

D. Mahser

(358)

Copyist.

6

7

U.S.C.T.

Albert Crockett
Priv, Co. I, 7 Reg't U. S. Col'd Infantry.

Appears on

Company Muster Roll

for *March + April*, 1865.

Present or absent *Present*

Stoppage, \$ *100* for

Due Gov't, \$ *100* for *2 Canteens*

Remarks:

Book mark:

D. Mahor

(358)

Copyist.

6

7

U.S.C.T.

Albert Crockett

Priv, Co. I, 7 Reg't U. S. Col'd Infantry.

Appears on

Company Muster Roll

for *May & June*, 1865.

Present or absent *Present*

Stoppage, \$..... 100 for

Due Gov't, \$..... 100 for

Remarks:.....

Book mark:.....

D. Maher

(358)

Copyist.

6 | 7 | U.S.C.T.

Albert Crockett
Priv, Co. 1, 7 Reg't U. S. Col'd Infantry.

Appears on

Company Muster Roll

for *July + Aug.*, 1865.

Present or absent *Present*

Stoppage, \$ 100 for

Due Gov't, \$ *1.* ⁴⁴100. for *C. & G. Equipage*

" " ²⁰100. " *Ordinance &c.*

Remarks:

Book mark:

(358)

A. Maher
Copyist.

C

7

U.S.C.T.

Albert Crockett

Priv, Co. I, 7 Reg't U. S. Col'd Infantry!

Appears on

Company Muster Roll

for *Sept. & Oct.*, 1865.

Present or absent *Present*

Stoppage, \$ *100* for

Due Gov't, \$ *1.* ^{*47*}/_{*100*}, for *C. & G. Equipage*

" " *20¢* " *Ordnance, &c.*

Remarks:

Book mark:

D. Maher

Copyist.

6

7

U.S.C.T.

Albert Crockett

Priv, Co. I, 7 Reg't U. S. Col'd Infantry.

Appears on

Company Muster Roll

for Nov. & Decr., 1865.

Present or absent Present

Stoppage, \$ 100 for

Due Gov't, \$ 1. ⁴⁷/₁₀₀ for C & G. Equipage

" " 20% " Ordnance, &c.

Remarks:

Book mark:

D. Maher

(358)

Copyist.

6

7

U.S.C.T.

Albert Crockett

Pvt, Co. I, 7 Reg't U. S. Col'd Infantry.

Appears on

Company Muster Roll

for Jan + Feb, 1866.

Present or absent Present.

Stoppage, \$ 100 for

Due Gov't; \$ 100 for

Remarks:

Book mark:

Sabine
Copyist.

6

7

U.S.C.T.

Albert Rockett

Private, Co. I, 7 Reg't U. S. Col'd Infantry.

Appears on

Company Muster Roll

for Mar + Apr, 1866.

Present or absent Present.

Stoppage, \$ 100 for

Due Gov't, \$ 100 for

Remarks:

Book mark:

Sabine

Copyist.

(358)

6

7

U.S.C.T.

Albert Crocker

Private, Co. I, 7 Reg't U. S. Col'd Infantry.

Appears on

Company Muster Roll

for Feb. 28 to June 30, 1866.

Present or absent Not stated.

Stoppage, \$ 100 for

Due Gov't, \$ 100 for

Remarks:

Book mark:

Sabine

(358)

Copyist.

6

7

U.S.C.T.

Albert Crocker

Private, Co. I, 7 Reg't U. S. Col'd Infantry.

Appears on

Company Muster Roll

for July to Aug, 1866.

Present or absent Present.

Stoppage, \$100 for

Due Gov't, \$100 for

Remarks:

Book mark:

S. W. ...
Copyist.

(358)

C | *7* | U.S.C.T.

Albert Crockett
Priv, Co D, 7 Reg't U. S. Col'd Infantry.

Appears on **Co. Muster-out Roll**, dated
Indianola, Texas
October, 13, 1866.

Muster-out to date *Oct, 13*, 1866.

Last paid to *June 30*, 1866.

Clothing account:

Last settled....., 186 ; drawn since \$..... 100

Due soldier \$ *42⁴⁷* 100; due U. S. \$..... 100

Am't for cloth'g in kind or money adv'd \$..... 100

Due U. S. for arms, equipments, &c., \$ *6* 100

Bounty paid \$..... 100; due \$ *100* 100

Remarks: *Joined co. at ori-*
ginal organization.
Retains one Co. Muster
set of accoutrements,
per G.O. 101, War Dept.,
May 30, '65.

Book mark *PK8 P47-69.*

Sabine
 Copyist.

Crockett, Albert

P. I., Co. *J.*

7

Reg't **U.S.C. Inf.**

Enclosures.

Bed Cards	Descriptive Lists
Burial Records	Final Statements
Certs. of Dis. for Discharge	Furloughs
C. M. Charges	Med. Des. Lists
Med. Certificates	Orders

Other papers relating to—

Admission to Hosp'l	Furlough
Casualty Sheet (Officer's)	Med. Examination
Confinement	Misc. Information
Contracts	Pay or Clothing
Death or Effects	Personal Reports
Desertions	Rank
Discharge from Hosp'l	Transfer to Hosp'l
Discharge from Service	Transfer to V. R. C.
Duty	Transportation

MICROFILM PUBLICATION M 1849

COMPILED MILITARY SERVICE RECORDS
OF VOLUNTEER UNION SOLDIERS WHO SERVED WITH
THE UNITED STATES COLORED TROOPS (USCT)
7TH REGIMENT OF INFANTRY

PERSONAL PAPERS' TARGET SHEET

PLEASE NOTE THE CHECKED INFORMATION ABOUT THE PERSONAL PAPERS IN
THIS FILE:

- NO PERSONAL PAPERS WERE FOUND IN THIS FILE WHEN THE
RECORDS WERE ARRANGED FOR MICROFILMING.
- 3 PERSONAL PAPER(S) FOUND IN THIS FILE WHEN THE RECORDS
WERE ARRANGED FOR MICROFILMING.

A.

No. 517

CLAIMANT'S CERTIFICATE.

I, Edward Fowler a loyal citizen, and a resident
of Somerset, County of _____, State of
Maryland, hereby claim compensation, under the provisions of
General Orders, No. 329, 1863, for my slave Albert Fowler on Albert Fowler
enlisted November 1863, at Salisbury
by Lieutenant Chinnery in the Seventh
Regiment U. S. Colored Troops, Co. D; certificate of which enlistment, and a
descriptive list, as required, accompany this application.

In proof of my loyalty to the Constitution and Government of the United States, I
present the accompanying oath, which I have taken, signed, and acknowledged, to be filed
with this application, in accordance with requirement of said General Orders.

Edward Fowler

February 20th 1864

B.

OATH OF ALLEGIANCE.



I, Edward Fowler, do solemnly swear that I have never joined, or been concerned in, any insurrection or rebellion; that I have never borne arms against the United States; that I have never given any aid, countenance, counsel, or encouragement to any person or persons engaged, or whom I had reason to believe were about to engage, in insurrection, rebellion, or armed hostility against the United States; that I have neither sought, nor accepted, nor attempted to exercise the functions of any office, civil or military, nor to perform any service whatever, under any authority or pretended authority in hostility to the United States; that I have not yielded a voluntary support to any insurrection, rebellion, or pretended government, authority, power, or constitution within the United States hostile thereto. And I do further swear that, to the best of my knowledge and ability, I have supported and defended, and will continue to support and defend, the United States against all enemies, foreign and domestic; and that I have supported, defended, and obeyed, and will continue to support, defend, and obey, the Constitution and laws of the United States; that I will bear true faith and allegiance to the same; and that I take this oath freely, without any mental reservation or purpose of evasion: So help me God.

Edward Fowler

Sworn to and subscribed before me, at my office
 this 26th day of February, 1864.



Geo. A. Moore J.P.

C.

I present herewith evidence of my title to the slave Albert Fowler
or Albert Crockett enlisted as aforesaid, and in consideration of the sum of
..... by me received, I hereby covenant and
agree with the United States, that I, my heirs, executors, or assigns, shall never hereafter make
or enforce any claim to the labor or services of said slave; and pledge myself to execute
a valid Deed of Manumission and Release of all my claims to service forever of said
Albert Fowler to be filed with the Board of Claims
now in session at Baltimore Md



February 26th, 1864.

Edward Fowler

Original of [unclear] [unclear]

No. 517

APPLICATION OF

Edna Fowler

OF

Somerset County

For Compensation for Service of Slave,

Albert ~~Rock~~ ~~Rock~~

Enlisted in 7th Regiment

U. S. Colored Troops, Co. 1

Received, Feb 29th 1864.

COMPENSATION AWARDED

July 26th 1865

Dollars.

For Cause of Rejection of this Claim see remarks endorsed on claim 510.

Thos. Simmons
President Board of Claims

Recd. 19th July 31. 1865.

EVIDENCE OF TITLE.

I, Edward Fowler, of Annurset
 County, Md., do solemnly swear that Albert Fowler or Albert (white)
 who has been enlisted in the 7th Regiment, U. S. Colored Troops,
 Co. A; is my slave for life; (his term of service expiring on
 the _____ day of _____ 186 _____;) and that
 I became possessed of him by I raised him, in the month
 of _____, eighteen hundred and _____. And I
 do further swear that I have not purchased said slave from any person or persons disloyal
 to the Government of the United States, with the object of obtaining compensation for
 the same; and furthermore, that I have no agency for obtaining compensation for any per-
 son or persons but such as, to my knowledge, are loyal citizens of the United States.

Edward Fowler

February 26th 1864

STATE OF MARYLAND,

Somerset County, to wit:

On this *Twenty Sixth* day of *February* in the year 1864, before me, the subscriber, a Justice of the Peace of the State and County aforesaid, personally appeared *Edward Fowler*, and took, signed, and acknowledged the oaths preceding; and further made oath, in due form of law, that all the statements made in this application are, to the best of *his* knowledge and belief, strictly true.

Geo. A. Moore

Also personally appeared before me *George W. Waller* and *Hudson L. Mills*, loyal citizens of the United States, residents of *Somerset county*, well acquainted with the said *Edward Fowler*, and in no manner interested in the prosecution of this claim, and made oath, in due form of law, that the said *Edward Fowler* is the owner of the slave *Albert Foster*, as a fact of public notoriety; that they believe all the statements herein made by *him*, in reference thereto, are correct, and that *he* is unquestionably loyal to the Government of the United States. Witness their signatures:

Geo. W. Waller
Hudson L. Mills



Geo. A. Moore Justice of the Peace.

STATE OF MARYLAND,

Somerset County, to wit:

I, *Sevin Wolford*, Clerk of the Circuit Court for
Somerset County, do hereby certify that *George A. Moore Esquire*
before whom the foregoing affidavits were made, was, at the time of signing the same, a
Justice of the Peace for the County and State aforesaid, duly commissioned and sworn;
and that his signature thereto is genuine, and that full faith and credit should be given to
his official acts.

Witness my hand and the seal of said Court, this *26th* day of

February, A. D. 1864.

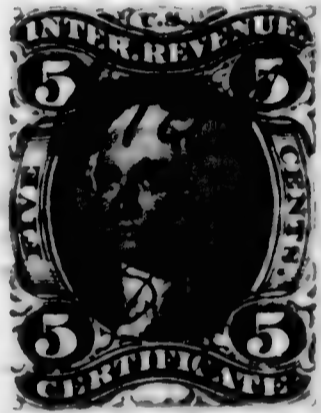

Sevin Wolford CLERK.

E.

Deed of Manumission and Release of Service.

Whereas my slave Albert Crockett, has enlisted in the service of the United States; now, in consideration thereof, I Edward Fowler of Somerset county, State of Maryland do hereby, in consideration of said enlistment, manumit, set free and release the above-named Albert Crockett from all service due me; his freedom to commence from the 26. October 1863, the date of his enlistment as aforesaid in the Nineteenth Regiment of Colored Troops in the Service of the United States. Witness my hand and seal this 16th day of May 1864.

Witness: Spencer M. Cordrey
John S. Cordrey
Thomas Williams

Edward Fowler Seal

Somerset County, State of Maryland 1864. Before me appeared this day 16th Edward Fowler Jr. and acknowledged the above Deed of Manumission and Release of Service to be his free act and deed.



Edw^d. Fowler Jr. S. P.

State of Maryland Somerset County Court. I hereby certify that that the foregoing Deed of Manumission is truly copied from the Original now on file and of record in the Office of the Clerk of the

Circuit Court for Somerset County.

In Testimony whereof I hereto subscribe my
name and affix my the Seal of the said Circuit
Court this Seventeenth day of May Anno Dom-
ini eight hundred and sixty four.

Levin Woolford CLK.



134

349

Cropper Emma L.

Co., 7 U.S. Col'd Inf.

Private

Private

CARD NUMBERS.

1	6279230	26
2		27
3		28
4		29
5		30
6		31
7		32
8		33
9		34
10		35
11		36
12		37
13		38
14		39
15		40
16		41
17		42
18		43
19		44
20		45
21		46
22		47
23		48
24		49
25		50

Book Mark:

See also

6 | 7

U.S.C.T

Emma L. Copper

Appears with rank of on

Muster and Descriptive Roll of a Detachment of Drafted Men and Substitutes forwarded

for the *7* Reg't U.S. Col'd *Inf.* Roll dated *Baltimore Md, April 18, 1865*

Where born *Worcester Co. Md.*

Age *33* years; occupation *Laborer*

Drafted and mustered in:

When *Mar 20*, 186*5*!

Where *Easton Md.*

Period *1* years.

Eyes *Blk*; hair *Blk*

Complexion *Blk*; height *5* ft *1 1/2* in.

Paid bounty and advance pay, \$ *100*

Bounty due \$ *100*

Where credited

Company to which assigned

Remarks: *Drafted from 3 Sub Dist Worcester Co. 1 Dist. Md. Not taken up on Roll of Reg*

Book mark:

(340)

J. M. Tandy Copyist.

[Handwritten signature]

CARD NUMBERS.

1	6292463	26
2	6292563	27
3	6292663	28
4	6292764	29
5	6292861	30
6	6292956	31
7	6293046	32
8	6293147	33
9	6293245	34
10	6293344	35
11	6293441	36
12	6279275	37
13	6293538	38
14	6293627	39
15	6293716	40
16	6293802	41
17	6293876	42
18	6293949	43
19	6294021	44
20	6294171	45
21	9066785	46
22		47
23		48
24		49
25		50

Book Mark:

See also

RP 52835-1

2

7

U.S.C.T.

George Curtis

Co. 2, 7 Reg't U.S. Col'd Inf.

Appears on

Company Descriptive Book

of the organization named above.

DESCRIPTION.

Age 23 years; height 5 feet 3/2 inches.

Complexion Black

Eyes Black; hair Black

Where born St. Marys, Maryland

Occupation

ENLISTMENT.

When Oct. 31, 1863.

Where St. Marys.

By whom Col. Wm. S. Sney; term 3 y'rs.

Remarks: Died at Indianola Tex. Sept. 8. 1866, of Epidemic Cholera. Final statements rendered Sept. 10. 1866. Buried Nov. 5. 1866 by Dr. Col. Haskell.

J. G. White

Copyist.

C. J. 7 U.S.C.T.

George Curtis

Pt., Co. *H.*, 7 Reg't U. S. Col'd Inf.

Age *23* years.

Appears on

Company Muster-in Roll

of the organization named above. Roll dated
of Stanton Charles Co. Md. Nov. 5, 1863.

Muster-in to date *Nov. 5*, 1863

Joined for duty and enrolled:

When *Oct. 31*, 1863.

Where *St. Mary, Md.*

Period *3* years.

Remarks: _____

Book mark: _____

Stick

C. J. 7 U.S.C.T.

George Curtis

Pt., Co. *H.*, 7 Reg't U. S. Col'd Inf.

Age *23* years.

Appears on

Company Muster-in Roll

of the organization named above. Roll dated
of Stanton, Charles Co. Md. Nov. 5, 1863.

Muster-in to date *Nov. 5*, 1863

Joined for duty and enrolled:

When *Oct. 31*, 1863.

Where *St. Mary, Md.*

Period *3* years.

Remarks: _____

Book mark: _____

Stick

C+

7

U.S.C.T.

Garry S. Curtis,

Pf., Co. H, 7 Reg't U. S. Col'd Infantry.

Appears on

Company Muster Roll

for Nov. and Dec., 1863.

Present or absent Present.

Stoppage, \$ 100 for

Due Gov't, \$ 100 for

Remarks: Dec \$2 enlistment premium.

Book mark:

State

(858)

Copyist

6

7

U.S.C.T.

George Curtis

Pt., Co. H, 7 Reg't U. S. Col'd Infantry.

Appears on

Company Muster Roll

for *Jan. + Feb.*, 1864.

Present or absent *Present*

Stoppage, \$ *100* for

Due Gov't, \$ *100* for

Remarks:

Book mark:

Hub

(858)

Copyist

61

7

U.S.C.T.

George Curtis,

P/, Co. H, 7 Reg't U. S. Col'd Infantry.

Appears on

Company Muster Roll

for *1 Mch. 1864*

Present or absent

Present

Stoppage, \$ _____ 100 for _____

Due Gov't, \$ _____ 100 for _____

Remarks:

Book mark:

Stall

Copyist

61 7 U.S.C.T.

George Curtis
Co. H, 7 Reg't U. S. Col'd Infantry.

Appears on

Company Muster Roll

for May & June, 1864

Present or absent Present

Stoppage, \$ 100 for

Due Gov't, \$ 100 for

Remarks:

Book mark:

Steele

(858)

Copyist

6 | 7 | U.S.C.T.

George Curtis
Pl., Co. H, 7 Reg't U. S. Col'd Infantry.

Appears on

Company Muster Roll

for July and Aug, 1864.

Present or absent Absent

Stoppage, \$ 100 for

Due Gov't, \$ 100 for

Remarks: Stop for one
harassment. On
detached service
as ambulance
driver

Book mark:

Stub

61

7

U.S.C.T.

George Curtis

Co. H, 7 Reg't U. S. Col'd Infantry.

Appears on

Company Muster Roll

for Sept. & Oct., 1864.

Present or absent Present.

Stoppage, \$ 100 for

Due Gov't, \$ 100 for

Remarks: Stab for one hour on the detached Service in ambulance Corps for DC. Mo. 1 Aug 15 1864. VS of No 3 B. Dec *

* Pa...

Book mark:

Stewart

40

7

U.S.C.T.

George Curtiss

Co., Co. H, 7 Reg't U. S. Col'd Infantry.

Appears on

Company Muster Roll

for *Nov. and Dec.*, 1864.

Present or absent *Absent*

Stoppage, \$ *100* for

Due Gov't, \$ *100* for

Remarks: *On det. com's service in
ambulance corps for S.O. No 1 Aug 11
Stop for 1 hour sick.*

Book mark:

W. H. Merrill

(858)

Copyist

C

7

U.S.C.T.

George Curtiss

Priv, Co. H, 7 Reg't U. S. Col'd Infantry.

Appears on

Company Muster Roll

for *Jan and Feb*, 1865.

Present or absent *absent*

Stoppage, \$ *100* for

Due Gov't, \$ *100* for

Remarks: *Detached with the ambulance
Corps. A.O. No 1 Aug 11. 64
Stop for 1 week 20c*

Book mark:

N. H. Merrill

(858)

Copyist

C | 7 | U.S.C.T.

George Curtis

Private, Co. H, 7 Reg't U. S. Col'd Infantry.

Appears on

Company Muster Roll

for March and April, 1865.

Present or absent Present

Stoppage, \$ 100 for >

Due Gov't, \$ 100 for

Remarks: Wrote rec with ambulance
 Corp. by S. O. No 1 Aug 1. 64
Stop for one n. for 20c

Book mark:

H. H. Merrill

6 | 7 | U.S.C.T.

George Curtis
Priv, Co. H, 7 Reg't U. S. Col'd Infantry.

Appears on

Company Muster Roll

for *May and June*, 1863.

Present or absent *absent*

Stoppage, \$ *100* for

Due Gov't, \$ *100* for

Remarks: *Withdrawn from Amb. Corps*
A. C. 1 1st Reg since Aug 13. 64
Stop for 1 miber 20^c

Book mark:

W. H. Russell

C | 7

U.S.C.T.

George Curtis
Pvt, Co A, 7 Reg't U. S. Col'd Infantry.

Appears on a

Detachment Muster Roll

of the organization named above

for *May & June*, 1865.

Station *White Ranch Texas*

Present or absent *Present*

Stoppage, \$ *100* for

Due Gov't, \$ *100* for

Remarks:

Book mark:

L. Y. Spann

6

7

U.S.C.T.

George Curtis

1st, Co. H, 7 Reg't U. S. Col'd Infantry.

Appears on

Company Muster Roll

for *July and Aug*, 186*4*.

Present or absent *absent*

Stoppage, \$ *100* for

Due Gov't, \$ *100* for

Remarks: *Not with army corps 2, Co. 701*

1st Reg. 3rd Cav. 10 A.C. Aug 13, 64

Book mark:

H. H. Merrill

(858)

Copyist

6

7

U.S.C.T.

George Curtis

Paw, Co. H, 7 Reg't U. S. Col'd Infantry.

Appears on

Company Muster Roll

for *Sept and Oct*, 186*4*.

Present or absent *Absent*

Stoppage, \$ *100* for

Due Gov't, \$ *100* for

Remarks: *Det with Am Corps by D.O. No 1*
1 Brig 3^d 10 A.C. Aug 13 64

Book mark:

N. H. Merrill

40

7

U.S.C.T.

George Curtis

Private, Co. H, 7 Reg't U. S. Col'd Infantry.

Appears on

Company Muster Roll

for *Nov and Dec*, 1863.

Present or absent *absent*

Stoppage, \$ *100* for

Due Gov't, \$ *100* for

Remarks: *Det. with Am Corps by D.C. No. 1*

1st Brig. 3rd Div. 10 A.S. May 13, 64

Book mark:

W. H. Merrill

(858)

Copyist

Co. | 7 | U.S.C.T.

George Curtis
Pvt., Co. H, 7 Reg't U. S. Col'd Infantry.

Appears on

Company Muster Roll

for Jan & Feb., 1866.

Present or absent Present

Stoppage, \$ 100 for

Due Gov't, \$ 100 for

Remarks:

Book mark:

J. J. Kearney
Copyist

Co. | 7 | **U.S.C.T.**

George Curtis
Priv, Co. H, 7 Reg't U. S. Col'd Infantry.

Appears on

Company Muster Roll

for March & April, 1866.

Present or absent Present

Stoppage, \$ 75 for Co. & G. & C.
100

Due Gov't, \$ 100 for

Remarks:

Book mark: _____

(858) _____ J. J. Harney
Copyist

C. | **7** | **U.S.C.T.**

George Curtis

Prvt, Co. H, 7 Reg't U. S. Col'd Infantry.

Appears on

Company Muster Roll

for *May & June*, 186*6*.

Present or absent *Present*

Stoppage, \$ *100* for

Due Gov't, \$ *100* for

Remarks:

Book mark:

J. J. Kearney

(858)

Copyist

6 | 7 | **U.S.C.T.**

George Curtis
Pr, Co. H, 7 Reg't U. S. Col'd Infantry.

Appears on

Company Muster Roll

for July & Aug., 1866.

Present or absent Present

Stoppage, \$ 100 for

Due Gov't, \$ 100 for

Remarks:

Book mark:

(858)

J. J. Mcarney
Copyist

Co. | 7 | U.S.C.T.

George Curtis
Capt, Co. No., 7 Reg't U. S. Col'd Inf.

Appears on Co. Muster-out Roll, dated
Indiana, Tex., Oct. 13, 1866.

Muster-out to date _____, 186 .
Last paid to June 30, 1866 .

Clothing account:

Last settled _____, 186 ; drawn since \$ 100
Due soldier \$ 100; due U. S. \$ 100
Am't for cloth'g in kind or money adv'd \$ 100

Due U. S. for arms, equipments, &c., \$ 100
Bounty paid \$ 100; due \$ 100

Remarks: Died Sept. 8 '66 at Indian
-ola, Tex. of Cholera. Final
statements rendered Sept. 10 '66

Book mark: F.S.

(361)

J. J. Kearney Copyist.

Curtis Geo.
 P. H. 7, Reg't
 2 Enclosures.

Bed Cards	Final Statements /
Burial Records	Furloughs or L. of A.
Certs. of Dis. for Discharge	Med. Certificates
C. M. Charges	Med. Des. Lists
Descriptive Lists	Orders
Discharge Certificates	Pris. of War Record
Enlistment Papers	Resignations

Other papers relating to—

Admission to Hosp'l	Furlough or L. of A.
Casualty Sheet	Med. Examination
Confinement	Misc. Information
Contracts	Pay or Clothing
Death or Effects /	Personal Reports
Desertion	Rank
Discharge from Hosp'l	Transfer to Hosp'l
Discharge from Service	Transfer to V. R. C.
Duty	Transportation

NARA 95

Extract from Act of Congress.

SEC. 12. *And be it further enacted,* That the fees of agents and attorneys for making out and causing to be executed the papers necessary to establish a claim for a pension, bounty, and other allowance before the Pension Office, under this act, shall not exceed the following rates: For making out and causing to be duly executed a declaration by the applicant, with the necessary affidavits, and forwarding the same to the Pension Office, with the requisite correspondence, ten dollars; which sum shall be received by such agent or attorney in full for all services in obtaining such pension, and shall not be demanded or received, in whole or in part, until such pension shall be obtained; and the sixth and seventh sections of an act entitled "An act to grant pensions," approved July [fourteenth,] eighteen hundred and sixty-two, are hereby repealed.

SEC. 13. *And be it further enacted,* That any agent or attorney who shall, directly or indirectly, demand or receive any greater compensation for his services under this act than is prescribed in the preceding section of this act, or who shall contract or agree to prosecute any claim for a pension, bounty, or other allowance under this act, on the condition that he shall receive a per centum upon any portion of the amount of such claim, or who shall wrongfully withhold from a pensioner or other claimant the whole or any part of the pension or claim allowed and due to such pensioner or claimant, shall be deemed guilty of a high misdemeanor, and, upon conviction thereof, shall, for every such offense, be fined not exceeding three hundred dollars, or imprisoned at hard labor not exceeding two years, or both, according to the circumstances and aggravations of the offense.

Approved July 4, 1864.

NOTE 10.—If any soldier is charged a higher fee than that allowed by the above act, he should report the fact and the name of the agent to the Adjutant General, in order that steps may be taken to have the same refunded.

ADJUTANT GENERAL'S OFFICE
Sept 24
Duplicate with Inventor

FINAL STATEMENT

- A -

P. G. Curtis
of
7 Reg't of U.S.A.
VOLUNTEERS.
Disch Sept 8th 1864

NOTE 1.—Two of these certificates (or duplicates) are to be given to each Volunteer Soldier or drafted man who may be discharged without being mustered out (Final Statements are never given to men mustered out of service,) that he may at once receive from the Paymaster the pay, &c., due him, and the captain or other COMMISSIONED officer commanding the company will certify to the act of the delivery of the duplicate certificates; with these certificates the Soldier is "entitled to" his discharge, and should also present his discharge to the Paymaster to have the payment endorsed on it. The discharge is to be given back to the Soldier by the Paymaster; the latter only retaining as his vouchers the duplicate certificates.

NOTE 2.—If the Soldier is entitled to pay for the use of his horse, the Company Commander will certify to that fact on the back of both these final statements, and also to the time he has pay due for having been so mounted on his own horse.

NOTE 3.—When a Soldier is furnished with final statements, his descriptive list, if he has one, should be taken up by the officer who gives the Soldier these statements, and endorsed with a statement to this effect by the officer. The endorsement should exhibit a full statement of the time for which the Soldier was allowed pay on his final statements, the clothing account, and all other charges against him or in his favor, so as to comprise a complete exhibit of his account. It will then be transmitted to the Company Commander of the Soldier, who will enter all the data necessary to a full understanding of the Soldier's account on the muster roll upon which the Soldier's discharge is reported. The descriptive list will then be destroyed. The object of this is, that the remaining portion of the Soldier's account may be settled upon the receipt of these muster rolls, and the Soldier receive any pay or allowances that may be due him at the time of his discharge, and which may not appear on his last final statements from the fact that his descriptive list is incomplete. These accounts for back pay, &c., are settled by the 2d Auditor of the Treasury Department.

NOTE 4.—Charges for loss or injury to ordnance, horse equipments, and other miscellaneous charges, should appear under the heading of "Other Stoppages."

NOTE 5.—Bounty paid by State authorities, and not by the United States, will not be entered on this statement.

NOTE 6.—Amounts due the Sutler and Laundress must be entered on the muster roll on which the discharge, death, desertion, &c., is reported, as well as on the final statement, otherwise the amount cannot be collected from the United States.

NOTE 7.—This blank will be used for deceased volunteers and drafted men, as well as for others.

NOTE 8.—Where a Soldier dies in Hospital or on detached service, his descriptive list, if he has one, should be sent with his final statements, in duplicate, to the Adjutant General, Washington, D. C.

NOTE 9.—If the soldier is a drafted man or substitute, the space for time, &c., of enrolled, should contain only the word *drafted* or *substitute*, as the case may be. If the Soldier is a "VETERAN," (or RECRUIT,) the words *as a veteran*, (or *recruit*,) should be interlined after the words *mustered into the service of the U. S.* A statement of all the installments of *Veteran* or *Recruit Bounty* RECEIVED by the Soldier must be made on the back of each final statement.

RECEIVED
SEP 24 1864
OFFICE
Curtis

I certify, on honor, that George Curtis, a Private of
 Captain Russell Hall Company 2d of the 7 Regiment of U.S.C.
VOLUNTEERS, of the State of _____, born in St Marys, State
 of Maryland, aged 23 years; 5 feet 3 1/2 inches high; Blk complexion,
Blk eyes, Blk hair, and by occupation a Turner, who joined for service
 and was enrolled (see Note 9) on the 31 day of Oct, 1863, at St Marys
 by Col. W. Spry, for the period of 3 years, and mustered into
 the service of the United States on the 5 day of Nov, 1863, at
Pump Station, by W. Col. Haskell; and having served
 HONESTLY and FAITHFULLY with his Company to the present date, is now entitled to a
DISCHARGE by reason of Death in Hoep. Sept 8th 1866

The said George Curtis was last paid by Paymaster
Wm. Underwood, to include the 30th day of June, 1866, and
 has pay due him from that time to the present date; he is entitled to pay and subsistence for
TRAVELING to place of enrollment, and whatever other allowances are authorized to volunteer
 soldiers, drafted men, or militia, so discharged. He has received from the United States **CLOTHING**
 amounting to \$27. ⁶⁴/₁₀₀ dollars, since the 30th day of June,
 1866, when his clothing account was last settled. ~~He has received from the United States~~
_____ ¹⁰⁰ dollars advanced **BOUNTY**.

There is to be stopped from him, on account of the State of _____, or other
 authorities, for **CLOTHING, &c.**, received on entering service, _____ ¹⁰⁰ dollars; and
 for other stoppages, viz: _____

_____ ¹⁰⁰ dollars.
 He has been furnished with **TRANSPORTATION** in kind from the place of his discharge to
 _____; and he has been **SUBSISTED** for **TRAVELING** to his
 place of enrollment, up to the _____, 186 .

He is indebted to _____, **SUTLER**, _____ ¹⁰⁰ dollars.
 He is indebted to _____, **LAUNDRESS**, _____ ¹⁰⁰ dollars.

Given in Duplicate, at Indianapolis Tex, this 13th day
 of September, 1866

W. D. Wilcox
1st Lieut. 7. U.S.C.
 Commanding Company.

MARR 97

1866

7

79 on file N.M.
INVENTORY OF THE EFFECTS

ARTICLES OF WAR.

ART. 95. When any non-commissioned officer or soldier shall die, or be killed in the service of the United States, the then commanding officer of the troop or company shall, in the presence of two other commissioned officers, take an account of what effects he died possessed of, above his arms and accoutrements, and transmit the same to the office of the Department of War, which said effects are to be accounted for, and paid to the representatives of such deceased non-commissioned officer or soldier. And in case any of the officers, so authorized to take care of the effects of deceased officers and soldiers, should, before they have accounted to their representatives for the same, have occasion to leave the regiment or post, by preferment or otherwise, they shall, before they be permitted to quit the same, deposit in the hands of the commanding officer, or of the assistant military agent, all the effects of such deceased non-commissioned officers and soldiers, in order that the same may be secured for, and paid to, their respective representatives.

DIRECTIONS.

NOTE 1.—One copy of the inventories of the effects of deceased non-commissioned officers and soldiers, required by the 95th Article of War, will be forwarded to the Adjutant General, by the commander of the company to which the deceased belonged, and a duplicate of the same to the colonel of the regiment. Final statements of pay, clothing, &c., in duplicate, will be sent to the Adjutant General with one copy of the inventory. Both inventory and final statements should be forwarded, as a general rule, through Regimental Headquarters. When a soldier dies at a post or station absent from his company, it will be the duty of his immediate commander to furnish, direct to the Adjutant General, the required inventory and final statements, and, at the same time, to forward to the commanding officer of the company to which the soldier belonged, a report of his death, specifying the date, place, and cause; to what time he was last paid, and the money or other effects in his possession at the time of his decease; which report will be noted on the next muster roll of the company to which the man belonged. Each inventory will be endorsed, "Inventory of the effects of _____, late of company (—) _____ regiment of _____, who died at _____, the _____ day of _____, 186—." If a legal representative receive the effects, it will be stated in the report. If the soldier leave no effects, the fact will be reported on the blank for inventory.

NOTE 2.—Should the effects of a deceased non-commissioned officer or soldier not be administered upon within a short period after his decease, they shall be disposed of by a Council of Administration, under the authority of the commanding officer of the post, and the proceeds deposited with the Paymaster, to the credit of the United States, until they shall be claimed by the legal representatives of the deceased.

NOTE 3.—In all such cases of sales by the Council of Administration, a statement in detail, or account of the proceeds duly certified by the Council and commanding officer, (Form 5) accompanied by the Paymaster's receipt for the proceeds, will be forwarded by the commanding officer to the Adjutant General. The statement will be endorsed, "Report of the proceeds of the effects of _____, late of company (—) _____ regiment of _____, who died at _____, the _____ day of _____, 186—."

NOTE 4.—The effects in all cases, when called for, should be turned over to the legal representative, without further authority from the Adjutant General. When the effects are turned over to the relatives of the deceased before these inventories are sent to the Adjutant General, their receipts therefor should be attached to the inventories. In all other cases, one copy will be sent with a letter of transmittal direct to the Adjutant General, and a duplicate retained by the officer.

NOTE 5.—Particular care should be taken to take receipts in duplicate from the Paymaster for any funds turned over to him; one copy should be sent direct to the Adjutant General and one retained by the officer.

George Quinter
Late of Company *H*
7 Reg't of *U.S.C.*
Volunteers, who died at *Indianapolis Ind*
on the *5* day of *September* 186*6*.



Inventory of the effects of George Curtis late
 a Private of Captain Russell Hall Company No of
 the 4th Regiment of USCT Volunteers, who was enrolled as
 a Private at St Marys in the State of Maryland on
 the 31 day of October 1863, and mustered into the service of the United
 States as a Private on the 5 day of Nov 1863, at Camp Stanton
 in Company No, 4 Regiment of USCT Volunteers, to serve 3
 years or during the war; he was born in St. Mary in the State
 of Maryland; he was 23 years of age, 5 feet 3 1/2 inches
 high, Bk complexion, Bk eyes, Bk hair, and by occupation, when enrolled,
 a Farmer; he died in Hospital, at
Indianola Tex on the 8th day of Sept 1866, by
 reason of Epidemic Cholera.

INVENTORY.					
ARTICLES.	No.	ARTICLES.	No.	ARTICLES.	No.
Hats.....		Pairs trousers.....		Knapsacks.....	
Caps.....		Pairs flannel drawers.....			
Forage caps.....		Pairs cotton drawers.....			
Great coats.....		Flannel shirts.....			
Uniform coats.....		Cotton shirts.....			
Uniform jackets.....		Pairs boots.....			
Flannel sack coats.....		Pairs shoes.....			
Blouses.....		Pairs socks.....			
Stable frocks.....		Blankets.....			
Fatigue overalls.....		Haversacks.....			
				MONEY.	
				Specie.....	\$
				Notes.....	\$

I CERTIFY, ON HONOR, that the above inventory comprises all the effects of _____
 _____, deceased, and that the effects are in the hands
 of _____ at _____
 _____ to be disposed of by a Council of Administration.

(DUPLICATES.)

STATION: Indianola Tex

DATE: Sep 13 1866

[A. G. O. No. 104.]

J. D. Whitcomb
1st Lt USCT.
 Commanding the Company.

Curtis James A.

Co. A, 7 U.S. Col'd Inf.

Private Private

CARD NUMBERS.

1	6	2	9	2	4	6	4	26
2	6	2	9	2	5	6	4	27
3	6	2	9	2	6	6	4	28
4	6	2	9	2	7	6	5	29
5	6	2	9	2	8	6	5	30
6	6	2	9	2	9	5	7	31
7	6	2	9	3	0	4	7	32
8	6	2	9	3	1	4	8	33
9	6	2	9	3	2	4	6	34
10	6	2	9	3	3	4	5	35
11	6	2	9	3	4	4	2	36
12	6	2	9	3	5	3	9	37
13	6	2	9	3	6	5	8	38
14	6	2	9	3	7	1	7	39
15	6	2	9	3	8	0	3	40
16	6	2	9	3	8	7	7	41
17	6	2	9	3	9	5	0	42
18	6	2	9	4	0	2	2	43
19	6	2	9	4	0	9	3	44
20	9	0	6	6	7	8	6	45
21								46
22								47
23								48
24								49
25								50

Book Mark:

See also

REP 366955-

S. 1453 & 60, P.O. Nixon

S. 2028960 P.O. Nixon

C. | 7 | U.S.C.T.

James A. Curtis

Co. *D*, 7 Reg't U.S. Col'd Inf.

Appears on

Company Descriptive Book

of the organization named above.

DESCRIPTION.

Age *18* years; height *5* feet *3* inches.

Complexion *Black*

Eyes *Black*; hair *Black*

Where born *St. Mary, Maryland*

Occupation

ENLISTMENT.

When *Oct. 26*, 1863.

Where *St. Mary*

By whom *Wm. Birney*; term *3* y'rs.

Remarks: *Admitted Nov. 5. 1863
by St. Col. Haskell*

J. A. White

C. J. 7 U.S.C.T.

James A. Curtis,
Pt. H., Co. *H.,* 7 Reg't U. S. Col'd Inf.

Age 18 years.

Appears on

Company Muster-in Roll

of the organization named above. Roll dated
Cp. Stanton Charles Co. Md. Nov. 5, 1863.

Muster-in to date Nov. 5, 1863

Joined for duty and enrolled:

When Oct 26, 1863.

Where St. Mary, Md.

Period 3 years.

Remarks:

Book mark:

Steel,

A

7

U.S.C.T.

James G. Linton
C.P., Co. H, 7 Reg't U. S. Col'd Infantry.

Appears on

Company Muster Roll

for *Nov. & Dec.*, 1863.

Present or absent *Present*

Stoppage, \$ *100* for

Due Gov't, \$ *100* for

Remarks: *Due \$ which must premium*

Book mark:

Stute

G

7

U.S.C.T.

James V. Lupton,
Pl., Co. H, 7 Reg't U. S. Col'd Infantry.

Appears on

Company Muster Roll

for Jan & Feby., 1864.

Present or absent Present

Stoppage, \$ 100 for

Due Gov't, \$ 100 for

Remarks:

Book mark:

Stull

6 | 7 | U.S.C.T.

James A. Burtin,
Pl., Co. H, 7 Reg't U. S. Col'd Infantry.

Appears on

Company Muster Roll

for *Mch. & Apr., 1864.*

Present or absent *Present*

Stoppage, \$ 100 for

Due Gov't, \$ 100 for

Remarks:

Book mark:

Steele

(858)

Copyist

61

7

U.S.C.T.

James H. Curtis
Co., Co. H, 7 Reg't U. S. Col'd Infantry.

Appears on

Company Muster Roll

for May & June, 1864.

Present or absent Present

Stoppage, \$ 100 for

Due Gov't, \$ 100 for

Remarks: Sick in
Hosp. since
May 28/64

Book mark:

Steel

61

7

U.S.C.T.

James W. Curtis,
Pvt., Co. H, 7 Reg't U. S. Col'd Infantry.

Appears on

Company Muster Roll

for July & Aug., 1864.

Present or absent Present

Stoppage, \$ 100 for

Due Gov't, \$ 100 for

Remarks: Stopped for one
piece shelter
tent.

Book mark:

Steele

(858)

Copyist

C. | 7 | U.S.C.T.

James A. Curtis
P., Co. H, 7 Reg't U. S. Col'd Infantry.

Appears on

Company Muster Roll

for Sept. & Oct., 1864.

Present or absent Present

Stoppage, \$ 100 for

Due Gov't, \$ 100 for

Remarks:

Book mark:

Steele

6

7

U.S.C.T.

James W. Cortiss

Co. H, Co. H, 7 Reg't U. S. Col'd Infantry.

Appears on

Company Muster Roll

for *Nov. and Dec.*, 1864.

Present or absent *Present*

Stoppage, \$ *100* for

Due Gov't, \$ *100* for

Remarks: *Ship per 1 Cartridge box, plate
and ripen Haversack + canteen*

Book mark:

H. K. Merrill

(858)

Copyist

46

7

U.S.C.T.

James A. Curtiss

Priv, Co. H, 7 Reg't U. S. Col'd Infantry.

Appears on

Company Muster Roll

for *Jan and Feb*, 1865.

Present or absent *Absent*

Stoppage, \$ *100* for

Due Gov't, \$ *100* for

Remarks: *sent to Hosp. Jan. 9 1865*

Stop for 1 week 20c

Book mark:

W. H. Newell

(858)

Copyist

40

7

U.S.C.T.

James A. Curtis

Co., Co. H, 7 Reg't U. S. Col'd Infantry.

Appears on

Company Muster Roll

for *March and Apr*, 1865.

Present or absent *Present*

Stoppage, \$ *100* for

Due Gov't, \$ *100* for

Remarks: *Stop for one pipe 200
and one acc'tors*

Book mark:

N. K. Merrill

(858)

Copyist

46

7

U.S.C.T.

James W. Curtis

P110, Co. H, 7 Reg't U. S. Col'd Infantry.

Appears on

Company Muster Roll

for *May and June*, 1865.

Present or absent *Present*

Stoppage, \$ *100* for

Due Gov't, \$ *100* for

Remarks: *Stop for 1 week & return*

Book mark:

W. H. Merrill

(858)

Copyist

6

7

U.S.C.T.

James An Curtis

Priv, Co. H, 7 Reg't U. S. Col'd Infantry.

Appears on

Company Muster Roll

for *July and Aug*, 1863.

Present or absent *Present*

Stoppage, \$ *100* for

Due Gov't, \$ *100* for

Remarks:

Book mark:

N. H. Merrill

6

7

U.S.C.T.

James A. Curtis

Co. H, Co. H, 7 Reg't U. S. Col'd Infantry.

Appears on

Company Muster Roll

for *Sept and Oct*, 186*1*.

Present or absent *Present*

Stoppage, \$ *100* for

Due Gov't, \$ *100* for

Remarks:

Book mark: _____

N. H. Merrill

4 | 7 | U.S.C.T.

James W. Curtis

200, Co. H, 7 Reg't U. S. Col'd Infantry.

Appears on

Company Muster Roll

for *March and April*, 1863.

Present or absent *Present*

Stoppage, \$ *100* for

Due Gov't, \$ *100* for

Remarks:

Book mark:

N. H. Merrill

C. | 7 | **U.S.C.T.**

James A. Courtis

Cpt, Co. H, 7 Reg't U. S. Col'd Infantry.

Appears on

Company Muster Roll

for *Jan. & Feb.*, 1866.

Present or absent *Present*

Stoppage, \$ 100 for

Due Gov't, \$ 100 for

Remarks:

Book mark: _____

(858)

J. J. Kearney
Copyist

6

7

U.S.C.T.

James A. Curtis

Priv., Co. H, 7 Reg't U. S. Col'd Infantry.

Appears on

Company Muster Roll

for March & April, 1866.

Present or absent Present

Stoppage, \$ 100 for

Due Gov't, \$ 100 for

Remarks:

Book mark:

(858)

J. J. Kearney

Copist

Co. | **7** | **U.S.C.T.**

James S. Curtis

Prt, Co. H, 7 Reg't U. S. Col'd Infantry.

Appears on

Company Muster Roll

for *May & June*, 186*6*.

Present or absent *Present*

Stoppage, \$ *100* for

Due Gov't, \$ *100* for

Remarks:

Book mark:

(358)

L. J. Harnoy
Copyist

Co. | 7 | U.S.C.T.

James A. Curtis

Prvt, Co. H, 7 Reg't U. S. Col'd Infantry.

Appears on

Company Muster Roll

for July & Aug, 1864.

Present or absent Present

Stoppage, \$ 100 for

Due Gov't, \$ 100 for

Remarks:

Book mark:

(858)

J. J. Kearney

Copyist

6 | 7 | **U.S.C.T.**

James A. Curtis
Prvt, Co. *No.*, 7 Reg't U. S. Col'd Infantry.

Appears on **Co. Muster-out Roll**, dated
Indianola, Tex., *Oct. 13*, 186*6*.

Muster-out to date *Oct. 13*, 186*6*.

Last paid to *June 30*, 186*6*.

Clothing account:

Last settled....., 186 ; drawn since \$ 100

Due soldier \$ 100; due U. S. \$ *43* 100

Am't for cloth'g in kind or money adv'd \$ 100

Due U. S. for arms, equipments, &c., \$ 100

Bounty paid \$ 100; due \$ *100* 100

Remarks: *Joined at Orig^l - Organzⁿ*

Book mark: *928 1883 - 464 309*

J. J. Kearney Copyist.

352
Curtis John A.

Co A, 7 U.S. Col'd Inf.

Private Private

CARD NUMBERS.

1	6 2 7 8 7 3 9	26
2	6 2 4 1 1 4 1	27
3	6 2 9 1 2 4 5	28
4	6 2 9 1 3 4 3	29
5	6 2 9 1 4 2 3	30
6	6 2 9 1 5 2 0	31
7	6 2 4 1 6 6 9	32
8	6 2 9 2 3 8 3	33
9	9 0 6 6 7 2 9	34
10		35
11		36
12		37
13		38
14		39
15		40
16		41
17		42
18		43
19		44
20		45
21		46
22		47
23		48
24		49
25		50

Book Mark:

See also

C | W | U.S.C.T.

John W. Curtis
Co. G, 7 Reg't U.S. Col'd Inf.

Appears on
Company Descriptive Book
of the organization named above.

DESCRIPTION.

Age 25 years; height 5 feet $\frac{3}{4}$ inches.

Complexion *Grieff*

Eyes *Black*; hair *Curlly*

Where born *St. Marys Md.*

Occupation *Farmer*

ENLISTMENT.

When *Mar 16*, 1864.

Where *St. Marys*

By whom *Genl Wm. P. King*; term *3* y'rs.

Remarks: *Killed Sept 28 1864. in the charge of St. Helena Va.*

* *As it is on book.*

J. P. Brown
Copyist.

C 1 7 | **U.S.C.T.**

John H. Curtis
 _____, Co. *G*, 7 Reg't U. S. Col'd Infantry.

Age *23* years.

Appears on a

Detachment Muster-in Roll

of the organization named above. Roll dated

Benedict, Md., Jan. 16, 1864.

Muster-in to date *Jan. 16, 1864.*

Joined for duty and enrolled:

When *Jan. 16*, 1864.

Where *St. Mary's*

Period *3* years.

Remarks: _____

Book mark: _____

W. Beck
 Copyist.

6

7

U.S.C.T.

John H. Curtis

Priv., Co. G, 7 Reg't U. S. Col'd Infantry.

Appears on

Company Muster Roll

for *Jan. 7* to *Feb.*, 1864.

Present or absent *Present*

Stoppage, \$ 100 for

Due Gov't, \$ 100 for

Remarks: *Joined as Recruit*
Jan. 18", 1864. Absent on
recruiting service from
Jan. 30" to Feb. 11", 1864,
Genl. orders No. 22 from
Brig. Hd. Qrs. dated Jan.
30", 1864.

Book mark:

Sandoz
Copyst

(858)

C

7

U.S.C.T.

John H. Curtis
Priv., Co. G, 7 Reg't U. S. Col'd Infantry.

Appears on

Company Muster Roll

for *March & Apr.*, 1864.

Present or absent *Present*

Stoppage, \$ *100* for

Due Gov't, \$ *100* for

Remarks:

Book mark:

(858)

Sandoy
Copyist

C

7

U.S.C.T.

John H. Curtis

Priv., Co. G, 7 Reg't U. S. Col'd Infantry.

Appears on

Company Muster Roll

for *May & June*, 1864.

Present or absent *Present*

Stoppage, \$ *100* for

Due Gov't, \$ *100* for

Remarks:

Book mark:

Sandoy
Copyist

(858)

C

7

U.S.C.T.

John H. Curtis
Corp., Co. G, 7 Reg't U. S. Col'd Infantry.

Appears on

Company Muster Roll

for *July & Aug.*, 1864.

Present or absent *Present*

Stoppage, \$ 100 for

Due Gov't, \$ 100 for

Remarks: *Free on or before*
April 19, 1861. Promoted
July 30 /64.

Book mark:

Sandoz
Clerk

(858)

C

7

U.S.C.T.

John H. Curtis
Corp., Co. G, 7 Reg't U. S. Col'd Infantry.

Appears on

Company Muster Roll

for *Sept. 8* *Oct.*, 1864.

Present or absent *Absent*

Stoppage, \$ 100 for

Due Gov't, \$ 100 for

Remarks: *Missing in action*
Sept. 29, 1864. Free on
or before April 19,
1865.

Book mark:

Sandoz

(858)

Copyist

C

7

U.S.C.T.

John H. Curtis
Capt., Co. G, 7 Reg't U. S. Col'd Infantry.

Appears on

Company Muster Roll

for *Nov + Dec*, 1864

Present or absent

Stoppage, \$ 100 for

Due Gov't, \$ 100 for

Remarks:

Missing in action
Sept 29 64 & omitted
from before ay

Book mark:

(858)

J. W. Ames
Copyist

C | **7** | **U.S.C.T.**

John H. Curtis
PT, Co. *4*, 7 Reg't U. S. Col'd Infantry.

Appears on **Co. Muster-out Roll**, dated
Indianola Texas Oct 13, 1866 .

Muster-out to date _____, 186 .

Last paid to *April 30*, 1864 .

Clothing account:

Last settled _____, 186 ; drawn since \$ _____ 100

Due soldier \$ _____ 100; due U. S. \$ _____ 100

Am't for cloth'g in kind or money adv'd \$ _____ 100

Due U. S. for arms, equipments, &c., \$ _____ 100

Bounty paid \$ _____ 100; due \$ _____ 100

Remarks: *Killed in action at
Fort Gilmer September 29
1864 final statement rec-
-dered **

** Roll torn*

Book mark: *F.S.*

Hadfield

Lewis, John H.

P, Co. G, 7 U.S.C. Inf. Reg't

7 Enclosures.

Bed Cards	Descriptive Lists
Burial Records	Final Statements
Certs. of Dis. for Discharge	Furloughs
C. M. Charges	Med. Des. Lists
Med. Certificates	Orders

Other papers relating to—

Admission to Hosp'l	Furlough
Casualty Sheet (Officer's)	Med. Examination
Confinement	Misc. Information
Contracts	Pay or Clothing
Death or Effects	Personal Reports
Desertions	Rank
Discharge from Hosp'l	Transfer to Hosp'l
Discharge from Service	Transfer to V. R. C.
Duty	Transportation

Extract from Act of Congress.

SEC. 12. *And be it further enacted,* That the fees of agents and attorneys for making out and causing to be executed the papers necessary to establish a claim for a pension, bounty, and other allowance before the Pension Office, under this act, shall not exceed the following rates: For making out and causing to be duly executed a declaration by the applicant, with the necessary affidavits, and forwarding the same to the Pension Office, with the requisite correspondence, ten dollars; which sum shall be received by such agent or attorney in full for all services in obtaining such pension, and shall not be demanded or received, in whole or in part, until such pension shall be obtained; and the sixth and seventh sections of an act entitled "An act to grant pensions," approved July [fourteenth,] eighteen hundred and sixty-two, are hereby repealed.

SEC. 13. *And be it further enacted,* That any agent or attorney who shall, directly or indirectly, demand or receive any greater compensation for his services under this act than is prescribed in the preceding section of this act, or who shall contract or agree to prosecute any claim for a pension, bounty, or other allowance under this act, on the condition that he shall receive a per centum upon any portion of the amount of such claim, or who shall wrongfully withhold from a pensioner or other claimant the whole or any part of the pension or claim allowed and due to such pensioner or claimant, shall be deemed guilty of a high misdemeanor, and, upon conviction thereof, shall, for every such offense, be fined not exceeding three hundred dollars, or imprisoned at hard labor not exceeding two years, or both, according to the circumstances and aggravations of the offense.

Approved July 4, 1864.

NOTE 10.—If any soldier is charged a higher fee than that allowed by the above act, he should report the fact and the name of the agent to the Adjutant General, in order that steps may be taken to have the same refunded.

ADJUTANT GENERAL'S OFFICE
Aug 25th 1864
Duplicate with Inventory sent 21st Madison.

45
FINAL STATEMENT 38

or
Private John H. Currier
7th Reg't of W. Col. Troops

Volunteers.
Died Sept 29th 1864

NOTE 1.—Two of these certificates (or duplicates) are to be given to each Volunteer Soldier or drafted man who may be discharged without being mustered out. (Final Statements are never given to men mustered out of service) that he may at once receive from the Paymaster the pay, &c. due him, and the captain or other COMMISSIONED officer commanding the company will certify to the act of the delivery of the duplicate certificates; with these certificates the Soldier is "entitled to" his discharge, and should also present his discharge to the Paymaster to have the payment endorsed on it. The discharge is to be given back to the Soldier by the Paymaster; the latter only retaining as his vouchers the duplicate certificates.

NOTE 2.—If the Soldier is entitled to pay for the use of his horse, the Company Commander will certify to that fact on the back of both these final statements, and also to the time he has pay due for having been so mounted on his own horse.

NOTE 3.—When a Soldier is furnished with final statements, his descriptive list, if he has one, should be taken up by the officer who gives the Soldier these statements, and endorsed with a statement to this effect by the officer. The endorsement should exhibit a full statement of the time for which the Soldier was allowed pay on his final statements, the clothing account, and all other charges against him or in his favor, so as to comprise a complete exhibit of his account. It will then be transmitted to the Company Commander of the Soldier, who will enter all the data necessary to a full understanding of the Soldier's account on the muster roll upon which the Soldier's discharge is reported. The descriptive list will then be destroyed. The object of this is, that the remaining portion of the Soldier's account may be settled upon the receipt of these muster rolls, and the Soldier receive any pay or allowances that may be due him at the time of his discharge, and which may not appear on his last final statements from the fact that his descriptive list is incomplete. These accounts for back pay, &c., are settled by the 2d Auditor of the Treasury Department.

NOTE 4.—Charges for loss or injury to ordnance, horse equipments, and other miscellaneous charges, should appear under the heading of "Other Stoppages."

NOTE 5.—Bounty paid by State authorities, and not by the United States, will not be entered on this statement.

NOTE 6.—Amounts due the Sutler and Laundress must be entered on the muster roll on which the discharge, death, desertion, &c., is reported, as well as on the final statement, otherwise the amount cannot be collected from the United States.

NOTE 7.—This blank will be used for deceased volunteers and drafted men, as well as for others.

NOTE 8.—Where a Soldier dies in Hospital or on detached service, his descriptive list, if he has one, should be sent with his final statements, in duplicate, to the Adjutant General, Washington, D. C.

NOTE 9.—If the soldier is a drafted man or substitute, the words for time, &c., of enrolled, should contain only the word *drafted* or *substitute*, as the case may be. If the Soldier is a "VETERAN," (or RECRUIT) the words *as a veteran*, (or *recruit*,) as the case may be, should be inserted after the words *mustered into the service of the U. S.* As statements for all the installments of *Veteran or Recruit Bounty RECEIVED* by the Soldier must be made on the back of each final statement.

Currier
RECEIVED
AUG 25 1864
ADJUTANT GENERAL'S OFFICE

I certify, on honor, that John H. Curtis, a Private of
 Captain Wm. Smith's Company (1) of the 7th Regiment of W. Geol. Cook's
VOLUNTEERS, of the State of Maryland, born in St. Mary's Co., State
 of Maryland, aged 15 years; 5 feet 4 inches high; Ruff complexion,
Black eyes, Black hair, and by occupation a Farmer, who joined for service
 and was enrolled (see Note 9) on the 16th day of January, 1864, at Camp Stanton Md
 by Genl Wm. Barry, for the period of 3 years, and mustered into
 the service of the United States on the 16th day of January, 1864, at
Camp Stanton Md by Genl Wm. Barry; and having served
 HONESTLY and FAITHFULLY with his Company to the present date, is now entitled to a
DISCHARGE by reason of Death, Killed in Charge in
Fort Gilman Va. Sept 29th 1864.

The said Private John H. Curtis was last paid by Paymaster
A. W. Cornell, to include the 30th day of April, 1864, and
 has pay due him from that time to the present date; he is entitled to pay and subsistence for
TRAVELING to place of enrollment, and whatever other allowances are authorized to volunteer
 soldiers, drafted men, or militia, so discharged. He has received from the United States **CLOTHING**
 amounting to \$ 53 ¹⁴/₁₀₀ dollars, since the 16th day of January,
 1864, when his clothing account was last settled. He has received from the United States
 _____ ¹⁰⁰/₁₀₀ dollars advanced **BOUNTY**.

There is to be stopped from him, on account of the State of _____, or other
 authorities, for **CLOTHING, &c.**, received on entering service, _____ ¹⁰⁰/₁₀₀ dollars; and
 for other stoppages, viz: _____

_____ ¹⁰⁰/₁₀₀ dollars.
 He has been furnished with **TRANSPORTATION** in kind from the place of his discharge to
 _____; and he has been **SUBSISTED** for **TRAVELING** to his
 place of enrollment, up to the _____, 1864.

He is indebted to _____, **SUTLER**, _____ ¹⁰⁰/₁₀₀ dollars.
 He is indebted to _____, **LAUNDRESS**, _____ ¹⁰⁰/₁₀₀ dollars.

Given in Duplicate, at Victoria, Texas, this 13th day
 of August, 1866.

A. K. Long
1st Lieut. 7th Regt

 Commanding Company.

353
Curtis Lewis

Co G, 7 U.S. Col'd Inf.

Private

CARD NUMBERS.

1	6279240	26
2	6291847	27
3	6291919	28
4	6291988	29
5	6292055	30
6	6292118	31
7	6292199	32
8	6279553	33
9	62192356	34
10	9066746	35
11	896-05-1877	36
12		37
13		38
14		39
15		40
16		41
17		42
18		43
19		44
20		45
21		46
22		47
23		48
24		49
25		50

Book Mark: 2B vol 12 - P 312
896 - V 12 6J - 77

See also

RTP 524801

10 | 11 | U.S.C.T.

Lewis Curtis
Co. G, 7 Reg't U.S. Col'd Inf.

Appears on
Company Descriptive Book
of the organization named above.

DESCRIPTION.

Age 19 years; height 5 feet 6 1/2 inches.

Complexion Black

Eyes Blue; hair Black

Where born Del.

Occupation Laborer

ENLISTMENT.

When Apr 4, 1865.

Where Wilmington, Del.

By whom Capt. Wilmer term 1 y'r.

Remarks: Sub. of George Webb, Kent Co. Del. Mustered into service Apr 4, '65 by Capt. Wilmer Wilmington, Del. See Register of Discharged - Discharged Apr 4 '66, at Galveston, Tex., by expiration of service.

W. J. Wilmer

6 | 7 | U.S.C.T

Lewis Curtis

Appears with rank of _____ on
Muster and Descriptive Roll of a Detach-
ment of Drafted Men and Substitutes
forwarded

for the 7 Reg't U.S. Col'd Inf. Roll dated
Baltimore, Md., April 8, 1863

Where born Delaware

Age 19 years; occupation Laborer

Drafted and mustered in:

When April 4, 1863

Where Wilmington Del.

Period 1 years.

Eyes Blue; hair Blue

Complexion Blue; height 5 ft. 6 in.

Paid bounty and advance pay, \$ 100

Bounty due \$ 100

Where credited _____

Company to which assigned _____

Remarks: Sub for George Webb
Kent Co. Delaware

Book mark: _____

(340)

J. M. Fairley
Copyist.

C

7

U.S.C.T.

Lewis Curtis

Pvt., Co. G, 7 Reg't U. S. Col'd Infantry.

Appears on

Company Muster Roll

for May & June, 1865.

Present or absent Present

Stoppage, \$ 100 for

Due Gov't, \$ 100 for

Remarks:

Due from draft Remedy
Vans \$ 280.00 210 C.B. 1124

Book mark:

J. W. Curtis

(858)

Copyst

C

7

U.S.C.T.

Lewis Curtis

Private, Co. G, 7 Reg't U. S. Col'd Infantry.

Appears on

Company Muster Roll

for July & Aug., 1865.

Present or absent Present

Stoppage, \$ 100 for

Due Gov't, \$ 100 for

Remarks:

Book mark:

(858)

J. W. [Signature]

Copyist

6

7

U.S.C.T.

Lewis Curtiss

Plt, Co. G, 7 Reg't U. S. Col'd Infantry.

Appears on

Company Muster Roll

for Sept & Oct, 1863

Present or absent Present

Stoppage, \$ 100 for

Due Gov't, \$ 100 for

Remarks:

Book mark:

(858)

J. W. [Signature]

Copyist

C

7

U.S.C.T.

Lewis Curtis

Plt, Co. G, 7 Reg't U. S. Col'd Infantry.

Appears on

Company Muster Roll

for *Nov. + Dec.*, 186 *5*

Present or absent *Present*

Stoppage, \$ *100* for

Due Gov't, \$ *100* for

Remarks:

Book mark: _____

J. W. Ames
Copyist

(858)

6

7

U.S.C.T.

Lewis Curtis
Pot, Co. G, 7 Reg't U. S. Col'd Infantry.

Appears on

Company Muster Roll

for Jan & Feb, 1866.

Present or absent Present

Stoppage, \$ 100 for

Due Gov't, \$ 100 for

Remarks: Due from draft
Rendezvous \$280.00 no.
check book 1124

Book mark: Muster out on file

Hadfield

(858)

Copyist

C

7

U.S.C.T.

Lewis Curtis
Pot, Co. G, 7 Reg't U. S. Col'd Infantry.

Appears on

Company Muster Roll

for *mar & apr*, 1866.

Present or absent

Stoppage, \$ 100 for

Due Gov't, \$ 100 for

Remarks: *mustered out of service*
Apr 4 on expiration of
term of service at Galves
ton Texas

Book mark *discharged april 3/66*
(over)

Hudfield

(858)

Copyist

JAN. 21

6292199

18810

0

V.B. $\frac{12}{312}$

6 | 7 U.S.C.T.

Lewis Curtiss
Det., Co. G, 7 Reg't U. S. Col'd Infantry.

Appears on a

Detachment Muster-out Roll

of the organization named above. Roll dated

Galveston Texas April 3, 1866.

Muster-out to date April 3, 1866.

Last paid to Dec 31, 1865

Clothing account:

Last settled _____, 186 ; drawn since \$ _____ 100

Due soldier \$ _____ 100; due U. S. \$19 ³⁴/₁₀₀

Am't for cloth'g in kind or money adv'd \$ _____ 100

Due U. S. for arms, equipments, &c., \$6 ⁰⁰/₁₀₀

Bounty paid \$ _____ 100 due \$ _____ 100

Remarks: Entered service as
Substitute for Geo. Webb.
Kent, Co. Del. Due the
soldier from draft
redemption \$2.80. No
of check book 1124.
(over)

Book mark: _____

Jentines

JAN. 20

6279553

1881

Retains Springfield
Musket, and equipments
per G. O. 101 War
Dept. U. S. A. 1865.

Mustered out by
reason of expiration
of term of service.

6 | 7 | **U.S.C.T.**

Lewis Curtis
Pvt, Co. *G*, 7 Reg't U. S. Col'd Infantry.

Appears on **Co. Muster-out Roll**, dated
Indianola Texas, Oct 13, 1866.

Muster-out to date _____, 186__ .

Last paid to *Dec 31*, 1865 .

Clothing account:

Last settled _____, 186__ ; drawn since \$ _____ 100

Due soldier \$ _____ 100; due U. S. \$ _____ 100

Am't for cloth'g in kind or money adv'd \$ _____ 100

Due U. S. for arms, equipments, &c., \$ _____ 100

Bounty paid \$ _____ 100; due \$ _____ 100

Remarks: *Discharged by rea-*
son of expiration of term
of service at Galveston
Texas April 4 1866

Book mark: *M. Confile*
(over)

(361)

Hadfield
Copyist.

MAR 14 1966

JAN. 21

6292356

AL 8910

*e.g.O. discharged
april 3/66 EVB V12 P 312
896 V12 c.t. 77*

C | 7 | U. S. C. I.

Lewis Curtis

, Co. G, 7th Reg't U. S. C. I.

NOTATION.

Book mark: E-B-12-312.
896-C-I-1877.

War Department,

Adjutant General's Office,

Washington, May 7, 1877.

Mustered out April 3, 1866.

W. Allen

Curtis, Lewis

....., Co.

Reg't *U.S.C. 7*

Enclosures.

Bed Cards	Final Statements
Burial Records	Furloughs or L. of A.
Certs. of Dis. for Discharge	Med. Certificates
C. M. Charges	Med. Des. Lists
Descriptive Lists	Orders
Discharge Certificates	Pris. of War Record
Enlistment Papers	Resignations

Other papers relating to—

Admission to Hosp'l	Furlough or L. of A.
Casualty Sheet	Med. Examination
Confinement	Misc. Information
Contracts	Pay or Clothing
Death or Effects	Personal Reports
Desertion	Rank
Discharge from Hosp'l	Transfer to Hosp'l
Discharge from Service	Transfer to V. R. C.
Duty	Transportation

DECLARATION OF SUBSTITUTE.

Lewis Curtis (Col), desiring to ENLIST
in the Army of the United States, for ~~THREE~~ **THREE** YEARS, **Do declare**, That I am
thirteen years and _____ months of age; that I have
never been discharged from the United States service on account of disability or by sentence of
a court martial; and I know of no impediment to my serving honestly and faithfully as a soldier
for ~~three~~ **two** years.

GIVEN at *Wilmington Del*
the *5th* day of *April 1865*

WITNESS:
Saml Biddle
Lewis Curtis
marks

No. *46* / *6/65*
Lewis Curtis (Col)
Enlisted at *Wilmington*
As Substitute for
George Webb
On the *4th* day of *April*, 186*5*
By
Edwin Wilmer
Saml Biddle
H. G. Fisher
Board of Enrollment,
Dist. of *Del*

SUBSTITUTE

VOLUNTEER ENLISTMENT.

STATE OF

TOWN OF

Delaware

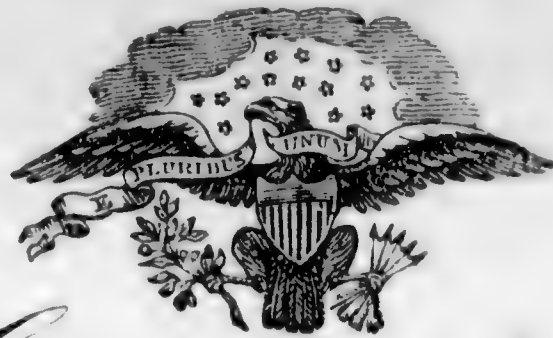

Wilmington

I, *Lewis Curtis (Col)*, born in the State of *Delaware*, aged *Nineteen* years, and by occupation a *Laborer*, Do HEREBY ACKNOWLEDGE to have agreed with *George Webb*, Esq., of *East Mifflord Ad Kent County Delaware*

to become his **SUBSTITUTE** in the Military Service, for a sufficient consideration paid and delivered to me, on the *Fourth* day of *April*, 1863; and having thus agreed with said *George Webb*, I DO HEREBY ACKNOWLEDGE to have enlisted this *Fourth* day of *April*, 1863 to serve as a **Soldier** in the **Army of the United States of America**, for the period of ~~THREE YEARS~~, unless sooner discharged by proper authority. I do also agree to accept such bounty, pay, rations, and clothing as are, or may be, established by law for soldiers. And I do solemnly swear that I will bear true and faithful allegiance to the **United States of America**; that I will serve them honestly and faithfully against all their enemies or opposers whomsoever; and that I will observe and obey the orders of the President of the United States and the orders of the officers appointed over me, according to the Rules and Articles of War.

SWORN and subscribed to, at *Wilmington*
this *4th* of *April*, 1863
BEFORE *Wm. M. [Signature]* *Lewis's* *Curtis*
mark

Not entitled to bounty (Single)

We certify, on honor, That we have carefully examined the above-named Volunteer Substitute agreeably to the Regulations, and that, in our opinion, he is free from all bodily defects and mental infirmity which would in any way disqualify him from performing the duties of a soldier; that he was entirely sober when enlisted; that he is of lawful age, (not under 18 years;) and that, in accepting him as duly qualified to perform the duties of an able-bodied soldier, and as a Substitute in lieu of

George Webb, drafted in *East Mifflord Ad Kent Co. Del. Feb. 20*, 1863, we have strictly observed the Regulations which govern in such cases. This soldier has *blue* eyes, *blue* hair, *blue* complexion; is *5* feet *6 1/2* inches high.

Wm. M. [Signature]

Provost Marshal.

Sam. Bidwell

Commissioner of Board.

Wm. G. [Signature]

Surgeon of Board.

Board of Enrollment of *Cons. Dist. of Delaware*

354

Curvin, Isaac

Co. G., 7 U.S. Col'd Inf.

Private Private

CARD NUMBERS.

1	6290938	26
2	6291037	27
3	6291139	28
4	6291243	29
5	6291406	30
6	6292388	31
7	9066656	32
8		33
9		34
10		35
11		36
12		37
13		38
14		39
15		40
16		41
17		42
18		43
19		44
20		45
21		46
22		47
23		48
24		49
25		50

Book Mark:

See also

Headstone 5/18/39 W.L.

C | **7** | **U.S.C.T.**

Isaac Curwin
....., Co. *C*, 7 Reg't U. S. Col'd Inf.

Appears on
Company Descriptive Book
of the organization named above.

DESCRIPTION.

Age *20* years; height *5* feet *4* inches.
Complexion *Griff*
Eyes *Black*; hair *Curly*
Where born *Somerset, Md.*
Occupation *Farmer*

ENLISTMENT.

When *Oct 22*, 186*4*.
Where *Somerset*
By whom *Col. W. R. R. ...*; term *3* y'rs.

Remarks: *Rec'd at U.S. Army
Hospital Baltimore, Md.
April 22 "1864.*

Isaac Curwin
Copryst.

C | 7 | U.S.C.T.

Isaac Curwin

Pvt., Co. G, 7 Reg't U. S. Col'd Inf.

Age 20 years.

Appears on

Company Muster-in Roll

of the organization named above. Roll dated

Camp Stator, Charles Co., Md., Nov. 5, 1863.

Muster-in to date Nov. 5, 1863.

Joined for duty and enrolled:

When Oct. 22, 1863.

Where Somerset, Md.

Period 3 years.

Remarks:

Book mark:

Sando Copyist.

C

7

U.S.C.T.

Isaac Cirwin

Priv., Co. G, 7 Reg't U. S. Col'd Infantry.

Appears on

Company Muster Roll

for Nov. 5 to Dec. 31, 1863.

Present or absent Present

Stoppage, \$ 100 for

Due Gov't, \$ 100 for

Remarks: Premium for enlistment \$2.00 (due)

Book mark:

Sanday
Copyist

(858)

C

7

U.S.C.T.

Isaac Cirvin

Priv., Co. G, 7 Reg't U. S. Col'd Infantry.

Appears on

Company Muster Roll

for Jan. 8 & Feby., 1864.

Present or absent Present.

Stoppage, \$ 100 for

Due Gov't, \$ 100 for

Remarks:

[Empty lines for remarks]

Book mark:

(858)

Sandoz
Copyist

C

7

U.S.C.T.

Isaac Curvin.

Priv., Co. G, 7 Reg't U. S. Col'd Infantry.

Appears on

Company Muster Roll

for Mch. & Apr., 1864.

Present or absent Absent.

Stoppage, \$ 100 for

Due Gov't, \$ 100 for

Remarks: Sent to Hospital, at Baltimore, Md. March 14th, 1864.

Book mark:

Sandoz

Copyist

(858)

C

7

U.S.C.T.

Isaac Curwin

....., Co. G, 7 Reg't U. S. Col'd Infantry.

Appears on

Company Muster Roll

for *May & June*, 1864

Present or absent

Stoppage, \$ 100 for

Due Gov't, \$ 100 for

Remarks: *Died in Hospital,
Baltimore, Md.*

Book mark: *Died in US Hos-*

Sandoz

(858)

Copyist

NOV 14 1964

JAN. 21

6291406

61891*

putal, Baltimore, Md.,
Apr. 22, '64, congestion
of brain, F.S.

6 | 7 | U.S.C.T.

Isaac Curwin

Pvt, Co. G, 7 Reg't U. S. Col'd Infantry.

Appears on Co. Muster-out Roll, dated Indianola Texas Oct 13, 1866.

Muster-out to date _____, 186 .

Last paid to Dec 31, 1863 .

Clothing account:

Last settled _____, 186 ; drawn since \$ 100

Due soldier \$ 100 ; due U. S. \$ 100

Am't for cloth'g in kind or money adv'd \$ 100

Due U. S. for arms, equipments, &c., \$ 100

Bounty paid \$ 100 ; due \$ 100

Remarks: Died at US Hospital Baltimore Md April 22 1864 final statement rendered September

* Roll torn

Book mark: Jan 11. 68 2^d and 6469 (over)

Hadfield

NOVA 100

JAN. 21

6292388

018910

G. S.

Curvin, Isaac -

P. Co. 7 Reg't USCT,

4 ~~3~~ Enclosures.

Bed Cards	Descriptive Lists
Burial Records	Final Statements
Certs. of Dis. for Discharge	Furloughs
C. M. Charges	Med. Des. Lists
Med. Certificates	Orders

Other papers relating to—

Admission to Hosp'l	Furlough
Casualty Sheet (Officer's)	Med. Examination
Confinement	Misc. Information
Contracts	Pay or Clothing
Death or Effects	Personal Reports
Desertions	Rank
Discharge from Hosp'l	Transfer to Hosp'l
Discharge from Service	Transfer to V. R. C.
Duty	Transportation

Balto Md

Name of Hospital, *Medford*

Name of Patient, *J. C. ...*

Disease or Injury, *Acute Rheumatism*

Result, *Death April 22/15*

Date of Transmission,

REMARKS AS TO CONDITION OF PATIENT, &c.

Pris 97 uscs

DIET.

TREATMENT.

DATE.

MEDICAL DESCRIPTIVE LIST.

Ward *I*, Bed *14*

General Hospital at *McClellan Marine Barracks*

Name *Jane Curless*, Age *28*, Rank *Private*, Co. *F*, Regiment *1st USCT*

Disease or Injury, *Acute Rheumatism*

Result, _____

Admission, *March 5th 1864*

Return to duty, cured, _____

Furlough, _____

DATE OF

Discharge from service, _____

[Name of attending Medical Officer.]

Transfer to another Hospital, _____

C. C. Topoff, Asst Surg 1st USCT

Death, *April 22nd 64*

NOTE.—When a patient is first received into a General Hospital, the entries on this Descriptive List will be commenced. All important changes in his condition will be noted on it, (in ink,) from time to time, by the Surgeon in charge of the Ward. When the patient has been wounded, the date and character of the wound will be stated, the nature of the operation, (if any,) and, above all, the result. In case of transfer, this list will be sent, through the Officer in charge of the transportation, or failing one, by mail, to the Surgeon in charge of the Hospital receiving the patient. When this Medical History shall have been completed, by the cure, discharge, furlough, or death of the patient, it will, with the treatment and result, carefully noted, be transmitted directly to the Surgeon General.

DATE.	TREATMENT.	DIET.	REMARKS AS TO CONDITION OF PATIENT, &c.
<i>March 5th</i>	<i>℞ Vin Calcium 10 drs eny 6 Huncs Pillsulatub g. x.</i>	<i>Half-</i>	
			<i>Died April 22nd 64 of Congestion of Brain</i>

1864, Sept. 26th
Des. list, & inventory of effects sent
2^d Auditor
P.

✓ 46 ~~29~~

FINAL STATEMENT

OF

Leaac Currier

7th Reg't of U.S. Troops

2^d Auditor

VOLUNTEERS.

Died April 23rd 1864

NOTE 1.—Two of these certificates (or duplicates) are to be given to each volunteer soldier who may be discharged previously to the discharge of his company, that he may at once receive from the Paymaster the pay, &c., due him, and the captain or other officer commanding the company will certify to the act of the delivery of the duplicate certificates; on these certificates the Soldier is "entitled to" his discharge, and should also present his discharge to the Paymaster to have the payment endorsed on it. The discharge is to be given back to the Soldier by the Paymaster; the latter only retaining as his voucher the duplicate certificates.

NOTE 2.—If the Soldier is entitled to pay for the use of his horse, the Company Commander will certify to that fact, and also to the time he has pay due for having been so mounted on his own horse.

NOTE 3.—Amounts due the Sutler and Laundress must be entered on the Muster Roll on which the death, desertion, &c., is reported, as well as on the final statement, otherwise the amount cannot be collected from the United States.

NOTE 4.—This blank will be used for deceased volunteers as well as others.

Sent
R

ADJUTANT GENERAL'S OFFICE

May 2^d 1864

Duplicate with Inventory sent 2d Auditor.

Currier, R. of Cur.

I certify, on honor, that Isaac Curwin a Private of
 Captain Wm C Smith's Company (Co) of the 7th Regiment of U.S. Col. Regts
VOLUNTEERS, of the State of _____, born in Somerset Co., State
 of Maryland, aged 20 years; 5 feet 1 inches high; Fair complexion,
Dark eyes, Curly hair, and by occupation a Farmer, having joined the company on
 its original organization at _____, and enrolled in it at the muster into
 the service of the United States at _____, on the _____ day
 of _____, 186- , (or was mustered in service as a recruit, by Ch. Col. G. F.
Muster, at Charlottesville, on the fifth day of November,
 186 3, to serve in the Regiment,) for the term of Three Years
 and having served **HONESTLY** and **FAITHFULLY** with his Company in various places
 to the present date, is now entitled to a **DISCHARGE** by reason of Death, died
in U.S. Army General Hospital Mc Kearns Mansion Balt. Md April
22d 1864 of "Congestion of Brain"

The said Isaac Curwin was last paid by Paymaster
Maj. Malou to include the 31st day of December, 1863, and has
 pay due him from that time to the present date; he is entitled to pay and subsistence for
TRAVELING to place of enrollment and whatever other allowances are authorized to volunteer
 soldiers, or militia, so discharged. He has received Thirty Seven — $\frac{62}{100}$ dollars,
 advanced by the United States on account of **CLOTHING**.

There is to be stopped from him, on account of the State of _____, or other
 authorities for **CLOTHING, &c.**, received on entering service, _____ dollars; also,
 for expenses of **SUBSISTENCE** for **TRAVELING** from place of enrollment to the place of rendezvous,
 amounting to _____ dollars: and on account of the United States for **EXTRA**
CLOTHING received in kind from _____ and for other
 stoppages, viz:

_____ amounting to _____ dollars;
 and he has been **SUBSISTED** for **TRAVELING** to his place of enrollment, up to the _____
 _____, 186- .

He is indebted to _____, **SUTLER**, _____ dollars.

He is indebted to _____, **LAUNDRESS**, _____ dollars.

Given in Duplicate, at Balt Md this 23rd day of April, 1864.

Lavinia Quirk
Surgeon U.S.A.
 Commanding Company
 in charge of Hospital

HOSPITAL RECORD,

SUBJECT TO THE

ORDER OF THE SURGEON GENERAL

UNITED STATES ARMY.

Isaac Curwin
7 W.D. O.S. Post "G"
April 22, 1864
McKim Bldg
Balto Md

No. 1.

RECORD OF DEATH AND INTERMENT.

Name and number of person interred.	<i>Isaac Curvin</i>
Number and locality of the grave . .	<i>Laurel Cemetery</i>
Hospital number of the deceased . .	
Regiment, rank, and company	<i>4th U.S.C Troops. Private. G</i>
Residence before enlistment	<i>Somerset Co Maryland</i>
Conjugal condition, (and if married,) the residence of the widow) . . . }	
Cause of death }	<i>Congestion of the brain</i>
Age of the deceased	<i>twenty</i>
Nativity	<i>Somerset Co Maryland</i>
References and remarks }	
Date of death and burial	<i>Died April 22, 1864. Burial 11 A.M. April 24 1864.</i>

Duplicates sent to the Adjutant General of the United States Army, and to the Sexton of the
 Cemetery.

Memoranda: of effects
One (1) Overcoat
One (1) Blouse
One (1) Pair Pants
One (1) Cap
One (1) Pair shoes

COPY OF RECORD

FOR THE

ADJUTANT GENERAL U. S. ARMY.

No. 2.

RECORD OF DEATH AND INTERMENT.

Name and number of person interred.	<i>Isaac Curwin</i>
Number and locality of the grave . . .	<i>Laurel Cemetery</i>
Hospital number of the deceased . . .	
Regiment, rank, and company	<i>7 U.S. Troops, Private, Co G</i>
Residence before enlistment	<i>Somerset Co Maryland</i>
Conjugal condition, (and if married,) the residence of the widow)	
Cause of death	<i>Congestion of the brain</i>
Age of the deceased	<i>Twenty</i>
Nativity	<i>Somerset Co Maryland</i>
References and remarks	
Date of death and burial	<i>Died Apl 22. 1864. Burial 3 P.M Apl 24 1864.</i>

[A duplicate of this Record has been forwarded to the Sexton, and another remains at this Hospital.]

To

.....

SIR :

It becomes my duty to inform you that the person above described died at this Hospital as herein stated ; and that it is desired his remains should be interred with the usual military honors.

Respectfully,

Larrington Dyer
Surgeon U. S. Army.
In charge of Hospital

MILITARY HOSPITAL, *McKim's Mansion*
Baltimore

This copy of Record is to be transmitted to the Adjutant General at Washington immediately after the place of burial and the number of the grave have been ascertained and registered. The above notification is to remain attached.

355

Private Benjamin

Co *K*, 7 U.S. Col'd Inf.

Private Private

CARD NUMBERS.

1	6 2 9 5 9 8 9	26
2	6 2 9 6 0 8 9	27
3	6 2 9 6 1 8 7	28
4	6 2 9 6 2 9 0	29
5	6 2 9 6 3 8 6	30
6	6 2 9 6 4 7 9	31
7	6 2 9 6 5 7 2	32
8	6 2 9 6 7 1 7	33
9	6 2 7 9 3 5 2	34
10	6 2 9 7 7 5 6	35
11	9 0 6 7 0 2 7	36
12		37
13		38
14		39
15		40
16		41
17		42
18		43
19		44
20		45
21		46
22		47
23		48
24		49
25		50

Book Mark: *EB. 12-365*

See also

S1077809 Po Retd

\$1900812 - Po Retd

C. 1 7 U.S.C.T.

Benjamin Curtis

Co. K, 7 Reg't U.S. Col'd Inf.

Appears on

Company Descriptive Book

of the organization named above.

DESCRIPTION.

Age 38 years; height 5 feet 1 inches.

Complexion Gray

Eyes Black; hair Black.

Where born Accomac, Virginia.

Occupation Tanner.

ENLISTMENT.

When Nov. 5, 1863.

Where Barracks

By whom Lt. H. Birney; term 3 y'rs.

Remarks: Mustered into serv. at Camp Stanton, Ches. Co. Md. by Lt. Col. Haskelle Nov. 12. 63.

Missing in action Sept. 29. 64.

H. White

6 | 7 | U.S.C.T.

Benjamin Custis

Privat, Co. K., 7 Reg't U. S. Col'd Inf.

Age 38 years.

Appears on

Company Muster-in Roll

of the organization named above. Roll dated

Stanton Charles Co. Md., Nov. 12, 1863.

Muster-in to date Nov. 12, 1863

Joined for duty and enrolled:

When Nov 6, 1863.

Where Calvert Md.

Period 3 years.

Remarks:

Book mark: 45 - P. 43-69

D. M. Kennedy

(356)

Copyist.

6 | 7 | U.S.C.T.

Benjamin Custus
Privat, Co. K, 7 Reg't U. S. Col'd Infantry.

Appears on

Company Muster Roll

for Nov. 12 to Dec 31, 1863.

Present or absent Present

Stoppage, \$ 100 for

Due Gov't, \$ 100 for

Remarks: Enlistment Premium
\$ 2 00 dollars due.

Book mark:

D. M. Kennedy
Copyist.

(358)

6 | 7 | U.S.C.T.

Benjamin Custus
Pvt., Co. K, 7 Reg't U. S. Col'd Infantry.

Appears on

Company Muster Roll

for Jan. v Feb., 1864.

Present or absent Present

Stoppage, \$ 100 for

Due Gov't, \$ 100 for

Remarks:

Book mark:

D. M. Kennedy
Copist.

6 | 7 | **U.S.C.T.**

Benjamin Gustus
Privt, Co. K, 7 Reg't U. S. Col'd Infantry.

Appears on

Company Muster Roll

for *Mch* v. *Apr*, 1864.

Present or absent *Present*.

Stoppage, \$ 100 for

Due Gov't, \$ 100 for

Remarks:

Book mark:

D. M. Kennedy

Copyist.

6 | 7 | U.S.C.T.

Benjamin Custis
Privt., Co. K, 7 Reg't U. S. Col'd Infantry.

Appears on

Company Muster Roll

for *May & June*, 1864.

Present or absent *Present*

Stoppage, \$ *100* for

Due Gov't, \$ *100* for

Remarks:

Book mark:

D. Kennedy
Copyist.

6

7

U.S.C.T.

Benjamin Custis

Privt, Co. K, 7 Reg't U. S. Col'd Infantry.

Appears on

Company Muster Roll

for *July* v. *Aug.*, 186 *4*

Present or absent *Present*

Stoppage, \$ *100* for

Due Gov't, \$ *100* for

Remarks:

Book mark:

P. M. Kennedy

Copyist.

6

7

U.S.C.T.

Benjamin Custis
Privt, Co. K, 7 Reg't U. S. Col'd Infantry.

Appears on

Company Muster Roll

for Sept. & Oct., 1864

Present or absent Absent

Stoppage, \$ 100 for

Due Gov't, \$ 100 for

Remarks: Missing in action
Sept. 29" 1864

Book mark:

D. M. Kennedy

(358)

Copyist.

6 | 7 | **U.S.C.T.**

Benjamin Gustis
Priv, Co. K, 7 Reg't U. S. Col'd Infantry.

Appears on

Company Muster Roll

for *Nov + Dec*, 1864

Present or absent *Absent*

Stoppage, \$ 100 for

Due Gov't, \$ 100 for

Remarks: *Missing in action Sep. 29th 1864 and omitted to be dropped*

Book mark: *Discharged June 28/65 E.B. 1012*

(358)

Leary
Copyist.

JAN. 21

6296717

AL8910

$\frac{12}{365}$

617

U.S.C.T.

Benjamin Custer
Smith, Co. K, 7 Reg't U. S. Col'd Inf.

Appears on an

Individual Muster-out Roll

of the organization named above. Roll dated

Baltimore, Md. June 28, 1865.

Muster-out to date June 28, 1865.

Last paid to Apr. 30, 1864.

Clothing account:

Last settled....., 186 ; drawn since \$..... 100

Due soldier \$..... 100; due U. S. \$..... 100

Am't for cloth'g in kind or money adv'd \$..... 100

Due U. S. for arms, equipments, &c., \$..... 100

Bounty paid \$..... 100; due \$..... 100

Remarks: Due U.S. for
clothing overdrawn \$1.23
Captured at Fort
Gilmore, Sept. 27th
1864 and released (over)

Book mark: V181, P53. 74 (over)

C. R. Owen

JAN. 20

6279352

1891*

at Atlanta, Ga., May 1,
1865,

Ordered to report from
Camp Parole Annapo-
olis Md. to Baltimore
Md. for muster out-
service June 5, 1865,
and is entitled to three
(3) months extra
pay in accordance
with telegram dated
War Dept. A. G. O.
Washington, D. C.,
May 30, 1865 -

Book Marks (Contn)

V. 105, P. 177, & 7

435, 235-

C | 7 | U.S.C.T.

Benjamin Custiss
Priv., Co. K, 7 Reg't U. S. Col'd Inf.

Appears on Co. Muster-out Roll, dated
Indianola, Texas, Oct. 13th, 1866.

Muster-out to date _____, 186 .

Last paid to Feb. 29th, 1864.

Clothing account:

Last settled _____, 186 ; drawn since \$ 100

Due soldier \$ 100; due U. S. \$ 100

Am't for cloth'g in kind or money adv'd \$ 100

Due U. S. for arms, equipments, &c., \$ 100

Bounty paid \$ 100; due \$ 100

Remarks A prisoner of War
since Sept. 29th 64. Mis-
sing in action.

Book mark: 2nd And. 4912, Oct 9/67.
U. S. P. 43, 1869. - U. S. P. 53, 74.
(over)

Randall

MARR 1965

JAN. 21

6297756

18910

Book Mark: V. 105. P. 179. 69.
435. 235. - Discharged
June 28/65. E. B. $\frac{12}{365}$.

Ernest Benjamin
Adk 7 Reg't *1st*
Co. ,

2 Enclosures.

Bed Cards	Final Statements
Burial Records	Furloughs or L. of A.
Certs. of Dis. for Discharge	Med. Certificates
C. M. Charges	Med. Des. Lists
Descriptive Lists	Orders
Discharge Certificates	Pris. of War Record /
Enlistment Papers	Resignations

Other papers relating to—

Admission to Hosp'l	Furlough or L. of A.
Casualty Sheet	Med. Examination
Confinement	Misc. Information /
Contracts	Pay or Clothing
Death or Effects	Personal Reports
Desertion	Rank
Discharge from Hosp'l	Transfer to Hosp'l
Discharge from Service	Transfer to V. R. C.
Duty	Transportation

MICROFILM PUBLICATION M 1849

COMPILED MILITARY SERVICE RECORDS
OF VOLUNTEER UNION SOLDIERS WHO SERVED WITH
THE UNITED STATES COLORED TROOPS (USCT)
7TH REGIMENT OF INFANTRY

PERSONAL PAPERS' TARGET SHEET

PLEASE NOTE THE CHECKED INFORMATION ABOUT THE PERSONAL PAPERS IN
THIS FILE:

NO PERSONAL PAPERS WERE FOUND IN THIS FILE WHEN THE
RECORDS WERE ARRANGED FOR MICROFILMING.

5 PERSONAL PAPER(S) FOUND IN THIS FILE WHEN THE RECORDS
WERE ARRANGED FOR MICROFILMING.

MEMORANDUM FROM PRISONER OF WAR RECORDS.

No. _____

(This blank to be used only in the arrangement of said records.)

2nd Lieut

NAME.	RANK.	ORGANIZATION.				INFORMATION OBTAINED FROM—				
		No. of Reg't.	State.	Arm of Service.	Co.	Records of—	Vol.	Page.	Vol.	Page.
<i>Curtis Quig</i>	<i>Capt</i>	<i>7th</i>	<i>USCT</i>			<i>Escap. Recs</i>	<i>32</i>	<i>101</i>	<i>File 5</i>	

Captured at *Forkblmore Sep 29*, 186*4*, confined at Richmond, Va., _____, 186 .

Admitted to Hospital at _____

where he died _____, 186 , of _____

Paroled at *Atlanta Ga May 1/64*, 186 ; reported at Camp Parole, Md., _____, 186 .

*Escaped date & place not stated - Rept'd at Dept of South date not given
Sent to prison for Wash. D.C. for St. Ste of the South, May 24/64 -*

Copied by *J.M.C.* ✓

MEMORANDUM FROM PRISONER OF WAR RECORDS.

No. _____

(This blank to be used only in the arrangement of said records.)

2nd
Custer

NAME.	RANK.	ORGANIZATION.				INFORMATION OBTAINED FROM—				
		No. of Reg't.	State.	Arm of Service.	Co.	Records of—	Vol.	Page.	Vol.	Page.
<i>Curtis Quij</i>	<i>Pvt</i>	<i>17</i>	<i>USA</i>	<i>USA</i>	<i>USA</i>	<i>Recap Rec 32</i>	<i>101</i>	<i>File 5</i>		

Captured at *Ft. Monroe Sep 29*, 186*4*, confined at Richmond, Va., _____, 186*4*.

Admitted to Hospital at _____

where he died _____, 186*4*, of _____

Paroled at *Atlanta Ga May 11/64*, 186*4*; reported at Camp Parole, Md., _____, 186*4*.

Escaped date & place not stated. Reptd at Dept of South date not given. Sent to prison for Wash D.C. for Ste Star of the South, May 24/64

Copied by *JM* ✓

MEMORANDUM FROM PRISONER OF WAR RECORDS.

No. 15

(This blank to be used only in the arrangement of said records.)

NAME.	RANK.	ORGANIZATION.				INFORMATION OBTAINED FROM—				
		No. of Reg't.	State.	Army or Service.	Co.	Records of—	Vol.	Page.	Vol.	Page.
<i>Custer } Benj. Curtiss }</i>						<i>Colts</i>	<i>22</i>	<i>38</i>	<i>8</i>	<i>41</i>
						<i>Mis</i>	<i>39</i>	<i>61</i>	<i>21</i>	<i>30</i>
						<i>CP Md.</i>	<i>10</i>	<i>48</i>		
<i>Custer Benjamin P</i>			<i>U.S.</i>	<i>16</i>						

Captured at *Dr. Gilmore Sept. 29*, 1864, confined at Richmond, Va., *Sept. 29*, 1864.

* *Transfd. to Castle Thunder by S.O. No. 150. Nov 9 '64*

Admitted to Hospital at *21 Richmond Va. Oct. 7 '64. V.S.* * *Farmer Age 30*
where he died _____, 186____, of *Rept. Co. B. Annap Md. June 3/65. sent to C.P. Md.*

Paroled at *Atlanta Ga. May 1*, 1865; reported at Camp Parole, Md., *June 8*, 1865.

* *sent to Baltimore Md. June 9 '65*

Cl. June 4/65.

Copied by *(over)*

(Record continued.)

Furloughed _____, 186 , for _____ days; returned _____, 186 ;
deserted _____, 186 ;

Enlisted as Benjamin Coates, Co K, 7th U.S.C.V.

Woodward
Pen. Case to L.A. Branch April 23/83

Copied by *WDR* *Apr 14/83*
DC

This is accepted as referring to

Coates

Benjamin

Co. *K*,

Reg't,

118th O.V.

and records will be corrected accordingly.

WDR

Assistant Adjutant Gen'l.

Adjutant General's Office,

April 16, 1883.

MEMORANDUM FROM PRISONER OF WAR RECORDS.

No. _____

(This blank to be used only in the arrangement of said records.)

NAME	RANK.	ORGANIZATION.				INFORMATION OBTAINED FROM—				
		No. of Reg't.	State.	Arm of Service.	Co.	Records of—	Vol.	Page.	Vol.	Page.
<i>Custer</i>						<i>mis Camp R</i>	<i>45</i>	<i>file 6</i>		
<i>Sister Pen.</i>		<i>P 4</i>	<i>A. S. G. T.</i>		<i>A.</i>	<i>mis</i>	<i>69</i>	<i>50</i>		

Captured at *Chafin's Farm, Va. Sept. 29*, 1864, confined at Richmond, Va., *Sept. 29*, 1864.
Slave owned by Dr. Young, Drummer & team - Transferred to C. S. A. S. Nov. 9/64

Admitted to Hospital at _____
 where he died _____, 186 , of _____

Paroled at *Lees Ferry Soldiers Rest*, 186 ; reported at Camp Parole, Md., *June 30*, 186 .
Wash. D.C. to CP

Copied by *March*

NOV 19 1877

[OFFICE ENDORSEMENT.]

War Department,

ADJUTANT GENERAL'S OFFICE,

July 20, 1877.

The discharge of *Benjamin*
W. Co., *Co.*, *Reg't U.S.*
Colored *troop*, is reported as follows:

On Company Muster Roll.
For *1865*, *1865*

Company Muster-out Roll.
1865, *1865*

Company Descriptive Book.
1865

Company Morning Reports.
1865

Soldier's Final Statement.
1865

Soldier's Record of Death and Interment.
1865

Soldier's Inventory of Effects.
1865

Soldier's Certificate of Disability for Discharge.
1865

Soldier's Individual Muster-out Roll.
1865

Regimental Return.
June 28, *1865*

Regimental Quarterly Returns.
1865

Regimental Descriptive Book.
1865

By Surgeon General.
1865

(*June 28*) *1865*, is held to be
the correct date, and the Company Muster
Rolls will be amended accordingly.

L. H. Stange
Assistant Adjutant General.

E 13 $\frac{12}{365}$

Noted *gld*

22810
Letter to 2d

Descriptive List
of
Private B. Crutts
Co. "K" 7th U.S.C. Troops.

June 28/65.

Mustered-out, June 28/65

War Department,

Adjutant General's Office,

Washington, June 26th, 1865.

Sir:

In reply to your letter requesting a Descriptive List of Benjamin Custis, a Private in Company "K", 7th Regiment U. S. C. Inf. Volunteers, I have the honor to furnish the following "Descriptive List" obtained from the records of this Office: which, from the want of the necessary data, (which is in the possession of the Company Commander,) is only "partial."

NAME, RANK AND REGIMENT, DESCRIPTION, &c.

Benjamin Custis, a Private in Company "K", 7th Regiment of U. S. C. Troops Volunteers, is 38 years of age; but no further "description" can be obtained from the files of this Office. He was enrolled on the 6th day of November, 1863, at the town of Accomac in the State of Maryland by Col. Wm. Briney, and mustered into the service of the United States on the 12th day of November, 1863, at the town of Charles in the State of Maryland by Lieut. Col. J. F. Haskell, to serve for the period of Three years, or "during the war."

ACCOUNT OF PAY.

It is stated on the Muster Rolls of his Company for the months of Nov. & Dec. 1864 - last roll on which his name appears, that he was last paid by Paymaster Major W. Cornell to the Thirtieth day of April, 1864. It is stated on said rolls that there is due U. S. for clothing overdrawn, \$13.39.

ACCOUNT OF CLOTHING.

The files of this Office furnish no account of clothing; it must be obtained, if obtained at all, from his Company Commander.

REMARKS.

On Roll of his Co. for Nov. & Dec. 1864, his name is dropped with the following remarks, "Missing in action Sept. 29th 1864". It is not found on any of the subsequent rolls of the Co. on file in this Office.

Very respectfully,

Your obedient servant,

Wm. Hazard

Assistant Adjutant General.

To Col. Wm. H. Brown
Pro. War. Gen. for Md. & Del.
Baltimore Md.

This "Partial Descriptive List" is given in order that the soldier may be discharged at once, without waiting for a descriptive list from his company commander; and, having been used by the proper officer to make out the soldier's final statements, should be endorsed with a statement to that effect by this officer. This endorsement should exhibit a full statement of the time for which the soldier was allowed pay on his final statements, the clothing account, and all other charges against him or in his favor, so as to comprise a complete exhibit of his account. It will then be transmitted to the company commander of the soldier, who will enter all the data necessary to a full understanding of the soldier's account on the muster roll upon which the soldier's discharge is reported. This list will then be destroyed. The object of this is, that the remaining portion of the soldier's account may be settled upon the receipt of these muster rolls, and the soldier receive any pay or allowances that may be due him at the time of his discharge, and which may not appear on his final statements from the fact that this list is incomplete or "partial."

H. S.

356

Cutshumber, Jacob

Co *L*, 7 U.S. Col'd Inf.

Private | *Private*

CARD NUMBERS.

1	6 2 9 0 9 3 9	26
2	6 2 9 1 0 3 8	27
3	6 2 9 1 1 4 0	28
4	6 2 9 1 2 4 4	29
5	6 2 9 1 3 4 2	30
6	6 2 9 1 4 4 0	31
7	6 2 9 1 5 3 9	32
8	6 2 9 1 6 2 3	33
9	6 2 9 1 7 3 2	34
10	6 2 9 1 7 7 7	35
11	6 2 9 1 8 4 4	36
12	6 2 9 1 9 1 5	37
13	6 2 9 1 9 8 5	38
14	6 2 9 2 0 5 2	39
15	6 2 9 2 1 1 5	40
16	6 2 9 2 1 7 1	41
17	6 2 9 2 2 2 9	42
18	6 2 9 2 2 7 6	43
19	6 2 9 2 3 2 4	44
20	6 2 9 2 4 2 5	45
21	9 0 6 6 6 5 7	46
22		47
23		48
24		49
25		50

Book Mark:

See also

6 | 7 | U.S.C.T.

Jacob Cutchumber
Co. 4, 7 Reg't U.S. Col'd Inf.

Appears on
Company Descriptive Book
of the organization named above.

DESCRIPTION.

Age 29 years; height 5 feet 4 1/2 inches.
Complexion *Rose*
Eyes *Blue*; hair *Curly*
Where born *St. Mary, Md.*
Occupation *Farmer*

ENLISTMENT.

When *Oct 26*, 186 .
Where *St. Mary*
By whom *Col. W. Riney*; term *3* y'rs.

Remarks: *mustered into service
by Col Wm Riney, at
Benedict, Md.*

J. J. Brown
Copist.

6 | 7 | U.S.C.T.

Jacob Cutchumber
Priv., Co. G, 7 Reg't U. S. Col'd Inf.

Age 22 years.

Appears on

Company Muster-in Roll

of the organization named above. Roll dated
Camp Stanton, Charles Co, Md, Nov. 5, 1863.

Muster-in to date Nov. 5, 1863.

Joined for duty and enrolled:

When Oct. 26, 1863.

Where St. Mary, Md.

Period 3 years.

Remarks:

Book mark:

Sanday
Copyist.

C

7

U.S.C.T.

Jacob Cutchumber
Priv., Co. G, 7 Reg't U. S. Col'd Infantry.

Appears on

Company Muster Roll

for Nov. 5 to Dec. 31, 1863.

Present or absent Present

Stoppage, \$ 100 for

Due Gov't, \$ 100 for

Remarks: Premium for en-
listment \$2.00 (due).

Book mark:

Sanday
Coryat

(858)

C

7

U.S.C.T.

Jacob Cutchumber
Priv., Co. G, 7 Reg't U. S. Col'd Infantry.

Appears on

Company Muster Roll

for *Jan. & Feby*, 1864.

Present or absent *Present*

Stoppage, \$ 100 for

Due Gov't, \$ 100 for

Remarks:

Book mark:

Sandoy
Copyist

(858)

C

7

U.S.C.T.

Jacob Cutchumber

Priv., Co. G, 7 Reg't U. S. Col'd Infantry.

Appears on

Company Muster Roll

for *Mch* *8* *Apr.*, 1864.

Present or absent *Present*

Stoppage, \$ 100 for

Due Gov't, \$ 100 for

Remarks:

Book mark:

Sandoy
Copyist

(858)

C

7

U.S.C.T.

Jacob Cutchumber
Priv., Co. G, 7 Reg't U. S. Col'd Infantry.

Appears on

Company Muster Roll

for May & June, 1864.

Present or absent Present.

Stoppage, \$ 100 for

Due Gov't, \$ 100 for

Remarks:

Book mark:

Sandoz
Cpyist.

C

7

U.S.C.T.

Jacob Cutchumber
Privt., Co. G, 7 Reg't U. S. Col'd Infantry.

Appears on

Company Muster Roll

for *July & Aug.*, 1864.

Present or absent *Present*

Stoppage, \$ *100* for

Due Gov't, \$ *100* for

Remarks:

Book mark:

(858)

Sandoz
Copyist

C

7

U.S.C.T.

Jacob Cutchumber
Priv., Co. G, 7 Reg't U. S. Col'd Infantry.

Appears on

Company Muster Roll

for Sept. 7 Oct. , 1864.

Present or absent Absent.

Stoppage, \$ 100 for

Due Gov't, \$ 100 for

Remarks: Missing in ac-
tion, Sept. 29", 1864.

Book mark:

Sandoz

Copypist

(858)

6

7

U.S.C.T.

Jacob Catehumber
Pvt., Co. G, 7 Reg't U. S. Col'd Infantry.

Appears on

Company Muster Roll

for Nov. & Dec., 1864

Present or absent Present

Stoppage, \$ 100 for

Due Gov't, \$ 100 for

Remarks:

Book mark:

J. W. Ames
(858) Copyist

C

7

U.S.C.T.

Jacob Catchumbe

Pvt., Co. G, 7 Reg't U. S. Col'd Infantry.

Appears on

Company Muster Roll

for Jan + Feb, 1865

Present or absent Present

Stoppage, \$ 100 for

Due Gov't, \$ 100 for

Remarks:

Stop for one canteen,

Book mark:

J. W. Chiles

(858)

Copyist

Q

7

U.S.C.T.

Jacob Custer
Pvt., Co. G, 7 Reg't U. S. Col'd Infantry.

Appears on

Company Muster Roll

for *March & April*, 186 *7*

Present or absent *Present*

Stoppage, \$ 100 for

Due Gov't, \$ 100 for

Remarks:

Daily duty since Mar, 2/65 as Q, Cook

Book mark:

J. W. Cross

(858)

Copyist

C 7 U.S.C.T.

Jacob Catchum
Pr, Co. G, 7 Reg't U. S. Col'd Infantry.

Appears on

Company Muster Roll

for *May + June*, 186*0*.

Present or absent *Present*

Stoppage, \$ *100* for

Due Gov't, \$ *100* for

Remarks:

Book mark:

J. W. [Signature]
(858) Copyist

B

7

U.S.C.T.

Jacob Cutchumber

Pvt., Co. G, 7 Reg't U. S. Col'd Infantry.

Appears on

Company Muster Roll

for *July + Aug.*, 1865.

Present or absent *Present*

Stoppage, \$ *100* for

Due Gov't, \$ *100* for

Remarks:

Book mark:

J. W. [Signature]

(858)

Copyist

6

7

U.S.C.T.

Jacob Cutchumbers
Pr, Co. G, 7 Reg't U. S. Col'd Infantry.

Appears on

Company Muster Roll

for *Sept. + Oct.*, 186 *51*

Present or absent *Present*

Stoppage, \$ *100* for

Due Gov't, \$ *100* for

Remarks:

Book mark:

J. W. Ames

(858)

Copist

C **7** **U.S.C.T.**

Jacob Cutchumber
Priv, Co. G, 7 Reg't U. S. Col'd Infantry.

Appears on

Company Muster Roll

for *Nov. + Dec.*, 186*2*.

Present or absent *Present*

Stoppage, \$ _____ 100 for _____

Due Gov't, \$ _____ 100 for _____

Remarks: _____

Book mark: _____

(858)

J. W. Ames
Copyist

C

7

U.S.C.T.

Jacob Cutchumber

Pr, Co. G, 7 Reg't U. S. Col'd Infantry.

Appears on

Company Muster Roll

for *Jan - Feb*, 1866.

Present or absent *Present*

Stoppage, \$ 100 for

Due Gov't, \$ 100 for

Remarks: *Stop for Haversack
& Canteen*

Book mark:

Hadfield

(858)

Copyist

b

7

U.S.C.T.

Jacob Butchumber
Put, Co. G, 7 Reg't U. S. Col'd Infantry.

Appears on

Company Muster Roll

for *Mar & Apr*, 1866.

Present or absent *Present*

Stoppage, \$ *100* for

Due Gov't, \$ *100* for

Remarks:

Book mark:

Hadfield

(858)

Copyist

6

7

U.S.C.T.

Jacob Cutchumber
Pvt, Co. G, 7 Reg't U. S. Col'd Infantry.

Appears on

Company Muster Roll

for *May - June*, 1866.

Present or absent *Present*

Stoppage, \$ 100 for

Due Gov't, \$ 100 for

Remarks:

Book mark:

Hadfield

(858)

Copyist

6

7

U.S.C.T.

Jacob Cutchumber
Priv, Co. G, 7 Reg't U. S. Col'd Infantry.

Appears on

Company Muster Roll

for *July & Aug*, 1866.

Present or absent *Present*

Stoppage, \$ *100* for

Due Gov't, \$ *100* for

Remarks:

Book mark:

Hadfield

(858)

Copyist

6

7

U.S.C.T.

* Jacob Cuthumber
Co. G, 7 Reg't U. S. Col'd Infantry.

Appears on Co. Muster-out Roll, dated
Indianola Texas, Oct 13, 1866.

Muster-out to date Oct 13, 1866.

Last paid to June 30, 1866.

Clothing account:

Last settled....., 186 ; drawn since \$..... 100

Due soldier \$ 31 91 / 100; due U. S. \$..... 100

Am't for cloth'g in kind or money adv'd \$..... 100

Due U. S. for arms, equipments, &c., \$..... 100

Bounty paid \$..... 100; due \$ 100 / 100

Remarks: joined original organ-
ization Died since
Completion of Rolls

* Entire entry cancelled by line
drawn through

Book mark:

Madfield

C | 7 | **U.S.C.T.**

Jacob Butchumber
Priv, Co. G, 7 Reg't U. S. Col'd Infantry.

Appears on **Co. Muster-out Roll**, dated Indianola Texas, Oct 13, 1866.

Muster-out to date _____, 1866.

Last paid to June 30, 1866.

Clothing account:

Last settled _____, 1866 ; drawn since \$ _____ 100

Due soldier \$ _____ 100; due U. S. \$ _____ 100

Am't for cloth'g in kind or money adv'd \$ _____ 100

Due U. S. for arms, equipments, &c., \$ _____ 100

Bounty paid \$ _____ 100; due \$ _____ 100

Remarks: Died at Post Hos-
pital at Indianola Texas
October 10" 1866 of Cholera
final statements recd *

* Roll Form

Book mark: 8983 2^d a apr 18/68

Hadfield

Lutcheumber, Jacob

P, Co. G.

7

U. S. C. Inf. Reg't

3

Enclosures.

Bed Cards	Descriptive Lists
Burial Records	Final Statements
Certs. of Dis. for Discharge	Furloughs
C. M. Charges	Med. Des. Lists
Med. Certificates	Orders

Other papers relating to—

Admission to Hosp'l	Furlough
Casualty Sheet (Officer's) ^{Proc} 2	Med. Examination
Confinement	Misc. Information /
Contracts	Pay or Clothing
Death or Effects	Personal Reports
Desertions	Rank
Discharge from Hosp'l	Transfer to Hosp'l
Discharge from Service	Transfer to V. R. C.
Duty	Transportation

NARA 221

Surgeon General's Office,

Record and Pension Division,

August 9th, 1867.

Respectfully returned to *Asst. Surg.*

Genl. F. W. Taggart, U. S. A.

The death-records of this Office furnish no information in this case.

Records of Regt 3rd of Salisbury, N. C. furnish no evidence.

BY ORDER OF THE SURGEON GENERAL:

J. J. Woodward

Brevet Lt. Col. and Asst. Surgeon, U. S. A.

(49)

R. of A., Vol. *7* No. *2272*

R. OF A.
2272
VOL. 7

RECEIVED, RECORDS OF THE SURGEON GENERAL'S OFFICE.
AUG 9 1867

WAR DEPARTMENT,

ADJUTANT GENERAL'S OFFICE,

WASHINGTON, *May 7*, 186*7*.

SIR:

Final Statements in the cases of deceased soldiers are required to be sent to the Adjutant General's Office in duplicate, with one copy of the Inventory of Effects. The Descriptive List should also be sent to this Office in cases where the soldier was absent from his Company at the time of his death. Where there were no effects, it should be so stated on a blank Inventory, properly signed.

Certificates of Disability should be sent in duplicate. Special care should be taken that the date of discharge and signature of the discharging officer should be affixed.

No of the Final Statement *or* Inventory, has been received in the case of *Jacob Cutchamer, Private*, of Co. "*G*", *7* Regiment of *U.S. Cold Bnys* Volunteers, whose papers were forwarded to this Office. You will please forward the missing papers without delay.

I have the honor to be, sir,

Very respectfully,

Your obedient servant,

Alid
Salisbury, N.S.

Geo. Hazard

Assistant Adjutant General.
(110)

~~COMMANDING OFFICER~~

J. P. Woodward
as r. s. a.

a. f. B.

MODEL FOR SET OF PAPERS

FORM 1.—FINAL STATEMENT.

I CERTIFY, ON HONOR, that *John Smith*, a Private of Captain J. Brown's Company, (A.) of the 1st Regiment of Pennsylvania Volunteers, of the State of Pennsylvania, born in Pittsburg, State of Pennsylvania, aged 21 years, 5 feet 10 inches high, light complexion, blue eyes, dark hair, and by occupation a Farmer, having joined the Company on its original organization at Pittsburg, and enrolled in it at the muster into the service of the United States at Pittsburg, on the 1st day of July, 1861, (or was mustered in service as a recruit, by _____, at _____, on the _____ day of _____, 186—, or was drafted and mustered into the service of the United States from the _____ Enrollment District of the State of _____, at _____, on the _____ day of _____, 186—,) to serve in the Regiment for the term of Three Years, and having served *honestly* and *faithfully* with his Company in the field to the present date, is now entitled to a DISCHARGE by reason of death. Died in Regimental Hospital, Fort Brown, Texas, December 31, 1863, of typhoid fever.

The said John Smith was last paid by Paymaster Major Morse, to include the 31st day of October, 1863, and has pay due him from that time to the present date. He is entitled to pay and subsistence for *traveling* to place of enrollment, and whatever other allowances are authorized to volunteer soldiers, drafted men, or militia, so discharged. He has received from the United States *clothing* amounting to 20.⁰⁰/₁₀₀ dollars, since the 31st day of December, 1862, when his clothing account was last settled. He has received from the United States 25.⁰⁰/₁₀₀ dollars advanced *bounty*.

There is to be stopped from him on account of the State of _____, or other authorities, for *clothing*, &c., received on entering service, nothing, ⁰⁰/₁₀₀ dollars; and for other stoppages, viz: nothing, ⁰⁰/₁₀₀ dollars. He has been furnished with no *transportation* in kind from the place of his discharge to _____; and he has not been *subsisted* for *traveling* to his place of enrollment up to the _____, 186—.

He is indebted to _____, Sutler, _____ ⁰⁰/₁₀₀ dollars.

He is indebted to _____, Laundress, _____ ⁰⁰/₁₀₀ dollars.

GIVEN, IN DUPLICATE, at Fort Brown, Texas, this 31st day of December, 1863.

JAMES BROWN,
Captain Co. A, 1st Penn. Vols.,
Commanding Company.

FORM 2.

INVENTORY of the effects of John Smith, late a Private of Captain J. Brown's Company, (A.) of the 1st Regiment of Pennsylvania Volunteers, who was enrolled as a Private at Pittsburg, in the State of Pennsylvania, on the 1st day of July, 1861, and mustered into the service of the United States as a Private on the 1st day of July, 1861, at Pittsburg, in Company A, 1st Regiment of Pennsylvania Volunteers, to serve three years or during the war. He was born in Pittsburg, in the State of Pennsylvania; he was 21 years of age, 5 feet 10 inches high, light complexion, blue eyes, dark hair, and by occupation, when enrolled, a Farmer. He died in Regimental Hospital, at Fort Brown, Texas, on the 31st day of December, 1863, of typhoid fever.

INVENTORY.						
ARTICLES.	No.	ARTICLES.	No.	ARTICLES.	No.	
Hats	1	Pairs trousers.....	1	Knapsacks	1	
Caps		Pairs flannel drawers.....		Watch, silver.....		
Forage caps.....		Pairs cotton drawers.....		Specie.....		\$2 00
Great coats		Flannel shirts.....				
Uniform coats.....		Cotton shirts.....		MOSEY.		
Uniform jackets.....		Pairs boots.....				
Flannelsack coats.....		Pairs shoes.....				
Blouses		Pairs socks.....				
Stable frocks		Blankets				
Fatigue overalls.....		Haversacks				

I CERTIFY, ON HONOR, that the above inventory comprises all the effects of Private John Smith, deceased, and that the effects are in the hands of Captain J. Brown, at Fort Brown, Texas, to be disposed of by a Council of Administration, except the money, which has been turned over to Major Wm. C. Morse, Paymaster, U. S. Army, whose receipt is hereto annexed.*

STATION: Fort Brown, Texas.

DATE: December 31, 1863.

(Duplicates.)

JAMES BROWN,
Captain Co. A, 1st Penn. Vols.,
Commanding Company.

*NOTE.—If the effects have been turned over to relatives of deceased, so state on certificate, instead of "in the hands of Captain," &c., and give the names of the persons, and their relation to the deceased person.

FORM 3.—HEIR'S RECEIPT FOR EFFECTS.

RECEIVED of Captain John Brown, Company A, 1st Regiment of Pennsylvania Volunteers, the following effects of Private John Smith, late of Company A, 1st Regiment of Pennsylvania Volunteers, now deceased, which I claim as his wife's:
1 great coat, 1 flannel shirt, 1 silver watch, fifty dollars in notes, and two dollars in specie.

MARY SMITH.

FORM 4.—PAYMASTER'S RECEIPT FOR MONEY.

RECEIVED, this 31st day of December, 1863, at Fort Brown, Texas, of Captain James Brown, of Company A, 1st Pennsylvania Volunteers, fifty dollars in Treasury notes and two dollars in specie, the property of the late Private John Smith, of Company A, 1st Pennsylvania Volunteers, who died at Fort Brown, Texas, on the 31st day of December, 1863.

WM. C. MORSE, Paymaster, U. S. A.

FOR A DECEASED SOLDIER.

FORM 5.—PROCEEDINGS OF A COUNCIL OF ADMINISTRATION,

Convened at Fort Brown, Texas, pursuant to Orders, No. 1, dated Post Headquarters, Fort Brown, Texas, January 2, 1864—consisting of Captain James Keith, Company C, 1st Pennsylvania Volunteers; Captain John Brown, Company D, 1st Pennsylvania Volunteers; and Lieutenant William Roe, Company E, 1st Pennsylvania Volunteers—for the purpose of disposing of the effects of the late John Smith, of Company A, 1st Pennsylvania Volunteers:

The Council found that the effects consisted of the following articles. They were ordered to be sold at auction, which was accordingly done, and the amount set opposite the articles respectively obtained, for which the receipt of the Paymaster is annexed:

AT AUCTION.

I shirt	brought.....	\$1 00
I great coat	".....	2 50
I silver watch	".....	25 00
		\$28 50

JAMES KEITH,
Capt. Co. C, 1st Penn. Vols., President.
WILLIAM ROE,
Lieut. Co. E, 1st Penn. Vols., Recorder.

APPROVED:

JOHN SANDERS,
Colonel 1st Penn. Vols.,
Commanding Post.

FORM 6.—PAYMASTER'S RECEIPT.

RECEIVED from Captain John Brown, Company A, 1st Pennsylvania Volunteers, at Fort Brown, Texas, January 10, 1864, twenty-eight dollars and fifty cents, the result of the sale of the effects of the late Private John Smith, of Company A, 1st Pennsylvania Volunteers.

WM. C. MORSE, Paymaster U. S. Army.

ARTICLES OF WAR.

ART. 95. When any non-commissioned officer or soldier shall die, or be killed in the service of the United States, the then commanding officer of the troop or company shall, in the presence of two other commissioned officers, take an account of what effects he died possessed of, above his arms and accoutrements, and transmit the same to the office of the Department of War, which said effects are to be accounted for, and paid to the representatives of such deceased non-commissioned officer or soldier. And in case any of the officers, so authorized to take care of the effects of deceased officers and soldiers, should, before they have accounted to their representatives for the same, have occasion to leave the regiment or post, by preferment or otherwise, they shall, before they be permitted to quit the same, deposit in the hands of the commanding officer, or of the assistant military agent, all the effects of such deceased non-commissioned officers and soldiers, in order that the same may be secured for, and paid to, their respective representatives.

DIRECTIONS.

NOTE 1.—One copy of the inventories of the effects of deceased non-commissioned officers and soldiers required by the 95th Article of War, will be forwarded to the Adjutant General, by the commander of the company to which the deceased belonged, and a duplicate of the same to the colonel of the regiment. Final statements of pay, clothing, &c., in duplicate, will be sent to the Adjutant General with one copy of the inventory. Both inventory and final statements should be forwarded, as a general rule, through Regimental Headquarters. When a soldier dies at a post or station absent from his company, it will be the duty of his immediate commander to furnish, direct to the Adjutant General, the required inventory and final statements, and, at the same time, to forward to the commanding officer of the company to which the soldier belonged, a report of his death, specifying the date, place, and cause; to what time he was last paid, and the money or other effects in his possession at the time of his decease; which report will be noted on the next muster roll of the company to which the man belonged. Each inventory will be endorsed "Inventory of the effects of _____, late of company (—) _____ regiment of _____, who died at _____ the _____ day of _____, 186—." If a legal representative receive the effects, it will be stated in the report. If the soldier leave no effects, the fact will be reported on the blank for inventory.

NOTE 2.—Should the effects of a deceased non-commissioned officer or soldier not be administered upon within a short period after his decease, they shall be disposed of by a Council of Administration under the authority of the commanding officer of the post, and the proceeds deposited with the Paymaster, to the credit of the United States, until they shall be claimed by the legal representatives of the deceased. This should be done according to Forms 5 and 6, and one copy of each sent to the Adjutant General. No copy of the order convening the board is required, the approval of the commanding officer being sufficient.

NOTE 3.—In all such cases of sales by the Council of Administration, a statement in detail, or account of the proceeds duly certified by the Council and commanding officer, (Form 5.) accompanied by the Paymaster's receipt of the proceeds, will be forwarded by the commanding officer to the Adjutant General. The statement will be endorsed "Report of the proceeds of the effects of _____, late of company (—) _____ regiment of _____, who died at _____ the _____ day of _____, 186—."

NOTE 4.—The effects in all cases, when called for, should be turned over to the legal representative, without further authority from the Adjutant General. When the effects are turned over to the relatives of the deceased before these inventories are sent to the Adjutant General, their receipts therefor should be attached to the inventories. In all other cases, one copy will be sent with a letter of transmittal direct to the Adjutant General, and a duplicate retained by the officer.

NOTE 5.—Particular care should be taken to take receipts in duplicate from the Paymaster for any funds turned over to him; one copy should be sent direct to the Adjutant General, and one retained by the officer.

NOTE 6.—Where a soldier dies in hospital or on detached service, his descriptive list, if he has one, should be sent with his final statements, in duplicate, to the Adjutant General, Washington, D. C.

NOTE 7.—Form 1 will be forwarded in duplicate to the Adjutant General, through Regimental Headquarters, as soon as possible after the death of the soldier, accompanied by one copy of Forms 2 and 3, or 4, as the case may require. A duplicate of the inventory (Form 2) should be retained until the articles are finally disposed of.

NOTE 8.—The papers for each man should be made SEPARATELY for each man, and, when possible, fastened together. This is especially necessary, and must be done in all cases. The papers cannot be properly disposed of at the Adjutant General's Office unless this is done, and must be returned for correction.

NOTE 9.—Where there are no line officers, as, for instance, a general hospital without a line officer to command the guard, the Council of Administration may be made up from other commissioned officers, in the same way as prescribed for line officers.

NOTE 10.—Where a soldier dies away from his company or regiment, and the officer having charge of him cannot furnish Final Statements by reason of not being able to obtain a Descriptive List, he should notify the regimental or company commander, (giving him full particulars as to history and description of the man, as far as possible,) whose duty it will then be, in such case, to furnish the necessary papers from the best data he can obtain.

47

Sub. for May 7, 67

CASUALTY SHEET

Completed

No.

Jacob Cutchamer

Private of Company "G"

7 Regiment of U.S. S.

State Volunteers.

NATURE OF CASUALTY.

Killed

NARA 226

CASUALTY SHEET.

Name: Jacob Cutchamer.
Rank: Private Company: "G" Regiment: "J"
Arm: U.S. Cold Troops State: _____
Nature of Casualty: Death.

CAUSE OF CASUALTY—(NAME OF DISEASE, &c.)

BY WHOM DISCHARGED.

DEGREE OF DISABILITY.

FROM WHAT SOURCE THIS INFORMATION WAS OBTAINED.

Co. Mustered Out Roll.

BY WHOM CERTIFIED.

A. V. Smith

REMARKS.

Capt. Comdy Co.

DATE OF DISCHARGE, DEATH, &c.

PLACE OF DISCHARGE, DEATH, &c.

Salisbury, N.C.

A. J. Ball
Clerk.

CASUALTY SHEET

No. _____

Jesse C. Johnson
_____ of Company _____

Regiment of *10th* _____

State Volunteers.

NATURE OF CASUALTY.

Wounded

CASUALTY SHEET.

Name: *Jacob C. ...*
 Rank: *Private* Company: *7* Regiment: *15th I.*
 Arm: _____ State: _____
 Nature of Casualty: *Death*

CAUSE OF CASUALTY—(NAME OF DISEASE, &c.)

Cholera

BY WHOM DISCHARGED.

FROM WHAT SOURCE THIS INFORMATION WAS OBTAINED.

Mr. K. ...

DEGREE OF DISABILITY.

BY WHOM CERTIFIED.

*William ...
Cap. ...*

DATE OF DISCHARGE, DEATH, &c.

Oct 10 1866

PLACE OF DISCHARGE, DEATH, &c.

San Antonio Texas

REMARKS.

J. C. Jones
Clerk.

351

Cutler Lab

Co, 7 U.S. Col'd Inf.

Private | Private

CARD NUMBERS.

1	6279114	26
2		27
3		28
4		29
5		30
6		31
7		32
8		33
9		34
10		35
11		36
12		37
13		38
14		39
15		40
16		41
17		42
18		43
19		44
20		45
21		46
22		47
23		48
24		49
25		50

Book Mark:

See also

6 | 7 | U.S.C.T.

Bob Catter

Appears with rank of _____ on
**Muster and Descriptive Roll of a Detach-
 ment of Drafted Men and Substitutes
 forwarded**

for the 7 Reg't U. S. Col'd Inf. Roll dated
Baltimore Md, Apr 1, 1865

Where born *Albermarle Va*

Age 22 years; occupation *Laborer*

Drafted and mustered in:

When *Mar 20*, 1865

Where *E. Mills Md.*

Period 2 years.

Eyes *Blk*; hair *Blk*

Complexion *Blk*; height 5 ft. 7 in.

Paid bounty and advance pay, \$ 100

Bounty due \$ 100

Where credited _____

Company to which assigned _____

Remarks: *Sub for Howard T. Catter. 2nd Sub Dist of Cong. D. Md. Not taken up on Rolls of Regt*

Book mark: _____

J. M. Tandy

Cutler, Bob

....., Co., Reg't

2 Enclosures.

Bed Cards	Final Statements
Burial Records	Furloughs or L. of A.
Certs. of Dis. for Discharge	Med. Certificates
C. M. Charges	Med. Des. Lists
Descriptive Lists	Orders
Discharge Certificates	Pris. of War Record
Enlistment Papers	Resignations

Other papers relating to—

Admission to Hosp'l	Furlough or L. of A.
Casualty Sheet	Med. Examination
Confinement	Misc. Information
Contracts	Pay or Clothing
Death or Effects	Personal Reports
Desertion	Rank
Discharge from Hosp'l	Transfer to Hosp'l
Discharge from Service	Transfer to V. R. C.
Duty	Transportation

DECLARATION OF SUBSTITUTE.

I, Bob. Cutler, desiring to ENLIST in the Army of the United States, for ~~THREE~~^{two} YEARS, **Do declare**, That I am Twenty two years and _____ months of age; that I have never been discharged from the United States service on account of disability or by sentence of a court martial; and I know of no impediment to my serving honestly and faithfully as a soldier ^{two} for three years.

GIVEN at Ellicott Mills Md. the 25th day of March 1865

WITNESS: William Clark

Bob Cutler
Make

Gold

No. _____

Bob. Cutler

Enlisted at Ellicott Mills

As Substitute for

Howard T. Ritter

On the 25th day of March, 1865,

By

Capt. J. C. Holland Prov. Mar.

P. W. Whitwright Com.

R. E. Dorsey Surg.

Board of Enrollment,

5th Dist. of Med

Jan. 1878. This paper was formerly filed in the Enrollment Div. R. & P. O.

(No. 39.)

SUBSTITUTE VOLUNTEER ENLISTMENT.

STATE OF

TOWN OF

Maryland

Ellicotts Mills

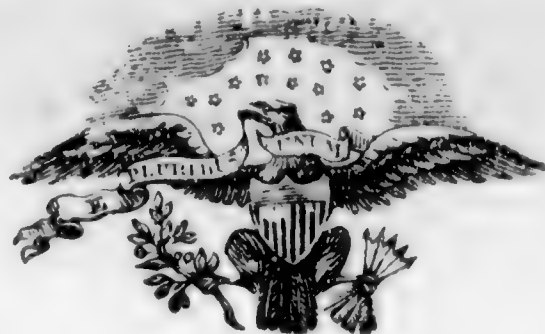

I, Bob. Cutler, born in the State of Virginia, aged Twenty two years, and by occupation a Laborer, Do HEREBY ACKNOWLEDGE to have agreed with Howard J. Ritter, Esq., of the 2nd District of Baltimore County, Md

to become his SUBSTITUTE in the Military Service, for a sufficient consideration paid and delivered to me, on the Twenty fifth day of March, 1865; and having thus agreed with said Howard J. Ritter, I DO HEREBY ACKNOWLEDGE to have enlisted this Twenty fifth day of March, 1865, to serve as a Soldier in the Army of the United States of America, for the period of THREE YEARS, unless sooner discharged by proper authority. I do also agree to accept such bounty, pay, rations, and clothing as are, or may be, established by law for soldiers. And I do solemnly swear that I will bear true and faithful allegiance to the United States of America; that I will serve them honestly and faithfully against all their enemies or opposers whomsoever; and that I will observe and obey the orders of the President of the United States and the orders of the officers appointed over me, according to the Rules and Articles of War.

Not entitled to Bounty

SWORN and subscribed to, at Ellicotts Mills, this 25th of March, 1865, BEFORE Capt. John C. Holland, Prov. Mar. 5th Dist. Md

Bob. Cutler

We certify, on honor, That we have carefully examined the above-named Volunteer Substitute agreeably to the Regulations, and that, in our opinion, he is free from all bodily defects and mental infirmity which would in any way disqualify him from performing the duties of a soldier; that he was entirely sober when enlisted; that he is of lawful age, (not under 18 years;) and that, in accepting him as duly qualified to perform the duties of an able-bodied soldier, and as a Substitute in lieu of Howard J. Ritter, drafted in the 2nd District Baltimore Co. on the 15th March, 1865, we have strictly observed the Regulations which govern in such cases. This soldier has black eyes, black hair, black complexion; is 5 feet 7 1/2 inches high.

J. C. Holland

Provost Marshal.

P. W. Wright

Commissioner of Board.

Resor

Surgeon of Board.

Board of Enrollment of 5th Dist. of Maryland

DECLARATION OF SUBSTITUTE.

I, Bob. Cutler, desiring to ENLIST
in the Army of the United States, for ⁶⁰THREE YEARS, Do declare, That I am
Twenty two years and _____ months of age; that I have
never been discharged from the United States service on account of disability or by sentence of
a court martial; and I know of no impediment to my serving honestly and faithfully as a soldier
for ^{three} three years.

GIVEN at Ellicotts Mills Md
the 25th day of March 1865

WITNESS: William Clark Bob. Cutler
Mark

No. _____

Bob. Cutler
Enlisted at Ellicotts Mills

As Substitute for

Howard J. Ritter

On the 25th day of March, 1865,

By

Capt. J. C. Holland Prov. Mar.
P. W. Whitwright Com.
R. E. Dorsey Surg.
Board of Enrollment,
5th Dist. of Med

THE BOARD OF ENROLLMENT WAS FORMED BY
ORDER OF THE SECRETARY OF WAR, FEB. 10, 1865.

(No. 39.)

SUBSTITUTE VOLUNTEER ENLISTMENT.

STATE OF

TOWN OF

Maryland Ellicotts Mills

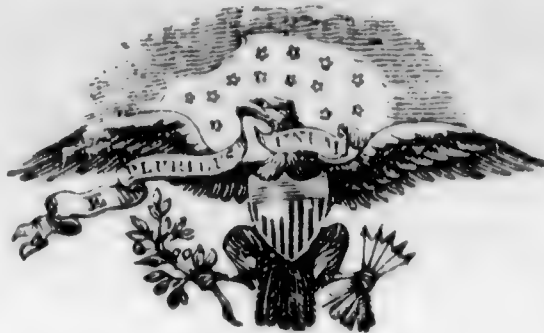

I, Bob Cutler, born in the State of Virginia, aged Twenty two years, and by occupation a Laborer, Do HEREBY ACKNOWLEDGE to have agreed with Howard J. Ritter Esq., of the 2nd District of Baltimore County, Md.

to become his SUBSTITUTE in the Military Service, for a sufficient consideration paid and delivered to me, on the Twenty fifth day of March, 1865; and having thus agreed with said Howard J. Ritter, I DO HEREBY ACKNOWLEDGE to have enlisted this Twenty fifth day of March, 1865, to serve as a Soldier in the Army of the United States of America, for the period of THREE YEARS, unless sooner discharged by proper authority. I do also agree to accept such bounty, pay, rations, and clothing as are, or may be, established by law for soldiers. And I do solemnly swear that I will bear true and faithful allegiance to the United States of America; that I will serve them honestly and faithfully against all their enemies or opposers whomsoever; and that I will observe and obey the orders of the President of the United States and the orders of the officers appointed over me, according to the Rules and Articles of War.

SWORN and subscribed to, at Ellicotts Mills this 25th of March, 1865, BEFORE Capt. John C. Holland Prov. Mar. 5th Dist. Md.

Bob Cutler

Not entitled to Bounty

We certify, on honor, That we have carefully examined the above-named Volunteer Substitute agreeably to the Regulations, and that in our opinion, he is free from all bodily defects and mental infirmity which would in any way disqualify him from performing the duties of a soldier; that he was entirely sober when enlisted; that he is of lawful age, (not under 18 years;) and that, in accepting him as duly qualified to perform the duties of an able-bodied soldier, and as a Substitute in lieu of Howard J. Ritter, drafted in the 2nd District Baltimore Co. on the 15th March, 1865, we have strictly observed the Regulations which govern in such cases. This soldier has black eyes, black hair, black complexion; is 5 feet 7 1/2 inches high.

J. C. Holland

Provost Marshal.

J. B. Pitwright

Commissioner of Board.

R. D. [Signature]

Surgeon of Board.

Board of Enrollment of 5th Dist. of Maryland

358
Cutter, Patrick

Co , 7 U.S. Col'd Inf.

Devault | *Devault*

CARD NUMBERS.

1	6 2 7 9 1 1 3	26
2		27
3		28
4		29
5		30
6		31
7		32
8		33
9		34
10		35
11		36
12		37
13		38
14		39
15		40
16		41
17		42
18		43
19		44
20		45
21		46
22		47
23		48
24		49
25		50

Book Mark: _____

See also _____

A 1415449. And co. d.

6 | 7 | U.S.C.T.

Patrick Hatter

Appears with rank of _____ on
**Muster and Descriptive Roll of a Detach-
ment of Drafted Men and Substitutes**
forwarded

for the *7* Reg't U. S. Col'd Inf. Roll dated
Baltimore Md. Apr 5, 1865

Where born *Nelson Co Va*

Age *19* years; occupation *Laborer*

Drafted and mustered in:

When *Mar 25*, 186*5*

Where *E. Mills Md*

Period *2* years.

Eyes *Blk*; hair *Blk*

Complexion *Blk*; height *5* ft. *5 1/2* in.

Paid bounty and advance pay, \$ *100*

Bounty due \$ *100*

Where credited _____

Company to which assigned _____

Remarks: *Sub for Elisab M. Way*

5 Sub. Dist. of Cong. D. Md.
Not taken up on Roll of Reg

Book mark: _____

J. M. Fairly

Cutler Patrick.

....., Co., Reg't

2 Enclosures.

Bed Cards	Final Statements
Burial Records	Furloughs or L. of A.
Certs. of Dis. for Discharge	Med. Certificates
C. M. Charges	Med. Des. Lists
Descriptive Lists	Orders
Discharge Certificates	Pris. of War Record
Enlistment Papers	Resignations

Other papers relating to—

Admission to Hosp'l	Furlough or L. of A.
Casualty Sheet	Med. Examination
Confinement	Misc. Information
Contracts	Pay or Clothing
Death or Effects	Personal Reports
Desertion	Rank
Discharge from Hosp'l	Transfer to Hosp'l
Discharge from Service	Transfer to V. R. C.
Duty	Transportation

DECLARATION OF SUBSTITUTE.

I, Patrick Cutler, desiring to ENLIST in the Army of the United States, for ^{two} THREE YEARS, Do declare, That I am Nineteen years and _____ months of age; that I have never been discharged from the United States service on account of disability or by sentence of a court martial; and I know of no impediment to my serving honestly and faithfully as a soldier ^{two} for three years.

GIVEN at Ellicott Mills Md the 25th day of March 1865

WITNESS: William Emery Patrick + Cutler
rank

Cold
No. _____

Patrick Cutler

Enlisted at Ellicott Mills

As Substitute for

Elisha M. Ways

On the 25th day of March, 1865,

By

Capt. J. C. Holland Prov. Mar.

P. H. Titwright Com.

Re. E. Dorsey Surg.

Board of Enrollment

5th Dist. of Md.

(No. 39.)

SUBSTITUTE
VOLUNTEER ENLISTMENT.

STATE OF

TOWN OF

Maryland  *Ellicott's Mills*

I, *Patrick Cutler*, born in the State of *Virginia*, aged *Nineteen* years, and by occupation a *Laborer*, Do HEREBY ACKNOWLEDGE to have agreed with *Elisha M. Wray*, Esq., of the *8th District of Baltimore County, Md*

to become his **SUBSTITUTE** in the Military Service, for a sufficient consideration paid and delivered to me, on the *Twenty fifth* day of *March*, 1865; and having thus agreed with said *Elisha M. Wray*, I DO HEREBY ACKNOWLEDGE to have enlisted this *Twenty fifth* day of *March*, 1865, to serve as a **Soldier** in the **Army of the United States of America**, for the period of ~~THREE YEARS~~, unless sooner discharged by proper authority. I do also agree to accept such bounty, pay, rations, and clothing as are, or may be, established by law for soldiers. And I do solemnly swear that I will bear true and faithful allegiance to the **United States of America**; that I will serve them honestly and faithfully against all their enemies or opposers whomsoever; and that I will observe and obey the orders of the President of the United States and the orders of the officers appointed over me according to the Rules and Articles of War.

Not entitled to Bonus

SWORN and subscribed to, at *Ellicott's Mills*
this *25th* of *March*, 1865,
BEFORE *Capt. John C. Holland*
Prov. Mar. 5th Dist. Md.

Patrick^{his} Cutler
mark

We certify, on honor, That we have carefully examined the above-named Volunteer Substitute agreeably to the Regulations, and that in our opinion, he is free from all bodily defects and mental infirmity which would in any way disqualify him from performing the duties of a soldier; that he was entirely sober when enlisted; that he is of lawful age, (not under 18 years;) and that, in accepting him as duly qualified to perform the duties of an able-bodied soldier, and as a Substitute in lieu of *Elisha M. Wray*, drafted in the *8th District Baltimore Co.* on the *16th* *March*, 1865, we have strictly observed the Regulations which govern in such cases. This soldier has *black* eyes, *black* hair, *black* complexion; is *5* feet *5 1/2* inches high.

J. C. Holland

Provost Marshal.

P. P. Wittwigs

Commissioner of Board.

R. D. ...

Surgeon of Board.

Board of Enrollment of *5th* Dist. of *Maryland*

MAR 24 242

DECLARATION OF SUBSTITUTE.

I, Patrick Cutler, desiring to ENLIST in the Army of the United States, for THREE YEARS, **Do declare**, That I am Nineteen years and two months of age; that I have never been discharged from the United States service on account of disability or by sentence of a court martial; and I know of no impediment to my serving honestly and faithfully as a soldier for three years.

GIVEN at Ellicott Mills Md. the 25th day of March 1863

WITNESS:

William Dorsey

Patrick^{sr} + Cutler
March

Cold

No. _____

Patrick Cutler

Enlisted at Ellicott Mills

As Substitute for

Elisha M. Hays

On the 25th day of March, 1863,

By

Capt. J. C. Holland Prov. Mar.

P. W. Witwright Com.

P. C. Dorsey Surg.

Board of Enrollment,

3rd Dist. of Md

(No. 39.)

SUBSTITUTE
VOLUNTEER ENLISTMENT.

STATE OF

TOWN OF

Maryland Ellicotts Mills

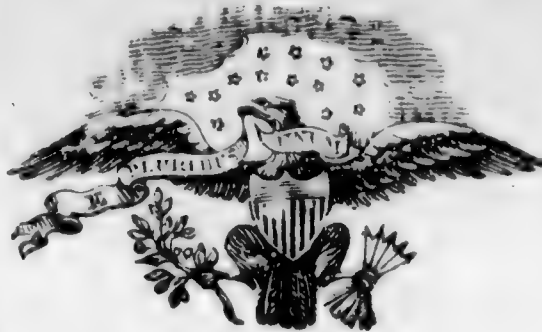

I, Patrick Cutler, born in the State of Virginia, aged Nineteen years, and by occupation a Laborer, Do HEREBY ACKNOWLEDGE to have agreed with Elisha M. Ways, Esq., of the 8th District of Baltimore County, Md. to become his **SUBSTITUTE** in the Military Service, for a sufficient consideration paid and delivered to me, on the Twenty fifth day of March, 1865; and having thus agreed with said Elisha M. Ways, I DO HEREBY ACKNOWLEDGE to have enlisted this Twenty fifth day of March, 1865, to serve as a **Soldier** in the **Army of the United States of America**, for the period of ~~THREE~~ **YEARS**, unless sooner discharged by proper authority. I do also agree to accept such bounty, pay, rations, and clothing as are, or may be, established by law for soldiers. And I do solemnly swear that I will bear true and faithful allegiance to the **United States of America**; that I will serve them honestly and faithfully against all their enemies or opposers whomsoever; and that I will observe and obey the orders of the President of the United States and the orders of the officers appointed over me, according to the Rules and Articles of War.

Not entitled to Bounty

SWORN and subscribed to, at Ellicotts Mills
this 25th of March, 1865,
BEFORE Capt. John C. Holland
Prov. Mar. 5th Dist. Md.

Patrick^{his} + Cutler
mark

We certify, on honor, That we have carefully examined the above-named Volunteer Substitute agreeably to the Regulations, and that in our opinion, he is free from all bodily defects and mental infirmity which would in any way disqualify him from performing the duties of a soldier; that he was entirely sober when enlisted; that he is of lawful age, (not under 18 years;) and that, in accepting him as duly qualified to perform the duties of an able-bodied soldier, and as a Substitute in lieu of Elisha M. Ways, drafted in the 8th District Baltimore Co on the 16th March, 1865, we have strictly observed the Regulations which govern in such cases. This soldier has black eyes, black hair, black complexion; is 5 feet 5 1/2 inches high.

J. C. Holland

Provost Marshal.

R. B. Pitman

Commissioner of Board.

R. D. Orsney

Surgeon of Board.

Board of Enrollment of 5th Dist. of Maryland

359

Abner Henry

Co - , *7* U.S. Col'd Inf.

CARD NUMBERS.

1	6279206	26
2		27
3		28
4		29
5		30
6		31
7		32
8		33
9		34
10		35
11		36
12		37
13		38
14		39
15		40
16		41
17		42
18		43
19		44
20		45
21		46
22		47
23		48
24		49
25		50

Book Mark:

See also *11745e*

D | *7* | U.S.C.T

Henry Rabney

Appears with rank of _____ on

Muster and Descriptive Roll of a Detachment of Drafted Men and Substitutes forwarded

for the *7* Reg't U.S. Col'd *Inf* Roll dated *Baltimore, Md, Epls, 1865*

Where born *Canada*

Age *19* years; occupation *Labourer*

Drafted and mustered in:

When *Apr 3*, 1863.

Where *Baltimore, Md.*

Period *1* years.

Eyes *Blk*; hair *Blk*

Complexion *Blk*; height *5 ft. 8 in.*

Paid bounty and advance pay, \$ *100*

Bounty due \$ *100*

Where credited _____

Company to which assigned _____

Remarks: *Sub for Wm G. Smith*
3 sub Dist 2 Cong. Dist. Md.
(over)

Book mark: _____

(340)

J. M. Fairly
Cpyist.

NO 244

JAN. 20

6279206

418814

*Not taken up on rolls
of regt*

360

Dorum, William

Co D, 7 U.S. Col'd Inf.

Private

CARD NUMBERS.

1	<i>See Dorum,</i>	26	<i>William</i>
2		27	
3		28	
4		29	
5		30	
6		31	
7		32	
8		33	
9		34	
10		35	
11		36	
12		37	
13		38	
14		39	
15		40	
16		41	
17		42	
18		43	
19		44	
20		45	
21		46	
22		47	
23		48	
24		49	
25		50	

Book Mark:

See also

361 of Joshua N. Noble, Jr.
Danforth J. N.

Co D, 7 U.S. Col'd Inf.

2nd Lieutenant 2nd Lieutenant

CARD NUMBERS.

1	627866V	26
2	6286V70	27
3	6286660	28
4	6286742	29
5	6286819	30
6	6286884	31
7	62869V0	32
8	6287006	33
9	6287062	34
10	9428722	35
11		36
12		37
13		38
14		39
15		40
16		41
17		42
18		43
19		44
20		45
21		46
22		47
23		48
24		49
25		50

Book Mark:

See also

MA. 1121313
PHE 2/1/61 R-15901 MAR 01

2 | 7 | U.S.C.T.

Joshua W. Danforth

2 Lt., Co., 7 Reg't U. S. Col'd Inf.

Appears on

Regimental Descriptive Book

(List of Commissioned Officers)

of the regiment named above.

Rank 2^d Lt.

Date of appointment May 20 1865.

Remarks: Appointed 2^d Lieut of
Co. 7th U. S. Col'd Inf. President U. States
Mustard June 15/65.
Born Massachusetts Resident
of Mass. Entered Service July
11, 64 as private in 5th M. C.
Inftry

W. H. Friday

D | 7th | U.S.C.T.

J. N. Danforth

2^d Lt., Co., 7 Reg't U. S. Col'd Infantry.

Age 20 years.

Appears on an

Individual Muster-in Roll

of the organization named above. Roll dated

Port Lavaca Texas, Aug 13, 1865.

Muster-in to date June 15, 1865.

Joined for duty and enrolled:

When June 15, 1865.

Where Mobile Bay, Ala.

Period 3 years.

Remarks: Citizen appointment - Promoted Lt - vice Long promoted.

Book mark:

C. S. Rozzell

(336)

Copyist.

20 | 7 | **U.S.C.T.**

J. Noble Dunforth
Lieut, Co. D, 7 Reg't U. S. Col'd Infantry.

Appears on

Company Muster Roll

for July 8. Aug., 1865.

Joined for duty and enrolled:

When May 26, 1865.*

Where Washington D.C. *

Period 3 years.*

Present or absent Present

Stoppage, \$ 100 for

Due Gov't \$ 100 for

Remarks: Appointed by the President. Joined for duty July 9 - 1865 per S.O. 52, U.S.C.T. Mustered June 15/65
* not appear on Roll

* See enrollment on card from muster-in roll.

Book mark: _____

(358c) J. N. Dunforth Copyist.

27 | 7 | U.S.C.T.

J. Noble Danforth
Lieutenant, Co. D, 7 Reg't U. S. Col'd Infantry.

Appears on

Company Muster Roll

for *Sept. & Oct.*, 1865.

Joined for duty and enrolled:

When *May 26*, 1865.*

Where *Washington DC.* *

Period *5* years.*

Present or absent *Present*

Stoppage, \$ *100* for

Due Gov't \$ *100* for

Remarks:

* See enrollment on card from muster-in roll.

Book mark: -----

(358c) *J. N. Danforth* Copyist.

D

7

U.S.C.T.

Josua H. Danforth

2nd Lieut, Co. D, 7 Reg't U. S. Col'd Infantry.

Appears on

Company Muster Roll

for *Nov. & Dec*, 1865.

Joined for duty and enrolled:

When *May 26*, 1865.*

Where *Washington DC* *

Period *3* years.*

Present or absent *Present*

Stoppage, \$ *100* for

Due Gov't \$ *100* for

Remarks: *Pay due for Comdg Co. A for Oct & Nov. 1865 - Relieved from command of Co. A. Nov. 29/65.*

* See enrollment on card from muster-in roll.

Book mark:

Hearst

(358c)

Copyist.

D | 7 | U.S.C.T.

Joshua N. Danforth

2nd Lieut, Co. D, 7 Reg't U. S. Col'd Infantry.

Appears on

Company Muster Roll

for Jan'y & Feb'y, 1866.

Joined for duty and enrolled:

When May 26, 1865.*

Where Washington D.C.*

Period 3 years.*

Present or absent Present

Stoppage, \$ 100 for

Due Gov't \$ 100 for

Remarks:

* See enrollment on card from muster-in roll.

Book mark:

Hearst

D

7

U.S.C.T.

John N. Danforth

2nd Lieut, Co. D, 7 Reg't U. S. Col'd Infantry.

Appears on

Company Muster Roll

for March & April, 1866.

Joined for duty and enrolled:

When May 26, 1863.*

Where Washington D C *

Period 3 years.*

Present or absent Present

Stoppage, \$ 100 for

Due Gov't \$ 100 for

Remarks:

* See enrollment on card from muster-in roll.

Book mark: _____

Hearst

D | 7 | U.S.C.T.

Joshua N. Danforth
2nd Lieut, Co. D, 7 Reg't U. S. Col'd Infantry.

Appears on

Company Muster Roll

for May & June, 1866.

Joined for duty and enrolled:

When May 26, 1865.*

Where Washington DC *

Period 3 years.*

Present or absent Absent

Stoppage, \$ 100 for

Due Gov't \$ 100 for

Remarks: Detached Act Com. Sub-
sistence Port Lavaca Tex. per
S.O. No. 101. dated Headquarters
Cent Dist Texas San Antonio
Texas Apl 24/66.

* See enrollment on card from muster-in roll.

Book mark:

Hearst

D | 7 | U.S.C.T.

John A. Danforth

2nd Lieut, Co. D, 7 Reg't U. S. Col'd Infantry.

Appears on

Company Muster Roll

for *July & Aug*, 1866.

Joined for duty and enrolled:

When *May 26*, 1865.*

Where *Washington D C* *

Period *3* years.*

Present or absent *Absent*

Stoppage, \$ *100* for

Due Gov't \$ *100* for

Remarks: *Det. Act Com Subsistence
Port Lavaca Texas pr. S.O. No. 101
dated 4th gr. Cent. Dist Texas
San Antonio Texas Apr 24 1866*

* See enrollment on card from muster-in roll.

Book mark:

Heard
(358c) Copyist.

D

7

U.S.C.T.

Joshua N. Danforth

Co. D, 7 Reg't U. S. Col'd Infantry.

Appears on Co. Muster-out Roll, dated Indianola Tex, Oct 13, 1866.

Muster-out to date Oct 13, 1866.

Last paid to June 30, 1866.

Clothing account:

Last settled....., 186 ; drawn since \$..... 100

Due soldier \$..... 100; due U. S. \$..... 100

Am't for cloth'g in kind or money adv'd \$..... 100

Due U. S. for arms, equipments, &c., \$..... 100

Bounty paid \$..... 100; due \$..... 100

Remarks: Joined Company Lavaca Tex. July 9. 65. Detached as actg Com. of Subsistence per S.O. 101. Hd Qrs Cent Dist. Tex. Apl 24. 66. Rejoined co. Sept 18. 66 Command pay due for mos. of Mch Apl & May 66.

Book mark:

Hearst

Noble

Danforth, J. ~~St~~

Lt., Co. 7 U.S.C. Inf.

2 Enclosures.

Bed Cards	Descriptive Lists
Burial Records	Final Statements
Certs. of Dis. for Discharge	Furloughs
C. M. Charges	Med. Des. Lists
Med. Certificates	Orders

Other papers relating to—

Admission to Hosp'l	Furlough
Casualty Sheet (Officer's)	Med. Examination
Confinement	Misc. Information
Contracts	Pay or Clothing
Death or Effects	Personal Reports
Desertions	Rank
Discharge from Hosp'l	Transfer to Hosp'l
Discharge from Service	Transfer to V. R. C.
Duty	Transportation

HEADQUARTERS U. S. FORCES,
CITY POINT Va June 15th 1865

Special Orders

No 69.

Lieut J. H. Danforth,
7th U. S. C. T. Assigned to the
10th U. S. C. T. for temporary duty

Hd Q. U.S. Force
 City Point Va June 15, 1865

Special Order
No 69

1. Lt J Noble Dauforth
 4th Regt. having reported to these
 Hd Q. will report to Lt Col
 E A Powell Comd'g 18th Regiment
 U.S. Inf. for temporary duty.

By Command of Brig Genl Russell
 Lt Col Lathrop
 Capt ~~Marshall~~

No. 10 11th 14th 19th Regts

Office A. C. S
Savannah, Tex. June 26. 1866.

Samuel Doshua N.

2nd Surg + A. C. S.

7 11 5 5

Application for leave
of absence of fifteen
(15) days for the purpose
of visiting Galveston, Texas.

L. R. B. D. J. (see S. O. No 141)

see S. O. No 141

MAR 25 1866

Office A. C. S.
Syraca, N. Y.
Nov 26 1866.

Sir O. M. Mitchell
Adjutant 17th U.S. I.
and U. S. A. Genl
Camp Fort Snare
N.Y.

I have the honor to ap-
ply for a Leave of Absence of Fifteen
Days for the purpose of visiting & at-
tending to my family & to see my
brother who will be there very soon, and
will leave soon after for the West.

I am, Sir,

Very respectfully,

Joshua W. Langford.

1st Lieut 17th U.S. I.
U. S. A. Depot
Syraca, N. Y.

362

Daniel William

Co E, 7 U.S. Col'd Inf.

Private | Private

CARD NUMBERS.

1	6278734	26
2	6287546	27
3	6287645	28
4	6287742	29
5	6287838	30
6	6287929	31
7	6288023	32
8	6288121	33
9	6288019	34
10	6288319	35
11	6288419	36
12	6288515	37
13	6288610	38
14	6288701	39
15	6288787	40
16	6288871	41
17	6288953	42
18	6289034	43
19	9066424	44
20		45
21		46
22		47
23		48
24		49
25		50

Book Mark:

See also

S. 132 3572. P.O. 700. 400.

S. 2182415 P.O. 100

A. 2639051 And WD

29

7

U.S.C.T.

William Daniel

Co. E, 7 Reg't U.S. Col'd Inf.

Appears on

Company Descriptive Book

of the organization named above.

DESCRIPTION.

Age 24 years; height 5 feet 5 1/2 inches.

Complexion Black

Eyes Black; hair Curly

Where born Queen Anne Md.

Occupation Farmer

ENLISTMENT.

When Jan 16, 1864.

Where Benedict, Md.

By whom Capt W. B. King; term 3 y'rs.

Remarks: Mustered Jan 16, 1864
by Gen W. B. King. 4 miles
from Queenstown, Free.

W. B. King

10

7

U.S.C.T.

William Daniel

Co E, 7 Reg't U. S. Col'd Infantry.

Age 24 years.

Appears on a

Detachment Muster-in Roll

of the organization named above. Roll dated

Benedict, Md., Jan. 16, 1864.

Muster-in to date Jan. 16, 1864.

Joined for duty and enrolled:

When Jan. 16, 1864.

Where Queen Ann Md.

Period 9 years.

Remarks:

Book mark:

Beck

Copyist.

(837)

D

7

U.S.C.T.

William Daniel
Pvt., Co. E, 7 Reg't U. S. Col'd Infantry

Appears on

Company Muster Roll

for Jan. & Feb., 1864.

Joined for duty and enrolled:

When Jan. 16, 1864*

Where Queen Ann.*

Period 3 years.*

Present or absent Present

Stoppage, \$ 100 for

Due Gov't \$ 100 for

Remarks: Joined for
duty Jan. 16, 1864.

* See enrollment on card from muster-in roll.

Book mark:

E. A. Ransier
Copyist.

D | 7 | U.S.C.T.

William Daniel
Pvt., Co. E, 7 Reg't U. S. Col'd Infantry.

Appears on

Company Muster Roll

for Mar. & Apr., 1864.

Joined for duty and enrolled:

When Jan. 16, 1864.*

Where Queen Ann.*

Period 8 years.*

Present or absent Present

Stoppage, \$ 100 for

Due Gov't \$ 100 for

Remarks:

* See enrollment on card from muster-in roll.

Book mark:

E. A. Rankin

D |

7

U.S.C.T.

William Daniel
Pvt., Co. E, 7 Reg't U. S. Col'd Infantry.

Appears on

Company Muster Roll

for Dated June 30, 1864.

Joined for duty and enrolled:

When Jan. 16, 1864.*

Where Queen Ann Co Md.*

Period years.*

Present or absent Absent.

Stoppage, \$ 100 for

Due Gov't \$ 100 for

Remarks: Absent sick in
Camp at Jackson
ville June 28th 1864.

* See enrollment on card from muster-in roll.

Book mark:

E. E. Rankin

(358c)

Copyist.

D | 7 | U.S.C.T.

William Daniel
Priv., Co. E, 7 Reg't U. S. Col'd

Appears on

Company Muster Roll
for Jul. & Aug. 1864

Joined for duty and enrolled:

When Jan. 16, 1864.*

Where Queen Ann. *

Period 3 years.*

Present or absent Absent.

Stoppage, \$ 100 for

Due Gov't, \$ 100 for

Valuation of horse, \$ 100

Valuation of horse equipments, \$ 100

Remarks: Sent to Hospital sick Aug. 13th.
Stop for wench.

* See enrollment on card from muster-in roll.

Book-mark :

D. P. Rankin
Copyist.

D. 1

7

U.S.C.T.

William Daniel

Co. E, 7 Reg't U. S. Col'd Infantry.

Appears on

Company Muster Roll

for Sept Oct, 1864.

Joined for duty and enrolled:

When Jan 16, 1864.

Where Green Army

Period 2 years.*

Present or absent Present

Stoppage, \$ 100 for

Due Gov't \$ 100 for

Remarks Top of pt. in field
little time not complete
of gun firing

* See enrollment on card from muster-in roll.

Book mark:

Thompson

Copyist.

D. | 7 | U.S.C.T.

William Daniels
e Cpt., Co. E, 7 Reg't U. S. Col'd Infantry.

Appears on

Company Muster Roll

for Nov & Dec, 1864.

Joined for duty and enrolled:

When Jan 16, 1864.

Where Queen Ann,

Period 2 years.*

Present or absent Present

Stoppage, \$ 100 for

Due Gov't \$ 100 for

Remarks: Exp for 1. Enfield
& Rifle Muzzle-Complete, one
Gun King, 1. Haversack,
15 Amtecu.

* See enrollment on card from muster-in roll.

Book mark:

Thompson

A. 1

7

U.S.C.T.

William Danick

Porto, Co. E, 7 Reg't U. S. Col'd Infantry.

Appears on

Company Muster Roll

for Jan 4th, 1865.

Joined for duty and enrolled:

When Jan 16th, 1864.

Where Queen Anne.

Period 2 years.*

Present or absent Present

Stoppage, \$ 100 for

Due Gov't \$ 100 for

Remarks: Stop for Post Box
Belt Plate & Wiper

* See enrollment on card from muster-in roll.

Book mark:

C. Thompson

10 | 7 | U.S.C.T.

William Daniel
Cate, Co. E, 7 Reg't U. S. Col'd Infantry.

Appears on

Company Muster Roll

for Mich't Apl., 1865.

Joined for duty and enrolled:

When Jan 16th, 1864.*

Where Green Run *

Period 2 years.*

Present or absent Present

Stoppage, \$ 100 for

Due Gov't \$ 100 for

Remarks: Stop for 7. and Box
Belt Plate

* See enrollment on card from muster-in roll.

Book mark:

C. Thompson

D. 1 | **7** | **U.S.C.T.**

William Daniel
Co., Co. E, 7 Reg't U. S. Col'd Infantry.

Appears on

Company Muster Roll

for *May & June*, 186*5*.

Joined for duty and enrolled:

When *Jan 16*, 186*5*.*

Where *Quincy Ill.*.*

Period *3* years.*

Present or absent *Present*

Stoppage, \$ *100* for

Due Gov't \$ *100* for

Remarks: *Clot for! Coat Box & Belt*
State.

* See enrollment on card from muster-in roll.

Book mark:

E. Thompson

D. | 7 | U.S.C.T.

William Dancels
Late, Co. E, 7 Reg't U. S. Col'd Infantry.

Appears on

Company Muster Roll

for July & Aug., 1865.

Joined for duty and enrolled:

When Jan 16, 1864.*

Where Queen Ann, Md.*

Period 3 years.*

Present or absent Present

Stoppage, \$ 100 for

Due Gov't \$ 100 for

Remarks:

* See enrollment on card from muster-in roll.

Book mark:

Thompson

W. | 7 | **U.S.C.T.**

William Daniel
Co. E, 7 Reg't U. S. Col'd Infantry.

Appears on

Company Muster Roll

for Sept - Oct, 1865.

Joined for duty and enrolled: ,

When Mar 16, 1864.*

Where Queen Anne Co. Md.*

Period 3 years.*

Present or absent Present

Stoppage, \$ 100 for

Due Gov't \$ 100 for

Remarks: Wm Daniel
Co. E, 7 Reg't U. S. Col'd Infantry
Queen Anne Co. Md.

* See enrollment on card from muster-in roll.

Book mark:

E. Thompson

S |

7

U.S.C.T.

William Daniels

Plt, Co. E, 7 Reg't U. S. Col'd Infantry.

Appears on

Company Muster Roll

for *Nov & Dec*, 1865.

Joined for duty and enrolled:

When *Jan. 16*, 1864.*

Where *Green Arm Co, Md.**

Period *3* years.*

Present or absent *Present*

Stoppage, \$ *6*⁵⁰/₁₀₀ for *Exy. Equipage*

Due Gov't \$ *100* for

Remarks: *Shop for 1 Bayonet
Scabbard, 1 Leather Pouch
and 1 Gun String.*

* See enrollment on card from muster-in roll.

Book mark: ..

(358c)

Jno J Bell

Copyist.

N |

7

U.S.C.T.

William Daniels

Pvt., Co. E, 7 Reg't U. S. Col'd Infantry.

Appears on

Company Muster Roll

for Jan, & Feb, 1866.

Joined for duty and enrolled:

When Jan. 14, 1864.

Where Queen Anne Co., Md.

Period 3 years.*

Present or absent Present

Stoppage, \$ 100 for

Due Gov't \$ 100 for

Remarks:

* See enrollment on card from muster-in roll.

Book mark:

(358c)

Jno J Bell

Copyist.

A |

7

U.S.C.T.

William Daniels
Sgt., Co. E, 7 Reg't U. S. Col'd Infantry.

Appears on

Company Muster Roll

for March & April, 1866.

Joined for duty and enrolled:

When Jan. 16, 1864*

Where Green Army Co., Md.*

Period 3 years.*

Present or absent Present

Stoppage, \$ 100 for

Due Gov't \$ 100 for

Remarks:

* See enrollment on card from muster-in roll.

Book mark: _____

(358c)

Geo J. Bell J.
Copyist.

21

7

U.S.C.T.

William Daniels
Pvt, Co. E, 7 Reg't U. S. Col'd Infantry.

Appears on

Company Muster Roll

for May & June, 1866.

Joined for duty and enrolled:

When Jan. 16, 1864

Where Green Am Co, Md.*

Period 3 years.*

Present or absent Present

Stoppage, \$ 100 for

Due Gov't \$ 100 for

Remarks:

* ~~See~~ See enrollment on card from muster-in roll.

Book mark:

(358c)

Geo. B. Bell

Copyist.

S | **7** | **U.S.C.T.**

William Daniels
Pr, Co. E, 7 Reg't U. S. Col'd Infantry.

Appears on

Company Muster Roll

for *July & Aug.*, 1866.

Joined for duty and enrolled:

When *Jan. 16*, 186 *4**

Where *Green Arm Co., Md.**

Period *3* years.*

Present or absent *Present.*

Stoppage, \$ *100* for

Due Gov't \$ *100* for

Remarks:

* See enrollment on card from muster-in roll.

Book mark: _____

Wm J. Bell Jr
(358c) Copyist.

A | 7 | U.S.C.T.

William Daniel
Pvt, Co. E, 7 Reg't U. S. Col'd Infantry.

Appears on Co. Muster-out Roll, dated
Indianola Texas, Oct. 13, 1864.

Muster-out to date Oct. 13, 1866.

Last paid to June 30, 1866.

Clothing account:

Last settled....., 186 ; drawn since \$ 100

Due soldier \$ 13 ⁴/₁₀₀; due U. S. \$ 100

Am't for cloth'g in kind or money adv'd \$ 100

Due U. S. for arms, equipments, &c., \$ 100

Bounty paid \$ 100; due \$ 100 ¹⁰⁰

Remarks: Stopped for ordnance \$ 6.00
Joined for duty Jan. 17, 1864
Retaisone E. P. Mucket
Set of accoutrements per
G.O. No. 101 War Dept
May 30, 1865.

Book mark:

(361) J. H. Bull Jr Copyist.

Daniel Munn

Co. *E*

Reg't *U.S.C.I.*

1 Inclosures.

Bed Cards
 Burial Records
 Certs. of Dis. for Discharge
 C. M. Charges
 Descriptive Lists
 Discharge Certificates
 Enlistment Papers

Final Statements
 Furloughs or L. of A.
 Med. Certificates
 Med. Des. Lists
 Orders
 Pris. of War Record
 Resignations

Other papers relating to—

Admission to Hosp'l
 Casualty Sheet
 Confinement
 Contracts
 Death or Effects
 Desertion
 Discharge from Hosp'l
 Discharge from Service
 Duty

Furlough or L. of A.
 Med. Examination
 Misc. Information
 Pay or Clothing
 Personal Reports
 Rank
 Transfer to Hosp'l
 Transfer to V. R. C.
 Transportation

5825 1

Statement of Service Reference Slip.

William Daniels,
(Name.)

Co. E, 7 Maryland Vols.
(Rank and organization.)

Request for military record of the above-named by applicant whose name and address are shown by attached carbon copy of answer.

Name not found on rolls of any Co., 7 Md. Inf., Civil War.

(There was no 7 Md. Cav.)

Johnson.

DSB.

411:

Is he in 7 U. S. C. T. (7

Md.)?

3 25.

DSB.

8. 25. 16.

William Daniels was
enrolled Jan'y 16, 64
^{Green Ark}
at ~~Benedict~~, Md. for
3 yrs
re-enrolled Jan'y 16, 64 at
Benedict, Md. as a
private in Co. E, 7
U.S.C. organized in
Md., and
re-enrolled as a private, with
Co., Oct. 13, 66 at
Indianola, Tex.

WFD

August 28, 1916.

Respectfully returned to

The Commander-in-Chief, Sons of Veterans,
U. S. A.,
Cincinnati, Ohio.

The records of this office show that William Daniels, Company E, 7th Regiment, United States Colored Troops was mustered into service January 16, 1864, and was honorably discharged October 13, 1866, a private.

H. P. McCall

The Adjutant General.

MR

3

363

Dartkiss Benjamin

Co. G, 7 U.S. Col'd Inf.

Private

CARD NUMBERS.

1	26
See Dartkiss Benjamin	27
3	28
4	29
5	30
6	31
7	32
8	33
9	34
10	35
11	36
12	37
13	38
14	39
15	40
16	41
17	42
18	43
19	44
20	45
21	46
22	47
23	48
24	49
25	50

Book Mark:

See also

³⁶⁴
Dorham, Edward

Co A, 7 U.S. Col'd Inf.

Private

CARD NUMBERS.

1	26
See Dorham,	Edward
3	28
4	29
5	30
6	31
7	32
8	33
9	34
10	35
11	36
12	37
13	38
14	39
15	40
16	41
17	42
18	43
19	44
20	45
21	46
22	47
23	48
24	49
25	50

Book Mark:

See also

365

Dorum, William

Co D, 7 U.S. Col'd Inf.

Private

CARD NUMBERS.

1	26
2	27
3	28
4	29
5	30
6	31
7	32
8	33
9	34
10	35
11	36
12	37
13	38
14	39
15	40
16	41
17	42
18	43
19	44
20	45
21	46
22	47
23	48
24	49
25	50

See Dorum,

William

Book Mark: /

See also

366

Rashfield Robert

Co K, 7 U.S. Col'd Inf.

Private | *Private*

CARD NUMBERS.

1	6279075	26
2	62718848	27
3	6296829	28
4	629693/8	29
5	62971043	30
6	6297145	31
7	629725-1	32
8	6297344	33
9	6297428	34
10	6297503	35
11	6297567	36
12	6297630	37
13	9067034	38
14		39
15		40
16		41
17		42
18		43
19		44
20		45
21		46
22		47
23		48
24		49
25		50

Book Mark:

See also

S. 2674848 Power

S. 1 7 U.S.C.T.

Robert Dashiieldy

, Co. K, 7 Reg't U. S. Col'd Inf.

Appears on

Company Descriptive Book

of the organization named above.

DESCRIPTION.

Age 19 years; height 5 feet 5 1/4 inches.

Complexion Black

Eyes Black ; hair Black.

Where born Maryland.

Occupation Laborer.

ENLISTMENT.

When Mar. 5, 1865.

Where Frederick

By whom Capt. Hail; term 3 y'rs.

Remarks: Mustered by Capt. Hail

Mar. 5. 65.

Substitute for John
L. Keifer 1st Dist. Md.

J. J. White.

D | *7* | **U.S.C.T.**

Robert Dashiels

Appears with rank of _____ on
**Muster and Descriptive Roll of a Detach-
ment of Drafted Men and Substitutes
forwarded**

for the *7* Reg't U. S. Col'd Inf. Roll dated
Baltimore Md, Mch 11, 1865

Where born *Maryland*
Age *19* years; occupation *Laborer*

Drafted and mustered in:

When *Mar. 6*, 1865

Where *Frederick*

Period *3* years.

Eyes *Blk*; hair *Blk*

Complexion *Blk*; height *5 ft. 2 1/4 in.*

Paid bounty and advance pay, \$ *100*

Bounty due \$ *100*

Where credited _____

Company to which assigned _____

Remarks: *Subs for John D.
Keeper. 4 Dist. Md.*

Book mark: _____

J. M. Farvly
(340) Copyist

10 | 7

U.S.C.T.

Robert Washfield

Priv, Co, 7 Reg't U. S. Col'd Infantry.

Age 19 years.

Appears on a

Detachment Muster-in Roll

of the organization named above. Roll dated

Baltimore, Md., Mar. 16, 1863.

Muster-in to date Mar. 16, 1863.

Joined for duty and enrolled:

When Mar. 6, 1863.

Where Frederick

Period 3 years.

Remarks: Substitute

Book mark:

W Beck
Copyist.

N | *7* | **U.S.C.T.**

Robert Dashields
Pvt, Co. K, 7 Reg't U. S. Col'd Infantry.

Appears on

Company Muster Roll

for *March & April*, 1865.

Present or absent *Present*

Stoppage, \$ *100* for

Due Gov't, \$ *100* for

Remarks: *joined for duty March 17.65. In place of John S. Keefe 4th Dist. Md.*

Book mark:

Leary
Copyist.

AD

7

U.S.C.T.

Robert Washields

Priv, Co. K, 7 Reg't U. S. Col'd Infantry.

Appears on

Company Muster Roll

for May and June, 1865.

Present or absent Present

Stoppage, \$ 100 for

Due Gov't, \$ 100 for

Remarks: Stop / Knapsack, 1 Wiper.

Book mark:

(358)

Leary Copyist.

20 | 7 | U.S.C.T.

Robert Washield

Priv, Co. K, 7 Reg't U. S. Col'd Infantry.

Appears on

Company Muster Roll

for July and Aug, 1865

Present or absent Present

Stoppage, \$ 100 for

Due Gov't, \$ 100 for

Remarks:

Book mark:

Seary Copyist.

20 | 7 | U.S.C.T.

Robert Washield
Pvt, Co. K, 7 Reg't U. S. Col'd Infantry.

Appears on

Company Muster Roll

for Sept + Oct, 1865

Present or absent Present

Stoppage, \$ 53/100 for Ordnance

Due Gov't, \$ 100 for

Remarks:

Book mark:

(358)

Seary Copyist.

10

7

U.S.C.T.

Robert Washburns

Priv, Co. K, 7 Reg't U. S. Col'd Infantry.

Appears on

Company Muster Roll

for *Nov + Dec*, 1865

Present or absent *Present*

Stoppage, \$ $\frac{53}{100}$ for *Ordinance*

Due Gov't, \$ $\frac{100}{100}$ for

Remarks:

Book mark:

Seay
Copyist.

D

7

U.S.C.T.

Robert Dashields

Pat., Co. K, 7 Reg't U. S. Col'd Infantry.

Appears on

Company Muster Roll

for *Jan. & Feb.*, 186*6*

Present or absent *Present*

Stoppage, \$ *100* for

Due Gov't, \$ *100* for

Remarks:

Book mark:

Randall

(358)

Copyist.

D

7

U.S.C.T.

Robert Dashielde
Sgt, Co. K, 7 Reg't U. S. Col'd Infantry.

Appears on

Company Muster Roll

for *March & April*, 1866.

Present or absent *Present*

Stoppage, \$ *1* ^{*14*}/_{*100*} for *Ordinance*

Due Gov't, \$ ^{*1*}/_{*100*} for

Remarks:

Book mark:

Randall

(358)

Copyist.

D

7

U.S.C.T.

Robert Dashields

Priv., Co. K, 7 Reg't U. S. Col'd Infantry.

Appears on

Company Muster Roll

for May & June, 1866

Present or absent Present

Stoppage, \$ 100 for

Due Gov't, \$ 100 for

Remarks:

Book mark:

Randall

(358)

Copyist.

D

7

U.S.C.T.

Robert Dashields

Priv, Co. K, 7 Reg't U. S. Col'd Infantry.

Appears on

Company Muster Roll

for *July & Aug.*, 186*6*

Present or absent *Present*

Stoppage, \$ *100* for

Due Gov't, \$ *100* for

Remarks:

Book mark: _____

Randall

(358)

Copyist.

a | **7** | **U.S.C.T.**

Robert Dashields
Priv., Co. K, 7 Reg't U. S. Col'd Infantry.

Appears on **Co. Muster-out Roll**, dated
Indianola, Texas, Oct. 13, 1866.

Muster-out to date *Oct. 13, 1866.*

Last paid to *June 30, 1866.*

Clothing account:

Last settled....., 186 ; drawn since \$..... 100

Due soldier \$ *23*^{*67*}/₁₀₀; due U. S. \$..... 100

Am't for cloth'g in kind or money adv'd \$..... 100

Due U. S. for arms, equipments, &c., \$..... 100

Bounty paid \$..... 100; due \$..... 100

Remarks: *Joined the Company at*
Fort Burnham, Va. Mar. 17. 65.
Substitute for John S. Keefer
4. Dist. Md. Retains one En-
field P.M. and one set of
Accountments per G.O. No. 101.
Mar. Dept. May 30. 65. (over)

Book mark *V. 135 P. 138. 72*

Randall
Copyist.

JAN. 21

6297635

W18910

Stop for Ordnance, \$6.00,

Dashields, Robert

....., Co., Reg't *U. S. C. I.*

3 Enclosures.

- | | |
|------------------------------------|----------------------------|
| Bed Cards | Final Statements |
| Burial Records | Furloughs or L. of A. |
| Certs. of Dis. for Discharge | Med. Certificates |
| C. M. Charges | Med. Des. Lists |
| Descriptive Lists | Orders |
| Discharge Certificates | Pris. of War Record |
| Enlistment Papers <i>2</i> | Resignations |

Other papers relating to—

- | | |
|------------------------------|---------------------------|
| Admission to Hosp'l | Furlough or L. of A. |
| Casualty Sheet | Med. Examination |
| Confinement | Misc. Information / |
| Contracts | Pay or Clothing |
| Death or Effects | Personal Reports |
| Desertion | Rank |
| Discharge from Hosp'l | Transfer to Hosp'l |
| Discharge from Service | Transfer to V. R. C. |
| Duty | Transportation |

DECLARATION OF SUBSTITUTE.

x, Robert Washields (Solo), desiring to ENLIST
in the Army of the United States, for THREE YEARS, Do declare, That I am
Twenty years and _____ months of age; that I have
never been discharged from the United States service on account of disability or by sentence of
a court martial; and I know of no impediment to my serving honestly and faithfully as a soldier
for three years.

GIVEN at Frederick Maryland
the 6th day of March 1865

WITNESS:
E. A. Guttinger
Robert Washields
mark

No. 499

Robert Washields (Solo)
Enlisted at Frederick Md.

As Substitute for

John S. Keefer
On the 6th day of March, 1865.

And is not entitled to Gov. Bounty
By

Henry C. Nail Capt.
Geo. J. Thomas Comm.
Chas. J. Baer Surg.

Board of Enrollment

4th Dist. of Md.

Jan. 1866, This paper was formed
filed in the Enrollment Div. R. & P.

(No. 39.)

SUBSTITUTE VOLUNTEER ENLISTMENT.

STATE OF

TOWN OF

Maryland

Fredericks



I, Robert Washields (Soldier), born in the State of Maryland, aged nineteen years, and by occupation a Laborer, Do HEREBY ACKNOWLEDGE to have agreed with

John L. Keefer, Esq., of Sub. dist. No. 42 Woodsboro. Election Dist. Frederick County, Maryland

to become his SUBSTITUTE in the Military Service, for a sufficient consideration paid and delivered to me, on the Sixth day of March, 1865;

and having thus agreed with said John L. Keefer, I DO HEREBY ACKNOWLEDGE to have enlisted this Sixth day of March,

1865, to serve as a Soldier in the Army of the United States of America, for the period of THREE YEARS, unless sooner discharged by proper authority. I do also agree to accept such bounty, pay, rations, and clothing as are, or may be, established by law for soldiers. And I do solemnly swear that I will bear true and faithful allegiance to the United States of America; that I will serve them honestly and faithfully against all their enemies or opposers whomsoever; and that I will observe and obey the orders of the President of the United States and the orders of the officers appointed over me according to the Rules and Articles of War.

SWORN and subscribed to, at Frederick Md, this 6th of March, 1865,

BEFORE Henry C. Nail, Capt. & Prov. Mar. 4th Dist. Md.

Robert Washields mark

Witness E. A. Gittinger

We certify, on honor, That we have carefully examined the above-named Volunteer Substitute agreeably to the Regulations, and that, in our opinion, he is free from all bodily defects and mental infirmity which would in any way disqualify him from performing the duties of a soldier; that he was entirely sober when enlisted; that he is of lawful age, (not under 18 years;) and that, in accepting him as duly qualified to perform the duties of an able-bodied soldier, and as a Substitute in lieu of John L. Keefer Enrolled in Woodsboro Dist. Frederick Co. Maryland August, 1863, we have strictly observed the Regulations which govern in such cases. This soldier has Black eyes, Black hair, Black complexion; is 5 feet 2 1/4 inches high.

Henry C. Nail, Capt. & Provost Marshal.

James Thomas, Commissioner of Board.

Charles B. Bair, Surgeon of Board.

Board of Enrollment of 4th Dist. of Maryland

DECLARATION OF SUBSTITUTE.

I, Robert Washields Cold, desiring to ENLIST in the Army of the United States, for THREE YEARS, do declare, That I am nineteen years and _____ months of age; that I have never been discharged from the United States service on account of disability or by sentence of a court martial; and I know of no impediment to my serving honestly and faithfully as a soldier for three years.

GIVEN at Frederick's Maryland the 6th day of March 1865

WITNESS:
E. A. Guttinger
Robert Washields
mark

No. 497

Robert Washields Cold

Enlisted at Frederick's Md.

As Substitute for

John L. Keefer

On the 6th day of March, 1865,

And is not entitled to 3y Gov. Bounty

Henry C. Naille Capt.

Jno. J. Thomas Comdr.

Chas. L. Baer Surg.

Board of Enrollment

4th Dist. of Md.

Jan. 1866, This paper was for-
filed in the Enrollment Div. R. &

(No. 39.)

SUBSTITUTE VOLUNTEER ENLISTMENT.

STATE OF

TOWN OF

Maryland



Fredericks

I, Robert Nashields (Colt), born in the State of Maryland, aged nineteen years, and by occupation a Laborer, Do HEREBY ACKNOWLEDGE to have agreed with

John L. Keifer, Esq., of Sub. Dist. No. 42 Woodboro, Dist. Frederick County, Maryland

to become his SUBSTITUTE in the Military Service, for a sufficient consideration paid and delivered to me, on the Sixty day of March, 1865;

and having thus agreed with said John L. Keifer, I DO HEREBY ACKNOWLEDGE to have enlisted this Sixty day of March, 1865,

to serve as a Soldier in the Army of the United States of America, for the period of THREE YEARS, unless sooner discharged by proper authority. I do also agree to accept such bounty, pay, rations, and clothing as are, or may be, established by law for soldiers. And I do solemnly swear that I will bear true and faithful allegiance to the United States of America; that I will serve them honestly and faithfully against all their enemies or opposers whomsoever; and that I will observe and obey the orders of the President of the United States and the orders of the officers appointed over me, according to the Rules and Articles of War.

SWORN and subscribed to, at Frederick Md.

this 6th of March, 1865,

BEFORE Henry Nail, Capt. & Pro. Mar. 4th Dist. Md.

Witness E. A. Gittinger

Robert X Nashields mark

We certify, on honor, That we have carefully examined the above-named Volunteer Substitute agreeably to the Regulations, and that, in our opinion, he is free from all bodily defects and mental infirmity which would in any way disqualify him from performing the duties of a soldier; that he was entirely sober when enlisted; that he is of lawful age, (not under 18 years;) and that, in accepting him as duly qualified to perform the duties of an able-bodied soldier, and as a Substitute in lieu of John L. Keifer Enrolled Md. August, 1863, we have strictly observed the Regulations which govern in such cases. This soldier has Blk eyes, Blk hair, Blk complexion; is 5 feet 2 1/4 inches high.

Henry Nail, Capt. & Pro. Mar. Marshal.

John Thomas, Commissioner of Board.

Chas. S. Barr, Surgeon of Board.

Board of Enrollment of 4th Dist. of Maryland

(P.M. 4th Dist Md 3)

Salisbury Md
March 27, 1865.

Graham Samuel A.

States that Robert Dashields
Cold. was enlisted as a substitute in your
Office, about March 8, 1865 - was obtained
by fraud, and requests the name of the
man who put him in

Office of the Pro. Mar. 4th Dist. Md
1st. Underarmment. Frederick Md. Mar 30, 1865.

Respectfully returned to Samuel A.
Graham, with the information that Robert
Dashields Cold. was presented at this Office
as a substitute by the firm of Smyth,
Brown & Thompson, Substitute Brokers -
Baltimore Maryland March 6, 1865. -

H. Clay Nail.

Capt. & Pro. Mar.

4th. Dist. Md.

Sent C. P. M. March 29, 1865,

367

Datcher Henry

Co *B*, 7 U.S. Col'd Inf.

Private | *Private*

CARD NUMBERS.

1	6279060	26
2	6384456	27
3	6384544	28
4	6384658	29
5	6384827	30
6	6385395	31
7	9066147	32
8		33
9		34
10		35
11		36
12		37
13		38
14		39
15		40
16		41
17		42
18		43
19		44
20		45
21		46
22		47
23		48
24		49
25		50

Book Mark. *E.B. 12/217*

See also

D

7

U.S.C.T.

Henry Hatcher

, Co. *C*, 7 Reg't U.S. Col'd Inf.

Appears on

Company Descriptive Book

of the organization named above.

DESCRIPTION.

Age *30* years; height *5* feet *4* inches.

Complexion *Black*

Eyes *Black*; hair *Black*

Where born *Md*

Occupation *Laborer*

ENLISTMENT.

When *Sept 21*, 186*4*.

Where *Elliot Mills*

By whom *Capt Holland*; term *1* y'rs.

Remarks: *Drafted 1st Dist
Chas Co Md.*

*Died at Hopt
Indiana Texas Feb
25, 65 of inflammation
of the bowels*

Enlisting
Co. C

D | *7* | **U.S.C.T.**

Henry Datches

Appears with rank of on
**Muster and Descriptive Roll of a Detach-
ment of Drafted Men and Substitutes
forwarded**

for the *7* Reg't U. S. Col'd Inf. Roll dated
At Annapolis, Md. Feb., 186*5*.

Where born

Age *30* years; occupation

Drafted and mustered in:

When *Sept. 21*, 186*4*

Where *E. Mills, Md.*

Period *1* years.

Eyes *Blk*; hair *Blk*

Complexion *Blk*; height *5* ft. *4* in.

Paid bounty and advance pay, \$ *100*

Bounty due \$ *100*

Where credited

Company to which assigned

Remarks: *1 Dist. Charles Co. Md.*
Remedy Paid. \$30.

Book mark:

J. M. Fairley
(340) *J. M. Fairley* Copyist

10 | 7 | U.S.C.T.

Henry Datcher
Sgt., Co. C, 7 Reg't U. S. Col'd Infantry.

Appears on

Company Muster Roll

for Jan. & Feb., 1864.

Joined for duty and enrolled:

When Sept. 21st, 1864.*

Where Ellicott Mills, Md.*

Period over years.*

Present or absent Present

Stoppage, \$ 100 for

Due Gov't \$ 100 for

Remarks: Joined the Co. Feb. 25th / 65 - In confinement undergoing sentence

* See enrollment on card from muster-in roll.

Book mark:

Mr. W. Murphy Copyist.

10 | 7 | U.S.C.T.

Henry Ketchum
Priv., Co. C, 7 Reg't U. S. Col'd Infantry.

Appears on

Company Muster Roll
for *Mar. & Apr.*, 1865.

Joined for duty and enrolled:

When *Sept. 21*, 1864.*

Where *Colcott Mills* *

Period *one* years.*

Present or absent *Present*

Stoppage, \$ *100* for

Due Gov't \$ *100* for

Remarks: *Joined Co. Feb. 25,*
1865. Stop for Paper

* See enrollment on card from muster-in roll.

Book mark:

M. M. Murphy
(358c) Copyist.

10 | 7 | U.S.C.T.

Henry Ditcher
Priv., Co. C, 7 Reg't U. S. Col'd Infantry.

Appears on

Company Muster Roll
for May & June, 1865.

Joined for duty and enrolled:

When Sept. 21", 1864.*

Where Ellicotts Mills *

Period one years.*

Present or absent Present

Stoppage, \$ 100 for

Due Gov't \$ 100 for

Remarks: Joined Co. Feb. 25/65
Stop for papers

* See enrollment on card from muster-in roll.

Book mark:

W. M. Murphy Copyist.

10 | 7 | U.S.C.T.

Henry Deitcher
Co. C, 7 Reg't U. S. Col'd Infantry.

Appears on

Company Muster Roll

for July & Aug., 1865.

Joined for duty and enrolled;

When Sept. 21, 1864.*

Where Elliotts Mills *

Period one years.*

Present or absent

Stoppage, \$ 100 for

Due Gov't \$ 100 for

Remarks: Died July 25/65
(Indianola, Texas)

* See enrollment on card from muster-in roll.

Book mark:

Wm Murphy

(358c)

Copyist.

D | 7 | U.S.C.T.

Henry Datcher
Pt. Co. 7 Reg't U. S. Col'd Infantry.

Appears on Co. Muster-out Roll, dated
Indianola Texas, Oct. 13, 1866.

Muster-out to date _____, 186 .

Last paid to *Pay due from Enrollment*

Clothing account:

Last settled _____, 186 ; drawn since \$ _____ 100

Due soldier \$ _____ 100 ; due U. S. \$ _____ 100

Am't for cloth'g in kind or money adv'd \$ _____ 100

Due U. S. for arms, equipments, &c., \$ _____ 100

Bounty paid \$ _____ 100 ; due \$ _____ 100

Remarks: *Died at Indianola Texas Aug 25 '65 of Inflammation of Bowels Final statements sent to aljo. Dec. 5 '65.*

Book mark: *See list of deserters*

(861)

Lopez
(over) Copyist.

JAN. 20

6285395

018910

on file. F.S. Died July
25th 65 E.B. 2/217

Dietcher, Henry

P. Co. C.

7 Reg't

U.S.C. Inf

4 Enclosures.

Bed Cards	Descriptive Lists
Burial Records	Final Statements 2
Certs. of Dis. for Discharge	Furloughs
C. M. Charges	Med. Des. Lists
Med. Certificates	Orders

Other papers relating to—

Admission to Hosp'l	Furlough
Casualty Sheet (Officer's) /	Med. Examination
Confinement	Misc. Information
Contracts	Pay or Clothing
Death or Effects /	Personal Reports
Desertions	Rank
Discharge from Hosp'l	Transfer to Hosp'l
Discharge from Service	Transfer to V. R. C.
Duty	Transportation

31

FINAL STATEMENT

OF

Frank Henry [unclear]
1st Reg't of [unclear]

VOLUNTEERS.

Dead July 25 1865

NOTE 1.—Two of these certificates (or duplicates) are to be given to each Volunteer Soldier or drafted man who may be discharged previously to the discharge of his company, that he may at once receive from the Paymaster the pay, &c., due him, and the captain or other COMMISSIONED officer commanding the company will certify to the act of the delivery of the duplicate certificates; on these certificates the Soldier is "entitled to" his discharge, and should also present his discharge to the Paymaster to have the payment endorsed on it. The discharge is to be given back to the Soldier by the Paymaster; the latter only retaining as his voucher the duplicate certificates.

NOTE 2.—If the Soldier is entitled to pay for the use of his horse, the Company Commander will certify to that fact on the back of both these final statements, and also to the time he has pay due for having been so mounted on his own horse.

NOTE 3.—When a Soldier is furnished with final statements, his descriptive list, if he has one, should be taken up by the officer who gives the Soldier these statements, and endorsed with a statement to this effect by the officer. This endorsement should exhibit a full statement of the time for which the Soldier was allowed pay on his final statements, the clothing account, and all other charges against him or in his favor, so as to comprise a complete exhibit of his account. It will then be transmitted to the Company Commander of the Soldier, who will enter all the data necessary to a full understanding of the Soldier's account on the muster roll upon which the Soldier's discharge is reported. The descriptive list will then be destroyed. The object of this is, that the remaining portion of the Soldier's account may be settled upon the receipt of these muster rolls, and the Soldier receive any pay or allowances that may be due him at the time of his discharge, and which may not appear on his final statements from the fact that his descriptive list is incomplete. These accounts for back pay, &c., are settled by the 2d Auditor of the Treasury Department.

NOTE 4.—Charges for loss or injury to ordnance, horse equipments, and other miscellaneous charges, should appear under the heading of "Other Stoppages."

NOTE 5.—Bounty paid by State authorities, and not by the United States, will not be entered on this statement.

NOTE 6.—Amounts due the Sutler and Laundress must be entered on the muster roll on which the discharge, death, desertion, &c., is reported, as well as on the final statement, otherwise the amount cannot be collected from the United States.

NOTE 7.—This blank will be used for deceased volunteers and drafted men, as well as for others.

NOTE 8.—Where a Soldier dies in Hospital or on detached service, his descriptive list, if he has one, should be sent with his final statements, in duplicate, to the Adjutant General, Washington, D. C.

Enc. in [unclear]

[OFFICE ENDORSEMENT.]

War Department,

ADJUTANT GENERAL'S OFFICE,

January 29, 1871

The death of *Henry Dickson*
Co. C, 7th Reg't U. S.
Colored *Infantry*, is reported as follows:

- On Company Muster Roll.
- For *July-Aug.*, 1865, *July 25*, 1865
- Company Muster-out Roll, *August 25*, 1865
- Company Descriptive Book., 186
- Company Morning Reports., 186
- Soldier's Final Statement. *July 25*, 1865
- Soldier's Record of Death and Interment., 186
- Soldier's Inventory of Effects. *July 25*, 1865
- Soldier's Certificate of Disability for Discharge., 186
- Soldier's Individual Muster-out Roll., 186
- Regimental Returns., 186
- For *July*, 1865, *July 25*, 1865
- Regimental Quarterly Returns. *3rd 1/4*
- July 25*, 1865
- Regimental Descriptive Book., 186
- By Surgeon General., 186

(July 25, 1865, is held to be the correct date, and the Company Muster-out Roll will be amended accordingly.)

Thomas M. [unclear]
Asst. Auditor General
12 March 1871
EPB 217

ADJUTANT GENERAL'S OFFICE

Aug 11th 1865

Duplicate with inventory sent 2d Auditor.

I certify, on honor, that Henry Dietcher a Private of
 Captain Geo. R. Sumner's Company (C) of the 73 Regiment of West Virginia
~~VOLUNTEERS~~, of the State of ~~Virginia~~, born in Ellicott's Mills, State
 of Maryland, aged 30 years; 5 feet 4 inches high; Black complexion,
Blk eyes, curly hair, and by occupation a Unknown, ~~having joined the company on~~
~~its original organization at~~ , and enrolled in it at the muster into
 the service of the United States at _____, on the _____ day
 of _____, 186 , (or was mustered in service as a recruit, by _____
 _____, at _____, on the _____ day of _____,
 186 , or was drafted and mustered into the service of the United States from the _____
 Enrollment District of the State of Maryland, at Ellicott's Mills,
 on the 21st day of October, 186,) to serve in the Regiment, for
 the term of one year : and having served HONESTLY and
 FAITHFULLY with his Company in the Regiment to the present date, is now
 entitled to a **DISCHARGE** by reason of Death

Died July 25 1865

The said Private Henry Dietcher was last paid by Paymaster
~~received no pay~~ to include the _____ day of _____, 186 , and has
 pay due him from that time to the present date; he is entitled to pay and subsistence for
 TRAVELING to place of enrollment, and whatever other allowances are authorized to volunteer
 soldiers, drafted men, or militia, so discharged. He has received from the United States **CLOTHING**
 amounting to 43 ⁷⁵/₁₀₀ dollars, since the 21st day of October,
 186 , when his clothing account was last settled. He has received from the United States
70 ⁰⁰/₁₀₀ dollars advanced **BOUNTY**.

There is to be stopped from him, on account of the State of _____, or other
 authorities, for **CLOTHING**, &c., received on entering service, _____ dollars; and
 for other stoppages, viz: one week

_____ dollars.
 He has been furnished with TRANSPORTATION in kind from the place of his discharge to
 _____; and he has been SUBSISTED for TRAVELING to his
 place of enrollment, up to the _____, 186 .

He is indebted to _____, **SUTLER**, _____ dollars.
 He is indebted to _____, **LAUNDRESS**, _____ dollars.

Given in Duplicate, at Cardinal's Texas, this 25th day
 of July, 1865.

Leifur E. ...
2nd Lieut
 Commanding Company.

1065 Dap 31

FINAL STATEMENT

OF Hill

Company James Dickler
Co. 6th Reg't of U.S. Cavalry

JUL 16 1871

VOLUNTEERS.

NOTE 1.—Two of these certificates (or duplicates) are to be given to each Volunteer Soldier or drafted man who may be discharged previously to the discharge of his company, that he may at once receive from the Paymaster the pay, &c., due him, and the captain or other COMMISSIONED officer commanding the company will certify to the act of the delivery of the duplicate certificates; on these certificates the Soldier is "entitled to" his discharge, and should also present his discharge to the Paymaster to have the payment endorsed on it. The discharge is to be given back to the Soldier by the Paymaster; the latter only retaining as his voucher the duplicate certificates.

NOTE 2.—If the Soldier is entitled to pay for the use of his horse, the Company Commander will certify to that fact on the back of both these final statements, and also to the time he has pay due for having been so mounted on his own horse.

NOTE 3.—When a Soldier is furnished with final statements, his descriptive list, if he has one, should be taken up by the officer who gives the Soldier these statements, and endorsed with a statement to this effect by the officer. This endorsement should exhibit a full statement of the time for which the Soldier was allowed pay on his final statements, the clothing account, and all other charges against him or in his favor, so as to comprise a complete exhibit of his account. It will then be transmitted to the Company Commander of the Soldier, who will enter all the data necessary to a full understanding of the Soldier's account on the muster roll upon which the Soldier's discharge is reported. The descriptive list will then be destroyed. The object of this is, that the remaining portion of the Soldier's account may be settled upon the receipt of these muster rolls, and the Soldier receive any pay or allowances that may be due him at the time of his discharge, and which may not appear on his final statements from the fact that his descriptive list is incomplete. These accounts for back pay, &c., are settled by the 2d Auditor of the Treasury Department.

NOTE 4.—Charges for loss or injury to ordnance, horse equipments, and other miscellaneous charges, should appear under the heading of "Other Stoppages."

NOTE 5.—Bounty paid by State authorities, and not by the United States, will not be entered on this statement.

NOTE 6.—Amounts due the Sutler and Laundress must be entered on the muster roll on which the discharge, death, desertion, &c., is reported, as well as on the final statement, otherwise the amount cannot be collected from the United States.

NOTE 7.—This blank will be used for deceased volunteers and drafted men, as well as for others.

NOTE 8.—Where a Soldier dies in Hospital or on detached service, his descriptive list, if he has one, should be sent with his final statements, in duplicate, to the Adjutant General, Washington, D. C.

I certify, on honor, that Henry Dietz a Private of
 Captain W. G. Sherman's Company (Co.) of the 7th Regiment of Volunteers
VOLUNTEERS, of the State of Maryland, born in Ellicott's Mill, State
 of Maryland, aged 30 years; 5 feet 4 inches high; Black complexion,
Blk eyes, Curly hair, and by occupation a Wentworth, having joined the company on
~~its original organization at~~ _____, and enrolled in it at the muster into
 the service of the United States at _____, on the _____ day
 of _____, 1864, (or was mustered in service as a recruit, by _____
 _____, at _____, on the _____ day of _____,
 1864, or was drafted and mustered into the service of the United States from the 1st
 Enrollment District of the State of Maryland, at Ellicott's Mill,
 on the 21st day of September, 1864.) to serve in the Regiment, for
 the term of one year: and having served HONESTLY and
 FAITHFULLY with his Company in this regiment to the present date, is now
 entitled to a **DISCHARGE** by reason of Death

The said Private Henry Dietz ~~was received~~ was last paid by Paymaster
no pay to include the _____ day of _____, 1864, and has
 pay due him from that time to the present date; he is entitled to pay and subsistence for
 TRAVELING to place of enrollment, and whatever other allowances are authorized to volunteer
 soldiers, drafted men, or militia, so discharged. He has received from the United States **CLOTHING**
 amounting to \$43 ⁷⁵/₁₀₀ dollars, since the 21st day of September,
 1864, when his clothing account was last settled. He has received from the United States
no bounty ¹⁰⁰/₁₀₀ dollars advanced **BOUNTY**.

There is ~~to be stopped from him, on account of the State of~~ _____, or other
 authorities, for **CLOTHING**, &c., received on entering service, _____ ¹⁰⁰/₁₀₀ dollars; and
 for other stoppages, viz: no other

_____ ¹⁰⁰/₁₀₀ dollars.
 He has been furnished with TRANSPORTATION in kind from the place of his discharge to
 _____; and he has been SUBSISTED for TRAVELING to his
 place of enrollment, up to the _____, 1864.

He is indebted to _____, **SUTLER**, _____ ¹⁰⁰/₁₀₀ dollars.
 He is indebted to _____, **LAUNDRESS**, _____ ¹⁰⁰/₁₀₀ dollars.

Given in Duplicate, at Indianola Texas, this 25th day
 of July, 1865

Edward Baker
and

 Commanding Company. 64

ARTICLES OF WAR.

ART. 95. When any non-commissioned officer or soldier shall die, or be killed in the service of the United States, the then commanding officer of the troop or company shall, in the presence of two other commissioned officers, take an account of what effects he died possessed of, above his arms and accoutrements, and transmit the same to the office of the Department of War, which said effects are to be accounted for, and paid to the representatives of such deceased non-commissioned officer or soldier. And in case any of the officers, so authorized to take care of the effects of deceased officers and soldiers, should, before they have accounted to their representatives for the same, have occasion to leave the regiment or post, by preferment or otherwise, they shall, before they be permitted to quit the same, deposit in the hands of the commanding officer, or of the assistant military agent, all the effects of such deceased non-commissioned officers and soldiers, in order that the same may be secured for, and paid to, their respective representatives.

ARMY REGULATIONS—EDITION OF 1863.

DECEASED SOLDIERS.

Par. 152. Inventories of the effects of deceased non-commissioned officers and soldiers, required by the 95th Article of War, will be forwarded to the Adjutant General, by the commander of the company to which the deceased belonged, and a duplicate of the same to the colonel of the regiment. Final statements of pay, clothing, &c., in duplicate, will be sent to the Adjutant General with one copy of the inventory. When a soldier dies at a post or station absent from his company, it will be the duty of his immediate commander to furnish the required inventory and final statements, and, at the same time, to forward to the commanding officer of the company to which the soldier belonged, a report of his death, specifying the date, place, and cause; to what time he was last paid, and the money or other effects in his possession at the time of his decease; which report will be noted on the next muster roll of the company to which the man belonged. Each inventory will be endorsed, "Inventory of the effects of _____, late of company (—) _____ regiment of _____, who died at _____, the _____ day of _____, 186—." If a legal representative receive the effects, it will be stated in the report. If the soldier leave no effects, the fact will be reported.

Par. 153. Should the effects of a deceased non-commissioned officer or soldier not be administered upon within a short period after his decease, they shall be disposed of by a Council of Administration, under the authority of the commanding officer of the post, and the proceeds deposited with the Paymaster, to the credit of the United States, until they shall be claimed by the legal representatives of the deceased.

Par. 154. In all such cases of sales by the Council of Administration, a statement in detail, or account of the proceeds, duly certified by the Council and commanding officer, accompanied by the Paymaster's receipt for the proceeds, will be forwarded by the commanding officer to the Adjutant General. The statement will be endorsed, "Report of the proceeds of the effects of _____, late of company (—) _____ regiment of _____, who died at _____, the _____ day of _____, 186—."

NOTE 1.—The effects in all cases, when called for, should be turned over to the legal representative, without further authority from the Adjutant General. When the effects are turned over to the relatives of the deceased before these inventories are sent to the Adjutant General, their receipts therefor should be attached to the inventories. In all other cases, one copy will be sent with a letter of transmittal direct to the Adjutant General, and a duplicate retained by the officer.

NOTE 2.—Particular care should be taken to take receipts in duplicate from the Paymaster for any funds turned over to him; one copy should be sent direct to the Adjutant General and one retained by the officer.

INVENTORY OF THE EFFECTS

OF

Private Henry Dietrich

Late of Company *C*

1st Reg't of *U.S. Co Troops*

~~Volunteers~~, who died at *Indianola Texas*

on the *1st* day of *July* 186*5*.



Inventory of the effects of Henry Dietcher late
 a private of Captain George P. Sherman's Company 4th of
 the 7th Regiment of W. S. West Troops Volunteers, who was enrolled as
 a private at Ellicotts Mill in the State of Maryland on
 the 21st day of September 1864, and mustered into the service of the United
 States as a private on the 21st day of September 1864, at Ellicotts Mill
 in Company W, 7th Regiment of W. S. West Troops Volunteers, to serve one
 year or during the war; he was born in Ellicotts Mill in the State
 of Maryland; he was 34 years of age, 5 feet 4 inches
 high, Black complexion, Black eyes, Curly hair, and by occupation, when enrolled,
 a Blacksmith; he died in Regimental Quarters, at
Indianola Texas on the 25th day of July 1863, by
 reason of Inflammation of the bowels

INVENTORY.					
ARTICLES.	No.	ARTICLES.	No.	ARTICLES.	No.
Hats.....		Pairs trousers.....		Knapsacks.....	
Caps.....		Pairs flannel drawers.....			
Forage Caps.....		Pairs cotton drawers.....			
Great coats.....		Flannel shirts.....			
Uniform coats.....		Cotton shirts.....			
Uniform jackets.....		Pairs boots.....			
Flannel sack coats.....		Pairs shoes.....			
Blouses.....		Pairs socks.....			
Sable frocks.....		Blankets.....			
Fatigue overalls.....		Haversacks.....			
			MONEY.	Specie.....	\$ <u>None</u>
				Notes.....	\$ <u>None</u>

I CERTIFY, ON HONOR, that the above inventory comprises all the effects of Private
Henry Dietcher, deceased, and that the effects were unseizable
 of any were used for the interment at of the referred
Henry Dietcher to be disposed of by a Council of Administration.

(DUPLICATES.)

STATION: Indianola Texas

DATE: July 25th 1863

Sylvester Coker
2nd Lieutenant
 Commanding the Company.

ARTICLES OF WAR.

ART. 95. When any non-commissioned officer or soldier shall die, or be killed in the service of the United States, the then commanding officer of the troop or company shall, in the presence of two other commissioned officers, take an account of what effects he died possessed of, above his arms and accoutrements, and transmit the same to the office of the Department of War, which said effects are to be accounted for, and paid to the representatives of such deceased non-commissioned officer or soldier. And in case any of the officers, so authorized to take care of the effects of deceased officers and soldiers, should, before they have accounted to their representatives for the same, have occasion to leave the regiment or post, by preferment or otherwise, they shall, before they be permitted to quit the same, deposit in the hands of the commanding officer, or of the assistant military agent, all the effects of such deceased non-commissioned officers and soldiers, in order that the same may be secured for, and paid to, their respective representatives.

ARMY REGULATIONS—EDITION OF 1863.

DECEASED SOLDIERS.

Par. 152. Inventories of the effects of deceased non-commissioned officers and soldiers, required by the 95th Article of War, will be forwarded to the Adjutant General, by the commander of the company to which the deceased belonged, and a duplicate of the same to the colonel of the regiment. Final statements of pay, clothing, &c., in duplicate, will be sent to the Adjutant General with one copy of the inventory. When a soldier dies at a post or station absent from his company, it will be the duty of his immediate commander to furnish the required inventory and final statements, and, at the same time, to forward to the commanding officer of the company to which the soldier belonged, a report of his death, specifying the date, place, and cause; to what time he was last paid, and the money or other effects in his possession at the time of his decease; which report will be noted on the next muster roll of the company to which the man belonged. Each inventory will be endorsed, "Inventory of the effects of _____, late of company (—) _____ regiment of _____, who died at _____, the _____ day of _____, 186—." If a legal representative receive the effects, it will be stated in the report. If the soldier leave no effects, the fact will be reported.

Par. 153. Should the effects of a deceased non-commissioned officer or soldier not be administered upon within a short period after his decease, they shall be disposed of by a Council of Administration, under the authority of the commanding officer of the post, and the proceeds deposited with the Paymaster, to the credit of the United States, until they shall be claimed by the legal representatives of the deceased.

Par. 154. In all such cases of sales by the Council of Administration, a statement in detail, or account of the proceeds, duly certified by the Council and commanding officer, accompanied by the Paymaster's receipt for the proceeds, will be forwarded by the commanding officer to the Adjutant General. The statement will be endorsed, "Report of the proceeds of the effects of _____, late of company (—) _____ regiment of _____, who died at _____, the _____ day of _____, 186—."

NOTE 1.—The effects in all cases, when called for, should be turned over to the legal representative, without further authority from the Adjutant General. When the effects are turned over to the relatives of the deceased before these inventories are sent to the Adjutant General, their receipts therefor should be attached to the inventories. In all other cases, one copy will be sent with a letter of transmittal direct to the Adjutant General, and a duplicate retained by the officer.

NOTE 2.—Particular care should be taken to take receipts in duplicate from the Paymaster for any funds turned over to him; one copy should be sent direct to the Adjutant General and one retained by the officer.

INVENTORY OF THE EFFECTS

OF

Private Henry Fletcher

Late of Company "C"

1st Reg't of *11th U.S. Troop*

Volunteers, who died at *Indianola, Texas*

on the *23rd* day of *July* 1865.



Inventory of the effects of Henry Dietcher late
 a private of Captain George B. Sherman's Company "C" of
 the 7th Regiment of U.S. Col. Troops Volunteers, who was drafted as
 a private at Ellicott's Mills in the State of Maryland on
 the 21st day of September 1864, and mustered into the service of the United
 States as a private on the 21st day of September 1864, at Ellicott's Mills
 in Company "C", 7th Regiment of U.S. Col. Troops Volunteers, to serve one
 year or during the war; he was born in Ellicott's Mills in the State
 of Maryland; he was 39 years of age, 5 feet 4 inches
 high, Black complexion, Black eyes, Curly hair, and by occupation, when enrolled,
 a Wagon Driver; he died in Regimental Quartermaster, at
Indianapolis, Texas on the 25th day of September 1865, by
 reason of Inflammation of the bowels

INVENTORY.					
ARTICLES.	No.	ARTICLES.	No.	ARTICLES.	No.
Hats.....		Pairs trousers.....		Knapsacks.....	
Caps.....		Pairs flannel drawers.....			
Forage Caps.....		Pairs cotton drawers.....			
Great coats.....		Flannel shirts.....			
Uniform coats.....		Cotton shirts.....			
Uniform jackets.....		Pairs boots.....			
Flannel sack coats.....		Pairs shoes.....			
Blouses.....		Pairs socks.....			
Sable frocks.....		Blankets.....		MONEY.	
Fatigue overalls.....		Haversacks.....		Specie.....	\$ none
				Notes.....	\$ none

I CERTIFY, ON HONOR, that the above inventory comprises all the effects of Private
Henry Dietcher deceased, and that the effects were uncerainly are in the hands
 of and used for the interment at of the aforesaid
Henry Dietcher to be disposed of by a Council of Administration.

(DUPLICATES.)

STATION: Indianapolis Texas

DATE: July 25th 1865

Sylvester C. Lee
2nd Lieutenant
 Commanding the Company.

368

Daughton, Shadrack

Co - , 7 U.S. Col'd Inf.

CARD NUMBERS.

1	6279145	26
2		27
3		28
4		29
5		30
6		31
7		32
8		33
9		34
10		35
11		36
12		37
13		38
14		39
15		40
16		41
17		42
18		43
19		44
20		45
21		46
22		47
23		48
24		49
25		50

Book Mark:

See also

A. 2635757 POWERS

A | 7 | **U.S.C.T.**

Shadrach Daughton

Appears with rank of _____ on
**Muster and Descriptive Roll of a Detach-
 ment of Drafted Men and Substitutes**
 forwarded

for the 7 Reg't U. S. Col'd Inf. Roll dated
Baltimore Md, Apr 5, 1865.

Where born Batts Md.

Age 39 years; occupation Laborer

Drafted and mustered in:

When Mar 27 , 186 5

Where E. Mills, Md.

Period 1 years.

Eyes Blk ; hair Blk

Complexion Blk ; height 5' 11 1/2"

Paid bounty and advance pay, \$ 100

Bounty due \$ 100

Where credited _____

Company to which assigned _____

Remarks Drafted from 5th Sub. R.
 5th Dist. Md. (over)

Book mark: _____

(340) J. M. Fairly Copyist

JAN. 20

6279145

1891*

*Name not taken up on
rolls of regt*

369

Davis Calvin

Co E, 7 U.S. Col'd Inf.

Private Private

CARD NUMBERS.

1	6288118	26
2	6388216	27
3	6288317	28
4	6288417	29
5	6388513	30
6	6388667	31
7	6279313	32
8	6289092	33
9	9060425	34
10		35
11		36
12		37
13		38
14		39
15		40
16		41
17		42
18		43
19		44
20		45
21		46
22		47
23		48
24		49
25		50

Book Mark:

See also

QSP 498071

9

7

U.S.C.T.

William Davis
Co. *E*, 7 Reg't U.S. Col'd Inf.

Appears on

Company Descriptive Book

of the organization named above.

DESCRIPTION.

Age *19* years; height *5* feet *6 1/2* inches.

Complexion *Brown*

Eyes *Black*; hair *Brown*

Where born *Pa.*

Occupation *Laborer*

ENLISTMENT.

When *Dec 12*, 1864.

Where *Washington D.C.*

By whom *Sp Jno. Knox*; term *1* y'rs.

Remarks: *Substitute 1. Sub*
list D.C. for Honor
1 year. Discharged
by reason of expiration
of term of service Dec
12 1865.

W. Brown

10 | 7 | U.S.C.T.

Calvin Davis

Qute, Co. E, 7 Reg't U. S. Col'd Infantry.

Appears on

Company Muster Roll

for Jan & Feb., 1865.

Joined for duty and enrolled:

When Dec 12", 1864.*

Where Washington D.C.*

Period 1 years.*

Present or absent Absent

Stoppage, \$ 100 for

Due Gov't \$ 100 for

Remarks: Joined for duty Jan 10" 1865.

(Enrolled & Mustered in Dec. 12/64, at Wash ington D.C. for 1 yr.)

* See enrollment on card from muster-in roll.

Book mark:

C. Thompson

L | **7** | **U.S.C.T.**

Calvin Davis
C, Co. E, 7 Reg't U. S. Col'd Infantry.

Appears on

Company Muster Roll
for *March & April*, 186*5*.

Joined for duty and enrolled:

When *Dec 12*, 186*4*.*

Where *Washington D C.* *

Period *1* year*s*.*

Present or absent *Present*

Stoppage, \$ *100* for

Due Gov't \$ *100* for

Remarks: *Joined for duty Jan 7th 1865.*

* See enrollment on card from muster-in roll.

Book mark: -----

E. Tomlinson
(358c) Copyist.

10 | 7 | U.S.C.T.

William Davis
Sergeant, Co. E, 7 Reg't U. S. Col'd Infantry.

Appears on

Company Muster Roll

for May 1865, 1865.

Joined for duty and enrolled:

When Dec 12, 1864.*

Where Washington, D.C. *

Period 1 years.*

Present or absent Present

Stoppage, \$ 100 for

Due Gov't \$ 100 for

Remarks: Joined for duty Jan 7 1865.

* See enrollment on card from muster-in roll.

Book mark:

W. J. Thompson

D. | 7 | U.S.C.T.

Calvin Davis,

Det, Co. E, 7 Reg't U. S. Col'd Infantry.

Appears on

Company Muster Roll

for July & Aug., 1865.

Joined for duty and enrolled:

When Dec 12, 1864.

Where Washington D.C.

Period 1 years.*

Present or absent Present.

Stoppage, \$ 100 for

Due Gov't \$ 100 for

Remarks:

* See enrollment on card from muster-in roll.

Book mark:

A. Thompson

21 | 7 | U.S.C.T.

Calvin Davis
of Co. E, 7 Reg't U. S. Col'd Infantry.

Appears on

Company Muster Roll

for Sept 1st, 1864.

Joined for duty and enrolled:

When Dec 12, 1864.

Where Washington, D.C.

Period 1 year.*

Present or absent Present

Stoppage, \$ 100 for

Due Gov't \$ 100 for

Remarks Capt for A. Overlock
H. ...

* See enrollment on card from muster-in roll.

Book mark:

[Handwritten signature]

(358c)

Copyist.

A | 7 | U.S.C.T.

Calvin Davis

Prk, Co. E, 7 Reg't U. S. Col'd Infantry.

Appears on

Company Muster Roll

for Nov. & Dec, 1865

Joined for duty and enrolled:

When Dec 12, 1865

Where Washington, DC

Period 1 years*

Present or absent

Stoppage, \$ 100 for

Due Gov't \$ 100 for

Remarks: Discharged Dec. 12, 1865 by reason of expiration of term of service.

* See enrollment on card from muster-in roll.

Book mark:

(358c) [Signature] Copyist.

217

U.S.C.T.

Calvin Davis
Priv., Co. E, 7 Reg't U. S. Col'd *Inf.*

Appears on an

Individual Muster-out Roll

of the organization named above. Roll dated
Indianola, Tex, Dec. 30, 1865.

Muster-out to date *Dec. 12, 1865.*

Last paid to *June 30, 1865.*

Clothing account:

Last settled....., 186 ; drawn since \$ $\frac{100}{100}$

Due soldier \$ $\frac{100}{100}$; due U. S. \$ $42 \frac{57}{100}$

Am't for cloth'g in kind or money adv'd \$ $\frac{100}{100}$

Due U. S. for arms, equipments, &c., \$ $9 \frac{75}{100}$

Bounty paid \$ ~~none~~ $\frac{100}{100}$; due \$ ~~none~~ $\frac{100}{100}$

Remarks: *Joined the Company
for duty Jan. 2nd 1865.
Substitute for Henry
Burch 1st Sub, Dist. D.C.
Spok for one knapsack
and one canteen \$3.75 (over)*

Book mark: _____

C. Bluen,

NR 347

JAN. 20

6279353

1891

Retain one Springfield rifle musket
and Equipments per
Gen. Order No. 101 War
Dept. Adjt. Gen. Office
Current - serves \$6.00
no further military
history,

Entitled to travel time
and subsistence to
place of enlistment.

Private Davis was
retained in service
until this date by
reason of the absence
of the the mustering
officer rendered neces-
sary by Special order
No. 67 Par. 5 dated Hq,
Gr. Dept. of Texas
Oct. 23, 1865. He has
performed the duties
of a soldier to date of
discharge. Muster
out - to take effect -
Dec. 12, 1865.

S | **7** | **U.S.C.T.**

Calvin Davis

Pvt, Co. *E*, 7 Reg't U. S. Col'd Infantry.

Appears on **Co. Muster-out Roll**, dated *Indiavola, Texas Oct. 13, 1864*.

Muster-out to date _____, 186 .

Last paid to *June 30, 1865*.

Clothing account:

Last settled _____, 186 ; drawn since \$ 100

Due soldier \$ 100; due U. S. \$ 100

Am't for cloth'g in kind or money adv'd \$ 100

Due U. S. for arms, equipments, &c., \$ 100

Bounty paid \$ 100; due \$ 100

Remarks: *Discharged the service
Dec. 12, 1865 by reason of
expiration
(Age 19.)*

Book mark: *McC. Ron Hill*

(361) *Geo J. Bull Jr* Copyist.

Davis Calvin

....., Co., Reg't *U.S. I.*

Enclosures.

Bed Cards	Final Statements
Burial Records	Furloughs or L. of A.
Certs. of Dis. for Discharge	Med. Certificates
C. M. Charges	Med. Des. Lists
Descriptive Lists	Orders
Discharge Certificates	Pris. of War Record
Enlistment Papers	Resignations

Other papers relating to—

Admission to Hosp'l	Furlough or L. of A.
Casualty Sheet	Med. Examination
Confinement	Misc. Information
Contracts	Pay or Clothing
Death or Effects	Personal Reports
Desertion	Rank
Discharge from Hosp'l	Transfer to Hosp'l
Discharge from Service	Transfer to V. R. C.
Duty	Transportation

DECLARATION OF SUBSTITUTE.

I, Calvin Davis, desiring to ENLIST
in the Army of the United States, for ~~THREE~~ ^{ONE} YEARS, **Do declare**, That I am
Nineteen years and 1 months of age; that I have
never been discharged from the United States service on account of disability or by sentence of
a court martial; and I know of no impediment to my serving honestly and faithfully as a soldier
for ~~three~~ ^{one} year.

GIVEN at Washington D.C.
the 12 day of December

WITNESS:
J. J. Elton
Calvin's mark

9

No. 104
Calvin Davis
Enlisted at Washington
As Substitute for
Henry Burch
On the 12 day of Dec., 1862,
By
J. C. Putnam
John Knott
A. D. Baldwin
Board of Enrollment,
Dist. of Col.



(No. 39.)

SUBSTITUTE

District VOLUNTEER ENLISTMENT Sub dis. STATE OF TOWN OF



Columbia Washington D.C.

I, Calvin Davis, born in the State of Virginia, aged nineteen years, and by occupation a laborer, Do HEREBY ACKNOWLEDGE to have agreed with Henry Burch, Esq., of 1 Sub dis. of D.C.,

to become his SUBSTITUTE in the Military Service, for a sufficient consideration paid and delivered to me, on the Twelfth day of December, 1864; and having thus agreed with said Henry Burch, I DO HEREBY ACKNOWLEDGE to have enlisted this Twelfth day of December, 1864, to serve as a Soldier in the Army of the United States of America, for the period of THREE YEARS, unless sooner discharged by proper authority. I do also agree to accept such bounty, pay, rations, and clothing as are, or may be, established by law for soldiers. And I do solemnly swear that I will bear true and faithful allegiance to the United States of America; that I will serve them honestly and faithfully against all their enemies or opposers whomsoever; and that I will observe and obey the orders of the President of the United States and the orders of the officers appointed over me, according to the Rules and Articles of War.

SWORN and subscribed to, at Washington D.C., this 12th of December, 1864, BEFORE Calvin Davis, Capt. 1 Regt. U.S. and Prov. Mar. D.C., Mark

We certify, on honor, That we have carefully examined the above-named Volunteer Substitute agreeably to the Regulations, and that, in our opinion, he is free from all bodily defects and mental infirmity which would in any way disqualify him from performing the duties of a soldier; that he was entirely sober when enlisted; that he is of lawful age, (not under 18 years;) and that, in accepting him as duly qualified to perform the duties of an able-bodied soldier, and as a Substitute in lieu of Henry Burch, drafted in 1 Sub dis. of D.C., Dec. 5, 1864, we have strictly observed the Regulations which govern in such cases. This soldier has brn eyes, blk hair, brn complexion; is 5 feet 6 1/2 inches high.

[Signature] Capt. 1 Regt. U.S. and Provost Marshal.

[Signature] Lieut. 7 Regt. U.S. and Actg. Commissioner of Board.

[Signature] Surgeon of Board.

Board of Enrollment of the Dist. of Columbia

370

Davis George

Co A, 7 U.S. Col'd Inf.

Private

CARD NUMBERS.

1	6278922	26
2	6278814	27
3	6296657	28
4	6296747	29
5	6296836	30
6	6296939	31
7	6297044	32
8	6297146	33
9	6297312	34
10	6279485	35
11	6297694	36
12	9067032	37
13		38
14		39
15		40
16		41
17		42
18		43
19		44
20		45
21		46
22		47
23		48
24		49
25		50

Book Mark: N. 95, Vol. 9. C. S. '72.
E. B. 12/366.

See also

7th. Rpt. 8 May 46 Jam

S 1921383, Pomer

9.

7

U.S.C.T.

George Davis

, Co. *A*, 7 Reg't U. S. Col'd Inf.

Appears on

Company Descriptive Book

of the organization named above.

DESCRIPTION.

Age *18* years; height *5* feet *1 1/2* inches.

Complexion *Black*

Eyes *Black*; hair *Black*

Where born *Baltimore City, Maryland*

Occupation *Laborer*

ENLISTMENT.

When *Oct. 5.*, 1864.

Where *Baltimore, Md.*

By whom *P. B. Bowman*; term *1* y'rs.

Remarks: *Mustered into serv. at Baltimore, Md. by Lt. C. R. Lykes Oct. 5. 64. - Free. \$100.00 Gov. Bounty due enlisted.*

Mustered out Nov. 15. 65 by reason of expiration of term of service!

J. O. White

D 7

U.S.C.T.

George Davis

Appears with rank of on

Muster and Descriptive Roll of a Detachment of U. S. Vols. forwarded

for the *7* Reg't U. S. Col'd Infantry. Roll dated *Baltimore Md, Oct 10*, 1864.

Where born *Balta City Md*

Age *18* y'rs; occupation *Oyster shucker*

When enlisted *Oct 3*, 1864.

Where enlisted *Baltimore Md*

For what period enlisted *1* years.

Eyes *Blk*; hair *Blk*

Complexion *Blk*; height *5 ft 1/2 in.*

When mustered in *Oct 6*, 1864.

Where mustered in *Baltimore*

Bounty paid \$ 100; due \$ 100

Where credited

Company to which assigned

Remarks: *None*

Book mark:

G. M. Deabrick

(340)

Copyist.

10 | 7 | **U.S.C.T.**

George Davis

_____, Co _____, 7 Reg't U. S. Col'd Infantry.

Age 18 years.

Appears on a

Detachment Muster-in Roll

of the organization named above. Roll dated

Baltimore, Md., Oct. 10, 1864.

Muster-in to date Oct. 10, 1864.

Joined for duty and enrolled:

When Oct. 5, 1864.

Where Baltimore

Period 2 years.

Remarks: Enlisted

Book mark: Copy Id. Ag. Md

See M. 95, Vol. 9, C. T., '72

Beck
Copyist.

20

7

U.S.C.T.

George Davis

Pvt, Co. K, 7 Reg't U. S. Col'd Infantry.

Appears on

Company Muster Roll

for *Nov & Dec*, 1864.

Present or absent *Present*

Stoppage, \$ *100* for

Due Gov't, \$ *100* for

Remarks: *Free. Joined Company Oct 31st
1864 in the field before Richmond
Stop for one week 20 cts*

Book mark:

Ray
Copyist.

(358)

10

7

U.S.C.T.

George Davis

Priv, Co. K, 7 Reg't U. S. Col'd Infantry.

Appears on

Company Muster Roll

for *Jan & Feb*, 1865.

Present or absent *Present*

Stoppage, \$ *100* for

Due Gov't, \$ *100* for

Remarks:

Book mark:

Leary
Copyist.

LB

7

U.S.C.T.

George Davids
Priv, Co. K, 7 Reg't U. S. Col'd Infantry.

Appears on

Company Muster Roll

for *March & April*, 1865

Present or absent *Present*

Stoppage, \$ *100* for

Due Gov't, \$ *100* for

Remarks:

Book mark:

Seay
Copyist.

20

7

U.S.C.T.

George Davis

Pvt, Co. K, 7 Reg't U. S. Col'd Infantry.

Appears on

Company Muster Roll

for *May and June*, 1865.

Present or absent *Present*

Stoppage, \$ *100* for

Due Gov't, \$ *100* for

Remarks: *Stop 1 Bayonet, 1 Harrocks,*
1 Screw driver and one wrench,
1 pipe.

Book mark:

(358)

Searcy
Copyist.

10 | 7 | U.S.C.T.

George Davis
Pvt, Co. K, 7 Reg't U. S. Col'd Infantry.

Appears on

Company Muster Roll

for *July and Aug*, 1865.

Present or absent *Present*

Stoppage, \$ $\frac{56}{100}$ for *Ordinance*

Due Gov't, \$ $\frac{100}{100}$ for

Remarks:

Book mark:

(358)

Leary
Copyist.

20

7

U.S.C.T.

George Davis

Pvt, Co. K, 7 Reg't U. S. Col'd Infantry.

Appears on

Company Muster Roll

for *Sept & Oct*, 1865

Present or absent *Present*

Stoppage, \$ *56* for *Ordinance*
100

Due Gov't, \$ *100* for

Remarks:

Book mark:

Leary
Copyist.

20

7

U.S.C.T.

George Davis

Priv, Co. K, 7 Reg't U. S. Col'd Infantry.

Appears on

Company Muster Roll

for *Nov & Dec*, 1865

Present or absent

Stoppage, \$ 100 for

Due Gov't, \$ 100 for

Remarks: *Mustered out Nov. 16. 65.*

*by reason of expiration of term
of service at Indianola, Tex.*

Book mark:

Leary

Copyist.

D | 7 | U.S.C.T.

George Davis
Priv., Co. *K*, 7 Reg't U. S. Col'd Infantry.

Appears on **Co. Muster-out Roll**, dated
Indianola Texas, Oct. 13, 1866.

Muster-out to date _____, 186 .

Last paid to *June 30*, 1865 .

Clothing account:

Last settled _____, 186 ; drawn since \$ _____ 100

Due soldier \$ _____ 100; due U. S. \$ _____ 100

Am't for cloth'g in kind or money adv'd \$ _____ 100

Due U. S. for arms, equipments, &c., \$ _____ 100

Bounty paid \$ _____ 100; due \$ _____ 100

Remarks: *Discharged by reason of expiration of term of service, Nov. 15* 1865.

Book mark: *Discharged Nov. 16/65*
C. B. 766

Randall
Copyist.

10 | 7 U.S.C.T.

George Davis,
Co. K, 7 Reg't U. S. Col'd Infantry.

Appears on a

Detachment Muster-out Roll

of the organization named above. Roll dated
Indianola Texas, Nov. 16, 1865.

Muster-out to date *Nov. 16, 1865.*

Last paid to *June 30, 1865*

Clothing account:

Last settled _____, 186 ; drawn since \$ _____ 100

Due soldier \$ _____ 100; due U. S. \$ *43* ⁶⁴/₁₀₀

Am't for cloth'g in kind or money adv'd \$ _____ 100

Due U. S. for arms, equipments, &c., \$ _____ ⁵⁶/₁₀₀

Bounty paid ~~None~~ 100 due \$ *100* - ⁰⁰/₁₀₀

Remarks *Free mustered in
as a Recruit and
joined the Co. near
Chapins Farm Va.
Oct 30, 1864. He returns
one knapsack, one
(over)*

Book mark : _____

(349)

Jenkins
Copyist.

JAN. 20

6279485

018910

haversack, one
canteen per G. O. 114
War Dept. Stop for one
screw driver, one
wiper & one spring
Nose (56 etc) lost in
the month of August
1865. No further Military
History. Mustered out
by reason of expiration
of term of service.

Retained in service ^{and}
awaiting muster out to
present date by reason
of absence of Mustering
Officer. Has performed
the duty of a soldier
to date of discharge.

Entitled to travel
time subsistence &
and transportation
to place of enlistment.

371

Davis Jake

Co - , 7 U.S. Col'd Inf.

CARD NUMBERS.

1	6279139	26
2		27
3		28
4		29
5		30
6		31
7		32
8		33
9		34
10		35
11		36
12		37
13		38
14		39
15		40
16		41
17		42
18		43
19		44
20		45
21		46
22		47
23		48
24		49
25		50

Book Mark:

See also

17 U.S.C.T.

Jake Davis

Appears with rank of _____ on
**Muster and Descriptive Roll of a Detach-
ment of Drafted Men and Substitutes**
forwarded

for the 7 Reg't U. S. Col'd Inf. Roll dated
Baltimore Md, Apr. 2, 1863.

Where born London Co. Va

Age 26 years; occupation Laborer

Drafted and mustered in:

When March 27, 1863.

Where E. Mills

Period 1 years.

Eyes Blk; hair Blk

Complexion Griff.; height 5' ft 5 in.

Paid bounty and advance pay, \$ 100

Bounty due \$ 100

Where credited _____

Company to which assigned _____

Remarks: Sub for Atwood Plant.
2 Sub. N. 5' Dist. Md. (over)

Book mark: _____

(310) J. M. Fairly Copyist

JAN. 20

6279159

418914

*Not taken up on rolls of
reel*

372 Mr. John H.

Davis John Henry

Co E, 7 U.S. Col'd Inf.

Private Corporal

CARD NUMBERS.

1	6287243	26
2	6287344	27
3	6287446	28
4	6287544	29
5	6287643	30
6	6287740	31
7	6287836	32
8	6287927	33
9	6288027	34
10	6288119	35
11	6288217	36
12	6288300	37
13	6288399	38
14	6288496	39
15	6288592	40
16	6288684	41
17	6288770	42
18	6288851	43
19	6288934	44
20	6289014	45
21	9066421	46
22		47
23		48
24		49
25		50

Book Mark:

See also

D. 1494078 Po. m. m.
S. 2047831 Po. m. m.
E 2532764. all
O. 2535385 and W. D. (9)

29 | 7 | U.S.C.T.

John Henry Davis
 Co. *E*, 7 Reg't U.S. Col'd Inf.

Appears on
Company Descriptive Book
 of the organization named above.

DESCRIPTION.

Age *30* years; height *5* feet *7* inches.

Complexion *Black*

Eyes *Black*; hair *Curly*

Where born *Cecil, Md.*

Occupation *Farmer*

ENLISTMENT.

When *Sept 27*, 186*3*.

Where *Baltimore*

By whom *Col W. W. Horney*; term *3* y'rs.

Remarks: *In the management*
on Johns Island, S.C. July
9. 64. Also at Deep Bottom
Va. Aug 14 " 1864. Appointed
Cont'd S. C. no. 43 16. Dec. 4'
U.S.C.T. May 19. 1865.

A. Brown

D | 7 | U.S.C.T.

John Henry Davis
Pvt., Co. E, 7 Reg't U. S. Colored Inf.

Age 30 years.

Appears on

Company Muster-in Roll

of the organization named above. Roll dated
Baltimore Md., Sept 30, 1863.

Muster-in to date Sept. 30, 1863.

Joined for duty and enrolled:

When Sept. 27, 1863.*

Where Cecil Co. Md.*

Period 3 years.*

Remarks:

*Muster in roll shows enrollment of all men of this company as of this date. See enrollment on subsequent card or cards.

Book mark:

A. A. Rankin

(356)

Col. Capt.

D

7

U.S.C.T.

John H. Davis
Priv., Co. E, 7 Reg't U. S. Col'd Infantry.

Appears on

Company Muster Roll

for Sept. 30/63 to Oct. 31, 1863.

Joined for duty and enrolled:

When Sept 27, 1863.

Where Cecil Md.

Period 3 years.*

Present or absent Absent.

Stoppage, \$ 100 for

Due Gov't \$ 100 for

Remarks: On detached
service at Baltimore
Md.

* See enrollment on card from muster-in roll.

Book mark:

E. E. Rankin

(358c)

Copyist.

101

7

U.S.C.T.

John H. Davis
Pvt., Co. E, 7 Reg't U. S. Col'd Infantry.

Appears on

Company Muster Roll

for Nov. + Dec., 1863.

Joined for duty and enrolled:

When Sept. 27, 1863.*

Where Cecil.*

Period 3 years.*

Present or absent Absent.

Stoppage, \$ 100 for

Due Gov't \$ 100 for

Remarks: Detached service
at Baltimore, Md.
by order Col. Bir-
ney Oct. 27, 1863.

* See enrollment on card from muster-in roll.

Book mark:

E. E. Rankin

(358c)

Copyist.

D | **7** | **U.S.C.T.**

John H. Davis
Prst, Co. E, 7 Reg't U. S. Col'd Infantry.

Appears on

Company Muster Roll
for *Jan & Feb.*, 186*4*

Joined for duty and enrolled:

When *Sept. 27*, 186*3*.*

Where *Cecil*.*

Period *3* years.*

Present or absent *Present.*

Stoppage, \$ *100* for

Due Gov't \$ *100* for

Remarks: *Returned from
recruiting service
Jan. 3, 1864.*

* ~~See~~ See enrollment on card from muster-in roll.

Book mark: _____

E. E. Rankin
(358c) Copyist.

D

7

U.S.C.T.

John H. Davis
Pvt., Co. E, 7 Reg't U. S. Col'd Infantry.

Appears on

Company Muster Roll
for Mar. & Apr., 1864

Joined for duty and enrolled:

When Sept. 27, 1863.*

Where Cecil *

Period 3 years.*

Present or absent Present.

Stoppage, \$ 100 for

Due Gov't \$ 100 for

Remarks:

* See enrollment on card from muster-in roll.

Book mark:

(358c)

A. E. Rankin

Copyist.

D |

7

U.S.C.T.

John H. Davis
Priv., Co. E, 7 Reg't U. S. Col'd Infantry.

Appears on

Company Muster Roll

for *Dated June 30, 1864.*

Joined for duty and enrolled:

When *Sept. 27*, 186*3*.*

Where *Cecil Co. Md.**

Period years.*

Present or absent *Present.*

Stoppage, \$ 100 for

Due Gov't \$ 100 for

Remarks:
.....
.....
.....
.....

* See enrollment on card from muster-in roll.

Book mark:

J. L. Rankin

(358c)

Copyist.

D | 7 | U.S.C.T.

John H. Davis
Reg't U. S. Col'd Inf'ty
Co. E, 7

Appears on

Company Muster Roll
for Jul. & Aug. 1864

Joined for duty and enrolled:

When Sept. 27, 1863.*

Where Cecil.*

Period 3 years.*

Present or absent Present

Stoppage, \$ 100 for

Due Gov't, \$ 100 for

Valuation of horse, \$ 100

Valuation of horse equipments, \$ 100

Remarks: Stop for one
Haversack.

* See enrollment on card from muster-in roll.

Book-mark :

E. E. Rankin
Coryist.

21 7 U.S.C.T.

John Q. Davis
Capt, Co. E, 7 Reg't U. S. Col'd Infantry

Appears on

Company Muster Roll

for Sept & Oct., 1864

Joined for duty and enrolled:

When Sept-27, 1863*

Where Cal *

Period 2 years.*

Present or absent Present

Stoppage, \$ 100 for

Due Gov't \$ 100 for

Remarks:

* See enrollment on card from muster-in roll.

Book mark:

E. Thompson

(358c)

Copyist.

D. | **7** | **U.S.C.T.**

John N. Davis
Porter, Co. E, 7 Reg't U. S. Col'd Infantry.

Appears on

Company Muster Roll

for *Nov & Dec*, 1864.

Joined for duty and enrolled:

When *Sept 27*, 1863.*

Where *Cecil*.*

Period *3* years.*

Present or absent *Present*

Stoppage, \$ *100* for

Due Gov't \$ *100* for

Remarks:

* See enrollment on card from muster-in roll.

Book mark: _____

C. Thompson
(358c) Copyist.

D. | 7 | U.S.C.T.

John H. David,
Private, Co. E, 7 Reg't U. S. Col'd Infantry.

Appears on

Company Muster Roll

for Jan & Feb., 1865.

Joined for duty and enrolled:

When Sept-27th, 1863.*

Where Cecil Md

Period 2 years.*

Present or absent Absent

Stoppage, \$ 100 for

Due Gov't \$ 100 for

Remarks: Detached, S.O. No 46
Ad 2nd 2nd Div, 25th Corp
Feb 23rd 1865 - Stop for
a knapsack complete

* See enrollment on card from muster-in roll.

Book mark:

E. Thompson

A. 1 **7** **U.S.C.T.**

John H. Davis
Co. E, 7 Reg't U. S. Col'd Infantry.

Appears on

Company Muster Roll

for *Mich Apl.*, 186*5*.

Joined for duty and enrolled:

When *Sept 27*, 186*3*.

Where *Cecil Co Md.*

Period *3* years.*

Present or absent *Absent*

Stoppage, \$ *100* for

Due Gov't \$ *100* for

Remarks: *Detached S.O. No*
46, Hd Qrs, 2nd Div,
25th Corps Feb 16th 1865.
Stop for 1. Discharge Complete.

* See enrollment on card from muster-in roll.

Book mark:

J. Thompson

J.

7

U.S.C.T.

John O. V. Parol

Capt, Co. E, 7 Reg't U. S. Col'd Infantry.

Appears on

Company Muster Roll

for *May & June*, 186*5*.

Joined for duty and enrolled:

When *Sept 27*, 186*3*.

Where *Recit*

Period *6⁰* years.*

Present or absent *Present*

Stoppage, \$ *100* for

Due Gov't \$ *100* for

Remarks: *Appointed S.O. No. 40
& Vet. Vet. U.S.C.T. May
17th 1865. Date for
discharge complete*

* See enrollment on card from muster-in roll.

Book mark:

E. Thompson

D. | **7** | **U.S.C.T.**

John H. Davis
Davis, Co. E, 7 Reg't U. S. Col'd Infantry.

Appears on

Company Muster Roll

for *July & Aug.*, 186*5*.

Joined for duty and enrolled:

When *Sept 2nd*, 186*5*.*

Where *Beal Md.* *

Period *2¹* years.*

Present or absent *Present*

Stoppage, \$ *100* for

Due Gov't \$ *100* for

Remarks:

* See enrollment on card from muster-in roll.

Book mark: -----

J. H. Davis
J. H. Davis

(358c)

Copyist.

201 | **7** | **U.S.C.T.**

John F. Davis
Capt, Co. E, 7 Reg't U. S. Col'd Infantry.

Appears on

Company Muster Roll

for *Capt & Det*, 186*3*.

Joined for duty and enrolled:

When *Sept 27*, 186*3*.*

Where *Co. E, 7th Regt*.*

Period *3* years.*

Present or absent *Present*

Stoppage, \$ *100* for

Due Gov't \$ *100* for

Remarks: *Stop for Harrodack*
Wanted.

* See enrollment on card from muster-in roll.

Book mark:

J. F. Davis

2 | 7 | **U.S.C.T.**

John N. Davis
Corpl, Co. E, 7 Reg't U. S. Col'd Infantry.

Appears on

Company Muster Roll

for Nov. & Dec, 1865.

Joined for duty and enrolled:

When Sept 27, 1865.*

Where Cecil Co, Md.*

Period 3 years.*

Present or absent Present

Stoppage, \$ 1⁶⁰/₁₀₀ for bol. Equipage

Due Gov't \$ 100 for

Remarks:

* See enrollment on card from muster-in roll.

Book mark: _____

(358c) John H. Bell Copyist.

A | 7 | U.S.C.T.

John H. Davis
Corpl, Co. E, 7 Reg't U. S. Col'd Infantry.

Appears on

Company Muster Roll
for Jan, & Feb, 1866

Joined for duty and enrolled:

When Sept 27, 1863.*

Where Cecil Co., Md.*

Period 3 years.*

Present or absent Present

Stoppage, \$ 100 for

Due Gov't \$ 100 for

Remarks:

* See enrollment on card from muster-in roll.

Book mark:

(358c) Joseph Bell Copyist.

D

7

U.S.C.T.

John H. Davis,
Corpl, Co. E, 7 Reg't U. S. Col'd Infantry.

Appears on

Company Muster Roll

for March & April, 1866

Joined for duty and enrolled:

When Sept. 27, 1863.*

Where Cecil Co., Md.*

Period 3 years.*

Present or absent Present

Stoppage, \$ 100 for

Due Gov't \$ 100 for

Remarks:

* See enrollment on card from muster-in roll.

Book mark: _____

(358c)

Geo H. Brels

Copyist.

21

7

U.S.C.T.

John H. Davis
Capt., Co. E, 7 Reg't U. S. Col'd Infantry.

Appears on

Company Muster Roll

for May + June, 1866.

Joined for duty and enrolled:

When Sept 27, 1863.

Where Cecil Co., Md.

Period 3 years.*

Present or absent Present

Stoppage, \$ 100 for

Due Gov't \$ 100 for

Remarks:

* See enrollment on card from muster-in roll.

Book mark:

(358c) *John H. Davis* Copyist.

A | **7** | **U.S.C.T.**

John H. Davis
Corpl, Co. E, 7 Reg't U. S. Col'd Infantry.

Appears on

Company Muster Roll

for *July & Aug*, 186*6*.

Joined for duty and enrolled:

When *Sept 27*, 186*3*.

Where *Cecil Co, Md**

Period *3* years.*

Present or absent *Present*

Stoppage, \$ *100* for

Due Gov't \$ *100* for

Remarks:

* See enrollment on card from muster-in roll.

Book mark:

Geo J. Bull Jr
(358c) Copyist.

2 | 7 | **U.S.C.T.**

John H. Davis
Capt. Co. E, 7 Reg't U. S. Col'd Infantry.

Appears on **Co. Muster-out Roll**, dated *Indianola, Texas, Oct. 13, 1866*.

Muster-out to date *Oct. 13, 1866*.

Last paid to *June 30, 1866*.

Clothing account:

Last settled _____, 186 ; drawn since \$ _____ 100

Due soldier \$ *11 ¹²/₁₀₀*; due U. S. \$ _____ 100

Am't for cloth'g in kind or money adv'd \$ _____ 100

Due U. S. for arms, equipments, &c., \$ _____ 100

Bounty paid \$ _____ 100; due \$ *100* 100

Remarks: *Joined for duty at original organization, Promoted Corporal S. O. No. 43, 100 Grs. 7th U. S. May 19, 1865.*

Book mark: *V 174, P. 84 - 73*

(361)

Geo. B. Hill
Copyist.

570
Davis William A.

Co B, 7 U.S. Col'd Inf.

Corporal | Corporal

CARD NUMBERS.

1	6281772	26
2	6281872	27
3	6281974	28
4	6282072	29
5	6282173	30
6	6282272	31
7	6282369	32
8	6282463	33
9	6282560	34
10	6282655	35
11	6282757	36
12	6282856	37
13	6282948	38
14	6283042	39
15	6283130	40
16	6283204	41
17	6283275	42
18	6283344	43
19	6283415	44
20	9066020	45
21		46
22		47
23		48
24		49
25		50

Book Mark:

See also

J. 2027106 P. 6 m m .

0

7

U.S.C.T.

William A. Davis

Co. B, 7 Reg't U.S. Col'd Inf.

Appears on

Company Descriptive Book

of the organization named above.

DESCRIPTION.

Age 29 years; height 5 feet 8 3/4 inches.

Complexion Black.

Eyes Black; hair wavy.

Where born Dorchester Md.

Occupation Farmer.

ENLISTMENT.

When Sept. 26, 1863.

Where Baltimore, Md.

By whom Col. H. Binney; term 3 y'rs.

Remarks: Promoted Corporal Dec. 30, 1863.

Mustered Sept. 26, 63, by Col. Mr. Binney.

J. Smith

9 | 7 | U.S.C.T.

William A. Davis
Capt., Co. B., 7 Reg't U. S. Colored Inf.

Age 29 years.

Appears on

Company Muster-in Roll

of the organization named above. Roll dated

Baltimore Md., Sept 26, 1863.

Muster-in to date Sept 26, 1863.

Joined for duty and enrolled:

When Sept 23, 1863.*

Where Dorchester Co. Md.*

Period 9 years.*

Remarks:

*Muster-in roll shows enrollment of all men of this company as of same date. See enrollment on subsequent card or cards.

Book mark:

J. S. Curry

9.

7

U.S.C.T.

William A. Davis

Cope, Co. B, 7 Reg't U. S. Col'd Infantry.

Appears on

Company Muster Roll

for Sept 26th to Oct 31st, 1863.

Joined for duty and enrolled:

When Sept 26th, 1863.*

Where Duchesta Co. Ind.*

Period 9 years.*

Present or absent Present

Stoppage, \$ 100 for

Due Gov't \$ 100 for

Remarks:

* See enrollment on card from muster-in roll.

Book mark:

(358c)

J. S. Casey

Copyist.

D

7

U.S.C.T.

William A. Davis

Capt, Co. B, 7 Reg't U. S. Col'd Infantry.

Appears on

Company Muster Roll

for *Nov & Dec*, 1863.

Joined for duty and enrolled:

When *Sept 23*, 1863 *

Where *Dorchester* *

Period *2* years.*

Present or absent *Present*

Stoppage, \$ *100* for

Due Gov't \$ *100* for

Remarks: *Enlistment premium
\$2.00 due.*

* See enrollment on card from muster-in roll.

Book mark:

(358c)

J. D. Casey

Copyist.

D

7

U.S.C.T.

William A. Davis

Capt, Co. B, 7 Reg't U. S. Col'd Infantry.

Appears on

Company Muster Roll

for Jan & Feb, 1864.

Joined for duty and enrolled:

When Sept 23, 1862.*

Where Dorchester *

Period 2 years.*

Present or absent Present.

Stoppage, \$ 100 for

Due Gov't \$ 100 for

Remarks: \$2.00 Enlistment premium due.

* See enrollment on card from muster-in roll.

Book mark:

(358c)

H. S. Casey

Copyist.

2

7

U.S.C.T.

William A. Davis

Corpl, Co. B, 7 Reg't U. S. Col'd Infantry.

Appears on

Company Muster Roll

for *Ench & apl*, 1864.

Joined for duty and enrolled:

When *Sept 22*, 1863.*

Where *Dorchester Ind.* *

Period *3* years.*

Present or absent *Present*

Stoppage, \$ *100* for

Due Gov't \$ *100* for

Remarks:

* See enrollment on card from muster-in roll.

Book mark: -----

(358c)

J. B. Casey Copyist.

D. | 7 | U.S.C.T.

William A. Davis
Corpl, Co. B, 7 Reg't U. S. Col'd Infantry.

Appears on

Company Muster Roll

for *May & June*, 1864.

Joined for duty and enrolled:

When *Sept 23rd*, 1863.*

Where *Dorchester, Ind* *

Period *2* years.*

Present or absent *Absent*

Stoppage, \$ *100* for

Due Gov't \$ *100* for

Remarks: *Sick at Jacksonville,*
Fla. since June 27, 1864.

* See enrollment on card from muster-in roll.

Book mark:

(358c) *J. Casey* Copyist.

D. 1 7 | U.S.C.T.

William A. Davis
Corp, Co. B., 7 Reg't U. S. Col'd Inft

Appears on

Company Muster Roll

for July & Aug, 1864.

Joined for duty and enrolled:

When Sept 23, 1863.*

Where Dorchester Md *

Period years.*

Present or absent Present

Stoppage, \$ 100 for

Due Gov't, \$ 100 for

Remarks:

* See enrollment on card from muster-in roll.

Book mark:

(358c) J. G. Casey Copyist.

D

7

U.S.C.T.

William A. Davis
Copt, Co. B, 7 Reg't U. S. Col'd Infantry.

Appears on

Company Muster Roll

for Sept & Oct, 1864.

Joined for duty and enrolled:

When Sept 23, 1863.*

Where Dorchester, Mo.*

Period 3 years.*

Present or absent Present

Stoppage, \$ 100 for

Due Gov't \$ 100 for

Remarks: Stop per 1 March
to 10 + 10 cents

* See enrollment on card from muster-in roll.

Book mark:

(358c)

W. B. Logg

Copyist.

D | 7 | U.S.C.T.

William A. Davis
 Corp'l, Co. B, 7 Reg't U. S. Col'd Infantry.

Appears on

Company Muster Roll
 for Nov + Dec, 1864.

Joined for duty and enrolled:

When Sept 23, 1863*

Where Dorchester, Md *

Period 3 years.*

Present or absent Present

Stoppage, \$ 100 for

Due Gov't \$ 100 for

Remarks: Appointed Corp'l
 Sept 26/64, 20, no
 37, Hd Qrs, 7 USCI.
 Dec 30/64. Stopped
 for 1 Starersack +
 Canteen

* See enrollment on card from muster-in roll.

Book mark:

(358c) W. H. [Signature] Copyist.

D | 7 | U.S.C.T.

William A. Davis
Capt., Co. B, 7 Reg't U. S. Col'd Infantry.

Appears on

Company Muster Roll
for Jan & Feb, 1865.

Joined for duty and enrolled:

When Sept 20, 1864*

Where Dorchester, M^o*

Period 7 years.*

Present or absent Present*

Stoppage, \$ 100 for

Due Gov't \$ 100 for

Remarks:

* See enrollment on card from muster-in roll.

Book mark:

W. B. Log

21 7 U.S.C.T.

William A. Davis
Capt, Co. B, 7 Reg't U. S. Col'd Infantry.

Appears on

Company Muster Roll
for Feb 28 to June 30, 1863.

Joined for duty and enrolled:

When Sept 23, 1863.*

Where Dorchester, Md.*

Period 3 years.*

Present or absent Present

Stoppage, \$ 100 for

Due Gov't \$ 100 for

Remarks: Stop for 1 Car-
tridge Box Belt
Plate, 1 wiper, 1
Cone wrench

* See enrollment on card from muster-in roll.

Book mark:

(358c) *W. A. Davis* Copyist.

2 | 7 | U.S.C.T.

William A. Davis
Coptl., Co. B, 7 Reg't U. S. Col'd Infantry.

Appears on

Company Muster Roll
for July & Aug, 1865.

Joined for duty and enrolled:

When Sept 23, 1863.*

Where Dorchester Co. Md.*

Period 3 years.*

Present or absent Present

Stoppage, \$ 100 for

Due Gov't \$ 100 for

Remarks:

* See enrollment on card from muster-in roll.

Book mark:

W. A. Davis
(358c) Copyist.

D | 7 | U.S.C.T.

William J. Davis
Corpl, Co. B, 7 Reg't U. S. Col'd Infantry.

Appears on

Company Muster Roll
for Sept & Oct, 1863.

Joined for duty and enrolled:

When Sept 23, 1863

Where Dorchester Co. Md.*

Period 3 years.*

Present or absent Present

Stoppage, \$ 100 for

Due Gov't \$ 100 for

Remarks:

* See enrollment on card from muster-in roll.

Book mark:

W. J. Davis Copyist.

20 | 7 | U.S.C.T.

William A. Davis

Corp., Co. B, 7 Reg't U. S. Col'd Infantry.

Appears on

Company Muster Roll

for Nov & Dec, 1863.

Joined for duty and enrolled:

When Sept 23, 1863.*

Where Danchester Co, Me.*

Period 3 years.*

Present or absent Present

Stoppage, \$ 100 for

Due Gov't \$ 100 for

Remarks:

[Empty lines for remarks]

* See enrollment on card from muster-in roll.

Book mark:

[Signature]

D 7

7

U.S.C.T.

William A. Paris

Corpl, Co. B, 7 Reg't U. S. Col'd Infantry.

Appears on

Company Muster Roll

for *Jan'y + Feb*, 1866.

Joined for duty and enrolled:

When *Sep 23*, 1863*

Where *Dorchester Co. Md* *

Period *3* years.*

Present or absent *Present*

Stoppage, \$ *100* for

Due Gov't \$ *100* for

Remarks:

* See enrollment on card from muster-in roll.

Book mark:

Holbrook

(358c)

Copyist.

D | **7** | **U.S.C.T.**

William A. Davis

Corpl, Co. B, 7 Reg't U. S. Col'd Infantry.

Appears on

Company Muster Roll

for *Mch and Apl*, 186 *6*.

Joined for duty and enrolled:

When *sep 23*, 186 *3*.*

Where *Dorchester msd* *

Period *3* years.*

Present or absent *Present*

Stoppage, \$ *100* for

Due Gov't \$ *100* for

Remarks:

* ~~42~~ See enrollment on card from muster-in roll.

Book mark: _____

Holbrook

DA

7

U.S.C.T.

William A. Davis

Corpr, Co. B, 7 Reg't U. S. Col'd Infantry.

Appears on

Company Muster Roll

for *May and June*, 186*6*.

Joined for duty and enrolled:

When *Sept 23*, 186*3*.*

Where *Dorchester Co Md* *

Period *3* years.*

Present or absent *Present*

Stoppage, \$ *100* for

Due Gov't \$ *100* for

Remarks:

* See enrollment on card from muster-in roll.

Book mark: -----

Holbrook

(358c)

Copyist.

DP

7

U.S.C.T.

William A. Davis
Corpl, Co. B, 7 Reg't U. S. Col'd Infantry.

Appears on

Company Muster Roll

for *July and Aug*, 1864.

Joined for duty and enrolled:

When *Sept. 23*, 1863*

Where *Dorchester Co, Md**

Period *3* years.*

Present or absent *Present*

Stoppage, \$ *100* for

Due Gov't \$ *100* for

Remarks:

* ~~See~~ See enrollment on card from muster-in roll.

Book mark: -----

(358c)

Holbrook
Copyist.

D

7

U.S.C.T.

William A. Davis

Corp, Co. *B*, 7 Reg't U. S. Col'd Infantry.

Appears on **Co. Muster-out Roll**, dated

Indianola Texas, *Oct 13*, 1866 .

Muster-out to date *Oct 13*, 1866 .

Last paid to *June 30*, 1866 .

Clothing account:

Last settled....., 186 ; drawn since \$..... 100

Due soldier \$ *60*^{*46*}/₁₀₀; due U. S. \$..... 100

Am't for cloth'g in kind or money adv'd \$..... 100

Due U. S. for arms, equipments, &c., \$ *38* 100

Bounty paid \$..... 100; due \$ *100* 100

Remarks: *Joined original organi-*
zation Corporal from muster in
to date stop for must roll
384

Book mark:

J Folbrook

374

Davis Zachariah

Co E, 7 U.S. Col'd Inf.

Private Private

CARD NUMBERS.

1	6287244	26
2	6287345	27
3	6287445	28
4	6287545	29
5	6287644	30
6	6287741	31
7	6287837	32
8	6287928	33
9	6288022	34
10	6288120	35
11	6288218	36
12	6288318	37
13	6288418	38
14	6288514	39
15	6288609	40
16	6288709	41
17	6288786	42
18	6288870	43
19	6288954	44
20	6289033	45
21	9066422	46
22		47
23		48
24		49
25		50

Book Mark:

See also

Ref 354523,

29

7

U.S.C.T.

Zachariah Davis
Co. *C*, 7 Reg't U.S. Col'd Inf.

Appears on
Company Descriptive Book
of the organization named above.

DESCRIPTION.

Age *21* years; height *5* feet *5 1/2* inches.

Complexion *Black*

Eyes *Black*; hair *Curly*

Where born *Conchester, Ind.*

Occupation *Farmer*

ENLISTMENT.

When *Sept 24*, 186*4*.

Where *Baltimore*

By whom *Col Wm R. ...*; term *3* y'rs.

Remarks: *In the ...
at Camp ...
Aug 14th 1864.*

A. Brown

7 | U.S.C.T.

Zachariah Davis
Pvt., Co. *E*, 7 Reg't U. S. Colored Inf.

Age *20* years.

Appears on

Company Muster-in Roll

of the organization named above. Roll dated

Baltimore Md., Sept. 30 1863.

Muster-in to date *Sept. 30, 1863.*

Joined for duty and enrolled:

When *Sept. 27, 1863.**

Where *Dorchester Co., Md.*

Period *3* years.*

Remarks:

*Muster in roll shows enrollment of all men of this company as of same date. See enrollment on subsequent card or cards.

Book mark:

A. C. Rankin
Co. Hist.

D1

7

U.S.C.T.

Gechariah Davis
Pvt., Co. E, 7 Reg't U. S. Col'd Infantry.

Appears on

Company Muster Roll

for *Sept 30/63 to Oct. 31, 1863.*

Joined for duty and enrolled:

When *Sept. 27, 1863.**

Where *Dorchester Md.*

Period *3* years.*

Present or absent *Absent*

Stoppage, \$ *100* for

Due Gov't \$ *100* for

Remarks: *On detached service at Baltimore Md.*

* ~~See~~ See enrollment on card from muster-in roll.

Book mark:

E. E. Rankin

D | **7** | **U.S.C.T.**

Zachariah Davis
Prh, Co. E, 7 Reg't U. S. Col'd Infantry

Appears on

Company Muster Roll

for *Nov. & Dec.*, 1863.

Joined for duty and enrolled:

When *Sept. 27*, 1863.*

Where *Dorchester*, *

Period *3* years.*

Present or absent *Absent*

Stoppage, \$ *100* for

Due Gov't \$ *100* for

Remarks: *Detached service at Baltimore Md. by order Col. W. Birney Oct. 27, 1863.*

* See enrollment on card from muster-in roll.

Book mark:

A. E. Rankin
(358c) Copyist.

81

7

U.S.C.T.

Zachariah Davis
Pvt, Co. E, 7 Reg't U. S. Col'd Infantry.

Appears on

Company Muster Roll

for Jan. & Feb., 1864.

Joined for duty and enrolled:

When Sept. 27, 1863.*

Where Dorchester*

Period 3 years.*

Present or absent Present

Stoppage, \$ 100 for

Due Gov't \$ 100 for

Remarks: Returned from
recruiting service
Jan. 3, 1864.

* See enrollment on card from muster-in roll.

Book mark:

E. C. Rauter

D | 7 | U.S.C.T.

Zachariah Davis
Priv., Co. E, 7 Reg't U. S. Col'd Infantry.

Appears on

Company Muster Roll

for *Mar. & Apr.*, 1864.

Joined for duty and enrolled:

When *Sept. 27*, 186*3*.*

Where *Dorchester*.*

Period *3* years.*

Present or absent *Absent*

Stoppage, \$ *100* for

Due Gov't \$ *100* for

Remarks: *Sick in Hospital*
Jacksonville Fla.
Apr. 4th 1864.

* See enrollment on card from muster-in roll.

Book mark:

A. L. Rankin

D |

7

U.S.C.T.

Zachariah Davis
Pvt., Co. E, 7 Reg't U. S. Col'd Infantry.

Appears on

Company Muster Roll

for Dated June 30, 1864.

Joined for duty and enrolled:

When Sept. 27, 1863.*

Where Dorchester Co. Ind.*

Period years.*

Present or absent Absent.

Stoppage, \$ 100 for

Due Gov't \$ 100 for

Remarks: Detached S. O. 47
Hd. Qrs. U. S. Forces
Jacksonville Fla.
June 4th 1864.

* See enrollment on card from muster-in roll.

Book mark:

A. C. Rankin

(358c)

Copyist.

D | 7 **U.S.C.T.**

Zachariah Davis
Pvt., Co. *E*, *7* Reg't U. S. Col'd *Inf.*

Appears on

Company Muster Roll

for *Jul. & Aug.* 186*4*

Joined for duty and enrolled:

When *Sept 27*, 186*3*.*

Where *Dorchester* *

Period *3* years.*

Present or absent *Present*

Stoppage, \$ *100* for

Due Gov't, \$ *100* for

Valuation of horse, \$ *100*

Valuation of horse equipments, \$ *100*

Remarks: *Stop for one*
Haversack.

* ~~See~~ See enrollment on card from muster-in roll.

Book-mark :

J. P. Rankin

D. | 7 | U.S.C.T.

Zachariah David
Gto, Co. E, 7 Reg't U. S. Col'd Infantry.

Appears on

Company Muster Roll

for Sept - Oct., 1864.

Joined for duty and enrolled:

When Oct-27, 1863.*

Where Rochester.*

Period 2 years.*

Present or absent Present-

Stoppage, \$ 100 for

Due Gov't \$ 100 for

Remarks:

* See enrollment on card from muster-in roll.

Book mark:

J. P. Crompton
Copyist.

No. 1

7

U.S.C.T.

Nathaniel Davis
Late, Co. E, 7 Reg't U. S. Col'd Infantry.

Appears on

Company Muster Roll

for Nov & Dec, 1864.

Joined for duty and enrolled:

When Sept 27, 1863.*

Where Rochester.*

Period 3 years.*

Present or absent Present

Stoppage, \$ 100 for

Due Gov't \$ 100 for

Remarks:

* See enrollment on card from muster-in roll.

Book mark:

E. O. Thompson

21 7 U.S.C.T.

Hachanah Davis
Pote, Co. E, 7 Reg't U. S. Col'd Infantry.

Appears on

Company Muster Roll
for *Jan + Feb*, 1865.

Joined for duty and enrolled:

When *Sept 27*, 1865.*

Where *Dorchester**

Period *2* years.*

Present or absent *Present*

Stoppage, \$ *100* for

Due Gov't \$ *100* for

Remarks: *Top for Wiper*

* See enrollment on card from muster-in roll.

Book mark:

S. P. Thompson

L.H. | **7** | **U.S.C.T.**

Nachman David
Capt, Co. E, 7 Reg't U. S. Col'd Infantry.

Appears on

Company Muster Roll

for *March to April*, 186*5*.

Joined for duty and enrolled:

When *Sept 27*, 186*3*.

Where *Rochester*.

Period *3* years.*

Present or absent *Present*

Stoppage, \$ *100* for

Due Gov't \$ *100* for

Remarks: *Detached, U.S. No. 37. Ad 2nd 1st Regt 2nd Div, 20th Corps, 23/60, stop for me Tripes*

* See enrollment on card from muster-in roll.

Book mark:

E. Thompson

D. | **7** | **U.S.C.T.**

Richard Davis
Cpl., Co. E, 7 Reg't U. S. Col'd Infantry.

Appears on

Company Muster Roll

for *May & June*, 186*5*.

Joined for duty and enrolled:

When *Sept 27* 186*3*.*

Where *Greensboro, N.C.*.*

Period *2* years.*

Present or absent *Present*

Stoppage, \$ *100* for

Due Gov't \$ *100* for

Remarks: *Stop on 1st of Nov.*

* See enrollment on card from muster-in roll.

Book mark:

E. Crombton

D. | 7 | U.S.C.T.

Zachariah David
e (D), Co. E, 7 Reg't U. S. Col'd Infantry.

Appears on

Company Muster Roll

for July & Aug., 1865.

Joined for duty and enrolled:

When Sept-27, 1863.*

Where Dorchester Co. Md.*

Period 3 years.*

Present or absent Present

Stoppage, \$ 100 for

Due Gov't \$ 100 for

Remarks:

* See enrollment on card from muster-in roll.

Book mark:

(358c) *S. Thompson* Copyist.

21 | 7 | U.S.C.T.

Michael Davis
Cpt., Co. E, 7 Reg't U. S. Col'd Infantry.

Appears on

Company Muster Roll

for *Sept & Oct.*, 186*5*.

Joined for duty and enrolled:

When *Sept 27*, 186*5*.*

Where *Prochester Co Md.* *

Period *3* years.*

Present or absent *Present*

Stoppage, \$ *100* for

Due Gov't \$ *100* for

Remarks: *E to the year 1865*

* See enrollment on card from muster-in roll.

Book mark:

E. J. ...

21

7

U.S.C.T.

Zachariah Davis
Pvt., Co. E, 7 Reg't U. S. Col'd Infantry.

Appears on

Company Muster Roll

for Nov. & Dec., 1865.

Joined for duty and enrolled:

When Sept. 27, 1863.*

Where Dorchester, Md.*

Period 3 years.*

Present or absent Present

Stoppage, \$ 95 for 100 for C. & G. Equipage

Due Gov't \$ 100 for

Remarks:

* See enrollment on card from muster-in roll.

Book mark:

(358c)

Wm J. Bell Jr.

Copyist.

N | 7 | U.S.C.T.

Zachariah Davis
Pvt, Co. E, 7 Reg't U. S. Col'd Infantry.

Appears on

Company Muster Roll
for Jan. & Feb, 1866.

Joined for duty and enrolled:

When Sept. 27, 1863.*

Where Dorchester Co., Md.*

Period 3 years.*

Present or absent Present

Stoppage, \$ 100 for

Due Gov't \$ 100 for

Remarks:

* See enrollment on card from muster-in roll.

Book mark:

Jno J. Bell
(358c) Copyist.

N | **7** | **U.S.C.T.**

Zachariah Davis
Prvt, Co. E, 7 Reg't U. S. Col'd Infantry.

Appears on

Company Muster Roll

for *March & April*, 186*6*.

Joined for duty and enrolled:

When *Sept. 27*, 186*3*.*

Where *Worcester Co., Md.*.*

Period *3* years.*

Present or absent *Present*

Stoppage, \$ *100* for

Due Gov't \$ *100* for

Remarks:

* See enrollment on card from muster-in roll.

Book mark: _____

Wm J. Bell
(358c) *Wm J. Bell* Copyist.

S | 7 | U.S.C.T.

Zachariah Davis
Prvt, Co. E, 7 Reg't U. S. Col'd Infantry.

Appears on

Company Muster Roll

for *May & June*, 186*6*

Joined for duty and enrolled:

When *Sept. 27*, 186*6*

Where *Dorchester Co., Md.*

Period *3* years.*

Present or absent *Present*

Stoppage, \$ *100* for

Due Gov't \$ *100* for

Remarks: *Set at Victoria per*
S.O. No. 56. 185. Yrs. Post
Victoria, Tex. Mch. 19, 1866

* ~~65~~ See enrollment on card from muster-in roll.

Book mark: _____

(358c)

Jno Bull Jr
Copyist.

S | **7** | **U.S.C.T.**

Zachariah Davis
Pr, Co. E, 7 Reg't U. S. Col'd Infantry.

Appears on

Company Muster Roll

for *July & Aug*, 186*6*.

Joined for duty and enrolled:

When *Sept. 27*, 186*3*.

Where *Dorchester Co., Md.*

Period *3* years.*

Present or absent *Present*.

Stoppage, \$ *100* for

Due Gov't \$ *100* for

Remarks: *Det. service at Victoria*
Tex. per D.O. No. 56, H.S. Gps.
Post Victoria, Tex.
March. 19, 1866.

* See enrollment on card from muster-in roll.

Book mark:

Jno Bull
(358c) Copyist.

S | 7 | U.S.C.T.

Zachariah Davis
Co. E, 7 Reg't U. S. Col'd Infantry.

Appears on **Co. Muster-out Roll**, dated Indiantola, Texas, Oct. 13, 1866.

Muster-out to date Oct. 13, 1866.

Last paid to June 30, 1866.

Clothing account:

Last settled....., 186 ; drawn since \$..... 100

Due soldier \$ 24 76 / 100; due U. S. \$..... 100

Am't for cloth'g in kind or money adv'd \$..... 100

Due U. S. for arms, equipments, &c., \$..... 100

Bounty paid \$..... 100; due \$ 100 / 100

Remarks: Joined for duty at original organization

Book mark: V 166 - P 1 - 73

(361) W. J. Bell Jr. Copyist.

375

Dow, William

Co *H*, 7 U.S. Col'd Inf.

Private

CARD NUMBERS.

¹ *See Dow, William* ²⁶

3	28
4	29
5	30
6	31
7	32
8	33
9	34
10	35
11	36
12	37
13	38
14	39
15	40
16	41
17	42
18	43
19	44
20	45
21	46
22	47
23	48
24	49
25	50

Book Mark:

See also

376

Dowdy, Samuel

Co *H*, 7 U.S. Col'd Inf.

Private

CARD NUMBERS.

1	26
<i>See Dowdy, Samuel</i>	
3	28
4	29
5	30
6	31
7	32
8	33
9	34
10	35
11	36
12	37
13	38
14	39
15	40
16	41
17	42
18	43
19	44
20	45
21	46
22	47
23	48
24	49
25	50

Book Mark:

See also

Dawson Charles

Co I, 7 U.S. Col'd Inf.

Private

Private

CARD NUMBERS.

1	6279045	26
2	6278796	27
3	6294909	28
4	6295004	29
5	6295104	30
6	6295205	31
7	6295308	32
8	6279304	33
9	6295911	34
10	9066902	35
11	43155759	36
12		37
13		38
14		39
15		40
16		41
17		42
18		43
19		44
20		45
21		46
22		47
23		48
24		49
25		50

Book Mark:

See also

S. 1 7 U.S.C.T.

Charles Sawson

, Co. D, 7 Reg't U. S. Col'd Inf.

Appears on

Company Descriptive Book

of the organization named above.

DESCRIPTION.

Age 44 years; height 5 feet 3 1/2 inches.

Complexion Blk

Eyes Blk; hair Blk.

Where born Del.

Occupation Laborer

ENLISTMENT.

When Sept. 28, 1864.

Where April. Del.

By whom Capt. Wilmer; term 1 yrs

Remarks: Drafted Wilmington Delaware. Abs sick from Mar. 20. 65. to June 65.

Mustered in at Wilmington, Del. Sept. 28. 64. by Capt. Wilmer.

Mustered out at Ft. Monroe, Va. June 23. 65. by order Secy. War.

J. S. White.

7

D1 used

Charles Dawson

Appears with rank of _____ on _____

Muster and Descriptive Roll

of Detachment of US Substitutes
& Drafted men turned over
to Col. S. M. Bowman Roll dated
Camp Bradford Md Oct 12, 1864.

Where born Delaware

Age 44 years; occupation Laborer

When enlisted Sept 28, 186

Where enlisted Wilmington

For what period enlisted 1 years.

Eyes Blk; hair Blk

Complexion Black; height 5 ft. 3 1/2 in.

When mustered in Sept 30, 186

Where mustered in _____

Bounty paid \$ 100; due \$ 100

Clothing account:

Last settled _____, 186 ; drawn since \$ 1631/100

Date of first muster _____, 186

Company to which assigned _____

Remarks: Drafted man
Wilmington, Del.

Book mark : _____

T. D. McGaw

D | *7* | U.S.C.T.

Charles Dawson

Appears with rank of _____ on
**Muster and Descriptive Roll of a Detach-
ment of Drafted Men and Substitutes
forwarded**

for the *7* Reg't U. S. Col'd Inf. Roll dated
Baltimore Md Oct 8, 1864.

Where born *Del.*

Age *44* years; occupation *Laborer*

Drafted and mustered in:

When *Sept 28*, 1864.

Where *Wil. Del.*

Period *1* years.

Eyes *Blk*; hair *Blk*

Complexion *Blk*; height *5 ft 3 1/2 in.*

Paid bounty and advance pay, \$ *100*

Bounty due \$ *100*

Where credited _____

Company to which assigned _____

Remarks: *Drafted, Wil. Del.*

Book mark: _____

J. M. Faculty
(340) Copyist

10 | 7 | U.S.C.T.

Charles Dawson

....., Co, *7* Reg't U. S. Col'd Infantry.

Age *44* years.

Appears on a

Detachment Muster-in Roll

of the organization named above. Roll dated

Baltimore, Md., Oct. 8, 186*4*.

Muster-in to date *Oct. 8,* 186*4*.

Joined for duty and enrolled:

When *Sept. 28*, 186*4*.

Where *Wilmington*

Period *1* years.

Remarks: *Drafted*

Book mark:

Weck
Coryist.

D

7

U.S.C.T.

Charles Dawson

Priv, Co. I, 7 Reg't U. S. Col'd Infantry.

Appears on

Company Muster Roll

for *Nov. & Decr.*, 1864

Present or absent *Present*

Stoppage, \$ *100* for

Due Gov't, \$ *100* for

Remarks:

*Charge for One wipes
Recruit from Depot. Joined Co. for
duty Nov. 1. 1864.*

Book mark:

D. Maher

Copyist.

(358)

A

7

U.S.C.T.

Charles Dawson

Priv, Co. 1, 7 Reg't U. S. Col'd Infantry.

Appears on

Company Muster Roll

for *Jan'y. + Feby*, 1865.

Present or absent *Present*

Stoppage, \$ *100* for

Due Gov't, \$ *100* for

Remarks:

Book mark:

D. Maher

Copyist.

(358)

D

7

U.S.C.T.

Charles Dawson

Priv, Co. I, 7 Reg't U. S. Col'd Infantry.

Appears on

Company Muster Roll

for March & April, 1865.

Present or absent Present

Stoppage, \$ 100 for

Due Gov't, \$ 100 for one Haversack

& One Canteen

Remarks:

Book mark:

D. Maher
Copyist.

A | **7** | **U.S.C.T.**

Charles Dawson

Priv, Co. I, 7 Reg't U. S. Col'd Infantry.

Appears on

Company Muster Roll

for *May + June*, 1865.

Present or absent *Absent*

Stoppage, \$ *100* for

Due Gov't, \$ *100* for

Remarks:

Absent sick since May 20. '65.

Book mark:

D. Maher
Copyist.

(358)

D

7

U.S.C.T.

Charles Dawson

Poir, Co. I, 7 Reg't U. S. Col'd Infantry.

Appears on

Company Muster Roll

for *July & Aug.*, 1865.

Present or absent

Stoppage, \$ *100* for

Due Gov't, \$ *4* ^{*67*}/_{*100*} for *C. & G. Equipage*

Remarks:

Mustered out at Fort Monroe, Va. June 23, '65. By order War Dept. dated May 3, '65.

Book mark:

D. Maher

Copyist.

(358)

D 1 7

U.S.C.T.

Charles Dawson
Priv., Co. F, 7 Reg't U. S. Col'd *Inf.*

Appears on an

Individual Muster-out Roll

of the organization named above. Roll dated
Fort. Monroe, Va. June 23, 1865.

Muster-out to date *June 23, 1865.*

Last paid to *Dec. 31, 1864.*

Clothing account:

Last settled *never*, 186 ; drawn since \$ 100

Due soldier \$ 100; due U. S. \$ 100

Am't for cloth'g in kind or money adv'd \$ *61* ⁴⁶/₁₀₀

Due U. S. for arms, equipments, &c., \$ 100

Bounty paid \$ 100; due \$ 100

Remarks: *Mustered out by
order of war Dept.
Dated May 3rd, 1865.
Patient in U.S. Genl.
Hospital, Fort Mon-
roe, Va.*

Book mark: _____

C. R. Owen

L

7

U.S.C.T.

Charles Dawson
Pvt, Co *D*, 7 Reg't U. S. Col'd Infantry.

Appears on Co. Muster-out Roll dated
Indianola Texas
October 13, 1866.

Muster-out to date _____, 186 .

Last paid to *Dec 31*, 1864.

Clothing account:

Last settled _____, 186 ; drawn since \$ _____ 100

Due soldier \$ _____ 100; due U. S. \$ _____ 100

Am't for cloth'g in kind or money adv'd \$ _____ 100

Due U. S. for arms, equipments, &c., \$ _____ 100

Bounty paid \$ _____ 100; due \$ _____ 100

Remarks *Discharged for*
disability at Ft Monroe,
Va. June 20, '65.

Book mark: _____

Sabine
Copyist.

378

Dean William

Co B, 7 U.S. Col'd Inf.

Private Private

CARD NUMBERS.

1	6286340	26
2	6286417	27
3	6286507	28
4	6286598	29
5	6286768	30
6	6279355	31
7	6287121	32
8	9066355	33
9		34
10		35
11		36
12		37
13		38
14		39
15		40
16		41
17		42
18		43
19		44
20		45
21		46
22		47
23		48
24		49
25		50

Book Mark:

See also

A 1576417 P.O. m + m
A 15-16098 P.O. aff 6
S. 20175-42 P.O. m m

291

7

U.S.C.T.

William Dean

Co. *D*, 7 Reg't U. S. Col'd Inf.

Appears on

Company Descriptive Book

of the organization named above.

DESCRIPTION.

Age *28* years; height *5* feet *4* inches.

Complexion *Swedish*

Eyes *Brown*; hair *Black*

Where born *Sweden*

Occupation *Shoemaker*

ENLISTMENT.

When *Dec. 10*, 186*4*

Where *Hamilton, N.C.*

By whom *Sub. Dist.*; term *1* y'rs

Remarks: *Was let into roll
by John K. ...
... 4. ... Discharged
... 10 '65, by order War
Dept., J. H. Monroe, C.A.*

J. H. Monroe

20

7

U.S.C.T.

William Dean

Private, Co. D, 7 Reg't U. S. Col'd Infantry.

Appears on

Company Muster Roll

for *Jan'y 8. Feb*, 186*5*.

Joined for duty and enrolled:

When *Dec. 10*, 186*4*.*

Where *Washington D.C.* *

Period *1* years.*

Present or absent *Present*

Stoppage, \$ *100* for

Due Gov't \$ *100* for

Remarks: *Joined for duty
Jan'y 10 / 65*

*(Drafted & Mustered in
Dec 10/64, at Wash-
ington, D.C. for 1 yr.)*

* See enrollment on card from muster-in roll.

Book mark:

(358c)

W. H. Neal

Copyist.

22

7

U.S.C.T.

William Dean

Priv., Co. D, 7 Reg't U. S. Col'd Infantry.

Appears on

Company Muster Roll

for *March & April*, 1865.

Joined for duty and enrolled:

When *Dec 10*, 1864.*

Where *Washington* *

Period *1* years.*

Present or absent *Present*

Stoppage, \$ *100* for

Due Gov't \$ *100* for

Remarks: *Joined for duty
Jan 10 1865*

* See enrollment on card from muster-in roll.

Book mark:

F. D. Neale

(358c)

Copyist.

20 | **7** | **U.S.C.T.**

William Dean

Priv., Co. D, 7 Reg't U. S. Col'd Infantry.

Appears on

Company Muster Roll

for May & June, 1865.

Joined for duty and enrolled:

When Dec 16, 1864.*

Where Washington DC. *

Period 1 years.*

Present or absent absent

Stoppage, \$ 100 for

Due Gov't \$ 100 for

Remarks: Absent. Sick in
hospital since May 20 -
1865

* See enrollment on card from muster-in roll.

Book mark: _____

(358c) F. W. Neal Copyist.

20 | 7 | U.S.C.T.

William Dean

Priv., Co. D, 7 Reg't U. S. Col'd Infantry.

Appears on

Company Muster Roll

for *July & Aug*, 1865.

Joined for duty and enrolled:

When *Dec. 16*, 1864.*

Where *Washington D.C.* *

Period *1* years.*

Present or absent *absent*

Stoppage, \$ *100* for

Due Gov't \$ *100* for

Remarks: *Absent pick in
hospital since May 1865*

* See enrollment on card from muster-in roll.

Book mark:

2 | **7** | **U.S.C.T.**

William Dean
Priv., Co. D, 7 Reg't U. S. Col'd Infantry.

Appears on

Company Muster Roll

for *Sept. & Oct.*, 186*5*.

Joined for duty and enrolled:

When *Dec 16*, 186*4*.*

Where *Washington D.C.* *

Period *1* years.*

Present or absent

Stoppage, \$ *100* for

Due Gov't \$ *100* for *U.S. Equipage*

Remarks: *Discharged*

Mustered Out June 12 -

65 by order War Dept

Notice rec'd Sept

1 25

* See enrollment on card from muster-in roll.

Book mark: *C.M.R. Mch 28, 1866*

(358c) *F.W. Meale* Copyist.

10 | 7

U.S.C.T.

William Deans
Priv. Co. D, Reg't U. S. Col'd Buff.

Appears on an

Individual Muster-out Roll

of the organization named above. Roll dated
Fort Mowrol, Va. June 12, 1865.

Muster-out to date June 12, 1865.

Last paid to Pay due from enrollment, 1865.

Clothing account:

Last settled ^{never} settled, 1865; drawn since \$ 100

Due soldier \$ 100; due U. S. \$ 100

Am't for cloth'g in kind or money adv'd \$ 53 33/100

Due U. S. for arms, equipments, &c., \$ 100

Bounty paid \$ 100; due \$ 100

Remarks: Accountable for knapsack,
haversack & canteen.
Mustered out by order War
Dept. dated May 31, 1865.
Patient in U.S. Genl. Hospi-
tal, Fort Mowrol, Va.

Book mark:

C. R. Owen.

(848)

Copyist.

D

7

U.S.C.T.

William Dean

Pvt, Co. D, 7 Reg't U. S. Col'd Infantry.

Appears on Co. Muster-out Roll, dated

Indianola Texas, Oct 13, 1866 .

Muster-out to date _____, 186 .

Last paid to Pay due from Enrollment, 186 .

Clothing account:

Last settled _____, 186 ; drawn since \$ _____ 100

Due soldier \$ _____ 100 ; due U. S. \$ _____ 100

Am't for cloth'g in kind or money adv'd \$ _____ 100

Due U. S. for arms, equipments, &c., \$ _____ 100

Bounty paid \$ _____ 100 ; due \$ _____ 100

Remarks: Discharged Ft. Monroe, Va.
June 12-65 Order W. Dept May 3 65

(Age 38.)

Book mark M.O.R. on file.

Hearst

Joseph H.
Dear born Joshua H

Co *H*, 7 U.S. Col'd Inf.

1st Lieutenant | 1st Lieutenant

CARD NUMBERS.

1	6278666	26
2	6296057	27
3	6296157	28
4	6296261	29
5	6296358	30
6	6296454	31
7	6296546	32
8	6296637	33
9	6296798	34
10	6279356	35
11	6297720	36
12	9428697	37
13		38
14		39
15		40
16		41
17		42
18		43
19		44
20		45
21		46
22		47
23		48
24		49
25		50

Book Mark:

See also *5 N.C. 9*

5-1234566 - Andrew D.

9 | 7 | U.S.C.T.

Joseph H. Scarborough

1st Co., 7 Reg't U. S. Col'd Inf.

Appears on

Regimental Descriptive Book

(List of Commissioned Officers)

of the regiment named above.

Rank 1st Lieut.

Date of appointment Oct 17 1863

Remarks: Born in the State of New Hampshire and a resident of said State entered the service of the U.S. as 1st Lieut. of 7th U.S.C.I. and resigned Oct 22/63. Re-appointed as 1st Lieut. in 3rd U.S.C.I. by order from Dept. War D.C. Dec 30/64

J. H. Scarborough

29 | 7th | U.S.C.T.

Josiah W Dearborn

1st Lt., Co., 7 Reg't U. S. Col'd Infantry.

Age 34 years.

Appears on an

Individual Muster-in Roll

of the organization named above. Roll dated
Camp Stanton, ^{Charles Co} Md Nov 22 1863.

Muster-in to date Nov 22, 1863.

Joined for duty and enrolled:

When Nov 22, 1863.

Where Camp Stanton Charles Co Md.

Period 3 years. or during the war

Remarks: Assigned to Co.
K 7 U.S.C.T.

Book mark:

C. S. Rozzell

(336)

Copyist.

D | 7 | U.S.C.T.

Joshua H. Dearborn
1Lt., Co. K, 7 Reg't U. S. Col'd Infantry.

Appears on

Company Muster Roll

for *Nov. 12 to Dec. 31*, 1863.

Present or absent *Present*.

Stoppage, \$ *100* for

Due Gov't, \$ *100* for

Remarks: *Joined for duty*
Nov. 22 1863 by order
of Col Wm Birney
Nov. 22 " 1863.

Book mark:

D. M. Kennedy

(358)

Copyist.

2

7

U.S.C.T.

Josiah H. Dearborn
Lieut, Co. K, 7 Reg't U. S. Col'd Infantry.

Appears on

Company Muster Roll

for *Jan. & Feb.*, 186 *4*

Present or absent *Present*

Stoppage, \$ *100* for

Due Gov't, \$ *100* for

Remarks:

Book mark:

D. M. Kennedy

(358)

Copyist.

2

7

U.S.C.T.

Josiah H. Dearborn
1 Lieut, Co. K, 7 Reg't U. S. Col'd Infantry.

Appears on

Company Muster Roll

for *Feb. & Apl.*, 1864.

Present or absent *Present*

Stoppage, \$ *100* for

Due Gov't, \$ *100* for

Remarks:

(Empty lines for remarks)

Book mark:

D. M. Kennedy
Spyist.

2

7

U.S.C.T.

Joseph H. Dearborn
Lieut, Co. K, 7 Reg't U. S. Col'd Infantry.

Appears on

Company Muster Roll

for May & June, 1864

Present or absent Absent

Stoppage, \$ 100 for

Due Gov't, \$ 100 for

Remarks: Absent sick in
Camp Jacksonville Fla since
28th June 1864

Book mark:

H. M. Kennedy
Copyist.

G

7

U.S.C.T.

Josiah Dearborn
Lieut., Co. K, 7 Reg't U. S. Col'd Infantry.

Appears on

Company Muster Roll

for *July & Aug.*, 186*4*.

Present or absent *Present*

Stoppage, \$ *100* for

Due Gov't, \$ *100* for

Remarks:

Book mark:

L. M. Kennedy

(358)

Copyist.

D | 7 | U.S.C.T.

J. H. Dearborn

1 Lieut, Co. K, 7 Reg't U. S. Col'd Infantry.

Appears on

Company Muster Roll

for *Sept. & Oct.*, 1864.

Present or absent *Present*

Stoppage, \$ 100 for

Due Gov't, \$ 100 for

Remarks: *In command of
Company from May 8"
to June 25" 1864.
Command of Company
from Oct. 10 to Oct 31" 64*

Book mark:

W. M. Kennedy

(358)

Copyist.

20

7

U.S.C.T.

J. H. Dearborn

121st, Co. K, 7 Reg't U. S. Col'd Infantry.

Appears on

Company Muster Roll

for *Nov & Dec*, 186*4*.

Present or absent *Present*

Stoppage, \$ *100* for

Due Gov't, \$ *100* for

Remarks: *Commanding Company from May 8th to June 25 inclusive. In command of Companies F & K from Oct 11th to Dec 5, 1864. In command of Companies G & K from Dec 5 to December 31st 1864.*

Book mark:

(358)

Leary

Copyist.

20 | 7 | U.S.C.T.

Joseph H. Dearborn
Lieut, Co. K, 7 Reg't U. S. Col'd Infantry.

Appears on

Company Muster Roll

for Jan & Feb, 1865

Present or absent

Stoppage, \$ 100 for

Due Gov't, \$ 100 for

Remarks: Promoted Capt. for S.C.
Dep. Va. and N.C. Transferred
to 5. U. S. C. I.

Book mark:

(358)

Seary
Copyist.

D 1 7

U.S.C.T.

Josiah H. Dearborn
1st Lt., Co. 7 Reg't U. S. Col'd Inf'ty

Appears on an

Individual Muster-out Roll

of the organization named above. Roll dated

Newberne, N.C. June 28, 1865.

Muster-out to date Jan. 1st, 1865.

Last paid to Dec. 31, 1864.

Clothing account:

Last settled....., 186 ; drawn since \$..... 100

Due soldier \$..... 100; due U. S. \$..... 100

Am't for cloth'g in kind or money adv'd \$..... 100

Due U. S. for arms, equipments, &c., \$..... 100

Bounty paid \$..... 100; due \$..... 100

Remarks: Mustered out for promotion from 1st Lieut, 7th U.S. Cr.I., to Captain 5th U.S. Cr.I. (vice Capt. Owen killed.) Appointment received (over)

Book mark:

C. R. Owen,

JAN. 20

6279356

1891

from Maj. Gen.
Butler, dated Dec. 30th,
1864,

Date of etch's muster
Jan'y. 7th 1865,

D

7

U.S.C.T.

Joshua H. Dearborn
1st Lt, Co. K, 7 Reg't U. S. Col'd Infantry.

Appears on **Co. Muster-out Roll**, dated
Indianola Texas, Oct. 13th, 1866.

Muster-out to date _____, 186 .

Last paid to _____, 186 .

Clothing account:

Last settled _____, 186 ; drawn since \$ _____ 100

Due soldier \$ _____ 100 ; due U. S. \$ _____ 100

Am't for cloth'g in kind or money adv'd \$ _____ 100

Due U. S. for arms, equipments, &c., \$ _____ 100

Bounty paid \$ _____ 100 ; due \$ _____ 100

Remarks *Transferred by pro-*
motion to 5th U.S.C.T.
Dec. 31st 1864.

Book mark : _____

Randall

Dearborn, J. W.

1st, Co., 7 Reg't U. S. C. I.

6 Enclosures.

Bed Cards	Final Statements
Burial Records	Furloughs or L. of A.
Certs. of Dis. for Discharge	Med. Certificates
C. M. Charges	Med. Des. Lists
Descriptive Lists	Orders
Discharge Certificates	Pris. of War Record
Enlistment Papers	Resignations

Other papers relating to—

Admission to Hosp'l	Furlough or L. of A.
Casualty Sheet	Med. Examination
Confinement	Misc. Information
Contracts	Pay or Clothing
Death or Effects	Personal Reports
Desertion	Rank
Discharge from Hosp'l	Transfer to Hosp'l
Discharge from Service	Transfer to V. R. C.
Duty	Transportation

Comp 7th U.S. Dec 3rd 1864
(I.B. 1 "D" 25th Ab.)
J.H. Dearborn
1st Lieut 7th U.S.

Tenders his resignation
as 1st Lieutenant
D. 37 (6) Va & 24, 1864

Hq Quarters 25th Ab.
In the file Va Dec 7th 1864
E. B. 149, 25th A.D.
Respectfully returned to Lieut
Dearborn and attention invited
to endorsement from Hq 2nd
Dept Va & 2nd U.S.

By order of Brig Gen Hickman
W. C. [Signature]
ally



Dec 20 1864

Head Qrs. 7th U.S.
Fort Burnham Dec 7th 1864

Respectfully forwarded
approved.

Lieut. Dearborn is a
wise and loyal officer,
his own sufferings and the
privations and hardships
of his family in Texas prior
to and immediately following
the outbreak of the Rebellion,
entitle his request to a fa-
vorable consideration.

L. O. Pratt
Lt. Col. Comdg. Regt.

Head Qrs. 1st Division
2 Div 25th Ab.
Dec 7, 1864

Respectfully forwarded
& endorsement of Col
Pratt appearing
James Champ
Col Comd.

Hq. 2nd Div. 25th A.C.
In the file Va. Dec. 7. 64

Respectfully forward-
ed, for decision of Major General
Butler.
Wm Birney,
Brig. Gen. (Comp.)

Headquarters 25th Ab.
In the file Va Dec 8th 1864
(E. B. 80 - 25th Ab.)
Respectfully forwarded with
reference to the above
endorsement
C. W. [Signature]
Brig Gen [Signature]

Camp 7th W. I. Colored Troops
December 3^d 1864

Sir:

I have the honor herewith to tender my resignation of my appointment as 1st Lieutenant in the 7th Regiment of W. I. Colored Troops upon the following grounds:

Important private business requires my personal presence and attention. - In this connection I have the honor to state, that I have a wife and child, residing within the lines of the enemy, from whom I have received no tidings since Dec. 1862, during which month I transmitted to them all the means at my command - Since that time I have had neither means or opportunity to render them any assistance, and I am convinced that their pecuniary resources must ere this have been entirely exhausted - I am very anxious to secure their exit from "The Confederacy", to a point where I can render them comfortable, & they will not daily be subjected to the reproaches of unfriendly neighbors. By permission of the military authorities of the Department of the West, I believe I can, with the fraternal assistance of men still true to the obligations of Duty to God, to Country, to their neighbors & to themselves, effect this object.

I have the honor to state that I am not indebted to the Gov. of W. I. on any account, and am responsible for no property, except such as I am now prepared to turn over to the officer authorized to receive the same.

I am, Sir, very respectfully,
Your Obedient Servant:

J. H. Dearborn
1st Lieutenant Co. "K"
7th Regiment of Colored Troops

C. C. Brown
1st Lieutenant Acty. Adjt.
7th Regt. C. T.

Ad. Qtr 2nd Div. 25th A. C.
In the field Va Dec 16, 1864
Copy returned with refer-
ence to previous endorsement
By order Brig. General Quincy
J. H. Glazier
Capt and A. A. S.

Hd Qrs. Dept. Va & M.C.

Army of the James
 McChesfield Dec. 14th 64

Respectfully returned
 Lieut. Harbour can
 have a leave of absence
 for sixty (60) days if
 during that time he
 can accomplish the
 removal of his family.

By Command of
 Maj. Genl. Ord.
 H. B. Scott

a. a. g. l.

Return and attend
 Justice

Hd Qrs 1st Brig 2^d Div 25th Div.
 Dec 17. 1864

Respy returned with refer-
 ence to previous endorse-
 ments,

By Command of
 1st Brig Genl. Russell,
 J. E. Lockwood
 Capt 11th U.S.C.T.
 a. a. g. l.

Head Quarters 25th Ab.
In the field Va Dec 21 1864
LAB 84

Respectfully returned for an
expression of opinion by the
Brigade Commander

By order of Brig Genl Hickman
[Signature]
Adj

Head Quarters 25th Ab.
Dec 23 1864

Respectfully forwarded
approved, and attention
invited to endorsement of
Major Genl commanding
Department on the
enclosure.

Wm P. S. Russell
Brig Genl
Ad. Qu., 2^d Div, 25th Corps,
Dec. 23, 1864.
Respy. forwarded.
Wm Birney
Brig. Gen. Camp.

Hd. Qtrs 2nd Div. 25th AC
 In the field Va Dec 21. 1864

Recd returned to Colonel
 Bartholomew for an expression
 of his opinion

By order Brig Gen Irving
 J. H. [Signature]
 1st Lt. [Signature] Capt and [Signature]

D 511 (C. 11. 117) 161864
Comd 7th U.S. Inf. Dec. 19th 64

(2 regts - 50000)
Absence of 1st Lieut
J. H. C. T.

Requests Leave of Absence
for 60 days

Hd Qrs. 7th U.S. Inf.
Dec. 19th 1864

Approved and respectfully
forwarded

O. E. Pratt
Lt. Col. Comd
7th U.S. Inf.

Hd Qrs. 2nd Div. 25th Ac.
Dec 20. 1864

Respectfully forwarded,
C. A. Bartholomew
Col. 109th U.S. Inf.
Comd

Rec'd B. 25th Ac. Dec 20. 1864 6.8.9.10.

Hd Qrs. 2nd Div. 25th Ac.
In the field Va Dec 20. 64

Respn. forwarded. Lieut. Dear
born should state whether he has
exhausted all the means he can
employ or set in operation by cor-
respondence. All efficient officers
will be needed here in ^{six} ~~eight~~
days. However, the case is ~~not~~
a strong one. Wm J. Birney

Brig. Gen. Comd.

Camp 7th of C.S.December 19th 1864

Sir

I have the honor to request leave of absence for sixty days and would respectfully invite attention to endorsement upon my tender of resignation heretofore forwarded and returned, and now accompanying this application. Said endorsement made at Department Hd. Qu. by command of Maj. Gen. Ord. as follows: "Hd. Qu. Dept. Va. & N.C. - Army of the James, in the Field Dec 14th 64 - Respectfully returned Lieut. Dearborn can have a leave of absence for sixty days if during that time he can accomplish the removal of his family."

I would ask leave to state that my family were left at a point 300 miles S. W. from Little Rock Ark. The intervening country bisected by numerous streams which at this season of the ^{year} are liable to be swollen and interrupt travel for days at a time. Under the most favorable auspices 60 days would be the shortest time in which a removal could be effected even "in light marching order" & without baggage or carriage of any sort. Hence I cannot hope to accomplish the

The object for which I request this leave within
the period designated, but merely to secure
if possible, & put into operation the services
of others, for that purpose

I am Sir Very Respectfully,

Your Obedient Servant

J. H. Deoband
1st Lieut. 7th Regt. C.S.

C. H. Brown

1st Lieut. 7th Regt. C.S.
& Actg. Adjutant.

Op 571 (Genl. Vassle) 864
(wrapped)

Hå Inantes 25^{te} Al.
In the fulu ba Dec 24 1864
L.A. 1864.

Respectfully forwarded
at

Alfred M. Mearns

Brig Genl

J. H. Dearborn

1st Lt. 7th Regt. I. C.

Col. J. H. Mearns

file

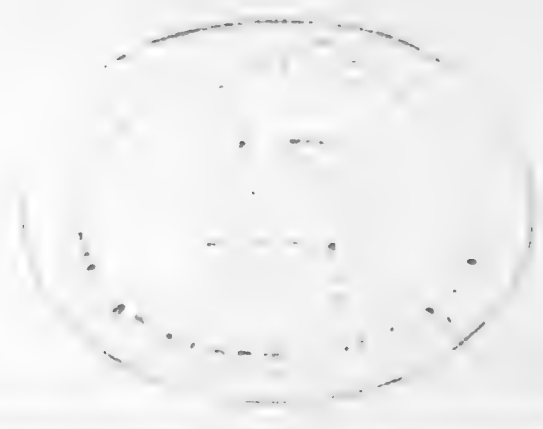

Hdqrs Army of James
Dec 28 1864

Special Order
No 418

Leave of ab-
sence for six y
days to 1st Sgt H.
Leaborn Yipes.

U.S. Army of James

In the Field at Dec 26. 1864

Special Orders 3

No 418

Extract

Leave of absence to
go out of the Department are
hereby granted to the following
named officers -

1st Lt. J. M. Dearborn 70 days
prospect for sixty days.

By Command of
Major General Ord
(sgd) H. B. Scott
a a y

Dearborn
J. H. Dearborn
Lieut. 7th U.S. C. I.

HEAD-QUARTERS
Second Division, Twenty-Fifth Army Corps,
ARMY OF THE JAMES,

In the Field, Va., December 26th 1864.

Special Order
No 418 Extract
4.

Leaves of absence to go out of the
Department are hereby granted to the following -
named officers.

Viz:-
1st Lieut. S. H. Dearborn, for 60 days.



By Command of Maj. Genl. Ord.
Sigsbee
Ad. Qrs. 2nd Div. 25th Ac.
Official

Capt. W. A. ...

...

Yacht Suriname
January 1st 1865

J. H. G. ...

1st ...

...
...
5th ...

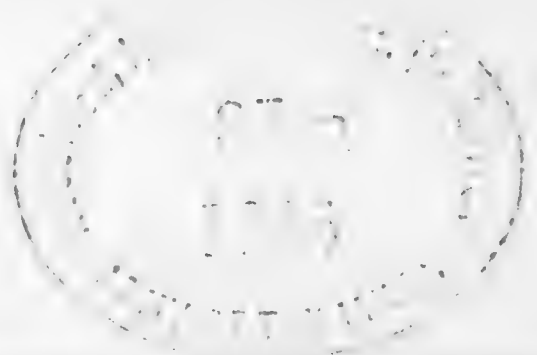

Fort Sumter Va
 January 1st. 1865

Sir

I have the honor to acknowledge the receipt of
 Order No. - dated Head Quarters, Dept. Va. & N. C. Army
 of the 30th Dec. 1864, by which I have been appointed
 Captain in the Fifth Regiment of N.Y. Colored Troops and
 I do hereby signify my acceptance of the Appointment.
 I am thirty five years of age, was born in Effingham
 State of New Hampshire and am a resident of that
 town -

Very Respectfully,

Your Obedient Servant,

J. H. Woodson

Private, 5th N.Y. C.T.

Col. Scott

Acting Adj. Genl.

Dept. Va. & N. C.

380

Recatur Farrell

Co *D*, **7** U.S. Col'd Inf.

Private | *Private*

CARD NUMBERS.

1	6294230	26
2	6294329	27
3	6294431	28
4	6294591	29
5	6295931	30
6	9066903	31
7		32
8		33
9		34
10		35
11		36
12		37
13		38
14		39
15		40
16		41
17		42
18		43
19		44
20		45
21		46
22		47
23		48
24		49
25		50

Book Mark *E.P. 7, P. 551.*

See also

D. | 7 | U.S.C.T.

Garrel Deatur

, Co. D, 7 Reg't U.S. Col'd Inf.

Appears on

Company Descriptive Book

of the organization named above.

DESCRIPTION.

Age 24 years; height 5 feet 6 inches.

Complexion Dark.

Eyes Blk; hair Blk.

Where born Acornae, Va.

Occupation Farmer.

ENLISTMENT.

When Nov. 1, 1863.

Where Acornae, Va.

By whom Capt. Wm. Birney; term 3 y'rs.

Remarks: Mustered in at Camp Stanton, Md. Nov. 5. 63, by Lt. Col. Haskell.

Died at Jacksonville, Fla. Apr. 7. 64. of disease.

On recruiting service from Dec. 20. 63. to Jan. 16. 64.

J. D. White.

Copist.

D | 7 | U.S.C.T.

Farrel Decatur

Priv., Co. J, 7 Reg't U. S. Col'd Inf.

Age 24 years.

Appears on

Company Muster-in Roll

of the organization named above. Roll dated
Camp Stanton, Charles Co., Md., Nov 5, 1863.

Muster-in to date Nov 5, 1863

Joined for duty and enrolled:

When Nov. 4, 1863

Where Accomac, Va.

Period 3 years.

Remarks:

Book mark:

J B Gage

D | 7 | U.S.C.T.

Farrel Decater

Pvt., Co. I, 7 Reg't U. S. Col'd Infantry.

Appears on

Company Muster Roll

for from Nov. 5 to Dec. 31, 1863.

Present or absent Absent

Stoppage, \$ 100 for

Due Gov't, \$ 100 for

Remarks: On detached service re-
cruiting since Dec. 20, 1863, by
order Col. Birney. Enlistment
premium \$2.00 due

Book mark:

(358)

J.B. Gage

Copyist.

9 | 7 | U.S.C.T.

Farrell Decater

Cpt, Co. I, 7 Reg't U. S. Col'd Infantry.

Appears on

Company Muster Roll

for Jan & Feb, 1864.

Present or absent Present

Stoppage, \$ 100 for

Due Gov't, \$ 100 for

Remarks: Enlistment premium \$2.00 due.

Book mark:

(358)

J B Gage

Copyist.

S

7

U.S.C.T.

Jared Secatur

It, Co *D*, 7 Reg't U. S. Col'd Infantry.

Appears on **Co. Muster-out Roll**, dated
Indianola, Texas
October, 13, 1866.

Muster-out to date _____, 186 .

Last paid to *Dec. 31*, 1866.

Clothing account:

Last settled _____, 186 ; drawn since \$ _____ 100

Due soldier \$ _____ 100; due U. S. \$ _____ 100

Am't for cloth'g in kind or money adv'd \$ _____ 100

Due U. S. for arms, equipments, &c., \$ _____ 100

Bounty paid \$ _____ 100; due \$ _____ 100

Remarks: *Act of disability*
at Jacksonville, Fla.
Apr. 6, '64.

Final papers sent
N.Y.C., Apr. 7, '64.

Book mark: *Sid Apr. 7, '64.*
Over

Sabine

NARA 599

JAN. 21

6295931

213910

*See B.B., 7.7 Q.551.
7.80 Q.183, 69.*

9

7

U.S.C.T.

Farrell Decatur

Pvt, Co. I, 7 Reg't U. S. Col'd Infantry.

Appears on

Company Muster Roll

for *March & Apr*, 1864.

Present or absent

Stoppage, \$ 100 for

Due Gov't, \$ 100 for

Remarks: *Died at Jacksonville, Fla., April 6, 1864, of Debility. Final Statements sent to A. G. O., April 7, 1864*

Book mark: *See E. B. 7, P. 551. Died (over)*

J. B. Gage

(358)

Copyist.

Ms. A. 9. 2. 10

JAN. 21

6294591

1891

at Jacksonville, Fla., April 7,
1864.

MISSISSIPPI

Deater, Furrill

P, Co. J

7 Reg't

U.S.C. Inf.



Enclosures.

Bed Cards	Descriptive Lists
Burial Records	Final Statements 3
Certs. of Dis. for Discharge	Furloughs
C. M. Charges	Med. Des. Lists
Med. Certificates	Orders

Other papers relating to—

Admission to Hosp'l <i>Priv.</i>	Furlough
Casualty Sheet (<i>Officer's</i>) 1	Med. Examination
Confinement	Misc. Information 1
Contracts	Pay or Clothing
Death or Effects	Personal Reports
Desertions	Rank
Discharge from Hosp'l	Transfer to Hosp'l
Discharge from Service	Transfer to V. R. C.
Duty	Transportation

CASUALTY SHEET

No. _____

Deeatur Farrell

Prof of Company *"D"*

7th Regiment of *U.S.V.*

State Volunteers.

NATURE OF CASUALTY.

Died April 6, 1864.

CASUALTY SHEET.

Name: *Decatur Farrell*

Rank: *Private* Company: *"I"* Regiment: *7*

Arm: *U.S. Troops* State: _____

Nature of Casualty: *Death*

CAUSE OF CASUALTY—(NAME OF DISEASE, &c.)

Debility

DEGREE OF DISABILITY.

BY WHOM CERTIFIED.

A. R. Walker
Capt Comd'g Co

DATE OF DISCHARGE, DEATH, &c.

April 6, 1864

PLACE OF DISCHARGE, DEATH, &c.

Jacksonville Fla.

BY WHOM DISCHARGED.

FROM WHAT SOURCE THIS INFORMATION WAS OBTAINED.

Commuted Roll
April 1864

REMARKS.

A. J. Ball

Clerk.

1864

48

FINAL STATEMENT

Inventory
 Dep
 Private Farrell Secatur
 "I" Co.
 7th Reg't of U.S. Colored Troops.

JUL
 18
 1871

~~VOLUNTEERS.~~

NOTE 1.—Two of these certificates (or duplicates) are to be given to each Volunteer Soldier or drafted man who may be discharged previously to the discharge of his company, that he may at once receive from the Paymaster the pay, &c., due him, and the captain or other COMMISSIONED officer commanding the company will certify to the act of the delivery of the duplicate certificates; on these certificates the Soldier is "entitled to" his discharge, and should also present his discharge to the Paymaster to have the payment endorsed on it. The discharge is to be given back to the Soldier by the Paymaster; the latter only retaining as his voucher the duplicate certificates.

NOTE 2.—If the Soldier is entitled to pay for the use of his horse, the Company Commander will certify to that fact on the back of both these final statements, and also to the time he has pay due for having been so mounted on his own horse.

NOTE 3.—When a Soldier is furnished with final statements, his descriptive list, if he has one, should be taken up by the officer who gives the Soldier these statements, and endorsed with a statement to this effect by the officer. This endorsement should exhibit a full statement of the time for which the Soldier was allowed pay on his final statements, the clothing account, and all other charges against him or in his favor, so as to comprise a complete exhibit of his account. It will then be transmitted to the company commander of the Soldier, who will enter all the data necessary to a full understanding of the Soldier's account on the muster roll upon which the Soldier's discharge is reported. The descriptive list will then be destroyed. The object of this is, that the remaining portion of the Soldier's account may be settled upon the receipt of these muster rolls, and the Soldier receive any pay or allowances that may be due him at the time of his discharge, and which may not appear on his final statements from the fact that his descriptive list is incomplete. These accounts for back pay, &c., are settled by the 2d Auditor of the Treasury Department.

NOTE 4.—Charges for loss or injury to ordnance, horse equipments, and other miscellaneous charges, should appear under the heading of "Other Stoppages."

NOTE 5.—Bounty paid by State authorities, and not by the United States, will not be entered on this statement.

NOTE 6.—Amounts due the Sutler and Laundress must be entered on the muster roll on which the discharge, death, desertion, &c., is reported, as well as on the final statement, otherwise the amount cannot be collected from the United States.

NOTE 7.—This blank will be used for deceased volunteers and drafted men, as well as for others.

NOTE 8.—Where a Soldier dies in Hospital or on detached service, his descriptive list, if he has one, should be sent with his final statements, in duplicate, to the Second Auditor, Washington, D. C.

I certify, on honor, that Farrell Decatur a Private of
 Captain A. R. Walker's Company (2^d) of the 7th Regiment of Colored Troops
~~VOLUNTEERS~~, of the State of United States, born in Accomac, State
 of Virginia, aged 24 years; 5 feet 6 inches high; Dark complexion,
Blk eyes, Blk hair, and by occupation a Farmer, having joined the company on
 its original organization at Accomac Va., and enrolled in it at the muster into
 the service of the United States at Camp Stanton Md on the Fifth day
 of November, 1863, (~~or was mustered in service as a recruit, by~~
~~at~~, ~~on the~~ day of ~~186~~,
~~or was drafted and mustered into the service of the United States from the~~
~~Enrollment District of the State of~~, at ~~186~~,
~~on the~~ day of ~~186~~), to serve in the Regiment, for
 the term of Three years or during the war: and having served HONESTLY and
 FAITHFULLY with his Company in The Capacity of private the present date, is now
 entitled to a **DISCHARGE** by reason of

Death

The said Private Farrell Decatur was last paid by Paymaster
Maj. Malou to include the 31st day of December, 1863, and has
 pay due him from that time to the present date; he is entitled ~~to pay and subsistence for~~
~~TRAVELING~~ to place of enrollment, and whatever other allowances are authorized to volunteer
 soldiers, drafted men, or militia, so discharged. He has received from the United States **CLOTHING**
 amounting to Forty one 41 dollars, since the Fifth day of November,
 1863, when his clothing account was last settled. ~~He has received from the United States~~
~~100~~ dollars advanced **BOUNTY**.

~~There is to be stopped from him, on account of the State of~~, or other
 authorities, for **CLOTHING**, &c., received on entering service, ~~100~~ dollars; and
~~for other stoppages, viz:~~ for other stoppages 1 Bayonet & Scabbard
1 Body Belt 1 Canteen 1 Knapsack 1 Piece Shelter tent
~~100~~ dollars.

~~He has been furnished with TRANSPORTATION in kind from the place of his discharge to~~
~~;~~ and he has been **SUBSISTED** for **TRAVELING** to his
 place of enrollment, up to the ~~186~~.

~~He is indebted to~~ SUTLER ~~100~~ dollars
~~He is indebted to~~ LAUNDRESS ~~100~~ dollars.

Given in Duplicate, at Jacksonville Florida, this 7th day
 of April, 1864. The deceased did possess of no effects.

A. R. Walker
2^d Regt. U.S.C.
 Commanding Company.

FINAL STATEMENT

OF

Private Farrell Decatur
"I." Co.
7th Reg't of U.S. Colored Troops



~~VOLUNTEERS.~~

NOTE 1.—Two of these certificates (or duplicates) are to be given to each Volunteer Soldier or drafted man who may be discharged previously to the discharge of his company, that he may at once receive from the Paymaster the pay, &c., due him, and the captain or other COMMISSIONED officer commanding the company will certify to the act of the delivery of the duplicate certificates; on these certificates the Soldier is "entitled to" his discharge, and should also present his discharge to the Paymaster to have the payment endorsed on it. The discharge is to be given back to the Soldier by the Paymaster; the latter only retaining as his voucher the duplicate certificates.

NOTE 2.—If the Soldier is entitled to pay for the use of his horse, the Company Commander will certify to that fact on the back of both these final statements, and also to the time he has pay due for having been so mounted on his own horse.

NOTE 3.—When a Soldier is furnished with final statements, his descriptive list, if he has one, should be taken up by the officer who gives the Soldier these statements, and endorsed with a statement to this effect by the officer. This endorsement should exhibit a full statement of the time for which the Soldier was allowed pay on his final statements, the clothing account, and all other charges against him or in his favor, so as to comprise a complete exhibit of his account. It will then be transmitted to the company commander of the Soldier, who will enter all the data necessary to a full understanding of the Soldier's account on the muster roll upon which the Soldier's discharge is reported. The descriptive list will then be destroyed. The object of this is, that the remaining portion of the Soldier's account may be settled upon the receipt of these muster rolls, and the Soldier receive any pay or allowances that may be due him at the time of his discharge, and which may not appear on his final statements from the fact that his descriptive list is incomplete. These accounts for back pay, &c., are settled by the 2d Auditor of the Treasury Department.

NOTE 4.—Charges for loss or injury to ordnance, horse equipments, and other miscellaneous charges, should appear under the heading of "Other Stoppages."

NOTE 5.—Bounty paid by State authorities, and not by the United States, will not be entered on this statement.

NOTE 6.—Amounts due the Sutler and Laundress must be entered on the muster roll on which the discharge, death, desertion, &c., is reported, as well as on the final statement, otherwise the amount cannot be collected from the United States.

NOTE 7.—This blank will be used for deceased volunteers and drafted men, as well as for others.

NOTE 8.—Where a Soldier dies in Hospital or on detached service, his descriptive list, if he has one, should be sent with his final statements, in duplicate, to the Second Auditor, Washington, D. C.

I certify, on honor, that Farrell Decatur a Private of
 Captain A. R. Walker's Company (D) of the 7th Regiment of Colored Troops
~~VOLUNTEERS~~, of the State of United States, born in Accomac, State
 of Virginia, aged 24 years; 5 feet 6 inches high; Dark complexion,
Blk eyes, Blk hair, and by occupation a Farmer, having joined the company on
 its original organization at Accomac Virginia, and enrolled in it at the muster into
 the service of the United States at Camp Stanton Md, on the 1st day
 of November, 1863, (~~or was mustered in service as a recruit, by~~
~~at~~, ~~on the~~ day of ~~186~~,
~~or was drafted and mustered into the service of the United States from the~~
~~Enrollment District of the State of~~, ~~at~~,
~~on the~~ day of ~~186~~), to serve in the Regiment, for
 the term of Three years or during the war; and having served HONESTLY and
 FAITHFULLY with his Company in the Capacity of private to the present date, is now
 entitled to a **DISCHARGE** by reason of Death

The said Farrell Decatur was last paid by Paymaster
Maj Malone to include the 31st day of December, 1863, and has
 pay due him from that time to the present date; he is entitled ~~to pay and subsistence for~~
~~TRAVELING~~ to place of enrollment, and whatever other allowances are authorized to volunteer
 soldiers, drafted men, or militia, so discharged. He has received from the United States **CLOTHING**
 amounting to Forty one 41/100 dollars, since the Fourth day of November,
 1863, when his clothing account was last settled. ~~He has received from the United States~~
~~100~~ dollars advanced ~~BOUNTY~~.

~~There is to be stopped from him, on account of the State of~~, ~~or other~~
~~authorities, for clothing, &c, received on entering service,~~ ~~100~~ dollars; and
~~for other stoppages, viz:~~ For other stoppages 1 Bayonet & Scabbard 1 Budy belt
1 Canteen 1 Knapsack 1 Piece of Shelter tent
~~100~~ dollars.

~~He has been furnished with TRANSPORTATION in kind from the place of his discharge to~~
~~; and he has been SUBSISTED for TRAVELING to his~~
~~place of enrollment, up to the~~ ~~186~~.

~~He is indebted to~~ ~~CUTLER~~ ~~100~~ dollars.
~~He is indebted to~~ ~~LAUNDRESS~~ ~~100~~ dollars.

Given in Duplicate, at Jacksonville Florida, this 7th day
 of April, 1864. The deceased died possessed of no effects.

A. R. Walker
I Co. 7th Regt U.S.C.
 Commanding Company.

48 40

FINAL STATEMENT

-D-
OR

Private Farrell Decatur

7th Reg't of U.S.C.

VOLUNTEERS.

Died April 7th 1864

NOTE 1.—Two of these certificates (or duplicates) are to be given to each Volunteer Soldier or drafted man who may be discharged previously to the discharge of his company, that he may at once receive from the Paymaster the pay, &c., due him, and the captain or other COMMISSIONED officer commanding the company will certify to the act of the delivery of the duplicate certificates; on these certificates the Soldier is "entitled to" his discharge, and should also present his discharge to the Paymaster to have the payment endorsed on it. The discharge is to be given back to the Soldier by the Paymaster; the latter only retaining as his voucher the duplicate certificates.

NOTE 2.—If the Soldier is entitled to pay for the use of his horse, the Company Commander will certify to that fact on the back of both these final statements, and also to the time he has pay due for having been so mounted on his own horse.

NOTE 3.—When a Soldier is furnished with final statements, his descriptive list, if he has one, should be taken up by the officer who gives the Soldier these statements, and endorsed with a statement to this effect by the officer. This endorsement should exhibit a full statement of the time for which the Soldier was allowed pay on his final statements, the clothing account, and all other charges against him or in his favor, so as to comprise a complete exhibit of his account. It will then be transmitted to the company commander of the Soldier, who will enter all the data necessary to a full understanding of the Soldier's account on the muster roll upon which the Soldier's discharge is reported. The descriptive list will then be destroyed. The object of this is, that the remaining portion of the Soldier's account may be settled upon the receipt of these muster rolls, and the Soldier receive any pay or allowances that may be due him at the time of his discharge, and which may not appear on his final statements from the fact that his descriptive list is incomplete. These accounts for back pay, &c., are settled by the 2d Auditor of the Treasury Department.

NOTE 4.—Charges for loss or injury to ordnance, horse equipments, and other miscellaneous charges, should appear under the heading of "Other Stoppages."

NOTE 5.—Bounty paid by State authorities, and not by the United States, will not be entered on this statement.

NOTE 6.—Amounts due the Soldier and Landress must be entered on the muster roll on which the discharge, death, desertion, &c., is reported, as well as on the final statement, otherwise the amount cannot be collected from the United States.

NOTE 7.—This blank will be used for deceased volunteers and drafted men, as well as for others.

NOTE 8.—Where a Soldier dies in Hospital or on detached service, his descriptive list, if he has one, should be sent with his final statements, in duplicate, to the Adjutant General, Washington, D. C.

Sent by
Capt. R. P. Cas

Adjutant General's Office
Washington, D.C., July 26th 1864.
E.S. Vol. 7. Page 351.

The Muster and Muster-Roll
Rolls of Company Ist of the 16th S.
Calored Troops, report the death
of Private Farrell Decatur April
16th 1864.

The Final Statement of the
soldier reports date of death April
7th 1864.

The latter date (April seventh
1864) is held to be correct and
Company Rolls will be amended
accordingly.

J. B. Richardson
Private Colonel, U. S. A.
In Charge Bureau Col^d Troops

For
John Jones
See letter of June
7. 64 to R. P. Cas

War Dept. Oyo.
April 23^d 1864
Respectfully returned for
date, place and cause of
death

Geo. Taggart
Adj.

ADJUTANT GENERAL'S OFFICE.
May 30th 1864
Duplicate with Inventory sent 2d Auditor.

I certify, on honor, that Farrell Decatur a Private of
 Captain A. R. Walker's Company (2) of the 7th Regiment of Colored Troops
~~VOLUNTEERS~~, of the State of United States, born in Accomac, State
 of Virginia, aged 24 years; 5 feet 6 inches high; Dark complexion,
Blk eyes, Blk hair, and by occupation a Farmer, having joined the company on
 its original organization at Accomac Va., and enrolled in it at the muster into
 the service of the United States at Camp Stanton Md., on the Fifth day
 of November, 1863, (~~or was mustered in service as a recruit, by~~
~~at~~, ~~on the~~ day of ~~186~~
~~or was drafted and mustered into the service of the United States from the~~
~~Enrollment District of the State of~~, at ~~on the~~ day of ~~186~~),

to serve in the Regiment, for
 the term of Three years or during the war; and having served HONESTLY and
 FAITHFULLY with his Company in the capacity of private to the present date, is now
 entitled to a **DISCHARGE** by reason of Death from General debility
at Jacksonville Fla. Apr 7 1864

The said Farrell Decatur was last paid by Paymaster
Maj. Malone to include the 31st day of December, 1863, and has
 pay due him from that time to the present date; he is entitled ~~to pay and subsistence for~~
~~TRAVELING~~ to place of enrollment, and whatever other allowances are authorized to volunteer
 soldiers, drafted men, or militia, so discharged. He has received from the United States **CLOTHING**
 amounting to Forty one $\frac{4}{10}$ dollars, since the Tenth day of November,
 1863, when his clothing account was last settled. ~~He has received from the United States~~
~~dollars advanced~~ **FOUNT**

~~There is to be stopped from him, on account of the State of~~, or other
 authorities, for ~~clothing, &c.~~, received on entering service, ~~100~~ dollars; and
 for other stoppages, viz: For Mr. Stoppages / Bayonet / Scabbard
1 / Body belt / Carbine / Knapsack / Rice / Shelter tent,
~~100~~ dollars

~~He has been furnished with TRANSPORTATION~~ in kind from the place of his discharge to
~~place of enrollment, up to the~~, 1863.
~~and he has been SUBSISTED for TRAVELING to his~~

He is indebted to ~~SUTLER~~ ~~100~~ dollars
 He is indebted to ~~LAUNDRESS~~ ~~100~~ dollars

Given in Duplicate, at Jacksonville Florida, this 7th day
 of April, 1864.

A. R. Walker
Co. 7th Regt U.S.C.
 Commanding Company.

7
Surgeon General's Office,
Record and Pension Division,

Feb 24th 1867.

Respectfully returned to

Asst Adj't
Genl J. W. Saggard A. G. C.

It appears from the records of U. S. Genl
Hosp Jacksonville Florida
on file in this Office, that Pvt. Fannet

Decatur. Pvt Co N 7 U. S. C. T.

(supposed to be the soldier referred
to within) was admitted Mar 23.

1864. - and died at that Hospital

April 7. 1864 from Pneumonia.

No evidence on file from
which Final Statements or
Inventory can be prepared.

By Order of the Surgeon General:

J. D. M.
Bvt. Major and Assistant Surgeon U. S. A.
1867
OFFICE, SURGEON GENERAL'S

RCF.
2847
VOL. 4

7
Surgeon General's Office,
Record and Pension Division,

Feb 24th 1867.

Respectfully returned to

Asst Adj't
Genl J. W. Saggard A. G. C.

It appears from the records of U.S. Genl
Hosp Jacksonville Florida
on file in this Office, that Privet James

Decatur Privet Co N^o 7 U.S.C.T.

(supposed to be the soldier referred
to within) was admitted Mar 23.

1864. - and died at that Hospital

April 7. 1864 from Bronchitis.

No evidence on file from
which Final Statements or
Inventory can be prepared.

By Order of the Surgeon General:

J. W. Saggard
Br. Major and Assistant Surgeon U. S. A.

R.O.F.A.
22847
VOL. 4

RECEIVED
FEB 24 1867
OFFICE. STAFFS

387

Decker George

Co - , 7 U.S. Col'd Inf.

Private | *Private*

CARD NUMBERS.

1	6482267	26
2	6279122	27
3		28
4		29
5		30
6		31
7		32
8		33
9		34
10		35
11		36
12		37
13		38
14		39
15		40
16		41
17		42
18		43
19		44
20		45
21		46
22		47
23		48
24		49
25		50

Book Mark:

See also

A | 7 | U.S.C.T.

George Deaker

Appears with rank of _____ on
**Muster and Descriptive Roll of a Detach-
ment of Drafted Men and Substitutes
forwarded**

for the *7* Reg't U. S. Col'd Inf. Roll dated
Baltimore Md. Apr 3 1863

Where born *Virginia*

Age *24* years; occupation *Waiter*

Drafted and mustered in:

When *Mar 23*, 1863

Where *Wilmington Del.*

Period *2* years.

Eyes *Blk*; hair *Blk*

Complexion *Blk*; height *5' 1/2* in.

Paid bounty and advance pay, \$ *100*

Bounty due \$ *100*

Where credited _____

Company to which assigned _____

Remarks: *Sub for R. L. Armstrong
New Castle Co. Del.*

Book mark: _____

J. M. Farley
(340) Copyist

NARA 516

A 1 7 U.S.C.T.

George Decker

Appears with rank of *Private* on

Muster and Descriptive Roll of a Detachment of Drafted Men and Substitutes forwarded

for the *7* Reg't U. S. Col'd Inf. Roll dated *Nov dated*, 186 .

Where born *Virginia*

Age *24* years; occupation *Writer*

Drafted and mustered in:

When *March 23*, 1865.

Where *Wilmington Del.*

Period *2* years.

Eyes *Black*; hair *Black*

Complexion *Black*; height *5 ft. 4 1/2 in.*

Paid bounty and advance pay, \$ *100*

Bounty due \$ *100*

Where credited _____

Company to which assigned _____

Remarks: *Substitute for Robt Armstrong Enrolled (over)*

Book mark: _____

Deadrick
Cpyist.

FEB. - 3.

6482267

1891*

*Notation up on rolls
of regt*

382

Deitcher, Henry

Co B, 7 U.S. Col'd Inf.

Private

CARD NUMBERS.

1	<i>See Deitcher, Henry</i>	26
2		27
3		28
4		29
5		30
6		31
7		32
8		33
9		34
10		35
11		36
12		37
13		38
14		39
15		40
16		41
17		42
18		43
19		44
20		45
21		46
22		47
23		48
24		49
25		50

Book Mark:

See also

383

Wemy Benjamin

Co. A, 7 U.S. Col'd Inf.

Private

Private

CARD NUMBERS.

1	6279846	26
2	6279947	27
3	6280056	28
4	6280150	29
5	6280254	30
6	6280352	31
7	6280450	32
8	6280548	33
9	6280647	34
10	6280746	35
11	6280846	36
12	6280948	37
13	6281049	38
14	6281148	39
15	6281244	40
16	6281336	41
17	6281422	42
18	6281505	43
19	6281588	44
20	6281670	45
21	9065595	46
22		47
23		48
24		49
25		50

Book Mark:

See also

D

7

U.S.C.T.

Benjamin Dumb

, Co. *A*, 7 Reg't U.S. Col'd Inf.

Appears on

Company Descriptive Book

of the organization named above.

DESCRIPTION.

Age *24* years; height *5* feet *6 3/4* inches.

Complexion *Blk.*

Eyes *Blk.*; hair *Curly*

Where born *Talbot, Md.*

Occupation *Farmer*

ENLISTMENT.

When *Sept. 23d.*, 186*2*.

Where *Baltimore, Md.*

By whom *Col. H. Binney*; term *3* y'rs.

Remarks:

Mustered Sept. 26, 63.

J. Smith,

9 | 7 | U.S.C.T.

Benjamin Demby
Co. A, 7 Reg't U. S. Col'd Infantry.

Appears on

Company Muster Roll

for from Sept. 26 to Oct. 31, 1863.

Joined for duty and enrolled:

When Sept. 23, 1863.*

Where Talbot Co. Md. *

Period 3 years.*

Present or absent Absent.

Stoppage, \$ 100 for

Due Gov't \$ 100 for

Remarks: Detached on recruiting
service in St. Mary's Co. Md.

* See enrollment on card from muster-in roll.

Book mark:

Baggett

G

7

U.S.C.T.

Benjamin Gemby
Pvt., Co. A, 7 Reg't U. S. Col'd Infantry.

Appears on

Company Muster Roll

for *Nov. & Dec.*, 1863.

Joined for duty and enrolled:

When *Sept. 23*, 1863.*

Where *Talbot Co. Md.**

Period *3* years.*

Present or absent *Present.*

Stoppage, \$ *100* for

Due Gov't \$ *100* for

Remarks: *Enlistment premium
of \$2.00 due.*

* See enrollment on card from muster-in roll.

Book mark:

Daggett

9

7

U.S.C.T.

Benjamin Gemby
Pt., Co. A, 7 Reg't U. S. Col'd Infantry.

Appears on

Company Muster Roll

for Jan. & Feb., 1864.

Joined for duty and enrolled:

When Sept. 23, 1863.*

Where Talbot Co., Md.*

Period 3 years.*

Present or absent Present.

Stoppage, \$ 100 for

Due Gov't \$ 100 for

Remarks: Joined from Recruiting
Feb. 5 1864 Enlistment
premium due.

* See enrollment on card from muster-in roll.

Book mark:

Daggett

9 | 7 | U.S.C.T.

Benjamin Gemby
Priv., Co. A, 7 Reg't U. S. Col'd Infantry.

Appears on

Company Muster Roll

for Mar. & Apr., 1864.

Joined for duty and enrolled:

When Sept. 23, 1863.*

Where Talbot Co. Md.*

Period 3 years.*

Present or absent Present.

Stoppage, \$ 100 for

Due Gov't \$ 100 for

Remarks:

* See enrollment on card from muster-in roll.

Book mark: -----

(358c)

Daggett

Copyist.

9 | 7 | U.S.C.T.

Benjamin Demby
Priv., Co. A, 7 Reg't U. S. Col'd Infantry.

Appears on

Company Muster Roll

for *May & June*, 1864.

Joined for duty and enrolled:

When *Sept. 23*, 1863.*

Where *Falbot Co. Md.**

Period *3* years.*

Present or absent *Absent.*

Stoppage, \$ *100* for

Due Gov't \$ *100* for

Remarks: *Absent sick in Jacksonville since June 28/64*

* See enrollment on card from muster-in roll.

Book mark:

Gaggett
(358c) Copyist.

9 | 7 | U.S.C.T.

Benjamin Demby
Pvt., Co. A, 7 Reg't U. S. Col'd Infantry.

Appears on

Company Muster Roll

for *July & Aug.*, 186*4*.

Joined for duty and enrolled:

When *Sept. 23*, 186*3*.*

Where *Talbot Co. Md.* *

Period *3* years.*

Present or absent *Present*

Stoppage, \$ *100* for

Due Gov't \$ *100* for

Remarks: *Stop for one haversack*

* See enrollment on card from muster-in roll.

Book mark:

Waggett

D | **7** | **U.S.C.T.**

Benjamin Lemby
Privt, Co. A, 7 Reg't U. S. Col'd Infantry.

Appears on

Company Muster Roll

for *Sept & Oct.*, 1864.

Joined for duty and enrolled:

When *Sept 23*, 1863.*

Where *Talbot*.*

Period _____ years.*

Present or absent *Present*

Stoppage, \$ 100 for _____

Due Gov't \$ 100 for _____

Remarks: *Stop for one set of metallic scales, couple*

* See enrollment on card from muster-in roll.

Book mark: _____

Conard
Copyist.

9 | 7 | U.S.C.T.

Benjamin Demby
Pvt., Co. A, 7 Reg't U. S. Col'd Infantry.

Appears on

Company Muster Roll

for Nov. & Dec., 1864.

Joined for duty and enrolled:

When Sept. 23, 1863.*

Where Talbot, Md.*

Period 3 years.*

Present or absent Present

Stoppage, \$ 100 for

Due Gov't \$ 100 for

Remarks: Stop for one set of metallic scales. Detached Nov. 6, per S.O. 13, 1 Brig 3 Div 10 A.C.

* See enrollment on card from muster-in roll.

Book mark:

(358c)

Conard
Copyist.

NARA 529

D | 7 | U.S.C.T.

Benjamin Demby
Pvt., Co. A, 7 Reg't U. S. Col'd Infantry.

Appears on

Company Muster Roll

for *Jan & Feb*, 1865.

Joined for duty and enrolled:

When *Sept. 23*, 1863.*

Where *Talbot, Md* *

Period *3* years.*

Present or absent *Present*.

Stoppage, \$ *100* for

Due Gov't \$ *100* for

Remarks:

* ~~See~~ See enrollment on card from muster-in roll.

Book mark: _____

(358c) *Conard* Copyist.

D |

7

U.S.C.T.

Benjamin Demby
Pvt., Co. A, 7 Reg't U. S. Col'd Infantry.

Appears on

Company Muster Roll

for Mch. & Apr., 1865.

Joined for duty and enrolled:

When Sept 23, 1863.*

Where Talbot.*

Period 3 years.*

Present or absent Present.

Stoppage, \$ 100 for

Due Gov't \$ 100 for

Remarks:

* See enrollment on card from muster-in roll.

Book mark:

(358c)

Conard
Copyist.

D

7

U.S.C.T.

Benjamin Derby
Pvt, Co. A, 7 Reg't U. S. Col'd Infantry.

Appears on

Company Muster Roll

for *May & June*, 1865.

Joined for duty and enrolled:

When *Sept 23*, 1863.*

Where *Talbot* *

Period *3* years.*

Present or absent *Present*

Stoppage, \$ *100* for

Due Gov't \$ *100* for

Remarks:

* See enrollment on card from muster-in roll.

Book mark

(358c)

Conard
Copyist.

D | **7** | **U.S.C.T.**

Benjamin Demby
Priv., Co. A, 7 Reg't U. S. Col'd Infantry.

Appears on

Company Muster Roll

for *July & Aug.*, 1865.

Joined for duty and enrolled:

When *Sept. 23*, 1863.*

Where *Talbot Co. Md.* *

Period *3* years.*

Present or absent *Present*

Stoppage, \$ *100* for

Due Gov't \$ *100* for

Remarks:

* See enrollment on card from muster-in roll.

Book mark: _____

(358c)

Conard
Copyist.

D | 7 | U.S.C.T.

Benjamin Demby
Pvt., Co. A, 7 Reg't U. S. Col'd Infantry.

Appears on

Company Muster Roll

for Sept. & Oct., 1865.

Joined for duty and enrolled:

When Sept. 23, 1863.*

Where Talbot *

Period 3 years.*

Present or absent Present.

Stoppage, \$ 100 for

Due Gov't \$ 100 for

Remarks:

* See enrollment on card from muster-in roll.

Book mark:

(358c)

Conard
Copyist.

D | **7** | **U.S.C.T.**

William Demby
Pvt., Co. A, 7 Reg't U. S. Col'd Infantry.

Appears on

Company Muster Roll
for *Nov. 9 Dec*, 186*5*.

Joined for duty and enrolled:

When *Sep 23*, 186*3*.*

Where *Talbot Co. Md.* *

Period *3* years.*

Present or absent *Present*

Stoppage, \$ *100* for

Due Gov't \$ *100* for

Remarks:

* ~~See~~ See enrollment on card from muster-in roll.

Book mark: -----

(358c)

James J.
Copyist.

D | **7** | **U.S.C.T.**

Benjamin Semby
Co. A, 7 Reg't U. S. Col'd Infantry.

Appears on

Company Muster Roll

for *me + Feb*, 186*6*.

Joined for duty and enrolled:

When *Sep 23*, 186*3*.*

Where *Salvador, Ind.**

Period *3* years.*

Present or absent *Present*

Stoppage, \$ *65* for *6 + GE*

Due Gov't \$ *100* for

Remarks:

* See enrollment on card from muster-in roll.

Book mark: _____

(858c)

Howing J.
Copyist.

21 7 U.S.C.T.

Benjamin Dewby
Priv., Co. A, 7 Reg't U. S. Col'd Infantry.

Appears on

Company Muster Roll
for Nov & Dec, 1866.

Joined for duty and enrolled:

When Sep 23, 1863.*

Where Gallop Co. Md.*

Period 3 years.*

Present or absent Present

Stoppage, \$ 100 for

Due Gov't \$ 100 for

Remarks:

* See enrollment on card from muster-in roll.

Book mark:

(358c)

Copyist.

21

7

U.S.C.T.

Benjamin Demby
Co. A, 7 Reg't U. S. Col'd Infantry.

Appears on

Company Muster Roll

for May & June, 1866.

Joined for duty and enrolled:

When Sep 23, 1863.*

Where Talbot Co. Md.*

Period 3 years.*

Present or absent Present

Stoppage, \$ 100 for

Due Gov't \$ 100 for

Remarks:

* See enrollment on card from muster-in roll.

Book mark:

(358c)

Copyist.

91 7 U.S.C.T.

Benjamin Demby
Pri, Co. A, 7 Reg't U. S. Col'd Infantry.

Appears on

Company Muster Roll

for July 9 Aug, 1866.

Joined for duty and enrolled:

When Sep 23, 1863.*

Where Gallatin Co. Ind.*

Period 3 years.*

Present or absent Present

Stoppage, \$ 100 for

Due Gov't \$ 100 for

Remarks:

* See enrollment on card from muster-in roll.

Book mark:

(358c)

Mowry J. Copyist.

D

7

U.S.C.T.

Benjamin Demby

Priv. Co. A, 7 Reg't U. S. Col'd Infantry.

Appears on **Co. Muster-out Roll**, dated

Indianola, Tex, Oct 13, 1866 .

Muster-out to date

Oct 13, 1866 .

Last paid to

June 30, 1866 .

Clothing account:

Last settled, 186 ; drawn since \$ $\frac{100}{100}$

Due soldier \$ *17* $\frac{29}{100}$; due U. S. \$ $\frac{100}{100}$

Am't for cloth'g in kind or money adv'd \$ $\frac{100}{100}$

Due U. S. for arms, equipments, &c., \$ $\frac{6}{100}$

Bounty paid \$ *None* $\frac{100}{100}$; due \$ *100* $\frac{00}{100}$

Remarks: *owned Orig. Ordnance Returns, Springfield Rifle & Musket & Set of Accoutrements, per G.O. 101, War Dept, May 30/65*

Book mark: *V 166 P 225 73*

(361)

Henry J. Copyist.

G | **7** | **U.S.C.T.**

Benjamin Lemby
Priv., Co. *A*, 7 Reg't U. S. Colored Inf.

Age *24* years.

Appears on

Company Muster-in Roll

of the organization named above. Roll dated

Baltimore Md. Sept. 26, 1863.

Muster-in to date

Sept. 26, 1863.

Joined for duty and enrolled:

When *Sept. 23*, 1863.*

Where *Talbot Co. Md.* *

Period *3* years.*

Remarks:

*Muster-in roll shows enrollment of all men of this company as of same date. See enrollment on subsequent card or cards.

Book mark:

Gaggett

Demby Lewis

Co *B*, *7* U.S. Col'd Inf.

Private

CARD NUMBERS.

1	6281803	26
2	6281902	27
3	6282003	28
4	6282100	29
5	6282200	30
6	6282299	31
7	6282395	32
8	6282488	33
9	6282589	34
10	6282682	35
11	6282783	36
12	6282880	37
13	6282974	38
14	6283066	39
15	6283150	40
16	6283224	41
17	6283296	42
18	6283367	43
19	6283436	44
20	9266021	45
21	D 63 - R.C.T. - 1867	46
22		47
23		48
24		49
25		50

Book Mark: *D. 63, Vol. 5 - R.C.T. - 1867.*

See also

9

7

U.S.C.T.

Lewis Demby
Co. B, 7 Reg't U.S. Col'd Inf.

Appears on
Company Descriptive Book
of the organization named above.

DESCRIPTION.

Age 25 years; height 5 feet 8 3/4 inches.
Complexion Blue.
Eyes Blue; hair curly.
Where born Talbot, Md.
Occupation Farmer.

ENLISTMENT.

When Sept. 21, 1863.
Where Baltimore, Md.
By whom Col. W. Binney; term 3 y'rs.
Remarks: Mustered Sept. 26, 63 by
Col. Wm. Binney.

J. Smith

D | 7 | U.S.C.T.

Lewis Demby.

, Co. B., 7 Reg't U.S. Colored Inf.

Age 25 years.

Appears on

Company Muster-in Roll

of the organization named above. Roll dated

Baltimore Md, Sept 26, 1863.

Muster-in to date Sept 26, 1863.

Joined for duty and enrolled:

When Sept 23, 1863.*

Where Calbot Cr. Md. *

Period 2 years.*

Remarks:

*Muster-in roll shows enrollment of all men of this company as of same date. See enrollment on subsequent card or cards.

Book mark: D 63-REG-1867

(356c) J. G. Casey (Official)

9 | 7 | U.S.C.T.

Lewis Demby.
Privt., Co. B, 7 Reg't U. S. Col'd Infantry.

Appears on

Company Muster Roll
for Sept 26th to Oct 9th, 1863.

Joined for duty and enrolled:

When Sept 26th, 1863.*

Where Talbot Co. Md.*

Period 3 years.*

Present or absent Present

Stoppage, \$ 100 for

Due Gov't \$ 100 for

Remarks:

* See enrollment on card from muster-in roll.

Book mark:

(358c)

J. E. Casey Copyist.

9

7

U.S.C.T.

Lewis Demby

Privt, Co. B, 7 Reg't U. S. Col'd Infantry.

Appears on

Company Muster Roll

for *Nov & Dec*, 186*9*.

Joined for duty and enrolled:

When *Sept 23*, 186*9*.*

Where *Falbot*.*

Period *3* years.*

Present or absent *Present*

Stoppage, \$ *100* for

Due Gov't \$ *100* for

Remarks: *Enlistment premium*
\$2.00 due

* See enrollment on card from muster-in roll.

Book mark:

(358c)

J. Demby

Copyist.

9 | 7 | **U.S.C.T.**

Lewis Demby

Privt, Co. B, 7 Reg't U. S. Col'd Infantry.

Appears on

Company Muster Roll

for Jan & Feb., 1864.

Joined for duty and enrolled:

When Sept 23", 1863.*

Where Salbot.*

Period 3 years.*

Present or absent Present

Stoppage, \$ 100 for

Due Gov't \$ 100 for

Remarks: Stop pay for one month
\$ 2.00 Enrollment premium
due

* See enrollment on card from muster-in roll.

Book mark:

(358c) J. S. Casey Copyist.

2

7

U.S.C.T.

Lewis Embury

Privt, Co. B, 7 Reg't U.S. Col'd Infantry.

Appears on

Company Muster Roll

for *March & April*, 186*4*.

Joined for duty and enrolled:

When *Sept 23rd*, 186*3*.*

Where *Salvator, Md* *

Period *3* years.*

Present or absent *Present*

Stoppage, \$ *100* for

Due Gov't \$ *100* for

Remarks: *Stop 1/2 allowance*

* ~~See~~ See enrollment on card from muster-in roll.

Book mark:

(358c)

J. G. Casey

Copyist.

D | 7 | U.S.C.T.

Lewis Demby
Privat, Co. B, 7 Reg't U. S. Col'd Infantry.

Appears on

Company Muster Roll

for May & June, 1864.

Joined for duty and enrolled:

When Sept 23, 1863.*

Where Talbot, Md.*

Period 3 years.*

Present or absent Present.

Stoppage, \$ 100 for

Due Gov't \$ 100 for

Remarks:

* See enrollment on card from muster-in roll.

Book mark:

(358c)

J. S. Casper

Copyist.

D. | 7.

U.S.C.T.

Lewis Demby

Privt, Co. B., 7 Reg't U.S. Col'd Inft.

Appears on

Company Muster Roll

for July & Aug, 1864.

Joined for duty and enrolled:

When Sept 23, 1863.*

Where Gallot, Md.*

Period years.*

Present or absent Present.

Stoppage, \$ 100 for

Due Gov't, \$ 100 for

Remarks:

* See enrollment on card from muster-in roll.

Book mark:

J. B. Curry

D | 7 | U.S.C.T.

Lewis Derby
Pvt, Co. B, 7 Reg't U. S. Col'd Infantry.

Appears on

Company Muster Roll
for Sept & Oct, 1864.

Joined for duty, and enrolled:

When Sept 23, 1863.*

Where Tallbot, Mo.*

Period 3 years.*

Present or absent Present

Stoppage, \$ 100 for

Due Gov't \$ 100 for

Remarks: Stop 1 Kuap-
Dach

* See enrollment on card from muster-in roll.

Book mark:

(358c) W. B. Log Copyist.

D | 7 | U.S.C.T.

Lewis Demby

Pvt, Co. B, 7 Reg't U. S. Col'd Infantry.

Appears on

Company Muster Roll

for *Nov + Dec*, 1864

Joined for duty and enrolled:

When *Sept 23*, 1863*

Where *Talbot Md**

Period *3* years.*

Present or absent *Present*

Stoppage, \$ *100* for

Due Gov't \$ *100* for

Remarks: *Stopped for ' Knapsack*

* See enrollment on card from muster-in roll.

Book mark:

W. J. Doe

D | 7 | U.S.C.T.

Lewis Demby
Pvt, Co. B, 7 Reg't U. S. Col'd Infantry.

Appears on

Company Muster Roll
for Jan & Feb, 1861.

Joined for duty and enrolled:

When Sept 23, 1861.*

Where Falbot Md *

Period 3 years.*

Present or absent Present

Stoppage, \$ 100 for

Due Gov't \$ 100 for

Remarks:

* See enrollment on card from muster-in roll.

Book mark:

(358c) W. D. [Signature] Copyist.

2 | 7 | U.S.C.T.

Lewis Demby
Pvt, Co. B, 7 Reg't U. S. Col'd Infantry.

Appears on

Company Muster Roll
for Sept 28 to June 30, 1861.

Joined for duty and enrolled:

When Sept 23, 1861.*

Where Fall at Co. Md.*

Period 3 years.*

Present or absent Present

Stoppage, \$ 100 for

Due Gov't \$ 100 for

Remarks: Stop for 1 Piece
Shelter tent

* See enrollment on card from muster-in roll.

Book mark:

(358c) W. B. Doe Copyist.

D | 7 | U.S.C.T.

Lewis Demby
Pvt, Co. B, 7 Reg't U. S. Col'd Infantry.

Appears on

Company Muster Roll
for July, & Aug, 1865.

Joined for duty and enrolled:

When Sept 23, 1863.*

Where Talbot Co. Md.*

Period 3 years.*

Present or absent Present

Stoppage, \$ 100 for

Due Gov't \$ 100 for

Remarks:

* See enrollment on card from muster-in roll.

Book mark:

[Signature]
Copyist.

D | 7 | U.S.C.T.

Lewis Demby
Private, Co. B, 7 Reg't U. S. Col'd Infantry.

Appears on

Company Muster Roll
for Sept & Oct, 1861.

Joined for duty and enrolled:

When Sept 23, 1861.*

Where Talbot Co Md *

Period 3 years.*

Present or absent Present

Stoppage, \$ 30/100 for Advance

Due Gov't \$ 100 for

Remarks:

* See enrollment on card from muster-in roll.

Book mark:

W. S. [Signature]

D | 7 | U.S.C.T.

Lewis Deuby
Pvt, Co. B, 7 Reg't U. S. Col'd Infantry.

Appears on

Company Muster Roll

for Nov 22, 1861.

Joined for duty and enrolled:

When Sept 23, 1861 *

Where Talbot Co Md *

Period 3 years.*

Present or absent Present

Stoppage, \$ 100 for

Due Gov't \$ 100 for

Remarks:

* See enrollment on card from muster-in roll.

Book mark:

Copyist.

D

7

U.S.C.T.

Lewis Denby

Pr, Co. B, 7 Reg't U. S. Col'd Infantry.

Appears on

Company Muster Roll

for *Jan'y*^{4th} *Feb*, 1864.

Joined for duty and enrolled:

When *sep 23*, 1863*

Where *Falboles md**

Period *3* years.*

Present or absent *Present*

Stoppage, \$ *100* for

Due Gov't \$ *100* for

Remarks:

* ~~See~~ See enrollment on card from muster-in roll.

Book mark: _____

Holbrook

SP

7

U.S.C.T.

Lewis Derby

Pn, Co. B, 7 Reg't U. S. Col'd Infantry.

Appears on

Company Muster Roll

for *Mch^{and} apr*, 1866.

Joined for duty and enrolled:

When *sep 23*, 1863.*

Where *Falbot md* *

Period *3* years.*

Present or absent *Present*

Stoppage, \$ *100* for

Due Gov't \$ *100* for

Remarks:

* See enrollment on card from muster-in roll.

Book mark:

Holbrook

(358c)

Copyist.

D

7

U.S.C.T.

Lewis Demby

Pri, Co. B, 7 Reg't U. S. Col'd Infantry.

Appears on

Company Muster Roll

for *May and June*, 186*6*.

Joined for duty and enrolled:

When *Sept 23*, 186*3**

Where *Balboys Geo. Md**

Period *3* years.*

Present or absent *Present*

Stoppage, \$ *100* for

Due Gov't \$ *100* for

Remarks:

* See enrollment on card from muster-in roll.

Book mark: _____

Holtbrook

D

7

U.S.C.T.

Lewis Demby

Pvt, Co. B, 7 Reg't U. S. Col'd Infantry.

Appears on

Company Muster Roll

for *July and Aug*, 186*6*.

Joined for duty and enrolled:

When *Sept. 23*, 186*3*.*

Where *Halbot's 2nd* *

Period *3* years.*

Present or absent *Present*

Stoppage, \$ *100* for

Due Gov't \$ *100* for

Remarks:

* See enrollment on card from muster-in roll.

Book mark: -----

(358c)

Halbrook

Copyist.

D | **7** | **U.S.C.T.**

Lewis Derby
Pi, Co. *D*, 7 Reg't U. S. Col'd Infantry.

Appears on **Co. Muster-out Roll**, dated
Indianola Tex, *Oct 13*, 1866.

Muster-out to date *Oct 13*, 1866.

Last paid to *June 30*, 1866.

Clothing account:

Last settled....., 186 ; drawn since \$..... 100

Due soldier \$ *14*^{*6/100*}; due U. S. \$..... 100

Am't for cloth'g in kind or money adv'd \$..... 100

Due U. S. for arms, equipments, &c., \$ *6* 100

Bounty paid \$..... 100; due \$ *100* 100

Remarks: *Found original organization*
Warrior Enfield Rifled musket
and complete set of accoutrements for
Co. D, 101 regt DEPT May 30. 1865

Book mark: *817-1831 1863 vol.*

8 12 63^x - 1867^x discharged
x corrected by J. B. Druel, Ex
Holbrook

D. 17" U.S. 6 J.
Lewis Demby
Co. B, 7" Reg't U.S. 6 J.

NOTATION.

Book mark: D. 63. B. 6. J. 1867.

War Department,
Adjutant General's Office,

Washington, Augt. 13th, 1867.
Discharge on file.

(438) E. P. Conroyer. Copyist.

505

Demby Thomas J.

Co. A, 7 U.S. Col'd Inf.

Private

Private

CARD NUMBERS.

1	6279847	26
2	6279948	27
3	6280051	28
4	6280151	29
5	6280255	30
6	6280353	31
7	6280451	32
8	6280611	33
9	6281742	34
10	9065896	35
11		36
12		37
13		38
14		39
15		40
16		41
17		42
18		43
19		44
20		45
21		46
22		47
23		48
24		49
25		50

Book Mark:

See also

S. 184396 800m
S. 1847165 000m

O

7

U.S.C.T.

Thomas J. Demby

Co. *A*, 7 Reg't U.S. Col'd Inf.

Appears on

Company Descriptive Book

of the organization named above.

DESCRIPTION.

Age *21* years; height *5* feet *5* inches.

Complexion *Griff*

Eyes *Blk.*; hair *Leuly.*

Where born *Queen Anne, Md.*

Occupation *Fanner.*

ENLISTMENT.

When *Sept. 23rd.*, 186*3*.

Where *Baltimore.*

By whom *Col. W. Binney*; term *3* y'rs.

Remarks: *Killed in action*

Sept. 29, 1864. Front Richmond Va.

Mustered Sept. 26, 63.

J. Smith

G | **7** | **U.S.C.T.**

Thomas J. Demby
Pvt., Co. *A*, 7 Reg't U. S. Colored Inf.

Age *21* years.

Appears on

Company Muster-in Roll

of the organization named above. Roll dated

Baltimore Md., Sept. 26, 1863.

Muster-in to date *Sept. 26, 1863.*

Joined for duty and enrolled:

When *Sept. 23*, 1863.*

Where *Queen Ann Co. Md.* *

Period *3* years.*

Remarks:

*Muster-in roll shows enrollment of all men of this company as of same date. See enrollment on subsequent card or cards.

Book mark:

Daeggett

2 | 7 | U.S.C.T.

Thomas J. Demby

Priv., Co. A, 7 Reg't U. S. Col'd Infantry.

Appears on

Company Muster Roll

for from Sept. 26 to Oct. 31, 1863.

Joined for duty and enrolled:

When Sept. 23, 1863.*

Where Queen Ann Co. Md.*

Period 3 years.*

Present or absent Absent.

Stoppage, \$ 100 for

Due Gov't \$ 100 for

Remarks: Detached on recruiting service in St. Mary's Co. Md.

* See enrollment on card from muster-in roll.

Book mark:

Daggett

G | 7 | U.S.C.T.

Thomas J. Demby
Pvt., Co. A, 7 Reg't U. S. Col'd Infantry.

Appears on

Company Muster Roll

for *Nov. & Dec.*, 1863.

Joined for duty and enrolled:

When *Sept. 23*, 1863.*

Where *Queen Anne Lee Md.**

Period *3* years.*

Present or absent *Present,*

Stoppage, \$ *100* for

Due Gov't \$ *100* for

Remarks: *Enlistment premium
of \$2.00 due.*

* See enrollment on card from muster-in roll.

Book mark:

Daggett

9 | 7 | U.S.C.T.

Thomas J. Gemby
Cpl., Co. A, 7 Reg't U. S. Col'd Infantry.

Appears on

Company Muster Roll

for Jan. & Feb., 1864.

Joined for duty and enrolled:

When Sept. 23, 1863.*

Where Queen Ann Co. Md. *

Period 3 years.*

Present or absent Present.

Stoppage, \$ 100 for

Due Gov't \$ 100 for

Remarks: Enlistment premium
due.

* See enrollment on card from muster-in roll.

Book mark:

Daggett

9 | 7 | U.S.C.T.

Thomas J. Demby
Priv., Co. A, 7 Reg't U. S. Col'd Infantry.

Appears on

Company Muster Roll
for Mar. & Apr., 1864.

Joined for duty and enrolled:

When Sept. 23, 1863.*

Where Queen Ann Co., Md. *

Period 3 years.*

Present or absent Present.

Stoppage, \$ 100 for

Due Gov't \$ 100 for

Remarks:

* See enrollment on card from muster-in roll.

Book mark:

Daggett
(358c) Copyist.

9 | 7 | **U.S.C.T.**

Thomas J. Gemby
Pvt., Co. A, 7 Reg't U. S. Col'd Infantry.

Appears on

Company Muster Roll

for *May & June*, 186*4*.

Joined for duty and enrolled:

When *Sept. 23*, 186*3*.*

Where *Queen Anne Co. Md.**

Period *3* years.*

Present or absent *Absent.*

Stoppage, \$ *100* for

Due Gov't \$ *100* for

Remarks: *Absent sick in Jacksonville since June 28/64*

* See enrollment on card from muster-in roll.

Book mark:

Daggett

9

7

U.S.C.T.

Thomas J. Demby

Pvt., Co. A, 7 Reg't U. S. Col'd Infantry.

Appears on

Company Muster Roll

for July & Aug., 1864.

Joined for duty and enrolled:

When Sept. 23, 1863.*

Where Queen Anne Co., Md. *

Period 3 years.*

Present or absent Absent.

Stoppage, \$ 100 for

Due Gov't \$ 100 for

Remarks: Absent sick in Jacksonville Fla. since June 28th 1864.

* See enrollment on card from muster-in roll.

Book mark:

Daggett

(358c)

Copyist.

D

7

U.S.C.T.

Thomas J. Demby

Pvt., Co. A, 7 Reg't U. S. Col'd Infantry.

Appears on

Company Muster Roll

for Sept. & Oct., 1864

Joined for duty and enrolled:

When Sept. 23, 1863.*

Where Queen Ann.*

Period 3 years.*

Present or absent

Stoppage, \$ 100 for

Due Gov't \$ 100 for

Remarks: Killed in action near Chapin farm, Va., Sept. 29, 1864.

* See enrollment on card from muster-in-roll.

Book mark: 9308

Conard
Copyist.

D | 7 | U.S.C.T.

Thomas J. Demby

Pri, Co. A, 7 Reg't U. S. Col'd Inf.

Appears on Co. Muster-out Roll, dated Indianapolis, Ind, Oct 13, 1866.

Muster-out to date, 186 .

Last paid to, 186 .

Clothing account:

Last settled, 186 ; drawn since \$ 100

Due soldier \$ 100; due U. S. \$ 100

Am't for cloth'g in kind or money adv'd \$ 100

Due U. S. for arms, equipments, &c., \$ 100

Bounty paid \$ 100; due \$ 100

Remarks: Killed in Action, Chapins Farm, Va. Sep. 29/64

Book mark: 93.083 .

(861)

Mowry Jr. Copyist.

Demby, Thomas J.

P, Co. *a.*, **7** Reg't **U.S.C. Inf.**

2 Enclosures.

Bed Cards.....	Descriptive Lists.....
Burial Records.....	Final Statements..... <i>1</i>
Certs. of Dis. for Discharge.....	Furloughs.....
C. M. Charges.....	Med. Des. Lists.....
Med. Certificates.....	Orders.....

Other papers relating to—

Admission to Hosp'l.....	Furlough.....
Casualty Sheet (<i>Paw</i> Officer's)..... <i>1</i>	Med. Examination.....
Confinement.....	Misc. Information.....
Contracts.....	Pay or Clothing.....
Death or Effects.....	Personal Reports.....
Desertions.....	Rank.....
Discharge from Hosp'l.....	Transfer to Hosp'l.....
Discharge from Service.....	Transfer to V. R. C.....
Duty.....	Transportation.....

62

CASUALTY SHEET

No.

Thomas J. Derby

Private of Company *"A"*

7th Regiment of *N. S. I.*

State Volunteers.

NATURE OF CASUALTY

Killed

CASUALTY SHEET.

Name: Thomas J. Derby
 Rank: Private Company: "A" Regiment: 7th
 Arm: U. S. I. P. State: _____

Nature of Casualty: _____
Killed

CAUSE OF CASUALTY—(NAME OF DISEASE, &C)

BY WHOM DISCHARGED.

DEGREE OF DISABILITY.

FROM WHAT SOURCE THIS INFORMATION WAS OBTAINED.

BY WHOM CERTIFIED.

Llewellyn A. Haskell

1st Lieut commanding
DATE OF ~~DISCHARGE~~, DEATH, &C.

Sept 29 and 30 1864
PLACE OF ~~DISCHARGE~~, DEATH, &C.

Chapins Farm, Va

REMARKS.
List of casualties in the of "U. S. I. P."
on the 29 + 30 of Sept 1864 at
Chapins Farm, Va.

Ind 50 S. 20 63.

Th. B. ...

Clerk.

49
-a-

77

FINAL STATEMENT

OF

Pat. Troop of Cavalry
7 Reg't of *Inf.*

VOLUNTEERS.

NOTE 1.—Two of these certificates (or duplicates) are to be given to each Volunteer Soldier or drafted man who may be discharged previously to the discharge of his company, that he may at once receive from the Paymaster the pay, &c., due him, and the captain or other COMMISSIONED officer commanding the company will certify to the act of the delivery of the duplicate certificates; on these certificates the Soldier is "entitled to" his discharge, and should also present his discharge to the Paymaster to have the payment endorsed on it. The discharge is to be given back to the Soldier by the Paymaster; the latter only retaining as his voucher the duplicate certificates.

NOTE 2.—If the Soldier is entitled to pay for the use of his horse, the Company Commander will certify to that fact on the back of both these final statements, and also to the time he has pay due for having been so mounted on his own horse.

NOTE 3.—When a Soldier is furnished with final statements, his descriptive list, if he has one, should be taken up by the officer who gives the Soldier these statements, and endorsed with a statement to this effect by the officer. This endorsement should exhibit a full statement of the time for which the Soldier was allowed pay on his final statements, the clothing account, and all other charges against him or in his favor, so as to comprise a complete exhibit of his account. It will then be transmitted to the Company Commander of the Soldier, who will enter all the data necessary to a full understanding of the Soldier's account on the muster roll upon which the Soldier's discharge is reported. The descriptive list will then be destroyed. The object of this is, that the remaining portion of the Soldier's account may be settled upon the receipt of these muster rolls, and the Soldier receive any pay or allowances that may be due him at the time of his discharge, and which may not appear on his final statements from the fact that his descriptive list is incomplete. These accounts for back pay, &c., are settled by the 2d Auditor of the Treasury Department.

NOTE 4.—Charges for loss or injury to ordnance, horse equipments, and other miscellaneous charges, should appear under the heading of "Other Stoppages."

NOTE 5.—Bounty paid by State authorities, and not by the United States, will not be entered on this statement.

NOTE 6.—Amounts due the Sutler and Laundress must be entered on the muster roll on which the discharge, death, desertion, &c., is reported, as well as on the final statement, otherwise the amount cannot be collected from the United States.

NOTE 7.—This blank will be used for deceased volunteers and drafted men, as well as for others.

NOTE 8.—Where a Soldier dies in Hospital or on detached service, his descriptive list, if he has one, should be sent with his final statements, in duplicate, to the Adjutant General, Washington, D. C.

ADJUTANT GENERAL'S OFFICE

May 8 1865

Duplicate with Inventory sent 2d Auditor.

Chas. R. Collett

I certify, on honor, that Thos J Plimby a Private of
 Captain Chas L Rice Company (2^d) of the 7 Regiment of U S Colored
VOLUNTEERS, of the State of _____, born in Freemans Co, State
 of Maryland, aged 21 years; 5 feet 5 inches high; Black complexion,
Black eyes, Curly hair, and by occupation a Farmer, having joined the company on
 its original organization at Baltimore Md, and enrolled in it at the muster into
 the service of the United States at Baltimore, on the Twenty first day
 of September, 1863, (or was mustered in service as a recruit, by _____
 _____, at _____, on the _____ day of _____,
 186 , or was drafted and mustered into the service of the United States from the _____
 Enrollment District of the State of _____, at _____,
 on the _____ day of _____, 186 .) to serve in the Regiment, for
 the term of Three Years; and having served **HONESTLY** and
FAITHFULLY with his Company in _____ to the present date, is now

entitled to a **DISCHARGE** by reason of Wounded in action
Near Chapin's Farm Va September 29, 1864

The said Thos J Plimby was last paid by Paymaster
M Connel to include the 30 day of April, 1864, and has
 pay due him from that time to the present date; he is entitled to pay and subsistence for
TRAVELING to place of enrollment, and whatever other allowances are authorized to volunteer
 soldiers, drafted men, or militia, so ~~discharged~~ ^{dead}. He has received from the United States **CLOTHING**
 amounting to 56 ¹⁶ 100 dollars, since the 21st day of September,
 1863, when his clothing account was last settled. He has received from the United States
 _____ 100 dollars advanced **BOUNTY**.

There is ~~to~~ be stopped from him, on account of the State of _____, or other
 authorities, for **CLOTHING**, &c., received on entering service, _____ 100 dollars; and
 for other stoppages, viz: _____

_____ 100 dollars.
 He has been furnished with **TRANSPORTATION** in kind from the place of his discharge to
 _____; and he has been **SUBSISTED** for **TRAVELING** to his
 place of enrollment, up to the _____, 186 .

He is indebted to _____, **SUTLER**, _____ 100 dollars.
 He is indebted to _____, **LAUNDRESS**, _____ 100 dollars.

Given in Duplicate, at Near Petersburg Va, this 2^d day
 of May, 1865

Wm J Noonan
1st Lt U S C

 Commanding Company.

Emby Jensen
 06, 7 U.S. Col'd Inf.

Corporal | *Private*

CARD NUMBERS.

1	6283554	26
2	6283655	27
3	6283756	28
4	6283857	29
5	6283958	30
6	6284059	31
7	6284160	32
8	6284261	33
9	6284362	34
10	6284463	35
11	6284564	36
12	6284665	37
13	6284766	38
14	6284867	39
15	6284968	40
16	6285069	41
17	6285170	42
18	9066144	43
19		44
20		45
21		46
22		47
23		48
24		49
25		50

Book Mark: *PV. 17. P. 133-71.*

See also

D. 3027039 Pomil

9

7

U.S.C.T.

Vincent Demby

Co. C, 7 Reg't U.S. Col'd Inf.

Appears on

Company Descriptive Book

of the organization named above.

DESCRIPTION.

Age 20 years; height 5 feet 4 1/4 inches.

Complexion *Gruff*.

Eyes *Black*; hair *Curly*

Where born *Queen Ann, Md.*

Occupation *Farmer*.

ENLISTMENT.

When *Sept. 16*, 1863.

Where *Baltimore Md.*

By whom *Cd. W. Binney*; term *3* y'rs.

Remarks: *Mustered at Baltimore*

Md. Sept. 26, 63, by Col.

W. Binney. Appointed

Corpl Oct. 1, 63.

Discharged Surgeon's Certificate of Disability at Wash.

Baltimore Md. Jan 14, 66.

J. J. Smith

20 | 7 | U.S.C.T.

Vincent Derby
Corpl, Co. G, 7 Reg't U. S. Colored Inf.

Age 20 years.

Appears on

Company Muster-in Roll

of the organization named above. Roll dated

Baltimore Md, Sept. 26, 1863

Muster-in to date Sept. 26, 1863.

Joined for duty and enrolled:

When Sept. 23, 1863*

Where Queen Anne Md. *

Period 3 years.*

Remarks:

*Muster in roll shows enrollment of all men of this company as of same date. See enrollment on subsequent card or cards.

Book mark:

Callaway

017 U.S.C.T.

Vincent Derby
Copt, Co. C, 7 Reg't U. S. Col'd Infantry.

Appears on

Company Muster Roll
for Sept. 26 & Oct. 31, 1863

Joined for duty and enrolled:

When Sept. 23, 1863*

Where Queen Anne Co, Md. *

Period 3 years.*

Present or absent Absent,

Stoppage, \$ 100 for

Due Gov't \$ 100 for

Remarks: Detached on recruiting
service Oct. 29, 63.

* See enrollment on card from muster-in roll.

Book mark:

Carraway
Copyist.

201

7

U.S.C.T.

Vincent Demby,
Corpl, Co. C, 7 Reg't U. S. Col'd Infantry.

Appears on

Company Muster Roll

for Nov^r Dec^r, 1863

Joined for duty and enrolled:

When Sept. 23, 1863*

Where Queen Anne's Md. *

Period 3 years.*

Present or absent Present

Stoppage, \$ 100 for

Due Gov't \$ 100 for

Remarks:

* See enrollment on card from muster-in roll.

Book mark:

Calloway

Copyist.

D

7

U.S.C.T.

Vincent Derby,
Coopl, Co. C, 7 Reg't U. S. Col'd Infantry.

Appears on

Company Muster Roll

for *Jan'y and Feb'y*, 1864.

Joined for duty and enrolled:

When *Sept. 23*, 1863*

Where *Queen Anne Co. Md.* *

Period *3* years.*

Present or absent *Present.*

Stoppage, \$ *100* for

Due Gov't \$ *100* for

Remarks:

* See enrollment on card from muster-in roll.

Book mark:

(358c)

Calloway

Copyist.

D. 1

7

U.S.C.T.

Vincent Demby
Corpl., Co. C, 7 Reg't U. S. Col'd Infantry.

Appears on

Company Muster Roll

for *March and April*, 1864.

Joined for duty and enrolled:

When *Sept. 23*, 1863.*

Where *Queen Anne Co, Md.**

Period *3* years.*

Present or absent *Present.*

Stoppage, \$ *100* for

Due Gov't \$ *100* for

Remarks:

* See enrollment on card from muster-in roll.

Book mark: _____

Calloway.

20

7

U.S.C.T.

Vincent Demby,
Corpl, Co. C, 7 Reg't U. S. Col'd Infantry.

Appears on

Company Muster Roll

for May and June, 1864.

Joined for duty and enrolled:

When Sept. 23, 1863*

Where Queen Anne Co. Md. *

Period 3 years.*

Present or absent Present.

Stoppage, \$ 100 for

Due Gov't \$ 100 for

Remarks: Stop for own reasons

* See enrollment on card from muster-in roll.

Book mark:

Callaway

20

7

U.S.C.T.

Vincent Demby
Corpl., Co. C, 7 Reg't U. S. Col'd Infantry.

Appears on

Company Muster Roll

for July and Aug., 1864.

Joined for duty and enrolled:

When Sept. 23, 1863*

Where Queen Anne Co., Md.*

Period 3 years.*

Present or absent Present.

Stoppage, \$ 100 for

Due Gov't \$ 100 for

Remarks:

* See enrollment on card from muster-in roll.

Book mark:

Callaway.

10 | 7 | U.S.C.T.

Vincent Demby
Corp., Co. C, 7 Reg't U. S. Col'd Infantry.

Appears on

Company Muster Roll
for *Sept. & Oct.*, 1864.

Joined for duty and enrolled:

When *Sept. 23*, 1863.*

Where *Queen Ann* *

Period *3* years.*

Present or absent *Absent*

Stoppage, \$ *100* for

Due Gov't \$ *100* for

Remarks: *Wounded and sent to Hospital Sept. 29*

* See enrollment on card from muster-in roll.

Book mark:

(358c)

J. M. Murphy
Copyist.

10 | 7 | U.S.C.T.

Vincent Demby
Corp., Co. C, 7 Reg't U. S. Col'd Infantry.

Appears on

Company Muster Roll
for Nov. & Dec., 1864.

Joined for duty and enrolled:

When Sept. 23rd, 1863.*

Where Queen Ann.*

Period 3 years.*

Present or absent Present

Stoppage, \$ 100 for

Due Gov't \$ 100 for

Remarks:

* See enrollment on card from muster-in roll.

Book mark:

(358c)

M. M. Murphy
Copyist.

10

7

U.S.C.T.

Vincent Remby
Corp., Co. C, 7 Reg't U. S. Col'd Infantry.

Appears on

Company Muster Roll

for Jan. & Feb., 1865.

Joined for duty and enrolled:

When Sept. 23", 1863.*

Where Queen Anne Co., Md.*

Period 3 years.*

Present or absent Present

Stoppage, \$ 100 for

Due Gov't \$ 100 for

Remarks: Stop & Carried

* See enrollment on card from muster-in roll.

Book mark:

M. M. Murphy

Copyist.

10 | 7 | U.S.C.T.

Vincent Dewby
Corp., Co. C, 7 Reg't U. S. Col'd Infantry.

Appears on

Company Muster Roll

for Mar. & Apr., 1865.

Joined for duty and enrolled;

When Sept. 23rd, 1863.*

Where Queen Ann, Md.*

Period 3 years.*

Present or absent Absent

Stoppage, \$ 100 for

Due Gov't \$ 100 for

Remarks: Wounded Apr. 2nd
1865 - In Hosp. Point
Rocks stop for Canteen

* See enrollment on card from muster-in roll.

Book mark:

(358c) M. M. Murphy Copyist.

10 | 7 | U.S.C.T.

Vincent Newby
Corp., Co. C, 7 Reg't U. S. Col'd Infantry.

Appears on

Company Muster Roll
for May 7 June, 1865.

Joined for duty and enrolled:

When Sept. 23, 1863.*

Where Queen Ann's Co. *

Period 3 years.*

Present or absent Absent

Stoppage, \$ 100 for

Due Gov't \$ 100 for

Remarks: Wounded Apr. 2/65 In Hosp Point of Rocks, Va. Stop- ped for 1 canteen

* See enrollment on card from muster-in roll.

Book mark:

M. M. Murphy Copyist.

10

7

U.S.C.T.

Vincent Dumby
Corp., Co. C, 7 Reg't U. S. Col'd Infantry.

Appears on

Company Muster Roll

for July & Aug., 1865

Joined for duty and enrolled:

When Sept. 23rd, 1863.*

Where Baltimore*

Period 3 years.*

Present or absent Absent

Stoppage, \$ 100 for

Due Gov't \$ 100 for

Remarks: Wounded sent
to Harpers Point Rocks
Apr. 27/65

* See enrollment on card from muster-in roll.

Book mark:

M. M. Murphy

(858c)

Copyist.

10

7

U.S.C.T.

Vincent Remby
Corp., Co. C, 7 Reg't U. S. Col'd Infantry.

Appears on

Company Muster Roll
for Sept. & Oct., 1863.

Joined for duty and enrolled:

When Sept. 16th, 1863.*

Where Green River, Ind.*

Period 3 years.*

Present or absent Not stated

Stoppage, \$ 100 for

Due Gov't \$ 100 for

Remarks:

* See enrollment on card from muster-in roll.

Book mark: S. 38 Vol. 3 Co. C. 7/66

(358c)

M. M. Murphy
Copyist.

D | 7 | U.S.C.T.

Vincent Demby
Corpl, Co. C, 7 Reg't U. S. Col'd Infantry.

Appears on

Company Muster Roll

for *Nov & Dec*, 186*5*

Joined for duty and enrolled:

When *Sept. 16*, 186*3**

Where *Queen Ann Md**

Period *3* years.*

Present or absent *Absent.*

Stoppage, \$ *100* for

Due Gov't \$ *100* for

Remarks: *In hospital since April 2 '65.*

* See enrollment on card from muster-in roll.

Book mark:

Sopez.

D

7

U.S.C.T.

Vincent Demby
Corpl, Co. C, 7 Reg't U. S. Col'd Infantry.

Appears on

Company Muster Roll

for Jan x Feb, 1866

Joined for duty and enrolled:

When Sept. 16, 1863*

Where Queen Ann Md*

Period 3 years.*

Present or absent.....

Stoppage, \$ 100 for.....

Due Gov't \$ 100 for.....

Remarks: Discharged on
Surgeons Cert. of Disa-
bility at Fort Monroe
Va. Jan. 19 '66.

* See enrollment on card from muster-in roll.

Book mark:.....

Lopez

S. | **7** | **U.S.C.T.**

Vincent Semby
Prvt, Co. C, 7 Reg't U. S. Col'd Infantry.

Appears on **Co. Muster-out Roll**, dated
Indianola Texas, Oct. 13, 1866.

Muster-out to date _____, 186 .

Last paid to *Dec. 31, 1864.*

Clothing account:

Last settled _____, 186 ; drawn since \$ _____ 100

Due soldier \$ _____ 100; due U. S. \$ _____ 100

Am't for cloth'g in kind or money adv'd \$ _____ 100

Due U. S. for arms, equipments, &c., \$ _____ 100

Bounty paid \$ _____ 100; due \$ _____ 100

Remarks: *Discharged at*
Baltimore Md. Jan.
19 '66 for disability

Book mark: *Pt. 17 Co. 33. 71 CD.*

(361)

Lopez Copyist.

Demby Vincent

Corp, Co. C, 37 Reg't USCT

3

Enclosures.

- | | |
|------------------------------|-------------------|
| Bed Cards | Descriptive Lists |
| Burial Records | Final Statements |
| Certs. of Dis. for Discharge | Furloughs |
| C. M. Charges | Med. Des. Lists |
| Med. Certificates | Orders |

Other papers relating to—

- | | |
|----------------------------|----------------------|
| Admission to Hosp'l | Furlough |
| Casualty Sheet (Officer's) | Med. Examination |
| Confinement | Misc. Information |
| Contracts | Pay or Clothing |
| Death or Effects | Personal Reports |
| Desertions | Rank |
| Discharge from Hosp'l | Transfer to Hosp'l |
| Discharge from Service | Transfer to V. R. C. |
| Duty | Transportation |

61

CASUALTY SHEET
OF WOUNDED.

Sirient Demby
Corporal Company "C"
No. 1 Regiment of *U.S.C.P.*

Volunteers at the battle of *Chapuis*

Arm. Va. Sept 29 & 30

1864.

CASUALTY SHEET.

Name, Vincent Dumbey
 Rank, Corporal, Company "C", Regiment, 7th
 Arm, U. S. A. I., State, _____
 Place of casualty, Chapins Farm, Va.
 Nature of casualty, Wounded
 Date of casualty, Sept 29 + 30 1864

FROM WHAT SOURCE THIS INFORMATION WAS OBTAINED.

Report of Killed, Wounded, and Missing of the _____ Regiment,
 Brigade, _____ Division, _____ Corps, dated _____
List of casualties in the U. S. A. I. on the 29th and
30th of Sept 1864, at Chapins Farm, Va.
(Sgd) Jewell W. Haskell,
Sent to the Command
Answered no 63.

J. H. Brodwick
 Clerk.

Hospital Number 13 13 ¹² 70

Name Vincent, George

Age 19 Activity 1st Lt

~~Married~~ or Single

Residence Centerville, Greenbush Co.

Post Office address of } Reach, Boone
wife or nearest relative. } Same

Rank 1st Lt. Co. C. Regiment 6th C. I.

When admitted Oct 28, 1864

From what source 1st Source

Diagnosis: (In surgical cases, state explicitly seat and character of wound or injury.)

G. S. Wound in right hand. Shunt.

Wm. G. H.
Baltimore, Md.

On what occasion wounded

Date

Nature of missile or weapon

TREATMENT.

[HERE NOTE IMPORTANT COMPLICATIONS AND ALL OPERATIONS.]

RESULT AND DATE.

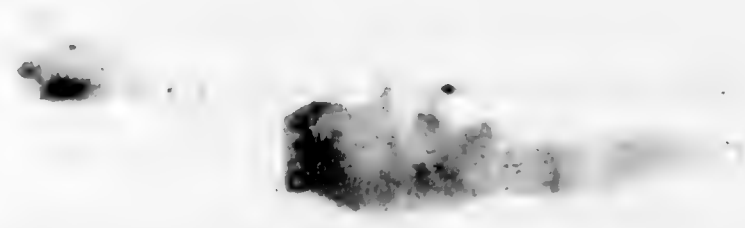

v D. 27, R. of Dix
7866

NOTE 1.

The company commander will here add a statement of all the facts known to him concerning the disease or wound, or cause of disability of the soldier; the time, place, manner, and all the circumstances under which the injury occurred, or disease originated or appeared; the duty, or service, or situation of the soldier at the time the injury was received or disease contracted, stating particularly whether the injury was received or the disease contracted in the line of his duty; and whatever other facts may aid a judgment as to the cause, immediate or remote, of the disability, and the circumstances attending it.

When the facts are not known to the company commander, the certificate of any officer or affidavit of other person having such knowledge, will be appended—as the surgeon in charge of a hospital, the officer commanding a detachment of recruits, &c., &c.

NOTE 2.

When a probable case for pension, special care must be taken to state the degree of disability—as $\frac{1}{2}$, $\frac{3}{4}$, &c., &c.; to describe particularly the disability, wound, or disease; the extent of which it deprives him of the use of any limb or faculty, or affects his health, strength, activity, constitution, or capacity to labor or earn his subsistence. The surgeon will add, from his knowledge of the facts and circumstances, and from the evidence in the case, his professional opinion of the cause or origin of the disability. In the case of discharges by Medical Inspectors, the last paragraph will state that the "discharge was given by consent of the soldier, after a personal examination, and for disability, the nature, degree and origin of which are correctly described in the within certificate."

Par. 1260 Regulations, Edit. 1861.

Medical officers, in giving certificates of disability, are to take particular care in all cases that have not been under their charge; and especially in epilepsy, convulsions, chronic rheumatism, derangement of the urinary organs, ophthalmia, ulcers, or any obscure disease liable to be feigned or purposely produced; and in no case shall such certificate be given until after sufficient time and examination to detect any attempt at deception.

DIRECTIONS.

This certificate will be made out in duplicate by the soldier's company commander, or other officer commanding the separate detachment to which he belongs, and sent by him to the surgeon who has charge of the hospital where the soldier is sick. The surgeon will then fill out and sign the surgeon's certificate, and forward these papers to the regimental, detachment, or post commander, who will forward them, with his action endorsed thereon, through the proper channel, to his division commander; or, if the troops are not attached to a division, to his corps, department, or other commander or officer to whom the authority to discharge enlisted men may be specially delegated.

These certificates, after having received the action of the highest authority to which they are required to be sent, will be returned through the same channel to the regimental, post, or detachment commander, who will, if the discharge is authorized by the endorsement of the proper authority, sign the soldier's discharge, and the last certificate on this paper; see that the soldier is furnished with the proper final statements in duplicate, and forward BOTH of these certificates direct to the Adjutant General United States Army, at Washington, D. C.; they will not, under any circumstances, be given into the hands of the soldier.

ADJUTANT GENERAL'S OFFICE

Jan 27 1866

Duplicate sent the Pension Office.

CERTIFICATE OF DISABILITY FOR DISCHARGE

IN THE CASE OF

Vincennes Kentucky
a Capt Co. C
7" Reg't of U.S.A.

MEDICAL DIRECTOR'S OFFICE

MIDDLE MILITARY DEPT.

Baltimore, Md. Jan. 18, 1866.

APPROVED.

Chas R Greenleaf
Evt. Maj. and Asst. Surg. U. S. A.
Act. Medical Director.

HEAD-QUARTERS MIDDLE MILITARY DEPARTMENT

Baltimore, Md., Jan. 18, 1866.

To be discharged

BY COMMAND OF MAJOR GENERAL HANCOCK.

Adam Druing
Asst. Adj. Genl.

Received (A. G. Office.) _____, 186

Handwritten signatures and stamps at the bottom right of the page.

ARMY OF THE UNITED STATES. CERTIFICATE

OF DISABILITY FOR DISCHARGE



Capt Vincent Dumbry of Captain... Company, (4th) of the 7th Regt of the United States Volunteers... was enlisted by Col W. Barney... on the 16th day of Feb, 1863, to serve three years; he was born in... in the State of... is twenty years of age, ... feet ... inches high, ... complexion, ... eyes, ... hair, and by occupation when enlisted a ... During the last two months said soldier has been unfit for duty ... days.*

STATION: Bullets, Md. "Hicks Gun Hospit" Thos. S. S. Surgeon U.S.V. DATE: Jan 11th. Commanding Hospital

I CERTIFY, that I have carefully examined the said Vincent Dumbry of Captain... Company, and find him incapable of performing the duties of a soldier because of † gun shot wound of right thumb received in action April 1st 1865 at Hatters Run Va, also flesh wound of right arm received in action Sept 29th 1864 at Deep Bottom Va. Disability one fourth (1/4)

DISCHARGED, this 19th day of January, 1866, at Hicks Gun Hospit Bullets Md. Thos. S. S. Surgeon U.S.V. Commanding the Regt Hospital

The Soldier desires to be addressed at Town: Queensteron County, State: Va

* See Note 1 on the back of this. † See Note 2 on the back of this. [A. G. O., No. 100 & 101—First.] [DUPLICATES.]

ARMY OF THE UNITED STATES
CERTIFICATE

OF DISABILITY FOR DISCHARGE



Corpl Vincent Dineby, of Captain
Company, () of the 1st Fleet Regt of the United States
was enlisted by W. Barney of
the 16th Regt of at
on the 16th day of Feb, 1868, to serve three years; he was born
in in the State of is twenty
years of age, feet inches high, complexion, eyes,
hair, and by occupation when enlisted a During the last two
months said soldier has been unfit for duty 110 days.*

STATION: Balt to Md "Hicks Gun Hosp" Thos. S. V.
DATE: Jan 11 '66
Surgeon U.S.V.
Commanding Hospital

I CERTIFY, that I have carefully examined the said Vincent Dineby
of Captain Company, and find him incapable of performing the duties of a
soldier because of gun shot wound of right thumb received
in action April 1st 1865 at Hatters Run Va, also
flash wound of right arm received in action
Sept 29th 1864 at Deep Bottom Va
Disability one fourth (1/4)
Thos. S. V.
Surgeon U.S.V.

DISCHARGED, this 19th day of January, 1866, at Hicks
Gun Hospital Balt to Md
Thos. S. V.
Surgeon U.S.V.
Commanding the Hospital

The Soldier desires to be addressed at
Town Queenstown County State Va

* See Note 1 on the back of this. † See Note 2 on the back of this
[A. G. O., No. 100 & 101—First.] [DUPLICATES.]

387

Demby Washington

Co B, 7 U.S. Col'd Inf.

Private

Private

CARD NUMBERS.

1	6281804	26
2	6281903	27
3	6282004	28
4	6282101	29
5	6282201	30
6	6282300	31
7	6282396	32
8	6282489	33
9	6282643	34
10	6283124	35
11	9066022	36
12		37
13		38
14		39
15		40
16		41
17		42
18		43
19		44
20		45
21		46
22		47
23		48
24		49
25		50

Book Mark:

See also

2

7

U.S.C.T.

Washington Dewby

Co. B, 7 Reg't U.S. Col'd Inf.

Appears on

Company Descriptive Book

of the organization named above.

DESCRIPTION.

Age 30 years; height 5 feet 1/4 inches.

Complexion *Griff.*

Eyes *Black*; hair *Curly*.

Where born *Talbot, Md.*

Occupation *Furrier.*

ENLISTMENT.

When *Sept. 21*, 186 *3*.

Where *Baltimore, Md.*

By whom *Col. W. Birney*; term *3* y'rs.

Remarks: *Enlisted Sept. 26, 63,*

by Col. Wm. Birney.

Died at Fort Monroe,

Va. Nov. 7, 1865.

*Disease *Cholera*.*

J. Smith,

D. | 7 | U.S.C.T.

Washington Derby
Co. D., 7 Reg't U. S. Colored Inf.

Age 30 years.

Appears on

Company Muster-in Roll

of the organization named above. Roll dated

Baltimore Md. Sept 26, 1863.

Muster-in to date Sept 26, 1863.

Joined for duty and enrolled:

When Sept 23, 1863.*

Where Fulton Co. Md.

Period 2 years.*

Remarks:

*Muster in roll shows enrollment of all men of this company as of that date. See enrollment on subsequent card or cards.

Book mark:

(856c)

J. B. Casey

Const.

D.

7

U.S.C.T.

Washington Demby

Priest, Co. B, 7 Reg't U. S. Col'd Infantry.

Appears on

Company Muster Roll

for *Sept 26th to Oct 31st*, 1863.

Joined for duty and enrolled:

When *Sept 26th*, 1863.*

Where *Falbot Pa. Ind.* *

Period *3* years.*

Present or absent *Present*

Stoppage, \$ *100* for

Due Gov't \$ *100* for

Remarks:

* See enrollment on card from muster-in roll.

Book mark: -----

(358c)

J. B. Caser

Copyist.

D

7

U.S.C.T.

Washington Demby

Privt . Co. B, 7 Reg't U. S. Col'd Infantry.

Appears on

Company Muster Roll

for *Nov & Dec.*, 1863 .

Joined for duty and enrolled:

When *Sept 13th*, 1863 .*

Where *Talbot* .*

Period *3* years.*

Present or absent *Present*

Stoppage, \$ *100* for

Due Gov't \$ *100* for

Remarks: *Enlistment premium
\$2.00 due.*

* ~~See~~ See enrollment on card from muster-in roll.

Book mark:

(358c)

J. B. [Signature]

Copyist.

9

7

U.S.C.T.

Washington Demby
Privt, Co. B, 7 Reg't U. S. Col'd Infantry.

Appears on

Company Muster Roll

for *Jan & Feb*, 1864.

Joined for duty and enrolled:

When *Sept 23*, 1864.*

Where *Talbot* *

Period *3* years.*

Present or absent *Present*

Stoppage, \$ *100* for

Due Gov't \$ *100* for

Remarks: *\$2.00 Enlistment pre-*
mium due.

* See enrollment on card from muster-in roll.

Book mark: _____

(358c)

J. G. Casey

Copyist.

9 | 7 | U.S.C.T.

Washington Denby
Ornit, Co. B, 7 Reg't U. S. Col'd Infantry.

Appears on

Company Muster Roll

for March & April, 1867.

Joined for duty and enrolled:

When Sept 23, 1863.*

Where Talbot, Md *

Period 3 years.*

Present or absent Present

Stoppage, \$ 100 for

Due Gov't \$ 100 for

Remarks:

* See enrollment on card from muster-in roll.

Book mark: _____

(358c) J. J. Cooney Copyist.

D.

7

U.S.C.T.

Washington Demby
Privt, Co. B, 7 Reg't U. S. Col'd Infantry.

Appears on

Company Muster Roll

for *May & June*, 1864.

Joined for duty and enrolled:

When *Sept 23*, 1863.*

Where *Talbot, Ind**

Period *?* years.*

Present or absent *Absent*

Stoppage, \$ *100* for

Due Gov't \$ *100* for

Remarks *Sick at Jacksonville*
Fla. since June 27, 64.

* See enrollment on card from muster-in roll.

Book mark:

(358c)

J. G. Casey

Copyist.

D. 17

U.S.C.T.

Washington Demby,
Privt, Co. B, Reg't U. S. Col'd Inf't

Appears on

Company Muster Roll

for July & Aug, 1864.

Joined for duty and enrolled:

When Sept 23, 1863.*

Where Galbet, Md. *

Period years.*

Present or absent Absent.

Stoppage, \$ 100 for

Due Gov't, \$ 100 for

Remarks: Sick in hospital at
Bermuda hundred since Aug
13. 1864.

Stop 1 knapsack.

* See enrollment on card from muster-in roll.

Book mark

J. B. Casey
Cypist.

2

7

U.S.C.T.

Washington Derby

Pr t , Co. B, 7 Reg't U. S. Col'd Infantry.

Appears on

Company Muster Roll

for Sept & Oct, 1863.

Joined for duty and enrolled:

When Sept 23, 1863.*

Where Talbot, Md.*

Period 3 years.*

Present or absent absent

Stoppage, \$ 100 for

Due Gov't \$ 100 for

Remarks: Stop 1 Kuap-
lack, Dick in
Hosp since Sept
28/63

* See enrollment on card from muster-in roll.

Book mark:

Wester

D | 7 | U.S.C.T.

Washington Demby
Pvt, Co. B, 7 Reg't U. S. Col'd Infantry.

Appears on

Company Muster Roll

for Apr & Dec, 1864.

Joined for duty and enrolled:

When Sept 23, 1863.*

Where Talbot Md *

Period 3 years.*

Present or absent _____

Stoppage, \$ 100 for _____

Due Gov't \$ 100 for _____

Remarks: Died in Hosp.
 Fort Monroe, Va
 Nov. 7/64

* ~~See~~ See enrollment on card from muster-in roll.

Book mark: _____

W. H. [Signature]
(358c) Copyist.

D

7

U.S.C.T.

Washington, D.C.
Pr, Co. *B*, 7 Reg't U. S. Col'd Infantry.

Appears on **Co. Muster-out Roll**, dated
Indianola Tex, *Oct 13*, 186*6*.

Muster-out to date _____, 186 .

Last paid to *apl 30*, 1864.

Clothing account:

Last settled _____, 186 ; drawn since \$ 100

Due soldier \$ 100 ; due U. S. \$ 100

Am't for cloth'g in kind or money adv'd \$ 100

Due U. S. for arms, equipments, &c., \$ 100

Bounty paid \$ 100 ; due \$ 100

Remarks: *Died at Hospital Ft.*
Monrovia. Nov. 7. 1864
Final statements rendered

Book mark: *294.388*

Hollivort

Demby, Washington

P, Co. *B.*

7
Reg't

U.S.C. Inf

4 Enclosures.

Bed Cards	Descriptive Lists
Burial Records	Final Statements <i>2</i>
Certs. of Dis. for Discharge	Furloughs
C. M. Charges	Med. Des. Lists
Med. Certificates	Orders

Other papers relating to—

Admission to Hosp'l	Furlough
Casualty Sheet (Officer's)	Med. Examination
Confinement	Misc. Information <i>/</i>
Contracts	Pay or Clothing
Death or Effects <i>/</i>	Personal Reports
Desertions	Rank
Discharge from Hosp'l	Transfer to Hosp'l
Discharge from Service	Transfer to V. R. C.
Duty	Transportation

MICROFILM PUBLICATION M.1849

COMPILED MILITARY SERVICE RECORDS
OF VOLUNTEER UNION SOLDIERS WHO SERVED WITH
THE UNITED STATES COLORED TROOPS (USCT)
7TH REGIMENT OF INFANTRY

PERSONAL PAPERS' TARGET SHEET

PLEASE NOTE THE CHECKED INFORMATION ABOUT THE PERSONAL PAPERS IN
THIS FILE:

- NO PERSONAL PAPERS WERE FOUND IN THIS FILE WHEN THE
RECORDS WERE ARRANGED FOR MICROFILMING.
- 5 PERSONAL PAPER(S) FOUND IN THIS FILE WHEN THE RECORDS
WERE ARRANGED FOR MICROFILMING.

Mr Gibson:

Please note inquiry from Pension Office, and report as to former owner.

The soldier was enrolled prior to the order for enrollment for draft.

Respy; H.A.
 Feb 11/86
 Mch. 6/86.

Mr Brown

MT Roll dated Balt Md Sept 26/63. & signed by Mr Birney Col 2nd U.S.C.T. Mo. Post. Shows that Col Edd Lloyd, Custon, as the former owner of Washington Demby

E 00020 }
 March 29, 86 } DO.

Respy
 M. Gibson

A-180 ¹/₂₉ Pension Register.

Washington Demby
 Pvt. Co. B. 7th U.S.C Troops.
 Pension Claim No. 294,388

A. G. L. Feb. 9, 1863,
copy of reports and 2 duplicates
L.

✓ 50 172
-B-

FINAL STATEMENT

OF

Washington Demy
7th Reg't of Indians

VOLUNTEERS.

And May 1864

NOTE 1.—Two of these certificates (or duplicates) are to be given to each Volunteer Soldier or drafted man who may be discharged previously to the discharge of his company, that he may at once receive from the Paymaster the pay, &c., due him, and the captain or other COMMISSIONED officer commanding the company will certify to the act of the delivery of the duplicate certificates; on these certificates the Soldier is "entitled to" his discharge, and should also present his discharge to the Paymaster to have the payment endorsed on it. The discharge is to be given back to the Soldier by the Paymaster; the latter only retaining as his voucher the duplicate certificates.

NOTE 2.—If the Soldier is entitled to pay for the use of his horse, the Company Commander will certify to that fact on the back of both these final statements, and also to the time he has pay due for having been so mounted on his own horse.

NOTE 3.—When a Soldier is furnished with final statements, his descriptive list, if he has one, should be taken up by the officer who gives the Soldier these statements, and endorsed with a statement to this effect by the officer. This endorsement should exhibit a full statement of the time for which the Soldier was allowed pay on his final statements, the clothing account, and all other charges against him or in his favor, so as to comprise a complete exhibit of his account. It will then be transmitted to the Company Commander of the Soldier, who will enter all the data necessary to a full understanding of the Soldier's account on the muster roll upon which the Soldier's discharge is reported. The descriptive list will then be destroyed. The object of this is, that the remaining portion of the Soldier's account may be settled upon the receipt of these muster rolls, and the Soldier receive any pay or allowances that may be due him at the time of his discharge, and which may not appear on his final statements from the fact that his descriptive list is incomplete. These accounts for back pay, &c., are settled by the 2d Auditor of the Treasury Department.

NOTE 4.—Charges for loss or injury to ordnance, horse equipments, and other miscellaneous charges, should appear under the heading of "Other Stoppages."

NOTE 5.—Bounty paid by State authorities, and not by the United States, will not be entered on this statement.

NOTE 6.—Amounts due the Sutler and Laundress must be entered on the muster roll on which the discharge, death, desertion, &c., is reported, as well as on the final statement, otherwise the amount cannot be collected from the United States.

NOTE 7.—This blank will be used for deceased volunteers and drafted men, as well as for others.

NOTE 8.—Where a Soldier dies in Hospital or on detached service, his descriptive list, if he has one, should be sent with his final statements, in duplicate, to the Adjutant General, Washington, D. C.

Crit. on the part of Demy

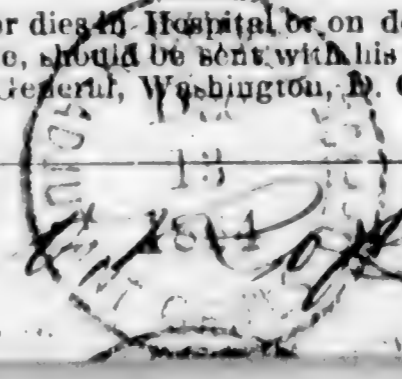

ADJUTANT GENERAL'S OFFICE
DEC 14 1864
Duplicate with Inventory sent 2d Auditor.

I certify on honor, that Washington Lemby a Private of
 former Company of the 7 Regiment of M. C. G.
VOLUNTEERS, of the State of Maryland, born in Talbot co., State
 of Maryland, aged 30 years; 5 feet 7 3/4 inches high; Griff complexion,
Black eyes, Curly hair, and by occupation a Farmer, having joined the company on
 its original organization at Baltimore, and enrolled in it at the muster into
 the service of the United States at Baltimore, on the 26th day
 of September, 1863, (or was mustered in service as a recruit, by
 _____, at _____, on the _____ day of _____,
 186 , or was drafted and mustered into the service of the United States from the _____
 Enrollment District of the State of _____, at _____,
 on the _____ day of _____, 186), to serve in the Regiment, for
 the term of Three years or during the war: and having served **HONESTLY** and
FAITHFULLY with his Company in 7th M. C. Group to the present date, is now
 entitled to a **DISCHARGE** by reason of death, Died in Hospital,
on November 7th 1864, of Chronic Diarrhea

The said Washington Lemby was last paid by Paymaster
Gen. McNeill to include the 30th day of April, 1864, and has
 pay due him from that time to the present date; he is entitled to pay and subsistence for
TRAVELING to place of enrollment, and whatever other allowances are authorized to volunteer
 soldiers, drafted men, or militia, so discharged. He has received from the United States **CLOTHING**
 amounting to Sixty ⁸⁵/₁₀₀ dollars, since the 21st day of September,
 1863, when his clothing account was last settled. He has received from the United States
 _____ ¹⁰⁰/₁₀₀ dollars advanced **BOUNTY**.

There is to be stopped from him, on account of the State of _____, or other
 authorities, for **CLOTHING**, &c., received on entering service, _____ ¹⁰⁰/₁₀₀ dollars; and
 for other stoppages, viz: One Knapsack
 _____ ¹⁰⁰/₁₀₀ dollars.

He has been furnished with **TRANSPORTATION** in kind from the place of his discharge to
 _____; and he has been **SUBSISTED** for **TRAVELING** to his
 place of enrollment, up to the _____, 186 .

He is indebted to _____, **SUTLER**, _____ ¹⁰⁰/₁₀₀ dollars.
 He is indebted to _____, **LAUNDRESS**, _____ ¹⁰⁰/₁₀₀ dollars.

Given in Duplicate, at Fort Sumner, Va., this 8th day
 of December, 1864

A. C. McKinstry
1st Lieut. 7th M. C. G.
 Commanding Company.

1864

50

Dup

FINAL STATEMENT

OF

Washington County
7th Reg't of U. S. A.

VOLUNTEERS.

NOTE 1.—Two of these certificates (or duplicates) are to be given to each Volunteer Soldier or drafted man who may be discharged previously to the discharge of his company, that he may at once receive from the Paymaster the pay, &c., due him, and the captain or other COMMISSIONED officer commanding the company will certify to the act of the delivery of the duplicate certificates; on these certificates the Soldier is "entitled to" his discharge, and should also present his discharge to the Paymaster to have the payment endorsed on it. The discharge is to be given back to the Soldier by the Paymaster; the latter only retaining as his voucher the duplicate certificates.

NOTE 2.—If the Soldier is entitled to pay for the use of his horse, the Company Commander will certify to that fact on the back of both these final statements, and also to the time he has pay due for having been so mounted on his own horse.

NOTE 3.—When a Soldier is furnished with final statements, his descriptive list, if he has one, should be taken up by the officer who gives the Soldier these statements, and endorsed with a statement to this effect by the officer. This endorsement should exhibit a full statement of the time for which the Soldier was allowed pay on his final statements, the clothing account, and all other charges against him or in his favor, so as to comprise a complete exhibit of his account. It will then be transmitted to the Company Commander of the Soldier, who will enter all the data necessary to a full understanding of the Soldier's account on the muster roll upon which the Soldier's discharge is reported. The descriptive list will then be destroyed. The object of this is, that the remaining portion of the Soldier's account may be settled upon the receipt of these muster rolls, and the Soldier receive any pay or allowances that may be due him at the time of his discharge, and which may not appear on his final statements from the fact that his descriptive list is incomplete. These accounts for back pay, &c., are settled by the 2d Auditor of the Treasury Department.

NOTE 4.—Charges for loss or injury to ordnance, horse equipments, and other miscellaneous charges, should appear under the heading of "Other Stoppages."

NOTE 5.—Bounty paid by State authorities, and not by the United States, will not be entered on this statement.

NOTE 6.—Amounts due the Sutler and Laundress must be entered on the muster roll on which the discharge, death, desertion, &c., is reported, as well as on the final statement, otherwise the amount cannot be collected from the United States.

NOTE 7.—This blank will be used for deceased volunteers and drafted men, as well as for others.

NOTE 8.—Where a Soldier dies in Hospital or on detached service, his descriptive list, if he has one, should be sent with his final statements, in duplicate, to the Adjutant General, Washington, D. C.

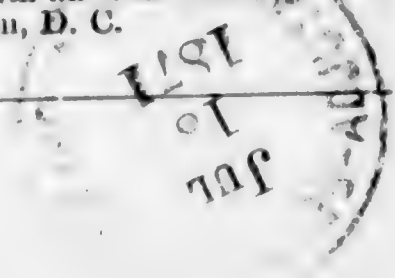

I certify, on honor, that Washington Leruby a Private of
 formerly John H. Ryder's Company (B) of the 5th Regiment of U. S. A. I.
VOLUNTEERS, of the State of Maryland, born in Talbot co., State
 of Maryland, aged 30 years; 5 feet 7 1/4 inches high; Gruff complexion,
Black eyes, Curly hair, and by occupation a Farmer, having joined the company on
 its original organization at Baltimore, and enrolled in it at the muster into
 the service of the United States at Baltimore, on the 26th day
 of September, 1863, (or was mustered in service as a recruit, by
 _____, at _____, on the _____ day of _____,
 186 , or was drafted and mustered into the service of the United States from the _____
 Enrollment District of the State of _____, at _____,
 on the _____ day of _____, 186 .) to serve in the Regiment, for
 the term of Three Years or during the war; and having served **HONESTLY** and
FAITHFULLY with his Company in 7th U. S. C. Groups to the present date, is now
 entitled to a **DISCHARGE** by reason of death, Died in Hospital
on November 7th 1864, of Chronic Diarrhea.

The said Washington Leruby was last paid by Paymaster
Lucy M. Cornwell to include the Thirtieth day of April, 1864, and has
 pay due him from that time to the present date; he is entitled to pay and subsistence for
TRAVELING to place of enrollment, and whatever other allowances are authorized to volunteer
 soldiers, drafted men, or militia, so discharged. He has received from the United States **CLOTHING**
 amounting to sixty dollars & 80 dollars, since the 21st day of September,
 1863, when his clothing account was last settled. He has received from the United States
 _____ dollars advanced **BOUNTY**.

There is to be stopped from him, on account of the State of _____, or other
 authorities, for **CLOTHING**, &c., received on entering service, _____ dollars; and
 for other stoppages, viz: One Knapsack

_____ dollars.
 He has been furnished with **TRANSPORTATION** in kind from the place of his discharge to
 _____; and he has been **SUBSISTED** for **TRAVELING** to his
 place of enrollment, up to the _____, 186 .

He is indebted to _____, **SUTLER**, _____ dollars.
 He is indebted to _____, **LAUNDRESS**, _____ dollars.

Given in Duplicate, at T. Dugrehan, this 7th day
 of December, 1864

H. M. Cuskey
1st Lieut. 7th U. S. C. G.
 Commanding Company.

ARTICLES OF WAR.

ART. 95. When any non-commissioned officer or soldier shall die, or be killed in the service of the United States, the then commanding officer of the troop or company shall, in the presence of two other commissioned officers, take an account of what effects he died possessed of, above his arms and accoutrements, and transmit the same to the office of the Department of War, which said effects are to be accounted for, and paid to the representatives of such deceased non-commissioned officer or soldier. And in case any of the officers, so authorized to take care of the effects of deceased officers and soldiers, should, before they have accounted to their representatives for the same, have occasion to leave the regiment or post, by preferment or otherwise, they shall, before they be permitted to quit the same, deposit in the hands of the commanding officer, or of the assistant military agent, all the effects of such deceased non-commissioned officers and soldiers, in order that the same may be secured for, and paid to, their respective representatives.

ARMY REGULATIONS—EDITION OF 1861.

DECEASED SOLDIERS.

Par. 152. Inventories of the effects of deceased non-commissioned officers and soldiers, required by the 95th Article of War, will be forwarded to the Adjutant General, by the commander of the company to which the deceased belonged, and a duplicate of the same to the colonel of the regiment. Final statements of pay, clothing, &c., will be sent with the inventories. When a soldier dies at a post or station absent from his company, it will be the duty of his immediate commander to furnish the required inventory, and, at the same time, to forward to the commanding officer of the company to which the soldier belonged, a report of his death, specifying the date, place, and cause; to what time he was last paid, and the money or other effects in his possession at the time of his decease; which report will be noted on the next muster roll of the company to which the man belonged. Each inventory will be endorsed, "Inventory of the effects of _____, late of company (—) _____ regiment of _____, who died at _____, the _____ day of _____, 186—." If a legal representative receive the effects, it will be stated in the report. If the soldier leave no effects, the fact will be reported.

Par. 153. Should the effects of a deceased non-commissioned officer or soldier not be administered upon within a short period after his decease, they shall be disposed of by a Council of Administration, under the authority of the commanding officer of the post, and the proceeds deposited with the Paymaster, to the credit of the United States, until they shall be claimed by the legal representatives of the deceased.

Par. 154. In all such cases of sales by the Council of Administration, a statement in detail, or account of the proceeds, duly certified by the Council and commanding officer, accompanied by the Paymaster's receipt for the proceeds, will be forwarded by the commanding officer to the Adjutant General. The statement will be endorsed, "Report of the proceeds of the effects of _____, late of company (—) _____ regiment of _____, who died at _____, the _____ day of _____, 186—."

NOTE 1.—The effects in all cases, when called for, should be turned over to the legal representative, without further authority from the Adjutant General. When the effects are turned over to the relatives of the deceased before these inventories are sent to the Adjutant General, their receipts therefor should be attached to the inventories. In all other cases, one copy will be sent with a letter of transmittal direct to the Adjutant General, and a duplicate retained by the officer.

NOTE 2.—Particular care should be taken to take receipts in duplicate from the Paymaster for any funds turned over to him; one copy should be sent direct to the Adjutant General and one retained by the officer.

INVENTORY OF THE EFFECTS

OF

Private Washington Senly

Late of Company *B*

7th Reg't of *Ind. C. Troops*

Volunteers, who died at *Fortress Monroe*

on the *7th* day of *September* 186*4*



Inventory of the effects of Washington Derby late
 a Private of Captain W. B. Ryder's 5th Ill Company B of
 the 7th Regiment of M. S. C. Troops Volunteers, who was enrolled as
 a Private at Baltimore in the State of Maryland on
 the 21st day of September 1863, and mustered into the service of the United
 States as a Private on the 26th day of September 1863, at Baltimore
 in Company B, 7th Regiment of M. S. C. T. Volunteers, to serve 3
 years or during the war; he was born in Salisbury County in the State
 of Maryland; he was 30 years of age, 5⁸ feet 7³/₄ inches
 high, Fair complexion, Black eyes, Curly hair, and by occupation, when enrolled,
 a Farmer; he died in Hospital, at
Fortress Monroe on the 7th day of September 1864, by
 reason of Chronic Diarrhea

INVENTORY.					
ARTICLES.	No.	ARTICLES.	No.	ARTICLES.	No.
Hats.....	No. Effects	Pairs trousers.....	No. Effects	Knapsacks.....	
Caps.....		Pairs flannel drawers.....			
Forage caps.....		Pairs cotton drawers.....			
Great coats.....		Flannel shirts.....			
Uniform coats.....		Cotton shirts.....			
Uniform jackets.....		Pairs boots.....			
Flannel sack coats.....		Pairs shoes.....			
Blouses.....		Pairs socks.....			
Stable frocks.....		Blankets.....			
Fatigue overalls.....		Haversacks.....			
				MONEY.	
				Specie.....	\$
				Notes.....	\$

I CERTIFY, ON HONOR, that the above inventory comprises all the effects of _____
 _____, deceased, and that the effects are in the hands
 of _____ at _____
 _____ to be disposed of by a Council of Administration.

(DUPLICATES.)

STATION: In front of Richmond
 DATE: December 8th 1864

Homer C. Munskey
2nd Lieut. U.S.A.
 Commanding the Company.

ARTICLES OF WAR.

ART. 95. When any non-commissioned officer or soldier shall die, or be killed in the service of the United States, the then commanding officer of the troop or company shall, in the presence of two other commissioned officers, take an account of what effects he died possessed of, above his arms and accoutrements, and transmit the same to the office of the Department of War, which said effects are to be accounted for, and paid to the representatives of such deceased non-commissioned officer or soldier. And in case any of the officers, so authorized to take care of the effects of deceased officers and soldiers, should, before they have accounted to their representatives for the same, have occasion to leave the regiment or post, by preferment or otherwise, they shall, before they be permitted to quit the same, deposit in the hands of the commanding officer, or of the assistant military agent, all the effects of such deceased non-commissioned officers and soldiers, in order that the same may be secured for, and paid to, their respective representatives.

ARMY REGULATIONS—EDITION OF 1861.

DECEASED SOLDIERS.

Par. 152. Inventories of the effects of deceased non-commissioned officers and soldiers, required by the 95th Article of War, will be forwarded to the Adjutant General, by the commander of the company to which the deceased belonged, and a duplicate of the same to the colonel of the regiment. Final statements of pay, clothing, &c., will be sent with the inventories. When a soldier dies at a post or station absent from his company, it will be the duty of his immediate commander to furnish the required inventory, and, at the same time, to forward to the commanding officer of the company to which the soldier belonged, a report of his death, specifying the date, place, and cause; to what time he was last paid, and the money or other effects in his possession at the time of his decease; which report will be noted on the next muster roll of the company to which the man belonged. Each inventory will be endorsed, "Inventory of the effects of _____, late of company (—) _____ regiment of _____, who died at _____, the _____ day of _____, 186—." If a legal representative receive the effects, it will be stated in the report. If the soldier leave no effects, the fact will be reported.

Par. 153. Should the effects of a deceased non-commissioned officer or soldier not be administered upon within a short period after his decease, they shall be disposed of by a Council of Administration, under the authority of the commanding officer of the post, and the proceeds deposited with the Paymaster, to the credit of the United States, until they shall be claimed by the legal representatives of the deceased.

Par. 154. In all such cases of sales by the Council of Administration, a statement in detail, or account of the proceeds, duly certified by the Council and commanding officer, accompanied by the Paymaster's receipt for the proceeds, will be forwarded by the commanding officer to the Adjutant General. The statement will be endorsed, "Report of the proceeds of the effects of _____, late of company (—) _____ regiment of _____, who died at _____, the _____ day of _____, 186—."

NOTE 1.—The effects in all cases, when called for, should be turned over to the legal representative, without further authority from the Adjutant General. When the effects are turned over to the relatives of the deceased before these inventories are sent to the Adjutant General, their receipts therefor should be attached to the inventories. In all other cases, one copy will be sent with a letter of transmittal direct to the Adjutant General, and a duplicate retained by the officer.

NOTE 2.—Particular care should be taken to take receipts in duplicate from the Paymaster for any funds turned over to him; one copy should be sent direct to the Adjutant General and one retained by the officer.

INVENTORY OF THE EFFECTS

OF

Private Washington Denny

Late of Company *B*

7 Reg't of *U. S. G. I.*

Volunteers, who died at *U. S. G. I. Fort Monroe Va*

on the *6th* day of *November* 186*4*.

*Duplicate copy with certificate
sent to A. G. Wash. D. C.
Dec 1864*

Inventory of the effects of Washington Derby late
 a Private of Captain U.S.C. Company B of
 the 7th Regiment of U.S.C. Volunteers, who was enrolled as
 a _____ at _____ in the State of _____ on
 the _____ day of _____ 186____, and mustered into the service of the United
 States as a _____ on the _____ day of _____ 186____, at _____
 in Company _____, _____ Regiment of _____ Volunteers, to serve _____
 years or during the war; he was born in _____ in the State
 of _____; he was _____ years of age, _____ feet _____ inches
 high, _____ complexion, _____ eyes, _____ hair, and by occupation, when enrolled,
 a _____; he died in U.S. Genl Hospital, at
Fort Monroe Va on the 7th day of November 1864, by
 reason of Chronic Diarrhea

INVENTORY.					
ARTICLES.	No.	ARTICLES.	No.	ARTICLES.	No.
Hats.....	No Effect	Pairs trousers.....	No Effect	Knapsacks.....	
Caps.....		Pairs flannel drawers.....			
Forage caps.....		Pairs cotton drawers.....			
Great coats.....		Flannel shirts.....			
Uniform coats.....		Cotton shirts.....			
Uniform jackets.....		Pairs boots.....			
Flannel sack coats.....		Pairs shoes.....			
Blouses.....		Pairs socks.....			
Stable frocks.....		Blankets.....			
Fatigue overalls.....		Haversacks.....			
			MONEY.	Specie.....	\$
				Notes.....	\$

I CERTIFY, ON HONOR, that the above inventory comprises all the effects of Washington Derby, deceased, and that the effects are in the hands of _____ at _____ to be disposed of by a Council of Administration.

(DUPLICATES.)

STATION: U.S.C. Fort Monroe Va

DATE: November 7th 1864

W. C. Sullivan
 Asst Surgeon U.S. Army
 Commanding the Company.
 Hospital

388

Derby, Vincent

Co *C*, 7 U.S. Col'd Inf.

Corporal

CARD NUMBERS.

1	26
2	27
3	28
4	29
5	30
6	31
7	32
8	33
9	34
10	35
11	36
12	37
13	38
14	39
15	40
16	41
17	42
18	43
19	44
20	45
21	46
22	47
23	48
24	49
25	50

See Derby, Vincent

Book Mark:

See also

389

Dennett George M

Co. A, 7 U.S. Col'd Inf.

Captain | *Captain*

CARD NUMBERS.

1	6278667	26
2	6279914	27
3	6280016	28
4	6279357	29
5	6281720	30
6		31
7		32
8		33
9		34
10		35
11		36
12		37
13		38
14		39
15		40
16		41
17		42
18		43
19		44
20		45
21		46
22		47
23		48
24		49
25		50

Book Mark:

See also *9 N.A.C.S.*

NVP 646187

S 20 24204 Paul M

~~Ab. G.~~ R & P. 647514

D | 7th | U.S.C.T.

George M Dennett

Capt; Co. , 7 Reg't U. S. Col'd Infantry.

Age 44 years.

Appears on an

Individual Muster-in Roll

of the organization named above. Roll dated

Baltimore Md, Oct-14, 1863.

Muster-in to date Oct-14, 1863.

Joined for duty and enrolled:

When October 14, 1863.

Where Baltimore Md

Period 3 years. or during the war

Remarks: Assigned to Co A. Seventh U.S. C Troops.

Book mark :

C. S. Rozzell

(336)

Copyist.

G

7

U.S.C.T.

George M. Duggett

Capt., Co. A, 7 Reg't U. S. Col'd Infantry.

Appears on

Company Muster Roll

for *from Sept. 26 to Oct. 31*, 1863.

Joined for duty and enrolled:

When *Oct. 9*, 1863.*

Where *Brooklyn N.Y.**

Period years.*

Present or absent *Present*

Stoppage, \$ *100* for

Due Gov't \$ *100* for

Remarks: *Rec'd my appointment Oct. 9th 1863 transmitted letter of acceptance & Oath of Office same day. Reported in person to Genl. Schenck Baltimore Md Oct. 14 and by his order reported to Col. Birney for duty same day.*

* See enrollment on card from muster-in roll.

Book mark:

Duggett

D | **7** | **U.S.C.T.**

George M. Bennett
Capt., Co. A, 7 Reg't U. S. Col'd Infantry.

Appears on

Company Muster Roll

for *Nov. & Dec.*, 1863.

Joined for duty and enrolled:

When *Oct. 9*, 1863.*

Where *Washington D.C.* *

Period years.*

Present or absent *Absent*

Stoppage, \$ *100* for

Due Gov't \$ *100* for

Remarks: *Detached to com'd*
9th U.S. C.T. by S.O. dated
Promoted Major 9th U.S. C.T.
and mustered out as Capt.
Nov. 16th 1863.

* See enrollment on card from muster-in roll.

Book mark:

Daggett
(358c) Copyist.

D 1 7

U.S.C.T.

George M. Mummett
Capt., Co. 7 Reg't U. S. Col'd Buff;

Appears on an

Individual Muster-out Roll

of the organization named above. Roll dated

Camp Stanton, Charles Co, Md, Nov. 17 1863.

Muster-out to date Nov. 16, 1863.

Last paid to Oct. 31, 1863.

Clothing account:

Oct 14

Last settled....., 186 ; drawn since \$..... 100

Due soldier \$..... 100; due U. S. \$..... 100

Am't for cloth'g in kind or money adv'd \$..... 100

Due U. S. for arms, equipments, &c., \$..... 100

Bounty paid \$..... 100; due \$..... 100

Remarks: Mustered out to
accept promotion to
Major 9th U. S. I.
This muster out
takes effect - Nov. 16,
1863.

Book mark:

C. Raven

D

7

U.S.C.T.

George M. Bennett
Capt. Co. A, 7 Reg't U. S. Col'd Infantry.

Appears on **Co. Muster-out Roll**, dated
Indiana Tex, Oct 13, 1866.

Muster-out to date , 186 .

Last paid to , 186 .

Clothing account:

Last settled , 186 ; drawn since \$ 100

Due soldier \$ 100 ; due U. S. \$ 100

Am't for cloth'g in kind or money adv'd \$ 100

Due U. S. for arms, equipments, &c., \$ 100

Bounty paid \$ 100 ; due \$ 100

Remarks: *Joined Co. Oct 15/63.
Discharged to accept
a commission as Major
in 9th U.S.C.T. Nov. 1863*

Book mark:

Murray J.
Copyist.

390

Dennington John

Co. 6, 7 U.S. Col'd Inf.

Private | Private

CARD NUMBERS.

1	6279069	26
2	6284457	27
3	6284545	28
4	6284659	29
5	6284763	30
6	6284861	31
7	6285005	32
8	6279498	33
9	6285343	34
10	9066150	35
11	214-05-1877	36
12		37
13		38
14		39
15		40
16		41
17		42
18		43
19		44
20		45
21		46
22		47
23		48
24		49
25		50

Book Mark: E.B. 12/219. 214
V. 12, a.j.o. E. 77

See also

S. 799799 2 and

S-914737-2^d and (Cathy)

Rep 381794-

51185328 Po aff

D1731545-20.11.11

52065243 Po aff

Pomil. J.C. 551542-3.26.13. Pgh

9

7

U.S.C.T.

John Drumington

, Co. *C*, 7 Reg't U. S. Col'd Inf.

Appears on

Company Descriptive Book

of the organization named above.

DESCRIPTION.

Age *33* years; height *5* feet *5* inches.

Complexion *Blue*

Eyes *Blue*; hair *Black*

Where born *Md.*

Occupation *Laborer.*

ENLISTMENT.

When *Sept. 21*, 186*4*.

Where *Ellicott Mills*

By whom *Capt Holland*; term *3* y'rs.

Remarks: *Draped 1st Dist. Ches. Co. Md. Mustered out by reason of expiration of term of service, Nov. 17, 1865 at Indianapolis.*

J. Smith,

21 | 7 | **U.S.C.T.**

John Huntington

Appears with rank of _____ on
**Muster and Descriptive Roll of a Detach-
ment of Drafted Men and Substitutes
forwarded**

for the 7 Reg't U. S. Col'd Inf. Roll dated
H. McHenry Md Feb, 1865.

Where born _____

Age 33 years; occupation _____

Drafted and mustered in:

When Sept 21, 1864.

Where E. Mills Md

Period 1 years.

Eyes Blk; hair Blk

Complexion Blk; height 5 ft. 7 in.

Paid bounty and advance pay, \$ 100

Bounty due \$ 100

Where credited _____

Company to which assigned _____

Remarks: Disch Charles Co Md
Remand Pay \$30

Book mark: _____

J. M. Fairley Copyist

10 | 7 | U.S.C.T.

John Remington
Priv.; Co. C, 7 Reg't U. S. Col'd Infantry.

Appears on

Company Muster Roll

for *Jan. & Feb.*, 186*5*.

Joined for duty and enrolled:

When *Sept. 21*, 186*4*.*

Where *Ellicott Mills. (Md.)* *

Period *one* years.*

Present or absent *Present*

Stoppage, \$ *100* for

Due Gov't \$ *100* for

Remarks: *Joined the Co. Jan. 25 '65. In confinement undergoing sentence*

* See enrollment on card from muster-in roll.

Book mark:

Ch. W. Murphy
Copyist.

10 | 7 | **U.S.C.T.**

John Pennington
Sgt., Co. C, 7 Reg't U. S. Col'd Infantry.

Appears on

Company Muster Roll
for *Mar. & Apr.*, 1865.

Joined for duty and enrolled:

When *Sept. 21*, 1864.*

Where *Ellicott Mills* *

Period *one* years.*

Present or absent *Present*

Stoppage, \$ 100 for

Due Gov't \$ 100 for

Remarks: *Joined Co. Feb. 25/65. Stop. for repair*

* See enrollment on card from muster-in roll.

Book mark:

M. M. Murphy
(358c) Copyist.

10 | 7 | U.S.C.T.

John Pennington
Pvt; Co. C, 7 Reg't U. S. Col'd Infantry.

Appears on

Company Muster Roll
for May & June, 1865.

Joined for duty and enrolled:

When Sept. 21, 1864.*

Where Ellicott's Mills *

Period one years.*

Present or absent Present

Stoppage, \$ 100 for

Due Gov't \$ 100 for

Remarks: Joined Feb. 25/65
Stop for sniper

* See enrollment on card from muster-in roll.

Book mark:

M. M. Murphy
(358c) Copyist.

10

7

U.S.C.T.

John Pennington
Sgt., Co. C, 7 Reg't U. S. Col'd Infantry.

Appears on

Company Muster Roll

for *July & Aug.*, 1865.

Joined for duty and enrolled:

When *Sept. 21st*, 1864.*

Where *Ellicotts Mills* *

Period *one* years.*

Present or absent *Present*

Stoppage, \$ *100* for

Due Gov't \$ *100* for

Remarks:

* See enrollment on card from muster-in roll.

Book mark: _____

(858c)

M. W. Murphy
Copyist.

D

7

U.S.C.T.

John Pennington
Priv.

Co. C, 7 Reg't U. S. Col'd Infantry.

Appears on

Company Muster Roll

for *Sept. & Oct.*, 186*5*.

Joined for duty and enrolled:

When *Sept. 21*, 186*4*.*

Where *Ellicott Mills, Md.* *

Period *one* years.*

Present or absent *Present*

Stoppage, \$ *100* for

Due Gov't \$ *100* for

Remarks: *Stoppage for*
apprehension \$ 30.00

* See enrollment on card from muster-in roll.

Book mark:

Ch. M. Murphy

(858c)

Copyist.

D. | 7 | U.S.C.T.

John Dennington
Pvt, Co. C, 7 Reg't U. S. Col'd Infantry.

Appears on

Company Muster Roll

for *Nov & Dec*, 186 *5*

Joined for duty and enrolled:

When *Sept. 21st*, 186 *4**

Where *Elliott's Mill* *

Period *3* years.*

Present or absent.....

Stoppage, \$ *100* for.....

Due Gov't \$ *100* for.....

Remarks: *Stop for apprehension \$30⁰⁰ Mustered out by reason of expiration of term of service - Nov. 18 '65.*

* See enrollment on card from muster-in roll.

Book mark:.....

Lopez

A 1 7

U.S.C.T.

John Cunningham
Col, Colo, 7 Reg't U. S. Col'd Infantry.

Appears on a

Detachment Muster-out Roll

of the organization named above. Roll dated
Indianola Texas Nov. 18, 1863.

Muster-out to date *Nov. 18, 1863.*

Last paid to *June 30, 1863*

Clothing account:

Last settled _____, 186 ; drawn since \$ _____ 100

Due soldier \$ *37* - ^{*67*}/₁₀₀; due U. S. \$ _____ 100

Am't for cloth'g in kind or money adv'd \$ _____ 100

Due U. S. for arms, equipments, &c., \$ _____ 100

Bounty paid \$ ~~None~~ 100 due \$ ~~None~~ 100

Remarks: *Joined the company at Fort Buchanan Va. Feb. 25, 1863, under guard. He participated in the campaign of 1863. He retains one newspaper, (over)*

Book mark: _____

Jenkins

JAN. 20

6279498

R1891*

one Haversack and
one Canteen per G.O.
114 War Dept, 1865.

Stop for apprehension
\$30.00. No further military
history. Mustered out,
by reason of expiration
of term of service.

(Awaiting muster
out, till date on account
of absence of Mustering
officer. Has performed
regular soldier's duty
until this date.)

Entitled to travel,
travel, subsistence and
transportation to
place of enlistment.

A. | 7 | U.S.C.T.

John Dennington
Priv. Co. C, 7 Reg't U. S. Col'd Infantry.

Appears on **Co. Muster-out Roll**, dated
Indianola Texas, Oct. 13, 1866.

Muster-out to date _____, 1866 .

Last paid to *June 30*, 1865.

Clothing account:

Last settled _____, 1866 ; drawn since \$ 100

Due soldier \$ 100; due U. S. \$ 100

Am't for cloth'g in kind or money adv'd \$ 100

Due U. S. for arms, equipments, &c., \$ 100

Bounty paid \$ 100; due \$ 100

Remarks: *Mustered out at
Indianola Texas Nov. 17
'65 at expiration of
term.*

Book mark: *The list of deserters on file*

(361)

(over)

Sopez

Copyist.

NARA 651

JAN. 20

6285343

018910

Discharged Nov 18/65
E.B. # 19-214 U.S. a.g.o.
CF 77.

D | 7. | U.S.C.I.

John Dennington

, Co. C, 7. Reg't U.S.C.I.

NOTATION.

E. B. 12. 219.

Book mark: 214-C-I-1877.

War Department,

Adjutant General's Office,

Washington, *Jan'y 29*, 1877.

Mustered out November 18,
1865.

M. Allen

Demmington, John

Co. C 7 Reg't 2nd Inf.

1 Inclosures.

Bed Cards	Final Statements
Burial Records	Furloughs or L. of A
Certs. of Dis. for Disch	Med. Certificates
C. M. Charges	Med. Des. Lists
Descriptive Lists	Orders
Discharge Certificates	Pris. of War Record
Enlistment Papers	Resignations

Other papers relating to—

Admission to Hosp'l	Furlough or L. of A
Casualty Sheet	Med. Examination
Confinement	Misc. Information
Contracts	Pay or Clothing
Death or Effects	Personal Reports
Desertion	Rank
Discharge from Hosp'l	Transfer to Hosp'l
Discharge from Service	Transfer to V. R. C.
Duty	Transportation

Statement of Service Reference Slip.

Office Pension

Claim No. 551542

John Dennington
(Name.)

, Co. C, 7 Reg't U.S.C. Inf

To Arch. Div. Mar. 26, 1913

For whereabouts between
Dec. 29/64 and Feb. 25/65.

See record cards herewith
Johnson
to.

R.R. Dur
Book 115 Records Pro. Mar
8. A.C. Ball's Ind. show him
confined Dec 29. 1864.

Drafted and failed to report
sent to Fort McHenry Dec
30. 1864

Book 136 Records of Fort
McHenry Ind. show him
confined Dec 30-1864

Statement furnished Mar. 27, 1913

P. J. J.

Charge Desertion
Transferred July. 20. 1865
as per S.O. 33.

No. 33 Office Comsq. of
Prisoners Fort M. Healey.

July. 18/1865

The Pro Mar will turn
over the following mentioned
detachments of drafted men
numbering in all 103, to
the officer detailed to take
charge and conduct them
to the Hd Qrs. of their
respective regiments:

12 men to the 7 U.S.C.I.
Army of the James.

Book 11. 25 A.C. Pro Year
Records 25 A.C. show

J. Dennington 7 U.S.C.I.
Forwarded to regt. July 24.
1865. Convalescent.

Harley
p J.M.

391

Demmis Aaron

Co *G*, 7 U.S. Col'd Inf.

Private

Private

CARD NUMBERS.

1	6290940	26
2	6291039	27
3	6291142	28
4	6291246	29
5	6291344	30
6	6291442	31
7	6291540	32
8	6291680	33
9	6291779	34
10	6291849	35
11	6291959	36
12	6292389	37
13	9066658	38
14		39
15		40
16		41
17		42
18		43
19		44
20		45
21		46
22		47
23		48
24		49
25		50

Book Mark: *E.A.V. 12. P. 310.*

See also

29

7

U.S.C.T.

Carroll Dennis

Co. 4, 7 Reg't U.S. Col'd Inf.

Appears on

Company Descriptive Book

of the organization named above.

DESCRIPTION.

Age 19 years; height 5 feet 4 inches.

Complexion Black

Eyes Black; hair Curly

Where born Worcester, Ind.

Occupation Farmer

ENLISTMENT.

When Oct 30, 186

Where Worcester

By whom Wm. H. ...; term 3 y'rs.

Remarks: See Register of Deaths - Died July 11 '65, at ... of disease.

W. H. ... Copyist.

D | 7 | U.S.C.T.

Aaron Dennis

Priv., Co. G, 7 Reg't U. S. Col'd Inf.

Age 18 years.

Appears on

Company Muster-in Roll

of the organization named above. Roll dated

Camp Stanton, Charles Co., Md., Nov. 5, 1863.

Muster-in to date Nov. 5, 1863.

Joined for duty and enrolled:

When Oct. 30, 1863.

Where Worcester, Md.

Period 3 years.

Remarks:

Book mark:

(856)

Sandg. Copyist.

D | 7 | U.S.C.T.

Aaron Dennis

Priv., Co. G, 7 Reg't U. S. Col'd Infantry.

Appears on

Company Muster Roll

for *Nov. 5 to Dec. 31*, 186*8*.

Present or absent *Present*

Stoppage, \$ *100* for

Due Gov't, \$ *100* for

Remarks: *Premium for en-*
listment \$2.00 (due.)

Book mark

Sandoz
Copyist

(858)

D

7

U.S.C.T.

Aaron Dennis

Priv., Co. G, 7 Reg't U. S. Col'd Infantry.

Appears on

Company Muster Roll

for *Jan* & *Feb.*, 1864.

Present or absent *Present.*

Stoppage, \$ 100 for

Due Gov't, \$ 100 for

Remarks:

Book mark:

(858)

Sandoz
Copyist

D

7

U.S.C.T.

Aaron Dennis

Priv., Co. G, 7 Reg't U. S. Col'd Infantry.

Appears on

Company Muster Roll

for March & Apr., 1864.

Present or absent Present

Stoppage, \$ 100 for

Due Gov't, \$ 100 for

Remarks:

Book mark:

(858)

Sandif
Copyist

D

7

U.S.C.T.

Aaron Dennis

Priv., Co. G, 7 Reg't U. S. Col'd Infantry.

Appears on

Company Muster Roll

for *May & June*, 1864.

Present or absent *Present*

Stoppage, \$ *100* for

Due Gov't, \$ *100* for

Remarks:

Book mark:

Sandy
Copyist

(858)

D

7

U.S.C.T.

Carow Dennis

Priv., Co. G, 7 Reg't U. S. Col'd Infantry.

Appears on

Company Muster Roll

for *July & Aug.*, 1864.

Present or absent *Present.*

Stoppage, \$ *100* for

Due Gov't, \$ *100* for

Remarks:

Book mark:

Sandoz

(858)

Copyist

D

7

U.S.C.T.

Arrou Dennis

Priv., Co. G, 7 Reg't U. S. Col'd Infantry.

Appears on

Company Muster Roll

for *Sept. & Oct.*, 1864

Present or absent *Absent*

Stoppage, \$ 100 for

Due Gov't, \$ 100 for

Remarks: *Missing in ac-
tion, Sept. 29", 1864.*

Book mark:

Sandoz
Copyist

(858)

D

7

U.S.C.T.

Arion Dennis

Pvt., Co. G, 7 Reg't U. S. Col'd Infantry.

Appears on

Company Muster Roll

for *Apr & Dec*, 1864

Present or absent

Stoppage, \$ 100 for

Due Gov't, \$ 100 for

Remarks:

*Missing in action Sept
29th 64 & Omitted to be
dropped.*

Book mark:

J. W. Ames

(858)

Copyist

D

7

U.S.C.T.

Carroll Dennis

Priv., Co. G, 7 Reg't U. S. Col'd Infantry.

Appears on

Company Muster Roll

for *March + April*, 186*5*.

Present or absent *Absent*

Stoppage, \$ *100* for

Due Gov't, \$ *100* for

Remarks:

*Gained from missing
in action sick in
Hospital, Baltimore Apr
1/65.*

Book mark:

(858)

J. W. Jones

Copyist

9

7

U.S.C.T.

Carow Dennis

Pvt., Co. G, 7 Reg't U. S. Col'd Infantry.

Appears on

Company Muster Roll

for *May & June*, 1865.

Present or absent *Absent*

Stoppage, \$ _____ 100 for _____

Due Gov't, \$ _____ 100 for _____

Remarks:

Absent sick since Apr. 29 / 65

Book mark: _____

J. W. Ames

(858)

Copyist

2

7

U.S.C.T.

Arvon Dennis

Pvt., Co. G, 7 Reg't U. S. Col'd Infantry.

Appears on

Company Muster Roll

for *July + Aug.*, 186*0*

Present or absent

Stoppage, \$ *100* for

Due Gov't, \$ *100* for

Remarks:

*Died at U.S. G. Hosp, Fort
Monroe Va June 30/65 also*

Book mark: *Died June 6/65 See Vol 8*

EBV 12 p. 310

x Carried by J B Dwyer

J. W. Lewis

(858)

Copyist

P

7

U.S.C.T.

Aaron Dennis

Plt, Co. G, 7 Reg't U. S. Col'd Infantry.

Appears on **Co. Muster-out Roll**, dated
Indianola Texas, Oct 13, 1866.

Muster-out to date _____, 1866.

Last paid to _____ April 30, 1866.

Clothing account:

Last settled _____, 1866 ; drawn since \$ 100

Due soldier \$ 100 ; due U. S. \$ 100

Am't for cloth'g in kind or money adv'd \$ 100

Due U. S. for arms, equipments, &c., \$ 100

Bounty paid \$ 100 ; due \$ 100

Remarks Died at US Hospital
Fort Monroe Va July 11 1865
final statement rendered
October 5 1866

* Rec'd from

Book mark: V33 P 89/68 40701880
over

Hadfield

JAN. 21

6292389

418910

a.g.v. died June 6/65
EB. 12/310 54042^d and
Nov 7/67 see F.S.

MARRA 674

Dennis Hargreaves
 Reg't 7
 5
 Enclosures.

Bed Cards	Final Statements
Burial Records	Furloughs or L. of A.
Certs. of Dis. for Discharge	Med. Certificates
C. M. Charges	Med. Des. Lists
Descriptive Lists	Orders
Discharge Certificates	Pris. of War Record
Enlistment Papers	Resignations

Other papers relating to—

Admission to Hosp'l	Furlough or L. of A.
Casualty Sheet	Med. Examination
Confinement	Misc. Information
Contracts	Pay or Clothing
Death or Effects	Personal Reports
Desertion	Rank
Discharge from Hosp'l	Transfer to Hosp'l
Discharge from Service	Transfer to V. R. C.
Duty	Transportation

[OFFICE ENDORSEMENT.]

War Department,

ADJUTANT GENERAL'S OFFICE,

May 7th, 1867

The *Account* of *William James*
Smith, Co. *G*, *7th* Regt U. S.
Colored *Infantry*, is reported as follows:

- On Company Muster Roll.
- For *July 11th*, 1865, *June 30th*, 1865
- Company Muster-out Roll.
- July 11th*, 1865
- Company Descriptive Book. *1865*
-, 1865
- Company Morning Reports. *1865*
-, 1865
- Soldier's Final Statement. *1865*
- June 6th*, 1865
- Soldier's Record of Death and Interment. *1865*
- June 6th*, 1865
- Soldier's Inventory of Effects. *1865*
-, 1865
- Soldier's Certificate of Disability for Discharge. *1865*
-, 1865
- Soldier's Individual Muster-out Roll. *1865*
-, 1865
- Regimental Return. *1865*
- For, 1865,, 1865
- Regimental Quarterly Returns. *1865*
-, 1865
- Regimental Descriptive Book. *1865*
-, 1865
- By Surgeon General. *1865*

June 6th, 1865, is held to be
the correct date, and the Company Muster
Rolls will be amended accordingly.

Thomas M. Stewart

Assistant Adjutant General.

Noted 26d1.

Noted on Reg.

6/13/10

11/18/1877
Ad. Sec. to Adj. Gen.

FINAL STATEMENT

1000

of Aaron Dennis

7 Reg't of U.S. Col, Troop

Volunteers. Dec July 11 1865

War Dept. A.G.O. Au 12/15 Respy. roll for date of By order J.W. Saggard A.G.O. Vols.

Letter sent to 30 dead. No 7. 60. 100. 200. The duplicate

NOTE 1.—Two of these certificates (or duplicates) are to be given to each Volunteer Soldier or drafted man who may be discharged without being mustered out. (Final Statements are never given to men mustered out of service, that he may at once receive from the Paymaster the pay, &c., due him, and the captain or other COMMISSIONED officer commanding the company will certify to the act of the delivery of the duplicate certificates; with these certificates the Soldier is "entitled to" his discharge, and should also present his discharge to the Paymaster to have the payment endorsed on it. The discharge is to be given back to the Soldier by the Paymaster; the latter only retaining as his vouchers the duplicate certificates.

NOTE 2.—If the Soldier is entitled to pay for the use of his horse, the Company Commander will certify to that fact on the back of both these final statements, and also to the time he has pay due for having been so mounted on his own horse.

NOTE 3.—When a Soldier is furnished with final statements, his descriptive list, if he has one, should be taken up by the officer who gives the Soldier these statements, and endorsed with a statement to this effect by the officer. The endorsement should exhibit a full statement of the time for which the Soldier was allowed pay on his final statements, the clothing account, and all other charges against him or in his favor, so as to comprise a complete exhibit of his account. It will then be transmitted to the Company Commander of the Soldier, who will enter all the data necessary to a full understanding of the Soldier's account on the muster roll upon which the Soldier's discharge is reported. The descriptive list will then be destroyed. The object of this is, that the remaining portion of the Soldier's account may be settled upon the receipt of these muster rolls, and the Soldier receive any pay or allowances that may be due him at the time of his discharge, and which may not appear on his last final statements from the fact that his descriptive list is incomplete. These accounts for back pay, &c., are settled by the 2d Auditor of the Treasury Department.

NOTE 4.—Charges for loss or injury to ordnance, horse equipments, and other miscellaneous charges, should appear under the heading of "Other Stoppages."

NOTE 5.—Bounty paid by State authorities, and not by the United States, will not be entered on this statement.

NOTE 6.—Amounts due the Sutler and Laundress must be entered on the muster roll on which the discharge, death, desertion, &c., is reported, as well as on the final statement, otherwise the amount cannot be collected from the United States.

NOTE 7.—This blank will be used for deceased volunteers and drafted men, as well as for others.

NOTE 8.—When a Soldier dies in Hospital or on detached service, his descriptive list, if he has one, should be sent with his final statements, in duplicate, to the Adjutant General, Washington, D. C.

NOTE 9.—If the soldier is a drafted man or substitute, the space for time, &c., of enlisted, should contain only the word drafted or substitute, as the case may be. If the Soldier is a "VETERAN," (or RECRUIT,) the words as a veteran (or recruit,) as the case may be, should be interlined after the words mustered into the service of the U. S. A statement of all the instalments of Veteran or Recruit Bounty RECEIVED by the Soldier must be made on the back of each final statement.

Aaron Dennis

ADJUTANT GENERAL'S OFFICE. Jan 19 1866 Duplicate with Inventory sent 2d Auditor.

MAR 674

I certify, on honor, that Rayon Dennis, a Private of
 Captain Wm V Smith's Company (E) of the 7 Regiment of U.S. Col Troops
VOLUNTEERS, of the State of Maryland, born in Worcester, State
 of Maryland, aged 19 years; 5 feet 4 inches high; Black complexion,
Blk eyes, Curly hair, and by occupation a Farmer, who joined for service
 and was enrolled (see Note 9) on the 21st day of Oct, 1863, at Somerset Ind
 by Col W Birney, for the period of 3 years, and mustered into
 the service of the United States on the 3rd day of November, 1863, at
Charles Co Ind, by Lt-Col Haskell; and having served
 HONESTLY and FAITHFULLY with his Company to the present date, is now entitled to a
DISCHARGE by reason of Death by Disease

Discharged July 11th 1865

The said Rayon Dennis was last paid by Paymaster
May M'Connell, to include the 30th day of April, 1864, and
 has pay due him from that time to the present date; he is entitled to pay and subsistence for
TRAVELING to place of enrollment, and whatever other allowances are authorized to volunteer
 soldiers, drafted men, or militia, so discharged. He has received from the United States **CLOTHING**
 amounting to 55⁶⁰ ¹⁰⁰ dollars, since the 5th day of November,
 1863, when his clothing account was last settled. He has received from the United States
100 dollars advanced **BOUNTY**.

There is to be stopped from him, on account of the State of _____, or other
 authorities, for **CLOTHING**, &c., received on entering service, _____ ¹⁰⁰ dollars; and
 for other stoppages, viz: _____

_____ ¹⁰⁰ dollars.
 He has been furnished with **TRANSPORTATION** in kind from the place of his discharge to
 _____; and he has been **SUBSISTED** for **TRAVELING** to his
 place of enrollment, up to the _____, 186 .

He is indebted to _____, **SUTLER**, _____ ¹⁰⁰ dollars.

He is indebted to _____, **LAUNDRESS**, _____ ¹⁰⁰ dollars.

Given in Duplicate, at Matagorda Texas, this 23rd day
 of October, 1863.

A. J. Lowe
13/10/65
 Commanding Company

Extract from Act of Congress.

SEC. 12. And be it further enacted, That the fees of agents and attorneys for making out and causing to be executed the papers necessary to establish a claim for a pension, bounty, and other allowance before the Pension Office, under this act, shall not exceed the following rates: For making out and causing to be duly executed a declaration by the applicant, with the necessary affidavits, and forwarding the same to the Pension Office, with the requisite correspondence, ten dollars; which sum shall be received by such agent or attorney in full for all services in obtaining such pension, and shall not be demanded or received, in whole or in part, until such pension shall be obtained; and the sixth and seventh sections of an act entitled "An act to grant pensions," approved July [fourteenth,] eighteen hundred and sixty-two, are hereby repealed.

SEC. 13. And be it further enacted, That any agent or attorney who shall, directly or indirectly, demand or receive any greater compensation for his services under this act than is prescribed in the preceding section of this act, or who shall contract or agree to prosecute any claim for a pension, bounty, or other allowance under this act, on the condition that he shall receive a per centum upon any portion of the amount of such claim, or who shall wrongfully withhold from a pensioner or other claimant the whole or any part of the pension or claim allowed and due to such pensioner or claimant, shall be deemed guilty of a high misdemeanor, and, upon conviction thereof, shall, for every such offense, be fined not exceeding three hundred dollars, or imprisoned at hard labor not exceeding two years, or both, according to the circumstances and aggravations of the offense.

Approved July 4, 1864.

NOTE 10.—If any soldier is charged a higher fee than that allowed by the above act, he should report the fact and the name of the agent to the Adjutant General, in order that steps may be taken to have the same refunded.

A. G. C.
See List vol 2
1864

ADJUTANT GENERAL'S OFFICE
June 13th 1865
Duplicate with Inventory sent 2d Auditor.

28

FINAL STATEMENT

OF

Private Aaron Dennis Co C
7 Reg't of Colored
VOLUNTEERS.
Disch June 1st 1865

NOTE 1.—Two of these certificates (or duplicates) are to be given to each Volunteer Soldier or drafted man who may be discharged without being mustered out (Final Statements are never given to men mustered out of service,) that he may at once receive from the Paymaster the pay, &c., due him, and the captain or other COMMISSIONED officer commanding the company will certify to the act of the delivery of the duplicate certificates; with these certificates the Soldier is "entitled to" his discharge, and should also present his discharge to the Paymaster to have the payment endorsed on it. The discharge is to be given back to the Soldier by the Paymaster; the latter only retaining as his vouchers the duplicate certificates.

NOTE 2.—If the Soldier is entitled to pay for the use of his horse, the Company Commander will certify to that fact on the back of both these final statements, and also to the time he has pay due for having been so mounted on his own horse.

NOTE 3.—When a Soldier is furnished with final statements, his descriptive list, if he has one, should be taken up by the officer who gives the Soldier these statements, and endorsed with a statement to this effect by the officer. The endorsement should exhibit a full statement of the time for which the Soldier was allowed pay on his final statements, the clothing account, and all other charges against him or in his favor, so as to comprise a complete exhibit of his account. It will then be transmitted to the Company Commander of the Soldier, who will enter all the data necessary to a full understanding of the Soldier's account on the muster roll upon which the Soldier's discharge is reported. The descriptive list will then be destroyed. The object of this is, that the remaining portion of the Soldier's account may be settled upon the receipt of these muster rolls, and the Soldier receive any pay or allowances that may be due him at the time of his discharge, and which may not appear on his last final statements from the fact that his descriptive list is incomplete. These accounts for back pay, &c., are settled by the 2d Auditor of the Treasury Department.

NOTE 4.—Charges for loss or injury to ordnance, horse equipments, and other miscellaneous charges, should appear under the heading of "Other Stoppages."

NOTE 5.—Bounty paid by State authorities, and not by the United States, will not be entered on this statement.

NOTE 6.—Amounts due the Sutler and Laundress must be entered on the muster roll on which the discharge, death, desertion, &c., is reported, as well as on the final statement, otherwise the amount cannot be collected from the United States.

NOTE 7.—This blank will be used for deceased volunteers and drafted men, as well as for others.

NOTE 8.—Where a Soldier dies in Hospital or on detached service, his descriptive list, if he has one, should be sent with his final statements, in duplicate, to the Adjutant General, Washington, D. C.

NOTE 9.—If the soldier is a drafted man or substitute, the space for time, &c., of enrolled, should contain only the word *drafted* or *substitute*, as the case may be. If the Soldier is a *VETERAN* (or *RECRUIT*) the words *of a veteran* (or *recruit*) as the case may be, should be interlined after the word *enrolled* in the Service of the U. S. A statement of the installments of *Veteran* or *Recruit* Bounty RECEIVED by the Soldier must be made on the back of each final statement.

Sept. 9, 1865
P. O. of A. G. C. 1865
you state sur 2^d aud.
1865



I certify, on honor, that Aaron Dennis, a Private of
 Captain _____ Company (G) of the 9th Regiment of Colored
VOLUNTEERS, of the State of _____, born in _____, State
 of Maryland, aged 19 years; 5 feet 4 inches high; Dark complexion,
Black eyes, Curly hair, and by occupation a _____, who joined for service
 and was enrolled (see Note 9) on the 5th day of November, 1863, at Charles Co Md
 by Lt Col L. F. Hastell, for the period of 3 years, and mustered into
 the service of the United States on the 5th day of November, 1863, at
Charles Co Md, by Lt Col L. F. Hastell; and having served
 HONESTLY and FAITHFULLY with his Company to the present date, is now entitled to a
DISCHARGE by reason of Death from Typhus Malarial Fever.
He died at McKim's Marine Hospital Baltimore Md June 6 1865

The said Aaron Dennis was last paid by Paymaster
Maj McConnell, to include the 30th day of April, 1864, and
 has pay due him from that time to the present date; he is entitled to pay and subsistence for
TRAVELING to place of enrollment, and whatever other allowances are authorized to volunteer
 soldiers, drafted men, or militia, so discharged. He has received from the United States **CLOTHING**
 amounting to \$15, ⁶⁵/₁₀₀ dollars, since the 1st day of January,
 1863, when his clothing account was last settled. He has received from the United States
 _____ ¹⁰⁰ dollars advanced **BOUNTY**.

There is to be stopped from him, on account of the State of _____, or other
 authorities, for **CLOTHING**, &c., received on entering service, _____ ¹⁰⁰ dollars; and
 for other stoppages, viz: _____
 _____ ¹⁰⁰ dollars.
 He has been furnished with **TRANSPORTATION** in kind from the place of his discharge to
 _____; and he has been **SUBSISTED** for **TRAVELING** to his
 place of enrollment, up to the _____, 1863.

He is indebted to _____, **SUTLER**, _____ ¹⁰⁰ dollars.
 He is indebted to _____, **LAUNDRESS**, _____ ¹⁰⁰ dollars.

Given in Duplicate, at McKim's Marine Hospital Baltimore Md, this 7th day
 of June, 1865.

Wm. S. ...
In Charge of Hospital

 Commanding Company.

"G"
FINAL STATEMENT

OF

Aaron Dennis

7 Reg't of U.S. Col Troops

VOLUNTEERS.

NOTE 1.—Two of these certificates (or duplicates) are to be given to each Volunteer Soldier or drafted man who may be discharged without being mustered out, (Final Statements are never given to men mustered out of service,) that he may at once receive from the Paymaster the pay, &c., due him, and the captain or other COMMISSIONED officer commanding the company will certify to the act of the delivery of the duplicate certificates; with these certificates the Soldier is "entitled to" his discharge, and should also present his discharge to the Paymaster to have the payment endorsed on it. The discharge is to be given back to the Soldier by the Paymaster; the latter only retaining as his vouchers the duplicate certificates.

NOTE 2.—If the Soldier is entitled to pay for the use of his horse, the Company Commander will certify to that fact on the back of both these final statements, and also to the time he has pay due for having been so mounted on his own horse.

NOTE 3.—When a Soldier is furnished with final statements, his descriptive list, if he has one, should be taken up by the officer who gives the Soldier these statements, and endorsed with a statement to this effect by the officer. The endorsement should exhibit a full statement of the time for which the Soldier was allowed pay on his final statements, the clothing account, and all other charges against him or in his favor, so as to comprise a complete exhibit of his account. It will then be transmitted to the Company Commander of the Soldier, who will enter all the data necessary to a full understanding of the Soldier's account on the muster roll upon which the Soldier's discharge is reported. The descriptive list will then be destroyed. The object of this is, that the remaining portion of the Soldier's account may be settled upon the receipt of these muster rolls, and the Soldier receive any pay or allowances that may be due him at the time of his discharge, and which may not appear on his last final statements from the fact that his descriptive list is incomplete. These accounts for back pay, &c., are settled by the 2d Auditor of the Treasury Department.

NOTE 4.—Charges for loss or injury to ordnance, horse equipments, and other miscellaneous charges, should appear under the heading of "Other Stoppages."

NOTE 5.—Bounty paid by State authorities, and not by the United States, will not be entered on this statement.

NOTE 6.—Amounts due the Sutler and Landress must be entered on the muster roll on which the discharge, death, desertion, &c., is reported, as well as on the final statement, otherwise the amount cannot be collected from the United States.

NOTE 7.—This blank will be used for deceased volunteers and drafted men, as well as for others.

NOTE 8.—Where a Soldier dies in Hospital or on detached service, his descriptive list, if he has one, should be sent with his final statements, in duplicate, to the Adjutant General, Washington, D. C.

NOTE 9.—If the soldier is a drafted man or substitute, the space for time, &c., of enrolled, should contain only the word *drafted* or *substitute*, as the case may be. If the Soldier is a "VETERAN," (or RECRUIT,) the words *as a veteran*, (or *recruit*,) as the case may be, should be interlined after the words *mustered into the service of the U. S.* A statement of all the installments of *Veteran*, or *Recruit Bounty RECEIVED* by the Soldier must be made on the back of each final statement.

ADJUTANT GENERAL'S OFFICE

Jan 19th 1866

Duplicate with Inventory for 2d Auditor.

I certify, on honor, that Aaron Dennis, a Private of
 Captain Wm V Smith's Company (G) of the 7 Regiment of W.I. Col Troops
VOLUNTEERS, of the State of Maryland, born in Warcester, State
 of Maryland, aged 49 years; 5 feet 4 inches high; Black complexion,
Black eyes, Curly hair, and by occupation a Farmer, who joined for service
 and was enrolled (see Note 9) on the 21st day of Oct, 1863, at Somerset Md
 by Col Wm Birney, for the period of 3 years, and mustered into
 the service of the United States on the 3rd day of November, 1863, at
Charles C Md, by Lt Col Haskell; and having served
 HONESTLY and FAITHFULLY with his Company to the present date, is now entitled to a
DISCHARGE by reason of Death by Disease

The said Aaron Dennis was last paid by Paymaster
Maj M Connell, to include the 30th day of April, 1864, and
 has pay due him from that time to the present date; he is entitled to pay and subsistence for
TRAVELING to place of enrollment, and whatever other allowances are authorized to volunteer
 soldiers, drafted men, or militia so discharged. He has received from the United States **CLOTHING**
 amounting to 55-60 ¹⁰⁰ dollars, since the 5th day of November,
 1863, when his clothing account was last settled. He has received from the United States
¹⁰⁰ dollars advanced **BOUNTY**.

There is to be stopped from him, on account of the State of _____, or other
 authorities, for **CLOTHING, &c.**, received on entering service, _____ ¹⁰⁰ dollars; and
 for other stoppages, viz: _____

_____ ¹⁰⁰ dollars.
 He has been furnished with **TRANSPORTATION** in kind from the place of his discharge to
 _____; and he has been **SUBSISTED** for **TRAVELING** to his
 place of enrollment, up to the _____, 186 .

He is indebted to _____, **SUTLER**, _____ ¹⁰⁰ dollars.
 He is indebted to _____, **LAUNDRESS**, _____ ¹⁰⁰ dollars.

Given in Duplicate, at Nabiyula Texas, this 25th day
 of October, 1863.

A. J. Long
Comd'g Co
 Commanding Company

1865 679

2 of 1. 500 2 71 Col of 1st of
Co. of 1st Regt
Co. of 1st

ARTICLES OF WAR.

ART. 95. When any non-commissioned officer or soldier shall die, or be killed in the service of the United States, the then commanding officer of the troop or company shall, in the presence of two other commissioned officers, take an account of what effects he died possessed of, above his arms and accoutrements, and transmit the same to the office of the Department of War, which said effects are to be accounted for, and paid to the representatives of such deceased non-commissioned officer or soldier. And in case any of the officers, so authorized to take care of the effects of deceased officers and soldiers, should, before they have accounted to their representatives for the same, have occasion to leave the regiment or post, by preferment or otherwise, they shall, before they be permitted to quit the same, deposit in the hands of the commanding officer, or of the assistant military agent, all the effects of such deceased non-commissioned officers and soldiers, in order that the same may be secured for, and paid to, their respective representatives.

ARMY REGULATIONS—EDITION OF 1861.

DECEASED SOLDIERS.

Par. 152. Inventories of the effects of deceased non-commissioned officers and soldiers, required by the 95th Article of War, will be forwarded to the Adjutant General, by the commander of the company to which the deceased belonged, and a duplicate of the same to the colonel of the regiment. Final statements of pay, clothing, &c., will be sent with the inventories. When a soldier dies at a post or station absent from his company, it will be the duty of his immediate commander to furnish the required inventory, and, at the same time, to forward to the commanding officer of the company to which the soldier belonged, a report of his death, specifying the date, place, and cause; to what time he was last paid, and the money or other effects in his possession at the time of his decease; which report will be noted on the next muster roll of the company to which the man belonged. Each inventory will be endorsed, "Inventory of the effects of _____, late of company (—) _____ regiment of _____, who died at _____, the _____ day of _____, 186—." If a legal representative receive the effects, it will be stated in the report. If the soldier leave no effects, the fact will be reported.

Par. 153. Should the effects of a deceased non-commissioned officer or soldier not be administered upon within a short period after his decease, they shall be disposed of by a Council of Administration, under the authority of the commanding officer of the post, and the proceeds deposited with the Paymaster, to the credit of the United States, until they shall be claimed by the legal representatives of the deceased.

Par. 154. In all such cases of sales by the Council of Administration, a statement in detail, or account of the proceeds, duly certified by the Council and commanding officer, accompanied by the Paymaster's receipt for the proceeds, will be forwarded by the commanding officer to the Adjutant General. The statement will be endorsed, "Report of the proceeds of the effects of _____, late of company (—) _____ regiment of _____, who died at _____, the _____ day of _____, 186—."

NOTE 1.—The effects in all cases, when called for, should be turned over to the legal representative, without further authority from the Adjutant General. When the effects are turned over to the relatives of the deceased before these inventories are sent to the Adjutant General, their receipts therefor should be attached to the inventories. In all other cases, one copy will be sent with a letter of transmittal direct to the Adjutant General, and a duplicate retained by the officer.

NOTE 2.—Particular care should be taken to take receipts in duplicate from the Paymaster for any funds turned over to him; one copy should be sent direct to the Adjutant General and one retained by the officer.

INVENTORY OF THE EFFECTS

OF

Uaron Dennis

Late of Company 'G'

7 Reg't of U.S. Col Troops

Volunteers, who died at Fort Mifflin Pa

on the 11th day of July 1865.



Inventory of the effects of Aaron Dennis late
a Private of Captain Wm Vermitts Company 'G' of
the 7 Regiment of U S Col Troops Volunteers, who was enrolled as
a Private at Worcester in the State of Maryland on
the 21 day of October 1863, and mustered into the service of the United
States as a Private on the 3 day of November 1863, at Charles Co Md,
in Company 'G', 7 Regiment of U S Col Troops Volunteers, to serve 3
years or during the war; he was born in Worcester in the State
of Maryland; he was 19 years of age, 5 feet 4 inches
high, Black complexion, Black eyes, Curly hair, and by occupation, when enrolled,
a Farmer; he died in U S Hospital, at
Fort Monroe Va on the 11 day of July 1865, by
reason of Disease

INVENTORY.							
ARTICLES.	No.	ARTICLES.	No.	ARTICLES.	No.		
Hats.....		Pairs trousers.....		Knapsacks.....			
Caps.....		Pairs flannel drawers.....					
Forage caps.....		Pairs cotton drawers.....					
Great coats.....		Flannel shirts.....					
Uniform coats.....		Cotton shirts.....					
Uniform jackets.....		Pairs boots.....					
Flannel sack coats.....		Pairs shoes.....					
Blouses.....		Pairs socks.....					
Stable frocks.....		Blankets.....					
Fatigue overalls.....		Haversacks.....					
						MONY.	
						Spent.....	\$
				Notes.....	\$		

No Effects

I CERTIFY, ON HONOR, that the above inventory comprises all the effects of Private
Aaron Dennis, deceased, and that the effects are in the hands
of _____ at _____
_____ to be disposed of by a Council of Administration.

(DUPLICATES.)

H. R. Long
Capt 7th U.S. Col.
Commanding the Company.

STATION: Hagerstown Force
DATE: October 23/65

[A. G. O. No. 104.]

HOSPITAL RECORD,

SUBJECT TO THE

ORDER OF THE SURGEON GENERAL

UNITED STATES ARMY.

W Dennis
U.S.C. I. Pvt G
June 6/65
McKins Bldg
Balto Md

No. 1.

RECORD OF DEATH AND INTERMENT.

Name and number of person interred.	<i>Aaron Dennis</i>
Number and locality of the grave . . .	<i>Laurel Cemetery</i>
Hospital number of the deceased . . .	<i>258</i>
Regiment, rank, and company	<i>7th U.S.C.T. = Private - Co. "C".</i>
Residence before enlistment	<i>New Tenn. Weston Co Md</i>
Conjugal condition, (and if married,) the residence of the widow) . . . }	<i>Single</i>
Cause of death }	<i>Dyspepsia Malarial Fever</i>
Age of the deceased	<i>19 Years</i>
Nativity	<i>Maryland</i>
References and remarks }	
Date of death and burial	<i>Died June 6th 1865. Buried June 7th 10. a. m. A M 1865.</i>

Duplicates sent to the Adjutant General of the United States Army, and to the Sexton of the Cemetery.

Memoranda:

- List of Effects.*
- 1 Blouse*
- 1 P^d Pants*
- 1 " Shoes*
- 1 Forage Cap.*

*Final Statement &
Inventory of Effects sent
to A. S. & Co Comdr
June 7th 1865*

COPY OF RECORD

FOR THE

ADJUTANT GENERAL U. S. ARMY.

*Have
7/2*

No. 2.

RECORD OF DEATH AND INTERMENT.

Name and number of person interred.	<i>Aaron Dennis</i>	
Number and locality of the grave . . .	<i>Laurel Cemetery</i>	
Hospital number of the deceased . . .	<i>258.</i>	
Regiment, rank, and company	<i>7th U. S. C. T. - Private - Co "G".</i>	
Residence before enlistment	<i>New Town. Worcester Co. Md</i>	
Conjugal condition, (and if married, } the residence of the widow) . . . }	<i>Single</i>	
Cause of death	<i>Typho Malarial Fever</i>	
Age of the deceased	<i>19 Years</i>	
Nativity	<i>Maryland</i>	
References and remarks }		
Date of death and burial	<i>Died June 6th Buried June 7th 10. o. c. A M</i>	<i>1865.</i>

[A duplicate of this Record has been forwarded to the Sexton, and another remains at this Hospital.]

To

Brig. Genl. C. D. Townsend A. A. S. M. A.

SIR:

It becomes my duty to inform you that the person above described died at this Hospital as herein stated; and that it is desired his remains should be interred with the usual military honors.

Respectfully,

[Signature]
Surgeon U. S. Army.

MILITARY HOSPITAL, *McHenry Barracks, Balt. Md.*

In charge of Hospital

This copy of Record is to be transmitted to the Adjutant General at Washington immediately after the place of burial and the number of the grave have been ascertained and registered. The above notification is to remain attached.

MEMORANDUM FROM PRISONER OF WAR RECORDS.

No. _____

(This blank to be used only in the arrangement of said records.)

NAME	RANK.	ORGANIZATION.				INFORMATION OBTAINED FROM—				
		No. of Reg't.	State.	Arm of Service.	Co.	Records of—	Vol.	Page.	Vol.	Page.
<i>Dennis A. ...</i>	<i>P</i>	<i>4</i>	<i>Ch. 67</i>		<i>9</i>	<i>Wis</i>	<i>69</i>	<i>56</i>	<i>39</i>	<i>772</i>

Captured at *Chapin, Tenn. Co. Sept 29*, 1864, confined at Richmond, Va., *Sept 29*, 1864.
Were owned by Samuel King, Home at ... Md. Retired from ... Feb 22/65

Admitted to Hospital at _____
where he died _____, 186 , of _____

Paroled at _____, 186 ; reported at Camp Parole, Md., _____, 186 .
See Book Reg Page 56 - other remarks illegible.

Copied by *[Signature]*

39

Dennis George

Co *C*, 7 U.S. Col'd Inf.

Sergeant | *Sergeant*

CARD NUMBERS.

1	6283546	26
2	6283647	27
3	6283748	28
4	6283849	29
5	6283951	30
6	6284081	31
7	6284176	32
8	6284271	33
9	6284355	34
10	6284458	35
11	6284546	36
12	6284634	37
13	6284767	38
14	6284864	39
15	6284961	40
16	6285045	41
17	6285113	42
18	6285184	43
19	6285240	44
20	6285297	45
21	9066145	46
22	D-60 R.C.J-1867	47
23		48
24		49
25		50

Book Mark: *D. 60. Vol. 5, R. C. J. 1867*

See also

~~NIP 646 187~~

9

7

U.S.C.T.

George Dennis

Co. *C*, 7 Reg't U.S. Col'd Inf.

Appears on

Company Descriptive Book

of the organization named above.

DESCRIPTION.

Age *19* years; height *5* feet *4 1/2* inches.

Complexion *briff*

Eyes *Black*; hair *Curly*

Where born *Somerset, Ind.*

Occupation *Farmer*

ENLISTMENT.

When *Sept. 16*, 186*3*

Where *Baltimore, Ind.*

By whom *Col. W. Biney*; term *3* y'rs.

Remarks: *Mustered at Baltimore
Ind. Sept. 26, 63, by Col.
W. Biney. Promoted
Supt. Oct. 1, 63. Reduced
to ranks June 21, 64.
Promoted corps. May 22, 65;
Reduced to ranks July 24, 65.*

J. Smith

D | 7 | U.S.C.T.

George Dennis.
Sgt., Co. C, 7 Reg't U. S. Colored Inf.

Age 14 years.

Appears on

Company Muster-in Roll

of the organization named above. Roll dated

Batterson, Md., Sept. 26, 1863.

Muster-in to date Sept. 26, 1863

Joined for duty and enrolled:

When Sept. 23, 1863.*

Where Somerset Co. Md. *

Period 3 years.*

Remarks:

*Muster-in roll shows enrollment of all men of this company as of same date. See enrollment on subsequent card or cards.

Book mark:

Callaway

10 | 7 | U.S.C.T.

George Dennis.
Sgt, Co. C, 7 Reg't U. S. Col'd Infantry.

Appears on

Company Muster Roll
for Sept 26 to Oct 31, 1863.

Joined for duty and enrolled:

When Sept 23, 1863.*

Where Somerset Co. Md. *

Period 3 years.*

Present or absent Present.

Stoppage, \$ 100 for

Due Gov't \$ 100 for

Remarks:

* See enrollment on card from muster-in roll.

Book mark:

(358c)

Casey Copyist.

2

7

U.S.C.T.

George Dennis.
Sgt, Co. C, 7 Reg't U. S. Col'd Infantry.

Appears on

Company Muster Roll

for *Nov and Dec*, 1863

Joined for duty and enrolled:

When *Sept. 23*, 1863*

Where *Somerset Co. Md.**

Period *3* years.*

Present or absent *Present.*

Stoppage, \$ *100* for

Due Gov't \$ *100* for

Remarks: *Stop for our knap-
sack & straps.*

* See enrollment on card from muster-in roll.

Book mark:

Callaway

D

7

U.S.C.T.

George Dennis.

Serjt, Co. C, 7 Reg't U. S. Col'd Infantry.

Appears on

Company Muster Roll

for *Jan'y and Feby*, 1864.

Joined for duty and enrolled:

When *Sept. 23*, 1863*

Where *Somerset Co, Md.* *

Period *3* years.*

Present or absent *Present*

Stoppage, \$ *100* for

Due Gov't \$ *100* for

Remarks:

* See enrollment on card from muster-in roll.

Book mark:

Calloway.

20

7

U.S.C.T.

George Dennis.

Sgt, Co. C, 7 Reg't U. S. Col'd Infantry.

Appears on

Company Muster Roll

for *March and April*, 1864.

Joined for duty and enrolled:

When *Sept. 23*, 186*3**

Where *Somerset Co. Md.* *

Period *3* years.*

Present or absent *Present*

Stoppage, \$ *100* for

Due Gov't \$ *100* for

Remarks: *Stop for 1/2 pr scales.*

* See enrollment on card from muster-in roll.

Book mark:

Calloway

10

7

U.S.C.T.

George Dennis

Priv., Co. C, 7 Reg't U. S. Col'd Infantry.

Appears on

Company Muster Roll

for May and June, 1864.

Joined for duty and enrolled:

When Sept. 23, 1863*

Where Cornwille, Md. *

Period 3 years.*

Present or absent Absent

Stoppage, \$ 100 for

Due Gov't \$ 100 for

Remarks: Detached as river picket June 18/64. Reduced from Sergt. June 1st priv. O. no. 61 R. Hd 2nd

* See enrollment on card from muster-in roll.

Book mark:

Caseway

10 | 7

U.S.C.T.

George Dennis,
Privt, Co. C, 7 Reg't U. S. Col's Inf.

Appears on

Company Muster Roll
for July and Aug. 1864.

Joined for duty and enrolled:

When Sept. 23, 1863*

Where Summit Co. Md. *

Period 3 years.*

Present or absent Present.

Stoppage, \$ 100 for

Due Gov't, \$ 100 for

Valuation of horse, \$ 100

Valuation of horse equipments, \$ 100

Remarks: Frequent before
Apr 19, 1861.

* See enrollment on card from muster-in roll.

Book-mark :

Callaway
Copist.

10 | 7 | U.S.C.T.

George Dennis
Pvt., Co. C, 7 Reg't U. S. Col'd Infantry.

Appears on

Company Muster Roll
for Sept & Oct., 1864.

Joined for duty and enrolled:

When Sept. 23, 1863.*

Where Somerset *

Period 3 years.*

Present or absent Present

Stoppage, \$ 100 for

Due Gov't \$ 100 for

Remarks: Free on or before
Apr. 19/64. Appointed
Sergeant Sept. 23/63 -
Entitled to back pay
as Sergeant over and
above that of (over)

* See enrollment on card from muster-in roll.

Book mark:

M. W. Murphy
(358c) Copyist.

NOVA 697

JAN. 20

6284271

ALBANY

Private up to June 16/64

D | 7 | **U.S.C.T.**

George Dennis
Priv., Co. C, 7 Reg't U. S. Col'd Infantry.

Appears on

Company Muster Roll

for *Nov. & Dec.*, 186*4*.

Joined for duty and enrolled:

When *Sept. 23*, 186*3*.*

Where *Somerset* *

Period *3* years.*

Present or absent *Absent*

Stoppage, \$ *100* for

Due Gov't \$ *100* for

Remarks: *Sick in Hosp*
since Dec. 24/64

* See enrollment on card from muster-in roll.

Book mark: _____

(358c)

M. M. Murphy
Copyist.

12 | 7 | U.S.C.T.

George Dennis

, Co. C, 7 Reg't U. S. Col'd Infantry.

Appears on

Company Muster Roll

for *Jan. & Feb.*, 186*3*.

Joined for duty and enrolled:

When *Sept. 23rd*, 186*3*.*

Where *Somerset Co. (Md.)*.*

Period *3* years.*

Present or absent *Present*

Stoppage, \$ *100* for

Due Gov't \$ *100* for

Remarks:

* See enrollment on card from muster-in roll.

Book mark:

M. M. Murphy

(358c)

Copyist.

10 | 7 | U.S.C.T.

George Dennis
Priv., Co. C, 7 Reg't U. S. Col'd Infantry.

Appears on

Company Muster Roll
for Mar. 7 Apr., 186 5.

Joined for duty and enrolled:

When Sept. 23", 186 3.*

Where Somerset Co., Md. *

Period 3 years.*

Present or absent Present

Stoppage, \$ 100 for

Due Gov't \$ 100 for

Remarks: Stop for Wiper

* See enrollment on card from muster-in roll.

Book mark:

M. M. Murphy
(358c) Copyist.

D | **7** | **U.S.C.T.**

George Dennis
Corp., Co. C, 7 Reg't U. S. Col'd Infantry.

Appears on

Company Muster Roll
for *May 7 June*, 186*5*.

Joined for duty and enrolled:

When *Sept. 23*, 186*3*.*

Where *Somerset Co.* *

Period *3* years.*

Present or absent *Present*

Stoppage, \$ *100* for

Due Gov't \$ *100* for

Remarks: *Stopped for*
Wiper

* See enrollment on card from muster-in roll.

Book mark:

M. W. Murphy
(258c) Copyist.

10

7

U.S.C.T.

George Dennis

Priv., Co. C, 7 Reg't U. S. Col'd Infantry.

Appears on

Company Muster Roll

for July & Aug., 1865.

Joined for duty and enrolled:

When Sept. 23rd, 1863.*

Where Somerset *

Period 3 years.*

Present or absent Present

Stoppage, \$ 100 for

Due Gov't \$ 100 for

Remarks: Reduced to the ranks for disobedience of order by S. O. No. 1

* See enrollment on card from muster-in roll.

Book mark:

J. W. Murphy Copyist.

(858c)

10 | 7 | U.S.C.T.

George Dennis
Priv., Co. C, 7 Reg't U. S. Col'd Infantry.

Appears on

Company Muster Roll
for Sept. & Oct., 1863.

Joined for duty and enrolled:

When Sept. 16, 1863.*

Where Somerset, Md. *

Period 3 years.*

Present or absent Present

Stoppage, \$ 100 for

Due Gov't \$ 100 for

Remarks:

* See enrollment on card from muster-in roll.

Book mark:

M. W. Murphy
(258c) Copyist.

L | 7 | U.S.C.T.

George Dennis
Pt. Co. C, 7 Reg't U. S. Col'd Infantry.

Appears on

Company Muster Roll

for Nov & Dec, 1865.

Joined for duty and enrolled:

When Sept. 16, 1863*

Where Somerset Md. *

Period 3 years.*

Present or absent Present

Stoppage, \$ 100 for

Due Gov't \$ 100 for

Remarks:

* See enrollment on card from muster-in roll.

Book mark:

(258c) Lopez Copyist.

D. | 7 | U.S.C.T.

George Dennis
Prk., Co. C, 7 Reg't U. S. Col'd Infantry.

Appears on

Company Muster Roll
for *Jan & Feb*, 1866.

Joined for duty and enrolled:

When *Sept. 16*, 1863*

Where *Somerset Md.**

Period *3* years.*

Present or absent *Present*

Stoppage, \$ *18* for *Ordnance*

Due Gov't \$ *100* for

Remarks:

* See enrollment on card from muster-in roll.

Book mark: -----

(258c)

Lopez

Copyist.

D. | 7 | **U.S.C.T.**

George Dennis
Co. C, 7 Reg't U. S. Col'd Infantry.

Appears on

Company Muster Roll
for *Wch + Apl*, 186*6*

Joined for duty and enrolled:

When *Sept 16*, 186*3**

Where *Somerset Md.**

Period *3* years.*

Present or absent *Present.*

Stoppage, \$ *100* for

Due Gov't \$ *100* for

Remarks:

* See enrollment on card from muster-in roll.

Book mark:-----

(358c) *Lopez* Copyist.

A

7

U.S.C.T.

George Dennis
Co. C, 7 Reg't U. S. Col'd Infantry.

Appears on

Company Muster Roll

for *May & June*, 186*6*

Joined for duty and enrolled:

When *Sept. 16*, 186*6**

Where *Somerset Md.**

Period *3* years.*

Present or absent *Present*

Stoppage, \$ *100* for

Due Gov't \$ *100* for

Remarks:

* See enrollment on card from muster-in roll.

Book mark:

Lopez

D

7

U.S.C.T.

George Dennis

Pr, Co. C, 7 Reg't U. S. Col'd Infantry.

Appears on

Company Muster Roll

for *July & Aug*, 186*6*

Joined for duty and enrolled:

When *Sept. 16*, 186*3**

Where *Somerset Md.* *

Period *3* years.*

Present or absent *Present.*

Stoppage, \$ *100* for

Due Gov't \$ *100* for

Remarks:

* See enrollment on card from muster-in roll.

Book mark: _____

Lopez

A. 7 | U.S.C.T.

George Dennis
Art. Co. Co. Reg't U. S. Col'd Infantry.

Appears on **Co. Muster-out Roll**, dated
Indianola Texas, Oct. 13, 1866.

Muster-out to date Oct. 13, 1866.

Last paid to June 30, 1866.

Clothing account:

Last settled _____, 1866; drawn since \$ _____ 100

Due soldier \$ 29⁸⁷ 100; due U. S. \$ _____ 100

Am't for cloth'g in kind or money adv'd \$ _____ 100

Due U. S. for arms, equipments, &c., \$ _____ 100

Bounty paid \$ _____ 100; due \$ 100 100

Remarks: Joined Co. at
original organization.
Sergt. from muster in to
June 21 '64 then Pvt.
to May 22 '65 then Corp'l
to July 24 '65 then Pvt.
to date.

Book mark: 247-622-Sub Vol. 5

(861)

Lopez
(over)

Copyist.

JAN. 20

6285297

e1891a

A. G. T. 1867 Discharge.

D. 17th U.S. b. J.

George Dennis

, Co. B, 7th Reg't U.S. b. J.

NOTATION.

Book mark: D. Co. B. b. J. 1867.

War Department,

Adjutant General's Office,

Washington, Aug. 13th 1867.

Discharge on file.

E. P. Conrazier.

Dennis, George

P. Co. C.

7 Reg't

U.S.C. Inf.

3 Enclosures.

Bed Cards	Descriptive Lists
Burial Records 1	Final Statements
Certs. of Dis. for Discharge	Furloughs
C. M. Charges	Med. Des. Lists
Med. Certificates	Orders

Other papers relating to—

Admission to Hosp'l	Furlough
Casualty Sheet (Officer's) ^{Pri} 2	Med. Examination
Confinement	Misc. Information
Contracts	Pay or Clothing
Death or Effects	Personal Reports
Desertions	Rank
Discharge from Hosp'l	Transfer to Hosp'l
Discharge from Service	Transfer to V. R. C.
Duty	Transportation

NA 713

George Dennis
Priv Co 4. U. S. C. 3.
Oct 19. 66.

Sedgwick G. H. La

HOSPITAL RECORD,

SUBJECT TO THE

ORDER OF THE SURGEON GENERAL

UNITED STATES ARMY.

No. 1.

RECORD OF DEATH AND INTERMENT.

Name and number of person interred.	<i>George Dennis</i>
Number and locality of the grave .	<i>H 24</i>
Hospital number of the deceased . .	<i>Private Co "C" 7th U.S. Inf.</i>
Regiment, rank, and company . . .	<i>Summersett Wtd.</i>
Residence before enlistment . . .	<i>Single</i>
Conjugal condition, (and if married, } the residence of the widow) . . }	
Cause of death }	<i>Cholera</i>
Age of the deceased }	<i>29</i>
Nativity }	
References and remarks }	
Date of death and burial }	<i>October 19</i> , 186 <i>4</i>

Duplicates sent to the Adjutant General of the United States Army, and to the Sexton of the Cemetery.

Memoranda:

Vertical stamp or marking on the right edge of the page.

2 pt. 2000 yrs. 1786, Nov 17, 1866

CASUALTY SHEET

No. _____

George Dennis

Priv. of Company *D*

7th Regiment of *V.S.C.V.*

State Volunteers.

NATURE OF CASUALTY.

Died Oct. 19, 1866,

*Act. m. l. and 2000
Act. m. l. and 2000
D. & 2000
D. & 2000*

Edward A. Rogers

CASUALTY SHEET.

Name: *George Dennis*
 Rank: *Private* Company: *C* Regiment: *7th*
 Arm: *U. S. C. Troops* State: _____
 Nature of Casualty: *Death*

CAUSE OF CASUALTY—(NAME OF DISEASE, &c.)

Cholera

DEGREE OF DISABILITY.

BY WHOM CERTIFIED.

A. Hartwell
J. H. A.

DATE OF DISCHARGE, DEATH, &c.

Oct. 19, 1866

PLACE OF DISCHARGE, DEATH, &c.

Sedgwick General Hospital
Greenville, Louisiana,

BY WHOM DISCHARGED.

FROM WHAT SOURCE THIS INFORMATION WAS OBTAINED.

Inv. of effects

REMARKS.

Inv. of effects sent
2^d Auditor. Nov. 15, 1866

Clerk.

58

CASUALTY SHEET
OF WOUNDED.

George Dennis
Private Company "K"
7th Regiment of N.S.V.
 Volunteers at the battle of Chapin's
Ham, Va., Sept 29 &
30/62.

CASUALTY SHEET.

Name, George Dennis
 Rank, Pat, Company "K", Regiment, 4th
 Arm, No. S. I. I., State, _____
 Place of casualty, Chapins Farm, Va.
 Nature of casualty, Wounded
 Date of casualty, Sept 29 + 30 / 62

FROM WHAT SOURCE THIS INFORMATION WAS OBTAINED

Report of Killed, Wounded, and Missing of the _____ Regiment,
 Brigade, _____ Division, _____ Corps, dated _____
at Chapins Farm, Va., on the 29 + 30
of Sept 1862, at Chapins Farm, Va.,
(Sgd. Jewellm F. Haskell
St. Cal. 10009,

Invo 2 no 63.

J. Brownish
 Clerk.

213

Dennis George W.
Co A, 7 U.S. Col'd Inf.

Private | Private

CARD NUMBERS.

1	6295990	26
2	6296090	27
3	6296189	28
4	6296293	29
5	6296388	30
6	6296481	31
7	6296573	32
8	6296656	33
9	6296746	34
10	6296831	35
11	6296940	36
12	6297045	37
13	6297218	38
14	6297462	39
15	6297688	40
16	9067026	41
17		42
18		43
19		44
20		45
21		46
22		47
23		48
24		49
25		50

Book Mark P.V. 13.130-69.

See also

A. 2328470 P.O. mm
A-2970812 avd

D. | 7 | U.S.C.T.

George W. Dennis

, Co. K, 7 Reg't U. S. Col'd Inf.

Appears on
Company Descriptive Book
of the organization named above.

DESCRIPTION.

Age 21 years; height 5 feet 3 1/2 inches.

Complexion Black

Eyes Black; hair Black

Where born Worcester, Maryland

Occupation Farmer

ENLISTMENT.

When Nov. 2, 1863.

Where near Snow Hill.

By whom Col. W. B. Boney; term 3 y'rs.

Remarks: Mustered into serv.

at Camp Stanton, Chas. Co. Md. by Lt. Col. Marshall

Nov. 12. 63. Severely wounded Sept. 29. 64.

Mustered out service June 12. 65. in Order of Sec. of War.

J. G. White.

Copyist.

D | **7** | **U.S.C.T.**

George W. Dennis
Private, Co. *K.*, 7 Reg't U. S. Col'd Inf.

Age *21* years.

Appears on

Company Muster-in Roll

of the organization named above. Roll dated
Co. Stanton
Charles Co. Md., *Nov. 12*, 186*3*.

Muster-in to date *Nov. 12*, 186*3*

Joined for duty and enrolled:

When *Nov. 21*, 186*3*.

Where *Worcester Md.*

Period *3* years.

Remarks:.....
.....
.....
.....
.....
.....

Book mark:.....

D. M. Kennedy

2

7

U.S.C.T.

George W. Dennis
Privt., Co. K, 7 Reg't U. S. Col'd Infantry.

Appears on

Company Muster Roll

for Nov. 12 to Dec 31, 1863.

Present or absent Present

Stoppage, \$ 100 for

Due Gov't, \$ 100 for

Remarks: Enlistment Premium
\$ 2 00 dollars due.

Book mark:

W. M. Kennedy
Copyist.

D | **7** | **U.S.C.T.**

George W. Dennis
Privt., Co. K, 7 Reg't U. S. Col'd Infantry.

Appears on

Company Muster Roll

for *Jan. v Feb.*, 186*4*

Present or absent *Present*

Stoppage, \$ *100* for

Due Gov't, \$ *100* for

Remarks:

Book mark:

D. M. Kennedy
Copyist.

G | **7** | **U.S.C.T.**

George W. Dennis
Privt., Co. K, 7 Reg't U. S. Col'd Infantry.

Appears on

Company Muster Roll

for *Mich* *or* *Apr*, 186 *4*

Present or absent *Present*

Stoppage, \$ *100* for

Due Gov't, \$ *100* for

Remarks:

Book mark:

D. M. Kennedy

Copyist.

G

7

U.S.C.T.

George W Dennis
Privt, Co. K, 7 Reg't U. S. Col'd Infantry.

Appears on

Company Muster Roll

for *May & June*, 186*4*.

Present or absent *Present*

Stoppage, \$ *100* for

Due Gov't, \$ *100* for

Remarks:

Book mark: _____

D. M. Kennedy
Copyist.

D | **7** | **U.S.C.T.**

George W. Dennis
Privt, Co. K, 7 Reg't U. S. Col'd Infantry.

Appears on

Company Muster Roll

for *July* v. *Aug.*, 186*4*

Present or absent *Present.*

Stoppage, \$ *100* for

Due Gov't, \$ *100* for

Remarks:

Book mark:

H. M. Kennedy
Copyist.

(358)

G | **7** | **U.S.C.T.**

George W. Dennis
Privt., Co. K, 7 Reg't U. S. Col'd Infantry.

Appears on

Company Muster Roll

for *Sept. & Oct.*, 186 *4*

Present or absent *Absent*

Stoppage, \$ *100* for

Due Gov't, \$ *100* for

Remarks: *In Hospital wounded*
Sept. 29 " 1864.

Book mark:

L. M. Kennedy
Copist.

10

7

U.S.C.T.

George W. Dennis

Pvt, Co. K, 7 Reg't U. S. Col'd Infantry.

Appears on

Company Muster Roll

for *Nov & Dec*, 1864

Present or absent *Absent*

Stoppage, \$ *100* for

Due Gov't, \$ *100* for

Remarks: *Wounded in Hrope since
Sep 29" 64*

Book mark:

Leary
Copyist.

(358)

20

7

U.S.C.T.

Geo. W. Dennis

Priv., Co. K, 7 Reg't U. S. Col'd Infantry.

Appears on

Company Muster Roll

for *Jan & Feb*, 1865

Present or absent *Absent*

Stoppage, \$ *100* for

Due Gov't, \$ *100* for

Remarks: *Wounded in Hosp.
since Sep. 29. 64.*

Book mark:

Leary
Copyist.

10

7

U.S.C.T.

George W. Dennis

Priv, Co. K, 7 Reg't U. S. Col'd Infantry.

Appears on

Company Muster Roll

for *March & April*, 1865.

Present or absent *Present*

Stoppage, \$ 100 for

Due Gov't, \$ 100 for

Remarks:

Book mark:-----

(358)

Seay
Copyist.

20

7

U.S.C.T.

George W. Dennis

Priv, Co. K, 7 Reg't U. S. Col'd Infantry.

Appears on

Company Muster Roll

for *May and June*, 1865.

Present or absent *Absent*

Stoppage, \$ *100* for

Due Gov't, \$ *100* for

Remarks *In hospital since May 21. 65. Stop for transportation \$6.10.*

Book mark:

Leary
Copyist.

20

7

U.S.C.T.

George W. Dennis

Priv, Co. K, 7 Reg't U. S. Col'd Infantry.

Appears on

Company Muster Roll

for *July and Aug*, 1865.

Present or absent *Absent*

Stoppage, \$ $\frac{87}{100}$ for *Ordinance*

Due Gov't, \$ $\frac{100}{100}$ for

Remarks: *In hospital since May 21.
65. Stop for transportation \$6.10.*

Book mark:

Leary
Copyist.

10

7

U.S.C.T.

George W. Dennis
Priv, Co. K, 7 Reg't U. S. Col'd Infantry.

Appears on

Company Muster Roll

for *Sept + Oct*, 1865

Present or absent

Stoppage, \$ $\frac{87}{100}$ for *Advance*

Due Gov't, \$ $\frac{100}{100}$ for

Remarks: *Mustered out June 12, 1865 per order of war. Dept.*

Book mark:

(358)

Sear
Copyist.

D | 7 U.S.C.T.

George W. Dennis,
Sgt., Co K, 7 Reg't U. S. Col'd Infantry.

Appears on a

Detachment Muster-out Roll

of the organization named above. Roll dated

Fort Monroe Va. June 12, 1865.

Muster-out to date June 12, 1865.

Last paid to Dec. 31, 1864.

Clothing account:

Last settled Nov. 2, 1864; drawn since \$ 100

Due soldier \$ 100; due U. S. \$ 100

Am't for cloth'g in kind or money adv'd \$ 51.84

Due U. S. for arms, equipments, &c., \$ 100

Bounty paid \$ 100 due \$ 100

Remarks: Accountable for
knapsack, haversack & canteen,
Also due U.S. for transportation
Pt. 1/100. Mustered out by order of
War Dept. dated May 3/65.
Patient in U.S. Gen. Hospital
(over)

Book mark PV 13. 130. 69.

Jenkins Copyist.

JAN. 20

6279462

1891

Fort Monroe
Va.

I

7

U.S.C.T.

George W. Dennis
Privt., Co. K, 7 Reg't U. S. Col'd Infantry.

Appears on **Co. Muster-out Roll**, dated
Indianola Texas, Oct. 13th, 1866.

Muster-out to date _____, 186 .

Last paid to *Dec. 31st*, 1864 .

Clothing account:

Last settled _____, 186 ; drawn since \$ 100

Due soldier \$ 100 ; due U. S. \$ 100

Am't for cloth'g in kind or money adv'd \$ 100

Due U. S. for arms, equipments, &c., \$ 100

Bounty paid \$ 100 ; due \$ 100

Remarks: *Discharged by order*
of War Dept. at Fort Monroe, Va.
June 12, 1865.

Book mark: *V. 164. P. 218. 73.*
P. V. 13. P. 130. 69.

Randall

394

Dennis Henry

Co. d, 7 U.S. Col'd Inf.

Private

Private

CARD NUMBERS.

1	6294231	26
2	6294330	27
3	6294433	28
4	6294532	29
5	6294637	30
6	6294719 1/2	31
7	6294811	32
8	6294904	33
9	6294999	34
10	6295099	35
11	6295200	36
12	6295300	37
13	6295394	38
14	6295482	39
15	6295571	40
16	6295644	41
17	6295714	42
18	6295788	43
19	6295860	44
20	9066905	45
21		46
22		47
23		48
24		49
25		50

Book Mark:

See also

D. 3033681 And. W.D.
Q. 3046391 And. W.D.

D. 1 7 U.S.C.T.

Henry Dennis

Co. G, 7 Reg't U. S. Col'd Inf.

Appears on

Company Descriptive Book

of the organization named above.

DESCRIPTION.

Age 22 years; height 5 feet 3 1/4 inches.

Complexion *Grill*

Eyes *Dark*; hair *Blk.*

Where born *Somerset, Md.*

Occupation *Farmer.*

ENLISTMENT.

When *Oct-31.*, 1863.

Where *Somerset, Md.*

By whom *Ed. Wm. Birney*; term 3 y'rs.

Remarks: *Mustered in at Camp Stanton, Md Nov 5. 63. by S. Col. Clarkell.*

On recruiting service from Jan. 29. 63. to Feb. 8. 63.

J. D. White

2 | 7 | U.S.C.T.

Henry Dennis
Priv. I, Co. 7 Reg't U. S. Col'd Inf.

Age 22 years.

Appears on

Company Muster-in Roll

of the organization named above. Roll dated
Camp Stanton
Charles Co., Md., Nov. 5, 1863.

Muster-in to date Nov. 5, 1863

Joined for duty and enrolled:

When Oct. 31, 1863.

Where Somerset, Md.

Period 3 years.

Remarks:

Book mark:

J.B. Gage

Copist.

2

7

U.S.C.T.

Henry Dennis

Priv., Co. I, 7 Reg't U. S. Col'd Infantry.

Appears on

Company Muster Roll

for from Nov. 5 to Dec. 31, 1863.

Present or absent Present

Stoppage, \$ 100 for

Due Gov't, \$ 100 for

Remarks: Enlistment premium \$2.00 due

Inserted by Corp.

Book mark:

J B Gage

(358)

Copyist.

D | 7 | U.S.C.T.

Henry Dennis
Pvt., Co. I, 7 Reg't U. S. Col'd Infantry.

Appears on

Company Muster Roll

for Jan & Feb, 1864.

Present or absent Present

Stoppage, \$ 100 for

Due Gov't, \$ 100 for

Remarks: Enlistment premium \$2.00 due. On detached service recruiting from Jan. 29 to Feb. 8, 1864

Book mark:

(358)

JTB Gage
Copyist.

21

7

U.S.C.T.

Henry Dennis

Priv, Co. I, 7 Reg't U. S. Col'd Infantry.

Appears on

Company Muster Roll

for Mch & Apr, 1864.

Present or absent Present

Stoppage, \$ 100 for

Due Gov't, \$ 100 for

Remarks:

Book mark:

JOB Gage Copyist.

(358)

91 7 U.S.C.T.

Henry Dennis

Pvt, Co. I, 7 Reg't U. S. Col'd Infantry.

Appears on

Company Muster Roll

for May & June, 1864.

Present or absent Present

Stoppage, \$ 100 for

Due Gov't, \$ 100 for

Remarks:

Book mark:

JOB Gage Copyist.

D

7

U.S.C.T.

Henry Dennis

Priv., Co. I, 7 Reg't U. S. Col'd Infantry.

Appears on

Company Muster Roll

for July & Aug, 1864

Present or absent Present

Stoppage, \$ 100 for

Due Gov't, \$ 100 for

Remarks:

Book mark:

J B Gage

Copyist.

9

7

U.S.C.T.

Henry Dennis

Private

Co. I, 7 Reg't U. S. Col'd Infantry.

Appears on

Company Muster Roll

for Sept & Oct, 1864.

Present or absent Present

Stoppage, \$ 100 for

Due Gov't, \$ 100 for

Remarks: Stop for one Knapsack,

Book mark:

J. B. Gage

(358)

Copyist.

D

7

U.S.C.T.

Henry Dennis

Priv, Co. I, 7 Reg't U. S. Col'd Infantry.

Appears on

Company Muster Roll

for *Nov. & Decr.*, 1864

Present or absent *Present*

Stoppage, \$ _____ 100 for _____

Due Gov't, \$ _____ 100 for *one Knapsack*

Remarks: _____

Book mark: _____

D. Maher

Copyist.

(358)

D | 7 | U.S.C.T.

Henry Dennis
Pvt, Co. I, 7 Reg't U. S. Col'd Infantry.

Appears on

Company Muster Roll

for *Jan'y. + Feby.*, 1865.

Present or absent *Present*

Stoppage, \$..... 100 for

Due Gov't, \$..... 100 for

Remarks:.....
.....
.....
.....
.....
.....
.....
.....
.....
.....
.....

Book mark:.....

(358)

D. Maher
Copyist.

A

7

U.S.C.T.

Henry Dennis
Priv, Co. I, 7 Reg't U. S. Col'd Infantry.

Appears on

Company Muster Roll

for March & April, 1865.

Present or absent Present

Stoppage, \$ 100 for

Due Gov't, \$ 100 for

Remarks:

Book mark:

(358)

D. Maher
Copyst.

D

7

U.S.C.T.

Henry Dennis
Priv, Co. I, 7 Reg't U. S. Col'd Infantry.

Appears on

Company Muster Roll

for *May + June*, 1865.

Present or absent *Present*

Stoppage, \$ _____ 100 for _____

Due Gov't, \$ _____ 100 for _____

Remarks: _____

Book mark: _____

D. Maher
Copyist.

(358)

D

7

U.S.C.T.

Henry Dennis
Priv, Co. I, 7 Reg't U. S. Col'd Infantry.

Appears on

Company Muster Roll

for *July & Aug.*, 1865.

Present or absent

Stoppage, \$ 100 for

Due Gov't, \$ ⁰²100, for *C & G. Equipage*

Remarks:

Book mark:

D. Maher

(358)

Copyist.

D

7

U.S.C.T.

Henry Dennis

Priv., Co. I, 7 Reg't U. S. Col'd Infantry.

Appears on

Company Muster Roll

for *Sept. & Oct.*, 1865.

Present or absent *Present*

Stoppage, \$ *100* for

Due Gov't, \$ *024/100*, for *C. & H. Equipage*

Remarks:

Book mark:

D. Mahser

Copyist.

(358)

D | **7** | **U.S.C.T.**

Henry Dennis

Priv, Co. I, 7 Reg't U. S. Col'd Infantry.

Appears on

Company Muster Roll

for *Nov. & Decr.*, 186*5*.

Present or absent *Present*

Stoppage, \$ *100* for

Due Gov't, \$ *04*/*100* for *C. & G. Equipage*

Remarks:

Book mark:

D. Mahser

(358)

Copyist.

D

7

U.S.C.T.

Henry Dennis

Pr, Co. I, 7 Reg't U. S. Col'd Infantry.

Appears on

Company Muster Roll

for Jan + Feb; 186 b.

Present or absent Pres.

Stoppage, \$ 100 for

Due Gov't, \$ 100 for

Remarks:

Book mark:

Savine Copyist.

(358)

D

7

U.S.C.T.

Henry Dennis

Priv., Co. I, 7 Reg't U. S. Col'd Infantry.

Appears on

Company Muster Roll

for Mar + Apr, 1866

Present or absent Present

Stoppage, \$ 100 for

Due Gov't, \$ 16/100 for Ordnance lost.

Remarks:

Book mark:

Sabine

Copyist.

(358)

8

7

U.S.C.T.

Henry Dennis

Private, Co. I, 7 Reg't U. S. Col'd Infantry.

Appears on

Company Muster Roll

for Jan 28 to June 30, 1866.

Present or absent not stated

Stoppage, \$ 16 for ordnance and ordnance stores.

Due Gov't, \$ 100 for _____

Remarks: _____

Book mark: _____

Savine

(358)

Copyist.

8

7

U.S.C.T.

Henry Dennis

Pvt, Co. I, 7 Reg't U. S. Col'd Infantry.

Appears on

Company Muster Roll

for July + Aug, 1866.

Present or absent Present.

Stoppage, \$ 100 for

Due Gov't, \$ 100 for

Remarks:

Book mark:

Sabine

Copyist.

(358)

L

7

U.S.C.T.

Henry Dennis
Capt, Co. *D*, 7 Reg't U. S. Col'd Infantry.

Appears on Co. Muster-out Roll, dated
Indianola, Texas,
October 13, 1866.

Muster-out to date *Oct. 13,* 1866.

Last paid to *June 30,* 1866.

Clothing account:

Last settled....., 186 ; drawn since \$..... 100

Due soldier \$ *68¹⁹* 100; due U. S. \$..... 100

Am't for cloth'g in kind or money adv'd \$..... 100

Due U. S. for arms, equipments, &c., \$ *6* 100

Bounty paid \$..... 100; due \$ *100* 100

Remarks: *Joined co. at ori-*
ginal organization.
Remains one A.R. mustlet
set of accoutrements per
G.O. 101 War Dept., May
30, '65.

Book mark: *7174 P. 211, 73.*

Safine

340
Dennis John

Co G, 7 U.S. Col'd Inf.

Private

Private

CARD NUMBERS.

1	6290941	26
2	6291040	27
3	6291143	28
4	6291247	29
5	6291345	30
6	6291443	31
7	6291541	32
8	6291624	33
9	6291723	34
10	6291780	35
11	6291850	36
12	6291922	37
13	6291990	38
14	6292057	39
15	6292120	40
16	6292172	41
17	6292230	42
18	6292277	43
19	6292335	44
20	9066659	45
21		46
22		47
23		48
24		49
25		50

Book Mark:

See also

S 591944 P.O. '95-

S. 4158926 P.O. M.W.

S 1075849 P.O. M.W.

Q 1583648. P.O. M.W.

S. 2032651 P.O. M.W.

S 2680212 P.O. M.W.

29

7

U.S.C.T.

John Dennis
 Co. *G*, 7 Reg't U.S. Col'd Inf.

Appears on

Company Descriptive Book

of the organization named above.

DESCRIPTION.

Age *18* years; height *5* feet *4* inches.

Complexion *Black*

Eyes *Black*; hair *Curly*

Where born *Procceton, Md.*

Occupation *Farmer*

ENLISTMENT.

When *Oct 30*, 186

Where *Procceton*

By whom *Col W. Birney*; term *3* y'rs.

Remarks: *Mustered into service
 Nov 5 '63, by Col Wm.
 Birney, at Benedict,
 Md.*

J. S. Brown Copyist.

D | 7 | U.S.C.T.

John Dennis
Priv., Co. *G*, 7 Reg't U. S. Col'd Inf.

Age *18* years.

Appears on

Company Muster-in Roll

of the organization named above. Roll dated
Camp Stanton Charles Co, Md, Nov 5, 1863.

Muster-in to date *Nov 5, 1863.*

Joined for duty and enrolled:

When *Oct 30*, 1863.

Where *Waverly, Md.*

Period *3* years.

Remarks: _____

Book mark: _____

Sandoz
Copyist.

D

7

U.S.C.T.

John Dennis

Priv., Co. G, 7 Reg't U. S. Col'd Infantry.

Appears on

Company Muster Roll

for *Nov. 5 to Dec. 31*, 186*3*.

Present or absent *Present*

Stoppage, \$ *100* for

Due Gov't, \$ *100* for

Remarks: *Premium for en-*
listment \$2.00 (due)

Book mark:

Sandoy

Copyist

D

7

U.S.C.T.

John Dennis

Priv., Co. G, 7 Reg't U. S. Col'd Infantry.

Appears on

Company Muster Roll

for *Jan. 8* & *Feb.*, 1864.

Present or absent *Present*

Stoppage, \$ 100 for

Due Gov't, \$ 100 for

Remarks:

Book mark:

Sandoz
Copyist

(858)

D

7

U.S.C.T.

John Dennis.

Priv., Co. G, 7 Reg't U. S. Col'd Infantry.

Appears on

Company Muster Roll

for , 1864.

Present or absent .

Stoppage, \$ 100 for

Due Gov't, \$ 100 for

Remarks:

Book mark

(858)

Sandoz
Copyist

D

7

U.S.C.T.

John Dennis

Priv., Co. G, 7 Reg't U. S. Col'd Infantry.

Appears on

Company Muster Roll

for *May & June*, 1864.

Present or absent *Absent*

Stoppage, \$ *100* for

Due Gov't, \$ *100* for

Remarks: *Sick at Jacksonville, Fla., since June 20/64.*

Book mark:

Sandoz
Coptist

(858)

D

7

U.S.C.T.

John Dennis

Priv., Co. G, 7 Reg't U. S. Col'd Infantry.

Appears on

Company Muster Roll

for *July & Aug.*, 1864.

Present or absent *Present.*

Stoppage, \$ *100* for

Due Gov't, \$ *100* for

Remarks:

Book mark:

Sandoz
Copyist

(858)

D

7

U.S.C.T.

John Dennis

Priv., Co. G, 7 Reg't U. S. Col'd Infantry.

Appears on

Company Muster Roll

for *Sept & Oct.*, 1864.

Present or absent *Present.*

Stoppage, \$ 100 for

Due Gov't, \$ 100 for

Remarks:

Book mark:

Sandoz

Copyist

(858)

D

7

U.S.C.T.

John Dennis
Pvt., Co. G, 7 Reg't U. S. Col'd Infantry.

Appears on

Company Muster Roll

for *Nov. + Dec.*, 1864.

Present or absent *present*

Stoppage, \$ *100* for

Due Gov't, \$ *100* for

Remarks:

Book mark:

(858)

J. W. Ames

Copyist

D

7

U.S.C.T.

John Dennis
Pvt., Co. G, 7 Reg't U. S. Col'd Infantry.

Appears on

Company Muster Roll

for *Jan'y & Feby*, 186 *6*

Present or absent *Present*

Stoppage, \$ *100* for

Due Gov't, \$ *100* for

Remarks:

Book mark: *371-277*

(858)

J. W. Ames
Copyist

Q

7

U.S.C.T.

John Dennis
priv, Co. G, 7 Reg't U. S. Col'd Infantry.

Appears on

Company Muster Roll

for *March + April*, 1865.

Present or absent *present*

Stoppage, \$ *100* for

Due Gov't, \$ *100* for

Remarks:

Book mark:

Ent Musters
Comp.

(858)

D | **7** | **U.S.C.T.**

John Dennis
Pvt., Co. G, 7 Reg't U. S. Col'd Infantry.

Appears on

Company Muster Roll

for *May & June*, 186 *52*

Present or absent *Present*

Stoppage, \$ *100* for

Due Gov't, \$ *100* for

Remarks:

Book mark: _____

J. M. [Signature]
(858) Copyist

D **7** **U.S.C.T.**

John Dennis
Pvt, Co. G, 7 Reg't U.S. Col'd Infantry.

Appears on

Company Muster Roll

for *July + Aug.*, 1865.

Present or absent *Present*

Stoppage, \$ _____ 100 for _____

Due Gov't, \$ _____ 100 for _____

Remarks: _____

Book mark: _____

J. W. Cross
(858) Copyist

D. 7 U.S.C.T.

John Dennis
Co. G, 7 Reg't U. S. Col'd Infantry.

Appears on

Company Muster Roll

for Sept & Oct, 1862

Present or absent Present

Stoppage, \$ 100 for

Due Gov't, \$ 100 for

Remarks:

Book mark:

John Dennis
(858) Copyist

D . **7** | **U.S.C.T.**

John Dennis
Priv, Co. G, 7 Reg't U. S. Col'd Infantry.

Appears on

Company Muster Roll

for *Nov & Dec*, 186 *5*

Present or absent *Present*

Stoppage, \$ *100* for

Due Gov't, \$ *100* for

Remarks:

Book mark:

(858)

J. W. Ames

Copyist

P.O.

7

U.S.C.T.

John Dennis
Pvt, Co. G, 7 Reg't U. S. Col'd Infantry.

Appears on

Company Muster Roll

for *Jan & Feb*, 186*6*

Present or absent *Present*

Stoppage, \$ *100* for

Due Gov't, \$ *100* for

Remarks: *stop for Haversack
& Canteen*

Book mark:

Hadfield

(858)

Copyist

10

7

U.S.C.T.

John Dennis
Pvt

Co. G, 7 Reg't U. S. Col'd Infantry.

Appears on

Company Muster Roll

for Mar & Apr, 1866.

Present or absent Present

Stoppage, \$ 100 for

Due Gov't, \$ 100 for

Remarks:

Book mark:

Hadfield

(858)

Copyist

20

7

U.S.C.T.

John Dennis
Pt

Co. G, 7 Reg't U. S. Col'd Infantry.

Appears on

Company Muster Roll

for May - June, 1866.

Present or absent Present

Stoppage, \$ 100 for

Due Gov't, \$ 100 for

Remarks:

Book mark:

Hadfield

(858)

Copyist

2

7 U.S.C.T.

John Dennis
PT, Co. G, 7 Reg't U. S. Col'd Infantry.

Appears on

Company Muster Roll

for *July & Aug*, 1866.

Present or absent *Present*

Stoppage, \$ *100* for

Due Gov't, \$ *100* for

Remarks:

Book mark:

(858)

Hadfield

Copyst

FD

7

U.S.C.T.

John Dennis

Co. G, 7 Reg't U. S. Col'd Infantry.

Appears on **Co. Muster-out Roll**, dated *Indiana Texas, Oct 13*, 1866.

Muster-out to date *Oct 13*, 1866.

Last paid to *June 30*, 1866.

Clothing account:

Last settled....., 186 ; drawn since \$..... 100

Due soldier \$ *34* ^{*40*} / 100; due U. S. \$..... 100

Am't for cloth'g in kind or money adv'd \$..... 100

Due U. S. for arms, equipments, &c., \$..... 100

Bounty paid \$..... 100; due \$ *100* / 100

Remarks: *Joined original organization*

Book mark: *V 186 P 266.74 (Mdy)*
(over)

Hudfield

(261)

Copyist.

NARA 792

JAN. 21

6292325

18914

8490 March 14/67

Dennis, John

_____, Co. _____, _____ Reg't _____

_____/_____
Enclosures.

Bed Cards	Final Statements
Burial Records	Furloughs or L. of A.
Certs. of Dis. for Discharge	Med. Certificates
C. M. Charges	Med. Des. Lists
Descriptive Lists	Orders
Discharge Certificates	Pris. of War Record
Enlistment Papers	Resignations

Other papers relating to—

Admission to Hosp'l	Furlough or L. of A.
Casualty Sheet	Med. Examination
Confinement	Misc. Information
Contracts	Pay or Clothing
Death or Effects	Personal Reports
Desertion	Rank
Discharge from Hosp'l	Transfer to Hosp'l
Discharge from Service	Transfer to V. R. C.
Duty	Transportation

Transportation furnished
from York Mount Va. to
Richmond Va. Dec 28.
1866.

A. G. Wytat
Rt. 2d Ave. N. W.

Dec. 25 / 1866

HEADQUARTERS, MILITARY DISTRICT OF FORT MONROE,

Fort Monroe, Va., December 28th 1866

SPECIAL ORDERS }
No. 230 }

II. Private John Dennis, 7th U.S.C.T. is hereby ordered to proceed, without delay, to Richmond, Va., reporting on his arrival to the Chief Mustering Officer, Dept of the Potomac, for muster out of service.

III. The Quartermaster's Department will furnish the necessary transportation

Private John Dennis
7th U.S.C.T.
Chgo. Surgeon in charge
of Post Hospital

By command of
John Rufus Lyon, Major
Adj. Gen.
1st Lieut. 5th U.S. Art'y
A. A. G.

396

Dennis John S.

Co G, 7 U.S. Col'd Inf.

Private

Private

CARD NUMBERS.

1	6290942	26
2	6291041	27
3	6291206	28
4	6279563	29
5	6292428	30
6	9066660	31
7		32
8		33
9		34
10		35
11		36
12		37
13		38
14		39
15		40
16		41
17		42
18		43
19		44
20		45
21		46
22		47
23		48
24		49
25		50

Book Mark:

See also

Q | 7 | U.S.C.T.

William S. Dennis
Co. *C*, 7 Reg't U. S. Col'd Inf.

Appears on
Company Descriptive Book
of the organization named above.

DESCRIPTION.

Age *20* years; height *5* feet *4 1/2* inches.

Complexion *Black*

Eyes *Black*; hair *Curly*

Where born *Worcester, Ind.*

Occupation *Farmer*

ENLISTMENT.

When *Nov 1*, 186*4*.

Where *Worcester*

By whom *Col. W. Birney*; term *3* y'rs.

Remarks: *Deserted from
service at Perrin, Ind.
Jan 1st 1864.*

W. Brown

D

7

U.S.C.T.

John S. Dennis
Privt., Co. G, 7 Reg't U. S. Col'd Inf.

Age 20 years.

Appears on

Company Muster-in Roll

of the organization named above. Roll dated
Camp Stanton, Charles Co, Md, Nov. 5, 1863.

Muster-in to date Nov. 5, 1863.

Joined for duty and enrolled:

When Nov. 1, 1863

Where Worcester, Md.

Period 3 years.

Remarks:

Book mark:

(856)

Sandoz
Copyist.

D

7

U.S.C.T.

John S. Dennis
Priv., Co. G, 7 Reg't U. S. Col'd Infantry.

Appears on

Company Muster Roll

for *Nov. 5 to Dec. 31*, 1863.

Present or absent *Absent*

Stoppage, \$ *100* for

Due Gov't, \$ *100* for

Remarks: *Sent to Hospital*
Nov. 12", 1863. Absented
himself without leave, date
unknown.

Book mark:

(858)

Sandoz
Copyist

2

7

U.S.C.T.

John S. Dennis

Priv., Co. G, 7 Reg't U. S. Col'd Infantry.

Appears on

Company Muster Roll

for *Jan. & Feby.*, 1864.

Present or absent

Stoppage, \$ 100 for

Due Gov't, \$ 100 for

Remarks: *Sent to Hospital at Benedict, Md., Nov. 12th, 1863. Discharged from Hospital, date unknown.*

Book mark:

Sandy
Copyist

(858)

Q 1 4

U.S.C.T.

John S. Dennis
Pri., Co. *G 4* Reg't U. S. Col'd Infantry.

Appears on

Descriptive List of Deserters

dated *Feb. 8th*, 186*4*.

Deserted :

When *Jan'y. —*, 186*4*.
Where *Benedict, Md.*

Arrested :

When _____, 186 .
Where _____

Remarks : *From Port Hospital
precise date not known.*

Book mark : _____

(851)

J. Smith

Copist.

PO

7

U.S.C.T.

John D Dennis

Pvt, Co. *4*, 7 Reg't U. S. Col'd Infantry.

Appears on **Co. Muster-out Roll**, dated *Indianola Texas Oct 13*, 1866.

Muster-out to date _____, 186 .

Last paid to *Pay due from* _____, 186 .
muster

Clothing account:

Last settled _____, 186 ; drawn since \$ _____ 100

Due soldier \$ _____ 100 ; due U. S. \$ _____ 100

Am't for cloth'g in kind or money adv'd \$ _____ 100

Due U. S. for arms, equipments, &c., \$ _____ 100

Bounty paid \$ _____ 100 ; due \$ _____ 100

Remarks: *Deserted at Camp Stanton Miss November 8 1863*

Book mark : _____

Hadfield

(361)

Copyist.

591

Dennis Robert

Co K, 7 U.S. Col'd Inf.

Private Private

CARD NUMBERS.

1	6295991	26
2	6296691	27
3	6296190	28
4	6296292	29
5	6296389	30
6	6296482	31
7	6296575	32
8	6296718	33
9	D 2 V 10 C. J. 74	34
10	9067027	35
11	D 2 - C. J. - 1874	36
12		37
13		38
14		39
15		40
16		41
17		42
18		43
19		44
20		45
21		46
22		47
23		48
24		49
25		50

Book Mark D 2, V. 10. C. J. 74

See also

9 | 7 | U.S.C.T.

Robert Dennis

, Co. K, 7 Reg't U. S. Col'd Inf.

Appears on

Company Descriptive Book

of the organization named above.

DESCRIPTION.

Age 18 years; height 5 feet 5 inches.

Complexion *Griff*

Eyes *Black*; hair *Black*

Where born *Somerset, Maryland*

Occupation *Farmer*

ENLISTMENT.

When *Nov. 3.*, 1863.

Where *Princess Ann*

By whom *W. H. Finney*; term 3 y'rs.

Remarks: *Mustered into serv. at
Camp Stanton, Chap. Co.
Md. by Lt. Col. Haskell.
Nov. 12. 63.*

*Severely wounded and
missing in action Sept. 29
64.*

J. G. White

D | **7** | **U.S.C.T.**

Robert Dennis

Privt, *Co. K*, 7 Reg't U. S. Col'd Inf.

Age *18* years.

Appears on

Company Muster-in Roll

of the organization named above. Roll dated
at Stanton
Charles Co. Md., *Nov 12*, 186*3*.

Muster-in to date *Nov. 12*, 186*3*

Joined for duty and enrolled:

When *Nov. 4*, 186*3*.

Where *Somerset Md.*

Period *3* years.

Remarks:-----

Book mark: *Md m 142 Vol 8.*

D. M. Kennedy

Q

7

U.S.C.T.

Robert Dennis

Private, Co. K, 7 Reg't U. S. Col'd Infantry.

Appears on

Company Muster Roll

for Nov. 12 to Dec 31, 1863

Present or absent Present

Stoppage, \$ 100 for

Due Gov't, \$ 100 for

Remarks: Enlistment premium
\$ 2 00 two dollars each.

Book mark:

D. M. Kennedy

(358)

Copyist.

D

7

U.S.C.T.

Robert Dennis

Privt., Co. K, 7 Reg't U. S. Col'd Infantry.

Appears on

Company Muster Roll

for *Jan.* or *Feb.*, 186*4*.

Present or absent *Present.*

Stoppage, \$ *100* for

Due Gov't, \$ *100* for

Remarks:

Book mark:

D. M. Kennedy

D | 7 | **U.S.C.T.**

Robert Dennis

Privt., Co. K, 7 Reg't U. S. Col'd Infantry.

Appears on

Company Muster Roll

for March or April, 1864.

Present or absent Present

Stoppage, \$ 100 for

Due Gov't, \$ 100 for

Remarks:

Book mark: _____

D. M. Kennedy
Coptist.

D

7

U.S.C.T.

Robert Dennis

Privt, Co. K, 7 Reg't U. S. Col'd Infantry.

Appears on

Company Muster Roll

for *May & June*, 186*4*

Present or absent *Absent*

Stoppage, \$ *100* for

Due Gov't, \$ *100* for

Remarks: *Absent detached service
Hospital Jacksonville Fla
since June 4th 1864. Order
49 H. Pers. of U.S.C.T.*

Book mark:

D. M. Kennedy

(358)

Copyist.

NARA 999

D

7

U.S.C.T.

Robert Dennis

Privt, Co. K, 7 Reg't U. S. Col'd Infantry.

Appears on

Company Muster Roll

for July or Aug., 1864

Present or absent Present

Stoppage, \$ 100 for

Due Gov't, \$ 100 for

Remarks: Free on or before April 19th 1864.

Book mark:

R. M. Kennedy Copyist.

D

7

U.S.C.T.

Robert Dennis

Privt, Co. K, 7 Reg't U. S. Col'd Infantry.

Appears on

Company Muster Roll

for Sept. & Oct., 1864

Present or absent Absent

Stoppage, \$ 100 for

Due Gov't, \$ 100 for

Remarks: Missing in action
Sept. 29 " 1864.

Name not borne on sub-
rolls of co.

Book mark:

N. M. Kennedy

Copyist.

20

7

U.S.C.T.

Robert Dennis

Pvt., Co. K, 7 Reg't U. S. Col'd Infantry.

Appears on

Company Muster Roll

for Nov & Dec, 1864

Present or absent Absent

Stoppage, \$ 100 for

Due Gov't, \$ 100 for

Remarks: Missing in action Sep. 29th 1864 and omitted to be dropped

Book mark: 206. 618. v. 170. P. 125. 73 (over)

Leary Copyist.

JAN. 21

6296718

18910

D. L. U. 10 C. J. 74.

D 17" U.S.G.I
Robert Dennis
, Co. B, 7" Reg't U.S.G.I

NOTATION.

Book mark: D. 2. 6. J. 1874,

Record and Pension Office.

WAR DEPARTMENT.

This book mark refers only to a report from the medical records, made by the Surgeon General to the Adjutant General, relative to the above-named man. As the medical records have since been carded, no transcript of this report is made hereon.

(491)

E. P. Sawyer.

Copyist.

9 | 7 | U.S.C.T.

Robert Dennis

Rank _____, Co. K, 7 Reg't U.S.C.T.

NOTATION.

Re. P. 268928 with
Book mark: D. 2. Vol. 10 C. T. 1874

War Department,

Record and Pension Division,

Washington, January 28, 1891.

Investigation fails to elicit any further information relative to this soldier.

Thos. Horn

Demison Robert
Co. *2nd* 7 Reg't *1st*

2 Enclosures.

Bed Cards	Final Statements
Burial Records	Furloughs or L. of A.
Certs. of Dis. for Discharge	Med. Certificates
C. M. Charges	Med. Des. Lists
Descriptive Lists	Orders
Discharge Certificates	Pris. of War Record /
Enlistment Papers	Resignations

Other papers relating to—

Admission to Hosp'l	Furlough or L. of A.
Casualty Sheet <i>2</i>	Med. Examination
Confinement	Misc. Information
Contracts	Pay or Clothing
Death or Effects	Personal Reports
Desertion	Rank
Discharge from Hosp'l	Transfer to Hosp'l
Discharge from Service	Transfer to V. R. C.
Duty	Transportation

59

CASUALTY SHEET
OF WOUNDED.Robt DennettCorporal Company "D"7th Regiment of U. S. C. I.Volunteers at the battle of ChapinArmy, Va. Sept 29 + 301864

CASUALTY SHEET.

Name, Robt Derinett
 Rank, Corporal, Company "D", Regiment, 7^o
 Arm, U. S. A., State,
 Place of casualty, Chapins Farm. Va.
 Nature of casualty, Wounded
 Date of casualty, Sept 29 + 30 / 64

FROM WHAT SOURCE THIS INFORMATION WAS OBTAINED.

Report of Killed, Wounded, and Missing of the _____ Regiment.
 Brigade, _____ Division, _____ Corps, dated _____
List of casualties in the of "U. S. A. on the 29^o
and 30^o / 64, of Sept 1864, at Chapins Farm. Va.
Sgd. Shewell F. Haskell
Lieut Col Comd g

Ind 505 2063

J. P. Broadwell

Clerk.

MEMORANDUM FROM PRISONER OF WAR RECORDS.

No. _____

(This blank to be used only in the arrangement of said records.)

NAME.	RANK.	ORGANIZATION.				INFORMATION OBTAINED FROM—				
		No. of Reg't.	State.	Arm of Service.	Co.	Records of—	Vol.	Page.	Vol.	Page.
<i>Admission</i>										
<i>Admission Robert P. of U.S. Army</i>						<i>Vol. 2</i>	<i>2950</i>	<i>69</i>	<i>56</i>	

Captured at *M. Harrison, Va.* *Sept 30*, 1864, confined at Richmond, Va., *Vol. 2*, 1864.

Admitted to Hospital at _____

where he died _____, 186____, of _____

Paroled at *Feb 5*, 1865; reported at Camp Parole, Md., _____, 186____.

Donner Hollis Pentecost 127,057 RR. No. 1,2291 Copied by *[Signature]*

3980 Zachary

Demmer J. P. or

Co. F., 7 U.S. Col'd Inf.

Asst. Surg. | Asst. Surg.

CARD NUMBERS.

1	6278668	26
2	6279711	27
3	6279709	28
4	6279724	29
5	6279736	30
6	6279749	31
7	6279762	32
8	6279775	33
9	6279787	34
10	6279798	35
11	9428675	36
12		37
13		38
14		39
15		40
16		41
17		42
18		43
19		44
20		45
21		46
22		47
23		48
24		49
25		50

Book Mark.

See also 27 N.Y. Val. & N.S.A.

D | 7 | U.S.C.T.

Frederick S. Dummer
1st Surg, Co., 7 Reg't U. S. Col'd Inf.

Appears on
Regimental Descriptive Book
(List of Commissioned Officers)

of the regiment named above.

Rank 1st Surg.

Date of appointment 186.....

Remarks: Entered service as Surgeon
of 7th Regt July 2, 1861 and mustered
out 1st day August 1863 from Aug
27/61 was Act. Surg U.S.A. ordinary
of 1st Regt Washington Fairfax Virginia
Corp. until May 20 1866,
Commissioned 1st Surg, 7th Regt May
20/66 & mustered June 7 1866, reported
to Gen. Russell at Fort Point Va and
assigned to duty with troops en route
to Texas, Reported for duty with
7th U.S.C.T. at Indianola Tex July
7, 1866

F. Fisher
Copyist.

2 | 7th | U.S.C.T.

G. P. Denuler

Asst. Surg, Co. , 7 Reg't U. S. Col'd Infantry.

Age 26 years.

Appears on an

Individual Muster-in Roll

of the organization named above. Roll dated

Port Lavaca Texas Aug 13, 1865.

Muster-in to date June 7, 1865.

Joined for duty and enrolled:

When June 7, 1865.

Where City Point - Va

Period 3 years.

Remarks: Citizen appointment. Promoted asst. Surgeon vice asst. Surg. Carl Morse promoted.

Book mark :

C. S. Rozzell

(336)

Copyist.

2 | 7

U.S.C.T.

Zachary P. Denner
Rank *A. Surg.*, *7* Reg't U. S. Col'd *Inf.*

Appears on

Field and Staff Muster Roll

for *July & Aug.*, 1865.

Present or absent *Absent*

Stoppage, \$ *100* for

Due Gov't, \$ *100* for

Valuation of horse, \$ *100*

Valuation of horse equipments, \$ *100*

Remarks: *Gained. App'd by
the President May
20, 1865*

Book mark:

Henderson

217

U.S.C.T.

Zachary P. Dencker
Rank *A. Surg.* Reg't U. S. Col'd *Inf.*

Appears on

Field and Staff Muster Roll

for *July & Aug.*, 1865.

Present or absent *Absent*

Stoppage, \$ *100* for

Due Gov't, \$ *100* for

Valuation of horse, \$ *100*

Valuation of horse equipments, \$ *100*

Remarks: *Det. as Quarantine Officer Matagorda Bay, Texas, S.O. 96 Regt. U. S. Forces Ind. Tex. Aug. 24, 1865*

Book mark:

Henderson

2 | 7

U.S.C.T.

Geachary P. Denner

Rank *A. Surg. M* Reg't U. S. Col'd *Inf.*

Appears on

Field and Staff Muster Roll

for *Sept. 3 Oct.* 1865.

Present or absent *Present*

Stoppage, \$ *100* for

Due Gov't, \$ *100* for

Valuation of horse, \$ *100*

Valuation of horse equipments, \$ *100*

Remarks: *Relieved from
Quarantine duty
Oct. 14, 1865*

Book mark:

Henderson

217

U.S.C.T.

Zachary P. Deener

Rank *A. Surg.* 7 Reg't U. S. Col'd *Inf.*

Appears on

Field and Staff Muster Roll

for *Nov. 7 Dec.*, 186*5*.

Present or absent *Present*

Stoppage, \$ *100* for

Due Gov't, \$ *100* for

Valuation of horse, \$ *100*

Valuation of horse equipments, \$ *100*

Remarks:

Book mark:

Henderson

217

U.S.C.T.

Georgy P. Dunder

Rank *A. Surg. 7* Reg't U. S. Col'd *Inf.*

Appears on

Field and Staff Muster Roll

for *Jan. 7, Feb.*, 186*6*.

Present or absent *Absent*

Stoppage, \$ *100* for

Due Gov't, \$ *100* for

Valuation of horse, \$ *100*

Valuation of horse equipments, \$ *100*

Remarks: *Det. in Chge Post
Coapt. Indianolo, Tex.*

Book mark:

Henderson

2 | 7

U.S.C.T.

Geachary P. Denner

Rank *A. Surg. 7* Reg't U. S. Col'd *Inf.*

Appears on

Field and Staff Muster Roll

for *Mar. 7* *Apr.* 186*6.*

Present or absent *Absent*

Stoppage, \$ *100* for

Due Gov't, \$ *100* for

Valuation of horse, \$ *100*

Valuation of horse equipments, \$ *100*

Remarks: *Act. In Charge
of Post Hospital
Indianola*

Book mark:

Henderson

217

U.S.C.T.

Zachary P. Denner
Rank, *1st. Surg.*, Reg't U. S. Col'd *Inf.*

Appears on

Field and Staff Muster Roll

for *May & June* 1866.

Present or absent *Absent*

Stoppage, \$ *100* for

Due Gov't, \$ *100* for

Valuation of horse, \$ *100*

Valuation of horse equipments, \$ *100*

Remarks: *In Charge Post
Hospital, Indianola,
Tex.*

Book mark:

Henderson

D 17

U.S.C.T.

Zachary P. Denner
Rank *A. Surg.*, *7* Reg't U. S. Col'd *Inf.*

Appears on

Field and Staff Muster Roll

for *July & Aug.*, 186*6*.

Present or absent *Absent*

Stoppage, \$ *100* for

Due Gov't, \$ *100* for

Valuation of horse, \$ *100*

Valuation of horse equipments, \$ *100*

Remarks: *In charge of
Post Hospital,
Indianola*

Book mark:

Henderson

2 | 7

U.S.C.T.

Zachary O. Gennler
Rank, *Asst. Surgeon*, 7 Reg't U. S. Col'd Inf.

Appears on

Field and Staff Muster-out Roll

of the organization named above. Roll dated
Indianola, Md. Oct. 13, 1866.
Muster-out to date *Oct. 13*, 1866.
Last paid to *Sept. 30*, 1866.

Clothing account:

Last settled _____, 186 ; drawn since \$ _____ 100

Due soldier \$ _____ 100; due U. S. \$ _____ 100

Am't for cloth'g in kind or money adv'd \$ _____ 100

Due U. S. for arms, equipments, &c., \$ _____ 100

Bounty paid \$ _____ 100; due \$ _____ 100

Remarks: *Entered service U.S. as Surgeon 27 N. Y. Vols. July 2, '61 Mustered out Aug. 1, '63. Was a. a. Surg. U. S. A. from Aug. 27, '63 to May 20, 1865 and performed duty as such (over)*

Book mark: _____

Henderson

JAN. 20

6279798

1881

at Judiciary Sq. Hoqpt. Wash-
ington, D.C. at Fairfax Sem-
inary, Va. Appointed Asst
Surg. 7th U. S. C. I. May 20, 1865
& reported to Gen. Russell
Comdy at City Point, Va., in
Compliance with orders from
Hd. Qrs. 25th a. C. for order
June 7, '65 and was assigned
to duty with troops en route
for Texas. Reported for duty
to 7th U. S. C. I. at Indianola,
Texas July 7, '65 Det. in
Charge Post Hoqpt. Indian-
ola, Tex. from Mar. 2, '66
to date. Mustered out to re-
main South, pursuant to
Gen. order 10, series 1865, Mil.
Div. Gulf. Entitled to mile-
age from place of final
discharge to Washington
D.C.

Denner, G. P.

Asst Surg

7

Reg't

U.S.C. Inf

1

Enclosures.

Bed Cards	Final Statements
Burial Records	Furloughs
Certs. of Dis. for Discharge	Med. Certificates
C. M. Charges	Med. Des. Lists
Descriptive Lists	Orders /
Discharge Certificates	Pris. of War Record

Other papers relating to—

Admission to Hosp'l	Furlough
Casualty Sheet	Med. Examination
Confinement	Misc. Information
Contracts	Pay or Clothing
Death or Effects	Personal Reports
Desertions	Rank
Discharge from Hosp'l	Transfer to Hosp'l
Discharge from Service	Transfer to V. R. C.
Duty	Transportation

HEADQUARTERS U. S. FORCES.
City Point Va June 7th /65

Extract

Special Orders

No 61

Assistant-Surgeon Z. P. Demler
will report to Lt-Col Powell
Comdg 10th U.S.C.T. without
delay.

Adj Gen W. S. Jones
 City Point, Va. June 7. 1865

Special Order }
 No 61 } (Extract)

x x x x x x
 " " 4. Asst Surgeon Z. P. Decker,
 having reported to these Adj Gens compliance
 to orders from Adj Gen 25th U.S. dated
 June 6. 1865, will report for duty to Lt Col
E. H. Powell, Comdg 10th U.S. Troops,
 without delay

By Command of
 Brig Gen C. D. Russell,
 Fort Lathford
 C.O. 10th U.S. Inf. Capt & Adjt G.

544

Herrick William

Co - , 7 U.S. Col'd Inf.

CARD NUMBERS.

1	6279154	26
2		27
3		28
4		29
5		30
6		31
7		32
8		33
9		34
10		35
11		36
12		37
13		38
14		39
15		40
16		41
17		42
18		43
19		44
20		45
21		46
22		47
23		48
24		49
25		50

Book Mark:

See also

599

Herriek William

Co - , 7 U.S. Col'd Inf.

CARD NUMBERS.

1	6279154	26
2		27
3		28
4		29
5		30
6		31
7		32
8		33
9		34
10		35
11		36
12		37
13		38
14		39
15		40
16		41
17		42
18		43
19		44
20		45
21		46
22		47
23		48
24		49
25		50

Book Mark: _____

See also _____

D | *7* | U.S.C.T.

William Herrick

Appears with rank of _____ on
**Muster and Descriptive Roll of a Detach-
ment of Drafted Men and Substitutes
forwarded**

for the *7* Reg't U. S. Col'd Inf. Roll dated
Baltimore Md, April 5, 1865.

Where born *Balto. Co. Md.*

Age *34* years; occupation *Labourer*

Drafted and mustered in:

When *March 28*, 1865

Where *E. Mills. Md.*

Period *1* years.

Eyes *Blk*; hair *Blk*

Complexion *Blk*; height *5* ft. *5* in.

Paid bounty and advance pay, \$ *100*

Bounty due \$ *100*

Where credited _____

Company to which assigned _____

Remarks: *Drafted from 5th Sub. D
of Dist. Md. (over)*

Book mark: _____

J. M. Fairley
(340) Copyist

NARA 828

JAN. 20

6279154

1891*

*Not taken up on rolls of
regt*

400

Derrickson Charles

Co A, 7 U.S. Col'd Inf.

Private Private

CARD NUMBERS.

1	6295992	26
2	6296092	27
3	6296191	28
4	6296294	29
5	6296390	30
6	6296483	31
7	6296576	32
8	6296710	33
9	6297745	34
10	9067628	35
11		36
12		37
13		38
14		39
15		40
16		41
17		42
18		43
19		44
20		45
21		46
22		47
23		48
24		49
25		50

Book Mark P.V. 2. P. 124-68.

See also

5. | 7 | U.S.C.T.

Charles Derickson

Co. K., 7 Reg't U. S. Col'd Inf.

Appears on

Company Descriptive Book

of the organization named above.

DESCRIPTION.

Age 18 years; height 5 feet 5 1/2 inches.

Complexion Black

Eyes Black; hair Black.

Where born Worcester, Maryland.

Occupation Farmer.

ENLISTMENT.

When Nov. 2, 1863.

Where Berlin

By whom W. H. Binney; term 3 y'rs.

Remarks: Mustered into service at
Camp Stanton, Chan. Co.,
Md. by Lt. Col. Haskell, Nov
12. 63.

64. Severely wounded Sept. 29.

64. Died of exhaustion from
wound Oct. 30. 64 at the Camp
Hospital, Davis Island New York
Harbor.

M. S. White

2 | 7 | **U.S.C.T.**

Charles Terrickson

Pilot, Co. K., 7 Reg't U. S. Col'd Inf.

Age 18 years.

Appears on

Company Muster-in Roll

of the organization named above. Roll dated

Co. Stanton
Charles Co. Md., Nov. 12, 1863.

Muster-in to date Nov. 12, 1863

Joined for duty and enrolled:

When Nov. 1, 1863.

Where Worcester Md.

Period 3 years.

Remarks:
.....
.....
.....
.....
.....
.....

Book mark:

D. M. Kerme dy.
Copyist.

D

7

U.S.C.T.

Charles Derickson

Privt., Co. K, 7 Reg't U. S. Col'd Infantry.

Appears on

Company Muster Roll

for *Nov. 12 to Dec 31*, 186*3*.

Present or absent *Present*

Stoppage, \$ *100* for

Due Gov't, \$ *100* for

Remarks: *Enlistment premium
\$2⁰⁰ dollars due.*

Book mark:

D. M. Kennedy

(358)

Copyist.

Q

7

U.S.C.T.

Charles Derrickson

Privt, Co. K, 7 Reg't U. S. Col'd Infantry.

Appears on

Company Muster Roll

for *Jan.* v. *Feb.*, 186*4*

Present or absent *Present.*

Stoppage, \$ *100* for

Due Gov't, \$ *100* for

Remarks:

Book mark:

D. M. Kennedy
Coylist.

G

7

U.S.C.T.

Charles Gerrickson

Privt., Co. K, 7 Reg't U.S. Col'd Infantry.

Appears on

Company Muster Roll

for *March & April*; 186*4*.

Present or absent *Present*

Stoppage, \$ *100* for

Due Gov't, \$ *100* for

Remarks:

Book mark:

P. M. Kennedy

Co. Q. Ist.

Q | **7** | **U.S.C.T.**

Charles Derrickson
Privt, Co. K, 7 Reg't U. S. Col'd Infantry.

Appears on

Company Muster Roll

for *May & June*, 186*4*

Present or absent *Present*

Stoppage, \$ *100* for

Due Gov't, \$ *100* for

Remarks:

Book mark:

D. M. Kennedy
Copyist.

D

7

U.S.C.T.

Charles Derrickson

Privt, Co. K, 7 Reg't U. S. Col'd Infantry.

Appears on

Company Muster Roll

for *July* v. *Aug.*, 186*4*.

Present or absent *Present.*

Stoppage, \$ *100* for

Due Gov't, \$ *100* for

Remarks:

Book mark:

L. M. Kennedy

(358)

Copyist.

G

7

U.S.C.T.

Charles Derrickson
Privt, Co. K, 7 Reg't U. S. Col'd Infantry.

Appears on

Company Muster Roll

for Sept. & Oct., 1864.

Present or absent Absent

Stoppage, \$ 100 for

Due Gov't, \$ 100 for

Remarks: In Hosp wounded
Sept. 29 " 1864.

Book mark:

W. M. Kennedy

(358)

Copyist.

20

7

U.S.C.T.

Charles Derrickson

Pvt, Co. K, 7 Reg't U. S. Col'd Infantry.

Appears on

Company Muster Roll

for Nov & Dec, 1864

Present or absent

Stoppage, \$ 100 for

Due Gov't, \$ 100 for

Remarks: Died of wounds De Camp
Hosp N.Y. Hahn Oct 30. 64.
Final statement sent Nov 11.
64.

Book mark:

Leary

Copyist.

D 17 7 U.S.C.T.

Charles Dickenson
Pot., Co. K., 7 Reg't U. S. Col'd Inf.

Appears on Co. Muster-out Roll, dated
Indianola, Texas, Oct. 13, 1866.

Muster-out to date _____, 186 .

Last paid to Feb. 29, 1864 .

Clothing account:

Last settled _____, 186 ; drawn since \$ _____ 100

Due soldier \$ _____ 100; due U. S. \$ _____ 100

Am't for cloth'g in kind or money adv'd \$ _____ 100

Due U. S. for arms, equipments, &c., \$ _____ 100

Bounty paid \$ _____ 100; due \$ _____ 100

Remarks: Died at De Camp Gen.
Hosp. N.Y. H. Oct. 30, 1864
of Gunshot Wounds.
(Age 18.)

Filed with Charles Dickenson

Book mark: P. V. 2. P. 124. 68. H. S.

Randall

Herrickson, Charles

P, Co. K, 7 U.S.C. Inf. Reg't

8 Enclosures.

Bed Cards	Descriptive Lists
Burial Records 1	Final Statements 1
Certs. of Dis. for Discharge	Furloughs
C. M. Charges	Med. Des. Lists
Med. Certificates	Orders

Other papers relating to—

Admission to Hosp'l	Furlough
Casualty Sheet (Officer's) ^{Pri} 2	Med. Examination
Confinement	Misc. Information 2
Contracts	Pay or Clothing
Death or Effects 2	Personal Reports
Desertions	Rank
Discharge from Hosp'l	Transfer to Hosp'l
Discharge from Service	Transfer to V. R. C.
Duty	Transportation

MICROFILM PUBLICATION M1849

COMPILED MILITARY SERVICE RECORDS
 OF VOLUNTEER UNION SOLDIERS WHO SERVED WITH
 THE UNITED STATES COLORED TROOPS (USCT)
 7TH REGIMENT OF INFANTRY

PERSONAL PAPERS' TARGET SHEET

PLEASE NOTE THE CHECKED INFORMATION ABOUT THE PERSONAL PAPERS IN
 THIS FILE:

- NO PERSONAL PAPERS WERE FOUND IN THIS FILE WHEN THE RECORDS WERE ARRANGED FOR MICROFILMING.
- 11 PERSONAL PAPER(S) FOUND IN THIS FILE WHEN THE RECORDS WERE ARRANGED FOR MICROFILMING.

James B. Dickson
F.
Chas. Dickson
878

BB

E.

DEED OF MANUMISSION AND RELEASE OF SERVICE.

Whereas, my slave Charles Dickerson has enlisted in the service of the United States: now, in consideration thereof, I, James B. Dirickson, of Worcester county, State of Maryland, do hereby, in consideration of said enlistment, manumit, set free, and release the above named Chas. Dickerson from all service due me; his freedom to commence from the _____, the date of his enlistment as aforesaid in the _____ Regiment of Colored Troops, in the service of the United States.

Witness my hand and seal, this 28th day of May 1864.

James B. Dirickson



Witness:

L. J. Powell
John D. Howell

Worcester County,
State of Maryland, 1864. May 28th

Before me appeared this day James B. Dirickson and acknowledged the above Deed of Manumission and Release of Service to be his free act and deed.

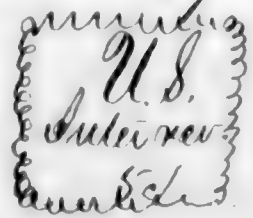

L. J. Powell A.P.

State of Maryland, Worcester County, to wit:

I, Geo. H. Richardson Clerk of the Circuit Court for Worcester County, hereby certify that the above is a true copy of the original, now on file in my office for record.

In Testimony whereof, I hereunto subscribe my name and affix the seal of the said Circuit Court, this twenty first day of May, Anno Domini eighteen hundred and sixty four.

Geo. H. Richardson Clerk

A.

No. CLAIMANT'S CERTIFICATE.

I, James B. Dirickson a loyal citizen, and a resident
of Worcester, County of the, State of
Maryland, hereby claim compensation, under the provisions of
General Orders, No. 329, 1863, for my slave Chas Dirickson
enlisted Nov 12th 1863, at Benedict
by Col Wm Binny in the 7th
Regiment U. S. Colored Troops, Co. K; certificate of which enlistment, and a
descriptive list, as required, accompany this application.

In proof of my loyalty to the Constitution and Government of the United States, I
present the accompanying oath, which I have taken, signed, and acknowledged, to be filed
with this application, in accordance with requirement of said General Orders.

James B. Dirickson

February 27th 1864.

NARA 945
B.

OATH OF ALLEGIANCE.

I, James B. Dickinson, do solemnly swear that I have never joined, or been concerned in, any insurrection or rebellion; that I have never borne arms against the United States; that I have never given any aid, countenance, counsel, or encouragement to any person or persons engaged, or whom I had reason to believe were about to engage, in insurrection, rebellion, or armed hostility against the United States; that I have neither sought, nor accepted, nor attempted to exercise the functions of any office, civil or military, nor to perform any service whatever, under any authority or pretended authority in hostility to the United States; that I have not yielded a voluntary support to any insurrection, rebellion, or pretended government, authority, power, or constitution within the United States hostile thereto. And I do further swear that, to the best of my knowledge and ability, I have supported and defended, and will continue to support and defend, the United States against all enemies, foreign and domestic; and that I have supported, defended, and obeyed, and will continue to support, defend, and obey, the Constitution and laws of the United States; that I will bear true faith and allegiance to the same; and that I take this oath freely, without any mental reservation or purpose of evasion: So help me God.

James B. Dickinson

Sworn to and subscribed before me, at Berlin

this 27 day of February 1864.



L. D. Powell

Justice of the Peace

C.

I present herewith evidence of my title to the slave Chas Dirickson
 _____ enlisted as aforesaid, and in consideration of the sum of
 _____ by me received, I hereby covenant and
 agree with the United States, that I, my heirs, executors, or assigns, shall never hereafter make
 or enforce any claim to the labor or services of said slave; and pledge myself to execute
 a valid Deed of Manumission and Release of all my claims to service forever of said
Chas Dirickson to be filed with the Board of Claims
 now in session at Baltimore

Geo B. Dirickson

Feb'y 27th, 1864.



EVIDENCE OF TITLE.

I, James B. Dickinson, of Worcester County, Md., do solemnly swear that Chas Dickinson who has been enlisted in the 7th Regiment, U. S. Colored Troops, Co. H; is my slave for Life; (his term of service expiring on the day of 186 ;) and that I became possessed of him by Acquisition of my Father, in the month of , eighteen hundred and . And I do further swear that I have not purchased said slave from any person or persons disloyal to the Government of the United States, with the object of obtaining compensation for the same; and furthermore, that I have no agency for obtaining compensation for any person or persons but such as, to my knowledge, are loyal citizens of the United States.

February 27th 1864.
James B. Dickinson

STATE OF MARYLAND,

Worcester County, to wit:

On this *27th* day of *February* in the year 1864,

before me, the subscriber, a Justice of the Peace of the State and County aforesaid, personally appeared *James B. Dickinson* and took, signed, and acknowledged the oaths preceding, and further made oath, in due form of law, that all the statements made in this application are, to the best of *his* knowledge and belief, strictly

true. Also personally appeared before me *Thomas Parrull* and

Wm B. Robins, loyal citizens of the United States, residents of

Worcester County, well acquainted with the said *James*

B. Dickinson, and in no manner interested in the prosecution of this

claim, and made oath, in due form of law, that the said *James B. Dickinson*

is the owner of the slave *Chas. Dickinson*, as a fact of public noto-

riety; that they believe all the statements herein made by *him*, in reference

thereto, are correct, and that *he* is unquestionably loyal to the Government of

the United States. Witness their signatures:

Witnes
L. J. Parrull

Thomas Parrull
Wm B. Robins



L. J. Parrull Justice of the Peace.

STATE OF MARYLAND,

Worcester County, to wit:

I, *George H. Richardson*, Clerk of the Circuit Court for

Worcester County, do hereby certify that *S. D. Powell Esq.*,

before whom the foregoing affidavits were made, was, at the time of signing the same, a Justice of the Peace for the County and State aforesaid, duly commissioned and sworn; and that his signature thereto is genuine, and that full faith and credit should be given to his official acts.

Witness my hand and the seal of said Court, this *first* day of

March, A. D. 1864.



Geo. H. Richardson CLERK.

STATE OF MARYLAND

G. No. 31 A. H.

No. 878

APPLICATION OF

James B. Derrickson

OF

Worcester Co. Md

For Compensation for Service of Slave,

Chas Derrickson

Enlisted in 7th Regiment

U. S. Colored Troops, Co. K.

Received, March 9th 1864.

COMPENSATION ~~AWARDED~~ Refused

August 10th 1865

The claimant has ~~never~~ been a well known rebel, - opposing the U. S. Government in its efforts to suppress the Rebellion -

Thos Finnon
Presid^t Bd. Claiming

Recd. A. H. Aug: 14. 1865.

J. B. Sweeney

VOLUNTEER DESCRIPTIVE LIST and ~~Account of Pay and Clothing~~

- NOTES. {
1. The amount of any *extra* pay for which the soldier may be mustered, *ex. gr.* as *Acting Hospital Steward*, as *Saddler*, &c., and which may be *still due* him, must be entered in the column headed "BOUNTY PAID," must be entered the *whole* amount *hitherto paid* him; in that of "BOUNTY DUE," the *whole* amount *yet due* him.
 2. Stoppages for *loss* or *damage* done to *arms*, or other *public property*, must be noted, and the *articles*, and *particular damage* to each specified.
 3. When stoppages are due, under sentence of a Court Martial, a *transcript of the same* must be entered here; and the amount *already stopped*, must be carefully noted.

No.	NAMES.	RANK.	DESCRIPTION.						WHERE BORN.		OCCUPATION.	Where
			Years of age.	Eyes.	Hair.	Complexion.	Feet.	Inches.	State or Kingdom.	Town or county.		
	<i>Charles Dickerson</i>		<i>18</i>	<i>Blk</i>	<i>Blk</i>	<i>Blk</i>	<i>5</i>	<i>5 1/2</i>	<i> Md</i>	<i> Worcester</i>	<i> Farmer</i>	<i> Vt.</i>

original paper

I CERTIFY that the above is a correct trans

STATION: *Benedict*
 DATE: *Feb 1864*

Pay and Clothing of *A. Recruit of U.S.C.*

and which may be still due him, must be carefully noted. "UE," the whole amount yet due him. age to each specified. amount already stopped, must be carefully stated.

NOTES: 5. In every case of desertion, the date, and that of delivery, or apprehension, must be given, together with a correct transcript of the... 6. A careful settlement of the man's CLOTHING ACCOUNT must be made, to date, and the amount DUE TO, or FROM him must be precise... 7. Should the man have been engaged in any action, or skirmish, it must be mentioned, together with date and place. 8. A full and particular mention will be made of any wounds he may have received in action, or other injury, whilst in the line of his...

COUNTY.	OCCUPATION.	ENROLLED.			MUSTERED.				LAST PAID.		BOUNTY.	
		When.	Where. (Town and State.)	By whom.	When.	Where. (Town and State.)	By whom.	Period.	By paymaster.	To what time.	Paid \$ (See note 2.)	Due \$ (See note 3.)
	<i>Farmer</i>	<i>17th, 2/12</i>	<i>North</i>	<i>Col. Birney Co. 12</i>		<i>Benedict</i>	<i>Col. Birney 3 yrs</i>					

The above is a correct transcript from the Records of this Great Rendezvous of Recruits from Maryland

STATION: *Benedict Md*
DATE: *February 20, 1864*

Wm Jirney
Brig Genl. U.S. Vol 4
U.S. Mustering Officer

Unit of U.S.C.S.

every case of desertion, the date, and that of delivery, or apprehension, must be given, together with a correct transcript of the order of sentence, or pardon. careful settlement of the man's CLOTHING ACCOUNT must be made, to date, and the amount DUE TO, or FROM him must be precisely stated. Should the man have been engaged in any action, or skirmish, it must be mentioned, together with date and place. full and particular mention will be made of any wounds he may have received in action, or other injury, whilst in the line of his duty.

whom.	MUSTERED.				LAST PAID.		BOUNTY.		REMARKS.
	When.	Where. (Town and State.)	By whom.	Period.	By paymaster.	To what time.	Paid \$ (See note 2.)	Due \$ (See note 2.)	
Birney Co., 12		Benedict	Col. Birney	3 yrs					Co. K 7th U.S. Colored Troops for Jas. B. Dickerson

This is a Receipt of Recruits from Maryland for U.S. Colored Troops
 Wm. Birney
 Brig. Genl. U.S. Vol. 4
 U.S. Mustering Officer

57

CASUALTY SHEET
OF WOUNDED.

Charles Derrickson

Private Company 'K'

17th Regiment of U.S. P.

Volunteers at the battle of Chapin's

Parrish, Va., Sept 29th

30th / 1864.

CASUALTY SHEET.

Name, Charles Derrickson
 Rank, Private, Company 'K', Regiment, 4th
 Arm, U.S.A., State, _____
 Place of casualty, Chapins Farm Va.
 Nature of casualty, wounded
 Date of casualty, Sept 29 & 30 / 04

FROM WHAT SOURCE THIS INFORMATION WAS OBTAINED.

Report of Killed, Wounded, and Missing of the _____ Regiment,
 Brigade, _____ Division, _____ Corps, dated _____
List of Casualties in the 4th U.S.A. on the
29 & 30 of Sept 1864, at Chapins Farm,
Va.
Sgt. Lewellyn A. Haskell
1st Col. Comdg
Index no 63

W. Broome
 Clerk.

RECEIVED BY THE ADJUTANT GENERAL

FOR THE

ADJUTANT GENERAL U. S. ARMY.



D 40 R. S. J. 1864

No. 2.

RECORD OF DEATH AND INTERMENT.

Name and number of person interred.	<i>Charles Dageron</i>	<i>1152</i>
Number and locality of the grave . . .	<i>19361</i>	
Hospital number of the deceased . . .	<i>7th U. S. Col. Prov. "Co. K"</i>	
Regiment, rank, and company . . .	<i>Belling Hooper Co. Md.</i>	
Residence before enlistment . . .	<i>Single</i>	
Conjugal condition, (and if married, } the residence of the widow). . . }		
Cause of death }	<i>Exhaustion from Wounds</i>	
Age of the deceased	<i>18 Years</i>	
Nativity	<i>U.S.</i>	
References and remarks }		
Date of death and burial	<i>Oct 30</i>	<i>1864</i>

[A duplicate of this Record has been forwarded to the Sexton, and another remains at this Hospital.]

To

Adj. General U. S. Army

SIR:

It becomes my duty to inform you that the person

stated; and that it is desired his remains should be interred with the usual military honors.

Respectfully,

Warren Webster

Asst. Surgeon U. S. Army.

In charge

MILITARY HOSPITAL, *David's Island N. Y. H.*

This copy of Record is to be transmitted to the Adjutant General at Washington immediately after the place of burial and the number of the grave have been ascertained and registered. The above notification is to remain attached.

MAR 9 1864

Charles Pagerson
Y. U. S. A. F., Riv. N.

Oct. 30. 64.
De Camp N. Y.

HOSPITAL RECORD,

SUBJECT TO THE

ORDER OF THE SURGEON GENERAL

UNITED STATES ARMY.

Deaths 1864

No. 1.

RECORD OF DEATH AND INTERMENT.

Name and number of person interred.	<i>Charles Dageron</i>	<i>1152</i>
Number and locality of the grave . . .	<i>19361</i>	
Hospital number of the deceased . . .	<i>7th U. S. Col. Inf. "Co. K."</i>	
Regiment, rank, and company . . .	<i>Belling Hooster Co. Md.</i>	
Residence before enlistment . . .	<i>Single</i>	
Conjugal condition, (and if married, } the residence of the widow) . . . }		
Cause of death }	<i>Exhaustion from Wounds</i>	
Age of the deceased	<i>18 Years</i>	
Nativity	<i>W. G.</i>	
References and remarks }		
Date of death and burial	<i>Oct 30th</i>	<i>1864</i>

Duplicates sent to the Adjutant General of the United States Army, and to the Sexton of the Cemetery.

Memoranda:

Effects
one Blouse one Dr. Trowsers

*Above effects sold March 7th 1866 for 20 cents.
Above amount (\$20) turned over to Maj. Almond Dageron, USA
March 26. 1866*

Recd Dec. 17th 1864
Sur. of Affairs cont'd Auditor
Adj. G. of Adm. & S. M.
Recd for 2nd 1/111
H.A.

51 43
K-
FINAL STATEMENT

OF

Charles Derickson
7th Reg't of W. Colored Troops

VOLUNTEERS.

NOTE 1.—Two of these certificates (or duplicates) are to be given to each Volunteer Soldier or drafted man who may be discharged previously to the discharge of his company, that he may at once receive from the Paymaster the pay, &c., due him, and the captain or other COMMISSIONED officer commanding the company will certify to the act of the delivery of the duplicate certificates; on these certificates the Soldier is "entitled to" his discharge, and should also present his discharge to the Paymaster to have the payment endorsed on it. The discharge is to be given back to the Soldier by the Paymaster; the latter only retaining as his voucher the duplicate certificates.

NOTE 2.—If the Soldier is entitled to pay for the use of his horse, the Company Commander will certify to that fact on the back of both these final statements, and also to the time he has pay due for having been so mounted on his own horse.

NOTE 3.—When a Soldier is furnished with final statements, his descriptive list, if he has one, should be taken up by the officer who gives the Soldier these statements, and endorsed with a statement to this effect by the officer. This endorsement should exhibit a full statement of the time for which the Soldier was allowed pay on his final statements, the clothing account, and all other charges against him or in his favor, so as to comprise a complete exhibit of his account. It will then be transmitted to the Company Commander of the Soldier, who will enter all the data necessary to a full understanding of the Soldier's account on the muster roll upon which the Soldier's discharge is reported. The descriptive list will then be destroyed. The object of this is, that the remaining portion of the Soldier's account may be settled upon the receipt of these muster rolls, and the Soldier receive any pay or allowances that may be due him at the time of his discharge, and which may not appear on his final statements from the fact that his descriptive list is incomplete. These accounts for back pay, &c., are settled by the 2d Auditor of the Treasury Department.

NOTE 4.—Charges for loss or injury to ordnance, horse equipments, and other miscellaneous charges, should appear under the heading of "Other Stoppages."

NOTE 5.—Bounty paid by State authorities, and not by the United States, will not be entered on this statement.

NOTE 6.—Amounts due the Sutler and Laundress must be entered on the muster roll on which the discharge, death, desertion, &c., is reported, as well as on the final statement, otherwise the amount cannot be collected from the United States.

NOTE 7.—This blank will be used for deceased volunteers and drafted men, as well as for others.

NOTE 8.—Where a Soldier dies in Hospital or on detached service, his descriptive list, if he has one, should be sent with his final statements, in duplicate, to the Adjutant General's Office, Washington, D. C.

Adj. G. of Adm. & S. M.
Cash (U.S. legal tender notes) in my hands
Ten dollars
G. S. [Signature]
Adj. G. of Adm. & S. M.

ADJUTANT GENERAL'S OFFICE.
Nov 21st 1864
Duplicate with Inventory sent 2d Auditor.

I certify, on honor, that Charles Derrickson a Private of 1st Lieut. J. H. Dearborn's Company (K.) of the 7th Regiment of U.S. Cavalry **VOLUNTEERS**, of the State of _____, born in Worcester Co., State of Maryland, aged 18 years; 5 feet 5/2 inches high; Black complexion, Black eyes, Black hair, and by occupation a Farmer, having joined the company on its original organization at Berlin, Md ^{Nov 26 63}; and enrolled in it at the muster into the service of the United States at Benedict, Md., on the 12th day of November, 1863, (or was mustered in service as a recruit, by _____, at _____, on the _____ day of _____, 186 , or was drafted and mustered into the service of the United States from the _____ Enrollment District of the State of _____, at _____, on the _____ day of _____, 186) to serve in the Regiment, for the term of Three years and having served **HONESTLY** and **FAITHFULLY** with his Company in The field in Florida ^{Virginia} to the present date, is now entitled to a **DISCHARGE** by reason of Death from wounds received in action before Fort Sumner, Va - Sep 29th 1864 ^{Oct 30th 64}.

The said Charles Derrickson was last paid by Paymaster Maj. McCormick to include the 30th day of April, 1864, and has pay due him from that time to the present date; he is entitled to pay and subsistence for **TRAVELING** to place of enrollment, and whatever other allowances are authorized to volunteer soldiers, drafted men, or militia, so discharged. He has received from the United States **CLOTHING** amounting to 56 ⁶³ 100 dollars, since the 2nd day of Nov., 1863, when his clothing account was last settled. He has received from the United States No 100 dollars advanced **BOUNTY**.

There is to be stopped from him, on account of the State of _____, or other authorities, for **CLOTHING**, &c., received on entering service, No 100 dollars; and for other stoppages, viz: He has retained pay due him, at the rate of \$6. per month, from the 1st of Jan'y 64, to the 30th Apr. 64, amounting to 24 20/100 dollars, he having received only 8 7/8 per month during that period _____ dollars. He has been furnished with **TRANSPORTATION** in kind from the place of his discharge to _____; and he has been **SUBSISTED** for **TRAVELING** to his place of enrollment, up to the _____, 186 .

He is indebted to _____, **SUTLER**, No 100 dollars.
He is indebted to _____, **LAUNDRESS**, No 100 dollars.

Given in Duplicate, at In the field, before Richmond, Va, this 10th day of November, 1864

J. H. Dearborn
1st Lieut., 7th U.S. Cavalry
Commanding Company.

1864

51

Duplicate

ARTICLES OF WAR.

INVENTORY OF THE EFFECTS

OF

Charles Herrickson

Late of Company K

7th Reg't of 2^d Colored Troop

*Volunteers, who died at Det Camp Hospital
Dovids Island N.Y. Harbor
on the 30 day of October 1864.*

ART. 95. When any non-commissioned officer or soldier shall die, or be killed in the service of the United States, the then commanding officer of the troop or company shall, in the presence of two other commissioned officers, take an account of what effects he died possessed of, above his arms and accoutrements, and transmit the same to the office of the Department of War, which said effects are to be accounted for, and paid to the representatives of such deceased non-commissioned officer or soldier. And in case any of the officers, so authorized to take care of the effects of deceased officers and soldiers, should, before they have accounted to their representatives for the same, have occasion to leave the regiment or post, by preferment or otherwise, they shall, before they be permitted to quit the same, deposit in the hands of the commanding officer, or of the assistant military agent, all the effects of such deceased non-commissioned officers and soldiers, in order that the same may be secured for, and paid to, their respective representatives.

ARMY REGULATIONS—EDITION OF 1863.

DECEASED SOLDIERS.

Par. 152. Inventories of the effects of deceased non-commissioned officers and soldiers, required by the 95th Article of War, will be forwarded to the Adjutant General, by the commander of the company to which the deceased belonged, and a duplicate of the same to the colonel of the regiment. Final statements of pay, clothing, &c., in duplicate, will be sent to the Adjutant General with one copy of the inventory. When a soldier dies at a post or station absent from his company, it will be the duty of his immediate commander to furnish the required inventory and final statements, and, at the same time, to forward to the commanding officer of the company to which the soldier belonged, a report of his death, specifying the date, place, and cause; to what time he was last paid, and the money or other effects in his possession at the time of his decease; which report will be noted on the next muster roll of the company to which the man belonged. Each inventory will be endorsed, "Inventory of the effects of _____, late of company (—) _____ regiment of _____, who died at _____, the _____ day of _____, 186—." If a legal representative receive the effects, it will be stated in the report. If the soldier leave no effects, the fact will be reported.

Par. 153. Should the effects of a deceased non-commissioned officer or soldier not be administered upon within a short period after his decease, they shall be disposed of by a Council of Administration, under the authority of the commanding officer of the post, and the proceeds deposited with the Paymaster, to the credit of the United States, until they shall be claimed by the legal representatives of the deceased.

Par. 154. In all such cases of sales by the Council of Administration, a statement in detail, or account of the proceeds, duly certified by the Council and commanding officer, accompanied by the Paymaster's receipt for the proceeds, will be forwarded by the commanding officer to the Adjutant General. The statement will be endorsed, "Report of the proceeds of the effects of _____, late of company (—) _____ regiment of _____, who died at _____, the _____ day of _____, 186—."

NOTE 1.—The effects in all cases, when called for, should be turned over to the legal representative, without further authority from the Adjutant General. When the effects are turned over to the relatives of the deceased before these inventories are sent to the Adjutant General, their receipts therefor should be attached to the inventories. In all other cases, one copy will be sent with a letter of transmittal direct to the Adjutant General, and a duplicate retained by the officer.

NOTE 2.—Particular care should be taken to take receipts in duplicate from the Paymaster for any funds turned over to him; one copy should be sent direct to the Adjutant General and one retained by the officer.



Inventory of the effects of Charles Herrickson late
a private of Captain Lieut J.H. Dearborn's Company X of
the 7th Regiment of Md. Colored Troops, Volunteers, who was enrolled as
a private at Berlin in the State of Maryland on
the 2nd day of November 1863, and mustered into the service of the United
States as a private on the 12th day of November 1863, at Benedict Md.,
in Company X, 7th Regiment of Md. Colored Troops Volunteers, to serve three
years or during the war; he was born in Worcester Co. in the State
of Maryland; he was 18 years of age, 5 feet 5 1/2 inches
high, Black complexion, Black eyes, Black hair, and by occupation, when enrolled,
a Farmer; he died in De Camp Gen. Hospital U.S.A., at
Quids Island N.Y. Harbor on the 30th day of October 1864, by
reason of Exhaustion from Wounds recd in action before Fort Gilmer Va.
Sept. 27th 1864.

INVENTORY.					
ARTICLES.	No.	ARTICLES.	No.	ARTICLES.	No.
Hats.....		Pairs trousers.....	1	Knapsacks.....	
Caps.....		Pairs flannel drawers.....			
Forage caps.....		Pairs cotton drawers.....			
Great coats.....		Flannel shirts.....			
Uniform coats.....		Cotton shirts.....			
Uniform jackets.....		Pairs boots.....			
Flannel sack coats.....		Pairs shoes.....			
Blouses.....		Pairs socks.....			
Stable frocks.....		Blankets.....			
Fatigue overalls.....		Haversacks.....			
				MONEY.	
				Specie.....	\$ none
				Notes.....	\$ 10 ⁰⁰ / ₁₀₀

I CERTIFY, ON HONOR, that the above inventory comprises all the effects of Charles
Herrickson, deceased, and that the effects are in the hands
of Warren Webster Asst. Surg. U.S.A. ^{Charge of the Camp Hospital} at Quids Island New York Harbor
Asst. Surgeon to be disposed of by a Council of Administration.
The Private (Herrickson) Asst. in my hands

(DUPLICATES.)

J.H. Dearborn 1st Lieut.
J.M.C.T.
Commanding the Company.

STATION: Before Richmond Va

DATE: Nov. 30th 1864

CASUALTY SHEET

No. 227
Chas Dagerson
Priv of Company K
7 Regiment of 22d Co
State Volunteers

NATURE OF CASUALTY.

Died Oct 30. 67

I. S. Tins sent for
Apr 16. 1867
The name of Charles
Dagerson is not borne
upon the Roll of Co K
22d Co. but the name
of Charles H. Kenyon is
borne upon the Roll of
Co "K" of 22d Co as having
died at the place & date given
on the Inventory of Effects
furnished by the 2d Auditor

CASUALTY SHEET.

Name: *Chas Dagerson*
 Rank: *Priv* Company: *K* Regiment: *1st*
 Arm: *U.S.C.S.* State: _____
 Nature of Casualty: *Death*

CAUSE OF CASUALTY—(NAME OF DISEASE, &C.)

BY WHOM DISCHARGED.

FROM WHAT SOURCE THIS INFORMATION WAS OBTAINED.

DEGREE OF DISABILITY.

BY WHOM CERTIFIED.

REMARKS.

Jas M. Moore
A. G. M.

DATE OF DISCHARGE, DEATH, &C.

Oct. 30th 1864

PLACE OF DISCHARGE, DEATH, &C. burial

Cypress Hill Cemetery
S. I. N.Y.

Roll of Honor N.Y.
Page 56,

Inventories of effects
sent to 2^d Auditor
Dec 30/64,

T. D. J. C.

Clerk.

ARTICLES OF WAR.

ART. 95. When any non-commissioned officer or soldier shall die, or be killed in the service of the United States, the then commanding officer of the troop or company shall, in the presence of two other commissioned officers, take an account of what effects he died possessed of, above his arms and accoutrements, and transmit the same to the office of the Department of War, which said effects are to be accounted for, and paid to the representatives of such deceased non-commissioned officer or soldier. And in case any of the officers, so authorized to take care of the effects of deceased officers and soldiers, should, before they have accounted to their representatives for the same, have occasion to leave the regiment or post, by preference or otherwise, they shall, before they be permitted to quit the same, deposit in the hands of the commanding officer, or of the assistant military agent, all the effects of such deceased non-commissioned officers and soldiers, in order that the same may be secured for, and paid to, their respective representatives.

DIRECTIONS.

NOTE 1.—One copy of the inventories of the effects of deceased non-commissioned officers and soldiers, required by the 95th Article of War, will be forwarded to the Adjutant General, by the commander of the company to which the deceased belonged, and a duplicate of the same to the colonel of the regiment. Final statements of pay, clothing, &c., in duplicate, will be sent to the Adjutant General with one copy of the inventory. Both inventory and final statements should be forwarded, as a general rule, through Regimental Headquarters. When a soldier dies at a post or station absent from his company, it will be the duty of his immediate commander to furnish, direct to the Adjutant General, the required inventory and final statements, and, at the same time, to forward to the commanding officer of the company to which the soldier belonged, a report of his death, specifying the date, place, and cause; to what time he was last paid, and the money or other effects in his possession at the time of his decease; which report will be noted on the next muster roll of the company to which the man belonged. Each inventory will be endorsed, "Inventory of the effects of _____, late of company _____, regiment of _____, who died at _____, the _____ day of _____, 186-." If a legal representative receive the effects, it will be stated in the report. If the soldier leave no effects, the fact will be reported on the blank for inventory.

NOTE 2.—Should the effects of a deceased non-commissioned officer or soldier not be administered upon within a short period after his decease, they shall be disposed of by a Council of Administration, under the authority of the commanding officer of the post, and the proceeds deposited with the Paymaster, to the credit of the United States, until they shall be claimed by the legal representatives of the deceased.

NOTE 3.—In all such cases of sales by the Council of Administration, a statement in detail, or account of the proceeds duly certified by the Council and commanding officer, (Form 5.) accompanied by the Paymaster's receipt for the proceeds, will be forwarded by the commanding officer to the Adjutant General. The statement will be endorsed, "Report of the proceeds of the effects of _____, late of company _____, regiment of _____, who died at _____, the _____ day of _____, 186-."

NOTE 4.—The effects in all cases, when called for, should be turned over to the legal representative, without further authority from the Adjutant General. When the effects are turned over to the relatives of the deceased before these inventories are sent to the Adjutant General, their receipts therefor should be attached to the inventories. In all other cases, one copy will be sent with a letter of transmittal direct to the Adjutant General, and a duplicate retained by the officer.

NOTE 5.—Particular care should be taken to take receipts in duplicate from the Paymaster for any funds turned over to him; one copy should be sent direct to the Adjutant General and one retained by the officer.

INVENTORY OF THE EFFECTS

OF

Eric Charles Dickenson
 Late of Company *K*
 7th Reg't of *U. S. Colored*
 Volunteers, who died at *Savannah*
 on the *30th* day of *October*, 1864.

Surgeon General's Office,

RECORD & PENSION BUREAU,

Washington, *December* 1867

The within Inventory is a true copy from the records
of De Camp Hospital
Savannah on file in
 this Office, and contains all the information in the case that
 can be found.

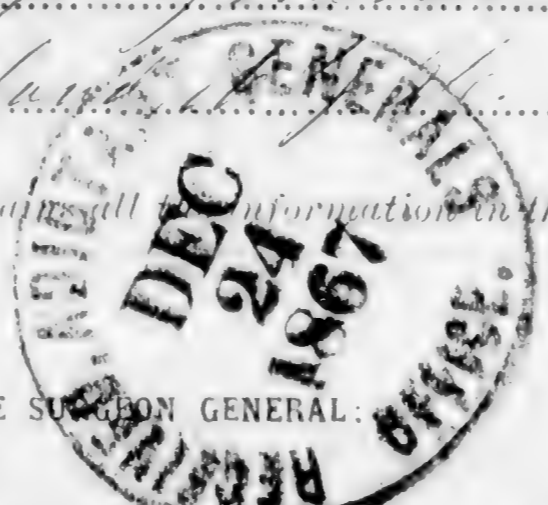

BY ORDER OF THE SURGEON GENERAL:

J. J. Woodward

Bvt. Major, Assistant Surgeon, U. S. A.

14
146

Dickenson

W. A. D.
Dec 20/67

The name of Charles
Dickenson is not borne
upon the rolls of the 7th
U. S. Colored
The name of Charles
Dickenson is borne upon
the rolls as having died at
the place & date given in this
Inventory.

Inventory of the effects of Charles Ferguson late
 a Private of Captain _____ Company A of
 the 7th Regiment of U.S. Colored Volunteers, who was enrolled as
 a _____ at _____ in the State of _____ on
 the _____ day of _____ 186 _____, and mustered into the service of the United
 States as a _____ on the _____ day of _____ 186 _____, at _____
 in Company _____, _____ Regiment of _____ Volunteers, to serve _____
 years or during the war; he was born in _____ in the State
 of _____: he was _____ years of age, _____ feet _____ inches
 high, _____ complexion, _____ eyes, _____ hair, and by occupation, when enrolled,
 a _____; he died in St. Paul Gen. Hosp., at
Naval Island, St. P. 26, on the 30th day of October 1864, by
 reason of g. & M. left hand, read at Hosp. Boston Sept. 29, 1864

Submitted Feb. 10, 1865, to the Council of Administration, St. P.

Exhibits and the 7, 1866, no. 2, 3, 4, 5, and proceeds turned over to Maj. Hood, Regt. U.S.A., March 25, 1866.

INVENTORY.					
ARTICLES.	No.	ARTICLES.	No.	ARTICLES.	No.
Hats.....		Pairs trousers.....	1	Knapsacks.....	
Caps.....		Pairs flannel drawers.....			
Forage Caps.....		Pairs cotton drawers.....			
Great coats.....		Flannel shirts.....			
Uniform coats.....		Cotton shirts.....			
Uniform jackets.....		Pairs boots.....			
Flannel sack coats.....		Pairs shoes.....			
Briouzes.....		Pairs socks.....			
Sable frocks.....		Blankets.....			
Fatigue overalls.....		Haversacks.....			
				MONEY.	
				Specie.....	\$
				Notes.....	\$

I CERTIFY, ON HONOR, that the above inventory comprises all the effects of _____
 _____, deceased, and that the effects are in the hands
 of _____ at _____
 _____ to be disposed of by a Council of Administration.

(DUPLICATES.)

STATION: _____

Commanding the Company.

DATE: _____

Surgeon General's Office,

Record and Pension Division,

January 24th, 1867.

Respectfully returned to Assistant Adjutant General *S. H. Cloupe*, A. G. O., with an Inventory of Effects enclosed, in case of *Pvt. Chas. Spang*, *Co. H, 7th U.S. Inf. Troop*, (supposed to be the soldier referred to within).

No evidence on file from which Final Statements can be prepared.

By Order of the Surgeon General



J. J. Woodward
Brevet Major and Assistant Surgeon, U. S. Army.

R. of A., Vol. *117* No. *118*

117
118



WAR DEPARTMENT,

ADJUTANT GENERAL'S OFFICE,

WASHINGTON, Dec 16, 1864

SIR:

Final Statements in the cases of deceased soldiers are required to be sent to the Adjutant General's Office in duplicate, with one copy of the Inventory of Effects. The Descriptive List should also be sent to this Office in cases where the soldier was absent from his Company at the time of his death. Where there were no effects, it should be so stated on a blank Inventory, properly signed.

Certificates of Disability should be sent in duplicate. Special care should be taken that the date of discharge and signature of the discharging officer should be affixed.

No of the Final Statement or Inventory, has been received in the case of Chas Sagerson, of Co. K, 1st Regiment of U.S.C. Volunteers, whose papers were forwarded to this Office. You will please forward the missing papers without delay.

I have the honor to be, sir,

Very respectfully,

Your obedient servant,

L. H. Plouse
Assistant Adjutant General.
(110)

Brig. Gen. Col
~~COMMANDING OFFICER~~

J. J. Woodward
A. J. U. S. A.

Died Oct 30 1864

Buried Cypress Hill Cemetery
L. H.

C

MODEL FOR SET OF PAPER

FORM 1.—FINAL STATEMENT.

I CERTIFY, ON HONOR, that *John Smith*, a Private of Captain J. Brown's Company, (A,) of the 1st Regiment of Pennsylvania Volunteers, of the State of Pennsylvania, born in Pittsburg, State of Pennsylvania, aged 21 years, 5 feet 10 inches high, light complexion, blue eyes, dark hair, and by occupation a Farmer, having joined the Company on its original organization at Pittsburg, and enrolled in it at the muster into the service of the United States at Pittsburg, on the 1st day of July, 1861, (or was mustered in service as a recruit, by ———, at ———, on the — day of ———, 186—, or was drafted and mustered into the service of the United States from the — Enrollment District of the State of ———, at ———, on the — day of ———, 186—,) to serve in the Regiment for the term of Three Years, and having served *honestly* and *faithfully* with his Company in the field to the present date, is now entitled to a DISCHARGE by reason of death. Died in Regimental Hospital, Fort Brown, Texas, December 31, 1863, of typhoid fever.

The said John Smith was last paid by Paymaster Major Morse, to include the 31st day of October, 1863, and has pay due him from that time to the present date. He is entitled to pay and subsistence for *traveling* to place of enrollment, and whatever other allowances are authorized to volunteer soldiers, drafted men, or militia, so discharged. He has received from the United States *clothing* amounting to 20.⁰⁰/₁₀₀ dollars, since the 31st day of December, 1862, when his clothing account was last settled. He has received from the United States 25.⁰⁰/₁₀₀ dollars advanced *bounty*.

There is to be stopped from him on account of the State of ———; or other authorities, for *clothing*, &c., received on entering service, nothing, ⁰⁰/₁₀₀ dollars; and for other stoppages, viz: nothing, ⁰⁰/₁₀₀ dollars. He has been furnished with no *transportation* in kind from the place of his discharge to ———; and he has not been *subsidized* for *traveling* to his place of enrollment up to the ———, 186—.

He is indebted to ———, Sutler, ——— ⁰⁰/₁₀₀ dollars.

He is indebted to ———, Laundress, ——— ⁰⁰/₁₀₀ dollars.

GIVEN, IN DUPLICATE, at Fort Brown, Texas, this 31st day of December, 1863.

JAMES BROWN,
Captain Co. A, 1st Penn. Vols.,
Commanding Company.

FORM 2.

INVENTORY of the effects of John Smith, late a Private of Captain J. Brown's Company, (A,) of the 1st Regiment of Pennsylvania Volunteers, who was enrolled as a Private at Pittsburg, in the State of Pennsylvania, on the 1st day of July, 1861, and mustered into the service of the United States as a Private on the 1st day of July, 1861, at Pittsburg, in Company A, 1st Regiment of Pennsylvania Volunteers, to serve three years or during the war. He was born in Pittsburg, in the State of Pennsylvania; he was 21 years of age, 5 feet 10 inches high, light complexion, blue eyes, dark hair, and by occupation, when enrolled, a Farmer. He died in Regimental Hospital, at Fort Brown, Texas, on the 31st day of December, 1863, of typhoid fever.

INVENTORY.					
ARTICLES.	No.	ARTICLES.	No.	ARTICLES.	No.
Hats.....		Pairs trousers.....		Knapsacks.....	
Caps.....		Pairs flannel drawers.....			
Forage caps.....		Pairs cotton drawers.....		Watch, silver.....	1
Great coats.....	1	Flannel shirts.....	1		
Uniform coats.....		Cotton shirts.....			
Uniform jackets.....		Pairs boots.....			
Flannel sack coats.....		Pairs shoes.....			
Blouses.....		Pairs socks.....			
Stable frocks.....		Blankets.....			
Fatigue overalls.....		Haversacks.....			
				MONEY.	
				Specie.....	\$2 00
				Notes.....	\$50 00

I CERTIFY, ON HONOR, that the above inventory comprises all the effects of Private John Smith, deceased, and that the effects are in the hands of Captain J. Brown, at Fort Brown, Texas, to be disposed of by a Council of Administration, except the money, which has been turned over to Major Wm. C. Morse, Paymaster, U. S. Army, whose receipt is hereto annexed.*

STATION: Fort Brown, Texas.

DATE: December 31, 1863.

(Duplicates.)

JAMES BROWN,
Captain Co. A, 1st Penn. Vols.,
Commanding the Company.

*NOTE.—If the effects have been turned over to relatives of deceased, so state on certificate, instead of "in the hands of Captain," &c., and give the names of the persons, and their relation to the deceased person.

FORM 3.—HEIR'S RECEIPT FOR EFFECTS.

RECEIVED of Captain John Brown, Company A, 1st Regiment of Pennsylvania Volunteers, the following effects of Private John Smith, late of Company A, 1st Regiment of Pennsylvania Volunteers, now deceased, which I claim as his wife:

1 great coat, 1 flannel shirt, 1 silver watch, fifty dollars in notes, and two dollars in specie.

MARY SMITH.

FORM 4.—PAYMASTER'S RECEIPT FOR MONEY.

RECEIVED, this 31st day of December, 1863, at Fort Brown, Texas, of Captain James Brown, of Company A, 1st Pennsylvania Volunteers, fifty dollars in Treasury notes and two dollars in specie, the property of the late Private John Smith, of Company A, 1st Pennsylvania Volunteers, who died at Fort Brown, Texas, on the 31st day of December, 1863.

WM. C. MORSE, Paymaster, U. S. A.

RS FOR A DECEASED SOLDIER.

FORM 5.—PROCEEDINGS OF A COUNCIL OF ADMINISTRATION,

Convened at Fort Brown, Texas, pursuant to Orders, No. 1, dated Post Headquarters, Fort Brown, Texas, January 2, 1864—consisting of Captain James Keith, Company C, 1st Pennsylvania Volunteers; Captain John Brown, Company D, 1st Pennsylvania Volunteers; and Lieutenant William Roe, Company E, 1st Pennsylvania Volunteers—for the purpose of disposing of the effects of the late John Smith, of Company A, 1st Pennsylvania Volunteers:

The Council found that the effects consisted of the following articles. They were ordered to be sold at auction, which was accordingly done, and the amount set opposite the articles respectively obtained, for which the receipt of the Paymaster is annexed:

AT AUCTION.		
1 shirt	brought.....	\$1 00
1 great coat	“.....	2 50
1 silver watch	“.....	25 00
		\$28 50

JAMES KEITH,

Capt. Co. C, 1st Penn. Vols., President.

WILLIAM ROE,

Lieut. Co. E, 1st Penn. Vols., Recorder.

APPROVED:

JOHN SANDERS,

Colonel 1st Penn. Vols.,

Commanding Post.

FORM 6.—PAYMASTER'S RECEIPT.

RECEIVED from Captain John Brown, Company A, 1st Pennsylvania Volunteers, at Fort Brown, Texas, January 10, 1864, twenty-eight dollars and fifty cents, the result of the sale of the effects of the late Private John Smith, of Company A, 1st Pennsylvania Volunteers.

WM. C. MORSE, *Paymaster U. S. Army.*

ARTICLES OF WAR.

ART. 95. When any non-commissioned officer or soldier shall die, or be killed in the service of the United States, the then commanding officer of the troop or company shall, in the presence of two other commissioned officers, take an account of what effects he died possessed of, above his arms and accoutrements, and transmit the same to the office of the Department of War, which said effects are to be accounted for, and paid to the representatives of such deceased non-commissioned officer or soldier. And in case any of the officers, so authorized to take care of the effects of deceased officers and soldiers, should, before they have accounted to their representatives for the same, have occasion to leave the regiment or post, by preferment or otherwise, they shall, before they be permitted to quit the same, deposit in the hands of the commanding officer, or of the assistant military agent, all the effects of such deceased non-commissioned officers and soldiers, in order that the same may be secured for, and paid to, their respective representatives.

DIRECTIONS.

NOTE 1.—One copy of the inventories of the effects of deceased non-commissioned officers and soldiers, required by the 95th Article of War, will be forwarded to the Adjutant General, by the commander of the company to which the deceased belonged, and a duplicate of the same to the colonel of the regiment. Final statements of pay, clothing, &c., in duplicate, will be sent to the Adjutant General with one copy of the inventory. Both inventory and final statements should be forwarded, as a general rule, through Regimental Headquarters. When a soldier dies at a post or station absent from his company, it will be the duty of his immediate commander to furnish, direct to the Adjutant General, the required inventory and final statements, and, at the same time, to forward to the commanding officer of the company to which the soldier belonged, a report of his death, specifying the date, place, and cause; to what time he was last paid, and the money or other effects in his possession at the time of his decease; which report will be noted on the next muster roll of the company to which the man belonged. Each inventory will be endorsed "Inventory of the effects of _____, late of company (—) _____ regiment of _____, who died at _____ the _____ day of _____, 186—." If a legal representative receive the effects, it will be stated in the report. If the soldier leave no effects, the fact will be reported on the blank for inventory.

NOTE 2.—Should the effects of a deceased non-commissioned officer or soldier not be administered upon within a short period after his decease, they shall be disposed of by a Council of Administration under the authority of the commanding officer of the post, and the proceeds deposited with the Paymaster, to the credit of the United States, until they shall be claimed by the legal representatives of the deceased. This should be done according to Forms 5 and 6, and one copy of each sent to the Adjutant General. No copy of the order convening the board is required, the approval of the commanding officer being sufficient.

NOTE 3.—In all such cases of sales by the Council of Administration, a statement in detail, or account of the proceeds duly certified by the Council and commanding officer, (Form 5,) accompanied by the Paymaster's receipt of the proceeds, will be forwarded by the commanding officer to the Adjutant General. The statement will be endorsed "Report of the proceeds of the effects of _____, late of company (—) _____ regiment of _____, who died at _____ the _____ day of _____, 186—."

NOTE 4.—The effects in all cases, when called for, should be turned over to the legal representative, without further authority from the Adjutant General. When the effects are turned over to the relatives of the deceased before these inventories are sent to the Adjutant General, their receipts therefor should be attached to the inventories. In all other cases, one copy will be sent with a letter of transmittal direct to the Adjutant General, and a duplicate retained by the officer.

NOTE 5.—Particular care should be taken to take receipts in duplicate from the Paymaster for any funds turned over to him; one copy should be sent direct to the Adjutant General, and one retained by the officer.

NOTE 6.—Where a soldier dies in hospital or on detached service, his descriptive list, if he has one, should be sent with his final statements, in duplicate, to the Adjutant General, Washington, D. C.

NOTE 7.—Form 1 will be forwarded in duplicate to the Adjutant General, through Regimental Headquarters, as soon as possible after the death of the soldier, accompanied by one copy of Forms 2 and 3, or 4, as the case may require. A duplicate of the inventory (Form 2) should be retained until the articles are finally disposed of.

NOTE 8.—The papers for each man should be made SEPARATELY for each man, and, when possible, fastened together. This is especially necessary, and must be done in all cases. The papers cannot be properly disposed of at the Adjutant General's Office unless this is done, and must be returned for correction.

NOTE 9.—Where there are no line officers, as for instance, a general hospital without a line officer to command the guard, the Council of Administration may be made up from other commissioned officers, in the same way as prescribed for line officers.

NOTE 10.—Where a soldier dies away from his company or regiment, and the officer having charge of him cannot furnish Final Statements by reason of not being able to obtain a Descriptive List, he should notify the regimental or company commander, (giving him full particulars as to history and description of the man, as far as possible,) whose duty it will then be, in such case, to furnish the necessary papers from the best data he can obtain.

Wesfield Henry

Co I, 7 U.S. Col'd Inf.

Private Private

CARD NUMBERS.

1	6294232	26
2	6294331	27
3	6294432	28
4	6294533	29
5	6294628	30
6	6294720	31
7	6294812	32
8	6294905	33
9	6295000	34
10	6295100	35
11	6295201	36
12	6295301	37
13	6295395	38
14	6295483	39
15	6295572	40
16	6295645	41
17	6295715	42
18	6295789	43
19	6295861	44
20	9066904	45
21		46
22		47
23		48
24		49
25		50

Book Mark:

See also

01692059 Bristol

01920656 Auburn

S-2097065 P.O. m m

ss. cr. sec. with letter
of C. J. Washfield.

1/23/27.
4.

D. | 7 | U.S.C.T.

Henry De Sields

Co. E, 7 Reg't U.S. Col'd Inf.

Appears on

Company Descriptive Book

of the organization named above.

DESCRIPTION.

Age 20 years; height 5 feet 5 1/4 inches.

Complexion *Blk.*

Eyes *Blk.*; hair *Blk.*

Where born *Somerset, Md.*

Occupation *Farmer.*

ENLISTMENT.

When *Oct. 22.*, 1863.

Where *Somerset, Md.*

By whom *Ed. Wm. Boring*; term 3 y'rs.

Remarks: *Mustered in at Camp Stanton, Md. Nov. 5. 63. by Dr. Ed. Haskell. Absent sick from May 25. 64. to Aug. 64.*

J. J. White

2 | 7 | U.S.C.T.

Henry Deshield
Pvt, Co. I, 7 Reg't U. S. Col'd Inf.

Age 20 years.

Appears on

Company Muster-in Roll

of the organization named above. Roll dated
Camp Stanton, Charles Co., Md., Nov. 5, 1863.

Muster-in to date Nov 5, 1863

Joined for duty and enrolled:

When Oct. 22, 186 .

Where Somerset, Md.

Period 3 years.

Remarks:

Book mark:

(856)

J. B. Gage

Copyist.

2

7

U.S.C.T.

Henry DeShields

Co. I, 7 Reg't U. S. Col'd Infantry.

Appears on

Company Muster Roll

for from Nov. 5 to Dec. 31, 1863.

Present or absent Present

Stoppage, \$ 100 for

Due Gov't, \$ 100 for

Remarks: Enlistment premium \$2.00 due.

Book mark:

J.B. Gage

(358)

Copyist.

2

7

U.S.C.T.

Henry Deshields

Priv., Co. I, 7 Reg't U. S. Col'd Infantry.

Appears on

Company Muster Roll

for Jan & Feb, 1864.

Present or absent Present

Stoppage, \$ 100 for

Due Gov't, \$ 100 for

Remarks: Enlistment premium \$2.00 due

Book mark:

J. B. Gage Copyist.

2

7

U.S.C.T.

Henry Deshields
Pvt, Co. I, 7 Reg't U. S. Col'd Infantry.

Appears on

Company Muster Roll

for *Mich & Apr*, 1864.

Present or absent *Present*

Stoppage, \$ *100* for

Due Gov't, \$ *100* for

Remarks:

Book mark:

(358)

J B Gage
Copyist.

21 7 U.S.C.T.

Henry Deshields

Priv., Co. I, 7 Reg't U. S. Col'd Infantry.

Appears on

Company Muster Roll

for May & June, 1864.

Present or absent Absent

Stoppage, \$ 100 for

Due Gov't, \$ 100 for

Remarks: Sick at Jacksonville, Fla., since June 28/64

Book mark:

J. B. Gage Copyist.

9

7

U.S.C.T.

Henry Deshields

Priv., Co. I, 7 Reg't U. S. Col'd Infantry.

Appears on

Company Muster Roll

for July & Aug, 1864

Present or absent Absent

Stoppage, \$ 100 for

Due Gov't, \$ 100 for

Remarks: Sick in Jacksonville, Fla., at Hosptl. since July 22, 1864

Book mark:

J.B. Gage

(358)

Copyist.

D

7

U.S.C.T.

Henry Deshields
Priv., Co. I, 7 Reg't U. S. Col'd Infantry.

Appears on

Company Muster Roll

for Sept & Oct, 1864

Present or absent Present

Stoppage, \$ 100 for

Due Gov't, \$ 100 for

Remarks: Stop for 1 Haversack.

Book mark:

(358)

J.B. Gage
Copyist.

D

7

U.S.C.T.

Henry Deshields

Sgt, Co. I, 7 Reg't U. S. Col'd Infantry.

Appears on

Company Muster Roll

for *Nov + Dec*, 186*4*

Present or absent *Present*

Stoppage, \$ *100* for

Due Gov't, \$ *100* for *One Haversack*

Remarks:

Inserted by Corp.

Book mark:

D. Maher

Copyist.

A | **7** | **U.S.C.T.**

Henry DeShields,
Priv, Co. 1, 7 Reg't U. S. Col'd Infantry.

Appears on

Company Muster Roll

for *Jan'y. + Feby.*, 186*5*.

Present or absent *Present*

Stoppage, \$ *100* for

Due Gov't, \$ *100* for

Remarks:

Book mark:

D. Maher
Copyist.

(358)

D

7

U.S.C.T.

Henry Deshields
Priv, Co. I, 7 Reg't U. S. Col'd Infantry.

Appears on

Company Muster Roll

for *March & April*, 1865.

Present or absent *Present*

Stoppage, \$ 100 for

Due Gov't, \$ 100 for

Remarks:

Book mark:

D. Maher
Copyist.

(358)

Q

7

U.S.C.T.

Handy Deshields
Priv, Co. I, 7 Reg't U. S. Col'd Infantry.

Appears on

Company Muster Roll

for *May & June*, 1865.

Present or absent *Present*

Stoppage, \$ 100 for

Due Gov't, \$ 100 for

Remarks:

Book mark:

D. Maher
Copyist.

B

7

U.S.C.T.

Henry Deshields.

Priv, Co. 1, 7 Reg't U. S. Col'd Infantry.

Appears on

Company Muster Roll

for *July + Aug.*, 1865.

Present or absent *Present*

Stoppage, \$ *100* for

Due Gov't, \$ *67* for *C + G, Equipage*

" " *43¢* " *Ordinance, &c.*

Remarks:

Book mark:

D. Mahr

Copyist.

D

7

U.S.C.T.

Henry Deshields

Priv., Co. 1, 7 Reg't U. S. Col'd Infantry.

Appears on

Company Muster Roll

for Sept. & Oct., 1865.

Present or absent Present

Stoppage, \$ 100 for

Due Gov't, \$ 43/100, for Ordnance, &c.

67 1/2 C. & G. Equipage

Remarks:

Book mark:

D. Maher Copyist.

A

7

U.S.C.T.

Henry Deshields

Priv., Co. I, 7 Reg't U. S. Col'd Infantry.

Appears on

Company Muster Roll

for Nov. + Decr., 1865.

Present or absent Present

Stoppage, \$ 100 for

Due Gov't, \$ 49 100, for Ordnance, &c.

" " 67 1/2 " C. & G. Equipage

Remarks:

Book mark:

D. Maher

(358)

Copyist.

D | 7 | U.S.C.T.

Henry Deshields

Pvt, Co. I, 7 Reg't U. S. Col'd Infantry.

Appears on

Company Muster Roll

for Jan + Feb, 1866.

Present or absent Pres.

Stoppage, \$ 100 for

Due Gov't, \$ 100 for

Remarks:

Book mark:

Sabine Copyist.

(358)

2 | 7 | U.S.C.T.

Henry Deshields

Private, Co. I, 7 Reg't U. S. Col'd Infantry.

Appears on

Company Muster Roll

for Mar & Apr, 1866.

Present or absent Present.

Stoppage, \$ 100 for

Due Gov't, \$ 34/100 for Ordnance

lost.

Remarks:

Book mark:

Sabine Copyist.

D

7

U.S.C.T.

Henry Deshields

Private, Co. I, 7 Reg't U. S. Col'd Infantry.

Appears on

Company Muster Roll

for Feb. 28 to June 30, 1866.

Present or absent Not stated.

Stoppage, \$ 34/100 for Ordnance and Ordnance stores.

Due Gov't, \$ 100 for

Remarks:

Book mark:

Sabine

Copyist.

(358)

D

7

U.S.C.T.

Henry Deshields

Pr- Co. I, 7 Reg't U. S. Col'd Infantry.

Appears on

Company Muster Roll

for July + Aug, 1866.

Present or absent Present.

Stoppage, \$ 100 for

Due Gov't, \$ 100 for

Remarks:

Book mark:

Sabine Copyist.

(358)

L

7

U.S.C.T.

Henry Ashfield
Pvt., Co. *B*, 7 Reg't U. S. Col'd Infantry.

Appears on **Co. Muster-out Roll**, dated
Indianola, Texas
October 13, 1866.

Muster-out to date *Oct 13*, 1866.

Last paid to *June 30*, 1866.

Clothing account:

Last settled....., 186 ; drawn since \$..... 100

Due soldier \$ *26 93* / 100; due U. S. \$..... 100

Am't for cloth'g in kind or money adv'd \$..... 100

Due U. S. for arms, equipments, &c., \$ *6* / 100

Bounty paid \$..... 100; due \$ *100* / 100

Remarks *Joined co. at ori-*
ginal organization.
Retains one E. R. musket
Set of accoutrements, per
YD 101, War Dept, May
30, '65.

Book mark: *1684 1881*
2175 1881

Sabine

Dashields, Henry

P., Co. *I.*, **7** Reg **U.S.C. Inf.**

Enclosures.

Bed Cards	Descriptive Lists
Burial Records	Final Statements
Certs. of Dis. for Discharge	Furloughs
C. M. Charges	Med. Des. Lists
Med. Certificates	Orders

Other papers relating to—

Admission to Hosp'l	Furlough
Casualty Sheet (Officer's)	Med. Examination
Confinement	Misc. Information /
Contracts	Pay or Clothing
Death or Effects	Personal Reports
Desertions	Rank
Discharge from Hosp'l	Transfer to Hosp'l
Discharge from Service	Transfer to V. R. C.
Duty	Transportation

MICROFILM PUBLICATION M 1849

COMPILED MILITARY SERVICE RECORDS
OF VOLUNTEER UNION SOLDIERS WHO SERVED WITH
THE UNITED STATES COLORED TROOPS (USCT)
7TH REGIMENT OF INFANTRY

PERSONAL PAPERS' TARGET SHEET

PLEASE NOTE THE CHECKED INFORMATION ABOUT THE PERSONAL PAPERS IN
THIS FILE:

- NO PERSONAL PAPERS WERE FOUND IN THIS FILE WHEN THE
RECORDS WERE ARRANGED FOR MICROFILMING.
- 6 PERSONAL PAPER(S) FOUND IN THIS FILE WHEN THE RECORDS
WERE ARRANGED FOR MICROFILMING.

Wm. W. W. W.

No. .

ABSTRACT OF DISBURSEMENTS.

....., 186 .

William Walker

Dollars *300* $\frac{00}{100}$

Paid , 186 .

The United States,

To William Walter Dr.

		DOLLARS.	CENTS.
1864	For amount awarded him by the Board of Claims, in consideration		
November 9 th	of the enlistment of Henry Deshields		
	in the 7 th Reg't N. S. Cold Troops	300	00
Total \$		300	00

I CERTIFY that the above account is correct and just; that the name of Henry Deshields is borne on the muster-in rolls of the 7th Reg't N. S. Cold Troops; and that the above amount was awarded by the Board of which Thos. Timmons Esq is President, said award being in accordance with section 24 of the act entitled "An act to amend an act entitled 'An act for enrolling and calling out the national forces, and for other purposes,'" approved Feb. 24, 1864.

Assistant Adjutant General.

RECEIVED _____, 186 , of Capt. G. Benedict, A. A. S. 206
dollars and _____ cents, in full of the above account.

Wm Walter

(SIGNED DUPLICATES.)

Wm. Walter

No. .

ABSTRACT OF DISBURSEMENTS.

....., 186 .

William Walter

Dollars *300* $\frac{00}{100}$

Paid , 186 .

The United States,

To William Walter Dr.

		DOLLARS.	CENTS.
1864.	For amount awarded him by the Board of Claims, in consideration		
Novem 19th	of the enlistment of <i>Henry Deshields</i>		
	in the <i>7th Regt U. S. Cold Troop</i>	300	00
<i>Total \$</i>		300.	00

I CERTIFY that the above account is correct and just; that the name of *Henry Deshields* is borne on the muster-in rolls of the *7th Regt U. S. Cold Troop*; and that the above amount was awarded by the Board of which *Thos. Finckhous Esq* is President, said award being in accordance with section 24 of the act entitled "An act to amend an act entitled 'An act for enrolling and calling out the national forces, and for other purposes,'" approved Feb. 24, 1864.

Assistant Adjutant General.

RECEIVED _____, 186 , of *Capt. S. Benedict, A. A. G. 806*
 _____ dollars and _____ cents, in full of the above account.

Wm Walter

(SIGNED DUPLICATES.)

Wm. Walter

No. .

ABSTRACT OF DISBURSEMENTS.

....., 186 .

William Walter

Dollars *300* $\frac{00}{100}$.

Paid, 186 .

The United States,

To William Walter Dr.

1864		DOLLARS.	CENTS.
November 9th	For amount awarded him by the Board of Claims, in consideration		
	of the enlistment of <u>Henry Deshields</u>		
	in the <u>7th Reg't N. S. Cold Troops</u>	300	00
Total \$		300	00

I CERTIFY that the above account is correct and just; that the name of Henry Deshields is borne on the muster-in rolls of the 7th Reg't U. S. Cold Troops; and that the above amount was awarded by the Board of which Thos. Timmons Esq is President, said award being in accordance with section 24 of the act entitled "An act to amend an act entitled 'An act for enrolling and calling out the national forces, and for other purposes,'" approved Feb. 24, 1864.

Assistant Adjutant General.

RECEIVED _____, 186 , of Capt. G. Benedict, A. A. S. 206 dollars and _____ cents, in full of the above account.

Wm Walter

(SIGNED DUPLICATES.)

No. 141 38. 1864.

No. 141 38.

APPLICATION OF

William Walter

OF

P.O. Tyaskin, Somerset County

For Compensation for Service of Slave,

Henry Dashields

Enlisted in Seventh Regiment

U. S. Colored Troops, Co. I

Received, February 12th 1864.

COMPENSATION AWARDED,

November 19th 1864.

Three Hundred Dollars.

Thos Simmons
President Board of Claims

Recd. A.C. Nov 20. 1864.

Received mch. 30. 62

Received

MAR 9 1864

*Case of compensation
for H.*

W. S. J. H. 1864

No. 141 38.

APPLICATION OF

William Walter

OF

P.O. Nyack, Somerset County

For Compensation for Service of Slave,

Henry D. Shields

Enlisted in *Seventh* Regiment

U. S. Colored Troops, Co. *D*

Received, *February 12th* 1864.

COMPENSATION AWARDED,

Nov 19th 1864.

Three Hundred Dollars.

Thos. Simmons
President Board of Claims

W. S. J. H. Nov. 20. 1864

Approved March 30. 64

Payment made

EVIDENCE OF TITLE.

I, William Walter, of Somerset
 County, Md., do solemnly swear that Henry Deshields
 who has been enlisted in the seventh Regiment, U. S. Colored Troops,
 Co. I; is my slave for life; (~~his term of service expiring on~~
 the _____ day of _____ 186 _____,) and that
 I became possessed of him by inheritance, in the month
 of December, eighteen hundred and forty five (1845). And I
 do further swear that I have not purchased said slave from any person or persons disloyal
 to the Government of the United States, with the object of obtaining compensation for
 the same; and furthermore, that I have no agency for obtaining compensation for any per-
 son or persons but such as, to my knowledge, are loyal citizens of the United States.

Wm Walter

February 13th 1864

STATE OF MARYLAND,

Baltimore City ~~County~~ to wit:

On this 13th day of February in the year 1864,

before me, the subscriber, a Justice of the Peace of the State and County aforesaid, personally appeared William Walter, and took, signed, and acknowledged the oaths preceding; and further made oath, in due form of law, that all the statements made in this application are, to the best of his knowledge and belief, strictly true.

Also personally appeared before me John Turner and Robert Evans ~~James A. J. Melling~~, loyal citizens of the United States, residents of Somerset County, well acquainted with the said William Walter, and in no manner interested in the prosecution of this claim, and made oath, in due form of law, that the said William Walter is the owner of the slave Henry Deshields, as a fact of public notoriety; that they believe all the statements herein made by him, in reference thereto, are correct, and that he is unquestionably loyal to the Government of the United States. Witness their signatures:

Jos W Stake
5 cts
Stamp

John Turner J.P.
Robert Evans R.E.

Justice of the Peace.

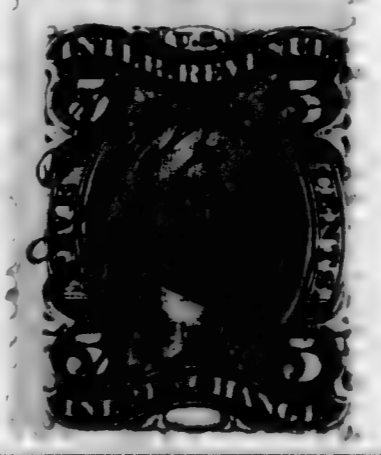

STATE OF MARYLAND,

Baltimore City County, to wit:

I, *Alford Mace*, Clerk of the *Superior* Court for

Balt. City County, do hereby certify that *J. W. Blatzer*,

before whom the foregoing affidavits were made, was, at the time of signing the same, a

Justice of the Peace for the *City* County and State aforesaid, duly commissioned and sworn

and that his signature thereto is genuine, and that full faith and credit should be given to

his official acts.

Witness my hand and the seal of said Court, this *Twenty Eighth* day of

October, A. D. 1864.

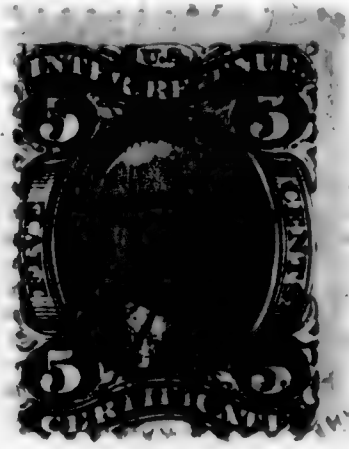

Alford Mace CLERK.
[Signature]

70-141

A.

No. 141 CLAIMANT'S CERTIFICATE.

I, William Walter a loyal citizen, and a resident
of Gyaskin, County of Somerset, State of
Maryland, hereby claim compensation, under the provisions of
General Orders, No. 329, 1863, for my slave Henry D. Shields
enlisted October 22 1864 at Somerset Court
by Col Wm Birney in the Seventh
Regiment U. S. Colored Troops, Co. D; certificate of which enlistment, and a
descriptive list, as required, accompany this application.

In proof of my loyalty to the Constitution and Government of the United States, I
present the accompanying oath, which I have taken, signed, and acknowledged, to be filed
with this application, in accordance with requirement of said General Orders.

Wm Walter W. W.

February 13th 1864

B.

OATH OF ALLEGIANCE.

I, *William Walter*, do solemnly swear that I have never joined, or been concerned in, any insurrection or rebellion; that I have never borne arms against the United States; that I have never given any aid, countenance, counsel, or encouragement to any person or persons engaged, or whom I had reason to believe were about to engage, in insurrection, rebellion, or armed hostility against the United States; that I have neither sought, nor accepted, nor attempted to exercise the functions of any office, civil or military, nor to perform any service whatever, under any authority or pretended authority in hostility to the United States; that I have not yielded a voluntary support to any insurrection, rebellion, or pretended government, authority, power, or constitution within the United States hostile thereto. And I do further swear that, to the best of my knowledge and ability, I have supported and defended, and will continue to support and defend, the United States against all enemies, foreign and domestic; and that I have supported, defended, and obeyed, and will continue to support, defend, and obey, the Constitution and laws of the United States; that I will bear true faith and allegiance to the same; and that I take this oath freely, without any mental reservation or purpose of evasion: So help me God.

Wm Walter m. m.

Sworn to and subscribed before me, at *Baltimore*
 the *13th* day of *February* 1864

Josh A Stake
Justice of the Peace

5 cts
 Stamp

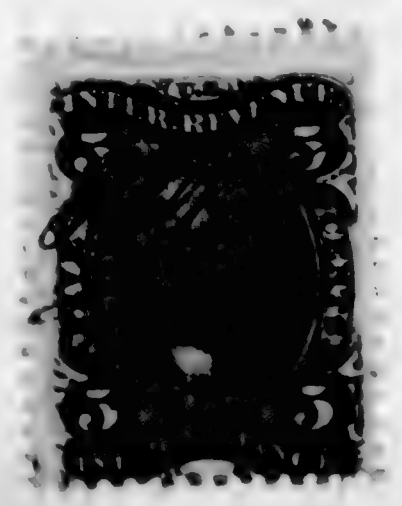

C.

I present herewith evidence of my title to the slave Henry
Dechields enlisted as aforesaid, and in consideration of the sum of
 _____ by me received, I hereby covenant and
 agree with the United States, that I, my heirs, executors, or assigns, shall never hereafter make
 or enforce any claim to the labor or services of said slave; and pledge myself to execute
 a valid Deed of Manumission and Release of all my claims to service forever of said
Henry Dechields to be filed with the Board of Claims
 now in session at Baltimore Md

Wm Walter m.r.

February 13th 1864



Maryland Somerset County Court: I Lewis Woolford clerk of the Circuit Court for Somerset County aforesaid hereby certify that the within is truly copied from the original now on file and of record in the office of the clerk of the Circuit Court for Somerset County aforesaid - In testimony whereof I hereunto subscribe my name and affix the seal of the said Circuit Court this 19th day of April anno Domini 1884

Lewis Woolford



141

R.C.

E.

DEED OF MANUMISSION AND RELEASE OF SERVICE.

Whereas my slave Henry Dashiell has enlisted in the service of the United States: now, in consideration thereof, I, William Walter, of Somerset county, State of Maryland, do hereby, in consideration of said enlistment, manumit, set free, and release the above-named Henry Dashiell from all service due me; his freedom to commence from the 22d day October 1863, the date of his enlistment as aforesaid in the Seventh Regiment of Colored Troops, in the service of the United States.

Witness my hand and seal, this 19th day of April, 1864

Wm Walter 

Witness:

Robert W. Dougherty
Henry J. White
Isaac Gibbons

Somerset County, April
State of Maryland 19, 1864

Before me appeared this day William Walter, and acknowledged the above Deed of Manumission and Release of Service to be his free act and deed.

Isaac Gibbons
a Justice of the Peace

141-12
Co. I, 7th U.S. Inf.,
Wm. Walter
Deshields Henry

A. S. Nov. 21, 1864

I certify that the name of Henry
Deshields, is borne on the Muster in
Roll of Company "I" 7th Regt U.S. C.
Troops on file in this Office. It
is stated on said Muster in Roll
that he was enrolled, at Somerset Md.
W. A.

G. W. Suggard
A. S. Gen'l

VOLUNTEER DESCRIPTIVE LIST and Account of Pay and Clothing of

No.	NAMES.	RANK.	DESCRIPTION.					WHERE BORN.		OCCUPATION.	ENRO	
			Years of age.	Eyes.	Hair.	Complexion.	HEIGHT.	State or Kingdom.	Town or county.		(For	
							Feet.	In.			When.	
	<i>Deshields Henry</i>		<i>20</i>	<i>Blk</i>	<i>Blk</i>	<i>Blk</i>	<i>5</i>	<i>3 1/2</i>	<i>Ms</i>	<i>Smurrah</i>	<i>Sailor</i>	<i>1863</i> <i>Oct 22</i>

NOTES.

- 1..The amount of any extra pay for which the soldier may be mustered, ex. gr. as Acting Hospital Steward, as Saddler, &c., and which may be still due him, must be carefully noted.
- 2..In the column headed "BOUNTY PAID," must be entered the whole amount hitherto paid him; in that of "BOUNTY DUE," the whole amount yet due him. Bounty paid by State authorities, and not by the United States, will not be entered on this statement.
- 3..Stoppages for loss or damage done to a. as, or other public property, must be noted, and the articles, and particular damage to each, specified. When stoppages are due, under sentence of a Court Martial, a transcript of the same must be entered here; and the amount already stopped, must be carefully stated.
- 4..In every case of desertion, the date, and that of delivery, or apprehension, must be given, together with a correct transcript of the order of sentence or pardon.
- 5..A careful settlement of the man's CLOTHING ACCOUNT must be made, to date, and the amount DUE TO, or FROM him must be precisely stated.
- 6..Should the man have been engaged in any action or skirmish, it must be mentioned, together with date and place. A full and particular mention will be made of any wounds he may have received in action, or other injury, whilst in the line of his duty.
- 7..If the soldier is entitled to pay for the use of his horse, the company commander will certify to that fact on this list, and also to the time he has pay due for having been so mounted on his own horse.
- 8..When a soldier is furnished with final statements, his descriptive list, if he has one, should be taken up by the officer who gives the soldier these statements, and endorsed with a statement to this effect by the officer. This endorsement should exhibit a full statement of the time for which the soldier was allowed pay on his final statements, the clothing account, and all other charges against him or in his favor, so as to comprise a complete exhibit of his account. It will then be transmitted to the company commander of the soldier, who will enter all the data necessary to a full understanding of the soldier's account on the muster roll upon which the soldier's discharge is reported. The descriptive list will then be destroyed. The object of this is, that the remaining portion of the soldier's account may be settled upon the receipt of these muster rolls, and the soldier receive any pay or allowances that may be due him at the time of his discharge, and which may not appear on his final statements from the fact that his descriptive list is incomplete. These accounts for back pay, &c., are settled by the 2d Auditor of the Treasury Dep't.
- 9..Where a soldier dies in Hospital or on detached service, his descriptive list, if he has one, should be sent with his final statement to the Adjutant General, Washington, D. C.
- 10..Men drafted will be considered as mustered in draft, and will be mustered for pay on the muster roll. On the same line as the soldier's name, under the heading "When Mustered in" will be given the date when drafted, or, if a substitute, when enlisted. Men mustered in by enlistment, or by the Enrollment Act, are mustered in by enlistment, and will be given the place from which they were enlisted; under the heading "By whom mustered in," will be given the name of the officer enlisting him. (When enlisted, the name of the Provost Marshal of the District, State of Massachusetts, must be given.)
- 11..A separate descriptive list should, as a general rule, be made for each company.
- 12..Descriptive lists must, in all cases, be signed by the commanding officer, or by an officer acting as such.

[A. G. O. No. 93.]

Clothing of

Present in 7th U.S.

REGIMENT.	ENROLLED OR ENLISTED. (For Drafted Men, see note 10.)			MUSTERED IN. (For Drafted Men, see note 10.)				LAST PAID.		BOUNTY.		CLOTHING
	When.	Where. (Town and State.)	By whom.	When.	Where. (Town and State.)	By whom. (In the case of drafted men, from what enrollment district.)	Period.	By paymaster.	To what time.	Paid \$ (See note 2.)	Due \$ (See note 3.)	Date of last ment.
	<i>1863</i>	<i>Mass</i>	<i>Company</i>	<i>1863</i>	<i>Andover</i>	<i>Company</i>						

REMARKS.

one, should be sent with his final statements, in duplicate, to the Adjutant General, Washington, D. C. The date of their mustering in will be considered as mustered in from the date of their enrollment. All be mustered for pay on the usual rolls for Volunteers. The line as the soldier's name, under the heading "joined for enrollment."—Commencement of First Payment by Time," will be the word drafted, or substitute, as the case may be; and under "When Mustered in" will be given the date when the soldier was drafted, or, if a substitute, when enlisted, (substitutes, under the Act, are mustered in by enlistment;) under "Where Mustered in" will be given the place from which drafted, (or, if a substitute, the place from which he was drafted;) under the heading "By whom Mustered in," will be given the name of the Enrollment District from which he was drafted, or to which it belongs, thus: 4th D. Mass.; meaning 4th District, State of Massachusetts.) Or if a substitute, the name of the officer enlisting him. (When enlisted by Board of Enrollment of the Provost Marshal of the Enrollment District.) A descriptive list should, as a general rule, be given for each man. This list must, in all cases, be signed by COMMISSIONED officers; and men acting as such.

I CERTIFY that the above is a correct transcript from the Records of *this Unit* *from Maryland for U.S. Colored Troops*

STATION: *Baltimore Md*
 DATE: *October 16th 1864*

By *Commanding Officer*
James Gutter *Chief Muster of*
Co. 4th U.S. Colored Troops
Capt. 30th Feb. 1865
of U.S. Colored

Recruit on 7th U.S.C.

MUSTERED IN. (For Drafted Men, see note 10.)				LAST PAID.		BOUNTY.		CLOTHING ACCOUNT	
When.	Where. (Town and State.)	By whom. (In the case of drafted men, from what enrollment district.)	Period.	By paymaster.	To what time.	Paid \$ (See note 2.)	Due \$ (See note 2.)	Date of last settlement.	Total money value of clothing drawn since last settlement.
<i>1863</i>	<i>St. Paul, Pa.</i>	<i>Wm. B. Denny</i>						<i>Oct 1st 1863</i>	

Wm. B. Denny

Wm. Walter

I CERTIFY that the above is a correct transcript from the Records of *this Co. 7th U.S.C.* from *Maryland for U.S. Colored Troops*

By command of
S. M. Bowman

Co. 7th U.S.C.
Commanding the Company.

STATION: *Baltimore Md.*
DATE: *October 16th 1864*

James G. Tuttle *Chief Clerk*
of U.S. Colored Troops
Cap. 30th Feb. 1864

NARA 915

F.

CERTIFICATE OF AWARD OF THE BOARD OF CLAIMS.

Office of the Board of Claims
For Slaves Enlisted in the Service of the United States,

Baltimore Md,

November 19th 1864.

No 344
\$300-

We hereby certify, that William Walter, of Somerset county, State of Maryland, having proved, under oath, his loyalty to the Constitution and Government of the United States, and established his title as to the ownership of Nerry Deshields, a slave enlisted at Somerset County Md, on the 22 day of October, 1863, by Col. Wm. Birney, in the service of the United States, in the 7th Regiment of Colored Troops, Co. I, and having filed a valid Deed of Manumission and Release of Service of said slave, is entitled to the sum of Three Hundred dollars, which has been awarded to him by this Board as a remuneration for all claim to the future labor or service of said slave, under the provision of General Orders, War Department, No. 329, 1863.

Thos. Inman, President of the Board.
L. E. Strangford, Member of the Board.
Wm. Jones, Member of the Board.

To Col. C. W. Foster,
Chief of the Bureau for the
Organization of Colored Troops, Washington, D. C.

402
Rickenson Charles

Co H, 7 U.S. Col'd Inf.

Private

CARD NUMBERS.

1	26
See Derrickson, Charles	
3	28
4	29
5	30
6	31
7	32
8	33
9	34
10	35
11	36
12	37
13	38
14	39
15	40
16	41
17	42
18	43
19	44
20	45
21	46
22	47
23	48
24	49
25	50

Book Mark:

See also

Dickerson David

Co *D*, 7 U.S. Col'd Inf.

Private | *Private*

CARD NUMBERS.

1	6294333	26
2	6294382	27
3	6294434	28
4	6294534	29
5	6294629	30
6	6294721	31
7	6294813	32
8	6294906	33
9	6295601	34
10	6295101	35
11	6295202	36
12	6295302	37
13	6295396	38
14	6295484	39
15	6295574	40
16	6295647	41
17	6295716	42
18	6295791	43
19	6295864	44
20	9066906	45
21		46
22		47
23		48
24		49
25		50

Book Mark:

See also

100
Dickerson David

Co 2, 7 U.S. Col'd Inf.

Private | Private

CARD NUMBERS.

1	6294233	26
2	6294382	27
3	6294434	28
4	6294534	29
5	6294629	30
6	6294721	31
7	6294813	32
8	6294906	33
9	6295001	34
10	6295101	35
11	6295202	36
12	6295302	37
13	6295396	38
14	6295484	39
15	6295574	40
16	6295647	41
17	6295716	42
18	6295791	43
19	6295864	44
20	9066906	45
21		46
22		47
23		48
24		49
25		50

Book Mark:

See also

S-2091060-PO mem

A 2342773 and wd

A 2371720 and wd

D. | 7 | U.S.C.T.

David Dickerson

, Co. E, 7 Reg't U. S. Col'd Inf.

Appears on

Company Descriptive Book

of the organization named above.

DESCRIPTION.

Age 20 years; height 5 feet 3 1/2 inches.

Complexion Blk.

Eyes Blk; hair Blk.

Where born Worcester, Md.

Occupation Farmer

ENLISTMENT.

When Oct-31, 1863.

Where Worcester, Md.

By whom Wm. Birney; term 3 y'rs.

Remarks: Mustered in at Camp Stanton, Md. Nov 5. 63, by Lt. Col. Clarke.

Det. at Mandarin Fla. June 23. 64. to July. 64.

A. D. White

9 | 7 | U.S.C.T.

David Dickerson.

Pvt., Co. I, 7 Reg't U. S. Col'd Inf.

Age 20 years.

Appears on

Company Muster-in Roll

of the organization named above. Roll dated
Camp Stanton,
Charles Co., Md., Nov. 5, 1863.

Muster-in to date Nov. 5, 1863.

Joined for duty and enrolled:

When Oct 31, 1863.

Where Worcester, Md.

Period 3 years.

Remarks:

Book mark:

(856)

J. B. Gage

Copyist.

9

7

U.S.C.T.

David Dickenson

Pvt., Co. I, 7 Reg't U. S. Col'd Infantry.

Appears on

Company Muster Roll

for from Nov. 5 to Dec. 31, 1863.

Present or absent Present

Stoppage, \$ 100 for

Due Gov't, \$ 100 for

Remarks: Enlistment premium \$2.00 due

Book mark:

J.B. Gage

(358)

Copyist.

D. | 7 | U.S.C.T.

David Dickerson

Pvt., Co. I, 7 Reg't U. S. Col'd Infantry.

Appears on

Company Muster Roll

for Jan & Feb, 1864

Present or absent Present

Stoppage, \$ 100 for

Due Gov't, \$ 100 for

Remarks: Enlistment premium \$2.00 due

Book mark:

J. B. Gage Copyist.

(358)

D | 7 | U.S.C.T.

David Dickerson

Pvt., Co. I, 7 Reg't U. S. Col'd Infantry.

Appears on

Company Muster Roll

for Mch & Apr, 1864

Present or absent Present

Stoppage, \$ 100 for

Due Gov't, \$ 100 for

Remarks:

Book mark:

(358)

Job Gage Copyist.

9 | 7 | **U.S.C.T.**

David Dickerson

Pvt, Co. I, 7 Reg't U. S. Col'd Infantry.

Appears on

Company Muster Roll

for *May & June*, 186*4*.

Present or absent *Absent*

Stoppage, \$ 100 for

Due Gov't, \$ 100 for

Remarks: *Detached at Mandarin Fla., by S. O. No. 64, Hd. Qrs. U. S. C. I. June 23, 1864. Charge for one pair Shoulder Scales.*

Book mark:

J. B. Gage

(358)

Copyist.

D | 7 | U.S.C.T.

David Dickerson

Priv., Co. I, 7 Reg't U. S. Col'd Infantry.

Appears on

Company Muster Roll

for July & Aug, 1864

Present or absent Present

Stoppage, \$ 100 for

Due Gov't, \$ 100 for

Remarks:

Book mark: 573, 100

(358)

J. B. Gage

Copyist.

D

7

U.S.C.T.

David Dickerson

Pvt, Co. I, 7 Reg't U. S. Col'd Infantry.

Appears on

Company Muster Roll

for Sept & Oct, 1864.

Present or absent Present

Stoppage, \$ 100 for

Due Gov't, \$ 100 for

Remarks: Stop for 1 Knapsack, 1 Haversack & 1 Canteen.

Book mark:

J B Gage Copyist.

D

7

U.S.C.T.

David Dickerson

Priv, Co. I, 7 Reg't U. S. Col'd Infantry.

Appears on

Company Muster Roll

for *Nov. & Decr.*, 1864.

Present or absent *Present*

Stoppage, \$ *100* for

Due Gov't, \$ *100* for *one Knapsack, one
Haversack & one Canteen.*

Remarks:

Book mark:

D. Maher

(358)

Copyist.

B

7

U.S.C.T.

David Dickerson

Priv, Co. I, 7 Reg't U. S. Col'd Infantry.

Appears on

Company Muster Roll

for *Jan'y. + Feby.*, 1865.

Present or absent *Present*

Stoppage, \$ *100* for

Due Gov't, \$ *100* for

Remarks:

Book mark:

D. Maher

(358)

Copyist.

29

7

U.S.C.T.

David Dickerson

Priv, Co. I, 7 Reg't U. S. Col'd Infantry.

Appears on

Company Muster Roll

for March & April, 1865.

Present or absent Present

Stoppage, \$ 100 for

Due Gov't, \$ 100 for

Remarks:

Book mark:

D. Maher
Copyist.

(358)

29

7

U.S.C.T.

David Dickerson

Priv., Co. I, 7 Reg't U. S. Col'd Infantry.

Appears on

Company Muster Roll

for *May + June*, 1865.

Present or absent *Present*

Stoppage, \$ *100* for

Due Gov't, \$ *100* for

Remarks:

Book mark:

D. Maher

Copyist.

(358)

D

7

U.S.C.T.

David Dickerson

Priv, Co. I, 7 Reg't U. S. Col'd Infantry.

Appears on

Company Muster Roll

for *July & Aug.*, 1865.

Present or absent *Present.*

Stoppage, \$ *100* for

Due Gov't, \$ *2*/₁₀₀, for *C & G. Equipage*

Remarks:

Book mark:

D. Maher

(358)

Copyist.

A | **7** | **U.S.C.T.**

David Dickerson

Priv, Co. I, 7 Reg't U. S. Col'd Infantry.

Appears on

Company Muster Roll

for *Sept. & Oct.*, 1865.

Present or absent *Present.*

Stoppage, \$ *100* for

Due Gov't, \$ *99* for *C. & G. Equipage*

Remarks:

To forfeit One Months pay by Sentence of F. O. Court.

Book mark:

D. Maher
Copyist.

D

7

U.S.C.T.

David Dickerson

Priv, Co. I, 7 Reg't U. S. Col'd Infantry.

Appears on

Company Muster Roll

for Nov. & Decr., 1865.

Present or absent Present

Stoppage, \$ 100 for

Due Gov't, \$ 99 100, for C & G, Equipage

Remarks:

To forfeit one months pay & sentence of F. O. Court.

Book mark:

D. Maher

Copyist.

(358)

S

7

U.S.C.T.

David Dickerson

Private, Co. I, 7 Reg't U. S. Col'd Infantry.

Appears on

Company Muster Roll

for Jan + Feb, 1866.

Present or absent Present.

Stoppage, \$ 100 for

Due Gov't, \$ 100 for

Remarks:

Book mark:

(358)

Sabine Copyist.

B

7

U.S.C.T.

David Dickerson

Pvt., Co. I, 7 Reg't U. S. Col'd Infantry.

Appears on

Company Muster Roll

for Mar + Apr, 1866.

Present or absent Present.

Stoppage, \$ 100 for

Due Gov't, \$ 08/100 for Ordnance
lost

Remarks:

Book mark:

Sabine
Copyist.

(358)

8

7

U.S.C.T.

David Dickerson

Priv., Co. I, 7 Reg't U. S. Col'd Infantry.

Appears on

Company Muster Roll

for Jan. 28 to June 30, 1866.

Present or absent Not stated.

Stoppage, \$ 08 for ordnance
and ordnance stores.

Due Gov't, \$ 100 for

Remarks:

Book mark:

Sabine
Copyist.

(358)

D

7

U.S.C.T.

David Dickerson

Pvt., Co. I, 7 Reg't U. S. Col'd Infantry.

Appears on

Company Muster Roll

for July - Aug, 1866.

Present or absent Present

Stoppage, \$ 100 for

Due Gov't, \$ 100 for

Remarks:

Book mark:

(358)

Sabine Copyist.

S

7

U.S.C.T.

David Dickerson
 Pvt, Co. *D*, 7 Reg't U. S. Col'd Infantry.

Appears on **Co. Muster-out Roll** dated
Indianola, Texas
October 13, 1866.

Muster-out to date *Oct. 13*, 1866.

Last paid to *June 30*, 1866.

Clothing account:

Last settled....., 186 ; drawn since \$..... 100

Due soldier \$ *26*^{*10*}/₁₀₀; due U. S. \$..... 100

Am't for cloth'g in kind or money adv'd \$..... 100

Due U. S. for arms, equipments, &c., \$ *6* 100

Bounty paid \$..... 100; due \$ *100* 100

Remarks *joined co. at ori-*
ginal organization.
Retains one B. R. mus.
Set of accoutrements
per G.O. 101, War Dept.,
May 30, '65.

Book mark:

Sabine

(361)

Copyist.

Dickerson David
Co. *C*, 7th Reg't *Inf*

Enclosures.

Bed Cards	Final Statements
Burial Records	Furloughs or L. of A.
Certs. of Dis. for Discharge	Med. Certificates
C. M. Charges	Med. Des. Lists
Descriptive Lists	Orders
Discharge Certificates	Pris. of War Record
Enlistment Papers	Resignations

Other papers relating to—

Admission to Hosp'l	Furlough or L. of A.
Casualty Sheet	Med. Examination
Confinement	Misc. Information
Contracts	Pay or Clothing <i>/</i>
Death or Effects	Personal Reports
Desertion	Rank
Discharge from Hosp'l	Transfer to Hosp'l
Discharge from Service	Transfer to V. R. C.
Duty	Transportation

David Jackson

Co. I. 7th U.S. Inf.

NARA 941

Adjutant General's Office,

COLORED TROOPS BRANCH,

June 19, 1877

Vol. 7

C. T., 187

Wanted in the case of David Dickerson, Co. D,

7th Reg't

U.S.C. information as to trial
MR. Sells Oct 15 "to forfeit imprisonment pay by
sentence S. O. C."

Respectfully,

L. A. Woodward

Chief Clerk.

P. J. Halson

Adjutant General's Office,

Div. Records Discontinued Courts &c

June 27th, 1877

Vol.

C. T., 187

Reply in case of

7th Reg't

U.S.C. David Dickerson, Co. D,
Co. Morning Report book shows Sept. 19th 1875: from duty to
in Arrest. - Oct. 20th 75: for duty. -
Cause of confinement not stated.
No evidence of trial on Reg't Co. records.

C.D.F.

404

Rickerson Isaac

Co *H*, 7 U.S. Col'd Inf.

Private

Private

CARD NUMBERS.

1	6292465	26
2	6292565	27
3	6292667	28
4	6292768	29
5	6292865	30
6	6292959	31
7	6293049	32
8	6293149	33
9	6293247	34
10	6293346	35
11	6293443	36
12	6293540	37
13	6293629	38
14	6293718	39
15	6293804	40
16	6293848	41
17	6293951	42
18	6294023	43
19	6294094	44
20	9066790	45
21		46
22		47
23		48
24		49
25		50

Book Mark:

See also

J. 848447. PO aff

D 1055-395 PO M m

2 | 7 | U.S.C.T.

Isaac Giderson

Co. D, 7 Reg't U.S. Col'd Inf.

Appears on

Company Descriptive Book

of the organization named above.

DESCRIPTION.

Age 22 years; height 5 feet 3 inches.

Complexion Black.

Eyes Black; hair Black.

Where born Worcester, Maryland.

Occupation

ENLISTMENT.

When Nov. 2, 1862.

Where Worcester.

By whom Col. Wm. Birney; term 3 y'rs.

Remarks: Mustered Nov. 5, 1862
by Lt. Col. Haskell.

J. G. White

Copist.

A | 7 | U.S.C.T.

Isaac Dickerson
Pt., Co., 7 Reg't U. S. Col'd Inf.

Age 22 years.

Appears on

Company Muster-in Roll

of the organization named above. Roll dated

C. Stanton Charles, Nov. 5, 1863.

Muster-in to date Nov. 5, 1863

Joined for duty and enrolled:

When Nov. 2, 1863.

Where Worcester, Ms

Period 3 years.

Remarks:

Book mark:

Stuck

D.

7

U.S.C.T.

Isaac Dickerson,

Pl., Co. H, 7 Reg't U. S. Col'd Infantry.

Appears on

Company Muster Roll

for *Nov. & Dec.*, 1863.

Present or absent *Absent.*

Stoppage, \$ *100* for

Due Gov't, \$ *100* for

Remarks: *Detached on re-
cruiting service by
order Col. Wm
Birney Dec. 20/63
Dues to Enlistment
Fund.*

Book mark:

Heck

N. 7 U.S.C.T.

Isaac Dickerson

Pt., Co. H, 7 Reg't U. S. Col'd Infantry.

Appears on

Company Muster Roll

for Jan. and Feb., 1864.

Present or absent Present

Stoppage, \$ 100 for

Due Gov't, \$ 100 for

Remarks: Returned from recruiting service Jan. 15/64

Book mark:

State

(858)

Copyist

N.

7

U.S.C.T.

Isaac Dickerson

Pl., Co. H, 7 Reg't U. S. Col'd Infantry.

Appears on

Company Muster Roll

for March & April, 1864.

Present or absent

Present

Stoppage, \$ 100 for

Due Gov't, \$ 100 for

Remarks:

Book mark:

Hick

(858)

Copyist

D.

7

U.S.C.T.

Isaac Dickerson
D., Co. H, 7 Reg't U. S. Col'd Infantry.

Appears on

Company Muster Roll

for *May & June*, 1864.

Present or absent *Present*

Stoppage, \$ *100* for

Due Gov't, \$ *100* for

Remarks:

Book mark:

Steele

(858)

Copyist

A | 7 | U.S.C.T.

Isaac Dickerson

Pf., Co. H, 7 Reg't U. S. Col'd Infantry.

Appears on

Company Muster Roll

for July & Aug., 1864.

Present or absent Present

Stoppage, \$ 100 for

Due Gov't, \$ 100 for

Remarks: Slap for one
Cauterans

Book mark:

Steel

NARA 951

A. | 7 | U.S.C.T.

Isaac Dickerson
Pl., Co. H, 7 Reg't U. S. Col'd Infantry.

Appears on

Company Muster Roll

for Sep. & Oct., 1864.

Present or absent Present

Stoppage, \$ 100 for

Due Gov't, \$ 100 for

Remarks:

Book mark

Steel

(858)

Copyist

10

7

U.S.C.T.

Isaac Dickerson

Priv, Co. H, 7 Reg't U. S. Col'd Infantry.

Appears on

Company Muster Roll

for *March and April*, 1864.

Present or absent *Present*

Stoppage, \$ *100* for

Due Gov't, \$ *100* for

Remarks:

Book mark:

N. H. Merrill

(858)

Copyist

10

7

U.S.C.T.

Isaac Dickson

Private, Co. H, 7 Reg't U. S. Col'd Infantry.

Appears on

Company Muster Roll

for Jan and Feb, 1865.

Present or absent Present

Stoppage, \$ 100 for

Due Gov't, \$ 100 for

Remarks: Stop for 1 week 20c

Book mark:

N. H. Merrill

(858)

Copyist

10

7

U.S.C.T.

Isaac Dickerson

Private, Co. H, 7 Reg't U. S. Col'd Infantry.

Appears on

Company Muster Roll

for March and April, 1863.

Present or absent Present

Stoppage, \$ 100 for

Due Gov't, \$ 100 for

Remarks: Stop for one month 200

Book mark:

N. H. Merrill

10

7

U.S.C.T.

Isaac Wickerson

Private, Co. H, 7 Reg't U. S. Col'd Infantry.

Appears on

Company Muster Roll

for *May and June*, 1865.

Present or absent *Present*

Stoppage, \$ *100* for

Due Gov't, \$ *100* for

Remarks: *Stop for 1 week*

Book mark:

N. H. Merrill

(858)

Copyist

10

7

U.S.C.T.

Isaac Dickerson

Priv, Co. H, 7 Reg't U. S. Col'd Infantry.

Appears on

Company Muster Roll

for *July and Aug*, 1865.

Present or absent *Present*

Stoppage, \$ *100* for

Due Gov't, \$ *100* for

Remarks:

Book mark:

H. W. Merrill

(858)

Copyist

H

7

U.S.C.T.

Isaac Nickerson

Priv, Co. H, 7 Reg't U. S. Col'd Infantry.

Appears on

Company Muster Roll

for *Sept and Oct*, 1865.

Present or absent *Present*

Stoppage, \$ *100* for

Due Gov't, \$ *100* for

Remarks:

Book mark:

N. H. Merrill

(858)

Copyist

10

7

U.S.C.T.

Irma Nickerson

Pr, Co. H, 7 Reg't U. S. Col'd Infantry.

Appears on

Company Muster Roll

for *Michigan Dec.*, 186*5*.

Present or absent *Present*

Stoppage, \$ *100* for

Due Gov't, \$ *100* for

Remarks:

Book mark:

N. H. Merrill

(858)

Copyist

Al. | **7** | **U.S.C.T.**

Isaac Dickerson

Prvt, Co. H, 7 Reg't U. S. Col'd Infantry.

Appears on

Company Muster Roll

for Jan & Feb., 1866.

Present or absent Present

Stoppage, \$ 100 for

Due Gov't, \$ 100 for

Remarks:

Book mark:

(858)

J. J. Kearney
Copyist

22

7

U.S.C.T.

Isaac Dickerson

Priv, Co. H, 7 Reg't U. S. Col'd Infantry.

Appears on

Company Muster Roll

for March 1866, 1866.

Present or absent Present

Stoppage, \$ 100 for

Due Gov't, \$ 100 for

Remarks:

Book mark:

J. J. Kearney

(858)

Copyist

10

7

U.S.C.T.

Esac Dickerson

Cpl, Co. H, 7 Reg't U. S. Col'd Infantry.

Appears on

Company Muster Roll

for *May & June*, 1866.

Present or absent *Present*

Stoppage, \$ *100* for

Due Gov't, \$ *100* for

Remarks:

Book mark:

(858)

J. J. Kearney

Copyist

20 | 7 | **U.S.C.T.**

Isaac Dickerson

Priv, Co. H, 7 Reg't U. S. Col'd Infantry.

Appears on

Company Muster Roll

for July & Aug, 1866.

Present or absent Present

Stoppage, \$ 100 for

Due Gov't, \$ 100 for

Remarks:

Book mark:

J. J. Kearney
(858) Copyist

10 | 7 | **U.S.C.T.**

Isaac Dickerson

Pvt, Co. H, 7 Reg't U. S. Col'd Infantry.

Appears on **Co. Muster-out Roll**, dated Indianola, Texas, Oct. 13, 1866.

Muster-out to date Oct. 13, 1866.

Last paid to June 30, 1866.

Clothing account:

Last settled....., 186 ; drawn since \$..... 100

Due soldier \$ 24 ³⁰/₁₀₀; due U. S. \$..... 100

Am't for cloth'g in kind or money adv'd \$..... 100

Due U. S. for arms, equipments, &c., \$..... 100

Bounty paid \$..... 100; due \$ 100 ¹⁰⁰/₁₀₀

Remarks: Joined at Orig'l Organizⁿ

Book mark: V. 1785 P. 179 73

J. J. Kearney
Copyist.

405

Dickerson William

Co K, 7 U.S. Col'd Inf.

Private Private

CARD NUMBERS.

1	6295993	26
2	6296093	27
3	6296193	28
4	6296296	29
5	6296392	30
6	6296485	31
7	6296578	32
8	6296719	33
9	6297748	34
10	7067629	35
11		36
12		37
13		38
14		39
15		40
16		41
17		42
18		43
19		44
20		45
21		46
22		47
23		48
24		49
25		50

Book Mark:

See also

D. | 7 | U.S.C.T.

William Gekerson

Co. K, 7 Reg't U. S. Col'd Inf.

Appears on

Company Descriptive Book

of the organization named above.

DESCRIPTION.

Age 19 years; height 5 feet 5 1/2 inches.

Complexion Black

Eyes Black; hair Black.

Where born Worcester Maryland.

Occupation Farmer.

ENLISTMENT.

When Nov. 5, 1863.

Where Ft. Snow Hill.

By whom W. H. Binney; term 3 y'rs.

Remarks: Mustered into serv. at
Camp Stanton, Chap. Co. 9th
by H. C. Haskell, Nov. 12,
63.

Missing in action Sept.
29, 64.

Died Dec. 16, 64 while
a Prisoner of War at Sal-
isbury, N.C.

W. G. White.

D | **7** | **U.S.C.T.**

William Dickerson
Privt., Co. K., 7 Reg't U. S. Col'd Inf.

Age *19* years.

Appears on

Company Muster-in Roll

of the organization named above. Roll dated
CP Stanton Md., Nov. 12, 1863.
Charles Co.

Muster-in to date *Nov. 12, 1863*

Joined for duty and enrolled:

When *Nov. 2, 1863.*

Where *Worcester Md.*

Period *3* years.

Remarks:

Book mark :

D. M. Kennedy
Copyist.

I | **7** | **U.S.C.T.**

William Dickerson

Privt, Co. K, 7 Reg't U. S. Col'd Infantry.

Appears on

Company Muster Roll

for *Nov. 12 to Dec 31*, 186*3*.

Present or absent *Present*

Stoppage, \$ *100* for

Due Gov't, \$ *100* for

Remarks: *Enlistment premium
\$ 2⁰⁰ dollars due.*

Book mark:

D. M. Kennedy
Copyist.

2

7

U.S.C.T.

William Dickerson
Privt., Co. K, 7 Reg't U. S. Col'd Infantry.

Appears on

Company Muster Roll

for Jan. v. Feb., 1864.

Present or absent Present

Stoppage, \$ 100 for

Due Gov't, \$ 100 for

Remarks:

Book mark:

D. M. Kennedy
Coptist.

D

7

U.S.C.T.

William Dickerson
Privt, Co. K, 7 Reg't U. S. Col'd Infantry.

Appears on

Company Muster Roll

for *Mch v, Apl*, 1864.

Present or absent *Present*

Stoppage, \$ *100* for

Due Gov't, \$ *100* for

Remarks:

Book mark:

D. M. Kennedy

(358)

Spyist.

D

7

U.S.C.T.

William Dickerson

Privt, Co. K, 7 Reg't U. S. Col'd Infantry.

Appears on

Company Muster Roll

for May & June, 1864.

Present or absent Present

Stoppage, \$ 100 for

Due Gov't, \$ 100 for

Remarks:

Book mark:

N. M. Kennedy

Cpyist.

D | 7 | U.S.C.T.

William Dickerson

Privt, Co. K, 7 Reg't U. S. Col'd Infantry.

Appears on

Company Muster Roll

for *July or Aug.*, 186*4*.

Present or absent *Present*

Stoppage, \$ *100* for

Due Gov't, \$ *100* for

Remarks: *Free on or before April 19th 1861.*

Book mark:

D. M. Kennedy

(358)

Copyist.

2 | 7 | **U.S.C.T.**

William Dickerson

Privt, Co. K, 7 Reg't U. S. Col'd Infantry.

Appears on

Company Muster Roll

for Sept. to Oct., 1864.

Present or absent Absent

Stoppage, \$ 100 for

Due Gov't, \$ 100 for

Remarks: Missing in action
Sept. 29" 1864.

Book mark:

D. M. Kennedy
Copyist.

20

7

U.S.C.T.

William Dickerson

Priv, Co. K, 7 Reg't U. S. Col'd Infantry.

Appears on

Company Muster Roll

for *Nov + Dec*, 1864

Present or absent *Absent*

Stoppage, \$ *100* for

Due Gov't, \$ *100* for

Remarks: *Wiping in action Sep 29th 1864 and omitted to be dropped*

Book mark:

(358)

Leary
Copyist.

D

7

U.S.C.T.

William Dickerson
Pot., Co. K, 7 Reg't U. S. Col'd Inf.

Appears on Co. Muster-out Roll, dated
Indianola, Texas, Oct. 13, 1866.

Muster-out to date _____, 186 .

Last paid to Feb 29, 1864.

Clothing account:

Last settled _____, 186 ; drawn since \$ 100

Due soldier \$ 100; due U. S. \$ 100

Am't for cloth'g in kind or money adv'd \$ 100

Due U. S. for arms, equipments, &c., \$ 100

Bounty paid \$ 100; due \$ 100

Remarks: Died at Salisbury, N.C.
Dec. 16, 1865. While Prisoner
of War.

Book mark: A.G.O. Died Jan 15/65.
See H.S. & C. on file. - F.S. (over)

Randall

APR 975

JAN. 21

6297748

18916

*Book Mark: 5007. 2" And.
Oct. 15/67.*

Dickerson Wm
Co. 7 Reg't 1st Inf

7 Enclosures.

- | | |
|------------------------------------|-----------------------------|
| Bed Cards | Final Statements |
| Burial Records | Furloughs or L. of A. |
| Certs. of Dis. for Discharge | Med. Certificates |
| C. M. Charges | Med. Des. Lists |
| Descriptive Lists | Orders |
| Discharge Certificates | Pris. of War Record 2 |
| Enlistment Papers | Resignations |

Other papers relating to—

- | | |
|------------------------------|---------------------------|
| Admission to Hosp'l | Furlough or L. of A. |
| Casualty Sheet 2 | Med. Examination |
| Confinement | Misc. Information 2 |
| Contracts | Pay or Clothing |
| Death or Effects | Personal Reports |
| Desertion | Rank |
| Discharge from Hosp'l | Transfer to Hosp'l |
| Discharge from Service | Transfer to V. R. C. |
| Duty | Transportation |

Mr. Pratt

New Decker late Private
Co. 1st Regt 11th S. C. Troops is reported as
having died at Salisbury N. C. while
prisoner of war in Dec. 1864 or January
1865. Please report date, ^{and} cause of death.

Very
1

J. Anderson
(over)

Co. I, 10th S. C. Troops
July 20, 1874

Prisoner of War Records
show Wm Dickerson.
Co. "K" of the 7th U.S. I. died at
Salisbury, N.C. Jan'y. 15,
1865. Cause not given.

Div. of Rec. of
Pris. of War. }
JMP July 20. 77. }

[OFFICE ENDORSEMENT.]

War Department,

ADJUTANT GENERAL'S OFFICE,

....., 187

The death of William
Wackerly Co. H, 7 Reg't U.S.
Colored Troops, is reported as follows:

On Company Muster Roll.
For ~~March~~, 1864, ~~September~~, 1864

Company Muster-out Roll.
~~at Salisbury~~ December 14, 1865

Company Descriptive Book.
....., 186

Company Morning Reports.
....., 186

Soldier's Final Statement.
~~No date~~, 186

Soldier's Record of Death and Interment.
....., 186

Soldier's Inventory of Effects.
....., 186

Soldier's Certificate of Disability for Discharge.
....., 186

Soldier's Individual Muster-out Roll.
....., 186

Regimental Return.
For, 186,, 186

Regimental Quarterly Returns.
....., 186

Regimental Descriptive Book.
....., 186

By Surgeon General.
(.....), 186

....., 186, is held to be
the correct date, and the Company Muster
Roll will be amended accordingly.

Assistant Adjutant General.

on Dead Book Vol 2 Part 1- Page 132 appears

Wm Dickerson CoK 7th USC.I

Died at Salisbury N.C. Jan'y 15. 65

Cause of death not stated

also appears

Same page - Wm Dickson 7th USC.I

Died at Salisbury N.C. Dec 16. 64

Cause of death unknown -

Seay
W.W.O.

-K- 30
FINAL STATEMENT

OF

Wm Ackerson Co R

7 Reg't of *W S Colours*

VOLUNTEERS.

Dec 15 1865

NOTE 1.—Two of these certificates (or duplicates) are to be given to each Volunteer Soldier or drafted man who may be discharged without being mustered out (Final Statements are never given to men mustered out of service,) that he may at once receive from the Paymaster the pay, &c., due him, and the captain or other COMMISSIONED officer commanding the company will certify to the act of the delivery of the duplicate certificates; with these certificates the Soldier is "entitled to" his discharge, and should also present his discharge to the Paymaster to have the payment endorsed on it. The discharge is to be given back to the Soldier by the Paymaster; the latter only retaining as his vouchers the duplicate certificates.

NOTE 2.—If the Soldier is entitled to pay for the use of his horse, the Company Commander will certify to that fact on the back of both these final statements, and also to the time he has pay due for having been so mounted on his own horse.

NOTE 3.—When a Soldier is furnished with final statements, his descriptive list, if he has one, should be taken up by the officer who gives the Soldier these statements, and endorsed with a statement to this effect by the officer. The endorsement should exhibit a full statement of the time for which the Soldier was allowed pay on his final statements, the clothing account, and all other charges against him or in his favor, so as to comprise a complete exhibit of his account. It will then be transmitted to the Company Commander of the soldier, who will enter all the data necessary to a full understanding of the Soldier's account on the muster roll upon which the Soldier's discharge is reported. The descriptive list will then be destroyed. The object of this is, that the remaining portion of the Soldier's account may be settled upon the receipt of these muster rolls, and the Soldier receive any pay or allowances that may be due him at the time of his discharge, and which may not appear on his last final statements from the fact that his descriptive list is incomplete. These accounts for back pay, &c., are settled by the 2d Auditor of the Treasury Department.

NOTE 4.—Charges for loss or injury to ordnance, horse equipments, and other miscellaneous charges, should appear under the heading of "Other Stoppages."

NOTE 5.—Bounty paid by State authorities, and not by the United States, will not be entered on this statement.

NOTE 6.—Amounts due the Sutler and Laundress must be entered on the muster roll on which the discharge, death, desertion, &c., is reported, as well as on the final statement, otherwise the amount cannot be collected from the United States.

NOTE 7.—This blank will be used for deceased volunteers and drafted men, as well as for others.

NOTE 8.—Where a Soldier dies in hospital, or on detached service, his descriptive list, if he has one, should be sent with his final statements, in duplicate, to the Adjutant General, Washington, D. C.

NOTE 9.—If the soldier is a drafted man or substitute, the space for time, &c., of enrolled, should contain only the word *drafted* or *substitute*, as the case may be. If the soldier is a *VETERAN* (or *RECRUIT*) the words as a *veteran*, (or *recruit*) in the case of *U. S.* should be interlined after the words *mustered into the service of the U. S.* Statement of all the instalments of *Veteran* or *Recruit* BOUNTY RECEIVED by the Soldier must be made on the back of each final statement.

Wm Ackerson

ADJUTANT GENERAL'S OFFICE
Apr 27 1866
Duplicate with Inventor; sent 2d Auditor.

I certify, on honor, that William Dickerson, a Private of
 Captain Bjornbo Company (K) of the 4 Regiment of U S Colored
VOLUNTEERS, of the State of U S, born in Worcester Co, State
 of Mass, aged 19 years; 5 feet 5 1/2 inches high; Blk complexion,
Blk eyes, Blk hair, and by occupation a farmer, who joined for service
 and was enrolled (see Note 9) on the 12 day of Nov, 1863, at Camp Stanton
 by Cot Berry, for the period of 3 years, and mustered into
 the service of the United States on the 12 day of November, 1863, at
Camp Stanton by Lt Col Haskell; and having served
 HONESTLY and FAITHFULLY with his Company to the present date, is now entitled to a
DISCHARGE by reason of Health Deterioration in Prison at
Saratoga while in service of war, disease unknown

The said William Dickerson was last paid by Paymaster
My McConnell, to include the 30 day of April, 1864, and
 has pay due him from that time to the present date; he is entitled to pay and subsistence for
~~TRAVELING to place of enrollment, and whatever other allowances are authorized to volunteer~~
~~soldiers, drafted men, or militia, so discharged.~~ He has received from the United States **CLOTHING**
 amounting to 60 ⁰¹/₁₀₀ dollars, since the 12th day of November,
 1863, when his clothing account was last settled. ~~He has received from the United States~~
~~_____ dollars advanced BOUNTY.~~

~~There is to be stopped from him, on account of the State of _____, or other~~
~~authorities, for CLOTHING, &c., received on entering service, _____ dollars; and~~
~~for other stoppages, viz. _____~~

~~_____ dollars.~~
 He has been furnished with **TRANSPORTATION** in kind from the place of his discharge to
 _____; and he has been **SUBSISTED** for **TRAVELING** to his
 place of enrollment, up to the _____, 186 .

He is indebted to _____, **SUTLER**, _____ dollars.
 He is indebted to _____, **LAUNDRESS**, _____ dollars.

Given in Duplicate, at Saratoga, this 26 day
 of Feb, 1866.

Wm J. ...
Adjutant General
 Commanding Company. K

1/20/40



Camp Keokuk U.S.C.T.
Iowa Feb 26 1862

Adjutant General }
W.S.A. }
}

General

I have the honor to transmit herewith the final
Statements of Post William R. Keokuk
Co. K 7th Colored troops
who died while prisoners of war
at Salisbury N.Y. Cause of death and
diseases unknown.

I have the honor
to be, your obedient
servant,
Wm. Keokuk
by Capt

WAR DEPARTMENT,

ADJUTANT GENERAL'S OFFICE,

WASHINGTON, *June 13th*, 1865.

SIR:

Final Statements in the cases of deceased soldiers are required to be sent to the Adjutant General's Office in duplicate, with one copy of the Inventory of Effects. The Descriptive List should also be sent to this Office in cases where the soldier was absent from his Company at the time of his death. Where there were no effects, it should be so stated on a blank Inventory, properly signed.

Certificates of Disability should be sent in duplicate. Special care should be taken that the date of discharge and signature of the discharging officer should be affixed.

No of the Final Statement *(and no)* Inventory, has been received in the case of *Wm. Dickson*, of Co. *A*, *7* Regiment of *U.S. Inf.* Volunteers, whose papers were forwarded to this Office. You will please forward the missing papers without delay.

I have the honor to be, sir,

Very respectfully,

Your obedient servant,

Assistant Adjutant General.

(110)

COMMANDING OFFICER

7th U.S. Infantry
Died Dec. 16, 1864 of disease unknown, while a Priv.
of war, at Salisbury N.C.

W.D.

MODEL FOR SET OF PAPER

FORM 1.—FINAL STATEMENT.

I CERTIFY, ON HONOR, that *John Smith*, a Private of Captain J. Brown's Company, (A,) of the 1st Regiment of Pennsylvania Volunteers, of the State of Pennsylvania, born in Pittsburg, State of Pennsylvania, aged 21 years, 5 feet 10 inches high, light complexion, blue eyes, dark hair, and by occupation a Farmer, having joined the Company on its original organization at Pittsburg, and enrolled in it at the muster into the service of the United States at Pittsburg, on the 1st day of July, 1861, (or was mustered in service as a recruit, by ———, at ———, on the — day of ———, 186—, or was drafted and mustered into the service of the United States from the ——— Enrollment District of the State of ———, at ———, on the — day of ———, 186—,) to serve in the Regiment for the term of Three Years, and having served *honestly* and *faithfully* with his Company in the field to the present date, is now entitled to a DISCHARGE by reason of death. Died in Regimental Hospital, Fort Brown, Texas, December 31, 1863, of typhoid fever.

The said John Smith was last paid by Paymaster Major Morse, to include the 31st day of October, 1863, and has pay due him from that time to the present date. He is entitled to pay and subsistence for *traveling* to place of enrollment, and whatever other allowances are authorized to volunteer soldiers, drafted men, or militia, so discharged. He has received from the United States *clothing* amounting to 20.⁰⁰/₁₀₀ dollars, since the 31st day of December, 1862, when his clothing account was last settled. He has received from the United States 25.⁰⁰/₁₀₀ dollars advanced *bounty*.

There is to be stopped from him on account of the State of ———, or other authorities, for *clothing*, &c., received on entering service, nothing, ⁰⁰/₁₀₀ dollars; and for other stoppages, viz: nothing, ⁰⁰/₁₀₀ dollars. He has been furnished with no *transportation* in kind from the place of his discharge to ———; and he has not been *subsisted* for *traveling* to his place of enrollment up to the ———, 186—.

He is indebted to ———, Sutler, ——— ⁰⁰/₁₀₀ dollars.

He is indebted to ———, Laundress, ——— ⁰⁰/₁₀₀ dollars.

GIVEN, IN DUPLICATE, at Fort Brown, Texas, this 31st day of December, 1863.

JAMES BROWN,
Captain Co. A, 1st Penn. Vols.,
Commanding Company.

FORM 2.

INVENTORY of the effects of John Smith, late a Private of Captain J. Brown's Company, (A,) of the 1st Regiment of Pennsylvania Volunteers, who was enrolled as a Private at Pittsburg, in the State of Pennsylvania, on the 1st day of July, 1861, and mustered into the service of the United States as a Private on the 1st day of July, 1861, at Pittsburg, in Company A, 1st Regiment of Pennsylvania Volunteers, to serve three years or during the war. He was born in Pittsburg, in the State of Pennsylvania; he was 21 years of age, 5 feet 10 inches high, light complexion, blue eyes, dark hair, and by occupation, when enrolled, a Farmer. He died in Regimental Hospital, at Fort Brown, Texas, on the 31st day of December, 1863, of typhoid fever.

INVENTORY.						
ARTICLES.	No.	ARTICLES.	No.	ARTICLES.	No.	
Hats.....	1	Pairs trousers.....	1	Knapsacks.....		
Caps.....		Pairs flannel drawers.....				
Forage caps.....		Pairs cotton drawers.....		Watch, silver.....	1	
Great coats.....		Flannel shirts.....		MONEY.	Specie.....	\$2 00
Uniform coats.....		Cotton shirts.....			Notes.....	\$50 00
Uniform jackets.....		Pairs boots.....				
Flannel sack coats.....		Pairs shoes.....				
Blouses.....		Pairs socks.....				
Stable frocks.....		Blankets.....				
Fatigue overalls.....		Haversacks.....				

I CERTIFY, ON HONOR, that the above inventory comprises all the effects of Private John Smith, deceased, and that the effects are in the hands of Captain J. Brown, at Fort Brown, Texas, to be disposed of by a Council of Administration, except the money, which has been turned over to Major Wm. C. Morse, Paymaster, U. S. Army, whose receipt is hereto annexed.*

STATION: Fort Brown, Texas.

DATE: December 31, 1863.

(Duplicates.)

JAMES BROWN,
Captain Co. A, 1st Penn. Vols.,
Commanding the Company.

*NOTE.—If the effects have been turned over to relatives of deceased, so state on certificate, instead of "in the hands of Captain," &c., and give the names of the persons, and their relation to the deceased person.

FORM 3.—HEIR'S RECEIPT FOR EFFECTS.

RECEIVED of Captain John Brown, Company A, 1st Regiment of Pennsylvania Volunteers, the following effects of Private John Smith, late of Company A, 1st Regiment of Pennsylvania Volunteers, now deceased, which I claim as his wife:

1 great coat, 1 flannel shirt, 1 silver watch, fifty dollars in notes, and two dollars in specie.

MARY SMITH.

FORM 4.—PAYMASTER'S RECEIPT FOR MONEY.

RECEIVED, this 31st day of December, 1863, at Fort Brown, Texas, of Captain James Brown, of Company A, 1st Pennsylvania Volunteers, fifty dollars in Treasury notes and two dollars in specie, the property of the late Private John Smith, of Company A, 1st Pennsylvania Volunteers, who died at Fort Brown, Texas, on the 31st day of December, 1863.

WM. C. MORSE, Paymaster, U. S. A.

RS FOR A DECEASED SOLDIER.

FORM 5.—PROCEEDINGS OF A COUNCIL OF ADMINISTRATION,

Convened at Fort Brown, Texas, pursuant to Orders, No. 1, dated Post Headquarters, Fort Brown, Texas, January 2, 1864—consisting of Captain James Keith, Company C, 1st Pennsylvania Volunteers; Captain John Brown, Company D, 1st Pennsylvania Volunteers; and Lieutenant William Roe, Company E, 1st Pennsylvania Volunteers—for the purpose of disposing of the effects of the late John Smith, of Company A, 1st Pennsylvania Volunteers:

The Council found that the effects consisted of the following articles. They were ordered to be sold at auction, which was accordingly done, and the amount set opposite the articles respectively obtained, for which the receipt of the Paymaster is annexed:

AT AUCTION.		
1 shirt	brought.....	\$1 00
1 great coat	“	2 50
1 silver watch	“	25 00
		\$28 50

JAMES KEITH,
Capt. Co. C, 1st Penn. Vols., President.
WILLIAM ROE,
Lieut. Co. E, 1st Penn. Vols., Recorder.

APPROVED:
JOHN SANDERS,
Colonel 1st Penn. Vols.,
Commanding Post.

FORM 6.—PAYMASTER'S RECEIPT.

RECEIVED from Captain John Brown, Company A, 1st Pennsylvania Volunteers, at Fort Brown, Texas, January 10, 1864, twenty-eight dollars and fifty cents, the result of the sale of the effects of the late Private John Smith, of Company A, 1st Pennsylvania Volunteers.

WM. C. MORSE, Paymaster U. S. Army.

ARTICLES OF WAR.

ART. 95. When any non-commissioned officer or soldier shall die, or be killed in the service of the United States, the then commanding officer of the troop or company shall, in the presence of two other commissioned officers, take an account of what effects he died possessed of, above his arms and accoutrements, and transmit the same to the office of the Department of War, which said effects are to be accounted for, and paid to the representatives of such deceased non-commissioned officer or soldier. And in case any of the officers, so authorized to take care of the effects of deceased officers and soldiers, should, before they have accounted to their representatives for the same, have occasion to leave the regiment or post, by preferment or otherwise, they shall, before they be permitted to quit the same, deposit in the hands of the commanding officer, or of the assistant military agent, all the effects of such deceased non-commissioned officers and soldiers, in order that the same may be secured for, and paid to, their respective representatives.

DIRECTIONS.

NOTE 1.—One copy of the inventories of the effects of deceased non-commissioned officers and soldiers, required by the 95th Article of War, will be forwarded to the Adjutant General, by the commander of the company to which the deceased belonged, and a duplicate of the same to the colonel of the regiment. Final statements of pay, clothing, &c., in duplicate, will be sent to the Adjutant General with one copy of the inventory. Both inventory and final statements should be forwarded, as a general rule, through Regimental Headquarters. When a soldier dies at a post or station absent from his company, it will be the duty of his immediate commander to furnish, direct to the Adjutant General, the required inventory and final statements, and, at the same time, to forward to the commanding officer of the company to which the soldier belonged, a report of his death, specifying the date, place, and cause; to what time he was last paid, and the money or other effects in his possession at the time of his decease; which report will be noted on the next muster roll of the company to which the man belonged. Each inventory will be endorsed "Inventory of the effects of _____, late of company (—) _____ regiment of _____, who died at _____ the _____ day of _____, 186—." If a legal representative receive the effects, it will be stated in the report. If the soldier leave no effects, the fact will be reported on the blank for inventory.

NOTE 2.—Should the effects of a deceased non-commissioned officer or soldier not be administered upon within a short period after his decease, they shall be disposed of by a Council of Administration under the authority of the commanding officer of the post, and the proceeds deposited with the Paymaster, to the credit of the United States, until they shall be claimed by the legal representatives of the deceased. This should be done according to Forms 5 and 6, and one copy of each sent to the Adjutant General. No copy of the order convening the board is required, the approval of the commanding officer being sufficient.

NOTE 3.—In all such cases of sales by the Council of Administration, a statement in detail, or account of the proceeds duly certified by the Council and commanding officer, (Form 5,) accompanied by the Paymaster's receipt of the proceeds, will be forwarded by the commanding officer to the Adjutant General. The statement will be endorsed "Report of the proceeds of the effects of _____, late of company (—) _____ regiment of _____, who died at _____ the _____ day of _____, 186—."

NOTE 4.—The effects in all cases, when called for, should be turned over to the legal representative, without further authority from the Adjutant General. When the effects are turned over to the relatives of the deceased before these inventories are sent to the Adjutant General, their receipts therefor should be attached to the inventories. In all other cases, one copy will be sent with a letter of transmittal direct to the Adjutant General, and a duplicate retained by the officer.

NOTE 5.—Particular care should be taken to take receipts in duplicate from the Paymaster for any funds turned over to him; one copy should be sent direct to the Adjutant General, and one retained by the officer.

NOTE 6.—Where a soldier dies in hospital or on detached service, his descriptive list, if he has one, should be sent with his final statements, in duplicate, to the Adjutant General, Washington, D. C.

NOTE 7.—Form 1 will be forwarded in duplicate to the Adjutant General, through Regimental Headquarters, as soon as possible after the death of the soldier, accompanied by one copy of Forms 2 and 3, or 4, as the case may require. A duplicate of the inventory (Form 2) should be retained until the articles are finally disposed of.

NOTE 8.—The papers for each man should be made SEPARATELY for each man, and, when possible, fastened together. This is especially necessary, and must be done in all cases. The papers cannot be properly disposed of at the Adjutant General's Office unless this is done, and must be returned for correction.

NOTE 9.—Where there are no line officers, as for instance, a general hospital without a line officer to command the guard, the Council of Administration may be made up from other commissioned officers, in the same way as prescribed for line officers.

NOTE 10.—Where a soldier dies away from his company or regiment, and the officer having charge of him cannot furnish Final Statements by reason of not being able to obtain a Descriptive List, he should notify the regimental or company commander, (giving him full particulars as to history and description of the man, as far as possible,) whose duty it will then be, in such case, to furnish the necessary papers from the best data he can obtain.

MEMORANDUM FROM PRISONER OF WAR RECORDS.

No. _____

(This blank to be used only in the arrangement of said records.)

NAME.	RANK.	ORGANIZATION.				INFORMATION OBTAINED FROM—				
		No. of Reg't.	State.	Arm of Service.	Co.	Records of—	Vol.	Page.	Vol.	Page.
Dickson Wm		7	U.S.	C. I. K.		MR	12	188		

Captured at _____, 186____, confined at Richmond, Va., _____, 186____.

Admitted to Hospital at Salisbury N.C.
 where he died Dec. 16, 1864, of Unknown.

Paroled at _____, 186____; reported at Camp Parole, Md., _____, 186____.
73-

✓ Copied by J.P. 16

MEMORANDUM FROM PRISONER OF WAR RECORDS.

No. _____

(This blank to be used only in the arrangement of said records.)

NAME	RANK.	ORGANIZATION.				INFORMATION OBTAINED FROM—				
		No. of Reg't.	State.	Arm of Service.	Co.	Records of—	Vol.	Page.	Vol.	Page.
Dickerson	—									
Dickinson Wm	Pvt	U.S.A.				Mis	12 2415	69 56	39 79	

Captured at Chapin Farm, Va Sept 29, 1864, confined at Richmond, Va., Sept 29, 1864.
True Worcester Co. Mass Sent to Salisbury N.H. Nov 24/64

Admitted to Hospital at Salisbury N.H.

where he died Jan 15, 1865, of _____

Paroled at _____, 186 ; reported at Camp Parole, Md., _____, 186 .

Copied by Wm

2600 S. 10th St. N. W. Wash. D. C.

CASUALTY SHEET

No. _____

Wm Dickerson

of Company _____

7th Regiment of *U. S. C.*

~~State Volunteers.~~

NATURE OF CASUALTY.

Death

*Died at Salisbury, N.C.,
Jan. 13, 1863*

*Page 8
Salisbury Records*

CASUALTY SHEET

Name: Wm Dickerson

Rank: _____ Company: A Regiment: 7

Arm: Inf State: U.S.C.

Nature of Casualty: Death

CAUSE OF CASUALTY—(NAME OF DISEASE, &c.)

BY WHOM DISCHARGED.

DEGREE OF DISABILITY.

FROM WHAT SOURCE THIS INFORMATION WAS OBTAINED.

BY WHOM CERTIFIED.

Full permitted by
Army Seal of Pres
REMARKS.

Det. Major W. S. Harts
U.S.A.

DATE OF DISCHARGE, DEATH, &c.

Jan, 15, 1865

PLACE OF DISCHARGE, DEATH, &c.

Salisbury, N.C.

[Signature]

[Signature]

Clerk.

CASUALTY SHEET

No. _____

Wm Dickson

of Company *H*

4 Regiment of *United States*

C. V.

~~State Volunteers.~~

NATURE OF CASUALTY.

Death

*Died at Salisbury Hospital N.C.
Decr 16th 1861.*

Page - 11

Salisbury Hosp't Records.

CASUALTY SHEET

Name: *Frederick Dickson*

Rank: _____ Company: *K* Regiment: *7*

Arm: *Infantry* State: *United States Col. Troops*

Nature of Casualty: *Death*

CAUSE OF CASUALTY—(NAME OF DISEASE, &c.)

BY WHOM DISCHARGED.

DEGREE OF DISABILITY.

FROM WHAT SOURCE THIS INFORMATION WAS OBTAINED.

BY WHOM CERTIFIED.

Roll furnished by Army General of Business

REMARKS.

Bot Maj W. T. Hartz A. C. G.

DATE OF DISCHARGE, DEATH, &c.

Dec 16 " 1861.

PLACE OF DISCHARGE, DEATH, &c.

Salisbury Hosp N. C.

J. C. Bristol

Clerk.

(170)

J. M. S.

406

Rickson Thomas

Co - , 7 U.S. Col'd Inf.

CARD NUMBERS.

1	6279165
2	
3	
4	
5	
6	
7	
8	
9	
10	
11	
12	
13	
14	
15	
16	
17	
18	
19	
20	
21	
22	
23	
24	
25	

26
27
28
29
30
31
32
33
34
35
36
37
38
39
40
41
42
43
44
45
46
47
48
49
50

Book Mark:

See also:

406

Rickson Thom

Co - , 7 U.S. Col

CARD NUMBERS.

1	6279165	26
2		27
3		28
4		29
5		30
6		31
7		32
8		33
9		34
10		35
11		36
12		37
13		38
14		39
15		40
16		41
17		42
18		43
19		44
20		45
21		46
22		47
23		48
24		49
25		50

Book Mark:

See also:

A | 7 | U.S.C.T.

Thomas Dickson

Appears with rank of _____ on
**Muster and Descriptive Roll of a Detach-
ment of Drafted Men and Substitutes**
forwarded

for the 7 Reg't U. S. Col'd Inf. Roll dated
Baltimore, Md, Apr 5, 1865.

Where born Alexandria Va

Age 21 years; occupation Laborer

Drafted and mustered in:

When March 29, 1865

Where E. Mills, Md.

Period 1 years.

Eyes Blu; hair Blk

Complexion Yellow; height 5' 5 1/2 in.

Paid bounty and advance pay, \$ 100

Bounty due \$ 100

Where credited _____

Company to which assigned _____

Remarks: Sub for Andrew P.
Reigan 2nd Sub Dist 5 Dist Md
(over)

Book mark: _____

(340) J. M. Tandy Copyist

JAN. 20

6279165

AL891*

Not taken up in rolls of regt

Dickson Thomas
 _____, Co. _____, *7¹* Reg't *USA*

2 Enclosures.

Bed Cards	Final Statements
Burial Records	Furloughs or L. of A.
Certs. of Dis. for Discharge	Med. Certificates
C. M. Charges	Med. Des. Lists
Descriptive Lists	Orders <i>2</i>
Discharge Certificates	Pris. of War Record
Enlistment Papers	Resignations

Other papers relating to—

Admission to Hosp'l	Furlough or L. of A.
Casualty Sheet	Med. Examination
Confinement	Misc. Information
Contracts	Pay or Clothing
Death or Effects	Personal Reports
Desertion	Rank
Discharge from Hosp'l	Transfer to Hosp'l
Discharge from Service	Transfer to V. R. C.
Duty	Transportation

SPECIAL ORDERS, } WAR DEPARTMENT,
No. 634. } ADJUTANT GENERAL'S OFFICE,
Washington, December 12th, 1865.

(Extract.)

* * * * *

16. Private *Thomas Dickson*, a substitute, assigned to the ~~7th U. S.~~ Colored Troops, in April, 1865, not having joined that regiment, and his name not having been taken up on the rolls of any regiment, is hereby permanently assigned to the 4th U. S. Colored Troops.

* * * * *

By order of the Secretary of War :

E. D. TOWNSEND,
Assistant Adjutant General.

OFFICIAL :

Assistant Adjutant General.

Colonel Foster.

Thomas Dickson

79 & C7

SPECIAL ORDERS, } WAR DEPARTMENT,
No. 634. } ADJUTANT GENERAL'S OFFICE,
Washington, December 12th, 1865.

(Extract.)

* * * * *

16. Private *Thomas Dickson*, a substitute, assigned to the 7th U. S. Colored Troops, in April, 1865, not having joined that regiment, and his name not having been taken up on the rolls of any regiment, is hereby permanently assigned to the 4th U. S. Colored Troops.

* * * * *

By order of the Secretary of War :

E. D. TOWNSEND,

Assistant Adjutant General.

OFFICIAL :

Assistant Adjutant General.

General Brock.

Dingle Isaac

Co B, 7 U.S. Col'd Inf.

Private

Private

CARD NUMBERS.

1	6279076	26
2	6278849	27
3	6284551	28
4	6284664	29
5	6284768	30
6	6284865	31
7	6284962	32
8	6285046	33
9	6285158	34
10	6274537	35
11	6285344	36
12	9066151	37
13	212-05-1877	38
14		39
15		40
16		41
17		42
18		43
19		44
20		45
21		46
22		47
23		48
24		49
25		50

Book Mark: *E.B. 12/218, 4212, V. 12, A.F.O. C.S. 77*

See also

NARA 1993

51051436 Roman
A2338307 P.O. Box

9

7

U.S.C.T.

Isaac Dingel

Co. C, 7 Reg't U. S. Col'd Inf.

Appears on

Company Descriptive Book

of the organization named above.

DESCRIPTION.

Age 24 years; height 5 feet 6 inches.

Complexion Black.

Eyes Black; hair Black.

Where born Delaware.

Occupation Laborer.

ENLISTMENT.

When March 9, 1863.

Where Wilmington

By whom Capt. Wilson; term 1 yr.

Remarks: Drafted Surveyor.

Del. Isaac Dingel

mustered not present

at New York Jan. 20, 66.

J. Smith

d | *7* | **U.S.C.T.**

Leaves Dingle

Appears with rank of _____ on
**Muster and Descriptive Roll of a Detach-
 ment of Drafted Men and Substitutes
 forwarded**

for the *7* Reg't U. S. Col'd Inf. Roll dated
Baltimore Md, Mch 11, 1865.

Where born *Delaware*

Age *24* years; occupation *Laborer*

Drafted and mustered in:

When *Mch 9*, 186*5*.

Where *Wilmington*

Period *1* years.

Eyes *Blk*; hair *Blk*

Complexion *Blk*; height *5* ft. *6* in.

Paid bounty and advance pay, \$ *100*

Bounty due \$ *100*

Where credited _____

Company to which assigned _____

Remarks: *Drafted from Sussex Co
 Delaware.*

Book mark: _____

J. M. Taylor
 (340) *Copyist*

10 | 7 | U.S.C.T.

Isaac Dingle
Priv., Co., 7 Reg't U. S. Col'd Infantry.

Age 24 years.

Appears on a

Detachment Muster-in Roll

of the organization named above. Roll dated
Baltimore Md, Mar. 16, 1863:

Muster-in to date Mar. 16, 1863:

Joined for duty and enrolled:

When Mar. 9, 1863:

Where Wilmington

Period 1 years.

Remarks: Drafted

Book mark:

10 | 7 | U.S.C.T.

Isaac Dingle
Sgt., Co. C, 7 Reg't U. S. Col'd Infantry.

Appears on
Company Muster Roll
for Mar. & Apr., 1865.

Joined for duty and enrolled:
When "May 9", 1865.*
Where "New York, Del."*
Period 3 years.*

Present or absent "Present"
Stoppage, \$ 100 for
Due Gov't \$ 100 for

Remarks: "Joined Co. Mar. 18/65" "Stop for Wifes"

* See enrollment on card from muster-in roll.

Book mark:

(358c) M. M. Murphy Copyist.

10 | 7 | U.S.C.T.

Isaac Bingle
Priv., Co. C, 7 Reg't U.S. Col'd Infantry.

Appears on

Company Muster Roll
for May 7 June, 1865.

Joined for duty and enrolled:

When Mar. 9, 1865.*

Where Sussex, Del. *

Period 3 years.*

Present or absent Present

Stoppage, \$ 100 for

Due Gov't \$ 100 for

Remarks: Joined Co. Mar. 18/65
Stop'd for wiper

* See enrollment on card from muster-in roll.

Book mark:

M. M. Murphy
(258c) Copyist.

10 | 7 | **U.S.C.T.**

Isaac Dingle
Priv., Co. C, 7 Reg't U. S. Col'd Infantry.

Appears on

Company Muster Roll

for *July & Aug.*, 186*5*.

Joined for duty and enrolled:

When *Mar. 5*, 186*5*.*

Where *Dewey, Del.* *

Period *3* years.*

Present or absent *Present*

Stoppage, \$ *100* for

Due Gov't \$ *100* for

Remarks:

* ~~See~~ See enrollment on card from muster-in roll.

Book mark: _____

W. M. Murphy
Copyist.

(258c)

10 | 7 | U.S.C.T.

Isaac Ringel
Priv., Co. C, 7 Reg't U. S. Col'd Infantry.

Appears on

Company Muster Roll
for Sept. 7 Oct., 1865.

Joined for duty and enrolled:

When Mar. 9, 1865.*

Where Wilmington, Del. *

Period one years.*

Present or absent Present

Stoppage, \$ 100 for

Due Gov't \$ 100 for

Remarks:

* See enrollment on card from muster-in roll.

Book mark:

(358c) J. M. Murphy Copyist.

D. 1

7

U.S.C.T.

Isaac Dingel
Pt., Co. C, 7 Reg't U. S. Col'd Infantry.

Appears on

Company Muster Roll

for Nov. & Dec, 1865.

Joined for duty and enrolled:

When Mch 9, 1865.*

Where Wilmington Del.*

Period 3 years.*

Present or absent Present.

Stoppage, \$ 100 for

Due Gov't \$ 100 for

Remarks:

* See enrollment on card from muster-in roll.

Book mark:

Lopez.

D 7 U.S.C.T.

Isaac Dingel
Pvt, Co. C, 7 Reg't U. S. Col'd Infantry.

Appears on

Company Muster Roll

for Jan x Feb, 1866

Joined for duty and enrolled:

When March 9, 1865*

Where Wilmington Del. *

Period 1 years.*

Present or absent Present.

Stoppage, \$ 100 for

Due Gov't \$ 100 for

Remarks:

* See enrollment on card from muster-in roll.

Book mark:

(358c) Lopez Copyist.

A

7

U.S.C.T.

Isaac Dingel
Pvt, Co. C, 7 Reg't U. S. Col'd Infantry.

Appears on

Company Muster Roll

for *March x April*, 1866.

Joined for duty and enrolled:

When *March 9*, 1865*

Where *Wilmington Del**

Period *1* years.*

Present or absent

Stoppage, \$ *100* for

Due Gov't \$ *100* for

Remarks: *Discharged by reason of expiration of term of service*

* See enrollment on card from muster-in roll.

Book mark: *Discharged March 8*

(358c)

Saper
(over)

Copyist.

JAN. 20

6285150

el891a

"66 EB" 12/18 V 212
Via U.S.O.C. 77.

17

U.S.C.T.

Samuel Dingle,
7th, Co. *C*, 7 Reg't U. S. Col'd Infantry.

Appears on a

Detachment Muster-out Roll

of the organization named above. Roll dated

Galveston Texas, Mar. 8, 1866.

Muster-out to date *Mar. 8, 1866.*

Last paid to *Dec. 31, 1865*

Clothing account:

Last settled _____, 186 ; drawn since \$ _____ 100

Due soldier \$ _____ 100; due U. S. \$ ~~11~~ _____ 100

Am't for cloth'g in kind or money adv'd \$ _____ 100

Due U. S. for arms, equipments, &c., \$ _____ 100

Bounty paid \$ *None* 100 due \$ *None* 100

Remarks: *joined Co. as recruit*
at Fort Harrison Va.
Mar. 18. 1865. Mustered
out by expiration of term
of service.

Book mark: _____

(349)

J. H. ...

Copyist.

A | 7 | U.S.C.T.

Isaac Single
Co. C, 7 Reg't U. S. Col'd Infantry.

Appears on Co. Muster-out Roll, dated
Indianola Texas, Oct 3, 1866.

Muster-out to date _____, 1866 .

Last paid to Dec 31, 1865.

Clothing account:

Last settled _____, 1866 ; drawn since \$ 100

Due soldier \$ 100 ; due U. S. \$ 100

Am't for cloth'g in kind or money adv'd \$ 100

Due U. S. for arms, equipments, &c., \$ 100

Bounty paid \$ 100 ; due \$ 100

Remarks: Mustered out at
New York Jan 20 '66
at expiration of term.

Book mark: Discharged Mch 8

(361)

(over) Lopez Copyist.

19991917

JAN. 20

6285344

018910

"66 EB" 218-212 V. 2 U.S.
D.F. 77. no on file

D | 7th | U.S.C.S.

Isaac Dingel

, Co. C, 7th Reg't U.S.C.S.

NOTATION.

E.B. 12. 218.

Book mark: 212-C-J-1877.

War Department,

Adjutant General's Office,

Washington, Jan'y 27, 1877.

Mustered out March 8. 1866.

H. J. Allen

D | 7th | U. S. C. I.

Isaac Dingel

, Co. C, 7th Reg't U. S. C. I.

NOTATION.

E. B. 12. 218.

Book mark: 212-C-I-1877.

War Department,

Adjutant General's Office,

Washington, *Jan'y 27*, 1877.

Mustered out March 8. 1866.

W. Allen

408 James H.
Dixon James Lewis

Co A, 7 U.S. Col'd Inf.

Private

Private

CARD NUMBERS.

1	6 2 8 5 4 6 2	26
2	6 2 8 5 5 6 3	27
3	6 2 8 5 6 6 0	28
4	6 2 8 5 7 6 4	29
5	6 2 8 5 8 6 8	30
6	6 2 8 5 9 6 8	31
7	6 2 8 6 0 6 5	32
8	6 2 8 6 1 5 8	33
9	6 2 8 6 2 3 6	34
10	6 2 8 6 3 4 1	35
11	6 2 8 6 4 1 8	36
12	6 2 8 6 5 0 8	37
13	6 2 8 6 6 5 4	38
14	6 2 7 9 4 5 5	39
15	6 2 8 7 1 2 2	40
16	9 2 6 6 2 8 2	41
17		42
18		43
19		44
20		45
21		46
22		47
23		48
24		49
25		50

Book Mark:

See also

A. 2481568 PONTM

21 | 7 | U.S.C.T.

James Lewis Dixon
Co: D, 7 Reg't U.S. Col'd Inf.

Appears on

Company Descriptive Book

of the organization named above.

DESCRIPTION.

Age 24 years; height 5 feet 10 3/4 inches.

Complexion Black

Eyes Black; hair Curly

Where born Caroline, Md.

Occupation Farmer

ENLISTMENT.

When Sept 26, 1863.

Where Queen Ann.

By whom Col. H. King; term 3 yrs.

Remarks: Mustered, Sept 29 '63.
Discharged May 31 '65,
for disability with wound.

9

7

U.S.C.T.

James Lewis Dixon
Pvt, Co. D, 7 Reg't U. S. Colored Inf.

Age 24 years.

Appears on

Company Muster-in Roll

of the organization named above. Roll dated

Baltimore Md., Sept 29, 1863.

Muster-in to date Sept 29, 1863.

Joined for duty and enrolled:

When Sept 26, 1863.*

Where Queen Ann. Co., Md.

Period 3 years.*

Remarks:

*4. Muster-in roll shows enrollment of all men of this company as of same date. See enrollment on subsequent card or cards.

Book mark:

R. S. Shelton

D | 7 | U.S.C.T.

James Lewis Dixon
Pet, Co. D, 7 Reg't U. S. Col'd Infantry.

Appears on

Company Muster Roll

for from Sept. 29 to Oct. 31, 1863.

Joined for duty and enrolled:

When Sept 26, 1863.*

Where Queen Ann. Co. Md.*

Period 3 years.*

Present or absent Present

Steppage, \$ 100 for

Due Gov't \$ 100 for

Remarks:

* See enrollment on card from muster-in roll.

Book mark:

R. S. Shelton

(358c)

Copyist.

9 | 7 | U.S.C.T.

James Lewis Dixon
Priv., Co. D, 7 Reg't U. S. Col'd Infantry.

Appears on

Company Muster Roll

for Nov + Dec, 1863

Joined for duty and enrolled:

When Sept 26, 1863*

Where Queen Ann Md *

Period 3 years.*

Present or absent Present

Stoppage, \$ 100 for

Due Gov't \$ 100 for

Remarks: Stop for 1 Bayonet.

* See enrollment on card from muster-in roll.

Book mark:

R B Shelton

D

7

U.S.C.T.

James Lewis Dixon
Pol, Co. D, 7 Reg't U. S. Col'd Infantry.

Appears on

Company Muster Roll

for *Jan & Feb*, 1864.

Joined for duty and enrolled:

When *Sept 26*, 1863.*

Where *Queen Ann Md.**

Period *3* years.*

Present or absent *Present*

Stoppage, \$ *100* for

Due Gov't \$ *100* for

Remarks:

* See enrollment on card from muster-in roll.

Book mark: -----

R S Shelton

(358c)

Copyist.

A

7

U.S.C.T.

James S Dixon
Capt, Co. D, 7 Reg't U. S. Col'd Infantry.

Appears on

Company Muster Roll

for Micho Apl, 1864!

Joined for duty and enrolled:

When Sept 29, 1863.*

Where Queen Ann Md.*

Period 3 years.*

Present or absent Present

Stoppage, \$ 100 for _____

Due Gov't \$ 100 for _____

Remarks: _____

* See enrollment on card from muster-in roll.

Book mark: _____

R S Shelton

9

7

U.S.C.T.

James S. Dixon

Plt, Co. D, 7 Reg't U. S. Col'd Infantry.

Appears on

Company Muster Roll

for May & June, 1864.

Joined for duty and enrolled:

When Sept 26, 1863.*

Where Queen Ann Co. Md.*

Period 3 years.*

Present or absent Present

Stoppage, \$ 100 for

Due Gov't \$ 100 for

Remarks:

* See enrollment on card from muster-in roll.

Book mark:

R B Shelton

(358c)

Copyist.

9

7

U.S.C.T.

James L. Dixon
Pvt., Co. D, 7 Reg't U. S. Col'd Infantry.

Appears on

Company Muster Roll

for July & Aug., 1864.

Joined for duty and enrolled:

When Sept 26, 1863.*

Where Queen Ann Md.*

Period 3 years.*

Present or absent Present

Stoppage, \$ 100 for

Due Gov't \$ 100 for

Remarks:

* See enrollment on card from muster-in roll.

Book mark:

R. B. Shelton

20 | 7 | U.S.C.T.

James L. Dixon
Private, Co. D, 7 Reg't U. S. Col'd Infantry.

Appears on

Company Muster Roll

for Sept. & Oct, 1864.

Joined for duty and enrolled:

When Sept. 26, 1864.*

Where Green Cove *

Period 3 years.*

Present or absent absent

Stoppage, \$ 100 for

Due Gov't \$ 100 for

Remarks: detached as
steamer Date and
locality unknown.

* does not appear on Roll

* See enrollment on card from muster-in roll.

Book mark:

J. W. Neale

Copyist.

20 | 7 | U.S.C.T.

James L. Dixon
Private, Co. D, 7 Reg't U. S. Col'd Infantry.

Appears on

Company Muster Roll

for *Nov. 8. Rec.*, 1864.

Joined for duty and enrolled:

When *Sept 26*, 1863.*

Where *Queen Anne* *

Period *3* years.*

Present or absent *Present*

Stoppage, \$ *100* for

Due Gov't \$ *100* for

Remarks:

* See enrollment on card from muster-in roll.

Book mark: -----

F. H. Neal

Copyist.

101

7

U.S.C.T.

James L. Dixon
Priv., Co. D, 7 Reg't U. S. Col'd Infantry.

Appears on

Company Muster Roll

for *Jan'y 8. Feb.*, 1865.

Joined for duty and enrolled:

When *Sept. 26*, 1863.*

Where *American Arm. Co**

Period *3* years.*

Present or absent *Present*

Stoppage, \$ *100* for

Due Gov't \$ *100* for

Remarks:

* ~~See~~ See enrollment on card from muster-in roll.

Book mark: _____

(358c)

F. H. Neale

Copyist.

D | 7 | **U.S.C.T.**

James L. Dixon
Priv., Co. D, 7 Reg't U. S. Col'd Infantry.

Appears on

Company Muster Roll

for March & April, 1865.

Joined for duty and enrolled:

When Sept. 26, 1865.*

Where Queen Co. Md. *

Period 3 years.*

Present or absent absent

Stoppage, \$ 100 for

Due Gov't \$ 100 for

Remarks: Hosp'l since March
27 - 1865

* See enrollment on card from muster-in roll.

Book mark:

(358c)

J. M. [Signature]

Copyist.

2 | **7** | **U.S.C.T.**

James Harrison

Co. D, Co. D, 7 Reg't U. S. Col'd Infantry.

Appears on

Company Muster Roll

for *May 2, 1865*, 186*5*.

Joined for duty and enrolled:

When *Sept. 20*, 186*3*.*

Where *Greenwood Md.* *

Period *2* years.*

Present or absent *Absent*

Stoppage, \$ *100* for

Due Gov't \$ *100* for

Remarks: *Absent. In Hospital from Wounds rec'd Sept. 27 - 1864*

* See enrollment on card from muster-in roll.

Book mark:

F. D. Wells
(358c) Copyist.

D |

7

U.S.C.T.

James L. Dixon
Priv., Co. D, 7 Reg't U. S. Col'd Infantry.

Appears on

Company Muster Roll

for *July 8: Aug.*, 186*5*.

Joined for duty and enrolled:

When *Sept. 26*, 186*5*.*

Where *Queen Ann. Tid.**

Period *3* years.*

Present or absent

Stoppage, \$ *100* for

Due Gov't \$ *100* for

Remarks: *Dixey*
20 for his ability
was 31 - 1865 at Fort
Monroe Va.

* See enrollment on card from muster-in roll.

Book mark:

J. H. Neal

Copyist.

J. I. U.S.C.T.

James S. Dixon
Co. D, 7 Reg't U. S. Col'd Infantry.

Appears on a

Detachment Muster-out Roll

of the organization named above. Roll dated

Marquette Va. May 31, 1865.

Muster-out to date *May 31, 1865.*

Last paid to *Dec. 31, 1864*

Clothing account:

Last settled *Sept 1864*; drawn since \$ 100

Due soldier \$ 100; due U. S. \$ 100

Am't for cloth'g in kind or money adv'd \$ 60.40

Due U. S. for arms, equipments, &c., \$ 100

Bounty paid \$ 100 due \$ 100

Remarks: *Mustered out by order of the War Dept, dated May 31, 1865.*

No account of bounty on Description List. Discharged from

Book mark:

Justin
Copyist.

JAN. 20

6279455

1891

1 Balfour Genl. Hospital,
Portsmouth Va.

Pay due for months
of May, June, July
(Chegs. Sept, & Oct) 1864.

2

7

U.S.C.T.

James L. Dixon

Pvt., Co. D, 7 Reg't U. S. Col'd Infantry.

Appears on **Co. Muster-out Roll**, dated *Indianola Texas, Oct 13, 1866*.

Muster-out to date _____, 186 .

Last paid to *Dec 31, 1864*.

Clothing account:

Last settled _____, 186 ; drawn since \$ _____ 100

Due soldier \$ _____ 100; due U. S. \$ _____ 100

Am't for cloth'g in kind or money adv'd \$ _____ 100

Due U. S. for arms, equipments, &c., \$ _____ 100

Bounty paid \$ _____ 100; due \$ _____ 100

Remarks: *Discharged at Norfolk, Va. May 31. 65. Order U. Dept. May 3. 65.*

Book mark *M.O.R. on file. 279,042.*

Hearst

Roane John

Co B, 7 U.S. Col'd Inf.

Private

Private

CARD NUMBERS.

1	6283580	26
2	6283681	27
3	6283783	28
4	6283884	29
5	6283986	30
6	6284082	31
7	6284177	32
8	6284272	33
9	6284356	34
10	6284459	35
11	6284547	36
12	6284660	37
13	6284764	38
14	6284862	39
15	6284960	40
16	6285044	41
17	6285112	42
18	6285183	43
19	6285239	44
20	6285296	45
21	9066146	46
22		47
23		48
24		49
25		50

Book Mark:

See also

S1437090 - S.V.

S.2667283 P.C. mil.

9

7

U.S.C.T.

John Dourne

Co. C, 7 Reg't U.S. Col'd Inf.

Appears on

Company Descriptive Book

of the organization named above.

DESCRIPTION.

Age 36 years; height 5 feet 3 3/4 inches.

Complexion *light*

Eyes *Blue*; hair *Curly*

Where born *Tulbot co, Maryland.*

Occupation *Farmer*

ENLISTMENT.

When *Sept. 21*, 186*3*.

Where *Baltimore, Md.*

By whom *Col. W. Biney*; term *3* y'rs.

Remarks: *Mustered at Baltimore
Md. Sept. 26, 63, by Col.
W. Biney.*

W. Smith

D | **7** U.S.C.T.

John Doane,
Pratt, Co. *D*, 7 Reg't U. S. Colored Inf.

Age *36* years.

Appears on

Company Muster-in Roll

of the organization named above. Roll dated

Baltimore, Md. Sept. 26, 1863

Muster-in to date *Sept. 26, 1863*

Joined for duty and enrolled:

When *Sept. 23, 1863**

Where *Talbot Co., Md. **

Period *3* years.*

Remarks:

*Muster-in roll shows enrollment of all men of this company as of same date. See enrollment on subsequent cards or cards.

Book mark: *K 4 Md*

Calloway

20 | 7 | U.S.C.T.

John Doane
Private, Co. C, 7 Reg't U. S. Col'd Infantry.

Appears on

Company Muster Roll
 for *Sept. 26 to Oct. 31*, 186 *3*

Joined for duty and enrolled:

When *Sept. 23*, 186 *3**

Where *Falbert Co. Md.* *

Period *3* years.*

Present or absent *Absent*

Stoppage, \$ *100* for

Due Gov't \$ *100* for

Remarks: *Absent sick at*
Biney Barracks.

* See enrollment on card from muster-in roll.

Book mark:

(358c)

Calloway
 Copyist.

20 | 7 | **U.S.C.T.**

John Doane,
Privt, Co. C, 7 Reg't U. S. Col'd Infantry.

Appears on

Company Muster Roll
for Nov Dec,, 186 3

Joined for duty and enrolled:

When Sept. 23, 186 3*

Where Talbot Co. Md. *

Period 3 years.*

Present or absent Absent,

Stoppage, \$ 100 for

Due Gov't \$ 100 for

Remarks: Absent sick in
Hosptl - Baltimore Oct. 22-
1863.

* See enrollment on card from muster-in roll.

Book mark: _____

Calloway
(358c) Copyist.

2 | 7 | **U.S.C.T.**

John Doane,
Privt, Co. C, 7 Reg't U. S. Col'd Infantry.

Appears on

Company Muster Roll
for Jerry W. Feby, 1864

Joined for duty and enrolled:

When Sept. 23, 1863.*

Where

Period 3 years.*

Present or absent Present

Stoppage, \$ 100 for

Due Gov't \$ 100 for

Remarks:

* See enrollment on card from muster-in roll.

Book mark:

Calloway
(358c) Copyist.

D

7

U.S.C.T.

John Doane,
Privt, Co. C, 7 Reg't U. S. Col'd Infantry.

Appears on

Company Muster Roll

for *March and April*, 1864.

Joined for duty and enrolled:

When *Sept. 23*, 1863*

Where *Talbot Co. Md.**

Period *3* years.*

Present or absent *Present*

Stoppage, \$ *100* for

Due Gov't \$ *100* for

Remarks:

* See enrollment on card from muster-in roll.

Book mark:

Lalloway

D

7

U.S.C.T.

John Doane,
Pvt., Co. C, 7 Reg't U. S. Col'd Infantry.

Appears on

Company Muster Roll

for *May to June*, 1864.

Joined for duty and enrolled:

When *Sept. 23*, 1863*

Where *Talbot's Md.* *

Period *3* years.*

Present or absent *Absent.*

Stoppage, \$ *100* for

Due Gov't \$ *100* for

Remarks: *Stop for arr canteen,*
Absent sick in Jackson-
ville.

* See enrollment on card from muster-in roll.

Book mark:

Callaway.

20 | 7

U.S.C.T.

John Doane,
Priv., Co. C, 7 Reg't U. S. Col'd Inf.

Appears on

Company Muster Roll
for July and Aug, 1864

Joined for duty and enrolled:

When Sept. 23, 1863*

Where Labotho, Md. *

Period 3 years.*

Present or absent Present.

Stoppage, \$ 100 for

Due Gov't, \$ 100 for

Valuation of horse, \$ 100

Valuation of horse equipments, \$ 100

Remarks:

* See enrollment on card from muster-in roll.

Book-mark:

Calloway, Copist.

R | 7 | **U.S.C.T.**

John Poore
Priv., Co. C, 7 Reg't U. S. Col'd Infantry.

Appears on

Company Muster Roll
for Sept. & Oct., 1864.

Joined for duty and enrolled:

When Sept. 23, 1863.*

Where Talbot *

Period 3 years.*

Present or absent Present

Stoppage, \$ 100 for

Due Gov't \$ 100 for

Remarks:

* See enrollment on card from muster-in roll.

Book mark: _____

(358c) Wm. M. Murphy Copyist.

19 | 7 | U.S.C.T.

John Downer
Sgt., Co. C, 7 Reg't U. S. Col'd Infantry.

Appears on
Company Muster Roll
for *Nov. 7 Dec.*, 1864.

Joined for duty and enrolled:
When *Sept. 23*, 1863.*
Where *Tullahoma**
Period *3* years.*

Present or absent *Present*

Stoppage, \$ *100* for

Due Gov't \$ *100* for

Remarks: *Due the soldier*
\$4.41

* See enrollment on card from muster-in roll.

Book mark:

M. M. Murphy
Copyist.

D

7

U.S.C.T.

John Doane
Pvt., Co. C, 7 Reg't U. S. Col'd Infantry.

Appears on

Company Muster Roll

for *Jan. & Feb.*, 1865.

Joined for duty and enrolled:

When *Sept. 23*, 1863.*

Where *Jalbot Co., Ind.**

Period *3* years.*

Present or absent *Present*

Stoppage, \$ *100* for

Due Gov't \$ *100* for

Remarks:

* See enrollment on card from muster-in roll.

Book mark: _____

M. M. Murphy
(358c) Copyist.

10 | 7 | U.S.C.T.

John Downe
Sgt., Co. C, 7 Reg't U. S. Col'd Infantry.

Appears on

Company Muster Roll
for Mar. & Apr., 1865.

Joined for duty and enrolled:

When Sept. 23, 1863.*

Where Tullot Co., Ind. *

Period 3 years.*

Present or absent Present

Stoppage, \$ 100 for

Due Gov't \$ 100 for

Remarks:

* See enrollment on card from muster-in roll.

Book mark:

M. M. Murphy Copyist.

10 | 7 | **U.S.C.T.**

John Deane
Priv.; Co. C, 7 Reg't U. S. Col'd Infantry.

Appears on

Company Muster Roll

for *May & June*, 186*5*.

Joined for duty and enrolled:

When *Sept. 23*, 186*3*.*

Where *Fallot* *

Period *3* years.*

Present or absent *Present*

Stoppage, \$ *100* for

Due Gov't \$ *100* for

Remarks:

* ~~See~~ See enrollment on card from muster-in roll.

Book mark: -----

W. M. Murphy
(258c) Copyist.

10 | 7 | U.S.C.T.

John Bone
Priv., Co. C, 7 Reg't U. S. Col'd Infantry.

Appears on

Company Muster Roll

for *July 7 Aug.*, 186*5*.*

Joined for duty and enrolled:

When *Sept. 23rd*, 186*3*.*

Where *Tullop*.*

Period *3* years.*

Present or absent *Present*

Stoppage, \$ 100 for

Due Gov't \$ 100 for

Remarks:

* ~~See~~ See enrollment on card from muster-in roll.

Book mark: -----

M. M. Murphy
(358c) Copyist.

12 | 7 | U.S.C.T.

John Douma
Priv., Co. C, 7 Reg't U. S. Col'd Infantry.

Appears on

Company Muster Roll
for *Sept. & Oct.*, 186*3*.*

Joined for duty and enrolled:

When *Sept. 21.*, 186*3*.*

Where *Fullop, Ind.* *

Period *3* years.*

Present or absent *Present*

Stoppage, \$ *100* for

Due Gov't \$ *100* for

Remarks:

* See enrollment on card from muster-in roll.

Book mark: -----

M. M. Murphy
(358c) Copyist.

D | 7 | U.S.C.T.

John Doane
Co. C, 7 Reg't U. S. Col'd Infantry.

Appears on

Company Muster Roll

for Nov. & Dec, 1865

Joined for duty and enrolled:

When Sept. 21, 1863

Where Talbot Md.*

Period 3 years.*

Present or absent Absent.

Stoppage, \$ 100 for

Due Gov't \$ 100 for

Remarks: Detached as
orderly per O. N. 50
W. T. and Texas Div.
17 65

* See enrollment on card from muster-in roll.

Book mark:

Lopez

D. | 7 | U.S.C.T.

John Doane
Pvt., Co. C, 7 Reg't U. S. Col'd Infantry.

Appears on

Company Muster Roll

for Jan & Feb, 1866

Joined for duty and enrolled:

When Apr. 21, 1866

Where Talbot Md. *

Period 3 years.*

Present or absent Present.

Stoppage, \$ 100 for

Due Gov't \$ 100 for

Remarks:

* See enrollment on card from muster-in roll.

Book mark:

Sopez.

AD

7

U.S.C.T.

John Doane

Pvt., Co. C, 7 Reg't U. S. Col'd Infantry.

Appears on

Company Muster Roll

for *March* - *April*, 1866

Joined for duty and enrolled:

When *Sept. 21*, 186*6**

Where *Talbot Md.**

Period *3* years.*

Present or absent *Absent*

Stoppage, \$ *100* for

Due Gov't \$ *100* for

Remarks *Detached per S.O. No 150 Regt*

Ad Ord 7 USCJ-17 Dec. 1866

Inserted by Comparer

* See enrollment on card from muster-in roll.

Book mark:

Super

D

7

U.S.C.T.

John Doane
Pr, Co. C, 7 Reg't U. S. Col'd Infantry.

Appears on

Company Muster Roll

for *May & June*, 186 *6*

Joined for duty and enrolled:

When *Sept. 21*, 186 *3**

Where *Tolbot Md.* *

Period *3* years.*

Present or absent *Present*

Stoppage, \$ *100* for

Due Gov't \$ *100* for

Remarks:

* See enrollment on card from muster-in roll.

Book mark:

Lopez

D

7

U.S.C.T.

John Doane
Co. C, 7 Reg't U. S. Col'd Infantry.

Appears on

Company Muster Roll

for *July & Aug*, 186*6*

Joined for duty and enrolled:

When *Sept. 21*, 186*6* ^{*2*}*

Where *Talbot Md.* *

Period *3* years.*

Present or absent *Present.*

Stoppage, \$ *100* for

Due Gov't \$ *100* for

Remarks:

* See enrollment on card from muster-in roll.

Book mark: _____

(358c)

Sopez Copyist.

A. 1 **7** **U.S.C.T.**

John Doane
Prvt., Co. "C", 7 Reg't U. S. Col'd Infantry.

Appears on **Co. Muster-out Roll**, dated
Indianola, Texas, Oct 3, 1866.

Muster-out to date Oct 3, 1866.

Last paid to June 30, 1866.

Clothing account:

Last settled....., 1866 ; drawn since \$..... 100

Due soldier \$ 58 52 100; due U. S. \$..... 100

Am't for cloth'g in kind or money adv'd \$..... 100

Due U. S. for arms, equipments, &c., \$..... 100

Bounty paid \$..... 100; due \$ 100 100

Remarks: Joined Co. at original organization.

Book mark: V. 67 - P. 64. 73.

Lopez.

Loane John

, Co.

C 7
2

Reg't

U.S.C.

Enclosures.

Bed Cards	Final Statements
Burial Records	Furloughs or L. of A.
Certs. of Dis. for Discharge	Med. Certificates
C. M. Charges	Med. Des. Lists
Descriptive Lists	Orders
Discharge Certificates	Pris. of War Record
Enlistment Papers	Resignations

Other papers relating to—

Admission to Hosp'l	Furlough or L. of A.
Casualty Sheet	Med. Examination
Confinement	Misc. Information
Contracts	Pay or Clothing
Death or Effects	Personal Reports
Desertion	Rank
Discharge from Hosp'l	Transfer to Hosp'l
Discharge from Service	Transfer to V. R. C.
Duty	Transportation

MICROFILM PUBLICATION M 1849

COMPILED MILITARY SERVICE RECORDS
OF VOLUNTEER UNION SOLDIERS WHO SERVED WITH
THE UNITED STATES COLORED TROOPS (USCT)
7TH REGIMENT OF INFANTRY

PERSONAL PAPERS' TARGET SHEET

PLEASE NOTE THE CHECKED INFORMATION ABOUT THE PERSONAL PAPERS IN
THIS FILE:

- NO PERSONAL PAPERS WERE FOUND IN THIS FILE WHEN THE
RECORDS WERE ARRANGED FOR MICROFILMING.
- 3 PERSONAL PAPER(S) FOUND IN THIS FILE WHEN THE RECORDS
WERE ARRANGED FOR MICROFILMING.

MICROFILM PUBLICATION M 1849

COMPILED MILITARY SERVICE RECORDS
OF VOLUNTEER UNION SOLDIERS WHO SERVED WITH
THE UNITED STATES COLORED TROOPS (USCT)
7TH REGIMENT OF INFANTRY

PERSONAL PAPERS' TARGET SHEET

PLEASE NOTE THE CHECKED INFORMATION ABOUT THE PERSONAL PAPERS IN
THIS FILE:

- NO PERSONAL PAPERS WERE FOUND IN THIS FILE WHEN THE
RECORDS WERE ARRANGED FOR MICROFILMING.
- 3 PERSONAL PAPER(S) FOUND IN THIS FILE WHEN THE RECORDS
WERE ARRANGED FOR MICROFILMING.

Endorsement.

No. 7

APPLICATION OF

Elizabeth I. Winder

OF

Talbot County

for compensation for service of slave,

John Dome ^{aka} Dorum

enlisted 23rd September, 1863,

in C Co. 5th Regiment

U. S. Colored Troops.

Received Balto Dec 17th, 1866.

Compensation awarded,

186

Dollars.

President Board of Claims.

P. O. ADDRESS OF CLAIMANT:

Care.

Wpshur Lloyd

93 Smiths Whf.

Balto Md

CLAIM FOR COMPENSATION FOR ENLISTED SLAVE.

No.

I, Elizabeth T Winder a loyal citizen, and a resident of Talbot, County of Talbot, State of Maryland, hereby claim compensation, under the provisions of Section 24, Act approved February 24, 1864, and Section 2, Act approved July 28, 1866, for my slave John Doane alias Dorum, enlisted 21st of Sept 1863, at Baltimore, by Col. Jomey, in the Seventh Regiment U. S. Colored Troops, Co. B; certificate of which enlistment and a descriptive list, as required, accompany this application.

In proof of my loyalty to the Constitution and Government of the United States, I present the accompanying oath, which I have taken, signed and acknowledged; to be filed with this application, in accordance with requirement of General Orders, No. 329, 1863, War Department, Adjutant General's Office.

E. J. Winder

Baltimore, Dec 11th, 1864.

OATH OF ALLEGIANCE.

I, Elizabeth T. Winder, the owner and claimant, do solemnly swear that the foregoing claim is a just and true claim due to me as master and owner of the said slave, and that the facts alleged in said claim in respect to the draft or enlistment (as the case may be) of said slave into the military service of the United States are true. And I do further swear that I have never joined, or been concerned in, any insurrection or rebellion; that I have never borne arms against the United States; that I have never given any aid, countenance, counsel or encouragement to any person or persons engaged, or whom I had reason to believe were about to engage, in insurrection, rebellion or armed hostility against the United States; that I have neither sought, nor accepted, nor attempted to exercise the functions of any office, civil or military, nor to perform any service whatever, under any authority or pretended authority in hostility to the United States; that I have not yielded a voluntary support to any insurrection, rebellion or pretended government, authority, power or constitution within the United States hostile thereto. And I do further swear that, to the best of my knowledge and ability, I have supported and defended, and will continue to support and defend, the United States against all enemies, foreign and domestic; and that I have supported, defended and obeyed, and will continue to support, defend and obey, the Constitution and laws of the United States; that I will bear true faith and allegiance to the same; and that I take this oath freely, without any mental reservation or purpose of evasion: So help me God.

E. J. Winder

Sworn to and subscribed before me, at Baltimore, Md. this 11th day of December, 1864.

Allen E. Corbett, Justice of the Peace.

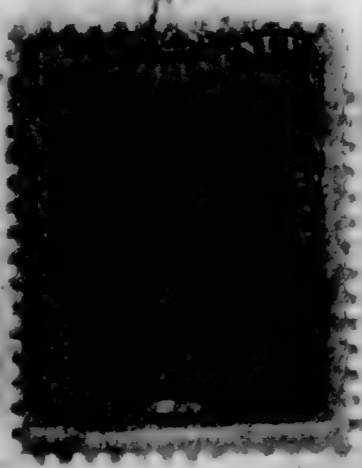

War Department,

ADJUTANT GENERAL'S OFFICE,

Washington, *May 9* 186*7*.

Respectfully returned to the Commission for the State of *Maryland*, with the information that *John Doane* was enlisted at *Talbot, Md* *Sept 23, 1863* and was mustered in as *Pvt. in Co. "C," 1st U. S. I., Sept 26, 1863.*

M. S. Mer

F. J. Saggard

Asst. Adj't General.

M. H. L.

EVIDENCE OF TITLE.

I Elizabeth J Winder of Talbot County Maryland, do solemnly swear that John Doane alias Doran who has been enlisted in the Seventh Regiment, U. S. Colored Troops, Co. C; was my Slave for life at the time of said enlistment; and that I became possessed of him by ownership of his mother at the time of his birth, the being my slave in the month of August, eighteen hundred and twenty one. And I do further swear that I have not purchased said Slave from any person or persons disloyal to the Government of the United States, with the object of obtaining compensation for the same: and furthermore, that I have no agency for obtaining compensation for any person or persons but such as to my knowledge are loyal citizens of the United States.



Sworn and subscribed before

E J Winder
Allen E. Forrester,
Justice of the Peace.

STATE OF MARYLAND,

Baltimore City County, to wit:

On this 11th day of December in the year 1866, before me, the subscriber, a Justice of the Peace of the State and City aforesaid, personally appeared Elizabeth J. Pennington a resident of Baltimore City County, State of Maryland and Mary Winder a resident of Talbot County, State of Maryland having first been duly sworn, upon their oaths declare that they reside respectively in Baltimore City County, State of Maryland and Talbot County, State of Maryland; that they are personally acquainted with Elizabeth J. Winder claimant for compensation for her Slave John Doane alias John Doran under the Acts of Congress of February 24, 1864, and July 28, 1866, and that they know that said "claimant hath firmly and faithfully maintained her allegiance and adherence to the Government of the United States, by defending its cause against the Government of the so-called Confederate States of America, in all suitable and practicable ways, and according to her ability and opportunity;" they also swear that they have themselves maintained a like adherence and allegiance to the Government of the United States, and they have no interest in said claim.



Sworn and subscribed before

E J Pennington
Mary Winder
Allen E. Forrester,
Justice of the Peace.

STATE OF MARYLAND, City of Baltimore, Cal. County, to wit:

I, Alford Mace Clerk of the Circuit Court for Baltimore County, do hereby certify that Allen E. Forrester before whom the foregoing affidavits were made, was, at the time of signing the same, a Justice of the Peace for the County and State aforesaid, duly commissioned and sworn; and that his signature thereto is genuine, and that full faith and credit should be given to his official acts.

Witness my hand and the Seal of said Court, this 12th day of December A. D. 1866



Alford Mace
Clerk.

John Doane

C. 7 CT

N^o 13

Co. C. 7th W. S. Ct.
M^{rs}. E. J. Winder
John Doane

~~John Doane~~
112

VOLUNTEER DESCRIPTIVE LIST and Account of Pay and Clothing of *A. H. Hill*

No.	NAMES.	RANK.	DESCRIPTION.					WHERE BORN.		OCCUPATION.	ENROLLED OR ENLISTED. (For Drafted Men, see note 10.)			
			Years of age.	Eyes.	Hair.	Com- plexion.	HEIGHT.		State or Kingdom.		Town or county.	When.	Where. (Town and State.)	By whom
							Feet.	In.						
	<i>Doane John</i>		<i>36</i>	<i>Blk</i>	<i>Curly</i>	<i>Griff</i>	<i>5</i>	<i>3 3/4</i>	<i>M^o</i>	<i>Talbot</i>	<i>Farmer</i>	<i>Sept 21</i>	<i>Talbot</i>	<i>Col Binn</i>

REMARKS.

NOTES.

- 1..The amount of any extra pay for which the soldier may be mustered, ex. gr. as Acting Hospital Steward, as Saddler, &c., and which may be still due him, must be carefully noted.
- 2..In the column headed "BOUNTY PAID," must be entered the whole amount hitherto paid him; in that of "BOUNTY DUE," the whole amount yet due him. Bounty paid by State authorities, and not by the United States, will not be entered on this statement.
- 3..Stoppages for loss or damage done to arms, or other public property, must be noted, and the articles, and particular damage to each, specified. When stoppages are due, under sentence of a Court Martial, a transcript of the same must be entered here; and the amount already stopped, must be carefully stated.
- 4..In every case of desertion, the date, and that of delivery, or apprehension, must be given, together with a correct transcript of the order of sentence or pardon.
- 5..A careful settlement of the man's CLOTHING ACCOUNT must be made, to date, and the amount DUE TO, or FROM him must be precisely stated.
- 6..Should the man have been engaged in any action or skirmish, it must be mentioned, together with date and place. A full and particular mention will be made of any wounds he may have received in action, or other injury, whilst in the line of his duty.
- 7..If the soldier is entitled to pay for the use of his horse, the company commander will certify to that fact on this list, and also to the time he has pay due for having been so mounted on his own horse.
- 8..When a soldier is furnished with final statements, his descriptive list, if he has one, should be taken up by the officer who gives the soldier these statements, and endorsed with a statement to this effect by the officer. This endorsement should exhibit a full statement of the time for which the soldier was allowed pay on his final statements, the clothing account, and all other charges against him or in his favor, so as to comprise a complete exhibit of his account. It will then be transmitted to the company commander of the soldier, who will enter all the data necessary to a full understanding of the soldier's account on the muster roll upon which the soldier's discharge is reported. The descriptive list will then be destroyed. The object of this is, that the remaining portion of the soldier's account may be settled upon the receipt of these muster rolls, and the soldier receive any pay or allowances that may be due him at the time of his discharge, and which may not appear on his final statements from the fact that his descriptive list is incomplete. These accounts for back pay, &c., are settled by the 2d Auditor of the Treasury Dep't.
- 9..Where a soldier dies in Hospital or on detached service, his descriptive list, if he has one, should be sent with his final statements, in duplicate, to the Adjutant General, Washington, D. C.
- 10..Men drafted will be considered as mustered in from the date of their draft, and will be mustered for pay on the usual rolls for Volunteers. On the same line as the soldier's name, under the heading "Joined for Duty and Enrolled.—Commencement of First Payment by Time," will be written the word *drafted*, or *substitute*, as the case may be; and under the heading "When Mustered in" will be given the date when the soldier was drafted, or, if a substitute, when enlisted, (substitutes, under the Enrollment Act, are mustered in by enlistment;) under "Where Mustered in," will be given the place from which drafted, (or if a substitute, where enlisted;) under the heading "By whom Mustered in," will be given the No. of the Enrollment District from which he was drafted, and the State to which it belongs, thus: *4th D. Mass.*; (meaning 4th Enrollment District, State of Massachusetts.) Or if a substitute, the name of the officer enlisting him. (When enlisted by Board of Enrollment, the name of the Provost Marshal of the Enrollment District.)
- 11..A separate descriptive list should, as a general rule, be given for each man.
- 12..Descriptive lists must, in all cases, be signed by COMMISSIONED officers; not by enlisted men acting as such.

A. Hewitt in 7th Regt U.S. Colored Troops

DRAFTED OR ENLISTED. (For Drafted Men, see note 10.)		MUSTERED IN. (For Drafted Men, see note 10.)			LAST PAID.		BOUNTY.		CLOTHING ACCOUNT.		
Where. (Town and State.)	By whom.	When.	Where. (Town and State.)	By whom. (In the case of drafted men, from what enrollment district.)	Period.	By paymaster.	To what time.	Paid \$ (See note 2.)	Due \$ (See note 2.)	Date of last settlement.	Total money value of clothing drawn since last settlement.
<i>Falbt</i>	<i>Ed Biny</i>	<i>Sept 24</i>	<i>Benedict</i>	<i>Ed Biny</i>	<i>3 yrs</i>					<i>U.S. C.T.</i>	
											<i>Mr E. J. Winder</i>

REMARKS.

final statements, in duplicate, C. rec'd in from the date of their the usual rolls for Volunteers. under the heading "Joined for First Payment by Time," will as the case may be; and under given the date when the sol- enlisted, (substitutes, under the stment;) under "Where Mus- tak drafted, (or if a substitute, whom Mustered in," will be from which he was drafted, 4th D. Mass.; (meaning 4th etc.) Or if a substitute, the enlisted by Board of Enroll- the Enrollment District.) rule, be given for each man. by COMMISSIONED officers;

I CERTIFY that the above is a correct transcript from the Records of *this General Armory* of *Recruits from Maryland for U.S.C.T.*

STATION: *Baltimore Md*
 DATE: *August 28th 1865*

Col. J. Pennell
 Commanding the Company.

Wm. H. Spear Chief Clerk and Recy. Officer
 1st Lt. U.S.C.T. Inspector of U.S. Col. Troops for Md.

410

Robson John

Co B, 7 U.S. Col'd Inf.

Private Private

CARD NUMBERS.

1	62835-81	26
2	6283682	27
3	6283784	28
4	6283945	29
5	6285-394	30
6	9066148	31
7		32
8		33
9		34
10		35
11		36
12		37
13		38
14		39
15		40
16		41
17		42
18		43
19		44
20		45
21		46
22		47
23		48
24		49
25		50

Book Mark P.V. 17, P. 16-71

See also

MAR 1971

410

Robson John

Co B, 7 U.S. Col'd Inf.

Private Private

CARD NUMBERS.

1	62835-81	26
2	6283682	27
3	6283784	28
4	6283945	29
5	6285-394	30
6	9066148	31
7		32
8		33
9		34
10		35
11		36
12		37
13		38
14		39
15		40
16		41
17		42
18		43
19		44
20		45
21		46
22		47
23		48
24		49
25		50

Book Mark P.V. 17, P. 16-71

See also

9

7

U.S.C.T.

John Dobson

, Co. *C*, 7 Reg't U.S. Col'd Inf.

Appears on

Company Descriptive Book

of the organization named above.

DESCRIPTION.

Age *20* years; height *5* feet *4* inches.

Complexion *Gruff*

Eyes *Black*; hair *Curly*

Where born *Talbot Co., Md.*

Occupation *Farmer*

ENLISTMENT.

When *Sept. 23*, 186*3*.

Where *Baltimore, Md.*

By whom *Col. H. Binney*; term *3* y'rs.

Remarks: *Mustered at Baltimore Md. Sept. 26, 63, by Col. H. Binney.*

Died at Hosp. Benedict, Md. February 4th, 64 of Diarrhoea.

Wm. Smith

D | 7 | U.S.C.T.

Johny Dobson,
Co. G, 7 Reg't U. S. Colored Inf.

Age 20 years.

Appears on

Company Muster-in Roll

of the organization named above. Roll dated

Baltimore, Md, Sept. 26, 1863

Muster-in to date Sept. 26, 1863

Joined for duty and enrolled:

When Sept. 23, 1863*

Where Talbot, Md. *

Period 3 years.*

Remarks:

* Muster in roll shows enrollment of all men of this company as of the date. See enrollment on subsequent card or cards.

Book mark :

Calloway

D

7

U.S.C.T.

John Johnson

Private, Co. C, 7 Reg't U. S. Col'd Infantry.

Appears on

Company, Muster Roll

for Sept. 26 to Oct. 31, 1863

Joined for duty and enrolled:

When Sept. 23, 1863*

Where Talbot Co., Md. *

Period 3 years.*

Present or absent Present

Stoppage, \$ 100 for

Due Gov't \$ 100 for

Remarks:

* See enrollment on card from muster-in roll.

Book mark:

Caloway

21

7

U.S.C.T.

John Johnson,
Privt., Co. C, 7 Reg't U. S. Col'd Infantry.

Appears on

Company Muster Roll

for *Novth Dec,* 186*3*

Joined for duty and enrolled:

When *Sept. 23*, 186*3**

Where *Talbot Co. Md.* *

Period *3* years.*

Present or absent *Present.*

Stoppage, \$ *100* for

Due Gov't \$ *100* for

Remarks:

* See enrollment on card from muster-in roll.

Book mark: -----

Calloway.

(358c)

Copyist.

D

7

U.S.C.T.

John Johnson.
Priv., Co. C; 7 Reg't U. S. Col'd Infantry.

Appears on

Company Muster Roll

for *Jany^{ary} Feb'y*, 1864.

Joined for duty and enrolled:

When *Sept. 23*, 1863.*

Where *Talbot Co. Md.* *

Period *3* years.*

Present or absent.....

Stoppage, \$ *100* for.....

Due Gov't \$ *100* for.....

Remarks: *Died at Benedict Hospital Feb'y 4. of disease. Final statements sent.*

* See enrollment on card from muster-in roll.

Book mark:.....

(358c)

Carroway

Copyist.

L. 7 | **U.S.C.T.**

John Dobson
Co. *6*, *7* Reg't U. S. Col'd Infantry.

Appears on **Co. Muster-out Roll**, dated *Indianola Texas, Oct 13*, 186 *6*.

Muster-out to date _____, 186 .

Last paid to *Dec 3*, 186 *3*.

Clothing account:

Last settled _____, 186 ; drawn since \$ _____ *100*

Due soldier \$ _____ *100*; due U. S. \$ _____ *100*

Am't for cloth'g in kind or money adv'd \$ _____ *100*

Due U. S. for arms, equipments, &c., \$ _____ *100*

Bounty paid \$ _____ *100*; due \$ _____ *100*

Remarks: *Died at Benedict*
Md. Feb. 4 '64 of Diarrhoea
Final statements sent
to algo.

Book mark: *Pt. 17 P. 16. 71 W 4 Md.*

(361)

Lopez Copyist.

(over)

JAN. 20

6285394

018910

V. 117 P285.70 F.S.

Dobson, John

P. Co. C.

7

U.S.C. Inf.
Reg't

Enclosures.

Bed Cards	Descriptive Lists
Burial Records	Final Statements /
Certs. of Dis. for Discharge	Furloughs
C. M. Charges	Med. Des. Lists
Med. Certificates	Orders

Other papers relating to—

Admission to Hosp'l	Furlough
Casualty Sheet (Officer's)	Med. Examination
Confinement	Misc. Information
Contracts	Pay or Clothing
Death or Effects	Personal Reports
Desertions	Rank
Discharge from Hosp'l	Transfer to Hosp'l
Discharge from Service	Transfer to V. R. C.
Duty	Transportation

✓ 52 #4

FINAL STATEMENT S

OF
Pvt. John Dobson
Co. "C"
7th Reg't of U.S.C. Troops.

VOLUNTEERS.

NOTE 1.—Two of these certificates (or duplicates) are to be given to each volunteer soldier who may be discharged previously to the discharge of his company, that he may at once receive from the Paymaster the pay, &c., due him, and the captain or other officer commanding the company will certify to the act of the delivery of the duplicate certificates; on these certificates the Soldier is "entitled to" his discharge, and should also present his discharge to the Paymaster to have the payment endorsed on it. The discharge is to be given back to the Soldier by the Paymaster; the latter only retaining as his voucher the duplicate certificates.

NOTE 2.—If the Soldier is entitled to pay for the use of his horse, the Company Commander will certify to that fact, and also to the time he has pay due for having been so mounted on his own horse.

NOTE 3.—Amounts due the Sutler and Laundress must be entered on the Muster Roll on which the death, desertion, &c., is reported, as well as on the final statement, otherwise the amount cannot be collected from the United States.

NOTE 4.—This blank will be used for deceased volunteers as well as others.

ADJUTANT GENERAL'S OFFICE.

Sept 16th 1864

Duplicate with Inventory sent 2d Auditor.



Curran or [unclear] [unclear]

I certify, on honor, that John Dobson a Private of
 Captain J. A. Warr Company (C) of the 2nd Regiment of U.S. Col. Troop
VOLUNTEERS, of the State of Ma, born in Talbot Co. State
 of Ma, aged 20 years; 5 feet 4 inches high; Blk complexion,
Blk eyes, Curly hair, and by occupation a Farmer, having joined the company on
 its original organization at Baltimore, and enrolled in it at the muster into
 the service of the United States at Baltimore Md. on the 26th day
 of Sept., 186 3, (or was mustered in service as a recruit, by _____
 _____, at _____, on the _____ day of _____,
 186 _____, to serve in the Regiment,) for the term of 3 yrs. or the war
 and having served **HONESTLY** and **FAITHFULLY** with his Company in Ma.

to the present date, is now entitled to a **DISCHARGE** by reason of death. He
died in Hosp. Benedict, Md. Feby. 4th 1864
of Dysentery.

The said Private John Dobson was last paid by Paymaster
Malone to include the 31st day of Dec., 186 3 and has
 pay due him from that time to the present date; he is entitled to pay and subsistence for
TRAVELING to place of enrollment and whatever other allowances are authorized to volunteer
 soldiers, or militia, so discharged. He has received 46 $\frac{32}{100}$ dollars,
 advanced by the United States on account of **CLOTHING**.

There is to be stopped from him, on account of the State of _____, or other
 authorities for **CLOTHING, &c.**, received on entering service, _____ dollars; also,
 for expenses of **SUBSISTENCE** for **TRAVELING** from place of enrollment to the place of rendezvous,
 amounting to _____ dollars: and on account of the United States for **EXTRA**
CLOTHING received in kind from _____ and for other
 stoppages, viz:

_____ amounting to _____ dollars;
 and he has been **SUBSISTED** for **TRAVELING** to his place of enrollment, up to the _____
 _____, 186 _____.

He is indebted to _____, **SUTLER**, _____ dollars.
 He is indebted to _____, **LAUNDRESS**, _____ dollars.

Given in Duplicate, at Benedict this 11th day of Februey, 186 4
Julius A. Warr
Capt 7th U.S. Col.
 Commanding Company.

411

Rocking Levin

Co - , 7 U.S. Col'd Inf.

CARD NUMBERS.

1	627.9237	26
2		27
3		28
4		29
5		30
6		31
7		32
8		33
9		34
10		35
11		36
12		37
13		38
14		39
15		40
16		41
17		42
18		43
19		44
20		45
21		46
22		47
23		48
24		49
25		50

Book Mark:

See also

217 | **U.S.C.T**

Levin Hocking

Appears with rank of _____ on

Muster and Descriptive Roll of a Detachment of Drafted Men and Substitutes forwarded

for the 7 Reg't U.S. Col'd Inf. Roll dated Baltimore Md, Apr 1865

Where born Dorchester Co. Md.

Age 40 years; occupation Laborer

Drafted and mustered in:

When Mar 20, 1865.

Where Easton, Md.

Period 1 years.

Eyes Blu; hair Blu

Complexion Blu; height 5' 1/2 ft. 3 in.

Paid bounty and advance pay, \$ 100

Bounty due \$ 100

Where credited _____

Company to which assigned _____

Remarks: Drafted from 3 Sub Dist
Dorchester Co. 1 Dist (over)

Book mark: _____

J. M. Farley
Coppert.

JAN. 20

6279232

ALB910

*Not taken up in rolls of
rept*

912

Donald James Wesley

Co *A*, 7 U.S. Col'd Inf.

Private Private

CARD NUMBERS.

1	6 2 8 9 1 5 5 -	26
2	6 2 8 9 2 5 5 -	27
3	6 2 8 9 3 5 4	28
4	6 2 8 9 4 5 5	29
5	6 2 8 9 5 5 9	30
6	6 2 8 9 6 5 4	31
7	6 2 8 9 7 5 0	32
8	6 2 8 9 8 4 3	33
9	6 2 8 9 9 4 1	34
10	6 2 9 0 0 3 9	35
11	6 2 9 0 1 3 7	36
12	6 2 9 0 2 3 2	37
13	6 2 9 0 3 2 3	38
14	6 2 9 0 4 1 4	39
15	6 2 9 0 5 0 2	40
16	6 2 9 0 5 8 2	41
17	6 2 9 0 6 6 0	42
18	6 2 9 0 7 3 3	43
19	6 2 9 0 8 0 6	44
20	9 0 6 6 5 3 3	45
21		46
22		47
23		48
24		49
25		50

Book Mark:

See also

LQ

7

U.S.C.T.

James M. Donald

....., Co. *G*, 7 Reg't U.S. Col'd Inf.

Appears on

Company Descriptive Book

of the organization named above.

DESCRIPTION.

Age *21* years; height *5* feet *5* inches.

Complexion *Fair*

Eyes *Dark*; hair *Light*

Where born *Cent. Md.*

Occupation *Farmer*

ENLISTMENT.

When *Sept 24*, 186*5*.

Where *Baltimore, Md.*

By whom *Col. H. Perry*; term *3* y'rs.

Remarks: *Mustered Sept 30 1865
by Col. Wm Perry.*

J. J. Brown

21

7

U.S.C.T.

James Wesley Donald

Plt., Co. F, 7 Reg't U. S. Col'd Infantry.

Appears on

Company Muster Roll

for *Sept 30 to Oct 31*, 186*3*.

Joined for duty and enrolled:

When *Sept 27*, 186*3*.*

Where *Queen Anne's Co Md* *

Period *3* years.*

Present or absent *Present*

Stoppage, \$ *100* for

Due Gov't \$ *100* for

Remarks:

* See enrollment on card from muster-in roll.

Book mark: -----

(358c)

J. C. Hill
Copyist.

21

7

U.S.C.T.

James W. Donald

Co. F, 7 Reg't U. S. Col'd Infantry.

Appears on

Company Muster Roll

for Nov. & Dec., 1863.

Joined for duty and enrolled:

When Sept 27, 1863.*

Where Quantico Co. Md. *

Period 3 years.*

Present or absent Present

Stoppage, \$ 100 for

Due Gov't \$ 100 for

Remarks:

* See enrollment on card from muster-in roll.

Book mark:

(358c)

Copyist.

2 | 7 | U.S.C.T.

James W. Donald
Sgt., Co. F, 7 Reg't U. S. Col'd Infantry.

Appears on

Company Muster Roll

for *Com & Co*, 1864.

Joined for duty and enrolled:

When *Sept 21*, 1863.*

Where *Queen Ann Co Md* *

Period years.*

Present or absent *Present*

Stoppage, \$ 100 for

Due Gov't \$ 100 for

Remarks: *Stopped for Season*
Chase

* See enrollment on card from muster-in roll.

Book mark:

[Signature]
Copyist.

27 7 U.S.C.T.

James H. Donald
Capt., Co. F, 7 Reg't U.S. Col'd Infantry.

Appears on

Company Muster Roll

for March & April, 1864.

Joined for duty and enrolled:

When Sept 27, 1863.*

Where Queen Ann Co. Md. *

Period 3 years.*

Present or absent Present

Stoppage, \$ 100 for

Due Gov't \$ 100 for

Remarks:

* See enrollment on card from muster-in roll.

Book mark:

Copyist.

21 | 7 | U.S.C.T.

James H. Donald
Pvt, Co. F, 7 Reg't U. S. Col'd Infantry.

Appears on

Company Muster Roll

for *May & June*, 1864.

Joined for duty and enrolled:

When *Sept 27*, 1863.*

Where *Quincy Arm Co. Ill.**

Period *3* years.*

Present or absent *Present*

Stoppage, \$ *100* for

Due Gov't \$ *100* for

Remarks: *Aspt for one bugle
& one trench*

* See enrollment on card from muster-in roll.

Book mark:

Copyist
Copyist.

D | 7 | U.S.C.T.

James W. Donald
Pvt, Co. F, 7 Reg't U. S. Col'd Infantry.

Appears on

Company Muster Roll
for July & Aug, 1867.

Joined for duty and enrolled:

When Sept 27, 1863.*

Where Queen Ann Co., Md.*

Period 3 years.*

Present or absent Present

Stoppage, \$ 100 for

Due Gov't \$ 100 for

Remarks: Stopped for
Bugle, come wound
free on on before
Apr 19/61

* See enrollment on card from muster-in roll.

Book mark:

W. H. Doe

91

7

U.S.C.T.

James W. Donald

Private, Co. F, 7 Reg't U. S. Col'd Infantry.

Appears on

Company Muster Roll

for *Sept. and Oct.*, 1864.

Joined for duty and enrolled:

When *Sept. 30*, 1863.*

Where *Dorchester Co., Md.* *

Period *3* years.*

Present or absent *Present.*

Stoppage, \$ *100* for

Due Gov't \$ *100* for

Remarks: _____

* See enrollment on card from muster-in roll.

Book mark: _____

(858c)

Keefe

Copyist.

D 1 7

U.S.C.T.

James M. Donald
Private Co. F, 7 Reg't U. S. Col'd Infantry.

Appears on

Company Muster Roll

for *Nov and Dec*, 1864.

Joined for duty and enrolled:

When *Sept. 27*, 1863.*

Where *Queen Anne's Co., Md* *

Period *3* years.*

Present or absent *Present*

Stoppage, \$ *100* for

Due Gov't \$ *100* for

Remarks:

* ~~See~~ See enrollment on card from muster-in roll.

Book mark: _____

(358c)

Keefe
Copyist.

91 7 U.S.C.T.

James W. Donald
Private Co. F, 7 Reg't U. S. Col'd Infantry.

Appears on

Company Muster Roll

for Jan. and Feb., 1865

Joined for duty and enrolled:

When Sept 27, 1863.*

Where Queen Anne Co., Md.*

Period 3 years.*

Present or absent Present

Stoppage, \$ 100 for

Due Gov't \$ 100 for

Remarks:

* See enrollment on card from muster-in roll.

Book mark:

(358c) Keifer Copyist.

A | 7 | U.S.C.T.

James W. Donald
Private, Co. F, 7 Reg't U. S. Col'd Infantry.

Appears on

Company Muster Roll

for *Mar. & Apr.*, 1865.

Joined for duty and enrolled:

When *Sep. 27*, 1863.*

Where *Queen Anne's Md.**

Period *3* years.*

Present or absent *Present*

Stoppage, \$ *100* for

Due Gov't \$ *100* for

Remarks:

* See enrollment on card from muster-in roll.

Book mark: _____

(358c) *Keefe* Copyist.

D | **7** | **U.S.C.T.**

James W. Donald
Private Co. F, 7 Reg't U. S. Col'd Infantry.

Appears on

Company Muster Roll

for *May and June*, 1863.

Joined for duty and enrolled:

When *Sep. 27*, 1863.*

Where *Queen Anne* *

Period *3* years.*

Present or absent *Present*

Stoppage, \$ *100* for

Due Gov't \$ *100* for

Remarks: *To be stopped for
Shelter Tent Price,
Wrench and Wiper*

* See enrollment on card from muster-in roll.

Book mark:

Keeper
(358c) Copyist.

A | **7** | **U.S.C.T.**

James W. Donald

Private Co. F, 7 Reg't U. S. Col'd Infantry.

Appears on

Company Muster Roll

for *July^{2nd} Aug.*, 1863.

Joined for duty and enrolled:

When *Sep. 27*, 1863.*

Where *Queen Anne Co., Md.* *

Period *3* years.*

Present or absent *Present.*

Stoppage, \$ *100* for

Due Gov't \$ *100* for

Remarks: _____

* ~~See~~ See enrollment on card from muster-in roll.

Book mark: _____

Keefe

D

7

U.S.C.T.

James W. Donald
Priv., Co. F, 7 Reg't U. S. Col'd Infantry.

Appears on

Company Muster Roll

for *Sept. & Oct.*, 1865.

Joined for duty and enrolled:

When *Sept. 27*, 1863.*

Where *Queen Anne Co., Md.*

Period *3* years.*

Present or absent *Present*

Stoppage, \$ *100* for

Due Gov't \$ *100* for

Remarks:

* See enrollment on card from muster-in roll.

Book mark:

Keefe

rl. |

7

U.S.C.T.

James H. Donald
Capt., Co. F, 7 Reg't U. S. Col'd Infantry.

Appears on

Company Muster Roll

for Nov. + Dec., 1865.

Joined for duty and enrolled:

When Sept. 27, 1863.*

Where Queen Anne Md.*

Period 3 years.*

Present or absent Present.

Stoppage, \$ 100 for

Due Gov't \$ 100 for

Remarks:

* See enrollment on card from muster-in roll.

Book mark:

Brooks

(858c)

Copyist.

N 1

7

U.S.C.T.

James McDonald
Pvt., Co. F, 7 Reg't U. S. Col'd Infantry.

Appears on

Company Muster Roll

for Jan. + Feb., 1866.

Joined for duty and enrolled:

When Sept. 27, 1863.*

Where Queen Ann Co. Md. *

Period 3 years.*

Present or absent Present

Stoppage, \$ 100 for

Due Gov't \$ 100 for

Remarks:

* See enrollment on card from muster-in roll.

Book mark:

Crooks

nl. 1

7

U.S.C.T.

James W. Donald
Co., Co. F, 7 Reg't U. S. Col'd Infantry.

Appears on

Company Muster Roll

for Mar. & April, 1866.

Joined for duty and enrolled:

When Sept. 27, 1863.*

Where Queen Anne, Md. *

Period 3 years.*

Present or absent Present.

Stoppage, \$ 100 for

Due Gov't \$ 100 for

Remarks:

* See enrollment on card from muster-in roll.

Book mark: 505-1

Brooks

AG. 1 7 U.S.C.T.

James H. Donald
Pvt., Co. F, 7 Reg't U. S. Col'd Infantry.

Appears on

Company Muster Roll

for May & June, 1866.

Joined for duty and enrolled:

When Sept. 27, 1863.*

Where Queen Ann, Md. *

Period 3 years.*

Present or absent Present

Stoppage, \$ 100 for

Due Gov't \$ 100 for

Remarks:

NEXT ROLL ON FILE MUSTER OUT.

* See enrollment on card from muster-in roll.

Book mark:

Brooks

Al. | 7 | **U.S.C.T.**

James M. Donald
Pvt., Co. D., 7 Reg't U. S. Col'd Infantry.

Appears on **Co. Muster-out Roll**, dated
Indianola, Texas, Oct. 13, 1866.

Muster-out to date Oct. 13, 1866.

Last paid to June 30, 1866.

Clothing account:

Last settled....., 186 ; drawn since \$..... 100

Due soldier \$ 3 / 82 / 100; due U. S. \$..... 100

Am't for cloth'g in kind or money adv'd \$..... 100

Due U. S. for arms, equipments, &c., \$..... 100

Bounty paid \$..... 100; due \$ 100 / 100

Remarks: Joined Co. at
original organization.

Book mark :

Brooks

D | 7 | U.S.C.T.

James Wesley Donald
Det. Co. F, 7 Reg't U. S. Colored Inf.

Age 21 years.

Appears on

Company Muster-in Roll

of the organization named above. Roll dated

Baltimore Md. Sept 30, 1863.

Muster-in to date

Sept 30, 1863.

Joined for duty and enrolled:

When Sept. 27, 1863.*

Where Queen Anne's *.

Period 3 years.*

Remarks:

*Muster in roll shows enrollment of all men of this company as of some date. See enrollment on subsequent card or cards.

Book mark:

(250)

J. A. Miller
Comdr.

Dorman, Daniel

Co *D*, 7 U.S. Col'd Inf.

Private

CARD NUMBERS.

1	<i>See Dorman, Daniel</i>	26
2		
3		28
4		29
5		30
6		31
7		32
8		33
9		34
10		35
11		36
12		37
13		38
14		39
15		40
16		41
17		42
18		43
19		44
20		45
21		46
22		47
23		48
24		49
25		50

Book Mark:

See also

414

Donnan, William

Co D, 7 U.S. Col'd Inf.

Private

CARD NUMBERS.

1	26
See Donnan,	William
2	27
3	28
4	29
5	30
6	31
7	32
8	33
9	34
10	35
11	36
12	37
13	38
14	39
15	40
16	41
17	42
18	43
19	44
20	45
21	46
22	47
23	48
24	49
25	50

Book Mark:

See also

Dorham Edward

Co. A, 7 U.S. Col'd Inf.

Private Corporal

CARD NUMBERS.

1	6 2 7 9 8 4 8	26
2	6 2 7 9 9 4 9	27
3	6 2 8 0 0 5 2	28
4	6 2 8 0 1 5 2	29
5	6 2 8 0 2 5 6	30
6	6 2 8 0 3 5 4	31
7	6 2 8 0 4 3 1	32
8	6 2 8 0 5 2 8	33
9	6 2 8 0 6 2 6	34
10	6 2 8 0 7 2 4	35
11	6 2 8 0 8 2 4	36
12	6 2 8 0 9 2 6	37
13	6 2 8 1 0 2 7	38
14	6 2 8 1 1 2 7	39
15	6 2 8 1 2 2 6	40
16	6 2 8 1 3 1 8	41
17	6 2 8 1 4 0 3	42
18	6 2 8 1 4 8 6	43
19	6 2 8 1 5 6 9	44
20	6 2 8 1 6 5 1	45
21	9 0 6 5 8 9 7	46
22		47
23		48
24		49
25		50

Book Mark: N. 7. No. 726

See also

8.1424124 P.O. 0.47
5.2024013 P.O. 0.47

D

7

U.S.C.T.

Edward Durham

, Co. *A*, 7 Reg't U.S. Col'd Inf.

Appears on

Company Descriptive Book

of the organization named above.

DESCRIPTION.

Age *21* years; height *5* feet *6 1/2* inches.

Complexion *Griff*,

Eyes *gray* ; hair *leucy*.

Where born *Talbot, Md.*

Occupation *Farmer*.

ENLISTMENT.

When *Sept. 23d.*, 186*3*.

Where *Baltimore, Md.*

By whom *Col. W. Binney* ; term *3* y'rs.

Remarks: *Mustered Sept. 26, 63.*

Promoted Corporal Aug. 20, 1864.

J. Smith

9

7

U.S.C.T.

Edward Gorham

Plt, Co. A, 7 Reg't U. S. Col'd Infantry.

Appears on

Company Muster Roll

for term Sept. 26 to Oct. 31, 1863.

Joined for duty and enrolled:

When Sept. 23, 1863.*

Where Talbot Co. Md.*

Period 3 years.*

Present or absent Absent.

Stoppage, \$ 100 for

Due Gov't \$ 100 for

Remarks: Detached on recruiting service in St Mary's Co. Md.

* See enrollment on card from muster-in roll.

Book mark:

Taggett

G | **7** | **U.S.C.T.**

Edward Gorham

Prst, Co. A, 7 Reg't U. S. Col'd Infantry.

Appears on

Company Muster Roll

for *Nov. & Dec.*, 1863.

Joined for duty and enrolled:

When *Sept. 23*, 1863.*

Where *Talbot Co. Md.**

Period *3* years.*

Present or absent *Present.*

Stoppage, \$ *100* for

Due Gov't \$ *100* for

Remarks: *Enlistment premium of \$200 due.*

* ~~See~~ See enrollment on card from muster-in roll.

Book mark: _____

Daggett

D | **7** | **U.S.C.T.**

Edward Gorham

Pvt., Co. A, 7 Reg't U. S. Col'd Infantry.

Appears on

Company Muster Roll

for *Jan. & Feb.*, 1864.

Joined for duty and enrolled:

When *Sept. 23*, 1863.*

Where *Talbot Co. Md.* *

Period *3* years.*

Present or absent *Present*

Stoppage, \$ *100* for

Due Gov't \$ *100* for

Remarks: *Joined from Recruiting July 5th 1864
Enlistment Premium due.*

* See enrollment on card from muster-in roll.

Book mark: -----

Daggett

2 | 7 | **U.S.C.T.**

Edward Gorham

Pvt., Co. A, 7 Reg't U. S. Col'd Infantry.

Appears on

Company Muster Roll

for *Mar. & Apr.*, 1864.

Joined for duty and enrolled:

When *Sept. 23*, 1863.*

Where *Talbot Co. Md.**

Period *3* years.*

Present or absent *Present*

Stoppage, \$ *100* for

Due Gov't \$ *100* for

Remarks:

* See enrollment on card from muster-in roll.

Book mark: _____

Taggitt
Copyist.

G | **7** | **U.S.C.T.**

Edward Gorham

Pvt., Co. A, 7 Reg't U. S. Col'd Infantry.

Appears on

Company Muster Roll

for *May & June*, 1864.

Joined for duty and enrolled:

When *Sept. 23*, 1863.*

Where *Talbot Co. Md.**

Period *3* years.*

Present or absent *Absent*

Stoppage, \$ *100* for

Due Gov't \$ *100* for

Remarks: *Absent detached by
vir. S. O. dated 4th Dec. Dist
of Fla.*

* See enrollment on card from muster-in roll.

Book mark:

Daggett

D | 7 | U.S.C.T.

Edward Gorham
Corp., Co. A, 7 Reg't U. S. Col'd Infantry.

Appears on

Company Muster Roll

for *July & Aug.*, 1864.

Joined for duty and enrolled:

When *Sept. 23*, 1863.*

Where *Falbot Co. Md.* *

Period *3* years.*

Present or absent *Present*

Stoppage, \$ *100* for

Due Gov't \$ *100* for

Remarks: *Stop for (1) One*
Haversack & One Canteen
App. Corp. Aug. 20/64.

* ~~See~~ See enrollment on card from muster-in roll.

Book mark:

Daggett

9 | 7 | U.S.C.T.

Edward Gorham

Corpl, Co. A, 7 Reg't U. S. Col'd Infantry.

Appears on

Company Muster Roll

for Sept. & Oct., 1864.

Joined for duty and enrolled:

When Sept. 23, 1863.*

Where Talbot *

Period years.*

Present or absent Present.

Stoppage, \$ 100 for

Due Gov't \$ 100 for

Remarks: Stop for one set of metallic scales, Corpl's. Appt'd Corpl Aug. 20/64.

* See enrollment on card from muster-in roll.

Book mark:

(358c)

Conard Copyist.

917 U.S.C.T.

Edward Darham

Capt, Co. A, 7 Reg't U. S. Col'd Infantry.

Appears on

Company Muster Roll

for Nov. & Dec., 1864

Joined for duty and enrolled:

When Sept. 23, 1863.*

Where Talbot, Md.*

Period 3 years.*

Present or absent Present

Stoppage, \$ 100 for

Due Gov't \$ 100 for

Remarks: Stop for one set of metallic scales

* See enrollment on card from muster-in roll.

Book mark:

(358c)

Conard Copyist.

917 U.S.C.T.

Edward Darham

Capt, Co. A, 7 Reg't U. S. Col'd Infantry.

Appears on

Company Muster Roll

for Jan & Feb, 1865.

Joined for duty and enrolled:

When Sept 23, 1863.*

Where Talbot, Md *

Period years.*

Present or absent Present

Stoppage, \$ 100 for

Due Gov't \$ 100 for

Remarks:

* See enrollment on card from muster-in roll.

Book mark:

(358c) Bonard Copyist.

217 U.S.C.T.

Edward Torham

Co. A, 7 Reg't U. S. Col'd Infantry.

Appears on

Company Muster Roll

for Mich & Apr, 1865.

Joined for duty and enrolled:

When Sept. 23, 1863.*

Where Talbot *

Period 3 years.*

Present or absent Present.

Stoppage, \$ 100 for

Due Gov't \$ 100 for

Remarks:

* See enrollment on card from muster-in roll.

Book mark: _____

(358c)

Conard
Copyist.

2 | 7 | U.S.C.T.

Edward Dorham

Co. A, 7 Reg't U. S. Col'd Infantry.

Appears on

Company Muster Roll

for May & June, 1865.

Joined for duty and enrolled:

When Sept 23, 1863.*

Where Talbot *

Period 3 years.*

Present or absent Present.

Stoppage, \$ 100 for

Due Gov't \$ 100 for

Remarks: _____

* See enrollment on card from muster-in roll.

Book mark: _____

Leonard
Copyist.

D | **7** | **U.S.C.T.**

Edward Dorham

Capt., Co. A, 7 Reg't U. S. Col'd Infantry.

Appears on

Company Muster Roll

for *July & Aug.*, 1865.

Joined for duty and enrolled:

When *Sept. 23*, 1863.*

Where *Talbot Co, Md.**

Period *3* years.*

Present or absent *Present.*

Stoppage, \$ *100* for

Due Gov't \$ *100* for

Remarks:

* See enrollment on card from muster-in roll.

Book mark: _____

Leonard
Copyist.

2 | 7 | U.S.C.T.

Edward Gorham

Capt., Co. A, 7 Reg't U.S. Col'd Infantry.

Appears on

Company Muster Roll

for Sept. & Oct., 1865.

Joined for duty and enrolled:

When Sept. 23, 1863.*

Where Talbot *

Period 3 years.*

Present or absent Present.

Stoppage, \$ 100 for

Due Gov't \$ 100 for

Remarks:

* See enrollment on card from muster-in roll.

Book mark:

(358c)

Conard
Copyist.

I | 7 | U.S.C.T.

Edward Torham

Corp, Co. A, 7 Reg't U. S. Col'd Infantry.

Appears on

Company Muster Roll

for Nov. & Dec, 1865.

Joined for duty and enrolled:

When Sep 23, 1863.*

Where Talbot Co. Md *

Period 3 years.*

Present or absent Present

Stoppage, \$ 100 for

Due Gov't \$ 100 for

Remarks:

* See enrollment on card from muster-in roll.

Book mark:

(358c)

Mowry J. Copyist.

31 7 U.S.C.T.

Edward Forham
Cap., Co. A, 7 Reg't U. S. Col'd Infantry.

Appears on

Company Muster Roll

for Jan & Feb, 1866.

Joined for duty and enrolled:

When Sept 23, 1865.*

Where Gallop Co. Md.*

Period 3 years.*

Present or absent Present

Stoppage, \$ 65 100 for C. & G. E.

Due Gov't \$ 100 for

Remarks:

* See enrollment on card from muster-in roll.

Book mark:

(358c)

Henry J. Copyist.

51

7

U.S.C.T.

Edward Doherty
Corp, Co. A, 7 Reg't U. S. Col'd Infantry.

Appears on

Company Muster Roll

for *March & April*, 1866

Joined for duty and enrolled:

When *Sept 23*, 186*3**

Where *Talbot Co. Md*

Period *3* years.*

Present or absent *Present*

Stoppage, \$ *100* for

Due Gov't \$ *100* for

Remarks:

* See enrollment on card from muster-in roll.

Book mark: _____

(858c)

Henry J.
Copyist.

D 7 U.S.C.T.

Edward Doham

Corp., Co. A, 7 Reg't U. S. Col'd Infantry.

Appears on

Company Muster Roll

for *May & June*, 186*6*

Joined for duty and enrolled:

When *Sept 23*, 186*3*.*

Where *Talbot Co. Md.* *

Period *3* years.*

Present or absent *Present*

Stoppage, \$ *100* for

Due Gov't \$ *100* for

Remarks:

* ~~45~~ See enrollment on card from muster-in roll.

Book mark: -----

(358c)

Provy J.
Copyist.

I

7

U.S.C.T.

Edward Doham

Corp, Co. A, 7 Reg't U. S. Col'd Infantry.

Appears on

Company Muster Roll

for July & Aug, 1866.

Joined for duty and enrolled:

When Sep 23, 1865.*

Where Talbot Co Md.*

Period 3 years.*

Present or absent Present

Stoppage, \$ 100 for

Due Gov't \$ 100 for

Remarks:

[Empty lines for remarks]

* See enrollment on card from muster-in roll.

Book mark:

Mowry Jr
Copyist.

D

7

U.S.C.T.

Edward Durham
Corp, Co. *A*, 7 Reg't U. S. Col'd Infantry.

Appears on **Co. Muster-out Roll**, dated
Indianola Tex, Oct 13, 1866 .

Muster-out to date *Oct 13, 1866* .

Last paid to *June 30, 1866* .

Clothing account:

Last settled....., 186 ; drawn since \$ 100

Due soldier \$ *7*^{*5-4*} / 100; due U. S. \$ 100

Am't for cloth'g in kind or money adv'd \$ 100

Due U. S. for arms, equipments, &c., \$ 100

Bounty paid \$ *None* 100; due \$ *100* ^{*00*} / 100

Remarks: *Joined Orig. Org'n;*
apptd Corp. Aug. 20 1864.

Book mark: *A. 7 Md. 726. 1881. 2977. 1879*

(361)

Mowry J.
 Copyist.

10 | 7 | U.S.C.T.

Edward Dorham
Pvt., Co. A, 7 Reg't U. S. Colored Inf.

Age 21 years.

Appears on

Company Muster-in Roll

of the organization named above. Roll dated
Baltimore Md., Sept. 26, 1863.

Muster-in to date Sept. 26, 1863.

Joined for duty and enrolled:

When Sept. 23, 1863.*

Where Talbot Co. Md. *

Period 3 years.*

Remarks:

*Muster-in roll shows enrollment of all men of this company as of same date. See enrollment on subsequent card or cards.

Book mark: N 7 Md.

Maggett

Dookum, Edward

P. Co. A., 7 Reg't U.S.C. Inf.

1 Enclosures.

Bed Cards	Descriptive Lists
Burial Records	Final Statements
Certs. of Dis. for Discharge	Furloughs
C. M. Charges	Med. Des. Lists
Med. Certificates	Orders

Other papers relating to—

Admission to Hosp'l	Furlough
Casualty Sheet (Officer's)	Med. Examination
Confinement	Misc. Information /
Contracts	Pay or Clothing
Death or Effects	Personal Reports
Desertions	Rank
Discharge from Hosp'l	Transfer to Hosp'l
Discharge from Service	Transfer to V. R. C.
Duty	Transportation

Ed Sorham

1/10 -

Ed Larkham

No 7

No 23

Co. H. 7th Regt. U.S. C. I.
Elizabeth J.
~~Henry~~ Under
Edward Edward

VOLUNTEER DESCRIPTIVE LIST and Account of Pay and Clothing of *A*

NAMES.	RANK.	DESCRIPTION.						WHERE BORN.		OCCUPATION.	ENROLLED OR ENLISTED (For Drafted Men, see note)	
		Years of age.	Eyes.	Hair.	Complexion.	HEIGHT.		State or Kingdom.	Town or county.		When.	Where. (Town and State.)
						Feet.	In.					
1 Gorham Edward	2d	21	Grey	Blk	Swf	5	6 1/2	Me	Talbot	Coachman	Sept 21/1863	Baltimore

REMARK

NOTES.

- The amount of any extra pay for which the soldier may be mustered, *ex. gr.* as Acting Hospital Steward, as Saddler, &c., and which may be still due him, must be carefully noted.
- In the column headed "BOUNTY PAID," must be entered the whole amount hitherto paid him; in that of "BOUNTY DUE," the whole amount yet due him. Bounty paid by State authorities, and not by the United States, will not be entered on this statement.
- Stoppages for loss or damage done to arms, or other public property, must be noted, and the articles, and particular damage to each, specified. When stoppages are due, under sentence of a Court Martial, a transcript of the same must be entered here; and the amount already stopped, must be carefully stated.
- In every case of desertion, the date, and that of delivery, or apprehension, must be given, together with a correct transcript of the order of sentence or pardon.
- A careful settlement of the man's CLOTHING ACCOUNT must be made, to date, and the amount DUE TO, or FROM him must be precisely stated.
- Should the man have been engaged in any action or skirmish, it must be mentioned, together with date and place. A full and particular mention will be made of any wounds he may have received in action, or other injury, whilst in the line of his duty.
- If the soldier is entitled to pay for the use of his horse, the company commander will certify to that fact on this list, and also to the time he has pay due for having been so mounted on his own horse.
- When a soldier is furnished with final statements, his descriptive list, if he has one, should be taken up by the officer who gives the soldier these statements, and endorsed with a statement to this effect by the officer. This endorsement should exhibit a full statement of the time for which the soldier was allowed pay on his final statements, the clothing account, and all other charges against him or in his favor, so as to comprise a complete exhibit of his account. It will then be transmitted to the company commander of the soldier, who will enter all the data necessary to a full understanding of the soldier's account on the muster roll upon which the soldier's discharge is reported. The descriptive list will then be destroyed. The object of this is, that the remaining portion of the soldier's account may be settled upon the receipt of these muster rolls, and the soldier receive any pay or allowances that may be due him at the time of his discharge, and which may not appear on his final statements from the fact that his descriptive list is incomplete. These accounts for back pay, &c., are settled by the 2d Auditor of the Treasury Dep't.
- Where a soldier dies in Hospital or on detached service, his descriptive list, if he has one, should be sent with his final statements, in duplicate to the Adjutant General, Washington, D. C.
- Men drafted will be considered as mustered in from the date of their draft and will be mustered for pay on the usual rolls for Volunteers. On the same line as the soldier's name, under the heading "Joined for Duty or Enrolled.—Commencement of First Payment by Time," will be written the word *drafted*, or *substitute*, as the case may be; and under the heading "When Mustered in" will be given the date when the soldier was drafted, or, if a substitute, when enlisted, (substitutes, under the Enrollment Act, are mustered in by enlistment;) under "Where Mustered in" will be given the place from which drafted, (or if a substitute, where enlisted;) under the heading "By whom Mustered in," will be given the No. of the Enrollment District from which he was drafted, and the State to which it belongs, thus: *4th D. Mass.*; (meaning 4th Enrollment District of the State of Massachusetts.) Or if a substitute, the name of the officer enlisting him. (When enlisted by Board of Enrollment, the name of Provost Marshal of the Enrollment District.)
- A separate descriptive list should, as a general rule, be given for each man.
- Descriptive lists must, in all cases, be signed by COMMISSIONED officers, not by enlisted men acting as such.

MAR 13 1865

A Recruit in 7th US Inf

DRAFTED OR ENLISTED. (For Drafted Men, see note 10.)		MUSTERED IN. (For Drafted Men, see note 10.)				LAST PAID.		BOUNTY.		CLOTHING ACCOUNT.	
Where. (Town and State.)	By whom.	When.	Where. (Town and State.)	By whom. (In the case of drafted men, from what enrollment district.)	Period.	By paymaster.	To what time.	Paid \$ (See note 2.)	Due \$ (See note 2.)	Date of last settlement.	Total money value of clothing drawn since last settlement.
<i>Baltimore</i>	<i>John H. Williams</i>	<i>Sept 26th 1863</i>	<i>Benedict</i>	<i>John H. Williams</i>	<i>3 1/2 yrs</i>					<i>Co I 7th US Inf</i>	<i>Mrs. E. J. Wain</i>
						<i>Ludwig Winter</i>					

REMARKS.

I CERTIFY that the above is a correct transcript from the Records of *the Co I 7th US Inf*
from Maryland for US 6th Regt

statements, in duplicate,
from the date of their draft,
for Volunteers. On the
"Joined for Duty and
by Time," will be written
be; and under the head-
when the soldier was
stitutes, under the Enroll-
"Where Mustered in,"
or if a substitute, where
red in," will be given the
was drafted, and the State
g 4th Enrollment District,
the name of the officer
rollment, the name of the
le, be given for each man.
y COMMISSIONED officers;

STATION: *Baltimore Md*
DATE: *August 28th 1865*

William K Spear
1st Lt. V.R. Inspector

Edw. J. Wain
Commanding the Company.
of 7th US Inf

unit in 7th Regt I

m.	MUSTERED IN. (For Drafted Men, see note 10.)				LAST PAID.		BOUNTY.		CLOTHING ACCOUNT.	
	When.	Where. (Town and State.)	By whom. (In the case of drafted men, from what enrollment district.)	Period.	By paymaster.	To what time.	Paid \$ (See note 2.)	Due \$ (See note 2.)	Date of last settlement.	Total money value of clothing drawn since last settlement.
	Sept 26 th 1863	Benedict	<i>[Signature]</i>	3 rd Yr	<i>[Signature]</i>				Co I 7 th Regt I	
					<i>[Signature]</i>				Mrs. E. J. Whelan	

I CERTIFY that the above is a correct transcript from the Records of *the Comd. Regiment of Scouts from Maryland for U.S. Colored Troops*

STATION: *Baltimore Md*
 DATE: *August 28th 1865*

Horan K Spear
 1st Lt. U.S. Army Inspector

[Signature]
 Commanding the Company, *Printed Office*
 of the *[Signature]*

War Department,

ADJUTANT GENERAL'S OFFICE,

Washington, *May 9th* 1867.

Respectfully returned to the Commission for the State of Maryland, with the information that Edward Norham was enlisted at Falbot, Md Sept 23, 1863 and was mustered in as Pvt in Co "A" 7th U.S. Col. Sept 26, 1863.

J. W. Hazard

Asst. Adj't General.

W. F. Med

W. F. Med

EVIDENCE OF TITLE.

I Elizabeth T Winder of Talbot County Maryland, do solemnly swear that Ed. Durham, alias Ned Dorum, who has been enlisted in the Seventh Regiment, U. S. Colored Troops, Co. A; was my Slave for life at the time of said enlistment; and that I became possessed of him by ~~purchase~~ ^{as the time} ~~in the month of~~ ^{the} ~~his birth~~ ^{she being} ~~eighteen~~ ^{my slave} hundred and ~~by purchase~~. And I do further swear that I have not purchased said Slave from any person or persons disloyal to the Government of the United States, with the object of obtaining compensation for the same: and furthermore, that I have no agency for obtaining compensation for any person or persons but such as to my knowledge are loyal citizens of the United States.

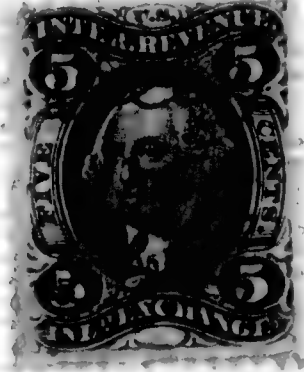

Sworn and subscribed before

E. J. Winder
Allen E. Forrester,
Justice of the Peace.

STATE OF MARYLAND,
Baltimore City County, to wit:

On this 11th day of December in the year 1866, before me, the subscriber, a Justice of the Peace of the State and County aforesaid, personally appeared Elizabeth T. Pennington a resident of Baltimore City County, State of Maryland and Mary Winder a resident of Talbot County, State of Maryland having first been duly sworn, upon their oaths declare that they reside respectively in Baltimore City County, State of Maryland and Talbot County, State of Maryland; that they are personally acquainted with Elizabeth T. Winder claimant for compensation for her Slave Ed. Durham alias Ned Dorum under the Acts of Congress of February 24, 1864, and July 28, 1866, and that they know that said "claimant hath firmly and faithfully maintained her allegiance and adherence to the Government of the United States, by defending its cause against the Government of the so-called Confederate States of America, in all suitable and practicable ways, and according to her ability and opportunity;" they also swear that they have themselves maintained a like adherence and allegiance to the Government of the United States, and they have no interest in said claim.



Sworn and subscribed before

E. J. Pennington
Mary Winder
Allen E. Forrester,
Justice of the Peace.

STATE OF MARYLAND, City of Baltimore, to wit:
County, to wit:

I, Alford Meace Clerk of the Superior Circuit Court for Baltimore County, do hereby certify that Allen E. Forrester before whom the foregoing affidavits were made, was, at the time of signing the same, a Justice of the Peace for the County and State aforesaid, duly commissioned and sworn; and that his signature thereto is genuine, and that full faith and credit should be given to his official acts.

Witness my hand and the Seal of said Court, this 12th day of December A. D. 1866



Alford Meace
Clerk.

No to want

Endorsement.

No. 7
APPLICATION OF

Elizabeth T. Kinder
OF

Tallahassee County

for compensation for service of slave,

Ed. Darthson

enlisted September 21st, 1863,

in F. Co. Seventh Regiment

U. S. Colored Troops.

Received December 14th, 1866.

Compensation awarded,

....., 186

Dollars.

President Board of Claims.

P. O. ADDRESS OF CLAIMANT:

Care Wahne Lloyd
193 Smiths Wk
Beltroad

CERTIFICATE OF AWARD OF THE BOARD OF CLAIMS.

OFFICE OF THE BOARD OF CLAIMS,

For Slaves Enlisted or Drafted in the Service of the United States,

....., 186 .

We hereby certify that, of

..... county, State of,

having proved, under oath,, loyalty to the Constitution and Government of the United States, and established, title to the ownership of

....., a slave enlisted or drafted (*as the case may be*) and mustered at

....., on the, day of,

186 , by, in the service of the United States, in the, Regiment of Colored Troops, Co., the sum of

..... dollars has been awarded to, by this Board, subject

to the approval of the Secretary of War, as a compensation for the said slave, under the provisions of Section 24, Act approved February 24, 1864, and Section 2, Act approved July 28, 1866.

....., *President of the Board.*

....., *Member of the Board.*

....., *Member of the Board.*

To

Chief of the Bureau for the

Organization of Colored Troops, Washington, D. C.

CLAIM FOR COMPENSATION FOR ENLISTED SLAVE.

No. _____

I, Elizabeth T Winder a loyal citizen, and a resident of Maryland, County of Talbot, State of Maryland, hereby claim compensation, under the provisions of Section 24, Act approved February 24, 1864, and Section 2, Act approved July 28, 1866, for my slave Ed. Dotham alias Ted Dorum, enlisted 21 of Sept 1863, at Baltimore, by Col. Birney, in the Seventh Regiment U. S. Colored Troops, Co. A; certificate of which enlistment and a descriptive list, as required, accompany this application.

In proof of my loyalty to the Constitution and Government of the United States, I present the accompanying oath, which I have taken, signed and acknowledged; to be filed with this application, in accordance with requirement of General Orders, No. 329, 1863, War Department, Adjutant General's Office.

E. J. Winder

December 11th, 1866.

OATH OF ALLEGIANCE.

I, Elizabeth T Winder, the owner and claimant, do solemnly swear that the foregoing claim is a just and true claim due to me as master and owner of the said slave, and that the facts alleged in said claim in respect to the draft or enlistment (*as the case may be*) of said slave into the military service of the United States are true. And I do further swear that I have never joined, *or been concerned in, any insurrection or rebellion; that I have never borne arms against the United States; that I have never given any aid, countenance, counsel or encouragement* to any person or persons engaged, or whom I had reason to believe were about to engage, in insurrection, rebellion or armed hostility against the United States; that I have neither sought, nor accepted, nor attempted to exercise the functions of any office, civil or military, nor to perform any service whatever, under any authority or pretended authority in hostility to the United States; that I have not yielded a voluntary support to any insurrection, rebellion or pretended government, authority, power or constitution within the United States hostile thereto. And I do further swear that, to the best of my knowledge and ability, I have supported and defended, and will continue to support and defend, the United States against all enemies, foreign and domestic; and that I have supported, defended and obeyed, and will continue to support, defend and obey, the Constitution and laws of the United States; that I will bear true faith and allegiance to the same; and that I take this oath freely, without any mental reservation or purpose of evasion: So help me God.

E. J. Winder

Sworn to and subscribed before me, at Baltimore, Md }
 this 11th day of December, 1866.

Allen E. Corbett
Justice of the Peace

Dorshins Benjamin

Co G, 7 U.S. Col'd Inf.

Private

Private

CARD NUMBERS.

1 6290943
 2 6291042
 3 6291207
 4 6279562
 5 6292429
 6 9066661
 7 656-0J-1880
 8
 9
 10
 11
 12
 13
 14
 15
 16
 17
 18
 19
 20
 21
 22
 23
 24
 25

26
 27
 28
 29
 30
 31
 32
 33
 34
 35
 36
 37
 38
 39
 40
 41
 42
 43
 44
 45
 46
 47
 48
 49
 50

Book Mark. 656-0. J. 80. L. B. 13/342

See also

20 | 7 | U.S.C.T.

Benjamin Perkins
Co. G, 7 Reg't U.S. Col'd Inf.

Appears on
Company Descriptive Book
of the organization named above.

DESCRIPTION.

Age *18* years; height *5* feet *4 3/4* inches.

Complexion *Black*

Eyes *Black*; hair *Curly*

Where born *Calvert, Ind.*

Occupation *Farmer*

ENLISTMENT.

When *Oct 22*, 186*5*.

Where *Calvert*

By whom *Col. W. Roney*; term *3* y'rs.

Remarks: *Musician. Deserted
from Reg't at Bendlet,
Ind. Nov 16 - 1865.*

J. B. Brown
Copist.

D | 7 | U.S.C.T.

Benjamin Dorking
Priv., Co. *G*, 7 Reg't U. S. Col'd Inf.

Age *18* years.

Appears on

Company Muster-in Roll

of the organization named above. Roll dated

Camp Stanton Charles Co., Md., Nov. 5, 1863.

Muster-in to date *Nov. 5, 1863.*

Joined for duty and enrolled:

When *Oct. 22*, 1863.

Where *Calvert, Md.*

Period *3* years.

Remarks: _____

Book mark: _____

Sandy
Copyist.

D

7

U.S.C.T.

Benjamin Dorkins

Priv., Co. G, 7 Reg't U. S. Col'd Infantry.

Appears on

Company Muster Roll

for *Nov. 5 to Dec. 31*, 1863.

Present or absent *Absent*

Stoppage, \$ *100* for

Due Gov't, \$ *100* for

Remarks: *Sent to Hospital
Nov. 12", 1863. Absented
himself without leave,
date unknown.*

Book mark:

(858)

Sandoy
Copyist

D

7

U.S.C.T.

Benjamin Parkins

Priv., Co. G, 7 Reg't U. S. Col'd Infantry.

Appears on

Company Muster Roll

for *Jan. & Feby.*, 1864.

Present or absent

Stoppage, \$ 100 for

Due Gov't, \$ 100 for

Remarks: *Sent to Hospital, Benedict, Md., Nov. 12, 1863. Deserted from Hospital, date unknown.*

Book mark:

Sandq.
Copyist

(858)

9 | 4

U.S.C.T.

Benj. Parkins
Pri., Co. G 7 Reg't U. S. Col'd Infantry.

Appears on

Descriptive List of Deserters

dated Feb. 8th, 1864.

Deserted:

When Jan'y. - , 1864.

Where Benedict, Md.

Arrested:

When _____, 186 .

Where _____

Remarks: From Post Hospital
Precise date not known.

Book mark : _____

(851)

J. H. Smith
Copist.

P

7

U.S.C.T.

Benjamin Watkins

Pvt, Co. G, 7 Reg't U. S. Col'd Infantry.

Appears on Co. Muster-out Roll, dated Indianola Texas, Oct 13, 1866.

Muster-out to date, 1866.

Last paid to Pay due from muster, 1866.

Clothing account:

Last settled, 1866; drawn since \$ 100

Due soldier \$ 100; due U. S. \$ 100

Am't for cloth'g in kind or money adv'd \$ 100

Due U. S. for arms, equipments, &c., \$ 100

Bounty paid \$ 100; due \$ 100

Remarks: Deserted at Camp Stanton md Nov 18 1863

Book mark: 3403. 1880 ago.

over

Hadfield

JAN. 21

6292429

1891

Charge of desertion re-
moved died Nov 18/63
at Camp Stanton Md
cause of death unknown
656 C-80 L B. / 13/342

217 U.S.C.T.

Benjamin Dorkins,
Co. G, 7th Reg't U.S.C.T.

RB. 13/342 **NOTATION.**

Book mark: 656. 6. J. 1880.

War Department,

Adjutant General's Office,

Washington, June 8th, 1880.

"Charge of desertion removed -
died Nov. 18, 1863 at Camp
Stanton, Md. - cause of death
unknown."

E. P. Conrazier

Norman Daniel

Co D, 7 U.S. Col'd Inf.

Private

Private

CARD NUMBERS.

1	6 2 8 5 4 6 3	26
2	6 2 8 5 5 6 4	27
3	6 2 8 5 6 6 1	28
4	6 2 8 5 7 6 5	29
5	6 2 8 5 8 6 9	30
6	6 2 8 5 9 6 9	31
7	6 2 8 6 0 6 6	32
8	6 2 8 6 1 5 9	33
9	6 2 8 6 2 3 4	34
10	6 2 8 6 3 4 2	35
11	6 2 8 6 4 1 9	36
12	6 2 8 6 5 0 9	37
13	6 2 8 6 5 9 9	38
14	6 2 8 6 6 8 6	39
15	6 2 8 6 7 6 8	40
16	6 2 8 6 8 4 6	41
17	6 2 8 6 9 0 8	42
18	6 2 8 6 9 7 4	43
19	6 2 8 7 0 2 9	44
20	6 2 8 7 0 8 5	45
21	9 0 6 6 2 8 3	46
22		47
23		48
24		49
25		50

Book Mark:

See also

29 | 7 | U.S.C.T.

Samuel Norman
 _____, Co. *A*, 7 Reg't U.S. Col'd Inf.

Appears on
Company Descriptive Book
 of the organization named above.

DESCRIPTION.

Age *40* years; height *5* feet *7* inches.

Complexion *Black*

Eyes *Black*; hair *Curly*

Where born *Talbot, Md.*

Occupation *Farmer*

ENLISTMENT.

When *Sept 26*, 186*3*.

Where *Queen Ann*

By whom *Col. W. B. King*; term *3* y'rs.

Remarks: *mustered Sept*
29. 63.

Samuel Norman

D | 7 | U.S.C.T.

Daniel Dorman
Pvt, Co. D, 7 Reg't U. S. Colored Inf.

Age 40 years.

Appears on

Company Muster-in Roll

of the organization named above. Roll dated
Baltimore Md, Sep. 29, 1863.

Muster-in to date Sep. 29, 1863.

Joined for duty and enrolled:

When Sep 26, 1863.*

Where Queen Ann Co. Md.

Period 9 years.*

Remarks:

*Muster-in roll shows enrollment of all men of this company as of same date. See enrollment on subsequent card or cards.

Book mark :

R. S. Shelton

D

7

U.S.C.T.

Daniel Dorman

Private, Co. D, 7 Reg't U. S. Col'd Infantry.

Appears on

Company Muster Roll

for from Sept 29 to Oct 31, 1863.

Joined for duty and enrolled:

When Sept 26, 1863*

Where Queen Anns. Co. Md.*

Period 3 years.*

Present or absent Present

Stoppage, \$ 100 for

Due Gov't \$ 100 for

Remarks:

[Empty lines for remarks]

* See enrollment on card from muster-in roll.

Book mark:

R. S. Shelton

(358c)

Copyist.

D | **7** | **U.S.C.T.**

Daniel Gorman

Priv, Co. D, 7 Reg't U. S. Col'd Infantry.

Appears on

Company Muster Roll

for *Nov + Dec*, 186*3*

Joined for duty and enrolled:

When *Sept 26*, 186*3**

Where *Queen Ann Md**

Period *3* years.*

Present or absent *Present*

Stoppage, \$ *100* for

Due Gov't \$ *100* for

Remarks:

* See enrollment on card from muster-in roll.

Book mark: _____

R B Shelton

D | **7** | **U.S.C.T.**

Daniel Dorman
Priv, Co. D, 7 Reg't U. S. Col'd Infantry.

Appears on

Company Muster Roll

for *Jan & Feb*, 1864.

Joined for duty and enrolled:

When *Sept 26*, 186*3**

Where *Queen Ann Md**

Period *3* years.*

Present or absent *Present*

Stoppage, \$ *100* for

Due Gov't \$ *100* for

Remarks:

* See enrollment on card from muster-in roll.

Book mark:

R S Shetton
(358c) Copyist.

9

7

U.S.C.T.

Daniel Dorman
Priv., Co. D, 7 Reg't U. S. Col'd Infantry.

Appears on

Company Muster Roll

for Michapl, 1864.

Joined for duty and enrolled:

When Sept 26, 1863*

Where Queen Ann Md *

Period 3 years.*

Present or absent Present

Stoppage, \$ 100 for

Due Gov't \$ 100 for

Remarks:

* See enrollment on card from muster-in roll.

Book mark:

R S Shelton

(358c)

Copyist.

9

7

U.S.C.T.

Daniel Dorman

Priv, Co. D, 7 Reg't U. S. Col'd Infantry.

Appears on

Company Muster Roll

for May & June, 1864.

Joined for duty and enrolled:

When Sept 26, 1863*

Where Queen Ann Co. Md.*

Period 3 years.*

Present or absent Present

Stoppage, \$ 100 for

Due Gov't \$ 100 for

Remarks:

* See enrollment on card from muster-in roll.

Book mark:

R. S. Shelton

D | 7 | U.S.C.T.

Daniel Dorman

Pvt, Co. D, 7 Reg't U. S. Col'd Infantry.

Appears on

Company Muster Roll

for July & Aug, 1864.

Joined for duty and enrolled:

When Sept 26, 1863*

Where Queen Ann Md.*

Period 3 years.*

Present or absent Present

Stoppage, \$ 100 for

Due Gov't \$ 100 for

Remarks:

* See enrollment on card from muster-in roll.

Book mark:

R S Shelton

(358c)

Copyist.

D

7

U.S.C.T.

Daniel Dorman
Priv., Co. D, 7 Reg't U. S. Col'd Infantry.

Appears on

Company Muster Roll

for *Sept. & Oct.*, 186*3*.

Joined for duty and enrolled:

When *Sept 26*, 186*3*.*

Where *Queen Ann* *

Period *3* years.*

Present or absent *absent*

Stoppage, \$ *100* for

Due Gov't \$ *100* for

Remarks: *Sick in Hospital*
date & locality unknown.

* See enrollment on card from muster-in roll.

Book mark:

(358c)

A. W. Neal

Copyist.

10

7

U.S.C.T.

Daniel Donnan
Private, Co. D, 7 Reg't U. S. Col'd Infantry.

Appears on

Company Muster Roll

for *Nov. & Dec.*, 186*4*.

Joined for duty and enrolled:

When *Sept. 26*, 186*3**

Where *Queen Ann**

Period *3* years.*

Present or absent *Present*

Stoppage, \$ *100* for

Due Gov't \$ *100* for

Remarks:

* See enrollment on card from muster-in roll.

Book mark:

F. W. Asale

(358c)

Copyist.

D

7

U.S.C.T.

Daniel Dorman

Private, Co. D, 7 Reg't U. S. Col'd Infantry.

Appears on

Company Muster Roll

for Jan'y 4. Feb, 1865.

Joined for duty and enrolled:

When Sept. 26, 1863.*

Where Queen Ann Co *

Period 3 years.*

Present or absent Present

Stoppage, \$ 100 for

Due Gov't \$ 100 for

Remarks: Stop / canteen

* See enrollment on card from muster-in roll.

Book mark:

F. W. Neale

(358c)

Copyist.

10 | 7 | **U.S.C.T.**

Daniel Donnan
Private, Co. D, 7 Reg't U. S. Col'd Infantry.

Appears on

Company Muster Roll

for March & April, 1865.

Joined for duty and enrolled:

When Sept. 26, 1865.*

Where Queen Co. Md. *

Period 3 years.*

Present or absent Present

Stoppage, \$ 100 for

Due Gov't \$ 100 for

Remarks: Stop 1 canteen

* See enrollment on card from muster-in roll.

Book mark: _____

(358c) F. D. Neale Copyist.

D | 7 | **U.S.C.T.**

Daniel Daman

Priv., Co. D, 7 Reg't U. S. Col'd Infantry.

Appears on

Company Muster Roll

for *May 8, June*, 186*5*.

Joined for duty and enrolled:

When *Sept. 26*, 186*5*.*

Where *Green Ann Md.* *

Period *3* years.*

Present or absent *Present*

Stoppage, \$ *100* for

Due Gov't \$ *100* for

Remarks:

* See enrollment on card from muster-in roll.

Book mark: _____

F. M. ... Copyist.

D

7

U.S.C.T.

Daniel Donnan

Priv., Co. D, 7 Reg't U. S. Col'd Infantry.

Appears on

Company Muster Roll

for *July & Aug*, 186*5*.

Joined for duty and enrolled:

When *Sept 26*, 186*3*.*

Where *Queen Ann Co. Md.* *

Period *3* years.*

Present or absent *Present*

Stoppage, \$ *100* for

Due Gov't \$ *100* for

Remarks:

* See enrollment on card from muster-in roll.

Book mark: -----

(358c)

F.M. Neal

Copyist.

D

7

U.S.C.T.

Daniel Dorman

Pvt., Co. D, 7 Reg't U. S. Col'd Infantry.

Appears on

Company Muster Roll

for *Sept. & Oct.*, 1865.

Joined for duty and enrolled:

When *Sept 26*, 1865.*

Where *Queen Ann Ind.* *

Period *3* years.*

Present or absent *Present*

Stoppage, \$ *100* for

Due Gov't \$ *100* for

Remarks:

* See enrollment on card from muster-in roll.

Book mark: _____

(358c)

J. M. Neale

Copyist.

D

7

U.S.C.T.

Daniel Dorman

Pvt, Co. D, 7 Reg't U. S. Col'd Infantry.

Appears on

Company Muster Roll

for Nov. & Dec, 1868.

Joined for duty and enrolled:

When Sept 26, 1863.*

Where Queen Ann Md.*

Period 3 years.*

Present or absent Present

Stoppage, \$ 100 for

Due Gov't \$ 1.02 for Ordnance & Ord. stores

Remarks:

* See enrollment on card from muster-in roll.

Book mark:

Hearst

2 | 7 | U.S.C.T.

Daniel Dorman

Pvt, Co. D, 7 Reg't U. S. Col'd Infantry.

Appears on

Company Muster Roll

for Jan'y & Feby, 1866.

Joined for duty and enrolled:

When Sept. 26, 1863.*

Where Q. Anns Md. *

Period 3 years.*

Present or absent Present

Stoppage, \$ 100 for

Due Gov't \$ 100 for

Remarks: Det. in Q. M. Dept. S. O. No. 1 dated 4th Q. M. Post Lavaca Tex Feb. 12 1866

* See enrollment on card from muster-in roll.

Book mark:

Hearst

D | 7 | U.S.C.T.

Daniel Dorman

Priv., Co. D, 7 Reg't U. S. Col'd Infantry.

Appears on

Company Muster Roll

for Mch & Apr, 1866.

Joined for duty and enrolled:

When Sept 26, 1863.*

Where Q Annis Md *

Period 3 years.*

Present or absent Present

Stoppage, \$ 100 for

Due Gov't \$ 100 for

Remarks:

* See enrollment on card from muster-in roll.

Book mark:

Hurst

D

7

U.S.C.T.

Daniel Dorman

Plt, Co. D, 7 Reg't U. S. Col'd Infantry.

Appears on

Company Muster Roll

for May & June, 1866.

Joined for duty and enrolled:

When Sept 26, 1863.*

Where G. Ann Md *

Period 3 years.*

Present or absent Present

Stoppage, \$ 100 for

Due Gov't \$ 100 for

Remarks:

* See enrollment on card from muster-in roll.

Book mark:

Yeart Copyist.

D | 7 | U.S.C.T.

Daniel Dorman

Pol, Co. D, 7 Reg't U. S. Col'd Infantry.

Appears on

Company Muster Roll

for July & Aug, 1866.

Joined for duty and enrolled:

When Sept 26, 1863.*

Where G. Ann Md *

Period 3 years.*

Present or absent Present

Stoppage, \$ 100 for

Due Gov't \$ 100 for

Remarks:

* See enrollment on card from muster-in roll.

Book mark:

(358c) Heard Copyist.

7

U.S.C.T.

Daniel Dorman

Prvt, Co. *D*, 7 Reg't U. S. Col'd Infantry.

Appears on **Co. Muster-out Roll**, dated *Indianola Texas*, *Oct 13*, 186*6*.

Muster-out to date *Oct 13*, 186*6*.

Last paid to *June 30*, 186*6*.

Clothing account:

Last settled....., 186 ; drawn since \$..... 100

Due soldier \$ *26*^{*44*}/₁₀₀; due U. S. \$..... 100

Am't for cloth'g in kind or money adv'd \$..... 100

Due U. S. for arms, equipments, &c., \$ *1*^{*50*}/₁₀₀

Bounty paid \$..... 100; due \$ *100*^{*00*}/₁₀₀

Remarks: *Joined at original Organization*
Stop for one Bayonet scabbard - One C.B.
Belt - One C.B.B Plate. One Gun sling
and one wipe & \$1.50

Book mark: *V. 165. P. 193. 43. 311. 799.*

Hearst

418

Dorsey, Alfred

Co 6, 7 U.S. Col'd Inf.

Private | Private

CARD NUMBERS.

1	6 2 7 9 0 7 7	26
2	6 2 7 8 8 5 0	27
3	6 2 8 4 5 5 8	28
4	6 2 8 4 6 6 3	29
5	6 2 8 4 7 6 6	30
6	6 2 8 4 9 1 9	31
7	6 2 7 9 3 5 8	32
8	6 2 8 5 3 4 1	33
9	9 0 6 6 1 5 2	34
10		35
11		36
12		37
13		38
14		39
15		40
16		41
17		42
18		43
19		44
20		45
21		46
22		47
23		48
24		49
25		50

Book Mark E. B. 12 / 214. E. B. V. 10, P. 49

See also

9

7

U.S.C.T.

Alfred Dorsey

Co. *C*, 7 Reg't U.S. Col'd Inf.

Appears on

Company Descriptive Book

of the organization named above.

DESCRIPTION.

Age *26* years; height *5* feet *5 1/2* inches.

Complexion *Black*.

Eyes *Black*; hair *Black*.

Where born *Virginia*.

Occupation *Laborer*.

ENLISTMENT.

When *March 9*, 186*3*.

Where *Fredrick*.

By whom *Capt. Nail*; term *3* y'rs.

Remarks: *Substitute for Benjamin Frick 4 Comg. Dist. Wm. wounded out by order of the Sec. of the War dated May 3, 65. Discharged fr. Balfour W.S. Gen. Dist. Portsmouth Va.*

J. Smith

2 | 7 | U.S.C.T.

Alfred Dorsey

Appears with rank of _____ on
**Muster and Descriptive Roll of a Detach-
ment of Drafted Men and Substitutes
forwarded**

for the 7 Reg't U. S. Col'd Inf. Roll dated
Baltimore Md, Mar 11, 1865.

Where born Virginia

Age 26 years; occupation Laborer

Drafted and mustered in:

When Mar 9th, 1865.

Where Frederick

Period 3 years.

Eyes Blk; hair Blk

Complexion Blk; height 5 ft. 5 in.

Paid bounty and advance pay, \$ 100

Bounty due \$ 100

Where credited _____

Company to which assigned _____

Remarks: Subs for Benjamin
Grick 4 Dist Md

Book mark: _____

J. M. Tait
(340) Copyist

0 1 7 | **U.S.C.T.**

Alfred Dorsey
Prw, Co., *7* Reg't U. S. Col'd Infantry.

Age *26* years.

Appears on a

Detachment Muster-in Roll

of the organization named above. Roll dated

Baltimore, Md., Mar. 16, 186*5*.

Muster-in to date *Mar. 16*, 186*5*.

Joined for duty and enrolled:

When *Mar. 9*, 186*5*.

Where *Frederick*

Period *3* years.

Remarks: *Substitute*

Book mark: _____

10 | 7 | U.S.C.T.

Alfred Dorsey
Pvt., Co. C, 7 Reg't U. S. Col'd Infantry.

Appears on

Company Muster Roll
for Mar. & Apr., 1865.

Joined for duty and enrolled:

When Mar. 29, 1865.*

Where *

Period 3 years.*

Present or absent Absent

Stoppage, \$ 100 for

Due Gov't \$ 100 for

Remarks: Joined Co. Mar. 18/65
Sick Point-Rocks since
Mar. 25/65

* See enrollment on card from muster-in roll.

Book mark:

(358c) M. M. Murphy Copyist.

10 | 7 | U.S.C.T.

Alfred Hovey
Private, Co. C, 7 Reg't U. S. Col'd Infantry.

Appears on

Company Muster Roll
for May 7 June, 1865.

Joined for duty and enrolled:

When Mar. 9, 1865.*

Where Howard *

Period 3 years.*

Present or absent Absent

Stoppage, \$ 100 for

Due Gov't \$ 100 for

Remarks: Joined Co. Mar. 18/65
Sick in Point of Rocks
since May 25/65

* See enrollment on card from muster-in roll.

Book mark:

(258c) M. M. Murphy Copyist.

10

7

U.S.C.T.

Alfred Dorsey

Private, Co. C, 7 Reg't U. S. Col'd Infantry.

Appears on

Company Muster Roll

for July & Aug., 1865

Joined for duty and enrolled:

When Mar. 8, 1865*

Where Howard *

Period one years.*

Present or absent Absent

Stoppage, \$ 100 for

Due Gov't \$ 100 for

Remarks: Sick in Point
Rock's Hosp. since
May 25/65

* See enrollment on card from muster-in roll.

Book mark:

Wm. M. Murphy

(258c)

Copyist.

10 | 7 | U.S.C.T.

Alfred Borsey
Priv., Co. C, 7 Reg't U. S. Col'd Infantry.

Appears on

Company Muster Roll
for Sept. & Oct., 1865.

Joined for duty and enrolled:

When Mar. 9, 1865.*

Where Frederick, Md. *

Period 3 years.*

Present or absent

Stoppage, \$ 100 for

Due Gov't \$ 100 for

Remarks: Mustered out
by order War Dept.
June 3/65

* See enrollment on card from muster-in roll.

Book mark: Discharged (over)

M. M. Murphy
Copyist.

6284919

JAN. 20

6284919

018910

(May 19/65 E. B. $\frac{1^2}{214}$)

20 | 7

U.S.C.T.

Alfred Torsey
Priv., Co. C, 7 Reg't U. S. Col'd *Inf.*

Appears on an

Individual Muster-out Roll

of the organization named above. Roll dated

Norfolk, Va. June 3, 1865.

Muster-out to date June 3, 1865.

Last paid to *Pay due from enlistment,* 186 .

Clothing account:

Last settled ^{never} Settled 186 ; drawn since \$ 100

Due soldier \$ 100; due U. S. \$ 100

Am't for cloth'g in kind or money adv'd \$ ^{since last settlement} 27 ¹³/₁₀₀

Due U. S. for arms, equipments, &c., \$ 100

Bounty paid \$ 100; due \$ 100

Remarks: Mustered out by order of the War Dept, dated May 3rd, 1865. Discharged from Balfour U.S. Genl. Hospital Portsmouth, Va.
(over)

Book mark: 2^d and Mch '72

C. R. Owen

JAN. 20

6279358

1891

Five Soldier Two
Hundred & Eighty
(280) Dollars, Amount
taken from him
at Draft Rendez-
vous, Bradford, Md.
by Major W. H.
Nichols, P.M., U. S. A.,
under G. O. No. 205,
War Dept. 1864,

S. | 7 | U.S.C.T.

Alfred Dorsey
Co. C, 7 Reg't U. S. Col'd Infantry.

Appears on **Co. Muster-out Roll**, dated
Indianola Texas, Oct 13, 1866.

Muster-out to date _____, 186 .

Last paid to Pay due from Enrollment, 186 .

Clothing account:

Last settled _____, 186 ; drawn since \$ _____ 100

Due soldier \$ _____ 100; due U. S. \$ _____ 100

Am't for cloth'g in kind or money adv'd \$ _____ 100

Due U. S. for arms, equipments, &c., \$ _____ 100

Bounty paid \$ _____ 100; due \$ _____ 100

Remarks: Discharged at
Postmouth Va May 3
"65 for disability.

Book mark: U35 P41. 72

(361)

Fopez
(over)

Copyist.

JAN. 20

6285341

818918

*Recharged June 3" 65
E.B. 40 P49.*

417
Dorsey Eli

Co G, 7 U.S. Col'd Inf.

Private

Private

CARD NUMBERS.

1	6290944	26
2	6291043	27
3	6291208	28
4	6279567	29
5	6292430	30
6	9066662	31
7		32
8		33
9		34
10		35
11		36
12		37
13		38
14		39
15		40
16		41
17		42
18		43
19		44
20		45
21		46
22		47
23		48
24		49
25		50

Book Mark:

See also:

Q 611159 Q, 0, 90 Rth
Rep 413346

29

7

U.S.C.T.

Eli Hovey

Co. G, 7 Reg't U. S. Col'd Inf.

Appears on

Company Descriptive Book

of the organization named above.

DESCRIPTION.

Age 22 years; height 5 feet 4 1/2 inches.

Complexion Black

Eyes Black; hair curly

Where born St. Mary, Md.

Occupation Farmer

ENLISTMENT.

When Nov 2, 186 .

Where St. Mary

By whom Col. M. Barry, term 3 y'rs.

Remarks: * Killed Sept. 27, 1864. Inherited Camp Stanton, Md. Feb 7 '64.

* As it is on book.

J. B. Brown

D

7

U.S.C.T.

Eli Dorsey

Priv., Co. G., 7 Reg't U. S. Col'd Inf.

Age 22 years.

Appears on

Company Muster-in Roll

of the organization named above. Roll dated

Camp Stanton, Charles Co., Md. Nov. 5, 1863.

Muster-in to date Nov. 5, 1863.

Joined for duty and enrolled:

When Nov. 2, 1863.

Where St. Marys, Md.

Period 3 years.

Remarks:

Book mark:

Sandys
Copyist.

D

7

U.S.C.T.

Eli Dorsey

Priv., Co. G, 7 Reg't U. S. Col'd Infantry.

Appears on

Company Muster Roll

for Nov. 5 to Dec. 31, 1863.

Present or absent Absent

Stoppage, \$ 100 for

Due Gov't, \$ 100 for

Remarks: Premium for enlistment \$2.00 due. Detailed recruiting at Baltimore, Md., Reg'l. order Dec. 20, 1863.

Book mark:

Sandq
Cpyist

(858)

D

7

U.S.C.T.

Eli Dorsey

Priv., Co. G, 7 Reg't U. S. Col'd Infantry.

Appears on

Company Muster Roll

for *Jan. & Feby*, 1864.

Present or absent

Stoppage, \$ 100 for

Due Gov't, \$ 100 for

Remarks: *Deserted from
Camp Stanton, Feb.
7th, 1864.*

Book mark:

(858)

Sandy
Copyist

Q | 4

U.S.C.T.

Ely Dorsey
Pri., Co. *G 7* Reg't U. S. Col'd Infantry.

Appears on

Descriptive List of Deserters

dated *March 1*, 186*4*.

Deserted :

When *Feb. 7*, 186*4*.

Where *Camp Stanton, Md.*

Arrested :

When, 186 .

Where

Remarks : *O. Thompson owned.*

Book mark :

(851)

J. Smith,
Copist.

P

7

U.S.C.T.

Eli Dorsey

Pvt, Co. *G*, 7 Reg't U. S. Col'd Infantry.

Appears on **Co. Muster-out Roll**, dated *Indianola Texas, Oct 13*, 1866.

Muster-out to date _____, 186 .

Last paid to *Dec 1*, 1863 .

Clothing account:

Last settled _____, 186 ; drawn since \$ _____ 100

Due soldier \$ _____ 100; due U. S. \$ _____ 100

Am't for cloth'g in kind or money adv'd \$ _____ 100

Due U. S. for arms, equipments, &c., \$ _____ 100

Bounty paid \$ _____ 100; due \$ _____ 100

Remarks: *Deserted at Camp Stanton Md February 7 1864*

Book mark: _____

Hadfield

(361)

Copyist.

420

Dorsey Frederick

Co. 6, 7 U.S. Col'd Inf.

Private

CARD NUMBERS.

1	6279068	26
2	6284460	27
3	62845-48	28
4	6284661	29
5	6284765-	30
6	6284863	31
7	6285006	32
8	6279499	33
9	6285-3410	34
10	9066149	35
11		36
12		37
13		38
14		39
15		40
16		41
17		42
18		43
19		44
20		45
21		46
22		47
23		48
24		49
25		50

Book Mark:

See also

S810634 Dand-

S1086195 " " Ret-per. des.
REP417522

S1249903 ~~domin~~

Rep547047

9 | 7 | U.S.C.T.

Fred Dorey
 Co. *C*, 7 Reg't U.S. Col'd Inf.

Appears on
Company Descriptive Book
 of the organization named above.

DESCRIPTION.

Age *21* years; height *5* feet *4* inches.

Complexion *Black.*

Eyes *Black*; hair *Black*

Where born *Ma.*

Occupation *Lumber.*

ENLISTMENT.

When *Sept. 21*, 186*4*.

Where *Ellicott Mills.*

By whom *Capt. Hilland*; term *1* y'rs.

Remarks: *Drafted 1st. Dist.*
Chas. Co. Md.
Mustered out by reason of
expiration of term of service
Nov. 17, 1865 at Indianola
Tex.

R. Smith

217 | U.S.C.T.

Fred Dorsy

Appears with rank of _____ on

Muster and Descriptive Roll of a Detachment of Drafted Men and Substitutes forwarded

for the 7 Reg't U. S. Col'd Inf. Roll dated

H. McHenry, Md. Feb, 1865

Where born _____

Age 21 years; occupation _____

Drafted and mustered in:

When Sept 21, 1864

Where E Mills, Md.

Period 1 years.

Eyes Blk; hair Blk

Complexion Blk; height 5 ft. 4 in.

Paid bounty and advance pay, \$ 100

Bounty due \$ 100

Where credited _____

Company to which assigned _____

Remarks: 1 Dist Charles C. Md
Reward Paid \$30.

Book mark: _____

J. M. Gandy Copyist

10 | 7 | U.S.C.T.

Fred Dorsey
Priv., Co. C, 7 Reg't U. S. Col'd Infantry.

Appears on

Company Muster Roll

for Jan. & Feb., 1865.

Joined for duty and enrolled;

When Sept. 21, 1864.*

Where Ellicott's Mills, Md. *

Period one years.*

Present or absent Present

Stoppage, \$ 100 for

Due Gov't \$ 100 for

Remarks: I joined the Co. Feb. 25/65 - In confinement undergoing sentence

* See enrollment on card from muster-in roll.

Book mark:

M. M. Murphy
(358c) Copyist.

10 | 7 | U.S.C.T.

Frederick Dorsey
Priv., Co. C, 7 Reg't U. S. Col'd Infantry.

Appears on

Company Muster Roll
for Mar. & Apr., 1865.

Joined for duty and enrolled:

When Sept. 21, 1864.*

Where Elliott Mills, *

Period one years.*

Present or absent Present

Stoppage, \$ 100 for

Due Gov't \$ 100 for

Remarks: Joined Co. Feb. 25/65

* See enrollment on card from muster-in roll.

Book mark:

M. M. Murphy
(358c) Copyist.

10 | 7 | U.S.C.T.

Frederick Dorsey
Priv., Co. C, 7 Reg't U. S. Col'd Infantry.

Appears on

Company Muster Roll

for May & June, 1865.

Joined for duty and enrolled:

When Sept. 21, 1864.*

Where Collicott's Mills *

Period one years.*

Present or absent Present

Stoppage, \$ 100 for

Due Gov't \$ 100 for

Remarks: joined Co. Feb. 25/65

* See enrollment on card from muster-in roll.

Book mark:

M. M. Murphy
(358c) Copyist.

10 | 7 | U.S.C.T.

Frederick Dorsey
Priv., Co. C, 7 Reg't U. S. Col'd Infantry.

Appears on

Company Muster Roll

for July & Aug., 1865:

Joined for duty and enrolled:

When Sept 21, 1864.*

Where Ellicotts Mills *

Period 1 years.*

Present or absent

Stoppage, \$ 100 for

Due Gov't \$ 100 for

Remarks:

* See enrollment on card from muster-in roll.

Book mark:

(358c)

B. M. Brown
Asst. Surg.

10 | 7 | U.S.C.T.

Frederick Dorsey
Priv., Co. C, 7 Reg't U. S. Col'd Infantry.

Appears on

Company Muster Roll
for Sept. & Oct., 1865.

Joined for duty and enrolled:

When Sept. 21, 1864.*

Where Elliott Mills, Ind.*

Period one years.*

Present or absent Present

Stoppage, \$ 100 for

Due Gov't \$ 100 for

Remarks: Stoppage for
apprehension \$ 30.00

* See enrollment on card from muster-in roll.

Book mark:

M. M. Murphy
(358c) Copyist.

D, | 7 | U.S.C.T.

Frederich Dorsey
Pr, Co. C, 7 Reg't U. S. Col'd Infantry.

Appears on

Company Muster Roll
for Nov & Dec, 1865.

Joined for duty and enrolled:

When Sept. 21, 1864.*

Where Elliott's Mill *

Period 3 years.*

Present or absent

Stoppage, \$ 100 for

Due Gov't \$ 100 for

Remarks: Stop for apprehensions \$ 30.00 Mustered by reason of expiration of term of service - Nov. 18, '65

* See enrollment on card from muster-in roll.

Book mark:

(358c)

Lopez

Copyist.

NA 991257

N. | 7 | U.S.C.T.

Frederick Horsey
Pvt, Co. C, 7 Reg't U. S. Col'd Infantry.

Appears on Co. Muster-out Roll, dated
Indianola Texas Oct 13, 1866.

Muster-out to date _____, 186 .

Last paid to June 30, 1865.

Clothing account:

Last settled _____, 186 ; drawn since \$ 100

Due soldier \$ 100; due U. S. \$ 100

Am't for cloth'g in kind or money adv'd \$ 100

Due U. S. for arms, equipments, &c., \$ 100

Bounty paid \$ 100; due \$ 100

Remarks: Mustered out at
Indianola Texas Nov.
18 '65 at expiration of
term.

Book mark See list of deserters on file.

Lopez

(361)

Copyist.

NA 81793

1017 U.S.C.T.

Fred Dorsey
Sgt., Co. 7 Reg't U. S. Col'd Infantry.

Appears on a

Detachment Muster-out Roll

of the organization named above. Roll dated

Austin, Texas, Nov. 18, 1865.

Muster-out to date Nov. 18, 1865.

Last paid to June 20, 1865

Clothing account:

Last settled _____, 1865; drawn since \$ 100

Due soldier \$ 2 ⁸⁴ 100; due U. S. \$ 100

Am't for cloth'g in kind or money adv'd \$ 100

Due U. S. for arms, equipments, &c., \$ 100

Bounty paid \$ None 100 due \$ None 100

Remarks: joined the Company
at Fort Buchanan Va.
July 25. 1865 under guard.
He participated in the
Campaign of 1865. He retains
one knapsack and harness
(over)

Book mark: _____

(349)

J. J. [Signature]

Copyist.

JAN. 20

6279499

018910

one Curteen per G. O. 114
 War Dept, 1863.

Stop for apprehension
 \$30.00. No further
 military history.

Mustered out by
 reason of expiration of
 term of service.

Awaiting muster
 out till date on
 account of absence of
 mustering officer.

Has performed
 regular soldier's duty
 all this date.

Entitled to travel-
 time, subsistence and
 transportation to
 place of enlistment.

421 *George*
Rorsey George
 Co 6, 7 U.S. Col'd Inf.

Private | *Private*

CARD NUMBERS.

1	6 2 8 3 5-8 2	26
2	6 2 8 3 6 8 3	27
3	6 2 8 3 7 8 5	28
4	6 2 8 3 8 8 5	29
5	6 2 8 3 9 8 4	30
6	6 2 8 4 0 8 3	31
7	6 2 8 4 1 7 8	32
8	6 2 8 4 2 7 3	33
9	6 2 8 4 3 5 4	34
10	6 2 8 4 4 6 1	35
11	6 2 8 4 5 4 9	36
12	6 2 8 4 6 6 2	37
13	6 2 8 4 8 2 6	38
14	6 2 7 9 3 6 6	39
15	6 2 8 5 3 3 9	40
16	9 0 6 6 1 4 3	41
17		42
18		43
19		44
20		45
21		46
22		47
23		48
24		49
25		50

Book Mark: *P.V. 11. P. 140-69. E.B. 9/1999*

See also

0963666 @ Bureau

D. 2985966 And wd

P 3033862 " "

2 m - Hdwr app - 4/16/38 - 220

2

7

U.S.C.T.

George J. Darsey

Co. *C*, 7 Reg't U.S. Col'd Inf.

Appears on

Company Descriptive Book

of the organization named above.

DESCRIPTION.

Age *18* years; height *5* feet *4 1/4* inches.

Complexion *Light*.

Eyes *Blue*; hair *Curly*.

Where born *Howard Md.*

Occupation *Farmer*.

ENLISTMENT.

When *Oct. 2*, 186*3*.

Where *Baltimore Md.*

By whom *Col. W. Binney*; term *3* y'rs.

Remarks: *Mustered at Bal-
timore Md. Oct. 2, 63,
by Col. W. Binney.*

*Discharged by order of
Sec. of War at Annapolis
Md, May 31, 65.*

J. Smith

20

7

U.S.C.T.

George Dorney

Prov, Co. C, 7 Reg't U. S. Col'd Infantry.

Appears on

Company Muster Roll

for *Sept. 26 to Oct. 31*, 1863.

Joined for duty and enrolled:

When *Sept. 23*, 1863*

Where *Howard Co. Md.* *

Period *3* years.*

Present or absent *Absent*

Stoppage, \$ *100* for

Due Gov't \$ *100* for

Remarks: *Detached on Recruiting service Oct. 29 1863.*

* See enrollment on card from muster-in roll.

Book mark:

Calloway

(358c)

Copyist.

1863

20

7

U.S.C.T.

George Dorsey,
Privt, Co. C, 7 Reg't U. S. Col'd Infantry.

Appears on

Company Muster Roll

for *Nov. 10th Dec.*, 186 *3*

Joined for duty and enrolled:

When *Sept. 23*, 186 *3*.*

Where *Howard Co. Md.* *

Period *3* years.*

Present or absent *Present*

Stoppage, \$ *100* for

Due Gov't \$ *100* for

Remarks: *Stop for our pair of scales.*

* See enrollment on card from muster-in roll.

Book mark:

Calloway

(358c)

Copyist.

201 7 U.S.C.T.

George Dorsey
Priv., Co. C, 7 Reg't U. S. Col'd Infantry.

Appears on

Company Muster Roll
for Jan'y and Feby, 1864.

Joined for duty and enrolled:

When Sept. 23, 1863.*

Where Howard Co. Md. *

Period 3 years.*

Present or absent Present.

Stoppage, \$ 100 for

Due Gov't \$ 100 for

Remarks:

* See enrollment on card from muster-in roll.

Book mark:

Calloway Copyist.

20

7

U.S.C.T.

George Dorsey.

Priv Co. C, 7 Reg't U. S. Cold Infantry.

Appears on

Company Muster Roll

for March Apr, 1864.

Joined for duty and enrolled:

When Sept. 23, 1863*

Where Howard Co. Md.*

Period 3 years.*

Present or absent Present.

Stoppage, \$ 100 for

Due Gov't \$ 100 for

Remarks: Stop for no knap-
sack & canteen.

* See enrollment on card from muster-in roll.

Book mark:

Callaway.

D | 7 | U.S.C.T.

George Dorsey,
Priv, Co. C, 7 Reg't U. S. Col'd Infantry.

Appears on

Company Muster Roll
for May 15/64, 1864.

Joined for duty and enrolled:

When Sept. 23, 1863*

Where Howard Co. Md. *

Period 3 years.*

Present or absent Present

Stoppage, \$ 100 for

Due Gov't \$ 100 for

Remarks:

* See enrollment on card from muster-in roll.

Book mark:

Baccoway
(358c) Copyist.

20 | 7 | U.S.C.T.

George Dorsey
Privt, Co. C, 7 Reg't U. S. Col'd Inf.

Appears on

Company Muster Roll
for July and Aug, 1864

Joined for duty and enrolled:

When Sept. 23, 1863*

Where Howard Co. Md. *

Period 3 years.*

Present or absent Present.

Stoppage, \$ 100 for

Due Gov't, \$ 100 for

Valuation of horse, \$ 100

Valuation of horse equipments, \$ 100

Remarks:

* See enrollment on card from muster-in roll.

Book-mark:

Calloway
Copyist.

LD | 7 | **U.S.C.T.**

George Dorsey
Pvt., Co. C, 7 Reg't U. S. Col'd Infantry.

Appears on

Company Muster Roll
for *Sept. 7 Oct.*, 1864.

Joined for duty and enrolled:

When *Sept. 23^d*, 1863.*

Where *Howard* *

Period *3* years.*

Present or absent *Absent*

Stoppage, \$ *100* for

Due Gov't \$ *100* for

Remarks: *Wounded in action and sent to H. sept. Sept 28.*

* See enrollment on card from muster-in roll.

Book mark:

M. M. Murphy
(358c) Copyist.

10 | 7 | U.S.C.T.

George Dorsey
Priv., Co. C, 7 Reg't U. S. Col'd Infantry.

Appears on

Company Muster Roll

for Nov. & Dec., 1864.

Joined for duty and enrolled:

When Sept. 23, 1863.*

Where Howard *

Period 3 years.*

Present or absent Absent

Stoppage, \$ 100 for

Due Gov't \$ 100 for

Remarks Wounded in
action and sent
to Hosp. Oct. 28/64

* See enrollment on card from muster-in roll.

Book mark:

M. M. Murphy
Copyist.

10 | 7 | U.S.C.T.

George J. Dorsey
Priv., Co. C, 7 Reg't U. S. Col'd Infantry.

Appears on

Company Muster Roll

for Jan. - Feb., 1866.

Joined for duty and enrolled:

When Sept. 23", 1863.*

Where Howard Co., Md. *

Period 3 years.*

Present or absent Absent

Stoppage, \$ 100 for

Due Gov't \$ 100 for

Remarks: Wounded in
action Sept. 29"/64
In Hosp. Portsmouth,
Va.

* See enrollment on card from muster-in roll.

Book mark:

J. M. Murphy

10 | 7 | **U.S.C.T.**

George J. Dorsey
Sgt., Co. C, 7 Reg't U. S. Col'd Infantry.

Appears on

Company Muster Roll
for *Mar. & Apr.*, 186*5*.

Joined for duty and enrolled:

When *Sept. 23*, 186*3*.*

Where *Howard Co.* *

Period *3* years.*

Present or absent *Absent*

Stoppage, \$ *100* for

Due Gov't \$ *100* for

Remarks: *Pay due for*
mos. of Sept & Oct.
1864. In Hosp. Port-
smouth, Va. since Sept.
29, 1864

* See enrollment on card from muster-in roll.

Book mark:

M. C. Murphy
(358c) Copyist.

10

7

U.S.C.T.

George J. Dorsey

Priv., Co. C, 7 Reg't U. S. Col'd Infantry.

Appears on

Company Muster Roll

for *May & June*, 1865.

Joined for duty and enrolled:

When *Sept. 23*, 1863.*

Where *Howard* *

Period *3* years.*

Present or absent *absent*

Stoppage, \$ *100* for

Due Gov't \$ *100* for

Remarks: *Pay due for mos. of Sept. to Oct. /64. In Hosp. Portsmouth, Va. since Sept. 29/64*

* See enrollment on card from muster-in roll.

Book mark:

M. M. Murphy

(358c)

Copyist.

10 | 7 | U.S.C.T.

Geo. J. Dorsey
Priv. Co. C, 7 Reg't U. S. Col'd Infantry.

Appears on

Company Muster Roll

for July & Aug., 1865.

Joined for duty and enrolled:

When Sept. 23, 1863.*

Where Howard Co. *

Period 3 years.*

Present or absent.....

Stoppage, \$ 100 for.....

Due Gov't \$ 100 for.....

Remarks: Discharged
May 26/65 for
disability, by order
of Sec. of War

* See enrollment on card from muster-in roll.

Book mark: Discharged (over)

W. M. Murphy
Copyist.

NR 91 229

JAN. 20

6284826

01891*

May 31/65 E. B. 299

D | 7 | U.S.C.T.

George J. Darsey
Priv., Co. C, Reg't U. S. Col'd (Inf.)

Appears on an

Individual Muster-out Roll

of the organization named above. Roll dated
Norfolk, Va. May 31, 1865.

Muster-out to date May 31, 1865.

Last paid to Dec. 31, 1864.

Clothing account:

Last settled _____, 186 ; drawn since \$ 100

Due soldier \$ 100; due U. S. \$ 100

Since last settlement
Am't for cloth'g in kind or money adv'd \$ 101 ⁷⁵/₁₀₀

Due U. S. for arms, equipments, &c., \$ 100

Bounty paid \$ 100; due \$ 100 ⁰⁰/₁₀₀

Remarks: Mustered out by
order of the war Dept.
dated May 3rd 1865;
Clothing account never
been settled or no date
on descriptive list. (over)

Book mark: V123. P308, 71- 474, 002
2nd and. rpl 15/71

C. R. Owen,

JAN. 20

6279366

018910

The Company records
do not show that this
man has rec'd pay
for the mos. of Sept. &
Oct. 1864.

Discharged from
Balfour Gen. Hospi-
tal, Portsmouth, Va.

S | **7** | **U.S.C.T.**

George J. Torsey
Pvt, *Co. H*, *7* Reg't U. S. Col'd Infantry.

Appears on **Co. Muster-out Roll**, dated
Indianola Texas, Oct 13, 1866.

Muster-out to date _____, 186 .

Last paid to *Dec 31*, 1864.

Clothing account:

Last settled _____, 186 ; drawn since \$ _____ 100

Due soldier \$ _____ 100; due U. S. \$ _____ 100

Am't for cloth'g in kind or money adv'd \$ _____ 100

Due U. S. for arms, equipments, &c., \$ _____ 100

Bounty paid \$ _____ 100; due \$ _____ 100

Remarks: *Discharged at*
Norfolk Va. May 31 '65
for disability.

Book mark: *Pt. 11 P. 40. 69*

(361) *(over)* *Lopez* Copyist.

JAN. 20

6285339

018910

V. 23 P. 308. 71-474.002

20 | 7 | U.S.C.T.

George Dorsey,
Prov. Co. C, 7 Reg't U. S. Colored Inf.

Age 18 years.

Appears on

Company Muster-in Roll

of the organization named above. Roll dated

Baltimore, Md., Sept. 26, 1863.

Muster-in to date

Sept. 26, 1863

Joined for duty and enrolled:

When Sept. 23, 1863*

Where Howard Co., Md. *

Period 3 years.*

Remarks:

*The Muster-in roll shows enrollment of all men of this company as of same date. See enrollment on subsequent card or cards.

Book mark: P 11 P 140 69

Callaway
Copyist.

Dossey *Geo*
P. C. #7 *1st Lt*
_____, Co. _____, Reg't _____

Enclosures.

- | | |
|------------------------------------|----------------------------|
| Bed Cards | Final Statements |
| Burial Records | Furloughs or L. of A. |
| Certs. of Dis. for Discharge | Med. Certificates |
| C. M. Charges | Med. Des. Lists |
| Descriptive Lists | Orders |
| Discharge Certificates | Pris. of War Record |
| Enlistment Papers | Resignations |

Other papers relating to—

- | | |
|------------------------------|---------------------------|
| Admission to Hosp'l | Furlough or L. of A. |
| Casualty Sheet | Med. Examination |
| Confinement | Misc. Information |
| Contracts | Pay or Clothing |
| Death or Effects | Personal Reports |
| Desertion | Rank |
| Discharge from Hosp'l | Transfer to Hosp'l |
| Discharge from Service | Transfer to V. R. C. |
| Duty | Transportation |

53

CASUALTY SHEET
OF WOUNDED.

George Dorsey

Private Company B

7 Regiment of U.S.C.

Volunteers at the battle of _____

Oct 28-1864

CASUALTY SHEET.

Name, George Dorsey
Rank, Private, Company 6, Regiment, 7th
Arm, U.S.A., State, _____
Place of casualty, _____

Nature of casualty, Wounded

Date of casualty, Oct 28th 1864

FROM WHAT SOURCE THIS INFORMATION WAS OBTAINED.

Report of Killed, Wounded, and Missing of the _____ Regiment,
_____ Brigade, _____ Division, _____ Corps, dated _____

List of Casualties in the 7th Regt U.S. Col. Troops
in the Action of Oct 27th & 28th 1864.

(Signed) Llewellyn F Haskell
Lt Col Comdg Regt

Ind 502 no 59

W. F. Thompson

Clerk.

MAR 1929

Dorsey George
Co F, 7 U.S. Col'd Inf.

Private - Private

CARD NUMBERS.

1	6 2 7 8 9 0 9	26
2	6 2 8 9 4 5 6	27
3	6 2 8 9 5 6 0	28
4	6 2 8 9 6 5 5	29
5	6 2 8 9 7 5 1	30
6	6 2 8 9 8 4 4	31
7	6 2 8 9 9 4 2	32
8	6 2 9 0 0 4 0	33
9	6 2 9 0 1 3 8	34
10	6 2 9 0 2 3 3	35
11	6 2 9 0 3 2 4	36
12	6 2 9 0 4 1 5	37
13	6 2 9 0 5 0 3	38
14	6 2 9 0 6 8 3	39
15	6 2 9 0 6 6 1	40
16	6 2 9 0 7 3 4	41
17	6 2 9 0 8 0 7	42
18	9 0 6 6 5 3 4	43
19	4 3 1 5 2 4 0 8	44
20		45
21		46
22		47
23		48
24		49
25		50

Book Mark

P. 111 - P. 140 - 69

See also

A. 2895312 Potmil
S. 2897985 and MD
1. 2965-218. and D.

L

7

U.S.C.T.

George Horsey
 Co. *B*, 7 Reg't U.S. Col'd Inf.

Appears on

Company Descriptive Book

of the organization named above.

DESCRIPTION.

Age *24* years; height *5* feet *4* inches.

Complexion *Yellow*

Eyes *Blk*; hair *Curly*

Where born *Baltimore, Md.*

Occupation *Laborer*

ENLISTMENT.

When *Jan 5*, 186*4*.

Where *Baltimore, Md.*

By whom _____; term *3* y'rs.

Remarks: *Drafted 3^d Dist
 Md. Jan 5 " 1864.*

J. S. Brown

10 | 7 | U.S.C.T.

Geo. Dorsey, (Col'd.)

Appears with rank of _____ on
Muster and Descriptive Roll

of Detachment of men drafted,
 forwarded for U.S. Colored Troops
 x Co. F, 7 Regt. Roll dated
 Benedict, Charles Co., Md., Jan. 16, 1864.

Where born Baltimore, Maryland
 Age 24 y'rs; occupation Laborer

Drafted and mustered in:

When Jan'y. 5, 1864.

Where Balt. Md.

Enrollment district 3 Cong. Dist.

Period 3 years.

Eyes Black; hair Woolly

Complexion Yellow; height 5 ft. 4 in.

Bounty paid \$ 100; due \$ 100

Clothing account:

Last settled _____, 186 ; drawn since \$ 24 ⁷⁹/₁₀₀

Date of commencement of service Jan'y. 5, 1864.

Company to which assigned _____

Remarks: Drafted man.

x From margin of roll.

Book mark : _____

W. H. Hibbard

10 | 7 | U.S.C.T.

George Pursey
Priv., Co. *F*, *7* Reg't U. S. Col'd *Infy*

Age *24* years.

Appears on a

Detachment Muster-in Roll

of the organization named above. Roll dated
Baltimore, Md., Apr. 18, 1863.

Muster-in to date *June 16,* 1864.

Joined for duty and enrolled:

When *Dec. 24,* 1863 .

Where *Baltimore, Md.*

Period *3* years.

Valuation of horse, \$ *100*

Valuation of horse equipments, \$ *100*

Remarks: *Drafted*

Book mark: _____

Wreck
Copyist.

29 | 7 | U.S.C.T.

George Dorsey
Priv., Co. F, 7 Reg't U.S. Col'd Infantry.

Appears on

Company Muster Roll

for *Jan & Feb*, 1864.

Joined for duty and enrolled:

When *June 5th*, 1864.*

Where *Baltimore Md.* *

Period _____ years.*

Present or absent *Present*

Stoppage, \$ 100 for _____

Due Gov't \$ 100 for _____

Remarks: *Joined for duty
Jan 16th 1864.*

* ~~See~~ See enrollment on card from muster-in roll.

Book mark: _____

(358c)

C. F. Miller
Copyist.

21

7

U.S.C.T.

George Dorsey

Sgt., Co. F, 7 Reg't U. S. Col'd Infantry.

Appears on

Company Muster Roll

for *March & April*, 186*4*.

Joined for duty and enrolled:

When *July 5*, 186*4*.*

Where *2d Artillery Co Md.* *

Period *3* years.*

Present or absent *Present*

Stoppage, \$ *100* for

Due Gov't \$ *100* for

Remarks: _____

* See enrollment on card from muster-in roll.

Book mark: _____

(358c)

E. K. Hill
Copyist.

21 7 U.S.C.T.

George Dorsey
Plt, Co. F, 7 Reg't U. S. Col'd Infantry.

Appears on

Company Muster Roll

for May & June, 1864.

Joined for duty and enrolled:

When Cont. S., 1864.

Where Baltimore, Md. *

Period 3 years.*

Present or absent Present

Stoppage, \$ 100 for

Due Gov't \$ 100 for

Remarks: Hope for one letter
single & for scales

* See enrollment on card from muster-in roll.

Book mark:

J. A. Miller
Copyist.

D | 7 | U.S.C.T.

George Dorsey
Prt, Co. F, 7 Reg't U. S. Col'd Infantry.

Appears on

Company Muster Roll
for July, & Aug, 1864.

Joined for duty and enrolled:

When Jan 5, 1864.*

Where Baltimore, Md.*

Period 3 years.*

Present or absent Present

Stoppage, \$ 100 for

Due Gov't \$ 100 for

Remarks: Stopped for 1
letter, Pr Deale

* See enrollment on card from muster-in roll.

Book mark:

(358c)

W. B. ...

Copyist.

91 7 U.S.C.T.

George Darsey
Private Co. F, 7 Reg't U. S. Col'd Infantry.

Appears on

Company Muster Roll

for Sept. 2nd Dist., 1864.

Joined for duty and enrolled:

When Jan 5, 1864.*

Where Baltimore Co. Md.*

Period 3 years.*

Present or absent Absent.

Stoppage, \$ 100 for

Due Gov't \$ 100 for

Remarks In Hosp. wounded since Sept. 29. 64 - Stopped for letters & 1 pr scales.

* See enrollment on card from muster-in roll.

Book mark:

(858c)

Keefe

Copyist.

D | 7 U.S.C.T.

George Doosey

Private, Co. F, 7 Reg't U. S. Col'd Infantry.

Appears on

Company Muster Roll

for *Nov. 2^d Dec., 1864.*

Joined for duty and enrolled:

When *Jan. 5th*, 1864.*

Where *Baltimore* *

Period *3* years.*

Present or absent *Present*

Stoppage, \$ *100* for

Due Gov't \$ *100* for

Remarks: *Stopped for 1 letter, 1 pr sculis.*

* ~~See~~ See enrollment on card from muster-in roll.

Book mark: _____

Keefer

NA 991 249

29 | 7 | U.S.C.T.

George Dorsey
Private, Co. F, 7 Reg't U. S. Col'd Infantry.

Appears on

Company Muster Roll

for *Jan. and Feb.*, 1865.

Joined for duty and enrolled:

When *Jan 5*, 1864.*

Where *Baltimore* *

Period *3* years.*

Present or absent *Present*

Stoppage, \$ *100* for

Due Gov't \$ *100* for

Remarks:

* See enrollment on card from muster-in roll.

Book mark: _____

(358c) *Kiefer* Copyist.

1864

5 | 7 | U.S.C.T.

George Dorsey
Private, Co. F, 7 Reg't U. S. Col'd Infantry.

Appears on

Company Muster Roll

for *Mar. & Apr.*, 1865.

Joined for duty and enrolled:

When *Jan. 5*, 1864.*

Where *Baltimore* *

Period *3* years.*

Present or absent *Absent*

Stoppage, \$ *100* for

Due Gov't \$ *100* for

Remarks: *Absent sick since
March 27, '65.*

* See enrollment on card from muster-in roll.

Book mark: -----

(358c) *Keefe* Copyist.

D | **7** | **U.S.C.T.**

George Torsey

Private Co. F, 7 Reg't U. S. Col'd Infantry.

Appears on

Company Muster Roll

for *May and June*, 1865.

Joined for duty and enrolled:

When *Jan. 5*, 1864.*

Where *Baltimore* *

Period *3* years.*

Present or absent *Present*.

Stoppage, \$ *100* for

Due Gov't \$ *100* for

Remarks: *To be stopped for 1
sawnten'yd 1 Wiper.*

* ~~See~~ See enrollment on card from muster-in roll.

Book mark: _____

Keefe

9 | **7** | **U.S.C.T.**

George Dorsey

Private Co. F, 7 Reg't U. S. Col'd Infantry.

Appears on

Company Muster Roll

for *July^{2nd} & Aug., 1865.*

Joined for duty and enrolled:

When *Jan. 5th*, 1864.*

Where *Baltimore Co., Md.* *

Period *3* years.*

Present or absent *Present*

Stoppage, \$ *100* for

Due Gov't \$ *100* for

Remarks:

* ~~02~~ See enrollment on card from muster-in roll.

Book mark: _____

Keeper

(358c) Copyist.

J

7

U.S.C.T.

George Dorsey

Priv., Co. F, 7 Reg't U. S. Col'd Infantry.

Appears on

Company Muster Roll

for *Sept. & Oct.*, 1865.

Joined for duty and enrolled:

When *Jan. 5*, 1864.*

Where *Baltimore Co., Md.* *

Period *3* years.*

Present or absent *Present*

Stoppage, \$ *18* for *Ordnance*

Due Gov't \$ *100* for

Remarks: _____

* See enrollment on card from muster-in roll.

Book mark: _____

Keefe

221

7

U.S.C.T.

George Dorsey

Co. F, 7 Reg't U. S. Col'd Infantry.

Appears on

Company Muster Roll

for Nov. & Dec., 1865.

Joined for duty and enrolled:

When Jan. 5, 1864.*

Where Baltimore, Md. *

Period 3 years.*

Present or absent Present.

Stoppage, \$ 100 for

Due Gov't \$ 100 for

Remarks: Stop for ordnance 18 cts.

* See enrollment on card from muster-in roll.

Book mark:

Brewster

Al. 1

7

U.S.C.T.

George Morsey
Capt., Co. F, 7 Reg't U. S. Col'd Infantry.

Appears on

Company Muster Roll

for Jan. & Feb., 1866.

Joined for duty and enrolled:

When Jan. 5, 1864.*

Where Baltimore Co. Md.*

Period 3 years.*

Present or absent Present.

Stoppage, \$ 100 for

Due Gov't \$ 100 for

Remarks:

* See enrollment on card from muster-in roll.

Book mark:

Brooks

B. 1

7

U.S.C.T.

George Hoisey
Capt., Co. F, 7 Reg't U. S. Col'd Infantry.

Appears on

Company Muster Roll

for Mar. + April, 1866.

Joined for duty and enrolled:

When Jan. 5, 1864.*

Where Baltimore, Md. *

Period 3 years.*

Present or absent Present.

Stoppage, \$ 100 for

Due Gov't \$ 100 for

Remarks:

* See enrollment on card from muster-in roll.

Book mark:

Brooks

Al. 1 7 | **U.S.C.T.**

George Dorsey.
Pvt., Co. F, 7 Reg't U. S. Col'd Infantry.

Appears on

Company Muster Roll

for May + June, 1866.

Joined for duty and enrolled:

When Jan. 8, 1864.*

Where Baltimore, Md. *

Period 3 years.*

Present or absent Present

Stoppage, \$ 100 for _____

Due Gov't \$ 100 for _____

Remarks: _____

NEXT ROLL ON FILE MUSTER OUT.

* See enrollment on card from muster-in roll.

Book mark: _____

(858c)

Brooker

Copyist.

10. |

7

U.S.C.T.

George Horsey

Cpt., Co. B, 7 Reg't U. S. Col'd Infantry.

Appears on Co. Muster-out Roll, dated Indianola, Texas Oct. 13, 1866.

Muster-out to date Oct. 13, 1866.

Last paid to June 30, 1866.

Clothing account:

Last settled, 186 ; drawn since \$ 100

Due soldier \$ 7¹⁰/₁₀₀; due U. S. \$ 100

Am't for cloth'g in kind or money adv'd \$ 100

Due U. S. for arms, equipments, &c., \$ 100

Bounty paid \$ 100; due \$ 100

Remarks: Joined Co. Jan 16, '64. Retains one Springfield Rifle Musket + set accoutrements per G.O. 101, Wash. May 30, 65. Rec'd U.S. for ordnance \$6.00.

Book mark: PM 14069

Brooke

Rossey *Regt.*
P. Co. *H. J. [unclear]*

Enclosures.

Bed Cards	Final Statements
Burial Records	Furloughs or L. of A.
Certs. of Dis. for Discharge	Med. Certificates
C. M. Charges	Med. Des. Lists
Descriptive Lists	Orders
Discharge Certificates	Pris. of War Record
Enlistment Papers	Resignations

Other papers relating to—

Admission to Hosp'l	Furlough or L. of A.
Casualty Sheet	Med. Examination
Confinement	Misc. Information
Contracts	Pay or Clothing
Death or Effects	Personal Reports
Desertion	Rank
Discharge from Hosp'l	Transfer to Hosp'l
Discharge from Service	Transfer to V. R. C.
Duty	Transportation

54

CASUALTY SHEET
OF WOUNDED.

Geo Dorey

Private Company "F"

17. Regiment of W. S. G. I

Volunteers at the battle of Chapin's

Marv. Va. Sept 29 & 30/64

CASUALTY SHEET.

Name, George Dorey
 Rank, Private, Company "A", Regiment, 7th
 Arm, U. S. I. P., State, _____
 Place of casualty, Chapeins Farm, Va.
 Nature of casualty, Wounded
 Date of casualty, Sept 29 or 30 / 64

FROM WHAT SOURCE THIS INFORMATION WAS OBTAINED.

Report of Killed, Wounded, and Missing of the _____ Regiment,
 Brigade, _____ Division, _____ Corps, dated _____
List of casualties in the 7th U. S. I. P. on the 29 + 30
of Sept / 64, at Chapeins Farm, Va.
(Sgd) Sewell H. Harker
Sicut dea loonidg
Ind 502, no 63.

H. Brown
 Clerk.

420

Dorsey George A.
Co E, 7 U.S. Col'd Inf.

Private Private

CARD NUMBERS.

1	6287245	26
2	6287346	27
3	6287447	28
4	6287547	29
5	6287646	30
6	6287799	31
7	6289106	32
8	9066423	33
9		34
10		35
11		36
12		37
13		38
14		39
15		40
16		41
17		42
18		43
19		44
20		45
21		46
22		47
23		48
24		49
25		50

Book Mark 337-C.A. 80.

See also

J

7

U.S.C.T.

George A. Cooper

Co. *C*, 7 Reg't U.S. Col'd Inf.

Appears on

Company Descriptive Book

of the organization named above.

DESCRIPTION.

Age *24* years; height *5* feet *6.2* inches.

Complexion *Black*

Eyes *Black*; hair *Curly*

Where born *Worcester, Md.*

Occupation *Farmer*

ENLISTMENT.

When *Sept 20*, 186*4*.

Where *Baltimore*

By whom *Col McRaney*; term *3* y'rs.

Remarks: *Rec'd May 24 1864.*

J. Brown

20

7

U.S.C.T.

George A. Losey
 Pvt., Co. E, 7 Reg't U. S. Col'd Infantry.

Appears on

Company Muster Roll
 for *Sept. 30/63 to Oct. 31*, 1863.

Joined for duty and enrolled:

When *Sept. 27*, 1863.*

Where *Dorchester Md.**

Period *3* years.*

Present or absent *Absent*

Stoppage, \$ *100* for

Due Gov't \$ *100* for

Remarks: *On detached service at Baltimore Md.*

* See enrollment on card from muster-in roll.

Book mark:

E. C. Rankin

D

7

U.S.C.T.

George A. Dorsey
Pvt., Co. E, 7 Reg't U. S. Col'd Infantry

Appears on

Company Muster Roll

for Nov. & Dec., 1863.

Joined for duty and enrolled:

When Sept 27, 1863.

Where Dorchester.

Period 3 years.*

Present or absent Absent.

Stoppage, \$ 100 for

Due Gov't \$ 100 for

Remarks: Detached serv-
ice at Baltimore
Md. by order Col.
W. Birney Oct. 27,
1863.

* See enrollment on card from muster-in roll.

Book mark:

E. E. Rankin

(358c)

Copyist.

D 1

7

U.S.C.T.

George A. Dusey
Pvt, Co. E, 7 Reg't U. S. Col'd Infantry.

Appears on

Company Muster Roll

for Jan. & Feb., 1864.

Joined for duty and enrolled:

When Sept. 27, 1863.*

Where Dorchester.*

Period 3 years.*

Present or absent Present

Stoppage, \$ 100 for

Due Gov't \$ 100 for

Remarks: Returned from
recruiting service
Jan. 3, 1864.

* See enrollment on card from muster-in roll.

Book mark:

E. A. Rankin

(358c)

Copyist.

D | 7 | U.S.C.T.

George A. Dorsey
Private, Co. E, 7 Reg't U. S. Col'd Infantry.

Appears on

Company Muster Roll
for Mar. & Apr., 1864.

Joined for duty and enrolled:

When Sept. 27, 1863.*

Where Dorchester*

Period 3 years.*

Present or absent Present

Stoppage, \$ 100 for

Due Gov't \$ 100 for

Remarks:

* See enrollment on card from muster-in roll.

Book mark:

A. E. Rankin
Copyist.

NARA 1259

D

7

U.S.C.T.

George A. Dorsey
Pvt., Co. E, 7 Reg't U. S. Col'd Infantry.

Appears on

Company Muster Roll

for *Dated June 30*, 1864.

Joined for duty and enrolled:

When *Sept 27*, 1863.*

Where *Dorchester Co. Ind.**

Period years.*

Present or absent

Stoppage, \$ 100 for

Due Gov't \$ 100 for

Remarks: *Died in Hospital Jacksonville Florida May 24th 1864.*

* See enrollment on card from muster-in roll.

Book mark: *95,382.*

A. C. Rankin

(358c)

Copyist.

2

7

U.S.C.T.

George A. Horsey
Pt, Co. E, 7 Reg't U. S. Col'd Infantry.

Appears on Co. Muster-out Roll, dated
Indianna, Texas, Oct. 13, 1866.

Muster-out to date _____, 186 .

Last paid to Feb. 29, 1864.

Clothing account:

Last settled _____, 186 ; drawn since \$ _____ 100

Due soldier \$ _____ 100; due U. S. \$ _____ 100

Am't for cloth'g in kind or money adv'd \$ _____ 100

Due U. S. for arms, equipments, &c., \$ _____ 100

Bounty paid \$ _____ 100; due \$ _____ 100

Remarks: Died in Post Hospital
Jacksonville Fla. May 24,
1864. Final statements
forwarded to A. J. O.
May 27, 1864.

Book mark: 337-6.5.80. 95-382

(361)

Prof. Bell Jr

Copist.

D | 7 | U.S.C.T.

George A. Dorsey
Pvt., Co. E, 7 Reg't U. S. Colored Inf.

Age 24 years.

Appears on

Company Muster-in Roll

of the organization named above, Roll dated
Baltimore Md, Sept 30 1863.

Muster-in to date Sept 30 1863.

Joined for duty and enrolled:

When Sept 27 1863.*

Where Dorchester Co. Md.*

Period 3 years.*

Remarks:

*Muster-in roll shows enrollment of all men of this company as of some date. See enrollment on subsequent card or cards.

Book mark:

A. C. Rankin

(356)

Corvial.

Dorsey, George a.

P, Co. E., 7 Reg't U.S.C. Inf.

3 Enclosures.

Bed Cards.....	Descriptive Lists.....
Burial Records.....	Final Statements..... 3
Certs. of Dis. for Discharge.....	Furloughs.....
C. M. Charges.....	Med. Des. Lists.....
Med. Certificates.....	Orders.....

Other papers relating to—

Admission to Hosp'l.....	Furlough.....
Casualty Sheet (Officer's).....	Med. Examination.....
Confinement.....	Misc. Information.....
Contracts.....	Pay or Clothing.....
Death or Effects.....	Personal Reports.....
Desertions.....	Rank.....
Discharge from Hosp'l.....	Transfer to Hosp'l.....
Discharge from Service.....	Transfer to V. R. C.....
Duty.....	Transportation.....

1864

May 64

DUP

Final Statements

JUL 15 1871

of

George A Dorsey

7th Regt of U.S. Col Graps

MAY 1864

I Certify on honor that - George A Dorsey a Private of Captain A P Spaulding's Company (E) of the 7th Regiment of U S Col Troops Born in Dorchester Co State of Maryland Aged: 24 years 5 feet 6 1/2 inches high: Black Complexion: Black hair: eyes Curly hair and by occupation a Farmer Having joined the Company on its original organization at Baltimore Md on the 30th day of September 1863 and enrolled in it - at the muster into the service of the United States at Baltimore Md on the 30th day of September 1863 to serve in the regiment - for the term of three years or during the war and having served honestly and faithfully with his Company in the 7th U S Col Troops to the present date is now entitled to Discharge by reason of Death Died in Hospital at Jacksonville Florida May 24th 1864

The said George A Dorsey was last paid by Paymaster Luskwood to include the 29th day of February 1864 and has pay due him from that time to the present - date

He has received from the United States Clothing amounting to \$ 52 ¹³/₁₀₀ dollars since the 30th day of September 1863 when his clothing account was last settled

Given in Duplicate at Jacksonville Florida this 27th day of May 1864

No Effects

Harlan P Spaulding
Capt Co E 7th U S Col

Harlan P Spaulding

Capt Co E 7th U S Col
Commanding Company

1864

57

FINAL STATEMENT

Dup
OF

76 M.
George A Parsey

7th Reg't of U S Col. Troops

JUL
15
1871

VOLUNTEERS.

NOTE 1.—Two of these certificates (or duplicates) are to be given to each Volunteer Soldier or drafted man who may be discharged previously to the discharge of his company, that he may at once receive from the Paymaster the pay, &c., due him, and the captain or other COMMISSIONED officer commanding the company will certify to the act of the delivery of the duplicate certificates; on these certificates the Soldier is "entitled to" his discharge, and should also present his discharge to the Paymaster to have the payment endorsed on it. The discharge is to be given back to the Soldier by the Paymaster; the latter only retaining as his voucher the duplicate certificates.

NOTE 2.—If the Soldier is entitled to pay for the use of his horse, the Company Commander will certify to that fact on the back of both these final statements, and also to the time he has pay due for having been so mounted on his own horse.

NOTE 3.—When a Soldier is furnished with final statements, his descriptive list, if he has one, should be taken up by the officer who gives the Soldier these statements, and endorsed with a statement to this effect by the officer. This endorsement should exhibit a full statement of the time for which the Soldier was allowed pay on his final statements, the clothing account, and all other charges against him or in his favor, so as to comprise a complete exhibit of his account. It will then be transmitted to the company commander of the Soldier, who will enter all the data necessary to a full understanding of the Soldier's account on the muster roll upon which the Soldier's discharge is reported. The descriptive list will then be destroyed. The object of this is, that the remaining portion of the Soldier's account may be settled upon the receipt of these muster rolls, and the Soldier receive any pay or allowances that may be due him at the time of his discharge, and which may not appear on his final statements from the fact that his descriptive list is incomplete. These accounts for back pay, &c., are settled by the 2d Auditor of the Treasury Department.

NOTE 4.—Charges for loss or injury to ordnance, horse equipments, and other miscellaneous charges, should appear under the heading of "Other Stoppages."

NOTE 5.—Bounty paid by State authorities, and not by the United States, will not be entered on this statement.

NOTE 6.—Amounts due the Sutler and Laundress must be entered on the muster roll on which the discharge, death, desertion, &c., is reported, as well as on the final statement, otherwise the amount cannot be collected from the United States.

NOTE 7.—This blank will be used for deceased volunteers and drafted men, as well as for others.

NOTE 8.—Where a Soldier dies in Hospital or on detached service, his descriptive list, if he has one, should be sent with his final statements, in duplicate, to the Adjutant General, Washington, D. C.

I certify, on honor, that George A Darsey a Private of
 Captain H P Spaulding Company (E) of the 7th Regiment of U S C Troops
VOLUNTEERS, of the State of _____, born in Dorchester Co, State
 of Maryland, aged ~~24~~ years; 5 feet 6 1/2 inches high; Black complexion,
Black eyes, Curl hair, and by occupation a Farmer, having joined the company on
 its original organization at Baltimore Md, and enrolled in it at the muster into
 the service of the United States at Baltimore Md, on the 30th day
 of September, 1863, (or was mustered in service as a recruit, by _____
 _____, at _____, on the _____ day of _____,
 186 , or was drafted and mustered into the service of the United States from the _____
 Enrollment District of the State of _____, at _____,
 on the _____ day of _____, 186 ,) to serve in the Regiment, for
 the term of Three years or during the war; and having served **HONESTLY** and
FAITHFULLY with his Company in the 7th U S Col Troops to the present date, is now
 entitled to a **DISCHARGE** by reason of Death. Died in Hospital
at Jacksonville Florida May 24th 1864

The said George A Darsey was last paid by Paymaster
Lockwood to include the 29th day of February, 1864, and has
 pay due him from that time to the present date; he is entitled to pay and subsistence for
TRAVELING to place of enrollment, and whatever other allowances are authorized to volunteer
 soldiers, drafted men, or militia, so discharged. He has received from the United States **CLOTHING**
 amounting to \$ 52 ¹³/₁₀₀ dollars, since the 30th day of September,
 1863, when his clothing account was last settled. He has received from the United States
1863 ¹⁰⁰ dollars advanced **BOUNTY**.

There is to be stopped from him, on account of the State of _____, or other
 authorities, for **CLOTHING**, &c., received on entering service, _____ ¹⁰⁰ dollars; and
 for other stoppages, viz: _____
 _____ ¹⁰⁰ dollars.

He has been furnished with **TRANSPORTATION** in kind from the place of his discharge to
 _____; and he has been **SUBSISTED** for **TRAVELING** to his
 place of enrollment, up to the _____, 186 .

He is indebted to _____, **SUTLER**, _____ ¹⁰⁰ dollars.
 He is indebted to _____, **LAUNDRESS**, _____ ¹⁰⁰ dollars.

Given in Duplicate, at Jacksonville Florida, this 27th day
 of May, 1864.

No Effect
H P Spaulding
 Capt Co E 7th U S C Troops

Nathan P Spaulding
 Capt Co E 7th U S C Troops
 Commanding Company.

MAR 12 1867

✓ 54 H

FINAL STATEMENT

-6-
OF

George A Parsley

7th Reg't of U S Col Troops

VOLUNTEERS.

Died May 24th 1864

NOTE 1.—Two of these certificates (or duplicates) are to be given to each Volunteer Soldier or drafted man who may be discharged previously to the discharge of his company, that he may at once receive from the Paymaster the pay, &c., due him, and the captain or other COMMISSIONED officer commanding the company will certify to the act of the delivery of the duplicate certificates; on these certificates the Soldier is "entitled to" his discharge, and should also present his discharge to the Paymaster to have the payment endorsed on it. The discharge is to be given back to the Soldier by the Paymaster; the latter only retaining as his voucher the duplicate certificates.

NOTE 2.—If the Soldier is entitled to pay for the use of his horse, the Company Commander will certify to that fact on the back of both these final statements, and also to the time he has pay due for having been so mounted on his own horse.

NOTE 3.—When a Soldier is furnished with final statements, his descriptive list, if he has one, should be taken up by the officer who gives the Soldier these statements, and endorsed with a statement to this effect by the officer. This endorsement should exhibit a full statement of the time for which the Soldier was allowed pay on his final statements, the clothing account, and all other charges against him or in his favor, so as to comprise a complete exhibit of his account. It will then be transmitted to the company commander of the Soldier, who will enter all the data necessary to a full understanding of the Soldier's account on the muster roll upon which the Soldier's discharge is reported. The descriptive list will then be destroyed. The object of this is, that the remaining portion of the Soldier's account may be settled upon the receipt of these muster rolls, and the Soldier receive any pay or allowances that may be due him at the time of his discharge, and which may not appear on his final statements from the fact that his descriptive list is incomplete. These accounts for back pay, &c., are settled by the 2d Auditor of the Treasury Department.

NOTE 4.—Charges for loss or injury to ordnance, horse equipments, and other miscellaneous charges, should appear under the heading of "Other Stoppages."

NOTE 5.—Bounty paid by State authorities, and not by the United States, will not be entered on this statement.

NOTE 6.—Amounts due the Sattler and Laundress must be entered on the muster roll on which the discharge, death, desertion, &c., is reported, as well as on the final statement, otherwise the amount cannot be collected from the United States.

NOTE 7.—This blank will be used for deceased volunteers and drafted men, as well as for others.

NOTE 8.—Where a Soldier dies in Hospital or on detached service, his descriptive list, if he has one, should be sent with his final statements, in duplicate, to the Adjutant General, Washington, D. C.

Geo. A. Parsley
Recd. Adj. G. June 4th 1864

ADJUTANT GENERAL'S OFFICE.

June 9th 1864

Duplicate with inventory sent 2d Auditor.

I certify, on honor, that George A Dorsey a Private of
 Captain H P Spaulding Company (E) of the 7th Regiment of U S Col Troops
VOLUNTEERS, of the State of _____, born in Dorchester Co, State
 of Maryland, aged 24 years; 5 feet 8 inches high; Black complexion,
Black eyes, Curly hair, and by occupation a Farmer, having joined the company on
 its original organization at Baltimore Md, and enrolled in it at the muster into
 the service of the United States at Baltimore Md, on the 30th day
 of September, 1863, (or was mustered in service as a recruit, by _____,
 at _____, on the _____ day of _____,
 186 , or was drafted and mustered into the service of the United States from the _____
 Enrollment District of the State of _____, at _____,
 on the _____ day of _____, 186), to serve in the Regiment, for

the term of Three Years or during the War and having served **HONESTLY** and
FAITHFULLY with his Company in the 7th U S C Troops to the present date, is now
 entitled to a **DISCHARGE** by reason of Death. Died in Hospital
at Jacksonville Florida May 24th 1864

The said George A Dorsey was last paid by Paymaster
Lockwood to include the 29th day of February, 1864, and has
 pay due him from that time to the present date; he is entitled to pay and subsistence for
TRAVELING to place of enrollment, and whatever other allowances are authorized to volunteer
 soldiers, drafted men, or militia, so discharged. He has received from the United States **CLOTHING**
 amounting to \$ 32 18 dollars, since the 30th day of September,
 1863, when his clothing account was last settled. He has received from the United States
 _____ dollars advanced **BOUNTY**.

There is to be stopped from him, on account of the State of _____, or other
 authorities, for **CLOTHING**, &c., received on entering service, _____ dollars; and
 for other stoppages, viz: _____

_____ dollars.
 He has been furnished with **TRANSPORTATION** in kind from the place of his discharge to
 _____; and he has been **SUBSISTED** for **TRAVELING** to his
 place of enrollment, up to the _____, 186 .

He is indebted to _____, **BUTLER**, _____ dollars.
 He is indebted to _____, **LAUNDRESS**, _____ dollars.

Given in Duplicate, at Jacksonville Florida, this 27th day
 of May, 1864.

(Signature)
 H P Spaulding
 Capt Co E 7th U S C T
 Sept 27 1864

(Signature)
 H P Spaulding
 Capt Co E 7th U S C T
 Commanding Company.

424

Dorsey Peter

Co - , 7 U.S. Col'd Inf.

CARD NUMBERS.

1	6 2 7 9 1 1 2 ✓	26
2		27
3		28
4		29
5		30
6		31
7		32
8		33
9		34
10		35
11		36
12		37
13		38
14		39
15		40
16		41
17		42
18		43
19		44
20		45
21		46
22		47
23		48
24		49
25		50

Book Mark:

See also:

A | 7

U.S.C.T.

Peter Dancy

Appears with rank of _____ on

Muster and Descriptive Roll of a Detachment of Drafted Men and Substitutes forwarded

for the 7 Reg't U. S. Col'd Inf. Roll dated

Baltimore Md Apr 5, 1865

Where born Howard Co. Md.

Age 23 years; occupation Laborer

Drafted and mustered in:

When Mch 24, 1865

Where E. Mills, Md.

Period 7 years.

Eyes BLK; hair BLA

Complexion BLK; height 5 ft. 8 in.

Paid bounty and advance pay, \$ 100

Bounty due \$ 100

Where credited _____

Company to which assigned _____

Remarks: Drafted from 7th Sub Dist 5 Cong. D. Md. (over)

Book mark: _____

J. M. Fawcett Copyist

JAN. 20

6279112

1891*

*Not taken up in rolls of
rept*

425

Dorsey Samuel

Co G, 7 U.S. Col'd Inf.

Private

Private

CARD NUMBERS.

1	6 2 9 0 9 4 5	26
2	6 2 9 1 0 4 4	27
3	6 2 9 1 1 4 4	28
4	6 2 9 1 2 4 8	29
5	6 2 9 1 3 4 6	30
6	6 2 9 1 4 4 4	31
7	6 2 9 1 5 4 2	32
8	6 2 9 1 6 8 1	33
9	6 2 9 2 3 9 0	34
10	9 0 6 6 6 6 3	35
11		36
12		37
13		38
14		39
15		40
16		41
17		42
18		43
19		44
20		45
21		46
22		47
23		48
24		49
25		50

Book Mark:

See also

91

7

U.S.C.T.

Samuel Corsey
Co. G, 7 Reg't U.S. Col'd Inf.

Appears on

Company Descriptive Book

of the organization named above.

DESCRIPTION.

Age 21 years; height 5 feet 4 inches.

Complexion Black

Eyes Black; hair Curly

Where born Calvert, Md.

Occupation Farmer

ENLISTMENT.

When Oct 22, 186 .

Where Calvert

By whom Cal. Army; term 3 y'rs.

Remarks: Killed Sept 27, 1864.

John S. Brown

D | 7 | U.S.C.T.

Samuel Dorsey
1st, Co. G, 7 Reg't U. S. Col'd Inf

Age 21 years.

Appears on

Company Muster-in Roll

of the organization named above. Roll dated

Camp Stanton, Charles Co., Md, Nov. 5, 1863.

Muster-in to date Nov. 5, 1863.

Joined for duty and enrolled:

When Oct 21, 1863.

Where Somerset, Md

Period 3 years.

Valuation of horse, \$ 100

Valuation of horse equipments, \$ 100

Remarks:

Book mark:

(356)

Est. Mearns
Camp. Copied

D

7

U.S.C.T.

Samuel Dorsey

Priv., Co. G, 7 Reg't U. S. Col'd Infantry.

Appears on

Company Muster Roll

for Nov. 5 to Dec. 31, 1863.

Present or absent Present

Stoppage, \$ 100 for

Due Gov't, \$ 100 for

Remarks: Premium for enlistment \$2.00 (due).

Book mark:

5 0507042

Sanday

Copyist

D

7

U.S.C.T.

Samuel Dorsey

Priv., Co. G, 7 Reg't U. S. Col'd Infantry.

Appears on

Company Muster Roll

for *Jan. & Feby.*, 1864.

Present or absent *Present*.

Stoppage, \$ 100 for

Due Gov't, \$ 100 for

Remarks:

Book mark:

(858)

Sandoz
Copyist

D

7

U.S.C.T.

Samuel Dorsey

Private, Co. G, 7 Reg't U. S. Col'd Infantry.

Appears on

Company Muster Roll

for Mch. & Apr., 1864.

Present or absent Present

Stoppage, \$ 100 for

Due Gov't, \$ 100 for

Remarks:

Book mark:

Sawyer
- Copyist

(858)

D

7

U.S.C.T.

Samuel Dorsey

Priv., Co. G, 7 Reg't U. S. Col'd Infantry.

Appears on

Company Muster Roll

for May & June, 1864.

Present or absent Present

Stoppage, \$ 100 for

Due Gov't, \$ 100 for

Remarks:

Book mark:

Sandoz
Coptist

D | 7 | U.S.C.T.

Samuel Dorsey

Priv., Co. G, 7 Reg't U. S. Col'd Infantry.

Appears on

Company Muster Roll

for July & Aug., 1864.

Present or absent Present.

Stoppage, \$ 100 for

Due Gov't, \$ 100 for

Remarks:

Book mark:

(858)

Sandoz Copyist

D

7

U.S.C.T.

Samuel Dorsey

Private, Co. G, 7 Reg't U. S. Col'd Infantry.

Appears on

Company Muster Roll

for Sept. & Oct., 1864.

Present or absent Absent

Stoppage, \$ 100 for

Due Gov't, \$ 100 for

Remarks: Missing in action, Sept 29" 1864.

Book mark:

(858)

Sandoy

Copyist

D

7

U.S.C.T.

Samuel Doney
Pr.

Co. G, 7 Reg't U. S. Col'd Infantry.

Appears on

Company Muster Roll

for *Nov. & Dec.*, 186*4*

Present or absent

Stoppage, \$ 100 for

Due Gov't, \$ 100 for

Remarks:

Missing in action
Sept. 29th 64. Omitted
to be dropped.

Book mark:

(858)

J. W. Lewis

Copyist

P

7

U.S.C.T.

Samuel Dorsey

Pvt, Co. G, 7 Reg't U. S. Col'd Infantry.

Appears on Co. Muster-out Roll, dated Indianola Texas, Oct 13, 1866.

Muster-out to date _____, 186 .

Last paid to April 30, 1864.

Clothing account:

Last settled _____, 186 ; drawn since \$ 100

Due soldier \$ 100; due U. S. \$ 100

Am't for cloth'g in kind or money adv'd \$ 100

Due U. S. for arms, equipments, &c., \$ 100

Bounty paid \$ 100; due \$ 100

Remarks: Killed in action at Fort Gilmer Va September 29 1864 final state - ment rendered *

* Roll torn

Book mark:

Hadfield

Dorsey Samuel
G. 17, Co., Reg't *1505*

~~10~~ Enclosures.

Bed Cards	Final Statements
Burial Records	Furloughs or L. of A.
Certs. of Dis. for Discharge	Med. Certificates
C. M. Charges	Med. Des. Lists
Descriptive Lists	Orders
Discharge Certificates	Pris. of War Record 2
Enlistment Papers	Resignations

Other papers relating to—

Admission to Hosp'l	Furlough or L. of A.
Casualty Sheet 2	Med. Examination
Confinement	Misc. Information 6
Contracts	Pay or Clothing
Death or Effects	Personal Reports
Desertion	Rank
Discharge from Hosp'l	Transfer to Hosp'l
Discharge from Service	Transfer to V. R. C.
Duty	Transportation

Spent sent for 35 July 1865
RC Nov 1868
RC Nov 1868

CASUALTY SHEET

No. _____

Saml D. Orsary

of Company

Regiment of

State Volunteers.

NATURE OF CASUALTY.

Died at Salisbury
Mo. Jan 15th 65
E 25. Vol. 3 R.C. 3. 1862
refd to R.C. April 466
Regt mustered out, records
with Chief Messy of Pa. Batt.
Md. Co
I. 617 Vol. 3 R.C. 3. 1866.
Salisbury
Regt of Pa.
Cut. in R.C. of Pa.

CASUALTY SHEET

Name: *Samuel D. Orsary*

Rank: _____ Company: *Co* Regiment: *7th*

Arm: *Inftry* State: *N. C. I.*

Nature of Casualty: *Death*

CAUSE OF CASUALTY—(NAME OF DISEASE, &c.)

BY WHOM DISCHARGED.

DEGREE OF DISABILITY.

FROM WHAT SOURCE THIS INFORMATION WAS OBTAINED.

Roll furnished by Orsary Sub. of Prisoners

BY WHOM CERTIFIED.

Sub. Maj. W. J. Hartz A. A. G.

REMARKS.

DATE OF DISCHARGE, DEATH, &c.

July 15th 1865.

PLACE OF DISCHARGE, DEATH, &c.

Salisbury N. C.

Geo. W. Clark
Clerk.

[Large signature]

MEMORANDUM FROM PRISONER OF WAR RECORDS.

No. _____

(This blank to be used only in the arrangement of said records.)

NAME	RANK.	ORGANIZATION.				INFORMATION OBTAINED FROM—				
		No. of Reg't.	State.	Arm of Service.	Co.	Records of—	Vol.	Page.	Vol.	Page.
<i>Dalton Samuel</i>	<i>Pvt</i>	<i>7</i>	<i>Ark.</i>	<i>Inf.</i>	<i>G.</i>	<i>Min</i>	<i>69</i>	<i>56</i>	<i>39</i>	<i>79</i>

Captured at *Shafiqi Farm* *Sept 29*, 186 4, confined at Richmond, Va., *Sept 29*, 186 4.

Admitted to Hospital at _____, 186 _____, of *Dist to Solidy, U.S.A Nov. 24/64*

where he died _____, 186 _____, of _____

Paroled at _____, 186 _____; reported at Camp Parole, Md., _____, 186 _____.

Copied by *[Signature]*

MEMORANDUM FROM PRISONER OF WAR RECORDS.

No. 328

(This blank to be used only in the arrangement of said records.)

INFORMATION OBTAINED FROM—

NAME.	RANK.	ORGANIZATION.				Records of—	Vol.	Page.	Vol.	Page.
		No. of Reg't.	State.	Arm of Service.	Co.					
Orray Samuel D						Mis	69	58	12	246
						DB	2	283		
Dorsey Samuel	P 7	U S	65	6						

Captured at Ft Gilmore Va Sept 29, 1864, brought from _____, and
 confined at Richmond, Va., date not given, 1864, slave owned by Richard Stanton - Calvert Co
 Md. sent to Salisbury NC Nov 24/64
 Admitted to Hospital at Salisbury NC _____, 1864; treated for # 98
 Where he died Jan 15, 1865; of _____
 Paroled at _____, 1865; reported at _____, 1865.

(Record continued.)

Furloughed _____, 186 , for _____ days; returned _____, 186 ;
deserted _____, 186 ;

Enrolled as Samuel Dorsey, B 7 U.S. C.T.
The name Samuel D. or G. Orsay is not borne
on rolls of Co. B or Co. C, 7th U.S. C.T.

2^d Div. V.M.M. 7th M.M.
1-26-87. ~~88~~

6 lbs case Recd. also Nov. 17. 88. Returned July 1. 89.

Copied by E.M. 1-24-89

Adjutant General's Office.

This is accepted as referring to

Samuel D. Orsay, 18 89

Co. *B*, *7th* Reg't

M. D. Orsay

and records will be corrected accordingly.

Assistant Adjutant Gen'l.

MB

CASUALTY SHEET

No.

Samuel W. Wasey

Capt of Company *4*

41 Regiment of *W.S.C.*

State Volunteers.

NATURE OF CASUALTY.

CASUALTY SHEET.

Name: *Samuel Vason*

Private

"I"

Company:

7th

Regt

State:

of Casualty:

Death

OF CASUALTY—(NAME OF DISEASE, &C.)

BY WHOM DISCHARGED

FROM WHAT SOURCE THIS INFORMATION
OBTAINED.

1. 1. 1. 1. 1. 1.

DEGREE OF DISABILITY.

BY WHOM CERTIFIED.

J. M. C. Smith

Camp

DATE OF DISCHARGE, DEATH, &C.

September 24 1864

PLACE OF DISCHARGE, DEATH, &C.

Fort Mifflin Pa.

REMARKS.

1. 1. 1. 1. 1. 1.

NARA 1291

C. G. Benedict,
C. G. Vol's.
Washington, D.C.

Baltimore
May 1866

Please make

payment to the order of William
Baltimore City, Md. Martha S.

Paid

Dollars

210⁰⁰/₁₀₀

, 1866

Martha S.

United States,

To Martha Stanfo

For amount awarded him by the Board of Claims, in consideration of the enlistment of Samuel Dorsey in the 7th Reg't U. S. Colored Troops,

Total \$

That the above account is correct and just; that the name of Dorsey is borne on the muster-in rolls of the 7th Reg't U. S. Colored Troops; and that the above amount was awarded by the Board of Claims, the Board of Stretcher Esq. is President, said award being in accordance with the act entitled "An act to amend an act entitled 'An act for the relief of the colored soldiers of the national forces, and for other purposes,'" approved Feb. 24, 1864.

Assistant Adjutant

and Hundred, 186, of Capt. L. G. Benedict dollars and cents, in full of the above

Martha Stanfo

(SIGNED DUPLICATES.)

G. Benedict,
Wol. s.
Washington, D. C.

Baltimore
May the 2

Please make it
to the order of William
Baltimore City, Md. *Martha*

Paid

Dollars *217* ⁰⁰/₁₀₀

Martha

, 186 .

, 186 .

CASUALTY SHEET.

Name: *Charles W. Smith*
 Rank: *Private* Company: *7th* Regiment: *115th*
 Arm: _____ State: _____
 Nature of Casualty: *Wound*

CAUSE OF CASUALTY—(NAME OF DISEASE, &c.)

BY WHOM DISCHARGED.

DEGREE OF DISABILITY.

FROM WHAT SOURCE THIS INFORMATION WAS OBTAINED.

BY WHOM CERTIFIED.

REMARKS.

DATE OF DISCHARGE, DEATH, &c.

PLACE OF DISCHARGE, DEATH, &c.

W. C. Smith
Company Clerk
September 29 1864
St. Louis, Mo.

W. C. Smith
 Clerk.

Capt. L. G. Benedict,
A. A. G. Vol's.
Washington, D.C.

Baltimore.
May 27th 1864.

Please make check
payable to the order of William Daniel of
Baltimore City, Md. Martha Starforth

57

No. .

ABSTRACT OF DISBURSEMENTS.

, 186 .

Martha Starforth

Dollars *311* ⁰⁰/₁₀₀

Paid, 186 .

The United States,

To Martha Stanforth, Dr.

186 .	For amount awarded him by the Board of Claims, in consideration of the enlistment of <i>Samuel Dorsey</i> in the <i>7th. Reg't U. S. Colored Troops,</i>	DOLLARS.	CENTS.
		300	00
	<i>Total \$</i>	300	00

I CERTIFY that the above account is correct and just; that the name of *Samuel Dorsey* is borne on the muster-in rolls of the *7th. Reg't U. S. Colored Troops*; and that the above amount was awarded by the Board of which *S. F. Struter Esq.* is President, said award being in accordance with section 24 of the act entitled "An act to amend an act entitled 'An act for enrolling and calling out the national forces, and for other purposes,'" approved Feb. 24, 1864.

Assistant Adjutant General.

RECEIVED _____, 186 , of *Capt. L. G. Benedict, A. A. G. U. S. A.* dollars and _____ cents, in full of the above account.

Martha Stanforth

(SIGNED DUPLICATES.)

Capt. L. G. Benedict,
A. A. G. Wols.
Washington, D. C.

Baltimore.
May the 27th 1864.

Please make check
payable to the order of William Daniel
of Baltimore City, Md. *Martina Stanforth*

577

No. .

ABSTRACT OF DISBURSEMENTS.

....., 186 .

Martina Stanforth
Dollars *311*

100⁰⁰

Paid , 186 .

The United States,

To *Martha Staunton Dr.*

186 .

For amount awarded him by the Board of Claims, in consideration

of the enlistment of *Samuel Dorsey*

in the *7th Regt U.S. Colored Troops*

DOLLARS.

CENTS.

300.00

Total \$ 300.00

I CERTIFY that the above account is correct and just; that the name of *Samuel Dorsey* is borne on the muster-in rolls of the *7th Regt U.S. Colored Troops*; and that the above amount was awarded by the Board of which *S. F. Stebbins* is President, said award being in accordance with section 24 of the act entitled "An act to amend an act entitled 'An act for enrolling and calling out the national forces, and for other purposes,'" approved Feb. 24, 1864.

Assistant Adjutant General.

RECEIVED

Three Hundred

, 186 , of

Capt S. G. Benedict, Cash

dollars and

cents,

in full of the above account.

Martha Staunton

(SIGNED DUPLICATES.)

Martha Stanforth

to Copy of Deed of
Manumission

Samuel Dorsey

U.
M.

Whereas my slave Samuel Dorsey has enlisted in the Service of the United States; now in consideration thereof of Martha Stanforth of Calvert County State of Maryland do hereby in consideration of said enlistment, manumit, set free and release the above named Saml Dorsey from all service due and his freedom to commence from the 22nd of Oct 1863 the date of his enlistment as aforesaid in the 7th Regiment of Colored Troops in the Service of the United States. Witness my hand & seal this 27th day Apr 1864

Witness Martha Stanforth

Geo L. Wall
George Peterson
Joseph Griffin

500 Stamp
5 cents

Calvert County State Maryland 1864

Before me appeared this day Martha Stanforth and acknowledged the above Deed of Manumission and Release of Service to be her free act and deed.

Wm King J.P.

Recorded Apr 28th & returned per Calvert County Sec

M. B. Deen Clk

I hereby certify that the above is a true copy of the original Deed as recorded in Liber. D. B. 10. one of the Land Record Books of Calvert County

In testimony whereof I hereunto set my hand & affix the seal of the Circuit Court for Calvert County this 28th day of April A. D. 1864

Dennis B. M. Deen Clk

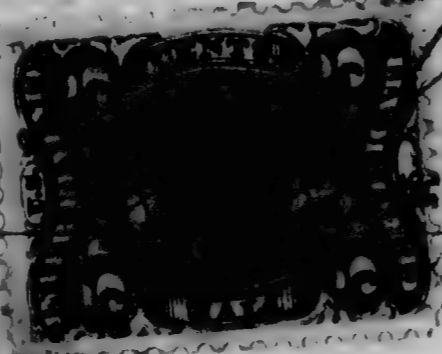

F.

CERTIFICATE OF AWARD OF THE BOARD OF CLAIMS.

Office of the Board of Claims

For Slaves Enlisted in the Service of the United States,

No 123

Baltimore Md,

\$300

May 23^d, 1864

We hereby certify, that Martha Stanforth, of Calvert county, State of Maryland, having proved, under oath, her loyalty to the Constitution and Government of the United States, and established her title as to the ownership of Samuel Dorsey, a slave enlisted at Calvert County Md, on the 22^d day of October, 1863, by Col Wm. Birney, in the service of the United States, in the Seventh Regiment of Colored Troops, Co. G, and having filed a valid Deed of Manumission and Release of Service of said slave, is entitled to the sum of Three Hundred dollars, which has been awarded to her by this Board as a remuneration for all claim to the future labor or service of said slave, under the provision of General Orders, War Department, No. 329, 1863.

J. Street, President of the Board.

Thos. Simons, Member of the Board.

S. C. Stranghn, Member of the Board.

To Maj. C. W. Foster,

Chief of the Bureau for the
Organization of Colored Troops, Washington, D. C.

1070

Martha Stewart

E. J. Davis

A.

No. 1070

CLAIMANT'S CERTIFICATE.

I, Martha Staunfort a loyal citizen, and a resident of _____, County of Calvert, State of Maryland, hereby claim compensation, under the provisions of General Orders, No. 329, 1863, for my slave Samuel Dorsie enlisted October 22, 1863, at Calvert County, Md. by Col. Wm Pirney in the Seventh Regiment U. S. Colored Troops, Co. G; certificate of which enlistment, and a descriptive list, as required, accompany this application.

In proof of my loyalty to the Constitution and Government of the United States, I present the accompanying oath, which I have taken, signed, and acknowledged, to be filed with this application, in accordance with requirement of said General Orders.

Feb 8th

1864.

Martha Staunfort

B.

OATH OF ALLEGIANCE.

I. Martha Stanforth, do solemnly swear that I have never joined, or been concerned in, any insurrection or rebellion; that I have never borne arms against the United States; that I have never given any aid, countenance, counsel, or encouragement to any person or persons engaged, or whom I had reason to believe were about to engage, in insurrection, rebellion, or armed hostility against the United States; that I have neither sought, nor accepted, nor attempted to exercise the functions of any office, civil or military, nor to perform any service whatever, under any authority or pretended authority in hostility to the United States; that I have not yielded a voluntary support to any insurrection, rebellion, or pretended government, authority, power, or constitution within the United States hostile thereto. And I do further swear that, to the best of my knowledge and ability, I have supported and defended, and will continue to support and defend, the United States against all enemies, foreign and domestic; and that I have supported, defended, and obeyed, and will continue to support, defend, and obey, the Constitution and laws of the United States; that I will bear true faith and allegiance to the same; and that I take this oath freely, without any mental reservation or purpose of evasion: So help me God.

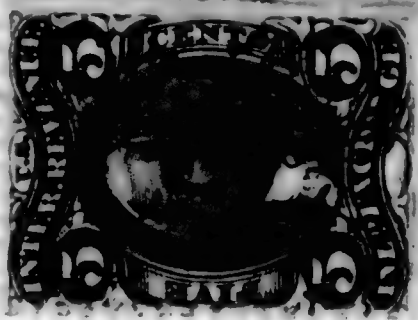

Martha Stanforth

Sworn to and subscribed before me, at St Leonards

this 11th day of February 1864

Wm. King Justice of Peace

C.

I present herewith evidence of my title to the slave Samuel Dorsey
 enlisted as aforesaid, and in consideration of the sum of
 by me received, I hereby covenant and
 agree with the United States, that I, my heirs, executors, or assigns, shall never hereafter make
 or enforce any claim to the labor or services of said slave; and pledge myself to execute
 a valid Deed of Manumission and Release of all my claims to service forever of said
Samuel Dorsey to be filed with the Board of Claims
 now in session at Baltimore.

my
July 8th, 1864.

3 Martha Stanforth

Ms. A. 9. 2. 33

S. No. 27. S. C. T. 1864

For descriptive list, see 1069

No. 1070 M. 57

APPLICATION OF

Martha Stanforth,

OF

Calvert County, Md.

For Compensation for Service of Slave,

Samuel Dorsey,

Enlisted in Seventh Regiment

U. S. Colored Troops, Co. G.

Received, March 11 1864.

COMPENSATION AWARDED,

May 23rd 1864.

Three Hundred Dollars.

J. S. Shetter

Presdt Bd of Claims.

This copy is returned to the State

of Md. Samuel Dorsey's estate

by the following

Recd A. G. O. May 29. 1864.

Del. A. M. [unclear] [unclear]

Thru [unclear] [unclear]

Received March 30. 67

War Department
U. S. C. Washington D. C.
June 8. 1864.

Respectfully returned for
evidence that the bounty due
the recruit from the State of Maryland
has been paid.

By order:

J. S. Dimesick,
Capt. U. S. Army
U. S. M.

Recd back. W. D. Sept. 13. 1864

EVIDENCE OF TITLE.

I, *Martha Stanforth*, of *Calvert* County, Md., do solemnly swear that *Samuel Dorsey* who has been enlisted in the *Seventh* Regiment, U. S. Colored Troops, Co. *G*; is my slave for *life*; (~~his term of service expiring on the~~ ~~day of~~ ~~186~~;) and that I became possessed of him ~~by~~ *in consequence of the purchase of his mother*, in the month of *November*, eighteen hundred and *43*. And I do further swear that I have not purchased said slave from any person or persons disloyal to the Government of the United States, with the object of obtaining compensation for the same; and furthermore, that I have no agency for obtaining compensation for any person or persons but such as, to my knowledge, are loyal citizens of the United States.

M. Stanforth
Martha Stanforth
 1864.

STATE OF MARYLAND.

Seabert — County, to wit:

On this *8th* day of *Feb* in the year 1864,

before me, the subscriber, a Justice of the Peace of the State and County aforesaid, personally appeared *Martha Staunfort*, and took, signed, and acknowl-

edged the oaths preceding; and further made oath, in due form of law, that all the statements made in this application are, to the best of *her* knowledge and belief, strictly

true. Also personally appeared before me *James Y Hall* and

George Peterson, loyal citizens of the United States, residents of

Seabert County, well acquainted with the said *Martha*

Staunfort, and in no manner interested in the prosecution of this

claim, and made oath, in due form of law, that the said *Martha Staunfort*

is the owner of the slave *Samuel Dorsey*, as a fact of public noto-

riety: that they believe all the statements herein made by *her*, in reference

thereto, are correct, and that *she* is unquestionably loyal to the Government of

the United States. Witness their signatures:

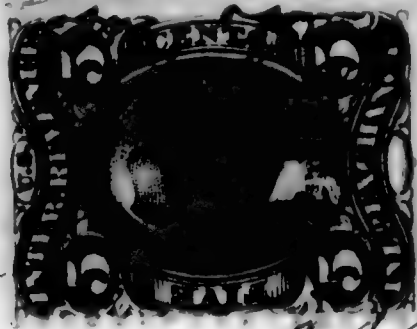

J. M. King

5 J. Y. Hall

G. Peterson

Justice of the Peace.

STATE OF MARYLAND,

Calvert County, to wit:

I, *Dennis B. McDivory*, Clerk of the Circuit Court for

Calvert County, do hereby certify that *William King, Esq*

before whom the foregoing affidavits were made, was, at the time of signing the same, a Justice of the Peace for the County and State aforesaid, duly commissioned and sworn; and that his signature thereto is genuine, and that full faith and credit should be given to his official acts.

Witness my hand and the seal of said Court, this *Tenth* day of

May, A. D. 1864.



Dennis B. McDivory CLERK.

426

Jorsey William

Co *L*, 7 U.S. Col'd Inf.

Private | *Private*

CARD NUMBERS.

1	6 2 9 4 2 3 4	26
2	6 2 9 4 3 3 3	27
3	6 2 9 4 4 3 5	28
4	6 2 9 4 5 3 5	29
5	6 2 9 4 6 3 0	30
6	6 2 9 4 7 2 3	31
7	6 2 9 4 8 1 5	32
8	6 2 9 4 9 0 8	33
9	6 2 9 5 0 0 3	34
10	6 2 9 5 1 0 3	35
11	6 2 9 5 2 0 4	36
12	6 2 9 5 3 0 4	37
13	6 2 9 5 3 9 8	38
14	6 2 9 5 4 8 6	39
15	6 2 9 5 5 7 3	40
16	6 2 9 5 6 4 6	41
17	6 2 9 5 7 1 7	42
18	6 2 9 5 7 9 0	43
19	6 2 9 5 8 6 2	44
20	9 0 6 6 9 0 7	45
21		46
22		47
23		48
24		49
25		50

Book Mark:

See also

p. 1227519 P.O. in mi
D-3039168 - Aud. N.D.
D-3073022 . " " " (Clo)

S. 1 7 U.S.C.T.

William Gorsey

, Co. G, 7 Reg't U. S. Col'd Inf.

Appears on Company Descriptive Book of the organization named above.

DESCRIPTION.

Age 25 years; height 5 feet 5 inches.

Complexion Dark

Eyes Blk; hair Blk.

Where born St. Marys, Md.

Occupation Farmer.

ENLISTMENT.

When Oct. 26, 1863.

Where St. Marys, Md.

By whom Chas. M. Birney; term 3 y'rs.

Remarks: Mustered in at Camp Stanton, Md. Nov. 5. 63. by Lt. Col. Haskell.

J. A. White

Copyist.

9 | 7 | U.S.C.T.

William Dorsey
Pvt., Co. J, 7 Reg't U. S. Col'd Inf.

Age 25 years.

Appears on

Company Muster-in Roll

of the organization named above. Roll dated
Camp Stanton, Charles Co., Md., Nov. 5, 1863.

Muster-in to date Nov. 5, 1863

Joined for duty and enrolled:

When Oct. 26, 186 .

Where St. Mary

Period 3 years.

Remarks:

Book mark:

J. B. Gage

D | **7** | **U.S.C.T.**

William Dorsey
Priv, Co. I, 7 Reg't U. S. Col'd Infantry.

Appears on

Company Muster Roll

for *from Nov. 5 to Dec. 31*, 186*3*

Present or absent *Present*

Stoppage, \$ *100* for

Due Gov't, \$ *100* for

Remarks: *Enlistment premium*
\$2.00 due.

Book mark:

(358)

J.B. Gage
Copyist.

D

7

U.S.C.T.

William Dorsey
Pvt, Co. I, 7 Reg't U. S. Col'd Infantry.

Appears on

Company Muster Roll

for Jan & Feb, 1864.

Present or absent Present

Stoppage, \$ 100 for

Due Gov't, \$ 100 for

Remarks: Enlistment premium
\$2.00 due.

Book mark:

J. B. Gage
Copyist.

(358)

2

7

U.S.C.T.

William Dorsey

Priv., Co. I, 7 Reg't U. S. Col'd Infantry.

Appears on

Company Muster Roll

for Mch & Apr, 1864.

Present or absent Present

Stoppage, \$ 100 for

Due Gov't, \$ 100 for

Remarks:

Book mark:

J B Gage

Copyist.

(358)

D | 7 | U.S.C.T.

William Dorsey
Pvt, Co. I, 7 Reg't U. S. Col'd Infantry.

Appears on

Company Muster Roll

for May & June, 1864.

Present or absent Present

Stoppage, \$ 100 for

Due Gov't, \$ 100 for

Remarks:

Book mark:

J. B. Yager

D

7

U.S.C.T.

William Dorsey

Prst, Co. I, 7 Reg't U. S. Col'd Infantry.

Appears on

Company Muster Roll

for *July & Aug*, 186*4*.

Present or absent *Present*

Stoppage, \$ *100* for

Due Gov't, \$ *100* for

Remarks:

Book mark:

J. B. Gage

(358)

Copyist.

2

7

U.S.C.T.

William Dorsey
Pvt, Co. I, 7 Reg't U. S. Col'd Infantry.

Appears on

Company Muster Roll

for Sept & Oct, 1864

Present or absent Present

Stoppage, \$ 100 for

Due Gov't, \$ 100 for

Remarks:

Book mark:

(358)

J B Gage
Copyist.

A | **7** | **U.S.C.T.**

William Dorsey

Priv, Co. I, 7 Reg't U. S. Col'd Infantry.

Appears on

Company Muster Roll

for *Nov. & Decr.*, 1864.

Present or absent *Present*

Stoppage, \$ *100* for

Due Gov't, \$ *100* for

Remarks:

Book mark:

D. Mahor

A

7

U.S.C.T.

William Dorsey

Priv, Co. I, 7 Reg't U. S. Col'd Infantry.

Appears on

Company Muster Roll

for *Jan'y. & Feby.*, 1865.

Present or absent *Present*

Stoppage, \$ *100* for

Due Gov't, \$ *100* for

Remarks:

Book mark:

D. Maher

Copyist.

B

7

U.S.C.T.

William Dorsey

Priv, Co. I, 7 Reg't U. S. Col'd Infantry.

Appears on

Company Muster Roll

for *March + April*, 1865.

Present or absent *Present*

Stoppage, \$ *100* for

Due Gov't, \$ *100* for

Remarks:

Book mark:

D. Mahser
Copyist.

A

7

U.S.C.T.

William Dorsey

Priv, Co. I, 7 Reg't U. S. Col'd Infantry.

Appears on

Company Muster Roll

for *May + June*, 1865.

Present or absent *Present*

Stoppage, \$ *100* for

Due Gov't, \$ *100* for

Remarks:

Book mark:

D. Maher
Copyist.

A

7

U.S.C.T.

William Dorsey

Priv, Co. I, 7 Reg't U. S. Col'd Infantry.

Appears on

Company Muster Roll

for *July & Aug.*, 1865.

Present or absent *Present*

Stoppage, \$ *100* for

Due Gov't, \$ *02* for *C. & G. Equipage*

Remarks:

Book mark:

D. Mahrt

Copyist.

D

7

U.S.C.T.

William Dorsey
Priv, Co. I, 7 Reg't U. S. Col'd Infantry.

Appears on

Company Muster Roll

for *Sept. & Oct.*, 1865.

Present or absent *Present*

Stoppage, \$ *100* for

Due Gov't, \$ *04* for *C. & G. Equipage*

Remarks:

Book mark:

D. Maher

(358)

Copyist.

D

7

U.S.C.T.

William Dorsey

Priv., Co. I, 7 Reg't U. S. Col'd Infantry.

Appears on

Company Muster Roll

for *Nov. + Decr.*, 1865.

Present or absent *Present*

Stoppage, \$ *100* for

Due Gov't, \$ *04* for *C. + G. Equipage*

Remarks:

Book mark:

D. Mahser

(358)

Copyist.

D

7

U.S.C.T.

William Dorsey

Private, Co. I, 7 Reg't U. S. Col'd Infantry.

Appears on

Company Muster Roll

for Jan. + Feb., 1866.

Present or absent Present.

Stoppage, \$ 100 for

Due Gov't, \$ 100 for

Remarks:

Book mark:

Sabine

Copyst.

(358)

D

7

U.S.C.T.

William Dorsey

Private, Co. I, 7 Reg't U. S. Col'd Infantry.

Appears on

Company Muster Roll

for Mar + Apr, 1866.

Present or absent Present.

Stoppage, \$ 100 for

Due Gov't, \$ 08/100 for Ordnance lost.

Remarks:

Book mark:

Sabine

Copyist.

(358)

D

7

U.S.C.T.

William Dorsey

Priv., Co. I, 7 Reg't U. S. Col'd Infantry.

Appears on

Company Muster Roll

for Feb 28 to June 30, 1866.

Present or absent Not stated.

Stoppage, \$ 08 for 100 for ordnance and ordnance stores.

Due Gov't, \$ 100 for

Remarks:

Book mark:

Sabine

Copyist.

(358)

D

7

U.S.C.T.

William Dorsey

Private, Co. I, 7 Reg't U. S. Col'd Infantry.

Appears on

Company Muster Roll

for July + Aug, 1866.

Present or absent Present

Stoppage, \$ 100 for

Due Gov't, \$ 100 for

Remarks:

Book mark:

(358)

Sabine Copyist.

L

7

U.S.C.T.

William Dorsey
Pr, Co *D*, 7 Reg't U. S. Col'd Infantry.

Appears on **Co. Muster-out Roll** dated
Indianola Texas,
October 13, 1866.

Muster-out to date *Oct. 13,* 1866.

Last paid to *June 30,* 1866.

Clothing account:

Last settled....., 186 ; drawn since \$..... 100

Due soldier \$ *25.62* 100; due U. S. \$..... 100

Am't for cloth'g in kind or money adv'd \$..... 100

Due U. S. for arms, equipments, &c., \$ *6* 100

Bounty paid \$..... 100; due \$ *100* 100

Remarks: *Joined co. at ori-*
ginal organization.
Retains one E. R. mustlet
** set of accoutrements,*
per G.O. 10, War Dept.,
May 30, '65.

Book mark:

Sabine

Copyist.

John William

Co B, 7 U.S. Col'd Inf

Private

Private

CARD NUMBERS.

1	6 2 8 5-4 6 5	26
2	6 2 8 5-5-6 6	27
3	6 2 8 5-6 6 3	28
4	6 2 8 5-7 6 7	29
5	6 2 8 5-8 7 1	30
6	6 2 8 5-9 7 1	31
7	6 2 8 6 0 6 7	32
8	6 2 8 6 1 6 0	33
9	6 2 8 6 2 3 8	34
10	6 2 8 6 3 4 3	35
11	6 2 8 6 4 7 1	36
12	6 2 8 6 5 1 1	37
13	6 2 8 6 6 0 1	38
14	6 2 8 6 6 8 8	39
15	6 2 8 6 7 7 0	40
16	6 2 8 6 8 4 8	41
17	6 2 8 6 9 1 0	42
18	6 2 8 6 9 7 6	43
19	6 2 8 7 0 3 0	44
20	6 2 8 7 0 8 6	45
21	9 0 6 6 2 8 5	46
22		47
23		48
24		49
25		50

Book Mark:

See also

S-1579853 P.O. aff.

D. 2764992 And. W.D.

R

7

U.S.C.T.

William Rorum

....., Co. *A*, 7 Reg't U. S. Col'd Inf.

Appears on

Company Descriptive Book

of the organization named above.

DESCRIPTION.

Age *19* years; height *5* feet *7 3/4* inches.

Complexion *Black*

Eyes *Black*; hair *Curly*

Where born *Salisbury, Md.*

Occupation *Farmer*

ENLISTMENT.

When *Sept 26*, 186*3*.

Where *Salisbury*

By whom *Wm. R. Rorer*; term *5* y'rs.

Remarks: *enlisted Sep 27 63.*

202222

D | **7** | **U.S.C.T.**

William Dorum
Pvt, Co. *D*, 7 Reg't U. S. Colored Inf.

Age *19* years.

Appears on

Company Muster-in Roll

of the organization named above. Roll dated

Baltimore Md, Sep. 29, 1863.

Muster-in to date *Sep. 29, 1863.*

Joined for duty and enrolled:

When *Sept. 26, 1863**

Where *Talbot Co. Md**

Period *3* years.*

Remarks:

*Master-in roll shows enrollment of all men of this company as of same date. See enrollment on subsequent card or cards.

Book mark: *L. 16. Md.*

R. S. Shelton

D | 7 | U.S.C.T.

William Dorman
Priv., Co. D, 7 Reg't U. S. Col'd Infantry.

Appears on

Company Muster Roll

for from Sept 29 to Oct 31, 1863.

Joined for duty and enrolled:

When Sept 26, 1863.*

Where Tolbat Co. Md. *

Period 3 years.*

Present or absent Present

Stoppage, \$ 100 for

Due Gov't \$ 100 for

Remarks:

* See enrollment on card from muster-in roll.

Book mark:

R. S. Shelton

0

7

U.S.C.T.

William Dorum

Pat, Co. D, 7 Reg't U. S. Col'd Infantry.

Appears on

Company Muster Roll

for *Nov + Dec*, 186*3*.

Joined for duty and enrolled:

When *Sept 26.*, 186*3*.*

Where *Talbot Md.*.*

Period *3* years.*

Present or absent *Present*

Stoppage, \$ *100* for

Due Gov't \$ *100* for

Remarks: *Stop for 1. Canteen*

* See enrollment on card from muster-in roll.

Book mark:

R S Shelton

(358c)

Copyist.

D

7

U.S.C.T.

William Damm

Priv, Co. D, 7 Reg't U. S. Col'd Infantry.

Appears on

Company Muster Roll

for *Jan + Feb*, 1864.

Joined for duty and enrolled:

When *Sept 26*, 186*3*

Where *Talbot Md* *

Period *3* years.*

Present or absent *Present*

Stoppage, \$ *100* for

Due Gov't \$ *100* for

Remarks:

* ~~See~~ See enrollment on card from muster-in roll.

Book mark: _____

R. S. Shetton

(358c)

Copyist.

D

7

U.S.C.T.

William Dawson

Pvt, Co. D, 7 Reg't U. S. Col'd Infantry.

Appears on

Company Muster Roll

for Micho Apl, 1864.

Joined for duty and enrolled:

When Sept 26, 1863.*

Where Talbot Md. *

Period 3 years.*

Present or absent Present

Stoppage, \$ 100 for

Due Gov't \$ 100 for

Remarks:

* See enrollment on card from muster-in roll.

Book mark:

R. S. Shelton

9 | 7 | **U.S.C.T.**

William Down
Priv, Co. D, 7 Reg't U. S. Col'd Infantry.

Appears on

Company Muster Roll

for May & June, 1864.

Joined for duty and enrolled:

When Sept 26, 1863*

Where Talbot Co. Md.*

Period 3 years.*

Present or absent Present

Stoppage, \$ 100 for _____

Due Gov't \$ 100 for _____

Remarks: _____

* See enrollment on card from muster-in roll.

Book mark: _____

R. S. Shelton

(358c)

Copyist.

D

7

U.S.C.T.

William Dorum
Pvt, Co. D, 7 Reg't U. S. Col'd Infantry.

Appears on

Company Muster Roll

for July & Aug., 1864.

Joined for duty and enrolled:

When Sept 26, 1863*

Where Galbot Md. *

Period 3 years.*

Present or absent Present

Stoppage, \$ 100 for

Due Gov't \$ 100 for

Remarks:

* See enrollment on card from muster-in roll.

Book mark:

R. S. Shelton

(358c)

Copyist.

D

7

U.S.C.T.

William Dorem

Private, Co. D, 7 Reg't U. S. Col'd Infantry.

Appears on

Company Muster Roll

for *Sept. & Oct.*, 186*4*.

Joined for duty and enrolled:

When *Sept. 26*, 186*3*.*

Where *Talbot* *

Period *3* years.*

Present or absent *absent*

Stoppage, \$ *100* for

Due Gov't \$ *100* for

Remarks: *Wounded & in
Hospital Date and lo-
cality unknown*

* See enrollment on card from muster-in roll.

Book mark:

W.D. Meale

Copyist.

20

7

U.S.C.T.

William Dornan

Private, Co. D, 7 Reg't U. S. Col'd Infantry.

Appears on

Company Muster Roll

for *Nov. & Dec.*, 1864.

Joined for duty and enrolled:

When *Sept 26*, 1863.*

Where *Falbot* *

Period *3* years.*

Present or absent *Present*

Steppage, \$ *100* for

Due Gov't \$ *100* for

Remarks:

* See enrollment on card from muster-in roll.

Book mark:

J. P. Neal

A

7

U.S.C.T.

William Dorem
Priv, Co. D, 7 Reg't U. S. Col'd Infantry.

Appears on

Company Muster Roll

for *Jan'y 4. Feb.*, 1865.

Joined for duty and enrolled:

When *Sept 26*, 1863.*

Where *Talbot co**

Period *3* years.*

Present or absent *Present*

Steppage, \$ *100* for

Due Gov't \$ *100* for

Remarks: *Stop / Canteen*

* See enrollment on card from muster-in roll.

Book mark:

(358c)

F. W. Neal

Copyist.

21 | 7 | **U.S.C.T.**

William Dorum

Priv., Co. D, 7 Reg't U. S. Col'd Infantry.

Appears on

Company Muster Roll

for *March & April*, 186 *5*

Joined for duty and enrolled:

When *Sept 26*, 186 *5*.*

Where *Talbot Co. Md.* *

Period *3* years.*

Present or absent *Present*

Stoppage, \$ *100* for

Due Gov't \$ *100* for

Remarks: *Stop 1 canton*

* ~~42~~ See enrollment on card from muster-in roll.

Book mark:

(358c)

F.M. Neale

Copyist.

D

7

U.S.C.T.

William Darum

Priv., Co. D, 7 Reg't U. S. Col'd Infantry.

Appears on

Company Muster Roll

for *May & June*, 1865.

Joined for duty and enrolled:

When *Sept 26*, 1863.*

Where *Callot Md.**

Period *3* years.*

Present or absent *Present*

Stoppage, \$ *100* for

Due Gov't \$ *100* for

Remarks: *stop one township*

* See enrollment on card from muster-in roll.

Book mark:

(358c)

F. D. Neale

Copyist.

D

7

U.S.C.T.

William Donnan

Capt., Co. D, 7 Reg't U. S. Col'd Infantry.

Appears on

Company Muster Roll

for *July & Aug.*, 186*5*.

Joined for duty and enrolled:

When *Sept. 26*, 186*3*.*

Where *Fallot Co. Md* *

Period *3* years.*

Present or absent *Present*

Stoppage, \$ *100* for

Due Gov't \$ *100* for

Remarks:

* ~~45~~ See enrollment on card from muster-in roll.

Book mark: -----

(358c)

F. D. Neale

Copyist.

D | 7 | **U.S.C.T.**

William Dorem
Priv., Co. D, 7 Reg't U. S. Col'd Infantry.

Appears on

Company Muster Roll

for *Sept. & Oct.*, 186*5*.

Joined for duty and enrolled:

When *Sept 26*, 186*5*.*

Where *Talbot Md* *

Period *3* years.*

Present or absent *Present*

Stoppage, \$ 100 for _____

Due Gov't \$ 100 for _____

Remarks: _____

* See enrollment on card from muster-in roll.

Book mark: _____

(358c) *J. H. Neale* Copyist.

2

7

U.S.C.T.

William Dorum

Priv., Co. D, 7 Reg't U. S. Col'd Infantry.

Appears on

Company Muster Roll

for Nov. & Dec, 1865.

Joined for duty and enrolled:

When Sept 26, 1863.*

Where Talbot Md. *

Period 3 years.*

Present or absent Present

Stoppage, \$ 100 for

Due Gov't \$ 100 for

Remarks:

* See enrollment on card from muster-in roll.

Book mark:

Hearn

D | 7 | U.S.C.T.

William Dorum
Pvt, Co. D, 7 Reg't U. S. Col'd Infantry.

Appears on

Company Muster Roll

for Jan'y & Feby, 1866.

Joined for duty and enrolled:

When Sept 26, 1863.*

Where Talbot Md *

Period 3 years.*

Present or absent Present

Stoppage, \$ 100 for

Due Gov't \$ 100 for

Remarks:

* See enrollment on card from muster-in roll.

Book mark:

Heard

2

7

U.S.C.T.

William Dornum

Pvt, Co. D, 7 Reg't U. S. Col'd Infantry.

Appears on

Company Muster Roll

for Mich & Apr, 1864.

Joined for duty and enrolled:

When Sept 26, 1863.*

Where Talbot, Md *

Period 3 years.*

Present or absent Present,

Stoppage, \$ 100 for

Due Gov't \$ 100 for

Remarks:

* See enrollment on card from muster-in roll.

Book mark:

Hearst

D

7

U.S.C.T.

William Downum

Pvt, Co. D, 7 Reg't U. S. Col'd Infantry.

Appears on

Company Muster Roll

for May & June, 1866.

Joined for duty and enrolled:

When Sept 26, 1863.*

Where Falbot. Md.*

Period 3 years.*

Present or absent Present

Stoppage, \$ 100 for

Due Gov't \$ 100 for

Remarks:

* See enrollment on card from muster-in roll.

Book mark:

(358c)

Hearn

Copyist.

D | 7 | U.S.C.T.

William Dorum

Priv., Co. D, 7 Reg't U. S. Col'd Infantry.

Appears on

Company Muster Roll

for July & Aug, 1864.

Joined for duty and enrolled:

When Sept 26, 1863.*

Where Gallat. Md *

Period 3 years.*

Present or absent Present

Stoppage, \$ 100 for

Due Gov't \$ 100 for

Remarks:

* See enrollment on card from muster-in roll.

Book mark:

Head

D | **7** | **U.S.C.T.**

William Dorum
Pat, Co. *D*, 7 Reg't U. S. Col'd Infantry.

Appears on **Co. Muster-out Roll**, dated
Indianola Texas, *Oct 13*, 186*6*.

Muster-out to date *Oct 13*, 186*6*.

Last paid to *June 30*, 186*6*.

Clothing account:

Last settled....., 186 ; drawn since \$ 100

Due soldier \$ 100; due U. S. \$ / ⁵⁸/₁₀₀

Am't for cloth'g in kind or money adv'd \$ 100

Due U. S. for arms, equipments, &c., \$ ⁵⁵/₁₀₀

Bounty paid \$ 100; due \$ *100* ⁰⁰/₁₀₀

Remarks: *Joined at original organization*
stop for one C.B. Plate one gun sling
*and one wiper. 55**

Book mark: *V. 175. P. 176. 73. L. 16 Ind.*

Hearst

Dezman, Tom
Pal, Co. *7* Reg't *1st*

Enclosures.

- | | |
|------------------------------------|----------------------------|
| Bed Cards | Final Statements |
| Burial Records | Furloughs or L. of A. |
| Certs. of Dis. for Discharge | Med. Certificates |
| C. M. Charges | Med. Des. Lists |
| Descriptive Lists | Orders |
| Discharge Certificates | Pris. of War Record |
| Enlistment Papers | Resignations |

Other papers relating to—

- | | |
|------------------------------|---------------------------|
| Admission to Hosp'l | Furlough or L. of A. |
| Casualty Sheet | Med. Examination |
| Confinement | Misc. Information |
| Contracts | Pay or Clothing |
| Death or Effects | Personal Reports |
| Desertion | Rank |
| Discharge from Hosp'l | Transfer to Hosp'l |
| Discharge from Service | Transfer to V. R. C. |
| Duty | Transportation |

MICROFILM PUBLICATION M 1849

COMPILED MILITARY SERVICE RECORDS
OF VOLUNTEER UNION SOLDIERS WHO SERVED WITH
THE UNITED STATES COLORED TROOPS (USCT)
7TH REGIMENT OF INFANTRY

PERSONAL PAPERS' TARGET SHEET

PLEASE NOTE THE CHECKED INFORMATION ABOUT THE PERSONAL PAPERS IN
THIS FILE:

- NO PERSONAL PAPERS WERE FOUND IN THIS FILE WHEN THE
RECORDS WERE ARRANGED FOR MICROFILMING.
- 4 PERSONAL PAPER(S) FOUND IN THIS FILE WHEN THE RECORDS
WERE ARRANGED FOR MICROFILMING.

4891354

War Department,

ADJUTANT GENERAL'S OFFICE,

Washington, *May 9* 1867.

Respectfully returned to the Commission for the State of Maryland, with the information that William L. Parvus was enlisted at Talbot Md Sept 26, 1863, and was mustered in as Pvt in Co. D, 7th U.S.C. Sept 29, 1863.

Le. 16 Md

J. W. Hazard

Asst. Adj't General.

WLD

to the approval of the
visions of Section 24,
28, 1866.

To

Chief of the B
Organizat

Endorsement.

No. 76

APPLICATION OF

David Lloyd

OF

Dorchester County

for compensation for service of slave,

Wm Dorum

enlisted September 26, 1863,

in D Co. Seventh Regiment

U. S. Colored Troops.

Received December 17th, 1866.

Compensation awarded,

186

Dollars.

President Board of Claims.

P. O. ADDRESS OF CLAIMANT:

47th St
93 South W
Baltimore

CERTIFICATE OF AWARD OF THE BOARD OF CLAIMS.

OFFICE OF THE BOARD OF CLAIMS,

For Slaves Enlisted or Drafted in the Service of the United States,

186

We hereby certify that _____, of _____, of

_____ county, State of _____,

having proved, under oath, _____ loyalty to the Constitution and Government of the United States, and established _____ title to the ownership of _____

_____ a slave enlisted or drafted (as the case may be) and mustered at _____, on the _____ day of _____,

186 _____, by _____, in the service of the United States, in the _____ Regiment of Colored Troops, Co. _____, the sum of _____

dollars has been awarded to _____ by this Board, subject to the approval of the Secretary of War, as a compensation for the said slave, under the provisions of Section 24, Act approved February 24, 1864, and Section 2, Act approved July 28, 1866.

_____, President of the Board.

_____, Member of the Board.

_____, Member of the Board.

To _____

Chief of the Bureau for the

Organization of Colored Troops, Washington, D. C.

CLAIM FOR COMPENSATION FOR ENLISTED SLAVE.

No.

I, Daniel Lloyd a loyal citizen, and a resident of Cambridge, County of Dorchester, State of Maryland, hereby claim compensation, under the provisions of Section 24, Act approved February 24, 1864, and Section 2, Act approved July 28, 1866, for my slave Mr. Dorum, enlisted Sept. 26 1863, at Faltemore, by Cor. Bimney, in the Seventh Regiment U. S. Colored Troops, Co. D; certificate of which enlistment and a descriptive list, as required, accompany this application.

In proof of my loyalty to the Constitution and Government of the United States, I present the accompanying oath, which I have taken, signed and acknowledged; to be filed with this application, in accordance with requirement of General Orders, No. 329, 1863, War Department, Adjutant General's Office.

Daniel Lloyd

December 10th, 1866.

OATH OF ALLEGIANCE.

I, Daniel Lloyd, the owner and claimant, do solemnly swear that the foregoing claim is a just and true claim due to me as master and owner of the said slave, and that the facts alleged in said claim in respect to the draft or enlistment (as the case may be) of said slave into the military service of the United States are true. And I do further swear that I have never joined, or been concerned in, any insurrection or rebellion; that I have never borne arms against the United States; that I have never given any aid, countenance, counsel or encouragement to any person or persons engaged, or whom I had reason to believe were about to engage, in insurrection, rebellion or armed hostility against the United States; that I have neither sought, nor accepted, nor attempted to exercise the functions of any office, civil or military, nor to perform any service whatever, under any authority or pretended authority in hostility to the United States; that I have not yielded a voluntary support to any insurrection, rebellion or pretended government, authority, power or constitution within the United States hostile thereto. And I do further swear that, to the best of my knowledge and ability, I have supported and defended, and will continue to support and defend, the United States against all enemies, foreign and domestic; and that I have supported, defended and obeyed, and will continue to support, defend and obey, the Constitution and laws of the United States; that I will bear true faith and allegiance to the same; and that I take this oath freely, without any mental reservation or purpose of evasion: So help me God.

Daniel Lloyd

Sworn to and subscribed before me, at Cambridge Md., }
 this 10th day of December, 1866.

W. S. Winterbottom
Justice of the Peace



60

CASUALTY SHEET
OF WOUNDED.

William Donnan

Private Company "D"

of Regiment of U. S. C. P.

Volunteers at the battle of Chapsin

Farm. Va. Sept 29 + 30

1864

CASUALTY SHEET.

Name, William Doman
 Rank, Private, Company "D", Regiment, 7th
 Arm, U. S. A., State, _____
 Place of casualty, Chapins Farm, Va.
 Nature of casualty, Wounded
 Date of casualty, Sept 29th and 30th 1864

FROM WHAT SOURCE THIS INFORMATION WAS OBTAINED.

Report of Killed, Wounded, and Missing of the _____ Regiment,
 _____ Brigade, _____ Division, _____ Corps, dated _____
List of casualties in the U. S. A. on the 29th and 30th
of Sept 1864, at Chapins Farm, Va.
(Sgd) Sturtevant F. Haskell
Suit box bound 9

Ind 50 S M 63.

Thos Brodwin

Clerk.

EVIDENCE OF TITLE.

I Daniel Lloyd of Dorchester County Maryland, do solemnly swear that Wm Dorum who has been enlisted in the Seventh Regiment, U. S. Colored Troops, Co. D; was my Slave for life at the time of said enlistment; and that I became possessed of him by ownership of his mother at the time of his birth, she being my slave in the month of August eighteen hundred and by inheritance. And I do further swear that I have not purchased said Slave from any person or persons disloyal to the Government of the United States, with the object of obtaining compensation for the same: and furthermore, that I have no agency for obtaining compensation for any person or persons but such as to my knowledge are loyal citizens of the United States.

Daniel Lloyd

Sworn and subscribed before

W. J. Winterbottom

Justice of the Peace.

STATE OF MARYLAND,

County, to wit:

On this twelfth day of December in the year 1866 before me, the subscriber, a Justice of the Peace of the State and County aforesaid, personally appeared Wm. A. Cook a resident of Dorchester County, State of Maryland and Wm. H. Grace a resident of Dorchester County, State of Maryland having first been duly sworn, upon their oaths declare that they reside respectively in Dorchester County, State of Maryland and Dorchester County, State of Maryland; that they are personally acquainted with Daniel Lloyd Dorum claimant for compensation for his Slave William under the Acts of Congress of February 24, 1864, and July 28, 1866, and that they know that said "claimant hath firmly and faithfully maintained his allegiance and adherence to the Government of the United States, by defending its cause against the Government of the so-called Confederate States of America, in all suitable and practicable ways, and according to his ability and opportunity;" they also swear that they have themselves maintained a like adherence and allegiance to the Government of the United States, and they have no interest in said claim.



Wm. A. Cook

Wm. H. Grace

W. J. Winterbottom

Sworn and subscribed before

Justice of the Peace.

STATE OF MARYLAND,

Dorchester County, to wit:

I, Francis J. Henry Clerk of the Circuit Court for Dorchester County, do hereby certify that William J. Winterbottom before whom the foregoing affidavits were made, was, at the time of signing the same, a Justice of the Peace for the County and State aforesaid, duly commissioned and sworn; and that his signature thereto is genuine, and that full faith and credit should be given to his official acts.

Witness my hand and the Seal of said Court, this twelfth day of December A. D. 1866



Francis J. Henry
Clerk.

21

Co D "7" U.S.C Troops
Daniel Lloyd
Dorham Wm

Mr. [unclear]

~~10/16~~

10/16

VOLUNTEER DESCRIPTIVE LIST and Account of Pay and Clothing of *a Recruit*

NAMES.	RANK.	DESCRIPTION.						WHERE BORN.		OCCUPATION.	ENROLLED OR ENLISTED (For Drafted Men, see note 10.)		By
		Years of age.	Eyes.	Hair.	Complexion.	HEIGHT. Feet. In.		State or Kingdom.	Town or county.		When.	Where. (Town and State.)	
<i>Dorum, William</i>		<i>19</i>	<i>Blk</i>	<i>Blk</i>	<i>Blk</i>	<i>5</i>	<i>9³/₄</i>	<i>Ma</i>	<i>Talbot</i>	<i>Farmer</i>	<i>Sept-26th 1863</i>	<i>Talbot</i>	

REMARKS.

NOTES.

- The amount of any extra pay for which the soldier may be mustered, *ex. gr.* as Acting Hospital Steward, as Saddler, &c., and which may be still due him, must be carefully noted.
- In the column headed "BOUNTY PAID," must be entered the whole amount *hitherto paid* him; in that of "BOUNTY DUE," the whole amount yet due him. Bounty paid by State authorities, and not by the United States, will not be entered on this statement.
- Stoppages for loss or damage done to arms, or other public property, must be noted, and the *articles*, and particular damage to each, specified. When stoppages are due, under sentence of a Court Martial, a transcript of the same must be entered here; and the amount already stopped, must be carefully stated.
- In every case of desertion, the *date*, and that of delivery, or apprehension, must be given, together with a correct transcript of the order of sentence or pardon.
- A careful settlement of the man's CLOTHING ACCOUNT must be made, to date, and the amount DUE TO, or FROM him must be precisely stated.
- Should the man have been engaged in any action or skirmish, it must be mentioned, together with *date* and *place*. A full and particular mention will be made of any *wounds* he may have received in action, or other injury, whilst in the line of his duty.
- If the soldier is entitled to pay for the use of his horse, the company commander will certify to that fact on this list, and also to the time he has pay due for having been so mounted on his own horse.
- When a soldier is furnished with final statements, his descriptive list, if he has one, should be taken up by the officer who gives the soldier these statements, and endorsed with a statement to this effect by the officer. This endorsement should exhibit a full statement of the time for which the soldier was allowed pay on his final statements, the clothing account, and all other charges against him or in his favor, so as to comprise a complete exhibit of his account. It will then be transmitted to the company commander of the soldier, who will enter all the data necessary to a full understanding of the soldier's account on the muster roll upon which the soldier's discharge is reported. The descriptive list will then be destroyed. The object of this is, that the remaining portion of the soldier's account may be settled upon the receipt of these muster rolls, and the soldier receive any pay or allowances that may be due him at the time of his discharge, and which may not appear on his final statements from the fact that his descriptive list is incomplete. These accounts for back pay, &c., are settled by the 2d Auditor of the Treasury Dept.
- Where a soldier dies in Hospital or on detached service, his descriptive list, if he has one, should be sent with his final statements, in duplicate, to the Adjutant General, Washington, D. C.
- Men drafted will be considered as mustered in from the date of their draft, and will be mustered for pay on the usual rolls for Volunteers. On the same line as the soldier's name, under the heading "Joined for Duty and Enrolled.—Commencement of First Payment by Time," will be written the word *drafted*, or *substitute*, as the case may be; and under the heading "When Mustered in" will be given the date when the soldier was drafted, or, if a substitute, when enlisted, (substitutes, under the Enrollment Act, are mustered in by enlistment;) under "Where Mustered in," will be given the place from which drafted, (or if a substitute, where enlisted;) under the heading "By whom Mustered in," will be given the No. of the Enrollment District from which he was drafted, and the State to which it belongs, thus: *4th D. Mass.*; (meaning 4th Enrollment District, State of Massachusetts.) Or if a substitute, the name of the officer enlisting him. (When enlisted by Board of Enrollment, the name of the Provost Marshal of the Enrollment District.)
- A separate descriptive list should, as a general rule, be given for each man.
- Descriptive lists must, in all cases, be signed by COMMISSIONED officers; not by enlisted men acting as such.

a recruit from 7th U.S. Colored Troops

DRAFTED OR ENLISTED. (For Drafted Men, see note 10.)		MUSTERED IN. (For Drafted Men, see note 10.)				LAST PAID.		BOUNTY.		CLOTHING ACCOUNT.	
Where. (Town and State.)	By whom.	When.	Where. (Town and State.)	By whom. (In the case of drafted men, from what enrollment district.)	Period.	By paymaster.	To what time.	Paid \$ (See note 2.)	Due \$ (See note 2.)	Date of last settlement.	Total money value of clothing drawn since last settlement.
Talbot	Col W. Binney	Sept. 29 th 1863	Benedict Md	Col W. Binney	Three years	Company D	7 th U.S. Col ^d Troops			Daniel Lloyd	

REMARKS.

Original statements, in duplicate, to be given for each man, by COMMISSIONED officers;

I CERTIFY that the above is a correct transcript from the Records of His General Rendezvous of
Recruits from Maryland of U.S.C. Troops

STATION: Baltimore Md
DATE: July 15th 1864

Vivian K. Spear.
1st Lt. 20th I.R.C. & Inspector

Col J. B. Reno
Commanding the Company.
Chief Mustg & Records
J. H. [unclear]

MAR 21 1864

from 7th U.S. Colored Troops

MUSTERED IN. (For Drafted Men, see note 10.)				LAST PAID.		BOUNTY.		CLOTHING ACCOUNT.	
When.	Where. (Town and State.)	By whom. (In the case of drafted men, from what enrollment district.)	Period.	By paymaster.	To what time.	Paid \$ (See note 2.)	Due \$ (See note 2.)	Date of last settlement.	Total money value of clothing drawn since last settlement.
Sept. 29 th 1863	Benedict Md	Col Wm Binney	Three years	Company D	7th U.S. Colored Troops			Daniel Lloyd	

I CERTIFY that the above is a correct transcript from the Records of this General Rendezvous of recruits from Maryland of U.S.C. Troops

STATION: Baltimore Md
DATE: July 15th 1864

Vivian K. Spear.
1st Lt. 20th V.R.C. & Inspector

~~Col Wm Binney~~
Commanding the Company.
Chief Musty & Bounty Officer
of U.S.C. Troops Maryland

420
Dowdy, Samuel

Co H, 7 U.S. Col'd Inf.

Private

CARD NUMBERS.

1	26
2	27
3	28
4	29
5	30
6	31
7	32
8	33
9	34
10	35
11	36
12	37
13	38
14	39
15	40
16	41
17	42
18	43
19	44
20	45
21	46
22	47
23	48
24	49
25	50

See Dowdy, Samuel

Book Mark:

See also

Douglas John
Co *G*, 7 U.S. Col'd Inf.

Private | *Private*

CARD NUMBERS.

1	6 7 9 0 9 4 6	26
2	6 2 9 1 0 4 5	27
3	6 2 9 1 1 4 5	28
4	6 2 9 1 2 4 9	29
5	6 2 9 1 3 4 7	30
6	6 2 9 1 4 4 5	31
7	6 2 9 1 5 4 3	32
8	6 2 9 1 6 2 5	33
9	6 2 9 1 7 2 4	34
10	6 2 9 1 7 8 1	35
11	6 2 9 1 8 5 1	36
12	6 2 9 1 9 2 1	37
13	6 2 9 1 9 9 1	38
14	6 2 9 2 0 5 8	39
15	6 2 9 2 1 2 1	40
16	6 2 9 2 1 7 3	41
17	6 2 9 2 2 3 1	42
18	6 2 9 2 2 7 8	43
19	6 2 9 2 3 2 6	44
20	9 0 6 6 6 6 4	45
21	4 0 7 6 2 2 0 8	46
22		47
23		48
24		49
25		50

Back Mark:

See also

Colours MAR 14 1929 FM

Mr Carl B. Zelenyger - Phil. Pa

5-7-57 alm

9

7

U.S.C.T.

John Douglas
Co. G, 7 Reg't U.S. Col'd Inf.

Appears on
Company Descriptive Book
of the organization named above.

DESCRIPTION.

Age 20 years; height 5 feet 4 1/4 inches.

Complexion Black

Eyes Black; hair Curly

Where born Somerset, Ind.

Occupation Farmer

ENLISTMENT.

When Oct 21, 186 .

Where Somerset.

By whom Col. W. Kirney; term 3 y'rs.

Remarks: Mustered into service
Nov 5-63 by Col W. Kirney
at Benedict, Ind.

H. Brown Copyist.

D | 7 | U.S.C.T.

John Douglas.
Priv., Co. G, 7 Reg't U. S. Col'd Inf.

Age 20 years.

Appears on

Company Muster-in Roll

of the organization named above. Roll dated

Camp Stanton, Charles Co, Md, Nov 5, 1863.

Muster-in to date Nov 5, 1863.

Joined for duty and enrolled:

When Oct. 21, 1863.

Where Somerset, Md.

Period 3 years.

Remarks:

Book mark:

Sandoz
Copyist.

D

7

U.S.C.T.

John Douglass

Priv., Co. G, 7 Reg't U. S. Col'd Infantry.

Appears on

Company Muster Roll

for *Nov. 5th Dec. 31*, 1863.

Present or absent *Present*

Stoppage, \$ *100* for

Due Gov't, \$ *100* for

Remarks: *Premium for en-*
listment \$2.00 (due)

Book mark:

Sandoz
Copyist

(858)

D | 7 | U.S.C.T.

John Douglass.
Privt., Co. G, 7 Reg't U. S. Col'd Infantry.

Appears on

Company Muster Roll

for *Jan. 8 Feby*, 1864.

Present or absent *Present*

Stoppage, \$ *100* for

Due Gov't, \$ *100* for

Remarks:

Book mark: _____

(858)

Sandoy
Cpyist

D

7

U.S.C.T.

John Douglass.

Priv., Co. G, 7 Reg't U. S. Col'd Infantry.

Appears on

Company Muster Roll

for *Mch. & Apr.*, 1864.

Present or absent *Present*

Stoppage, \$ *100* for

Due Gov't, \$ *100* for

Remarks:

Book mark: *504378*

(858)

Sandy
Coppist

D

7

U.S.C.T.

John Douglas
Priv., Co. G, 7 Reg't U. S. Col'd Infantry.

Appears on

Company Muster Roll

for *May & June*, 1864.

Present or absent *Present*

Stoppage, \$ 100 for

Due Gov't, \$ 100 for

Remarks:

Book mark:

(858)

Sandoz
Coyt

D

7

U.S.C.T.

John Douglas

Priv., Co. G, 7 Reg't U. S. Col'd Infantry.

Appears on

Company Muster Roll

for *July 8* *Aug.*, 1864.

Present or absent *Present*

Stoppage, \$ *100* for

Due Gov't, \$ *100* for

Remarks:

Book mark:

(858)

Sandoz
Copyist

D

7

U.S.C.T.

John Douglas
Priv., Co. G, 7 Reg't U. S. Col'd Infantry.

Appears on

Company Muster Roll

for *Sept. & Oct.*, 1864.

Present or absent *Present.*

Stoppage, \$ 100 for

Due Gov't, \$ 100 for

Remarks:

Book mark:

Sandoz
Copyist

D

7

U.S.C.T.

John Douglas

Pvt., Co. G, 7 Reg't U. S. Col'd Infantry.

Appears on

Company Muster Roll

for Nov. & Dec., 1864.

Present or absent Present

Stoppage, \$ 100 for

Due Gov't, \$ 100 for

Remarks:

Book mark:

(858)

J. W. Ames

Copyist

D

7

U.S.C.T.

John Douglass

Pvt., Co. G, 7 Reg't U. S. Col'd Infantry.

Appears on

Company Muster Roll

for *Jan & Feb*, 1865.

Present or absent *Present*

Stoppage, \$ 100 for

Due Gov't, \$ 100 for

Remarks:

Book mark:

(858)

J. W. Cross

Copyist

D

7

U.S.C.T.

John Douglass

Prvt., Co. G, 7 Reg't U. S. Col'd Infantry.

Appears on

Company Muster Roll

for *March + April*, 186*5*.

Present or absent *Present*

Stoppage, \$ *100* for

Due Gov't, \$ *100* for

Remarks:

Book mark:

A. W. Cross

(858)

Copyist

D

7

U.S.C.T.

John Sanglass
Pr, Co. G, 7 Reg't U. S. Col'd Infantry.

Appears on

Company Muster Roll

for *May & June*, 186*5*.

Present or absent *Present*

Stoppage, \$ *100* for

Due Gov't, \$ *100* for

Remarks:

Book mark:

(858)

J. W. C. [Signature]

Copyist

D

7

U.S.C.T.

John Douglas

Pvt., Co. G, 7 Reg't U. S. Col'd Infantry.

Appears on

Company Muster Roll

for *July + Aug.*, 1865.

Present or absent *Absent*

Stoppage, \$ *100* for

Due Gov't, \$ *100* for

Remarks:

*Absent on Det service
at Indianola Texas.*

Book mark:

(858)

J. W. Jones

Copyist

D | 7 | U.S.C.T.

John Douglas
Prk, Co. G, 7 Reg't U. S. Col'd Infantry.

Appears on

Company Muster Roll

for *Sept + Oct*, 186 *J.A*

Present or absent *Absent*

Stoppage, \$ 100 for

Due Gov't, \$ 100 for

Remarks:

*Absent on Det Service
at Indianola Texas*

Book mark:

J. W. Cross
(858) Copyist

2

7

U.S.C.T.

John Douglass
Pvt, Co. G, 7 Reg't U. S. Col'd Infantry.

Appears on

Company Muster Roll

for *Nov. + Dec.*, 1865.

Present or absent *Present*

Stoppage, \$ 100 for

Due Gov't, \$ 100 for

Remarks:

Book mark:

(858)

J. W. Cross

Copyist

P

7

U.S.C.T.

John Douglass
Pvt, Co. G, 7 Reg't U. S. Col'd Infantry.

Appears on

Company Muster Roll
for *Jan & Feb*, 186*6*
Present or absent *Present*

Stoppage, \$ *100* for

Due Gov't, \$ *100* for

Remarks: *Stop for Haversack
& Canteen*

Book mark:

Hadfield

(858)

Copyist

20

7

U.S.C.T.

John Douglass
Pvt, Co. G, 7 Reg't U. S. Col'd Infantry.

Appears on

Company Muster Roll

for *Mar & Apr*, 186 *6*

Present or absent *Present*

Stoppage, \$ *100* for

Due Gov't, \$ *100* for

Remarks:

Book mark:

Hadfield

(858)

Copyist

20

7

U.S.C.T.

John Douglass
Pvt, Co. G, 7 Reg't U. S. Col'd Infantry.

Appears on

Company Muster Roll

for *May & June*, 186*6*.

Present or absent *Present*

Stoppage, \$ *100* for

Due Gov't, \$ *100* for

Remarks:

Book mark:

Hadzield

20

7

U.S.C.T.

John Douglas

Pvt, Co. G, 7 Reg't U. S. Col'd Infantry.

Appears on

Company Muster Roll

for July & Aug, 1866.

Present or absent Present

Stoppage, \$ 100 for

Due Gov't, \$ 100 for

Remarks:

Book mark:

Hadfield

(858)

Copyist

D | 7 | U.S.C.T.

John Douglass,
Post, Co. G., 7 Reg't U. S. Col'd Inf.

Appears on Returns as follows:

Nov 1863, absent det in
bakery.
Jan 1864 absent Prov. guard,
Apr to June 1864, on duty Pioneer.
July 1864, absent sick June
26, at Jacksonville.
Dec 1864, absent Pioneer, de-
facted order no - Brig
St Dis 1 Brig 2 Div 25 a &
Feb 1865, absent on sick.
July to Oct 1865, absent on det
service.
Nov 1865, absent on det service
at Indianola Tex.
Dec 1865 to Apr 1866, on duty
Pioneer.

Book mark:

A. M. Shannon

J

7

U.S.C.T.

John Douglass
Pet *Co. G*, 7 Reg't U. S. Col'd Infantry.

Appears on **Co. Muster-out Roll**, dated *Indianola Texas, Oct 13*, 1866.

Muster-out to date *Oct 13*, 1866.

Last paid to *June 30*, 1866.

Clothing account:

Last settled....., 186 ; drawn since \$..... 100

Due soldier \$ *33*^{*68*} / 100; due U. S. \$..... 100

Am't for cloth'g in kind or money adv'd \$..... 100

Due U. S. for arms, equipments, &c., \$ *1*^{*20*} / 100

Bounty paid \$..... 100; due \$ *100* / 100

Remarks: *joined original organization*

Book mark: *V 2307 R 2066 7 4*

Hadfield

Douglas John

Co. *G*, Reg't *7* " *U.S.C.*

2

Enclosures.

Bed Cards	Final Statements
Burial Records	Furloughs or L. of A.
Certs. of Dis. for Discharge	Med. Certificates
C. M. Charges	Med. Des. Lists
Descriptive Lists	Orders
Discharge Certificates	Pris. of War Record
Enlistment Papers	Resignations

Other papers relating to—

Admission to Hosp'l	Furlough or L. of A.
Casualty Sheet	Med. Examination
Confinement	Misc. Information /
Contracts	Pay or Clothing
Death or Effects	Personal Reports
Desertion	Rank
Discharge from Hosp'l	Transfer to Hosp'l
Discharge from Service	Transfer to V. R. C.
Duty	Transportation

MICROFILM PUBLICATION M 1849

COMPILED MILITARY SERVICE RECORDS
OF VOLUNTEER UNION SOLDIERS WHO SERVED WITH
THE UNITED STATES COLORED TROOPS (USCT)
7TH REGIMENT OF INFANTRY

PERSONAL PAPERS' TARGET SHEET

PLEASE NOTE THE CHECKED INFORMATION ABOUT THE PERSONAL PAPERS IN
THIS FILE:

- NO PERSONAL PAPERS WERE FOUND IN THIS FILE WHEN THE
RECORDS WERE ARRANGED FOR MICROFILMING.
- 10 PERSONAL PAPER(S) FOUND IN THIS FILE WHEN THE RECORDS
WERE ARRANGED FOR MICROFILMING.

Somerset Co. July 2nd, 1864.

Capt. L. G. Benedict,
A. A. G. Vol's.
Washington, D.C.

Please make check pay-
able to the order of William Daniel of
Baltimore City.

Margaret Conway

13.00

No. .

ABSTRACT OF DISBURSEMENTS.

186 .

Margaret P. Conway

Dollars 300

To

Paid

186 .

The United States,

To Margaret R. Conway Dr.

1864

Nov 12th

For amount awarded him by the Board of Claims, in consideration

of the enlistment of John Douglass

in the 7th Regt U. S. Col'd Troop

DOLLARS. CENTS.

300 00

Total \$ 300 00

I CERTIFY that the above account is correct and just; that the name of John Douglass is borne on the muster-in rolls of the 7th Regt U. S. Col'd Troop; and that the above amount was awarded by the Board of which Thos Simmons Esq is President, said award being in accordance with section 24 of the act entitled "An act to amend an act entitled 'An act for enrolling and calling out the national forces, and for other purposes,'" approved Feb. 24, 1864.

Assistant Adjutant General.

RECEIVED

, 186 , of G. H. Benedict, A. A. G., Col, dollars and cents, in full of the above account.

Margaret R Conway

(SIGNED DUPLICATES.)

Somerset Co. July 2nd, 1864,

Capt. L. G. Benedict,
A. A. G. Vol's.
Washington, D. C.

Please make check
payable to the order of William Dan-
iel of Baltimore City.

Margaret R Conroy

01641/1864

No.

ABSTRACT OF DISBURSEMENTS.

186

Margaret R Conroy

Dollars

300

00

100

Paid

186

The United States,

To Margaret R. Conway Dr.

1864		DOLLARS.	CENTS.
November 12 th	For amount awarded him by the Board of Claims, in consideration of the enlistment of <u>John Douglass</u> in the <u>7th Regt. U.S. Colored Troops</u>	300	00
Total \$		300	00

I CERTIFY that the above account is correct and just; that the name of John Douglass is borne on the muster-in rolls of the 7th Regt. U.S. Colored Troops; and that the above amount was awarded by the Board of which Thos. Simmons Esq. is President, said award being in accordance with section 24 of the act entitled "An act to amend an act entitled 'An act for enrolling and calling out the national forces, and for other purposes,'" approved Feb. 24, 1864.

Assistant Adjutant General.

RECEIVED

, 186 , of Capt. Selg. Benedict a.d.g. Vol
dollars and _____ cents, in full of the above account.

Margaret R Conway

(SIGNED DUPLICATES.)

F.

CERTIFICATE OF AWARD OF THE BOARD OF CLAIMS.

Office of the Board of Claims
 For Slaves Enlisted in the Service of the United States,

No. 318

Baltimore Md

\$300-

November 21st, 1864

We hereby certify, that Margaret R. Conway, of Somerset county, State of Maryland, having proved, under oath, her loyalty to the Constitution and Government of the United States, and established her title as to the ownership of John Douglass, a slave enlisted at Somerset County Md, on the 21st day of October, 1863, by Col Wm. Pirney, in the service of the United States, in the 7th Regiment of Colored Troops, Co. G, and having filed a valid Deed of Manumission and Release of Service of said slave, is entitled to the sum of Three Hundred dollars, which has been awarded to her by this Board as a remuneration for all claim to the future labor or service of said slave, under the provision of General Orders, War Department, No. 329, 1863.

Thos. Timmons, President of the Board.

L. E. Strangher, Member of the Board.

Emms Jones, Member of the Board.

To Col. C. W. Foster,

Chief of the Bureau for the
 Organization of Colored Troops, Washington, D. C.

Drs. List of
John Douglass,
Slave of Margaret R.
Conway — Son. Md

Wm. Lloyd Garrison
New York

Wm. Lloyd Garrison
New York
I certify that the name of John Douglass
is borne on the printer's note of company
"5" 7th Regt U.S. Art. as follows in this
Office. It is stated on said note that
that he was smelted at Democrat Md.
Wm. Lloyd Garrison

MAR 13 1897

VOLUNTEER DESCRIPTIVE LIST ~~and Account of Pay and Clothing of~~

No.	NAMES.	RANK.	DESCRIPTION.						WHERE BORN.		OCCUPATION.	(For D)	
			Years of age.	Eyes.	Hair.	Complexion.	Feet.	Inches.	State or Kingdom.	Town or county.		When.	
	<i>John Douglas</i>		<i>20</i>	<i>Blk</i>	<i>Curly</i>	<i>Blk</i>	<i>5</i>	<i>4 1/2</i>	<i>Ma</i>	<i>Sumner</i>	<i>Farmer</i>	<i>1863</i>	<i>Oct 21</i>

NOTES.

- The amount of any extra pay for which the soldier may be mustered, *ex. gr.* as Acting Hospital Steward, as Saddler, &c., and which may be still due him, must be carefully noted.
- In the column headed "BOUNTY PAID," must be entered the whole amount hitherto paid him; in that of "BOUNTY DUE," the whole amount yet due him. Bounty paid by State authorities, and not by the United States, will not be entered on this statement.
- Stoppages for loss or damage done to arms, or other public property, must be noted, and the articles, and particular damage to each, specified. When stoppages are due, under sentence of a Court Martial, a transcript of the same must be entered here; and the amount already stopped, must be carefully stated.
- In every case of desertion, the date, and that of delivery, or apprehension, must be given, together with a correct transcript of the order of sentence or pardon.
- A careful settlement of the man's CLOTHING ACCOUNT must be made, to date, and the amount DUE TO, or FROM him, must be precisely stated.
- Should the man have been engaged in any action or skirmish, it must be mentioned, together with date and place. A full and particular mention will be made of any wounds he may have received in action, or other injury, whilst in the line of his duty.
- If the soldier is entitled to pay for the use of his horse, the company commander will certify to that fact on this list, and also to the time he has pay due for having been so mounted on his own horse.
- When a soldier is furnished with final statements, his descriptive list, if he has one, should be taken up by the officer who gives the soldier these statements, and endorsed with a statement to this effect by the officer. This endorsement should exhibit a full statement of the time for which the soldier was allowed pay on his final statements, the clothing account, and all other charges against him or in his favor, so as to comprise a complete exhibit of his account. It will then be transmitted to the company commander of the soldier, who will enter all the data necessary to a full understanding of the soldier's account on the muster roll upon which the soldier's discharge is reported. The descriptive list will then be destroyed. The object of this is, that the remaining portion of the soldier's account may be settled upon the receipt of these muster rolls, and the soldier receive any pay or allowances that may be due him at the time of his discharge, and which may not appear on his final statements from the fact that his descriptive list is incomplete. These accounts for back pay, &c., are settled by the 2d Auditor of the Treasury Department.
- Where a soldier dies in Hospital or on detached list, if he has one, should be sent with his final statement to the Second Auditor, Washington, D. C.
- Men drafted will be considered as mustered in on draft, and will be mustered for pay on the usual date. On the same line as the soldier's name, under the heading "Duty and Enrolled,"—Commencement of First Pay will be written the word *drafted*; and under the heading "When Mustered in," will be given the date when the soldier was drafted. Under "By whom Mustered in," will be given the name of the District from which he was drafted, and the name of the Regiment, thus: *4th D. Mass.*; (meaning 4th Enrolled Massachusetts.)
- A separate descriptive list should, as a general rule, be made for each man.
- Descriptive lists must, in all cases, be signed by the commanding officer, and not by enlisted men acting as such.

[A. G. O. No. 93.]

Clothing of *A Recruitment Co 7th USCT*

ENROLLED. (For Drafted Men, see note 10.)			MUSTERED IN. (For Drafted Men, see note 10.)			LAST PAID.		BOUNTY.		REMARKS	
When.	Where. (Town and State.)	By whom.	When.	Where. (Town and State.)	By whom. (In case of drafted men, from what enrollment district.)	Period.	By paymaster.	To what time.	Paid \$ (See note 2.)		Due \$ (See note 2.)
<i>1863</i>			<i>1863</i>								
<i>Oct 21</i>	<i>Somerset</i>	<i>W.D. Dime</i>	<i>Nov 3</i>	<i>Dumfries</i>	<i>W.D. Dime</i>	<i>March 1864</i>					<i>Co 7th USCT</i>
											<i>for March</i>

...dies in Hospital or on detached service, his descriptive list should be sent with his final statements, in duplicate, to the Auditor, Washington, D. C. ... will be considered as mustered in from the date of their death. ... must be mustered for pay on the usual rolls for Volunteers. ... as the soldier's name, under the heading "Joined for Service," will be entered on the roll. ... Commencement of First Payment by Time," will be entered under the heading "When Mustered in," and under the heading "When Mustered in," will be given the date when the soldier was drafted; under "Where Mustered in," will be given the place from which drafted; under "By whom Mustered in," will be given the No. of the Enrollment from which he was drafted, and the State to which it belongs. ... D. Mass.; (meaning 4th Enrollment District, State of Massachusetts.)

I CERTIFY that the above is a correct transcript from the Records of this Regiment from *Maryland for US Colored Troops*

STATION: *Benedict, Md.*
 DATE: *February 10, 1864*

William D. ...
Prq Genl
Mustering

Recruit in Co. G 7th U.S.C.

Whom.	MUSTERED IN. (For Drafted Men, see note 10.)		By whom. (In case of drafted men, from what regiment district.)	Period.	LAST PAID.		BOUNTY.		REMARKS.
	When.	Where. (Town and State.)			By paymaster.	To what time.	Paid \$ (See note 2.)	Due \$ (See note 2.)	
<i>Benny</i>	<i>1863</i>	<i>Benedict</i>	<i>W. Binney</i>	<i>March 1863 to 11th March 1864</i>	<i>—</i>	<i>—</i>	<i>—</i>	<i>—</i>	<i>Co. G, 7th U.S.C. for Margaret, R. Conway</i>

I CERTIFY that the above is a correct transcript from the Records of *this Co. G 7th U.S.C.* Recruits from *Maryland for U.S. Colored Troops*

STATION: *Benedict, Md.*
DATE: *February 10th 1864*

William Binney,
Priv Genl U.S. Arts
Commanding the Company
Mustering Officer

Mayland Somerset County Set: I hereby certify that the
within is truly Copied from the Original on file and of record in
the office of the Clerk of the Circuit Court for Somerset County

In testimony whereof I hereunto subscribe
my name and affix the Seal of the said
Circuit Court this 24th day of May Anno
Domini 1864 Levin Woolford clerk



Mayland County

158

25/

E.

DEED OF MANUMISSION AND RELEASE OF SERVICE.

Whereas my slave John Douglass has enlisted
 in the service of the United States: now, in consideration thereof,
 I, Margaret R Conway, of Somerset - county,
 State of Maryland, do hereby, in consideration
 of said enlistment, manumit, set free, and release the above-named
John Douglass from all service due me; his freedom
 to commence from the 21st of October 1863, the date of his
 enlistment as aforesaid in the 7th Regiment of Colored Troops,
 in the service of the United States.

Witness my hand and seal, this twentieth day of May, 1864.

Margaret R Conway



Witness:

George W. Adams
Geo Riall

Somerset County,

State of Maryland, 1864. May the twentieth

Before me appeared this day Margaret R. Conway
 and acknowledged the above Deed of Manumission and Release of
 Service to be his free act and deed.

John M. D. Anderson

Affidavit of
Margaret R. Conroy
Slave of the United States

L G

State of Maryland, Somerset County,
to wit:-

Personally appeared before me
Margaret R. Conway, of Somerset County,
Maryland, and made oath that, John Douglas,
about 5 feet 4 or 5 or 6 inches high, of rather
a chestnut color, about 21 or 22 years
of age, a man of African descent, and
supposed to be enlisted in the United
States Colored Troops, is her slave for
life under the laws of the State of Maryland.

Margaret R Conway

Sworn to and subscribed before
me, at Somerset County, Maryland,
this Twenty Eighth day of January, Eigh-
teen Hundred and Sixty-four.

John W. D. Anderson Justice of the Peace.

State of Maryland, Somerset County to wit.

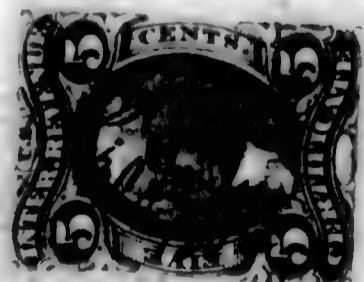

I LEVIN WOOLFORD Clerk of the Circuit Court
for Somerset County aforesaid, hereby certify
that John W. D. Anderson Esquire,
before whom the above affidavit
appears to have been made, and whose name
appears thereto signed, was at the time the
same bears date, one of the Justices of the
Peace of the State of Maryland, in and for Somerset County afore-
said, duly commissioned and sworn,

In testimony whereof I hereunto subscribe my name and affix
the seal of the said Circuit Court, this 30th day of January
Anno Domini 1864

Levin Woolford

MUSTER-IN AND DESCRIPTIVE

R O U S E

#116

John Douglass,
Co. G - 7th Mass. Troop.

BUREAU OF THE
JAN 23
1870
CLAIM BUREAU

MUSTER-IN and DESCRIPTIVE-ROLL of *One Man* in the
 Colonel *- Co "G"*, called into the service of the United States
 1863, for the term of *Three Years* unless sooner discharged.

NAMES.	RANK.	MUSTERED INTO SERVICE.			PERI
		WHEN.	WHERE.	BY WHOM.	
<i>John Douglass</i>	<i>Private</i>	<i>Oct 30 / 63.</i>	<i>Maryland Camp Stanton</i>	<i>Sr Col Haskell</i>	<i>3'</i>
<i>+</i>		<i>+</i>	<i>+</i>	<i>+</i>	
<i>+</i>		<i>+</i>	<i>+</i>	<i>+</i>	
<i>+</i>		<i>+</i>	<i>+</i>	<i>+</i>	

I CERTIFY, ON HONOR, That I have carefully examined..... whose name borne on this
 Roll, and have accepted into the service of the United States for the term of.....
 from this..... day of..... 186 .

Signed

.....

 *Mustering Officer.*

DATE:

STATION:

A true extrac

7th Regiment of *1st Colored Troops* Volunteers, commanded by
 , by *The President* from the *30th* day of *October*

NO.	DESCRIPTION.					REMARKS.	
	AGE.	EYES.	HAIR.	COMPLEXION.	HEIGHT.		
					FEET.	INCHES.	
<i>1</i>	<i>20</i>	<i>Blue</i>	<i>Brown</i>				<i>Mustered out Indianola Texas, Oct 13 - 1866. Honorably Discharged.</i>
							<i>x</i>
							<i>x</i>
							<i>x</i>

WAR DEPARTMENT, ADJUTANT GENERAL'S OFFICE,
 Washington, 186
 t from original Muster-in Rolls on file in this Office

 Signed _____
 Asst. Adjutant General U. S. A.

STATE OF MARYLAND,
 ADJUTANT GENERAL'S OFFICE,
 Annapolis, *Oct 3* 1868.
 I CERTIFY, ON HONOR, that the foregoing is a true extract from the
 Records on file in this Office.

 Adjutant General of Maryland.

FRANCIS PUTNAM STEVENS,
Attorney and Counsellor at Law,
 63 W. Fayette Street,

Baltimore, Jan 14 1875.

John Douglass. (Colored)
 No 20. West 12th St.
 Wilmington Del.

Sir:

Yours of 18th received, I do
 not owe you any money,
 I delivered your discharge
 to Thomas J Baer, Esq your
 attorney a year ago.

I enclose you a descriptive
 roll, which is the only paper
 of yours in my office.

I have answered a letter
 of our Page of Princess Anne,
 and shall not write any
 more.

Respy

Henry Page of Princess Anne
 Maryland

F. P. Stevens,

State of Maryland, Somerset County to wit.



I LEVIN WOOLFORD Clerk of the Circuit Court for Somerset County aforesaid, hereby certify that *John W. D. Anderson* Esquire, before whom the *above affidavit* appears to have been made, and whose name appears thereto signed, was at the time the same bears date, one of the Justices of the

Peace of the State of Maryland, in and for Somerset County aforesaid, duly commissioned and sworn,

In testimony whereof I hereunto subscribe my name and affix the seal of the said Circuit Court, this *23rd* day of *January* Anno Domini 186*4*

Levin Woolford Clerk

members of her family, and made oath in due form of law, that the said Margaret R. Conway is the owner of the slave, John Douglass as of public notoriety, and that they believe that all the statements herein made by her in reference thereto, are correct.

George N Crosby
Isaac J. Hopkins } Witnesses

John W. Anderson Magistrate.

Feb. 24. D. C. 1864
No. 1587. No. 13.
Application of
Margaret R. Conway

of Somerset County, Md.
for compensation for service
of slave

John Douglass
Enlisted in 7th Regt
U.S. Colored Troops Co. G.

Received February 16 1864

Compensation Awarded

October 31st. 1864

Three Hundred Dollars

Thos. Timmons
President Board of Claims

Filed by Wm. Daniel
Feb. 16. 1864

By John W. Anderson
Magistrate

Claimants Certificate.

No. 158.

To the Board of Claims for
Slaves enlisted in the service of the
United States.

I, Margout R. Conway, a loyal citizen
and resident of Somerset County, Md., by William
Daniel, my attorney in fact, hereby claim remunera-
tion, under the provisions of General Orders,
No. 329, War Department, 1863, for my slave,
John Douglas: a slave for life.

aged about twenty one years
of rather chestnut color, well made, healthy & strong,
~~was~~^{was} enlisted or received for enlistment on
Board Steamer Genl. Meigs, in Somerset County,
whilst on a recruiting expedition, on or about the ~~10th~~
~~at 21st~~ October 1863.

by Col Binney ^{and as I have been informed} the 7th Regiment U.S. Col^d Troop, Co. G.
~~is~~ is enlisted in ~~a Cavalry Regt of Genl. Birney's~~
~~Regiment, U.S. Col^d Troop~~ a certificate
of which enlistment, as required, accompa-
nies this application, a certificate of which
enlistment & Des. List, accompany this application.

I ^{do solemnly swear} further state that the said
John Douglas is a - slave for
life -
and that I have owned him ever

2-

since his birth, having owned his
Mother before him.

And further, "I do solemnly swear
that I have not purchased or obtained the
slave for whom I now claim compensa-
tion from any person or persons disloyal
to the Government of the United States,
with a view of obtaining compensation
for the same; and further, that I have no
agency for obtaining compensation for
any person or persons" whatever.

I also pledge myself to file with
the Board of Claims a good and sufficient
deed of manumission and a release of ser-
vice of the said John Douglass -
_____ as soon as the pres-
ent law of the state prohibiting manu-
mission shall have been repealed, or as
soon thereafter as the Board may require.

In proof of my loyalty to the Con-
stitution and Government of the United
States, "I do solemnly swear, that I will bear
true allegiance to the United States, and support and sustain
the Constitution and Laws thereof; that I will maintain
the National sovereignty paramount to that of all State.

County or Corporate powers; that I will discourage, discountenance and forever oppose secession, Rebellion, and the disintegration of the Federal Union; that I disclaim and denounce all faith and fellowship with the so-called Confederate States and Confederate armies, and pledge my property and my life to the sacred performance of this my solemn oath of allegiance to the Government of the United States."

Signed

Margaret R. Conway Applicant.

John W. Anderson Witness.

State of Maryland,

Somerset County, to wit;

On this twenty second day of January in the year 1864, before me, the subscriber, a Justice of the Peace of the State and County aforesaid, personally appeared Margaret R. Conway, and took, signed and acknowledged the oaths preceding, and declared that all the statements made in this application are to the best of her knowledge and belief, strictly true.

At the same time, personally appeared before me, George S. Crosby and Isaac S. Hopkins loyal citizens, residents of the neighborhood wherein the said Margaret R. Conway dwells, and not

Ed. of Somerset
to H.

T. No. 24. D. C. S. 1864
No. 1587 No. 13.

Application of
Margaret R. Conway
of Somerset County, Md.
For compensation for service
of slave

John Douglas
Enlisted in 7th Regt
U.S. Colored Troops Co. G.
Received February 16 1864

Compensation Awarded

October 31st 1864

Three Hundred Dollars

Thos. Simmons
President Board of Claims

Enclosure of property treated

Recd. S. G. O. November 26, 1864

Filed by Wm Daniel
Feb. 16 1864

Barney

Claimant's Certificate.

No. 158.

To the Board of Claims for
Slaves enlisted in the service of the
United States.

I, Margout R. Conway, a loyal citizen
and resident of Somerset County, Md., by William
Daniel, my attorney in fact, hereby claim remunera-
tion, under the provisions of General Orders,
No. 329, War Department, 1863, for my slave,
John Douglas; a slave for life,

aged about twenty one years
of rather chestnut color, well made, healthy & strong,
~~was~~^{was} enlisted or received for enlistment on
Board Steamer Genl. Meigs, in Somerset County,
whilst on a recruiting expedition, on or about ~~the~~
~~at~~ ~~27th~~ October 1863.

by Col Binney ^{and as I have been informed} the 7th Regiment U.S. Col. Troop, ^{Co. G.}
~~is enlisted in a~~ ~~Company~~ ~~of~~ ~~the~~ ~~7th~~ ~~Regiment~~ ~~U.S.~~ ~~Col.~~ ~~Troop~~ ~~Co. G.~~
~~Regiment, U.S. Col. Troop~~ a certificate
of which enlistment, as required, accompa-
nies this application, a certificate of which
enlistment & Des. List, accompany this application.

I ^{do solemnly swear} ~~solemnly state~~ that the said
John Douglas is a - slave for
life -
and that I have owned him ever

2-

since his birth, having owned his
Mother before him.

And further, "I do solemnly swear
that I have not purchased or obtained the
slave for whom I now claim compensa-
tion from any person or persons disloyal
to the Government of the United States,
with a view of obtaining compensation
for the same; and further, that I have no
agency for obtaining compensation for
any person or persons" whatever.

I also pledge myself to file with
the Board of Claims a good and sufficient
deed of manumission and a release of ser-
vice of the said John Douglass -

as soon as the pres-
ent law of the state prohibiting manu-
mission shall have been repealed, or as
soon thereafter as the Board may require.

In proof of my loyalty to the Con-
stitution and Government of the United
States, "I do solemnly swear, that I will bear
true allegiance to the United States, and support and sustain
the Constitution and Laws thereof; that I will maintain
the National sovereignty paramount to that of all State.

3.

County or Corporate powers; that I will discourage, discountenance and forever oppose secession, Rebellion, and the disintegration of the Federal Union; that I disclaim and denounce all faith and fellowship with the so-called Confederate States and Confederate armies, and pledge my property and my life to the sacred performance of this my solemn oath of allegiance to the Government of the United States."

Signed

Margaret R. Conway Applicant.

John W. Anderson Witness.

State of Maryland,

Somerset County, to wit;

On this twenty second day of January in the year 1864, before me, the subscriber, a Justice of the Peace of the State and County aforesaid, personally appeared Margaret R. Conway, and took, signed and acknowledged the oaths preceding, and declared that all the statements made in this application are to the best of her knowledge and belief, strictly true.

At the same time, personally appeared before me, George N. Crosby and Isaac S. Hopkins loyal citizens, residents of the neighborhood wherein the said Margaret R. Conway dwells, and not

members of her family, and made oath
in due form of law, that the said ~~M~~
Margaret R. Leomay is the owner of the
slave, John Douglas as of public
notoriety, and that they believe that
all the statements herein made by
her in reference thereto, are correct.

George N. Crosby
Isaac J. Hopkins } Witnesses

John W. Anderson Magistrate.

MAR 14 1870

7748 Vol. 6. R. & F. H. B. B. 3070
War Department,
Bureau R., F., & A. L.,
Claim Division,

Ex. M. No. 243. Vol. 9. 1870.
Washington, March 16th 1870.

Respectfully returned to you
B. Higgins, Corp. Agent & Co.
Box R. 7, and A. L., Wilmington
Del. The two second
Auditor reports no claim filed
in this case.

A claim can be filed
through this Bureau, with affi-
davit setting forth facts in
relation to his discharge

By order of Bvt. Maj.-Gen. O. O. HOWARD,
Commissioner.

William A. Drew
Agent Bu. R., F., & A. L., Chief of CLAIM DIVISION.

John Douglass

7 USC 7

Wilmington Del
January 28th 1870

The within master out roll and
Letter are very respectfully re-
ferred to Maj Gen O. O. Howards
Com^o with the following

Statement

made to me by John Douglass the
Claimant in substance as follows
to wit:

That something over two years
ago he called on Francis P. Stevens
63 W. Fayette Street Baltimore placed
his Discharge paper in his hands
after making his claim for \$300
Bounty &c. that on the same day
he made his claim a young man
apparently a Clerk of Stevens took
him into the entry of the building
put \$15 in his hands and told
him he would be paid the balance
when his discharge came back from
Washington - He further states that
he does not know such a man as
Thomas S. Baer never employed
and other person in the business
except Stevens. Has never seen
his discharge since he placed
it in Stevens hands, nor has he
ever received any Bounty or money
other than the \$15 mentioned -

That Henry Page of Princess
Anne Maryland knows him the
said Douglass well and can vouch
for his truthfulness.

Wm Wigginton
Agent

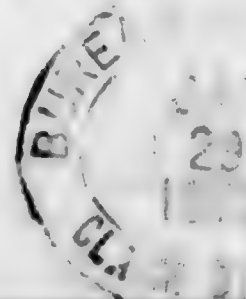

personally appeared before me, **HANSON HARMAN**, Clerk of the United States District Court for the District of Delaware, aged _____ years, a resident of _____ in the State of _____ who being duly sworn according to law, declares that _____ is the identical _____ to whom was granted Pension Certificate No. _____ payable at the agency at _____ and dated _____; that under the limitations of the Act of _____ was denied a pension from the date of his discharge, and believing that he is entitled to the same, under the Sixth Section of the Act of July 27th, 1868, he makes this declaration in order to secure the arrears accrued thereunder. That he has not been employed in any branch of the Civil Government of the United States during the period commencing March 3d, 1865, and ending June 6th, 1866, nor has he ever been employed in any branch of such Civil Government.

His Post Office address is as follows _____ and he requests that any communications relative hereto, may be sent to him in care of his Attorney, **WILLIAM B. WIGGINS**, No. 510 Market Street, Wilmington, Delaware.

ALSO personally appeared _____ and _____ residents of the _____ of _____ in the State of _____ persons whom I certify to be respectable and entitled to credit, and who, being by me duly sworn, say that they were present and saw _____ to the foregoing declaration; and they further swear, that they have every reason to believe, from the appearance of the applicant and their acquaintance with him that he is the identical person he represents himself to be, and they further swear that they reside as above stated, and that they have no interest in the prosecution of this claim.

Sworn to and subscribed before me, this _____ day of _____ A. D. 18 _____ and I hereby certify, that I have no interest, direct or indirect in the prosecution of this claim. I further certify, that the foregoing declaration and joint affidavit were read over to and understood by the respective parties before they made their several signatures to the same.

Clerk U. S. D. C.,
District of Delaware.

1914
Douglas Patrick
Co H, 7 U.S. Col'd Inf

Private

Private

CARD NUMBERS.

1	6 2 9 2 4 6 6	26
2	6 2 9 2 5 6 6	27
3	6 2 9 2 6 6 8	28
4	6 2 9 2 7 6 9	29
5	6 2 9 2 8 6 6	30
6	6 2 9 2 9 6 0	31
7	6 2 9 3 0 5 0	32
8	6 2 9 3 1 5 0	33
9	6 2 9 3 2 4 8	34
10	6 2 9 3 3 4 7	35
11	6 2 9 3 4 4 4	36
12	6 2 9 3 5 4 1	37
13	6 2 9 3 6 3 0	38
14	6 2 9 3 7 1 9	39
15	6 2 9 3 8 4 9	40
16	6 2 9 4 1 4 9	41
17	9 0 6 6 7 9 1	42
18		43
19		44
20		45
21		46
22		47
23		48
24		49
25		50

Book Mark:

C. D. V. 176. P. 282-73.

See also

S. | 7 | U.S.C.T.

Patrick Donohoe
Co. K, 7 Reg't U.S. Col'd Inf.

Appears on
Company Descriptive Book
of the organization named above.

DESCRIPTION.

Age 19 years; height 5 feet 3/8 inches.
Complexion Black
Eyes Black; hair Black.
Where born St. Mary, Maryland.
Occupation

ENLISTMENT.

When Oct. 25, 1864
Where St. Mary
By whom Wm. B. Boney; term 3 y'rs.

Remarks: Discharged on Surgeon's certificate of disability on account of wounds received in action near Richmond, Va. Oct. 28, 1864. January 31, 1865, at this U.S. Gen. Hosp., Balt. Md.
Mustered Nov 5, 1863, by Lt. Col. Haskell.

J. D. White

D

7

U.S.C.T.

Patrick Douglas

Pt., Co. A., 7 Reg't U. S. Col'd Inf.

Age 19 years.

Appears on

Company Muster-in Roll

of the organization named above. Roll dated

of Stanton Charles Co. Md., Nov. 5, 1863.

Muster-in to date Nov. 5, 1863

Joined for duty and enrolled:

When Oct 26, 1863.

Where St. Mary, Md.

Period 3 years.

Remarks: _____

Book mark: _____

Steele

A

7

U.S.C.T.

Patrick Sweeney

Co. H, 7 Reg't U. S. Col'd Infantry.

Appears on

Company Muster Roll

for Mar. & Dec., 1863.

Present or absent Present

Stoppage, \$ 100 for

Due Gov't, \$ 100 for

Remarks: Due to enlistment premium

Book mark:

Stub

(858)

Copyist

D, | 7 | U.S.C.T.

Patrick Douglas,
Co., Co. H, 7 Reg't U. S. Col'd Infantry.

Appears on

Company Muster Roll

for Jan Aug Feb, 1864.

Present or absent Present

Stoppage, \$ 100 for

Due Gov't, \$ 100 for

Remarks:

Book mark:

Heck

A. 1

7

U.S.C.T.

Patrick Douglas

Co. H, 7 Reg't U. S. Col'd Infantry.

Appears on

Company Muster Roll

for March & April, 1864.

Present or absent Absent

Stoppage, \$ 100 for

Due Gov't, \$ 100 for

Remarks: On detached service at St. Ann's P.M. since April 26th 1864.

Book mark:

Steele

N. |

7

U.S.C.T.

Patrick Douglas
71, Co. H, 7 Reg't U. S. Col'd Infantry.

Appears on

Company Muster Roll

for May & June, 1864.

Present or absent Absent.

Stoppage, \$ 100 for

Due Gov't, \$ 100 for

Remarks: On detached
Service at St.
Gregory. P. Q. M.
Sailed Apr. 28/64.
Per S.O. No 47
R. H. Ins.

Book mark:

Steel,

Q. | 7 | **U.S.C.T.**

Patrick Douglas,
Pf., Co. H, 7 Reg't U. S. Col'd Infantry.

Appears on

Company Muster Roll

for *July & Aug.*, 186*4*.

Present or absent *Present*

Stoppage, \$ 100 for

Due Gov't, \$ 100 for

Remarks:

Book mark: *...*

(858)

Steck
Copyist

N. 1

7

U.S.C.T.

Pattick Douglas
Pt., Co. H, 7 Reg't U. S. Col'd Infantry.

Appears on

Company Muster Roll

for *Sept & Oct*, 1864.

Present or absent *Absent*

Stoppage, \$ *100* for

Due Gov't, \$ *100* for

Remarks: *Wounded in
action and sent
to Wash. Oct
28-*

Book mark:

Stein

(858)

Copyist

10

7

U.S.C.T.

Patriot Douglass

Pm, Co. H, 7 Reg't U. S. Col'd Infantry.

Appears on

Company Muster Roll

for *Nov. and Dec*, 1861.

Present or absent *absent*

Stoppage, \$ *100* for

Due Gov't, \$ *100* for

Remarks: *Wounded in action and sent to Hosp. Oct. 28th*

Book mark: *100*

N. H. Merrill

(858)

Copyist

1864 1427

10

7

U.S.C.T.

Patrieto Douglas

Paw, Co. H, 7 Reg't U. S. Col'd Infantry.

Appears on

Company Muster Roll

for *Jan and Feb.*, 1865.

Present or absent *absent*

Stoppage, \$ *100* for

Due Gov't, \$ *100* for

Remarks: *Wounded and sent to Hosp.*

Oct. 23 1864

Book mark:

N. H. Merrill

(858)

Copyist

10

7

U.S.C.T.

Patrick Douglas

Priv, Co. H, 7 Reg't U. S. Col'd Infantry.

Appears on

Company Muster Roll

for *March and Apr*, 1865.

Present or absent *Absent*

Stoppage, \$ *100* for

Due Gov't, \$ *100* for

Remarks: *Wounded and sent to Hosp.*

Aug 1st 1864

Book mark:

N. H. Merrill

(858)

Copist

10

7

U.S.C.T.

Patrick Mayless

Private, Co. H, 7 Reg't U. S. Col'd Infantry.

Appears on

Company Muster Roll

for *May and June*, 1865.

Present or absent *absent*

Stoppage, \$ *100* for

Due Gov't, \$ *100* for

Remarks: *Wounded and sent to Hosp.*

May 13 64

Book mark:

N. H. Merrill

(858)

Copist

10

7

U.S.C.T.

Patrick Douglas

Private, Co. H, 7 Reg't U. S. Col'd Infantry.

Appears on

Company Muster Roll

for *July and Aug*, 1865.

Present or absent *present*

Stoppage, \$ *100* for

Due Gov't, \$ *100* for

Remarks: *Wounded and sent to Hos p.*
Aug. 13 1864

Book mark:

H. H. Merrill

(858)

Copyist

10

7

U.S.C.T.

Patrick Douglas

Priv, Co. H, 7 Reg't U. S. Col'd Infantry.

Appears on

Company Muster Roll

for *Sept and Oct*, 1865.

Present or absent *absent*

Stoppage, \$ *100* for

Due Gov't, \$ *100* for

Remarks: *Wounded and sent to Hosp.*

Aug 13, 64

Paid for medicine sent by Maj. P. S. ...

Book mark:

N. H. Merrill

11

7

U.S.C.T.

Patrick Weyglass

111, Co. H, 7 Reg't U. S. Col'd Infantry.

Appears on

Company Muster Roll

for *November 1863*, 1863 .

Present or absent *absent*

Stoppage, \$ *100* for

Due Gov't, \$ *100* for

Remarks: *In Hospital since Aug 13 64*

Wounded

Paid for May & June 65 47 maj. Purshifan

Book mark:

N. H. Merrill

D.

7

U.S.C.T.

Patrick Douglas

Pvt., Co. H, 7 Reg't U. S. Col'd Infantry.

Appears on

Company Muster Roll

for Jan. & Feb., 1866.

Present or absent

Stoppage, \$ 100 for

Due Gov't, \$ 100 for

Remarks: Discharged Jan. 30, 1866 at
Wicks U.S.A. Genl. Hosp'l, Balto-
Md. on Surgeon Certificate of
disability from wounds
received in action near of
Richmond, Va Oct. 28, '64

Book mark: A.G.O. Discharged on S.C.D. from
over

(858)

J. J. Kearney

Copyist

9291434

Genl Hospital. Balto, Md. January
31. '66 because of wounds
received in action at Chapin
Farm, Va. Oct. 1864 See
Endorsement on b.D.

JAN. 21
6293849
1891

10 | 7 | **U.S.C.T.**

Patrick Douglas

Pat., Co. H., 7 Reg't U. S. Col'd Inf.

Appears on **Co. Muster-out Roll**, dated
Cardinala, Tex., Oct. 13, 1866.

Muster-out to date _____, 1866.

Last paid to Dec. 31, 1864.

Clothing account:

Last settled _____, 1866 ; drawn since \$ _____ 100

Due soldier \$ _____ 100; due U. S. \$ _____ 100

Am't for cloth'g in kind or money adv'd \$ _____ 100

Due U. S. for arms, equipments, &c., \$ _____ 100

Bounty paid \$ _____ 100; due \$ _____ 100

Remarks: Discharged Feb. 1866 at
U.S. Hoapl. at Balto, Md. on
Surge. Certif. of Disability

Book mark: La. 76 P. 282, 73 V. 33
535, 575 a over

(361)

J. J. Kearney
Copyist.

6294149

JAN. 21

6294149

AL8914

P. 91 68. 232 692 119 740
A.S.O. Discharged Jan 31. '66
End mit - on C. D.

Douglas, Patrick

P. Co. H.

7

Reg't U.S.C. Inf.

3

Enclosures.

- | | |
|------------------------------|-------------------|
| Bed Cards | Descriptive Lists |
| Burial Records | Final Statements |
| Certs. of Dis. for Discharge | Furloughs |
| C. M. Charges | Med. Des. Lists |
| Med. Certificates | Orders |

Other papers relating to—

- | | |
|---|----------------------|
| Admission to Hosp'l | Furlough |
| Casualty Sheet (Officer's) | Med. Examination |
| Confinement | Misc. Information |
| Contracts | Pay or Clothing |
| Death or Effects | Personal Reports |
| Desertions | Rank |
| Discharge from Hosp'l | Transfer to Hosp'l |
| Discharge from Service | Transfer to V. R. C. |
| Duty | Transportation |

MICROFILM PUBLICATION M 1849

COMPILED MILITARY SERVICE RECORDS
OF VOLUNTEER UNION SOLDIERS WHO SERVED WITH
THE UNITED STATES COLORED TROOPS (USCT)
7TH REGIMENT OF INFANTRY

PERSONAL PAPERS' TARGET SHEET

PLEASE NOTE THE CHECKED INFORMATION ABOUT THE PERSONAL PAPERS IN
THIS FILE:

- NO PERSONAL PAPERS WERE FOUND IN THIS FILE WHEN THE
RECORDS WERE ARRANGED FOR MICROFILMING.
- 14 PERSONAL PAPER(S) FOUND IN THIS FILE WHEN THE RECORDS
WERE ARRANGED FOR MICROFILMING.

X. No 33

Adj't General's Office
Washington D. C.

June 19th 1865.

I certify that the name
of Patrick Douglas is
borne on the Muster
Roll of Co. "H" 7th Regt.
U. S. C. Troop file in this
Office.

It is stated on said
Roll that he was enrolled
in the Regt. by H. D.

J. W. Sargent
Asst. Adj't. General

VOLUNTEER DESCRIPTIVE LIST ~~and Account of Pay and Clothing of~~

- NOTES. {
1. The amount of any *extra* pay for which the soldier may be mustered, *ex. gr.* as *Acting Hospital Steward*, as *Saddler*, &c., and which may be *still due* him, must be carefully noted.
 2. In the column headed "BOUNTY PAID," must be entered the *whole* amount *hitherto paid* him; in that of "BOUNTY DUE," the *whole* amount *yet due* him.
 3. Stoppages for *loss* or *damage* done to *arms*, or other *public property*, must be noted, and the *articles*, and *particular damage* to each specified.
 4. When stoppages are due, under sentence of a Court Martial, a *transcript of the same* must be entered here; and the amount *already stopped*, must be *carefully* stated.
- NOTES. {

No.	NAMES.	RANK.	DESCRIPTION.						WHERE BORN.		OCCUPATION.	ENROLLED.	
			Years of age.	Eyes.	Hair.	Complexion.	Feet.	Inches.	State or Kingdom.	Town or county.		When.	Where. (Town and State.)
1	<i>Patrick Douglas</i>	<i>Private</i>	<i>19</i>	<i>Black</i>	<i>Black</i>	<i>Black</i>	<i>5</i>	<i>3 1/2</i>	<i>St. Marys, Md.</i>	<i>Farmer</i>	<i>Oct. 26/63.</i>	<i>-----</i>	

I CERTIFY that the above is a correct transcript from the Record

STATION: *Benedict, Md.*

DATE: *January 9, 1864*

ly noted.

- NOTES.
- 5..In every case of desertion, the date, and that of delivery, or apprehension, must be given, together with a correct transcript of the order of sentence, or pardon.
 - 6..A careful settlement of the man's CLOTHING ACCOUNT must be made, to date, and the amount DUE TO, or FROM him must be precisely stated.
 - 7..Should the man have been engaged in any action, or skirmish, it must be mentioned, together with date and place.
 - 8..A full and particular mention will be made of any wounds he may have received in action, or other injury, whilst in the line of his duty.

ENROLLED.		MUSTERED.				LAST PAID.		BOUNTY.		REMARKS.
Where. (Town and State.)	By whom.	When.	Where. (Town and State.)	By whom.	Period.	By paymaster.	To what time.	Paid \$ (See note 2.)	Due \$ (See note 2.)	
	Col. Wm. Boney		Camp Stanton.	Col. Wm. Boney	3 1/2 Years in the War.	---	---	---	---	
			Co. H 7th U.S.C.T.							

Charles County of St Charles State of Maryland. 1864
 Personally appeared before me Gustavus Carter
 and makes oath that the above named
 recruit is his slave.

Gustavus Carter
 Sworn and subscribed to before
 me this Ninth day of January 1864. —

John E. Stewart
 1st Lieut 9th U.S.C.T.
 acting Post Adjt

from the Records of Co. H, Seventh U.S.C.T.
 Md.
 9, 1864.

Wm. Boney
 Br. General U.S.V.
 U.S. Mustering Officer

No 35.

Dr G. Carter

Ev. Title matter p. C. C.

A.

No. 33

CLAIMANT'S CERTIFICATE.

I, Dr Gustavus Canter a loyal citizen, and a resident
of St. Marys, County of the, State of
Maryland; hereby claim compensation, under the provisions of
General Orders, No. 329, 1863, for my slave Patrick Douglas
enlisted October 26th 1863, at Camp Stanton Charles Co
by Col William Winney in the seventh
Regiment U. S. Colored Troops, Co. H; certificate of which enlistment, and a
descriptive list, as required, accompany this application.

In proof of my loyalty to the Constitution and Government of the United States, I
present the accompanying oath, which I have taken, signed, and acknowledged, to be filed
with this application, in accordance with requirement of said General Orders.

Gustavus Canter

February 1st 1864.

MAR 14 1864

B.

OATH OF ALLEGIANCE.

I, *Dr Gustavus Canter*, do solemnly swear that I have never joined, or been concerned in, any insurrection or rebellion; that I have never borne arms against the United States; that I have never given any aid, countenance, counsel, or encouragement to any person or persons engaged, or whom I had reason to believe were about to engage, in insurrection, rebellion, or armed hostility against the United States; that I have neither sought, nor accepted, nor attempted to exercise the functions of any office, civil or military, nor to perform any service whatever, under any authority or pretended authority in hostility to the United States; that I have not yielded a voluntary support to any insurrection, rebellion, or pretended government, authority, power, or constitution within the United States hostile thereto. And I do further swear that, to the best of my knowledge and ability, I have supported and defended, and will continue to support and defend, the United States against all enemies, foreign and domestic; and that I have supported, defended, and obeyed, and will continue to support, defend, and obey, the Constitution and laws of the United States; that I will bear true faith and allegiance to the same; and that I take this oath freely, without any mental reservation or purpose of evasion: So help me God.

Gustavus Canter

Sworn to and subscribed before me, at *Baltimore City*
 this *1st* day of *February* 1864.

Jos. W. Stake
 Justice of the Peace



C.

I present herewith evidence of my title to the slave Patrick Douglas
..... enlisted as aforesaid, and in consideration of the sum of
..... by me received, I hereby covenant and
agree with the United States, that I, my heirs, executors, or assigns, shall never hereafter make
or enforce any claim to the labor or services of said slave; and pledge myself to execute
a valid Deed of Manumission and Release of all my claims to service forever of said
Patrick Douglas to be filed with the Board of Claims
now in session at Baltimore City

Gustavus CarterFebruary 1st, 1864.

Correct

P.O. Charlotte Hall

S. Miss. p. 100
7. 10. 43. 1861
No. 35

APPLICATION OF
Dr. Gustavus Cantley
 OF
S. Mary's County
 For Compensation for Service of Slave,
Patrick Douglas
 Enlisted in *Seventh* Regiment
 U. S. Colored Troops *Co. H.*
 Received, *February 2d* 1864.

COMPENSATION AWARDED,
May 26th 1865
Three hundred Dollars.
Thos. Timmons
President Board of Genl
address No 16 S. Calvert St
Balt

Wm. G. Lee
Secretary
written to for information
reference court. 5-14-65

100
1865

7-117

EVIDENCE OF TITLE.

I, *Dr Gustavus Canter*, of *St. Marys*
 County, Md., do solemnly swear that *Patrick Douglas*
 who has been enlisted in the *seventh* Regiment, U. S. Colored Troops,
 Co. *H*; is my slave for *life*; (~~his term of service expiring on~~
 the ~~day of~~ *186*;) and that
 I became possessed of him by *inheritance*, in the month
 of *November*, eighteen hundred and *fifty nine*. And I
 do further swear that I have not purchased said slave from any person or persons disloyal
 to the Government of the United States, with the object of obtaining compensation for
 the same; and furthermore, that I have no agency for obtaining compensation for any per-
 son or persons but such as, to my knowledge, are loyal citizens of the United States.

February 1st 1864.

Gustavus Canter



STATE OF MARYLAND.

Baltimore City ~~County~~, to wit:

On this *first* day of *February* in the year 1864,

before me, the subscriber, a Justice of the Peace of the State and County aforesaid, personally appeared *Dr Gustavus Canter*, and took, signed, and acknowledged the oaths preceding: and further made oath, in due form of law, that all the statements made in this application are, to the best of *his* knowledge and belief, strictly true. Also personally appeared before me *Thomas M Stephens* and *George D Alvey*, loyal citizens of the United States, residents of *Baltimore City*, well acquainted with the said *Dr Gustavus Canter*, and in no manner interested in the prosecution of this claim, and made oath, in due form of law, that the said *Dr Gustavus Canter* is the owner of the slave *Patrick Douglas*, as a fact of public notoriety: that they believe all the statements herein made by *him*, in reference thereto, are correct, and that *he* is unquestionably loyal to the Government of the United States. Witness their signatures:

Jos W Stake

Thomas M Stephens
Geo D Alvey
Justice of the Peace.



STATE OF MARYLAND,

City of Baltimore ~~County~~, to wit:

I, *Alford Mease*

Superior
Clerk of the ~~Circuit~~ Court for

Balt. City ~~County~~, do hereby certify that *W. H. Blake*,

before whom the foregoing affidavits were made, was, at the time of signing the same, a Justice of the Peace for the ~~County~~ *City* and State aforesaid, duly commissioned and sworn; and that his signature thereto is genuine, and that full faith and credit should be given to his official acts.

Witness my hand and the seal of said Court, this *Eight* day of

April, A. D. 1864.

Alford Mease CLERK.

D. M. Sells, Officer
Washington, D. C.

Feb. 20th 1864.

I have known Dr. Gustavus
Carter for some time past &
believe him to be truly loyal
D. J. Gibbon
U. S. A.

Instantu Carter

&

Patrick Douglass

1840

Cost

55

Stamp.

02

100

E.

Deed of Manumission and Release of Service.

WHEREAS my slave Patrick Douglas has enlisted in the service of the United States: now, in consideration thereof, I, Gustavus Carter, of Baltimore City county, State of Maryland, do hereby, in consideration of said enlistment, manumit, set free, and release the above-named Patrick Douglas from all service due me; his freedom to commence from the 21st October 1863, the date of his enlistment as aforesaid in the 7th Regiment of Colored Troops, in the service of the United States.

Witness my hand and seal, this 21st day of May, 1864

Gustavus Carter, 

WITNESS: { Joseph W. Blake
Benj. M. Murphy
J. P. Stevens

Baltimore City County,

State of Maryland May 4th, 1864

Before me appeared this day Gustavus Carter, and acknowledged the above Deed of Manumission and Release of Service to be his free act and deed.

Jos. W. Blake
Justice of the Peace

Received for record May 4th 1864; same day recorded and examined,

Per Alford Mace

Clerk of the Superior Court of Baltimore City.

In Testimony that the foregoing is a true copy taken from the Original, I herewith subscribe my Alford Mace the Superior Court of Baltimore City, this 4th day of May A. D. 1864

Alford Mace
Clerk of the Superior Court of Baltimore City.

* Remond to Baltimore since filing his claim.



Office of Assistant Quarter Master,

June 13

1864

Gentlemen,

This is to certify that I have known Dr Gustavus Cauter some time previous to the commencement of this rebellion, and can safely say that I have never known him to say or do anything disloyal to the government of the United States. He has always been considered and known as a loyal man, and so I have no hesitation in testifying to his loyalty to the government of the United States

Very Respectfully

Your Obedt Servant

J. B. F. Johnson

U. S. Army

to the

Commd. of Encls

Slave of Me }

To the Board of Claims for
 Enlisted Slaves of Maryland

Dear Gentlemen

I have known
 Dr Gustavus Canter, Mr E B Canter
 and Miss E. B. Canter for several
 years, long before this war commenced
 and I can say to the best of my
 knowledge, that they have never
 said or done anything disloyal to
 the government of the United
 States, we are all residents of
 the 5th district of St Mary's County
 therefore I have had ample oppor-
 tunities for observation of their
 actions towards our government

Thomas Pennel

cc

Sept 21st 1864

President of Board
of Claims for Entitled
Slaves in Maryland

As it will be
several months before I can
return to the city, so when
you receive my claim
see Miss Elizabeth R. Carter
- Miss Elizabeth C. Carter's
claims please send the
notice of your having examined
them by mail to Charlotte
Hall P.O. Saint Mary's County
Md. and you will confer
a great favour on me. My
claim was filed long
before my mother & sisters so as
soon as mine is examined send
the notice to the above Post Office
yours Truly
G. Carter. J. S.

56

CASUALTY SHEET
OF WOUNDED.

Patrick Douglass
Private Company 26
7 Regiment of USCP

Volunteers at the battle of _____

Oct 28 - 1864

CASUALTY SHEET.

Name, *Patrick Douglass*
Rank, *Private*, Company *No*, Regiment, *7th*
Arm, *USA*, State, _____
Place of casualty, _____

Nature of casualty, *Wounded*

Date of casualty, *Oct 28th 1864*

FROM WHAT SOURCE THIS INFORMATION WAS OBTAINED.

Report of Killed, Wounded, and Missing of the _____ Regiment,
_____ Brigade, _____ Division, _____ Corps, dated _____
*List of Casualties in the 7th Regt US Col Troops in
the Action of Oct 27th & 28th 1864
(Signed) Lewellyn F. Haskell
Lt Col Comd'g Regt*

Ind 502 no 59

W. F. Thompson

Clerk.

NARA 1459

R.G. Love
by
C. Anker

St Clements Bay St Marys Co Md
Feb 20th '65

John S Sears,

Dear Sir

I have your letter of the
14th asking my opinion in reference
to the loyalty of Dr Gustavus, Carter
Mr Elizabeth R Carter and Miss
Elizabeth C Carter. I am ^{but} slightly
acquainted with the parties named
above they live some distance above
me. I am satisfied that Dr Carter
has never acted with the Union par-
ty, but I refer you to Mr Thomas
Perry who resides in the same
election district with the parties
named, and any information he
may give you you can rely upon.
(Mr Perry Post Office, Charlotte Hall,
St Marys Co Md)

Yours Respectfully,
P. S. Lovel

Charlotte Hall S. Marys C. M.^d
May 11th 1865.

To the Board of Claims.
Baltimore.

Gentlemen.

I take pleasure in stating
that I am personally acquainted with Dr. Gustavus Carter
and know him to be now, and before the Rebellion, truly
loyal to the Government of the United States.

Very Respectfully.
H. M. Lyon

F.

CERTIFICATE OF AWARD OF THE BOARD OF CLAIMS.

40598

Office of the Board of Claims
For Slaves Enlisted in the Service of the United States,

Baltimore Md,

May 27th, 1865.

\$300-

We hereby certify, that Gustavus Canter, of St. Mary's county, State of Maryland, having proved, under oath, his loyalty to the Constitution and Government of the United States, and established his title as to the ownership of Patrick Douglass, a slave enlisted at Camp Stanton Md, on the 26th day of October, 1863, by Col. Wm. Birney, in the service of the United States, in the 7th Regiment of Colored Troops, Co. H, and having filed a valid Deed of Manumission and Release of Service of said slave, is entitled to the sum of Three Hundred dollars, which has been awarded to him by this Board as a remuneration for all claim to the future labor or service of said slave, under the provision of General Orders, War Department, No. 329, 1863.

Thos Simmons, President of the Board.
L E Stranahan, Member of the Board.
Wm Rogers, Member of the Board.

To Col. C. W. Foster,

Chief of the Bureau for the
Organization of Colored Troops, Washington, D. C.

Mr. G. W. ...

No. .

ABSTRACT OF DISBURSEMENTS.

....., 186 .

Carter ...

Dollars *300* 100.

Paid , 186 .

The United States,

To *Gustavus Lanter* Dr.

1865.		DOLLARS.	CENTS.
<i>May 27th</i>	For amount awarded him by the Board of Claims, in consideration		
	of the enlistment of <i>Patrick Donlaff</i>		
	in the <i>7th Regt U. S. Col'd Troops</i>	<i>300</i>	<i>00</i>
		<i>Total \$</i>	<i>300 00</i>

I CERTIFY that the above account is correct and just; that the name of *Patrick Donlaff* is borne on the muster-in rolls of the *7th Regt U. S. Col'd Troops*; and that the above amount was awarded by the Board of which *Mos. Simmons Esq* is President, said award being in accordance with section 24 of the act entitled "An act to amend an act entitled 'An act for enrolling and calling out the national forces, and for other purposes,'" approved Feb. 24, 1864.

Assistant Adjutant General.

RECEIVED

, 186 , of *Maj. A. F. Rockwell, A. A. S. Col*
dollars and _____ cents, in full of the above account.

Gustavus Lanter M.D

(SIGNED DUPLICATES.)

C. S. S. S.

No. .

ABSTRACT OF DISBURSEMENTS.

....., 186 .

Carver Gustavus

Dollars *300* 100.

Paid, 186 .

The United States,

To *Gustavus Canter* Dr.

1865.
May, 27th

	DOLLARS.	CENTS.
For amount awarded him by the Board of Claims, in consideration of the enlistment of <i>Patrick Douglass</i> in the <i>7th Regt U. S. Cold Corps</i>	<i>300</i>	<i>00</i>
<i>Total \$</i>	<i>300</i>	<i>00</i>

I CERTIFY that the above account is correct and just; that the name of *Patrick Douglass* is borne on the muster-in rolls of the *7th Regt U. S. Cold Corps*; and that the above amount was awarded by the Board of which *Thomas Simmons Esq* is President, said award being in accordance with section 24 of the act entitled "An act to amend an act entitled 'An act for enrolling and calling out the national forces, and for other purposes,'" approved Feb. 24, 1864.

Assistant Adjutant General.

RECEIVED _____, 186 _____, of *Maj. A. F. Rockwell, U.S. Army* dollars and _____ cents, in full of the above account.

Gustavus Canter M.D.

(SIGNED DUPLICATES.)

NOTE 1.

The company commander will here add a statement of all the facts known to him concerning the disease or wound, or cause of disability of the soldier; the time, place, manner, and all the circumstances under which the injury occurred, or disease originated or appeared; the duty, or service, or situation of the soldier at the time the injury was received or disease contracted, stating particularly whether the injury was received or the disease contracted in the line of his duty; and whatever other facts may aid a judgment as to the cause, immediate or remote, of the disability, and the circumstances attending it.

When the facts are not known to the company commander, the certificate of any officer or affidavit of other person having such knowledge, will be appended—as the surgeon in charge of a hospital, the officer commanding a detachment of recruits, &c., &c.

NOTE 2.

When a probable case for pension, special care must be taken to state the degree of disability—as $\frac{1}{2}$, $\frac{3}{4}$, &c., &c.; to describe particularly the disability, wound, or disease; the extent of which it deprives him of the use of any limb or faculty, or affects his health, strength, activity, constitution, or capacity to labor or earn his subsistence. The surgeon will add, from his knowledge of the facts and circumstances, and from the evidence in the case, his professional opinion of the cause or origin of the disability. In the case of discharges by Medical Inspectors, the last paragraph will state that the "discharge was given by consent of the soldier, after a personal examination, and for disability, the nature, degree and origin of which are correctly described in the within certificate."

Par. 1260 Regulations, Edit. 1861.

Medical officers, in giving certificates of disability, are to take particular care in all cases that have not been under their charge; and especially in epilepsy, convulsions, chronic rheumatism, derangement of the urinary organs, ophthalmia, ulcers, or any obscure disease liable to be feigned or purposely produced; and in no case shall such certificate be given until after sufficient time and examination to detect any attempt at deception.

DIRECTIONS.

This certificate will be made out in duplicate by the soldier's company commander, or other officer commanding the separate detachment to which he belongs, and sent by him to the surgeon who has charge of the hospital where the soldier is sick. The surgeon will then fill out and sign the surgeon's certificate, and forward these papers to the regimental, detachment, or post commander, who will forward them, with his action endorsed thereon, through the proper channel, to his division commander; or, if the troops are not attached to a division, to his corps, department, or other commander or officer to whom the authority to discharge enlisted men may be specially delegated.

These certificates, after having received the action of the highest authority to which they are required to be sent, will be returned through the same channel to the regimental, post, or detachment commander, who will, if the discharge is authorized by the endorsement of the proper authority, sign the soldier's discharge, and the last certificate on this paper; see that the soldier is furnished with the proper final statements in duplicate, and forward both of these certificates direct to the Adjutant General United States Army, at Washington, D. C.; they will not, under any circumstances, be given into the hands of the soldier.

ADJUTANT GENERAL'S OFFICE

July 5th 1866

Duplicate sent the Pension Office.

Q. 23. R. of Dis. 4
1866.

CERTIFICATE OF DISABILITY FOR DISCHARGE

IN THE CASE OF

Patrick Douglass
a Private Co. "H"
7th Reg't of Inf't.

MEDICAL DIRECTOR'S OFFICE

MIDDLE MILITARY DEPT.

Baltimore, Md. Jan. 29, 1866.

APPROVED.

Chas. R. Greenleaf
Asst. Surg. U. S. A.
Act. Medical Director.

HEAD-QUARTERS MIDDLE MILITARY DEPARTMENT

Baltimore, Md., Jan. 29, 1866.

To be discharged

BY COMMAND OF MAJOR GENERAL HANCOCK.

Adam Spring
Asst. Adj. Genl.

Received (A. G. Office.) _____, 1866

Curran to Co of A

Adjutant General's Office
Washington, D. C., Dec. 24, 1868.

Exp. ac. 3732 447
The Muster and Muster Roll
Rolls of Company "H" 7th Reg't
Colored Troops, will be made
to show that late Private Patrick
Douglass, of said company was
discharged on Surgeon's Certificate
of Disability, from General Hospital
Baltimore, Md., January 31st 1866
because of wounds received in
action at Chapin's Farm, Va.
October 1864, viz:— gunshot wound
of left fore-arm, and ball through
left arm and left side; passing
out at inferior angle of the scapula

Thomas D. Stewart
Asst. Adj. General

Matthew M. M. D. 1866

Dec 30, 68
Vide letter of Jan 8th & 9th 69
to Auditor & Com. Pension

MARR 467

ARMY OF THE UNITED STATES.
CERTIFICATE

OF DISABILITY



FOR DISCHARGE

Private Patrick Douglass, of Captain _____
 _____ Company, (A) of the 7th _____ Regiment of the United States
 Col. Troops was enlisted by Col. Birney _____ of
 the _____ Regiment of _____ at St. Marys Co. - Md.
 on the 26th day of October, 1863, to serve 3 years; he was born
 in _____ in the State of _____, is White
 years of age, _____ feet _____ inches high, _____ complexion, _____ eyes,
 _____ hair, and by occupation when enlisted a _____ During the last two
 months said soldier has been unfit for duty 60 days.*

STATION: Hicks Gen. Hosp. Balto Md
 DATE: Jan 27 1866

Thos. Sim
 Surgeon U.S. Vols
 Commanding Company Hosp'l

I CERTIFY, that I have carefully examined the said Patrick Douglass
 of Captain _____ Company, and find him incapable of performing the duties of a
 soldier because of gun shot wound of the left arm, ball passing
through the arm, and entering the left side passing out at
the inferior angle of the scapula. Also gun shot wound
of left fore arm fracturing radius. He has only partial
extension of elbow and fingers, wounded in action at Chapin's
Farm Va. Oct. 1864

Disability one half (1/2)

Thos. Sim
 Surgeon U.S. V.

DISCHARGED, this 31 day of January, 1866, at Hicks
Gen Hosp'l Balto Md

Thos. Sim
 Surgeon U.S. Vols
 Commanding the Regt. Hosp'l

The Soldier desires to be addressed at

Town Charlotte Hill County St Marys State Md

* See Note 1 on the back of this.

† See Note 2 on the back of this.

Low William

Co. H, 7 U.S. Col'd Inf.

Private

Private

CARD NUMBERS.

<i>6292467</i>	26
<i>6292567</i>	27
<i>6292669</i>	28
<i>6292770</i>	29
<i>6292867</i>	30
<i>6292961</i>	31
<i>6293051</i>	32
<i>6293151</i>	33
<i>6293249</i>	34
<i>6293402</i>	35
<i>6294148</i>	36
<i>9066792</i>	37
	38
	39
	40
	41
	42
	43
	44
	45
	46
	47
	48
	49
	50

Book Mark:

See also

E. | 7 | U.S.C.T.

William Dow

, Co. K, 7 Reg't U.S. Col'd Inf.

Appears on

Company Descriptive Book

of the organization named above.

DESCRIPTION.

Age 18 years; height 5 feet 3 inches.

Complexion Black.

Eyes Black; hair Black

Where born Calvert, Maryland

Occupation

ENLISTMENT.

When Oct. 24, 1861

Where Calvert

By whom Wm. B. Birney; term 3 y'rs.

Remarks: Discharged Feb. 10, 1862
on order of Maj. Gen. Canby,
Comd'g. Dept. of Va.
on account of wounds rec'd.
in action at Deep Bottom, Va.
Aug. 14, 1861.

Murdered Nov. 5, 1863
by Lt. Col. Haskell.

J. D. White

A. | 7 | U.S.C.T.

William Daw

Pt., Co. H, 7 Reg't U. S. Col'd Inf.

Age 18 years.

Appears on

Company Muster-in Roll

of the organization named above. Roll dated

of Stanton, Charles Co. Md. Nov. 5, 1863.

Muster-in to date Nov. 5, 1863

Joined for duty and enrolled:

When Oct. 24, 1863

Where Calverton Md.

Period 3 years.

Remarks:

Book mark:

Steel

D. | 7 | U.S.C.T.

William Daw

P., Co. H, 7 Reg't U. S. Col'd Infantry.

Appears on

Company Muster Roll

for Nov. & Dec., 1863.

Present or absent Present

Stoppage, \$ 100 for

Due Gov't, \$ 100 for

Remarks: Due \$2 enlistment premium.

Book mark:

Stue

D. | 7 | U.S.C.T.

William Daw
C., Co. H, 7 Reg't U. S. Col'd Infantry.

Appears on

Company Muster Roll

for Jan. and Feb., 1864.

Present or absent Present.

Stoppage, \$ 100 for

Due Gov't, \$ 100 for

Remarks:

Book mark:

Steele

No. 1

7

U.S.C.T.

William Drew

Co. H, 7 Reg't U. S. Col'd Infantry.

Appears on

Company Muster Roll

for *4* Mch. *1864*, 1864.

Present or absent *Present*

Stoppage, \$ *100* for

Due Gov't, \$ *100* for

Remarks:

Book mark:

Steele

D. | 7 | U.S.C.T.

William Daw,
Pt., Co. H, 7 Reg't U. S. Col'd Infantry.

Appears on

Company Muster Roll

for *1 May to June, 1864.*

Present or absent *Present*

Stoppage, \$ *100* for

Due Gov't, \$ *100* for

Remarks:

Book mark:

Steel

D. | 7 | U.S.C.T.

William Daw,

Pf., Co. H, 7 Reg't U. S. Col'd Infantry.

Appears on

Company Muster Roll

for July & Aug., 1864.

Present or absent Present

Stoppage, \$ 100 for

Due Gov't, \$ 100 for

Remarks: Stay for one piece shelter tent. Wounded in arm & sent to G.H. Aug 16/64.

Book mark:

Steele

D | 7 | **U.S.C.T.**

William Daw

D, Co. H, 7 Reg't U. S. Col'd Infantry.

Appears on

Company Muster Roll

for Sept Oct, 1864.

Present or absent Absent

Stoppage, \$ 100 for

Due Gov't, \$ 100 for

Remarks: Wounded in
action and sent to
Hosp. Aug. 14.
Star) for one piece
of Shelter tent.

Book mark:

Steele

10

7

U.S.C.T.

William Dow

Dow, Co. H, 7 Reg't U. S. Col'd Infantry.

Appears on

Company Muster Roll

for *Nov. and Dec*, 186*1*.

Present or absent *absent*

Stoppage, \$ *100* for

Due Gov't, \$ *100* for

Remarks: *Wounded in action and sent to
Hosp. Aug 14
Stop for one piece of S.T.*

Book mark:

W. H. Mitchell

(858)

Copyist

20

7

U.S.C.T.

William Owen

Pvt., Co. H, 7 Reg't U. S. Col'd Infantry.

Appears on

Company Muster Roll

for *Jan and Feb*, 1865.

Present or absent *Absent*

Stoppage, \$ *100* for

Due Gov't, \$ *100* for

Remarks: *Wounded and sent to Hosp*

Aug 14 1864

Book mark:

N. H. Merrill

(858)

Copyist

10

7

U.S.C.T.

William Cow

Private, Co. H, 7 Reg't U. S. Col'd Infantry.

Appears on

Company Muster Roll

for March and Apr., 1863.

Present or absent

Stoppage, \$ 100 for

Due Gov't, \$ 100 for

Remarks: Discharged

Discharged Feb. 10 1865 by order of Maj. Gen. Cadwalader Colden Kept of Pennsylvania on account of wounds rec'd in action at Deep Bottom Va. Aug. 14. 61

Step for one Knapsack, one Hammock one canteen and one shelter tent

Book mark:

N. H. Merrill

(858)

Copyist

20 | 7 | U.S.C.T.

William Dow

Pvt, Co. *76*, 7 Reg't U. S. Col'd Inf.

Appears on Co. Muster-out Roll, dated
Andimole, Tex., Oct. 31, 1866 .

Muster-out to date _____, 186 .

Last paid to *Dec. 31*, 1864 .

Clothing account:

Last settled _____, 186 ; drawn since \$ _____ 100

Due soldier \$ _____ 100; due U. S. \$ _____ 100

Am't for cloth'g in kind or money adv'd \$ _____ 100

Due U. S. for arms, equipments, &c., \$ _____ 100

Bounty paid \$ _____ 100; due \$ _____ 100

Remarks: *Discharged at U.S. Genl. Hosp. Phila. Pa. Feb. 10 '65 by reason of gunshot wound rec'd in action at Deep Bottom, Va., Aug. 18 '64*

Book mark: *S. D.*

(861)

J. J. Kearney Copyist.

Lawson

Co. H, 7 Reg't

4 Enclosures.

Bed Cards	Final Statements
Burial Records	Furloughs or L. of A.
Certs. of Dis. for Discharge	Med. Certificates
C. M. Charges	Med. Des. Lists
Descriptive Lists	Orders
Discharge Certificates	Pris. of War Record
Enlistment Papers	Resignations

Other papers relating to —

Admission to Hosp'l	Furlough or L. of A.
Casualty Sheet	Med. Examination
Confinement	Misc. Information
Contracts	Pay or Clothing
Death or Effects	Personal Reports
Desertion	Rank
Discharge from Hosp'l	Transfer to Hosp'l
Discharge from Service	Transfer to V. R. C.
Duty	Transportation

55
(2)CASUALTY SHEET
OF WOUNDED.

Wm Dow

Private Company *36*

7 Regiment of *U.S.A.*

Volunteers at the battle of *Near Deep*

Bottom Va, Aug 16/64.

CASUALTY SHEET.

Name, *Wm Dow*
 Rank, *Private*, Company *A*, Regiment, *4th*
 Arm, *usct*, State, _____
 Place of casualty, *("Near Deep Bottom Va" Ind. Co No 119)*
 Nature of casualty, *Wounded L. Arm*
 Date of casualty, *Aug 16th 1864*

FROM WHAT SOURCE THIS INFORMATION WAS OBTAINED.

Report of Killed, Wounded, and Missing of the _____ Regiment.
 Brigade, _____ Division, _____ Corps, dated _____
List of killed and wounded in Brigade of Colored Troops, 10th Army Corps, commanded by Col Shaw 7th usct
(Signed) A. P. Reichhold Surgeon 8th usct. Chief med officer Shaw's Brigade

Ind 50 & no 68

W F Thompson
 Clerk.

55
(2)

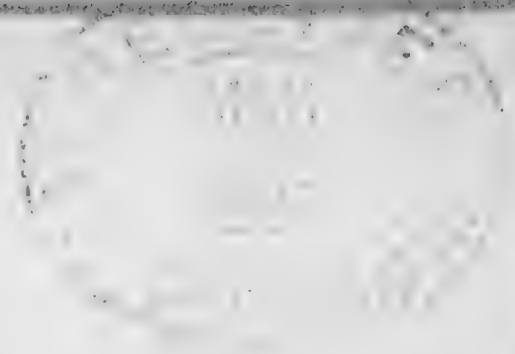

CASUALTY SHEET
OF WOUNDED.

Am Row

Priv Company *A*

7th Regiment of *U.S.C.*

Volunteers at the battle of _____

Aug 16/64

CASUALTY SHEET.

Name, *Wm Row*
 Rank, *Priv*, Company *A*, Regiment, *1st*
 Arm, *Infy* State, *U.S.A.*
 Place of casualty, *Not stated*
 Nature of casualty, *wounded, L arm*
 Date of casualty, *Aug 16/64*

FROM WHAT SOURCE THIS INFORMATION WAS OBTAINED.

Report of Killed, Wounded, and Missing of the _____ Regiment,
Shaw's Brigade, _____ Division, _____ Corps, dated _____
 Signed *A. R. Reichhold*
Surg 8th U.S.C. Inf, Med,
Off. Shaw's Brig
Ord 50. L. P. 4. 1868.

A. D. Logan
 Clerk
8/21/80

Hospital Number *H/23. 7781*

Name *Wm. Dow*

Age *17* Nativity *American*

~~Married~~ or Single *Single*

Residence *Maysland Colbert Co*

Post Office address of } *Samuel Dow*
wife or nearest relative. } *Genis Creek Colbert Co*

Rank *Pr.* ~~Co.~~ *Regiment 7 U.S.I.*

When admitted *August 18th 1864*

From what source *City Point Va*

Diagnosis: (in surgical cases state explicitly seat and character of wound or injury.)

Amputation.
Left Arm.

Summit House G. H.
Philadelphia, Pa.

On what occasion wounded *Deep Bottom Va*

Date *July 30th 1864*

Nature of missile or weapon *Minié Ball*

TREATMENT.

[HERE NOTE IMPORTANT COMPLICATIONS AND ALL OPERATIONS.]

Over to ash dressing

RESULT AND DATE.

Transferred to 3d Ward
 4th, F-65-6. U. S. Army

Discharged from U. S. service
 Feb. 28th 1865
 Admitted to hospital by 3 Wash.

U. S. A. Genl. Hospital
Summit House Phila.
Q. 21. A of Dis. 19
1865.

HEAD QUARTERS
DEPT OF PENNSYLVANIA.
PHILADELPHIA PA.
FEB. 2. 1865.

NOTE 1.

The company commander will here add a statement of all the facts known to him concerning the disease or wound, or cause of disability of the soldier; the time, place, manner, and all the circumstances under which the injury occurred, or disease originated or appeared; the duty, or service, or situation of the soldier at the time the injury was received or disease contracted, stating particularly whether the injury was received or the disease contracted in the line of his duty; and whatever other facts may aid a judgment as to the cause, immediate or remote, of the disability, and the circumstances attending it.

When the facts are not known to the company commander, the certificate of any officer, or affidavit of other person having such knowledge, will be appended—as the surgeon in charge of a hospital, the officer commanding a detachment of recruits, &c., &c.

NOTE 2.

When a probable case for pension, special care must be taken to state the degree of disability—as 1/2, 3/4, &c., &c.; to describe particularly the disability, wound, or disease: the extent of which it deprives him of the use of any limb or faculty, or affects his health, strength, activity, constitution, or capacity to labor or earn his subsistence. The surgeon will add, from his knowledge of the facts and circumstances, and from the evidence in the case, his professional opinion of the cause or origin of the disability. In the case of discharges by Medical Inspectors, the last paragraph will state that the "discharge was given by consent of the soldier, after a personal examination, and for disability, the nature, degree, and origin of which are correctly described in the within certificate."

Par. 1260 Regulations, Edit. 1861.
Medical officers, in giving certificates of disability, are to take particular care in all cases that have not been under their charge; and especially in epilepsy, convulsions, chronic rheumatism, derangement of the urinary organs, ophthalmia, ulcers, or any obscure disease liable to be feigned or purposely produced; and in no case shall such certificate be given until after sufficient time and examination to detect any attempt at deception.

DIRECTIONS.

This certificate will be made out in duplicate by the soldier's company commander, or other officer commanding the separate detachment to which he belongs, and sent by him to the surgeon who has charge of the hospital where the soldier is sick. The surgeon will then fill out and sign the surgeon's certificate, and forward these papers to the regimental, post, or post commander, who will forward them, with his endorsement thereon, through the proper channel, to his division commander; or if the troops are not attached to a division, to his corps, department, or other commander or officer to whom the authority to discharge enlisted men may be specially delegated.

These certificates, after having received the action of the highest authority to which they are required to be sent, will be returned through the same channel to the regimental, post, or detachment commander, who will, if the discharge is authorized by the endorsement of the proper authority, sign the soldier's discharge, and the last certificate on this paper, so that the soldier is furnished with a duplicate of the same, and forward one of these certificates to the Adjutant General, United States Army, at Washington, D. C.; they will not, under any circumstances, be given to the hands of the soldier.

CERTIFICATE OF DISABILITY FOR DISCHARGE

IN THE CASE OF

Williams Dow
Private Co. "B"
7th Regt of U.S. Colored Troops

APPROVED
John C. Fisher
SURGEON U.S.A.
MEDICAL DIRECTOR

TO BE DISCHARGED THE
UNITED STATES SERVICE
BY COMMAND OF
MAJ GEN CADWALADER.
Robert Greenleaf
Capt, ASST ADJT GENL.

111
DB
220

EMTA

Received (A.G. Office) Feb 25 1865
Enthorn

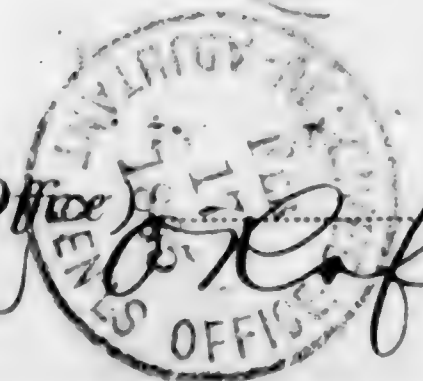

Duplicate sent the Pension Office.

ARMY OF THE UNITED STATES. CERTIFICATE OF DISABILITY FOR DISCHARGE.



Private William Dow, of Captain A. H. Churney's Company, (Co.) of the 7th Regiment of the United States was enlisted by Lieut. Col. Cascall of the 7th Regiment of at Benedict Md on the 5th day of November, 1863, to serve three years; he was born in Calvert Co. in the State of Maryland, is 18 years of age, 5 feet 3 inches high, Black complexion, Black eyes, Black hair, and by occupation when enlisted a Hammer. During the last two months said soldier has been unfit for duty days. Private Dow was admitted to this Hospital on the 20 August 1864 from the Point, Va. with Amputation of Left Arm from Gun Shot Wound received at Deep Bottom Va. on the 18 August 1864.

STATION: U.S.A. Genl. Hosp. Summit House DATE: Philad. 30 Jan'y 1865.

W. H. Taylor Surgeon U.S.A. Commanding Company In ch Hospital

I CERTIFY, that I have carefully examined the said William Dow of Captain Churney's Company, and find him incapable of performing the duties of a soldier because of + gun shot wound of left arm resulting amputation at lower third forearm. Degree of disability three fourths (3/4)

W. H. Taylor Surgeon U.S.A. In ch Hospital

DISCHARGED, this 7th day of February, 1865, at Philadelphia, Summit House U.S.A. General Hospital

W. H. Taylor Surgeon U.S.A. Commanding the Reg't In ch Hospital

The Soldier desires to be addressed at Town Leonard's Creek County Talbot State Maryland

* See Note 1 on the back of this. † See Note 2 on the back of this [A. G. O. No. 100 & 101 - First.] [DUPLICATES.]

435

Rowdy Samuel
Co. *H*, 7 U.S. Col'd Inf.

Private | *Private*

CARD NUMBERS.

1	6 2 9 2 4 6 8	26
2	6 2 9 2 5 6 8	27
3	6 2 9 2 6 7 0	28
4	6 2 9 2 7 7 1	29
5	6 2 9 2 8 6 8	30
6	6 2 9 2 9 6 2	31
7	6 2 9 3 0 5 2	32
8	6 2 9 3 1 5 2	33
9	6 2 9 3 2 5 0	34
10	6 2 9 3 3 4 8	35
11	6 2 9 3 4 4 5	36
12	6 2 9 3 5 4 2	37
13	6 2 9 3 6 3 1	38
14	6 2 9 3 7 2 0	39
15	6 2 9 3 8 0 5	40
16	6 2 9 3 8 7 9	41
17	6 2 9 3 9 5 2	42
18	6 2 9 4 0 2 4	43
19	6 2 9 4 0 9 5	44
20	9 0 6 6 7 9 3	45
21		46
22		47
23		48
24		49
25		50

Book Mark: _____

See also _____

S 811 517 Poaff
S 874 303 - Poaff
D. 2150799 P. R. L.
D 2852 823 and wd

D. | 7 | U.S.C.T.

Samuel Gandy

, Co. K., 7 Reg't U. S. Col'd Inf.

Appears on

Company Descriptive Book

of the organization named above.

DESCRIPTION.

Age 19 years; height 5 feet 4 inches.

Complexion Muratto.

Eyes Black; hair Black

Where born Aeomae, Virginia

Occupation

ENLISTMENT.

When Nov. 4, 1863

Where Aeomae, Va.

By whom Col. Wm. Brime; term 3 y'rs.

Remarks: Mustered Nov. 5. 1863
by Lt. Col. Haskell.

W. J. White

D,

7

U.S.C.T.

Amuel Dawdy

Pf., Co. N, 7 Reg't U. S. Col'd Inf.

Age 19 years.

Appears on

Company Muster-in Roll

of the organization named above. Roll dated

Cpt. Stuart Charles C. M. S. Nov. 5, 1863.

Muster-in to date Nov. 5, 1863

Joined for duty and enrolled:

When Nov. 4, 1863.

Where Accomac, Va.

Period 3 years.

Remarks:

Book mark:

C. Stuck

D | 7 | U.S.C.T.

Samuel Dausy
Pl., Co. H, 7 Reg't U. S. Col'd Infantry.

Appears on

Company Muster Roll

for Nov. & Dec., 1863.

Present or absent Present

Stoppage, \$ 100 for

Due Gov't, \$ 100 for

Remarks: Due to enlistment premium

Book mark:

Stute

D.

7

U.S.C.T.

Samuel Dondy,
Pt., Co. H, 7 Reg't U. S. Col'd Infantry.

Appears on

Company Muster Roll

for *Jan. and Feb.*, 1864.

Present or absent *Present*

Stoppage, \$ *100* for

Due Gov't, \$ *100* for

Remarks:

Book mark:

Steele,

N. | 7 | U.S.C.T.

Samuel Doudy
Pf., Co. H, 7 Reg't U. S. Col'd Infantry.

Appears on

Company Muster Roll

for *March & Apr.*, 1864.

Present or absent *Present*

Stoppage, \$ *100* for

Due Gov't, \$ *100* for

Remarks:

Book mark:

Steele

(858)

Copyist

D. | 7 | U.S.C.T.

Samuel Dandy,
Pl., Co. H, 7 Reg't U. S. Col'd Infantry.

Appears on

Company Muster Roll

for May & June, 1864.

Present or absent Present

Stoppage, \$ 100 for

Due Gov't, \$ 100 for

Remarks:

Book mark:

(858)

Steel
Copyist

D. |

7

U.S.C.T.

Samuel Dowsy,
Co. H, 7 Reg't U. S. Col'd Infantry.

Appears on

Company Muster Roll

for July & Aug., 1864.

Present or absent Present

Stoppage, \$ 100 for

Due Gov't, \$ 100 for

Remarks:

Book mark: 650300

Stut

(858)

Copyist

N.

7

U.S.C.T.

Samuel Davody

St., Co. H, 7 Reg't U. S. Col'd Infantry.

Appears on

Company Muster Roll

for *Sept & Oct.*, 186*4*.

Present or absent *Present*

Stoppage, \$ *100* for

Due Gov't, \$ *100* for

Remarks:

Book mark:

Steele

(858)

Copyist

10

7

U.S.C.T.

Samuel Woudy

Priv, Co. H, 7 Reg't U. S. Col'd Infantry.

Appears on

Company Muster Roll

for *Nov. and Dec*, 1864.

Present or absent *Present*

Stoppage, \$ *100* for

Due Gov't, \$ *100* for

Remarks: *Ship for 1 Haversack & Cartrage*

Book mark:

N. H. Merrill

(858)

Copyist

10

7

U.S.C.T.

Samuel Cowdy

Pr, Co. H, 7 Reg't U. S. Col'd Infantry.

Appears on

Company Muster Roll

for *Jan and Feb*, 1865.

Present or absent *Present*

Stoppage, \$ *100* for

Due Gov't, \$ *100* for

Remarks: *Stop for 1 miper 200*

Book mark:

W. H. Merrill

Copyist

10

7

U.S.C.T.

Samuel Cowdy

Pari, Co. H, 7 Reg't U. S. Col'd Infantry.

Appears on

Company Muster Roll

for *March and Apr*, 1865.

Present or absent *Absent*

Stoppage, \$ *100* for

Due Gov't, \$ *100* for

Remarks: *Stop for wages 20c*
Dicta in Hosp. since Apr. 24. 65

Book mark:

N. K. Merrill

(858)

Copyist

10

7

U.S.C.T.

Samuel Cowdy

Priv, Co. H, 7 Reg't U. S. Col'd Infantry.

Appears on

Company Muster Roll

for *May and June*, 1865.

Present or absent *Absent*

Stoppage, \$ *100* for

Due Gov't, \$ *100* for

Remarks: *Sick since June 29, 65*
Stop for 1 week 20

Book mark:

N. C. Merrill

(858)

Copyist

10

7

U.S.C.T.

Samuel Newby

Private, Co. H, 7 Reg't U. S. Col'd Infantry.

Appears on

Company Muster Roll

for *July and Aug*, 1863.

Present or absent *Present*

Stoppage, \$ *100* for

Due Gov't, \$ *100* for

Remarks:

Book mark:

W. H. Merrill

10

7

U.S.C.T.

Samuel Cowdy

Priv, Co. H, 7 Reg't U. S. Col'd Infantry.

Appears on

Company Muster Roll

for *Sept and Oct*, 1865.

Present or absent *Present*

Stoppage, \$ *100* for

Due Gov't, \$ *100* for

Remarks:

Book mark:

N. H. Merrill

(858)

Copyist

4891566

10

7

U.S.C.T.

Samuel Henry

Private, Co. H, 7 Reg't U. S. Col'd Infantry.

Appears on

Company Muster Roll

for *Nov & Dec*, 1865.

Present or absent *Present*

Stoppage, \$ *100* for

Due Gov't, \$ *100* for

Remarks:

Book mark:

H. H. Merrill

(858)

Copyist

A.

7

U.S.C.T.

Samuel Dowdy

Pvt, Co. H, 7 Reg't U. S. Col'd Infantry.

Appears on

Company Muster Roll

for *Jan. & Feb.*, 186*6*.

Present or absent *Present*

Stoppage, \$ *100* for

Due Gov't, \$ *100* for

Remarks:

Book mark:

J. J. Kearney

(858)

Copyist

10

7

U.S.C.T.

Samuel Dowdy

Priv, Co. H, 7 Reg't U. S. Col'd Infantry.

Appears on

Company Muster Roll

for *March & April*, 1866.

Present or absent *Present*

Stoppage, \$ ^{*95*}
100 for *6. & 8. E.*

Due Gov't, \$ *100* for

Remarks:

Book mark:

J. J. Kearney

(858)

Copyist

A.

7

U.S.C.T.

Samuel Howdy

Pr, Co. H, 7 Reg't U. S. Col'd Infantry.

Appears on

Company Muster Roll

for *May & June*, 186*6*.

Present or absent *Present*

Stoppage, \$ *100* for

Due Gov't, \$ *100* for

Remarks:

Book mark:

(858)

J. J. Kearney

Copyist

H. |

7

U.S.C.T.

Samuel Downey
Prvt, Co. H, 7 Reg't U. S. Col'd Infantry.

Appears on

Company Muster Roll

for *July & Aug*, 1866.

Present or absent *Present*

Stoppage, \$ *100* for

Due Gov't, \$ *100* for

Remarks:

Book mark: _____

(858)

J. J. Kearney
Copyist

MAR 15 11

A. | 7 | **U.S.C.T.**

Samuel Dowdy
Prvt, Co. *H*, 7 Reg't U. S. Col'd Infantry.

Appears on **Co. Muster-out Roll**, dated
Indiana, Ind, *Oct 13*, 1866.

Muster-out to date *Oct 13*, 1866.

Last paid to *June 30*, 1866.

Clothing account:

Last settled _____, 186 ; drawn since \$ _____ 100

Due soldier \$ *26* ^{*77*} / 100; due U. S. \$ _____ 100

Am't for cloth'g in kind or money adv'd \$ _____ 100

Due U. S. for arms, equipments, &c., \$ _____ 100

Bounty paid \$ _____ 100; due \$ *100* / 100

Remarks: *Joined at Orig'l Organizⁿ*

Book mark ^{*41*} *V. 220 P. 205 75-*

J. J. Kearney
Copyist.

Howell Isaac

Co. A, 7 U.S. Col'd Inf.

Private Private

CARD NUMBERS.

1	6278889	26
2	6280153	27
3	6280257	28
4	6280355-	29
5	6280512	30
6	6281743	31
7	9065900	32
8	43152406	33
9		34
10		35
11		36
12		37
13		38
14		39
15		40
16		41
17		42
18		43
19		44
20		45
21		46
22		47
23		48
24		49
25		50

Book Mark:

See also

D

7

U.S.C.T.

Isaac Dowell

Co. *A*, 7 Reg't U.S. Col'd Inf.

Appears on

Company Descriptive Book

of the organization named above.

DESCRIPTION.

Age *21* years; height *5* feet *5* inches.

Complexion *Black*.

Eyes *Black*; hair *Curly*.

Where born *Washington, D.C.*

Occupation *Laborer*.

ENLISTMENT.

When *June 5*, 1864.

Where *Baltimore 3d. Cong. Dist.*

By whom _____; term *3* y'rs.

Remarks: *Killed in action John's Island S. C. July 9, 1864. Mustered June 5, 64.*

J. Smith,

10 | 7 U.S.C.T.

Isaac Dowell (Col'd.)

Appears with rank of _____ on
Muster and Descriptive Roll

of Detachment of men drafted, forwarded
for U.S. Colored Troops

*Co. A, 7 Regt. Roll dated
Benedict, Charles Co, Md, Jan. 16, 1864.

Where born Washington, D.C.
Age 21 y'rs; occupation Laborer

Drafted and mustered in:
When Enlisted Jan. 5, 1864.
Where Balt'o., Md.
Enrollment district 3 Cong. Dist.
Period 3 years.

Eyes Black; hair Woolly
Complexion Black; height 5 ft. 5 in.
Bounty paid \$ 100; due \$ 100

Clothing account:
Last settled _____, 186 ; drawn since \$ 24⁷⁹/₁₀₀

Date of commencement of service Jan. 5, 1864.

Company to which assigned _____
Remarks Substitute - accepted in place of Fredk.
Taylor, Col'd; drafted in 18th Ward, Balt'o.
Decem. 4, 1863.

* From margin of roll.
Book mark : _____

W. W. Hibbard
Copyist.

10 | 7 | U.S.C.T.

Isaac Powell

Pri., Co. A, 7 Reg't U. S. Col'd Infy

Age 21 years.

Appears on a

Detachment Muster-in Roll

of the organization named above. Roll dated

Baltimore, Md., Apr. 18, 1865.

Muster-in to date Jan. 16, 1864.

Joined for duty and enrolled:

When Jan. 13, 1864.

Where Baltimore, Md.

Period 3 years.

Valuation of horse, \$ 100

Valuation of horse equipments, \$ 100

Remarks: Substitute

Book mark:

Orzech
Copyist.

Q

7

U.S.C.T.

Isaac Powell

Prvt., Co. A, 7 Reg't U. S. Col'd Infantry.

Appears on

Company Muster Roll

for *Jan. & Feb.*, 1864.

Joined for duty and enrolled:

When *Jan. 5*, 1864.*

Where *Baltimore Co. Md.* *

Period *3* years.*

Present or absent *Present*

Stoppage, \$ *100* for

Due Gov't \$ *100* for

Remarks: *Joined for duty
Jan. 16/64 Substitute
accepted in place of Rich'd
Gross (vol)*

* See enrollment on card from muster-in roll.

Book mark:

Daggett

(358c)

Copyist.

9 | 7 | **U.S.C.T.**

Isaac Howell

Pvt., Co. A, 7 Reg't U. S. Col'd Infantry.

Appears on

Company Muster Roll
for *Mar. & Apr.*, 1864.

Joined for duty and enrolled:

When *Jan. 5*, 1864.*

Where *Baltimore Md.* *

Period *3* years.*

Present or absent *Present*

Stoppage, \$ *100* for

Due Gov't \$ *100* for

Remarks: *Substitute accepted
in place of Richard Gross
(Vol)*

* See enrollment on card from muster-in roll.

Book mark:

Xaggett

D | **7** | **U.S.C.T.**

Isaac Dowell

Priv., Co. A, 7 Reg't U. S. Col'd Infantry.

Appears on

Company Muster Roll

for *May & June*, 1864.

Joined for duty and enrolled:

When *Jan. 5*, 1864.*

Where *Baltimore Co. Md.* *

Period *3* years.*

Present or absent *Present*

Stoppage, \$ *100* for

Due Gov't \$ *100* for

Remarks:

* ~~60~~ See enrollment on card from muster-in roll.

Book mark: -----

Daggett

D | 7 | U.S.C.T.

Isaac Dowell

Pvt., Co. A, 7 Reg't U. S. Col'd Infantry.

Appears on

Company Muster Roll

for *July + Aug.*, 1864.

Joined for duty and enrolled:

When *Jan. 2*, 1864.*

Where *Baltimore* *

Period *3* years.*

Present or absent _____

Stoppage, \$ *100* for _____

Due Gov't \$ *100* for _____

Remarks: *Killed in action on John's Island S. C. July 9th 1864. Final Statements forwarded A. G. O.*

* ~~See~~ See enrollment on card from muster-in roll.

Book mark: *266.119*

Gaggett

D | 7 | U.S.C.T.

Isaac Dowell

Pi, Co. *A*, 7 Reg't U. S. Col'd Inf.

Appears on Co. Muster-out Roll, dated *Indianola Tex Oct 13, 1866*.

Muster-out to date _____, 186 .

Last paid to _____, 186 .

Clothing account:

Last settled _____, 186 ; drawn since \$ _____ 100

Due soldier \$ _____ 100; due U. S. \$ _____ 100

Am't for cloth'g in kind or money adv'd \$ _____ 100

Due U. S. for arms, equipments, &c., \$ _____ 100

Bounty paid \$ _____ 100; due \$ _____ 100

Remarks: *Killed in action, John's Island, S.C. July 9 1864.*

Book mark: *266.119*

(861)

Murray, Jr.
(copyist.)

Dowell, Isaac

P, Co. A,

7

Reg't

U. S. C. Inf.

Enclosures.

Bed Cards	Descriptive Lists
Burial Records	Final Statements
Certs. of Dis. for Discharge	Furloughs
C. M. Charges	Med. Des. Lists
Med. Certificates	Orders

Other papers relating to—

Admission to Hosp'l	Furlough
Casualty Sheet (Officer's)	Med. Examination
Confinement	Misc. Information
Contracts	Pay or Clothing
Death or Effects	Personal Reports
Desertions	Rank
Discharge from Hosp'l	Transfer to Hosp'l
Discharge from Service	Transfer to V. R. C.
Duty	Transportation

53

#5

-a-

FINAL STATEMENT

OF

Pvt. Isaac Dowell
7 Reg't of *afcs*

VOLUNTEERS.

NOTE 1.—Two of these certificates (or duplicates) are to be given to each Volunteer Soldier or drafted man who may be discharged previously to the discharge of his company, that he may at once receive from the Paymaster the pay, &c., due him, and the captain or other COMMISSIONED officer commanding the company will certify to the act of the delivery of the duplicate certificates; on these certificates the Soldier is "entitled to" his discharge, and should also present his discharge to the Paymaster to have the payment endorsed on it. The discharge is to be given back to the Soldier by the Paymaster; the latter only retaining as his voucher the duplicate certificates.

NOTE 2.—If the Soldier is entitled to pay for the use of his horse, the Company Commander will certify to that fact on the back of both these final statements, and also to the time he has pay due for having been so mounted on his own horse.

NOTE 3.—When a Soldier is furnished with final statements, his descriptive list, if he has one, should be taken up by the officer who gives the Soldier these statements, and endorsed with a statement to this effect by the officer. This endorsement should exhibit a full statement of the time for which the Soldier was allowed pay on his final statements, the clothing account, and all other charges against him or in his favor, so as to comprise a complete exhibit of his account. It will then be transmitted to the Company Commander of the Soldier, who will enter all the data necessary to a full understanding of the Soldier's account on the muster roll upon which the Soldier's discharge is reported. The descriptive list will then be destroyed. The object of this is, that the remaining portion of the Soldier's account may be settled upon the receipt of these muster rolls, and the Soldier receive any pay or allowances that may be due him at the time of his discharge, and which may not appear on his final statements from the fact that his descriptive list is incomplete. These accounts for back pay, &c., are settled by the 2d Auditor of the Treasury Department.

NOTE 4.—Charges for loss or injury to ordnance, horse equipments, and other miscellaneous charges, should appear under the heading of "Other Stoppages."

NOTE 5.—Bounty paid by State authorities, and not by the United States, will not be entered on this statement.

NOTE 6.—Amounts due the Sutler and Laundress must be entered on the muster roll on which the discharge, death, desertion, &c., is reported, as well as on the final statement, otherwise the amount cannot be collected from the United States.

NOTE 7.—This blank will be used for deceased volunteers and drafted men, as well as for others.

NOTE 8.—Where a Soldier dies in Hospital or on detached service, his descriptive list, if he has one, should be sent with his final statements, in duplicate, to the Adjutant General, Washington, D. C.

ADJUTANT GENERAL'S OFFICE.

May 8th 1865

Duplicate with Inventory sent 2d Auditor.

Isaac Dowell
Co. 5, 7th Reg't of AFCS

I certify, on honor, that Samuel Dowell a Private of
 Captain Chas. Rice Company (a) of the 4th Regiment of U.S. Colored
VOLUNTEERS, of the State of _____, born in Washington, State
 of District Columbia aged 21 years; 5 feet 5 inches high; Black complexion,
Black eyes, Curly hair, and by occupation a Solam, having joined the company on
 its original organization at _____, and enrolled in it at the muster into
 the service of the United States at _____ on the _____ day
 of _____, 1864, (or was mustered in service as a recruit, by W. S. Chamberlain
Provost Marshal, at Baltimore Md, on the Second day of January,
 1864 or was drafted and mustered into the service of the United States from the _____
 Enrollment District of the State of _____, at _____,
 on the _____ day of _____, 1864) to serve in the Regiment, for
 the term of _____: and having served **HONESTLY** and
FAITHFULLY with his Company in _____ to the present date, is now
 entitled to a **DISCHARGE** by reason of Being killed in Action Johns
Island S. C. July 9th 1864.

The said Samuel Dowell was last paid by Paymaster
Wm M Connell to include the 30th day of April, 1864, and has
 pay due him from that time to the present date; he is entitled to pay and subsistence for
TRAVELING to place of enrollment, and whatever other allowances are authorized to volunteer
 soldiers, drafted men, or militia, so discharged. He has received from the United States **CLOTHING**
 amounting to 47 ²⁵/₁₀₀ dollars, since the 3rd day of January,
 1864, when his clothing account was last settled. He has received from the United States
 _____ ¹⁰⁰/₁₀₀ dollars advanced **BOUNTY**.

There is to be stopped from him, on account of the State of _____, or other
 authorities, for **CLOTHING**, &c., received on entering service, _____ ¹⁰⁰/₁₀₀ dollars; and
 for other stoppages, viz: _____

 _____ ¹⁰⁰/₁₀₀ dollars.

He has been furnished with **TRANSPORTATION** in kind from the place of his discharge to
 _____; and he has been **SUBSISTED** for **TRAVELING** to his
 place of enrollment, up to the _____, 1864.

He is indebted to _____, **SUTLER**, _____ ¹⁰⁰/₁₀₀ dollars.
 He is indebted to _____, **LAUNDRESS**, _____ ¹⁰⁰/₁₀₀ dollars.

Given in Duplicate, at New Petersburg Va, this 2nd day
 of May, 1865

Wm M. Noonan
1st Lieut U.S.C.
 Commanding Company.

Co. A, 7 U.S. Col'd Inf.

Private

Private

CARD NUMBERS.

1	6 2 7 9 8 4 9	26
2	6 2 7 9 9 5 0	27
3	6 2 8 0 0 5 3	28
4	6 2 8 0 1 5 4	29
5	6 2 8 0 2 5 8	30
6	6 2 8 0 3 5 6	31
7	6 2 8 0 4 5 2	32
8	6 2 8 0 5 4 9	33
9	6 2 8 0 6 4 8	34
10	6 2 8 0 7 4 7	35
11	6 2 8 0 8 4 7	36
12	6 2 8 0 9 4 9	37
13	6 2 8 1 0 5 0	38
14	6 2 8 1 2 0 9	39
15	6 2 8 1 3 3 7	40
16	6 2 8 1 4 2 3	41
17	6 2 8 1 5 0 6	42
18	6 2 8 1 5 8 4	43
19	6 2 8 1 7 6 1	44
20	6 2 8 1 6 7 1	45
21	9 0 6 5 8 9 8	46
22		47
23		48
24		49
25		50

Book Mark:

See also

51325960 Poaff
0141631-89 Poaff

NARA 1526

G

7

U.S.C.T.

Allen Downs

, Co. A, 7 Reg't U.S. Col'd Inf.

Appears on

Company Descriptive Book

of the organization named above.

DESCRIPTION.

Age 18 years; height 5 feet 5 1/2 inches.

Complexion *Mulatto,*

Eyes *Bkk.*; hair *brn.*

Where born *Talbot, Md.*

Occupation *Farmer.*

ENLISTMENT.

When *Sept. 23d.*, 1863.

Where *Baltimore, Md.*

By whom *Col. W. Birney*; term *3* y'rs.

Remarks: *Mutered Sept. 26, 63.*

Died at Ft. Monroe June 19, 65-

*of Anemia of Heart. **

Returned to co. Feb. 8,

66.

** As it appears in his book.*

J. Smith,

Copyist.

(3830)

G | 7 | U.S.C.T.

Allen Downs

Pvt., Co. *A*, 7 Reg't U. S. Colored Inf.

Age *18* years.

Appears on

Company Muster-in Roll

of the organization named above. Roll dated *Baltimore Md.*, *Sept. 26*, 1863.

Muster-in to date *Sept. 26*, 1863.

Joined for duty and enrolled:

When *Sept. 23*, 1863.*

Where *Talbot Co. Md.* *

Period *3* years.*

Remarks:

*47. Muster-in roll shows enrollment of all men of this company as of same date. See enrollment on subsequent card or cards.

Book mark: _____

Gaggett

9 | 7 | U.S.C.T.

Allen Downs

Pat., Co. A, 7 Reg't U. S. Col'd Infantry.

Appears on

Company Muster Roll

for from Sept. 26 to Oct. 31, 1863.

Joined for duty and enrolled:

When Sept. 23, 1863.*

Where Talbot Co. Md. *

Period 3 years.*

Present or absent Absent.

Stoppage, \$ 100 for

Due Gov't \$ 100 for

Remarks: Detached on recruiting service in St. Mary's Co. Md.

* See enrollment on card from muster-in roll.

Book mark:

Daggett

G |

7

U.S.C.T.

Allen Downs

Priv., Co. A, 7 Reg't U. S. Col'd Infantry.

Appears on

Company Muster Roll

for *Nov. & Dec.*, 1863.

Joined for duty and enrolled:

When *Sept. 23*, 1863.*

Where *Talbot Co. Md.* *

Period *3* years.*

Present or absent *Present*

Stoppage, \$ *100* for

Due Gov't \$ *100* for

Remarks: *Enlistment premium of \$2.00 due.*

* See enrollment on card from muster-in roll.

Book mark:

Daggett

(358c)

Copyist.

WAR 1539

9

7

U.S.C.T.

Allen Downs

Priv., Co. A, 7 Reg't U. S. Col'd Infantry.

Appears on

Company Muster Roll

for *Jan. & Feb.*, 1864.

Joined for duty and enrolled:

When *Sept. 23*, 1863.*

Where *Talbot Co. Md.**

Period *3* years.*

Present or absent *Present*

Stoppage, \$ *100* for

Due Gov't \$ *100* for

Remarks: *Stop for one Ramrod.
Enlistment premium due.*

* See enrollment on card from muster-in roll.

Book mark:

Daygett

(358c)

Copyist.

D | **7** | **U.S.C.T.**

Allen Gowns

Pvt., Co. A, 7 Reg't U. S. Col'd Infantry.

Appears on

Company Muster Roll

for *Mar. & Apr.*, 186 *4*.

Joined for duty and enrolled:

When *Sept. 23*, 186 *3*.*

Where *Talbot Co. Md.* *

Period *3* years.*

Present or absent *Present.*

Stoppage, \$ *100* for

Due Gov't \$ *100* for

Remarks:

* See enrollment on card from muster-in roll.

Book mark:

Duggett

D |

7

U.S.C.T.

Allen Gowns

Prvt., Co. A, 7 Reg't U. S. Col'd Infantry.

Appears on

Company Muster Roll

for *May & June*, 1864.

Joined for duty and enrolled:

When *Sept. 23*, 1863.*

Where *Talbot Co. Md.* *

Period *3* years.*

Present or absent *Present*

Stoppage, \$ *100* for

Due Gov't \$ *100* for

Remarks:

* See enrollment on card from muster-in roll.

Book mark:

(358c)

Daggett

Copyist.

9 | 7 | U.S.C.T.

Allen Downs

Priv., Co. A, 7 Reg't U. S. Col'd Infantry.

Appears on

Company Muster Roll

for July & Aug., 1864.

Joined for duty and enrolled:

When Sept. 23, 1863.*

Where Talbot Co. Md. *

Period 3 years.*

Present or absent Absent

Stoppage, \$ 100 for

Due Gov't \$ 100 for

Remarks: Detached service
S. O. No. 6. Hd. Qrs. Birney's
Div. 10 A. C.

* See enrollment on card from muster-in roll.

Book mark:

(358c) Taggett Copyist.

9 | 7 | **U.S.C.T.**

Allen Jones

Pvt, Co. A, 7 Reg't U. S. Col'd Infantry.

Appears on

Company Muster Roll

for *Sept. & Oct.*, 1864.

Joined for duty and enrolled:

When *Sept. 23*, 1863.*

Where *Talbot**

Period _____ years.*

Present or absent *Present*

Stoppage, \$ 100 for _____

Due Gov't \$ 100 for _____

Remarks: *Stop for one set of metallic scales, Corp's.*

* See enrollment on card from muster-in roll.

Book mark: _____

Conard
Copyist.

21 | 7 | **U.S.C.T.**

Allen Downs

Pvt, Co. A, 7 Reg't U. S. Col'd Infantry.

Appears on

Company Muster Roll

for Nov & Dec, 1864.

Joined for duty and enrolled:

When Sept. 23, 1863.*

Where Talbot, Md. *

Period 3 years.*

Present or absent Present

Stoppage, \$ 100 for

Due Gov't \$ 100 for

Remarks: Stop for one set of me-
talic scales.

* See enrollment on card from muster-in roll.

Book mark: _____

(358c)

Leonard
Copyist.

9 | 7 | U.S.C.T.

Allen Downs

Pvt, Co. A, 7 Reg't U. S. Col'd Infantry.

Appears on

Company Muster Roll

for *Jan & Feb*, 186*5*.

Joined for duty and enrolled:

When *Sept. 23*, 1863.*

Where *Talbot, Md.**

Period *3* years.*

Present or absent *Present.*

Stoppage, \$ *100* for

Due Gov't \$ *100* for

Remarks:

* ~~See~~ See enrollment on card from muster-in roll.

Book mark: _____

(358c) *Conard* Copyist.

D |

7

U.S.C.T.

Allen Downs

Pvt, Co. A, 7 Reg't U. S. Col'd Infantry.

Appears on

Company Muster Roll

for Mch & Apr, 1865.

Joined for duty and enrolled:

When Sept. 23, 1863.*

Where Talbot *

Period 3 years.*

Present or absent Present.

Stoppage, \$ 100 for

Due Gov't \$ 100 for

Remarks:

* See enrollment on card from muster-in roll.

Book mark:

Conard

Copyist.

(358c)

D | **7** | **U.S.C.T.**

Allen Downs

Pvt., Co. A, 7 Reg't U. S. Col'd Infantry.

Appears on

Company Muster Roll

for *May & June*, 1865.

Joined for duty and enrolled:

When *Sept. 23*, 1863.*

Where *Talbot* *

Period *3* years.*

Present or absent *Absent*

Stoppage, \$ *100* for

Due Gov't \$ *100* for

Remarks: *Absent sick since May 31/65.*

* See enrollment on card from muster-in roll.

Book mark:

(358c)

Edward
Copyist.

D

7

U.S.C.T.

Allen Downs

Priv, Co. A, 7 Reg't U. S. Col'd Infantry.

Appears on

Company Muster Roll

for *July & Aug.*, 1865.

Joined for duty and enrolled:

When *Sept. 23*, 1863.*

Where *Talbot Co. Md* *

Period *3* years.*

Present or absent *Absent.*

Stoppage, \$ *100* for

Due Gov't \$ *100* for

Remarks: *Absent sick since May 31, 1865.*

* See enrollment on card from muster-in roll.

Book mark:

(358c)

Conard
Copyist.

D | **7** | **U.S.C.T.**

Allen Downs
Pvt, Co. A, 7 Reg't U. S. Col'd Infantry.

Appears on

Company Muster Roll

for *Sept. & Oct*, 1865.

Joined for duty and enrolled:

When *Sept. 23*, 1863.*

Where *Talbot* *

Period *3* years.*

Present or absent

Stoppage, \$ *100* for

Due Gov't \$ *100* for

Remarks: *Died at Fort Monroe, Va, June 19/65, of Hypertrophy of the Heart.*

* See enrollment on card from muster-in roll.

Book mark:

(358c) *Conard*
Copyist.

21

7

U.S.C.T.

Allen Downs

Co. A, 7 Reg't U. S. Col'd Infantry.

Appears on

Company Muster Roll

for Jan. & Feb., 1866.

Joined for duty and enrolled:

When Sep. 23, 1863.*

Where Fallot Co. Ind.*

Period 3 years.*

Present or absent Present

Stoppage, \$ 68/100 for K.T.G.

Due Gov't \$ 100 for

Remarks: Reported "Dead" by Surg. Chas. H. Hoop. Ft. Monroe, Va. & dropped from rolls Sep 29/65. No final statement given.

* See enrollment on card from muster-in roll.

Book mark:

Murray J. Copyist.

I

7

U.S.C.T.

Allen Downe

Pr., Co. A, 7 Reg't U. S. Col'd Infantry.

Appears on

Company Muster Roll

for *Nov & Dec*, 1866

Joined for duty and enrolled:

When *Sep 23*, 1863.*

Where *Talbot Co. Md.**

Period *3* years.*

Present or absent *Present*

Stoppage, \$ *65* / 100 for *C & G E.*

Due Gov't \$ *100* for

Remarks: *Absent sick in
U.S. Gen. Hosp Ft. Mon-
roe from May 3/65
to Feb. 8/66*

* See enrollment on card from muster-in roll.

Book mark:

Downe Jr.

21 | 7 | **U.S.C.T.**

Allen Jones

Pris, Co. A, 7 Reg't U. S. Col'd Infantry.

Appears on

Company Muster Roll

for *May & June*, 186*6*.

Joined for duty and enrolled:

When *Sep 23*, 186*3*.*

Where *Galati Co. Ind* *

Period *3* years.*

Present or absent *Present*

Stoppage, \$ *100* for

Due Gov't \$ *100* for

Remarks:

* See enrollment on card from muster-in roll.

Book mark: _____

(358c)

Murray J.
Copyist.

D | 7 | U.S.C.T.

Allen Downs

Pi, Co. A, 7 Reg't U. S. Col'd Infantry.

Appears on

Company Muster Roll

for *July & Aug*, 186*6*.

Joined for duty and enrolled:

When *Sep 23*, 186*3*.*

Where *Fallov Co. Md* *

Period *3* years.*

Present or absent *Present*

Stoppage, \$ *100* for

Due Gov't \$ *100* for

Remarks:

* See enrollment on card from muster-in roll.

Book mark:

Murray Jr.
Copyist.

D

7

U.S.C.T.

Allen Downs

Co. A, 7 Reg't U. S. Col'd Inf.

Appears on Co. Muster-out Roll, dated

Indianola, Tex. Oct 13, 1866.

Muster-out to date, 1866.

Last paid to, 1866.

Clothing account:

Last settled, 1866; drawn since \$100

Due soldier \$100; due U. S. \$100

Am't for cloth'g in kind or money adv'd \$100

Due U. S. for arms, equipments, &c., \$100

Bounty paid \$100; due \$100

Remarks:

Book mark: See May & June '65 Rolls

Mowry, J. Agent.

(861)

9

7

U.S.C.T.

Allen Downs

Co. A, 7 Reg't U. S. Col'd Infantry.

Appears on Co. Muster-out Roll, dated Indianola Tex, Oct 13, 1866.

Muster-out to date Oct 13, 1866.

Last paid to June 30, 1866.

Clothing account:

Last settled, 186 ; drawn since \$ 100

Due soldier \$ 25.99 100; due U. S. \$ 100

Am't for cloth'g in kind or money adv'd \$ 100

Due U. S. for arms, equipments, &c., \$ 100

Bounty paid \$ None 100; due \$ 100 00

Remarks: Joined Orig. Organ Absent sick at Ft. Monroe Va. from May 30/65 to Feb. 8/66. Reported dead, by Surg. in charge of Md. Gen. Hosp. Ft. Monroe June 19/65. Dropped from the rolls Sep. 29/65.

Book mark: 1442-1878 --- 462-1878 (over)

(361)

Mooney, J. Copyist.

JAN. 20

6281671

1891*

*Returned to duty & taken
up on Co. Rolls, Feb. 8/66.*

Downs Allen
P. Co. A 7th Reg't 10th Inf.

Enclosures.

- | | |
|------------------------------------|----------------------------|
| Bed Cards | Final Statements |
| Burial Records | Furloughs or L. of A. |
| Certs. of Dis. for Discharge | Med. Certificates |
| C. M. Charges | Med. Des. Lists |
| Descriptive Lists | Orders |
| Discharge Certificates | Pris. of War Record |
| Enlistment Papers | Resignations |

Other papers relating to—

- | | |
|---------------------------------|----------------------------------|
| Admission to Hosp'l | Furlough or L. of A. |
| Casualty Sheet <i>2</i> | Med. Examination |
| Confinement | Misc. Information <i>2</i> |
| Contracts | Pay or Clothing <i>4</i> |
| Death or Effects <i>2</i> | Personal Reports |
| Desertion | Rank |
| Discharge from Hosp'l | Transfer to Hosp'l |
| Discharge from Service | Transfer to V. R. C. |
| Duty | Transportation |

clothing Account of

Priv. Allen Downes Co. Vth U.S. I.
 while at Convalescent Camp Bedloe's Island N.Y.

Date	Articles	Amount	Amount	
			Doll	Cents
Dec. 15 th	one pair Drawers	1.60	1	60
	one Shirt	2.32	2	32
1865	one Blauker	7.00	7	00

I certify that the above account is correct

Wm. C. Penfield
 2d Lieut 5th U.S. I.
 Comdg Detachment

Dorn, Allen
P. A.

Allen Dorn,

MAR 15 1865

U. S. General Hospital
Fortress Monroe Va

Nov 3rd 1865

Comdg Officer

Co A 7th U. S. Col

Sir

I have to report that
Allen Down of your company has received
the following clothing at this Hospital

- (1) one pair pants \$ 4,75
 - (1) one Flannel Shirt " 2,32
 - (1) one pair shoes " 2,70
 - (1) one pair socks " 48
- \$10,25

You are Respectfully requested to
acknowledge the receipt of this communication

Very Respectfully

Your Obedt Servt

J. S. Russell
1st Lieut U. S. Army

~~This man reported~~
~~sent by his clothing~~
~~and settled before~~
~~the company with~~
~~British Commission~~
A. 22. 11
9. 1. 20

Dennis, Allen
P. A.

U.S. NATIONAL ARCHIVES
1015 ...

1880 ... *Suzons, Allen*

P. A.

	<i>...</i>	<i>...</i>
--	------------	------------

1880

U. S. GENERAL HOSPITAL,
Fortress Monroe, Va.,

July 24, 1865.

COMMANDING OFFICER

J. A. [unclear] Capt. *U. S. Army*

Sir

I have to Report that *Allen Davis*
of your Company, has received the following Clothing at this Hospital.

	No.
Cap,	
Great Coat,	
Flannel Sack Coat,	
Blanket,	
Uniform Coat,	
Trowsers,	
(1) Shirts,	one 2,32
(1) Drawers, prs.	one 1,60
Bootees, prs.	
Boots, prs.	
(1) Stockings, prs	one 18

You are respectfully requested to acknowledge the receipt of this *com. 4711*
communication.

Very Respectfully, Yours Obedt. Servt.

Robert Cullen

LIEUT. VET. RESERVE CORPS,
AND
A. A. Q. M.

NARA 555

U. S. GENERAL HOSPITAL,
Fortress Monroe, Va.,

Sept 4th, 1865.

COMMANDING OFFICER

Co. *1st Regt. U.S. Troops*

Sir

I have to report that *John J. Dwyer*
of your Company, has received the following Clothing at this Hospital.

ARTICLES	No.	VALUE.	
		DOLLS.	CTS
CAP,.....			
GREAT COAT,.....			
<i>(1)</i> FLANNEL SACK COAT.....	<i>on</i> 4	<i>80</i>	
BLANKET,.....			
UNIFORM COAT,.....			
<i>(1)</i> TROUSERS,.....	<i>on</i> 4	<i>85</i>	
SHIRTS,.....			
DRAWERS,.....			
<i>(1)</i> BOOTEES, Pcs.....	<i>on</i> 2	<i>70</i>	
BOOTS, Pcs.....			
STOCKINGS, Pcs.....			
		<i>12</i>	<i>25</i>

You are respectfully requested to acknowledge the receipt of this communication.

Very Respectfully, Yours
Robert Cullen

Robert Cullen

LIEUT. VET. RESERVE CORPS,
AND A. A. Q. M.

*Recd in report of John J. Dwyer
This clothing is all from the
clothes in this man's
m.c.*

Downe, Allan

O. R.

Copy of certificate for A. S. Jones June 12, 67
32

CASUALTY SHEET

Owen No. _____
or Allen Downs
Priv of Company "A"
7th Regiment of U.S.V.
State Volunteers.

NATURE OF CASUALTY.

Wid June 19, 1865.

Inv. of effects in
case of Owen
Downs sent
2^d and 3^d Feb, 14th 67
M

This man is present
in month of June
Capt. A. R. Allen.

CASUALTY SHEET.

Over
 Name: *Allen Downs*
 Rank: *Private* Company: *A* Regiment: *7*
 Arm: *U.S. Troops* State: _____
 Nature of Casualty: *Death*

CAUSE OF CASUALTY—(NAME OF DISEASE, &c.) <i>Hypertrophy of Heart.</i>	BY WHOM DISCHARGED.
DEGREE OF DISABILITY. 	FROM WHAT SOURCE THIS INFORMATION WAS OBTAINED. <i>See Muster Roll</i> <i>Oct. 1865</i>
BY WHOM CERTIFIED. <i>J. M. Banforth</i> <i>2^d Lieut Army Co</i>	REMARKS.
DATE OF DISCHARGE, DEATH, &c. <i>June 19th 1865</i>	
PLACE OF DISCHARGE, DEATH, &c. <i>Fort Monroe</i>	

A. J. Ball
 Clerk.

Miss Files

CASUALTY SHEET

No.

Owen Downs

Private of Company *A*

1st Regiment of *Mass.*

State Volunteers.

NATURE OF CASUALTY.

Died June 19th 1865

CASUALTY SHEET.

Name: *Owen G. Jones*
 Rank: *Private* Company: *(A)* Regiment: *(7th)*
 Arm: *(U. S. Cold Inj)* State: _____
 Nature of Casualty: _____

Death

CAUSE OF CASUALTY—(NAME OF DISEASE, &c.)

Hypertrophy of Heart

BY WHOM DISCHARGED.

FROM WHAT SOURCE THIS INFORMATION WAS OBTAINED.

Inv. of effects which was sent 2^d Auditor.

DEGREE OF DISABILITY.

BY WHOM CERTIFIED.

E. McClellan
Surg. U. S. A.

DATE OF DISCHARGE, DEATH, &c.

June 19th 1865.

PLACE OF DISCHARGE, DEATH, &c.

Fort Monroe Va
U. S. A. Gen. Hosp.

REMARKS.

This man was reported as a member of Co. C, 7th U. S. C. I. to which organization he never belonged. The case was returned to Surg. McClellan who could give no further information.

James Beerswith,
Clerk.

7
Surgeon General's Office,
Record and Pension Division,

Sept 7th 1867.

Respectfully returned to *Act. Supt*
General J. W. Saggard, A.G.O.

It appears from the records of *Hampton*
General Hoop's Fort Hancock Va
on file in this Office, that *Private Allen*
Downs, Co. H. 7th U.S. was admitted
Nov. 30th 1865 from *Point of Rocks*, and
returned to duty, Nov 8th 1865. It also
appears from the records of *that Hoop's*
that Siml Owen Downs, Co. H. 7th U.S.
was admitted *Nov. 14th 1865* from *Field*
and died *June 19th 1865.* Inventory of
Effects enclosed, no evidence on
file here which to prepare *Final*
Statements.

By Order of the Surgeon General

J. J. Howard

Bvt. Major and Assistant Surgeon, U. S. A.

R.O.F.A.
2030
VOL. 4



Jef

NO 91562

RECEIVED, ADJUTANT GENERAL'S
OFFICE. STYRAIS
FEB
8
1867

REC'D
C.D.*

S.O.F.A.
702850
Vol. 2

St. Louis, Mo.

14

WAR DEPARTMENT,

ADJUTANT GENERAL'S OFFICE,

WASHINGTON, *Jan'y 12th*, 1867.

SIR:

Final Statements in the cases of deceased soldiers are required to be sent to the Adjutant General's Office in duplicate, with one copy of the Inventory of Effects. The Descriptive List should also be sent to this Office in cases where the soldier was absent from his Company at the time of his death. Where there were no effects, it should be so stated on a blank Inventory, properly signed.

Certificates of Disability should be sent in duplicate. Special care should be taken that the date of discharge and signature of the discharging officer should be affixed.

No of the Final Statement *or* Inventory, has been received in the case of *Allen Downs, Private*, of Co. *A*, *7th* Regiment of *U.S.V.* Volunteers, whose papers were forwarded to this Office. You will please forward the missing papers without delay.

I have the honor to be, sir,

Very respectfully,

Your obedient servant,

*Died June 19, 1865.
Fort Monroe, Va*

W. H. Hazard

Assistant Adjutant General.
(110)

COMMANDING OFFICER

*J. J. Woodward
A.S.W.*

Information from Co. Muster Roll

afB.

MODEL FOR SET OF PAPER

FORM 1.—FINAL STATEMENT.

I CERTIFY, ON HONOR, that *John Smith*, a Private of Captain J. Brown's Company, (A.) of the 1st Regiment of Pennsylvania Volunteers, of the State of Pennsylvania, born in Pittsburg, State of Pennsylvania, aged 21 years, 5 feet 10 inches high, light complexion, blue eyes, dark hair, and by occupation a Farmer, having joined the Company on its original organization at Pittsburg, and enrolled in it at the muster into the service of the United States at Pittsburg, on the 1st day of July, 1861, (or was mustered in service as a recruit, by ———, at ———, on the ——— day of ———, 186—, or was drafted and mustered into the service of the United States from the ——— Enrollment District of the State of ———, at ———, on the ——— day of ———, 186—,) to serve in the Regiment for the term of Three Years, and having served *honestly* and *faithfully* with his Company in the field to the present date, is now entitled to a DISCHARGE by reason of death. Died in Regimental Hospital, Fort Brown, Texas, December 31, 1863, of typhoid fever.

The said John Smith was last paid by Paymaster Major Morse, to include the 31st day of October, 1863, and has pay due him from that time to the present date. He is entitled to pay and subsistence for *traveling* to place of enrollment, and whatever other allowances are authorized to volunteer soldiers, drafted men, or militia, so discharged. He has received from the United States *clothing* amounting to 20⁰⁰/₁₀₀ dollars, since the 31st day of December, 1862, when his clothing account was last settled. He has received from the United States 25⁰⁰/₁₀₀ dollars advanced *bounty*.

There is to be stopped from him on account of the State of ———, or other authorities, for *clothing, &c.*, received on entering service, nothing, ⁰⁰/₁₀₀ dollars; and for other stoppages, viz: nothing, ⁰⁰/₁₀₀ dollars. He has been furnished with no *transportation* in kind from the place of his discharge to ———; and he has not been *subsisted* for *traveling* to his place of enrollment up to the ———, 186—.

He is indebted to ———, Sutler, ———⁰⁰/₁₀₀ dollars.

He is indebted to ———, Laundress, ———⁰⁰/₁₀₀ dollars.

GIVEN, IN DUPLICATE, at Fort Brown, Texas, this 31st day of December, 1863.

JAMES BROWN,
Captain Co. A, 1st Penn. Vols.,
Commanding Company.

FORM 2.

INVENTORY of the effects of John Smith, late a Private of Captain J. Brown's Company, (A.) of the 1st Regiment of Pennsylvania Volunteers, who was enrolled as a Private at Pittsburg, in the State of Pennsylvania, on the 1st day of July, 1861, and mustered into the service of the United States as a Private on the 1st day of July, 1861, at Pittsburg, in Company A, 1st Regiment of Pennsylvania Volunteers, to serve three years or during the war. He was born in Pittsburg, in the State of Pennsylvania; he was 21 years of age, 5 feet 10 inches high, light complexion, blue eyes, dark hair, and by occupation, when enrolled, a Farmer. He died in Regimental Hospital, at Fort Brown, Texas, on the 31st day of December, 1863, of typhoid fever.

INVENTORY.					
ARTICLES.	NO.	ARTICLES.	NO.	ARTICLES.	NO.
Hats		Pairs trowsers		Knapsacks	
Caps		Pairs flannel drawers			
Forage caps		Pairs cotton drawers		Watch, silver	1
Great coats	1	Flannel shirts	1		
Uniform coats		Cotton shirts			
Uniform jackets		Pairs boots		MONEY.	
Flannel sack coats		Pairs shoes		Specie	\$2 00
Blouses		Pairs socks		Notes	\$50 00
Stable frocks		Blankets			
Fatigue overalls		Haversacks			

I CERTIFY, ON HONOR, that the above inventory comprises all the effects of Private John Smith, deceased, and that the effects are in the hands of Captain J. Brown, at Fort Brown, Texas, to be disposed of by a Council of Administration, except the money, which has been turned over to Major Wm. C. Morse, Paymaster, U. S. Army, whose receipt is hereto annexed.*

STATION: Fort Brown, Texas.

DATE: December 31, 1863.

(Duplicates.)

JAMES BROWN,
Captain Co. A, 1st Penn. Vols.,
Commanding the Company.

*NOTE.—If the effects have been turned over to relatives of deceased, so state on certificate, instead of "in the hands of Captain," &c., and give the names of the persons, and their relation to the deceased person.

FORM 3.—HEIR'S RECEIPT FOR EFFECTS.

RECEIVED of Captain John Brown, Company A, 1st Regiment of Pennsylvania Volunteers, the following effects of Private John Smith, late of Company A, 1st Regiment of Pennsylvania Volunteers, now deceased, which I claim as his wife:

1 great coat, 1 flannel shirt, 1 silver watch, fifty dollars in notes, and two dollars in specie.

MARY SMITH.

FORM 4.—PAYMASTER'S RECEIPT FOR MONEY.

RECEIVED, this 31st day of December, 1863, at Fort Brown, Texas, of Captain James Brown, of Company A, 1st Pennsylvania Volunteers, fifty dollars in Treasury notes and two dollars in specie, the property of the late Private John Smith, of Company A, 1st Pennsylvania Volunteers, who died at Fort Brown, Texas, on the 31st day of December, 1863.

WM. C. MORSE, Paymaster, U. S. A.

RS FOR A DECEASED SOLDIER.

FORM 5.—PROCEEDINGS OF A COUNCIL OF ADMINISTRATION,

Convened at Fort Brown, Texas, pursuant to Orders, No. 1, dated Post Headquarters, Fort Brown, Texas, January 2, 1864—consisting of Captain James Keith, Company C, 1st Pennsylvania Volunteers; Captain John Brown, Company D, 1st Pennsylvania Volunteers; and Lieutenant William Roe, Company E, 1st Pennsylvania Volunteers—for the purpose of disposing of the effects of the late John Smith, of Company A, 1st Pennsylvania Volunteers:

The Council found that the effects consisted of the following articles. They were ordered to be sold at auction, which was accordingly done, and the amount set opposite the articles respectively obtained, for which the receipt of the Paymaster is annexed:

AT AUCTION.

1 shirt	brought.....	\$1 00
1 great coat	"	2 50
1 silver watch	"	25 00
		<u>\$28 50</u>

JAMES KEITH,
Capt. Co. C, 1st Penn. Vols., President.
WILLIAM ROE,
Lieut. Co. E, 1st Penn. Vols., Recorder.

APPROVED: JOHN SANDERS,
Colonel 1st Penn. Vols.,
Commanding Post.

FORM 6.—PAYMASTER'S RECEIPT.

RECEIVED from Captain John Brown, Company A, 1st Pennsylvania Volunteers, at Fort Brown, Texas, January 10, 1864, twenty-eight dollars and fifty cents, the result of the sale of the effects of the late Private John Smith, of Company A, 1st Pennsylvania Volunteers.

WM. C. MORSE, Paymaster U. S. Army.

ARTICLES OF WAR.

ART. 95. When any non-commissioned officer or soldier shall die, or be killed in the service of the United States, the then commanding officer of the troop or company shall, in the presence of two other commissioned officers, take an account of what effects he died possessed of, above his arms and accoutrements, and transmit the same to the office of the Department of War, which said effects are to be accounted for, and paid to the representatives of such deceased non-commissioned officer or soldier. And in case any of the officers, so authorized to take care of the effects of deceased officers and soldiers, should, before they have accounted to their representatives for the same, have occasion to leave the regiment or post, by preferment or otherwise, they shall, before they be permitted to quit the same, deposit in the hands of the commanding officer, or of the assistant military agent, all the effects of such deceased non-commissioned officers and soldiers, in order that the same may be secured for, and paid to, their respective representatives.

DIRECTIONS.

- NOTE 1.—One copy of the inventories of the effects of deceased non-commissioned officers and soldiers, required by the 95th Article of War, will be forwarded to the Adjutant General, by the commander of the company to which the deceased belonged, and a duplicate of the same to the colonel of the regiment. Final statements of pay, clothing, &c., in duplicate, will be sent to the Adjutant General with one copy of the inventory. Both inventory and final statements should be forwarded, as a general rule, through Regimental Headquarters. When a soldier dies at a post or station absent from his company, it will be the duty of his immediate commander to furnish, direct to the Adjutant General, the required inventory and final statements, and, at the same time, to forward to the commanding officer of the company to which the soldier belonged, a report of his death, specifying the date, place, and cause; to what time he was last paid, and the money or other effects in his possession at the time of his decease; which report will be noted on the next muster roll of the company to which the man belonged. Each inventory will be endorsed "Inventory of the effects of _____, late of company (—) _____ regiment of _____, who died at _____ the _____ day of _____, 186—." If a legal representative receive the effects, it will be stated in the report. If the soldier leave no effects, the fact will be reported on the blank for inventory.
- NOTE 2.—Should the effects of a deceased non-commissioned officer or soldier not be administered upon within a short period after his decease, they shall be disposed of by a Council of Administration under the authority of the commanding officer of the post, and the proceeds deposited with the Paymaster, to the credit of the United States, until they shall be claimed by the legal representatives of the deceased. This should be done according to Forms 5 and 6, and one copy of each sent to the Adjutant General. No copy of the order convening the board is required, the approval of the commanding officer being sufficient.
- NOTE 3.—In all such cases of sales by the Council of Administration, a statement in detail, or account of the proceeds duly certified by the Council and commanding officer, (Form 5,) accompanied by the Paymaster's receipt of the proceeds, will be forwarded by the commanding officer to the Adjutant General. The statement will be endorsed "Report of the proceeds of the effects of _____, late of company (—) _____ regiment of _____, who died at _____ the _____ day of _____, 186—."
- NOTE 4.—The effects in all cases, when called for, should be turned over to the legal representative, without further authority from the Adjutant General. When the effects are turned over to the relatives of the deceased before these inventories are sent to the Adjutant General, their receipts therefor should be attached to the inventories. In all other cases, one copy will be sent with a letter of transmittal direct to the Adjutant General, and a duplicate retained by the officer.
- NOTE 5.—Particular care should be taken to take receipts in duplicate from the Paymaster for any funds turned over to him; one copy should be sent direct to the Adjutant General, and one retained by the officer.
- NOTE 6.—Where a soldier dies in hospital or on detached service, his descriptive list, if he has one, should be sent with his final statements, in duplicate, to the Adjutant General, Washington, D. C.
- NOTE 7.—Form 1 will be forwarded in duplicate to the Adjutant General, through Regimental Headquarters, as soon as possible after the death of the soldier, accompanied by one copy of Forms 2 and 3, or 4, as the case may require. A duplicate of the inventory (Form 2) should be retained until the articles are finally disposed of.
- NOTE 8.—The papers for each man should be made SEPARATELY for each man, and, when possible, fastened together. This is especially necessary, and must be done in all cases. The papers cannot be properly disposed of at the Adjutant General's Office unless this is done, and must be returned for correction.
- NOTE 9.—Where there are no line officers, as for instance, a general hospital without a line officer to command the guard, the Council of Administration may be made up from other commissioned officers, in the same way as prescribed for line officers.
- NOTE 10.—Where a soldier dies away from his company or regiment, and the officer having charge of him cannot furnish Final Statements by reason of not being able to obtain a Descriptive List, he should notify the regimental or company commander, (giving him full particulars as to history and description of the man, as far as possible,) whose duty it will then be, in such case, to furnish the necessary papers from the best data he can obtain.

Recd from Div of Discontinued
Commands *Filed August 23/75*
Inventory

of the Effects of *Pirate*
Owen Downe

late of Co. "A", 7 Regt.

U. S. C. A., who died

at U. S. General Hospital, Fortress Monroe.

No., *June 19th*, 1865.



NARA 567

U. S. General Hospital,

Fortress Monroe, Va.,

June 19th, 1865.

Commanding Officer,

Co. "A", 4 Regt. U. S. C. I.

I have the honor to inform you that Private Owen Downis, of your Co., died in this Hospital, on June 19th 1865 of Hypertrophy of Heart; and to forward Inventory of his Effects. In accordance with I. O. from the A. G. O., you will please forward his Descriptive List, that Final Statements may be made.

HATS,	/	SHOES, Prs.,	1
CAPS,	/	STOCKINGS, Prs.,	2
DRESS COATS,	/	BLANKETS,	/
OVERCOATS,	/	KNAPSACKS,	/
JACKETS,	/	CANTEENS,	/
BLOUSES,	/	HAVERSACKS,	/
TROUSERS,	1/2	MONEY,	
SHIRTS,	
DRAWERS,	
BOOTS, Prs.,	

Very Respectfully, Yours, &c.,

E. P. Callahan

ASST. SURGEON, U. S. ARMY,
IN CHARGE HOSPITAL.

ARTICLES OF WAR.

ART. 95. When any non-commissioned officer or soldier shall die, or be killed in the service of the United States, the then commanding officer of the troop or company shall, in the presence of two other commissioned officers, take an account of what effects he died possessed of, above his arms and accoutrements, and transmit the same to the office of the Department of War, which said effects are to be accounted for, and paid to the representatives of such deceased non-commissioned officer or soldier. And in case any of the officers, so authorized to take care of the effects of deceased officers and soldiers, should, before they have accounted to their representatives for the same, have occasion to leave the regiment or post, by preference or otherwise, they shall, before they be permitted to quit the same, deposit in the hands of the commanding officer, or of the assistant military agent, all the effects of such deceased non-commissioned officers and soldiers, in order that the same may be secured for, and paid to, their respective representatives.

DIRECTIONS.

NOTE 1.—One copy of the inventories of the effects of deceased non-commissioned officers and soldiers, required by the 95th Article of War, will be forwarded to the Adjutant General, by the commander of the company to which the deceased belonged, and a duplicate of the same to the colonel of the regiment. Final statements of pay, clothing, &c., in duplicate, will be sent to the Adjutant General with one copy of the inventory. Both inventory and final statements should be forwarded, as a general rule, through Regimental Headquarters. When a soldier dies at a post or station absent from his company, it will be the duty of his immediate commander to furnish, direct to the Adjutant General, the required inventory and final statements, and, at the same time, to forward to the commanding officer of the company to which the soldier belonged, a report of his death, specifying the date, place, and cause; to what time he was last paid, and the money or other effects in his possession at the time of his decease; which report will be noted on the next muster roll of the company to which the man belonged. Each inventory will be endorsed, "Inventory of the effects of ———, late of company (—) ——— regiment of ———, who died at ———, the ——— day of ———, 186—." If a legal representative receive the effects, it will be stated in the report. If the soldier leave no effects, the fact will be reported on the blank for inventory.

NOTE 2.—Should the effects of a deceased non-commissioned officer or soldier not be administered upon within a short period after his decease, they shall be disposed of by a Council of Administration, under the authority of the commanding officer of the post, and the proceeds deposited with the Paymaster, to the credit of the United States, until they shall be claimed by the legal representatives of the deceased.

NOTE 3.—In all such cases of sales by the Council of Administration, a statement in detail, or account of the proceeds duly certified by the Council and commanding officer, (Form 5) accompanied by the Paymaster's receipt for the proceeds, will be forwarded by the commanding officer to the Adjutant General. The statement will be endorsed, "Report of the proceeds of the effects of ———, late of company (—) ——— regiment of ———, who died at ———, the ——— day of ———, 186—."

NOTE 4.—The effects in all cases, when called for, should be turned over to the legal representative, without further authority from the Adjutant General. When the effects are turned over to the relatives of the deceased before these inventories are sent to the Adjutant General, their receipts therefor should be attached to the inventories. In all other cases, one copy will be sent with a letter of transmittal direct to the Adjutant General, and a duplicate retained by the officer.

NOTE 5.—Particular care should be taken to take receipts in duplicate from the Paymaster for any funds turned over to him; one copy should be sent direct to the Adjutant General and one retained by the officer.

INVENTORY OF THE EFFECTS

OF

Private George Daniels
Late of Company *A*
of Reg't of *1st Reg't*

Volunteers, who died at *Fort Monroe Va*
on the *19* day of *June* 186*5*.

Surgeon General's Office,

RECORD & PENSION BUREAU,

Washington, *1865*

The within Inventory is a true copy from the records of..... Hospital..... on file in this Office, and contains all the information in the case that can be found.

BY ORDER OF THE SURGEON GENERAL:

Bvt. Major, Assistant Surgeon, U. S. A.

*Acpt. copy with certificate forward
to A. G. C. Washington D.C.
June 27 1865*

Inventory of the effects of Owen Deems late
 a Private of Captain _____ Company A of
 the 7 Regiment of U.S.T. Volunteers, who was enrolled as
 a _____ at _____ in the State of _____ on
 the _____ day of _____ 186 _____, and mustered into the service of the United
 States as a _____ on the _____ day of _____ 186 _____, at _____
 in Company _____, _____ Regiment of _____ Volunteers, to serve _____
 years or during the war; he was born in _____ in the State
 of _____; he was _____ years of age, _____ feet _____ inches
 high, _____ complexion, _____ eyes, _____ hair, and by occupation, when enrolled,
 a _____; he died in U.S. Gen. Hospital, at
 reason of Hypertrophy of Heart

INVENTORY.					
ARTICLES.	No.	ARTICLES.	No.	ARTICLES.	No.
Hats.....	/	Pairs trousers.....	/	Knapsacks.....	/
Caps.....	/	Pairs flannel drawers.....	/	<u>knapsack</u>	/
Forage Caps.....	/	Pairs cotton drawers.....	/		
Great coats.....	/	Flannel shirts.....	2		
Uniform coats.....	/	Cotton shirts.....	/		
Uniform jackets.....	/	Pairs boots.....	/		
Flannel sack coats.....	/	Pairs shoes.....	1		
Blouses.....	/	Pairs socks.....	2		
Stable frocks.....	/	Blankets.....	/		
Fatigue overalls.....	/	Haversacks.....	/		
				MONEY.	
				Specie.....	\$
				Notes.....	\$

I CERTIFY, ON HONOR, that the above inventory comprises all the effects of Owen Deems, deceased, and that the effects are in the hands of E. M. McCallan (Asst. Surg. U.S.A.) at U.S. Gen. Hospital Fort Monroe Va. to be disposed of by a Council of Administration or turned over to legal representatives of deceased.

(DUPLICATES.)

E. M. McCallan
Asst. Surg. U.S.A.
 Commanding the Company.
Hospital

STATION: U.S. Gen. H. Ft. Monroe Va.

DATE: June 19th 1865

Refer to 1190.

U. S. GENERAL HOSPITAL,

Fortress Monroe, Va.,

October 23^d 1865

Respectfully Returned.

I have the honor to report that the within named man appears in the records of this Hospital as belonging to Co A 1st Regt W. S. I. The above is all that can be ascertained from the records of this Hosp



J. H. France

Asst Surg. U. S. Army.
In Charge Hospital

War Dept. A.G.O. Nov. 8, 1865
Resby. Transmitted to 2^d Auditor.

U. S. Treasury
By order:
J. W. Saggard
A. A. G. S.

ARTICLES OF WAR

ART. 95. When any non-commissioned officer or soldier shall die, or be killed in the service of the United States, the then commanding officer of the troop or company shall, in the presence of two other commissioned officers, take an account of what effects he died possessed of, above his arms and accoutrements, and transmit the same to the office of the Department of War, which said effects are to be accounted for, and paid to the representatives of such deceased non-commissioned officer or soldier. And in case any of the officers, so authorized to take care of the effects of deceased officers and soldiers, should, before they have accounted to their representatives for the same, have occasion to leave the regiment or post, by preferment or otherwise, they shall, before they be permitted to quit the same, deposit in the hands of the commanding officer, or of the assistant military agent, all the effects of such deceased non-commissioned officers and soldiers, in order that the same may be secured for, and paid to, their respective representatives.

ARMY REGULATIONS—EDITION OF 1861

DECEASED SOLDIERS

Par. 152. Inventories of the effects of deceased non-commissioned officers and soldiers, required by the 95th Article of War, will be forwarded to the Adjutant General, by the commander of the company to which the deceased belonged, and a duplicate of the same to the colonel of the regiment. Final statements of pay, clothing, &c., will be sent with the inventories. When a soldier dies at a post or station absent from his company, it will be the duty of his immediate commander to furnish the required inventory, and, at the same time, to forward to the commanding officer of the company to which the soldier belonged, a report of his death, specifying the date, place, and cause; to what time he was last paid, and the money or other effects in his possession at the time of his decease; which report will be noted on the next muster roll of the company to which the man belonged. Each inventory will be endorsed, "Inventory of the effects of _____, late of company (—) _____ regiment of _____, who died at _____, the _____ day of _____, 186—." If a legal representative receive the effects, it will be stated in the report. If the soldier leave no effects, the fact will be reported.

Par. 153. Should the effects of a deceased non-commissioned officer or soldier not be administered upon within a short period after his decease, they shall be disposed of by a Council of Administration, under the authority of the commanding officer of the post, and the proceeds deposited with the Paymaster, to the credit of the United States, until they shall be claimed by the legal representatives of the deceased.

Par. 154. In all such cases of sales by the Council of Administration, a statement in detail, or account of the proceeds, duly certified by the Council and commanding officer, accompanied by the Paymaster's receipt for the proceeds, will be forwarded by the commanding officer to the Adjutant General. The statement will be endorsed, "Report of the proceeds of the effects of _____, late of company (—) _____ regiment of _____, who died at _____, the _____ day of _____, 186—."

NOTE 1.—The effects in all cases, when called for, should be turned over to the legal representative, without further authority from the Adjutant General. When the effects are turned over to the relatives of the deceased before these inventories are sent to the Adjutant General, their receipts therefor should be attached to the inventories. In all other cases, one copy will be sent with a letter of transmittal direct to the Adjutant General, and a duplicate retained by the officer.

NOTE 2.—Particular care should be taken to take receipts in duplicate from the Paymaster for any funds turned over to him; one copy should be sent direct to the Adjutant General and one retained by the officer.

H. S. Jones

NA ✓

INVENTORY OF THE EFFECTS

OF

Private Owen Jones

Late of Company "A"

Reg't of *U. S. C. I.*

Volunteers, who died at *U. S. G. H. Ft. Monroe, Va*

on the *19th* day of *June* 1865.

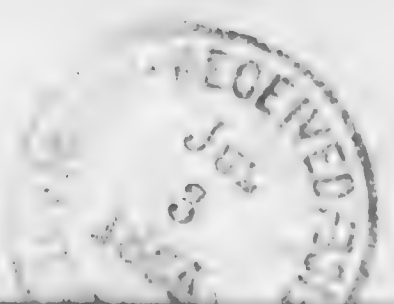
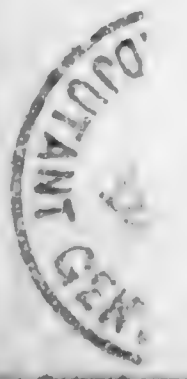
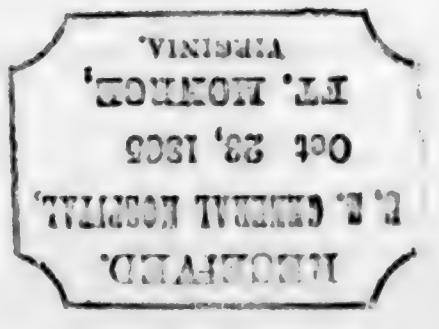

War Department A.G.O.
Oct. 19th 1865.

Resby. returned to Surgeon in Charge U. S. General Hospital, Fort Monroe, Va.

with information that the within named man never belonged to the 7th Regt. U. S. C. I., as reported.

The case will be carefully investigated with a view to ascertain to what regt. he did belong.

J. W. Saggard
A. A. G. S.

Inventory of the effects of Owen Downs late
a Private of Captain _____ Company "A" of
the 7 Regiment of U. S. C. I. ~~Volunteers~~ who was enrolled as
a _____ at _____ in the State of _____ on
the _____ day of _____ 186 , and mustered into the service of the United
States as a _____ on the _____ day of _____ 186 , at _____
in Company _____, _____ Regiment of _____ Volunteers, to serve _____
years or during the war; he was born in _____ in the State
of _____; he was _____ years of age, _____ feet _____ inches
high, _____ complexion, _____ eyes, _____ hair, and by occupation, when enrolled,
a _____; he died in U. S. Genl Hospital, at
Fort Monroe Va on the 19th day of June 1865, by
reason of Hypertrophy of Heart

INVENTORY.					
ARTICLES.	No.	ARTICLES.	No.	ARTICLES.	No.
Hats.....	/	Pairs trousers.....	/	Knapsacks.....	/
Caps.....		Pairs flannel drawers.....		<u>Canteen</u>	/
Forage caps.....		Pairs cotton drawers.....			
Great coats.....	/	Flannel shirts.....	2		
Uniform coats.....		Cotton shirts.....			
Uniform jackets.....		Pairs boots.....			
Flannel sack coats.....		Pairs shoes.....	/		
Blouses.....	/	Pairs socks.....	2		
Stable frocks.....		Blankets.....			
Fatigue overalls.....		Haversacks.....	/		
				MONEY.	
				Specie.....	\$ _____
				Notes.....	\$ _____

I CERTIFY, ON HONOR, that the above inventory comprises all the effects of _____
Owen Downs, deceased, and that the effects are in the hands
of E. M. Bellaw Asst Surg U.S.A. at U. S. Genl Hospital
Fort Monroe Va to be disposed of by a Council of Administration.
or turned over to legal representative of deceased

(DUPLICATES.)

STATION: U. S. G. Hosp. Ft. Monroe Va

E. M. Bellaw
Asst. Surgeon U.S. Army
Commanding the Company.

DATE: June 19th 1865

Jones George L.

Co. A, 7 U.S. Col'd Inf

Private Corporal

CARD NUMBERS.

1	6 2 7 8 8 9 0	26
2	6 2 8 0 1 5 5	27
3	6 2 8 0 2 5 9	28
4	6 2 8 0 3 5 7	29
5	6 2 8 0 4 5 3	30
6	6 2 8 0 5 2 4	31
7	6 2 8 0 6 2 4	32
8	6 2 8 0 7 2 5	33
9	6 2 8 0 8 2 5	34
10	6 2 8 0 9 2 7	35
11	6 2 8 1 0 2 8	36
12	6 2 8 1 1 2 8	37
13	6 2 8 1 2 2 7	38
14	6 2 8 1 3 1 4	39
15	6 2 8 1 4 0 4	40
16	6 2 8 1 4 8 7	41
17	6 2 8 1 5 7 0	42
18	6 2 8 1 6 5 2	43
19	9 0 6 5 8 9 9	44
20	4 3 1 5 2 3 9 7	45
21		46
22		47
23		48
24		49
25		50

Book Mark:

See also

NARA 1574

A. 772890 RCO
5800516 90

Q

7

U.S.C.T.

George W. Downs

, Co. *A*, 7 Reg't U.S. Col'd Inf.

Appears on

Company Descriptive Book

of the organization named above.

DESCRIPTION.

Age *32* years; height *5* feet *4* inches.

Complexion *Brown*

Eyes *Black*; hair *Curly*.

Where born *Tullot, Md.*

Occupation *Laborer.*

ENLISTMENT.

When *June 13*, 1864.

Where *Baltimore 3d. Cong. Dist.*

By whom ; term *3* y'rs.

Remarks:

*Mustered Jan. 13th, 64.
Joined Co. Jan. 16, 1864.
Promoted. Corp. R.S.D.
Aug. 31st, 64.*

J. H. Smith

10 | 7 U.S.C.T.

Geo. H. Downs (Col'd.)

Appears with rank of _____ on

Muster and Descriptive Roll

of Detachment of drafted men, forwarded for U.S. Colored Troops. (Co. A, 7 Regt.)

Roll dated Baltimore, Jan. 13, 1864.

Where born Talbot Co., Maryland

Age 32 y'rs; occupation Laborer

Drafted and mustered in:

When Drafted Jan. 13, 1864.

Where Balto., Md.

Enrollment district 3 Cong. Dist.

Period 3 years.

Eyes Black ; hair Woolly

Complexion Brown ; height 5 ft. 4 in.

Bounty paid \$ 100 ; due \$ 100

Clothing account:

Last settled _____, 186 ; drawn since \$ 24⁷⁹/₁₀₀

Date of commencement of service Jan. 13, 1864.

Company to which assigned _____

Remarks: Drafted man.

^x From margin of roll.

Book mark : _____

H. H. Hibbard Copyist.

10 | 4 | U.S.C.T.

George Downer
Priv., Co. A, 7 Reg't U. S. Col'd Infy
Age 34 years.

Appears on a
Detachment Muster-in Roll
of the organization named above. Roll dated
Baltimore, Md., Apr. 18, 1863.
Muster-in to date Jan. 16, 1864.

Joined for duty and enrolled:
When Jan. 13, 1864.
Where Baltimore, Md.
Period 3 years.

Valuation of horse, \$ 100
Valuation of horse equipments, \$ 100
Remarks: Drafted

Book mark:

W Beck
Copyist.

9

7

U.S.C.T.

George W. Downe
Pvt., Co. A, 7 Reg't U. S. Col'd Infantry.

Appears on

Company Muster Roll

for Jan. & Feb., 1864.

Joined for duty and enrolled:

When Jan. 5, 1864.*

Where Baltimore Co. Md.*

Period 3 years.*

Present or absent Present

Stoppage, \$ 100 for

Due Gov't \$ 100 for

Remarks: Joined for duty
Jan 16/64 Substitute
accepted in place of
Frederick Taylor (vol)

* See enrollment on card from muster-in roll.

Book mark:

Waggett

9 | 7 | U.S.C.T.

George W. Downs
Pvt., Co. A, 7 Reg't U. S. Col'd Infantry.

Appears on

Company Muster Roll
for Mar. & Apr., 1864.

Joined for duty and enrolled:

When Jan. 5, 1864.*

Where Baltimore Md. *

Period 3 years.*

Present or absent Present.

Stoppage, \$ 100 for

Due Gov't \$ 100 for

Remarks: Substitute accepted
in place of Frederick Taylor
(Col.)

* See enrollment on card from muster-in roll.

Book mark:

Waggett

Q | 7 | U.S.C.T.

George W. Downs
Pvt., Co. A, 7 Reg't U. S. Col'd Infantry.

Appears on

Company Muster Roll
for May & June, 1864.

Joined for duty and enrolled:

When Jan. 5, 1864.*

Where Baltimore Co. Md. *

Period 3 years.*

Present or absent Present.

Stoppage, \$ 100 for _____

Due Gov't \$ 100 for _____

Remarks: _____

* ~~42~~ See enrollment on card from muster-in roll.

Book mark: _____

Daggett

2 | 7 | U.S.C.T.

George W. Downs
Md., Co. A, 7 Reg't U. S. Col'd Infantry.

Appears on

Company Muster Roll

for July & Aug., 1864.

Joined for duty and enrolled:

When Jan. 13, 1864.*

Where Baltimore Co. Md.*

Period 3 years.*

Present or absent Present.

Stoppage, \$ 100 for

Due Gov't \$ 100 for

Remarks: Stop for One Haversack
& One Canteen. Free on or
before April 19/61

* See enrollment on card from muster-in roll.

Book mark:

Gaggett

D | 7 | U.S.C.T.

George W. Downs

Co. A, 7 Reg't U. S. Col'd Infantry.

Appears on

Company Muster Roll

for Sept. & Oct., 1864.

Joined for duty and enrolled:

When Jan 13, 1864.*

Where Baltimore *

Period years.*

Present or absent Present.

Stoppage, \$ 100 for

Due Gov't \$ 100 for

Remarks: Promoted Stop for one set of metallic scales, Co. A, and one Knapsack. A. Sgt. Aug. 31/64.

* See enrollment on card from muster-in roll.

Book mark:

(358e)

Boyard Copyist.

91 | 7 | **U.S.C.T.**

George W. Downs
Corpl, Co. A, 7 Reg't U. S. Col'd Infantry.

Appears on

Company Muster Roll

for Nov & Dec, 1864.

Joined for duty and enrolled:

When Jan 13, 1864.*

Where Baltimore Md. *

Period 3 years.*

Present or absent Present

Stoppage, \$ 100 for

Due Gov't \$ 100 for

Remarks: Stop for one set of metallic scales & one knapsack.

* See enrollment on card from muster-in roll.

Book mark:

(358c)

Conard
Copyist.

9 | 7 | U.S.C.T.

George W. Downs
Copt, Co. A, 7 Reg't U. S. Col'd Infantry.

Appears on

Company Muster Roll

for Jan. & Feb., 1865.

Joined for duty and enrolled:

When Jan. 13, 1864.*

Where Baltimore, Md.*

Period years.*

Present or absent Absent.

Stoppage, \$ 100 for

Due Gov't \$ 100 for

Remarks: On furlough since Feb. 22/65.

* See enrollment on card from muster-in roll.

Book mark:

(358c)

Conard
Copyist.

D | **7** | **U.S.C.T.**

Geo. W. Downs

Capl., Co. A, 7 Reg't U. S. Col'd Infantry.

Appears on

Company Muster Roll

for *Mich & Apr*, 1865.

Joined for duty and enrolled:

When *Jan 13*, 1864.*

Where *Baltimore**

Period *3* years.*

Present or absent *Present*.

Stoppage, \$ *100* for

Due Gov't \$ *100* for

Remarks:

* See enrollment on card from muster-in roll.

Book mark: -----

(358c)

Conard

Copyist.

D | **7** | **U.S.C.T.**

George W. Downs
Copt, Co. A, 7 Reg't U. S. Col'd Infantry.

Appears on

Company Muster Roll

for *May & June*, 1865.

Joined for duty and enrolled:

When *Jan'y 13*, 1864.*

Where *Baltimore* *

Period *3* years.*

Present or absent *Present*

Stoppage, \$ *100* for

Due Gov't \$ *100* for

Remarks: *Charge 1 Ball Screw & 1 Wiper.*

* See enrollment on card from muster-in roll.

Book mark: *521000*

(358c) *Conard*
Copyist.

D

7

U.S.C.T.

George W. Downs

Corpl., Co. A, 7 Reg't U. S. Col'd Infantry.

Appears on

Company Muster Roll

for *July & Aug.*, 1865.

Joined for duty and enrolled:

When *Jan 13*, 1864.*

Where *Baltimore, Md.**

Period *3* years.*

Present or absent *Present*

Stoppage, \$ *100* for

Due Gov't \$ *100* for

Remarks: *Sick in Hosp. at Indianola, Tex, since Aug. 27, 1865.*

* See enrollment on card from muster-in roll.

Book mark:

Conard
Copyist.

D | 7 | U.S.C.T.

George W. Downs

Capt., Co. A, 7 Reg't U. S. Col'd Infantry.

Appears on

Company Muster Roll

for Sept. & Oct, 1865.

Joined for duty and enrolled:

When Jan 13, 1864.*

Where Baltimore *

Period 3 years.*

Present or absent Present.

Stoppage, \$ 100 for

Due Gov't \$ 100 for

Remarks:

* See enrollment on card from muster-in roll.

Book mark:

(358c)

Conard Copyist.

D

7

U.S.C.T.

George W. Devons
Corp., Co. A, 7 Reg't U. S. Col'd Infantry.

Appears on

Company Muster Roll

for Nov. & Dec, 1865.

Joined for duty and enrolled:

When Jan 13, 1864*

Where Baltimore Co. Md.*

Period 3 years.*

Present or absent Present

Stoppage, \$ 100 for

Due Gov't \$ 100 for

Remarks:

* See enrollment on card from muster-in roll.

Book mark:

(358c)

Mowry, J.
Copyist.

D | 7 | U.S.C.T.

George A. Downs
Corp, Co. A, 7 Reg't U. S. Col'd Infantry.

Appears on

Company Muster Roll

for Jan & Feb, 1864.

Joined for duty and enrolled:

When Jan 13, 1864

Where Baltimore Co., Md.*

Period 3 years.*

Present or absent Present

Stoppage, \$ 65 for 69 G.E.

Due Gov't \$ 100 for

Remarks:

* See enrollment on card from muster-in roll.

Book mark:

(358c) Mowry J. Copyist.

I | 7 | U.S.C.T.

George W. Downs
Cap., Co. A, 7 Reg't U. S. Col'd Infantry.

Appears on

Company Muster Roll
for March & April, 1866.

Joined for duty and enrolled:

When Jan 13, 1866 *

Where Balto. Co. Md *

Period 3 years.*

Present or absent Present

Stoppage, \$ 100 for _____

Due Gov't \$ 100 for _____

Remarks: _____

* See enrollment on card from muster-in roll.

Book mark: _____

(358c)

Moving
Copyist.

91 7 U.S.C.T.

George W. Downs

Corp Co. A, 7 Reg't U. S. Col'd Infantry.

Appears on

Company Muster Roll

for May & June, 1866.

Joined for duty and enrolled:

When Jan 13, 1864.*

Where Balt. Co. Md. *

Period 3 years.*

Present or absent Present

Stoppage, \$ 100 for

Due Gov't \$ 100 for

Remarks:

* See enrollment on card from muster-in roll.

Book mark:

Proving Jr. Copyist.

D | **7** | **U.S.C.T.**

George W. Downe
Corp, Co. A, 7 Reg't U. S. Col'd Infantry.

Appears on

Company Muster Roll
for *July & Aug*, 186*6*.

Joined for duty and enrolled:

When *Jan 13*, 186*4*.*

Where *Balto. Co. Md.*.*

Period *3* years.*

Present or absent *Present*

Stoppage, \$ *100* for

Due Gov't \$ *100* for

Remarks:

* ~~See~~ See enrollment on card from muster-in roll.

Book mark: -----

Murray J.
Consist.

2 | 7 | **U.S.C.T.**

George W. Downe
Corp., Co. A, 7 Reg't U. S. Col'd Infantry.

Appears on **Co. Muster-out Roll**, dated
Indianola, Tex, Oct 13, 1866.

Muster-out to date Oct 13, 1866.

Last paid to June 30, 1866.

Clothing account:

Last settled _____, 186 ; drawn since \$ _____ 100

Due soldier \$ 38 65/100; due U. S. \$ _____ 100

Am't for cloth'g in kind or money adv'd \$ _____ 100

Due U. S. for arms, equipments, &c., \$ _____ 100

Bounty paid \$ None 100; due \$ _____ 100

Remarks: Joined res. Jan. 16/64;
appt'd Corp. Aug. 31/64.

Book mark: _____

(361)

Mowry, Jr.
Copyist.

Downs, George H.

P, Co. *A*,

7 Reg't **U.S.C. Inf.**

Enclosures.

Bed Cards.....	Descriptive Lists.....
Burial Records.....	Final Statements.....
Certs. of Dis. for Discharge.....	Furloughs.....
C. M. Charges.....	Med. Des. Lists.....
Med. Certificates.....	Orders.....

Other papers relating to—

Admission to Hosp'l.....	Furlough.....
Casualty Sheet (Officer's).....	Med. Examination.....
Confinement.....	Misc. Information.....
Contracts.....	Pay or Clothing.....
Death or Effects.....	Personal Reports.....
Desertions.....	Rank.....
Discharge from Hosp'l.....	Transfer to Hosp'l.....
Discharge from Service.....	Transfer to V. R. C.....
Duty.....	Transportation.....

Mustering roll for July & Aug.
1864 reports him drafted
Jan'y. 13/64, Baltimore, Md.,
3rd Dist., and is so reported
on all subsequent rolls.
June 1/85. *JMB*

Mr Gibson:
 ✓ Muster roll of Co. A-7th
 U.S.C.T. for Jan'y. & Feby. /64
 reports George W. Downs,
 enrolled Jan'y. 5/64, Baltimore Md,
 by D.S. Thimmonio, P.M., a sub.
 for Frederick Taylor, Colored.

Please furnish copy of ^{over}
 his M & D. roll.

May 26/85. Respy., E.A.W.,
 (For Mr Masi) *[Signature]*

Mr. Woodward:

Copy of
 must. & des. roll for
 this man herewith

E. D. A. G. O. } Respy.
 June 2. 85. } *[Signature]*

See Md St-Rolls
 (Jones) June 4/85-

Hammond *William*
Co. *A*, 7 U.S. Col'd Inf.

Private | *Private*

CARD NUMBERS.

1	6 2 9 5 9 9 4	26
2	6 2 9 6 0 9 4	27
3	6 2 9 6 1 9 2	28
4	6 2 9 6 2 9 5	29
5	6 2 9 6 3 9 1	30
6	6 2 9 6 4 8 4	31
7	6 2 9 6 5 7 7	32
8	6 2 9 6 6 5 8	33
9	6 2 9 6 7 4 8	34
10	6 2 9 6 8 3 2	35
11	6 2 9 6 9 4 1	36
12	6 2 9 7 0 4 6	37
13	6 2 9 7 1 4 7	38
14	6 2 9 7 2 5 2	39
15	6 2 9 7 3 4 5	40
16	6 2 9 7 4 2 9	41
17	6 2 9 7 5 0 2	42
18	6 2 9 7 5 6 8	43
19	6 2 9 7 6 3 6	44
20	9 0 6 7 0 3 0	45
21	3 3 2 0 7 5 5 2	46
22	4 0 7 6 2 2 1 6	47
23		48
24		49
25		50

Book Mark: _____

See also _____

09138218002ff

S.1069997. P.O. M. & M.

A.4.1504897

D.3088647 and 1978

S. | 7 | U.S.C.T.

William Drummond

, Co. K, 7 Reg't U. S. Col'd Inf.

Appears on

Company Descriptive Book

of the organization named above.

DESCRIPTION.

Age 27 years; height 5 feet 2 inches.

Complexion *Griff.*

Eyes *Black*; hair *Black*.

Where born *Accomac, Virginia*

Occupation *Farmer*.

ENLISTMENT.

When *Nov. 6*, 1863.

Where *Drummondtown*

By whom *Col. W. Birney*; term 3 y'rs.

Remarks: *Entered into serv. at
Camp Stanton, Va. Co. Ind.
by Lt. Col. Lawrence Nov. 12.
1863.*

W. H. White

G

7

U.S.C.T.

William Drummond

Priest, Co. H., 7 Reg't U. S. Col'd Inf.

Age 24 years.

Appears on

Company Muster-in Roll

of the organization named above. Roll dated

at Stanton Charles Co. Md., Nov. 12, 1863.

Muster-in to date Nov. 12, 1863

Joined for duty and enrolled:

When Nov. 6, 1863.

Where Accomac Va

Period 3 years.

Remarks:

Book mark:

D. M. Kennedy

(356)

Copyist.

9 | 7 | U.S.C.T.

William Drummond
Pvt., Co. K, 7 Reg't U. S. Col'd Infantry.

Appears on

Company Muster Roll

for Nov. 12 to Dec 31, 1863.

Present or absent Present

Stoppage, \$ 100 for

Due Gov't, \$ 100 for

Remarks: Enlistment Premium
\$ 2 00 dollars due.

Book mark: _____

D. M. Kennedy
Copyist.

Q

7

U.S.C.T.

Willson Drummond

Private, Co. K, 7 Reg't U. S. Col'd Infantry.

Appears on

Company Muster Roll

for *Jan.* v. *Feb.*, 1864.

Present or absent *Present*

Stoppage, \$ *100* for

Due Gov't, \$ *100* for

Remarks:

Book mark: *305*

D. M. Kennedy

(358)

Copyist.

D

7

U.S.C.T.

William Drummond

Privt, Co. K, 7 Reg't U. S. Col'd Infantry.

Appears on

Company Muster Roll

for *Mch* v *Apr.*, 186*4*.

Present or absent *Present*

Stoppage, \$ *100* for

Due Gov't, \$ *100* for

Remarks:

Book mark:

D. M. Kennedy
Coylist.

D

7

U.S.C.T.

William Drummond

Privt, Co. K, 7 Reg't U. S. Col'd Infantry.

Appears on

Company Muster Roll

for *May & June*, 1864.

Present or absent *Present*

Stoppage, \$ *100* for

Due Gov't, \$ *100* for

Remarks:

Book mark:

D. M. Kennedy

(358)

Spyist.

D | 7 | U.S.C.T.

William Drummond
Privt., Co. K, 7 Reg't U. S. Col'd Infantry.

Appears on

Company Muster Roll

for July & Aug., 1864.

Present or absent Absent

Stoppage, \$ 100 for

Due Gov't, \$ 100 for

Remarks: Sick in hospital
Bermuda Hundred since
Aug. 16" 1864. Free
before April 19" 1861.

Book mark:

D. M. Kennedy
Copyist.

D | 7 | U. S. C. I.

William Drummond

Pvt, Co. K, 7 Reg't U. S. Col.

Appears on

Hospital Muster Roll

of U. S. A. Post Hospital,

at Bermuda Hundred, Va.,

for July & Aug, 186 4.

Attached to hospital:

When Aug 19, 186 4.

How employed.....

Last paid by Maj.....

to, 186 .

Bounty paid \$ 100; due \$ 100

Present or absent Present

Remarks: No Descriptive List.

Book mark:.....

D. J. Males

D

7

U.S.C.T.

William Drummond

Privat, Co. K, 7 Reg't U. S. Col'd Infantry.

Appears on

Company Muster Roll

for *Sept. or Oct.*, 1864.

Present or absent *Present*

Stoppage, \$ *100* for

Due Gov't, \$ *100* for

Remarks:

Book mark:

D. M. Kennedy
Copyist.

20

7

U.S.C.T.

William Drummond

Pvt, Co. K, 7 Reg't U. S. Col'd Infantry.

Appears on

Company Muster Roll

for *Nov Dec*, 1864

Present or absent *Present*

Stoppage, \$ *100* for

Due Gov't, \$ *100* for

Remarks:

Book mark:

(358)

Leary
Copyist.

20 | **7** | **U.S.C.T.**

Wm Drummond

Priv, Co. K, 7 Reg't U. S. Col'd Infantry.

Appears on

Company Muster Roll

for *Jan & Feb*, 1865.

Present or absent *Present*

Stoppage, \$ *100* for

Due Gov't, \$ *100* for

Remarks:

Book mark:

(858)

Seay
Copyist.

20

7

U.S.C.T.

William Drummond

Pvt, Co. K, 7 Reg't U. S. Col'd Infantry.

Appears on

Company Muster Roll

for *Mich & Apr*, 1865.

Present or absent *Present*

Stoppage, \$ 100 for

Due Gov't, \$ 100 for

Remarks:

Book mark:

Leary
Copyist.

20

7

U.S.C.T.

William Drummond

Pvt., Co. K, 7 Reg't U. S. Col'd Infantry.

Appears on

Company Muster Roll

for *May and June*, 1865.

Present or absent *Present*

Stoppage, \$ *100* for

Due Gov't, \$ *100* for

Remarks:

Book mark:

Searcy

Copyist.

20

7

U.S.C.T.

William Drummond

Priv., Co. K, 7 Reg't U. S. Col'd Infantry.

Appears on

Company Muster Roll

for July and Aug, 1865

Present or absent Present

Stoppage, \$ 100 for

Due Gov't, \$ 100 for

Remarks:

Book mark:

Leary

Copyist.

20

7

U.S.C.T.

William Drummond

Pr, Co. K, 7 Reg't U. S. Col'd Infantry.

Appears on

Company Muster Roll

for *Sept + Oct*, 1865.

Present or absent *Present*

Stoppage, \$ *26* for *ordnance*
100

Due Gov't, \$ *100* for

Remarks:

Book mark:

(358)

Searcy
Copyist.

AL

7

U.S.C.T.

William Drummond

Prvt, Co. K, 7 Reg't U. S. Col'd Infantry.

Appears on

Company Muster Roll

for *Nov & Dec*, 1865.

Present or absent *Present*

Stoppage, \$ *26* / *100* for *Ordinance*

Due Gov't, \$ *100* for

Remarks:

Book mark:

(358)

Leary
Copyist.

D

7

U.S.C.T.

William Drummond

Privat, Co. K, 7 Reg't U. S. Col'd Infantry.

Appears on

Company Muster Roll

for *Jan. & Feb.*, 186*6*

Present or absent *Present*

Stoppage, \$ *100* for

Due Gov't, \$ *100* for

Remarks:

Book mark:

Randall

(358)

Copyist.

D

7

U.S.C.T.

William Drummond

Pvt., Co. K, 7 Reg't U. S. Col'd Infantry.

Appears on

Company Muster Roll

for *Mch. & Apr.*, 1866

Present or absent *Present*

Stoppage, \$ *—* ^{*84*}/_{*100*} for *Ordinance*

Due Gov't, \$ *—* ^{*100*}/_{*100*} for *—*

Remarks: *—*

Book mark: *—*

Randall

(358)

Copyist.

D

7

U.S.C.T.

William Drummond
Pvt., Co. K, 7 Reg't U. S. Col'd Infantry.

Appears on

Company Muster Roll

for *May & June*, 1866

Present or absent

Stoppage, \$ 100 for

Due Gov't, \$ 100 for

Remarks:

Book mark:

Randall
Copyist.

(358)

D

7

U.S.C.T.

William Drummond
Pat., Co. K, 7 Reg't U. S. Col'd Infantry.

Appears on

Company Muster Roll

for *July & Aug.*, 186 *6*

Present or absent *Present*

Stoppage, \$ *100* for

Due Gov't, \$ *100* for

Remarks:

Book mark:

Randa
Copyist.

D | 7 | U.S.C.T.

William Drummonds
 Pvt., Co. K, 7 Reg't U. S. Col'd Inf.

Appears on Returns as follows:

Nov 1863, on duty cook,
 Dec 1863, on duty Gen Wm
 Birnie's orderly
 Jan 1864, on duty orderly
 at Brig Hd Qrs.
 July 1864, absent sick leave
 Jacksonville July 22 '64
 Aug 1864, absent sick Hospl
 Bermuda Hundred since
 Aug 16 '64.

Book mark:

A. M. Hannan

D

7

U.S.C.T.

William Drummond

Pvt., Co. K., 7 Reg't U. S. Col'd Infantry.

Appears on **Co. Muster-out Roll**, dated

Indianola, Tex., Oct. 13, 1866.

Muster-out to date

Oct. 13, 1866.

Last paid to

June 30, 1866.

Clothing account:

Last settled....., 186 ; drawn since \$.....¹⁰⁰

Due soldier \$ *23⁰⁷*/₁₀₀; due U. S. \$.....¹⁰⁰

Am't for cloth'g in kind or money adv'd \$.....¹⁰⁰

Due U. S. for arms, equipments, &c., \$.....¹⁰⁰

Bounty paid \$.....¹⁰⁰; due \$ *100*/₁₀₀

Remarks: *Joined original organiza-*
tion, Retains one Spring-
field R. M. and one set of ac-
countments, per G.O. No. 101.
War Dept. May, 30, 65. Stop
for ordnance, \$6.00.

Book mark :.....

Randall

(361)

Copyist.

MICROCOPY

1820

ROLL

94

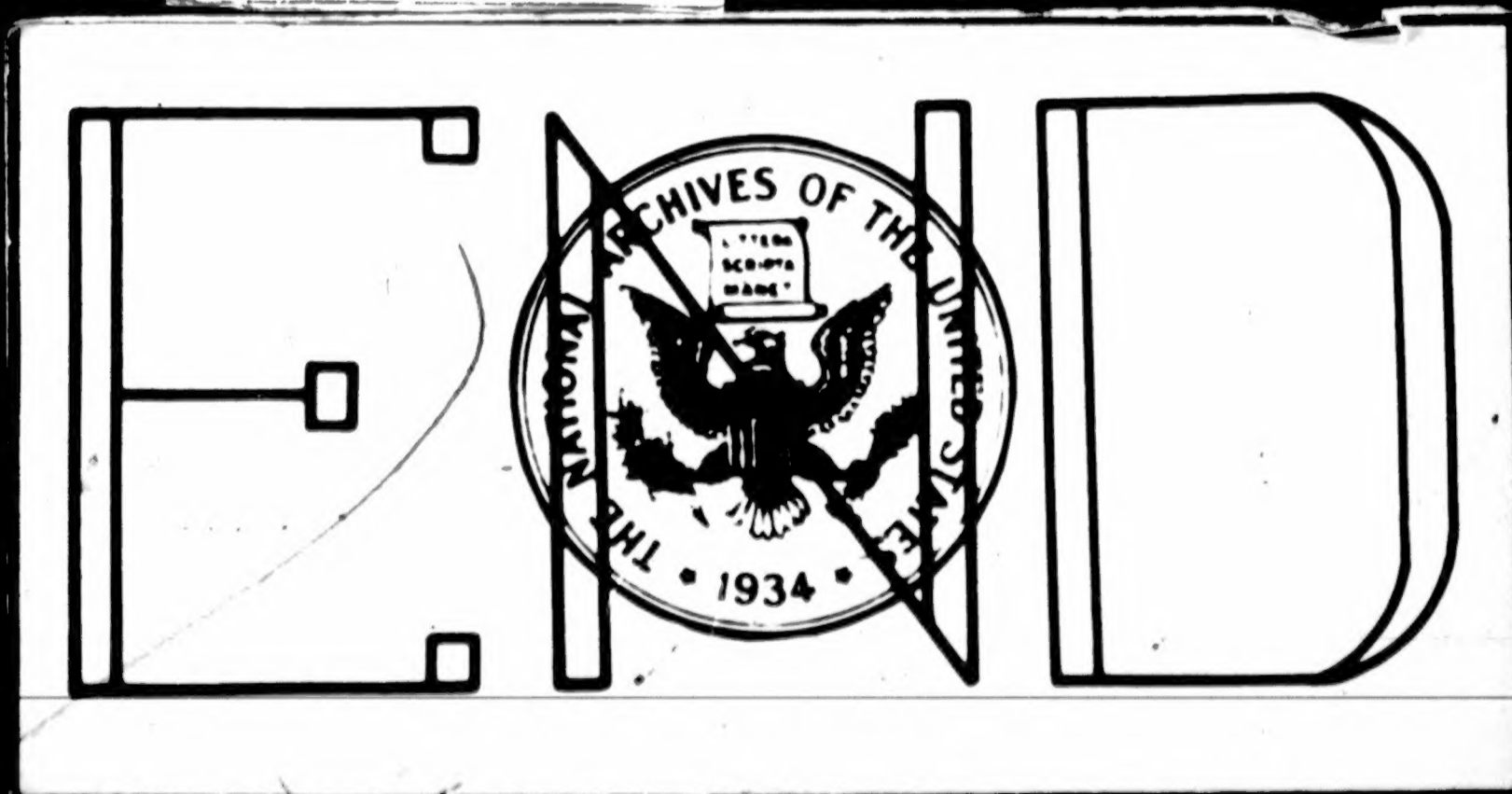
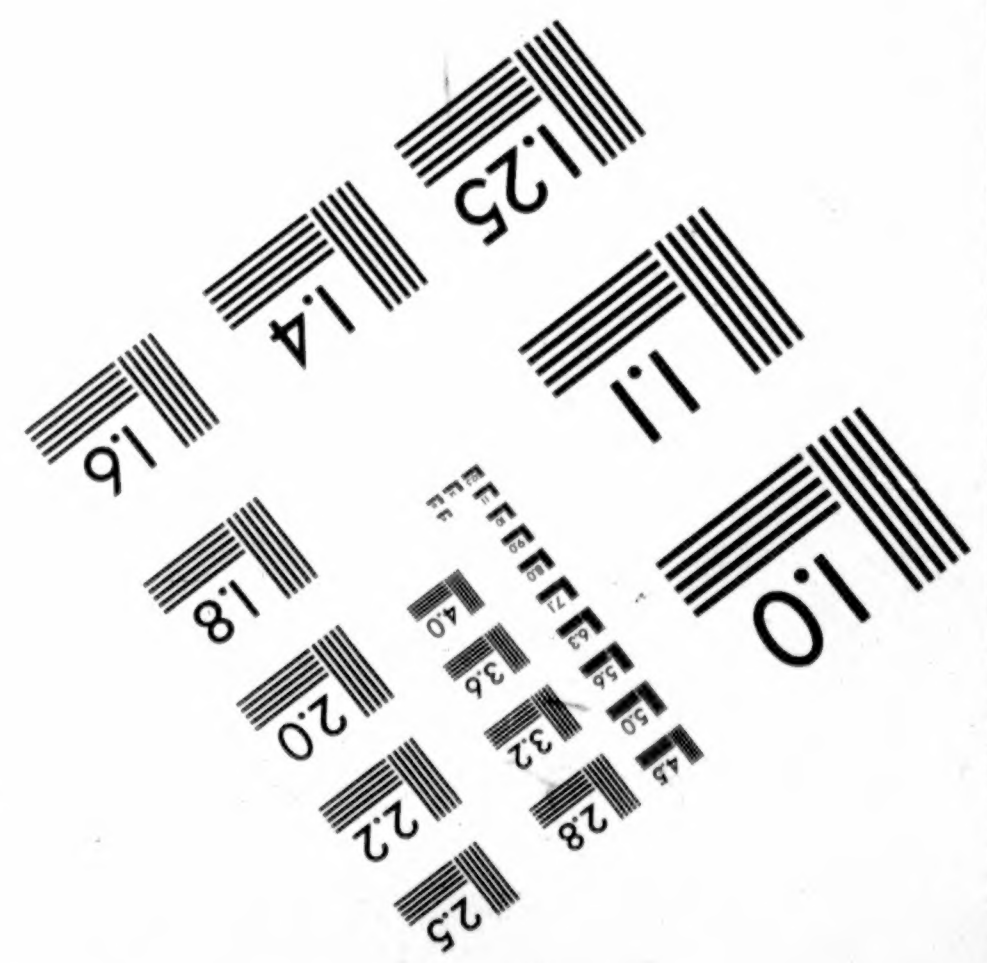
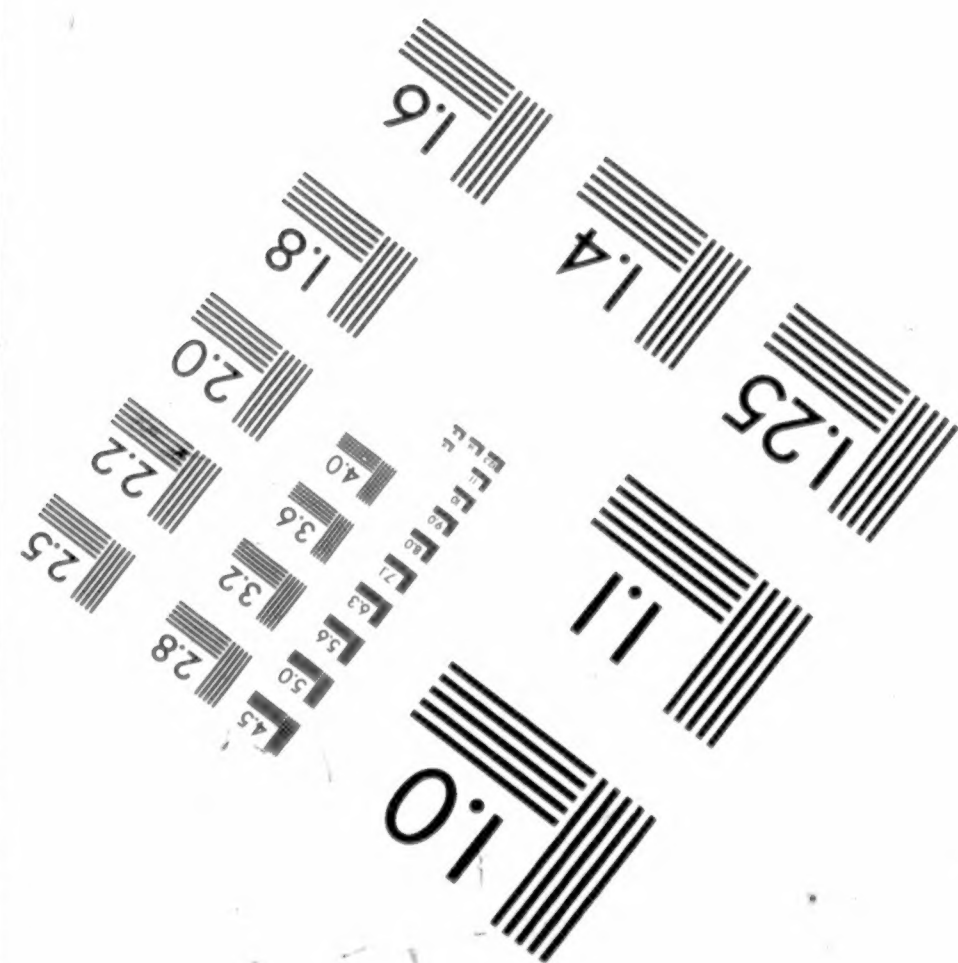
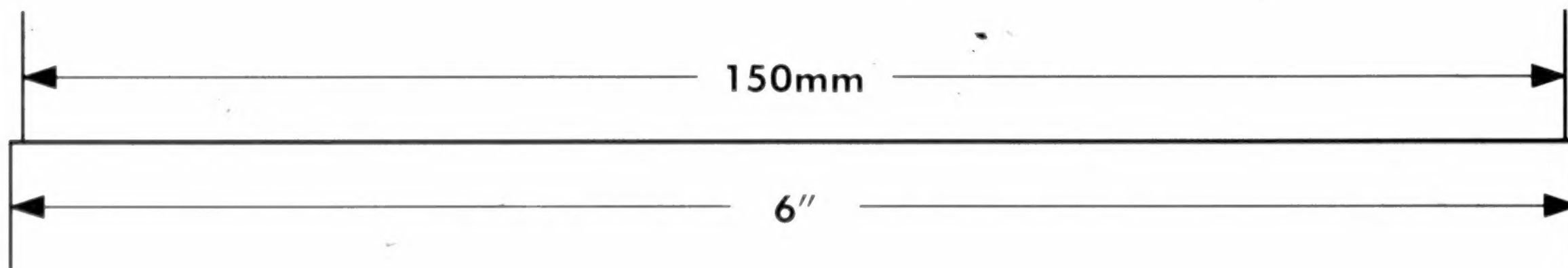
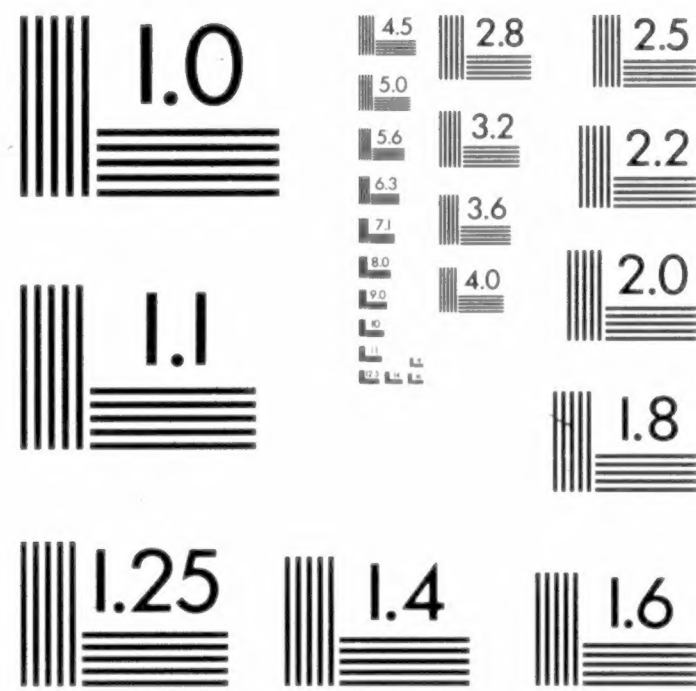
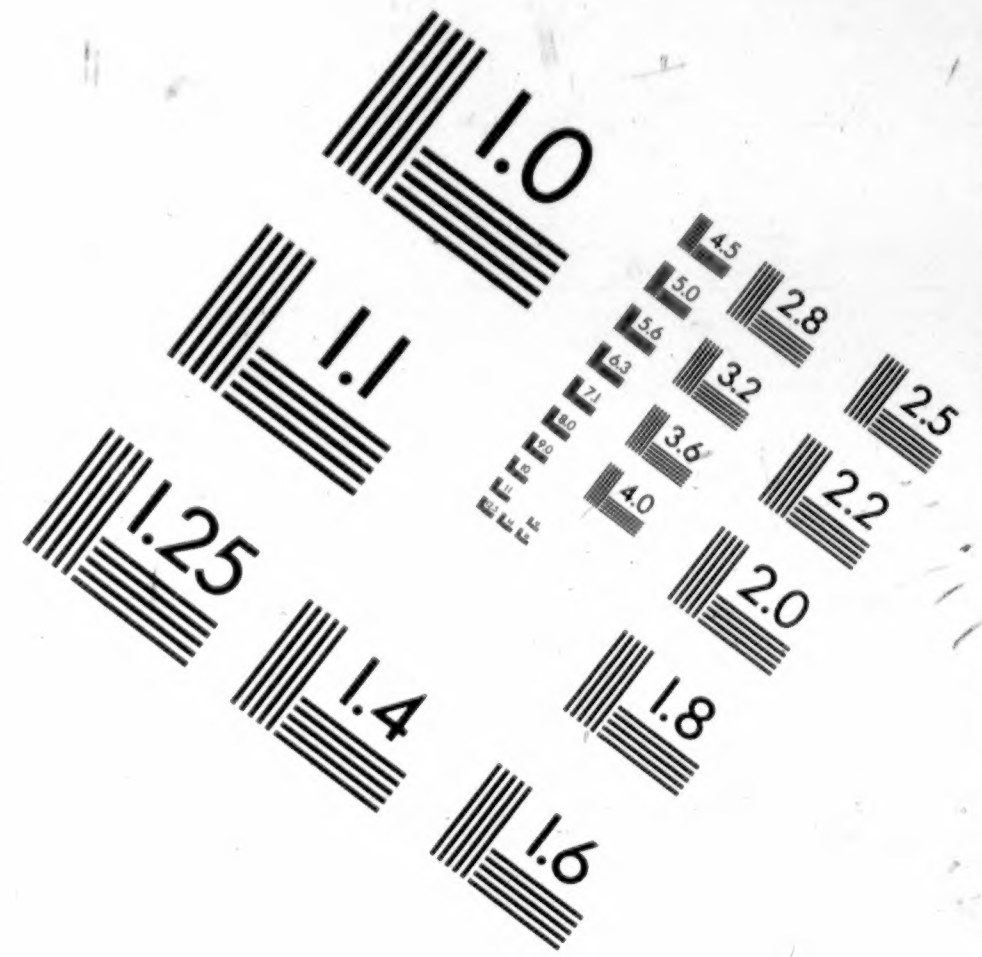
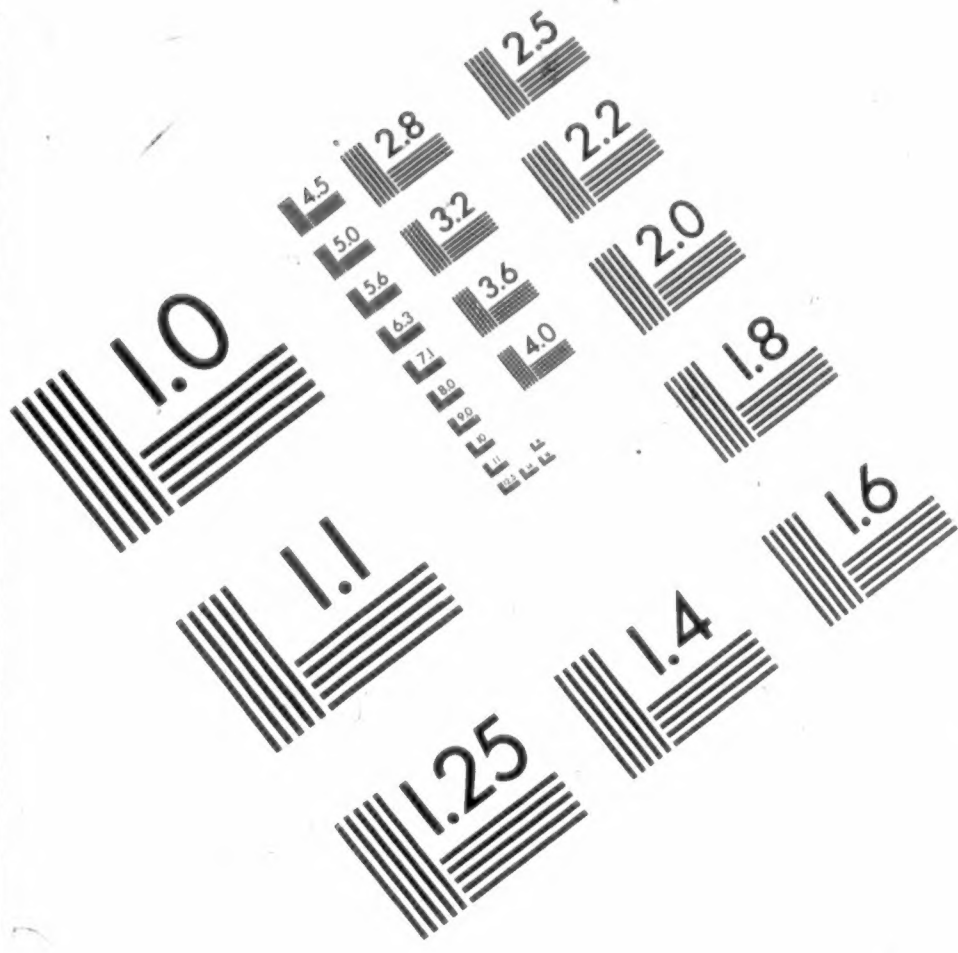

IMAGE EVALUATION TEST TARGET (QA-3)



APPLIED IMAGE, Inc
1653 East Main Street
Rochester, NY 14609 USA
Phone: 716/482-0300
Fax: 716/288-5989

© 1993, Applied Image, Inc., All Rights Reserved

THE END

PLEASE

REWIND