

NATIONAL
ARCHIVES
MICROFILM
PUBLICATONS

IMAGE EVALUATION TEST TARGET (QA-3)

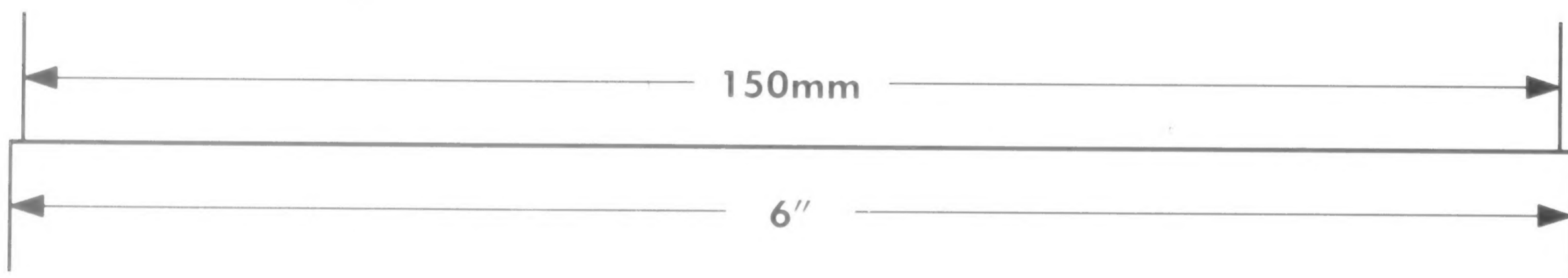
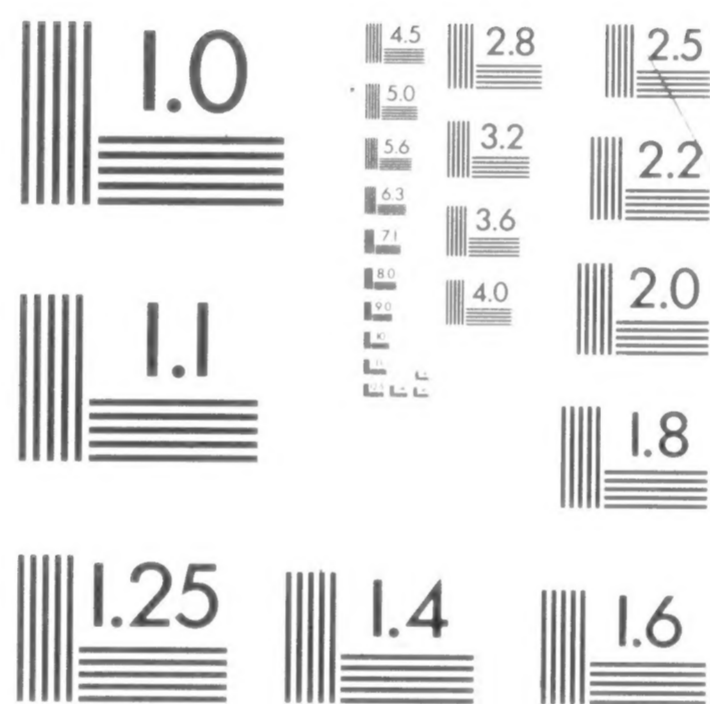
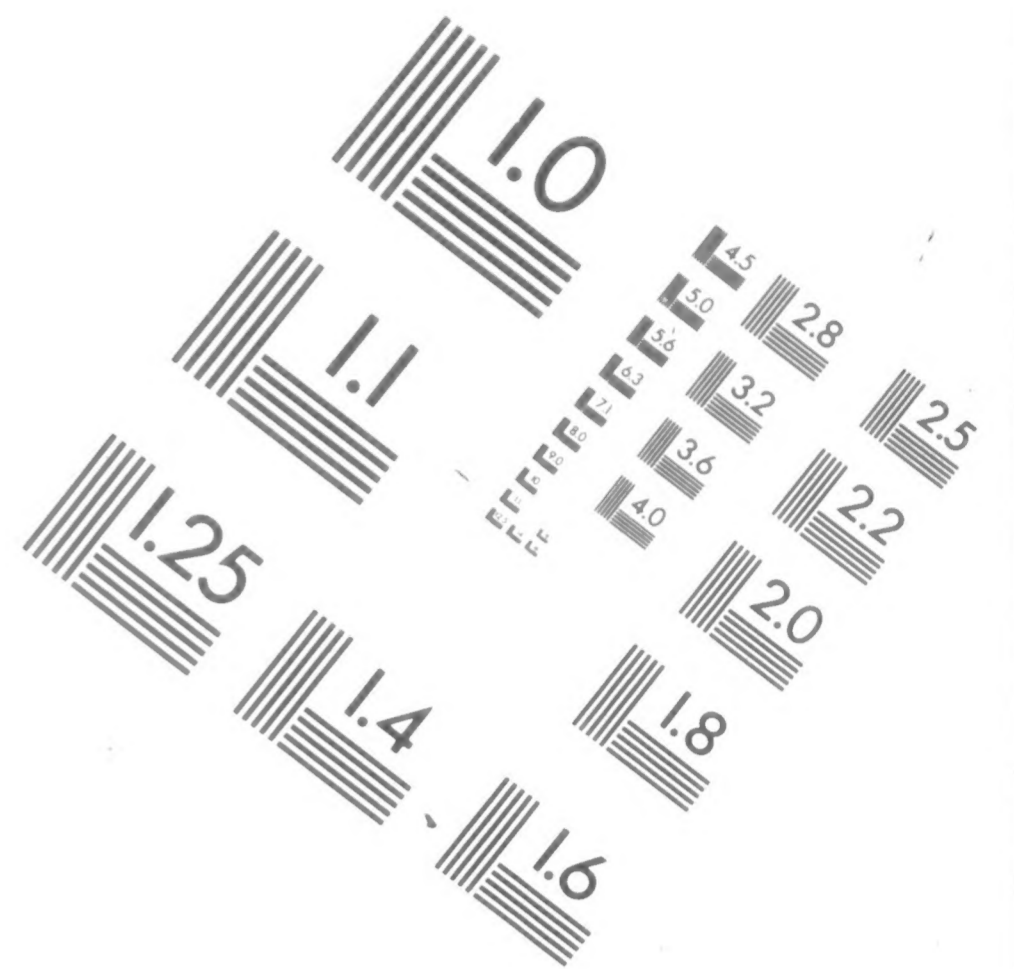
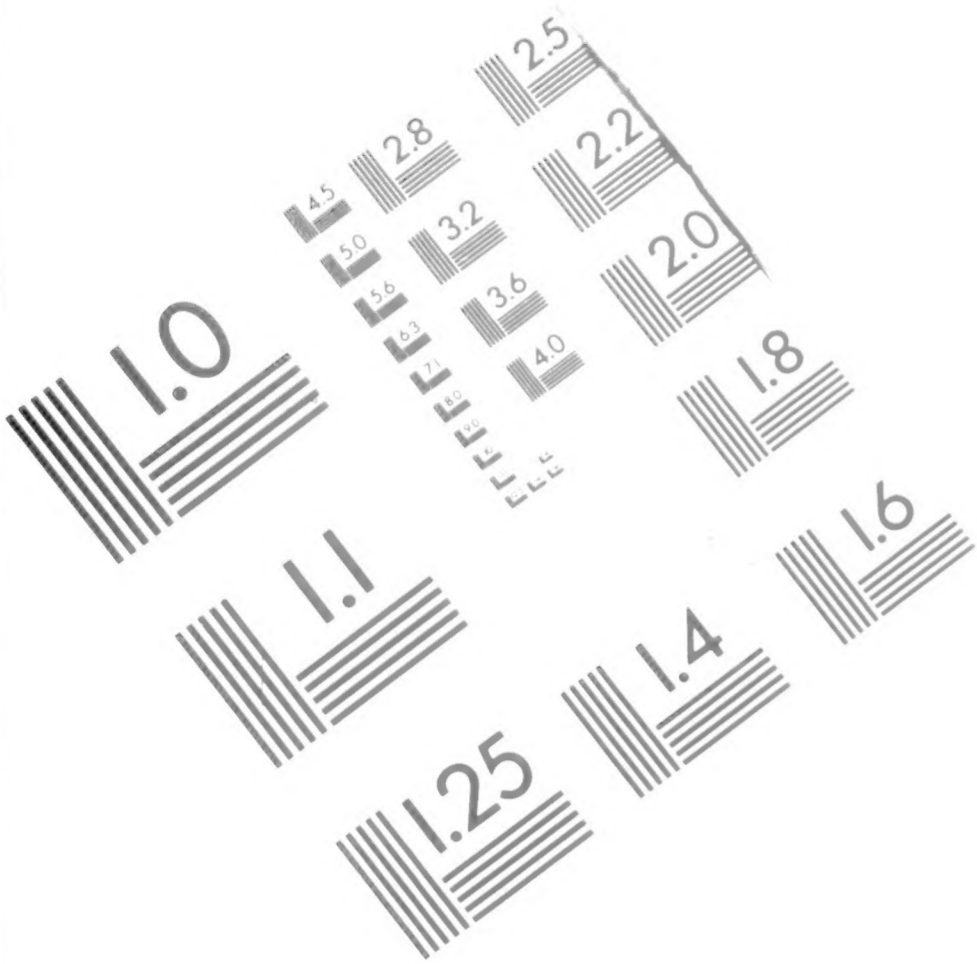

APPLIED IMAGE, Inc
1653 East Main Street
Rochester, NY 14609 USA
Phone: 716/482-0300
Fax: 716/288-5989

© 1993, Applied Image, Inc., All Rights Reserved

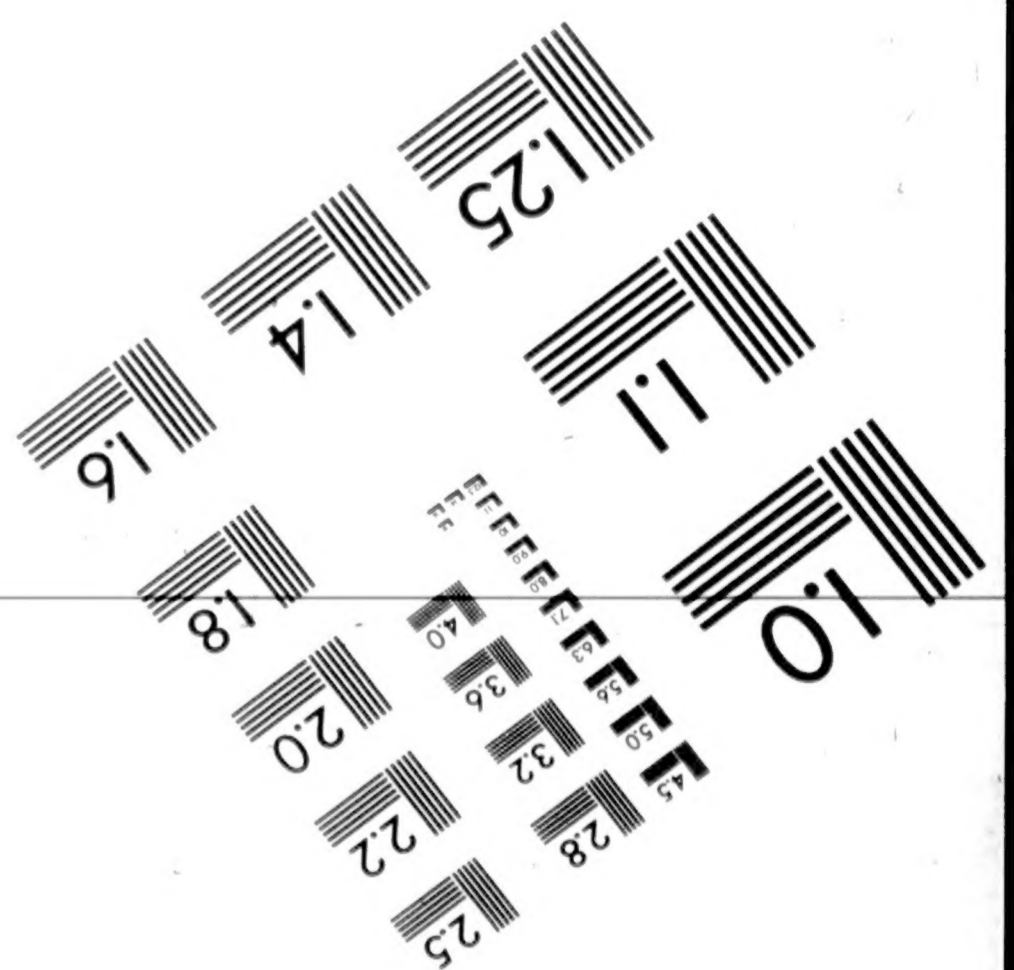
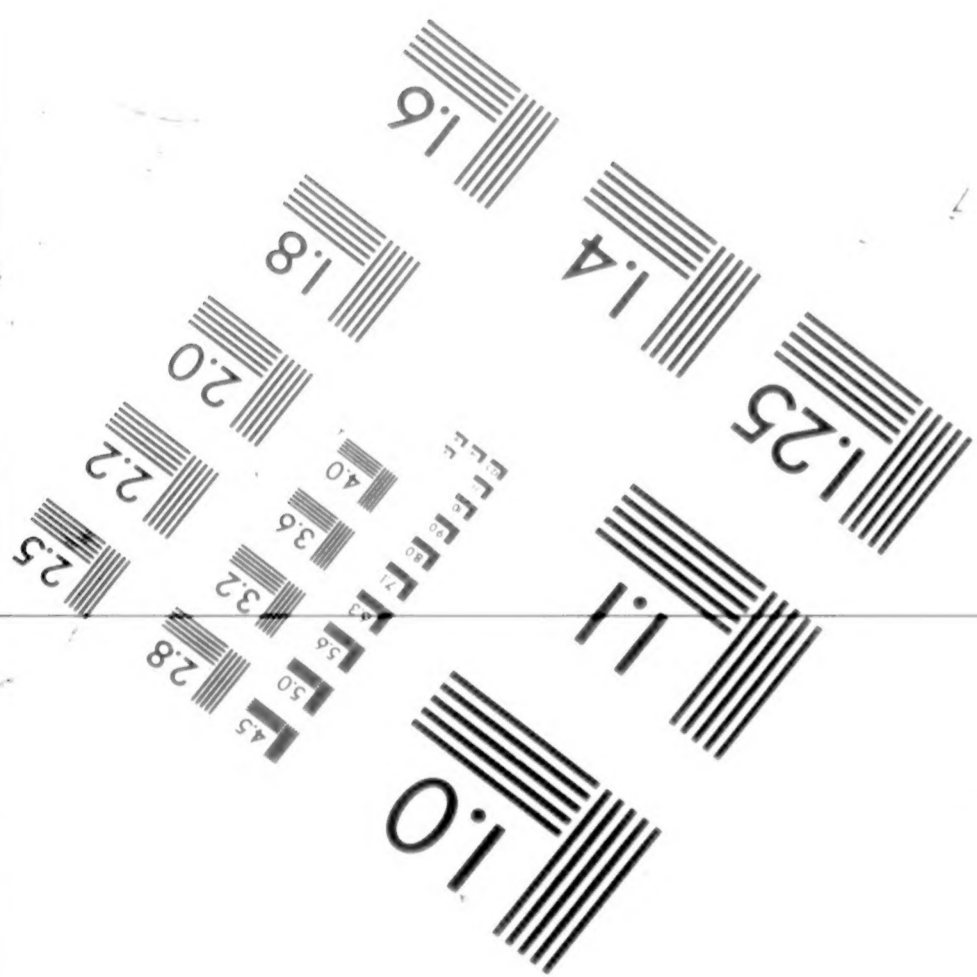

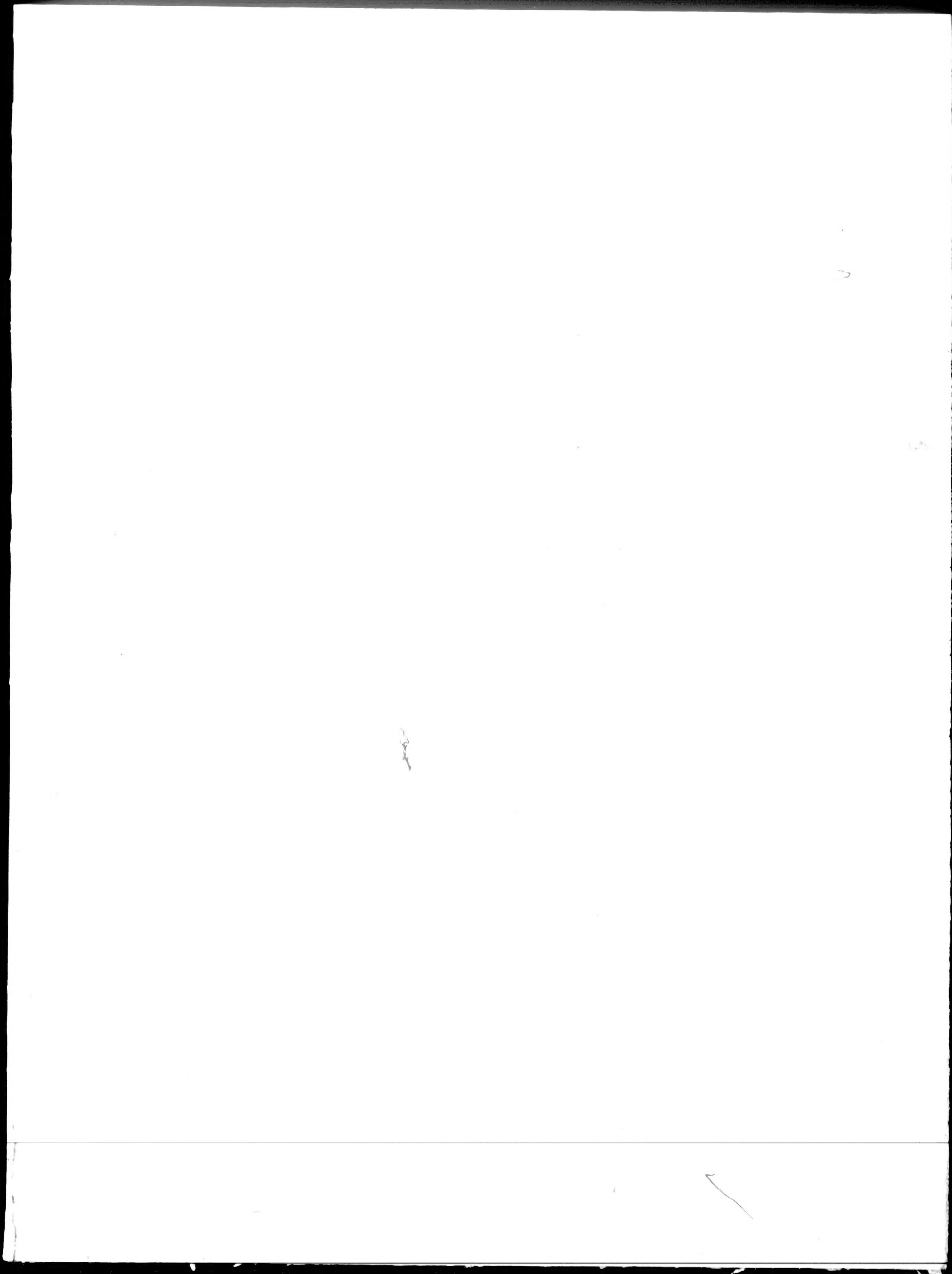

National Archives at College Park



8601 Adelphi Road College Park MD 20740-6001

Rebecca Sullivan

Z3

OPERATOR

CAMERA

October 15, 1997

10

DATE FILMED

REDUCTION RATIO

35mm

FILM EMULSION NUMBER

817

105

PROJECT NUMBER

ROLL NUMBER

MICROCOPY

1 8 1 7

ROLL

1 0 3

M1817

COMPILED MILITARY SERVICE RECORDS OF
VOLUNTEER UNION SOLDIERS WHO SERVED WITH THE
UNITED STATES COLORED TROOPS:
1st Through 5th United States Colored Cavalry
5th Massachusetts Cavalry (Colored)
6th United States Colored Cavalry

Introduction by Michael E. Pilgrim

Records prepared for microfilming by members of
the Civil War Conservation Corps

Budge Weidman, Project Director

Pat Alfredson	Naomi Glass	Dave Murray
Phyllis Altrogge	Sue Goward*	Ray Puzio
Kenneth Ashton	Bert Greenstein	Bill Schneider
Sue Barnard*	Anne Greenwood	Sylvia Scott
Dee Benson	Jim Harris	Lynn Shearouse
Ann N. Brown	Walter Hayden	Mary Stack-Dunne
Robert Budway	Mary Hayden	Ben Stearns
MaryAnn Castellana*	Pat Ikonen	Bill Stormer*
Mary Lou Cole	Dick Ives	Pat Sullivan
Marjory Cooper	Sarah Jaffe	Gorman Tidball*
Giovanni Croce	Barbara Kemp	Cathy Tinston
B. H. Custer	Bev Manypenny	John Toole
Bob Denney	Frank Masterson	Maryellen Toole
Richard Dow	Joe Mazur	Milt Weatherhead
Yvette Fallin	Sarah McDougall	C. Lois Young
	Ben Miles	

Team leaders are indicated by the asterisk.

National Archives and Records Administration
1997

INTRODUCTION

On the 107 rolls of this microfilm publication, M1817, are reproduced the compiled military service records of volunteer Union soldiers belonging to the 1st through 5th United States Colored Cavalry, the 5th Massachusetts Cavalry (Colored), and the 6th United States Colored Cavalry. While the 5th Massachusetts did retain its state designation, these units were all part of the United States Colored Troops (USCT). The USCT included 7 numbered cavalry regiments; 14 numbered artillery regiments; 144 numbered infantry regiments; plus Brigade Bands Nos. 1 & 2 (Corps d'Afrique and US Colored Troops); Powell's Regiment Colored Infantry; Southard's Company Colored Infantry; Quartermaster Detachment; Pioneer Corps, 1st Division, 16th Army Corps; Unassigned Company A Colored Infantry and Unassigned USCT. The records reproduced are part of the Records of the Adjutant General's Office, 1780's-1917, Record Group (RG) 94.

Background

United States Colored Troops

Since the time of the American Revolution, African Americans have volunteered to serve their country in time of war. The Civil War was no exception. Official sanction was the difficulty. In the fall of 1862 there were four Union regiments of African Americans raised in New Orleans, LA: the 1st, 2d, and 3d Louisiana Native Guard, and the 1st Louisiana Heavy Artillery (African Descent). The 1st South Carolina Infantry (African Descent) was not officially organized until January 1863; however, three companies of the regiment were on coastal expeditions as early as November 1862. Similarly, the 1st Kansas Colored Infantry was not mustered into Federal service until January 1863, even though the regiment had already participated in the action at Island Mound, MO, on October 27, 1862. These early unofficial regiments received little Federal support, but they showed the strength of the African American soldier's desire to fight for freedom.

The first official authorization to employ African Americans in Federal service was the Second Confiscation and Militia Act of July 17, 1862. This act allowed President Abraham Lincoln to receive into the military or naval service persons of African descent and gave him permission to use them for any purpose "he may judge best for the public welfare." However, the President did not authorize use of African Americans until issuance of the Emancipation Proclamation on January 1, 1863.

In late January 1863, Gov. John Andrew of Massachusetts received permission to raise a regiment of African American soldiers. The pace of organizing additional regiments was very slow. In March Secretary of War Edwin M. Stanton sent Gen. Lorenzo Thomas to the lower Mississippi Valley to recruit

free and contraband African Americans. Thomas was given broad authority. He was to explain the administration's policy regarding African American soldiers and recruit volunteers to raise and command them. Stanton wanted all officers of such units to be white, but that policy was softened to allow African American surgeons and chaplains. By the end of the war, in addition to the chaplains and surgeons, there were some 87 African-American officers. Thomas's endeavor was very successful, and on May 22, 1863, the Bureau of Colored Troops was established to coordinate and organize regiments from all parts of the country. Created under War Department General Order No. 143, the bureau was responsible for handling "all matters relating to the organization of Colored Troops." The bureau was directly under the Adjutant General's Office and its procedures and rules were specific and strict. All African American regiments were now to be designated United States Colored Troops (USCT). At this time there were some African American regiments with state names and a few regiments in the Department of the Gulf designated as Corps d'Afrique. All these were ultimately assimilated into the USCT, even though some of the regiments, such as the 5th Massachusetts, retained their state designations.

To facilitate recruiting in the states of Maryland, Missouri, Tennessee, and eventually Kentucky, the War Department issued General Order No. 329 on October 3, 1863. Section 6 of the order stated that if any citizen should offer his or her slave for enlistment into the military service, that person would, "if such slave be accepted, receive from the recruiting officer a certificate thereof, and become entitled to compensation for the service or labor of said slave, not exceeding the sum of three hundred dollars, upon filing a valid deed of manumission and of release, and making satisfactory proof of title." For this reason, some records of manumission are contained in the compiled service records reproduced in this publication.

The USCT fought in 39 major engagements and over 400 lesser ones. Sixteen African American soldiers received Medals of Honor. As it was in other units, the death toll from disease was very high in the USCT. Deaths from disease and battle totaled 37,000. The last regiment of the USCT was mustered out of Federal service in December 1867.

Important sources for information about African American units in the Civil War are the War Department's *The War of the Rebellion: A Compilation of the Official Records of the Union and Confederate Armies* (Washington, DC: 1880-1901; reprinted Harrisburg, 1971 and 1985) and the Navy Department's *The War of the Rebellion; A Compilation of the Official Records of the Union and Confederate Navies* (Washington, DC: 1874-1922; reprinted Harrisburg, 1971 and 1985). These multivolume works contains reports of operations and other official correspondence.

1st United States Colored Cavalry

This regiment was organized at Camp Hamilton, VA, on December 22, 1863, and assigned to duty in the Department of Virginia and North Carolina. The 1st participated in Gen. Benjamin F. Butler's operations on the south side of the James River and against Petersburg and Richmond, May 4-28, 1864. These included the capture of Bermuda Hundred and City Point, VA, on May 5, and events leading up to and including the siege of Petersburg. In August 1864 it was transferred to the defenses of Portsmouth, District of Eastern Virginia. On June 10, 1865, the 1st sailed from City Point, VA, to Texas where it was assigned duty on the Rio Grande and various other areas of the state. The unit was mustered out on February 4, 1866. Compiled casualty figures are not available.

2d United States Colored Cavalry

This regiment was organized at Fort Monroe, VA, on December 22, 1863, and assigned to duty in the Department of Virginia and North Carolina. The 2d participated in Gen. Benjamin F. Butler's operations on the south side of the James River and against Petersburg and Richmond, May 4-28, 1864. These included the capture of Bermuda Hundred and City Point, VA, on May 5, and events leading up to and including the siege of Petersburg. In February 1865 it was transferred to Norfolk, District of Eastern Virginia. On June 10, 1865, the 2d sailed from City Point, VA, to Texas where it was assigned duty on the Rio Grande and various other areas of the state. The unit was mustered out on February 12, 1866. Losses included 19 killed in action and 161 dead from disease and other causes.

3d United States Colored Cavalry

Organized at Vicksburg, MS, on October 9, 1863, as the 1st Mississippi Cavalry (African Descent), this regiment was redesignated the 3d U.S. Colored Cavalry on March 11, 1864. From its organization until March 1864, the unit was attached to the District of Northeast Louisiana and from January to March 1864 participated in operations up the Yazoo River and the occupation of Yazoo City. The regiment was then transferred to the District of Vicksburg, Department of Tennessee, where it remained until December 1864. That month the unit moved to Memphis, TN, and from December 21, 1864, to January 5, 1865, participated in Gen. Benjamin Grierson's raid to destroy the Mobile & Ohio Railroad. The 3d remained on duty in Memphis and the District of West Tennessee and took part in the expedition from Memphis to Brownsville, MS, April 23-26, 1865. On April 29 the regiment returned to Vicksburg and operated around Natchez in search of fugitive Confederate President Jefferson Davis. The unit remained in the District of West Tennessee and Department of Mississippi until January 26, 1866, when it was mustered out. Losses included 37 killed in action and 367 dead from disease and other causes.

4th United States Colored Cavalry

Organized on September 12, 1863, as the 1st Corps d'Afrique Cavalry, this regiment was redesignated the 4th United States Colored Cavalry on April 4, 1864. From its organization until August 1864, it was attached to the Defenses of New Orleans, Department of the Gulf. On August 8, 1864, the 4th was ordered to Baton Rouge, LA, District of Port Hudson, and remained on duty at that post until July 1865 when it was transferred to the Department of Mississippi. It performed duties at various points in that department until it was mustered out on March 20, 1866. Compiled casualty figures are not available.

5th United States Colored Cavalry

This regiment was organized at Camp Nelson, KY, on October 24, 1864, and attached to the 1st Division, District of Kentucky, Department of Ohio. December 10-29, 1864, it participated in Stoneman's Raid into southwestern Virginia, including the capture of Saltville and the destruction of saltworks on December 20-21. In February 1865 the regiment was transferred to the Military District and Department of Kentucky until December of that year when it was ordered to the Department of Arkansas. During the latter period the unit performed mostly garrison duty. The regiment was mustered out March 20, 1866. Losses included 35 killed in action and 152 dead from disease and other causes.

5th Massachusetts Cavalry (Colored)

This regiment was organized at Camp Meigs, Reedville, MA, in the spring of 1864, and sent to Washington, DC, in May of that year. On May 13 the regiment moved to City Point, VA, where it was attached to the 18th Army Corps. Until June 16 it functioned as an infantry unit and participated in the siege of Petersburg. On June 30 it was moved to Point Lookout, MD, to guard prisoners of war. In July 1864 the regiment, still at Point Lookout, became part of the 22d Army Corps. It was transferred to the 25th Army Corps in March 1865 and ordered to the field near Richmond and Petersburg. In June the regiment was ordered to the Department of Texas where it was assigned duty at Clarksville until October 31, 1865, when it was mustered out. Losses included 7 men killed in action and 116 dead from disease and other causes.

6th United States Colored Cavalry

This regiment was organized at Camp Nelson, KY, on October 24, 1864, and attached to the 1st Division, District of Kentucky, Department of Ohio. December 10-29, 1864, it participated in Stoneman's Raid, including the destruction of the lead mines in southwestern Virginia. At the end of December the regiment returned to Camp Nelson and in February 1865 was transferred to the Military District and Department of Kentucky. It remained there until December

1865 when it was ordered to the Department of Arkansas. The unit was mustered out on April 15, 1866. Compiled casualty figures are not available.

Records Description

Compiled service records consist of a jacket-envelope for each soldier, labeled with his name, rank, unit, and card numbers. The compilation of service records of Union soldiers began in 1890 under the direction of Col. Fred C. Ainsworth, head of the Record and Pension Office of the Adjutant General's Office, Department of War. Information from muster rolls, regimental returns, descriptive books, and other records was copied verbatim onto cards. A separate card was prepared each time an individual name appeared on a document. These cards were numbered on the back, and these numbers were entered onto the outside jacket containing the cards. The carded information was verified by a separated operation of comparison; great care was taken to ensure that the cards were accurate.

A typical jacket contains card abstracts of entries found in original records relating to the soldier and original documents relating solely to that soldier. Examples of the latter include enlistment papers, substitute certificates, casualty sheets, death reports, prisoner-of-war memorandums, and correspondence. Unique to the records of the USCT are deeds of manumission, oaths of allegiance, proof of ownership, certificates of monetary award, and bills of sale. These items appear most frequently in units recruited in the border states of Kentucky, Missouri, and Maryland. These states remained in the Union but were slave states. Jackets and cards include a section labeled "bookmark" which was reserved for cross-references to other records relating to the individual or his unit. The service records are arranged by arm of service, thereunder numerically by regiment or independent battalion or company and thereunder alphabetically by name of the soldier. Records for officers are interfiled alphabetically by name with the records of enlisted men. If an individual served in more than one unit, which was typical for USCT officers, there will be a separate service record for each unit in which he served.

Related Records

Among the records of the Adjutant General's Office in the National Archives are many of the original records that were abstracted or "carded" by the Record and Pension Office. These include the individual unit's muster rolls, returns and descriptive books. Other series in RG 94 that contain information relating to volunteer Union soldiers who served with the USCT include carded records relating to Union staff officers, carded medical records of volunteer Union soldiers, unbound and bound regimental records and "record of events" cards. The regimental records of the 54th Massachusetts Infantry (Colored) have been

NATIONAL ARCHIVES MICROFILM PUBLICATIONS

reproduced as Microfilm Publication M1659, *Records of the Fifty-fourth Massachusetts Infantry Regiment (Colored), 1863-1865*.

The "record of events" cards include information copied from the unit's muster rolls and returns. They show the stations of the field and staff and those of the various companies of the regiment at the time the muster roll or return was prepared and sometimes mention battles, skirmishes, or other activities in which the regiment participated. The cards have been reproduced as Microfilm Publication M594 *Compiled Records Showing Service of Military Units in Volunteer Union Organizations*.

Record Group 94 also includes a card index for the USCT, reproduced as Microfilm Publication M589, *Index to Compiled Military Service Records of Volunteer Union Soldiers Who Served with U.S. Colored Troops*, which may be used to locate the regiment of USCT personnel. An index card gives the name of the soldier and his rank, as well as the unit in which he served; sometimes there is a cross-reference to his service in other units or organizations. The National Archives is continually producing microfilm publications of volunteer Union compiled military service records. A complete listing of finished publications can be found in the National Archives' *Microfilm Resources for Research: A Comprehensive Catalog* which is available online at <http://www.nara.gov>.

The Records of the Colored Troops Division, within RG 94, include division correspondence and records relating to recruiting, the appointment of officers, and the slave or free status of individuals; and a compilation of historical extracts and official papers concerning the military service of African Americans from the colonial period through the Civil War entitled *The Negro in the Military Service of the United States 1639-1886*. This compilation is reproduced as Microfilm Publication M858. The Records of the Bounty and Claims Division, also in RG 94, include correspondence of the division and records relating to bounties and claims paid to loyal owners of slaves by the Slave Claims Commissions of Delaware, Kentucky, Maryland, Missouri, Tennessee and West Virginia.

If an application for a pension was made, the pension application case file may be among the Records of the Veterans Administration (RG 15). Indexes to the pension applications have been reproduced as Microfilm Publication T288, *General Index to Pension Files, 1861-1934*, and T289, *Organizational Index to Pension Files of Veterans Who Served Between 1861 and 1900*.

If a soldier or officer was tried before a general court-martial or if an individual or his unit was the subject of a court of inquiry or military commission, transcripts of the proceedings may be among the Records of the Office of the Judge Advocate General (Army) (RG 153). The registers to the proceedings have been reproduced as Microfilm Publication M1105, *Registers of the Records of the Proceedings of the U.S. Army General Courts-Martial, 1809-1890*.

Other record groups having information pertaining to the USCT include Records of the Bureau of Refugees, Freedmen, and Abandoned Lands (RG 105); Records of the Provost Marshal General's Bureau (Civil War) (RG 110); Records of the Accounting Officers of the Department of the Treasury (RG 217); and Records of U.S. Army Continental Commands, 1821-1920 (RG 393).

NATIONAL ARCHIVES MICROFILM PUBLICATIONS

ROLL LIST

Roll Description

1st United States Colored Cavalry

- 1 Akess, Alexander - Bom, John H.
- 2 Bomer, James - Cartwright, John
- 3 Casey, Thomas - Davenport, John J.
- 4 Davis, Augustus - Floyd, George
- 5 Fly, Benjamin - Griffin, Oliver
- 6 Griffin, Quinton - Holstead, Peter
- 7 Holt, George - Jones, Herbert
- 8 Jones, Howell - Macoy, Peter
- 9 Madry, Andrew - Mosley, Jacob
- 10 Moss, James - Polk, James
- 11 Pollard, Sipio - Sales, William
- 12 Sample, Abram (Abraham) - Smith, Ives
- 13 Smith, James - Times, Nelson
- 14 Tines, Archer - Wheldon, Charles M.
- 15 Whitby, Joseph - Wilson, Isaac
- 16 Wilson, James - Zoe (no first name)

2d United States Colored Cavalry

- 17 Abbot, John - Bell, Charles
- 18 Bell, Henry - Burns, Richard
- 19 Burroughs, George L. - Cotton, Samuel
- 20 Coues, Alexander - Duncan, Levi
- 21 Dunkins, Ezikiah James - Gardner, Richard
- 22 Garris, Henry - Harrison, Thomas
- 23 Harrison, William - Humphries, David
- 24 Hunter, Francis - Jones, Robert
- 25 Jones, Robert F. - Martin, Robert (Martin)
- 26 Martin, Thaddeus or Martin, Thaddeus W. - Osborne, Henry S.
- 27 Oulden, Jacob - Prior, Edward or Edmund
- 28 Proctor, David - Sawyer, Wilson
- 29 Scabber, Charles - Stanley, William
- 30 Stanley, Wright or Right - Upshear, Neverson
- 31 Upshear, Samuel - Whites, Joe
- 32 Whites, Silas - Zodrick, Isaiah A. or Isaiah

3d United States Colored Cavalry

- 33 Aaron, John - Black, David
- 34 Black, Richard - Cameron, Wyatt

NATIONAL ARCHIVES MICROFILM PUBLICATIONS

Roll Description

- 35 Cammel, Austin - Cooper, Stephen
- 36 Coran, Joseph - Erving, Tilson
- 37 Erwin, Anderson - Gool, George
- 38 Gordon, Alfred - Haskins, Jasper
- 39 Hawkins, Frank - Jackson, Harvey
- 40 Jackson, Henry - Kembro, Abraham
- 41 Kenedy, Lemuel - Lott, Judge
- 42 Lott, Matton - Mitchell, Berry
- 43 Mitchell, George - Pettis, Edmond
- 44 Pettis, George - Roberson, Jefferson
- 45 Roberson, Wallace - Simpson, Levi
- 46 Sims, Anderson - Taylor, Phillip
- 47 Taylor, Richard - Washington, Isaac
- 48 Washington, Oscar - Williams, Mitchel
- 49 Williams, Moses - Young, Mathew

4th United States Colored Cavalry

- 50 Abraham, Randall - Blanchan, William
- 51 Blanchard, Moses - Clark, Moses
- 52 Clark, Theodore - Ellars, James
- 53 Ellars, John - Heath, Culbert
- 54 Henderson, George - Johnson, Henderson
- 55 Johnson, Henry - Mayberry, Nelson
- 56 Macomory, John - Oliver, Celestine
- 57 Olsten, Alexander - Robinson, William
- 58 Robinson, William E. - Thomas, Stephen
- 59 Thomas, William - Williams, Horace
- 60 Williams, Isaac - Zulia, Francois

5th United States Colored Cavalry

- 61 Abel, Fletcher - Biggs, Randall
- 62 Birch, Benjamin - Burly, Frank
- 63 Burly, James - Coffman, James D.
- 64 Coke, Samuel - Dudley, John
- 65 Duke, John - Givens, Peter
- 66 Glen, John - Harriden, Edmund
- 67 Harrigan, Harden - Hughes, Thomas
- 68 Hulse, James - Keller, Ephraim
- 69 Kelley, Franklin - Matthews, Benjamin
- 70 Maupin, Preston - Murry, Ned
- 71 Murtney, Morton - Ray, John
- 72 Ray, Thomas - Sherrod, Willlliam

NATIONAL ARCHIVES MICROFILM PUBLICATIONS

Roll Description

- 73 Shrewsbury, Joseph - Stone, John
- 74 Stone, Lewis - Trye, Benjamin
- 75 Trueheart, Samuel - Williams, James
- 76 Williams, Jerry - Yowell, Joseph

5th Massachusetts Cavalry (Colored)

- 77 Abbey, David - Biers, William
- 78 Billings, Jeremiah - Burgess, Williams
- 79 Burnett, Lewis - Cook, Joseph T.
- 80 Cooper, Isaac - Dunmore, William
- 81 Durbin, Stephen - Furman, Seneca A.
- 82 Gadson, James - Gurley, Joseph L.
- 83 Guy, James - Hill, John W.
- 84 Hill, Richard - Johns, Thomas H.
- 85 Johnson, Aaron - Lambert, William
- 86 Lancaster, James - Mason, John
- 87 Mason, John H. - Nelson, Philip
- 88 Nelson, Preston - Preston, Thomas
- 89 Price, Adam - Sampson, George P.
- 90 Sanborn, Madison - Stringer, William
- 91 Strother, Frank - Vance, William H.
- 92 Van Hoesen, Charles - Wilkinson, Simon
- 93 Williams, Abram H. - Young, Thomas

6th United States Colored Cavalry

- 94 Abbot, John - Birch, James
- 95 Bivins, Gabriel - Buckner, George
- 96 Buckner, Henderson - Compton, James
- 97 Cook, Benjamin - Ellis, William
- 98 Ellis, Wyatt - Godley, Isaac
- 99 Gooch, Alexander - Herston, Abraham
- 100 Heywood, John R. - Johnson, Jackson
- 101 Johnson, James M. - Marshall, Lyman
- 102 Marshall, William - Neihardt, Isaac D.
- 103 Nelson, Joseph - Redd, Tiney
- 104 Redway, Hamilton K. - Sebree, Bob Woodcock
- 105 Sebree, Crittenden - Sumpter, John
- 106 Sutherland, Williams - Washington, Charles
- 107 Washington, George - Wren (no first name)

NATIONAL ARCHIVES MICROFILM PUBLICATIONS

Microfilm Publication M1817

COMPILED MILITARY SERVICE RECORDS OF VOLUNTEER UNION
SOLDIERS WHO SERVED WITH THE UNITED STATES COLORED
TROOPS: 1st Through 5th United States Colored Cavalry, 5th Massachusetts
Cavalry (Colored), 6th United States Colored Cavalry

Roll 103

6th United States Colored Cavalry

Nelson, Joseph - Redd, Tiney

NATIONAL ARCHIVES AND RECORDS ADMINISTRATION

988

Nelson, Joseph

Co C, 6 U. S. Col'd Cav.

Private Private

CARD NUMBERS.

1	5387155	26
2	5390159	27
3	5390253	28
4	5390912	29
5	9093018	30
6	40732667	31
7		32
8		33
9		34
10		35
11		36
12		37
12		38
14		39
15		40
16		41
17		42
18		43
19		44
20		45
21		46
22		47
23		48
24		49
25		50

Book Mark: EP 7.10.4.584,

See also

A 6 Cav. | U.S.C.T.

Joseph Nelson
....., Co. *C*, 6 Reg't U. S. Col'd Cav.

Appears on

Company Descriptive Book

of the organization named above.

DESCRIPTION.

Age *21* years; height *5* feet *5* inches.

Complexion *Blk*

Eyes *Blk*; hair *Blk*

Where born *Ivy*

Occupation *Farmer*

ENLISTMENT.

When *Oct 4*, 186*4*.

Where *Camp Nelson*

By whom *J. C. Randolph*, term *3* y'rs.

Remarks:

.....

.....

.....

.....

.....

.....

.....

.....

.....

.....

.....

.....

.....

.....

.....

.....

.....

.....

.....

.....

.....

.....

.....

.....

.....

.....

.....

.....

Bryner

(383g)

Copyist.

N | **6 Cav.** | **U.S.C.T.**

Joseph Nelson

Appears with rank of *Priv.* on

Muster and Descriptive Roll of a Detachment of U. S. Vols. forwarded

for the 6 Reg't U. S. Col'd Cavalry. Roll dated

Camp Nelson Ky. Oct. 27, 1864.

Where born *Kentucky*

Age *21* y'rs; occupation *Farmer*

When enlisted *Oct. 4*, 1864.

Where enlisted *Camp Nelson Ky.*

For what period enlisted *3* years.

Eyes *Blk*; hair *Blk*

Complexion *Blk*; height *5* ft. *3* in.

When mustered in *Oct. 4*, 1864.

Where mustered in *Camp Nelson Ky.*

Bounty paid \$ *100*; due \$ *100*

Where credited

Company to which assigned

Remarks: *Credited to Jessamine Co.*

7 Dist. Ky.

Jefferson Dilaha, Owner.

Book mark:

C. E. M. Laughlin

N **6 Cav. U.S.C.T.**

Joseph Nelson

Co. C, Co. *C*, 6 Reg't U. S. Col'd Cavalry.

Appears on

Company Muster-in and Descriptive Roll

of the organization named above. Roll dated

Camp Nelson, Ky, ~~Nov~~ *Nov*, 1864.

Where born *Kentucky*

Age *21* y'rs; occupation *Farmer*

When enlisted *Oct 27*, 186 .

Where enlisted *Camp Nelson Ky*

For what period enlisted *3* years.

Eyes *Black*; hair *Black*

Complexion *Black*; height *5* ft. *5* in.

When mustered in *Oct 4*, 186 .

Where mustered in *Camp Nelson*

Bounty paid \$ *100*; due \$ *100*

Where credited *7" Dist Ky*

Company to which assigned *C*

Remarks:

Book mark:

W G House

(356d)

Copyist.

6 Cav. U.S.C.T.

John T. ...
John T. ...
Co. C, 6 Reg't U. S. Colored Cavalry.

Appears on

Company Muster Roll

for *July 1864*, 1864.

Present or absent

Stoppage, \$ 100 for

Due Gov't, \$ 100 for

Valuation of horse, \$ 100

Valuation of horse equipments, \$ 100

Remarks: *Living at ...*
...

Book mark:

...
...

7 | **6 Cav.** | **U.S.C.T.**

Joseph Nelson
Co. C, 6 Reg't U. S. Col'd Cav.

Appears on Returns as follows:

Dec 1864 Dec 20 64
Painville Ky Died
in Hosp

Book mark:

J. B. Daugh
(546) Copyist.

07 | **6 Cav.** | **U.S.C.T.**

Joseph Nelson
Co. *C*, 6 Reg't U. S. Col'd Cavalry.

Appears on **Co. Muster-out Roll**, dated *Howards Bluff Ark. Apr. 15*, 1866.

Muster-out to date _____, 186 .

Last paid to *Pay due for Enlistment*, 186 .

Clothing account:

Last settled _____, 186 ; drawn since \$ _____ 100

Due soldier \$ _____ 100; due U. S. \$ _____ 100

Am't for cloth'g in kind or money adv'd \$ _____ 100

Due U. S. for arms, equipments, &c., \$ _____ 100

Bounty paid \$ _____ 100; due \$ *100* 100

Remarks: *died Gaintville Ky*
Dec. 30 64
Final statement forwarded
accordg to law.

Book mark: *died Dec. 20/64 EB.V.10.P.584.*

W. H. Ferguson
(861) Copyist.

Nelson, Joseph
Co. C, 6 U.S.C. Cav.

3 Enclosures.

Bed Cards	Descriptive Lists
Burial Records	Final Statements
Certs. of Dis. for Discharge	Furloughs
C. M. Charges	Med. Des. Lists
Med. Certificates	Orders

Other papers relating to—

Admission to Hosp'l	Furlough
Casualty Sheet (Officer's)	Med. Examination
Confinement	Misc. Information
Contracts	Pay or Clothing
Death or Effects 2	Personal Reports
Desertions	Rank
Discharge from Hosp'l	Transfer to Hosp'l
Discharge from Service	Transfer to V. R. C.
Duty	Transportation

ARTICLES OF WAR.

ART. 95. When any non-commissioned officer or soldier shall die, or be killed in the service of the United States, the then commanding officer of the troop or company shall, in the presence of two other commissioned officers, take an account of what effects he died possessed of, above his arms and accoutrements, and transmit the same to the office of the Department of War, which said effects are to be accounted for, and paid to the representatives of such deceased non-commissioned officer or soldier. And in case any of the officers, so authorized to take care of the effects of deceased officers and soldiers, should, before they have accounted to their representatives for the same, have occasion to leave the regiment or post, by precept or otherwise, they shall, before they be permitted to quit the same, deposit in the hands of the commanding officer, or of the assistant military agent, all the effects of such deceased non-commissioned officers and soldiers, in order that the same may be secured for, and paid to, their respective representatives.

ARMY REGULATIONS—EDITION OF 1863.

DECEASED SOLDIERS.

PAR. 152. Inventories of the effects of deceased non-commissioned officers and soldiers, required by the 95th Article of War, will be forwarded to the Adjutant General, by the commander of the company to which the deceased belonged, and a duplicate of the same to the colonel of the regiment. Final statements of pay, clothing, &c., in duplicate, will be sent to the Adjutant General with one copy of the inventory. When a soldier dies at a post or station absent from his company, it will be the duty of his immediate commander to furnish the required inventory and final statements, and, at the same time, to forward to the commanding officer of the company to which the soldier belonged, a report of his death, specifying the date, place, and cause; to what time he was last paid, and the money or other effects in his possession at the time of his decease; which report will be noted on the next muster roll of the company to which the man belonged. Each inventory will be endorsed, "Inventory of the effects of _____, late of company (—) _____ regiment of _____, who died at _____, the _____ day of _____, 186—." If a legal representative receive the effects, it will be stated in the report. If the soldier leave no effects, the fact will be reported.

PAR. 153. Should the effects of a deceased non-commissioned officer or soldier not be administered upon within a short period after his decease, they shall be disposed of by a Council of Administration, under the authority of the commanding officer of the post, and the proceeds deposited with the Paymaster, to the credit of the United States, until they shall be claimed by the legal representatives of the deceased.

PAR. 154. In all such cases of sales by the Council of Administration, a statement in detail, or account of the proceeds, duly certified by the Council and commanding officer, accompanied by the Paymaster's receipt for the proceeds, will be forwarded by the commanding officer to the Adjutant General. The statement will be endorsed, "Report of the proceeds of the effects of _____, late of company (—) _____ regiment of _____, who died at _____, the _____ day of _____, 186—."

NOTE 1.—The effects in all cases, when called for, should be turned over to the legal representative, without further authority from the Adjutant General. When the effects are turned over to the relatives of the deceased before these inventories are sent to the Adjutant General, their receipts therefor should be attached to the inventories. In all other cases, one copy will be sent with a letter of transmittal direct to the Adjutant General, and a duplicate retained by the officer.

NOTE 2.—Particular care should be taken to take receipts in duplicate from the Paymaster for any funds turned over to him; one copy should be sent direct to the Adjutant General and one retained by the officer.

INVENTORY OF THE EFFECTS

OF

Joseph Nelson

Late of Company "B"

5th Reg't of U.S. Colored Troop.

~~Private~~ who died at Parrotville Ky.

on the 20th day of December 1864.

Inventory of the effects of Joseph Nelson late
 a Private of Captain Sam. J. Fitch's Company 10 of
 the 5th Regiment of W. S. Blair's ~~Volunteers~~, who was enrolled as
 a Recruit at Camp Nelson in the State of Kentucky on
 the 4th day of October 1864, and mustered into the service of the United
 States as a Soldier on the 4th day of October 1864, at Camp Nelson
 in Company —, 5th Regiment of W. S. Blair's ~~Volunteers~~, to serve three
 years or during the war; he was born in _____ in the State
 of Kentucky; he was 21 years of age, 5 feet 5 inches
 high, Rbk complexion, Rbk eyes, Rbk hair, and by occupation, when enrolled,
 a Farmer; he died in Hospital, at
Paintville on the 20th day of Dec. 1864, by
 reason of _____

INVENTORY.					
ARTICLES.	No.	ARTICLES.	No.	ARTICLES.	No.
Hats.....		Pairs trousers.....		Knapsacks.....	
.....		Pairs flannel drawers.....			
Forge Caps.....				
Great coats.....		Flannel shirts.....			
Uniform coats.....		Cotton shirts.....			
Uniform jackets.....		Pairs boots.....			
Flannel sack coats.....		Pairs shoes.....			
Blouses.....		Pairs socks.....			
Sable frocks.....		Blankets.....			
Fatigue overalls.....		Haversacks.....			
				MONEY.	
					Specie.....
				Notes.....	\$

I CERTIFY, ON HONOR, that the above inventory comprises all the effects of _____
 _____, deceased, and that the effects are in the hands
 of _____ at _____
 _____ to be disposed of by a Council of Administration.

(DUPLICATES.)

Geo. W. Bates
1st Lieut. Co. 5th W. S. Blair's
 Commanding the Company.

STATION: Lexington Ky
 DATE: August 23rd 1865

Extract from Act of Congress.

SEC. 12. And be it further enacted, That the fees of agents and attorneys for making out and causing to be executed the papers necessary to establish a claim for a pension, bounty, and other allowance before the Pension Office, under this act, shall not exceed the following rates: For making out and causing to be duly executed a declaration by the applicant, with the necessary affidavits, and forwarding the same to the Pension Office, with the requisite correspondence, ten dollars: which sum shall be received by such agent or attorney in full for all services in obtaining such pension, and shall not be demanded or received, in whole or in part, until such pension shall be obtained; and the sixth and seventh sections of an act entitled "An act to grant pensions," approved July [fourteenth.] eighteen hundred and sixty-two, are hereby repealed.

SEC. 13. And be it further enacted, That any agent or attorney who shall, directly or indirectly, demand or receive any greater compensation for his services under this act than is prescribed in the preceding section of this act, or who shall contract or agree to prosecute any claim for a pension, bounty, or other allowance under this act, on the condition that he shall receive a per centum upon any portion of the amount of such claim, or who shall wrongfully withhold from a pensioner or other claimant the whole or any part of the pension or claim allowed and due to such pensioner or claimant, shall be deemed guilty of a high misdemeanor, and, upon conviction thereof, shall, for every such offense, be fined not exceeding three hundred dollars, or imprisoned at hard labor not exceeding two years, or both, according to the circumstances and aggravations of the offense.

Approved July 4, 1864.

NOTE 10.—If any soldier is charged a higher fee than that allowed by the above act, he should report the fact and the name of the agent to the Adjutant General, in order that steps may be taken to have the same refunded.

FINAL STATEMENT

OF
Private
Joseph Nelson Leale
Reg't of W. G. Leale's Col. 6th Reg't U. S.
Colored Cavalry

VOLUNTEERS.

See Ser 20

NOTE 1.—Two of these certificates (or duplicates) are to be given to each Volunteer Soldier or drafted man who may be discharged without being mustered out. (Final Statements are never given to men mustered out of service) that he may at once receive from the Paymaster the pay, &c., due him, and the captain or other COMMISSIONED officer commanding the company will certify to the act of the delivery of the duplicate certificates; with these certificates the Soldier is "entitled to" his discharge, and should also present his discharge to the Paymaster to have the payment endorsed on it. The discharge is to be given back to the Soldier by the Paymaster; the latter only retaining as his vouchers the duplicate certificates.

NOTE 2.—If the Soldier is entitled to pay for the use of his horse, the Company Commander will certify to that fact on the back of both these final statements, and also to the time he has pay due for having been so mounted on his own horse.

NOTE 3.—When a Soldier is furnished with final statements, his descriptive list, if he has one, should be taken up by the officer who gives the Soldier these statements, and endorsed with a statement to this effect by the officer. The endorsement should exhibit a full statement of the time for which the Soldier was allowed pay on his final statements, the clothing account, and all other charges against him or in his favor, so as to comprise a complete exhibit of his account. It will then be transmitted to the Company Commander of the Soldier, who will enter all the data necessary to a full understanding of the Soldier's account on the muster roll upon which the Soldier's discharge is reported. The descriptive list will then be destroyed. The object of this is, that the remaining portion of the Soldier's account may be settled upon the receipt of these muster rolls, and the Soldier receive any pay or allowances that may be due him at the time of his discharge, and which may not appear on his last final statements from the fact that his descriptive list is incomplete. These accounts for back pay, &c., are settled by the 2d Auditor of the Treasury Department.

NOTE 4.—Charges for loss or injury to ordnance, horse equipments, and other miscellaneous charges, should appear under the heading of "Other Stoppages."

NOTE 5.—Bounty paid by State authorities, and not by the United States, will not be entered on this statement.

NOTE 6.—Amounts due the Sutler and Laundress must be entered on the muster roll on which the discharge, death, desertion, &c., is reported, as well as on the final statement, otherwise the amount cannot be collected from the United States.

NOTE 7.—This blank will be used for deceased volunteers and drafted men, as well as for others.

NOTE 8.—Where a Soldier dies in Hospital or on detached service, his descriptive list, if he has one, should be sent with his final statements, in duplicate, to the Adjutant General, Washington, D. C.

NOTE 9.—If the soldier is a drafted man or substitute, the space for time, &c., of enrolment, should contain only the word *drafted* or *substitute*, as the case may be. If the Soldier is a "VETERAN," (or RECRUIT,) the words *as a veteran*, (or *recruit*,) as the case may be, should be interlined after the words *mustered into the service of the U. S.* A statement of all the installments of *Veteran* or *Recruit* Bounty RECEIVED by the Soldier must be made on the back of each final statement.

[OFFICE ENDORSEMENT.]

War Department,
ADJUTANT GENERAL'S OFFICE,
February 4th, 1874

The Cloth of Joseph Nelson
Private, Co. C, 6th Reg't U. S.
Colored Cavalry, is reported as follows:—

On Company Muster Roll.
For See Ser 20, 1864, See 20, 1864
Company Muster-out Roll.
December 20, 1864
Company Descriptive Book. _____, 186
Company Morning Reports. _____, 186
Soldier's Final Statement.
December 20, 1864
Soldier's Record of Death and Interment. _____, 186
Soldier's Inventory of Effects. _____, 186
Soldier's Certificate of Disability for Discharge. _____, 186
Soldier's Individual Muster-out Roll. _____, 186
Regimental Return.
For December, 1864, See 20, 1864
Regimental Quarterly Returns. _____, 186
Regimental Descriptive Book. _____, 186
By Surgeon General. _____, 186

See Ser 20, 1864 is held to be the correct date, and the Company Muster-out Roll will be amended accordingly.

Prima facie
It is seen see letter to Adj. Gen.
dated Mar 10 1874
Signed [Signature]

ADJUTANT GENERAL'S OFFICE
Jan 11th, 1864
Duplicats were sent to [unclear]

I certify, on honor, that Joseph Nelson, a Private of
 Captain Sam W. Fitch Company (6) of the 5th Regiment of W. S. 100th Regt
VOLUNTEERS, of the State of _____, born in _____, State
 of Kentucky, aged 21 years; 5 feet 5 inches high; Blk complexion,
Blk eyes, Blk hair, and by occupation a Farmer, who joined for service
 and was enrolled (see Note 9) on the 4th day of October, 1864, at Camp Nelson Ky.
 by J. L. Ran Dolph, for the period of Three years, and mustered into
 the service of the United States on the 4th day of October, 1864, at
Camp Nelson Ky., by Capt. A. L. Kinney; and ~~having served~~
~~HONESTLY and FAITHFULLY with his Company to the present date, is now entitled to a~~
~~DISCHARGE~~ by reason of died at Painville Ky, Dec. 20th 1864

The said Joseph Nelson was last paid by Paymaster
has pay due, to include the from day of Enrollment, 1864, and
~~has pay due him from that time to the present date~~; he is entitled to pay and subsistence for
TRAVELING to place of enrollment, and whatever other allowances are authorized to volunteer
 soldiers, drafted men, or militia, so discharged. He has received from the United States **CLOTHING**
 amounting to Clothing Recd. 100 dollars, since the _____ day of _____,
 1864, when his clothing account was last settled. He has received from the United States
 _____ 100 dollars advanced **BOUNTY**.

There is to be stopped from him, on account of the State of _____, or other
 authorities, for **CLOTHING, &c.**, received on entering service, _____ 100 dollars; and
 for other stoppages, viz: _____

_____ 100 dollars.
 He has been furnished with **TRANSPORTATION** in kind from the place of his discharge to
 _____; and he has been **SUBSISTED** for **TRAVELING** to his
 place of enrollment, up to the _____, 1864.

He is indebted to _____, **SUTLER**, _____ 100 dollars.
 He is indebted to _____, **LAUNDRESS**, _____ 100 dollars.

Given in Duplicate, at Lexington Ky., this 1st day
 of August 1864.

W. S. 100th Regt
1st Lt. W. S. 100th Regt

 Commanding Company.

Joseph Nelson

Co. "C" 6th N. H. Cavalry

Cause of Death not stated
on Gen. Hospital records of 1864

McEunbrook Adjutant General's Office,
COLORED TROOPS BRANCH,

Day C, 1871

Vol. C. T., 187
Wanted in case of Joseph Wilson Private, Co. C,
Reg't 24th Col. Col. Died at Pointville
by 100th Reg't. Please give cause of
death.

Respectfully,
W. A. Woodward
Chief Clerk.
R. J. Walton

Adjutant General's Office,
Record Room
Feb. 12th, 1871

Vol. C. T., 187
Reply in case of Joseph Wilson Private, Co. C,
10th Reg't U. S. Colored Cav.
Cause of death not stated in company or
regimental records.
W.A.

989

Nelson, Giles

Co B, 6 U. S. Col'd Cav.

Private | *Private*

CARD NUMBERS.

1	5387977	26
2	5389648	27
3	5389745	28
4	5389837	29
5	5389927	30
6	5390020	31
7	9092900	32
8	40732668	33
9	32083898	34
10	32079588	35
11	32079607	36
12		37
13		38
14		39
15		40
16		41
17		42
18		43
19		44
20		45
21		46
22		47
23		48
24		49
25		50

Book Mark:

See also *120" used*

8797452. Pogo
L... 217 - ...
S- 2230900 ...

D. F. Miller, Esq.

A 6 Cav. | U.S.C.T.

Miles Nelson

, Co B, 6 Reg't U. S. Col'd Cav.

Appears on

Company Descriptive Book

of the organization named above.

DESCRIPTION.

Age 20 years; height 5 feet 4 inches.

Complexion *Blk*

Eyes *Blk*; hair *Blk*

Where born *Jefferson Ky*

Occupation *Farmer*

ENLISTMENT.

When *Apr 24*, 1867.

Where *Lawson Ky*

By whom *Capt Patridge*; term 3 y'rs.

Remarks: *Mustered in 24 64
at Lawson Ky by Capt
Gusson.*

Breyer

N 120 U.S.C.T.

Miles Nelson
Priv., Co. B, 120 Reg't U.S. Col.

Appears on

Hospital Muster Roll

of 1 Division U. S. A. General Hospital,

at Evansville, Ind.,

for Nov. Dec, 1866.

Attached to hospital:

When _____, 1866.

How employed _____

Last paid by Maj. _____

to _____, 1866.

Bounty paid \$ 100; due \$ 100

Present or absent Present

Remarks: _____

Book mark: _____

N. | 120 | U.S.C.T

Miles Nelson

Privat, Co. B, 120 Reg't U.S.C.T

Appears on

Hospital Muster Roll

of U. S. A General Hospital,

at Evansville, Ind.,

for Jan + Dec, 1865.

Attached to hospital :

When _____, 186 .

How employed _____

Last paid by Maj. Bailey

to for Nov. + Dec, 1865

Bounty paid \$ 100; due \$ 100

Present or absent Present

Remarks: _____

Book mark : _____

Keplinger

N. | 120 | U.S.C.T

Miles Nelson

Out, Co. B, 120 Reg't U.S.C.T

Appears on

Hospital Muster Roll

of U. S. A General Hospital,

at Evansville, Ind.,

for Mar + Apr, 1865.

Attached to hospital :

When _____, 186 .

How employed _____

Last paid by Maj. Turrell

to Feb 28, 1865.

Bounty paid \$ 100; due \$ 100

Present or absent Present

Remarks: _____

Book mark : _____

Specimen

W. C. Law **U.S.C.T.**

Miles Nelson
Co., 6 Reg't U. S. Col'd

Appears on a

Detachment Muster Roll
Unassigned Recruits
of the organization named above

for *June 10 to 30*, 1865.

Station *Camp Nelson Ky*

Present or absent *Present*

Stoppage, \$ *100* for

Due Gov't, \$ *100* for

Valuation of horse, \$ *100*

Valuation of horse equipments, \$ *100*

Remarks *Transferred from 120th Regt
1st Inf - Kentucky State
Troops - see No 20105 dated Hq
Dep't Ky June 10 - 1865*

Book mark :

L. B. Sayre

(357)

Copyist.

6 Cav. U.S.C.T.

Walter Nelson
Co. B, 6 Reg't U. S. Col'd Cavalry.

Appears on

Company Muster Roll

for *July & Aug*, 1865.

Present or absent *present*

Stoppage, \$ *100* for

Due Gov't, \$ *100* for

Valuation of horse, \$ *100*

Valuation of horse equipments, \$ *100*

Remarks: *transferred from Co B to Co A and Co A must be paid No. 05 dated 3rd of Aug. 1865*

Book mark:

(358)

B. A. Harper

Copyist.

M. | **6 Cav.** | **U.S.C.T.**

Walter Smith
Feb, Co. B, 6 Reg't U. S. Col'd Cavalry.

Appears on

Company Muster Roll

for *Sept & Oct*, 186 .

Present or absent *present*

Stoppage, \$ *100* for

Due Gov't, \$ *69* for *C. & E.*

Valuation of horse, \$ *100*

Valuation of horse equipments, \$ *100*

Remarks:

Book mark:

W. J. Purjes
Copyist.

N | **6 Cav.** | **U.S.C.T.**

Miles Nelson

Pt, Co. B, 6 Reg't U. S. Col'd Cavalry.

Appears on

Company Muster Roll

for *Nov & Dec*, 186 *5*

Present or absent *Present*

Stoppage, \$ *100* for

Due Gov't, \$ *100* for

Valuation of horse, \$ *100*

Valuation of horse equipments, \$ *100*

Remarks:

Book mark:

(358) *J. W. Ames* Copyist.

cr. #

6 Cav. U.S.C.T.

Nelson, Miles

Pvt., Co. B, 6 Reg't U. S. Col'd Cavalry.

Appears on

Company Muster Roll

for *January & February*, 1866.

Present or absent *Present*

Stoppage, \$ 100 for

Due Gov't, \$ 100 for

Valuation of horse, \$ 100

Valuation of horse equipments, \$ 100

Remarks:

Book mark:

(258)

J. W. Cross

Copist.

77 | **6 Cav.** | **U.S.C.T.**

Miles Nelson
Co. B, 6 Reg't U. S. Col'd Cav.

Appears on Returns as follows:

July 1865 June 28, 05
Camp Nelson Ky
Transd from 120
U.S. I per S.O. No 105
dated Hd Qrs D.K.
June 21/65

Book mark:

(546) *J. E. Douglas*
Copyist.

N | **6 Cav.** | **U.S.C.T.**

Miles Nelson

Pl, Co. *B*, 6 Reg't U. S. Col'd Cavalry.

Appears on **Co. Muster-out Roll**, dated
De Vails Bluff Ark, Apr. 15, 1866.

Muster-out to date *Apr. 15, 1866.*

Last paid to *July 28, 1866.*

Clothing account:

Last settled _____, 186 ; drawn since \$ 100

Due soldier \$ *11*^{*91*} 100; due U. S. \$ 100

Am't for cloth'g in kind or money adv'd \$ 100

Due U. S. for arms, equipments, &c., \$ *3*^{*54*} 100

Bounty paid \$ *100* 100; due \$ 100

Remarks:
*Transferred from 120th U.S. Co.
I. June 2/65 for S. U. S.
Head Qu. Dept. Tex. June
2/65.*

Book mark: _____

(361) *J. W. Ames* Copyist.

990
Lewis A. Nesmith, Louisville,

Co B, 6 U. S. Col'd Cav.

2nd Lieutenant 2nd Lieutenant

CARD NUMBERS.

1	5387035	26
2	5389966	27
3	9436309	28
4	42621674	29
5	40732670	30
6		31
7		32
8		33
9		34
10		35
11		36
12		37
13		38
14		39
15		40
16		41
17		42
18		43
19		44
20		45
21		46
22		47
23		48
24		49
25		50

Book Mark:

See also

Ac 4, 1585486

D. J. Miller, Esq.

W. H. Coan U.S.C.T.

L. G. Neenick

2nd Reg't Co., 6 Reg't U. S. Col'd Cav

Appears on

Regimental Descriptive Book

(List of Commissioned Officers)

of the regiment named above.

Rank 2nd Lieutenant

Date of appointment Feb 24 1866

Remarks: Mustered
in as "A" Co. "13"
1st Reg't Cavalry
promoted to 2nd Lieut
March 2 1866

H. W. Coan

A | *Co* | *Car.* | **U.S.C.T.**

Louis W. Nesmith

2^d Co. B, 6 Reg't U. S. Col'd *Car.*

Age - years.

Appears on an

Individual Muster-in Roll

of the organization named above. Roll dated
Wells Bluff, Mo, 1866.

Muster-in to date *March 22*, 1866.

Joined for duty and enrolled :

When *March 22*, 1866 .

Where *Wells Bluff*

Period *3* years.

Valuation of horse, \$ 100

Valuation of horse equipments, \$ 100

Remarks: *Appointed from civil life to be 2^d Co. B 6th U.S. Col'd Car. via Andrew, promoted. Reed has accepted appointment*

Book mark :

(over)

J. M. Harmon

JAN. 10

5387035

1891

March 2⁵ 1866.

Joined for Service
and mustn to take
effect. all ch 2 2 / 66.

A | **6 Cav.** | **U.S.C.T.**

Lewis A. Nesmith

2 *Lieut*, Co. *B.*, 6 Reg't U. S. Col'd Cavalry.

Appears on **Co. Muster-out Roll**, dated
De Vello Bluff Ark. Apr. 15, 186*7*.

Muster-out to date _____, 186 .

Last paid to *paid due from enrollment*, 186 .

Clothing account:

Last settled _____, 186 ; drawn since \$ _____ 100

Due soldier \$ _____ 100; due U. S. \$ _____ 100

Am't for cloth'g in kind or money adv'd \$ _____ 100

Due U. S. for arms, equipments, &c., \$ _____ 100

Bounty paid \$ _____ 100; due \$ _____ 100

Remarks: *App'd. 2 Lieut 6" U.S. 66,*
Feby 24/66 Travelling from
Civil life Mustered into this
Co. Mch. 22/66 Travelling allow-
ances to D.M.H. place of residence
when appointed and whose appl-
over

Book mark: _____

(861)

J. W. Jones

Copyist.

JAN. 10

5389966

1891

was received and accepted

N 16 bar 1202.6.5

H. W. Meswith

2^d Lt Co. B. 6 Regt 9th U.S. 6.6

Return

of the Post of De Vall's Bluff, Ark.,

for the month of March, 1866,

dated March 31, 1866,

shows the following with regard to the person
named above:

Post or station

Remarks:

Book mark:

(546)

Curtis Clark

Copyist.

10 | 6 Cav. | U.S.C.T.

L A Hewitt
2 Lt, Co. B, 6 Reg't U. S. Col'd Cav.

Appears on Returns as follows:

Mar 1866 Present joined
by Appt Assigned to
Co. 1 per R. O. No. 23
dated Hd Qrs 6 MS 66
Mar 9 '66

Book mark:

(546)

E Douglas
Copyist.

Nesmith S. A.

2 St., Co. B, 6 Reg't U.S.C. Cav.

1 Enclosures.

Bed Cards	Final Statements
Burial Records	Furloughs or L. of A.
Certs. of Dis. for Discharge	Med. Certificates
C. M. Charges	Med. Des. Lists
Descriptive Lists	Orders
Discharge Certificates	Pris. of War Record
Enlistment Papers	Resignations

Other papers relating to—

Admission to Hosp'l	Furlough or L. of A.
Casualty Sheet	Med. Examination
Confinement	Misc. Information
Contracts	Pay or Clothing
Death or Effects	Personal Reports
Desertion	Rank
Discharge from Hosp'l	Transfer to Hosp'l
Discharge from Service	Transfer to V. R. C.
Duty	Transportation

Affidavit of Nonindebtedness to U. S.,

of *L. A. Nesmith*

late *2d Lieut Co B 6th* Reg't

USC Cav. on which was

based Certificate of Nonindebtedness
to U. S.,

Dated *April 21st* 1866.

STATE OF

COUNTY

Delaware
Prince

ss.



John W. ...
late 1st ... Regiment ...
I, *John W. ...*
do solemnly declare on oath, that I have duly accounted for all Public
Property, for which I have ever been responsible as an Officer of the Volunteer
Forces of the United States: that I have rendered all returns and reports, re-
quired by Revised Army Regulations of 1863 and existing orders: that
I am not now, on any account whatever, indebted to the General Government
except as stated on Muster-out Rolls.

John W. ...
W. ...

Sworn and subscribed before me, at *Scranton Pa*
this *21* day of *April* 1866.



Wm. ...
Notary Public

991

Neville James

Co *L*, **6** U. S. Col'd Cav.

Private | *Private*

CARD NUMBERS.

1	5387738	26
2	5387716	27
3	5387371	28
4	5394790	29
5	5394878	30
6	5394962	31
7	5395070	32
8	5395329	33
9	193721	34
10	40732671	35
11		36
12		37
13		38
14		39
15		40
16		41
17		42
18		43
19		44
20		45
21		46
22		47
23		48
24		49
25		50

Book Mark: _____

See also _____

S. 1149124 and W.D.

D. J. Miller, Esq.

N | **6 Cav. U.S.C.T.**

Jamies Neville
....., Co. *D*....., 6 Reg't U. S. Col'd Cav.

Appears on

Company Descriptive Book

of the organization named above.

DESCRIPTION.

Age *35* years; height *5* feet *6* inches.

Complexion *Yellow*

Eyes *Blk*; hair *Blk*

Where born *Shelby Co Ky*

Occupation *Farmer*

ENLISTMENT.

When *Nov 23*, 186 *5*.

Where *Louisville Ky*

By whom *Capt Womack*; term *5* y'rs.

Remarks: *Credited to S A Ky*
Sent to Genl Hosptl
Camp Nelson Ky July
6/65. where he died
July 9/65 of Pneumo-
nia

Tomms
Copyist.

M

6

U.S.C.T.

James Neville

Appears with rank of *Priv* on

Muster and Descriptive Roll of a Detachment of Substitutes forwarded

for the *6* Reg't U. S. Col'd Cavalry. Roll dated

Draft Rendezvous Louisville Ky. Mch 25, 1865.

Where born *Shelby Kentucky*

Age *35* y'rs; occupation *Farmer*

When enlisted *Mch 23*, 1865.

Where enlisted *Louisville*

For what period enlisted *3* years.

Eyes *Blk*; hair *Blk*.

Complexion *Yellow*; height *5* ft. *6* in.

When mustered in *Mch 23*, 1865.

Where mustered in *Louisville*.

Bounty paid \$ *100*; due \$ *100*

Where credited *5th Dist. Ky.*

Company to which assigned

Remarks:

Book mark:

(340c)

Bonard
Copyist.

M : *6* | **U.S.C.T.**

James Neville

Appears with rank of *Priv* on

Muster and Descriptive Roll of a Detachment of Substitutes forwarded

for the *6* Reg't U. S. Col'd Cavalry, Roll dated *Draft Rendezvous, Louisville, Ky, Mch 25 1865.*

Where born *Shelby Kentucky*

Age *35* y'rs ; occupation *Farmer*

When enlisted *Mch 23*, 1865.

Where enlisted *Louisville*

For what period enlisted *3* years.

Eyes *Black* ; hair *Black*

Complexion *Yellow* ; height *5* ft. *6* in.

When mustered in *Mch 23*, 1865.

Where mustered in *Louisville*

Bounty paid \$ *100* ; due \$ *100*

Where credited *5" Dist. Ky.*

Company to which assigned

Remarks :

Book mark :

(340c)

Conard
Copyist.

N. | **6 Cav.** | **U.S.C.T.**

James Neville

Appears with rank of Rec't. on

Muster and Descriptive Roll of a Detachment of U. S. Vols. forwarded

for the 6 Reg't U. S. Col'd Cavalry. Roll dated

Louisville Ky, Mich 23, 1865.

Where born Shelby Co. Ky.

Age 35 y'rs; occupation farmer.

When enlisted Mich 23, 1865.

Where enlisted Louisville Ky

For what period enlisted 3 years.

Eyes blk; hair blk.

Complexion blk; height 5 ft. 6 in.

When mustered in Mich 23, 1865!

Where mustered in Louisville Ky.

Bounty paid \$ 100; due \$ 100

Where credited Union. Jefferson Co. 5 Dist Ky.

Company to which assigned _____

Remarks: _____

Book mark: _____

A. Hall

N

6 Cav. U.S.C.T.

James Neville

Privt. I., Co. *I.*, 6 Reg't U. S. Col'd Cavalry.

Appears on

Company Muster-in and Descriptive Roll

of the organization named above. Roll dated

Camp Nelson Ky., Apr 29 1865.

Where born *Shelby Co. Ky.*

Age *35* y'rs; occupation *Farmer.*

When enlisted *Mar. 23.*, 1865.

Where enlisted *Louisville*

For what period enlisted *3* years.

Eyes *Blk*; hair *Blk*

Complexion *Yellow*; height *5* ft. *6* in.

When mustered in *Mar. 23*, 1865.

Where mustered in *Louisville*

Bounty paid \$ *none pd.* 100; due \$ 100

Where credited *5 Dist Ky*

Company to which assigned *I.*

Remarks:

Book mark:

L. M. Kennedy

(356d)

J Copyist.

N 6 Cav. U.S.C.T.

James Neville

Privt. I., Co. *I.*, 6 Reg't U. S. Col'd Cavalry.

Appears on

Company Muster-in and Descriptive Roll

of the organization named above. Roll dated

Camp Nelson Ky., Apr 29 1865.

Where born *Shelby Co. Ky.*

Age *35* y'rs; occupation *Farmer.*

When enlisted *Mar. 23.*, 1865.

Where enlisted *Louisville*

For what period enlisted *3* years.

Eyes *Blk.*; hair *Blk.*

Complexion *Yellow*; height *5 ft. 6* in.

When mustered in *Mar. 23*, 1865.

Where mustered in *Louisville*

Bounty paid \$ *none pd.* 100; due \$ 100

Where credited *5 Dist Ky*

Company to which assigned *I.*

Remarks:

Book mark:

L. M. Kennedy
Copyist.

(356d)

N | **6 Cav.** | **U.S.C.T.**

James Neville
Privt, Co. I, 6 Reg't U. S. Col'd Cavalry.

Appears on

Company Muster Roll

for *Enrolment to Apl 30*, 186*5*.

Present or absent *Present*

Stoppage, \$ *100* for

Due Gov't, \$ *100* for

Valuation of horse, \$ *100*

Valuation of horse equipments, \$ *100*

Remarks:

1st Instalment County due.

Book mark:

(358)

D. M. Kennedy
Copyist.

N | **6 Cav.** | **U.S.C.T.**

James Neville
Privt, Co. I, 6 Reg't U. S. Col'd Cavalry.

Appears on

Company Muster Roll

for *May or June*, 186*5*.

Present or absent *Present*

Stoppage, \$ *100* for

Due Gov't, \$ *100* for

Valuation of horse, \$ *100*

Valuation of horse equipments, \$ *100*

Remarks:
1st Instalment County due

Book mark:

(358)

D. M. Kennedy
Copyist.

Ch

6 Cav. | U.S.C.T.

James Neville

Privt, Co. I, 6 Reg't U. S. Col'd Cavalry.

Appears on

Company Muster Roll

for *July & Aug*, 1865-

Present or absent

Stoppage, \$ 100 for

Due Gov't, \$ 100 for

Valuation of horse, \$ 100

Valuation of horse equipments, \$ 100

Remarks: *1st installment bounty due. Died in Gen. Hosp. G. P. Nelson, Ky. July 9/65. of Pneumonia.*

Book mark:

(358)

J. V. Casey

Copyist.

11 | **6 Cav.** | **U.S.C.T.**

James Neville
Capt. Co. I . 6 Reg't U. S. Col'd Cav.

Appears on Returns as follows:

Subs 1865 July 9 65
Camp Nelson Ky
Died in Gen Hosp
Camp Nelson Ky of
pneumonia

Book mark :

(546) *J. E. Douglas* Copyist.

N. **6 Cav. U.S.C.T.**

James Neville
Co. B, 6 Reg't U. S. Col'd Cavalry.

Appears on **Co. Muster-out Roll**, dated
Swad's Bluff Ark, April 13 1866.

Muster-out to date _____, 186 .

Last paid to _____, 186 .

Clothing account:

Last settled _____, 186 ; drawn since \$ _____ 100

Due soldier \$ _____ 100; due U. S. \$ _____ 100

Am't for cloth'g in kind or money adv'd \$ _____ 100

Due U. S. for arms, equipments, &c., \$ _____ 100

Bounty paid \$ _____ 100; due \$ _____ 100

Remarks: *Died in service*
at Camp Nelson
Ky. only 9/65 of
Pneumonia.

Book mark: *120.964 2233. 1883*
(over)

(861) *J. A. Stearns* Copyist.

JAN. 10

5395329

1891

1. 23. $L\frac{1}{11}$ Aud.

Neville James

_____, Co. *I*, *6* Reg't *U.S.C. Cav.*

4 **Enclosures.**

Bed Cards	Final Statements <i>/</i>
Burial Records <i>/</i>	Furloughs or L. of A.
Certs. of Dis. for Discharge	Med. Certificates
C. M. Charges	Med. Des. Lists
Descriptive Lists	Orders
Discharge Certificates	Pris. of War Record
Enlistment Papers <i>/</i>	Resignations

Other papers relating to—

Admission to Hosp'l	Furlough or L. of A.
Casualty Sheet <i>/</i>	Med. Examination
Confinement	Misc. Information
Contracts	Pay or Clothing
Death or Effects	Personal Reports
Desertion	Rank
Discharge from Hosp'l	Transfer to Hosp'l
Discharge from Service	Transfer to V. R. C.
Duty	Transportation
.....

NOTE 1.—This blank will be used for enlistments of United States colored troops. They will be made out in duplicate in all cases—one to accompany the recruiting return of the superintendent (not the recruiting officer) to the Adjutant General, and one to accompany the accounts of the officer who pays bounty, &c.

NOTE 2.—An enlistment holds to service. A muster-in must, in all cases, precede payment of pay, bounty, pension, &c. A muster-in roll, must in all cases, be made in the Adjutant General's Office as evidence of muster-in. The mustering officer, commissary, or assistant commissary of musters, as the case may be, will countersign both enlistments as having mustered the soldiers into the service of the United States before either of them is given to the disbursing officer.

DECLARATION OF RECRUIT

I, James Reville desiring to volunteer as a soldier in the ARMY OF THE UNITED STATES, for the term of Three Years, DO DECLARE That I am 35 years and months of age; that I have never been discharged from the United States service on account of disability or by sentence of a court-martial, or by order before the expiration of a term of enlistment; and I know of no impediment to my serving honestly and faithfully as a soldier for three years.

GIVEN at Louisville Ky the 25 day of March 1865

Witness: A. J. Campbell

James Reville
Volunteered at Louisville Ky
March 25 1865
By A. W. Wmack
Capt-Gen Man S-Min-Og
No. Sixty one
James Reville

Consent of Parent or Guardian in case of a Minor, if a Free Man, or in the case of a Slave, of the Person to whom he owes Service:

I, Do CERTIFY, That I am the that the said is years of age; and I do freely give my CONSENT to his volunteering as a SOLDIER in the Army of the United States, for the period of THREE YEARS, under the conditions of the laws of the United States.

GIVEN at the day of

Witness:

UNITED STATES COLORED TROOPS ENLISTMENT.

STATE OF

County
TOWN OF

Kentucky County *Jefferson*

I *James Neville* born in *Shelby Co*

in the State of *Kentucky* aged *35* years

and by occupation a *Lam hand* Do HEREBY ACKNOWLEDGE TO

have volunteered *23* day of *March* 186*5*

to serve as a **Soldier** in the **Army of the United States of America**, for the period of **THREE YEARS**, unless sooner discharged by proper authority: Do also agree to accept such bounty, pay, rations, and clothing, as are, or may be, established by law for the U. S. colored troops.

And I, *James Neville* do solemnly swear that I will bear true faith and allegiance to the **United States of America**, and that I will serve them honestly and faithfully against all their enemies or opposers whomsoever; and that I will observe and obey the orders of the President of the United States, and the orders of the officers appointed over me, according to the Rules and Articles of War.

Sworn and subscribed to, at *Louisville Ky* this *23* day of *March* *James X Neville*

Before *Capt & Pro Mar 5th Dis Ky*

I CERTIFY, ON HONOR, That I have carefully examined the above named Volunteer agreeably to the General Regulations of the Army, and that, in my opinion, he is free from all bodily defects and mental infirmity, which would in any way disqualify him from performing the duties of a soldier.

J. M. ...
EXAMINING SURGEON.

I CERTIFY, ON HONOR, That I have minutely inspected the Volunteer, previously to his enlistment, and that he was entirely sober when enlisted; that, to the best of my judgment and belief, he is of lawful age; and that, in accepting him, as duly qualified to perform the duties of an able-bodied soldier, I have strictly observed the regulations which govern the recruiting service. This soldier has *5* eyes, *5* hair, *19* complexion, is *5* feet *6* inches high.

J. M. ...
Pro Mar & RECRUITING OFFICER OR AGENT.

Mustered into the United States Service *23* day of *March* 186*5*

J. M. ...
Pro Mar & Mustering Officer

Mustered into the service of the United States, for three years or during the war, from date of enlistment, in Company
Regiment of
Volunteers, on the
day of
186, at

7047
2.65

CASUALTY SHEET

No.

James Neville

Driver of Company "D"

6th Regiment of U.S. Cav.

State Volunteers.

NATURE OF CASUALTY.

Killed July 9, 1865

CASUALTY SHEET.

Name: *James Nevill*
Rank: *Private* Company: *D* Regiment: *C*
Arm: *U.S. Army* State: _____
Nature of Casualty: *Died*

CAUSE OF CASUALTY—(NAME OF DISEASE, &C.)

Pneumonia

BY WHOM DISCHARGED.

FROM WHAT SOURCE THIS INFORMATION WAS OBTAINED.

*Or Ret. of Deed. Soldier's
Sept 30th 1865*

DEGREE OF DISABILITY.

BY WHOM CERTIFIED.

*W. Coates
Adj. Comdr. Regt.*

DATE OF DISCHARGE, DEATH, &C.

July 9th 1865

PLACE OF DISCHARGE, DEATH, &C.

Camp Nelson Ky

REMARKS.

[Signature]

Clerk.

Notice

James Neal
Co "I" 6th U.S.C.
Died July 9th 1865.
Buried at: Camp Nelson, Ky.

No. 1.

RECORD OF DEATH AND INTERMENT.

Name and number of person interred

James Neal

Number and locality of the grave

1231

Hospital number of the deceased

7494

Regiment, rank and company

Pr. Co "D" 6th Regt

Residence before enlistment.

Conjugal relation, (and if married the res-)

idence of the widow.) }

Cause of death. }

Pneumonia

Age of the deceased.

Nativity.

References and remarks.

No Ref

Date of Death and burial.

July 9th 1865

MEMORANDA OF EFFECTS.

Hat.

Cap.

Shirts

Drawers

Pants.

Stockings, prs.

Boots.

Shoes.

Haversack.

Canteen.

Knapsack.

Money.

*right name
(Pat Neville)*

Surgeon M. J. W. in charge.

Extract from Act of Congress.

SEC. 12. *And be it further enacted*, That the fees of agents and attorneys for making out and causing to be executed the papers necessary to establish a claim for a pension, bounty, and other allowance before the Pension Office, under this act, shall not exceed the following rates: For making out and causing to be duly executed a declaration by the applicant, with the necessary affidavits, and forwarding the same to the Pension Office, with the requisite correspondence, ten dollars; which sum shall be received by such agent or attorney in full for all services in obtaining such pension, and shall not be demanded or received, in whole or in part, until such pension shall be obtained; and the sixth and seventh sections of an act entitled "An act to grant pensions," approved July [fourteenth,] eighteen hundred and sixty-two, are hereby repealed.

SEC. 13. *And be it further enacted*, That any agent or attorney who shall, directly or indirectly, demand or receive any greater compensation for his services under this act than is prescribed in the preceding section of this act, or who shall contract or agree to prosecute any claim for a pension, bounty, or other allowance under this act, on the condition that he shall receive a per centum upon any portion of the amount of such claim, or who shall wrongfully withhold from a pensioner or other claimant the whole or any part of the pension or claim allowed and due to such pensioner or claimant, shall be deemed guilty of a high misdemeanor, and, upon conviction thereof, shall, for every such offense, be fined not exceeding three hundred dollars, or imprisoned at hard labor not exceeding two years, or both, according to the circumstances and aggravations of the offense.

Approved July 4, 1864.

NOTE 10.—If any soldier is charged a higher fee than that allowed by the above act, he should report the fact and the name of the agent to the Adjutant General, in order that steps may be taken to have the same refunded.

J
FINAL STATEMENT

OF

41.
Pvt. James Neville
6th Reg't of W. S. C. Cav.

VOLUNTEERS.

Disch. July 9th 1865

NOTE 1.—Two of these certificates (or duplicates) are to be given to each Volunteer Soldier or drafted man who may be discharged without being mustered out (Final Statements are never given to men mustered out of service,) that he may at once receive from the Paymaster the pay, &c., due him, and the captain or other COMMISSIONED officer commanding the company will certify to the act of the delivery of the duplicate certificates: with these certificates the Soldier is "entitled to" his discharge, and should also present his discharge to the Paymaster to have the payment endorsed on it. The discharge is to be given back to the Soldier by the Paymaster; the latter only retaining as his vouchers the duplicate certificates.

NOTE 2.—If the Soldier is entitled to pay for the use of his horse, the Company Commander will certify to that fact on the back of both these final statements, and also to the time he has pay due for having been so mounted on his own horse.

NOTE 3.—When a Soldier is furnished with final statements, his descriptive list, if he has one, should be taken up by the officer who gives the Soldier these statements, and endorsed with a statement to this effect by the officer. The endorsement should exhibit a full statement of the time for which the Soldier was allowed pay on his final statements, the clothing account, and all other charges against him or in his favor, so as to comprise a complete exhibit of his account. It will then be transmitted to the Company Commander of the Soldier, who will enter all the data necessary to a full understanding of the Soldier's account on the muster roll upon which the Soldier's discharge is reported. The descriptive list will then be destroyed. The object of this is, that the remaining portion of the Soldier's account may be settled upon the receipt of these muster rolls, and the Soldier receive any pay or allowances that may be due him at the time of his discharge, and which may not appear on his last final statements from the fact that his descriptive list is incomplete. These accounts for back pay, &c., are settled by the 2d Auditor of the Treasury Department.

NOTE 4.—Charges for loss or injury to ordnance, horse equipments, and other miscellaneous charges, should appear under the heading of "Other Stoppages."

NOTE 5.—Bounty paid by State authorities, and not by the United States, will not be entered on this statement.

NOTE 6.—Amounts due the Sutler and Laundress must be entered on the muster roll on which the discharge, death, desertion, &c., is reported, as well as on the final statement, otherwise the amount cannot be collected from the United States.

NOTE 7.—This blank will be used for ~~deceased~~ volunteers and drafted men, as well as for others.

NOTE 8.—Where a Soldier dies in Hospital or on detached service, his descriptive list, if he has one, should be sent with his final statements, in duplicate, to the Adjutant General, Washington, D. C.

NOTE 9.—If the soldier is a drafted man or substitute, the space for time, &c., of enrolled, should contain only the word *drafted* or *substitute*, as the case may be. If the Soldier is a "VETERAN," (or RECRUIT,) the words *as a veteran*, (or *recruit*;) as the case may be, should be interlined after the words *mustered into the service of the U. S.* A statement of all the installments of *Veteran* or *Recruit* Bounty RECEIVED by the Soldier must be made on the back of each final statement.

W. C. Jones 11/18/64
Recd. Sub. 11/18/64
W. C. Jones

W. C. Jones 11/18/64
Notice of Official
Order, not for comm.
Assessment value 11/18/64

ADJUTANT GENERAL'S OFFICE
Jan 11 1866
with Inventory sent 2d Auditor.

I certify, on honor, that James Neville, a private, of
 Captain John R. Heywood Company (I) of the 6th Regiment of W. S. C. Cav.
~~VOLUNTEERS, of the State of~~, born in Whitby Co., State
 of Kentucky, aged 25 years; 5 feet 6 inches high; Yellow complexion,
Black eyes, Black hair, and by occupation a Farmer, who joined for service
 and was enrolled (see Note 9) on the 23^d day of March, 1865, at Louisville, Ky.
 by Capt. Womack, for the period of three years, and mustered into
 the service of the United States, ^[as a recruit] on the 23^d day of March, 1865, at
Louisville, Ky., by Capt. Womack; and having served
 HONESTLY and FAITHFULLY ~~with his Company~~ to the present date, is now ~~entitled to~~
~~DISCHARGE~~ Discharged by death.

The said James Neville ~~was last paid by Paymaster~~
~~to include the~~ day of 186 ~~and~~
^[date of enrollment] has pay due him from ~~that time~~ to the present date; he is entitled to pay and subsistence for
 TRAVELING to place of enrollment, and whatever other allowances are authorized to volunteer
 soldiers, drafted men, or militia, so discharged. He has received from the United States **CLOTHING**
 amounting to Thirty five ⁷⁴/₁₀₀ dollars, since the 23^d day of March,
 1865; ~~when~~ ^[never] his clothing account was ~~last~~ settled. He has received from the United States
~~100~~ 100 dollars advanced **BOUNTY**.

There is to be stopped from him, ~~on account of the State of~~, or other
~~authority~~, for **CLOTHING, &c.**, received ~~on entering service~~, Thirty five ¹⁸/₁₀₀ dollars; and
 for other stoppages, viz: _____

~~_____ dollars.~~
 He has been furnished with **TRANSPORTATION** in kind from the place of his discharge to
 _____; ~~and he has been SUBSISTED & TRAVELING~~ to his
 place of enrollment, up to the _____, 1865.

He is indebted to _____ **SUTLER**, _____ ¹⁰⁰/₁₀₀ dollars.
 He is indebted to _____ **LAUNDRESS**, _____ ¹⁰⁰/₁₀₀ dollars.

Given in Duplicate, at Camp Nelson, Ky., this 9th day
 of July, 1865.

John R. Heywood
Capt. Co. I, 6th W. S. C. Cav.
 Commanding Company.

992

Newland, Henry

Co M, 6 U. S. Col'd Cav.

Private Private

CARD NUMBERS.

1	5396563	26
2	5396656	27
3	5396749	28
4	5396842	29
5	5396938	30
6	5397030	31
7	5397116	32
8	9093990	33
9		34
10		35
11		36
12		37
12		38
14		39
15		
16		
17		42
18		43
19		44
20		45
21		46
22		47
23		48
24		49
25		50

Book Mark:

See also 120 USC Inf

Rep 458368
J 1404933 P.O. Miami

S. 4210804
P.O. Mil. D.C. 1105347-6.23.13 094

D. J. Miller, Jr.

N | **6 Cav. | U.S.C.T.**

Henry Newland

....., Co. *M* 6 Reg't U. S. Col'd Cav.

Appears on

Company Descriptive Book

of the organization named above.

DESCRIPTION.

Age *20* years; height *5* feet *7* inches.

Complexion *Blk*

Eyes *Blk*; hair *Blk*

Where born *Madison Ky*

Occupation *Far*

ENLISTMENT.

When *Nov 24*, 186*4*.

Where *Quensboro*

By whom *Capt. Partridge* term *3* y'rs.

Remarks: *Mustered into
U.S. Service Nov 24/64
Quensboro Ky by Capt
Crissum*

Forrest

A

6 Cav. U.S.C.T.

Henry Newland

Co. M, 6 Reg't U. S. Col'd Cavalry.

Appears on

Company Muster-in and Descriptive Roll

of the organization named above. Roll dated

Camp Nelson Ky, N.Y., July 10, 1864.

Where born *Madison Kentucky*

Age *20* y'rs; occupation *farmer*

When enlisted *Nov 24*, 186*4*.

Where enlisted *Carrsborow*

For what period enlisted *3* years.

Eyes *black*; hair *black*

Complexion *black*; height *5 ft. 7 in.*

When mustered in *no record date Nov 24, 1864.*

Where mustered in *Carrsborow Ky*

Bounty paid \$ *none paid* 100; due \$ *100*

Where credited *2d Dist of Ky*

Company to which assigned *M*

Remarks: *Transferred from Co.*

A. 120 U.S.C.

Book mark:

Joseph Newland

(356d)

Copyist.

et

6 Cav. U.S.C.T.

Terry Howland
Priv., Co. M, 6 Reg't U. S. Col'd Cavalry.

Appears on

Company Muster Roll

for *June 21 to June 30, 1865*.

Present or absent *Present*

Stoppage, \$ *100* for

Due Gov't, \$ *100* for

Valuation of horse, \$ *100*

Valuation of horse equipments, \$ *100*

Remarks: *Transferred from*
120 U.S.C.T. per No. 10,
105 dated 4d per
XK, June 10 1865.

Book mark:

(358) *Joseph Stewart*
Copyist.

71 6 Cav U.S.C.T

Henry Newland
Pot., Co. M, Reg't U. S. Col'd Cav

Appears on

Company Muster Roll

for Dated Aug 31, 1865.

Present or absent Present

Stoppage, \$ 100 for

Due Gov't, \$ 100 for

Valuation of horse, \$ 100

Valuation of horse equipments, \$ 100

Remarks:

Book mark:

M O'Grance

(358)

Copyist.

A **6 Cav. U.S.C.T.**

Henry Stinson
24, Co. M, 6 Reg't U. S. Col'd Cavalry.

Appears on

Company Muster Roll

for *Sept Oct*, 1865.

Present or absent (*Present*)

Stoppage, \$ 100 for

Due Gov't, \$ 100 for

Valuation of horse, \$ 100

Valuation of horse equipments, \$ 100

Remarks:

Book mark:

(358)

Shoene

Copyist.

A 6 Cav. U.S.C.T.

Henry Newland
Pr, Co. M, 6 Reg't U. S. Col'd Cavalry.

Appears on

Company Muster Roll

for *Nov Dec*, 1865.

Present or absent *Present*.

Stoppage, \$ *100* for

Due Gov't, \$ *100* for

Valuation of horse, \$ *100*

Valuation of horse equipments, \$ *100*

Remarks: *Due U.S. for*
6798 \$3.20

Book mark: _____

(358)

Shawne
Copist.

N

6 Cav.

U.S.C.T.

Henry Newland

Co. M, Co. M, 6 Reg't U. S. Col'd Cavalry.

Appears on

Company Muster Roll

for *Jan & Feb*, 186*6*.

Present or absent *Present*

Stoppage, \$ *100* for

Due Gov't, \$ *100* for

Valuation of horse, \$ *100*

Valuation of horse equipments, \$ *100*

Remarks: *Due M. for let*
to Co. M. 100

Book mark:

(358)

C. S. M. Langhlin

Copyist.

72

6 Cav. U.S.C.T.

Henry Newland,

Co. M, 6 Reg't U. S. Col'd Cavalry.

Appears on Co. Muster-out Roll, dated

Abolts Bluff, Ark, Apr 15, 1866.

Muster-out to date Apr 15, 1866.

Last paid to Feb 28, 1866.

Clothing account:

Last settled....., 186 ; drawn since \$ 100

Due soldier \$ 100; due U. S. \$ 52 ¹⁰/₁₀₀

Am't for cloth'g in kind or money adv'd \$ 100

Due U. S. for arms, equipments, &c., \$ 100

Bounty paid \$ 100 ⁰⁰/₁₀₀; due \$ 100

Remarks:

Book mark:

C. M. Langhlin

(361)

Copyist.

993 Alexander S.
Alexander
Newsom, L. S.

Co G, 6 U. S. Col'd Cav.

Private Private

CARD NUMBERS.

1	5387282	26
2	5393283	27
3	5393367	28
4	5393447	29
5	5393533	30
6	5393624	31
7	5393721	32
8	5393815	33
9	5393902	34
10	5393990	35
11	9043526	36
12	40732672	37
13		38
14		39
15		40
16		41
17		42
18		43
19		44
20		45
21		46
22		47
23		48
24		49
25		50

Book Mark:

See also

Co. 6 Cav. U.S.C.T.

Alex. S. Newsum

Co. 6, 6 Reg't U. S. Col'd Cav.

Appears on

Company Descriptive Book

of the organization named above.

DESCRIPTION.

Age *18* years; height *5* feet *3* inches.

Complexion *Black*

Eyes *black*; hair *black*

Where born *Admwell Ky*

Occupation *Laborer*

ENLISTMENT.

When *Feb. 7*, 186*5*.

Where *Lexington*

By whom *Capt. Moore*; term *3* y'rs.

Remarks:

Amey Webb

N | 6 Cav. | U.S.C.T.

L. S. Newsom

Appears with rank of *Priv.* on

Muster and Descriptive Roll of a Detachment of U. S. Vols. forwarded

for the 6 Reg't U. S. Col'd Cavalry. Roll dated *Lexington Ky. Feb. 7, 1865.*

Where born *Caldwell Co. Ky.*

Age *18* y'rs; occupation *Labourer*

When enlisted *Feb. 7*, 186 .

Where enlisted *Lexington Ky.*

For what period enlisted *3* years.

Eyes *Blk*; hair *Blk*

Complexion *Blk*; height *5* ft. *3* in.

When mustered in *Feb. 7*, 186 .

Where mustered in *Lexington Ky.*

Bounty paid \$ *100*; due \$ *100*

Where credited

Company to which assigned

Remarks: *Credited to Caldwell*

Co. 1 D. Ky.

Martha Newsom, Owner.

Book mark:

C. E. McLaughlin

(339)

Copyist.

N **6 Cav. U.S.C.T.**

L. S. Newsom

Pratt, Co. *G*, 6 Reg't U. S. Col'd Cavalry.

Appears on

Company Muster-in and Descriptive Roll

of the organization named above. Roll dated

Lexington, Ky, N. Y., Feb 23, 1865.

Where born *Caldwell, Ky*

Age *18* y'rs; occupation *Labourer*

When enlisted *Feb 7*, 1865.

Where enlisted *Lexington*

For what period enlisted *3* years.

Eyes *Black*; hair *Black*

Complexion *Copper*; height *5* ft. *3* in.

When mustered in *Feb 7*, 1865.

Where mustered in *Lexington*

Bounty paid \$ *100*; due \$ *100*

Where credited *1st Dist Ky*

Company to which assigned

Remarks:

Book mark:

W. B. B.

(356d)

Copyist.

M

6 Cav. | U. S. C. T.

Alex. S. Stevenson

Pr, Co. G, 6 Reg't U. S. Col'd Cavalry.

Appears on

Company Muster Roll

for *Jan & Feb*, 186 *1*.

Present or absent *Present*

Stoppage, \$ *100* for

Due Gov't, \$ *100* for

Valuation of horse, \$ *100*

Valuation of horse equipments, \$ *100*

Remarks: *1st installment
Bounty due, \$100*

Book mark:

115-5-102

N

6 Cav. | U. S. C. T.

Wm. S. Lawrence
Privt, Co. G, 6 Reg't U. S. Col'd Cavalry.

Appears on

Company Muster Roll

for *Sept & Oct*, 186*5*.

Present or absent *Present*

Stoppage, \$ *100* for

Due Gov't, \$ *100* for

Valuation of horse, \$ *100*

Valuation of horse equipments, \$ *100*

Remarks: *First installment bounty due*

Book mark: _____

(358)

W. S. Lawrence

Copyist.

N

6 Cav. | U. S. C. T.

Alex. S. Newsom

Private, Co. G, 6 Reg't U. S. Col'd Cavalry.

Appears on

Company Muster Roll

for *May & June*, 186*5*.

Present or absent *Present*

Stoppage, \$ *100* for

Due Gov't, \$ *100* for

Valuation of horse, \$ *100*

Valuation of horse equipments, \$ *100*

Remarks: *1st Installment
Security due.*

Book mark: _____

(358)

Keefe

Copyist.

M

6 Cav. | U. S. C. T.

Wm S. Newson

Private, Co. G, 6 Reg't U. S. Col'd Cavalry.

Appears on

Company Muster Roll

for *July & Aug.*, 1865.

Present or absent *Present*

Stoppage, \$ *100* for

Due Gov't, \$ *100* for

Valuation of horse, \$ *100*

Valuation of horse equipments, \$ *100*

Remarks: _____

Book mark: _____

(358)

Keefe

Copyist.

N

6 Cav. | U.S.C.T.

Alex. S. Newson

Private Co. G, 6 Reg't U. S. Col'd Cavalry.

Appears on

Company Muster Roll

for *Sept. & Oct.*, 186*5*.

Present or absent *Present*.

Stoppage, \$ *100* for

Due Gov't, \$ *100* for

Valuation of horse, \$ *100*

Valuation of horse equipments, \$ *100*

Remarks:

Book mark:

(358)

Keefer

Copyist.

A

6 Cav. | U. S. C. T.

Max O. Newson
Plt, Co. G, 6 Reg't U. S. Col'd Cavalry.

Appears on

Company Muster Roll

for *Nov & Dec*, 1865.

Present or absent *Present*

Stoppage, \$ 100 for

Due Gov't, \$ 100 for

Valuation of horse, \$ 100

Valuation of horse equipments, \$ 100

Remarks:

Book mark:

(358)

J. L. Morris

Copyist.

A

6 Cav. | U. S. C. T.

Alex Newson
Pat, Co. G, 6 Reg't U. S. Col'd Cavalry.

Appears on

Company Muster Roll

for *Jan'y & Feby*, 186 *6*.

Present or absent *Present*

Stoppage, \$ *100* for

Due Gov't, \$ *100* for

Valuation of horse, \$ *100*

Valuation of horse equipments, \$ *100*

Remarks: _____

Book mark: _____

(358)

J. L. Morris

Copyist.

7 | 6 Cav. | U.S.C.T.

Alex Newson
Cor, Co. E, 6 Reg't U. S. Col'd Cav.

Appears on Returns as follows:

July 1885 Absent on detached
service as safe guard by
order of Col. Kearse

Sept 1885 On duty at Post
stables Lexington Ky

Nov 1885 On duty RQM
Dept: taking care of
horses

Book mark:

J. E. Dougherty
Copyist.

(546)

A | **6 Cav. | U.S.C.T.**

Alexander Newson
Priv, Co. *G*, 6 Reg't U. S. Col'd Cavalry.

Appears on **Co. Muster-out Roll**, dated
Dwells Bluff, Ark, April 15, 1866.

Muster-out to date *April 15, 1866.*

Last paid to _____, 186 ____.

Clothing account:

Last settled _____, 186 ____; drawn since \$ _____ 100

Due soldier \$ _____ 100; due U. S. \$ *7* ^{*26*} ₁₀₀

Am't for cloth'g in kind or money adv'd \$ _____ 100

Due U. S. for arms, equipments, &c., \$ _____ 100

Bounty paid \$ *100* ^{*00*} 100; due \$ _____ 100

Remarks: _____

Book mark: _____

(861)

J. L. Morris

Copyist.

994

Newton Bell

Co F, 6 U. S. Col'd Cav.

Private Private

CARD NUMBERS.

1	5392552	26
2	5392626	27
3	5392711	28
4	5392799	29
5	5392896	30
6	5392993	31
7	5393086	32
8	5393179	33
9	9093416	34
10	43150697	35
11	40732679	36
12		37
13		38
14		39
15		40
16		41
17		42
18		43
19		44
20		45
21		46
22		47
23		48
24		49
25		50

Book Mark:

See also:

S. 1170392, P.O. Ret.

D. J. Miller, Esq.

N | **6 Cav. | U.S.C.T.**

Bill Newton
Gov, Co. *F*, 6 Reg't U. S. Col'd Cav.

Appears on

Company Descriptive Book

of the organization named above.

DESCRIPTION.

Age *15* years; height *5* feet *3* inches.

Complexion *Black*

Eyes *Black*; hair *Black*

Where born *Carolina, Va.*

Occupation *Laborer*

ENLISTMENT.

When *Jan 15*, 1865.

Where *Lexington, Ky.*

By whom *Capt. Moore*; term *3* y'rs.

Remarks: *Mustered in Jan 15th 65 at Lexington Ky by Capt. Moore.*

James Webb

5 | 6000 | U.S.C.S.

Bill Newton

Appears with rank of Pvt on

Muster and Descriptive Roll

of Detachment of U.S. Colored Volunteers
forwarded to Lexington Ky.

Roll dated
Lexington Ky, Jan. 15, 1865.

Where born Caroline Va.

Age _____ years; occupation Labourer.

When enlisted Jan 15, 186 .

Where enlisted Lexington Ky

For what period enlisted 3 years.

Eyes Blk ; hair Blk.

Complexion Blk ; height 5 ft. 3 in.

When mustered in Jan 15, 186 .

Where mustered in Lexington Ky

Bounty paid \$ 100; due \$ 100

Clothing account:

Last settled _____, 186 ; drawn since \$ 100

Date of first muster Jan 15, 1865 .

Company to which assigned _____

Remarks: Credited to blank Co-7th W. Ky

Free

Book mark : _____

W. Walker

A 6 Cav. U.S.C.T.

Bill Mendenhall

M. P., Co. *H*, 6 Reg't U. S. Col'd Cavalry.

Appears on

Company Muster-in and Descriptive Roll

of the organization named above. Roll dated

Lexington Ky, N. Y., *Jan 26*, 1865.

Where born *Carroll Co Va*

Age *15* y'rs; occupation *Farmer*

When enlisted *Jan 15*, 1865

Where enlisted *Lexington Ky*

For what period enlisted *3* years.

Eyes *Blk*; hair *Blk*

Complexion *Blk*; height *5* ft. *3* in.

When mustered in *Jan 15*, 1865.

Where mustered in *Lexington Ky*

Bounty paid \$ *100*; due \$ *100*

Where credited *7th Ky*

Company to which assigned

Remarks:

Book mark:

(356d)

Breger

Copyist.

A 6 Cav. U.S.C.T.

Bill Newton

P, Co. F, 6 Reg't U.S. Col'd Cavalry.

Appears on

Company Muster Roll

for *Jan 24 to April 30*, 186*5*.

Present or absent *Present*

Stoppage, \$ *100* for

Due Gov't, \$ *100* for

Valuation of horse, \$ *100*

Valuation of horse equipments, \$ *100*

Remarks:

Book mark:

(358)

Breger

Copyist.

H. H. ... U.S.C.T

Bill Minter
Plt, Co. F, 4 Reg't U. S. Col'd *War*

Appears on

Company Muster Roll

for *May & June*, 186*5*.

Present or absent *Present*

Stoppage, \$ *100* for

Due Gov't, \$ *100* for

Valuation of horse, \$ *100*

Valuation of horse equipments, \$ *100*

Remarks:
.....
.....
.....
.....
.....
.....
.....
.....
.....
.....

Book mark:

Beary

(358)

Copyist.

7

6 Cav. U.S.C.T.

Bill Newton

Prv

Co. F, 6 Reg't U. S. Col'd Cavalry.

Appears on

Company Muster Roll

for *July & Aug*, 1865.

Present or absent *Present*

Stoppage, \$ 100 for

Due Gov't, \$ 100 for

Valuation of horse, \$ 100

Valuation of horse equipments, \$ 100

Remarks: *1st inst. of bounty due.*

Book mark:

(358)

J. E. Chapin

Copyist.

N

6 Cav. U.S.C.T.

Bill Newton

Pro, Co. F, 6 Reg't U. S. Col'd Cavalry.

Appears on

Company Muster Roll

for *Sept + Oct*, 1865.

Present or absent *Present*

Stoppage, \$ *100* for

Due Gov't, \$ *100* for

Valuation of horse, \$ *100*

Valuation of horse equipments, \$ *100*

Remarks: *Due Gov't 80 for Ord.*

Book mark:

J. E. Chapin

(358)

Copyist.

N 6 Cav. **U.S.C.T**

Bill Newton

Pro, Co. *H*, 6 Reg't U. S. Col'd *Cav.*

Appears on

Company Muster Roll

for *Nov & Dec*, 1865.

Present or absent *Present*

Stoppage, \$ *100* for

Due Gov't, \$ *100* for

Valuation of horse, \$ *100*

Valuation of horse equipments, \$ *100*

Remarks:

Book mark:

J. E. Chapin

(358)

Copyist.

A 6 Cav. U.S.C.T.

Bill Newton

Par, Co. F, 6 Reg't U. S. Col'd Cavalry.

Appears on

Company Muster Roll

for *Jan & Feb*, 186*6*.

Present or absent *Present*

Stoppage, \$ *100* for

Due Gov't, \$ *100* for

Valuation of horse, \$ *100*

Valuation of horse equipments, \$ *100*

Remarks:

Book mark:

J. H. Smith

(358)

Copyist.

| **6 Cav.** | **U.S.C.T.**

Bill Newton
Co. E, 6 Reg't U. S. Col'd Cav.

Appears on Returns as follows:

Sept & Oct 1865 On duty at
Big Hd Qrs

Jan 1866 Absent sick at
Desalls Bluff Ark since
Jan 25 66

Mar 1866 Absent sick in
Hoop at Desalls Bluff
since Mar 1/66

Book mark:

J. E. Douglas
Copyist.

A 6 Cav. U.S.C.T.

Bill Newton
Pr, Co. *F*, 6 Reg't U. S. Col'd Cavalry.

Appears on Co. Muster-out Roll, dated
Bevalls Bluff, Ark, Apr 15, 1866.

Muster-out to date *Apr 15, 1866*.

Last paid to *Oct 31, 1865*.

Clothing account:

Last settled....., 186 ; drawn since \$ 100

Due soldier \$ 100; due U. S. \$ *19* ³⁵ 100

Am't for cloth'g in kind or money adv'd \$ 100

Due U. S. for arms, equipments, &c., \$ 100

Bounty paid \$ *100* 100; due \$ 100

Remarks:

Book mark: } *5356. P. M. G. June 6/66*
 { *U. 212, P. G. 74*

H. A. Smith
Copyst.

995
Nicholas Spencer

Co, 6 U. S. Col'd Cav.

Private

CARD NUMBERS.

1	5387261	26
2		27
3		28
4		29
5		30
6		31
7		32
8		33
9		34
10		35
11		36
12		37
13		38
14		39
15		40
16		41
17		42
18		43
19		44
20		45
21		46
22		47
23		48
24		49
25		50

Book Mark: _____

See also _____

N | 6 Cav. | U.S.C.T.

Spencer Nicholas

Appears with rank of *Privt.* on

Muster and Descriptive Roll of a Detachment of U. S. Vols. forwarded

for the 6 Reg't U. S. Col'd Cavalry. Roll dated

Lexington Ky. Jan. 14, 1865.

Where born *Mercer Kentucky*

Age *22* y'rs; occupation *Farmer*

When enlisted *Aug. 19*, 186 .

Where enlisted *Cp. Nelson*

For what period enlisted *3* years.

Eyes *Blk*; hair *Blk*

Complexion *Blk*; height *5* ft. *7* in.

When mustered in *Aug. 19*, 186 .

Where mustered in *Cp. Nelson*

Bounty paid \$ *100*; due \$ *100*

Where credited

Company to which assigned

Remarks: *Martin Nichols, owner*

Not taken up on rolls

of Regt.

Book mark:

C. C. McLaughlin

(339)

Copyist.

996

Nichols, Daniel

Co C, 6 U. S. Col'd Cav.

Private

Private

CARD NUMBERS.

1	5387972	26
2	5390548	27
3	5390634	28
4	5390718	29
5	5390855	30
6	5390886	31
7	43174797	32
8	40732674	33
9		34
10		35
11		36
12		37
13		38
14		39
15		40
16		41
17		42
18		43
19		44
20		45
21		46
22		47
23		48
24		49
25		50

Book Mark:

See also 120 use ind

N

6 Cavalry.

U. S. C. T.

Daniel Nichols

Co. B, 6 Reg't U. S. Col'd Cav.

Appears on

Regimental Descriptive Book

of the regiment named above.

DESCRIPTION.

Age 14 years; height 5 feet 7 inches.

Complexion black

Eyes Blue; hair Black

Where born Muhlenberg Co Ky.

Occupation farmer

ENLISTMENT.

When May 28, 1865.

Where Henderson, Ky.

By whom Capt Billings, term 3 years.

Remarks:

L. D. Barton

(384b)

Copyist.

C. N. C. Co **U.S.C.T.**

Daniel Nichols
Qm, Co., *6* Reg't U. S. Col'd *Co*

Appears on a

Detachment Muster Roll

unassigned recruits
of the organization named above

for *June 10 to 30*, 1865.

Station *Camp Nelson Ky*

Present or absent *Present*

Stoppage, \$ *100* for

Due Gov't, \$ *100* for

Valuation of horse, \$ *100*

Valuation of horse equipments, \$ *100*

Remarks: *Transfd from 120th Ill 2*
1st Regt Cavalry and
Transfd from 120th Ill, is detail to
2nd Div, 1st Regt, 10-1865

Book mark:

H B Sawyer

(357)

Copyist.

A

6 Cav. U.S.C.T.

Daniel Nichols

Priv, Co. C, 6 Reg't U. S. Colored Cavalry.

Appears on

Company Muster Roll

for *July & Aug*, 186*5*.

Present or absent *Absent*

Stoppage, \$ *100* for

Due Gov't, \$ *100* for

Valuation of horse, \$ *100*

Valuation of horse equipments, \$ *100*

Remarks: *Sick in Hosp Lexington Ky
since Aug 26th 1865. 1st Instal-
ment bounty due*

Book mark:

(358)

S. P. York

Copyist.

N. | **6 Cav. U.S.C.T.**

Daniel Nichols
Priv, Co. C, 6 Reg't U. S. Colored Cavalry.

Appears on

Company Muster Roll

for *Sept + Oct*, 186*5*.

Present or absent *Present*

Stoppage, \$ *100* for

Due Gov't, \$ *100* for

Valuation of horse, \$ *100*

Valuation of horse equipments, \$ *100*

Remarks: *Dick at Post Hospital
Lexington Ky*

Book mark: _____

(358)

S. P. York

Copyist.

N **6 Cav. U.S.C.T.**

Samuel Nichols
Priv, Co. C, 6 Reg't U. S. Colored Cavalry.

Appears on

Company Muster Roll

for *Nov. & Dec.*, 1865.

Present or absent *Present*

Stoppage, \$ *100* for

Due Gov't, \$ *100* for

Valuation of horse, \$ *100*

Valuation of horse equipments, \$ *100*

Remarks: *\$100 bounty due*

Book mark:

(358)

W. B. Ferguson
Copyist.

A | **6 Cav. U.S.C.T.**

Daniel Nichols
Pvt., Co. C, 6 Reg't U. S. Colored Cavalry.

Appears on

Company Muster Roll

for *Jan. 1 Feb.*, 1866.

Present or absent *Present*

Stoppage, \$ *100* for

Due Gov't, \$ *100* for

Valuation of horse, \$ *100*

Valuation of horse equipments, \$ *100*

Remarks:

Book mark:

(358)

W. Ferguson

Copyist.

7 | **6 Cav.** | **U.S.C.T.**

Daniel Nichols
Pvt., Co. C, 6 Reg't U. S. Col'd Cav.

Appears on Returns as follows:

July 1865 Laid by trans-
fer Camp Nelson Ky

Sep 1865 Absent sick
Hosp Lexington Ky
since Aug 26/65

Oct. 1865 Absent sick at
Post Hosp Lexington Ky

Book mark:

(546) *[Signature]* Copyist.

N | **6 Cav.** | **U.S.C.T.**

Samuel Nichols
Priv., Co. *C*, 6 Reg't U. S. Col'd Cavalry.

Appears on **Co. Muster-out Roll**, dated
Newalls Bluff Ark, Apl. 15, 1866.
Muster-out to date *Apl. 15*, 1866.
Last paid to *Feb. 28*, 1866.

Clothing account:

Last settled....., 186 ; drawn since \$..... 100
Due soldier \$ *28 87* / 100; due U. S. \$..... 100
Am't for cloth'g in kind or money adv'd \$..... 100

Due U. S. for arms, equipments, &c., \$ *60* / 100

Bounty paid \$..... 100; due \$..... 100

Remarks:

Book mark:

(361) *W B Ferguson* Copyist.

997

Nichols Ferdinand

Co *B*, 6 U. S. Col'd Cav.

Private | *Private*

CARD NUMBERS.

1	5389200	26
2	5389335	27
3	5389425	28
4	5389496	29
5	5389563	30
6	5389657	31
7	5389746	32
8	5389838	33
9	5389928	34
10	5390021	35
11	9092910	36
12	40732673	37
13	31407597	38
14	31407695	39
15		40
16		41
17		42
18		43
19		44
20		45
21		46
22		47
23		48
24		49
25		50

Book Mark: _____

See also *115 U.S.C. Inf.*

3-753295 - P.O. aff-
D. 1329671. P.O. aff-
H670783 leaf
S. 2253739 P.O. aff-
MS. 2540416 P.O. aff-
S. 2540871 P.O. aff-
D. 2555157 P.O. aff-
D. 2701865 " "
2 2829626 Am. aff-

D. J. Miller, Esq.

A | **6 Cav. | U.S.C.T.**

Ferdinand Nichols

....., Co *B*....., 6 Reg't U. S. Col'd Cav.

Appears on

Company Descriptive Book

of the organization named above.

DESCRIPTION.

Age *20* years; height *5* feet *6* inches.

Complexion *Brown*

Eyes *Black*; hair *Brown*

Where born *Simpson Ky*

Occupation *Farmer*

ENLISTMENT.

When *Aug 8*....., 186*4*.

Where *Burling Green Ky*

By whom *Wm Hobson*.....; term *3* y'rs.

Remarks:

Wm Hobson

(383g)

Copyist.

N 6 Cav. U.S.C.T.

Ferdinand Nichols

Privat, Co. B, 6 Reg't U. S. Col'd Cavalry.

Appears on

Company Muster-in and Descriptive Roll

of the organization named above. Roll dated

Camp Nelson Ky, ~~Nov~~ Nov 1st, 1864.

Where born *Simpson Co. Ky,*

Age *20* y'rs; occupation *Farmer*

When enlisted *July 8th*, 1864.

Where enlisted *Bowling Green Ky*

For what period enlisted *3* years.

Eyes *Brown*; hair *Blk*

Complexion *Brown*; height *5* ft. *6* in.

When mustered in *Aug 8*, 1864.

Where mustered in *Bowling Green Ky*

Bounty paid \$ *100*; due \$ *100*

Where credited *3^d Dist. Ky*

Company to which assigned

Remarks: *Transferred from Co. C*

115, U.S.C.T. per S.O. No. 39, dated

June 10/65, Washington D.C.,

signed L. Thomas, A.G.,

(over)

Book mark:

G.M. Rowe

(356d)

Copyist.

JAN. 10

5389260

1891

Owner
King H. Nicoll

A | **6 Cav. U.S.C.T.**

Ferdinand Nichols

Privt, Co. B, 6 Reg't U. S. Col'd Cavalry.

Appears on

Company Muster Roll

for *Nov & Dec*, 1864.

Present or absent *absent*

Stoppage, \$ *100* for

Due Gov't, \$ *100* for

Valuation of horse, \$ *100*

Valuation of horse equipments, \$ *100*

Remarks: *Detached service at*

Pound Gap Ky. Dec 25/64.

Dismounted during Saltville
raid.

Book mark:

G. M. Rowe

(358)

Copyist.

N 6 Cav. U.S.C.T.

Ferdinand Nichols

Private, Co. B, 6 Reg't U. S. Col'd Cavalry.

Appears on

Company Muster Roll

for *Jan & Feb*, 186*5*.

Present or absent *Absent*

Stoppage, \$ *100* for

Due Gov't, \$ *100* for

Valuation of horse, \$ *100*

Valuation of horse equipments, \$ *100*

Remarks: *1st installment bounty due \$100, sick in Hospital Ireland Ky, Jan 31, 1865.*

Book mark:

W. H. ...

(358)

Copist.

N 1 6 Sav U.S.C.

Ferdinand Nichols
Pvt, Co. *B*, *6* Reg't *U.S.C.*

Appears on

Hospital Muster Roll

of U. S. A. General Hospital,

at Ashland, Ky.,

for *Jan & Feb*, 1865.

Attached to hospital:

When *Jan 2*, 1865.

How employed *present*

Last paid by Maj.

to *Pay due from enlistment*, 1865.

Bounty paid \$ *100*; due \$ *100*

Present or absent *present*

Remarks:

Book mark :

(343)

J. Devyn
Copyist.

A | **6 Cav. U.S.C.T.**

Ferdinand Nichols
Privat, Co. B, 6 Reg't U. S. Col'd Cavalry.

Appears on

Company Muster Roll

for *March & April*, 186*5*.

Present or absent *Absent*.

Stoppage, \$ *100* for

Due Gov't, \$ *100* for

Valuation of horse, \$ *100*

Valuation of horse equipments, \$ *100*

Remarks: *Initialment County*
due \$100, sick at Oakland Ky
Scamp. bit furnished.

Book mark: _____

(358)

G. M. Rowe

Copist.

C. J. | I. Car U.S.C.C.

Ferdinand Nichols

Pvt., Co. 10, 6 Reg't U.S.C.C.

Appears on

Hospital Muster Roll

of U. S. A. General Hospital,

at Ashland, Ky.,

for *March & April*, 1865.

Attached to hospital:

When *May 2*, 1865.

How employed *Patient*

Last paid by Maj. _____

to *Pay due from enlistment*, 1865.

Bounty paid \$ 100; due \$ 100

Present or absent *Present*

Remarks: _____

Book mark: _____

(343)

J. Perry

Copyist.

Ty | **6 Cav. | U.S.C.T.**

Richard Nichols
Co. B, 6 Reg't U. S. Col'd Cavalry.

Appears on

Company Muster Roll

for *March*, 1865.

Present or absent *Present*

Stoppage, \$ 100 for

Due Gov't, \$ *18⁸⁸* 100 for *and*
for C & Equip \$1.¹²

Valuation of horse, \$ 100

Valuation of horse equipments, \$ 100

Remarks: *1st installment*
due \$100.

** Added up 1.5. 1865, 987*

Book mark:

G. E. Harper

(356)

Copist.

57

6 Cav. U.S.C.T.

Ferdinand Nichols

of, Co. B, 6 Reg't U. S. Col'd Cavalry.

Appears on

Company Muster Roll

for *July 1st Aug*, 186*5*.

Present or absent *Present*

Stoppage, \$ *100* for

Due Gov't, \$ *18 88* for *ord*

for only Equip \$ 48

Valuation of horse, \$ *100*

Valuation of horse equipments, \$ *100*

Remarks: *"instable"*
over the doc.

Book mark:

(358)

F. A. Barber
Copyist.

T. H. | **6 Cav. | U.S.C.T.**

Ferdinand Nichols
Private, Co. B, 6 Reg't U. S. Col'd Cavalry.

Appears on

Company Muster Roll

for *Sept & Oct*, 186*5*.

Present or absent *present*

Stoppage, \$ *100* for

Due Gov't, \$ *66* for *C. & G. E.*

Valuation of horse, \$ *100*

Valuation of horse equipments, \$ *100*

Remarks:

Book mark: -----

F. H. [Signature]
Copyist.

A | **6 Cav.** | **U.S.C.T.**

Ferdinand Nichols

Sgt, Co. B, 6 Reg't U. S. Col'd Cavalry.

Appears on

Company Muster Roll

for *Nov & Dec*, 186 *5*

Present or absent *Present*

Stoppage, \$ *100* for

Due Gov't, \$ *100* for

Valuation of horse, \$ *100*

Valuation of horse equipments, \$ *100*

Remarks:

Book mark:

J. W. Ames
(358) Copyist.

7 | 6 Cav. | U.S.C.T.

Ferdinand Nichols
Com. Co. B 6 Reg't U. S. Col'd Cav.

Appears on Returns as follows:

Dec 1864 Absent on detached service found
Lap by Dec 25 64

Jan to May 1865 Absent
sick in Hosp Ash-
land by Dec 30 64

Book mark:

(546) J. E. Douglas Copyist.

A 6 Cav. U.S.C.T.

Frederick Nicholas

A, Co. *B*, 6 Reg't U. S. Col'd Cavalry.

Appears on Co. Muster-out Roll, dated

De Valls Bluff Ark, Apr. 15, 1866.

Muster-out to date

Apr. 15, 1866.

Last paid to

Feb. 28, 1866.

Clothing account:

Last settled....., 186 ; drawn since \$..... 100

Due soldier \$..... 100; due U. S. \$..... 100

Am't for cloth'g in kind or money adv'd \$ *17*³/₁₀₀

Due U. S. for arms, equipments, &c., \$..... 100

Bounty paid \$ *100* 100; due \$ *100* 100

Remarks:

Book mark:

(861)

J. W. Jones

Copyist.

Nichols, Ferdinand.

A, Co. B.

8 Reg't U.S.C. Cav.

Enclosures.

Bed Cards	Descriptive Lists
Burial Records	Final Statements
Certs. of Dis. for Discharge	Furloughs
C. M. Charges	Med. Des. Lists
Med. Certificates	Orders

Other papers relating to—

Admission to Hosp'l	Furlough
Casualty Sheet (Officer's)	Med. Examination
Confinement	Misc. Information
Contracts	Pay or Clothing
Death or Effects	Personal Reports
Desertions	Rank
Discharge from Hosp'l	Transfer to Hosp'l
Discharge from Service	Transfer to V. R. C.
Duty	Transportation

MICROFILM PUBLICATION M 1823

COMPILED MILITARY SERVICE RECORDS
OF VOLUNTEER UNION SOLDIERS WHO
SERVED WITH THE USCT (US COLORED TROOPS)
6TH REGIMENT OF CAVALRY

PERSONAL PAPERS' TARGET SHEET

PLEASE NOTE THE CHECKED INFORMATION ABOUT THE PERSONAL PAPERS IN
THIS FILE:

NO PERSONAL PAPERS WERE FOUND IN THIS FILE WHEN THE
RECORDS WERE ARRANGED FOR MICROFILMING.

2 PERSONAL PAPER(S) FOUND IN THIS FILE WHEN THE RECORDS
WERE ARRANGED FOR MICROFILMING.

War Department,

ADJUTANT GENERAL'S OFFICE,

Washington, Apr 10th 1867.

Respectfully returned to the
Commission for the State of
Ky, with the informa-
tion that Ferdinand Nicoll
was enlisted at Brewers Green
Ky July 31st 1864 and was
mustered in as Priv 1st B Co
US Col. 8th 1864
US Col. 8th 1864

[Handwritten signature]

Asst. Adj't General.

No. 2270

APPLICATION OF

King S. Nicoll

OF

~~[Redacted Name]~~

FOR COMPENSATION FOR SLAVE.

Named Ferdinand Nicoll

Enlisted Aug 31st 1864

In Com. 3rd U.S.C.T. Regt.

U. S. COLORED TROOPS.

Received March 8th 1867

Compensation Awarded

186
Dollars.

President of Board of Claims.

Claimant's Attorney,

G. W. Whitesides

Franklin Ky

Claimant's Post-office address,

King S. Nicoll

Franklin Ky
Simpson County
FRANKFORT COMMONWEALTH PRINT.

Headquarters Kentucky Volunteers,

Adjutant-General's Office,

Frankfort, September 26, 1866.

I hereby certify, that it appears from the U. S. Muster-In
Rolls on file in this Office, that Ferdinand Shiell
was enrolled on the 8th day of August, 1864, at
Bouling Green Ky. by Capt. A. G. Hobson,
and mustered into the U. S. service on the 31st day of August
1864, at Bouling Green Ky. by Capt. A. G. Hobson
to serve Three years. Said Ferdinand Shiell
is described as follows: Twenty age, Black eyes, Black hair,
Black complexion, 5 ft 6 inches height and is reported
as having served service to King R. Shiell, and
is credited to Simpson Co. and is further reported
as having been assigned to Captain J. J. McRee's
Co. B of S. Co. H Coats 6th Regiment of U. S. Cav

In Testimony Whereof, I have herewith set my
hand, and affixed my Official Seal, this

26th day of September, 1866

D. W. Lindsay

Adjutant General of Kentucky.



1277 1866 C. W. C. C.

untary support to any insurrection

within the United States hostile thereto. And I do further swear that, to the best of my knowledge
and ability, I have supported and defended, and will continue to support and defend, the United

CLAIM OF

King D. Nicoll of Simpson County Ky.
FOR THE COMPENSATION OF SLAVE NAMED

Lerdiana Nicoll

I, *King D. Nicoll* a loyal citizen, and a resident of
County of *Simpson* State of Kentucky, hereby claim compensation, under
the provisions of Section 24, act approved February 24, 1864, and section 2, act approved July, 28,
1866, for my slave *Lerdiana Nicoll* enlisted *August 31st*
1864, at *Bowling Green Ky.* by *Capt O. L. Hobson*
in the *6th S. C. Col. 16th* regiment U. S. Colored Troops, Co. "B"; certificate of
which enlistment, and a descriptive list as required, accompany this application. That I did not ac-
quire said slave subsequent to said enlistment, but had a valid title to him at the date of said enlist-
ment, and previous thereto; I having acquired my title to him and my ownership over him as fol-
lows, to-wit: *By inheritance from the estate of*

In proof of my loyalty to the Constitution and Government of the United States, I present the ac-
companying oath, which I have taken, signed and acknowledged; to be filed with this application, in
accordance with requirement of General Orders, No. 329, 1863, War Department, Adjutant General's
Office.

January 3rd 1867.

King D. Nicoll

OATH OF ALLEGIANCE.

I, *King D. Nicoll* the owner and Claimant, do solemnly swear that
the foregoing claim is a just and true claim due to me as master and owner of the said slave, and that
the facts alleged in said claim in respect to the draft or enlistment (as the case may be) of said slave
into the Military service of the United States are true. And I do further swear that I have never
joined, or been concerned in, any insurrection or rebellion; that I have never borne arms against the
United States; that I have never given any aid, countenance, counsel or encouragement to any person
or persons engaged, or whom I had reason to believe were about to engage, in insurrection, rebellion
or armed hostility against the United States; that I have neither sought, nor accepted, nor attempted
to exercise the functions of any office, civil or military, nor to perform any service whatever, under
any authority or pretended authority in hostility to the United States; that I have not yielded a vol-
untary support to any insurrection, rebellion or pretended government, authority, power or constitution
within the United States hostile thereto. And I do further swear that, to the best of my knowledge
and ability, I have supported and defended, and will continue to support and defend, the United
States against all enemies, foreign and domestic; and that I have supported, defended and obeyed, and
will continue to support, defend and obey, the Constitution and laws of the United States; that I will
bear true faith and allegiance to the same; and that I take this oath freely, without any mental reserva-
tion or purpose of evasion: So help me God.

King D. Nicoll

Sworn to and subscribed before me, at *Franklin Ky.*
this *3rd* day of *January*, 1867.

Geo S. Mahan

Justice of the Peace for Simpson Co Ky

CERTIFICATE OF AWARD OF THE BOARD OF CLAIMS.

OFFICE OF THE BOARD OF CLAIMS
FOR SLAVES ENLISTED OR DRAFTED IN THE SERVICE OF THE U. S.

186

We hereby certify, that _____ of _____ county, State of Kentucky, having proved, under oath, _____ loyalty to the Constitution and Government of the United States, and established _____ title as to the ownership of _____, a slave, _____ and mustered at _____ on the _____ day of _____, 186 _____, by _____ in the service of the United States, in the _____ Regiment of Colored Troops, Co. _____, the sum of _____ dollars has been awarded to _____ by this Board, subject to the approval of the Secretary of War, as a compensation for the said slave, under the provisions of section 24, Act approved February 24, 1864, and section 2, Act approved July 28, 1866.

_____, President of the Board.
_____, Member of the Board.
_____, Member of the Board.

To _____
Chief of the Bureau for the Organization of Colored Troops, Washington, D. C.

PROOF OF OWNERSHIP.

STATE OF KENTUCKY.

COUNTY OF *Simpson* } ss.

We *J S Stanford* and *A J Hampton* each of lawful age, and resident citizens of the State and County aforesaid, do certify that *King D Nicoll* of the State and County aforesaid, was on the *31st* day of *August* 1864, the lawful owner of the slave named *Ludman Nicoll* referred to and described in the foregoing claim for compensation.

J S Stanford
A J Hampton
Sworn to and subscribed before me a *Justice of the Peace* for the County of *Simpson* State of Kentucky, this the *31st* day of *July* 186*7*
J R Hope J P for Simpson county Ky

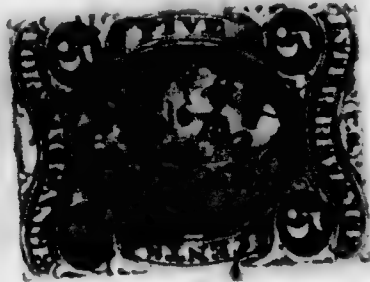

PROOF OF LOYALTY.

STATE OF KENTUCKY.

COUNTY OF *Simpson* } ss.

We *Chas F Potter* and *W J Seaward* loyal men and each of lawful age, and resident citizens of the _____ of _____ in the State and County aforesaid, upon our oaths declare that we have known *King D Nicoll* a resident of the State and County aforesaid, since the 4th day of March, 1861, and know that he has firmly and faithfully maintained his or her adherence and allegiance to the Government of the United States, by defending its cause against the Government and forces of the so-called Confederate States of America, in all suitable and practicable ways, and according to his or her ability and opportunity.

Chas F Potter
W J Seaward
Sworn to and subscribed before me a *Justice of the Peace* for the county of *Simpson* State of Kentucky, this the *19th* day of *Febry* 1867.
J R Hope J P for Simpson county Ky



POWER OF ATTORNEY.

My Post-Office address is *Franklin* County of *Simpson* State of Kentucky, and I hereby direct that all communications to me, touching this claim, be sent under cover to *Est Whitesides*, who is hereby appointed and constituted my true and lawful attorney, to prosecute this claim for me, and who is hereby authorized and empowered to receive and receipt for any award, order, draft, certificate, voucher, warrant, papers or money that may be issued in the adjustment of this claim, or the payment thereof, the same as I might or could do in person were I present and acting for myself, and to file any additional evidence or papers that may be required in the prosecution of this claim.

[WITNESS.] _____
The owner signs here. } *King D Nicoll*

50 CENT STAMP.

J S Stanford
J W Morris

Two witnesses to owner's signature sign here.



998

Nisbett, John
Co E, 6 U. S. Col'd Cav.

Private | *Private*

CARD NUMBERS.

1	5389197	26
2	5391794	27
3	5391890	28
4	5391978	29
5	5392457	30
6	9093276	31
7	9093188	32
8	40732669	33
9		34
10		35
11		36
12		37
12		38
14		39
15		40
16		41
17		42
18		43
19		44
20		45
21		46
22		47
23		48
24		49
25		50

Book Mark: _____

See also _____

A. E. Cor U.S.C.T.

John Kerbett

E, Co. *E*, *E* Reg't U. S. Col'd *Cor*

Appears on

Company Descriptive Book

of the organization named above.

DESCRIPTION.

Age *22* years; height *5* feet *5* inches.

Complexion *Blk*

Eyes *Blk*; hair *Blk*

Where born *Hopkins City*

Occupation *Farmer*

ENLISTMENT.

When *Apr 20*, 186*4*.

Where *Burling Green*

By whom *Hobson*; term *1* y'rs.

Remarks: *Mustered Apr 20/64*

Burling Green Hobson

Bryer

W. | **6 Cav. | U.S.C.T.**

John Hissbett

....., Co. E, 6 Reg't U. S. Col'd Cav.

Appears on

Company Descriptive Book

of the organization named above.

DESCRIPTION.

Age 22 years; height 5 feet 5 inches.

Complexion Black

Eyes black; hair black

Where born Hopkinton Ky.

Occupation Farmer

ENLISTMENT.

When Nov. 30., 1864.

Where B. Green

By whom Hobson; term 3 y'rs.

Remarks:

Mustered Nov. 30. 1864 Hob
son in Bowling Green Ky

C. H. Powell

N | 6 Cav. | U.S.C.T.

John Nisbett

Appears with rank of Pri. on

Muster and Descriptive Roll of a Detachment of U. S. Vols. forwarded

for the 6 Reg't U. S. Col'd Cavalry. Roll dated Bowling Green Ky. Nov. 30, 1864.

Where born Hopkins Co. Ky.

Age 22 y'rs; occupation Farmer

When enlisted Nov. 20, 1864.

Where enlisted Bowling Green

For what period enlisted 3 years.

Eyes Blk; hair Blk

Complexion Blk; height 6 ft. 5 in.

When mustered in Nov. 20, 1864.

Where mustered in _____

Bounty paid \$ 100; due \$ 100

Where credited _____

Company to which assigned _____

Remarks: New Recruit Hopkins
Owes Service to Ray Nisbett

Book mark: _____

C. E. M. Laughlin

(339)

Copyist.

A. | 6 Cav | U. S. C. T.

John Wisbell
Priv., Co. E., 6 Reg't U. S. Col'd Cav

Appears on

Company Muster-in and Descriptive Roll
of the organization named above. Roll dated

Leavington, Ky, Jan. 15, 1865.

Where born Hopkins, Ky.

Age 22 y'rs; occupation farmer

When enlisted Nov. 20, 1864.

Where enlisted Bowling Green

For what period enlisted 3 years.

Eyes blk; hair blk

Complexion blk; height 5 ft. 5 in.

When mustered in Nov. 20, 1864.

Where mustered in Bowling Green Ky.

Bounty paid \$ 100; due \$ 100

Where credited Hopkins Co., Ky. 2 dist.

Company to which assigned

Remarks:

Book mark:

(3567)

Wreck
Copyist.

N

6 Cav. U.S.C.T.

John Wisbett

Priv., Co. E, 6 Reg't U. S. Col'd Cav.

Appears on

Company Muster Roll

for *Jan. 15 to Apr. 30*, 1865.

Present or absent *Absent*

Stoppage, \$ *100* for

Due Gov't, \$ *100* for

Valuation of horse, \$ *100*

Valuation of horse equipments, \$ *100*

Remarks: *Captured at Smithfield, Ky. Jan. 5, 1865; in action by Jersey's Guerrillas*

Book mark:

Beck

Copyist.

(358)

A

6 Cav. U.S.C.T.

John Wisbett

Priv., Co. E, 6 Reg't U. S. Col'd Cav.

Appears on

Company Muster Roll

for *May & June*, 1865:

Present or absent *Absent*

Stoppage, \$ *100* for

Due Gov't, \$ *100* for

Valuation of horse, \$ *100*

Valuation of horse equipments, \$ *100*

Remarks: *Captured in action at Smith's Hill, Ky. Jan 5 '65. Reported missing in action since muster of Apr. 30 '65.*

(M.O. Roll upon which name appears.)

Book mark:

Beck

(358)

Copyist.

22 | **6 Cav.** | **U.S.C.T.**

John Nesbeth
Co. E, 6 Reg't U. S. Col'd Cav.

Appears on Returns as follows:

Jan 1865 Jan 5 65
Smithfield Ky miss-
ing in action or
captured by a band
of Guerrillas under
the command of the
notorious Jesse

Book mark:

(546)

J. E. Douglas
Copyist.

No. **6 Cav. U.S.C.T.**

John D. Smith
 , Co. E, 6 Reg't U. S. Col'd Cavalry.

Appears on **Co. Muster-out Roll**, dated , , 186 .

Muster-out to date , 186 .

Last paid to , 186 .

Clothing account:

Last settled , 186 ; drawn since \$ 100

Due soldier \$ 100; due U. S. \$ 100

Am't for cloth'g in kind or money adv'd \$ 100

Due U. S. for arms, equipments, &c., \$ 100

Bounty paid \$ 100; due \$ 100

Remarks:

Book mark:

(361) Copyist.

999

Noland Henry
Co A, 6 U.S. Col'd Cav.

Private | *Private*

CARD NUMBERS.

1	5388397	26
2	5388481	27
3	5388564	28
4	5388588	29
5	5388726	30
6	5389186	31
7	9092804	32
8	43147898	33
9	40732677	34
10		35
11		36
12		37
13		38
14		39
15		40
16		41
17		42
18		43
19		44
20		45
21		46
22		47
23		48
24		49
25		50

Book Mark: *E.B. H. 9. 1. 365.*

See also

583272. A. C. '98.

01210876 P. O. M. T. M.
2315637 P. O. M. T. M.

D. F. Miller, Ch.

A 6 Cav. | U.S.C.T.

Henry Adams

Co. *A*, 6 Reg't U. S. Col'd Cav.

Appears on

Company Descriptive Book

of the organization named above.

DESCRIPTION.

Age *27* years; height *5* feet *6* inches.

Complexion *Blk*

Eyes *Blk*; hair *Blk*

Where born *Hardin Ky*

Occupation *farmer*

ENLISTMENT.

When *Sept 25*, 186*4*

Where *Camp Nelson*

By whom *J. C. Randolph*; term *3* y'rs.

Remarks: *Sic in Camp Nelson*

Oct 8 1864

600

M. S. S.

Henry Meland

Appears with rank of Sgt on

Muster and Descriptive Roll

of Detachment of U.S. Colored
Spears, mustered into U.S.
service for the U.S.A. Roll dated

Camp Nelson Ky, Oct. 3, 1864.

Where born Harrods, Ky

Age 20 years; occupation Farmer.

When enlisted Sept. 28, 1864.

Where enlisted Camp Nelson, Ky

For what period enlisted 3 years.

Eyes Black; hair Black

Complexion Black; height 5 ft. 6 in.

When mustered in Sept. 28, 1864.

Where mustered in Camp Nelson

Bounty paid \$ 100; due \$ 100

Clothing account:

Last settled _____, 186 ; drawn since \$ 100

Date of first muster _____, 186 .

Company to which assigned _____

Remarks: Pay due from enlist-

ment. Name of reported

owner, James Meland,

located at Clarke, 7 West Ky

Book mark: _____

(356m)

M. M. Feltner

Copyist.

N **6 Cav. U.S.C.T.**

Henry Noland

Priv., Co. *A*, 6 Reg't U. S. Col'd Cavalry.

Appears on

Company Muster-in and Descriptive Roll

of the organization named above. Roll dated *Camp Nelson Ky, N.Y., Nov. 1, 1864.*

Where born *Hardin Kentucky*

Age *30* y'rs; occupation *Farmer*

When enlisted *Sept. 28*, 186 .

Where enlisted *Camp Nelson Ky*

For what period enlisted *3* years.

Eyes *Black*; hair *Black*

Complexion *Black*; height *5 ft. 6 in.*

When mustered in *Sept. 28*, 186 .

Where mustered in *Camp Nelson Ky*

Bounty paid \$ *100*; due \$ *100*

Where credited *7 Dist Kentucky*

Company to which assigned

Remarks:

Book mark:

Waggett

(356d) Copyist.

N

6 Cav. U.S.C.T.

Henry Holin

Plt

Co. A, 6 Reg't U. S. Col'd Cavalry.

Appears on

Company Muster Roll

for

Nov. & Dec.

1864.

Present or absent

Absent

Stoppage, \$

100 for

Due Gov't, \$

100 for

Valuation of horse, \$

100

Valuation of horse equipments, \$

100

Remarks:

*Missing in action
at Battle of Marion Va. Dec
18th 1864*

Book mark:

Daggett

(358)

Copyist.

N. **6 Cav. U.S.C.T.**

Henry Roland
Pr., Co. A, 6 Reg't U. S. Col'd Cavalry.

Appears on

Company Muster Roll

for *Jan. & Feb.*, 1865.

Present or absent.....

Stoppage, \$..... 100 for

Due Gov't, \$..... 100 for

Valuation of horse, \$..... 100

Valuation of horse equipments, \$..... 100

Remarks:.....

** Entire entry cancelled by a
line drawn through.*

Book mark:.....

W. J. Baggett

N. 6 Cav. U.S.C.T.

Henry Holund

Co. A, 6 Reg't U. S. Col'd Cavalry.

Appears on

Company Muster Roll

for Jan. & Feb., 1865.

Present or absent

Stoppage, \$ 100 for

Due Gov't, \$ 100 for

Valuation of horse, \$ 100

Valuation of horse equipments, \$ 100

Remarks: Missing in action
at Marion Va. Dec. 18/64
First instalment Bounty
due.

(Roll May & June '65, next
on which name appears.)

Book mark:

Jaggett

(358)

Copyist.

M

6 Cav. U.S.C.T.

Henry Holand
1100, Co. A, 6 Reg't U. S. Col'd Cavalry.

Appears on

Company Muster Roll

for *May & June*, 186*5*.

Present or absent

Stoppage, \$ *100* for

Due Gov't, \$ *100* for

Valuation of horse, \$ *100*

Valuation of horse equipments, \$ *100*

Remarks: *I was seriously*
reported missing
in Action. Died in
Hospital Camp Mel-
bourne Oct 8th 1865.
No inventory of
effects received

Book mark *Died Oct 8/64 E.H.*

(358) *Joseph Stewart*
Copyist.

JAN. 10

5388726

1891

Book mark;
Vol 9 P 365.

6 Cav. U.S.C.T.

Henry Nolan
Par. Co. A. 6 Reg't U. S. Col'd Cav.

Appears on Returns as follows:

Dec 1864 Missing in
action Dec 1864
Marion, Va.

June 1865 June 30 Camp
Nelson Coroner's
reported missing in
action at Satterlee -
Loss Died at Hosp
Camp Nelson Ky Co - 5
Notice Recd June 30, 1864

The notifi-
cation in regard to the
death of this man was
sent to 5 U S C C &
after a long delay was
forwarded to the 6 U S C C
Loss June 25 Camp
Nelson Died

Book mark:

(546) J. E. Douglas Copyist.

6 Cav. U.S.C.T.

Henry Holand

Pvt, Co. *A*, 6 Reg't U. S. Col'd Cavalry.

Appears on **Co. Muster-out Roll**, dated
Qualls Bluff Ark. April 15, 1866.

Muster-out to date _____, 186 .

Last paid to _____, 186 .

Pay due from enlistment

Clothing account:

Last settled _____, 186 ; drawn since \$ _____ 100

Due soldier \$ _____ 100; due U. S. \$ _____ 100

Am't for cloth'g in kind or money adv'd \$ _____ 100

Due U. S. for arms, equipments, &c., \$ _____ 100

Bounty paid \$ _____ 100; due \$ _____ 100

Remarks: *Died in Hospital at
Camp - Disease not named
Oct 8 " 61.*

Final statement furnished.

Book mark: *V. 131. P. 149. 71. V. 125 - P. 8. 71*

R. S. Helton

Noland, Henry

P. Co. A., 6 Reg' **S. C. Cav.**

² **Enclosures.**

Bed Cards	Descriptive Lists
Burial Records	Final Statements /
Certs. of Dis. for Discharge	Furloughs
C. M. Charges	Med. Des. Lists
Med. Certificates	Orders

Other papers relating to—

Admission to Hosp'l	Furlough
Casualty Sheet (Officer's) ^{<i>Priv.</i>} /	Med. Examination
Confinement	Misc. Information
Contracts	Pay or Clothing
Death or Effects	Personal Reports
Desertions	Rank
Discharge from Hosp'l	Transfer to Hosp'l
Discharge from Service	Transfer to V. R. C.
Duty	Transportation

Extract from Act of Congress.

SEC. 12. And be it further enacted, That the fees of agents and attorneys for making out and causing to be executed the papers to establish a claim for a pension, bounty, and other benefits under this act, shall not exceed the sum of ten dollars: For making out and causing to be executed the same to the Pension Office, with the requisite certificate, ten dollars: which sum shall be received by such agent or attorney in full for all services in obtaining such benefits, and shall not be demanded or received, in whole or in part, until such pension shall be obtained; and the sixth and seventh sections of an act entitled "An act to grant pensions approved July [fourteen,] eighteen hundred and sixty-two, are hereby repealed.

SEC. 13. And be it further enacted, That any agent or attorney who shall, directly or indirectly, demand or receive any greater compensation for services under this act than is prescribed in the preceding sections of this act, or who shall contract or agree to prosecute a claim for a pension, bounty, or other allowance under this act, on the condition that he shall receive a per centum of any portion of the amount of such claim, or who shall knowingly withhold from a pensioner or other claimant any portion of the pension or claim allowed and due to such pensioner or claimant, shall be deemed guilty of a high misdemeanor, and, upon conviction thereof, shall, for every such offense, be fined not exceeding three hundred dollars, or imprisoned at hard labor not exceeding two years, or both, according to the circumstances and aggravations of the offense.

Approved July 4, 1864

NOTE 10.—If any soldier is charged a higher fee than that allowed by the above act, he should report the fact and the name of the agent to the Adjutant General, in order that steps may be taken to have the same refunded.

FINAL STATEMENT

OF

Henry Holand

6th Reg't of Vols. 6. Co

VOLUNTEERS.

Dec 11 1864

NOTE 1.—Two of these certificates (or duplicates) are to be given to each Volunteer Soldier or drafted man who may be discharged without being mustered out (Final Statements are never given to men mustered out of service,) that he may at once receive from the Paymaster the pay, &c. due him, and the captain or other COMMISSIONED officer commanding the company will certify to the act of the delivery of the duplicate certificates; with these certificates the Soldier is "entitled to" his discharge, and should also present his discharge to the Paymaster to have the payment endorsed on it. The discharge is to be given back to the Soldier by the Paymaster; the latter only retaining as his vouchers the duplicate certificates.

NOTE 2.—If the Soldier is entitled to pay for the use of his horse, the Company Commander will certify to that fact on the back of both these final statements, and also to the time he has pay due for having been so mounted on his own horse.

NOTE 3.—When a Soldier is furnished with final statements, his descriptive list, if he has one, should be taken up by the officer who gives the Soldier these statements, and endorsed with a statement to this effect by the officer. The endorsement should exhibit a full statement of the time for which the Soldier was allowed pay on his final statements, the clothing account, and all other charges against him or in his favor, so as to comprise a complete exhibit of his account. It will then be transmitted to the Company Commander of the Soldier, who will enter all the data necessary to a full understanding of the Soldier's account on the muster roll upon which the Soldier's discharge is reported. The descriptive list will then be destroyed. The object of this is, that the remaining portion of the Soldier's account may be settled upon the receipt of these muster rolls, and the Soldier receive any pay or allowances that may be due him at the time of his discharge, and which may not appear on his last final statements from the fact that his descriptive list is incomplete. These accounts for back pay, &c., are settled by the 2d Auditor of the Treasury Department.

NOTE 4.—Charges for loss or injury to ordnance, horse equipments, and other miscellaneous charges, should appear under the heading of "Other Stoppages."

NOTE 5.—Bounty paid by State authorities, and not by the United States, will not be entered on this statement.

NOTE 6.—Amounts due the Sutler and Laundress must be entered on the muster roll on which the discharge, death, desertion, &c., is reported, as well as on the final statement, otherwise the amount cannot be collected from the United States.

NOTE 7.—This blank will be used for deceased volunteers and drafted men, as well as for others.

NOTE 8.—Where a Soldier dies in Hospital or on detached service, his descriptive list, if he has one, should be sent with his final statements, in duplicate, to the Adjutant General, Washington, D. C.

NOTE 9.—If the soldier is a drafted man or substitute, the space for time, &c., of enrolment, should contain only the word drafted or substitute, as the case may be. If the Soldier is a "VETERAN," (or RECRUIT,) the words as a veteran (or recruit) as the case may be, should be interlined after the words mustered into the service of the U. S. A statement of all the installments of Veteran or Recruit Bounty RECEIVED by the Soldier must be made on the back of each final statement.

Adjutant General's Office
Washington D.C. July 10. 1871

The Muster-Roll of Co. "F" 6th U.S. Colored Cavalry for the months of May and June 1865 reports the death of Private Henry Holand October 8, 1865—the Muster-out Roll of the Company and the Final Statement of the soldier "October 8, 1864"

The latter date (October eighth (8th) 1864) is held to be correct and the Company Muster-Roll for May and June 1865 will be amended accordingly.

Wm. M. Stewart

Adj. Adjutant General

MA.

In letter of July 10. 71 to Adj. Gen.

ADJUTANT GENERAL'S OFFICE

Jan 16 1876

Duplicate with Inventory sent 2d Auditor

I certify, on honor, that Henry Hobard, a Private of
 Captain W. A. Mahous Company (A) of the 1st Regiment of W. S. G. Co
VOLUNTEERS, of the State of _____, born in Madison Co. State
 of Kentucky, aged 30 years; 5 feet 1 inches high; Blk complexion,
Blk eyes, Blk hair, and by occupation a Farmer, who joined for service
 and was enrolled (see Note 9) on the 28 day of Sept, 1863, at Camp Nelson
 by J. C. Randolph, for the period of Three years, and mustered into
 the service of the United States on the 28 day of Sept, 1863, at
Camp Nelson, by Capt. W. C. Perry; and having served
 HONESTLY and FAITHFULLY with his Company to the present date, is now entitled to a
DISCHARGE by reason of (Death) Died Oct 8th 1864 at

Camp Nelson (Disease Not Known) is Expect.

The said Henry Hobard Non Paid was ~~last paid by Paymaster~~
Non paid, to include the _____ day of _____, 1863, and
 has pay due him from that time to the present date: he is entitled to pay and subsistence for
TRAVELING to place of enrollment, and whatever other allowances are authorized to volunteer
 soldiers, drafted men, or militia, so discharged. He has received from the United States **CLOTHING**
 amounting to Nothing 100 dollars, since the _____ day of _____,
 1863, when his clothing account was last settled. He has received from the United States
No Bounty 100 dollars advanced **BOUNTY**.

There is to be stopped from him, on account of the State of _____, or other
 authorities, for **CLOTHING, &c.**, received on entering service, _____ 100 dollars; and
 for other stoppages, viz: _____

_____ 100 dollars.
 He has been furnished with **TRANSPORTATION** in kind from the place of his discharge to
 _____; and he has been **SUBSISTED** for **TRAVELING** to his
 place of enrollment, up to the 7th day of Oct, 1864.

He is indebted to _____, **SUTLER**, _____ 100 dollars.
 He is indebted to _____, **LAUNDRESS**, _____ 100 dollars.

Given in Duplicate, at Madison, this 15 day
 of Dec, 1863.

W. A. Mahous
Capt. Co. 1st W. S. G. Co.
 Commanding Company

Dec 1, 65
ret. ...

CASUALTY SHEET

No.

Henry Toland
Private of Company A
6th Regiment of U.S.C.

State Volunteers.

NATURE OF CASUALTY.

Dec 8th 1864

CASUALTY SHEET.

Name: Henry Roland
Rank: Private Company: A Regiment: 6"
Arm: WJC State:
Nature of Casualty: Died

CAUSE OF CASUALTY—(NAME OF DISEASE, &C.) BY WHOM DISCHARGED.
Unknown

DEGREE OF DISABILITY. FROM WHAT SOURCE THIS INFORMATION WAS OBTAINED.
Reh Decr Soldiers June 30 / 65

BY WHOM CERTIFIED. REMARKS.
A. Coate Lt Col. Comdr Regt. No Effects

DATE OF DISCHARGE, DEATH, &C. PLACE OF DISCHARGE, DEATH, &C.
Oct 5: 1864 Camp Nelson Ky

D. J. Cook
Clerk.

--	--	--

Molin, Henry
 _____, Co. _____, Reg't *N.S.C.I.*

Enclosures.

- | | |
|---|----------------------------|
| Bed Cards | Final Statements |
| Burial Records | Furloughs or L. of A. |
| Certs. of Dis. for Discharge | Med. Certificates |
| C. M. Charges | Med. Des. Lists |
| Descriptive Lists | Orders |
| Discharge Certificates | Pris. of War Record |
| Enlistment Papers <input checked="" type="checkbox"/> | Resignations |

Other papers relating to—

- | | |
|------------------------------|---------------------------|
| Admission to Hosp'l | Furlough or L. of A. |
| Casualty Sheet | Med. Examination |
| Confinement | Misc. Information |
| Contracts | Pay or Clothing |
| Death or Effects | Personal Reports |
| Desertion | Rank |
| Discharge from Hosp'l | Transfer to Hosp'l |
| Discharge from Service | Transfer to V. R. C. |
| Duty | Transportation |
| | |

NOTE 1.—This blank will be used for enlistments of United States colored troops. They will be made out in duplicate in all cases—one to accompany the recruiting returns of the superintendent (not the recruiting officer) to the Adjutant General, and one to accompany the accounts of the officer who pays bounty, &c.

NOTE 2.—An enlistment holds to the muster-in. The muster-in must, in all cases, precede payment of pay, bounty, pension, &c. A muster-in roll, must in all cases, be filed in the Adjutant General's Office as evidence of muster-in. The mustering officer, commissary, or assistant commissary of musters, as the case may be, will countersign both enlistments as having mustered the soldiers into the service of the United States before either of them is given to the disbursing officer.

DECLARATION OF RECRUIT.

I, Henry Stolin desiring to volunteer as a soldier in the ARMY OF THE UNITED STATES, for the term of Three Years, DO DECLARE That I am 30 years and months of age; that I have never been discharged from the United States service on account of disability or by sentence of a court-martial, or by order before the expiration of a term of enlistment; and I know of no impediment to my serving honestly and faithfully as a soldier for three years.

GIVEN at Camp Veterans the 20 day of Sept 1864

Witness:

J. N. Pope

Henry Stolin
No. 10
mustered at Camp Veterans
Sept 25 1864
2d Pennsylvania
Blanche Co.
James Stolin
35

Consent of Parent or Guardian in case of a Minor, if a Free Man, or in the case of a Slave, of the Person to whom he owes Service:

I, Do CERTIFY, That I am the that the said is years of age; and I do freely give my CONSENT to his volunteering as a SOLDIER in the Army of the United States, for the period of THREE YEARS, under the conditions of the laws of the United States.

GIVEN at the day of

Witness:

James Stolin

UNITED STATES COLORED TROOPS ENLISTMENT.

STATE OF



TOWN OF

I, Henry Nolin born in Wardens Lee
 in the State of Kentucky aged Thirty years
 and by occupation a Farmer Do HEREBY ACKNOWLEDGE to
 have volunteered Twenty Eight day of Sept 1864
 to serve as a **Soldier** in the **Army of the United States of America**, for the
 period of **THREE YEARS**, unless sooner discharged by proper authority: Do
 also agree to accept such bounty, pay, rations, and clothing, as are, or may be,
 established by law for the U. S. colored troops.

And I, Henry Nolin
 do solemnly swear that I will bear true faith and allegiance to the **United States**
of America, and that I will serve them honestly and faithfully against all their
 enemies or opposers whomsoever; and that I will observe and obey the orders
 of the President of the United States, and the orders of the officers appointed
 over me, according to the Rules and Articles of War.

Sworn and subscribed to, at Camp Nelson
 this 28th day of Sept 1864 Henry Nolin
 Before J. Randolph U. S. P. M. his mark

I CERTIFY, ON HONOR, That I have carefully examined the above named Volunteer agree-
 ably to the General Regulations of the Army, and that, in my opinion, he is free from all bodily
 defects and mental infirmity, which would in any way disqualify him from performing the
 duties of a soldier.

B. Hobbs
Apt Surgeon 114 4562
 EXAMINING SURGEON.

I CERTIFY, ON HONOR, That I have minutely inspected the Volunteer Henry Nolin
 previously to his enlistment, and that he was entirely sober when enlisted; that, to the best of
 my judgment and belief, he is of lawful age; and that, in accepting him as duly qualified to per-
 form the duties of an able-bodied soldier, I have strictly observed the regulations which govern
 the recruiting service. This soldier has 13 1/2 eyes, 13 1/2 hair, light com-
 plexion, is five feet 10 inches high.

J. Randolph
U. S. P. M.
 RECRUITING OFFICER OR AGENT.

Mustered into the United States Service 28 day of Sept 1864

McKinney
Capt 1864
 Mustering Officer.

Mustered into the service of the United States for three years or during the war, from date of enlistment, in Company

 Regiment of U. S. Colored Cavalry Volunteers, on the 28 day of Sept 1864 at Camp Nelson

McKinney
Capt 1864
Mustering Officer

NOTE 1.—This blank will be used for enlistments of United States colored troops. They will be made out in duplicate in all cases—one to accompany the recruiting
 agent of the superintendent (not the recruiting officer) to the Adjutant General, and one to accompany the accounts of the officer who pays bounty, &c.
 NOTE 2.—An enlistment holds to service. A muster-in must, in all cases, precede payment of pay, bounty, pension, &c. A muster-in roll, must in all cases, be filed in
 the Adjutant General's office use of muster-in. The mustering officer, commissary, or assistant commissary of musters, as the case may be, will countersign both
 enlistments as having mustered the soldiers into the service of the United States before either of them is given to the disbursing officer.

DECLARATION OF RECRUIT.

I, Henry Nolin desiring
 to volunteer as a soldier in the ARMY OF THE UNITED STATES, for the term of Three Years,
 DO DECLARE That I am 30 years and months of age; that I have
 never been discharged from the United States service on account of disability or by sentence of a
 court-martial, or by order before the expiration of a term of enlistment; and I know of no
 impediment to my serving honestly and faithfully as a soldier for three years.

GIVEN at Camp Nelson
 the 28 day of Sept 1864

Witness:
J. W. Doyle

Henry Nolin
 Volunteered at
 No.



Consent of Parent or Guardian in case of a Minor, if a Free Man, or in the case of
 a Slave, of the Person to whom he owes Service:

I, Do CERTIFY, That I am
 the

that the said is years of age; and I
 do freely give my CONSENT to his volunteering as a SOLDIER in the Army of the United States,
 for the period of THREE YEARS, under the conditions of the laws of the United States.

GIVEN at
 the day of

Witness:
[Signature]

UNITED STATES COLORED TROOPS ENLISTMENT.

STATE OF

TOWN OF

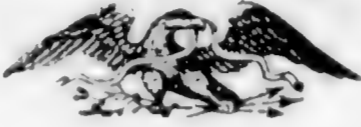

Kentucky *Franklin*

I *Henry Collins* born in *Franklin*

in the State of *Kentucky* aged *30* years

and by occupation a *Driver* Do HEREBY ACKNOWLEDGE to

have volunteered *Twenty Eight* day of *September* 1864

to serve as a **Soldier** in the **Army of the United States of America**, for the

period of **THREE YEARS**, unless sooner discharged by proper authority: Do

not know or may be

established by law for the U.S. colored troops.

And I, *Henry Collins*

do solemnly swear that I will bear true faith and allegiance to the **United States**

of America, and that I will serve them honestly and faithfully against all their

enemies or opposers whomsoever; and that I will observe and obey the orders

of the President of the United States, and the orders of the officers appointed

over me, according to the Rules and Articles of War.

Sworn and subscribed to, at *Franklin*

this *28* day of *Sept 1864*

Before *J. Randolph*

Henry Collins
his
mark

I CERTIFY, ON HONOR, That I have carefully examined the above named Volunteer agreeably to the General Regulations of the Army, and that, in my opinion, he is free from all bodily defects and mental infirmity, which would in any way disqualify him from performing the duties of a soldier.

B. Hobbs
EXAMINING SURGEON.

I CERTIFY, ON HONOR, That I have minutely inspected the Volunteer *Henry Collins* previously to his enlistment, and that he was entirely sober when enlisted; that, to the best of my judgment and belief, he is of lawful age; and that, in accepting him as duly qualified to perform the duties of an able-bodied soldier, I have strictly observed the regulations which govern the recruiting service. This soldier has *18* eyes, *18* hair, *18* complexion, is *5* feet *10* inches high.

J. Randolph
RECRUITING OFFICER OR AGENT.

Mustered into the United States Service *28* day of *Sept* 1864

J. H. Kennedy
Mustering Officer

Mustered into the service of the United States, for three years or during the war, from date of enlistment, in Company *Voluntary* Regiment of *119* Color Volunteers, on the *28* day of *September* 1864 at *Franklin Kentucky*

Capt. H. S. Kennedy
119th Col. U.S.A.
Mustering Officer

1000
Norman, Jacob

Co M, 6 U. S. Col'd Cav.

Private Private

CARD NUMBERS.

1	5396562	26
2	5396655	27
3	5396748	28
4	5396841	29
5	5396937	30
6	5397029	31
7	5397115	32
8	9093988	33
9	40732678	34
10		35
11		36
12		37
13		38
14		39
15		40
16		41
17		42
18		43
19		44
20		45
21		46
22		47
23		48
24		49
25		50

Book Mark:

See also 120 use. Inf.

D. 12495-37 P. C. M. M.

D. J. Miller, Esq.

A | **6 Cav. | U.S.C.T.**

Jacob Norman
Co. *M*, 6 Reg't U. S. Col'd Cav.

Appears on

Company Descriptive Book

of the organization named above.

DESCRIPTION.

Age *45* years ; height *3* feet *6* inches.

Complexion *Blk*

Eyes *Blk* ; hair *Blk*

Where born *L. Winberg, Va*

Occupation *Far*

ENLISTMENT.

When *Nov 24*, 186 *11*

Where *Queensboro*

By whom *Capt Partridge* term *3* y'rs.

Remarks: *Mustered into
US service Nov 24/61
Queensboro Ny by Capt
Grissum*

Tomish
Copyist.

A

6 Cav. U.S.C.T.

Jacob Herman

Pvt, Co. *M*, 6 Reg't U. S. Col'd Cavalry.

Appears on

Company Muster-in and Descriptive Roll

of the organization named above. Roll dated

Camp Nelson Ky, N.Y. July 10, 186*5*.

Where born *Lynchburg Virginia*

Age *45* y'rs; occupation *Farmer*

When enlisted *Nov 24*, 186*4*.

Where enlisted *Orange County*

For what period enlisted *3* years.

Eyes *black*; hair *black*

Complexion *black*; height *5* ft. *6* in.

When mustered in *Nov 24 by Lt. date Nov 24*, 186*4*.

Where mustered in *Orange County Ky*

Bounty paid *\$ one paid* *100*; due \$ *100*

Where credited *2d Dist of Ky*

Company to which assigned *M*

Remarks: *Drum & fdr Co I*

1st U.S.C.

Book mark:

J. H. Stewart

(356d)

Copyist.

A.

6 Cav. U.S.C.T.

Jacob Norman
Prior, Co. M, 6 Reg't U. S. Col'd Cavalry.

Appears on

Company Muster Roll

for *June 21 to June 30, 1864*.

Present or absent *Present*

Stoppage, \$ *100* for

Due Gov't, \$ *100* for

Valuation of horse, \$ *100*

Valuation of horse equipments, \$ *100*

Remarks: *Transferred from*
120 U.S.C.T. per A.C.
101 dated Hd Qrs.
11 June 10 1864.

Book mark:

Joseph Stewart
(358) Copyist.

N *6 Cav* **U.S.C.T**

Jacob Norman
Plt, Co. M, 6 Reg't U. S. Col'd *Cav*

Appears on

Company Muster Roll

for *Dated Aug 31*, 1865.

Present or absent *Present*

Stoppage, \$ *100* for

Due Gov't, \$ *100* for

Valuation of horse, \$ *100*

Valuation of horse equipments, \$ *100*

Remarks:

Book mark:

M O Chance

e/ **6 Cav. U.S.C.T.**

George Truman

24, Co. M, 6 Reg't U. S. Col'd Cavalry.

Appears on

Company Muster Roll

for *Sept Oct*, 186*5*.

Present or absent *Present*

Stoppage, \$ *100* for

Due Gov't, \$ *100* for

Valuation of horse, \$ *100*

Valuation of horse equipments, \$ *100*

Remarks:

Book mark:

(358)

Carroll

Copyist.

A **6 Cav. U.S.C.T.**

Jacob Torman
Cpl, Co. M, 6 Reg't U. S. Col'd Cavalry.

Appears on

Company Muster Roll

for *Nov Dec*, 1865.

Present or absent *Present*.

Stoppage, \$ *100* for

Due Gov't, \$ *100* for

Valuation of horse, \$ *100*

Valuation of horse equipments, \$ *100*

Remarks:

Book mark: *100*

(358)

Sabine
Copyist.

N 6 Cav. U.S.C.T.

Joseph Norman

Priv, Co. M, 6 Reg't U. S. Col'd Cavalry.

Appears on

Company Muster Roll

for Jan. 10. 1866, 1866.

Present or absent Present

Stoppage, \$ 100 for

Due Gov't, \$ 100 for

Valuation of horse, \$ 100

Valuation of horse equipments, \$ 100

Remarks:

Book mark:

C. S. McLaughlin

Copyist.

7 | **6 Cav. | U.S.C.T.**

Jacob Norman
Pvt. Co. M. 6 Reg't U. S. Col'd Cav.

Appears on Returns as follows:

*June to Dec 1865 On duty
Co. cook*

*Mar 1866 On duty detailed
as cook for Co.*

Book mark :

E. Douglas

(546)

Copyist.

N

6 Cav. U.S.C.T.

Jacob Norman

Co. M, 6 Reg't U. S. Col'd Cavalry.

Appears on **Co. Muster-out Roll**, dated *Delaware Co. Pa. April 15*, 186*6*.

Muster-out to date *Apr 15*, 186*6*.

Last paid to *Feb 25*, 186*6*.

Clothing account:

Last settled....., 186 ; drawn since \$ 100

Due soldier \$ 100; due U. S. \$ *35* ^{*52*} 100

Am't for cloth'g in kind or money adv'd \$ 100

Due U. S. for arms, equipments, &c., \$ 100

Bounty paid \$ *100* ^{*00*} 100; due \$ 100

Remarks:

Book mark: *837/83*

(861)

C. S. M. Loughlin
Copyist.

1001
Osell Osbe

Co. A, 6 U. S. Col'd Cav.

Sergeant Sergeant

CARD NUMBERS.

1	5387723	26
2	5387624	27
3	5387752	28
4	5394734	29
5	5394828	30
6	5394913	31
7	5394997	32
8	5395078	33
9	5395220	34
10	5388203	35
11	5395334	36
12	4093722	37
13	43155570	38
14	40732680	39
15		40
16		41
17		42
18		43
19		44
20		45
21		46
22		47
23		48
24		49
25		50

Book Mark: _____

See also _____

| **6 Cav. | U.S.C.T.**

Wade Odell

....., Co *A*, 6 Reg't U. S. Col'd Cav.

Appears on

Company Descriptive Book

of the organization named above.

DESCRIPTION.

Age *18* years; height *5* feet *4* inches.

Complexion *Mulatto*

Eyes *Blk*; hair *Blk*

Where born *Algham Ky*

Occupation *Farmer*

ENLISTMENT.

When *July 20*, 186*5*.

Where *Louisville Ky*

By whom *Capt Womack* term *3* y'rs.

Remarks *Exp'dited to 62nd Regt*

sub for J. Kable

.....

.....

.....

.....

.....

.....

.....

.....

.....

.....

.....

.....

.....

.....

.....

.....

.....

.....

Pomest

(383g)

Copyist.

6 Grav

Rank

Take

Appears with rank of *1st Lt* on

Muster and Descriptive Roll

of *Government of New District of*
Muster into Service of U.S.A.

Roll dated
Samuel H. Taylor, 1865.

Where born *Kentucky*
Age *18* y'rs; occupation *Farmer*

Drafted and mustered in:

When *Sept 1st*, 1865

Where *Samuel H. Taylor*

Enrollment district *5 Dist Ky*

Period *3* years.

Eyes *Blue*; hair *Brown*

Complexion *Mulatto*; height *5* ft. *4* in.

Bounty paid \$ *100*; due \$ *100*

Clothing account:

Last settled _____, 1865; drawn since \$ *100*

Date of commencement of service *Sept 1st*, 1865.

Company to which assigned _____

Remarks: *Sub of No 1000 1st Regt /*
sub dist 5 Dist Ky
into aft. 3 yrs
As clothing amt \$ 159.3

Book mark: _____

Jacobson

(356m)

Copyist.

T 6 U.S.C.T.

Tobe

Appears with rank of Pvt. on

Muster and Descriptive Roll of a Detachment of Substitutes forwarded

for the 6 Reg't U. S. Col'd Cavalry. Roll dated Draft Rendezvous, Louisville, Ky. Feb 15, 1865.

Where born Kentucky

Age 18 y'rs; occupation Farmer

When enlisted, 186

Where enlisted Substitute

For what period enlisted 3 years.

Eyes Black; hair Black

Complexion Mulatto; height 5 ft. 4 in.

When mustered in Feb 20, 1865.

Where mustered in Louisville

Bounty paid \$ 100; due \$ 100

Where credited 5th Dist. Ky.

Company to which assigned

Remarks: Sub. for J. Robb ante draft.

only cancelled except

Book mark:

0 | 6

U.S.C.T.

Tobe (Odell*)

Appears with rank of *Priv* on

Muster and Descriptive Roll of a Detachment of Substitutes forwarded

for the *6* Reg't U. S. Col'd Cavalry, Roll dated *Draft Rendezvous, Louisville, Ky, Feb 25, 1865.*

Where born *Kentucky*

Age *18* y'rs; occupation *Farmer*

When enlisted _____, 186 .

Where enlisted *Substitute*

For what period enlisted *3* years.

Eyes *Black*; hair *Black*

Complexion *Milatto*; height *5* ft. *4* in.

When mustered in *Feb 20*, 1865.

Where mustered in *Louisville*

Bounty paid \$ *100*; due \$ *100*

Where credited *5th Dist. Ky.*

Company to which assigned _____

Remarks: *Sub. for J. Robb.*

Book mark: _____

Conard
Copyist.

T | 6 | U.S.C.T.

Tobe

Appears with rank of *Pvt* on

Muster and Descriptive Roll of a Detachment of Substitutes forwarded

for the *6* Reg't U. S. Col'd Cavalry. Roll dated *Draft Rendezvous, Louisville, Ky, Feb 25, 1865.*

Where born *Kentucky*

Age *18* y'rs; occupation *Farmer*

When enlisted _____, 186 .

Where enlisted *Substitute*

For what period enlisted _____, *3* years.

Eyes *Blk*; hair *Blk*

Complexion *Mulatto*; height *5* ft. *4* in.

When mustered in *Feb 20*, 1865.

Where mustered in *Louisville*

Bounty paid \$ *100*; due \$ *100*

Where credited *5th Dist. Ky.*

Company to which assigned _____

Remarks: *Sub. for J. Rold.*

Book mark : _____

Conard
Copyist.

O

6 Cav. U.S.C.T.

Toler (O'Dell)

Serjt, Co. I, 6 Reg't U. S. Col'd Cavalry.

Appears on

Company Muster-in and Descriptive Roll

of the organization named above. Roll dated

Camp Nelson Ky, Apr 29, 1865.

Where born Oldham Co. Ky.

Age 18 y'rs; occupation Farmer

When enlisted, 1865

Where enlisted Substitute

For what period enlisted 3 years.

Eyes Black; hair Black

Complexion Mulatto; height 5 ft. 4 in.

When mustered in Feb. 20, 1865.

Where mustered in Louisville Ky.

Bounty paid \$ none paid; due \$ 100

Where credited

Company to which assigned I.

Remarks: 17 G. Co. sub for J. Robt. Barne on muster as Toler.

Book mark:

D. M. Kennedy

(356d)

Copyist.

(1) | 6 Cav. | U.S.C.T.

Jobe Odell

Serjt, Co. I, 6 Reg't U. S. Col'd Cavalry.

Appears on

Company Muster Roll

for *Enlistment to Apl 30, 1865.*

Present or absent *Present*

Stoppage, \$ *100* for

Due Gov't, \$ *100* for

Valuation of horse, \$ *100*

Valuation of horse equipments, \$ *100*

Remarks:

1st Instalment bounty due

Book mark:

(358)

L. M. Kennedy
Copyist.

C

6 Cav. | U.S.C.T.

Yobe Odell

Serj, Co. I, 6 Reg't U. S. Col'd Cavalry.

Appears on

Company Muster Roll

for *May & June*, 186*5*.

Present or absent *Present*.

Stoppage, \$ *100* for

Due Gov't, \$ *100* for

Valuation of horse, \$ *100*

Valuation of horse equipments, \$ *100*

Remarks:
1st Instalment bounty due

Book mark:

L. M. Kennedy
Copt. Ast.

(358)

C | **6 Cav.** | **U.S.C.T.**

John Odell

Serjt, Co. I, 6 Reg't U. S. Col'd Cavalry.

Appears on

Company Muster Roll

for *July & Aug*, 186*5*.

Present or absent *Present*

Stoppage, \$ 100 for

Due Gov't, \$ 100 for

Valuation of horse, \$ 100

Valuation of horse equipments, \$ 100

Remarks:

Book mark:

(358)

J. G. Cary

Copyist.

0

6 Cav. | U.S.C.T.

John Odell

Sgt, Co. I, 6 Reg't U. S. Col'd Cavalry.

Appears on

Company Muster Roll

for *Sept & Oct*, 1865.

Present or absent *Absent*

Stoppage, \$ 100 for

Due Gov't, \$ 100 for

Valuation of horse, \$ 100

Valuation of horse equipments, \$ 100

Remarks: *Absent without leave since Oct. 27th 65.*

Due P.M. for 1 nipple wrench & screw driver, 30-¢

Book mark:

(358)

J. B. Casey

Copyist.

C | **6 Cav.** | **U.S.C.T.**

John Cassin

Privt, Co. I, 6 Reg't U. S. Col'd Cavalry.

Appears on

Company Muster Roll

for Nov & Dec, 1865.

Present or absent _____

Stoppage, \$ _____ 100 for _____

Due Gov't, \$ _____ 100 for _____

Valuation of horse, \$ _____ 100

Valuation of horse equipments, \$ _____ 100

Remarks: Deserted Oct. 27, 65 - at
Covington, Ky.
Reduced from Sgt to
Privt in Order No. 130 - Hd. Qrs.
6th U.S. C. C. Dec. 27, 65 - to later
and from Nov. 1, 65.

Book mark: _____

(358)

J. Cassin

Copyist.

101 | *101* | **U.S.C.T.**

101, Co., Reg't U. S. Col'd *101*

Appears on

Descriptive List of Deserters

dated _____, 186 .

Deserted :

When *101*, 186 .

Where _____

Arrested :

When _____, 186 .

Where _____

Remarks : *101*

101

Book mark : _____

| **6 Cav.** | **U.S.C.T.**

Tobe Odell

Sgt, Co. 8, 6 Reg't U. S. Col'd Cav.

Appears on Returns as follows:

*Oct 1865 Absent without
leave since Oct 27 '65*

*Nov 1865 Absent without
leave at Covington Ky*

*Dec 1865 Oct 27/65 Covington
Ky Deserted Oct 27
65 While on guard
at Covington Ky*

Book mark: _____

(546)

J E Douglas
Copyist.

O.

6 Cav. U.S.C.T.

Toke Adell^{*}

Serjt., Co. *A*, 6 Reg't U. S. Col'd Cavalry.

Appears on **Co. Muster-out Roll**, dated

Sevalls Bluff Ark., *April 15*, 186*6*.

Muster-out to date _____, 186 .

Last paid to _____, 186 .

Clothing account:

Last settled _____, 186 ; drawn since \$ _____ 100

Due soldier \$ _____ 100; due U. S. \$ _____ 100

Am't for cloth'g in kind or money adv'd \$ _____ 100

Due U. S. for arms, equipments, &c., \$ _____ 100

Bounty paid \$ _____ 100; due \$ _____ 100

Remarks: *Deserted. Serjt. at organization. Deserted. Oct. 27/65, at Covington, Ky. Reduced to Pvt. Oct. 31/65.*

* Last name in parentheses:

Book mark: _____

(861)

J. Shearn

Copyist.

21

Tobe,

....., Co., *6* Reg't *N. A. Cav.*

2 Enclosures.

Bed Cards	Final Statements
Burial Records	Furloughs or L. of A
Certs. of Dis. for Discharge	Med. Certificates
C. M. Charges	Med. Des. Lists
Descriptive Lists	Orders
Discharge Certificates	Pris. of War Record
Enlistment Papers	Resignations

Other papers relating to—

Admission to Hosp'l	Furlough or L. of A
Casualty Sheet	Med. Examination
Confinement	Misc. Information
Contracts	Pay or Clothing
Death or Effects	Personal Reports
Desertion	Rank
Discharge from Hosp'l	Transfer to Hosp'l
Discharge from Service	Transfer to V. R. C.
Duty	Transportation

T. J. [unclear]

No. 997

John

Enlisted at *Louisville Ky*

As Substitute for

John Robb

On the *20* day of *February*, 1863, -

~~6~~ *6* *USE* *Case*

Wm. Mack Pres

W. R. Henry Com

J. S. Bell Secy

Board of Enrollment,

5 Dist. of *Ky*

Case

Mr Gibson:

Please report as to full name in case of E.P. herewith.

Respy. W. A.,
Mch. 23/86. *J. J. [unclear]*

Mr. Anderson
received of his full name in file.

Respy
May 5/87
Gibson

Mr Gibson:
Please report as to his assignment. Respy. W. A.,
May 6/87. *J. J. [unclear]*

Mr. Anderson
The man was received at Louisville Ky March 20/86. Sent to the 6488 Cav March 25/86. Late and present date in records stated. Partially they was delivered at Camp Nelson Ky. The records of which are not in file. *Respy*
June 20/87
Gibson

SUBSTITUTE
VOLUNTEER ENLISTMENT.

STATE OF

TOWN OF

Kentucky  *Louisville*

I, *Tobe* *(U.S.)*, born in the State of *Kentucky*, aged *18* years, and by occupation a *farmer*, Do HEREBY ACKNOWLEDGE to have agreed with *John Robb*, Esq., of *Jefferson* County *Ky*

to become his **SUBSTITUTE** in the Military Service, for a sufficient consideration paid and delivered to me, on the *20* day of *February*, 186*5*; and having thus agreed with said *John Robb*, I DO HEREBY ACKNOWLEDGE to have enlisted this *20* day of *February*, 186*5*, to serve as a **Soldier** in the **Army of the United States of America**, for the period of **THREE YEARS**, unless sooner discharged by proper authority. I do also agree to accept such bounty, pay, rations, and clothing as are, or may be, established by law for ~~soldiers~~ *colored troops*. And I do solemnly swear that I will bear true and faithful allegiance to the **United States of America**; that I will serve them honestly and faithfully against all their enemies or opposers whomsoever; and that I will observe and obey the orders of the President of the United States and the orders of the officers appointed over me, according to the Rules and Articles of War.

SWORN and subscribed to, at *Louisville Ky* this *20* of *February*, 186*5*, BEFORE *G. M. M. M. M. M.* *Capt. W. B. M. M. M.* *Ed. M. M.*

Tobe his *mark*

We certify, on honor, That we have carefully examined the above-named Volunteer Substitute agreeably to the Regulations, and that, in our opinion, he is free from all bodily defects and mental infirmity which would in any way disqualify him from performing the duties of a soldier; that he was entirely sober when enlisted; that he is of lawful age, (not under 18 years;) and that, in accepting him as duly qualified to perform the duties of an able-bodied soldier, and as a Substitute in lieu of *John Robb* of *Jefferson County*, drafted in *5 Dist. Ky*, 186*5*, we have strictly observed the Regulations which govern in such cases. This soldier has *Hack* eyes, *black* hair, *mulatto* complexion; is *5* feet *4* inches high. *Arise aft - 8 yrs*

G. M. M. M. M.
Provost Marshal.

Will R. Hervey
Commissioner of Board.

J. A. Bell
Surgeon of Board.

Board of Enrollment of *3* Dist. of *Ky*

DECLARATION OF SUBSTITUTE.

I, John, desiring to ENLIST
in the Army of the United States, for THREE YEARS, **Do declare**, That I am
18 years and _____ months of age; that I have
never been discharged from the United States service on account of disability or by sentence of
a court martial; and I know of no impediment to my serving honestly and faithfully as a soldier
for three years.

GIVEN at Louisville Ky
the 20 day of February 1863-

WITNESS:

A. J. Campbren

John ^{his}
X
made

J

No. 997

Tobe

Enlisted at Louisville Ky

As Substitute for

John Robb

On the 20 day of July, 1868

By

S. M. Momaek Pres

W. R. Hervey Com

T. S. Bell Surg

Board of Enrollment,

3 Dist. of Ky

DECLARATION OF SUBSTITUTE.

I, John, desiring to ENLIST
in the Army of the United States, for THREE YEARS, **Do declare**, That I am
18 years and _____ months of age; that I have
never been discharged from the United States service on account of disability or by sentence of
a court martial; and I know of no impediment to my serving honestly and faithfully as a soldier
for three years.

GIVEN at Louisville Ky
the 20 day of February 1865

WITNESS:

C. D. Campbell

John ^{his} X
man

1002

Ogden, Wesley

Co H, 6 U. S. Col'd Cav.

Private Private

CARD NUMBERS.

1	5392553	26
2	5392627	27
3	5392712	28
4	5392855	29
5	5392897	30
6	5392994	31
7	5393087	32
8	5393180	33
9	9093417	34
10	43147650	35
11	40732695	36
12		37
13		38
14		39
15		40
16		41
17		42
18		43
19		44
20		45
21		46
22		47
23		48
24		49
25		50

Book Mark:

See also

S 657332 - Page 172

S 1202380 P.O. m. m.

S. 1390959 P.O. aff

A 1737624 P.O. m. m.

D. J. Miller, Esq.

Q | 6 Cav. | U.S.C.T.

Wesley Gardner,
Co. F, 6 Reg't U. S. Col'd Cav.

Appears on

Company Descriptive Book

of the organization named above.

DESCRIPTION.

Age 23 years; height 5 feet 10 1/4 inches.

Complexion D. Brown

Eyes Black; hair Black

Where born Murray Ky.

Occupation Farmer

ENLISTMENT.

When Sept 11, 1864.

Where Bowling Green, Ky.

By whom Capt. Hobson; term 3 y'rs.

Remarks: Mustered in Sept 11
by Bowling Green, Ky.
by Capt. Hobson

* Sent to Hosp with deep
List Nov 22 '64

* As it appears on roll.

Dwight Webb

0

6 bar

U.S.C.T

Wesley Ogden

Appears with rank of Private on

Muster and Descriptive Roll

of Detachment U.S. Colored
Recruits forwarded

Roll dated Bowling Green Ky, Sept. 30, 1864.

Where born Warren Ky

Age 29 years; occupation Farmer

When enlisted Sept. 11, 1864.

Where enlisted Bowling Green

For what period enlisted 9 years.

Eyes Blue; hair Black

Complexion Light Brown; height 5 ft 10 3/4 in.

When mustered in _____, 186 .

Where mustered in _____

Bounty paid \$ _____ 100; due \$ _____ 100

Clothing account:

Last settled _____, 186 ; drawn since \$ _____ 100

Date of first muster Sept. 11, 1864.

Company to which assigned _____

Remarks: New Recruit Warren Co
Ordered sent to David Phillips

Book mark : _____

A C Black

(356m)

Copyist.

C **6 Cav. U.S.C.T.**

Wesley Ogden
Co. H, Co. *H*, 6 Reg't U. S. Col'd Cavalry.

Appears on

Company Muster-in and Descriptive Roll
of the organization named above. Roll dated

Lexington Ky, N. Y. *Jan 24*, 1865.

Where born *Warren Ky*

Age *23* y'rs; occupation *Farmer*

When enlisted *Sept 11*, 1864.

Where enlisted *Bond Green Ky*

For what period enlisted *3* years.

Eyes *Blk*; hair *Blk*

Complexion *Brown*; height *5 ft. 10 3/4* in.

When mustered in *Sept 4*, 1864.

Where mustered in *Bond Green Ky*

Bounty paid \$ *100*; due \$ *100*

Where credited *Warren Co. by J. Dix*

Company to which assigned

Remarks:

Book mark:

Greger

(356d)

Copyist.

C **6 Cav. U.S.C.T.**

Henry Ogden
H., Co. F, 6 Reg't U.S. Col'd Cavalry.

Appears on

Company Muster Roll

for *June 22 to Sept 30*, 186*5*.

Present or absent *Absent*

Stoppage, \$ *100* for

Due Gov't, \$ *100* for

Valuation of horse, \$ *100*

Valuation of horse equipments, \$ *100*

Remarks: *On detached service*
in Big Bend for 10 mo
dated Ad for U.S. Col'd Cavalry
from Ky Jan - 1865.

Book mark:

(358)

Bryer
Copyist.

U. S. C. T.

Wagner - U. S. C. T.
Co. F, 6 Reg't U. S. Col'd

Appears on

Company Muster Roll

for *May & June*, 186*5*.

Present or absent *Absent*

Stoppage, \$ *100* for

Due Gov't, \$ *100* for

Valuation of horse, \$ *100*

Valuation of horse equipments, \$ *100*

Remarks: *Was detached to service
in Brig Band since Jan '65*

Book mark:

Bieger

(358)

Copyist.

0

6 Cav. U.S.C.T.

Wesley Ogden

Present, Co. F, 6 Reg't U. S. Col'd Cavalry.

Appears on

Company Muster Roll

for July & Aug., 1865.

Present or absent Present

Stoppage, \$ 100 for

Due Gov't, \$ 100 for

Valuation of horse, \$ 100

Valuation of horse equipments, \$ 100

Remarks: Present of bounty due.

Book mark:

(358) J. E. Chapin Copyist.

O

6 Cav. U.S.C.T.

Wesley Ogden

Pro

, Co. F, 6 Reg't U.S. Col'd Cavalry.

Appears on

Company Muster Roll

for Sept. & Oct., 1865.

Present or absent Present

Stoppage, \$ 100 for

Due Gov't, \$ 100 for

Valuation of horse, \$ 100

Valuation of horse equipments, \$ 100

Remarks:

Book mark:

J. E. Chapin

(358)

Copyist.

O 6 Cav. U.S.C.T

Wesley Ogden

Pvt, Co. F, 6 Reg't U. S. Col'd Cav.

Appears on

Company Muster Roll

for Nov + Dec, 1865.

Present or absent Present

Stoppage, \$ 100 for

Due Gov't, \$ 100 for

Valuation of horse, \$ 100

Valuation of horse equipments, \$ 100

Remarks: In Reg Band m S. O. No. dated

Book mark:

J. P. ...

(358)

Copyist.

0 | **6 Cav. U.S.C.T.**

Nesley Ogden
Par, Co. F, 6 Reg't U.S. Col'd Cavalry.

Appears on

Company Muster Roll

for *Jan & Feb*, 186*6*

Present or absent *Present*

Stoppage, \$ *100* for

Due Gov't, \$ *100* for

Valuation of horse, \$ *100*

Valuation of horse equipments, \$ *100*

Remarks: *On daily*
duty in Reg't.
Barred per S.O. #

Book mark:

W. A. Smith

(358)

Copyist.

6 Cav. U.S.C.T.

Wesley Ogden
Capt, Co. F, 6 Reg't U. S. Col'd Cav.

Appears on Returns as follows:

Jan to July 1865 Absent on detached service in Big Band since Jan 1/65 pro D O No - dated 2d 20th 66 Lexington Jan 1865

Aug 1865 On duty in Band

Sept 1865 to Mar 1866 On duty in Regl Band

Book mark:

(546) J. E. Douglas Copyist.

O 6 Cav. U.S.C.T.

Wesley Ogden
Priv., Co. F, 6 Reg't U. S. Col'd Cavalry.

Appears on Co. Muster-out Roll, dated
Murrells Bluff, Ark. Apr 15 1866.

Muster-out to date Apr 15, 1866.

Last paid to Feb 28, 1866.

Clothing account:

Last settled _____, 186 ; drawn since \$ 100

Due soldier \$ 13³⁶ 100; due U. S. \$ 100

Am't for cloth'g in kind or money adv'd \$ 100

Due U. S. for arms, equipments, &c., \$ 100

Bounty paid \$ 100 100; due \$ 100 100

Remarks:

Book mark:

W. Smith

(861)

Copyist.

Ogden Wesley

....., Co.

Reg't *U.S.C.I.*

2

Enclosures.

Bed Cards	Final Statements
Burial Records	Furloughs or L. of A.
Certs. of Dis. for Discharge	Med. Certificates
C. M. Charges	Med. Des. Lists
Descriptive Lists	Orders
Discharge Certificates	Pris. of War Record
Enlistment Papers <i>2</i>	Resignations

Other papers relating to—

Admission to Hosp'l	Furlough or L. of A.
Casualty Sheet	Med. Examination
Confinement	Misc. Information
Contracts	Pay or Clothing
Death or Effects	Personal Reports
Desertion	Rank
Discharge from Hosp'l	Transfer to Hosp'l
Discharge from Service	Transfer to V. R. C.
Duty	Transportation

NOTE 1.—This blank will be used for enlistments of United States colored troops. They will be made out in duplicate in all cases—one to accompany the recruiting return of the superintendent (not the recruiting officer) to the Adjutant General, and one to accompany the accounts of the officer who pays bounty, &c.

NOTE 2.—An enlistment holds to service. A muster-in must, in all cases, precede payment of pay, bounty, pension, &c. A muster-in roll, must in all cases, be filed in the Adjutant General's Office as evidence of muster-in. The mustering officer, commissary, or assistant commissary of musters, as the case may be, will countersign both enlistments as having mustered the soldiers into the service of the United States before either of them is given to the disbursing officer.

DECLARATION OF RECRUIT.

I, Wesley Gordon desiring to volunteer as a soldier in the ARMY OF THE UNITED STATES, for the term of Three Years, DO DECLARE That I am 23 years and months of age; that I have never been discharged from the United States service on account of disability or by sentence of a court-martial, or by order before the expiration of a term of enlistment; and I know of no impediment to my serving honestly and faithfully as a soldier for three years.

GIVEN at Wilmington, Delaware the 11th day of Sept. 1864

Witness:

A. Johnson, Capt. Pro M.
Adj. Gen.

Wesley Gordon
Recruit

No. 2554
Wesley Gordon
Volunteer at Wilmington, Del.
September 11 1864
By A. Johnson
Capt. and Pro M. Adj. Gen.

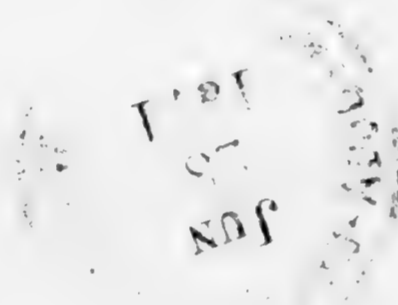

Consent of Parent or Guardian in case of a Minor, if a Free Man, or in the case of a Slave, of the Person to whom he owes Service:

I, Do CERTIFY, That I am the that the said is years of age; and I do freely give my CONSENT to his volunteering as a SOLDIER in the Army of the United States, for the period of THREE YEARS, under the conditions of the laws of the United States.

GIVEN at the day of

Witness:

UNITED STATES COLORED TROOPS ENLISTMENT.

STATE OF



TOWN OF

Kentucky *Franklin County*

I, *Wesley C. Allen* born in *Warren Co.*

in the State of *Kentucky* aged *Twenty Three* years

and by occupation a *Farmer* Do HEREBY ACKNOWLEDGE TO

have volunteered *Eleventh* day of *September* 186*4*

to serve as a **Soldier** in the **Army of the United States of America**, for the period of **THREE YEARS**, unless sooner discharged by proper authority: Do also agree to accept such bounty, pay, rations, and clothing, as are, or may be, established by law for the U. S. colored troops.

And I, *Wesley C. Allen* do solemnly swear that I will bear true faith and allegiance to the **United States of America**, and that I will serve them honestly and faithfully against all their enemies or opposers whomsoever; and that I will observe and obey the orders of the President of the United States, and the orders of the officers appointed over me, according to the Rules and Articles of War.

Sworn and subscribed to, at *Franklin County* this *11th* day of *Sept* 186*4* Before *A. G. Nelson, Capt. & Pro. Mar. of Dist. of East. Ky. & West. Va.*

I CERTIFY, ON HONOR, That I have carefully examined the above named Volunteer agreeably to the General Regulations of the Army, and that, in my opinion, he is free from all bodily defects and mental infirmity, which would in any way disqualify him from performing the duties of a soldier.

J. R. Bailey
EXAMINING SURGEON.

I CERTIFY, ON HONOR, That I have minutely inspected the Volunteer, *Wesley C. Allen* previously to his enlistment, and that he was entirely sober when enlisted; that in my judgment and belief, he is of lawful age; and that, in accepting him as duly qualified to perform the duties of an able-bodied soldier, I have strictly observed the regulations which govern the recruiting service. This soldier has *Blue* eyes, *Black* hair, *Light* complexion, is *five* feet *11* inches high.

A. G. Nelson, Capt. & Pro. Mar. of Dist. of East. Ky. & West. Va.
RECRUITING OFFICER OR AGENT.

Mustered into the United States Service *11th* day of *Sept* 186*4*

A. G. Nelson, Capt. & Pro. Mar. of Dist. of East. Ky. & West. Va.
Mustering Officer.

Mustered into the service of the United States, for three years or during the war, from date of enlistment, in Company
Regiment of Volunteers, on the day of 186*4* at

NOTE 1.—This blank will be used for enlistments of United States colored troops. They will be made out in duplicate in all cases—one to accompany the recruiting return of the superintendent (not the recruiting officer) to the Adjutant General, and one to accompany the accounts of the officer who pays bounty, &c.

NOTE 2.—An enlistment holds to service. A muster-in must, in all cases, precede payment of pay, bounty, pension, &c. A muster-in roll, must in all cases, be filed in the Adjutant General's Office as evidence of muster-in. The mustering officer, commissary, or assistant commissary of musters, as the case may be, will countersign both enlistments as having mustered the soldiers into the service of the United States before either of them is given to the disbursing officer.

DECLARATION OF RECRUIT.

I, John W. White desiring to volunteer as a soldier in the ARMY OF THE UNITED STATES, for the term of Three Years, DO DECLARE That I am 27 years and months of age; that I have never been discharged from the United States service on account of disability or by sentence of a court-martial, or by order before the expiration of a term of enlistment; and I know of no impediment to my serving honestly and faithfully as a soldier for three years.

GIVEN at St. Louis, Mo., 11/1 the 11 day of Sept. 1861.

Witness:

Wm. H. Hunt Capt. 20
Wm. H. Hunt Capt. 20

West
B^y Wm. H. Hunt
Volunteered at St. Louis, Mo.
No. 44228
Sept 11 1861
Capt. Wm. H. Hunt

Handwritten signature

Consent of Parent or Guardian in case of a Minor, if a Free Man, or in the case of a Slave, of the Person to whom he owes Service:

I, Do CERTIFY, That I am the that the said is years of age; and I do freely give my CONSENT to his volunteering as a SOLDIER in the Army of the United States, for the period of THREE YEARS, under the conditions of the laws of the United States.

GIVEN at the day of

Witness:

UNITED STATES COLORED TROOPS ENLISTMENT.

STATE OF Kentucky TOWN OF Newport

I, Wm. H. Carter born in Kentucky
 in the State of Kentucky aged Twenty Three years
 and by occupation a Farmer Do HEREBY ACKNOWLEDGE TO
 have volunteered Eleventh day of Sept 1864

to serve as a **Soldier** in the **Army of the United States of America**, for the period of **THREE YEARS**, unless sooner discharged by proper authority: Do also agree to accept such bounty, pay, rations, and clothing, as are, or may be, established by law for the U. S. colored troops.

And I, Wm. H. Carter do solemnly swear that I will bear true faith and allegiance to the **United States of America**, and that I will serve them honestly and faithfully against all their enemies or opposers whomsoever; and that I will observe and obey the orders of the President of the United States, and the orders of the officers appointed over me, according to the Rules and Articles of War.

Sworn and subscribed to, at Newport this 11th day of Sept 1864
 Before A. G. Webster Capt. 10th Regt. Col. 2^d Dist. Ky. Wm. H. Carter

I CERTIFY, ON HONOR, That I have carefully examined the above named Volunteer agreeably to the General Regulations of the Army, and that, in my opinion, he is free from all bodily defects and mental infirmity, which would in any way disqualify him from performing the duties of a soldier.

J. V. Bailey
 EXAMINING SURGEON.

I CERTIFY, ON HONOR, That I have minutely inspected the Volunteer Wm. H. Carter previously to his enlistment, and that he was entirely sober when enlisted; that, to the best of my judgment and belief, he is of lawful age; and that, in accepting him as duly qualified to perform the duties of an able-bodied soldier, I have strictly observed the regulations which govern the recruiting service. This soldier has black eyes, black hair, black complexion, is 5 feet 10 1/2 inches high.

A. G. Webster Capt. 10th Regt. Col. 2^d Dist. Ky.
 RECRUITING OFFICER OR AGENT.

Mustered into the United States Service 11th day of Sept 1864
A. G. Webster Capt. 10th Regt. Col. 2^d Dist. Ky.
 Mustering Officer.

Mustered into the service of the United States, for three years or during the war, from date of enlistment, in Company Regiment of Volunteers, on the day of 1864 at

1003

Oglesby William

Co M, 6 U. S. Col'd Cav.

Private Private

CARD NUMBERS.

1	5396564	26
2	5396657	27
3	5396750	28
4	5396843	29
5	5396939	30
6	5397031	31
7	5397117	32
8	909399	33
9	40732681	34
10		35
11		36
12		37
13		38
14		39
15		40
16		41
17		42
18		43
19		44
20		45
21		46
22		47
23		48
24		49
25		50

Book Mark:

See also 120 U.S.A. Army.

O | Gen U.S.C.T.

William Oglesby
, Co. M, 6 Reg't U. S. Col'd Gen

Appears on

Company Descriptive Book

of the organization named above.

DESCRIPTION.

Age 16 years; height 5 feet 6 inches.

Complexion Copper

Eyes Blue; hair Black

Where born Webster Ky

Occupation Farmer

ENLISTMENT.

When Dec 13, 1864.

Where Owensboro

By whom Gen McArthur; term 3 y'rs.

Remarks: Mustered into
11A Service Dec 13
Owensboro Ky by Capt
Grissom

Forrest
Corrlist.

()

6 Cav. U.S.C.T.

William Oglesby

Priv, Co. *M*, 6 Reg't U. S. Col'd Cavalry.

Appears on

Company Muster-in and Descriptive Roll

of the organization named above. Roll dated

Camp Wilson Ky, N.Y. July 10, 1865.

Where born *Wester Kentucky*

Age *16* y'rs; occupation *Fabrics*

When enlisted *Dec 13th*, 186*4*.

Where enlisted *Cumstonrow*

For what period enlisted *3* years.

Eyes *black*; hair *black*

Complexion *Copper*; height *5* ft. *6* in.

When mustered in *Dec 13th date Dec 13, 1864.*

Where mustered in *Cumstonrow Ky*

Bounty paid *\$none paid*; due \$ *100*

Where credited *1st Dist of Ky.*

Company to which assigned *M.*

Remarks: *Transf'd from Co.*

A. 120. U.S.C.T.

Book mark: _____

Joseph Stewart

(356d)

Copyist.

()

6 Cav. U.S.C.T.

William Cyclesby
Priv, Co. M, 6 Reg't U. S. Col'd Cavalry.

Appears on

Company Muster Roll

for *June 21 to June 30, 1861.*

Present or absent *Present*

Stoppage, \$ *100* for

Due Gov't, \$ *100* for

Valuation of horse, \$ *100*

Valuation of horse equipments, \$ *100*

Remarks: *Transferred*
from 120 U.S. Col.
per A.C. 105 dated
U.S. Gen. Ad. Service
10 1861

Book mark:

(358) *Joseph Stewart*
Copyist.

D. C. Law U.S.C.T

William Oglesby
Co. C, 6 Reg't U. S. Col'd Cav

Appears on

Company Muster Roll

for Dated Aug 31, 1865.

Present or absent Present.

Stoppage, \$ 100 for

Due Gov't, \$ 100 for

Valuation of horse, \$ 100

Valuation of horse equipments, \$ 100

Remarks:

Book mark:

M. O. Chance

(358)

Copyist.

P 6 Cav. U.S.C.T.

William Smith

Co, Co. M, 6 Reg't U. S. Co'd Cavalry.

Appears on

Company Muster Roll

for *Sept 24*, 1865.

Present or absent *Present*

Stoppage, \$ *100* for

Due Gov't, \$ *100* for

Valuation of horse, \$ *100*

Valuation of horse equipments, \$ *100*

Remarks:

Book mark:

(358)

Smith

Copyist.

F

6 Cav. U.S.C.T.

William Oglesby
Co, Co. M, 6 Reg't U. S. Col'd Cavalry.

Appears on

Company Muster Roll

for *Nov Dec*, 1865.

Present or absent *Present*.

Stoppage, \$ *100* for

Due Gov't, \$ *100* for

Valuation of horse, \$ *100*

Valuation of horse equipments, \$ *100*

Remarks *Due him for*
Exp 2, 95 cts.

Book mark: *1865*

(358)

Jabine
Copyist.

O

6 Cav. U.S.C.T.

Wm Oglesby

Capt, Co. M, 6 Reg't U. S. Col'd Cavalry.

Appears on

Company Muster Roll

for *Jan & Feb*, 186*6*.

Present or absent *Present*

Stoppage, \$ *100* for

Due Gov't, \$ *100* for

Valuation of horse, \$ *100*

Valuation of horse equipments, \$ *100*

Remarks: *From U.S. for
Co. & H. Co. 100 etc.*

Book mark: *1*

(358)

W. M. Laughlin
Copyist.

O | 6 Cav. | U.S.C.T.

Wm. Oakes
Par. Co. M, 6 Reg't U. S. Col'd Cav.

Appears on Returns as follows:

Sep 1865 Absent sick
Lexington Ky

Book mark:

(546)

J. E. Douglas

Copyist.

O

6 Cav. U.S.C.T.

Wm. Oglesby
Co. *M*, 6 Reg't U. S. Col'd Cavalry.

Appears on **Co. Muster-out Roll**, dated
Bellevue Bluff Ark, Apr 15, 1866.

Muster-out to date *Apr 15, 1866*.

Last paid to *July 28, 1866*.

Clothing account:

Last settled....., 186 ; drawn since \$..... 100

Due soldier \$..... 100; due U. S. \$ *46* ^{*15*}/₁₀₀

Am't for cloth'g in kind or money adv'd \$..... 100

Due U. S. for arms, equipments, &c., \$..... 100

Bounty paid \$ *100* ^{*00*}/₁₀₀; due \$..... 100

Remarks:

Book mark:

(861)

A. M. Laughlin

Copyist.

1004

Oldham Thomas

Co A, 6 U. S. Col'd Cav.

Private

Private

CARD NUMBERS.

1	5388398	26
2	5388482	27
3	5388510	28
4	5388599	29
5	8388670	30
6	5388802	31
7	5388894	32
8	5388984	33
9	5389073	34
10	5389154	35
11	9092805	36
12	4314788	37
13	40732682	38
14	32116196	39
15	32116352	40
16		41
17		42
18		43
19		44
20		45
21		46
22		47
23		48
24		49
25		50

Book Mark:

See also

S1285382 - P.O. rtd

D. J. Miller, Esq.

Q | **6 Cav.** | **U.S.C.T.**

Thomas Aldham

....., Co. *A*, 6 Reg't U. S. Col'd Cav.

Appears on

Company Descriptive Book

of the organization named above.

DESCRIPTION.

Age *24* years; height *5* feet *1* inches.

Complexion *Black*

Eyes *Black*; hair *Black*

Where born *Montgomery Ky*

Occupation *farmer*

ENLISTMENT.

When *Sept 23*, 186*5*

Where *Camp Nelson*

By whom *J. C. Randolph*; term *3* y'rs.

Remarks: *Appointed sergt Jan 1st 1865 Reduced July 1865
per Regtl Order No 84.*

Bryce

624
C. I. M. 1165

Thomas Oldham

Appears with rank of Priv on

Muster and Descriptive Roll

of Detachment of U.S. Colored
Regiment, mustered into U.S.
service for the U.S.A. Roll dated
Camp Nelson Ky. Oct. 3, 1864.

Where born Montgomery Ky.

Age 24 years; occupation Farmer

When enlisted Sept. 23, 1864.

Where enlisted Camp Nelson Ky.

For what period enlisted 3 years.)

Eyes Blue; hair Black

Complexion Black; height 5 ft. 10 in.

When mustered in Sept. 23, 1864.

Where mustered in Camp Nelson Ky.

Bounty paid \$ 100; due \$ 100

Clothing account:

Last settled _____, 186 _____; drawn since \$ 100

Date of first muster _____, 186 _____.

Company to which assigned _____

Remarks: Pay due from enlist
ment. Name of reputed
owner Marion Oldham
credited to Montgomery, Ky.

Book mark: _____

(356m)

W. W. J. Ecker
Copyist.

6 Cav. U.S.C.T.

Thomas Oldham

Priv., Co. A, 6 Reg't U. S. Col'd Cavalry.

Appears on

Company Muster-in and Descriptive Roll of the organization named above. Roll dated

Camp Nelson Ky, N.Y., Nov. 1, 1864.

Where born Montgomery Kentucky

Age 24 y'rs; occupation Farmer

When enlisted Sept. 23, 1864

Where enlisted Camp Nelson Ky

For what period enlisted 3 years.

Eyes Black; hair Black

Complexion Black; height 5 ft. 11 in.

When mustered in Sept. 23, 1864

Where mustered in Camp Nelson Ky

Bounty paid \$ 100; due \$ 100

Where credited Grist. Kentucky

Company to which assigned

Remarks:

Book mark:

W. J. G. G. G.

(356d)

Copyist.

Q

6 Cav. U.S.C.T.

Thomas Oldham

P. 1

Co. A, 6 Reg't U. S. Col'd Cavalry.

Appears on

Company Muster Roll

for Nov. + Dec., 1864.

Present or absent Absent

Stoppage, \$ 100 for

Due Gov't, \$ 100 for

Valuation of horse, \$ 100

Valuation of horse equipments, \$ 100

Remarks: In detached service left at Pound Gap Ky. Due U.S. for ordnance \$ 21.00

Book mark:

Dagg

6 Cav. U.S.C.T.

Thomas Oldham

Sergh., Co. A, 6 Reg't U. S. Col'd Cavalry.

Appears on

Company Muster Roll

for *Jan. & Feb.*, 1863.

Present or absent *Present*

Stoppage, \$ *100* for

Due Gov't, \$ *100* for

Valuation of horse, \$ *100*

Valuation of horse equipments, \$ *100*

Remarks: *First instalment
Bounty due appointed
Sergh. Dec. 31st 1864*

Book mark:

(358)

Page 7

Copyist.

6 Cav. U.S.C.T.

Thomas William

Sergt., Co. A, 6 Reg't U. S. Col'd Cavalry.

Appears on

Company Muster Roll

for *March 1st*, 186*5*.

Present or absent *Absent*

Stoppage, \$ *100* for

Due Gov't, \$ *100* for

Valuation of horse, \$ *100*

Valuation of horse equipments, \$ *100*

Remarks: *Sick in Hospital*

Paris Ky. First instalment

Bounty due.

Book mark:

Waggett

(1)

6 Cav. U.S.C.T.

Thomas Adham

Sgt., Co. A, 6 Reg't U. S. Col'd Cavalry.

Appears on

Company Muster Roll

for May & June, 1864.

Present or absent Absent

Stoppage, \$ 100 for

Due Gov't, \$ 100 for

Valuation of horse, \$ 100

Valuation of horse equipments, \$ 100

Remarks: Absent sick in Hospital Camp Nelson Ky 1st Instalment of Bounty due \$100.

Book mark:

Joseph Stewart

10

6 Cav. U.S.C.T.

Thomas Odham

Ser., Co. A, 6 Reg't U. S. Col'd Cavalry.

Appears on

Company Muster Roll

for July & Aug, 1865.

Present or absent Absent

Stoppage, \$ 100 for

Due Gov't, \$ 100 for

Valuation of horse, \$ 100

Valuation of horse equipments, \$ 100

Remarks: Sick in Hospital
Camp Nelson Ky
Reduced to Ranks per
Regt Order No 50. 1st
Installment of Bounty
due \$100.

Book mark:

Joseph Stewart Copyist.

(358)

O | 66 | USC T

Thomas Oldham

Pvt, Co. A, 6 Reg't U.S.C.C

Appears on

Hospital Muster Roll

of U. S. A. Post Hospital,

at Camp Nelson, Ky.,

for July + Aug, 1865.

Attached to hospital:

When, 186 .

How employed

Last paid by Maj.

to, 186 .

Bounty paid \$ 100; due \$ 100

Present or absent Present

Remarks:

Book mark:

C. L. Parker

C **6 Cav. U.S.C.T.**

Henry Adams

Regt., Co. A, 6 Reg't U. S. Col'd Cavalry.

Appears on

Company Muster Roll

for *Sept 1864*, 186 *J.*

Present or absent *Absent*

Stoppage, \$ *100* for

Due Gov't, \$ *100* for

Valuation of horse, \$ *100*

Valuation of horse equipments, \$ *100*

Remarks: *Absent sick in
Hospital of Nelson
Ky.*

Book mark:

Joseph Stewart
Copyist.

(358)

0 | 66 | U.S.C.T

Thomas Oldham

Pr't, Co. A, 6 Reg't U.S.C.C

Appears on

Hospital Muster Roll

of U. S. A. Post Hospital,

at Camp Nelson, Ky.,

for Sept + Oct, 1865.

Attached to hospital:

When _____, 186 .

How employed _____

Last paid by Maj. _____

to _____, 186 .

Bounty paid \$ 100; due \$ 100

Present or absent Present

Remarks: _____

Book mark : _____

C. C. Parker

(343)

Copyist.

C

6 Cav. U.S.C.T.

Thomas Oldham

Plt, Co. A, 6 Reg't U. S. Col'd Cavalry.

Appears on

Company Muster Roll

for Nov + Dec, 1865.

Present or absent Present

Stoppage, \$ 100 for

Due Gov't, \$ 100 for

Valuation of horse, \$ 100

Valuation of horse equipments, \$ 100

Remarks:

Book mark:

R B Shellm

(358)

Copyist.

O

6 Cav. U.S.C.T.

Thomas Oldham

Pat, Co. A, 6 Reg't U. S. Col'd Cavalry.

Appears on

Company Muster Roll

for *Jan & Feb*, 186*6*.

Present or absent *Present*

Stoppage, \$ *100* for

Due Gov't, \$ *100* for

Valuation of horse, \$ *100*

Valuation of horse equipments, \$ *100*

Remarks:

Book mark:

R. S. Shelton

(358)

Copyist.

C

6 Cav.

U.S.C.T.

Thomas Oldham
Sgt., Co. A, 6 Reg't U. S. Col'd Cav.
Sgt

Appears on Returns as follows:

Dec 1864 Absent Detach
service left at Pound
Gap Ky by order Prot
Maj Gen S. B. Burbridge
on return from Salt-
ville Dec 1864

Mar 1865 (Sgt) Absent
Detachd service per
R.O. No dated 1865

Apr 1865 (Sgt) Absent sick
Hosp Camp Nelson Ky

June & July 1865 (Sgt) Absent
sick Hosp Camp Nelson
Ky since June 22 '65

Aug to Oct 1865 Absent sick Hosp
Camp Nelson Ky since Aug 7/65

Book mark:

J. E. Douglas
(546) Copyist.

0

6 Cav. U.S.C.T.

Thomas Oldham
Priv., Co. A, 6 Reg't U. S. Col'd Cavalry.

Appears on Co. Muster-out Roll, dated
Qualls Bluff Ark, Apr. 15, 1866.

Muster-out to date Apr. 15, 1866.

Last paid to Feb 28, 1866.

Clothing account:

Last settled _____, 186 ; drawn since \$ 100

Due soldier \$ 100; due U. S. \$ 47 ⁷⁰/₁₀₀

Am't for cloth'g in kind or money adv'd \$ 100

Due U. S. for arms, equipments, &c., \$ 100

Bounty paid \$ 100; due \$ 100

Remarks:

Book mark: 5357. P.M.G. June 6/66
(over)

R. S. Shelton

JAN. 10

5389159

1891 *

493844 V. 212, P. 3-74.

Oldham Thomas

....., Co., Reg't *U. S. C. I.*

Enclosures.

Bed Cards	Final Statements
Burial Records	Furloughs or L. of A.
Certs. of Dis. for Discharge	Med. Certificates
C. M. Charges	Med. Des. Lists
Descriptive Lists	Orders
Discharge Certificates	Pris. of War Record
Enlistment Papers <input checked="" type="checkbox"/>	Resignations

Other papers relating to—

Admission to Hosp'l	Furlough or L. of A.
Casualty Sheet	Med. Examination
Confinement	Misc. Information
Contracts	Pay or Clothing
Death or Effects	Personal Reports
Desertion	Rank
Discharge from Hosp'l	Transfer to Hosp'l
Discharge from Service	Transfer to V. R. C.
Duty	Transportation

NOTE 1.—This blank will be used for enlistments of United States colored troops. They will be entered out in duplicate in all cases, one copy to accompany the recruiting return of the superintendent and the other to the Adjutant General's Office. The original copy of the recruiting return must, in all cases, precede payment of bounty, and must be filed in the Adjutant General's Office as evidence of muster-in. The mustering officer, commissary, or assis-

NOTE 2.—An enlistment roll, must, in all cases, precede payment of bounty, and must be filed in the Adjutant General's Office as evidence of muster-in. The mustering officer, commissary, or assis- must, in all cases, precede payment of bounty, and must be filed in the Adjutant General's Office as evidence of muster-in. The mustering officer, commissary, or assis-

DECLARATION OF RECRUIT.

I, Thomas Alderson desiring to volunteer as a soldier in the ARMY OF THE UNITED STATES, for the term of Three Years, do DECLARE That I am 24 years and months of age; that I have never been discharged from the United States service on account of disability or by sentence of a court-martial, or by order before the expiration of a term of enlistment; and I know of no impediment to my serving honestly and faithfully as a soldier for three years.

GIVEN at Camp Nelson the 28th day of Sept 1864

Witness: Jeruy Hill

Thomas Alderson

Volunteered at Camp Nelson
Sept 28th 1864
131
Jeruy Hill
6 Weeks
Thomas Alderson

Consent of Parent or Guardian in case of a Minor, if a Free Man, or in the case of a Slave, of the Person to whom he owes Service:

I, Do CERTIFY, That I am the

that the said is years of age; and I do freely give my CONSENT to his volunteering as a SOLDIER in the Army of the United States, for the period of THREE YEARS, under the conditions of the laws of the United States.

GIVEN at the day of

Witness: Jeruy Hill

UNITED STATES COLORED TROOPS ENLISTMENT.

STATE OF

TOWN OF

Kentucky

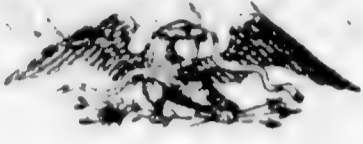

Camp Nelson

Thomas Oldham born in *Madison*

in the State of *Kentucky* aged *twenty four* years

and by occupation a *Farmer* Do HEREBY ACKNOWLEDGE TO

have volunteered *Twenty third* day of *September* 1864

to serve as a **Soldier** in the **Army of the United States of America**, for the period of **THREE YEARS**, unless sooner discharged by proper authority: Do also agree to accept such bounty, pay, rations, and clothing, as are, or may be, established by law for the U. S. colored troops.

And I, *Thomas Oldham*

do solemnly swear that I will bear true faith and allegiance to the **United States of America**, and that I will serve them honestly and faithfully against all their enemies or opposers whomsoever; and that I will observe and obey the orders of the President of the United States, and the orders of the officers appointed over me, according to the Rules and Articles of War.

Sworn and subscribed to, at *Camp Nelson*

this *23rd* day of *Sept. 1864* *Thomas Oldham*

Before *J. H. Barrett* *Notary*

I CERTIFY, ON HONOR, That I have carefully examined the above named Volunteer agreeably to the General Regulations of the Army, and that, in my opinion, he is free from all bodily defects and mental infirmity, which would in any way disqualify him from performing the duties of a soldier.

J. H. Barrett
Asst Surgt Major
EXAMINING SURGEON

I CERTIFY, ON HONOR, That I have minutely inspected the Volunteer, *T. Oldham* previously to his enlistment, and that he was entirely sober when enlisted; that, to the best of my judgment and belief, he is of lawful age; and that, in accepting him as duly qualified to perform the duties of an able-bodied soldier, I have strictly observed the regulations which govern the recruiting service. This soldier has *light* eyes, *dark* hair, *dark* complexion, is *5* feet *6* inches high.

J. H. Barrett
Notary
And *J. H. Barrett*
RECRUITING OFFICER OR AGENT.

Mustered into the United States Service *23* day of *Sept* 1864.

J. H. Barrett
Capt 18th U. S. I
Mustering Officer

Mustered into the service of the United States, for three years or during the war, from date of enlistment, in Company *B* Regiment of *U. S. Colored Cavalry*, on the *23* day of *September* 1864 at *Camp Nelson* *Kentucky*

W. H. Finney
Capt 18th U. S. I
Mustering Officer

NOTE 1.—This blank will be used for enlistments of United States colored troops. They will be made out in duplicate in all cases—one to accompany the recruiting return of the superintendent (not the recruiting officer) to the Adjutant General, and one to accompany the accounts of the officer who pays bounty, &c.

NOTE 2.—An enlistment holds to service until the soldier is mustered in, in all cases, precede payment of pay, bounty, pension, &c. A muster-in roll, must in all cases, be filed in the Adjutant General's Office as evidence of muster-in. The mustering officer, commissary, or assistant commissary of musters, as the case may be, will countersign both enlistments as having mustered the soldiers into the service of the United States before either of them is given to the disbursing officer.

DECLARATION OF RECRUIT.

I, Thomas Caldwell, desiring to volunteer as a soldier in the ARMY OF THE UNITED STATES, for the term of Three Years, DO DECLARE That I am 24 years and months of age; that I have never been discharged from the United States service on account of disability or by sentence of a court-martial, or by order before the expiration of a term of enlistment; and I know of no impediment to my serving honestly and faithfully as a soldier for three years.

GIVEN at Camp Nelson the 23^d day of Sept 1864

Witness: Yerby Smith

Thomas Caldwell

Volunteer of Camp Nelson
Sept 23 1864
Postmaster
Mr. Montgomery
Marion Allen

Thomas Caldwell
Private & Sergeant

Consent of Parent or Guardian in case of a Minor, if a Free Man, or in the case of a Slave, of the Person to whom he owes Service:

I, DO CERTIFY, That I am the that the said is years of age; and I do freely give my CONSENT to his volunteering as a SOLDIER in the Army of the United States, for the period of THREE YEARS, under the conditions of the laws of the United States.

GIVEN at the day of

Witness: Yerby Smith

UNITED STATES COLORED TROOPS ENLISTMENT.

STATE OF

TOWN OF

Kentucky

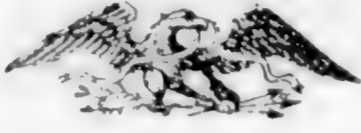

Camp Nelson

Thomas O. Othman born in Montgomery

in the State of Kentucky aged Twenty five years

and by occupation a Farmer Do HEREBY ACKNOWLEDGE TO

have volunteered Twenty third day of September 1864

to serve as a Soldier in the Army of the United States of America, for the

period of THREE YEARS, unless sooner discharged by proper authority: Do

also agree to accept such bounty, pay, rations, and clothing, as are, or may be,

established by law for the U. S. colored troops.

And I, Thomas O. Othman

do solemnly swear that I will bear true faith and allegiance to the United States

of America, and that I will serve them honestly and faithfully against all their

enemies or opposers whomsoever: and that I will observe and obey the orders

of the President of the United States, and the orders of the officers appointed

over me, according to the Rules and Articles of War.

Sworn and subscribed to, at Camp Nelson

this 23 day of Sept 1864 Thomas O. Othman

Before J. H. Barrett

I CERTIFY, ON HONOR, That I have carefully examined the above named Volunteer agree- ably to the General Regulations of the Army, and that, in my opinion, he is free from all bodily defects and mental infirmity, which would in any way disqualify him from performing the duties of a soldier.

J. H. Barrett, Asst Surgt Genl, EXAMINING SURGEON.

I CERTIFY, ON HONOR, That I have minutely inspected the Volunteer, Thomas O. Othman previously to his enlistment, and that he was entirely sober when enlisted; that, to the best of my judgment and belief, he is of lawful age; and that, in accepting him as duly qualified to perform the duties of an able-bodied soldier, I have strictly observed the regulations which govern the recruiting service. This soldier has blue eyes, dark hair, dark complexion, is five feet six inches high.

J. H. Barrett, RECRUITING OFFICER OR AGENT.

Mustered into the United States Service 23 day of Sept 1864.

J. H. Barrett, Capt 18th U. S. I, Mustering Officer

Mustered into the service of the United States, for three years or during the war, from date of enlistment, in Company ... Regiment of U. S. Colored Volunteers, on the 23 day of September 1864 at Camp Nelson Ky

Vertical signature and date: Sept 18th 1864 at Camp Nelson Ky

1005

Chier Pain

Co., 6 U. S. Col'd Cav.

Private

CARD NUMBERS.

1	5387262	26
2		27
3		28
4		29
5		30
6		31
7		32
8		33
9		34
10		35
11		36
12		37
13		38
14		39
15		40
16		41
17		42
18		43
19		44
20		45
21		46
22		47
23		48
24		49
25		50

Book Mark:

See also

O

6 Cav. U.S.C.T.

Roim Oliver

Appears with rank of *Priv.* on

Muster and Descriptive Roll of a Detachment of U. S. Vols. forwarded

for the 6 Reg't U. S. Col'd Cavalry. Roll dated

Lexington, Ky. Jan. 14, 1865.

Where born *Franklin Kentucky*

Age *23* y'rs; occupation *Farmer*

When enlisted *Sept. 16*, 186 .

Where enlisted *Cp. Nelson*

For what period enlisted *3* years.

Eyes *Blk*; hair *Blk*

Complexion *Blk*; height *5 ft. 4 in.*

When mustered in *Sept. 16*, 186 .

Where mustered in *Cp. Nelson*

Bounty paid \$ *100*; due \$ *100*

Where credited

Company to which assigned

Remarks: *Wm Risk, Owner*

(Not taken up on rolls

of Regt.)

Book mark:

C. E. M. Laughlin

(339)

Copyist.

7006
Owsley, Court

Co A, 6 U. S. Col'd Cav.

Private Sergeant

CARD NUMBERS.

1	5387513	26
2	5395936	27
3	5396018	28
4	5396100	29
5	5396183	30
6	5396263	31
7	5396340	32
8	5396413	33
9	9093843	34
10	2524-A-1888	35
11		36
12		37
13		38
14		39
15		40
16		41
17		42
18		43
19		44
20		45
21		46
22		47
23		48
24		49
25		50

Book Mark: 2524-A-'88.

See also

1911472 Populna

D. J. Miller, Ex.

D | 6 Cav. | U.S.C.T.

Mount Owsley
Sergeant, Co. G., 6 Reg't U. S. Col'd Cav.

Appears on

Company Descriptive Book

of the organization named above.

DESCRIPTION.

Age 22 years; height 5 feet 11 inches.

Complexion Brown

Eyes Black; hair Black

Where born Lincoln Co. Ky

Occupation Farmer

ENLISTMENT.

When May 30, 1865.

Where Camp Wilson

By whom Jas Powell; term 3 y'rs.

Remarks Appointed Sergeant
Nov 1/65.

Powell

6 Cav. U.S.C.T.

James Casley

Appears with rank of *Priv* on

Muster and Descriptive Roll of a Detachment of U. S. Vols. forwarded

for the 6 Reg't U. S. Col'd Cavalry. Roll dated *Washington D.C. Jan 1, 1865*

Where born *Fredericktown Ky*

Age *22* y'rs; occupation *Farmer*

When enlisted *Aug 30*, 186*4*.

Where enlisted *Camp Nelson*

For what period enlisted *3* years.

Eyes *Blue*; hair *Red*

Complexion *Fair*; height *5* ft. *11* in.

When mustered in *Jan 1*, 186*5*.

Where mustered in *Washington D.C.*

Bounty paid \$ *100*; due \$ *100*

Where credited *Fredericktown Ky*

Company to which assigned

Remarks: *James S. Casley*

Book mark: *2524-A-1888*

6 Cav. U.S.C.T.

John Wesley

Sergeant, Co. *L*, 6 Reg't U. S. Col'd Cavalry.

Appears on

Company Muster-in and Descriptive Roll

of the organization named above. Roll dated

Camp Nelson, N. Y. ^{*Ky.*} *June 9*, 186*5*.

Where born *Lincoln Co. Ky*

Age *22* y'rs; occupation *Farmer*

When enlisted *May 30*, 186*5*.

Where enlisted *Camp Nelson*

For what period enlisted *3* years.

Eyes *Blue*; hair *Blue*

Complexion *Blue*; height *5* ft. *11* in.

When mustered in *June 1*, 186*5*.

Where mustered in *Lexington*

Bounty paid \$ *100*; due \$ *100*

Where credited *Lincoln Co. Ky*

Company to which assigned *L*

Remarks: *see Inst Bounty due.*

Book mark:

(356d)

Henry J.
Copyist.

(10) | **6 Cav.** | **U.S.C.T.**

Forrest Owsley
Sergeant, Co. L, 6 Reg't U.S. Col'd Cavalry.

Appears on

Company Muster Roll

for *June 9 to June 30, 1865.*

Present or absent *Present*

Stoppage, \$ 100 for

Due Gov't, \$ 100 for

Valuation of horse, \$ 100

Valuation of horse equipments, \$ 100

Remarks:

Book mark: -----

(358)

Murray J.
Copyist.

C | **6 Cav. | U.S.C.T.**

Frank Owsley

Sergt., Co. L, 6 Reg't U. S. Col'd Cavalry.

Appears on

Company Muster Roll

for *July & Aug*, 186*5*.

Present or absent *Present*

Stoppage, \$ *100* for

Due Gov't, \$ *100* for

Valuation of horse, \$ *100*

Valuation of horse equipments, \$ *100*

Remarks:

Book mark:

(358)

Mowry, J.
Copyist.

O | 6 Cav. | U.S.C.T.

Fauk Ousley

Sgt, Co. L, 6 Reg't U. S. Col'd Cavalry.

Appears on

Company Muster Roll

for *Sept and Oct*, 1865.

Present or absent *Present*

Stoppage, \$ 100 for

Due Gov't, \$ 100 for

Valuation of horse, \$ 100

Valuation of horse equipments, \$ 100

Remarks:

Book mark:

(358)

Fas. v. Kearney
Copyist.

0 | 6 Cav. | U.S.C.T.

French Ousley

1st Sgt, Co. L, 6 Reg't U. S. Col'd Cavalry.

Appears on

Company Muster Roll

for *Nov and Dec*, 186*5*.

Present or absent *Present*

Stoppage, \$ *100* for

Due Gov't, \$ *100* for

Valuation of horse, \$ *100*

Valuation of horse equipments, \$ *100*

Remarks:

Book mark:

(358)

J. v. R. Kearny
Copyist.

0

6 Cav. | U.S.C.T.

Fount Ousley

1st Sergt., Co. L, 6 Reg't U. S. Col'd Cavalry.

Appears on

Company Muster Roll

for *Jan'y & Feb*, 186*6*.

Present or absent *Present*

Stoppage, \$ *100* for

Due Gov't, \$ *27*/*100* for *Ord'n.*

Valuation of horse, \$ *100*

Valuation of horse equipments, \$ *100*

Remarks:

Book mark: -----

(358)

J. B. Gage

Copyist.

O

6 Cav. U.S.C.T.

Fount Ousley

1st Sergt, Co. L, 6 Reg't U. S. Col'd Cavalry.

Appears on **Co. Muster-out Roll**, dated *Devalls Bluff, Ark, Apr 15, 1866.*

Muster-out to date *April 15, 1866.*

Last paid to *Feb. 28, 1866.*

Clothing account:

Last settled _____, 186 ; drawn since \$ 100

Due soldier \$ 100; due U. S. \$ *45.70*/₁₀₀

Am't for cloth'g in kind or money adv'd \$ 100

Due U. S. for arms, equipments, &c., \$ 100

Bounty paid \$ 100; due \$ 100

Remarks: *Was Sergt. from Orig*
Pro 1st Sergt. Nov. 1, 1865

Book mark: *429.342, No. 57 S.C. - 1979*
(over)

(861)

J B Gage

Copyist.

JAN. 10

5396413

1891

1881. 2524a. 88

O. C. Cav: U.S.C.

Fount Cusley
1st Sergt., Co. L., 6 Reg't U.S.C. Cav.

NOTATION.

Book mark: 2524. A. 1888.

War Department.

Adjutant General's Office,

Washington, June 12. 1888.

Application for certificate in lieu of lost discharge.

One Certificate furnished.

Rorn

(4766)

Original.

Owsley, Forest
P. Co. 2, 6 U.S.C. Cav
Reg't

3 Enclosures.

Bed Cards	Descriptive Lists
Burial Records	Final Statements
Certs. of Dis. for Discharge	Furloughs
C. M. Charges	Med. Des. Lists
Med. Certificates	Orders
Enlistments 2	

Other papers relating to—

Admission to Hosp'l	Furlough
Casualty Sheet (Officer's)	Med. Examination
Confinement	Misc. Information
Contracts	Pay or Clothing
Death or Effects	Personal Reports
Desertions	Rank
Discharge from Hosp'l	Transfer to Hosp'l
Discharge from Service	Transfer to V. R. C.
Duty	Transportation

ENDORSEMENT.

No. 1

APPLICATION OF

John B. Owsley

OF

Lincoln County Ky

for compensation for service of slave,

Fount Owsley

enlisted May 30th 1865

in L Co 6th Regiment

U. S. Colored Troops Cavalry

Received Dec 8th 1866

Compensation awarded

186

Dollars.

President Board of Claims

P. O. ADDRESS OF CLAIMANT:

Box at Lexington Ky

War Department,

ADJUTANT GENERAL'S OFFICE.

Washington, Dec 26 1866.

Respectfully returned to the Commission for the State of Kentucky, with the information that Fount Owsley was enlisted at Camp Kentucky May 30th 1865, and was mustered in as Pvt. in Co. L. 6th U. S. Colored June 1st 1865. O.S.

A. R. R. R. R.

13.

1000 Adj. Genl. 1865.

CLAIM FOR COMPENSATION FOR ENLISTED SLAVE.

No.

I, John B. Cusley, a loyal citizen, and a resident of Berke Orchard, County of Lincoln, State of Kentucky, hereby claim compensation, under the provisions of Section 24, Act approved February 24, 1864, and Section 2, Act approved July 28, 1866, for my slave Forest Cusley, enlisted May 30th 1865, at Co. Camp Nelson, Ky., by Sgt. James P. Powell and recruited in the U.S. Army of Gen. Grant at Lexington 15th day of June 1865, in the 6th Regiment U.S. Colored Troops, Co. D certificate of which enlistment, and a descriptive list, as required, accompany this application

In proof of my loyalty to the Constitution and Government of the United States, I present the accompanying oath, which I have taken, signed and acknowledged; to be filed with this application, in accordance with requirement of General Orders, No. 329, 1863, War Department, Adjutant General's Office.

Dec 6th, 1866 John B Cusley

OATH OF ALLEGIANCE.

I, John B. Cusley, the owner and claimant, do solemnly swear that the

foregoing claim is a just and true claim due to me as master and owner of the said slave, and that the facts alleged in said claim in respect to the draft or enlistment (as the case may be) of said slave into the military service of the United States are true. And I do further swear that I have never joined, or been concerned in, any insurrection or rebellion; that I have never borne arms against the United States; that I have never given any aid, countenance, counsel or encouragement, to any person or persons engaged, or whom I had reason to believe were about to engage, in insurrection, rebellion or armed hostility against the United States; that I have neither sought, nor accepted, nor attempted to exercise the functions of any office, civil or military, nor to perform any service whatever, under any authority, or pretended authority, in hostility to the United States; that I have not yielded a voluntary support to any insurrection, rebellion or pretended government authority, power or constitution within the United States hostile thereto. And I do further swear that, to the best of my knowledge and ability, I have supported and defended, and will continue to support and defend the United States against all enemies, foreign and domestic, and that I have supported, defended and obeyed, and will continue to support, defend and obey, the Constitution and Laws of the United States; that I will bear true faith and allegiance to the same; and that I take this oath freely, without any mental reservation or purpose of evasion: So help me God.

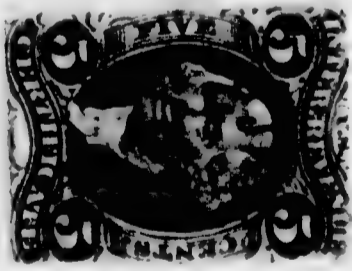

John B Cusley

Sworn to and subscribed before me by J. C. C. this 6th day of Dec 1866

J. J. M. Roberts J. C. C.

Headquarters Kentucky Volunteers,

Adjutant-General's Office,

Frankfort, November 19th, 1864.

I hereby certify, that it appears from the U. S. Muster-Inw
Rolls on file in this Office, that Mount Owsley
was enrolled on the 30th day of May, 1865, at
Camp Nelson Ky, by Lieut Jas^d Powell
and mustered into the U. S. service on the 1st day of June
1865, at Lexington Ky, by Wm Goodlow
to serve three years. Said Mount Owsley
is described as follows: 22 years age, Black eyes, Black hair,
Brown complexion, 5ft 11 in height. It further appears from
said Rolls, that Mount Owsley owed service to Doctor
Owsley was credited to Lincoln County Ky
and was assigned to Company "L" 6th Regt
U. S. C. Cavalry.

In Testimony Whereof, I have hereunto set my
hand, and affixed my Official Seal, this
19th day of November, 1864.

D. W. Lindsay
Adjutant General of Kentucky.



B404R939

... and allegiance to the Government of the United States, by
defending its cause against the Government and forces of the so-called Confederate States of America, in
all suitable and practicable ways, and according to his or her abilities...

PROOF OF OWNERSHIP.

State of Kentucky,

County of Lincoln } ss.

We Henry Clay and W. W. Cessley each of lawful age, and resident citizens of the State and county aforesaid, do certify that John B. Cessley of the State and county aforesaid, was on the 10th day of May 1866, the lawful owner of the slave named Grant Cessley; referred to and described in the foregoing claim for compensation.

Sworn to and subscribed before me a Clerk of Circuit Court for the county of Lincoln State of Kentucky, this the 6th day of Dec 1866 J. J. M. Roberts, clk. S. C. C.



PROOF OF LOYALTY.

State of Kentucky,

County of Lincoln } ss.

We W. W. Cessley and J. J. M. Roberts loyal men and each of lawful age, and a resident citizens of the Lincoln County of the State and county aforesaid, upon our oaths declare that we have known John B. Cessley a resident of the State and county aforesaid, since the 4th day of March, 1861, and know that he has firmly and faithfully maintained his or her adherence and allegiance to the Government of the United States, by defending its cause against the Government and forces of the so-called Confederate States of America, in all suitable and practicable ways, and according to his or her ability and opportunity.

Sworn to and subscribed before me a Clerk of Circuit Court for the county of Lincoln State of Kentucky, this the 6th day of Dec 1866 J. J. M. Roberts, clk. S. C. C.

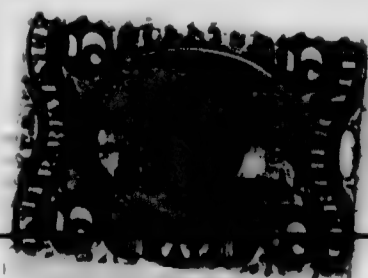

CERTIFICATE OF AWARD OF THE BOARD OF CLAIMS.

OFFICE OF THE BOARD OF CLAIMS,

For Slaves Enlisted or Drafted in the Service of the United States.

We hereby certify, that ... of ... county, State of ... having proved, under oath, ... loyalty, to the Constitution and Government of the United States; and established ... title as to the ownership of ... a slave enlisted or drafted (as the case may be) and mustered at ... on the ... day of ... 1866 ... in the service of the United States, in the ... Regiment of Colored Troops, Co. ... the sum of ... dollars has been awarded to ... by this Board, subject to the approval of the Secretary War, as a compensation for the said ... under the provisions of Section 24, Act approved February 24, 64, and Section 2, Act approved July 28, 1866.

President of the Board.
Member of the Board.
Member of the Board.

Chief of the Bureau for the Organization of Colored Troops, Washington D. C.

NOTE 1.—This blank will be used for enlistments of United States colored troops. They will be made out in duplicate in all cases—one to accompany the recruiting return of the superintendent (not the recruiting officer) to the Adjutant General, and one to accompany the accounts of the officer who pays bounty, &c.

NOTE 2.—An enlistment binds to service. A muster in must, in all cases, precede payment of pay, bounty, pension, &c. A muster in fail, must in all cases, be filed in the Adjutant General's Office as evidence of muster-in. The mustering officer, commissary, or assistant commissary of musters, as the case may be, will countersign both enlistments as having mustered the soldiers into the service of the United States before either of them is given to the disbursing officer.



DECLARATION OF RECRUIT.

I, Mount Ousely desiring to volunteer as a soldier in the ARMY OF THE UNITED STATES, for the term of Three Years, DO DECLARE That I am 22 years and _____ months of age; that I have never been discharged from the United States service on account of disability or by sentence of a court-martial, or by order before the expiration of a term of enlistment; and I know of no impediment to my serving honestly and faithfully as a soldier for three years.

GIVEN at Ep. Nelson the 30 day of May 1865

Witness:

Mount Ousely
his
mark

By

Volunteered at

No.

Ep-N

18

Mount Ousely

Consent of Parent or Guardian in case of a Minor, if a Free Man, or in the case of a Slave, of the Person to whom he owes Service:

I, Mr. Ousely Do CERTIFY, That I am the _____

that the said _____ is _____ years of age; and I do freely give my CONSENT to his volunteering as a SOLDIER in the Army of the United States, for the period of THREE YEARS, under the conditions of the laws of the United States.

GIVEN at _____ the _____ day of _____

Witness:

Credited to Lincoln Co

AK

UNITED STATES COLORED TROOPS ENLISTMENT.

STATE OF

TOWN OF

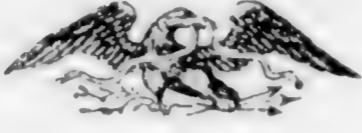

I, Mount Ousely born in Lincoln Co
in the State of Mo aged 22 years
and by occupation a Farmer Do HEREBY ACKNOWLEDGE TO
have volunteered 30 day of May 1866

to serve as a **Soldier** in the **Army of the United States of America**, for the
period of **THREE YEARS**, unless sooner discharged by proper authority: Do
also agree to accept such bounty, pay, rations, and clothing, as are, or may be,
established by law for the U. S. colored troops.

And I, Mount Ousely
do solemnly swear that I will bear true faith and allegiance to the **United States
of America**, and that I will serve them honestly and faithfully against all their
enemies or opposers whomsoever; and that I will observe and obey the orders
of the President of the United States, and the orders of the officers appointed
over me, according to the Rules and Articles of War.

Sworn and subscribed to, at St. James
this 30 day of May 1866 Mount Ousely
Before St. James Powell 6 yfc

I CERTIFY, ON HONOR, That I have carefully examined the above named Volunteer agree-
ably to the General Regulations of the Army, and that, in my opinion, he is free from all bodily
defects and mental infirmity, which would in any way disqualify him from performing the
duties of a soldier.

W. H. Riley
1st Lt. Surgeon U.S.A.
EXAMINING SURGEON.

I CERTIFY, ON HONOR, That I have minutely inspected the Volunteer Mount Ousely
previously to his enlistment, and that he was entirely sober when enlisted; that, to the best of
my judgment and belief, he is of lawful age; and that, in accepting him as duly qualified to per-
form the duties of an able-bodied soldier, I have strictly observed the regulations which govern
the recruiting service. This soldier has blue eyes, black hair, dark com-
plexion, is 5.7 feet 11 inches high.

St. James Powell
6 yfc RECRUITING OFFICER OR AGENT.

Mustered into the United States Service.....day of186 .

Mustered into the service of the United States, for three years or during the war, from date of enlistment, in Company,
Regiment of 1st Volunteers, on the 1st day of June 1866 at Beershear Mo

William Gamble
1st Lt. Surgeon U.S.A.
Mustering Officer

Mustering Officer.

NOTE 1.—This blank will be used for enlistments of United States colored troops. They will be made out in duplicate in all cases—one to accompany the recruiting return of the superintendent (not the recruiting officer) to the Adjutant General, and one to accompany the accounts of the officer who pays bounty, &c.

NOTE 2.—An enlistment holds to service. A muster in must, in all cases, precede payment of pay, bounty, pension, &c. A mustered-in man, in all cases, be made in the Adjutant General's Office as evidence of muster-in. The mustering officer, commissary, or assistant commissary of musters, as the case may be, will countersign both enlistments as having mustered the soldiers into the service of the United States before either of them is given to the disbursing officer.

DECLARATION OF RECRUIT.

I, Mount Casey desiring to volunteer as a soldier in the ARMY OF THE UNITED STATES, for the term of Three Years, DO DECLARE That I am 22 years and — months of age; that I have never been discharged from the United States service on account of disability or by sentence of a court-martial, or by order before the expiration of a term of enlistment; and I know of no impediment to my serving honestly and faithfully as a soldier for three years.

GIVEN at G. Nelson

the 30 day of May 1865

Witness:

Sub
Mount Casey
mastr

001225

6th M. S. C. Regt

Volunteered at Carl Nelson
30 May 1865
By James Nelson

No. —
3004 Co. 109 - (Col)

Consent of Parent or Guardian in case of a Minor, if a Free Man, or in the case of a Slave, of the Person to whom he owes Service:

I, W. Casey Do CERTIFY, That I am the

that the said — is — years of age; and I do freely give my CONSENT to his volunteering as a SOLDIER in the Army of the United States, for the period of THREE YEARS, under the conditions of the laws of the United States.

GIVEN at —

the — day of —

Witness:

credited Lincoln Co. 7th Dist. N.Y.
UNITED STATES COLORED TROOPS ENLISTMENT.

STATE OF



TOWN OF

I, *Mount Cusely* born in *Lincoln Co.*
in the State of *N.Y.* aged *22* years
and by occupation a *Farmer* Do HEREBY ACKNOWLEDGE TO
have volunteered *30* day of *May* 186*5*

to serve as a **Soldier** in the **Army of the United States of America**, for the
period of **THREE YEARS**, unless sooner discharged by proper authority: Do
also agree to accept such bounty, pay, rations, and clothing, as are, or may be,
established by law for the U. S. colored troops.

And I, *Mount Cusely*
do solemnly swear that I will bear true faith and allegiance to the **United States
of America**, and that I will serve them honestly and faithfully against all their
enemies or opposers whomsoever; and that I will observe and obey the orders
of the President of the United States, and the orders of the officers appointed
over me, according to the Rules and Articles of War.

Sworn and subscribed to, at *St. James Parish*
this *30* day of *May* 186*5* } *his*
Before *St. James Parish* } *Mount Cusely*
6 P.M. } *man*

I CERTIFY, ON HONOR, That I have carefully examined the above named Volunteer agree-
ably to the General Regulations of the Army, and that, in my opinion, he is free from all bodily
defects and mental infirmity, which would in any way disqualify him from performing the
duties of a soldier.

W. H. Bailey
6 P.M.
EXAMINING SURGEON.

I CERTIFY, ON HONOR, That I have minutely inspected the Volunteer *Mount Cusely*
previously to his enlistment, and that he was entirely sober when enlisted; that, to the best of
my judgment and belief, he is of lawful age; and that, in accepting him as duly qualified to per-
form the duties of an able-bodied soldier, I have strictly observed the regulations which govern
the recruiting service. This soldier has *blue* eyes, *black* hair; *black* com-
plexion, is *5-2-0* feet *0* inches high.

St. James Parish
6 P.M.
RECRUITING OFFICER OR AGENT.

Mustered into the United States Service.....day of186 .

Mustering Officer.

Mustered into the service of the United States, for three years or during the war, from date of enlistment, in Company,
Regiment of Volunteers, on the *1st* day of *June* 186*5* at *Lexington N.Y.*

William H. ...
Mustering officer

1007

Orndorff Wesley
Co *B*, 6 U. S. Col'd Cav.

Private | *Private*

CARD NUMBERS.

1	5389261	26
2	5389336	27
3	5389426	28
4	5389497	29
5	5389864	30
6	5389651	31
7	5389747	32
8	5389839	33
9	5389929	34
10	5390022	35
11	9092911	36
12	40732683	37
12	40902825	38
14		39
15		40
16		41
17		42
18		43
19		44
20		45
21		46
22		47
23		48
24		49
25		50

Book Mark:

See also

D. 2818665 And. WD
S 3031107 Acco. W.D.

D. J. Miller, Esq.

C 6 Cav. U.S.C.T.

Wesley Chandler
Privet, Co B, 6 Reg't U. S. Col'd Cavalry.

Appears on

Company Muster-in and Descriptive Roll

of the organization named above. Roll dated

Camp Nelson Ky, ~~Nov 1st~~ Nov 1st, 1864.

Where born Logan Co, Ky

Age 23 y'rs; occupation Farmer

When enlisted Aug 11th, 1864.

Where enlisted Bowling Green Ky

For what period enlisted 3 years.

Eyes Blk; hair Blk

Complexion Blk; height 5 ft. 5 1/2 in.

When mustered in Aug 16, 1864.

Where mustered in Bowling Green Ky

Bounty paid \$ 100; due \$ 100

Where credited 3rd Dist. Ky.

Company to which assigned

Remarks: Transferred from Co D

115, U.S.C.T., per SO. No. 39, dated

June 15, Washington D.C.,

signed L. Thomas, C.G.,

(over)

Book mark:

C. M. Rowe

(356d)

Copyist.

JAN. 10

5389261

1891

Owner
Eli Oundoff.

Q | **6 Cav.** | **U.S.C.T.**

Westly Amhoff

, Co. B, 6 Reg't U. S. Col'd Cav.

Appears on

Company Descriptive Book

of the organization named above.

DESCRIPTION.

Age 23 years; height 5 feet 5 1/2 inches.

Complexion Blk

Eyes Blk; hair Blk

Where born Logan

Occupation Farmer

ENLISTMENT.

When Aug 11, 1864.

Where Bowling Green Ky

By whom Capt Watson; term 3 y'rs.

Remarks:

Bryer

(3837)

Copyist.

U 6 Cav. U.S.C.T.

Wesley Orndoff,
Must, Co. B, 6 Reg't U. S. Col'd Cavalry.

Appears on

Company Muster Roll

for Nov & Dec, 1864.

Present or absent present,

Stoppage, \$ 100 for

Due Gov't, \$ 100 for

Valuation of horse, \$ 100

Valuation of horse equipments, \$ 100

Remarks: Due U.S. for ord. \$21.90,
For C & G, Equipage \$1.12,

Book mark:

(358)

G. W. Row

Copyist.

C 6 Cav. U.S.C.T.

Wesley Orndoff
Private, Co. B, 6 Reg't U. S. Col'd Cavalry.

Appears on

Company Muster Roll

for *Jan & Feb*, 1865

Present or absent *Absent*

Stoppage, \$ *100* for

Due Gov't, \$ *100* for

Valuation of horse, \$ *100*

Valuation of horse equipments, \$ *100*

Remarks: *Due U.S. for Ord \$21.90,
de C & G, Equip \$1.12,
Installation bounty, due \$100,
Det'd N. Haven, Ky July 15'
1865.*

Book mark:

(358)

M. Moore

Copist.

C 6 Cav. U.S.C.T.

Wesley Orndoff
Privt, Co. B, 6 Reg't U. S. Col'd Cavalry.

Appears on

Company Muster Roll

for *March & April*, 1865.

Present or absent *Absent*

Stoppage, \$ *100* for

Due Gov't, \$ *100* for

Valuation of horse, \$ *100*

Valuation of horse equipments, \$ *100*

Remarks: *1st installment bounty
due \$100, due U.S. for Co.
\$21.90, for C & G Equip. \$1.12.
Det. Ser. A. Haven, Ky.*

Book mark:

G. M. Rowe

(358)

Copyist.

(C) | **6 Cav. | U.S.C.T.**

Wesley Curndoff
_____, Co. B, 6 Reg't U. S. Col'd Cavalry.

Appears on

Company Muster Roll

for *May June*, 1865.

Present or absent *present*

Stoppage, \$ _____ *100* for _____

Due Gov't, \$ *21⁹⁰* *100* for *ard*

for C. & G. Equip \$112

Valuation of horse, \$ _____ *100*

Valuation of horse equipments, \$ _____ *100*

Remarks: *"install
bounty due
\$100."*

Book mark: _____

(358)

C. E. Harper
Copyist.

6 Cav. U.S.C.T.

Wesley Orndoff
Pl, Co. B, 6 Reg't U. S. Col'd Cavalry.

Appears on

Company Muster Roll

for *July & Aug*, 1865.

Present or absent *Present*

Stoppage, \$ *100* for

Due Gov't, \$ *00* for *000*

or out of Equip^{ts}

Valuation of horse, \$ *100*

Valuation of horse equipments, \$ *100*

Remarks: *Present*

Account closed

Book mark:

O 6 Cav. U.S.C.T.

Masby Crandoff
Priv, Co. B, 6 Reg't U. S. Col'd Cavalry.

Appears on

Company Muster Roll

for *Sept & Oct*, 1865.

Present or absent *absent*

Stoppage, \$ *100* for

Due Gov't, \$ *100* for *11 1/2 lbs*

Valuation of horse, \$ *100*

Valuation of horse equipments, \$ *100*

Remarks: *Not present*
in "Big" Co
Oct 15, 1865.

Book mark:

L. E. Harber
Copyist.

0

6 Cav. U.S.C.T.

Wesley Orndoff

Pvt., Co. B, 6 Reg't U. S. Col'd Cavalry.

Appears on

Company Muster Roll

for Nov & Dec, 1865.

Present or absent Present

Stoppage, \$ 100 for

Due Gov't, \$ 100 for

Valuation of horse, \$ 100

Valuation of horse equipments, \$ 100

Remarks:

Book mark:

(358) J. H. Ames Copyist.

W

6 Cav. U.S.C.T.

Wesley Condo

Sept, Co. B, 6 Reg't U. S. Col'd Cavalry.

Appears on

Company Muster Roll

for *Jan'y + Feby*, 1866.

Present or absent *Present*

Stoppage, \$ *100* for

Due Gov't, \$ *100* for

Valuation of horse, \$ *100*

Valuation of horse equipments, \$ *100*

Remarks:

Filed with Condo, Wesley

Book mark:

(358)

J. W. Ames

Copyist.

0 | **6 Cav.** | **U.S.C.T.**

Orndoff
Co. B, 6 Reg't U. S. Col'd Cav.

Appears on Returns as follows:

Feb to Apr 1865 Absent
detached service New-
Haven Ky Feb 15/65

● Sep 1865 Absent on detached
service at guard Post
Fort Lexington Ky
Sep 8, 65

0-5 1865 Absent detached
service at Hdqrs 13th Brig
1 Div. & Ky since Sep
8/65 as guard

Book mark:

(546)

E. Douglas

Copyist.



115

U.S.C.T.

Wesley Oardorff,
Priv. Co. Ad., 115 Reg't U. S. Colored Inf

Appears on Returns as follows:

Aug 18 64 - Lost - Aug 26/64,
Bowling Green, Transferred

Book mark:

(546)

J. T. Hensley

Copyist.

0

6 Cav. U.S.C.T.

Wesley Orndoff

A. Co. B., 6 Reg't U. S. Col'd Cavalry.

Appears on **Co. Muster-out Roll**, dated *DeValls Bluff Ark, Apr. 15, 1866.*

Muster-out to date *Apr. 15, 1866.*

Last paid to *July 28, 1866.*

Clothing account:

Last settled....., 186 ; drawn since \$..... 100

Due soldier \$..... 100; due U. S. \$..... 100

Am't for cloth'g in kind or money adv'd \$ *9* ^{*89*} 100

Due U. S. for arms, equipments, &c., \$..... 100

Bounty paid \$ *100* 100; due \$ *100* 100

Remarks:

Book mark:

(861)

J. C. Brown

Copyist.

1008

Osborn, Jacob

Co *A*, **6** U. S. Col'd Cav.

Private | *Private*

CARD NUMBERS.

1	5387973	26
2	5388804	27
3	5388896	28
4	5388986	29
5	5389075	30
6	5389162	31
7	9092810	32
8	40732684	33
9	32116197	34
10		35
11		36
12		37
13		38
14		39
15		40
16		41
17		42
18		43
19		44
20		45
21		46
22		47
23		48
24		49
25		50

Book Mark:

See also *120 usc. inf.*

D. 2034601 P.M.M.

D. 2281049 NORTH

0730 3681 P.M.M.

D. 3077343 P.M.M.

D. F. Miller, Ex.

A | **6 Cav. | U.S.C.T.**

Robert Astorn

....., Co. A, 6 Reg't U. S. Col'd Cav.

Appears on

Company Descriptive Book

of the organization named above.

DESCRIPTION.

Age 23 years; height 5 feet 7 inches.

Complexion Blk

Eyes Blk; hair Blk

Where born Henderson Ky

Occupation farmer

ENLISTMENT.

When May 29, 1865.

Where Henderson

By whom Capt B Mung; term 5 y'rs.

Remarks: Mustered June 6 1865

(383g)

Beyer

Copyist.

O. C. Co. **U.S.C.T.**

Herb Osborn

P.W. Co., 4 Reg't U. S. Col'd. Co.

Appears on a

Detachment Muster Roll

unassigned recruits
of the organization named above

for *June 10 to 30*, 1865.

Station *Camp Nelson Ky*

Present or absent *Present*

Stoppage, \$ *100* for

Due Gov't, \$ *100* for

Valuation of horse, \$ *100*

Valuation of horse equipments, \$ *100*

Remarks: *Trans. a few 120 up to 2
In SO No 105 dated Old Dr
Camp Ky June 10 - 1865*

Book mark:

L B Sayer

(357)

Copyist.

0 | 66 | U.S.C.T

Hurd Osborn

Pvt, Co. A, 6 Reg't U.S.C.C.

Appears on

Hospital Muster Roll

of **U. S. A. Post Hospital,**

at **Camp Nelson, Ky.,**

for July + Aug, 1865.

Attached to hospital:

When _____, 186 .

How employed _____

Last paid by Maj. _____

to _____, 186 .

Bounty paid \$ 100; due \$ 100

Present or absent Present

Remarks: _____

Book mark: _____

C. L. Parker

(343)

Copyist.

C

6 Cav. U.S.C.T.

Norah Osborn

Pvt., Co. A, 6 Reg't U. S. Col'd Cavalry.

Appears on

Company Muster Roll

for July & Aug, 1865.

Present or absent Present

Stoppage, \$ 100 for

Due Gov't, \$ 100 for

Valuation of horse, \$ 100

Valuation of horse equipments, \$ 100

Remarks: Transferred from
120 (no. Co. Capt. per
Special Order No 105
Dated 11th
Sick in Hospital Camp
New York)

Book mark:

Joseph Stewart

(358)

Copyist.

() | 6 Cav. | U.S.C.T.

Harold Osborn
Lieut, Co. A, 6 Reg't U. S. Col'd Cavalry.

Appears on

Company Muster Roll

for *Sept Oct*, 186*1*.

Present or absent *Present*

Stoppage, \$ *100* for

Due Gov't, \$ *100* for

Valuation of horse, \$ *100*

Valuation of horse equipments, \$ *100*

Remarks: *Once U.S. \$100*
for W & E *100*

Book mark:

(358)

Joseph Stewart
Copyist.

0

6 Cav. U.S.C.T.

Horub Osborne

Priv, Co. A, 6 Reg't U. S. Col'd Cavalry.

Appears on

Company Muster Roll

for Nov + Dec, 1865.

Present or absent Present

Stoppage, \$ 100 for

Due Gov't, \$ 60/100 for Ordnance

Valuation of horse, \$ 100

Valuation of horse equipments, \$ 100

Remarks:

Book mark:

R S Shelton

(358)

Copyist.

O **6 Cav. U.S.C.T.**

Herb Osborne

Priv, Co. A, 6 Reg't U. S. Col'd Cavalry.

Appears on

Company Muster Roll

for *Jan & Feb*, 186*6*.

Present or absent *Present*

Stoppage, \$ *100* for

Due Gov't, \$ *60* for *Ordinance*

Valuation of horse, \$ *100*

Valuation of horse equipments, \$ *100*

Remarks:

Book mark:

R. S. Shelton

| **6 Cav.** | **U.S.C.T.**

Horob Osborne
Co. A, 6 Reg't U. S. Col'd Cav.

Appears on Returns as follows:

July 1865 July 15 65
Camp Nelson Ky
Joined by Transfer
from 120th U.S. Col'd Cav
per order No. 105 dated
Ad 2nd Dept Ky June
15/65

Aug 1865 Absent sick
Hosp Camp Nelson Ky
Aug 7/65

Jan 1866 On extra or
daily duty

Book mark: _____

(546)

J. E. Douglas
Copyist.

O

6 Cav.

U.S.C.T.

Horub Oustorn

Plt, Co. *A*, 6 Reg't U. S. Col'd Cavalry.

Appears on **Co. Muster-out Roll**, dated *Duvall's Bluff Ark*, *Apr 15*, 1866.

Muster-out to date *Apr 15*, 1866.

Last paid to *Feb 28* 1866.

Clothing account:

Last settled....., 186 ; drawn since \$ 100

Due soldier \$ *16 07*; due U. S. \$ 100

Am't for cloth'g in kind or money adv'd \$ 100

Due U. S. for arms, equipments, &c., \$ 100

Bounty paid \$ 100: due \$ 100

Remarks:

Book mark:

R. S. Shelton

(861)

Copyist.

1009
Osborn, Isaac

Co G, 6 U. S. Col'd Cav.

Private Private

CARD NUMBERS.

1	5387974	26
2	5388803	27
3	5388895	28
4	5388985	29
5	5389074	30
6	5389160	31
7	9092809	32
8	40732685	33
9		34
10		35
11		36
12		37
13		38
14		39
15		40
16		41
17		42
18		43
19		44
20		45
21		46
22		47
23		48
24		49
25		50

Book Mark: 118261 R.H.O. 90.

See also 120 U.S. Army

D-1682503. P.O. mmm

S- 1719436- P.O. net.

A. 2222746 P.O. PLS

Q 2312152 P.P. net.

S.S. 2-03. 5/18/25. 21.

D. J. Miller, Ch.

Q | **6 Cav. | U.S.C.T.**

Isaac Boston

, Co. *A*, 6 Reg't U. S. Col'd Cav.

Appears on

Company Descriptive Book

of the organization named above.

DESCRIPTION.

Age *24* years; height *5* feet *7* inches.

Complexion *Rlk*

Eyes *Rlk*; hair *Blk*

Where born *Henderson Ky*

Occupation *farmer*

ENLISTMENT.

When *May 29*, 18*65*.

Where *Henderson*

By whom *Capt Billings*; term *3* y'rs.

Remarks: *Mustered June 6/65-*

Breyer

(383g)

Copyist.

O. C. Law U.S.C.T.

Isaac Osborn
Inf. Co. , 6 Reg't U. S. Col'd

Appears on a

Detachment Muster Roll

unassigned recruits
of the organization named above

for *June 10 to 30*, 1865.

Station *Camp Nelson Ky*

Present or absent *Present*

Stoppage, \$ *100* for

Due Gov't, \$ *100* for

Valuation of horse, \$ *100*

Valuation of horse equipments, \$ *100*

Remarks: *Trans'd from 120 of 12
as S.O. no 105 dated 1st of 1865
by June 10-1865*

Book mark:

A. B. Taylor

(357)

Copyist.

()

6 Cav. U.S.C.T.

Isaac Christian

no, Co. A, 6 Reg't U. S. Col'd Cavalry.

Appears on

Company Muster Roll

for July 1st Aug, 1864.

Present or absent Present

Stoppage, \$ 100 for

Due Gov't, \$ 100 for

Valuation of horse, \$ 100

Valuation of horse equipments, \$ 100

Remarks: transferred from 120 U.S.C. Inf. for Special Order No. 101 Dated 11th to take effect from July 1st 1864. Due acct for 600 \$ 600

Book mark:

Joseph Stewart

(358)

Copyist.

(2)

6 Cav. U.S.C.T.

Isaac Obern

Co. A, 6 Reg't U. S. Col'd Cavalry.

Appears on

Company Muster Roll

for Sep & Oct, 1865.

Present or absent Present

Stoppage, \$ 100 for

Due Gov't, \$ 100 for

Valuation of horse, \$ 100

Valuation of horse equipments, \$ 100

Remarks: None (U.S.)
\$ 200 for (U.S.)

Book mark:

Joseph Stewart

(358)

Copyist.

6 Cav. U.S.C.T.

Isaac Osborne

Plt, Co. A, 6 Reg't U. S. Col'd Cavalry.

Appears on

Company Muster Roll

for Nov & Dec, 1865.

Present or absent Present

Stoppage, \$ 100 for

Due Gov't, \$ 60/100 for Ordnance

Valuation of horse, \$ 100

Valuation of horse equipments, \$ 100

Remarks:

Book mark:

R. S. Shelton

(35)

Copyist.

C 6 Cav. U.S.C.T.

Isaac Osborne

Pvt, Co. A, 6 Reg't U. S. Col'd Cavalry.

Appears on

Company Muster Roll

for Jan & Feb, 1866.

Present or absent Present

Stoppage, \$ 100 for

Due Gov't, \$ 60/100 for Ordnance

Valuation of horse, \$ 100

Valuation of horse equipments, \$ 100

Remarks:

Book mark:

R. S. Shelton

(358)

Copyist.

D | 6 Cav. | U.S.C.T.

Isaac Osborn
W. Co. A. 6 Reg't U. S. Col'd Cav.

Appears on Returns as follows:

July 1865 July 15 '65
Camp Nelson Ky
Joined by transfer
from 120 U.S. Col Inf
per order No. 105 dated
Hd Qrs Dept Ky June
15/65

Jan 1 86 Absent on detached
duty per S.O. No. 14 Hd
Qrs White River Dist
Jan 24 86

Mar-1866 Absent in 2nd
Dept as wagoner Du-
vall's Bluff Ark per
order No. 14 dated White
River District Jan
26/66

Book mark:

J. E. Douglas
Copyist.

0 **6 Cav. U.S.C.T.**

Isaac Osborn

vt, Co. *A*, 6 Reg't U. S. Col'd Cavalry.

Appears on **Co. Muster-out Roll**, dated

Duval's Bluff Ark, *Apr 15*, 1866.

Muster-out to date *Apr 15*, 1866.

Last paid to *Feb 28*, 1866.

Clothing account:

Last settled....., 186 ; drawn since \$ 100

Due soldier \$ *39 68* / 100; due U. S. \$ 100

Am't for cloth'g in kind or money adv'd \$ 100

Due U. S. for arms, equipments, &c., \$ 100

Bounty paid \$ 100; due \$ 100

Remarks:

Book mark: *118.261-R.P.2-90*

R S Shelton

(361)

Copyist.

1010

Osborn, Horeb,

Co A, 6 U.S. Col'd Cav.

private

private

CARD NUMBERS.

1	26
2	27
3	28
4	29
5	30
6	31
<i>See Osborn Horeb</i>	
8	33
9	34
10	35
11	36
12	37
13	38
14	39
15	40
16	41
17	42
18	43
19	44
20	45
21	46
22	47
23	48
24	49
25	50

Book Mark

See also

1011

Osborn, Robert

Co E, 6 U.S. Col'd Cav.

Private

Private

CARD NUMBERS.

1	5387975	26
2	5392055	27
3	5392152	28
4	5392248	29
5	5392343	30
6	5392429	31
7	4093348	32
8	40732667	33
9	32083899	34
10		35
11		36
12		37
13		38
14		39
15		40
16		41
17		42
18		43
19		44
20		45
21		46
22		47
23		48
24		49
25		50

Book Mark:

See also

120 U.S.C. Inf

10 | 6 Cav. | U.S.C.T.

Robert - Osborn

Co. 6, 6 Reg't U. S. Col'd Cav.

Appears on

Company Descriptive Book

of the organization named above.

DESCRIPTION.

Age 31 years; height 5 feet 7 inches.

Complexion black

Eyes black; hair black

Where born Henderson, Ky

Occupation Farmer

ENLISTMENT.

When Dec. 10, 1865.

Where Henderson

By whom Lt. Col. Glenn; term 3 yrs.

Remarks:

Mustered Feb. 10/65. Served
with Ky. Capt. Wornack.

C. G. Powell

(383g)

Copyist.

O & Co U.S.C.T.

Robert Osborn
Punco, & Reg't U. S. Col'd. Co

Appears on a

Detachment Muster Roll
unassigned recruits
of the organization named above

for June 10 to 30, 1865.

Station Camp Nelson Ky

Present or absent Present

Stoppage, \$ 100 for

Due Gov't, \$ 100 for

Valuation of horse, \$ 100

Valuation of horse equipments, \$ 100

Remarks: Transferred from 120 Reg't
Ist S.C. No 105 dated Hdqrs
Reg't Ky. June 10 - 1865

Book mark:

(357)

C. B. Sayre
Copyist.

C

6 Cav. U.S.C.T.

Robert Ashorn
Pvt, Co. E, 6 Reg't U. S. Col'd Cav.

Appears on

Company Muster Roll

for July and Aug, 1865.

Present or absent Present

Stoppage, \$ 100 for

Due Gov't, \$ 100 for

Valuation of horse, \$ 100

Valuation of horse equipments, \$ 100

Remarks: 1st Installment of
county dues \$100
Transferred from 120
U.S. C. Inf No 120 Hd
Qrs Dept Ky Louisville
June 21 1865

Book mark:

J. M. Ashorn

(358)

Copyist.

Q

6 Cav. U.S.C.T.

Robert Osborn

Pvt, Co. E, 6 Reg't U. S. Col'd Cav.

Appears on

Company Muster Roll

for *Sept & Oct*, 1865.

Present or absent *Present*

Stoppage, \$ *100* for

Due Gov't, \$ *100* for

Valuation of horse, \$ *100*

Valuation of horse equipments, \$ *100*

Remarks: *First Installment
of Bounty due*

Book mark:

W. M. Callum

(358)

Copyist.

G

6 Cav. U.S.C.T.

Robert Ashorn

Pvt, Co. E, 6 Reg't U. S. Col'd Cav.

Appears on

Company Muster Roll

for Novem + Decem, 1865.

Present or absent Present

Stoppage, \$ 100 for

Due Gov't, \$ 100 for

Valuation of horse, \$ 100

Valuation of horse equipments, \$ 100

Remarks:

Book mark:

W M Calhoun

(358)

Copyist.

6 Cav. U.S.C.T.

Wm. H. ...
....., Co. E, 6 Reg't U. S. Col'd Cav.

Appears on

Company Muster Roll

for *17th Feb*, 186*7* .

Present or absent *Present*

Stoppage, \$ *100* for

Due Gov't, \$ *100* for

Valuation of horse, \$ *100*

Valuation of horse equipments, \$ *100*

Remarks:

Book mark:

O | 6 Cav. | U.S.C.T.

Robert Osborn
Pvt, Co. E . 6 Reg't U. S. Col'd Cav.

Appears on Returns as follows:

June 1865 June 2 - 05
Camp Nelson Ky
Transferred from 120
U.S. 6 Inf by order of
the secretary of war
S.O. No. 29 signed L
Thomas Adj't Genl

July 1865 July 5 - 05
Nelson Transferred
from 120 U.S. 6 Inf
in compliance with
S.O. No. 105 Hd Qrs Dept
of Ky dated Louisville
Ky June 21 1865

Jan 1866 Absent on ex-
tra duty in the QM
Dept as teamster or
laborer per S.O. No. 4
(over)

Book mark:

(546)

J. E. Douglas
Copyist.

JAN. 19.

40732687

1899.

Ad. G. White River
Dist dated Dec. 11
1898 by
order of Bing Lee
C. H. Morgan

6 Cav. U.S.C.T.

Richard Carter

Co. F, 6 Reg't U. S. Col'd Cavalry.

Appears on **Co. Muster-out Roll**, dated

Apr 15, 186*0*.

Muster-out to date *Apr 15*, 186*0*.

Last paid to *Apr 15*, 186*0*.

Clothing account:

Last settled....., 186*0* ; drawn since \$..... 100

Due soldier \$..... 100²⁵; due U. S. \$..... 100

Am't for cloth'g in kind or money adv'd \$..... 100

Due U. S. for arms, equipments, &c., \$..... $\frac{20}{100}$

Bounty paid \$..... 100; due \$..... 100

Remarks: *Stephens Co. Camp, 40. 20
equipment \$4.20*

Book mark: *V 126. P. 213. 711*

(861)

W. B. Smith
Copied.

Oscar,

1012

Ex. number, 1012-a
Tom

Co H, 6 U. S. Col'd Cav.

Private

Private

CARD NUMBERS.

1	5387333	26
2	5387350	27
3	5387364	28
4	5394093	29
5	5394178	30
6	5394260	31
7	5394355	32
8	5394435	33
9	5394525	34
10	5394599	35
11	5394667	36
12	4593631	37
13	40732686	38
14		39
15		40
16		41
17		42
18		43
19		44
20		45
21		46
22		47
23		48
24		49
25		50

Book Mark:

See also

Q. 6 Cav. U.S.C.T.

Thomas Oscar

Co. K, 6 Reg't U. S. Col'd Cav

Appears on

Company Descriptive Book

of the organization named above.

DESCRIPTION.

Age 18 years; height 5 feet 4 1/4 inches.

Complexion black

Eyes black; hair black.

Where born Tennessee

Occupation Farmer

ENLISTMENT.

When March 16, 1865

Where Louisville

By whom Capt Wauzek, term 3 y'rs.

Remarks:

Dwight Webb

O | 6 Cav. | U.S.C.T.

Tom Ocean

Appears with rank of *private* on

Muster and Descriptive Roll of a Detachment of U. S. Vols. forwarded

for the 6 Reg't U. S. Col'd Cavalry. Roll dated

Louisville Ky, Mich 16, 1865.

Where born *Tennessee*

Age *18* y'rs; occupation *farmer*

When enlisted *Mich 16, 1865.*

Where enlisted *Louisville Ky*

For what period enlisted *3* years.

Eyes *black*; hair *black*

Complexion *black*; height *5 ft 4 1/4 in.*

When mustered in *Mich 16, 1865.*

Where mustered in *Louisville, Ky.*

Bounty paid \$ *100*; due \$ *100*

Where credited *Jeff C. 5th Dist Ky*

Company to which assigned

Remarks:

Book mark:

(339)

C. R. Ball

Copyist.

O

6 Cav. U.S.C.T.

Tom Oscar

Appears with rank of private on Muster and Descriptive Roll of a Detachment of U. S. Vols. forwarded

for the 6 Reg't U. S. Col'd Cavalry. Roll dated 5th Rendezvous Louisville Ky, March 17, 1865.

Where born Tennessee

Age 18 y'rs; occupation farm hand.

When enlisted March 16, 1865.

Where enlisted Louisville Ky.

For what period enlisted 3 years.

Eyes black; hair black

Complexion black; height 5 ft. 4 1/2 in.

When mustered in March 16, 1865.

Where mustered in Louisville Ky.

Bounty paid \$ 100; due \$ 100

Where credited 5 Dist. Ky.

Company to which assigned

Remarks:

Book mark:

(339)

A. C. Hall

Copyist.

6 Cav. U.S.C.T.

Tom Oscar

Appears with rank of *private* on

Muster and Descriptive Roll of a Detachment of U. S. Vols. forwarded

for the 6 Reg't U. S. Col'd Cavalry. Roll dated

St. Radez. Louis & Ky. Feb 17, 1865.

Where born *Tennessee*

Age *18* y'rs; occupation *Farm hand.*

When enlisted *Feb 16, 1865.*

Where enlisted *Louisville Ky*

For what period enlisted *6* years.

Eyes *black*; hair *black*

Complexion *black*; height *5* ft. *4 1/2* in.

When mustered in *Feb 16, 1865.*

Where mustered in *Louisville Ky.*

Bounty paid \$ *100*; due \$ *100*

Where credited *5 Dist. Ky.*

Company to which assigned

Remarks:

Book mark:

(339)

W. F. East

Copyist.

O 6 Cav. U. S. C. T.

Tom Oscar

Priv, Co. H. 6 Reg't U. S. Col'd Cavalry

Appears on

Company Muster-in and Descriptive Roll

of the organization named above. Roll dated

Covington, Ky. , Mch 26, 1865.

Where born Tennessee

Age 18 y'rs; occupation Farm hand.

When enlisted Mch 16, 1865.

Where enlisted Louisville, Ky.

For what period enlisted 3 years.

Eyes Black; hair Black

Complexion Black; height 5 ft. 4 1/2 in.

When mustered in Mch. 16, 1865.

Where mustered in Louisville, Ky.

Bounty paid \$ 100; due \$ 100

Where credited 5 Dist. Ky.

Company to which assigned H.

Remarks:

Book mark:

Conard

0 | **6 Cav. U.S.C.T.**

Tom Oscar
Pvt., Co. H, 6 Reg't U. S. Col'd Cavalry.

Appears on

Company Muster Roll

for *from Mch 16 to Apr 30*, 1865.

Present or absent *Present.*

Stoppage, \$ *100* for

Due Gov't, \$ *100* for

Valuation of horse, \$ *100*

Valuation of horse equipments, \$ *100*

Remarks:
.....
.....
.....
.....
.....
.....
.....
.....

Book mark:

(358)

Conard
Copyist.

O **6 Cav. U.S.C.T.**

Tom Oscar
Privt, Co. H, 6 Reg't U. S. Col'd Cavalry.

Appears on

Company Muster Roll

for *May & June*, 1865.

Present or absent *Present.*

Stoppage, \$ *100* for

Due Gov't, \$ *100* for

Valuation of horse, \$ *100*

Valuation of horse equipments, \$ *100*

Remarks: *1st Instalment Bounty due.*

Book mark:

(358)

Leonard
Copyist.

6 Cav. U.S.C.T.

John Oscar

John, Co. H, 6 Reg't U. S. Col'd Cavalry.

Appears on

Company Muster Roll

for *July 1st*, 1865.

Present or absent *Present*

Stoppage, \$ 100 for

Due Gov't, \$ 100 for

Valuation of horse, \$ 100

Valuation of horse equipments, \$ 100

Remarks:

Book mark:

(358)

John

Copyist.

F 6 Cav. U.S.C.T.

Tom Lucas
Co. H, Co. H, 6 Reg't U. S. Col'd Cavalry.

Appears on

Company Muster Roll

for *Sept Oct*, 1865.

Present or absent *Present*

Stoppage, \$ 100 for

Due Gov't, \$ 100 for

Valuation of horse, \$ 100

Valuation of horse equipments, \$ 100

Remarks:

Book mark: -----

(358)

W. J. ...
Copyist.

D 6 Cav. U.S.C.T.

Tom Pizar

24, Co. H, 6 Reg't U. S. Col'd Cavalry.

Appears on

Company Muster Roll

for *15 Dec*, 1865.

Present or absent *Present*

Stoppage, \$ *100* for

Due Gov't, \$ *100* for

Valuation of horse, \$ *100*

Valuation of horse equipments, \$ *100*

Remarks:

Book mark:

(358)

Patine

Copyist.

0 | 6 Cav. | U.S.C.T.

Tom Oscar

Priv., Co. H, 6 Reg't U. S. Col'd Cavalry.

Appears on

Company Muster Roll

for *May & July*, 186*6*.

Present or absent *Present*

Stoppage, \$ *100* for

Due Gov't, \$ *Ca. 100* for *Advance*

\$100 for O & E

Valuation of horse, \$ *100*

Valuation of horse equipments, \$ *100*

Remarks:

Book mark:

J. M. Harmon

0 | 6 Cav. | U.S.C.T.

Oscar
Priv., Co. H, 6 Reg't U. S. Col'd Cav.

Appears on Returns as follows:

June 1865 Absent sick
at Camp Nelson Gen
Hosp Camp Nelson Ky

Jan 1866 On duty in 2
M stables

Book mark:

(546)

H. E. Douglas
Copyist.

O **6 Cav. | U.S.C.T.**

Tom Oscar
Art, Co. *A*, 6 Reg't U. S. Col'd Cavalry.

Appears on **Co. Muster-out Roll**, dated
Revals Bluff Ark April 15, 1866.

Muster-out to date *April 15*, 1866.

Last paid to *July 28*, 1866.

Clothing account:

Last settled....., 186 ; drawn since \$..... 100

Due soldier \$..... 100; due U. S. \$ *//* ⁵¹..... 100

Am't for cloth'g in kind or money adv'd \$..... 100

Due U. S. for arms, equipments, &c., \$..... 100

Bounty paid \$ *100* 100; due \$..... 100

Remarks:

Book mark:

J. W. Harmon

(861)

Copyist.

1012-A

Ousley, Fount

L E US Army

Private | Sergeant

REFERENCE ENVELOPE.

Cards filed with

Ousley, Fount

Previous number ¹⁰¹³ 1062-a

Masley Joseph

Co *C*, **6** U. S. Col'd Cav.

Private | *Private*

CARD NUMBERS.

1	5390160	26
2	5387186	27
3	5390237	28
4	5390319	29
5	5390397	30
6	5390424	31
7	5390497	32
8	5390585	33
9	5390672	34
10	5390784	35
11	5390840	36
12	9093019	37
13	40732692	38
14	32115533	39
15		40
16		41
17		42
18		43
19		44
20		45
21		46
22		47
23		48
24		49
25		50

Book Mark:

See also

Form No 1009892 9/6/13
PHE

D. J. Miller, Ex.

Q | **6 Cav.** | **U.S.C.T.**

Joseph Ansley

....., Co. C, 6 Reg't U. S. Col'd Cav.

Appears on

Company Descriptive Book

of the organization named above.

DESCRIPTION.

Age 20 years; height 5 feet 3 inches.

Complexion Blk

Eyes Blk; hair Blk

Where born Lincoln Ky

Occupation Farmer

ENLISTMENT.

When Dec 8, 1864.

Where Camp Nelson

By whom J. C. Randolph, term 3 y'rs.

Remarks:

.....
.....
.....
.....
.....
.....
.....
.....
.....
.....

Bryson

10

6 Cav. U.S.C.T.

Joseph Ousley

Appears with rank of *Priv.* on

Muster and Descriptive Roll of a Detachment of U. S. Vols. forwarded

for the 6 Reg't U. S. Col'd Cavalry. Roll dated

Camp Nelson Ky, Oct. 27, 1864.

Where born *Lincoln Ky.*

Age *20* y'rs; occupation *Farmer*

When enlisted *Oct. 8*, 1864.

Where enlisted *Camp Nelson Ky.*

For what period enlisted *3* years.

Eyes *Blk*; hair *Blk*

Complexion *Blk*; height *5* ft. *3* in.

When mustered in *Oct. 10*, 1864.

Where mustered in *Camp Nelson Ky.*

Bounty paid \$ *100*; due \$ *100*

Where credited

Company to which assigned

Remarks: *Credited to Lincoln Co.*

7 Dist Ky.

Franklin Ousley, Owner.

Book mark:

C. E. M. Laughlin

(339)

Copyist.

6 Cav. U.S.C.T.

Company *Cusley*
Co. K, Co. *K*, 6 Reg't U. S. Col'd Cavalry.

Appears on

Company Muster-in and Descriptive Roll

of the organization named above. Roll dated

Camp Nelson N.Y. *Nov 1*, 1864.

Where born *Lincoln Kentucky*

Age *21* y'rs; occupation *Farmer*

When enlisted *Oct 8*, 1864.

Where enlisted *Camp Nelson N.Y.*

For what period enlisted *2* years.

Eyes *Black*; hair *Black*

Complexion *Black*; height *5* ft. *3* in.

When mustered in *Oct 10*, 1864.

Where mustered in *Camp Nelson*

Bounty paid \$ *100*; due \$ *100*

Where credited *1st Div. 1st Reg. Cav.*

Company to which assigned *C*

Remarks:

Book mark:

W. G. Howser
(356d) Copyist.

0

6 Cav. U.S.C.T.

Joseph ...

..., Co. C, 6 Reg't U. S. Colored Cavalry.

Appears on

Company Muster Roll

for *...*, 186*...*

Present or absent *...*

Stoppage, \$ *...* 100 for *...*

Due Gov't, \$ *...* 100 for *...*

Valuation of horse, \$ *...* 100

Valuation of horse equipments, \$ *...* 100

Remarks: *...*

Book mark: *...*

(358)

...

Copyist.

6 Cav. U.S.C.T.

James M. [unclear]
1864, Co. C, 6 Reg't U. S. Colored Cavalry.

Appears on

Company Muster Roll

for *James M. [unclear]*, 186*4*.

Present or absent *Present*

Stoppage, \$ *100* for

Due Gov't, \$ *100* for

Valuation of horse, \$ *100*

Valuation of horse equipments, \$ *100*

Remarks: *James M. [unclear]*
Company [unclear]
or [unclear] [unclear]
due

Book mark: _____

[Signature]
[Signature]

C. C. Co. 112.0.7

Joseph Custer
1st Lt., Co. C, 6th Reg't U.S. Cavalry

Appears on

Hospital Muster Roll

of Nelson U. S. A. General Hospital,

at Camp Nelson, Ky.,

for *June 2* to *July*, 186*5*.

Attached to hospital:

When _____, 186 .

How employed _____

Last paid by Maj. _____

to *Reg't from 1st Cavalry*, 186 .

Bounty paid \$ _____ 100; due \$ _____ 100

Present or absent *Present*

Remarks: _____

Book mark : _____

J. C. Custer
(845) *Copied*

U.S.C.T

James H. ...
... Co. ... Reg't U. S. Col'd ...

Appears on

Company Muster Roll

for *James H. ...*, 186*...*

Present or absent *...*

Stoppage, \$ *...* 100 for *...*

Due Gov't, \$ *...* 100 for *...*

Valuation of horse, \$ *...* 100

Valuation of horse equipments, \$ *...* 100

Remarks: *...*
...
...
...

Book mark: *...*

...
...
...

(358)

Copyist.

0

6 Cav. U.S.C.T.

Joseph Crossley
Bugler Co. C, 6 Reg't U. S. Colored Cavalry.

Appears on

Company Muster Roll

for *May & June*, 1865.

Present or absent *Present*

Stoppage, \$ *100* for

Due Gov't, \$ *100* for

Valuation of horse, \$ *100*

Valuation of horse equipments, \$ *100*

Remarks: *Promoted from Private*
June 15th 1865 by order No 87
dated Hd Qrs 6th U.S.C.C. Camp
Nelson Ky June 30th 1865 -
1st Installment bounty due.

Book mark: _____

(358)

D. P. York

Copyist.

0

6 Cav. U.S.C.T.

Joseph Crossley
Bugler, Co. C, 6 Reg't U. S. Colored Cavalry.

Appears on

Company Muster Roll

for July & Aug, 1860.

Present or absent Present

Stoppage, \$ 100 for

Due Gov't, \$ 100 for

Valuation of horse, \$ 100

Valuation of horse equipments, \$ 100

Remarks: Due U.S. for B & H E. \$ 160

Book mark:

(358)

S. P. York Copyist.

11

6 Cav. U.S.C.T.

Joseph Owensley

Bugles Co. C, 6 Reg't U. S. Colored Cavalry.

Appears on

Company Muster Roll

for *Sept + Oct*, 186*5*.

Present or absent *Present*

Stoppage, \$ *100* for

Due Gov't, \$ *100* for

Valuation of horse, \$ *100*

Valuation of horse equipments, \$ *100*

Remarks: *Sick at Post Hospital
Lexington Ky*

Book mark:

(358)

D. P. York

Copyist.

0

6 Cav. U.S.C.T.

Joseph Cusley
Cavalry, Co. C, 6 Reg't U. S. Colored Cavalry.

Appears on

Company Muster Roll

for *Nov. & Dec.*, 1865.

Present or absent *Present*

Stoppage, \$ 100 for

Due Gov't, \$ 100 for

Valuation of horse, \$ 100

Valuation of horse equipments, \$ 100

Remarks:

Book mark:

(358)

W. B. Ferguson
Copyist.

0

6 Cav. U.S.C.T.

Joseph Cusley
Cusley, Co. C, 6 Reg't U. S. Colored Cavalry.

Appears on

Company Muster Roll

for *Jan. & Feb.*, 1866.

Present or absent *Present*

Stoppage, \$ *100* for

Due Gov't, \$ *100* for

Valuation of horse, \$ *100*

Valuation of horse equipments, \$ *100*

Remarks:

Book mark:

(358)

W. Ferguson

Copyist.

C

6 Cav.

U.S.C.T.

William Douglas
Sgt., Co. C, 6 Reg't U. S. Col'd Cav.

Dugler

Appears on Returns as follows:

Dec 1864 to Mar 1865
Absent sick in Hosp
Camp Nelson Ky

Sept 1865 Dugler Absent
sick Hosp Lexington Ky
since Sep 23/65

Oct 1865 Absent sick at
P. H. Lexington Ky

Book mark:

(546)

W. Douglas
Copyist.

C

6 Cav. U.S.C.T.

Richard Cusley
Bugler, Co. *C*, 6 Reg't U.S. Col'd Cavalry.

Appears on **Co. Muster-out Roll**, dated
Newalls Bluff Ark, April 15, 186*6*.

Muster-out to date *April 15*, 186*6*.

Last paid to *Feb. 28*, 186*6*.

Clothing account:

Last settled _____, 186 ____; drawn since \$ _____ 100

Due soldier \$ _____ 100; due U. S. \$ *10* ⁹⁵/₁₀₀

Am't for cloth'g in kind or money adv'd \$ _____ 100

Due U. S. for arms, equipments, &c., \$ _____ 100

Bounty paid \$ *100* 100; due \$ *100* 100

Remarks: *Promoted to Bugler*
June 30 65. *S.O. No. 57*
due U.S. 6.6 and 4.2
9.10 25

Book mark: *1768, 1882*

(861)

W. B. Ferguson

Copyist.

Ousley Josephus

....., Co.

6 Reg't *U.S.A.*

2 Enclosures.

Bed Cards	Final Statements
Burial Records	Furloughs or L. of A.
Certs. of Dis. for Discharge	Med. Certificates
C. M. Charges	Med. Des. Lists
Descriptive Lists	Orders
Discharge Certificates	Pris. of War Record
Enlistment Papers 2	Resignations

Other papers relating to—

Admission to Hosp'l	Furlough or L. of A.
Casualty Sheet	Med. Examination
Confinement	Misc. Information
Contracts	Pay or Clothing
Death or Effects	Personal Reports
Desertion	Rank
Discharge from Hosp'l	Transfer to Hosp'l
Discharge from Service	Transfer to V. R. C.
Duty	Transportation
<i>Dep't Reg 1</i>	

MICROFILM PUBLICATION M 1823

COMPILED MILITARY SERVICE RECORDS
OF VOLUNTEER UNION SOLDIERS WHO
SERVED WITH THE USCT (US COLORED TROOPS)
6TH REGIMENT OF CAVALRY

PERSONAL PAPERS' TARGET SHEET

PLEASE NOTE THE CHECKED INFORMATION ABOUT THE PERSONAL PAPERS IN
THIS FILE:



NO PERSONAL PAPERS WERE FOUND IN THIS FILE WHEN THE
RECORDS WERE ARRANGED FOR MICROFILMING.



3 PERSONAL PAPER(S) FOUND IN THIS FILE WHEN THE RECORDS
WERE ARRANGED FOR MICROFILMING.

55

NOTE 1.—This blank will be used for enlistments of United States colored troops. They will be made out in duplicate in all cases—one to accompany the recruiting return of the superintendent (not the recruiting officer) to the Adjutant General, and one to accompany the accounts of the officer who pays bounty, &c.

NOTE 2.—An enlistment holds to service unless otherwise stated. In all cases, precede payment of pay, bounty, pension, &c. A muster-in roll, must in all cases, be filed in the Adjutant General's Office as evidence of muster-in. The mustering officer, commissary, or assistant commissary of musters, as the case may be, will countersign both enlistments as having mustered the soldiers into the service of the United States before either of them is given to the disbursing officer.

DECLARATION OF RECRUIT.

I, Josephus Oasly desiring to volunteer as a soldier in the ARMY OF THE UNITED STATES, for the term of Three Years, DO DECLARE That I am 20 years and months of age; that I have never been discharged from the United States service on account of disability or by sentence of a court-martial, or by order before the expiration of a term of enlistment; and I know of no impediment to my serving honestly and faithfully as a soldier for three years.

GIVEN at Camp Nelson the 2^d day of October 1864

Witness: M. L. Palmer

Josephus Oasly
is a Free Man
No. 444
of Company Nelson
October 1864
John A. Smith
or Lincoln Co.
Franklin Co.

Consent of Parent or Guardian in case of a Minor, if a Free Man, or in the case of a Slave, of the Person to whom he owes Service

I, Do CERTIFY, That I am the that the said is years of age; and I do freely give my CONSENT to his volunteering as a SOLDIER in the Army of the United States, for the period of THREE YEARS, under the conditions of the laws of the United States.

GIVEN at the day of

Witness: C. J. ...

UNITED STATES COLORED TROOPS ENLISTMENT.

STATE OF

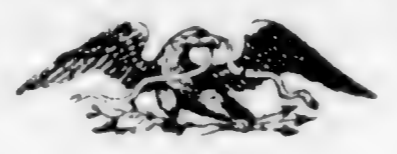

TOWN OF

Kentucky *Camp Nelson*

I *Josephus Onsey* born in *Lincoln* (w)
in the State of *Kentucky* aged *Twenty* years

and by occupation a *Farmer* Do HEREBY ACKNOWLEDGE TO

have volunteered *Eight* day of *October* 1864

to serve as a **Soldier** in the **Army of the United States of America**, for the period of **THREE YEARS**, unless sooner discharged by proper authority: Do also agree to accept such bounty, pay, rations, and clothing, as are, or may be, established by law for the U. S. colored troops.

And I, *Josephus Onsey* do solemnly swear that I will bear true faith and allegiance to the **United States of America**, and that I will serve them honestly and faithfully against all their enemies or opposers whomsoever: and that I will observe and obey the orders of the President of the United States, and the orders of the officers appointed over me, according to the Rules and Articles of War.

Sworn and subscribed to at *Camp Nelson* this *8th* day of *Oct* 1864 before *Joseph Onsey* *mark*

I CERTIFY, ON HONOR, That I have carefully examined the above named Volunteer agreeably to the General Regulations of the Army, and that, in my opinion, he is free from all bodily defects and mental infirmity, which would in any way disqualify him from performing the duties of a soldier.

Robt. S. Mitchell
a a Surg Mja.
EXAMINING SURGEON.

I CERTIFY, ON HONOR, That I have minutely inspected the Volunteer, *Joseph Onsey* previously to his enlistment, and that he was entirely sober when enlisted: in my judgment and belief, he is of lawful age; and that, in accepting him, as duty requires, to perform the duties of an able-bodied soldier, I have strictly observed the regulations which govern the recruiting service. This soldier has *blue* eyes, *black* hair, *dark* complexion, is *five* feet *three* inches high.

Chas. Randolph
RECRUITING OFFICER OR AGENT.

Mustered into the United States Service *10* day of *Oct* 1864

C. W. Ramsey
Capt 18th S. B.
Mustering Officer

Mustered into the service of the United States for three years or during the war, from date of enlistment, in Company *A* of *2nd* Regiment of *U.S. Colored* Volunteers, on the *8* day of *October* 1864 at *Camp Nelson*

1.—This blank will be used for enlistments of United States colored troops. They will be made out in duplicate in all cases—one to accompany the recruiting officer of the superintendent (not the recruiting officer) to the Adjutant General, and one to accompany the accounts of the officer who pays bounty, &c.

2.—An enlistment holds to service. In all cases, precede payment of pay, bounty, pension, &c. A muster-in roll, must in all cases, be filed in the Adjutant General's Office as evidence of muster-in. The mustering officer, commissary, or assistant commissary of musters, as the case may be, will countersign both enlistments as having mustered the soldiers into the service of the United States before either of them is given to the disbursing officer.

DECLARATION OF RECRUIT.

I, Josephus Orsley desiring to volunteer as a soldier in the ARMY OF THE UNITED STATES, for the term of Three Years, DO DECLARE That I am 20 years and months of age; that I have never been discharged from the United States service on account of disability or by sentence of a court-martial, or by order before the expiration of a term of enlistment; and I know of no impediment to my serving honestly and faithfully as a soldier for three years.

GIVEN at Camp Nelson the 8th day of October 1864

Witness: M. L. Palmer

Josephus Orsley
By Josephus Orsley

62000000
Orsley
Orsley

Entered at Camp Nelson 1864

No. 62000000



Consent of Parent or Guardian in case of a Minor, if a Free Man, or in the case of a Slave, of the Person to whom he owes Service:

I, Do CERTIFY, That I am the that the said is years of age; and I do freely give my CONSENT to his volunteering as a SOLDIER in the Army of the United States, for the period of THREE YEARS, under the conditions of the laws of the United States.

GIVEN at the day of

Witness: Orsley

UNITED STATES COLORED TROOPS ENLISTMENT.

STATE OF



TOWN OF

Kentucky

Camp Nelson

I, *Josephus Onsey* born in *Lincoln co*
in the State of *Kentucky* aged *Twenty* years

and by occupation a *Farmer* Do HEREBY ACKNOWLEDGE TO

have volunteered *Eight* day of *October* 1864

to serve as a **Soldier** in the **Army of the United States of America**, for the period of **THREE YEARS**, unless sooner discharged by proper authority: Do also agree to accept such bounty, pay, rations, and clothing, as are, or may be, established by law for the U. S. colored troops.

And I, *Josephus Onsey* do solemnly swear that I will bear true faith and allegiance to the **United States of America**, and that I will serve them honestly and faithfully against all their enemies or opposers whomsoever: and that I will observe and obey the orders of the President of the United States, and the orders of the officers appointed over me, according to the Rules and Articles of War.

Sworn and subscribed to, at *Camp Nelson* in
this *8th* day of *Oct 1864* *Josephus Onsey*
Before *J. P. Randolph* *J. P. P. M. S. P.*

I CERTIFY, ON HONOR, That I have carefully examined the above named Volunteer agreeably to the General Regulations of the Army, and that, in my opinion, he is free from all bodily defects and mental infirmity, which would in any way disqualify him from performing the duties of a soldier.

Robt S. Mitchell
a-a say up
EXAMINING SURGEON.

I CERTIFY, ON HONOR, That I have minutely inspected the Volunteer, *J. Onsey* previously to his enlistment, and that he was entirely sober when enlisted, that to the best of my judgment and belief, he is of lawful age; and that, in accepting him as duly qualified to perform the duties of an able-bodied soldier, I have strictly observed the regulations which govern the recruiting service. This soldier has *5 1/2* eyes, *1 1/2* hair, *1 1/2* complexion, is *five* feet *three* inches high.

J. P. Randolph
J. P. P. M. S. P.
RECRUITING OFFICER OR AGENT.

Mustered into the United States Service *10* day of *Oct* 1864

A. C. Kinney
Capt 18th U.S.I.
Mustering Officer

Mustered into the service of the United States, for three years or during the war, from date of enlistment, in Company
Regiment of *U.S. Colored* Volunteers, on the *10* day of *October* 1864 at *Camp Nelson Ky*

Capt 18th U.S.I.
A. C. Kinney
Private Officer

Statement of Service Reference Slip.

Office Pension

Claim No. No. 1009892

Joseph Owsley
(Name.)

, Co. C, 6 Reg't USA Cal Cav

To Med Div. 9-6-, 1913

For Med History

no med for Rts
Johnson
JWS
a

med stmt made

12 cards ret'd

Statement furnished 9-6, 1913

W.G.S.

1014

Qusley, William

Co C, 6 U. S. Col'd Cav.

Private Private

CARD NUMBERS.

1	5387158	26
2	5390161	27
3	5390238	28
4	5390320	29
5	5390344	30
6	5390465	31
7	5390549	32
8	5390636	33
9	5390719	34
10	5390801	35
11	5390887	36
12	4093070	37
13	40732694	38
14		39
15		40
16		41
17		42
18		43
19		44
20		45
21		46
22		47
23		48
24		49
25		50

Book Mark:

See also

Q | **6 Cav. | U.S.C.T.**

William Ansley

....., Co. *C*....., 6 Reg't U. S. Col'd Cav.

Appears on

Company Descriptive Book

of the organization named above.

DESCRIPTION.

Age *19* years; height *5* feet *4* inches.

Complexion *Blk*

Eyes *Blk*; hair *Blk*

Where born *Liverpool*

Occupation *Farmer*

ENLISTMENT.

When *Oct 11*....., 186*4*.

Where *Camp Nelson*

By whom *J. C. Randolph*, term *3*..... y'rs.

Remarks: *Promoted to Capt Mar*
19, 65 by special Order 14
Par II Reduced 2 Ranks
May 20 1865 by order to 42
Par (2) II

Oreger

10

6 Cav. U.S.C.T.

William Ousley

Appears with rank of Priv. on

Muster and Descriptive Roll of a Detachment of U. S. Vols. forwarded

for the 6 Reg't U. S. Col'd Cavalry. Roll dated Camp Nelson Ky., Oct. 27, 1864.

Where born Lincoln Ky.

Age 19 y'rs; occupation Farmer

When enlisted Oct. 11, 1864.

Where enlisted Camp Nelson Ky.

For what period enlisted 3 years.

Eyes Blk; hair Blk

Complexion Blk; height 5 ft. 4 in.

When mustered in Oct. 12, 1864.

Where mustered in Camp Nelson Ky.

Bounty paid \$ 100; due \$ 100

Where credited

Company to which assigned

Remarks: Credited to Lincoln Co.

7 Dist. Ky.

Samuel Ousley Owner

Book mark:

C. E. McLaughlin

(339)

Copyist.

0 6 Cav. U.S.C.T.

William Wesley

B, Co. *C*, 6 Reg't U. S. Col'd Cavalry.

Appears on

Company Muster-in and Descriptive Roll

of the organization named above. Roll dated

Camp Nelson, Ky, Nov. 11, 1864.

Where born *Lincoln Kentucky*

Age *19* y'rs; occupation *Farmer*

When enlisted *Oct 11*, 186 .

Where enlisted *Camp Nelson Ky*

For what period enlisted *7* years.

Eyes *Black*; hair *Black*

Complexion *Black* height *5* ft. *4* in.

When mustered in *Oct 12*, 186 .

Where mustered in *Camp Nelson*

Bounty paid \$ *100*; due \$ *100*

Where credited *7th Dist Ky*

Company to which assigned *C*

Remarks:

Book mark:

W. C. Howler

(356d)

Copyist.

6 Cav. U.S.C.T.

[Handwritten Name], Co. C, 6 Reg't U. S. Colored Cavalry.

Appears on

Company Muster Roll

for *[Handwritten Date]*, 186*[Handwritten]*.

Present or absent *[Handwritten]*

Stoppage, \$ *[Handwritten]* 100 for *[Handwritten]*

Due Gov't, \$ *[Handwritten]* 100 for *[Handwritten]*

Valuation of horse, \$ *[Handwritten]* 100

Valuation of horse equipments, \$ *[Handwritten]* 100

Remarks: *[Handwritten]*

Book mark: *[Handwritten]*

6 Cav. U.S.C.T.

[Faint handwritten name], Co. C, 6 Reg't U. S. Colored Cavalry.

Appears on

Company Muster Roll

for *[Faint handwritten name]*, 186*[Faint handwritten number]*.

Present or absent *[Faint handwritten mark]*

Stoppage, \$ *[Faint handwritten number]* 100 for *[Faint handwritten number]*

Due Gov't, \$ *[Faint handwritten number]* 100 for *[Faint handwritten number]*

Valuation of horse, \$ *[Faint handwritten number]* 100

Valuation of horse equipments, \$ *[Faint handwritten number]* 100

Remarks: *[Faint handwritten notes]*

Book mark: *[Faint handwritten notes]*

'6 Cav. U.S.C.T.

William Dudley
Dudley, Co. C, 6 Reg't U. S. Colored Cavalry.

Appears on

Company Muster Roll

for *March & April*, 1867.

Present or absent *Absent*

Stoppage, \$ *100* for

Due Gov't, \$ *100* for

Valuation of horse, \$ *100*

Valuation of horse equipments, \$ *100*

Remarks: *Man detached*
to office Robinson's
from 1st Detachment
accounts due & provided
under his direction
Order to be made

Book mark: _____

W. E. [Signature]

0

6 Cav. U.S.C.T.

William Orosley

Priv, Co. C, 6 Reg't U. S. Colored Cavalry.

Appears on

Company Muster Roll

for *May & June*, 186*5*.

Present or absent *Present*

Stoppage, \$ *100* for

Due Gov't, \$ *100* for

Valuation of horse, \$ *100*

Valuation of horse equipments, \$ *100*

Remarks *Reduced to ranks from
Corporal May 21st by order No 42
dated Hd Qrs 6th M. S. C. Camp
Nelson Ky May 20th 1865
1st Constable County due*

Book mark:

S. P. York

(358)

Copyist.

0

6 Cav. U.S.C.T.

William Owsley

Pris, Co. C, 6 Reg't U. S. Colored Cavalry.

Appears on

Company Muster Roll

for *July & Aug*, 186*5*.

Present or absent *Present*

Stoppage, \$ *100* for

Due Gov't, \$ *100* for

Valuation of horse, \$ *100*

Valuation of horse equipments, \$ *100*

Remarks: *Due U.S. for horse & eq. \$100*

Book mark:

S. J. York

(358)

Copyist.

0

6 Cav. U.S.C.T.

William Crossley

William, Co. C, 6 Reg't U. S. Colored Cavalry.

Appears on

Company Muster Roll

for *Sept & Oct*, 186*5*.

Present or absent *Present*

Stoppage, \$ *100* for

Due Gov't, \$ *100* for

Valuation of horse, \$ *100*

Valuation of horse equipments, \$ *100*

Remarks:

Book mark:

(358)

D. P. York

Copyist.

0

6 Cav. U.S.C.T.

William Cusley
Priv, Co. C, 6 Reg't U. S. Colored Cavalry.

Appears on

Company Muster Roll

for *Nov. & Dec.*, 1865.

Present or absent *Present*

Stoppage, \$ 100 for

Due Gov't, \$ 100 for

Valuation of horse, \$ 100

Valuation of horse equipments, \$ 100

Remarks:

Book mark:

(358)

W. B. Ferguson
Copyist.

0

6 Cav. U.S.C.T.

William Busley
Priv., Co. C, 6 Reg't U. S. Colored Cavalry.

Appears on

Company Muster Roll

for Jan. & Feb., 1866.

Present or absent Present

Stoppage, \$ 100 for

Due Gov't, \$ 100 for

Valuation of horse, \$ 100

Valuation of horse equipments, \$ 100

Remarks:

Book mark:

W. H. Ferguson

(358)

Copyist.

0

6 Cav.

U.S.C.T.

William Daws

, Co. C, 6 Reg't U. S. Col'd Cav.

Appears on Returns as follows:

Mar + Apr 1855 Present
on det service at Robin-
sons Station Kibb
since Mar-29, '55

Book mark:

(546)

W Daws

Copyist.

C 6 Cav. U.S.C.T.

William Cusley
Priv, Co. *C*, 6 Reg't U.S. Col'd Cavalry.

Appears on Co. Muster-out Roll, dated
Howards Bluff Ark, Apl. 15, 1866.

Muster-out to date *Apl. 15*, 1866.

Last paid to *Feb. 28*, 1866.

Clothing account:

Last settled _____, 186 ; drawn since \$ 100

Due soldier \$ *17*^{*94*} 100; due U. S. \$ 100

Am't for cloth'g in kind or money adv'd \$ 100

Due U. S. for arms, equipments, &c., \$ 100

Bounty paid \$ *100* 100; due \$ *100* 100

Remarks: _____

Book mark: _____

(861)

W B Ferguson

Copyist.

Ousley William
_____, Co. _____, _____ Reg't *U. S. C. I.*

2 **Enclosures.**

Bed Cards	Final Statements
Burial Records	Furloughs or L. of A.
Certs. of Dis. for Discharge	Med. Certificates
C. M. Charges	Med. Des. Lists
Descriptive Lists	Orders
Discharge Certificates	Pris. of War Record
Enlistment Papers <i>2</i>	Resignations

Other papers relating to—

Admission to Hosp'l	Furlough or L. of A.
Casualty Sheet	Med. Examination
Confinement	Misc. Information
Contracts	Pay or Clothing
Death or Effects	Personal Reports
Desertion	Rank
Discharge from Hosp'l	Transfer to Hosp'l
Discharge from Service	Transfer to V. R. C.
Duty	Transportation
.....

NOTE 1.—This blank will be used for enlistments of United States colored troops. They will be made out in duplicate in all cases—one to accompany the recruiting return of the superintendent (not the recruiting officer), to the Adjutant General, and one to accompany the accounts of the officer who pays bounty, &c.

NOTE 2.—An enlistment holds to service, and must, in all cases, precede payment of pay, bounty, pension, &c. A muster-in roll, must in all cases, be filed in the Adjutant General's Office as evidence of muster-in. The mustering officer, commissary, or assistant commissary of musters, as the case may be, will countersign both enlistments as having mustered the soldiers into the service of the United States before either of them is given to the disbursing officer.

DECLARATION OF RECRUIT.

I, William Owsley desiring to volunteer as a soldier in the ARMY OF THE UNITED STATES, for the term of Three Years, DO DECLARE That I am 19 years and months of age, that I have never been discharged from the United States service on account of disability or by sentence of a court-martial, or by order before the expiration of a term of enlistment; and I know of no impediment to my serving honestly and faithfully as a soldier for three years.

GIVEN at Camp Nelson the 41 day of October 1864

Witness: J. M. Dickerson

Witness: Wm. Owsley
Volunteered at Camp Nelson
October 18 64
J. M. Dickerson
or J. M. Dickerson
James Owsley
No. 1000
William Owsley
James Owsley

Consent of Parent or Guardian in case of a Minor, if a Free Man, or in the case of a Slave, of the Person to whom he owes Service:

I, Do CERTIFY, That I am the that the said is years of age; and I do freely give my CONSENT to his volunteering as a SOLDIER in the Army of the United States, for the period of THREE YEARS, under the conditions of the laws of the United States.

GIVEN at the day of

Witness: J. M. Dickerson

UNITED STATES COLORED TROOPS ENLISTMENT.

STATE OF

TOWN OF

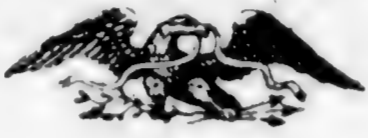

Kentucky *Camp Nelson*

I *William Owsley* born in *Lincoln* in the State of *Kentucky* aged *thirteen* years and by occupation *Farmer* Do HEREBY ACKNOWLEDGE TO have volunteered *Eleventh* day of *October* 186*4*

to serve as a **Soldier** in the **Army of the United States of America**, for the period of **THREE YEARS**, unless sooner discharged by proper authority: Do also agree to accept such bounty, pay, rations, and clothing, as are, or may be, established by law for the U. S. colored troops.

And I *William Owsley* do solemnly swear that I will bear true faith and allegiance to the **United States of America**, and that I will serve them honestly and faithfully against all their enemies or opposers whomsoever; and that I will observe and obey the orders of the President of the United States, and the orders of the officers appointed over me, according to the Rules and Articles of War.

Sworn and subscribed to at *Camp Nelson* this *11th* day of *Oct* 186*4* *William Owsley* Before *J. Randolph* *mark*

I CERTIFY, ON HONOR, That I have carefully examined the above named Volunteer agreeably to the General Regulations of the Army, and that, in my opinion, he is free from all bodily defects and mental infirmity, which would in any way disqualify him from performing the duties of a soldier.

J. P. ...
EXAMINING SURGEON.

I CERTIFY, ON HONOR, That I have minutely inspected the Volunteer previously to his enlistment, and that he was entirely sober when enlisted; that, in my judgment and belief, he is of lawful age; and that, in accepting him as duly qualified to perform the duties of an able-bodied soldier, I have strictly observed the regulations which govern the recruiting service. This soldier has *dark* eyes, *dark* hair, *13 1/2* complexion, is *fair* feet *fair* inches high.

J. Randolph
RECRUITING OFFICER OR AGENT.

Mustered into the United States Service *12* day of *Oct* 186*4*

N. Owsley
Mustering Officer

Mustered into the service of the United States, for three years or during the war, from date of enlistment, in Company *1st* Regiment of *1st* *Volunteers*, on the *12* day of *October* 186*4* at *Camp Nelson*

W. Owsley
Capt 18-11-86

DECLARATION OF RECRUIT.

I, William Owsley desiring to volunteer as a soldier in the ARMY OF THE UNITED STATES, for the term of Three Years, DO DECLARE That I am 19 years and months of age; that I have never been discharged from the United States service on account of disability or by sentence of a court-martial, or by order before the expiration of a term of enlistment; and I know of no impediment to my serving honestly and faithfully as a soldier for three years.

GIVEN at Camp Nelson the 11th day of October 1864

Witness: J. M. Dickerson

Wm Owsley
By Mark

Shannon Owsley
or Lincoln Co

Volunteered at
No.
18



Consent of Parent or Guardian in case of a Minor, if a Free Man, or in the case of a Slave, of the Person to whom he owes Service:

I, DO CERTIFY, That I am the that the said is years of age; and I do freely give my CONSENT to his volunteering as a SOLDIER in the Army of the United States, for the period of THREE YEARS, under the conditions of the laws of the United States.

GIVEN at the day of

Witness: [Signature]

NOTE 1.—This blank will be used for enlistments of United States colored troops. They will be made out in duplicate in all cases—one to accompany the recruiting return of the superintendent (not the recruiting officer) to the Adjutant General, and one to accompany the accounts of the officer who pays bounty, &c.
NOTE 2.—An enlistment held in service by a recruit in must, in all cases, precede payment of pay, bounty, pension, &c. A muster-in roll, must in all cases, be filed in the Adjutant General's Office as evidence of muster-in. The mustering officer, commissary, or assistant commissary of musters, as the case may be, will countersign both enlistments as having mustered the soldiers into the service of the United States before either of them is given to the disbursing officer.

UNITED STATES COLORED TROOPS ENLISTMENT.

STATE OF

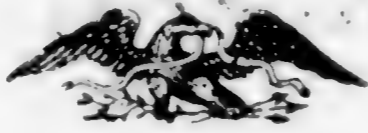

TOWN OF

Kentucky

Camp Nelson

I *William Owsley* born in *Lincoln* in the State of *Kentucky* aged *nineteen* years and by occupation a *farmer* Do HEREBY ACKNOWLEDGE to have volunteered *eleventh* day of *October* 1864

to serve as a **Soldier** in the **Army of the United States of America**, for the period of **THREE YEARS**, unless sooner discharged by proper authority: Do also agree to accept such bounty, pay, rations, and clothing, as are, or may be, established by law for the U. S. colored troops.

And I, *William Owsley* do solemnly swear that I will bear true faith and allegiance to the **United States of America**, and that I will serve them honestly and faithfully against all their enemies or opposers whomsoever; and that I will observe and obey the orders of the President of the United States, and the orders of the officers appointed over me, according to the Rules and Articles of War.

Sworn and subscribed to, at *Camp Nelson* this *11th* day of *Oct 1864* Before *J. C. Randolph* *Wm Owsley*

I CERTIFY, ON HONOR, That I have carefully examined the above named Volunteer agreeably to the General Regulations of the Army, and that, in my opinion, he is free from all bodily defects and mental infirmity, which would in any way disqualify him from performing the duties of a soldier.

J. R. Tamm
as Surg U.S.A.
EXAMINING SURGEON.

I CERTIFY, ON HONOR, That I have minutely inspected the Volunteer previously to his enlistment, and that he was entirely sober when enlisted; that, to the best of my judgment and belief, he is of lawful age; and that, in accepting him as duly qualified to perform the duties of an able-bodied soldier, I have strictly observed the regulations which govern the recruiting service. This soldier has *dark* eyes, *dark* hair, *dark* complexion, is *five* feet *four* inches high.

J. C. Randolph
and *J. P. Jones*
RECRUITING OFFICER OR AGENT.

Mustered into the United States Service *12* day of *Oct* 1864

V. O. Kinney
Capt 18th U.S.C.
Mustering Officer

Mustered into the service of the United States, for three years or during the war, from date of enlistment, in Company *C* Regiment of *110th Col* Volunteers, on the *12* day of *October* 1864 at *Camp Nelson Ky*

Wm Owsley
Capt 18th U.S.C.
Wm Owsley

1015

Overstreet, Lewis

Co H, 6 U. S. Col'd Cav.

Private

Private

CARD NUMBERS.

1	5387614	26
2	5387581	27
3	5387672	28
4	5394094	29
5	5394179	30
6	5394261	31
7	5394386	32
8	5394436	33
9	5394524	34
10	5394598	35
11	5394668	36
12	9093632	37
13	140732689	38
14		39
15		40
16		41
17		42
18		43
19		44
20		45
21		46
22		47
23		48
24		49
25		50

Book Mark:

See also

1175812. P. 1175812

R. A. Miller, Esq.

0 | 6 | U.S.C.T.

Lewis Overstreet

Appears with rank of *Priv* on

Muster and Descriptive Roll of a Detachment of Substitutes forwarded

for the *6* Reg't U. S. Col'd Cavalry Roll dated
Draft Rendezvous, Louisville, Ky, March 15, 1865.

Where born *Russell, Kentucky*

Age *18* y'rs; occupation *Laborer*

When enlisted _____, 186 .

Where enlisted *Substitute*

For what period enlisted _____ *1* years.

Eyes *Black*; hair *Black*

Complexion *Black*; height *5* ft. *6½* in.

When mustered in *Feb 25*, 1865.

Where mustered in *Lebanon*

Bounty paid \$ *100*; due \$ *100*

Where credited *4" Dist. Ky.*

Company to which assigned _____

Remarks: *Sub. for William Brown.*

Book mark: _____

666 U.S.C.T.

Lewis Overstreet

Appears with rank of _____ on _____

Muster and Descriptive Roll of a Detachment of Substitutes forwarded

for the 6th Reg't U. S. Col'd Cav. Roll dated

Lebanon Ky, Feb 28, 1865.

Where born Russell Kentucky

Age 18 y'rs; occupation Laborer

When enlisted Feb 25, 1865.

Where enlisted Lebanon

For what period enlisted 1 year.

Eyes black; hair black

Complexion black; height 5 ft. 6 1/2 in.

When mustered in Feb 25, 1865.

Where mustered in Lebanon

Bounty paid \$ 100; due \$ 100

Where credited.

Company to which assigned

Remarks: William Brown, drafted
Man, Nelson Co Ky

Book mark:

(340b)

D. J. Griffith

Copyist.

0

6

U.S.C.T.

Lewis Overstreet

Appears with rank of *Pvt.* on

Muster and Descriptive Roll of a Detachment of Substitutes forwarded

for the *6* Reg't U. S. Col'd Cavalry. Roll dated *Draft Rendezvous, Louisville, Ky, Feb 15, 1865*.

Where born *Russell Kentucky*

Age *18* y'rs; occupation *Laborer*

When enlisted _____, 186 .

Where enlisted *Substitute*

For what period enlisted _____ years.

Eyes *Black*; hair *Black*

Complexion *Black*; height *5 ft. 6 1/2 in.*

When mustered in *Feb. 25*, 1865.

Where mustered in *Lebanon*

Bounty paid \$ *100*; due \$ *100*

Where credited *4" Dist. Ky.*

Company to which assigned _____

Remarks: *Sub. for William Brown*

Book mark: _____

(339c)

Conard

Copyist.

O Cav. U. S. C. T.

Lewis Overstreet
Priv. Co. H. 6 Reg't U. S. Col'd Cavalry

Appears on

Company Muster-in and Descriptive Roll
of the organization named above. Roll dated

Covington, Ky., Mch 26, 1865.

Where born Russell, Kentucky

Age 18 y'rs; occupation Laborer.

When enlisted _____, 186 .

Where enlisted Substitute.

For what period enlisted _____ 1 year.

Eyes Black; hair Black.

Complexion Black; height 5 ft. 6 1/2 in.

When mustered in Feb. 25, 1865.

Where mustered in Lebanon, Ky.

Bounty paid \$ 100; due \$ 100

Where credited 4th Dist. Ky.

Company to which assigned F. C.

Remarks: Sub. for Wm. Brown.

Book mark : _____

Conard

(356d)

Copyist.

0 6 Cav. U.S.C.T.

Lewis Overstreet
Pvt, Co. H, 6 Reg't U. S. Col'd Cavalry.

Appears on

Company Muster Roll

for from Mch. 16 to Apr. 30, 1865.

Present or absent Present.

Stoppage, \$ 100 for

Due Gov't, \$ 100 for

Valuation of horse, \$ 100

Valuation of horse equipments, \$ 100

Remarks:

Book mark:

(358)

Conard
Copyist.

0

6 Cav. U.S.C.T.

Lewis Overstreet

Priv., Co. H, 6 Reg't U. S. Col'd Cavalry.

Appears on

Company Muster Roll

for *May & June*, 1865.

Present or absent *Present*

Stoppage, \$ 100 for

Due Gov't, \$ 100 for

Valuation of horse, \$ 100

Valuation of horse equipments, \$ 100

Remarks:

Book mark:

(358)

Conard
Copyist.

F 6 Cav. U.S.C.T.

John Bennett

John, Co. H, 6 Reg't U. S. Co'd Cavalry.

Appears on

Company Muster Roll

for *John Bennett*, 1865.

Present or absent *Present*

Stoppage, \$ 100 for

Due Gov't, \$ 100 for

Valuation of horse, \$ 100

Valuation of horse equipments, \$ 100

Remarks:

Book mark:

(358)

John Bennett
Copyist.

3 | **6 Cav. U.S.C.T.**

James Overstreet
Co., Co. H, 6 Reg't U. S. Col'd Cavalry.

Appears on

Company Muster Roll

for *Sept Oct*, 1865.

Present or absent *Present*.

Stoppage, \$ *100* for

Due Gov't, \$ *100* for

Valuation of horse, \$ *100*

Valuation of horse equipments, \$ *100*

Remarks:

Book mark: -----

(358)

Chavins

Copyist.

6 Cav. U.S.C.T.

Simon

Simon, Co. H, 6 Reg't U. S. Col'd Cavalry.

Appears on

Company Muster Roll

for *Jan 1865*, 1865.

Present or absent *Present*.

Stoppage, \$ *100* for

Due Gov't, \$ *100* for

Valuation of horse, \$ *100*

Valuation of horse equipments, \$ *100*

Remarks:

Book mark:

(358)

Simon

Copyist.

0 | 6 Cav. | U.S.C.T.

Lewis Overstreet
Pvt., Co. H, 6 Reg't U. S. Col'd Cavalry.

Appears on

Company Muster Roll

for January & Feb, 1866.

Present or absent Present

Stoppage, \$ 100 for

Due Gov't, \$ 0 ³⁰/₁₀₀ for ordnance

\$100 for Q & S

Valuation of horse, \$ 100

Valuation of horse equipments, \$ 100

Remarks:

Book mark:

J. M. Harmon

O

6 Cav. U.S.C.T.

Levin Corrostruet

Pat, Co. *A.*, 6 Reg't U. S. Col'd Cavalry.

Appears on Co. Muster-out Roll, dated

Deeralls Bluff ark, Apr 15, 1866.

Muster-out to date *Apr 15*, 1866.

Last paid to *July 28*, 1866.

Clothing account:

Last settled....., 186 ; drawn since \$ 100

Due soldier \$ 100; due U. S. \$ *10⁴²* 100

Am't for cloth'g in kind or money adv'd \$ 100

Due U. S. for arms, equipments, &c., \$ 100

Bounty paid \$ 100; due \$ 100

Remarks:

Book mark:

J. M. Harmon

(861)

Copyist.

D. | 6 Cav. | U.S.C.T.

Lewis Overstreet
Co. H, 6 Reg't U.S. Col'd Cav.

Appears on

Company Descriptive Book

of the organization named above.

DESCRIPTION.

Age 18 years; height 5 feet 6 1/2 inches.

Complexion black

Eyes black; hair black

Where born Russell Co. Ky

Occupation Labourer

ENLISTMENT.

When Feb. 27 1865.

Where Lebanon, Ky.

By whom Capt. Fidler; term 3 y'rs.

Remarks: Substitute

Lewis Overstreet

C | 6 Cav. | U.S.C.T.

⁺ Lewis Carpenter
Capt. Co. H. 6 Reg't U. S. Col'd Cav.

Appears on Returns as follows:

Nov 1865 Present in the
line since Nov 30 65

Jan 1866 On duty in the
stables

⁺ Supplied from Mo Rolls by
[Signature]

Book mark:

(546)

[Signature]

Copyist.

Owenstreet Lewis
 Pvt, Co. H, 6 Reg't U.S.C.

/ Enclosures.

- | | |
|------------------------------------|----------------------------|
| Bed Cards | Final Statements |
| Burial Records | Furloughs or L. of A. |
| Certs. of Dis. for Discharge | Med. Certificates |
| C. M. Charges | Med. Des. Lists |
| Descriptive Lists | Orders |
| Discharge Certificates | Pris. of War Record |
| Enlistment Papers | Resignations |

Other papers relating to—

- | | |
|------------------------------|---------------------------|
| Admission to Hosp'l | Furlough or L. of A. |
| Casualty Sheet | Med. Examination |
| Confinement | Misc. Information |
| Contracts | Pay or Clothing |
| Death or Effects | Personal Reports |
| Desertion / | Rank |
| Discharge from Hosp'l | Transfer to Hosp'l |
| Discharge from Service | Transfer to V. R. C. |
| Duty | Transportation |

Lewis & Clark

Private Secy H. C. M. C. C.

Requesting return from Clark with letter.

U.S.A.

80

Adjutant General's Office,

COLORED TROOPS BRANCH,

Mr Ellerbroom

May 6, 1874

Vol.

C. T., 187

Wanted in case of Lewis Overstreet, Pvt, Co. "H",
6th Reg't W. S. C. Co. reported absent without
leave since Nov 30, 1865. Please give date of
return to Company, and copy of sentence if tried

Respectfully,

R. A. Woodward
Chief Clerk
S. R.

Adjutant General's Office,

Rec'd Rec.

May 9, 1874

Vol.

C. T., 187

Reply in case of

Reg't

W. S. C. Co. ...
The following report ...
Nov 2, 1865 ...
...

1016

Quinn Abram

Co C, 6 U. S. Col'd Cav.

1st Sergeant *Private*

CARD NUMBERS.

1	5-387264	26
2	5-387157	27
3	5-390090	28
4	5-390175	29
5	5-390260	30
6	5-390337	31
7	5-390474	32
8	5-390926	33
9	7873-A-1888	34
10	43174798	35
11	40732690	36
12		37
13		38
14		39
15		40
16		41
17		42
18		43
19		44
20		45
21		46
22		47
23		48
24		49
25		50

Book Mark *ED. N. 10. p. 585-7873-A-88.*

See also

D. 826062 - P. O. aff.

D. J. Miller, Esq.

0

6 Cavalry.

U. S. C. T.

Abram Owens

-----, Co. *B* 6 Reg't U. S. Col'd Cav.

Appears on

Regimental Descriptive Book

of the regiment named above.

DESCRIPTION.

Age *29* years; height *5* feet *7* inches.

Complexion *black*

Eyes *Blk*; hair *Blk*

Where born *Montgomery Co Ky.*

Occupation *farmer*

ENLISTMENT.

When *Oct 13*, 1864.

Where *Cp Nelson, Ky*

By whom *Cpr J. E. Randolph*; term *3* years.

Remarks: *Dischg'd on Surg's Cert. of Disability at Cp Nelson, Ky. May 29, 1865*

L. D. Barton

(384b)

Copist.

A | Clear | **U. S. C. T.**

Amos Abram

5th, Co. 6, 6 Reg't U. S. Col'd 6th

Appears on

Company Muster-in and Descriptive Roll
of the organization named above. Roll dated
Camp Nelson
Kentucky Nov 1, 1864.

Where born Montgomery Kentucky

Age 29 y'rs; occupation Farmer

When enlisted Oct 13, 1864.

Where enlisted Camp Nelson Ky

For what period enlisted 3 years.

Eyes Black; hair Black

Complexion Black; height 5 ft. 7 in.

When mustered in Oct 13, 1864.

Where mustered in Camp Nelson

Bounty paid \$ 100; due \$ 100

Where credited 9th Dist Kentucky

Company to which assigned 0

Remarks:

Book mark: 7873-2-1888

A. C. Howser
(356d) Copyist.

6

6 Cav. U.S.C.T.

Abram Owens

Appears with rank of Priv. on

Muster and Descriptive Roll of a Detachment of U. S. Vols. forwarded

for the 6 Reg't U. S. Col'd Cavalry. Roll dated Camp Nelson Ky., Oct. 27, 1864.

Where born Montgomery Ky.

Age 29 y'rs; occupation Farmer

When enlisted Oct. 13, 1864.

Where enlisted Camp Nelson Ky.

For what period enlisted 3 years.

Eyes Blk; hair Blk

Complexion Blk; height 5 ft. 7 in.

When mustered in Oct. 13, 1864.

Where mustered in Camp Nelson Ky.

Bounty paid \$ 100; due \$ 100

Where credited

Company to which assigned

Remarks: Credited to Montgomery Co. 9 Dist. Ky.

Joshua Owens, Owner

Book mark:

C. E. M. Laughlin

(339)

Copyist.

(C)

6 Cav. U.S.C.T.

Abraam Owens

Appears with rank of *Privt.* on

Muster and Descriptive Roll of a Detachment of U. S. Vols. forwarded

for the 6 Reg't U. S. Col'd Cavalry. Roll dated

Lexington Ky. Jan. 14, 1865.

Where born *Montgomery, Kentucky*

Age *29* y'rs; occupation *Farmer*

When enlisted *Oct. 13*, 186 .

Where enlisted *Cp. Nelson*

For what period enlisted *3* years.

Eyes *Blk.*; hair *Blk.*

Complexion *Blk.*; height *5* ft. *7* in.

When mustered in *Oct. 13*, 186 .

Where mustered in *Cp. Nelson*

Bounty paid \$ *100*; due \$ *100*

Where credited

Company to which assigned

Remarks: *Joshua Owen, Owner*

Book mark:

(339)

C. E. McLaughlin

Copyist.

0

6 Cav. U.S.C.T.

Abram Owens

1st Regt, Co. C, 6 Reg't U. S. Colored Cavalry.

Appears on

Company Muster Roll

for *Nov & Dec*, 186*4*.

Present or absent *present*

Stoppage, \$ *100* for

Due Gov't, \$ *100* for

Valuation of horse, \$ *100*

Valuation of horse equipments, \$ *100*

Remarks:

Book mark:

W. G. Howler

(358)

Copyist.

0

6 Cav. U.S.C.T.

Abram Owens

1st Regt, Co. C, 6 Reg't U. S. Colored Cavalry.

Appears on

Company Muster Roll

for *Nov & Dec*, 186*4*.

Present or absent *present*

Stoppage, \$ *100* for

Due Gov't, \$ *100* for

Valuation of horse, \$ *100*

Valuation of horse equipments, \$ *100*

Remarks:

Book mark:

W. G. Howler

(358)

Copyist.

6 Cav. U.S.C.T.

John Smith
Co. C, 6 Reg't U. S. Colored Cavalry.

Appears on

Company Muster Roll

for *John Smith*, 186*5*

Present or absent *Present*

Stoppage, \$ *100* for

Due Gov't, \$ *100* for

Valuation of horse, \$ *100*

Valuation of horse equipments, \$ *100*

Remarks: *Present*

Account

Book mark:

6 Cav. U.S.C.T.

21st Co. C, 6 Reg't U. S. Colored Cavalry.

Appears on

Company Muster Roll

for *Jan - Dec*, 1865.

Present or absent *Present*

Stoppage, \$ *100* for

Due Gov't, \$ *100* for

Valuation of horse, \$ *100*

Valuation of horse equipments, \$ *100*

Remarks: *1st Muster roll*

*found to be correct by
audit & signed by
Lieut. H. Van -
Mar 19 1865*

Book mark:

21st Co. C
(358) Copyist.

A

6 Cav. U.S.C.T.

Crews Abram

Serg't., Co. C, 6 Reg't U. S. Colored Cavalry.

Appears on

Company Muster Roll

for *May & June*, 1865.

Present or absent

Stoppage, \$ *100* for

Due Gov't, \$ *100* for

Valuation of horse, \$ *100*

Valuation of horse equipments, \$ *100*

Remarks: *Discharged May 29th 1865
on Surgeons Certificate of Disability
by order of Maj Genl J. M. Palmer
Comdg. Dept of Ky Jan'y 24th 1865*

Book mark:

S. P. York

(358)

Copyist.

C | 6 Cav. | U.S.C.T.

Abraham Owens
Sgt, Co. C, 6 Reg't U. S. Col'd Cav.

Appears on Returns as follows:

May 1865 - May 29, 65
Camp Nelson Ky. Disch'd
on Surgeon's certificate
of disability

Book mark:

(546)

W. D. Jones

Copyist.

0

6 Cav. U.S.C.T.

Abram Owens
Priv., Co. C, 6 Reg't U. S. Col'd Cavalry.

Appears on Co. Muster-out Roll, dated
Bluffs Bluff Ark., Apr. 15", 1866.

Muster-out to date _____, 186 .

Last paid to Feb. 28", 1865 .

Clothing account:

Last settled _____, 186 ; drawn since \$ _____ 100

Due soldier \$ _____ 100; due U. S. \$ _____ 100

Am't for cloth'g in kind or money adv'd \$ _____ 100

Due U. S. for arms, equipments, &c., \$ _____ 100

Bounty paid \$ _____ 100; due \$ 100 100

Remarks: this Surg. Gen'l. Nelson
By May 24" 65

Book mark: this May '65 E.B.V. 10.P. 585.
(over)

(361)

W.B. Ferguson

Copyist.

JAN 10

5390926

1881

7873 a : 88

V 215. P 239.75.

O. C. Cary W.C.D.

Abraham Owens

Co. C. 6 Reg't W.C. Cary

NOTATION.

Book mark: 7873-A-1888-

War Department.

Adjutant General's Office.

Washington, July 21. 1888.

Application for certificate in lieu of lost discharge.

One Certificate furnished.

A. M. Muzzey

Owens, Abram
Reg't, Co. C, 6 U.S.C. Cav.

Enclosures.

Bed Cards	Descriptive Lists
Burial Records	Final Statements
Certs. of Dis. for Discharge	Furloughs
C. M. Charges	Med. Des. Lists
Med. Certificates	Orders

Other papers relating to—

Admission to Hosp'l	Furlough
Casualty Sheet (Officer's)	Med. Examination
Confinement	Misc. Information
Contracts	Pay or Clothing
Death or Effects	Personal Reports
Desertions	Rank
Discharge from Hosp'l	Transfer to Hosp'l
Discharge from Service	Transfer to V. R. C.
Duty	Transportation

[OFFICE INDORSEMENT.]

War Department,

ADJUTANT GENERAL'S OFFICE,

February 4th, 1874 -

The discharge of Abram Owens
Sergeant, Co. C, 6th Reg't U. S.
Colored Coif, is reported as follows:

On Company Muster Roll.
For May and June, 1865, May 29th, 1865

Company Muster-out Roll.
May 24th, 1865

Company Descriptive Book. , 186

Company Morning Reports. , 186

Soldier's Final Statement. , 186

Soldier's Record of Death and Interment. , 186

Soldier's Inventory of Effects. , 186

Soldier's Certificate of Disability for Discharge.
May 29th, 1865

Soldier's Individual Muster-out Roll. , 186

Regimental Return. , 186

For , 186 , , 186
Regimental Quarterly Returns. , 186

Regimental Descriptive Book. , 186

By Surgeon General. , 186

May 20th, 1865, is held to be

the correct date, and the Company Muster-out
Roll will be amended accordingly.

Thomas M. Stewart
E. B. 10
385
Solicitor
Joint on 1/4
Assistant Adjutant General.
See letter to 2^d and
Mar 10 1874

1865

✓

//

CERTIFICATE OF DISABILITY FOR DISCHARGE

IN THE CASE OF

Abram Owens
a Sergeant Co. C
Sixth Reg't of U. S. C. I.

Received (A. G. Office) , 186

Emerson O. Prof. Cas

ADJUTANT GENERAL'S OFFICE.
June 5th 1865
Duplicate sent the Pension Office.

NOTE 1.

The company commander will here add a statement of all the facts known to him concerning the disease or wound, or cause of disability of the soldier; the time, place, manner, and all the circumstances under which the injury occurred, or disease originated or appeared; the duty, or service, or situation of the soldier at the time the injury was received or disease contracted, stating particularly whether the injury was received or the disease contracted in the line of his duty; and whatever other fact may aid a judgment as to the cause, immediate or remote of the disability, and the circumstances attending it.

When the facts are not known to the company commander, the certificate of any officer, or affidavit of other person having such knowledge, will be appended—as the surgeon in charge of a hospital, the officer commanding a detachment of recruits, &c., &c.

NOTE 2.

When a probable case for pension, special care must be taken to state the degree of disability—as *l. l.*, &c., &c. to describe particularly the disability, wound, or disease the extent of which it deprives him of the use of any limb or faculty, or affects his health, strength, activity, constitution, or capacity to labor or earn his subsistence. The surgeon will add, from his knowledge of the facts and circumstances, and from the evidence in the case, his professional opinion of the cause or origin of the disability. In the case of discharges by Medical Inspectors, the last paragraph will state that the "discharge was given by consent of the soldier, after a personal examination, and for disability, the nature, degree, and origin of which are correctly described in the within certificate."

Par. 1260 Regulations, Edit. 1861.

Medical officers, in giving certificates of disability, are to take particular care in all cases that have not been under their charge; and especially in epilepsy, convulsions, chronic rheumatism, derangement of the urinary organs, ophthalmia, ulcers, or any obscure disease liable to be feigned or purposely produced; and in no case shall such certificate be given until after sufficient time and examination to detect any attempt at deception.

DIRECTIONS.

This certificate will be made out in duplicate by the soldier's company commander, or other officer commanding the separate detachment to which he belongs, and sent by him to the surgeon who has charge of the hospital where the soldier is sick. The surgeon will then fill out and sign the surgeon's certificate, and forward these papers to the regimental, detachment, or post commander, who will forward them, with his action endorsed thereon, through the proper channel, to his division commander; or, if the troops are not attached to a division, to his corps, department, or other commander or officer to whom the authority to discharge enlisted men may be specially delegated.

These certificates, after having received the action of the highest authority to which they are required to be sent, will be returned through the same channel to the regimental, post, or detachment commander, who will, if the discharge is authorized by the endorsement of the proper authority, sign the soldier's discharge, and the last certificate on this paper; see that the soldier is furnished with the proper final statements in duplicate, and forward BOTH of these certificates direct to the Adjutant General United States Army, at Washington, D. C.; they will not, under any circumstances, be given into the hands of the soldier.

1505
✓
11
CERTIFICATE OF DISABILITY FOR DISCHARGE

IN THE CASE OF

Abraham Owens
a Sergeant Co. 11
Sixth Reg't of U.S. I. L.

Received (A. G. Office) 186

Emm O Raf Cas

ADJUTANT GENERAL'S OFFICE

June 5th 1865
Duplicate sent the Pension Office.

Head quarters 24th Regt
of Col. [unclear]
at [unclear] [unclear]

ARMY
of the United States

CERTIFICATE OF THE UNITED STATES OF DISABILITY FOR DISCHARGE.



44, 1/2
A. J. Phelps
Med. Director

Sergeant Abram Owens, of Captain Sam D. Fitch
Company, (10) of the Sixth Regiment of the United States
Army was enlisted by J. L. Randolph, Deputy of
the Provost Regiment of Marshall at Camp Nelson Ky
on the thirteenth day of October, 1864, to serve three years; he was born
in Montgomery, Ky, in the State of Kentucky, is twenty nine
years of age, five feet seven inches high, Black complexion, Black eyes,
Black hair, and by occupation when enlisted a Farmer. During the last two
months said soldier has been unfit for duty 60 days.* By reason of a wound
received before enlistment,

STATION: Camp Nelson Ky
DATE: Nov 10 1865

Sam D. Fitch
Capt. 1st U.S. Col.
Commanding Company.

I CERTIFY, that I have carefully examined the said Sergt. Abram Owens
of Captain Sam D. Fitch's Company, and find him incapable of performing the duties of a
soldier because of † a wound of the chest which apparently
extends into the substance of the lungs, causing on
slight exertions a spitting of blood to the extent
of reducing his strength so much that he is unable to
do duty. Unfit for Vet. Res. Corps.

C. W. Riley, M.D.
Assistant Surgeon (in charge)

DISCHARGED, this 29th day of May, 1865, at Camp
Nelson, Kentucky

F. Coates
Lieut. Col. [unclear]
Commanding the Reg't.

The Soldier desires to be addressed at
Town _____ County _____ State _____

* See Note 1 on the back of this. † See Note 2 on the back of this.

1017
Quens, Charles

Co A, 6 U. S. Col'd Cav.

Private Private

CARD NUMBERS.

1	5388402	26
2	5388485	27
3	5388567	28
4	5388649	29
5	5388715	30
6	5388801	31
7	5388893	32
8	5388983	33
9	5389072	34
10	5389161	35
11	9092808	36
12	43147879	37
13	40732691	38
14		39
15		40
16		41
17		42
18		43
19		44
20		45
21		46
22		47
23		48
24		49
25		50

Book Mark:

See also

S 1076438

11722

D 3185675 P.B. Ret

P.O. 11722 674, 350-7-1-18

Hay

D. J. Miller, Esq.

6 20 25 Cur

U.S.A.

Charles Lewis

Appears with rank of Priv on

Muster and Descriptive Roll

of Detachment of U.S. Colored
Regiments mustered into U.S.

service for the U.S.C. Roll dated
Camp Nelson Ky., Oct. 3, 1864.

Where born Madison, Ky.

Age 18 years; occupation Farmer

When enlisted Oct. 1, 1864

Where enlisted Camp Nelson Ky.

For what period enlisted 3 years.

Eyes Black; hair Black

Complexion Black; height 5 ft. 7 in.

When mustered in Oct. 1, 1864

Where mustered in Camp Nelson

Bounty paid \$ 100; due \$ 100

Clothing account:

Last settled , 186 ; drawn since \$ 100

Date of first muster , 186

Company to which assigned

Remarks: Pay due from enlistment
Warrant of a private
John Lewis, credited
to Madison, & West Ky.

Book mark:

(356m)

W. W. Jackson
Copyist.

6 Cav. U.S.C.T.

Charles Owens

Prvt., Co. *A*, 6 Reg't U. S. Col'd Cavalry.

Appears on

Company Muster-in and Descriptive Roll

of the organization named above. Roll dated

Camp Nelson, N.Y., Nov. 1, 1864.

Where born *Madison Kentucky*

Age *18* y'rs; occupation *Farmer*

When enlisted *Oct. 1*, 186 .

Where enlisted *Camp Nelson N.Y.*

For what period enlisted *3* years.

Eyes *Black*; hair *Black*

Complexion *Black*; height *5* ft. *7* in.

When mustered in *Oct. 1*, 186 .

Where mustered in *Camp Nelson N.Y.*

Bounty paid \$ *100*; due \$ *100*

Where credited *8 West Kentucky*

Company to which assigned _____

Remarks: _____

Book mark: _____

Waggett

(356d)

Copyist.

Q | **6 Cav. | U.S.C.T.**

Charles Ivers

....., Co. *A*, 6 Reg't U. S. Col'd Cav.

Appears on

Company Descriptive Book

of the organization named above.

DESCRIPTION.

Age *18* years; height *5* feet *5* inches.

Complexion *Blk*

Eyes *Blk*; hair *Blk*

Where born *Madison Ky*

Occupation *farmer*

ENLISTMENT.

When *Oct 10th*, 186 .

Where *Camp Nelson*

By whom *J. C. Randolph*; term *6* y'rs.

Remarks:

.....
.....
.....
.....
.....
.....
.....
.....
.....
.....

Bryer

(383g)

Copyist.

6 Cav. U.S.C.T.

Charles Owens

Co. A, 6 Reg't U. S. Col'd Cavalry.

Appears on

Company Muster Roll

for Nov. & Dec., 1864.

Present or absent Absent

Stoppage, \$ 100 for

Due Gov't, \$ 100 for

Valuation of horse, \$ 100

Valuation of horse equipments, \$ 100

Remarks: On detached Service left at Round Gap by

Book mark:

(358)

Gaggett

Copyist.

6 Cav. U.S.C.T.

Charles Cronis

P.A., Co. A, 6 Reg't U. S. Col'd Cavalry.

Appears on

Company Muster Roll

for *Jan. & Feb.*, 1865.

Present or absent *Absent*

Stoppage, \$ *100* for

Due Gov't, \$ *100* for

Valuation of horse, \$ *100*

Valuation of horse equipments, \$ *100*

Remarks: *From Detached Service to Sick in hosp't Camp Nelson Ky. First instalment Bounty due*

Book mark: *2248262*

Jaggett

(1)

6 Cav. U.S.C.T.

Charles Owens

Private, Co. A, 6 Reg't U. S. Col'd Cavalry.

Appears on

Company Muster Roll

for *March & Apr.*, 1863.

Present or absent *Present*

Stoppage, \$ *100* for

Due Gov't, \$ *100* for

Valuation of horse, \$ *100*

Valuation of horse equipments, \$ *100*

Remarks: *First installment
Bounty Due*

Book mark:

W. A. [Signature]

(358)

Copyist.

(1)

6 Cav. U.S.C.T.

Charles Owens

Priv, Co. A, 6 Reg't U. S. Col'd Cavalry.

Appears on

Company Muster Roll

for *May & June*, 1865.

Present or absent *Present*

Stoppage, \$ *100* for

Due Gov't, \$ *100* for

Valuation of horse, \$ *100*

Valuation of horse equipments, \$ *100*

Remarks: *1st Instalment of Bounty Due \$100.*

Book mark:

(358)

Joseph Stewart
Copyist.

C | **6 Cav. | U.S.C.T.**

Charles Curran

Pvt., Co. A, 6 Reg't U. S. Col'd Cavalry.

Appears on

Company Muster Roll

for *July's duty*, 186*5*.

Present or absent... *Present*

Stoppage, \$ *100* for

Due Gov't, \$ *100* for

Valuation of horse, \$ *100*

Valuation of horse equipments, \$ *100*

Remarks: *1st installment
Bounty due \$100,*

Book mark:

Joseph Stewart

(358)

Copyist.

C

6 Cav. U.S.C.T.

Charles Adams

Priv, Co. A, 6 Reg't U. S. Col'd Cavalry.

Appears on

Company Muster Roll

for *Sept & Oct*, 186*4*.

Present or absent *Present*

Stoppage, \$ *100* for

Due Gov't, \$ *100* for

Valuation of horse, \$ *100*

Valuation of horse equipments, \$ *100*

Remarks: *Due stoppage 100
for 2 months*

Book mark:

(17-)
Joseph Stewart
Copyist.

0 | **6 Cav. | U.S.C.T.**

Charles Caven

Pvt, Co. A, 6 Reg't U. S. Col'd Cavalry.

Appears on

Company Muster Roll

for *Nov & Dec*, 1863.

Present or absent *Present*

Stoppage, \$ *100* for

Due Gov't, \$ *100* for

Valuation of horse, \$ *100*

Valuation of horse equipments, \$ *100*

Remarks:

Book mark:

R B Shelton

(358)

Copyist.

6 Cav. U.S.C.T.

Charles Owens

Pvt, Co. A, 6 Reg't U. S. Col'd Cavalry.

Appears on

Company Muster Roll

for *Jan & Feb*, 1866.

Present or absent *Present*

Stoppage, \$ *100* for

Due Gov't, \$ *100* for

Valuation of horse, \$ *100*

Valuation of horse equipments, \$ *100*

Remarks:

Book mark:

R. S. Shelton

(358)

Copyist.

J | 6 Cav. | U.S.C.T.

Thomas Owen

Co. A 6 Reg't U. S. Col'd Cav.

Appears on Returns as follows:

Dec 1864 Absent, Gettysburg
service until at Round
Bay, Md. by order of
Major General R. B. R. R. R.
on return from Salt-
ville Dec 1864

Jan to Mar 1865 Absent
sick Gen Hosp Camp
Mason Ky. Service
Dec 1, 64

Book mark:

(546) R. E. Douglas Copyist.

0

6 Cav. U.S.C.T.

Charles Owens
Pvt, Co. A, 6 Reg't U. S. Col'd Cavalry.

Appears on Co. Muster-out Roll, dated
Dwalls Bluff Ark April 15 1866.
Muster-out to date April 15, 1866.
Last paid to Feb. 28, 1866.

Clothing account:

Last settled _____, 186 ; drawn since \$ 100
Due soldier \$ 100; due U. S. \$ 21 ²⁵/₁₀₀
Am't for cloth'g in kind or money adv'd \$ 100

Due U. S. for arms, equipments, &c., \$ 100
Bounty paid \$ 100 [✓]/₁₀₀; due \$ 100 [✓]/₁₀₀

Remarks: _____

Book mark: _____

R. S. Shelton

(861)

Copyist.

W. Owens, Charles
~~*W. Owens, Charles*~~
P. A. G. 5 use leg
 , Co. *J. 5* Reg't *U.S. C. Cav.*

Enclosures.

- | | |
|------------------------------------|-------------------------|
| Bed Cards | Descriptive Lists |
| Burial Records | Final Statements |
| Certs. of Dis. for Discharge | Furloughs |
| C. M. Charges | Med. Des. Lists |
| Med. Certificates | Orders |
- Earl Spear 1*

Other papers relating to—

- | | |
|----------------------------------|---------------------------|
| Admission to Hosp'l | Furlough |
| Casualty Sheet (Officer's) | Med. Examination |
| Confinement | Misc. Information |
| Contracts | Pay or Clothing |
| Death or Effects | Personal Reports |
| Desertions | Rank |
| Discharge from Hosp'l | Transfer to Hosp'l |
| Discharge from Service | Transfer to V. R. C. |
| Duty | Transportation |

NOTE 1.—This blank will be used for enlistments of United States colored troops. They will be made out in duplicate in all cases—one to accompany the recruiting

return of the superintendent (not the recruiting officer) to the Adjutant General, and one to accompany the accounts of the officer who pays bounty, &c.

NOTE 2.—An enlistment holds only until the soldier is mustered in must, in all cases, precede payment of pay, bounty, pension, &c. A muster-in roll, must in all cases, be filed in

the Adjutant General's Office as evidence of muster-in. The mustering officer, commissary, or assistant commissary of musters, as the case may be, will countersign both

enlistments as having mustered the soldiers into the service of the United States before either of them is given to the disbursing officer.

DECLARATION OF RECRUIT.

I, Charles Owens desiring to volunteer as a soldier in the ARMY OF THE UNITED STATES, for the term of Three Years, DO DECLARE That I am 18 years and months of age; that I have never been discharged from the United States service on account of disability or by sentence of a court-martial, or by order before the expiration of a term of enlistment; and I know of no impediment to my serving honestly and faithfully as a soldier for three years.

GIVEN at Camp Nelson the 1st day of October 1864

Witness: John Hardy

Volunteered at Camp Nelson by Charles Owens or Maclean John Owens

No. 100 Charles Owens John Owens

Consent of Parent or Guardian in case of a Minor, if a Free Man, or in the case of a Slave, of the Person to whom he owes Service:

I, Charles Owens Do CERTIFY, That I am the

that the said..... is..... years of age; and I do freely give my CONSENT to his volunteering as a SOLDIER in the Army of the United States, for the period of THREE YEARS, under the conditions of the laws of the United States.

GIVEN at the day of

Witness: John Hardy

UNITED STATES COLORED TROOPS ENLISTMENT.

STATE OF

TOWN OF

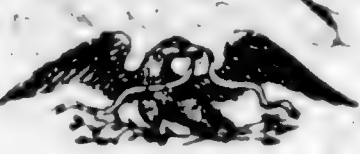
Kentucky  *Franklin*

I, *Charles Owens* born in *Madison*
in the State of *Kentucky* aged *Eighteen* years
and by occupation *Farmer* Do HEREBY ACKNOWLEDGE TO
have volunteered *First* day of *October* 1864

to serve as a **Soldier** in the **Army of the United States of America**, for the
period of **THREE YEARS**, unless sooner discharged by proper authority: Do
also agree to accept such bounty, pay, rations, and clothing, as are, or may be,
established by law for the U. S. colored troops.

And I, *Charles Owens*
do solemnly swear that I will bear true faith and allegiance to the **United States
of America**, and that I will serve them honestly and faithfully against all their
enemies or opposers whomsoever; and that I will observe and obey the orders
of the President of the United States, and the orders of the officers appointed
over me, according to the Rules and Articles of War.

Sworn and subscribed to, at *Franklin*
this *1st* day of *Oct* 1864 *Charles Owens*
Before *H. Standolph* *mark*

I CERTIFY, ON HONOR, That I have carefully examined the above named Volunteer agree-
ably to the General Regulations of the Army, and that, in my opinion, he is free from all bodily
defects and mental infirmity, which would in any way disqualify him from performing the
duties of a soldier.

B. Hobbs
As Sup 119 U.S.C.
EXAMINING SURGEON.

I CERTIFY, ON HONOR, That I have minutely inspected the Volunteer *Charles Owens*
previously to his enlistment, and that he was entirely sober when enlisted; that, to the best of
my judgment and belief, he is of lawful age; and that, in accepting him as duly qualified to per-
form the duties of an able-bodied soldier, I have strictly observed the regulations which govern
the recruiting service. This soldier has *Blue* eyes *Black* hair, *Black* com-
plexion, is *5.5* feet *5.5* inches high

H. Standolph
and *D. D. M.*
RECRUITING OFFICER OR AGENT.

Mustered into the United States Service..... *1* day of *Oct* 1864.

A. C. Kimmey
Oct 18 1864
Mustering Officer

Mustered into the service of the United States, for three years or during the war, from date of enlistment, in Company
.....
Regiment of *48th Colored* Volunteers, on the *1* day of *October*, 1864 at *Franklin Kentucky*

W. C. Kimmey
Capt 1st U.S.C.
Private Officer

1018

Quens, Charles

Co. *C*, 6 U. S. Col'd Cav.

Private | *Private*

CARD NUMBERS.

1	5-387976	26
2	5-392054	27
3	5-392151	28
4	5-392247	29
5	5-392342	30
6	5-392428	31
7	9093349	32
8	40732697	33
9		34
10		35
11		36
12		37
13		38
14		39
15		40
16		41
17		42
18		43
19		44
20		45
21		46
22		47
23		48
24		49
25		50

Book Mark: _____

See also *120 "use inf"*

D 1743 2 4 4 P.O. m + 24
S. 2433553 And. wd.
Pomil J. C. 667686-4.4.13 879

D. J. Miller, Esq.

(10) | 6 Cav. | U.S.C.T.

Charles Owens

....., Co. *E.*, 6 Reg't U. S. Col'd Cav.

Appears on

Company Descriptive Book

of the organization named above.

DESCRIPTION.

Age *17* years; height *5* feet *7* inches.

Complexion *Copper*

Eyes *black*; hair *black*

Where born *Hopkins Ky*

Occupation *Farmer*

ENLISTMENT.

When *Jan. 23.*, 186*5*.

Where *Haughtsville*

By whom *S. C. Glenn*; term *3* y'rs.

Remarks:

*Murdered, Feb. 10. / 65. Louisville -
ville, Ky. Capt. W. M. Mack*

C. J. Powell

(383g)

Copyist.

O. G. Saw **U.S.C.T.**

Charles Owens,
Pr. Co., 6 Reg't U. S. Col'd

Appears on a

Detachment Muster Roll

Unassigned Regiment
of the organization named above

for *June 10 to 30*, 1865.

Station *Camp Nelson Ky.*

Present or absent *Present*

Stoppage, \$ *100* for

Due Gov't, \$ *100* for

Valuation of horse, \$ *100*

Valuation of horse equipments, \$ *100*

Remarks: *Transferred from 120th Regt
to 6th Regt 105th Detd Hd Qrs 1st Ky
June 10 - 1865*

Book mark:

C. B. Sawyer

(357)

Copyist.

C

6 Cav. U.S.C.T.

Charles Owen

Priv, Co. E, 6 Reg't U. S. Col'd Cav.

Appears on

Company Muster Roll

for *July and Aug*, 1865.

Present or absent *Present*

Stoppage, \$ *100* for

Due Gov't, \$ *100* for

Valuation of horse, \$ *100*

Valuation of horse equipments, \$ *100*

Remarks: *1st Installment of bounty due \$120. Transferred from 120 U.S.C. & per S.C. 120 Reg't D. by Louisville June 28 1865 -*

Book mark:

M. L. Ashmore

(358)

Copyist.

C

6 Cav. U.S.C.T.

Charles Owen
Priv, Co. E, 6 Reg't U. S. Col'd Cav.

Appears on

Company Muster Roll

for *Sept and Oct*, 186*0*.

Present or absent *Present*

Stoppage, \$ *100* for

Due Gov't, \$ *100* for

Valuation of horse, \$ *100*

Valuation of horse equipments, \$ *100*

Remarks: *First installment of Bounty due*

Book mark:

J. M. Collier

(358)

Copyist.

O **6 Cav. U.S.C.T.**

Charles Curtis
Cvt, Co. E, 6 Reg't U. S. Col'd Cav.

Appears on

Company Muster Roll

for *Novem & Decem*, 186 *5*.

Present or absent *Absent*

Stoppage, \$ *100* for

Due Gov't, \$ *100* for

Valuation of horse, \$ *100*

Valuation of horse equipments, \$ *100*

Remarks: *Absent in confinement in Military Prison at Helena Ark.*

Book mark: _____

W. M. Callow
(358) Copyist.

6 Cav. U.S.C.T.

William ...

, Co. E, 6 Reg't U. S. Col'd Cav.

Appears on

Company Muster Roll

for *March 1864*, 1864 .

Present or absent *Present*

Stoppage, \$ *100* for

Due Gov't, \$ *100* for

Valuation of horse, \$ *100*

Valuation of horse equipments, \$ *100*

Remarks:

Book mark:

W. H. ...

0

6 Cav. U.S.C.T.

Charles Owen

Priv, Co. *E*, 6 Reg't U. S. Col'd Cavalry.

Appears on **Co. Muster-out Roll**, dated

March 13 *1861*, *11* *1861*

Muster-out to date *11*, 1861

Last paid to *11*, 1861

Clothing account:

Last settled _____, 1861 ; drawn since \$ _____ 100

Due soldier \$ *15* ^{*33*} 100 ; due U. S. \$ _____ 100

Am't for cloth'g in kind or money adv'd \$ _____ 100

Due U. S. for arms, equipments, &c., \$ *4* ^{*75*} 100

Bounty paid \$ _____ 100 ; due \$ _____ 100

Remarks: *stopped by order of the*

company of arms & equipments # 4.2.1

Book mark : _____

(861)

U. S. M. A.

Copyist.

C | 6 Cav. | U.S.C.T.

Charles Cannon
Supt, Co. C, 6 Reg't U. S. Col'd Cav.

Appears on Returns as follows:

June 1865 June 27 65
Camp Union Va
Transferred from 120
U & S. by order of
the Secretary of war
E O No 29 signed by
Thomas Adj't Genl

July 1865 July 15 65 Sp
Nelson transferred
from 120 U & S. in
compliance with E O
No. 105 H. G. Dept of
Ky dated Louisville
Ky June 21, 1865

Dec 1865 Absent in confine-
ment at the mili-
tary prison at Leavenworth
Ark since the 4th Dec
1865 (over)

Book mark:

(546)

J. E. Douglas
Copyist.

JAN. 19.

40732697

1899.

Jan 1896 On duty at
Hunt Stables Loan
Dept. at Inverall Bank
Clark

Owen Charles
 Pvt, Co. E, 6 Reg't USMC

/ Enclosures.

Bed Cards	Final Statements
Burial Records	Furloughs or L. of A.
Certs. of Dis. for Discharge	Med. Certificates
C. M. Charges	Med. Des. Lists
Descriptive Lists	Orders
Discharge Certificates	Pris. of War Record
Enlistment Papers	Resignations

Other papers relating to—

Admission to Hosp'l	Furlough or L. of A.
Casualty Sheet	Med. Examination
Confinement /	Misc. Information
Contracts	Pay or Clothing
Death or Effects	Personal Reports
Desertion	Rank
Discharge from Hosp'l	Transfer to Hosp'l
Discharge from Service	Transfer to V. R. C.
Duty	Transportation

Charles C. ¹⁸⁹¹
 Company "C" 1st N.S.C.
 11th Division of Cavalry
 Martial, Jan 12th 1866.

11th Division Cavalry

Adjutant General's Office,

COLORED TROOPS BRANCH,

McEllenbrook

March 13, 1871

Vol. C. T., 187
Wanted in case of Charles Owens Private, Co. C,
Reg't H. S. Co. reported absent in confinement
in Military Prison Helena, Ark. Please give cause
and sentence if tried

Respectfully,

R. A. Woodward

Chief Clerk.

P. H. Hallon

Adjutant General's Office,

Record & Bk Room

3-16-71

Vol. C. T., 187
Reply in case of _____, Co. _____,
Reg't _____

Headquarters St Francis River Dist
Helena, Ark. Jan'y 12-1866.

General Order
No. 1.

Extract

Private Charles Owens Co E 6 1st Cold Cash

Charge: — "Sarceny"

Pl'a: — "Not Guilty"

Finding: — "Not Guilty"

and the Court does therefore acquit him.

Approved

By Command of Prov. Mag. Genl. E. A. Carr,
(Sgd.) M. H. C. Jaques

1019.

Owens, Henry
Co. F., 6 U. S. Col'd Cav.

Private | Private

CARD NUMBERS.

1	5392557	26
2	5392628	27
3	5392713	28
4	5392801	29
5	5392898	30
6	5392995	31
7	5393088	32
8	539318	33
9	9093418	34
10	43149316	35
11		36
12		37
12		38
14		39
15		40
16		41
17		42
18		43
19		44
20		45
21		46
22		47
23		48
24		49
25		50

Book Mark:

See also

1

D | **6 Cav. | U.S.C.T.**

Jervis Owens
Co. F, 6 Reg't U. S. Col'd Cav.

Appears on

Company Descriptive Book

of the organization named above.

DESCRIPTION.

Age *22* years; height *5* feet *5* inches.

Complexion *black*

Eyes *black*; hair *black*

Where born *Dubasky, Ky*

Occupation *Farmer*

ENLISTMENT.

When *Nov. 8*, 186*4*.

Where *Camp Nelson, Ky*

By whom *J. C. Randolph*, term *3* y'rs.

Remarks: *Mustered in Nov. 8th*
1864, Camp Nelson, Ky.
Capt. Finney

Dwight Webb

(3837)

Copyist.

6
C. T. [unclear] U.S.A.

Henry [unclear]

Appears with rank of [unclear] on

Muster and Descriptive Roll

of a Detachment of U.S. Colored

Regiment Mustered into the Service
for the Regt. of U.S. Colored organizing at
Camp Nelson Ky.

Roll dated
Camp Nelson Ky, Nov 17, 1864.

Where born Pulaski Ky.

Age 22 years; occupation Farmer

When enlisted Nov 8, 1864.

Where enlisted Camp Nelson Ky.

For what period enlisted 3 years.

Eyes Black; hair Black

Complexion Black; height 5 ft. 5 in.

When mustered in Nov 8, 1864.

Where mustered in Camp Nelson Ky.

Bounty paid \$ 100; due \$ 100

Clothing account:

Last settled [unclear], 186 [unclear]; drawn since \$ 100

Date of first muster [unclear], 186 [unclear].

Company to which assigned [unclear]

Remarks: Reputed owner John
C. [unclear] Credited to Montgomery
Co. 9. Dist Ky.

Book mark: [unclear]

[unclear]
(356m) [unclear] Copyist.

C **6 Cav. U.S.C.T.**

Henry Crover

Ordn, Co. *H*, 6 Reg't U. S. Col'd Cavalry.

Appears on

Company Muster-in and Descriptive Roll

of the organization named above. Roll dated

Lexington Ky, N. Y. Jan 24, 1865.

Where born *Culaski Kentucky*

Age *22* y'rs; occupation *Farmer*

When enlisted *Nov 8*, 186*4*.

Where enlisted *Camp Nelson Ky.*

For what period enlisted *9* years.

Eyes *Blue*; hair *Blue*

Complexion *Blue*; height *5* ft. *0* in.

When mustered in *Nov 8*, 186*4*.

Where mustered in *Camp Nelson Ky.*

Bounty paid \$ *100*; due \$ *100*

Where credited *7th Dist Ky.*

Company to which assigned

Remarks:

Book mark:

Boyer

(356d)

Copyist.

C | **6 Cav. U.S.C.T.**

Henry Over
P, Co. F, 6 Reg't U. S. Col'd Cavalry.

Appears on

Company Muster Roll

for *Jan 24 to Apr 30*, 186*5*.

Present or absent *Present*

Stoppage, \$ *100* for

Due Gov't, \$ *100* for

Valuation of horse, \$ *100*

Valuation of horse equipments, \$ *100*

Remarks:
.....
.....
.....
.....
.....
.....
.....
.....
.....
.....

Book mark :

(358)

Dreyer

Copyist.

A. C. ... **U.S.C.T**

Henry Lewis
Co. 1, 4 Reg't U. S. Col'd

Appears on

Company Muster Roll

for *May 1st*, 186*5*.

Present or absent *Present*

Stoppage, \$ *100* for

Due Gov't, \$ *100* for

Valuation of horse, \$ *100*

Valuation of horse equipments, \$ *100*

Remarks:

Book mark: -----

(358)

Bregu

Copyist.

0

6 Cav. U.S.C.T.

Henry Owens

Pvt, Co. F, 6 Reg't U.S. Col'd Cavalry.

Appears on

Company Muster Roll

for July & Aug, 1865.

Present or absent Present

Stoppage, \$ 100 for

Due Gov't, \$ 100 for

Valuation of horse, \$ 100

Valuation of horse equipments, \$ 100

Remarks: List of bounty due.

Book mark:

(358) J. E. Chapin Copyist.

0

6 Cav. U.S.C.T.

Amey Owens

Pvt, Co. F, 6 Reg't U. S. Col'd Cavalry.

Appears on

Company Muster Roll

for *Sept. & Oct.*, 186*5*.

Present or absent *Present*

Stoppage, \$ *100* for

Due Gov't, \$ *100* for

Valuation of horse, \$ *100*

Valuation of horse equipments, \$ *100*

Remarks:

Book mark:

J. E. Chapin

(358)

Copyist.

O 6 Cav, U.S.C.T

Henry Owens

Pvt, Co. *F*, 6 Reg't U. S. Col'd *Cav.*

Appears on

Company Muster Roll

for *Nov + Dec*, 186 *5*

Present or absent *Present*

Stoppage, \$ *100* for

Due Gov't, \$ *100* for

Valuation of horse, \$ *100*

Valuation of horse equipments, \$ *100*

Remarks:

Book mark:

(358)

J. E. Chapin

Copyist.

O 6 Cav. U.S.C.T.

Henry Owens
Private, Co. F, 6 Reg't U. S. Col'd Cavalry.

Appears on

Company Muster Roll
for Jan & Feb, 1866
Present or absent Present

Stoppage, \$ 100 for

Due Gov't, \$ 4/100 for C & G. E

Valuation of horse, \$ 100

Valuation of horse equipments, \$ 100

Remarks:

Book mark:

(358)

H. A. Smith
Copyist.

O

6 Cav. U.S.C.T.

Henry Overend
Co. F, 6 Reg't U. S. Col'd Cavalry.

Appears on Co. Muster-out Roll, dated
Duvalls Bluff Ark. Apr 15 1866.

Muster-out to date Apr 15 1866.

Last paid to Feb 28 1866.

Clothing account:

Last settled _____, 186 ; drawn since \$ 100

Due soldier \$ 100; due U. S. \$ 100

Am't for cloth'g in kind or money adv'd \$ 100

Due U. S. for arms, equipments, &c., \$ 100

Bounty paid \$ 100 100; due \$ 100

Remarks:

Book mark: V. 134, P. 224-72

(861)

H. Smith

Copyist.

1020
Powsley Brent

Co A, 6 U. S. Col'd Cav.

Private Private

CARD NUMBERS.

1	5388399	26
2	5388483	27
3	5388565	28
4	5388647	29
5	5388713	30
6	5388799	31
7	5388891	32
8	5388981	33
9	5389070	34
10	5389157	35
11	9092806	36
12	43147881	37
13	40732688	38
14		39
15		40
16		41
17		42
18		43
19		44
20		45
21		46
22		47
23		48
24		49
25		50

Book Mark:

See also

R. & P. 352995

S-1083187 - Po. Ret. (Mitt)

\$1186354 - Po. aff

\$198130 and 100

\$1987180 and 100

R-P 703100

D. J. Miller, Ex.

2 | **6 Cav. | U.S.C.T.**

Brent Busby

Co. A, 6 Reg't U. S. Col'd Cav.

Appears on

Company Descriptive Book

of the organization named above.

DESCRIPTION.

Age 23 years; height 5 feet 6 inches.

Complexion Blk

Eyes Blk; hair Blk

Where born Blaski Ky

Occupation farmer

ENLISTMENT.

When Sept 23, 1865.

Where Camp Nelson

By whom J. S. Randolph; term 3 y'rs.

Remarks: _____

Breyer

6 war
O. T. M. S. S.

Parent (Cusley)

Appears with rank of (Private) on

Muster and Descriptive Roll

of Detachment of 11th Colored
Regiment, mustered into U.S.

Service for the 11th Roll dated
Camp Nelson, Ky. Oct. 3, 1864.

Where born Nicholas, Ky.

Age 23 years; occupation Farmer

When enlisted Sept. 23, 1864.

Where enlisted Camp Nelson, Ky.

For what period enlisted 3 years.

Eyes Black; hair Black

Complexion Black height 5 ft. 4 in.

When mustered in Sept. 23, 1864.

Where mustered in Camp Nelson, Ky.

Bounty paid \$ 100; due \$ 100

Clothing account:
Last settled , 186 ; drawn since \$ 100

Date of first muster , 186 .

Company to which assigned

Remarks: Pay due from enlistment. Name of reported owner, Walter Cusley credited to Lincoln, Ky.

Book mark:

(356m) W. H. Jackson Copyist.

() **6 Cav. U.S.C.T.**

Drum Curley

RA., Co. *A.*, 6 Reg't U. S. Col'd Cavalry.

Appears on

Company Muster-in and Descriptive Roll

of the organization named above. Roll dated

Camp Nelson Ky, N. Y., Nov. 1, 1864.

Where born *Pulaski Kentucky*

Age *23* y'rs; occupation *Farmer*

When enlisted *Sept. 23*, 186 .

Where enlisted *Camp Nelson Ky*

For what period enlisted *3* years.

Eyes *Black*; hair *Black*

Complexion *Black*; height *5* ft. *9* in.

When mustered in *Sept. 23*, 186 .

Where mustered in *Camp Nelson Ky*

Bounty paid \$ *100*; due \$ *100*

Where credited *Dist. Kentucky*

Company to which assigned

Remarks:

Book mark:

(356d)

W. Curley

Copyist.



6 Cav. U.S.C.T.

Brent Wesley

Prk., Co. A, 6 Reg't U. S. Col'd Cavalry.

Appears on

Company Muster Roll

for *Nov. + Dec.*, 1864.

Present or absent *Present*

Stoppage, \$ *100* for

Due Gov't, \$ *100* for

Valuation of horse, \$ *100*

Valuation of horse equipments, \$ *100*

Remarks:

Book mark:

Daggett

6 Cav. U.S.C.T.

Brent Cusley

Pvt., Co. A, 6 Reg't U. S. Col'd Cavalry.

Appears on

Company Muster Roll

for Jan. & Feb., 1865.

Present or absent Present.

Stoppage, \$ 100 for

Due Gov't, \$ 100 for

Valuation of horse, \$ 100

Valuation of horse equipments, \$ 100

Remarks: First instalment
Bounty due.

Book mark:

Daggett

(1)

6 Cav. U.S.C.T.

Brent Cusley

Prvt., Co. A, 6 Reg't U. S. Col'd Cavalry.

Appears on

Company Muster Roll

for *Mar. & April*, 1865.

Present or absent *Absent*

Stoppage, \$ *100* for

Due Gov't, \$ *100* for

Valuation of horse, \$ *100*

Valuation of horse equipments, \$ *100*

Remarks: *Sick in Hospital
Paris by first instalment
Bounty due.*

Book mark:

Quiggett

O

6 Cav. U.S.C.T.

Brent Ousby

Priv, Co. A, 6 Reg't U. S. Col'd Cavalry.

Appears on

Company Muster Roll

for *May & June*, 186*5*.

Present or absent... *Present*

Stoppage, \$ *100* for

Due Gov't, \$ *100* for

Valuation of horse, \$ *100*

Valuation of horse equipments, \$ *100*

Remarks: *1st Instalment of 1st Bonus Due \$100.*

Book mark:

(358)

Joseph Stewart
Copyist.

C

6 Cav. U.S.C.T.

Frank Cusby
Co. A, 6 Reg't U. S. Col'd Cavalry.

Appears on

Company Muster Roll

for July & Aug, 1861.

Present or absent Present

Stoppage, \$ 100 for

Due Gov't, \$ 100 for

Valuation of horse, \$ 100

Valuation of horse equipments, \$ 100

Remarks: 1st installment
Monthly pay \$100.

Book mark:

(358)

Joseph Stewart
Copyist.

6 Cav. U.S.C.T.

Frank Crowley
Co. A, 6 Reg't U. S. Cold Cavalry.

Appears on

Company Muster Roll

for Sept & Oct, 1865.

Present or absent Present

Stoppage, \$ 100 for

Due Gov't, \$ 100 for

Valuation of horse, \$ 100

Valuation of horse equipments, \$ 100

Remarks: Due M.A. \$ 100
for O & G.E.

Book mark:

Joseph Stewart
Copyist.

O

6 Cav. U.S.C.T.

Grent Ousley
Pvt, Co. A, 6 Reg't U. S. Col'd Cavalry.

Appears on

Company Muster Roll

for Nov & Dec, 1865.

Present or absent Present

Stoppage, \$ 100 for

Due Gov't, \$ 100 for

Valuation of horse, \$ 100

Valuation of horse equipments, \$ 100

Remarks: On Daily Duty
per R. O. No. 142 Dated
Hd. Qrs. 6th U.S. Col. Dec 26/
65.

Book mark:

R. S. Shelton

(358)

Copyist.

0

6 Cav. U.S.C.T.

Grent Ousley

Plt, Co. A, 6 Reg't U. S. Col'd Cavalry.

Appears on

Company Muster Roll

for Jan & Feb, 1866.

Present or absent Present

Stoppage, \$ 100 for

Due Gov't, \$ 100 for

Valuation of horse, \$ 100

Valuation of horse equipments, \$ 100

Remarks:

Book mark:

R. S. Shelton

(358)

Copyist.

6 Cav. U.S.C.T.

Ernest Owsley
Co. A 6 Reg't U. S. Col'd Cav.

Appears on Returns as follows:

Nov 1864 to Jan 1865 On duty Reg't teamster

Mar 1865 Absent Detach'd service per R.O dated 1865

Apr & May 1865 Absent sick horse camp Nelson Ky Apr

July to Sep. 1865 In a. T. on detail at 2nd Sta

Nov 1865 On duty detached in 2nd Sta Detach'd per R.O No 3 dated Feb 23 65

Dec 1865 Jan 1866 On duty at 2nd Sta per R.O No 142

Book mark:

(546)

J. J. Douglas
Copyist.

6 Cav. U.S.C.T.

Fremt Ousley
Pat., Co. *A*, 6 Reg't U. S. Col'd Cavalry.

Appears on Co. Muster-out Roll, dated
Duwall's Bluff. Ark. Apr. 15 1866.

Muster-out to date *Apr 15, 1866.*

Last paid to *Feb 28 1866.*

Clothing account:

Last settled _____, 186 ; drawn since \$ _____ 100

Due soldier \$ *13 83* 100; due U. S. \$ _____ 100

Am't for cloth'g in kind or money adv'd \$ _____ 100

Due U. S. for arms, equipments, &c., \$ _____ 100

Bounty paid \$ *100* 100; due \$ *100* 100

Remarks:

Book mark: *N. 625. 6. 380. 076*
(over)

R. S. Shetton

(361)

Copyist.

JAN. 10

5389157

1891

V. 178. P. 232. 73.

Ousley Brent

....., Co., Reg't U. S. C. I.

2 Enclosures.

Bed Cards	Final Statements
Burial Records	Furloughs or L. of A.
Certs. of Dis. for Discharge	Med. Certificates
C. M. Charges	Med. Des. Lists
Descriptive Lists	Orders
Discharge Certificates	Pris. of War Record
Enlistment Papers 2	Resignations

Other papers relating to—

Admission to Hosp'l	Furlough or L. of A.
Casualty Sheet	Med. Examination
Confinement	Misc. Information
Contracts	Pay or Clothing
Death or Effects	Personal Reports
Desertion	Rank
Discharge from Hosp'l	Transfer to Hosp'l
Discharge from Service	Transfer to V. R. C.
Duty	Transportation

Feb. Sept 25/03

[Signature]

NOTE 1.—This blank will be used for enlistments of United States colored troops. They will be made out in duplicate in all cases—one to accompany the recruiting return of the superintendent (not the recruiting officer) to the Adjutant General, and one to accompany the accounts of the officer who pays bounty, &c.

NOTE 2.—An enlistment holds good only in all cases, precede payment of pay, bounty, pension, &c. A muster-in roll, must in all cases, be filed in the Adjutant General's Office as evidence of muster-in. The mustering officer, commissary, or assistant commissary of musters, as the case may be, will countersign both enlistments as having mustered the soldiers into the service of the United States before either of them is given to the disbursing officer.

DECLARATION OF RECRUIT.

I, Brent Casaley, desiring to volunteer as a soldier in the ARMY OF THE UNITED STATES, for the term of Three Years, DO DECLARE That I am 23 years and months of age; that I have never been discharged from the United States service on account of disability or by sentence of a court-martial, or by order before the expiration of a term of enlistment; and I know of no impediment to my serving honestly and faithfully as a soldier for three years.

GIVEN at Camp Nelson the 23rd day of Sept 1864

Witness: John Dickerson

Brent Casaley
mark



Volunteered at Camp Nelson by
Sept 23rd 1864
 No. 10119
Waller

Consent of Parent or Guardian in case of a Minor, if a Free Man, or in the case of a Slave, of the Person to whom he owes Service:

I, Do CERTIFY, That I am the that the said is years of age; and I do freely give my CONSENT to his volunteering as a SOLDIER in the Army of the United States, for the period of THREE YEARS, under the conditions of the laws of the United States.

GIVEN at the day of

Witness: [Signature]

UNITED STATES COLORED TROOPS ENLISTMENT.

STATE OF

TOWN OF

Kentucky  *Camp Nelson*

I, *Brent Cusley* born in *Pulaski*
in the State of *Kentucky* aged *Twenty three* years
and by occupation a *Farmer* Do HEREBY ACKNOWLEDGE TO
have volunteered *Twenty third* day of *September* 1864
to serve as a **Soldier** in the **Army of the United States of America**, for the
period of **THREE YEARS**, unless sooner discharged by proper authority: Do
also agree to accept such bounty, pay, rations, and clothing, as are, or may be,
established by law for the U. S. colored troops.

And I, *Brent Cusley*
do solemnly swear that I will bear true faith and allegiance to the **United States**
of America, and that I will serve them honestly and faithfully against all their
enemies or opposers whomsoever; and that I will observe and obey the orders
of the President of the United States, and the orders of the officers appointed
over me, according to the Rules and Articles of War.

Sworn and subscribed to, at *Camp Nelson*
this *23rd* day of *Sept.* 1864, *Brent Cusley*
Before *W. C. Kinney* *mark*

I CERTIFY, ON HONOR, That I have carefully examined the above named Volunteer agree-
ably to the General Regulations of the Army, and that, in my opinion, he is free from all bodily
defects and mental infirmity, which would in any way disqualify him from performing the
duties of a soldier.

P. G. Barrett
Asst Surgt
EXAMINING SURGEON.

I CERTIFY, ON HONOR, That I have minutely inspected the Volunteer, *Brent Cusley*,
previously to his enlistment, and that he was entirely sober when enlisted; that, to the best of
my judgment and belief, he is of lawful age; and that, in accepting him as duly qualified to per-
form the duties of an able-bodied soldier, I have strictly observed the regulations which govern
the recruiting service. This soldier has *dark* eyes, *dark* hair, *dark* com-
plexion, is *five* feet *three* inches high.

W. C. Kinney
and *J. P. M.*
RECRUITING OFFICER OR AGENT.

Mustered into the United States Service *23* day of *Sept* 1864.

W. C. Kinney
Capt 18th U.S.C.
Mustering Officer

Mustered into the service of the United States, for three years or during the war, from date of enlistment, in Company
Regiment of *U.S. Cavalry* Volunteers, on the *23* day of *September* 1864, at *Camp Nelson Ky*

W. C. Kinney
Capt 18th U.S.C.
Mustering Officer

MARK #11

NOTE 1.—This blank will be used for enlistments of United States colored troops. They will be made out in duplicate in all cases—one to accompany the recruiting return of the superintendent (not the recruiting officer) to the Adjutant General, and one to accompany the accounts of the officer who pays bounty, &c.
NOTE 2.—An ~~enlistment~~ ^{must} be made in all cases, precede payment of pay, bounty, pension, &c. A muster-in roll, must in all cases, be filed in the Adjutant General's Office as evidence of muster-in. The mustering officer, commissary, or assistant commissary of musters, as the case may be, will countersign both enlistments as having mustered the soldiers into the service of the United States before either of them is given to the disbursing officer.

DECLARATION OF RECRUIT.

I, Brent Cusley desiring to volunteer as a soldier in the ARMY OF THE UNITED STATES, for the term of Three Years, DO DECLARE That I am 23 years and 0 months of age; that I have never been discharged from the United States service on account of disability or by sentence of a court-martial, or by order before the expiration of a term of enlistment; and I know of no impediment to my serving honestly and faithfully as a soldier for three years.

GIVEN at Camp Nelson the 23 day of September 1864.

Witness: W. Dickerson

Brent Cusley
his mark
No. 532
Adjutant of Camp Nelson
Sept 23 1864
Wm. Dickerson
or Lincoln Co
Master Smith

Consent of Parent or Guardian in case of a Minor, if a Free Man, or in the case of a Slave, of the Person to whom he owes Service:

I, Do CERTIFY, That I am the that the said is years of age; and I do freely give my CONSENT to his volunteering as a SOLDIER in the Army of the United States, for the period of THREE YEARS, under the conditions of the laws of the United States.

GIVEN at the day of

Witness: Wm. Dickerson

65

UNITED STATES COLORED TROOPS ENLISTMENT.

STATE OF

TOWN OF

Kentucky  *Carrysburg*

I, *Brent Wesley* born in *Pulaski* in the State of *Kentucky* aged *Twenty three* years and by occupation a *Farmer* Do HEREBY ACKNOWLEDGE to

have volunteered *Twenty third* day of *September* 1864 to serve as a **Soldier** in the **Army of the United States of America**, for the period of **THREE YEARS**, unless sooner discharged by proper authority: Do also agree to accept such bounty, pay, rations, and clothing, as are, or may be, established by law for the U. S. colored troops.

And I, *Brent Wesley*

do solemnly swear that I will bear true faith and allegiance to the **United States of America**, and that I will serve them honestly and faithfully against all their enemies or opposers whomsoever: and that I will observe and obey the orders of the President of the United States, and the orders of the officers appointed over me according to the Rules and Articles of War.

Sworn and subscribed to, at *Carrysburg* this *23rd* day of *Sept* 1864 *Brent Wesley* Before *J. S. Randolph* *D. M.*

I CERTIFY, ON HONOR, That I have carefully examined the above named Volunteer agreeably to the General Regulations of the Army, and that, in my opinion, he is free from all bodily defects and mental infirmity, which would in any way disqualify him from performing the duties of a soldier.

P. G. Barrett
Assistant Surgeon
EXAMINING SURGEON.

I CERTIFY, ON HONOR, That I have minutely inspected the Volunteer, *B. Wesley* previously to his enlistment, and that he was entirely sober when enlisted; that, to the best of my judgment and belief, he is of lawful age; and that, in accepting him, as duly qualified to perform the duties of an able-bodied soldier, I have strictly observed the regulations which govern the recruiting service. This soldier has *Blue* eyes, *Black* hair, *Blue* complexion, is *Five* feet *2 1/2* inches high.

J. S. Randolph
D. M.
RECRUITING OFFICER OR AGENT.

Mustered into the United States Service *23* day of *Sept* 1864

W. H. Timney
Capt 18th U.S.C. Mustered Officer

Mustered into the service of the United States, for three years or during the war, from date of enlistment, in Company *Cavalry* Regiment of *U.S. Colored Volunteers*, on the *23* day of *September* 1864

W. H. Timney
Capt 18th U.S.C.
Mustered Officer

21

Owsley, Brent.
 P, Co. A, 6 Reg't U.S.C. Coy.

Enclosures.

- | | |
|------------------------------|-------------------|
| Bed Cards | Descriptive Lists |
| Burial Records | Final Statements |
| Certs. of Dis. for Discharge | Furloughs |
| C. M. Charges | Med. Des. Lists |
| Med. Certificates | Orders |

Other papers relating to—

- | | |
|----------------------------|----------------------|
| Admission to Hosp'l | Furlough |
| Casualty Sheet (Officer's) | Med. Examination |
| Confinement | Misc. Information |
| Contracts | Pay or Clothing |
| Death or Effects | Personal Reports |
| Desertions | Rank |
| Discharge from Hosp'l | Transfer to Hosp'l |
| Discharge from Service | Transfer to V. R. C. |
| Duty | Transportation |
| | <i>Enclain</i> |

ENDORSEMENT.

No. _____

APPLICATION OF

W. W. Owsley

OF

Lincoln County Ky

for compensation for service of slave,

Brent Owsley

enlisted *Sept 23^d* 186*4*

in *A Co 6th* Regiment

U. S. Colored ~~Troops~~ *Cavalry*

Received *Dec 8th* 186*6*

Compensation awarded

186_____

_____ Dollars.

President Board of Claims.

P. O. ADDRESS OF CLAIMANT:

Stanford Ky

War Department,

ADJUTANT GENERAL'S OFFICE.

Washington, *Dec 26* 1866.

Respectfully returned to the
Commissioner for the State of
Kentucky, with the informa-
tion that *Brent Owsley*
was enlisted at *Hamlet Ky*
September 23 1864, and was
mustered in as *Private Co. 1st 6th*
U. S. Colored Sept 23 1864.

O. W.

A. F. Rowell

W.

1st Lieut Genl 1865

CLAIM FOR COMPENSATION FOR ENLISTED SLAVE.

No.

I, W W Owensley, a loyal citizen, and a resident of Lincoln County of Kentucky State of Kentucky, hereby claim compensation, under the provisions of Section 24, Act approved February 24, 1864, and Section 2, Act approved July 28, 1866, for my slave Brent Owensley, enlisted Sept 21st 1864, at Camp Adams Ky, by J. C. Randolph capt of 1st Regt U. S. Colored Troops in the 6th Co certificate of which enlistment, and a descriptive list, as required, accompany this application

In proof of my loyalty to the Constitution and Government of the United States, I present the accompanying oath, which I have taken, signed and acknowledged; to be filed with this application, in accordance with requirement of General Orders, No. 329, 1863, War Department, Adjutant General's Office.

Stanford Ky Dec 6th 1866 W W Owensley

OATH OF ALLEGIANCE.

I, W W Owensley, the owner and claimant, do solemnly swear that the

foregoing claim is a just and true claim due to me as master and owner of the said slave, and that the facts alleged in said claim in respect to the draft or enlistment (as the case may be) of said slave into the military service of the United States are true. And I do further swear that I have never joined, or been concerned in, any insurrection or rebellion; that I have never borne arms against the United States; that I have never given any aid, countenance, counsel or encouragement, to any person or persons engaged, or whom I had reason to believe were about to engage, in insurrection, rebellion or armed hostility against the United States; that I have neither sought, nor accepted, nor attempted to exercise the functions of any office, civil or military, nor to perform any service whatever, under any authority, or pretended authority, in hostility to the United States: that I have not yielded a voluntary support to any insurrection, rebellion or pretended government authority, power or constitution within the United States hostile thereto. And I do further swear that, to the best of my knowledge and ability, I have supported and defended, and will continue to support and defend the United States against all enemies, foreign and domestic, and that I have supported, defended and obeyed, and will continue to support, defend and obey, the Constitution and Laws of the United States; that I will bear true faith and allegiance to the same; and that I take this oath freely, without any mental reservation or purpose of evasion: So help me God.

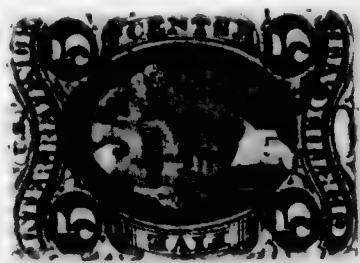

W W Owensley

Sworn to and subscribed before me W H L C C }
this 6th day of Dec 1866 }

J S M Roberts, M J C C

Headquarters Kentucky Volunteers,

Adjutant-General's Office,

Frankfort, November 19th, 1864.

I hereby certify, that it appears from the U. S. Muster-Inw
Rolls on file in this Office, that Bount Owsley
was enrolled on the 23rd day of September, 1864, at
Camp Nelson Ky, by J. C. Randolph
and mustered into the U. S. service on the 23rd day of September,
1864, at Camp Nelson Ky, by Capt W. H. Kenney,
to serve ~~three~~ years. Said Bount Owsley
is described as follows: 23 years age, Black eyes, Black hair,
Black complexion, 5ft 9in height. It further appears from
said Rolls, that Bount Owsley owed service to
Walter Owsley was credited to Lincoln
County Ky and was assigned to Company
"A" 6th Regt U. S. C. Cavalry.



In Testimony Whereof, I have hereunto set my
hand, and affixed my Official Seal, this
19th day of November, 1864.

D. W. Lindsey
Adjutant General of Kentucky.

B411R417

defending its cause against the Government and forces of the so-called Confederate States of America, in
all suitable and practicable ways and means.

PROOF OF OWNERSHIP.

State of Kentucky,

County of

Lincoln } ss.

We... Henry Clay... and... Fayette... Cusley... each of law-
ful age, and resident citizens of the State and county aforesaid, do certify that... W. W. Cusley...
...of the State and county aforesaid, was on the... 21st... day of... Sept...
1864... the lawful owner of the slave named... Brent Cusley...; referred
to and described in the foregoing claim for compensation.

Henry Clay
Fayette Cusley
his mark
mark

Sworn to and subscribed before me a... J. J. M. Roberts... for the county of
Lincoln... State of Kentucky, this the... 6th... day of... Dec... 1866...

J. J. M. Roberts lkh L C C



PROOF OF LOYALTY.

State of Kentucky,

County of

Lincoln } ss.

We... R. E. Warran... and... J. J. M. Roberts... loyal men and
each of lawful age, and a resident citizens of the... of...
in the State and county aforesaid, upon our oaths declare that we have known...
a resident of the State and county aforesaid, since the 4th day of March, 1861, and know that he has firmly
and faithfully maintained his or her adherence and allegiance to the Government of the United States, by
defending its cause against the Government and forces of the so-called Confederate States of America, in
all suitable and practicable ways, and according to his or her ability and opportunity.

Robert J. Roberts
J. J. M. Roberts

Sworn to and subscribed before me a... J. J. M. Roberts... for the county of
Lincoln... State of Kentucky, this the... 6th... day of... Dec... 1866...

J. J. M. Roberts lkh L C C

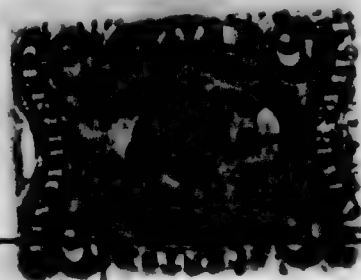

1021
Wesley, Clark

Co A, 6 U. S. Col'd Cav.

Private Private

CARD NUMBERS.

1	5388408	26
2	5288484	27
3	5288566	28
4	5288648	29
5	5288714	30
6	5288808	31
7	5288892	32
8	5288982	33
9	5389071	34
10	5389158	35
11	9092807	36
12	43147882	37
13	40732696	38
14		39
15		40
16		41
17		42
18		43
19		44
20		45
21		46
22		47
23		48
24		49
25		50

Book Mark:

See also

S. 712942 R.C. Ash
S. 2270891 P. R. H.
S. 2689953 P. R. H.

D. J. Miller, Esq.

2 | **6 Cav. | U.S.C.T.**

Mark Insley

....., Co. A, 6 Reg't U. S. Col'd Cav.

Appears on

Company Descriptive Book

of the organization named above.

DESCRIPTION.

Age 25 years; height 5 feet 9 inches.

Complexion Blk

Eyes Blk; hair Blk

Where born Polonki Ky

Occupation farmer

ENLISTMENT.

When Sept 23, 1866

Where Camp Nelson

By whom J. Randolph; term 3 y'rs.

Remarks:

.....

.....

.....

.....

.....

.....

.....

.....

.....

.....

.....

.....

.....

.....

.....

.....

.....

.....

.....

.....

.....

Breyer

(383g)

Copyist.

0-22

11563

Black Owsley

Appears with rank of Pvt on

Muster and Descriptive Roll

of Detachment of 11th Colored
Regiment, mustered into U.S.

service for the U.S. to. Roll dated

Camp Nelson Ky. Oct. 3, 1864.

Where born Delarki Ky.

Age 25 years; occupation Farmer

When enlisted Sept. 23, 1864.

Where enlisted Camp Nelson Ky.

For what period enlisted 3 years.

Eyes Black; hair Black

Complexion Black; height 5 ft. 6 in.

When mustered in Sept. 23, 1864.

Where mustered in Camp Nelson Ky.

Bounty paid \$ 100; due \$ 100

Clothing account:

Last settled _____, 186 ; drawn since \$ 100

Date of first muster _____, 186 .

Company to which assigned _____

Remarks: Say due prominent
man. Name of reputed
owner Walter Owsley, credited
to Lincoln, 7 Dist. Ky.

Book mark: _____

(356m)

W. W. Spencer
Copyist.

6 Cav. U.S.C.T.

Clark Owsley

M., Co. *A*, 6 Reg't U. S. Col'd Cavalry.

Appears on

Company Muster-in and Descriptive Roll

of the organization named above. Roll dated

Camp Nelson Ky, ~~NY~~, Nov. 1, 1864.

Where born *Pulaski Kentucky*

Age *25* y'rs; occupation *Farmer*

When enlisted *Sept. 23*, 186 .

Where enlisted *Camp Nelson Ky.*

For what period enlisted *3* years.

Eyes *Black*; hair *Black*

Complexion *Black*; height *5* ft. *6* in.

When mustered in *Sept. 23*, 186 .

Where mustered in *Camp Nelson Ky.*

Bounty paid \$ *100*; due \$ *100*

Where credited *W. Va. Kentucky*

Company to which assigned

Remarks:

Book mark:

W. J. G. H.

6 Cav. U.S.C.T.

Clark Cowley

Wt., Co. A, 6 Reg't U. S. Col'd Cavalry.

Appears on

Company Muster Roll

for *Nov. & Dec.*, 1864.

Present or absent *Present*

Stoppage, \$ *100* for

Due Gov't, \$ *100* for

Valuation of horse, \$ *100*

Valuation of horse equipments, \$ *100*

Remarks:

Book mark:

Sageatt

(358)

Copyist.

(

6 Cav. U.S.C.T.

Clark Wesley

Private, Co. A, 6 Reg't U. S. Col'd Cavalry.

Appears on

Company Muster Roll

for *Jan. & Feb.*, 1865.

Present or absent *Absent*

Stoppage, \$ *100* for

Due Gov't, \$ *100* for

Valuation of horse, \$ *100*

Valuation of horse equipments, \$ *100*

Remarks: *On Detached Service
Regt. Muster per Order
No. 3 Extract 6 First
instalment Bounty due*

Book mark:

W. J. Baggett

(358)

Copyist.

C

6 Cav. U.S.C.T.

Clark Cusley

Plt., Co. A, 6 Reg't U. S. Col'd Cavalry.

Appears on

Company Muster Roll

for March & April, 1863.

Present or absent Absent

Stoppage, \$ 100 for

Due Gov't, \$ 100 for

Valuation of horse, \$ 100

Valuation of horse equipments, \$ 100

Remarks: On detached service
Reg. Teamster Per order
no. 3 Extract 6. First
instalment Bounty Due.

Book mark:

Waggett

(358)

Copyist.

0

6 Cav. U.S.C.T.

Chuck Ousby
Priv, Co. A, 6 Reg't U. S. Col'd Cavalry.

Appears on

Company Muster Roll

for *May & June*, 186*5*.

Present or absent *Present*

Stoppage, \$ *100* for

Due Gov't, \$ *100* for

Valuation of horse, \$ *100*

Valuation of horse equipments, \$ *100*

Remarks: *1st installment of Bounty Due \$100.*

Book mark:

(358)

Joseph Stewart

Copyist.

11 6 Cav. U.S.C.T.

Walter Cusby

111, Co. A, 6 Reg't U. S. Col'd Cavalry.

Appears on

Company Muster Roll

for July & Aug, 1861.

Present or absent Present

Stoppage, \$ 100 for

Due Gov't, \$ 100 for

Valuation of horse, \$ 100

Valuation of horse equipments, \$ 100

Remarks: 1st installment
of bounty due \$100.

Book mark:

Joseph Howard

(358)

Copyist.

C 6 Cav. U.S.C.T.

Clark Overley
Priv, Co. A, 6 Reg't U. S. Col'd Cavalry.

Appears on

Company Muster Roll

for Sep & Oct, 1864.

Present or absent Present

Stoppage, \$ 100 for

Due Gov't, \$ 100 for

Valuation of horse, \$ 100

Valuation of horse equipments, \$ 100

Remarks: Due U.S. \$100
for U.S. G.E.

Book mark:

(158) Joseph Stewart
Coppist.

0

6 Cav. U.S.C.T.

Clair Oursley
Priv, Co. A, 6 Reg't U. S. Col'd Cavalry.

Appears on

Company Muster Roll

for *Nov + Dec*, 1865.

Present or absent *Present*

Stoppage, \$ *100* for

Due Gov't, \$ *100* for

Valuation of horse, \$ *100*

Valuation of horse equipments, \$ *100*

Remarks: *On Daily Duty per*
N. O. No. 1112 Dated Hd. Qrs.
6 U.S.C. Co. Dec 26. 1865

Book mark:

R. S. Shelton

(358)

Copyist.

0

6 Cav. U.S.C.T.

Blank Oursley

Pvt, Co. A, 6 Reg't U. S. Col'd Cavalry.

Appears on

Company Muster Roll

for Jan. Feb, 1866.

Present or absent Present

Stoppage, \$ 100 for

Due Gov't, \$ 100 for

Valuation of horse, \$ 100

Valuation of horse equipments, \$ 100

Remarks:

Book mark:

R. S. Sheltm

(358)

Copyist.

0

6 Cav. U.S.C.T.

Clark Owsley
Pot, Co. A, 6 Reg't U. S. Col'd Cav.

Appears on Returns as follows:

Nov 1864 to Feb 1865 On duty detached by order No 3 extract 6 as Reg't teamster

Mar + Apr 1865 Absent Detch'd service per R.O No dated 1865 since Mar 28/65 Camp Nelson Ky

May 1865 On duty 2nd M Dept by order Maj A H Bowen 6 U.S.C.

July to Sep 1865 On duty detailed 1st 2nd M stable

Nov 1865 On duty detailed in 2nd M Dept per R.O No 3 dated Feb 23 65

Dec 1865 + Jan 1866 On duty at 2nd M stable per R.O No 142

Book mark:

(546)

J. D. Douglas

Copyist.

0

6 Cav. U.S.C.T.

Clark Owsley
Priv., Co. A, 6 Reg't U. S. Col'd Cavalry.

Appears on Co. Muster-out Roll, dated
Duvall's Bluff Ark. April 15, 1866.

Muster-out to date April 15, 1866.

Last paid to Feb 28 1866.

Clothing account:

Last settled _____, 186 ; drawn since \$ 100

Due soldier \$ 632¹⁰⁰; due U. S. \$ 100

Am't for cloth'g in kind or money adv'd \$ 100

Due U. S. for arms, equipments, &c., \$ 100

Bounty paid \$ 100¹⁰⁰; due \$ 100¹⁰⁰

Remarks:

Book mark: A. 6/15, C.

(861)

R. S. Shelton

Copyist.

Ousley Clark

, Co. *A*, *6* Reg't *U. S. C. Tro*

2

Enclosures.

Bed Cards	Final Statements
Burial Records	Furloughs or L. of A.
Certs. of Dis. for Discharge	Med. Certificates
C. M. Charges	Med. Des. Lists
Descriptive Lists	Orders
Discharge Certificates	Pris. of War Record
Enlistment Papers <i>2</i>	Resignations

Other papers relating to—

Admission to Hosp'l	Furlough or L. of A.
Casualty Sheet	Med. Examination
Confinement	Misc. Information
Contracts	Pay or Clothing
Death or Effects	Personal Reports
Desertion	Rank
Discharge from Hosp'l	Transfer to Hosp'l
Discharge from Service	Transfer to V. R. C.
Duty	Transportation
.....	<i>Slave claim,</i>

MICROFILM PUBLICATION M.1823

COMPILED MILITARY SERVICE RECORDS
OF VOLUNTEER UNION SOLDIERS WHO
SERVED WITH THE USCT (US COLORED TROOPS)
6TH REGIMENT OF CAVALRY

PERSONAL PAPERS' TARGET SHEET

PLEASE NOTE THE CHECKED INFORMATION ABOUT THE PERSONAL PAPERS IN
THIS FILE:

- NO PERSONAL PAPERS WERE FOUND IN THIS FILE WHEN THE
RECORDS WERE ARRANGED FOR MICROFILMING.
- 3 PERSONAL PAPER(S) FOUND IN THIS FILE WHEN THE RECORDS
WERE ARRANGED FOR MICROFILMING.

NOTE 1.—This blank will be used for enlistments of United States colored troops. They will be made out in duplicate in all cases—one to accompany the return of the superintendent (not the recruiting officer) to the Adjutant General, and one to accompany the accounts of the officer who pays bounty, &c.

NOTE 2.—An enlistment holds to service. A muster-in must, in all cases, precede payment of pay, bounty, pension, &c. A muster-in roll, must in all cases, be filed in the Adjutant General's office as evidence of muster-in. The mustering officer, commissary, or assistant commissary of musters, as the case may be, will countersign enlistments as having mustered the soldiers into the service of the United States before either of them is given to the disbursing officer.

DECLARATION OF RECRUIT.

I, C. Clark Qualey, desiring to volunteer as a soldier in the ARMY OF THE UNITED STATES, for the term of Three Years, DO DECLARE That I am 18 years and months of age; that I have never been discharged from the United States service on account of disability or by sentence of a court-martial, or by order before the expiration of a term of enlistment; and I know of no impediment to my serving honestly and faithfully as a soldier for three years.

GIVEN at Camp Nelson the 28th day of September 1864

Witness: J. M. Dickerson

C. Clark Qualey
Volunteer
1st

Camp Nelson
Sept 23rd 1864
John M. Dickerson
Adjutant General
of the Army

Clark Qualey
Private

Consent of Parent or Guardian in case of a Minor, if a Free Man, or in the case of a Slave, of the Person to whom he owes Service:

I, Do CERTIFY, That I am the that the said is years of age; and I do freely give my CONSENT to his volunteering as a SOLDIER in the Army of the United States, for the period of THREE YEARS, under the conditions of the laws of the United States.

GIVEN at the day of

Witness: J. M. Dickerson

UNITED STATES COLORED TROOPS ENLISTMENT.

STATE OF



TOWN OF

Kentucky *Camp Nelson*

I *Clark Cusley* born in *Pulasky* *20*

in the State of *Kentucky* aged *Twenty five* years

and by occupation a *Farmer* Do HEREBY ACKNOWLEDGE TO

have volunteered *Twentythird* day of *September* 186*4*

to serve as a **Soldier** in the **Army of the United States of America**, for the

period of **THREE YEARS**, unless sooner discharged by proper authority: Do

also agree to accept such bounty, pay, rations, and clothing, as are, or may be,

established by law for the U. S. colored troops.

And I, *Clark Cusley*

do solemnly swear that I will bear true faith and allegiance to the **United States**

of America, and that I will serve them honestly and faithfully against all their

enemies or opposers whomsoever; and that I will observe and obey the orders

of the President of the United States, and the orders of the officers appointed

over me, according to the Rules and Articles of War.

Sworn and subscribed to, at *Camp Nelson*
this *23rd* day of *Sept* 186*4* by *Clark Cusley*

Before *J. G. Barrett*

I CERTIFY, ON HONOR, That I have carefully examined the above named Volunteer agree-
ably to the General Regulations of the Army, and that, in my opinion, he is free from all bodily
defects and mental infirmity, which would in any way disqualify him from performing the
duties of a soldier.

J. G. Barrett
Asst Surg 7th Reg
EXAMINING SURGEON.

I CERTIFY, ON HONOR, That I have minutely inspected the Volunteer, *Clark Cusley*
previously to his enlistment, and that he was entirely sober when enlisted; that, to the best of
my judgment and belief, he is of lawful age; and that, in accepting him as duly qualified to per-
form the duties of an able-bodied soldier, I have strictly observed the regulations which govern
the recruiting service. This soldier has *Dark* eyes, *Dark* hair, *Dark* complexion, is *Five* feet *Six* inches high.

J. G. Barrett
RECruITING OFFICER OR AGENT.

Mustered into the United States Service *23* day of *Sept* 186*4*

J. C. Kinney
Capt 18th U.S.I
Mustering Officer

Mustered into the service of the United States, for three years or during the war, from date of enlistment, in Company *C* Regiment of *43rd Central Volunteers*, on the *23* day of *September* 186*4* at *Camp Nelson Ky*

Sept 18th 1864

J. C. Kinney

J. C. Kinney

NOTE 1.—This blank will be used for enlistments of United States colored troops. They will be made out in duplicate in all cases—one to accompany the recruiting return of the superintendent (not the recruiting officer) to the Adjutant General, and one to accompany the accounts of the officer who pays bounty, &c.

NOTE 2.—An enlistment ~~is not~~ holds to ~~service~~. A muster-in roll, in all cases, precede payment of pay, bounty, pension, &c. A muster-in roll, must in all cases, be filed in the Adjutant General's Office as evidence of muster-in. The mustering officer, commissary, or assistant commissary of musters, as the case may be, will countersign both enlistments as having mustered the soldiers into the service of the United States before either of them is given to the disbursing officer.

DECLARATION OF RECRUIT.

I, Clark C. Wesley, desiring to volunteer as a soldier in the ARMY OF THE UNITED STATES, for the term of Three Years, DO DECLARE That I am 18 years and months of age; that I have never been discharged from the United States service on account of disability or by sentence of a court-martial, or by order before the expiration of a term of enlistment; and I know of no impediment to my serving honestly and faithfully as a soldier for three years.

GIVEN at Camp Wilson the 23 day of September 1864.

Witness: J. W. Dickerson

Clark C. Wesley



Dr. Lincoln
Walter Wesley

Volunteered at Camp Wilson by Clark C. Wesley
No. 1121
23rd 1864

Consent of Parent or Guardian in case of a Minor, if a Free Man, or in the case of a Slave, of the Person to whom he owes Service:

I, Do CERTIFY, That I am the that the said is years of age; and I do freely give my CONSENT to his volunteering as a SOLDIER in the Army of the United States, for the period of THREE YEARS, under the conditions of the laws of the United States.

GIVEN at the day of

Witness: [Signature]

UNITED STATES COLORED TROOPS ENLISTMENT.

STATE OF

TOWN OF

Kentucky  *Campbellton*

I, *Mark Chesley* born in *Princeton* in the State of *Kentucky* aged *Twenty five* years and by occupation *Farmer* Do HEREBY ACKNOWLEDGE to have volunteered *Twenty third* day of *September* 1864, to serve as a **Soldier** in the **Army of the United States of America**, for the period of **THREE YEARS**, unless sooner discharged by proper authority: Do also agree to accept such bounty, pay, rations, and clothing, as are, or may be, established by law for the U. S. colored troops.

And I, *Clark Cowley* do solemnly swear that I will bear true faith and allegiance to the **United States of America**, and that I will serve them honestly and faithfully against all their enemies or opposers whomsoever: and that I will observe and obey the orders of the President of the United States, and the orders of the officers appointed over me, according to the Rules and Articles of War.

Sworn and subscribed to, at *Campbellton* this *23rd* day of *Sept-1864* Before *J. W. ...*

I CERTIFY, ON HONOR, That I have carefully examined the above named Volunteer agreeably to the General Regulations of the Army, and that, in my opinion, he is free from all bodily defects and mental infirmity, which would in any way disqualify him from performing the duties of a soldier.

P. G. Barnett
Asst Surg *7th Corps*
EXAMINING SURGEON.

I CERTIFY, ON HONOR, That I have minutely inspected the Volunteer, *Mark Chesley* previously to his enlistment, and that he was entirely sober when enlisted; that, to the best of my judgment and belief, he is of lawful age; and that, in accepting him as duly qualified to perform the duties of an able-bodied soldier, I have strictly observed the regulations which govern the recruiting service. This soldier has *13 1/2* eyes, *13 1/2* hair, *13 1/2* complexion, is *5 1/2* feet *2 1/2* inches high.

J. W. ...
RECRUITING OFFICER OR AGENT.

Mustered into the United States Service *23* day of *Sept* 1864.

W. O. ...
Capt 18th U.S.P. Mustering Officer

Mustered into the service of the United States, for three years or during the war, from date of enlistment, in Company *...* Regiment of *23rd Colored Cavalry* Volunteers, on the *23* day of *Sept* 1864 at *Campbellton Ky*

W. O. ...
Capt 18th U.S.P. Mustering Officer

ENDORSEMENT.

No. _____

APPLICATION OF

W. W. Owsley

OF

Lincoln County Ky

for compensation for service of slave,

Clark Owsley

enlisted *Sept 23^d* 186*4*

in *A^o* Co *6th* Regiment

U. S. Colored ~~Troops~~ *Cavalry*

Received *Dec 8th* 186*6*

Compensation awarded

_____ 186

_____ Dollars.

President Board of Claims

P. O. ADDRESS OF CLAIMANT:

Stanford Ky

War Department,

ADJUTANT GENERAL'S OFFICE,

Washington, *Dec 26th* 1866.

Respectfully returned to the Commission for the State of Kentucky, with the information that *Clark Owsley* was enlisted at *Camp Liberty Ky* September 23^d 1864, and was mustered in as *Private 6th* U. S. Col. Cav. Sept 23^d 1864.

O. G.

A. F. Rockwood

97

Asst. Adj. Gen. Col.

CLAIM FOR COMPENSATION FOR ENLISTED SLAVE.

No.

I, *W W Quesley*, a loyal citizen, and a resident of County of *Lincoln* State of *Kentucky*

hereby claim compensation, under the provisions of Section 24, Act approved February 24, 1864, and Section 2, Act approved July 28, 1866, for my slave *Blank Quesley* enlisted *25th Sept* 1864, at *Camp Nelson Ky* by *J. E. Randolph* *in U S service at Camp Nelson 18th Sept 1864* *6th Capt W E King Cavalry* in the Regiment U. S. Colored Troops, Co. *A* certificate of which enlistment, and a descriptive list, as required, accompany this application

In proof of my loyalty to the Constitution and Government of the United States, I present the accompanying oath, which I have taken, signed and acknowledged; to be filed with this application, in accordance with requirement of General Orders, No. 329, 1863, War Department, Adjutant General's Office.

Stanford Ky Dec 6th 1866 *W W Quesley*

OATH OF ALLEGIANCE.

I, *W W Quesley*, the owner and claimant, do solemnly swear that the

foregoing claim is a just and true claim due to me as master and owner of the said slave, and that the facts alleged in said claim in respect to the draft or enlistment (as the case may be) of said slave into the military service of the United States are true. And I do further swear that I have never joined, or been concerned in, any insurrection or rebellion; that I have never borne arms against the United States; that I have never given any aid, countenance, counsel or encouragement, to any person or persons engaged, or whom I had reason to believe were about to engage, in insurrection, rebellion or armed hostility against the United States; that I have neither sought, nor accepted, nor attempted to exercise the functions of any office, civil or military, nor to perform any service whatever, under any authority, or pretended authority, in hostility to the United States: that I have not yielded a voluntary support to any insurrection, rebellion or pretended government authority, power or constitution within the United States hostile thereto. And I do further swear that, to the best of my knowledge and ability, I have supported and defended, and will continue to support and defend the United States against all enemies, foreign and domestic, and that I have supported, defended and obeyed, and will continue to support, defend and obey, the Constitution and Laws of the United States; that I will bear true faith and allegiance to the same; and that I take this oath freely, without any mental reservation or purpose of evasion: So help me God.



W W Quesley

Sworn to and subscribed before me *John L. C. C.* }
this *6th* day of *Dec* 1866 }

J J M Roberts John L. C. C.

Headquarters Kentucky Volunteers,

Adjutant-General's Office,

Frankfort, November 19th, 1866.

I hereby certify, that it appears from the U. S. Muster-In
Rolls on file in this Office, that Clark Owsley
was enrolled on the 23rd day of September, 1864, at
Camp Nelson Ky, by J. C. Randolph
and mustered into the U. S. service on the 23rd day of September,
1864, at Camp Nelson Ky, by Capt N. C. Kinsley,
to serve three years. Said Clark Owsley
is described as follows: 25 years age, Black eyes, Black hair,
Black complexion, 5ft 6 in height. It further appears from
said Rolls, that Clark Owsley owed service to
Walter Owsley was credited to Lincoln
County Ky and was assigned to Company
"A" 6th Regt U. S. C. Cavalry.



In Testimony Whereof, I have hereunto set my
hand, and affixed my Official Seal, this
19th day of November, 1866.

D. W. Lindsay
Adjutant General of Kentucky.



3412R417

...in accordance to the Government of the United States, by
defending its cause against the Government and forces of the so-called Confederate States of America, in
all entitled...

PROOF OF OWNERSHIP.

State of Kentucky,

County of Lincoln } ss.

We... Logan Wesley... and... Henry Hays... each of law-
ful age, and resident citizens of the State and county aforesaid, do certify that... W. W. Wesley.
..... of the State and county aforesaid, was on the 21st day of Sept.....
1864, the lawful owner of the slave named... Belark Wesley....., related
to and described in the foregoing claim for compensation.

Logan Hays Wesley
Henry Hays Wesley

Sworn to and subscribed before me a. Belk... Circuit... Court... for the county of
Lincoln... State of Kentucky, this the 6th day of Dec... 1864.

J. J. M. Roberts Belk L. C. C.



PROOF OF LOYALTY.

State of Kentucky,

County of Lincoln } ss.

We... R. E. Barrow... and... J. J. M. Roberts... loyal men and
each of lawful age, and a resident citizens of the... Stanford...
in the State and county aforesaid, upon our oaths declare that we have known... W. W. Wesley.
a resident of the State and county aforesaid, since the 4th day of March, 1861, and know that he has firmly
and faithfully maintained his or her adherence and allegiance to the Government of the United States, by
defending its cause against the Government and forces of the so-called Confederate States of America, in
all suitable and practicable ways, and according to his or her ability and opportunity.

Robert E. Barrow
J. J. M. Roberts

Sworn to and subscribed before me a. Belk... Circuit... Court... for the county of
Lincoln... State of Kentucky, this the 6th day of Dec... 1864.

J. J. M. Roberts Belk L. C. C.

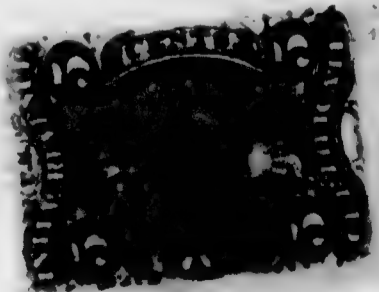

1022

Owsley Logan

Co *A*, **6** U. S. Col'd Cav.

Private

Private

CARD NUMBERS.

1	5387263	26
2	5392558	27
3	5392629	28
4	5392714	29
5	5392802	30
6	5392899	31
7	5393120	32
8	5393204	33
9	9093419	34
10	40437693	35
11		36
12		37
13		38
14		39
15		40
16		41
17		42
18		43
19		44
20		45
21		46
22		47
23		48
24		49
25		50

Book Mark:

See also

S 199772 Q175
New York. 492809 - V. 4. 13 P. 89

D. F. Miller, Ck.

S 17199772 Q175
Acad. misc. 492809 - v. 4. 13 P. 89

D. J. Miller, Jr.

0 | 6 Cav. | U.S.C.T.

Logan Jewley
Det., Co. F, 6 Reg't U. S. Col'd Cav.

Appears on

Company Descriptive Book

of the organization named above.

DESCRIPTION.

Age 37 years; height 5 feet 7 inches.

Complexion black

Eyes black; hair black

Where born Jessy, Ky

Occupation Farmer

ENLISTMENT.

When Nov. 8, 1864.

Where Camp Nelson, Ky

By whom J. C. Randolph, term 3 y'rs.

Remarks:

Mustered in
Nov. 8, 1864. Camp
Nelson, Ky. Capt.
Rearney. Sent to
Hospital with dis. list
Nov. 22 '65.

Jury Webb

(383g)

Copyist.

4000

① _____ M. E. J.

Lagan Cingley

Appears with rank of *1st Lt.* on _____

Muster and Descriptive Roll

of a *Detachment of U.S. Colored*
Regiment Mustered into the Service
for the *Regt of U.S. Col.* organizing at
Camp Nelson Ky. Roll dated

Camp Nelson Ky., Nov. 17, 1864.

Where born *Casey Ky.*

Age *27* years; occupation *Farmer*

When enlisted *Nov 8, 1864.*

Where enlisted *Camp Nelson Ky.*

For what period enlisted *3* years.

Eyes *Black*; hair *Black*

Complexion *Black*; height *5* ft. *7* in.

When mustered in *Nov 8, 1864.*

Where mustered in *Camp Nelson Ky.*

Bounty paid \$ *100*; due \$ *100*

Clothing account:
Last settled _____, 186 _____; drawn since \$ *100*

Date of first muster _____, 186 _____.

Company to which assigned _____

Remarks: *reputed owner William*
Casey Credited to Montgomery
Co 9 Dist Ky.

Book mark: _____

(356m)

W. M. Potter

Copyist.

O

6 Cav. U.S.C.T.

^x Logan Owsley

Appears with rank of Priv. on

Muster and Descriptive Roll of a Detachment of U. S. Vols. forwarded

for the 6 Reg't U. S. Col'd Cavalry. Roll dated

Lexington Ky. Jan. 14, 1865.

Where born Casey Kentucky

Age 37 y'rs; occupation Farmer

When enlisted Nov. 8, 186 .

Where enlisted Co. Nelson

For what period enlisted 3 years.

Eyes Blk; hair Blk

Complexion Blk; height 5 ft. 7 in.

When mustered in Nov. 8, 1864.

Where mustered in Co. Nelson

Bounty paid \$ 100; due \$ 100

Where credited _____

Company to which assigned _____

Remarks: He Owsley, Owner

^x Name appears on roll but
called by line drawn through it

Book mark: _____

C. E. M. Laughlin

(339)

Copyist.

C **6 Cav. U.S.C.T.**

Logan Crosby
Co. H, Co. *H*, 6 Reg't U. S. Col'd Cavalry.

Appears on

Company Muster-in and Descriptive Roll
of the organization named above. Roll dated
Lexington Ky, N. Y. Jan 24, 1865.

Where born *Wasey Ky*

Age *37* y'rs; occupation *Farmer*

When enlisted *Nov 8*, 186*4*.

Where enlisted *Camp Nelson Ky*

For what period enlisted *3* years.

Eyes *Blk*; hair *Blk*

Complexion *Blk*; height *5 ft. 7* in.

When mustered in *Nov 8*, 186*4*.

Where mustered in *Camp Nelson*

Bounty paid \$ *100*; due \$ *100*

Where credited *7th Cav Ky*

Company to which assigned

Remarks:

Book mark:

(356d)

Breyer
Copyist.

C **6 Cav. U.S.C.T.**

Logan Crosby

Pt, Co. F, 6 Reg't U. S. Col'd Cavalry.

Appears on

Company Muster Roll

for *Jan 24 to Apr 30, 1865*

Present or absent *Absent*

Stoppage, \$ *100* for

Due Gov't, \$ *100* for

Valuation of horse, \$ *100*

Valuation of horse equipments, \$ *100*

Remarks: *took in Hospital one week with Texas fever Nov 14, 64*

Book mark:

Breger

(358)

Copyist.

C *4402* **U.S.C.T**

George (C. S. G.)
P. Co. T., 4 Reg't U. S. Col'd

Appears on

Company Muster Roll

for *May & June*, 1865.

Present or absent *present*

Stoppage, \$ *100* for

Due Gov't, \$ *100* for

Valuation of horse, \$ *100*

Valuation of horse equipments, \$ *100*

Remarks: *Absent sick in Hospital at Nashville Tenn. since Nov 14, 64.*

Book mark:

Breyer

(358)

Copyist.

6 Cav. U.S.C.T.

Logan Orwley

Prv, Co. F, 6 Reg't U. S. Col'd Cavalry.

Appears on

Company Muster Roll

for *July & Aug*, 1865.

Present or absent *Present*

Stoppage, \$ *100* for

Due Gov't, \$ *100* for

Valuation of horse, \$ *100*

Valuation of horse equipments, \$ *100*

Remarks: *1st inst. of bounty due*

Book mark:

(358)

J. E. Chapin

Copyist.

0

6 Cav. U.S.C.T.

Logan Owsley

Pro ..., Co. F, 6 Reg't U. S. Col'd Cavalry.

Appears on

Company Muster Roll

for *Sept - Oct* ..., 186 *5*

Present or absent *Present*

Stoppage, \$ *100* for

Due Gov't, \$ *100* for

Valuation of horse, \$ *100*

Valuation of horse equipments, \$ *100*

Remarks: _____

Book mark: _____

(358)

J. E. Chapin

Copyist.

6 Cav. | **U.S.C.T**

Logan Wheeler
Prs, Co. *F*, Reg't U. S. Col'd *Cav.*

Appears on

Company Muster Roll

for *Nov + Dec*, 186 *5*.

Present or absent

Stoppage, \$ *100* for

Due Gov't, \$ *100* for

Valuation of horse, \$ *100*

Valuation of horse equipments, \$ *100*

Remarks: *Disch'd Dec 11/65, per*
Surg. Cert. of Dis.

Book mark:

(358)

J. E. Chapin

Copyist.

| **6 Cav.** | **U.S.C.T.**

Edgar Crossin
Co. *F* 6 Reg't U. S. Col'd Cav.

Appears on Returns as follows:

Feb to July 1865 Absent sick in U.S. Hosp at Nashville Tenn. Nov 14/64

Nov 1865 Absent sick in Hosp at Louisville Ky since Nov 24/65

Dec 1865 Dec 11/65 Louisville Ky. Discharged per certificate of disability

Jan 1865 Absent sick in Hosp at Nashville Tenn. since Nov 15/64

Book mark: _____

(546)

J. E. Douglas

Copyist.

0

6 Cav. U.S.C.T.

Logan Owsley
Pvt., Co. F, 6 Reg't U. S. Col'd Cavalry.

Appears on Co. Muster-out Roll, dated
Dunwells Bluff, Ark, Apr 15, 1866.

Muster-out to date _____, 186 .

Last paid to Oct 31, 1865 .

Clothing account:

Last settled _____, 186 ; drawn since \$ 100

Due soldier \$ 100; due U. S. \$ 100

Am't for cloth'g in kind or money adv'd \$ 100

Due U. S. for arms, equipments, &c., \$ 100

Bounty paid \$ 100; due \$ 100

Remarks: Discharged from
Post Hosp. Louisville, Ky
Dec. 11, '65, per Surg. Genl.
of Disability.

Book mark: # 63 S.C

M. Smith

(861)

Copyist.

Owsley, Logan

P, Co. 1

6 Reg't U.S.C. Cav.

6 Enclosures.

Bed Cards	/	Descriptive Lists
Burial Records		Final Statements
Certs. of Dis. for Discharge	/	Furloughs
C. M. Charges		Med. Des. Lists
Med. Certificates		Orders

EP 2

Other papers relating to—

Admission to Hosp'l	Furlough
Casualty Sheet (Officer's)	Med. Examination
Confinement	Misc. Information /
Contracts	Pay or Clothing
Death or Effects	Personal Reports
Desertions	Rank
Discharge from Hosp'l	Transfer to Hosp'l
Discharge from Service	Transfer to V. R. C.
Duty	Transportation

S. of S. Reg. slip 1

NOTE 1—This blank will be used for enlistments of United States colored troops. They will be made out in duplicate in all cases—one to accompany the recruiting return of the superintendent (not the recruiting officer) to the Adjutant General, and one to accompany the accounts of the officer who pays bounty, &c.

NOTE 2—An enlistment holds to service. A muster-in must, in all cases, precede payment of pay, bounty, pension, &c. A muster-in roll, must in all cases, be filed in the Adjutant General's office as evidence of muster-in. The mustering officer, commissary, or assistant commissary of musters, as the case may be, will countersign both enlistments as having mustered the soldiers into the service of the United States before either of them is given to the disbursing officer.

DECLARATION OF RECRUIT.

I, Josiah Guseley desiring to volunteer as a soldier in the ARMY OF THE UNITED STATES, for the term of Three Years, DO DECLARE THAT I am 37 years and 0 months of age; that I have never been discharged from the United States service on account of disability or by sentence of a court-martial, or by order before the expiration of a term of enlistment; and I know of no impediment to my serving honestly and faithfully as a soldier for three years.

GIVEN at Camp Nelson the 8 day of Apr 1864

Witness: J. M. Dickerson Josiah Guseley
Wm Guseley
 Mustered at Camp Nelson Ky
 Nov 8 1864

Consent of Parent or Guardian in case of a Minor, if a Free Man, or in the case of a Slave, of the Person to whom he owes Service:

I, J. M. Dickerson Do CERTIFY, That I am the father of Josiah Guseley that the said Josiah Guseley is 37 years of age; and I do freely give my CONSENT to his volunteering as a SOLDIER in the Army of the United States, for the period of THREE YEARS, under the conditions of the laws of the United States.

GIVEN at Camp Nelson the 8 day of Apr

Witness: J. M. Dickerson

UNITED STATES COLORED TROOPS ENLISTMENT.

STATE OF

Kentucky County of *Madison*

I, *Logan Owsley* born in *Bassey*
in the State of *Kentucky* aged *Thirty Seven* years
and by occupation a *Farmer*. Do HEREBY ACKNOWLEDGE TO
have volunteered *Eighth* day of *November*, 1864,
to serve as a **Soldier** in the **Army of the United States of America**, for the
period of **THREE YEARS**, unless sooner discharged by proper authority: Do
also agree to accept such bounty, pay, rations, and clothing, as are, or may be,
established by law for the U. S. colored troops.

And I, *Logan Owsley*
do solemnly swear that I will bear true faith and allegiance to the **United States
of America**, and that I will serve them honestly and faithfully against all their
enemies or opposers whomsoever: and that I will observe and obey the orders
of the President of the United States, and the orders of the officers appointed
over me, according to the Rules and Articles of War.

Sworn and subscribed to, at *Camp Nelson*
this *8th* day of *Nov* 1864, *Logan Owsley*
Before *J. C. Randolph* mark

I CERTIFY, ON HONOR, That I have carefully examined the above named Volunteer agree-
ably to the General Regulations of the Army, and that, in my opinion, he is free from all bodily
defects and mental infirmity, which would in any way disqualify him from performing the
duties of a soldier.

Orin A. Horn
Asst. Surg. U.S.A., Lt.
EXAMINING SURGEON.

I CERTIFY, ON HONOR, That I have minutely inspected the Volunteer *L. Owsley*
previously to his enlistment, and that he was entirely sober when enlisted; that, to the best of
my judgment and belief, he is of lawful age; and that, in accepting him as duly qualified to per-
form the duties of an able-bodied soldier, I have strictly observed the regulations which govern
the recruiting service. This soldier has *blue* eyes, *black* hair, *black* com-
plexion, is *five* feet *seven* inches high.

J. C. Randolph
RECRUITING OFFICER OR AGENT.

Mustered into the United States Service *8th* day of *Nov* 1864

A. C. Kimmey
Capt. 7th U.S.C. Mustering Officer

Mustered into the service of the United States, for three years or during the war, from date of enlistment, in Company
Regiment of *U.S. Colored Volunteers*, on the *Eighth* day of *November*, 1864, *Company A*

A. C. Kimmey
Mustering Officer

NOTE 1.—This blank will be used for enlistments of United States colored troops. They will be made out in duplicate in all cases—one to accompany the recruiting return of the superintendent (not the recruiting officer) to the Adjutant General, and one to accompany the accounts of the officer who pays bounty, &c.

NOTE 2.—An enlistment holds to service. A muster-in must, in all cases, precede payment of pay, bounty, pension, &c. A muster-in roll, must in all cases, be filed in the Adjutant General's Office ~~where~~ of muster-in. The mustering officer, commissary, or assistant commissary of musters, as the case may be, will countersign both enlistments as having mustered the soldiers into the service of the United States before either of them is given to the disbursing officer.

DECLARATION OF RECRUIT.

I, Logan Owsley desiring to volunteer as a soldier in the ARMY OF THE UNITED STATES, for the term of Three Years, DO DECLARE That I am 37 years and months of age; that I have never been discharged from the United States service on account of disability or by sentence of a court-martial, or by order before the expiration of a term of enlistment; and I know of no impediment to my serving honestly and faithfully as a soldier for three years.

GIVEN at Camp Nelson the 8 day of Nov 1864

Witness: J. M. Dickerson

Logan Owsley
Volunteered at Camp Nelson
No. 44. 4th Regt
Nov 1864
W. M. Dickerson
W. M. Dickerson

Consent of Parent or Guardian in case of a Minor, if a Free Man, or in the case of a Slave, of the Person to whom he owes Service:

W. M. Dickerson Do CERTIFY, That I am the father

that the said is years of age; and I do freely give my CONSENT to his volunteering as a SOLDIER in the Army of the United States, for the period of THREE YEARS, under the conditions of the laws of the United States.

GIVEN at the day of

Witness: W. M. Dickerson

UNITED STATES COLORED TROOPS ENLISTMENT.

STATE OF

Kentucky

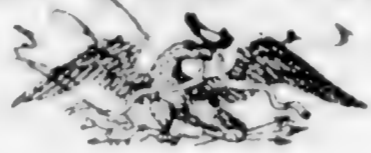

COUNTY OF *Madison*

I, *Joseph Owsley*, born in *Casey*

in the State of *Kentucky* aged *Thirty Seven* years

and by occupation a *Farmer* DO HEREBY ACKNOWLEDGE TO

have volunteered *Eighth* day of *November* 1864,

to serve as a *Soldier* in the *Army of the United States of America*, for the

period of *THREE YEARS*, unless sooner discharged by proper authority: Do

also agree to accept such bounty, pay, rations, and clothing, as are, or may be,

established by law for the U. S. colored troops.

And I, *Joseph Owsley*

do solemnly swear that I will bear true faith and allegiance to the *United States*

of America, and that I will serve them honestly and faithfully against all their

enemies or opposers whomsoever; and that I will observe and obey the orders

of the President of the United States, and the orders of the officers appointed

over me, according to the Rules and Articles of War.

Sworn and subscribed to, at *Camp Nelson*

this *8th* day of *Nov 1864* *Joseph Owsley*

Before *J. Randolph* mark

I CERTIFY, ON HONOR, That I have carefully examined the above named Volunteer agreeably to the General Regulations of the Army, and that, in my opinion, he is free from all bodily defects and mental infirmity, which would in any way disqualify him from performing the duties of a soldier.

Orin A. How
Examining Surgeon
EXAMINING SURGEON.

I CERTIFY, ON HONOR, That I have minutely inspected the Volunteer *J. Owsley* previously to his enlistment, and that he was entirely sober when enlisted; that, to the best of my judgment and belief, he is of lawful age; and that, in accepting him as duly qualified to perform the duties of an able-bodied soldier, I have strictly observed the regulations which govern the recruiting service. This soldier has *blue* eyes, *black* hair, *dark* complexion, is *five* feet *seven* inches high.

J. Randolph
RECRUITING OFFICER OR AGENT.

Mustered into the United States Service..... *8th* day of *Nov* 1864

A. C. Kinney
Mustered in Office

Mustered into the service of the United States, for three years or during the war, from date of enlistment, in Company

Regiment of *21st Co. Kentucky* Volunteers, on the *Eighth* day of *November* 1864

A. C. Kinney
1st Lt

1165 10

CERTIFICATE OF DISABILITY FOR DISCHARGE

In the case of

Logan O'Keefe
a Private Co. "E"
6th N.S. Col. Reg't of Cav. Inf.

[Handwritten signature]

ADJUTANT GENERAL'S OFFICE
Dec 23rd 1865
Duplicate sent the Pension Office.

Received (A. G. Office) *[Signature]* 1865

ARMY OF THE UNITED STATES.



Chas. Smith

CERTIFICATE OF DISABILITY FOR DISCHARGE.

(To be used, in duplicate, in all cases of discharge on account of disability.)

Private Logan O'waley, of Captain Daniel Coates Company, (E) of the 6th Colored Cavalry was enlisted by J. C. Randolph of the 1st Regiment of at Leavenworth, Mo. on the 20th day of November 1864 to serve 3 years; he was born in Leavenworth, Mo. in the State of Kentucky is thirty-seven years of age, five feet nine inches high, black complexion, black eyes, black hair, and by occupation when enlisted a farmer. During the last two months said soldier has been unfit for duty 60 days. (Here consult directions on Form 13, p. 325, Medical Dept. Gen. Reg.)

STATION: Jefferson U.S.A. Genl. Hospital, Leavenworth, Mo.
DATE: December 5th 1865.

W. Goldsmith
Surgeon U.S. Army, Coates Company, Leavenworth, Mo.

I CERTIFY, that I have carefully examined the said Logan O'waley of Captain Coates Company, and find him incapable of performing the duties of a soldier because of *amnesia* *incomplete - was insured before entering the service*

W. Goldsmith
Surgeon U.S. Army, Leavenworth, Mo.

DISCHARGED, this eleventh day of December, 1865, at Jefferson U.S.A. General Hospital, Leavenworth, Mo. *W. Goldsmith*
Surgeon U.S. Army, Leavenworth, Mo.

NOTE 1.—When a probable case for pension, special care must be taken to state the degree of disability.
NOTE 2.—The place where the soldier desires to be addressed may be here added.
Town—*Lancaster* County—*Sanett* State—*Ky.*

TREATMENT.

[HERE NOTE IMPORTANT COMPLICATIONS AND ALL OPERATIONS.]

RESULT AND DATE.

Discharged Decbr. 11. 1865.

Ward 17
Hospital Number 10083. Bed 34

Name Logan Cusley
Age 35 Nativity Ky
Married or Single
Residence Lincoln Co Ky
Post Office address of wife or nearest relative. Millie Cusley
Lancaster Ky
Rank Priv. Co. F Regiment 6 U.S. Cav.

When admitted Nov 22nd 65
From what source Louisville Ky

Diagnosis: (in surgical cases, state explicitly seat and character of wound or injury.)

Amaurosis

Jefferson G. H.
Jeffersonville, Ind.

On what occasion wounded

Date

Nature of missile or weapon

ENDORSEMENT.

No. 11

APPLICATION OF

W. W. Cawley

OF

Lincoln County Ky

for compensation for service of slave,

Logan Cawley

enlisted November 8th 1864

in F Co 6th Regiment

U. S. Colored Troops. Cavalry

Received Decr 8th 1866

Compensation awarded

186

Dollars.

President Board of Claims.

P. O. ADDRESS OF CLAIMANT:

Stanford Ky

War Department,

ADJUTANT GENERAL'S OFFICE.

Washington, Nov. 26 1866

Respectfully returned to the
Commission for the State of
Kentucky, with the informa-
tion that Logan Cawley
was enlisted at Camp Nelson Ky
November 8. 1864. and was
mustered in as Pvt. in Co. F 6th
U. S. Col. Cav. Dec: 8. 1864.

W. W.

A. F. Rockwell

W. B.

Asst. Adj. Gen. 4012.

CLAIM FOR COMPENSATION FOR ENLISTED SLAVE.

No.

I, W. W. Owensley, a loyal citizen, and
a resident of County of Green State of
Kentucky, hereby claim compensation, under the provisions of

Section 24, Act approved February 24, 1864, and Section 2, Act approved July 28, 1866, for my slave

..... L. O. G. Owensley, enlisted Nov. 8th
1864, at Camp Nelson Ky, by Capt W. C. Keeney
in the 1st Regt U. S. Colored Troops

..... It certificate of which enlistment, and a descriptive list, as required, accompany
this application

In proof of my loyalty to the Constitution and Government of the United States, I present the accom-
panying oath, which I have taken, signed and acknowledged; to be filed with this application, in accordance
with requirement of General Orders, No. 329, 1863, War Department, Adjutant General's Office.

Stanford Dec 6th 1866 W. W. Owensley

OATH OF ALLEGIANCE.

I, W. W. Owensley, the owner and claimant, do solemnly swear that the

foregoing claim is a just and true claim due to me as master and owner of the said slave, and that the facts
alleged in said claim in respect to the draft or enlistment (as the case may be) of said slave into the military
service of the United States are true. And I do further swear that I have never joined, or been concerned in,
any insurrection or rebellion; that I have never borne arms against the United States; that I have never given
any aid, countenance, counsel or encouragement, to any person or persons engaged, or whom I had reason to
believe were about to engage, in insurrection, rebellion or armed hostility against the United States; that I
have neither sought, nor accepted, nor attempted to exercise the functions of any office, civil or military,
nor to perform any service whatever, under any authority, or pretended authority, in hostility to the United
States: that I have not yielded a voluntary support to any insurrection, rebellion or pretended government
authority, power or constitution within the United States hostile thereto. And I do further swear that, to
the best of my knowledge and ability, I have supported and defended, and will continue to support and defend
the United States against all enemies, foreign and domestic, and that I have supported, defended and obeyed, and will
continue to support, defend and obey, the Constitution and Laws of the United States; that I will bear true faith and
allegiance to the same; and that I take this oath freely, without any mental reservation or purpose of evasion:
So help me God.



W. W. Owensley

Sworn to and subscribed before me Chas. L. C. C.
this 6th day of Dec 1866

J. S. M. Roberts Chas. L. C. C.

Headquarters Kentucky Volunteers,

Adjutant-General's Office,

Frankfort, November 19th, 1864.

I hereby certify, that it appears from the U. S. Muster-In
Rolls on file in this Office, that Logan Owsley
was enrolled on the 8th day of November, 1864, at
Camp Nelson Ky, by J. L. Randolph
and mustered into the U. S. service on the 8th day of November,
1864, at Camp Nelson Ky, by Capt N. C. Kissary,
to serve three years. Said Logan Owsley
is described as follows: 37 years age, Black eyes, Black hair,
Black complexion, 5ft 7in height. It further appears from
said Rolls, that Logan Owsley owed service to
William Owsley was credited to Montgomery
County Ky and was assigned to Company
"H" 6th Regt U. S. C. Cavalry



In Testimony Whereof, I have hereunto set my
hand, and affixed my Official Seal, this
19th day of November, 1864.



D. W. Lindsay
Adjutant General of Kentucky.

B177R453

defending its cause against the Government and forces of the so-called Confederate States of America, in
all suitable and practicable ways and means.

PROOF OF OWNERSHIP.

State of Kentucky,

County of Lincoln } ss.

We... Henry Helay... and... Fayette Cusley... each of law-
ful age, and resident citizens of the State and county aforesaid, do certify that... W. W. Cusley...
...of the State and county aforesaid, was on the... 8th... day of... Nov...
1864... the lawful owner of the slave named... L. G. Cusley...; referred
to and described in the foregoing claim for compensation.

his
Henry Helay
Fayette Cusley
mark
with

Sworn to and subscribed before me a... blkh... her... court... for the county of
... Lincoln... State of Kentucky, this the... 6th... day of... Dec... 1864...

J. J. M. Roberts, blkh L. C. C.



PROOF OF LOYALTY.

State of Kentucky,

County of Lincoln } ss.

We... R. E. Barron... and... J. J. M. Roberts... loyal men and
each of lawful age, and a resident citizens of the... Town... of... Stanford...
in the State and county aforesaid, upon our oaths declare that we have known...
a resident of the State and county aforesaid, since the 4th day of March, 1861, and know that he has firmly
and faithfully maintained his or her adherence and allegiance to the Government of the United States, by
defending its cause against the Government and forces of the so-called Confederate States of America, in
all suitable and practicable ways, and according to his or her ability and opportunity.

Robert E. Barron
J. J. M. Roberts

Sworn to and subscribed before me a... blkh... her... court... for the county of
... Lincoln... State of Kentucky, this the... 6th... day of... Dec... 1864...

J. J. M. Roberts, blkh L. C. C.

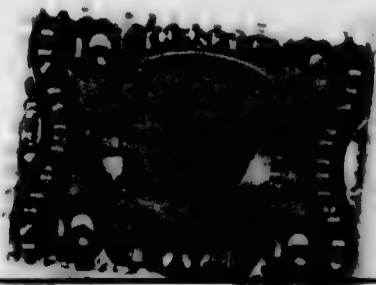

Statement of Service Reference Slip.

Office Am. W. B.

Claim No. 492809

Logan Overley
(Name.)

F, 6 Reg't U.S. Co.
Co.

To Wm. Div. Apr. 4, 1913

For clo. etc.

1 m. pp. Linneth.

Johnson
A

7th St. Army clothing
drawn in hospl.
D.S.

No record of clothing
found Nov & Dec. 1865.

Manning
4.5-'13.
no record of clothing fd.
 1 card ret'd
 R.P. ret'd

Statement furnished 4-5, 1913

D.S.

1023

Page Alexander

Co B, 6 U. S. Col'd Cav.

Private Corporal

CARD NUMBERS.

1	26
2	27
3	28
4	29
5	30
6	31
7	32
8	33
9	34
10	35
11	36
12	37
12	38
14	39
15	40
16	41
17	42
18	43
19	44
20	45
21	46
22	47
23	48
24	49
25	50

See Poque Alexander

Book Mark:

See also

1024

Paine Peter

Co C., 6 U.S. Col'd Cav.

Private

Private

CARD NUMBERS.

1	5387977	26
2	5390550	27
3	5390637	28
4	5390720	29
5	5390802	30
6	5390888	31
7	43174800	32
8	40732698	33
9		34
10		35
11		36
12		37
13		38
14		39
15		40
16		41
17		42
18		43
19		44
20		45
21		46
22		47
23		48
24		49
25		50

Book Mark:

See also 120 U.S.C. 2

S. 60712 P.C. 2nd 1.
D 2440716 And WD
D. 2441846 P.C. aff
WA. 151795
D-30 30045 - And in R.
P.O. 1130506 1914-1915

A. Jordan
A

P.

6 Cavalry.

U. S. C. T.

Peter Paine

Co. B, 6 Reg't U. S. Col'd Cav.

Appears on

Regimental Descriptive Book

of the regiment named above.

DESCRIPTION.

Age 28 years; height 5 feet 7 inches.

Complexion black

Eyes Blue; hair Blue

Where born Union Co. Ky.

Occupation farmer

ENLISTMENT.

When May 28, 1865.

Where Henderson, Ky.

By whom Capt Billings; term 3 years.

Remarks:

[Empty dashed lines for remarks]

L. D. Barton

(384b)

Copyist.

P. 6 600 U.S.C.T.

Peter Paine
Inw, Co., & Reg't U. S. Col'd

Appears on a

Detachment Muster Roll
Unassigned Recruits
of the organization named above

for June 10 to 30, 1865.

Station Camp Nelson Ky

Present or absent Present

Stoppage, \$ 100 for

Due Gov't, \$ 100 for

Valuation of horse, \$ 100

Valuation of horse equipments, \$ 100

Remarks: Transferred from 120th Regt
"inst. duty done"
Transferred from 1st Regt 15th Dist
2nd Div Ky June 10 1865

Book mark:

L. B. Sayer
Copyist.

P

6 Cav. U.S.C.T.

Peter Paine

Pis, Co. C, 6 Reg't U. S. Colored Cavalry.

Appears on

Company Muster Roll

for *July & Aug*, 186*5*.

Present or absent *Present*

Stoppage, \$ *100* for

Due Gov't, \$ *100* for

Valuation of horse, \$ *100*

Valuation of horse equipments, \$ *100*

Remarks: *1st Installment bounty due*

Book mark: _____

(358)

S. P. York

Copyist.

2

6 Cav. U.S.C.T.

Peter Payne

Priv, Co. C, 6 Reg't U. S. Colored Cavalry.

Appears on

Company Muster Roll

for *Sept & Oct*, 186*5*.

Present or absent *Present*

Stoppage, \$ *100* for

Due Gov't, \$ *100* for

Valuation of horse, \$ *100*

Valuation of horse equipments, \$ *100*

Remarks:

Filed with Return Peter

Book mark:

(358)

S. P. York

Copyist.

P **6 Cav. U.S.C.T.**

Peter Payne

Priv, Co. C, 6 Reg't U. S. Colored Cavalry.

Appears on

Company Muster Roll

for *Nov. & Dec.*, 1865.

Present or absent *Present*

Stoppage, \$ *100* for

Due Gov't, \$ *100* for

Valuation of horse, \$ *100*

Valuation of horse equipments, \$ *100*

Remarks: *\$100 bounty due*

Book mark:

(358)

W. B. Ferguson

Copyist.

P

6 Cav. U.S.C.T.

Peter Payne

Priv, Co. C, 6 Regt U. S. Colored Cavalry.

Appears on

Company Muster Roll

for Jan. 4 Feb. 1866.

Present or absent Present

Stoppage, \$ 100 for

Due Gov't, \$ 100 for

Valuation of horse, \$ 100

Valuation of horse equipments, \$ 100

Remarks:

Book mark:

W. B. Ferguson

P | 6 Cav. | U.S.C.T.

Peter Pine
Priv., Co. C, 6 Reg't U. S. Col'd Cav.

Appears on Returns as follows:

July 1865, Gain by transfer
Camp Nelson Ky.

Jan'y 1866. On extra or
daily duty.

Book mark:

L. M. Loan

(546)

Copyist.

P | **6 Cav. | U.S.C.T.**

Peter Paine

Priv, Co. *B*, 6 Reg't U. S. Col'd Cavalry.

Appears on **Co. Muster-out Roll**, dated *Muwall's Bluff Ark, Apl. 15*, 1866.

Muster-out to date *Apl. 15*, 1866.

Last paid to *Feb. 28*, 1866.

Clothing account:

Last settled....., 186 ; drawn since \$..... 100

Due soldier \$ *5 75* / 100; due U. S. \$..... 100

Am't for cloth'g in kind or money adv'd \$..... 100

Due U. S. for arms, equipments, &c., \$..... 100

Bounty paid \$..... 100; due \$..... 100

Remarks:

.....

.....

.....

Book mark:

W. B. Ferguson

(861)

Copyist.

1025

Palmer Green.

Co F., 6 U. S. Col'd Cav.

Private. Private

CARD NUMBERS.

1	5392557	26
2	5392631	27
3	5392716	28
4	5392803	29
5	5392901	30
6	5392996	31
7	5393089	32
8	5393182	33
9	4093421	34
10	43150695	35
11	40732699	36
12		37
13		38
14		39
15		40
16		41
17		42
18		43
19		44
20		45
21		46
22		47
23		48
24		49
25		50

Book Mark:

See also

Q | **6 Cav. | U.S.C.T.**

Green Palmer
Co. *F*, 6 Reg't U. S. Col'd Cav.

Appears on

Company Descriptive Book

of the organization named above.

DESCRIPTION.

Age *26* years; height *5* feet *5* inches.

Complexion *Black*

Eyes *Black*; hair *Black*

Where born *Shelby Tenn*

Occupation *Laborer*

ENLISTMENT.

When *Jan. 15*, 186 *5*.

Where *Lexington*

By whom *Capt. Moore*; term *3* y'rs.

Remarks: *Enlisted in Jan. 15 '65 Lexington by Capt. Moore*

Amey Webb
Copyist.

1

12.5.65

Green Palmer

Appears with rank of Priv on

Muster and Descriptive Roll

of Detachment of U.S. Colored Volunteers
forwarded to Lexington Ky.

Roll dated
Lexington Ky, Jan. 15, 1865.

Where born Shelton Tenn

Age _____ years; occupation Labourer

When enlisted Jan 15, 1865

Where enlisted Lexington Ky

For what period enlisted 3 years.

Eyes Blue; hair Blue

Complexion Blue; height 5 ft. 5 in.

When mustered in Jan 15, 1865

Where mustered in Lexington Ky

Bounty paid \$ 100; due \$ 100

Clothing account:

Last settled _____, 1865; drawn since \$ 100

Date of first muster Jan 15, 1865

Company to which assigned _____

Remarks: credited to blank bo. 7 D. Ky
free

Book mark : _____

Green Palmer

(356m)

Copyist.

J **6 Cav. U.S.C.T.**

Green Palmer

C, Co. *H*, 6 Reg't U. S. Col'd Cavalry.

Appears on

Company Muster-in and Descriptive Roll

of the organization named above. Roll dated

Lexington Ky, N. Y. *Jan 26*, 1865.

Where born *Chelby Tennessee*

Age *26* y'rs; occupation *Labourer*

When enlisted *Jan 15*, 1865.

Where enlisted *Lexington Ky*

For what period enlisted *3* years.

Eyes *Blk*; hair *Blk*

Complexion *Blk*; height *5 ft. 5 in.*

When mustered in *Jan 15*, 1865.

Where mustered in *Lexington Ky*

Bounty paid \$ *100*; due \$ *100*

Where credited *7th Surv Ky*

Company to which assigned

Remarks:

Book mark:

(356d)

Bryer

Copyist.

P 6 Cav. U.S.C.T.

Green Palmer

P, Co. F, 6 Reg't U.S. Col'd Cavalry.

Appears on

Company Muster Roll

for *Jan 24 to Apr 20*, 1865.

Present or absent *Present*

Stoppage, \$ *100* for

Due Gov't, \$ *100* for

Valuation of horse, \$ *100*

Valuation of horse equipments, \$ *100*

Remarks: *Sick in Hospital at Camp
Belton by order Jan 1 65*

Book mark:

Breyer

(358)

Copyist.

P *400* **U.S.C.T**

James Palmer
Co. F, 4 Reg't U. S. Col'd *Car*

Appears on

Company Muster Roll

for *May & June*, 186*4*

Present or absent *Present*

Stoppage, \$ *100* for

Due Gov't, \$ *100* for

Valuation of horse, \$ *100*

Valuation of horse equipments, \$ *100*

Remarks:

Book mark:

James Palmer

P

6 Cav. U.S.C.T.

Green Palmer

Pvt, Co. F, 6 Reg't U. S. Col'd Cavalry.

Appears on

Company Muster Roll

for *July & Aug*, 1865.

Present or absent *Present*

Stoppage, \$ *100* for

Due Gov't, \$ *100* for

Valuation of horse, \$ *100*

Valuation of horse equipments, \$ *100*

Remarks: *1st inst. of bounty due.*

Book mark:

J. E. Chapin
(358) Copyist.

P

6 Cav. U.S.C.T.

Green Palmer

Prv, Co. F, 6 Reg't U. S. Col'd Cavalry.

Appears on

Company Muster Roll

for *Sept + Oct*, 186*5*.

Present or absent *Present*

Stoppage, \$ *100* for

Due Gov't, \$ *100* for

Valuation of horse, \$ *100*

Valuation of horse equipments, \$ *100*

Remarks: *Due Gov't 8¢ for Ord.*

Book mark:

J. E. Chapin

(358)

Copyist.

P to Cav, **U.S.C.T**

Green Palmer

Plt, Co. *H*, Reg't U. S. Col'd *Cav.*

Appears on

Company Muster Roll

for *Nov. + Dec*, 186 *57*

Present or absent *Present*

Stoppage, \$ *100* for

Due Gov't, \$ *100* for

Valuation of horse, \$ *100*

Valuation of horse equipments, \$ *100*

Remarks:

Book mark:

(358)

J. E. Chapman

Copyist.

P 6 Cav. U.S.C.T.

Green Palmer
Co, Co. F, 6 Reg't U. S. Col'd Cavalry.

Appears on

Company Muster Roll
for *Jan & Feb*, 186*6*
Present or absent *Present*

Stoppage, \$ *100* for

Due Gov't, \$ *3* for *C & G. E.*

Valuation of horse, \$ *100*

Valuation of horse equipments, \$ *100*

Remarks:

Book mark:

(358)

H. A. Smith

Copyist.

40 | 6 Cav. | U.S.C.T.

Green Palmer
Pratt, Co. F., 6 Reg't U. S. Col'd Cav.

Appears on Returns as follows:

Jan'y to April 1865;
Absent sick in
Hospital at Camp
Nelson Ky, since
Jan'y 1. 65.

Book mark:

C. M. Rowe

(546)

Copyist.

P

6 Cav. U.S.C.T.

Green Palmer

Pr, Co. F, 6 Reg't U. S. Col'd Cavalry.

Appears on Co. Muster-out Roll, dated

Duval's Bluff, Ark. Apr 15, 1866.

Muster-out to date Apr 15, 1866.

Last paid to Feb 28, 1866.

Clothing account:

Last settled, 186 ; drawn since \$ 100

Due soldier \$ 100; due U. S. \$ 2468/100

Am't for cloth'g in kind or money adv'd \$ 100

Due U. S. for arms, equipments, &c., \$ 100

Bounty paid \$ 100 100; due \$ 100

Remarks:

Book mark:

H. Smith

(861)

Copyist.

1026

Palmer Harry.

Co K., 6 U. S. Col'd Cav.

Private | Sergeant

CARD NUMBERS.

1	5387415	26
2	5395365	27
3	5395452	28
4	5395539	29
5	5395616	30
6	5395697	31
7	5395776	32
8	5395850	33
9	9043814	34
10	40732700	35
11	32116293	36
12		37
13		38
14		39
15		40
16		41
17		42
18		43
19		44
20		45
21		46
22		47
23		48
24		49
25		50

Book Mark:

See also

P | **6 Cav. | U.S.C.T.**

Henry Palmer

....., Co. *A*, 6 Reg't U. S. Col'd Cav.

Appears on

Company Descriptive Book

of the organization named above.

DESCRIPTION.

Age *24* years ; height *5* feet *8* inches.

Complexion *Blk*

Eyes *Blk* ; hair *Blk*

Where born *Madison Ky*

Occupation *Farmer*

ENLISTMENT.

When *April 3*, 1865 .

Where *Chapel Hill*

By whom *F. Jessand*, term *3* y'rs.

Remarks: *Mustered May 6/65
By Wm Goodloe at
Lexington*

Powell
Copyright.

6 Cav. | U.S.C.T.

Fanny Almer

Appears with rank of *Cpl* on

Muster and Descriptive Roll of a Detachment of U. S. Vols. forwarded

for the 6 Reg't U. S. Col'd Cavalry. Roll dated

Lynchburg Va, May 5, 1865.

Where born *Madison Co Va*

Age *24* y'rs; occupation *Farmer*

When enlisted *April 3*, 1865.

Where enlisted *Camp Nelson*

For what period enlisted *3* years.

Eyes *Blue*; hair *Black*

Complexion *Cop*; height *5 ft. 8 in.*

When mustered in *May 5*, 1865.

Where mustered in *Lynchburg Va*

Bounty paid \$ *100*; due \$ *100*

Where credited *Madison Co & Dally*

Company to which assigned

Remarks: *Discharged*

Book mark:

P | 66 | U. S. C. T.

Harry Palmer
Sgt, Co. K, 6 Reg't U. S. Col'd Cav

Appears on
Company Muster-in and Descriptive Roll
of the organization named above. Roll dated

Camp Nelson Ky May 29, 1865.

Where born Madison Ky

Age 24 y'rs; occupation Farmer

When enlisted Apr 3, 1865.

Where enlisted

For what period enlisted 3 years.

Eyes black; hair black

Complexion brown; height 5 ft. 8 in.

When mustered in May 6, 1865.

Where mustered in Lexington

Bounty paid \$ 100; due \$ 100

Where credited 8" D. Ky

Company to which assigned

Remarks:

Book mark:

(356d) D. J. Giffick Copist.

P

6 Cav.

U.S.C.T.

Harry Palmer
Sgt., Co. K, 6 Reg't U. S. Col'd Cav.

Appears on

Company Muster Roll

for May 25 to June 30, 1865.

Present or absent Present

Stoppage, \$ 100 for

Due Gov't, \$ 100 for

Valuation of horse, \$ 100

Valuation of horse equipments, \$ 100

Remarks: Appointed Sgt
from private May 25, 1865

Book mark:

(358)

D. Giffith

Copyist.

D | **6 Cav.** | **U.S.C.T.**

Harry Palmer
Sgt, Co. K, 6 Reg't U. S. Col'd Cav.

Appears on

Company Muster Roll

for *July & August*, 186*5*.

Present or absent *Absent*

Stoppage, \$ *100* for

Due Gov't, \$ *100* for

Valuation of horse, \$ *100*

Valuation of horse equipments, \$ *100*

Remarks: *Appointed Sgt*
from priv, May 25/65
to rank as such from date,
Pick in Camp Nelson,
Genl Hoopst

Book mark:

(358)

D. Giffith
Copyist.

P 66 U.S.C.T

Harvey Palmer
Pvt, Co. K, 6 Reg't U.S.C.

Appears on

Hospital Muster Roll

of U. S. A. Post Hospital,

at Camp Nelson, Ky.,

for July + Aug, 1865.

Attached to hospital:

When, 186 .

How employed

Last paid by Maj.

to, 186 .

Bounty paid \$ 100; due \$ 100

Present or absent Present

Remarks:

Book mark:

C. L. Parker

(343)

Copist.

P

6 Cav. U.S.C.T.

Harry Palmer
Sgt., Co. K, 6 Reg't U. S. Col'd Cav.

Appears on

Company Muster Roll

for *Sept. & Oct.*, 1865.

Present or absent *Present*

Stoppage, \$ 100 for

Due Gov't, \$ 100 for

Valuation of horse, \$ 100

Valuation of horse equipments, \$ 100

Remarks:

Book mark:

J. M. Jackson
(358) *Copyist.*

P

6 Cav. U.S.C.T.

Harry Palmer
Sgt., Co. K, 6 Reg't U. S. Col'd Cav.

Appears on

Company Muster Roll

for *Nov. 7 Dec*, 186*4*

Present or absent *Present*

Stoppage, \$ *100* for

Due Gov't, \$ *100* for

Valuation of horse, \$ *100*

Valuation of horse equipments, \$ *100*

Remarks:

Book mark:

N. M. Jackson

(358)

Copyist.

J

6 Cav. U.S.C.T.

Amos J. ...

J. ..., Co. K, 6 Reg't U. S. Col'd Cav.

Appears on

Company Muster Roll

for *Amos J. ...*, 186 *6*.

Present or absent *A*

Stoppage, \$ *100* for

Due Gov't, \$ *100* for

Valuation of horse, \$ *100*

Valuation of horse equipments, \$ *100*

Remarks: *Continued duty ... O. J. ... 16 dated ... White River List. ... 23, 1866.*

Book mark :

O. J. Markle

(358)

Copyist.

70

6 Cav. U.S.C.T.

Harry Palmer
Sergt., Co. K, 6 Reg't U. S. Col'd Cav.

Appears on Returns as follows:

Jan'y 1866, Absent on
Detached duty Helena
Ark since Jan 25/66

Feb 1866, Absent on
Detached duty at
De Valls Bluff, Ark,
since Jan 25/66,

Book mark:

G. M. Row

(546)

Copyist.

P

6 Cav. U.S.C.T.

Harry Palmer

Sgt., Co. ⁴, 6 Reg't U. S. Col'd Cavalry.

Appears on Co. Muster-out Roll, dated
Cerrillos bluff, Ark, Apr. 10, 1866.

Muster-out to date Apr. 10, 1866.

Last paid to Oct 31, 1866.

Clothing account:

Last settled _____, 186 ; drawn since \$ 100

Due soldier \$ ^{18 78} ~~44~~ ⁵⁰ 100; due U. S. \$ 100

Am't for cloth'g in kind or money adv'd \$ 100

Due U. S. for arms, equipments, &c., \$ 100

Bounty paid \$ 100 100; due \$ 100

Remarks: Det. from Organization.

x 100 100 in the Roll.

Book mark:

C. J. Markle,

(861)

Copyst.

Palmer, Henry

Sgt., Co. K.

6 U.S.C. Cav.
Reg't

↓ Enclosures.

Bed Cards	Descriptive Lists
Burial Records	Final Statements
Certs. of Dis. for Discharge	Furloughs
C. M. Charges	Med. Des. Lists
Med. Certificates	Orders

Enlistments /

Other papers relating to—

Admission to Hosp'l	Furlough
Casualty Sheet (Officer's)	Med. Examination
Confinement	Misc. Information
Contracts	Pay or Clothing
Death or Effects	Personal Reports
Desertions	Rank
Discharge from Hosp'l	Transfer to Hosp'l
Discharge from Service	Transfer to V. R. C.
Duty	Transportation

E. 1.—This blank will be used for both enlistments and re-enlistments—enlistment of veterans, &c., &c., in the volunteer service. They will be made out in duplicate
 2.—one to accompany the recruiting return of the superintendent (not the recruiting officer) to the Adjutant General, and one to accompany the accounts of the officer
 county, &c. The Regiment and Company in which the soldier last served should be given on the back.
 E. 2.—An enlistment holds to service. A muster-in must, in all cases, precede payment of pay, bounty, pension, &c. A muster-in roll must, in all cases, be filed in the
 general's Office as evidence of muster-in. The mustering officer, commissary, or assistant commissary of musters, as the case may be, will countersign both enlistments
 mustered the soldier into the service of the United States before either of them is given to the disbursing officer.

DECLARATION OF RECRUIT.

I, Harry Palmer, desiring
 VOLUNTEER as a Soldier in the Army of the United States, for the term of THREE YEARS,
 Do Declare, That I am Twenty four years and _____ months
 of age; that I have never been discharged from the United States service on account of disability or by
 sentence of a court martial, or by order before the expiration of a term of enlistment; and I know of no
 impediment to my serving honestly and faithfully as a soldier for three years.

GIVEN at Camp Nelson
 the 3 day of April 1865

Witness: W. Nelson Harry Palmer
mark

Volunteered at Camp Nelson
3 April, 1865
 By W. Nelson
 Regiment of 1st M S R. Reg
 enlistment; last served in Company ()
 Regt of _____
 Discharged _____, 18 _____

W. Nelson
Harry Palmer (Co. 1)
Co. 1st Regt
1st M S R. Regt

CONSENT IN CASE OF MINOR.

I, Mrs Palmer (Madison Co), Do CERTIFY, That I am
 the _____ of _____; that the
 said _____ is _____ years of age; and I
 do hereby freely give my CONSENT to his volunteering as a SOLDIER in the ARMY OF THE UNITED STATES
 for the period of THREE YEARS.

GIVEN at _____
 the _____ day of _____

W

Credited to Madison Co. & 2 Co

VOLUNTEER ENLISTMENT.

STATE OF



TOWN OF

Kentucky

Co of Jessamine

I, Harry Palmer, born in Madison Co, in the State of Kentucky, aged twenty four years, and by occupation a Farmer, do HEREBY ACKNOWLEDGE to have volunteered this third day of April, 1865, to serve as a Soldier in the Army of the United States of America, for the period of THREE YEARS, unless sooner discharged by proper authority: Do also agree to accept such bounty, pay, rations, and clothing, as are, or may be, established by law for volunteers. And I, Harry Palmer do solemnly swear, that I will bear true faith and allegiance to the United States of America, and that I will serve them honestly and faithfully against all their enemies or opposers whomsoever; and that I will observe and obey the orders of the President of the United States, and the orders of the officers appointed over me, according to the Rules and Articles of War.

Sworn and subscribed to, at

Camp Nelson

this 3 day of

April 1865

Before

J. Passand Lieut Adj't 5th U.S.C.

Harry Palmer

I CERTIFY, ON HONOR, That I have carefully examined the above-named Volunteer, agreeably to the General Regulations of the Army, and that, in my opinion, he is free from all bodily defects and mental infirmity, which would in any way disqualify him from performing the duties of a soldier.

Examining Surgeon

EXAMINING SURGEON.

I CERTIFY, ON HONOR, That I have minutely inspected the Volunteer

Harry Palmer

previously to his enlistment, and that he was entirely sober when enlisted; that, to the best of my judgment and belief, he is of lawful age; and that, in accepting him as duly qualified to perform the duties of an able-bodied soldier, I have strictly observed the Regulations which govern the recruiting service. This soldier has blue eyes, black hair, fair complexion, is five feet eight inches high.

J. Passand Lieut Adj't 5th U.S.C.

Regiment of U.S.C. Volunteers,

RECRUITING OFFICER.

Mustered into the service of the United States, for three years or during the war, from date of enlistment, in Co. 6th day of May, 1865, at Lexington, in the County of Jessamine, in the State of Kentucky, as the case may be.

Bounty paid at time of Muster-in:

U. S. Bounty.

Local Bounty.

William Wallace Capt 2nd Regt 9th

1027

Palmer Wesley

Co. I., 6 U. S. Col'd Cav.

Private Private

CARD NUMBERS.

1	5387717	26
2	5387740	27
3	5394791	28
4	5394879	29
5	5394963	30
6	5395042	31
7	5395122	32
8	5395188	33
9	5395259	34
10	5395309	35
11	1593720	36
12	431574	37
13		38
14		39
15		40
16		41
17		42
18		43
19		44
20		45
21		46
22		47
23		48
24		49
25		50

Book Mark:

See also

S. 1289548 P5 21 PM
55 Mrs. Hattie Palmer Taylor 4151 Vincennes
ave. Chicago, Ill. 172/40 P40
Attn. Mrs. Hattie J. Taylor
139 - 71. Susan St.
Chicago, Ill. 8/14/20

A. Jordan
A

S 1289548 P3 2/17/20
SS Mrs. Hattie Palmer Taylor 4151 Vincennes
ave. Chicago, Ill. 172/40 P40
At to Mrs. Hattie J. Taylor
139. 71. Susan St.
Chicago, Ill. 8/14/20

A. B. Jordan
Ex

P | **6 Cav. | U.S.C.T.**

Wesley Palmer

....., Co....., 6 Reg't U. S. Col'd Cav.

Appears on

Company Descriptive Book

of the organization named above.

DESCRIPTION.

Age *50* years; height *5* feet *10* inches.

Complexion *Black*

Eyes *Blk*; hair *Blk*

Where born *Henry Co Ky*

Occupation *Farmer*

ENLISTMENT.

When *May 25*, 186*4*

Where *Louisville Ky*

By whom *S-O Ky*; term *3* y'rs.

Remarks: *Drafted reported
May 28/64 credited
to 6 A. Ky*

Forrest
Coptist.

6 Co. 21365-1

Westley

Priv

Appears with rank of _____ on _____

Muster and Descriptive Roll

of *Detachment of new Drafted and mustered into Service of U.S.*

Roll dated *Louisville Ky, May 25, 1864.*

Where born *Cumby Kentucky*

Age *30* y'rs; occupation *Farmer*

Drafted and mustered in:

When *May 25, 1864*

Where *Louisville Ky*

Enrollment district *5 Long Dist Ky*

Period *3* years.

Eyes *Black*; hair *Black*

Complexion *Copper*; height *5 ft. 1/2 in.*

Bounty paid \$ *100*; due \$ *100*

Clothing account:

Last settled _____, 186 ; drawn since \$ *100*

Date of commencement of service _____, 186 .

Company to which assigned _____

Remarks: *Issued one dress coat one pair pants one blanket one knapsack one canteen one plate one spoon one cup one knife & fork*

Book mark: _____

J. Jacobson

(356m)

Copyist.

OCT. 12

43155054

1906.

*F. W. ... - to Gladys
Paine*

P 6 U.S.C.T.

Wesley Palmer

Appears with rank of *Priv.* on

Muster and Descriptive Roll of a Detachment of Substitutes forwarded

for the *6* Reg't U. S. Col'd Cavalry. Roll dated *Draft Henderson, Louisville, Ky, Mch 25, 1865.*

Where born *Ferry Kentucky*

Age *30* y'rs; occupation *Farmer*

When enlisted _____, 186 .

Where enlisted *Drafted.*

For what period enlisted *3* years.

Eyes *Blk*; hair *Blk*

Complexion *Blk*; height *5 ft. 10 1/2 in.*

When mustered in *May 25*, 1865.

Where mustered in *Louisville*

Bounty paid \$ *100*; due \$ *100*

Where credited *5th Dist. Ky.*

Company to which assigned _____

Remarks: _____

Filed with Palmer Wesley.

Book mark: _____

P 6 U.S.C.T.

Wesley Palmer

Appears with rank of Pvt on

Muster and Descriptive Roll of a Detachment of Substitutes forwarded

for the 6 Reg't U. S. Col'd Cavalry, Roll dated Draft Rendezvous, Louisville, Ky, Mch 25, 1865.

Where born Henry, Kentucky

Age 30 y'rs; occupation Farmer

When enlisted _____, 186 .

Where enlisted Drafted

For what period enlisted 3 years.

Eyes Black; hair Black

Complexion Black; height 5 ft. 10 1/2 in.

When mustered in Mch 23, 186 4.

Where mustered in Louisville

Bounty paid \$ 100; due \$ 100

Where credited 5th Dist. Ky.

Company to which assigned _____

Remarks: _____

Book mark: _____

Conard
Copyist.

P

6 Cav. U.S.C.T.

Wesley Palmer
Privt, Co. I., 6 Reg't U. S. Col'd Cavalry.

Appears on

Company Muster-in and Descriptive Roll
of the organization named above. Roll dated

Camp Nelson, Ky., Apl 29, 1865.

Where born Henry Co. Ky.

Age 30 y'rs; occupation Farmer.

When enlisted, 186 .

Where enlisted Drafted.

For what period enlisted 3 years.

Eyes Blk; hair Blk

Complexion Blk; height 5 ft. 10 1/2 in.

When mustered in May 25, 1864.

Where mustered in Louisville Ky.

Bounty paid \$ none paid; due \$ 100

Where credited 5 dist Ky.

Company to which assigned I.

Remarks:

Book mark:

D. M. Kennedy
Coryist.

(356d)

SP | **6 Cav.** | **U.S.C.T.**

Wesley Palmer

Privt., Co. I, 6 Reg't U. S. Col'd Cavalry.

Appears on

Company Muster Roll

for *Enrolment to Apl 30*, 186*5*.

Present or absent *Present*.

Stoppage, \$ *100* for

Due Gov't, \$ *100* for

Valuation of horse, \$ *100*

Valuation of horse equipments, \$ *100*

Remarks:

1st Instalment bounty due

Book mark:

(358)

D. Mc. Kennedy
Copyist.

P | **6 Cav.** | **U.S.C.T.**

Wesley Palmer
Privt, Co. I, 6 Reg't U. S. Col'd Cavalry.

Appears on

Company Muster Roll

for *May or June*, 186*5*.

Present or absent *Present*.

Stoppage, \$ 100 for

Due Gov't, \$ 100 for

Valuation of horse, \$ 100

Valuation of horse equipments, \$ 100

Remarks:
Reported May 25th 1864

Book mark:

(358) *S. M. Kennedy*
Copyist.

P

6 Cav. | U.S.C.T.

Stacey Palmer

Private, Co. I, 6 Reg't U. S. Col'd Cavalry.

Appears on

Company Muster Roll

for *July & Aug*, 186*7*.

Present or absent *Present*

Stoppage, \$ *100* for

Due Gov't, \$ *100* for

Valuation of horse, \$ *100*

Valuation of horse equipments, \$ *100*

Remarks: *Reported May 25/64*

Book mark:

(358)

J. B. Casey

Copyist.

F

6 Cav. | U.S.C.T.

Henry Palmer
Private, Co. I, 6 Reg't U. S. Col'd Cavalry.

Appears on

Company Muster Roll

for *Sept 7 Oct*, 1867.

Present or absent *Present*.

Stoppage, \$ 100 for

Due Gov't, \$ 100 for

Valuation of horse, \$ 100

Valuation of horse equipments, \$ 100

Remarks:

Book mark:

(358)

H. C. Case

Copyist.

P

6 Cav. U.S.C.T.

Wesley Palmer

Pratt, Co. I, 6 Reg't U. S. Col'd Cavalry.

Appears on

Company Muster Roll

for Nov & Dec, 1862.

Present or absent Present

Stoppage, \$ 100 for

Due Gov't, \$ 100 for

Valuation of horse, \$ 100

Valuation of horse equipments, \$ 100

Remarks:

Book mark:

(358)

W. C. Casper

Copyist.

P. | **6 Cav.** | **U.S.C.T.**

Wesley Palmer

Private, Co. I, 6 Reg't U. S. Col'd Cavalry.

Appears on

Company Muster Roll

for Nov & Dec, 1867.

Present or absent Present

Stoppage, \$ 100 for

Due Gov't, \$ 100 for

Valuation of horse, \$ 100

Valuation of horse equipments, \$ 100

Remarks:

Book mark:

(358)

W. Casey

Copyist.

J. | **6 Cav. | U.S.C.T.**

Melroy Palmer
Pr., Co. I, 6 Reg't U. S. Col'd Cavalry.

Appears on

Company Muster Roll

for *Jan. + Feb.*, 186*6*.

Present or absent *Present*.

Stoppage, \$ *100* for

Due Gov't, \$ *100* for

Valuation of horse, \$ *100*

Valuation of horse equipments, \$ *100*

Remarks:

Book mark:

(358)

J. J. [Signature]

Copyist.

J.

6 Cav. U.S.C.T.

Mary Palmer

Co. B, 6 Reg't U. S. Col'd Cavalry.

Appears on **Co. Muster-out Roll**, dated

Sevalls Buff Am. April 13, 1866.

Muster-out to date *April 13*, 1866.

Last paid to *Feb. 28*, 1866.

Clothing account:

Last settled....., 186 ; drawn since \$..... 100

Due soldier \$ *11 59* 100; due U. S. \$..... 100

Am't for cloth'g in kind or money adv'd \$..... 100

Due U. S. for arms, equipments, &c., \$ *8 00* 100

Bounty paid \$..... 100; due \$..... 100

Remarks: *One soldier for*
not drawn
\$11.59. Stop for 1
carbine & set accounts
retained, \$8.

Book mark: *V 131 P 182. 74.*

(861)

W. H. Stearns

Copyist.

1028

Parker Charles.

Co B, 6 U. S. Col'd Cav.

Private

Private

CARD NUMBERS.

1	5387978	26
2	5389658	27
3	5389754	28
4	5389846	29
5	5389937	30
6	5390030	31
7	9042925	32
8	40732702	33
9		34
10		35
11		36
12		37
12		38
14		39
15		40
16		41
17		42
18		43
19		44
20		45
21		46
22		47
23		48
24		49
25		50

Book Mark: 166230. R. P. Div. '90.

See also 120 U. S. C. A.

6 Cav. | U.S.C.T.

Charles Parker

Co B, 6 Reg't U. S. Col'd Cav.

Appears on

Company Descriptive Book

of the organization named above.

DESCRIPTION.

Age 41 years; height 5 feet 4 1/2 inches.

Complexion Blk

Eyes Blk; hair Blk

Where born Hopkins Ky

Occupation Farmer

ENLISTMENT.

When Apr 13, 1865

Where Henderson Ky

By whom Capt Billings, term 3 y'rs.

Remarks: Mustered Apr 28/65 -
at Annersboro Ky by Capt
Grison.

Bryce

(383g)

Copyist.

Page 6 Car **U.S.C.T.**

Charles Parker
Dr. Co., 4 Reg't U. S. Col'd Car

Appears on a

Detachment Muster Roll

Wassgnell Recut
of the organization named above

for June 10 to 30, 1865.

Station Camp Nelson Ky

Present or absent Present

Stoppage, \$ 100 for

Due Gov't, \$ 100 for

Valuation of horse, \$ 100

Valuation of horse equipments, \$ 100

Remarks Transfd from 120 Reg't
1st Cav'ty det

Trans'd from 50th Reg't
Had got Dep'ty June 10 - 1865

Book mark :

L. B. Sawyer

(357)

Copyist.

6 Cav. U.S.C.T.

Charles Asper
Sgt, Co. B, 6 Reg't U. S. Col'd Cavalry.

Appears on

Company Muster Roll

for July & Aug, 1865.

Present or absent present

Stoppage, \$ 100 for

Due Gov't, \$ 100 for

Valuation of horse, \$ 100

Valuation of horse equipments, \$ 100

Remarks: Transferred
from Co E 120
U. S. Cavalry for
200.05 dated 27th Dec
1865

Book mark:

(358)

Charles Asper
Copyist.

P

6 Cav. | U.S.C.T.

Charles Parker

W., Co. B, 6 Reg't U. S. Col'd Cavalry.

Appears on

Company Muster Roll

for *Sept & Oct*, 1865.

Present or absent *present*

Stoppage, \$ *100* for

Due Gov't, \$ *100* for

Valuation of horse, \$ *100*

Valuation of horse equipments, \$ *100*

Remarks:

Book mark:

C. Parker
Copyist.

P

6 Cav. | U.S.C.T.

Charles Parker
Plt., Co. B, 6 Reg't U. S. Col'd Cavalry.

Appears on

Company Muster Roll

for *Nov. & Dec.*, 186*2*

Present or absent *Present*

Stoppage, \$ *100* for

Due Gov't, \$ *4* for *bt of Equipmt*

Valuation of horse, \$ *100*

Valuation of horse equipments, \$ *100*

Remarks:

Book mark:

(358)

J. V. Ames
Copyist.

P 6 Cav. U.S.C.T.

Charles Parker
Ch, Co. B, 6 Reg't U. S. Col'd Cavalry.

Appears on

Company Muster Roll

for *Jan'y & Feby*, 1866.

Present or absent *Present*

Stoppage, \$ *100* for

Due Gov't, \$ *4* for *6 & 9 Equip't*

Valuation of horse, \$ *100*

Valuation of horse equipments, \$ *100*

Remarks:

Book mark:

J. H. Ames
(358) Copyist.

P | 6 Cav. | U.S.C.T.

Charles Parker
Pot., Co. B., 6 Reg't U. S. Col'd Cav.

Appears on Returns as follows:

July 1865, Gain; June 20/65,
Camp Nelson Ky
Transferred from 120
USCT, per S.O.
No 105, dated Hd Qrs,
D K June 21/65;

Oct & Nov, 1865. On daily
duty as Co Cook,

Book mark:

G M Row

(546)

Copyist.

P

6 Cav. U.S.C.T.

Charles P. Hill

Private, Co. B, 6 Reg't U. S. Col'd Cavalry.

Appears on Co. Muster-out Roll, dated

Seville, Ky, Oct. 15, 1866.

Muster-out to date

Oct. 15, 1866.

Last paid to

July 7, 1866.

Clothing account:

Last settled....., 186 ; drawn since \$..... 100

Due soldier \$ 25-38 100; due U. S. \$..... 100

Am't for cloth'g in kind or money adv'd \$..... 100

Due U. S. for arms, equipments, &c., \$..... 100

Bounty paid \$ 100 100; due \$..... 100

Remarks:

Transferred from 120th Regt. Co. I, June 24th 65. S. C. 105. Hd. Qrs. 1st Regt. June 24th 65.

Book mark: 116230 R + P. Dis. / 90.

(361)

J. C. Williams

Copyist.

1029

Parker Henry.

Co B., 6 U. S. Col'd Cav.

Private | *Private*

CARD NUMBERS.

1	5389263	26
2	5389370	27
3	5390060	28
4	4092912	29
5	40732703	30
6	40902838	31
7	9.9.201	32
8		33
9		34
10		35
11		36
12		37
12		38
14		39
15		40
16		41
17		42
18		43
19		44
20		45
21		46
22		47
23		48
24		49
25		50

Book Mark: *473, 1878,*
9.9.201

See also

93 PB
C 01727459

3/2/34
JL

H. Jordan
a

B | **6 Cav. | U.S.C.T.**

Henry Parker

....., Co. *B*, 6 Reg't U. S. Col'd Cav.

Appears on

Company Descriptive Book

of the organization named above.

DESCRIPTION.

Age *19* years; height *5* feet *5³/₄* inches.

Complexion *Black*

Eyes *Brown*; hair *Black*

Where born *Saritt Ky*

Occupation *Farmer*

ENLISTMENT.

When *Aug 13*, 186*4*.

Where *Bowling Green Ky*

By whom *Capt Watson*; term *3* y'rs.

Remarks:

.....

.....

.....

.....

.....

.....

.....

.....

.....

.....

.....

.....

.....

.....

.....

.....

.....

.....

.....

.....

.....

.....

.....

.....

.....

.....

.....

.....

.....

.....

.....

.....

.....

Breger

(383g)

Copyist.

G 6 Cav. U.S.C.T.

Henry Parker

Privat, Co. B, 6 Reg't U. S. Col'd Cavalry.

Appears on

Company Muster-in and Descriptive Roll

of the organization named above. Roll dated

Camp Nelson Ky, ~~Nov~~ Nov, 1st, 1864.

Where born *Garratt Co Ky*

Age *19* y'rs; occupation *Farmer*

When enlisted *Aug 13*, 1864.

Where enlisted *Bowling Green Ky*

For what period enlisted *3* years.

Eyes *Brown*; hair *Blk*

Complexion *Blk*; height *5* ft. *3 1/4* in.

When mustered in *Aug 13*, 1864.

Where mustered in *Bowling Green Ky*

Bounty paid \$ *100*; due \$ *100*

Where credited *3rd Dist Ky*

Company to which assigned

Remarks: *Transferred from Co. C*

115, U.S.C.T. par. 5, no. 39, dated

June 10/65, Washington D.C,

signed L. Thomas, A.C.

(vici)

Book mark:

M. Rowe

(356d)

Copyist.

JAN. 10

5389263

☆ 1891 ☆

Owner
Sam Jennings (Heirs)

P. **6 Cav. U.S.C.T.**

Henry Parker

Private, Co. B, 6 Reg't U. S. Col'd Cavalry.

Appears on

Company Muster Roll

for *Nov & Dec*, 1864.

Present or absent

Stoppage, \$ *100* for

Due Gov't, \$ *100* for

Valuation of horse, \$ *100*

Valuation of horse equipments, \$ *100*

Remarks: *Mirring in action
at Marion Va, Dec 19, 1864*

Book mark:

(358)

S. M. Mower

Copypist.

P | **6 Cav.** | **U.S.C.T.**

Henry Parker
Pvt, Co. *B*, 6 Reg't U. S. Col'd Cav.

Appears on Returns as follows:

Dec 1864. Loss Dec 19/64
Marine Va Missing
in action.

Book mark :

(546)

C. W. Bour

Copyist.

P

115

U.S.C.T.

Henry Parker,

Co. C, 115 Reg't U. S. Colored Inf.

Appears on Returns as follows:

Aug 1864 - Loss: Aug 26/64,
Bowling Green. Transferred.

Book mark:

(646)

J. T. Mansley

Copyist.

9 | **6 Cav. U.S.C.T.**

Henry Parker

Pr -----, *Co B* -----, 6 Reg't U. S. Col'd Cavalry.

Appears on **Co. Muster-out Roll**, dated
DeValls Bluff, Apr 15, 1861.

Muster-out to date -----, 186 .

Last paid to *Pay due from Enlist*, 186 .

Clothing account:

Last settled -----, 186 ; drawn since \$ ----- 100

Due soldier \$ ----- 100; due U. S. \$ ----- 100

Am't for cloth'g in kind or money adv'd \$ ----- 100

Due U. S. for arms, equipments, &c., \$ ----- 100

Bounty paid \$ ----- 100; due \$ ----- 100

Remarks:

*Missing after battle of
Marion Dec 15/64*

Book mark: *473-1878*

(361) *J. W. Ames*

Copyist.

WAR DEPARTMENT
THE ADJUTANT GENERAL'S OFFICE

WASHINGTON

Filed March 2, 1934 W.F.L.

NOTATION

Henry Parker

Pvt. Co. C, 115th U. S. C. Inf.
Pvt. Co. B, 6th U. S. C. Cav.

BOOKMARK: A. G. 201

March 1, 1934.

It has this day (March 1, 1934) been determined from the records on file in this office and from information received from the General Accounting Office, that the above-named soldier DIED DECEMBER 19, 1864.

By authority of the Secretary
of War:

James F. McKinley
Major General,
The Adjutant General.
By J. P. Wade

1030 or Leroy.
Parker Lewis.

Co. A., 6 U. S. Col'd Cav.

Private | Sergeant.

CARD NUMBERS.

1	5387437	26
2	5395376	27
3	5395455	28
4	5395542	29
5	5395619	30
6	5395700	31
7	5395779	32
8	5395853	33
9	9093812	34
10		35
11		36
12		37
12		38
14		39
15		40
16		41
17		42
18		43
19		44
20		45
21		46
22		47
23		48
24		49
25		50

Book Mark: 300.775.

See also

S 62885 Co. 7th
S 718796 2d and
S 97111 - 9th 16th

A. Jordan
Ex

P | 6 Cav. | U.S.C.T.

James Parker

....., Co. *K*, 6 Reg't U. S. Col'd Cav.

Appears on

Company Descriptive Book

of the organization named above.

DESCRIPTION.

Age *19* years ; height *5* feet *7* inches.

Complexion *Blk*

Eyes *Blk* ; hair *Blk*

Where born *Bourbon Co Ky*

Occupation *Farmer*

ENLISTMENT.

When *Aug 1*, 186*4*.

Where *Camp Nelson*

By whom *H. Blackaller*; term *3* y'rs.

Remarks: *Examined May 1865
By Wm Gordon at
Harrison*

Pomeroy
Copyist.

P

6 Cav. | U.S.C.T.

Henry Parker

Appears with rank of *Priv* on

Muster and Descriptive Roll of a Detachment of U. S. Vols. forwarded

for the 6 Reg't U. S. Col'd Cavalry. Roll dated *Louisville Ky, May 16, 1865.*

Where born *Bourbon Co Ky*

Age *19* y'rs; occupation *Farmer*

When enlisted *Aug*, 186 *4*

Where enlisted *Camp Nelson Ky*

For what period enlisted *3* years.

Eyes *Blk*; hair *Blk*

Complexion *Blk*; height *5 ft. 7* in.

When mustered in *May 16*, 186 *5*.

Where mustered in *Louisville Ky.*

Bounty paid \$ *100*; due \$ *100*

Where credited *Bourbon Co Ky 70*

Company to which assigned

Remarks: *Henry Parker*

Book mark:

W. Allen

(339) Copyist.

P | 6 Cav | **U. S. C. T.**

Lewis Parker

Corpl, Co. K, 6 Reg't U. S. Col'd Cav

Appears on

Company Muster-in and Descriptive Roll
of the organization named above. Roll dated

Camp Nelson Ky, May 28, 1865.

Where born Bourbon Ky

Age 19 y'rs; occupation Farmer

When enlisted Aug 1, 1864.

Where enlisted Camp Nelson

For what period enlisted 3 years.

Eyes black; hair black

Complexion black; height 5 ft. 7 in.

When mustered in May 16, 1865.

Where mustered in Lexington

Bounty paid \$ 100; due \$ 100

Where credited 7 D. Ky

Company to which assigned _____

Remarks: _____

Book mark: _____

D. J. Giffith

(356d)

Copyist.

P

6 Cav.

U.S.C.T.

Lewis Parker

Serq't, Co. K, 6 Reg't U. S. Col'd Cav.

Appears on

Company Muster Roll

for May 25 to June 30, 1865.

Present or absent Present

Stoppage, \$ 100 for

Due Gov't, \$ 100 for

Valuation of horse, \$ 100

Valuation of horse equipments, \$ 100

Remarks: Promoted Sgt from private May 25, 1865

Book mark:

(358)

D. J. Gifford

Copyist.

P | **6 Cav.** | **U.S.C.T.**

Lewis Parker

Sgt, Co. K, 6 Reg't U. S. Col'd Cav.

Appears on

Company Muster Roll

for *July & August*, 186*5*.

Present or absent *Present*

Stoppage, \$ *100* for

Due Gov't, \$ *100* for

Valuation of horse, \$ *100*

Valuation of horse equipments, \$ *100*

Remarks: *Appointed Sgt
from priv May 25/65
to rank as such from date.*

Book mark:

(358)

T. J. Guppich Copyist.

P

6 Cav. U.S.C.T.

Lewis Parker

Sgt., Co. K, 6 Reg't U. S. Col'd Cav.

Appears on

Company Muster Roll

for *Sept & Oct.*, 186*4*

Present or absent *Present*

Stoppage, \$ *100* for

Due Gov't, \$ *100* for

Valuation of horse, \$ *100*

Valuation of horse equipments, \$ *100*

Remarks:

Book mark:

J. M. Jackson

(358)

Copyist

P

6 Cav. U.S.C.T.

Lewis Parker

Sgt., Co. K, 6 Reg't U. S. Col'd Cav.

Appears on

Company Muster Roll

for *Nov. + Dec*, 186*5*

Present or absent *Present*

Stoppage, \$ *100* for

Due Gov't, \$ *100* for

Valuation of horse, \$ *100*

Valuation of horse equipments, \$ *100*

Remarks:

Book mark:

M. Jackson

(358)

Copyist.

J | **6 Cav.** | **U.S.C.T.**

James ...

..., Co. K, 6 Reg't U. S. Col'd Cav.

Appears on

Company Muster Roll

for *Nov. 5*, 186 *6*.

Present or absent *Present*

Stoppage, \$ *100* for

Due Gov't, \$ *100* for

Valuation of horse, \$ *100*

Valuation of horse equipments, \$ *100*

Remarks: *2. ...*
div.

Book mark:

C. J. Markle

(358)

Copyist.

6 Cav. | U.S.C.T.

Lewis Parker

D. C., Co. *F*, 6 Reg't U. S. Col'd Cavalry.

Appears on **Co. Muster-out Roll**, dated *Levelland, Ark, Apr. 10*, 1866.

Muster-out to date *Apr. 10*, 1866.

Last paid to *Oct. 31*, 1866.

Clothing account:

Last settled....., 186 ; drawn since \$..... 100

Due soldier \$ ^{31 71/2} ~~64~~ 100; due U. S. \$..... 100

Am't for cloth'g in kind or money adv'd \$..... 100

Due U. S. for arms, equipments, &c., \$..... 100

Bounty paid \$ *10* 100; due \$ *10* 100

Remarks: *Sgt. from Organization.*

all on the Roll.

Book mark: *300.775*

A. J. Markle,

Parker, Lewis

....., Co., 6 Reg't *W. S. C. Co.*

Enclosures.

Bed Cards	Final Statements
Burial Records	Furloughs or L. of A
Certs. of Dis. for Discharge	Med. Certificates
C. M. Charges	Med. Des. Lists
Descriptive Lists	Orders
Discharge Certificates	Pris. of War Record
Enlistment Papers	Resignations

Other papers relating to—

Admission to Hosp'l	Furlough or L. of A
Casualty Sheet	Med. Examination
Confinement	Misc. Information
Contracts	Pay or Clothing
Death or Effects	Personal Reports
Desertion	Rank
Discharge from Hosp'l	Transfer to Hosp'l
Discharge from Service	Transfer to V. R. C.
Duty	Transportation

NOTE 1.—This blank will be used for both enlistments and re-enlistments—enlistment of veterans, &c., &c., in the volunteer service. They will be made out in duplicate in all cases—one to accompany the recruiting return of the superintendent (not the recruiting officer) to the Adjutant General, and one to accompany the accounts of the officer who pays bounty, &c. The Regiment and Company in which the soldier last served should be given on the back.

NOTE 2.—An enlistment holds to service. A muster-in must, in all cases, precede payment of pay, bounty, pension, &c. A muster-in roll must, in all cases, be filed in the Adjutant General's Office as evidence of muster-in. The mustering officer, commissary, or assistant commissary of musters, as the case may be, will countersign both enlistments as having mustered the soldier into the service of the United States before either of them is given to the disbursing officer

DECLARATION OF RECRUIT.

I, Lewis Parker, desiring
VOLUNTEER as a Soldier in the Army of the United States, for the term of THREE YEARS,
Do Declare, That I am 19 years and _____ months
of age; that I have never been discharged from the United States service on account of disability or by
sentence of a court martial, or by order before the expiration of a term of enlistment; and I know of no
impediment to my serving honestly and faithfully as a soldier for three years.

GIVEN at Camp Nelson No 7
the 1 day of Aug. 1864

Witness:

Lewis Parker
mark

Lewis Parker. (Cora)
No. _____

Volunteered at Camp Nelson
1st August, 1864
By W. M. Blackstall
Capt Regiment of 49th
W. M. S. R. Regt
enlistment; last served in Company ()
Reg't of _____
Discharged _____, 18 _____

CONSENT IN CASE OF MINOR.

I, Geo. Parker (Poultow Co) Do CERTIFY, That I am
the _____ of _____; that the
said _____ is _____ years of age; and I
do hereby freely give my CONSENT to his volunteering as a SOLDIER in the ARMY OF THE UNITED STATES
for the period of THREE YEARS.

GIVEN at _____
the _____ day of _____

Witness:

Credited to Bourbon Co 7th Dist
VOLUNTEER ENLISTMENT.

STATE OF

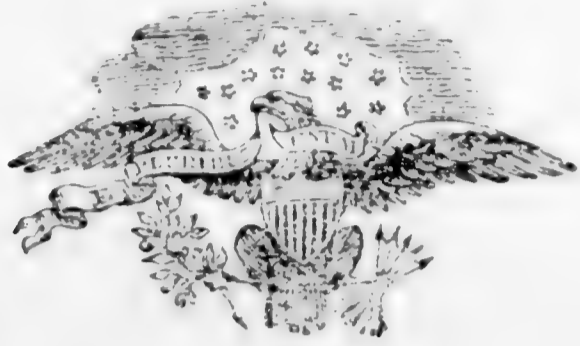

TOWN OF

Mo

I, *Sevis Parker*, born in *Bourbon Co* in the State of *Mo*, aged *19* years, and by occupation a *Farmer*, Do HEREBY ACKNOWLEDGE to have volunteered this *1st* day of *Aug*, 186*4*, to serve as a **Soldier** in the **Army of the United States of America**, for the period of **THREE YEARS**, unless sooner discharged by proper authority: Do also agree to accept such bounty, pay, rations, and clothing, as are, or may be, established by law for volunteers. And I, *Sevis Parker*, do solemnly swear, that I will bear true faith and allegiance to the **United States of America**, and that I will serve them honestly and faithfully against all their enemies or opposers whomsoever; and that I will observe and obey the orders of the President of the United States, and the orders of the officers appointed over me, according to the Rules and Articles of War.

Sworn and subscribed to, at *St. Louis Mo*, his *Sevis Parker* this *1st* day of *August*, 186*4*.
 BEFORE *Wm Blackaller* *mark*
Sgt. White

I CERTIFY, ON HONOR, That I have carefully examined the above-named Volunteer, agreeably to the General Regulations of the Army, and that, in my opinion, he is free from all bodily defects and mental infirmity, which would in any way disqualify him from performing the duties of a soldier.

W. H. Riley
asst Surg. Genl.
 EXAMINING SURGEON.

I CERTIFY, ON HONOR, That I have minutely inspected the Volunteer *S. Parker* previously to his enlistment, and that he was entirely sober when enlisted; that, to the best of my judgment and belief, he is of lawful age; and that, in accepting him as duly qualified to perform the duties of an able-bodied soldier, I have strictly observed the Regulations which govern the recruiting service. This soldier has *Blue* eyes, *Blue* hair, *Blue* complexion, is *five* feet *7* inches high.

Wm Blackaller
1st Regiment of *Missile* Volunteers,
 RECRUITING OFFICER.

(A. G. O. No. 74 & 76.)

Certificate for the Signature of the Mustering Officer, Commissary, or Assistant Commissary of Musters, as the case may be.
 Mustered into the service of the United States, for three years or during the war, from date of enlistment, in or
 Regiment of *Col. Coar* Volunteers, on the *16* day of *May*, 1865, at *Washington Dc*
 and credited to *Ward*, (or Sub-district,) in the Town of _____, in the County of _____,
 _____th Congressional District, in the State of _____
 Bounty paid at time of Muster-in:
 U. S. Bounty, _____
 Local Bounty, _____
William Blackaller
Capt. St. Br. Nov 1864
and Mustering Officer

1031
Parks Charles.

Co No., 6 U. S. Col'd Cav.

Private Corporal.

CARD NUMBERS.

1	5387321	26
2	5394050	27
3	5394180	28
4	5394227	29
5	5394308	30
6	5394396	31
7	5394487	32
8	5394561	33
9	5394632	34
10	9093634	35
11		36
12		37
13		38
14		39
15		40
16		41
17		42
18		43
19		44
20		45
21		46
22		47
23		48
24		49
25		50

Book Mark:

See also

1394402. Po. m. m.

H. Jordan
A

P | 6 Cav. | U.S.C.T.

Charles Parks

Appears with rank of *private* on
Muster and Descriptive Roll of a Detach-
ment of U. S. Vols. forwarded

for the 6 Reg't U. S. Col'd Cavalry. Roll dated
Lexington Ky, March 16, 1865.

Where born *Madison Ky*

Age *22* y'rs; occupation *farmer.*

When enlisted *March 7, 1865.*

Where enlisted *Camp Nelson Ky*

For what period enlisted *3* years.

Eyes *black*; hair *black*

Complexion *black*; height *5* ft. *11* in.

When mustered in *March 16, 1865.*

Where mustered in *Lexington Ky*

Bounty paid \$ *100*; due \$ *100*

Where credited *Estill Co. S. D. Ky.*

Company to which assigned

Remarks:

owner John Parks

Book mark:

A. B. Paul

(339) Copyist.

D. 6 Cav U.S.C.T.

Charles Park,

, Co. H, 6 Reg't U.S. Col'd Cav.

Appears on

Company Descriptive Book

of the organization named above.

DESCRIPTION.

Age 22 years; height 5 feet 11 inches.

Complexion *black*

Eyes *black*; hair *black*

Where born *Marion, Ky*

Occupation *Farmer*

ENLISTMENT.

When *Mar. 7*, 1865.

Where *Camp Nelson*

By whom *Capt. Randolph*, term *3* y'rs.

Remarks:

Henry Webb

P | 6 Cav. | **U. S. C. T.**

Charles Parks

Co. H, 6 Reg't U. S. Col'd Cavalry

Appears on

Company Muster-in and Descriptive Roll
of the organization named above. Roll dated

Lexington, Ky, Mch 26, 1865.

Where born *Marrion Co. Kentucky*

Age *22* y'rs; occupation *Farmer.*

When enlisted *Mch 7, 1865.*

Where enlisted *Camp Nelson, Ky.*

For what period enlisted *3* years.

Eyes *Black*; hair *Black.*

Complexion *Black*; height *5* ft. *11* in.

When mustered in *Mch 16, 1865.*

Where mustered in *Lexington, Ky.*

Bounty paid \$ *100*; due \$ *100*

Where credited *Estill Co. 8 Dist, Ky.*

Company to which assigned *H.*

Remarks: *Substitute for John Parks,*
owner.

Book mark :

Conard

P

6 Cav. U.S.C.T.

Charles Parks

Pvt, Co. H, 6 Reg't U. S. Col'd Cavalry.

Appears on

Company Muster Roll

for from Mch. 16 to Apr. 30, 1865.

Present or absent Present.

Stoppage, \$ 100 for

Due Gov't, \$ 100 for

Valuation of horse, \$ 100

Valuation of horse equipments, \$ 100

Remarks:

Book mark:

Leonard

(358)

Copyist.

P

6 Cav. U.S.C.T.

Charles Parks

Corpl., Co. H, 6 Reg't U. S. Col'd Cavalry.

Appears on

Company Muster Roll

for May & June, 1865.

Present or absent Present.

Stoppage, \$ 100 for

Due Gov't, \$ 100 for

Valuation of horse, \$ 100

Valuation of horse equipments, \$ 100

Remarks: 1st Instalment Bounty due, App'd Corpl. per R.O. No. 50, dated June 12th, to rank from June 1st, 1865.

Book mark:

Leonard

(358)

Copyist.

5 6 Cav. U.S.C.T.

Charles Parker
Corp, Co. H, 6 Reg't U. S. Col'd Cavalry.

Appears on

Company Muster Roll

for July 5th, 1865.

Present or absent Present.

Stoppage, \$ 100 for

Due Gov't, \$ 100 for

Valuation of horse, \$ 100

Valuation of horse equipments, \$ 100

Remarks:

Book mark:

(358)

Carline Copyist.

5 | **6 Cav. U.S.C.T.**

Charles Parks
Corp, Co. H, 6 Reg't U. S. Col'd Cavalry.

Appears on

Company Muster Roll

for *Sept Oct*, 1865.

Present or absent *Present*.

Stoppage, \$ *100* for

Due Gov't, \$ *100* for

Valuation of horse, \$ *100*

Valuation of horse equipments, \$ *100*

Remarks:

Book mark:

(358)

Sabine
Copyist.

6 Cav. U.S.C.T.

William Parke
Sergeant, Co. H, 6 Reg't U. S. Col'd Cavalry.

Appears on

Company Muster Roll

for *Sept Dec*, 1865.

Present or absent *Present*.

Stoppage, \$ 100 for

Due Gov't, \$ 100 for

Valuation of horse, \$ 100

Valuation of horse equipments, \$ 100

Remarks:

Book mark:

(358)

Parke
Copyist.

P | **6 Cav.** | **U.S.C.T.**

Charles Parks

Capt., Co. H, 6 Reg't U. S. Col'd Cavalry.

Appears on

Company Muster Roll

for *Jan'y & Feb'y*, 186*6*.

Present or absent *Present*

Stoppage, \$ *100* for

Due Gov't, \$ *0* ^{*30*}/_{*100*} for *Ordinance*

& \$100 for O & G. E.

Valuation of horse, \$ *100*

Valuation of horse equipments, \$ *100*

Remarks:

Book mark: -----

J. M. Harmon

P

6 Cav. U.S.C.T.

Charles Parks

Corp., Co. A., 6 Reg't U. S. Col'd Cavalry.

Appears on Co. Muster-out Roll, dated

Walls Bluff Ark, April 15, 1866.

Muster-out to date April 15, 1866.

Last paid to Feb. 28, 1866.

Clothing account:

Last settled....., 186 ; drawn since \$..... 100

Due soldier \$..... 100; due U. S. \$ 10 ⁴⁰/₁₀₀

Am't for cloth'g in kind or money adv'd \$..... 100

Due U. S. for arms, equipments, &c., \$ 0 ⁵⁶/₁₀₀

Bounty paid \$ 100 ⁰⁰/₁₀₀; due \$..... 100

Remarks: Corp'l from June 1/65

Due U.S. for ord. 0 ⁵⁶/₁₀₀

Book mark: 5358 P. M. G. June 6/66.

J. M. Harnum

(861)

Copyist.

Parks, Charles

Co. H, 6 U.S. Reg't 6. bavy

2 Enclosures.

Bed Cards	Final Statements
Burial Records	Furloughs or L. of A.
Certs. of Dis. for Discharge	Med. Certificates
C. M. Charges	Med. Des. Lists
Descriptive Lists	Orders
Discharge Certificates	Pris. of War Record
Enlistment Papers 2	Resignations

Other papers relating to—

Admission to Hosp'l	Furlough or L. of A.
Casualty Sheet	Med. Examination
Confinement	Misc. Information
Contracts	Pay or Clothing
Death or Effects	Personal Reports
Desertion	Rank
Discharge from Hosp'l	Transfer to Hosp'l
Discharge from Service	Transfer to V. R. C.
Duty	Transportation

NOTE 1.—This blank will be used for enlistments of United States colored troops. They will be made out in duplicate in all cases—one to accompany the recruiting agent of the superintendent (not the recruiting officer) to the Adjutant General, and one to accompany the accounts of the officer who pays bounty, &c.

NOTE 2.—An enlistment holds to service. A muster-in must, in all cases, precede payment of pay, bounty, pension, &c. A muster-in roll, must in all cases, be filed in the Adjutant General's Office as evidence of muster-in. The mustering officer, commissary, or assistant commissary of musters, as the case may be, will countersign both enlistments as having mustered the soldiers into the service of the United States before either of them is given to the disbursing officer.

DECLARATION OF RECRUIT.

I, Charles Parks desiring to volunteer as a soldier in the ARMY OF THE UNITED STATES, for the term of Three Years, DO DECLARE That I am 21 years and months of age; that I have never been discharged from the United States service on account of disability or by sentence of a court-martial, or by order before the expiration of a term of enlistment; and I know of no impediment to my serving honestly and faithfully as a soldier for three years.

GIVEN at Camp Nelson the 7 day of March 1865

Witness: Chas. Nelson

Charles X. Parks
mark



ke 10

Volunteered at
 No.
 18

Consent of Parent or Guardian in case of a Minor, if a Free Man, or in the case of a Slave, of the Person to whom he owes Service:

I, John Parks Do CERTIFY, That I am the

that the said is years of age; and I do freely give my CONSENT to his volunteering as a SOLDIER in the Army of the United States, for the period of THREE YEARS, under the conditions of the laws of the United States.

GIVEN at the day of

Witness:

8 Sixty 4

UNITED STATES COLORED TROOPS ENLISTMENT.

STATE OF

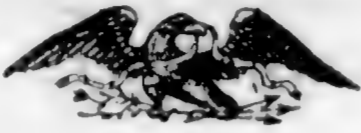

TOWN OF

Kentucky County *Cass*
I, *Charles Parks* born in *Madison*
in the State of *Kentucky* aged *twenty-two* years

and by occupation a *Farmer* Do HEREBY ACKNOWLEDGE to
have volunteered *Seventh* day of *March* 186*4*
to serve as a **Soldier** in the **Army of the United States of America**, for the
period of **THREE YEARS**, unless sooner discharged by proper authority: Do
also agree to accept such bounty, pay, rations, and clothing, as are, or may be,
established by law for the U. S. colored troops.

And I, *Charles Parks*
do solemnly swear that I will bear true faith and allegiance to the **United States
of America**, and that I will serve them honestly and faithfully against all their
enemies or opposers whomsoever; and that I will observe and obey the orders
of the President of the United States, and the orders of the officers appointed
over me, according to the Rules and Articles of War.

Sworn and subscribed to, at *Camp Adams*
this *7* day of *March* 186*4*
Before *J. Randolph*

I CERTIFY, ON HONOR, That I have carefully examined the above named Volunteer agree-
ably to the General Regulations of the Army, and that, in my opinion, he is free from all bodily
defects and mental infirmity, which would in any way disqualify him from performing the
duties of a soldier.

W. H. Baker
EXAMINING SURGEON.

I CERTIFY, ON HONOR, That I have minutely inspected the Volunteer *Charles Parks*
previously to his enlistment, and that he was entirely sober when enlisted; that, to the best of
my judgment and belief, he is of lawful age, and that, in accepting him as duly qualified to per-
form the duties of an able-bodied soldier, I have strictly observed the regulations which govern
the recruiting service. This soldier has *blue* eyes, *black* hair, *com-*
plexion, is *five* feet *seven* inches high.

J. Randolph
RECRUITING OFFICER OR AGENT.

Mustered into the United States Service *16* day of *March* 186*4*

Thos H. Moore
Capt & Pro Mar 30 64 Mustering Officer.

Mustered into the service of the United States, for three years or during the war, from date of enlistment, in Company *.....* Regiment of *.....* Volunteers, on the *.....* day of *.....* 186*4*, at *.....*

1. This blank will be used for enlistments of United States colored troops. They will be made out in duplicate in all cases—one to accompany the recruiting superintendent (not the recruiting officer) to the Adjutant General, and one to accompany the accounts of the officer who pays bounty, &c.

2. An enlistment holds to service. A muster-in must, in all cases, precede payment of pay, bounty, pension, &c. A muster-in roll, must in all cases, be filed in the Adjutant General's Office as evidence of muster-in. The mustering officer, commissary, or assistant commissary of musters, as the case may be, will countersign both musters as having mustered the soldiers into the service of the United States before either of them is given to the disbursing officer.

DECLARATION OF RECRUIT.

I, Charles Carter desiring to volunteer as a soldier in the ARMY OF THE UNITED STATES, for the term of Three Years, DO DECLARE That I am 21 years and months of age; that I have never been discharged from the United States service on account of disability or by sentence of a court-martial, or by order before the expiration of a term of enlistment; and I know of no impediment to my serving honestly and faithfully as a soldier for three years.

GIVEN at Camp Nelson the 17 day of March 1865

Witness: [Signature]

Charles Carter
 Volunteered at Fort Sumter
March 9th 1865
Co. H 1st S.C. Artillery
Regt. 1st S.C. Artillery

Consent of Parent or Guardian in case of a Minor, if a Free Man, or in the case of a Slave, of the Person to whom he owes Service:

I, [Signature] Do CERTIFY, That I am the that the said is years of age; and I do freely give my CONSENT to his volunteering as a SOLDIER in the Army of the United States, for the period of THREE YEARS, under the conditions of the laws of the United States.

GIVEN at the day of

Witness:

Enlistment of 8 Dist

UNITED STATES COLORED TROOPS ENLISTMENT.

STATE OF

Kentucky



TOWN OF

*Courtyot
Es Hill*

I, *Charles Parks* born in *Louisiana*
in the State of *Kentucky* aged *Twenty two* years
and by occupation a *Farmer* Do HEREBY ACKNOWLEDGE to
have volunteered *Seventh* day of *March* 1865

to serve as a **Soldier** in the **Army of the United States of America**, for the
period of **THREE YEARS**, unless sooner discharged by proper authority: Do
also agree to accept such bounty, pay, rations, and clothing, as are, or may be,
established by law for the U. S. colored troops.

And I, *Charles Parks*
do solemnly swear that I will bear true faith and allegiance to the **United States
of America**, and that I will serve them honestly and faithfully against all their
enemies or opposers whomsoever; and that I will observe and obey the orders
of the President of the United States, and the orders of the officers appointed
over me, according to the Rules and Articles of War.

Sworn and subscribed to *Charles Parks*

this *7* day of *March* 1865

Before *Wm Randolph*

Charles Parks
mark

I CERTIFY, ON HONOR, That I have carefully examined the above named Volunteer agree-
ably to the General Regulations of the Army, and that, in my opinion, he is free from all bodily
defects and mental infirmity, which would in any way disqualify him from performing the
duties of a soldier.

C. H. Rice
EXAMINING SURGEON.
C. Parks

I CERTIFY, ON HONOR, That I have minutely inspected the Volunteer
previously to his enlistment, and that he was entirely sober when enlisted; that, to the best of
my judgment and belief, he is of lawful age; and that, in accepting him, as duly qualified to per-
form the duties of an able-bodied soldier, I have strictly observed the regulations which govern
the recruiting service. This soldier has *blue* eyes, *dark* hair, *fair* com-
plexion, is *five* feet *seven* inches high.

Wm Randolph
RECRUITING OFFICER OR AGENT.

Mustered into the United States Service *16* day of *March* 1865

Geo H Moore
Capt & Pro Mar 7 1865 Mustered Officer

..... Mustered into the service of the United States, for three years or during the war, from date of enlistment, in Company
..... Regiment of Volunteers, on the day of 1865, at

1032 or David
Parks Dued

Co L, 6 U. S. Col'd Cav.

Private Private

CARD NUMBERS.

1	5387523	26
2	5395998	27
3	5396078	28
4	5396158	29
5	5396239	30
6	5396319	31
7	5396396	32
8	5396468	33
9	9092905	34
10		35
11		36
12		37
13		38
14		39
15		40
16		41
17		42
18		43
19		44
20		45
21		46
22		47
23		48
24		49
25		50

Book Mark:

See also

6 Cav. U.S.C.T.

David Parker

Appears with rank of (Capt) on

Muster and Descriptive Roll of a Detachment of U. S. Vols. forwarded

for the 6 Reg't U. S. Col'd Cavalry. Roll dated Lexington Ky, June 3, 1865.

Where born Madison Co Ky

Age 35 y'rs; occupation Farmer

When enlisted May 29, 1865.

Where enlisted Camp Nelson Ky

For what period enlisted 3 years.

Eyes Blk; hair Blk

Complexion Brn; height ft. in.

When mustered in June 3, 1865.

Where mustered in Lexington Ky

Bounty paid \$ 100; due \$ 100

Where credited Madison Co 80 Ky

Company to which assigned

Remarks: (unclear)

Book mark:

Wiley

6 Cav. U.S.C.T.

L
Ima Harper

Pi, Co. *L*, 6 Reg't U. S. Col'd Cavalry.

Appears on

Company Muster-in and Descriptive Roll

of the organization named above? Roll dated

Camp Nelson, N. Y., June 9, 1865

Where born *Harrison Co. W. Va.*

Age *16* y'rs; occupation *Farmer*

When enlisted *May 29*, 1865.

Where enlisted *Camp Nelson*

For what period enlisted *3* years.

Eyes *Bl*; hair *Br*

Complexion *Br.*; height *5* ft. *6* in.

When mustered in *June 3*, 1865.

Where mustered in *Lexington*

Bounty paid \$ *100*; due \$ *100*

Where credited *Harrison Co. S. Dk*

Company to which assigned *L*

Remarks: *Let Mt. Bounty be*

Book mark: _____

(356d)

Henry J.
Copyist.

D | **6 Cav. U.S.C.T.**

Edward Parks
Private, Co. *G*, 6 Reg't U. S. Col'd Cav.

Appears on

Company Descriptive Book

of the organization named above.

DESCRIPTION.

Age *16* years; height *5* feet *6* inches.

Complexion *Brown*

Eyes *Bl*; hair *Blk*

Where born *Madison Co Ky*

Occupation *Farmer*

ENLISTMENT.

When *May 29*, 1865.

Where *Camp Nelson*

By whom *James Powell* term *3* y'rs.

Remarks:

Powell
Copyist.

6 Cav. U.S.C.T.

David Burke

Co. L, 6 Reg't U.S. Col'd Cavalry.

Appears on

Company Muster Roll

for June 9 to June 30, 1864.

Present or absent Absent

Stoppage, \$ 100 for

Due Gov't, \$ 100 for

Valuation of horse, \$ 100

Valuation of horse equipments, \$ 100

Remarks: Camp Nelson, Ky.

Book mark:

(358)

Henry J. Copyist.

P | **6 Cav.** | **U.S.C.T.**

David Parks

Tri, Co. L, 6 Reg't U. S. Col'd Cavalry.

Appears on

Company Muster Roll

for *July + Aug.*, 186*5*!

Present or absent *present*

Stoppage, \$ 100 for

Due Gov't, \$ 100 for

Valuation of horse, \$ 100

Valuation of horse equipments, \$ 100

Remarks:

Book mark:

(358)

Henry, Jr.
Copyist.

P | 6 Cav. | U.S.C.T.

David Parks

Pk, Co. L, 6 Reg't U.S. Col'd Cavalry.

Appears on

Company Muster Roll

for *Sept and Oct*, 1865.

Present or absent *Present*

Stoppage, \$ 100 for

Due Gov't, \$ 100 for

Valuation of horse, \$ 100

Valuation of horse equipments, \$ 100

Remarks:

Book mark:

(358)

Fair. Keamy
Copyist.

P

6 Cav.

U.S.C.T.

David Parks

Pk, Co. L, 6 Reg't U. S. Col'd Cavalry.

Appears on

Company Muster Roll

for *Nov and Dec*, 1865.

Present or absent *Present*

Stoppage, \$ 100 for

Due Gov't, \$ 95 for *C. & G. equipage.*

Valuation of horse, \$ 100

Valuation of horse equipments, \$ 100

Remarks:

Book mark:

(358)

Jas. V. Kearny
Copyist.

P | **6 Cav.** | **U.S.C.T.**

Durd Parks

Priv, Co. L, 6 Reg't U. S. Col'd Cavalry.

Appears on

Company Muster Roll

for *Jan'y & Feb*, 186*6*.

Present or absent *Present*

Stoppage, \$ *100* for

Due Gov't, \$ *34*/*100* for *Ordn*

Due Gov't. \$1.60 for C. C. & G. E.

Valuation of horse, \$ *100*

Valuation of horse equipments, \$ *100*

Remarks:

Book mark:

(358)

J. B. Gage

Copyist.

P

6 Cav. U.S.C.T.

Durd Parks

Pvt, Co. L, 6 Reg't U. S. Col'd Cavalry.

Appears on Co. Muster-out Roll, dated Devalls Bluffs, Ark, Apr 15, 1866.

Muster-out to date Apr. 15, 1866.

Last paid to Feby 28, 1866.

Clothing account:

Last settled, 186 ; drawn since \$ 100

Due soldier \$ 100; due U. S. \$ 49.⁰⁰/₁₀₀

Am't for cloth'g in kind or money adv'd \$ 100

Due U. S. for arms, equipments, &c., \$ 100

Bounty paid \$ 100; due \$ 100

Remarks:

Book mark:

(361)

J. B. Gage

Copyist.

Parks, Durd

, Co. , Reg't *1st C. Cav.*

² Enclosures.

Bed Cards	Final Statements
Burial Records	Furloughs or L. of A
Certs. of Dis. for Discharge	Med. Certificates
C. M. Charges	Med. Des. Lists
Descriptive Lists	Orders
Discharge Certificates	Pris. of War Record
Enlistment Papers ²	Resignations

Other papers relating to—

Admission to Hosp'l	Furlough or L. of A
Casualty Sheet	Med. Examination
Confinement	Misc. Information
Contracts	Pay or Clothing
Death or Effects	Personal Reports
Desertion	Rank
Discharge from Hosp'l	Transfer to Hosp'l
Discharge from Service	Transfer to V. R. C.
Duty	Transportation

NOTE 1.—This blank will be used for both enlistments and re-enlistments—enlistment of veterans, &c., &c., in the volunteer service. They will be made out in duplicate in all cases—one to accompany the recruiting return of the superintendent (not the recruiting officer) to the Adjutant General, and one to accompany the accounts of the officer who pays bounty, &c. The Regiment and Company in which the soldier last served should be given on the back.

NOTE 2.—An enlistment holds to service. A muster-in must, in all cases, precede payment of pay, bounty, pension, &c. A muster-in roll must, in all cases, be filed in the Adjutant General's Office as evidence of muster-in. The mustering officer, commissary, or assistant commissary of musters, as the case may be, will countersign both enlistments as having mustered the soldier into the service of the United States before either of them is given to the disbursing officer.

DECLARATION OF RECRUIT.

I, Durd Parks, desiring
 VOLUNTEER as a Soldier in the Army of the United States, for the term of THREE YEARS,
 Do Declare, That I am 16 years and _____ months
 of age; that I have never been discharged from the United States service on account of disability or by
 sentence of a court martial, or by order before the expiration of a term of enlistment; and I know of no
 impediment to my serving honestly and faithfully as a soldier for three years.

GIVEN at St. Nelson
 the 29 day of May 1865
 Witness: Durd Parks

Frank

Discharged _____, 1865

Reg't of _____

enlistment; last served in Company ()

6th M S C Bn

By James Powell
 Regiment of A Y E C

Volunteered at Camp Seabury
29th Aug, 1865

No. 111

Durd Parks (color)

CONSENT, IN CASE OF MINOR.

I, John Parks (Madison), Do CERTIFY, That I am
 the _____ of _____; that the
 said _____ is _____ years of age; and I
 do hereby freely give my CONSENT to his volunteering as a SOLDIER in the ARMY OF THE UNITED STATES
 for the period of THREE YEARS.

GIVEN at _____
 the _____ day of _____

Witness: _____

Credited to Madison Co & Dky

VOLUNTEER ENLISTMENT.

STATE OF

TOWN OF

Ky

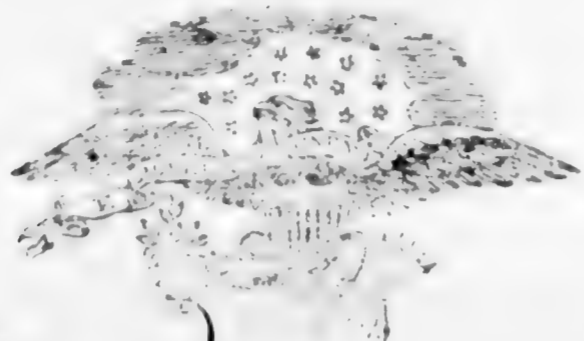

I, Quard Parks, born in Madison Co, in the State of Ky, aged 16 years, and by occupation a Farmer, Do HEREBY ACKNOWLEDGE to have volunteered this 29 day of May, 1865, to serve as a **Soldier** in the **Army of the United States of America**, for the period of **THREE YEARS**, unless sooner discharged by proper authority: Do also agree to accept such bounty, pay, rations, and clothing, as are, or may be, established by law for volunteers. And I, Quard Parks, do solemnly swear, that I will bear true faith and allegiance to the **United States of America**, and that I will serve them honestly and faithfully against all their enemies or opposers whomsoever; and that I will observe and obey the orders of the President of the United States, and the orders of the officers appointed over me, according to the Rules and Articles of War.

Sworn and subscribed to, at Cp Nelson Ky this 29 day of May, 1865, Quard Parks BEFORE St James Powell 6 Wfce Mark

I CERTIFY, ON HONOR, that I have carefully examined the above-named Volunteer, agreeably to the General Regulations of the Army, and that, in my opinion, he is free from all bodily defects and mental infirmity, which would in any way disqualify him from performing the duties of a soldier.

Stewart Cowper
Act Asst Surg 6th U.S.C.C.
EXAMINING SURGEON.

I CERTIFY, ON HONOR, That I have minutely inspected the Volunteer D Parks previously to his enlistment, and that he was entirely sober when enlisted; that, to the best of my judgment and belief, he is of lawful age; and that, in accepting him as duly qualified to perform the duties of an able-bodied soldier, I have strictly observed the Regulations which govern the recruiting service. This soldier has Blk eyes, Blk hair, Blk complexion, is five feet 6 inches high.

St James Powell
6 Regiment of Wfce Volunteers,
RECRUITING OFFICER.

Certificate for the Signature of the Mustering Officer, Commissary, or Assistant Commissary of Musters, as the case may be.
Mustered into the service of the United States, for three years or during the war, from date of enlistment, in Co. 6th Regiment of W.C. Cav Volunteers, on the 3 day of June, 1865, at Lexington Ky and credited to Ward, (or Sub-district,) in the Town of Ward, in the County of Ward, in the State of Ward th Congressional District, in the State of Ward
Bounty paid at time of Muster-in: W.C. Cav
T. S. Bounty, W.C. Cav
Local Bounty, W.C. Cav
McWilliam
Capt & Pro Marshal
Mustering Officer

NOTE 1.—This blank will be used for enlistments of United States colored troops. They will be made out in duplicate in all cases—one to accompany the recruiting return of the superintendent (not the recruiting officer) to the Adjutant General, and one to accompany the accounts of the officer who pays bounty, &c.

NOTE 2.—An enlistment holds to service. A muster-in must, in all cases, precede payment of pay, bounty, pension, &c. A muster-in roll, must in all cases, be filed in the Adjutant General's Office as evidence of muster-in. The mustering officer, commissary, or assistant commissary of musters, as the case may be, will countersign both enlistments as having mustered the soldiers into the service of the United States before either of them is given to the disbursing officer.

DECLARATION OF RECRUIT.

I, Durd Parks desiring to volunteer as a soldier in the ARMY OF THE UNITED STATES, for the term of Three Years, DO DECLARE That I am 16 years and _____ months of age; that I have never been discharged from the United States service on account of disability or by sentence of a court-martial, or by order before the expiration of a term of enlistment; and I know of no impediment to my serving honestly and faithfully as a soldier for three years.

GIVEN at G. Nelson the 29 day of May 1865

Witness:

Durd Parks ^{his} mark

By

Volunteered at

No.

18

Consent of Parent or Guardian in case of a Minor, if a Free Man, or in the case of a Slave, of the Person to whom he gives Service:

I, John Parks (Madison Co) DO CERTIFY, That I am the _____

that the said _____ is _____ years of age; and I do freely give my CONSENT to his volunteering as a SOLDIER in the Army of the United States, for the period of THREE YEARS, under the conditions of the laws of the United States.

GIVEN at _____ the _____ day of _____

Witness:

Credited to Madison Co D 10

UNITED STATES COLORED TROOPS ENLISTMENT.

STATE OF



TOWN OF

I, *Durd Parks* born in *Madison Co*
in the State of *Mo* aged *16* years
and by occupation a *Farmer* Do HEREBY ACKNOWLEDGE to
have volunteered *29* day of *May* 186*5*
to serve as a **Soldier** in the **Army of the United States of America**, for the
period of **THREE YEARS**, unless sooner discharged by proper authority: Do
also agree to accept such bounty, pay, rations, and clothing, as are, or may be,
established by law for the U. S. colored troops.

And I, *Durd Parks*
do solemnly swear that I will bear true faith and allegiance to the **United States
of America**, and that I will serve them honestly and faithfully against all their
enemies or opposers whomsoever; and that I will observe and obey the orders
of the President of the United States, and the orders of the officers appointed
over me, according to the Rules and Articles of War.

Sworn and subscribed to, at *St. James* } *his*
this *29* day of *May 1865* } *Durd X Parks*
Before *St. James Powell* } *mark*
6 ofcc

I CERTIFY, ON HONOR, That I have carefully examined the above named Volunteer agree-
ably to the General Regulations of the Army, and that, in my opinion, he is free from all bodily
defects and mental infirmity, which would in any way disqualify him from performing the
duties of a soldier.

Stewart Cooper
Act Adjt Surg 6th U.S.C.C. EXAMINING SURGEON.

I CERTIFY, ON HONOR, That I have minutely inspected the Volunteer *D Parks*
previously to his enlistment, and that he was entirely sober when enlisted; that, to the best of
my judgment and belief, he is of lawful age; and that, in accepting him, as duly qualified to per-
form the duties of an able-bodied soldier, I have strictly observed the regulations which govern
the recruiting service. This soldier has *blue* eyes, *blue* hair, *blue* com-
plexion, is *five* feet *6* inches high.

St. James Powell
6 ofcc RECRUITING OFFICER OR AGENT.

Mustered into the United States Service.....day of186 .

Mustering Officer.

Mustered into the service of the United States, for three years or during the war, from date of enlistment, in Company
6 Regiment of *Col Cav* Volunteers, on the *3* day of *June* 186*5*, at *Levinburg*

Capital & Co
Levinburg
June 10 1865
St. James Powell

1033
Parke Joseph

Co E., 6 U. S. Col'd Cav.

Private

Private

CARD NUMBERS.

1	5387979	26
2	5392056	27
3	5392153	28
4	5392249	29
5	5392344	30
6	5392430	31
7	9093349	32
8	40732704	33
9		34
10		35
11		36
12		37
13		38
14		39
15		40
16		41
17		42
18		43
19		44
20		45
21		46
22		47
23		48
24		49
25		50

Book Mark:

See also 120 U. S. C. I.

S. 149962 B P. E. 20191111
S. 1654395 P.O. aff
P. 20191111

L. Jordan
L

6 Cav. U.S.C.T.

Joseph Parks

Co. B, 6 Reg't U. S. Col'd Cav.

Appears on

Company Descriptive Book

of the organization named above.

DESCRIPTION.

Age 22 years; height 5 feet 7 inches.

Complexion black

Eyes black; hair black

Where born Ohio, Ky

Occupation Farmer

ENLISTMENT.

When April 12, 1865.

Where Hartford

By whom S. J. Andrews, term 3 y'rs.

Remarks:

Murdered May 12/65, Owens-borrow, Capt. Garrison

C. G. Powell

P. C. Co. U.S.C.T.

Joseph Parks
Co., 6 Reg't U. S. Col'd

Appears on a

Detachment Muster Roll

Washington Regiment
of the organization named above

for June 10 to 30, 1865.

Station Camp Nelson Ky

Present or absent Present

Stoppage, \$ 100 for

Due Gov't, \$ 100 for

Valuation of horse, \$ 100

Valuation of horse equipments, \$ 100

Remarks: Transferred from 120 US 62
1st - Kentucky Ave

Transferred to 120 US 62
Camp Nelson June 10 - 1865

Book mark:

L. B. Sawyer

(357)

Copyist.

P

6 Cav. U.S.C.T.

Joseph Parks
Cvt

Co. E, 6 Reg't U. S. Col'd Cav.

Appears on

Company Muster Roll

for July and Aug, 1865.

Present or absent Present

Stoppage, \$ 100 for

Due Gov't, \$ 100 for

Valuation of horse, \$ 100

Valuation of horse equipments, \$ 100

Remarks: 1st Installment
of bounty due \$, 50
Transferred from 120 N.S.
Inf per S.O. 120 H. I. I.
of Louisville June 21, 1865

Book mark:

A. M. Calhoun

(358)

Copyist.

P | **6 Cav.** | **U.S.C.T.**

Joseph Parks
Priv, Co. E, 6 Reg't U. S. Col'd Cav.

Appears on

Company Muster Roll

for *Sept and Oct*, 186*5*.

Present or absent *Present*

Stoppage, \$ *100* for

Due Gov't, \$ *100* for

Valuation of horse, \$ *100*

Valuation of horse equipments, \$ *100*

Remarks:

Book mark:

(358)

A. M. Calhoun

Copyist.

P

6 Cav. U.S.C.T.

Joseph Parker
Private, Co. E, 6 Reg't U. S. Col'd Cav.

Appears on

Company Muster Roll

for November & Dec, 1865.

Present or absent Present

Stoppage, \$ 100 for

Due Gov't, \$ 100 for

Valuation of horse, \$ 100

Valuation of horse equipments, \$ 100

Remarks:

Book mark:

(358)

M. Callow

Copyist.

6 Cav. U.S.C.T.

John H. Smith
.....
John H. Smith, Co. E, 6 Reg't U. S. Col'd Cav.

Appears on

Company Muster Roll

for *September 1864*, 1864.

Present or absent *Present*

Stoppage, \$ *100* for

Due Gov't, \$ *100* for

Valuation of horse, \$ *100*

Valuation of horse equipments, \$ *100*

Remarks:

Book mark:

(358)

John H. Smith
.....
Copyist.

J.P. | **6 Cav.** | **U.S.C.T.**

Joseph Parks
Pvt, Co. *E*, 6 Reg't U. S. Col'd Cav.

Appears on Returns as follows:

June 1865, Quin June 27, 65,
Camp Nelson Ky,
Transferred from 120,
U S C Inf. by order
of the Secretary of War
S.O. No 29. signed
L Thomas Lieut Genl,

July 1865, Quin July 13, 65
Cp. Nelson, Transferred
from 120, U S C Inf,
in compliance with S.O.
No 105, Hd Qrs. Dept.
of Ky, dated Louisville
Ky, June 21, 1865,

Book mark:

C. M. Row

6 Cav. U.S.C.T.

Joseph Winters

, Co. *E*, 6 Reg't U. S. Col'd Cavalry.

Appears on **Co. Muster-out Roll**, dated

Henrietta Buffards, *Apr 15*, 186*6*.

Muster-out to date *Apr 15*, 186*6*.

Last paid to *Feb 28*, 186*6*.

Clothing account:

Last settled , 186*6* ; drawn since \$ *100*

Due soldier \$ *6*^{*51*} *100*; due U. S. \$ *100*

Am't for cloth'g in kind or money adv'd \$ *100*

Due U. S. for arms, equipments, &c., \$ *74*/*100*

Bounty paid \$ *100* *100*; due \$ *100*

Remarks: *Stop page for camp, provision*

Equipage 74⁰⁰

Book mark:

1034

Palmer Wesley

Co I, 6 U. S. Col'd Cav.

Private

Private

CARD NUMBERS..

1	26
2	27
3	28
4	29
5	30
6	31
7	32
8	33
9	34
10	35
11	36
12	37
13	38
14	39
15	40
16	41
17	42
18	43
19	44
20	45
21	46
22	47
23	48
24	49
25	50

See Palmer Wesley

Book Mark:

See also

-1035

Parrish Edward

Co *I*, **6** U. S. Col'd Cav.

Private | *Private*

CARD NUMBERS.

1	5387802	26
2	5387775	27
3	5394792	28
4	5394880	29
5	5394964	30
6	5395043	31
7	5395123	32
8	5388094	33
9	5395214	34
10	5395352	35
11	9093924	36
12	40732705	37
13		38
14		39
15		40
16		41
17		42
18		43
19		44
20		45
21		46
22		47
23		48
24		49
25		50

Book Mark:

See also

S-727681-0090

57579/Procurer

81640095

81663926

Jordan
Ex

P | **6 Cav. | U.S.C.T.**

Edward Parrish

....., Co. *P*....., 6 Reg't U. S. Col'd Cav.

Appears on

Company Descriptive Book

of the organization named above.

DESCRIPTION.

Age *30* years; height *5* feet *8 3/4* inches.

Complexion *Brown*

Eyes *Brown*; hair *Blk*

Where born *Barnes Co Ky*

Occupation *Farmer*

ENLISTMENT.

When *Sept, 20*, 18*64*.

Where *Bowl. Green Ky*

By whom *B. D. Ky*; term *1* y'rs.

Remarks: *Drafted, reported April 7/65 Credited 11 3 2 Ky*

Parrish
Coptist.

P

6 Cav. U.S.C.T.

Edward Parish

Privt. Co. I., 6 Reg't U. S. Col'd Cavalry.

Appears on

Company Muster-in and Descriptive Roll

of the organization named above. Roll dated

Camp. Nelson Ky. Apl 29, 1865.

Where born *Barren Co. Ky.*

Age *30* y'rs; occupation *Farmer.*

When enlisted _____, 186 .

Where enlisted *Drafted.*

For what period enlisted *1* years.

Eyes *Bro.*; hair *Blk.*

Complexion *Bro.*; height *5 ft. 8 3/4 in.*

When mustered in *Sept. 26, 1864.*

Where mustered in *Bowling Green Ky.*

Bounty paid \$ *none pd.* 100; due \$ 100

Where credited *3 Dist Ky.*

Company to which assigned *I.*

Remarks:

Book mark:

D. M. Kennedy

(356d)

Copyist.

P | 6 | U.S.C.T.

Edward Parrish

Appears with rank of *Pvt* on

Muster and Descriptive Roll of a Detachment of Substitutes forwarded

for the *6* Reg't U. S. Col'd Cavalry. Roll dated

Draft Rendezvous, Louisville, Ky, April 12, 1865.

Where born *Barren Kentucky*

Age *30* y'rs; occupation *Farmer*

When enlisted _____, 186 .

Where enlisted *Drafted*

For what period enlisted _____ *1* years.

Eyes *Brown*; hair *Black*

Complexion *Brown*; height *5* ft. *8 3/4* in.

When mustered in *Sept. 26*, 1864.

Where mustered in *Bowling Green*

Bounty paid \$ *100*; due \$ *100*

Where credited *3^d Dist. Ky.*

Company to which assigned _____

Remarks : _____

Book mark : _____

P | 6 | **U.S.C.T.**

Edward Parish

Appears with rank of Pvt. on

Muster and Descriptive Roll of a Detachment of Substitutes forwarded

for the 6 Reg't U. S. Col'd heavy. Roll dated Draft Rendezvous Louisville, Ky., April 12, 1865.

Where born Barren Kentucky

Age 30 y'rs; occupation Farmer

When enlisted _____, 1865.

Where enlisted Drafted

For what period enlisted _____ 1 years.

Eyes Brown; hair Blk

Complexion Brown; height 5 ft. 8 3/4 in.

When mustered in Sept. 26, 1864.

Where mustered in Bowling Green 3^d Dist. Ky.

Bounty paid \$ 100; due \$ 100

Where credited 3^d Dist. Ky.

Company to which assigned _____

Remarks : _____

Book mark : _____

(339c)

Leonard

Copyist.

P *6 Col'd Cav* | **U.S.C.T.**

Edward Farnum
Pri, Co. *A*, *6* Reg't U. S. Col'd *Cav*

Appears on a

Detachment Muster-out Roll

of the organization named above. Roll dated

Lexington Ky, *Oct 19*, 1865.

Muster-out to date *Oct 19*, 1865.

Last paid to *June 30*, 1865.

Clothing account:

Last settled....., 186 ; drawn since \$..... 100

Due soldier \$..... 100; due U. S. \$ *13* ^{*65*}/₁₀₀

Am't for cloth'g in kind or money adv'd \$..... 100

Due U. S. for arms, equipments, &c., \$..... 100

Bounty paid \$..... 100; due \$..... 100

Remarks: *Stop pay for Feb*
G. E. 99. Indebted to F. B
Stuller, sutler \$2.00
Drawn paid. Mustered out by
was on expiration of term
of service
Discharge furnished.

Book mark:

Holbrook

P

6 Cav. U.S.C.T.

Edward Parrish

Privt, Co. I, 6 Reg't U. S. Col'd Cavalry.

Appears on

Company Muster Roll

for *Enrolment to Apl. 30, 1865.*

Present or absent *Present*

Stoppage, \$ *100* for

Due Gov't, \$ *100* for

Valuation of horse, \$ *100*

Valuation of horse equipments, \$ *100*

Remarks: *1 "Instalment County due"*

Book mark:

D. M. Kennedy

(358)

Copyist.

P

6 Cav. | U.S.C.T.

Edward Parrish

Privt, Co. I, 6 Reg't U. S. Col'd Cavalry.

Appears on

Company Muster Roll

for *May v. June*, 1865.

Present or absent *Present*

Stoppage, \$ *100* for

Due Gov't, \$ *100* for

Valuation of horse, \$ *100*

Valuation of horse equipments, \$ *100*

Remarks: *Reported Apr. 27 " 1865*

Book mark:

(358)

D. M. Kennedy
Spyist.

P.

6 Cav. | U.S.C.T.

Edward Parrish

Privt, Co. I, 6 Reg't U. S. Col'd Cavalry.

Appears on

Company Muster Roll

for *July & Aug*, 186*7*.

Present or absent *Present*.

Stoppage, \$ *100* for

Due Gov't, \$ *100* for

Valuation of horse, \$ *100*

Valuation of horse equipments, \$ *100*

Remarks: *Reported Apr. 7/67*

Book mark:

(358)

J. G. Casey

Copyist.

2 | **6 Cav.** | **U.S.C.T.**

Edwin P. French

Private, Co. I, 6 Reg't U. S. Col'd Cavalry.

Appears on

Company Muster Roll

for Sept + Oct, 1867.

Present or absent absent

Stoppage, \$ 100 for

Due Gov't, \$ 100 for

Valuation of horse, \$ 100

Valuation of horse equipments, \$ 100

Remarks: Sent to Sizing up, by
Set. 18th 65, for musters & muster
Descriptive Roll sent

Book mark: _____

(358)

J. W. Casey

Copyist.

2

6 Cav. U.S.C.T.

Edward Parrish

Private, Co. I, 6 Reg't U. S. Col'd Cavalry.

Appears on

Company Muster Roll

for *Nov & Dec*, 1865.

Present or absent

Stoppage, \$ 100 for

Due Gov't, \$ 100 for

Valuation of horse, \$ 100

Valuation of horse equipments, \$ 100

Remarks: *Mustered out by reason of expiration of term of service Oct. 7/65.*

Book mark: *5*

(358)

J. B. Casey

Copyist.

P | **6 Cav.** | **U.S.C.T.**

Ed Parrish
Priv, Co. *I*, 6 Reg't U. S. Col'd Cav.

Appears on Returns as follows:

Oct 1865, Absent,
Sent to Lexington Ky,
Oct 18/65, for muster
Out of service.

Nov 1865, Lost. Oct 19. 65;
Lexington Ky. Mustered
out of service.

Book mark:

O. M. Row

(546)

Copyist.

J.

6 Cav. U.S.C.T.

Edward Talish

Co. C, Co. *C*, 6 Reg't U. S. Col'd Cavalry.

Appears on **Co. Muster-out Roll**, dated

Several Buffs Act, April 13, 1866.

Muster-out to date _____, 186 .

Last paid to _____, 186 .

Clothing account:

Last settled _____, 186 ; drawn since \$ _____ 100

Due soldier \$ _____ 100; due U. S. \$ _____ 100

Am't for cloth'g in kind or money adv'd \$ _____ 100

Due U. S. for arms, equipments, &c., \$ _____ 100

Bounty paid \$ _____ 100; due \$ _____ 100

Remarks: *Mustered out by*

reason of expiration

of term of service

Sept 14 65.

Book mark: _____

W. Stearns

(861)

Copyist.

Farrish Henry

Co. D., 6 U.S. Col'd Cav.

Private | *Private*

CARD NUMBERS.

1	5389262	26
2	5389337	27
3	5389427	28
4	5389498	29
5	5389563	30
6	5389653	31
7	5389749	32
8	5389841	33
9	5389931	34
10	5390024	35
11	9092913	36
12	40732701	37
12	40902842	38
14	32130390	39
15	32129366	40
16	32129390	41
17		42
18		43
19		44
20		45
21		46
22		47
23		48
24		49
25		50

Book Mark:

See also

S 195 0794 POWAN

D. Jordan
ex

D | **6 Cav. | U.S.C.T.**

Henry Parish

....., Co. *D*, 6 Reg't U. S. Col'd Cav.

Appears on

Company Descriptive Book

of the organization named above.

DESCRIPTION.

Age *24* years; height *5* feet *4 1/2* inches.

Complexion *Sh Brown*

Eyes *Black*; hair *Blk*

Where born *Barren Ky*

Occupation *Farmer*

ENLISTMENT.

When *July 25*, 18*64*.

Where *Bowling Green Ky*

By whom *Capt Hobson*; term *3* y'rs.

Remarks:

.....

.....

.....

.....

.....

.....

.....

.....

.....

Bryer

(383g)

Copyist.

P 6 Cav. U.S.C.T.

Henry Parrish
Privat, Co. B, 6 Reg't U. S. Col'd Cavalry.

Appears on

Company Muster-in and Descriptive Roll
of the organization named above. Roll dated

Camp Nelson, Ky. Nov 1st, 1864.

Where born *Barraco, Ky.*

Age *24* y'rs; occupation *Farmer*

When enlisted *July 25*, 1864.

Where enlisted *Bowling Green Ky.*

For what period enlisted *3* years.

Eyes *Blk*; hair *Blk*

Complexion *R. Brown*; height *5* ft. *4 1/2* in.

When mustered in *July 25*, 1864.

Where mustered in *Bowling Green Ky.*

Bounty paid \$ *100*; due \$ *100*

Where credited *Barraco, 3rd Dist, Ky.*

Company to which assigned

Remarks *Transferred from Co. A.*

115th U.S. C. I, para 50, No. 39, dated

June 10/65, Washington D.C.,

signed L. Thomas Lt. Col.

(over)

Book mark:

C. M. Row

(356d)

Copyist.

JAN. 10

5389262

1891

(Owner
Mills Parvish,

P | **6 Cav. U.S.C.T.**

Henry Parrish
Privet, Co. B, 6 Reg't U. S. Col'd Cavalry.

Appears on

Company Muster Roll

for *Nov & Dec*, 186*4*.

Present or absent *Present*

Stoppage, \$ *100* for

Due Gov't, \$ *100* for

Valuation of horse, \$ *100*

Valuation of horse equipments, \$ *100*

Remarks: _____

Book mark: _____

(358)

M. Row
Copyist.

P 6 Cav. U.S.C.T.

Henry Parish
Privat, Co. B, 6 Reg't U. S. Col'd Cavalry.

Appears on

Company Muster Roll

for Jan & Feb, 1863.

Present or absent Absent.

Stoppage, \$ 100 for

Due Gov't, \$ 100 for

Valuation of horse, \$ 100

Valuation of horse equipments, \$ 100

Remarks: 1st installment bounty
due \$100, Det'd N. Haven,
Ky Feb. 15, 1863.

Book mark:

[Signature]

(358)

Copyist.

P | 6 Cav. | U.S.C.T.

Henry Parish
Private, Co. B, 6 Reg't U. S. Col'd Cavalry.

Appears on

Company Muster Roll

for *March & April*, 1865.

Present or absent *Absent*

Stoppage, \$ _____ 100 for _____

Due Gov't, \$ _____ 100 for _____

Valuation of horse, \$ _____ 100

Valuation of horse equipments, \$ _____ 100

Remarks: *1st installment bounty
due \$100, Det. Ser, New
Haven Ky, Feb, 15, 1865,*

Book mark: _____

(358)

M. Howe

Copist.

D. W. C. Case 1 11564

Henry Parish
Pvt., Co. B, 6 Reg't US Col

Appears on

Hospital Muster Roll

of Branch No. 2 Eruptive U. S. A. General Hospital,

at **Louisville, Ky.,**

for *March and April, 1865*

Attached to hospital :

When _____, 186 .

How employed _____

Last paid by Maj. _____

to _____, 186 .

Bounty paid \$ *100* ; due \$ *100*

Present or absent *Present*

Remarks : _____

(343)

Casey

Copyist.

P | **6 Cav. U.S.C.T.**

Henry Parrish
Pot., Co. B, 6 Reg't U. S. Col'd Cavalry.

Appears on

Company Muster Roll
for *May & June*, 1865.

Present or absent *absent*

Stoppage, \$ *100* for

Due Gov't, \$ *100* for

Valuation of horse, \$ *100*

Valuation of horse equipments, \$ *100*

Remarks: *Sick in Hoapl Louisville Ky
Apr 15, 65 Descript list furnished*

Book mark: _____

(358)

J. E. Harper
Copyist.

P | 6 Cav US CJ

Henry Parish
Pt. B. 6 Reg't U.S.C.

Appears on
Hospital Muster Roll

of Erective U. S. A. General Hospital,

at Louisville, Ky.,

for *May & June*, 186*5*.

Attached to hospital:

When _____, 186 .

How employed _____

Last paid by Maj. *Pay due from*
to *enlistment*, 186 .

Bounty paid \$ ~~100~~; due \$ *100* 100

Present or absent *Present*

Remarks:

Book mark: _____

Nowlin

6 Cav. U.S.C.T.

Jerry Parrish
Priv, Co. B, 6 Reg't U. S. Col'd Cavalry.

Appears on

Company Muster Roll

for *July & Aug*, 186*5*.

Present or absent *absent*

Stoppage, \$ *100* for

Due Gov't, \$ *100* for

Valuation of horse, \$ *100*

Valuation of horse equipments, \$ *100*

Remarks: *in Hospital*
Poussville, Mo
12.15/65. Receipt
list furnished.

Book mark:

(358)

F. S. Harper
Copyist.

P | *Claw* *U.S.*
Henry Parish
Rt. Co. B. C. Reg't U.S.C.

Appears on

Hospital Muster Roll

of **Eruptive U. S. A. General Hospital,**

at **Louisville, Ky.,**

for *July* *1865*, 186 *5*.

Attached to hospital :

When, 186 .

How employed

Last paid by Maj. *Pay due*

to *Government*, 186 .

Bounty paid \$ *100* due \$ *100* 100

Present or absent *Present*

Remarks:

.....

.....

.....

.....

.....

.....

.....

.....

.....

.....

.....

.....

.....

.....

.....

.....

.....

.....

.....

.....

.....

B **6 Cav. U.S.C.T.**

Henry Parrish
Det., Co. B, 6 Reg't U. S. Col'd Cavalry.

Appears on

Company Muster Roll
for *Sept & Oct*, 1865.

Present or absent *present*

Stoppage, \$ *100* for

Due Gov't, \$ *100* for

Valuation of horse, \$ *100*

Valuation of horse equipments, \$ *100*

Remarks: *Disbanded*
Account due \$ 00.

Book mark:

H. C. Farson
Copyist.

P | **6 Cav.** | **U.S.C.T.**

Henry Parish
Pvt., Co. B, 6 Reg't U. S. Col'd Cavalry.

Appears on

Company Muster Roll

for *Nov & Dec*, 186*2*

Present or absent *Present*

Stoppage, \$ *100* for

Due Gov't, \$ *100* for

Valuation of horse, \$ *100*

Valuation of horse equipments, \$ *100*

Remarks:

Book mark:

J. W. Ames
(358) Copyist.

9 | **6 Cav. U.S.C.T.**

Henry Parish
Pvt., Co. B, 6 Reg't U. S. Col'd Cavalry.

Appears on

Company Muster Roll
for *Jan'y & Feby*, 186*6*.
Present or absent *Present*

Stoppage, \$ *100* for

Due Gov't, \$ *100* for

Valuation of horse, \$ *100*

Valuation of horse equipments, \$ *100*

Remarks:

Book mark:

J. W. Jones
(358) *Compt.*

P | 6 Cav. | U.S.C.T.

Henry Parrish
Pot., Co. B., 6 Reg't U. S. Col'd Cav.

Appears on Returns as follows:

Feb'y to April 1865; Absent
Detached service, New
Haven N.Y. Feb 15th 65;

May & June 1865; Absent
Sick in Hospital New
Albany Ind. April 8/65;

July & Aug 1865; Absent
Sick in Hosp'l Louisville
Ky. since April 15/65;

Book mark:

A. M. Row

(546)

Copyist.

P

115

U.S.C.T.

Henry Parrish,
Private, Co. A, 115 Reg't U. S. Colored Inf.

Appears on Returns as follows:

Aug. 1864 - Loss; Aug. 26/64
Bowling Green, transferred.

Book mark:

(546)

J. T. Muelay

Copyist.

7 **6 Cav. U.S.C.T.**

Henry Parish

Prf, Co. *B*, 6 Reg't U. S. Col'd Cavalry.

Appears on **Co. Muster-out Roll**, dated

DeWalls Bluff Ark Apr 15, 1866.

Muster-out to date

Apr 15, 1866.

Last paid to

July 28, 1866.

Clothing account:

Last settled _____, 186 ; drawn since \$ _____ 100

Due soldier \$ _____ 100; due U. S. \$ _____ 100

Am't for cloth'g in kind or money adv'd \$ *52* 18 100

Due U. S. for arms, equipments, &c., \$ _____ 100

Bounty paid \$ *100* 100; due \$ *100* 100

Remarks:

Book mark: *V. 162. P. 116. 73.*

(361)

J. W. Ames

Copyist.

Parrish, Henry
P, Co. B, 6 U.S.C. Reg't

Enclosures.

- | | |
|------------------------------|-------------------|
| Bed Cards | Descriptive Lists |
| Burial Records | Final Statements |
| Certs. of Dis. for Discharge | Furloughs |
| C. M. Charges | Med. Des. Lists |
| Med. Certificates | Orders |

Other papers relating to—

- | | |
|----------------------------|----------------------|
| Admission to Hosp'l | Furlough |
| Casualty Sheet (Officer's) | Med. Examination |
| Confinement | Misc. Information |
| Contracts | Pay or Clothing |
| Death or Effects | Personal Reports |
| Desertions | Rank |
| Discharge from Hosp'l | Transfer to Hosp'l |
| Discharge from Service | Transfer to V. R. C. |
| Duty | Transportation |

War Department,

ADJUTANT GENERAL'S OFFICE.

Washington, *March 4* 1867.

Respectfully returned to the
Commission for the State of
Kentucky, with the informa-

tion that *Henry Parrish*
was enlisted at Bowling Green Ky
July 25, 1864 and was
mustered in as *ser.* in *Co. B*
6th U. S. Colored *July 25/64.*

1854-55

A. J. R. [Signature]

A. J. R.

Asst. Adj't General.

ENDORSEMENT.

No. 13

APPLICATION OF

Henry Parrish

OF

Henry Parrish

For compensation of service of slave.

Henry Parrish

Enlisted

186

in *B* Co. *6th Cavalry* Regiment
U. S. Colored Troops.

Received

24 Jan'y

1867

Compensation awarded

186

Dollars.

President Board of Claims.

CLAIMANT'S ATTORNEYS,

J. W. CARDWELL & CO.,

LOUISVILLE, KY.

CLAIMANT'S P. O. ADDRESS,

CLAIM FOR COMPENSATION FOR ENLISTED SLAVE.

No. _____

I, B. Mills Parrish, a loyal citizen, and
a resident of _____ County of Shannon State of _____

hereby claim compensation, under the provisions of
section 24, Act approved February 24, 1864, and Section 2, Act approved July 28, 1866, for my

slave Henry Parrish enlisted⁶

186 _____ at _____ by⁸

in the 6th _____ Regiment U. S. Colored Troops,

Co.¹⁰ B certificate of enlistment, and a descriptive list, as required, accompany
this application.

In proof of my loyalty to the Constitution and Government of the United States, I present
the accompanying oath, which I have taken, signed and acknowledged; to be filed with this
application, in accordance with requirement of General Orders, No. 329, 1863, War Department,
Adjutant General's Office.

Witness: B. Mills Parrish Applicant.

Henry G. Parrish
George W. Parrish } Two witnesses to
owner's signature
sign here.

186 _____

OATH OF ALLEGIANCE.

I, B. Mills Parrish, the owner and claimant, do solemnly swear that the foregoing
claim is a just and true claim due to me as master and owner of the said slave, and that the facts alleged in said claim, in respect to the
draft or enlistment (as the case may be) of said slave into the military service of the United States, are true. And I do further swear that I
have never joined, or been concerned in, any insurrection or rebellion; that I have never borne arms against the United States; that I have
never given any aid, countenance, counsel or encouragement, to any person or persons engaged, or whom I had reason to believe were about to
engage, in insurrection, rebellion, or armed hostility against the United States; that I have neither sought, nor accepted, nor attempted to
exercise the functions of any office, civil or military, nor to perform any service whatever, under any authority, or pretended authority, in
hostility to the United States; that I have not yielded a voluntary support to any insurrection, rebellion, or pretended government
authority, power or constitution within the United States hostile thereto. And I do further swear that, to the best of my knowledge and
ability, I have supported and defended, and will continue to support and defend, the United States against all enemies foreign and domestic;
and that I have supported, defended and obeyed, and will continue to support, defend and obey, the Constitution and laws of the United States;
that I will bear true faith and allegiance to the same; and that I take this oath freely, without any mental reservation or purpose of
evasion: So help me God.

5 CENT STAMP. The owner } B. Mills Parrish
signs here. }

Sworn to and subscribed before me W. L. Lasley



this fifth day of January 186 _____

The officer swear- } W. L. Lasley
ing the owner signs }
here. } Police Judge Horse Cave Hart County Ky } L.S.

POWER OF ATTORNEY.

My Post Office address is Horse Cave County of Hart State _____

of Kentucky, and I hereby direct that all communications to me, touching this claim, may be sent under cover to

_____ who is hereby appointed and constituted my true and lawful attorney, to prose-

cute this claim for me, and who is hereby authorized and empowered to receive and receipt for any award, order, draft, certificate, voucher,
warrant, papers, or money that may be issued in the adjustment of this claim, or the payment thereof, the same as I might or could do in
person were I present and acting for myself, and to file any additional evidence or papers that may be required in the prosecution of this
claim.

Witness: Henry G. Parrish The owner } B. Mills Parrish
signs here. }

50 CENT STAMP. George W. Parrish } Two witnesses to
owner's signature
sign here.



DIRECTIONS FOR FILLING UP THE ABOVE BLANKS.

1. Name of claimant; his name must be given in full, and he must be the owner, in his own right, of the slave claimed at the time he
was mustered into the United States service, and the time application is made.
 2. Name of city or town in which claimant lives.
 3. Name of county in which claimant lives.
 4. Name of State in which claimant lives.
 5. Name of slave for whom compensation is claimed.
 6. Date of his enlistment.
 7. Where he enlisted.
 8. By whom he was enlisted.
 9. Number of Regiment to which he was assigned.
 10. Letter of Company he served in.
- Note.—Where there is a doubt as to the fact stated in a blank, do not fill the blank.

I Henry Garrison late a private in Company D
 6th Regiment, United States Colored Cavalry, do hereby state under oath
 that before and at the time of being mustered into the United States Service I was the slave
 of Wm. Garrison of Barren County, State of Kentucky.

That I am personally acquainted with _____, late a
 _____ in Company _____ of _____ Regiment United States Colored
 _____, and know that before and at the time he was mustered
 into the United States Service, he was the slave of _____
 of _____ County, State of Kentucky.

ATTEST:

W. C. Lafferty
 Town Clerk

Henry Garrison
 mark

Sworn to, and subscribed in my presence,

at Horse Cave Ky, this 4th day of January 1863

Official
 Signatures.

Robert Stewart Justice of
 the Peace for Hart County

INSTRUCTIONS.

- 1 Name of affiant as found on the Muster Roll, regardless of the name known by at home.
 - 2 Rank—Private, Corporal or Sergeant.
 - 3 Letter of Company and Number of Regiment.
 - 4 Cavalry, Infantry or Artillery, as the case may be.
 - 5 The name of his former owner.
 - 6 Name of the County in which the owner lives.
 - 7 Name of the Soldier the affiant wishes to identify. (The name must be given as it is borne on the Muster Rolls in all cases.)
 - 8 Names of Two disinterested witnesses.
- NOTE.—Where the former slave identifies himself, blank No. 7 and all below to the Sixth need not be filled up. Claimants needing more blanks can be supplied by calling on our Agent, or at the Office, No. 120 Jefferson Street, Louisville, Ky.

I, _____, ~~do hereby~~ have been for several years well acquainted with
Wm. Garrison the applicant, and Henry Garrison
 and George W. Garrison his witnesses, and from my personal acquaintance with
 them believe their statements to be entitled to full faith and credit.

Sworn to and subscribed before me, a _____ for the County
 of _____ State of _____ this _____ day
 of _____ 1863

5 CENT STAMP

NOTE.—If the applicant and his witnesses are not personally known to one or more of the Commissioners, the above certificate should be signed by two citizens who are well known to the Commissioners, or by a Post Master or other Government officer; if signed by a United States officer it need not be sworn to, but if by citizens it must be sworn to. When a United States officer signs it the witnesses need not, and when the witnesses sign it the United States officer need not.

PROOF OF OWNERSHIP.

State of Kentucky, }
 County of Hart } ss.

We, Henry C. Parrish and George W. Parrish each of lawful age, and resident citizens of the State and County aforesaid, do certify that B. Mill Parrish of the State and County aforesaid, was on the 4th day of March 1861, the lawful owner of the Slave named Henry Parrish, referred to and described in the foregoing claim for compensation.

Two witnesses to ownership sign here.

Henry C. Parrish
 George W. Parrish

Sworn to and subscribed before me, a Police Judge for the County of Hart State of Kentucky, this the 5 day of January, 1861



STAMP.

The officer swearing the witnesses signs here.

U. V. Gasley
 Police Judge Hart County Ky

PROOF OF LOYALTY.

State of Kentucky, }
 County of Hart } ss.

We, W. B. Young and Thomas H. Mustine local men, and each of lawful age, and resident citizens of the State and County aforesaid, upon our oaths declare that we have known B. Mill Parrish a resident of the State and County aforesaid, since the 4th day of March, 1861, and know that he has firmly and faithfully maintained his or her adherence and allegiance to the Government of the United States, by defending its cause against the Government and forces of the so-called Confederate States of America, in all suitable and practicable ways, and according to his or her ability and opportunity.



STAMP.

W. B. Young

Thomas H. Mustine
 at Hart County Ky

Sworn to and subscribed before me, a _____ for the County of _____ State of _____ this _____ day of _____ 1861

The officer swearing the witnesses signs here.

L. S.

We, J. Thomas H. Mustine, Post Master at Hart County Ky, resident of the County of Hart in the State of Kentucky, do state that we are and have been for several years well acquainted with B. Mill Parrish the applicant, and Henry C. Parrish and George W. Parrish his witnesses, and from our personal acquaintance with them believe their statements to be entitled to full faith and credit.

Sworn to and subscribed before me, a _____ for the County of _____ State of _____ this _____ day of _____ 1861

5 CENT STAMP

NOTE.—If the applicant and his witnesses are not personally known to one or more of the Commissioners, the above certificate should be signed by two citizens who are well known to the Commissioners, or by a Post Master or other Government officer; if signed by a United States officer it need not be sworn to, but if by citizens it must be sworn to. When a United States officer signs it the witnesses need not, and when the witnesses sign it the United States officer need not.

1037

Parrott Charles.

Co B., 6 U.S. Col'd Cav.

Private Private

CARD NUMBERS.

1	5389264	26
2	5389338	27
3	5389428	28
4	5389499	29
5	5389566	30
6	5389654	31
7	5389750	32
8	5389842	33
9	5389932	34
10	5390025	35
11	9092914	36
12	43147754	37
13	40732706	38
14		39
15		40
16		41
17		42
18		43
19		44
20		45
21		46
22		47
23		48
24		49
25		50

Book Mark: 1756 - 83.

See also

S-1025-516-40. *Perk.*
D. 1491142 sub 1012
M. D. 1076006

Al Jordan
of

P | **6 Cav. | U.S.C.T.**

Charles Parrot

....., Co. *B*, 6 Reg't U. S. Col'd Cav.

Appears on

Company Descriptive Book

of the organization named above.

DESCRIPTION.

Age *25* years; height *5* feet *7 1/2* inches.

Complexion *Copper*

Eyes *Blk*; hair *Blk*

Where born *Knox Ky*

Occupation *Farmer*

ENLISTMENT.

When *Sept 12*, 1864.

Where *Burling Green*

By whom *Capt Hobson*; term *3* y'rs.

Remarks:

.....
.....
.....
.....
.....
.....
.....
.....
.....
.....

Boyer

P

Claw

U.S.C.T

Charles Parrot

Appears with rank of Private on

Muster and Descriptive Roll

of Detachment U.S. Col R recruits
forwarded

Roll dated London Ky, Sept. 30, 1864.

Where born Knox Co. Ky

Age 25 years; occupation Farmer

When enlisted Sept. 12, 1864

Where enlisted London Ky

For what period enlisted 3 years.

Eyes Blue; hair Blue

Complexion Copper; height 5 ft. 7/2 in.

When mustered in Sept 30, 1864.

Where mustered in London Ky

Bounty paid \$ 100; due \$ 100

Clothing account: nothing issued

Last settled 186; drawn since \$ 100

Date of first muster Sept. 12, 1864.

Company to which assigned

Remarks Created to Knox Co & Dist Ky

name of man Arruited Parrot

H. Co. Knox Co. Ky

Book mark :

A. C. Black

(356m)

Copyist.

G

6 Cav. U.S.C.T.

Charles Parrott

Priv, Co. *B*, 6 Reg't U. S. Col'd Cavalry.

Appears on

Company Muster-in and Descriptive Roll

of the organization named above. Roll dated

Camp Nelson Ky, ~~Nov~~, *Nov 1st*, 1864.

Where born *Knox Co, Ky*,

Age *24* y'rs; occupation *Farmer*

When enlisted *Sept 12*, 1864.

Where enlisted *Landon Ky*

For what period enlisted *3* years.

Eyes *Black*; hair *Black*

Complexion *Copper*; height *5* ft. *7 1/2* in.

When mustered in *Sept 30*, 1864.

Where mustered in *Landon Ky*

Bounty paid \$ *100*; due \$ *100*

Where credited *S Dist, Ky*

Company to which assigned

Remarks: *Farmer,*

Amended Parrot,

Book mark:

A. M. Row

(356d)

Copyist.

P | **6 Cav. | U.S.C.T.**

Charles Parrot

Priv, Co. B, 6 Reg't U. S. Col'd Cavalry.

Appears on

Company Muster Roll

for *Nov & Dec*, 1864.

Present or absent *present*.

Stoppage, \$ *100* for

Due Gov't, \$ *100* for

Valuation of horse, \$ *100*

Valuation of horse equipments, \$ *100*

Remarks:

Book mark:

D. M. Rowe

D 6 Cav. U.S.C.T.

Charles Parrot

Private, Co. B, 6 Reg't U. S. Col'd Cavalry.

Appears on

Company Muster Roll

for *Jan & Feb*, 1865.

Present or absent *Absent*

Stoppage, \$ *100* for

Due Gov't, \$ *100* for

Valuation of horse, \$ *100*

Valuation of horse equipments, \$ *100*

Remarks: *1st installment bounty
due \$100, Det'd. N. Haven Ky
Feb. 15, 1865,*

Book mark:

C. M. Moore

P 6 Cav. U.S.C.T.

Charles Purcut
Privat, Co. B, 6 Reg't U. S. Col'd Cavalry.

Appears on

Company Muster Roll

for March & April, 1865.

Present or absent Absent,

Stoppage, \$ 100 for

Due Gov't, \$ 100 for

Valuation of horse, \$ 100

Valuation of horse equipments, \$ 100

Remarks: Installation bounty
due \$100, New Haven, Conn.,
Feb. 15, 1865.

Book mark:

(358)

A. M. Rowe

Copist.

C | **6 Cav.** | **U.S.C.T.**

Charles Carroll

Pvt., Co. B, 6 Reg't U. S. Col'd Cavalry.

Appears on

Company Muster Roll

for *May & June*, 1865.

Present or absent *present*

Stoppage, \$ *100* for

Due Gov't, \$ *100* for

Valuation of horse, \$ *100*

Valuation of horse equipments, \$ *100*

Remarks: *1" install bounty
due \$100*

Book mark:

B. C. Harper
Copyist.

6 Cav. U.S.C.T.

Charles Barrett
Sgt., Co. B, 6 Reg't U. S. Col'd Cavalry.

Appears on

Company Muster Roll

for *Sept & Oct*, 186*4*.

Present or absent *present*

Stoppage, \$ *100* for

Due Gov't, \$ *100* for

Valuation of horse, \$ *100*

Valuation of horse equipments, \$ *100*

Remarks: *no ball*
1 month due

Book mark:

(358)

W. Harper
Copyist.

10 | **6 Cav. U.S.C.T.**

Co
Charles Barrett
Priv, Co. B, 6 Reg't U. S. Col'd Cavalry.

Appears on

Company Muster Roll
for *Sept & Oct*, 186*5*.

Present or absent *Present*

Stoppage, \$ *100* for

Due Gov't, \$ *100* for

Valuation of horse, \$ *100*

Valuation of horse equipments, \$ *100*

Remarks: _____

Book mark: _____

(358)

A. E. Barber
Copyist.

2 | **6 Cav. | U.S.C.T.**

Charles Parrott
Pvt., Co. B, 6 Reg't U. S. Col'd Cavalry.

Appears on

Company Muster Roll

for *Nov & Dec*, 186*5*.

Present or absent *Present*

Stoppage, \$ *100* for

Due Gov't, \$ *60* for *ordnance*

Valuation of horse, \$ *100*

Valuation of horse equipments, \$ *100*

Remarks:

Book mark:

(358) *J. W. Ames* Copyist.

op

6 Cav. U.S.C.T.

Charles Innott

Ch, Co. B, 6 Reg't U. S. Col'd Cavalry.

Appears on

Company Muster Roll

for *Jan'y & Feby*, 1866.

Present or absent *Present*

Stoppage, \$ *100* for

Due Gov't, \$ *60* for *allowance*

Valuation of horse, \$ *100*

Valuation of horse equipments, \$ *100*

Remarks:

Book mark:

(358)

J. W. Jones

Copyist.

J | **6 Cav.** | **U.S.C.T.**

⁺ *Chas Parrott*
Pvt, Co. *B*. 6 Reg't U. S. Col'd Cav.

Appears on Returns as follows:

Feb 7 to April 1865, Absent
Detached Service
New Haven Ky,
Feb 15 65.

⁺ *Supplied from no Roll by*
1860

Book mark: _____

(546)

C. M. Rowan

Copyist.

P

6 Cav. U.S.C.T.

Charles Parratt

Pvt., Co. B., 6 Reg't U. S. Col'd Cavalry.

Appears on Co. Muster-out Roll, dated

De Valls Bluff, Apr. 15, 1866.

Muster-out to date Apr. 15, 1866.

Last paid to Feb. 28, 1866.

Clothing account:

Last settled _____, 186 ; drawn since \$ 100

Due soldier \$ 100; due U. S. \$ 100

Am't for cloth'g in kind or money adv'd \$ 98 100

Due U. S. for arms, equipments, &c., \$ 4 100

Bounty paid \$ 100; due \$ 100

Remarks:

Book mark: 1756-83

J. W. Ames Copyist.

(261)

Parratt Charles

Co. B, 6 Reg't US Cavalry

Enclosures.

Bed Cards	Final Statements
Burial Records	Furloughs or L. of A.
Certs. of Dis. for Discharge	Med. Certificates
C. M. Charges	Med. Des. Lists
Descriptive Lists	Orders
Discharge Certificates	Pris. of War Record
Enlistment Papers	Resignations

Other papers relating to—

Admission to Hosp'l	Furlough or L. of A.
Casualty Sheet	Med. Examination
Confinement	Misc. Information
Contracts	Pay or Clothing
Death or Effects	Personal Reports
Desertion	Rank
Discharge from Hosp'l	Transfer to Hosp'l
Discharge from Service	Transfer to V. R. C.
Duty	Transportation

NOTE 1. This blank will be filled up by the Adjutant General of the United States, and the recruit will be made out in duplicate in all cases—one to accompany the recruiting agent of the recruiting agent, and the other to the Adjutant General, and one to accompany the recruit in all cases, to pay bounty, &c.

NOTE 2. An enlistment bond is required in all cases, to be paid by the recruit, or by the Adjutant General, or by the Adjutant General's Office, as the case may be, will countersign both enlistments as having witnessed the soldier's enlistment in the United States before either of them is given to the disbursing officer.

TWENTY-THIRD REGIMENT
DECLARATION OF RECRUIT.

I, Charles Parrot desiring to volunteer as a soldier in the ARMY OF THE UNITED STATES, for the term of Three Years, DO DECLARE That I am 21 years and 00 months of age; that I have never been discharged from the United States service on account of disability or by sentence of a court-martial, or by order before the expiration of a term of enlistment; and I know of no impediment to my serving honestly and faithfully as a soldier for three years.

GIVEN at Lawrence the 12th day of Sept 1864

Witness: Robert Gray

Charles Parrot



Volunteered at Lawrence Kan by Charles Parrot Sept 12th 1864

Robert Gray

Sept 12th 1864

Consent of Parent or Guardian in case of a Minor, or in the case of a Slave, of the Person to whom he owes Service:

I, Do CERTIFY, That I am the _____ that the said _____ is _____ years of age; and I do freely give my CONSENT to his volunteering as a SOLDIER in the Army of the United States, for the period of THREE YEARS, under the conditions of the laws of the United States.

GIVEN at _____ the _____ day of _____

Witness:

UNITED STATES COLORED TROOPS ENLISTMENT.

STATE OF

TOWN OF

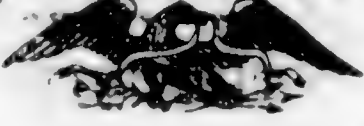
Kentucky  *Pandora*

I, *Charles Parrot* born in *Knop County*
in the State of *Kennuckty* aged *25* years
and by occupation a *Farmer* Do HEREBY ACKNOWLEDGE to
have volunteered *13th* day of *Sept* 186*4*

to serve as a **Soldier** in the **Army of the United States of America**, for the
period of **THREE YEARS**, unless sooner discharged by proper authority: Do
also agree to accept such bounty, pay, rations, and clothing, as are, or may be,
established by law for the U. S. colored troops.

And I, *Charles Parrot*
do solemnly swear that I will bear true faith and allegiance to the **United States
of America**, and that I will serve them honestly and faithfully against all their
enemies or opposers whomsoever; and that I will observe and obey the orders
of the President of the United States, and the orders of the officers appointed
over me, according to the Rules and Articles of War.

Sworn and subscribed to, at *Pandora Ky*
this *13th* day of *Sept* *Charles Parrot*
Before *Robert Hoops* *make*
Capt 4th Mar 5 Dist 14

I CERTIFY, ON HONOR, That I have carefully examined the above named Volunteer agree-
ably to the General Regulations of the Army, and that, in my opinion, he is free from all bodily
defects and mental infirmity, which would in any way disqualify him from performing the
duties of a soldier.

Wm. H. Foster *Surg Gen*
Bd Emmet Dist Ky EXAMINING SURGEON.

I CERTIFY, ON HONOR, That I have minutely inspected the Volunteer *Charles Parrot*
previously to his enlistment, and that he was entirely sober when enlisted; that, to the best of
my judgment and belief, he is of lawful age; and that, in accepting him as duly qualified to per-
form the duties of an able-bodied soldier, I have strictly observed the regulations which govern
the recruiting service. This soldier has *black* eyes, *black* hair, *coffee* com-
plexion, is *5* feet *11* inches high.

Robert Hoops
Capt 4th Mar 5 Dist 14 RECRUITING OFFICER OR AGENT.

Mustered into the United States Service *30th* day of *September* 186*4*

Robert Hoops
Capt 4th Mar 5 Dist 14 Mustering Officer

Mustered into the service of the United States, for three years or during the war, from date of enlistment, in Company
Regiment of
Volunteers, on the
day of
1864, at

Note 1. This blank will be used for the enlistment of colored troops. They will be made out in duplicate in all cases—one to accompany the recruiting officer of the superintendent and the recruiting officer to the Adjutant General, and one to accompany the recruit who pays bounty, &c.

Note 2. An enlistment holds to service. A musketeer must, in all cases, precede payment of pay, bounty, pension, &c. A musketeer in roll, must in all cases, be filed in the Adjutant General's office in evidence of musketeer. The musketeer, officer, commissary, or assistant commissary of musters, as the case may be, will countersign both enlistments as having mustered the soldier into the service of the United States before either of them is given to the disbursing officer.

ENLISTMENT DECLARATION OF RECRUIT.

I, Charles Parrot desiring to volunteer as a soldier in the ARMY OF THE UNITED STATES, for the term of Three Years, DO DECLARE That I am 25 years and — months of age; that I have never been discharged from the United States service on account of disability or by sentence of a court-martial, or by order before the expiration of a term of enlistment; and I know of no impediment to my serving honestly and faithfully as a soldier for three years.

GIVEN at Louday, Miss the 15th day of Sept 1864

Witness: Robert Hays

Charles Parrot

Volunteer of Louisiana
Sept 15th 1864
Robert Hays
Captain 8th Regt

Consent of Parent or Guardian in case of a Minor, if a Free Man, or in the case of a Slave, of the Person to whom he owes Service:

I, _____ Do CERTIFY, That I am the _____ that the said _____ is _____ years of age; and I do freely give my CONSENT to his volunteering as a SOLDIER in the Army of the United States, for the period of THREE YEARS, under the conditions of the laws of the United States.

GIVEN at _____ the _____ day of _____

Witness: _____

UNITED STATES COLORED TROOPS ENLISTMENT.

STATE OF

TOWN OF

Kentucky  Lawton

I, Charles Parrot born in Cross Lanes in the State of Kentucky aged 25 years and by occupation a Farmer Do HEREBY ACKNOWLEDGE to have volunteered 13th day of Sept 1864

to serve as a Soldier in the Army of the United States of America, for the period of THREE YEARS, unless sooner discharged by proper authority: Do also agree to accept such bounty, pay, rations, and clothing, as are, or may be, established by law for the U. S. colored troops.

And I, Charles Parrot do solemnly swear that I will bear true faith and allegiance to the United States of America, and that I will serve them honestly and faithfully against all their enemies or opposers whomsoever: and that I will observe and obey the orders of the President of the United States, and the orders of the officers appointed over me, according to the Rules and Articles of War.

Sworn and subscribed to, at Louisville this 13th day of Sept 1864 Charles Parrot Before Robert Hays Master

I CERTIFY, ON HONOR, That I have carefully examined the above named Volunteer agreeably to the General Regulations of the Army, and that, in my opinion, he is free from all bodily defects and mental infirmity, which would in any way disqualify him from performing the duties of a soldier.

John D. Hunter M.D. EXAMINING SURGEON. Capt. B. Smith M.D. Dist. Ky.

I CERTIFY, ON HONOR, That I have minutely inspected the Volunteer, previously to his enlistment, and that he was entirely sober when enlisted; that, to the best of my judgment and belief, he is of lawful age; and that, in accepting him as duly qualified to perform the duties of an able-bodied soldier, I have strictly observed the regulations which govern the recruiting service. This soldier has black eyes, black hair, complexion, is 5 feet 7 inches high.

Robert Hays RECRUITING OFFICER OR AGENT. Capt. P. M. Smith Dist. Ky.

Mustered into the United States Service 30th day of September 1864

Robert Hays Mustering Officer. Capt. P. M. Smith Dist. Ky.

Mustered into the service of the United States, for three years or during the war, from date of enlistment, in Company _____ Regiment of _____ Volunteers, on the _____ day of _____, 1864, at _____

1038

Patrum George.

Co *M.*, 6 U. S. Col'd Cav.

Sergeant | *Sergeant.*

CARD NUMBERS.

1	5396501	26
2	5396594	27
3	5396687	28
4	5396780	29
5	5396880	30
6	5396975	31
7	5397062	32
8	9093928	33
9	40732705	34
10		35
11		36
12		37
12		38
14		39
15		40
16		41
17		42
18		43
19		44
20		45
21		46
22		47
23		48
24		49
25		50

Book Mark: _____

See also _____

8789809-P090

S-7064303-R. C. M. M. 90th.

W. Jordan
Cu

P | 6 Cav. | U.S.C.T.

George Patman
Co. No. 6 Reg't U. S. Col'd Cav.

Appears on

Company Descriptive Book

of the organization named above.

DESCRIPTION.

Age 27 years ; height 5 feet 11 inches.

Complexion *Copper*

Eyes *Blk* ; hair *Blk*

Where born *Trumbull, Ky*

Occupation *Farmer*

ENLISTMENT.

When *Nov 24*, 1864

Where *Owensboro*

By whom *Capt Partridge*; term *2* y'rs.

Remarks: *Mustered into U. S. service Nov 24/64 Owensboro Ky by Capt G. W. Garrison*

Patman

6 Cav. U.S.C.T.

George Abram
Sgt., Co. M., 6 Reg't U. S. Col'd Cavalry.

Appears on

Company Muster-in and Descriptive Roll

of the organization named above. Roll dated

Camp Nelson, ~~NY~~, ~~1861~~, 1861.

Where born *Franklin Kentucky*

Age 27 y'rs; occupation *Farmer*

When enlisted *Feb 21*, 1861.

Where enlisted *Washington*

For what period enlisted *3* years.

Eyes *black*; hair *black*

Complexion *robin*; height *5* ft. *11* in.

When mustered in *To date Nov 24*, 1861.

Where mustered in *Washington*

Bounty paid \$ *paid* 100; due \$ 100

Where credited *1st Dist of Ky*

Company to which assigned *M.*

Remarks: *Transferred to Co. D.*

120th Regt. Inf. 100

detached to 21 Co. 11th

Gen. Hospital

Book mark:

(356d)

Joseph Stewart

Copyist.

6 Cav. U.S.C.T.

George Patrum
Serjeant, Co. M, 6 Reg't U. S. Col'd Cavalry.

Appears on

Company Muster Roll

for *June 21 to June 30, 1865*.

Present or absent *absent*

Stoppage, \$ *100* for

Due Gov't, \$ *100* for

Valuation of horse, \$ *100*

Valuation of horse equipments, \$ *100*

Remarks: *Transferred from*
130 U.S.C. for S.C. 105
dated Hd qrs. D.K.
Louisville Ky June 10
1865 in Genl Harple
Louisville Ky June 25 65

Book mark :

Joseph Stewart
(358) Copyist.

6 Cav. U.S.C.T.

George W. Brown

Sgt, Co. M, 6 Reg't U. S. Col'd Cavalry.

Appears on

Company Muster Roll

for *rolled May 31*, 186*5*.

Present or absent *Present*

Stoppage, \$ *100* for

Due Gov't, \$ *100* for

Valuation of horse, \$ *100*

Valuation of horse equipments, \$ *100*

Remarks:

Book mark:

Joseph W. Brown
(358) Copyist.

P

6 Cav. U.S.C.T.

George Sumner
Sgt., Co. M, 6 Reg't U. S. Col'd Cavalry.

Appears on

Company Muster Roll

for *Sept. 1st*, 1865.

Present or absent *Present*.

Stoppage, \$ *100* for

Due Gov't, \$ *100* for

Valuation of horse, \$ *100*

Valuation of horse equipments, \$ *100*

Remarks:

Book mark:

(358)

Sumner
Copyist.

6 Cav. U.S.C.T.

George Catman

Dist, Co. M, 6 Reg't U. S. Col'd Cavalry.

Appears on

Company Muster Roll

for *1st Dec*, 1865.

Present or absent *Absent*.

Stoppage, \$ *100* for

Due Gov't, \$ *100* for

Valuation of horse, \$ *100*

Valuation of horse equipments, \$ *100*

Remarks: *First installment
bounty due.*

Book mark:

(358)

Shaw
Copyist.

6 Cav. U.S.C.T.

George Petrus
Sergeant, Co. M, 6 Reg't U. S. Col'd Cavalry.

Appears on

Company Muster Roll

for *Jan & Feb*, 186*6*.

Present or absent *Present*

Stoppage, \$ *100* for

Due Gov't, \$ *100* for

Valuation of horse, \$ *100*

Valuation of horse equipments, \$ *100*

Remarks: *Must be returned
to company clerks.*

Book mark:

C. J. N. Laughlin
Copyist.

G | **6 Cav.** | **U.S.C.T.**

George Patrum
Sgt, Co. *M*, 6 Reg't U. S. Col'd Cav.

Appears on Returns as follows:

June & July 1865, Absent
sick in Gen Hospital
Louisville Ky.
June 23 / 65.

Book mark:

C M Row

(546)

Copyist.

6 Cav. U.S.C.T.

George Patrum
Sergt., Co. *M*, 6 Reg't U. S. Col'd Cavalry.

Appears on **Co. Muster-out Roll**, dated
McValls Bluff Ark April 15, 1866.

Muster-out to date *Apr 15, 1866*.

Last paid to *Feb 28, 1866*.

Clothing account:

Last settled _____, 186 ; drawn since \$ _____ 100

Due soldier \$ _____ 100; due U. S. \$ *27* ⁸⁹ 100

Am't for cloth'g in kind or money adv'd \$ _____ 100

Due U. S. for arms, equipments, &c., \$ _____ 100

Bounty paid \$ *100 00* 100; due \$ _____ 100

Remarks: *Sergt. from Organization*

Book mark : _____

(361)

C. F. M. Laughlin
Copyist.

1039

Pottinger Anthony

Co K., 6 U. S. Col'd Cav.

Private | *Corporal.*

CARD NUMBERS.

1	26
2	27
3	28
4	29
5	30
6	31
7	32
8	33
9	34
10	35
11	36
12	37
12	38
14	39
15	40
16	41
17	42
18	43
19	44
20	45
21	46
22	47
23	48
24	49
25	50

See Pottinger Anthony

Book Mark:

See also

1040

Pattiniger Robert

Co K., 6 U. S. Col'd Cav.

Private Private

CARD NUMBERS.

1	5387385	26
2	5387396	27
3	5395430	28
4	5395511	29
5	5395598	30
6	5395674	31
7	5395752	32
8	5395830	33
9	5395903	34
10	9090817	35
11	40732732	36
12		37
13		38
14		39
15		40
16		41
17		42
18		43
19		44
20		45
21		46
22		47
23		48
24		49
25		50

Book Mark:

See also

P. | **6 Cav. | U.S.C.T.**

Robert Pottinger

....., Co. *K*, 6 Reg't U.S. Col'd Cav.

Appears on

Company Descriptive Book

of the organization named above.

DESCRIPTION.

Age *44* years; height *5* feet *7 1/2* inches.

Complexion *Copp*

Eyes *Blk*; hair *Blk*

Where born *Woodford Co Ky*

Occupation *Farmer*

ENLISTMENT.

When *April 24*, 1865.

Where *Louisville*

By whom *Capt Womack*; term *3* yrs.

Remarks: *Mustered April 24/65. By Capt Womack at Louisville*

(3839)

James L
Copyist.

6 Cav. U.S.C.T.

Robert Lattimer

Appears with rank of *Rec't* on

Muster and Descriptive Roll of a Detachment of U. S. Vols. forwarded

for the 6 Reg't U. S. Col'd Cavalry. Roll dated

Louisville Ky, April 24, 1865.

Where born *Woodward Co Ky*

Age *44* y'rs; occupation *Farmer*

When enlisted *April 24*, 1865.

Where enlisted *Louisville Ky*

For what period enlisted *3* years.

Eyes *Blk*; hair *Blk*

Complexion *Blk*; height *5* ft. *7 1/2* in.

When mustered in *April 24*, 1865.

Where mustered in *Louisville*

Bounty paid \$ *100*; due \$ *100*

Where credited *Weldon Co 4 Dist Ky*

Company to which assigned

Remarks:

Book mark:

6 Cav. U.S.C.T.

Robert Patterson

Appears with rank of *Capt* on

Muster and Descriptive Roll of a Detachment of U. S. Vols. forwarded

for the 6 Reg't U. S. Col'd Cavalry. Roll dated

Louisville Ky, Apr 16, 1865.

Where born *Woodford Va*

Age *27* yrs; occupation *Farmer*

When enlisted *Apr 24*, 1865.

Where enlisted *Louisville Ky*

For what period enlisted *3* years.

Eyes *Blk*; hair *Blk*

Complexion *Blk*; height *5 ft. 7 in.*

When mustered in *Apr 24*, 1865.

Where mustered in *Louisville Ky*

Bounty paid \$ *100*; due \$ *100*

Where credited *4 Dist Ky*

Company to which assigned

Remarks:

Book mark:

P *6000* **U.S.C.T.**

Robert Pattinger
priv., Co. *A*, 6 Reg't U. S. Col'd *Cav.*

Appears on

Company Muster-in and Descriptive Roll
of the organization named above. Roll dated

Camp Nelson Ky May 29 1865.

Where born *Woodford Co., Ky*

Age *44* y'rs; occupation *Farmer*

When enlisted *Apr 24*, 1865.

Where enlisted *Louisville Ky*

For what period enlisted *3* years.

Eyes *black*; hair *black*

Complexion *coppr*; height *5* ft. *7 1/2* in.

When mustered in *Apr 24*, 1865.

Where mustered in *Louisville*

Bounty paid \$ *100*; due \$ *100*

Where credited *H. D. Ky*

Company to which assigned

Remarks:

Filed with Pattinger Robert.

Book mark:

(356d)

G. J. Giffith

Copyist.

S | **6 Cav.** | **U.S.C.T.**

Robert Pottinger

ser -----, Co. K, 6 Reg't U. S. Col'd Cav.

Appears on

Company Muster Roll

for *May 25 to June 30*, 186*5*.

Present or absent *Present*

Stoppage, \$ *100* for -----

Due Gov't, \$ *100* for -----

Valuation of horse, \$ *100*

Valuation of horse equipments, \$ *100*

Remarks: -----

Book mark: -----

(358) *D. J. Griffith* Copyist.

P | **6 Cav.** | **U.S.C.T.**

Robert Pottinger
ser, Co. K, 6 Reg't U. S. Col'd Cav.

Appears on

Company Muster Roll

for *July & August, 1865.*

Present or absent *Present*

Stoppage, \$ 100 for

Due Gov't, \$ 100 for

Valuation of horse, \$ 100

Valuation of horse equipments, \$ 100

Remarks:

Book mark:

(358)

F. J. Griffith
Copyist.

9

6 Cav. | U.S.C.T.

Robert Pottinger
Co. K, 6 Reg't U. S. Col'd Cav.

Appears on

Company Muster Roll

for *Sept. 1 Oct.*, 186*2*.

Present or absent *Present*

Stoppage, \$ *100* for

Due Gov't, \$ *100* for

Valuation of horse, \$ *100*

Valuation of horse equipments, \$ *100*

Remarks:

Book mark:

J. M. Jackson
(358) Copyist

P

6 Cav. U.S.C.T.

Robert Pottinger
Private, Co. K, 6 Reg't U. S. Col'd Cav.

Appears on

Company Muster Roll

for *Nov. Dec*, 186*5*

Present or absent *Present*

Stoppage, \$.....100 for

Due Gov't, \$.....100 for

Valuation of horse, \$.....100

Valuation of horse equipments, \$.....100

Remarks:

Book mark:

A. M. Jackson
(358) *Copyist.*

P

6 Cav. U.S.C.T.

Robert Pottenger

Crisate, Co. K, 6 Reg't U. S. Col'd Cav.

Appears on

Company Muster Roll

for Jan. & Feb., 1866

Present or absent Absent

Stoppage, \$ 100 for

Due Gov't, \$ 100 for

Valuation of horse, \$ 100

Valuation of horse equipments, \$ 100

Remarks: On detached duty, U.S.A. No. 10 dated H.S. White River Dist. De Sells Bluff, Ark. Jan. 23, 1866.

Book mark:

O. J. Markle

(358)

Copyist.

P | 6 Cav. | U.S.C.T.

Robert Pöttinger
Pot, Co. K, 6 Reg't U. S. Col'd Cav.

Appears on Returns as follows:

Jan'y 1866, Absent on
detached duty Helena
Ark. since Jan'y 23/66,

Feb 1866, Absent on detached
duty at De valls Bluff
Ark since Jan 25 66,

Book mark :

W. M. Road

(546)

Copyist.

Q

6 Cav. U.S.C.T.

Robert Winger
Company, Co. *K*, 6 Reg't U. S. Col'd Cavalry.

Appears on **Co. Muster-out Roll**, dated
Co. Muster-out Roll, Ark., Apr. 10, 1866
Muster-out to date *Apr. 10, 1866*
Last paid to *Co. 31, 1866*

Clothing account:

Last settled _____, 1866; drawn since \$ 100
Due soldier \$ ~~100~~ ²⁴ ₄ 100; due U. S. \$ 100
Am't for cloth'g in kind or money adv'd \$ 100

Due U. S. for arms, equipments, &c., \$ 100
Bounty paid \$ 100; due \$ 100

Remarks: _____

x *Winger in the field.*
Book mark: *V. 3111*

(361) *C. J. Markle* Copyist.

Pottinger, Robert

P, Co. R,

6 U.S.C. Cavalry
Reg't

Enclosures.

Bed Cards	Descriptive Lists
Burial Records	Final Statements
Certs. of Dis. for Discharge	Furloughs
C. M. Charges	Med. Des. Lists
Med. Certificates	Orders

Other papers relating to—

Admission to Hosp'l	Furlough
Casualty Sheet (Officer's)	Med. Examination
Confinement	Misc. Information
Contracts	Pay or Clothing
Death or Effects	Personal Reports
Desertions	Rank
Discharge from Hosp'l	Transfer to Hosp'l
Discharge from Service	Transfer to V. R. C.
Duty	Transportation

War Department,

ADJUTANT GENERAL'S OFFICE,

Washington, *Apr 10th 1867*

Respectfully returned to the Commission for the State of Ky, with the information that Robert Pottinger was enlisted at Louisville Ky. Apr 24th 1864 and was mustered in as Pvt 1st Regt US Colored Troops. Apr 24th 1865

Wm. H. Hayward
Adj't General.

anne

ENDORSEMENT.

No. *11*

APPLICATION OF

G. W. Pottinger

OF

Nelson County Ky

For compensation of service of slave.

Robert Pottinger

Enlisted *April 24* 1864

in Co. *K*, *6th* Regiment
U. S. Colored Troops. *Cavalry*

Received *2nd* 1867

Compensation awarded

186

Dollars

President Board of Claims.

CLAIMANT'S ATTORNEYS,

E. E. MCKAY.

BARDSTOWN, KY

CLAIMANT'S P. O. ADDRESS,

Headquarters Kentucky Volunteers,

Adjutant-General's Office,

Frankfort, Feb 27th 1866

I hereby certify, that it appears from the U.S. Muster-Rolls on file in this Office, that Robt Pettenger was enrolled on the 24th day of April 1865, at Louisville Ky. by Capt Wornack and mustered into the U. S. service on the 24th day of April 1865 at Louisville Ky by Capt Wornack to serve 3 years. Said Robt Pettenger is described as follows: Age, 44 years; eyes, Black; hair, Black complexion, Black; height, 5 feet 7 1/2 inches. It further appears from said Rolls that Robt Pettenger owed service to George Pettenger, was credited to Nelson County, Ky., and was assigned to Co. "K" 6th Regiment U. S. Cavalry

In Testimony Whereof, I have hereunto set my hand, and affixed my Official Seal, this 27th day of Feb, 1866

D. Lindsay
Adjutant-General of Kentucky.

B. 91, B. 762

U
a
1
se
sl
18
C
th
va
tit
th
aj
A

COMPENSATION FOR ENLISTED SLAVE.

I, George W Pottinger, a loyal citizen, and
a resident of² Kentucky County of³ Nelson State of

Kentucky, hereby claim compensation, under the provisions of
section 24, Act approved February 24, 1864, and Section 2, Act approved July 28, 1866, for my

slave⁴ Robert Alexander Pottinger enlisted⁶ & mustered April 24
1865, at⁷ Louisville by⁸ Capt Womack
in the⁹ 6th Cav Regiment U. S. Colored Troops

Co.¹⁰ K, certificate of enlistment, and a descriptive list, as required, accompany
this application. That I did not acquire said slaves subsequent to said enlistment, but had a
valid title to him at the date of said enlistment, and previous thereto: I having acquired my
title to him and my ownership over him as follows, to-wit: by purchase from

John Wilson a son of Robert W Pottinger dec'd
about 1839

In proof of my loyalty to the Constitution and Government of the United States, I present
the accompanying oath, which I have taken, signed and acknowledged; to be filed with this
application, in accordance with requirement of General Orders, No. 329, 1863, War Department,
Adjutant General's Office.

Witness: James B. [unclear] George W Pottinger
Charles Gipe Applicant.

Two witnesses to
owner's signature
sign here.

186

OATH OF ALLEGIANCE.

I, George W Pottinger, the owner and claimant, do solemnly swear that the foregoing
claim is a just and true claim due to me as master and owner of the said slave, and that the facts alleged in said claim, in respect to the
draft or enlistment (as the case may be) of said slave into the military service of the United States, are true. And I do further swear that I
have never joined, or been concerned in, any insurrection or rebellion; that I have never borne arms against the United States; that I have
never given any aid, countenance, counsel or encouragement, to any person or persons engaged, or whom I had reason to believe were about to
engage, in insurrection, rebellion, or armed hostility against the United States; that I have neither sought, nor accepted, nor attempted to
exercise the functions of any office, civil or military, nor to perform any service whatever, under any authority, or pretended authority, in
hostility to the United States; that I have not yielded a voluntary support to any insurrection, rebellion, or pretended government
authority, power or constitution within the United States hostile thereto. And I do further swear that, to the best of my knowledge and
ability, I have supported and defended, and will continue to support and defend, the United States against all enemies foreign and domestic,
and that I have supported, defended and obeyed, and will continue to support, defend and obey, the Constitution and laws of the United States;
that I will bear true faith and allegiance to the same; and that I take this oath freely, without any mental reservation or purpose of
evasion: So help me God.

5 CENT STAMP. The owner } George W Pottinger
signs here. }

Sworn to and subscribed before me John Wilson
this 12th day of May 1865



The officer swear- } John Wilson Notary
ing the owner signs } Public for Nelson County Ky { L. S. }

POWER OF ATTORNEY.

My Post Office address is _____ County of _____ State

of Kentucky, and I hereby direct that all communications to me, touching this claim, may be sent under cover to E. E. MCKAY,
Bardstown, Kentucky, who is hereby appointed and constituted my true and lawful attorney, to prosecute this claim for me, and who is
hereby authorized and empowered to receive and receipt for any award, order, draft, certificate, voucher, warrant, papers, or money that
may be issued in the adjustment of this claim, or the payment thereof, the same as I might or could do in person were I present and acting
for myself, and to file any additional evidence or papers that may be required in the prosecution of this claim.

Witness: James B. [unclear] George W Pottinger
Charles Gipe The owner }
signs here. }

50 CENT STAMP. Charles Gipe Two witnesses to
owner's signature
sign here.

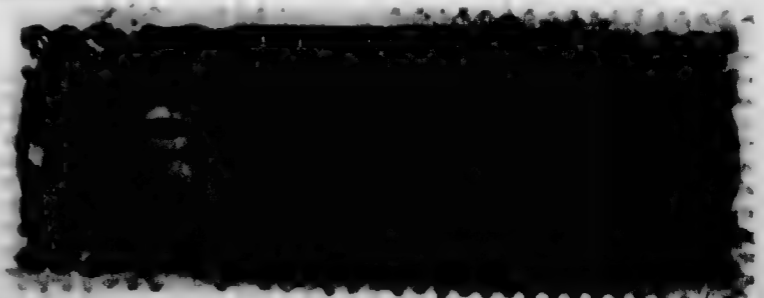

PROOF OF OWNERSHIP.

State of Kentucky, }
 County of Nelson } ss.

We, James B. Atherston and Charles Gipe each of lawful age, and resident citizens of the State and County aforesaid, do certify that George W. Pottinger of the State and County aforesaid, was on the 24 day of April 1865, the lawful owner of the Slave named Robert Pottinger referred to and described in the foregoing claim for compensation.

Two witnesses to ownership sign here.

James B. Atherston
 Charles Gipe

Sworn to and subscribed before me, a Notary Public for the County of Nelson State of Kentucky, this the 12th day of February, 1867



The officer swearing the witnesses signs here.

Geo W. Malone Notary Public for Nelson County Ky L.S.

PROOF OF LOYALTY.

State of Kentucky, }
 County of Nelson } ss.

We, Charles Gipe and James B. Atherston loyal men, and each of lawful age, and resident citizens of the Town of New Haven in the State and County aforesaid, upon our oaths declare that we have known a resident of the State and County aforesaid, since the 4th day of March, 1861, and know that he has firmly and faithfully maintained his or her adherence and allegiance to the Government of the United States, by defending its cause against the Government and forces of the so-called Confederate States of America, in all suitable and practicable ways, and according to his or her ability and opportunity.



Sworn to and subscribed before me, a Notary Public for the County of Nelson State of Kentucky this 12th day of February 1867

The officer swearing the witnesses signs here.

Geo W. Malone Notary Public for Nelson County Ky L.S.

L. Benjamin F. Atherston resident of the County of Nelson

Post Master at New Haven Ky in the State of Kentucky

do hereby state that I am and have been for years well acquainted with George W. Pottinger and Charles Gipe the applicant, and James B. Atherston his witnesses, and from our personal acquaintance with them believe their statements to be entitled to full faith and credit.

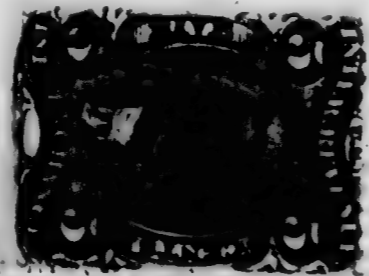

Benjamin F. Atherston - Post Master at New Haven Ky

Sworn to and subscribed before me, a Notary Public for the County of Nelson State of Kentucky this 12th day of February 1867

of Nelson State of Kentucky this 12th day of February 1867

5 CENT STAMP.

NOTE.—If the applicant and his witnesses are not personally known to one or more of the Commissioners, the above certificate should be signed by two citizens who are well known to the Commissioners, or by a Post Master or other Government officer; if signed by a United States officer it need not be sworn to, but if by citizens it must be sworn to. When a United States officer signs it the witnesses need not, and when the witnesses sign it the United States officer need not.

1041

Patton Charles

Co D., 6 U. S. Col'd Cav.

Private | Sergeant

CARD NUMBERS.

1	5389266	26
2	5389340	27
3	5389387	28
4	5389460	29
5	5389529	30
6	5389594	31
7	5389690	32
8	5389785	33
9	5389878	34
10	5389970	35
11	9092916	36
12	43147755	37
13	40732750	38
14		39
15		40
16		41
17		42
18		43
19		44
20		45
21		46
22		47
23		48
24		49
25		50

Book Mark:

See also

A-1743041- Aud NYD,
S-1352176 Aud '00

L Jordan
E

A-1743041-And NYO,
S-1352176 And '00

L. Jordan
C

P

U.S.C.T.

Charles Patton

Appears with rank of *Private* on

Muster and Descriptive Roll

of *Detachment U.S. Col R recruits*
forwarded

Roll dated *London Ky, Sept. 30, 1864.*

Where born *Knox Co Ky*

Age *26* years; occupation *Farmer*

When enlisted *Sept 26*, 1864

Where enlisted *London Ky*

For what period enlisted *3* years.

Eyes *Blue*; hair *Blue*

Complexion *Copper*; height *5-ft. 8* in.

When mustered in *Sept. 30*, 1864

Where mustered in *London Ky*

Bounty paid \$ *100*; due \$ *100*

Clothing account: *nothing issued*

Last settled _____, 1864; drawn since \$ *100*

Date of first muster *Sept. 26*, 1864

Company to which assigned _____

Remarks: *Credited to Knox Co. & Dist. Ky*

own name Eliza Patton

Knox Co. Ky

Book mark : _____

A. Black

(356m)

Copyist.

GP

6 Cav. U.S.C.T.

Charles Patton
Privt, Co B, 6 Reg't U. S. Col'd Cavalry.

Appears on

Company Muster-in and Descriptive Roll

of the organization named above. Roll dated

Camp Nelson Ky, N. Y. Nov 1st, 1864.

Where born *Knop Co. Ky*

Age *26* y'rs; occupation *Farmer*

When enlisted *Sept 26*, 1864.

Where enlisted *Landon Ky*

For what period enlisted *3* years.

Eyes *Blk*; hair *Blk*

Complexion *Copper*; height *5* ft. *8* in.

When mustered in *Sept 30*, 1864.

Where mustered in *Landon, Ky*

Bounty paid \$ *100*; due \$ *100*

Where credited *St. Louis, Mo,*

Company to which assigned *B,*

Remarks: *None,*

Eliza Patton,

Book mark:

EM Rowe

(356d)

Copyist.

P | **6 Cav.** | **U.S.C.T.**

Charles Patton

....., Co. B....., 6 Reg't U. S. Col'd Cav.

Appears on

Company Descriptive Book

of the organization named above.

DESCRIPTION.

Age 26 years; height 5 feet 8 inches.

Complexion Wopper

Eyes Blk; hair Blk

Where born Knox Ky

Occupation Farmer

ENLISTMENT.

When Sept 26, 1864.

Where Landon Ky

By whom Serge R. Day; term 3 y'rs.

Remarks:

*Appointed Sergt Jan 1/53.
found P. No 1 1/2 hrs. C. S. S. S. S.*

Brizer

(383g)

Copyist.

P

6 Cav. U.S.C.T.

Charles Patten

Srvt., Co. B, 6 Reg't U. S. Col'd Cavalry.

Appears on

Company Muster Roll

for Nov & Dec, 1864.

Present or absent present,

Stoppage, \$ 100 for

Due Gov't, \$ 100 for

Valuation of horse, \$ 100

Valuation of horse equipments, \$ 100

Remarks: Due to, for Dec \$ 1.15,

Book mark:

G. M. Moore

S 6 Cav. U.S.C.T.

Charles Patton

Sergt, Co. B, 6 Reg't U. S. Col'd Cavalry.

Appears on

Company Muster Roll

for *Jan & Feb*, 1865.

Present or absent *Absent*

Stoppage, \$ *100* for

Due Gov't, \$ *100* for

Valuation of horse, \$ *100*

Valuation of horse equipments, \$ *100*

Remarks: *Due U.S. for Ord. \$ 2.15,
1st installment bounty due \$ 100,
Detached A Haven Ky, Feb 13/65;
Appointed Sergt. from Privt.
Jan 1st 1865, Special order No. 1,
Ad Gen. 6th U.S.C.C.*

Book mark:

C. M. Moore

(358)

Copyist.

P 6 Cav. U.S.C.T.

Charles Patton
Sergt., Co. B, 6 Reg't U. S. Col'd Cavalry.

Appears on

Company Muster Roll

for March & April, 1865.

Present or absent Present.

Stoppage, \$ 100 for

Due Gov't, \$ 100 for

Valuation of horse, \$ 100

Valuation of horse equipments, \$ 100

Remarks: 1st installment bounty
due \$100. & see 103 for C. & G.
Equipage \$112. for Ord #213,
Detached service New Haven, Ky.
Feb 13, 1865.

Book mark:

EMC

(358)

Copyist.

A | **6 Cav. | U.S.C.T.**

Charles Fulton
Greer, Co. B, 6 Reg't U. S. Col'd Cavalry.

Appears on

Company Muster Roll
for *May & June*, 1865.

Present or absent *Present*

Stoppage, \$ *100* for

Due Gov't, \$ *12* / *100* for *A & Equip.*

Valuation of horse, \$ *100*

Valuation of horse equipments, \$ *100*

Remarks: *1" in ballment*
remains, should be

Book mark:

A. H. Turpey
Copyist.

6 Cav. | U.S.C.T.

Charles Patton
Sergeant, Co. B, 6 Reg't U. S. Col'd Cavalry.

Appears on

Company Muster Roll

for *July & Aug*, 186*5*.

Present or absent *present*

Stoppage, \$ *100* for

Due Gov't, \$ *1* ^{*12*}/_{*100*} for *6.7: Camp's*

Valuation of horse, \$ *100*

Valuation of horse equipments, \$ *100*

Remarks: *Mustard County*
due

Book mark:

A. E. Barber

J | **6 Cav.** | **U.S.C.T.**

Charles Fadden
sergeant, Co. B, 6 Reg't U. S. Col'd Cavalry.

Appears on

Company Muster Roll

for *Sept & Oct*, 1865.

Present or absent *present*

Stoppage, \$ *100* for

Due Gov't, \$ *100* for

Valuation of horse, \$ *100*

Valuation of horse equipments, \$ *100*

Remarks:

Book mark:

J. P. Parker
Copyist.

P

6 Cav. U.S.C.T.

Charles Patton

Sgt, Co. B, 6 Reg't U. S. Col'd Cavalry.

Appears on

Company Muster Roll

for *Nov. & Dec.*, 186^{*7*}.

Present or absent *Present*

Stoppage, \$ *100* for

Due Gov't, \$ *81* for *Co. & G. Equip'ts.*

Valuation of horse, \$ *100*

Valuation of horse equipments, \$ *100*

Remarks:

Book mark:

(358)

J. W. Ames

Copyist.

P 6 Cav. U.S.C.T.

Charles Patten

Sgt, Co. B, 6 Reg't U. S. Col'd Cavalry.

Appears on

Company Muster Roll

for *Jan'y & Feby*, 186*6*.

Present or absent *Absent*

Stoppage, \$ *100* for

Due Gov't, \$ *100* for *Co & G. Equip*

Valuation of horse, \$ *100*

Valuation of horse equipments, \$ *100*

Remarks:

*Absent sick at Fort-Keese,
I. Valls Bluff Ark.*

Book mark:

(358) *J. W. Thomas* Copyist.

P | **6 Cav.** | **U.S.C.T.**

C. Patton
Sgt., Co. *B*, 6 Reg't U. S. Col'd Cav.

Appears on **Returns** as follows:

Feb'y to April 1865, Absent,
On detached service
New Haven Ky Feb 13/65

Feb'y 1866, Absent sick
in Post Hosp,
Deualls Bluff Ark,

Book mark :

(546)

G M Row

Copyist.

I

6 Cav. U.S.C.T.

Charles Puttow

Sgt., Co. *B*, 6 Reg't U. S. Col'd Cavalry.

Appears on **Co. Muster-out Roll**, dated

Se Valls Bluff, *Apr. 15*, 1866.

Muster-out to date *Apr. 15*, 1866.

Last paid to *Feb. 28*, 1865.

Clothing account:

Last settled....., 186 ; drawn since \$..... 100

Due soldier \$..... 100; due U. S. \$..... 100

Am't for cloth'g in kind or money adv'd \$ *38* ^{*35*} 100

Due U. S. for arms, equipments, &c., \$..... 100

Bounty paid \$ *100* 100; due \$ *100* 100

Remarks:

*Private from Org. to Jan 1861
then Sgt. to President
times.*

Book mark:

(861)

J. W. Ames

Copyist.

1042

Patton John,

Co B, 6 U. S. Col'd Cav.

Private. Corporal.

CARD NUMBERS.

1	5389267	26
2	5389341	27
3	5389393	28
4	5389465	29
5	5389534	30
6	5389601	31
7	5389696	32
8	5389790	33
9	5389883	34
10	5389975	35
11	9092919	36
12	43147756	37
13	40732709	38
14		39
15		40
16		41
17		42
18		43
19		44
20		45
21		46
22		47
23		48
24		49
25		50

Book Mark:

See also

J 6 Cav. U.S.C.T.

John Patten
Privt, Co *B*, 6 Reg't U. S. Col'd Cavalry.

Appears on

Company Muster-in and Descriptive Roll
of the organization named above. Roll dated

Camp Nelson, Ky, N. Y. *Nov 1*, 186*4*.

Where born *Knaw Co, Ky*

Age *20* y'rs; occupation *Fanner*

When enlisted *Sept 27*, 186*4*.

Where enlisted *Landon, Ky*

For what period enlisted *3* years.

Eyes *Blk*; hair *Blk*

Complexion *Blk*; height *5* ft. *5* in.

When mustered in *Sept 30*, 186*4*.

Where mustered in *Landon, Ky*

Bounty paid \$ *100*; due \$ *100*

Where credited *S. Wick Ky*

Company to which assigned *B*

Remarks: *Quar*

Eliza Patten

Book mark:

A M Roar

(356d)

Copyist.

P

6 lower

U.S.C.T.

John Patton

Appears with rank of Private on

Muster and Descriptive Roll

of Detachment U.S. Col'd Recruits
forwarded

Roll dated London Ky, Sept 30, 1864

Where born Knox Co Ky

Age 20 years; occupation Farmer

When enlisted Sept 27, 1864.

Where enlisted London Ky

For what period enlisted 3 years.

Eyes Blue; hair Black

Complexion Black; height 5 ft. 5 in.

When mustered in Sept 30, 1864.

Where mustered in London Ky

Bounty paid \$ 100; due \$ 100

Clothing account: nothing issued

Last settled _____, 1864; drawn since \$ 100

Date of first muster Sept 27, 1864.

Company to which assigned _____

Remarks: Credited to Knox Co & Dist Ky

Owns name Eliza Patton

Knox Co. Ky

Book mark : _____

A C Black

(356m)

Copyist.

9 | **6 Cav. | U.S.C.T.**

John Patton

....., Co. B, 6 Reg't U. S. Col'd Cav.

Appears on

Company Descriptive Book

of the organization named above.

DESCRIPTION.

Age 20 years; height 5 feet 5 inches.

Complexion Blk

Eyes Blk; hair Blk

Where born Knox Ky

Occupation Farmer

ENLISTMENT.

When Sept 27, 1864.

Where Loudon Ky

By whom Capt A Hays; term 3 y'rs.

Remarks: Appointed Capt Jan 1/55
for J.C. for the 2nd Cav 6th
C.C.

Bryer

(3837)

Copyist.

P

6 Cav. U.S.C.T.

John Patton

Pvt, Co. B, 6 Reg't U. S. Col'd Cavalry.

Appears on

Company Muster Roll

for *Nov. & Dec.*, 186*4*.

Present or absent *present*

Stoppage, \$ *100* for

Due Gov't, \$ *100* for

Valuation of horse, \$ *100*

Valuation of horse equipments, \$ *100*

Remarks:

Book mark:

C. P. Moore

(358)

Copypist.

J.P.

6 Cav. U.S.C.T.

John Patton
Caval., Co. B, 6 Reg't U. S. Col'd Cavalry.

Appears on

Company Muster Roll

for *Jan & Feb*, 1865.

Present or absent *absent*.

Stoppage, \$ *100* for

Due Gov't, \$ *100* for

Valuation of horse, \$ *100*

Valuation of horse equipments, \$ *100*

Remarks: *Installation bounty due \$100, Det. S. A. Haven, Ky, Feb. 15, 1865. Appointed Caval from Privt June 1/65, S.O. No. 114 Det. U.S.C.*

Book mark:

J.M. Rowe

J

6 Cav. U.S.C.T.

John Patton

Capt., Co. B, 6 Reg't U. S. Col'd Cavalry.

Appears on

Company Muster Roll

for *March & April*, 1865.

Present or absent *Absent*

Stoppage, \$ *100* for

Due Gov't, \$ *100* for

Valuation of horse, \$ *100*

Valuation of horse equipments, \$ *100*

Remarks: *Installation Security
due \$100. Due U.S. for C & G,
Equipage \$0.67. Detached
service at Havana by Feb. 15,
1865.*

Book mark:

J. M. Lowe

R | **6 Cav.** | **U.S.C.T.**

John Patton
Corpl, Co. B, 6 Reg't U. S. Col'd Cavalry.

Appears on

Company Muster Roll

for *May June*, 186*5*.

Present or absent *present*

Stoppage, \$ *100* for

Due Gov't, \$ *67* for *W & G Equip*

Valuation of horse, \$ *100*

Valuation of horse equipments, \$ *100*

Remarks: *"install"*
to company due \$

Book mark: _____

R. C. Harper
Copyist.

6 Cav. | U.S.C.T.

John Tattow
Corpl, Co. B, 6 Reg't U. S. Col'd Cavalry.

Appears on

Company Muster Roll

for *July & Aug*, 1865.

Present or absent

Stoppage, \$ 100 for

Due Gov't, \$ 66 for *C & G Equip*

Valuation of horse, \$ 100

Valuation of horse equipments, \$ 100

Remarks: *"install"*
bounty

Book mark:

(358)

A. E. Warner
Copyist.

D | **6 Cav.** | **U.S.C.T.**

John Chapman
Capt., Co. B, 6 Reg't U. S. Col'd Cavalry.

Appears on

Company Muster Roll

for *Sept & Oct*, 1865.

Present or absent *present*

Stoppage, \$ *100* for

Due Gov't, \$ *100* for *C & G E*

Valuation of horse, \$ *100*

Valuation of horse equipments, \$ *100*

Remarks:

Book mark:

J. A. Harper
Copyist.

S **6 Cav. U.S.C.T.**

John Tattou
Capt, Co. B, 6 Reg't U. S. Col'd Cavalry.

Appears on

Company Muster Roll

for *Nov & Dec*, 186*5*.

Present or absent *Present*

Stoppage, \$ *100* for

Due Gov't, \$ *30* for *ordnance*

Valuation of horse, \$ *100*

Valuation of horse equipments, \$ *100*

Remarks:

Book mark:

(358) *J. W. Ames* Copyist.

99 | **6 Cav.** | **U.S.C.T.**

John Patton

Capt., Co. B, 6 Reg't U. S. Col'd Cavalry.

Appears on

Company Muster Roll

for *Jan'y + Feb'y*, 186*6*.

Present or absent *Present*

Stoppage, \$----- *100* for -----

Due Gov't, \$----- *30* / *100* for *ordnance*

Valuation of horse, \$----- *100*

Valuation of horse equipments, \$----- *100*

Remarks: -----

Book mark: -----

J. W. Cross

(358) *J. W. Cross* Copyist.

P | **6 Cav.** | **U.S.C.T.**

Patten

Capt., Co. *B.* 6 Reg't U. S. Col'd Cav.

Appears on **Returns** as follows:

*Feb to April 1865, Present
detached service New
Haven Ky, Feb 15/65,*

Book mark : _____

J. M. Row

(546)

Copyist.

P

6 Cav. U.S.C.T.

John Patton
Co. B., 6 Reg't U. S. Col'd Cavalry.

Appears on **Co. Muster-out Roll**, dated
De Valls Bluff Ark. Apr. 15, 1866.

Muster-out to date *Apr. 15,* 1866.

Last paid to *Feb. 28* 1866.

Clothing account:

Last settled _____, 186 ; drawn since \$ _____ 100

Due soldier \$ _____ 100; due U. S. \$ _____ 100

Am't for cloth'g in kind or money adv'd \$ *19*¹⁴/₁₀₀

Due U. S. for arms, equipments, &c., \$ _____ 100

Bounty paid \$ *100* 100; due \$ *100* 100

Remarks:

Private from Org. to Jan. 1/65 then Corp.

Book mark:

(861)

J. W. Ames

Copyist.

1043

Payne Joe.

Co I., 6 U. S. Col'd Cav.

Private

Private.

CARD NUMBERS.

1	5387758	26
2	5387741	27
3	5387718	28
4	5394793	29
5	5394881	30
6	5394965	31
7	5395044	32
8	5395124	33
9	5395190	34
10	5395260	35
11	5395310	36
12	9093725	37
12	40732710	38
14		39
15		40
16		41
17		42
18		43
19		44
20		45
21		46
22		47
23		48
24		49
25		50

Book Mark:

See also

1756807 - P.O. 777 8771
S-2837329 And. N. 10

H. Jordan
Et

P *6 Cav* **U. S. C. T.**

Joe Payne

Appears with rank of _____ on _____

Muster and Descriptive Roll of a Detachment of Substitutes forwarded

for the *6* Reg't U. S. Col'd *Cav.* Roll dated

Lebanon Ky, *March 31*, 1865.

Where born *Anderson Kentucky*

Age *18* y'rs; occupation *Laborer*

When enlisted *March 17*, 1865.

Where enlisted *Lebanon*

For what period enlisted *3* years.

Eyes *black*; hair *black*

Complexion *black*; height *5* ft. *3* in.

When mustered in *March 17*, 1865.

Where mustered in *Lebanon*

Bounty paid \$ *100*; due \$ *100*

Where credited _____

Company to which assigned _____

Remarks: *David Goodlett, drafted in Anderson Co., Ky.*

Book mark: _____

(340b)

D. J. Giffith

Copyist.

P 6 U.S.C.T.

Joe Payne

Appears with rank of *Pvt.* on

Muster and Descriptive Roll of a Detachment of Substitutes forwarded

for the *6* Reg't U. S. Col'd *Cavalry*. Roll dated

Draft Rendezvous Louisville Ky. Mch 25 1865.

Where born *Anderson Kentucky*

Age *18* y'rs; occupation *Labourer*

When enlisted _____, 186 .

Where enlisted *Substitute*

For what period enlisted *3* years.

Eyes *Blk*; hair *Blk*

Complexion *Blk*; height *5* ft. *3* in.

When mustered in *Mch 17*, 1865.

Where mustered in *Lebanon*

Bounty paid \$ *100*; due \$ *100*

Where credited *4th Dist. Ky.*

Company to which assigned _____

Remarks: *Sub. for David Goodlett*

Book mark : _____

Conard
Copyist.

P | **6 Cav. | U.S.C.T.**

Joe Payne
Co. *A*, 6 Reg't U. S. Col'd Cav.

Appears on

Company Descriptive Book

of the organization named above.

DESCRIPTION.

Age *18* years; height *5* feet *3* inches.

Complexion *Black*

Eyes *Blk*; hair *Blk*

Where born *Anderson Co Ky*

Occupation *Laborer*

ENLISTMENT.

When *March 17*, 186 *3*.

Where *Lebanon Ky*

By whom *Capt Bidler*; term *3* y'rs.

Remarks: *Credited by 4. D. Ky Sub for David Goodlett*

Goodlett
Copyist.

P

6

U.S.C.T.

Joe Payne

Appears with rank of *Priv* on

Muster and Descriptive Roll of a Detachment of Substitutes forwarded

for the *6* Reg't U. S. Col'd Cavalry. Roll dated *Draft Rendezvous, Louisville, Ky., Mch 25 1865.*

Where born *Anderson, Kentucky*

Age *18* y'rs; occupation *Laborer*

When enlisted _____, 186 .

Where enlisted *Substitute.*

For what period enlisted *3* years.

Eyes *Black*; hair *Black*

Complexion *Black*; height *5* ft. *3* in.

When mustered in *Mch 17*, 1865.

Where mustered in *Lebanon*

Bounty paid \$ *100*; due \$ *100*

Where credited *4th Dist. Ky.*

Company to which assigned _____

Remarks: *Sub. for David Goodlett.*

Book mark: _____

(340c)

Conard
Copyist.

P 6 Cav. U.S.C.T.

Joe Payne

Privt, Co. I, 6 Reg't U. S. Col'd Cavalry.

Appears on

Company Muster-in and Descriptive Roll

of the organization named above. Roll dated

Camp Nelson, Ky., Apl. 29, 1865.

Where born *Anderson Co. Ky.*

Age *18* y'rs; occupation *Laborer*

When enlisted _____, 186 _____

Where enlisted *Substitute*

For what period enlisted *3* years.

Eyes *Blk*; hair *Blk*

Complexion *Blk*; height *5 ft. 3* in.

When mustered in *Mar. 17, 1865.*

Where mustered in *Lebanon*

Bounty paid \$ *none paid* 100; due \$ 100

Where credited *4 Dist. Ky.*

Company to which assigned *I.*

Remarks:

Sub. for David Goddett.

Book mark:

D. McKennedy

(356d)

Copyist.

P

6 Cav. | U.S.C.T.

Joe Payne

Privt, Co. I, 6 Reg't U. S. Col'd Cavalry.

Appears on

Company Muster Roll

for *Enlistment to Apl 30*, 186*5*.

Present or absent *Present*

Stóppage, \$ *100* for

Due Gov't, \$ *100* for

Valuation of horse, \$ *100*

Valuation of horse equipments, \$ *100*

Remarks:

1" Instalment bounty due

Book mark:

D. M. Kennedy

(358)

Copyist.

P

6 Cav. U.S.C.T.

Joe Payne

Privt., Co. I, 6 Reg't U. S. Col'd Cavalry.

Appears on

Company Muster Roll

for *May v. June*, 186*5*.

Present or absent *Present.*

Stoppage, \$ 100 for

Due Gov't, \$ 100 for

Valuation of horse, \$ 100

Valuation of horse equipments, \$ 100

Remarks:

Book mark:

D. M. Keene dy
Copyist.

| **6 Cav.** | **U.S.C.T.**

Joe Payne
Privt, Co. I, 6 Reg't U. S. Col'd Cavalry.

Appears on

Company Muster Roll

for July & Aug, 1865-

Present or absent Present

Stoppage, \$ 100 for

Due Gov't, \$ 100 for

Valuation of horse, \$ 100

Valuation of horse equipments, \$ 100

Remarks: Reported

Book mark: _____

(358) J. Casey Copyist.

3

6 Cav. | U.S.C.T.

James P. ...
Smith, Co. I, 6 Reg't U. S. Col'd Cavalry.

Appears on

Company Muster Roll

for *Sept 9 Oct*, 1867

Present or absent *Present*

Stoppage, \$ *100* for

Due Gov't, \$ *100* for

Valuation of horse, \$ *100*

Valuation of horse equipments, \$ *100*

Remarks:

Book mark:

(358)

J. Casey

Copyist.

2 | **6 Cav.** | **U.S.C.T.**

Joe Payne
Private, Co. I, 6 Reg't U. S. Col'd Cavalry.

Appears on

Company Muster Roll

for Nov & Dec, 1865.

Present or absent Present.

Stoppage, \$ 100 for

Due Gov't, \$ 100 for

Valuation of horse, \$ 100

Valuation of horse equipments, \$ 100

Remarks:

Book mark : -----

J. B. Casper
Copyist.

P.

6 Cav.

U.S.C.T.

John Payne
.....
Plt., Co. I, 6 Reg't U. S. Col'd Cavalry.

Appears on

Company Muster Roll

for *Jan. + Feb.*, 1866.

Present or absent *Present.*

Stoppage, \$..... *100* for

Due Gov't, \$..... *100* for

Valuation of horse, \$..... *100*

Valuation of horse equipments, \$..... *100*

Remarks:

Book mark:

[Signature]

P | **6 Cav.** | **U.S.C.T.**

Joe Payne
Pos, Co. *D*, 6 Reg't U. S. Col'd Cav.

Appears on Returns as follows:

Jan & March 1866. On duty
Stable duty.

Book mark:

G M Rowe

(546)

Copyist.

P

6 Cav. U.S.C.T.

John Payne
Co. *D*, 6 Reg't U. S. Col'd Cavalry.

Appears on **Co. Muster-out Roll**, dated
Severe's Bluff Tex. April 15, 1866.
Muster-out to date *April 15*, 1866.
Last paid to *Feb. 28*, 1866.

Clothing account:
Last settled....., 186 ; drawn since \$..... 100
Due soldier \$..... 100; due U. S. \$..... 100
Am't for cloth'g in kind or money adv'd \$ *54*¹⁸ 100

Due U. S. for arms, equipments, &c., \$..... 100
Bounty paid \$..... 100; due \$..... 100

Remarks:

Book mark:

(861) *John Payne* Copyist.

Payne, Joe
....., Co., Reg't *Usat*

Enclosures.

Bed Cards	Final Statements
Burial Records	Furloughs or L. of A.
Certs. of Dis. for Discharge	Med. Certificates
C. M. Charges	Med. Des. Lists
Descriptive Lists	Orders
Discharge Certificates	Pris. of War Record
Enlistment Papers	Resignations

Other papers relating to—

Admission to Hosp'l	Furlough or L. of A.
Casualty Sheet	Med. Examination
Confinement	Misc. Information
Contracts	Pay or Clothing
Death or Effects	Personal Reports
Desertion	Rank
Discharge from Hosp'l	Transfer to Hosp'l
Discharge from Service	Transfer to V. R. C.
Duty	Transportation

P 21

No. 4

Joe Payne
Enlisted at Lebanon

As Substitute for

David Goddett

On the 17th day of March, 1865,

By

Capt James M. Fidler

A. B. Merimee

John C. Maxwell

Board of Enrollment,

4th Dist. of Ky

6 U. S. C. Cox

SUBSTITUTE

VOLUNTEER ENLISTMENT.

STATE OF United to Anderson County TOWN OF Anderson

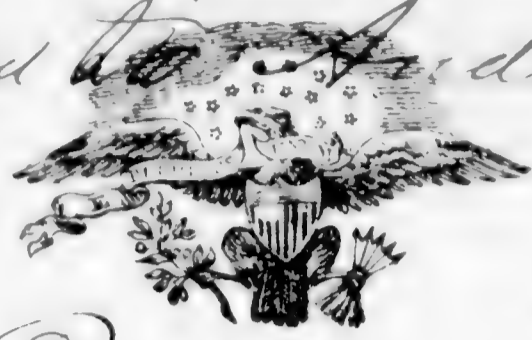

I, Joe Payne, born in the State of Ky - Anderson aged 18 years, and by occupation a Laborer, Do HEREBY ACKNOWLEDGE to have agreed with David Goodlett, Esq., of Anderson Co Kentucky

to become his **SUBSTITUTE** in the Military Service, for a sufficient consideration paid and delivered to me, on the 17th day of March, 1863; and having thus agreed with said David Goodlett, I DO HEREBY ACKNOWLEDGE to have enlisted this 17th day of March, 1863, to serve as a **Soldier** in the **Army of the United States of America**, for the period of **THREE YEARS**, unless sooner discharged by proper authority. I do also agree to accept such bounty, pay, rations, and clothing as are, or may be, established by law for soldiers. And I do solemnly swear that I will bear true and faithful allegiance to the **United States of America**; that I will serve them honestly and faithfully against all their enemies or opposers whomsoever; and that I will observe and obey the orders of the President of the United States and the orders of the officers appointed over me, according to the Rules and Articles of War.

SWORN and subscribed to, at Sebanora this 17th of March, 1863 BEFORE James W. Fowler Joe Payne Capt. Geo. Mar 4th Dist Mark

We certify, on honor, That we have carefully examined the above-named Volunteer Substitute agreeably to the Regulations, and that, in our opinion, he is free from all bodily defects and mental infirmity which would in any way disqualify him from performing the duties of a soldier; that he was entirely sober when enlisted; that he is of lawful age, (not under 18 years;) and that, in accepting him as duly qualified to perform the duties of an able-bodied soldier, and as a Substitute in lieu of David Goodlett Sept 21st, drafted in Anderson County Ky, 1864, we have strictly observed the Regulations which govern in such cases. This soldier has Black eyes, Black hair, Black complexion; is 5 feet 9 inches high.

James W. Fowler
Provost Marshal.

J. B. Minnie
Commissioner of Board.

John C. Maxwell
Surgeon of Board.

Board of Enrollment of 4th Dist. of Kentucky

DECLARATION OF SUBSTITUTE.

I, Joe Payne, desiring to ENLIST
in the Army of the United States, for THREE YEARS, **Do declare**, That I am
18 years and _____ months of age; that I have
never been discharged from the United States service on account of disability or by sentence of
a court martial; and I know of no impediment to my serving honestly and faithfully as a soldier
for three years.

GIVEN at Lebanon Ky
the 14th day of March 1915

WITNESS:

W. J. Hoge

Joe Payne
his mark

1044

Payne, Peter

Co. B, 6 U. S. Col'd Cav.

Private

Private

CARD NUMBERS.

1	26
2	27
3 <i>See Payne, Peter</i>	28
4	29
5	30
6	31
7	32
8	33
9	34
10	35
11	36
12	37
13	38
14	39
15	40
16	41
17	42
18	43
19	44
20	45
21	46
22	47
23	48
24	49
25	50

Book Mark:

See also

1045
Parson John.

Co., 6 U. S. Col'd Cav.

CARD NUMBERS.

#		
1	5387823	26
2		27
3		28
4		29
5		30
6		31
7		32
8		33
9		34
10		35
11		36
12		37
13		38
14	# Card withdrawn and filed	39
15	with 2 Regt U.S. C. Cav.	40
16	when it properly belongs	41
17	873197.	42
18		43
19		44
20		45
21		46
22		47
23		48
24		49
25		50

Book Mark:

See also

1046

Pebbles, George

Co *B*, 6 U. S. Col'd Cav.

Private

Private

CARD NUMBERS.

1	26
2	27
3	28
4	29
5	30
6	31
7	32
8	33
9	34
10	35
11	36
12	37
13	38
14	39
15	40
16	41
17	42
18	43
19	44
20	45
21	46
22	47
23	48
24	49
25	50

See Pebbles, George

Book Mark:

See also

1047

Pepples Lee

Co 6, 6 U. S. Col'd Cav.

Private

Private

CARD NUMBERS.

1	26
2	27
3	28
4	29
5	30
6	31
7	32
8	33
9	34
10	35
11	36
12	37
13	38
14	39
15	40
16	41
17	42
18	43
19	44
20	45
21	46
22	47
23	48
24	49
25	50

Book Mark:

See also

1048

Pendleton Anderson

Co *A.*, 6 U. S. Col'd Cav.

Private | Private

CARD NUMBERS.

1	5387340	26
2	5387351	27
3	5387365	28
4	5394095	29
5	5394181	30
6	5394262	31
7	5394357	32
8	5394437	33
9	5394526	34
10	5394600	35
11	5394669	36
12	9093032	37
12	40732713	38
14		39
15		40
16		41
17		42
18		43
19		44
20		45
21		46
22		47
23		48
24		49
25		50

Book Mark:

See also

P 16 av. U.S.C.T.

Anderson Pendleton

Co. 2, 2 Reg't U.S. Col'd Cav

Appears on

Company Descriptive Book

of the organization named above.

DESCRIPTION.

Age 21 years; height 5 feet 6 inches.

Complexion black

Eyes Blue; hair Black

Where born Tennessee

Occupation Farmer

ENLISTMENT.

When Mar. 16, 1865.

Where Louisville, Ky.

By whom Capt. Womack; term 3 y'rs.

Remarks:

Amos Webb

P

6 Cav. U.S.C.T.

Anderson Judleton

Appears with rank of *private* on

Muster and Descriptive Roll of a Detachment of U. S. Vols. forwarded

for the 6 Reg't U. S. Col'd Cavalry. Roll dated

Louisville Ky, March 16, 1865.

Where born *Tennessee*

Age *27* y'rs; occupation *Farmer*

When enlisted *March 16, 1865.*

Where enlisted *Louisville Ky*

For what period enlisted *3* years.

Eyes *black*; hair *black*

Complexion *black*; height *5* ft. *-* in.

When mustered in *March 16, 1865.*

Where mustered in *Louisville Ky.*

Bounty paid \$ *100*; due \$ *100*

Where credited *Jeff Co. 5th Dist. Ky.*

Company to which assigned

Remarks :

Book mark :

A. B. Brad

P

6 Cav.

U.S.C.T.

Anderson Ruddebow

Appears with rank of *private* on

Muster and Descriptive Roll of a Detachment of U. S. Vols. forwarded

for the 6 Reg't U. S. Col'd Cavalry. Roll dated

St. Louis Ky. Feb 17, 1865.

Where born *Tennessee*

Age *21* y'rs; occupation *farm hand.*

When enlisted *Feb 16, 1865.*

Where enlisted *Louisville Ky*

For what period enlisted *3* years.

Eyes *black*; hair *black*

Complexion *black*; height *5* ft. *0* in.

When mustered in *Feb 16, 1865.*

Where mustered in *Louisville Ky.*

Bounty paid \$ *100*; due \$ *100*

Where credited *5 Dist. Ky.*

Company to which assigned

Remarks:

Book mark:

P

6 Cav.

U.S.C.T.

Anderson Pendleton

Appears with rank of *private* on

Muster and Descriptive Roll of a Detachment of U. S. Vols. forwarded

for the 6 Reg't U. S. Col'd Cavalry. Roll dated

St. Louis v. Ky *Mch 17, 1865.*

Where born *Tennessee*

Age *21* y'rs; occupation *farm hand*

When enlisted *Mch 16, 1865.*

Where enlisted *Louisville Ky*

For what period enlisted *30* years.

Eyes *black*; hair *black*

Complexion *black*; height *5* ft. *0* in.

When mustered in *Mch 16, 1865.*

Where mustered in *Louisville Ky*

Bounty paid \$ *100*; due \$ *100*

Where credited *5 Dist. Ky*

Company to which assigned

Remarks:

Book mark:

A. B. Bell

P

Clav. U. S. C. T.

Anderson Pendleton
Pvt, Co. H. 6 Reg't U. S. Col'd Cavalry

Appears on

Company Muster-in and Descriptive Roll
of the organization named above. Roll dated
Covington, Ky. Mch. 26, 1865.

Where born Tennessee

Age 21 y'rs; occupation Farm hand.

When enlisted Mch 16, 1865.

Where enlisted Louisville, Ky.

For what period enlisted 3 years.

Eyes Black; hair Black

Complexion Black; height 5 ft. 6 1/2 in.

When mustered in Mch 16, 1865.

Where mustered in Louisville, Ky.

Bounty paid \$ 100; due \$ 100

Where credited 5th Dist. Ky.

Company to which assigned H.

Remarks:

Book mark:

Conard

(356d)

Copyist.

P

6 Cav. U.S.C.T.

Anderson Pendleton

Pvt, Co. H, 6 Reg't U. S. Col'd Cavalry.

Appears on

Company Muster Roll

for from Mch 16 to Apr. 30, 1865.

Present or absent Absent.

Stoppage, \$ 100 for

Due Gov't, \$ 100 for

Valuation of horse, \$ 100

Valuation of horse equipments, \$ 100

Remarks: On detached duty cruises
Creek, Ky. C. R. R.

Book mark:

(358)

Conard
Copyist.

P

6 Cav. U.S.C.T.

Anderson Pendleton

Priv., Co. H, 6 Reg't U. S. Col'd Cavalry.

Appears on

Company Muster Roll

for May & June, 1865.

Present or absent Absent

Stoppage, \$ 100 for

Due Gov't, \$ 100 for

Valuation of horse, \$ 100

Valuation of horse equipments, \$ 100

Remarks: 1st Instalment Bounty due. Sick in Hosp'l. Camp Nelson Ky. since —

Book mark:

(358)

Conard Copyist.

6 Cav. U.S.C.T.

Madison, Indiana
Ed, Co. H, 6 Reg't U. S. Col'd Cavalry.

Appears on

Company Muster Roll

for *John L. Lee*, 1865.

Present or absent *Present*.

Stoppage, \$ *100* for

Due Gov't, \$ *100* for

Valuation of horse, \$ *100*

Valuation of horse equipments, \$ *100*

Remarks:

Book mark:

(358)

James

Copyist.

6 Cav. U.S.C.T.

James M. ...
... Co. H, 6 Reg't U. S. Col'd Cavalry.

Appears on

Company Muster Roll

for *Sept Oct*, 1865.

Present or absent *Present*

Stoppage, \$ 100 for

Due Gov't, \$ 100 for

Valuation of horse, \$ 100

Valuation of horse equipments, \$ 100

Remarks:

Book mark:

(358)

James M. ...

Copyist.

6 Cav. U.S.C.T.

Anderson
Co., Co. H, 6 Reg't U. S. Col'd Cavalry.

Appears on

Company Muster Roll

for *Jan Dec*, 1865.

Present or absent *Remount*

Stoppage, \$ *100* for

Due Gov't, \$ *100* for

Valuation of horse, \$ *100*

Valuation of horse equipments, \$ *100*

Remarks:

Book mark: -----

(358)

Shoemaker
Copyist.

6 Cav. U.S.C.T.

Anderson Punditon

Capt., Co. H, 6 Reg't U. S. Col'd Cavalry.

Appears on

Company Muster Roll

for *Jan & Feb*, 1866.

Present or absent *Present*

Stoppage, \$ 100 for

Due Gov't, \$ 0 ⁶⁰/₁₀₀ for *ordnance*

Valuation of horse, \$ 100

Valuation of horse equipments, \$ 100

Remarks: *on daily duty Co.*
Cook

Book mark:

J. M. Harmon

P | **6 Cav.** | **U.S.C.T.**

+ Anderson Pendleton
Pot., Co. A, 6 Reg't U. S. Col'd Cav.

Appears on Returns as follows:

April 1865, Absent On
Detached service at
Crosses Creek Ky
C.R.R.

May & June 1865, Absent
sick at Camp Nelson Ky
Gen Hospital.

July to March 1866, On
daily duty as Co
Cook.

+ Supplied from mo. Roll by
H.C.

Book mark:

H.M. Row

(546)

Copyist.

P

6 Cav. U.S.C.T.

Anderson Pundleton

Prnt, Co. *N*, 6 Reg't U. S. Col'd Cavalry.

Appears on **Co. Muster-out Roll**, dated

Devalls Bluffen, Apr 15, 1866.

Muster-out to date *Apr 15*, 1866.

Last paid to *Feb 28*, 1866.

Clothing account:

Last settled _____, 186 ; drawn since \$ _____ 100

Due soldier \$ _____ 100; due U. S. \$ *2 94*/₁₀₀

Am't for cloth'g in kind or money adv'd \$ _____ 100

Due U. S. for arms, equipments, &c., \$ _____ 100

Bounty paid \$ *100* 100; due \$ _____ 100

Remarks: _____

Book mark: _____

M. Harmon

(861)

Copyright.

1049
Pendleton James.

Co. A., 6 U. S. Col'd Cav.

Private Private

CARD NUMBERS.

1	5388401	26
2	5388486	27
3	5388516	28
4	5388605	29
5	5388676	30
6	5388742	31
7	5388897	32
8	5388987	33
9	5389086	34
10	5389187	35
11	9092811	36
12	819-05-1874	37
13	818-05-1874	38
14	43147887	39
15	40732751	40
16		41
17		42
18		43
19		44
20		45
21		46
22		47
23		48
24		49
25		50

Book Mark

E.B.V. 10. P. 584 - S. 192.
10. 6. 74. S. 18. 2. 10. 6. 74.

See also

P | **6 Cav. | U.S.C.T.**

James Pendleton

....., Co. *A*, 6 Reg't U. S. Col'd Cav.

Appears on

Company Descriptive Book

of the organization named above.

DESCRIPTION.

Age *21* years; height *5* feet *4* inches.

Complexion *Blk*

Eyes *Blk*; hair *Blk*

Where born *Clark Ky*

Occupation *farmer*

ENLISTMENT.

When *Sept 23*....., 1864.

Where *Camp Nelson*

By whom *C. Randolph*; term *3* y'rs.

Remarks: *Appointed Capt Jan 1st 1865 Died Jan 23/65 at Helena Ark.*

Bryson

6600
11163

James Sandleton

Appears with rank of Sgt on

Muster and Descriptive Roll

of Detachment of 11th Colored
Regiment mustered into the
service for the U.S.A. Roll dated
Camp Nelson, Ky. Oct. 3, 1864.

Where born Clark, Ky.

Age 21 years; occupation farmer

When enlisted Sept. 23, 1864

Where enlisted Camp Nelson, Ky.

For what period enlisted 2 years.

Eyes Black; hair Black

Complexion Black; height 5 ft. 4 in.

When mustered in Sept. 23, 1864

Where mustered in Camp Nelson, Ky.

Bounty paid \$ 100; due \$ 100

Clothing account:

Last settled , 186 ; drawn since \$ 100

Date of first muster , 186

Company to which assigned

Remarks: Say due from enlist-
ment. Name of reputed
owner, James Sandleton
credited to Clark, Ky.

Book mark:

(356m) Copyist.

P

6 Cav. U.S.C.T.

James Pendleton

Prvt., Co. A, 6 Reg't U. S. Col'd Cavalry.

Appears on

Company Muster-in and Descriptive Roll

of the organization named above. Roll dated

Camp Nelson Ky, N.Y., Nov. 1, 1864.

Where born Clark, Kentucky

Age 21 y'rs; occupation Farmer

When enlisted Sept. 23, 1864

Where enlisted Camp Nelson Ky

For what period enlisted 3 years.

Eyes Blue; hair Black

Complexion Blue; height 5 ft. 11 in.

When mustered in Sept. 23, 1864

Where mustered in Camp Nelson Ky

Bounty paid \$ 100; due \$ 100

Where credited 7 Dist. Kentucky

Company to which assigned

Remarks:

Book mark:

W. J. G. J. G.

(356d)

Copyist.

7

6 Cav. U.S.C.T.

James Pendleton
Pvt., Co. A, 6 Reg't U. S. Col'd Cavalry.

Appears on

Company Muster Roll

for *Nov + Dec.*, 1864.

Present or absent *Present*

Stoppage, \$ *100* for

Due Gov't, \$ *100* for *100*

Valuation of horse, \$ *100*

Valuation of horse equipments, \$ *100*

Remarks:

Book mark:

(358)

Daygett

Copyist.

9

6 Cav. U.S.C.T.

James Pendleton
Warp, Co. A, 6 Reg't U. S. Col'd Cavalry.

Appears on

Company Muster Roll

for Jan. & Feb., 1865.

Present or absent Present

Stoppage, \$ 100 for

Due Gov't, \$ 100 for

Valuation of horse, \$ 100

Valuation of horse equipments, \$ 100

Remarks: First instalment
Bounty due. Appointed
Capt. Dec. 31st 1864

Book mark:

~~James Pendleton~~
Daggett

(358)

Copyist.

P **6 Cav. U.S.C.T.**

James Pundleton
Corp., Co. A, 6 Reg't U. S. Col'd Cavalry.

Appears on

Company Muster Roll

for Mar. 7 1863, 1863.

Present or absent Absent

Stoppage, \$ 100 for

Due Gov't, \$ 100 for

Valuation of horse, \$ 100

Valuation of horse equipments, \$ 100

Remarks: In detached service
fulfillment by first
instalment Bounty due.

Book mark: _____

(358)

Waggett

Copyist.

1 | **6 Cav. | U.S.C.T.**

James Bullen
Cap., Co. A, 6 Reg't U. S. Col'd Cavalry.

Appears on

Company Muster Roll

for *May & June, 1863.*

Present or absent *Present*

Stoppage, \$ *100* for

Due Gov't, \$ *100* for

Valuation of horse, \$ *100*

Valuation of horse equipments, \$ *100*

Remarks: *1st installment
of bounty due \$100.
Due Gov't for C. & S.
\$ 100
100*

Book mark: *19*

Joseph Stewart
(358) Copyist.

6 Cav. U.S.C.T.

James Maddison
Sgt., Co. A, 6 Reg't U. S. Col'd Cavalry.

Appears on

Company Muster Roll

for July 1864, 1864.

Present or absent Present

Stoppage, \$ 100 for

Due Gov't, \$ 100 for

Valuation of horse, \$ 100

Valuation of horse equipments, \$ 100

Remarks: 1st installment
of bounty due \$100.
Promoted per Regt
Order No. 50 to date
from Aug 1st 1864.
Bounty due for Co. A.
\$100
100

Book mark:

Joseph Stewart
(358) Copyist.

17 | **6 Cav. | U.S.C.T.**

James Pendleton

Priv., Co. A, 6 Reg't U. S. Col'd Cavalry.

Appears on

Company Muster Roll

for *Sept & Oct*, 186*1*.

Present or absent *Absent*

Stoppage, \$ *100* for _____

Due Gov't, \$ *100* for _____

Valuation of horse, \$ *100*

Valuation of horse equipments, \$ *100*

Remarks: *Absent on detached service per Regt order no 101 reduced from Regt Sept. 1. 61.*

Book mark: _____

Joseph Stewart

(358) *Copyist.*

P 6 Cav. U.S.C.T.

James Pendleton
Pot, Co. A, 6 Reg't U. S. Col'd Cavalry.

Appears on

Company Muster Roll

for Nov & Dec, 1865.

Present or absent Absent

Stoppage, \$ 100 for

Due Gov't, \$ 100 for

Valuation of horse, \$ 100

Valuation of horse equipments, \$ 100

Remarks: Sick in Hospital
at Helena Ark. since
Dec 13" 1865.

Book mark:

R. S. Shelton

J.

6 Cav. U.S.C.T.

James Pendleton

Priv, Co. A, 6 Reg't U. S. Col'd Cavalry.

Appears on

Company Muster Roll

for *Jan - Feb*, 1866.

Present or absent

Stoppage, \$ 100 for

Due Gov't, \$ 100 for

Valuation of horse, \$ 100

Valuation of horse equipments, \$ 100

Remarks: *Died at Helena Ark
Jan'y. 16. 1866 of inflammation of
Stomach. Due U.S. for C. & G.
Equipage \$7.80
Final Statements fur-
nished.*

Book mark: *Died Jan 21/66. E.B.V.10. P.584*

R. B. Shelton

P | 6 Cav. | U.S.C.T.

James Pendleton
Pvt., Co. A, 6 Reg't U. S. Col'd Cav.
Copt.

Appears on Returns as follows:

Nov 1864 to June 1865,
On duty in 2nd Dept.

March & April 1865, (Copt)
Absent on detached
service since Mar 28/65,
Camp Nelson Ky
Pr R.O.

Oct & Nov 1865 (Pvt) On
duty, Detailed in Reg't
Band per R. S. O. No 101,
signed Lt Col Coats
Candy, Oct 21. 65.

Dec 1865, & Jan 1866. Absent,
sick in Hospital Helena
since Dec 13/65.

Feb'y, 1866. Died at
Helena Ark Jan 26. 66,
of inflammation of stomach, no efforts.

Book mark:

G. M. Cow

P | **6 Cav.** | **U.S.C.T.**

James Puddledton
Priv, Co. *A*, 6 Reg't U. S. Col'd Cavalry.

Appears on **Co. Muster-out Roll**, dated
General, Bluff A. Co., Apr 15, 1866.

Muster-out to date _____, 186 .

Last paid to *Oct. 31, 1865.*

Clothing account:

Last settled _____, 186 ; drawn since \$ _____ 100

Due soldier \$ _____ 100; due U. S. \$ _____ 100

Am't for cloth'g in kind or money adv'd \$ _____ 100

Due U. S. for arms, equipments, &c., \$ _____ 100

Bounty paid \$ _____ 100; due \$ _____ 100

Remarks: *Died in Hospital at*
Helena Mt. Inflammation
of Stomach Jan 26
1866

Book mark: *V. 81. P. 159. 69. B. 19. V. 10*
vrr.

R. S. Shelton

(861)

Copyist.

JAN. 10

5389187

* 1891 *

C.S. 74. D. 18. Y. 10. C.S. 74.

P | 6th Cav. | U.S.C.S.

James Pendleton

, Co. A, 6th Reg't U.S.C. Cav.

NOTATION.

Book mark: S-18-C-S-1874.

War Department,

Adjutant General's Office,

Washington, Jan'y 24, 1874.

Died January 26, 1866.

(438)

W. Allen

Corpst.

SP 6th Cav. U.S.C.

James Pendleton

Co. A, 6th Reg't U.S.C.

NOTATION.

Book mark: *S-14-C-J-1874.*

Record and Pension Office.

WAR DEPARTMENT.

This book mark refers only to a report from the medical records, made by the Surgeon General to the Adjutant General, relative to the above-named man. As the medical records have since been carded, no transcript of this report is made hereon.

(491)

M. Allen

Copyist.

Pendleton, James
Co. a, 6 Reg't U. S. C. Cav.

2 Enclosures.

Bed Cards	Descriptive Lists
Burial Records	Final Statements
Certs. of Dis. for Discharge	Furloughs
C. M. Charges	Med. Des. Lists
Med. Certificates	Orders

Other papers relating to—

Admission to Hosp'l	Furlough
Casualty Sheet (Officer's)	Med. Examination
Confinement	Misc. Information
Contracts	Pay or Clothing
Death or Effects	Personal Reports
Desertions	Rank
Discharge from Hosp'l	Transfer to Hosp'l
Discharge from Service	Transfer to V. R. C.
Duty	Transportation

[OFFICE INDORSEMENT.]

War Department,

ADJUTANT GENERAL'S OFFICE,

February 1, 1871,

The death of James Puddleton
Private, Co. "C", 6th Reg't U. S.
Colored Cavalry, is reported as follows:—

On Company Muster Roll.

For January 1866, January 1866,
Company Muster-out Roll.

January 1866, 1866,
Company Descriptive Book.

Company Morning Reports. , 186

Soldier's Final Statement. , 186

Soldier's Record of Death and Interment. , 186

Soldier's Inventory of Effects. , 186

Soldier's Certificate of Disability for Discharge. , 186

Quarterly Returns of Company Soldiers, 186

January 1866, 1866,
Regimental Return.

For February 1866, January 1866,
Regimental Quarterly Returns.

Regimental Descriptive Book. , 186

By Surgeon General.

January 1866, 1866

January 1866, 1866, is held to be

the correct date, and the Company Muster

Roll will be amended accordingly.

James D. Linn
379th
584 Puddleton's Band
Held on Mar 10 1874

FINAL STATEMENT

OF

James Puddleton Co. A

6th Reg't of U. S. Col. Cavalry

VOLUNTEERS.

December 31 1866

NOTE 1.—Two of these certificates (or duplicates) are to be given to each volunteer soldier who may be discharged previously to the discharge of his company, that he may at once receive from the Paymaster the pay, &c., due him, and the captain or other officer commanding the company will certify to the act of the delivery of the duplicate certificates; on these certificates the Soldier is "entitled to" his discharge, and should also present his discharge to the Paymaster to have the payment endorsed on it. The discharge is to be given back to the Soldier by the Paymaster; the latter only retaining as his voucher the duplicate certificates.

NOTE 2.—If the Soldier is entitled to pay for the use of his horse, the Company Commander will certify to that fact, and also to the time he has pay due for having been so mounted on his own horse.

NOTE 3.—Amounts due the Sutler and Laundress must be entered on the Muster Roll on which the death, desertion, &c., is reported, as well as on the final statement, otherwise the amount cannot be collected from the United States.

NOTE 4.—This blank will be used for deceased volunteers as well as others.

James D. Linn

[OFFICE ENDORSEMENT.]

War Department,

ADJUTANT GENERAL'S OFFICE,

February 1, 1874.

The death of James Pundleton
Private, Co. "C", 6th Reg't U. S.
Colored Cavalry, is reported as follows:—

On Company Muster Roll.

For January 1866, and 1866,
Company Muster-out Roll.

January 1866,
Company Descriptive Book.

Company Morning Reports. 186

Soldier's Final Statement. 186

Soldier's Record of Death and Interment. 186

Soldier's Inventory of Effects. 186

Soldier's Certificate of Disability for Discharge. 186

Quarterly Returns of Colored Soldiers. 186

January 1866, 1866,
Regimental Return.

For February 1866, January 1866,
Regimental Quarterly Returns.

Regimental Descriptive Book. 186

By Surgeon General. 186

January 1866, 1866,
is held to be

the correct date, and the Company Muster

Roll will be amended accordingly.

James Pundleton
No. 584
Included on Mar 10 1874

FINAL STATEMENT

OF

James Pundleton Co. A

6th Reg't of U. S. Col. Cavalry

VOLUNTEERS.

December 1866

NOTE 1.—Two of these certificates (or duplicates) are to be given to each volunteer soldier who may be discharged previously to the discharge of his company, that he may at once receive from the Paymaster the pay, &c., due him, and the captain or other officer commanding the company will certify to the act of the delivery of the duplicate certificates; on these certificates the Soldier is "entitled to" his discharge, and should also present his discharge to the Paymaster to have the payment endorsed on it. The discharge is to be given back to the Soldier by the Paymaster; the latter only retaining as his voucher the duplicate certificates.

NOTE 2.—If the Soldier is entitled to pay for the use of his horse, the Company Commander will certify to that fact, and also to the time he has pay due for having been so mounted on his own horse.

NOTE 3.—Amounts due the Sutler and Laundress must be entered on the Muster Roll on which the death, desertion, &c., is reported, as well as on the final statement, otherwise the amount cannot be collected from the United States.

NOTE 4.—This blank will be used for deceased volunteers as well as others.

James Pundleton

1

20

FINAL STATEMENT

OF

James Pendleton Co. A

6th Reg't of U. S. Col. Cavalry

VOLUNTEERS.

Dec 17 1866

NOTE 1.—Two of these certificates (or duplicates) are to be given to each volunteer soldier who may be discharged previously to the discharge of his company, that he may at once receive from the Paymaster the pay, &c., due him, and the captain or other officer commanding the company will certify to the act of the delivery of the duplicate certificates; on these certificates the Soldier is "entitled to" his discharge, and should also present his discharge to the Paymaster to have the payment endorsed on it. The discharge is to be given back to the Soldier by the Paymaster; the latter only retaining as his voucher the duplicate certificates.

NOTE 2.—If the Soldier is entitled to pay for the use of his horse, the Company Commander will certify to that fact, and also to the time he has pay due for having been so mounted on his own horse.

NOTE 3.—Amounts due the Sutler and Laundress must be entered on the Muster Roll on which the death, desertion, &c., is reported, as well as on the final statement, otherwise the amount cannot be collected from the United States.

NOTE 4.—This blank will be used for deceased volunteers as well as others.

ASSISTANT GENERAL'S OFFICE

Nov 17 1866

Duplicate with Inventory sent 2d Auditor.

James Pendleton

1866

I certify, on honor, that James Pendleton a Private of
 Captain J. H. Watson Company (A) of the 1st Regiment of U.S. Cavalry
VOLUNTEERS, of the State of _____, born in Black Lea, State
 of Kentucky, aged 21 years; 5 feet 4 inches high; Black complexion,
Black eyes, Black hair, and by occupation a Farmer, having joined the company on
 its original organization at Camp Nelson Ky, and enrolled in it at the muster into
 the service of the United States at Camp Nelson Ky, on the 23rd day
 of September, 1864, (or was mustered in service as a recruit, by Captain
J. C. Kenney, at Camp Nelson Ky, on the 23 day of September
 1864, to serve in the Regiment,) for the term of Three Years
 and having served **HONESTLY** and **FAITHFULLY** with his Company in the field

to the present date, is now entitled to a **DISCHARGE** by reason of Death
died at Helena Arkansas in Hospital January 26th 1865
of inflammation of Stomach

The said James Pendleton was last paid by Paymaster
May Crover to include the 31st day of October, 1865, and has
 pay due him from that time to the present date; he is entitled to pay and subsistence for
TRAVELING to place of enrollment and whatever other allowances are authorized to volunteer
 soldiers, or militia, so discharged. He has received 48 dollars,
 since October 1st 1865 when his clothing acct was last settled. He has received
 advanced by the United States on account of **CLOTHING**. from the United States one Hundred Dollars advance Bounty

There is to be stopped from him, on account of the State of _____, or other
 authorities for **CLOTHING**, &c., received on entering service, _____ dollars; also,
 for expenses of **SUBSISTENCE** for **TRAVELING** from place of enrollment to the place of rendezvous,
 amounting to _____ dollars: and on account of the United States for **EXTRA**
CLOTHING received in kind from _____ and for other
 stoppages, viz:

For Camp and Garrison Equipage
 amounting to 7.80 dollars;
 and he has been **SUBSISTED** for **TRAVELING** to his place of enrollment, up to the _____
 _____, 186 .

He is indebted to _____, **SUTLER**, _____ dollars.
 He is indebted to _____, **LAUNDRESS**, _____ dollars.

Given in Duplicate, at Snells Bluff Ark, this 7th day of March, 1866.

Stanford Bradley
2^d Lieut U.S. Cavalry
 Commanding Company. AS

CASUALTY SHEET

No. _____

James Pindilton
Private of Company "A"
6th Regiment of N. H. Cavalry

State Volunteers.

NATURE OF CASUALTY.

Death

CASUALTY SHEET.

Name: *James Pindleton*
Rank: *Private* "A" Company: *C* Regiment: *U.S.*
Arm: *Co. Cavalry* State: _____
Nature of Casualty: *Death*

CAUSE OF CASUALTY—(NAME OF DISEASE, &C.)
Inflammation of Stomach

BY WHOM DISCHARGED.

DEGREE OF DISABILITY.

FROM WHAT SOURCE THIS INFORMATION WAS OBTAINED.
Master Cutt Roll of Company Regimental

BY WHOM CERTIFIED.
W.A. Watson
Capt Comdg Co A

REMARKS.
Return for Feb'y 1866, and Quarterly Return of Discharged Soldiers for the 1st Quarter of 1866.

DATE OF DISCHARGE, DEATH, &C.
January 26th 1866
PLACE OF DISCHARGE, DEATH, &C.
Hosp Helena Ark

W.P. Burdick
Clerk.

1050

Pennington James

Co A., 6 U. S. Col'd Cav.

Private | Private

CARD NUMBERS.

1	5388403	26
2	5388487	27
3	5388568	28
4	5388650	29
5	5388723	30
6	5389188	31
7	9092812	32
8	519-03-1874	33
9	43147883	34
10	40732714	35
11		36
12		37
13		38
14		39
15		40
16		41
17		42
18		43
19		44
20		45
21		46
22		47
23		48
24		49
25		50

Book Mark: 519-03-1874

See also

P | **6 Cav. U.S.C.T.**

James Pennington

....., Co. *A*., 6 Reg't U. S. Col'd Cav.

Appears on

Company Descriptive Book

of the organization named above.

DESCRIPTION.

Age *22* years; height *5* feet *12* inches.

Complexion *Blk*

Eyes *Blk*; hair *Blk*

Where born *Lincoln Ky*

Occupation *farmer*

ENLISTMENT.

When *Oct 3*, 1864.

Where *Camp Nelson*

By whom *J. C. Randolph*; term *3* y'rs.

Remarks: *Died Sept. 9, 1864 through
some error this mans muster
occurs on the rolls after his
reported death.*

Breyer

(383g)

Copyist.

6
8. 11167

James Pennington

Appears with rank of Sgt on

Muster and Descriptive Roll

of Detachment of U.S. Colored
Regiment, mustered into U.S.

service for the U.S. Roll dated
Camp Nelson, Ky. Oct. 3, 1864.

Where born Lexington, Ky

Age 22 years; occupation Farmer

When enlisted Oct 3, 1864

Where enlisted Camp Nelson, Ky

For what period enlisted 3 years.

Eyes Black; hair Black

Complexion Black; height 5 ft. 10 in.

When mustered in Oct 3, 1864

Where mustered in Camp Nelson, Ky

Bounty paid \$ 100; due \$ 100

Clothing account:

Last settled _____, 186 ; drawn since \$ 100

Date of first muster _____, 186 .

Company to which assigned _____

Remarks: Say due from enlist-
ment. Name of reputed
wife Jane Pennington
deceased to Jeremiah, 7 Dist. Ky.

Book mark: _____

(356m) J. H. Jackson Copyist.

P. *Claw* U.S.C.T.

James Pennington
Reg't U. S. Col'd

Appears on

Company Muster-in and Descriptive Roll
of the organization named above. Roll dated

Camp Nelson, Ky., Nov. 1, 1864

Where born *Lincoln, Ky*

Age *22* y'rs; occupation *Farmer*

When enlisted *Oct. 1*, 186 .

Where enlisted *Camp Nelson, Ky*

For what period enlisted *3* years.

Eyes *Blk*; hair *Blk*

Complexion *Blk*; height *5 ft. 10 in.*

When mustered in *Oct. 3*, 186 .

Where mustered in *Camp Nelson*

Bounty paid \$ *100*; due \$ *100*

Where credited *7 Dist Ky*

Company to which assigned

Remarks:

Book mark: *219-05-1874*

(356d)

Fitz
Compr.

P

6 Cav. U.S.C.T.

James Pendington

Private, Co. A, 6 Reg't U. S. Col'd Cavalry.

Appears on

Company Muster Roll

for Nov. & Dec., 1864.

Present or absent Present

Stoppage, \$ 100 for

Due Gov't, \$ 100 for

Valuation of horse, \$ 100

Valuation of horse equipments, \$ 100

Remarks: On detached Service
left at Pound Gap Ky.

Book mark:

(358)

Daggett

Copyist.

P

6 Cav. U.S.C.T.

James Pennington

Priv., Co. A, 6 Reg't U. S. Col'd Cavalry.

Appears on

Company Muster Roll

for Jan. & Feb., 1865.

Present or absent Absent

Stoppage, \$ 100 for

Due Gov't, \$ 100 for

Valuation of horse, \$ 100

Valuation of horse equipments, \$ 100

Remarks: From Detached Service to sick in hosp't. First instalment Bounty due.

Book mark:

~~James Pennington~~

Waggett

P. **6 Cav. U.S.C.T.**

James Pennington
Pvt., Co. A, 6 Reg't U. S. Col'd Cavalry.

Appears on

Company Muster Roll

for *Mar. & Apr.*, 186*5*.

Present or absent *Absent.*

Stoppage, \$ *100* for

Due Gov't, \$ *100* for

Valuation of horse, \$ *100*

Valuation of horse equipments, \$ *100*

Remarks: *Absent sick in*
Hosp. First instalment
Bounty Due.

Book mark:

Waggett

(358)

Copyist.

4

6 Cav. U.S.C.T.

James Cunningham

100, Co. A, 6 Reg't U. S. Col'd Cavalry.

Appears on

Company Muster Roll

for *May's Muster*, 186*4*.

Present or absent

Stoppage, \$ *100* for

Due Gov't, \$ *100* for

Valuation of horse, \$ *100*

Valuation of horse equipments, \$ *100*

Remarks: *Died in Hospital
Camp Nelson Ky
1864. No recovery
of effects received*

Book mark:

Joseph Stewart
(358) Copyist.

1000004
No 6 Cav. U.S.C.T.

James Pennington
Pot, Co. A, 6 Reg't U. S. Col'd Cav.

Appears on Returns as follows:

Dec 1864, Absent

Detached service left
at Pound Gap Ky by
Order Bro. Maj Genl
J. G. Burbridge on return
from Saltville,

Dec 1864,

June to May 1865, Absent
Sick Genl Hospital
Camp Nelson Ky
Since Dec 1864,

June 1865, Lost June 25,
Camp Nelson, Died,

Book mark:

C. M. Rowe

(546)

Copyist.

P

6 Cav. U.S.C.T.

James Pennington
Priv., Co. A, 6 Reg't U. S. Col'd Cavalry.

Appears on Co. Muster-out Roll, dated
Annull's Buff Ark. Apr. 15, 1866.

Muster-out to date _____, 186 .

~~Last paid to~~ _____, 186 .

Pay due from Enlistment

Clothing account:

Last settled _____, 186 ; drawn since \$ _____ 100

Due soldier \$ _____ 100; due U. S. \$ _____ 100

Am't for cloth'g in kind or money adv'd \$ _____ 100

Due U. S. for arms, equipments, &c., \$ _____ 100

Bounty paid \$ _____ 100; due \$ _____ 100

Remarks: Died in Hospital at
Camp Nelson Ky. of
Typhoid Fever, Sept 14. 64
Notification rec'd. as Ch's
Pennington with date of death
twenty days before date of Muster

Book mark: _____

(861)

Pitz

Copyist.

Compr.

P^t Co. Cav. U. S. C. S.

James Pennington
Co. H, 6th Reg't U. S. Cav.

NOTATION.

Book mark: S-14-6-3-1874.

Record and Pension Office.

WAR DEPARTMENT.

This book mark refers only to a report from the medical records, made by the Surgeon General to the Adjutant General, relative to the above-named man. As the medical records have since been carded, no transcript of this report is made hereon.

(491)

M. Allen

Copyist.

Pennington, James
P, Co. A, 6 Regt S. C. Cav.

3 Enclosures.

Bed Cards	Descriptive Lists
Burial Records	Final Statements
Certs. of Dis. for Discharge	Furloughs
C. M. Charges	Med. Des. Lists
Med. Certificates	Orders

Other papers relating to—

Admission to Hosp'l	Furlough
Casualty Sheet (Officer's) <i>Pair</i>	Med. Examination
Confinement	Misc. Information
Contracts	Pay or Clothing
Death or Effects	Personal Reports
Desertions	Rank
Discharge from Hosp'l	Transfer to Hosp'l
Discharge from Service	Transfer to V. R. C.
Duty	Transportation

Pennington, James

P, Co. A, 6

Regt S. C. Cav.

3 Enclosures.

Bed Cards

Burial Records

Certs. of Dis. for Discharge

C. M. Charges

Med. Certificates

Descriptive Lists

Final Statements

Furloughs

Med. Des. Lists

Orders

Other papers relating to—

Admission to Hosp'l

Casualty Sheet (Officer's)

Confinement

Contracts

Death or Effects

Desertions

Discharge from Hosp'l

Discharge from Service

Duty

Furlough

Med. Examination

Misc. Information

Pay or Clothing

Personal Reports

Rank

Transfer to Hosp'l

Transfer to V. R. C.

Transportation

*Effects for company of James Pennington
Sept 21, 1864*

ARTICLES OF WAR.

INVENTORY OF THE EFFECTS

ART. 95. When any non-commissioned officer or soldier shall die, or be killed in the service of the United States, the then commanding officer of the troop or company shall, in the presence of two other commissioned officers, take an account of what effects he died possessed of, above his arms and accoutrements, and transmit the same to the office of the Department of War, which said effects are to be accounted for, and paid to the representatives of such deceased non-commissioned officer or soldier. And in case any of the officers, so authorized to take care of the effects of deceased officers and soldiers, should, before they have accounted to their representatives for the same, have occasion to leave the regiment or post, by proferment or otherwise, they shall, before they be permitted to quit the same, deposit in the hands of the commanding officer, or of the assistant military agent, all the effects of such deceased non-commissioned officers and soldiers, in order that the same may be secured for, and paid to, their respective representatives.

OF

James Pennington

Late of Company *A*

1st Reg't of *Upl C*

Volunteers, who died at *Camp Nelson, Va*

on the *19th* day of *Sept* 1864.

ARMY REGULATIONS—EDITION OF 1863.

DECEASED SOLDIERS.

PAR. 151. Inventories of the effects of deceased non-commissioned officers and soldiers, required by the 95th Article of War, will be forwarded to the Adjutant General, by the commander of the company to which the deceased belonged, and a duplicate of the same to the colonel of the regiment. Final statements of pay, clothing, &c., in duplicate, will be sent to the Adjutant General with one copy of the inventory. When a soldier dies at a post or station absent from his company, it will be the duty of his immediate commander to furnish the required inventory and final statements, and, at the same time, to forward to the commanding officer of the company to which the soldier belonged, a report of his death, specifying the date, place, and cause; to what time he was last paid, and the money or other effects in his possession at the time of his decease; which report will be noted on the next muster roll of the company to which the man belonged. Each inventory will be endorsed, "Inventory of the effects of _____, late of company (—) _____ regiment of _____, who died at _____, the _____ day of _____, 1864." If a legal representative receives the effects, it will be stated in the report. If the soldier leave no effects, the fact will be reported.

PAR. 152. Should the effects of a deceased non-commissioned officer or soldier not be administered upon within a short period after his decease, they shall be disposed of by a Council of Administration, under the authority of the commanding officer of the post, and the proceeds deposited with the Paymaster, to the credit of the United States, until they shall be claimed by the legal representatives of the deceased.

PAR. 153. In all such cases of sales by the Council of Administration, a statement in detail, or account of the proceeds, duly certified by the Council and commanding officer, accompanied by the Paymaster's receipt for the proceeds, will be forwarded by the commanding officer to the Adjutant General. The statement will be endorsed, "Report of the proceeds of the effects of _____, late of company (—) _____ regiment of _____, who died at _____, the _____ day of _____, 1864."

NOTE 1. The effects in all cases, when called for, should be turned over to the legal representative, without further authority from the Adjutant General. When the effects are turned over to the relatives of the deceased before these inventories are sent to the Adjutant General, their receipts therefor should be attached to the inventories. In all other cases, one copy will be sent with a letter of transmittal direct to the Adjutant General, and a duplicate retained by the officer.

NOTE 2.—Particular care should be taken to take receipts in duplicate from the Paymaster for any funds turned over to him; one copy should be sent direct to the Adjutant General and one retained by the officer.

3
4, 5, 2, 1, 6, 3, 2, 1, 6



Inventory of the effects of James Pennington late
 a Private of Captain W. A. Harrou Company A of
 the 1st Regiment of W. S. C. Co Volunteers, who was enrolled as
 a Private at Camp Nelson in the State of Kentucky on
 the 3rd day of Oct 1864, and mustered into the service of the United
 States as a Priv on the 3rd day of Oct 1864, at Camp Nelson
 in Company A, 1st Regiment of W. S. C. Co Volunteers, to serve Three
 years or during the war; he was born in Siuda in the State
 of Kentucky; he was 32 years of age, 5 feet 10 inches
 high, Blk complexion, Blk eyes, Blk hair, and by occupation, when enrolled,
 a Farmer; he died in U. S. M. Hospital, at
Camp Nelson Ky on the 19th day of Sept 1865, by
 reason of Typhoid Fever

INVENTORY.					
ARTICLES.	No.	ARTICLES.	No.	ARTICLES.	No.
Hats.....	/	Pairs trousers.....		Knapsacks.....	/
Caps.....		Pairs flannel drawers.....			
Forage Caps.....		Pairs cotton drawers.....			
Great coats.....		Flannel shirts.....			
Uniform coats.....		Cotton shirts.....			
Uniform jackets.....		Pairs boots.....	/		
Flannel sack coats.....		Pairs shoes.....			
Blouses.....		Pairs socks.....			
Sable frocks.....		Blankets.....	/		
Fatigue overalls.....		Haversacks.....			
				MONEY.	
				Specie.....	\$
				Notes.....	\$

I CERTIFY, ON HONOR, that the above inventory comprises all the effects of Private
James Pennington, deceased, and that the effects are in the hands
 of Daniel Mucka at Camp Nelson Ky
 to be disposed of by a Council of Administration.

(DUPLICATES.)

STATION: Boalsville Ark

DATE: Dec 15th 1865

W. A. Harrou
Capt Co A W. S. C. Co
 Commanding the Company.

[OFFICE INDORSEMENT.]

War Department,

ADJUTANT GENERAL'S OFFICE,

The Death of James Pennington
Private, Co. "A", "6" Reg't U. S.
Colored Cavalry, is reported as follows:—

On Company Muster Roll.
For May & June, 1865, *u r*, 1864

Company Muster-out Roll.
September 14 "6" *u r*, 1864

Company Descriptive Book.
Sept 19th, 1864

Company Morning Reports.
Sept 19th, 1864

Soldier's Final Statement.
, 186

Soldier's Record of Death and Interment.
, 186

Soldier's Inventory of Effects.
, 186

Soldier's Certificate of Disability for Discharge.
, 186

Quartermaster's Return of Accrued Soldier's Individual Muster-out Roll.
September 19 " , 1864

Regimental Return.
For June, 1865, *Sept 19*, 1864

Regimental Quarterly Returns.
, 186

Regimental Descriptive Book.
Sept 19th, 1864

By Surgeon General.
(*Sept 19*), 186

, 1864, is held to be the correct date, and the Company ~~Muster~~ Roll will be amended accordingly.

Asst. Adj. Gen.

J.B. R.R.D. 12.30.73. *over*

CASUALTY SHEET

No. _____

James Pennington
Private of Company "I"
6" Regiment of W.G. Corps

State Volunteers.

NATURE OF CASUALTY.

Death

Regt. Am. Troops
report of his man
died Sept 19th 1864
at Nelson Genl.
Hosp. Camp Nelson
Ky.

R. R. D.
12.30.73. J. M.

CASUALTY SHEET.

Name: *James Punington*

Rank:

Private

Company: *"A" Co*

Regiment: *W.S.*

Arm:

C. Cavalry

State:

Nature of Casualty:

Death

CAUSE OF CASUALTY—(NAME OF DISEASE, &c.)

M. Anemia

BY WHOM DISCHARGED.

FROM WHAT SOURCE THIS INFORMATION WAS OBTAINED.

*Must be Out Roll of Company
Regimental Return for*

REMARKS.

*June 1865. And Quarterly
Return of Absent Soldiers*

DEGREE OF DISABILITY.

BY WHOM CERTIFIED.

*Capt W. A. Watson
Capt Condy Co "A"*

DATE OF DISCHARGE, DEATH, &c.

PLACE OF DISCHARGE, DEATH, &c.

W. B. Burdick

Clerk.

[OFFICE INDORSEMENT.]

War Department,

ADJUTANT GENERAL'S OFFICE,

January 7, 1874

The death of *late James Pennington*, Co. *F*, 6th Reg't U. S. Colored Cavalry, is reported as follows:—

On Company Muster Roll.	
For <i>May and June</i> , 1865,	1864
Company Muster-out Roll.	
<i>September 11</i> , 1864,	1864
Company Descriptive Book.	
.	186
Company Morning Reports.	
.	186
Soldier's Final Statement.	
<i>September 19</i> , 1864,	1864
Soldier's Record of Death and Interment.	
.	186
Soldier's Inventory of Effects.	
<i>September 19</i> , 1864,	1864
Soldier's Certificate of Disability for Discharge.	
.	186
Soldier's Individual Muster-out Roll.	
.	186
Regimental Return.	
For <i>June</i> , 1864, <i>Sept 19</i> , 1864,	1864
Regimental Quarterly Returns.	
<i>September 19</i> , 1864,	1864
Regimental Descriptive Book.	
.	186
By Surgeon General.	
.	186

September 19, 1864, is held to be the correct date, and the Company Muster Roll will be amended accordingly.

Suma on file out
E.V. 10
500. All letters to *2nd* *Prud.*
Filed on *10* Feb 10/874

A

FINAL STATEMENT

OF

James Pennington Co A
6th Reg't of U. S. Col. Cavalry

VOLUNTEERS.

Dec 19 1864

NOTE 1.—Two of these certificates (or duplicates) are to be given to each volunteer soldier who may be discharged previously to the discharge of his company, that he may at once receive from the Paymaster the pay, &c., due him, and the captain or other officer commanding the company will certify to the act of the delivery of the duplicate certificates; on these certificates the Soldier is "entitled to" his discharge, and should also present his discharge to the Paymaster to have the payment endorsed on it. The discharge is to be given back to the Soldier by the Paymaster; the latter only retaining as his voucher the duplicate certificates.

NOTE 2.—If the Soldier is entitled to pay for the use of his horse, the Company Commander will certify to that fact, and also to the time he has pay due for having been so mounted on his own horse.

NOTE 3.—Amounts due the Sutler and Laundress must be entered on the Muster Roll on which the death, desertion, &c., is reported, as well as on the final statement, otherwise the amount cannot be collected from the United States.

NOTE 4.—This blank will be used for deceased volunteers as well as others.

D 11/11/74

[OFFICE INDORSEMENT.]

War Department,

ADJUTANT GENERAL'S OFFICE,

January 7, 1874.

The death of *Sgt James Pennington*, Co. F, 6th Reg't U. S. Colored Cavalry, is reported as follows:—

- On Company Muster Roll. For *May 3rd June*, 1865., 1864
- Company Muster-out Roll. *September 1st*, 1864.
- Company Descriptive Book., 186
- Company Morning Reports., 186
- Soldier's Final Statement. *September 19*, 1864.
- Soldier's Record of Death and Interment., 186
- Soldier's Inventory of Effects. *September 19*, 1864.
- Soldier's Certificate of Disability for Discharge., 186
- Soldier's Individual Muster-out Roll., 186
- Regimental Return.

FINAL STATEMENT

OF

James Pennington Co A
6th Reg't of *U. S. Col Cavalry*

VOLUNTEERS.

Dec 1st 19th 1864

NOTE 1.—Two of these certificates (or duplicates) are to be given to each volunteer soldier who may be discharged previously to the discharge of his company, that he may at once receive from the Paymaster the pay, &c., due him, and the captain or other officer commanding the company will certify to the act of the delivery of the duplicate certificates; on these certificates the Soldier is "entitled to" his discharge, and should also present his discharge to the Paymaster to have the payment endorsed on it. The discharge is to be given back to the Soldier by the Paymaster; the latter only retaining as his voucher the duplicate certificates.

NOTE 2.—If the Soldier is entitled to pay for the use of his horse, the Company Commander will certify to that fact, and also to the time he has pay due for having been so mounted on his own horse.

NOTE 3.—Amounts due the Sutler and Laundress must be entered on the Muster Roll on which the death, desertion, &c., is reported, as well as on the final statement, otherwise the amount cannot be collected from the United States.

NOTE 4.—This blank will be used for deceased volunteers as well as others.

ADJUTANT GENERAL'S OFFICE
Nov 17th 1864
Duplicate to Inventory sent to Auditor

Pennington
1864

I certify, on honor, that James Pennington a Private of
 Captain W. A. Watrous Company (a) of the 4th Regiment of U. S. Col. Cavalry
VOLUNTEERS, of the State of _____, born in Seneca, State
 of Kentucky, aged 23 years; 5 feet 10 inches high; Blue complexion,
Black eyes, Black hair, and by occupation a Farmer, having joined the company on
 its original organization at Camp Nelson Ky, and enrolled in it at the muster into
 the service of the United States at Camp Nelson Ky, on the 3rd day
 of October, 1864, (or was mustered in service as a recruit, by Captain
W. C. Kenney, at Camp Nelson Ky on the 3rd day of October
 1864, to serve in the Regiment,) for the term of Three Years

and having served **HONESTLY** and **FAITHFULLY** with his Company in the field
 to the present date, is now entitled to a **DISCHARGE** by reason of Death
Died in Hospital at Camp Nelson Ky Sept 19th 1864
of Typhoid Fever
 The said James Pennington was ~~last~~ paid by Paymaster
never paid to include the _____ day of _____, 186____, and has
 pay due him from that time to the present date; he is entitled to pay and subsistence for
TRAVELING to place of enrollment and whatever other allowances are authorized to volunteer
 soldiers, or militia, so discharged. He has received _____ dollars,
 advanced by the United States on account of **CLOTHING**.

There is to be stopped from him, on account of the State of _____, or other
 authorities for **CLOTHING**, &c., received on entering service, _____ dollars; also,
 for expenses of **SUBSISTENCE** for **TRAVELING** from place of enrollment to the place of rendezvous,
 amounting to _____ dollars: and on account of the United States for **EXTRA**
CLOTHING received in kind from _____ and for other
 stoppages, viz:

_____ amounting to _____ dollars;
 and he has been **SUBSISTED** for **TRAVELING** to his place of enrollment, up to the _____
 _____, 186____.

He is indebted to _____, **SUTLER**, _____ dollars.

He is indebted to _____, **LAUNDRESS**, _____ dollars.

Given in Duplicate, at Shelville Bluff Ark, this 7th day of March, 1866.

Samford Brubaker
2nd Lieut 4th U.S. Cavalry
 Commanding Company. W

Clothing account never received by company commander

Samford Brubaker was the man's muster account on the rolls.

1051
Pense Lewis

Co B., 6 U. S. Col'd Cav.

Private. | Private

CARD NUMBERS.

1	5389268	26
2	5389377	27
3	5388130	28
4	5390081	29
5	9092918	30
6	40732715	31
7	40902846	32
8		33
9		34
10		35
11		36
12		37
12		38
14		39
15		40
16		41
17		42
18		43
19		44
20		45
21		46
22		47
23		48
24		49
25		50

Book Mark:

See also

6115 U.S.C.I.

P | **6 Cav. | U.S.C.T.**

Lewis Penne

B, 6 Reg't U. S. Col'd Cav.

Appears on

Company Descriptive Book

of the organization named above.

DESCRIPTION.

Age *25* years; height *5* feet *7½* inches.

Complexion *Yellow*

Eyes *Brown*; hair *Black*

Where born *Logan Ky*

Occupation *Farmer*

ENLISTMENT.

When *Aug 13*, 1864.

Where *Bowling Green Ky*

By whom *Capt Hobson*; term *3* y'rs.

Remarks: *Deserted at Bowling Green Ky Sept 1, 1864.*

(383g)

Beyer

Copyist.

D 6 Cav. U.S.C.T.

Lewis, Peruse

Privat, Co. *B*, 6 Reg't U. S. Col'd Cavalry.

Appears on

Company Muster-in and Descriptive Roll
of the organization named above. Roll dated

Camp Nelson Ky., W. F., Nov. 1, 1864.

Where born *Logan Co. Ky.*

Age *25* y'rs; occupation *Farmer*

When enlisted *Aug 13*, 1864.

Where enlisted *Bowling Green, Ky.*

For what period enlisted *3* years.

Eyes *Brown*; hair *Blk*

Complexion *Yellow*; height *5* ft. *7 1/2* in.

When mustered in *Aug 13*, 1864.

Where mustered in *Bowling Green Ky.*

Bounty paid \$ *100*; due \$ *100*

Where credited *3rd Dist. Ky.*

Company to which assigned

Remarks: *Transferred from Co.*

115. U. S. C. I. per S. O. No 39, dated,

Washington D. C. June 10/65

Signed L. Thomas, A. G.

Book mark: *(over)*

C. M. Rowd

JAN. 10

5389268

* 1891 *

*Owner
Amos Perry*

P 6 Cav. U.S.C.T.

Lewis Pense

Priest, Co. B, 6 Reg't U. S. Col'd Cavalry.

Appears on

Company Muster Roll

for *Nov & Dec*, 1864.

Present or absent

Stoppage, \$ 100 for

Due Gov't, \$ 100 for

Valuation of horse, \$ 100

Valuation of horse equipments, \$ 100

Remarks: *Deserted at Bowling Green Ky, Sept 1' 1864*

Book mark:

J. M. Rowe

(358)

Copyist.

J. | 6 bar U.S.C.T.

Lewis Reese
Priv., Co. B, 6 Reg't U. S. Col'd bar.

Appears on

Descriptive List of Deserters

dated *November 30*, 186*4*.

Deserted:

When *Sept 1*, 186*4*.

Where *Bowling Green Ky*

Arrested:

When _____, 186 .

Where _____

Remarks:

Probably to be found at Bowling Green Ky

Book mark: _____

(351)

J. Stearns

Copyist.

P

115

U.S.C.T.

Lewis Pence,
Priv. Co. C, 115 Reg't U. S. Colored Inf.

Appears on Returns as follows:

Aug, 1864 - Loss; Aug. 26/64,
Bowling Green, Transferred.

Book mark:

(546)

J. S. Hurley

Copyist.

J | **6 Cav.** | **U.S.C.T.**

Lewis Tense
Pvt., Co. *B.*, 6 Reg't U. S. Col'd Cav.

Appears on **Returns** as follows:

Nov 1864. Loss. Sept 1/64
Bowling Green. Ky
Deserted.

Book mark :

A. M. Row

(546)

Copyist.

J | *6 Cav* | **U. S. C. T.**

Lewis Perrot

A, Co. *B*, *6* Reg't U. S. Col'd Cavalry

Appears on **Co. Muster-out Roll**, dated

De Valls Bluff Ark, *Apr*, *15*, 186*6*.

Muster-out to date _____, 186 .

Last paid to *pay due from* *Gov't*, 186 .

Clothing account:

Last settled _____, 186 ; drawn since \$ _____ 100

Due soldier \$ _____ 100; due U. S. \$ _____ 100

Am't for cloth'g in kind or money adv'd \$ _____ 100

Due U. S. for arms, equipments, &c., \$ _____ 100

Bounty paid \$ _____ 100 due \$ _____ 100

Remarks:

Deserted Sept 1/64 at
Bowling Green,

Book mark: _____

(361)

A. G. Ames

Copyist.

Miss E.

Co., 6 U.S. Army

Private. Private.

CARD NUMBERS.

1	5387161	26
2	5390162	27
3	5390239	28
4	5390321	29
5	5390398	30
6	5390466	31
7	5390551	32
8	5390638	33
9	5390721	34
10	5390803	35
11	5390889	36
12	9093021	37
13	40732711	38
14		39
15		40
16		41
17		42
18		43
19		44
20		45
21		46
22		47
23		48
24		49
25		50

Book Mark:

See also

P | **6 Cav.** | **U.S.C.T.**

George Pepples

....., Co. *C*....., 6 Reg't U. S. Col'd Cav.

Appears on

Company Descriptive Book

of the organization named above.

DESCRIPTION.

Age *21* years ; height *5* feet *6* inches.

Complexion *Blk*

Eyes *Blk* ; hair *Blk*

Where born *Ky*

Occupation *Farmer*

ENLISTMENT.

When *Oct 24*....., 186*4*.

Where *Camp Nelson*

By whom *J. C. Randolph*, term *3* y'rs.

Remarks :
.....
.....
.....
.....
.....
.....
.....
.....
.....
.....

Breyer

(383g)

Copyist.

P

6 Cav. U.S.C.T.

George Pepples

Appears with rank of *Priv.* on

Muster and Descriptive Roll of a Detachment of U. S. Vols. forwarded

for the 6 Reg't U. S. Col'd Cavalry. Roll dated

Camp Nelson Ky., Oct. 27, 1864.

Where born *Kentucky*

Age *21* y'rs; occupation *Farmer*

When enlisted *Oct. 24, 1864.*

Where enlisted *Camp Nelson Ky.*

For what period enlisted *3* years.

Eyes *Blk*; hair *Blk*

Complexion *Blk*; height *5* ft. *6* in.

When mustered in *Oct. 24, 1864.*

Where mustered in *Camp Nelson Ky.*

Bounty paid \$ *100*; due \$ *100*

Where credited

Company to which assigned

Remarks: *Credited to Montgomery*

Co. - 9 Dist. Ky.

Hiram Pipler, Owner

Book mark:

C. E. M. Laughlin

(339)

Copyist.

C **6 Cav. U.S.C.T.**

George Pepples
Private, Co. *C*, 6 Reg't U. S. Col'd Cavalry.

Appears on

Company Muster-in and Descriptive Roll
of the organization named above. Roll dated

Camp Nelson, Ky. Nov 1, 186*4*.

Where born *Kentucky*

Age *21* y'rs; occupation *Driver*

When enlisted *Oct 24*, 186*4*.

Where enlisted *Camp Nelson, Ky.*

For what period enlisted *3* years.

Eyes *Black*; hair *Black*.

Complexion *Black*; height *5 ft. 6 in.*

When mustered in *Oct 24*, 186*4*.

Where mustered in *Camp Nelson*

Bounty paid \$ *100*; due \$ *100*

Where credited *9th Dist. Ky.*

Company to which assigned *C*

Remarks:

Book mark:

W E Howser

(356d)

Copyist.

6 Cav. U.S.C.T.

George Higgins
Co. C, 6 Reg't U. S. Colored Cavalry.

Appears on

Company Muster Roll

for *Sept - Dec*, 186*4*.

Present or absent *Present*

Stoppage, \$ *100* for

Due Gov't, \$ *100* for

Valuation of horse, \$ *100*

Valuation of horse equipments, \$ *100*

Remarks: *Sick in hospital*
camp prison by

Book mark:

W. B. Howler

(358)

Copyist.

6 Cav. U.S.C.T.

James H. Apple
Co. C, Co. C, 6 Reg't U. S. Colored Cavalry.

Appears on

Company Muster Roll

for *March 1862*, 186*2*.

Present or absent *present*

Stoppage, \$ *100* for

Due Gov't, \$ *100* for

Valuation of horse, \$ *100*

Valuation of horse equipments, \$ *100*

Remarks: *no horse*
county due

Book mark:

U.S.C.T

Co., Reg't U. S. Col'd

Appears on

Company Muster Roll

for , 186

Present or absent

Stoppage, \$ 100 for

Due Gov't, \$ 100 for

Valuation of horse, \$ 100

Valuation of horse equipments, \$ 100

Remarks:

Book mark:

2

6 Cav. U.S.C.T.

George Peoples

Priv., Co. C, 6 Reg't U. S. Colored Cavalry.

Appears on

Company Muster Roll

for May & June, 1865.

Present or absent Present

Stoppage, \$ 100 for

Due Gov't, \$ 100 for

Valuation of horse, \$ 100

Valuation of horse equipments, \$ 100

Remarks: 1st Instalment bounty due

Book mark:

(358)

S P York

Copyist.

J

6 Cav. U.S.C.T.

George Peoples

Priv, Co. C, 6 Reg't U. S. Colored Cavalry.

Appears on

Company Muster Roll

for *July + Aug*, 186*J*.

Present or absent *Present*

Stoppage, \$ *100* for

Due Gov't, \$ *100* for

Valuation of horse, \$ *100*

Valuation of horse equipments, \$ *100*

Remarks: *Due U.S. for 6 mths E 70 $\frac{20}{11}$*

Book mark:

J. P. York

(358)

Copyist.

P

6 Cav. U.S.C.T.

George Pebbles

Priv., Co. C, 6 Reg't U. S. Colored Cavalry.

Appears on

Company Muster Roll

for Sept + Oct, 1862

Present or absent Present

Stoppage, \$ 100 for

Due Gov't, \$ 100 for

Valuation of horse, \$ 100

Valuation of horse equipments, \$ 100

Remarks:

Book mark:

(358)

S J York

Copyist.

P 6 Cav. U.S.C.T.

George Pebbles

Priv, Co. C, 6 Reg't U. S. Colored Cavalry.

Appears on

Company Muster Roll

for *Nov. & Dec.*, 1865.

Present or absent *Present*

Stoppage, \$ *100* for

Due Gov't, \$ *100* for

Valuation of horse, \$ *100*

Valuation of horse equipments, \$ *100*

Remarks:

Book mark:

(358)

W. J. Ferguson

Copyist.

P | **6 Cav. | U.S.C.T.**

George Pebbles
Privt, Co. C, 6 Reg't U. S. Colored Cavalry.

Appears on

Company Muster Roll
for *Jan. & Feb.*, 1866.

Present or absent *Present*

Stoppage, \$ *100* for

Due Gov't, \$ *100* for

Valuation of horse, \$ *100*

Valuation of horse equipments, \$ *100*

Remarks:
.....
.....
.....
.....
.....
.....
.....
.....
.....
.....

Book mark:

W. B. Ferguson
(358) *W. B. Ferguson* Copyist.

P | 6 Cav. | U. S. C. T.

Geo Pebbles *

Pvt, Co. C, 6 Reg't U. S. Col'd Cav.

Appears on Returns as follows:

Dec 1864 Absent sick in
Hosp Camp Nelson, Ky

July 1866 On extra or
daily duty.

* Name appears also as
Geo Pepples.

Book mark:

Hottel

(546)

Copyist.

P

6 Cav. U.S.C.T.

George Cobles

Cri- Co. 6, 6 Reg't U. S. Col'd Cavalry.

Appears on **Co. Muster-out Roll**, dated *Newalls Bluff Ark, Apl. 15*, 1866.

Muster-out to date *Apl. 15*, 1866.

Last paid to *Feb. 28*, 1866.

Clothing account:

Last settled _____, 186 ; drawn since \$ 100

Due soldier \$ 100; due U. S. \$ *3 88* 100

Am't for cloth'g in kind or money adv'd \$ 100

Due U. S. for arms, equipments, &c., \$ 100

Bounty paid \$ *100* 100; due \$ 100

Remarks: *New U. S. Co. 6th Cav. G. E.*
\$ 3 88

Book mark : _____

W. B. Ferguson

(861)

Copyist.

1053

Pepples Lee

C., 6 U. S. Col'd Ca

Private

Private

CARD NUMBERS.

387160	26
390163	27
390240	28
390322	29
390399	30
390467	31
390552	32
390639	33
390722	34
390804	35
390890	36
093022	37
0732712	38
	39
	40
	41
	42
	43
	44
	45
	46
	47
	48
	49
	50

Mark: 500.082,

also

0757658 Proof
8-836526-P.O. off
Ref 554312
2046043 pointer
2 My History 3/10/2

L. Jordan
Q

9 | **6 Cav. | U.S.C.T.**

Lee Pepples

....., Co. C, 6 Reg't U. S. Col'd Cav.

Appears on

Company Descriptive Book

of the organization named above.

DESCRIPTION.

Age 18 years ; height 5 feet 4 inches.

Complexion Blk

Eyes Blk ; hair Blk

Where born Ky

Occupation Farmer

ENLISTMENT.

When Oct 24, 1864.

Where Camp Nelson

By whom J. C. Randolph, term 3 y'rs.

Remarks:

Bryer

(383g)

Copyist.

P

6 Cav. U.S.C.T.

Lee Papples

Appears with rank of Priv. on

Muster and Descriptive Roll of a Detachment of U. S. Vols. forwarded

for the 6 Reg't U. S. Col'd Cavalry. Roll dated

Camp Nelson Ky., Oct. 27, 1864.

Where born Kentucky

Age 18 y'rs; occupation Farmer

When enlisted Oct. 24, 1864.

Where enlisted Camp Nelson Ky.

For what period enlisted 3 years.

Eyes Blk; hair Blk

Complexion Blk; height 5 ft. 4 in.

When mustered in Oct. 24, 1864.

Where mustered in Camp Nelson Ky.

Bounty paid \$ 100; due \$ 100

Where credited

Company to which assigned

Remarks: Credited to Montgomery Co.

9 Dist. Ky.

Hiram Papples, Owner.

Book mark:

C. E. M. Laughlin

(339)

Copyist.

J 6 Cav. U.S.C.T.

Lee Peppers

A, Co. *B*, 6 Reg't U. S. Col'd Cavalry.

Appears on

Company Muster-in and Descriptive Roll

of the organization named above. Roll dated

Camp Nelson, Ky, Nov 1, 1864.

Where born *Kentucky*

Age *18* y'rs; occupation *Farmer*

When enlisted *Oct 24*, 186 .

Where enlisted *Camp Nelson, Ky,*

For what period enlisted *3* years.

Eyes *Black*; hair *Black*

Complexion *Black*; height *5* ft. *4* in.

When mustered in *Oct 24*, 186 .

Where mustered in *Camp Nelson*

Bounty paid \$ *100*; due \$ *100*

Where credited *W. L. Lusk, Ky*

Company to which assigned *B*

Remarks:

Book mark:

W. E. Mowser

(356d)

Copyist.

6 Cav. U.S.C.T.

John Tappan
John, Co. C, 6 Reg't U. S. Colored Cavalry.

Appears on

Company Muster Roll

for *Jan 1864*, 1864.

Present or absent *Present*

Stoppage, \$ *100* for

Due Gov't, \$ *100* for

Valuation of horse, \$ *100*

Valuation of horse equipments, \$ *100*

Remarks:

Book mark:

(358)

John Tappan

Copyist.

6 Cav. U.S.C.T.

William H. ...
... Co. C, 6 Reg't U. S. Colored Cavalry.

Appears on

Company Muster Roll

for ... 186...

Present or absent *absent*

Stoppage, \$ 100 for

Due Gov't, \$ 100 for

Valuation of horse, \$ 100

Valuation of horse equipments, \$ 100

Remarks: *sh install ...
county ...*

Book mark:

W. H. ...
Copyist.

U.S.C.T

Co., Co., Reg't U. S. Col'd

Appears on

Company Muster Roll

for *...*, 186*7*.

Present or absent *...*

Stoppage, \$ *...* 100 for

Due Gov't, \$ *...* 100 for

Valuation of horse, \$ *...* 100

Valuation of horse equipments, \$ *...* 100

Remarks: *...*
...
...
...

Book mark:

P

6 Cav. U.S.C.T.

Lee Pepples

Pri, Co. C, 6 Reg't U. S. Colored Cavalry.

Appears on

Company Muster Roll

for *May & June*, 186*d.*

Present or absent *Present*

Stoppage, \$ *100* for

Due Gov't, \$ *100* for

Valuation of horse, \$ *100*

Valuation of horse equipments, \$ *100*

Remarks: *1st Instalment bounty due*

Book mark:

S. P. York

(358)

Copyist.

2

6 Cav. U.S.C.T.

Lee Pepples

Priv., Co. C, 6 Reg't U. S. Colored Cavalry.

Appears on

Company Muster Roll

for July & Aug, 1865.

Present or absent Present

Stoppage, \$ 100 for

Due Gov't, \$ 100 for

Valuation of horse, \$ 100

Valuation of horse equipments, \$ 100

Remarks: Due U.S. for 6 + 4 E & 0 95

Book mark:

D. P. York

(358)

Copyist.

P

6 Cav. U.S.C.T.

Lee Pebbles

Tris, Co. C, 6 Reg't U. S. Colored Cavalry.

Appears on

Company Muster Roll

for *Sept + Oct*, 186*5*.

Present or absent *Present*

Stoppage, \$ *100* for

Due Gov't, \$ *100* for

Valuation of horse, \$ *100*

Valuation of horse equipments, \$ *100*

Remarks:

Book mark:

(358)

S P York

Copyist.

P | **6 Cav. U.S.C.T.**

Lee Pebbles

Priv, Co. C, 6 Reg't U. S. Colored Cavalry.

Appears on

Company Muster Roll

for *Nov. & Dec.*, 1865.

Present or absent *Present*

Stoppage, \$ *100* for

Due Gov't, \$ *100* for

Valuation of horse, \$ *100*

Valuation of horse equipments, \$ *100*

Remarks:

Book mark:

(358)

W. B. Ferguson
Copyist.

P | **6 Cav.** | **U.S.C.T.**

Lee Pebbles

Priv, Co. C, 6 Reg't U. S. Colored Cavalry.

Appears on

Company Muster Roll

for *Jan & Feb.*, 1866.

Present or absent *Present*

Stoppage, \$ 100 for

Due Gov't, \$ 100 for

Valuation of horse, \$ 100

Valuation of horse equipments, \$ 100

Remarks:

Book mark:

(358)

W. B. Ferguson

Copyist.

70 | 6 Cav. | U.S.C.T.

L. Pebbles

, Co. C, 6 Reg't U. S. Col'd Cav.

Appears on Returns as follows:

March & April 1865, Absent
on Det Service, Robinsons
Station K C R R,
Nov 29/65,

Book mark:

J. M. Roar

(546)

Copyist.

P | **6 Cav. | U.S.C.T.**

Lee Pebbles

Priv, Co. *C*, 6 Reg't U. S. Col'd Cavalry.

Appears on **Co. Muster-out Roll**, dated *Newalls Bluff Ark, Apl. 15"*, 1866.

Muster-out to date *Apl. 15"*, 1866.

Last paid to *Feb. 28"*, 1866.

Clothing account:

Last settled....., 186 ; drawn since \$..... 100

Due soldier \$..... 100; due U. S. \$ *17*/₁₀₀

Am't for cloth'g in kind or money adv'd \$..... 100

Due U. S. for arms, equipments, &c., \$..... 100

Bounty paid \$ *100* 100; due \$..... 100

Remarks: *due U. S. 6.6th & E*
17th

Book mark: *500.082*

(861)

M. Ferguson

Copyist.

Pepples, Lee

, Co. C, 6 Reg't 115th

1 Enclosures.

Bed Cards	Final Statements
Burial Records	Furloughs or L. of A.
Certs. of Dis. for Discharge	Med. Certificates
C. M. Charges	Med. Des. Lists
Descriptive Lists	Orders
Discharge Certificates	Pris. of War Record
Enlistment Papers	Resignations

Other papers relating to—

Admission to Hosp'l	Furlough or L. of A.
Casualty Sheet	Med. Examination
Confinement	Misc. Information
Contracts	Pay or Clothing
Death or Effects	Personal Reports
Desertion	Rank
Discharge from Hosp'l	Transfer to Hosp'l
Discharge from Service	Transfer to V. R. C.
Duty	Transportation

NOTE 1.—This blank will be used for enlistments of United States colored troops. They will be made out in duplicate in all cases, one accompanied by recruiting return of the superintendent (not the recruiting officer) to the Adjutant General, and one to accompany the accounts of the officer who pays bounty, &c.

NOTE 2.—An enlistment holds service. A muster-in must, in all cases, precede payment of pay, bounty, pension, &c. A muster-in roll, must in all cases, be filed in the Adjutant General's Office as evidence of muster-in. The mustering officer, commissary, or assistant commissary of musters, as the case may be, will countersign both enlistments as having mustered the soldiers into the service of the United States before either of them is given to the disbursing officer.

DECLARATION OF RECRUIT.

I, Lee Papples desiring to volunteer as a soldier in the ARMY OF THE UNITED STATES, for the term of Three Years, DO DECLARE That I am 18 years and months of age; that I have never been discharged from the United States service on account of disability or by sentence of a court-martial, or by order before the expiration of a term of enlistment; and I know of no impediment to my serving honestly and faithfully as a soldier for three years.

GIVEN at Camp Hill the 24 day of October, 1864

Witness: G. Hardy

Lee Papples
 Mustered at Camp Hill
 No. 103-104-13
1864
John Papples
John Papples
John Papples

Consent of Parent or Guardian in case of a Minor; if a Free Man, or in the case of a Slave, of the Person to whom he owes Service

I, DO CERTIFY, That I am the that the said is years of age; and I do freely give my CONSENT to his volunteering as a SOLDIER in the Army of the United States, for the period of THREE YEARS, under the conditions of the laws of the United States.

GIVEN at the day of

Witness: [Signature]

UNITED STATES COLORED TROOPS ENLISTMENT.

STATE OF

TOWN OF

Kentucky  *Camp Nelson*

I, *Lee Papples* born in _____
in the State of *Kentucky* aged *Eighteen* years
and by occupation a *Farmer* Do HEREBY ACKNOWLEDGE to
have volunteered *Twenty-fourth* of *October* 1864
to serve as a **Soldier** in the **Army of the United States of America**, for the
period of **THREE YEARS**, unless sooner discharged by proper authority: Do
also agree to accept such bounty, pay, rations, and clothing, as are, or may be,
established by law for the U. S. colored troops.

And I, *Lee Papples*
do solemnly swear that I will bear true faith and allegiance to the **United States
of America**, and that I will serve them honestly and faithfully against all their
enemies or opposers whomsoever; and that I will observe and obey the orders
of the President of the United States, and the orders of the officers appointed
over me according to the Rules and Articles of War.

Sworn and subscribed to at *Camp Nelson*
this *24th* day of *Oct 1864* *Lee Papples*
Before *James Randolph* *mark*

I CERTIFY, ON HONOR, That I have carefully examined the above named Volunteer agree-
ably to the General Regulations of the Army, and that, in my opinion, he is free from all bodily
defects and mental infirmity, which would in any way disqualify him from performing the
duties of a soldier.

Osborn A. Horr
Assistant Surgeon U.S.A.
EXAMINING SURGEON.

I CERTIFY, ON HONOR, That I have minutely inspected the Volunteer, *L. Papples*
previously to his enlistment, and that he was entirely sober when enlisted; that, to the best of
my judgment and belief, he is of lawful age; and that, in accepting him as duly qualified to per-
form the duties of an able-bodied soldier, I have strictly observed the regulations which govern
the recruiting service. This soldier has *blue* eyes, *black* hair, *fair* com-
plexion, is *five* feet *seven* inches high.

James Randolph
RECRUITING OFFICER OR AGENT.

Mustered into the United States Service *24th* day of *Oct* 1864

W. McKinney
Capt 18th U.S.C.
Mustering Officer

Mustered into the service of the United States, for three years or during the war, from date of enlistment, in Company _____
Regiment of *11th Colored* *Coaling* Volunteers, on the *24th* day of *October* 1864 at *Camp Nelson*

James Randolph
Capt 18th U.S.C.
Mustering Officer

1054
Perkins John

Co K., 6 U. S. Col'd Cav.

Private | *Private*

CARD NUMBERS.

1	5387458	26
2	5395428	27
3	5395509	28
4	5395596	29
5	5395672	30
6	5395750	31
7	5395843	32
8	5395918	33
9	4093815	34
10	40732717	35
11		36
12		37
13		38
14		39
15		40
16		41
17		42
18		43
19		44
20		45
21		46
22		47
23		48
24		49
25		50

Book Mark:

See also

S.6999a, 2nd Aud.

2712-20 2000

L. Jordan
Ex

P

6 Cav. U.S.C.T.

John Perkins

Co. K, 6 Reg't U. S. Col'd Cav.

Appears on

Company Descriptive Book

of the organization named above.

DESCRIPTION.

Age 20 years; height 5 feet 6 inches.

Complexion Copper

Eyes Blk; hair Blk

Where born Madison Ky

Occupation Farmer

ENLISTMENT.

When Nov 10, 1864

Where Cap Nelson

By whom Jas Powell, term 3 y'rs.

Remarks: Mustered May 21st
By Wm Goodloe at Lexington Ky.

Perms

(3837)

Copist.

P

6 Cav. U.S.C.T.

John Perkins

Appears with rank of Pvt on

Muster and Descriptive Roll of a Detachment of U. S. Vols. forwarded

for the 6 Reg't U. S. Col'd Cavalry. Roll dated Lexington Ky May 24, 1865.

Where born Madison Co Ky

Age 20 y'rs; occupation Farmer

When enlisted Nov 10, 1864

Where enlisted Camp Nelson Ky

For what period enlisted 3 years.

Eyes Blk; hair Blk

Complexion Blk; height 5 ft. 6 in.

When mustered in May 24, 1865.

Where mustered in Lexington Ky

Bounty paid \$ 100; due \$ 100

Where credited Madison Co Ky

Company to which assigned

Remarks: ...

Book mark:

W. Kelley

P 6th Cav U.S.C.T.

John Perkins
Co. H, 6th Reg't U. S. Col'd Cav

Appears on

Company Muster-in and Descriptive Roll
of the organization named above. Roll dated

Camp Nelson Ky May 29, 1865.

Where born *Madison Co. Ky*

Age *20* y'rs; occupation *Farmer*

When enlisted *Nov 10*, 1864.

Where enlisted *Camp Nelson*

For what period enlisted *3* years.

Eyes *black*; hair *black*

Complexion *Copp*; height *5* ft. *6* in.

When mustered in *May 24*, 1865.

Where mustered in *Lexington*

Bounty paid \$ *100*; due \$ *100*

Where credited *S. D. Ky*

Company to which assigned

Remarks:

Book mark:

(356d)

D. J. Griffith

Copyist.

P | **6 Cav. | U.S.C.T.**

John Perkins

Perkins, Co. K, 6 Reg't U. S. Col'd Cav.

Appears on

Company Muster Roll

for *May 25 to June 30*, 186*5*.

Present or absent *Present*

Stoppage, \$ *100* for -----

Due Gov't, \$ *100* for -----

Valuation of horse, \$ *100*

Valuation of horse equipments, \$ *100*

Remarks: -----

Book mark: -----

(358)

A. J. Griffith

Copyist.

P | **6 Cav. U.S.C.T.**

John Perkins

present, Co. K, 6 Reg't U. S. Col'd Cav.

Appears on

Company Muster Roll

for *July & August*, 186*5*.

Present or absent *Present*

Stoppage, \$ _____ *100* for _____

Due Gov't, \$ _____ *100* for _____

Valuation of horse, \$ _____ *100*

Valuation of horse equipments, \$ _____ *100*

Remarks: _____

Book mark: _____

(358)

D. G. Whiffish

Copyist.

P | **6 Cav.** | **U.S.C.T.**

John Perkins
Priv, Co. K, 6 Reg't U. S. Col'd Cav.

Appears on

Company Muster Roll
for *Sept. + Oct., 1865*

Present or absent *Present*

Stoppage, \$ *100* for

Due Gov't, \$ *100* for

Valuation of horse, \$ *100*

Valuation of horse equipments, \$ *100*

Remarks:

Book mark:

J. M. Jackson
(358) *Copypist.*

P | **6 Cav.** | **U.S.C.T.**

John Perkins
Priv, Co. K, 6 Reg't U. S. Col'd Cav.

Appears on

Company Muster Roll

for *Nov. & Dec*, 1865

Present or absent *Present*

Stoppage, \$ *100* for

Due Gov't, \$ *100* for

Valuation of horse, \$ *100*

Valuation of horse equipments, \$ *100*

Remarks:

Book mark:

(358)

M. M. Jackson
Copyist.

P

6 Cav. U.S.C.T.

John Perkins

Private, Co. K, 6 Reg't U. S. Col'd Cav.

Appears on

Company Muster Roll

for ... 1866

Present or absent

Stoppage, \$ 100 for

Due Gov't, \$ 100 for

Valuation of horse, \$ 100

Valuation of horse equipments, \$ 100

Remarks: Lied ...

Book mark:

O. J. Markle

(358)

Copyist.

P | 6 Cav. | U.S.C.T.

John Perkins

Pvt, Co. H. 6 Reg't U. S. Col'd Cav.

Appears on Returns as follows:

Jan'y 1866. Absent sick
in Post Hosp'l Helena
Ark. since Jan 9/66,

Feb'y 1866. Lost. Jan 12/66
Helena Ark. Died of
Small Pox in Post
Hosp'l.

Book mark :

C. M. Cowe

(546)

Copyist.

C

6 Cav. U.S.C.T.

John Perkins

Private, Co. *F*, 6 Reg't U. S. Col'd Cavalry.

Appears on **Co. Muster-out Roll**, dated
Genalls Bluff, Ark. Apr. 10, 1866.

Muster-out to date _____, 186__.

Last paid to *Oct. 31*, 186*5*.

Clothing account:

Last settled _____, 186__ ; drawn since \$ _____ 100

Due soldier \$ _____ 100 ; due U. S. \$ _____ 100

Am't for cloth'g in kind or money adv'd \$ _____ 100

Due U. S. for arms, equipments, &c., \$ _____ 100

Bounty paid \$ _____ 100 ; due \$ _____ 100

Remarks: *Died Jan. 17, 1866 at
Helena, Ark. Small Pox*

Book mark: *P. 2222 Ky. V. 209 P. 58. 74.*

(361)

U. J. Markle,

Copyist.

Perkins, John

P, Co. K, 6 U.S.C. Cav.

4 Enclosures.

Bed Cards	Descriptive Lists
Burial Records	Final Statements
Certs. of Dis. for Discharge	Furloughs
C. M. Charges	Med. Des. Lists
Med. Certificates	Orders
<i>Enlistments</i>	

Other papers relating to—

Admission to Hosp'l	Furlough
Casualty Sheet (Officer's)	Med. Examination
Confinement	Misc. Information
Contracts	Pay or Clothing
Death or Effects	Personal Reports
Desertions	Rank
Discharge from Hosp'l	Transfer to Hosp'l
Discharge from Service	Transfer to V. R. C.
Duty	Transportation

Note 1.—This blank will be used for enlistments of United States colored troops. They will be made out in duplicate in all cases—one to accompany the recruiting return of the superintendent (not the recruiting officer) to the Adjutant General, and one to accompany the accounts of the officer who pays bounty, &c.

Note 2.—An enlistment holds to service. A muster-in must, in all cases, precede payment of pay, bounty, pension, &c. A muster-in roll, must in all cases, be filed in the Adjutant General's Office as evidence of muster-in. The mustering officer, commissary, or assistant commissary of musters, as the case may be, will countersign both enlistments as having mustered the soldiers into the service of the United States before either of them is given to the disbursing officer.

DECLARATION OF RECRUIT.

I, John Perkins desiring to volunteer as a soldier in the ARMY OF THE UNITED STATES, for the term of *Three Years*, DO DECLARE That I am 20 years and _____ months of age; that I have never been discharged from the United States service on account of disability or by sentence of a court-martial, or by order before the expiration of a term of enlistment; and I know of no impediment to my serving honestly and faithfully as a soldier for three years.

GIVEN at Camp Nelson the 10 day of Nov 1864

Witness:

John Perkins his mark

By James J. Farrell
 Volunteered at Camp Nelson
10th Nov 1864
6th Regt
1st M. S. Colored Regt

No. _____
John Perkins. (Col)

Consent of Parent or Guardian in case of a Minor, if a Free Man, or in the case of a Slave, of the Person to whom he owes Service:

I, Jeff Perkins (Madison Co) Do CERTIFY, That I am the _____

that the said _____ is _____ years of age; and I

do freely give my CONSENT to his volunteering as a SOLDIER in the Army of the United States, for the period of THREE YEARS, under the conditions of the laws of the United States.

GIVEN at _____ the _____ day of _____

Witness:

Credited to Madison Co, 8th Dist

UNITED STATES COLORED TROOPS ENLISTMENT.

STATE OF



TOWN OF

I, *John Perkins* born in *Madison Co*
in the State of *Mo* aged *20* years

and by occupation a *Farmer* Do HEREBY ACKNOWLEDGE to
have volunteered *10* day of *Nov* 186*4*

to serve as a **Soldier** in the **Army of the United States of America**, for the
period of **THREE YEARS**, unless sooner discharged by proper authority: Do
also agree to accept such bounty, pay, rations, and clothing, as are, or may be,
established by law for the U. S. colored troops.

And I, *John Perkins*
do solemnly swear that I will bear true faith and allegiance to the **United States
of America**; and that I will serve them honestly and faithfully against all their
enemies or opposers whomsoever; and that I will observe and obey the orders
of the President of the United States, and the orders of the officers appointed
over me, according to the Rules and Articles of War.

Sworn and subscribed to, at *C. Nelson*
this *10* day of *Nov 1864* *John Perkins*
Before *James Powell* *mark*
6 U.C.C.

I CERTIFY, ON HONOR, That I have carefully examined the above named Volunteer agree-
ably to the General Regulations of the Army, and that, in my opinion, he is free from all bodily
defects and mental infirmity, which would in any way disqualify him from performing the
duties of a soldier.

C. H. Kelly
6 U.C.C. EXAMINING SURGEON.

I CERTIFY, ON HONOR, That I have minutely inspected the Volunteer *John Perkins*
previously to his enlistment, and that he was entirely sober when enlisted; that, to the best of
my judgment and belief, he is of lawful age; and that, in accepting him as duly qualified to per-
form the duties of an able-bodied soldier, I have strictly observed the regulations which govern
the recruiting service. This soldier has *Blue* eyes, *Dark* hair, *Dark* com-
plexion, is *five* feet *1* inches high.

St. James Powell
6 U.C.C. RECRUITING OFFICER OR AGENT.

Mustered into the United States Service.....day of186

Mustering Officer.

Mustered into the service of the United States, for three years or during the war, from date of enlistment, in Company
6th Regiment of *W.P.C.* Volunteers, on the *24* day of *Nov* 186*4* at *de Kemp's*
William Powell
Capt. Powell
Mustering Officer

Extract from Act of Congress.

SEC. 12. *And be it further enacted,* That the fees of agents and attorneys for making out and causing to be executed the papers necessary to establish a claim for a pension, bounty, and other allowance before the Pension Office, under this act, shall not exceed the following rates: For making out and causing to be duly executed a declaration by the applicant, with the necessary affidavits, and forwarding the same to the Pension Office, with the requisite correspondence, ten dollars; which sum shall be received by such agent or attorney in full for all services in obtaining such pension, and shall not be demanded or received, in whole or in part, until such pension shall be obtained; and the sixth and seventh sections of an act entitled "An act to grant pensions," approved July [fourteenth,] eighteen hundred and sixty-two, are hereby repealed.

SEC. 13. *And be it further enacted,* That any agent or attorney who shall, directly or indirectly, demand or receive any greater compensation for his services under this act than is prescribed in the preceding section of this act, or who shall contract or agree to prosecute any claim for a pension, bounty, or other allowance under this act, on the condition that he shall receive a per centum upon any portion of the amount of such claim, or who shall wrongfully withhold from a pensioner or other claimant the whole or any part of the pension or claim allowed and due to such pensioner or claimant, shall be deemed guilty of a high misdemeanor, and, upon conviction thereof, shall, for every such offense, be fined not exceeding three hundred dollars, or imprisoned at hard labor not exceeding two years, or both, according to the circumstances and aggravations of the offense.

Approved July 4, 1864.

NOTE 10.—If any soldier is charged a higher fee than that allowed by the above act, he should report the fact and the name of the agent to the Adjutant General, in order that steps may be taken to have the same refunded.

ADJUTANT GENERAL'S OFFICE

March 16th 1866

Duplicate with Inventory sent 2d Auditor

FINAL STATEMENT

James T. [unclear]
Reg't of [unclear] Co.

VOLUNTEERS.

NOTE 1.—Two of these certificates (or duplicates) are to be given to each Volunteer Soldier or drafted man who may be discharged without being mustered out (Final Statements are never given to men mustered out of service) that he may at once receive from the Paymaster the pay, &c., due him, and the captain or other COMMISSIONED officer commanding the company will certify to the act of the delivery of the duplicate certificates; with these certificates the Soldier is "entitled to" his discharge, and should also present his discharge to the Paymaster to have the payment endorsed on it. The discharge is to be given back to the Soldier by the Paymaster; the latter only retaining as his vouchers the duplicate certificates.

NOTE 2.—If the Soldier is entitled to pay for the use of his horse, the Company Commander will certify to that fact on the back of both these final statements, and also to the time he has pay due for having been so mounted on his own horse.

NOTE 3.—When a Soldier is furnished with final statements, his descriptive list, if he has one, should be taken up by the officer who gives the Soldier these statements, and endorsed with a statement to this effect by the officer. The endorsement should exhibit a full statement of the time for which the Soldier was allowed pay on his final statements, the clothing account, and all other charges against him or in his favor, so as to comprise a complete exhibit of his account. It will then be transmitted to the Company Commander of the Soldier, who will enter all the data necessary to a full understanding of the Soldier's account on the muster roll upon which the Soldier's discharge is reported. The descriptive list will then be destroyed. The object of this is, that the remaining portion of the Soldier's account may be settled upon the receipt of these muster rolls, and the Soldier receive any pay or allowances that may be due him at the time of his discharge, and which may not appear on his last final statements from the fact that his descriptive list is incomplete. These accounts for back pay, &c., are settled by the 2d Auditor of the Treasury Department.

NOTE 4.—Charges for loss or injury to ordnance, horse equipments, and other miscellaneous charges, should appear under the heading of "Other Stoppages."

NOTE 5.—Bounty paid by State authorities, and not by the United States, will not be entered on this statement.

NOTE 6.—Amounts due the Sutler and Laundry must be entered on the muster roll on which the discharge, death, desertion, &c., is reported, as well as on the final statement, otherwise the amount cannot be collected from the United States.

NOTE 7.—This blank will be used for deceased volunteers and drafted men, as well as for others.

NOTE 8.—Where a Soldier dies in Hospital or on detached service, his descriptive list, if he has one, should be sent with his final statements, in duplicate, to the Adjutant General, Washington, D. C.

NOTE 9.—If the soldier is a drafted man or substitute, the place for time, &c., of enrolment, should contain only the word *drafted* or *substitute*, as the case may be. If the Soldier is a "VETERAN," (or RECRUIT,) the words *as a veteran*, (or *recruit*), as the case may be, should be interlined after the words *mustered into the service of the U. S.* A statement of all the instruments of *Veteran* or *Recruit* Bounty RECEIVED by the Soldier must be made on the back of each final statement.

I certify, on honor, that John Perkins, a Private of
 Captain _____ Company (X) of the 6th Regiment of M. S. Cav.
VOLUNTEERS, of the State of _____, born in Madison Co., State
 of Kentucky, aged 20 years; 5 feet 6 inches high, Light complexion,
Black eyes, Black hair, and by occupation a Farmer, who joined for service
 and was enrolled (see Note 9) on the 10th day of Nov, 1864, at Camp Nelson Ky
 by W. Howell, for the period of 3 years, and mustered into
 the service of the United States on the 24th day of May, 1865, at
Lexington Ky, by Capt Goodloe (as Recruit) and having served
 HONESTLY and FAITHFULLY with his Company to the present date, is now entitled to a
DISCHARGE by reason of Death - Died at Post Hospital
Helena Ark Jan 17th 1866. J. M. Cox

The said John Perkins was last paid by Paymaster
May Cowen, to include the 31st day of October, 1865, and
 has pay due him from that time to the present date; he is entitled to pay and subsistence for
TRAVELING to place of enrollment, and whatever other allowances are authorized to volunteer
 soldiers, drafted men, or militia, so discharged. He has received from the United States **CLOTHING**
 amounting to ninety one $\frac{10}{100}$ dollars, since the 10th day of November,
 1864, when his clothing account was last settled. He has received from the United States
one hundred $\frac{00}{100}$ dollars advanced **BOUNTY**.

There is to be stopped from him, on account of the State of _____, or other
 authorities, for **CLOTHING, &c.**, received on entering service, _____ $\frac{00}{100}$ dollars; and
 for other stoppages, viz: _____

_____ $\frac{00}{100}$ dollars.
 He has been furnished with **TRANSPORTATION** in kind from the place of his discharge to
 _____; and he has been **SUBSISTED** for **TRAVELING** to his
 place of enrollment, up to the _____, 186 .

He is indebted to _____, **SUTLER**, _____ $\frac{00}{100}$ dollars.
 He is indebted to _____, **LAUNDRESS**, _____ $\frac{00}{100}$ dollars.

Given in Duplicate, at Evening Shade Ark, this 28th day
 of February, 1866.

C. H. Brown
1st Lieut. M. S. Cav.
 Commanding Company.

ARTICLES OF WAR.

ART. 95. When any non-commissioned officer or soldier shall die, or be killed in the service of the United States, the then commanding officer of the troop or company shall, in the presence of two other commissioned officers, take an account of what effects he died possessed of, above his arms and accoutrements, and transmit the same to the office of the Department of War, which said effects are to be accounted for, and paid to the representatives of such deceased non-commissioned officer or soldier. And in case any of the officers, so authorized to take care of the effects of deceased officers and soldiers, should, before they have accounted to their representatives for the same, have occasion to leave the regiment or post, by preferment or otherwise, they shall, before they be permitted to quit the same, deposit in the hands of the commanding officer, or of the assistant military agent, all the effects of such deceased non-commissioned officers and soldiers, in order that the same may be secured for, and paid to, their respective representatives.

ARMY REGULATIONS—EDITION OF 1861.

DECEASED SOLDIERS.

Par. 152. Inventories of the effects of deceased non-commissioned officers and soldiers, required by the 95th Article of War, will be forwarded to the Adjutant General, by the commander of the company to which the deceased belonged, and a duplicate of the same to the colonel of the regiment. Final statements of pay, clothing, &c., will be sent with the inventories. When a soldier dies at a post or station absent from his company, it will be the duty of his immediate commander to furnish the required inventory, and, at the same time, to forward to the commanding officer of the company to which the soldier belonged, a report of his death, specifying the date, place, and cause; to what time he was last paid, and the money or other effects in his possession at the time of his decease; which report will be noted on the next muster roll of the company to which the man belonged. Each inventory will be endorsed, "Inventory of the effects of _____, late of company (—) _____ regiment of _____, who died at _____, the _____ day of _____, 186—." If a legal representative receive the effects, it will be stated in the report. If the soldier leave no effects, the fact will be reported.

Par. 153. Should the effects of a deceased non-commissioned officer or soldier not be administered upon within a short period after his decease, they shall be disposed of by a Council of Administration, under the authority of the commanding officer of the post, and the proceeds deposited with the Paymaster, to the credit of the United States, until they shall be claimed by the legal representatives of the deceased.

Par. 154. In all such cases of sales by the Council of Administration, a statement in detail, or account of the proceeds, duly certified by the Council and commanding officer, accompanied by the Paymaster's receipt for the proceeds, will be forwarded by the commanding officer to the Adjutant General. The statement will be endorsed, "Report of the proceeds of the effects of _____, late of company (—) _____ regiment of _____, who died at _____, the _____ day of _____, 186—."

NOTE 1.—The effects in all cases, when called for, should be turned over to the legal representative, without further authority from the Adjutant General. When the effects are turned over to the relatives of the deceased before these inventories are sent to the Adjutant General, their receipts therefor should be attached to the inventories. In all other cases, one copy will be sent with a letter of transmittal direct to the Adjutant General, and a duplicate retained by the officer.

NOTE 2.—Particular care should be taken to take receipts in duplicate from the Paymaster for any funds turned over to him; one copy should be sent direct to the Adjutant General and one retained by the officer.

INVENTORY OF THE EFFECTS

OF

John ...

Late of Company *A*

Reg't of

Volunteers, who died at

on the _____ day of _____ 186

Inventory of the effects of John Perkins late
 a Private of Captain _____ Company N^o of
 the 5th Regiment of M. S. C. A. Volunteers, who was enrolled as
 a Private at Camp Nelson in the State of Kentucky on
 the 10th day of November 1864, and mustered into the service of the United
 States as a Private on the 24th day of May 1866, at Lexington Ky
 in Company N^o 1 Regiment of M. S. C. A. Volunteers, to serve 3
 years or during the war; he was born in Madison Co in the State
 of Kentucky; he was 20 years of age, 5 feet 6 inches
 high, Copper complexion, Black eyes, Black hair, and by occupation, when enrolled,
 a Farmer; he died in Post Hospital, at
Helena Ark on the 17th day of January 1866, by
 reason of Small Pox

INVENTORY.					
ARTICLES.	No.	ARTICLES.	No.	ARTICLES.	No.
Hats.....		Pairs trousers.....		Knapsacks.....	
Caps.....		Pairs flannel drawers.....			
Forage caps.....		Pairs cotton drawers.....			
Great coats.....		Flannel shirts.....			
Uniform coats.....		Cotton shirts.....			
Uniform jackets.....		Pairs boots.....			
Flannel sack coats.....		Pairs shoes.....			
Blouses.....		Pairs socks.....			
Stable frocks.....		Blankets.....			
Fatigue overalls.....		Haversacks.....			
				MONEY.	
				Specie.....	\$
				Notes.....	\$

I CERTIFY, ON HONOR, that the above inventory comprises all the effects of Private
John Perkins, deceased, and that the effects are in the hands
 _____ at _____
 _____ to be disposed of by a Council of Administration.

(DUPLICATES.)

STATION: Evening Shade Ark
 DATE: Feb 28 1866.

C. H. Brown
1st Lieut. M. S. C. A.
 Commanding the Company.

War Department,

ADJUTANT GENERAL'S OFFICE,

Washington, *April 10th 1867*

Respectfully returned to the
Commission for the State of
Ky with the informa-
tion that *John Perkins*
was enlisted at *Camp Nelson Ky*
Nov 10th 1864 and was
mustered in as *Priv. Co. K' 6th US*
Colo. May 21st 1865

Richard

Asst. Adj't General.

unme

No. *11*

APPLICATION OF

Jefferson Perkins

OF

Madison County Ky

FOR COMPENSATION FOR SLAVE,

Named *John Perkins*

Enlisted *11th Nov 1864*

In *Co. K' 6th Cavalry Regiment,*

U. S. COLORED TROOPS.

Received *March 5th 1867*

Compensation Awarded

186

Dollars.

President of Board of Claims.

Claimant's Attorney,

Burman & Carpenter,

Richmond Ky.

Claimant's Post-office Address,

Richmond

Kentucky

FRANKFORT COMMONWEALTH PRINT.

No.

CLAIM OF

Jefferson Perkins

FOR THE COMPENSATION OF SLAVE NAMED

John Perkins

I Jefferson Perkins a loyal citizen, and a resident of the County of Madison, State of Kentucky, hereby claim compensation, under the provisions of Section 24, act approved February 24, 1864, and section 2, act approved July, 28, 1866, for my slave John, enlisted 10th September 1864, at Camp Nelson, by Jas. Powell in the 6th Cavalry regiment U. S. Colored Troops, Co. "K"; certificate of which enlistment, and a descriptive list, as required, accompany this application. That I did not acquire said slave subsequent to said enlistment, but had a valid title to him at the date of said enlistment, and previous thereto: I having acquired my title to him and my ownership over him as follows, to-wit:

I bought the slave John at the sale of Allen Williams, about 5 or 6 years ago and he entered my property till he enlisted -

In proof of my loyalty to the Constitution and Government of the United States, I present the accompanying oath, which I have taken, signed and acknowledged; to be filed with this application, in accordance with requirement of General Orders, No. 329, 1863, War Department, Adjutant General's Office.

2nd March, 1867.

Jefferson Perkins

OATH OF ALLEGIANCE.

I Jefferson Perkins, the owner and Claimant, do solemnly swear that the foregoing claim is a just and true claim due to me as master and owner of the said slave, and that the facts alleged in said claim in respect to the draft or enlistment (as the case may be) of said slave into the Military service of the United States are true. And I do further swear that I have never joined, or been concerned in, any insurrection or rebellion; that I have never borne arms against the United States; that I have never given any aid, countenance, counsel or encouragement to any person or persons engaged, or whom I had reason to believe were about to engage, in insurrection, rebellion or armed hostility against the United States; that I have neither sought, nor accepted, nor attempted to exercise the functions of any office, civil or military, nor to perform any service whatever, under any authority or pretended authority in hostility to the United States; that I have not yielded a voluntary support to any insurrection, rebellion or pretended government, authority, power or constitution within the United States hostile thereto. And I do further swear that, to the best of my knowledge and ability, I have supported and defended, and will continue to support and defend, the United States against all enemies, foreign and domestic; and that I have supported, defended and obeyed, and will continue to support, defend and obey, the Constitution and laws of the United States; that I will bear true faith and allegiance to the same; and that I take this oath freely, without any mental reservation or purpose of evasion: So help me God.

Jefferson Perkins

Sworn to and subscribed before me, at Richmond Ky, this 2nd day of March, 1867.

E. J. Walker

White Madison County Court

STAMP



PROOF OF OWNERSHIP.

STATE OF KENTUCKY,

COUNTY OF *Madison*

} SS.

We *Jerry G. Perkins* and *John Taylor* each of lawful age, and resident citizens of the State and County aforesaid, do certify that *Jefferson Perkins* of the State and County aforesaid, was on the *10th* day of *November* 1864, the lawful owner of the slave named *John Wilson*; referred to and described in the foregoing claim for compensation.

Jerry G. Perkins

John Taylor

Sworn to and subscribed before me *Clerk of the County Court* for the County of *Madison* State of Kentucky, this the *2nd* day of *March* 1867.

*C. J. Walker Clerk
Madison County Court*



PROOF OF LOYALTY.

STATE OF KENTUCKY,

COUNTY OF *Madison*

} SS.

We *Jerry G. Perkins* and *James M. Shadlock* loyal men and each of lawful age, and resident citizens of the *town* of *Richmond* in the State and County aforesaid, upon our oaths declare that we have known *Jefferson Perkins* a resident of the State and County aforesaid, since the 4th day of March, 1861, and know that he has firmly and faithfully maintained his or her adherence and allegiance to the Government of the United States, by defending its cause against the Government and forces of the so-called Confederate States of America, in all suitable and practicable ways, and according to his ~~own~~ ability and opportunity.

*Jerry G. Perkins
Witness*

Sworn to and subscribed before me *Clerk of the County Court* for the county of *Madison* State of Kentucky, this the *2nd* day of *March* 1867.

*C. J. Walker Clerk
Madison County Court*



POWER OF ATTORNEY.

My Post-Office address is *Richmond* County of *Madison* State of Kentucky, and I hereby direct that all communications to me, touching this claim, be sent under cover to *Merriman & Caperton, Attys*, who is hereby appointed and constituted my true and lawful attorney, to prosecute this claim for me, and who is hereby authorized and empowered to receive and receipt for any award, order, draft, certificate, voucher, warrant, papers or money that may be issued in the adjustment of this claim, or the payment thereof, the same as I could do in person were I present and acting for myself, and to file any additional evidence and papers that may be required in the prosecution of this claim.

[WITNESS.]

The owner signs here.

Jefferson Perkins

Two witnesses to owner's signature sign here.

*J. H. Williams
L. H. Hill*

CENT
AMP.

1855

Pettis Daniel

Co No., 6 U. S. Col'd Cav.

Private Private

CARD NUMBERS.

1	5387616	26
2	5387694	27
3	5394097	28
4	5394182	29
5	5394263	30
6	5394358	31
7	5394477	32
8	5388191	33
9	5394706	34
10	9093635	35
11	43151188	36
12	40732718	37
13		38
14		39
15		40
16		41
17		42
18		43
19		44
20		45
21		46
22		47
23		48
24		49
25		50

Book Mark:

See also

S-11 5181 - Arch. N.S.
R.P. 490849

L. Jordan
Ex

D. | 6 Cav | U.S.C.T.

Daniel Pettis

, Co. 6 Reg't U. S. Col'd Cav.

Appears on

Company Descriptive Book

of the organization named above.

DESCRIPTION.

Age 19 years; height 5 feet 7 inches.

Complexion black

Eyes black; hair black

Where born Alabama

Occupation Farmer

ENLISTMENT.

When Feb. 14, 1865

Where Bowling Green

By whom Capt. Hobson; term 3 y'rs.

Remarks:

Substitute,
deserted.

D. Perry Webb

(3839)

Coylist.

P | 6 bar | U.S.C.

Daniel Pettie's

Appears with rank of Pvt on

Muster and Descriptive Roll

of Detachment of U.S. Colored Recruits forwarded

Roll dated Bowling Green Ky Feb 28, 1865

Where born Alabama

Age 19 years; occupation Farmer

When enlisted Feb. 14, 1865

Where enlisted B. Green Ky

For what period enlisted 3 years.

Eyes Blk; hair Blk

Complexion Blk; height 5 ft. 7 in.

When mustered in _____, 1865

Where mustered in _____

Bounty paid \$ 100; due \$ 100

Clothing account:

Last settled _____, 1865; drawn since \$ 17²⁴/₁₀₀

Date of first muster Feb. 14, 1865

Company to which assigned _____

Remarks: Old substitute for John W. Potter of Warner Co. Credited to the 3^d Cong. Dist. Ky

Book mark: _____

R. W. Fish

(356m)

Copyist.

P | 6 | U.S.C.T.

Daniel Pettis

Appears with rank of *Pvt.* on

Muster and Descriptive Roll of a Detachment of Substitutes forwarded

for the *6* Reg't U. S. Col'd Cavalry. Roll dated *Draft Rendezvous Louisville Ky. Feb 15 1865.*

Where born *Alabama*

Age *19* y'rs; occupation *Farmer*

When enlisted _____, 186 .

Where enlisted *Substitute*

For what period enlisted *3* years.

Eyes *Black*; hair *Black*

Complexion *Black*; height *5* ft. *7* in.

When mustered in *Feb 14*, 186 *5*.

Where mustered in *Bowl. Green*

Bounty paid \$ *100*; due \$ *100*

Where credited *3^d Dist. Ky.*

Company to which assigned _____

Remarks: *Sub. for John W. Potter*

Book mark: _____

(340c) *Conard*
Copyist.

P

6

U.S.C.T.

Daniel Pettis

Appears with rank of *Priv* on

Muster and Descriptive Roll of a Detachment of Substitutes forwarded

for the *6* Reg't U. S. Col'd Cavalry. Roll dated *Draft Rendezvous, Louisville, Ky, March 15, 1865*.

Where born *Alabama*

Age *19* y'rs; occupation *Farmer*

When enlisted _____, 186 .

Where enlisted *Substitute*

For what period enlisted *3* years.

Eyes *Black*; hair *Black*

Complexion *Black*; height *5* ft. *7* in.

When mustered in *Feb. 14*, 1865.

Where mustered in *Bowling Green*

Bounty paid \$ *100*; due \$ *100*

Where credited *3^d Dist. Ky.*

Company to which assigned _____

Remarks: *Sub. for John W. Potter*

Book mark: _____

(339c)

Leonard

Copyist.

P

6 Cav. U. S. C. T.

Daniel Pettis

Priv., Co. H. 6 Reg't U. S. Col'd Cavalry

Appears on

Company Muster-in and Descriptive Roll
of the organization named above. Roll dated

Bowling Green, Ky., Feb 26, 1865.

Where born Alabama

Age 19 y'rs; occupation Farmer.

When enlisted _____, 186 .

Where enlisted Substitute.

For what period enlisted 3 years.

Eyes Black; hair Black.

Complexion Black; height 5 ft. 7 in.

When mustered in Feb. 14, 1865.

Where mustered in Bowling Green, Ky.

Bounty paid \$ 100; due \$ 100

Where credited 3d Dist. Ky.

Company to which assigned H.

Remarks: Sub. for John W. Potter.

Book mark: _____

Leonard

(356d)

Copyist.

D | **6 Cav. U.S.C.T.**

Daniel Pettis

Priv., Co. H, 6 Reg't U. S. Col'd Cavalry.

Appears on

Company Muster Roll

for *from Mch 16 to Apr. 30*, 1865.

Present or absent *Present.*

Stoppage, \$ *100* for

Due Gov't, \$ *100* for

Valuation of horse, \$ *100*

Valuation of horse equipments, \$ *100*

Remarks:

Book mark:

(358)

Conard
Copyist.

P | **6 Cav. U.S.C.T.**

Daniel Pettis

Pvt, Co. H, 6 Reg't U. S. Col'd Cavalry.

Appears on

Company Muster Roll

for *May & June*, 186*5*.

Present or absent *Present*.

Stoppage, \$ *100* for

Due Gov't, \$ *100* for

Valuation of horse, \$ *100*

Valuation of horse equipments, \$ *100*

Remarks:

Book mark:

(358)

Leonard

Copyist.

6 Cav. U.S.C.T.

Samuel P. Little

It, Co. H, 6 Reg't U. S. Col'd Cavalry.

Appears on

Company Muster Roll

for *John Little*, 1865.

Present or absent *Present*

Stoppage, \$ *100* for

Due Gov't, \$ *100* for

Valuation of horse, \$ *100*

Valuation of horse equipments, \$ *100*

Remarks:

Book mark:

(358)

Little

Copyist.

6 Cav. U.S.C.T.

Samuel Pettie

Pettie, Co. H, 6 Reg't U. S. Col'd Cavalry.

Appears on

Company Muster Roll

for *Sept*, 1865.

Present or absent

Stoppage, \$ 100 for

Due Gov't, \$ 100 for

Valuation of horse, \$ 100

Valuation of horse equipments, \$ 100

Remarks *Discharged*

5.10.65, Camp

Book mark:

Quinn

J. O'Leary U.S.C.T.

Daniel Pettis
Co. H, 6 Reg't U. S. Col'd *1st*

Appears on

Descriptive List of Deserters

dated *September 30*, 186*5*.

Deserted:

When *Sept 5*, 186*5*.

Where *at Fort Sumter*

Arrested:

When _____, 186 .

Where _____

Remarks: *Not known*

where he may

be found

Book mark: _____

J | **6 Cav.** | **U.S.C.T.**

Daniel Pettes
Priv, Co. *H*, 6 Reg't U. S. Col'd Cav.

Appears on Returns as follows:

Sept 1863 Loss. Sept 5/63
Camp Nelson Ky.
Deserted.

Book mark:

(546)

W M Rouse

Copyist.

P

6 Cav. U.S.C.T.

Samuel Pettis

Pr, Co. *H*, 6 Reg't U. S. Col'd Cavalry.

Appears on **Co. Muster-out Roll**, dated
at Walla Walla, Ark. Apr 10, 1866.

Muster-out to date _____, 186__.

Last paid to *June 30, 1865.*

Clothing account:

Last settled _____, 186__ ; drawn since \$ _____ 100

Due soldier \$ _____ 100; due U. S. \$ _____ 100

Am't for cloth'g in kind or money adv'd \$ _____ 100

Due U. S. for arms, equipments, &c., \$ _____ 100

Bounty paid \$ _____ 100; due \$ _____ 100

Remarks: *at receipt Sept 5/65*
at Camp Nelson Ky.

Book mark: _____

W. H. Harmon

Pettis Daniel

....., Co.,

Reg't *U.S.C.T.*

..... / **Enclosures.**

Bed Cards	Final Statements
Burial Records	Furloughs or L. of A
Certs. of Dis. for Discharge	Med. Certificates
C. M. Charges	Med. Des. Lists
Descriptive Lists	Orders
Discharge Certificates	Pris. of War Record
Enlistment Papers	Resignations

Other papers relating to—

Admission to Hosp'l	Furlough or L. of A
Casualty Sheet	Med. Examination
Confinement	Misc. Information
Contracts	Pay or Clothing
Death or Effects	Personal Reports
Desertion	Rank
Discharge from Hosp'l	Transfer to Hosp'l
Discharge from Service	Transfer to V. R. C.
Duty	Transportation

20

~~201~~
Pe

No. 4

Pellie, Daniel

Enlisted at Burlington Ky

As Substitute for

John M. Potter
On the 14 day of Feb, 1865

By

A. G. Brown

W. A. Brown

W. H. Bailey

Board of Enrollment,

2d Dist. of Ky

SUBSTITUTE VOLUNTEER ENLISTMENT.

STATE OF

TOWN OF

Kentucky

Bowling Green



I, Daniel Pettis born in the State of Alabama, aged seventeen years, and by occupation a Farmer

DO HEREBY ACKNOWLEDGE to have agreed with John W. Foster, Esq., of Kentucky

to become his **SUBSTITUTE** in the Military Service, for a sufficient consideration paid and delivered to me, on the fourteenth day of February, 1865; and having thus agreed with said John W. Foster, I DO HEREBY ACKNOWLEDGE to have enlisted this fourteenth day of February, 1865, to serve as a **Soldier** in the **Army of the United States of America**, for the period of **THREE YEARS**, unless sooner discharged by proper authority: I do also agree to accept such bounty, pay, rations, and clothing, as are, or may be, established by law for soldiers. And I do solemnly swear that I will bear true and faithful allegiance to the **United States of America**; that I will serve them honestly and faithfully against all their enemies or opposers whomsoever; and that I will observe and obey the orders of the President of the United States, and the orders of the Officers appointed over me, according to the Rules and Articles of War.

SWORN and subscribed to, at Bowling Green Ky.

this 14th day of February 1865.

BEFORE John W. Foster Capt. & Prov. Mar.

3^d Dist. of Ky. Recruiting Office

Daniel Pettis
(Mar 1)

We certify, on honor, That we have carefully examined the above-named Volunteer Substitute agreeably to the Regulations, and that, in our opinion, he is free from all bodily defects and mental infirmity which would in any way disqualify him from performing the duties of a soldier; that he was entirely sober when enlisted; that he is of lawful age, (not under 18 years;) and that, in accepting him as duly qualified to perform the duties of an able-bodied soldier, and as a Substitute in lieu of John W. Foster before draft, drafted in _____, 1865, we have strictly observed the Regulations which govern in such cases. This soldier has Blue eyes, Blue hair, Blue complexion; is 5 feet _____ inches high.

J. G. Hobson
Provost Marshal

D. J. Hobson
Commissioner of Board

J. R. Bailey
Surgeon of Board

Board of Enrollment of 3^d Dist. of Kentucky

DECLARATION OF SUBSTITUTE.

I, Daniel Pettis desiring to ENLIST in the Army of the United States, for THREE YEARS, **Do declare**, That I am twenty years and _____ months of age; that I have never been discharged from the United States service on account of disability or by sentence of a court martial; and I know of no impediment to my serving honestly and faithfully as a soldier for three years.

GIVEN at Bowling Green Kentucky the 14th day of February 1865

WITNESS A. Wilson, Capt. & Rec. Mgr. 3^d Dist. of Ky. Recruiting Officer } Daniel Pettis
(over)

Mustered into the Service of the
United States this 14th day of
February 1865

A. Wilson, Capt. & Rec. Mgr.
3^d Dist. of Ky.
Mustering Officer

1056

Peyton John.

Co. I., 6 U. S. Col'd Cav.

Private Private

CARD NUMBERS.

1	5387719	26
2	5387742	27
3	5394794	28
4	5394882	29
5	5394966	30
6	5395045	31
7	5395125	32
8	5395189	33
9	5395262	34
10	5388123	35
11	5395353	36
12	9093726	37
13	43155595	38
14	40732719	39
15		40
16		41
17		42
18		43
19		44
20		45
21		46
22		47
23		48
24		49
25		50

Book Mark:

See also

S:848902 - Land
S-990203 - Land.

L. Jordan
C

D 6 Can 1865

John Peyton
Capt

Appears with rank of _____ on _____

Muster and Descriptive Roll

of A Detachment of New Drafted and
Mustered into Service of U.S.

Smithville Ky, Roll dated March 14, 1865.

Where born Kentucky

Age 44 y'rs; occupation Farmer

Drafted and mustered in:

When March 14, 1865.

Where Smithville Ky

Enrollment district 5 Dist Ky

Period 1 years.

Eyes Black; hair Black

Complexion Black; height 5 ft. 5 in.

Bounty paid \$ 100; due \$ 100

Clothing account:

Last settled _____, 186 _____; drawn since \$ 100

Date of commencement of service March 14, 1865.

Company to which assigned _____

Remarks: Sub Geo W. Webb

Quoted from list of Disb by

Sub Sept 2/64

No clothing account \$ 1894

Book mark: _____

J. Jacobson

(356m)

Copyist.

P | 6 | U.S.C.T.

John Peyton

Appears with rank of *Priv* on

Muster and Descriptive Roll of a Detachment of Substitutes forwarded

for the *6* Reg't U. S. Col'd Cavalry. Roll dated

Draft Rendezvous Louisville, Ky. Mch 25 1865.

Where born *Kentucky*

Age *49* y'rs; occupation *Farmer*

When enlisted _____, 186 .

Where enlisted *Substitute*

For what period enlisted _____ years.

Eyes *Black*; hair *Black*

Complexion *Black*; height *5 ft. 5 1/2 in.*

When mustered in *Mch 14*, 1865.

Where mustered in *Louisville*

Bounty paid \$ *100*; due \$ *100*

Where credited *5th Dist. Ky.*

Company to which assigned _____

Remarks: *Sub. for L. W. Webb*

Book mark: _____

(340c)

Conard
Copyist.

P | 6 | U.S.C.T.

John Peyton
Appears with rank of *Priv.* on

Muster and Descriptive Roll of a Detachment of Substitutes forwarded

for the *6* Reg't U. S. Col'd Cavalry, Roll dated
Draft Rendezvous, Louisville, Ky, March 25 1865.

Where born *Kentucky*

Age *49* y'rs; occupation *Farmer*

When enlisted _____, 186 .

Where enlisted *Substitute*

For what period enlisted _____ / years.

Eyes *Blk*; hair *Blk*

Complexion *Blk*; height *5 ft. 5 1/2* in.

When mustered in *March 14*, 1865.

Where mustered in *Louisville*

Bounty paid \$ *100*; due \$ *100*

Where credited *5th Dist. Ky.*

Company to which assigned _____

Remarks: *Sub. for S. W. Webb*

Book mark: _____

P

6 Cav. U.S.C.T.

John Peyton
Sergeant, Co. D., 6 Reg't U. S. Col'd Cavalry.

Appears on

Company Muster-in and Descriptive Roll
of the organization named above. Roll dated
Camp Nelson, Ky, Apr 29, 1865.

Where born Ky.

Age 49 y'rs; occupation Farmer

When enlisted _____, 186 _____

Where enlisted Substitute

For what period enlisted 1 years.

Eyes Blk; hair Blk

Complexion Blk; height 5 ft. 5 1/2 in.

When mustered in Mar. 14, 1865.

Where mustered in Louisville

Bounty paid \$ 100; due \$ 100

Where credited 5 Dist. Ky.

Company to which assigned _____

Remarks:
Sub. for G. W. Webb.

Book mark: _____

D. M. Kennedy
Coptist.

(356d)

P | **6 Cav. U.S.C.T.**

John Peyton
Co. *A*, 6 Regt U. S. Col'd Cav.

Appears on

Company Descriptive Book

of the organization named above.

DESCRIPTION.

Age *49* years; height *5* feet *5 1/2* inches.

Complexion *Black*

Eyes *Blk*; hair *Blk*

Where born *Kentucky*

Occupation *Farmer*

ENLISTMENT.

When *Nov 14*, 186 *5*.

Where *Louisville Ky*

By whom *Capt Womack* term *1* y'rs.

Remarks: *Credited to 5 L Ky*
Sub gov G. W. Webb

Peyton
Copyist

P | **6 Cav. | U.S.C.T.**

John Peyton
Privt, Co. I, 6 Reg't U. S. Col'd Cavalry.

Appears on

Company Muster Roll
for *Enlistment to Apl 30, 1865.*

Present or absent *Present*

Stoppage, \$ *100* for

Due Gov't, \$ *100* for

Valuation of horse, \$ *100*

Valuation of horse equipments, \$ *100*

Remarks:

1 Instalment County due.

Book mark:

(358)

D. M. Kennedy
Cpyist.

P | **6 Cav. | U.S.C.T.**

John Peyton
Ser't, Co. I, 6 Reg't U. S. Col'd Cavalry.

Appears on

Company Muster Roll

for *May & June*, 186*5*.

Present or absent *Absent*

Stoppage, \$ *100* for *5*

Due Gov't, \$ *100* for

Valuation of horse, \$ *100*

Valuation of horse equipments, \$ *100*

Remarks: *Sent to Gen Kearsy
Camp Nelson Ky June
9th 1865.*

Book mark:

(358)

L. M. Kennedy
Copyist.

Q

6 Cav. | U.S.C.T.

John Peyton

Pvt, Co. I, 6 Reg't U. S. Col'd Cavalry,

Appears on

Company Muster Roll

for *July & Aug*, 1861:

Present or absent *Present*

Stoppage, \$ *100* for

Due Gov't, \$ *100* for

Valuation of horse, \$ *100*

Valuation of horse equipments, \$ *100*

Remarks:

Book mark:

(358)

J. G. Casey
Copyist.

3 | 6 Cav. | U.S.C.T.

John P. ...
Plat, Co. I, 6 Reg't U. S. Col'd Cavalry.

Appears on

Company Muster Roll

for *Sept + Oct*, 1867

Present or absent *Present*

Stoppage, \$ 100 for

Due Gov't, \$ 100 for

Valuation of horse, \$ 100

Valuation of horse equipments, \$ 100

Remarks:

Book mark:

(358)

J. L. Casey
Copyist.

5 | **6 Cav.** | **U.S.C.T.**

John Smith

Private, Co. I, 6 Reg't U. S. Col'd Cavalry.

Appears on

Company Muster Roll

for Jan - Dec, 1867.

Present or absent Present

Stoppage, \$ 100 for

Due Gov't, \$ 100 for

Valuation of horse, \$ 100

Valuation of horse equipments, \$ 100

Remarks:

Book mark:

(358)

J. Casey

Copyist.

P.

6 Cav. U.S.C.T.

John P. Taylor

Co., Co. I, 6 Reg't U. S. Col'd Cavalry.

Appears on

Company Muster Roll

for *Jan + Feb*, 186*6*.

Present or absent *Present*

Stoppage, \$ *100* for

Due Gov't, \$ *100* for

Valuation of horse, \$ *100*

Valuation of horse equipments, \$ *100*

Remarks:

Book mark: *Muster out on file*

(358)

J. P. Taylor

Copyist.

P | *6 Col'd Cav* | **U.S.C.T.**

John Peyton
Cn, Co. I, 6 Reg't U. S. Col'd *Cav*

Appears on a

Detachment Muster-out Roll

of the organization named above. Roll dated

Deerfield Bluff Ark, *Mar 21*, 186*6*.

Muster-out to date *Mar 20*, 186*6*.

Last paid to *Feb 28*, 186*6*.

Clothing account:

Last settled....., 186 ; drawn since \$ 100

Due soldier \$ *12*^{*16*}/₁₀₀; due U. S. \$ 100

Am't for cloth'g in kind or money adv'd \$ 100

Due U. S. for arms, equipments, &c., \$ 100

Bounty paid \$ 100; due \$ 100

Remarks: *Mustered out to date*

*Mar 20 - 66 under new Dept
Circular 41 of 1864*

Book mark: _____

(349)

Holburn

Copyist.

P | 6 Cav. | U.S.C.T.

John Peyton
Pot., Co. I, 6 Reg't U. S. Col'd Cav.

Appears on Returns as follows:

May 1865 On duty Co Cook,

June 1865 Absent sick in
Gen Hosp. Camp Nelson Ky.

Aug 1865 to Feby 1866,
On duty Co Cook,

March 1866 Absent at
Little Rock Ark,
Awaiting winter out
of service,

Book mark:

(546)

J. M. Row

Copyist.

P. **6 Cav. U.S.C.T.**

John P. Sutton
P., Co. *P.*, 6 Reg't U. S. Col'd Cavalry.

Appears on **Co. Muster-out Roll**, dated
Washington, D.C., April 15, 1866.

Muster-out to date _____, 186 .

Last paid to _____, 186 .

Clothing account:

Last settled _____, 186 ; drawn since \$ _____ 100

Due soldier \$ _____ 100; due U. S. \$ _____ 100

Am't for cloth'g in kind or money adv'd \$ _____ 100

Due U. S. for arms, equipments, &c., \$ _____ 100

Bounty paid \$ _____ 100; due \$ _____ 100

Remarks: *Discharged on my*
release of operations
at end of service
Mar. 20 66.

Book mark : _____

(861)

J. P. Sutton

Copyist.

Peyton, John

_____, Co. _____, 6 Reg't U.S. Cav.

_____ 1 Enclosures.

Bed Cards	Final Statements
Burial Records	Furloughs or L. of A.
Certs. of Dis. for Discharge	Med. Certificates
C. M. Charges	Med. Des. Lists
Descriptive Lists	Orders
Discharge Certificates	Pris. of War Record
Enlistment Papers	Resignations

Other papers relating to—

Admission to Hosp'l	Furlough or L. of A.
Casualty Sheet	Med. Examination
Confinement	Misc. Information
Contracts	Pay or Clothing
Death or Effects	Personal Reports
Desertion	Rank
Discharge from Hosp'l	Transfer to Hosp'l
Discharge from Service	Transfer to V. R. C.
Duty	Transportation
_____	_____

130

P/65

No. 1035

John Pyle

Enlisted at Lewisville,

As Substitute for

George W. Webb

On the 14 day of March, 1865

By

G. W. Wernick Post

Will. R. Harvey Secy

J. Gardner Secy

Board of Enrollment,

5 Dist. of 05

SUBSTITUTE
VOLUNTEER ENLISTMENT.

STATE OF



TOWN OF

Kentucky

Louisville

I, John Peyton (C.S.) born in the State
of Kentucky, aged 44 years, and by
occupation a Farmer

Do HEREBY ACKNOWLEDGE to have agreed with

George W. Webb, Esq., of Owen
County Kentucky

to become his **SUBSTITUTE** in the Military Service, for a sufficient consideration paid and
delivered to me, on the 14 day of March, 1865

and having thus agreed with said George W. Webb, I DO HEREBY
ACKNOWLEDGE to have enlisted this 14 day of March

1865 to serve as a **Soldier** in the **Army of the United States of America**, for the period
of one ~~THREE~~ **YEARS**, unless sooner discharged by proper authority: I do also agree to accept such
bounty, pay, rations, and clothing, as are, or may be, established by law for soldiers. And I do
solemnly swear that I will bear true and faithful allegiance to the **United States of America**;
that I will serve them honestly and faithfully against all their enemies or opposers whomsoever;
and that I will observe and obey the orders of the President of the United States, and the orders
of the Officers appointed over me, according to the Rules and Articles of War.

SWORN and subscribed to, at Louisville

this 14 day of March 1865

BEFORE

G. M. Mammack } John P. Peyton
Capt. Prov. Marshal } mark
offly

We certify, on honor, That we have carefully examined the above-named Volunteer Substitute
agreeably to the Regulations, and that, in our opinion, he is free from all bodily defects and mental infirmity
which would in any way disqualify him from performing the duties of a soldier; that he was entirely sober
when enlisted; that he is of lawful age, (not under 18 years;) and that, in accepting him as duly qualified to
perform the duties of an able-bodied soldier, and as a Substitute in lieu of George W. Webb
of Owen Co Ky, drafted in 5th Dist - Ky
Sept 20th, 1864, we have strictly observed the Regulations which govern
in such cases. This soldier has black eyes, black hair, black complexion; is 5 feet 5 1/2
inches high.

G. M. Mammack

Provost Marshal

Will R. Hervey

Commissioner of Board

J. Gardner

Surgeon of Board

DECLARATION OF SUBSTITUTE.

I, John Peyton desiring to ENLIST
in the Army of the United States, for ~~THREE~~ one YEARS, **Do declare**, That I am
44 years and _____ months of age; that I have
never been discharged from the United States service on account of disability or by sentence of
a court martial; and I know of no impediment to my serving honestly and faithfully as a soldier
for ~~three~~ one years.

GIVEN at Louisville Ky
the 14 day of March 1865

WITNESS:

C. J. Campbell

his
John Peyton
man

1057 R. I.

Philip Robert T

Co A, 6 U. S. Col'd Cav.

2^d Lieutenant 2^d Lieutenant

CARD NUMBERS.

1	5388332	26
2	5387036	27
3	5388417	28
4	5388502	29
5	5388591	30
6	5388662	31
7	5388735	32
8	5388826	33
9	5388999	34
10	5388064	35
11	5389091	36
12	AH 36791	37
13	P. 427 - C. I. - 1864	38
14	40732752	39
15		40
16		41
17		42
18		43
19		44
20		45
21		46
22		47
23		48
24		49
25		50

Book Mar { LB ¹² 415 + 1088 R. I. 81.
P. 427 - C. I. - 1864

See also

A. 2472289 P.O. M. T. W.

H. Jordan
C.

J. J. ... **U.S.C.T.**

J. J. ...
Co., *C* Reg't U. S. Col'd *C*

Appears on

Regimental Descriptive Book
(List of Commissioned Officers)

of the regiment named above.

Rank *2nd Lieut.*

Date of appointment *Oct 21* 186*4*

Remarks: *Admitted to service
in 1st Reg't U.S. Col'd
Mass. 10/21/64
Admission certificate
no. 107 issued Boston
District Office, Feb. 11,
1865*

J. J. ...

P | 6 Cav. | **U.S.C.T.**

R. T. Phillips

2d., Co. A, 6 Reg't U. S. Col'd Cav.

Age 21 years.

Appears on an

Individual Muster-in Roll

of the organization named above. Roll dated

Camp Nelson Ky., Nov. 3, 1864

Muster-in to date Nov. 1, 1864

Joined for duty and enrolled:

When Nov. 1, 1864

Where Camp Nelson, Ky.

Period 3 years.

Valuation of horse, \$ 100

Valuation of horse equipments, \$ 100

Remarks: Mustered in upon
appointment of the Presi-
dent of the U.S. Det'd Balto,
Md. Oct 21/64. To rank

Book mark: _____

(over)

J. M. Harmon

(336)

Copyist.

JAN. 10

5387036

1891

As a 2^d Lt. in the 6th Regt
Md. Cold. Cav. from the
21st day of October
1864. Assigned to
duty with his Co. (A)
November 1. 1864. En-
listed in of said
Co. was mustered in
(to the minimum)
on or before said
date.

P | 6 Car. | **U. S. C. T.**

R. S. Philip

2 Sgt., Co. a., 6 Reg't U. S. Col'd Car.

Appears on

Company Muster-in and Descriptive Roll
of the organization named above. Roll dated

Camp Nelson Ky, Nov. 1, 1864.

Where born

Age 21 y'rs; occupation

When enlisted _____, 186 .

Where enlisted

For what period enlisted _____ years.

Eyes _____; hair _____

Complexion _____; height _____ ft. _____ in.

When mustered in _____, 186 .

Where mustered in

Bounty paid \$ _____¹⁰⁰; due \$ _____¹⁰⁰

Where credited

Company to which assigned

Remarks: Resides Hillsdale Co
Mich.

Book mark:

(356d)

Gaggett

Copyist.

P 6 Cav. U.S.C.T.

R. T. Phillips

2^d Lieut., Co. A, 6 Reg't U. S. Col'd Cavalry.

Appears on

Company Muster Roll

for *Nov. & Dec.*, 1864.

Present or absent... *Present*

Stoppage, \$ *100* for

Due Gov't, \$ *100* for

Valuation of horse, \$ *100*

Valuation of horse equipments, \$ *100*

Remarks: *In command of Company from the first day of November 1864 to the present date and responsible for U.S. Property during that time.*

Book mark:

Duggett

P. | 6" Cav. | U.S. C. J.
Robert J. Phillips
Co. | 6" Reg't U.S. C. Cav.

NOTATION.

Book mark: LA 12/4/5, 1088-C.T.-1881,
.427. C. J. 1862.

War Department,

Adjutant General's Office,

Washington. Nov. 4" , 18 85.

See also Co. 76" 11" Mich. Cav.

E. P. Conrazier.

P

6 Cav. U.S.C.T.

R. T. Phillips

2^d Lt., Co. A, 6 Reg't U. S. Col'd Cavalry.

Appears on

Company Muster Roll

for *Jan. & Feb.*, 186*5*.

Present or absent *Present*

Stoppage, \$ *100* for

Due Gov't, \$ *100* for

Valuation of horse, \$ *100*

Valuation of horse equipments, \$ *100*

Remarks:

Book mark:

Daggett

P

6 Cav. U.S.C.T.

R. I. Phillips

2^d Lieut, Co. A, 6 Reg't U. S. Col'd Cavalry.

Appears on

Company Muster Roll

for *Mar. & Apr.*, 1865.

Present or absent *Present*

Stoppage, \$ *100* for

Due Gov't, \$ *100* for

Valuation of horse, \$ *100*

Valuation of horse equipments, \$ *100*

Remarks: *In command of Company from Apr. 1st 1865*

Book mark:

Copyist

S

6 Cav. U.S.C.T.

R. T. Phillips

2nd Lt., Co. A, 6 Reg't U. S. Col'd Cavalry.

Appears on

Company Muster Roll

for *May & June*, 186*2*.

Present or absent *Absent*

Stoppage, \$ *100* for

Due Gov't, \$ *100* for

Valuation of horse, \$ *100*

Valuation of horse equipments, \$ *100*

Remarks: *Out Detached service per Order No. 61 signed Lt. Col. A. C. ... commanding Co. H. 1st Cav. In command of Company till June 1st 1862.*

Book mark:

Wm Stewart
Copyist.

(358)

6 Cav. U.S.C.T.

A. H. Phillips

1st Lt., Co. A, 6 Reg't U. S. Col'd Cavalry.

Appears on

Company Muster Roll

for *July & Aug.*, 186⁵.

Present or absent *Present*

Stoppage, \$ *100* for

Due Gov't, \$ *100* for

Valuation of horse, \$ *100*

Valuation of horse equipments, \$ *100*

Remarks: *Acc for pay
not drawn for
commencing Com-
pany from Feb 28th
to May 31st 1865.*

Book mark:

(358)

Wm Stewart

Copyist.

1 **6 Cav. U.S.C.T.**

P. H. Phillips

2nd Lieut., Co. A, 6 Reg't U. S. Col'd Cavalry.

Appears on

Company Muster Roll

for *Sept & Oct*, 186*4*.

Present or absent *not stated*

Stoppage, \$ *100* for

Due Gov't, \$ *100* for

Valuation of horse, \$ *100*

Valuation of horse equipments, \$ *100*

Remarks:

Book mark: *206*

Joseph Stewart
(358) Copyist.

P

6 Cav. U.S.C.T.

R. J. Phillips

2nd St., Co. A, 6 Reg't U. S. Col'd Cavalry.

Appears on

Company Muster Roll

for Nov & Dec, 1865.

Present or absent

Stoppage, \$ 100 for

Due Gov't, \$ 100 for

Valuation of horse, \$ 100

Valuation of horse equipments, \$ 100

Remarks: Mustered out per S. O. No. 188 Dated Hd. Qrs. Dept. Ky Sept. 21st 1865.

Book mark: L.B. ¹²/₄₁₅ Discharged (over)

R. S. Shelton

(358)

Copyist.

JAN. 10

5388999

1891 ☆

Sept. 28" 1865,

JP | **6 Cav.** | **U.S.C.T.**

R. J. Phillips
2 Lt., Co. A, 6 Reg't U. S. Col'd Cav.

Appears on Returns as follows:

Nov 1864 to Jan'y 1865,
Present, signs return
as Comdy Co.

Feb'y 1865, Present

March to May 1865, Present,
signs return, Comdy Co.

June 1865, Absent on detached
service per O. No. 34
date June, 28/65.

signed Lt Col. R Coats
Comdy 6th U S C

July 1865, Present, joined
for duty July 9/65.

Aug 1865, Present,

Sept & Oct 1865, Absent
per S. O. No. - dated 1865

signed Maj Gen Palmer
Comdy Dept Ky,

(over)

Book mark:

(546)

G. W. Roane

Copyist.

JAN. 19

40732752

1899.

Nov 1865: Loss, must out
per S. C. No 128, dated
the 21. Sept 1865.

F 6 Cav, U.S.C.T.

R. T. Phillips
2^d Lt, Co. A, 6 Reg't U. S. Col'd Cav

Appears on an

Individual Muster-out Roll

of the organization named above. Roll dated

Louisville, Oct 5, 1865.

Muster-out to date Sept. 28, 1865.

Last paid to June 30, 1865.

Clothing account:

Last settled _____, 1865 ; drawn since \$ _____ 100

Due soldier \$ _____ 100; due U. S. \$ _____ 100

Am't for cloth'g in kind or money adv'd \$ _____ 100

Due U. S. for arms, equipments, &c., \$ _____ 100

Bounty paid \$ _____ 100 due \$ _____ 100

Remarks: Mustered out
of service under the
provisions of S. O. No. 188
par 6 Head Quarters
Dept. of Ky, Sept. 26th 1865
Accounts unsettled

Book mark: (over)

A. B. Smith

JAN. 10

5388064

1891

Harry Bright 1st Lieut.
+ 2nd M.
H. M. Blackaller 1st Lieut
+ Adjt.
His charge furnished

9

6 Cav. U.S.C.T.

Robert J Phillips

2nd St. Co. A, 6 Reg't U. S. Col'd Cavalry.

Appears on Co. Muster-out Roll, dated

Duval's Bluff Ark. Apl. 15 1866.

Muster-out to date _____, 186 .

Last paid to _____, 186 .

Clothing account:

Last settled _____, 186 ; drawn since \$ _____ 100

Due soldier \$ _____ 100; due U. S. \$ _____ 100

Am't for cloth'g in kind or money adv'd \$ _____ 100

Due U. S. for arms, equipments, &c., \$ _____ 100

Bounty paid \$ _____ 100; due \$ _____ 100

Remarks: 2nd St. from organi-
zation of Cav. till Sept
26" 1865. Mustered out
of service per S. O. No. 188,
Dated Hd. Qrs. Dept of Ky,
Sept. 26, 1865

Book mark: 4088 C. I. 81. Discharged
(over)

R S Shelton

(861)

Copyist.

JAN 10

5389091

* 1891 *

September 28/65 S.B. $\frac{12}{415}$

Phillips R. F.

Co. 6 Reg't U.S. Cav.

5 Enclosures.

Bed Cards	Final Statements
Burial Records	Furloughs or L. of A.
Certs. of Dis. for Discharge	Med. Certificates
C. M. Charges	Med. Des. Lists
Descriptive Lists	Orders /
Discharge Certificates	Pris. of War Record
Enlistment Papers	Resignations

Other papers relating to—

Admission to Hosp'l	Furlough or L. of A.
Casualty Sheet	Med. Examination
Confinement	Misc. Information 4
Contracts	Pay or Clothing
Death or Effects	Personal Reports
Desertion	Rank
Discharge from Hosp'l	Transfer to Hosp'l
Discharge from Service	Transfer to V. R. C.
Duty	Transportation

Handwritten notes on the left page, including a horizontal line and some illegible scribbles.

Handwritten notes on the right page, including a vertical line and some illegible scribbles.

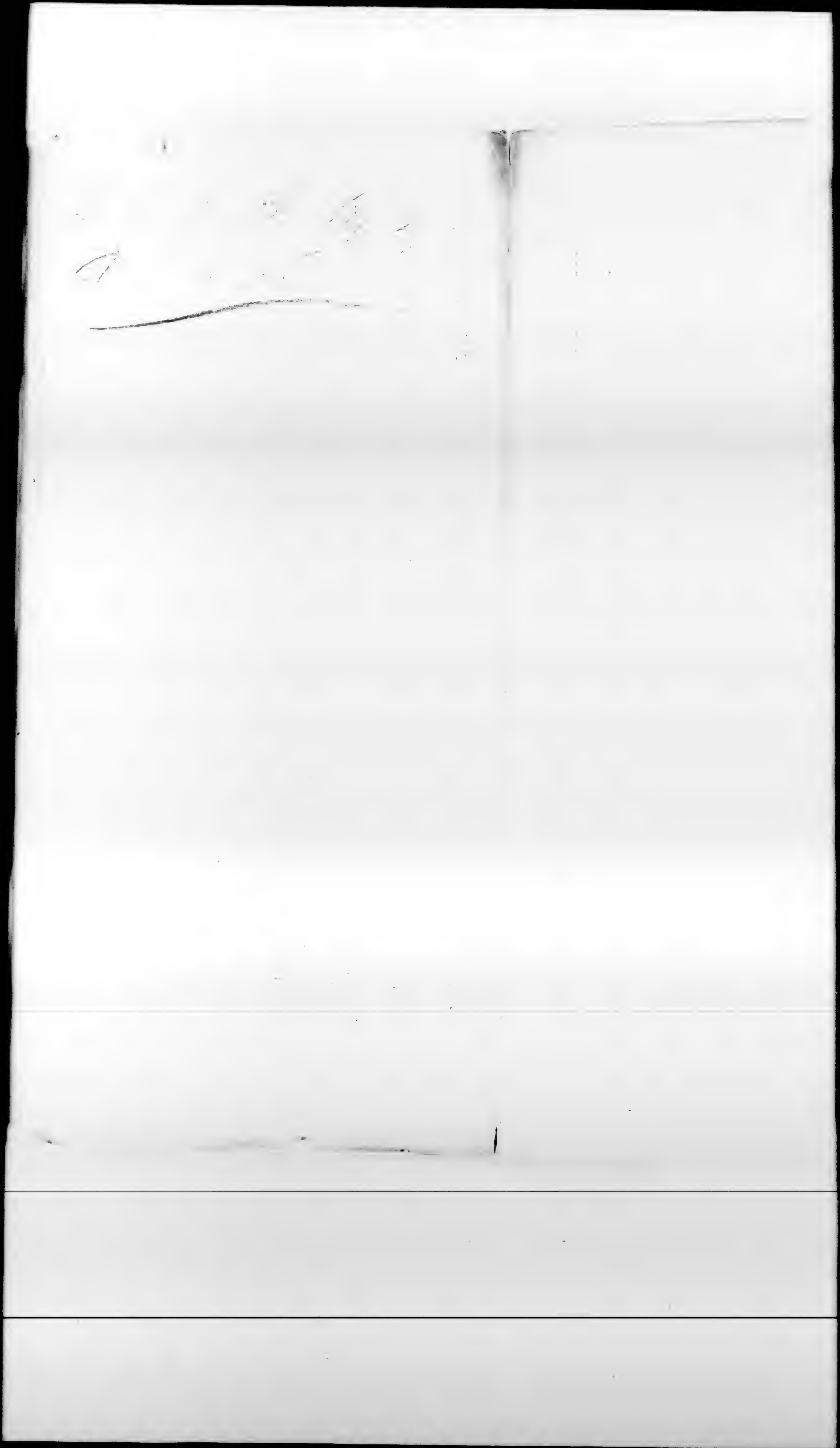

Camp 6th U.S.C.

Co. 3rd / 65

I certify on honor that Lieut R F Phillips
Co. 6th U.S.C. is not indebted to the
Q.M. Dept of the 6th U.S.C. for any of the
property there he has not properly accounted for
I being up in the name of B. Abrahamson
Lieut & Co. 6th U.S.C.

Det 2nd U.S.C.

Camp 6th U.S.C.

I certify on honor that 2nd Det R F Phillips is
not responsible for any Ordnance or Ordnance stores
or Quarter Master stores pertaining to Company
"A" Camp 6th U.S.C. but what he has properly
accounted for

"A" Co. 10th U.S.C.

Det 2nd U.S.C. Capt Co. 6th U.S.C.
This is a true copy, true - Register
Co. 6th U.S.C.

Det 2nd U.S.C.

at Louisville Kentucky

H. McCarr.

Notary Public - J. P. Co.



I, J. C. Phillips, late 2^d Lieutenant of Company A, of the 6th Regiment of U. S. C. Cavalry do hereby ^{October 21st 64} depose and say that I was commissioned as 2^d Lieutenant and mustered into the service of the United States as such on the 1st day of November 1864, and was mustered out of said service on the Twenty eighth day of September, 1865, then holding the rank of 2^d Lieutenant in the 6th Regiment of U. S. C. Cavalry, that I never served in any other organizations than the above mentioned; that, during my term of service, I have, to the best of my ability, duly rendered complete and correct returns of all Clothing and Camp and Garrison Equipage for which I ever received or became in any manner responsible, whether said Government property was captured from the enemy, duly invoiced to me, or came informally into my possession, and that I am not indebted to the United States in any account whatever.

J. C. Phillips

Subscribed before me

Sworn and subscribed to before me, this Twenty day of October 1865, at Louisville Kentucky

H. McCarr

Notary Public - W. Co.



Camp Nelson, N.Y.
Jan'y 10th 1865

This is to certify that R.
L. Phillips was mustered by
me as a Second Lieutenant
in the 6th Regiment U. S. Cold
Cavalry on the first day of
November, 1864, in accordance
with appointment of the Pres-
ident of the United States.

A. C. Hinney
Capt. 18th U. S. C.
Mustg. Officer

Camp Nelson, N.Y.
Jan. 25. 1865.

Phillips R. T.
2^d S. C. Co. 6th Regt.

Applicant for a discharge
as Corp. Co. "H" 11th
Mich. Cav. having ten
months in as an officer

S. O. 31st Regt.

Recd. A. O. 31st Jan 25 5

Head Qu. Mil. Div. N.Y.
Office A. C. M.
Gen. N.Y. Jan 30/65

Refy' forwarded to Capt
J. Bacon Dickens, A. C. M.
with the recommendation
that the applicant
be discharged out of
his former grade to
date Oct. 31. 1864, the
day previous to his date
in as an officer.

J. C. Henderson
Maj. A. C. M.

71-5 A. C. M. 65

Camp Nelson Ky

Jan 25th/65

Majors

Please find below a brief sketch
of my military history and if it be sufficient
present my discharge which I request by reason of
prevention to 2nd Lieut in U.S.C. Co.,

I first joined the "76" 11th Mich Inf Co.,
October 22nd, and was mustered October 23rd 1863
as a Private, was promoted to Corp. March 16th 1864
which rank I held when I went before the board of
commissioners from which received an appointment as 2nd Lieut
in which capacity I have been acting. Since was mustered
in as 2nd Lieut November 1st, first 1864

I am Majors.

Very respectfully yours Obedient Servant,

Wm. J. Phillips 2nd Lieut Co. A.

U.S.C. Co.

Majors J. C. Henderson,
Lexington Ky.

Please find below as true as my name

Sept. 28, 1865

Journal Entry

R. F. Phillips

L. G. U. S. C. Co.

Head-Quarters Sixth U. S. Colored Cavalry,
CAMP NELSON, KY.

Bristow

Sept 25th 1865.

ORDER

No. 105

EXTRACT:

1. The following named Officers of the 6th U. S. Cavalry,
hereto relieved from duty with this command in order to
report at Louisville Ky. to Major Post of Service

+

2nd Lieut R. I. Phillips in A.

+

Being relieved from duty with this command will
transmit all public property they may have in their possession
to their respective Quartermasters (Commanders)

By Order of

Lt. Col. A. Coats,

Commanding 6th U. S. Cavalry.

W. M. Lachatter

1st Lieut. and Adjutant.

1058

Philips Nat.

Co J., 6 U. S. Col'd Cav.

Corporal.

Corporal.

CARD NUMBERS.

1	5394740	26
2	5394834	27
3	5394919	28
4	5395003	29
5	5395083	30
6	5395159	31
7	5395231	32
8	5395287	33
9	9093727	34
10	43151169	35
11		36
12		37
13		38
14		39
15		40
16		41
17		42
18		43
19		44
20		45
21		46
22		47
23		48
24		49
25		50

Book Mark:

See also

Rep 478909

S. 2076706 O. M. M. M.

D. Jordan
Esq

P | **6 Cav. | U.S.C.T.**

Mat Phillips
....., Co. *P*, 6 Reg't U. S. Col'd Cav.

Appears on
Company Descriptive Book
of the organization named above.

DESCRIPTION.

Age *26* years; height *5* feet *7* inches.

Complexion *Blk*

Eyes *Blk*; hair *Blk*

Where born *Marion Co Ky*

Occupation *Farmer*

ENLISTMENT.

When *July 29*, 186*5*.

Where *Lebanon Ky*

By whom *Capt Kiplassa*, term *3* y'rs.

Remarks: *As Phillips Marion Co Ky owner without consent*

Forrest
Copyist.

(383g)

P | **6 Cav. | U.S.C.T.**

Isaac Phillips
....., Co. *P*, 6 Reg't U. S. Col'd Cav.

Appears on

Company Descriptive Book

of the organization named above.

DESCRIPTION.

Age *26* years; height *5* feet *7* inches.

Complexion *Blk*

Eyes *Blk*; hair *Blk*

Where born *Marion Co Ky*

Occupation *Farmer*

ENLISTMENT.

When *July 29*, 186*5*.

Where *Lebanon Ky*

By whom *Capt Kiplassa*, term *3* y'rs.

Remarks: *Isaac Phillips Marion Co Ky owner without consent*

Powers
Copyist.

P 660 U.S.C.T.

Mark Phillips

Appears with rank of _____ on _____

Muster and Descriptive Roll

of *Detachment of U.S. Side Volunteer Recruits*

forwarded Roll dated *Sebanon, Ky, Feb. 28, 1865.*

Where born *Marion, Ky*

Age *26* years; occupation *Farmer.*

When enlisted *Feb. 20*, 1865.

Where enlisted *Sebanon*

For what period enlisted *3* years.

Eyes *Black*; hair *Black*

Complexion *Black*, height *5* ft. *7* in.

When mustered in *Feb. 27*, 1865.

Where mustered in *Sebanon.*

Bounty paid \$ _____ *100*; due \$ _____ *100*

Clothing account:

Last settled _____, 186 _____; drawn since \$ _____ *100*

Date of first muster *Feb. 27*, 1865.

Company to which assigned _____

Remarks: *For Co. U.S. C. Cavalry.*

Master James Phillips,

Marion, Ky. without con-

sent.

Book mark : _____

R. O. Fish

D

6 Cav. U.S.C.T.

Nat Philips

Corp, Co. *D*, 6 Reg't U. S. Col'd Cavalry.

Appears on

Company Muster-in and Descriptive Roll

of the organization named above. Roll dated

Camp Nelson Ky, *Apr 29*, 1865.

Where born *Martin Co Ky*.

Age *26* y'rs; occupation *Farmer*

When enlisted *Feb. 20*, 1865.

Where enlisted *Lebanon Ky*.

For what period enlisted *3* years.

Eyes *Blk*; hair *Blk*

Complexion *Blk*; height *5* ft. *7* in.

When mustered in *Feb. 24*, 1865.

Where mustered in *Lebanon Ky*.

Bounty paid \$ *none paid* 100; due \$ 100

Where credited

Company to which assigned *D*.

Remarks: *Without consent,*

4 Co Ky.

Book mark:

D. M. Kennedy

(356d)

Copyist.

P | 6 Cav. | U.S.C.T.

Nat. Philips
Copl., Co. I, 6 Reg't U. S. Col'd Cavalry.

Appears on

Company Muster Roll
for Enlistment to Apl 30, 1865.

Present or absent Present

Stoppage, \$ 100 for

Due Gov't, \$ 100 for

Valuation of horse, \$ 100

Valuation of horse equipments, \$ 100

Remarks:
1st installment bounty due

Book mark:

(358) D. M. Kennedy
Copyist.

P

6 Cav. | U.S.C.T.

Nat Philips
Corp, Co. I, 6 Reg't U. S. Col'd Cavalry.

Appears on

Company Muster Roll

for *May or June*, 1865.

Present or absent *Present*

Stoppage, \$ *100* for

Due Gov't, \$ *100* for

Valuation of horse, \$ *100*

Valuation of horse equipments, \$ *100*

Remarks,

1" Instalment County Due.

Book mark:

(358)

J. M. Kennedy
Copyist.

P.

6 Cav. U.S.C.T.

Wm. Smith

Capt., Co. I, 6 Reg't U. S. Col'd Cavalry.

Appears on

Company Muster Roll

for July & Aug, 1865-

Present or absent Present

Stoppage, \$ 100 for

Due Gov't, \$ 100 for

Valuation of horse, \$ 100

Valuation of horse equipments, \$ 100

Remarks: 1st installment bounty due

Book mark:

(358)

J. B. Casey

Copyist.

2 | 6 Cav. | U.S.C.T.

Wm. Phillips

Capt, Co. I, 6 Reg't U. S. Col'd Cavalry.

Appears on

Company Muster Roll

for *Sept & Oct*, 1865.

Present or absent *Present*

Stoppage, \$ *100* for

Due Gov't, \$ *100* for

Valuation of horse, \$ *100*

Valuation of horse equipments, \$ *100*

Remarks:

Book mark:

(358)

J. W. Casey

Copyist.

2 | **6 Cav.** | **U.S.C.T.**

Wm Phillips

Capt, Co. I, 6 Reg't U. S. Col'd Cavalry.

Appears on

Company Muster Roll

for *Nov & Dec*, 186*7*.

Present or absent *Present*.

Stoppage, \$ *100* for

Due Gov't, \$ *100* for

Valuation of horse, \$ *100*

Valuation of horse equipments, \$ *100*

Remarks:

Book mark:

(358)

J. G. Carr

Copyist.

J. | 6 Cav. | U.S.C.T.

Nat Philips
Col, Co. I, 6 Reg't U. S. Col'd Cavalry.

Appears on

Company Muster Roll

for Jan 7 Feb, 1866.

Present or absent Present

Stoppage, \$ 100 for

Due Gov't, \$ 100 for

Valuation of horse, \$ 100

Valuation of horse equipments, \$ 100

Remarks: One Sarcina
Wound, Sarcina
35 etc.

Book mark:

(358)

J. P. Stearns

Copyist.

P.

6 Cav. U.S.C.T.

Nat Phillips

Co., Co. *P.*, 6 Reg't U. S. Col'd Cavalry.

Appears on **Co. Muster-out Roll**, dated

Sevalls Bluff Ark., April 15, 1866

Muster-out to date

April 15, 1866

Last paid to

Feb. 28, 1866

Clothing account:

Last settled _____, 186 ; drawn since \$ _____ 100

Due soldier \$ _____ 100; due U. S. \$ _____ 100

Am't for cloth'g in kind or money adv'd \$ *31 92* _____ 100

Due U. S. for arms, equipments, &c., \$ _____ 100

Bounty paid \$ *100* 100; due \$ _____ 100

Remarks:

*Corp. at
organization*

Book mark: _____

(861)

J. H. Stearns

Copyist.

Philipps Nat

, Co. , 6 Reg't U.S.C.

/ Enclosures.

Bed Cards	Final Statements
Burial Records	Furloughs or L. of A.
Certs. of Dis. for Discharge	Med. Certificates
C. M. Charges	Med. Des. Lists
Descriptive Lists	Orders
Discharge Certificates	Pris. of War Record
Enlistment Papers	Resignations

Other papers relating to—

Admission to Hosp'l	Furlough or L. of A.
Casualty Sheet	Med. Examination
Confinement	Misc. Information
Contracts	Pay or Clothing
Death or Effects	Personal Reports
Desertion	Rank
Discharge from Hosp'l	Transfer to Hosp'l
Discharge from Service	Transfer to V. R. C.
Duty	Transportation

NOTE 1.—This blank will be used for enlistments of United States colored troops. They will be made out in duplicate in all cases—one to accompany the recruiting return of the superintendent (not the recruiting officer) to the Adjutant General, and one to accompany the accounts of the officer who pays bounty, &c.

NOTE 2.—An enlistment holds to service. A muster-in must, in all cases, precede payment of pay, bounty, pension, &c. A muster-in roll, must in all cases, be filed in the Adjutant General's Office as evidence of muster-in. The mustering officer, commissary, or assistant commissary of musters, as the case may be, will countersign both enlistments as having mustered the soldiers into the service of the United States before either of them is given to the disbursing officer.

DECLARATION OF RECRUIT.

I, Max Phillips, desiring to volunteer as a soldier in the ARMY OF THE UNITED STATES, for the term of Three Years, DO DECLARE That I am 24 years and 0 months of age; that I have never been discharged from the United States service on account of disability or by sentence of court-martial, or by order before the expiration of a term of enlistment; and I know of no impediment to my serving honestly and faithfully as a soldier for three years.

GIVEN at Seaboard N.C. the 27th day of Febry 1865

Witness: P. Kuttman
Cap to 1400

Max Phillips
Volunteered at Seaboard
Febry 21st 1865
By P. Kuttman
Cap to 1400

Consent of Parent or Guardian in case of a Minor, if a Free Man, or in the case of a Slave, of the Person to whom he owes Service;

I, DO CERTIFY, That I am the that the said is years of age; and I do freely give my CONSENT to his volunteering as a SOLDIER in the Army of the United States, for the period of THREE YEARS, under the conditions of the laws of the United States.

GIVEN at the day of

Witness:

UNITED STATES COLORED TROOPS ENLISTMENT.

STATE OF



TOWN OF

Kentucky

Lebanon

I, *Mar Philips* born in *Mason County*
in the State of *Kentucky* aged *Twenty 5 1/4* years
and by occupation a *Farmer* Do HEREBY ACKNOWLEDGE TO
have volunteered *the 20th* day of *July* 186 *2*

to serve as a **Soldier** in the **Army of the United States of America**, for the
period of **THREE YEARS**, unless sooner discharged by proper authority: Do
also agree to accept such bounty, pay, rations, and clothing, as are, or may be,
established by law for the U. S. colored troops.

And I, *Mar Philips*
do solemnly swear that I will bear true faith and allegiance to the **United States
of America**, and that I will serve them honestly and faithfully against all their
enemies or opposers whomsoever; and that I will observe and obey the orders
of the President of the United States, and the orders of the officers appointed
over me, according to the Rules and Articles of War.

Sworn and subscribed to, at *Lebanon Ky.*
this *20th* day of *July 1865* *Mar Philips*
Before *Peter Kulloassa Capt* *with*

I CERTIFY, ON HONOR, That I have carefully examined the above named Volunteer agree-
ably to the General Regulations of the Army, and that, in my opinion, he is free from all bodily
defects and mental infirmity, which would in any way disqualify him from performing the
duties of a soldier.

W. S. Robbins

EXAMINING SURGEON.

I CERTIFY, ON HONOR, That I have minutely inspected the Volunteer, *Mar Philips*
previously to his enlistment, and that he was entirely sober when enlisted; that, to the best of
my judgment and belief, he is of lawful age; and that, in accepting him as duly qualified to per-
form the duties of an able-bodied soldier, I have strictly observed the regulations which govern
the recruiting service. This soldier has *black* eyes, *black* hair, *black* com-
plexion, is *5 1/2* feet *seven* inches high.

Peter Kulloassa Capt
C. M. P. C.

RECRUITING OFFICER OR AGENT.

Mustered into the United States Service *29* day of *July* 186 *5*

James M. Groves
Capt Wm. A. ... *Mustering Officer*

Regiment of Volunteers, on the day of, 186, at

1059

Phillips. Adam

Col., 6 U. S. Col'd Cav.

Private

Private

CARD NUMBERS.

1		26
2	<i>See Phillips. Adam.</i>	27
3		28
4		29
5		30
6		31
7		32
8		33
9		34
10		35
11		36
12		37
13		38
14		39
15		40
16		41
17		42
18		43
19		44
20		45
21		46
22		47
23		48
24		49
25		50

Book Mark:

See also

1060

Phillips Benjamin

Co D., 6 U. S. Col'd Cav.

Private Private

CARD NUMBERS.

1	5389269	26
2	5389342	27
3	5389430	28
4	5389501	29
5	5389569	30
6	5389656	31
7	5389753	32
8	5389845	33
9	5389936	34
10	5390029	35
11	9592919	36
12	40732720	37
12	40902852	38
14		39
15		40
16		41
17		42
18		43
19		44
20		45
21		46
22		47
23		48
24		49
25		50

Book Mark: 2140.1580.

See also

P | **6 Cav. | U.S.C.T.**

Benjamin Phillips

....., Co. P, 6 Reg't U. S. Col'd Cav.

Appears on

Company Descriptive Book

of the organization named above.

DESCRIPTION.

Age 22 years; height 5 feet 6 inches.

Complexion Blk

Eyes Blk; hair Blk

Where born Warren Ky

Occupation Waiter

ENLISTMENT.

When Aug 22, 1864.

Where Bowling Green Ky

By whom Capt Hobson; term 3 y'rs.

Remarks:

.....

.....

.....

.....

.....

.....

.....

.....

.....

(383g)

Bryer

Copyist.

90

6 Cav. U.S.C.T.

Benjamin Phillips
Privt, Co B, 6 Reg't U. S. Col'd Cavalry.

Appears on

Company Muster-in and Descriptive Roll
of the organization named above. Roll dated

Camp Nelson Ky, N.Y., Nov 1st, 1864.

Where born Harlan Co. Ky,

Age 22, y'rs; occupation Waiter,

When enlisted Aug 22, 1864.

Where enlisted Bowling Green, Ky

For what period enlisted 3 years.

Eyes Blk; hair Blk

Complexion Blk; height 5 ft. 6 in.

When mustered in Aug 22, 1864.

Where mustered in Bowling Green, Ky

Bounty paid \$ 100; due \$ 100

Where credited 3rd Dist Ky,

Company to which assigned B

Remarks: Transferred from Co. E,

115th U.S. C., per S.O. No 39, dated

Washington D.C., June 10/65,

signed L. Thomas, A.G.

(over)

Book mark:

C. M. Row

(356d)

Copyist.

JAN. 10

5389269

1891 *

Owner
Joseph Phillips.

S | **6 Cav. U.S.C.T.**

Benjamin Phillips
Private, Co. B, 6 Reg't U. S. Col'd Cavalry.

Appears on

Company Muster Roll

for *Nov & Dec*, 186*4*.

Present or absent *present*

Stoppage, \$ *100* for

Due Gov't, \$ *100* for

Valuation of horse, \$ *100*

Valuation of horse equipments, \$ *100*

Remarks: *Due U.S. for Ord,*
\$ 2.90.

Book mark: _____

(358)

G. M. Lowe

Copist.

S | **6 Cav. U.S.C.T.**

Benjamin Phillips
Must, Co. B, 6 Reg't U. S. Col'd Cavalry.

Appears on

Company Muster Roll

for *Jan 21st*, 1865.

Present or absent *Present*

Stoppage, \$ *100* for

Due Gov't, \$ *100* for

Valuation of horse, \$ *100*

Valuation of horse equipments, \$ *100*

Remarks: *1st installment bounty due \$100. On duty duty Company kept.*

Book mark:

V. M. Moore

(358)

Copist.

P | **6 Cav.** | **U.S.C.T.**

Benj. Phillips
Privt., Co. B, 6 Reg't U. S. Col'd Cavalry.

Appears on

Company Muster Roll

for *March 1861*, 1861.

Present or absent *present*

Stoppage, \$ *100* for

Due Gov't, \$ *100* for

Valuation of horse, \$ *100*

Valuation of horse equipments, \$ *100*

Remarks: *1st installment bounty due \$100.*

Book mark:

(358)

W. B. ...

Copyist.

6 Cav. U.S.C.T.

Benj Phillips
Sgt, Co. B, 6 Reg't U. S. Col'd Cavalry.

Appears on

Company Muster Roll

for *May 1865*, 1865.

Present or absent *present*

Stoppage, \$ *100* for

Due Gov't, \$ *100* for

Valuation of horse, \$ *100*

Valuation of horse equipments, \$ *100*

Remarks: *1" install bounty due \$100.*

Book mark:

C. E. Harper
Copist.

6 Cav. U.S.C.T.

Benjamin Phillips
Phillips, Co. B, 6 Reg't U. S. Col'd Cavalry.

Appears on

Company Muster Roll

for *March 1864*, 186*4*.

Present or absent *present*

Stoppage, \$ *100* for

Due Gov't, \$ *100* for

Valuation of horse, \$ *100*

Valuation of horse equipments, \$ *100*

Remarks: *no horse*
account due

Book mark:

B. Barber
Copyist.

A | **6 Cav.** | **U.S.C.T.**

James M. Phillips
Private, Co. B, 6 Reg't U. S. Col'd Cavalry.

Appears on

Company Muster Roll
for *Sept & Oct*, 1865.

Present or absent *absent*

Stoppage, \$ *100* for

Due Gov't, \$ *100* for

Valuation of horse, \$ *100*

Valuation of horse equipments, \$ *100*

Remarks: *Capt. Ser. Bryant*
Station, Tex. since
Oct. 25, 1865

Book mark:

B. C. Parker
Copyist.

(358)

P | 6 Cav. | U.S.C.T.

Benjamin Phillips
B.H., Co. B, 6 Reg't U. S. Col'd Cavalry.

Appears on

Company Muster Roll

for Nov & Dec, 1865.

Present or absent Present

Stoppage, \$ 100 for

Due Gov't, \$ 100 for

Valuation of horse, \$ 100

Valuation of horse equipments, \$ 100

Remarks:

Daily duty in Reg't, Army
Dept per R.O. 114, Dec,
24, 65,

Book mark:

(358) J. W. [Signature] Copyist.

1866

W

6 Cav. U.S.C.T.

Benjamin Phillips
69, Co. B, 6 Reg't U. S. Col'd Cavalry.

Appears on

Company Muster Roll

for *Jan'y & Feby*, 1866.

Present or absent *Present*

Stoppage, \$ *100* for

Due Gov't, \$ *100* for

Valuation of horse, \$ *100*

Valuation of horse equipments, \$ *100*

Remarks:

*Daily duty in Regt
Company Dept, per P.O. No. 111
dated Oct 8th 65,*

Book mark:

(358)

J. W. Ames

Compt.

P | 6 Cav. | U.S.C.T.

Benj Phillips
Pot Co. B. 6 Reg't U. S. Col'd Cav.

Appears on Returns as follows:

Dec 1864, & Jan'y 1865,

On daily duty Co Cook,

Feb 1865; On daily duty,

Commissary Dept

March 1865; Absent on

furlough, fifteen days

since Mar 27, '65

May to Sept 1865; On duty

in Regtl Commissary

Dept;

Oct 1865; Absent on Detch' Serv

near Lex Ky, as Issuing

Clerk Regtl Com Dept,

since Oct 8/65 per R. O

No 111, dated Hd qrs,

C. U. S. C., Oct 8/65;

Nov 1865, to March 1866, On

daily duty, as Issuing

Clerk, Regtl Commissary Dept,

since Oct 8/65 per R. O No 111,

dated Hd qrs, C. U. S. C. Co Oct 8/65;

Book mark:

G. M. Rowe

P

115

U.S.C.T.

Benjamin Phillips,
Priv. Co. E, 115 Reg't U. S. Colored Inf

Appears on Returns as follows:

Aug 18 64 - Loss; Aug. 26/64,
Bowling Green, Transferred

Book mark:

(648)

J. H. Hensley

Copyist

P

6 Cav. U.S.C.T.

Benjamin Phillips
Pat, Co. *B*, 6 Reg't U. S. Col'd Cavalry.

Appears on **Co. Muster-out Roll**, dated

De Valls Reg't, *Apr 15*, 186*6*.

Muster-out to date *Apr 15*, 186*6*.

Last paid to *Feb 18*, 186*6*.

Clothing account:

Last settled....., 186 ; drawn since \$..... 100

Due soldier \$ *7 58* 100; due U. S. \$..... 100

Am't for cloth'g in kind or money adv'd \$..... 100

Due U. S. for arms, equipments, &c., \$..... 100

Bounty paid \$ *100* 100; due \$ *100* 100

Remarks:

Book mark: *2140-1880*

(861)

J. W. Oliver

Copyist.

1061
Phillips James.

Co F., 6 U. S. Col'd Cav.

Private. Private.

CARD NUMBERS.

1	5392558	26
2	5392661	27
3	5388151	28
4	5393226	29
5	9093422	30
6	43147651	31
7	40732721	32
8		33
9		34
10		35
11		36
12		37
13		38
14		39
15		40
16		41
17		42
18		43
19		44
20		45
21		46
22		47
23		48
24		49
25		50

Book Mark:

See also

J.

6 Cav. U.S.C.T.

James Phillips

Co. F, 6 Reg't U. S. Col'd Cav.

Appears on

Company Descriptive Book

of the organization named above.

DESCRIPTION.

Age 19 years; height 5 feet 9 1/2 inches.

Complexion Black

Eyes Black; hair black

Where born Warren, Ky.

Occupation Farmer.

ENLISTMENT.

When Aug. 12, 1864.

Where Bowling Green,

By whom Capt. Hobson; term 3 yrs.

Remarks:

Registered in Aug. 12
Bowling Green, Ky. by
Capt. Hobson.

J. M. Webb

D **6 Cav. U.S.C.T.**

James Phillips
Co. D, Co. *D*, 6 Reg't U. S. Col'd Cavalry.

Appears on

Company Muster-in and Descriptive Roll
of the organization named above. Roll dated

Washington Ky, N. Y., *Jan 24*, 1865.

Where born *Warren Ky*

Age *19* y'rs; occupation *Farmer*

When enlisted *Aug 12*, 1864.

Where enlisted *Bart Green Ky*

For what period enlisted *3* years.

Eyes *Blk*; hair *Blk*

Complexion *Blk*; height *5 ft. 9 1/2* in.

When mustered in *Aug 12*, 1864.

Where mustered in *Bart Green Ky*

Bounty paid \$ *100*; due \$ *100*

Where credited *Warren Co Ky 3 Dist*

Company to which assigned

Remarks:

Book mark:

Breyer

(356d)

Copyist.

P | 6 Cas | U.S.C.T.

James Philips

Appears with rank of *Priv* on

Muster and Descriptive Roll

of *Detachment U.S. Colored*
Recruits forwarded

Roll dated *Bowling Green Ky, Sept. 30, 1864.*

Where born *Warren Ky*

Age *18* years; occupation *Farmer*

When enlisted *Sept-12*, 1864

Where enlisted *Bowling Green*

For what period enlisted *3* years.

Eyes *Blue*; hair *Black*

Complexion *Black*; height *5 ft 8 1/2 in.*

When mustered in _____, 186 .

Where mustered in _____

Bounty paid \$ _____ *100*; due \$ _____ *100*

Clothing account:

Last settled _____, 186 ; drawn since \$ _____ *100*

Date of first muster *Sept. 12*, 1864.

Company to which assigned _____

Remarks: *new Recruit Allen Co.*
owed penic to Henry Sears

Book mark: _____

Al Black

(356m)

Copyist.

P 6 Cav. U.S.C.T.

James Phillips

Pvt., Co. F, 6 Reg't U.S. Col'd Cavalry.

Appears on

Company Muster Roll

for *Jan 24 to April 30*, 1865.

Present or absent

Stoppage, \$ *100* for

Due Gov't, \$ *100* for

Valuation of horse, \$ *100*

Valuation of horse equipments, \$ *100*

Remarks: *Deserted at Camp Nelson
Ky Jan 24, 65*

Book mark:

Dreger

(358)

Copyist.

P | 6 Cav. | U.S.C.T.

James Phillips
Pot., Co. F. 6 Reg't U. S. Col'd Cav.

Appears on Returns as follows:

June 1863; Jan 15/65,
Camp Nelson Ky,
Deserted.

Book mark :

G M Row

(546)

Copyist.

P. *blear* | U.S.C.T.

James Philips
Chi., Co. *F*, *b* Reg't U. S. Col'd *blear*

Appears on

Descriptive List of Deserters

dated *January 31*, 186*5*.

Deserted:

When *Jan 25*, 186*5*.

Where *Cap Nelson Ky*

Arrested:

When _____, 186 .

Where _____

Remarks: *Probably to be found in Bowling Green Ky*

Book mark: _____

(351)

J. B. Stearns
Copyist.

17

6 Cav. U.S.C.T.

James Phillips
Co., Co., 6 Reg't U. S. Col'd Cavalry.

Appears on Co. Muster-out Roll, dated
Mulle Bluff, Ark, Apr 15, 1866.

Muster-out to date _____, 186 .

Last paid to *Pay due from* _____, 186 .

Clothing account:

Last settled _____, 186 ; drawn since \$ 100

Due soldier \$ 100; due U. S. \$ 100

Am't for cloth'g in kind or money adv'd \$ 100

Due U. S. for arms, equipments, &c., \$ 100

Bounty paid \$ 100; due \$ 100

Remarks: *Accepted*
James Phillips
at St. Louis, Mo. June
24 65

Book mark: _____

Mark

James P Phillips

, Co. , 6th Reg't US 6 Cav

2 Inclosures.

Bed Cards	Final Statements
Burial Records	Furloughs or L. of A.
Certs. of Dis. for Discharge	Med. Certificates
C. M. Charges	Med. Des. Lists
Descriptive Lists	Orders
Discharge Certificates	Pris. of War Record
Enlistment Papers <u>2</u>	Resignations

Other papers relating to—

Admission to Hosp'l	Furlough or L. of A.
Casualty Sheet	Med. Examination
Confinement	Misc. Information
Contracts	Pay or Clothing
Death or Effects	Personal Reports
Desertion	Rank
Discharge from Hosp'l	Transfer to Hosp'l
Discharge from Service	Transfer to V. R. C.
Duty	Transportation

NOTE 1.—This blank will be used for enlistments of United States colored troops. They will be made out in duplicate in all cases—one to accompany the recruiting return of the superintendent (not the recruiting officer) to the Adjutant General, and one to accompany the accounts of the officer who pays bounty, &c.

NOTE 2.—An enlistment holds to service. A muster-in must, in all cases, precede payment of pay, bounty, pension, &c. A muster-in roll, must in all cases, be filed in the Adjutant General's Office as evidence of muster-in. The mustering officer, commissary, or assistant commissary of musters, as the case may be, will countersign both enlistments as having mustered the soldiers into the service of the United States before either of them is given to the disbursing officer.

DECLARATION OF RECRUIT.

I, James Philips desiring to volunteer as a soldier in the ARMY OF THE UNITED STATES, for the term of Three Years, DO DECLARE That I am 19 years and months of age; that I have never been discharged from the United States service on account of disability or by sentence of a court-martial, or by order before the expiration of a term of enlistment; and I know of no impediment to my serving honestly and faithfully as a soldier for three years.

GIVEN at Barrenburg Green Ky the 12th day of Sept. 1864

Witness: Al. Johnson Capt & Pro mar 3^d
Sickly & Reclaiming Officer

James Philips
By Mark
Volunteered at Barrenburg Green
Sept. 19th 1864
3^d Regt Ky Artillery
1864
James Philips
1864

Consent of Parent or Guardian in case of a Minor, if a Free Man, or in the case of a Slave, of the Person to whom he owes Service:

I, Do CERTIFY, That I am the that the said is years of age; and I do freely give my CONSENT to his volunteering as a SOLDIER in the Army of the United States, for the period of THREE YEARS, under the conditions of the laws of the United States.

GIVEN at the day of

Witness:
.....
(A. G. O. No. 74 & 76.)

UNITED STATES COLORED TROOPS ENLISTMENT.

STATE OF

TOWN OF

Kentucky

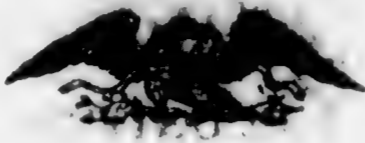

Burlington

I, *James Philip* born in *Murray Co*
in the State of *Kentucky* aged *Nineteen* years
and by occupation a *Tanner* Do HEREBY ACKNOWLEDGE to
have volunteered *Twelfth* day of *Sept* 1864

to serve as a **Soldier** in the **Army of the United States of America**, for the
period of **THREE YEARS**, unless sooner discharged by proper authority: Do
also agree to accept such bounty, pay, rations, and clothing, as are, or may be,
established by law for the U. S. colored troops.

And I, *James Philip*
do solemnly swear that I will bear true faith and allegiance to the **United States
of America**, and that I will serve them honestly and faithfully against all their
enemies or opposers whomsoever; and that I will observe and obey the orders
of the President of the United States, and the orders of the officers appointed
over me, according to the Rules and Articles of War.

Sworn and subscribed to, at *Burlington*
this *12*" day of *Sept 1864* *James Philip*
Before *Altaber Capt & Pro Mar 3^d Dist Ky* *mark*

I CERTIFY, ON HONOR, That I have carefully examined the above named Volunteer agree-
ably to the General Regulations of the Army, and that, in my opinion, he is free from all bodily
defects and mental infirmity, which would in any way disqualify him from performing the
duties of a soldier.

Nathan B. Chase
a. c. Surg. U.S.A.
EXAMINING SURGEON

I CERTIFY, ON HONOR, That I have minutely inspected the Volunteer, *James Philip*
previously to his enlistment, and that he was entirely sober when enlisted; that, to the best of
my judgment and belief, he is of lawful age; and that, in accepting him, as duly qualified to per-
form the duties of an able-bodied soldier, I have strictly observed the regulations which govern
the recruiting service. This soldier has *Black* eyes, *Black* hair, *Black* com-
plexion, is *5* feet *9* inches high.

Altaber Capt & Pro Mar 3^d Dist
Ky. and
RECRUITING OFFICER OR AGENT.

Mustered into the United States Service *12*" day of *Sept* 1864

Altaber Capt & Pro Mar 3^d
Dist Ky. and Mustering Officer.

Mustered into the service of the United States, for three years or during the war, from date of enlistment. in Company
Regiment of
Volunteers, on the
day of
1864, at

NOTE 1.—This blank will be used for enlistments of United States colored troops. They will be made out in duplicate in all cases—one to accompany the recruiting return of the superintendent (not the recruiting officer) to the Adjutant General, and one to accompany the accounts of the officer who pays bounty, &c.

NOTE 2.—An enlistment holds to service. A muster-in must, in all cases, precede payment of pay, bounty, pension, &c. A muster-in roll, must in all cases, be filed in the Adjutant General's Office as evidence of muster-in. The mustering officer, commissary, or assistant commissary of musters, as the case may be, will countersign both enlistments as having mustered the soldiers into the service of the United States before either of them is given to the disbursing officer.

DECLARATION OF RECRUIT.

I, James Philip desiring to volunteer as a soldier in the ARMY OF THE UNITED STATES, for the term of Three Years, DO DECLARE That I am 19 years and months of age; that I have never been discharged from the United States service on account of disability or by sentence of a court-martial, or by order before the expiration of a term of enlistment; and I know of no impediment to my serving honestly and faithfully as a soldier for three years.

GIVEN at Bowling Green Ky the 12th day of Sept. 1864

Witness: Abraham Capt & Pro Mar 30
Sixty & Recting Officers

James Philip
mark

Consent of Parent or Guardian in case of a Minor, if a Free Man, or in the case of a Slave, of the Person to whom he owes Service:

I, Do CERTIFY, That I am the that the said is years of age; and I do freely give my CONSENT to his volunteering as a SOLDIER in the Army of the United States, for the period of THREE YEARS, under the conditions of the laws of the United States.

GIVEN at the day of

Witness:

UNITED STATES COLORED TROOPS ENLISTMENT.

STATE OF

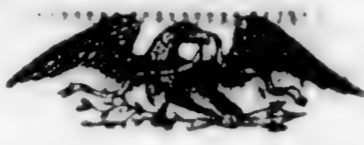

TOWN OF

Kentucky *Bowling Green*

I, *James Phillips* born in *Warren Co*
in the State of *Kentucky* aged *Nineteen* years

and by occupation a *Farmer* Do HEREBY AGKNOWLEDGE to
have volunteered *Twelfth* day of *September*, 186*4*

to serve as a **Soldier** in the **Army of the United States of America**, for the
period of **THREE YEARS**, unless sooner discharged by proper authority: Do
also agree to accept such bounty, pay, rations, and clothing, as are, or may be,
established by law for the U. S. colored troops.

And I, *James Phillips*
do solemnly swear that I will bear true faith and allegiance to the **United States
of America**, and that I will serve them honestly and faithfully against all their
enemies or opposers whomsoever; and that I will observe and obey the orders
of the President of the United States, and the orders of the officers appointed
over me, according to the Rules and Articles of War.

Sworn and subscribed to, at *Bowling Green*
this *12th* day of *Sept 1864* *James Phillips*

Before *A. A. Tolson Capt & Pro Mar 3^d Dist Ky & Reeling Officer* *mark*

I CERTIFY, ON HONOR, That I have carefully examined the above named Volunteer agree-
ably to the General Regulations of the Army, and that, in my opinion, he is free from all bodily
defects and mental infirmity, which would in any way disqualify him from performing the
duties of a soldier.

Nathan B. Chase
capt. Surg. U.S.A.
EXAMINING SURGEON. *James Phillips*

I CERTIFY, ON HONOR, That I have minutely inspected the Volunteer, previously to his enlistment, and that he was entirely sober when enlisted; that, to the best of
my judgment and belief, he is of lawful age; and that, in accepting him as fully qualified to per-
form the duties of an able-bodied soldier, I have strictly observed the regulations which govern
the recruiting service. This soldier has *black* eyes, *black* hair, *black* com-
plexion, is *5* feet *4 1/2* inches high.

A. A. Tolson Capt & Pro Mar 3^d Dist Ky and
RECRUITING OFFICER OR AGENT.

Mustered into the United States Service *12th* day of *Sept.* 186*4*

A. A. Tolson Capt & Pro Mar 3^d Dist Ky and
Mustering Officer.

Mustered into the service of the United States, for three years or during the war, from date of enlistment, in Company
Regiment of Volunteers, on the day of 186, at

1062 of J.M.
Phillips Joseph.

Co No., 6 U. S. Col'd Cav.

Private.

Corporal.

CARD NUMBERS.

1	5394098	26
2	5394142	27
3	5394226	28
4	5394307	29
5	5394394	30
6	5394486	31
7	5394560	32
8	5394631	33
9	9093636	34
10	43151168	35
11		36
12		37
13		38
14		39
15		40
16		41
17		42
18		43
19		44
20		45
21		46
22		47
23		48
24		49
25		50

Book Mark:

See also

S-756963 - P. G. AM.
A 1431548 aud. W.D.
C. 1432709 aud. W.D.
A 1502333 Pomeroy

AL Jordan
E

D. | 6 Cav. | **U.S.C.T.**

J. H. Phillips

, Co. *F*, 6 Reg't U. S. Col'd *Cav.*

Appears on

Company Descriptive Book

of the organization named above.

DESCRIPTION.

Age *23* years; height *5* feet *6* inches.

Complexion *brown*

Eyes *black* hair *black*

Where born *Marion, Ky.*

Occupation *Farmer*

ENLISTMENT.

When *Feb. 13*, 1865.

Where *Lebanon, Ky.*

By whom *Capt. Kilbass*; term *3* y'rs.

Remarks:

J. H. Phillips

(383g)

Copyst.

S. S. Co. **U.S.C.T.**
John Phillips
, Co. 5 Reg't U.S. Col'd *3rd*

Appears on

Company Descriptive Book

of the organization named above.

DESCRIPTION.

Age *23* years; height *5* feet *6* inches.
Complexion *brown*
Eyes *black* hair *black*
Where born *Marion, Ky.*
Occupation *Farmer*

ENLISTMENT.

When *Feb. 13*, 1865.
Where *Lebanon, Ky.*
By whom *Capt. Phillips*; term *3* y'rs.

Remarks:

Copyist

P *used*

A. M. Phillips

Appears with rank of _____ on _____

Muster and Descriptive Roll

of *10th Cavalry U.S. Col.*
Volunteer Recruits

forwarded Roll dated
Sebanon, Ky, Feb 28, 1865.

Where born *Marion, Ky*

Age *23* years; occupation *Farmer*

When enlisted *Feb 13*, 1865.

Where enlisted *Sebanon*

For what period enlisted *3* years.

Eyes *Black*; hair *Black*

Complexion *Brown*; height *5 ft. 6 in.*

When mustered in *Feb 17*, 1865.

Where mustered in *Sebanon*

Bounty paid \$ *100*; due \$ *100*

Clothing account:
Last settled _____, 1865; drawn since \$ *100*

Date of first muster *Feb 17*, 1865.

Company to which assigned _____

Remarks: *Mustered Philip Phillips*
Marion, Ky. without consent
For Co. U.S.C. Cavalry

Book mark: _____

R. W. Fish

P

Clare U. S. C. T.

J. M. Phillips
Pvt, Co. H. 6 Reg't U. S. Col'd Cavalry

Appears on

Company Muster-in and Descriptive Roll
of the organization named above. Roll dated

Lovington, Ky. , Mch. 26, 1865.

Where born Marion, Kentucky

Age 23 y'rs; occupation Farmer

When enlisted Feb. 13, 1865.

Where enlisted Lebanon.

For what period enlisted 3 years.

Eyes Black; hair Black

Complexion Brown; height 5 ft. 6 in.

When mustered in Feb. 17, 1865.

Where mustered in Lebanon, Ky.

Bounty paid \$ 100; due \$ 100

Where credited 4th Dist. Ky.

Company to which assigned H.

Remarks: Fel. y Phillips, Marion Co.,
master; without consent.

Book mark :

Conard

(356d)

Copyst.

6 Cav. U.S.C.T.

Joseph Phillips
Co. H, 6 Reg't U. S. Col'd Cavalry.

Appears on

Company Muster Roll

for from Mch 16 to Apl 30, 1865.

Present or absent Present

Stoppage, \$ 100 for

Due Gov't, \$ 100 for

Valuation of horse, \$ 100

Valuation of horse equipments, \$ 100

Remarks: App'd. Co. H, Mch 16, 1865
per R. O. No. 31, Hd. qrs. 6 U. S. C. Cav.
Camp Nelson, Ky.

Book mark:

(358)

Conard
Copyist.

P

6 Cav. U.S.C.T.

Joseph Phillips
Corpl, Co. H, 6 Reg't U. S. Col'd Cavalry.

Appears on

Company Muster Roll

for *May & June*, 1865.

Present or absent *Present.*

Stoppage, \$ *100* for

Due Gov't, \$ *100* for

Valuation of horse, \$ *100*

Valuation of horse equipments, \$ *100*

Remarks: *1st Instalment Bounty due: App'd Corpl per R.O. No. 50, dated June 12, to rank from June 1, 1865.*

Book mark:

(358)

Conar
Copyist.

6 Cav. U.S.C.T.

Philip ...
..., Co. H, 6 Reg't U. S. Col'd Cavalry.

Appears on

Company Muster Roll

for *Philip ...*, 1865.

Present or absent *Present*.

Stoppage, \$ *100* for

Due Gov't, \$ *100* for

Valuation of horse, \$ *100*

Valuation of horse equipments, \$ *100*

Remarks:

Book mark:

(358)

...

Copyist.

J

6 Cav. U.S.C.T.

Joseph Phillips
Corb, Co. H, 6 Reg't U. S. Col'd Cavalry.

Appears on

Company Muster Roll

for *Sept Oct*, 1865.

Present or absent *Present*.

Stoppage, \$ *100* for

Due Gov't, \$ *100* for

Valuation of horse, \$ *100*

Valuation of horse equipments, \$ *100*

Remarks:

Book mark:

(358)

Sabini

Copyist.

5 | **6 Cav. U.S.C.T.**

James D. ...
..., Co. H, 6 Reg't U. S. Col'd Cavalry.

Appears on

Company Muster Roll

for *...*, 186*5*.

Present or absent *Present*.

Stoppage, \$ *100* for

Due Gov't, \$ *100* for

Valuation of horse, \$ *100*

Valuation of horse equipments, \$ *100*

Remarks:

Book mark:

P

6 Cav. U.S.C.T.

Joseph Phillips

Cork, Co. H, 6 Reg't U. S. Col'd Cavalry.

Appears on

Company Muster Roll

for January 1866

Present or absent Present

Stoppage, \$ 100 for

Due Gov't, \$ 0 60/100 for ordnance

& \$ 1.60 for Q & E

Valuation of horse, \$ 100

Valuation of horse equipments, \$ 100

Remarks:

Book mark:

M. Harmon

(358)

Copyist.

P

6 Cav. U.S.C.T.

Joseph Phillips

Capt, Co. *H*, 6 Reg't U. S. Col'd Cavalry.

Appears on **Co. Muster-out Roll**, dated

Swalls Bluff Ark, Apr 15, 1866.

Muster-out to date *Apr 15, 1866.*

Last paid to *Feb 28, 1866.*

Clothing account:

Last settled....., 186 ; drawn since \$..... 100

Due soldier \$ *10*^{*28*}/₁₀₀; due U. S. \$..... 100

Am't for cloth'g in kind or money adv'd \$..... 100

Due U. S. for arms, equipments, &c., \$ *0*^{*66*}/₁₀₀

Bounty paid \$ *100*/₁₀₀; due \$..... 100

Remarks: *Capt from organiza*
tion due res for
ord \$ 100

Book mark :

J. M. Warren

(861)

Copyist.

Philip Joseph
_____, Co. _____, _____
6 Reg't U.S.C.

2 Enclosures.

Bed Cards	Final Statements
Burial Records	Furloughs or L. of A.
Certs. of Dis. for Discharge	Med. Certificates
C. M. Charges	Med. Des. Lists
Descriptive Lists	Orders
Discharge Certificates	Pris. of War Record
Enlistment Papers <i>2</i>	Resignations

Other papers relating to—

Admission to Hosp'l	Furlough or L. of A.
Casualty Sheet	Med. Examination
Confinement	Misc. Information
Contracts	Pay or Clothing
Death or Effects	Personal Reports
Desertion	Rank
Discharge from Hosp'l	Transfer to Hosp'l
Discharge from Service	Transfer to V. R. C.
Duty	Transportation
.....

NOTE 1.—This Mark will be used for enlistments of United States colored troops. They will be made out in duplicate in all cases—one to accompany the recruiting roll of the superintendent (not the recruiting officer) to the Adjutant General, and one to accompany the accounts of the officer who pays bounty, &c.
 NOTE 2.—An enlistment holds to service. A muster-in must, in all cases, precede payment of pay, bounty, pension, &c. A muster-in roll, must in all cases, be filed in the Adjutant General's Office as evidence of muster-in. The mustering officer, commissary, or assistant commissary of musters, as the case may be, will countersign both enlistments as having mustered the soldiers into the service of the United States before either of them is given to the disbursing officer.

DECLARATION OF RECRUIT.

I, S. M. Phillips desiring to volunteer as a soldier in the ARMY OF THE UNITED STATES, for the term of Three Years, DO DECLARE That I am 23 years and months of age; that I have never been discharged from the United States service on account of disability or by sentence of a court-martial, or by order before the expiration of a term of enlistment; and I know of no impediment to my serving honestly and faithfully as a soldier for three years.

GIVEN at Seeburn, Pa. the 13th day of February 1863

Witness:

John P. Kroll
Capt 6th Regt Cavalry

Signed S. M. Phillips
 mark

Master James
Stiles Phillips
Contracted with the Government

Volunteered on Seeburn, Pa.
Sept 13th 1863
 By Capt J. Stiles Phillips
1st Regt Cavalry

No. 24
Seeburn, Pa.

Consent of Parent or Guardian in case of a Minor, if a Free Man, or in the case of a Slave, of the Person to whom he owes Service:

I, Do CERTIFY, That I am the that the said is years of age; and I do freely give my CONSENT to his volunteering as a SOLDIER in the Army of the United States, for the period of THREE YEARS, under the conditions of the laws of the United States.

GIVEN at the day of

Witness:

Credited to Marion
UNITED STATES COLORED TROOPS ENLISTMENT.

STATE OF

TOWN OF

Kentucky

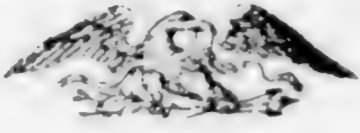

Marion County

I, *J. M. Philips* born in *Marion Co.*

in the State of *Kentucky* aged *23* years

and by occupation a *Farmer* Do HEREBY ACKNOWLEDGE TO

have volunteered *13*" day of *February* 186*5*

to serve as a **Soldier** in the **Army of the United States of America**, for the period of **THREE YEARS**, unless sooner discharged by proper authority: Do also agree to accept such bounty, pay, rations, and clothing, as are, or may be, established by law for the U. S. colored troops.

And I, *J. M. Philips*

do solemnly swear that I will bear true faith and allegiance to the **United States of America**, and that I will serve them honestly and faithfully against all their enemies or opposers whomsoever; and that I will observe and obey the orders of the President of the United States, and the orders of the officers appointed over me, according to the Rules and Articles of War.

Sworn and subscribed to, at *Sebanon Ky.*

this *13*" day of *Feb. 1865* } *J. M. Philips*
mark

Before *Peter Kialbassa*

Capt. Co. U. S. Cavalry

I CERTIFY, ON HONOR, That I have carefully examined the above named Volunteer agreeably to the General Regulations of the Army, and that, in my opinion, he is free from all bodily defects and mental infirmity, which would in any way disqualify him from performing the duties of a soldier.

Signed M. S. Robbins

EXAMINING SURGEON.

I CERTIFY, ON HONOR, That I have minutely inspected the Volunteer, *J. M. Philips* previously to his enlistment, and that he was entirely sober when enlisted; that, to the best of my judgment and belief, he is of lawful age; and that, in accepting him as duly qualified to perform the duties of an able-bodied soldier, I have strictly observed the regulations which govern the recruiting service. This soldier has *Black* eyes, *Black* hair, *Black* complexion, is *5* feet *6* inches high.

Signed Peter Kialbassa
Capt. Co. U. S. Cavalry

RECRUITING OFFICER OR AGENT.

Mustered into the United States Service *17*" day of *February* 186*5*.

Signed James M. Fidler
Capt. Co. U. S. Cavalry

Mustered into the service of the United States, for three years or during the war, from date of enlistment, in Company
Regiment of Volunteers, on the day of 186, at

A. H. ...
Attest ...

James M. Fidler
Capt. Co. U. S. Cavalry

NOTE 1.—This blank will be used for enlistments of United States colored troops. They will be made out in duplicate in all cases—one to accompany the recruiting return of the superintendent (not the recruiting officer) to the Adjutant General, and one to accompany the accounts of the officer who pays bounty, &c.

NOTE 2.—An enlistment holds to service. A muster-in must, in all cases, precede payment of pay, bounty, pension, &c. A muster-in roll, must in all cases, be filed in the Adjutant General's Office as evidence of muster-in. The mustering officer, commissary, or assistant commissary of musters, as the case may be, will countersign both enlistments as having mustered the soldiers into the service of the United States before either of them is given to the disbursing officer.

DECLARATION OF RECRUIT.

I, Joseph Mar Phelps desiring to volunteer as a soldier in the ARMY OF THE UNITED STATES, for the term of Three Years, DO DECLARE That I am Twenty three years and 3 months of age; that I have never been discharged from the United States service on account of disability or by sentence of court-martial, or by order before the expiration of a term of enlistment; and I know of no impediment to my serving honestly and faithfully as a soldier for three years.

GIVEN at Selma Ala the 13 day of July 1865

Witness J. M. Phelps
Capt 6th Co

J. M. Phelps
mark
Volunteered at Selma Ala
July 13th 1865
Capt 6th Co
Phelps

Consent of Parent or Guardian in case of a Minor, if a Free Man, or in the case of a Slave, of the Person to whom he owes Service:

I, Do CERTIFY, That I am the that the said is years of age; and I do freely give my CONSENT to his volunteering as a SOLDIER in the Army of the United States, for the period of THREE YEARS, under the conditions of the laws of the United States.

GIVEN at the day of

Witness:

MAR 1863

Credited to Marine County

UNITED STATES COLORED TROOPS ENLISTMENT.

STATE OF

TOWN OF

Kentucky

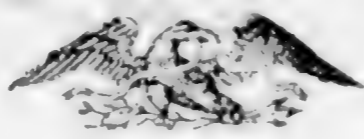

Sebanon

I, *Joseph M. Philips* born in *Marion County*
in the State of *Kentucky* aged *Twenty three* years

and by occupation a *Farmer* Do HEREBY ACKNOWLEDGE to

have volunteered *chs 13th* day of *February* 186*3*

to serve as a **Soldier** in the **Army of the United States of America**, for the period of **THREE YEARS**, unless sooner discharged by proper authority: Do also agree to accept such bounty, pay, rations, and clothing, as are, or may be, established by law for the U. S. colored troops.

And I, *Joseph M. Philips* do solemnly swear that I will bear true faith and allegiance to the **United States of America**, and that I will serve them honestly and faithfully against all their enemies or opposers whomsoever; and that I will observe and obey the orders of the President of the United States, and the orders of the officers appointed over me, according to the Rules and Articles of War.

Sworn and subscribed to, at *Sebanon Ky*
this *13th* day of *Feb* 186*3* by *J. M. Philips*
Before *Peter K. Kellassa Capt* mark
6th U. S. C.

I CERTIFY, ON HONOR, That I have carefully examined the above named Volunteer agreeably to the General Regulations of the Army, and that, in my opinion, he is free from all bodily defects and mental infirmity, which would in any way disqualify him from performing the duties of a soldier.

W. D. Phillips

EXAMINING SURGEON.

I CERTIFY, ON HONOR, That I have minutely inspected the Volunteer, *J. M. Philips* previously to his enlistment, and that he was entirely sober when enlisted, that, to the best of my judgment and belief, he is of lawful age; and that, in accepting him as duly qualified to perform the duties of an able-bodied soldier, I have strictly observed the regulations which govern the recruiting service. This soldier has *black* eyes, *black* hair, *brown* complexion, is *5.5* feet *7* inches high.

Peter Kellassa Capt
6th U. S. C.
RECRUITING OFFICER OR AGENT.

Mustered into the United States Service *17* day of *Feb* 186*3*

James M. Foster
Capt 4th U. S. Col
1st Div 4th
Mustering Officer.

Regiment of Volunteers, on the day of 186*3*, at

MAR 1950

1063
Phipps Adams.

Co E., 6 U. S. Col'd Cav.

Private Private

CARD NUMBERS.

1	5391795	26
2	5391866	27
3	5391953	28
4	5392057	29
5	5392154	30
6	5392250	31
7	5392345	32
8	5392431	33
9	9093277	34
10	43150700	35
11	40731952	36
12		37
13		38
14		39
15		40
16		41
17		42
18		43
19		44
20		45
21		46
22		47
23		48
24		49
25		50

Book Mark:

See also

P | **6 Cav. | U.S.C.T.**

Adam (Philips)
....., Co. *W*, 6 Reg't U. S. Col'd Cav.

Appears on

Company Descriptive Book

of the organization named above.

DESCRIPTION.

Age *20* years ; height *5* feet *6* inches.

Complexion *Copper*

Eyes *blue* ; hair *black*

Where born *Johnson, Va*

Occupation *Laborer*

ENLISTMENT.

When *Nov. 15*, 186*5*.

Where *Lexington, Ky*

By whom *Wison* ; term *3* y'rs.

Remarks:

*Mustered Nov. 15. 1865.
Lexington, Ky. Capt.
Wison*

C. J. Ponce

(383g)

Copyist.

10 | 100 | 12.8.65

Edom Phillips

Appears with rank of Pvt on

Muster and Descriptive Roll

of Detachment of U.S. Colored Volunteers
forwarded to Lexington Ky.

Roll dated
Lexington Ky, Jan 15, 1865.

Where born Johnson Va

Age _____ years; occupation Laborer.

When enlisted Jan 5, 1865.

Where enlisted Lexington Ky

For what period enlisted 3 years.

Eyes Blue; hair Blue

Complexion Dark; height 5 ft. 0 in.

When mustered in Jan 15, 1865.

Where mustered in Lexington Ky

Bounty paid \$ 100; due \$ 100

Clothing account:

Last settled _____, 1865; drawn since \$ 100

Date of first muster Jan 15, 1865.

Company to which assigned _____

Remarks: credited to blank Co. 7th W. Ky
Free

Book mark : _____

(356m)

Approved

Copyist.

P | 6 Cav | **U. S. C. T.**

Adam Philippe
Pvt, Co. E, 6 Reg't U. S. Col'd Cav

Appears on

Company Muster-in and Descriptive Roll
of the organization named above. Roll dated

Lexington, Ky., Jan. 15, 1865.

Where born Johnson Va.

Age 20 y'rs; occupation laborer

When enlisted Jan. 15, 1865.

Where enlisted Lexington

For what period enlisted 3 years.

Eyes blk; hair blk

Complexion copper; height 5 ft. 6 in.

When mustered in Jan. 15, 1865.

Where mustered in Lexington, Ky.

Bounty paid \$ 100; due \$ 100

Where credited 7 Dist. Ky.

Company to which assigned _____

Remarks: _____

Book mark: _____

P

6 Cav. U.S.C.T.

Adam Phillips

Priv., Co. E, 6 Reg't U. S. Col'd Cav.

Appears on

Company Muster Roll

for Jan. 15 to Apr. 30, 1865.

Present or absent absent

Stoppage, \$ 100 for

Due Gov't, \$ 100 for

Valuation of horse, \$ 100

Valuation of horse equipments, \$ 100

Remarks: On detached duty in Camp Nelson, Ky, since Apr. 1 '65

Filed with Phipps, Adam

Book mark:

Beck

Copyist.

(358)

P

6 Cav. U.S.C.T.

Adam Phillips

Priv, Co. E, 6 Reg't U. S. Col'd Cav.

Appears on

Company Muster Roll

for May & June, 1863.

Present or absent Present

Stoppage, \$ 100 for

Due Gov't, \$ 100 for

Valuation of horse, \$ 100

Valuation of horse equipments, \$ 100

Remarks:

Book mark:

W Beck

(358)

Copyist.

1865

P **6 Cav. U.S.C.T.**

Adam Philips
Priv, Co. E, 6 Reg't U. S. Col'd Cav.

Appears on

Company Muster Roll

for *July and Aug*, 186*5*.

Present or absent *Present*

Stoppage, \$ *100* for

Due Gov't, \$ *100* for

Valuation of horse, \$ *100*

Valuation of horse equipments, \$ *100*

Remarks: *1st Installment of
bounty due \$ 10*

Book mark:

J. M. Mallum

(358)

Copyist.

P

6 Cav. U.S.C.T.

Adam Phillips

Priv., Co. E, 6 Reg't U. S. Col'd Cav.

Appears on

Company Muster Roll

for Sept and Oct, 1865.

Present or absent Present

Stoppage, \$ 100 for

Due Gov't, \$ 100 for

Valuation of horse, \$ 100

Valuation of horse equipments, \$ 100

Remarks:

Book mark:

M. M. Colman

(358)

Copyist.

P

6 Cav. U.S.C.T.

Adam Philips
Priv, Co. E, 6 Reg't U. S. Col'd Cav.

Appears on

Company Muster Roll

for *Nov + Dec*, 1865.

Present or absent *Present*

Stoppage, \$ *100* for

Due Gov't, \$ *100* for

Valuation of horse, \$ *100*

Valuation of horse equipments, \$ *100*

Remarks:

Book mark:

M. M. Callow

(358)

Copyist.

6 Cav. U.S.C.T.

William Smith

Smith, Co. E, 6 Reg't U. S. Col'd Cav.

Appears on

Company Muster Roll

for *June 1st*, 186*2*

Present or absent *Present*

Stoppage, \$ *100* for

Due Gov't, \$ *100* for

Valuation of horse, \$ *100*

Valuation of horse equipments, \$ *100*

Remarks:

Book mark:

Wm. Smith

A | 6 Cav. | U.S.C.T.

Philip Adams
Co. E, 6 Reg't U. S. Col'd Cav.

Appears on Returns as follows:

Apr. 1865. Absent on
duty, detachd in
to Nelson Ky. since
Apr. 1, 1865.

Book mark :

(546)

J. A. Feaster
Copyist.

P

6 Cav. U.S.C.T.

Adam Phillips

Priv, Co. *E*, 6 Reg't U. S. Col'd Cavalry.

Appears on **Co. Muster-out Roll**, dated

Newell's Bluff Ark, *Apr 5*, 186*6*.

Muster-out to date *Apr 5*, 186*6*.

Last paid to *Apr 25*, 186*6*.

Clothing account:

Last settled _____, 186*6* ; drawn since \$ _____ 100

Due soldier \$ _____ ²⁷100; due U. S. \$ _____ 100

Am't for cloth'g in kind or money adv'd \$ _____ 100

Due U. S. for arms, equipments, &c., \$ _____ ²¹100

Bounty paid \$ _____ 100; due \$ _____ 100

Remarks: *Discharge of Co. and pay for*

Service for \$44.74

Book mark: *5359 - 11.9 June 6/66*

W. E. Merrill

(361)

Copied.

1064
Phipps John

Co D., 6 U. S. Col'd Cav.

Private

Corporal

CARD NUMBERS.

1 5391305	26
2 5391402	27
3 5391495	28
4 5391590	29
5 5391646	30
6 9093125	31
7 40732722	32
8	33
9	34
10	35
11	36
12	37
13	38
14	39
15	40
16	41
17	42
18	43
19	44
20	45
21	46
22	47
23	48
24	49
25	50

Book Mark:

See also

170 U. S. C. I.

D. 709⁸44 - P.O. aff
D. 909500 - (P.O. aff)
D. 1031068 P.O. aff
D. 2911069 and wd
Return of 901031 (P.O. aff)

D. Jordan
EX

9 | 6 Cav. | U.S.C.T.

John Phillip
....., Co. *A*, 6 Reg't U. S. Col'd Cav.

Appears on

Company Descriptive Book

of the organization named above.

DESCRIPTION.

Age *23* years; height *5* feet *8* inches.

Complexion *Copper*

Eyes *Blk*; hair *Blk*

Where born *Shirley, Va.*

Occupation *Farmer*

ENLISTMENT.

When *Apr 12*, 186*5*.

Where *North*

By whom *A. C. Anderson*, term *3* y'rs.

Remarks:
.....
.....
.....
.....
.....
.....
.....
.....
.....
.....

Boyer

(383g)

Copyist.

F **6 Cav. U.S.C.T.**

John Phillips
_____, Co. D, 6 Reg't U.S. Col'd Cavalry.

Appears on

Company Muster Roll

for *May & June*, 1865.

Present or absent *Present*

Stoppage, \$ *100* for _____

Due Gov't, \$ *100* for _____

Valuation of horse, \$ *100*

Valuation of horse equipments, \$ *100*

Remarks: *Transferred from 120 Reg't
Col'd Cavalry dated Feb 21
1865*

FILED IN THE OFFICE OF THE
COMMISSIONER OF THE GENERAL LAND OFFICE

Book mark: _____

J. M. Baker

(358)

Copyist.

P **6 Cav. U.S.C.T.**

John Phillips

Plat, Co. D, 6 Reg't U. S. Col'd Cavalry.

Appears on

Company Muster Roll

for *Sept & Oct*, 186 *5*.

Present or absent *Present*

Stoppage, \$ *100* for

Due Gov't, \$ *100* for

Valuation of horse, \$ *100*

Valuation of horse equipments, \$ *100*

Remarks: *None*

Book mark:

J. W. Tucker

(358)

Copist.

F

6 Cav. U.S.C.T.

John Phipps

But, Co. D, 6 Reg't U.S. Col'd Cavalry.

Appears on

Company Muster Roll

for *Nov & Dec*, 186*5*

Present or absent *Present*

Stoppage, \$ *100* for

Due Gov't, \$ *40* for *ordnance*

Valuation of horse, \$ *100*

Valuation of horse equipments, \$ *100*

Remarks:

Book mark:

A. A. Smith

(358)

Copyist.

L **6 Cav. U.S.C.T.**

John Phipps
1st, Co. D, 6 Reg't U.S. Col'd Cavalry.

Appears on

Company Muster Roll

for *Jan 9, Feb*, 1860.

Present or absent *Present*

Stoppage, \$ *100* for

Due Gov't, \$ *100* for

Valuation of horse, \$ *100*

Valuation of horse equipments, \$ *100*

Remarks: *Due U.S. for advance*
\$0 ⁴⁰/₁₀₀

Book mark:

J. A. Stand

(358)

Copyist.

P | 6 Cav. | U.S.C.T.

John Phipps
Priv. Co. D, 6 Reg't U. S. Col'd Cav.

Appears on Returns as follows:

June 1865, Gain June 20/65
Camp Nelson, Frank
from 120, U.S.C.T., per
S.O. No. 105, dated
H. A. gen. Dept Ky
June 21/65,

Book mark:

C. M. Roe

(546)

Copyist.

J

6 Cav. U.S.C.T.

John Thibault
Corpl, Co. *X*, 6 Reg't U. S. Col'd Cavalry.

Appears on **Co. Muster-out Roll**, dated
Le Vall's Inf. Regt, Apr 15, 1866.

Muster-out to date *Apr 15, 1866.*

Last paid to *Feb 28, 1866.*

Clothing account:

Last settled _____, 186 ; drawn since \$ 100

Due soldier \$ *19*^{*99*} 100; due U. S. \$ 100

Am't for cloth'g in kind or money adv'd \$ 100

Due U. S. for arms, equipments, &c., \$ 100

Bounty paid \$ *100* 100; due \$ 100

Remarks: _____

Book mark: _____

J. A. Ward

1065

Pigg Allen.

Co. C., 6 U. S. Col'd Cav.

Private | 1st Sergeant.

CARD NUMBERS.

1	5387159	26
2	5390093	27
3	5390178	28
4	5390263	29
5	5390336	30
6	5390408	31
7	5390481	32
8	5390569	33
9	5390655	34
10	5390737	35
11	5390823	36
12	43174799	37
12	40732723	38
14		39
15		40
16		41
17		42
18		43
19		44
20		45
21		46
22		47
23		48
24		49
25		50

Book Mark:

See also

S. 1448 367 P.O. recd

A. Jordan
Et

P.

6 Cavalry.

U. S. C. T.

Allen Pigg

Co. B, 6 Reg't U. S. Col'd Cav.

Appears on

Regimental Descriptive Book

of the regiment named above.

DESCRIPTION.

Age 21 years; height 5 feet 10 inches.

Complexion black

Eyes Blue; hair Black

Where born Ky

Occupation farmer

ENLISTMENT.

When Oct 24, 1864.

Where Camp Nelson, Ky

By whom Capt J. Randolph, U.S.M.; term 3 years.

Remarks:

(384b)

L. D. Barton

Copyist.

P | 6 Cav. | U.S.C.T.

Allen Piggy

Appears with rank of *Priv.* on

Muster and Descriptive Roll of a Detachment of U. S. Vols. forwarded

for the 6 Reg't U. S. Col'd Cavalry. Roll dated

Camp Nelson Ky. Oct. 27, 1864.

Where born *Kentucky*

Age *21* y'rs; occupation *Farmer*

When enlisted *Oct. 24*, 1864.

Where enlisted *Camp Nelson Ky.*

For what period enlisted *3* years.

Eyes *Blk*; hair *Blk*

Complexion *Blk*; height *5* ft. *10* in.

When mustered in *Oct. 24*, 1864.

Where mustered in *Camp Nelson Ky.*

Bounty paid \$ *100*; due \$ *100*

Where credited

Company to which assigned

Remarks: *Credited to Montgomery Co.*

1 Dist. Ky.

Harrison Piggy, Owner

Book mark:

C. E. McLaughlin

1860
F | 6 | U. S. C. T.

Allen Pegg
Sgt., Co. B, 6 Reg't U. S. Col'd Cav.

Appears on

Company Muster-in and Descriptive Roll
of the organization named above. Roll dated
Camp Nelson
Kentucky, Nov 1, 1864.

Where born Kentucky

Age 21 y'rs; occupation Farmer

When enlisted Oct 24, 1864

Where enlisted Camp Nelson Ky

For what period enlisted 3 years.

Eyes Blue; hair Black

Complexion Blue; height 5 ft. 11 in.

When mustered in Oct 24, 1864

Where mustered in Camp Nelson

Bounty paid \$ 100; due \$ 100

Where credited 9th Dist Kentucky

Company to which assigned C

Remarks:

Book mark:

W. C. Howser

(356d)

Copyist.

A

6 Cav. U.S.C.T.

Allen Pigg
Sgt, Co. C, 6 Reg't U. S. Colored Cavalry.

Appears on

Company Muster Roll

for *Nov + Dec*, 186*4*

Present or absent *present*

Stoppage, \$ *100* for

Due Gov't, \$ *100* for

Valuation of horse, \$ *100*

Valuation of horse equipments, \$ *100*

Remarks:

Book mark:

W. W. Newson
(358) *Copyist.*

6 Cav. U.S.C.T.

John G. ...
..., Co. C, 6 Reg't U. S. Colored Cavalry.

Appears on

Company Muster Roll

for *...*, 186*...*

Present or absent *...*

Stoppage, \$ *...* 100 for *...*

Due Gov't, \$ *...* 100 for *...*

Valuation of horse, \$ *...* 100

Valuation of horse equipments, \$ *...* 100

Remarks: *...*
...

Book mark: *...*

(358)

...

Copyist.

P

6 Cav. U.S.C.T.

Allen Pigg

1st Srgt, Co. C, 6 Reg't U. S. Colored Cavalry.

Appears on

Company Muster Roll

for *May & June*, 186*5*.

Present or absent *Present*

Stoppage, \$ *100* for

Due Gov't, \$ *100* for

Valuation of horse, \$ *100*

Valuation of horse equipments, \$ *100*

Remarks: *1st Instalment bounty due*

Book mark: _____

(358)

S. J. York Copyist.

9

6 Cav. U.S.C.T.

Allen Piggy

Sergt, Co. C, 6 Reg't U. S. Colored Cavalry.

Appears on

Company Muster Roll

for *July + Aug*, 186*0*.

Present or absent *Present*

Stoppage, \$ *100* for

Due Gov't, \$ *100* for

Valuation of horse, \$ *100*

Valuation of horse equipments, \$ *100*

Remarks: *Due U.S. for 6 + G.E. \$1.60*

Book mark: _____

(358)

J. P. York

Copyist.

6

6 Cav. U.S.C.T.

Allen Pigg

1st Sergt., Co. C, 6 Reg't U. S. Colored Cavalry.

Appears on

Company Muster Roll

for *Sept & Oct*, 186*5*.

Present or absent *Present*

Stoppage, \$ *100* for

Due Gov't, \$ *100* for

Valuation of horse, \$ *100*

Valuation of horse equipments, \$ *100*

Remarks:

Book mark:

(358)

S. P. York Copyist.

O

6 Cav. U.S.C.T.

Allen Pigg
Sergt, Co. C, 6 Reg't U. S. Colored Cavalry.

Appears on

Company Muster Roll

for *Nov. & Dec.*, 1865.

Present or absent *Present*

Stoppage, \$ 100 for

Due Gov't, \$ 100 for

Valuation of horse, \$ 100

Valuation of horse equipments, \$ 100

Remarks:

Book mark:

(358)

W. B. Ferguson
Copyist.

P

6 Cav. U.S.C.T.

Allen Pegg

1st Supt, Co. C, 6 Reg't U. S. Colored Cavalry.

Appears on

Company Muster Roll

for *Jan. & Feb.*, 1866.

Present or absent *Present*

Stoppage, \$ *100* for

Due Gov't, \$ *100* for

Valuation of horse, \$ *100*

Valuation of horse equipments, \$ *100*

Remarks:

.....
.....
.....
.....
.....
.....
.....
.....
.....
.....

Book mark:

.....

(358)

W B Ferguson

Copyist.

1864
J^d | 6 Cav. | U.S.C.T.

A. Pigg
, Co. C, 6 Reg't U. S. Col'd Cav.

Appears on Returns as follows:

March & April 1865, absent
on Det serv, Robinsons
Station K C R R, since
March 29/65,

Book mark :

(546)

G M Row

Copyist.

P

6 Cav. U.S.C.T.

Allen Pigg

1st Supt, Co. *6*, 6 Reg't U. S. Col'd Cavalry.

Appears on **Co. Muster-out Roll**, dated *Howalls Bluff Ark, April 15th*, 1866.

Muster-out to date *April 15th*, 1866.

Last paid to *Feb. 28th*, 1866.

Clothing account:

Last settled....., 186 ; drawn since \$..... 100

Due soldier \$ *15*⁵⁰/₁₀₀; due U. S. \$..... 100

Am't for cloth'g in kind or money adv'd \$..... 100

Due U. S. for arms, equipments, &c., \$..... ⁶⁰/₁₀₀

Bounty paid \$ *100* 100; due \$..... 100

Remarks: *Promoted in ranks*
to 1st Supt Mar. 19th 65 S.O.
No. 4 Par 2

Book mark :

(861)

W. B. Ferguson

Copyist.

Pegg, *Allen*
 Co., Reg't *U.S.A.*

Enclosures.

Serial 42397

Bed Cards	Final Statements
Burial Records	Furloughs or L. of A
Certs. of Dis. for Discharge	Med. Certificates
C. M. Charges	Med. Des. Lists
Descriptive Lists	Orders
Discharge Certificates	Pris. of War Record
Enlistment Papers <i>2</i>	Resignations

Other papers relating to—

Admission to Hosp'l	Furlough or L. of A
Casualty Sheet	Med. Examination
Confinement	Misc. Information
Contracts	Pay or Clothing
Death or Effects	Personal Reports
Desertion	Rank
Discharge from Hosp'l	Transfer to Hosp'l
Discharge from Service	Transfer to V. R. C.
Duty	Transportation
.....

NOTE 1.—This blank will be used for enlistments of United States colored troops. They will be made out in duplicate in all cases—one to accompany the recruiting return of the superintendent (not the recruiting officer) to the Adjutant General, and one to accompany the accounts of the officer who pays bounty, &c.

NOTE 2.—An enlistment holds for three years, unless sooner discharged. A muster-in roll, must in all cases, be filed in the Adjutant General's office at the time of mustering. The mustering officer, commissary, or assistant commissary of musters, as the case may be, will countersign both enlistments as having mustered the soldiers into the service of the United States before either of them is given to the discharging officer.

DECLARATION OF RECRUIT.

I, Allen Pigg desiring to volunteer as a soldier in the ARMY OF THE UNITED STATES, for the term of Three Years, DO DECLARE That I am 21 years and months of age; that I have never been discharged from the United States service on account of disability or by sentence of a court-martial, or by order before the expiration of a term of enlistment; and I know of no impediment to my serving honestly and faithfully as a soldier for three years.

GIVEN at Camp Nelson the 24th day of October 1864

Witness: [Signature]

Allen Pigg
No. 347
Allen Pigg
No. 347
Allen Pigg
No. 347
Discharged at Camp Nelson
October 18 64
[Signature]
[Signature]
[Signature]

Consent of Parent or Guardian in case of a Minor, if a Free Man, or in the case of a Slave, of the Person to whom he owes Service:

I, Do CERTIFY, That I am the that the said is years of age; and I do freely give my CONSENT to his volunteering as a SOLDIER in the Army of the United States, for the period of THREE YEARS, under the conditions of the laws of the United States.

GIVEN at the day of

Witness: [Signature]

UNITED STATES COLORED TROOPS ENLISTMENT.

STATE OF



TOWN OF

Kentucky

Camp Nelson

I *Allen Pigg*

born in

in the State of *Kentucky* aged *Twentyone* years

and by occupation a *Farmer* Do HEREBY ACKNOWLEDGE TO

have volunteered *Twentyfourth* day of *Oct* 1864

to serve as a **Soldier** in the **Army of the United States of America**, for the

period of **THREE YEARS**, unless sooner discharged by proper authority: Do

also agree to accept such bounty, pay, rations, and clothing, as are, or may be,

established by law for the U. S. colored troops.

And I,

do solemnly swear that I will bear true faith and allegiance to the **United States**

of America, and that I will serve them honestly and faithfully against all their

enemies or opposers whomsoever; and that I will observe and obey the orders

of the President of the United States, and the orders of the officers appointed

over me, according to the Rules and Articles of War.

Sworn and subscribed to,

this *24th* day of *Oct* 1864

Before

I CERTIFY, ON HONOR, That I have carefully examined the above named Volunteer agreeably to the General Regulations of the Army, and that, in my opinion, he is free from all bodily defects and mental infirmity, which would in any way disqualify him from performing the duties of a soldier.

Osmer A. Horr
Asst. Surgeon U.S.A.
EXAMINING SURGEON.

I CERTIFY, ON HONOR, That I have minutely inspected the Volunteer *A. Pigg* previously to his enlistment, and that he was entirely sober when enlisted; that, to the best of my judgment and belief, he is of lawful age; and that, in accepting him, as duly qualified to perform the duties of an able-bodied soldier, I have strictly observed the regulations which govern the recruiting service. This soldier has *Blue* eyes, *Black* hair, *Dark* complexion, is *5.10* feet *0.0* inches high.

Wm. H. ...
RECRUITING OFFICER OR AGENT.

Mustered into the United States Service *24* day of *Oct* 1864

W. H. ...
Mustering Officer

Mustered into the service of the United States, for three years or during the war, from date of enlistment, in Company *Company* of *15th U.S.C.T.* Regiment of *Volunteers*, on the *24* day of *Oct* 1864 at *Camp Nelson Ky*

W. H. ...
Mustering Officer

NOTE 1.—This blank will be used for enlistments of United States colored troops. They will be made out in duplicate in all cases—one to accompany the recruiting return of the superintendent (not the recruiting officer) to the Adjutant General, and one to accompany the accounts of the officer who pays bounty, &c.

NOTE 2.—An enlistment holds to service. A muster-in must, in all cases, precede payment of pay, bounty, pension, &c. A muster-in roll, must in all cases, be filed in the Adjutant General's Office as evidence of muster-in. The mustering officer, commissary, or assistant commissary of musters, as the case may be, will countersign both enlistments as having mustered the soldiers into the service of the United States before either of them is given to the disbursing officer.

DECLARATION OF RECRUIT

I, Allen Pigg desiring to volunteer as a soldier in the ARMY OF THE UNITED STATES, for the term of Three Years, DO DECLARE That I am 21 years and months of age; that I have never been discharged from the United States service on account of disability or by sentence of a court-martial, or by order before the expiration of a term of enlistment; and I know of no impediment to my serving honestly and faithfully as a soldier for three years

GIVEN at Camp Nelson the 24 day of Oct 1864

Witness: W. Palmer

Allen Pigg Volunteered at
No.



James Pigg
James Pigg

Consent of Parent or Guardian in case of a Minor, if a Free Man, or in the case of a Slave, of the Person to whom he owes Service:

I, Do CERTIFY, That I am the that the said is years of age; and I do freely give my CONSENT to his volunteering as a SOLDIER in the Army of the United States, for the period of THREE YEARS, under the conditions of the laws of the United States.

GIVEN at the day of

Witness: James Pigg

UNITED STATES COLORED TROOPS ENLISTMENT.

STATE OF Kentucky TOWN OF Camp Nelson

Allen Pigg born in Kentucky aged Twenty one years
in the State of Kentucky and by occupation a Farmer
and by occupation a Farmer DO HEREBY ACKNOWLEDGE to
have volunteered Twenty fourth day of October 1864
to serve as a **Soldier** in the **Army of the United States of America**, for the
period of **THREE YEARS**, unless sooner discharged by proper authority: Do
also agree to accept such bounty, pay, rations, and clothing, as are, or may be,
established by law for the U. S. colored troops.

And I, Allen Pigg
do solemnly swear that I will bear true faith and allegiance to the **United States
of America**, and that I will serve them honestly and faithfully against all their
enemies or opposers whomsoever; and that I will observe and obey the orders
of the President of the United States; and the orders of the officers appointed
over me, according to the Rules and Articles of War.

Sworn and subscribed to, at Camp Nelson this 24th day of October
Before H. Russell W. P. M.

I CERTIFY, ON HONOR, That I have carefully examined the above named Volunteer agree-
ably to the General Regulations of the Army, and that, in my opinion, he is free from all bodily
defects and mental infirmity, which would in any way disqualify him from performing the
duties of a soldier.

Carew A. Herr
Assist. Surgeon U.S.A.
EXAMINING SURGEON.

I CERTIFY, ON HONOR, That I have minutely inspected the Volunteer, Allen Pigg
previously to his enlistment, and that he was entirely sober when enlisted; that to the best of
my judgment and belief, he is of lawful age and that, in accepting him as duly qualified to per-
form the duties of an able-bodied soldier, I have strictly observed the regulations which govern
the recruiting service. This soldier has 5 feet 10 inches high.
Complexion, is fair eyes blue hair black

H. Russell
and W. P. M.
RECRUITING OFFICER OR AGENT.

Mustered into the United States Service 24 day of Oct 1864

W. P. M.
Mustering Officer

Mustered into the service of the United States, for three years or during the war, from date of enlistment, in Company
Regiment of Madison Volunteers, on the 24 day of October 1864 at Camp Nelson Ky

W. P. M.
W. P. M.
W. P. M.

1066
Putnam, Lewis

Co L, 6 U. S. Col'd Cav.

Private *Private*

CARD NUMBERS.

1	26
2	27
3	28
4	29
5	30
6	31
7	32
8	33
9	34
10	35
11	36
12	37
12	38
14	39
15	40
16	41
17	42
18	43
19	44
20	45
21	46
22	47
23	48
24	49
25	50

Book Mark:

See also

1067

Pittman, Joseph

Co B, 6 U.S. Col'd Cav.

Sergeant | Private

CARD NUMBERS.

1	5389211	26
2	5389298	27
3	5389385	28
4	5389408	29
5	5389527	30
6	5389652	31
7	5389748	32
8	5389840	33
9	5389930	34
10	5390023	35
11	4092920	36
12	40732753	37
13	40902858	38
14	31407596	39
15	31407694	40
16		41
17		42
18		43
19		44
20		45
21		46
22		47
23		48
24		49
25		50

Book Mark:

See also

D | **6 Cav. | U.S.C.T.**

Joseph Pittman

B, Co *B*, 6 Reg't U. S. Col'd Cav.

Appears on

Company Descriptive Book

of the organization named above.

DESCRIPTION.

Age *36* years; height *5* feet *10* inches.

Complexion *Yellow*

Eyes *Black*; hair *Black*

Where born *Essex N.C.*

Occupation *Farmer*

ENLISTMENT.

When *Aug 16*, 1864.

Where *Bowling Green Ky*

By whom *Capt Hobson*; term *3* y'rs.

Remarks:

*Mustered in as Sergeant
1, 1864.*

Bryson

(3837)

Copyist.

P | *Clav.* | **U. S. C. T.**

Joseph Pittman

Sgt., Co. *B*, *6* Reg't U. S. Col'd *Cavry*

Appears on

Company Muster-in and Descriptive Roll
of the organization named above. Roll dated

Camp Nelson Ky, Nov. 1st, 1864.

Where born *Iredell N. C.*

Age *36* y'rs; occupation *Farmer*

When enlisted *Aug. 16*, 1864.

Where enlisted *Bowling Green*

For what period enlisted *3* years.

Eyes *Brown*; hair *Black*

Complexion *Yellow*; height *5* ft. *10* in.

When mustered in *Aug. 16*, 1864.

Where mustered in *Bowling Green*

Bounty paid \$ *100*; due \$ *100*

Where credited *2^d Dist of Ky*

Company to which assigned *B*

Remarks: *Transferred from Co. D, 113th U. S. C. S.*

S. O. No. 29, dated Washington D. C.

June 14/65; signed by S. Thomas, A. G.
(over)

Book mark :

A. M. Rowe

(356d)

Copyist.

JAN. 10

5389211

1891

Owner Berth Pitman

P

6 Cav. | U.S.C.T.

Joseph Pittman
Sergt, Co. B, 6 Reg't U. S. Col'd Cavalry.

Appears on

Company Muster Roll

for *Nov & Dec*, 186*4*.

Present or absent *Absent*

Stoppage, \$ *100* for

Due Gov't, \$ *100* for

Valuation of horse, \$ *100*

Valuation of horse equipments, \$ *100*

Remarks: *sick in Hospital*
Orkland Ky, Dec 30, 64
Due U.S. for Cal. \$21.90

Book mark:

J. M. Mow

(358)

Copyist.

Sp

6 Cav. U.S.C.T.

Joseph Pittman
Serg't, Co. B, 6 Reg't U. S. Col'd Cavalry.

Appears on

Company Muster Roll

for *Jan & Feb*, 1865.

Present or absent *Absent*

Stoppage, \$ *100* for

Due Gov't, \$ *100* for

Valuation of horse, \$ *100*

Valuation of horse equipments, \$ *100*

Remarks: *Due U.S. for Ord \$24.90,
1st installment bounty due
\$100. Sick in Hoapl
Ashland Ky, Dec 30, /64.*

Book mark:

C. M. Rowe

(358)

Copyist.

D
Car - U.S.C.

Joseph C. Pittman
Sgt., Co. B, 5 Reg't U.S.C.

Appears on
Hospital Muster Roll

of U. S. A. General Hospital,
at Ashland, Ky.,

for *Jan'y & Feb*, 1865.

Attached to hospital:

When *Jan'y 5*, 1865.

How employed *patient*

Last paid by Maj. _____

to *Pay due from enlistment*, 186 .

Bounty paid \$ 100; due \$ 100

Present or absent *Present*

Remarks: _____

Book mark : _____

(343)

J. Perry

Copyist.

P | **6 Cav. U.S.C.T.**

Joseph Pittman
Sergt., Co. B, 6 Reg't U. S. Col'd Cavalry.

Appears on

Company Muster Roll

for *March & April*, 1865.

Present or absent *Absent*

Stoppage, \$ *100* for

Due Gov't, \$ *100* for

Valuation of horse, \$ *100*

Valuation of horse equipments, \$ *100*

Remarks: *1 month bounty due \$100, sick in Hospital Ashland Ky, Dec, 30 1864, Descriptive list furnished,*

Book mark:

G. M. Row

C | *Star* | *U.S.C.*

Joseph D. Wittman
Sgt., Co. *12*, *5* Reg't *U.S.C.*

Appears on

Hospital Muster Roll

of **U. S. A. General Hospital,**

at **Ashland, Ky.,**

for *March & April*, 1865.

Attached to hospital:

When *Jan 5*, 1865.

How employed *patient*

Last paid by Maj. _____

to *Pay due from entitlement*, 186 .

Bounty paid \$ *100*; due \$ *100*

Present or absent *present*

Remarks: *Due U.S. for the following*

advance lost through

carelessness (1) one Enfield

Rifle & bucket \$19.00 (1) one

set of counterments

\$2.90 - \$21.90

Book mark: _____

(343)

J. D. Wittman
Copyist.

14 | **6 Cav. | U.S.C.T.**

Joseph Putnam
Sergeant, Co. B, 6 Reg't U. S. Col'd Cavalry.

Appears on

Company Muster Roll

for *May June*, 1865.

Present or absent *absent*

Stoppage, \$ *100* for

Due Gov't, \$ *100* for

Valuation of horse, \$ *100*

Valuation of horse equipments, \$ *100*

Remarks: *Sick in Hospital
Ashland, Ky. Discript
list furnished*

Book mark:

A. D. Harper
Copyist.

6 Cav. U.S.C.T.

Joseph Cushman
Co. B, 6 Reg't U. S. Col'd Cavalry.

Appears on

Company Muster Roll

for *Aug*, 1865.

Present or absent *absent*

Stoppage, \$ *100* for

Due Gov't, \$ *100* for

Valuation of horse, \$ *100*

Valuation of horse equipments, \$ *100*

Remarks: *Joseph Cushman
No description
list furnished*

Book mark:

J. P. Harper
Copyist.

6 Cav. U.S.C.T.

Joseph H. Hillman
ser, Co. B, 6 Reg't U. S. Col'd Cavalry.

Appears on

Company Muster Roll

for *Sept & Oct*, 186*5*.

Present or absent *present*

Stoppage, \$ *100* for

Due Gov't, \$ *100* for

Valuation of horse, \$ *100*

Valuation of horse equipments, \$ *100*

Remarks: *Installation*
to county due \$100.

Book mark:

H. Harper

(358)

Copyist.

P

6 Cav. | U.S.C.T.

Joseph Pittman
Pvt., Co. B, 6 Reg't U. S. Col'd Cavalry.

Appears on

Company Muster Roll

for *Nov. & Dec.*, 186*5*.

Present or absent *Present*

Stoppage, \$ *100* for

Due Gov't, \$ *100* for

Valuation of horse, \$ *100*

Valuation of horse equipments, \$ *100*

Remarks:

Book mark:

(358)

J. W. Ames

Copyist.

Op

6 Cav. U.S.C.T.

Joseph Pitman

Pr, Co. B, 6 Reg't U. S. Col'd Cavalry.

Appears on

Company Muster Roll

for *January & February*, 1866.

Present or absent *Present*

Stoppage, \$ *100* for

Due Gov't, \$ *100* for

Valuation of horse, \$ *100*

Valuation of horse equipments, \$ *100*

Remarks:

Book mark:

J. V. Ames
(358) Copyist.

P

115

U.S.C.T.

Joseph Pittman,
Private, Co. D, 115 Reg't U. S. Colored Inf

Appears on Returns as follows:

Aug. 1864 - Loss: Aug. 26/64,
Bowling Green, Transferred.

Book mark:

(548)

J. T. Hunsley

Copyist

P | **6 Cav.** | **U.S.C.T.**

Joseph Pittman
Serg't, Co. B, 6 Reg't U. S. Col'd Cav.
Pot;

Appears on Returns as follows:

Dec 1864 to June 1865, absent
sick in Hosptl Ashland Ky
since Dec 30/64.
July & Aug 1865, absent sick
in hosptl Covington Ky
since May 25, 65 (Pot)

Book mark:

G M Rowe

(546)

Copyist.

6 Cav. U.S.C.T.

Joseph P. ...
Co. B, 6 Reg't U. S. Col'd Cavalry.

Appears on Co. Muster-out Roll, dated
DeValls Bluff Ark, Apr 15, 1866.

Muster-out to date Apr 15, 1866.

Last paid to July 28, 1866.

Clothing account:

Last settled _____, 186 ; drawn since \$ 100

Due soldier \$ 111⁹⁴/₁₀₀; due U. S. \$ 100

Am't for cloth'g in kind or money adv'd \$ 100

Due U. S. for arms, equipments, &c., \$ 100

Bounty paid \$ 100; due \$ 100

Remarks:

Book mark:

(861)

J. W. ...
Copyist.

1068

Pogue Alexander

Co B., 6 U. S. Col'd Cav.

Private

Corporal

CARD NUMBERS.

1	5389270	26
2	5389343	27
3	5389431	28
4	5389502	29
5	5389570	30
6	5389657	31
7	5389699	32
8	5389792	33
9	5389885	34
10	5389977	35
11	9092971	36
12	43147757	37
13		38
14		39
15		40
16		41
17		42
18		43
19		44
20		45
21		46
22		47
23		48
24		49
25		50

Book Mark:

See also

A. 2630102 P.O. Retu

D. Jordan
Cf

P | **6 Cav. | U.S.C.T.**

Alexander Ponge

, Co. *B*, 6 Reg't U. S. Col'd Cav.

Appears on

Company Descriptive Book

of the organization named above.

DESCRIPTION.

Age *22* years; height *5* feet *8 3/4* inches.

Complexion *Blk*

Eyes *Blk*; hair *Blk*

Where born *Lexington Ky*

Occupation *Farmer*

ENLISTMENT.

When *Sept 27*, 186*4*.

Where *Lexington Ky*

By whom *Capt R Wray*; term *3* y'rs.

Remarks:

Ponge

P 16 car U.S.C.T.

Andrew Pucher
Co. M, 4 Reg't U. S. Col'd car

Appears on

Company Descriptive Book

of the organization named above.

DESCRIPTION.

Age 37 years; height 5 feet 4 inches.

Complexion *Blk*

Eyes *Blk*; hair *Blk*

Where born *Payette Ky*

Occupation *Farmer*

ENLISTMENT.

When *Nov 24*, 186 *4*.

Where *Owensboro*

By whom *Capt. Partridge*, term *3* y'rs.

Remarks: *Mustered into
U.S. service Nov 24/64
Owensboro Ky by Capt
Grissum*

Pomeroy
Copyist.

P

in bar

U.S.C.A.

Alexander Pogue

Appears with rank of Private on

Muster and Descriptive Roll

of Detachment U.S. Col & Recruits
forwarded

Roll dated London Ky Sept 30, 1864.

Where born Knox Co. Ky

Age 22 years; occupation Farmer

When enlisted Sept 27, 1864.

Where enlisted London Ky

For what period enlisted 3 years.

Eyes Blue; hair Blue

Complexion Black; height 5. ft. 9/4 in.

When mustered in Sept 30, 1864.

Where mustered in London Ky

Bounty paid \$ 100; due \$ 100

Clothing account: nothing issued

Last settled _____, 186 ; drawn since \$ 100

Date of first muster Sept. 27, 1864.

Company to which assigned _____

Remarks Credited to Knox Co & sent to

own name James Pogue Knox

Co. Ky

Book mark : _____

Alex Black

(356m)

Copyist.

JP

6 Cav. U.S.C.T.

Alexander Poque

Privt, Co *B*, 6 Reg't U. S. Col'd Cavalry.

Appears on

Company Muster-in and Descriptive Roll

of the organization named above. Roll dated

Camp Nelson Ky, ~~Nov~~ *Nov 1st*, 1864.

Where born *Knox Co Ky*,

Age *22* y'rs; occupation *Farmer*

When enlisted *Sept 27*, 1864.

Where enlisted *London Ky*

For what period enlisted *3* years.

Eyes *Blk*; hair *Blk*

Complexion *Blk*; height *5* ft. *3 1/4* in.

When mustered in *Sept 27*, 1864.

Where mustered in *London Ky*

Bounty paid \$ *100*; due \$ *100*

Where credited *S' Aicut Ky*,

Company to which assigned *B*

Remarks: *Came,*

James Poque

Book mark:

C. M. Rowe

(356d)

Copyist.

P | **6 Cav. U.S.C.T.**

Alexander Punge
Private, Co. B, 6 Reg't U. S. Col'd Cavalry.

Appears on

Company Muster Roll

for *Nov & Dec*, 1864.

Present or absent *Present*

Stoppage, \$ *100* for

Due Gov't, \$ *100* for

Valuation of horse, \$ *100*

Valuation of horse equipments, \$ *100*

Remarks:

Book mark:

(358)

Miller

Copyist.

P 6 Cav. U.S.C.T.

Alexander Pogue
Privat, Co. B, 6 Reg't U. S. Col'd Cavalry.

Appears on

Company Muster Roll

for *Jan & Feb*, 1865.

Present or absent *present*

Stoppage, \$ *100* for

Due Gov't, \$ *100* for

Valuation of horse, \$ *100*

Valuation of horse equipments, \$ *100*

Remarks: *1st installment bounty
due \$100.*

Book mark:

(358)

J. D. Moore

Copist.

P 6 Cav. U.S.C.T.

Alexander Pogue
Pvt., Co. B, 6 Reg't U. S. Col'd Cavalry.

Appears on

Company Muster Roll

for *March 1865*, 1865.

Present or absent *present*

Stoppage, \$ *100* for

Due Gov't, \$ *100* for

Valuation of horse, \$ *100*

Valuation of horse equipments, \$ *100*

Remarks: *Installation bounty,
due \$100.*

Book mark:

G. M. Rowe

(358)

Copyist.

D | **6 Cav. | U.S.C.T.**

Alex. Toque
Toque, Co. B, 6 Reg't U. S. Col'd Cavalry.

Appears on

Company Muster Roll

for *May & June*, 1865.

Present or absent *Present*

Stoppage, \$ *100* for

Due Gov't, \$ *100* for

Valuation of horse, \$ *100*

Valuation of horse equipments, \$ *100*

Remarks: *1st install bounty due \$100.*

Book mark: _____

A. E. Harper

(358)

Copyst.

6 Cav. U.S.C.T.

Alexander Ogden
Co. B, 6 Reg't U. S. Col'd Cavalry.

Appears on

Company Muster Roll

for July & Aug, 1865.

Present or absent present

Stoppage, \$ 100 for

Due Gov't, \$ 100 for

Valuation of horse, \$ 100

Valuation of horse equipments, \$ 100

Remarks: unsteady
country dues

Book mark:

W. Harper

(35)

Copist.

65

6 Cav. U.S.C.T.

Wm. ...
Corpl, Co. B, 6 Reg't U. S. Col'd Cavalry.

Appears on

Company Muster Roll

for *Sept & Oct*, 1865.

Present or absent *present*

Stoppage, \$ *100* for

Due Gov't, \$ *100* for

Valuation of horse, \$ *100*

Valuation of horse equipments, \$ *100*

Remarks: *Appointed*
Corpl from Private
per R. O. No. 95
Sept, 1865.

Book mark:

J. L. Harper
Copyist.

(558)

ORIGINAL

P | **6 Cav. U.S.C.T.**

Alexander Logree
Co. B, Co. B, 6 Reg't U. S. Col'd Cavalry.

Appears on

Company Muster Roll

for *Nov. & Dec,*, 186*5*.

Present or absent *Present*

Stoppage, \$ *100* for

Due Gov't, \$ *100* for

Valuation of horse, \$ *100*

Valuation of horse equipments, \$ *100*

Remarks: _____

Book mark: _____

(358) *J. W. Ames* *Compt.*

P | **6 Cav. | U.S.C.T.**

Alexander Page
Capt., Co. B, 6 Reg't U. S. Col'd Cavalry.

Appears on

Company Muster Roll

for *June & July*, 1866.

Present or absent *Present*

Stoppage, \$ *100* for

Due Gov't, \$ *100* for

Valuation of horse, \$ *100*

Valuation of horse equipments, \$ *100*

Remarks:

Filed with Paym. Alexander

Book mark:

(358)

J. W. Jones
Copyist.

P

6 Cav. U.S.C.T.

Alexander C. C. C. C.
Capl., Co. *B*, 6 Reg't U. S. Col'd Cavalry.

Appears on **Co. Muster-out Roll**, dated
De Valls Bluff Ark, Apr. 15, 1866.
Muster-out to date *Apr. 15, 1866.*
Last paid to *Feb. 24, 1865.*

Clothing account:

Last settled....., 186 ; drawn since \$..... 100

Due soldier \$..... 100; due U. S. \$..... 100

Am't for cloth'g in kind or money adv'd \$ *2 20* 100

Due U. S. for arms, equipments, &c., \$ *1* 100

Bounty paid \$ *100* 100; due \$ *100* 100

Remarks:

Private from Org. to Sept. 1/65 then Corp.

Book mark:

(261)

J. W. Jones

Copyist.

1869
Fogues Charles.

Co F., 6 U. S. Col'd Cav.

Private

Private

CARD NUMBERS.

1	5392556	26
2	5392630	27
3	5392715	28
4	5392828	29
5	5393205	30
6	9092420	31
7	43150531	32
8	40732725	33
9		34
10		35
11		36
12		37
13		38
14		39
15		40
16		41
17		42
18		43
19		44
20		45
21		46
22		47
23		48
24		49
25		50

Book Mark: 4992881

See also

S-95-8348. Po aff
S-95-9385--Po. Rev.

DB Jordan
(4)

D

6 Cav. U.S.C.T.

Charles Poque

Co. F, 6 Reg't U. S. Col'd Cav.

Appears on

Company Descriptive Book

of the organization named above.

DESCRIPTION.

Age 21 years; height 5 feet 5 inches.

Complexion Black

Eyes Black; hair Black

Where born Knox, Ky.

Occupation Farmer

ENLISTMENT.

When Jan 4, 1865

Where Camp Nelson

By whom C. Randolph term 3 yrs.

Remarks: Mustered in Jan 4 65 Lexington Ky Capt. Moore. Discharged Aug 17 1865. Final statements given - was indebted to M. J. Willis Sutter at date of discharge \$1.00 wishes to be addressed at Garboursville Knox Co. Ky.

D. W. With

1865
1865

Thomas Payne

Appears with rank of Pvt on

Muster and Descriptive Roll

of Detachment of U.S. Colored Volunteers
forwarded to Camp Nelson.

Roll dated
Lexington Ky, Jan 9, 1865.

Where born Shroveton Ky

Age 21 years; occupation Farmer

When enlisted Jan 3, 1865.

Where enlisted Camp Nelson

For what period enlisted 3 years.

Eyes Blk; hair Blk

Complexion Blk; height 5 ft. 5 in.

When mustered in Jan 9, 1865.

Where mustered in Lexington

Bounty paid \$ 100; due \$ 100

Clothing account:

Last settled _____, 1865; drawn since \$ 100

Date of first muster Jan 9, 1865.

Company to which assigned _____

Remarks: Ordinary, 5' 8" H. 130 lbs. 3" W. 14y
James Payne, owner

Book mark :

Amal

(356m)

Copyist.

D **6 Cav. U.S.C.T.**

Charles Fogue
D, Co. *F*, 6 Reg't U. S. Col'd Cavalry.

Appears on

Company Muster-in and Descriptive Roll
of the organization named above. Roll dated

Lexington Ky, N. Y. Jan 24, 1865.

Where born *Kemp Ky*

Age *21* y'rs; occupation *Farmer*

When enlisted *Jan 4*, 1865.

Where enlisted *Camp Nelson Ky*

For what period enlisted *3* years.

Eyes *Blk*; hair *Blk*

Complexion *Blk*; height *5* ft. *5* in.

When mustered in *Jan 9*, 1865.

Where mustered in *Lexington Ky*

Bounty paid \$ *100*; due \$ *100*

Where credited *to dest Ky*

Company to which assigned

Remarks:

Book mark:

Breger

(356d)

Copyist.

D 6 Cav. U.S.C.T.

Charles Pogue
P, Co. F, 6 Reg't U.S. Col'd Cavalry.

Appears on

Company Muster Roll

for *Jan 24 to Apr 30*, 186*5*.

Present or absent *Present*

Stoppage, \$ *100* for

Due Gov't, \$ *100* for

Valuation of horse, \$ *100*

Valuation of horse equipments, \$ *100*

Remarks:

Book mark:

Breyer
(358) *Breyer* Copyist.

D of *War* U.S.C.T

Charles Foy
M, Co. *H*, 4 Reg't U. S. Col'd *1st*

Appears on

Company Muster Roll

for *May & June*, 186*5*.

Present or absent *Present*

Stoppage, \$ *100* for

Due Gov't, \$ *100* for

Valuation of horse, \$ *100*

Valuation of horse equipments, \$ *100*

Remarks: *See Gen'l O. 79 also for
ordnance*

Book mark :

(358)

Bryer

Copyist.

D

6 Cav. U.S.C.T.

Charles Pogue

Prv Co. F, 6 Reg't U. S. Col'd Cavalry.

Appears on

Company Muster Roll

for *July + Aug* 186 *5*.

Present or absent

Stoppage, \$ 100 for

Due Gov't, \$ 100 for

Valuation of horse, \$ 100

Valuation of horse equipments, \$ 100

Remarks: ~~*Capt. Aug. 1765*~~ ~~*Prv. S.O. Aug 1765*~~ *1st inst of bounty due. Due Govt. 79¢ for Ord. Discharged on Surgeons cert. of Disability Aug 1765*

x
as on roll

Book mark:

(358) *J. E. Chapin* Copyist.

P | **6 Cav.** | **U.S.C.T.**

Charles Poque
Put, Co. *A*, 6 Reg't U. S. Col'd Cav.

Appears on Returns as follows:

July 1865, Absent sick
in U.S. Genl Hospital at
Camp Nelson Ky.
July 25/65;

Aug 1865, Loss, Aug 17/65;
Lexington Ky, Discharged
on Surgeons certificate
of disability.

Book mark :

(546)

G. W. Hoar

Copyist.

SP

6 Cav. U.S.C.T.

Charles Poque

Pvt, Co. *F*, 6 Reg't U. S. Col'd Cavalry.

Appears on **Co. Muster-out Roll**, dated

Durwalls Bluff, Ark, Apr 15, 1866.

Muster-out to date _____, 186 .

Last paid to *June 30, 1865.*

Clothing account:

Last settled _____, 186 ; drawn since \$ _____ 100

Due soldier \$ _____ 100; due U. S. \$ _____ 100

Am't for cloth'g in kind or money adv'd \$ _____ 100

Due U. S. for arms, equipments, &c., \$ _____ 100

Bounty paid \$ *100* 100; due \$ _____ 100

Remarks: *Discharged at
Camp Nelson, Ky. Aug
17/65 per Surg. Certif. of
Disability.*

Book mark: *499228*

H. A. Smith

(861)

Copyist.

Pogue, Charles

P. J., Co.

6

Reg't U.S.C. Cav.

Enclosures.

Bed Cards

Burial Records

Certs. of Dis. for Discharge

C. M. Charges

Med. Certificates

Descriptive Lists

Final Statements

Furloughs

Med. Des. Lists

Orders

EP

Other papers relating to—

Admission to Hosp'l

Casualty Sheet (Officer's)

Confinement

Contracts

Death or Effects

Desertions

Discharge from Hosp'l

Discharge from Service

Duty

Furlough

Med. Examination

Misc. Information

Pay or Clothing

Personal Reports

Rank

Transfer to Hosp'l

Transfer to V. R. C.

Transportation

MAR 11 1950
MICROFILM PUBLICATION M 1822

COMPILED MILITARY SERVICE RECORDS
OF VOLUNTEER UNION SOLDIERS WHO
SERVED WITH THE USCT (US COLORED TROOPS)
5TH MASSACHUSETTS REGIMENT OF CAVALRY

PERSONAL PAPERS' TARGET SHEET

PLEASE NOTE THE CHECKED INFORMATION ABOUT THE PERSONAL PAPERS IN
THIS FILE:



NO PERSONAL PAPERS WERE FOUND IN THIS FILE WHEN THE
RECORDS WERE ARRANGED FOR MICROFILMING.



3 PERSONAL PAPER(S) FOUND IN THIS FILE WHEN THE RECORDS
WERE ARRANGED FOR MICROFILMING.

NOTE 1.—This blank will be used for enlistments of United States colored troops. They will be made out in duplicate in all cases—one to accompany the recruiting turn of the superintendent (not the recruiting officer) to the Adjutant General, and one to accompany the accounts of the officer who pays bounty, &c.

NOTE 2.—An enlistment holds to service. A muster-in must, in all cases, precede payment of pay, bounty, pension, &c. A muster-in roll, must in all cases, be filed in the Adjutant General's Office as evidence of muster-in. The mustering officer, commissary, or assistant commissary of musters, as the case may be, will countersign both enlistments as having mustered the soldiers into the service of the United States before either of them is given to the disbursing officer.

DECLARATION OF RECRUIT.

I, Charles Pogue desiring to volunteer as a soldier in the ARMY OF THE UNITED STATES, for the term of Three Years, DO DECLARE That I am 21 years and months of age; that I have never been discharged from the United States service on account of disability or by sentence of a court-martial, or by order before the expiration of a term of enlistment; and I know of no impediment to my serving honestly and faithfully as a soldier for three years.

GIVEN at Camp Nelson the 4th day of Jan 1865

Witness:

J. M. Dickerson

Charles Pogue
No. 1177
Enlisted at Camp Nelson
Jan 4 1865
By James Pogue
Adj. Mustering

Consent of Parent or Guardian in case of a Minor, if a Free Man, or in the case of a Slave, of the Person to whom he owes Service:

I, Do CERTIFY, That I am the

that the said is years of age; and I do freely give my CONSENT to his volunteering as a SOLDIER in the Army of the United States, for the period of THREE YEARS, under the conditions of the laws of the United States.

GIVEN at the day of

Witness:

James Pogue

Credited To Knox Co & Dist
UNITED STATES COLORED TROOPS ENLISTMENT

STATE OF *Kentucky* TOWN OF *County of Jessamine*

I, *Charles Dagne* born in *Knox Co*
in the State of *Kentucky* aged *Twenty one* years

and by occupation a *Farmer* Do HEREBY ACKNOWLEDGE to
have volunteered *Fourth* day of *January* 186*2*
to serve as a **Soldier** in the **Army of the United States of America**, for the
period of **THREE YEARS**, unless sooner discharged by proper authority: Do
also agree to accept such bounty, pay, rations, and clothing, as are, or may be,
established by law for the U. S. colored troops.

And I, *Charles Dagne*
do solemnly swear that I will bear true faith and allegiance to the **United States
of America**, and that I will serve them honestly and faithfully against all their
enemies or opposers whomsoever; and that I will observe and obey the orders
of the President of the United States, and the orders of the officers appointed
over me, according to the Rules and Articles of War.

Sworn and subscribed to, at *Camp Nelson* this *4th* day of *Jan 1862*
Charles Dagne
Before *Joseph*

I CERTIFY, ON HONOR, That I have carefully examined the above named Volunteer agree-
ably to the General Regulations of the Army, and that, in my opinion, he is free from all bodily
defects and mental infirmity, which would in any way disqualify him from performing the
duties of a soldier.

C. H. Riley
Capt. Surg W. C. Carr EXAMINING SURGEON.

I CERTIFY, ON HONOR, That I have minutely inspected the Volunteer, *Charles Dagne*
previously to his enlistment, and that he was entirely sober when enlisted; that, to the best of
my judgment and belief, he is of lawful age; and that, in accepting him as duly qualified to per-
form the duties of an able-bodied soldier, I have strictly observed the regulations which govern
the recruiting service. This soldier has *blue* eyes, *black* hair, *black* com-
plexion, is *five* feet *five* inches high.

Joseph
RECRUITING OFFICER OR AGENT.

Mustered into the United States Service *Jan 7 1862*
John W. Moore
Capt. P. W. Moore Mustering Officer.

Mustered into the service of the United States, for three years or during the war, from date of enlistment, in Company
 Regiment of
 Volunteers, on the
 day of
 186*2*, at

NOTE 1.—This blank will be used for enlistments of United States colored troops. They will be made out in duplicate in all cases—one to accompany the recruiting return of the superintendent (not the recruiting officer) to the Adjutant General, and one to accompany the accounts of the officer who pays bounty, &c.

NOTE 2.—An enlistment holds to service. A muster-in must, in all cases, precede payment of pay, bounty, pension, &c. A muster-in roll, must in all cases, be filed in the Adjutant General's Office as evidence of muster-in. The mustering officer, commissary, or assistant commissary of musters, as the case may be, will countersign both enlistments as having mustered the soldiers into the service of the United States before either of them is given to the disbursing officer.

DECLARATION OF RECRUIT.

I, Charles Payne, desiring to volunteer as a soldier in the ARMY OF THE UNITED STATES, for the term of Three Years, DO DECLARE That I am 21 years and months of age; that I have never been discharged from the United States service on account of disability or by sentence of a court-martial, or by order before the expiration of a term of enlistment; and I know of no impediment to my serving honestly and faithfully as a soldier for three years.

GIVEN at Camp Nelson the 4th day of Jan 1865

Witness:

J. M. Dickerson

Charles Payne
By mark

James P. Payne

By

18



Consent of Parent or Guardian in case of a Minor, or of the owner of the said child or a Slave, of the Person to whom he owes Service:

I, Do CERTIFY, That I am the that the said is years of age; and I do freely give my CONSENT to his volunteering as a SOLDIER in the Army of the United States, for the period of THREE YEARS, under the conditions of the laws of the United States.

GIVEN at

the day of

Witness

Credited to Knox Ser 8th Dy
UNITED STATES COLORED TROOPS ENLISTMENT.

STATE OF

TOWN OF

Kentucky

County of Jessamine

I, *Charles Pogue*, born in *Knox Co*
in the State of *Kentucky* aged *Seventy ones* years
and by occupation a *Farmer* Do HEREBY ACKNOWLEDGE to
have volunteered *Fourth* day of *January* 186*5*

to serve as a **Soldier** in the **Army of the United States of America**, for the
period of **THREE YEARS**, unless sooner discharged by proper authority: Do
also agree to accept such bounty, pay, rations, and clothing, as are, or may be,
established by law for the U. S. colored troops.

And I, *Charles Pogue*,
do solemnly swear that I will bear true faith and allegiance to the **United States
of America**; and that I will serve them honestly and faithfully against all their
enemies or opposers whomsoever; and that I will observe and obey the orders
of the President of the United States, and the orders of the officers appointed
over me, according to the Rules and Articles of War.

Sworn and subscribed to, at *Camp Nelson*
this *4th* day of *Jan* 186*5* by *Charles Pogue*
Before *J. H. Randolph*

I CERTIFY, ON HONOR, That I have carefully examined the above named Volunteer agree-
ably to the General Regulations of the Army, and that, in my opinion, he is free from all bodily
duties or a ~~total~~ infirmity, which

C. H. Riley

EXAMINING SURGEON.

I CERTIFY, ON HONOR, That I have minutely inspected the Volunteer *C. Pogue*,
previously to his enlistment, and that he was entirely sober when enlisting. In my
my judgment and belief, he is of law mind; and in accepting him as an Volunteer I per-
form the duties of an able bodied soldier. I have minutely observed *his* great *well* with
the recruiting service. This soldier has *blue* eyes, *well* hair, *well* com-
plexion, is *five* feet *five* inches high.

J. H. Randolph
J. H. Randolph

RECRUITING OFFICER OR AGENT.

Mustered into the United States Service *4th* day of *Jan* 186*5*

Capt. P. W. Moore
P. W. Moore
Mustered into

Mustered into the service of the United States, for three years or during the war, from date of enlistment, in Company
Regiment of Volunteers, on the day of 1865, at

NOTE 1.

The company commander will here add a statement of all the facts known to him concerning the disease or wound, or cause of disability of the soldier; the time, place, manner, and all the circumstances under which the injury occurred, or disease originated or appeared; the duty, or service, or situation of the soldier at the time the injury was received or disease contracted, stating particularly whether the injury was received or the disease contracted in the line of his duty; and whatever other facts may aid a judgment as to the cause, immediate or remote, of the disability, and the circumstances attending it.

When the facts are not known to the company commander, the certificate of any officer, or affidavit of other person having such knowledge, will be appended—as the surgeon in charge of a hospital, the officer commanding a detachment of recruits, &c., &c.

NOTE 2.

When a probable case for pension, special care must be taken to state the degree of disability—as $\frac{1}{2}$, $\frac{3}{4}$, &c., &c.; to describe particularly the disability, wound, or disease; the extent of which it deprives him of the use of any limb or faculty, or affects his health, strength, activity, constitution, or capacity to labor or earn his subsistence. The surgeon will add, from his knowledge of the facts and circumstances, and from the evidence in the case, his professional opinion of the cause or origin of the disability. In the case of discharges by Medical Inspectors, the last paragraph will state that the "discharge was given by consent of the soldier, after a personal examination, and for disability, the nature, degree, and origin of which are correctly described in the within certificate."

Par. 1260 Regulations, Edit. 1861.

Medical officers, in giving certificates of disability, are to take particular care in all cases that have not been under their charge; and especially in epilepsy, convulsions, chronic rheumatism, derangement of the urinary organs, ophthalmia, ulcers, or any obscure disease liable to be feigned or purposely produced; and in no case shall such certificate be given until after sufficient time and examination to detect any attempt at deception.

DIRECTIONS.

This certificate will be made out in duplicate by the soldier's company commander, or other officer commanding the separate detachment to which he belongs, and sent by him to the surgeon who has charge of the hospital where the soldier is sick. The surgeon will then fill out and sign the surgeon's certificate, and forward these papers to the regimental, detachment, or post commander, who will forward them, with his action endorsed thereon, through the proper channel, to his division commander; or, if the troops are not attached to a division, to his corps, department, or other commander or officer to whom the authority to discharge enlisted men may be specially delegated.

These certificates, after having received the action of the highest authority to which they are required to be sent, will be returned through the same channel to the regimental, post, or detachment commander, who will, if the discharge is authorized by the endorsement of the proper authority, sign the soldier's discharge, and the last certificate on this paper; see that the soldier is furnished with the proper final statements in duplicate, and forward BOTH of these certificates direct to the Adjutant General United States Army, at Washington, D. C.; they will not, under any circumstances, be given into the hands of the soldier.

ADJUTANT GENERAL'S OFFICE

Aug 29 1865

Duplicate sent the Pension Office.

CERTIFICATE OF DISABILITY FOR DISCHARGE

IN THE CASE OF

1165 12
No 1193
Charles Pogue
a private Co. F
Sixth Reg't of U.S.C. Co

Headquarters U.S.C. Co.
Camp Nelson, Ky.
July 22 1865

Respectfully forwarded.
Approved: Discharge
recommended.

J. Hoats

St. Col. C. W. Claiborne

Head Quarters, 1st Div. Dept of Ky.
Lexington July 31 1865

Approved and respectfully
forwarded -

C. F. Wade
Capt. Brig. Genl.
Comd'g Div.

Received (A. G. Office) 186

Em on Rof Cas

ARMY OF THE UNITED STATES
 CERTIFICATE
 OF DISABILITY FOR DISCHARGE.

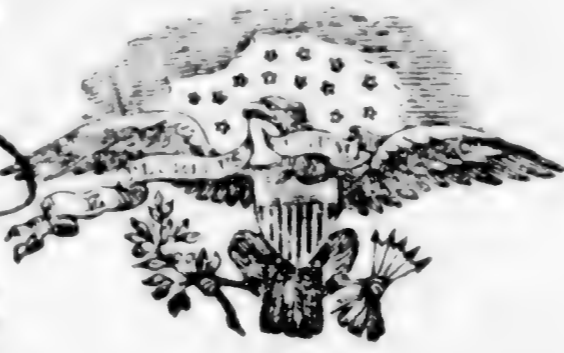

Ed. Coates Capt. 1st Regt. 1st Div. 1865
W. J. Sullivan
121st. Co. 1st Regt. 1st Div. 1865

Charles Pogue a *Private* of Captain *Daniel Coates* Company, (*Co.*) of the *Sixth* Regiment of the United States was enlisted by *J. C. Randolph & Bro. Marshal* of the *121st* Regiment of *Co.* at *Camp Nelson Ky* on the *14th* day of *January*, 1865, to serve *Three* years; he was born in *Franklin* in the State of *Kentucky*, is *Twenty-one (21)* years of age, *5* feet *5* inches high, *Black* complexion, *Black* eyes, *Black* hair, and by occupation when enlisted a *Farmer*. During the last two months said soldier has been unfit for duty *60* days.

Said Char. Pogue had been troubled with a weakness in his eyes - until about the 27th of April, 65 - when they commenced swelling since that time he has had little use of them.

STATION: *Camp Nelson Ky*
 DATE: *July 22nd 1865*

Daniel Coates
 Captain
 Commanding Company.

I CERTIFY, that I have carefully examined the said *Charles Pogue a Private* of Captain *Daniel Coates* Company, and find him incapable of performing the duties of a soldier because of *Retrusion of the upper lid of left eye occasioned by an injury received previous to his enlistment - The man never had physical ability sufficient to enable him to perform the duties of a soldier and his enlistment was improper - As a soldier he is utterly worthless*

John Ridgey
 Surgeon. *22566*

DISCHARGED, this *Seventeenth* day of *August*, 1865, at *Lexington Ky.*

St. Col. B. S. Swan
 Commanding the Reg't

The Soldier desires to be addressed at
 Town *Parisville* County *Knox* State *Kentucky*

* See Note 1 on the back of this. † See Note 2 on the back of this.
 [A. G. O. No. 100 & 101 - First.] [DUPLICATES]

1079
Pope James.

Co., 6 U. S. Col'd Cav.

Private Private

CARD NUMBERS.

1	5387265	26
2		27
3		28
4		29
5		30
6		31
7		32
8		33
9		34
10		35
11		36
12		37
13		38
14		39
15		40
16		41
17		42
18		43
19		44
20		45
21		46
22		47
23		48
24		49
25		50

Book Mark:

See also

P | 6 Cav. | U.S.C.T.

James Pope

Appears with rank of Privt. on

Muster and Descriptive Roll of a Detachment of U. S. Vols. forwarded

for the 6 Reg't U. S. Col'd Cavalry. Roll dated

Lexington Ky. Jan. 14, 1865.

Where born Washington, Kentucky

Age 29 y'rs; occupation Farmer

When enlisted Sept. 17, 186 .

Where enlisted Cp. Nelson

For what period enlisted 3 years.

Eyes Blk; hair Blk

Complexion Blk; height 5 ft. 10 in.

When mustered in Sept. 17, 186 .

Where mustered in Cp. Nelson

Bounty paid \$ 100; due \$ 100

Where credited

Company to which assigned

Remarks: Henry Pope, Owner

Name not taken up on

Muster Roll of Regt.

Book mark:

C. E. McLaughlin

(339)

Copyist.

1071
Poplar Thomas,

Co. A., 6 U. S. Col'd Cav.

Private. Private

CARD NUMBERS.

1	5387641	26
2	5387696	27
3	5394099	28
4	5387757	29
5	5394183	30
6	5394264	31
7	5394359	32
8	5394438	33
9	5394527	34
10	5394601	35
11	5394722	36
12	5388111	37
13	9093638	38
14	40732726	39
15		40
16		41
17		42
18		43
19		44
20		45
21		46
22		47
23		48
24		49
25		50

Book Mark: EBV. 11 P. 60.

See also

25 Cav. U.S.C.T.

Thomas P. Star

, Co. H., 2 Reg't U. S. Col'd Cav.

Appears on

Company Descriptive Book

of the organization named above.

DESCRIPTION.

Age 17 years; height 5 feet 5 1/2 inches.

Complexion copper

Eyes black; hair black

Where born Russell, Ky.

Occupation Laborer

ENLISTMENT.

When Mar. 3, 1865.

Where Lebanon, Ky.

By whom Capt Fidler; term 1 y'rs.

Remarks:

Substitute -
Discharged Mar. 20 '66
Expiration of service.

Henry West

(383g)

Copyist.

P 6 U.S.C.T.

Thomas Poplar

Appears with rank of *Pvt* on

Muster and Descriptive Roll of a Detachment of Substitutes forwarded

for the *6* Reg't U. S. Col'd Cavalry. Roll dated *Draft Rendezvous Louisville Ky, Mch 15, 1865.*

Where born *Russell Kentucky*

Age *18* y'rs; occupation *Laborer.*

When enlisted _____, 186 .

Where enlisted *Substitute.*

For what period enlisted _____ *1* year.

Eyes *Black*; hair *Black*

Complexion *Copper*; height *5* ft. *5 1/2* in.

When mustered in *Mch 3*, 1865.

Where mustered in *Labanon*

Bounty paid \$ *100*; due \$ *100*

Where credited *4" Dist. Ky.*

Company to which assigned _____

Remarks: *Sub. for J. T. Williams*

Book mark : _____

(340c)

Conard
Copyist.

P

6

U.S.C.T.

Thomas Poplar

Appears with rank of *Pvt.* on

Muster and Descriptive Roll of a Detachment of Substitutes forwarded

for the *6* Reg't U. S. Col'd Cavalry. Roll dated *Draft Rendezvous, Louisville, Ky, Mch. 15*, 186*5*.

Where born *Russell, Kentucky*

Age *18* y'rs; occupation *Labourer*

When enlisted _____, 186 .

Where enlisted *Substitute*

For what period enlisted _____ *1* years.

Eyes *Black*; hair *Black*

Complexion *Copper*; height *5 ft. 5 1/2* in.

When mustered in *Mch. 3*, 186*4*.

Where mustered in *Lebanon*

Bounty paid \$ *100*; due \$ *100*

Where credited *4th Dist. Ky.*

Company to which assigned _____

Remarks: *Sub. for J. J. Williams*

Book mark: _____

(339c)

Conard

Copyist.

P

66av U. S. C. T.

Thomas Poplar
Pvt, Co. H. 6 Reg't U. S. Col'd Cavalry

Appears on

Company Muster-in and Descriptive Roll
of the organization named above. Roll dated
Lexington, Ky., Mch. 26, 1865.

Where born Russell, Kentucky

Age 18 y'rs; occupation Laborer.

When enlisted _____, 186 .

Where enlisted Substitute.

For what period enlisted _____ years.

Eyes Black; hair Black

Complexion Copper; height 5 ft. 5 1/2 in.

When mustered in Mar 3, 1865.

Where mustered in Lebanon, Ky.

Bounty paid \$ 100; due \$ 100

Where credited 4th Dist. Ky.

Company to which assigned H

Remarks: Sub. for J. F. Williams, in
Hospital

Book mark : _____

Conard

(356d)

Copyist.

P 6 Cav U.S.C.T.
Thomas Poplar

Appears with rank of on

Muster and Descriptive Roll of a Detachment of Substitutes forwarded

for the 6 Reg't U. S. Col'd Cav Roll dated

Lebanon Ky Mch 31, 1865.

Where born Russell Kentucky

Age 18 y'rs; occupation Laborer

When enlisted March 3, 1865.

Where enlisted Lebanon

For what period enlisted 1 year.

Eyes black; hair black

Complexion *leop*; height 5 ft. 5/2 in.

When mustered in March 3, 1865.

Where mustered in Lebanon

Bounty paid \$ 100; due \$ 100

Where credited

Company to which assigned

Remarks: J. F. Williams, Drafted
in Nelson Co., Ky.

Book mark:

(340b)

J. J. Giffith

Copyist.

P | **6 Cav. U.S.C.T.**

Thomas Poplar

Priv., Co. H, 6 Reg't U. S. Col'd Cavalry.

Appears on

Company Muster Roll

for *from Mch 16 to Apr. 30*, 1865.

Present or absent *Absent*

Stoppage, \$ *100* for

Due Gov't, \$ *100* for

Valuation of horse, \$ *100*

Valuation of horse equipments, \$ *100*

Remarks: *Sick in Camp Nelson
Genl. Hosp. since Mch. 27, 1865.*

Book mark:

(358)

Conard
Copyist.

P

6 Cav. U.S.C.T.

Thomas Poplar

Priv., Co. H, 6 Reg't U. S. Col'd Cavalry.

Appears on

Company Muster Roll

for May & June, 1865.

Present or absent Present.

Stoppage, \$ 100 for

Due Gov't, \$ 100 for

Valuation of horse, \$ 100

Valuation of horse equipments, \$ 100

Remarks:

Book mark:

(358)

Conard

Copyist.

6 Cav. U.S.C.T.

Thomas F. ...

Co., Co. H, 6 Reg't U. S. Col'd Cavalry.

Appears on

Company Muster Roll

for *June 5th*, 1865.

Present or absent *Present*.

Stoppage, \$ *100* for

Due Gov't, \$ *100* for

Valuation of horse, \$ *100*

Valuation of horse equipments, \$ *100*

Remarks:

Book mark:

(358)

Chas. ...

Copyist.

6 Cav. U.S.C.T.

Thomas P. ...

... Co. H, 6 Reg't U. S. Col'd Cavalry.

Appears on

Company Muster Roll

for *Sept & Oct*, 1865.

Present or absent *Present*

Stoppage, \$ 100 for

Due Gov't, \$ 100 for

Valuation of horse, \$ 100

Valuation of horse equipments, \$ 100

Remarks:

Book mark:

(358)

Thomas P. ...
Copyist.

6 Cav. U.S.C.T.

Thomas Taylor

Taylor, Co. H, 6 Reg't U. S. Col'd Cavalry.

Appears on

Company Muster Roll

for *Nov Dec*, 1865.

Present or absent *Present*.

Stoppage, \$ *100* for

Due Gov't, \$ *100* for

Valuation of horse, \$ *100*

Valuation of horse equipments, \$ *100*

Remarks:

Book mark:

(358)

Carroll

Copyist.

D | **6 Cav. | U.S.C.T.**

Thomas Poplar

Cpl., Co. H, 6 Reg't U. S. Col'd Cavalry.

Appears on

Company Muster Roll

for *Aug & Feb*, 186*6*

Present or absent *Present*

Stoppage, \$ *100* for

Due Gov't, \$ *0.30* for *ordnance*

& \$1.00 for O & G E.

Valuation of horse, \$ *100*

Valuation of horse equipments, \$ *100*

Remarks:

Book mark:

J. M. Harmon

(358)

Copyist.

P | *6000* | U.S.C.T.

Thomas Poplar
In, Co., *6* Reg't U. S. Col'd *Car*

Appears on a

Detachment Muster-out Roll

of the organization named above. Roll dated
Little Rock Ark, mch 19, 1866.

Muster-out to date *mch 19, 1866.*

Last paid to *Feb 28, 1866.*

Clothing account:

Last settled *Feb 28, 1866*; drawn since \$ *4 ²⁶/₁₀₀*

Due soldier \$ *100*; due U. S. \$ *100*

Am't for cloth'g in kind or money adv'd \$ *100*

Due U. S. for arms, equipments, &c., \$ *100*

Bounty paid \$ *100*; due \$ *100*

Remarks: *slave April 74 - 1861*

*Due U.S. for camp + Garrison Eq pay
1.60¢ for Ord. .60¢ - mustered out
to date mch 19 1866 under Circular
no. 41 from War Dept. 1864*

Book mark:

(349)

Holbrook

Copyist.

T | **6 Cav.** | **U.S.C.T.**

Thomas Poplar

Priv, Co. *A*, 6 Reg't U. S. Col'd Cav.

Appears on Returns as follows:

March & April 1865 present
sick at Camp Nelson
Genl Hospital since
March 15/65,

June 1866 On duty in
S & M Stables,

March 1866, Less, Mar 31/66
Little Rock Ark.
Disch'd in consequence
of expiration of service.

Book mark:

C. M. Roan

1077100

J **6 Cav. U.S.C.T.**

Thomas Poplar

Priv, Co. *A*, 6 Reg't U. S. Col'd Cavalry.

Appears on **Co. Muster-out Roll**, dated

Arvalls Bluff, Ark, April 15, 1866

Muster-out to date _____, 186 .

Last paid to _____, 186 .

Clothing account:

Last settled _____, 186 ; drawn since \$ _____ 100

Due soldier \$ _____ 100; due U. S. \$ _____ 100

Am't for cloth'g in kind or money adv'd \$ _____ 100

Due U. S. for arms, equipments, &c., \$ _____ 100

Bounty paid \$ _____ 100; due \$ _____ 100

Remarks: *Mustered out. Discharged*
at Ark 20/66, in consequence
of Exp. of service

Book mark *checked Mar. 19/66, S. A. U. S. Co.*

J. M. Harmon

(861)

Copyist.

1072

Porter Allison

Co., 6 U. S. Col'd Cav.

Private Private

CARD NUMBERS.

1	✓ 387785	26
2		27
3		28
4		29
5		30
6		31
7		32
8		33
9		34
10		35
11		36
12		37
12		38
14		39
15		40
16		41
17		42
18		43
19		44
20		45
21		46
22		47
23		48
24		49
25		50

Book Mark:

See also

P

6

U.S.C.T.

Allison Porter

Appears with rank of *Privat* on

Muster and Descriptive Roll of a Detachment of Substitutes forwarded

for the *6* Reg't U. S. Col'd *Artillery* Roll dated *March 4, 1865*
Miss.

Where born *Bedford Co., Tenn.*

Age *20* y'rs; occupation *Farmer*

When enlisted *Feb. 28*, 1865.

Where enlisted *Vicksburg, Miss.*

For what period enlisted *3* years.

Eyes *Blk*; hair *Blk*

Complexion *Blk*; height *5 ft. 6 1/2 in.*

When mustered in _____, 186 .

Where mustered in _____

Bounty paid \$ *100*; due \$ *100*

Where credited *On the quota of the State of New York,*
Chautauqua Co. 31 Long. Dist. Town of Schenwright.
Company to which assigned _____

Remarks: _____

*Sum not taken up on
muster Roll of Regt.*

Book mark: _____

Conard

(339c)

Copyist.

1073
Porter Thomas.

Co *D*, 6 U. S. Col'd Cav.

Private | *Private*

CARD NUMBERS.

1	5389273	26
2	5389378	27
3	5388131	28
4	5390082	29
5	9092924	30
6	40732727	31
7		32
8		33
9		34
10		35
11		36
12		37
12		38
14		39
15		40
16		41
17		42
18		43
19		44
20		45
21		46
22		47
23		48
24		49
25		50

Book Mark:

See also *6115 U.S.C.I.*

P | **6 Cav. | U.S.C.T.**

Thomas Foster

....., Co. *B*, 6 Reg't U. S. Col'd Cav.

Appears on

Company Descriptive Book

of the organization named above.

DESCRIPTION.

Age *18* years; height *5* feet *7 1/2* inches.

Complexion *Blk*

Eyes *Blk*; hair *Blk*

Where born *Allen Ky*

Occupation *Farmer*

ENLISTMENT.

When *July 31*, 18*64*.

Where *Bowling Green Ky*

By whom *Capt Hobson*; term *3* y'rs.

Remarks: *Deserted at Bowling Green Ky Sept 1, 1864*

Breyer

(383g)

Copyist.

Sp 6 Cav. U.S.C.T.

Thomas Porter

Privt., Co. *B*, 6 Reg't U. S. Col'd Cavalry.

Appears on

Company Muster-in and Descriptive Roll

of the organization named above. Roll dated

Camp Nelson Ky, Nov. 1st, 1864.

Where born *Allen Co. Ky*

Age *18* y'rs; occupation *Farmer*

When enlisted *July 31*, 1864.

Where enlisted *Bowling Green, Ky.*

For what period enlisted *3* years.

Eyes *Blk*; hair *Blk*

Complexion *Blk*; height *5* ft. *10* in.

When mustered in *July 31*, 1864.

Where mustered in *Bowling Green Ky*

Bounty paid \$ *100*; due \$ *100*

Where credited *3 Dist. Ky.*

Company to which assigned

Remarks: *Transferred from Co. C*

115th U.S. Col. Inf. No 39. dated

Washington D. C. June 10/65.

signed L. Thomas Adj.

(over)

Book mark:

C. M. Rowe

JAN. 10

5389273

1891

*Owner,
Amich Porter,*

P 6 Cav. U.S.C.T.

Thomas Porter

Privat, Co. B, 6 Reg't U. S. Col'd Cavalry.

Appears on

Company Muster Roll

for *Nov, & Dec,*, 1864.

Present or absent

Stoppage, \$ *100* for

Due Gov't, \$ *100* for

Valuation of horse, \$ *100*

Valuation of horse equipments, \$ *100*

Remarks: *Deserted at Bowling Green Ky. Sept 1st 1864.*

Book mark:

G. M. Row

(358)

Copist.

J. Clew | **U.S.C.T.**

Thomas Porter
Priv., Co. B, 6 Reg't U. S. Col'd

Appears on

Descriptive List of Deserters

dated *November 30*, 186*4*.

Deserted:

When *Sept. 1*, 186*4*.

Where *Bowling Green Ky*

Arrested:

When _____, 186 .

Where _____

Remarks: *Probably to be found at Bowling Green Ky.*

Book mark: _____

(351)

J. Clew

Copist.

P | 6 Cav. | U.S.C.T.

Thomas Porter
Priv., Co. B., 6 Reg't U. S. Col'd Cav.

Appears on Returns as follows:

Nov 1864. Lost. Sept 1. 64,
Bowling Green Ky.
Deserted.

Book mark : _____

(546)

G. M. Row

Copyist.

10 | 6 Co | **U. S. C. T.**

Thomas Foster

A., Co. *B.*, 6 Reg't U. S. Col'd Cavalry

Appears on **Co. Muster-out Roll**, dated

DeValls Bluff Ark, Apr, 15, 1866.

Muster-out to date _____, 186 .

Last paid to *Pay due from Enlist.*, _____, 186 .

Clothing account:

Last settled _____, 186 ; drawn since \$ _____ 100

Due soldier \$ _____ 100; due U. S. \$ _____ 100

Am't for cloth'g in kind or money adv'd \$ _____ 100

Due U. S. for arms, equipments, &c., \$ _____ 100

Bounty paid \$ _____ 100 due \$ _____ 100

Remarks:

*Discharged Sept 1864 at
Bowling Green Ky.*

Book mark:

(361) *J. W. Thomas* Copyist.

1074
Posey George.

Co A., 6 U. S. Col'd Cav.

Private

Private

CARD NUMBERS.

1	5387980	26
2	5388806	27
3	5388899	28
4	5388988	29
5	5389076	30
6	5389163	31
7	4092816	32
8	40732728	33
9		34
10		35
11		36
12		37
13		38
14		39
15		40
16		41
17		42
18		43
19		44
20		45
21		46
22		47
23		48
24		49
25		50

Book Mark:

See also

170 U.S.C.I.

D. 2294648 POKET.
O 2300 842 PINE
AY. 1660947
D. 3094191 POKET.

D. Jordan
Q

P | **6 Cav. | U.S.C.T.**

George Posey

....., Co. *A*, 6 Reg't U. S. Col'd Cav.

Appears on

Company Descriptive Book

of the organization named above.

DESCRIPTION.

Age *21* years; height *5* feet *7* inches.

Complexion *Blk*

Eyes *Blk*; hair *Blk*

Where born *Clark Ky*

Occupation *farmer*

ENLISTMENT.

When *May 23*, 186*5*.

Where *Henderson*

By whom *Cpt Bellings*; term *3* y'rs.

Remarks: *Mustered June 9, 65*

Posey

(383g)

Copyist.

P. C. Co. Cav U.S.C.T.
George Posey
Pvt. Co. , 6 Reg't U. S. Col'd Cav

Appears on a

Detachment Muster Roll

unassigned recruits
of the organization named above

for *June 10 to 30*, 1865.

Station *Camp Nelson Ky*

Present or absent *Present*

Stoppage, \$ *100* for

Due Gov't, \$ *100* for

Valuation of horse, \$ *100*

Valuation of horse equipments, \$ *100*

Remarks: *Transferred from 120 reg't
1st Kentucky
Transferred per S.O. No. 115 dated 1st
grade Ky June 10 - 1865*

Book mark:

(357)

L. B. Sawyer
Copyist.

7 | **6 Cav. | U.S.C.T.**

George Percy

iii, Co. A, 6 Reg't U. S. Col'd Cavalry.

Appears on

Company Muster Roll

for *July 1st 1861*, 186*1*.

Present or absent *Present*

Stoppage, \$ *100* for

Due Gov't, \$ *100* for

Valuation of horse, \$ *100*

Valuation of horse equipments, \$ *100*

Remarks: *Transferred from
120 U.S.C.T. per Special
Order No. 105 Dated 11th
Sept. 1861*

Book mark:

(358)

Joseph Stewart

Copyist.

S | **6 Cav.** | **U.S.C.T.**

George Posey
Pvt, Co. A, 6 Reg't U. S. Col'd Cavalry.

Appears on

Company Muster Roll

for *Sep & Oct*, 186*5*.

Present or absent *Present*

Stoppage, \$ 100 for

Due Gov't, \$ 100 for

Valuation of horse, \$ 100

Valuation of horse equipments, \$ 100

Remarks:

Book mark:

Joseph Stewart
(358) Copyist.

P 6 Cav. U.S.C.T.

George Poser
Plt, Co. A, 6 Reg't U. S. Col'd Cavalry.

Appears on

Company Muster Roll

for *Nov + Dec*, 1865.

Present or absent *Present*

Stoppage, \$ *100* for

Due Gov't, \$ *60* for *Ordinance*

Valuation of horse, \$ *100*

Valuation of horse equipments, \$ *100*

Remarks:

Book mark:

R. S. Shelton

(358)

Copyist.

P

6 Cav. U.S.C.T.

George Posey

Pvt, Co. A, 6 Reg't U. S. Col'd Cavalry.

Appears on

Company Muster Roll

for Jan & Feb, 1866.

Present or absent Present

Stoppage, \$ 100 for

Due Gov't, \$ 60 100 for Ordnance

Valuation of horse, \$ 100

Valuation of horse equipments, \$ 100

Remarks:

Book mark:

R. S. Shelton

(358)

Copyist.

P | 6 Cav. | U.S.C.T.

George Posey
Pot Co. A. 6 Reg't U. S. Col'd Cav.

Appears on Returns as follows:

July 1865, Gain July 15/65
Camp Nelson Ky.
Joined by transfer from
120th U.S. Col Inf. per
Order No 105, dated
Hq 2d. Dept Ky,
June 15/65,

July 1866, On Extra or
Daily duty.

Book mark:

G M Row

(546)

Copyist.

P | **6 Cav. U.S.C.T.**

George Porley
Priv, Co. *A*, 6 Reg't U. S. Col'd Cavalry.

Appears on **Co. Muster-out Roll**, dated
Dunalls Bluff Ark. April 15, 1866.

Muster-out to date *April 15, 1866.*

Last paid to *Feb 28 1866.*

Clothing account:

Last settled....., 186 ; drawn since \$..... 100

Due soldier \$..... 100; due U. S. \$ *33* ^{*45*}/₁₀₀

Am't for cloth'g in kind or money adv'd \$..... 100

Due U. S. for arms, equipments, &c., \$..... 100

Bounty paid \$..... 100; due \$..... 100

Remarks:

Book mark:

R S Shelton

(861)

Copyist.

1075
Patter Calvin

Co D., 6 U. S. Col'd Cav.

Private Private

CARD NUMBERS.

1	5389265	26
2	5389339	27
3	5389429	28
4	5389500	29
5	5389567	30
6	5389655	31
7	5389752	32
8	5389844	33
9	5389934	34
10	5390027	35
11	9092915	36
12	40902874	37
13	40732734	38
14	32109860	39
15	40732731	40
16		41
17		42
18		43
19		44
20		45
21		46
22		47
23		48
24		49
25		50

Book Mark: 273. 448.

See also

P | **6 Cav.** | **U.S.C.T.**

Calvin Potter

....., Co B....., 6 Reg't U. S. Col'd Cav.

Appears on

Company Descriptive Book

of the organization named above.

DESCRIPTION.

Age 18 years; height 5 feet 5 inches.

Complexion Yellow

Eyes Brown; hair Black

Where born Warren Ky

Occupation Farmer

ENLISTMENT.

When July 30....., 1864.

Where Bowling Green Ky

By whom Capt. Weston; term 3 y'rs.

Remarks:

.....

.....

.....

.....

.....

.....

.....

.....

.....

.....

.....

.....

.....

.....

.....

.....

.....

.....

.....

.....

.....

.....

.....

.....

.....

.....

.....

.....

.....

.....

.....

.....

.....

(383g)

Bryce

Copyist.

Op 6 Cav. U.S.C.T.

Calvin Porter

Private, Co. *B*, 6 Reg't U. S. Col'd Cavalry.

Appears on

Company Muster-in and Descriptive Roll

of the organization named above. Roll dated

Camp Nelson Ky, Nov, 1st, 1864.

Where born *Nashville Ky.*

Age *18* y'rs; occupation *Farmer*

When enlisted *July 30th*, 1864.

Where enlisted *Bowling Green Ky.*

For what period enlisted *3* years.

Eyes *Brown*; hair *Blk*

Complexion *Yellow*; height *5* ft. *5* in.

When mustered in *July 30th*, 1864.

Where mustered in *Bowling Green Ky.*

Bounty paid \$ *100*; due \$ *100*

Where credited *3rd Dist of Ky.*

Company to which assigned *B.*

Remarks: *Transferred from Co. C*

115, U.S.C.T., per S.O. No 39 dated

Washington D.C. June 10/65,

signed L. Thomas A. G.

Book mark:

C. Moore

JAN. 10

5389265

1891

Owner
Henry Potter.

P 6 Cav. U.S.C.T.

Calvin Potter
Privt, Co. B, 6 Reg't U. S. Col'd Cavalry.

Appears on

Company Muster Roll

for *Nov & Dec*, 1864.

Present or absent *present*

Stoppage, \$ *100* for

Due Gov't, \$ *100* for

Valuation of horse, \$ *100*

Valuation of horse equipments, \$ *100*

Remarks: *Due US for Out \$21.90*

Book mark:

L. M. Moore

(358)

Copist.

P | **6 Cav. U.S.C.T.**

Calvin Potter

Pvt, Co. B, 6 Reg't U. S. Col'd Cavalry.

Appears on

Company Muster Roll

for *Jan & Feb*, 1865.

Present or absent *Absent*

Stoppage, \$ *100* for

Due Gov't, \$ *100* for

Valuation of horse, \$ *100*

Valuation of horse equipments, \$ *100*

Remarks: *Due U.S. for Oct \$21.90
1st installment bounty due \$100,
Det'd N. Haven, Ky July 13, 1865*

Book mark: _____

G M Row

(358)

Copyist.

P 6 Cav. U.S.C.T.

Calvin Potter

Private, Co. B, 6 Reg't U. S. Col'd Cavalry.

Appears on

Company Muster Roll

for March Report, 1865.

Present or absent Absent

Stoppage, \$ 100 for

Due Gov't, \$ 100 for

Valuation of horse, \$ 100

Valuation of horse equipments, \$ 100

Remarks: 1st installment bounty due \$100, due U.S. for Ord \$21.90, Det. ser. New Haven Ky, Feb. 15.

Book mark:

A. M. Moore

1 May 1867

Salmon C. Carter
Co., Co., Reg't *U.S.A.*

Appears on

Hospital Muster Roll

of Corps d'Afrique U. S. A. General Hospital,

at New Albany, Ind.,

for *March*, 186*7*.

Attached to hospital :

When _____, 186*7*.

How employed _____

Last paid by Maj. _____

to _____, 186*7*.

Bounty paid \$ 100 ; due \$ 100

Present or absent *Present*

Remarks : _____

Book mark : _____

R | **6 Cav. | U.S.C.T.**

Calvin Potter

Priv., Co. B, 6 Reg't U. S. Col'd Cavalry.

Appears on

Company Muster Roll

for *May & June*, 1865.

Present or absent *absent*

Stoppage, \$ *100* for

Due Gov't, \$ *100* for

Valuation of horse, \$ *100*

Valuation of horse equipments, \$ *100*

Remarks: *Sick in Hosp
New Albany Ind
Apt 15, 1865
Descript list
furnished.*

Book mark:

D. S. Harper
Copyist.

6 Cav. U.S.C.T.

Calvin *Abner*
et, Co. B, 6 Reg't U. S. Col'd Cavalry.

Appears on

Company Muster Roll

for *July Aug*, 1865.

Present or absent *present*

Stoppage, \$ *100* for

Due Gov't, \$ *21⁹⁰* 100 for *ord*

Valuation of horse, \$ *100*

Valuation of horse equipments, \$ *100*

Remarks: *install*
money due

Book mark:

(35)

Carper
Copyist.

T. H. | **6 Cav.** | **U.S.C.T.**

William J. Foster
ser, Co. B, 6 Reg't U. S. Col'd Cavalry.

Appears on

Company Muster Roll

for *Sept & Oct*, 1865.

Present or absent

Stoppage, \$ 100 for

Due Gov't, \$ *4* ^{*92*}/₁₀₀ for

Valuation of horse, \$ 100

Valuation of horse equipments, \$ 100

Remarks:

Book mark:

(358)

G. B. Harper
Copyist.

P

6 Cav. | U.S.C.T.

Calvin Potter
Pvt., Co. B, 6 Reg't U. S. Col'd Cavalry.

Appears on

Company Muster Roll

for *Nov. & Dec.*, 186*3*

Present or absent

Stoppage, \$ 100 for

Due Gov't, \$ 30 for *ordnance*
49 cts. 6 & 4, Equipt.

Valuation of horse, \$ 100

Valuation of horse equipments, \$ 100

Remarks:

Book mark:

J. C. Ames
(358) Copist.

9 | **6 Cav. U.S.C.T.**

Cabriel Carter
Carter, Co. B, 6 Reg't U. S. Col'd Cavalry.

Appears on

Company Muster Roll

for *Jan'y & Feb'y*, 1866.

Present or absent *Present*

Stoppage, \$ *100* for

Due Gov't, \$ *100* for *advance*

99 Cts for 9 Equip.

Valuation of horse, \$ *100*

Valuation of horse equipments, \$ *100*

Remarks:

Book mark:

(358) *J. W. Ames* Copyist.

P

115

U.S.C.T.

Calvin Patter,

Pr. Co. A, 115 Reg't U. S. Colored Inf.

Appears on Returns as follows:

Aug. 1864 - Loss; Aug. 26/64
Bowling Green, Transferred

Book mark:

(546)

J. H. Hensley

Copyist.

P | 6 Cav. | U.S.C.T.

Potter

Potter, Co. B., 6 Reg't U. S. Col'd Cav.

Appears on Returns as follows:

Dec 1864, Absent on
detached service Penn
Gap Ky, Dec 25/64,

Feb to April 1865, Absent
on detached service
New Haven Ky, Feb 15/65

Book mark:

C. M. Row

(546)

Copyist.

JP | **6 Cav.** | **U.S.C.T.**

E. Potter,
Pvt. Co. *B.* 6 Reg't U. S. Col'd Cav.

Appears on Returns as follows:

May & June 1865, Absent
Sick in Hosp. New Albany
Ind since Apr 15/65,

Book mark : _____

(546)

C. M. Roan

Copyist.

P | 6 Cav. | U.S.C.T.

Calvin Potter
P.M., Co. B, 6 Reg't U. S. Col'd Cavalry.

Appears on Co. Muster-out Roll, dated
S. Vail's Bluff Co., Apr. 15, 1866.
Muster-out to date Apr. 15, 1866.
Last paid to Feb. 28, 1866.

Clothing account:

Last settled....., 186 ; drawn since \$..... 100

Due soldier \$..... 100; due U. S. \$..... 100

Am't for cloth'g in kind or money adv'd \$ 55.00

Due U. S. for arms, equipments, &c., \$ 100

Bounty paid \$ 100.00; due \$ 100.00

Remarks:
.....
.....
.....
.....

Book mark: 273.448

(361) J. W. Jones Copyist.

1076
Potter Henry.

Co B., 6 U. S. Col'd Cav.

Private. | Private.

CARD NUMBERS.

1	5389291	26
2	5389344	27
3	5389432	28
4	5389503	29
5	5389568	30
6	5389605	31
7	5389702	32
8	5389798	33
9	5389935	34
10	5390028	35
11	9092422	36
12	40732735	37
13	40902876	38
14	31407599	39
15	31407697	40
16		41
17		42
18		43
19		44
20		45
21		46
22		47
23		48
24		49
25		50

Book Mark:

See also

P | **6 Cav. U.S.C.T.**

Henry Potter

....., Co. *B*, 6 Reg't U. S. Col'd Cav.

Appears on

Company Descriptive Book

of the organization named above.

DESCRIPTION.

Age *16* years; height *5* feet *2* inches.

Complexion *Blk*

Eyes *Blk*; hair *Blk*

Where born *Warren Ky*

Occupation *Farmer*

ENLISTMENT.

When *Aug 1st*, 1864.

Where *Bowling Green Ky*

By whom *Capt Hobson*; term *3* y'rs.

Remarks:

.....
.....
.....
.....
.....
.....
.....
.....
.....
.....

Breger

J

6 Cav. U.S.C.T.

Henry Potter
Privt., Co B, 6 Reg't U. S. Col'd Cavalry.

Appears on

Company Muster-in and Descriptive Roll
of the organization named above. Roll dated

Camp Nelson Ky, N.Y. Nov. 1st, 1864.

Where born *Warren Co. Ky*

Age *16* y'rs; occupation *Farmer*

When enlisted *Aug 1st*, 1864.

Where enlisted *Bowling Green Ky*

For what period enlisted *3* years.

Eyes *Blk*; hair *Blk*

Complexion *Blk*; height *5* ft. *2* in.

When mustered in *Aug 1st*, 1864.

Where mustered in *Bowling Green*

Bounty paid \$ *100*; due \$ *100*

Where credited *3rd Dist. Ky*

Company to which assigned

Remarks: *Transferred from Co B*

115. U.S.C.T. in 50, No 39, dated

Washington D.C. June 10/65

signed L. Thomas A.G.

(over)

Book mark:

G.M. Howe

(356d)

Copyist.

JAN. 10

5389271

1891

Owner,
Henry Potter,

P 6 Cav. U.S.C.T.

Henry Potter
Sergeant, Co. B, 6 Reg't U. S. Col'd Cavalry.

Appears on

Company Muster Roll

for Nov & Dec, 1864.

Present or absent Absent,

Stoppage, \$ 100 for

Due Gov't, \$ 100 for

Valuation of horse, \$ 100

Valuation of horse equipments, \$ 100

Remarks: Detached service at
Round Gap, Ky, Dec 25/64,
Dismounted during battle
said, Due U. S. for Ordnance \$21.90

Book mark:

(358)

G. M. Lewis

Copyist.

P | 6 Cav. U.S.C.T.

Henry Potter
Private, Co. B, 6 Reg't U. S. Col'd Cavalry.

Appears on

Company Muster Roll

for Jan & Feb., 1863.

Present or absent Absent.

Stoppage, \$ 100 for

Due Gov't, \$ 100 for

Valuation of horse, \$ 100

Valuation of horse equipments, \$ 100

Remarks: Due to, & for Ord \$11.90,
1st installment bounty due
\$100, sick in Hosp
Ashland Ky Jan 31, 1863;

Book mark:

C. M. Rowe

(358)

Copist.

O | *5600 U.S.A.*

James Carter

1st, Co. *H*, *5* Reg't *U.S.A.*

Appears on

Hospital Muster Roll

of U. S. A. General Hospital,

at Ashland, Ky.,

for *Jan & Feb*, 1865.

Attached to hospital:

When *Jan 2*, 1865.

How employed *patient*

Last paid by Maj.

to *Pay due from enlistment*, 1865.

Bounty paid \$ *100*; due \$ *100*

Present or absent *present*

Remarks:

Book mark :

(343)

Joey

Copyist.

P

6 Cav. U.S.C.T.

Henry Potter

Private, Co. B, 6 Reg't U. S. Col'd Cavalry.

Appears on

Company Muster Roll

for March April, 1865.

Present or absent Absent

Stoppage, \$ 100 for

Due Gov't, \$ 100 for

Valuation of horse, \$ 100

Valuation of horse equipments, \$ 100

Remarks: Discharge from duty due \$100, sick Arkansas, & descriptive list furnished.

Book mark:

J. M. Moore

(358)

Copyist.

C^D | C. Lar | B. S. C.

Henry Potter

3rd, Co. 1st, 6th Reg't B. S. C.

Appears on

Hospital Muster Roll

of U. S. A. General Hospital,

at Ashland, Ky.,

for *March & April*, 1865.

Attached to hospital:

When *May 2*, 1865.

How employed *patient*

Last paid by Maj. _____

to *pay due from enlistment*, 186 .

Bounty paid \$ *100*; due \$ *100*

Present or absent *Present*

Remarks: *Due \$5. for the following
promance cost through
careless men: one Enfield
rifle in kettt \$ 19.⁰⁰
1) one set of accoutrements
\$ 29.⁰⁰ - \$ 21.⁹⁰*

Book mark: _____

(343)

Cherwin
Copyist.

6 Cav. U.S.C.T.

William Tupper
Tupper, Co. B, 6 Reg't U. S. Col'd Cavalry.

Appears on

Company Muster Roll

for *May June*, 1865.

Present or absent *Present*

Stoppage, \$ *100* for

Due Gov't, \$ *21* ^{*90*}/_{*100*} for *paid*

Valuation of horse, \$ *100*

Valuation of horse equipments, \$ *100*

Remarks: *First falliment*
bound by law
\$100. Sick in hospital
Camp Nelson, Ky
June 28, 65.

Book mark:

D. O. Harper

(358)

Copyist.

6 Cav. U.S.C.T.

Henry Potter
Bugler, Co. B, 6 Reg't U. S. Col'd Cavalry.

Appears on

Company Muster Roll

for July & Aug, 1865.

Present or absent Present

Stoppage, \$ 100 for

Due Gov't, \$ 100 for

for C & S Equip 69

Valuation of horse, \$ 100

Valuation of horse equipments, \$ 100

Remarks: "This all amount
due up for Bugler
from private acct
of Co. No. 6 July 9 1865

Book mark:

H. Harper

(558)

Copyist.

F

6 Cav. U.S.C.T.

Henry Potter
Bugler, Co. B, 6 Reg't U. S. Col'd Cavalry.

Appears on

Company Muster Roll

for *Sept - Oct*, 1865.

Present or absent *present*

Stoppage, \$ *100* for

Due Gov't, \$ *69*/₁₀₀ for *copy*

Valuation of horse, \$ *100*

Valuation of horse equipments, \$ *100*

Remarks: *Uppt Bugler*
from private
from R. O. Noble
July 1, 1865.

Book mark:

H. Harper

(358)

Copyist.

F

6 Cav. U.S.C.T.

Henry Patter
Bugler, Co. B, 6 Reg't U. S. Col'd Cavalry.

Appears on

Company Muster Roll

for *Nov. & Dec.*, 186*5*.

Present or absent *Present*

Stoppage, \$ *100* for

Due Gov't, \$ *73* for *Co & G. Equipmt.*

Valuation of horse, \$ *100*

Valuation of horse equipments, \$ *100*

Remarks:
*Appt. Bugler from 124th Regt
R.O. No. 61. July 1865.*

Book mark:

J. W. Ames
(358) *Captist.*

op 6 Cav. U.S.C.T.

Henry Patten
Co., Co. B, 6 Reg't U. S. Col'd Cavalry.

Appears on

Company Muster Roll

for *January & February*, 186*6*.

Present or absent *Present*

Stoppage, \$ *100* for

Due Gov't, \$ *43* for *6 + 9 Equip*

Valuation of horse, \$ *100*

Valuation of horse equipments, \$ *100*

Remarks:
App'd. Bugler from Post per
Regt. O, No. 11 July 11 65. reduced
to rank from R O No. 15 - July 12,
66.

Book mark:

J. W. Ames
(258) *J. W. Ames* Copyist.

P | 6 Cav. | U.S.C.T.

A. Potter,
Priv., Co. B., 6 Reg't U. S. Col'd Cav.

Appears on Returns as follows:

Jan'y to May 1865, Absent
sick in Hosp'l Ashland
Ky. Dec 30. 64.

June 1865, Absent sick
in hosp'l Camp Nelson
Ky since Jan 1865.

July 1865 Absent sick in
hosp'l Louisville Ky
since Apr 15th 65.

Book mark:

C. M. Roan

(546)

Copyist.

P

115

U.S.C.T.

Henry Potter,
Co. B, 115 Reg't U. S. Colored Inf

Appears on Returns as follows:

Aug. 1864 - Loss; Aug. 26/64,
Bowling Green, transferred

Book mark:

(548)

J. T. Munday

Copyist

6 Cav. U.S.C.T.

Henry Putter

Co. B, 6 Reg't U. S. Col'd Cavalry.

Appears on Co. Muster-out Roll, dated

DeValls Bluff Ark, Apr. 15, 1866.

Muster-out to date Apr. 15, 1866.

Last paid to July 18, 1866.

Clothing account:

Last settled, 186 ; drawn since \$ 100

Due soldier \$ 100; due U. S. \$ 100

Am't for cloth'g in kind or money adv'd \$ 55⁶¹ 100

Due U. S. for arms, equipments, &c., \$ 100

Bounty paid \$ 100 100; due \$ 100 100

Remarks:

Book mark:

(861)

J. W. Thomas

Copyist.

1077
Patter Shy

Co I, 6 U.S. Col'd Cav.

Private | Private.

CARD NUMBERS.

1	5389272	26
2	5389345	27
3	5389386	28
4	5389459	29
5	5389528	30
6	5389593	31
7	5389751	32
8	5389843	33
9	5389933	34
10	5390026	35
11	9092923	36
12	93147758	37
13	40732736	38
14	40732733	39
15		40
16		41
17		42
18		43
19		44
20		45
21		46
22		47
23		48
24		49
25		50

Book Mark:

See also

9 | **6 Cav. | U.S.C.T.**

Shy Potter

B, 6 Reg't U. S. Col'd Cav.

Appears on

Company Descriptive Book

of the organization named above.

DESCRIPTION.

Age *34* years; height *5* feet *0* inches.

Complexion *Copper*

Eyes *Black*; hair *Black*

Where born *Klax Ky*

Occupation *Farmer*

ENLISTMENT.

When *Sept 24*, 18*64*.

Where *Londan Ky*

By whom *Capt R Hays*; term *3* y'rs.

Remarks: *Appointed Sergt Jan 12 1865 per S.O. Hd Quors G. H. S. C. C.*

Boggs

(383g)

Copyist.

P

6 bar

U.S.C.T.

Shy Potter

Appears with rank of Private on

Muster and Descriptive Roll

of Detachment U.S. Col'd Recruits
forwarded

Roll dated London Ky, Sept. 30, 1864.

Where born Clay Co. Ky.

Age 34 years; occupation Tanner

When enlisted Sept. 24, 1864.

Where enlisted London Ky.

For what period enlisted 3 years.

Eyes Blue; hair Blue

Complexion Copper; height 5 ft. 10 in.

When mustered in Sept 30, 1864.

Where mustered in London Ky.

Bounty paid \$ 100; due \$ 100

Clothing account: nothing issued

Last settled _____, 1864; drawn since \$ 100

Date of first muster Sept 24, 1864.

Company to which assigned _____

Remarks: Credited to Clay Co. & Dist. Ky.

once name Barton Potter

Clay Co. Ky.

Book mark : _____

A. V. Blain

(356m)

Copyist.

JP 6 Cav. U.S.C.T.

Jay Potter

Privet, Co. *B*, 6 Reg't U. S. Col'd Cavalry.

Appears on

Company Muster-in and Descriptive Roll
of the organization named above. Roll dated

Camp Meade, N.Y., Nov 1st, 186*4*.

Where born *Clay Co., Ky.*

Age *34* y'rs; occupation *Farmer*

When enlisted *Sept 24*, 186*4*.

Where enlisted *Landon, Ky.*

For what period enlisted *3* years.

Eyes *Blk*; hair *Blk*

Complexion *Copper*; height *5* ft. *10* in.

When mustered in *Sept. 30*, 186*4*.

Where mustered in *Landon Ky*

Bounty paid \$ *100*; due \$ *100*

Where credited *S. Dick Ky.*

Company to which assigned

Remarks: *Owner,*

Barton Potter

Book mark:

W. Row

(356d)

Copyist.

P | **6 Cav. U.S.C.T.**

Shy Potter
Prnt, Co. B, 6 Reg't U. S. Col'd Cavalry.

Appears on

Company Muster Roll

for *Nov & Dec*, 186*7*.

Present or absent *Absent*

Stoppage, \$ *100* for

Due Gov't, \$ *100* for

Valuation of horse, \$ *100*

Valuation of horse equipments, \$ *100*

Remarks:

Book mark:

(358)

J. M. Row

Copyist.

PS 6 Cav. U.S.C.T.

Shy Potter
Sergt., Co. B, 6 Reg't U. S. Col'd Cavalry.

Appears on

Company Muster Roll

for Jan & Feb, 1865.

Present or absent absent

Stoppage, \$ 100 for

Due Gov't, \$ 100 for

Valuation of horse, \$ 100

Valuation of horse equipments, \$ 100

Remarks: 1st installment bounty
due \$100, det'd service
N. Haven, Ky, Feb. 15/65,
Appointed Sergt. from Pvt.
Jan 1' 1865, Special order
No. 1, Hd Qrs, 6 U.S. Cav.

Book mark:

(358)

J. M. Rowan
Coryist.

Sp **6 Cav. U.S.C.T.**

Shy Potter
Sergt, Co. B, 6 Reg't U. S. Col'd Cavalry.

Appears on

Company Muster Roll

for *March* *Sept*, 186*5*.

Present or absent *Absent*,

Stoppage, \$ *100* for

Due Gov't, \$ *100* for

Valuation of horse, \$ *100*

Valuation of horse equipments, \$ *100*

Remarks: *Installation bounty*
due \$100, Due U.S. for C & G
Equipage \$112, Detached
service at New Haven Ky
Feb. 15, 1865,

Book mark:

(358)

G. M. Rowe
Copyist.

P

6 Cav. | U.S.C.T.

Wm. Potter
Sergeant, Co. B, 6 Reg't U. S. Col'd Cavalry.

Appears on

Company Muster Roll

for *May to June*, 1865.

Present or absent *Present*

Stoppage, \$ *100* for

Due Gov't, \$ *112* for *car & equip*

Valuation of horse, \$ *100*

Valuation of horse equipments, \$ *100*

Remarks: *Install*
numbers due \$100.

Book mark:

J. H. Harper

2 | **6 Cav.** | **U.S.C.T.**

John Cooper
Serant, Co. B, 6 Reg't U. S. Col'd Cavalry.

Appears on

Company Muster Roll

for *May & Aug*, 1865.

Present or absent *present*

Stoppage, \$ *100* for

Due Gov't, \$ *12* ^{*12*}/_{*100*} for *S. T. Equip.*

Valuation of horse, \$ *100*

Valuation of horse equipments, \$ *100*

Remarks: *"inst ball county
due"*

Book mark: _____

(358)

A. Soaper

Copyist.

A **6 Cav. U.S.C.T.**

Shy Potter

Co. B, Co. B, 6 Reg't U. S. Col'd Cavalry.

Appears on

Company Muster Roll

for *Sept & Oct*, 186*5*.

Present or absent *absent*

Stoppage, \$ *100* for

Due Gov't, \$ *100* for *and*

by Regt \$100

Valuation of horse, \$ *100*

Valuation of horse equipments, \$ *100*

Remarks: *Sept - as Regt
absent all of same
month, \$100 assigned
but no receipt
at Regt. Sept 21, 1865
received same date*

Book mark:

J. G. Larkner
J. G. Larkner

P

6 Cav. | U.S.C.T.

Shy Potter

P.A., Co. B, 6 Reg't U. S. Col'd Cavalry.

Appears on

Company Muster Roll

for *Nov & Dec*, 186*5*.

Present or absent *Present*

Stoppage, \$ *100* for

Due Gov't, \$ *25* for *ordnance*

Valuation of horse, \$ *100*

Valuation of horse equipments, \$ *100*

Remarks:

*Daily duty as Musician
in Regt Band per R.O.
No. 101 dated Sept, 21st 1865,*

Book mark:

J. W. Ames
(358) Copyist.

W 6 Cav. U.S.C.T.

Sy Patten
24, Co. B, 6 Reg't U. S. Col'd Cavalry.

Appears on

Company Muster Roll

for *Jerry V. Patten*, 1866.

Present or absent *Present*

Stoppage, \$ 100 for

Due Gov't, \$ 45 for *67 G. Equip*

Valuation of horse, \$ 100

Valuation of horse equipments, \$ 100

Remarks: *Daily duty as musician in Reg't Band for R.O. No. 101 dated Sept. 20, 65.*

Book mark:

J. W. Thomas
(258) Copyist.

SP | 6 Cav. | U.S.C.T.

Henry Potter,
Priv. Co. B., 6 Reg't U. S. Col'd Cav.

Appears on Returns as follows:

Nov 1864. Absent sick in
hosp. Camp Nelson Ky
since Oct 1864,

Oct 1865, Absent detached
Tex. near Lexington Ky
as musician in Reg't Band
since Sept 21, 65, per
R.O. No 101, dated
Ad. Des., G. U.S.C.C.,
Sept 21, 65,

Nov 1865 to March 1866,
On daily duty, musician
in Reg't Band since Sep 24/65
per R.O. No 101, dated
Ad. Des., G. U.S.C.C. Army
Sept 21, 65,

Book mark:

C. M. Rous

(546)

Copyist.

P | 6 Cav. | U.S.C.T.

Potter

Sgt., Co. B, 6 Reg't U. S. Col'd Cav.

Appears on Returns as follows:

Feb. to April 1865, Absent
on detached service
New Haven Ky. Feb 15/65.

Book mark:

G. M. Rowan

(546)

Copyist.

9

6 Cav. U.S.C.T.

Shy Peter

21, Co. *B*, 6 Reg't U. S. Col'd Cavalry.

Appears on **Co. Muster-out Roll**, dated

De Vail's Bluff, Ala., 1866.

Muster-out to date *March 5*, 1866.

Last paid to *July 28* 1866.

Clothing account:

Last settled _____, 186 ; drawn since \$ _____ 100

Due soldier \$ _____ 100; due U. S. \$ _____ 100

Am't for cloth'g in kind or money adv'd \$ *12*^{*4*} 100

Due U. S. for arms, equipments, &c., \$ _____ 100

Bounty paid \$ *100* 100; due \$ *100* 100

Remarks: _____

Book mark: _____

(861)

J. W. Thomas

Copyist.

Patten,
P. B., Co. B

Shy.
6 U.S.C. Cav.
Reg't

Enclosures.

Bed Cards	Descriptive Lists
Burial Records	Final Statements
Certs. of Dis. for Discharge	Furloughs
C. M. Charges	Med. Des. Lists
Med. Certificates	Orders

Other papers relating to—

Admission to Hosp'l	Furlough
Casualty Sheet (Officer's)	Med. Examination
Confinement	Misc. Information /
Contracts	Pay or Clothing
Death or Effects	Personal Reports
Desertions	Rank
Discharge from Hosp'l	Transfer to Hosp'l
Discharge from Service	Transfer to V. R. C.
Duty	Transportation

War Department,

ADJUTANT GENERAL'S OFFICE,

Washington, Feb 2 1867.

Respectfully returned to the Commission for the State of Kentucky, with the information that *Shy Peller*

was enlisted at *London, Ky* September 30, 1864 and was mustered in as private in Co. "B", 5th U.S.C.T. Sept 30, 1864.

663. Gen.

A. J. Rowan

Asst. Adj't General.

13413.

etc. _____

APPLICATION OF

Shy Peller

of
Mr. Chester

FOR COMPENSATION FOR SLAVE.

Named *Shy Peller*

Enlisted *24 September 1864*

In Com. *B. Co* Regiment,

U. S. COLORED TROOPS.

Received *Dec 12, 1867*

Compensation Awarded

March 5th, 1867

Shy Peller

President of Board of Claims.

Claimant's Attorney,

L. A. Brown

Albany, Ga.

Claimant's Post-office address,

Manchester

Kentucky

A

CLAIM OF

Barton Potter

FOR THE COMPENSATION OF SLAVE NAMED

Shy Potter

I, Barton Potter a loyal citizen, and a resident of Manchester, County of Clay, State of Kentucky, hereby claim compensation, under the provisions of Section 24, act approved February 24, 1864, and section 2, act approved July, 28, 1866, for my slave Shy Potter, enlisted 24th day September 1864, at London Kentucky, by Capt R. Hoop in the 6th Cavalry regiment U. S. Colored Troops, Co. B; certificate of

which enlistment, and a descriptive list, as required, accompany this application. That I did not acquire said slave subsequent to said enlistment, but had a valid title to him at the date of said enlistment, and previous thereto: I having acquired my title to him and my ownership over him as follows, to-wit: That I purchased the said slave Shy Potter from John Hoarse of Clay County Ky in the year

April 1849-

In proof of my loyalty to the Constitution and Government of the United States, I present the accompanying oath, which I have taken, signed and acknowledged; to be filed with this application, in accordance with requirement of General Orders, No. 329, 1863, War Department, Adjutant General's Office.

Barton Potter

186

OATH OF ALLEGIANCE.

I, Barton Potter, the owner and Claimant, do solemnly swear that the foregoing claim is a just and true claim due to me as master and owner of the said slave, and that the facts alleged in said claim in respect to the draft or enlistment (as the case may be) of said slave into the Military service of the United States are true. And I do further swear that I have never joined, or been concerned in, any insurrection or rebellion; that I have never borne arms against the United States; that I have never given any aid, countenance, counsel or encouragement to any person or persons engaged, or whom I had reason to believe were about to engage, in insurrection, rebellion or armed hostility against the United States; that I have neither sought, nor accepted, nor attempted to exercise the functions of any office, civil or military, nor to perform any service whatever, under any authority or pretended authority in hostility to the United States; that I have not yielded a voluntary support to any insurrection, rebellion or pretended government, authority, power or constitution within the United States hostile thereto. And I do further swear that, to the best of my knowledge and ability, I have supported and defended, and will continue to support and defend, the United States against all enemies, foreign and domestic; and that I have supported, defended and obeyed, and will continue to support, defend and obey, the Constitution and laws of the United States; that I will bear true faith and allegiance to the same; and that I take this oath freely, without any mental reservation or purpose of evasion: So help me God.

Barton Potter

Sworn to and subscribed before me, at Manchester, this 22 day of December, 1864

Wm. Clark
Clay Circuit Court

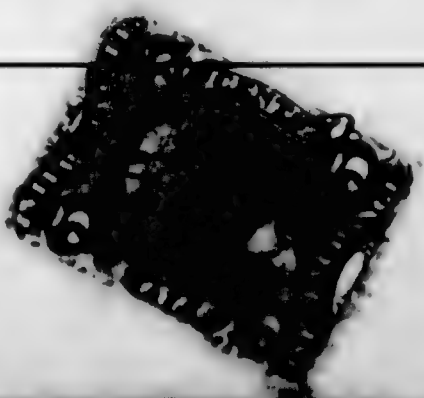

CERTIFICATE OF AWARD OF THE BOARD OF CLAIMS.

OFFICE OF THE BOARD OF CLAIMS
FOR SLAVES ENLISTED OR DRAFTED IN THE SERVICE OF THE U. S. }

Frankfort Ky,
Mch 11th, 1867.

We hereby certify, that Barton Potter of Clay county, State of Kentucky, having proved, under oath, his loyalty to the Constitution and Government of the United States, and established his title as to the ownership of Shy Patten, a slave, enlisted and mustered at London Ky. on the 20 day of Sept, 1864, by Capt R. Hays in the service of the United States, in the 6th Regiment of Colored Troops, Co. B, the sum of Three Hundred dollars has been awarded to him by this Board, subject to the approval of the Secretary of War, as a compensation for the said slave, under the provisions of section 24, Act approved February 24, 1864, and section 2, Act approved July 28, 1866.

A. S. Moore, President of the Board.
Geo. Blake, Member of the Board.
Member of the Board.

To
Chief of the Bureau for the Organization of Colored Troops, Washington, D. C.

Headquarters Kentucky Volunteers,

Adjutant-General's Office,

Frankfort, November 17th, 1866.

I hereby certify, that it appears from the U. S. Muster-In Books on file in this Office, that Shy Potter was enrolled on the 24th day of September, 1864, at London Ky. by Capt R. Hays and mustered into the U. S. service on the 30th day of September, 1864, at London Ky. by Capt R. Hays to serve three years. Said Shy Potter is described as follows: 34 years age, Black eyes, Black hair, Copper complexion, 5ft 10in height. It further appears from said Books, that Shy Potter owed service to Barton Potter and was credited to Clay County Ky.



B 37 R 399



In Testimony Whereof, I have hereunto set my hand, and affixed my Official Seal, this 17th day of November, 1866.

D. W. Lindsey
Adjutant General of Kentucky.

very correct linal

POWER OF ATTORNEY.

My Post-Office address is Manchester County of Clay State of Kentucky, and I hereby direct that all communications to me, touching this claim, be sent under cover to C. A. Byron of Manchester Ky., who is hereby appointed and constituted my true and lawful attorney, to prosecute this claim for me, and who is hereby authorized and empowered to receive and receipt for any award, order, draft, certificate, voucher, warrant, papers or money that may be issued in the adjustment of this claim, or the payment thereof, the same as I might or could do in person were I present and acting for myself, and to file any additional evidence or papers that may be required in the prosecution of this claim.

[WITNESS.]

The owner signs here.

Barton Potter

50 CENT
STAMP.

Wm. L. Ward
William McDaniel

Two witnesses to owner's signature sign here.

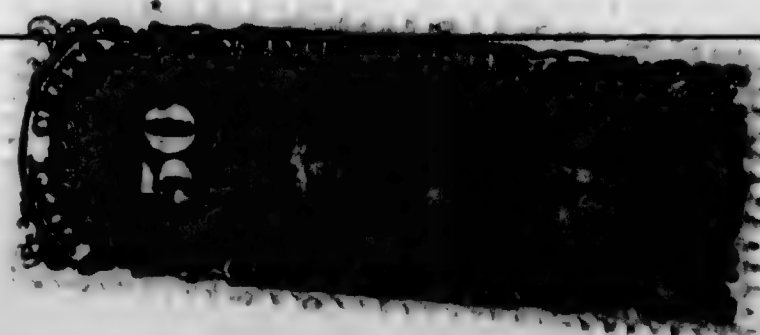

PROOF OF OWNERSHIP.

STATE OF KENTUCKY,

COUNTY OF *Clay*

} SS.

We *Thomas J. Baughman* and *William M. Daniel* each of lawful age, and resident citizens of the State and County aforesaid, do certify that *Barton Potter* of the State and County aforesaid, was on the *24th* day of *September* 1864, the lawful owner of the slave named *Sky Potter*; referred to and described in the foregoing claim for compensation.

Thomas J. Baughman

William M. Daniel

Sworn to and subscribed before me a *Clerk of the Circuit Court* for the County of *Clay* State of Kentucky, this the *22nd* day of *December* 1864.

*G. W. Price Clerk
Clay Circuit Court*

5 CENT STAMP.



PROOF OF LOYALTY.

STATE OF KENTUCKY,

COUNTY OF *Clay*

} SS.

We *John S. Herd* and *John D. Goldiron* loyal men and each of lawful age, and resident citizens of the of in the State and County aforesaid, upon our oaths declare that we have known *Barton Potter* a resident of the State and County aforesaid, since the 4th day of March, 1861, and know that he has firmly and faithfully maintained his or her adherence and allegiance to the Government of the United States, by defending its cause against the Government and forces of the so-called Confederate States of America, in all suitable and practicable ways, and according to his or her ability and opportunity.

*John S. Herd
John D. Goldiron*

Sworn to and subscribed before me a *Clerk of the Circuit Court* for the county of *Clay* State of Kentucky, this the *22* day of *December* 1864.

*G. W. Price Clerk
Clay Circuit Court*

5 CENT STAMP.



POWER OF ATTORNEY.

My Post-Office address is *Manchester* County of *Clay* State of Kentucky, and I hereby direct that all communications to me, touching this claim, be sent under cover to *L. A. Byrow of Manchester Ky*, who is hereby appointed and constituted my true and lawful attorney, to prosecute this claim for me, and who is hereby authorized and empowered to receive and receipt for any award, order, draft, certificate, voucher, warrant, papers or money that may be issued in the adjustment of this claim, or the payment thereof, the same as I might or could do in person were I present and acting for myself, and to file any additional evidence or papers that may be required in the prosecution of this claim.

[WITNESS.]

The owner signs here.

Barton Potter

50 CENT STAMP.

*H. S. Ward
William M. Daniel*

Two witnesses to owner's signature sign here.



State of Kentucky
County of Clay ss.

I, William S. White, Clerk of the County Court in and
aid for the County and State, do hereby certify that
Mr. Price before whom the foregoing proof was made
and taken and subscribed was at the time of said proof
the Clerk of the Clay Circuit Court and was duly authorized
by law to administer oaths and that his signature thereto
are genuine - I further certify that the foregoing
Power of attorney from Barton Potter to S. A. Bepko
was duly acknowledged before me by ^{said} Barton Potter
to be his act and deed for the purposes therein
named - All of which is certified

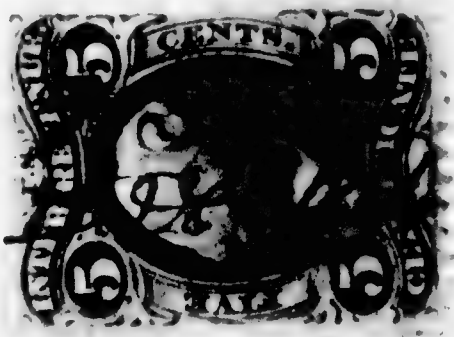

Given under my hand and official
Seal at office in the town of Harbes-
ler, County of Clay & State of Kentucky
This 22nd day December 1866

W. S. White Clerk
Clay County Court Kentucky

1078

Pottinger, Anthony

Co K, 6 U. S. Col'd Cav.

Private

Corporal

CARD NUMBERS.

1	5387412	26
2	5387395	27
3	5395429	28
4	5395510	29
5	5395597	30
6	5395673	31
7	5395751	32
8	5395787	33
9	5395860	34
10	9093916	35
11	40732730	36
12		37
13		38
14		39
15		40
16		41
17		42
18		43
19		44
20		45
21		46
22		47
23		48
24		49
25		50

Book Mark:

See also

S. 883184 Pomeroy Ret
S. 1523989, Aud. W. D.
A 2248671 Pomeroy
S. 2285213 Pomeroy
A 2304168 Pomeroy
A 2416291 Pomeroy
S. 2013629 Aud.

D. Jordan
Ex

P. | **6 Cav.** | **U.S.C.T.**

Anthony Challenger

Appears with rank of *Rec't* on

Muster and Descriptive Roll of a Detachment of U. S. Vols. forwarded

for the 6 Reg't U. S. Col'd Cavalry. Roll dated *Louisville Ky, Apr 22, 1865.*

Where born *Wellsboro Ohio*

Age *22* y'rs; occupation *Farmer*

When enlisted *April 18,* 186*5.*

Where enlisted *Wellsboro Ohio*

For what period enlisted *2* years.

Eyes *blue*; hair *black*

Complexion *dark*; height *5* ft. *7* in.

When mustered in *Apr 22,* 186*5.*

Where mustered in *Louisville Ky*

Bounty paid \$ *100*; due \$ *100*

Where credited *Louisville Ky*

Company to which assigned

Remarks :

Book mark :

(339)

W. Kelly Copyist.

6 Cav. | U.S.C.T.

Anthony Pottinger

Appears with rank of *Priv* on

Muster and Descriptive Roll of a Detachment of U. S. Vols. forwarded

for the 6 Reg't U. S. Col'd Cavalry. Roll dated

Louisville Ky, April 23, 1865

Where born *Nelson Ky*

Age *22* y'rs; occupation *Farmer*

When enlisted *April 18*, 1865.

Where enlisted *New Haven Conn*

For what period enlisted *3* years.

Eyes *Blk*; hair *Blk*

Complexion *Blk*; height *5-9* ft. *9* in.

When mustered in *April 22*, 1865.

Where mustered in *Louisville Ky*

Bounty paid \$ *100*; due \$ *100*

Where credited *Dist Ky*

Company to which assigned

Remarks:

Filed with Pottinger Anthony

Book mark:

P *6* *Car* **U.S.C.T.**

Anthony Pottinger
priv, Co. *A*, *6* Reg't U. S. Col'd *Car*

Appears on

Company Muster-in and Descriptive Roll
of the organization named above. Roll dated

Camp Nelson Ky May 29 1865.

Where born *Nelson Co Ky*

Age *20* y'rs; occupation *Farmer*

When enlisted *Apr 18*, 1865.

Where enlisted *New Haven Ky*

For what period enlisted *3* years.

Eyes *black*; hair *black*

Complexion *copp*; height *5* ft. *9* in.

When mustered in *Apr 22*, 1865.

Where mustered in *Louisville*

Bounty paid \$ *100*; due \$ *100*

Where credited *H. D. Ky*

Company to which assigned

Remarks:

Book mark:

D. J. Crippick

(356d)

Copyist.

D

6 Cav. | U.S.C.T.

Anthony Partinger

....., Co. *A*, 6 Reg't U. S. Col'd Cav.

Appears on

Company Descriptive Book

of the organization named above.

DESCRIPTION.

Age *23* years ; height *5* feet *9* inches.

Complexion *Copper*

Eyes *Blk* ; hair *Blk*

Where born *Nelson Co Ky*

Occupation *Farmer*

ENLISTMENT.

When *April 18*, 186*5*.

Where *Gen Haven*

By whom *Cpt Kioclass*; term *3* y'rs.

Remarks *Mustered April 22/65
By Capt Hornum at Lewis
ville Ky*

Foster
Coryist.

(383g)

1865

P | **6 Cav.** | **U.S.C.T.**

Anthony Pottenger
priv, Co. K, 6 Reg't U. S. Col'd Cav.

Appears on

Company Muster Roll

for *May 25 to June 30*, 186*5*.

Present or absent *Present*

Stoppage, \$ *100* for

Due Gov't, \$ *100* for

Valuation of horse, \$ *100*

Valuation of horse equipments, \$ *100*

Remarks:

Book mark: -----

(358)

D. J. Giffick

Copyist.

P | **6 Cav.** | **U.S.C.T.**

Anthony Pottinger
July, Co. K, 6 Reg't U. S. Col'd Cav.

Appears on

Company Muster Roll

for *July & August*, 186*5*.

Present or absent *Present*

Stoppage, \$ *100* for

Due Gov't, \$ *100* for

Valuation of horse, \$ *100*

Valuation of horse equipments, \$ *100*

Remarks:

Book mark:

(358)

E. J. Gifford
Copyist.

P

6 Cav. | U.S.C.T.

Anthony Pottinger
Pr, Co. K, 6 Reg't U. S. Col'd Cav.

Appears on

Company Muster Roll

for *Sept. to Oct.*, 186*5*

Present or absent *Present*

Stoppage, \$ *100* for

Due Gov't, \$ *100* for

Valuation of horse, \$ *100*

Valuation of horse equipments, \$ *100*

Remarks:

Book mark:

J. M. Jackson

S

6 Cav. U.S.C.T.

Anthony Lotteger
Priv, Co. *K*, 6 Reg't U. S. Col'd Cav.

Appears on

Company Muster Roll

for *Nov. & Dec*, 186*5*.

Present or absent *Present*

Stoppage, \$ *100* for

Due Gov't, \$ *100* for

Valuation of horse, \$ *100*

Valuation of horse equipments, \$ *100*

Remarks:

Book mark:

J. M. Jackson
(358) *Copyist.*

6 Cav. U.S.C.T.

Anthony Hengel
Co. K, 6 Reg't U. S. Col'd Cav.

Appears on

Company Muster Roll

for *Jan. & Feb.*, 1866.

Present or absent *present*

Stoppage, \$ *100* for

Due Gov't, \$ *100* for

Valuation of horse, \$ *100*

Valuation of horse equipments, \$ *100*

Remarks: *Copied since an 4/11/66*

Book mark:

U. J. Markle

(358)

Copyist.

P | **6 Cav.** | **U.S.C.T.**

Anthony Pottinger
Pot, Co. *A*, 6 Reg't U. S. Col'd Cav.

Appears on Returns as follows:

Aug 7. Sept 1865. On
Duly Co Cook,

Book mark:

C. M. Pove

(546)

Copyist.

P

6 Cav. U.S.C.T.

Anthony Pottinger

Captain, Co. K, 6 Reg't U. S. Col'd Cavalry.

Appears on Co. Muster-out Roll, dated

Gen. S. Buff, Ark, April 10, 1866.

Muster-out to date Apr. 10, 1866.

Last paid to Oct. 31, 1866.

Clothing account:

Last settled, 186 ; drawn since \$ 100

Due soldier \$ ^{17 75}/_{4 38} 100; due U. S. \$ 100

Am't for cloth'g in kind or money adv'd \$ 100

Due U. S. for arms, equipments, &c., \$ 100

Bounty paid \$ 100; due \$ 100

Remarks: Appears Camp. ser. 1, 1866.

Book mark: A. 210

(861)

C. D. Markle

Copyist.

Pottinger Anthony
P., Co. K, 6 Reg't U.S.C.

Enclosures.

Bed Cards	Final Statements
Burial Records	Furloughs or L. of A.
Certs. of Dis. for Discharge	Med. Certificates
C. M. Charges	Med. Des. Lists
Descriptive Lists	Orders
Discharge Certificates	Pris. of War Record
Enlistment Papers	Resignations

Other papers relating to—

Admission to Hosp'l	Furlough or L. of A.
Casualty Sheet	Med. Examination
Confinement	Misc. Information /
Contracts	Pay or Clothing
Death or Effects	Personal Reports
Desertion	Rank
Discharge from Hosp'l	Transfer to Hosp'l
Discharge from Service	Transfer to V. R. C.
Duty	Transportation

NOTE 1.—This blank will be used for enlistments of United States colored troops. They will be made out in duplicate in all cases—one to accompany the recruiting return of the superintendent (not the recruiting officer), to the Adjutant General, and one to accompany the accounts of the officer who pays bounty, &c.

NOTE 2.—An enlistment holds to service. A muster-in must, in all cases, precede payment of pay, bounty, fission, &c. A muster-in roll, must in all cases, be made in the Adjutant General's Office as evidence of muster-in. The mustering officer, commissary, or assistant commissary of musters, as the case may be, will countersign both enlistments as having mustered the soldiers into the service of the United States before either of them is given to the disbursing officer.

DECLARATION OF RECRUIT.

I, *Anthony Pottenger* desiring to volunteer as a soldier in the ARMY OF THE UNITED STATES, for the term of *Three Years*, DO DECLARE That I am *23* years and *Five* months of age; that I have never been discharged from the United States service on account of disability or by sentence of a court-martial, or by order before the expiration of a term of enlistment; and I know of no impediment to my serving honestly and faithfully as a soldier for three years.

GIVEN at *New Haven Ky* the *18* day of *Sept* 1865

Witness: *Wm. T. Thomas*
Capt

Anthony Pottenger

Anthony Pottenger

Subscribed at *New Haven Ky*
April 18th 1865
By *Wm. T. Thomas*
611

104

on file

Consent of Parent or Guardian in case of a Minor, if a Free Man, or in the case of a Slave, of the Person to whom he owes Service:

I, Do CERTIFY, That I am
the
that the said is years of age; and I
do freely give my CONSENT to his volunteering as a SOLDIER in the Army of the United States,
for the period of THREE YEARS, under the conditions of the laws of the United States.

GIVEN at
the day of

Witness:

UNITED STATES COLORED TROOPS ENLISTMENT.

STATE OF

TOWN OF

Kentucky



New Haven

I, *Anthony Pottenger* born in *Nelson County*
in the State of *Kentucky* aged *Twenty Three* years
and by occupation a *Farmer* Do HEREBY ACKNOWLEDGE to
have volunteered *18th* day of *April* 1865

to serve as a **Soldier** in the **Army of the United States of America**, for the
period of **THREE YEARS**, unless sooner discharged by proper authority: Do
also agree to accept such bounty, pay, rations, and clothing, as are, or may be,
established by law for the U. S. colored troops.

And I, *Anthony Pottenger*
do solemnly swear that I will bear true faith and allegiance to the **United States**
of America, and that I will serve them honestly and faithfully against all their
enemies or opposers whomsoever; and that I will observe and obey the orders
of the President of the United States, and the orders of the officers appointed
over me, according to the Rules and Articles of War.

Sworn and subscribed to, at *New Haven*

this *18th* day of *April* 1865

Before *Peter Robbins Capt*

I CERTIFY, ON HONOR, That I have carefully examined the above named Volunteer agree-
ably to the General Regulations of the Army, and that, in my opinion, he is free from all bodily
defects and mental infirmity, which would in any way disqualify him from performing the
duties of a soldier.

P. W. Robbins

EXAMINING SURGEON.

I CERTIFY, ON HONOR, That I have minutely inspected the Volunteer *A. Pottenger*
previously to his enlistment, and that he was entirely sober when enlisted; that, to the best of
my judgment and belief, he is of lawful age; and that, in accepting him as duly qualified to per-
form the duties of an able-bodied soldier, I have strictly observed the regulations which govern
the recruiting service. This soldier has *black* eyes, *black* hair, *black* com-
plexion, is *five* feet *seven* inches high.

Peter Robbins Capt

RECRUITING OFFICER OR AGENT.

Mustered into the United States Service *22* day of *April* 1865

W. M. M...

Pro Mar 9 Mastering Officer

Mustered into the service of the United States, for three years or during the war, from date of enlistment, in Company
Regiment of
Volunteers, on the
day of
1865, at

War Department,

ADJUTANT GENERAL'S OFFICE,

Washington, Apr 10th 1867

Respectfully returned to the
Commission for the State of
Ky, with the informa-
tion that Anthony Pottinger
was enlisted at New Haven Ky
Apr 18th 1865 and was
mustered in as Pvt. Co. K 6th
U.S. Colored Apr 22nd 1865

P. 11048

W. C. Hazard

Asst. Adj't General.

amud

ENDORSEMENT.

No.

APPLICATION OF

G. M. Pottinger

OF

Melen County Ky

For compensation of service of slave.

Anthony Pottinger

Enlisted *April 18th* 1865

in Co. *K*, 6th Regiment
U. S. Colored Troops. Cavalry

Received *1* 1867

Compensation awarded

186

Dollars

President Board of Claims.

CLAIMANT'S ATTORNEYS,

E. E. MCKAY,

BARDSTOWN, KY

CLAIMANT'S P. O. ADDRESS.

Headquarters Kentucky Volunteers,

Adjutant-General's Office,

Frankfort, July 27th 1867

I hereby certify, that it appears from the U. S. Muster-Rolls on file in this Office, that Anthony Pettenger was enrolled on the 18th day of April 1865, at New Haven Ky., by Capt Keolbarsa and mustered into the U. S. service on the 22^d day of April 1865, at Louisville by Capt Womack to serve 3 years. Said Anthony Pettenger is described as follows: Age, 23 years; eyes, Black; hair, Black complexion, Black; height, 5 feet 4 inches. It further appears from said Rolls that Anthony Pettenger owed service to George Pettenger, was credited to Nelson County, Ky., and was assigned to Co. "K" 1st Regiment U. S. Cavalry.



In Testimony Whereof, I have hereunto set my hand, and affixed my Official Seal, this 27th day of July, 1867.

D. Lindsay
Adjutant-General of Kentucky.

B. 196, R. 769

CLAIM FOR COMPENSATION FOR ENLISTED SLAVE.

No.

I, *George W. Pottinger*, a loyal citizen, and
 a resident of *Kentucky* County of *Nelson* State of

Kentucky, hereby claim compensation, under the provisions of
 section 24, Act approved February 24, 1864, and Section 2, Act approved July 28, 1866, for my
 slave *Anthony Pottinger* enlisted *April 18th 1865*
~~at~~ at *Louisville Ky* by *Capt Keobasa*
 in the *109th Regt* Regiment U. S. Colored Troops

Co. *A* certificate of enlistment, and a descriptive list, as required, accompany
 this application. That I did not acquire said slaves subsequent to said enlistment, but had a
 valid title to him at the date of said enlistment, and previous thereto: I having acquired my
 title to him and my ownership over him as follows, to-wit: *by Purchase*
in the year 1863 from an
Missioner appointed by a decree of the Nelson Circuit
Court in the Case of J. M. Gaslin & others vs. J. H. Talbot

In proof of my loyalty to the Constitution and Government of the United States, I present
 the accompanying oath, which I have taken, signed and acknowledged; to be filed with this
 application, in accordance with requirement of General Orders, No. 329, 1863, War Department.
 Adjutant General's Office.

Witness: *James B. Alkerton* *George W. Pottinger* Applicant.
Charles Gipe
Feb 12th 1865 1865
) Two witnesses to
) owner's signature
) sign here.

OATH OF ALLEGIANCE.

I, *George W. Pottinger*, the owner and claimant, do solemnly swear that the foregoing
 claim is a just and true claim due to me as master and owner of the said slave, and that the facts alleged in said claim, in respect to the
 draft or enlistment (as the case may be) of said slave into the military service of the United States, are true. And I do further swear that I
 have never joined, or been concerned in, any insurrection or rebellion; that I have never borne arms against the United States; that I have
 never given any aid, countenance, counsel or encouragement, to any person or persons engaged, or whom I had reason to believe were about to
 engage, in insurrection, rebellion, or armed hostility against the United States; that I have neither sought, nor accepted, nor attempted to
 exercise the functions of any office, civil or military, nor to perform any service whatever, under any authority, or pretended authority, in
 hostility to the United States; that I have not yielded a voluntary support to any insurrection, rebellion, or pretended government
 authority, power or constitution within the United States hostile thereto. And I do further swear that, to the best of my knowledge and
 ability, I have supported and defended, and will continue to support and defend, the United States against all enemies, foreign and domestic,
 and that I have supported, defended and obeyed, and will continue to support, defend and obey, the Constitution and laws of the United States;
 that I will bear true faith and allegiance to the same; and that I take this oath freely, without any mental reservation or purpose of
 evasion: So help me God.

5 CENT STAMP. The owner } *George W. Pottinger*
 signs here. }

Sworn to and subscribed before me *J. H. Malone*
 this *12th* day of *February* 1865
 The officer swear- } *J. H. Malone Notary* { L. S. }
 ing the owner signs } *Public for Nelson County Ky*
 here. }

POWER OF ATTORNEY.

My Post Office address is _____ County of _____ State
 of Kentucky, and I hereby direct that all communications to me, touching this claim, may be sent under cover to E. E. McKAY,
 Bard-town, Kentucky, who is hereby appointed and constituted my true and lawful attorney, to prosecute this claim for me, and who is
 hereby authorized and empowered to receive and receipt for any award, order, draft, certificate, voucher, warrant, papers, or money that
 may be issued in the adjustment of this claim, or the payment thereof, the same as I might or could do in person were I present and acting
 for myself, and to file any additional evidence or papers that may be required in the prosecution of this claim.

Witness: *James B. Alkerton* The owner } *George W. Pottinger*
Charles Gipe signs here. }

50 CENT STAMP.



PROOF OF OWNERSHIP.

State of Kentucky,

County of Nelson

SS.

We, James B. Asherton and Charles Gipe each of lawful age, and resident citizens of the State and County aforesaid, do certify that George W. Pottinger of the State and County aforesaid, was on the 18th day of April 1867 the lawful owner of the Slave named Anthony Pottinger referred to and described in the foregoing claim for compensation.

Two witnesses to ownership sign here.

James B. Asherton
Charles Gipe

Sworn to and subscribed before me, a Notary Public, for the County of Nelson State of Kentucky, this, the 12th day of February, 1867



The officer swearing the witnesses signs here.

J. W. M. Gore Notary Public for Nelson County, Ky. L. S.

PROOF OF LOYALTY.

State of Kentucky,

County of Nelson

SS.

We, James B. Asherton and Charles Gipe loyal men, and each of lawful age, and resident citizens of the Town of New Haven in the State and County aforesaid, upon our oaths declare that we have known George W. Pottinger a resident of the State and County aforesaid, since the 4th day of March, 1861, and know that he has firmly and faithfully maintained his or her adherence and allegiance to the Government of the United States, by defending its cause against the Government and forces of the so-called Confederate States of America, in all suitable and practicable ways, and according to his or her ability and opportunity.



Sworn to and subscribed before me, a Notary Public, for the County of Nelson State of Kentucky, this 12th day of February 1867

The officer swearing the witnesses signs here.

J. W. M. Gore Notary Public for Nelson County, Ky. L. S.
Post Master at New Haven each of us

I, Benjamin F. Asherton residents of the County of Nelson on oath state that I am and have been for 7 years well acquainted with George W. Pottinger the applicant, and James B. Asherton and Charles Gipe his witnesses, and from our personal acquaintance with them believe their statements to be entitled to full faith and credit.

Benjamin F. Asherton Post Master at New Haven Ky.

Sworn to and subscribed before me, a Notary Public, for the County of Nelson State of Kentucky, this 12th day of February 1867

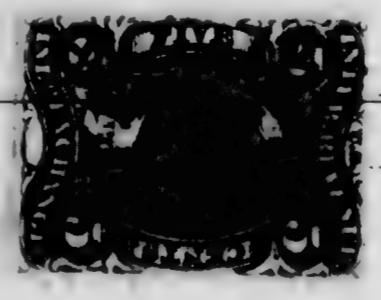

5 CENT STAMP.

NOTE.—If the applicant and his witnesses are not personally known to one or more of the Commissioners, the above certificate should be signed by two citizens who are well known to the Commissioners, or by a Post Master or other Government officer; if signed by a United States officer it need not be sworn to, but if by citizens it must be sworn to. When a United States officer signs it the witnesses need not, and when the witnesses sign it the United States officer need not.

1079

Pottinger, Robert

Co K, 6 U. S. Col'd Cav.

Private

Private

CARD NUMBERS.

1	26
2	27
3	28
4	29
5	30
6	31
7	32
8	33
9	34
10	35
11	36
12	37
13	38
14	39
15	40
16	41
17	42
18	43
19	44
20	45
21	46
22	47
23	48
24	49
25	50

Sr Pottinger, Robert

Book Mark:

See also

1080

Pogue, Alexander

Co B, 6 U.S. Col'd Cav.

Private

Corporal

CARD NUMBERS.

1	26
2	27
3	28
4	29
5	30
6	31
7	32
8	33
9	34
10	35
11	36
12	37
13	38
14	39
15	40
16	41
17	42
18	43
19	44
20	45
21	46
22	47
23	48
24	49
25	50

Book Mark:

See also

11085
Powell George.

Co A., 6 U.S. Col'd Cav.

Private

Corporal

CARD NUMBERS.

1	5387981	26	
2	5388805	27	
3	5388898	28	
4	5388928	29	
5	5389016	30	
6	5389105	31	
7	1092817	32	
8	40732737	33	
9	32083900	34	
10		35	
11		36	
12		37	
13		38	
14		39	
15		40	
16		41	
17		42	
18		43	
19		44	
20		45	
21		46	
22		47	
23		48	
24		49	
25		50	

Book Mark 4880, 1880,

See also 120 U.S.C. 2

J. C. B. 917 70 3rd
S. 840665 P.O. M.

W. Jordan
A

P | **6 Cav. | U.S.C.T.**

George Powell

Co. *A*, 6 Reg't U. S. Col'd Cav.

Appears on

Company Descriptive Book

of the organization named above.

DESCRIPTION.

Age *27* years; height *5* feet *1* inches.

Complexion *Blk*

Eyes *Blk*; hair *Blk*

Where born *Henderson Ky*

Occupation *farmer*

ENLISTMENT.

When *May 30*, 1865

Where *Henderson*

By whom *Capt Williams*; term *3* y'rs.

Remarks: *Mustered June 6/65*
Appointed Capt Dec 1, 65

Oregon

(3837)

Copyist.

C. C. Lee U.S.C.T.

George Powell
Inf. Co. , 4 Reg't U. S. Col'd *Lee*

Appears on a

Detachment Muster Roll
Unassigned Recruits
of the organization named above

for *June 10 to 30*, 1865.

Station *Camp Nelson Ky*

Present or absent *Present*

Stoppage, \$ *100* for

Due Gov't, \$ *100* for

Valuation of horse, \$ *100*

Valuation of horse equipments, \$ *100*

Remarks: *Transferred from 120 Reg't
1st Inf. to 4th Reg't
transferred to 10th 105th Reg't
Dept Ky June 10-1865*

Book mark:

A. B. Sayer

(357)

Copyist.

6 Cav. U.S.C.T.

George Howell

1st, Co. A, 6 Reg't U. S. Col'd Cavalry.

Appears on

Company Muster Roll

for July & Aug, 1861.

Present or absent Present

Stoppage, \$ 100 for

Due Gov't, \$ 100 for

Valuation of horse, \$ 100

Valuation of horse equipments, \$ 100

Remarks: Transferred from 120 U.S.C.T. per special order No 101 dated 11th Sept 61.

Book mark:

(358)

Joseph Stewart

Copyist.

6 Cav. U.S.C.T.

George Powell

Priv., Co. A, 6 Reg't U. S. Col'd Cavalry.

Appears on

Company Muster Roll

for Sep 1865, 1865

Present or absent Present

Stoppage, \$ 100 for

Due Gov't, \$ 100 for

Valuation of horse, \$ 100

Valuation of horse equipments, \$ 100

Remarks:

Book mark:

Joseph Stewart

(358)

Copist.

P

6 Cav. U.S.C.T.

George Powell
Cpl., Co. A, 6 Reg't U. S. Col'd Cavalry.

Appears on

Company Muster Roll

for Nov + Dec, 1865.

Present or absent Present

Stoppage, \$ 100 for

Due Gov't, \$ 100 for

Valuation of horse, \$ 100

Valuation of horse equipments, \$ 100

Remarks: Appointed Cpl.
per R. Order No. 138. to
Rank from Dec 1st 1865.

Book mark:

C. S. Sheltm

(258)

Copist.

P 6 Cav. U.S.C.T.

George Powell
Corp., Co. A, 6 Reg't U. S. Col'd Cavalry.

Appears on

Company Muster Roll
for Jan & Feby, 1866.

Present or absent Present

Stoppage, \$ 100 for

Due Gov't, \$ 100 for

Valuation of horse, \$ 100

Valuation of horse equipments, \$ 100

Remarks:

Book mark:

R. S. Shelton

(358)

Copyist.

SP | **6 Cav.** | **U.S.C.T.**

George Powell
Pvt, Co. *A*, 6 Reg't U. S. Col'd Cav.

Appears on **Returns** as follows:

July 1865 gain July 15/65
Camp Nelson Ky by
transfer from 120. 68 Col
Infy. per order no 105,
dated Hd Qu Dept Ky
June 15 65,

Book mark:

C. M. Mour

(546)

Copyist.

120 U.S. C.

George Powell

1st, Co. B, 120 Reg't U.S. Inf.

Appears on

Hospital Muster Roll

of **1 Division U. S. A. General Hospital,**

at **Evansville, Ind.,**

for Nov. 8 Dec, 1864.

Attached to hospital:

When _____, 186 .

How employed _____

Last paid by Maj. _____

to _____, 186 .

Bounty paid \$ 100; due \$ 100

Present or absent Absent

Remarks: _____

Book mark : _____

P

6 Cav. U.S.C.T.

George Cowell
Corp., Co. A., 6 Reg't U. S. Col'd Cavalry.

Appears on Co. Muster-out Roll, dated
Dwalls Bluff Ark, Apl 15, 1866.

Muster-out to date Apl 15, 1866.

Last paid to Feb 28, 1866.

Clothing account:

Last settled _____, 186 ; drawn since \$ 100

Due soldier \$ 852¹⁰⁰; due U. S. \$ 100

Am't for cloth'g in kind or money adv'd \$ 100

Due U. S. for arms, equipments, &c., \$ 100

Bounty paid \$ 100; due \$ 100

Remarks: Private till Dec 1. 65.
Corp

Book mark: H 880. 1880.

R B Shetton

(361)

Copyist.

1082
Porrell James.

Co I., 6 U. S. Col'd Cav.

1st Lieutenant

1st Lieutenant

CARD NUMBERS.

1	5394727	26
2	5387037	27
3	5394821	28
	5394906	29
	5394991	30
	5395073	31
7	5395149	32
	5390653	33
8	5395222	34
10	5395277	35
11	9436289	36
12	42608131	37
13	42895435	38
14	42621531	39
15	42621600	40
16	42621660	41
17	40732735	42
18		43
19		44
20		45
21		46
22		47
23		48
24		49
25		50

Book Mark:

See also

1993471-Pomona

AB Jordan
Ex

J. H. ... U.S.C.T.

James ...
..., Co. ..., 1. Reg't U. S. Col'd *...*

Appears on

Regimental Descriptive Book

(List of Commissioned Officers)

of the regiment named above.

Rank *1st Lieutenant*

Date of appointment *Jan 7* 186*5*.

Remarks: *Commissioned in*
Jan 7 1865
Assigned to Co. ...

J

6 Cav. U.S.C.T.

James Powell
Lieut, Co. I, 6 Reg't U. S. Col'd Cavalry.

Appears on

Company Muster-in and Descriptive Roll
of the organization named above. Roll dated
Camp Nelson, Ky., Apl 29, 1865.

Where born

Age y'rs; occupation

When enlisted, 186 ..

Where enlisted

For what period enlisted years.

Eyes; hair

Complexion; height ft. in.

When mustered in, 186 ..

Where mustered in

Bounty paid \$ 100; due \$ 100

Where credited

Company to which assigned

Remarks:

Book mark:

(356d)

D. M. Kennedy
Copyist.

P | 6 Cav. | U.S.C.T.

James Powell
Lieut, Co. I, 6 Reg't U. S. Col'd Cavalry.

Appears on

Company Muster Roll

for *Enlistment to Apl 30*, 186 *5*.

Present or absent *Present*

Stoppage, \$ *100* for

Due Gov't, \$ *100* for

Valuation of horse, \$ *100*

Valuation of horse equipments, \$ *100*

Remarks: *App. by the Pres.*
Jan. 2^d 65 Acc Feb 2/65
Rep to Maj Bowen A. C
10th Feb. 1/65 for duty.

Book mark:

(358)

D. M. Kennedy
Copyist.

D | *6 Cav* | U.S.C.T.

James Powell
Reg't U. S. Col'd Cav.

Age *44* years.

Appears on an

Individual Muster-in Roll

of the organization named above. Roll dated

Covington Ky, May 2, 1865.

Muster-in to date *July 22, 1865.*

Joined for duty and enrolled:

When *July 2, 1865.*

Where *Camp Wilson Ky.*

Period - years.

Valuation of horse, \$ *100*

Valuation of horse equipments, \$ *100*

Remarks: *Mustered in on C.P. -
Appointment issued by the
President of the United
States, dated July 2, 1865*

Book mark:

A. M. Harmon

P | **6 Cav.** | **U.S.C.T.**

James Powell
Lieut., Co. I, 6 Reg't U. S. Col'd Cavalry.

Appears on

Company Muster Roll

for *May or June*, 186*5*.

Present or absent *Present*

Stoppage, \$ *100* for

Due Gov't, \$ *100* for

Valuation of horse, \$ *100*

Valuation of horse equipments, \$ *100*

Remarks: *Appl. by the Prest*
of the U. S. Jan 2/65
Accepted Feb. 2/65.
Reported to May Bowen
S. O. No. 102 Feb. 1/65

Book mark:

(358)

D. M. Kennedy
Copyist.

P.

6 Cav. U.S.C.T.

James Powell
Sgt., Co. I, 6 Reg't U. S. Col'd Cavalry.

Appears on

Company Muster Roll

for July & Aug, 1867.

Present or absent Absent

Stoppage, \$ 100 for

Due Gov't, \$ 100 for

Valuation of horse, \$ 100

Valuation of horse equipments, \$ 100

Remarks: Detached, per Order Lt. Col. Coats, Camp 6" N. H. E. C.

Book mark:

(358)

J. G. Coats

Copyist.

P

6 Cav. U.S.C.T.

James Powell
Sergeant, Co. I, 6 Reg't U. S. Col'd Cavalry.

Appears on

Company Muster Roll

for Sept & Oct, 1865.

Present or absent Absent

Stoppage, \$ 100 for

Due Gov't, \$ 100 for

Valuation of horse, \$ 100

Valuation of horse equipments, \$ 100

Remarks: Detached as Prov Marshal
Genl. of 1st Div. Dept. Tex.

Book mark:

(358)

J. G. Casey

Copyist.

3 | **6 Cav.** | **U.S.C.T.**

James Powell

Sgt, Co. I, 6 Reg't U. S. Col'd Cavalry.

Appears on

Company Muster Roll

for *Nov & Dec*, 186*7*.

Present or absent

Stoppage, \$ 100 for

Due Gov't, \$ 100 for

Valuation of horse, \$ 100

Valuation of horse equipments, \$ 100

Remarks: *Discharged from Co. G. 6th U.S. Cav.
in order of the 3rd of Dec. 1867
at Fort Stanton*

**Name same in column of names sent
with him down through it.*

Book mark: _____

(358)

J. G. Carter

Copyist.

6 Cav. U.S.C.T.

James Powell
1st Lieut, Co. C, 6 Reg't U. S. Colored Cavalry.

Appears on

Company Muster Roll

for Nov. & Dec., 1865.

Present or absent Present

Stoppage, \$ 100 for

Due Gov't, \$ 100 for

Valuation of horse, \$ 100

Valuation of horse equipments, \$ 100

Remarks: Co. I Commanding
Company per order No. 132
Ad. No 6th Lt C Helena
Ark Dec 5th 65

Book mark:

W. J. Ferguson
Copyist.

J. | **6 Cav.** | **U.S.C.T.**

James Powell

1st Lt., Co. I, 6 Reg't U. S. Col'd Cavalry.

Appears on

Company Muster Roll

for Jan & Feb., 1866.

Present or absent Absent

Stoppage, \$ 100 for

Due Gov't, \$ 100 for

Valuation of horse, \$ 100

Valuation of horse equipments, \$ 100

Remarks: Absent with leave.

Book mark: _____

(358)

J. J. Deaton

Copyist.

John V. Blair

James Jewell
1st. Co. U.S. Co.

Return

of the Post of Covington and Newport, Ky.,
for the month of Oct, 1865,
dated Oct 31, 1865,
shows the following with regard to the person
named above:

Post or station _____

Remarks: James P. M. G. 1st. Co.
Dept. of Ky.

Book mark: _____

G. R. McCaugh

(546)

Copied.

P 16 Cav W.S.C.

James Powell
1st Lieut 6th Regt U.S.C.

Return

of the Provisional Brigade, Dept. of Arkansas,
for the month of November, 1865,
dated En Route to Helena Ark
November 30, 1865.

shows the following with regard to the officer
named above :

Post or station _____

Remarks: A.A. D.C. per S.O. 3
dated 1st Prov Brig Louisville
Nov 22 65

Book mark: _____

(546)

D. K. Sangster,
Copyist.

P 16 Car U.S.G.

James Powell
1 Lieut 6 Regt U.S. Cal. Cav

Return

of the Post of De Vall's Bluff, Ark.,

for the month of *January*, 18*66*,

dated *Not Dtd*, 18*66*,

shows the following with regard to the person
named above:

Post or station _____

Remarks: _____

Book mark: _____

(546)

J. Jacobson

Copyist.

P 16 Law-Union
James Powell
De Valls Bluff Ark.

Return

of the Post of De Vall's Bluff, Ark.,

for the month of February, 1866,

dated Feb 24th, 1866,

shows the following with regard to the person
named above:

Post or station _____

Remarks: _____

Book mark: _____

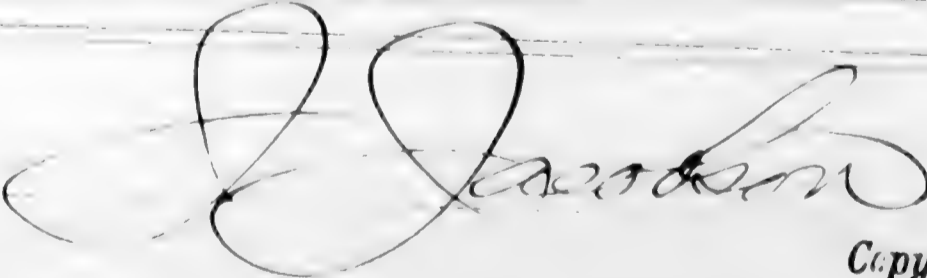
(546)  Copyist.

16600 1866

James Powell
Lieut. Co. D. 6 Regt. W. S. Cal.

Return

of the Post of De Vall's Bluff, Ark.,
for the month of March, 1866,
dated March 31, 1866,
shows the following with regard to the person
named above:

Post or station

Remarks: Returned from leave of absence
March 22, 1866

Book mark:

Curtis Clark

(546)

Copyist.

JP | **6 Cav.** | **U.S.C.T.**

James Powell
G.H. Co. I, 6 Reg't U. S. Col'd Cav.

Appears on Returns as follows:

April 1865 Present
Assigned to Co, at
Camp Nelson Ky Feb 24/65
per O. No 4. of Maj A H.
Bowen Comd'g C. U. S. C.
May 1865, Absent detached
June 1865, Present, Ret'd to Co,
from detached service
July to Oct 1865, Absent
Detached, per S O
Nov 1865, Absent on detached
service at Louisville Ky
per order (verbal) of
Lt Col W Coates, Comd'g
C. U. S. C.
Dec 1865 & Jan'y 1866, Present
Comd'g Co, C, 6th U. S. C.,
per order No 132, Dec 5/65.
Hd Qu. C. U. S. C.,
Feb'y 1866, Absent with
leave. (over)

Book mark:

(G.M. Row)

(546)

Copyist.

JAN. 19.

40732738

1899.

*March 1866, Present
Army & Co., 6th U.S.C.*

P 16 Cav U.S.C.T.

James Powell,
1st Lt, Co. I, 6 Reg't U. S. Col'd Cav

Appears on Co. Muster-out Roll, dated
Dewalls Bluff Ark, Apr 15, 1866.

Muster-out to date Apr 15, 1866.

Last paid to Feb 28, 1866.

Clothing account:

Last settled _____, 186 ; drawn since \$ _____ 100

Due soldier \$ _____ 100; due U. S. \$ _____ 100

Am't for cloth'g in kind or money adv'd \$ _____ 100

Due U. S. for arms, equipments, &c., \$ _____ 100

Bounty paid \$ _____ 100; due \$ _____ 100

Remarks: 1st Lt from organization
App'td from Civil life, Comd'g
Co "C" 6th U.S.C., since Dec 5/65.
Travelling allowance claimed
to West Springfield Erie Co. Pa.
place of residence & where
(over)

Book mark: _____

(361)

Price
Compared Copyright

JAN. 10

5395277

1891

received notice of appointment,
3 months pay proper
claimed,

Powell, James

1st Lt, Co. D, 6 U.S.C. Cav.

10 Enclosures.

Bed Cards	Descriptive Lists
Burial Records	Final Statements
Certs. of Dis. for Discharge	Furloughs /
C. M. Charges	Med. Des. Lists
Med. Certificates	Orders 0

Other papers relating to—

Admission to Hosp'l	Furlough 2
Casualty Sheet (Officer's)	Med. Examination
Confinement	Misc. Information
Contracts	Pay or Clothing
Death or Effects	Personal Reports /
Desertions	Rank
Discharge from Hosp'l	Transfer to Hosp'l
Discharge from Service	Transfer to V. R. C.
Duty	Transportation

Mr. Powell,

1 St. N. W. C. C. C.

Order

Head-Quarters 1st Division, Department of Kentucky,

Lexington, Kentucky, July 3^d 1865.

Special Orders, }
No. 128 }

(Extract.)

* * * * *
II " " 1st Lieut James Powell Co. "D" 6th U. S. Colored
Cavalry will proceed to Camp Nelson Ky and
report to the Commanding Officer of his Regiment
The Dept will furnish transportation

* * * * *
By Command of Brigadier General ~~J. F. Wade~~ ^{But} J. F. Wade *

* * * * *
A. R. Forster.
Capt & Acting Assistant Adjutant General.

APR 1911

James D. Well

Order

Head-Quarters Department of Kentucky,

Louisville Ky July 29 1865.

Special Orders,
No. 37

(Extract.)

Leave of Absence is hereby granted the following named officers, for the number of days set opposite their names:

Major James Powell, (C. I.) (U. S. A.)
C. for leave (20) days

The following extracts from Regulations and General Orders, relative to leaves of absence, will be strictly observed:
When not otherwise specified, leaves of absence will commence the day an officer is relieved from duty at his post, after receiving the order granting him leave.
At the expiration of his leave, the officer must report in person with his command, and not at the office from which his leave issued.
No officer is permitted to visit Washington without special permission from the Secretary of War, which must be stated in the order granting leave of absence.
If an officer be not able to travel at the expiration of his sick leave, he must report his address to the commander of his post, regiment or corps, and also to the Adjutant General of the Army; and in his first report state the day when his leave of absence commenced. These reports must be repeated every twenty days, and each one must be accompanied by the certificate of a medical officer of the army, made in the usual form, and stating that the officer is not able to travel. If there is no army physician in the place where the officer resides, the certificate of a citizen physician, the truth of which must be sworn to before a civil magistrate, may be substituted.
Extensions of leave are not granted in orders.
Officers absent from duty without leave, or beyond the time of their leaves, will not be allowed to draw pay until a court or commission, which will be ordered on their return to their post or command, shall determine whether there was sufficient cause for their absence. They will accordingly provide themselves with a full description of the nature and cause of their disability, certified by the proper medical authority, as required by existing orders and regulations.
And be it further enacted that any officer absent from duty with leave, except for sickness or wounds, shall, during his absence, receive half of the pay and allowances prescribed by law, and no more; and any officer absent without leave shall, in addition to the penalties prescribed by law or court-martial, forfeit all pay and allowances during such absence.
And be it further enacted that the thirty-first section of an act entitled "An act for enrolling and calling out the National forces, and for other purposes," approved March third one thousand eight hundred and sixty-three, be and the same is hereby so amended as that an officer may have, when allowed by order of his proper commander, leave of absence for other cause than sickness and wounds, without deduction from his pay or allowances; PROVIDED, that the aggregate of such absence shall not exceed thirty days in any one year.

By command of Major General

Geo. W. Sullivan
Assistant Adjutant General

C. I. S. C. C.

James Powell,
1st.

1st.

HEAD-QUARTERS 1st DIV. DEPT OF KY.,

Lexington, Ky., September 13th 1865.

SPECIAL ORDERS, }

No. 193-

"EXTRACT"

1st Lieut James Powell, Co. 116. S. W. Va. is detailed as Proc. War. Genl. in the Division Staff, and will be obeyed and respected accordingly.

By Command of

Brig. Genl. Jas. S. Bristow
N. L. Hunter

Capt. and A. A. A. G.

Mr. Powell
Lt.
C. B. C. C.

Head-Quarters First Division Department of Ky.

Lexington, Ky., Oct. 16th 1865.

SPECIAL ORDERS,

No. 10

"EXTRACT"

Lieut James Powell 6th U.S. C. Co. is hereby detailed as P.M. G.
1st Brig 1st Div. D. K. and will be obeyed and respected accordingly

By Command of Brig. Gen. JAS. S. BRISBIN,

S. A. Plummer

Capt. and A. A. A. G.

Mr. F. Powell,

1st. Co. 9

Head Quarters Provisional Brigade
Helena Ark Dec 4th 1865
Special Field Orders
No 6

1st Lt James F. Tavel Co 2^d
6th U. S. Colored Cavalry and A. A. S. C
is hereby relieved from duty on the Staff of
the Brig Gen Com'dy Provisional Brigade and
will report without delay to the Commanding
Officer of his Regiment for duty.

By Command of Brig Gen Jas. S. Brajlin
Com'dy Officer
6th U. S. C. C.
Camp Wade
Capt and A. A. S. C

Quarta...
P. W. H. / D. A. 1865
C. C. C.

Arriba...

...
...
...
...
...

He got the...
...
...
...

J. F. H. C. C.
...
...

...

L. S. A. ...

Quarterly Report
to the Board of Directors
of the Bank of the United States
for the quarter ending
the 31st day of March 1815

Capt. Charles C. Smith
of the U.S. Army

Captain

I have the honor to acknowledge the receipt of your letter of the 27th inst. in relation to the duty of the U.S. Army in the West, and in consequence of which I have the pleasure to inform you that the same has been forwarded to the proper authorities for their consideration.

I am, Sir, very respectfully,
Your obedient servant,
John C. Calhoun
Secretary of War

John C. Calhoun
Secretary of War

Headquarters Dept. Art.
Little Rock Ark
February 6th 1866

S. C. 1
No 211

Extract

2. Leave of absence for twenty days to go beyond the limits of this Department, with permission to apply to Court Charles W. Whitson, District of the Mississippi for an extension of ten days, is hereby granted the following named Officers:

1st Lt. James Forrest, Co. C. 6th Regt. A. C.

In command of

1st Lt. James Forrest

Charles C. ...

Capt. ...

at 11

May 6, 1866
James Powell
Lt. Col. U. S. C. C.,

see

H. A. Watson
Capt. U. S. C. C.,

Washington.

Leave.

Cairo Ill.
February 1866

Powell James, 1st Lt. Co. C. 67th Regt.

Request extension of leave
for ten days.

Cairo Ill.

February 13th 1866.

Col. R. N. Sanger
A. A. S. Mil. Co. Ill.

Sir

I have the honor this day to
transmit certified copy of leave of absence for twelve days,
from Col. S. G. P. with permission to apply for an
extension of ten days, from Col. R. N. Sanger.

I respectfully request that the extension be granted,
on account of the time expended in reaching my destination.

Should the request be approved, please
advise at my home in West Springfield, Erie Co. Penna.

Very respectfully

Chas. J. ...
James J. ...
West Co. C. C. H. Co.

Affidavit of Nonindebtedness to U. S.,

of *James Powell*

late *1st Lt. Co. "D." 6th* Reg't

N. S. C. Cav. on which was

based Certificate of Nonindebtedness

to U. S.,

Dated *April 21st* 1866.

STATE OF

COUNTY

Missouri } ss.
St. Louis
Barre

I, *James Sewell*

late *1st Regt* of *1st* Regiment *U.S.A.*

do solemnly declare on oath, that I have duly accounted for all Public Property, for which I have ever been responsible, as an officer of the Volunteer Forces of the United States; that I have rendered all returns and reports, required by Revised Army Regulations of 1863 and existing orders; that I am not now, on any account whatever, indebted to the General Government except as stated on Muster-out Rolls.

James Sewell

Sworn and subscribed before me, at *St. Louis* this

this *11* day of *April* 1866



James Sewell

1083

Porrell Nathan

Co *G.*, 6 U. S. Col'd Cav.

Private | *Private*

CARD NUMBERS.

1	5387982	26
2	5393625	27
3	5393722	28
4	5393816	29
5	5393904	30
6	5393991	31
7	9040568	32
8	40732739	33
9		34
10		35
11		36
12		37
13		38
14		39
15		40
16		41
17		42
18		43
19		44
20		45
21		46
22		47
23		48
24		49
25		50

Book Mark:

See also *120 U.S.C. 2.*

J-928387 - P.O. aff

8 1175491 P.O. aff

8 1175492 P.O. aff

83044506 and wd

L. Jordan
Ex

C. 6 Cav. | **U.S.C.T.**

Nathan Powell

, Co. G, 6 Reg't U. S. Col'd Cav.

Appears on

Company Descriptive Book

of the organization named above.

DESCRIPTION.

Age *24* years; height *5* feet *6* inches.

Complexion *Black*

Eyes *Black*; hair *Black*

Where born *Henderson, Ky.*

Occupation *Farmer,*

ENLISTMENT.

When *May 22*, 186*5*.

Where *Henderson*

By whom *Capt. Billings*, term *3* y'rs.

Remarks:

As per West

File **U.S.C.T.**

Nathan Powell
Dr. Co., *6* Reg't U. S. Col'd *6*

Appears on a

Detachment Muster Roll
unassigned recruits
of the organization named above

for *June 11 to 30*, 1865.

Station *Camp Nelson Ky*

Present or absent *Present*

Stoppage, \$ *100* for

Due Gov't, \$ *100* for

Valuation of horse, \$ *100*

Valuation of horse equipments, \$ *100*

Remarks:

Book mark:

(357)

A. B. Sawyer
Copyist.

P

6 Cav. | U. S. C. T.

Nathan Powell

Private, Co. G, 6 Reg't U. S. Col'd Cavalry.

Appears on

Company Muster Roll

for *July & Aug.*, 1865.

Present or absent

Stoppage, \$ 100 for

Due Gov't, \$ 100 for

Valuation of horse, \$ 100

Valuation of horse equipments, \$ 100

Remarks: *Transferred from the 120th U. S. C. I by order War Dept. 1st Installment Bounty due.*

Book mark:

(358)

Keefe

Copyist.

P

6 Cav. | U. S. C. T.

Nathan Powell

Private, Co. G, 6 Reg't U. S. Col'd Cavalry.

Appears on

Company Muster Roll

for *Sept. & Oct.*, 186*5*.

Present or absent *Present*

Stoppage, \$ *100* for

Due Gov't, \$ *100* for

Valuation of horse, \$ *100*

Valuation of horse equipments, \$ *100*

Remarks:

Book mark:

Keefer

(358)

Copyist.

P

6 Cav. | U. S. C. T.

Nathan Powell
1st Lt., Co. G, 6 Reg't U. S. Col'd Cavalry.

Appears on

Company Muster Roll

for *Nov & Dec*, 186 *5*.

Present or absent *Present*

Stoppage, \$ *100* for

Due Gov't, \$ *100* for

Valuation of horse, \$ *100*

Valuation of horse equipments, \$ *100*

Remarks: *1st installment of bounty due \$100.*

Book mark: _____

(358)

J. L. Harris

Copyist.

P

6 Cav. | U. S. C. T.

Nathan Powell
Priv, Co. G, 6 Reg't U. S. Col'd Cavalry.

Appears on

Company Muster Roll

for *Jan'y & Feby*, 186*6*.

Present or absent *Present*

Stoppage, \$ *100* for

Due Gov't, \$ *100* for

Valuation of horse, \$ *100*

Valuation of horse equipments, \$ *100*

Remarks: *1st installment of bounty due \$10000*

Book mark: _____

(358)

J. L. Morris

Copyist.

P | 6 Cav. | U.S.C.T.

Nathan Powell,
Pvt., Co. *G*, 6 Reg't U. S. Col'd Cav.

Appears on Returns as follows:

July 1865; Gain June 28/65
Camp Nelson transferred
from 120. C. I. to Co. G
6. U. S. C. C.

Book mark:

G. M. Roan

(546)

Copyist.

D

6 Cav. U.S.C.T.

Nathan Powell
Pvt., Co. *G*, 6 Reg't U. S. Col'd Cavalry.

Appears on **Co. Muster-out Roll**, dated

Dwight's Bluff, Ark., April 15, 1866.

Muster-out to date *April 15, 1866.*

Last paid to *Feb. 28, 1866.*

Clothing account:

Last settled _____, 186 ; drawn since \$ 100

Due soldier \$ 100; due U. S. \$ *9* ^{*08*} 100

Am't for cloth'g in kind or money adv'd \$ 100

Due U. S. for arms, equipments, &c., \$ 100

Bounty paid \$ 100; due \$ 100

Remarks: _____

Book mark: _____

(861)

J. L. Borris

Copyist.

1084

Orndorff Wesley

Co *B*, 6 U. S. Col'd Cav.

Private

Private

CARD NUMBERS.

1	26
2	27
3	28
4	29
5	30
6	31
7	32
8	33
9	34
10	35
11	36
12	37
13	38
14	39
15	40
16	41
17	42
18	43
19	44
20	45
21	46
22	47
23	48
24	49
25	50

See Orndorff Wesley

Book Mark:

See also

10855
Prewitt Sandford

Co M., 6 U. S. Col'd Cav.

Wagoner | Wagoner

CARD NUMBERS.

1	5396516	26
2	5396609	27
3	5396702	28
4	5396867	29
5	5397146	30
6	9043943	31
7	40732740	32
8		33
9		34
10		35
11		36
12		37
13		38
14		39
15		40
16		41
17		42
18		43
19		44
20		45
21		46
22		47
23		48
24		49
25		50

Book Mark:

EBV. 11. P. 127

See also

A 120. U. S. C. 2

D. 1255389 sub 5

L. B. Jordan
J. E.

D

6 Cav. U.S.C.T.

Sanford Bennett

Co. M., 6 Reg't U. S. Col'd Cav.

Appears on

Company Descriptive Book

of the organization named above.

DESCRIPTION.

Age 24 years; height 5 feet 5 inches.

Complexion Blk

Eyes Blk; hair Blk

Where born Henderson, Mo.

Occupation Farmer

ENLISTMENT.

When April 9, 1865.

Where Henderson

By whom Capt Bellings, term 3 yrs.

Remarks: Mustered into
US service April 25/65
Garrison Ky by Capt
Grissum.
Died of disease in
Camp Meade Lexington
Ky Sept 15/65

Forrest

6 Cav. U.S.C.T.

Davidson Hewitt
Majr, Co. M, 6 Reg't U. S. Col'd Cavalry.

Appears on

Company Muster-in and Descriptive Roll
of the organization named above. Roll dated

August 4, 1861, ~~NY~~, August 10, 1861.

Where born Henderson Kentucky

Age 31 y'rs; occupation Farmer

When enlisted April 9, 1861.

Where enlisted Henderson

For what period enlisted 1 year.

Eyes black; hair black

Complexion black; height 5 ft. 6 in.

When mustered in April 10, 1861.

Where mustered in Danvers Ky

Bounty paid \$100; due \$100

Where credited 2d Reg't of Ky

Company to which assigned M.

Remarks: Transferred to U. S. Col'd Cavalry

in U. S. C. T.

Book mark:

(356d)

Joseph Davidson

Copyist.

6 Cav. U.S.C.T.

Harford Bennett
Alguer, Co. M, 6 Reg't U. S. Col'd Cavalry.

Appears on

Company Muster Roll

for *June 21 to June 30, 1865.*

Present or absent *Present*

Stoppage, \$ *100* for

Due Gov't, \$ *100* for

Valuation of horse, \$ *100*

Valuation of horse equipments, \$ *100*

Remarks: *Transferred from
120 U.S. Col'd Cavalry
W.S. dated N.S. Las.
D.K. June 10 1865*

Book mark:

Joseph Stewart
(358) Copyist.

7

6 Cav. U.S.C.T.

Samford Merrill
.....
Myones, Co. M, 6 Reg't U. S. Col'd Cavalry.

Appears on

Company Muster Roll

for *April August*, 186*4*.

Present or absent *Present*

Stoppage, \$ *100* for

Due Gov't, \$ *100* for

Valuation of horse, \$ *100*

Valuation of horse equipments, \$ *100*

Remarks:

Book mark:

(358)

Joseph Stewart
.....
Coryist.

W. P. 6 Cav. U.S.C.T.

Samuel Dunsford

W. P., Co. M, 6 Reg't U. S. Col'd Cavalry.

Appears on

Company Muster Roll

for *Sept*, 1865.

Present or absent

Stoppage, \$ 100 for

Due Gov't, \$ 100 for

Valuation of horse, \$ 100

Valuation of horse equipments, \$ 100

Remarks: *Ind. in...*

...

...

Corrected by Jordan

Book mark *Ind. Dept. 22 over*

JAN. 10

5396867

1891

۵۰۵. ۵۳۹۶۸۶۷ (۱۰) ۲۷.

S | **6 Cav.** | **U.S.C.T.**

Sanford Prewitt
Pol, Co. *M*, 6 Reg't U. S. Col'd Cav.

Appears on Returns as follows:

Aug 1865. Absent sick
Hosp Lexington Ky

Oct 1865. Lost. Sept 25/65
Lexington Ky.
Died of disease.

Book mark:

A M Rowe

(546)

Copyist.

6 Cav. U.S.C.T.

Samuel Bennett

Regt. Co. M., 6 Reg't U. S. Col'd Cavalry.

Appears on **Co. Muster-out Roll**, dated

W. P. Waller, Bl. 46. April, Apr 13, 1866.

Muster-out to date _____, 186 .

Last paid to *Apr 30, 1865* .

Clothing account:

Last settled _____, 186 ; drawn since \$ 100

Due soldier \$ 100; due U. S. \$ 100

Am't for cloth'g in kind or money adv'd \$ 100

Due U. S. for arms, equipments, &c., \$ 100

Bounty paid \$ 100; due \$ 100

Remarks: *Admitted of presence in
and Hospital at Lexington
Ky. Sept. 13, 1865.
Final statements forwarded*

Book mark: *Recd Sept. 22/65 E. B. V. 11. P. 117*

(861)

W. Bennett

Copyist.

Prewett, Sandford,
Pri, Co. M, 6 Reg U.S.C. Cav.

3 Enclosures.

Bed Cards	Descriptive Lists
Burial Records	Final Statements
Certs. of Dis. for Discharge	Furloughs
C. M. Charges	Med. Des. Lists
Med. Certificates	Orders

Other papers relating to—

Admission to Hosp'l	Furlough
Casualty Sheet (Officer's)	Med. Examination
Confinement	Misc. Information
Contracts	Pay or Clothing
Death or Effects 2	Personal Reports
Desertions	Rank
Discharge from Hosp'l	Transfer to Hosp'l
Discharge from Service	Transfer to V. R. C.
Duty	Transportation

Sandford Bennett

1811

rel to death



Lexington N. Y. U. S. Army Post General Hospital,

September 22 1865

Captain

I have to report that Private Sanford Prewett
of Company ^A 6th Regiment U. S. Cav. Died at this General
Hospital this morning at 5 o'clock of Typhoid
Fever As he had no descriptive notes
I forward Inventory of effects so enable
you to make out his final statements

Very respectfully,

Your obedient Servant,

W C Satham
W. C. Satham
In Charge

Inventory of the effects of Private
 Sanford Prewitt of Co
 Co M. 6th Regt US Cav
 Volunteers who was enrolled as a
 at In the State of
 on the day of 186
 and mustered into the service of the
 United States as a on the day of
 186 at in Company
 Regt of Volunteers to serve
 years or during the war. he was born in
 in the state of he was years of age
 feet inches high complexion
 hair and by occupation when enroll
 ed a he died in Post Hospital
 at Lexington Va on the 22nd day of
 Sept. 1865 by reason of Typhoid Fever

Inventory

- Blouse 1
- Pairs Trowsers 1
- Pairs Boots 1
- Cap 1

I certify on honor that the above inventory
 comprises all the effects of Sanford Prewitt
 deceased and that they are in
 the hands of the Museum at this Post Lexington
 Va. We directed by a Council of Administration

Station Lexington Post Va
 Date September 22 1865

John W. ...
John W. ...
John W. ...

A. J. C. 4461 13/16
2000
1874

FINAL STATEMENT

OF

6th Reg't of W. Cavalry

VOLUNTEERS.

NOTE 1.—Two of these certificates (or duplicates) are to be given to each Volunteer Soldier or drafted man who may be discharged without being mustered out (Final Statements are never given to men mustered out of service,) that he may at once receive from the Paymaster the pay, &c., due him, and the captain or other COMMISSIONED officer commanding the company will certify to the act of the delivery of the duplicate certificates; with these certificates the Soldier is "entitled to" his discharge, and should also present his discharge to the Paymaster to have the payment endorsed on it. The discharge is to be given back to the Soldier by the Paymaster; the latter only retaining as his vouchers the duplicate certificates.

NOTE 2.—If the Soldier is entitled to pay for the use of his horse, the Company Commander will certify to that fact on the back of both these final statements, and also to the time he has pay due for having been so mounted on his own horse.

NOTE 3.—When a Soldier is furnished with final statements, his descriptive list, if he has one, should be taken up by the officer who gives the Soldier these statements, and endorsed with a statement to this effect by the officer. The endorsement should exhibit a full statement on the time for which the Soldier was allowed pay on his final statements, the existing account, and all other charges against him, or in his favor, and also a complete exhibit of his account. It will then be transmitted to the Company Commander of the Soldier, who will enter all the data necessary to a full understanding of the Soldier's account on the muster roll upon which the Soldier's discharge is reported. The descriptive list will then be destroyed. The object of this is, that the remaining portion of the Soldier's account may be settled upon the receipt of those muster rolls, and the Soldier receive any pay or allowances that may be due him at the time of his discharge, and which may not appear on his last final statements from the fact that his descriptive list is complete. These accounts for back pay, &c., are settled by the 2d Auditor of the Treasury Department.

NOTE 4.—Changes for loss or injury to ordnance, horse equipments, and other miscellaneous charges, should appear under the heading of "Other Stoppages."

NOTE 5.—Bounty paid by State authorities, and not by the United States, will not be entered on the statement.

NOTE 6.—Amounts due the Soldier and Laurels must be entered on the muster roll on which the discharge, death, desertion, &c., is reported, as well as on the final statement, otherwise the amount cannot be collected from the United States.

NOTE 7.—This blank will be used for deceased volunteers and drafted men, as well as for substitutes.

NOTE 8.—When a Soldier dies in Hospital or on detached service, his descriptive list, if he has one, should be sent with his final statements, in duplicate, to the Adjutant General, Washington, D. C.

NOTE 9.—If the soldier is a drafted man or substitute, the space for this, &c., at the end, should contain only the word *drafted* or *substitute*, as the case may be. If the Soldier is a "VETERAN," (or RECRUIT,) the words *as a veteran* (or *recruit*) as the case may be, should be inserted after the words *mustered into the service of the U. S.* A statement of all the instalments of *Veteran or Recruit Bounty RECEIVED* by the Soldier must be made on the back of each final statement.

[OFFICE INDORSEMENT.]

War Department,

ADJUTANT GENERAL'S OFFICE,

July 22^d, 1874

The death of *Sanford Brewett*
 Private, Co. "M", 6th Reg't U. S.

Colored Cavalry, is reported as follows:

On Company Muster Roll.

For Sept & Oct, 1865, no date, 1865

Company Muster-out Roll.

September 15th, 1865

Company Descriptive Book.

, 186

Company Morning Reports.

, 186

Soldier's Final Statement.

September 22^d, 1865

Soldier's Record of Death and Interment.

, 186

Soldier's Inventory of Effects.

September 22^d, 1865

Soldier's Certificate of Disability for Discharge.

, 186

Soldier's Individual Muster-out Roll.

, 186

Regimental Return.

For October, 186, September 25, 1865

Regimental Quarterly Returns.

, 186

Regimental Descriptive Book.

, 186

By Surgeon General.

() , 186

September 22^d, 1865, is held to be

the correct date, and the Company Muster-out

Rolls will be amended accordingly.

Martin
 Assistant Adjutant General.

See letter to Second Auditor

Aug 10 1874

157.

ADJUTANT GENERAL'S OFFICE
Martin
 Date with [unclear] 2d Auditor.

I certify, on honor, that Samuel Smith, a Private of Company (25) of the 6th Regiment of U.S.C. Cal Volunteers, of the State of Missouri, born in Missouri, State of Missouri, aged 26 years; 5 feet 6 inches high; Blk complexion, Blk eyes, Blk hair, and by occupation a Farmer, who joined for service and was enrolled (see Note 9) on the 9 day of April, 1865, at St. Louis, by Capt. Briggs, for the period of Three years, and mustered into the service of the United States on the 25 day of April, 1865, at St. Louis, by Capt. Garrison; and having served HONESTLY and FAITHFULLY with his Company to the present date, is now entitled to a **DISCHARGE** by reason of Ind. at Gen. Hospital Sept 22 1865

The said Samuel Smith was last paid by Paymaster May Harris, to include the 25 day of April, 1865, and has pay due him from that time to the present date; he is entitled to pay and subsistence for **TRAVELING** to place of enrollment, and whatever other allowances are authorized to volunteer soldiers, drafted men, or militia, so discharged. He has received from the United States **CLOTHING** amounting to 13 $\frac{75}{100}$ dollars, since the Nov day of April, 1865, when his clothing account was last settled. He has received from the United States 100 dollars advanced **BOUNTY**.

There is to be stopped from him, on account of the State of _____, or other authorities, for **CLOTHING, &c.**, received on entering service, _____ $\frac{100}{100}$ dollars; and for other stoppages, viz: _____ $\frac{100}{100}$ dollars.

He has been furnished with **TRANSPORTATION** in kind from the place of his discharge to _____; and he has been **SUBSISTED** for **TRAVELING** to his place of enrollment, up to the _____, 1865.

He is indebted to _____, **SUTLER**, _____ $\frac{100}{100}$ dollars.
 He is indebted to _____, **LAUNDRESS**, _____ $\frac{100}{100}$ dollars.

Given in Duplicate, at St. Louis, this 26 day of November, 1865.

[Handwritten Signature]

2nd Lieut 6th U.S.C. Cal
 Commanding Company

1086

Price Harrison

Co *F.*, 6 U. S. Col'd Cav.

Farrar

Farrier

CARD NUMBERS.

1	5392507	26
2	5392594	27
3	5392682	28
4	5392753	29
5	5392851	30
6	5392947	31
7	5393040	32
8	5393134	33
9	9093375	34
10	3150536	35
11	40732743	36
12		37
13		38
14		39
15		40
16		41
17		42
18		43
19		44
20		45
21		46
22		47
23		48
24		49
25		50

Book Mark:

See also

P | 6 Cav. | U.S.C.T.

Harrison Price
Farmer, Co. F, 6 Reg't U. S. Col'd Cav.

Appears on

Company Descriptive Book

of the organization named above.

DESCRIPTION.

Age 29 years; height 5 feet 8 inches.

Complexion brown

Eyes black; hair black

Where born Jessamine, Ky.

Occupation Farmer

ENLISTMENT.

When June 7, 1865

Where Camp Nelson

By whom J. C. Kaidolph; term 3 y'rs.

Remarks:

Mustered in Jan. 9/65 by
Law Ky Capt. Moore

C. J. Powell

(3837)

Copyist.

6 12 15
P 1 1865

Harrison Price

Appears with rank of _____ on

Muster and Descriptive Roll

of Attachment of U.S. Colored Volunteers
forwarded to Camp Nelson

Roll dated
Lexington Ky, Jan 9, 1865

Where born Jessamine Ky

Age 24 years; occupation Farmer

When enlisted Jan 3, 1865

Where enlisted Camp Nelson

For what period enlisted 3 years.

Eyes Blk; hair Blk

Complexion Blk; height 5 ft. 6 in.

When mustered in Jan 9, 1865

Where mustered in Lexington

Bounty paid \$ 100; due \$ 100

Clothing account:

Last settled _____, 1865; drawn since \$ 100

Date of first muster Jan 9, 1865

Company to which assigned _____

Remarks: Discharged to Jessamine Co. 7th Ky
Jessamine Price Owner

Book mark: _____

Martin

(356m)

Copyist

F. C. Co. | **U. S. C. T.**

Harrison Price
Co. H, 4 Reg't U. S. Col'd

Appears on

Company Muster-in and Descriptive Roll
of the organization named above. Roll dated

Lexington Ky, Jan 26, 1865.

Where born *Jessamine Ky*

Age *29* y'rs; occupation *Farmer*

When enlisted *Jan 7*, 1865.

Where enlisted *Camp Nelson*

For what period enlisted *3* years.

Eyes *Blk*; hair *Blk*

Complexion *Blk*; height *5* ft. *8* in.

When mustered in *Jan 9*, 1865.

Where mustered in *Lexington Ky*

Bounty paid \$ *100*; due \$ *100*

Where credited *7th*

Company to which assigned

Remarks:

Book mark:

Bryer

(356d)

Copist.

J

6 Cav. U.S.C.T.

Harrison Price
Farmer, Co. F, 6 Reg't U. S. Col'd Cavalry.

Appears on

Company Muster Roll

for *Jan 24 to Apr 30*, 186*5*.

Present or absent *Present*

Stoppage, \$ *100* for

Due Gov't, \$ *100* for

Valuation of horse, \$ *100*

Valuation of horse equipments, \$ *100*

Remarks:

Book mark:

Breggs

(358)

Copyist.

1777 1543
D 6 Cav. U.S.C.T.

William Price
Price, Co. F, 6 Reg't U. S. Col'd Cavalry.

Appears on

Company Muster Roll

for *May 1 June*, 186*4*.

Present or absent *present*

Stoppage, \$ 100 for

Due Gov't, \$ 100 for

Valuation of horse, \$ 100

Valuation of horse equipments, \$ 100

Remarks:

Book mark:

Preyer
(358) *Preyer* Copyist.

65

6 Cav. U.S.C.T.

Harrison Price

Garnier, Co. F, 6 Reg't U. S. Col'd Cavalry.

Appears on

Company Muster Roll

for *July & Aug.*, 1865.

Present or absent *Present*

Stoppage, \$ *100* for

Due Gov't, \$ *100* for

Valuation of horse, \$ *100*

Valuation of horse equipments, \$ *100*

Remarks: *1st inst. of bounty due,*

Book mark:

(358) *J. E. Chapin* Copyist.

50

6 Cav. U.S.C.T.

Harrison Rice

Famier, Co. F, 6 Reg't U. S. Col'd Cavalry.

Appears on

Company Muster Roll

for *Sept & Oct*, 1865.

Present or absent *Present*

Stoppage, \$ *100* for

Due Gov't, \$ *100* for

Valuation of horse, \$ *100*

Valuation of horse equipments, \$ *100*

Remarks:

Book mark:

(358)

J. E. Chapin

Copyist.

90 | 6 Cav U.S.C.T.

Harrison Price
Farriss, Co. F, 6 Reg't U. S. Col'd. 8 Cav

Appears on

Company Muster Roll

for Nov & Dec, 1865.

Present or absent Present

Stoppage, \$ 100 for

Due Gov't, \$ 100 for

Valuation of horse, \$ 100

Valuation of horse equipments, \$ 100

Remarks:

Book mark:

(358) J. E. Chapin Copyist.

P 6 Cav. U.S.C.T.

Harrison Price

F, Co. F, 6 Reg't U. S. Col'd Cavalry.

Appears on

Company Muster Roll

for *Jan & Feb*, 186*6*.

Present or absent *Present*

Stoppage, \$ *100* for

Due Gov't, \$ *100* for

Valuation of horse, \$ *100*

Valuation of horse equipments, \$ *100*

Remarks:

Book mark:

M. J. Smith

(358)

Copyist.

P | **6 Cav.** | **U.S.C.T.**

Harrison Price
Artif.
Harrison, Co. *H*, 6 Reg't U. S. Col'd Cav.

Appears on **Returns** as follows:

Sept 1865, On duty as
Reg't Carrier,

Jan'y 1866, On duty at
Post Stables,

Book mark :

A. M. Row

(546)

Copyist.

W P 6 Cav. U.S.C.T.

Wice, Harrison
Finner, Co. F, 6 Reg't U. S. Col'd Cavalry.

Appears on Co. Muster-out Roll, dated
Duwall's Bluff, Ark, Apr 15, 1866.

Muster-out to date *Apr 15*, 1866.

Last paid to *Feb 28*, 1866.

Clothing account:

Last settled _____, 186 ; drawn since \$ _____ 100

Due soldier \$ *16 35* 100; due U. S. \$ _____ 100

Am't for cloth'g in kind or money adv'd \$ _____ 100

Due U. S. for arms, equipments, &c., \$ _____ 100

Bounty paid \$ *100* 100; due \$ _____ 100

Remarks: _____

Corrected by Girault, Enr.

Book mark: _____

(361)

M. A. Smith

Copyist.

1087

Price James.

Co *F.*, **6** U. S. Col'd Cav.

Private | *Private*

CARD NUMBERS.

1	5392559	26
2	5392632	27
3	5392717	28
4	5392804	29
5	5392929	30
6	5393217	31
7	9093473	32
8	43149318	33
9	40732744	34
10	31413552	35
11	31413619	36
12	32116289	37
13		38
14		39
15		40
16		41
17		42
18		43
19		44
20		45
21		46
22		47
23		48
24		49
25		50

Book Mark

EBV. 11. P. 33, + 273468.

See also

C. | **6 Cav. | U.S.C.T.**

James Price

Priv., Co. *F.*, 6 Reg't U. S. Col'd Cav.

Appears on

Company Descriptive Book

of the organization named above.

DESCRIPTION.

Age *28* years; height *5* feet *5* inches.

Complexion *black*

Eyes *black*; hair *black*

Where born *Franklin, Ky*

Occupation *Farmer*

ENLISTMENT.

When *Nov. 2*, 1864.

Where *Camp Nelson*

By whom *S. C. Rausch*; term *3* y'rs.

Remarks: *Mustered in Nov. 2*
1864 Camp Nelson, Ky.
by Capt. Rimmer

James Price

(383g)

Copyist.

James Price *W. J. C. G.*

James Price
Appears with rank of *Private* on

Muster and Descriptive Roll

of *a Detachment of U.S. Colored*
Regiment Mustered into the Service
for the Regt of U.S. Col^d organizing
at Camp Nelson Ky Roll dated
Camp Nelson Ky, Nov 7, 1864
Where born *Franklin Ky*
Age *28* years; occupation *Farmer*
When enlisted *Nov 2*, 1864.
Where enlisted *Camp Nelson Ky*
For what period enlisted *3* years.
Eyes *Black*; hair *Black*
Complexion *Black*; height *5* ft. *5* in.
When mustered in *Nov 2*, 1864.
Where mustered in *Camp Nelson Ky*
Bounty paid \$ *100*; due \$ *100*

Clothing account:

Last settled _____, 186___; drawn since \$ *100*

Date of first muster _____, 186___.

Company to which assigned _____

Remarks: *Reputed owner Richard*
Young credited to Scott Co
W. Va.

Book mark: _____

W. J. Potter

(356m)

Copyist.

J 6 Cav. U.S.C.T.

James Price
Co. H, Co. *H*, 6 Reg't U. S. Col'd Cavalry.

Appears on

Company Muster-in and Descriptive Roll
of the organization named above. Roll dated

Lexington, N.Y., July 26, 1865.

Where born *Franklin, Ky.*

Age *28* y'rs; occupation *Farmer*

When enlisted *Apr 2*, 186*4*.

Where enlisted *Camp Nelson, Ky.*

For what period enlisted *3* years.

Eyes *Blk*; hair *Blk*

Complexion *Blk*; height *5 ft. 5 in.*

When mustered in *Apr 2*, 186*4*.

Where mustered in *Camp Nelson*

Bounty paid \$ *100*; due \$ *100*

Where credited *7th Dist Ky.*

Company to which assigned

Remarks:

Book mark:

C. Vege

(356d) Copyist.

F 6 Cav. U.S.C.T.

James Price
P, Co. F, 6 Reg't U. S. Col'd Cavalry.

Appears on

Company Muster Roll

for *Jan 24 to Sept 30*, 186*3*.

Present or absent *Absent*

Stoppage, \$ *100* for

Due Gov't, \$ *100* for

Valuation of horse, \$ *100*

Valuation of horse equipments, \$ *100*

Remarks: *Sick in Hospital at Camp*
Admitted by Surgeon Jan 1863

Book mark:

(358)

Breyer
Copyist.

P | *6 Cav.* | *U.S.C.P.*

James Price.
Pvt., Co. F, 6 Reg't U.S.C.

Appears on

Hospital Muster Roll

of **Convalescent Camp U. S. A. Hospital,**

at **Camp Nelson, Ky.,**

for *Jan. & Feb.*, 1865.

Attached to hospital:

When *Jan 21*, 1865.

How employed *Patient.*

Last paid by Maj. _____

to _____, 186 .

Bounty paid \$ *100*; due \$ *100*

Present or absent *Present.*

Remarks: _____

Book mark: _____

Camp Nelson,

P | 6 Cav. | U.S.C.T.

James Price
Priv., Co. A, 6 Reg't U.S.C.T.

Appears on

Hospital Muster Roll

of Convalescent Camp U. S. A. Hospital,

at Camp Nelson, Ky.,

for March & April, 1865.

Attached to hospital:

When Apr. 27, 1865.

How employed Patient

Last paid by Maj. _____

to _____, 1865.

Bounty paid \$ 100; due \$ 100

Present or absent Present

Remarks: _____

Book mark: _____

(343) Dickerson Copyright.

P. C. Co. U.S.C.T

James P. Co.
P. Co. H. 1 Reg't U. S. Col'd *War*

Appears on

Company Muster Roll

for *May & June*, 186*5*.

Present or absent *Present*

Stoppage, \$ *100* for

Due Gov't, \$ *100* for

Valuation of horse, \$ *100*

Valuation of horse equipments, \$ *100*

Remarks: *Due Gov't \$100 for
ordnance.*

Book mark:

Preyer

(358)

Copyist.

1865

7

6 Cav. U.S.C.T.

James Price

Pvt., Co. F, 6 Reg't U.S. Col'd Cavalry.

Appears on

Company Muster Roll

for July & Aug., 1865.

Present or absent Absent

Stoppage, \$ 100 for

Due Gov't, \$ 100 for

Valuation of horse, \$ 100

Valuation of horse equipments, \$ 100

Remarks: Not exist of bounty due. Sick in Hosp. at Camp Nelson since Aug. 1865.

Book mark:

(358)

J. E. Chapin

Copyist.

P | 66 | U.S.C.

James Price
Priv., Co. F, 6 Reg't U.S.C.

Appears on

Hospital Muster Roll

of U. S. A. Post Hospital,

at Camp Nelson, Ky.,

for July & Aug, 1865.

Attached to hospital:

When, 186 .

How employed

Last paid by Maj.

to Never Paid, 186 .

Bounty paid \$ 100; due \$ 100

Present or absent Present

Remarks:

Book mark :

L. L. Parker

(343)

Copist.

P

6 Cav. U.S.C.T.

James Parisé

Private

Co. F, 6 Reg't U. S. Col'd Cavalry.

Appears on

Company Muster Roll

for *Sept & Oct*, 1865.

Present or absent

Stoppage, \$ 100 for

Due Gov't, \$ 100 for

Valuation of horse, \$ 100

Valuation of horse equipments, \$ 100

Remarks: *Died in Hosp. at Ft. Nelson
San Ky. Oct. 18/65.*

Book mark: *Died Oct. 12/65 - E.R. Vol. 1, P. 33.*

(358)

J. E. Chapin

Copyist.

P | 6 Cav. | U.S.C.T.

James Price

Pvt., Co. F, 6 Reg't U. S. Col'd Cav.

Appears on Returns as follows:

Jan'y to April 1865, Absent
Sick in Hosp'l Camp
Nelson Ky since
Jan'y 1865.

July 1865, Absent sick
in U.S. Gen Hosp at
Camp Nelson Ky
July 1865

Aug & Sept 1865, Absent
Sick in Hosp'l at Cp
Nelson Ky since Aug
25/65.

Oct 1865, Lorn Oct 12/65
Cp Nelson Ky, Died
of disease in U.S Gen
Hosp'l

Book mark:

G. M. Row

(546)

Copyist.

J

6 Cav. U.S.C.T.

James Rice

B, Co., 6 Reg't U. S. Col'd Cavalry.

Appears on **Co. Muster-out Roll**, dated

Durall, Bluffton, S.C., April, 186 .

Muster-out to date, 186 .

Last paid to *June 3rd* 1865 .

Clothing account:

Last settled, 186 ; drawn since \$ 100

Due soldier \$ 100; due U. S. \$ 100

Am't for cloth'g in kind or money adv'd \$ 100

Due U. S. for arms, equipments, &c., \$ 100

Bounty paid \$ *100* 100; due \$ 100

Remarks: *Died in Wash's*
Camp Nelson, N.Y., Oct
12, '65 of inflammation of
Lungs.
Final stat. furnished

Book mark: *273468*

J. M. Smith

(861)

Copyist.

Price, James

P., Co. *F.*, 6 Regt. S. C. Cav.

2 Enclosures.

Bed Cards	Descriptive Lists
Burial Records	Final Statements
Certs. of Dis. for Discharge	Furloughs
C. M. Charges	Med. Des. Lists
Med. Certificates	Orders

Other papers relating to—

Admission to Hosp'l	Furlough
Casualty Sheet (Officer's)	Med. Examination
Confinement	Misc. Information
Contracts	Pay or Clothing
Death or Effects	Personal Reports
Desertions	Rank
Discharge from Hosp'l	Transfer to Hosp'l
Discharge from Service	Transfer to V. R. C.
Duty	Transportation

[OFFICE INDORSEMENT.]

War Department,

ADJUTANT GENERAL'S OFFICE,

March 28, 1874.

The Death of James Price
Private, Co. I, 6th Reg't U. S.

Colored Cavalry, is reported as follows:

On Company Muster Roll.
For Sept^r Oct., 1865, Oct 18th, 1865

Oct 12th Company Muster-out Roll. 1865

Company Descriptive Book. 186

Company Morning Reports. 186

Oct 12th Soldier's Final Statement. 1865

Soldier's Record of Death and Interment. 186

Soldier's Inventory of Effects. 186

Soldier's Certificate of Disability for Discharge. 186

Soldier's Individual Muster-out Roll. 186

Regimental Return. 186

For Regimental Quarterly Returns. 186

Regimental Descriptive Book. 186

By Surgeon General. 186

Oct 12, 1865, is held to be

the correct date, and the Company Muster

Roll will be appended accordingly.

See Copy to 2nd Aid. May 24, 1874.

Wm. M. Stewart
E. B. " 33.

Assistant Adjutant General.

Noted on R
16th 113

FINAL STATEMENT

OF

James Price - Co F
16th Reg't of U. S. Cavalry

VOLUNTEERS.

NOTE 1.—Two of these certificates (or duplicates) are to be given to each Volunteer Soldier or drafted man who may be discharged without being mustered out. (Final Statements are never given to men mustered out of service,) that he may at once receive from the Paymaster the pay, &c., due him, and the captain or other COMMISSIONED officer commanding the company will certify to the act of the delivery of the duplicate certificates; with these certificates the Soldier is "entitled to" his discharge, and should also present his discharge to the Paymaster to have the payment endorsed on it. The discharge is to be given back to the Soldier by the Paymaster; the latter only retaining as his vouchers the duplicate certificates.

NOTE 2.—If the Soldier is entitled to pay for the use of his horse, the Company Commander will certify to that fact on the back of both these final statements, and also to the time he has pay due for having been so mounted on his own horse.

NOTE 3.—When a Soldier is furnished with final statements, his descriptive list, if he has one, should be taken up by the officer who gives the Soldier these statements, and endorsed with a statement to this effect by the officer. The endorsement should exhibit a full statement of the time for which the Soldier was allowed pay on his final statements, the clothing account, and all other charges against him or in his favor, so as to comprise a complete exhibit of his account. It will then be transmitted to the Company Commander of the Soldier, who will enter all the data necessary to a full understanding of the Soldier's account on the muster roll upon which the Soldier's discharge is reported. The descriptive list will then be destroyed. The object of this is, that the remaining portion of the Soldier's account may be settled upon the receipt of these muster rolls, and the Soldier receive any pay or allowances that may be due him at the time of his discharge, and which may not appear on his last final statements from the fact that his descriptive list is incomplete. These accounts for back pay, &c., are settled by the 2d Auditor of the Treasury Department.

NOTE 4.—Charges for loss or injury to ordnance, horse equipments, and other miscellaneous charges, should appear under the heading of "Other Stoppages."

NOTE 5.—Bounty paid by State authorities, and not by the United States, will not be entered on this statement.

NOTE 6.—Amounts due the Sutler and Laundress must be entered on the muster roll on which the discharge, death, desertion, &c., is reported, as well as on the final statement, otherwise the amount cannot be collected from the United States.

NOTE 7.—This blank will be used for deceased volunteers and drafted men, as well as for others.

NOTE 8.—Where a Soldier dies in Hospital or on detached service, his descriptive list, if he has one, should be sent with his final statements, in duplicate, to the Adjutant General, Washington, D. C.

NOTE 9.—If the soldier is a drafted man or substitute, the space for time, &c., of enrolled, should contain only the word drafted or substitute, as the case may be. If the Soldier is a "VETERAN," (or RECRUIT,) the words as a veteran, (or recruit,) as the case may be, should be interlined after the words mustered into the service of the U. S. A statement of all the installments of Veteran or Recruit Bounty RECEIVED by the Soldier must be made on the back of each final statement.

I Aid James Price has received the 1st installment of bounty - \$100.00

Extract from Act of Congress.

SEC. 12. *And be it further enacted,* That the fees of agents and attorneys for making out and causing to be executed the papers necessary to establish a claim for a pension, bounty, and other allowance before the Pension Office, under this act, shall not exceed the following rates: For making out and causing to be duly executed a declaration by the applicant, with the necessary affidavits, and forwarding the same to the Pension Office, with the requisite correspondence, ten dollars; which sum shall be received by such agent or attorney in full for all services in obtaining such pension, and shall not be demanded or received, in whole or in part, until such pension shall be obtained; and the sixth and seventh sections of an act entitled "An act to grant pensions," approved July [fourteenth,] eighteen hundred and sixty-two, are hereby repealed.

SEC. 13. *And be it further enacted,* That any agent or attorney who shall, directly or indirectly, demand or receive any greater compensation for his services under this act than is prescribed in the preceding section of this act, or who shall contract or agree to prosecute any claim for a pension, bounty, or other allowance under this act, on the condition that he shall receive a per centum upon any portion of the amount of such claim, or who shall wrongfully withhold from a pensioner or other claimant the whole or any part of the pension or claim allowed and due to such pensioner or claimant, shall be deemed guilty of a high misdemeanor, and, upon conviction thereof, shall, for every such offense, be fined not exceeding three hundred dollars, or imprisoned at hard labor not exceeding two years, or both, according to the circumstances and aggravations of the offense.

Approved July 4, 1864.

NOTE 10.—If any soldier is charged a higher fee than that allowed by the above act, he should report the fact and the name of the agent to the Adjutant General, in order that steps may be taken to have the same refunded.

P. G. of Adm. & P. M.
receipt for \$2.15 sent
3rd and 1st reg. 28th 64

ADJUTANT GENERAL'S OFFICE.

Oct 15 1864

Duplicate with Inventory sent 2d Auditor.

FINAL STATEMENT

OF

James Price - Co F
16th Reg't of U. S. Cavalry
VOLUNTEERS.
Am. Feb 11. 1864

Said James Price has
received the 1st installment
of bounty - \$100.00

NOTE 1.—Two of these certificates (or duplicates) are to be given to each Volunteer Soldier or drafted man who may be discharged without being mustered out. (Final Statements are never given to men mustered out of service.) that he may at once receive from the Paymaster the pay, &c., due him, and the captain or other COMMISSIONED officer commanding the company will certify to the act of the delivery of the duplicate certificates; with these certificates the Soldier is "entitled to" his discharge, and should also present his discharge to the Paymaster to have the payment endorsed on it. The discharge is to be given back to the Soldier by the Paymaster; the latter only retaining as his vouchers the duplicate certificates.

NOTE 2.—If the Soldier is entitled to pay for the use of his horse, the Company Commander will certify to that fact on the back of both these final statements, and also to the time he has pay due for having been so mounted on his own horse.

NOTE 3.—When a Soldier is furnished with final statements, his descriptive list, if he has one, should be taken up by the officer who gives the Soldier these statements, and endorsed with a statement to this effect by the officer. The endorsement should exhibit a full statement of the time for which the Soldier was allowed pay on his final statements, the clothing account, and all other charges against him or in his favor, so as to comprise a complete exhibit of his account. It will then be transmitted to the Company Commander of the Soldier, who will enter all the data necessary to a full understanding of the Soldier's account on the muster roll upon which the Soldier's discharge is reported. The descriptive list will then be destroyed. The object of this is, that the remaining portion of the Soldier's account may be settled upon the receipt of these muster rolls, and the Soldier receive any pay or allowances that may be due him at the time of his discharge, and which may not appear on his last final statements from the fact that his descriptive list is incomplete. These accounts for back pay, &c., are settled by the 2d Auditor of the Treasury Department.

NOTE 4.—Charges for loss or injury to ordnance, horse equipments, and other miscellaneous charges, should appear under the heading of "Other Stoppages."

NOTE 5.—Bounty paid by State authorities, and not by the United States, will not be entered on this statement.

NOTE 6.—Amounts due the Sutler and Laundress must be entered on the muster roll on which the discharge, death, desertion, &c., is reported, as well as on the final statement, otherwise the amount cannot be collected from the United States.

NOTE 7.—This blank will be used for deceased volunteers and drafted men, as well as for others.

NOTE 8.—Where a Soldier dies in Hospital or on detached service, his descriptive list, if he has one, should be sent with his final statements, in duplicate, to the Adjutant General, Washington, D. C.

NOTE 9.—If the soldier is a drafted man or substitute, the space for time, &c., of enrolled, should contain ~~only~~ the word *drafted* or *substitute*, as the case may be. If the Soldier is a "VETERAN," (or RECRUIT,) the words *as a veteran*, (or *recruit*;) as the case may be, should be interlined after the words *mustered into the service of the U. S.* A statement of all the installments of *Veteran* or *Recruit* Bounty RECEIVED by the Soldier must be made on the back of each final statement.

I certify, on honor, that James Price, a Private of
Captain Paul Coates Company (E) of the 6th Regiment of U.S. Col.
VOLUNTEERS, of the State of Kentucky, born in Franklin State
of Kentucky, aged 28 years; 5 feet 5 inches high; Blk complexion,
Blk eyes, Blk hair, and by occupation a Tanner, who joined for service
and was enrolled (see Note 9) on the 2^d day of November, 1864, at Camp Nelson Ky
by J. P. Randolph, for the period of three years, and mustered into
the service of the United States on the 2^d day of November, 1864, at
Camp Nelson Ky by Capt. Quincy; and having served

HONESTLY and FAITHFULLY with his Company to the present date, is now entitled to a
DISCHARGE by reason of death from Inflammation of the Lungs
at Camp Nelson Ky on the 2^d day of October 1865

The said James Price was last paid by Paymaster
Maj. Halloway, to include the 30th day of June, 1865, and
has pay due him from that time to the present date; he is entitled to pay and subsistence for
TRAVELING to place of enrollment, and whatever other allowances are authorized to volunteer
soldiers, drafted men, or militia, so discharged. He has received from the United States **CLOTHING**
amounting to 897 $\frac{12}{100}$ dollars, since the — day of April, 1865,
1865, when his clothing account was last settled. He has received from the United States
170 $\frac{00}{100}$ dollars **ADVANCED BOUNTY**.

There is to be stopped from him, on account of the State of —, or other
authorities, for **CLOTHING**, &c., received on entering service, — $\frac{—}{100}$ dollars; and
for other stoppages, viz: —

— $\frac{—}{100}$ dollars.

He has been furnished with **TRANSPORTATION** in kind from the place of his discharge to
—; and he has been **SUBSISTED** for **TRAVELING** to his
place of enrollment, up to the —, 1865.

He is indebted to —, **SUTLER**, — $\frac{—}{100}$ dollars.

He is indebted to —, **LAUNDRESS**, — $\frac{—}{100}$ dollars.

Given in Duplicate, at Camp Bristol Ky, this 14th day
of October, 1865.

Daniel Coates
Captain

Commanding Company.



Washington D.C.

July 23rd, 1867.

Friends of Robert B. Mitchell, late U. S. Surgeon, U. S. Army,
through S. H. Hoar, as Capt. Genl. U. S. Army, Five dollars and
pictorial note, the proceeds of sale of effects of the late James
Lewis Combs, U. S. A. U. S. Army, deceased.

\$2.15

(Copy of Receipt)

(Receipt) addnl. Combs, U. S. Army.

1088
Price William

Co K., 6 U. S. Col'd Cav.

Private | Private.

CARD NUMBERS.

1	5395446	26
2	5395534	27
3	5388175	28
4	5395930	29
5	9093818	30
6	43154442	31
7	40732745	32
8		33
9		34
10		35
11		36
12		37
12		38
14		39
15		40
16		41
17		42
18		43
19		44
20		45
21		46
22		47
23		48
24		49
25		50

Book Mark:

See also

REP 325828
S 659 117-0090

AB Jordan
Ex

P | **6 Cav. | U.S.C.T.**

William Price

....., Co. *K*, 6 Reg't U. S. Col'd Cav.

Appears on

Company Descriptive Book

of the organization named above.

DESCRIPTION.

Age *18* years; height *5* feet *5* inches.

Complexion *Blk*

Eyes *Blk*; hair *Blk*

Where born *Kentucky*

Occupation *Laborer*

ENLISTMENT.

When *Feb 21*, 186*5*.

Where *Lexington*

By whom *Thos. Moore*; term *3* y'rs.

Remarks: *cf. us. leave Feb 25/65
By Capt. T. Moore at
Lexington*

Power

(3837)

Copyist.

P *6 Cav* **U.S.C.T.**

Will Price

priv., Co. *K*, *6* Reg't U. S. Col'd *Cav*

Appears on

Company Muster-in and Descriptive Roll
of the organization named above. Roll dated

Camp Nelson Ky, May 29, 1865.

Where born *Ky*

Age *18* y'rs; occupation *Labourer*

When enlisted *Feb 25*, 1865.

Where enlisted *Lexington*

For what period enlisted *3* years.

Eyes *black*; hair *black*

Complexion *black*; height *5* ft. *4* in.

When mustered in *Feb 25*, 1865.

Where mustered in *Lexington*

Bounty paid \$ *100*; due \$ *100*

Where credited *F. D., Ky*

Company to which assigned

Remarks: *Deserted*

Book mark:

(356d)

D. J. Griffith

Copyist.

P | *Price* *U.S.C.T.*

Will Price (Col)

Appears with rank of *Priv* on

Muster and Descriptive Roll

of a Detachment of U.S. Substitutes
Enlisted, Mustered & forwarded

Roll dated
Lexington, Ky, Oct 30th, 1865.

Where born *Kentucky*

Age *18* years; occupation *Laborer*

When enlisted *Feb 25*, 1865.

Where enlisted *Lexington, Ky.*

For what period enlisted *3* years.

Eyes *Blk*; hair *Blk*

Complexion *Blk*; height *5 ft. 4 in.*

When mustered in *Feb 25*, 1865.

Where mustered in *Lexington, Ky.*

Bounty paid \$ *100*; due \$ *100*

Clothing account:

Last settled _____, 186 ; drawn since \$ *100*

Date of first muster *Feb 25*, 1865.

Company to which assigned _____

Remarks: *For whom substituted
Steven R. Hogan, Enrolled man
credited to Nelson Co. 4th D. Ky*

Book mark : _____

(356m)

J. Harris

Copyist.

P | **6 Cav.** | **U.S.C.T.**

William Price

ser, Co. K, 6 Reg't U. S. Col'd Cav.

Appears on

Company Muster Roll

for *May 25 to June 30, 1865*

Present or absent

Stoppage, \$ 100 for

Due Gov't, \$ 100 for

Valuation of horse, \$ 100

Valuation of horse equipments, \$ 100

Remarks: *Deserted at Camp Nelson June - time not known,*

Book mark:

(358)

G. J. Grippick
Copyist.

C. Clear U.S.C.T.

William Price
Mi, Co. *K*, 6 Reg't U. S. Col'd *Clear*

Appears on

Descriptive List of Deserters

dated *July 31*, 186*5*.

Deserted:

When _____, 186 .

Where *Wagon Nelson's*

Arrested:

When _____, 186 .

Where _____

Remarks: *Deserted*

*upon organization
of company*

Book mark: _____

(351)

W. H. Thomas
Copyist.

P | **6 Cav.** | **U.S.C.T.**

William Price

Pvt, *Co. H*, 6 Reg't U. S. Col'd Cav.

Appears on **Returns** as follows:

May 1865 Loss, May 24/65,
Deserted before
organization of Co.

Book mark :

C. M. Brown

(546)

Copyist.

P

6 Cav. U.S.C.T.

William Price

Omata, Co. K, 6 Reg't U. S. Col'd Cavalry.

Appears on **Co. Muster-out Roll**, dated

Cerrills Bluff, Ark, Apr. 10, 1866 .

Muster-out to date _____, 186 .

~~Last paid to~~ *Pay due from enlistment* 186 .

Clothing account:

Last settled _____, 186 ; drawn since \$ _____ 100

Due soldier \$ _____ 100; due U. S. \$ _____ 100

Am't for cloth'g in kind or money adv'd \$ _____ 100

Due U. S. for arms, equipments, &c., \$ _____ 100

Bounty paid \$ _____ 100; due \$ _____ 100

Remarks: *Created at Camp Nelson Ky.*

Book mark: _____

C. J. Markle

(361)

Copyist.

--	--	--

Price *William*
P., Co. *K*, *6* Reg't *U.S.C.*

Enclosures.

- | | |
|------------------------------------|----------------------------|
| Bed Cards | Final Statements |
| Burial Records | Furloughs or L. of A. |
| Certs. of Dis. for Discharge | Med. Certificates |
| C. M. Charges | Med. Des. Lists |
| Descriptive Lists | Orders |
| Discharge Certificates | Pris. of War Record |
| Enlistment Papers | Resignations |

Other papers relating to—

- | | |
|------------------------------|---------------------------|
| Admission to Hosp'l | Furlough or L. of A. |
| Casualty Sheet | Med. Examination |
| Confinement | Misc. Information |
| Contracts | Pay or Clothing |
| Death or Effects | Personal Reports |
| Desertion / | Rank |
| Discharge from Hosp'l | Transfer to Hosp'l |
| Discharge from Service | Transfer to V. R. C. |
| Duty | Transportation |
| | |

[OFFICE INDORSEMENT.]

War Department,

ADJUTANT GENERAL'S OFFICE,

1867

The desertion of William Price
Private, Co. K, 6th Reg't U. S.
Colored Coop, is reported as follows:

On Company Muster Roll.

From Oct. 1864 to June 30, 1865, No date, 186

Company Muster-out Roll.

No date, 186

Company Descriptive Book.

186

Company Morning Reports.

186

Descriptive List of Deserters, 186

Soldier's Final Statement.

No date, 186

Soldier's Record of Death and Interment.

186

Soldier's Inventory of Effects.

186

Soldier's Certificate of Disability for Discharge.

186

Soldier's Individual Muster-out Roll.

186

Regimental Return.

For July, 1865, No date; 186

Regimental Quarterly Returns.

Where transfer of Co from *Madison* to Regt, 186

Regimental Descriptive Book.

186

By Surgeon General.

() , 186

, 186, is held to be
the correct date, and the Company Muster
Roll will be amended accordingly.

Assistant Adjutant General.

Complere

1089

Friest Stephen

Co. A., 6 U. S. Col'd Cav.

Private | *Private*

CARD NUMBERS.

1	5388406	26
2	5388488	27
3	5388569	28
4	5388651	29
5	5388716	30
6	5388750	31
7	5388841	32
8	5388930	33
9	5389019	34
10	5389164	35
11	9092815	36
12	43147886	37
13	40732741	38
14		39
15		40
16		41
17		42
18		43
19		44
20		45
21		46
22		47
23		48
24		49
25		50

Book Mark: _____

See also _____

9 | **6 Cav. U.S.C.T.**

Stephen Paul

, Co. *A*, 6 Reg't U. S. Col'd Cav.

Appears on

Company Descriptive Book

of the organization named above.

DESCRIPTION.

Age *19* years; height *5* feet *5* inches.

Complexion *Blk*

Eyes *Blk*; hair *Blk*

Where born *Montgomery Ky*

Occupation *farmer*

ENLISTMENT.

When *Sept 23*, 1864

Where *Camp Nelson*

By whom *J. L. Randolph*; term *3* y'rs.

Remarks: *Appointed Bugler 1865*

Reduced to ranks Mich

1, 1866 per order No. 29.

Breyer

6600

P. [] U.S.A.

Stephen Priest

Appears with rank of Pvt on

Muster and Descriptive Roll

of Detachment of U.S. Colored

Regiments, mustered into U.S.

Service for the U.S.A. Roll dated

Camp Nelson Ky Oct 2, 1864.

Where born Montgomery Ky.

Age 24 years; occupation Farmer

When enlisted Sept 23, 1864.

Where enlisted Camp Nelson Ky

For what period enlisted 2 years.

Eyes Black; hair Black

Complexion Black; height 5 ft. 5 in.

When mustered in Sept 23, 1864.

Where mustered in Camp Nelson Ky.

Bounty paid \$ 100; due \$ 100

Clothing account:

Last settled , 186 ; drawn since \$ 100

Date of first muster , 186 .

Company to which assigned

Remarks: Pay due from enlist-

ment. Name of a partner

owner Daniel Priest

transferred to Montgomery & Dist. Ky.

Book mark:

(356m)

W. H. [] Copyist.

P **6 Cav. U.S.C.T.**

Stephen Priest

Pvt., Co. *11*, 6 Reg't U. S. Col'd Cavalry.

Appears on

Company Muster-in and Descriptive Roll

of the organization named above. Roll dated

Camp Nelson Ky, N.Y., Nov. 1, 1864.

Where born *Montgomery Kentucky*

Age *19* y'rs; occupation *Farmer*

When enlisted *Sept. 23*, 186 .

Where enlisted *Camp Nelson Ky*

For what period enlisted *3* years.

Eyes *Black*; hair *Black*

Complexion *Black*; height *5* ft. *5* in.

When mustered in *Sept 23*, 186 .

Where mustered in *Camp Nelson Ky.*

Bounty paid \$ *100*; due \$ *100*

Where credited *9th Dist Kentucky*

Company to which assigned

Remarks:

Book mark:

Jaggott

(356d)

Copyist.

P

6 Cav. U.S.C.T.

Stephen Priest

Pvt., Co. A, 6 Reg't U. S. Col'd Cavalry.

Appears on

Company Muster Roll

for *Nov. & Dec.*, 1864.

Present or absent *Absent*

Stoppage, \$ *100* for

Due Gov't, \$ *100* for

Valuation of horse, \$ *100*

Valuation of horse equipments, \$ *100*

Remarks: *Sick in Hospital at
Camp Nelson Ky.*

Book mark:

Daggett

(358)

Copyist.

P

6 Cav. U.S.C.T.

Stephen Priest.

Pvt., Co. A, 6 Reg't U. S. Col'd Cavalry.

Appears on

Company Muster Roll

for *Jan. & Feb.*, 186*5*.

Present or absent *Absent*

Stoppage, \$ *100* for

Due Gov't, \$ *100* for

Valuation of horse, \$ *100*

Valuation of horse equipments, \$ *100*

Remarks: *Sick in hosp. at
Camp Nelson Ky. First
instalment Bounty due.*

Book mark:

W. J. [Signature]

P **6 Cav. U.S.C.T.**

Stephen Priest
Priv., Co. A, 6 Reg't U. S. Col'd Cavalry.

Appears on

Company Muster Roll

for *Mar. & Apr.*, 1863.

Present or absent *Present*

Stoppage, \$ *100* for

Due Gov't, \$ *100* for

Valuation of horse, \$ *100*

Valuation of horse equipments, \$ *100*

Remarks: *First installment
Bounty Due.*

Book mark:

Maggett

I **6 Cav. U.S.C.T.**

Stephen Biesch

Priv, Co. A, 6 Reg't U. S. Col'd Cavalry.

Appears on

Company Muster Roll

for *May & June*, 186*5*.

Present or absent... *Present*

Stoppage, \$ *100* for

Due Gov't, \$ *100* for

Valuation of horse, \$ *100*

Valuation of horse equipments, \$ *100*

Remarks: *1st Instalment of Bounty Due \$100.*

Book mark:

Wm Stewart
(358) Copyist.

P

6 Cav. U.S.C.T.

Stephen Priest
Snyder, Co. A, 6 Reg't U. S. Col'd Cavalry.

Appears on

Company Muster Roll

for July 1st Aug, 1865.

Present or absent Present

Stoppage, \$ 100 for

Due Gov't, \$ 100 for

Valuation of horse, \$ 100

Valuation of horse equipments, \$ 100

Remarks: 1st installment
of Bounty due \$100.
Promoted per Regt
Order No 50 to date
from July 1st/65

Book mark:

(358)

Joseph Stewart

Copist.

P 6 Cav. U.S.C.T.

Stephen Priest
Myler, Co. A, 6 Reg't U. S. Col'd Cavalry.

Appears on

Company Muster Roll

for Sept Oct, 1861.

Present or absent absent

Stoppage, \$ 100 for

Due Gov't, \$ 100 for

Valuation of horse, \$ 100

Valuation of horse equipments, \$ 100

Remarks: Discharged per
Reg't Order No 101
Signed Lt. Col. A. Geats
Quincy Co. U.S.C.C.

Book mark:

(358) Joseph Stewart Copyist.

P 6 Cav. U.S.C.T.

Stephen Priest
Bugler, Co. A, 6 Reg't U. S. Col'd Cavalry.

Appears on

Company Muster Roll

for *Nov & Dec*, 1865.

Present or absent *Present*

Stoppage, \$ *100* for

Due Gov't, \$ *100* for

Valuation of horse, \$ *100*

Valuation of horse equipments, \$ *100*

Remarks: *On Daily Duty in*
Regt. Band per R.O. No.
101. Dated Hd. Quarters
W.F.C. Oct 21. /65

Book mark: _____

R.S. Shelton

(358)

Copyist.

P

6 Cav. U.S.C.T.

Stephen Priest

Bugler, Co. A, 6 Reg't U. S. Col'd Cavalry.

Appears on

Company Muster Roll

for Jan's Feby, 1866.

Present or absent Present

Stoppage, \$ 100 for

Due Gov't, \$ 100 for

Valuation of horse, \$ 100

Valuation of horse equipments, \$ 100

Remarks: On Daily Duty in Regt. Band per Regt. Order No. 101, dated Hd. Qrs. 6" U.S. Co. Co. Oct 21. 1865.

Book mark :

R B Shelton

(358)

Copist.

P | 6 Cav. | U.S.C.T.

Stephen Priest

Pvt, Co. A, 6 Reg't U. S. Col'd Cav.
Murray

Appears on Returns as follows:

Nov 1864 to Feby 1865
Absent sick Genl
Hospt Camp Nelson Ky
since Dec 1, 64,

Oct 1865 to March 1866 (Murray)
On daily duty, Detailed
in Regt Band by S.O
No 101, signed Lt Col
Coats, Comd'g Oct 21/65,

Book mark:

G. W. Rorer

(546)

Copyist.

6 Cav. U.S.C.T.

Stephen Priest

W, Co. *A*, 6 Reg't U. S. Col'd Cavalry.

Appears on **Co. Muster-out Roll**, dated

Duvals Bluff Ark. Apr 15, 1866.

Muster-out to date *Apr 15, 1866.*

Last paid to *Feb 28, 1866.*

Clothing account:

Last settled _____, 186 ; drawn since \$ _____ 100

Due soldier \$ _____ 100; due U. S. \$ *7*^{*02*}/_{*100*}

Am't for cloth'g in kind or money adv'd \$ _____ 100

Due U. S. for arms, equipments, &c., \$ _____ 100

Bounty paid \$ *100* 100; due \$ *100* 100

Remarks: *Private till July 1st 1865.*

Appointed Bugler. Reduced to ranks March 1. '66. per Regl Order No. 29.

Book mark : _____

R. S. Shelton

(361)

Copyist.

1090 or Audrain
Prest Ambrose.

Co A., 6 U. S. Col'd Cav.

Private | Private

CARD NUMBERS.

1	5388404	26
2	5388498	27
3	5389175	28
4	4092813	29
5	43147884	30
6	40732746	31
7		32
8		33
9		34
10		35
11		36
12		37
13		38
14		39
15		40
16		41
17		42
18		43
19		44
20		45
21		46
22		47
23		48
24		49
25		50

Book Mark: 130892

See also

9 | **6 Cav. | U.S.C.T.**

Andrew J. Smith

....., Co. *A*., 6 Reg't U. S. Col'd Cav.

Appears on

Company Descriptive Book

of the organization named above.

DESCRIPTION.

Age *24* years; height *5* feet *6* inches.

Complexion *Blk*

Eyes *Blk*; hair *Blk*

Where born *Carey Ky*

Occupation *farmer*

ENLISTMENT.

When *Sept 27*, 186*1*.

Where *Camp Nelson*

By whom *J. C. Randolph* term *3* y'rs.

Remarks *Killed at Manim*
see 18, 1864

Bryer

(3837)

Copyist.

6600
11.11.11

Amber Pruitt

Appears with rank of Sgt. on

Muster and Descriptive Roll

of Detachment of U.S. Colored
Regiment, mustered into U.S.

service for the U.S. C. Co. Roll dated
Camp Nelson, Ky. Oct. 3, 1864.

Where born Lacey, Ky.

Age 24 years; occupation Farmer

When enlisted Sept. 27, 1864.

Where enlisted Camp Nelson, Ky.

For what period enlisted 2 years)

Eyes Black; hair Black

Complexion Black; height 5 ft. 6 in.

When mustered in Sept. 27, 1864.

Where mustered in Camp Nelson, Ky.

Bounty paid \$ 100; due \$ 100

Clothing account:

Last settled , 186 ; drawn since \$ 100

Date of first muster , 186 .

Company to which assigned

Remarks: Pay due from enlist
ment. Name of reported
owner S. M. Pruitt. Credited
Lacey, Ky.

Book mark:

(356m)

Copyist.

J. **6 Cav. U.S.C.T.**

Clambrose Pruitt

Pvt., Co. *A.*, 6 Reg't U. S. Col'd Cavalry.

Appears on

Company Muster-in and Descriptive Roll

of the organization named above. Roll dated

Camp Nelson Ky, N.Y., Mar. 1, 1864.

Where born *Cassey Kentucky*

Age *24* y'rs; occupation *Farmer*

When enlisted *Sept. 27*, 186 .

Where enlisted *Camp Nelson Ky*

For what period enlisted *3* years.

Eyes *Black*; hair *Black*

Complexion *Black*; height *5* ft. *6* in.

When mustered in *Sept. 27*, 186 .

Where mustered in *Camp Nelson Ky*

Bounty paid \$ *100*; due \$ *100*

Where credited *4 Dist Kentucky*

Company to which assigned _____

Remarks: _____

Book mark: _____

(356d)

Suggs

Copyist.

P 6 Cav. U.S.C.T.

Andrew Pruitt

Pat., Co. A, 6 Reg't U. S. Col'd Cavalry.

Appears on

Company Muster Roll

for Nov. & Dec., 1864.

Present or absent

Stoppage, \$ 100 for

Due Gov't, \$ 100 for

Valuation of horse, \$ 100

Valuation of horse equipments, \$ 100

Remarks: Killed in action
at Battle of Mairson,
Dec. 18/64.

Book mark: 130 pgs.

(358)

Pritz

Compr

Compr

1420
P | **6 Cav.** | **U.S.C.T.**

Andrew Pruitt

Pvt, Co. *A*, 6 Reg't U. S. Col'd Cav.

Appears on Returns as follows:

Dec 1864, Loss, Dec 18/64

Marion Va.

Killed in action

Book mark : _____

(546)

B. M. Rowe

Copyist.

P

6 Cav. U.S.C.T.

Andrew Smith

Priv., Co. A, 6 Reg't U. S. Col'd Cavalry.

Appears on Co. Muster-out Roll, dated

Duwall's Bluff Ark, Apr 15, 1866.

Muster-out to date _____, 186 .

Last paid to _____, 186 .

Pay due from enlistment

Clothing account:

Last settled _____, 186 ; drawn since \$ _____ 100

Due soldier \$ _____ 100 ; due U. S. \$ _____ 100

Am't for cloth'g in kind or money adv'd \$ _____ 100

Due U. S. for arms, equipments, &c., \$ _____ 100

Bounty paid \$ _____ 100 ; due \$ _____ 100

Remarks: Killed in Action in
Marion Va. Dec. 18, 1864.
Final Statements furnished.

Book mark: 130892

R. S. Shelton

(861)

Copyist.

Pruit, Andrew

P. Co. a, 6 Reg't U. S. C. Cav.

2 Enclosures.

Bed Cards	Descriptive Lists
Burial Records	Final Statements
Certs. of Dis. for Discharge	Furloughs
C. M. Charges	Med. Des. Lists
Med. Certificates	Orders

Other papers relating to—

Admission to Hosp'l	Furlough
Casualty Sheet (Officer's)	Med. Examination
Confinement	Misc. Information
Contracts	Pay or Clothing
Death or Effects	Personal Reports
Desertions	Rank
Discharge from Hosp'l	Transfer to Hosp'l
Discharge from Service	Transfer to V. R. C.
Duty	Transportation

ARTICLES OF WAR.

ART. 95. When any non-commissioned officer or soldier shall die, or be killed in the service of the United States, the then commanding officer of the troop or company shall, in the presence of two other commissioned officers, take an account of what effects he died possessed of, above his arms and accoutrements, and transmit the same to the office of the Department of War, which said effects are to be accounted for, and paid to the representatives of such deceased non-commissioned officer or soldier. And in case any of the officers, so authorized to take care of the effects of deceased officers and soldiers, should, before they have accounted to their representatives for the same, have occasion to leave the regiment or post, by preferment or otherwise, they shall, before they be permitted to quit the same, deposit in the hands of the commanding officer, or of the assistant military agent, all the effects of such deceased non-commissioned officers and soldiers, in order that the same may be secured for, and paid to, their respective representatives.

ARMY REGULATIONS—EDITION OF 1861.

DECEASED SOLDIERS.

Par. 152. Inventories of the effects of deceased non-commissioned officers and soldiers, required by the 95th Article of War, will be forwarded to the Adjutant General, by the commander of the company to which the deceased belonged, and a duplicate of the same to the colonel of the regiment. Final statements of pay, clothing, &c., will be sent with the inventories. When a soldier dies at a post or station absent from his company, it will be the duty of his immediate commander to furnish the required inventory, and, at the same time, to forward to the commanding officer of the company to which the soldier belonged, a report of his death, specifying the date, place, and cause; to what time he was last paid, and the money or other effects in his possession at the time of his decease; which report will be noted on the next muster roll of the company to which the man belonged. Each inventory will be endorsed, "Inventory of the effects of _____, late of company (—) _____ regiment of _____, who died at _____, the _____ day of _____, 186—." If a legal representative receive the effects, it will be stated in the report. If the soldier leave no effects, the fact will be reported.

Par. 153. Should the effects of a deceased non-commissioned officer or soldier not be administered upon within a short period after his decease, they shall be disposed of by a Council of Administration, under the authority of the commanding officer of the post, and the proceeds deposited with the Paymaster, to the credit of the United States, until they shall be claimed by the legal representatives of the deceased.

Par. 154. In all such cases of sales by the Council of Administration, a statement in detail, or account of the proceeds, duly certified by the Council and commanding officer, accompanied by the Paymaster's receipt for the proceeds, will be forwarded by the commanding officer to the Adjutant General. The statement will be endorsed, "Report of the proceeds of the effects of _____, late of company (—) _____ regiment of _____, who died at _____, the _____ day of _____, 186—."

NOTE 1.—The effects in all cases, when called for, should be turned over to the legal representative, without further authority from the Adjutant General. When the effects are turned over to the relatives of the deceased before these inventories are sent to the Adjutant General, their receipts therefor should be attached to the inventories. In all other cases, one copy will be sent with a letter of transmittal direct to the Adjutant General, and a duplicate retained by the officer.

NOTE 2.—Particular care should be taken to take receipts in duplicate from the Paymaster for any funds turned over to him; one copy should be sent direct to the Adjutant General and one retained by the officer.

INVENTORY OF THE EFFECTS

OF

Andrew Puit

Late of Company *A*

6 Reg't of *U.S. Cavalry*
was killed

Volunteers, who died at *Monrovia*

on the *18* day of *Dec* 1864.

Inventory of the effects of Andrew Pruitt late
 a Private of Captain W. A. Watrous Company A of
 the 6th Regiment of U.S.C. Can. Volunteers, who was enrolled as
 a Private at Camp Nelson in the State of Kentucky on
 the 27th day of September 1864, and mustered into the service of the United
 States as a Private on the 27th day of Sept 1864, at Camp Nelson Ky
 in Company A, 6 Regiment of U.S.C. Can. Volunteers, to serve 3
 years or during the war; he was born in Cassy County in the State
 of Kentucky; he was 24 years of age, 5 feet 6 inches
 high, Black complexion, Black eyes, Black hair, and by occupation, when enrolled,
 a Fanner; he died in was killed, at
Manion Va on the 18th day of Dec 1864 by
 reason of

INVENTORY.					
ARTICLES.	No.	ARTICLES.	No.	ARTICLES.	No.
Hats.....		Pairs trousers.....		Knapsacks.....	
Caps.....		Pairs flannel drawers.....		<i>Effects</i>	
Forage caps.....		Pairs cotton drawers.....			
Great coats.....		Flannel shirts.....			
Uniform coats.....		Cotton shirts.....			
Uniform jackets.....		Pairs boots.....			
Flannel park coats.....		Pairs shoes.....			
Blouses.....		Pairs socks.....			
Woolen frocks.....		Blankets.....			
Fatigue overalls.....		Haversacks.....			
					Specie.....
				Notes.....	\$

I CERTIFY, ON HONOR, that the above inventory comprises all the effects of Private
Andrew Pruitt, deceased, and that the effects are in the hands
 of _____ at _____
 _____ to be disposed of by a Council of Administration.

(DUPLICATES.)

W. A. Watrous
Capt. Co., U.S.C.
 Commanding the Company.

STATION: Camp Nelson Ky
 DATE: March 11th 1865

Extract from Act of Congress

SEC. 12. *And be it further enacted*, That the fees of agents and attorneys for making out and causing to be executed the papers necessary to establish a claim for a pension, bounty, and other allowance before the Pension Office, under this act, shall not exceed the following rates: For making out and causing to be duly executed a declaration by the applicant, with the necessary affidavits, and forwarding the same to the Pension Office, with the requisite correspondence, ten dollars: which sum shall be received by such agent or attorney in full for all services in obtaining such pension, and shall not be demanded or received, in whole or in part, until such pension shall be obtained: and the sixth and seventh sections of an act entitled "An act to grant pensions," approved July [fourteenth,] eighteen hundred and sixty-two, are hereby repealed.

SEC. 13. *And be it further enacted*, That any agent or attorney who shall, directly or indirectly, demand or receive any greater compensation for his services under this act than is prescribed in the preceding section of this act, or who shall contract or agree to prosecute any claim for a pension, bounty, or other allowance under this act, on the condition that he shall receive a per centum upon any portion of the amount of such claim, or who shall wrongfully withhold from a pensioner or other claimant the whole or any part of the pension or claim allowed and due to such pensioner or claimant, shall be deemed guilty of a high misdemeanor, and, upon conviction thereof, shall, for every such offense, be fined not exceeding three hundred dollars, or imprisoned at hard labor not exceeding two years, or both, according to the circumstances and aggravations of the offense.

Approved July 4, 1864.

NOTE 10.—If any soldier is charged a higher fee than that allowed by the above act, he should report the fact and the name of the agent to the Adjutant General, in order that steps may be taken to have the same refunded.

ADJUTANT GENERAL'S OFFICE.

July 16th 1865.

Duplicate with Inventory sent 2d Auditor.

FINAL STATEMENT

OF

Andrew Pruitt

6th Reg't of U.S.C. Cav.

VOLUNTEERS

NOTE 1.—Two of these certificates (or duplicates) are to be given to each Volunteer Soldier or drafted man who may be discharged without being mustered out (Final Statements are never given to men mustered out of service,) that he may at once receive from the Paymaster the pay, &c., due him, and the captain or other COMMISSIONED officer commanding the company will certify to the act of the delivery of the duplicate certificates; with these certificates the Soldier is "entitled to" his discharge and should also present his discharge to the Paymaster to have the payment endorsed on it. The discharge is to be given back to the Soldier by the Paymaster; the latter only retaining as his vouchers the duplicate certificates.

NOTE 2.—If the Soldier is entitled to pay for the use of his horse, the Company Commander will certify to that fact on the back of both these final statements, and also to the time he has pay due for having been so mounted on his own horse.

NOTE 3.—When a Soldier is furnished with final statements, his descriptive list, if he has one, should be taken up by the officer who gives the Soldier these statements, and endorsed with a statement to this effect by the officer. The endorsement should exhibit a full statement of the time for which the Soldier was allowed pay on his final statements, the clothing account, and all other charges against him or in his favor, so as to comprise a complete exhibit of his account. It will then be transmitted to the Company Commander of the Soldier, who will enter all the data necessary to a full understanding of the Soldier's account on the muster roll upon which the Soldier's discharge is reported. The descriptive list will then be destroyed. The object of this is, that the remaining portion of the Soldier's account may be settled upon the receipt of these muster rolls, and the Soldier receive any pay or allowances that may be due him at the time of his discharge, and which may not appear on his last final statements from the fact that his descriptive list is incomplete. These accounts for back pay, &c., are settled by the 2d Auditor of the Treasury Department.

NOTE 4.—Charges for loss or injury to ordnance, horse equipments, and other miscellaneous charges, should appear under the heading of "Other Stoppages."

NOTE 5.—Bounty paid by State authorities, and not by the United States, will not be entered on this statement.

NOTE 6.—Amounts due the Sutler and Laundress must be entered on the muster roll on which the discharge, death, desertion, &c., is reported, as well as on the final statement, otherwise the amount cannot be collected from the United States.

NOTE 7.—This blank will be used for deceased volunteers and drafted men, as well as for others.

NOTE 8.—Where a Soldier dies in Hospital or on detached service, his descriptive list, if he has one, should be sent with his final statements, in duplicate, to the Adjutant General, Washington, D. C.

NOTE 9.—If the soldier is a drafted man or substitute, the space for time, &c., of enrolled, should contain only the word *drafted* or *substitute*, as the case may be. If the Soldier is a "VETERAN," (or RECRUIT,) the words *as a veteran*, (or *recruit*) as the case may be, should be interlined after the words *mustered into the service of the U. S.* A statement of all the installments of *Veteran* or *Recruit* Bounty RECEIVED by the Soldier must be made on the back of each final statement.

I certify, on honor, that Andrew Puit, a Private of
 Captain W. A. Watson's Company (A) of the 2nd Regiment of U.S. Colored
~~VOLUNTEERS~~, of the State of _____, born in Casey Co, State
 of Kentucky, aged 24 years; 5 feet 0 inches high; Black complexion,
Black eyes, Black hair, and by occupation a Farmer, who joined for service
 and was enrolled (see Note 9) on the 27 day of Sept, 1864, at Camp Nelson
 by J. C. Randolph, for the period of 3 years, and mustered into
 the service of the United States on the 27th day of Sept, 1864, at
Camp Nelson, by Capt R. C. Kenney; and having served
 HONESTLY and FAITHFULLY with his Company to the present date, is now entitled to a
~~DISCHARGE~~ by reason of and was killed at Monroeville
Va Dec 18th 1864.

*Andrew Puit was clothed
 as an unregimented recruit and
 no account has been furnished
 The commanding officer of his company
 was to be paid for his clothing*

The said Andrew Puit was last paid by Paymaster
due from enlistment, to include the _____ day of _____, 186____, and
 has pay due him from that time to the present date; he is entitled to pay and subsistence for
~~TRAVELING~~ to place of enrollment, and whatever other allowances are authorized to volunteer
 soldiers, drafted men, or militia, so discharged. He has received from the United States CLOTHING
 amounting to Eighteen Dollars & 42/100 dollars, since the 27 day of Sept,
 1864, when his clothing account was last settled. He has received from the United States
 _____ dollars advanced BOUNTY.

—There is to be stopped from him, on account of the State of _____, or other
 authorities, for CLOTHING, &c., received on entering service, _____ dollars; and
 for other stoppages, viz: _____

_____ dollars.
 He has been furnished with TRANSPORTATION in kind from the place of his discharge to
 _____; and he has been SUBSISTED for TRAVELING to his
 place of enrollment, up to the _____, 186____.

He is indebted to _____, SUTLER, _____ dollars.
 He is indebted to _____, LAUNDRESS, _____ dollars.

Given in Duplicate, at Camp Nelson Ky, this 11th day
 of March, 1865.

W. A. Watson
Capt Co A U.S.C.
 Commanding Company.

1091
Pruit John.

Co A., 6 U. S. Col'd Cav.

Private Private.

CARD NUMBERS.

1	5388405	26
2	5388499	27
3	5389176	28
4	9092814	29
5	43147885	30
6	40732747	31
7		32
8		33
9		34
10		35
11		36
12		37
13		38
14		39
15		40
16		41
17		42
18		43
19		44
20		45
21		46
22		47
23		48
24		49
25		50

Book Mark:

See also

D | **6 Cav. | U.S.C.T.**

John Paul

....., Co. *A*, 6 Reg't U. S. Col'd Cav.

Appears on

Company Descriptive Book

of the organization named above.

DESCRIPTION.

Age *18* years; height *5* feet *9* inches.

Complexion *Blk*

Eyes *Blk*; hair *Blk*

Where born *Cass, Ky*

Occupation *farmer*

ENLISTMENT.

When *Sept 27*, 1864.

Where *Camp Nelson*

By whom *J. G. Randolph*; term *3* y'rs.

Remarks: *Killed at Marston*
Dec 18, 1864

Breyer

(383g)

Copyist.

6 Co
P. [] 11. 11. 64

John Pruitt

Appears with rank of Priv on

Muster and Descriptive Roll

of Detachment of 11th Colored
Regiment, mustered into the
service for the U.S.A. Roll dated
Camp Nelson Ky. Oct. 2, 1864.

Where born Lacey, Ky.

Age 15 years; occupation Soldier

When enlisted Sept. 27, 1864.

Where enlisted Camp Nelson Ky.

For what period enlisted ? years.

Eyes Black; hair Black

Complexion Black; height 5 ft. 9 in.

When mustered in Sept. 27, 1864.

Where mustered in Camp Nelson Ky.

Bounty paid \$ 100; due \$ 100

Clothing account:

Last settled ?, 186?; drawn since \$ 100

Date of first muster ?, 186?

Company to which assigned ?

Remarks: Pay due from enlist-
ment. Name of reputed
owner, Isaac Pruitt, credit-
ed to Lacey, 4 West, Ky.

Book mark: ?

(356m)

W. M. Jackson

Copyist.

P **6 Cav. U.S.C.T.**

John Pruitt

Bk., Co. *A*, 6 Reg't U. S. Col'd Cavalry.

Appears on

Company Muster-in and Descriptive Roll

of the organization named above. Roll dated

Camp Nelson Ky, N.Y., Nov. 1, 1864.

Where born *Casey Kentucky*

Age *18* y'rs; occupation *Farmer*

When enlisted *Sept. 27*, 186 .

Where enlisted *Camp Nelson Ky.*

For what period enlisted *3* years.

Eyes *Blch*; hair *Blch*

Complexion *Blch*; height *3 ft. 7 in.*

When mustered in *Sept. 29*, 186 .

Where mustered in *Camp Nelson Ky*

Bounty paid \$ *100*; due \$ *100*

Where credited *11 Dist. Kentucky*

Company to which assigned

Remarks:

Book mark:

(356d)

W. J. J. J.

Copyist.

P

6 Cav. U.S.C.T.

John Pruitt

Private, Co. A, 6 Reg't U. S. Col'd Cavalry.

Appears on

Company Muster Roll

for *Nov. & Dec.*, 1864.

Present or absent

Stoppage, \$ 100 for

Due Gov't, \$ 100 for

Valuation of horse, \$ 100

Valuation of horse equipments, \$ 100

Remarks: *killed in action at
Battle of Mirrorn Dec. 13th
1864*

Book mark:

Daggett

(358)

Copyist.

S | **6 Cav.** | **U.S.C.T.**

John Pruitt
Pvt., Co. *A*, 6 Reg't U. S. Col'd Cav.

Appears on Returns as follows:

Dec 1864. Lost Dec 18/64
Marion Va. Killed in
action.

Book mark :

C. M. Row

(546)

Copyist.

P

6 Cav. U.S.C.T.

John Iquit

Pvt., Co. A, 6 Reg't U. S. Col'd Cavalry.

Appears on Co. Muster-out Roll, dated
Dwalls Bluff Ark, April 15 1866.

Muster-out to date _____, 186 .

~~Last paid to~~ _____, 186 .

Pay due from Enlistment

Clothing account:

Last settled _____, 186 ; drawn since \$ _____ 100

Due soldier \$ _____ 100; due U. S. \$ _____ 100

Am't for cloth'g in kind or money adv'd \$ _____ 100

Due U. S. for arms, equipments, &c., \$ _____ 100

Bounty paid \$ _____ 100; due \$ _____ 100

Remarks: Killed in action in
Manin Va. Dec. 18, 1864.
Original Statements furnished.

Book mark : _____

R. D. Shelton

(861)

Copyist.

Pruit, John

P, Co. A, 6 Reg't U.S.C. Cav.

Enclosures.

Bed Cards

Burial Records

Certs. of Dis. for Discharge

C. M. Charges

Med. Certificates

Descriptive Lists

Final Statements

Furloughs

Med. Des. Lists

Orders

Other papers relating to—

Admission to Hosp'l

Casualty Sheet (Officer's)

Confinement

Contracts

Death or Effects

Desertions

Discharge from Hosp'l

Discharge from Service

Duty

Furlough

Med. Examination

Misc. Information

Pay or Clothing

Personal Reports

Rank

Transfer to Hosp'l

Transfer to V. R. C.

Transportation

Extract from Act of Congress.

SEC. 12. *And be it further enacted,* That the fees of agents and attorneys for making out and causing to be executed the papers necessary to establish a claim for a pension, bounty, and other allowance before the Pension Office, under this act, shall not exceed the following rates: For making out and causing to be duly executed a declaration by the applicant, with the necessary affidavits, and forwarding the same to the Pension Office, with the requisite correspondence, ten dollars: which sum shall be received by such agent or attorney in full for all services in obtaining such pension, and shall not be demanded or received, in whole or in part, until such pension shall be obtained: and the sixth and seventh sections of an act entitled "An act to grant pensions," approved July [fourteenth,] eighteen hundred and sixty-two, are hereby repealed.

SEC. 13. *And be it further enacted,* That any agent or attorney who shall, directly or indirectly, demand or receive any greater compensation for his services under this act than is prescribed in the preceding section of this act, or who shall contract or agree to prosecute any claim for a pension, bounty, or other allowance under this act, on the condition that he shall receive a per centum upon any portion of the amount of such claim, or who shall wrongfully withhold from a pensioner or other claimant the whole or any part of the pension or claim allowed and due to such pensioner or claimant, shall be deemed guilty of a high misdemeanor, and, upon conviction thereof, shall, for every such offense, be fined not exceeding three hundred dollars, or imprisoned at hard labor not exceeding two years, or both, according to the circumstances and aggravations of the offense.

Approved July 4, 1864.

NOTE 10.—If any soldier is charged a higher fee than that allowed by the above act, he should report the fact and the name of the agent to the Adjutant General, in order that steps may be taken to have the same refunded.

ADJUTANT GENERAL'S OFFICE.

Wm. H. ...

Duplicate with Inventory sent 2d Auditor.

FINAL STATEMENT

OF

John Pruitt

5th Reg't of U.S.C. Cav.

VOLUNTEERS.

NOTE 1.—Two of these certificates (or duplicates) are to be given to each Volunteer Soldier or drafted man who may be discharged without being mustered out (Final Statements are never given to men mustered out of service); that he may at once receive from the Paymaster the pay, &c., due him, and the captain or other COMMISSIONED officer commanding the company will certify to the act of the delivery of the duplicate certificates; with these certificates the Soldier is "entitled to" his discharge, and should also present his discharge to the Paymaster to have the payment endorsed on it. The discharge is to be given back to the Soldier by the Paymaster; the latter only retaining as his vouchers the duplicate certificates.

NOTE 2.—If the Soldier is entitled to pay for the use of his horse, the Company Commander will certify to that fact on the back of both these final statements, and also to the time he has pay due for having been so mounted on his own horse.

NOTE 3.—When a Soldier is furnished with final statements, his descriptive list, if he has one, should be taken up by the officer who gives the Soldier these statements, and endorsed with a statement to this effect by the officer. The endorsement should exhibit a full statement of the time for which the Soldier was allowed pay on his final statements, the clothing account, and all other charges against him or in his favor, so as to comprise a complete exhibit of his account. It will then be transmitted to the Company Commander of the Soldier, who will enter all the data necessary to a full understanding of the Soldier's account on the muster roll upon which the Soldier's discharge is reported. The descriptive list will then be destroyed. The object of this is, that the remaining portion of the Soldier's account may be settled upon the receipt of these muster rolls, and the Soldier receive any pay or allowances that may be due him at the time of his discharge, and which may not appear on his last final statements from the fact that his descriptive list is incomplete. These accounts for back pay, &c., are settled by the 2d Auditor of the Treasury Department.

NOTE 4.—Charges for loss or injury to ordnance, horse equipments, and other miscellaneous charges, should appear under the heading of "Other Stoppages."

NOTE 5.—Bounty paid by State authorities, and not by the United States, will not be entered on this statement.

NOTE 6.—Amounts due the Sutler and Laundress must be entered on the muster roll on which the discharge, death, desertion, &c., is reported, as well as on the final statement, otherwise the amount cannot be collected from the United States.

NOTE 7.—This blank will be used for deceased volunteers and drafted men, as well as for others.

NOTE 8.—Where a Soldier dies in Hospital or on detached service, his descriptive list, if he has one, should be sent with his final statements, in duplicate, to the Adjutant General, Washington, D. C.

NOTE 9.—If the soldier is a drafted man or substitute, the space for time, &c., of enrolled, should contain only the word *drafted* or *substitute*, as the case may be. If the Soldier is a "VETERAN," (OR RECRUIT,) the words *as a veteran*, (or *recruit*) as the case may be, should be interlined after the words *mustered into the service of the U. S.* A statement of all the installments of *Veteran* or *Recruit* Bounty RECEIVED by the Soldier must be made on the back of each final statement.

I certify, on honor, that John Pruitt, a Private of
 Captain W. A. Watrous Company (A) of the Sixth Regiment of U. S. C. Cal.
VOLUNTEERS, of the State of _____, born in Cassey State
 of Kentucky, aged 18 years; 5 feet 9 inches high; Black complexion.
Black eyes, Black hair, and by occupation a Farmer, who joined for service
 and was enrolled (see Note 9) on the 27 day of Sept, 1864, at Camp Nelson
 by J. C. Randolph, for the period of 3 years, and mustered into
 the service of the United States on the 27 day of September, 1864, at
Camp Nelson, by Capt. W. C. Kinnery; and having served
 HONESTLY and FAITHFULLY with his Company to the present date, is now entitled to a
DISCHARGE by reason of and was killed at
Manion Va. Dec 18, 1864

The said John Pruitt was last paid by Paymaster
 due from enlistment to include the _____ day of _____, 186____, and
 has pay due him from that time to the present date; he is entitled to pay and subsistence for
TRAVELING to place of enrollment, and whatever other allowances are authorized to volunteer
 soldiers, drafted men, or militia, so discharged. He has received from the United States **CLOTHING**
 amounting to Twenty one $\frac{21}{100}$ dollars, since the 27 day of September,
 1864, when his clothing account was last settled. He has received from the United States
 _____ $\frac{100}{100}$ dollars advanced **BOUNTY**.

There is to be stopped from him, on account of the State of _____, or other
 authorities, for **CLOTHING**, &c., received on entering service, _____ $\frac{100}{100}$ dollars, and
 for other stoppages, viz: _____

_____ $\frac{100}{100}$ dollars.
 He has been furnished with **TRANSPORTATION** in kind from the place of his discharge to
 _____; and he has been **SUBSISTED** for **TRAVELING** to his
 place of enrollment, up to the _____, 186____.

He is indebted to _____, **SUTLER**, _____ $\frac{100}{100}$ dollars.
 He is indebted to _____, **LAUNDRESS**, _____ $\frac{100}{100}$ dollars.

Given in Duplicate, at Camp Nelson, this 11th day
 of March, 1865.

W. A. Watrous
Capt. Co. A. U. S. C. Cal.
 Commanding Company.

*John Pruitt was clothed
 as an enlisted man
 and no account has
 given the commanding
 of his company as to the
 amount*

ARTICLES OF WAR.

ART. 95. When any non-commissioned officer or soldier shall die, or be killed in the service of the United States, the then commanding officer of the troop or company shall, in the presence of two other commissioned officers, take an account of what effects he died possessed of, above his arms and accoutrements, and transmit the same to the office of the Department of War, which said effects are to be accounted for, and paid to the representatives of such deceased non-commissioned officer or soldier. And in case any of the officers, so authorized to take care of the effects of deceased officers and soldiers, should, before they have accounted to their representatives for the same, have occasion to leave the regiment or post, by preference or otherwise, they shall, before they be permitted to quit the same, deposit in the hands of the commanding officer, or of the assistant military agent, all the effects of such deceased non-commissioned officers and soldiers, in order that the same may be secured for, and paid to, their respective representatives.

ARMY REGULATIONS—EDITION OF 1861.

DECEASED SOLDIERS.

Par. 152. Inventories of the effects of deceased non-commissioned officers and soldiers, required by the 95th Article of War, will be forwarded to the Adjutant General, by the commander of the company to which the deceased belonged, and a duplicate of the same to the colonel of the regiment. Final statements of pay, clothing, &c., will be sent with the inventories. When a soldier dies at a post or station absent from his company, it will be the duty of his immediate commander to furnish the required inventory, and, at the same time, to forward to the commanding officer of the company to which the soldier belonged, a report of his death, specifying the date, place, and cause; to what time he was last paid, and the money or other effects in his possession at the time of his decease; which report will be noted on the next muster roll of the company to which the man belonged. Each inventory will be endorsed, "Inventory of the effects of _____, late of company (—) _____ regiment of _____, who died at _____, the _____ day of _____, 186—." If a legal representative receive the effects, it will be stated in the report. If the soldier leave no effects, the fact will be reported.

Par. 153. Should the effects of a deceased non-commissioned officer or soldier not be administered upon within a short period after his decease, they shall be disposed of by a Council of Administration, under the authority of the commanding officer of the post, and the proceeds deposited with the Paymaster, to the credit of the United States, until they shall be claimed by the legal representatives of the deceased.

Par. 154. In all such cases of sales by the Council of Administration, a statement in detail, or account of the proceeds, duly certified by the Council and commanding officer, accompanied by the Paymaster's receipt for the proceeds, will be forwarded by the commanding officer to the Adjutant General. The statement will be endorsed, "Report of the proceeds of the effects of _____, late of company (—) _____ regiment of _____, who died at _____, the _____ day of _____, 186—."

NOTE 1.—The effects in all cases, when called for, should be turned over to the legal representative, without further authority from the Adjutant General. When the effects are turned over to the relatives of the deceased before these inventories are sent to the Adjutant General, their receipts therefor should be attached to the inventories. In all other cases, one copy will be sent with a letter of transmittal direct to the Adjutant General, and a duplicate retained by the officer.

NOTE 2.—Particular care should be taken to take receipts in duplicate from the Paymaster for any funds turned over to him; one copy should be sent direct to the Adjutant General and one retained by the officer.

INVENTORY OF THE EFFECTS

OF

John Puit
Late of Company *A.*

6th Reg't of *U.S.C. Co.*
was killed
at *Monrovia Va*

on the *18* day of *Dec* 186*4*.

Inventory of the effects of John Pruitt late
 a Private of Captain W.A. Warrons Company A of
 the Sixth Regiment of U.S. Cavalry ~~Volunteers~~, who was enrolled as
 a Private at Camp Nelson in the State of Kentucky on
 the 27th day of September 1864, and mustered into the service of the United
 States as a Private on the 27th day of Sept 1864, at Camp Nelson
 in Company A, 6 Regiment of U.S. Cavalry Volunteers, to serve 3
 years or during the war; he was born in Barry Co in the State
 of Kentucky; he was 18 years of age, 5 feet 9 inches
 high, Black complexion, Black eyes, Black hair, and by occupation, when enrolled,
 a Farmer; he ~~died in~~ was killed, at
Manion Va on the 10 day of Dec 1864, by
 reason of

INVENTORY.					
ARTICLES.	No.	ARTICLES.	No.	ARTICLES.	No.
Hats.....		Pairs trousers.....		Knapsacks.....	
Caps.....		Pairs flannel drawers.....		MONEY No Effects	
Forage caps.....		Pairs cotton drawers.....			
Great coats.....		Flannel shirts.....			
Uniform coats.....		Cotton shirts.....			
Uniform jackets.....		Pairs boots.....			
Flannel sack coats.....		Pairs shoes.....			
Blouses.....		Pairs socks.....			
Stable frocks.....		Baskets.....			Specie..... \$
Fatigue overalls.....		Haversacks.....			Notes..... \$

I CERTIFY, ON HONOR, that the above inventory comprises all the effects of Private
John Pruitt, deceased, and that the effects are in the hands
 of _____ at _____
 to be disposed of by a Council of Administration.

(DUPLICATES.)

STATION: Camp Nelson Ky

DATE: March 11th 1865

W.A. Warrons
Capt, Co, A, U.S.C.
 Commanding the Company.

10929

William John Henry

Co A., 6 U. S. Col'd Cav.

Private Private

CARD NUMBERS.

1	5387615	26
2	5387673	27
3	5394100	28
4	5394184	29
5	5394265	30
6	5394360	31
7	5394439	32
8	5394528	33
9	5394602	34
10	5394670	35
11	9093639	36
12	43151187	37
13	40732745	38
14		39
15		40
16		41
17		42
18		43
19		44
20		45
21		46
22		47
23		48
24		49
25		50

Book Mark:

See also

A. 1518367

AY. 1259590

L. Jordan
E

S. 6 Cav. U.S.C.T.

John Henry Brillian
, Co. H, 6 Reg't U. S. Col'd Cav.

Appears on

Company Descriptive Book

of the organization named above.

DESCRIPTION.

Age *18* years; height *5* feet *5* inches.

Complexion *brown*

Eyes *black*; hair *black*

Where born *Kentucky*

Occupation *Farmer*

ENLISTMENT.

When *Feb. 13*, 186*5*.

Where *Doubling Green*

By whom *Mr. Johnson*; term *2* y'rs.

Remarks:

Substitute

Henry Webb

P | 6 bar | U.S.C.A.

No Henry Pulliam

Appears with rank of Priv on

Muster and Descriptive Roll

of Detachment of U.S. Col'd
Recruits forwarded

Roll dated Bowling Green Ky Feb 28, 1865

Where born Ky

Age 18 years; occupation Farmer

When enlisted Feb 13 1865

Where enlisted B. Green Ky

For what period enlisted 2 years.

Eyes Blk; hair Blk

Complexion Brown, height 5 ft. 5 in.

When mustered in _____, 1865

Where mustered in _____

Bounty paid \$ _____ $\frac{100}{100}$; due \$ _____ $\frac{100}{100}$

Clothing account:

Last settled _____, 1865; drawn since \$ 19 $\frac{10}{100}$

Date of first muster Feb 13, 1865

Company to which assigned _____

Remarks: Col'd Substitute
for Wm. H. A. Claypool of
Warren Co, Credited
to the 3^d Cong. Dist. Ky.

Book mark : _____

R. W. Fish

(356m)

Copyist.

P

6

U.S.C.T.

John Henry Pulliam

Appears with rank of *1st* *Pvt* on

Muster and Descriptive Roll of a Detachment of Substitutes forwarded

for the *6* Reg't U. S. Col'd Cavalry. Roll dated

Draft Rendezvous, Louisville, Ky. Mch 15, 1865.

Where born *Kentucky*

Age *18* y'rs; occupation *Farmer*

When enlisted _____, 186 .

Where enlisted *Substitute.*

For what period enlisted _____ *2* years.

Eyes *Black*; hair *Black*

Complexion *Brown*; height *5* ft. *5* in.

When mustered in *Feb. 13*, 186 *5*.

Where mustered in *Bowl. Green*

Bounty paid \$ *100*; due \$ *100*

Where credited *3^d Dist. Ky*

Company to which assigned _____

Remarks: *Sub. for William H. H. Clay, pool.*

Book mark: _____

(340c)

Conard
Copyist.

P

6

U.S.C.T.

John Henry Pulliam
Appears with rank of *1st* *Put* on

Muster and Descriptive Roll of a Detachment of Substitutes forwarded

for the *6* Reg't U. S. Col'd *Lawabry*. Roll dated
Draft Rendezvous Louisville, Ky. Mch 15, 1865.

Where born *Kentucky*

Age *18* y'rs; occupation *Farmer*

When enlisted _____, 186 .

Where enlisted *Substitute*

For what period enlisted *2* years.

Eyes *Black*; hair *Black*

Complexion *Brown*; height *5* ft. *5* in.

When mustered in *Feb 13*, 1865.

Where mustered in *Bowling Green*

Bounty paid \$ *100*; due \$ *100*

Where credited *3^d Dist. Ky.*

Company to which assigned _____

Remarks: *Sub. for William H. H. Claypole (A. D.)*

Book mark: _____

(339c)

Leonard
Copyist.

P

Clav. U. S. C. T.

John Henry Pulliam
Pvt, Co. H. 6 Reg't U. S. Col'd

Appears on

Company Muster-in and Descriptive Roll
of the organization named above. Roll dated

Lexington, Ky., Mch. 26, 1865.

Where born Kentucky.

Age 18 y'rs; occupation Farmer.

When enlisted _____, 186 .

Where enlisted Substitute.

For what period enlisted 2 years.

Eyes Black; hair Black

Complexion Brown; height 5 ft. 5 in.

When mustered in Feb 13, 1865.

Where mustered in Bowling Green, Ky.

Bounty paid \$ 100; due \$ 100

Where credited 3d Dist. Ky.

Company to which assigned H

Remarks: Sub. for Wm. H. H. Clay-
port.

Book mark :

Conard

(356d)

Copyist.

P

6 Cav. U.S.C.T.

John Henry Pulliam
Pvt., Co. H, 6 Reg't U. S. Col'd Cavalry.

Appears on

Company Muster Roll

for from Mch 16 to Apl. 30, 1865.

Present or absent Present

Stoppage, \$ 100 for

Due Gov't, \$ 100 for

Valuation of horse, \$ 100

Valuation of horse equipments, \$ 100

Remarks:

Book mark:

(358)

Conard
Copyist.

P

6 Cav. U.S.C.T.

John F. Pulliam
Pvt, Co. H, 6 Reg't U. S. Col'd Cavalry.

Appears on

Company Muster Roll

for *May & June*, 186*5*.

Present or absent *Present.*

Stoppage, \$ *100* for

Due Gov't, \$ *100* for

Valuation of horse, \$ *100*

Valuation of horse equipments, \$ *100*

Remarks:
.....
.....
.....
.....
.....
.....
.....
.....

Book mark:

(358)

Conard
Copyist.

6 Cav. U.S.C.T.

William
Co. H, 6 Reg't U. S. Col'd Cavalry.

Appears on

Company Muster Roll

for *William*, 1865.

Present or absent (*Present*)

Stoppage, \$ 100 for

Due Gov't, \$ 100 for

Valuation of horse, \$ 100

Valuation of horse equipments, \$ 100

Remarks:

Book mark:

(358)

Shrine

Copyist.

6 Cav. U.S.C.T.

John Williams
Co. H, 6 Reg't U. S. Col'd Cavalry.

Appears on

Company Muster Roll

for *Sept Oct.*, 1865.

Present or absent *Present*

Stoppage, \$ *100* for

Due Gov't, \$ *100* for

Valuation of horse, \$ *100*

Valuation of horse equipments, \$ *100*

Remarks:

Book mark:

(358)

John Williams
Copyist.

3 6 Cav. U.S.C.T.

William
St., Co. H, 6 Reg't U. S. Col'd Cavalry.

Appears on

Company Muster Roll

for *Sept Dec*, 1865.

Present or absent *Present*.

Stoppage, \$ *100* for

Due Gov't, \$ *100* for

Valuation of horse, \$ *100*

Valuation of horse equipments, \$ *100*

Remarks:

Book mark:

(358)

Carline

Copyist.

D | **6 Cav.** | **U.S.C.T.**

John H Pulliam
Prvt, Co. H, 6 Reg't U. S. Col'd Cavalry.

Appears on

Company Muster Roll
for *Jan'y Feb'y*, 186*6*.
Present or absent *Present*.

Stoppage, \$ *100* for

Due Gov't, \$ *0* ^{*60*}/_{*100*} for *ordnance*
& \$1.60 for O & G E

Valuation of horse, \$ *100*

Valuation of horse equipments, \$ *100*

Remarks:

Book mark: -----

J. W. Harmon

(358)

Copyist.

J | **6 Cav.** | **U.S.C.T.**

+ John A Pulliam
Pvt, Co. A, 6 Reg't U. S. Col'd Cav.

Appears on Returns as follows:

May 1865. A. B. sent on
Det serv at Russell-
ville Ky. since May 17/65,

March 1866. On duty
in Q M. Dept Teamster

+ Supplied from no Roll by
New

Book mark :

W M Cow

(546)

Copyist.

P

6 Cav. U.S.C.T.

John H. Pulliam

Priv, Co. *A*, 6 Reg't U. S. Col'd Cavalry.

Appears on **Co. Muster-out Roll**, dated

Beulah Bluffport, April 15, 1866.

Muster-out to date *April 15, 1866.*

Last paid to *Feb 28, 1866.*

Clothing account:

Last settled _____, 186 ; drawn since \$ 100

Due soldier \$ *\$ 40* 100; due U. S. \$ 100

Am't for cloth'g in kind or money adv'd \$ 100

Due U. S. for arms, equipments, &c., \$ 100

Bounty paid \$ 100; due \$ 100

Remarks: _____

Book mark: _____

J. M. Harmon

(861)

Copyist.

--	--	--

Pulliam, John Henry
 _____, Co. _____, Reg't *1 Reg.*

2 Enclosures.

- | | |
|------------------------------------|-----------------------------|
| Bed Cards | Final Statements |
| Burial Records | Furloughs or L. of A |
| Certs. of Dis. for Discharge | Med. Certificates |
| C. M. Charges | Med. Des. Lists |
| Descriptive Lists | Orders |
| Discharge Certificates | Pris. of War Record |
| Enlistment Papers | 2 Resignations |

Other papers relating to—

- | | |
|------------------------------|----------------------------|
| Admission to Hosp'l | Furlough or L. of A |
| Casualty Sheet | Med. Examination |
| Confinement | Misc. Information |
| Contracts | Pay or Clothing |
| Death or Effects | Personal Reports |
| Desertion | Rank |
| Discharge from Hosp'l | Transfer to Hosp'l |
| Discharge from Service | Transfer to V. R. C. |
| Duty | Transportation |

No. 3

William John Kinsley
Enlisted at Warley, New York

As Substitute for

William M. Mc. Cays

On the 13 day of Nov., 1860.

By

A. Hobson

W. L. Hobson

O. R. Bailey

Board of Enrollment,

3^d Dist. of 1st

SUBSTITUTE VOLUNTEER ENLISTMENT.

STATE OF

TOWN OF



7-11-90

I, John Henry Sullivan born in the State of Kentucky, aged Eighteen years, and by occupation a Farmer DO HEREBY ACKNOWLEDGE to have agreed with William H. H. Claypool, Esq., of Warren County State of Kentucky

to become his **SUBSTITUTE** in the Military Service, for a sufficient consideration paid and delivered to me, on the Thirteenth day of February, 1865; and having thus agreed with said William H. H. Claypool, I DO HEREBY ACKNOWLEDGE to have enlisted this Thirteenth day of February 1865, to serve as a **Soldier** in the **Army of the United States of America**, for the period of ~~THREE~~ ^{one} **YEARS**, unless sooner discharged by proper authority: I do also agree to accept such bounty, pay, rations, and clothing, as are, or may be, established by law for soldiers. And I do solemnly swear that I will bear true and faithful allegiance to the **United States of America**; that I will serve them honestly and faithfully against all their enemies or opposers whomsoever; and that I will observe and obey the orders of the President of the United States, and the orders of the Officers appointed over me, according to the Rules and Articles of War.

SWORN and subscribed to, at Warrensburg this 13th day of Feb 1865.
BEFORE Robertson Capt. Ky. Regt.
3rd Dist. Ky. Recruiting Office

John Henry Sullivan
must

We certify, on honor, That we have carefully examined the above-named Volunteer Substitute agreeably to the Regulations, and that, in our opinion, he is free from all bodily defects and mental infirmity which would in any way disqualify him from performing the duties of a soldier; that he was entirely sober when enlisted; that he is of lawful age, (not under 18 years;) and that, in accepting him as duly qualified to perform the duties of an able-bodied soldier, and as a Substitute in lieu of William H. H. Claypool Substitute drafted in before the Draft, 1865, we have strictly observed the Regulations which govern in such cases. This soldier has Black eyes, Black hair, Wacon complexion; is five feet 3 inches high.

A. G. Johnson
Provost Marshal

W. H. Wilson
Commissioner of Board

J. W. Bailey
Surgeon of Board

Board of Enrollment of 3rd Dist. of Kentucky

DECLARATION OF SUBSTITUTE.

I, John Henry Clapp desiring to ENLIST in the Army of the United States, for ~~THREE~~^{SIX} YEARS, **Do declare**, That I am Eighteen years and _____ months of age; that I have never been discharged from the United States service on account of disability or by sentence of a court martial; and I know of no impediment to my serving honestly and faithfully as a soldier for ~~three~~^{SIX} years.

GIVEN at Portsmouth, New Hampshire the 13th day of February 1865.

WITNESSES A. G. Hobson Capt. 4th Pro. Mar. 3rd Dist. N. H. Recruiting Officer John Henry Clapp his Sullivan

Enlisted into the United States Service this 13th day of February 1865.
A. G. Hobson Capt. 4th Pro. Mar. 3rd Dist. N. H. Recruiting Officer

No. 3

William John Henry
Enlisted at Douglas, Ky

As Substitute for

William H. M. Claypool

On the 13th day of Nov, 1863.

By

J. C. McArthur

J. J. McArthur

J. H. [unclear]
Board of Enrollment,

2^d Dist. of Ky

SUBSTITUTE VOLUNTEER ENLISTMENT.

STATE OF

TOWN OF

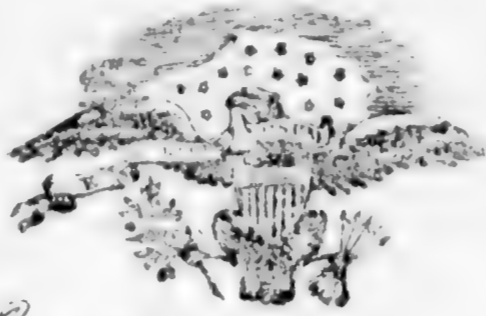

Kentucky Franklin

I, John Henry Sullivan born in the State of Kentucky, aged Eighteen years, and by occupation a Farmer

Do HEREBY ACKNOWLEDGE to have agreed with William H. Mc Claysport Esq., of Harrison County State of Kentucky

to become his **SUBSTITUTE** in the Military Service, for a sufficient consideration paid and delivered to me, on the Thirtieth day of February, 1865;

and having thus agreed with said William H. Mc Claysport, I DO HEREBY ACKNOWLEDGE to have enlisted this Thirtieth day of Feb.

1865, to serve as a **Soldier** in the **Army of the United States of America**, for the period of ~~THREE~~ ^{one} **YEARS**, unless sooner discharged by proper authority: I do also agree to accept such bounty, pay, rations, and clothing, as are, or may be, established by law for soldiers. And I do solemnly swear that I will bear true and faithful allegiance to the **United States of America**; that I will serve them honestly and faithfully against all their enemies or opposers whomsoever; and that I will observe and obey the orders of the President of the United States, and the orders of the Officers appointed over me, according to the Rules and Articles of War.

SWORN and subscribed to, at Franklin this 13th day of Feb. 1865.
BEFORE Wm. H. Mc Claysport John Henry Sullivan
Justice of Peace Must

We certify, on honor, That we have carefully examined the above-named Volunteer Substitute agreeably to the Regulations, and that, in our opinion, he is free from all bodily defects and mental infirmity which would in any way disqualify him from performing the duties of a soldier; that he was entirely sober when enlisted; that he is of lawful age, (not under 18 years;) and that, in accepting him as duly qualified to perform the duties of an able-bodied soldier, and as a Substitute in lieu of William H. Mc Claysport, drafted in _____, 1865, we have strictly observed the Regulations which govern in such cases. This soldier has Black eyes, Black hair, Wheat complexion; is five feet 5 inches high.

A. G. Hobson
Provost Marshal

M. J. Hobson
Commissioner of Board.

J. W. Bailey
Surgeon of Board.

Board of Enrollment of 3^d Dist. of Kentucky

DECLARATION OF SUBSTITUTE.

I, John Henry Sullivan desiring to ENLIST
in the Army of the United States, for ~~THREE~~^{Two} YEARS, **Do declare**, That I am
Eighteen years and _____ months of age; that I have
never been discharged from the United States service on account of disability or by sentence of
a court martial; and I know of no impediment to my serving honestly and faithfully as a soldier
for ~~three~~^{Two} years.

GIVEN at Franklin, Tenn.
the 13th day of February 1863

WITNESS:

A. G. Hobson Capt. & Co. Comm. John Henry Sullivan
3 Dist. Reg. Artillery Private

Mustered into U. S. Army Jan 13 Feb. 1863.
A. G. Hobson Capt. & Co. Comm. 3
Dist. Reg. Artillery

1093
William Sam

Co I., 6 U. S. Col'd Cav.

Private | Private.

CARD NUMBERS.

1	5387720	26
2	5387743	27
3	5394795	28
4	5394883	29
5	5394967	30
6	5395047	31
7	5395126	32
8	5395215	33
9	5388095	34
10	5395354	35
11	9093728	36
12	40732754	37
13		38
14		39
15		40
16		41
17		42
18		43
19		44
20		45
21		46
22		47
23		48
24		49
25		50

Book Mark:

See also

01584804.000000
01650524.000000
01929095.000000

L Jordan
E

P + **6 Cav. | U.S.C.T.**

Sam Pulliam

....., Co *P*, 6 Reg't U. S. Col'd Cav.

Appears on

Company Descriptive Book

of the organization named above.

DESCRIPTION.

Age *26* years; height *5* feet *10* inches.

Complexion *Black*

Eyes *Blk*; hair *Blk*

Where born *Allen Co Ky*

Occupation *Farmer*

ENLISTMENT.

When *Sept 23*, 186*4*

Where *Barcl Green Ky*

By whom *3 D. Ky*; term *1* y'rs.

Remarks: *Drafted reported
March 23/65 credited
to 3 D. Ky*

Powell
Copyist.

(383g)

P 6 U.S.C.T.

Sam Pulliam

Appears with rank of *Pvt.* on

Muster and Descriptive Roll of a Detachment of Substitutes forwarded

for the *6* Reg't U. S. Col'd Cavalry. Roll dated *Draft. Rendezvous, Louisville, Ky, Mch 25, 1865.*

Where born *Allen Kentucky*

Age *26* y'rs; occupation *Farmer.*

When enlisted _____, 186 .

Where enlisted *Drafted*

For what period enlisted _____ *1* years.

Eyes *Black*; hair *Black*

Complexion *Black*; height *5* ft. *10* in.

When mustered in *Sept. 23*, 186 *4*.

Where mustered in *Bowling Green*

Bounty paid \$ *100*; due \$ *100*

Where credited *3^d Dist. Ky.*

Company to which assigned _____

Remarks : _____

Book mark : _____

(340c)

Conard
Copyist.

P 6 U.S.C.T.

Sam Pulliam

Appears with rank of *Pvt* on

Muster and Descriptive Roll of a Detachment of Substitutes forwarded

for the *6* Reg't U. S. Col'd Cavalry. Roll dated

Draft Rendezvous, Louisville, Ky, March 25 1865.

Where born *Allen Kentucky*

Age *26* y'rs; occupation *Farmer*

When enlisted _____, 186 .

Where enlisted *Drafted.*

For what period enlisted _____ *1* year.

Eyes *Blk*; hair *Blk*

Complexion *Blk*; height *5* ft. *10* in.

When mustered in *Sept. 23*, 1864.

Where mustered in *B. Green*

Bounty paid \$ *100*; due \$ *100*

Where credited *3^d Dist. Ky.*

Company to which assigned _____

Remarks: _____

Book mark: _____

Conard
Copyist.

P 6 Cav. U.S.C.T.

Jam *William*

Priv, Co. *P*, 6 Reg't U. S. Col'd Cavalry.

Appears on

Company Muster-in and Descriptive Roll

of the organization named above. Roll dated

Camp Nelson, Ky., Apr 24, 1865.

Where born *Allen Co Ky.*

Age *26* y'rs; occupation *Farmer*

When enlisted _____, 186 _____

Where enlisted *Drafted*

For what period enlisted *1* years.

Eyes *Blk*; hair *Blk*

Complexion *Blk*; height *5* ft. *10* in.

When mustered in *Sept 23*, 186 *4*.

Where mustered in *Bowl. g gm Ky*

Bounty paid \$ *none pd*; due \$ *100*

Where credited *3 dist. Ky.*

Company to which assigned *I.*

Remarks: _____

Book mark: _____

D. M. Kennedy

(356d)

Copyright.

P

6 Cav. U.S.C.T.

Sam Pulliam

Privt, Co. I, 6 Reg't U. S. Col'd Cavalry.

Appears on

Company Muster Roll

for *Enlistment to Apl 30, 1865.*

Present or absent *Present*

Stoppage, \$ *100* for

Due Gov't, \$ *100* for

Valuation of horse, \$ *100*

Valuation of horse equipments, \$ *100*

Remarks:
1" Instalment County due.

Book mark:

D. M. Kennedy

(358)

Copyist.

P

6 Cav. | U.S.C.T.

Sam Pulliam

Privt, Co. I, 6 Reg't U. S. Col'd Cavalry.

Appears on

Company Muster Roll

for *May v. June*, 1865.

Present or absent *Present*

Stoppage, \$ *100* for

Due Gov't, \$ *100* for

Valuation of horse, \$ *100*

Valuation of horse equipments, \$ *100*

Remarks: *Reported May 23 1865.*

Book mark:

D. M. Kennedy

(358)

Copyist.

P | 6 Cav. | U.S.C.T.

Sam Pulliam

Privt, Co. I, 6 Reg't U. S. Col'd Cavalry.

Appears on

Company Muster Roll

for July & Aug, 1865.

Present or absent Present

Stoppage, \$ 100 for

Due Gov't, \$ 100 for

Valuation of horse, \$ 100

Valuation of horse equipments, \$ 100

Remarks: Reported Mar. 23 65

Book mark:

(358)

J. B. Casper

Copyist.

2 | 6 Cav. | U.S.C.T.

John Williams

Private, Co. I, 6 Reg't U. S. Col'd Cavalry.

Appears on

Company Muster Roll

for *Sept & Oct*, 1867.

Present or absent *Present*

Stoppage, \$ *100* for

Due Gov't, \$ *100* for

Valuation of horse, \$ *100*

Valuation of horse equipments, \$ *100*

Remarks: *sent to Quartermaster
Oct. 1867 for maintenance service
Descriptive list sent.*

Book mark:

(358)

J. B. Casper Copyist.

2

6 Cav. U.S.C.T.

Sam Williams

Private, Co. I, 6 Reg't U. S. Col'd Cavalry.

Appears on

Company Muster Roll

for Nov & Dec, 1865

Present or absent

Stoppage, \$ 100 for

Due Gov't, \$ 100 for

Valuation of horse, \$ 100

Valuation of horse equipments, \$ 100

Remarks: Mustered out by reason of expiration of term of service. Oct. 19/65

Book mark:

(358)

J. B. Casey Copyist.

P. 6 Cav. U.S.C.T.

Sam Williams
Co. D, Co. *D*, 6 Reg't U. S. Col'd Cavalry.

Appears on Co. Muster-out Roll, dated
Drills Bay Ark, April 13, 1866.

Muster-out to date _____, 186 .

Last paid to _____, 186 .

Clothing account:

Last settled _____, 186 ; drawn since \$ _____ 100

Due soldier \$ _____ 100; due U. S. \$ _____ 100

Am't for cloth'g in kind or money adv'd \$ _____ 100

Due U. S. for arms, equipments, &c., \$ _____ 100

Bounty paid \$ _____ 100; due \$ _____ 100

Remarks: *Subject was
in of equitation
in sum of service
Oct 1865.*

Book mark: _____

(861)

J. J. Stearns
Copyst.

F | *6 Col'd Cav* | **U.S.C.T.**

Sam Sullivan
Pr. Co. I, 6 Reg't U. S. Col'd *Cav*

Appears on a

Detachment Muster-out Roll

of the organization named above. Roll dated

Lexington Ky, *Oct 19*, 186*5*.

Muster-out to date *Oct 19*, 186*5*.

Last paid to *June 30*, 186*5*.

Clothing account:

Last settled....., 186 ; drawn since \$..... 100

Due soldier \$..... 100; due U. S. \$ *4* ^{*68*} 100

Am't for cloth'g in kind or money adv'd \$..... 100

Due U. S. for arms, equipments, &c., \$..... 100

Bounty paid \$..... 100; due \$..... 100

Remarks: *Stop pay for full*
Co. 44 - Drafted
Mustered out by reason of expiration of term of service
Discharge furnished.

Book mark:

(349)

Holbrook

Copyist.

P | 6 Cav. | U.S.C.T.

Sam Pulliam
Pvt., Co. I, 6 Reg't U. S. Col'd Cav.

Appears on Returns as follows:

Oct 1865, Absent sent
to Lexington Ky.
Oct 18/65, for muster
out of service

Nov 1865 Loss. Oct 19/65,
Lexington Ky.
Mustered out of service,

Book mark:

G M Row

(546)

Copyist.

1094

Putnam Lewis.

Co *L.*, 6 U. S. Col'd Cav.

Private | *Private.*

CARD NUMBERS.

1	5395999	26
2	5396079	27
3	5396159	28
4	5396261	29
5	5396492	30
6	9093906	31
7	40732724	32
8	32116287	33
9		34
10		35
11		36
12		37
12		38
14		39
15		40
16		41
17		42
18		43
19		44
20		45
21		46
22		47
23		48
24		49
25		50

Book Mark: _____

See also _____

P

6 Cav. U.S.C.T.

Lewis Putnam
Private, Co. L, 6 Reg't U. S. Col'd Cav.

Appears on

Company Descriptive Book

of the organization named above.

DESCRIPTION.

Age 18 years; height 5 feet 8 inches.

Complexion Copper

Eyes Blue; hair Black

Where born Franklin Ky

Occupation Farmer

ENLISTMENT.

When May 30, 1865.

Where Frankford

By whom G.W. Parker; term 3 yrs.

Remarks: Lewis Putnam died at Post Hospital Camp Nelson Ky. Sept 24/65. Disease typhoid fever. A inventory of effects & final statement sent to the A.G.O. Sept 25/65 by Lt James Mc Smiley of Co. L Co. 6 U.S. Col'd Cav.

Perush

(283g)

Copyist.

L. L. 6 Cav. U.S.C.T.

Lewis Latham

Latham, Co. *L*, 6 Reg't U. S. Col'd Cavalry.

Appears on

Company Muster-in and Descriptive Roll

of the organization named above? Roll dated

Camp Helena, N.Y., June 9, 1865

Where born *Franklin Co. N.Y.*

Age *18* y'rs; occupation *Farmer*

When enlisted *May 30*, 186*5*

Where enlisted *Frankfort*

For what period enlisted *3* years.

Eyes *Blk*; hair *Blk*

Complexion *Cop.*; height *5* ft. *8* in.

When mustered in *May 31*, 186*5*

Where mustered in *Leesington*

Bounty paid \$ *100*; due \$ *100*

Where credited: *Franklin Co. 7th Dth*

Company to which assigned *L*

Remarks: *1st Inst. Bounty due*

Book mark:

(356d)

Henry J.
Copyist.

P 6 Cav. U.S.C.T.

Levine Putnam

Pr, Co. L, 6 Reg't U.S. Col'd Cavalry.

Appears on

Company Muster Roll
for *June 1 to June 30, 1864*

Present or absent *Present*

Stoppage, \$ *100* for

Due Gov't, \$ *100* for

Valuation of horse, \$ *100*

Valuation of horse equipments, \$ *100*

Remarks:

Filed with Putnam Lewis

Book mark: -----

(358)

Mowing, Jr.
Copyist.

70

6 Cav. U.S.C.T.

Lewis Pitman

Pri, Co. L, 6 Reg't U. S. Col'd Cavalry.

Appears on

Company Muster Roll

for July & Aug., 1861.

Present or absent Present

Stoppage, \$ 100 for

Due Gov't, \$ 100 for

Valuation of horse, \$ 100

Valuation of horse equipments, \$ 100

Remarks: Sick in Gen Hospital at Camp Nelson, Ky.

Book mark:

(358)

Mowry, Jr. Copyist.

P | **6 Cav.** | **U.S.C.T.**

Lewis Pitman

Pk, Co. L, 6 Reg't U.S. Col'd Cavalry.

Appears on

Company Muster Roll

for *Sept and Oct*, 1865.

Present or absent

Stoppage, \$ 100 for

Due Gov't, \$ 100 for

Valuation of horse, \$ 100

Valuation of horse equipments, \$ 100

Remarks:

*Died in Hospital at Camp Nelson,
September 24, 1865.*

Book mark:

(358)

F. V. Kearny
Copyist.

P

6 Cav. U.S.C.T.

Lewis Pitman

Pvt., Co. L, 6 Reg't U. S. Col'd Cavalry.

Appears on Co. Muster-out Roll, dated
Newalls Bluff, Ark, Apr. 15, 1866.

Muster-out to date _____, 186 .

Last paid to June 30, 1865.

Clothing account:

Last settled _____, 186 ; drawn since \$ 100

Due soldier \$ 100; due U. S. \$ 100

Am't for cloth'g in kind or money adv'd \$ 100

Due U. S. for arms, equipments, &c., \$ 100

Bounty paid \$ 100; due \$ 100

Remarks: Died at Camp Nelson,
Ky, Sept. 24, 1865, of Measles.
Final Statements furnished.

Book mark: _____

(361)

J B Gage

Copyist.

70 | 6 Cav. | U.S.C.T.

Lewis Pitman
Pvt., Co. K, 6 Reg't U. S. Col'd Cav.

Appears on Returns as follows:

Aug 1865. Absent sick
in Hosp't at Camp
Nelson Ky.

Sept 1865. Lost. Sept 20,
65. Camp Nelson Ky
Died. Post Hosp't.

Book mark:

W M Row

(546)

Copyist.

P | 66 | U.S.C.T

Lewis Pittman
Pvt, Co. L, 6 Reg't U.S.C.C

Appears on
Hospital Muster Roll

of U. S. A. Post Hospital,
at Camp Nelson, Ky.,

for July & Aug, 186 .

Attached to hospital :

When, 186 .

How employed

Last paid by Maj.

to, 186 .

Bounty paid \$ 100; due \$ 100

Present or absent Present

Remarks:

Book mark :

C. C. Parker

(343)

Copyist.

Pitman, Lewis
P, Co. L, 6 U.S. C. Cav.

3 Enclosures.

Bed Cards	Descriptive Lists
Burial Records	Final Statements
Certs. of Dis. for Discharge	Furloughs
C. M. Charges	Med. Des. Lists
Med. Certificates	Orders

Other papers relating to—

Admission to Hosp'l	Furlough
Casualty Sheet (Officer's)	Med. Examination
Confinement	Misc. Information
Contracts	Pay or Clothing
Death or Effects 2	Personal Reports
Desertions	Rank
Discharge from Hosp'l	Transfer to Hosp'l
Discharge from Service	Transfer to V. R. C.
Duty	Transportation

ARTICLES OF WAR.

ART. 95. When any non-commissioned officer or soldier shall die, or be killed in the service of the United States, the then commanding officer of the troop or company shall, in the presence of two other commissioned officers, take an account of what effects he died possessed of, above his arms and accoutrements, and transmit the same to the office of the Department of War, which said effects are to be accounted for, and paid to the representatives of such deceased non-commissioned officer or soldier. And in case any of the officers, so authorized to take care of the effects of deceased officers and soldiers, should, before they have accounted to their representatives for the same, have occasion to leave the regiment or post, by preferment or otherwise, they shall, before they be permitted to quit the same, deposit in the hands of the commanding officer, or of the assistant military agent, all the effects of such deceased non-commissioned officers and soldiers, in order that the same may be secured for, and paid to, their respective representatives.

ARMY REGULATIONS—EDITION OF 1863.

DECEASED SOLDIERS.

Par. 152. Inventories of the effects of deceased non-commissioned officers and soldiers, required by the 95th Article of War, will be forwarded to the Adjutant General, by the commander of the company to which the deceased belonged, and a duplicate of the same to the colonel of the regiment. Final statements of pay, clothing, &c., in duplicate, will be sent to the Adjutant General with one copy of the inventory. When a soldier dies at a post or station absent from his company, it will be the duty of his immediate commander to furnish the required inventory and final statements, and, at the same time, to forward to the commanding officer of the company to which the soldier belonged, a report of his death, specifying the date, place, and cause; to what time he was last paid, and the money or other effects in his possession at the time of his decease; which report will be noted on the next muster roll of the company to which the man belonged. Each inventory will be endorsed, "Inventory of the effects of _____, late of company (---) _____ regiment of _____, who died at _____, the _____ day of _____, 186-." If a legal representative receive the effects, it will be stated in the report. If the soldier leave no effects, the fact will be reported.

Par. 153. Should the effects of a deceased non-commissioned officer or soldier not be administered upon within a short period after his decease, they shall be disposed of by a Council of Administration, under the authority of the commanding officer of the post, and the proceeds deposited with the Paymaster, to the credit of the United States, until they shall be claimed by the legal representatives of the deceased.

Par. 154. In all such cases of sales by the Council of Administration, a statement in detail, or account of the proceeds, duly certified by the Council and commanding officer, accompanied by the Paymaster's receipt for the proceeds, will be forwarded by the commanding officer to the Adjutant General. The statement will be endorsed, "Report of the proceeds of the effects of _____, late of company (---) _____ regiment of _____, who died at _____, the _____ day of _____, 186-."

NOTE 1.—The effects in all cases, when called for, should be turned over to the legal representative, without further authority from the Adjutant General. When the effects are turned over to the relatives of the deceased before these inventories are sent to the Adjutant General, their receipts therefor should be attached to the inventories. In all other cases, one copy will be sent with a letter of transmittal direct to the Adjutant General, and a duplicate retained by the officer.

NOTE 2.—Particular care should be taken to take receipts in duplicate from the Paymaster for any funds turned over to him; one copy should be sent direct to the Adjutant General and one retained by the officer.

INVENTORY OF THE EFFECTS

OF

Late of Company _____

Reg't of _____

Volunteers, who died at _____

on the _____ day of _____, 186-.



Inventory of the effects of _____ late
 a _____ of Captain _____ Company _____ of
 the _____ Regiment of _____ Volunteers, who was enrolled as
 a _____ at _____ in the State of _____ on
 the _____ day of _____ 186____, and mustered into the service of the United
 States as a _____ on the _____ day of _____ 186____ at _____
 in Company _____, _____ Regiment of _____ Volunteers, to serve
 _____ years or during the war; he was born in _____ in the State
 of _____; he was _____ years of age, _____ feet _____ inches
 high, _____ complexion, _____ eyes, _____ hair, and by occupation, when enrolled,
 a _____; he died in _____, at
 _____ on the _____ day of _____ 186____, by
 reason of _____

INVENTORY.					
ARTICLES.	No.	ARTICLES.	No.	ARTICLES.	No.
Hats.....		Pairs trousers.....		Knapsacks..... 	
Caps.....		Pairs flannel drawers.....			
Forage Caps.....		Pairs cotton drawers.....			
Great coats.....		Flannel shirts.....			
Uniform coats.....		Cotton shirts.....			
Uniform jackets.....		Pairs boots.....			
Flannel sack coats.....		Pairs shoes.....			
Blouses.....		Pairs socks.....			
Sable frocks.....		Blankets.....			
Pat. gne overalls.....		Haversacks.....			
				MONEY. Specie..... \$ Notes..... \$	

I CERTIFY, ON HONOR, that the above inventory comprises all the effects of _____
 _____, deceased, and that the effects are in the hands
 of _____ at _____
 _____ to be disposed of by a Council of Administration.

(DUPLICATES.)

[Handwritten Signature]

 Commanding the Company.

STATION: _____
 DATE: _____

Extract from Act of Congress.

SEC. 12. *And be it further enacted,* That the fees of agents and attorneys for making out and causing to be executed the papers necessary to establish a claim for a pension, bounty, and other allowance before the Pension Office, under this act, shall not exceed the following rates: For making out and causing to be duly executed a declaration by the applicant, with the necessary affidavits, and forwarding the same to the Pension Office, with the requisite correspondence, ten dollars; which sum shall be received by such agent or attorney in full for all services in obtaining such pension, and shall not be demanded or received, in whole or in part, until such pension shall be obtained; and the sixth and seventh sections of an act entitled "An act to grant pensions," approved July [fourteenth,] eighteen hundred and sixty-two, are hereby repealed.

SEC. 13. *And be it further enacted,* That any agent or attorney who shall, directly or indirectly, demand or receive any greater compensation for his services under this act than is prescribed in the preceding section of this act, or who shall contract or agree to prosecute any claim for a pension, bounty, or other allowance under this act, on the condition that he shall receive a per centum upon any portion of the amount of such claim, or who shall wrongfully withhold from a pensioner or other claimant the whole or any part of the pension or claim allowed and due to such pensioner or claimant, shall be deemed guilty of a high misdemeanor, and, upon conviction thereof, shall, for every such offense, be fined not exceeding three hundred dollars, or imprisoned at hard labor not exceeding two years, or both, according to the circumstances and aggravations of the offense.

Approved July 4, 1864.

NOTE 10.—If any soldier is charged a higher fee than that allowed by the above act, he should report the fact and the name of the agent to the Adjutant General, in order that steps may be taken to have the same refunded.

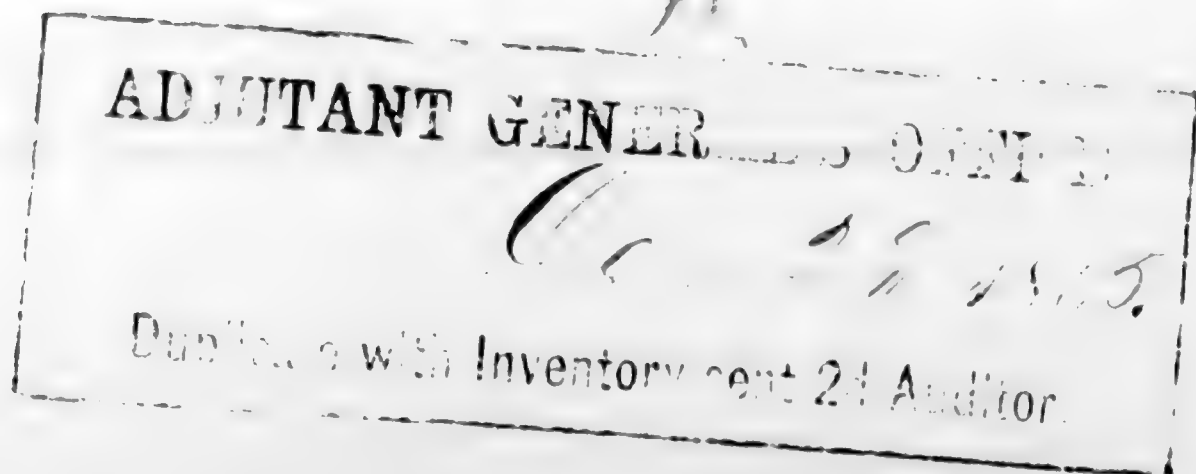

FINAL STATEMENT

OF

Reg't of

VOLUNTEERS.

NOTE 1.—Two of these certificates (or duplicates) are to be given to each Volunteer Soldier or drafted man who may be discharged without being mustered out (Final Statements are never given to men mustered out of service,) that he may at once receive from the Paymaster the pay, &c., due him, and the captain or other COMMISSIONED officer commanding the company will certify to the act of the delivery of the duplicate certificates; with these certificates the Soldier is entitled to his discharge and should also present his discharge to the Paymaster to have the payment endorsed on it. The discharge is to be given back to the Soldier by the Paymaster; the latter only retaining as his vouchers the duplicate certificates.

NOTE 2.—If the Soldier is entitled to pay for the use of his horse, the Company Commander will certify to that fact on the back of both these final statements, and also to the time he has pay due for having been so mounted on his own horse.

NOTE 3.—When a Soldier is furnished with final statements, his descriptive list, if he has one, should be taken up by the officer who gives the Soldier these statements, and endorsed with a statement to this effect by the officer. The endorsement should exhibit a full statement of the time for which the Soldier was allowed pay on his final statements, the clothing account, and all other charges against him or in his favor, so as to comprise a complete exhibit of his account. It will then be transmitted to the Company Commander of the Soldier, who will enter all the data necessary to a full understanding of the Soldier's account on the muster roll upon which the Soldier's discharge is reported. The descriptive list will then be destroyed. The object of this is, that the remaining portion of the Soldier's account may be settled upon the receipt of these muster rolls, and the Soldier receive any pay or allowances that may be due him at the time of his discharge, and which may not appear on his last final statements from the fact that his descriptive list is incomplete. These accounts for back pay, &c., are settled by the 2d Auditor of the Treasury Department.

NOTE 4.—Charges for loss or injury to ordnance, horse equipments, and other miscellaneous charges, should appear under the heading of "Other Stoppages."

NOTE 5.—Bounty paid by State authorities, and not by the United States, will not be entered on this statement.

NOTE 6.—Amounts due the Sutler and Laundress must be entered on the muster roll on which the discharge, death, desertion, &c., is reported, as well as on the final statement, otherwise the amount cannot be collected from the United States.

NOTE 7.—This blank will be used for deceased volunteers and drafted men, as well as for others.

NOTE 8.—Where a Soldier dies in Hospital or on detached service, his descriptive list, if he has one, should be sent with his final statements, in duplicate, to the Adjutant General, Washington, D. C.

NOTE 9.—If the soldier is a drafted man or substitute, the space for time, &c., of enrolled, should contain only the word *drafted* or *substitute*, as the case may be. If the Soldier is a "VETERAN," (or RECRUIT,) the words *as a veteran*, (or *recruit*) as the case may be, should be interlined after the words *mustered into the service of the U. S.* A statement of all the installments of *Veteran* or *Recruit* Bounty RECEIVED by the Soldier must be made on the back of each final statement.

I certify, on honor, that _____ a _____ of
Captain _____ Company () of the _____ Regiment of
VOLUNTEERS, of the State of _____, born in _____, State
of _____, aged _____ years; _____ feet _____ inches high; _____ complexion,
_____ eyes. _____ hair, and by occupation a _____, who joined for service
and was enrolled (see Note 9) on the _____ day of _____, 186____, at _____
by _____, for the period of _____ years, and mustered into
the service of the United States on the _____ day of _____, 186____, at
_____ by _____; and having served
HONESTLY and **FAITHFULLY** with his Company to the present date, is now entitled to a
DISCHARGE by reason of _____

The said _____ was last paid by Paymaster
_____ to include the _____ day of _____, 186____, and
has pay due him from that time to the present date; he is entitled to pay and subsistence for
TRAVELING to place of enrollment, and whatever other allowances are authorized to volunteer
soldiers, drafted men, or militia, so discharged. He has received from the United States **CLOTHING**
amounting to _____ ¹⁰⁰dollars, since the _____ day of _____,
186____, when his clothing account was last settled. He has received from the United States
_____ ¹⁰⁰dollars advanced **BOUNTY**.

There is to be stopped from him, on account of the State of _____, or other
authorities, for **CLOTHING**, &c., received on entering service, _____ ¹⁰⁰dollars; and
for other stoppages, viz: _____

_____ ¹⁰⁰dollars.
He has been furnished with **TRANSPORTATION** in kind from the place of his discharge to
_____; and he has been **SUBSISTED** for **TRAVELING** to his
place of enrollment, up to the _____, 186____.

He is indebted to _____, **SUTLER**, _____ ¹⁰⁰dollars.

He is indebted to _____, **LAUNDRESS**, _____ ¹⁰⁰dollars.

Given in Duplicate, at _____, this _____ day
of _____, 186____.

INVENTORY OF THE EFFECTS of *Henry Sumner, a Private*
Company L. Co. Regiment U.S. Col. Cavalry
 who died in the *Post* *General Hospital at Camp Nelson, Ky*
 on *September 24, 1865* *1865*

CAPS,.....	1.	BLANKETS,.....	
DRESS COATS,.....		KNAPSACKS,.....	
OVERCOATS,.....		CANTEENS,.....	
JACKETS,.....		HAVERSACKS,.....	
TROUSERS,.....		MUSKETS,.....	
SHIRTS,.....		BAYONETS,.....	
DRAWERS,.....	1.	CARTRIDGE BOX,.....	
BOOTS, pairs,.....	1.	BELT,.....	
SHOES, pairs,.....		MONEY,.....	
STOCKINGS,.....			

Inventory
 of the effects of *Private*
Henry Sumner
 late of *Co. L. Co. Regiment*
U.S. Col. Cavalry, who died
 at *Camp Nelson Post General*
Hospital, September 24,
1865.



Post

U. S. Army General Hospital,

Camp Nelson, Ky. September 24. 1865.

Commanding Officer Company, "L"

6th Regt. U. S. Cavalry. Sir.

that Private Lewis Pitman

in this Hospital on the 24th day of September 1865
of Measles.

I have to inform you
of your Company, died

I inclose his ~~descriptive list, with pay and clothing account,~~ and
inventory of his effects, which was also forwarded to Adjutant General's Office
where you will send Final Statements, the man having had no descriptive list
at the time of his ^{death}.
Very respectfully yours, &c.,

A. A. Keane

A. A. Surgeon U. S. A.

In charge of ^{Post} General Hospital.

1095
Bare Charles

Co B, 6 U. S. Col'd Cav.

Private Private

CARD NUMBERS.

1	5387548	26
2	5396001	27
3	5396081	28
4	5396161	29
5	5396241	30
6	5396337	31
7	5396493	32
8	9093908	33
9	40732755	34
10		35
11		36
12		37
13		38
14		39
15		40
16		41
17		42
18		43
19		44
20		45
21		46
22		47
23		48
24		49
25		50

Book Mark:

See also

S 171363 / P 9 1111 1111

Ed Safford &

Rg | **6 Cav.** | **U.S.C.T.**

Charles Rave
Linn, Co. *G*, 6 Reg't U. S. Col'd Cav.

Appears on

Company Descriptive Book

of the organization named above.

DESCRIPTION.

Age *21* years; height *5* feet *8* inches.

Complexion *Black*

Eyes *Bk*; hair *Bk*

Where born *Montgomery Ky*

Occupation *Farm*

ENLISTMENT.

When *May 27*, 186*3*.

Where *Paris Ky*

By whom *A. H. S. S. S.* term *3* y'rs.

Remarks:

Forrest
Copyist.

11

6 Cav. U.S.C.T.

Charles Paile

Appears with rank of *Capt* on

Muster and Descriptive Roll of a Detachment of U. S. Vols. forwarded

for the 6 Reg't U. S. Col'd Cavalry, Roll dated

Lexington Ky, June 3, 1865.

Where born *Mt Vernon Co Ky*

Age *21* y'rs; occupation *Farmer*

When enlisted *May 27, 1865.*

Where enlisted *Paris Ky*

For what period enlisted *8* years.

Eyes *Blue*; hair *Blue*

Complexion *Blk*; height _____ ft. _____ in.

When mustered in *June 3, 1865.*

Where mustered in *Lexington Ky*

Bounty paid \$ *100*; due \$ *100*

Where credited *Mt Vernon Co 7 D Ky*

Company to which assigned _____

Remarks: *Given James*

Paile

Book mark: _____

Wiley

6 Cav. U.S.C.T.
Charles Rice
Tri, Co. *L*, 6 Reg't U. S. Col'd Cavalry.

Appears on

Company Muster-in and Descriptive Roll
of the organization named above. Roll dated

Camp Nelson, N. Y., June 9, 1865.

Where born *Montgomery Co. Pa.*

Age *21* y'rs; occupation *Farmer*

When enlisted *May 27, 1865.*

Where enlisted *Paris*

For what period enlisted *3* years.

Eyes *Blk*; hair *Blk*

Complexion *Blk*; height *5* ft. *8* in.

When mustered in *June 3, 1865.*

Where mustered in *Lexington*

Bounty paid \$ *100*; due \$ *100*

Where credited *Montgomery Co. Pa.*

Company to which assigned *L*

Remarks: *pt. Mt. Bounty due*

Book mark: _____

(356d)

Henry J.
Copyist.

R | **6 Cav.** | **U.S.C.T.**

Charles Rare

P., Co. L, 6 Reg't U.S. Col'd Cavalry.

Appears on

Company Muster Roll

for *June 9 to June 30, 1865*.

Present or absent *Present*

Stoppage, \$ *100* for

Due Gov't, \$ *100* for

Valuation of horse, \$ *100*

Valuation of horse equipments, \$ *100*

Remarks:

Book mark:

(358)

Henry J.
Copyist.

R | **6 Cav.** | **U.S.C.T.**

Charles Rose

3rd, Co. L, 6 Reg't U.S. Col'd Cavalry.

Appears on

Company Muster Roll

for July 7 Aug, 1865.

Present or absent Present

Stoppage, \$ 100 for

Due Gov't, \$ 100 for

Valuation of horse, \$ 100

Valuation of horse equipments, \$ 100

Remarks:

Book mark: _____

(358)

M. W. J.
Copyist.

R

6 Cav.

U.S.C.T.

Charles Rade

Rk

, Co. L, 6 Reg't U. S. Col'd Cavalry.

Appears on

Company Muster Roll

for *Sept. and Oct*, 1865.

Present or absent *Present*

Stoppage, \$ *100* for

Due Gov't, \$ *100* for

Valuation of horse, \$ *100*

Valuation of horse equipments, \$ *100*

Remarks:

Book mark:

(358)

T. V. Kearny

Copyist.

R | **6 Cav.** | **U.S.C.T.**

Charles Rose

Rk, Co. L, 6 Reg't U.S. Col'd Cavalry.

Appears on

Company Muster Roll

for *Nov and Dec*, 1865.

Present or absent

Stoppage, \$ *100* for

Due Gov't, \$ *1* $\frac{89}{100}$ for *ordnance*

" " *4* $\frac{80}{100}$ "*C. & G. equipage.*

Valuation of horse, \$ *100*

Valuation of horse equipments, \$ *100*

Remarks:

*Died in Post Hoep. at Helena, Ark.,
Dec. 22, 1865.*

Book mark: *Op Smallpox. M.O.R.*

(358)

Jas. Keamy
Copyist.

R | **6 Cav.** | **U.S.C.T.**

Charles Rare
Priv, Co. *L*, 6 Reg't U. S. Col'd Cav.

Appears on **Returns** as follows:

Dec 1865, Los. Dec 25/65;
Post Hosp Helena Ark
Died of Small Pox,

Book mark :

(546)

C M Row

Copyist.

R

6 Cav. U.S.C.T.

Charles Rare
Pvt, Co. L, 6 Reg't U. S. Col'd Cavalry.

Appears on Co. Muster-out Roll, dated
Devalls Bluffs, Ark, Apr. 15, 1866.

Muster-out to date _____, 186 .

Last paid to Oct. 31, 1865.

Clothing account:

Last settled _____, 186 ; drawn since \$ 100

Due soldier \$ 100; due U. S. \$ 100

Am't for cloth'g in kind or money adv'd \$ 100

Due U. S. for arms, equipments, &c., \$ 100

Bounty paid \$ 100; due \$ 100

Remarks: Died at Helena, Ark.,
Dec. 25, 1865, of Small Pox.
Final Statements furnished.

Book mark: 2^d Aud. 9425, Apl. 30, 68

(361)

J. B. Gage

Copyist.

Rare, Charles

P, Co. 2, 6" Reg't U.S.C. Cav.

5 Enclosures.

Bed Cards	Final Statements
Burial Records	Furloughs or L. of A.
Certs. of Dis. for Discharge	Med. Certificates
C. M. Charges	Med. Des. Lists
Descriptive Lists	Orders
Discharge Certificates	Pris. of War Record
Enlistment Papers	Resignations

Other papers relating to—

Admission to Hosp'l	Furlough or L. of A.
Casualty Sheet	Med. Examination
Confinement	Misc. Information
Contracts	Pay or Clothing
Death or Effects	Personal Reports
Desertion	Rank
Discharge from Hosp'l	Transfer to Hosp'l
Discharge from Service	Transfer to V. R. C.
Duty	Transportation

NOTE 1.—This blank will be used for both enlistments and re-enlistments—enlistment of veterans, &c., &c., in the volunteer service. They will be made out in duplicate in all cases—one to accompany the recruiting return of the superintendent (not the recruiting officer) to the Adjutant General, and one to accompany the accounts of the officer who pays bounty, &c. The Regiment and Company in which the soldier last served should be given on the back.

NOTE 2.—An enlistment holds to service. A muster-in must, in all cases, precede payment of pay, bounty, pension, &c. A muster-in roll must, in all cases, be filed in the Adjutant General's Office as evidence of muster-in. The mustering officer, commissary, or assistant commissary of musters, as the case may be, will countersign both enlistments as having mustered the soldier into the service of the United States before either of them is given to the disbursing officer.

DECLARATION OF RECRUIT.

I, Charles Rare, desiring VOLUNTEER as a Soldier in the Army of the United States, for the term of THREE YEARS, Do Declare, That I am Twenty one years and _____ months of age: that I have never been discharged from the United States service on account of disability or by sentence of a court martial, or by order before the expiration of a term of enlistment; and I know of no impediment to my serving honestly and faithfully as a soldier for three years.

GIVEN at Paris Ky the 27 day of May 1863;

Witness: C. P. Brainard Charles Rare
Serjt 6th Mo. A. mark



Volunteered at _____, 18____,
 By _____, 18____,
 Regiment of _____,

 enlistment; last served in Company () _____
 Regt of _____,
 Discharged _____, 18____.

No. _____

C. P. Brainard
 81

CONSENT IN CASE OF MINOR.

I, James, Do CERTIFY, That I am the _____ of _____; that the said _____ is _____ years of age; and I do hereby freely give my CONSENT to his volunteering as a SOLDIER in the ARMY OF THE UNITED STATES for the period of THREE YEARS.

GIVEN at _____ the _____ day of _____

Witness: _____

Credited to Montgomery Co 9 174-

VOLUNTEER ENLISTMENT.

STATE OF

TOWN OF

Kentucky



I, Charles Rare, born in Montgomery Co, in the State of Kentucky, aged Twenty one years, and by occupation a Farmer, Do HEREBY ACKNOWLEDGE to have volunteered this Twenty seventh day of May, 1865, to serve as a Soldier in the Army of the United States of America, for the period of THREE YEARS, unless sooner discharged by proper authority: Do also agree to accept such bounty, pay, rations, and clothing, as are, or may be, established by law for volunteers. And I, Charles Rare, do solemnly swear, that I will bear true faith and allegiance to the United States of America, and that I will serve them honestly and faithfully against all their enemies or opposers whomsoever; and that I will observe and obey the orders of the President of the United States, and the orders of the officers appointed over me, according to the Rules and Articles of War.

Sworn and subscribed to, at Paris Ky, this 27 day of May 1865, BEFORE Aaron Middaugh, Recruiting Officer, Charles Rare mark

I CERTIFY, ON HONOR, That I have carefully examined the above-named Volunteer, agreeably to the General Regulations of the Army, and that, in my opinion, he is free from all bodily defects and mental infirmity, which would in any way disqualify him from performing the duties of a soldier.

C. H. Riley, Asst. Surg. Genl., Examining Surgeon.

I CERTIFY, ON HONOR, That I have minutely inspected the Volunteer previously to his enlistment, and that he was entirely sober when enlisted; that, to the best of my judgment and belief, he is of lawful age; and that, in accepting him as duly qualified to perform the duties of an able-bodied soldier, I have strictly observed the Regulations which govern the recruiting service. This soldier has Black eyes, Black hair, Black complexion, is 5 feet 8 inches high.

Aaron Middaugh Sr, 6th Regiment of W. S. G. Volunteers, Recruiting Officer.

Certificate for the Signature of the Mustering Officer, Commissary, or Assistant Commissary of Mustering, as the case may be. Mustered into the service of the United States, for three years or during the war, from date of enlistment, in Co. 5th day of June, 1865, at Lexington Ky, in the County of Wood, (or Sub-district) in the Town of ... 11th Congressional District, in the State of ... Bounty paid at time of Mustering: U. S. Bounty, Local Bounty, Mustering Officer, Capt. Geo. W. ...

NOTE 1.—This blank will be used for both enlistments and re-enlistments—enlistment of veterans, &c., &c., in the volunteer service. They will be made out in duplicate in all cases—one to accompany the recruiting return of the superintendent (not the recruiting officer) to the Adjutant General, and one to accompany the accounts of the officer who pays bounty, &c. The Regiment and Company in which the soldier last served should be given on the back.

NOTE 2.—An enlistment holds to service. A muster-in must, in all cases, precede payment of pay, bounty, pension, &c. A muster-in roll must, in all cases, be filed in the Adjutant General's Office as evidence of muster-in. The mustering officer, commissary, or assistant commissary of musters, as the case may be, will countersign both enlistments as having mustered the soldier into the service of the United States before either of them is given to the disbursing officer.

DECLARATION OF RECRUIT.

I, Charles Rare, desiring
VOLUNTEER as a Soldier in the Army of the United States, for the term of THREE YEARS,
Do Declare, That I am Twenty one years and _____ months
of age; that I have never been discharged from the United States service on account of disability or by
sentence of a court martial, or by order before the expiration of a term of enlistment; and I know of no
impediment to my serving honestly and faithfully as a soldier for three years.

GIVEN at Paris Ky
the 29 day of April 1865

Witness:
S. H. Bramard
Serjt G. H. H. H.

Charles Rare
mark

No. _____

Charles Rare

Volunteered at Paris Ky
29th May, 1865
By James H. H. H.
Ct. Regiment of U.S.C.
U.S.A.

Discharged _____, 18 ____

Reg't of _____

enlistment; last served in Company ()

CONSENT IN CASE OF MINOR.

I, James Rare, Do CERTIFY, That I am
the _____ of _____; that the
said _____ is _____ years of age; and I
do hereby freely give my CONSENT to his volunteering as a SOLDIER in the ARMY OF THE UNITED STATES
for the period of THREE YEARS.

GIVEN at _____
the _____ day of _____

Witness:

Note 1.—This blank is used for both enlistments and reenlistments—discharge of veterans, &c., &c., in the volunteer service. They will be returned to the applicant in all cases—due to a copy being returned to the recruiting office to the Adjutant General, and also to accompany the soldier's discharge, if he who pays bounty, &c. The Regiment and Company it will be in, and the date of discharge, must be filled in.

Note 2.—An affidavit is to be made by the recruit, in a case of a recruit, in the Adjutant General's Office as evidence of mustering. This affidavit is to be made by the Adjutant General, or by the recruiting officer, or by the Adjutant General, as the case may be, with countersigned by the enlistment as having mustered the soldier into the service of the United States before either of them is given to the enlisting officer.

DECLARATION OF RECRUIT.

I, *Charles Rase*

desiring VOLUNTEER as a Soldier in the Army of the United States, for the term of THREE YEARS, Do Declare, That I am *Twenty one* years and *10* months of age; that I have never been discharged from the United States service on account of disability or by sentence of a court martial, or by order before the expiration of a term of enlistment; and I know of no impediment to my serving honestly and faithfully as a soldier for three years.

GIVEN at *Paris Ky* the *27* day of *April 1865*

Witness: *S. H. Bramard*
Serjt G. W. S. Co

Charles Rase
mark

No. _____

Mustered at *Paris Ky*

27th May 1865

By *Loren Haddock*

Co Regiment of U.S.C.

U.S.C. Regt

enlistment; last served in Company _____

Reg't of _____

Discharged _____, 18 _____

Charles Rase

CONSENT IN CASE OF MINOR.

I, *Pat*, DO CERTIFY, That I am the _____ of _____; that the said _____ is _____ years of age; and I do hereby freely give my CONSENT to his volunteering as a SOLDIER in the ARMY OF THE UNITED STATES for the period of THREE YEARS.

GIVEN at _____ the _____ day of _____

Witness: _____

Credited to Montgomery Co 9 54-

VOLUNTEER ENLISTMENT.

STATE OF

TOWN OF

Kentucky



I, Charles B. Rare, born in Washington Co in the State of Kentucky, aged Twenty one years, and by occupation a Carpenter, Do HEREBY ACKNOWLEDGE to have volunteered this Twenty seventh day of May, 1863, to serve as a Soldier in the Army of the United States of America, for the period of THREE YEARS, unless sooner discharged by proper authority: Do also agree to accept such bounty, pay, rations, and clothing, as are, or may be, established by law for volunteers. And I, Charles Rare, do solemnly swear, that I will bear true faith and allegiance to the United States of America, and that I will serve them honestly and faithfully against all their enemies or opposers whomsoever; and that I will observe and obey the orders of the President of the United States, and the orders of the officers appointed over me, according to the Rules and Articles of War.

Sworn and subscribed to, at Paris Ky this 27 day of May 1863, BEFORE Aaron Middaugh 1st and Recruiting Officer

Charles B. Rare

I CERTIFY, ON HONOR, That I have carefully examined the above-named Volunteer, agreeably to the General Regulations of the Army, and that, in my opinion, he is free from all bodily defects and mental infirmity, which would in any way disqualify him from performing the duties of a soldier.

C. H. Riley, Examining Surgeon

I CERTIFY, ON HONOR, That I have minutely inspected the Volunteer previously to his enlistment, and that he was entirely sober when enlisted; that, to the best of my judgment and belief, he is of lawful age; and that, in accepting him as duly qualified to perform the duties of an able-bodied soldier, I have strictly observed the Regulations which govern the recruiting service. This soldier has Black eyes, Black hair, Black complexion, is 5 feet 8 inches high.

Aaron Middaugh, Recruiting Officer

A. G. O. No. 74 & 76.

Mustered into the service of the United States, for three years or during the war, from date of enlistment, in Co. 6th Regiment of W. S. G. Volunteers, on the 3 day of June, 1863 at Lexington Ky. and credited to Ward (or sub-district) in the Town of ... in the County of ... in the Congressional District, in the State of ... Bounty paid at time of Muster-in: U. S. Bounty, Local Bounty, ...

William ... Capt & Pres ...

Port Cha^s Parr
Co L^o 6th W. C. Co

Final Statement
Sent to A. G. C. June
25-1865-

Final Statement
Sent to A. G. C.
Dec 30, '65-

23	10
17	72
17	10
2	
41	52
15	



1865

Past. Hospital, Helena Ark

December 24th 1865

Sir:

I would respectfully inform you
that private Chas. Rose of 6th U.S. Cald. Co. died this A.M. of Small Pox
Will you please furnish a detail of men
to bury Rose, then report to Hospital
Steward at Past. Hospital please furnish
cove to dig grave.

Wm. Hedges

Surg. 6th U.S. Cald. Co.
Surg. in Charge Past. Hosp.

Adjutant - 6th U.S. Cav
Helena Ark.

P.S. I would suggest that you send
men who have had the Small Pox.

U. S. Army
1862

FINAL STATEMENT

OF

Private Charles Moore
6th Reg't of U.S. Col. Cal.

VOLUNTEERS.

NOTE 1.—Two of these certificates (or duplicates) are to be given to each Volunteer Soldier or drafted man who may be discharged without being mustered out (Final Statements are never given to men mustered out of service) that he may at once receive from the Paymaster the pay, &c., due him, and the captain or other commanding officer of the company will certify to the act of the company of the duplicate certificates; with these certificates the Soldier is "entitled to his discharge," and should also present for discharge to the Paymaster to have the payment endorsed on it. The discharge is to be given back to the Soldier by the Paymaster; the latter only retaining as his vouchers the duplicate certificates.

NOTE 2.—If the Soldier is entitled to pay for the use of his horse, the Company Commandant will certify to that fact on the back of both these final statements, and also to the time he has pay due for having been so mounted on his own horse.

NOTE 3.—When a Soldier is furnished with final statements, his descriptive list, if he has one, should be taken up by the officer who gives the Soldier these statements, and endorsed with a statement to that effect by the officer. The endorsement should exhibit a full statement of the time for which the Soldier was allowed pay on his final statements, the clothing account, and all other charges against him on his favor, so as to comprise a complete exhibit of his account. It will then be transmitted to the Company Commandant of the Soldier, who will enter all the data necessary to a full understanding of the Soldier's account on the muster roll upon which the Soldier's discharge is reported. The descriptive list will then be destroyed. The object of this is, that the remaining portion of the Soldier's account may be settled upon the receipt of those muster rolls, and the Soldier receive any pay or allowance that may be due him at the time of his discharge, and will pay no attention on his last final statements from the fact that his discharge is incorporated. These accounts for back pay, &c., are settled by the Adjutant of the Treasury Department.

NOTE 4.—Changes for loss or injury to ordnance, horse, equipments, and other miscellaneous charges, should appear under the heading of "Other Steps."

NOTE 5.—Bounty paid by State authorities, and not by the United States, will not be entered on this statement.

NOTE 6.—Amounts due the Suttler and Laurence must be entered on the muster roll on which the discharge, death, desertion, &c., is reported, as well as on the final statement; otherwise the amount cannot be collected from the United States.

NOTE 7.—This blank will be used for deceased volunteers and drafted men, as well as for others.

NOTE 8.—Where a Soldier dies in Hospital or on detached service, his descriptive list, if he has one, should be sent with his final statements, in duplicate, to the Adjutant General, Washington, D. C.

NOTE 9.—If the soldier is a drafted man or substitute, the space for time, &c., of enrolment, should contain only the word *drafted* or *substitute*, as the case may be. If the Soldier is a "VETERAN" (or RECRUIT,) the words *as a veteran* (or *recruit*) as the case may be, should be interlined after the words *mustered into the service of the U. S.* A statement of all the installments of *Veteran* or *Recruit* **Bounty RECEIVED** by the Soldier must be made on the back of each final statement.

ADJUTANT GENERAL'S OFFICE
Jan 9th 1862
Duplicate will be for [unclear]

[Signature]

I certify, on honor, that Charles R. Rare, a Private of
 Captain J. M. Smith's Company (1) of the Sixth Regiment of U.S. Volunteers
VOLUNTEERS, of the State of USA, born in Montgomery County State
 of Kentucky, aged 21 years; 5 feet 8 inches high; Rose complexion,
Blue eyes, Black hair, and by occupation a Farmer, who joined for service
 and was enrolled (see Note 9) on the 27 day of May, 1865, at Paris Ky
 by T. A. Maddox, for the period of 1 yr years, and mustered into
 the service of the United States on the 31 day of June, 1865, at
Jefferson Ky, by William Headlee; and having served
 HONESTLY and FAITHFULLY with his Company to the present date, is now entitled to a
DISCHARGE by reason of Death Disease Small Pox
The Supt Post Hospital Helena Ark Dec 25 1865

The said Charles R. Rare was last paid by Paymaster
Major Corwin to include the 31 day of October, 1865, and
 has pay due him from that time to the present date; he is entitled to pay and subsistence for
TRAVELING to place of enrollment, and whatever other allowances are authorized to volunteer
 soldiers, drafted men, or militia, so discharged. He has received from the United States **CLOTHING**
 amounting to \$ 112.87 cts 100 dollars, since the 27 day of May,
 1865, when his clothing account was ~~last~~ ^{never} settled. He has received from the United States
00 100 dollars advanced **BOUNTY**.

There is to be stopped from him, on account of the State of _____, or other
 authorities, for **CLOTHING**, &c., received on entering service, _____ 100 dollars, and
 for other stoppages, viz: _____
 _____ 100 dollars.

He has been furnished with **TRANSPORTATION** in kind from the place of his discharge to
 _____; and he has been **SUBSISTED** for **TRAVELING** to his
 place of enrollment, up to the _____, 1865.

He is indebted to _____, **SUTLER**, _____ 100 dollars.

He is indebted to _____, **LAUNDRESS**, _____ 100 dollars.

Given in Duplicate, at Helena Arkansas, this 30 day
 of December, 1865.

James M. Smith
James M. Smith
 Commanding Company.

ARTICLES OF WAR.

ART. 95. When any non-commissioned officer or soldier shall die, or be killed in the service of the United States, the then commanding officer of the troop or company shall, in the presence of two other commissioned officers, take an account of what effects he died possessed of, above his arms and accoutrements, and transmit the same to the office of the Department of War, which said effects are to be accounted for, and paid to the representatives of such deceased non-commissioned officer or soldier. And in case any of the officers, so authorized to take care of the effects of deceased officers and soldiers, should, before they have accounted to their representatives for the same, have occasion to leave the regiment or post, by preference or otherwise, they shall, before they be permitted to quit the same, deposit in the hands of the commanding officer, or of the assistant military agent, all the effects of such deceased non-commissioned officers and soldiers, in order that the same may be secured for, and paid to, their respective representatives.

ARMY REGULATIONS—EDITION OF 1861.

DECEASED SOLDIERS.

Par. 152. Inventories of the effects of deceased non-commissioned officers and soldiers, required by the 95th Article of War, will be forwarded to the Adjutant General, by the commander of the company to which the deceased belonged, and a duplicate of the same to the colonel of the regiment. Final statements of pay, clothing, &c., will be sent with the inventories. When a soldier dies at a post or station absent from his company, it will be the duty of his immediate commander to furnish the required inventory, and, at the same time, to forward to the commanding officer of the company to which the soldier belonged, a report of his death, specifying the date, place, and cause; to what time he was last paid, and the money or other effects in his possession at the time of his decease; which report will be noted on the next muster roll of the company to which the man belonged. Each inventory will be endorsed, "Inventory of the effects of _____, late of company (—) _____ regiment of _____, who died at _____, the _____ day of _____, 186—." If a legal representative receive the effects, it will be stated in the report. If the soldier leave no effects, the fact will be reported.

Par. 153. Should the effects of a deceased non-commissioned officer or soldier not be administered upon within a short period after his decease, they shall be disposed of by a Council of Administration, under the authority of the commanding officer of the post, and the proceeds deposited with the Paymaster, to the credit of the United States, until they shall be claimed by the legal representatives of the deceased.

Par. 154. In all such cases of sales by the Council of Administration, a statement in detail, or account of the proceeds, duly certified by the Council and commanding officer, accompanied by the Paymaster's receipt for the proceeds, will be forwarded by the commanding officer to the Adjutant General. The statement will be endorsed, "Report of the proceeds of the effects of _____, late of company (—) _____ regiment of _____, who died at _____, the _____ day of _____, 186—."

NOTE 1.—The effects in all cases, when called for, should be turned over to the legal representative, without further authority from the Adjutant General. When the effects are turned over to the relatives of the deceased before these inventories are sent to the Adjutant General, their receipts therefor should be attached to the inventories. In all other cases, one copy will be sent with a letter of transmittal direct to the Adjutant General, and a duplicate retained by the officer.

NOTE 2.—Particular care should be taken to take receipts in duplicate from the Paymaster for any funds turned over to him; one copy should be sent direct to the Adjutant General and one retained by the officer.

INVENTORY OF THE EFFECTS

OF

Private Charles Rose

Late of Company *G.*

4th Reg't of *U.S. Regulars*

Volunteers, who died at *Camp Harpoe*
Helena Ark
on the *25th* day of *December* 186*4*.

Inventory of the effects of Charles Parce late
 a Private of Captain St James M. Smith Company 1st of
 the 5th Regiment of US Col Col Volunteers, who was enrolled as
 a Soldier at Peris Ky in the State of USA on
 the 27 day of May 1865, and mustered into the service of the United
 States as a Private on the 30 day of June 1865, at Leanington Ky
 in Company 1st, 5th Regiment of US Col Col Volunteers, to serve 3
 years or during the war; he was born in Montgomery County in the State
 of Kentucky; he was 21 years of age, 5 feet 8 inches
 high, Black complexion, Black eyes, Black hair, and by occupation, when enrolled,
 a Farmer; he died in Pat Hospital, at
Helena Ark on the 25 day of December 1865, by
 reason of Small Pox

INVENTORY.					
ARTICLES.	No.	ARTICLES.	No.	ARTICLES.	No.
Hats.....		Pairs trowsers.....		Knapsacks.....	
Caps.....		Pairs flannel drawers.....		No Effects	
Forage caps.....		Pairs cotton drawers.....			
Great coats.....		Flannel shirts.....			
Uniform coats.....		Cotton shirts.....			
Uniform jackets.....		Pairs boots.....			
Flannel sack coats.....		Pairs shoes.....			
Blouses.....		Pairs socks.....			
Stable frocks.....		Blankets.....			
Fatigue overalls.....		Haversacks.....			
					MONEY.
				Specie.....	\$
				Notes.....	\$

I CERTIFY, ON HONOR, that the above inventory comprises all the effects of
Charles Parce deceased, and that the effects are in the hands
 of Charles Parce at Helena Ark
Helena Ark to be disposed of by a Council of Administration.

(DUPLICATES.)

STATION: Helena Ark James M. Smith
Lieut Col 1st US Col
 Commanding the Company.

DATE: December 30, 1865

1096

Patliff John

Co H, 6 U. S. Col'd Cav.

Private Private

CARD NUMBERS.

1	5387332	26
2	5387352	27
3	5387366	28
4	5394101	29
5	5394186	30
6	5394287	31
7	5394361	32
8	5394440	33
9	5394529	34
10	5394603	35
11	5394671	36
12	9093640	37
13	40722756	38
14		39
15		40
16		41
17		42
18		43
19		44
20		45
21		46
22		47
23		48
24		49
25		50

Book Mark:

See also

P. 6 Cav | **U. S. C. T.**

John Patlist
, Co. 6 Reg't U. S. Col'd Cav.

Appears on

Company Descriptive Book

of the organization named above.

DESCRIPTION.

Age *18* years; height *5* feet *6 1/2* inches.

Complexion *black*

Eyes *black* ; hair *black*

Where born *Tennessee*

Occupation *Farm hand*

ENLISTMENT.

When *Jan. 16*, 1865.

Where *Louisville, Ky.*

By whom *Capt. W. W. W. W.*; term *3* y'rs.

Remarks:

Amory Webb

(383g)

Copist.

R. | 6 Cav. | U.S.C.T.

John Ratcliff.

Appears with rank of private on

Muster and Descriptive Roll of a Detachment of U. S. Vols. forwarded

for the 6 Reg't U. S. Col'd Cavalry. Roll dated

Louisville Ky, March 16, 1865.

Where born Tennessee

Age 18 y'rs; occupation farmer

When enlisted March 16, 1865.

Where enlisted Louisville Ky

For what period enlisted 5 years.

Eyes black; hair black

Complexion black; height 5 ft. 6 1/2 in.

When mustered in March 16, 1865.

Where mustered in Louisville Ky

Bounty paid \$ 100; due \$ 100

Where credited Jeff. Co. 5th Dist Ky.

Company to which assigned

Remarks:

Book mark:

R. | **6 Cav.** | **U.S.C.T.**

John Rathliff
Appears with rank of private on

Muster and Descriptive Roll of a Detachment of U. S. Vols. forwarded

for the 6 Reg't U. S. Col'd Cavalry. Roll dated

St. Louis, Mo, March 17, 1865.

Where born Tennessee

Age 18 y'rs; occupation Farm hand.

When enlisted March 16, 1865.

Where enlisted Louisville Ky

For what period enlisted 3 years.

Eyes black; hair black

Complexion black; height 5 ft. 6 1/2 in.

When mustered in March 16, 1865.

Where mustered in Louisville Ky.

Bounty paid \$ 100; due \$ 100

Where credited 5 Dist Ky.

Company to which assigned _____

Remarks : _____

Book mark : _____

A. J. Pratt

P. | **6 Cav.** | **U.S.C.T.**

John Rattiff

Appears with rank of *private* on

Muster and Descriptive Roll of a Detachment of U. S. Vols. forwarded

for the 6 Reg't U. S. Col'd Cavalry. Roll dated

Off. Rendez. Louis v. Ky. Mch 17, 1865.

Where born *Tennessee*

Age *18* y'rs; occupation *Farm hand.*

When enlisted *Mch 16, 1865.*

Where enlisted *Louisville Ky.*

For what period enlisted *3* years.

Eyes *black*; hair *black.*

Complexion *black*; height *5 ft. 6 in.*

When mustered in *Mch 16, 1865.*

Where mustered in *Louisville Ky.*

Bounty paid \$ *100*; due \$ *100*

Where credited *5 Dist. Ky.*

Company to which assigned _____

Remarks: _____

Book mark: _____

(Signature)

R 6 Cav | U. S. C. T.

John Ratliff
Priv., Co. H. 6 Reg't U. S. Col'd

Appears on

Company Muster-in and Descriptive Roll
of the organization named above. Roll dated

Lovington, Ky., Mch 26, 1865.

Where born Tennessee

Age 18 y'rs; occupation Farm hand

When enlisted Mch 16, 1865.

Where enlisted Louisville, Ky.

For what period enlisted 3 years.

Eyes Black; hair Black

Complexion Black; height 5 ft. 6½ in.

When mustered in Mch 16, 1865.

Where mustered in Louisville, Ky.

Bounty paid \$ 100; due \$ 100

Where credited 5th Dist. Ky.

Company to which assigned H

Remarks:

Book mark:

(356d)

Conard
Copyist.

B | **6 Cav. U.S.C.T.**

John Batliff
Prvt., Co. H, 6 Reg't U. S. Col'd Cavalry.

Appears on

Company Muster Roll

for *from Mch. 16 to Apr. 30*, 1865.

Present or absent *Present*

Stoppage, \$ *100* for

Due Gov't, \$ *100* for

Valuation of horse, \$ *100*

Valuation of horse equipments, \$ *100*

Remarks:

Book mark:

(358)

Conard
Copyist.

MAR 1865

R

6 Cav. U.S.C.T.

John Ratliff

Pvt, Co. H, 6 Reg't U. S. Col'd Cavalry.

Appears on

Company Muster Roll

for May & June, 1865.

Present or absent Present.

Stoppage, \$ 100 for

Due Gov't, \$ 100 for

Valuation of horse, \$ 100

Valuation of horse equipments, \$ 100

Remarks: 1st Instalment Bounty due.

Book mark:

(358)

Leonard
Copyist.

P **6 Cav. U.S.C.T.**

James Patrick
P, Co. H, 6 Reg't U. S. Col'd Cavalry.

Appears on

Company Muster Roll

for *June 1865*, 1865.

Present or absent *Present*

Stoppage, \$ *100* for

Due Gov't, \$ *100* for

Valuation of horse, \$ *100*

Valuation of horse equipments, \$ *100*

Remarks:

Book mark:

(358)

James
Copyist.

P 6 Cav. U.S.C.T.

John Patton
Co., Co. H, 6 Reg't U. S. Col'd Cavalry.

Appears on

Company Muster Roll

for *Sept '65*, 1865.

Present or absent *Present*.

Stoppage, \$ *100* for

Due Gov't, \$ *100* for

Valuation of horse, \$ *100*

Valuation of horse equipments, \$ *100*

Remarks:

Book mark:

(358)

Swain

Copyist.

6 Cav. U.S.C.T.

John Smith
Smith, Co. H, 6 Reg't U. S. Col'd Cavalry.

Appears on

Company Muster Roll

for *Jan 20*, 1865.

Present or absent *Present*

Stoppage, \$ *100* for

Due Gov't, \$ *100* for

Valuation of horse, \$ *100*

Valuation of horse equipments, \$ *100*

Remarks:

Book mark:

(358)

Smith
Copyist.

R | **6 Cav.** | **U.S.C.T.**

John Radiff

Priv., Co. H, 6 Reg't U. S. Col'd Cavalry.

Appears on

Company Muster Roll

for *Jan'y & Feb'y*, 186*6*.

Present or absent *Present.*

Stoppage, \$ 100 for

Due Gov't, \$ *0* ^{*60*}/_{*100*} for *ordnance*

& \$1.60 for C & G. E.

Valuation of horse, \$ 100

Valuation of horse equipments, \$ 100

Remarks:

Book mark:

(358)

J. M. Harmon

Copyist.

R | **6 Cav.** | **U.S.C.T.**

+ *John Ruttiff,*
Plt, Co. *A*, 6 Reg't U. S. Col'd Cav.

Appears on **Returns** as follows:

Jan'y 1866. On daily duty
in D. M. Stables,

March 1866. On daily duty
in Q. M. Dept. Teamster,

+ *Supplied from M. Roll by*
A. B.

Book mark :

A. M. Moor

(546)

Copyist.

R

6 Cav. U.S.C.T.

John Ralliff

Priv., Co. A, 6 Reg't U. S. Col'd Cavalry.

Appears on Co. Muster-out Roll, dated
Devalls Bluff, Ark, April 10, 1866.

Muster-out to date April 15, 1866.

Last paid to Feb 28, 1866.

Clothing account:

Last settled _____, 1866 ; drawn since \$ 100

Due soldier \$ 100 ; due U. S. \$ 7 ¹¹/₁₀₀

Am't for cloth'g in kind or money adv'd \$ 100

Due U. S. for arms, equipments, &c., \$ 100

Bounty paid \$ 100 ; due \$ 100

Remarks:

Book mark: R 2423. Ky

(861)

J. M. Harmon

Copyist.

Ratliff,
P. H., Co. K,

John -
6 U.S.C. & V.
Reg't

Enclosures.

Bed Cards	Descriptive Lists
Burial Records	Final Statements
Certs. of Dis. for Discharge	Furloughs
C. M. Charges	Med. Des. Lists
Med. Certificates	Orders

Other papers relating to—

Admission to Hosp'l	Furlough
Casualty Sheet (Officer's)	Med. Examination
Confinement	Misc. Information
Contracts	Pay or Clothing
Death or Effects	Personal Reports
Desertions	Rank
Discharge from Hosp'l	Transfer to Hosp'l
Discharge from Service	Transfer to V. R. C.
Duty	Transportation

MICROFILM PUBLICATION M 1822

COMPILED MILITARY SERVICE RECORDS
OF VOLUNTEER UNION SOLDIERS WHO
SERVED WITH THE USCT (US COLORED TROOPS)
5TH MASSACHUSETTS REGIMENT OF CAVALRY

PERSONAL PAPERS' TARGET SHEET

PLEASE NOTE THE CHECKED INFORMATION ABOUT THE PERSONAL PAPERS IN
THIS FILE:

NO PERSONAL PAPERS WERE FOUND IN THIS FILE WHEN THE
RECORDS WERE ARRANGED FOR MICROFILMING.

2 PERSONAL PAPER(S) FOUND IN THIS FILE WHEN THE RECORDS
WERE ARRANGED FOR MICROFILMING.

War Department,

ADJUTANT GENERAL'S OFFICE.

Washington, April 13 1867.

Respectfully returned to the
Commissioner for the State of
Kentucky, with the informa-
tion that John Ratliff,
was enlisted at Louisville Ky
March 16 1864 and was
mustered in as private in Co "H"
6th U.S.C.T. March 16 1864

10 2423 441

J. S. Suggard

Asst. Adj't General.

ENDORSEMENT.

No.

APPLICATION OF

J. B. Ratliff

OF

Princeton Caldwell County 1300

for compensation for service of slave

Jno Ratliff

enlisted March 16th 1864

in H Co 6th Artillery Regiment

U. S. Colored Troops.

Received March 26 1867

Compensation awarded

186

Dollars

President Board of Claim.

P. O. ADDRESS OF CLAIMANT

Princeton Ky

CLAIM FOR COMPENSATION FOR ENLISTED SLAVE.

No. _____
 I, R B Ratcliff a loyal citizen, and a resident of Princeton
 County of Caldwell State of Kentucky hereby claim compensation,
 under the provisions of Section 24, Act approved February 24, 1864, and Section 2, Act approved July 28, 1866, for my
 slave Jas Ratley enlisted Mar 16 1864, at
Louisville by Capt G W Hancock
 in the Sixth Regiment U. S. Colored Regt Troops, Company H certificate of which enlist-
 ment, and a descriptive list, as required, accompany this application.

In proof of my loyalty to the Constitution and Government of the United States, I present the accompanying oath, which I have taken, signed and acknowledged; to be filed with this application, in accordance with requirement of General Orders, No. 329, 1863, War Department, Adjutant General's Office.

March 22 1864 R B Ratcliff

OATH OF ALLEGIANCE.

I, R B Ratcliff the owner and claimant, do solemnly swear that the

foregoing claim is a just and true claim due to me as master and owner of the said slave, and that the facts alleged in said claim in respect to the draft or enlistment (as the case may be) of said slave into the military service of the United States are true. And I do further swear that I have never joined, OR BEEN CONCERNED IN, ANY INSURRECTION or rebellion; THAT I HAVE NEVER BORNE ARMS against the United States; THAT I HAVE NEVER GIVEN ANY AID, COUNTENANCE, COUNSEL OR ENCOURAGEMENT, to any person or persons engaged, or whom I had reason to believe were about to engage, in insurrection, rebellion or armed hostility AGAINST THE UNITED STATES; that I have neither sought, nor accepted, nor attempted to exercise the functions of any office, civil or military; nor to perform any service whatever, under any authority, or pre-tended authority, in hostility to the United States; that I have not yielded a voluntary support to any insurrection, rebellion or pretended government authority, power or constitution within the United States hostile thereto. And I do further swear that, to the best of my knowledge and ability, I have supported and defended, and will continue to support and defend the United States AGAINST ALL ENEMIES, FOREIGN AND DOMESTIC, AND THAT I HAVE SUPPORTED, DEFENDED, OBEYED, AND WILL CONTINUE TO SUPPORT, DEFEND AND OBEY, THE CONSTITUTION AND LAWS OF THE UNITED STATES; that I will bear true faith and allegiance to the same; and that I take this oath freely, without any mental reservation or purpose of evasion: So help me God.

R B Ratcliff

Five Cent Stamp,



Sworn to and subscribed before me a Clerk this 22 day of March 1864

G. P. Pool Clerk
Caldwell County Court

PROOF OF OWNERSHIP.

State of Kentucky, County of Caldwell, SS:

We Dr J. J. McMary and Dr James A. Lear each of lawful age, and resident citizens of the State and County aforesaid, do certify that R. B. Kataliff of the State and county aforesaid, was on the 11th day of March 1862, the lawful owner of the slave named J. R. Kataliff referred to and described in the foregoing claim for compensation.

J. J. McMary
James A. Lear

Sworn to and subscribed before me a Clark for the county of Caldwell State of Kentucky, this the 22^d day of March 1862

G. P. Pool Clerk



Five Cent Stamp.

PROOF OF LOYALTY.

State of Kentucky, County of Caldwell SS.

We J. W. McCoy and Edward Patton loyal men and of lawful age, and resident citizens of the County of Princeton in the State and county aforesaid, upon our oaths declare that we have known R. B. Kataliff a resident of the State and county aforesaid, since the 4th day of March, 1861, and know that he has firmly and faithfully maintained his or her adherence and allegiance to the Government of the United States, by defending its cause against the Government and forces of the so-called Confederate States of America, in all suitable and practicable ways, and according to his or her ability and opportunity.

J. W. McCoy
Edward Patton

Sworn to and subscribed before me a County Clerk for the county of Caldwell State of Kentucky this the 22^d day of March 1862

G. P. Pool Clerk



Five Cent Stamp.

Headquarters Kentucky Volunteers,

Adjutant-General's Office,

Frankfort, 16th Jan'y, 1867

I hereby certify, that it appears from the U. S. Muster-rolls on file in this Office, that Ino Rattiff was enrolled on the 16th day of March, 1865, at Louisville, by Capt Womack, and mustered into the U. S. service on the 16th day of March, 1865, at Louisville, by Capt G. W. Womack, to serve 3 years. Said Ino Rattiff is described as follows: Age, 18 years; eyes, Black; hair, Black; complexion, Black; height, 5 feet 6 1/2 inches. It further appears from said Rolls, that Ino Rattiff owed service to _____, was credited to Jefferson County, Ky., and was assigned to Co. H, 6th Regiment U. S. Cavalry.

In Testimony Whereof, I have hereunto set my hand, and affixed my Official Seal, this 16th day of Jan'y, 1867.

D. Lindsay
Adjutant General of Kentucky.

B. 91, R. 746.



1097
Lawson Perry

Co H, 6 U. S. Col'd Cav.

Private | Private

CARD NUMBERS.

1	5387582	26
2	5387618	27
3	5387676	28
4	5394102	29
5	5394187	30
6	5394288	31
7	5394362	32
8	5394441	33
9	5394530	34
10	5394604	35
11	5394723	36
12	5388112	37
13	9093641	38
14	40732757	39
15		40
16		41
17		42
18		43
19		44
20		45
21		46
22		47
23		48
24		49
25		50

Book Mark: E. B. VII. p. 60

See also

D 1876108 P.O. 21/22
S. 1927671 P.O. aff

ES Safford

Co. 6 Cav. U.S.C.T.

Gerry Dawson,
Co. 6 Reg't U.S. Col'd Cav.

Appears on

Company Descriptive Book

of the organization named above.

DESCRIPTION.

Age 18 years; height 5 feet 5 inches.

Complexion yellow

Eyes black; hair black

Where born Jefferson, Ky

Occupation Laborer

ENLISTMENT.

When Feb. 14, 1865.

Where Lebanon, Ky.

By whom Capt. Fidler, term 1 y'rs.

Remarks:

Substitute
Discharged Mar 20 '65
Expiration of Service.

(383g)

Gerry Dawson

Copist.

R *6 Cav* U.S.C.T.

Perry Rowser

Appears with rank of _____ on _____

Muster and Descriptive Roll of a Detachment of Substitutes forwarded

for the *6* Reg't U. S. Col'd *Cav.* Roll dated

Lebanon Ky, *Feb 28*, 186*5*.

Where born *Jefferson Kentucky*

Age *18* yrs; occupation *Laborer*

When enlisted *Feb 14*, 186*5*.

Where enlisted *Lebanon*

For what period enlisted *1* years.

Eyes *black*; hair *black*

Complexion *yell*; height *5* ft. *6* in.

When mustered in *Feb 14*, 186*5*.

Where mustered in *Lebanon*

Bounty paid \$ *100*; due \$ *100*

Where credited _____

Company to which assigned _____

Remarks: *Charles Davis, drafted
Man, Hardin Co. Ky.*

Book mark: _____

(340b)

D. J. Griffith

Copyist.

R 6 U.S.C.T.

Perry Rawson

Appears with rank of *Priv* on

Muster and Descriptive Roll of a Detachment of Substitutes forwarded

for the *6* Reg't U. S. Col'd Cavalry. Roll dated

Draft Rendezvous, Louisville, Ky, Mch 15, 1865.

Where born *Jefferson Kentucky*

Age *18* y'rs; occupation *Laborer*

When enlisted _____, 186 .

Where enlisted *Substitute*

For what period enlisted _____ *1* years.

Eyes *Black* ; hair *Black*

Complexion *Yellow* ; height *5* ft. *6* in.

When mustered in *Feb 14*, 1865.

Where mustered in *Lebanon*

Bounty paid \$ *100*; due \$ *100*

Where credited *4" Dist. Ky.*

Company to which assigned _____

Remarks: *Sub. for Charles Davis.*

Book mark : _____

Conard
Coryist.

R

6

U.S.C.T.

Perry Rawson

Appears with rank of *Pvt* on

Muster and Descriptive Roll of a Detachment of Substitutes forwarded

for the *6* Reg't U. S. Col'd *Cavalry*. Roll dated *Draft Rendezvous, Louisville Ky. Mich. 15, 1865.*

Where born *Jefferson, Kentucky*

Age *48* y'rs; occupation *Labourer*

When enlisted _____, 186 .

Where enlisted *Substitute.*

For what period enlisted *1* years.

Eyes *Black*; hair *Black*

Complexion *Yellow*; height *5* ft. *6* in.

When mustered in *Feb 14*, 1865.

Where mustered in *Lebanon.*

Bounty paid \$ *100*; due \$ *100*

Where credited *4th Dist. Ky.*

Company to which assigned _____

Remarks: *Sub. for Charles Davis.*

Book mark: _____

(339c)

Bonard

Copist.

R 6 Cav. U. S. C. T.

Perry Rawson
Reg't, Co. H. 6 Reg't U. S. Col'd Cavalry

Appears on

Company Muster-in and Descriptive Roll
of the organization named above. Roll dated

Covington, Ky, *Mich 26*, 1865.

Where born *Jefferson, Kentucky*

Age *18* y'rs; occupation *Laborer*

When enlisted _____, 186 .

Where enlisted *Substitute*

For what period enlisted _____ *1* years.

Eyes *Black*; hair *Black*

Complexion *Yellow*; height *5* ft. *6* in.

When mustered in *Feb. 14*, 1865.

Where mustered in *Lebanon, Ky.*

Bounty paid \$ *100*; due \$ *100*

Where credited *4th Dist. Ky.*

Company to which assigned *H.*

Remarks: *Sub. for Charles Davis.*

Book mark : _____

Conard

(356d)

Copist.

B **6 Cav. U.S.C.T.**

Perry Rawson
Priv, Co. H, 6 Reg't U. S. Col'd Cavalry.

Appears on

Company Muster Roll

for *from Mch 16 to Apr. 30*, 1865.

Present or absent *Absent*

Stoppage, \$ *100* for

Due Gov't, \$ *100* for

Valuation of horse, \$ *100*

Valuation of horse equipments, \$ *100*

Remarks: *On detach'd duty cruises
Creek, Ky. C. R. R.*

Book mark: _____

(358)

Conard
Copyist.

R 6 Cav. U.S.C.T.

Perry Rawson
Pvt., Co. H, 6 Reg't U. S. Col'd Cavalry.

Appears on

Company Muster Roll

for May & June, 1865.

Present or absent Present

Stoppage, \$ 100 for

Due Gov't, \$ 100 for

Valuation of horse, \$ 100

Valuation of horse equipments, \$ 100

Remarks:
.....
.....
.....
.....
.....
.....
.....
.....
.....

Book mark:

(358)

Leonard
Copyist.

6 Cav. U.S.C.T.

James ...
..., Co. H, 6 Reg't U. S. Col'd Cavalry.

Appears on

Company Muster Roll

for *...*, 1865.

Present or absent *Present*.

Stoppage, \$ *100* for

Due Gov't, \$ *100* for

Valuation of horse, \$ *100*

Valuation of horse equipments, \$ *100*

Remarks:

Book mark:

(358)

James ...

Copyist.

B 6 Cav. U.S.C.T.

Ernest Dawson
Private, Co. H, 6 Reg't U. S. Col'd Cavalry.

Appears on

Company Muster Roll

for *Sept Oct*, 1865.

Present or absent *Present*.

Stoppage, \$ 100 for

Due Gov't, \$ 100 for

Valuation of horse, \$ 100

Valuation of horse equipments, \$ 100

Remarks:

Book mark:

(358)

Dawson
Copyist.

6 Cav. U.S.C.T.

John Rawson
Co. H, 6 Reg't U. S. Col'd Cavalry.

Appears on

Company Muster Roll

for *Jan Dec*, 1865.

Present or absent *Present*

Stoppage, \$ 100 for

Due Gov't, \$ 100 for

Valuation of horse, \$ 100

Valuation of horse equipments, \$ 100

Remarks:

Book mark:

(358)

John Rawson
Copyist.

R | **6 Cav.** | **U.S.C.T.**

Perry Rawson
B, Co. H, 6 Reg't U. S. Col'd Cavalry.

Appears on

Company Muster Roll
for *Jan'y & Feb'y*, 186 *6*
Present or absent *Present*

Stoppage, \$ *100* for

Due Gov't, \$ *0* ^{*30*}/_{*100*} for *Advance*
& \$1.00 for C & G E.

Valuation of horse, \$ *100*

Valuation of horse equipments, \$ *100*

Remarks:
.....
.....
.....
.....
.....
.....
.....
.....

Book mark:

J. M. Harmon
(358). Copyist.

R 6 Cav. U.S.C.T.

Terry Rawson
Pvt, Co. *G*, 6 Reg't U. S. Col'd Cavalry.

Appears on **Co. Muster-out Roll**, dated
Bealls Bluff Ark, Apr 11, 1866.

Muster-out to date _____, 186 .

Last paid to _____, 186 .

Clothing account:

Last settled _____, 186 ; drawn since \$ 100

Due soldier \$ 100; due U. S. \$ 100

Am't for cloth'g in kind or money adv'd \$ 100

Due U. S. for arms, equipments, &c., \$ 100

Bounty paid \$ 100: due \$ 100

Remarks: *Mustered out, Discharged*
11 March 20 1866 in consequence
of expiration of term of service

Book mark: *Booked Mar 14/66 S.B.V. U.S. Col*

J. W. Harmon
Copyist.

(861)

1865
P | 6 Cav. | U.S.C.T.

Perry Rawson
Pot. Co. A. 6 Reg't U. S. Col'd Cav.

Appears on Returns as follows:

April 1865. Absent on
Det. service at Crueses
Creek Ky. C. R. R.

May 1865. Absent on Det
service at Russellville
Ky. since May 17. 65.

March 1866. Lost Mar 31,
66. Little Rock Ark
Dischg. in consequence
of expiration of service.

Book mark:

G. M. Row

(546)

Copyist.

P | *6* | *holder* | **U.S.C.T.**

Ransom Person

Co., Co. *6*, Reg't U. S. Col'd *Car*

Appears on a

Detachment Muster-out Roll

of the organization named above. Roll dated

Little Rock Ark, *mch 19*, 1866.

Muster-out to date *mch 19*, 1866.

Last paid to *Feb. 28*, 1866.

Clothing account:

Last settled *Feb 28*, 1866; drawn since \$ *4* ^{*04*}/_{*100*}

Due soldier \$ *100*; due U. S. \$ *100*

Am't for cloth'g in kind or money adv'd \$ *100*

Due U. S. for arms, equipments, &c., \$ *100*

Bounty paid \$ *100*; due \$ *100*

Remarks: *mustered out to date*

mch 19-1861 under circular

no. 41 from War Dept 1864

slaw april 19-1861

Book mark:

Hobbs

(349)

Copyist.

Rawson, Perry.

....., Co., Reg't *U.S.F.*

Enclosures.

Bed Cards	Final Statements
Burial Records	Furloughs or L. of A.
Certs. of Dis. for Discharge	Med. Certificates
C. M. Charges	Med. Des. Lists
Descriptive Lists	Orders
Discharge Certificates	Pris. of War Record
Enlistment Papers	Resignations

Other papers relating to—

Admission to Hosp'l	Furlough or L. of A.
Casualty Sheet	Med. Examination
Confinement	Misc. Information
Contracts	Pay or Clothing
Death or Effects	Personal Reports
Desertion	Rank
Discharge from Hosp'l	Transfer to Hosp'l
Discharge from Service	Transfer to V. R. C.
Duty	Transportation
.....

103

No. 7

Henry Rawson

Enlisted at *Seabrook*

AS SUBSTITUTE FOR

Samuel Davis

On the 4 day of February 1865

BY

Capt James M. Fuller

J. H. Harrison

John C. Hazard

Board of Enrollment.

Dist. of *7*

(No. 40.)

SUBSTITUTE VOLUNTEER ENLISTMENT.

STATE OF

TOWN OF

Kentucky



Hardin County

I, *Perry Rawson* born in the State of
Ky Jefferson County aged *18* years, and by occupation a
Laborer, Do HEREBY ACKNOWLEDGE to have agreed with
Samuel Davis, Esq., of *Hardin County*
Kentucky

to become his SUBSTITUTE in the Military Service, for a sufficient consideration paid and delivered to me, on the *17* day of *February* 186*5*; and having thus agreed with said *Samuel Davis*, I DO HEREBY ACKNOWLEDGE to have enlisted this *17* day of *February* 186*5*, to serve as a SOLDIER in the Army of the United States of America, for the period of ~~THREE YEARS~~ ^{one} unless sooner discharged by proper authority: I do also agree to accept such bounty, pay, rations, and clothing, as are, or may be, established by law for soldiers. And I do solemnly swear that I will bear true and faithful allegiance to the United States of America; and that I will serve them honestly and faithfully against all their enemies or opposers whomsoever; and that I will observe and obey the orders of the President of the United States, and the orders of the Officers appointed over me, according to the Rules and Articles of War.

Sworn and subscribed to at *Shannon Ky*
 this *17* day of *February* 186*5*,
 before *W. W. Hester* *Perry Rawson*
Depy. Marshal Dist. *mark*

We Certify on Honor, That we have carefully examined the above-named Volunteer Substitute agreeably to the Regulations, and that, in our opinion, he is free from all bodily defects and mental infirmity which would in any way disqualify him from performing the duties of a soldier; that he was entirely sober when enlisted; that he is of lawful age, (not under 18 years;) and that in accepting him as duly qualified to perform the duties of an able-bodied soldier, and as a Substitute in lieu of

Samuel Davis drafted in *Hardin County Ky*
September 26 186*4*, we have strictly observed the Regulations which govern in such cases. This soldier has *Black* eyes, *Black* hair, *Yellow* complexion; is *5* feet *6* inches high.

W. W. Hester
 Provost Marshal

F. B. Manning
 Commissioner of Board.

John C. Maxwell
 Surgeon of Board,

Board of Enrollment of *4* Dist. of *Ky*

DECLARATION OF SUBSTITUE.

I, Perry Rawson
desiring to ENLIST in the Army of the United States, for ^{one} ~~THREE~~ YEARS, Do declare, That I am
18 years and months of age; that I have
never been discharged from the United States service on account of disability or by sentence of a court
martial; and I know of no impediment to my serving honestly and faithfully as a soldier for three years.

GIVEN AT Sebanon Pa
the 14th day of February 1863

WITNESS:

J. H. Hoge

Perry Rawson
Mark

1098 Benj. F.
Ray Benjamin

Co B, 6 U. S. Col'd Cav.

Private Private

CARD NUMBERS.

1	5389274	26
2	5389346	27
3	5389433	28
4	5389504	29
5	5389571	30
6	5389659	31
7	5389755	32
8	5389847	33
9	5389938	34
10	5390031	35
11	9092926	36
12	40732804	37
13	40902893	38
14	32115749	39
15	32115881	40
16	32115536	41
17		42
18		43
19		44
20		45
21		46
22		47
23		48
24		49
25		50

Book Mark:

See also 115 U.S. C. J.

S. 1174501
N. 2010753
S- 2792749

Ed. Safford

R | **6 Cav. U.S.C.T.**

Benjamin F Ray

B, Co. *B*, 6 Reg't U. S. Col'd Cav.

Appears on

Company Descriptive Book

of the organization named above.

DESCRIPTION.

Age *37* years ; height *5* feet *5* inches.

Complexion *Brown*

Eyes *Black* ; hair *Black*

Where born *Logan Ky*

Occupation *Farmer*

ENLISTMENT.

When *Aug 21*, 18*64*.

Where *Bowling Green Ky*

By whom *Capt Hobson* ; term *3* y'rs.

Remarks:

Boyer

(383g)

Copyist.

R 6 Cav. U.S.C.T.

Benj. M. Ray
Privt., Co. 'B', 6 Reg't U. S. Col'd Cavalry.

Appears on

Company Muster-in and Descriptive Roll
of the organization named above. Roll dated

Camp Nelson Ky, Nov. 1st, 1864.

Where born *Logan Co. Ky,*

Age *37* y'rs; occupation *Farmer*

When enlisted *Aug 21st*, 1864.

Where enlisted *Bowling Green Ky,*

For what period enlisted *3* years.

Eyes *Blk*; hair *Blk*

Complexion *Brown*; height *5* ft. *5* in.

When mustered in *Aug 21st*, 1864.

Where mustered in *Bowling Green Ky,*

Bounty paid \$ *100*; due \$ *100*

Where credited *3rd Dist Ky,*

Company to which assigned

Remarks: *Transferred from Co. B,*

115th U.S. Inf. reg't, No. 39, dated

Washington D.C. June 19th 65,

Signed L. Thomas, A.G.

Book mark:

C. M. Row

(356d)

Copyist.

JAN. 10

5389274

1891

Owner,
Mr. H. T. Ray.

R 6 Cav. U.S.C.T.

Benjamin F. Ray
Private, Co. B, 6 Reg't U. S. Col'd Cavalry.

Appears on

Company Muster Roll

for *Nov. & Dec.*, 1864.

Present or absent *Absent*

Stoppage, \$ *100* for

Due Gov't, \$ *100* for

Valuation of horse, \$ *100*

Valuation of horse equipments, \$ *100*

Remarks: *Sick in Hospital*
Camp Nelson Ky.
Oct 1864.

Book mark: _____

(358)

A. M. Moore

Copyist.

R | 6 Cav. U.S.C.T.

Benj. P. Ray
Private, Co. B, 6 Reg't U. S. Col'd Cavalry.

Appears on

Company Muster Roll

for *Jan & Feb.*, 1865.

Present or absent *absent.*

Stoppage, \$ *100* for

Due Gov't, \$ *100* for

Valuation of horse, \$ *100*

Valuation of horse equipments, \$ *100*

Remarks: *Disinrollment & bounty
of \$100. Sick in Hospital
Camp Nelson, Ky Oct. 31/64.*

Book mark:

C. M. Moore

(358)

Copyist.

R. C. Cantelero

Dr. J. P. [unclear]

[unclear], Co. B, 6 Reg't *U.S. Cav.*

Appears on

Hospital Muster Roll

of Nelson U. S. A. General Hospital,

at Camp Nelson, Ky.,

for *June & July*, 186*5*.

Attached to hospital:

When _____, 186 .

How employed _____

Last paid by Maj. _____

to *Pay due from [unclear]*, 186 .

Bounty paid \$ 100; due \$ 100

Present or absent *Present*

Remarks: _____

Book mark: _____

M. Cantelero

R 6 Cav. U.S.C.T.

Benj. G. Ray,
Private, Co. B, 6 Reg't U. S. Col'd Cavalry.

Appears on

Company Muster Roll

for *March & April*, 1865.

Present or absent *absent*

Stoppage, \$ *100* for

Due Gov't, \$ *100* for

Valuation of horse, \$ *100*

Valuation of horse equipments, \$ *100*

Remarks: *Installation bounty
due \$100. See Camp Return
& descriptive list furnished.*

Book mark:

(358)

S. M. Low

Copyist.

2 | **6 Cav.** | **U.S.C.T.**

Henry J. Day
_____, Co. B, 6 Reg't U. S. Col'd Cavalry.

Appears on

Company Muster Roll
for *May Term*, 1865.

Present or absent *Present*

Stoppage, \$ *100* for _____

Due Gov't, \$ *100* for _____

Valuation of horse, \$ *100*

Valuation of horse equipments, \$ *100*

Remarks: *Richd. H. Co. Capt.*
Camp Nelson Aug
10th, 1864
described as
present.

Book mark: _____

H. J. Day
(258) Copyist.

R. C. Co. 4207

Benjamin Ruff
Reg't 4207

Appears on

Hospital Muster Roll

of Nelson U. S. A. General Hospital,

at Camp Nelson, Ky.,

for *Sept 1*, 186*5*.

Attached to hospital:

When, 186 .

How employed

Last paid by Maj. *Decker*

to *July 28*, 186*5*.

Bounty paid \$ *100*; due \$ *100*

Present or absent *Present*

Remarks:

Book mark:

J. M. Coe
Copist.

1777 10 4 3
P 6 Dec 1861

Sergeant J. Ray
Regt. 6 Co. B

Appears on

Hospital Muster Roll

of Nelson U. S. A. General Hospital,

at Camp Nelson, Ky.,

for May & June, 1865.

Attached to hospital:

When _____, 1865.

How employed _____

Last paid by Maj. _____

to _____, 1865.

Bounty paid \$ 100; due \$ 100.00

Present or absent Present

Remarks: _____

Book mark: _____

M. O. _____

6 Cav. U.S.C.T.

Company Name
Name, Co. B, 6 Reg't U. S. Col'd Cavalry.

Appears on

Company Muster Roll

for *July 1 Aug*, 186*5*.

Present or absent *present*

Stoppage, \$ *100* for

Due Gov't, \$ *100* for

Valuation of horse, \$ *100*

Valuation of horse equipments, \$ *100*

Remarks: *install*

amount due

Book mark:

D. A. Harper
Copyist.

75

6 Cav. U.S.C.T.

Benjamin S. May
Sgt., Co. B, 6 Reg't U. S. Co'd Cavalry.

Appears on

Company Muster Roll

for *Sept 21st*, 186*5*.

Present or absent *present*

Stoppage, \$ *100* for

Due Gov't, \$ *100* for

Valuation of horse, \$ *100*

Valuation of horse equipments, \$ *100*

Remarks:

Book mark:

B. S. May
Coryist.

R | **6 Cav.** | **U.S.C.T.**

Brig. F. Ray
Br., Co. B, 6 Reg't U. S. Col'd Cavalry.

Appears on

Company Muster Roll

for *Apr. & Dec.*, 186*5*.

Present or absent *Present*

Stoppage, \$ *100* for

Due Gov't, \$ *100* for

Valuation of horse, \$ *100*

Valuation of horse equipments, \$ *100*

Remarks:

Book mark:

(358)

J. W. Ames

Copyist.

R

6 Cav. U.S.C.T.

Benjamin F. Ray

. Co. B, 6 Reg't U. S. Col'd Cavalry.

Appears on

Company Muster Roll

for *Jan'y & Feby*, 1866.

Present or absent *Present*

Stoppage, \$ *100* for

Due Gov't, \$ *100* for

Valuation of horse, \$ *100*

Valuation of horse equipments, \$ *100*

Remarks:

Book mark:

(358)

J. W. Ames

Compt.

R

115

U.S.C.T.

Benjamin F. Ray,
Priv., Co. D, 115 Reg't U. S. Colored Inf.

Appears on Returns as follows:

Aug. 1864 - Lost; Aug. 26/64,
Bowling Green, Transferred.

Book mark:

(548)

J. T. Hensley

Copyist.

P | **6 Cav.** | **U.S.C.T.**

B. F. Ray
Pat. Co. B., 6 Reg't U. S. Col'd Cav.

Appears on Returns as follows:

*Nov & Dec 1864, Absent
sick in Hoshl Camp,
Nelson Ky since
Oct 31/64.*

*Jan'y to June 1865, Absent
sick in Hoshl. Camp
Nelson Ky, Jan'y 10/65;*

Book mark : _____

(546)

G. M. Row

Copyist.

R **6 Cav. U.S.C.T.**

Benjamin Ray
Plt, Co. *B.*, 6 Reg't U. S. Col'd Cavalry.

Appears on **Co. Muster-out Roll**, dated
St. Paul, Minn., Apr. 15, 1866.

Muster-out to date *Apr. 15, 1866.*

Last paid to *July 28, 1866.*

Clothing account:

Last settled....., 186 ; drawn since \$..... 100

Due soldier \$..... 100; due U. S. \$..... 100

Am't for cloth'g in kind or money adv'd \$ *3 1/4* 100

Due U. S. for arms, equipments, &c., \$..... 100

Bounty paid \$ *100* 100; due \$ *100* 100

Remarks:

Book mark:

J. W. Thomas
(861) Copyist.

1099

Bay Robert

Co No, 6 U. S. Col'd Cav.

Private

Private

CARD NUMBERS.

1	5396565	26
2	5396658	27
3	5396751	28
4	5398844	29
5	5396940	30
6	5397032	31
7	5397118	32
8	9093992	33
9	40732758	34
10		35
11		36
12		37
13		38
14		39
15		40
16		41
17		42
18		43
19		44
20		45
21		46
22		47
23		48
24		49
25		50

Book Mark:

See also 120 U.S. G.I.

APR 1950

2654343-2nd
S1457007-P.O. 119th
S1955373 2d 2d

Ed Safford

Reg't 6 cav U.S.C.T.

Robert Ray

Cp. M. 6 Reg't U. S. Col'd Cav

Appears on

Company Descriptive Book

of the organization named above.

DESCRIPTION.

Age 25 years; height 5 feet 6 inches.

Complexion *Blk*

Eyes *Blk*; hair *Blk*

Where born *Christian Ky*

Occupation *Farmer*

ENLISTMENT.

When *Nov 24*, 186*5*

Where *Owensboro*

By whom *Capt Partridge*; term *5* yrs.

Remarks: *Mustered into
U.S. service Nov 24 1865
Owensboro Ky by
Capt Gridsum*

Forrest

6 Cav. U.S.C.T.

Robert Kay

Co. M, 6 Reg't U. S. Col'd Cavalry.

Appears on

Company Muster-in and Descriptive Roll

of the organization named above. Roll dated

Camp Nelson Ky, NY, June 10, 1865.

Where born Christian Kentucky

Age 25 y'rs; occupation Farmer

When enlisted Dec 24, 1864.

Where enlisted Cumberland Ky

For what period enlisted 3 years.

Eyes black; hair black

Complexion black; height 5 ft. 6 in.

When mustered in Cumberland Ky, 1865.

Where mustered in Cumberland Ky

Bounty paid \$none paid; due \$ 100

Where credited 1st Dist of Ky

Company to which assigned M

Remarks: Transf'd from Co. A,

120 U.S.C.T.

Book mark:

Joseph Stewart

(356d)

Copyist.

X'

6 Cav. U.S.C.T.

Robert Kay

Private, Co. M, 6 Reg't U. S. Col'd Cavalry.

Appears on

Company Muster Roll

for June 21 to June 30, 1865

Present or absent Present

Stoppage, \$ 100 for

Due Gov't, \$ 100 for

Valuation of horse, \$ 100

Valuation of horse equipments, \$ 100

Remarks: Horses per roll from 120 U.S.C. per Co. 1000 total Hd Quarters. Key price 10 1865.

Book mark:

(358) Joseph Stewart Copyist.

R 6 Cav U.S.C.T

Robert Ray

Sgt, Co. M, 6 Reg't U. S. Col'd Cav

Appears on

Company Muster Roll

for Dated Aug 31, 1865.

Present or absent Present.

Stoppage, \$ 100 for

Due Gov't, \$ 100 for

Valuation of horse, \$ 100

Valuation of horse equipments, \$ 100

Remarks:

Book mark:

No chance

P 6 Cav. U.S.C.T.

John W. ...

..., Co. M, 6 Reg't U. S. Col'd Cavalry.

Appears on

Company Muster Roll

for *Sept Oct*, 1865.

Present or absent *Present*

Stoppage, \$ *100* for

Due Gov't, \$ *100* for

Valuation of horse, \$ *100*

Valuation of horse equipments, \$ *100*

Remarks:

Book mark:

(358)

Chas. ...
Copyist.

P 6 Cav. U.S.C.T.

Robert Ray
Capt, Co. M, 6 Reg't U. S. Col'd Cavalry.

Appears on

Company Muster Roll

for *Nov Dec*, 1865.

Present or absent *Present*.

Stoppage, \$ *100* for

Due Gov't, \$ *100* for

Valuation of horse, \$ *100*

Valuation of horse equipments, \$ *100*

Remarks:

Book mark:

(358)

Labine
Copyist.

17

6 Cav. U.S.C.T.

Robert Ray

Co., Co. M, 6 Reg't U. S. Col'd Cavalry.

Appears on

Company Muster Roll

for *Jan 1 Feb*, 186*6*.

Present or absent *Present*

Stoppage, \$ *100* for

Due Gov't, \$ *100* for

Valuation of horse, \$ *100*

Valuation of horse equipments, \$ *100*

Remarks:

Book mark:

(358)

C. S. M. Langhlin
Copyist.

R | 6 Cav. | U.S.C.T.

+ Robert Rice

Plt., Co. M, 6 Reg't U. S. Col'd Cav.

Appears on Returns as follows:

June 1866, On duty
in Stables Cav Depot.

+ Supplied from Morocco by

Book mark:

W M Row

(546)

Copyist.

4

6 Cav. U.S.C.T.

Robert Ray

Lt., Co. *M.*, 6 Reg't U. S. Col'd Cavalry.

Appears on **Co. Muster-out Roll**, dated *Hebeles Bluff Ark. Apr 15, 1866*.

Muster-out to date *Apr 15, 1866*.

Last paid to *Feb 28, 1866*.

Clothing account:

Last settled _____, 186 ; drawn since \$ 100

Due soldier \$ 100; due U. S. \$ *26* ^{*12*} 100

Am't for cloth'g in kind or money adv'd \$ 100

Due U. S. for arms, equipments, &c., \$ *2* ^{*20*} 100

Bounty paid \$ *100* ^{*00*} 100; due \$ 100

Remarks: *Due U.S. for (100) \$2,20*

Book mark: *V 13, P. 177/68, 2395/79*

(861)

C. J. M. Laughlin,
Copyist.

1100
Reader, Alexander

Co G, 6 U. S. Col'd Cav.

Private | Private

CARD NUMBERS.

1		26
2		27
3	See Reader, Alexander	28
4		29
5		30
6		31
7		32
8		33
9		34
10		35
11		36
12		37
13		38
14		39
15		40
16		41
17		42
18		43
19		44
20		45
21		46
22		47
23		48
24		49
25		50

Book Mark:

See also

1101
Reader, Levi

Co D, 6 U. S. Col'd Cav.

Private | Sergeant

CARD NUMBERS.

1		26
2		27
3	See Reader, Levi	28
4		29
5		30
6		31
7		32
8		33
9		34
10		35
11		36
12		37
13		38
14		39
15		40
16		41
17		42
18		43
19		44
20		45
21		46
22		47
23		48
24		49
25		50

Book Mark: _____

See also _____

1102

Beed Finney

Co H, 6 U. S. Col'd Cav.

Private | Private

CARD NUMBERS.

1	5387325	26
2	5394154	27
3	5394188	28
4	5394289	29
5	5394363	30
6	5394442	31
7	5394531	32
8	5394605	33
9	5394672	34
10	9093642	35
11	40732761	36
12		37
13		38
14		39
15		40
16		41
17		42
18		43
19		44
20		45
21		46
22		47
23		48
24		49
25		50

Book Mark:

See also

D. 1724251 P.D. 1000

S. 2201152 2004 10. 2

Ally 2944495

St. M. 1000

1/24/25 1000

St. Lafford 9

R. | *6 Cav.* | **U.S.C.T.**

Imey Redd

Co. H., 6 Reg't U.S. Col'd Cav.

Appears on

Company Descriptive Book

of the organization named above.

DESCRIPTION.

Age *17* years; height *5* feet *8* inches.

Complexion *black*

Eyes *black*; hair *black*

Where born *Lawrence, Ky.*

Occupation *Farmer*

ENLISTMENT.

When *Mar. 16*, 186*5*.

Where *Camp Nelson*

By whom *Capt. Randolph*, term *3* y'rs.

Remarks:

Substitute

Remark cancelled by lines drawn through

James West

P

6 Cav. U.S.C.T.

Timothy Redd

Appears with rank of private on

Muster and Descriptive Roll of a Detachment of U. S. Vols. forwarded

for the 6 Reg't U. S. Col'd Cavalry. Roll dated

Lexington Ky, March 16, 1865.

Where born Laurel Ky

Age 18 y'rs; occupation farmer

When enlisted March 11, 1865.

Where enlisted Camp Nelson Ky

For what period enlisted 3 years.

Eyes black; hair black

Complexion black; height 5 ft. 8 in.

When mustered in March 11, 1865.

Where mustered in Lexington Ky.

Bounty paid \$ 100; due \$ 100

Where credited Rockcastle Co. 8 D. Ky.

Company to which assigned

Remarks:

owner Charles Redd,

Book mark:

A. C. Paul

B

6 Cav. | U. S. C. T.

Tiney Redd
Pvt, Co. H. 6 Reg't U. S. Col'd Cavalry.

Appears on

Company Muster-in and Descriptive Roll
of the organization named above. Roll dated

Lexington, Ky., Mch. 26, 1865.

Where born Laurel, Kentucky

Age 18 y'rs; occupation Farmer

When enlisted Mch. 11, 1865.

Where enlisted Camp Nelson, Ky.

For what period enlisted 3 years.

Eyes Black; hair Black

Complexion Black; height 5 ft. 8 in.

When mustered in Mch 16, 1865.

Where mustered in Lexington, Ky.

Bounty paid \$ 100; due \$ 100

Where credited Rockers Co, Ky, 8th Dist.

Company to which assigned H.

Remarks: Chas. Redd, owner.

Book mark :

(356d)

Conard

Copyist.

R 6 Cav. U.S.C.T.

Tiney Beadd
Pvt., Co. H, 6 Reg't U. S. Col'd Cavalry.

Appears on

Company Muster Roll

for from Mch 16 to Apl. 30, 1865.

Present or absent Present.

Stoppage, \$ 100 for

Due Gov't, \$ 100 for

Valuation of horse, \$ 100

Valuation of horse equipments, \$ 100

Remarks:

Book mark:

(358)

Conard
Copyist.

R 6 Cav. U.S.C.T.

Tiney Beed
Pvt., Co. H, 6 Reg't U. S. Col'd Cavalry.

Appears on

Company Muster Roll

for May & June, 1865.

Present or absent Present.

Stoppage, \$ 100 for

Due Gov't, \$ 100 for

Valuation of horse, \$ 100

Valuation of horse equipments, \$ 100

Remarks: 1st Installment Bounty due

Book mark:

(358)

Leonard
Copyist.

F | **6 Cav. U.S.C.T.**

Thomas P. ...

P..., Co. H, 6 Reg't U. S. Col'd Cavalry.

Appears on

Company Muster Roll

for *June 1865*, 1865.

Present or absent *Present*.

Stoppage, \$ *100* for

Due Gov't, \$ *100* for

Valuation of horse, \$ *100*

Valuation of horse equipments, \$ *100*

Remarks:

Book mark:

(358)

James

Copyist.

A **6 Cav. U.S.C.T.**

James P. Redd

Co. H, Co. H, 6 Reg't U. S. Col'd Cavalry.

Appears on

Company Muster Roll

for *Jan 1st*, 1865.

Present or absent *Present*.

Stoppage, \$ *100* for

Due Gov't, \$ *100* for

Valuation of horse, \$ *100*

Valuation of horse equipments, \$ *100*

Remarks:

Book mark:

(358)

Carine

Copyist.

6 Cav. U.S.C.T.

William B. ...

..., Co. H, 6 Reg't U. S. Col'd Cavalry.

Appears on

Company Muster Roll

for *Sept Dec*, 1865.

Present or absent *Present*

Stoppage, \$ 100 for

Due Gov't, \$ 100 for

Valuation of horse, \$ 100

Valuation of horse equipments, \$ 100

Remarks:

Book mark:

(358)

...
Copyist.

R. | **6 Cav.** | **U.S.C.T.**

Taney Kell

Plt., Co. H, 6 Reg't U. S. Col'd Cavalry.

Appears on

Company Muster Roll

for *Jan'y & Feb'y*, 186*6*.

Present or absent *Present*

Stoppage, \$ 100 for

Due Gov't, \$ *0*, ^{*60*}/_{*100*} for *ordnance*

& \$1.60 for O & G

Valuation of horse, \$ 100

Valuation of horse equipments, \$ 100

Remarks:

Book mark: -----

J. W. Harmon

1861

R | **6 Cav.** | **U.S.C.T.**

+ *Timothy Redd*
Priv, Co. *A*, 6 Reg't U. S. Col'd Cav.

Appears on **Returns** as follows:

*June 1866, On daily duty
in Q.M. Stables,*

+ *Supplied from M.R. Roll by
O.W.*

Book mark :

C. M. Row

(546)

Copyist.

R

6 Cav. U.S.C.T.

Timothy Reed
Co. H, 6 Reg't U. S. Col'd Cavalry.

Appears on **Co. Muster-out Roll**, dated
Wyallo Bluff Ark April 15, 1866.

Muster-out to date *April 15*, 1866.

Last paid to *July 28*, 1866.

Clothing account:

Last settled....., 186 ; drawn since \$..... 100

Due soldier \$..... 100; due U. S. \$ *9*^{*03*}..... 100

Am't for cloth'g in kind or money adv'd \$..... 100

Due U. S. for arms, equipments, &c., \$..... 100

Bounty paid \$ *100* 100; due \$..... 100

Remarks:

Book mark:

J. M. Harmon

(861)

Copyist.

Redd, Tines

Co.

Reg't

6th Reg't

2 Enclosures.

Bed Cards	Final Statements
Burial Records	Furloughs or L. of A
Certs. of Dis. for Discharge	Med. Certificates
C. M. Charges	Med. Des. Lists
Descriptive Lists	Orders
Discharge Certificates	Pris. of War Record
Enlistment Papers	Resignations

Other papers relating to—

Admission to Hosp'l	Furlough or L. of A
Casualty Sheet	Med. Examination
Confinement	Misc. Information
Contracts	Pay or Clothing
Death or Effects	Personal Reports
Desertion	Rank
Discharge from Hosp'l	Transfer to Hosp'l
Discharge from Service	Transfer to V. R. C.
Duty	Transportation

NOTE 1.—This blank will be used for both enlistments and re-enlistments—enlistment of veterans, &c., &c., in the volunteer service. They will be made out in duplicate in all cases—one to accompany the recruiting return of the superintendent (not the recruiting officer) to the Adjutant General, and one to accompany the accounts of the officer who pays bounty, &c. The Regiment and Company in which the soldier last served should be given on the back.

NOTE 2.—An enlistment holds to service. A muster-in must, in all cases, precede payment of pay, bounty, pension, &c. A muster-in roll must, in all cases, be filed in the Adjutant General's Office as evidence of muster-in. The mustering officer, commissary, or assistant commissary of musters, as the case may be, will countersign both enlistments as having mustered the soldier into the service of the United States before either of them is given to the disbursing officer.

DECLARATION OF RECRUIT.

I, Wm. Ladd, desiring
VOLUNTEER as a Soldier in the Army of the United States, for the term of **THREE YEARS**,
 Do Declare, That I am _____ years and _____ months
 of age; that I have never been discharged from the United States service on account of disability or by
 sentence of a court martial, or by order before the expiration of a term of enlistment; and I know of no
 impediment to my serving honestly and faithfully as a soldier for three years.

GIVEN at San Francisco
 the _____ day of _____

Witness: [Signature] [Signature]

No. _____

Volunteered at _____

By _____, 1875

Regiment of _____

_____ enlistment; last served in Company ()

Reg't of _____

Discharged _____, 18 _____

[Circular Stamp]

CONSENT IN CASE OF MINOR.

I, [Signature], Do CERTIFY, That I am
 the _____ of _____; that the
 said _____ is _____ years of age; and I
 do hereby freely give my CONSENT to his volunteering as a SOLDIER in the ARMY OF THE UNITED STATES
 for the period of **THREE YEARS**.

GIVEN at _____
 the _____ day of _____

Witness: _____

~~United States Army~~
Credit - Kentucky Co.
 United States Colored Troops (Enlistment)
Credit - Rockcastle Co. Ky.
~~ENLISTMENT~~

STATE OF

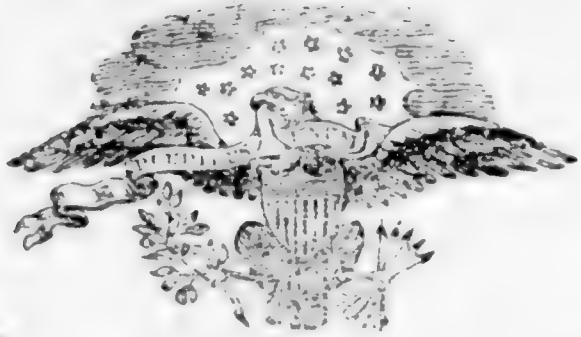

TOWN OF

Kentucky

Centerton

I, *Timothy Ridd*, born in *Lawrence Co* in the State of *Kentucky*, aged *21* years, and by occupation a *Farmer*, Do HEREBY ACKNOWLEDGE to have volunteered this *16th* day of *March*, 1865, to serve as a **Soldier** in the **Army of the United States of America**, for the period of **THREE YEARS**, unless sooner discharged by proper authority: Do also agree to accept such bounty, pay, rations, and clothing, as are, or may be, established by law for volunteers. And *Timothy Ridd*, do solemnly swear, that I will bear true faith and allegiance to the **United States of America**, and that I will serve them honestly and faithfully against all their enemies or opposers whomsoever; and that I will observe and obey the orders of the President of the United States, and the orders of the officers appointed over me, according to the Rules and Articles of War.

Sworn and subscribed to, at *Centerton* this *16th* day of *March*, 1865, BEFORE *Wesley Randolph*

I CERTIFY, ON HONOR, That I have carefully examined the above-named Volunteer, agreeably to the General Regulations of the Army, and that, in my opinion, he is free from all bodily defects and mental infirmity, which would in any way disqualify him from performing the duties of a soldier.

W. H. Riley
Apt. Surg. U.S. Ar.
 EXAMINING SURGEON.

I CERTIFY, ON HONOR, That I have minutely inspected the Volunteer *Timothy Ridd* previously to his enlistment, and that he was entirely sober when enlisted; that, to the best of my judgment and belief, he is of lawful age; and that, in accepting him as duly qualified to perform the duties of an able-bodied soldier, I have strictly observed the Regulations which govern the recruiting service. This soldier has *blue* eyes, *dark* hair, *fair* complexion, is *5* feet *6* inches high.

Wesley Randolph
 RECRUITING OFFICER.

Certificate for the signature of the Mustering Officer, Commissary, or Assistant Commissary of Musters, as the case may be.

Mustered into the service of the United States, for three years or during the war, from date of enlistment, in Co. *De Kaulbach*, Regiment of *U.S.C.T.* Volunteers, on the *16* day of *March*, 1865, at *Rockcastle* and credited to *Ward* (or Sub-district) in the Town of *Centerton*, in the State of *Kentucky*, in the County of *Rockcastle*, *8*th Congressional District, in the State of *Kentucky*.

Bounty paid at time of Muster-in: *U.S. Bounty*, *Local Bounty*.

Wesley Randolph
Mustering Officer

NOTE 1.—This blank will be used for both enlistments and re-enlistments—enlistment of veterans, &c., &c., in the volunteer service. They will be made out in duplicate in all cases—one to accompany the recruiting return of the superintendent (not the recruiting officer) to the Adjutant General, and one to accompany the accounts of the officer who pays bounty, &c. The Regiment and Company in which the soldier last served should be given on the back.

NOTE 2.—An enlistment holds to service. A muster-in must, in all cases, precede payment of pay, bounty, pension, &c. A muster-in roll must, in all cases, be filed in the Adjutant General's Office as evidence of muster-in. The mustering officer, commissary, or assistant commissary of musters, as the case may be, will countersign both enlistments as having mustered the soldier into the service of the United States before either of them is given to the disbursing officer.

DECLARATION OF RECRUIT.

I, Charles Read, desiring
VOLUNTEER as a Soldier in the Army of the United States, for the term of THREE YEARS,
Do Declare, That I am _____ years and _____ months
of age; that I have never been discharged from the United States service on account of disability or by
sentence of a court martial, or by order before the expiration of a term of enlistment; and I know of no
impediment to my serving honestly and faithfully as a soldier for three years.

GIVEN at Camp Sherman
the _____ day of March 1865

Witness:

[Signature] [Signature]

enlistment; last served in Company ()
Reg't of 11th
Discharged _____, 1865

By J. C. Partridge
Adjutant of Marshall

Volunteered at Camp Sherman

George M. ...
No. _____
Mr. ...

CONSENT IN CASE OF MINOR.

I, Charles Read, Do CERTIFY, That I am
the _____ of _____; that the
said _____ is _____ years of age; and I
do hereby freely give my CONSENT to his volunteering as a SOLDIER in the ARMY OF THE UNITED STATES
for the period of THREE YEARS.

GIVEN at _____
the _____ day of _____

Witness:

*Credited to Receivable Co & Co.
Credit Newton Co. Ky.*

**United States Colored Troops Enlistment
VOLUNTEER ENLISTMENT.**

STATE OF

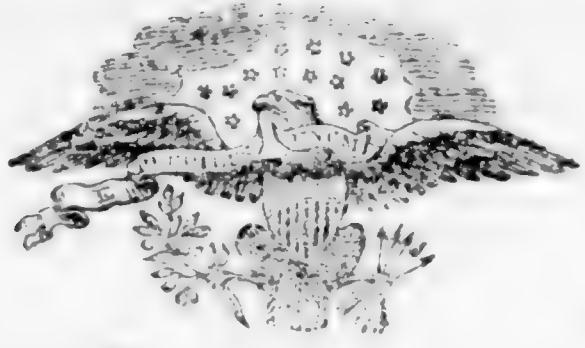

TOWN OF

Kentucky

Newton

I, *Jinny Redd*, born in *Laurel co* in the State of *Kentucky*, aged *Eighteen* years, and by occupation a *Farmer*, Do HEREBY ACKNOWLEDGE to have volunteered this *Eleventh* day of *March*, 1865, to serve as a **Soldier** in the **Army of the United States of America**, for the period of **THREE YEARS**, unless sooner discharged by proper authority: Do also agree to accept such bounty, pay, rations, and clothing, as are, or may be, established by law for volunteers. And I, *Jinny Redd*, do solemnly swear, that I will bear true faith and allegiance to the **United States of America**, and that I will serve them honestly and faithfully against all their enemies or opposers whomsoever; and that I will observe and obey the orders of the President of the United States, and the orders of the officers appointed over me, according to the Rules and Articles of War.

Sworn and subscribed to, at *Lebanon Nelson J. Jr's* this *11th* day of *March*, 1865, BEFORE *Jinny Redd* mark

I CERTIFY, ON HONOR, That I have carefully examined the above-named Volunteer, agreeably to the General Regulations of the Army, and that, in my opinion, he is free from all bodily defects and mental infirmity, which would in any way disqualify him from performing the duties of a soldier.

C. H. Riley
Apt. Surg. U.S.A.
EXAMINING SURGEON.

I CERTIFY, ON HONOR, That I have minutely inspected the Volunteer *Jinny Redd* previously to his enlistment, and that he was entirely sober when enlisted; that, to the best of my judgment and belief, he is of lawful age; and that, in accepting him as duly qualified to perform the duties of an able-bodied soldier, I have strictly observed the Regulations which govern the recruiting service. This soldier has *Blue* eyes, *Black* hair, *Black* complexion, is *five* feet *eight* inches high.

Lebanon Nelson J. Jr
REGIMENTAL OFFICER.

(A. G. O. No. 74 & 75.)

Certificate for the Signature of the Mustering Officer, Commissary, or Assistant Commissary of Musters, as the case may be.
Mustered into the service of the United States, for three years or during the war, from date of enlistment, in Co. *6th* Regiment of *U. S. Colored* Volunteers, on the *16* day of *March*, 1865, at *Lexington Ky* and credited to *8th* Ward, (or Sub-district,) in the Town of *Newton*, in the County of *Kentucky*, in the State of *Kentucky*, in the Congressional District, in the State of *Kentucky*.
Bounty paid at time of Muster-in: *U. S. Bounty,* *Local Bounty,*

Geo W Moore
Capt. U.S.A.
Mustering Officer

MICROCOPY

1817

ROLL

103

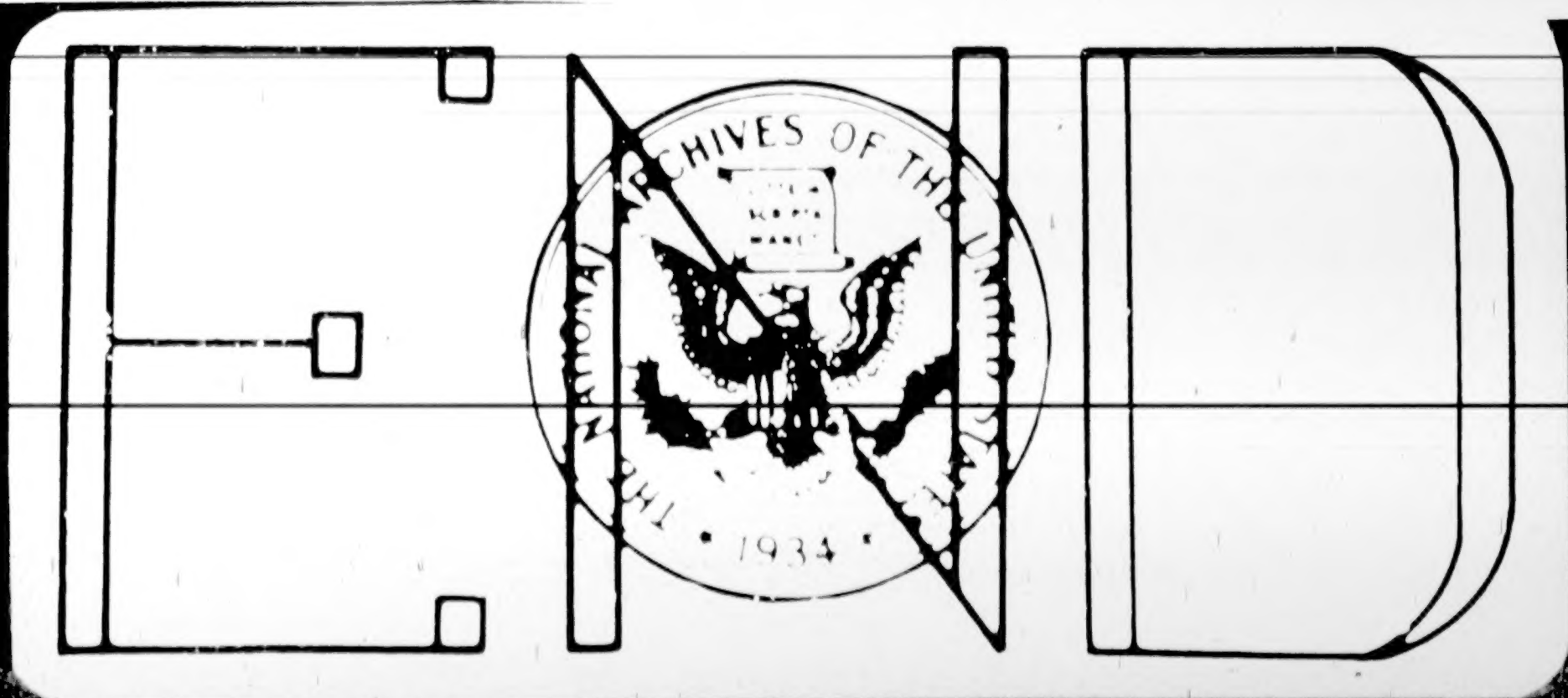
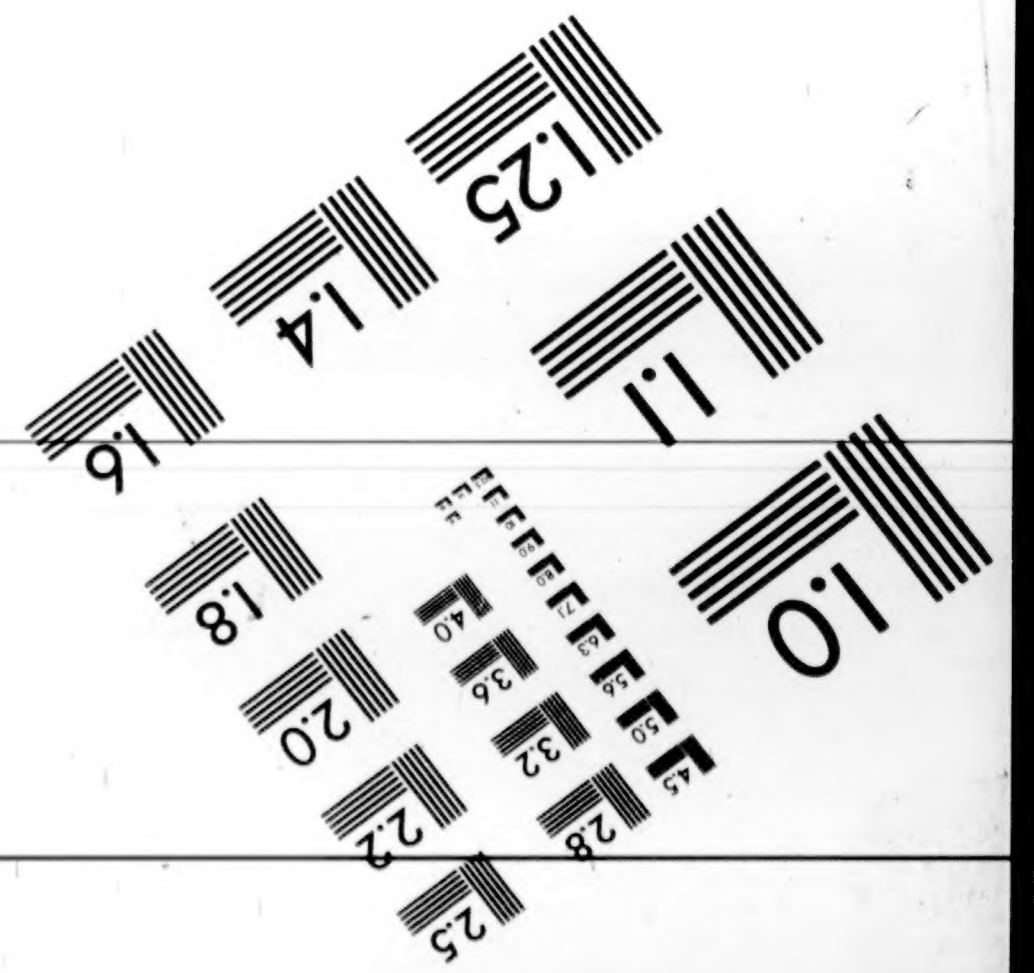
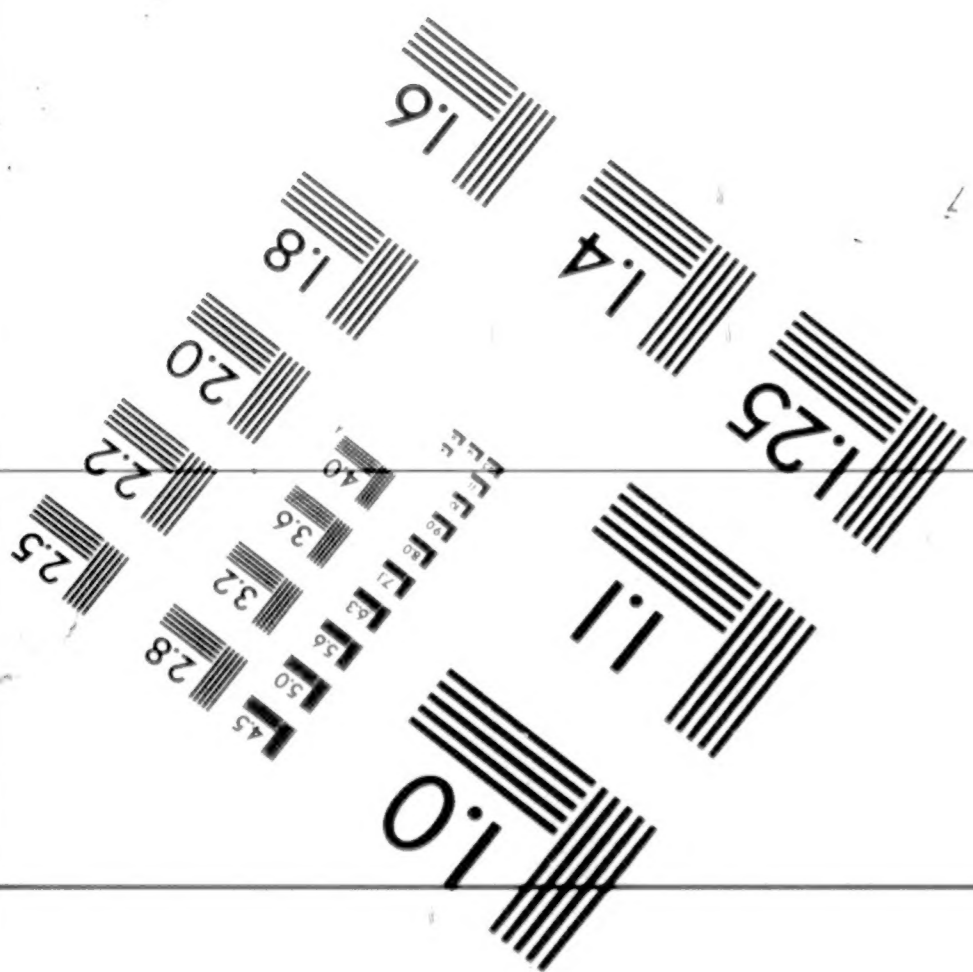
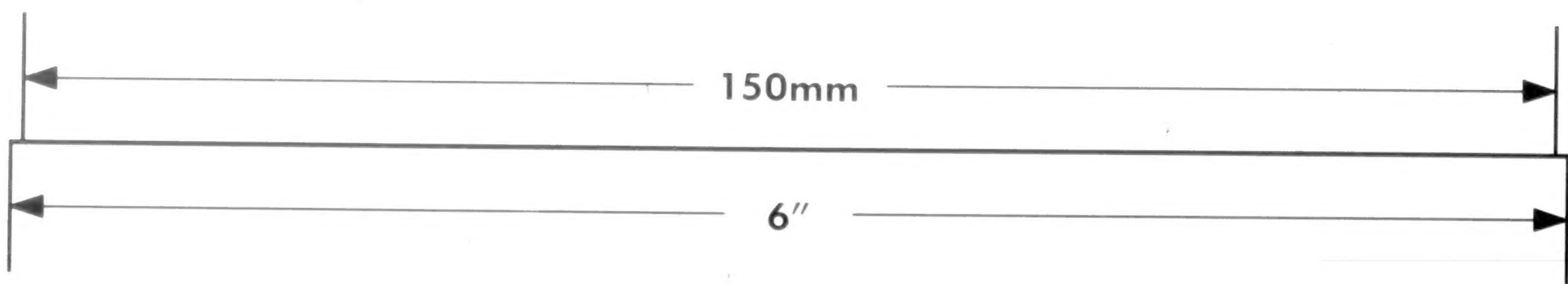
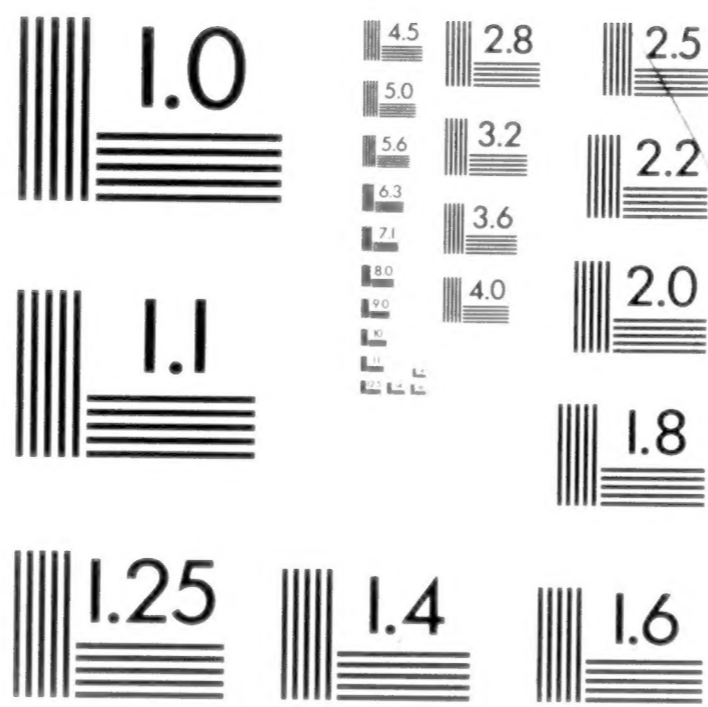
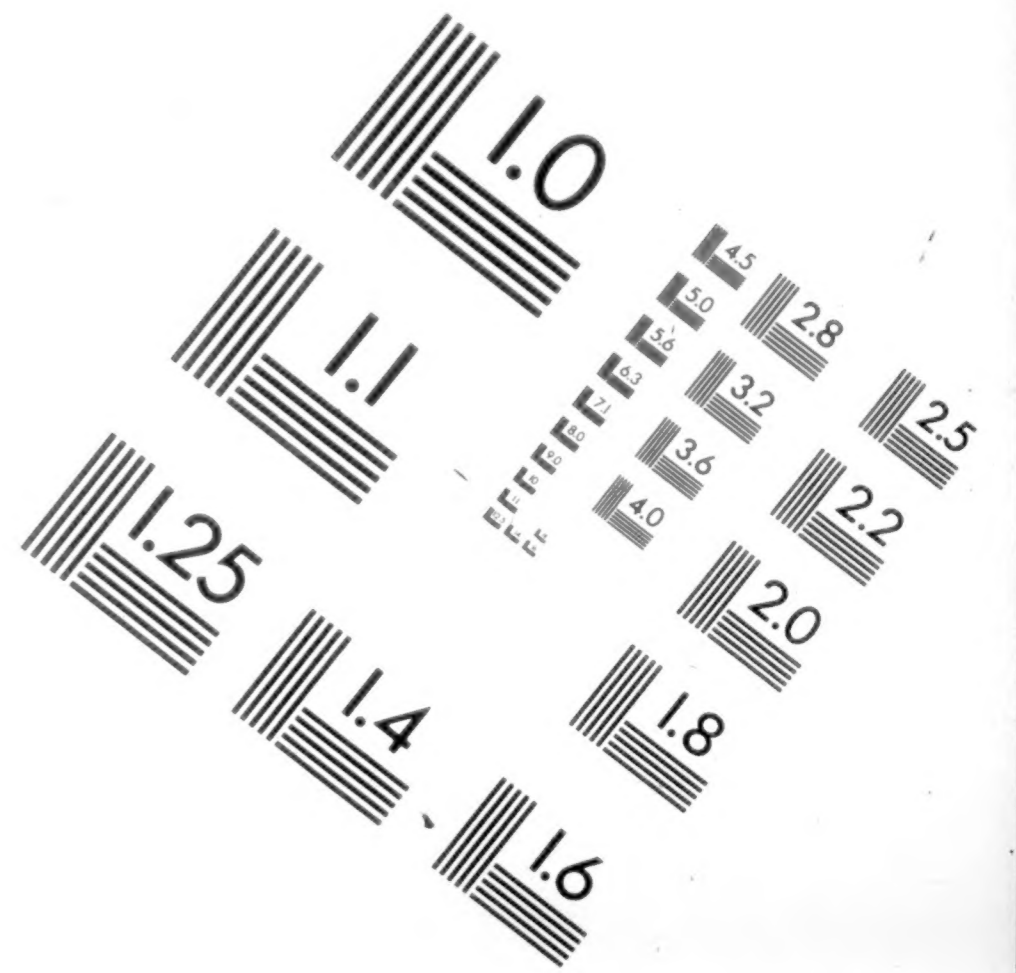
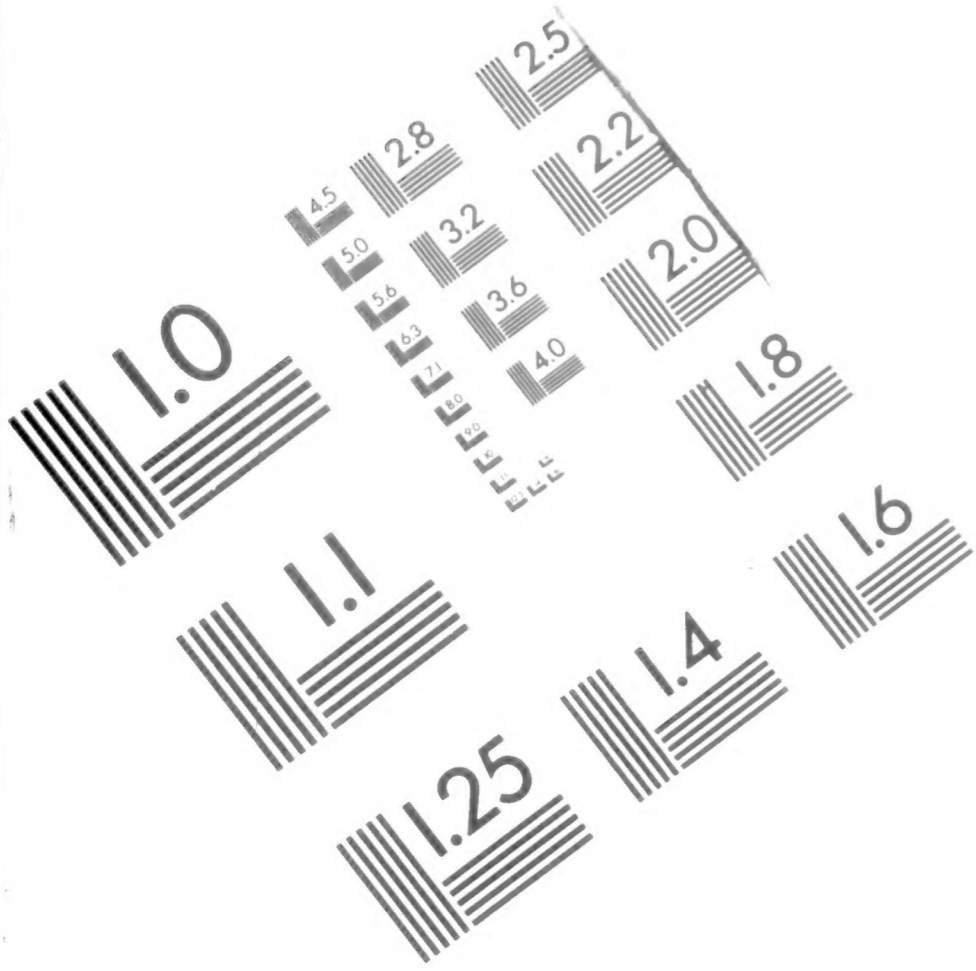

IMAGE EVALUATION TEST TARGET (QA-3)



APPLIED IMAGE, Inc.
1653 East Main Street
Rochester, NY 14609 USA
Phone: 716/482-0300
Fax: 716/288-5989

© 1993, Applied Image, Inc., All Rights Reserved

THE END

PLEASE

REWIND

